

2013

2013



CHINA

刹车片和刹车盘

PADS AND DISCS

PLAQUETTES ET DISQUES

PASTILLAS Y DISCOS

PASTILAS E DISCOS

PASTIGLIE E DISCHI

REMBLOKKEN EN REMSCHIJVEN

BREMSBELÄGE UND

BREMSSCHEIBEN

KLOCKI I TARCZE

BRZDOVÉ DESTIČKY

A KOTOUČE

FÉKBETÉTEK ÉS

FÉKTÁRCSÁK

BALATALARI VE DISKLERI

Колодки и диски

Δισκόφρενα &

Δισκόπλακες



WANT TO KNOW MORE?*



*en savoir plus

valeo added

www.valeoservice.com



Valeo

驶于科技，融于自然
Automotive technology, naturally

Valeo
法雷奥

	CN	RU	EN	TU	اللغة العربية	SP
	车型	Автомобиль	Vehicle	Arac	آلية ثقيلة أو شاحنة	Vehículo
	出厂年份	Выпуск	Date of vehicle	Uretim Tarihi	تاريخ الصنع	Periodo de fabricación
	页数	Номер страницы	Page number	Sayfa Numarası	رقم الصفحة	Número de pagina
	取消	Аннулирован	Cancel	İptal	إلغاء	Cancelación
	技术信息	Техническая информация	Technical information	Teknik Bilgiler	معلومات تقنية	Información técnica
	供应商编号	Поставщик - производитель запасной части	Manufacturer reference	Uretici Numarası	رقم المصنّع	Referencia constructor
	刹车卡钳	Скоба	Caliper	Kaliper	سيلندر فرامل	Pinza
	刹车盘厚度	Толщина диска	Thickness	Kalınlık	السماعة	Espesor
	磨损指示器	Датчик расхода	Wear indicator	Fren İkaz Kablosu	شريط كولييه	Indicador de desgaste
	四门轿车	Седан	Sedan	Sedan	سيارة بأربعة أبواب	Berlina
	旅行车	Универсал	Station wagon	Station Wagon	سيارة ستايشن	Break
	敞篷车	Кабриолет	Convertible	Kabrio	سيارة رياضية	Descapotable
	运动型双门轿跑车	Купе	2 doors	2 Kapı	سيارة ببابين	Coupé
	越野车	4 X 4	4 X 4	4 x 4	سيارة رباعية الدفع	4 X 4
	普通刹车盘	Диски сплошные	Solid disc	Fren Diski - Sogutmasız	ديسك فرامل دون تهوية	Disco macizo
	通风刹车盘	Диски вентилируемые	Ventilated disc	Fren Diski - 1 Sogutmal	ديسك فرامل مع تهوية	Disco freno ventilado
	螺栓孔数目	Количество болтов крепления колеса	Fixing holes number	Bijon Sayısı	عدد فتحات التثبيت	Número de taladros
	轮径	Диаметр колеса	Wheel diameter	Lastik Capı	قطر العجلة	Diametro de rueda
	新产品编号	Новая референция	New part number	Yeni Parca Numarası	أرقام جديدة	Nueva referencia
	即将面世产品编号	Доступен в ближайшее время	Product soon available	Yakında Ticari Olacak Referans	منتج سيتوفر قريباً	Referencia proximately disponible
	直到库存枯竭	Доступен до окончания на складе	Available until exhaustion of stocks	Referans Stok Bitimine Kadar Ticaridir	متوفر حتى نفاذ الكمية	Producto disponible hasta agotar existencias
	和	С	With	Beraber	مع	Con
	除了	Без	Except	Harıç	ماعدا	Excepto
	四轮驱动	4 X 4	4 wheels drive	4 Ceker	سيارة رباعية الدفع	4 ruedas motrices
	前刹车片	Передние тормозные колодки	Front brake pads	Ön Fren Balatası	فرامل أمامية	Freno delantero
	后刹车片	Задние тормозные колодки	Rear brake pads	Arka Fren Balatası	فرامل خلفية	Freno trasero
	手刹	Стояночный тормоз	Handbrake	El Freni	فرامل يد	Freno de mano
	所有发动机	Все двигатели	All engines	Tüm Motorlar	كُل المحركات	Todos los motores



舒适与安全 ——法雷奥制动产品

Comfort and safety: the valeo braking range

通过对产品材质的严苛要求以实现最大程度缩短制动距离及延长使用寿命。

高水平的机械加工工艺保证了精确的平面度，优化制动片与制动盘的贴合度，从而避免制动片抖动和缩短制动距离。

No compromise for product material quality for a long lasting usage. High level of machining precision for perfect mounting and vibration free brakes, providing shorter braking distances.

制动片/ Brake Pads

- 采用陶瓷基低金属配方满足不同车型需求。
- 预压工艺提高摩擦材料孔隙率及摩擦磨损性能，有效降低热衰退。
- 高温烧蚀工艺确保了制动片装车后快速达到最佳制动效能。
- 高档消音片及进口润滑脂能够最大程度降低噪音。
- Ceramic and low metal friction compounds adapted for various car applications.
- Pre-bedding process increases the porosity and performance of friction material, lessening fading effect.
- Scorching method ensures immediate excellent braking efficiency from start.
- Premium anti-noise shim and imported lubricant grease to maximize noise reduction and facilitate mounting.

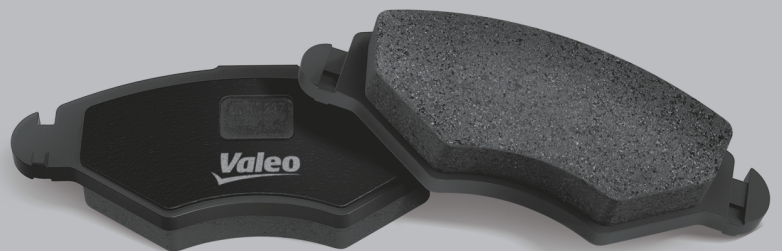

制动盘/ Brake Discs

- 平面跳动值小于15微米以确保稳定的制动感受。
- 高品质的铸件会有更好的表现。
- 不低于200布氏硬度。
- 应力释放工艺有效避免应力点断裂。
- A machining tolerance of 15 microns which provides vibration free braking.
- High quality casting for better performance.
- Hardness of >200 Brinell.
- Stress release process effectively prevents the breaks at stress points.

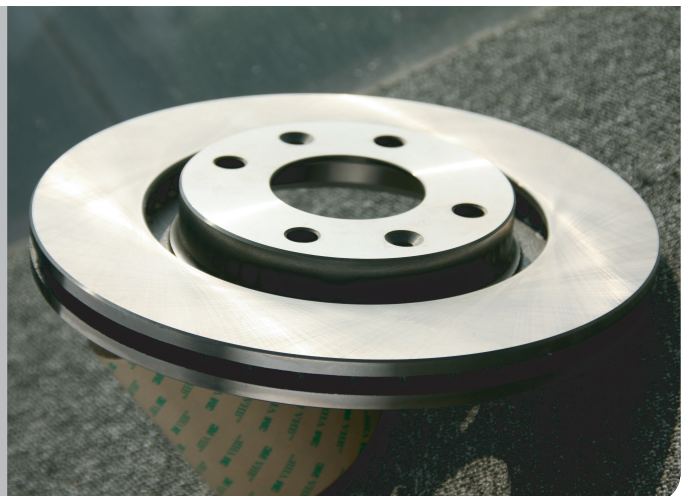

valeo added ■■■■■■

Automotive technology, naturally



法雷奥制动片全球首发创新包装

Valeo brake pads new packaging

A REAL INNOVATION FIRST USED FOR CHINA, EASY TO STORE, EASY TO SELL

- ✓ 信息清晰 MODERN
- ✓ 外形时尚 USEFULL
- ✓ 包装坚固 ATTRACTIVE
And VERY PROTECTIVE

- 包装优化
自锁设计提高强度
Improved box Safety lock
Improved pack resistance
- 产品外观
内部产品一目了然
Product visual
See what's inside the box
Show drivers how premium Valeo pads are
- 包装标贴人性化
可三面读取产品编码/信息
Part numbers on 3 faces
Simpler storage, faster pick-up from shelves
- 剖面图示
形象解析制造工艺
Product key benefits
for better understanding by the mechanics



valeo added ■■■■■■

Automotive technology, naturally



车型索引
Car Model List



3

国产车型
Domestic Car Models

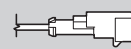

9

进口车型
Import Car Models

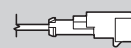

35

国产刹车片图片
Local Range Image

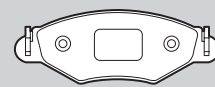

79

进口刹车片图片
Imported Range Image

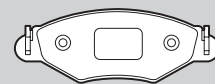

125

国产/进口刹车盘图片
Local/Imported Range
Brake Disc Image

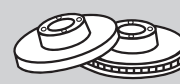

243

件号对照表
Part Number Cross List



257



车型索引 Car Model List

Pads and Discs

Plaquettes et Disques

Pastillas y Discos

Pastilas e Discos

Pastiglie e Dischi

Blokjes en Schijven

Bremsbeläge und Bremsscheiben

Klocki i Tarcze

Balatalari ve Diskleri

Колодки и диски

Δισκόφρενα & Δισκόπλακες

刹车片和刹车盘

بطانات و قرص

国产车型目录 / Domestic Car Models

一汽大众 / FAW-Volkswagen		
奥迪100 / Audi 100 (1988.8>1995.6)		10
奥迪A4(B6) / Audi A4(B6) (2003.2>2005.7)		10
奥迪A4(B7) / Audi A4(B7) (2005.7>2008.9)		10
奥迪A4L(B8) / Audi A4L(B8) (2007.12>)		10
奥迪A6(C5) / Audi A6(C5) (1999.9>2005.12)		10
奥迪A6L(C6) / Audi A6L(C6) (2005.3>)		11
宝来 / BORA (2001.12>)		11
宝来三厢 / BORA GP (2006.7>2008.12)		12
宝来两厢 / BORA HS (2006.10>2008.12)		12
开迪 / Caddy (2005.3>2007.12)		12
捷达 / Jetta (1991.5>)		12
捷达王 / Jetta King (1998.1>2002.1)		12
迈腾(B6) / Magotan(B6) (2007.6>2011.7)		12
迈腾(B7L) / Magotan(B7L) (2011.7>)		13
速腾 / Sagitar (2006.2>)		13
都市高尔夫 / City Golf (1996.5>2002.9)		13
高尔夫 / Golf (2003.7>2009.7)		13
上海大众 / SVW		
波罗 / Polo (2002.1>2006.3)		13
劲取 / Polo-Jinqu (2006.6>)		14
劲情 / Polo-Jinqing (2006.6>)		14
帕萨特(B5) / Passat (B5) (2000.4>2009.4)		14
帕萨特领驭(B5) / Passat Lingyu(B5) (2005.11>)		14
晶锐 / Fabia (2008.12>)		14
明锐 / Octavia (2007.6>2010.4)		15
桑塔纳 / Santana (1985.3>)		15
桑塔纳2000 / Santana 2000 (1995.4>2004.3)		15
桑塔纳3000 / Santana 3000 (2004.3>2007.10)		15
桑塔纳Vista志俊 / Santana Vista (2008.1>)		15
桑塔纳旅行车 / Santana Estate (1996.8>)		15
朗逸 / Lavidia (2008.4>)		16
途安 / Touran (2004.11>2008.1)		16
上海通用别克 / SGM-Buick		
GL8 / GL8 I (2000.5>2005.7)		16
GL8陆尊 / GL8 II (2005.7>)		16
凯越 / Excelle (2003.8>2008.5)		16
凯越HRV / Excelle HRV (2004.10>)		16
新凯越 / New Excelle (2008.5>)		17
凯越旅行车 / Excelle Estate (2005.11>)		17
英朗GT / Excelle GT (2010.06>)		17
英朗XT / Excelle XT (2010.01>)		17
别克世纪 / Century (1999.7>2002.12)		17
君威 / Regal I (2002.10>2008.12)		17
新君威 / Regal II (2008.12>)		18
君越 / Lacrosse (2006.3>2009.7)		18
新君越 II / Lacrosse II (2009.7>)		18

上海通用别克 / SGM-Buick		
赛欧 / Sail (2001.6>2005.2)		18
上海通用雪佛兰 / SGM-Chevrolet		
乐风 / Lova (2006.3>2011.3)		18
乐骋 / Aveo (2005.7>2010.5)		19
景程 / Epica (2006.4>)		19
科鲁兹 / Cruze (2009.4>)		19
赛欧 / Sail (2005.2>2007.12)		19
上汽通用五菱 / SAIC-GM-Wuling		
乐驰 / Spark (2003.12>)		19
一汽丰田 / FAW-Toyota		
RAV4 / RAV4 (2009.4>)		19
威驰 / Vios (2005.10>2008.2)		19
新威驰 / Vios (2008.10>)		20
普拉多 / Prado (2003.10>2010.6)		20
普锐斯 / Prius (2006.1>2009.12)		20
皇冠 / Crown Royal (2005.2>)		20
花冠 / Corolla (2004.2>2007.5)		20
花冠EX / Corolla EX (2007.5>)		20
卡罗拉 / Corolla (2007.5>)		20
锐志 / Reiz (2005.10>)		20
陆地巡洋舰 / Land Cruiser (2003.10>2007.7)		21
兰德酷路泽 / Land Cruiser (2007.12>)		21
广汽丰田 / Guangzhou-Toyota		
凯美瑞 / Camry (2006.6>)		21
汉兰达 / Highlander (2009.5>)		21
雅力士 / Yaris (2008.6>2010.9)		21
东风本田 / Dongfeng-Honda		
CR-V 思威 / CR-V (2004.6>2010.12)		21
思域 / Civic (2006.4>)		22
思铂睿 / Spiorior (2009.7>)		22
广汽本田 / Guangzhou-Honda		
奥德赛 / Odyssey (2002.4>)		22
思迪 / City (2006.4>2008.12)		22
锋范 / City (2008.12>)		22
雅阁 / ACCORD VI (1999.1>2007.12)		22
雅阁 / ACCORD VII (2003.1>2007.12)		22
雅阁 / ACCORD VIII (2008.1>)		23
飞度三厢 / Fit (2003.9>2006.4)		23
飞度两厢 / Fit Hatchback (2004.9>)		23
东风日产 / DongFeng-Nissan		
天籁 (J31) / Teana (J31) (2004.9>2008.6)		23
天籁 (J32) / Teana (J32) (2008.6>)		23
奇骏 / X-Trail (2008.11>)		24
蓝鸟 / Bluebird (2000.4>2006.12)		24
轩逸 / Bluebird Sylphy (2006.8>)		24

国产车型目录 / Domestic Car Models

东风日产 / DongFeng-Nissan	
逍客 / Qashqai (2008.3>2010.12)	24
阳光 / Sunny (2003.6>2007.12)	24
颐达 / Tiida Saloon (2005.4>)	24
骐达 / Tiida Hatchback (2005.7>)	24
骊威 / Livina (2007.4>2010.3)	25
骏逸 / Livina Geniss (2006.11>2010.1)	25
郑州日产 / Zhengzhou-Nissan	
帕拉丁 / Paladin (2003.2>)	25
东风雪铁龙 / Dong Feng-Citroen	
C2 / C2 (2006.10>)	25
C5 / C5 (2009.1>)	25
凯旋 / C-Triomphe (2006.5>)	25
富康三厢 / Fukang Saloon (1992.2>2008.12)	25
富康两厢 / Fukang Hatchback (1992.2>2008.12)	26
毕加索 / Xsara Picasso (2001.9>2007.3)	26
爱丽舍三厢 / Elysee Saloon (2002.6>)	26
爱丽舍两厢 / Elysee Hatchback (2009.2>)	26
赛纳 / Xsara Saloon (2003.5>2005.12)	26
世嘉三厢 / C-quatre Saloon (2009.6>)	26
东风标致 / Dong Feng-Peugeot	
206 / 206 (2006.1>2009.2)	26
307 / 307 (2004.8>)	27
408 / 408 (2010.1>)	27
东风悦达起亚 / Dongfeng Yueda Kia	
RIO锐欧 / Rio (2007.1>)	27
狮跑 / Sportage (2007.11>)	27
远舰 / Optima (2004.9>)	27
福瑞迪 / Forte (2009.6>)	27
北京现代 / Beijing Hyundai	
伊兰特·悦动 / Elantra Yue Dong (2008.4>)	28
伊兰特 / Elantra (2003.12>)	28
索纳塔 / Sonata (EF) (2002.12>2007.7)	28
索纳塔 御翔 / Sonata (NF) (2005.9>)	28
途胜 / Tucson (2005.5>)	28
雅绅特 / Accent (2006.2>)	28
i30 / i30 (2009.7>)	29
ix35 / ix35 (2010.4>)	29
华泰现代 / Huatai Automobile	
圣达菲 / Santa Fe (2006.10>)	29
特拉卡 / Terracan (2003.3>2008.12)	29
北京吉普 / Beijing-Jeep	
吉普2500 / Jeep 2500 (2003.6>2006.2)	29
北京汽车 / Beijing Automobile	
陆霸 / Luba (2003.6>)	29

一汽海马 / FAW-Haima	
普力马 / Freema (2007.3>2009.10)	30
海马3 / Haima 3 (2007.6>2010.12)	30
福美来2代 / Family II (2006.9>2010.11)	30
福美来3代 / Family III (2010.11>)	30
海南马自达 / Hainan Automobile	
普力马 / Freema (2001.1>2007.2)	30
福美来 / Familia (2002.10>2006.12)	30
长安福特 / Changan Ford	
嘉年华 / Fiesta (2003.3>)	30
福克斯 / Focus (2005.9>)	31
蒙迪欧 / Mondeo (2003.5>)	31
蒙迪欧-致胜 / Mondeo (2007.9>)	31
长安马自达 / Changan Mazda	
马自达2两厢 / 2 Hatchback (2007.10>)	31
马自达3 / 3 Saloon (2006.2>)	31
一汽夏利 / FAW Tianjin Xiali	
威乐 / Vela (2002.7>)	31
威姿 / Vizi (2003.1>)	31
威志两厢 / Weizhi Hatchback (2007.1>)	32
一汽轿车 / FAW Car Co., Ltd	
奔腾B70 / Besturn B70 (2006.9>)	32
红旗世纪星 / Century Star (CA7202) (2000.9>)	32
红旗旗舰 / Flagship (CA7460) (1999.2>)	32
红旗明仕 / Mingshi (CA7180) (2001.1>)	32
一汽马自达/FAW Mazda	
马自达6 (2003.4>)	32
华晨汽车 / Shenyang Brilliance	
尊驰 / Zunchi (M1) (2004.12>2008.12)	33
骏捷 / Junjie (M2) (2006.2>)	33
吉利汽车 / Geely	
远景 / Vision (2005.12>)	33
金刚 / KingKong (2005.6>)	33
奇瑞汽车 / Chery	
A5 / A5 (2006.1>)	33
东方之子 / Eastar (2003.6>)	33
旗云 / Qiyun (2003.8>2010.5)	33
QQ3 / QQ3 (2003.6>2010.3)	34
QQ6 / QQ6 (2006.12>)	34
瑞虎 / Tiggo (2005.3>2008.12)	34
比亚迪 / BYD	
F3 / F3 (2005.9>2010.12)	34
江淮汽车 / JAC	
宾悦 / Bin Yue (2007.11>)	34

进口车型目录 / Import Car Models

奥迪 / Audi	
奥迪 A3 / A3 (2010.6>)	36
奥迪 A4 / A4 (2003.2>2008.12)	36
奥迪 A5 / A5 (2007.6>)	36
奥迪 A6 / A6 (1999.9>2005.12)	37
奥迪 A8 / A8 (2004.5>2011.5)	37
奥迪 S8 / A8 (2007.12>2011.5)	38
奥迪 Q5 / Q5 (2009.10>)	38
奥迪 Q7 / Q7 (2006.3>)	38
奥迪 TT / TT (2002.4>)	38
奥迪 TTS / TTS (2011.1>)	39
奥迪 Allroad / ALLROAD (2004.5>2005.8)	39
宾利 / Bentley	
欧陆GT / Continental Coupe (2003.6>)	39
欧陆飞刺 / Continental Flying Spur (2008.9>)	39
奔驰 / Mercedes-Benz	
A级 (1999.2>)	39
B级 (2009.10>)	40
C级 (2002.5>2007.1)	40
CLK级 (1997.6>2002.10)	41
CLS级 (2004.10>)	41
E级 (1996.2>)	42
G级 (1998.4>)	43
GL级 (2006.9>)	43
GLK级 (2008.6>)	43
ML级 (2000.2>)	43
R级 (2006.1>)	44
S级 (2002.9>)	45
SL级 (1998.5>)	46
SLK级 (2004.4>)	46
唯雅诺(W639) / VIANO (2007.9>)	47
宝马 / BMW	
宝马1系 (2004.9>)	47
宝马3系 (1999.10>)	48
宝马5系 (1995.11>)	48
宝马6系 (2004.1>)	49
宝马7系 (1995.8>)	50
宝马M系 (2005.1>)	51
宝马X1 (2010.1>)	51
宝马X3 (2004.1>2010.7)	51
宝马X5 (2002.2>)	51
宝马X6 (2010.10>)	52
宝马Z3 (2000.8>2003.1)	52
宝马Z4 (2003.2>)	52
雪佛兰 / Chevrolet	
科帕奇 / CAPTIVA (2006.6>2011.11)	52

克莱斯勒 / Chrysler	
PT漫步者 / PT CRUISER (2000.6>2010.7)	53
交叉火力 / CROSSFIRE (2004.1>2008.8)	53
克莱斯勒 300C / 300 C (2004.9>)	53
大捷龙 / VOYAGER IV (2000.2>2007.12)	53
赛百灵 / SEBRING (2001.4>2006.8)	54
雪铁龙 / Citroen	
C4毕加索 / C4 Grand Picasso (2006.10>)	54
塞纳 / XSARA (2003.3>2007.2)	54
塞纳毕加索 / XSARA PICASSO (2000.2>2005.3)	54
雪铁龙 C3 / C3 (2002.2>)	54
雪铁龙 C4 / C4 (2008.7>)	55
雪铁龙 C5 / C5 (2004.8>)	55
雪铁龙 C6 / C6 (2005.9>)	55
大宇 / Daewoo	
旅行家 / Nubira (1997.5>2005.1)	55
蓝龙 / Lanos (1997.5>2003.9)	55
道奇 / Dodge	
酷博 / Caliber (2006.6>)	55
菲亚特 / Fiat	
博悦(198) / Bravo II (198) (2008.1>)	55
朋多 / Punto (1994.3>)	55
大朋多 / Grande Punto (2005.10>)	56
现代 / Hyundai	
君爵 / XG (1998.12>2006.1)	56
圣达菲 / Santa Fe (2008.7>)	56
特杰 / Trajet (FO) (2000.9>2007.6)	57
索纳塔 / Sonata IV (EF) (2002.1>)	57
美佳 / Matrix (FC) (2001.6>)	57
途胜 / Tucson (JM) (2005.8>)	57
雅尊 / GrandeUR (TG) (2006.1>)	57
捷豹 / Jaguar	
捷豹 / S-Type (CCX) (1999.1>2008.3)	57
捷豹 XF / XF (2008.3>)	57
捷豹 XJ / XJ (2003.5>)	57
捷豹 / X-Type (CF1) (2001.6>2009.5)	58
吉普 / Jeep	
切诺基 / Cherokee (2005.6>)	58
大切诺基 / Grand Cherokee (2005.6>)	58
指挥官 / Commander (2005.9>)	58
牧马人 / Wrangler (1996.8>)	58
起亚 / Kia	
佳乐 / Carens (2006.9>)	58
狮跑 / Sportage (2004.9>)	59



进口车型目录 / Import Car Models

路虎 / Land Rover	
卫士 / Defender (2007.1>)	59
发现 / Discovery (2004.7>)	59
极光 / Evoque (2011.6>)	59
神行者 / Freelander (2001.9>2007.3)	59
神行者2 / Freelander2 (2007.3>)	59
路虎揽胜 / Range Rover (2005.5>)	59
路虎运动版 / Range Rover Sport (2007.3>)	60
雷克萨斯 / Lexus	
GS300 (2005.4>)	60
GS450h (2006.2>)	60
IS200 (1999.4>2005.7)	60
IS250 (2008.12>)	60
LX470 (1998.5>2007.8)	60
RX300 (2003.2>)	60
SC430 (2005.8>2010.7)	60
马自达 / Mazda	
3 (BL) (2009.6>)	60
5 (CR19) (2005.3>)	61
RX-8(SE17) (2003.10>2008.4)	61
迷你 / Mini	
迷你 / MINI (R56) (2006.10>)	61
三菱 / Mitsubishi	
太空旅行车 / Space Wagon (1998.10>2004.12)	61
帕杰罗 / Pajero (2000.4>)	61
格兰迪斯 / Grandis (2004.4>2009.3)	61
欧蓝德 / Outlander (2007.10>2009.9)	61
日产 / Nissan	
霹雳马 / Primera (2002.3>2010.8)	62
欧宝 / Opel	
威达 / Vectra (2003.3>2008.10)	62
欧米茄 / Omega B (1999.9>2003.7)	62
赛飞利 / Zafira (2005.7>)	62
雅特 / Astra (2004.3>)	63
标致 / Peugeot	
标致 206CC / 206 CC (2000.9>2007.3)	63
标致 207 / 207 (2007.2>)	63
标致 307CC / 307CC (2003.10>2005.5)	63
标致 307SW / 307SW (2005.3>)	64
标致 308CC / 308CC (2009.6>)	64
标致 308SW / 308SW (2009.9>)	64
3008 / 3008 (2011.2>)	64
标致 406 / 406 (2000.3>2009.12)	64
标致 407 / 407 (2004.5>2006.12)	64
标致 607 / 607 (2000.2>)	65

保时捷 / Porsche	
卡雷拉 911(996) / 911 (996) (2010.1>)	65
博克斯特(987) / Boxster (987) (2004.11>)	65
卡宴(955) / Cayenne(955) (2004.1>)	65
卡宴 / Cayenne (2010.6>)	65
卡宴S (955) / Cayenne S (955) (2004.1>)	66
卡曼 (987) / Cayman(987) (2006.7>)	66
雷诺 / Renault	
拉古娜 III / Laguna III (2007.10>)	66
拉古娜 II / Laguna II (2001.4>2007.9)	66
梅甘娜 I / Megane I (1999.3>2003.8)	66
梅甘娜 II / MeganeII (2002.11>)	67
梅甘娜 III / MeganeIII (2008.11>)	67
科雷傲 / Koleos (2008.9>)	67
风景 II / Scenic II (2003.6>)	68
风景III / Scenic III (2009.2>)	68
萨博 / Saab	
萨博 9-3 / 9-3 (2002.1>)	68
萨博 9-5 / 9-5 (2003.7>)	68
斯柯达 / Skoda	
昊锐 / Superb (2002.2>)	68
明锐 / Octavia (2004.2>)	69
晶锐 / Fabia (2000.8>2007.8)	69
Smart / Smart	
Forfour / FORFOUR (2004.1>2006.6)	69
双龙 / SsangYong	
雷斯特 / Rexton (2002.4>)	69
斯巴鲁 / Subaru	
力狮 / Legacy (1996.6>2009.5)	70
森林人 / Forester (2005.9>)	70
铃木 / Suzuki	
吉姆尼 / Jimny (1998.9>)	70
丰田 / Toyota	
RAV 4 / RAV 4 (2005.11>)	70
兰德酷路泽100 / Land Cruiser 100 (1998.1>2007.9)	70
大众 / Volkswagen	
Eos / EOS (2006.3>)	71
尚酷 / Scirocco (2008.5>)	71
帕萨特 / Passat (2000.11>)	71
帕萨特CC / Passat CC (2008.6>)	71
甲壳虫 / New Beetle (2000.10>)	71
辉腾 / Phaeton (2003.5>)	72
途观 / Tiguan (2008.5>)	72
途锐 / Touareg (2003.4>)	72
高尔夫 / Golf (2002.1>)	73

进口车型目录 / Import Car Models

 	
沃尔沃 / Volvo	
沃尔沃C30 / C30 (2006.10>)	73
沃尔沃C70 / C70 (2006.3>2010.2)	73
沃尔沃S40 / S40 (2004.1>2007.7)	74
沃尔沃S60 / S60 (2000.11>)	75
沃尔沃S80 / S80 (TS, XY) (1999.1>)	75
沃尔沃XC60 / XC60 (2008.5>)	76
沃尔沃XC90 / XC90 (2002.10>)	76



国产车型 Domestic Car Models

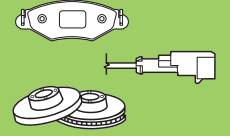

Pads and Discs

Plaquettes et Disques

Pastillas y Discos

Pastilas e Discos

Pastiglie e Dischi

Blokjes en Schijven

Bremsbeläge und Bremsscheiben

Klocki i Tarcze





















Balatalari ve Diskleri

Колодки и диски

Δισκόφρενα & Δισκόπλακες

刹车片和刹车盘

بطانات و قرص

							
一汽大众 / FAW-Volkswagen							
奥迪 100 / Audi 100							
1.8L	1988.8-1990.12	F	601157	2			
2.0L	1993.11-1994.7	F	601157	2			
2.2L	1989.8-1990.12	F	601157	2			
2.6L	1993.1-1995.6	F	601157	2			
奥迪 A4(B6) / Audi A4(B6)							
1.8 T	2003.2-2005.7	F	601195	1	 312 × 25(23)	9	197404
		R	601255	0	 255 × 11,9(10)	10	197438
2.4L	2004.1-2005.7	F	601195	1	 312 × 25(23)	9	197404
		R	601247	0	 255 × 11,9(10)	10	197438
3.0 quattro	2003.2-2005.7	F	601195	1			
		R	601255	0	 255 × 11,9(10)	10	197438
奥迪 A4(B7) / Audi A4(B7)							
1.8 T	2005.7-2008.9	F	601195	1	 312 × 25(23)	9	197404
		R	601255	0	 255 × 11,9(10)	10	197438
 287,7 × 12(10)	5+1				197038		
2.0 T	2005.7-2008.9	F	601195	1	 312 × 25(23)	9	197404
		R	601255	0	 255 × 11,9(10)	10	197438
 287,7 × 12(10)	5+1				197038		
3.0 quattro	2005.7-2008.9	F	601195	1	 312 × 25(23)	9	197404
		R	601255	0	 255 × 11,9(10)	10	197438
		R	601263	0	 287,7 × 12(10)	5+1	197038
奥迪 A4L(B8) / Audi A4L(B8)							
2.0 TFSI	2007.12-	F	601163	1			
奥迪 A6(C5) / Audi A6(C5)							
1.8L	2000.1-2005.12	F	601195	1	 288 × 24,9(23)	5	186271
		R	601255	0	 245 × 9,9(8)	5	186294
1.8 T	2000.1-2005.12	F	601195	1	 288 × 24,9(23)	5	186271
		R	601255	0	 245 × 9,9(8)	5	186294
2.4L	1999.9-2005.12	F	601195	1	 288 × 24,9(23)	5	186271
		R	601255	0	 245 × 9,9(8)	5	186294
2.5 柴油 /Diesel	2004.8-2005.12	F	601195	1	 288 × 24,9(23)	5	186271
		R	601255	0	 245 × 9,9(8)	5	186294

一汽大众 / FAW-Volkswagen							
奥迪 A6(C5) / Audi A6(C5)							
2.8L	2000.9-2005.7	F	601195	1	288 × 24,9(23)	5	186271
		R	601255	0	245 × 9,9(8)	5	186294
奥迪 A6L(C6) / Audi A6L(C6)							
2.0 TFSI	2005.9-2011.12	F			320,8 × 30(28)	5	197388
		R	601263	0	301,7 × 12(10)	9	197426
2.4L	2005.3-	F	601195	1	347 × 30(28)	5	197389
		R	601263	0	301,7 × 12(10)	9	197426
2.8L	2008.4-	R	601263	0	301,7 × 12(10)	9	197426
3.0 quattro	2005.3-	F			320,8 × 30(28)	5	197388
		R	601263	0	301,7 × 12(10)	9	197426
3.2 FSI quattro	2006.11-2008.10	F			320,8 × 30(28)	5	197388
		R	601263	0	301,7 × 12(10)	9	197426
4.2 FSI quattro	2006.11-2008.10	R			301,7 × 12(10)	9	197426
宝来 / BORA							
1.6L	2004.10-2006.9	F	601186	1	280 × 22(19)	5+1	186604
		R	601255	0	256 × 22(20)	5	197427
					231,7 × 9(7)	5	197442
1.6L	2008.11-	F	601186	1	280 × 22(19)	5+1	186604
		R	601255	0	231,7 × 9(7)	5	197442
1.8L	2001.12-2006.12	F	601186	1	280 × 22(19)	5+1	186604
		R	601255	0	256 × 22(20)	5	197427
					231,7 × 9(7)	5	197442
1.8 T	2001.12-2006.12	F	601209	1	288 × 24,9(22)	5	197230
		R	601255	0	256 × 22(20)	5	197427
					231,7 × 9(7)	5	197442
1.9 TDi	2004.3-2006.12	F	601186	1	280 × 22(19)	5+1	186604
		R	601255	0	231,7 × 9(7)	5	197442
2.0L	2008.11-2010.12	F	601186	1			
		R	601255	0			























											
一汽大众 / FAW-Volkswagen											
宝来三厢 / BORA GP											
1.6L	2006.7-2008.12	F	601186	1	 288 × 24,9(22)	5	197230				
		R	601255	0	 231,7 × 9(7)	5	197442				
1.8L	2006.7-2008.12	F	601186	1	 288 × 24,9(22)	5	197230				
		R	601255	0	 231,7 × 9(7)	5	197442				
宝来两厢 / BORA HS											
1.6L	2006.10-2008.12	F	601186	1	 288 × 24,9(22)	5	197230				
		R	601255	0	 231,7 × 9(7)	5	197442				
1.8L	2006.10-2008.12	F	601186	1	 288 × 24,9(22)	5	197230				
		R	601255	0	 231,7 × 9(7)	5	197442				
开迪 / Caddy											
1.6L	2005.3-2007.12	F			 279,9 × 22(19)	9	197394				
					 287,8 × 24,9(22)	9	197397				
		R	601263	0	 259,8 × 11,9(10)	9	197429				
2.0 柴油 /Diesel	2005.3-2007.12	F			 279,9 × 22(19)	9	197394				
					 287,8 × 24,9(22)	9	197397				
		R	601263	0	 259,8 × 11,9(10)	9	197429				
捷达 / Jetta											
1.6L	2000.4-	F	601188	0							
		R	564110(刹车蹄 /Shoes)								
1.6L	1991.5-1999.12	F			 239 × 11,9(10)	4+1	186245				
		R	564110(刹车蹄 /Shoes)								
1.9 TDi	1998.8-	R	564110(刹车蹄 /Shoes)								
捷达王 / Jetta King											
1.6L	1998.1-2002.1	F	601188	0							
		R	564110(刹车蹄 /Shoes)								
迈腾 (B6) / Magotan(B6)											
1.8 TSi	2007.6-2011.7	F			 312 × 25(22)	9	197384				
		R	601263	0	 286 × 12(10)	9+1	197031				
2.0L	2007.6-2008.4	F			 312 × 25(22)	9	197384				
		R	601263	0	 286 × 12(10)	9+1	197031				
2.0 TSi	2008.4-2011.7	F			 312 × 25(22)	9	197384				
		R	601263	0							









											
一汽大众 / FAW-Volkswagen											
迈腾 (B7L) / Magotan(B7L)											
1.8T	2011.7-	R	601263	0							
速腾 / Sagitar											
1.4 TSI	2009.9-	R	601263	0		259,8 × 11,9(10)	9	197429			
1.6L	2006.2-	F	601186	1		279,9 × 22(19)	9	197394			
		R	601263	0		259,8 × 11,9(10)	9	197429			
1.8 T	2006.4-2008.4	F				287,8 × 24,9(22)	9	197397			
		R	601263	0		259,8 × 11,9(10)	9	197429			
1.8 TSI	2008.7-	F				287,8 × 24,9(22)	9	197397			
		R	601263	0		259,8 × 11,9(10)	9	197429			
2.0L	2006.4-2009.6	F	601186	1		279,9 × 22(19)	9	197394			
		R	601263	0		259,8 × 11,9(10)	9	197429			
都市高尔夫 / City Golf											
1.6L	1996.5-2002.9	F	601186	1		256 × 21,9(19)	5+1	186603			
高尔夫 / Golf											
1.6L	2003.8-2005.1	F	601186(小卡钳 /Small caliper)	1		256 × 21,9(19)	5+1	186603			
						280 × 22(19)	5+1	186604			
		R	601255	0		231,7 × 9(7)	5	197442			
1.8L	2003.7-2009.7	F	601186(小卡钳 /Small caliper)	1		256 × 21,9(19)	5+1	186603			
						280 × 22(19)	5+1	186604			
		R	601255	0		231,7 × 9(7)	5	197442			
2.0L	2003.8-2005.12	F	601186(小卡钳 /Small caliper)	1		256 × 21,9(19)	5+1	186603			
						280 × 22(19)	5+1	186604			
		R	601255	0		231,7 × 9(7)	5	197442			
上海大众 / SVW											
波罗三厢 / Polo Saloon											
1.4L	2003.6-2006.3	F	601186	1		256 × 21,9(19)	5+1	186603			
		R	601255	0		231,7 × 9(7)	5	197442			
1.6L	2002.1-2006.1	F	601186	1		256 × 21,9(19)	5+1	186603			
		R	601255	0		231,7 × 9(7)	5	197442			
波罗两厢 / Polo Hatchback											
1.4L	2002.1-2006.3	F	601186	1		256 × 21,9(19)	5+1	186603			
		R	601255	0		231,7 × 9(7)	5	197442			

							
 R F							
上海大众 / SVW							
波罗两厢 / Polo Hatchback							
1.6L	2002.1-2006.1	F	601186	1	 256 × 21,9(19)	5+1	186603
		R	601255	0	 231,7 × 9(7)	5	197442
劲取 / Polo-Jinqu							
1.4L	2006.6-	F	601186	1	 256 × 21,9(19)	5+1	186603
		R	564110(刹车蹄 /Shoes)				
1.6L	2007.12-	F	601186	1	 256 × 21,9(19)	5+1	186603
		R	564110(刹车蹄 /Shoes)				
劲情 / Polo-Jinqing							
1.4L	2006.6-	F	601186	1	 256 × 21,9(19)	5+1	186603
		R	564110(刹车蹄 /Shoes)				
1.6L	2006.6-2007.12	F	601186	1	 256 × 21,9(19)	5+1	186603
		R	564110(刹车蹄 /Shoes)				
帕萨特 (B5) / Passat (B5)							
1.8L	2000.4-2003.2	F	601195	1	 288 × 24,9(23)	5	186271
		R	601255	0	 245 × 9,9(8)	5	186294
1.8 T	2001.1-2009.4	F	601195	1	 288 × 24,9(23)	5	186271
		R	601255	0	 245 × 9,9(8)	5	186294
2.0L	2003.2-2009.4	F	601195	1	 288 × 24,9(23)	5	186271
		R	601255	0	 245 × 9,9(8)	5	186294
2.8L	2001.12-2006.12	F	601195	1	 288 × 24,9(23)	5	186271
		R	601255	0	 245 × 9,9(8)	5	186294
帕萨特领驭 (B5) / Passat Lingyu(B5)							
1.8 T	2005.11-	F	601195	1	 288 × 24,9(23)	5	186271
		R	601255	0	 245 × 9,9(8)	5	186294
2.0L	2006.4-	F	601195	1	 288 × 24,9(23)	5	186271
		R	601255	0	 245 × 9,9(8)	5	186294
2.8L	2005.11-	F	601195	1	 288 × 24,9(23)	5	186271
		R	601255	0	 245 × 9,9(8)	5	186294
晶锐 / Fabia							
1.4L	2008.12-	F	601186	1			
		R	564110(刹车蹄 /Shoes)				
1.6L	2008.12-	F	601186	1			
		R	564110(刹车蹄 /Shoes)				

							
							
上海大众 / SVW							
明锐 / Octavia							
1.6L	2007.6-2010.4	F	601186	1	 279,9 × 22(19)	9	197394
		R	601263	0			
1.8 TSI	2007.6-2010.4	F	601186	1	 279,9 × 22(19)	9	197394
		R	601263	0			
2.0L	2007.6-2010.4	F	601186	1	 279,9 × 22(19)	9	197394
		R	601263	0			
桑塔纳 / Santana							
1.6L	1996.8-	F			 239 × 11,9(10)	4+1	186245
		R	564109(刹车蹄 /Shoes)				
1.8L	1985.3-1996.8	F			 239 × 11,9(10)	4+1	186245
		R	564109(刹车蹄 /Shoes)				
1.8L	1996.8-	F			 239 × 11,9(10)	4+1	186245
		R	564109(刹车蹄 /Shoes)				
桑塔纳 2000 / Santana 2000							
1.8L	1995.4-2004.3	F	601156	0	 256 × 19,9(18)	4+1	186247
		R	564110(刹车蹄 /Shoes)				
桑塔纳 3000 / Santana 3000							
1.8L	2004.3-2007.10	F	601156	0	 256 × 19,9(18)	4+1	186247
		R	564110(刹车蹄 /Shoes)				
2.0L	2006.5-2007.10	F	601156	0	 256 × 19,9(18)	4+1	186247
		R	564110(刹车蹄 /Shoes)				
桑塔纳 Vista 志俊 / Santana Vista							
1.6L	2010.7-	F	601156	0	 256 × 19,9(18)	4+1	186247
		R	564110(刹车蹄 /Shoes)				
1.8L	2008.1-	F	601156	0	 256 × 19,9(18)	4+1	186247
		R	564110(刹车蹄 /Shoes)				
2.0L	2008.1-	F	601156	0	 256 × 19,9(18)	4+1	186247
		R	564110(刹车蹄 /Shoes)				
桑塔纳旅行车 / Santana Estate							
1.8L	1996.8-	F			 239 × 11,9(10)	4+1	186245
		R	564109(刹车蹄 /Shoes)				

											
上海大众 / SVW											
朗逸 / Lavida											
1.4 TSi	2010.3-	F	601186	1							
		R	601255	0							
1.6L	2008.4-	F	601186	1							
		R	601255	0							
2.0L	2008.4-	F	601186	1							
		R	601255	0							
途安 / Touran											
1.8 T	2005.5-	F				287,8 × 24,9(22)	9	197397			
		R	601263	0		259,8 × 11,9(10)	9	197429			
2.0L	2004.11-2008.1	R	601263	0							
上海通用别克 / SGM-Buick											
GL8 / GL8 I											
2.5L	2000.5-2005.7	F	601196	0		277,9 × 32,2(30,7)	5	197392			
		R	601249	0		278 × 11(9)	5	197433			
3.0L	2000.5-2005.7	F	601196	0		277,9 × 32,2(30,7)	5	197392			
		R	601249	0		278 × 11(9)	5	197433			
GL8 陆尊 / GL8 II											
3.0L	2006.5-	F				297 × 32,2(30,7)	5	197387			
		R	601274(2008-)	2							
3.0L	2005.7-2006.5	F	601196	0		297 × 32,2(30,7)	5	197387			
		R				278 × 11(9)	5	197433			
凯越 / Excelle											
1.6L	2003.8-2008.5	F				255,8 × 24(22)	4	197406			
		R	601250(2003-2005)	0							
		R	601231(2006-)	0		257,8 × 10,5(8)	4	197440			
1.8L	2003.8-2008.5	F				255,8 × 24(22)	4	197406			
		R	601250(2003-2005)	0							
		R	601231(2006-)	0		257,8 × 10,5(8)	4	197440			
凯越 HRV / Excelle HRV											
1.6L	2004.10-	F				255,8 × 24(22)	4	197406			
		R	601231	0		257,8 × 10,5(8)	4	197440			

											
上海通用别克 / SGM-Buick											
新凯越 / New Excelle											
1.6L	2008.5-	F			 255,8 × 24(22)	4	197406				
		R	601250	0	 257,8 × 10,5(8)	4	197440				
1.8L	2008.5-	F			 255,8 × 24(22)	4	197406				
		R	601250	0	 257,8 × 10,5(8)	4	197440				
凯越旅行车 / Excelle Estate											
1.8L	2005.11-	F			 255,8 × 24(22)	4	197406				
		R	601231	0	 257,8 × 10,5(8)	4	197440				
英朗 GT / Excelle GT											
1.6L	2010.06-	F	601162	2							
		R	601229	2							
1.6 T	2010.06-	F	601162	2							
		R	601229	2							
1.8L	2010.06-	F	601162	2							
		R	601229	2							
英朗 XT / Excelle XT											
1.6L	2010.01-	F	601162	2							
		R	601229	2							
1.6 T	2010.01-	F	601162	2							
		R	601229	2							
1.8L	2010.01-	F	601162	2							
		R	601229	2							
别克世纪 / Century											
2.5L	1999.7-2002.12	F	601196	0	 277,9 × 32,2(30,7)	5	197392				
		R			 278 × 11(9)	5	197433				
3.0L	1999.7-2002.12	F	601196	0	 277,9 × 32,2(30,7)	5	197392				
		R			 278 × 11(9)	5	197433				
君威 / Regal I											
2.0L	2003.2-2008.12	F	601196	0	 277,9 × 32,2(30,7)	5	197392				
		R	601249	0	 278 × 11(9)	5	197433				
2.5L	2002.12-2008.12	F	601196	0	 277,9 × 32,2(30,7)	5	197392				
		R	601249	0	 278 × 11(9)	5	197433				
3.0L	2002.10-2006.5	F	601196	0	 277,9 × 32,2(30,7)	5	197392				
		R	601249	0	 278 × 11(9)	5	197433				



											
上海通用别克 / SGM-Buick											
新君威 / Regal II											
2.0L	2008.12-	F	601185	0							
		R	601241	0							
2.4L	2008.12-	F	601185	0							
		R	601241	0							
2.4L	2011.1-	R	601241	0							
GS 2.0	2009.6-	F	601185	0							
		R	601241	0							
君越 / Lacrosse											
2.4L	2006.3-2009.7	F				 297 × 32,2(30,7)	5	197387			
		R	601267	2		 270 × 14(12,5)	5	197432			
3.0L	2006.3-2009.7	F				 297 × 32,2(30,7)	5	197387			
		R	601267	2		 270 × 14(12,5)	5	197432			
新君越 II / Lacrosse II											
2.0T	2010.4-	F	601177	0							
		R	601267	2							
2.4L	2009.7-	F	601177	0							
		R	601267	2							
3.0L	2009.7-	F	601177	0							
		R	601267	2							
赛欧 SRV / Sail SRV											
1.6L	2001.6-2005.2	F	601194	0		 236 × 19,9(17)	6+1	186188			
		R	564116(刹车蹄 /Shoes)								
赛欧三厢 / Sail Saloon											
1.6L	2001.6-2005.2	F	601194	0		 236 × 19,9(17)	6+1	186188			
		R	564116(刹车蹄 /Shoes)								
上海通用雪佛兰 / SGM-Chevrolet											
乐风 / Lova											
1.2L	2008.12-2010.12	R	564124(刹车蹄 /Shoes)								
1.4L	2006.3-2011.7	F	601205	0							
		R	564124(刹车蹄 /Shoes)								
1.6L	2006.3-2011.3	F	601205	0							
		R	564124(刹车蹄 /Shoes)								











									
上海通用雪佛兰 / SGM-Chevrolet									
乐骋 / Aveo									
1.4L	2005.7-2010.5	F	601205	0					
景程 / Epica									
1.8L	2009.10-	F	601220	2					
2.0L	2006.4-2009.9	F	601220(2008-)	2					
		R	601268(2008-)	0					
		R	601240(2005-2008)	0					
科鲁兹 / Cruze									
1.6L	2009.4-	F	601162	2					
		R	601229	2					
1.8L	2009.4-	F	601162	2					
		R	601229	2					
赛欧 SRV / Sail SRV									
1.6L	2005.2-2007.12	F			 236 × 19,9(17)	6+1	186188		
赛欧三厢 / Sail Saloon									
1.6L	2005.2-2007.12	F			 236 × 19,9(17)	6+1	186188		
上汽通用五菱 / SAIC-GM-Wuling									
乐驰 / Spark									
0.8L	2003.12-2009.3	F	601191	0					
		R	564117(刹车蹄 /Shoes)						
1.0L	2004.12-2010.4	F	601191	0					
		R	564117(刹车蹄 /Shoes)						
1.0L	2010.4-	R	564117(刹车蹄 /Shoes)						
1.2L	2008.12-	R	564117(刹车蹄 /Shoes)						
一汽丰田 / FAW-Toyota									
RAV4 / RAV4									
2.0L	2009.4-	F	601224	0					
		R	601264	0					
2.4L 4WD	2009.4-	F	601224	0					
		R	601264	0					
威驰 / Vios									
1.3L	2005.10-2008.2	F	601198	0	 254,9 × 20(18)	4	197418		
		R	564118(刹车蹄 /Shoes)						

一汽丰田 / FAW-Toyota							
威驰 / Vios							
1.5L	2005.10-2008.2	F	601198	0	254,9 × 20(18)	4	197418
		R	564118(刹车蹄 /Shoes)				
新威驰 / Vios							
1.3L	2008.10-	F	601221	0			
		R	564118(刹车蹄 /Shoes)				
1.6L	2008.10-	F	601221	0			
		R	564118(刹车蹄 /Shoes)				
普拉多 / Prado							
4.0L 4WD	2003.10-2010.6	F	601165	0			
		R	601232	0			
普锐斯 / Prius							
1.5L	2006.1-2009.12	F	601172	0			
皇冠 / Crown Royal							
2.5L	2005.2-	F	601222	0			
		R	601269	2			
3.0L	2005.2-	F	601222	0			
		R	601269	2			
花冠 / Corolla							
1.8L	2004.2-2007.5	F	601198(2004.02-2005.02)	0	275 × 25(23)	4	197400
		F	601172(2005.02-)	0			
		R	601251(2004.02-2005.02)	0	268,9 × 9,3(7,4)	4	197423
		R	601242(2005.02-)	2			
花冠 EX / Corolla EX							
1.6L	2007.5-	F	601172	0	275 × 25(23)	4	197400
		R	601242	2	268,9 × 9,3(7,4)	4	197423
卡罗拉 / Corolla							
1.8L	2007.5-	F			275 × 25(23)	4	197400
锐志 / Reiz							
2.5L	2005.10-	F	601222	0			
		R	601269	2			
3.0L	2005.10-	F	601222	0			
		R	601269	2			

							
一汽丰田 / FAW-Toyota							
陆地巡洋舰 / Land Cruiser							
4.5L	2003.10-2007.4	F	601166	0			
		R	601253	0			
4.7 4WD	2003.10-2007.7	F	601166	0			
兰德酷路泽 / Land Cruiser							
4.0 4WD	2007.12-	F	601165	0			
		R	601232	0			
广汽丰田 / Guangzhou-Toyota							
凯美瑞 / Camry							
2.0L	2006.6-	F	601214	0			
		R	601264	0			
2.4L	2006.6-	F	601214	0			
		R	601264	0			
汉兰达 / Highlander							
2.7 FWD	2009.5-	F	601161	0			
		R	601228	0			
3.5L	2009.5-	F	601161	0			
		R	601228	0			
雅力士 / Yaris							
1.3L	2008.6-2010.9	F	601221	0			
		R	564126(刹车蹄 /Shoes)				
1.6L	2008.6-2010.9	F	601221	0			
		R	564126(刹车蹄 /Shoes)				
东风本田 / Dongfeng-Honda							
CR-V 思威 / CR-V							
2.0L 4WD	2004.6-2007.2	F	601208	0	281,7 × 23(21)	5	197267
		R	601248(2005-)	2			
2.0L 4WD	2007.3-2010.2	F	601179	2			
		R	601270	0			
2.4L 4WD	2004.6-2007.2	F	601208	0			
2.4L 4WD	2007.3-2010.12	F	601179	2			
		R	601270	0			

							
东风本田 / Dongfeng-Honda							
思域 / Civic							
1.8L	2006.4-	F	601217	2	281,7 × 23(21)	5	197267
		R	601244	2			
思铂睿 / Spior							
2.4L	2009.7-	F	601217	2			
		R	601245	2			
广汽本田 / Guangzhou-Honda							
奥德赛 / Odyssey							
2.3L	2002.4-2004.12	F	601217	2			
		R	601248	2			
2.4L	2005.3-2009.8	F	601217	2	300 × 28(26)	5	197393
2.4L	2009.8-	F	601217	2			
		R	601259	0			
思迪 / City							
1.3L	2006.4-2008.12	F	601207	2	239,5 × 21(19)	4	197420
		R	564119(刹车蹄 /Shoes)				
1.5L	2006.4-2008.12	F	601207	2	239,5 × 21(19)	4	197420
		R	564119(刹车蹄 /Shoes)				
锋范 / City							
1.5L	2008.12-	F	601181	2			
1.8L	2008.12-	F	601181	2			
		R	601244	2			
雅阁 / ACCORD VI							
2.0L	1999.1-2007.12	F			281,8 × 23(21)	5	197412
		R	601248	2			
2.3 Vtec	2000.6-2002.12	R	601244	2			
3.0 Vtec	2000.6-2002.12	F			281,8 × 23(21)	5	197412
		R	601244	2			
雅阁 / ACCORD VII							
2.0L	2003.1-2007.12	F	601217	2	281,8 × 23(21)	5	197412
		R	601244	2			
2.4L	2003.1-2007.12	F	601217	2	281,8 × 23(21)	5	197412
		R	601244	2			







									
广汽本田 / Guangzhou-Honda									
雅阁 / ACCORD VII									
3.0L	2003.1-2007.12	F	601217	2	 300 × 28(26)	5	197393		
		R	601244	2					
雅阁 / ACCORD VIII									
2.0L	2008.3-	F	601217	2					
		R	601245	2					
2.4L	2008.1-	F	601217	2					
		R	601245	2					
3.5L	2008.3-	F	601217	2					
		R	601245	2					
飞度三厢 / Fit									
1.3L	2003.9-2006.4	F	601207	2	 239,5 × 21(19)	4	197420		
		R	564119(刹车蹄 /Shoes)						
1.5L	2004.6-2006.4	F	601207	2	 239,5 × 21(19)	4	197420		
		R	564119(刹车蹄 /Shoes)						
飞度两厢 / Fit Hatchback									
1.3L	2004.9-2008.7	F	601207	2	 239,5 × 21(19)	4	197420		
		R	564119(刹车蹄 /Shoes)						
1.3L	2008.7-	F	601181	2					
1.5L	2004.9-2008.7	F	601207	2	 239,5 × 21(19)	4	197420		
		R	564119(刹车蹄 /Shoes)						
1.5L	2008.7-	F	601181	2					
东风日产 / DongFeng-Nissan									
天籁 (J31) / Teana (J31)									
2.0L	2006.4-2008.6	F	601176	2					
		R	601246	2					
2.3L	2004.9-2008.6	F	601176	2					
		R	601246	2					
3.5L	2004.9-2008.6	F	601176	2					
		R	601246	2					
天籁 (J32) / Teana (J32)									
2.0L	2008.6-	F	601176	2					
		R	601246	2					
2.5L	2008.6-	F	601176	2					
		R	601246	2					

											
东风日产 / DongFeng-Nissan											
天籁 (J32) / Teana (J32)											
3.5L	2008.6-2010.11	F	601176	2							
		R	601246	2							
奇骏 / X-Trail											
2.0L	2008.11-	F	601183	1							
		R	601246	2							
2.5L	2008.11-	F	601183	1							
		R	601246	2							
蓝鸟 / Bluebird											
2.0L	2000.4-2006.12	F	601187	0	 257 × 22(20)	4+2	186485(2002-2004)				
		R	601261	2							
轩逸 / Bluebird Sylphy											
1.6L	2007.1-	F	601211	0							
		R	601246	2							
2.0L	2006.8-	F	601176	2							
		R	601246	2							
逍客 / Qashqai											
1.6L	2008.11-2010.12	F	601182	0							
		R	601246	2							
2.0L	2008.3-2010.12	F	601182	0							
		R	601246	2							
阳光 / Sunny											
2.0L	2003.6-2007.12	F	601201	2	 257 × 22(20)	4+2	186485(2005-)				
		R	564120(刹车蹄 /Shoes)								
颐达 / Tiida Saloon											
1.6L	2005.4-	F	601211	0	 259,9 × 22(20)	4	197399				
		R	564125(刹车蹄 /Shoes)								
		R	601246	2							
骐达 / Tiida Hatchback											
1.6L	2005.7-	F	601211	0	 259,9 × 22(20)	4	197399				
		R	564125(刹车蹄 /Shoes)								
		R	601246	2							
1.6L	2011.05-	F	601176	2							
		R	601246	2							

									
东风日产 / DongFeng-Nissan									
骊威 / Livina									
1.6L	2007.4-2010.3	F	601211	0	 259,9 × 22(20)	4	197399		
骏逸 / Livina Geniss									
1.8L	2006.11-2010.1	F	601211	0					
郑州日产 / Zhengzhou-Nissan									
帕拉丁 / Paladin									
2.4L	2003.2-	F	601204	0					
		R	564123(刹车蹄 /Shoes)						
3.3 4WD	2003.2-	F	601204	0					
东风雪铁龙 / Dong Feng-Citroen									
C2 / C2									
1.4L	2006.10-	F	601184	0	 247 × 20,5(18,5)	4+2	186194		
		R	564113(刹车蹄 /Shoes)						
1.6L	2006.10-	F			 266 × 22(20,4)	4+2	186695		
		R	564113(刹车蹄 /Shoes)						
C5 / C5									
2.0L	2009.1-	F	601178	0					
		R	601256	0					
2.3L	2010.1-	F	601178	0					
		R	601256	0					
3.0L	2010.1-	F	601178	0					
		R	601256	0					
凯旋 / C-Triomphe									
2.0 L	2006.5-	F	601213	0	 283 × 26(24)	4+2	186693		
		R	601255	0					
富康三厢 / Fukang Saloon									
1.4L	1992.2-2001.8	F	601158(-ABS)	4	 247 × 20,5(18,5)	4+2	186194(2000-)		
		R	564112(刹车蹄 /Shoes, -ABS)						
1.4L	2007.12-2008.12	F			 266 × 22(20,4)	4+2	186695		
1.6L	1998.9-2008.12	F			 247 × 20,5(18,5)	4+2	186194		

东风雪铁龙 / Dong Feng-Citroen							
富康两厢 / Fukang Hatchback							
1.4L	1992.2-2005.12	F	601158(-ABS)	4	247 × 20,5(18,5)	4+2	186194(1998-)
		R	564112(刹车蹄 /Shoes, -ABS)				
1.6L	1997.2-2005.12	F			247 × 20,5(18,5)	4+2	186194(1998-)
1.6L	2005.5-2008.12	F			266 × 22(20,4)	4+2	186695
毕加索 / Xsara Picasso							
1.6L	2001.9-2007.3	R	564114(刹车蹄 /Shoes)				
2.0L	2002.4-2007.3	F	601213	0			
		R	601255	0			
爱丽舍三厢 / Elysee Saloon							
1.6L	2002.6-2008.4	F			266 × 22(20,4)	4+2	186695
		R	564113(刹车蹄 /Shoes)				
		R	564115(刹车蹄 /Shoes, -ABS)				
1.6L	2008.4-	R	564113(刹车蹄 /Shoes)				
		R	564115(刹车蹄 /Shoes, -ABS)				
爱丽舍两厢 / Elysee Hatchback							
1.6L	2009.2-	R	564113(刹车蹄 /Shoes)				
		R	564115(刹车蹄 /Shoes, -ABS)				
赛纳 / Xsara Saloon							
2.0L	2003.5-2005.12	F	601213	0	283 × 26(24)	4+2	186693
世嘉三厢 / C-quatre Saloon							
1.6L	2009.6-	F	601213	0			
		R	601255	0			
2.0L	2009.6-	F	601213	0			
		R	601255	0			
东风标致 / Dong Feng-Peugeot							
206 / 206							
1.4L	2006.7-2009.2	F	601184	0	266 × 22(20,4)	4+2	186695
		R	564113(刹车蹄 /Shoes)				
1.6L	2006.1-2009.2	F			266 × 22(20,4)	4+2	186695
		R	564113(刹车蹄 /Shoes)				

							
东风标致 / Dong Feng-Peugeot							
307 三厢 / 307 Saloon							
1.6L	2004.8-	F	601213	0	283 × 26(24)	4+2	186693
		R	601255	0			
2.0L	2004.8-	F	601213	0	283 × 26(24)	4+2	186693
		R	601255	0			
307 两厢 / 307 Hatchback							
1.6L	2008.2-	F	601213	0			
		R	601273	0			
2.0L	2008.2-	F	601213	0			
		R	601273	0			
408 / 408							
1.6L	2010.1-	F	601213	0			
		R	601273	0			
2.0L	2010.1-	F	601213	0			
		R	601273	0			
东风悦达起亚 / Dongfeng Yueda Kia							
RIO 锐欧 / Rio							
1.4L	2007.1-	F	601210	2			
		R			262 × 10(8,4)	4+3	197029
1.6L	2007.1-	F	601210	2			
		R			262 × 10(8,4)	4+3	197029
狮跑 / Sportage							
2.0L	2007.11-	F	601173	2			
		R	601236	2			
2.7L 4WD	2007.11-	F	601173	2			
		R	601236	2			
远舰 / Optima							
2.0L	2004.9-	F	601173	2			
		R	601236	2			
福瑞迪 / Forte							
1.6L	2009.6-	F	601175	0			
		R	601239	2			
2.0L	2009.6-	F	601175	0			
		R	601239	2			

						
北京现代 / Beijing Hyundai						
伊兰特·悦动 / Elantra Yue Dong						
1.6L	2008.4-	F	601175	0		
		R	601239	2		
1.8L	2008.4-	F	601175	0		
		R	601239	2		
伊兰特三厢 / Elantra Saloon						
1.6L	2003.12-	F	601169	0	 257 × 24(22,4)	4+2 186825
		R	601235	2	 258 × 10(8)	4 197441
1.8L	2003.12-	F	601169	0	 257 × 24(22,4)	4+2 186825
		R	601235	2	 258 × 10(8)	4 197441
伊兰特两厢 / Elantra Hatchback						
1.6L	2007.3-	F	601169	0	 257 × 24(22,4)	4+2 186825
		R	601235	2	 258 × 10(8)	4 197441
索纳塔 / Sonata (EF)						
2.0L	2002.12-2007.7	F	601173	2		
		R	601236	2		
2.5L	2002.12-2007.7	F	601173	2		
		R	601236	2		
索纳塔 御翔 / Sonata (NF)						
2.0L	2005.9-	F	601173	2		
		R	601236	2		
2.4L	2005.9-	F	601173	2		
		R	601236	2		
途胜 / Tucson						
2.0L	2005.5-	F	601173	2		
		R	601236	2		
2.7 4WD	2005.5-	F	601173	2		
		R	601236	2		
雅绅特 / Accent						
1.4L	2006.2-	F	601210	2		
		R	601239	2	 262 × 10(8,4)	4+3 197029
1.6L	2006.2-	F	601210	2		
		R	601239	2	 262 × 10(8,4)	4+3 197029





											
北京现代 / Beijing Hyundai											
i30 / i30											
1.6L	2009.7-	F	601175	0							
		R	601239	2							
2.0L	2009.7-	F	601175	0							
		R	601239	2							
ix35 / ix35											
2.0L	2010.4-	R	601239	2							
2.4L	2010.4-	R	601239	2							
华泰现代 / Huatai Hyundai											
圣达菲 / Santa Fe											
2.0 TDI 4WD	2006.10-	F	601164	2							
		R	601230	2							
2.7 4WD	2006.10-	F	601164	2							
		R	601230	2							
特拉卡 / Terracan											
2.5T 柴油 / Diesel	2003.3-2008.12	F	601167	2							
		R	601233	0							
2.9T 柴油 / Diesel	2005.4-2008.12	F	601168	0							
		R	601233	0							
北京吉普 / Beijing-Jeep											
吉普 2500 / Jeep 2500											
2.4L	2003.6-2006.2	R	601255	0							
2.4 4WD	2003.6-2006.2	R	601255	0							
北京汽车 / BEIJING Automobile											
陆霸 / Luba											
2.4 4WD	2004.6-	F	601166	0							
		R	601232	0							
2.4L	2004.6-	F	601166	0							
		R	601232	0							
3.0 4WD	2003.6-	F	601166	0							
		R	601232	0							

											
北京汽车 / BEIJING Automobile											
陆霸 / Luba											
3.4 4WD	2005.1-	F	601166	0							
		R	601232	0							
一汽海马 / FAW-Haima											
普力马 / Freema											
1.8L	2007.3-2009.10	R	601243	0							
海马 3 / Haima 3											
1.8L	2007.6-2010.12	R	601243	0							
福美来 2 代 / Family II											
1.6L	2006.9-2010.11	R	601243	0							
福美来 3 代 / Family III											
1.6L	2010.11-	R	601243	0							
海南马自达 / Hainan Automobile											
普力马 / Freema											
1.8L	2001.1-2007.2	R	601243	0							
福美来 / Familia											
1.6L	2003.3-2006.12	R	601243	0							
1.8L	2002.10-2006.12	R	601243	0							
长安福特 / Changan Ford											
嘉年华三厢 / Fiesta Saloon											
1.3L	2003.3-2006.6	R	564121(刹车蹄 /Shoes)								
1.3L	2010.3-	F	601225	2							
		R	564127(刹车蹄 /Shoes)								
1.5L	2009.2-	F	601225	2							
		R	564127(刹车蹄 /Shoes)								
1.6L	2003.3-2006.6	R	564121(刹车蹄 /Shoes)								
嘉年华两厢 / Fiesta Hatchback											
1.3L	2009.2-	F	601225	2							
		R	564127(刹车蹄 /Shoes)								
1.5L	2009.2-	F	601225	2							
		R	564127(刹车蹄 /Shoes)								

								
长安福特 / Changan Ford								
福克斯三厢 / Focus Saloon								
1.8L	2005.9-	R	601256	0	264,8 × 11(9)	5	197430	
2.0L	2005.9-	R	601256	0	264,8 × 11(9)	5	197430	
福克斯两厢 / Focus Hatchback								
1.8L	2006.8-	R	601256	0	264,8 × 11(9)	5	197430	
2.0L	2006.8-	R	601256	0	264,8 × 11(9)	5	197430	
蒙迪欧 / Mondeo								
2.0L	2003.5-	F	601206	0	300 × 24(22)	5	197390	
		R	601257(-2004)	0	280 × 12(10)	5	197431	
		R	601258	0				
2.5L	2003.5-	F	601206	0	300 × 24(22)	5	197390	
		R	601257(-2004)	0	280 × 12(10)	5	197431	
		R	601258	0				
蒙迪欧 – 致胜 / Mondeo								
2.0L	2007.9-	R	601266	0				
2.3L	2007.9-	R	601266	0				
长安马自达 / Changan Mazda								
马自达 2 两厢 / 2 Hatchback								
1.3L	2007.10-	F	601225	2				
		R	564127(刹车蹄 /Shoes)					
1.5L	2007.10-	F	601225	2				
		R	564127(刹车蹄 /Shoes)					
马自达 3 / 3 Saloon								
1.6L	2006.2-	R	601256	0				
2.0L	2006.2-	F			258 × 24(22)	5+1	186457	
		R	601256	0	264,8 × 11(9)	5	197430	
一汽夏利 / FAW Tianjin Xiali								
威乐 / Vela								
1.5L	2002.7-	F	601198	0	254,9 × 20(18)	4	197418(2007-)	
1.6L	2004.3-	R	564118(刹车蹄 /Shoes)					
威姿 / Vizi								
1.3L	2003.1-	F	601198	0	254,9 × 20(18)	4	197418	
		R	564118(刹车蹄 /Shoes)					

		R	F						
				Valeo	Valeo				Valeo
一汽夏利 / FAW Tianjin Xiali									
威志两厢 / Weizhi Hatchback									
1.3L	2007.1-	F				254,9 × 20(18)	4	197418	
一汽轿车 / FAW Car Co., Ltd									
奔腾 B70 / Besturn B70									
2.0L	2006.9-	F	601180		2				
红旗世纪星 / Century Star (CA7202)									
2.0L	2000.2-	F	601195	1		288 × 24,9(23)	5	186271	
		R	601255	0		245 × 9,9(8)	5	186294	
2.4L	2000.9-	F	601195	1					
		R	601255	0					
红旗旗舰 / Flagship (CA7460)									
4.6L	1999.2-	R	564111(刹车蹄 /Shoes)						
红旗明仕 / Mingshi (CA7180)									
1.8L	2001.1-	F	601195	1					
		R	601255	0					
		R	564111(刹车蹄 /Shoes)						
一汽马自达 /FAW Mazda									
马自达 6 旅行车 / 6 Estate									
2.0L	2003.4-	F				273,6 × 24(22)	5	197264	
2.3L	2003.4-	F				273,6 × 24(22)	5	197264	
		R				279,7 × 10(8)	5	197294	
马自达 6 三厢 / 6 Saloon									
2.0L	2003.4-	F	601180	2		273,6 × 24(22)	5	197264	
		R	601243	0		279,7 × 10(8)	5	197294	
2.3L	2003.4-	F	601180	2		273,6 × 24(22)	5	197264	
		R	601243	0		279,7 × 10(8)	5	197294	
马自达 6 睿翼 / 6 Rui Yi									
2.0L	2009.10-	F	601223	2					
		R	601271	0					
2.5L	2009.1-	F	601223	2					
		R	601271	0					

											
华晨汽车 / Shenyang Brilliance											
尊驰 / Zunchi (M1)											
2.0L	2004.12-	F	601157	2							
2.4L	2004.12-2008.12	F	601157	2							
骏捷 / Junjie (M2)											
2.0L	2006.2-2008.12	F	601157	2							
骏捷 Wagon / Junjie Wagon											
2.0L	2008.12-	F	601157	2							
吉利汽车 / Geely											
远景 / Vision											
1.8L	2005.12-	R	601242	2							
金刚 / KingKong											
1.5L	2006.5-	F	601198	0							
		R	564118(刹车蹄 /Shoes)								
1.6L	2006.5-	F	601198	0							
		R	564118(刹车蹄 /Shoes)								
1.8L	2005.6-	F	601198	0							
		R	564118(刹车蹄 /Shoes)								
奇瑞汽车 / Chery											
A5 / A5											
1.5L	2009.6-	F	601157	2							
1.6L	2006.1-2009.1	F	601157	2							
1.8L	2007.9-	F	601157	2							
2.0L	2006.1-	F	601157	2							
东方之子 / Eastar											
1.8L	2006.12-	F	601157	2							
2.0L	2004.3-2008.12	F	601157	2							
2.4L	2003.6-2007.12	F	601157	2							
旗云 / Qiyun											
1.3L	2006.9-2008.7	F	601188	0							
		R	564110(刹车蹄 /Shoes)								
1.5L	2008.7-2010.5	F	601188	0							
		R	564110(刹车蹄 /Shoes)								
1.6L	2003.8-2008.7	F	601188	0							
		R	564110(刹车蹄 /Shoes)								

  		 		 		
奇瑞汽车 / Chery						
QQ3 / QQ3						
0.8L	2004.3-	F	601191	0		
		R	564117(刹车蹄 /Shoes)			
1.1L	2003.6-2010.3	F	601191	0		
		R	564117(刹车蹄 /Shoes)			
QQ6 / QQ6						
1.1L	2006.12-	R	564117(刹车蹄 /Shoes)			
瑞虎 / Tiggo						
1.6L	2006.7-2007.12	F	601157	2		
2.0L	2005.3-2008.12	F	601157	2		
2.4L	2005.3-2008.12	F	601157	2		
比亚迪 / BYD						
F3 / F3						
1.5L	2007.9-2010.12	R	601242	2		
1.6L	2005.9-2010.12	R	601242	2		
江淮汽车 / JAC						
宾悦 / Bin Yue						
2.0L	2007.11-	F	601157	2		
2.4L	2007.11-	F	601157	2		

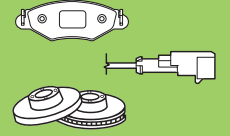

进口车型 Import Car Models

Pads and Discs

Plaquettes et Disques

Pastillas y Discos

Pastilas e Discos

Pastiglie e Dischi

Blokjes en Schijven

Bremsbeläge und Bremsscheiben

Klocki i Tarcze



























Balatalari ve Diskleri

Колодки и диски





















Δισκόφρενα & Δισκόπλακες







刹车片和刹车盘





































بطانات و قرص



































								
奥迪 / Audi								
奥迪 A3 / A3								
1.4 TFSI	2010.6-	F	ATE 21974 	598408	1	 280 × 22 (19)	5+5	186754
		R	LUC 20960 	598463	0 (D)		 255 × 10 (8)	9+1
1.8 TFSI	2010.6-	F	ATE 23587 	598635	1	 255 × 10 (8)	9+1	197325
		R	LUC 20960 	598463	0 (D)			186857
		R	LUC 23914 	598752	0			
奥迪 A4 / A4								
1.8 T	2003.2-2005.7	F				 280 × 22 (20)	5	186582
		F				 312 × 25 (23)	5+5	186758
		R	LUC 20960 	598463	0 (D)			
1.8 T	2005.7-2008.12	R	LUC 20960 	598463	0 (D)			
		R	LUC 20960 	598474	0 (D+C)			
2.0L	2003.2-2005.7	F				 280 × 22 (20)	5	186582
		F				 312 × 25 (23)	5+5	186758
		R	LUC 20960 	598463	0 (D)			
		R	LUC 20960 	598474	0 (D+C)			
3.0L quattro	2005.7-2008.12	F				 312 × 25 (23)	5+5	186758
		R	LUC 20960 	598463	0 (D)			
		R	LUC 20960 	598474	0 (D+C)			
奥迪 A5 / A5								
2.0 TFSI	2008.6-	R				 300 × 12 (10)	5+1	197126
2.0 TFSI quattro	2008.6-	F				 314 × 25 (23)	5+1	197213
		R				 300 × 12 (10)	5+1	197126
2.7 TDI	2007.6-	F	ATE 24705 	598996	1			
3.2 FSI	2008.4-	R				 300 × 12 (10)	5+1	197126
3.2 FSI quattro	2008.4-	R				 300 × 12 (10)	5+1	197126





















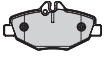

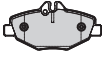
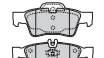

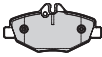



		 R F		 WVA		 Valeo		 Valeo		  Valeo	
奥迪 / Audi											
奥迪 A6 / A6											
1.8T	1999.9-2005.12	F							312 × 25 (23)	5+5	186758
		R	LUC 20960		598463	0 (D)					
1.8T quattro	1999.9-2005.12	F							312 × 25 (23)	5+5	186758
		R	LUC 20960		598463	0 (D)					
2.4L	1999.9-2005.12	F							312 × 25 (23)	5+5	186758
		R	LUC 20960		598463	0 (D)					
2.4 quattro	1999.9-2005.12	F							312 × 25 (23)	5+5	186758
		R	LUC 20960		598463	0 (D)					
2.8L	1999.9-2005.12	F	LUC 23118		598992	2					
		R	LUC 20960		598463	0 (D)					
3.0L	2004.5-2005.12	F							312 × 25 (23)	5+5	186758
		R	LUC 20960		598463	0 (D)					
3.0L quattro	2004.5-2005.12	F							312 × 25 (23)	5+5	186758
		R	LUC 20960		598463	0 (D)					
奥迪 A8 / A8											
2.8 FSI	2007.8-2011.5	F	ATE 23762		598779	2			321 × 30 (28)	5+1	197199
		R							280 × 22 (20)	5	186582
3.0L	2004.5-2011.5	F	ATE 23762		598779	2			321 × 30 (28)	5+1	197199
		R	LUC 23326		601004	0			280 × 22 (20)	5	186582
3.2 FSI	2005.6-2011.5	F	ATE 23762		598779	2			321 × 30 (28)	5+1	197199
		R	LUC 23326		601004	0			280 × 22 (20)	5	186582
3.2 FSI quattro	2005.6-2011.5	F	ATE 23762		598779	2			321 × 30 (28)	5+1	197199
		R	LUC 23326		601004	0			280 × 22 (20)	5	186582
3.7L quattro	2004.5-2011.5	F	ATE 23885		598845	2					
		R	LUC 23326		601004	0					

















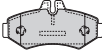
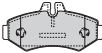

													
		R	F										
奥迪 / Audi													
奥迪 A8 / A8													
4.2 FSI quattro	2006.6-2010.7	F	ATE 23885		598845	2							
		R	LUC 23326		601004	0							
6.0L W12 quattro	2005.5-2011.5	F	ATE 23885		598845	2							
		R	LUC 23326		601004	0							
奥迪 S8 / S8													
5.2L quattro	2007.12-2011.5	F	ATE 23885		598845	2							
		R	LUC 23326		601004	0							
奥迪 Q5 / Q5													
2.0 TFSI quattro	2009.10-	R								300 × 12 (10)	5+1		197126
奥迪 Q7 / Q7													
3.0 TDI	2007.11-	F	BBO 23693		598656	0							
		R	BBO 23694		598770	0				358 × 28 (26)	5+2		197051
										330 × 28 (26)	5+2		197090
3.0 TFSI	2010.5-	F	BBO 23693		598656	0							
		R	BBO 23694		598770	0				330 × 28 (26)	5+2		197090
3.6 FSI	2006.8-2010.5	F	BBO 23693		598656	0							
		R	BBO 23694		598770	0				358 × 28 (26)	5+2		197051
										330 × 28 (26)	5+2		197090
4.2 FSI	2006.3-2010.5	F	BBO 23693		598656	0							
		R	BBO 23694		598770	0				358 × 28 (26)	5+2		197051
										330 × 28 (26)	5+2		197090
6.0 TDI	2008.9-	R	BBO 23694		598770	0							
奥迪 TT / TT													
1.8 T quattro	2002.4-2006.6	F	ATE 21911		598303	0							
		F	ATE 21911		598486	1				312 × 25 (23)	9+1		197246

























		 R F		 WVA Valeo		   			
奥迪 / Audi									
奥迪 TT / TT									
1.8 T quattro	2002.4-2006.6	R	LUC 20960		598180	0 (D)	232 × 9 (7)	5	186597
		R	LUC 20960		598463	0 (D)	239 × 8,9 (7)	5+1	197011
2.0 TFSI	2006.8-	F	ATE 23587		598635	1	312 × 25 (22)	5+5	197242
		R	LUC 23914		598752	0			
2.0 TFSI quattro	2008.6-	F	ATE 23587		598635	1	312 × 25 (22)	5+5	197242
		R	LUC 23914		598752	0			
3.2L V6 quattro	2006.8-	R	LUC 23914		598752	0			
奥迪 TTS / TTS									
2.0 TFSI quattro	2011.1-	F	ATE 23587		598635	1			
		R	LUC 23914		598752	0			
奥迪 Allroad / ALLROAD									
2.7 T quattro	2004.5-2005.8	R	LUC 20960		598463	0 (D)			
宾利 / Bentley									
欧陆 GT / Continental Coupe									
6.0L	2003.6-	R	ATE 23730		598820	0			
欧陆飞刺 / Continental Flying Spur									
6.0L	2008.9-	R	ATE 23730		598820	0			
奔驰 / Mercedes-Benz									
A160 (W168)									
1.6L	1999.2-2005.8	R	LUC 23138		598583	0			
A160 (W169)									
1.5L	2010.11-	F	LUC 24077		598704	0	276 × 12 (10)	5+1	186798
		R	LUC 23138		598583	0	258 × 8 (7)	5+1	197036
A180 (W169)									
1.7L	2010.11-	F	LUC 24077		598704	0	276 × 22 (19,4)	5+1	186799
		R	LUC 23138		598583	0	258 × 8 (7)	5+1	197036

























													
奔驰 / Mercedes-Benz													
A190 (W168)													
1.9L	2004.6-	R	LUC 23138 	598583	0								
B200 (W245)													
2.0L	2009.10-	F	LUC 23881 	598795	2	 288 × 25 (22,4)	5+1	197091					
		R	LUC 23138 	598583	0	 258 × 8 (7)	5+1	197036					
C180 (W204)													
1.6L	2008.1-	F				 295 × 28 (26)	5+1	197201					
		F							197316				
		R	ATE 24253 	601051	0	 300 × 10 (8,3)	5+1	197127					
						 278 × 9 (7,3)	5+1	197128					
C200 CGI Kompressor (W203)													
1.8L	2003.7-	F	LUC 23144 	598448	0	 288 × 25 (22,4)	5+2	186864					
		R	ATE 21919 	598444	0	 290 × 10 (8,3)	5	186469					
						 278 × 9 (7,3)	5+1	186470					
C200 Kompressor (W203)													
1.8L	2002.5-2007.1	F	LUC 23144 	598448	0	 288 × 25 (22,4)	5+2	186864					
		R	ATE 21919 	598444	0	 278 × 9 (7,3)	5+1	186470					
C200 Kompressor (W204)													
1.8L	2007.1-	F				 295 × 28 (26)	5+1	197201					
		F				 295 × 28 (25,4)	5+1	197202					
		R	ATE 24253 	601051	0	 300 × 10 (8,3)	5+1	197127					
C230													
2.5L	2005.1-	F	LUC 23144 	598448	0								
		R	ATE 21899 	598447	0	 290 × 10 (8,3)	5	186469					
2.5L	2007.1-	F				 295 × 28 (26)	5+1	197201					
		F				 295 × 28 (25,4)	5+1	197202					
		R	ATE 24253 	601051	0	 300 × 10 (8,3)	5+1	197127					



























													
奔驰 / Mercedes-Benz													
C230 Kompressor(W202)													
2.3L	2000.3-2004.4	F						 288 × 25 (22,4)	5+1	186467			
		R	ATE 21197		598272	0	 278 × 9 (7,3)	5+1	186470				
C240 4-matic(W203)													
2.6L	2002.7-	F	LUC 23144		598448	0							
		R	ATE 21899		598447	0	 290 × 10 (8,3)	5	186469				
C280(W203)													
3.0L	2005.1-	F	LUC 23144		598448	0							
		R	ATE 21899		598447	0	 290 × 10 (8,3)	5	186469				
CLK200K(C209)													
1.8L	2006.10-	F	LUC 23144		598448	0							
		R	ATE 21899		598447	0	 290 × 10 (8,3)	5	186469				
CLK230(C208)													
2.3L	1997.6-2002.10	F	ATE 21195		598357	0	 288 × 25 (22,4)	5+1	186467				
		R	ATE 21919		598444	0	 290 × 10 (8,3)	5	186469				
							 278 × 9 (7,3)	5+1	186470				
CLK240(C209)													
2.6L	2004.1-	F	LUC 23144		598448	0							
		R	ATE 21899		598447	0	 290 × 10 (8,3)	5	186469				
CLK280(A209)													
3.0L	2005.1-	F	LUC 23144		598448	0							
		R	ATE 21899		598447	0	 290 × 10 (8,3)	5	186469				
CLK350(A209)													
3.5L	2005.1-	F	LUC 23144		598448	0							
		R	ATE 21899		598447	0	 290 × 10 (8,3)	5	186469				
CLS350(C219)													
3.5L	2008.7-	F	BBO 23745		598659	0							
		F	BBO 23960		598995	0							
		R	ATE 23334		598637	0					197324		



















									
		R	F						
奔驰 / Mercedes-Benz									
CLS500(C219)									
5.0L	2004.10-	F	BBO 23745		598659	0			
		R	ATE 23334		598637	0			197324
E50AMG(W210)									
5.0L	1996.2-1997.8	R					 300 × 22 (19,4)	5+2	197094
E200									
1.8L	2002.11-	F	BOS 23743		598638	2			197326
		R	ATE 23334		598637	0	 300 × 10 (8,3)	5+1	197035
E240(W211)									
2.6L	2002.3-	F	BOS 23743		598638	2			197326
		R	ATE 23334		598637	0	 300 × 10 (8,3)	5+1	197035
E320 4-matic(W211)									
3.2L	2003.3-	F	ATE 21670		598636	0			
		R	ATE 23334		598637	0	 300 × 10 (8,3)	5+1	197035
3.5L	2005.3-	F	ATE 21670		598636	0			197326
		F	BBO 23745		598659	0			
		R	ATE 23334		598637	0			197324
E350 4-matic(W212)									
3.5L	2009.1-	R	ATE 23334		598637	0			197324
E500(W211)									
5.0L	2004.9-	F	BBO 23745		598659	0			
		R	ATE 23334		598637	0			197324
E500 4-matic(W211)									
5.0L	2004.9-	F	ATE 21484		598712	1	 330 × 32 (29,4)	5+1	197093
		R	ATE 23334		598637	0			197324

													
奔驰 / Mercedes-Benz													
E55AMG(W211)													
5.5L	2002.10-	R											197324
G500(W463)													
5.0L	1998.4-	R	BOS 23021		598300	0	272 × 16 (14)	5					187045
G55AMG(W463)													
5.5L	2006.8-	R	BOS 23021		598300	0	272 × 16 (14)	5					187045
GL450(X164)													
4.7L	2006.9-	F	ATE 23922		598728	0							
		R	ATE 23923		598802	0							
GL550 (X164)													
5.5L	2006.9-	F	ATE 23922		598728	0							
		R	ATE 23923		598802	0							
GLK300 4-matic (X204)													
3.0L	2009.7-	R	ATE 24253		601051	0							197324
GLK350 4-matic (X204)													
3.5L	2008.6-	R	ATE 24253		601051	0							197324
ML320(W163)													
3.2L	2002.6-	F	KH 23193		598442	1	345 × 31,9 (30)	5+3					186811
							303 × 26 (23)	5					197237
		R	KH 23189		598443	1	285 × 15 (13)	5+1					186753
		R	BOS 23189		598813	1							
ML350(W163)													
3.7L	2003.2-	F	BBO 23271		598445	0	345 × 31,9 (30)	5+3					186811
		R	BBO 23157		598719	0	285 × 15 (13)	5+1					186753

															
奔驰 / Mercedes-Benz															
ML350 4-matic(W164)															
3.5L	2005.7-2008.1	F	ATE 23922		598728	0	330 × 32 (29,4)	5+3	197092						
		R	ATE 23923		598802	0									
ML500 4-matic(W164)															
5.5L	2007.12-	R	ATE 23923		598802	0									
5.0L	2005.7-2008.1	F	ATE 23922		598728	0									
		R	ATE 23923		598802	0									
ML55AMG(W163)															
5.5L	2000.2-	F	BBO 23271		598445	0	345 × 31,9 (30)	5+3	186811						
		R	BBO 23157		598719	0									
ML63AMG 4-matic(W164)															
6.2L	2006.1-	F	ATE 23922		598728	0									
		R	ATE 23923		598802	0									
R300(W251,V251)															
3.0L	2009.7-	F	ATE 23922		598728	0	330 × 32 (29,4)	5+3	197092						
		R	ATE 23923		598802	0									
R350(W251,V251)															
3.5L	2007.1-	F	ATE 23922		598728	0	330 × 32 (29,4)	5+3	197092						
		R	ATE 23923		598802	0									
R500(W251,V251)															
5.0L	2006.1-	F	ATE 23922		598728	0									
		R	ATE 23923		598802	0									
R550(W251,V251)															
5.5L	2007.1-	R	ATE 23923		598802	0									



















																
		R	F													
奔驰 / Mercedes-Benz																
S280(W220)																
2.8L	2005.1-	F	BBO 23271		598445	0										
		F	BBO 23745		598659	0										
		R	ATE 23078		598446	0										
		R	ATE 23334		598637	0										
S320(W220)																
3.2 柴油 /Diesel	2005.12-	F	BBO 23745		598659	0										
		R	ATE 23334		598637	0										
S350(W220)																
3.7L	2005.12-	F	BBO 23745		598659	0										
		R	ATE 23334		598637	0										
S350(W221)																
3.5L	2005.10-	F	BBO 23960		598995	0										
		R	ATE 23334		598637	0										
S350 4-matic(W220)																
3.7L	2005.12-	F	ATE 21670		598636	0										
		R	ATE 23334		598637	0										
S400(W221)																
3.5L	2009.1-	F	BBO 23960		598995	0										
S430 4-matic(W220)																
4.3L	2005.12-	F	ATE 21484		598712	1										
		R	ATE 23334		598637	0										
S500(W221)																
5.5L	2005.10-	F	BBO 23960		598995	0										
		R	ATE 23334		598637	0										

																
奔驰 / Mercedes-Benz																
S500 4-matic(W220)																
5.0L	2002.9-2005.8	F	ATE 21484		598712	1										
		R	ATE 21305		598617	0										
		R	ATE 23334		598637	0										
S500 4-matic(W221)																
5.5L	2005.10-	F	BBO 23960		598995	0										
		R	ATE 23334		598637	0										
S600 (W220)																
5.5L	2005.8-	R	ATE 21305		598617	0										
SL350(R230)																
3.5L	2006.3-	F	BBO 23745		598659	0										
		R	ATE 23334		598637	0										
SL500 (R230)																
5.5L	2011.4-	F	BBO 23960		598995	0										
		R	ATE 23334		598637	0										
SL500(R129)																
5.0L	1998.5-2002.12	F	ATE 21153		598601	0										
		R	ATE 21197		598272	0										
		R	ATE 21305		598617	0										
SLK200K(R171)																
1.8L	2008.1-	F	LUC 23144		598448	0										
		R	ATE 21919		598444	0		278 × 9 (7,3)	5+1						186470	
SLK230(R170)																
2.3L	2004.4-	F	ATE 21195		598357	0		288 × 25 (22,4)	5+1						186467	
		R	ATE 21197		598272	0		278 × 9 (7,3)	5+1						186470	
		R	ATE 21197		598444	0										

									
		R	F						
奔驰 / Mercedes-Benz									
SLK280(R171)									
3.0L	2006.6-	F	LUC 23144 	598448	0				
		R	ATE 21919 	598444	0	278 × 9 (7,3)	5+1	186470	
SLK350(R171)									
3.5L	2004.6-2008.1	F	BBO 23745 	598659	0	330 × 28 (26)	5+2	197200	
		R	ATE 21899 	598447	0	290 × 10 (8,3)	5	186469	
3.5L	2008.1-	F	ATE 23945 	601034	0				
		R	ATE 21899 	598447	0	290 × 10 (8,3)	5	186469	
SLK55AMG (R171)									
5.5L	2011.4-	F	BBO 23745 	598659	0				
		R	ATE 21305 	598617	0				
唯雅诺 (W639) / VIANO									
3.5L	2007.9-	F	BBO 29192 	598882	0	300 × 28 (25)	5+1	186890	
		R	BOS 24008 	598765	2				
宝马 / BMW									
宝马 116i(E81, E87)									
1.6L	2007.9-	F				284 × 22 (20,4)	5+1	186816	
宝马 118d(E81, E87)									
2.0 柴油 /Diesel	2007.4-	F				292 × 22 (20,4)	5+1	186817	
宝马 118i(E81, E87)									
2.0L	2004.9-	R	LUC 23623 	598701	0				
宝马 120d(E81, E87)									
2.0 柴油 /Diesel	2004.9-	F	ATE 23935 	598700	0				
宝马 120d(E82)									
2.0 柴油 /Diesel	2007.10-	R				300 × 20 (18,4)	5+1	197181	
宝马 130i(E81, E87)									
3.0L	2005.3-2009.8	F				330 × 24 (22,4)	5+1	197073	
		R	ATE 23926 	598703	0	300 × 20 (18,4)	5+1	197158	

									
		R	F						
宝马 / BMW									
宝马 318i(E46)									
2.0L	2001.9-	F	ATE 21292 	598018	0	286 × 21,9 (20,4)	5	186275	
			300 × 22 (20,4)			5+1	186815		
		R	ATE 21934 	598753	0	276 × 18,9 (17,4)	5+1	186559	
			294 × 18,9 (17,4)			5+1	186861		
宝马 325i(E90)									
2.5L	2005.1-	F	ATE 23794 	598640	0	300 × 24 (22,4)	5+1	197234	
		F	ATE 23313 	601027	0	330 × 24 (22,4)	5+1	197073	
		R	ATE 23926 	598703	0	300 × 20 (18,4)	5+1	197049	
		R	ATE 23550 	598885	0				
宝马 330d(E46)									
3.0 柴油 / Diesel	1999.10-2005.2	R						197323	
宝马 330i(E90)									
3.0L	2005.1-	F	ATE 23794 	598640	0	300 × 24 (22,4)	5+1	197234	
			330 × 24 (22,4)			5+1	197073		
		R	ATE 23550 	598885	0	336 × 22 (20,4)	5+1	197175	
宝马 335i(E90)									
3.0L	2008.11-	F	ATE 23347 	598898	0	348 × 30 (28,4)	5+1	197176	
		R	ATE 23550 	598885	0	336 × 22 (20,4)	5+1	197175	
宝马 520i(E60)									
2.2L	2003.7-2005.7	F	ATE 23312 	598410	0	310 × 24 (22,4)	5	186732	
		F	ATE 23794 	598640	0	324 × 30 (28,4)	5+1	197193	
		R	ATE 21732 	598754	0				





























														
		R	F											
宝马 / BMW														
宝马 523i(E60)														
2.5L	2007.1-	F	ATE 23312		598410	0	324 × 30 (28,4)	5+1	197193					
		F	ATE 23794		598640	0								
		R	ATE 21732		598754	0								
宝马 525TDS (E39)														
2.5 柴油 /Diesel	1996.1-2003.6	F	ATE 21064		598409	0	298 × 9,9 (8,4)	5+1	186568					
		F	ATE 21677		598310	0								
		R												
宝马 528i (E39)														
2.8L	1995.11-2000.9	R					298 × 20 (18,4)	5+1	186860					
宝马 530d(E60)														
3.0 柴油 /Diesel	2003.7-	R							197319					
宝马 530i(E60)														
3.0L	2003.7-	F	ATE 23312		598410	0	324 × 30 (28,4)	5+1	197193					
		R	ATE 21732		598754	0								
		R	ATE 23730		598820	0								
宝马 540i (E39)														
4.4L	1996.4-2003.6	R	ATE 21691		598311	0								
宝马 545i(E60)														
4.4L	2003.9-2005.7	F	ATE 23312		598410	0								
		R	ATE 23730		598820	0								
宝马 630i(E63)														
3.0L	2004.9-2010.7	F	ATE 23312		598410	0	324 × 30 (28,4)	5+1	197193					
		R	ATE 21732		598754	0								
		R	ATE 23730		598820	0								

													
		R	F										
宝马 / BMW													
宝马 645i(E63)													
4.4L	2004.1-2005.6	F	ATE 23312		598410	0							
		R	ATE 23730		598820	0							
宝马 650i(E63)													
4.8L	2006.11-	F	ATE 23312		598410	0							
		R	ATE 23730		598820	0							
宝马 728Li(E38)													
2.8L	1995.8-2001.11	F								316 × 28 (26,4)	5+1	197227	
		R	ATE 21487		598580	0							
宝马 730Li(E65, E66)													
3.0L	2005.3-2008.10	F	ATE 23312		598410	0							
		R	ATE 21282		598411	0							
宝马 735i/Li(E65, E66)													
3.6L	2001.11-2008.10	F	ATE 23312		598410	0							
		R	ATE 21282		598411	0							
宝马 740i/Li (E65, E66)													
4.0L	2005.7-2009.4	F	ATE 23312		598410	0							
		R	ATE 23730		598820	0							
宝马 745Li(E65, E66)													
4.4L	2001.11-2006.5	F	ATE 23312		598410	0							
		R	ATE 23730		598820	0							
宝马 750i/Li(E65, E66)													
4.8L	2005.7-	F	ATE 23312		598410	0							
		R	ATE 23730		598820	0							

										
		R	F		WVA					
宝马 / BMW										
宝马 760Li (E65, E66)										
6.0L	2003.1-2008.12	F	ATE 23312		598410	0				
		R	ATE 23730		598820	0				
宝马 M3 (E90)										
4.0L	2007.3-	F	ATE 23312		598410	0				
		R	ATE 23730		598820	0				
宝马 M5 (E60)										
5.0L	2005.1-	R	ATE 23730		598820	0				
宝马 M6 (E63)										
5.0L	2005.9-	R	ATE 23730		598820	0				
宝马 X1 sDrive18i (E84)										
2.0L	2010.1-	F	ATE 23313		601027	0		312 × 23,9 (22,4)	5+1	197159
		R	ATE 23926		598703	0		300 × 20 (18,4)	5+1	197158
宝马 X1 (E84)										
3.0L	2010.1-	F	ATE 23347		598898	0		348 × 30 (28,4)	5+1	197176
		R	ATE 23550		598885	0		336 × 22 (20,4)	5+1	197175
宝马 X3(E83)										
2.5L	2006.9-2010.7	F	ATE 23183		598811	0		325 × 25 (23,4)	5+1	197083
		R	ATE 21487		598580	0		320 × 22 (20,4)	5+1	197251
3.0L	2004.1-2006.8	F	ATE 23183		598811	0		325 × 25 (23,4)	5+1	197083
		R	ATE 21487		598580	0		320 × 22 (20,4)	5+1	197251
宝马 X5(E53)										
4.4L	2003.12-	F	ATE 23449		598412	0		332 × 30 (28,4)	5+3	186808
		R	ATE 21487		598580	0		324 × 12 (10,4)	5+1	186809
4.6L	2002.2-2006.10	R	ATE 21487		598580	0				
4.8L	2004.4-2006.10	R	ATE 21487		598580	0				



											
											
宝马 / BMW											
宝马 X5(E70)											
3.0 柴油 /Diesel	2007.9-2008.9	R						 345 × 24 (22,4)	5+1	197180	
宝马 X5 xDrive(E70)											
3.0L	2008.9-2010.3	F						 332 × 29,9 (28,4)	5+1	197177	
宝马 X5 xDrive35i (E70)											
3.0L	2010.9-	F						 348 × 29,9 (28,4)	5+1	197178	
		R						 320 × 19,9 (18,4)	5+1	197179	
宝马 X6(E71, E72)											
4.4L Hybrid	2010.10-	R	ATE 23730		598820	0					
宝马 Z3(E36)											
2.2L	2000.8-2003.1	F	ATE 21292		598018	0	 286 × 21,9 (20,4)	5	186275		
宝马 Z4(E85)											
2.5L	2003.2-	F	ATE 21292		598018	0	 286 × 21,9 (20,4)	5	186275		
		R	ATE 21934		598753	0	 280 × 9,9 (8,4)	5+1	186295		
2.5Si	2006.1-	F	ATE 21292		598018	0	 300 × 22 (20,4)	5+1	186815		
		R	ATE 21934		598753	0					
3.0L	2003.2-	F	ATE 21292		598018	0	 300 × 22 (20,4)	5+1	186815		
		R	ATE 21934		598753	0					
3.0Si	2006.1-	F	ATE 23183		598811	0	 325 × 25 (23)	5+1	186731		
		R	ATE 21934		598753	0					
雪佛兰 / Chevrolet											
科帕奇 / CAPTIVA (C100, C140)											
3.2L 4WD	2006.6-2011.11	F	MDO 24510		598942	2	 296 × 29 (27,5)	5+1	197190		
		R	AKE 24498		598941	2	 303 × 20 (18,4)	5+2	197191		

										
		R	F		WVA					
克莱斯勒 / Chrysler										
PT 漫步者 / PT Cruiser										
2.0L	2000.6-2004.12	F	LUC 23532		598543	0		280 × 23 (21,4)	5	186734
		R	KH 23561		598544	0				
2.4L	2000.6-2010.7	F	LUC 23532		598543	0		280 × 23 (21,4)	5	186734
		R	KH 23561		598544	0				
交叉火力 / Crossfire										
3.2L	2004.1-2008.8	F	ATE 21670		598636	0				
		R	ATE 21919		598444	0				
克莱斯勒 300C / 300 C										
2.7L	2004.9-	F	BOS 23590		601032	8				
		R			601033	8				
3.5L	2004.9-	F	BOS 23590		601032	8				
		R			601033	8				
5.7 SRT8	2004.9-	F	BOS 23590		601032	8				
		R			601033	8				
大捷龙 / Voyager IV										
2.4L	2000.2-2007.12	F	ATE 23640		598415	2		281 × 28 (25,3)	5	197069
		F	ATE 23807		598756					
		R	KH 24036		598755	0			290 × 12,5 (11,25)	5
3.3L	2001.1-2007.12	F	ATE 23640		598415	2		281 × 28 (25,3)	5	197069
		F	ATE 23807		598756					
		R	KH 24036		598755	0			290 × 12,5 (11,25)	5
3.3L 4WD	2001.1-2007.12	F	ATE 23640		598415	2		281 × 28 (25,3)	5	197069
		F	ATE 23807		598756					
		R	KH 24036		598755	0			290 × 12,5 (11,25)	5









															
克莱斯勒 / Chrysler															
赛百灵 / Sebring															
2.7L V6	2001.4-2006.8	F	ATE 23951		598905	0									
雪铁龙 / Citroen															
C4 毕加索 / C4 Grand Picasso															
2.0L 16V	2006.10-	F	ATE 24557		598998	0	 302 × 26 (24)	4+2	197232						
		R	LUC 24540		598936	0	 267 × 12	4	197117						
塞纳 / Xsara															
2.0L 16V	2003.3-2007.2	F	BOS 23600		598465	0	 283 × 26 (24)	4+2	186693						
		R	BDX 20635		598396	0									
		R	LUC 23409		598501	0									
塞纳毕加索 / Xsara Picasso															
1.8L 16V	2000.2-2005.3	F	BOS 23599		598464	0	 283 × 26 (24)	4+2	186693						
		F	BOS 23600		598465	0	 266 × 22 (20,4)	4+2	186695						
		R	LUC 20960		598463	0 (D)	 247 × 9 (7)	4+2	186694						
雪铁龙 C3 / C3 Pluriel															
1.4L	2003.5-2005.9	F	LUC 23409		598501	0	 266 × 13 (11)	4+2	186599						
							 266 × 22 (20,4)	4+2	186695						
		R			562997 (刹车蹄 / Shoes)										
		R			564006 (刹车蹄 / Shoes)										
雪铁龙 C3 / C3															
1.6L 16V	2002.2-	F	BOS 23599		598464	0	 283 × 26 (24)	4+2	186693						
		F	LUC 23409		598501	0									
		F	BOS 23600		598465	0	 266 × 22 (20,4)	4+2	186695						
		R	LUC 20960		598463	0 (D)	 247 × 9 (7)	4+2	186694						

  		  			  			
雪铁龙 / Citroen								
雪铁龙 C4 / C4								
1.6 THP 140	2008.7-	F	BOS 23600 	598465	0	283 × 26 (24)	4+2	186693
		R	LUC 20960 	598463	0 (D)	249 × 9 (7)	4	197002
雪铁龙 C5 / C5								
2.0L 16V	2004.8-	F	BOS 23277 	598419	4	283 × 26 (24)	4+2	186693
		R	CIT 23305 	598418	0	275 × 14 (12)	4+2	186736
3.0L V6	2004.9-	F	BOS 23273 	598416	4	288 × 28 (26)	4	197220
		R	CIT 23305 	598418	0	275 × 14 (12)	4+2	186736
雪铁龙 C6 / C6								
3.0L V6	2005.9-	F	LUC 24133 	598663	2	330 × 30 (28)	5+3	197046
		R	LUC 24462 	598939	1			
大字 / Daewoo								
旅行家 / Nubira								
1.6L 16V	1997.5-2005.1	R		562078 (刹车蹄 / Shoes)				
蓝龙 / Lanos								
1.5L	1997.5-2003.9	F				236 × 19,9 (17)	6+1	186188
		R		562078 (刹车蹄 / Shoes)				
1.6L 16V	1997.5-2003.9	F	ATE 21201 	598184	0	256 × 23,9 (21)	6+1	186189
		R		562078 (刹车蹄 / Shoes)				
道奇 / Dodge								
酷博 / Caliber								
2.0L	2006.6-	R	AKE 24014 	598852	2			
菲亚特 / Fiat								
博悦 (198) / Bravo II (198)								
1.4L	2008.1-	F	BOS 23705 	598426	1	257 × 22 (20,5)	4	186590
		R	BOS 23714 	598633	0	251,5 × 10 (9)	4+2	186146
朋多 / Punto Evo								
1.6 柴油 / Diesel	2009.10-2012.2	R		601063				

















									
		R	F	 WVA	 Valeo	 Valeo			 Valeo
菲亚特 / Fiat									
朋多 (176) / Punto (176)									
1.2L	1994.3-1999.9	F	BDX 21365 	598012	0		257,5 × 11,9 (10,2)	4+2	186154
							240,5 × 10,9 (9,2)	4+1	186155
朋多 (188) / Punto (188)									
1.2L	2003.9-	R		562770 (刹车蹄 / Shoes)					
		R		562990 (刹车蹄 / Shoes)					
1.2L 16V	1999.9-	F	ATE 21930 	598605	0				
1.4L	2009.1-	F	ATE 21927 	601003	0		257,4 × 20 (18,2)	4+2	186153
		R		564083 (刹车蹄 / Shoes)					
1.9 柴油 / Diesel	2003.6-	F	ATE 21637 	598990	1		284 × 22 (20,2)	4	186297
		R	LUC 23661 	598425	0				
大朋多 (199) / Grande Punto Van (199)									
1.3 柴油 / Diesel	2008.4-	F		601062					
大朋多 (199) / Grande Punto (199)									
1.2L	2005.10-	F					257 × 12 (10)	4+4	197028
		R		564076 (刹车蹄 / Shoes)					
1.4L 16V	2005.10-	F	BOS 23349 	598721	1		257 × 22 (20)	4+4	197044
		F		601069			284 × 22 (20)	4+4	197045
		R		564064 (刹车蹄 / Shoes)			264 × 10 (8)	6+2	197008
1.9 柴油 / Diesel	2005.10-	R	BOS 24349 	598722	0				
现代 / Hyundai									
君爵 / XG									
3.0L	1998.12-2006.1	R	MDO 23543 	598748	2				
2.5L	1998.12-2006.1	R	MDO 23543 	598748	2		262 × 10(8,4)	5	197290
圣达菲 / Santa Fe									
2.4L 16V	2008.7-	R	MDO 23543 	598748	2				

									
		R	F		WVA				
现代 / Hyundai									
特杰 / Trajet (FO)									
2.0L	2000.3-2007.6	R		MDO 23543		598748	2		
2.7L V6	2000.9-2007.6	R		MDO 23543		598748	2		
索纳塔 / Sonata IV (EF)									
2.7L V6	2002.1-	R		MDO 23543		598748	2		
美佳 / Matrix (FC)									
1.6L	2001.6-	R		MDO 23543		598748	2		
1.8L	2001.6-	R		MDO 23543		598748	2		
途胜 / Tucson (JM)									
2.0L	2005.8-	R		MDO 23543		598748	2		
2.0L 4WD	2005.8-	R		MDO 23543		598748	2		
2.7L 4WD	2005.8-	R		MDO 23543		598748	2		
雅尊 / GrandeUR (TG)									
3.3L	2006.1-	R		MDO 23543		598748	2		
捷豹 / Jaguar									
捷豹 / S-Type (CCX)									
3.0L V6	1999.1-2008.3	F		LUC 23423		598439	0		
		R		LUC 23424		598438	0		
4.2L V8	2002.4-2008.3	F		LUC 23423		598439	0		
		R		LUC 23424		598438	0		
捷豹 XF / XF									
3.0L	2008.3-	R		ATE 24137		598783	0		
捷豹 XJ / XJ									
3.0L	2007.10-	F		LUC 23423		598439	0		
		R		LUC 23424		598438	0		
4.2L	2003.5-	F		LUC 23423		598439	0		
		R		LUC 23424		598438	0		

























  		  			  			
捷豹 / Jaguar								
捷豹 / X-Type (CF1)								
2.0L V6	2002.3-2009.5	F	BOS 23279 	598433	0			197327
		R	BOS 23557 	598434	0	280 × 12 (10)	5	186834
2.5L V6	2001.6-2007.3	F	BOS 23279 	598433	0			197327
		R	BOS 23557 	598434	0	280 × 12 (10)	5	186834
吉普 / Jeep								
切诺基 / Cherokee								
3.7L V6	2005.6-	R	KH 24036 	598755	0	290 × 12,5 (11,25)	5	197022
大切诺基 / Grand Cherokee								
4.7L V8	2005.6-	F	AKE 24250 	598872	2			
		R	KH 24111 	598920	2			
5.7L V8	2005.6-	F	AKE 24250 	598872	2			
		R	KH 24111 	598920	2			
指挥官 / Commander								
4.7L V8	2005.9-	F	AKE 24250 	598872	2			
		R	KH 24111 	598920	2			
5.7L V8	2005.9-	F	AKE 24250 	598872	2			
		R	KH 24111 	598920	2			
牧马人 / Wrangler								
2.5L	1996.8-	F	KH 21822 	598491	0			
		R		562768 (刹车蹄 / Shoes)		290 × 12,5 (11,25)	5	197022
起亚 / Kia								
佳乐 / Carens								
1.6L CVT	2011.3-	F	MDO 24501 	598934	1			
		R	MDO 24491 	598945	1			
2.0L CVT	2006.9-	F	MDO 24501 	598934	1			
		R	MDO 24491 	598945	1			























													
起亚 / Kia													
狮跑 / Sportage													
2.0L 16V 4WD	2004.9-	R	MDO 23543 	598748	2								
2.7L V6 4WD	2004.9-	R	MDO 23543 	598748	2								
路虎 / Land Rover													
卫士 / Defender													
2.4 柴油 /Diesel	2007.5-	R	AP 21237 	598497	1								
2.5 柴油 /Diesel 4WD	2007.1-	F	AP 21519 	598623	0								
		R	AP 21237 	598497	1								
发现 / Discovery													
2.7 TD	2007.1-	F	LUC 24191 	598741	0	 317 × 30 (27)	5+1	197155					
		R	LUC 24192 	598742	0	 325 × 20 (17)	5+2	197156					
4.4L	2004.7-	F	LUC 24191 	598741	0								
		R	LUC 24192 	598742	0								
极光 / Evoque													
2.0L	2011.6-	F				 300 × 28 (26)	5+1	197055					
神行者 / Freelander													
2.5L V6	2001.9-2007.3	F	LUC 23615 	598514	0	 277 × 20,9 (18)	5+2	186871					
		R		564030 (刹车蹄 / Shoes)									
神行者 2 / Freelander2													
3.2L HSE 4WD	2007.3-	F	ATE 24123 	598879	0								
路虎揽胜 / Range Rover													
3.6 TD	2006.4-	F	ATE 23399 	598658	0								
		R	ATE 21487 	598580	0	 354 × 11,9 (10,4)	5+2	197017					
4.2L	2005.5-	F	ATE 23399 	598658	0								
		R	ATE 21487 	598580	0	 354 × 11,9 (10,4)	5+2	197017					
4.4L	2005.5-	F	ATE 23399 	598658	0								
		R	ATE 21487 	598580	0	 354 × 11,9 (10,4)	5+2	197017					

											
		R	F		WVA		Valeo				
路虎 / Land Rover											
路虎运动版 / Range Rover Sport											
4.4L	2007.3-	R	LUC 24192		598742	0					
雷克萨斯 / Lexus											
GS300											
3.0L	2005.4-	R	AKE 24323		598888	2					
GS450h											
3.5L	2006.2-	R	AKE 24323		598888	2					
IS200											
2.0L	1999.4-2005.7	F	SUM 21490		601023	2		5+12	197194		
		R	SUM 23429		601025	2					
IS250											
2.5L	2008.12-	F	SUM 23983		601035	0					
		R	AKE 24323		598888	2					
LX470											
4.7L 4WD	1998.5-2007.8	F	SUM 23524		598535	2					
		R	AKE 23539		598865	0					
RX300											
3.0L V6	2003.2-	F	AKE 23703		598944	2					
SC430											
4.3L	2005.8-2010.7	F	SUM 21490		601023	2		5+12	197194		
		R	SUM 23429		601025	2					
马自达 / Mazda											
3 (BL)											
1.6L MZR	2009.6-	F	ATE 23723		598649	0		5	186872		
		R	AKE 23723		601008	0					

									
		R	F						
马自达 / Mazda									
5 (CR19)									
2.0L	2005.3-	F	ATE 23723 	598649	0	 278 × 25 (23)	5	186872	
		R	AKE 23723 	601008	0				
		R		601044	0				
RX-8(SE17)									
1.3L	2003.10-2008.4	R	AKE 24039 	598831	1				
迷你 / Mini									
迷你 / Mini (R56)									
1.6L Cooper	2006.10-	F	LUC 23915 	598699	0	 280 × 22 (20,4)	4+1	197074	
		R	LUC 24289 	601041	0	 259 × 9,9 (8,4)	4+1	186812	
1.6L Cooper S	2010.3-	F	LUC 23984 	598925	2	 294 × 22 (20,4)	4+1	197160	
		R	LUC 24289 	601041	0	 259 × 9,9 (8,4)	4+1	186812	
三菱 / Mitsubishi									
太空旅行车 / Space Wagon									
2.4 GDI	1998.10-2004.12	F	AKE 21370 	601020	2				
2.4 GDI 4WD	1998.10-2004.12	F	AKE 21370 	601020	2				
帕杰罗 (V60, V70) / Pajero (V60, V70)									
3.5 V6 GDI	2000.4-	F	SUM 21016 	598518	2	 290 × 26 (24,4)	6+2	186813	
		R	AKE 23582 	598520	2				
格兰迪斯 / Grandis									
2.4L	2004.4-2009.3	F	SUM 21016 	598518	2				
		R	AKE 23582 	598520	2				
欧蓝德 / Outlander II (CW_W)									
3.0L 4WD	2007.10-2009.9	R	AKE 23582 	598520	2	 302 × 10 (8,4)	5+3	197116	





























									
		R	F						
日产 / Nissan									
霹雳马 / Primera									
2.2 柴油 /Diesel	2002.3-2010.8	R	ATE 23482 	598472	0				
欧宝 / Opel									
威达 / Vectra C									
2.0L 16V Turbo	2003.3-2008.10	F	ATE 23402 	598678	0	 302 × 28 (25)	5+3	186880	
		R	ATE 23482 	598472	0	 278 × 11,9 (10)	5+3	186854	
		R	ATE 24137 	598783	0				
2.2L 16V	2005.9-2008.8	F	ATE 23402 	598678	0	 285 × 24,9 (22,2)	5+3	186881	
		R	ATE 23482 	598472	0	 278 × 11,9 (10)	5+3	186854	
		R	ATE 24137 	598783	0				
3.2L V6	2008.8-2005.9	F				 302 × 28 (25)	5+3	186880	
		R	ATE 23482 	598472	0	 292 × 19,9 (18)	5+3	186882	
威达 / Vectra B									
2.2L 16V	2001.9-2005.9	F	ATE 21829 	598305	0	 288 × 25 (21)	5	197226	
		R	ATE 21051 	598183	0	 286 × 10 (8)	5+2	186566	
欧米茄 / Omega B									
2.2L 16V	1999.9-2003.7	F	LUC 21368 	598256	0				
		R	ATE 21051 	598183	0				
赛飞利 / Aafira									
1.8L	2005.7-	F	ATE 23832 	598860	2	 280 × 25 (22)	5+1	186684	
		R				 263,4 × 10 (8)	5+1	186593	
2.0L	2011.1-	F	ATE 23402 	598678	0	 321 × 28 (25)	5+3	197150	
		R	LUC 23417 	598584	2				
2.2L	2005.7-	F	ATE 23832 	598860	2	 308 × 25 (23)	5+3	197244	
		R				 263,4 × 10 (8)	5+1	186593	

									
		R	F						
欧宝 / Opel									
雅特 / Astra G									
1.6L	2004.3-2010.3	F	ATE 23063 	598322	4	256 × 24 (21)	4+1	186592	
		R	LUC 23417 	598584	2		240 × 10 (8)	4	186594
		R	BOS 23258 	598926	2 (A)				
雅特 / Astra H									
1.7 柴油 /Diesel	2004.3-	R		564103 (刹车蹄 / Shoes)					
1.8L	2007.2-2010.3	F	ATE 23832 	598860	2	280 × 25 (22)	4+3	186869	
						280 × 25 (22)	5+1	186684	
雅特 / Astra J									
1.4L Turbo	2009.12-	F		601070					
1.6L Turbo	2009.12-	F		601071					
		R		601055					
2.0 柴油 /Diesel	2009.12-	F	MDO 24412 	601046	2				
标致 / Peugeot									
标致 206CC / 206 CC									
1.6L 16V	2000.9-2007.3	F	BOS 23599 	598464	0	266 × 22 (20,4)	4+2	186695	
		R	BDX 20635 	598396	0				
标致 207 / 207									
1.6L 16V VTi	2007.2-	F	BOS 23600 	598465	0	283 × 26 (24)	4+2	186693	
		R	LUC 20960 	598474	0 (D+C)	249 × 9 (7)	4	197002	
		R	BOS 24150 	598702	0				
标致 307CC / 307CC									
2.0L 16V	2003.10-2005.5	F	BOS 23600 	598465	0	283 × 26 (24)	4+2	186693	
		R	LUC 20960 	598463	0 (D)	247 × 9 (7)	4+2	186694	
		R	BOS 24150 	598702	0	249 × 9 (8)	4	186899	

  		  			 			
标致 / Peugeot								
标致 307SW / 307SW								
2.0L 16V	2005.3-	F	BOS 23600 	598465	0	283 × 26 (24)	4+2	186693
		R	LUC 20960 	598463	0 (D)	249 × 9 (8)	4	186899
		R	BO 24150 	598702	0	249 × 9 (7)	4	197002
标致 308CC / 308CC								
1.6L 16V	2009.6-	F	ATE 23589 	598715	0			197315
		R	LUC 20960 	598463	0 (D)	249 × 9 (8)	4	197100
标致 308SW / 308SW								
1.6L 16V	2009.9-	F	ATE 23589 	598715	0			197315
		R	LUC 24765 	601042	0	267 × 12	4	197117
3008 / 3008								
1.6L THP	2011.2-	F	ATE 23589 	598715	0			197315
		R		601061		267 × 12	4	197117
标致 406 / 406								
1.8L 16V	2000.10-2004.5	R	ATE 21279 	598063	0			
2.0L Turbo	2003.6-2009.12	R	ATE 21279 	598063	0			
3.0L V6	2000.3-2003.4	R	ATE 21279 	598063	0			
标致 407 / 407								
2.2L 16V	2005.9-2006.12	F	LUC 24133 	598663	2	330 × 30 (28)	5+3	197046
		R	LUC 24135 	598664	0	290 × 12 (10)	5+2	186747
3.0L	2004.5-2006.12	F	LUC 24133 	598663	2	330 × 30 (28)	5+3	197046
		R	LUC 24135 	598664	0	290 × 12 (10)	5+2	186747











  		  			 				
标致 / Peugeot									
标致 607 / 607									
2.2L 16V	2000.2-2004.11	F				283 × 26 (24)	5+2	186702	
		R	ATE 21279		598063	0	289 × 10 (8)	5+3	186785
3.0L V6 24V	2004.3-	F	LUC 24133		598663	2	330 × 30 (28)	5+3	197046
		R	LUC 24135		598664	0	290 × 12 (10)	5+2	186747
保时捷 / Porsche									
卡雷拉 911(996) / 911 (996)									
3.6L	2010.1-	F	BBO 23329		598767	0			
		R	BBO 21792		598768	0			
博克斯特 (987) / Boxster (987)									
2.7L	2004.11-	R	BBO 21792		598768	0			
2.7L	2011.5-	R	BBO 21792		598768	0			
S 3.2	2004.11-	F	BBO 23329		598767	0			
		R	BBO 21792		598768	0			
S 3.4	2009.6-	R	BBO 21792		598768	0			
Spyder 3.4	2011.2-	R	BBO 21792		598768	0			
卡宴 (955) / Cayenne(955)									
3.2L	2004.1-	F	BBO 23692		598655	0	330 × 32 (30)	5+1	197087
		F	BBO 23693		598656	0			197253
		R	BBO 23694		598770	0	330 × 28 (26)	5+2	197090
3.6L	2007.2-	F	BBO 23692		598655	0	330 × 32 (30)	5+1	197087
		F	BBO 23693		598656	0			197253
		R	BBO 23694		598770	0	358 × 28 (26)	5+2	197051
330 × 28 (26)	5+2						197090		
卡宴 / Cayenne									
4.8L Turbo	2010.6-	R					358 × 28 (26)	5+2	197051

保时捷 / Porsche										
卡宴 S (955) / Cayenne S (955)										
4.5 S	2004.1-	F	BBO 23693	598656	0					
		R	BBO 23694	598770	0	358 × 28 (26)	5+2	197051		
4.8 Turbo S	2007.2-	F	BBO 23692	598655	0	330 × 32 (30)	5+1	197087		
		F	BBO 23693	598656	0			197253		
		R	BBO 23694	598770	0	358 × 28 (26)	5+2	197051		
						330 × 28 (26)	5+2	197090		
卡曼 (987) / Cayman(987)										
2.7L	2006.7-	R	BBO 21792	598768	0					
S 3.4	2006.7-	F	BBO 23329	598767	0					
		R	BBO 21792	598768	0					
雷诺 / Renault										
拉古娜 III / Laguna III (BT0/1)										
2.0L 16V	2007.10-	F		601066						
		R	ATE 24137	598783	0					
拉古娜 II / Laguna II (BG0/1_)										
2.0L 16V IDE	2001.4-2007.9	F	ATE 23659	598471	0	300 × 26 (22,8)	5+1	197221		
		R	ATE 24137	598783	0			274 × 11 (9,5)	5	186896
										197312
梅甘娜 I / Megane I (BA0/1_)										
1.6L 16V	1999.3-	F	LUC 20916	598061	2					
1.9 柴油 /Diesel	1999.3-2003.7	F	LUC 20916	598473	0					
		R		562629 (刹车蹄 / Shoes)				197309		
梅甘娜 I / Megane I (DA0/1_)										
1.4L 16V	1999.3-2003.8	F	LUC 20772	598002	2 (B)					
2.0L	1996.3-2003.8	F				259 × 20,6 (17,7)	4+2	186208		



































										
		R	F							
雷诺 / Renault										
梅甘娜 I / Megane I (KA0/1_)										
1.6L 16V	1999.3-	R							197311	
梅甘娜 II / Meganell (BM0/1_, CM0/1_)										
1.4L 16V	2002.11-	F	BOS 23934 	598557	0	 260 × 22 (19,8)	4+2	186764		
1.9 柴油 /Diesel	2002.11-	F	BOS 23930	598558	0					
梅甘娜 II / Meganell (EM0/1_)										
1.6L	2003.9-2009.10	F	LUC 23930 	598558	0	 280 × 24 (21,8)	4+2	186655		
		F	ATE 24535 	601012	0					
		R	LUC 20960 	598180	0 (D)			197308		
		R	LUC 20960 	598474	0 (D+C)					
2.0L	2003.9-2009.10	F	LUC 23930 	598558	0	 280 × 24 (21,8)	4+2	186655		
		F	ATE 24535 	601012	0					
		R	LUC 20960 	598180	0 (D)			197308		
		R	LUC 20960 	598474	0 (D+C)					
		R	ATE 20916 	598472	0					
梅甘娜 II / Meganell (KM0/1_)										
1.9 柴油 /Diesel	2003.8-	R				 270 × 10 (9)	4	186898		
		R						197305		
梅甘娜 III / Meganell (BZ0_)										
1.6L 16V	2008.11-	R	BBO 24820 	601000	0					
梅甘娜 III / Meganell (DZ0/1_)										
2.0L	2008.11-	F	BBO 24162 	598861	0					
科雷傲 / Koleos (HY_)										
2.5L	2008.9-	R	AKE 24632 	601009	1					
2.5L 4WD	2008.9-	R	AKE 24632 	601009	1					

															
雷诺 / Renault															
风景 II / Scenic II (JM0/1_)															
1.9 柴油 /Diesel	2003.6-	F									300 × 24 (21,8)	4+2	197241		
2.0 柴油 /Diesel	2005.9-	F									300 × 24 (22)	4	197215		
2.0L	2003.6-	F	ATE 23245		598993	0									
风景 III / Scenic III (JZ0/1_)															
1.4L 16V	2009.2-	F	ATE 24710		601050	0									
1.5 柴油 /Diesel	2009.2-	F									280 × 24 (21,8)	5+2	197192		
萨博 / Saab															
萨博 9-3 / 9-3 (YS3D)															
2.0L Turbo	2002.1-	F	ATE 23116		598475	2					288 × 25 (21)	5	197226		
		R	ATE 21051		598183	0					286 × 10 (8)	5+2	186566		
萨博 9-3 / 9-3 (YS3F)															
2.0L Turbo	2002.9-	F	ATE 20224		598808	0					302 × 28 (25)	5+3	186880		
		R	ATE 23482		598472	0					278 × 11,9 (10)	5+3	186854		
											292 × 19,9 (18)	5+3	186882		
萨博 9-5 / 9-5 (YS3E)															
2.0T Biopower	2005.9-	F	ATE 23116		598475	2					288 × 25 (21)	5	197226		
											308 × 25 (23)	5+3	197244		
2.3L Turbo	2003.7-	R	ATE 21934		598753	0					286 × 10 (8)	5+2	197009		
							F	ATE 23116		598475	2				
2.3L Turbo	2003.7-	R	ATE 21934		598753	0					300 × 20 (18)	5+2	197050		
							F	ATE 21934		598753	0				
斯柯达 / Skoda															
昊锐 / Superb (3U4)															
1.8L Turbo	2002.2-	F									312 × 25 (22)	5+5	197242		
		R	LUC 20960		598463	0 (D)									
2.8L V6	2002.2-	F									312 × 25 (22)	5+5	197242		
		R	LUC 20960		598463	0 (D)									









































斯柯达 / Skoda									
明锐 / Octavia (1U2)									
1.6L	2004.2-	F	ATE 21974	598332	0	256 × 21,9 (19)	5+1	186603	
		F	ATE 21974	598408	1				
		R	LUC 20960	598463	0 (D)	232 × 9 (7)	5	186597	
2.0L	2005.10-	F	ATE 21974	598332	0	280 × 22 (19)	5+1	186604	
		F	ATE 21974	598408	1				
		R	LUC 20960	598463	0 (D)	232 × 9 (7)	5	186597	
RS 1.8 T	2007.6-	F	ATE 21911	598486	1	312 × 25 (23)	9+1	197246	
		R	LUC 20960	598463	0 (D)	256 × 22 (20)	5+1	197088	
晶锐 / Fabia (6Y2)									
1.4L	2000.8-2003.10	F	ATE 21974	598332	0	256 × 21,9 (19)	5+1	186603	
		F	ATE 21974	598408	1				
		R		562080 (刹车蹄 / Shoes)		232 × 9 (7)	5	186597	
1.4L 16V	2006.9-2007.8	F	ATE 21974	598408	1	256 × 21,9 (19)	5+1	186603	
		R		562080 (刹车蹄 / Shoes)		232 × 9 (7)	5	186597	
		R	LUC 20960	598463	0 (D)				
Smart / Smart									
Forfour / Forfour (454)									
1.5L	2004.1-2006.6	F	LUC 21920	598318	2	256 × 24 (21,5)	4	197214	
		R	LUC 21861	598319	2	250 × 10 (8)	4+2	197129	
双龙 / SsangYong									
雷斯特 / Rexton (GAB_)									
2.7 柴油 / Diesel	2004.8-	F	SUM 29877	598870	2				
		F	MDO 23726	598871	2				
		R				299 × 10,4 (8,5)	6+2	197122	









										
		R	F		WVA					
双龙 / SsangYong										
雷斯特 / Rexton (GAB_)										
3.2L	2002.4-	F	SUM 29877 	598870	2	278 × 23,8 (22)	6			197195
		F	MDO 23726 	598871	2					
		R					299 × 10,4 (8,5)	6+2		
斯巴鲁 / Subaru										
力狮 / Legacy II (BD, BG)										
2.5L 4WD	1996.6-1998.11	F	AKE 23558 	598530	2					
		R		562611 (刹车蹄 / Shoes)						
力狮 / Legacy IV (B13_)										
3.0 R	2003.9-2009.5	F	AKE 23865 	598853	2					
		R	AKE 23572 	598895	1					
森林人 / Forester (SG)										
2.0 X	2005.9-2007.11	F	AKE 23865 	598853	2					
		R		562611 (刹车蹄 / Shoes)						
2.5 XT	2005.9-	F	AKE 23865 	598853	2					
		R	AKE 24331 	598875	2					
铃木 / Suzuki										
吉姆尼 / Jimny (FJ)										
1.3L 4WD	1998.9-	F	AKE 21142 	598021	0	290 × 10 (8)	5+2			186504
		R		562591 (刹车蹄 / Shoes)						
1.5 柴油 / Diesel 4WD	2003.12-	F				287 × 17 (15)	5+2			186628
丰田 / Toyota										
RAV 4 / RAV 4 III										
2.4L WTi	2005.11-	F				296 × 28 (25)	5+2			197152
兰德酷路泽 100(UZJ100_) / Land Cruiser 100 (_J10_)										
4.7L	1998.1-2007.9	F	SUM 23524 	598535	2					
		R	AKE 23539 	598865	0					



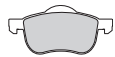





























				 WVA		 Valeo		 Valeo				 Valeo	
大众 / Volkswagen													
Eos / EOS (1F7, 1F8)													
2.0 TFSI	2006.3-	F	ATE 23587		598635	1		312 × 25 (22)	5+5	197242			
		R	LUC 23914		598752	0		286 × 12 (10)	9+1	197031			
尚酷 / Scirocco													
1.4 TSI	2008.5-	F	ATE 23587		598635	1				197325			
		R	LUC 23914		598752	0		260 × 12 (10)	9+1	186833			
2.0 TSI	2009.11-	F	ATE 23587		598635	1		312 × 25 (22)	5+5	197242			
帕萨特 / Passat (3B3)													
1.8 T 20V	2003.3-2005.5	R	LUC 20960		598463	0 (D)							
2.0L	2000.11-2005.5	F							5+5	186758			
		R	LUC 20960		598463	0 (D)							
帕萨特 / Passat (3C2)													
3.2 FSI 4motion	2005.11-	F	ATE 23801		598863	1		345 × 30 (27)	5+5	197197			
		R	LUC 23914		598752	0		310 × 22 (20)	5+5	197139			
帕萨特 CC / Passat CC													
2.0 TSI	2008.6-	F	ATE 23587		598635	1		312 × 25 (22)	5+5	197242			
		R	LUC 23914		598752	0		286 × 12 (10)	9+1	197031			
3.6 FSI 4motion	2008.6-	F	ATE 23801		598863	1		345 × 30 (27)	5+5	197197			
		R	LUC 23914		598752	0		310 × 22 (20)	5+5	197139			
甲壳虫 / New Beetle													
1.6L	2001.6-	F	ATE 21974		598408	1		280 × 22 (19)	5+1	186604			
1.8 T	2000.10-	F	ATE 21911		598486	1		288 × 24,9 (22)	5	197230			
		R						256 × 22 (20)	5+1	197088			
2.0L	2001.6-	F	ATE 21974		598408	1		280 × 22 (19)	5+1	186604			
		R	LUC 20960		598463	0 (D)		232 × 9 (7)	5	186597			





















													
大众 / Volkswagen													
辉腾 / Phaeton													
3.2L V6 4motion	2004.2-	F	ATE 23885		598845	2							
3.6L V6 4motion	2008.11-	F	ATE 23885		598845	2							
4.2L V8 4motion	2003.5-	F	ATE 23885		598845	2							
途观 / Tiguan													
2.0 TFSI	2008.5-	F							312 × 25 (22)	5+5		197242	
		R	LUC 23914		598752	0			286 × 12 (10)	9+1		197031	
途锐 / Touareg													
2.5 TDI	2003.8-2010.5	F	ATE 23467		598940	2							
		R							314 × 22 (18)	5+1		197243	
3.0L V6 TDI	2007.11-	F	BBO 24098		598994	0			330 × 32 (30)	5+1		197087	
		R							330 × 28 (26)	5+2		197090	
3.0L V6 TSI Hybrid	2010.4-	F							330 × 32 (30)	5+1		197087	
		R							330 × 28 (26)	5+2		197090	
3.2L V6	2004.5-2006.11	F	BBO 23692		598655	0						197253	
		F	BBO 24098		598994	0			330 × 32 (30)	5+1		197087	
		R	BBO 23694		598770	0			330 × 28 (26)	5+2		197090	
3.6L V6 FSI	2006.3-	F	BBO 24098		598994	0			330 × 32 (30)	5+1		197087	
		R							330 × 28 (26)	5+2		197090	
4.2L V8	2003.4-2006.11	F	BBO 23692		598655	0						197253	
		R	BBO 23694		598770	0			330 × 28 (26)	5+2		197090	
4.2L V8 FSI	2006.6-	F	BBO 24098		598994	0			330 × 32 (30)	5+1		197087	
		R	BBO 23694		598770	0			330 × 28 (26)	5+2		197090	

																
大众 / Volkswagen																
途锐 / Touareg																
6.0 W12	2005.8-	F	BBO 23693		598656	0										
		R	BBO 23694		598770	0		330 × 28 (26)	5+2	197090						
高尔夫 / Golf V																
1.4 TSI	2007.5-2009.5	F	ATE 21974		598408	1										
		R	LUC 20960		598463	0 (D)		255 × 10 (8)	9+1	186857						
2.0 GTI	2004.10-	F	ATE 21974		598408	1		312 × 25 (22)	5+5	197242						
		F	ATE 23587		598635	1										
		R	LUC 20960		598463	0 (D)		260 × 12 (10)	9+1	186833						
		R	LUC 23914		598752	0		286 × 12 (10)	9+1	197031						
高尔夫 / Golf IV																
1.6L 16V	2002.1-2005.6	F	ATE 21974		598408	1		256 × 21,9 (19)	5+1	186603						
		R	LUC 20960		598463	0 (D)		232 × 9 (7)	5	186597						
沃尔沃 / Volvo																
沃尔沃 C30 / C30																
2.0L	2006.10-	F	ATE 23723		598649	0		278 × 25 (23)	5	186819						
								300 × 25 (23)	5	186863						
		R	ATE 24137		598783	0		280 × 10,9 (9)	5	186843						
2.4 i	2006.10-	F	ATE 23723		598649	0		278 × 25 (23)	5	186819						
								300 × 25 (23)	5	186863						
		R	ATE 24137		598783	0		280 × 10,9 (9)	5	186843						
沃尔沃 C70 / C70 II																
2.4 柴油 /Diesel	2006.3-2010.2	F	ATE 23723		598649	0		278 × 25 (23)	5	186819						
								320 × 25 (23)	5	197143						
		F	ATE 23762		598822	0		300 × 25 (23)	5	186863						
							R	ATE 24137		598783	0		280 × 10,9 (9)	5	186843	

									
		R	F						
沃尔沃 / Volvo									
沃尔沃 C70 / C70 II									
2.5L	2007.3-2010.1	F	ATE 23723		598649	0	 278 × 25 (23)	5	186819
		F	ATE 23762		598822	0	 320 × 25 (23)	5	197143
		R	ATE 24137		598783	0	 300 × 25 (23)	5	186863
2.5L	2006.3-2007.3	F	ATE 23723		598649	0	 278 × 25 (23)	5	186819
		F	ATE 23762		598822	0	 320 × 25 (23)	5	197143
		R	ATE 24137		598783	0	 300 × 25 (23)	5	186863
沃尔沃 S40 / S40 I (VS)									
2.0T	2004.5-2007.7	F	LUC 21983		598493	0			
		R	LUC 21861		598319	2			
沃尔沃 S40 / S40 II (MS)									
2.4L	2004.1-2007.7	F	ATE 23723		598649	0	 278 × 25 (23)	5	186819
		F	ATE 23762		598822	0	 320 × 25 (23)	5	197143
		R	ATE 24137		598783	0	 300 × 25 (23)	5	186863
2.5L	2004.1-2007.7	F	ATE 23723		598649	0	 278 × 25 (23)	5	186819
		F	ATE 23762		598822	0	 320 × 25 (23)	5	197143
		F	ATE 23762		598822	0	 300 × 25 (23)	5	186863
		R	ATE 24137		598783	0	 280 × 10,9 (9)	5	186843
		R	ATE 23723		601005	0			

									
		R	F						
沃尔沃 / Volvo									
沃尔沃 S40 / S40 II (MS)									
2.5L 4WD	2004.4-2007.7	F	ATE 23723 	598649	0		278 × 25 (23)	5	186819
		F	ATE 23762 	598822	0		320 × 25 (23)	5	197143
		R	ATE 24137 	598783	0		300 × 25 (23)	5	186863
		R	ATE 23723 	601005	0		280 × 10,9 (9)	5	186843
沃尔沃 S60 / S60									
2.4L	2000.11-2004.4	F	ATE 23072 	598479	0		305 × 28 (25)	5+5	186741
		R	ATE 23075 	598480	0		286 × 26 (23)	5+5	186789
2.5L 4WD	2004.4-2006.7	F	ATE 23072 	598479	0		305 × 28 (25)	5+5	186741
		R	ATE 23075 	598480	0		286 × 26 (23)	5+5	186789
沃尔沃 S60 / S60 II									
2.0L	2010.4-	F	ATE 24123 	598879	0		300 × 28 (26)	5+1	197055
沃尔沃 S80 / S80 (TS, XY)									
2.4L	1999.1-2006.7	F	ATE 23072 	598479	0		305 × 28 (25)	5+5	186741
		R	ATE 23075 	598480	0		286 × 26 (23)	5+5	186789
2.4 T	2000.6-2006.7	F	ATE 23072 	598479	0		305 × 28 (25)	5+5	186741
		R	ATE 23075 	598480	0		286 × 26 (23)	5+5	186789
2.5 T 4WD	2003.7-2006.7	F	ATE 23072 	598479	0		305 × 28 (25)	5+5	186741
		R	ATE 23075 	598480	0		286 × 26 (23)	5+5	186789
2.9L	1999.3-2006.7	F					305 × 28 (25)	5+5	186741
		R					288 × 12 (10)	5+5	186841

									
		R	F						
沃尔沃 / Volvo									
沃尔沃 S80 / S80 II									
2.5 T	2006.3-	F	ATE 24123 	598879	0	 300 × 28 (26)	5+1	197055	
		F	ATE 24142 	601007	0				
		R	LUC 24496 	598928	0				
3.2L	2006.3-	F	ATE 24123 	598879	0	 300 × 28 (26)	5+1	197055	
		F	ATE 24142 	601007	0				
		R	LUC 24496 	598928	0				
4.4L V8 AWD	2006.3-	F	ATE 24123 	598879	0	 300 × 28 (26)	5+1	197055	
		F	ATE 24142 	601007	0				
		R	LUC 24496 	598928	0				
3.0L AWD	2007.1-	F	ATE 24123 	598879	0	 300 × 28 (26)	5+1	197055	
		F	ATE 24142 	601007	0				
		R	LUC 24496 	598928	0				
沃尔沃 XC60 / XC60									
2.0 T	2010.3-	R	LUC 24496 	598928	0				
3.0L AWD	2008.5-2010.4	R	LUC 24496 	598928	0				
沃尔沃 XC90 / XC90									
2.5 T	2002.10-	F	ATE 24141 	598657	0	 316 × 28 (25)	5+5	197057	
		F	ATE 23590 	601030	0				
		R	ATE 24011 	598829	0				

																		
沃尔沃 / Volvo																		
沃尔沃 XC90 / XC90																		
3.2L	2006.5-	F	ATE 24141		598657	0	316 × 28 (25)	5+5	197057	R	R	ATE 24011		598829	0			
		F	ATE 23590		601030	0												
		F	ATE 24141		598657	0	316 × 28 (25)	5+5	197057									
3.0L	2002.10-	F	ATE 24141		598657	0	316 × 28 (25)	5+5	197057	R	R	ATE 24011		598829	0			
		F	ATE 23590		601030	0												
		F	ATE 24141		598657	0	316 × 28 (25)	5+5	197057									
4.4L V8	2005.1-	F	ATE 24141		598657	0	316 × 28 (25)	5+5	197057	R	R	ATE 24011		598829	0			
		F	ATE 23590		601030	0												
		F	ATE 24141		598657	0												



国产刹车片图片 Local Range Image

Pads and Discs

Plaquettes et Disques

Pastillas y Discos

Pastilas e Discos

Pastiglie e Dischi

Blokjes en Schijven

Bremsbeläge und Bremsscheiben

Klocki i Tarcze

Balatalari ve Diskleri

Κολοдки и Диски

Δισκόφρενα & Δισκόπλακες

刹车片和刹车盘

بطانات و قرص



601156

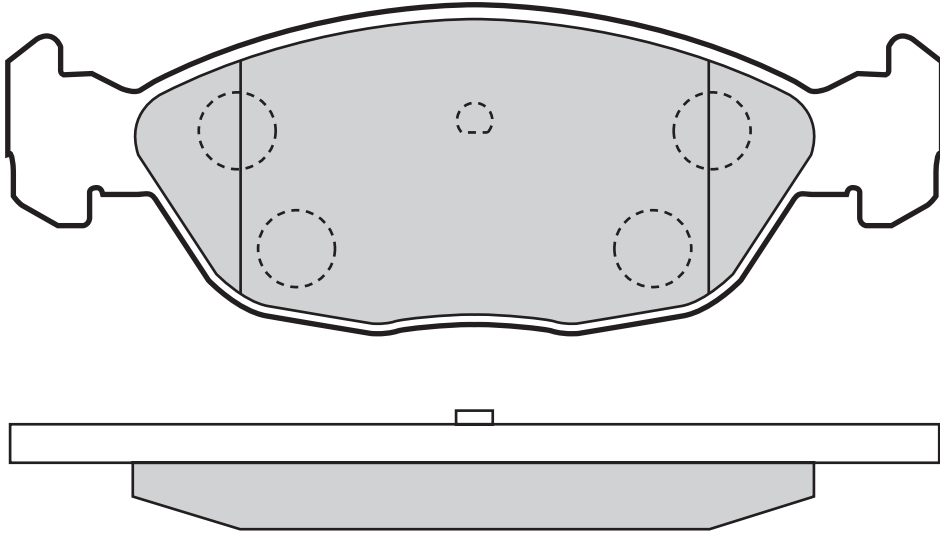

0	156,3	54,1	17,5

601157

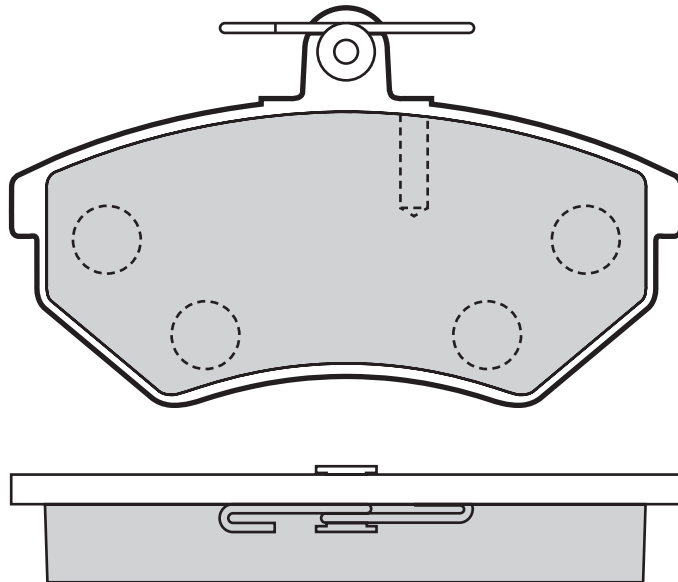

2	118,7	69,5	19



601158

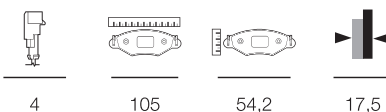
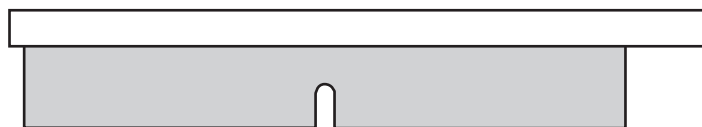
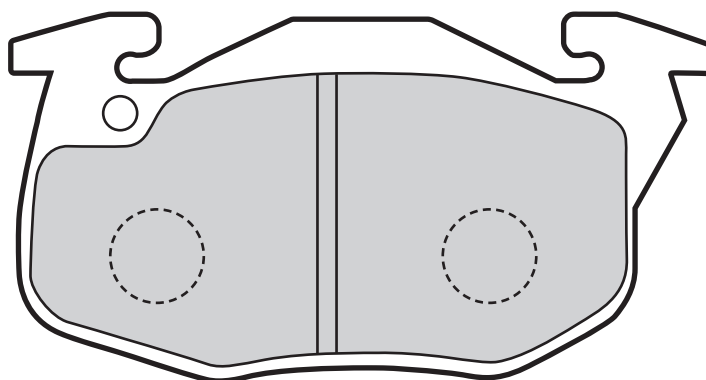

4

105

54,2

17,5

601161

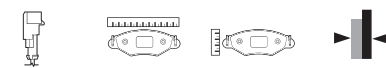
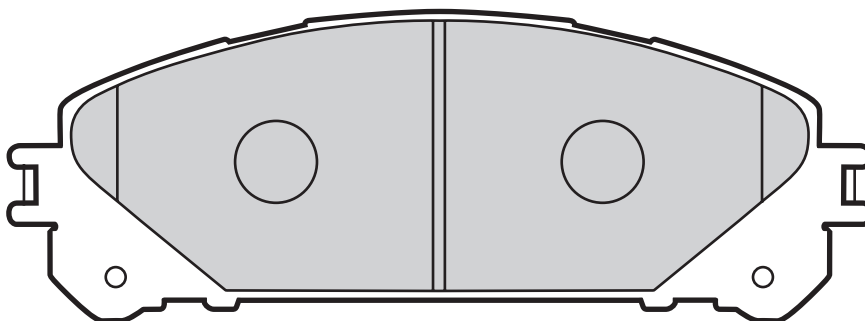

0

167

59,4

17,5

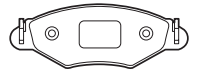

601162

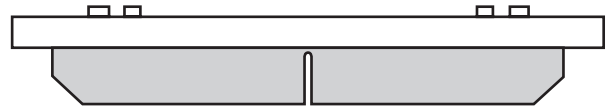
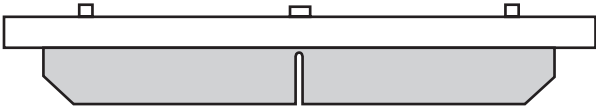
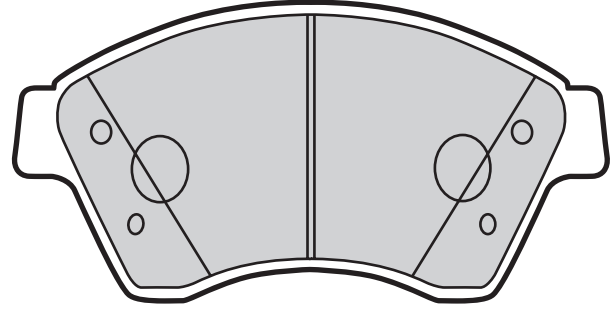
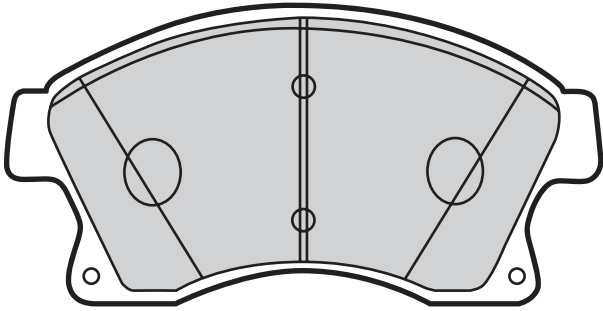

2



148,1



60,4



18,0

601163

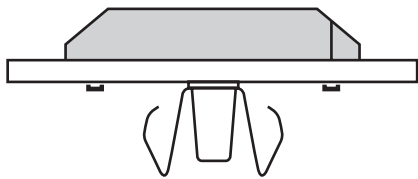
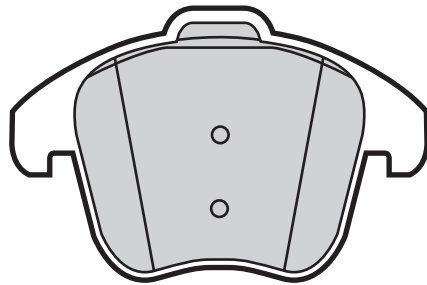
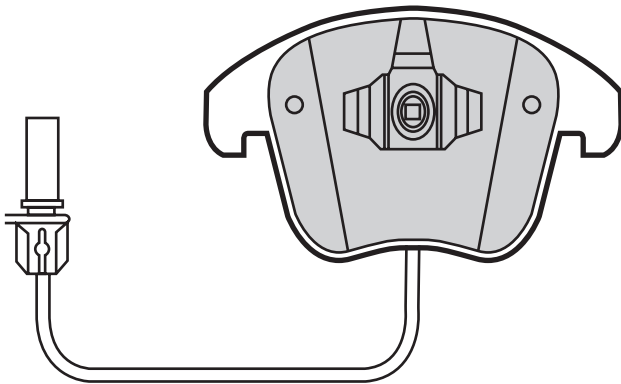

1



155,2



66,4/71,9



19,2



601164

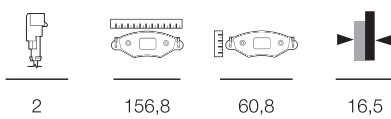
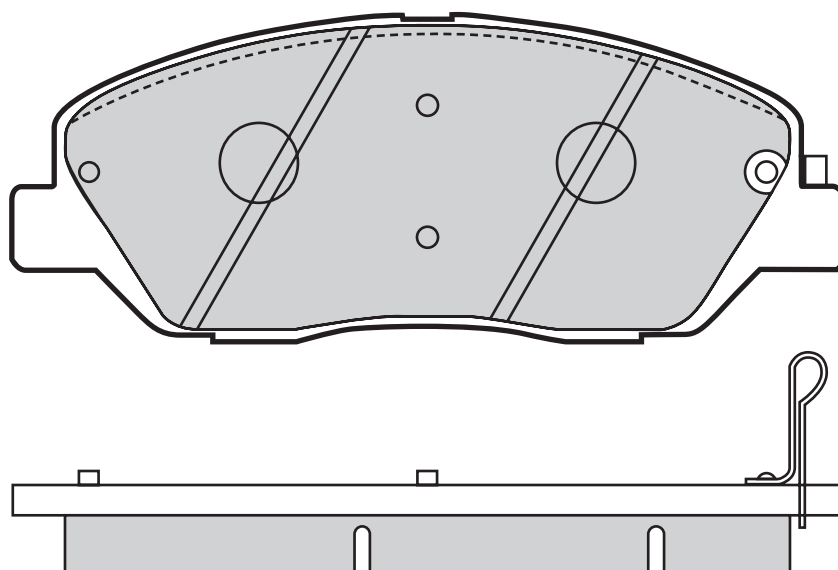



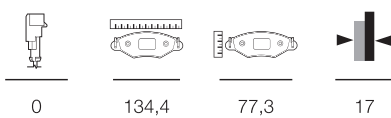
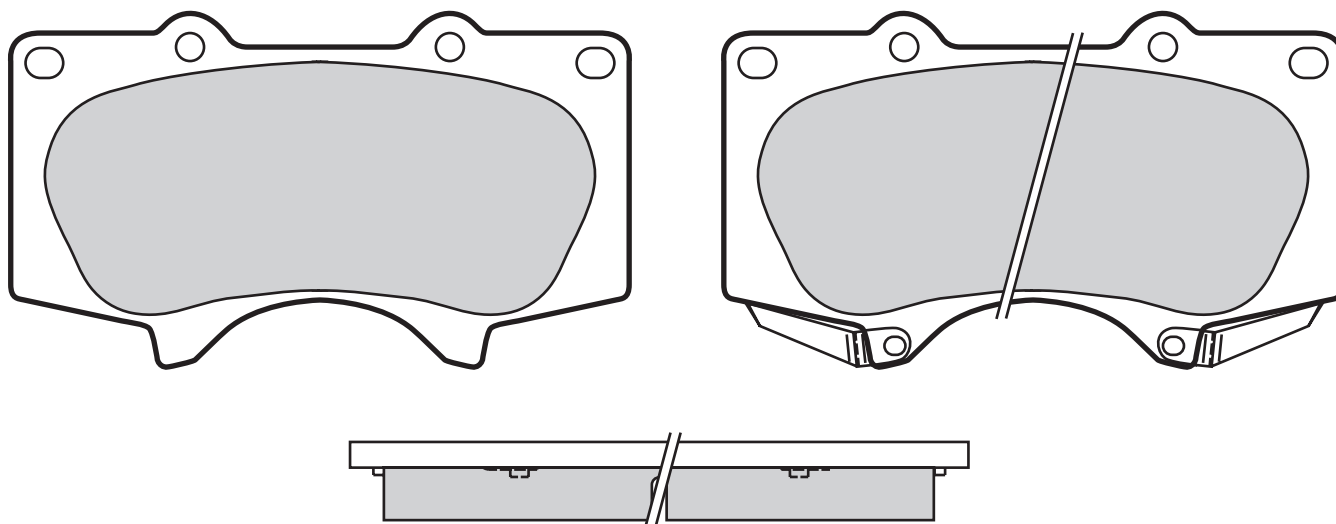

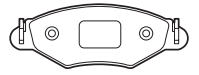
601165



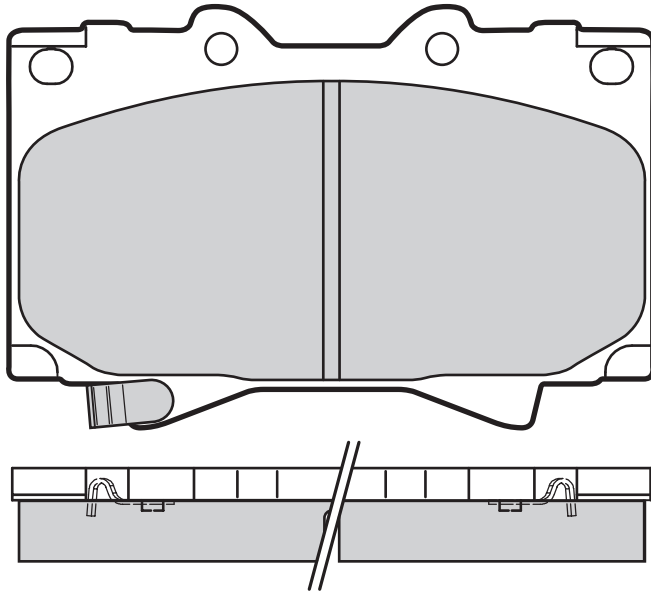





601166

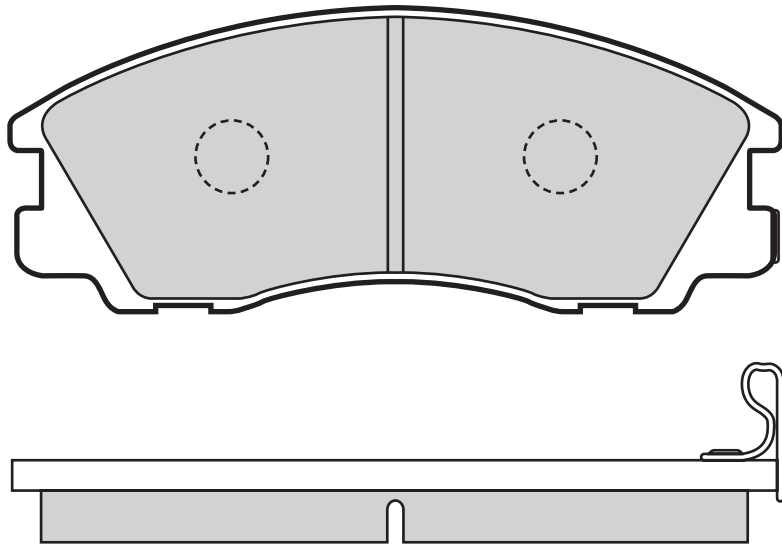

			
0	119,6	78	17

601167



			
2	149	57,9	16



601168

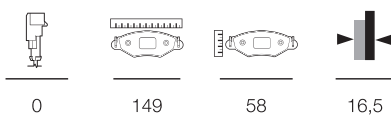
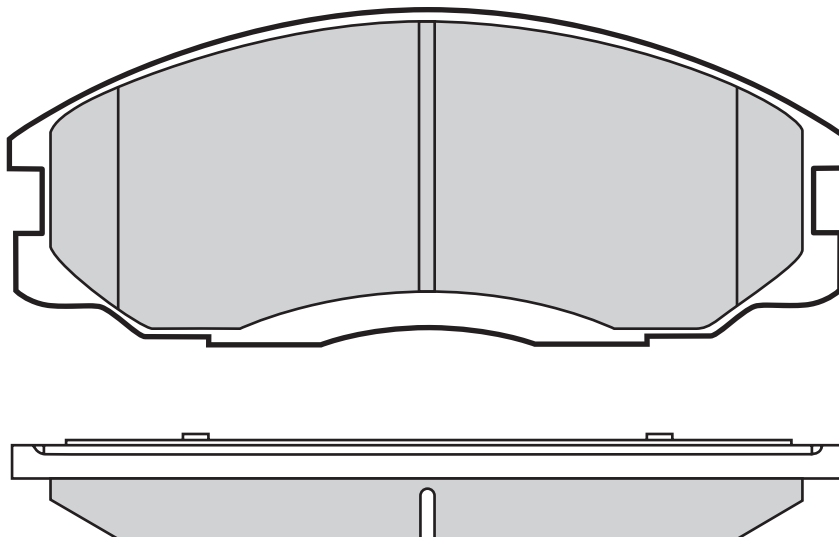



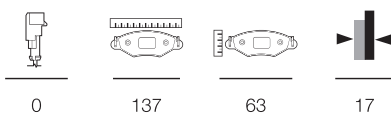
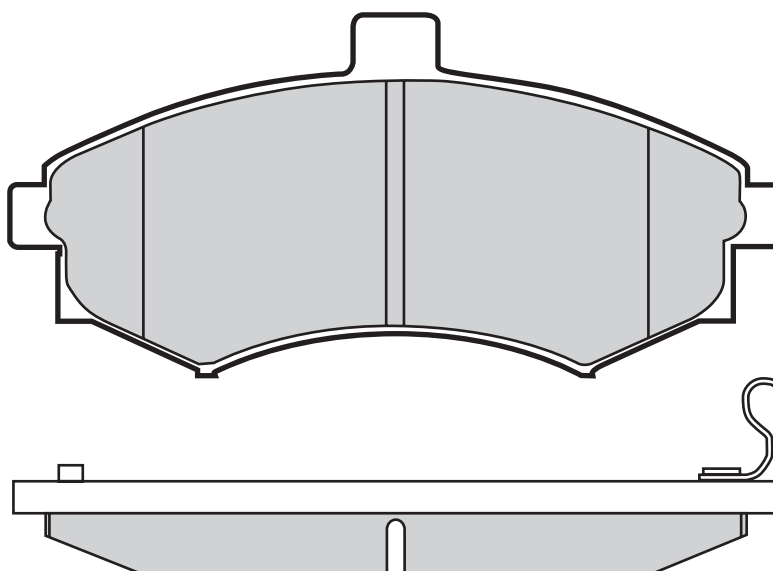

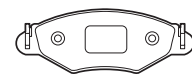
601169



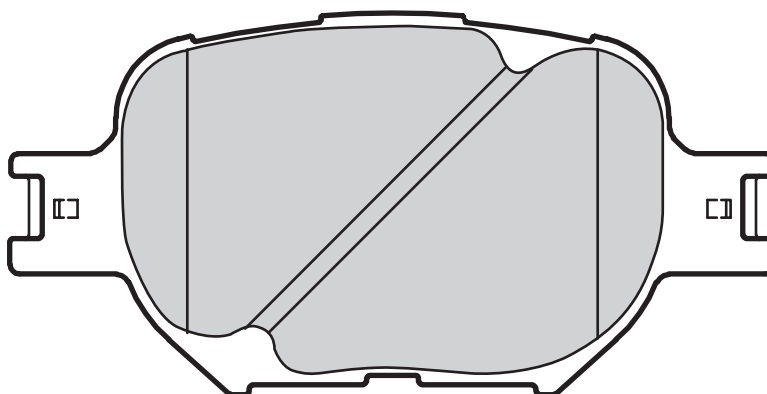





601172

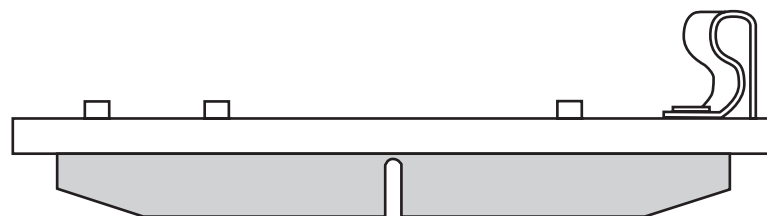
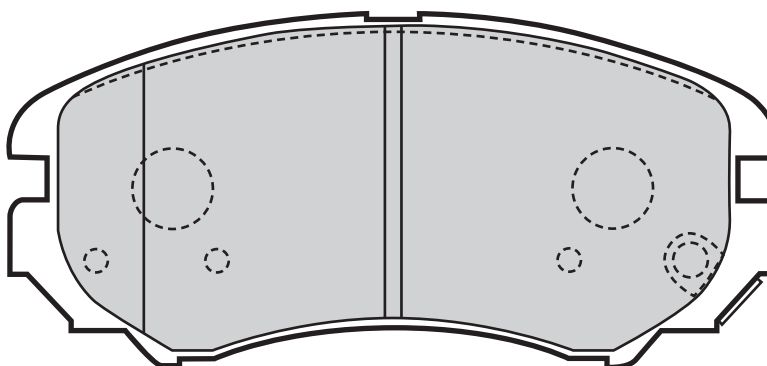

			
0	116,3	58,7	17,5

601173



			
2	131,4	60	17



601175

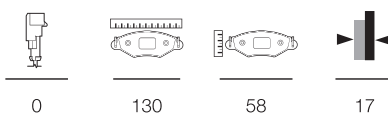
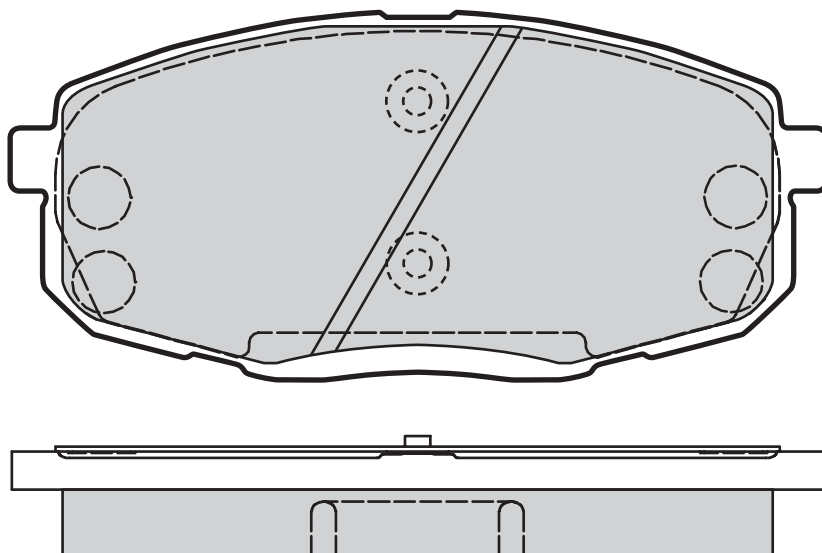

0

130

58

17

601176

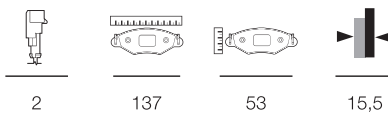
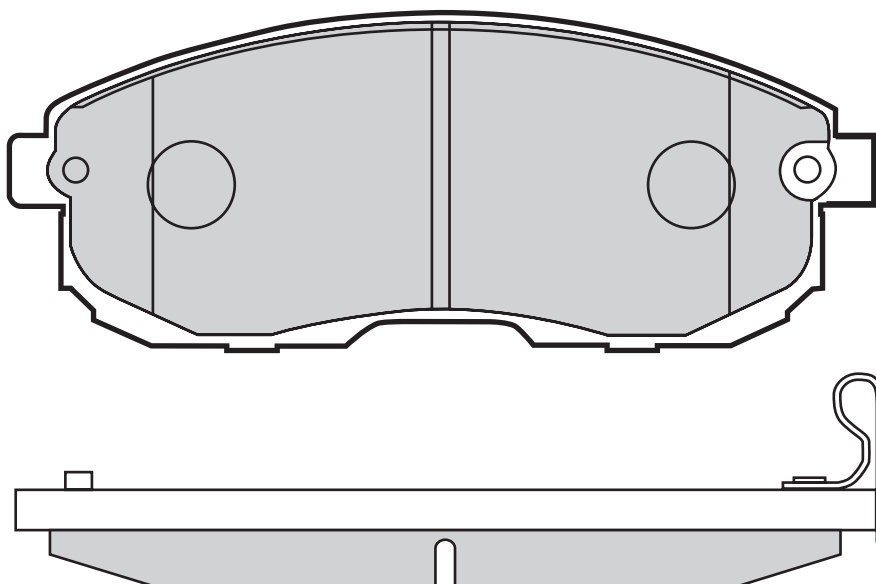

2

137



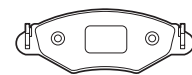

53

15,5

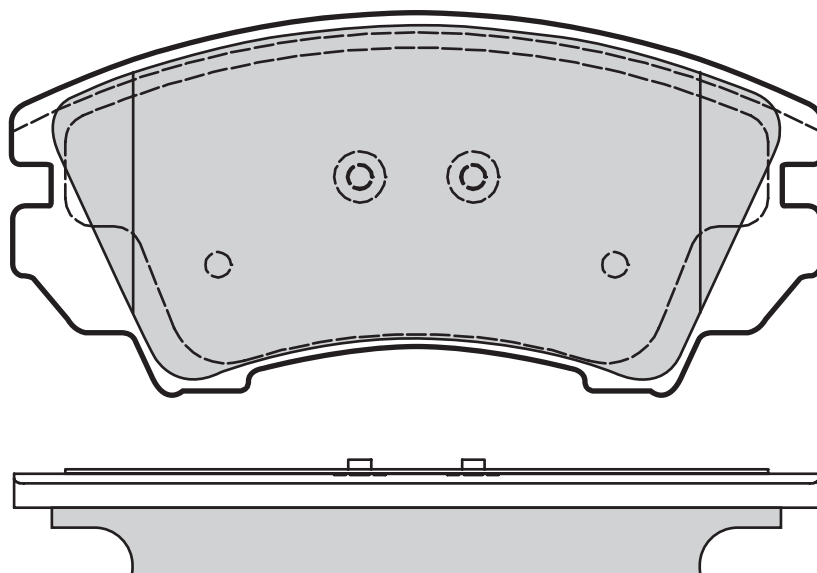





601177

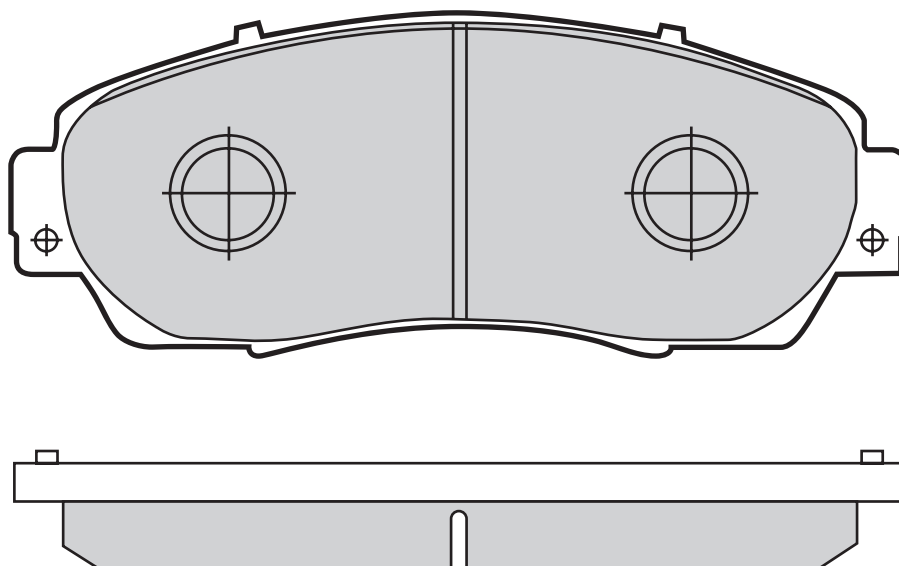

			
0	141,7	66,8	17,8

601179



			
2	154,7	58,4	18



601180

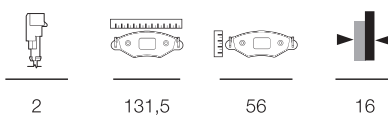
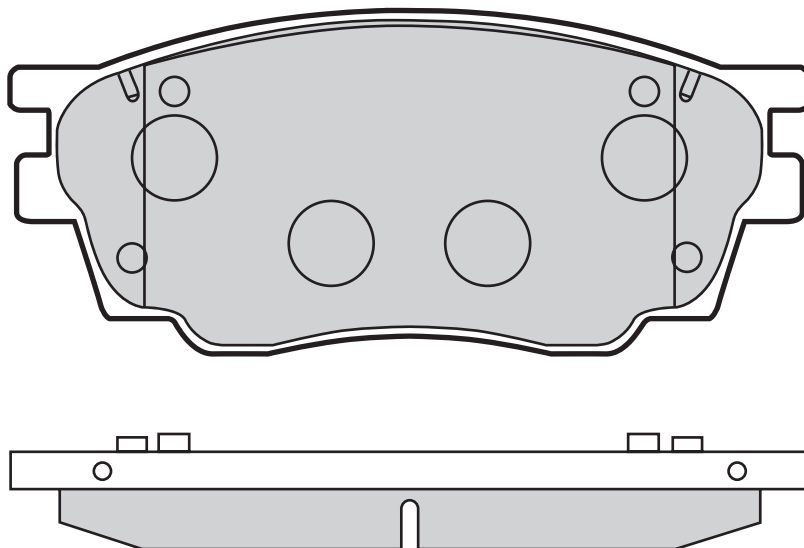



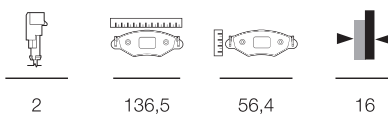
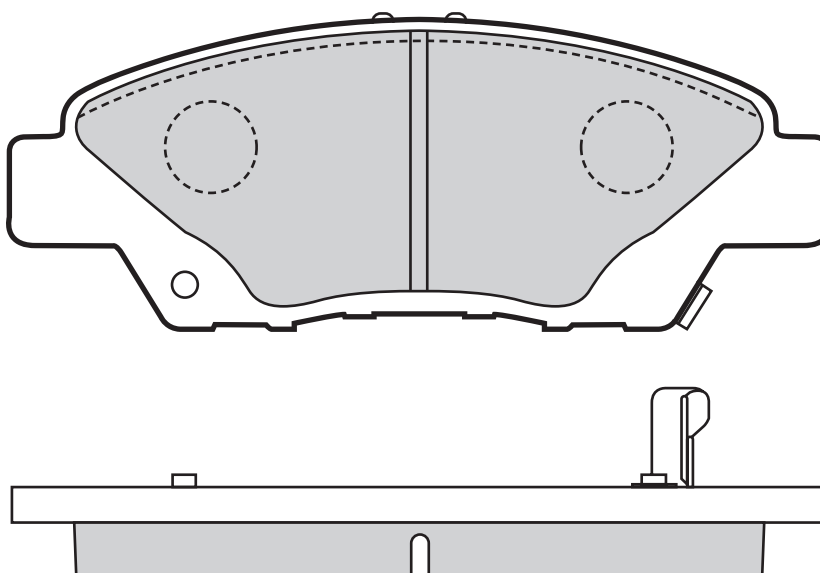

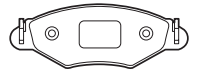
601181



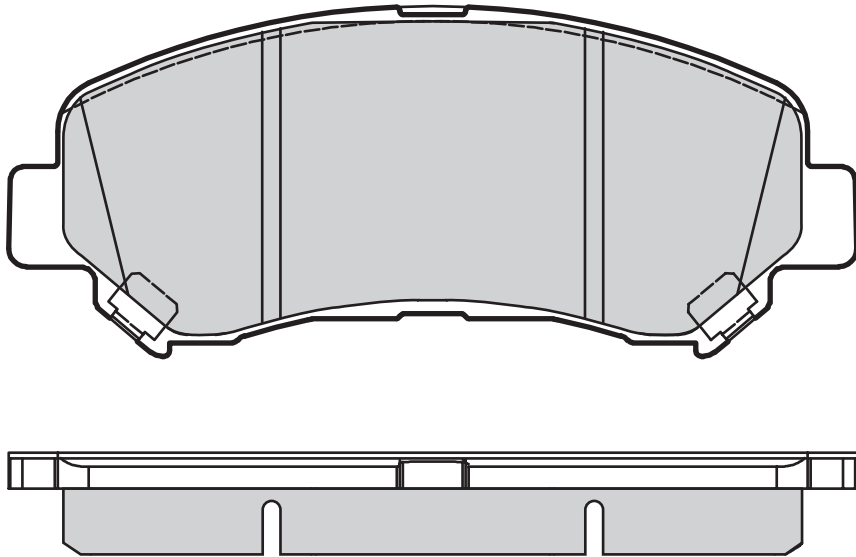





601182

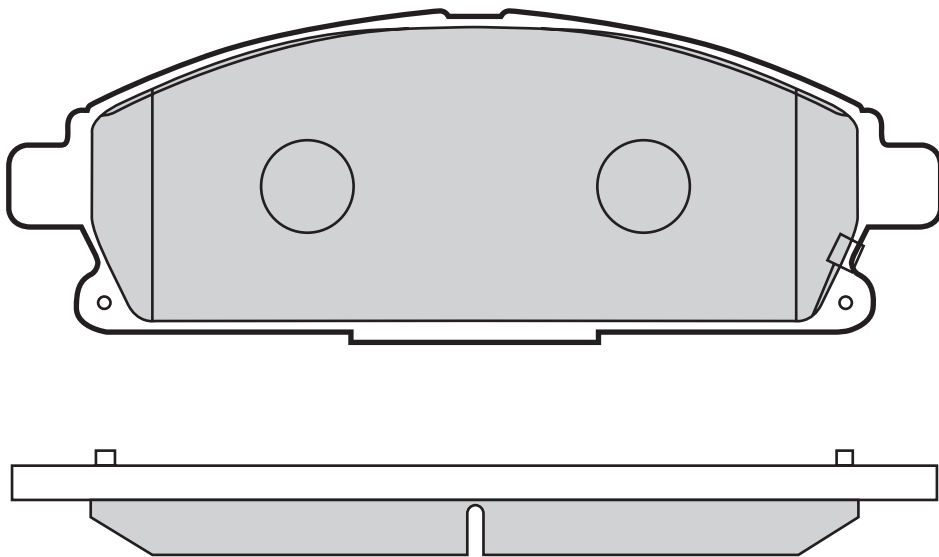

			
0	141,5	58,9	17

601183







			
1	158,8	56,1	15,3

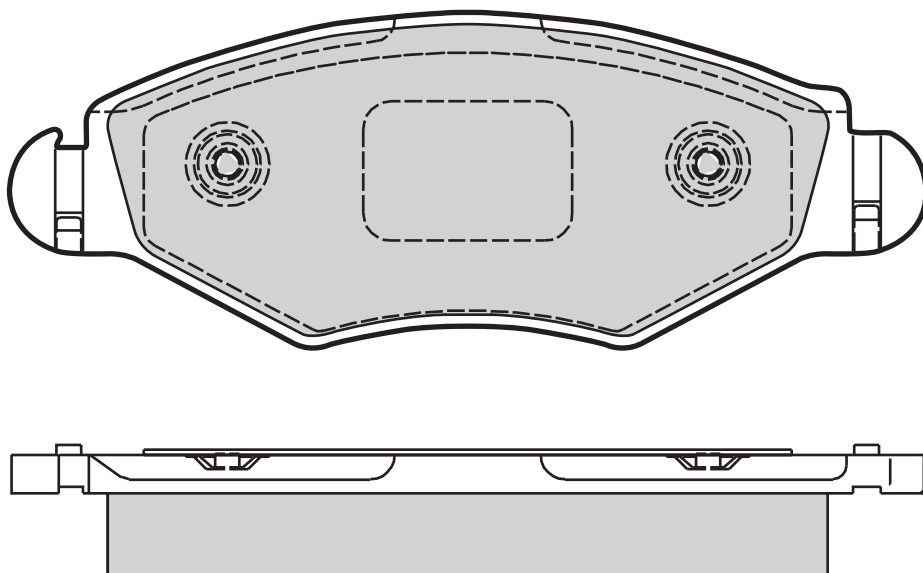





601184

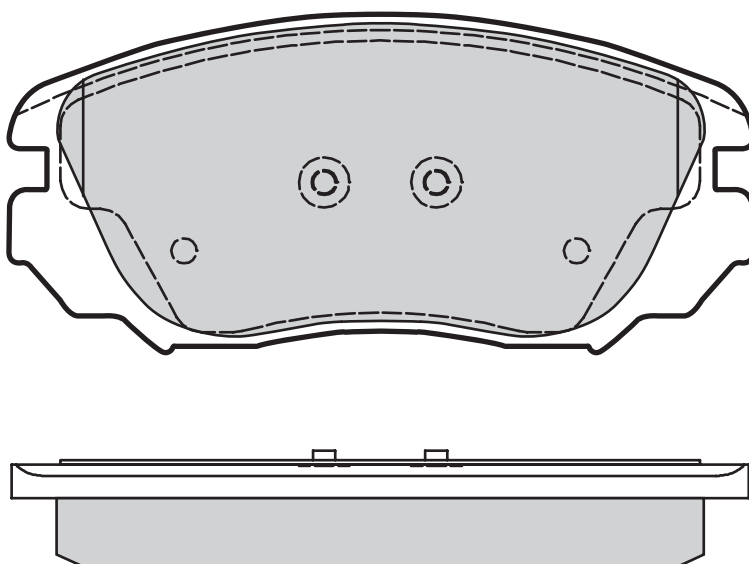

			
0	130,9	47,3	17

601185



			
0	131,4	59,8	16,9

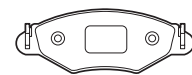

601186

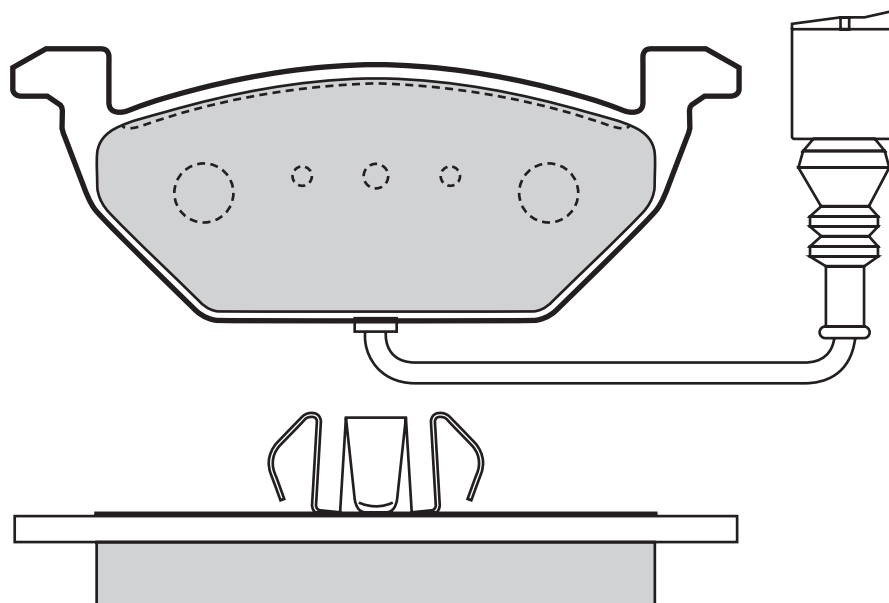

1	146	54,5	18,7

601187

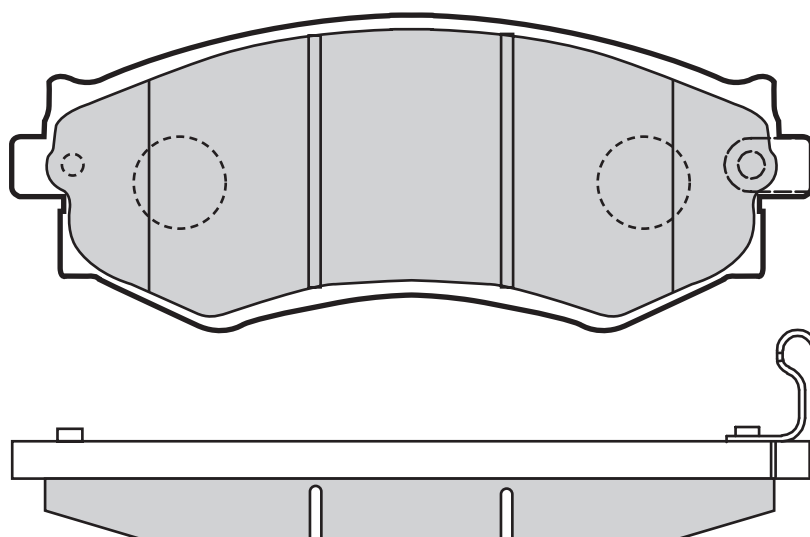

0	137	54	17



601188

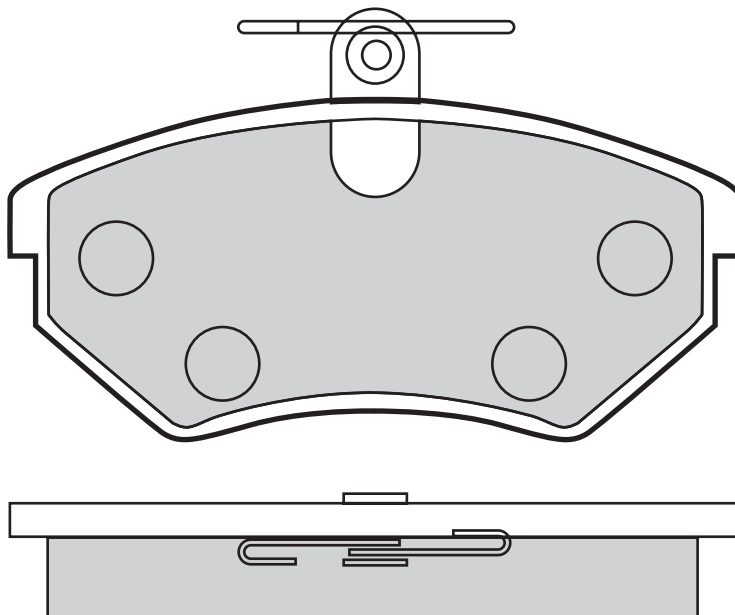

0	118,7	69,5	18,5

601191

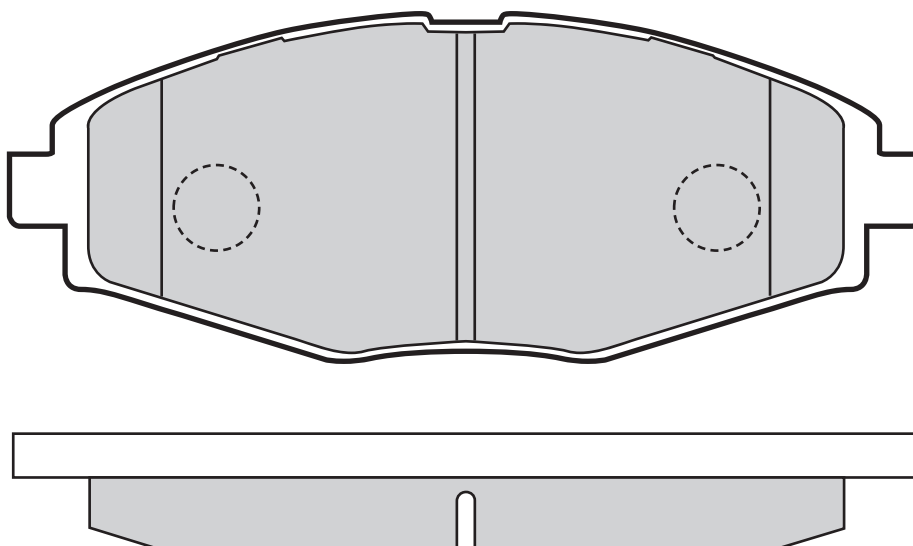

0	127	48	16



601194

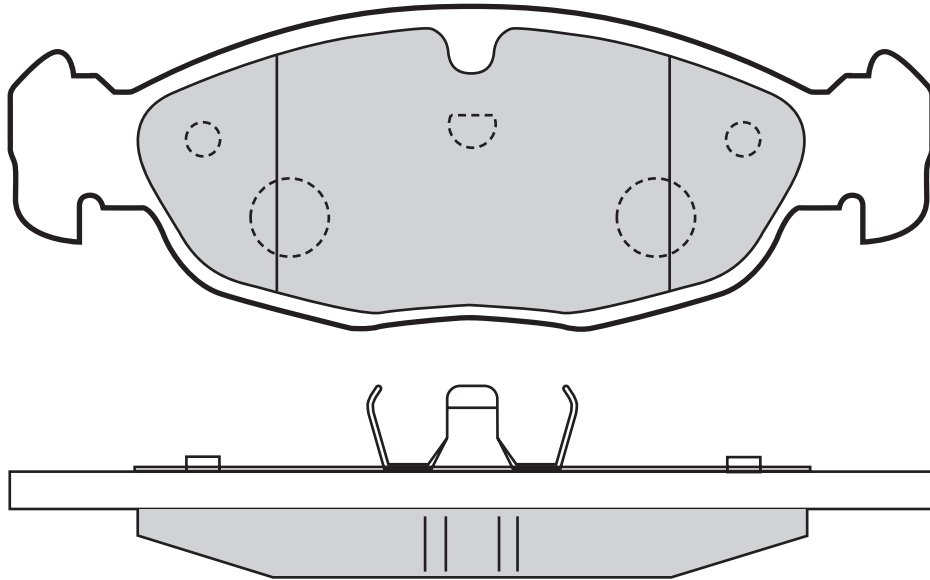

0	141,3/140	48,4	16

601195

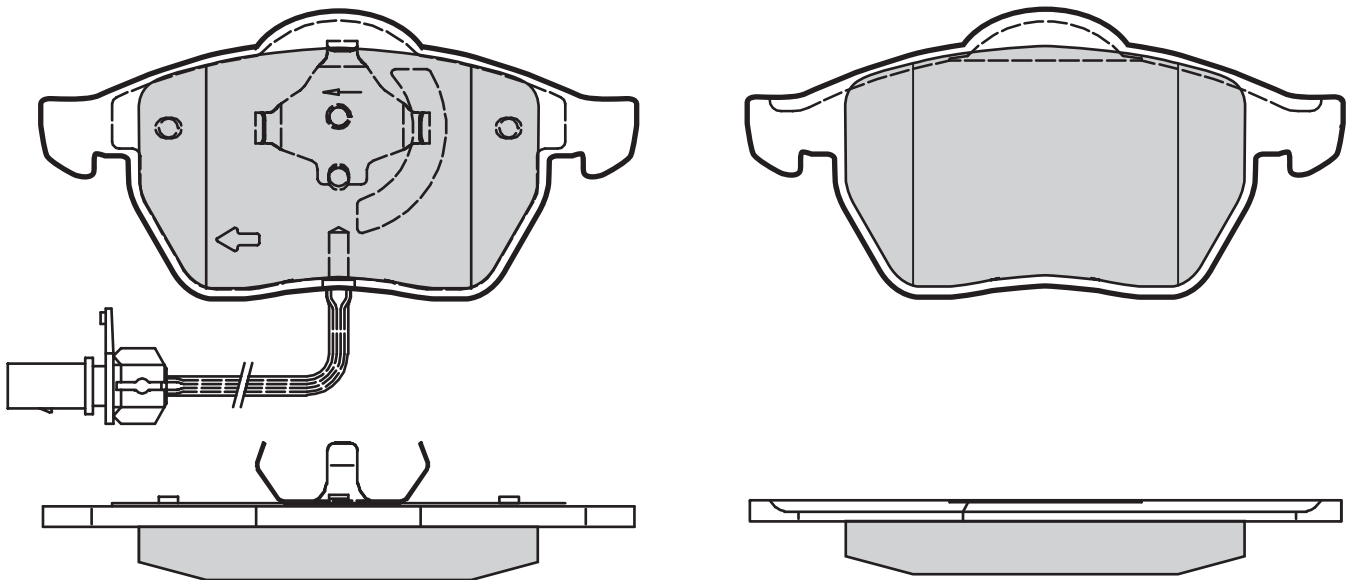

1	156,6	74,2	19,1



601196

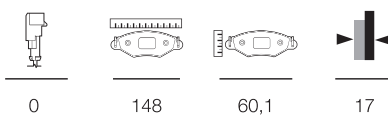
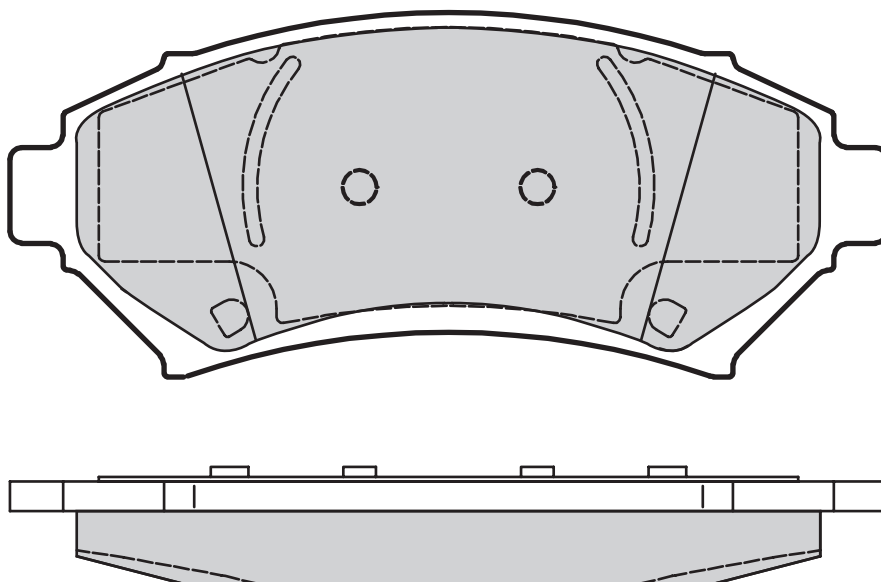

601198

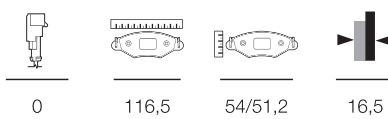
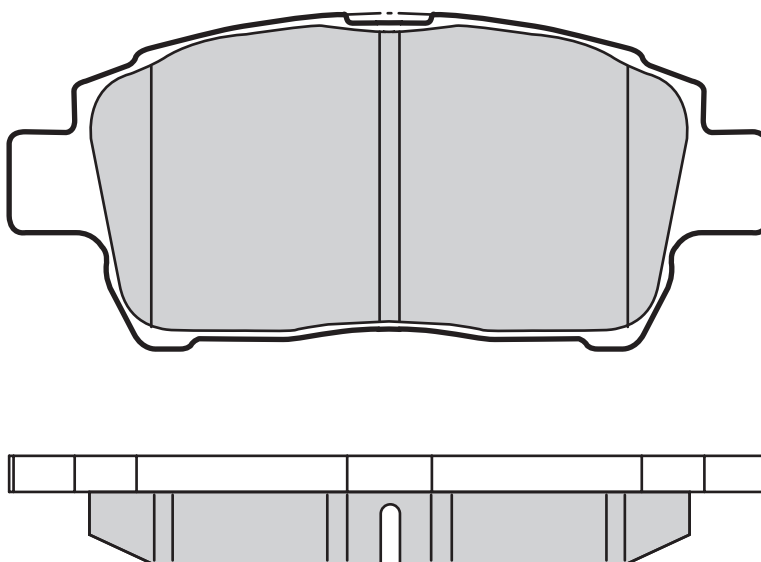



601201

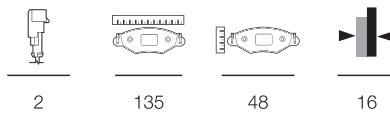
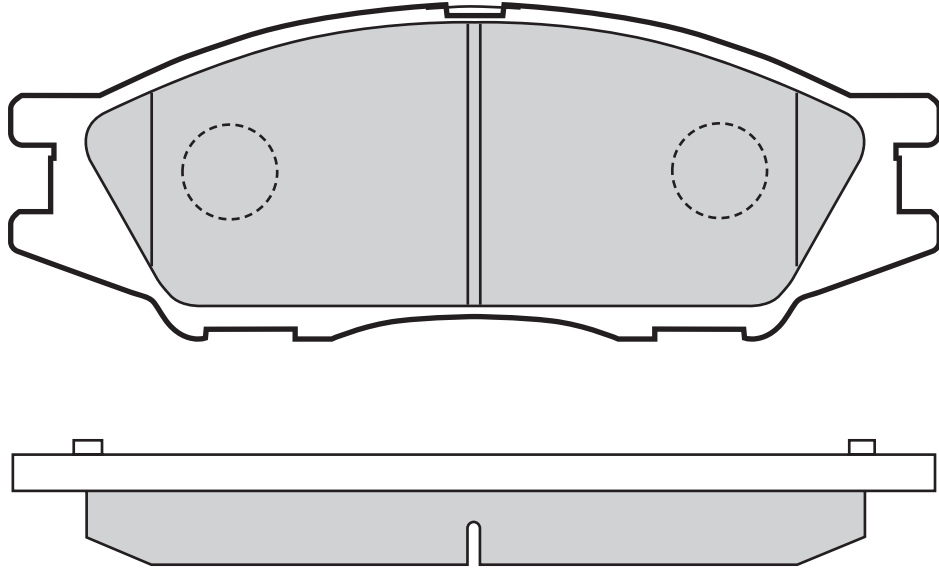

601204

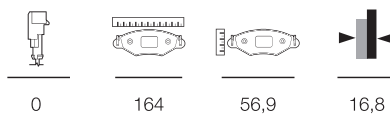
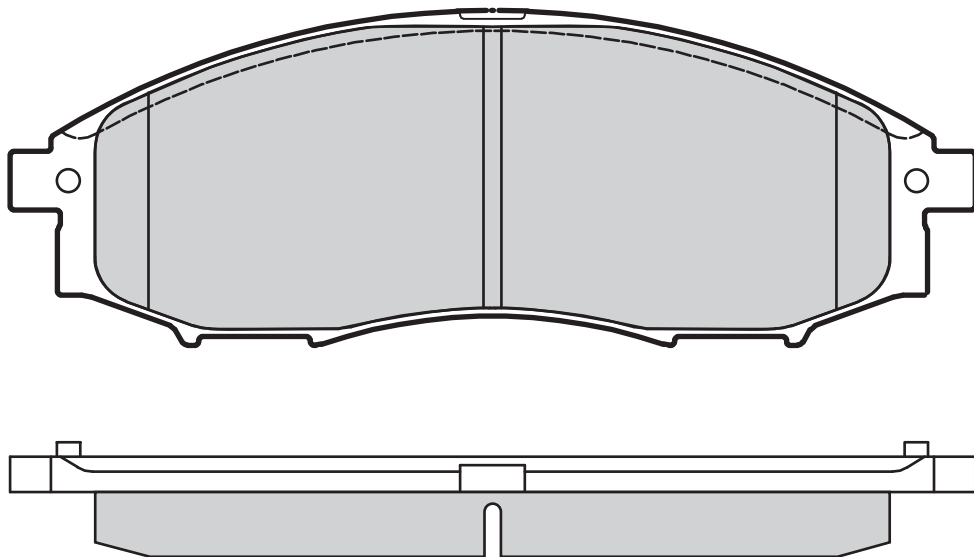



601205

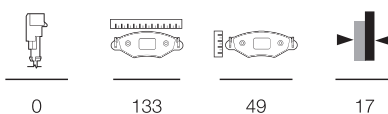
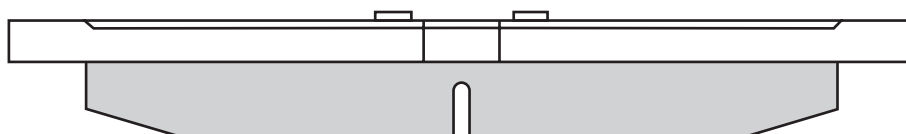
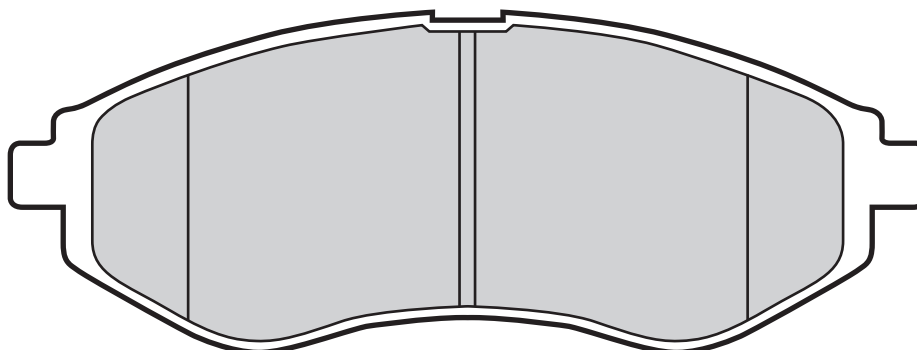

0

133

49

17

601206

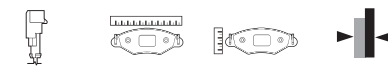
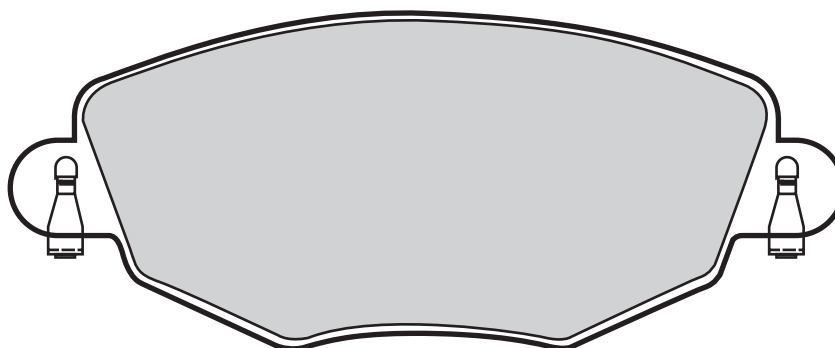

0

148,8

60

17,5

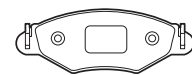

601207

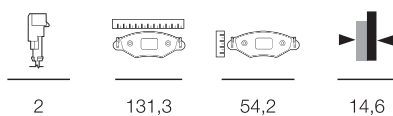
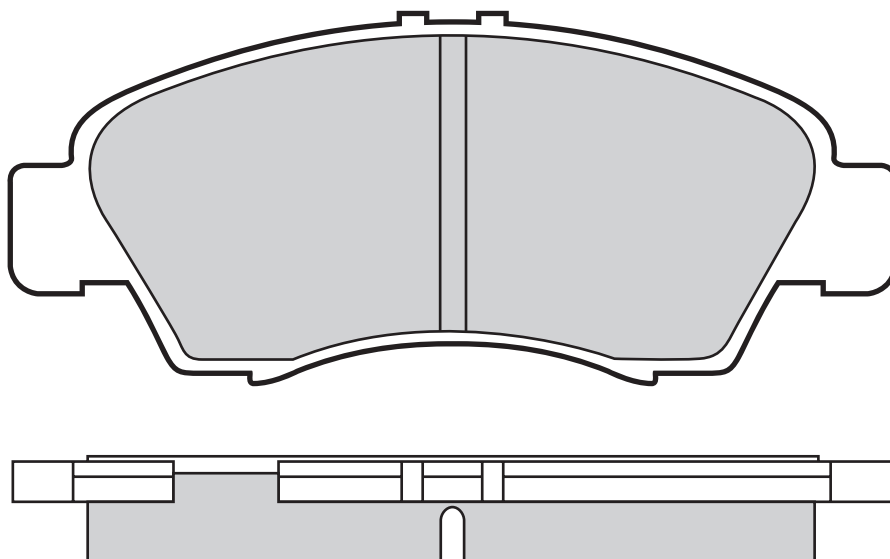

2

131,3

54,2

14,6

601208

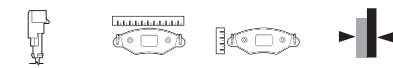
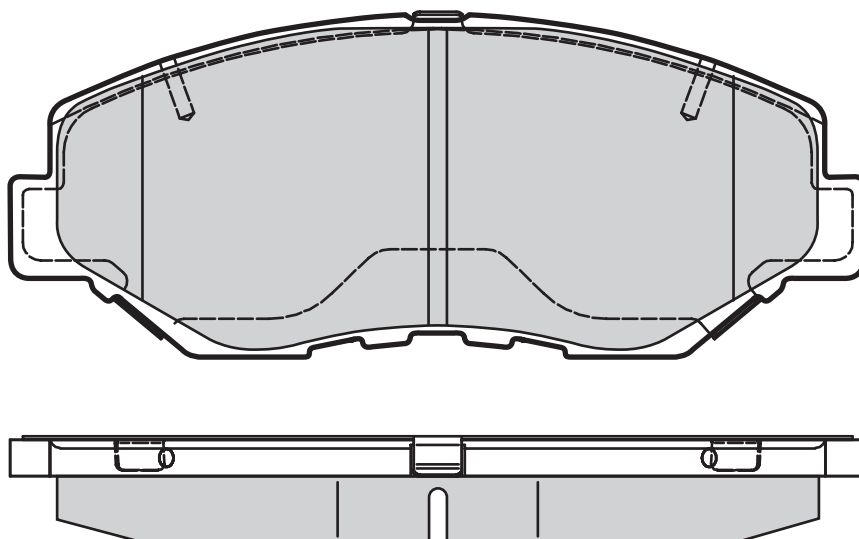

0

141,8

56,6

16,8



601209

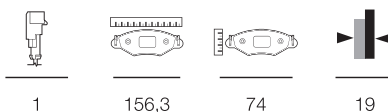
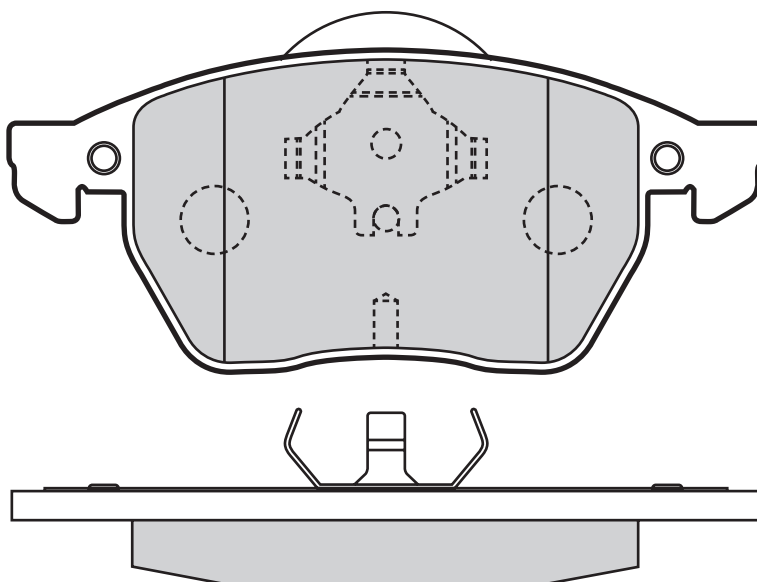

1

156,3

74

19

601210

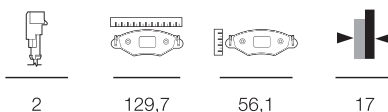
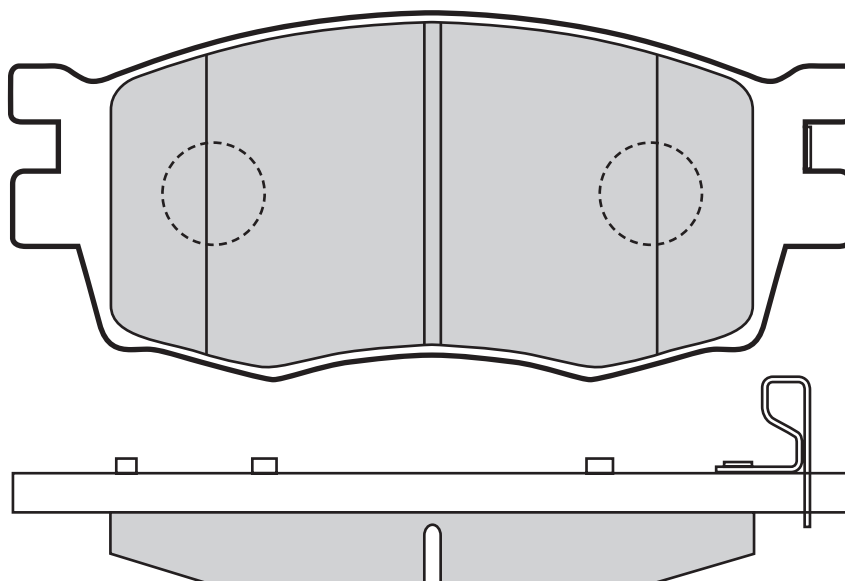

2

129,7





56,1

17

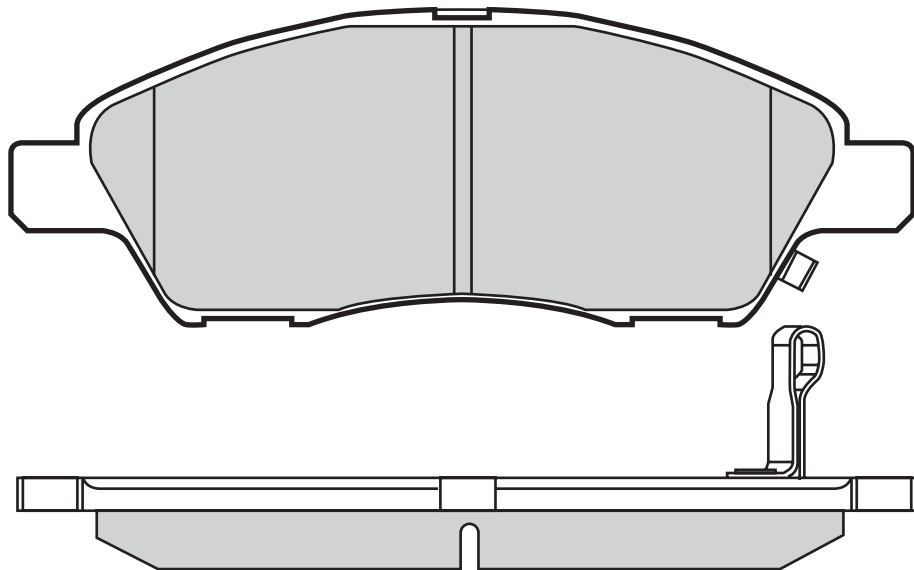





601211

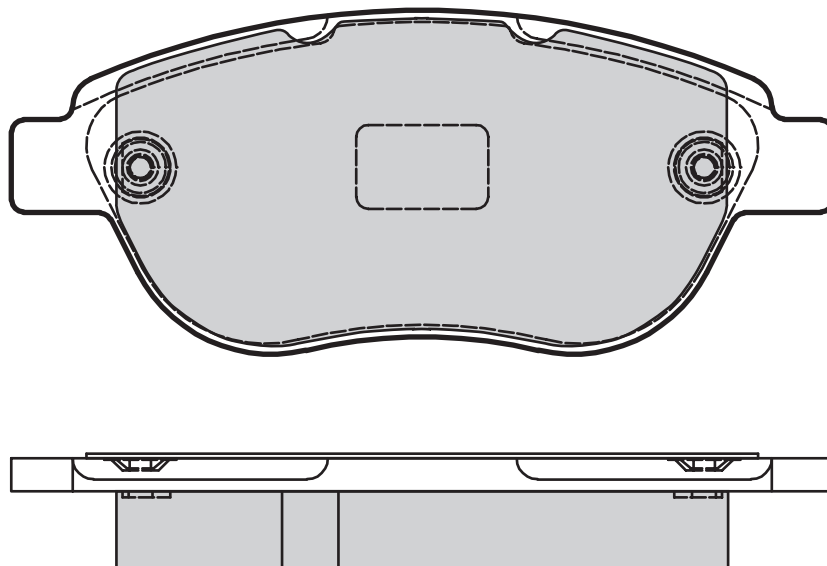

			
0	138,5	48,4	14

601213



			
0	136,8	57,1	18,5



601214

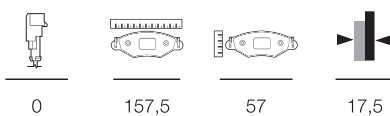
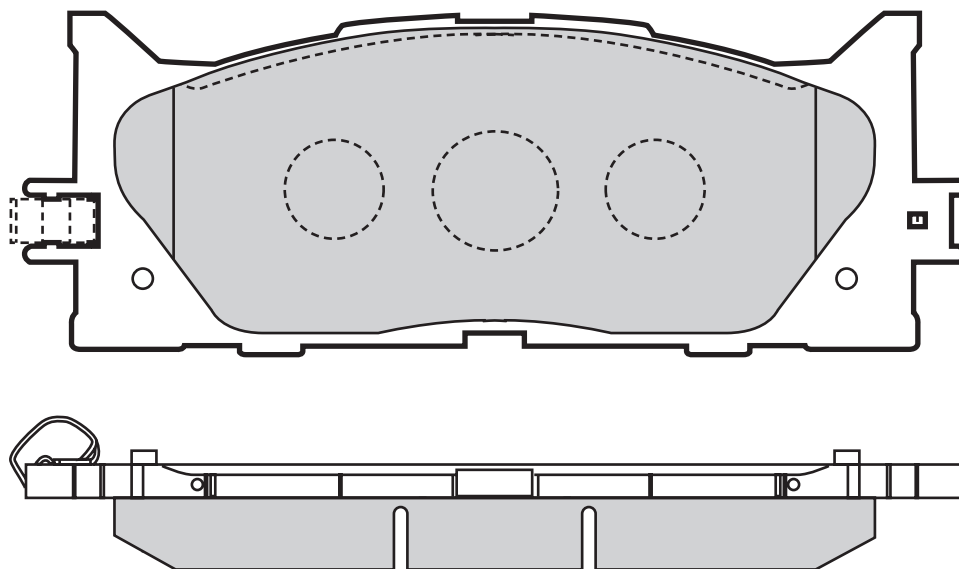

0

157,5

57

17,5

601217

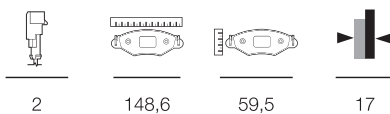
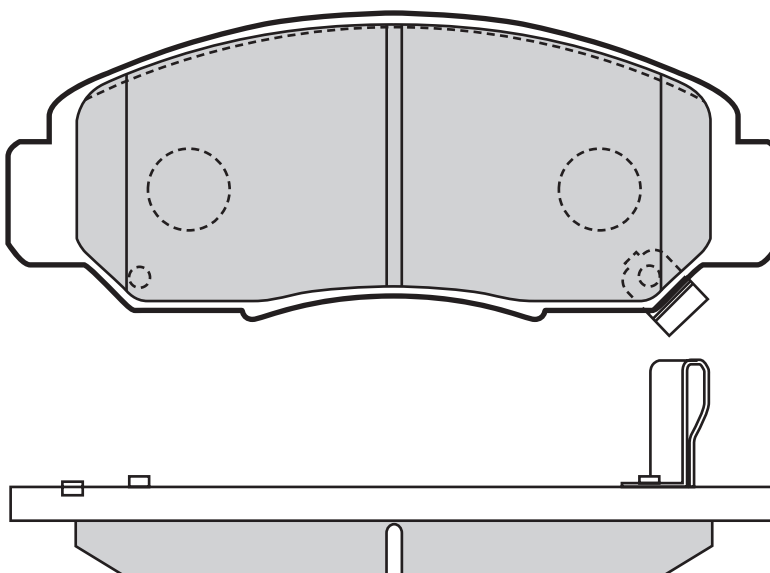

2

148,6

59,5

17

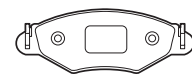

601220

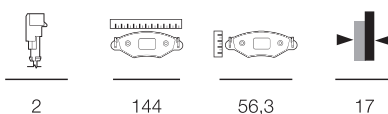
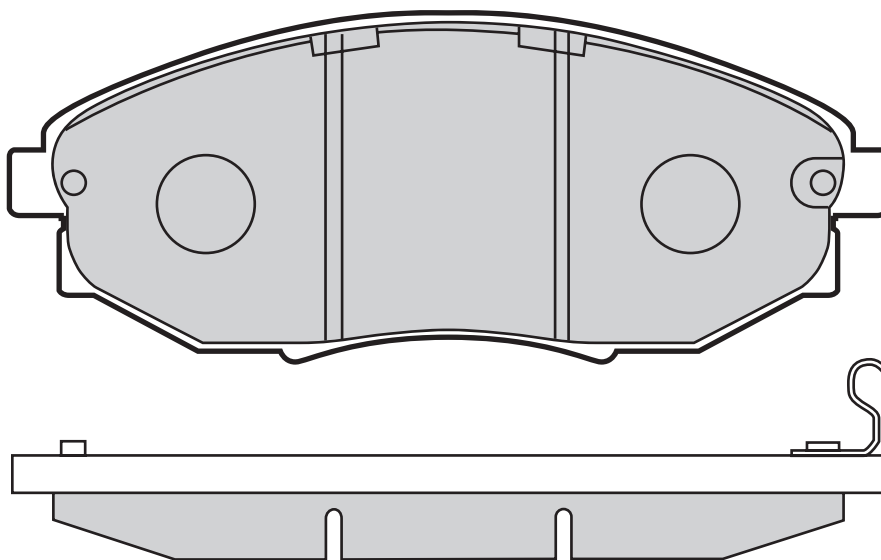

2



144



56,3



17

601221

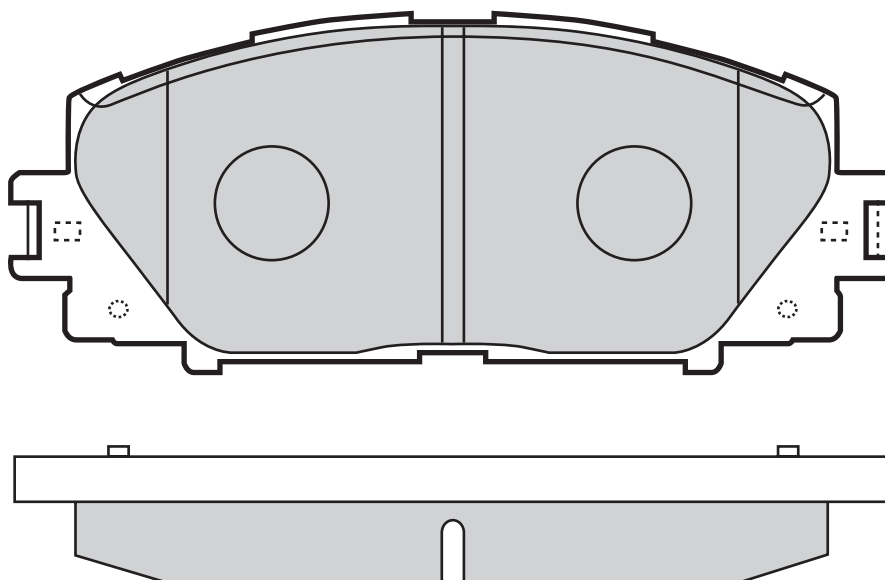

0



122,5



49,8







17,5

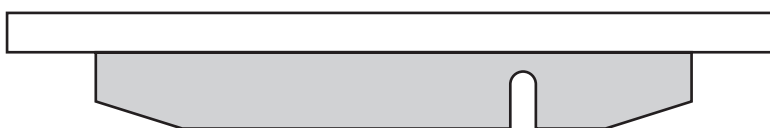
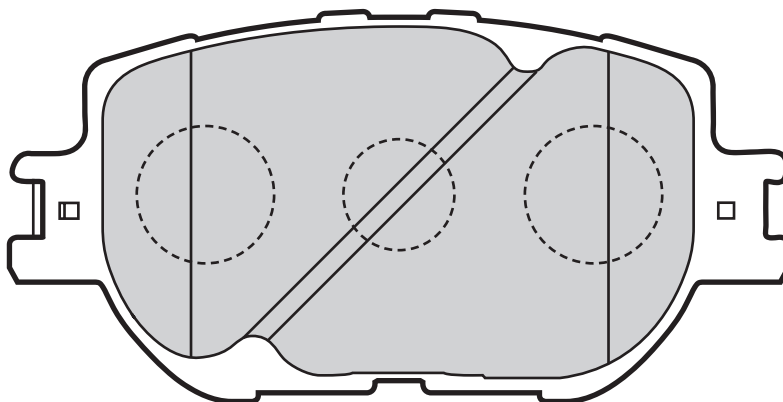





601222

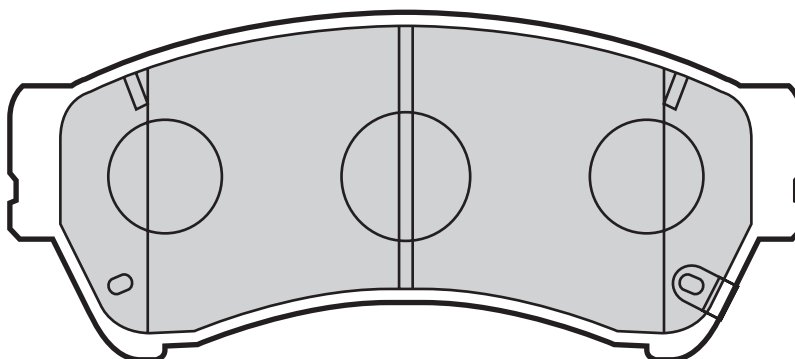

			
0	117,5	58,4	17,5

601223



			
2	136,8	59	16,3

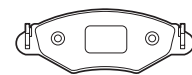

601224

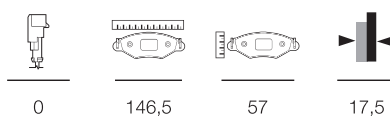
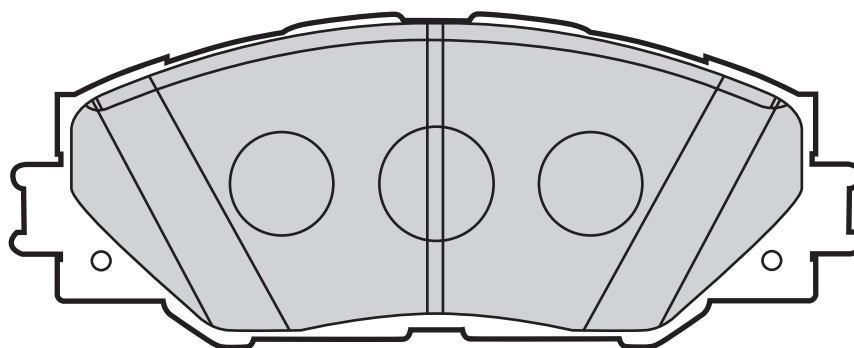

0 146,5 57 17,5

601225

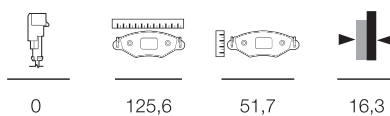
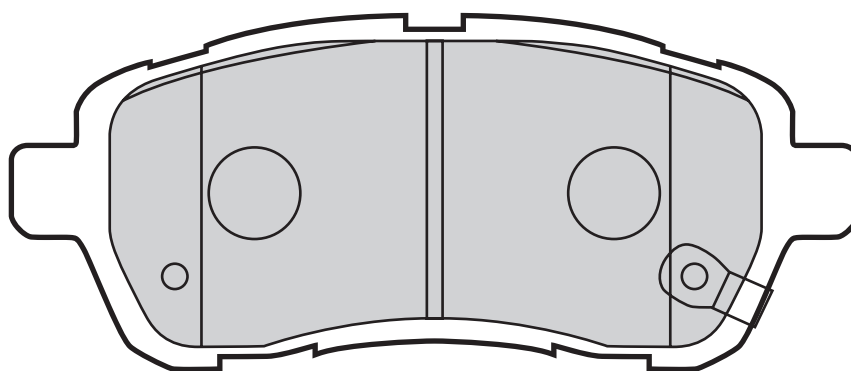

0 125,6 51,7 16,3



601228

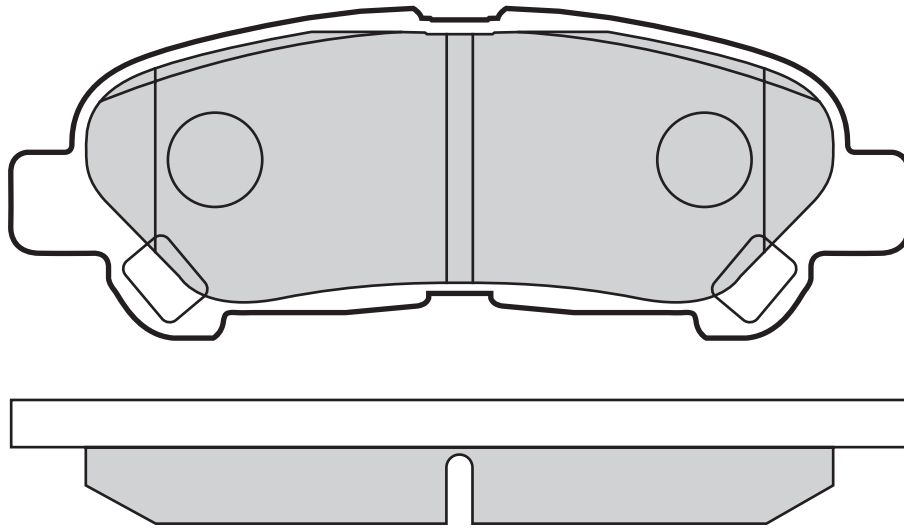

0	113,3	40,8	15,5

601229

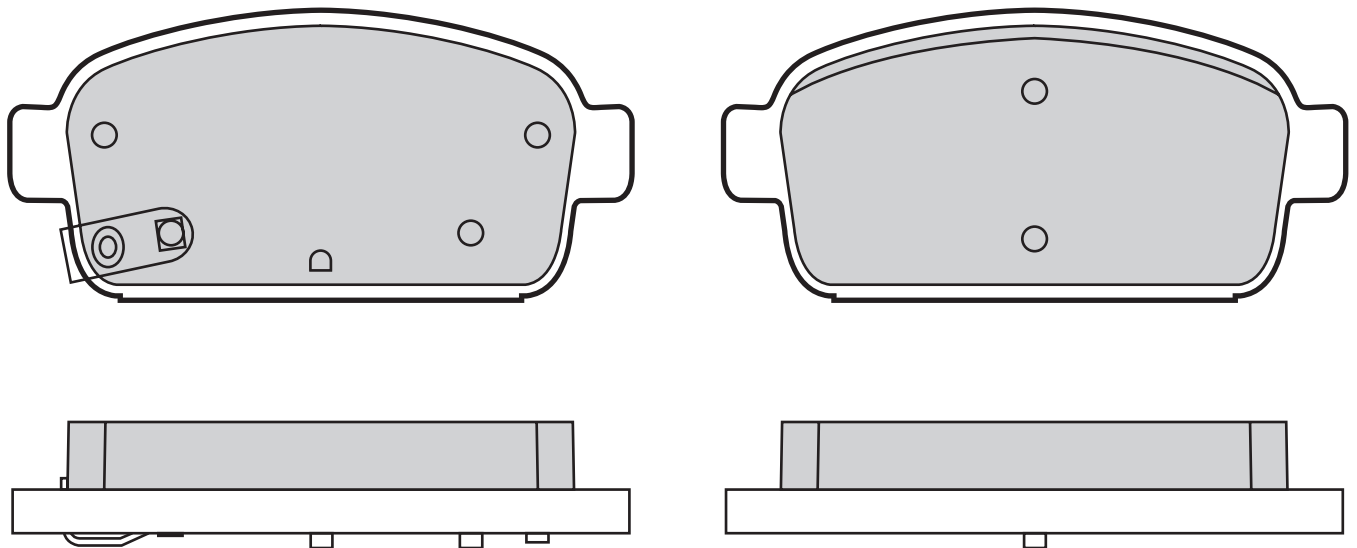

2	116,6	42,8	16,5



601230

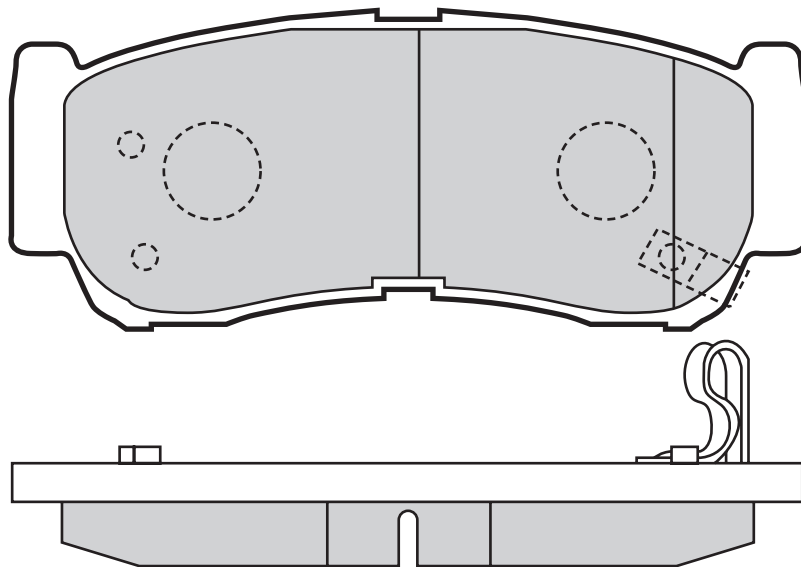

2	118,6	47,0	15,0

601231

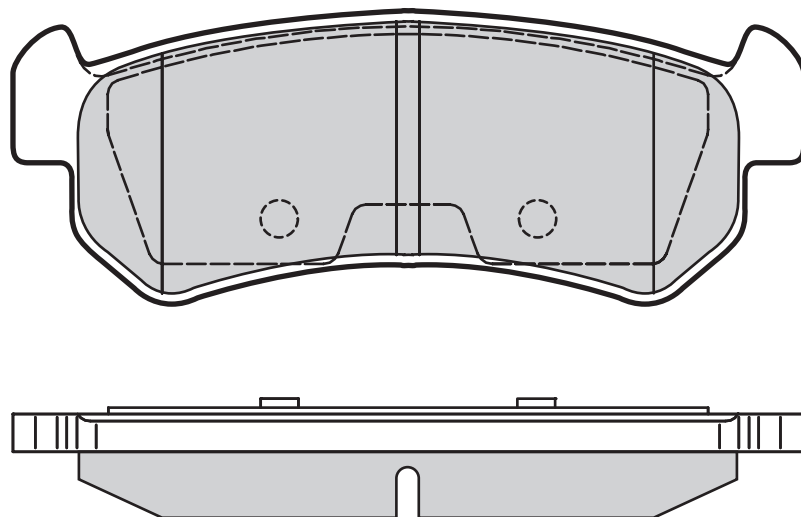

0	103,9	39	13,8



601232

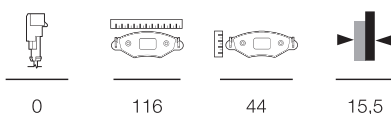
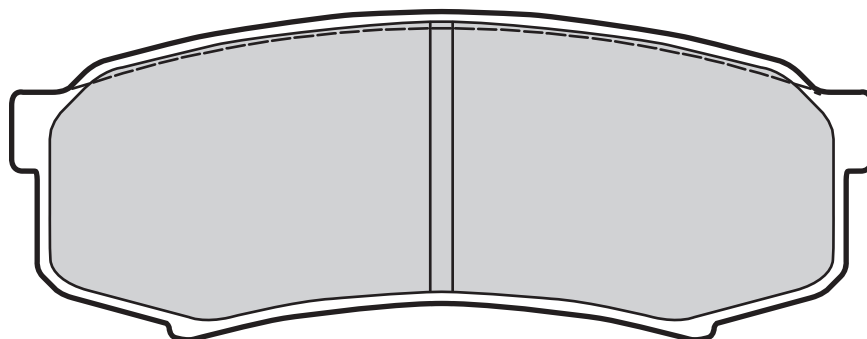

0

116

44

15,5

601233

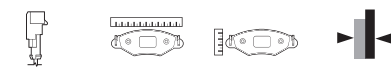
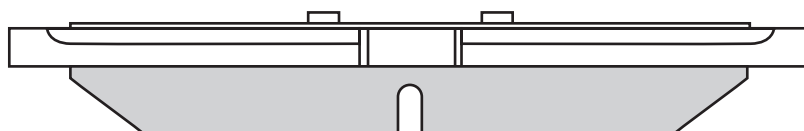
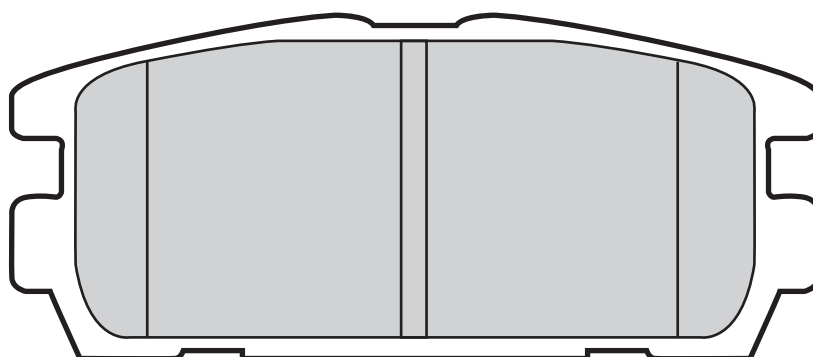

0

110,6

46,5

15



601235

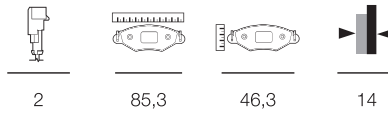
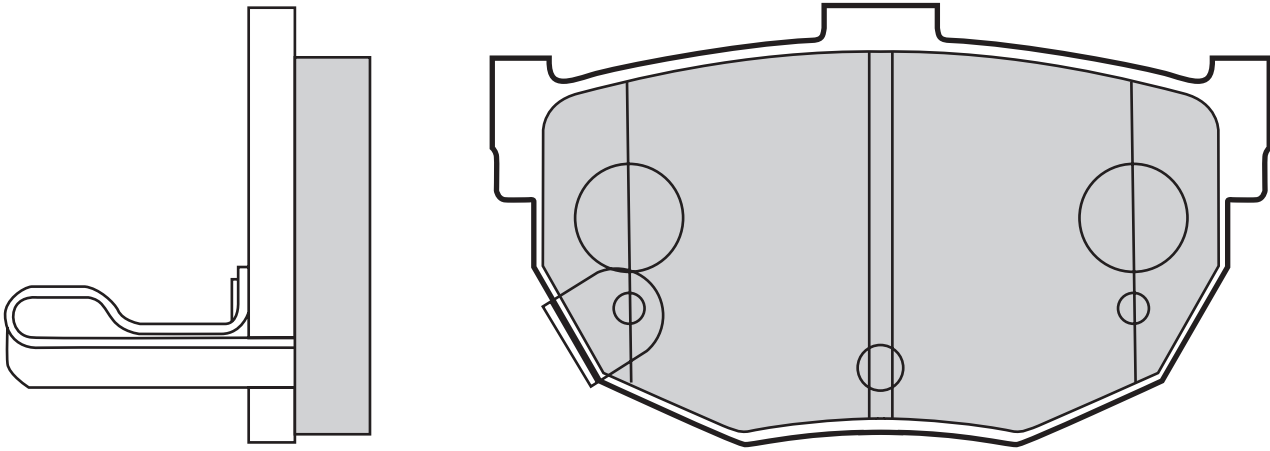

601236

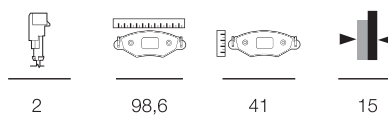
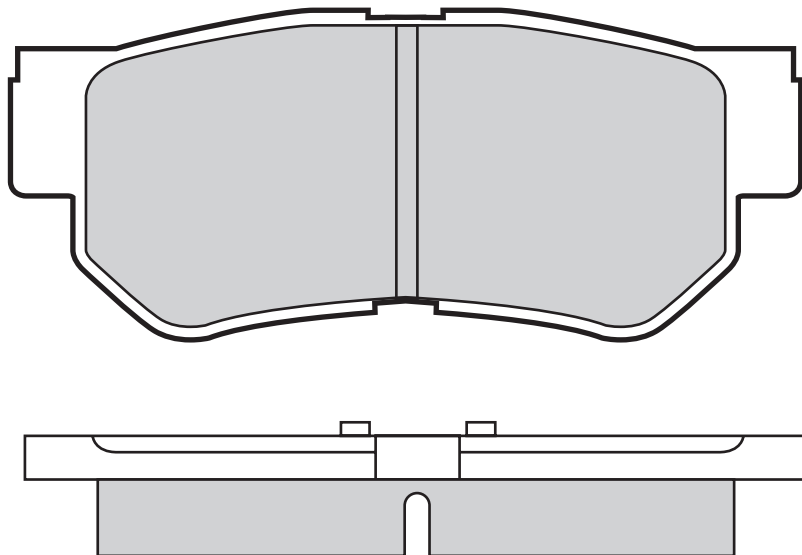



601239

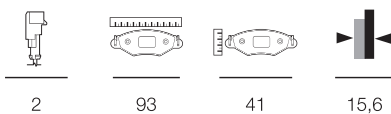
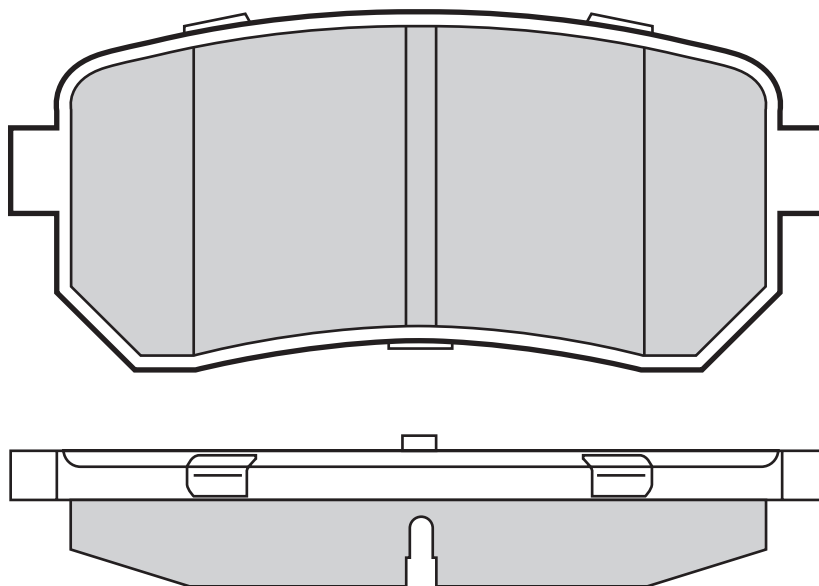

2

93

41

15,6

601240

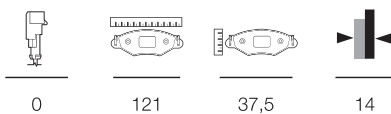
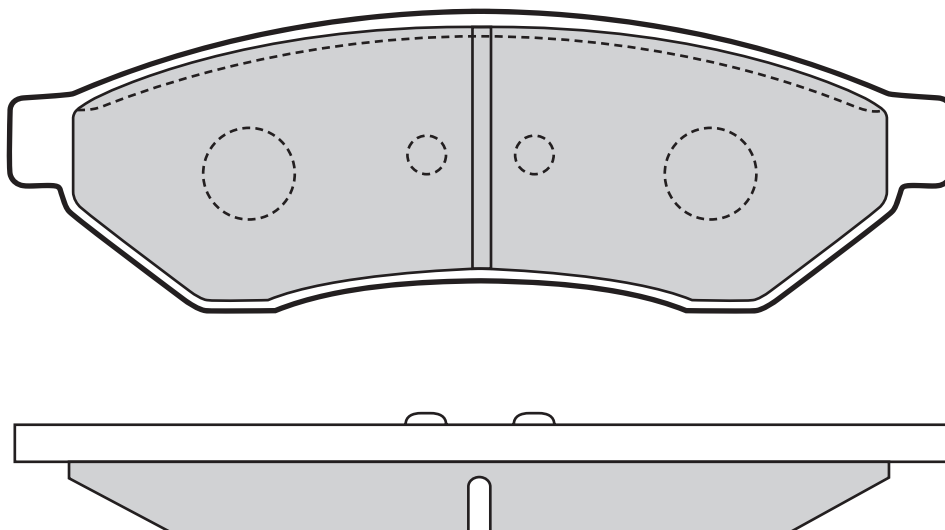

0

121

37,5

14

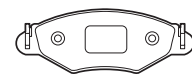

601241

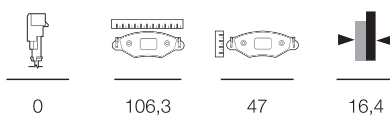
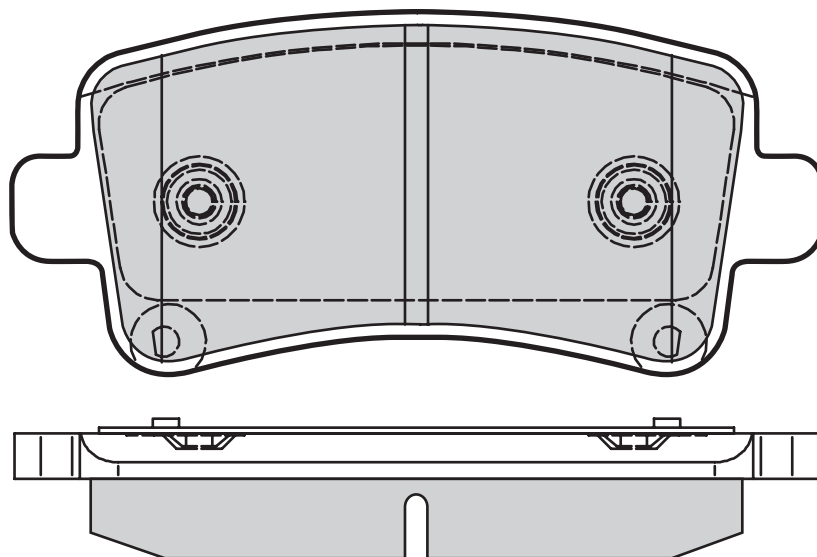

0 106,3 47 16,4

601242

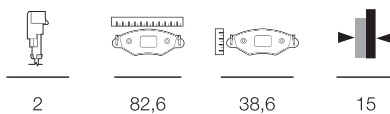
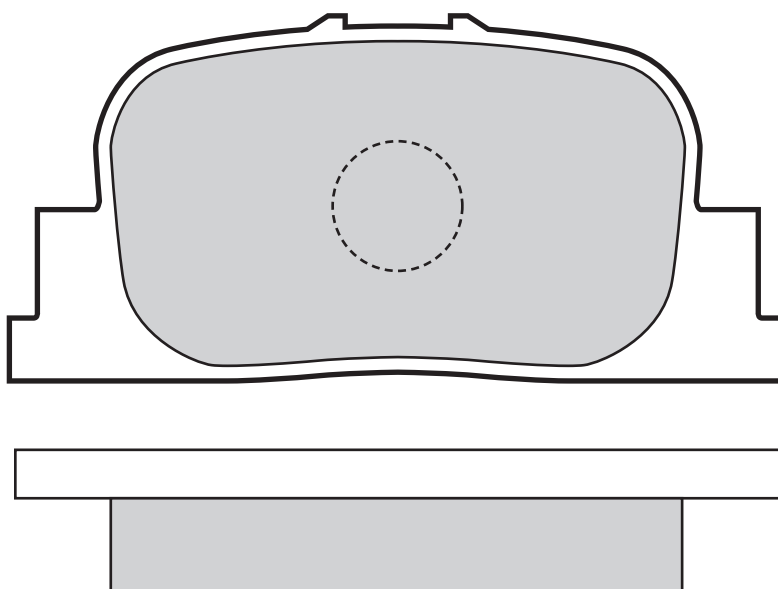

2 82,6 38,6 15



601243

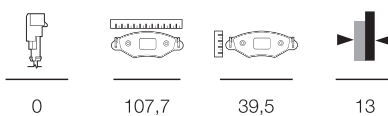
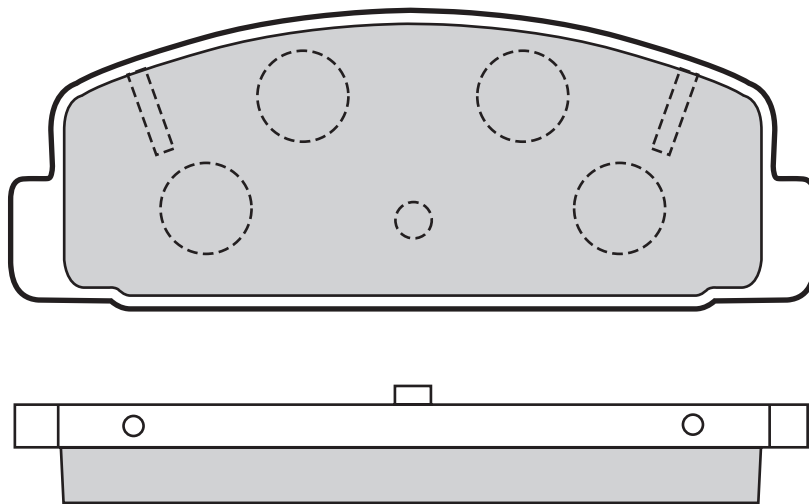

0

107,7

39,5

13

601244

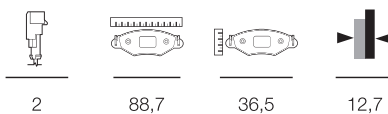
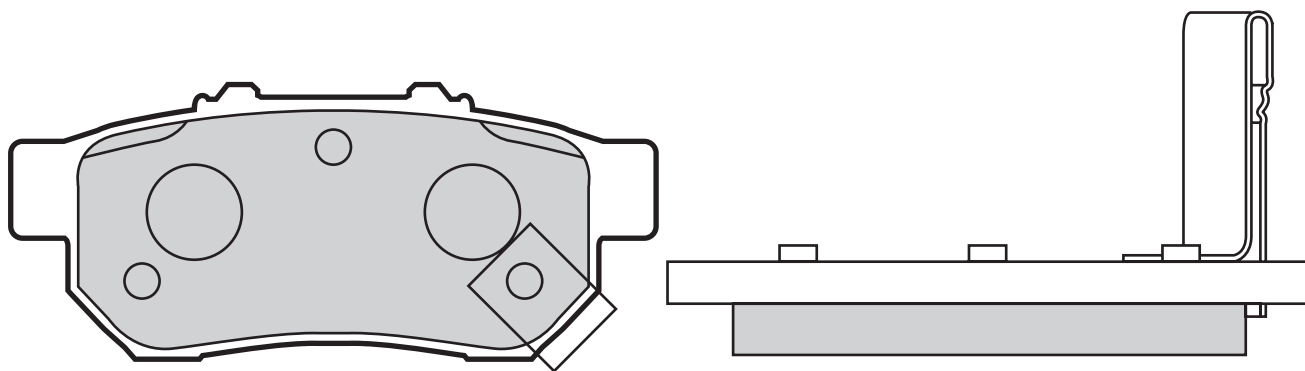

2

88,7





36,5

12,7

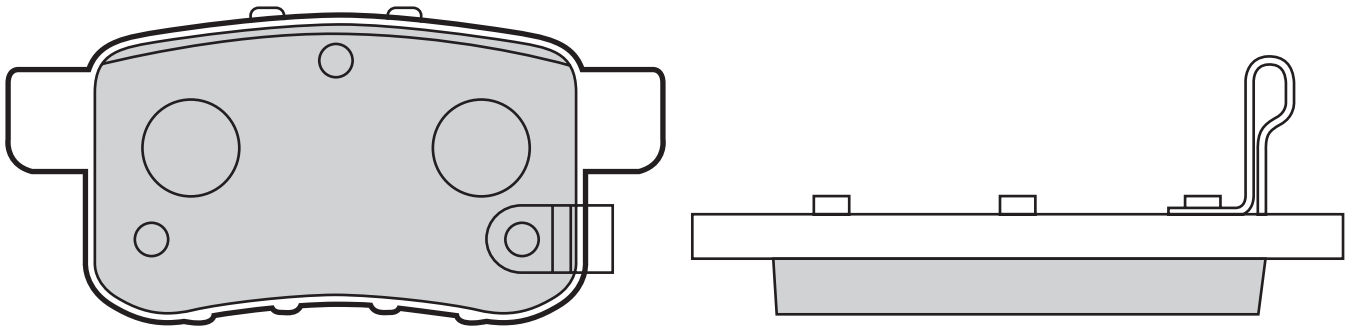





601245

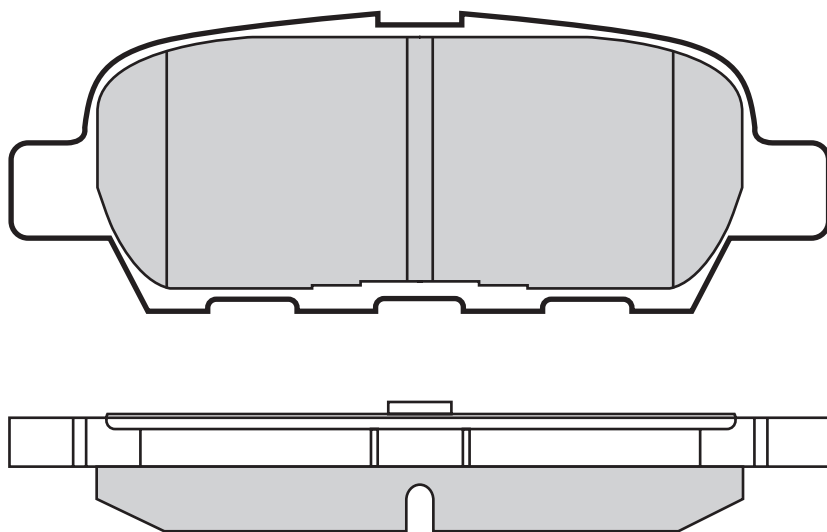

			
2	93,5	44,6	14,5

601246



			
2	105,4	37,8	14



601247

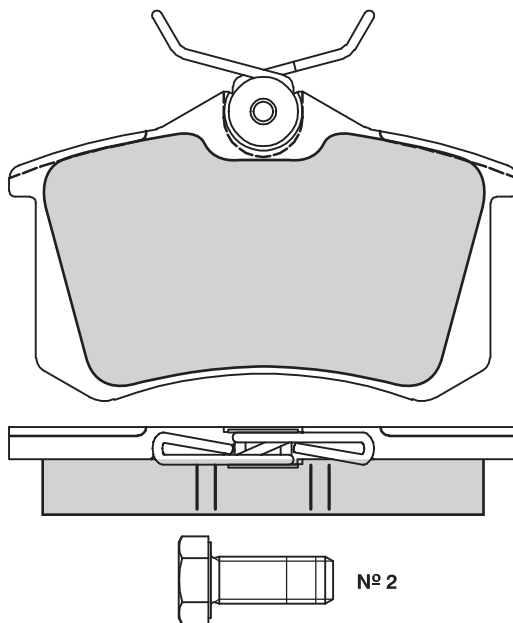

0	87,2	52,2	15

601248

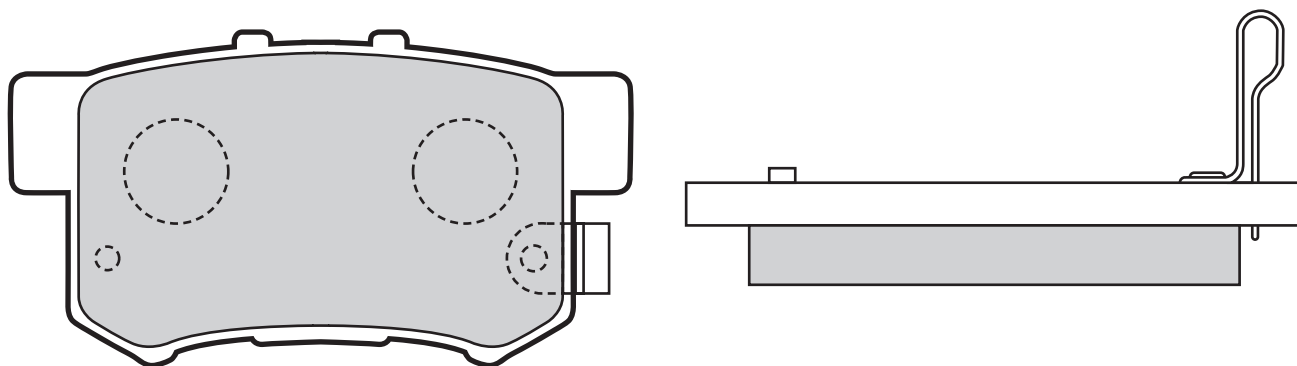

2	88,7	47,5	14,5

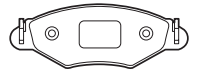

601249

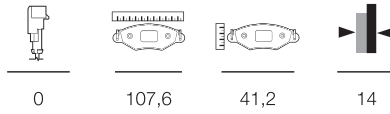
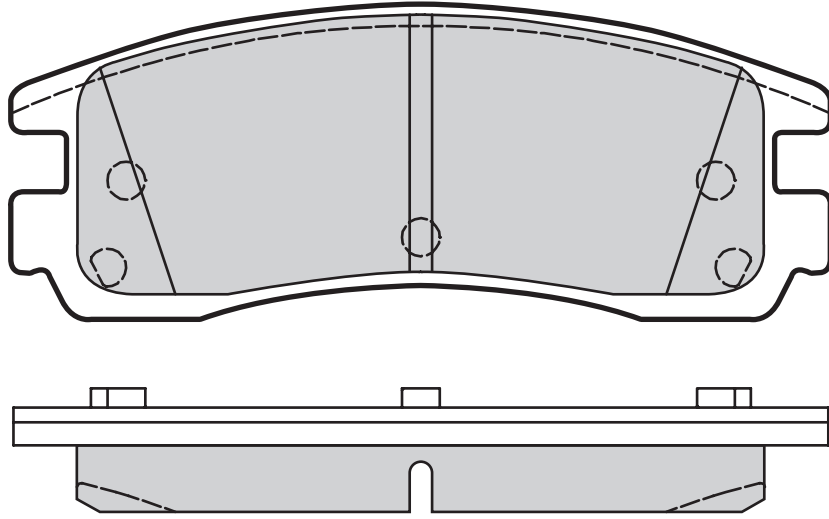

601250

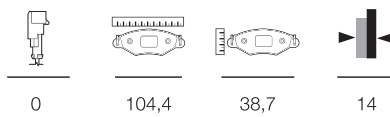
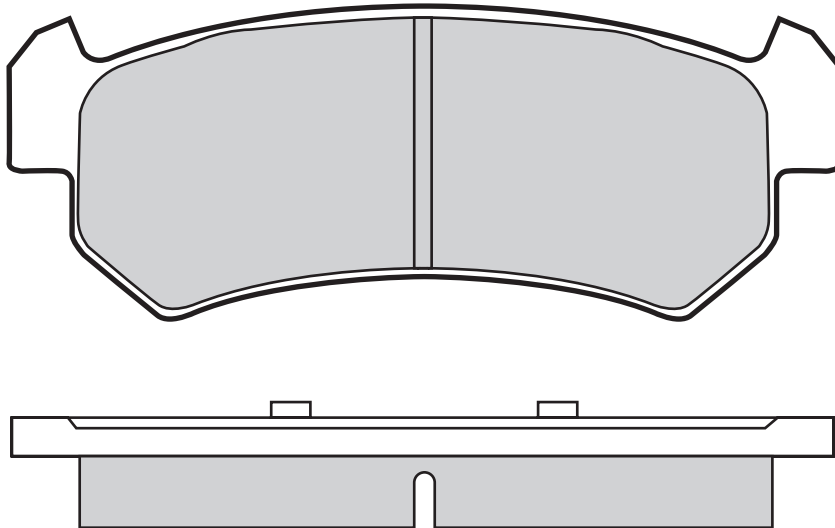



601251

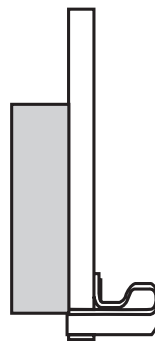
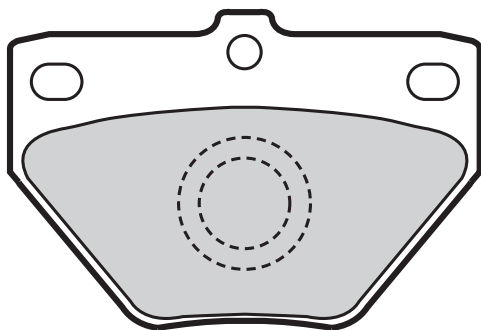
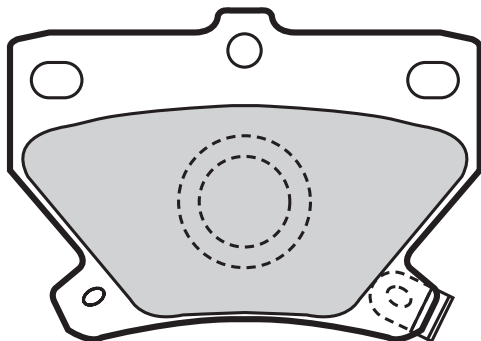

0



78,5



55/51,9



13,8

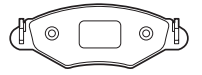

601255

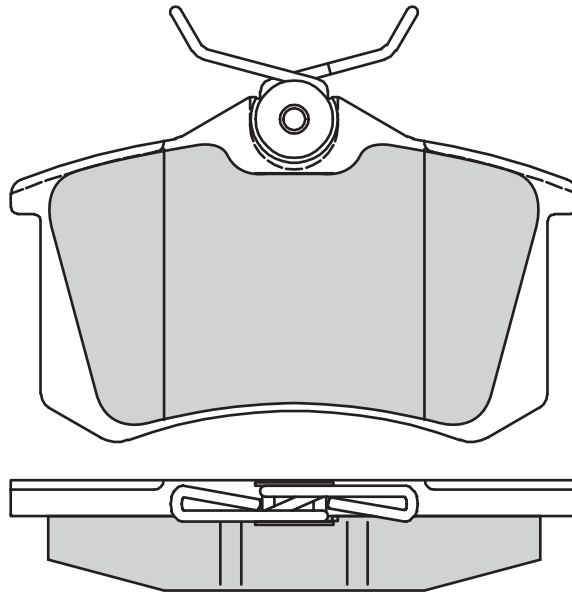

0	87,2	52,2	17

601256

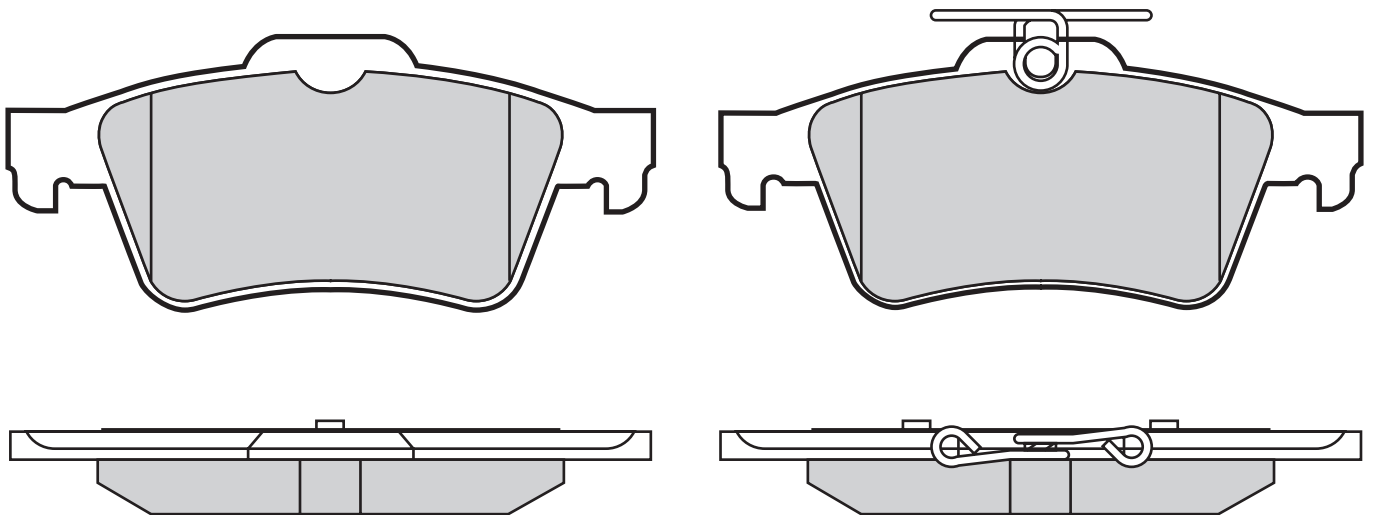

0	123,2	51,9	15,7



601257

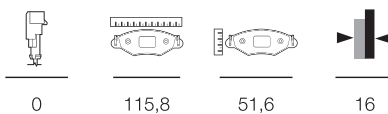
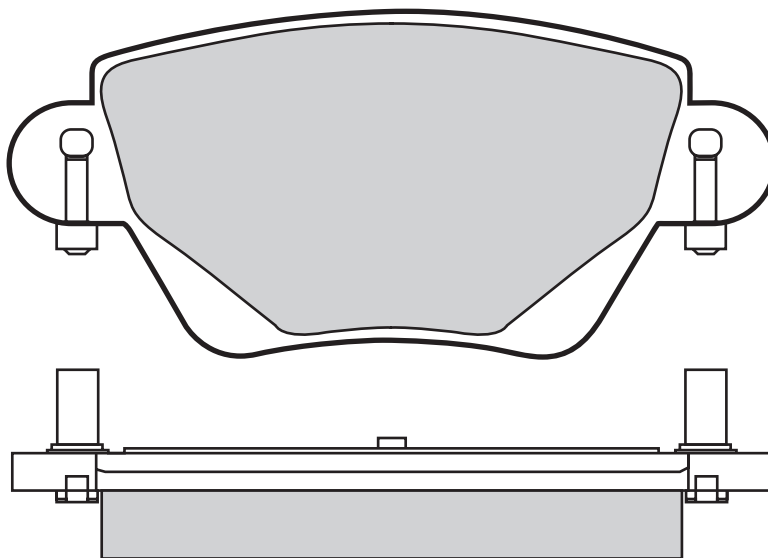

0 115,8 51,6 16

601258

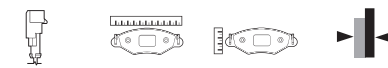
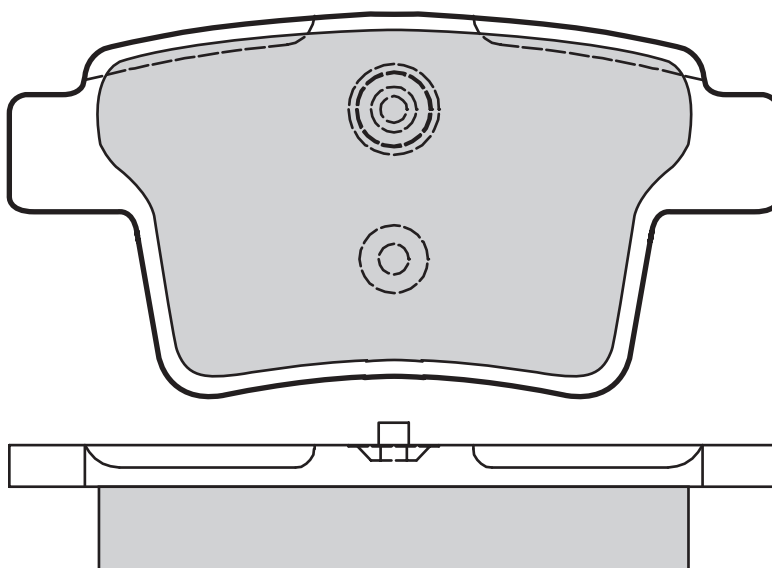



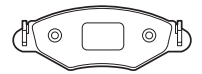

0 101,9 50,3 16,2

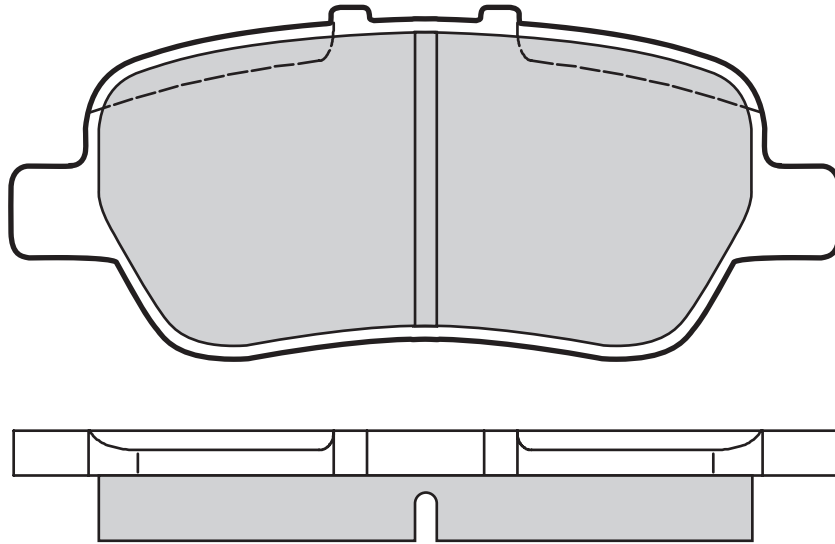





601259

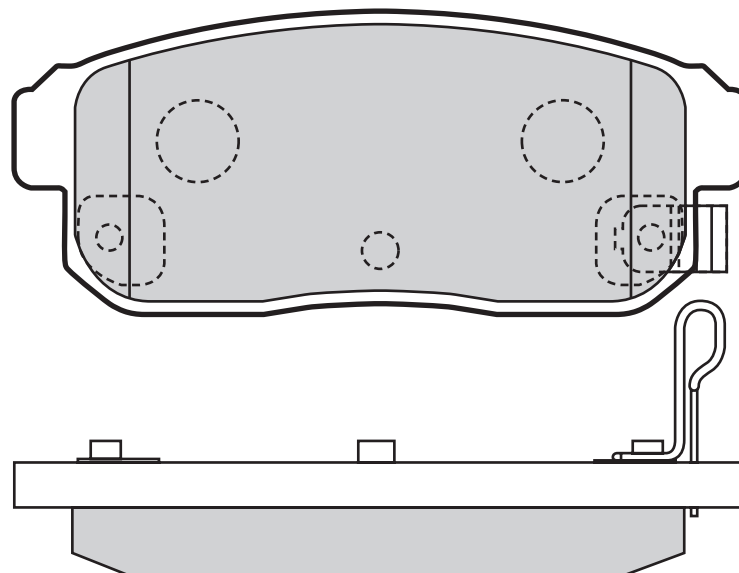

			
0	108,8	45,8	15

601261



			
2	105,5	43	16



601263

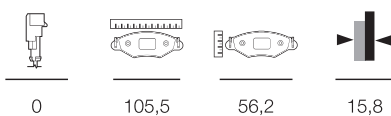
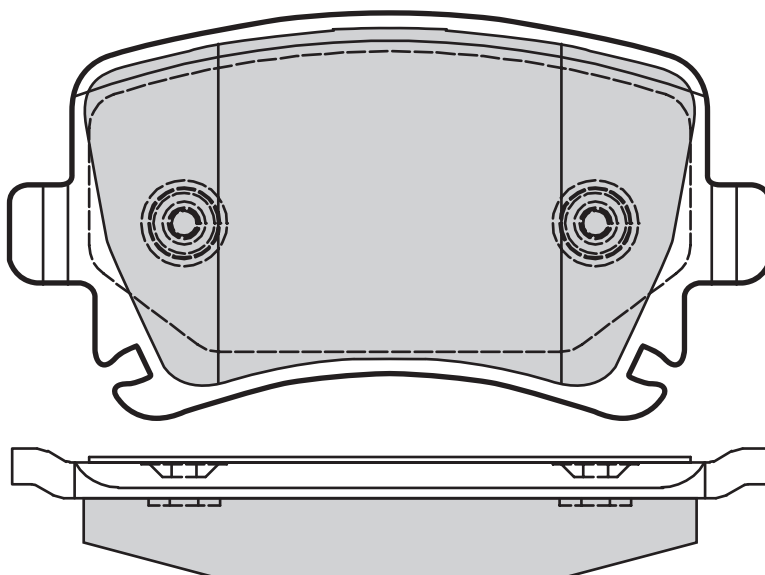

0 105,5 56,2 15,8

601264

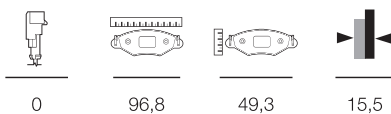
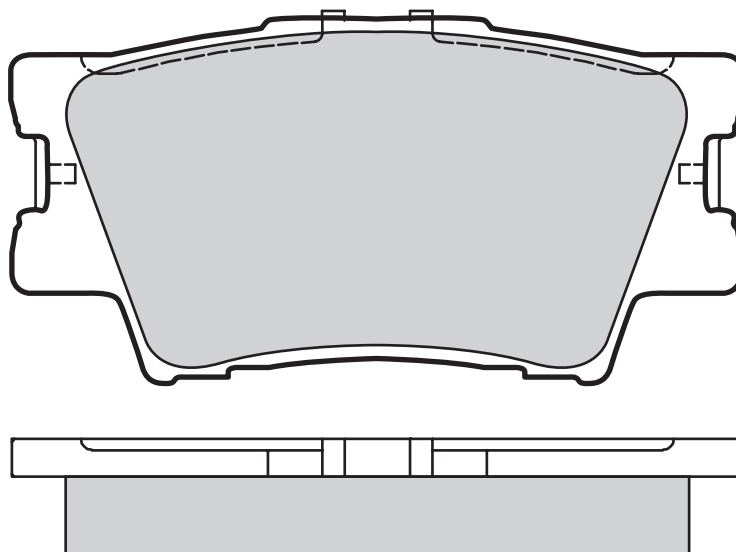

0 96,8 49,3 15,5

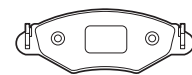

601266

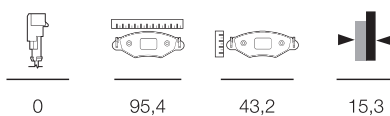
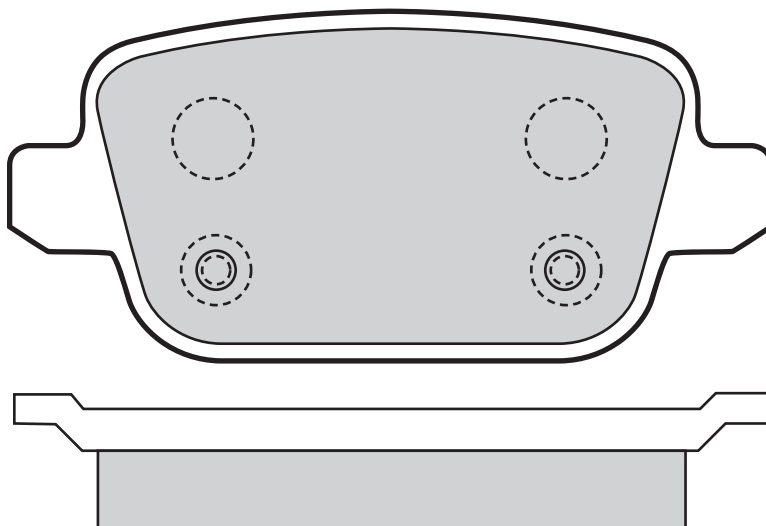

0 95,4 43,2 15,3

601267

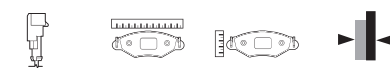
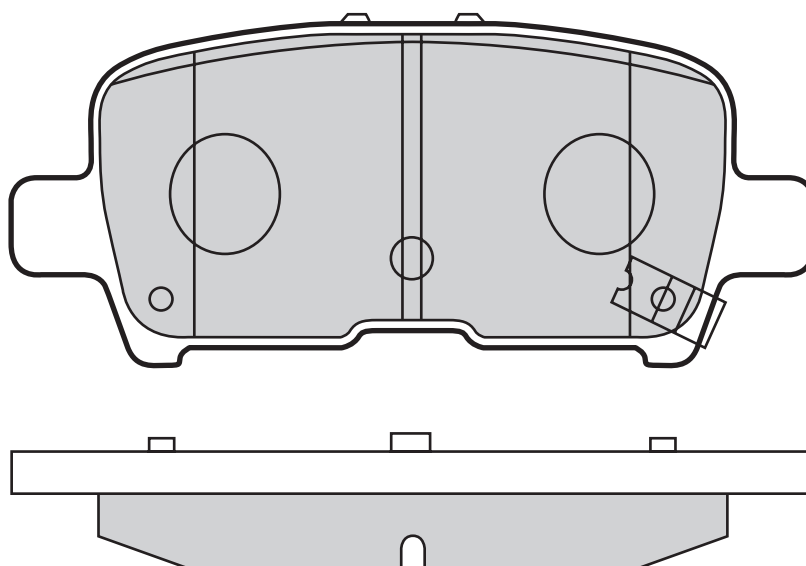

2 109 43 14



601268

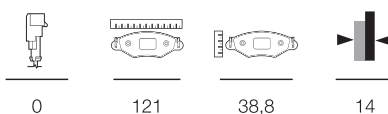
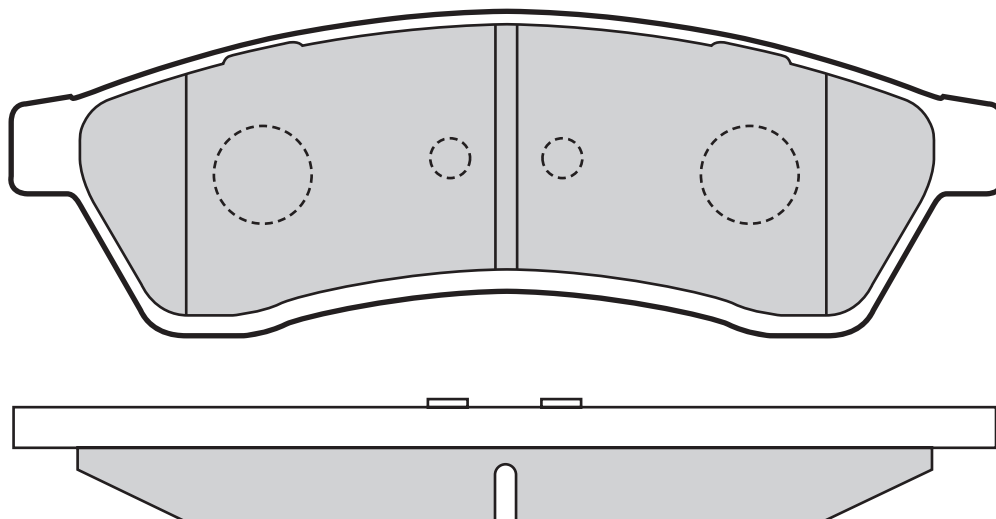

0

121

38,8

14

601269

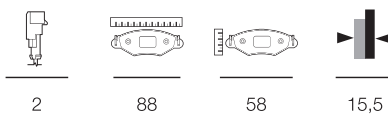
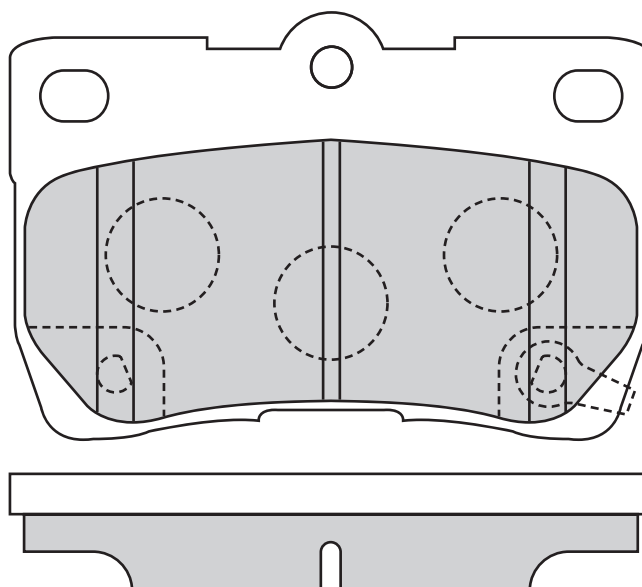

2

88

58

15,5

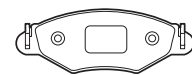

601270

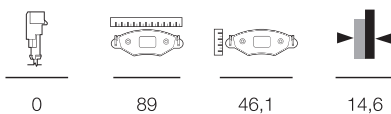
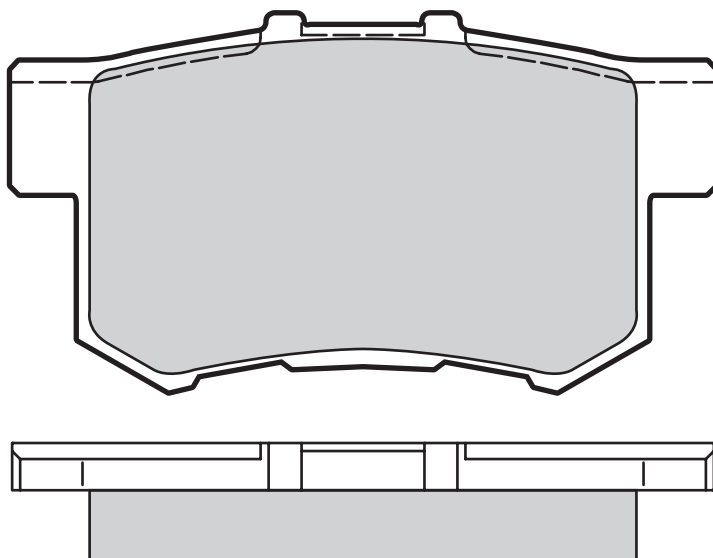

0 89 46,1 14,6

601271

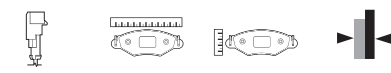
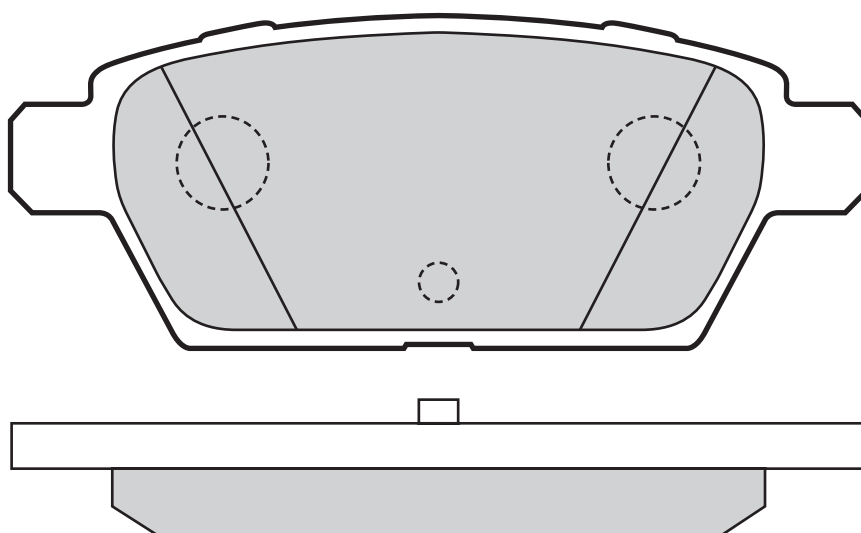





0 110,6 42,5 14,5

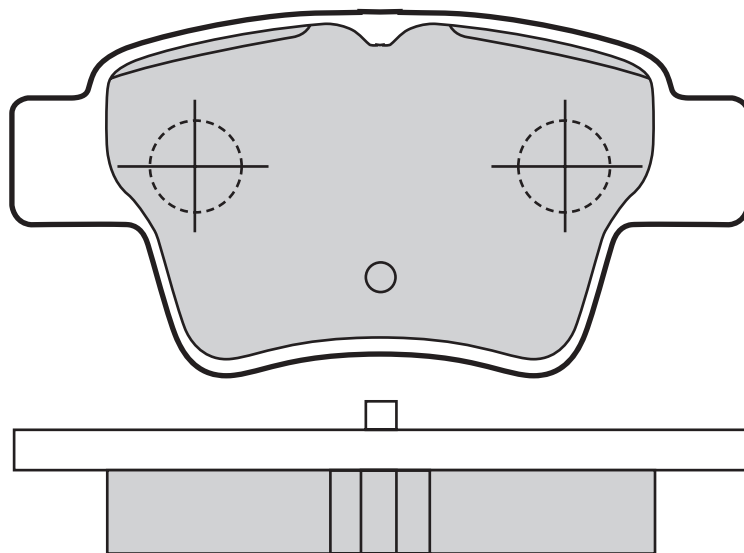





601273

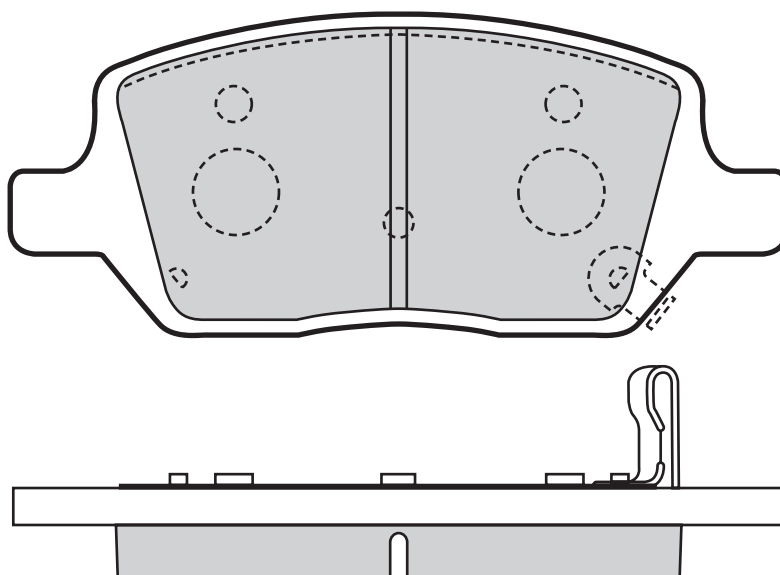

			
0	95,2	46,9	16,6

601274



			
2	124,8	51	14,1



进口刹车片图片 Imported Range Image

Pads and Discs

Plaquettes et Disques

Pastillas y Discos

Pastilas e Discos

Pastiglie e Dischi

Blokjes en Schijven

Bremsbeläge und Bremsscheiben

Klocki i Tarcze

Balatalari ve Diskleri

Κολοδκι и Дискки

Δισκόφρενα & Δισκόπλακες

刹车片和刹车盘

بطانات و قرص



20224 (WVA)

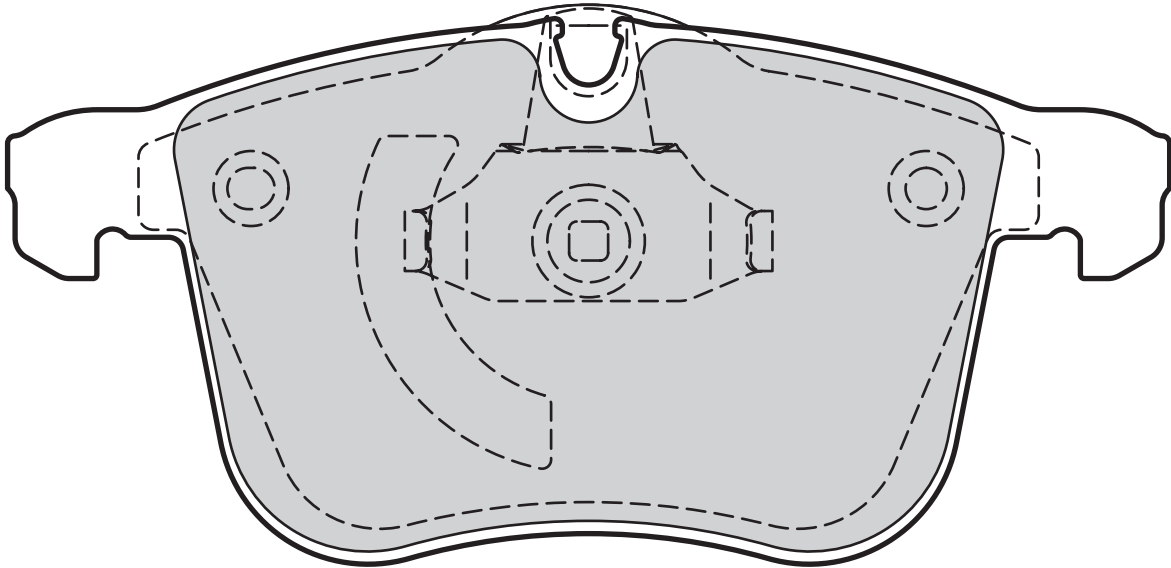
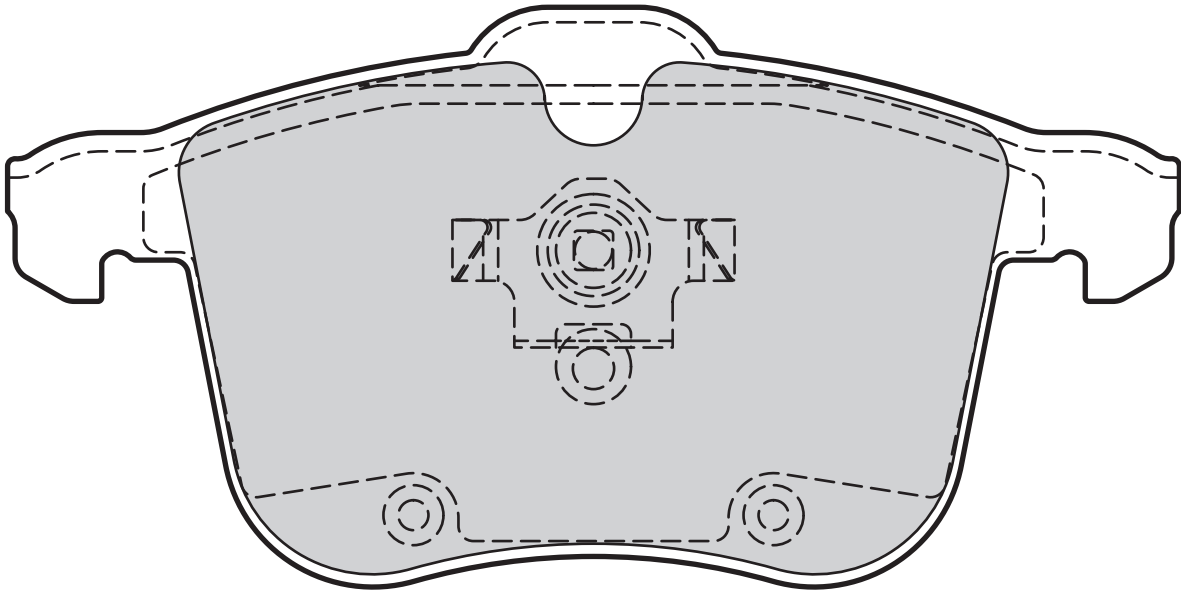

Valeo



598808

0

156,2

72,7

20,4

TEVES



Valeo

20635 (WVA)

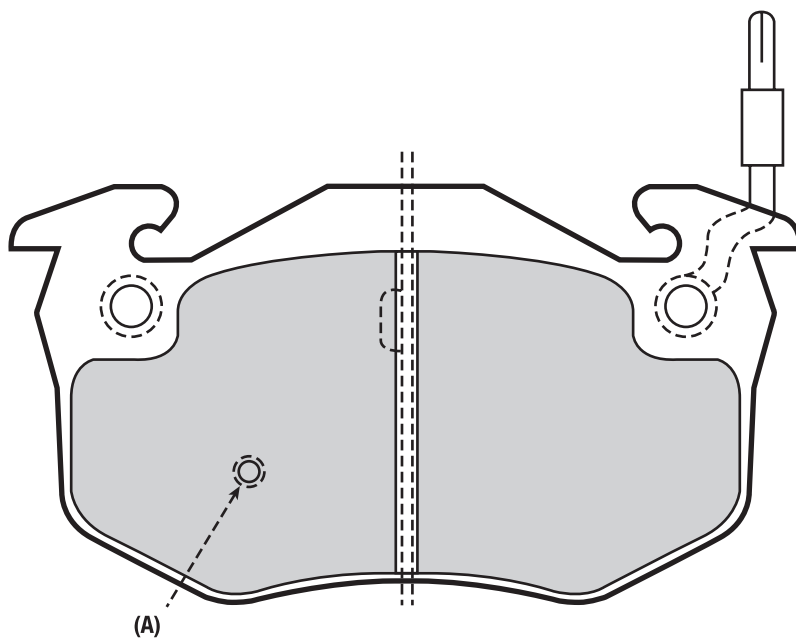

Valeo



598396

0

105

54,7

11

BENDIX

20772 (WVA)

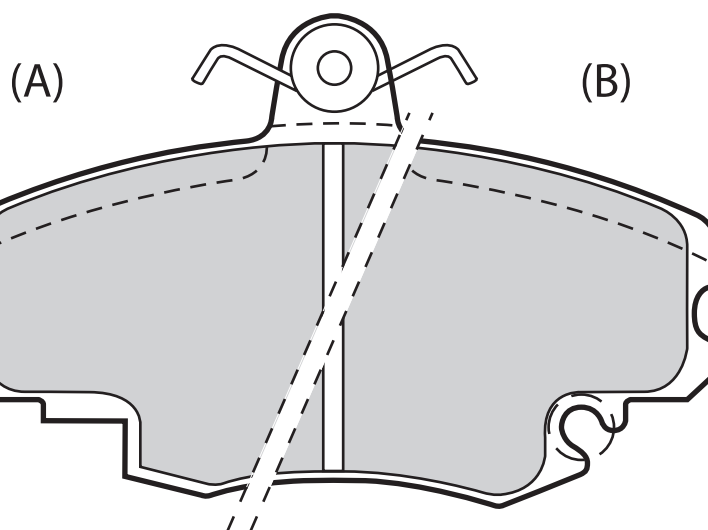

Valeo



598002

2(B)

100,2

64,9

18,2

LUCAS



20916 (WVA)

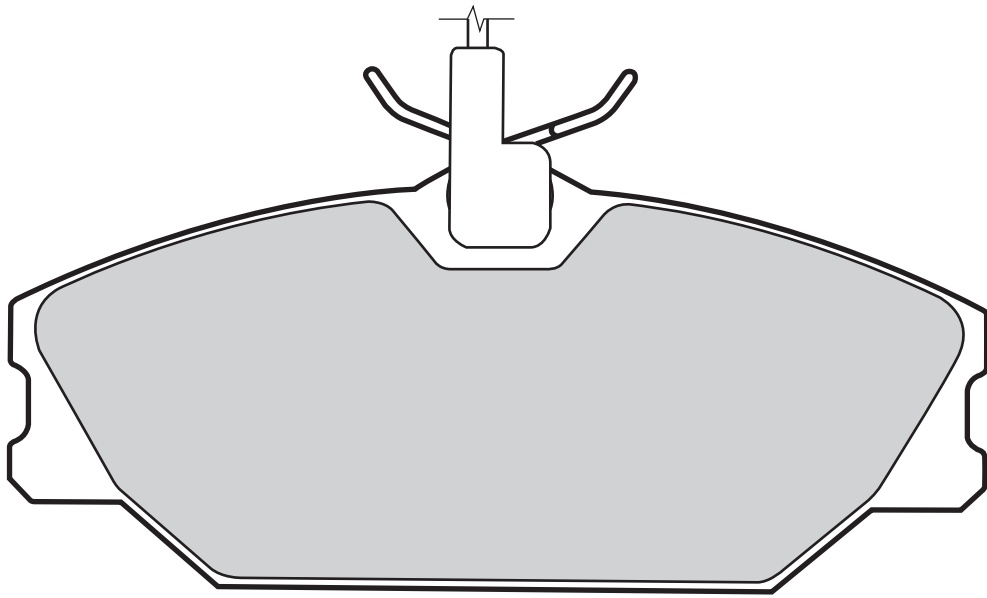

Valeo



598061

2

130

55

18

LUCAS

598473

0

129

55,6





18

LUCAS

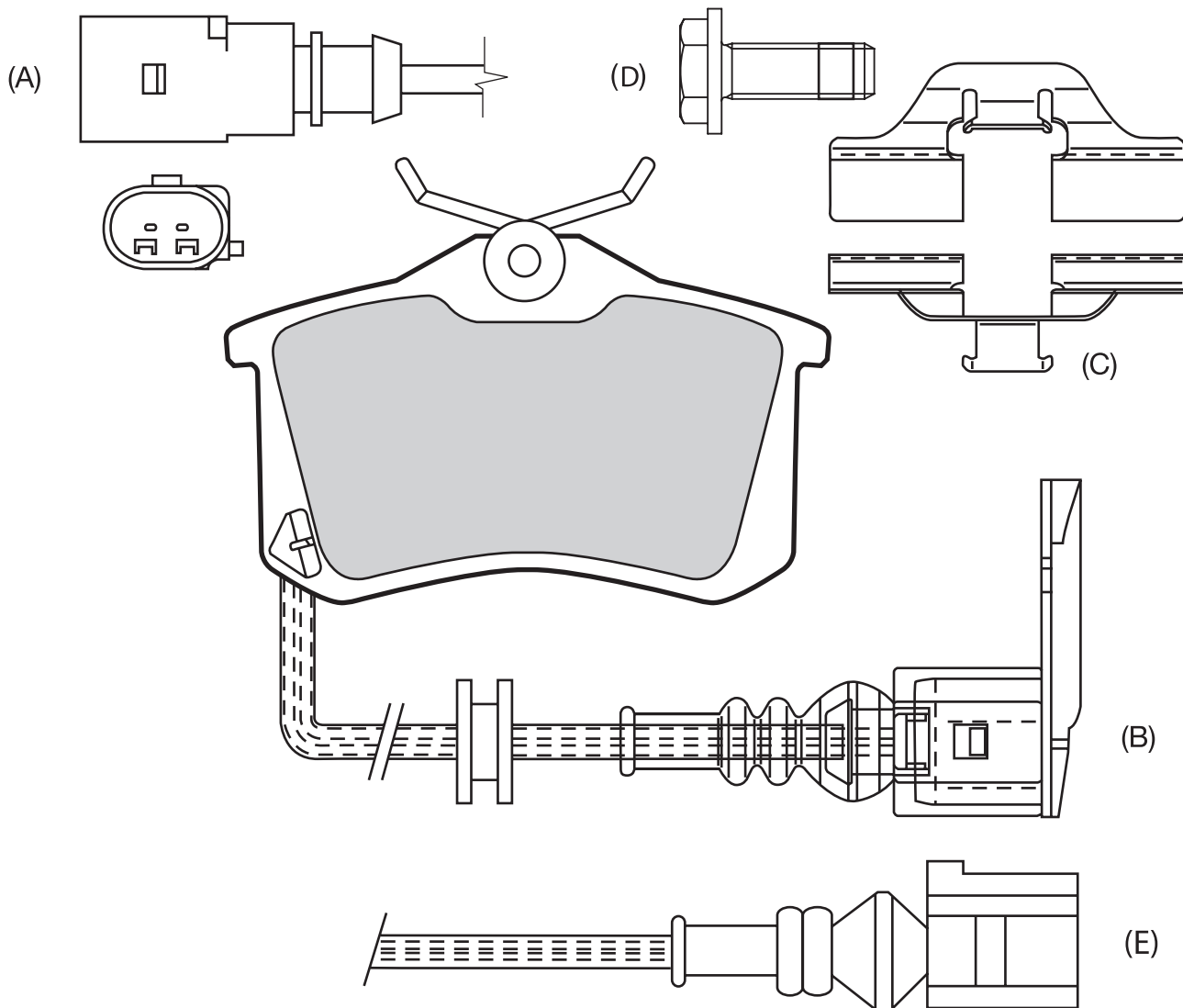

20960 (WVA)



Valeo					
598180	0(D)	87	53	15,2	LUCAS
598463	0(D)	87	53	17	LUCAS
598474	0(D+C)	87	53	16	LUCAS



21016 (WVA)

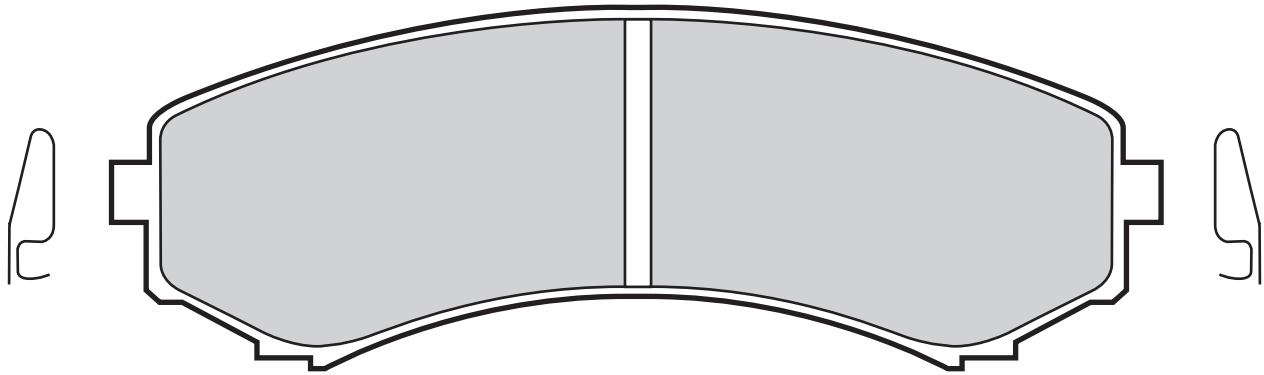

598518	2	139	58,5	16	SUMITOMO

21051 (WVA)

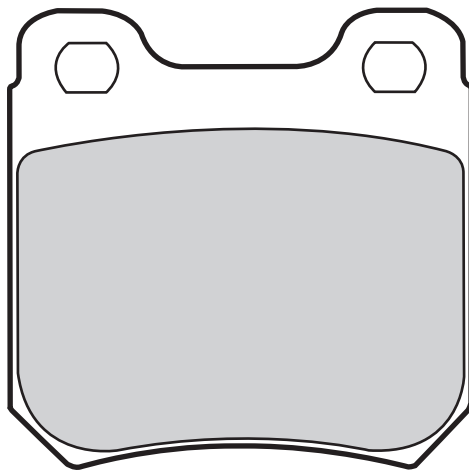

598183	0	61,7	61,2	15,7	TEVES



Valeo

21064 (WVA)

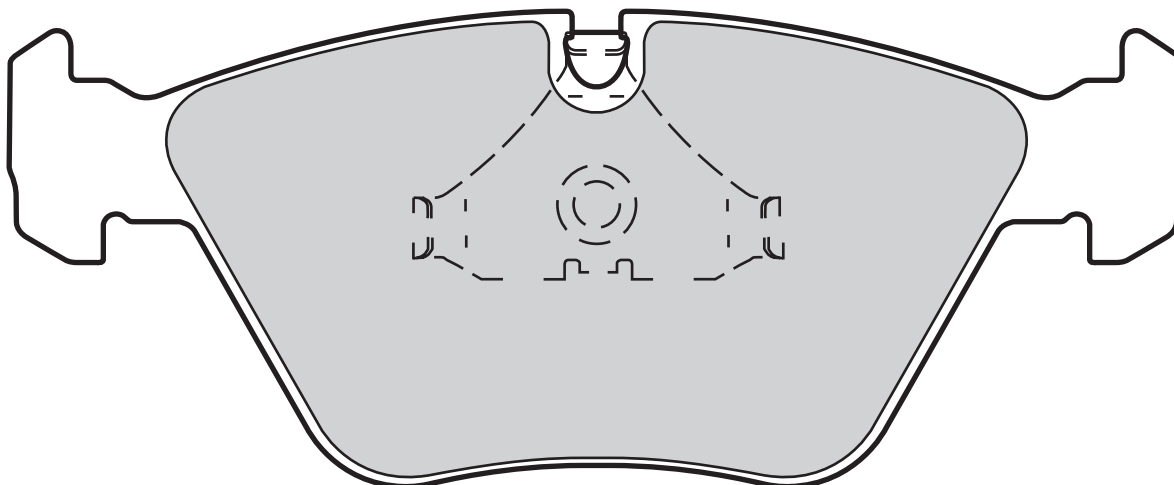

Valeo



598409

0

155,4

63,6

20

TEVES

21142 (WVA)

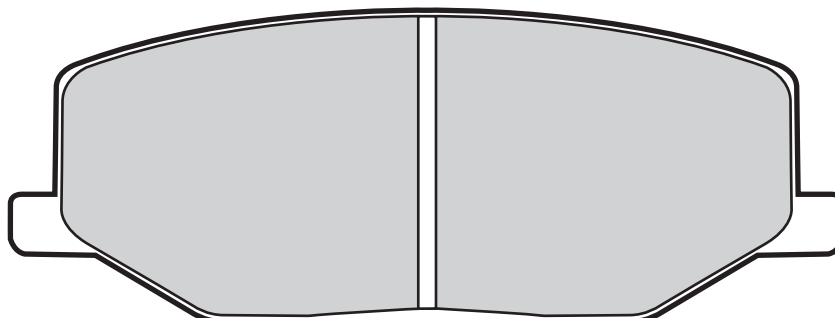

Valeo



598021

0

110,3

41,5

15

AKEBONO



21153 (WVA)

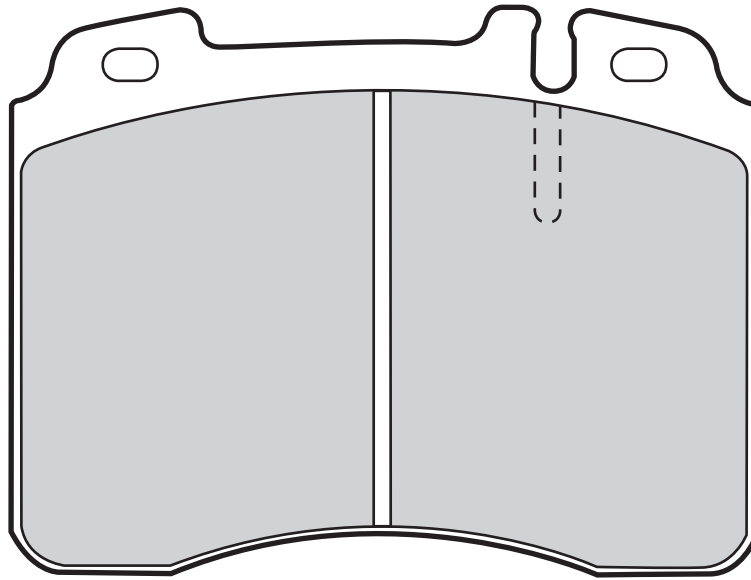

598601	0	98,8	73,5	16	TEVES

21195 (WVA)

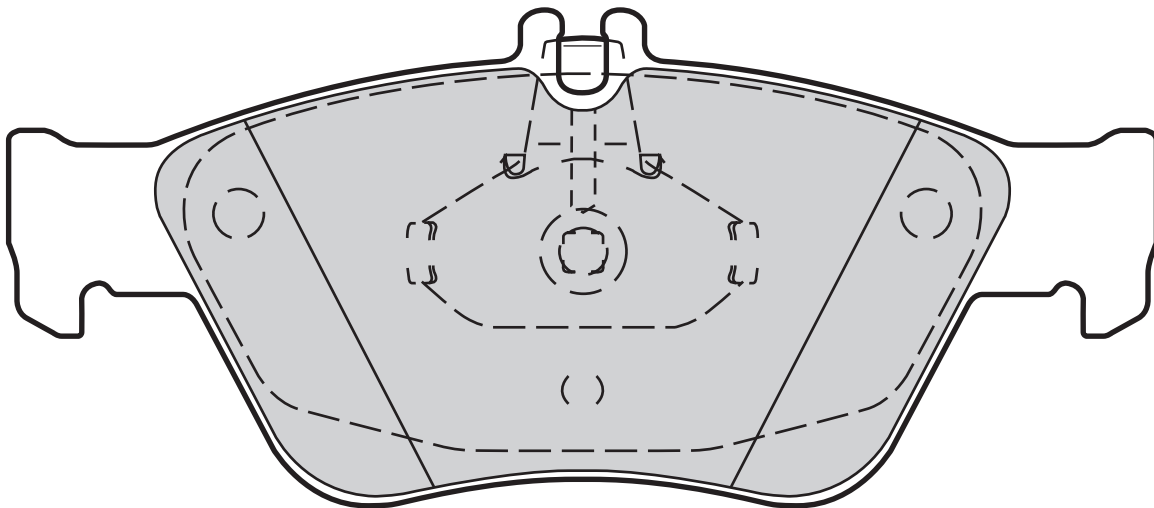

598357	0	151,4	66,1	19,3	TEVES



Valeo

21197 (WVA)

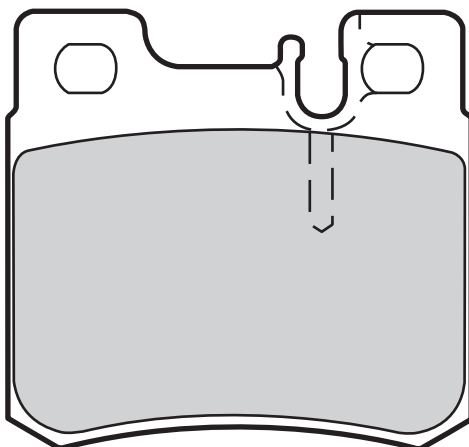

598272	0	61,6	58,6	15	TEVES	

21201 (WVA)

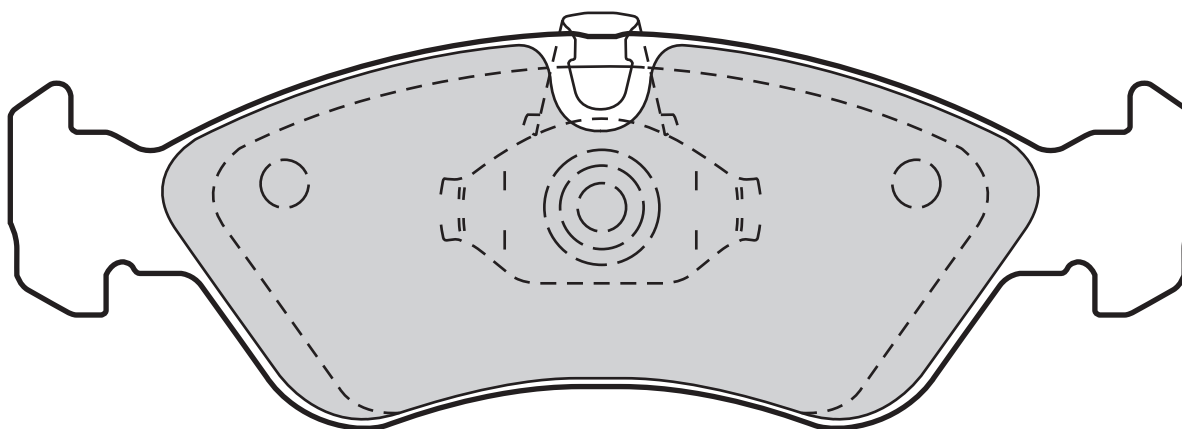

598184	0	156,3	52,6	17	TEVES	

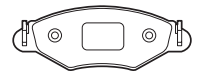

21237 (WVA)

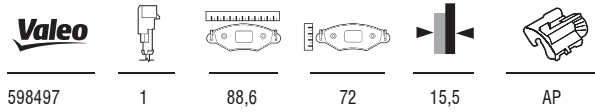
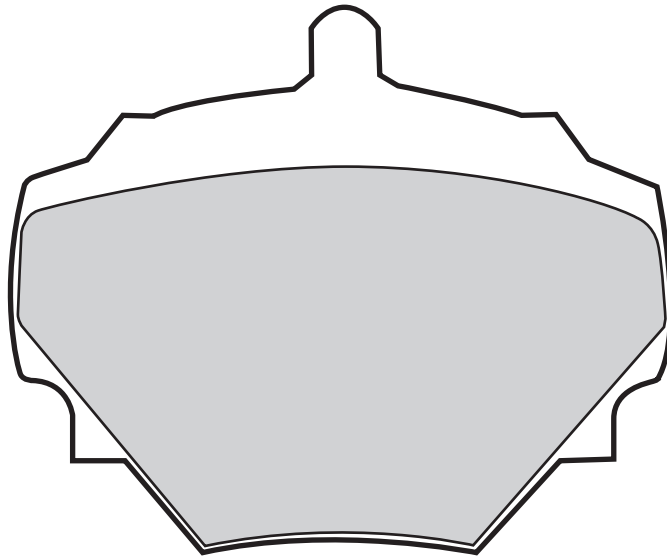

598497

1

88,6

72

15,5

AP

21279 (WVA)

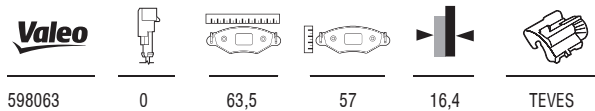
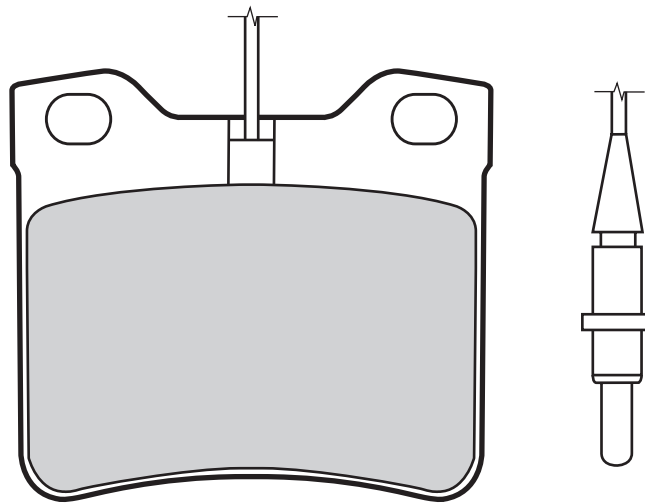

598063

0

63,5

57

16,4

TEVES



Valeo

21282 (WVA)

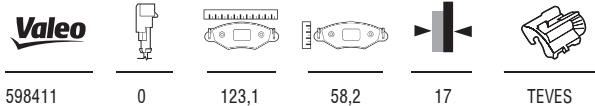
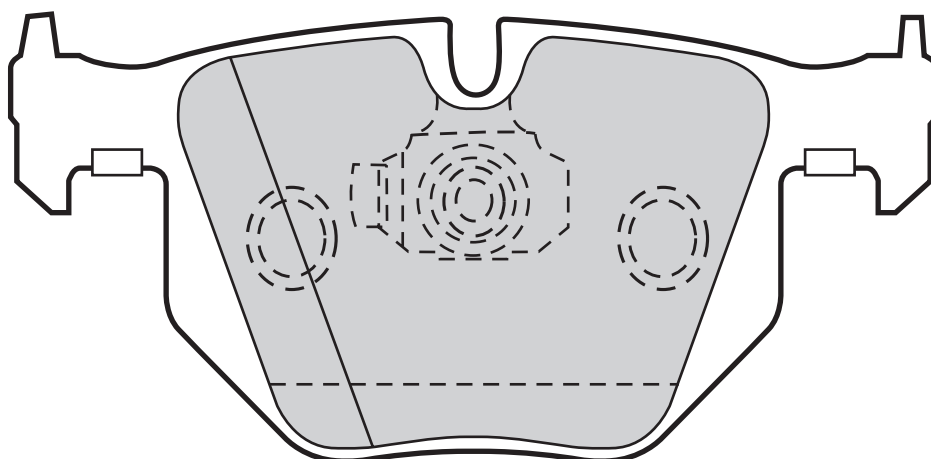
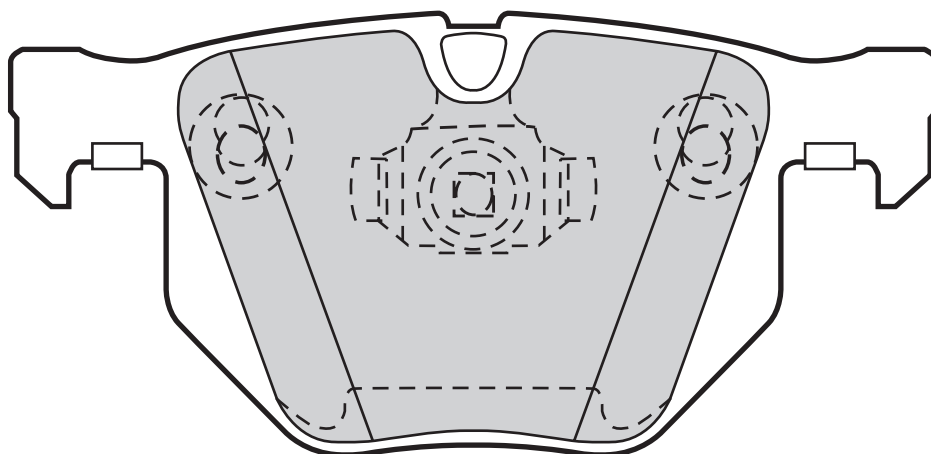

598411

0

123,1

58,2

17

TEVES

21292 (WVA)

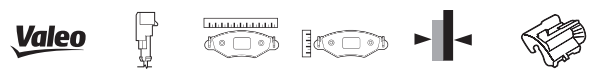
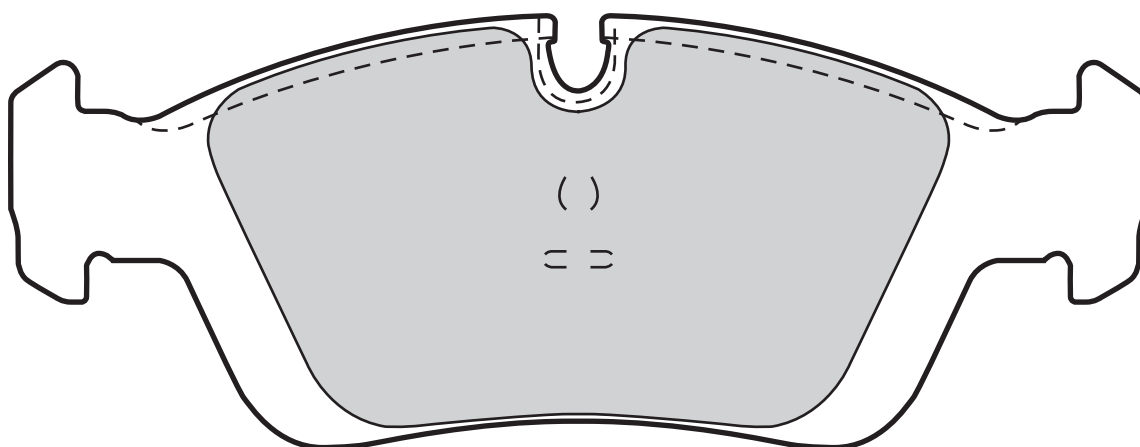

598018

0

151,3

57

17,3

TEVES



21305 (WVA)

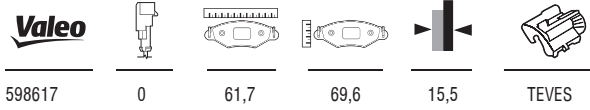
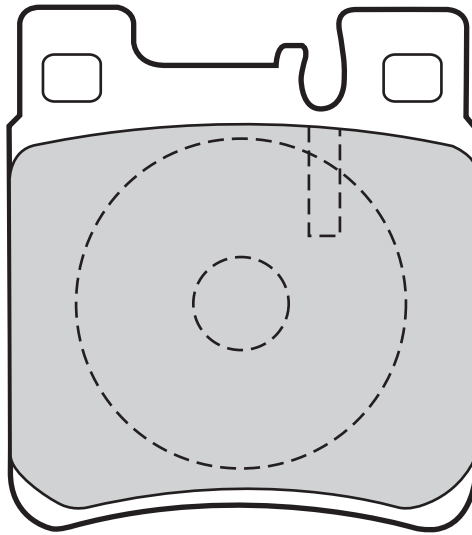

21365 (WVA)

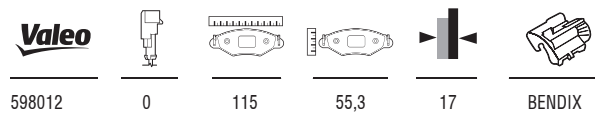
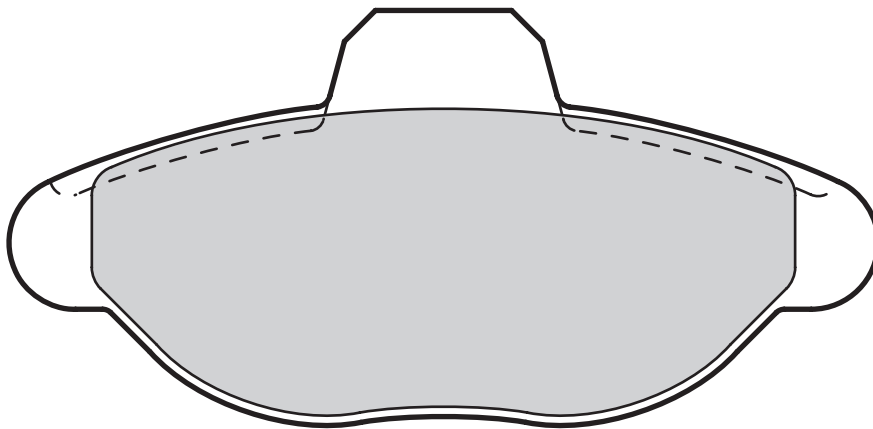



Valeo

21368 (WVA)

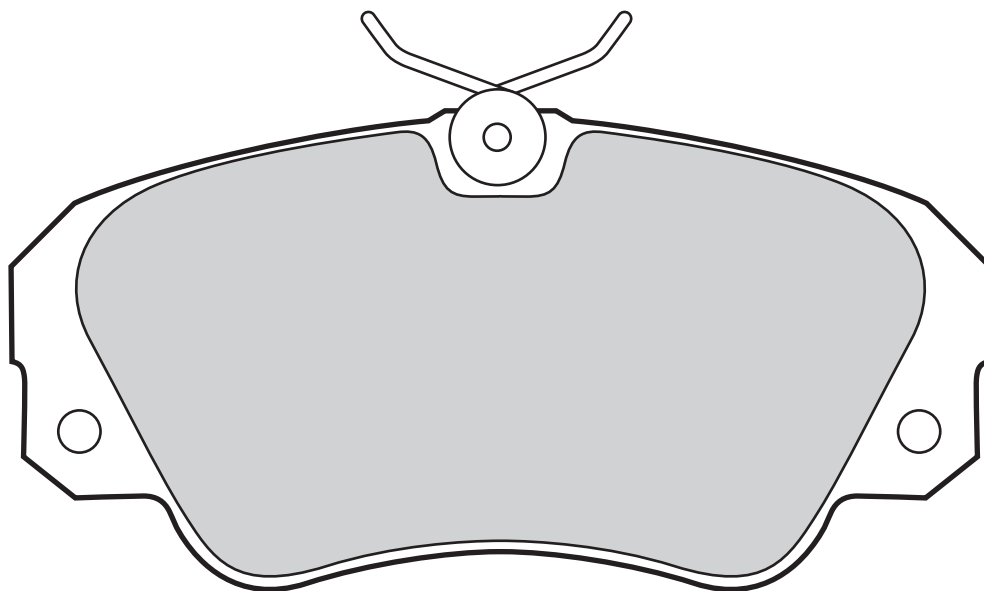

Valeo



598256

0

129,8

63,9

18,6

LUCAS

21370 (WVA)

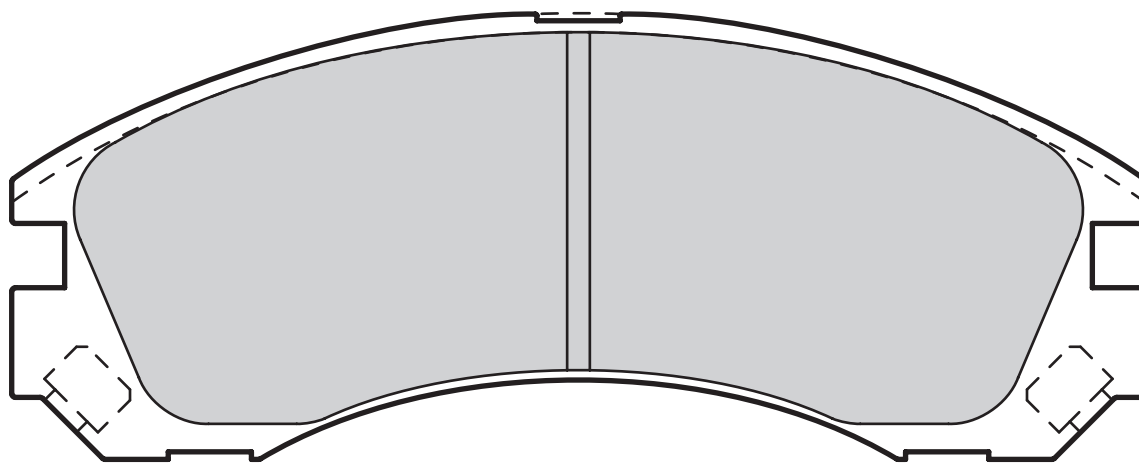

Valeo



601020

2

149,9

59

15,7

AKEBONO

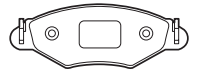

21484 (WVA)

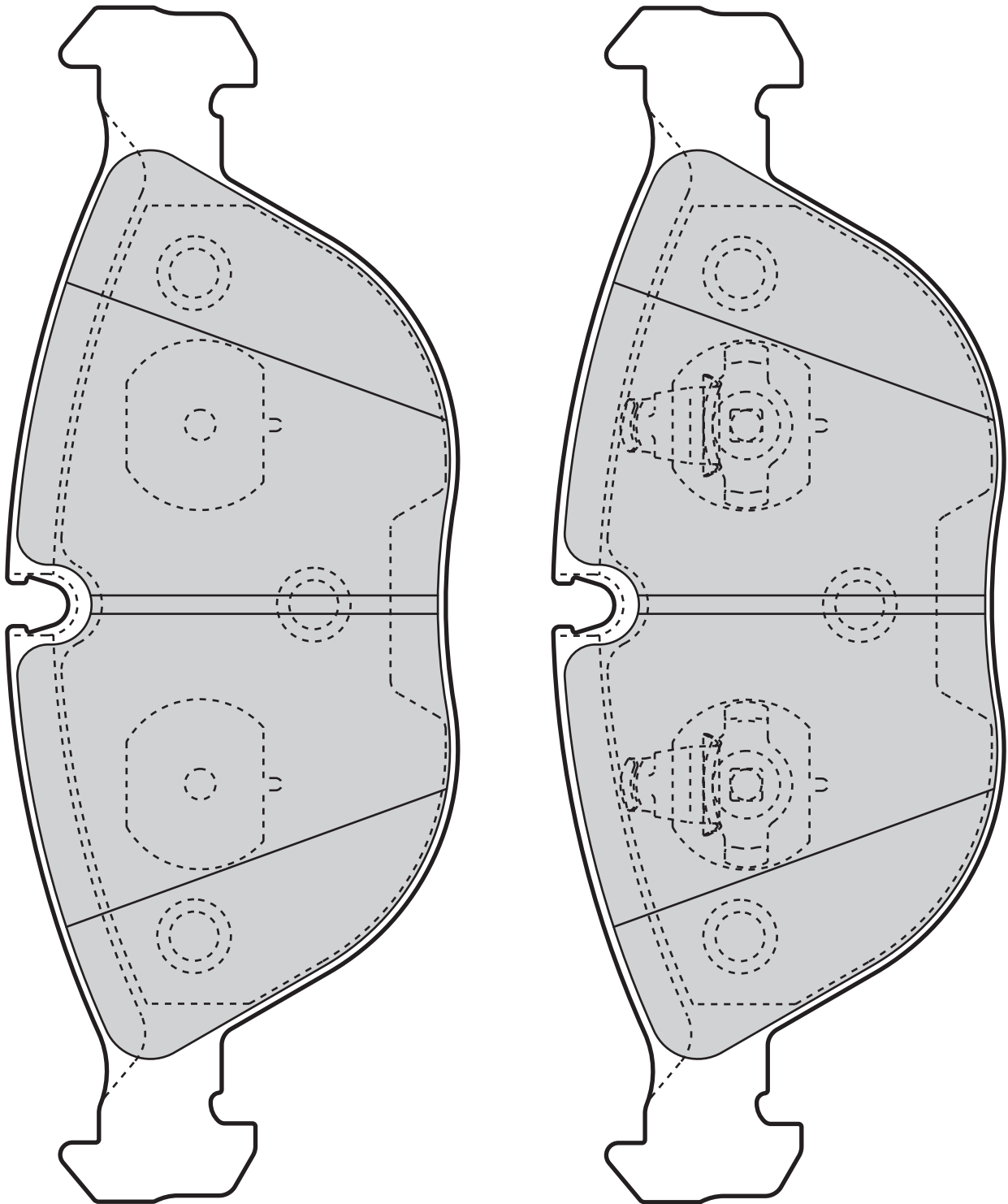

598712

1

194,5

73,5

20,5

TEVES



Valeo

21487 (WVA)

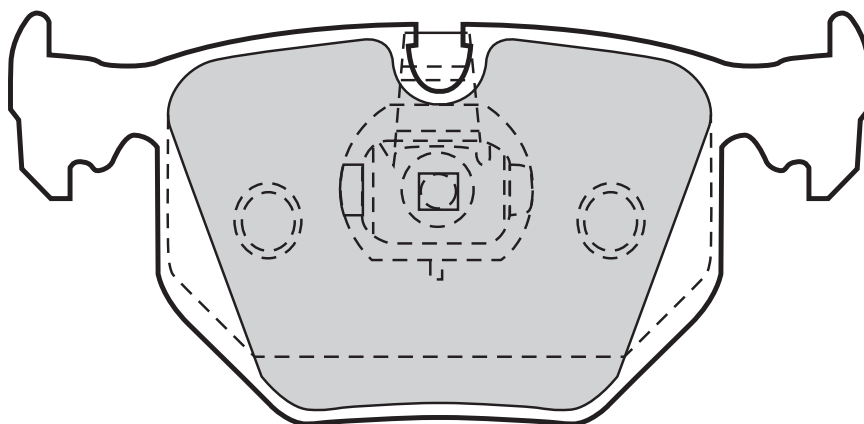

Valeo



598580

0

123,1

59,2

17

TEVES

21490 (WVA)

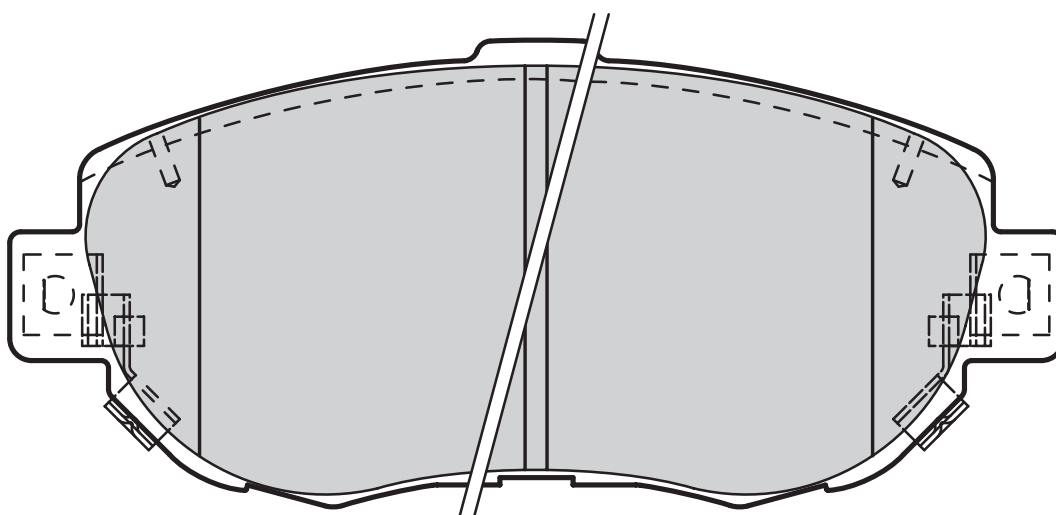
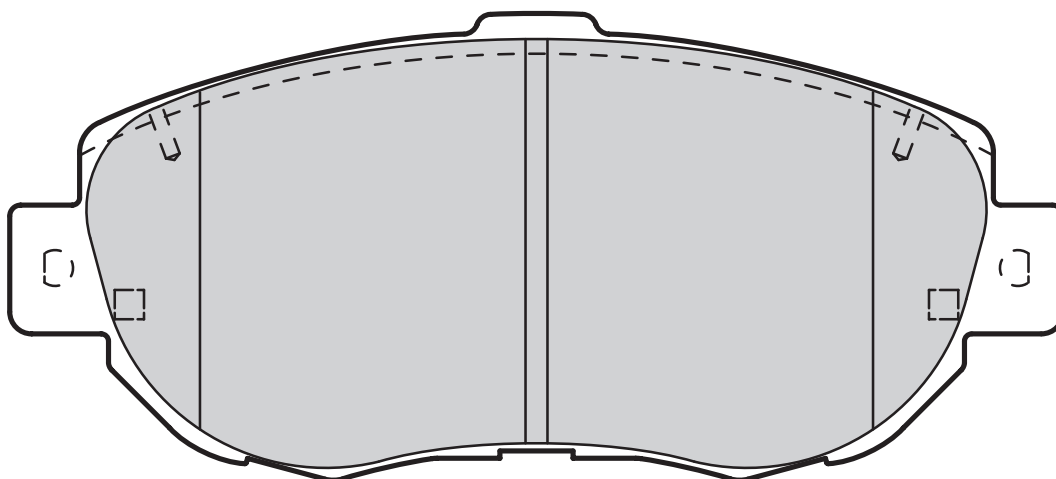

Valeo



601023

2

144

63,8

17

SUMITOMO

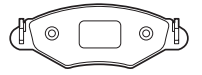

21519 (WVA)

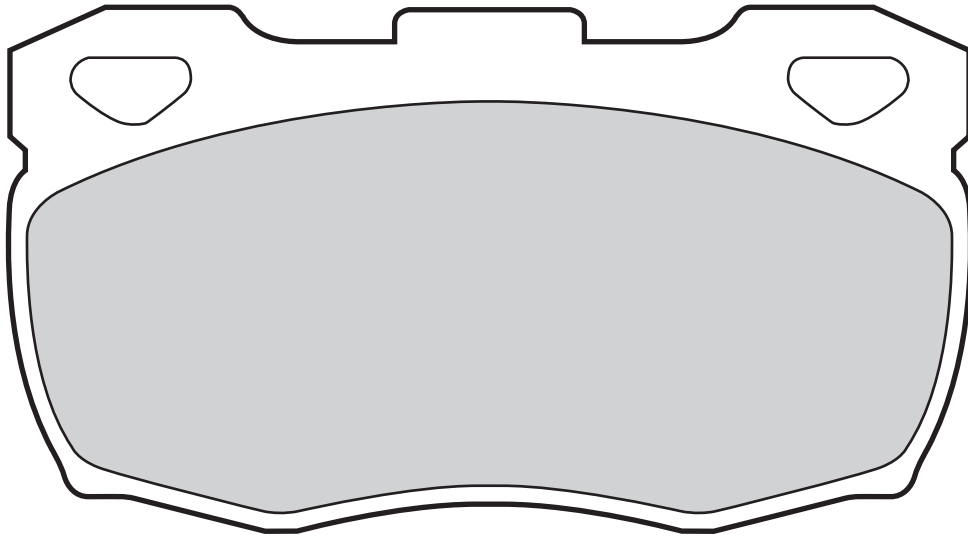

Valeo



598623

0

127

68,6

18

AP



Valeo

21637 (WVA)

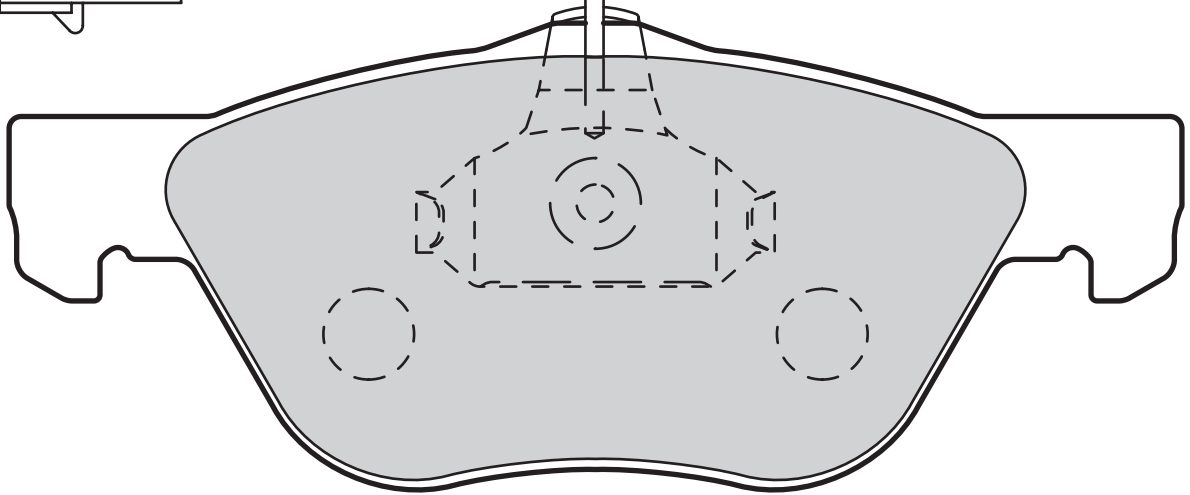
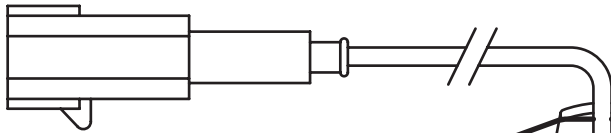
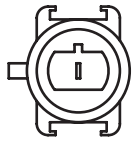
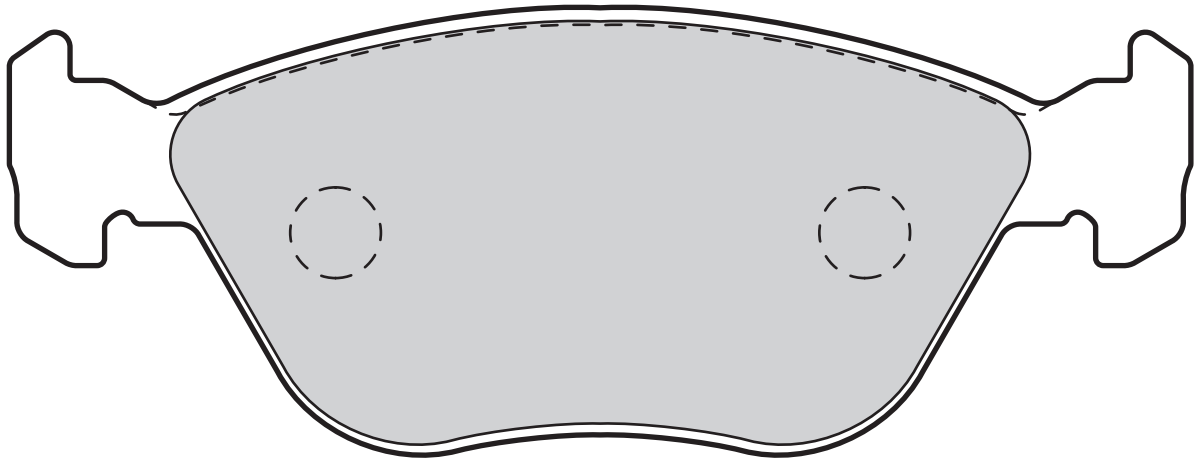

Valeo



598990

1

155,2

61,8

19,3

TEVES



21670 (WVA)

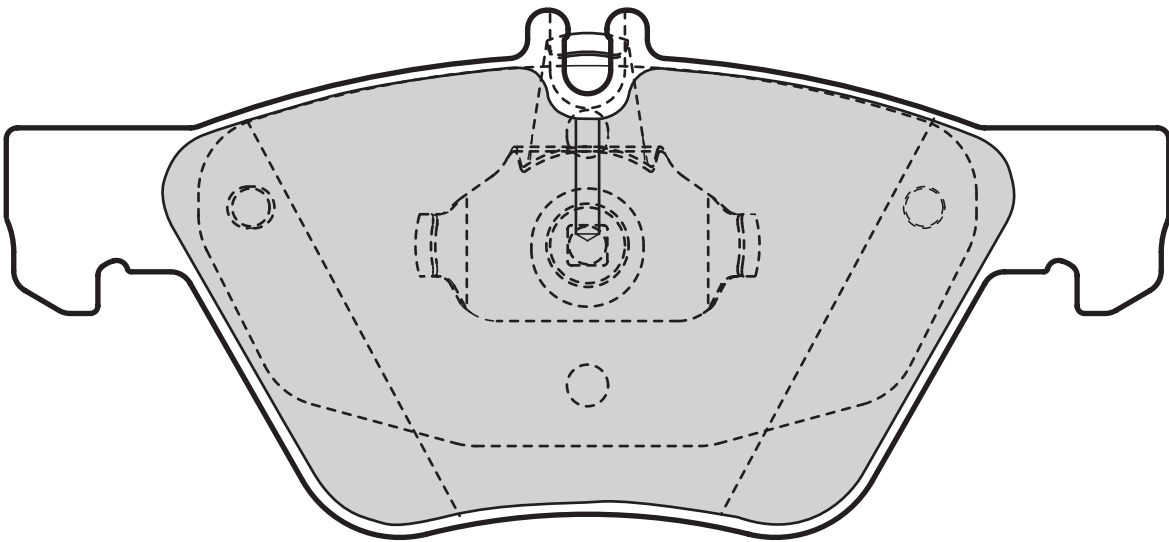
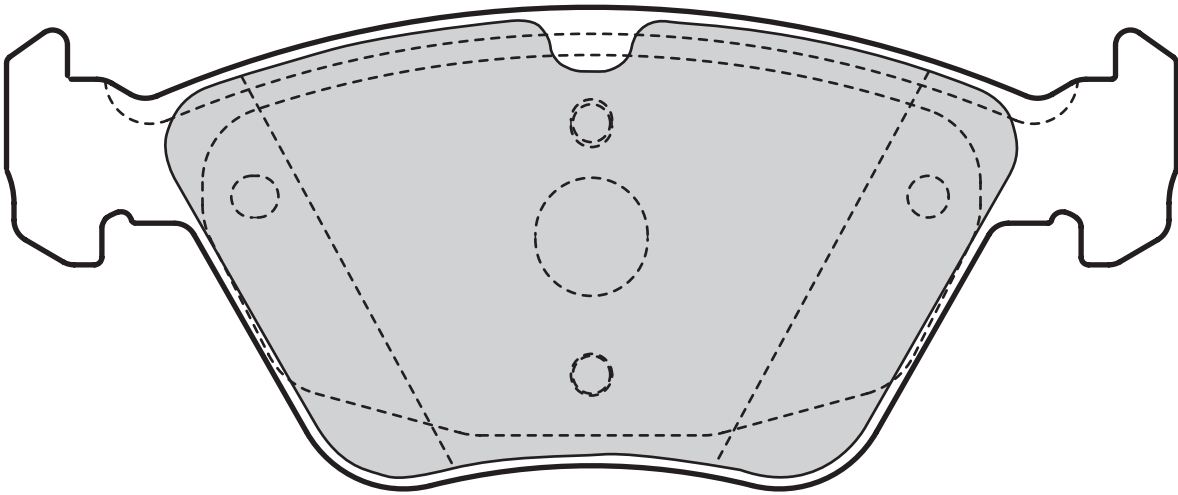

Valeo



598636

0



156,3



69,5



20,3



TEVES



Valeo

21677 (WVA)

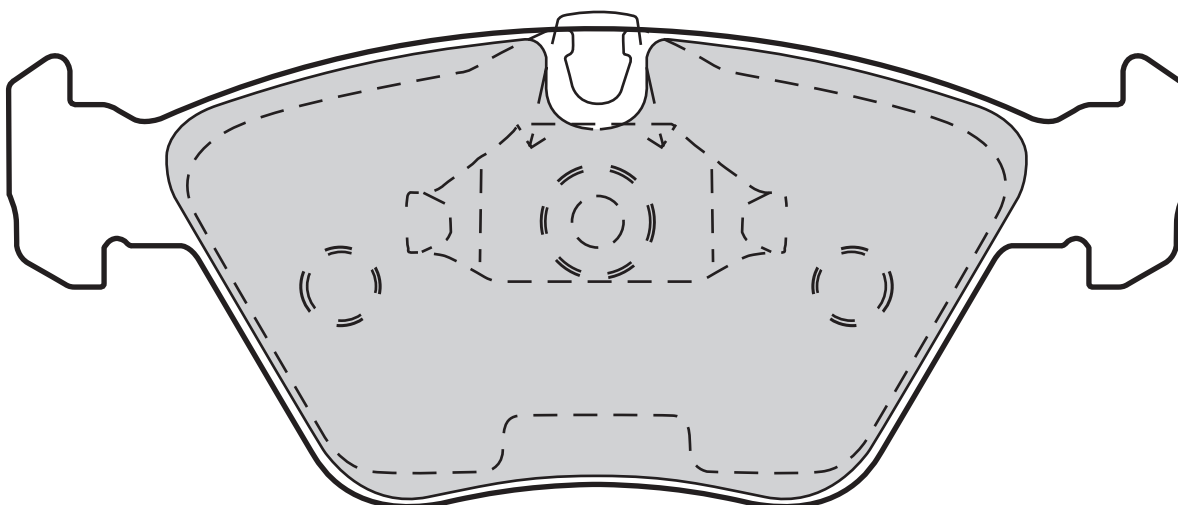

Valeo



598310

0

156,4

64

20,3

TEVES

21691 (WVA)

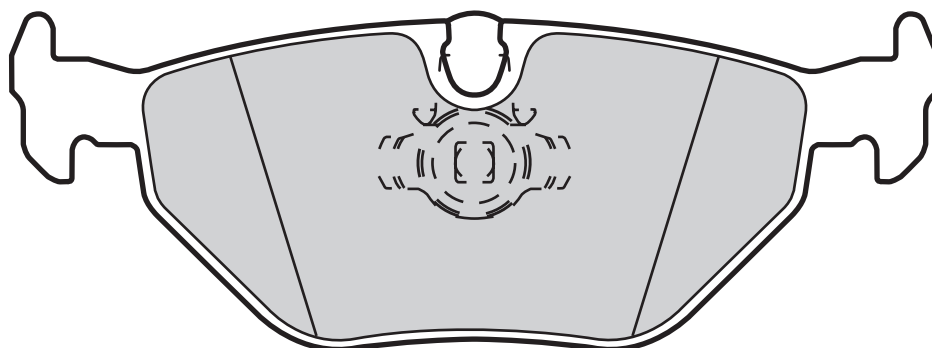

Valeo



598311

0

122

45

17,3

TEVES



21732 (WVA)

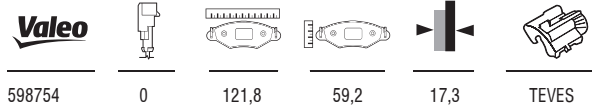
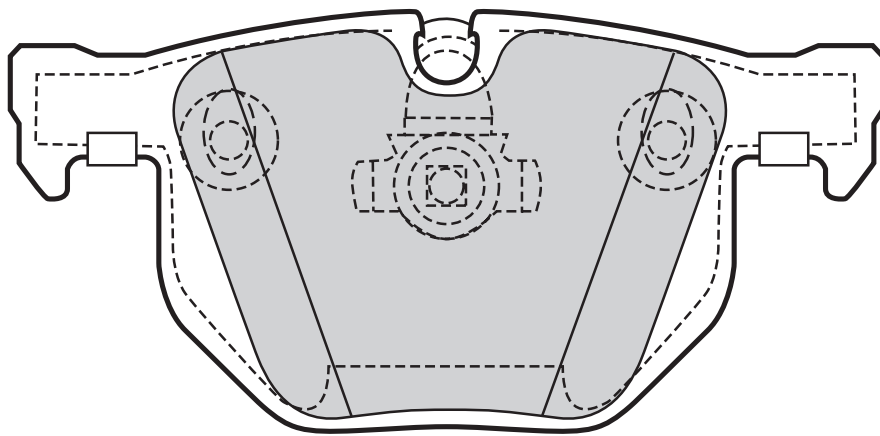
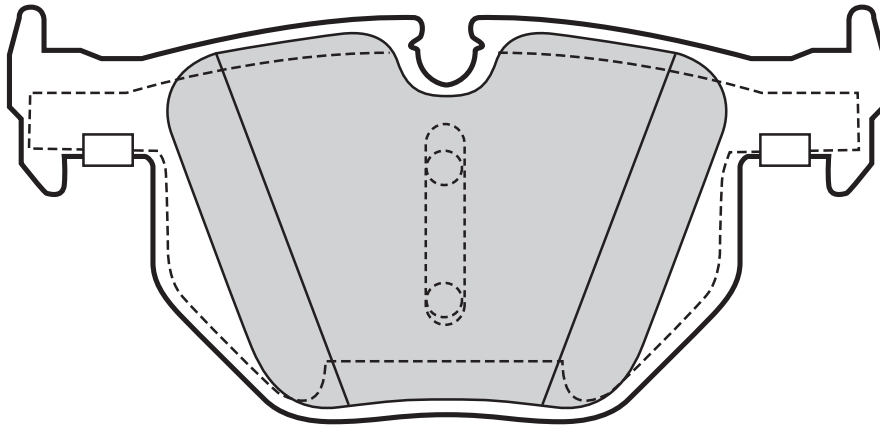

598754 0 121,8 59,2 17,3 TEVES

21792 (WVA)

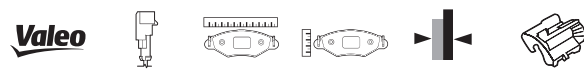
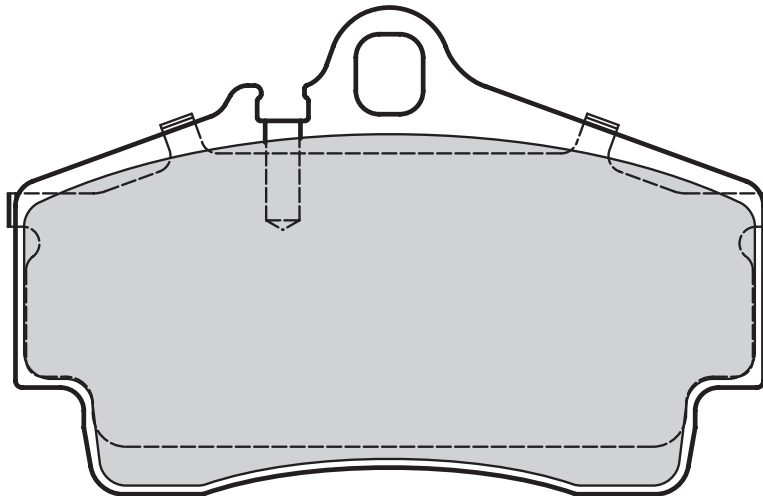

598768 0 112,2 73,2 16 BREMBO



Valeo

21822 (WVA)

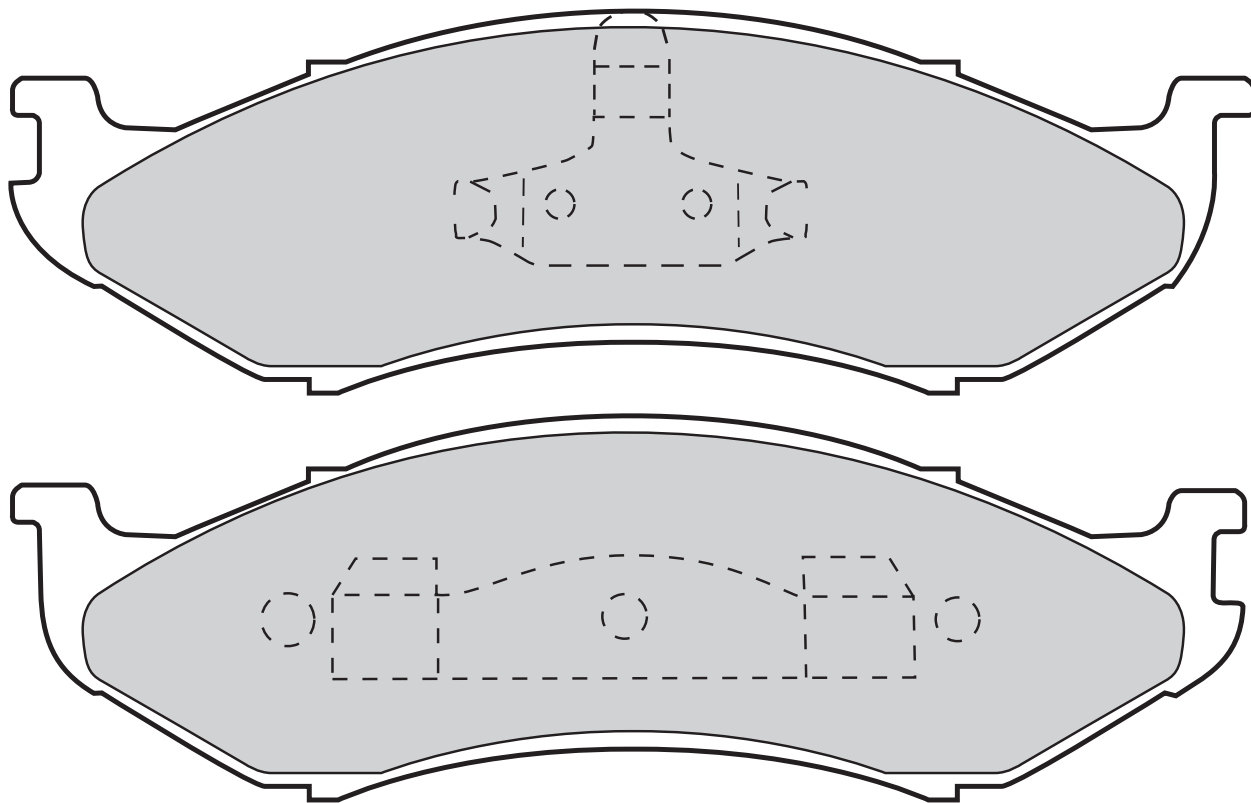

598491	0	177	55	17,1	KELSEY

21829 (WVA)

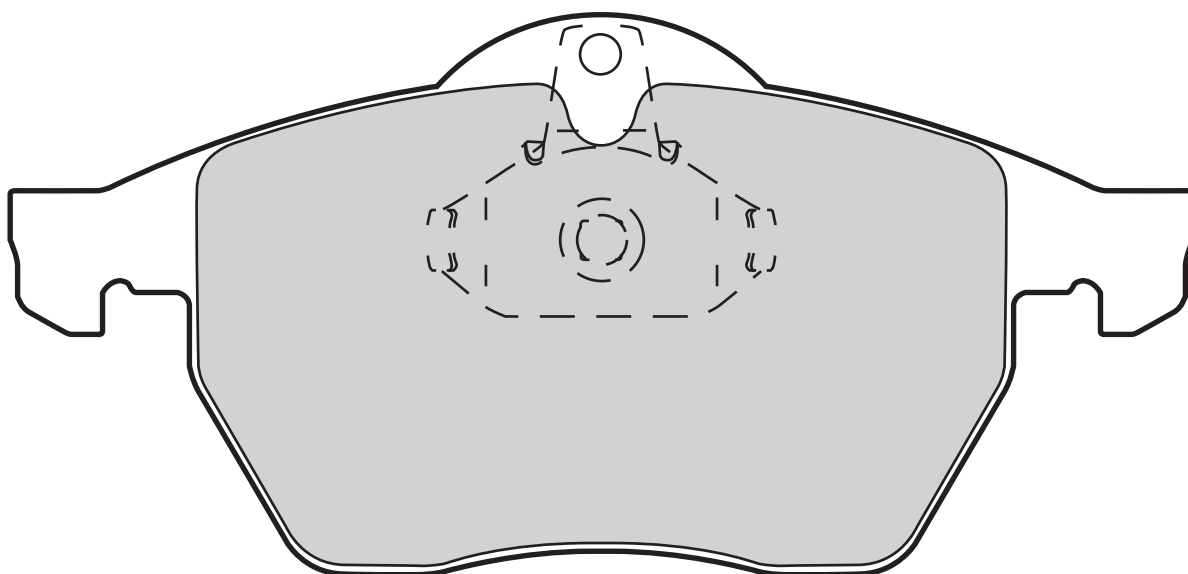

598305	0	156,3	74,2	20,3	TEVES



21861 (WVA)

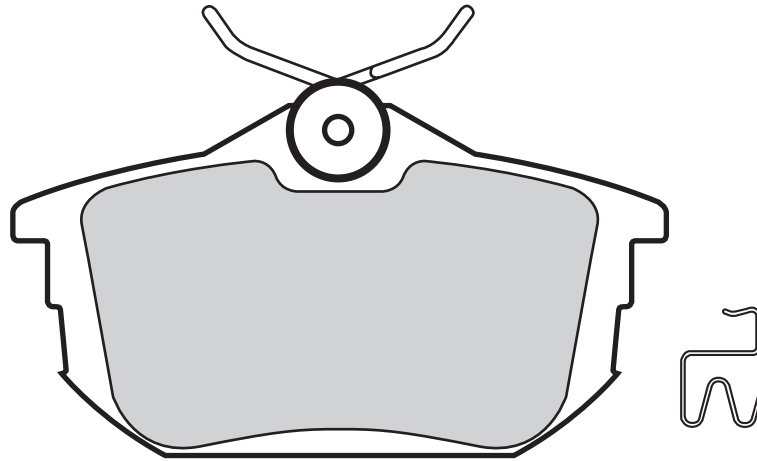

Valeo



598319

2

87,3

47

15,3

LUCAS

21899 (WVA)

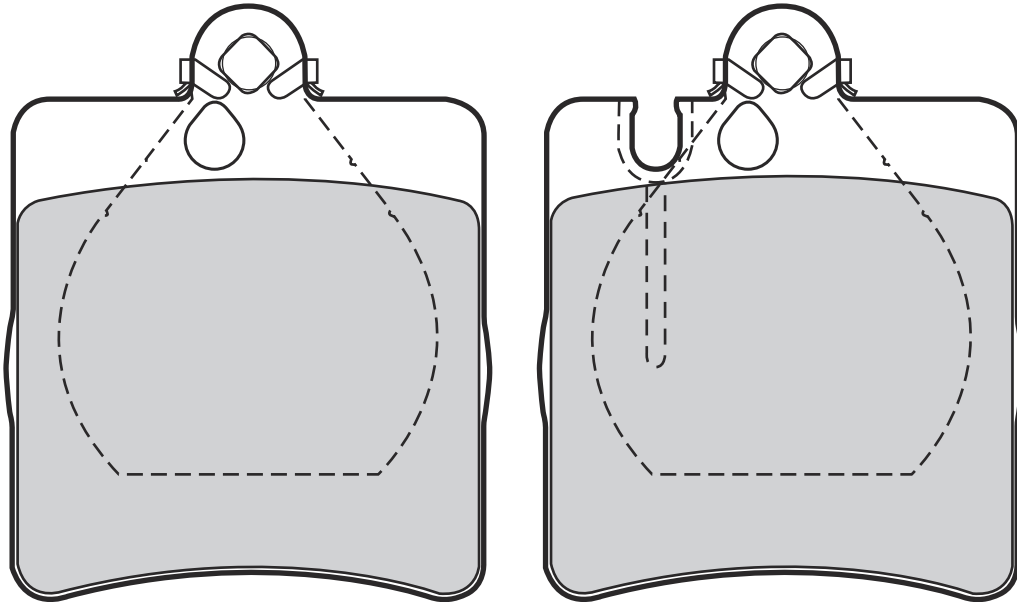

Valeo



598447

0

63,7

78,2

15,3

TEVES



Valeo

21911 (WVA)

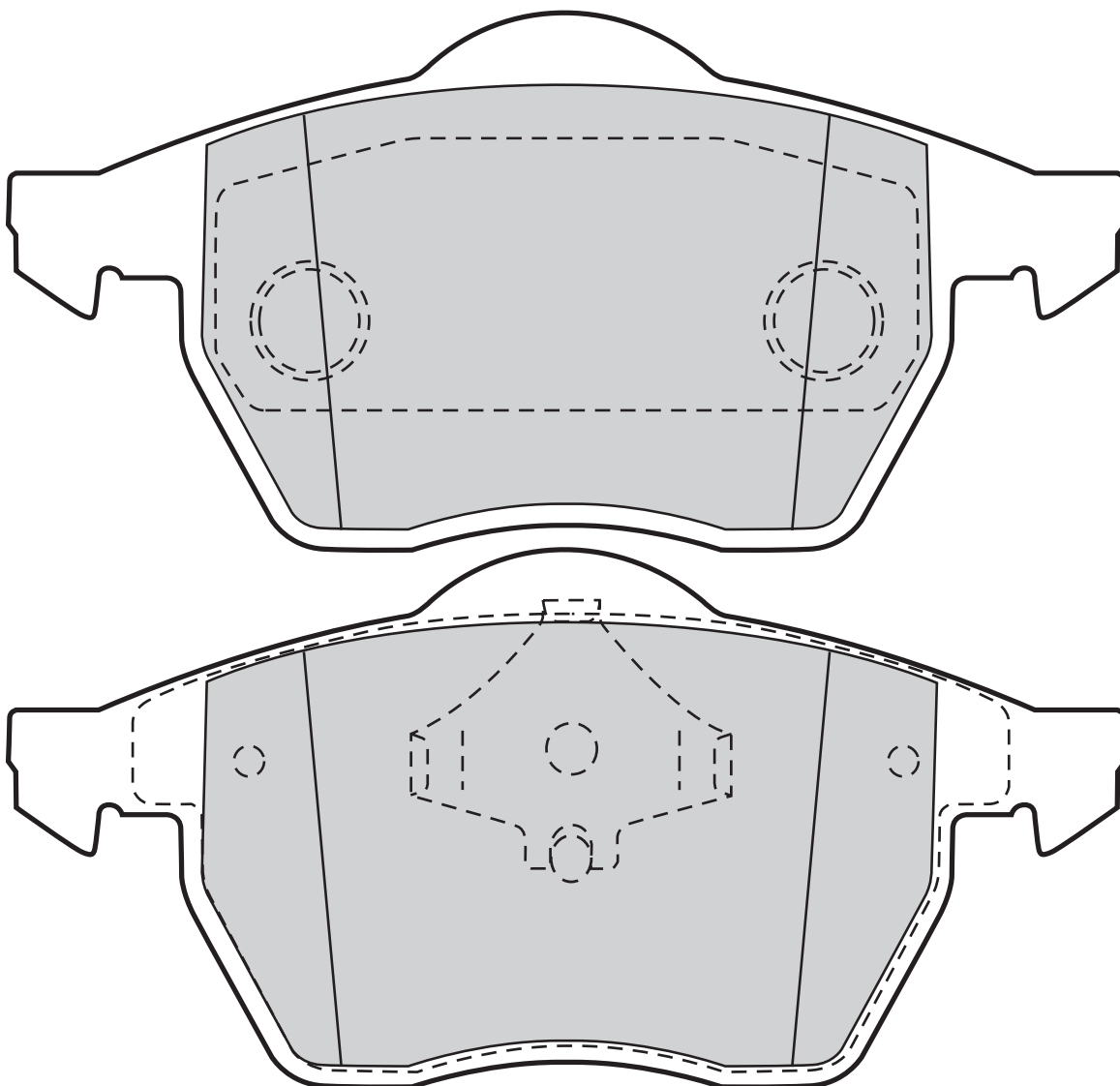

Valeo



598303

0

156,3

74

19,8

TEVES

598486

1

156,4

74,2

20,3

TEVES

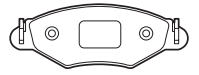

21919 (WVA)

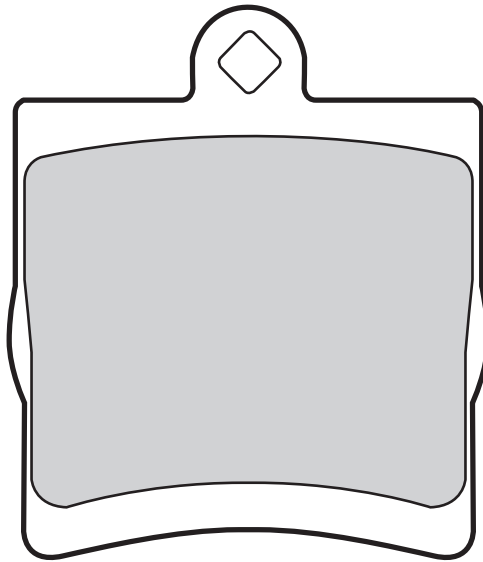

598444	0	63,7	73	15,3	TEVES

21920 (WVA)

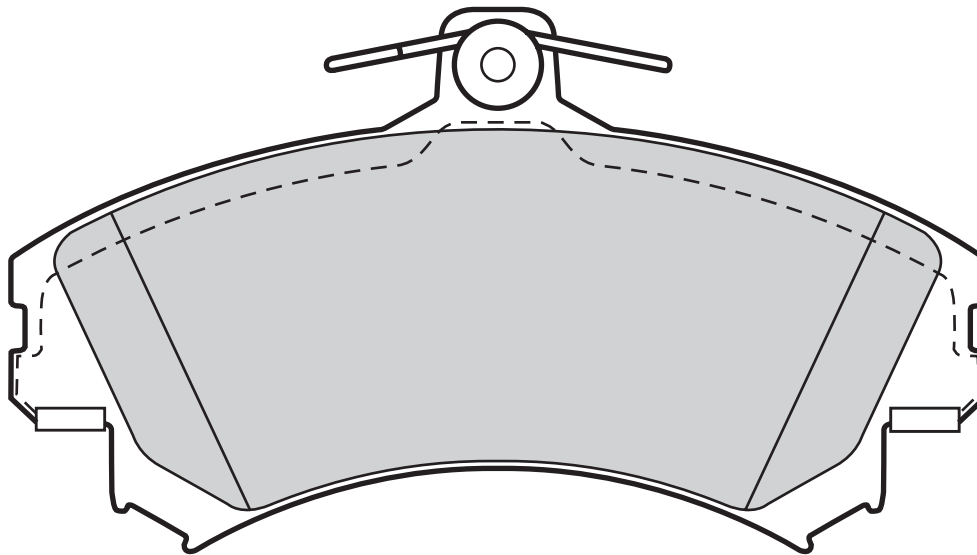

598318	2	130	72,6	15,1	LUCAS



Valeo

21927 (WVA)

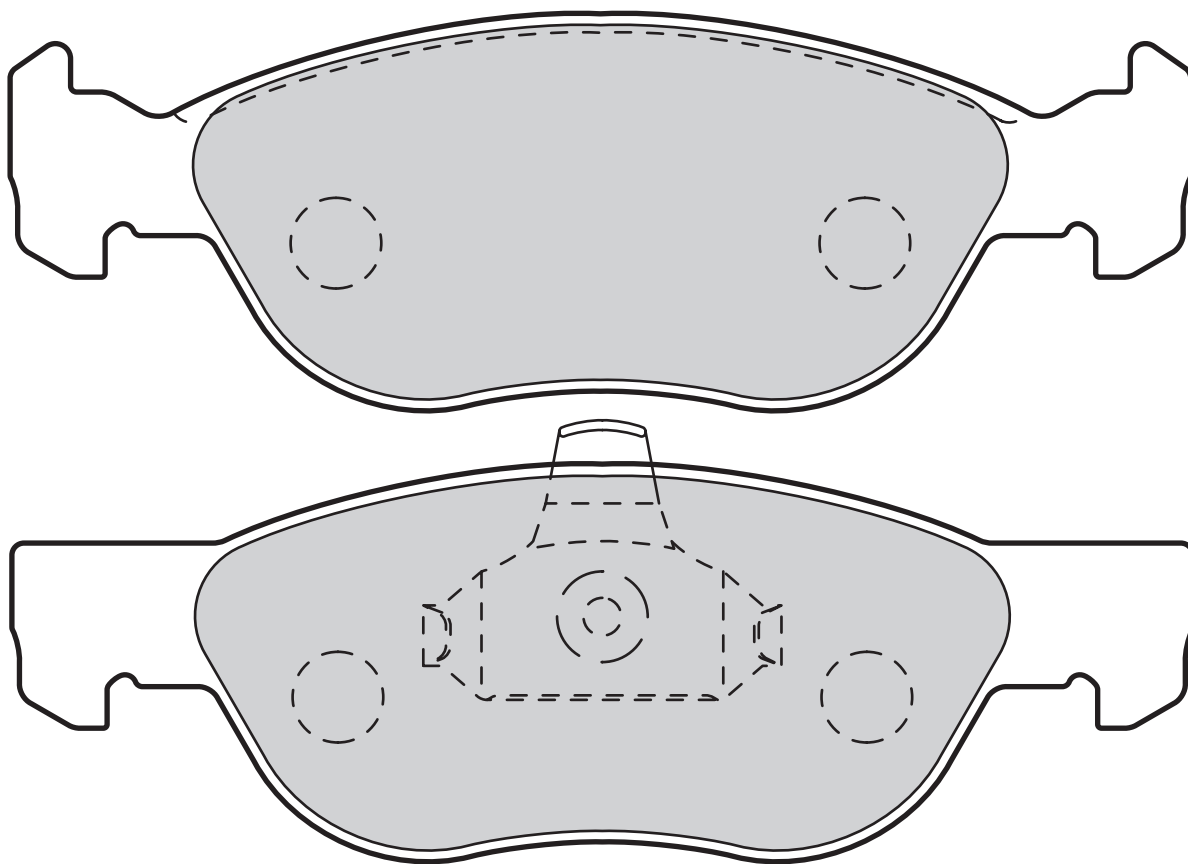

Valeo



601003

0

156,4

52,5

17,9

TEVES



21930 (WVA)

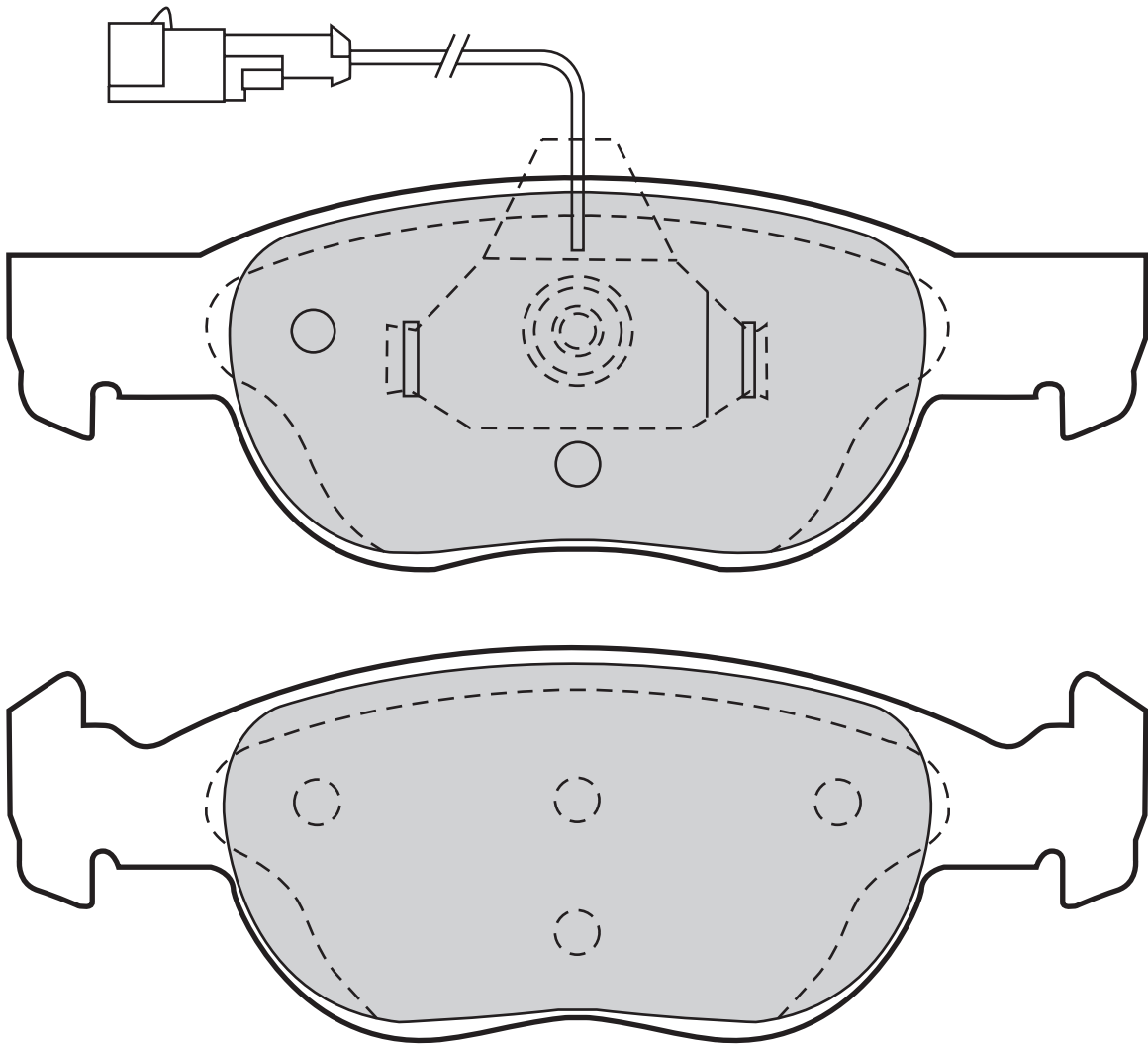

Valeo



598605

0



151,3



52



17,9



TEVES



Valeo

21934 (WVA)

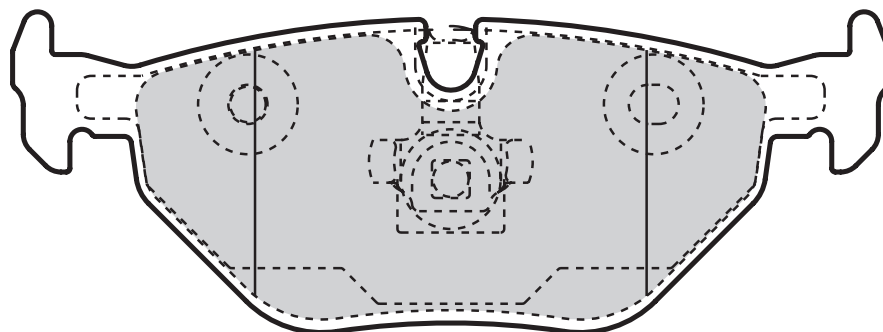
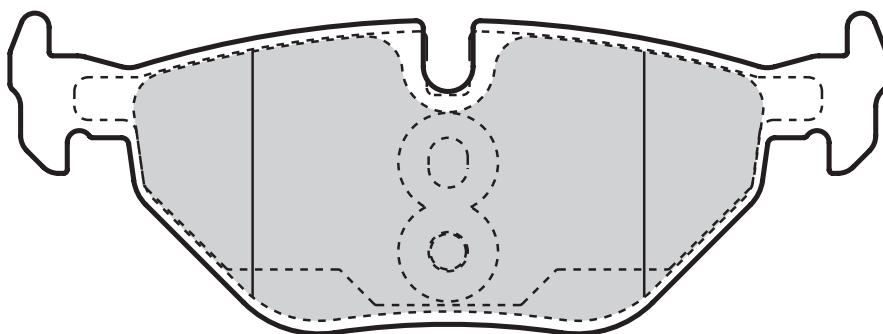

Valeo



598753

0

123

45

17

TEVES

21974 (WVA)

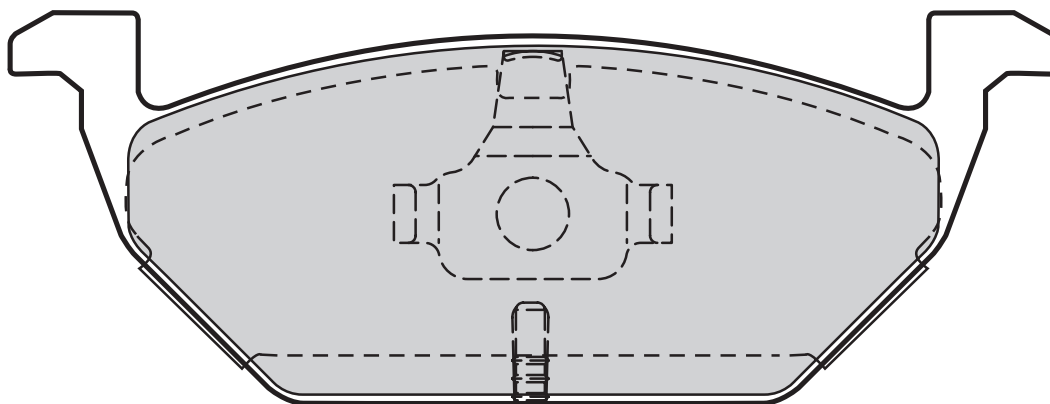

(A)

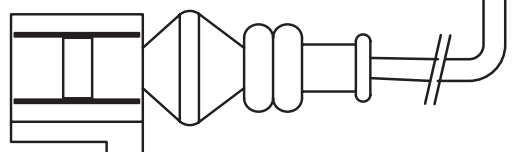

Valeo



598332

0

146

54,7

19,8

TEVES

598408

1

146

54,7

19,3

TEVES

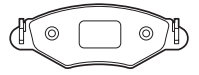

21983 (WVA)

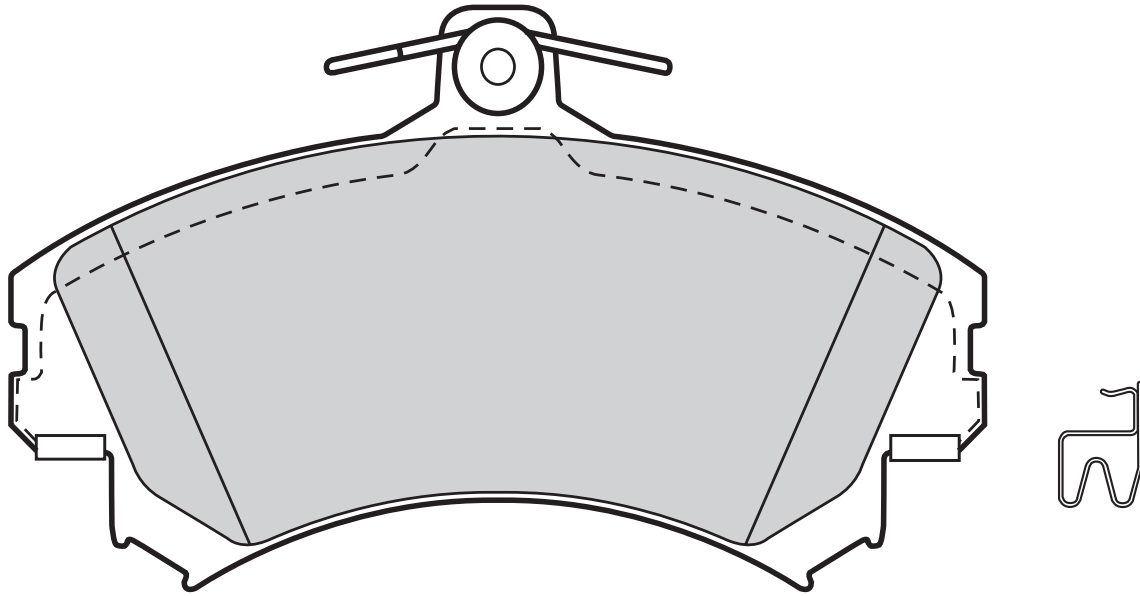

598493	0	130	77	17	LUCAS

23021 (WVA)

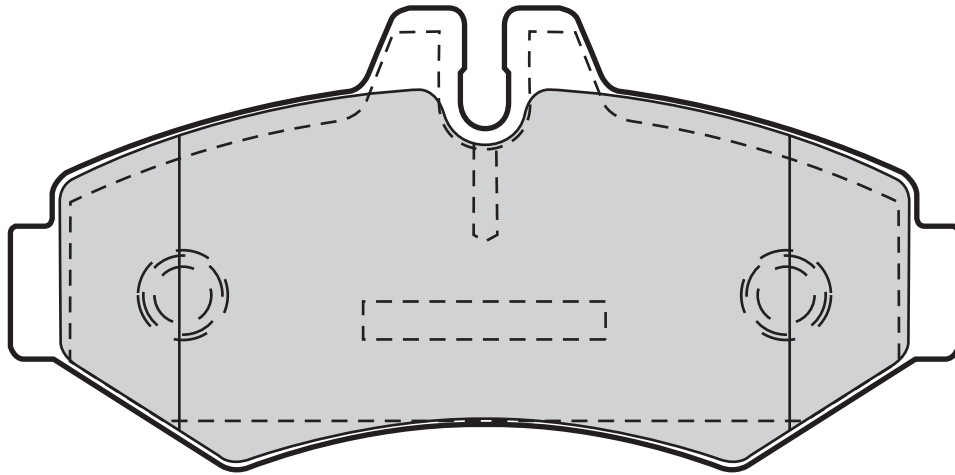

598300	0	125,7	61,8	18,4	BOSCH



Valeo

23063 (WVA)

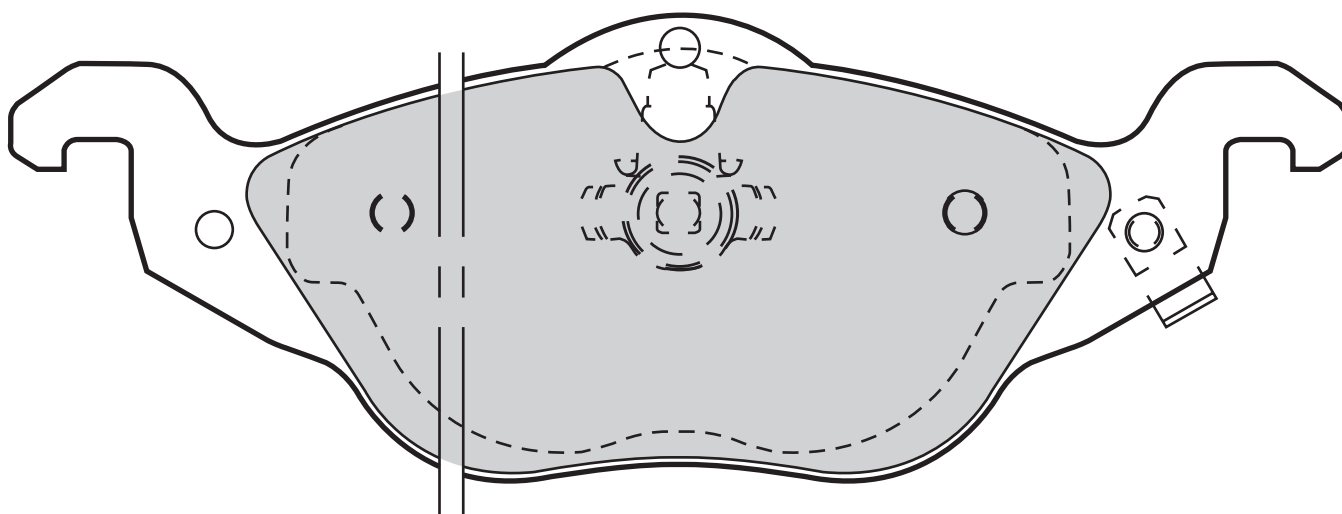
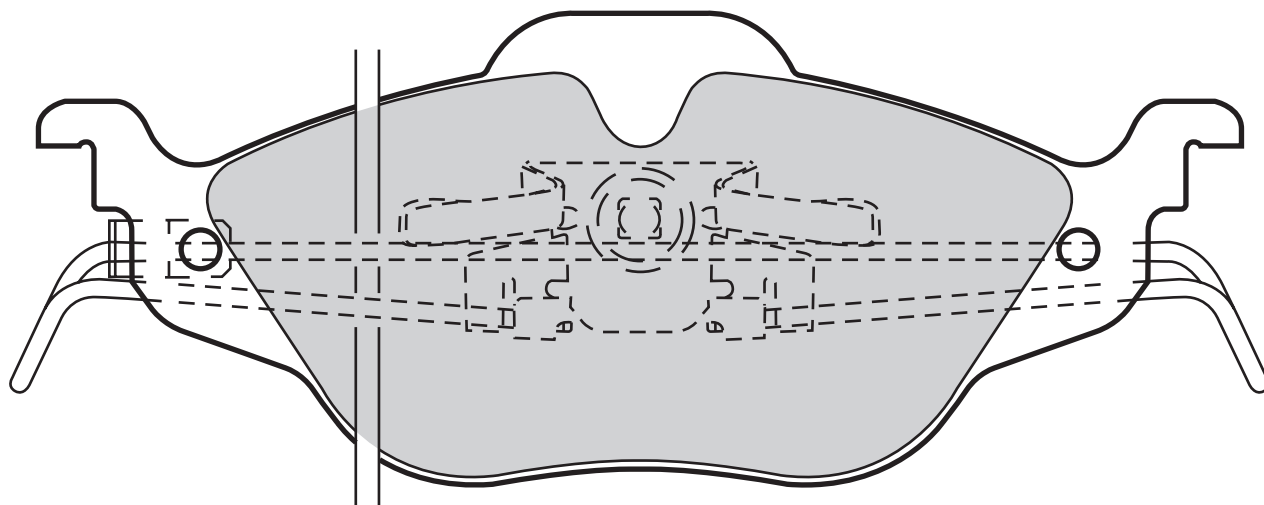

598322	4	160	62,1	18	TEVES



23072 (WVA)

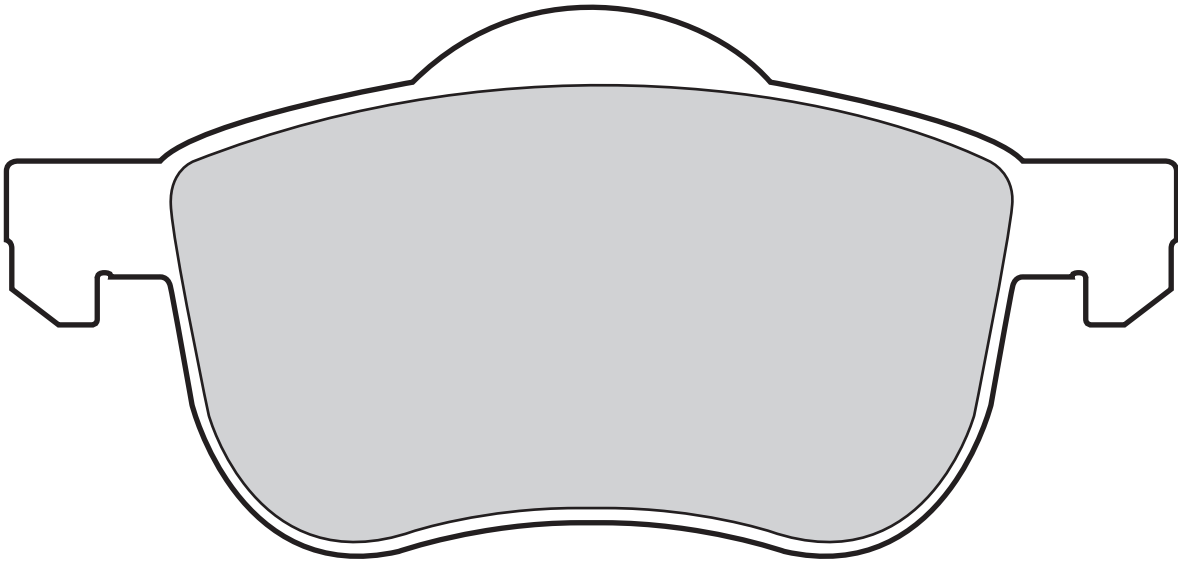

598479



0



155,4



69



18,5



TEVES

23075 (WVA)

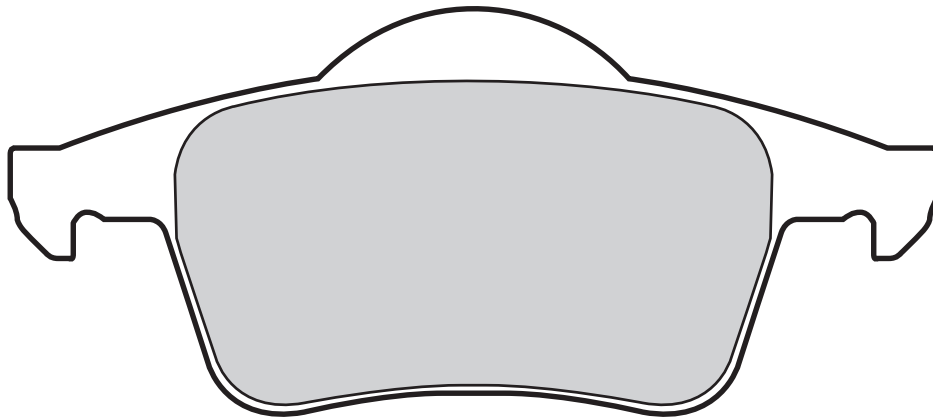

598480



0



122,6



53,8



17



TEVES



Valeo

23078 (WVA)

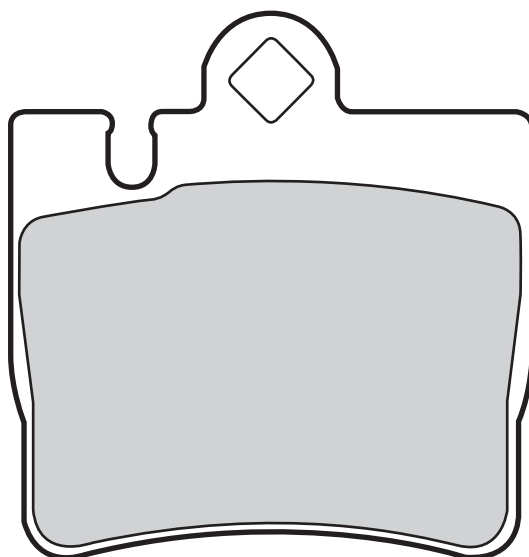

Valeo



598446

0

69

72

16

TEVES

23116 (WVA)

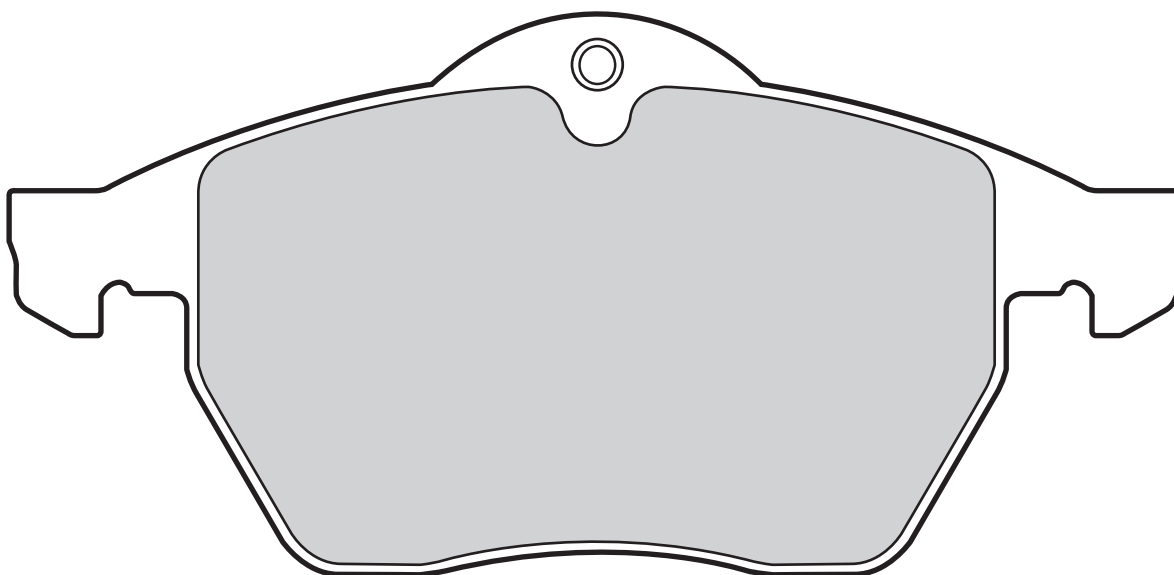

Valeo



598475

2

156,4

74,2

20,3

TEVES



23118 (WVA)

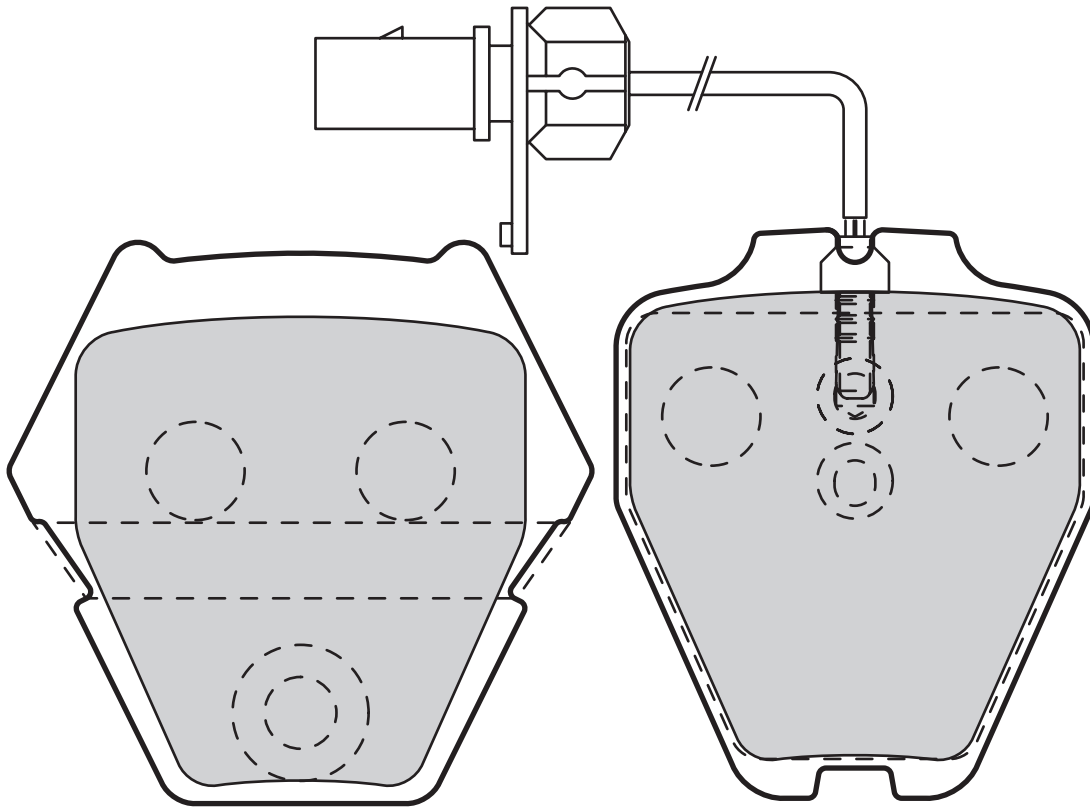

Valeo					
598992	2	63,2	75,2	17,5	LUCAS

23138 (WVA)

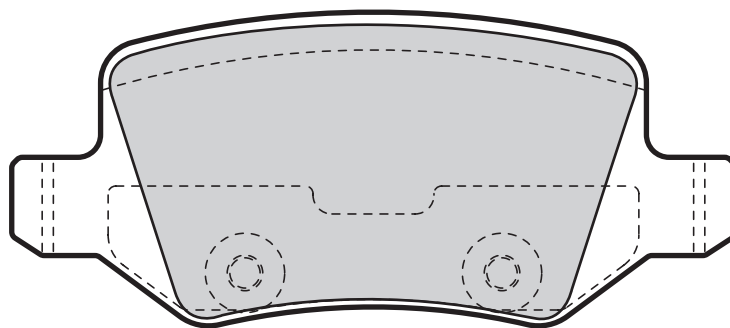

Valeo					
598583	0	95,8	41,5	14,3	LUCAS



Valeo

23144 (WVA)

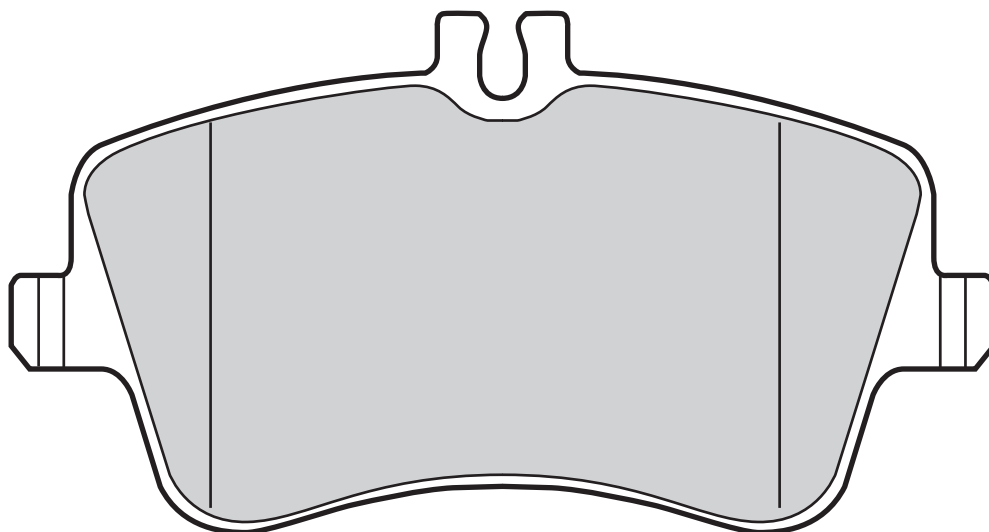

Valeo



598448

0

131,1

69,8

19,5

LUCAS

23157 (WVA)

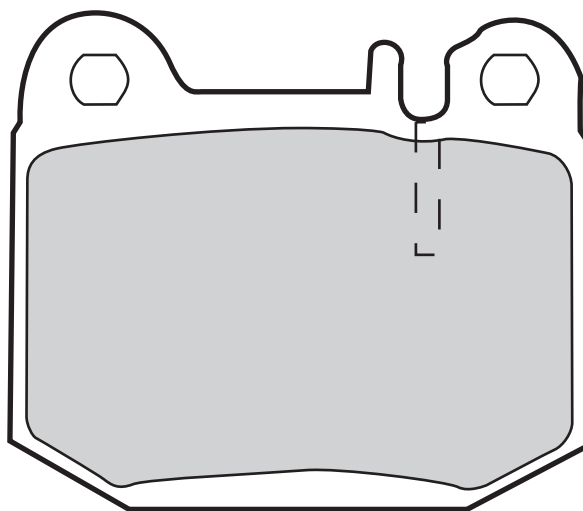

Valeo



598719

0

76,5

65,5

16,8

BREMBO



23183 (WVA)

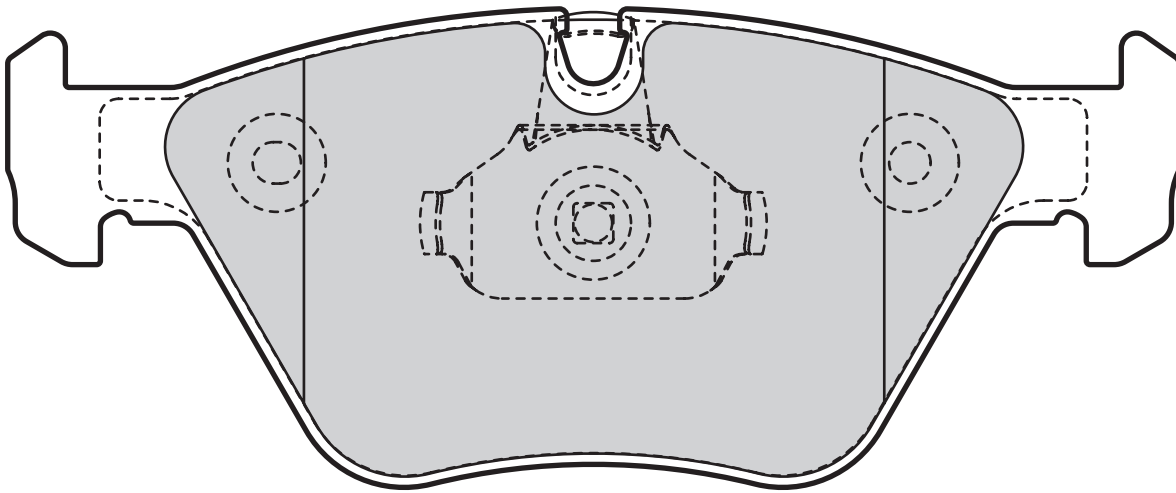
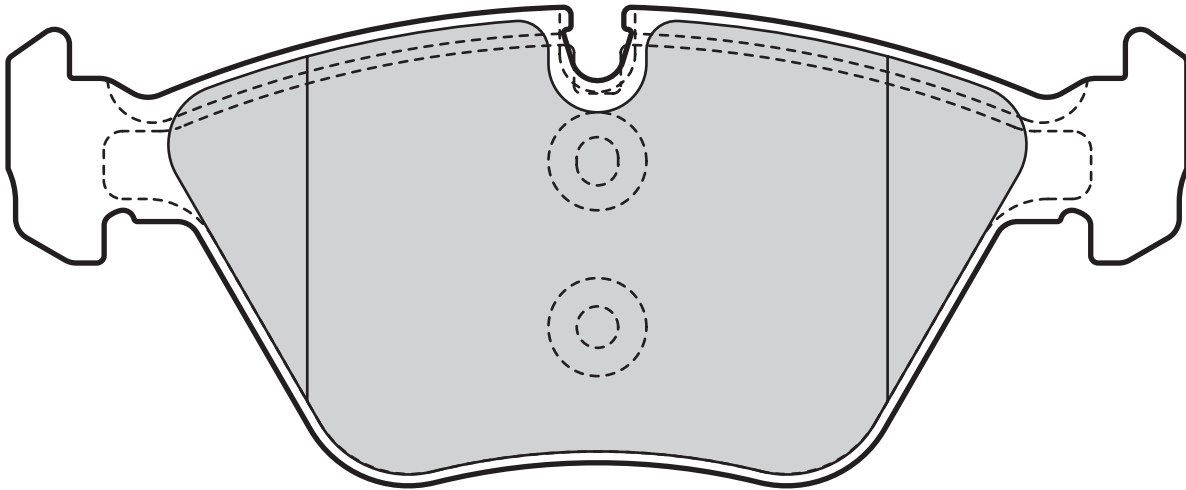

598811

0

156,2

63,5

20,3

TEVES



Valeo

23189 (WVA)

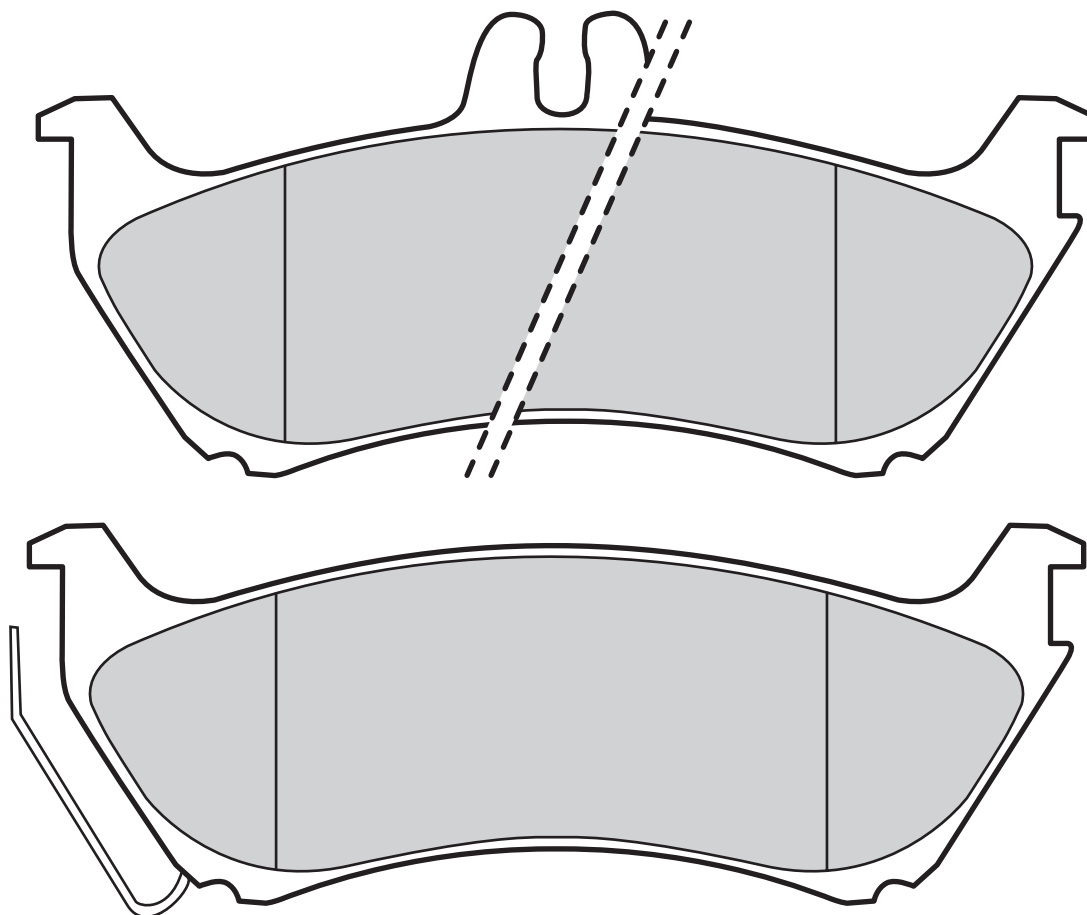

Valeo



598443

1

140,3

50,1

16,6

KELSEY

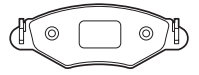

23189 (WVA)

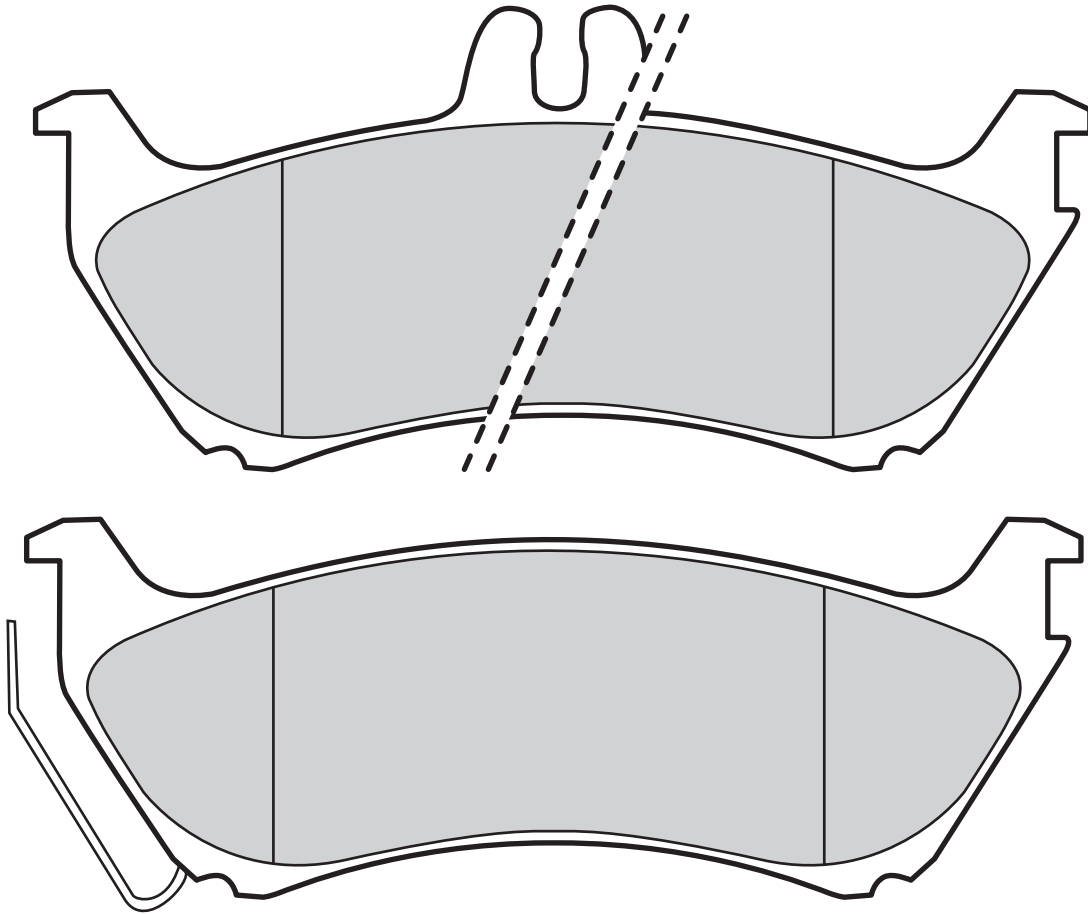

598813	1	140	50/61	16,7	BOSCH

23193 (WVA)

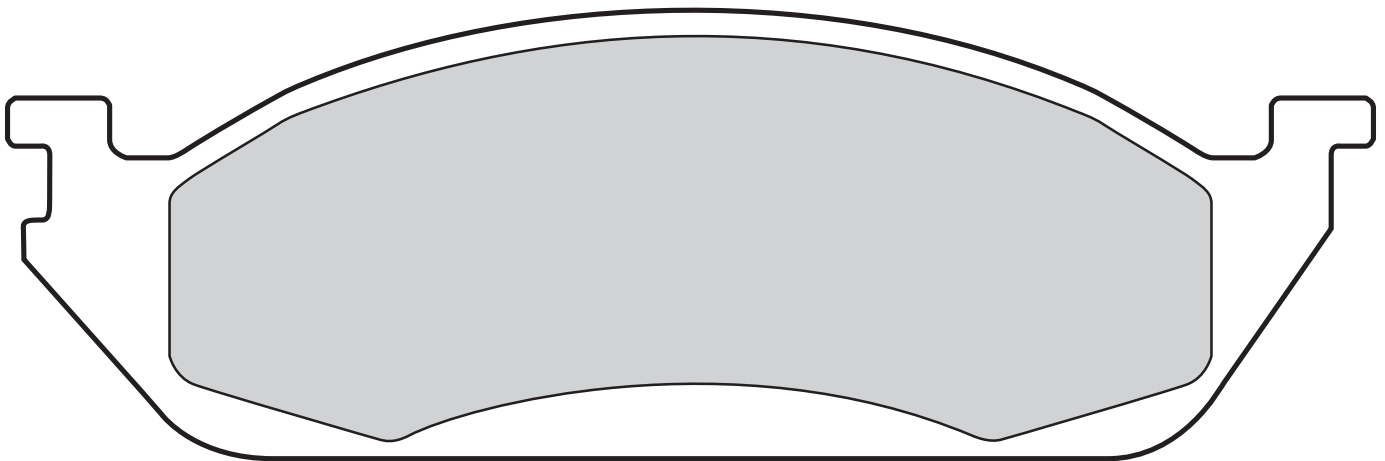

598442	1	188	58,9	17	KELSEY



Valeo

23245 (WVA)

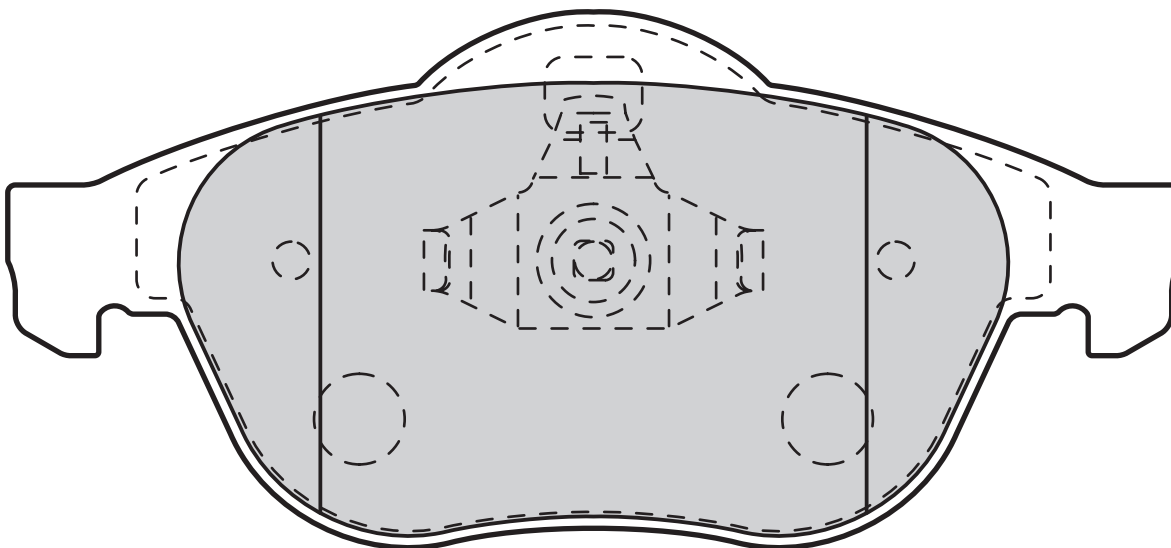
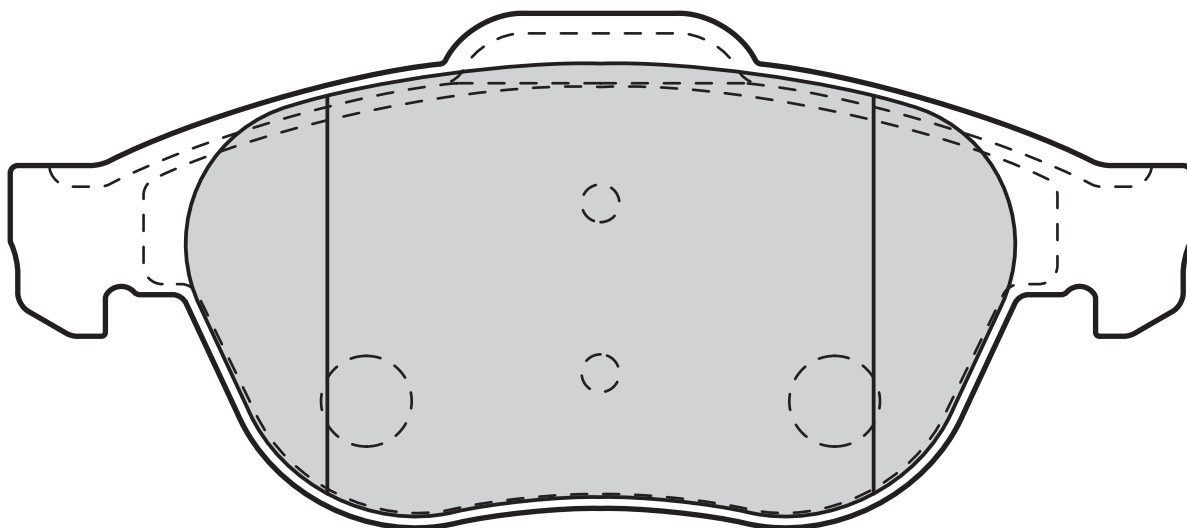

Valeo



598993

0

155,2

71

18,3

TEVES

23258 (WVA)

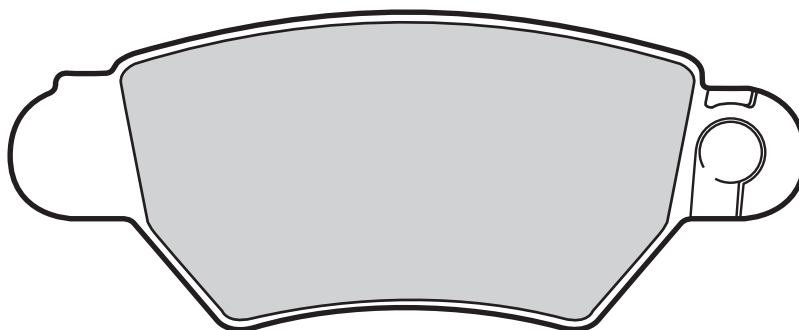

Valeo



598926

2(A)

105

42,7

17

BOSCH

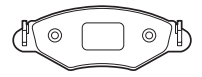

23271 (WVA)

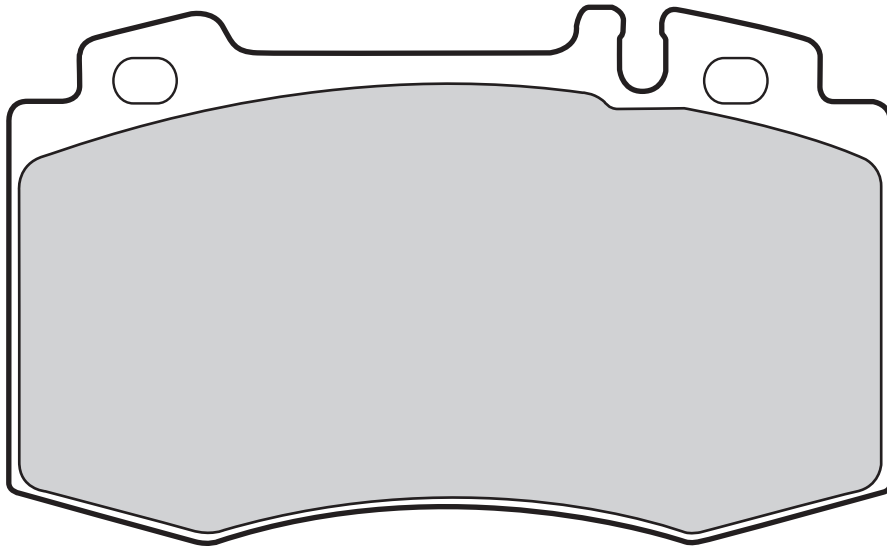

598445	0	117,8	71,6	17,2	BREMBO

23273 (WVA)

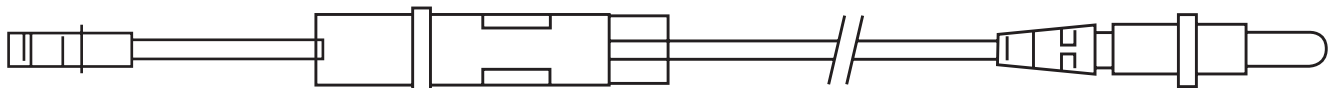
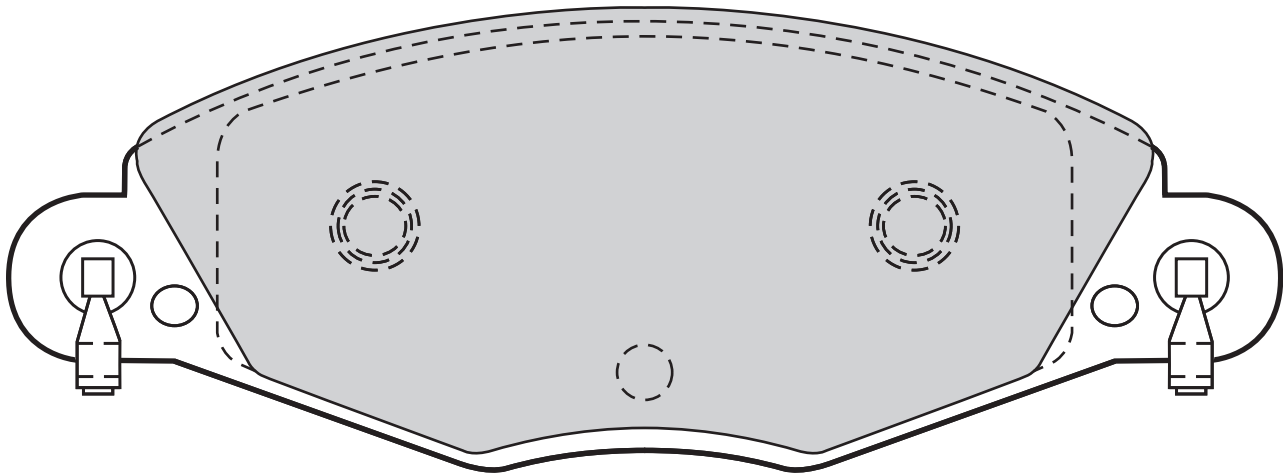

598416	4	168,8	61,3	17,8	BOSCH



Valeo

23277 (WVA)

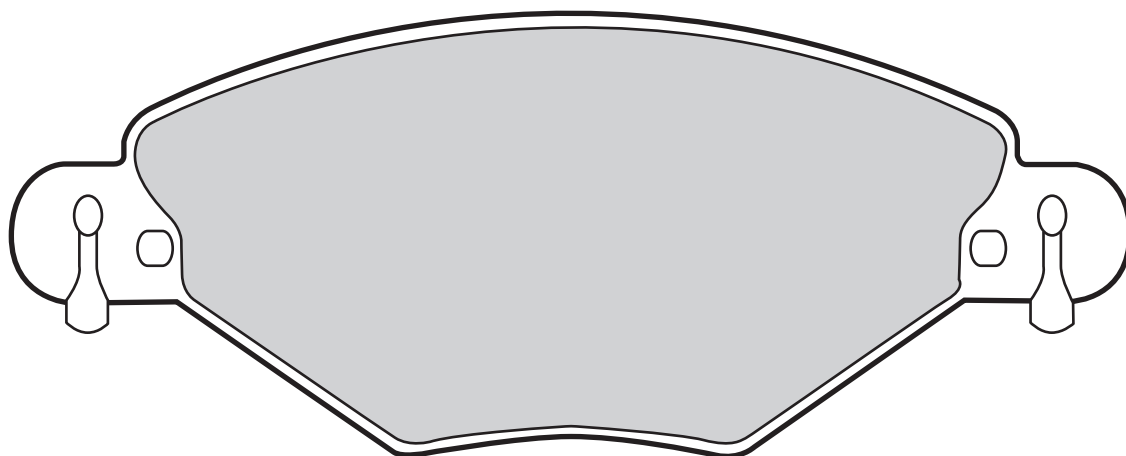

Valeo



598419

4

148,8

59

17,8

BOSCH

23279 (WVA)

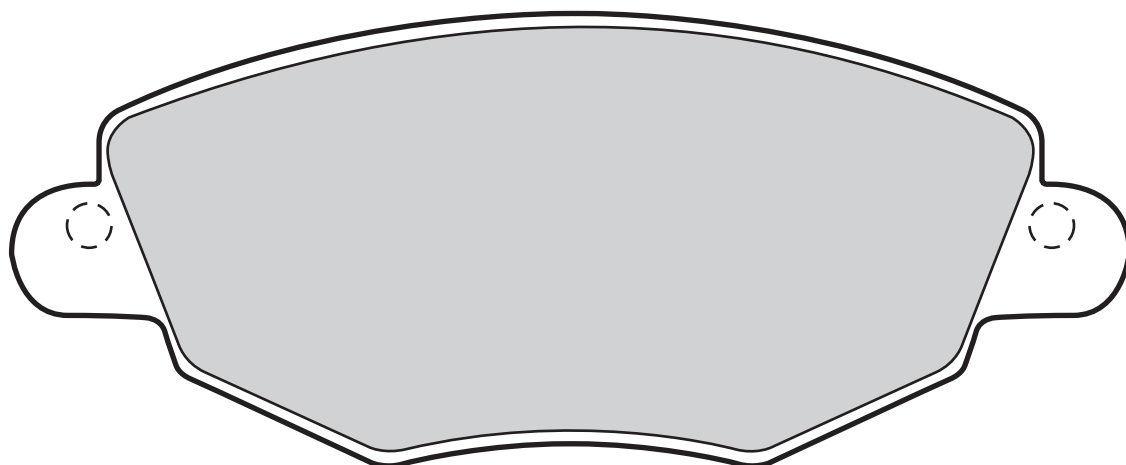

Valeo



598433

0

149

60,5

18

BOSCH

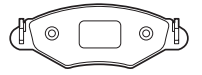

23305 (WVA)

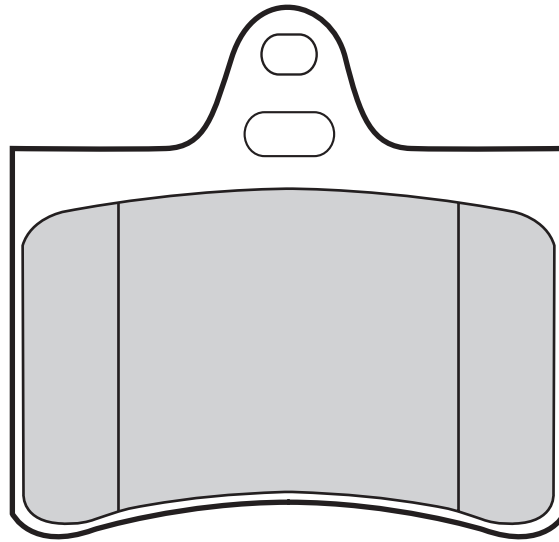

598418	0	73	70,8	15,2	CITROEN

23312 (WVA)

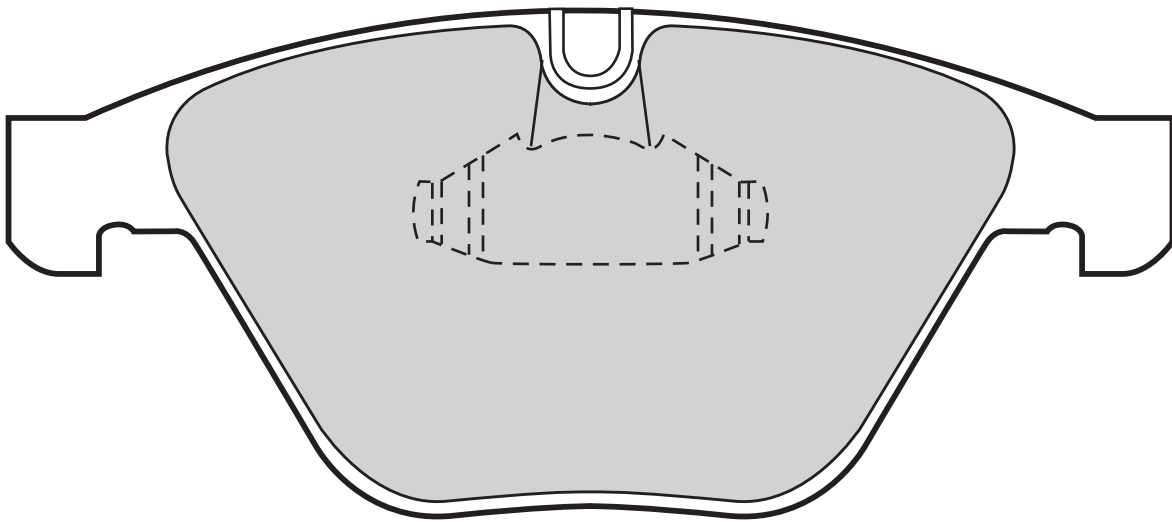

598410	0	155,3	68,5	19,8	TEVES



Valeo

23313 (WVA)

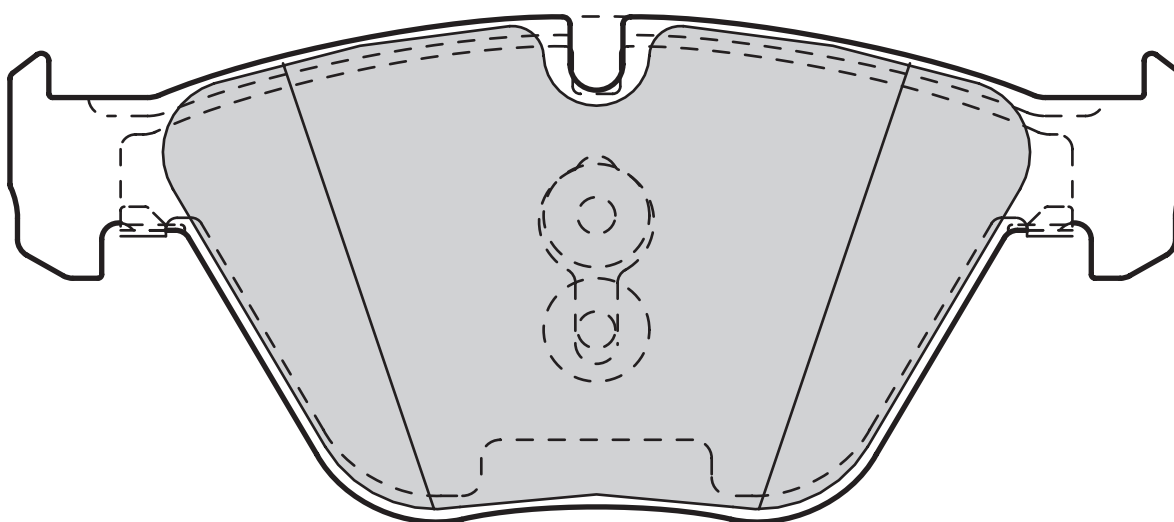
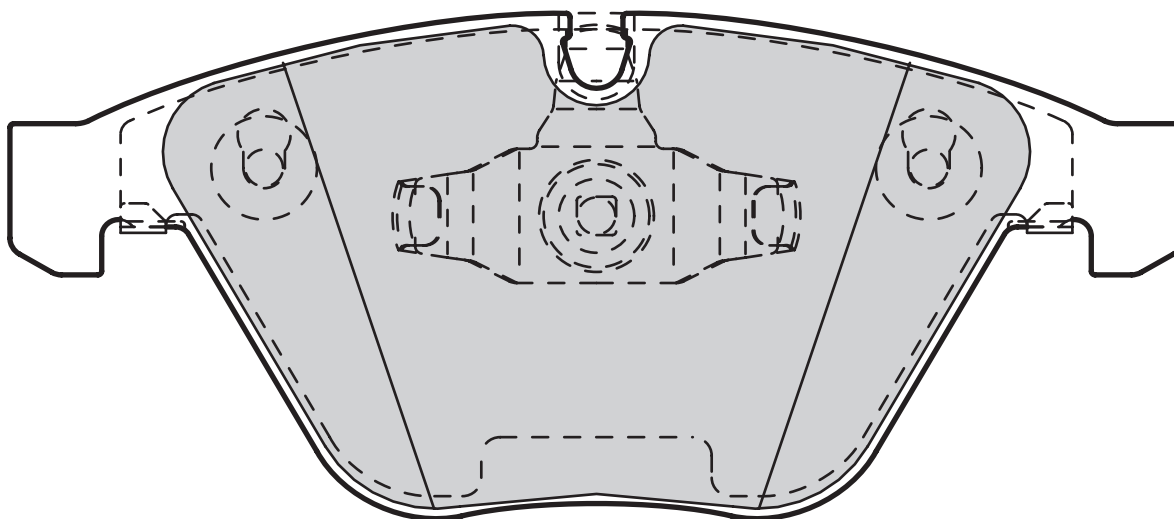

Valeo



601027

0

155,3

68,5

19,8

TEVES

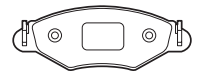

23326 (WVA)

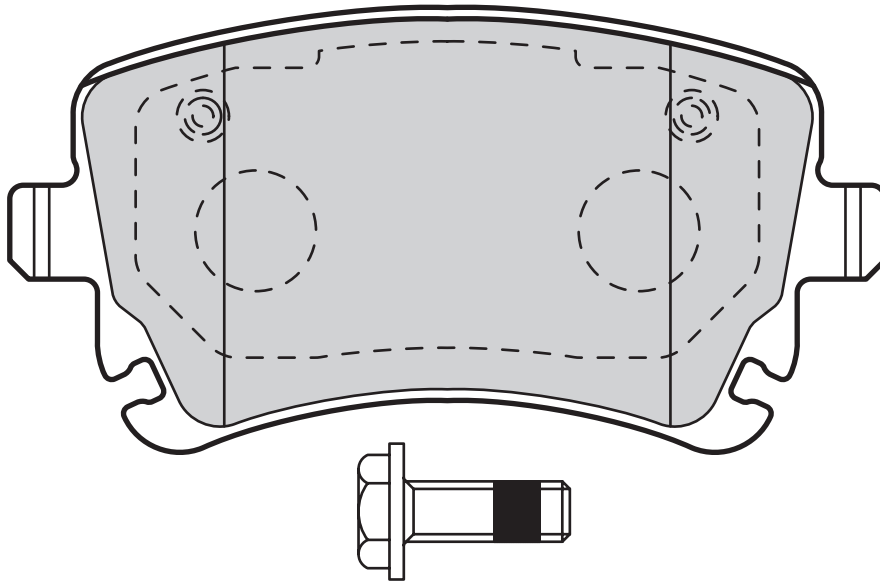

601004	0	115,95	58,92	17,4	LUCAS

23329 (WVA)

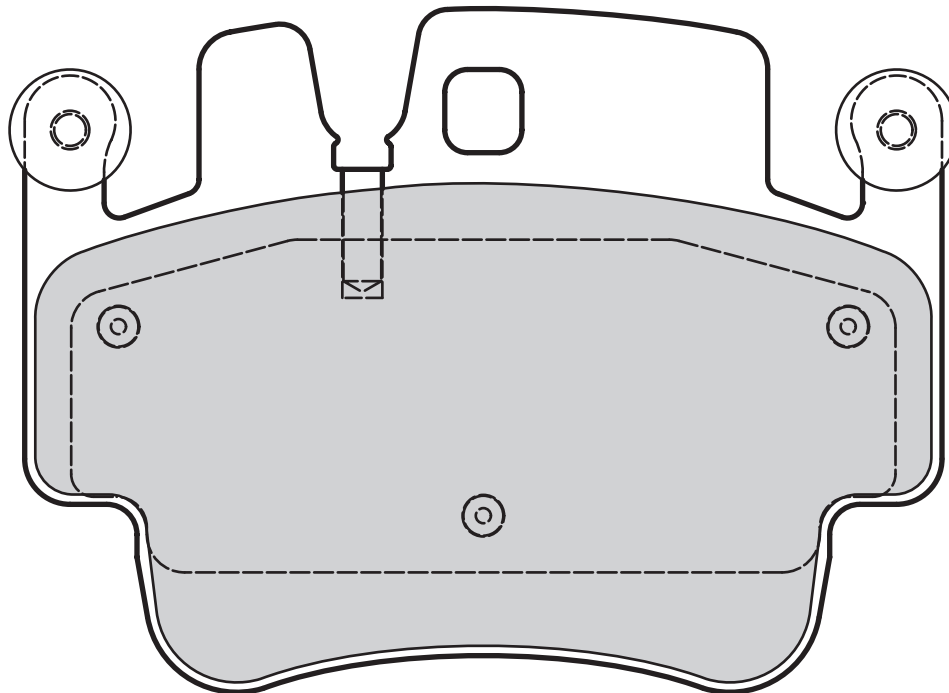

598767	0	125	90,2	17	BREMBO



Valeo

23334 (WVA)

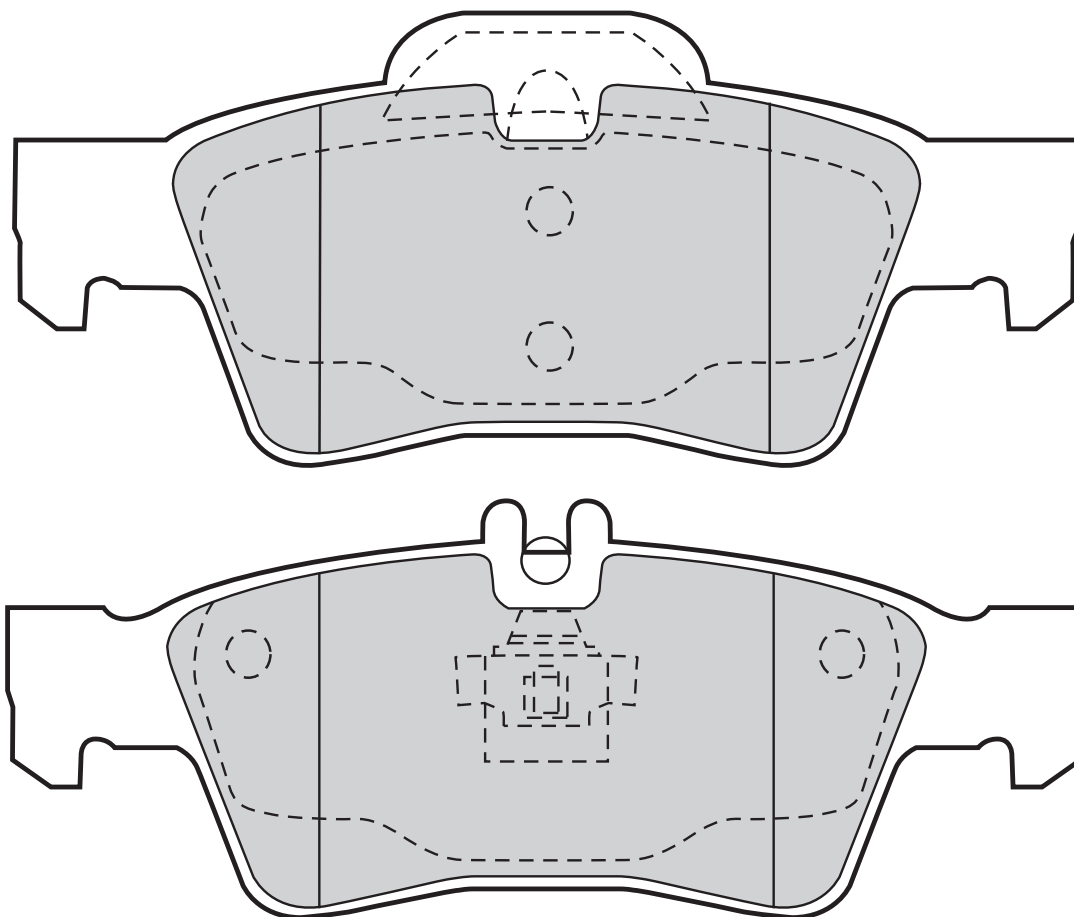

Valeo



598637

0

141,5

57,5

16,5

TEVES



23347 (WVA)

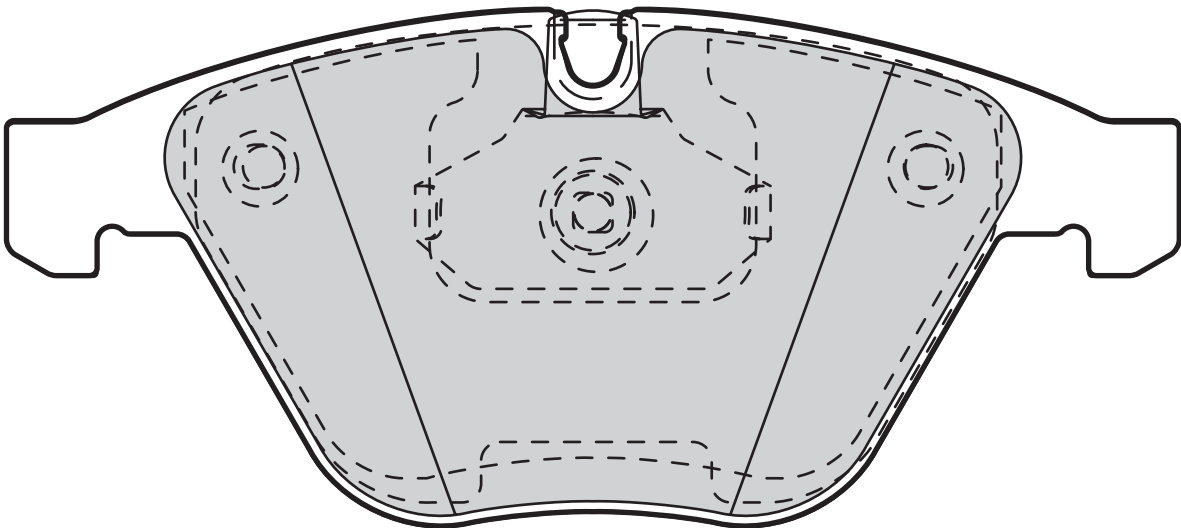
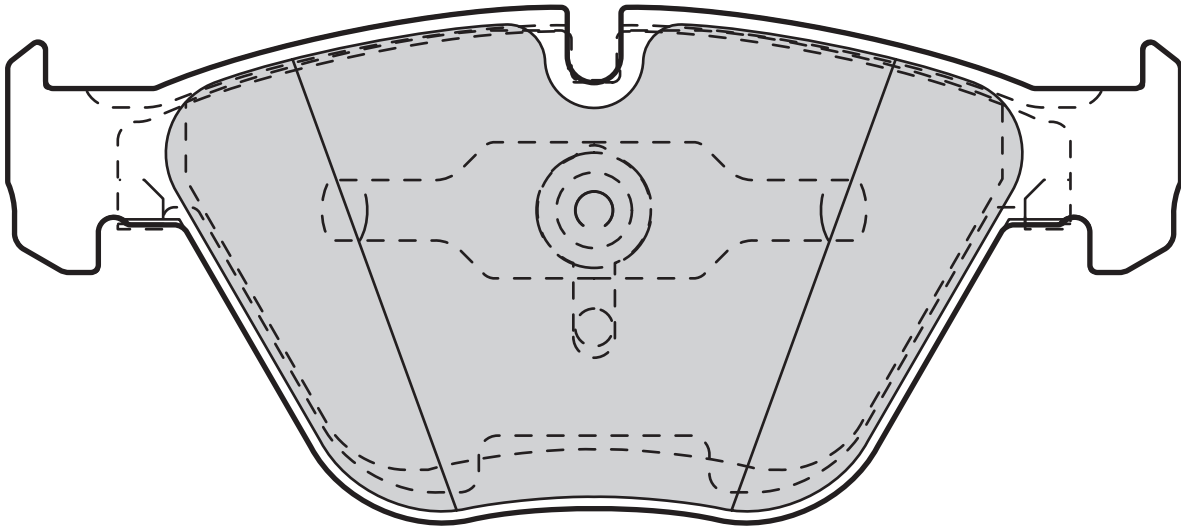

598898

0

155

68,27

20

TEVES



Valeo

23349 (WVA)

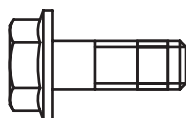
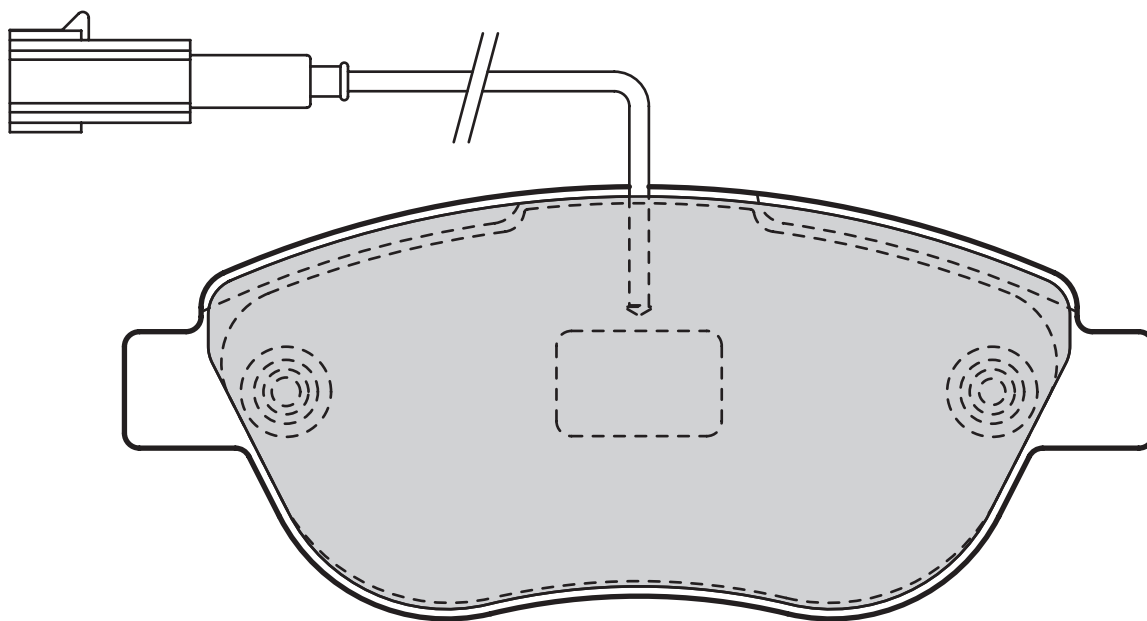

Valeo



598721

1

137

57,4

19

BOSCH

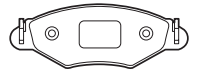

23399 (WVA)

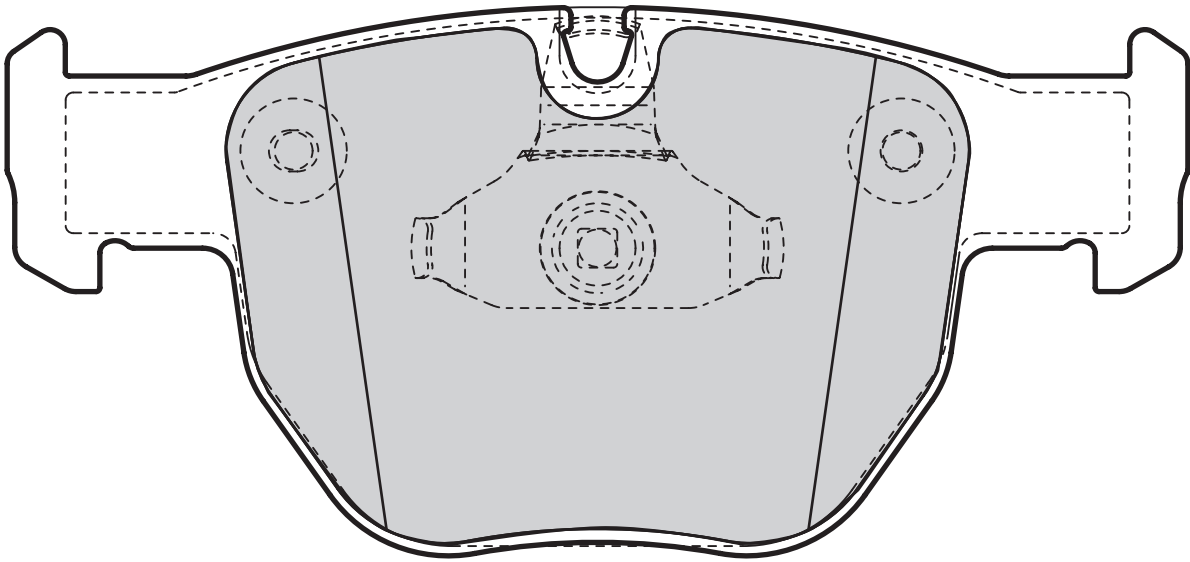
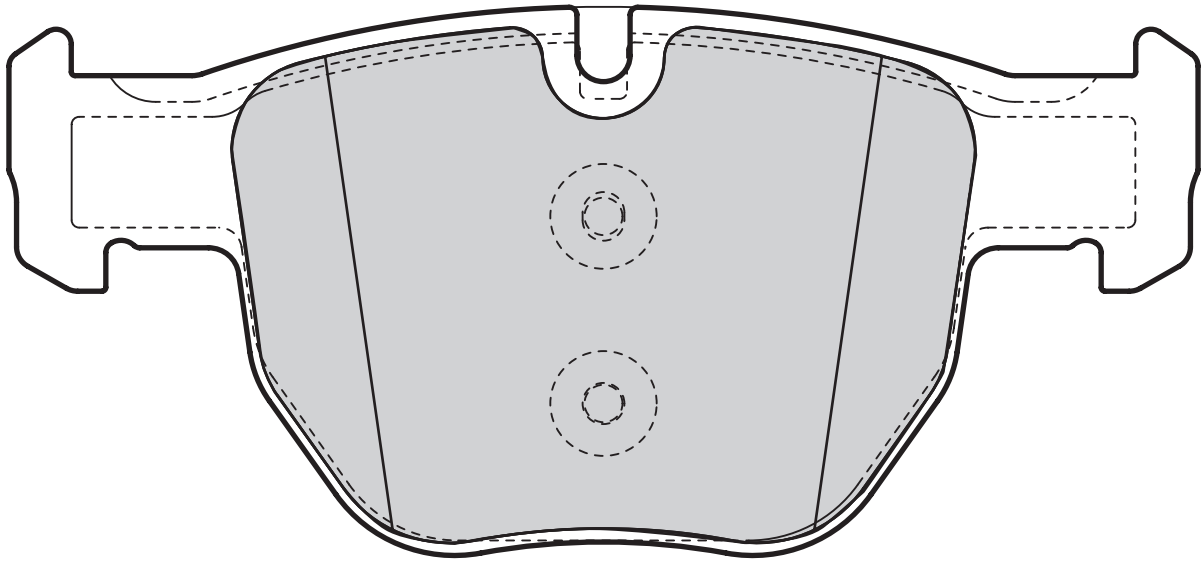

598658



0



156,3



73,5



19,4



TEVES



Valeo

23402 (WVA)

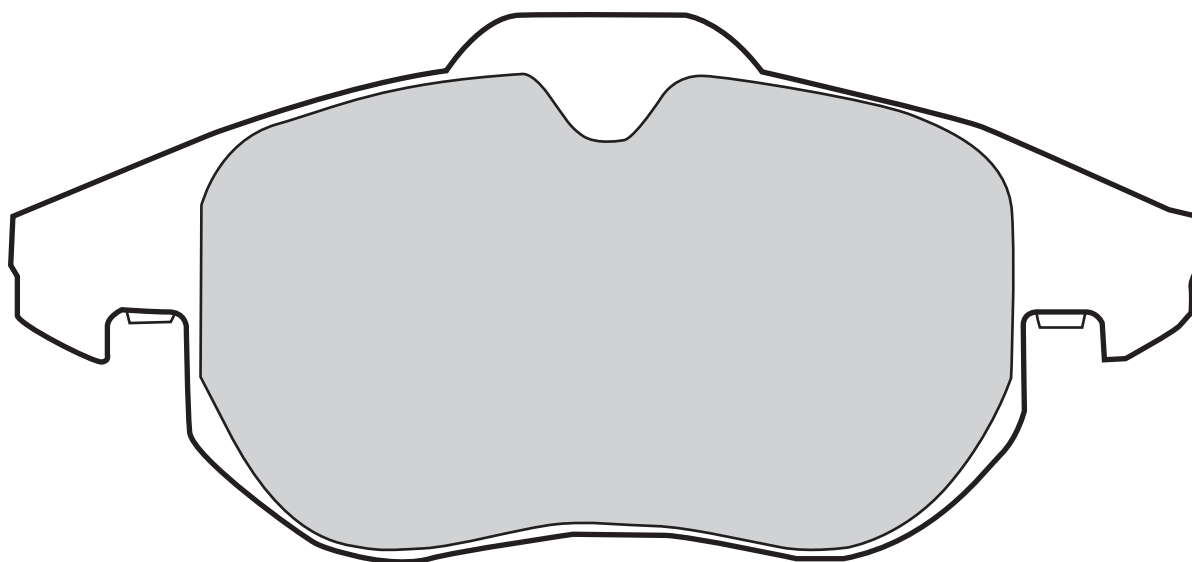
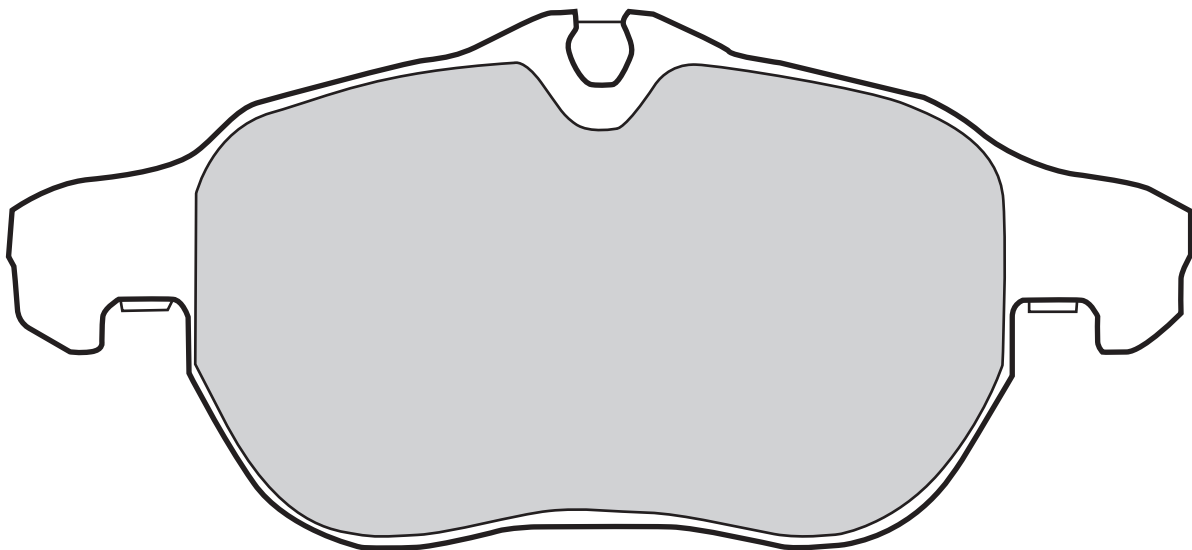

Valeo



598678

0

156,5

71

20,3

TEVES

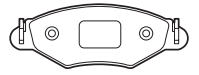

23409 (WVA)

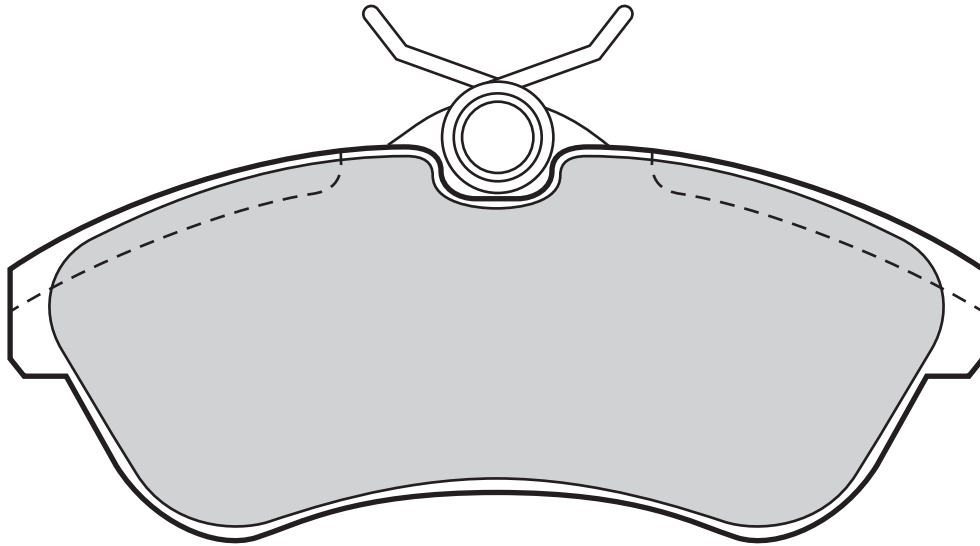

Valeo					
598501	0	129	56,2	19,3	LUCAS

23417 (WVA)

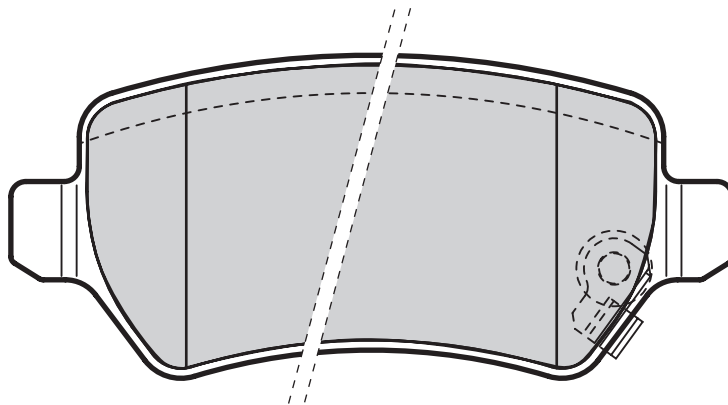

Valeo					
598584	2	95,5	42,7	15,2	LUCAS



Valeo

23423 (WVA)

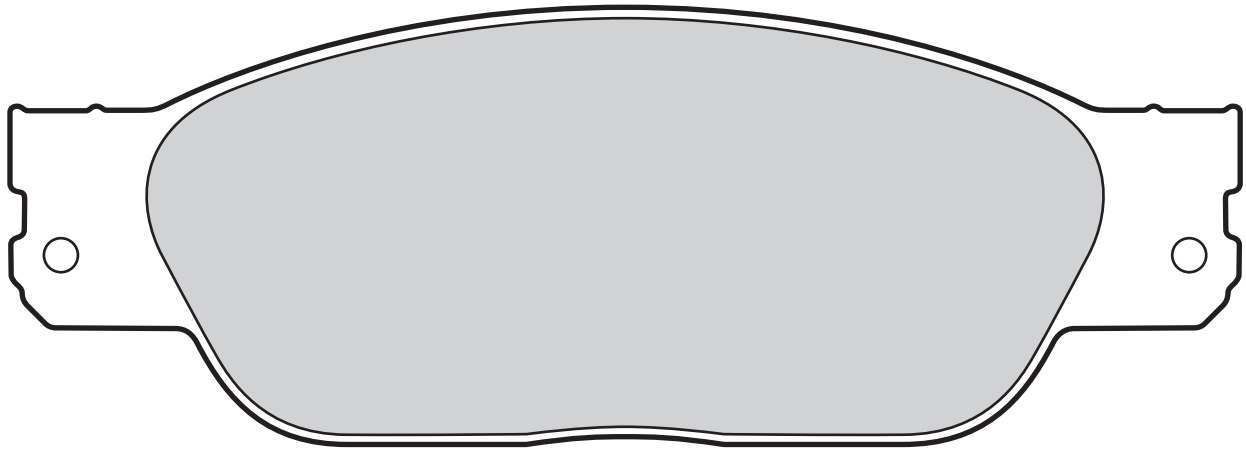

Valeo



598439

0

163,3

58

17,8

LUCAS

23424 (WVA)

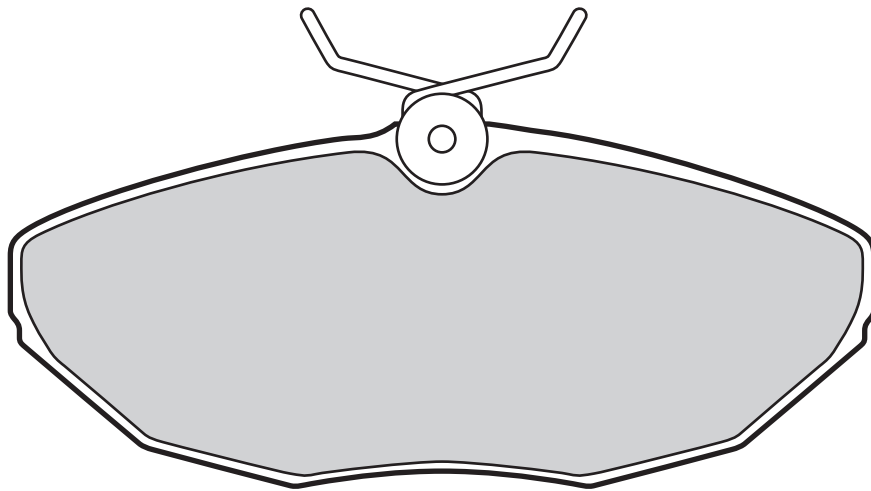

Valeo



598438

0

114,3

49,6

17,8

LUCAS

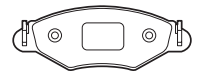

23429 (WVA)

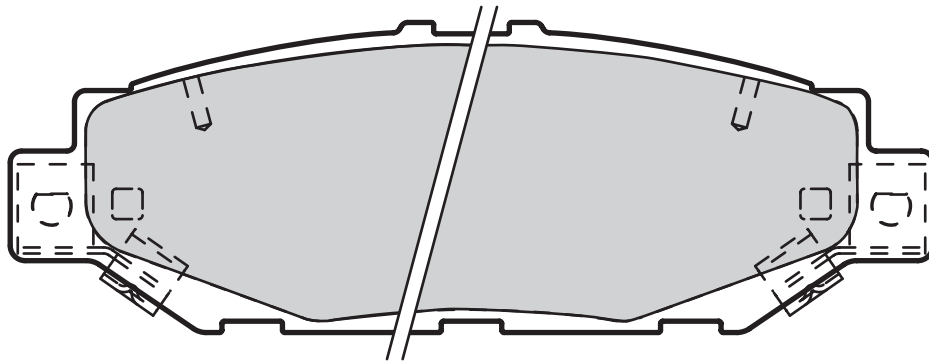

601025

2

57,2

63,8

15,5

SUMITOMO

23449 (WVA)

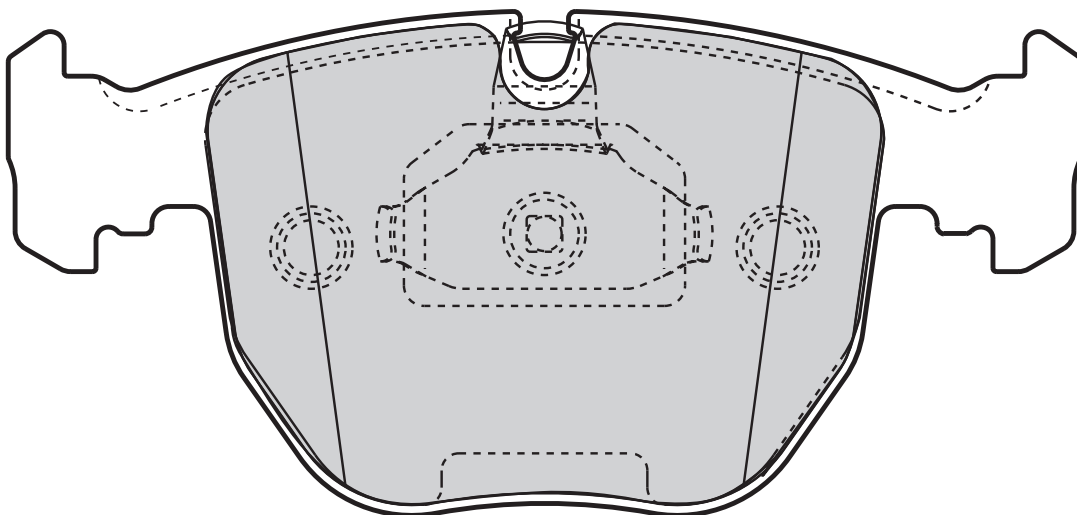
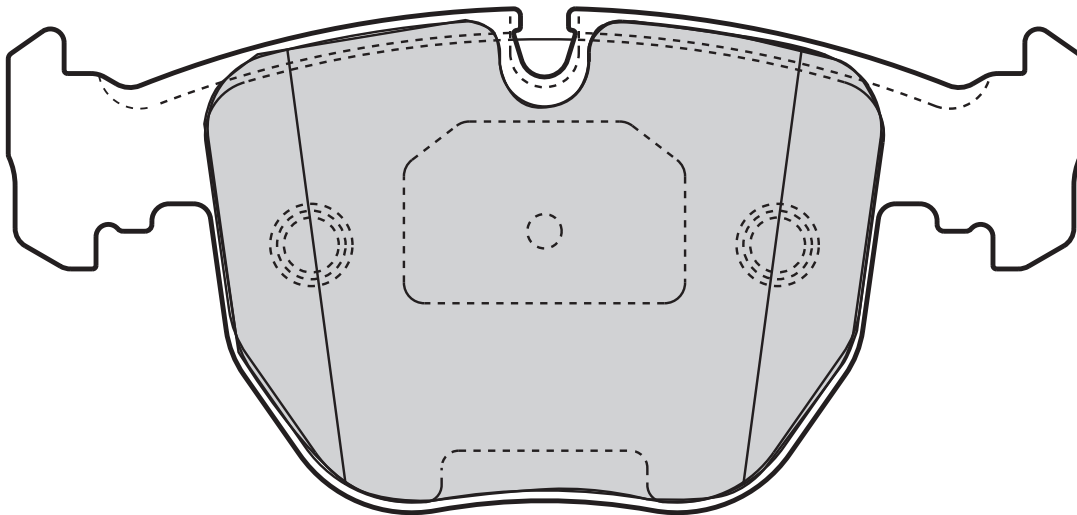

598412

0

156,4

73,6

19

TEVES



Valeo

23467 (WVA)

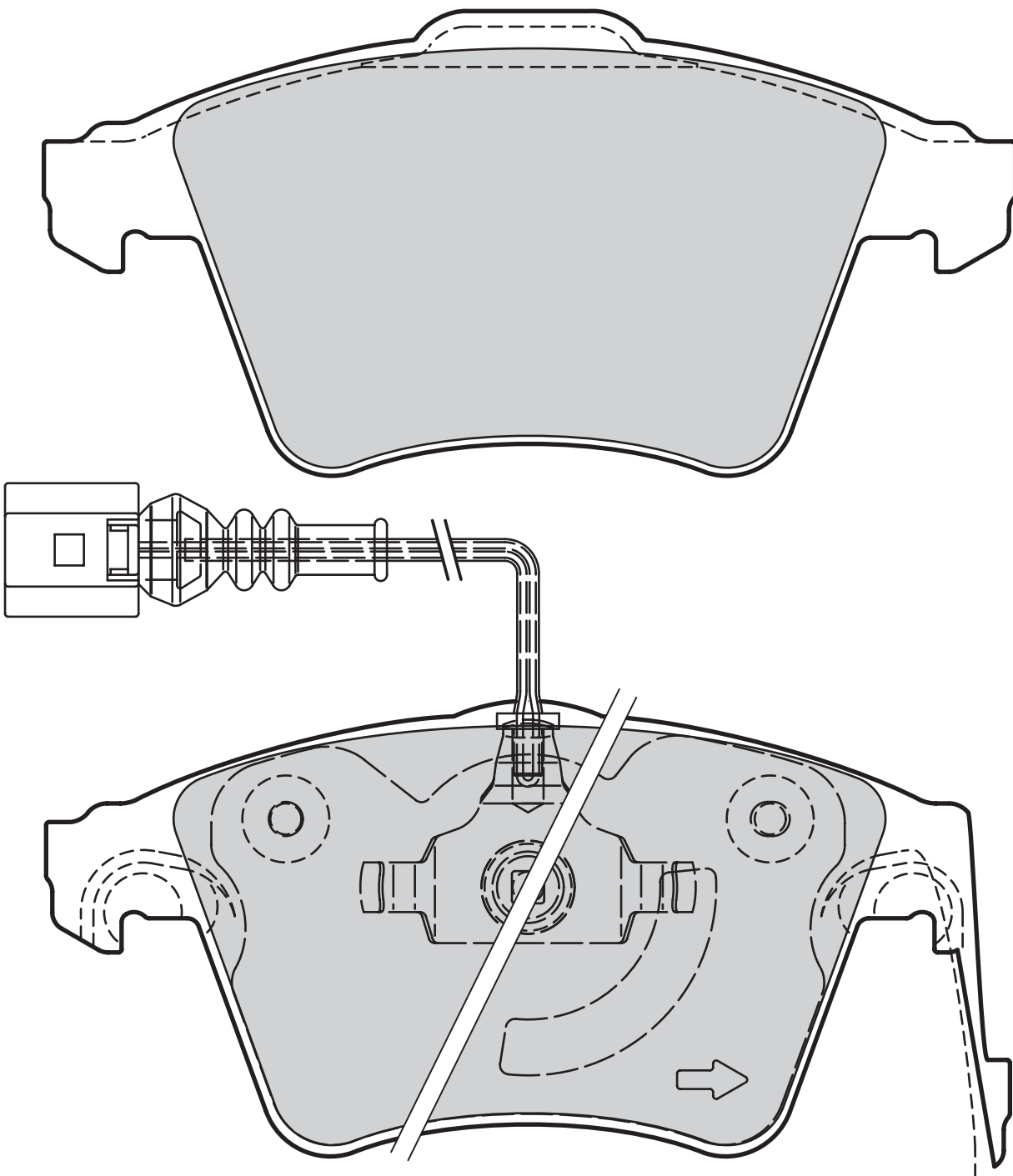

Valeo



598940

2



155



73



20



TEVES



23482 (WVA)

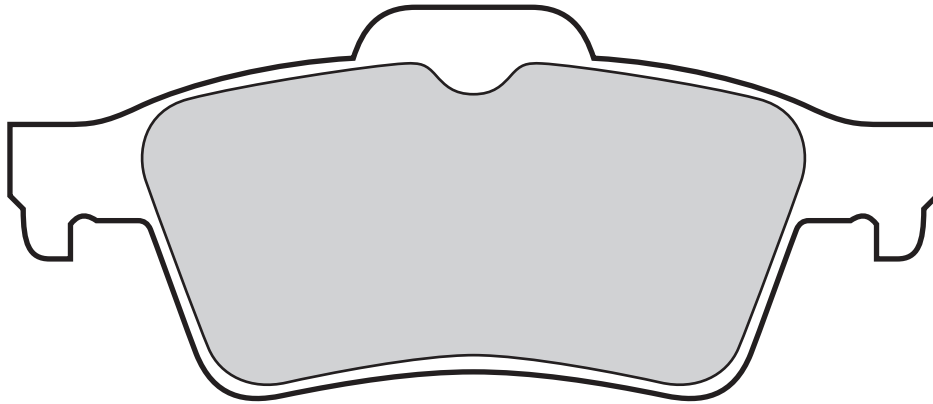

598472	0	123,1	52	16,6	TEVES

23524 (WVA)

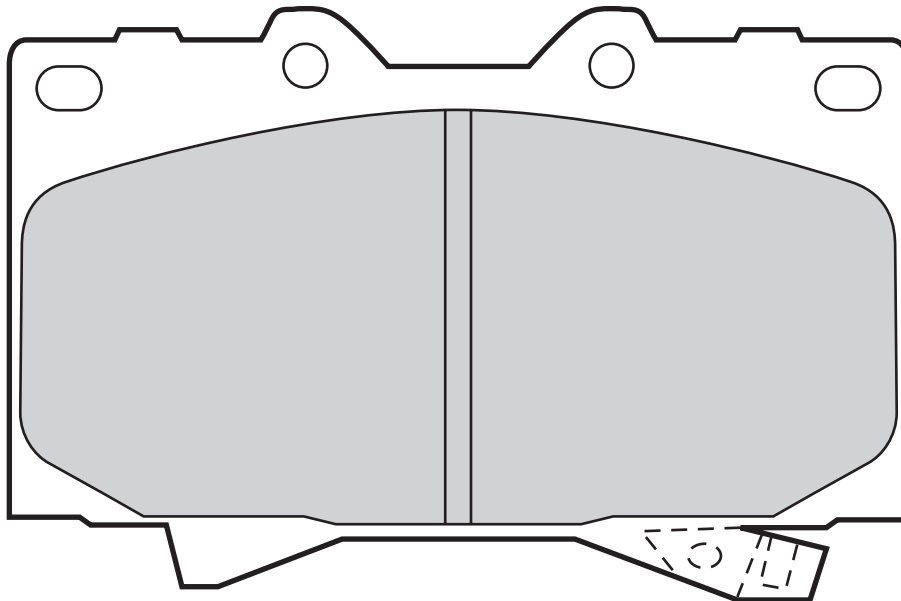

598535	2	119,6	78	15,5	SUMITOMO



Valeo

23532 (WVA)

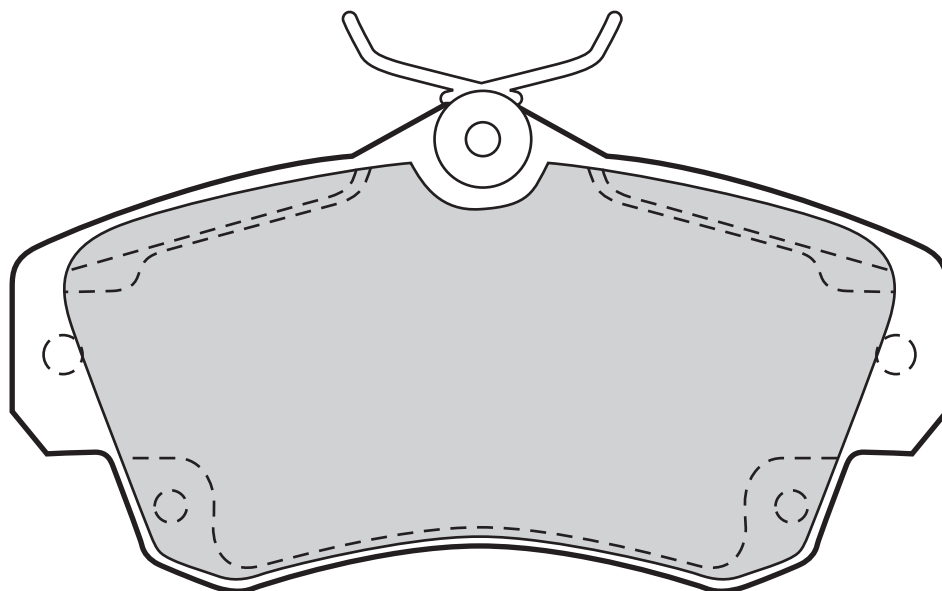

Valeo



598543

0

124

64,6

20

LUCAS

23539 (WVA)

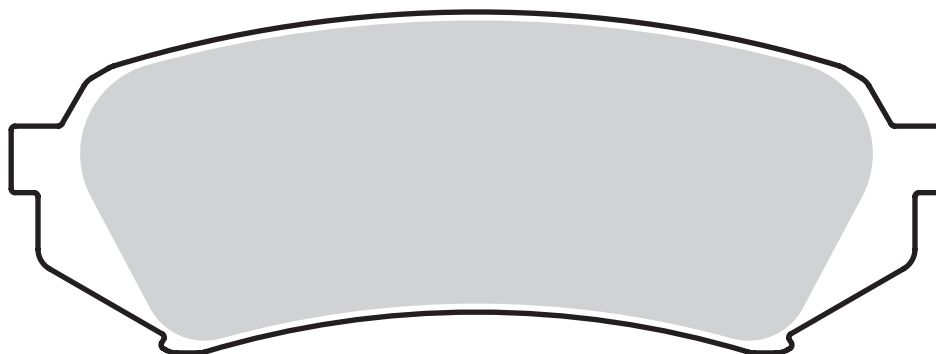

Valeo



598865

0

123,1

45,1

17,5

AKEBONO

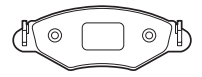

23543 (WVA)

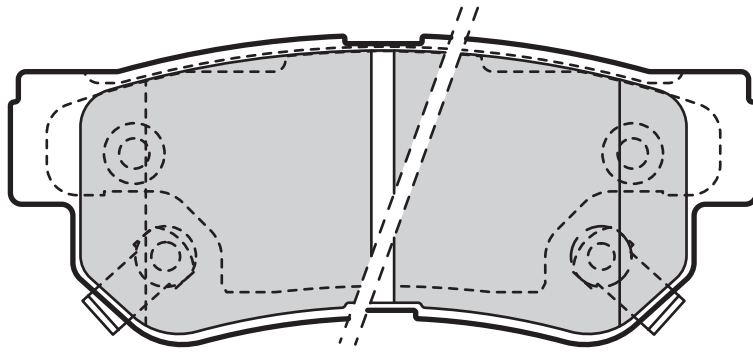

Valeo					
598748	2	98,7	40,8	15,7	MANDO

23550 (WVA)

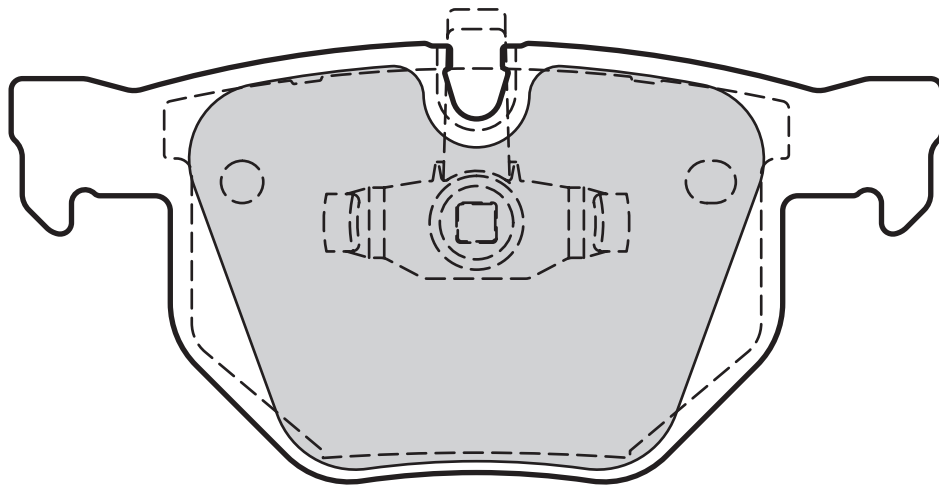
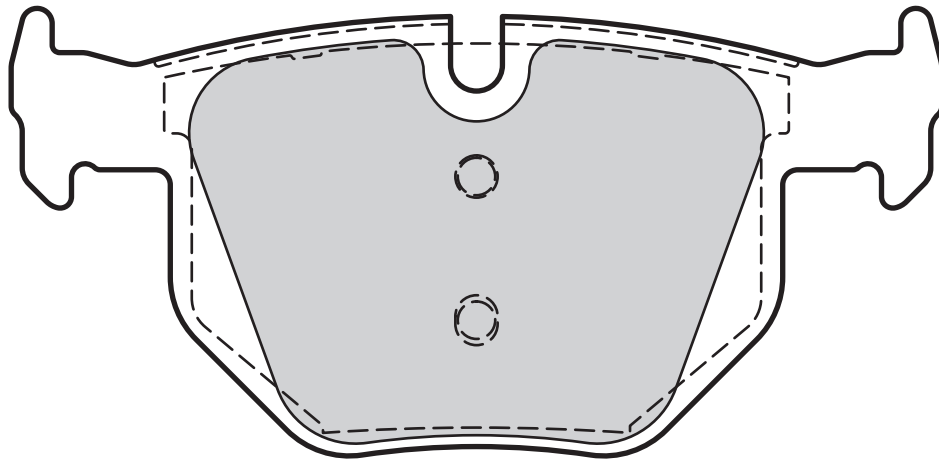

Valeo					
598885	0	123,1	59,2/58	17,3	TEVES



Valeo

23557 (WVA)

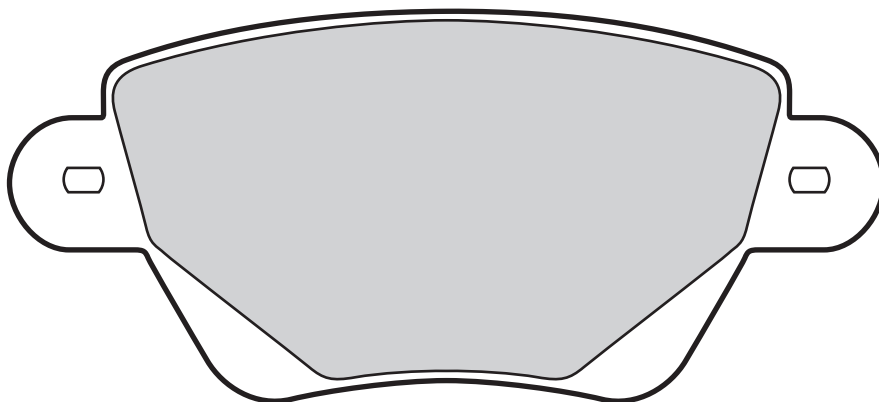

598434	0	115,9	51,9	16,8	BOSCH

23558 (WVA)

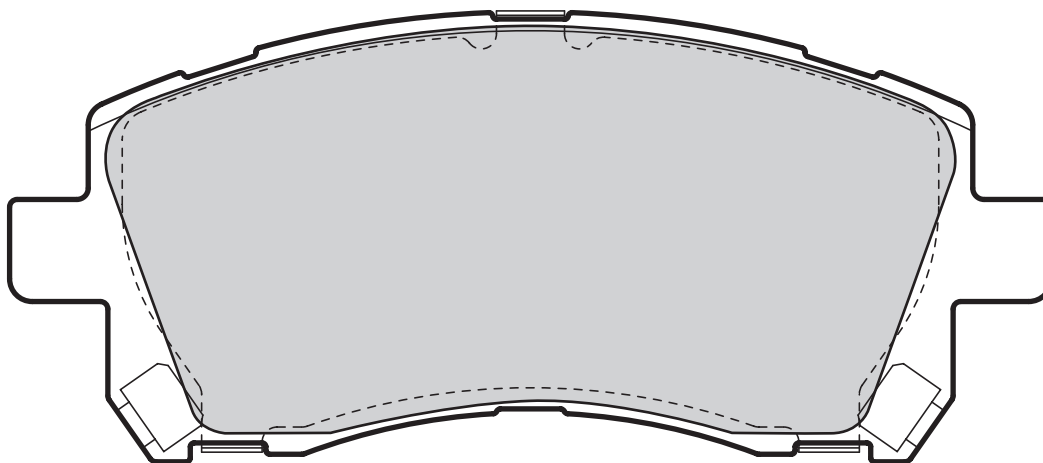

598530	2	137,5	59,5	17,8	AKEBONO



23561 (WVA)

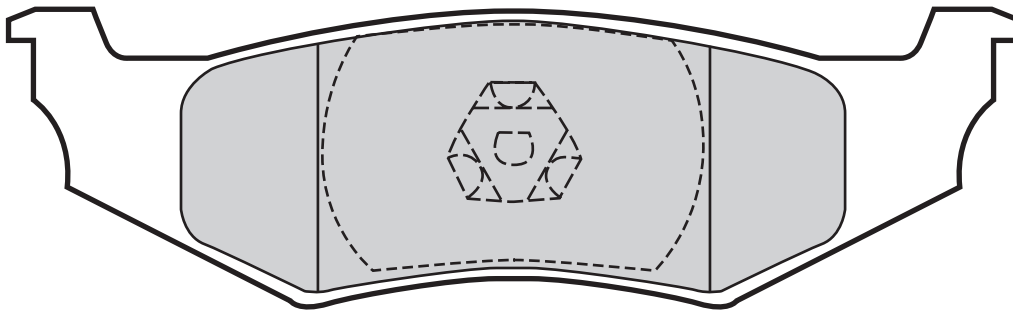

598544	0	133,6	39,9	18	KELSEY

23572 (WVA)

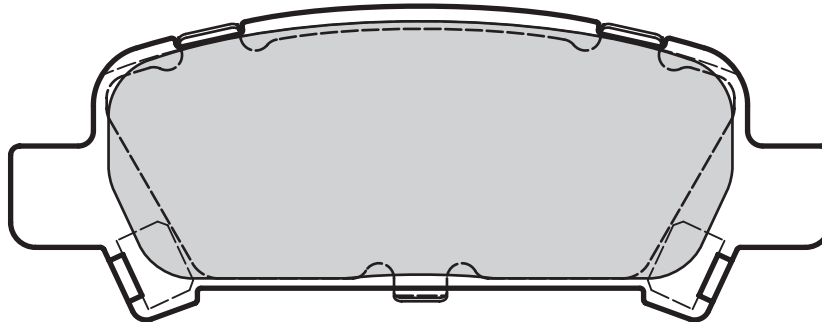

598895	1	108	41,7	14,5	AKEBONO



Valeo

23582 (WVA)

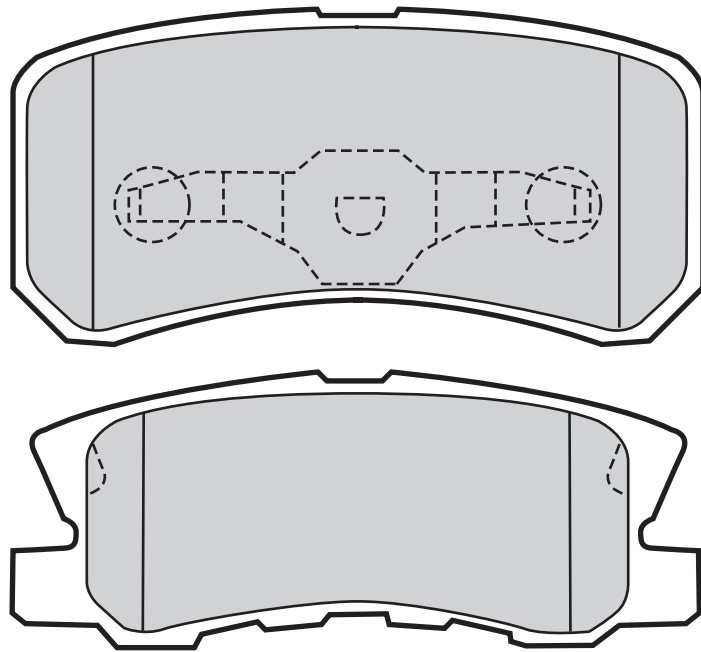

Valeo



598520

2

111,6

45

15,5

AKEBONO



23587 (WVA)

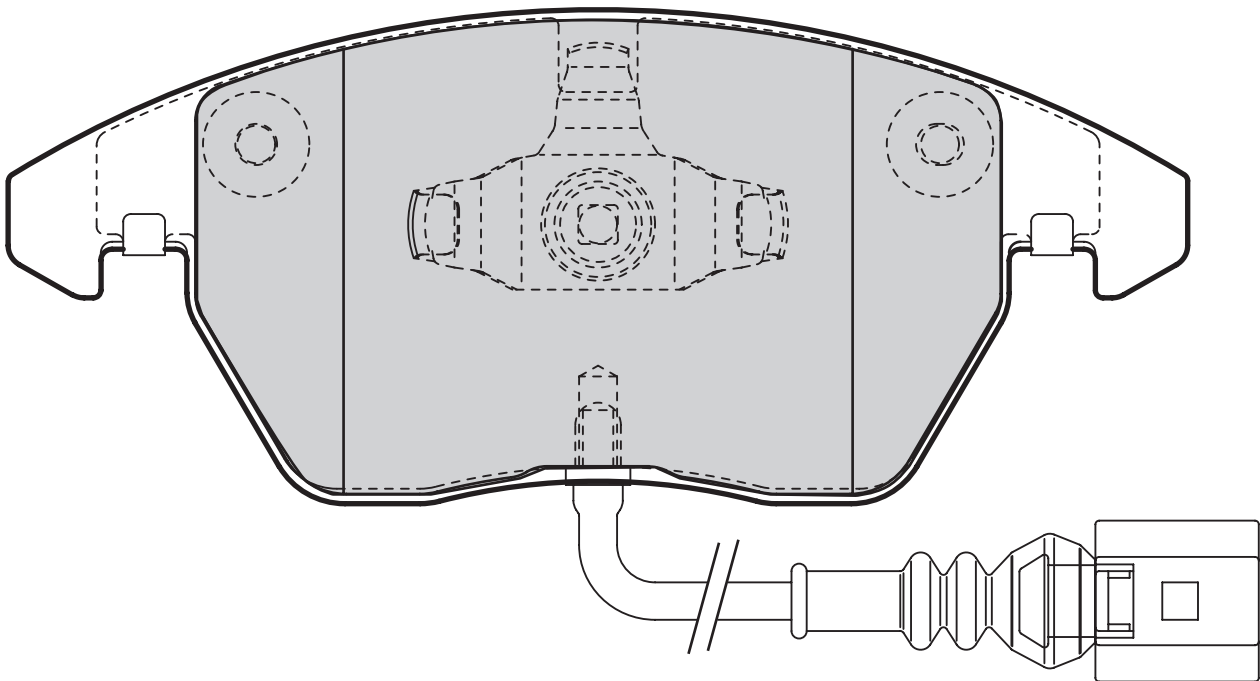
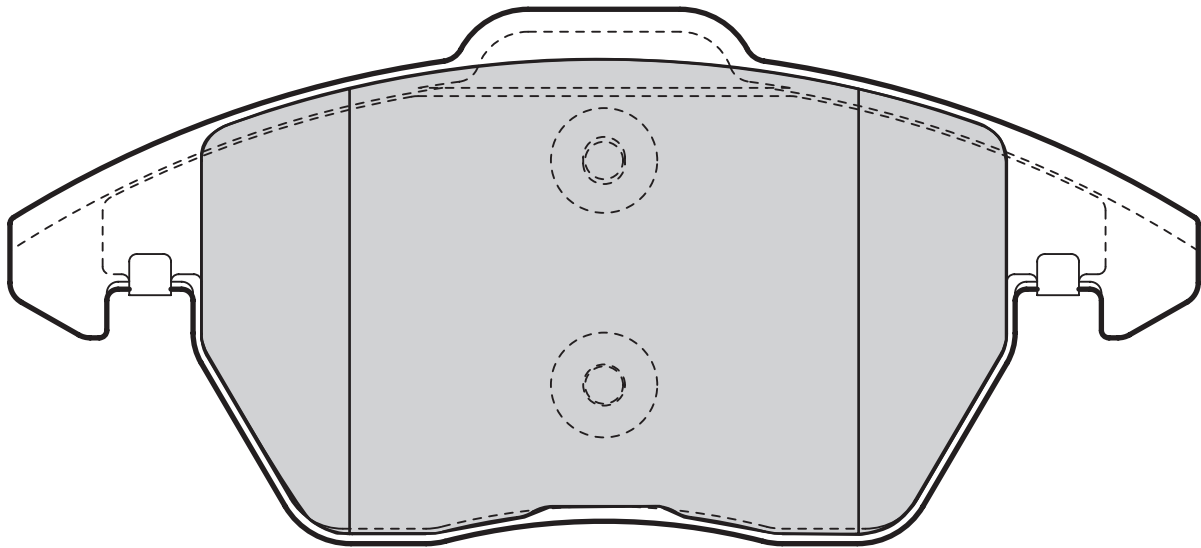

Valeo



598635

1

156,4

66/71,4

20,3

TEVES

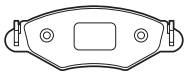

Valeo

23589 (WVA)

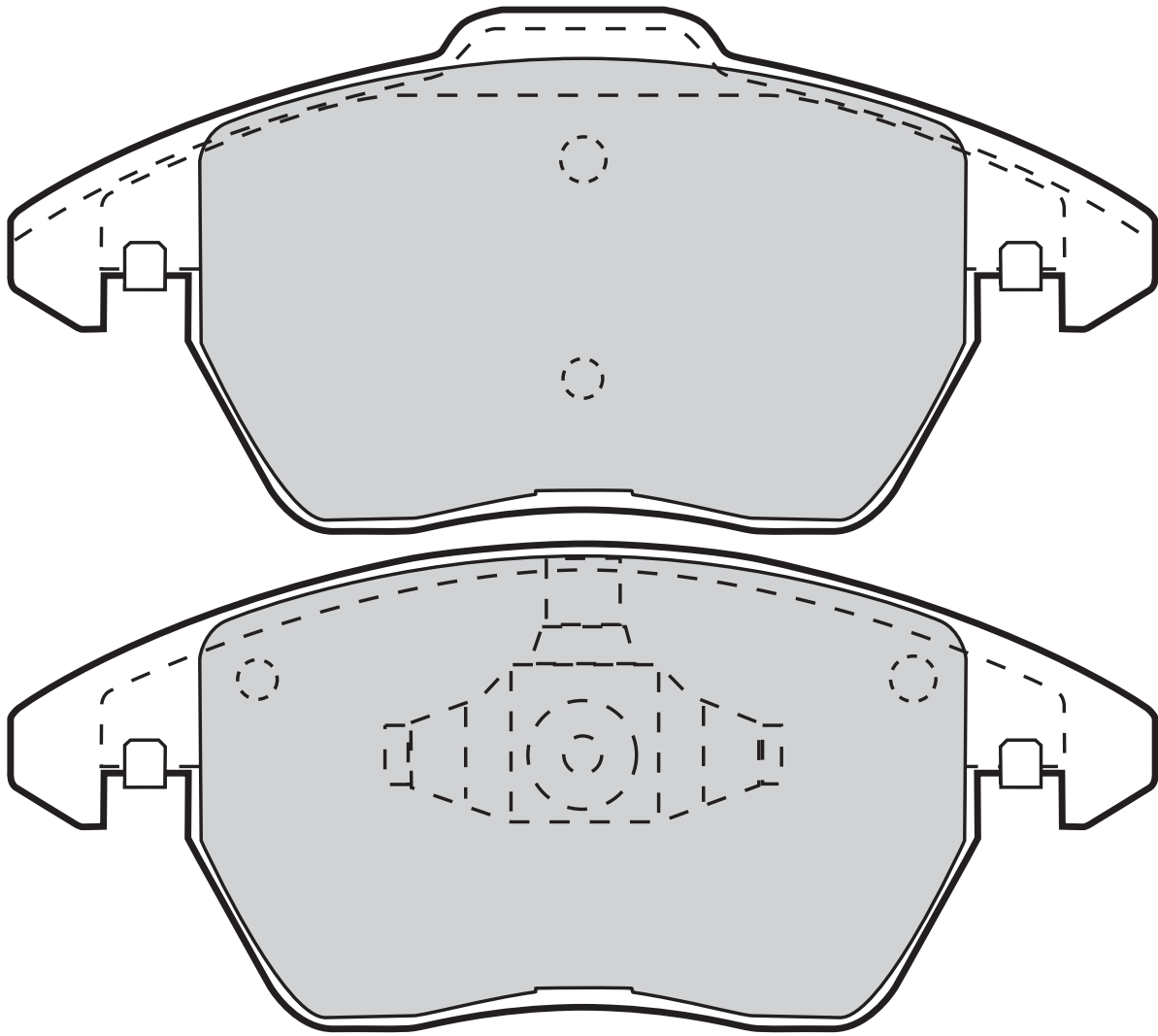

Valeo



598715

0

155/156

71,5

19

TEVES



23590 (WVA)

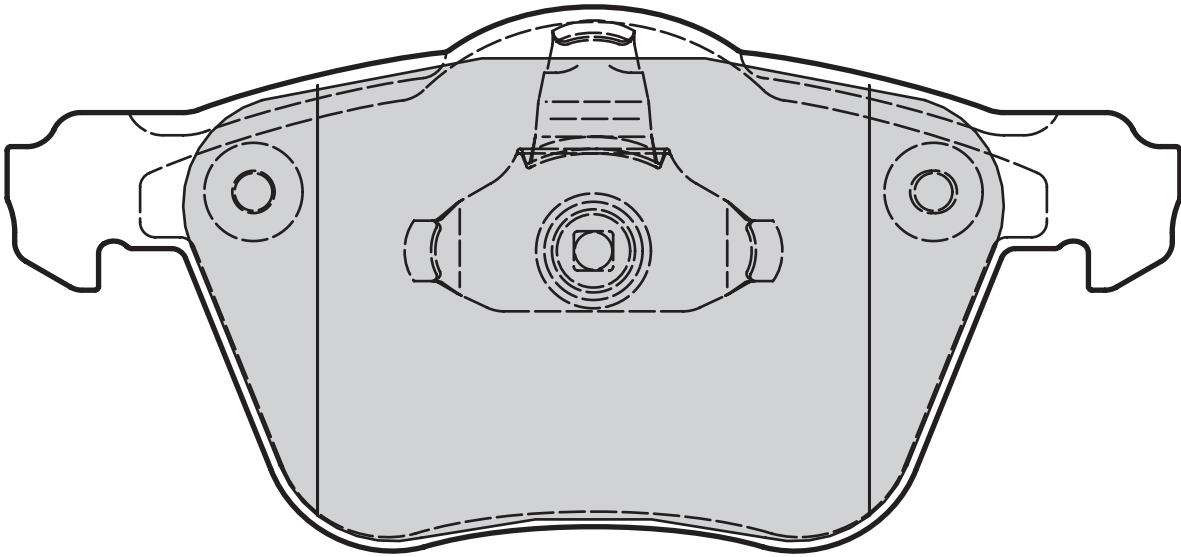
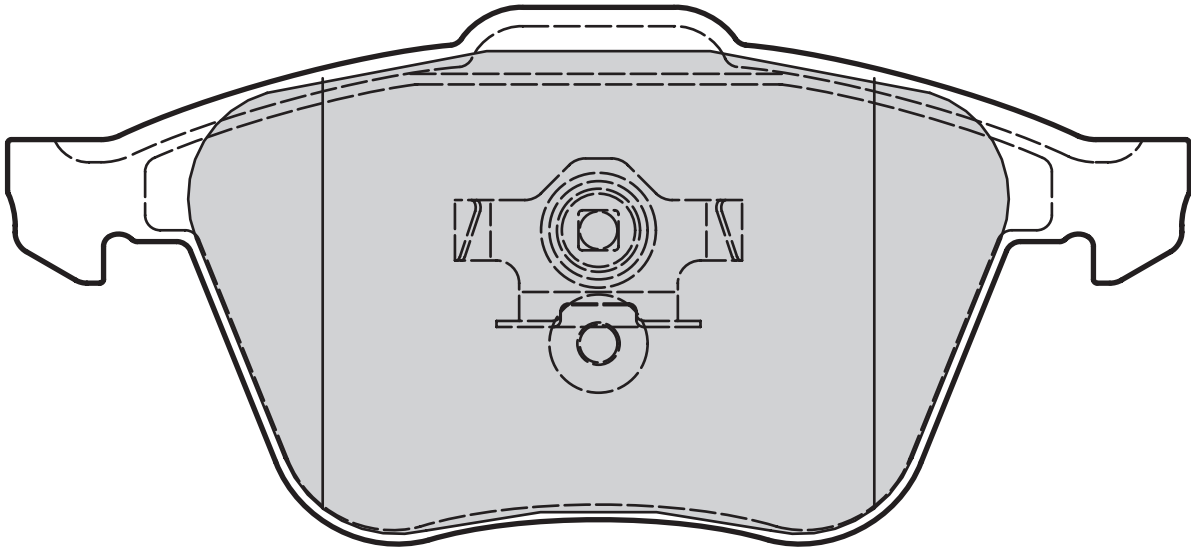

Valeo



601030

0

156,4

71/72

18,2

TEVES

601032

8

150,5

56,5

18,8

BOSCH



Valeo

23599 (WVA)

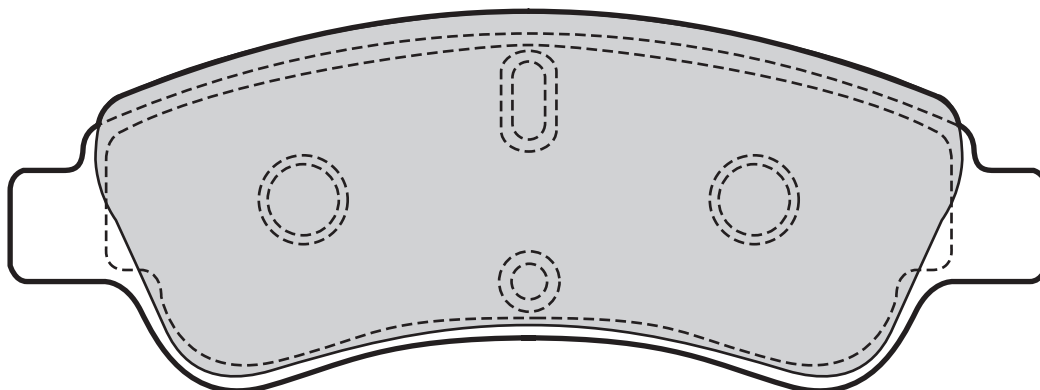

Valeo



598464

0

137

50

19

BOSCH

23600 (WVA)

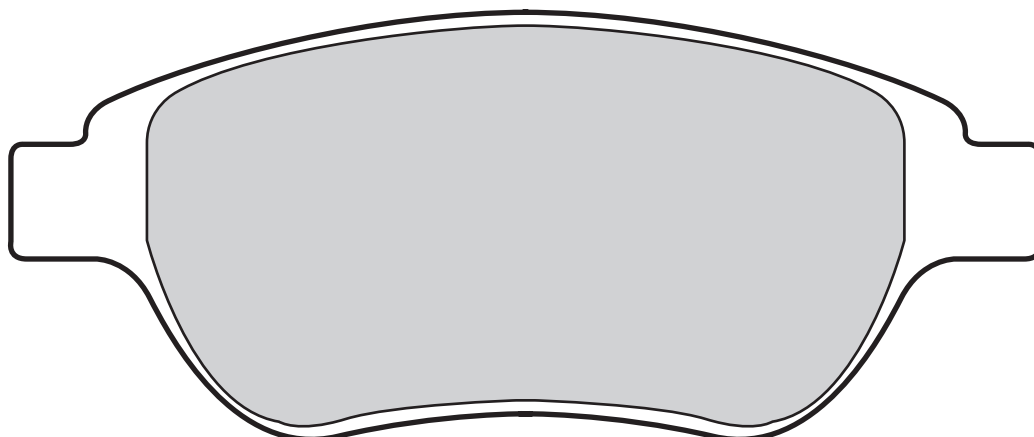

Valeo



598465

0

137

57,3

19

BOSCH



23615 (WVA)

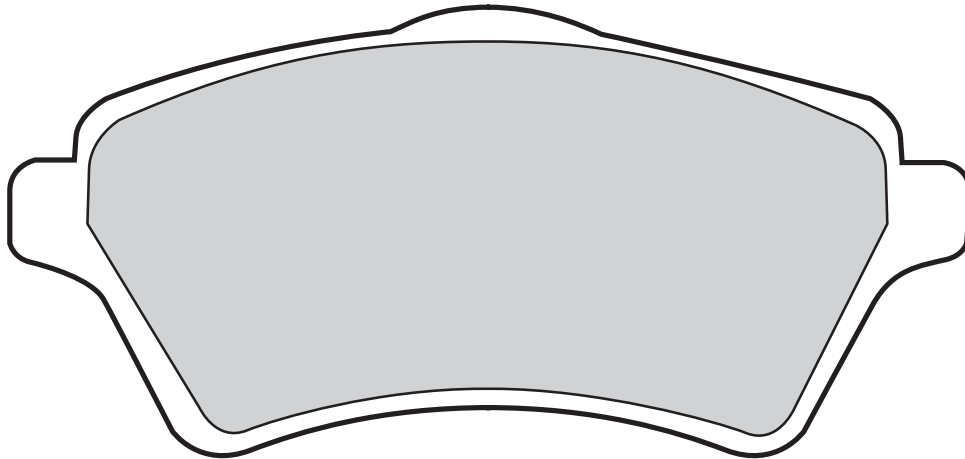

598514	0	131,5	62	18,2	LUCAS

23623 (WVA)

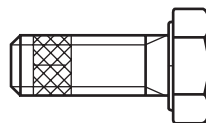
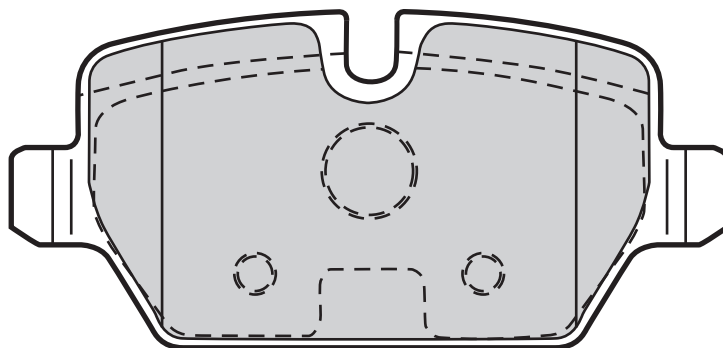
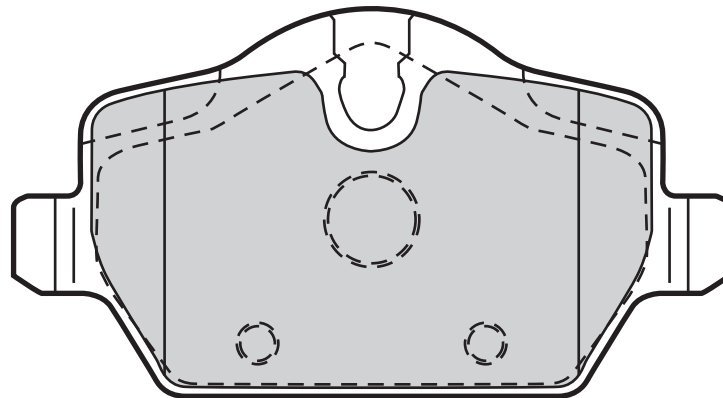

598701	0	95,2	44,7	17,5	LUCAS



Valeo

23640 (WVA)

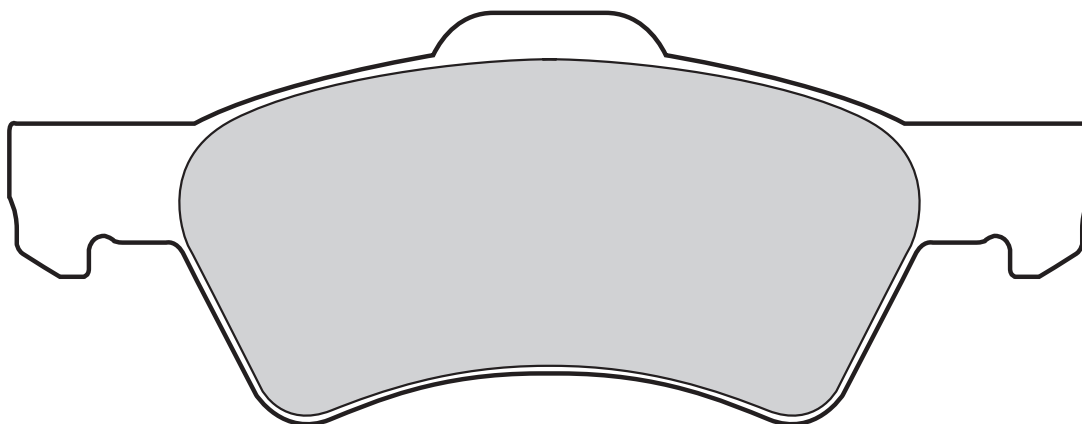

Valeo



598415

2

172,5

65,7

18,8

TEVES

23659 (WVA)

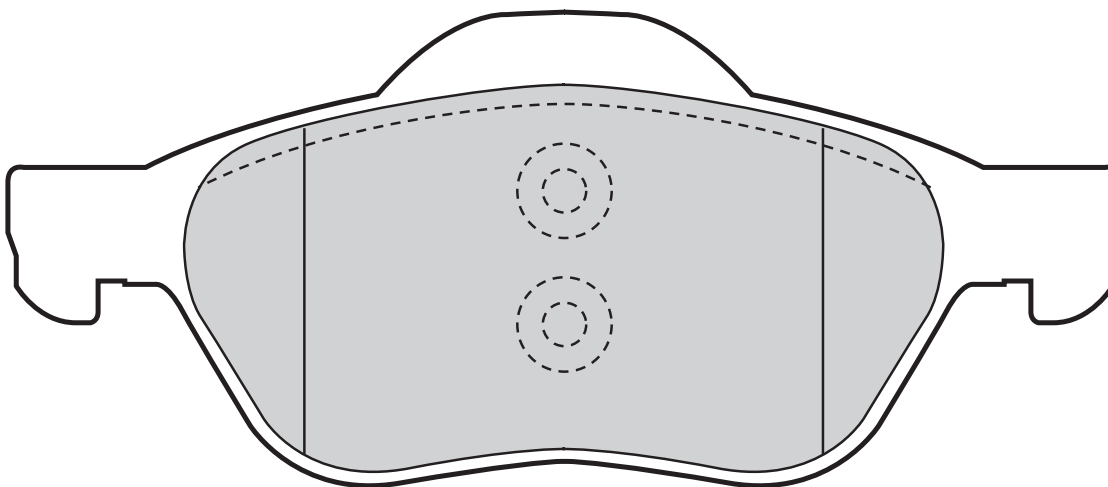
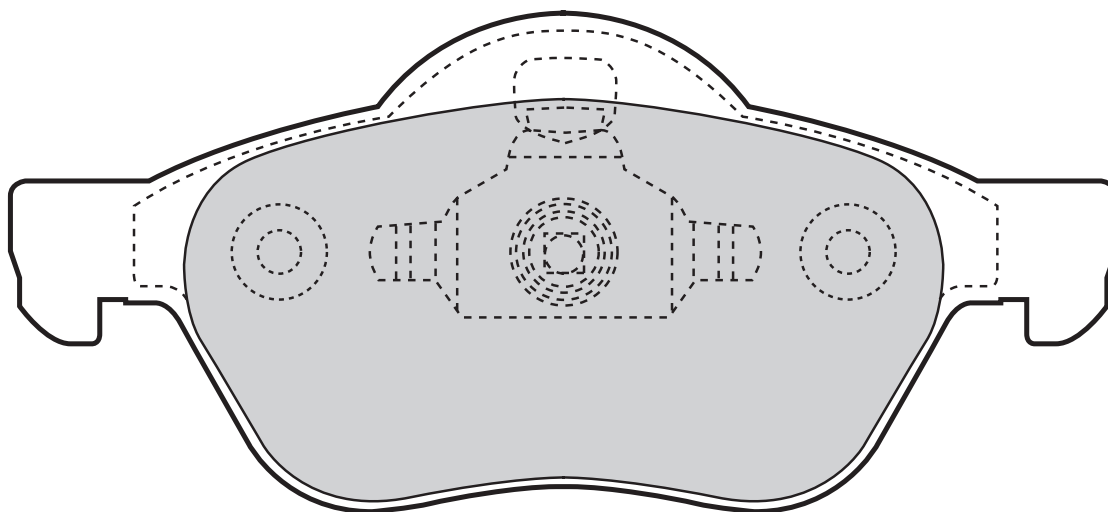

Valeo



598471

0

155,2

66,6

18

TEVES



23661 (WVA)

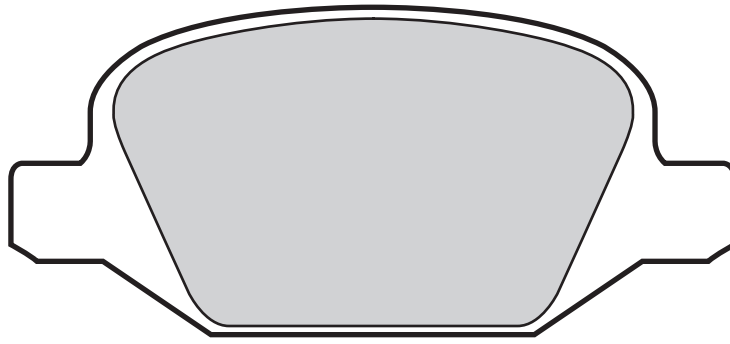

598425	0	95,8	43,9	13,7	LUCAS

23692 (WVA)

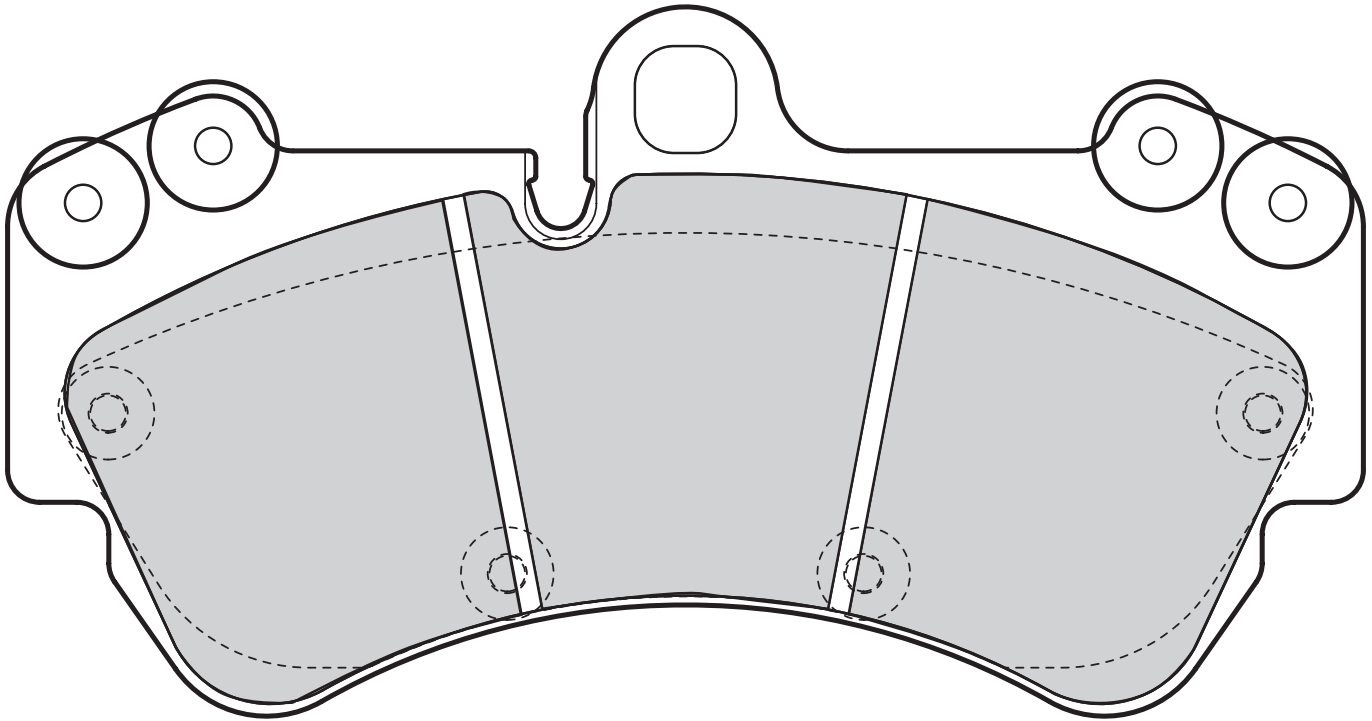

598655	0	190,2	99,5	16,6	BREMBO



Valeo

23693 (WVA)

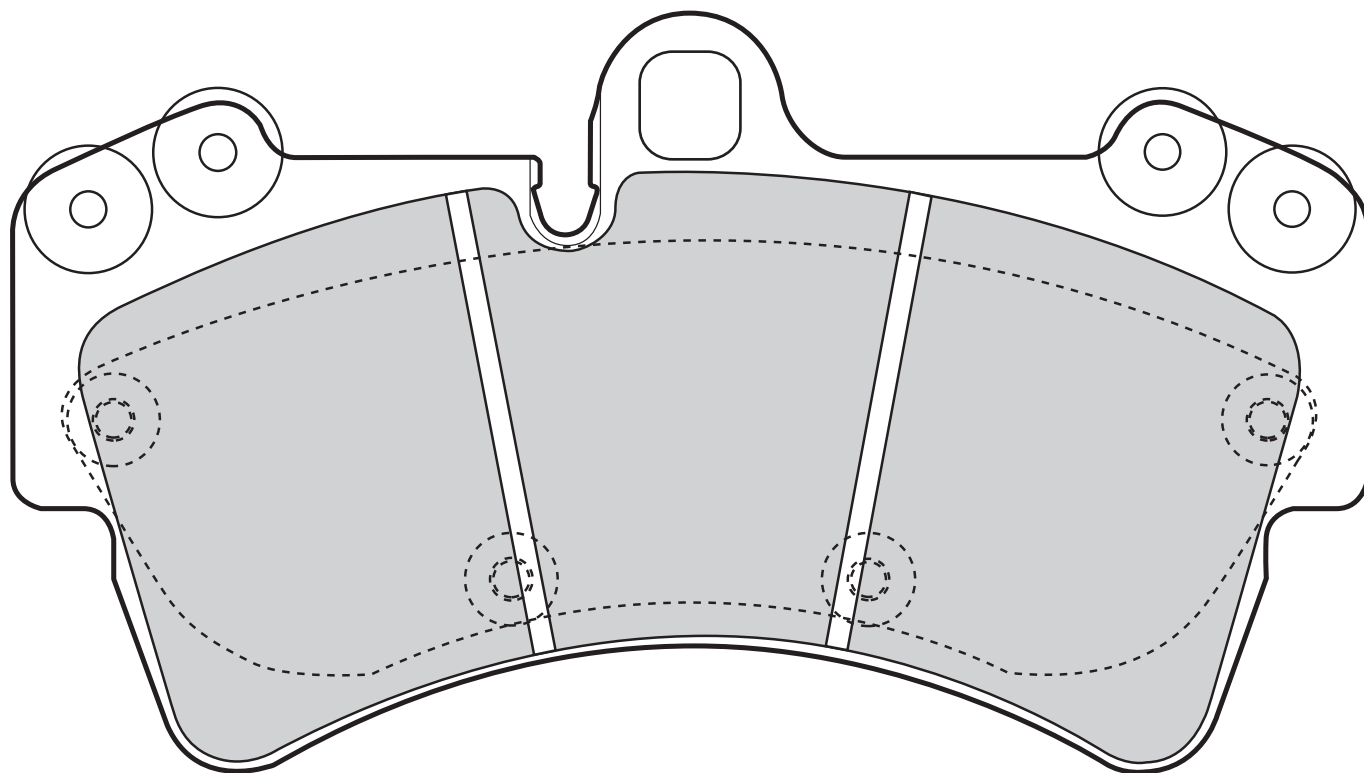

598656	0	190,2	106,5	16,6	BREMBO

23694 (WVA)

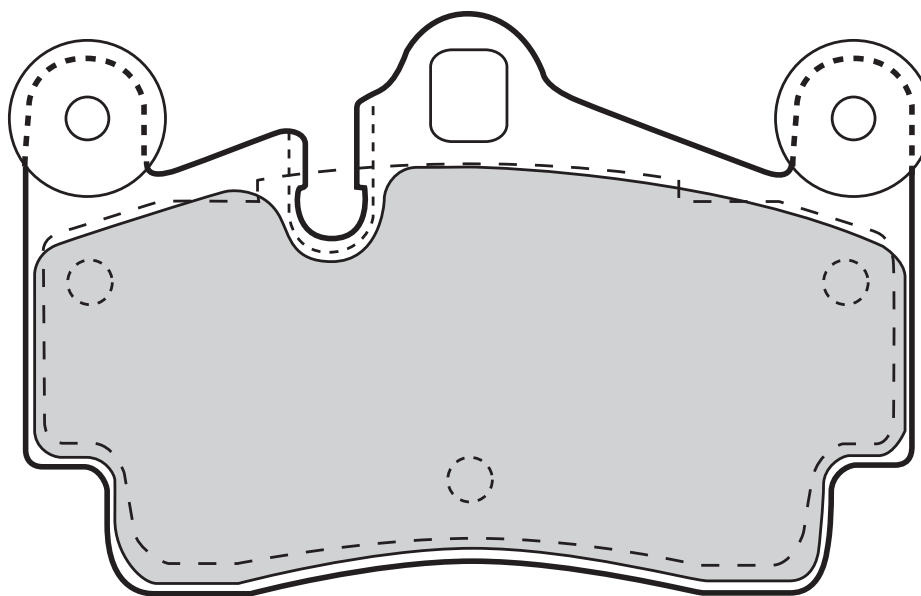

598770	0	117,3	73,1	16,7	BREMBO

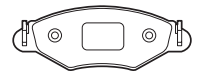

23703 (WVA)

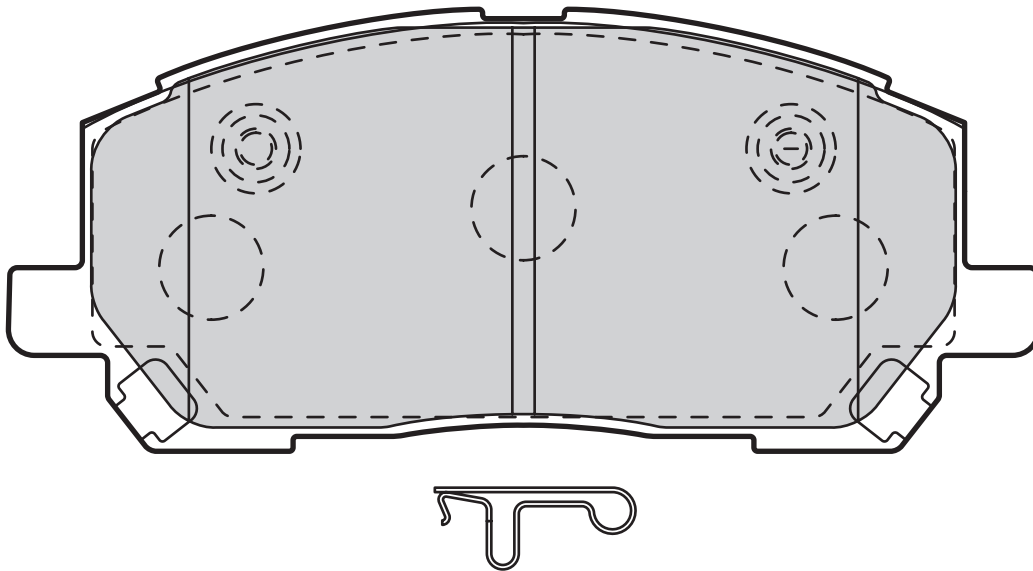

598944	2	138	60	18,6	AKEBONO

23705 (WVA)

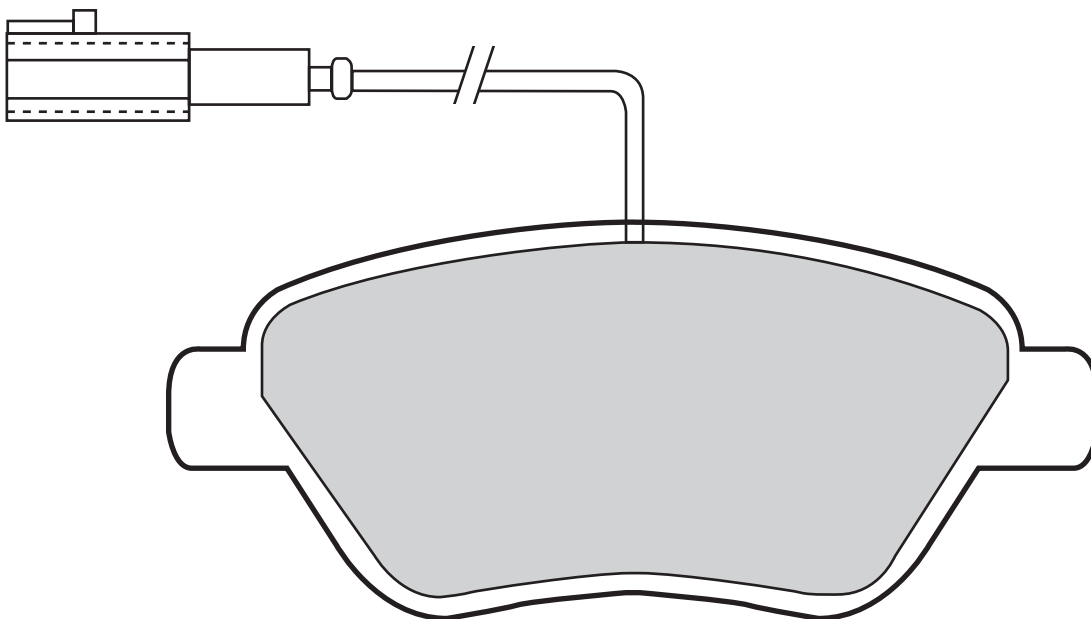

598426	1	123	53,3	17,8	BOSCH



Valeo

23714 (WVA)

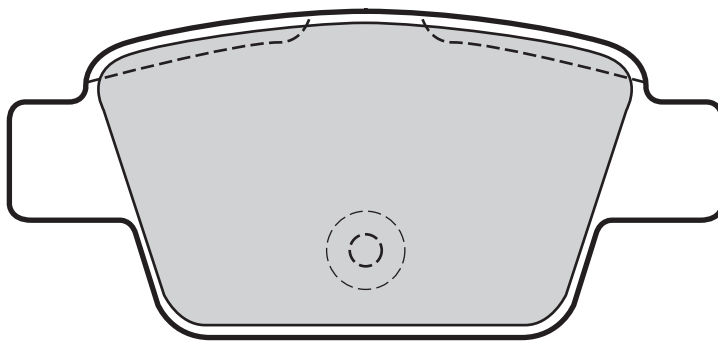

Valeo



598633

0

95

42,9

16

BOSCH

23723 (WVA)

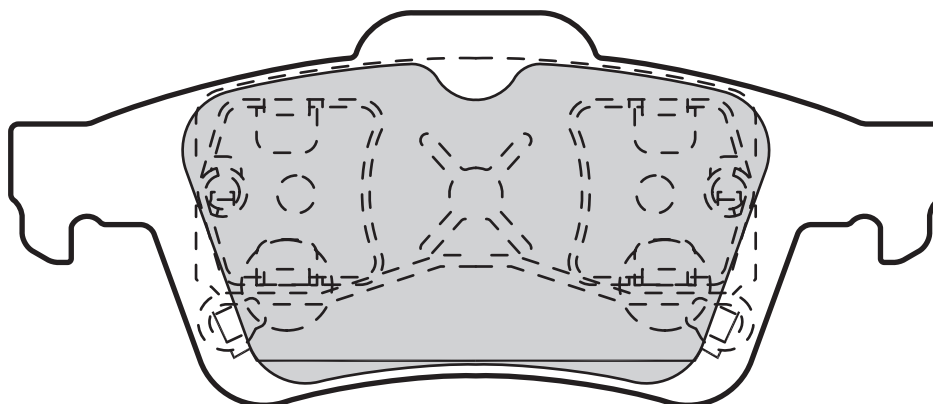
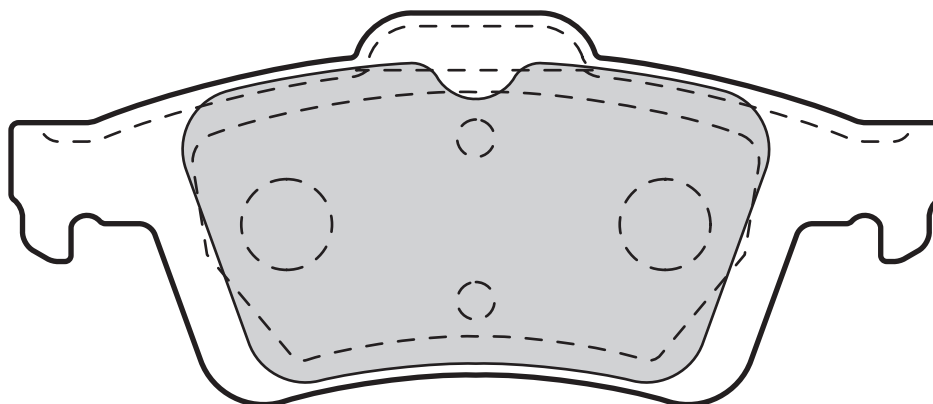

Valeo



598649

0

156,3

62,5/67

17,5

TEVES

601005

0

122,9

51,8

16,4

TEVES

601008

0

122,9

51,8

16,4

AKEBONO



23726 (WVA)

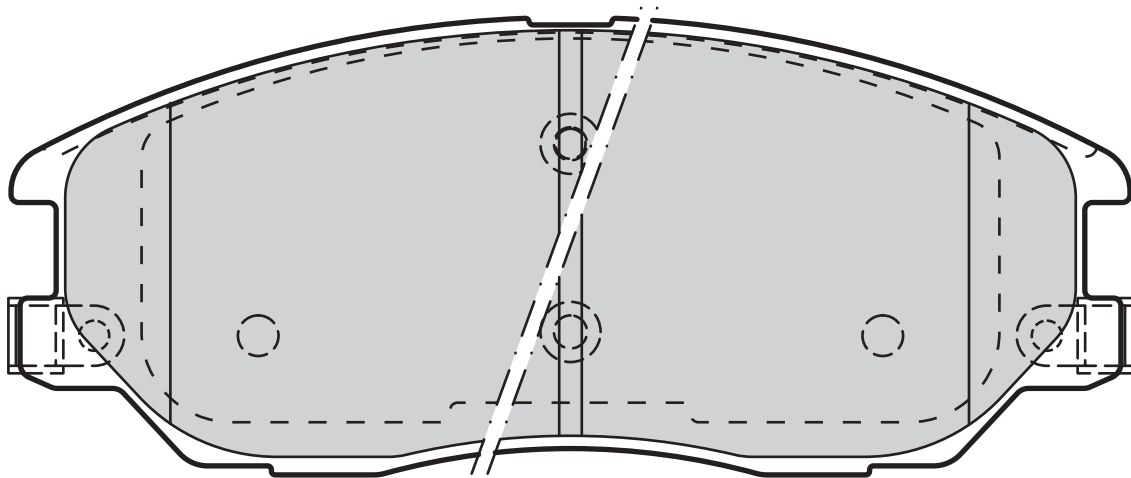

Valeo					
598871	2	148,7	60,8	17,2	MANDO

23730 (WVA)

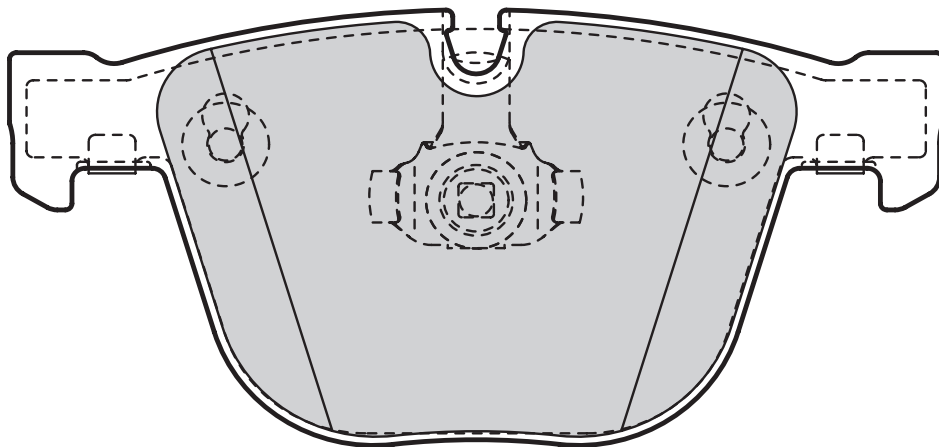
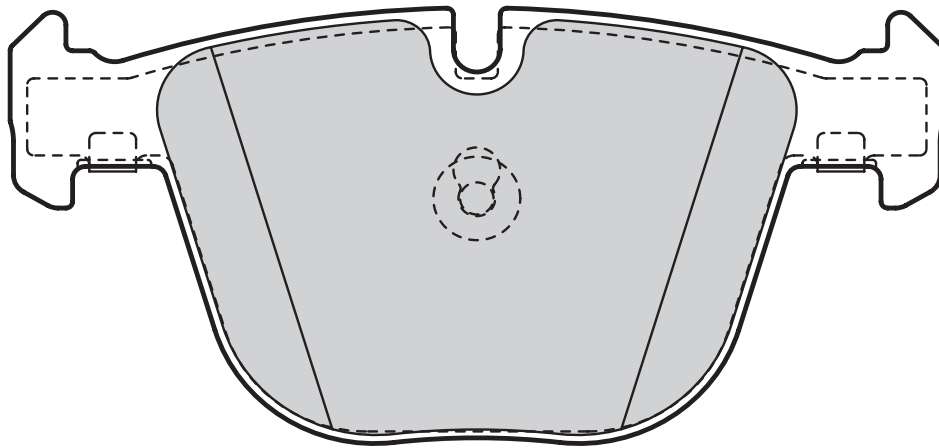

Valeo					
598820	0	137	63,4	18	TEVES



Valeo

23743 (WVA)

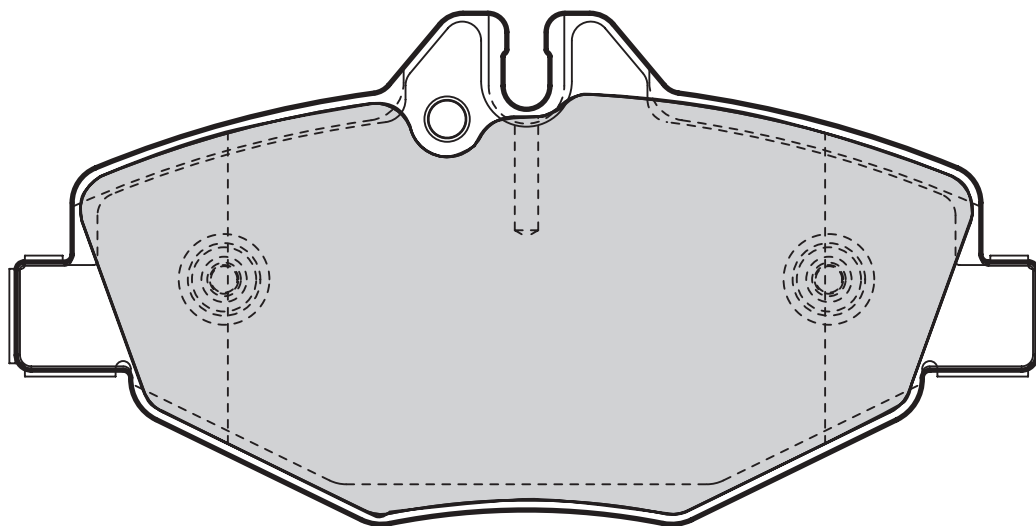

Valeo



598638

2



137



67,8



20



BOSCH

23745 (WVA)

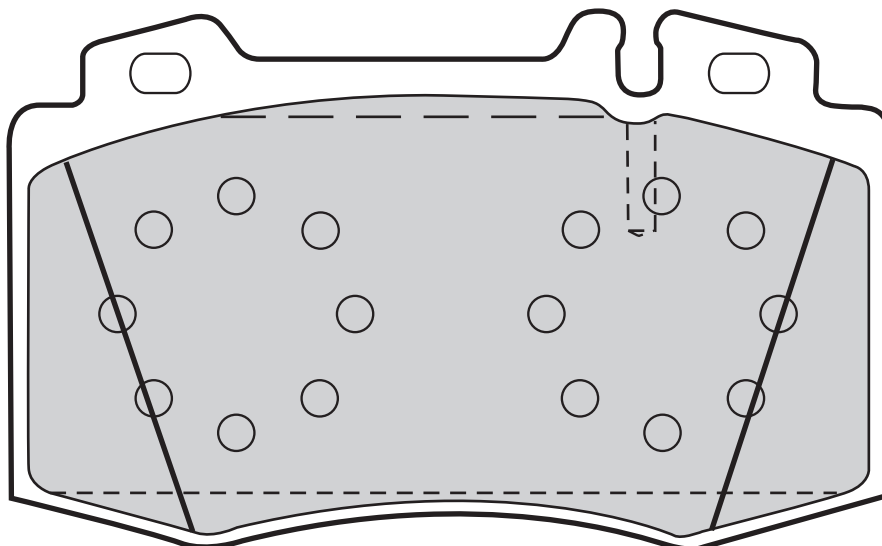
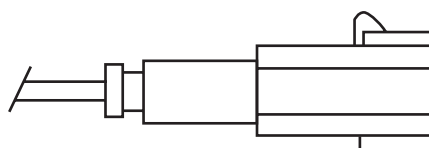

Valeo



598659

0



117,8



71,5



17,2



BREMBO



23762 (WVA)

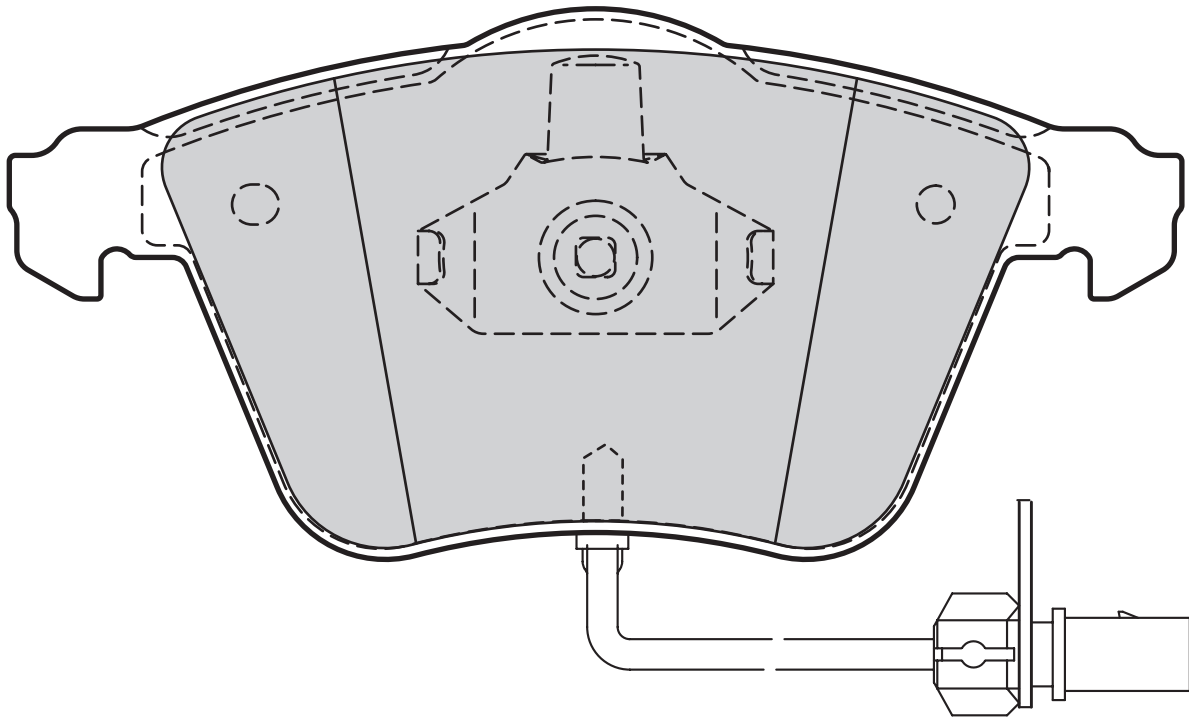
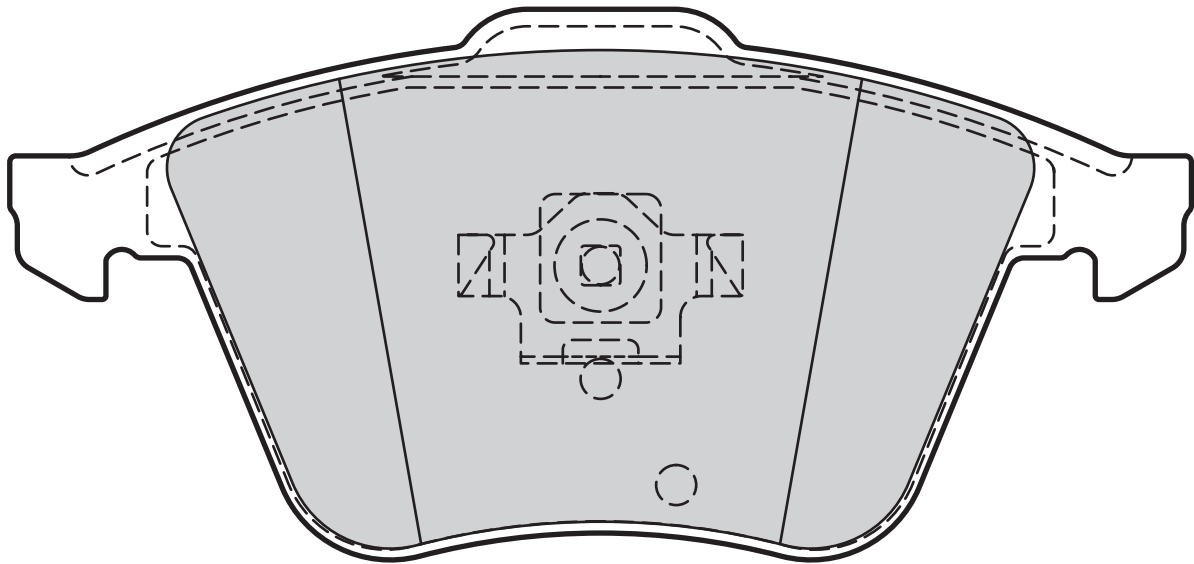

Valeo



598779

2

156,3

72,8

20,3

TEVES

598822

0

156,3

72,8

18,5

TEVES

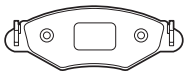

Valeo

23794 (WVA)

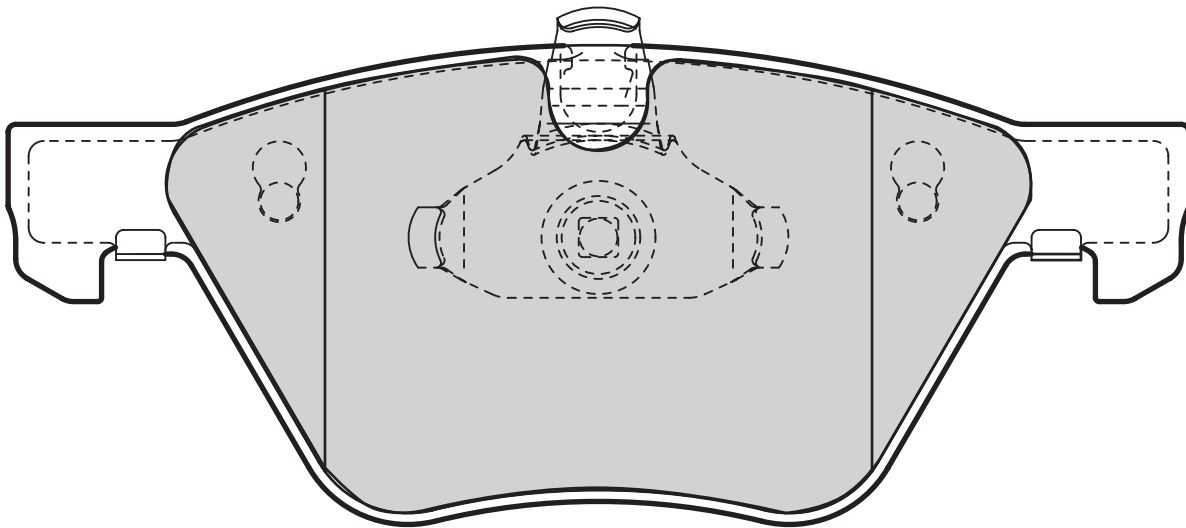
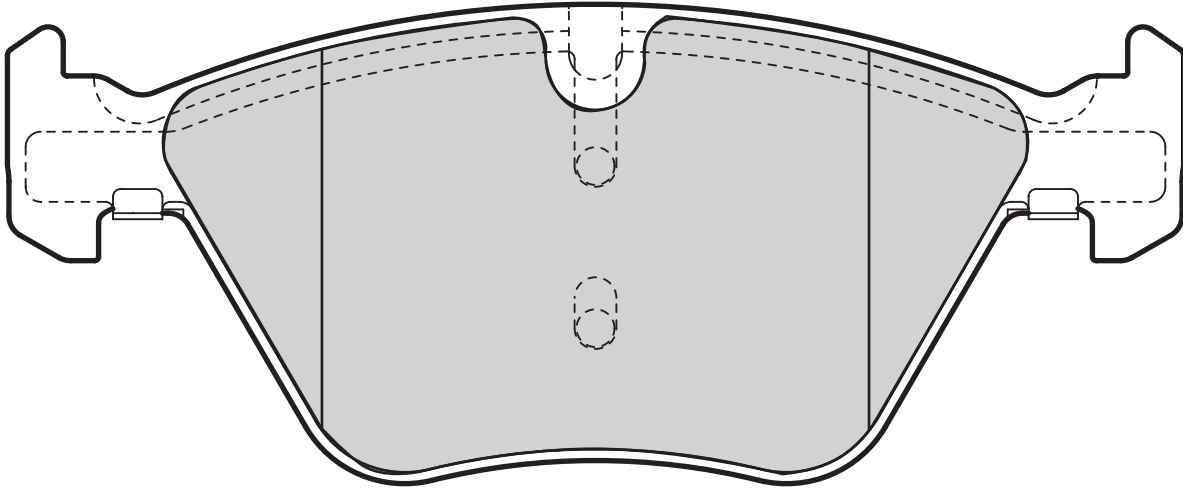

Valeo



598640

0

154,8

63,6

20

TEVES

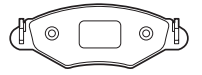

23801 (WVA)

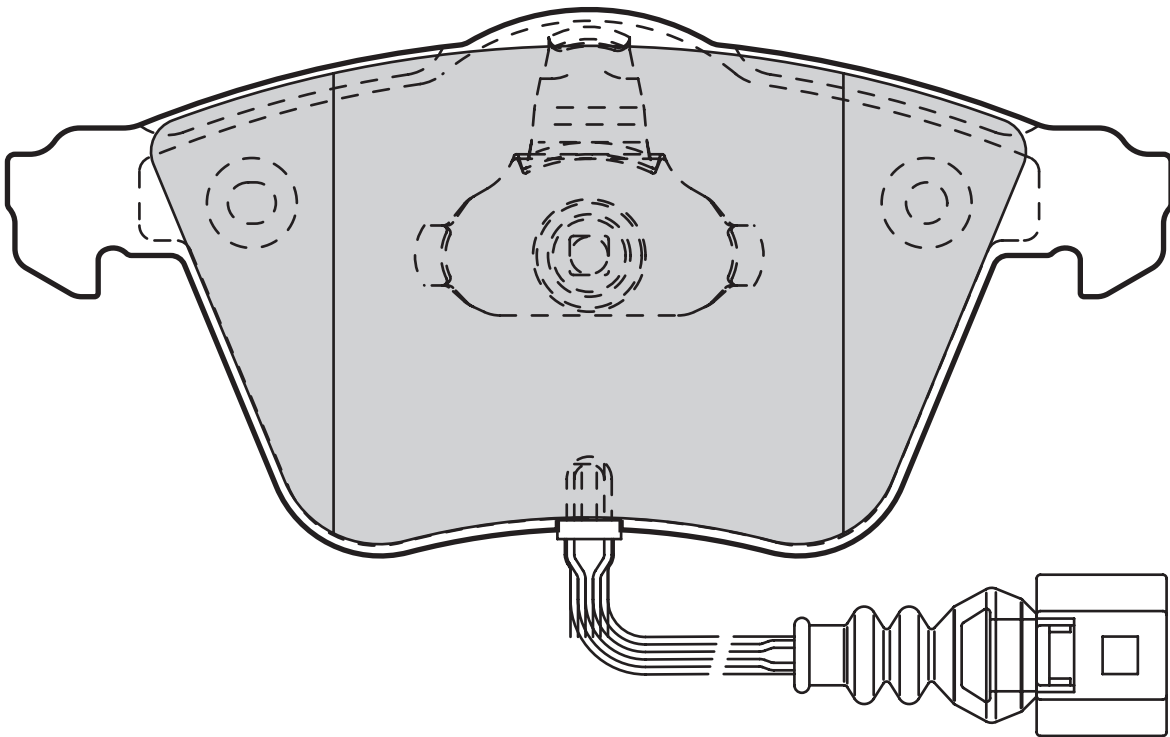
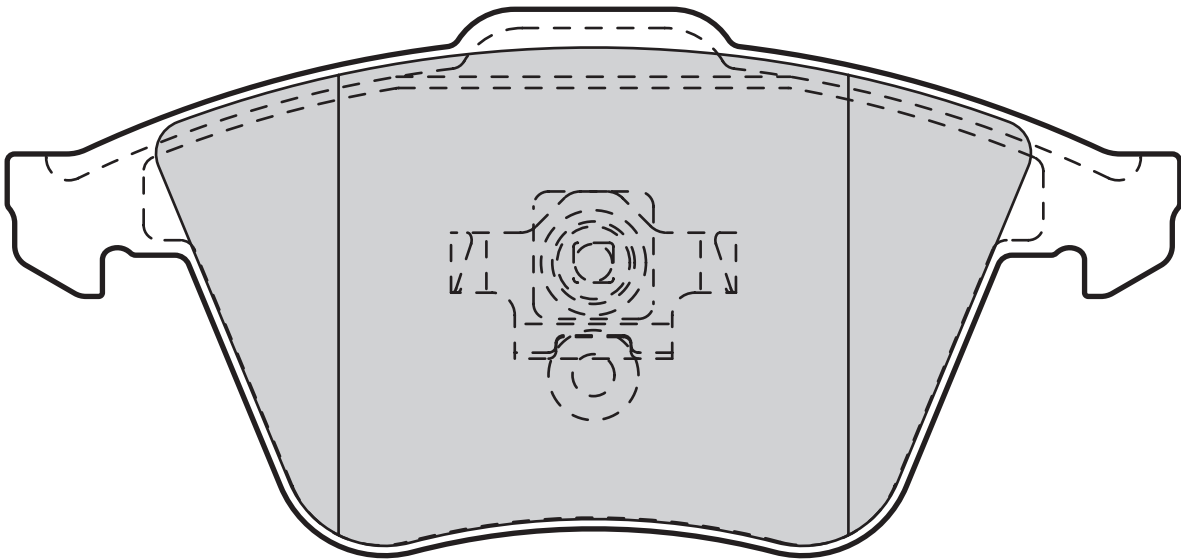

Valeo



598863

1



155,1



72,8



20,3



TEVES



Valeo

23807 (WVA)

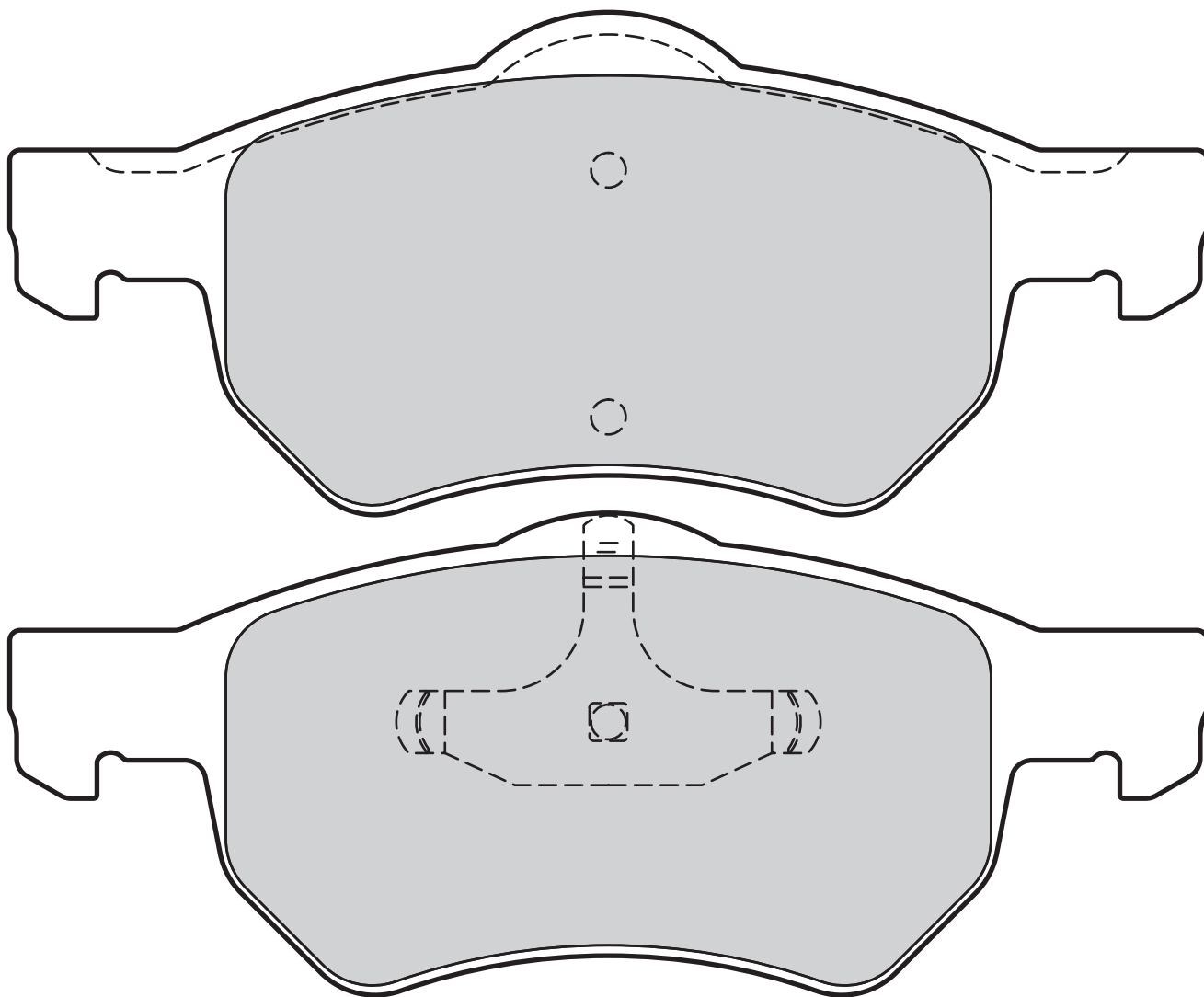

Valeo



598756

0

172,2

72,3

18,6

TEVES



23832 (WVA)

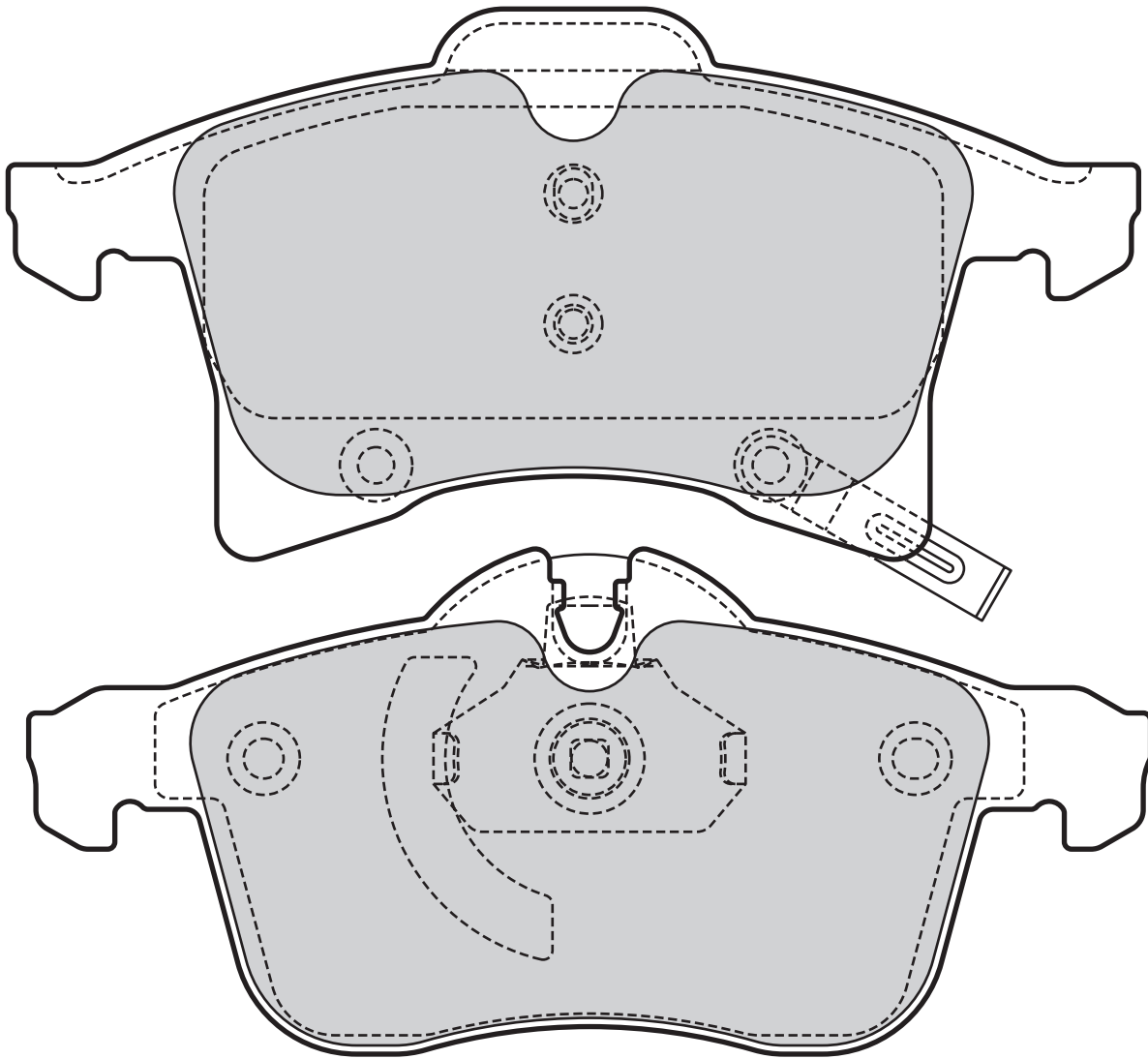

Valeo



598860

2

156,1

69,8

20,4

TEVES



Valeo

23865 (WVA)

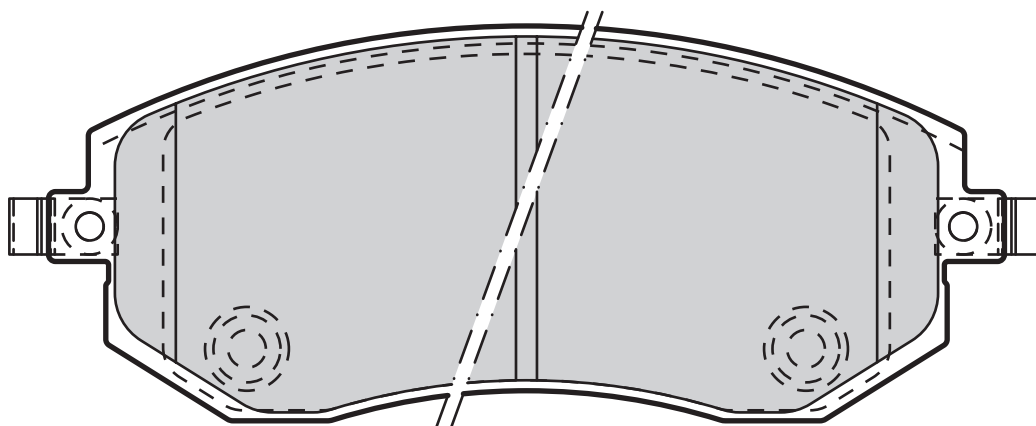

Valeo



598853

2

136,8

56,5

17,5

AKEBONO

23881 (WVA)

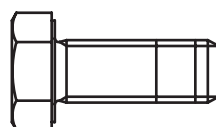
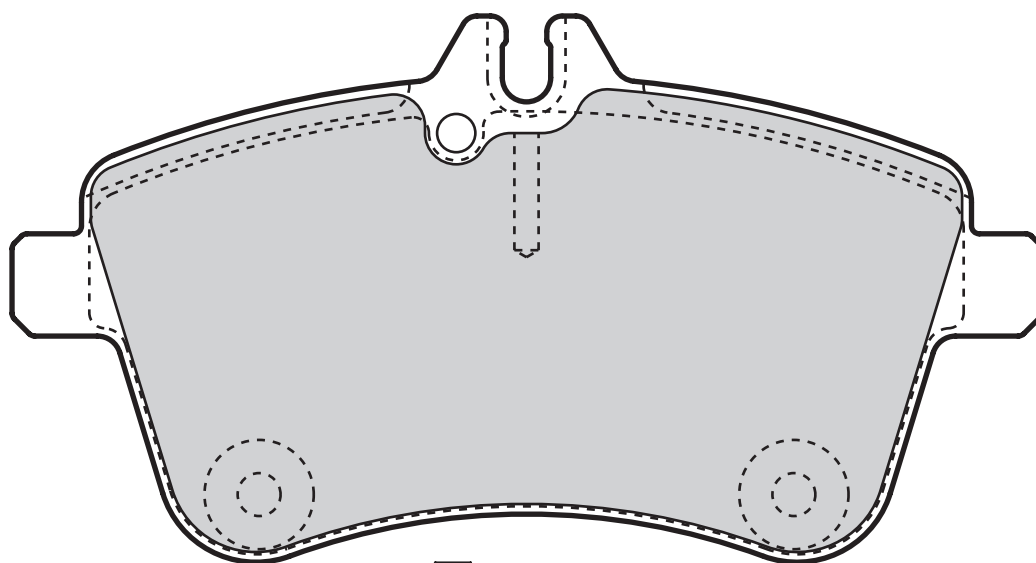

Valeo



598795

2

131,6

70

20,1

LUCAS



23885 (WVA)

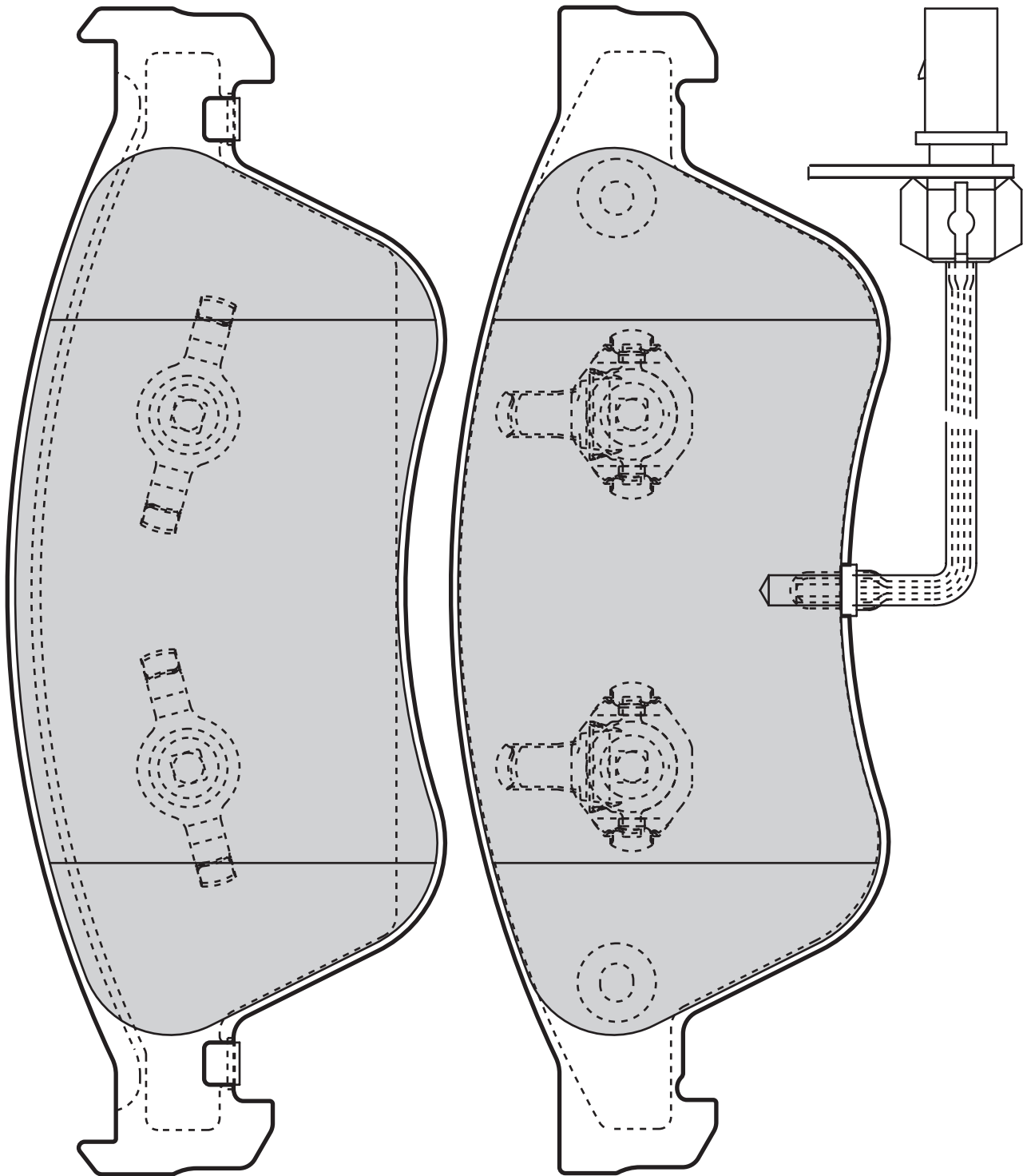

Valeo



598845

2

193,2

72,6

20,3

TEVES



Valeo

23914 (WVA)

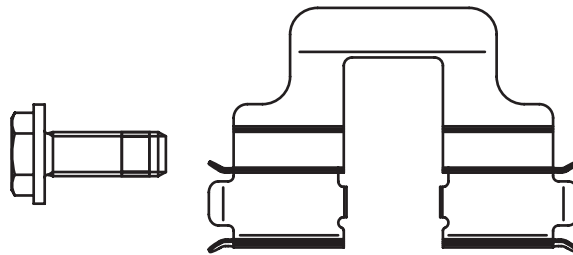
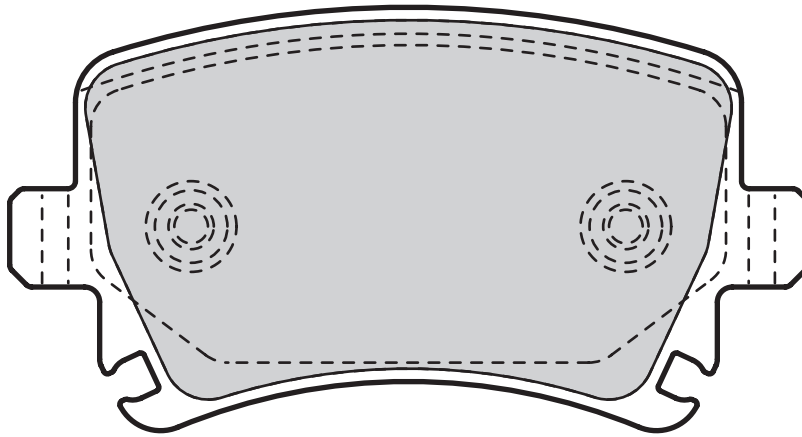

Valeo



598752

0

105,5

56

17

LUCAS

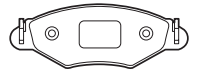

23915 (WVA)

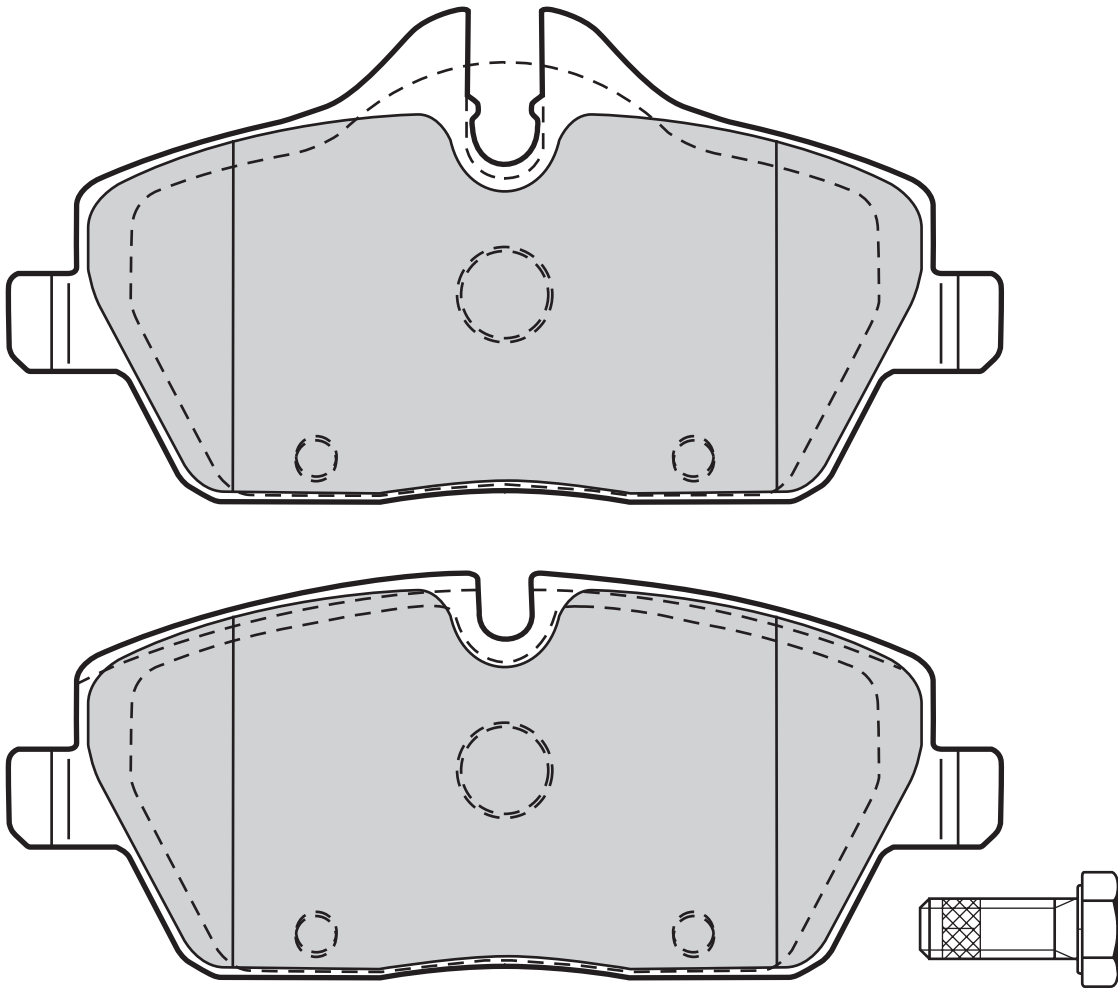

Valeo



598699

0



131,2



65/53,2



17,9



LUCAS



Valeo

23922 (WVA)

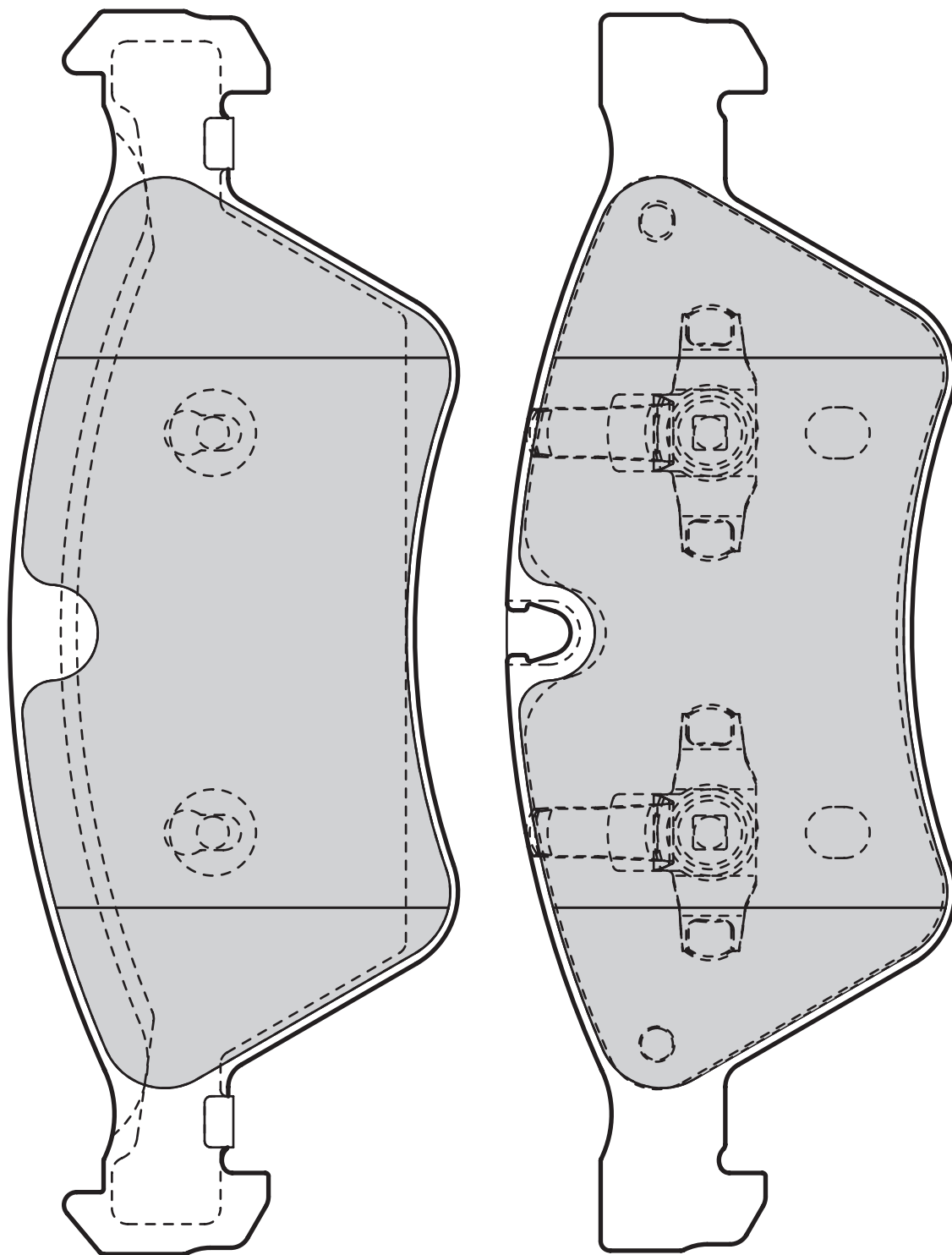

Valeo



598728

0

193,3

70

20,3

TEVES

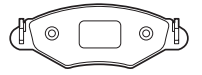

23923 (WVA)

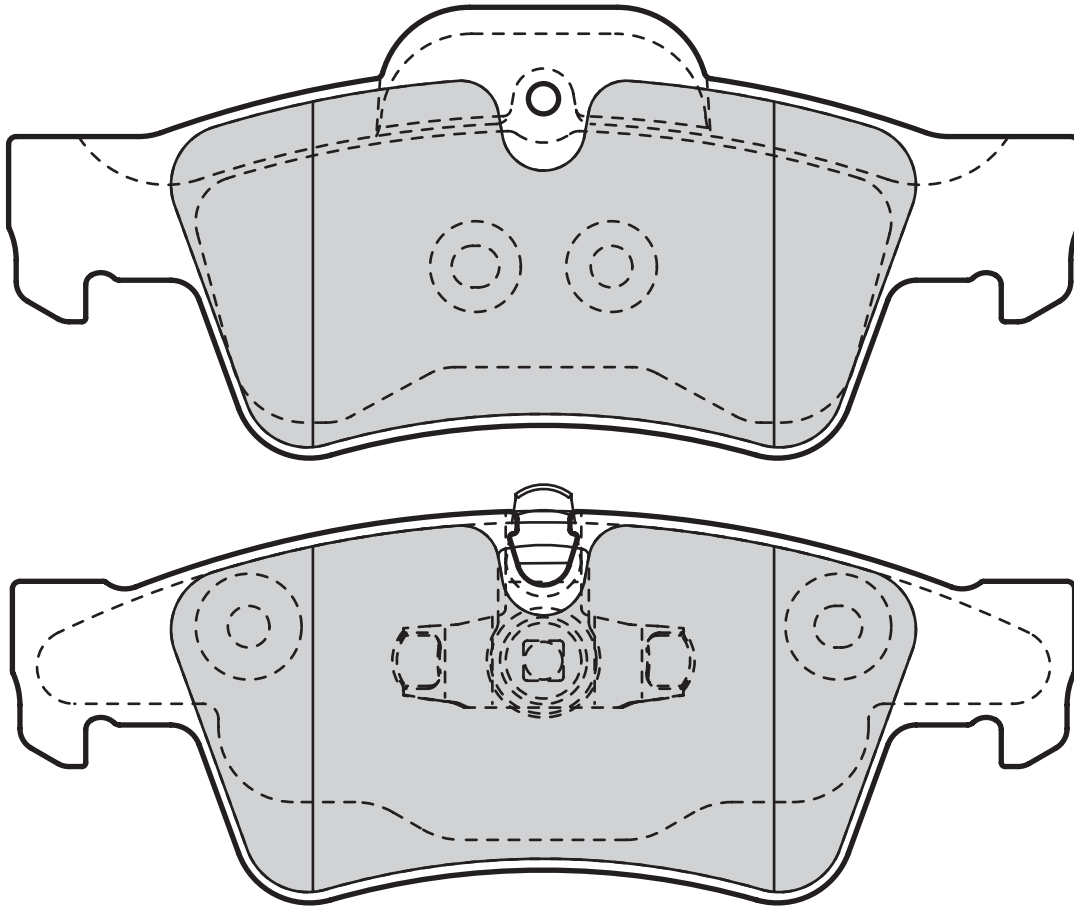

Valeo



598802

0

140,2

52

17,9

TEVES



Valeo

23926 (WVA)

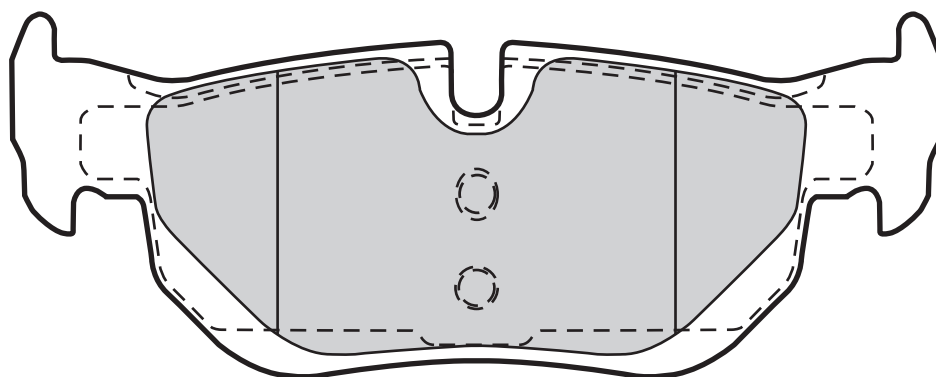
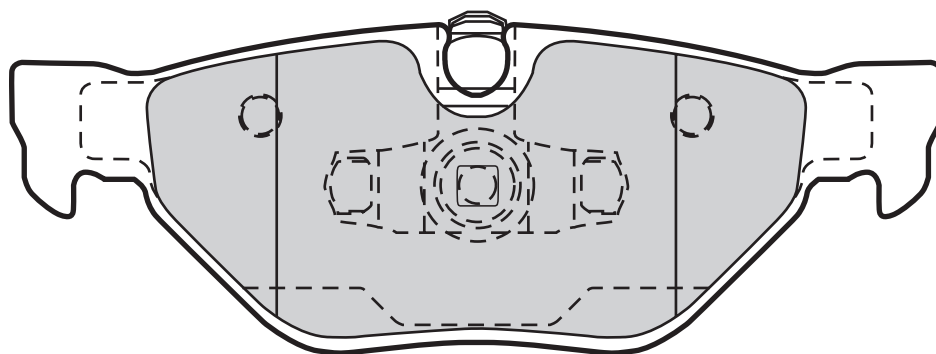

Valeo



598703

0

123

44,5

17,3

TEVES

23930 (WVA)

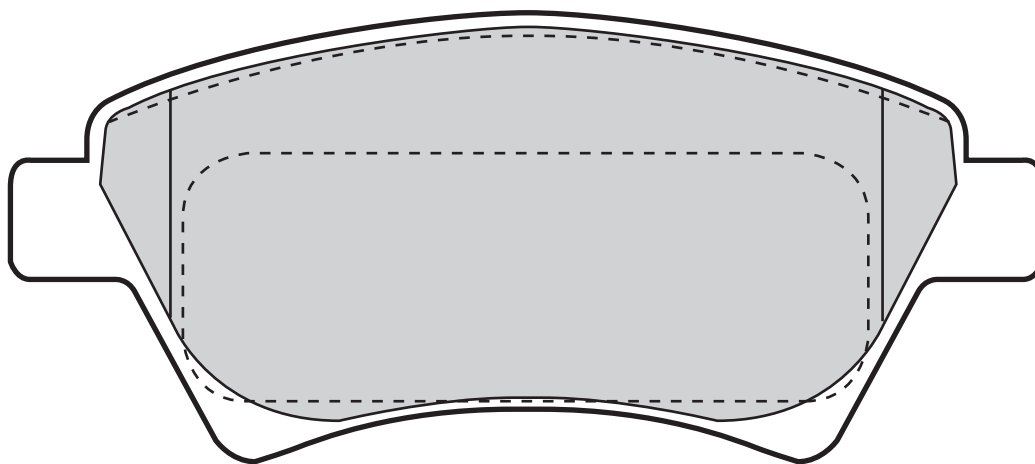

Valeo



598558

0

136,8

59,5

18,3

BOSCH

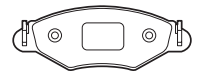

23934 (WVA)

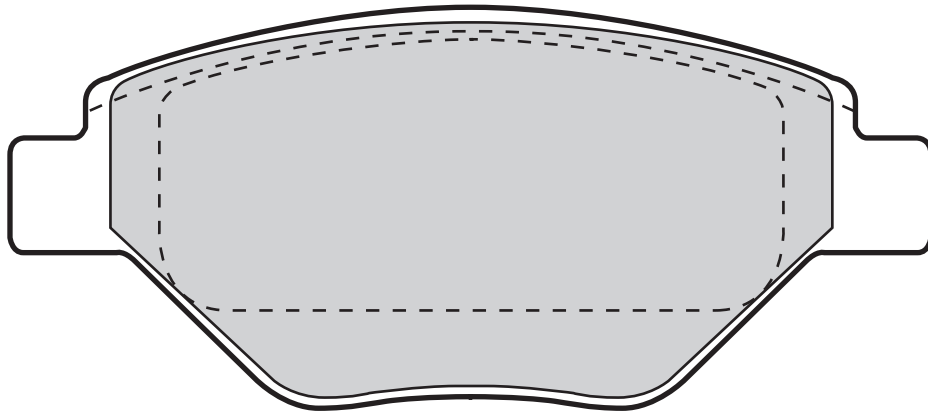

Valeo					
598557	0	122,8	54,3	18,3	BOSCH

23935 (WVA)

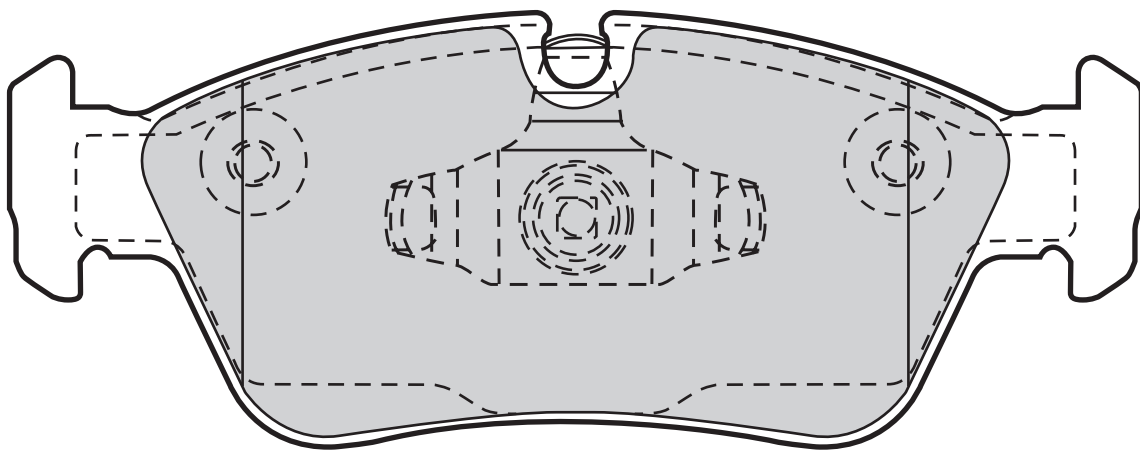
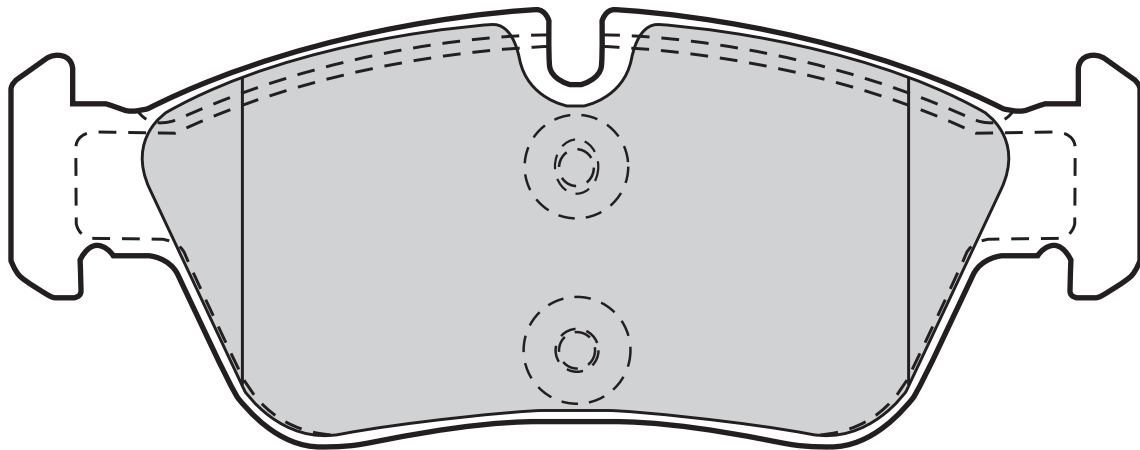

Valeo					
598700	0	149,4	57,5	17,8	TEVES



Valeo

23945 (WVA)

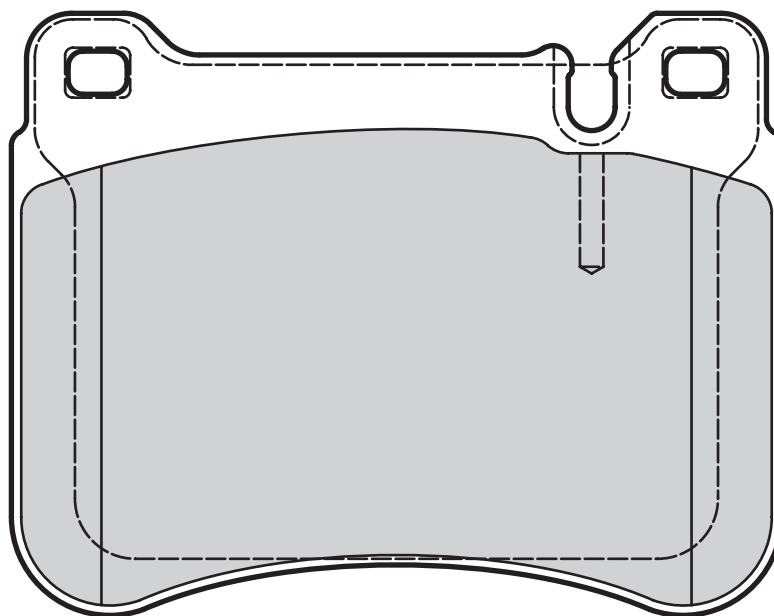

Valeo



601034

0

101,8

79,6

16,5

TEVES



23951 (WVA)

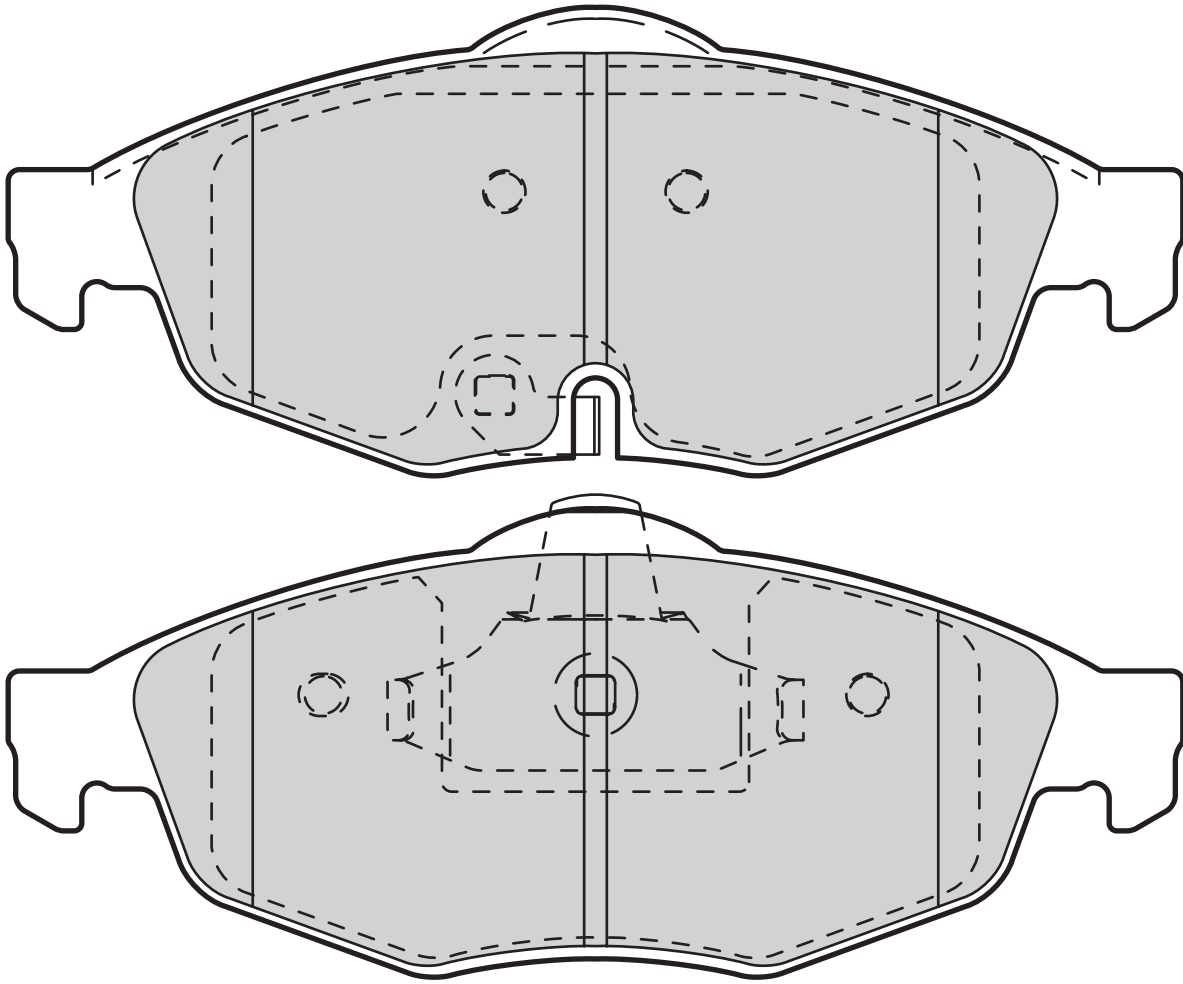

598905

0

155,45

62

20,5

TEVES



Valeo

23960 (WVA)

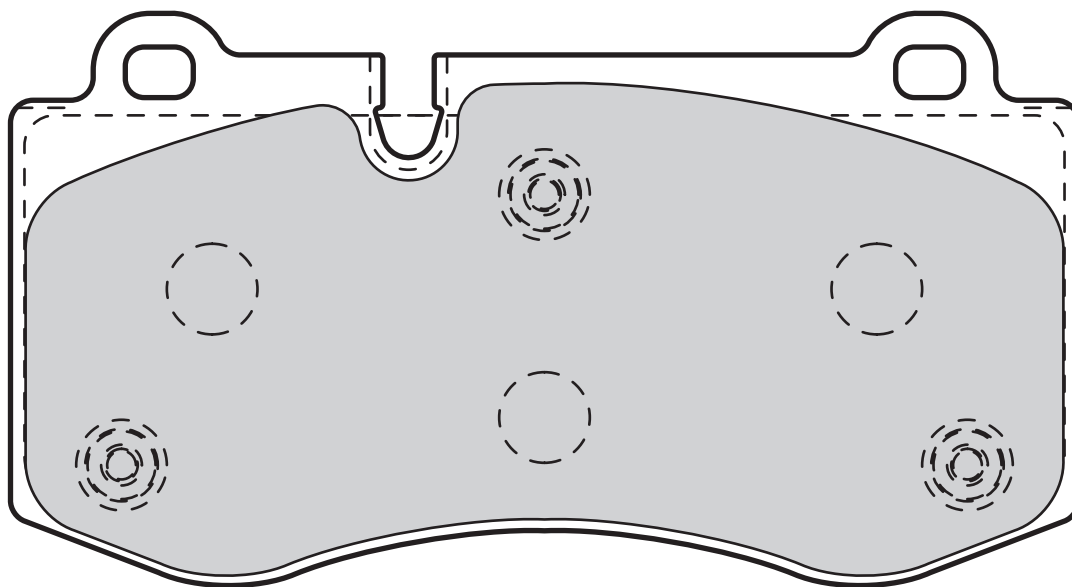

598995	0	141,4	75,8	17,8	BREMBO

23983 (WVA)

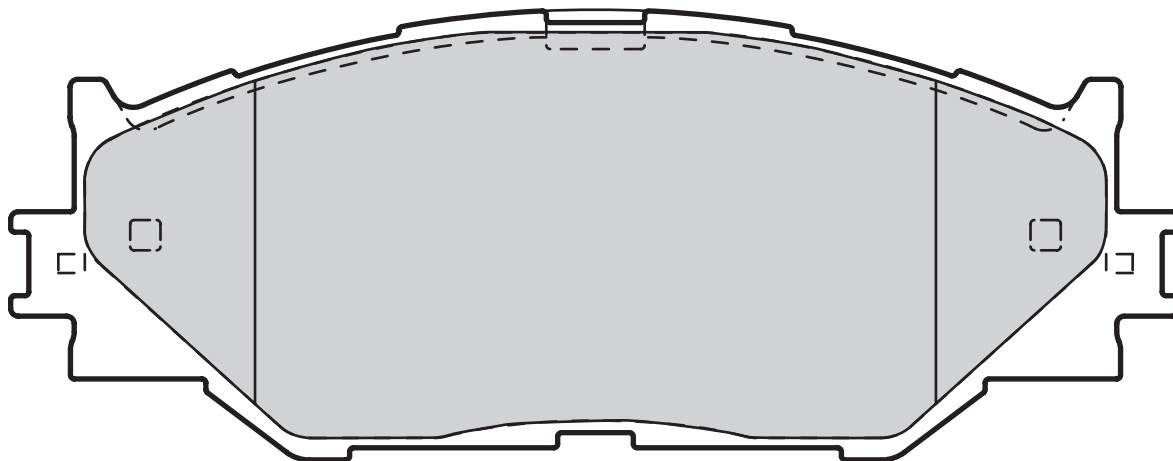

601035	0	154,6	59,5	17,7	SUMITOMO

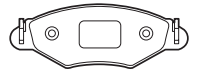

23984 (WVA)

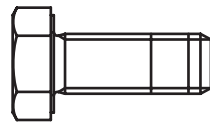
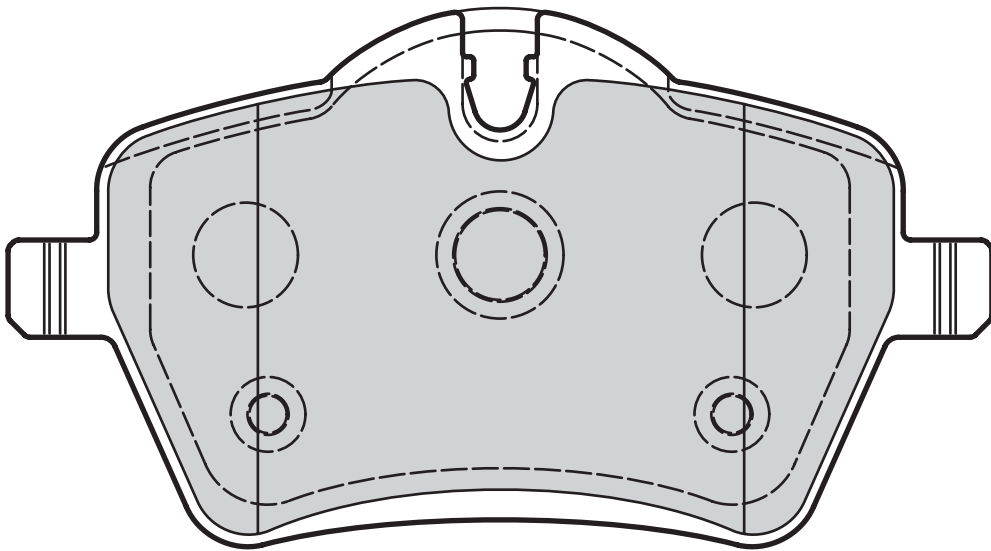
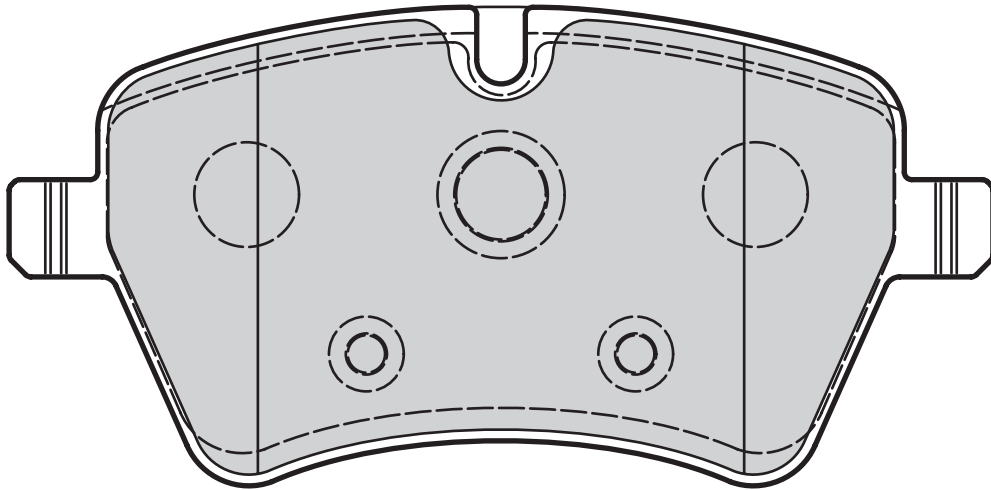

Valeo



598925

2

131,5

64/71,4

17,9

LUCAS



Valeo

24008 (WVA)

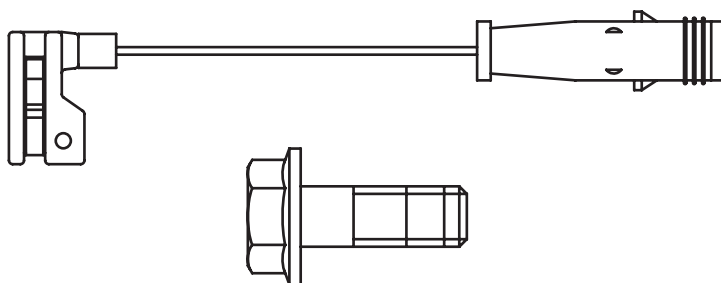
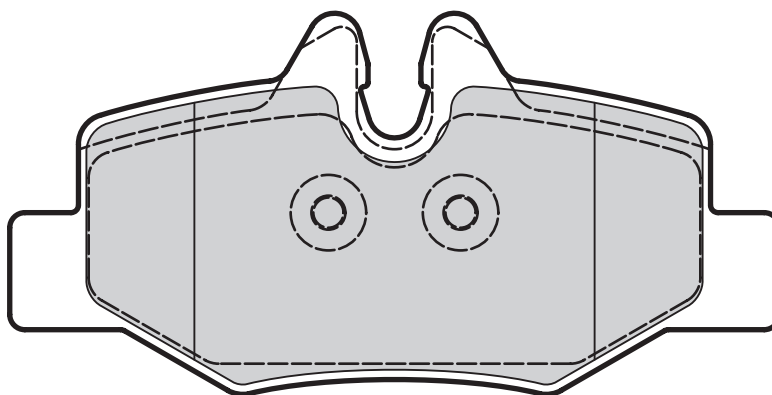

Valeo



598765

2

101,9

50,5

18,3

BOSCH

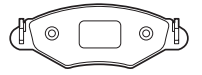

24011 (WVA)

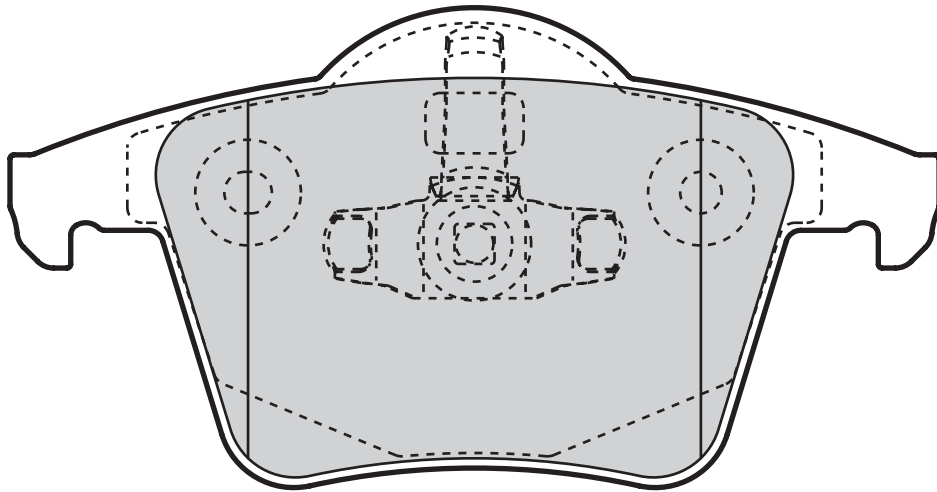
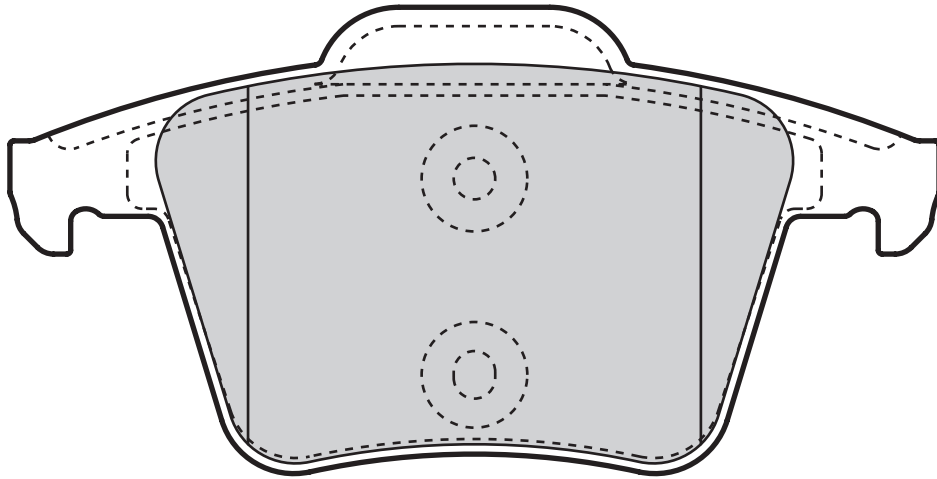

Valeo



598829

0



122,9



61,6



18,7



TEVES



Valeo

24014 (WVA)

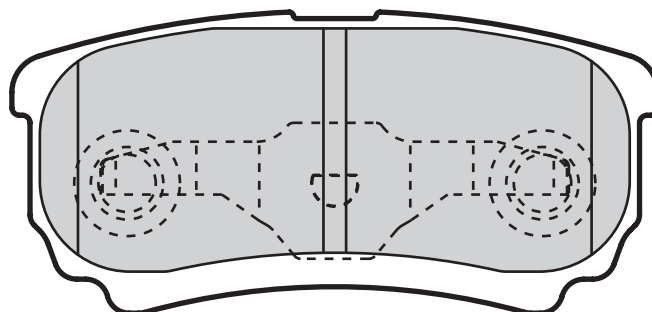
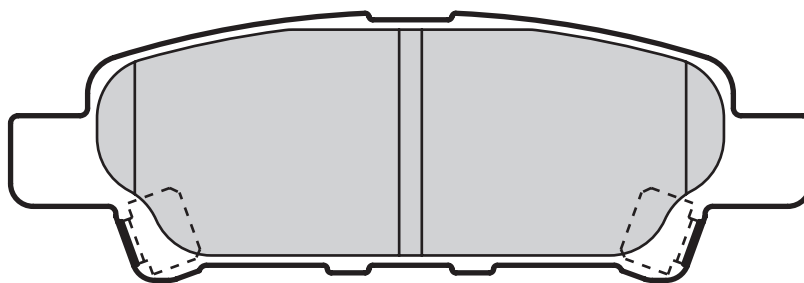

Valeo



598852

2

85,4

35,5

15,4

AKEBONO

24036 (WVA)

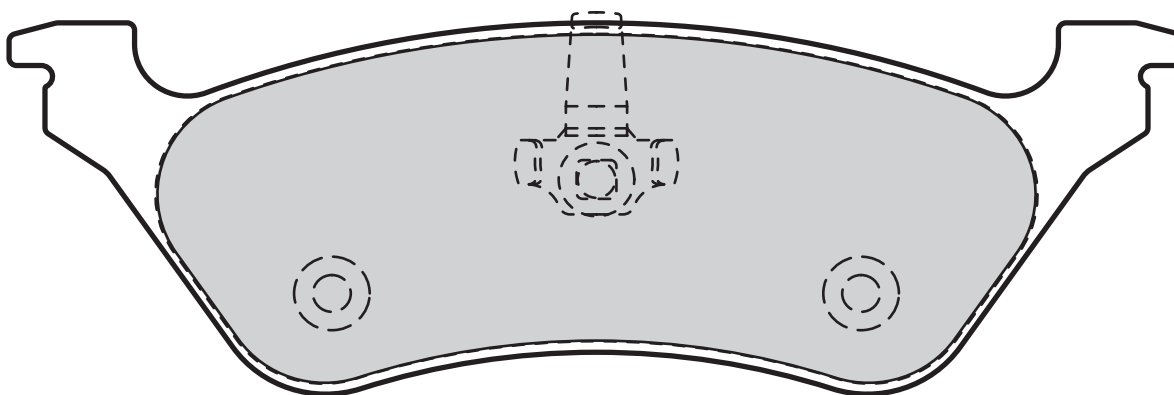

Valeo



598755

0

155,4

50,5

17

KELSEY

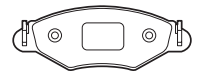

24039 (WVA)

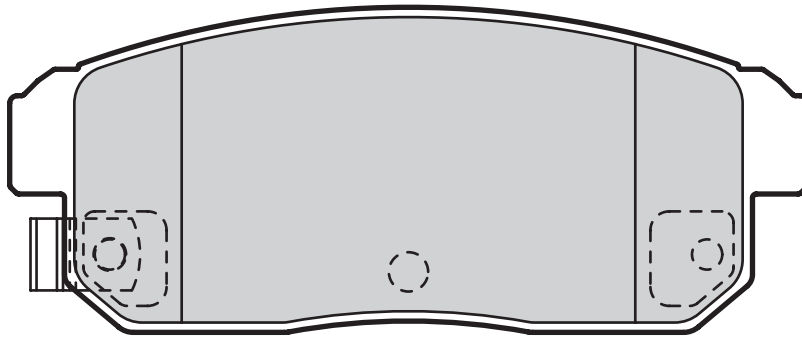

Valeo



598831

1

105,5

43

15

AKEBONO

24077 (WVA)

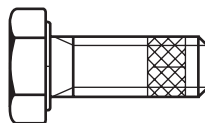
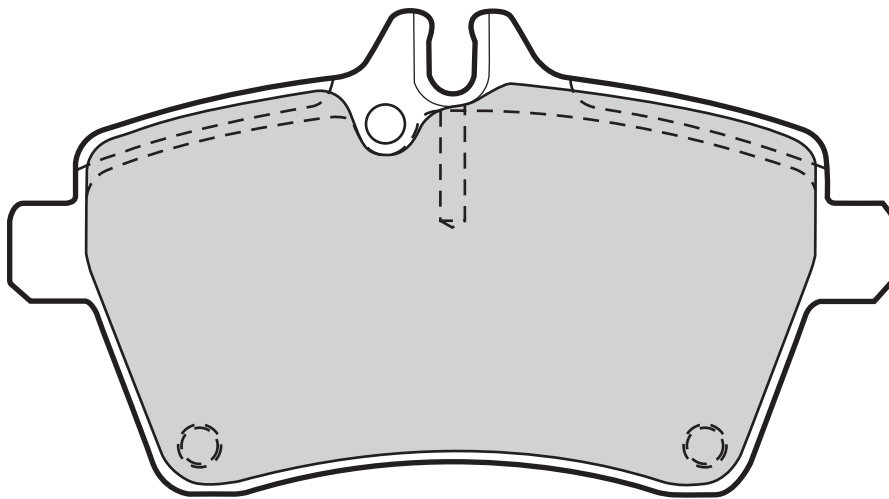

Valeo



598704

0

116,5

63,8

19

LUCAS



Valeo

24098 (WVA)

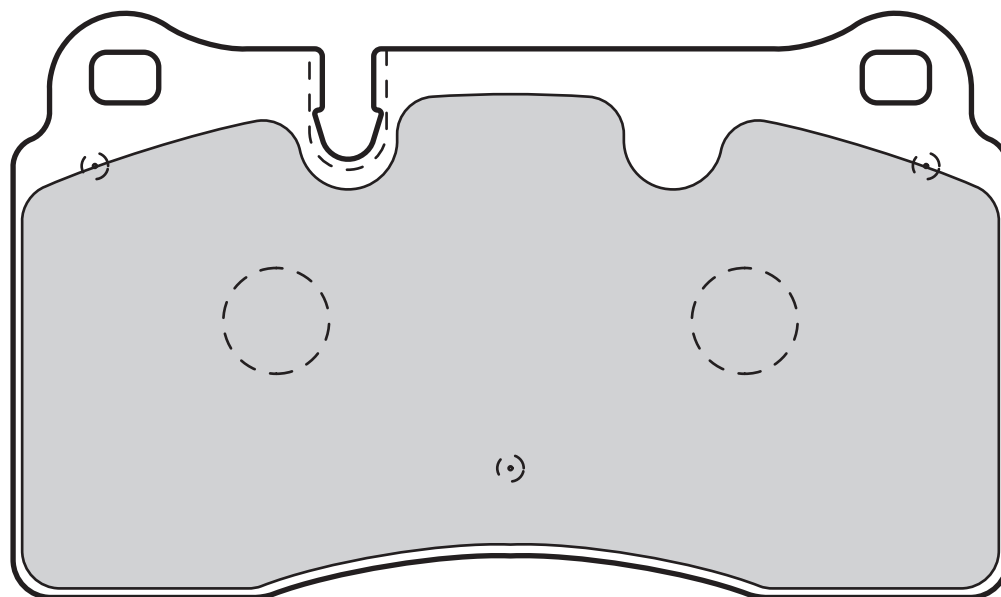

Valeo



598994

0

131,8

77,4

17,1

BREMBO

24111 (WVA)

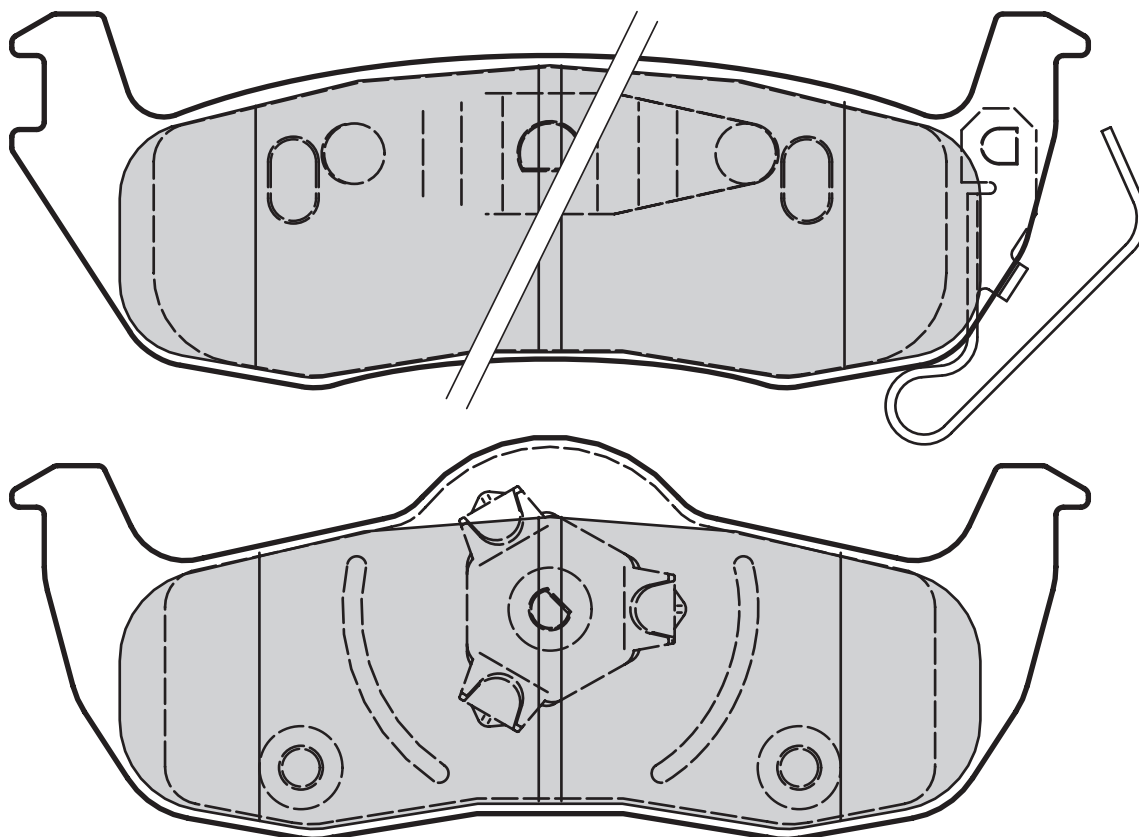

Valeo



598920

2

142

49/52,9

17,9

KELSEY



24123 (WVA)

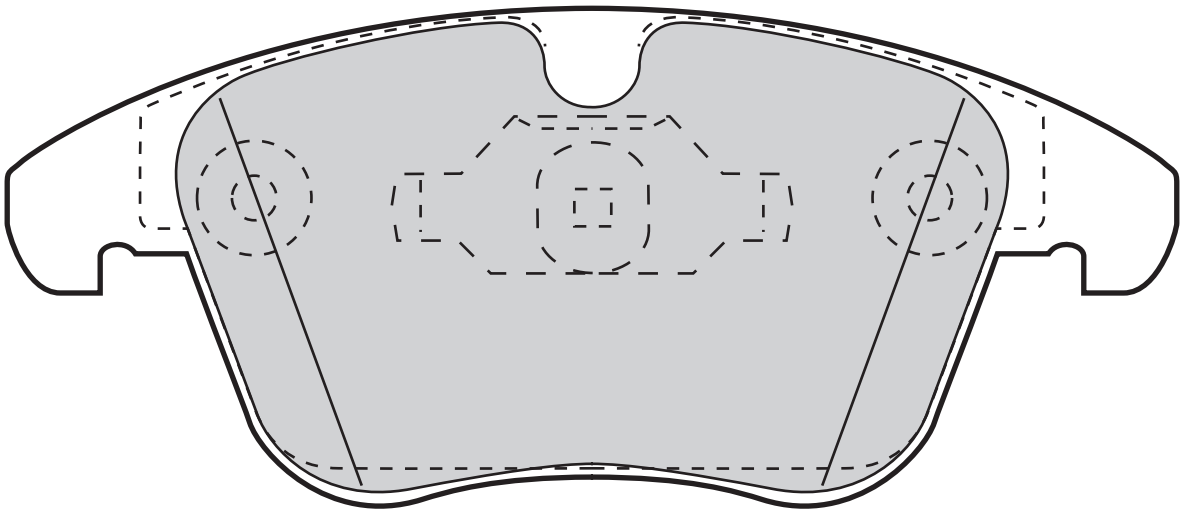
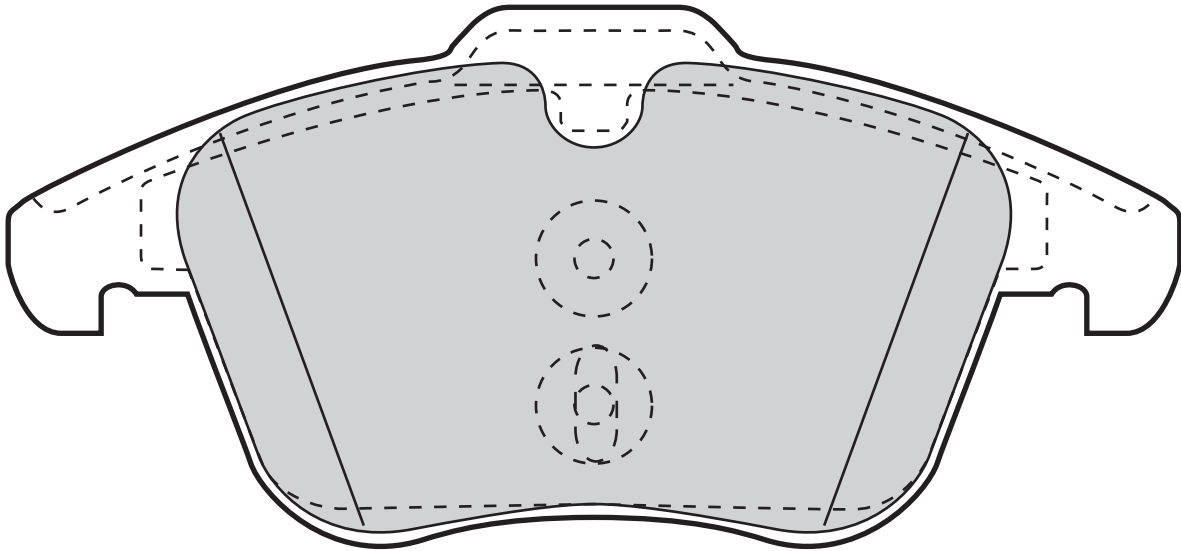

Valeo



598879

0

155,1

72/66,6

19,2

TEVES



Valeo

24133 (WVA)

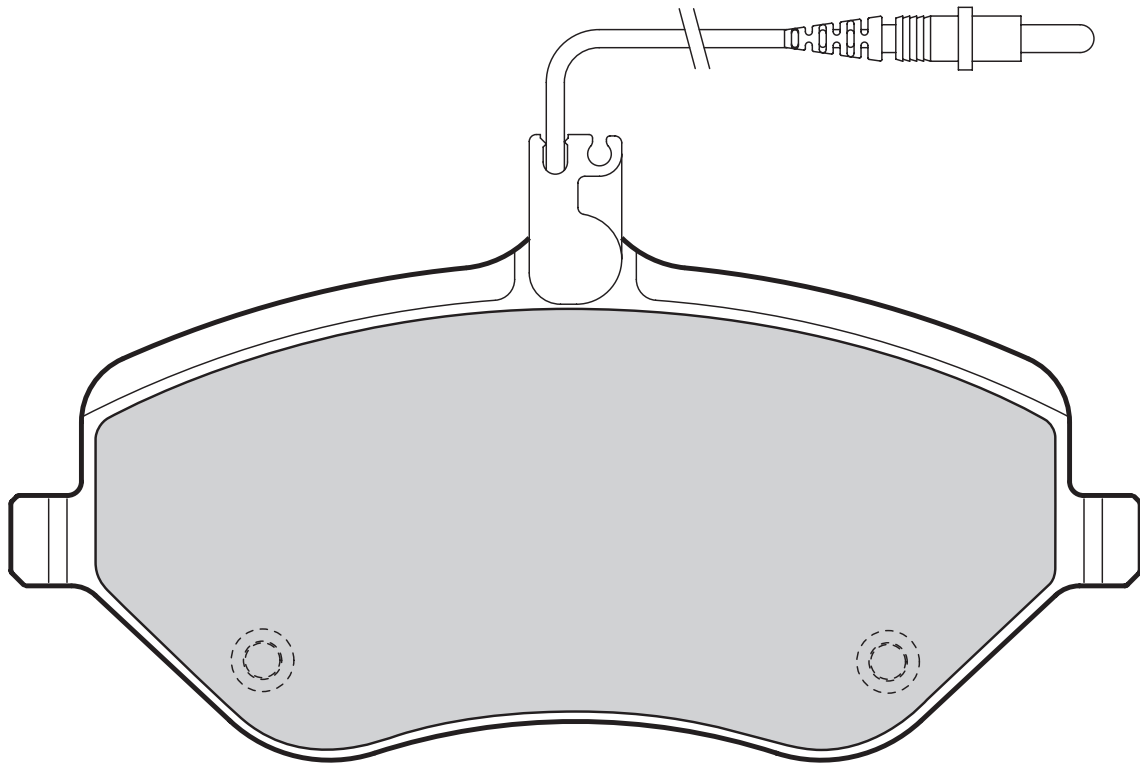

Valeo



598663

2

162,4

79

18,5

LUCAS

24135 (WVA)

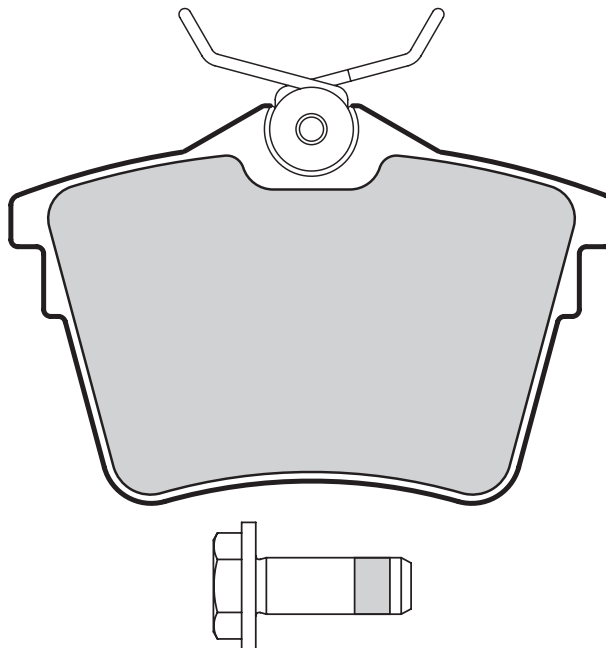

Valeo



598664

0

86,2

57

17,8

LUCAS

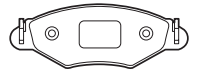

24137 (WVA)

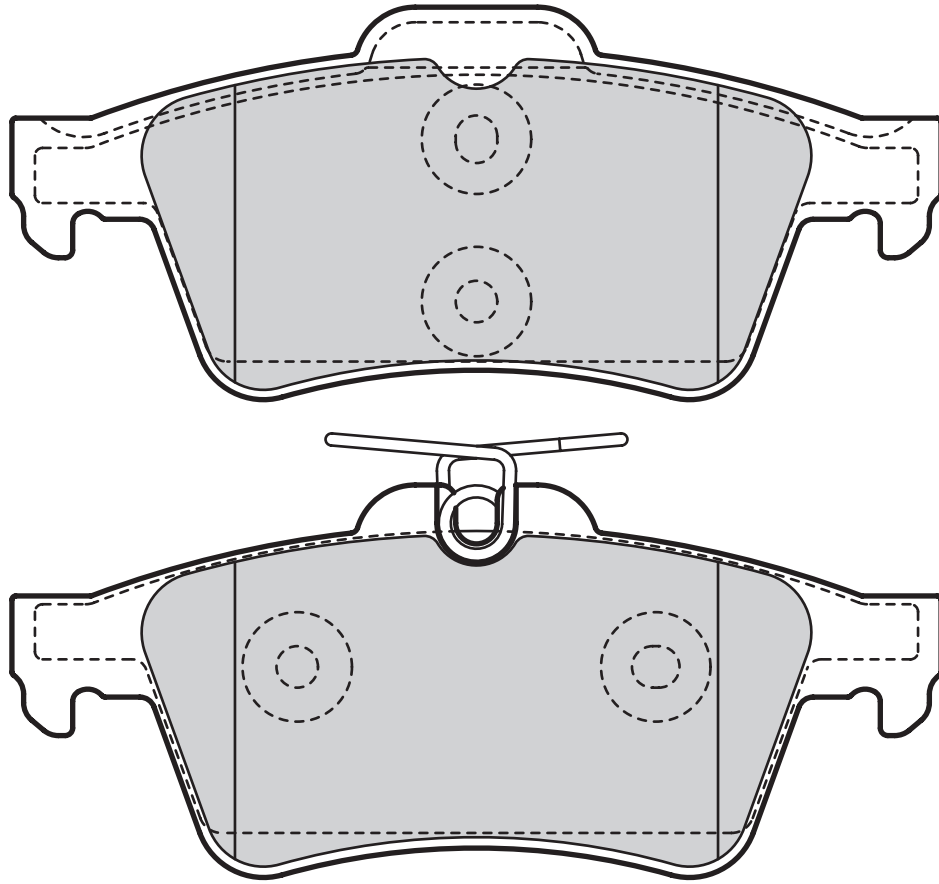

Valeo



598783

0

122,9

51,7

16,4

TEVES



Valeo

24141 (WVA)

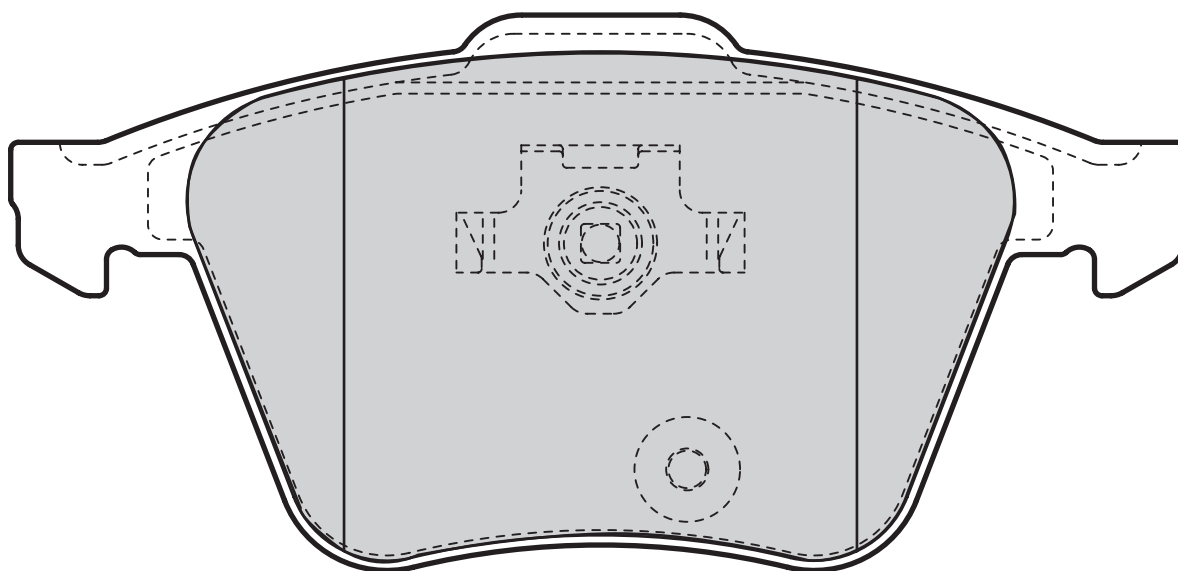
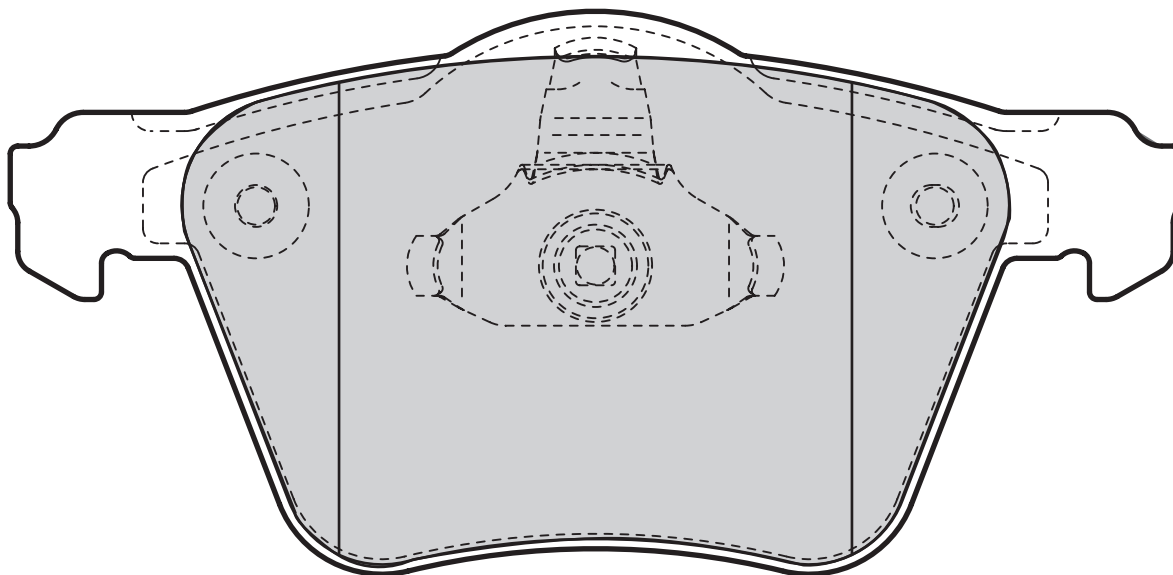

Valeo



0



155,2



74/75



19



TEVES

598657

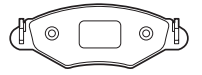

24142 (WVA)

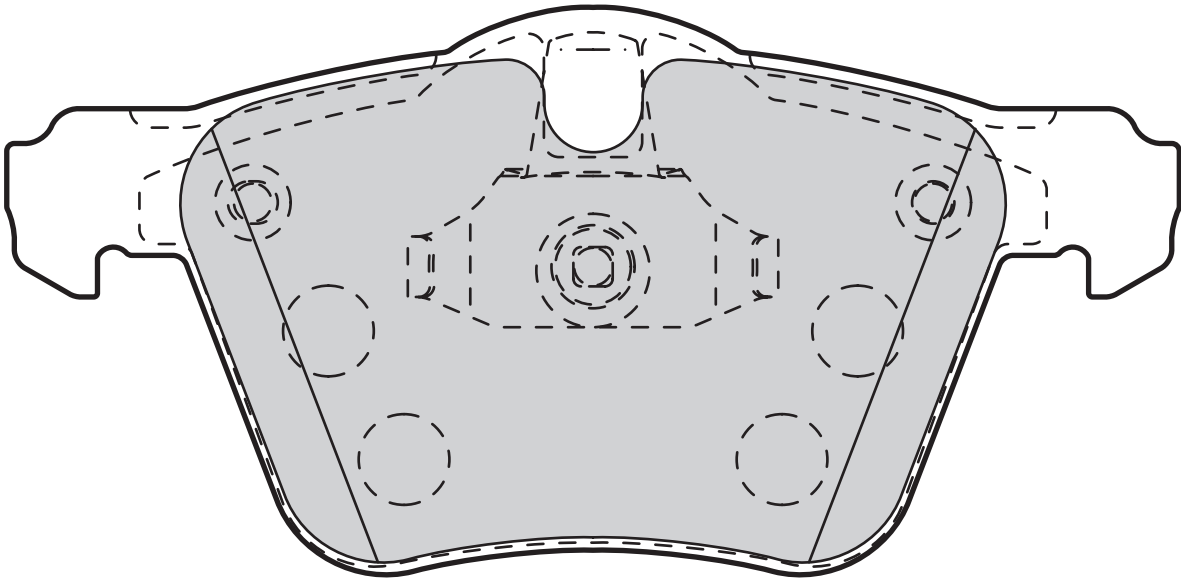
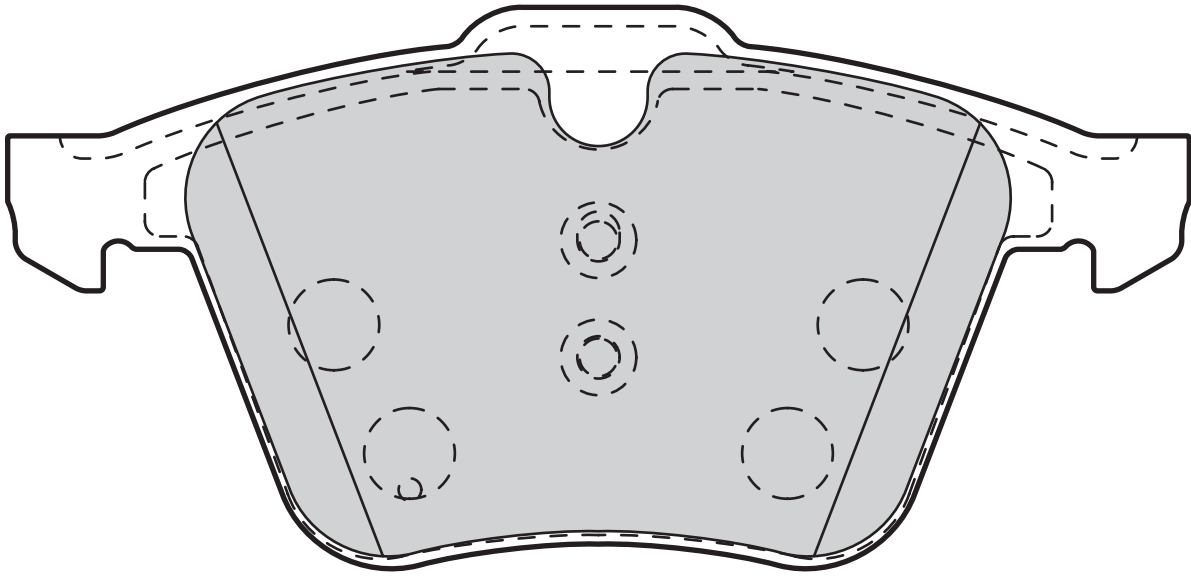

Valeo



601007

0



155,2



75,1



20,1



TEVES



Valeo

24150 (WVA)

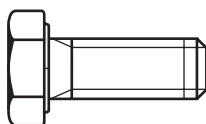
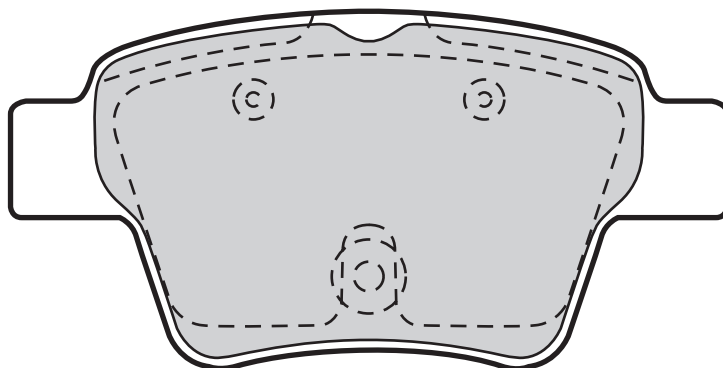

Valeo



598702

0

94,5

46,7

17,6

BOSCH

24162 (WVA)

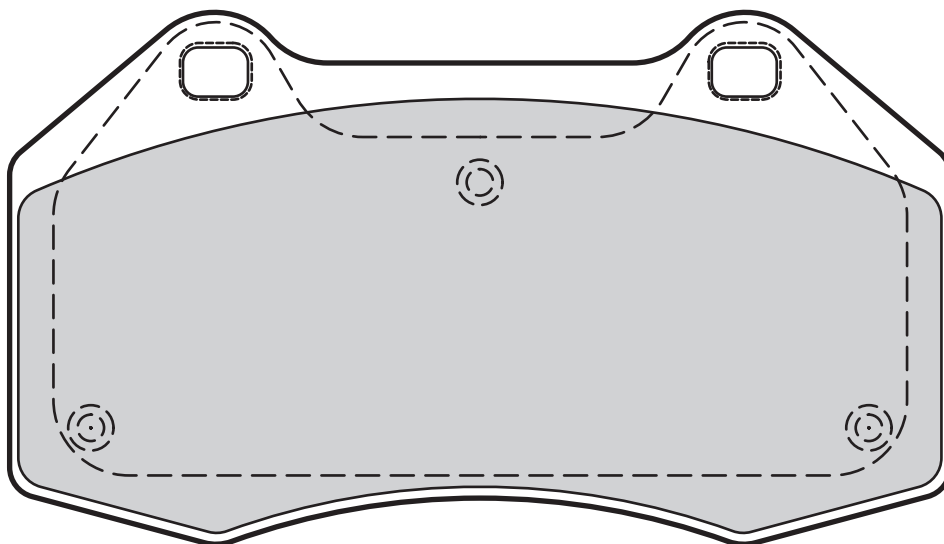

Valeo



598861

0

124,5

70,4

15,2

BREMBO



24191 (WVA)

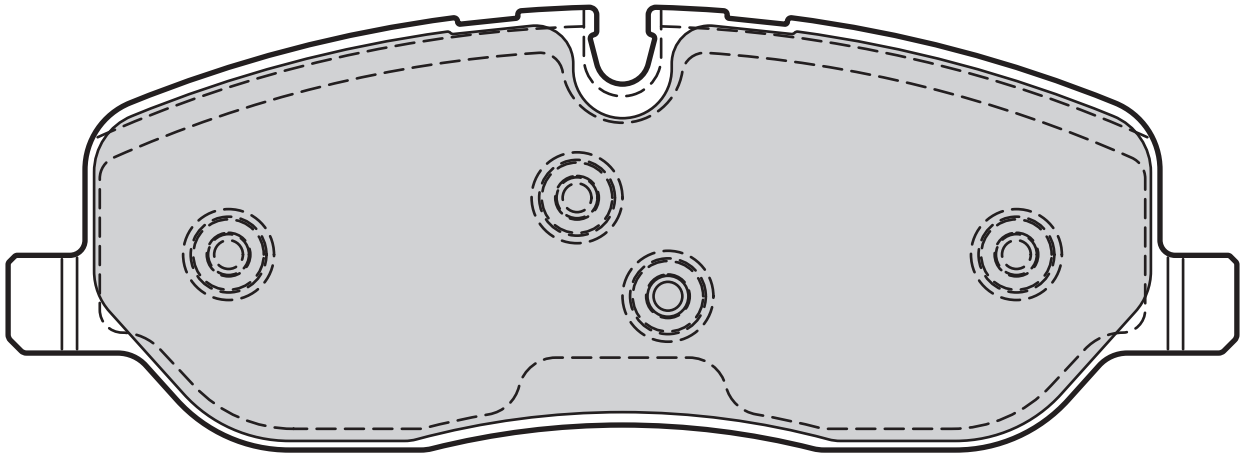

598741	0	162,5	58,5	18,1	LUCAS

24192 (WVA)

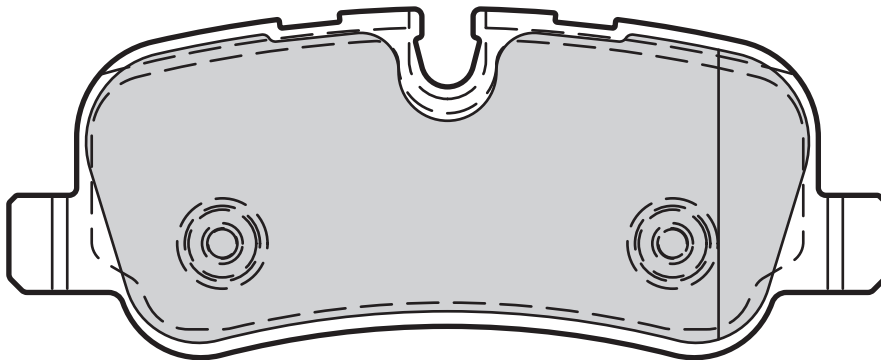

598742	0	116,5	46,3	17,5	LUCAS



Valeo

24250 (WVA)

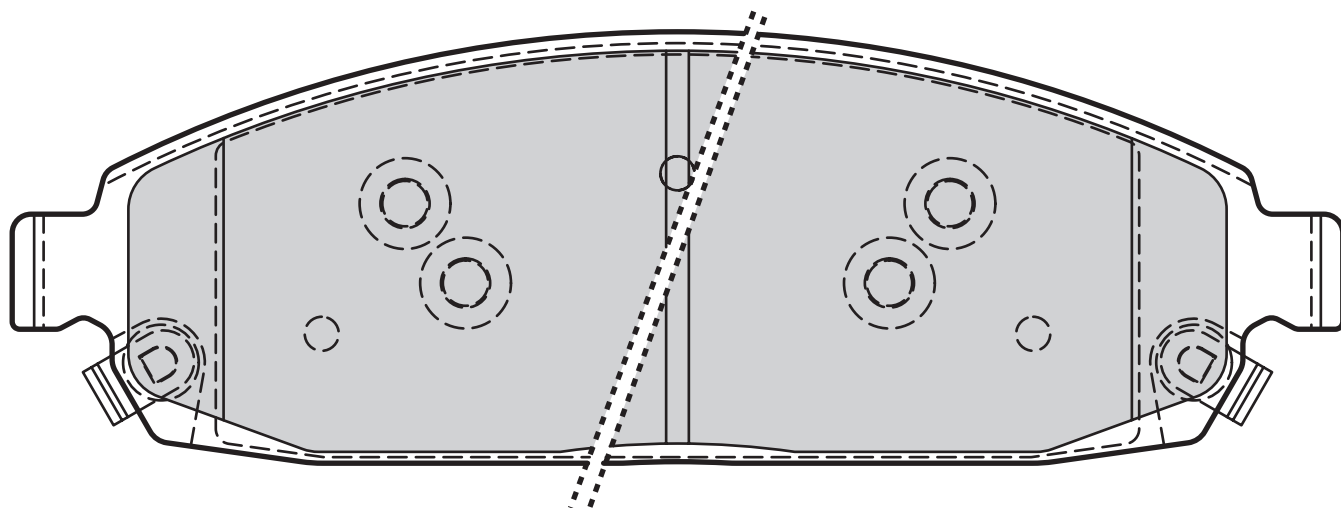

Valeo



598872

2

176

57

18,8

AKEBONO

24253 (WVA)

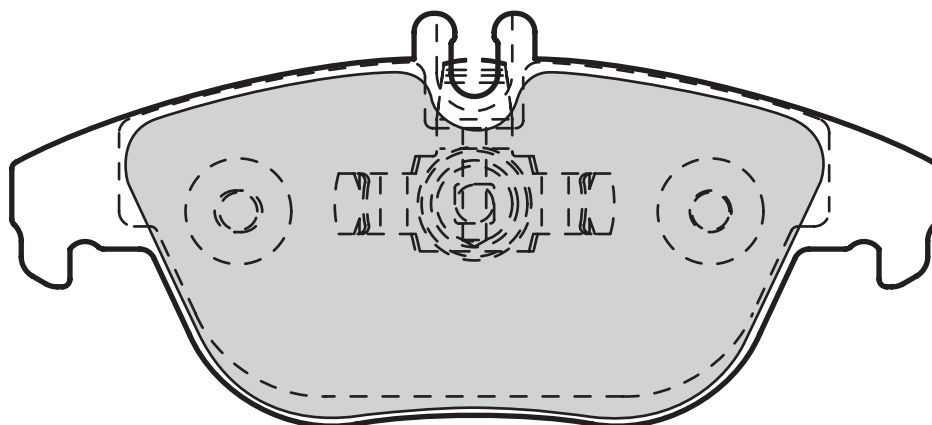
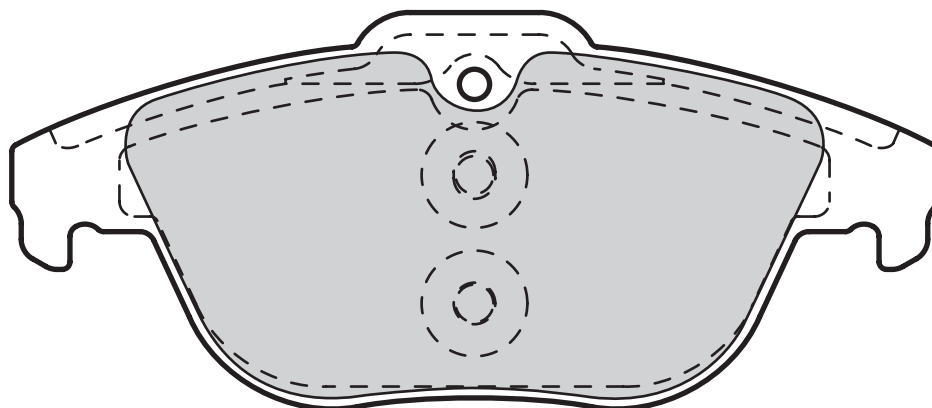

Valeo



601051

0

122,5

52,5

17,6

TEVES



24289 (WVA)

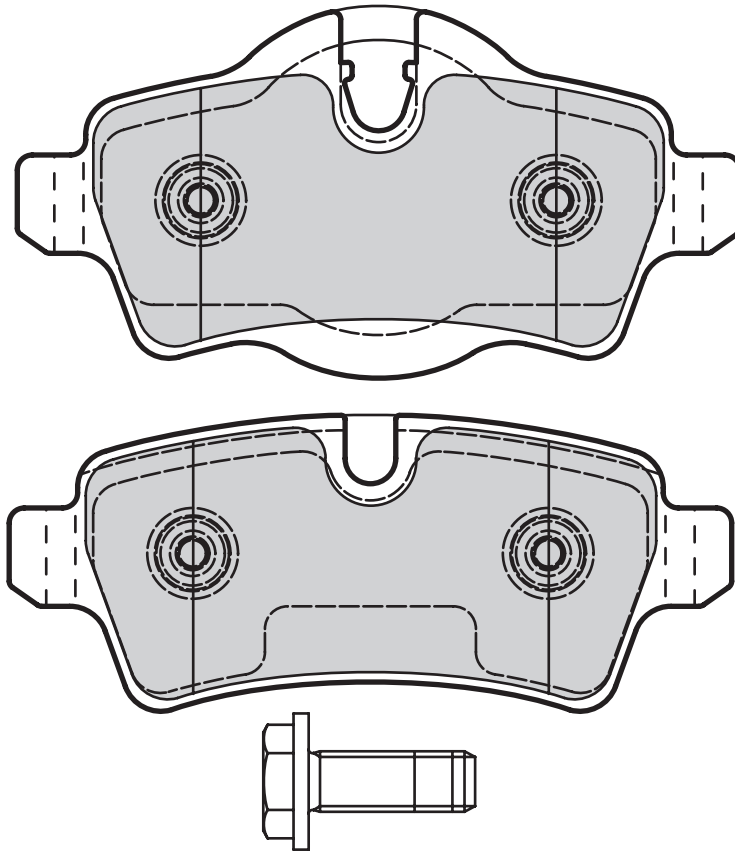

Valeo



601041

0

95,5

49,2

17

LUCAS



Valeo

24323 (WVA)

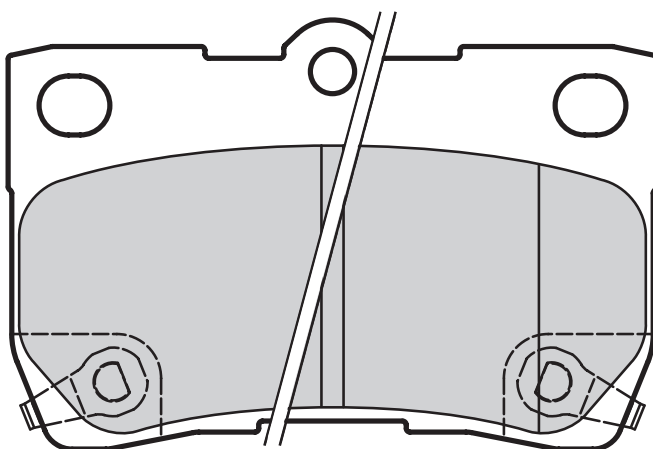
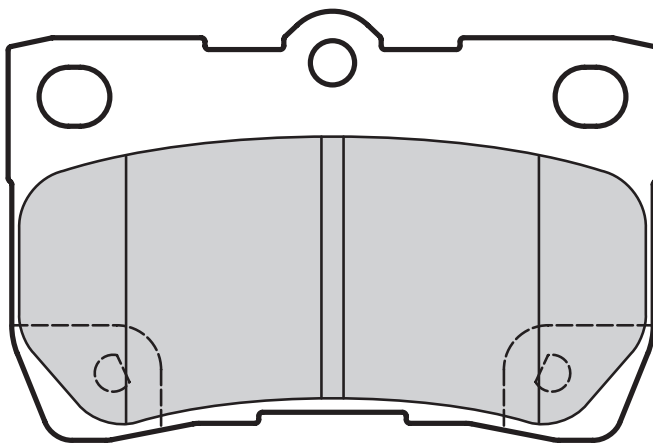

Valeo



598888

2

88

58,2

15,5

AKEBONO

24331 (WVA)

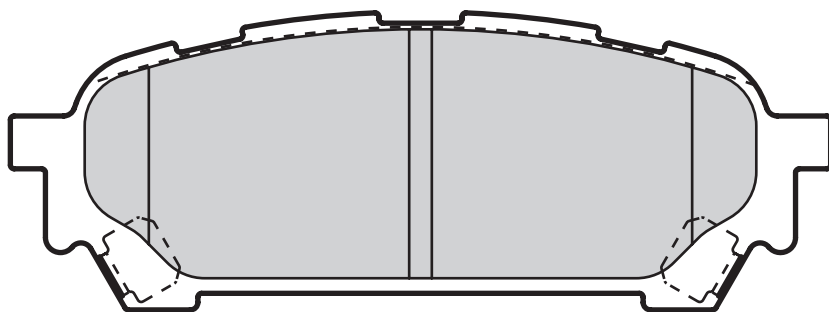

Valeo



598875

2

108,5

39,3

13,8

AKEBONO

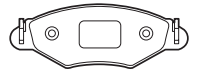

24349 (WVA)

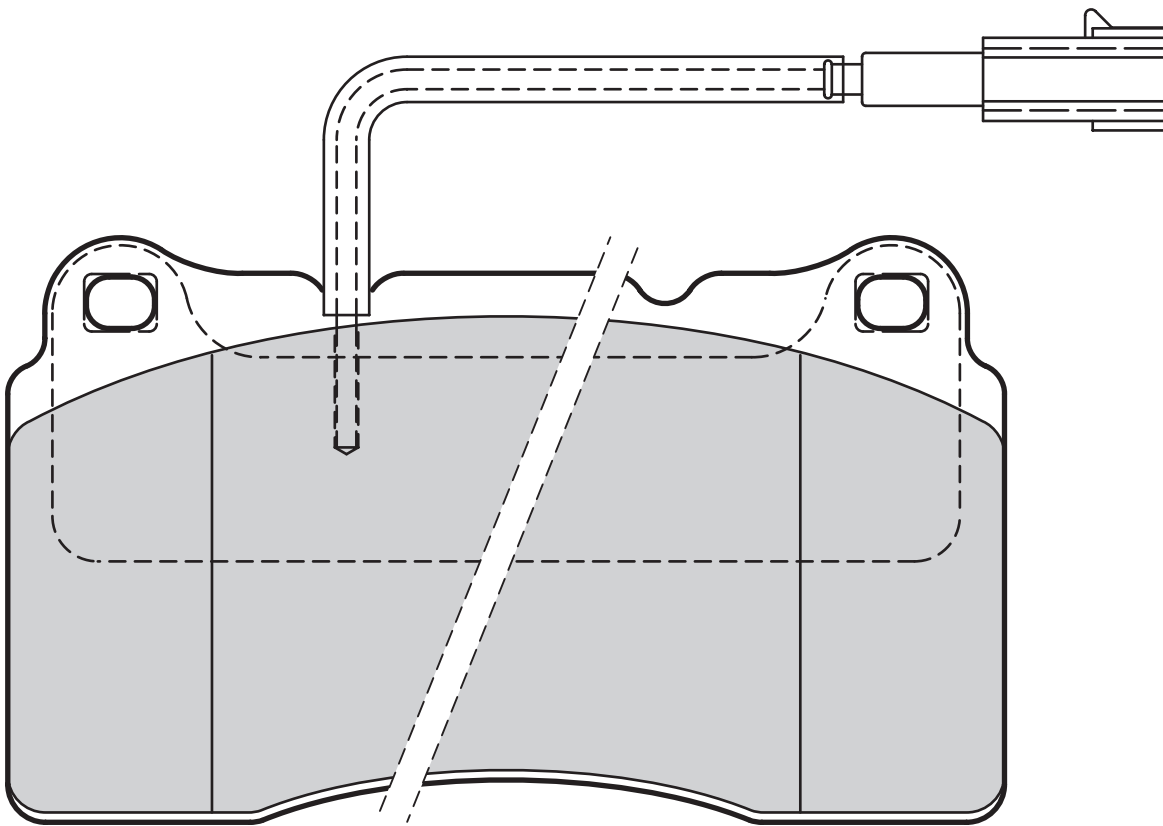
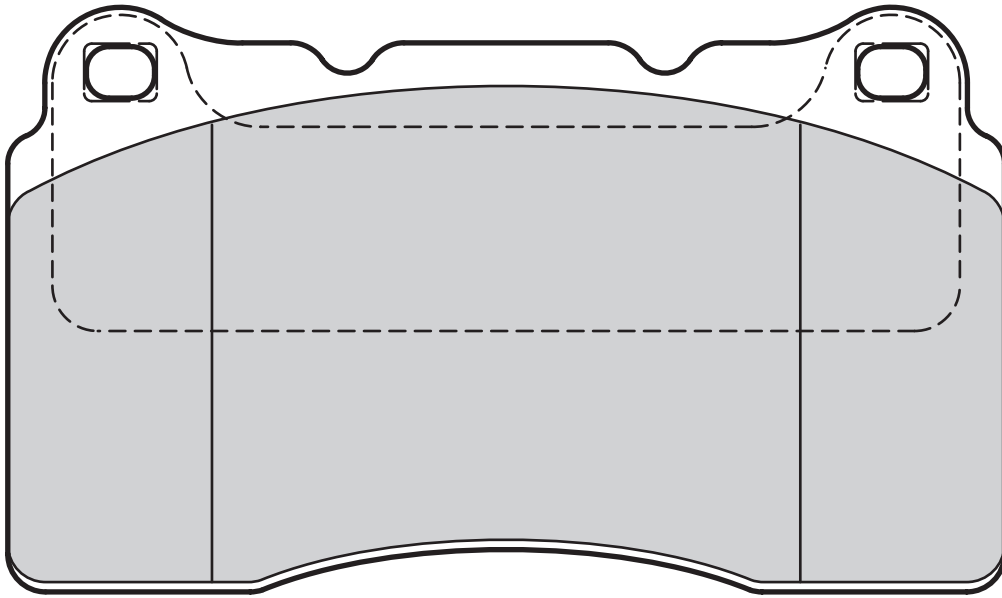

Valeo



598722

0

101,7

47,35

17,2

BOSCH



Valeo

24412 (WVA)

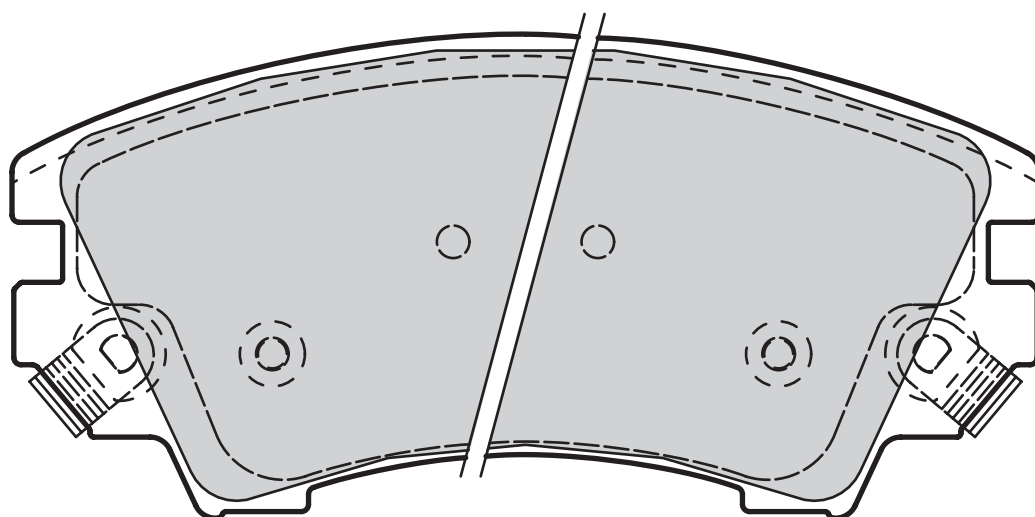
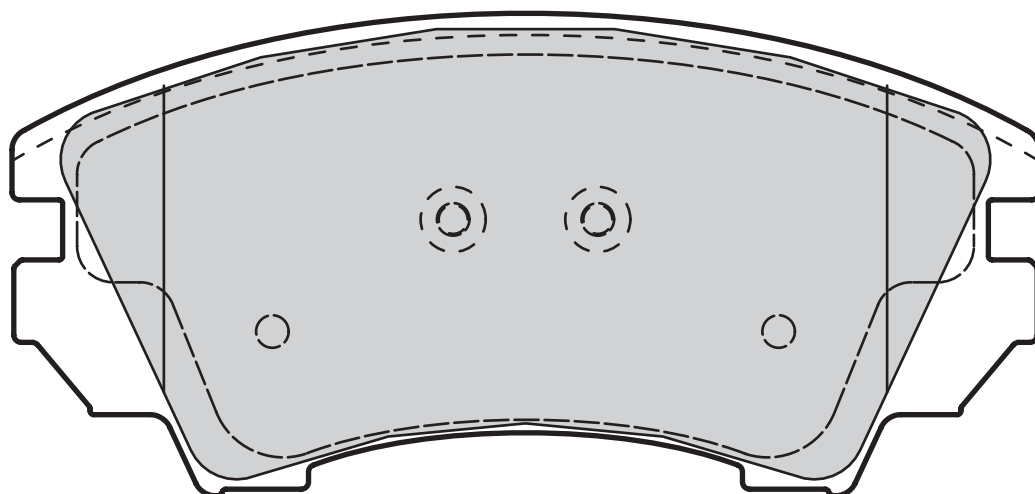

Valeo



601046

2

142

66,7

18,8

MANDO

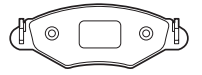

24462 (WVA)

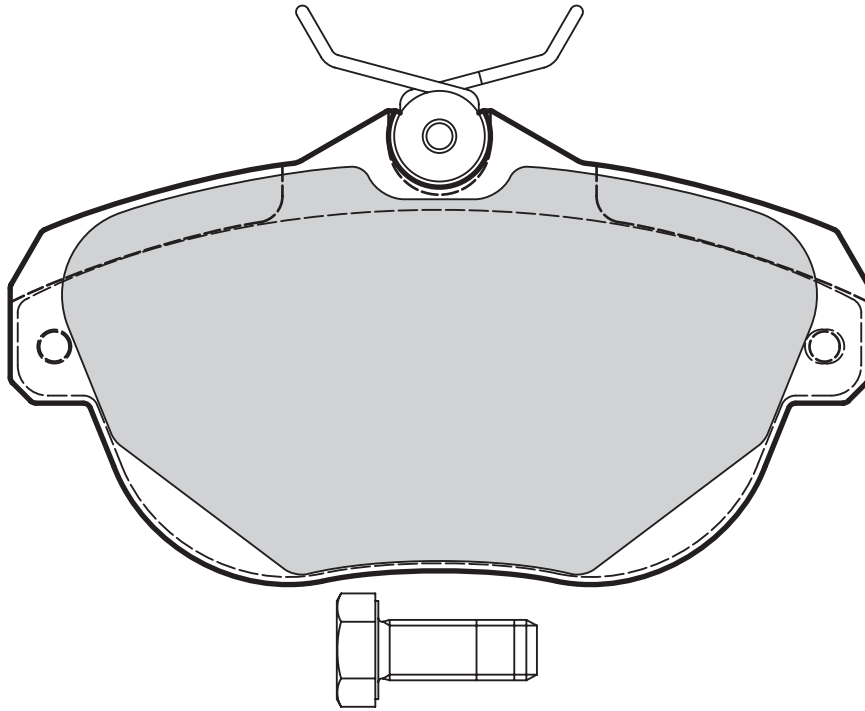

598939

1

114

63

17

LUCAS



Valeo

24491 (WVA)

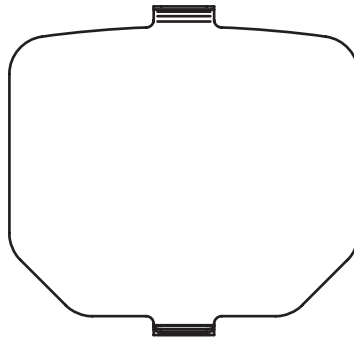
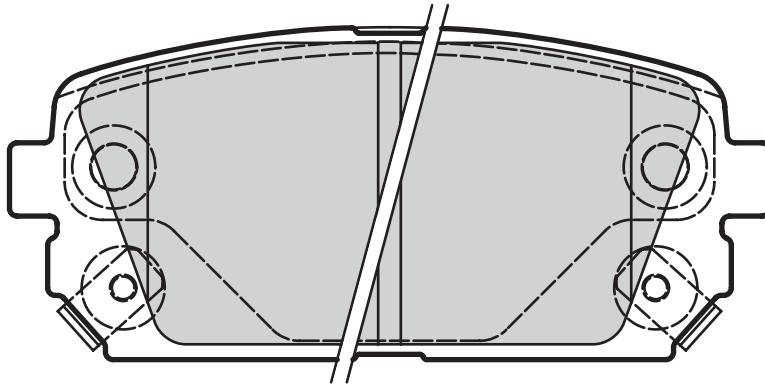
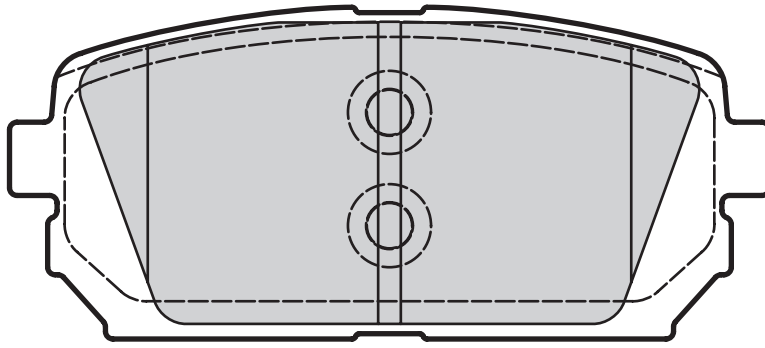

Valeo



598945

1

100

44

15

MANDO



24496 (WVA)

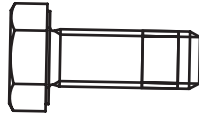
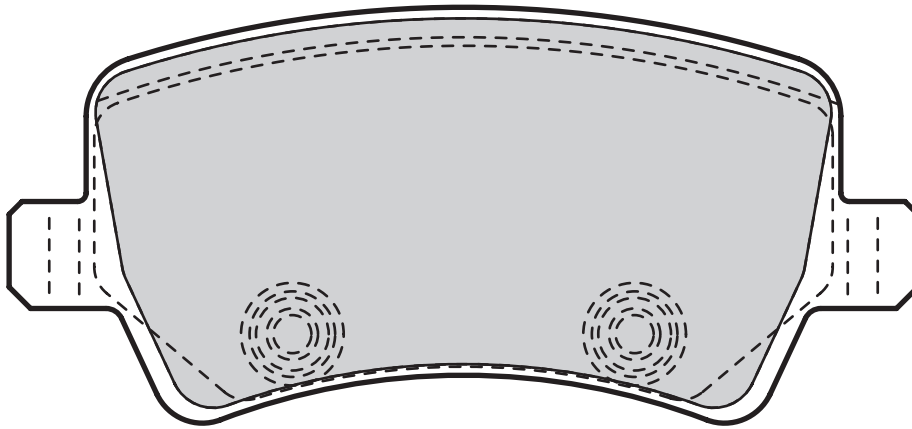

Valeo



598928

0

106

48,4

17

LUCAS



Valeo

24498 (WVA)

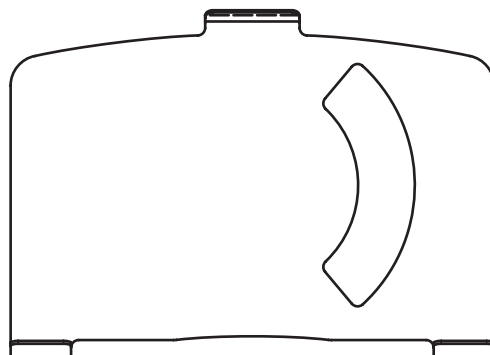
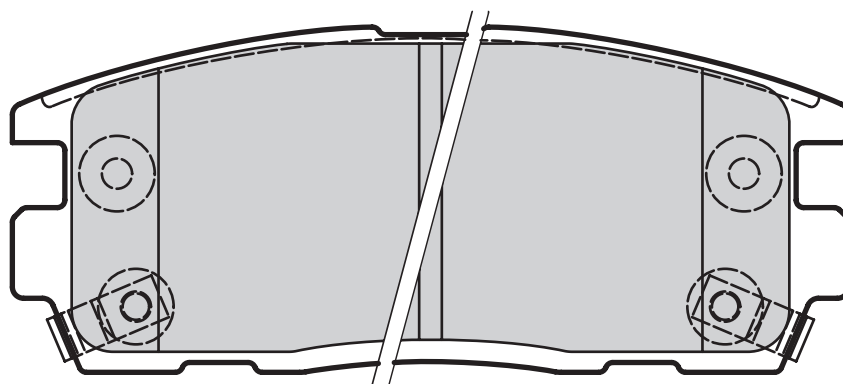
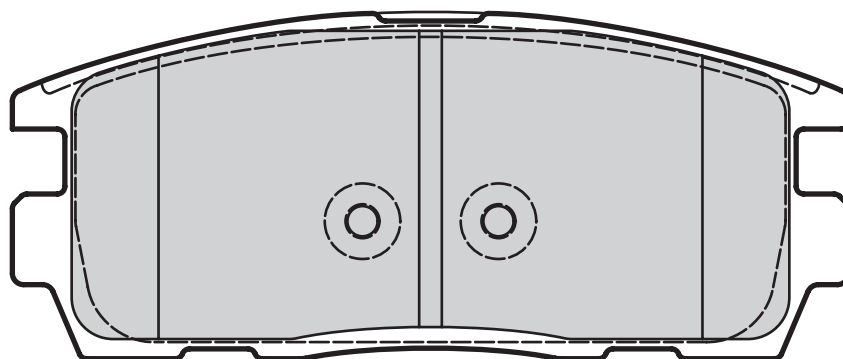

Valeo



598941

2

110

46

15

AKEBONO



24501 (WVA)

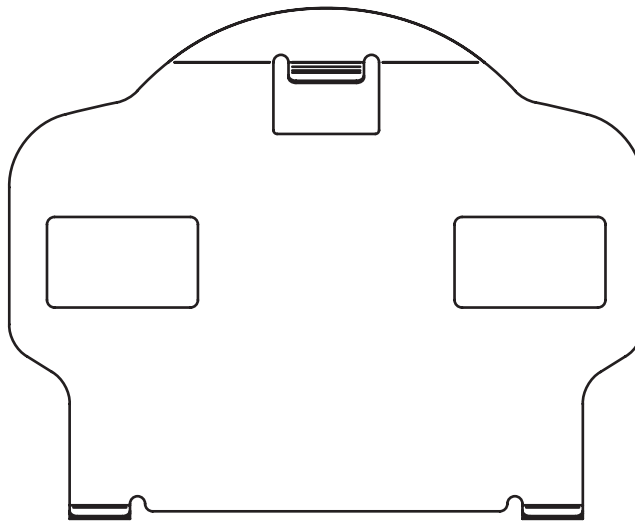
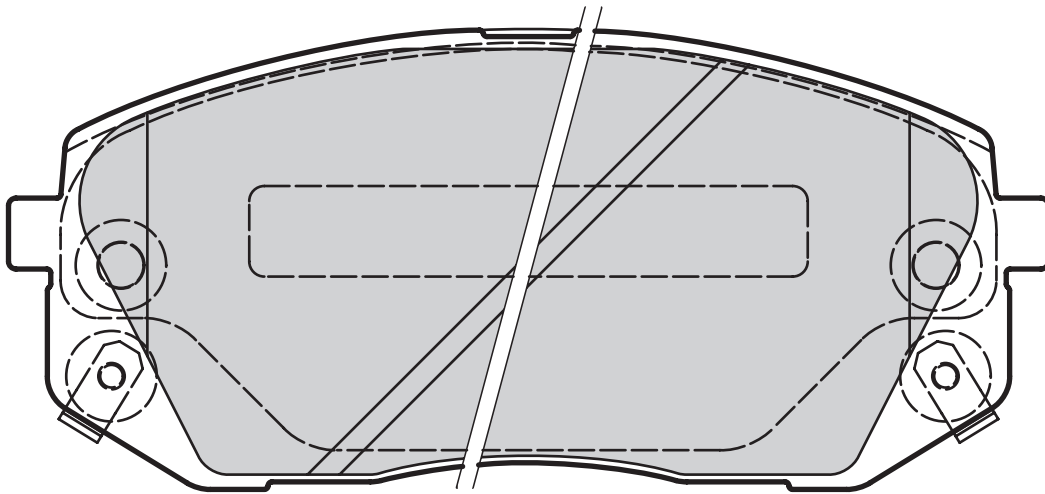
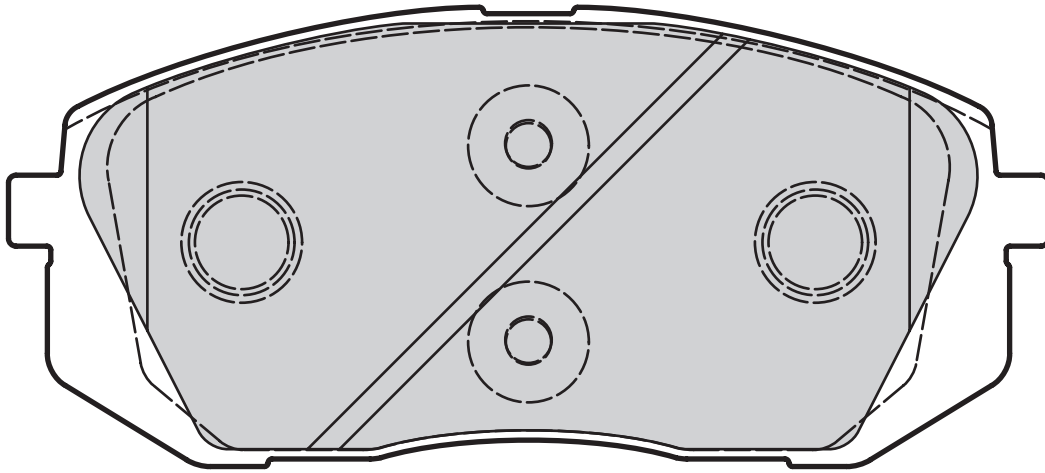

598934

1

138

61

16,5

MANDO



Valeo

24510 (WVA)

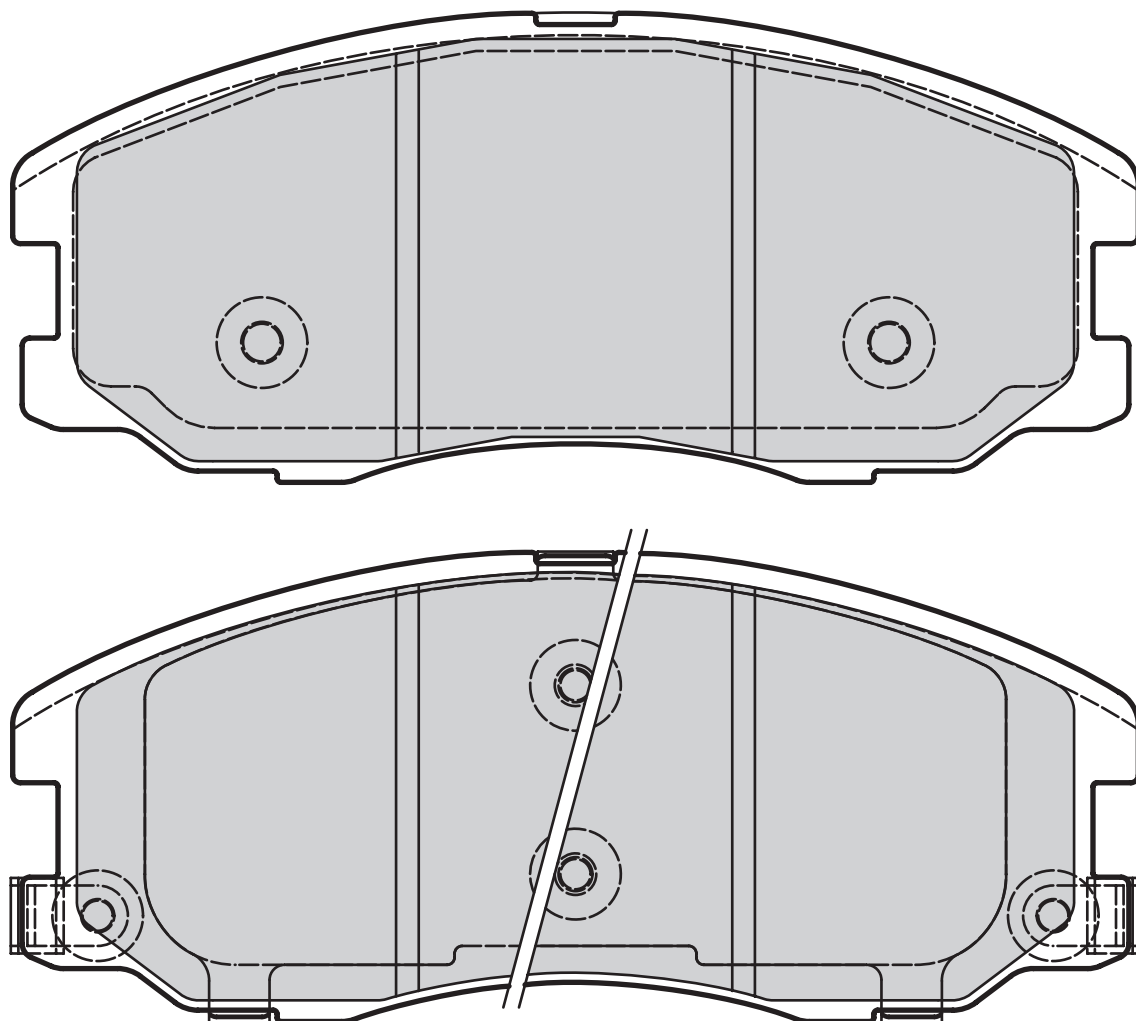

Valeo

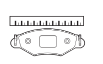

598942

2

149

62

17

MANDO

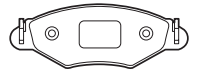

24535 (WVA)

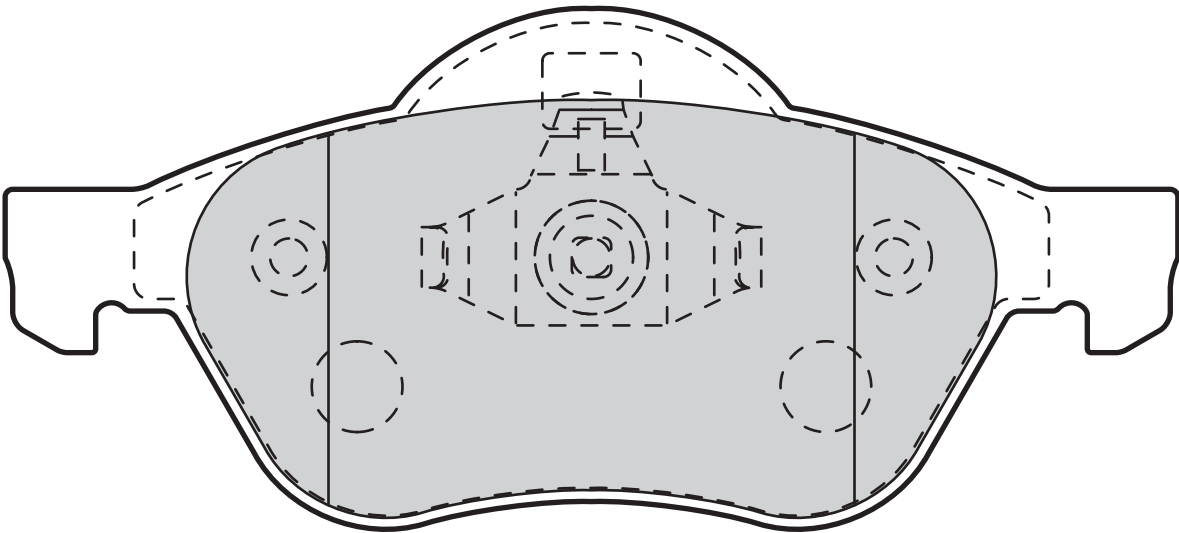
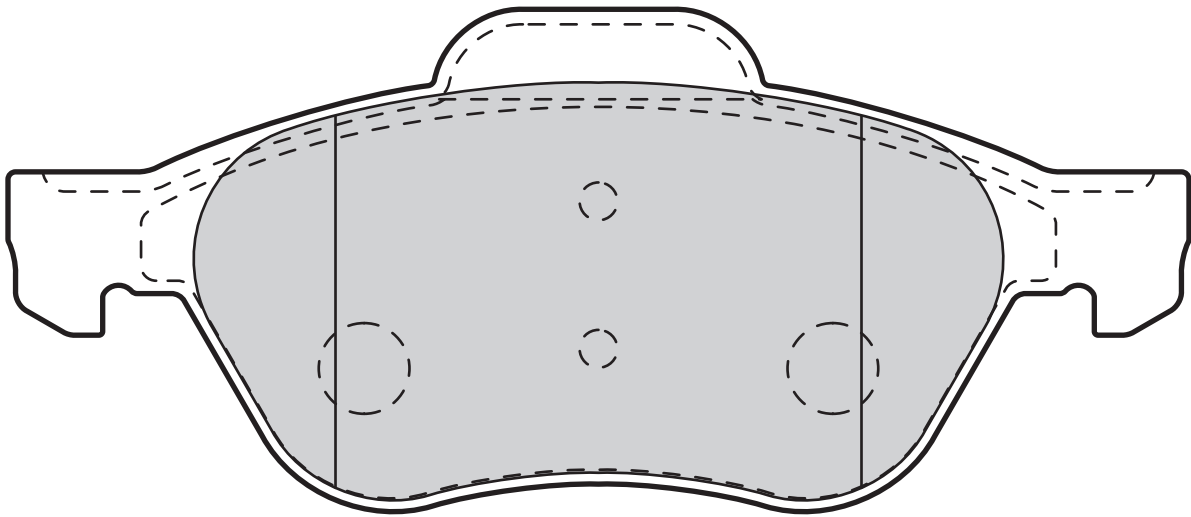

Valeo



601012

0

155,2

69

18,3

TEVES

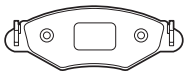

Valeo

24540 (WVA)

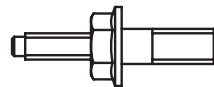
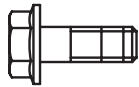
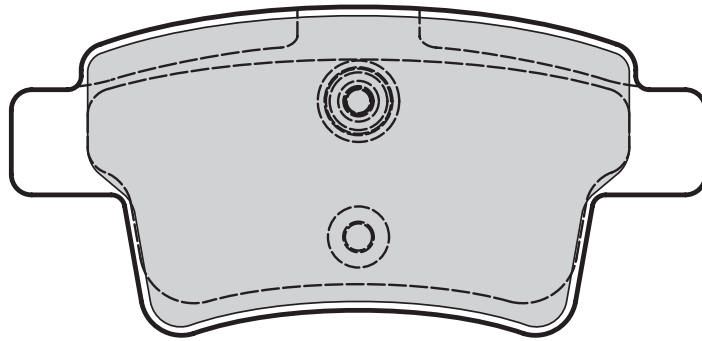

Valeo



598936

0

102

48

16

LUCAS

24557 (WVA)

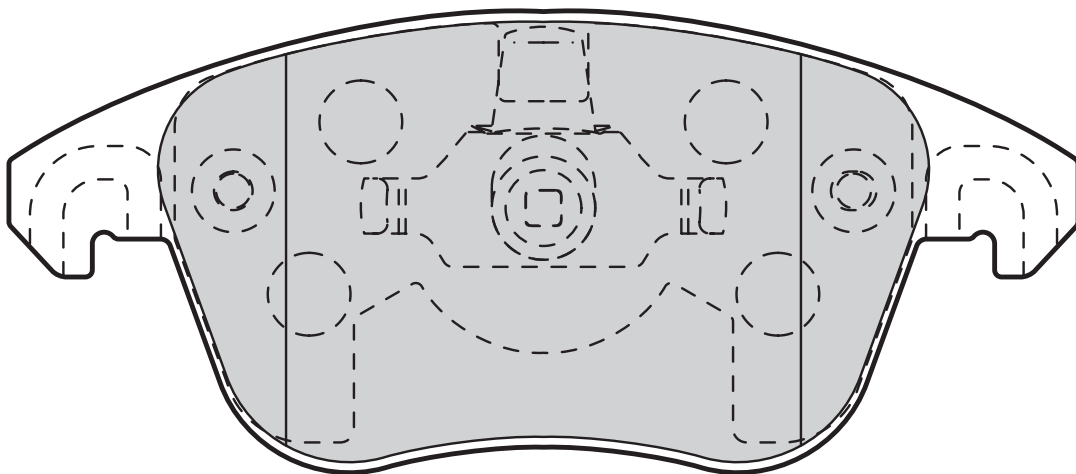
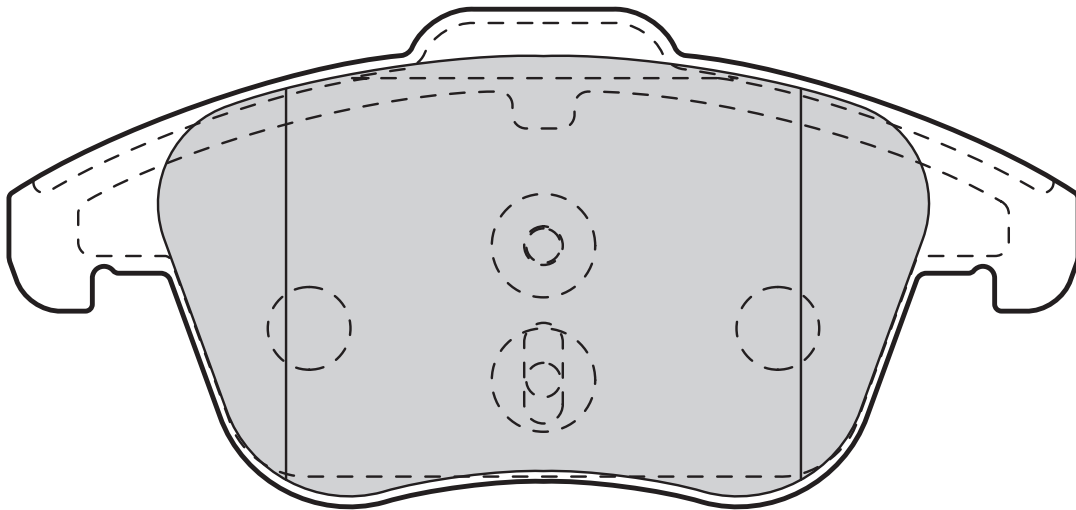

Valeo



598998

0

155,2

67

19,5

TEVES

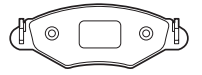

24632 (WVA)

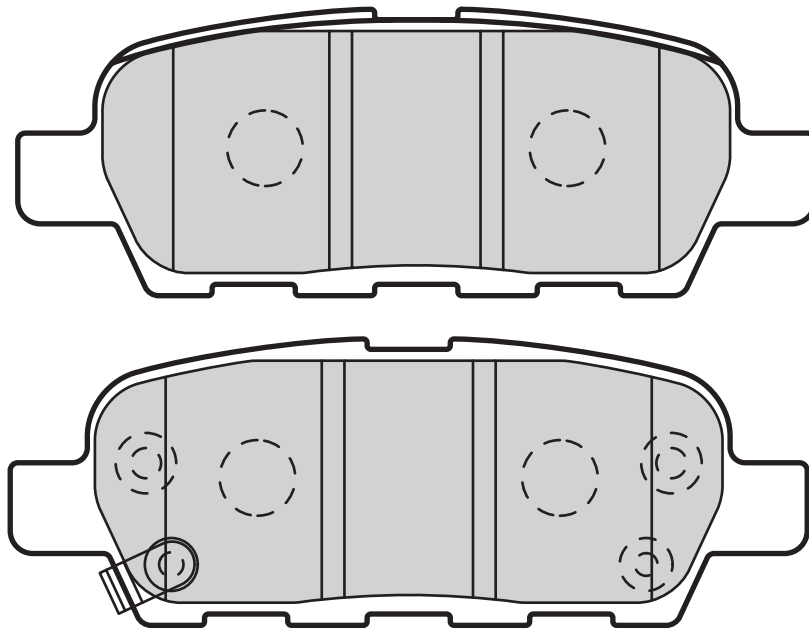

Valeo



601009

1

105,5

38

13,7

AKEBONO



Valeo

24705 (WVA)

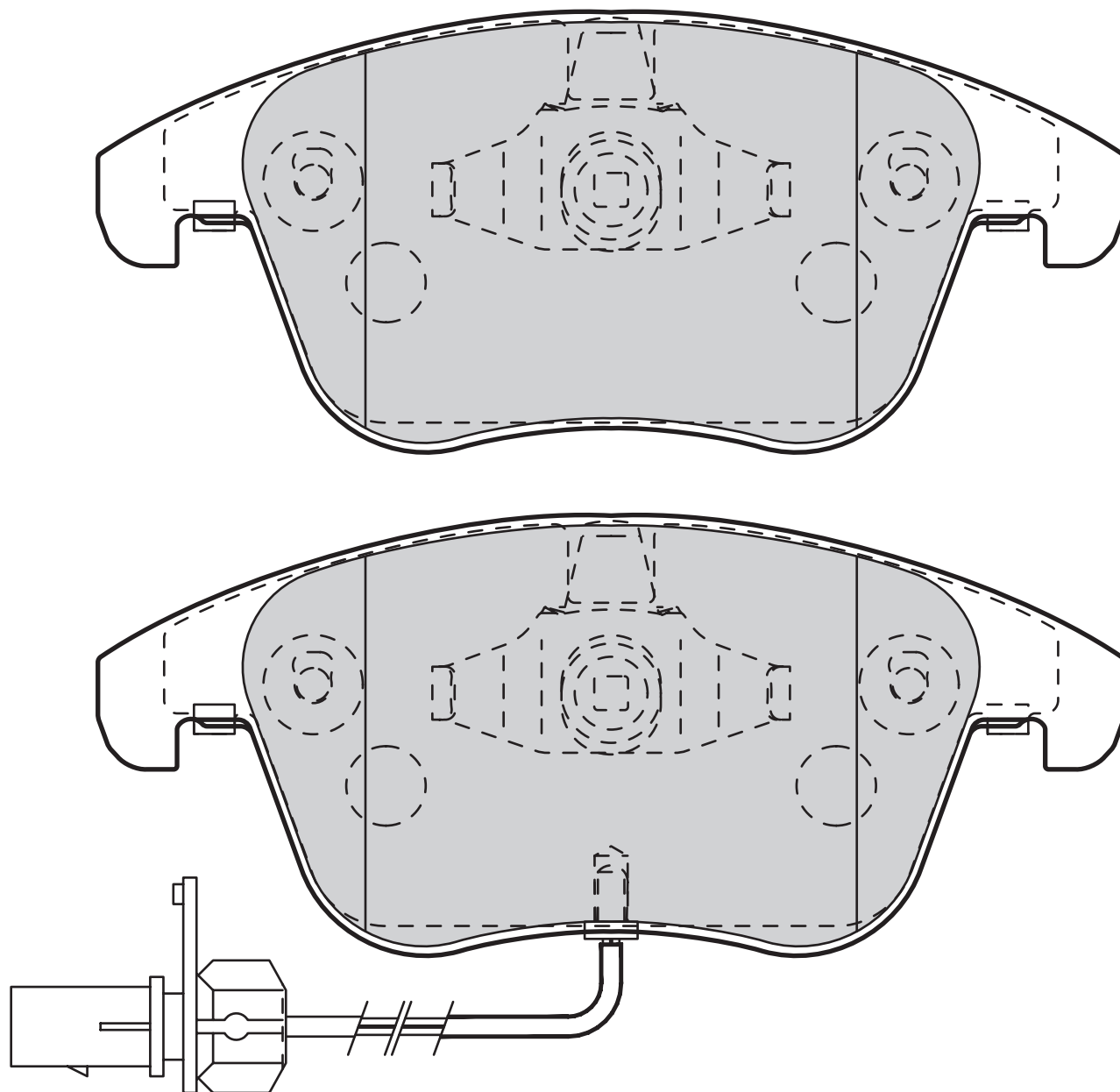

Valeo



598996

1

155,2

66,5

20,7

TEVES



24710 (WVA)

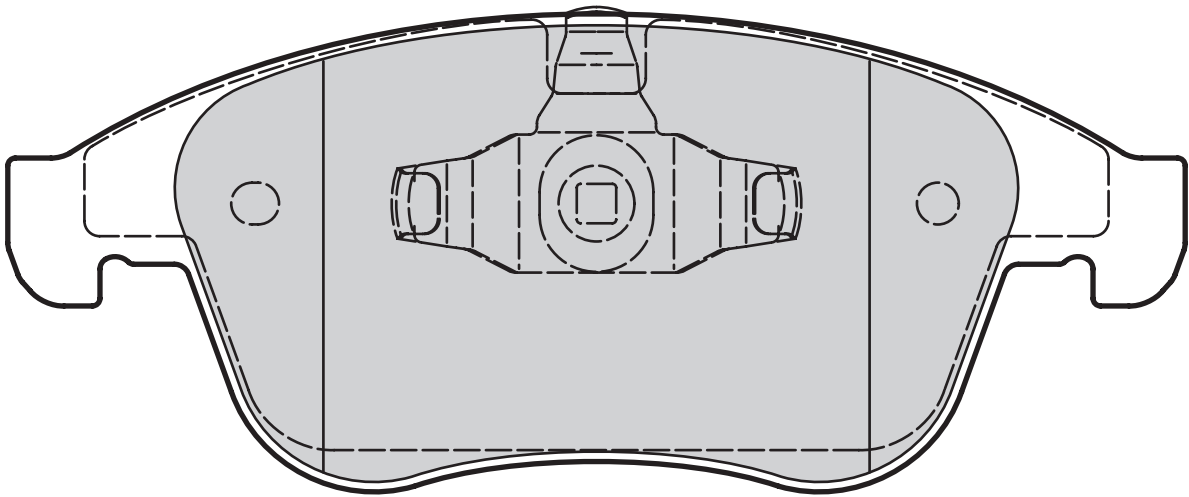
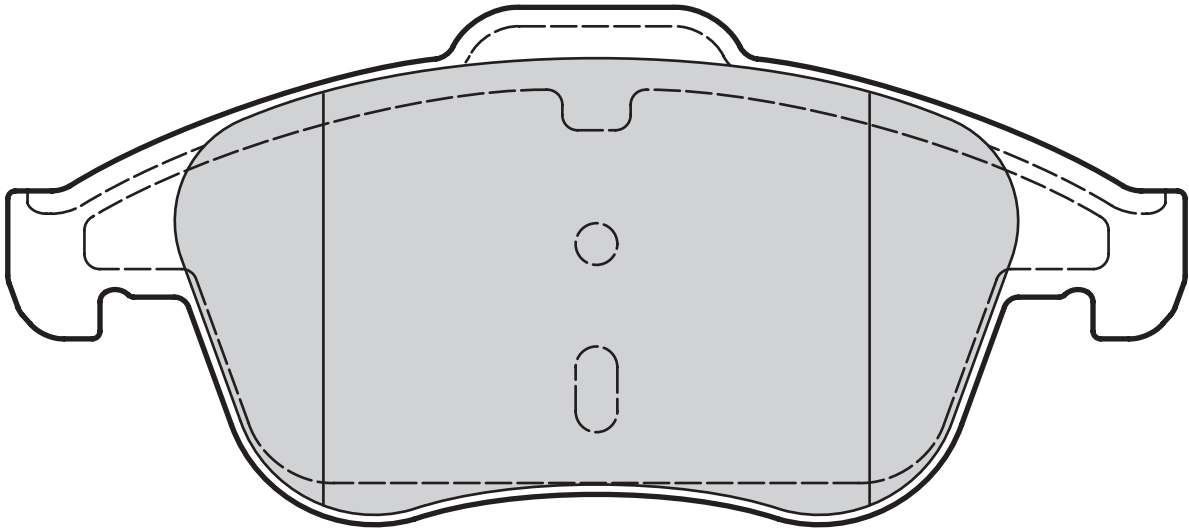

Valeo



601050

0

155,2

68,3

18

TEVES

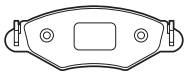

Valeo

24765 (WVA)

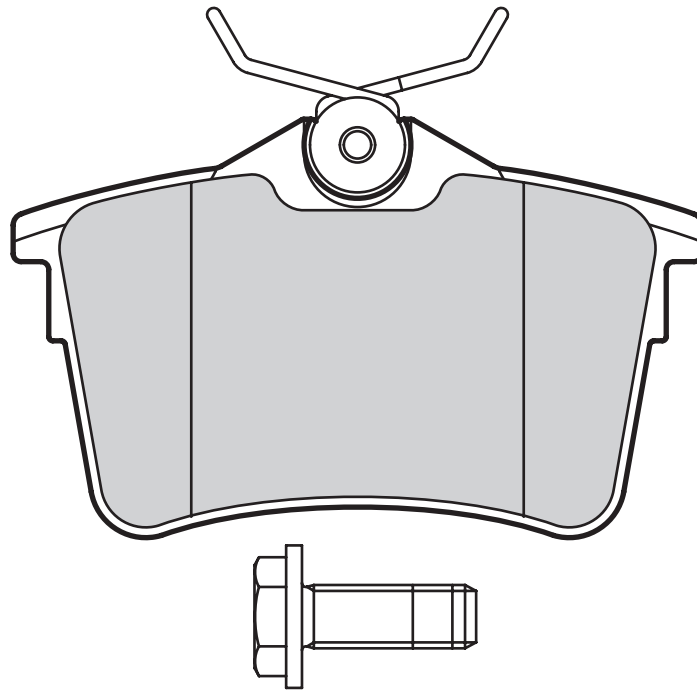

Valeo



601042

0

87

52,9

16,7

LUCAS

24820 (WVA)

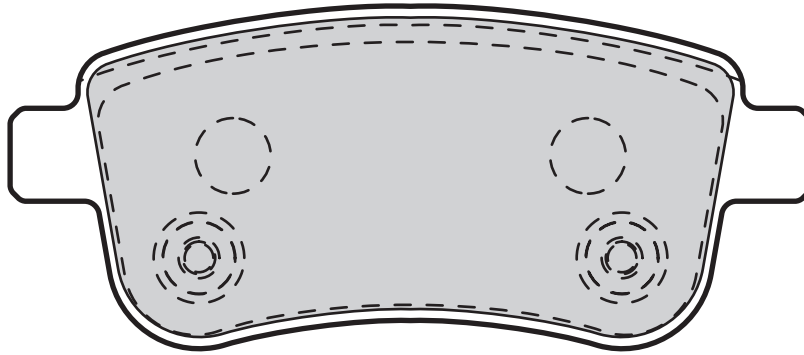

Valeo



598409

0

155,4

63,6

20

TEVES



29192 (WVA)

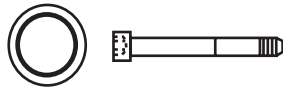
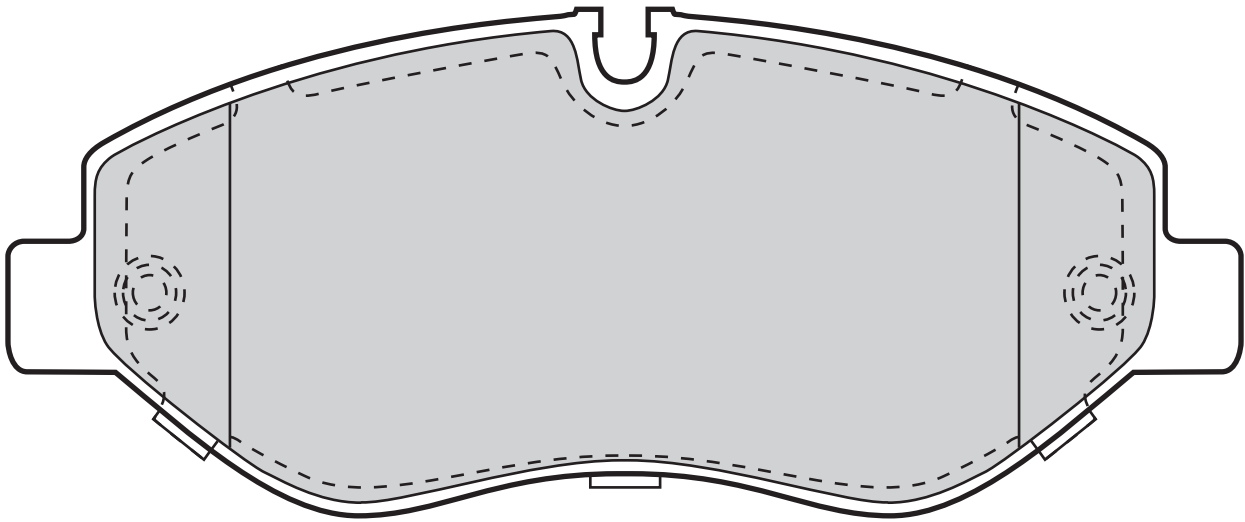

Valeo



598882

0

163,1

67,1

20,8

BREMBO



Valeo

29877 (WVA)

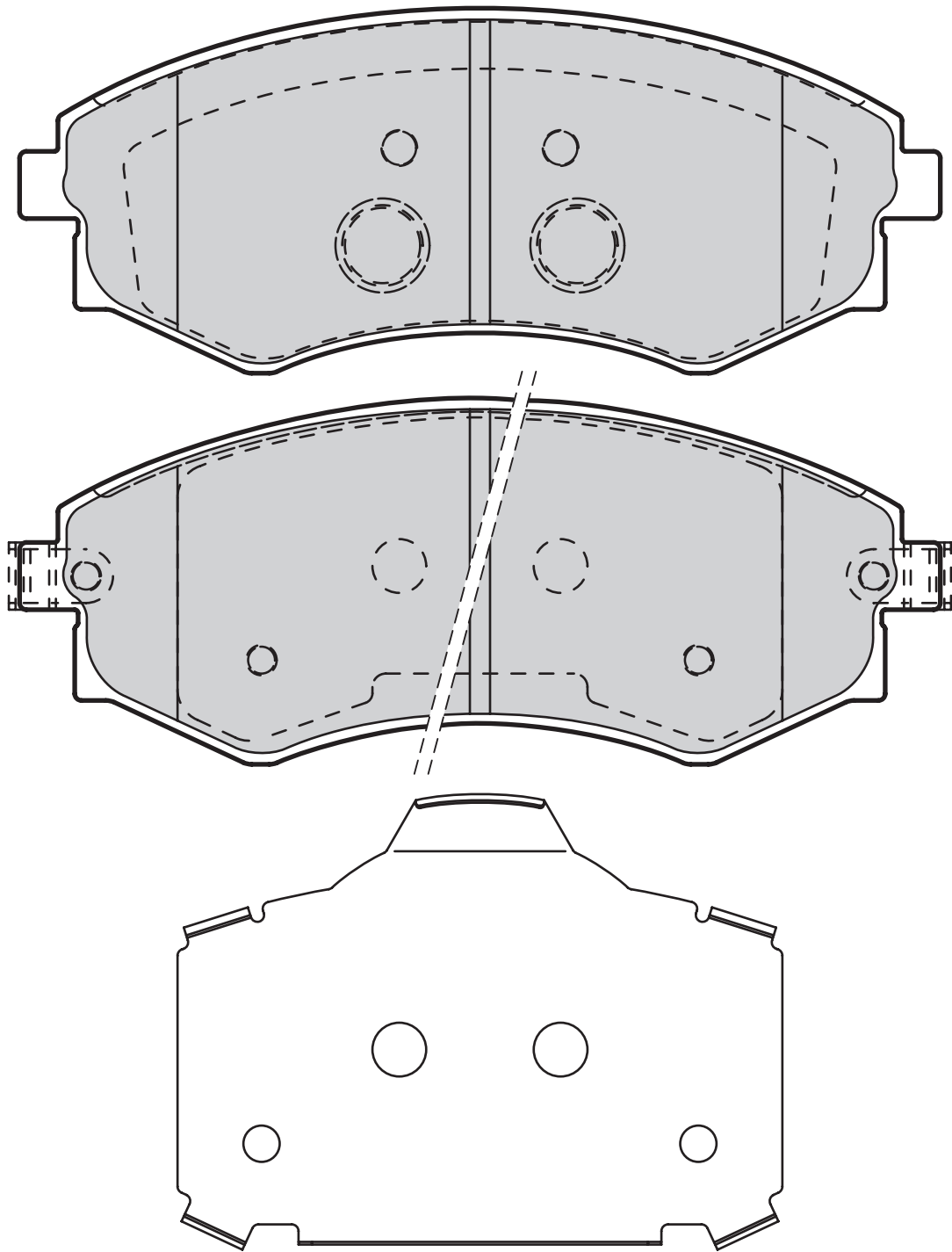

Valeo



598870

2

136,9

54

16,6

SUMITOMO



国产/进口刹车盘图片
Local/Imported Range
Brake Disc Image



Pads and Discs

Plaquettes et Disques

Pastillas y Discos

Pastilas e Discos

Pastiglie e Dischi

Blokjes en Schijven

Bremsbeläge und Bremsscheiben

Klocki i Tarcze

Balatalari ve Diskleri

Κολοдки и ДИСКИ

Δισκόφρενα & Δισκόπλακες

刹车片和刹车盘

بطانات و قرص

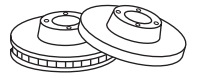

186146

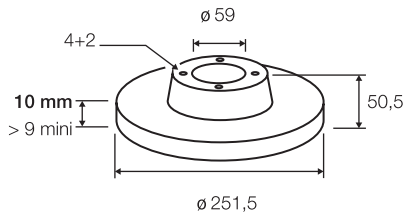

186153

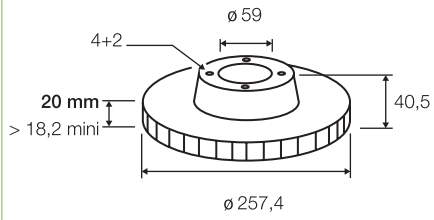

186154

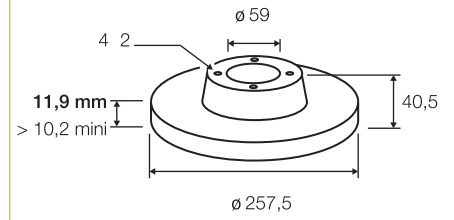

186155

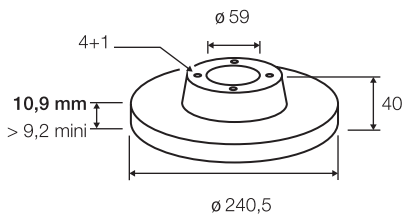

186188

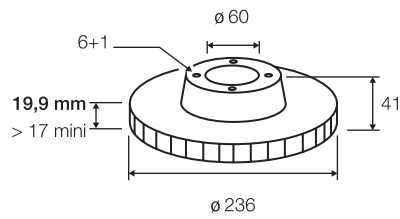

186189

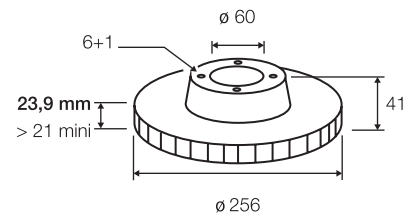

186194

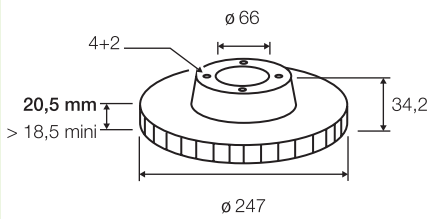

186208

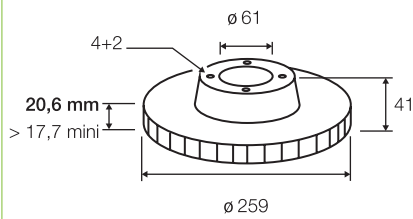

186245

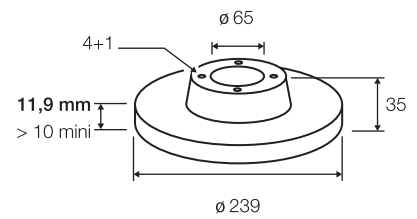

186247

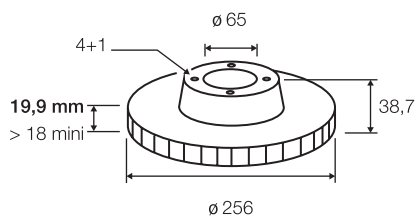

186271

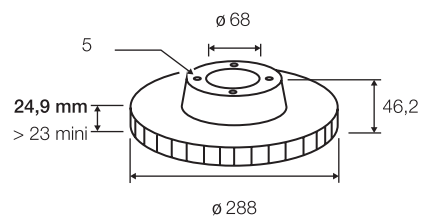

186275

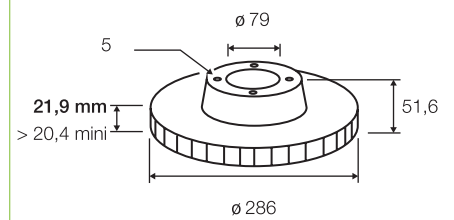

186294

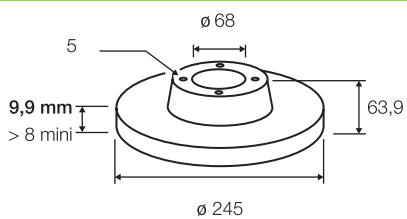

186295

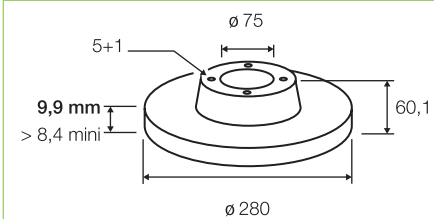

186297

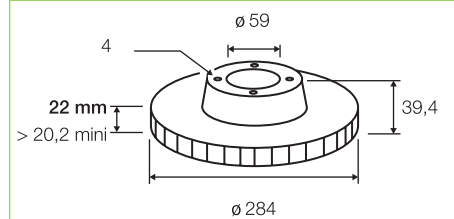

186457

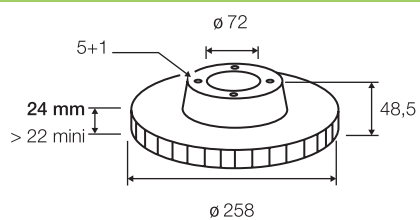

186467

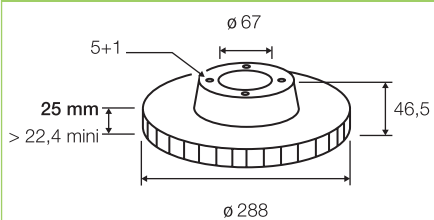

186469

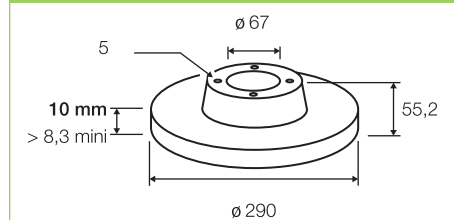

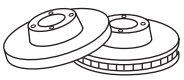

186470

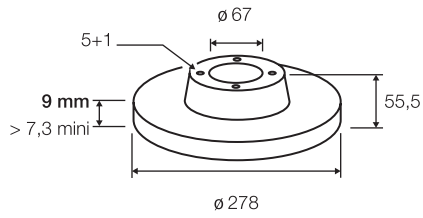

186485

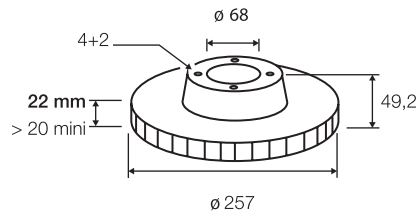

186504

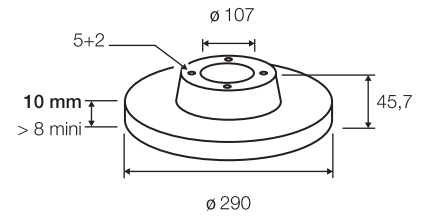

186559

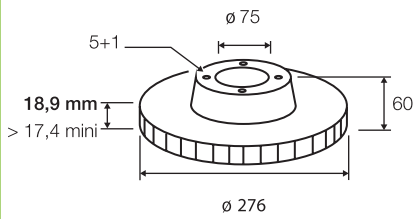

186566

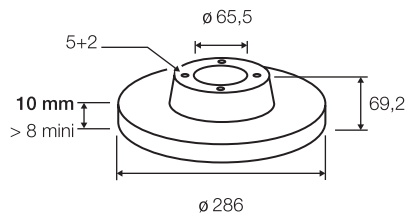

186568

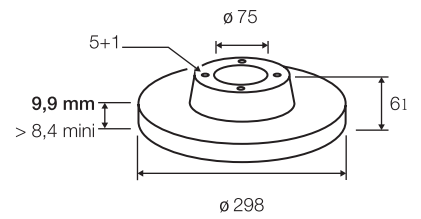

186582

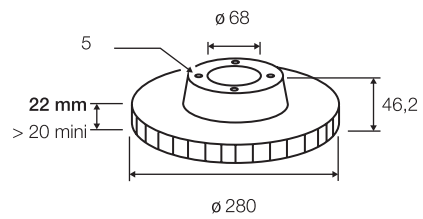

186590

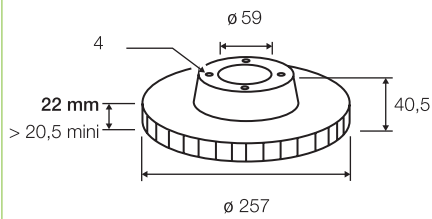

186592

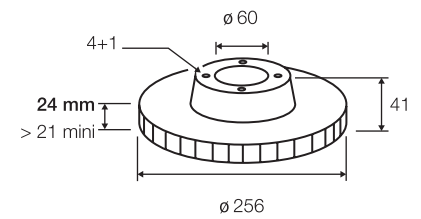

186593

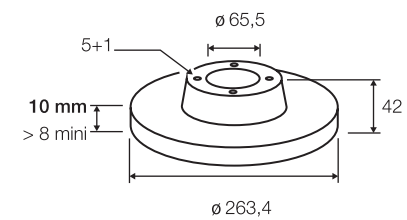

186594

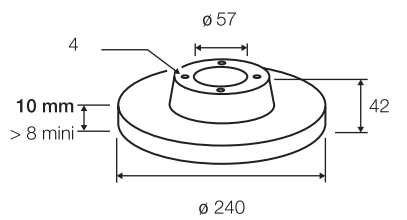

186597

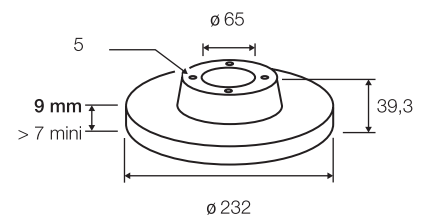

186599

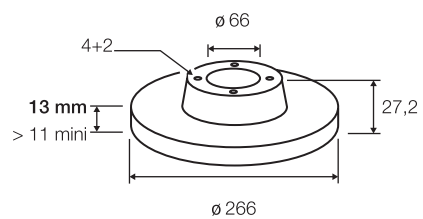

186603

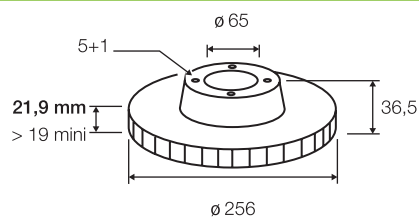

186604

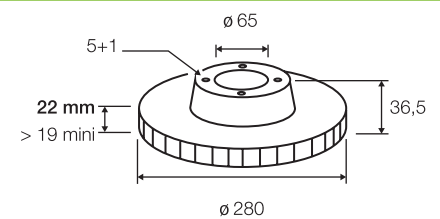

186628

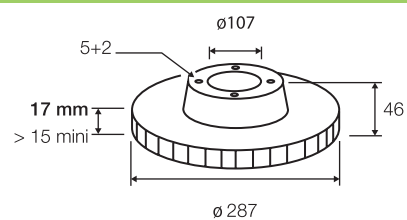

186655

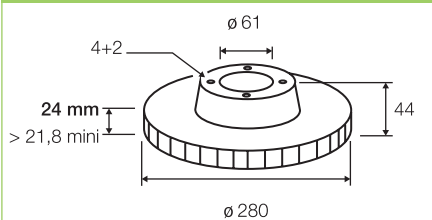

186684

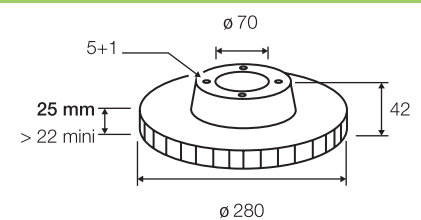

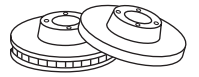

186693

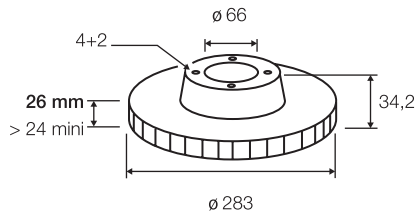

186695

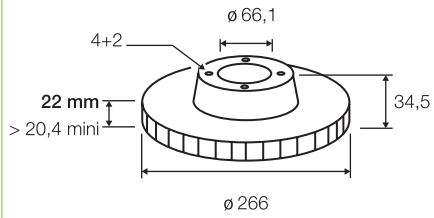

186702

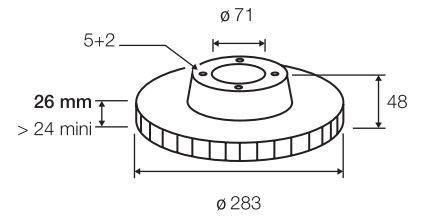

186731

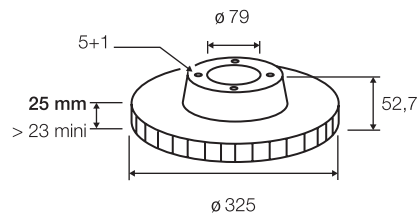

186732

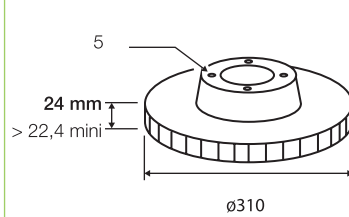

186734

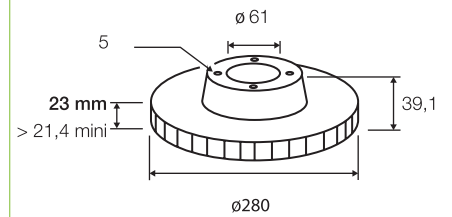

186736

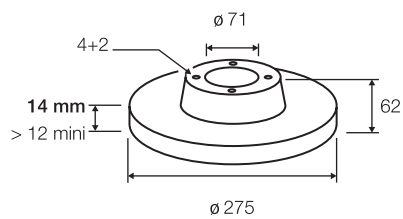

186741

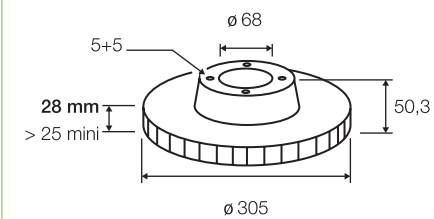

186747

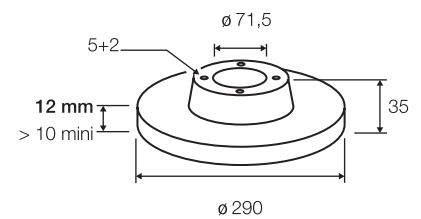

186753

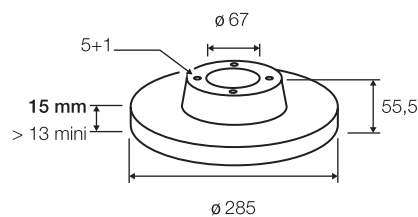

186754

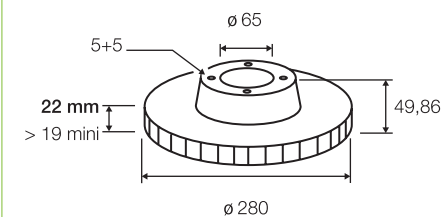

186758

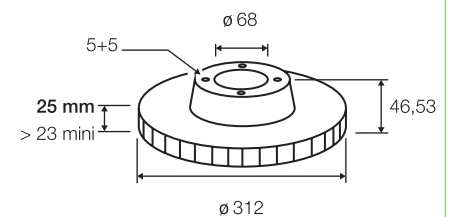

186764

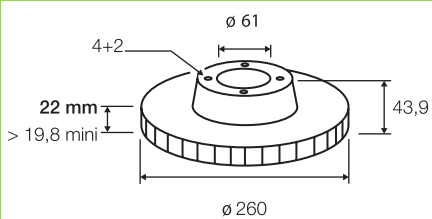

186785

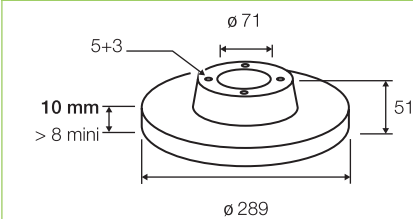

186789

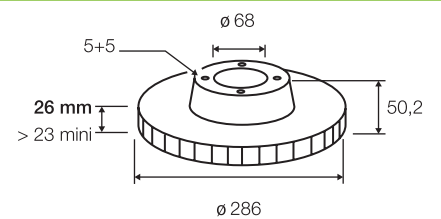

186798

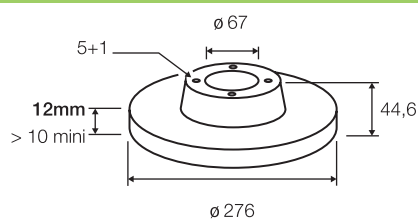

186799

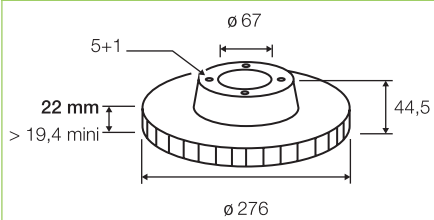

186808

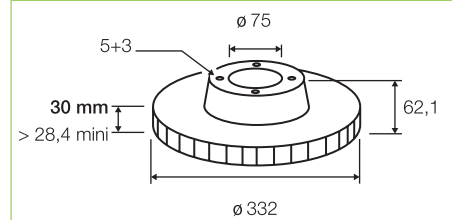

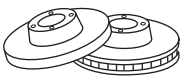

186809

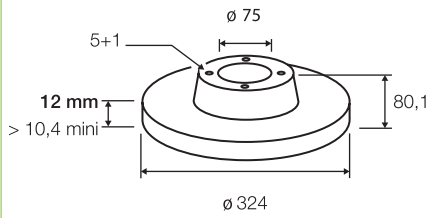

186811

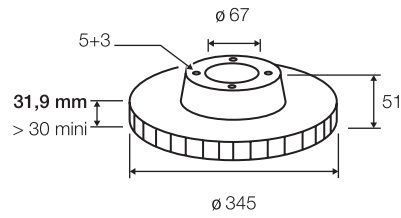

186812

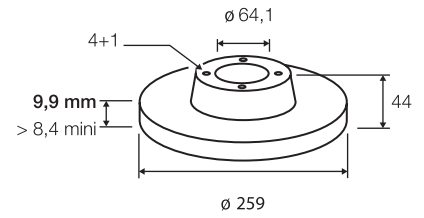

186813

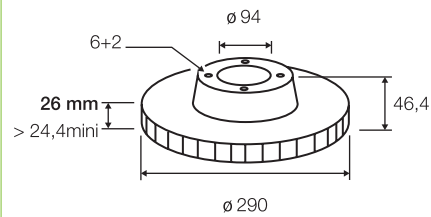

186815

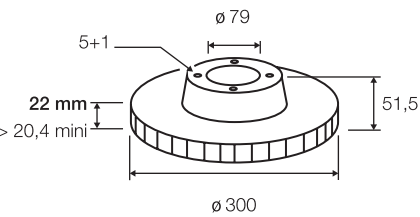

186816

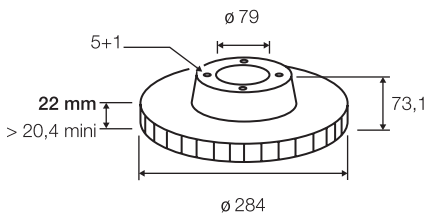

186817

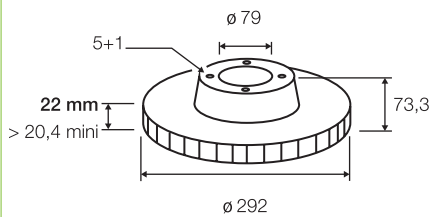

186819

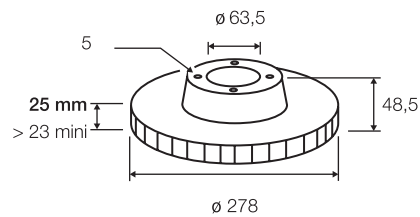

186825

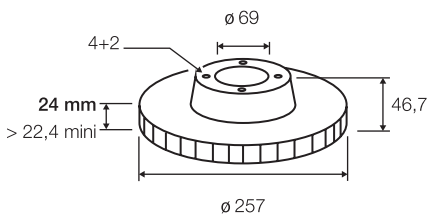

186833

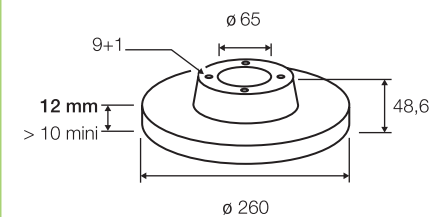

186834

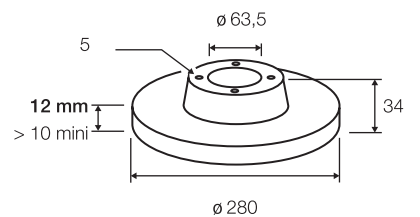

186841

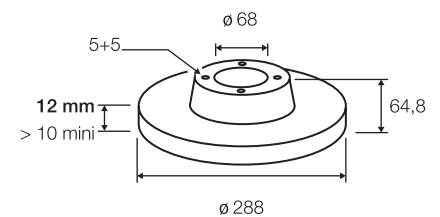

186843

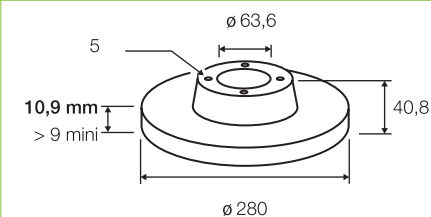

186854

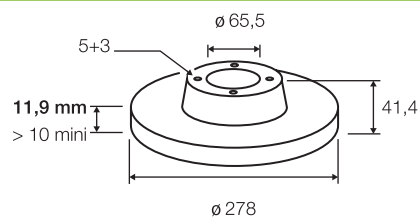

186857

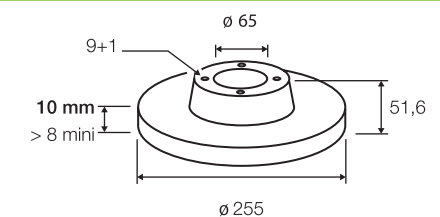

186860

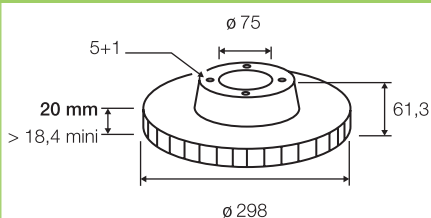

186861

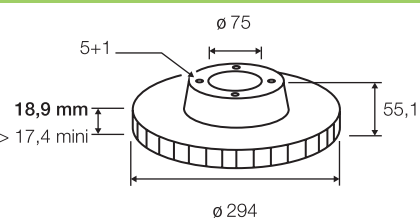

186863

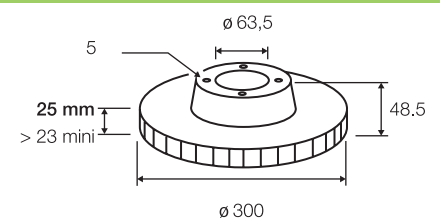

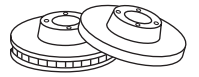

186864

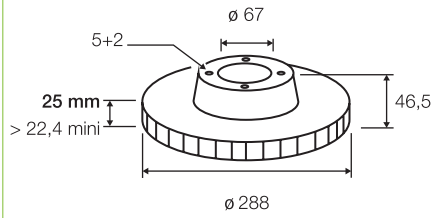

186869

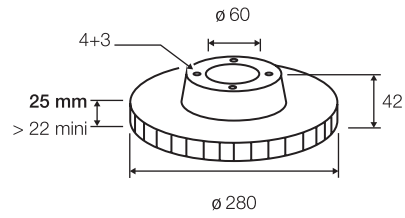

186871

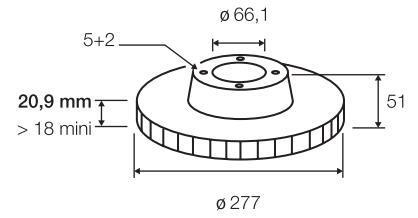

186872

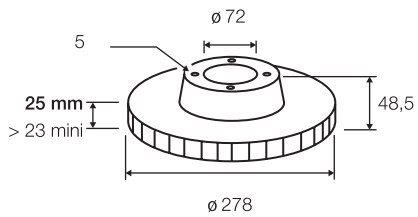

186880

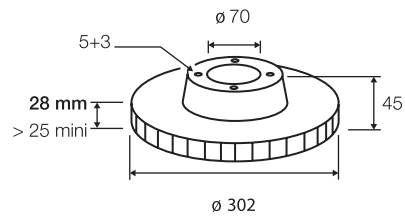

186881

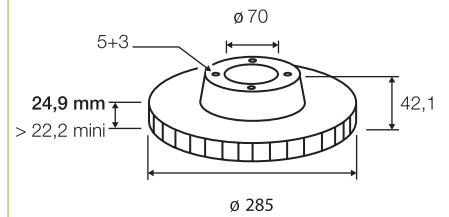

186882

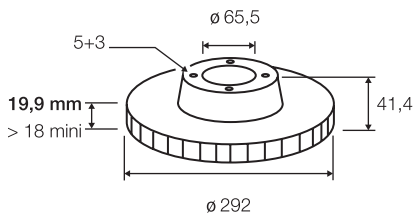

186890

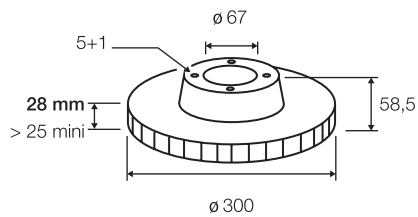

186896

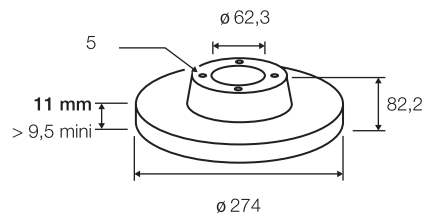

186898

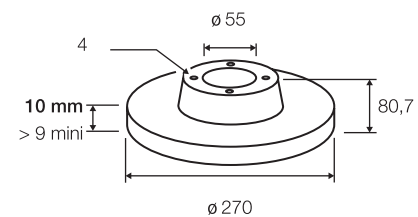

186899

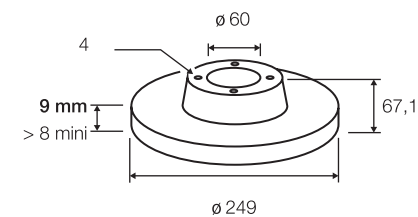

187045

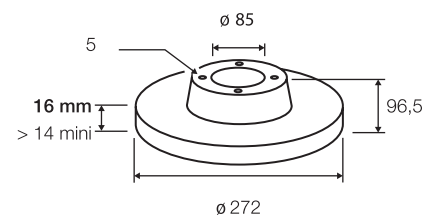

197002

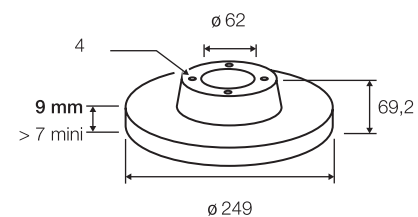

197008

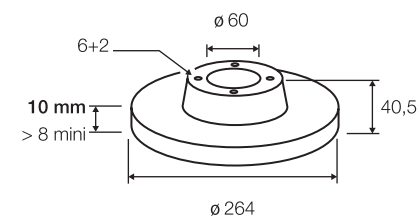

197009

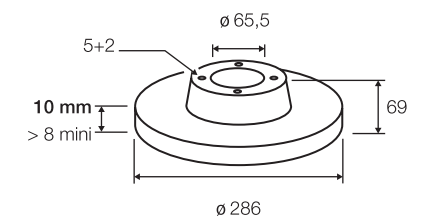

197011

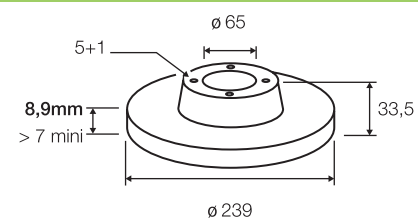

197017

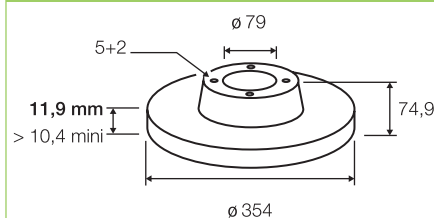

197022

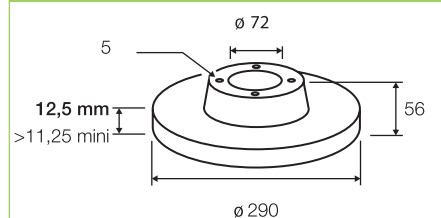

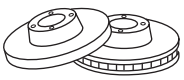

197028

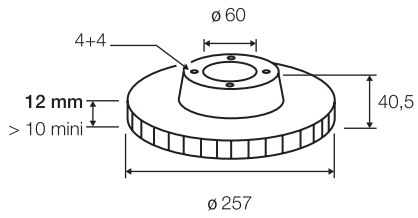

197029

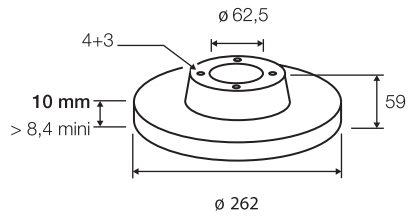

197031

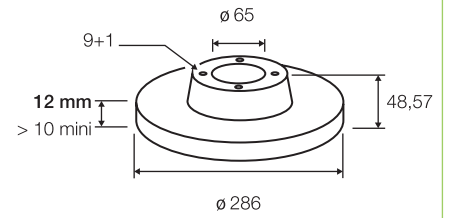

197035

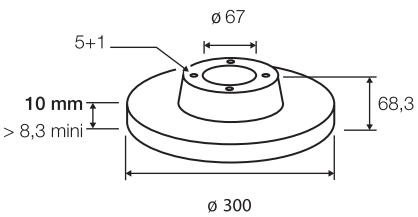

197036

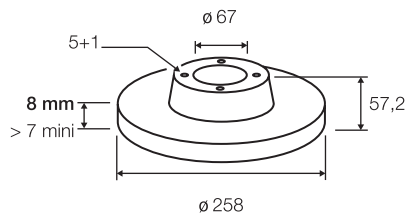

197038

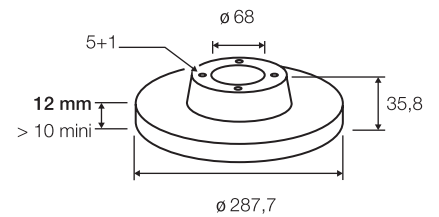

197044

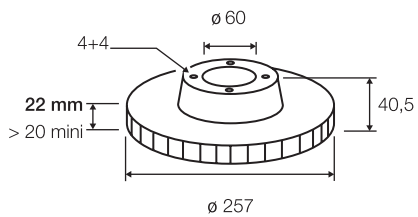

197045

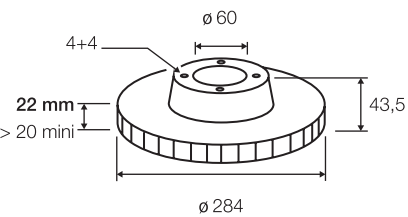

197046

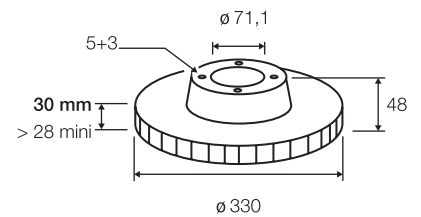

197049

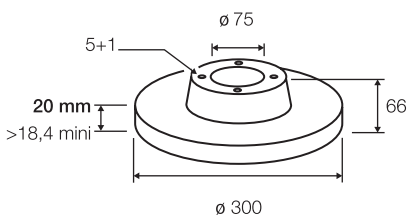

197050

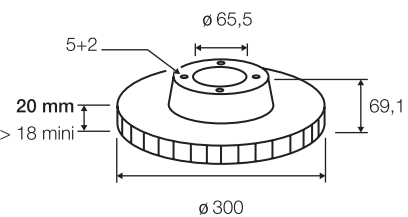

197051

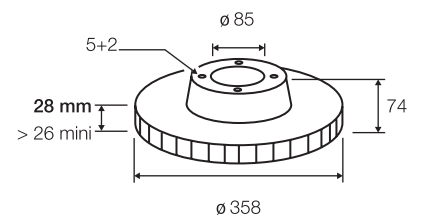

197055

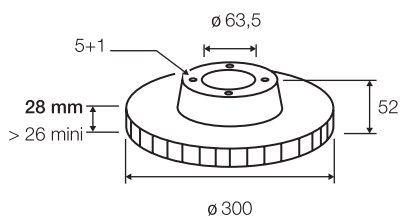

197057

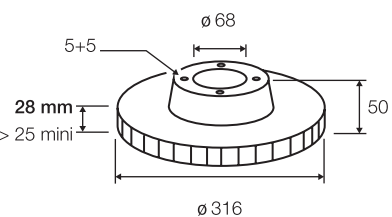

197069

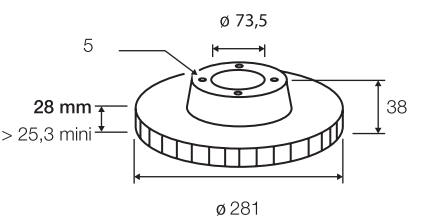

197073

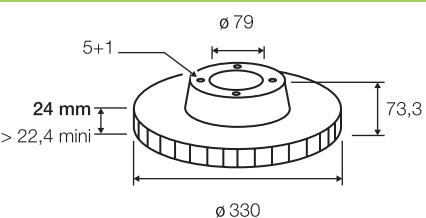

197074

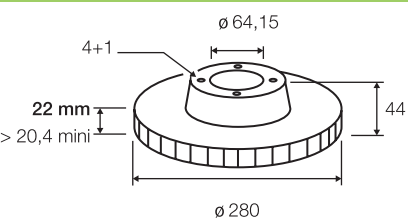

197083

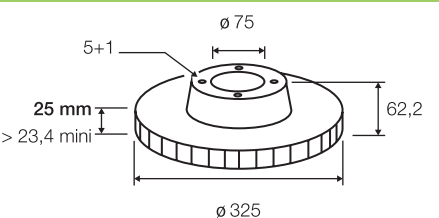

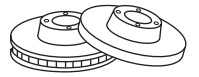

197087

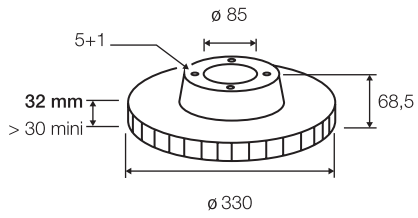

197088

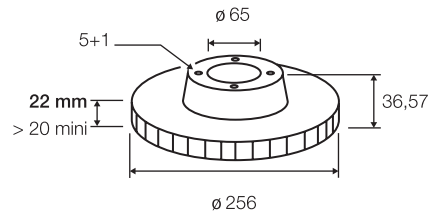

197090

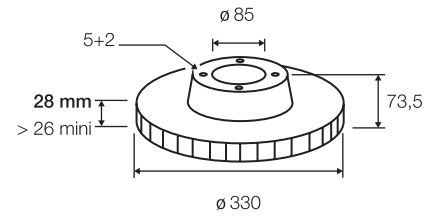

197091

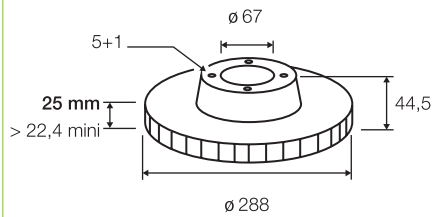

197092

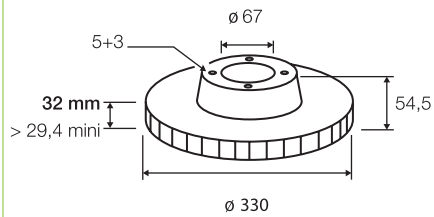

197093

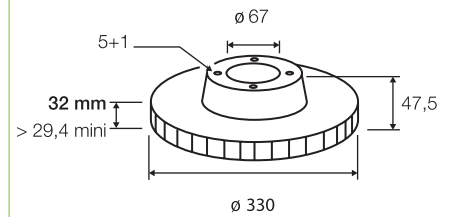

197094

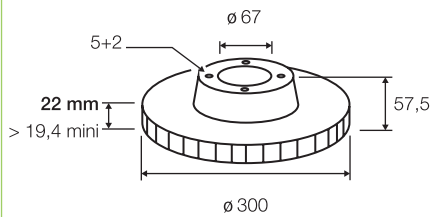

197100

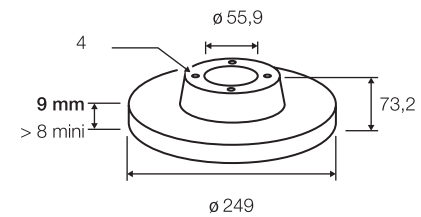

197116

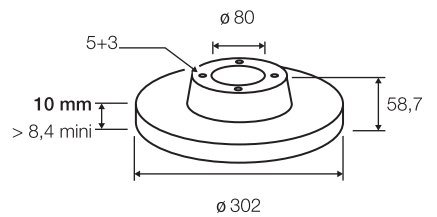

197117

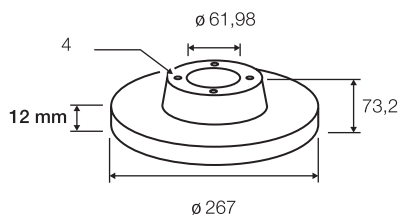

197122

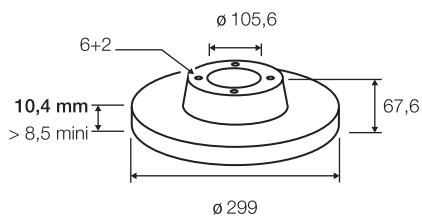

197126

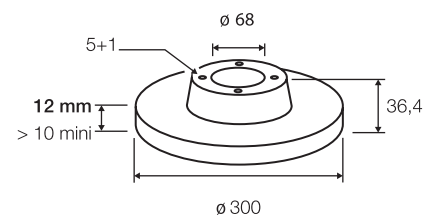

197127

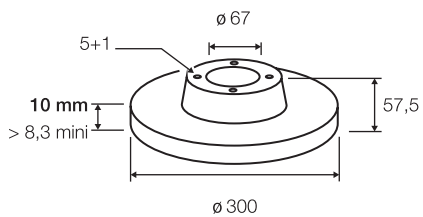

197128

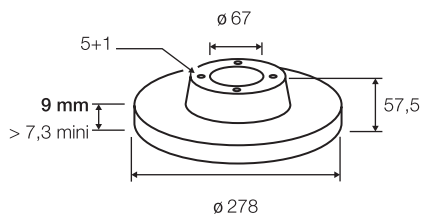

197129

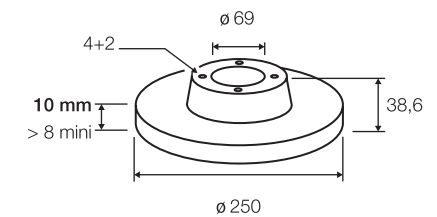

197139

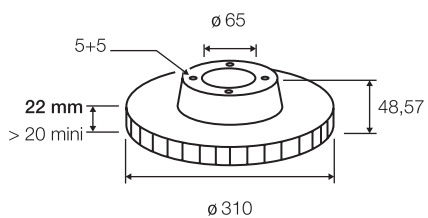

197143

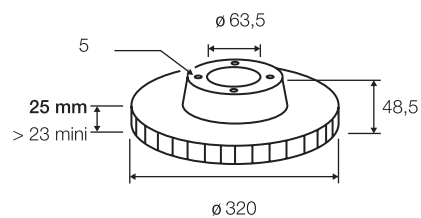

197150

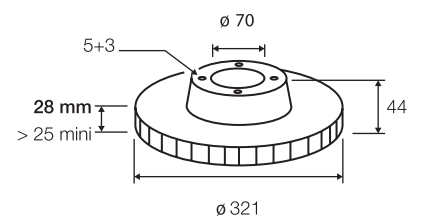

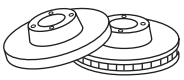

197152

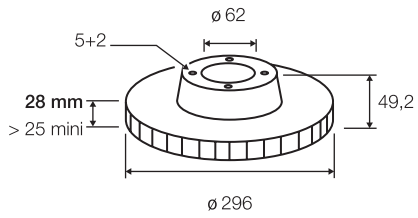

197155

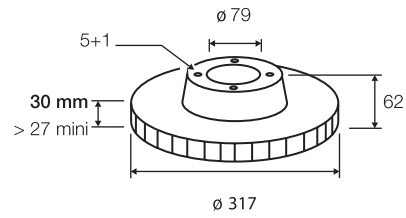

197156

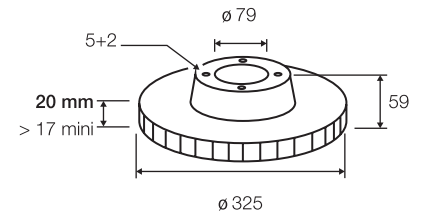

197158

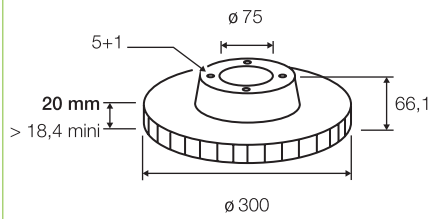

197159

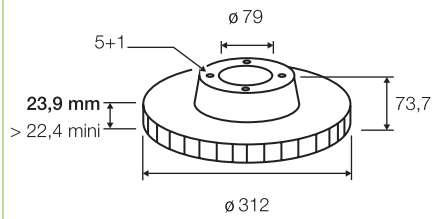

197160

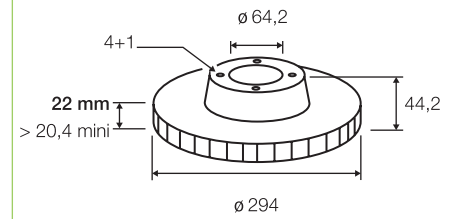

197175

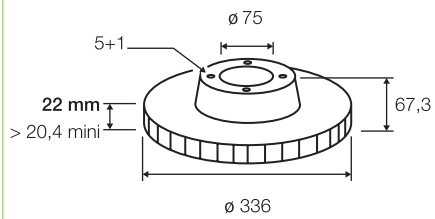

197176

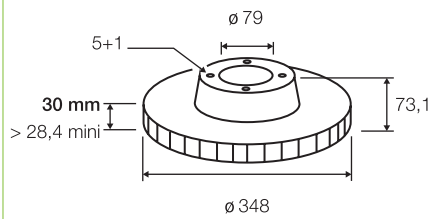

197177

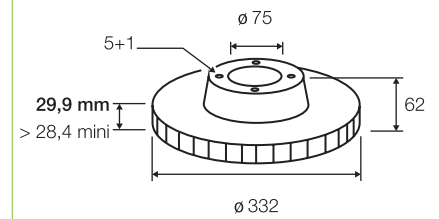

197178

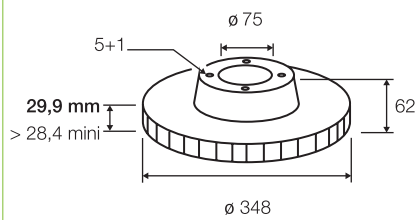

197179

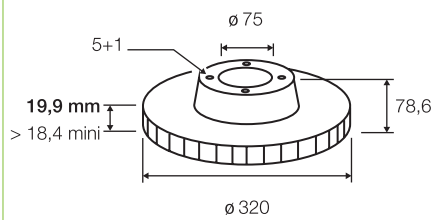

197180

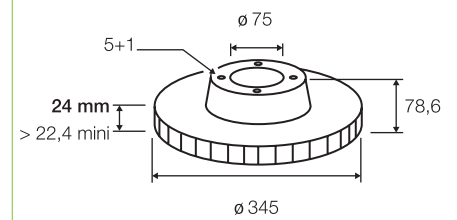

197181

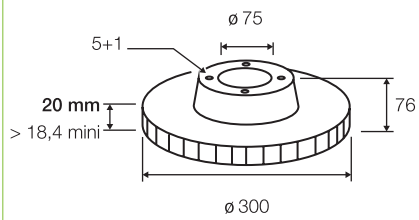

197190

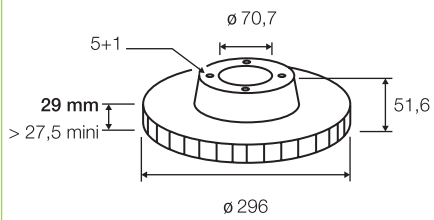

197191

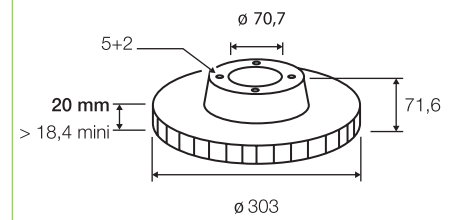

197192

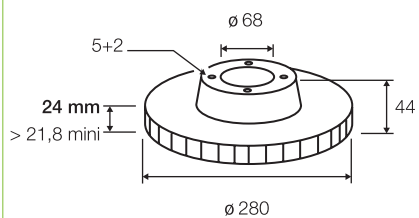

197193

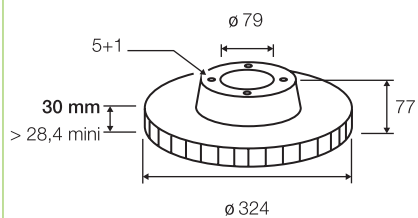

197194

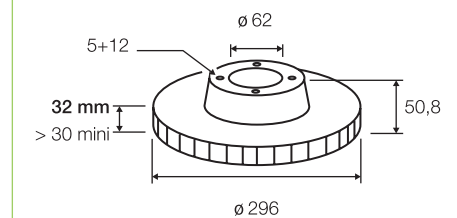

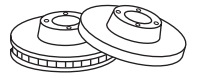

197195

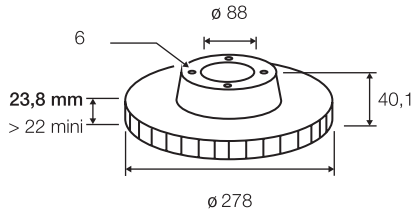

197197

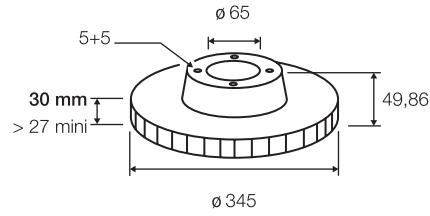

197199

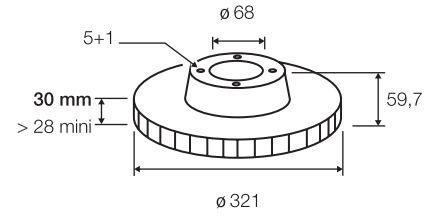

197200

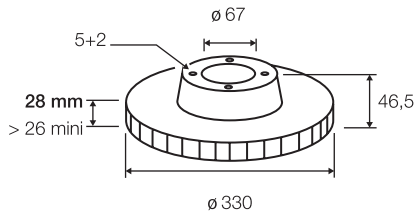

197201

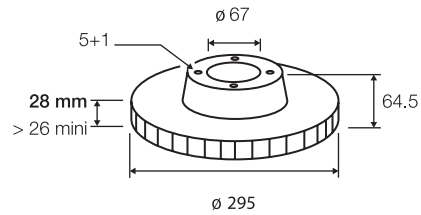

197202

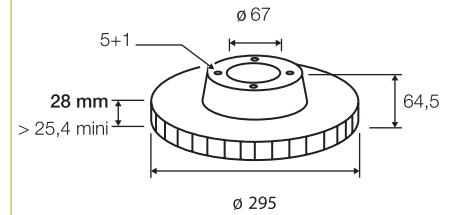

197213

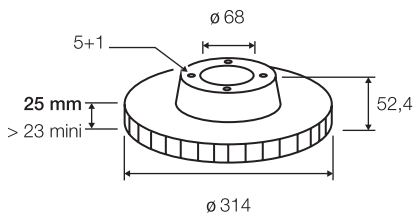

197214

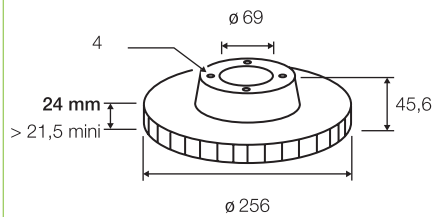

197215

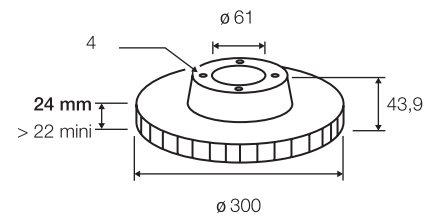

197220

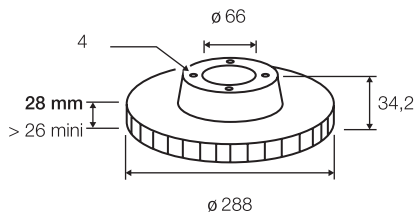

197221

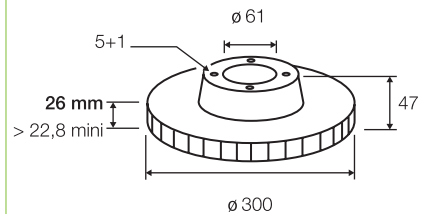

197226

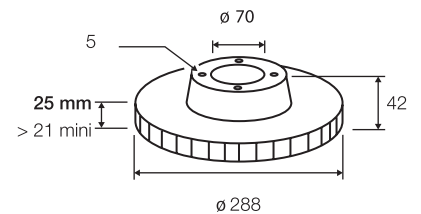

197227

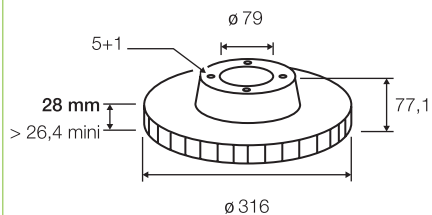

197230

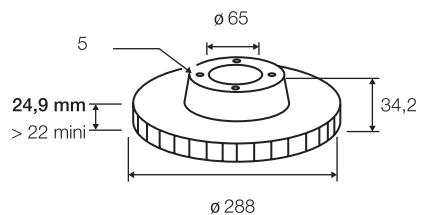

197232

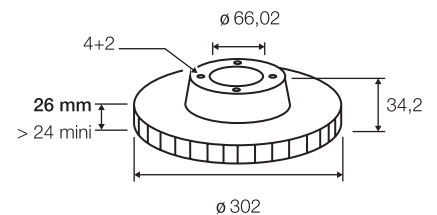

197234

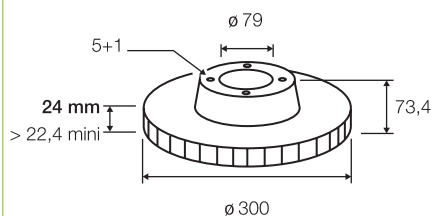

197237

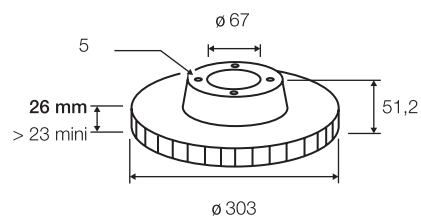

197241

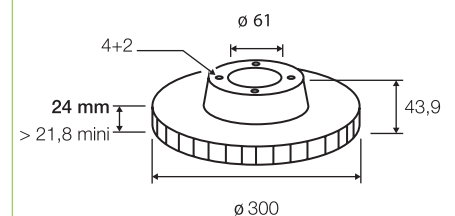

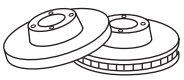

197242

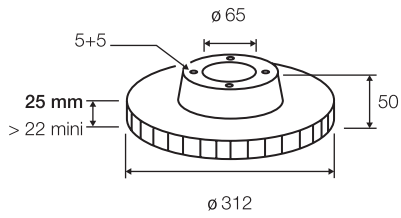

197243

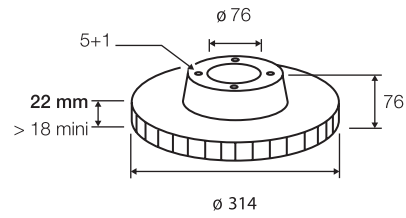

197244

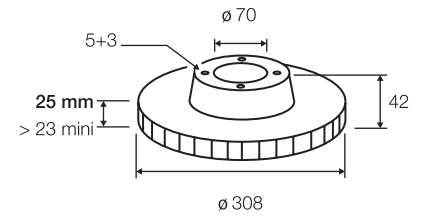

197246

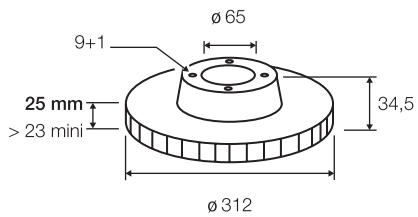

197251

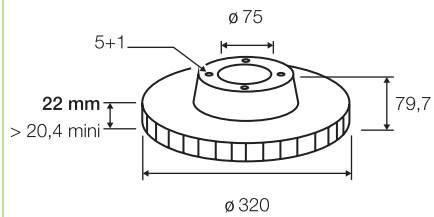

197264

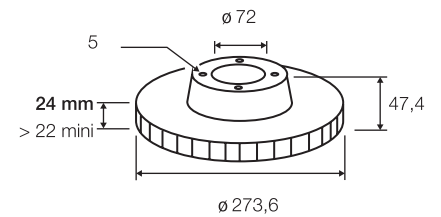

197267

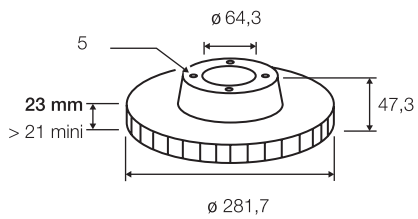

197294

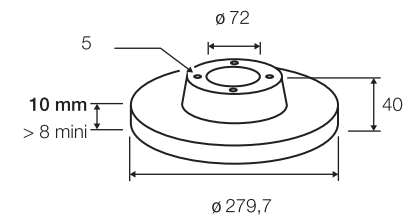

197384

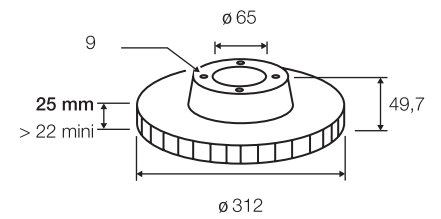

197387

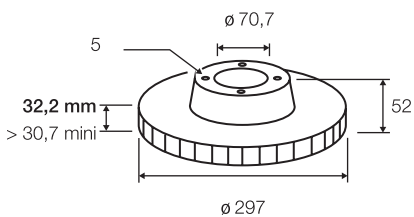

197388

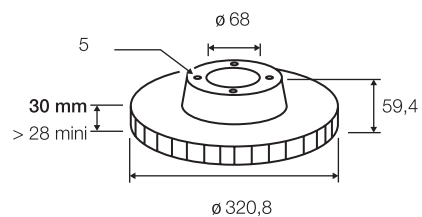

197389

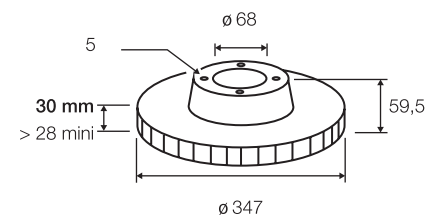

197390

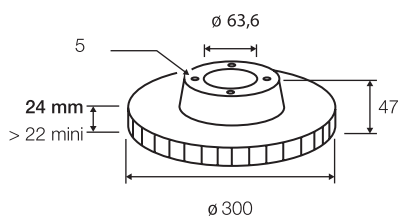

197392

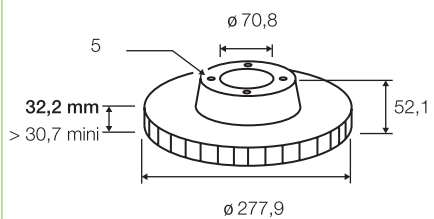

197393

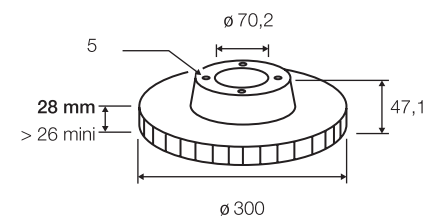

197394

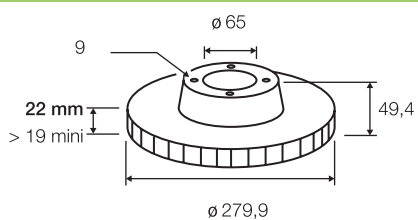

197397

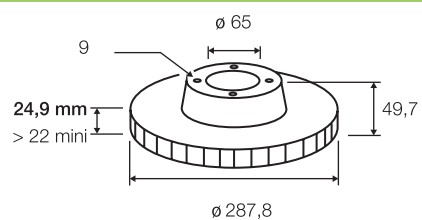

197399

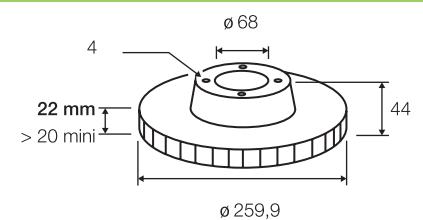

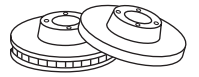

197400

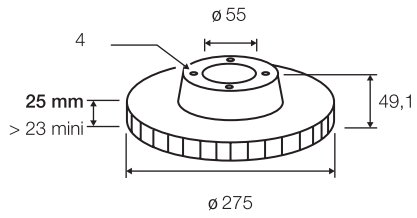

197404

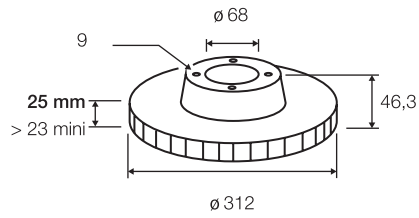

197406

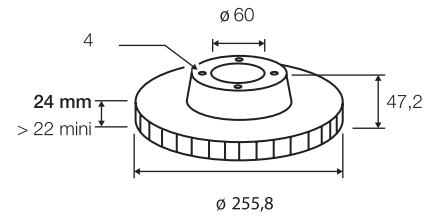

197412

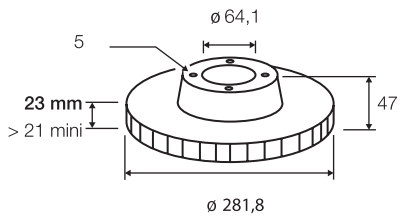

197418

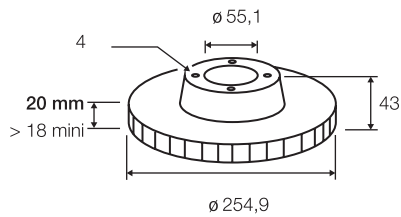

197420

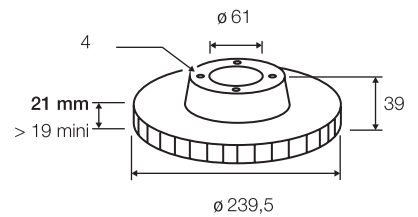

197423

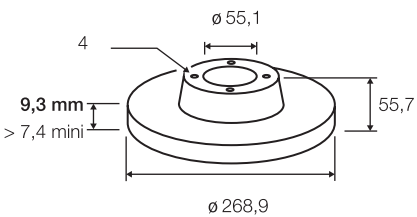

197426

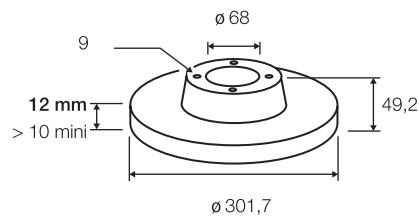

197427

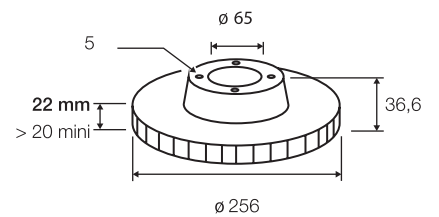

197429

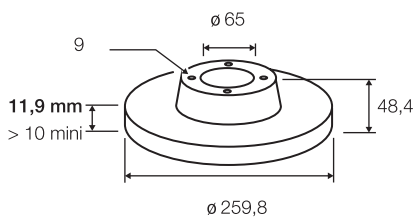

197430

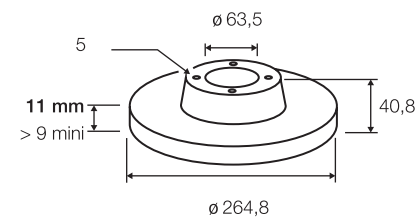

197431

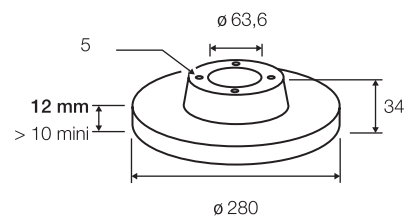

197432

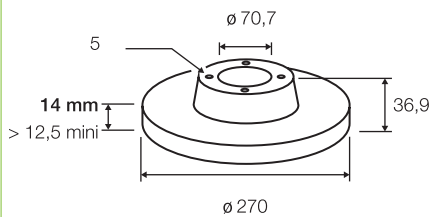

197433

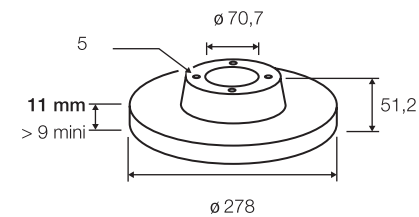

197438

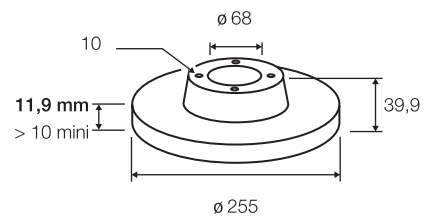

197440

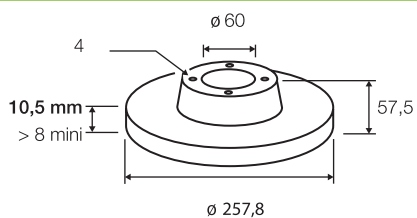

197441

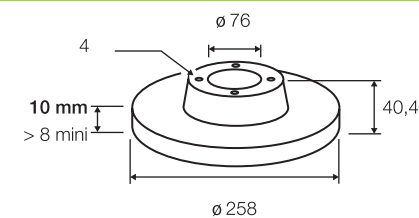

197442

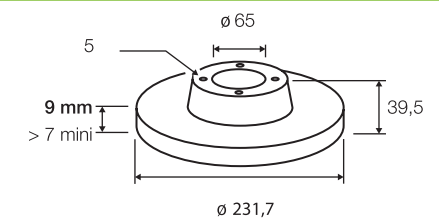

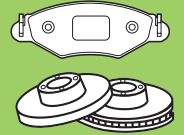

件号对照表 Part Number Cross List

Pads and Discs

Plaquettes et Disques

Pastillas y Discos

Pastilas e Discos

Pastiglie e Dischi

Blokjes en Schijven

Bremsbeläge und Bremsscheiben

Klocki i Tarcze

Balatalari ve Diskleri



Колодки и диски

Δισκόφρενα & Δισκόπλακες



刹车片和刹车盘



بطانات و قرص







	
BOSCH	
0986424728	598748
0986424805	598719
0986424816	598755
0 986 424 005	598392
0 986 424 016	598695
0 986 424 026	598145
0 986 424 027	598039
0 986 424 027	598502
0 986 424 029	598115
0 986 424 030	598070
0 986 424 031	598800
0 986 424 033	598064
0 986 424 037	598115
0 986 424 044	598129
0 986 424 044	598132
0 986 424 044	598380
0 986 424 045	598593
0 986 424 046	598594
0 986 424 047	598371
0 986 424 049	598351
0 986 424 050	598107
0 986 424 069	598591
0 986 424 080	598112
0 986 424 081	598091
0 986 424 092	598254
0 986 424 093	598116
0 986 424 098	598091
0 986 424 100	598093
0 986 424 110	598131
0 986 424 117	598130
0 986 424 134	598393
0 986 424 135	598052
0 986 424 135	598817
0 986 424 144	598596
0 986 424 145	598007
0 986 424 145	598139
0 986 424 147	598396
0 986 424 151	598118
0 986 424 160	598278
0 986 424 167	598006
0 986 424 172	598380
0 986 424 172	598391
0 986 424 173	598289
0 986 424 175	598135
0 986 424 176	540436
0 986 424 178	598271
0 986 424 182	598227
0 986 424 183	598177
0 986 424 183	598496
0 986 424 184	598005
0 986 424 192	598122
0 986 424 200	598619
0 986 424 204	598602
0 986 424 211	598476
0 986 424 211	598691
0 986 424 214	598022
0 986 424 215	598051
0 986 424 215	598574
0 986 424 215	598786
0 986 424 217	598599



	
BOSCH	
0 986 424 218	598044
0 986 424 219	598046
0 986 424 223	598069
0 986 424 223	598467
0 986 424 227	598068
0 986 424 229	598062
0 986 424 230	598266
0 986 424 233	598636
0 986 424 234	598357
0 986 424 236	598067
0 986 424 237	598120
0 986 424 240	598598
0 986 424 244	598019
0 986 424 246	598040
0 986 424 248	598065
0 986 424 248	598308
0 986 424 248	598990
0 986 424 251	598533
0 986 424 260	598227
0 986 424 261	598122
0 986 424 264	598815
0 986 424 266	598290
0 986 424 267	598497
0 986 424 268	598393
0 986 424 268	598897
0 986 424 274	598531
0 986 424 277	598035
0 986 424 278	598383
0 986 424 284	598491
0 986 424 286	598623
0 986 424 287	598129
0 986 424 287	598497
0 986 424 287	598498
0 986 424 289	598056
0 986 424 295	598780
0 986 424 299	598826
0 986 424 313	598777
0 986 424 319	598947
0 986 424 340	598523
0 986 424 347	598066
0 986 424 348	598989
0 986 424 351	598281
0 986 424 352	598630
0 986 424 359	598033
0 986 424 359	598120
0 986 424 360	598305
0 986 424 360	601006
0 986 424 361	598488
0 986 424 362	601003
0 986 424 363	598556
0 986 424 364	598332
0 986 424 365	598580
0 986 424 366	598460
0 986 424 367	598507
0 986 424 368	598634
0 986 424 369	598071
0 986 424 369	598697
0 986 424 370	598320
0 986 424 371	598318
0 986 424 373	598217



	
BOSCH	
0 986 424 374	598010
0 986 424 375	598482
0 986 424 376	598714
0 986 424 379	598011
0 986 424 379	598012
0 986 424 381	598169
0 986 424 382	598402
0 986 424 382	598540
0 986 424 382	598614
0 986 424 382	598947
0 986 424 383	598540
0 986 424 383	598983
0 986 424 383	598984
0 986 424 394	598085
0 986 424 400	598310
0 986 424 400	598409
0 986 424 400	598640
0 986 424 402	598675
0 986 424 410	598038
0 986 424 410	598074
0 986 424 411	598030
0 986 424 411	598156
0 986 424 411	598360
0 986 424 414	598326
0 986 424 415	598073
0 986 424 416	598043
0 986 424 416	598171
0 986 424 418	598817
0 986 424 421	598077
0 986 424 427	598319
0 986 424 449	598403
0 986 424 450	598317
0 986 424 451	598470
0 986 424 452	598074
0 986 424 453	598461
0 986 424 455	598726
0 986 424 456	598322
0 986 424 457	598454
0 986 424 457	598860
0 986 424 458	598271
0 986 424 459	598311
0 986 424 460	598303
0 986 424 461	598475
0 986 424 462	598212
0 986 424 463	598045
0 986 424 464	598844
0 986 424 465	598830
0 986 424 466	598458
0 986 424 467	598459
0 986 424 468	598330
0 986 424 469	598549
0 986 424 469	598582
0 986 424 470	598549
0 986 424 470	598582
0 986 424 471	598329
0 986 424 472	598431
0 986 424 473	598385
0 986 424 474	598361
0 986 424 474	598902
0 986 424 475	598445

	
BOSCH	
0 986 424 476	598299
0 986 424 478	598926
0 986 424 480	598490
0 986 424 481	598355
0 986 424 482	598483
0 986 424 482	598751
0 986 424 483	598018
0 986 424 484	598753
0 986 424 485	598310
0 986 424 487	598726
0 986 424 488	598305
0 986 424 488	598475
0 986 424 489	598806
0 986 424 489	601002
0 986 424 490	598057
0 986 424 490	598450
0 986 424 492	598037
0 986 424 496	598444
0 986 424 497	598763
0 986 424 501	598486
0 986 424 502	598735
0 986 424 503	598408
0 986 424 506	598581
0 986 424 507	598880
0 986 424 508	598017
0 986 424 510	598065
0 986 424 511	598420
0 986 424 512	598316
0 986 424 514	598423
0 986 424 514	601019
0 986 424 515	598424
0 986 424 516	598300
0 986 424 517	598448
0 986 424 518	598448
0 986 424 519	598444
0 986 424 520	598447
0 986 424 522	598583
0 986 424 523	598517
0 986 424 523	601020
0 986 424 527	598456
0 986 424 528	598457
0 986 424 529	598462
0 986 424 531	598470
0 986 424 531	598669
0 986 424 531	598861
0 986 424 532	598328
0 986 424 533	598473
0 986 424 534	598737
0 986 424 534	598917
0 986 424 535	598606
0 986 424 535	598737
0 986 424 537	598676
0 986 424 539	598480
0 986 424 540	598479
0 986 424 541	598493
0 986 424 542	598650
0 986 424 542	598681
0 986 424 543	598423
0 986 424 543	601019
0 986 424 544	598605



	
BOSCH	
0 986 424 544	598607
0 986 424 545	598142
0 986 424 545	598331
0 986 424 546	598433
0 986 424 547	598617
0 986 424 549	598453
0 986 424 551	598528
0 986 424 551	598998
0 986 424 553	598407
0 986 424 554	598422
0 986 424 554	598423
0 986 424 554	598424
0 986 424 556	598429
0 986 424 556	598430
0 986 424 558	598564
0 986 424 558	598639
0 986 424 559	598681
0 986 424 560	598478
0 986 424 561	598854
0 986 424 563	598497
0 986 424 564	598499
0 986 424 565	598441
0 986 424 566	598512
0 986 424 567	598129
0 986 424 568	598903
0 986 424 569	598768
0 986 424 570	598766
0 986 424 571	598464
0 986 424 572	598522
0 986 424 575	598575
0 986 424 576	598308
0 986 424 577	598309
0 986 424 577	598772
0 986 424 578	598065
0 986 424 578	598308
0 986 424 578	598990
0 986 424 579	598859
0 986 424 579	598998
0 986 424 580	598418
0 986 424 581	598416
0 986 424 582	598419
0 986 424 583	598398
0 986 424 584	598412
0 986 424 585	598544
0 986 424 585	598965
0 986 424 586	598543
0 986 424 587	598965
0 986 424 590	598850
0 986 424 593	598041
0 986 424 594	598633
0 986 424 595	598428
0 986 424 596	598427
0 986 424 596	598698
0 986 424 596	598721
0 986 424 597	598426
0 986 424 597	598670
0 986 424 598	598417
0 986 424 610	598548
0 986 424 611	598442
0 986 424 614	598537



	
BOSCH	
0 986 424 616	598471
0 986 424 617	598472
0 986 424 617	598783
0 986 424 617	601005
0 986 424 617	601044
0 986 424 618	598471
0 986 424 618	598993
0 986 424 619	598566
0 986 424 619	601012
0 986 424 626	598843
0 986 424 630	598577
0 986 424 632	598734
0 986 424 633	598489
0 986 424 634	598500
0 986 424 635	598501
0 986 424 636	598470
0 986 424 636	598545
0 986 424 640	598535
0 986 424 640	598777
0 986 424 641	598865
0 986 424 642	601024
0 986 424 643	598883
0 986 424 644	598172
0 986 424 644	598399
0 986 424 645	598563
0 986 424 646	598584
0 986 424 648	598443
0 986 424 649	598712
0 986 424 650	598895
0 986 424 651	598410
0 986 424 651	598898
0 986 424 652	598413
0 986 424 653	598411
0 986 424 654	598643
0 986 424 656	598906
0 986 424 657	598547
0 986 424 658	598466
0 986 424 659	598465
0 986 424 660	598461
0 986 424 661	598682
0 986 424 661	598758
0 986 424 662	598546
0 986 424 663	598436
0 986 424 665	598677
0 986 424 666	598510
0 986 424 667	598753
0 986 424 668	598756
0 986 424 669	598534
0 986 424 670	598908
0 986 424 671	598527
0 986 424 672	598814
0 986 424 673	598807
0 986 424 674	598484
0 986 424 675	598538
0 986 424 676	598305
0 986 424 677	598678
0 986 424 679	601001
0 986 424 680	598407
0 986 424 681	598767
0 986 424 683	598434



	
BOSCH	
0 986 424 683	598438
0 986 424 684	598374
0 986 424 685	598374
0 986 424 687	598658
0 986 424 690	598992
0 986 424 691	598432
0 986 424 692	598579
0 986 424 693	598841
0 986 424 694	598629
0 986 424 695	598453
0 986 424 695	598733
0 986 424 695	598832
0 986 424 696	598511
0 986 424 697	598856
0 986 424 698	598820
0 986 424 699	598637
0 986 424 700	598530
0 986 424 701	598639
0 986 424 702	598438
0 986 424 703	598568
0 986 424 704	598570
0 986 424 705	598659
0 986 424 706	598483
0 986 424 706	598751
0 986 424 707	598454
0 986 424 707	598860
0 986 424 708	598813
0 986 424 709	598518
0 986 424 711	598778
0 986 424 713	598521
0 986 424 714	598821
0 986 424 715	598452
0 986 424 716	598886
0 986 424 717	598520
0 986 424 719	598536
0 986 424 720	598784
0 986 424 721	598514
0 986 424 722	598887
0 986 424 723	598805
0 986 424 726	598821
0 986 424 727	598504
0 986 424 727	598574
0 986 424 729	598505
0 986 424 729	598759
0 986 424 729	598871
0 986 424 732	598697
0 986 424 734	598449
0 986 424 735	598679
0 986 424 738	598468
0 986 424 739	598656
0 986 424 740	598655
0 986 424 741	598770
0 986 424 741	598967
0 986 424 743	598808
0 986 424 745	598035
0 986 424 747	598482
0 986 424 748	598482
0 986 424 750	541705
0 986 424 751	598463
0 986 424 751	598474

	
BOSCH	
0 986 424 756	598425
0 986 424 757	598902
0 986 424 758	598632
0 986 424 760	598661
0 986 424 761	598541
0 986 424 762	598542
0 986 424 764	598410
0 986 424 765	598415
0 986 424 766	598754
0 986 424 766	598885
0 986 424 767	598231
0 986 424 767	598412
0 986 424 767	598811
0 986 424 768	598586
0 986 424 769	598569
0 986 424 770	598915
0 986 424 771	598682
0 986 424 771	598911
0 986 424 774	598557
0 986 424 775	601029
0 986 424 777	598565
0 986 424 779	598750
0 986 424 780	598801
0 986 424 781	598450
0 986 424 782	598835
0 986 424 784	598670
0 986 424 784	598913
0 986 424 785	598558
0 986 424 786	598696
0 986 424 787	598638
0 986 424 788	598736
0 986 424 789	598553
0 986 424 790	598680
0 986 424 791	598451
0 986 424 792	598761
0 986 424 793	598761
0 986 424 794	598649
0 986 424 795	598641
0 986 424 795	598847
0 986 424 796	598752
0 986 424 796	601004
0 986 424 797	598635
0 986 424 798	598812
0 986 424 799	598809
0 986 424 800	598642
0 986 424 801	598462
0 986 424 803	598737
0 986 424 803	598917
0 986 424 804	598991
0 986 424 806	598779
0 986 424 806	598845
0 986 424 808	598827
0 986 424 809	598757
0 986 424 810	598574
0 986 424 810	598781
0 986 424 811	598842
0 986 424 812	598820
0 986 424 813	598674
0 986 424 814	598852
0 986 424 815	598744







	
BOSCH	
0 986 424 817	598780
0 986 424 818	598644
0 986 424 819	598699
0 986 424 820	598701
0 986 424 821	598703
0 986 424 822	598640
0 986 424 823	598833
0 986 424 824	598752
0 986 424 825	598715
0 986 424 826	598435
0 986 424 827	598762
0 986 424 828	598440
0 986 424 829	598667
0 986 424 830	598446
0 986 424 831	598665
0 986 424 832	541664
0 986 424 832	598966
0 986 424 833	541662
0 986 424 833	541717
0 986 460 002	598301
0 986 460 101	598099
0 986 460 101	598187
0 986 460 111	598106
0 986 460 113	598111
0 986 460 113	598183
0 986 460 113	598256
0 986 460 346	598088
0 986 460 346	598099
0 986 460 346	598113
0 986 460 346	598187
0 986 460 390	598293
0 986 460 736	598090
0 986 460 736	598091
0 986 460 736	598603
0 986 460 741	598088
0 986 460 881	598338
0 986 460 932	598374
0 986 460 935	598021
0 986 460 938	598039
0 986 460 938	598356
0 986 460 939	598256
0 986 460 941	598025
0 986 460 941	598048
0 986 460 942	598006
0 986 460 942	598010
0 986 460 942	598985
0 986 460 943	598004
0 986 460 943	598016
0 986 460 944	598017
0 986 460 944	598252
0 986 460 946	598086
0 986 460 947	598000
0 986 460 948	598982
0 986 460 949	598172
0 986 460 950	598294
0 986 460 951	598280
0 986 460 952	598018
0 986 460 953	598082
0 986 460 954	598048
0 986 460 955	598253



	
BOSCH	
0 986 460 956	598029
0 986 460 957	598028
0 986 460 957	598294
0 986 460 958	598292
0 986 460 960	598020
0 986 460 961	598257
0 986 460 962	598037
0 986 460 963	598036
0 986 460 964	598386
0 986 460 964	598753
0 986 460 965	598617
0 986 460 965	598621
0 986 460 966	598601
0 986 460 967	598063
0 986 460 967	598295
0 986 460 968	601021
0 986 460 969	598034
0 986 460 970	598158
0 986 460 970	598396
0 986 460 971	598033
0 986 460 971	598619
0 986 460 971	598630
0 986 460 972	598047
0 986 460 972	598248
0 986 460 973	598135
0 986 460 974	598646
0 986 460 975	598629
0 986 460 977	598013
0 986 460 978	598597
0 986 460 979	598625
0 986 460 980	598626
0 986 460 981	598024
0 986 460 982	598382
0 986 460 983	598155
0 986 460 983	598181
0 986 460 984	598691
0 986 460 984	598915
0 986 460 986	598271
0 986 460 989	598015
0 986 460 991	598035
0 986 460 993	598057
0 986 460 995	598621
0 986 460 996	598291
0 986 460 997	598628
0 986 460 998	598138
0 986 460 998	598153
0 986 460 998	598179
0 986 461 006	598682
0 986 461 006	598911
0 986 461 006	601043
0 986 461 106	598258
0 986 461 111	598103
0 986 461 115	598230
0 986 461 117	598154
0 986 461 117	598353
0 986 461 119	598012
0 986 461 121	598051
0 986 461 121	598786
0 986 461 122	598014
0 986 461 123	598551



	
BOSCH	
0 986 461 123	598579
0 986 461 123	598809
0 986 461 124	598788
0 986 461 126	598495
0 986 461 126	598760
0 986 461 127	598051
0 986 461 127	598052
0 986 461 129	598050
0 986 461 130	598030
0 986 461 130	598156
0 986 461 131	598053
0 986 461 131	598437
0 986 461 133	598618
0 986 461 133	598851
0 986 461 136	598540
0 986 461 136	598984
0 986 461 138	598846
0 986 461 139	598787
0 986 461 141	598274
0 986 461 142	598627
0 986 461 142	598682
0 986 461 143	598828
0 986 461 144	598668
0 986 461 145	598519
0 986 461 145	598834
0 986 461 146	598624
0 986 461 147	598054
0 986 461 148	598055
0 986 461 148	598080
0 986 461 149	598158
0 986 461 149	598396
0 986 461 149	598077
0 986 461 396	598078
0 986 461 396	598085
0 986 461 661	598405
0 986 461 731	598099
0 986 461 750	598023
0 986 461 752	598616
0 986 461 753	598622
0 986 461 757	598031
0 986 461 759	598494
0 986 461 760	598840
0 986 461 763	598075
0 986 461 763	598081
0 986 461 763	598181
0 986 461 764	598038
0 986 461 765	598061
0 986 461 766	598269
0 986 461 767	598312
0 986 461 768	598519
0 986 461 769	598180
0 986 461 769	598463
0 986 461 769	598474
0 986 461 770	598125
0 986 461 770	598141
0 986 462 001	598337
0 986 462 072	598144
0 986 462 282	598099
0 986 462 283	598099
0 986 462 532	598193

	
BOSCH	
0 986 462 803	598109
0 986 462 803	598110
0 986 462 850	598362
0 986 462 971	598146
0 986 463 412	598110
0 986 463 473	598077
0 986 463 473	598078
0 986 463 473	598085
0 986 463 490	598077
0 986 463 490	598085
0 986 463 561	598147
0 986 463 641	598129
0 986 463 641	598391
0 986 463 736	598375
0 986 463 890	598207
0 986 463 921	598109
0 986 464 221	598165
0 986 464 361	598187
0 986 464 372	598107
0 986 464 421	598086
0 986 464 421	598366
0 986 464 671	598107
0 986 464 671	598187
0 986 464 681	598111
0 986 464 801	598076
0 986 464 881	598366
0 986 464 914	598168
0 986 465 111	598620
0 986 465 141	598182
0 986 465 733	598592
0 986 465 744	598205
0 986 465 745	598214
0 986 465 751	598148
0 986 465 751	598292
0 986 465 881	598108
0 986 465 941	598150
0 986 466 311	598077
0 986 466 311	598085
0 986 466 311	598175
0 986 466 346	598080
0 986 466 350	598151
0 986 466 402	598166
0 986 466 402	598212
0 986 466 403	598166
0 986 466 403	598334
0 986 466 601	598389
0 986 466 683	598180
0 986 466 683	598463
0 986 466 683	598474
0 986 466 693	598017
0 986 466 698	598004
0 986 466 700	598017
0 986 466 751	598103
0 986 466 871	598345
0 986 466 874	598105
0 986 467 311	598185
0 986 467 400	598221
0 986 467 411	598153
0 986 467 570	598104
0 986 467 590	598129



	
BOSCH	
0 986 467 602	598612
0 986 467 720	598002
0 986 467 720	598084
0 986 467 720	598474
0 986 467 760	598091
0 986 467 841	598613
0 986 467 930	598168
0 986 468 350	541655
0 986 468 380	598095
0 986 468 380	598141
0 986 468 380	598219
0 986 468 451	598163
0 986 468 520	598921
0 986 468 570	598167
0 986 468 613	598217
0 986 468 630	598122
0 986 468 701	598266
0 986 468 701	598402
0 986 468 870	598128
0 986 468 871	598124
0 986 468 871	598128
0 986 468 873	598128
0 986 468 890	598127
0 986 469 070	598120
0 986 469 070	598335
0 986 469 080	598120
0 986 469 111	598113
0 986 469 120	598351
0 986 469 191	598061
0 986 469 390	598182
0 986 469 410	598315
0 986 469 441	598130
0 986 469 550	598220
0 986 469 550	598224
0 986 469 570	598384
0 986 469 580	598278
0 986 469 580	598296
0 986 469 761	598186
0 986 469 790	598027
0 986 469 810	598240
0 986 469 820	598121
0 986 469 820	598312
0 986 469 860	598075
0 986 469 860	598081
0 986 469 860	598177
0 986 469 860	598181
0 986 469 860	598338
0 986 469 960	598103
0 986 469 960	598259
0 986 487 900	564109
0 986 487 901	564110
0 986 487 902	564111
0 986 487 903	564112
0 986 490 260	598272
0 986 490 410	598239
0 986 490 440	598047
0 986 490 500	598183
0 986 490 510	598243
0 986 490 550	598241
0 986 490 640	598231



	
BOSCH	
0 986 490 640	598811
0 986 490 680	598237
0 986 490 680	598269
0 986 490 800	598119
0 986 490 800	598176
0 986 490 930	598133
0 986 490 930	598134
0 986 490 990	598123
0 986 491 030	598125
0 986 491 030	598141
0 986 491 030	598142
0 986 491 030	598219
0 986 491 030	598331
0 986 491 050	598095
0 986 491 250	598964
0 986 491 260	598224
0 986 491 330	598126
0 986 491 330	598160
0 986 491 410	598032
0 986 491 410	598166
0 986 491 441	598125
0 986 491 441	598142
0 986 491 900	598182
0 986 491 900	598184
0 986 492 020	598043
0 986 492 020	598171
0 986 492 090	598179
0 986 493 340	598666
0 986 493 360	598532
0 986 493 450	598278
0 986 493 450	598296
0 986 493 480	598123
0 986 493 480	598618
0 986 493 550	598268
0 986 493 720	598266
0 986 493 720	598402
0 986 493 790	598250
0 986 494 000	598062
0 986 494 001	598636
0 986 494 002	598357
0 986 494 003	598067
0 986 494 004	598065
0 986 494 004	598308
0 986 494 004	598990
0 986 494 005	598488
0 986 494 006	598580
0 986 494 007	598310
0 986 494 007	598409
0 986 494 007	598640
0 986 494 008	598675
0 986 494 009	598311
0 986 494 009	598753
0 986 494 010	598330
0 986 494 011	598431
0 986 494 012	598445
0 986 494 013	598299
0 986 494 014	598926
0 986 494 015	598018
0 986 494 016	598444
0 986 494 017	598763



	
BOSCH	
0 986 494 018	598486
0 986 494 019	598408
0 986 494 020	598581
0 986 494 021	598017
0 986 494 021	598484
0 986 494 022	598447
0 986 494 023	598583
0 986 494 024	598473
0 986 494 025	598650
0 986 494 025	598681
0 986 494 026	598433
0 986 494 027	598464
0 986 494 028	598412
0 986 494 028	598658
0 986 494 029	598543
0 986 494 030	598633
0 986 494 031	598537
0 986 494 032	598472
0 986 494 032	598783
0 986 494 032	601005
0 986 494 033	598471
0 986 494 033	598993
0 986 494 034	598566
0 986 494 034	601012
0 986 494 035	598489
0 986 494 036	598410
0 986 494 036	598898
0 986 494 037	598547
0 986 494 038	598465
0 986 494 039	598461
0 986 494 040	598546
0 986 494 041	598807
0 986 494 042	598484
0 986 494 043	598538
0 986 494 044	598678
0 986 494 046	598434
0 986 494 046	598438
0 986 494 047	598432
0 986 494 048	598568
0 986 494 049	598570
0 986 494 050	598483
0 986 494 050	598751
0 986 494 051	598482
0 986 494 051	598650
0 986 494 052	598638
0 986 494 053	598752
0 986 494 054	598665
0 986 494 055	598063
0 986 494 055	598295
0 986 494 056	598382
0 986 494 057	598258
0 986 494 058	598241
0 986 494 059	598016
0 986 494 059	598125
0 986 494 059	598142
0 986 494 061	598703
0 986 494 062	598463
0 986 494 062	598752
0 986 494 063	598643
0 986 494 064	598707



	
BOSCH	
0 986 494 065	598718
0 986 494 068	598793
0 986 494 070	598426
0 986 494 071	598729
0 986 494 072	598722
0 986 494 073	598678
0 986 494 074	598698
0 986 494 075	601031
0 986 494 076	598740
0 986 494 077	598822
0 986 494 078	598647
0 986 494 079	598648
0 986 494 080	598836
0 986 494 081	598764
0 986 494 082	598765
0 986 494 085	598795
0 986 494 087	598704
0 986 494 090	598672
0 986 494 090	601009
0 986 494 092	598825
0 986 494 094	598722
0 986 494 095	598664
0 986 494 096	598700
0 986 494 097	598662
0 986 494 098	598663
0 986 494 099	598702
0 986 494 101	598896
0 986 494 101	601026
0 986 494 102	598829
0 986 494 103	598863
0 986 494 104	598779
0 986 494 105	598720
0 986 494 107	598651
0 986 494 107	598652
0 986 494 108	598671
0 986 494 110	598892
0 986 494 111	598891
0 986 494 113	598426
0 986 494 114	601015
0 986 494 115	598987
0 986 494 118	598640
0 986 494 118	601027
0 986 494 119	601004
0 986 494 120	598699
0 986 494 121	598882
0 986 494 122	541728
0 986 494 122	598876
0 986 494 123	541728
0 986 494 124	598727
0 986 494 125	598727
0 986 494 126	598727
0 986 494 127	598472
0 986 494 127	598783
0 986 494 127	601005
0 986 494 127	601008
0 986 494 127	601044
0 986 494 129	598804
0 986 494 130	601028
0 986 494 132	598427
0 986 494 132	598913







	
BOSCH	
0 986 494 133	598874
0 986 494 134	598873
0 986 494 135	598824
0 986 494 136	598803
0 986 494 138	598506
0 986 494 139	598868
0 986 494 141	598439
0 986 494 143	598654
0 986 494 144	598910
0 986 494 145	598706
0 986 494 146	598705
0 986 494 146	598910
0 986 494 147	598741
0 986 494 148	598742
0 986 494 150	598524
0 986 494 151	598738
0 986 494 152	598889
0 986 494 153	598857
0 986 494 154	598819
0 986 494 155	598575
0 986 494 155	598708
0 986 494 157	598825
0 986 494 157	598839
0 986 494 158	601030
0 986 494 159	598657
0 986 494 160	598847
0 986 494 162	601051
0 986 494 163	598899
0 986 494 164	598940
0 986 494 165	598728
0 986 494 166	601034
0 986 494 167	598995
0 986 494 168	598925
0 986 494 169	598879
0 986 494 170	598816
0 986 494 171	541736
0 986 494 174	601037
0 986 494 175	598928
0 986 494 192	601039
0 986 494 194	598881
0 986 494 196	601052
0 986 494 197	601017
0 986 494 222	598722
0 986 494 261	598927
0 986 503 000	601155
0 986 503 001	601156
0 986 503 002	601157
0 986 503 003	601158
0 986 505 097	598910
0 986 505 402	598862
0 986 524 438	598903
0 986 524 444	598391
0 986 AB1 201	598634
0 986 AB1 202	598051
0 986 AB1 203	598908
0 986 AB1 222	598506
0 986 AB1 224	598361
0 986 AB1 233	598708
0 986 AB1 241	598316
0 986 AB1 255	598874



	
BOSCH	
0 986 AB1 264	598511
0 986 AB1 266	598937
0 986 AB1 268	598870
0 986 AB1 270	598361
0 986 AB2 027	598393
0 986 AB2 031	598815
0 986 AB2 041	598540
0 986 AB2 061	598496
0 986 AB2 082	598984
0 986 AB2 084	601025
0 986 AB2 085	598827
0 986 AB2 089	598542
0 986 AB2 090	598577
0 986 AB2 093	598737
0 986 AB2 096	598857
0 986 AB2 102	598844
0 986 AB2 104	598520
0 986 AB2 106	598886
0 986 AB2 109	598853
0 986 AB2 110	598476
0 986 AB2 111	598907
0 986 AB2 115	598733
0 986 AB2 115	598832
0 986 AB2 116	598921
0 986 AB2 119	598402
0 986 AB2 119	598614
0 986 AB2 123	598809
0 986 AB2 125	598535
0 986 AB2 126	598865
0 986 AB2 127	598536
0 986 AB2 130	598888
0 986 AB2 135	601052
0 986 AB2 136	598933
0 986 AB2 137	598890
0 986 AB2 138	598819
0 986 AB2 141	598449
0 986 AB2 145	598524
0 986 AB2 160	598745
0 986 AB2 168	598929
0 986 AB2 169	598053
0 986 AB2 171	598788
0 986 AB2 173	598757
0 986 AB2 176	598760
0 986 AB2 178	598848
0 986 AB2 217	601002
0 986 AB2 219	598787
0 986 AB2 224	598628
0 986 AB2 226	598786
0 986 AB2 238	598618
0 986 AB2 245	598296
0 986 AB2 250	598452
0 986 AB2 308	598834
0 986 AB2 313	598519
0 986 AB2 330	598521
0 986 AB2 460	598646
0 986 AB2 462	598290
0 986 AB2 463	598629
0 986 AB2 555	598850
0 986 AB2 561	598856
0 986 AB2 563	598883



	
BOSCH	
0 986 AB2 609	598915
0 986 AB2 651	598047
0 986 AB2 658	598248
0 986 AB2 663	598682
0 986 AB2 664	598047
0 986 AB2 666	598760
0 986 AB2 675	598682
0 986 AB2 675	598911
0 986 AB2 751	598021
0 986 AB2 758	598830
0 986 AB2 758	598986
0 986 AB2 760	598023
0 986 AB2 761	598533
0 986 AB2 761	598534
0 986 AB2 764	598830
0 986 AB2 765	598534
0 986 AB2 766	598843
0 986 AB2 844	601159
0 986 AB2 845	601160
0 986 AB2 846	601161
0 986 AB2 847	601228
0 986 AB2 849	601162
0 986 AB2 850	601229
0 986 AB2 852	601163
0 986 AB2 856	601164
0 986 AB2 857	601230
0 986 AB2 882	601231
0 986 AB2 883	601165
0 986 AB2 884	601166
0 986 AB2 885	601232
0 986 AB2 889	601167
0 986 AB2 890	601233
0 986 AB2 891	601168
0 986 AB2 893	601169
0 986 AB2 939	601171
0 986 AB2 948	601172
0 986 AB2 955	601235
0 986 AB2 958	601173
0 986 AB2 959	601236
0 986 AB2 977	601175
0 986 AB2 978	601239
0 986 AB3 742	601176
0 986 AB3 748	601240
0 986 AB3 749	601177
0 986 AB3 753	601178
0 986 AB3 759	601241
0 986 AB3 770	601179
0 986 AB3 772	601242
0 986 AB3 775	601180
0 986 AB3 776	601243
0 986 AB3 779	601244
0 986 AB3 780	601181
0 986 AB3 781	601245
0 986 AB3 784	564113
0 986 AB3 789	601182
0 986 AB3 790	601246
0 986 AB3 791	601183
0 986 AB3 793	564114
0 986 AB3 794	601184
0 986 AB3 800	601185

	
BOSCH	
0 986 AB3 802	598408
0 986 AB3 802	601186
0 986 AB3 803	598463
0 986 AB3 803	601247
0 986 AB3 804	601187
0 986 AB3 805	598252
0 986 AB3 805	601188
0 986 AB3 806	601189
0 986 AB3 807	564115
0 986 AB3 808	598464
0 986 AB3 808	601190
0 986 AB3 809	601191
0 986 AB3 810	601192
0 986 AB3 811	598682
0 986 AB3 811	601248
0 986 AB3 812	601193
0 986 AB3 814	601194
0 986 AB3 815	564116
0 986 AB3 816	601195
0 986 AB3 817	601196
0 986 AB3 818	601249
0 986 AB3 825	564117
0 986 AB3 831	601197
0 986 AB3 832	601250
0 986 AB3 834	598917
0 986 AB3 834	601198
0 986 AB3 835	564118
0 986 AB3 836	601251
0 986 AB3 837	564119
0 986 AB3 838	598668
0 986 AB3 838	601252
0 986 AB3 839	598393
0 986 AB3 840	598777
0 986 AB3 840	601253
0 986 AB3 841	598535
0 986 AB3 842	598865
0 986 AB3 855	601201
0 986 AB3 856	564120
0 986 AB3 862	598523
0 986 AB3 866	601255
0 986 AB3 868	601202
0 986 AB3 869	564121
0 986 AB3 901	601204
0 986 AB3 902	564123
0 986 AB3 904	601256
0 986 AB3 905	601205
0 986 AB3 906	564124
0 986 AB3 912	601206
0 986 AB3 913	601257
0 986 AB3 914	601258
0 986 AB3 915	601207
0 986 AB3 917	601208
0 986 AB3 918	601259
0 986 AB3 919	601209
0 986 AB3 920	601210
0 986 AB3 934	601261
0 986 AB3 935	601211
0 986 AB3 936	564125
0 986 AB3 937	601212
0 986 AB3 939	601213



	
BOSCH	
0 986 AB3 940	601263
0 986 AB3 944	601214
0 986 AB3 945	601264
0 986 AB3 948	601216
0 986 AB3 949	601217
0 986 AB3 950	601218
0 986 AB3 951	601266
0 986 AB3 954	601219
0 986 AB3 955	601267
0 986 AB3 956	601220
0 986 AB3 957	601268
0 986 AB3 961	601221
0 986 AB3 962	564126
0 986 AB3 963	601269
0 986 AB3 965	601270
0 986 AB3 966	601222
0 986 AB3 967	601223
0 986 AB3 968	601271
0 986 AB3 970	601273
0 986 AB3 971	601224
0 986 AB3 972	601225
0 986 AB3 973	564127
0 986 AB3 977	601227
0 986 AB3 978	601274
0 986 AB4 026	598921
0 986 AB4 034	598614
0 986 AB4 036	598122
0 986 AB4 121	598984
0 986 AB4 150	598777
0 986 AB4 166	598184
0 986 AB4 166	598356
0 986 AB4 189	598356
0 986 AB4 275	598834
0 986 AB4 278	598449
0 986 AB4 279	598625
0 986 AB4 292	598912
0 986 AB4 297	598305
0 986 BB0 056	598112
0 986 BB0 161	598142
0 986 BB0 173	598838
0986AB2004	598266
0986AB2004	598579
0986AB2022	598897
0986AB2026	598947
0986AB2028	598777
0986AB2044	601023
0986AB2050	598393
0986AB2054	601022
0986AB2058	598393
0986AB2058	598897
0986AB2059	598496
0986AB2207	598123
0986AB2210	598384
0986AB2213	598123
0986AB2213	598618
0986AB2221	598916
0986AB2222	598668
0986AB2309	598517
0986AB2309	601020
0986AB2311	598625



	
BOSCH	
0986AB2322	598522
0986AB2328	598517
0986AB2455	598250
0986AB2456	598846
0986AB2458	598780
0986AB2461	598274
0986AB2476	598515
0986AB2565	601024
0986AB2602	598476
0986AB2602	598691
0986AB2603	598691
0986AB2604	598828
0986AB2608	598530
0986AB2610	598895
0986AB2662	598627
0986AB2665	598494
0986AB3806	598155
0F026000014	598018
0F026000071	598454
0F026000079	598737
0F026000079	598917
0F026000120	598053
0F026000120	598437
F 005 X10 237	598050
F 01G 09G 03Y	598710
F 026 000 000	598040
F 026 000 001	598065
F 026 000 001	598308
F 026 000 001	598990
F 026 000 002	598488
F 026 000 003	598675
F 026 000 004	598038
F 026 000 004	598074
F 026 000 005	598403
F 026 000 006	598074
F 026 000 007	598212
F 026 000 008	598018
F 026 000 009	598753
F 026 000 010	598172
F 026 000 010	598399
F 026 000 011	598563
F 026 000 012	598039
F 026 000 012	598356
F 026 000 013	598025
F 026 000 013	598048
F 026 000 014	598018
F 026 000 015	598258
F 026 000 016	598166
F 026 000 016	598212
F 026 000 017	598124
F 026 000 017	598128
F 026 000 018	598128
F 026 000 019	598127
F 026 000 020	598315
F 026 000 022	598011
F 026 000 022	598012
F 026 000 023	598156
F 026 000 023	598360
F 026 000 024	598319
F 026 000 025	598461



	
BOSCH	
F 026 000 026	598549
F 026 000 027	598926
F 026 000 028	598457
F 026 000 029	598650
F 026 000 029	598681
F 026 000 030	598584
F 026 000 031	598090
F 026 000 031	598603
F 026 000 032	598338
F 026 000 035	598035
F 026 000 036	598012
F 026 000 037	598158
F 026 000 037	598396
F 026 000 038	598077
F 026 000 038	598085
F 026 000 039	598148
F 026 000 039	598292
F 026 000 041	598002
F 026 000 041	598084
F 026 000 042	598091
F 026 000 043	598182
F 026 000 044	598075
F 026 000 044	598081
F 026 000 044	598177
F 026 000 044	598181
F 026 000 044	598338
F 026 000 045	598243
F 026 000 046	598241
F 026 000 047	598141
F 026 000 047	598142
F 026 000 047	598331
F 026 000 048	598067
F 026 000 049	598317
F 026 000 050	598355
F 026 000 051	598070
F 026 000 052	598064
F 026 000 053	598254
F 026 000 054	598116
F 026 000 055	598091
F 026 000 056	598052
F 026 000 056	598817
F 026 000 057	598022
F 026 000 058	598069
F 026 000 058	598467
F 026 000 060	598019
F 026 000 061	598066
F 026 000 063	598332
F 026 000 064	598318
F 026 000 065	598217
F 026 000 066	598326
F 026 000 067	598073
F 026 000 068	598043
F 026 000 068	598171
F 026 000 070	598322
F 026 000 071	598454
F 026 000 072	598303
F 026 000 073	598330
F 026 000 074	598763
F 026 000 075	598017
F 026 000 076	598456



	
BOSCH	
F 026 000 078	598473
F 026 000 081	598676
F 026 000 081	598858
F 026 000 082	598480
F 026 000 083	598479
F 026 000 083	601030
F 026 000 084	598493
F 026 000 085	598605
F 026 000 085	598607
F 026 000 086	598564
F 026 000 087	598577
F 026 000 088	598305
F 026 000 092	598256
F 026 000 093	598004
F 026 000 093	598016
F 026 000 094	598017
F 026 000 094	598252
F 026 000 095	598982
F 026 000 096	598172
F 026 000 097	598082
F 026 000 098	598048
F 026 000 099	598253
F 026 000 100	598292
F 026 000 102	598037
F 026 000 103	598036
F 026 000 104	598034
F 026 000 105	598396
F 026 000 106	598033
F 026 000 106	598619
F 026 000 106	598630
F 026 000 107	598013
F 026 000 108	598626
F 026 000 111	598057
F 026 000 112	598621
F 026 000 113	598291
F 026 000 114	598682
F 026 000 114	598911
F 026 000 116	598154
F 026 000 116	598353
F 026 000 117	598014
F 026 000 118	598551
F 026 000 118	598809
F 026 000 119	598030
F 026 000 119	598156
F 026 000 120	598053
F 026 000 120	598437
F 026 000 122	598274
F 026 000 123	598627
F 026 000 123	598682
F 026 000 124	598668
F 026 000 125	598055
F 026 000 125	598080
F 026 000 126	598077
F 026 000 126	598078
F 026 000 126	598085
F 026 000 127	598616
F 026 000 128	598622
F 026 000 129	598031
F 026 000 130	598075
F 026 000 130	598081







	
BOSCH	
F 026 000 130	598181
F 026 000 131	598038
F 026 000 132	598061
F 026 000 133	598180
F 026 000 133	598463
F 026 000 135	598099
F 026 000 136	598182
F 026 000 137	598205
F 026 000 139	598080
F 026 000 140	598151
F 026 000 141	598166
F 026 000 142	598180
F 026 000 143	598017
F 026 000 144	598017
F 026 000 145	598345
F 026 000 146	598105
F 026 000 147	598221
F 026 000 148	598095
F 026 000 148	598141
F 026 000 148	598219
F 026 000 149	598167
F 026 000 150	598266
F 026 000 150	598402
F 026 000 151	598128
F 026 000 152	598120
F 026 000 152	598335
F 026 000 153	598384
F 026 000 154	598240
F 026 000 155	598183
F 026 000 156	598119
F 026 000 156	598176
F 026 000 157	598123
F 026 000 158	598095
F 026 000 159	598125
F 026 000 159	598142
F 026 000 161	598182
F 026 000 161	598184
F 026 000 162	598043
F 026 000 162	598171
F 026 000 163	598179
F 026 000 164	598666
FERODO	
FDB100	598363
FDB1000	598064
FDB1001	598712
FDB1002	598073
FDB1003	598502
FDB101	598090
FDB1011	598836
FDB1013	598844
FDB1015	598460
FDB1017	598507
FDB102	598094
FDB102	598141
FDB1020	598533
FDB1021	598777
FDB1021	601232
FDB1034	598695
FDB1038	598044



	
FERODO	
FDB1040	598040
FDB1040	598607
FDB1040B	598040
FDB1040B	598607
FDB1044	598062
FDB1049	598357
FDB105	598099
FDB1050	598636
FDB1052	598065
FDB1052	598308
FDB1052	598990
FDB1052B	598065
FDB1052B	598308
FDB1052B	598990
FDB1054	598066
FDB1055	598067
FDB1055	598463
FDB1056	598040
FDB1056	598041
FDB1056	601003
FDB1056B	598040
FDB1056B	598041
FDB1056B	601003
FDB106	598077
FDB106	598078
FDB106	598085
FDB1062	598068
FDB1063	598069
FDB1063	598467
FDB1067	598184
FDB1068	598305
FDB1069	598385
FDB1070	598207
FDB1072	598258
FDB1072G	598258
FDB1073	598310
FDB1073	598409
FDB1073	598811
FDB1075	598311
FDB1080	601156
FDB1081	598212
FDB1083	598180
FDB1083	598463
FDB1083	601255
FDB1085	598061
FDB1091	598071
FDB1092	598320
FDB1094	598332
FDB1096	598450
FDB1098	598556
FDB1099	598965
FDB11	598017
FDB11	598111
FDB1100	598830
FDB1101	598488
FDB1104	598668
FDB1109	598156
FDB1112	598326
FDB1113	598125
FDB1113	598141



	
FERODO	
FDB1113	598142
FDB1113	598219
FDB1113	598331
FDB1114	598420
FDB1116	598361
FDB1117	598183
FDB1117	598187
FDB1117B	598183
FDB1117B	598187
FDB1124	598470
FDB1129	598906
FDB113	598077
FDB113	598078
FDB113	598085
FDB1134	598880
FDB1135	598726
FDB114	598077
FDB114	598085
FDB1156	598528
FDB1157	598854
FDB116	598108
FDB1160	598605
FDB1162	598329
FDB1166	598806
FDB1166	601002
FDB1167	598355
FDB1168	598074
FDB11X	598111
FDB123	598375
FDB1254	598904
FDB126	598147
FDB1263	598452
FDB1264	598459
FDB1264	601249
FDB1265	598458
FDB1265	601196
FDB1276	598399
FDB1278	598328
FDB128	598099
FDB128	598106
FDB128	598109
FDB1285	598616
FDB1288	598403
FDB1289	598017
FDB1291	598512
FDB1293	598322
FDB1294	598926
FDB1295	598454
FDB130	598174
FDB130	598375
FDB1300	598018
FDB1301	598753
FDB1303	598549
FDB1304	598299
FDB1305	598301
FDB1307	598766
FDB1308	598768
FDB1310	598763
FDB1311	598444
FDB1312	598330

	
FERODO	
FDB1318	598317
FDB1319	598431
FDB1319B	598431
FDB1321	598478
FDB1322	598447
FDB1323	598483
FDB1323	601195
FDB1324	598425
FDB1325	598406
FDB1326	598575
FDB1327	598530
FDB1333	598895
FDB1334	598772
FDB1336	598902
FDB1337	598316
FDB1349	598407
FDB1355	598632
FDB1356	598582
FDB1357	598549
FDB1368	598606
FDB1370	598462
FDB1376	598422
FDB1376	598424
FDB1377	598424
FDB1378	598461
FDB1378	601184
FDB1379	598466
FDB1380	598527
FDB1382	601030
FDB1383	598480
FDB1392	598737
FDB1393	598563
FDB1394	598564
FDB1395	598577
FDB1395	601251
FDB1398	598408
FDB1398	601186
FDB1399	598464
FDB1399	601160
FDB1399	601189
FDB1399	601190
FDB1399	601212
FDB1400	598442
FDB1401	598443
FDB1407	598750
FDB1409	598557
FDB1410	598417
FDB1411	598419
FDB1412	598416
FDB1413	598418
FDB1414	598638
FDB1415	598063
FDB1415	598664
FDB1416	598434
FDB1416	601257
FDB1419	598667
FDB142	598178
FDB1420	598473
FDB1421	598843
FDB1422	598522



 	
FERODO	
FDB1423	598453
FDB1424	598456
FDB1425	598433
FDB1425	601206
FDB1426	598445
FDB1426	598659
FDB1427	598446
FDB1428	598448
FDB1429	598448
FDB143	598109
FDB1433	598476
FDB1434	598523
FDB1439	598436
FDB1440	598566
FDB1440	601012
FDB1441	598471
FDB1442	598543
FDB1444	598907
FDB1445	598515
FDB1446	598516
FDB1447	598653
FDB1451	598484
FDB1454	598449
FDB1455	598548
FDB1456	598535
FDB1457	598865
FDB1457	601253
FDB1458	598579
FDB1459	598991
FDB1460	598967
FDB1463	598180
FDB1463	598486
FDB1463	601209
FDB1466	598426
FDB1467	598427
FDB1467	598698
FDB1467	598721
FDB1468	598428
FDB1469	598633
FDB1470	601001
FDB1471	601029
FDB1472	598457
FDB1473	598514
FDB1475	598755
FDB1476	598465
FDB1476	601213
FDB1477	598398
FDB1481	598681
FDB1482	598482
FDB1482	598650
FDB1482	598681
FDB1483	598580
FDB1485	598439
FDB1486	598438
FDB149	598165
FDB1491	598180
FDB1493	598764
FDB1494	598765
FDB1495	598481
FDB1496	598489



 	
FERODO	
FDB1497	598565
FDB1499	598413
FDB1500	598643
FDB1501	598856
FDB1502	598393
FDB1505	598627
FDB1506	598758
FDB1508	598988
FDB1510	598415
FDB1511	598661
FDB1512	598719
FDB1513	598736
FDB1514	598536
FDB1515	598545
FDB1517	598735
FDB1520	598678
FDB1521	598584
FDB1523	598510
FDB1524	598677
FDB1526	598637
FDB1527	598784
FDB1528	598827
FDB1529	598541
FDB1530	598542
FDB1531	598673
FDB1532	598733
FDB1532	598832
FDB1533	598848
FDB1535	598475
FDB1536	598511
FDB1540	598472
FDB1541	598471
FDB1542	598500
FDB1543	598501
FDB1544	598558
FDB1545	598468
FDB1551	598697
FDB1554	598912
FDB1556	598553
FDB1556	598793
FDB1557	601180
FDB1559	598912
FDB1564	601023
FDB1565	598534
FDB1569	598841
FDB1570	598778
FDB1573	598679
FDB1574	598680
FDB1580	598451
FDB1581	598761
FDB1582	598761
FDB1593	598704
FDB1594	598649
FDB1594	601171
FDB1595	598821
FDB1596	598521
FDB1597	598658
FDB1599	598462
FDB160	598375
FDB1600	598745



 	
FERODO	
FDB1601	598435
FDB1603	598518
FDB1604	598520
FDB1605	598505
FDB1605	598759
FDB1605	601164
FDB1606	598748
FDB1606	601230
FDB1606	601236
FDB1607	598989
FDB1608	598813
FDB161	598107
FDB1610	601025
FDB1612	598915
FDB1613	598742
FDB1615	598741
FDB1617	598641
FDB162	598187
FDB1620	598862
FDB1621	598886
FDB1625	598655
FDB1626	598656
FDB1627	598770
FDB1628	598410
FDB1629	598652
FDB1629	598779
FDB1629	601163
FDB163	598107
FDB1630	598012
FDB1631	598657
FDB1632	598829
FDB1633	598734
FDB1634	598805
FDB1635	598408
FDB1636	598752
FDB1636	601263
FDB1637	598463
FDB1639	598853
FDB164	598107
FDB164	598187
FDB1640	598860
FDB1641	598635
FDB1641	601216
FDB1645	598674
FDB1646	598523
FDB1648	598665
FDB1649	598812
FDB1651	601003
FDB1652	598696
FDB1654	598801
FDB1655	601004
FDB1658	598757
FDB1658	601208
FDB1661	598659
FDB1662	598720
FDB1663	598772
FDB1666	598670
FDB1666	598913
FDB1667	598861
FDB1668	598483



 	
FERODO	
FDB1668	598751
FDB1669	598887
FDB1669	601217
FDB167	598168
FDB1670	598506
FDB1670	601167
FDB1670	601168
FDB1672	598820
FDB1673	598411
FDB1675	601005
FDB1676	598643
FDB1679	598682
FDB1679	601248
FDB1686	601242
FDB1691	601252
FDB1691	601261
FDB1692	601176
FDB1693	598672
FDB1698	598857
FDB1698	601166
FDB1699	598644
FDB1699	601205
FDB1700	598883
FDB1702	598855
FDB1703	601022
FDB1704	598824
FDB1706	598822
FDB1709	598992
FDB1711	598439
FDB1713	598438
FDB1717	598751
FDB1721	598780
FDB1725	598662
FDB1726	598663
FDB1727	598664
FDB1728	598715
FDB173	598182
FDB173	598356
FDB1733	598744
FDB1733	601173
FDB1735	598654
FDB1736	598823
FDB1737	598574
FDB1738	598318
FDB1742	598767
FDB1745	598889
FDB1745	601204
FDB1747	598699
FDB1749	598704
FDB175	598124
FDB175	598128
FDB175	598205
FDB1750	598795
FDB1751	598700
FDB1753	598035
FDB1757	598515
FDB176	598076
FDB1765	598863
FDB1766	598472
FDB1766	598783







	
FERODO	
FDB1770	598180
FDB1773	598640
FDB1781	598002
FDB1782	598583
FDB1783	598707
FDB1784	598702
FDB1784	601273
FDB1787	598553
FDB1788	598180
FDB1788	598463
FDB1790	598718
FDB1794	598772
FDB1795	601029
FDB1796	601029
FDB1797	598727
FDB1798	598727
FDB1805	598729
FDB1806	598701
FDB1807	598703
FDB1808	598885
FDB1826	598940
FDB1827	598484
FDB1827	598751
FDB1829	601221
FDB1830	598728
FDB1831	598802
FDB1832	598845
FDB1833	598808
FDB1835	598770
FDB1838	598939
FDB1839	598852
FDB1840	598781
FDB1840	601169
FDB1841	601233
FDB1858	598722
FDB1859	598803
FDB186	598614
FDB1861	598875
FDB1862	598849
FDB1865	598993
FDB1866	601012
FDB1867	598753
FDB1868	598710
FDB1869	598842
FDB1875	598804
FDB1877	598994
FDB1881	598738
FDB1885	598740
FDB1885	601258
FDB1889	598874
FDB1889	601250
FDB1890	601026
FDB1892	598819
FDB1892	601264
FDB1894	598746
FDB1895	598810
FDB1896	598859
FDB1897	598879
FDB1897	601218
FDB1898	601007



	
FERODO	
FDB190	598113
FDB1902	598706
FDB1905	601197
FDB1907	601034
FDB1910	598932
FDB1911	598944
FDB1912	601201
FDB1917	598935
FDB1917	601266
FDB1918	598928
FDB1919	598839
FDB192	598108
FDB1920	598825
FDB1922	598722
FDB1931	598472
FDB1931	598783
FDB1931	601044
FDB1931	601256
FDB1932	598935
FDB1933	598935
FDB1934	598942
FDB1935	598941
FDB1936	601035
FDB194	598377
FDB1944	598987
FDB1945	601015
FDB1946	598426
FDB1947	598929
FDB195	598389
FDB1950	598708
FDB1955	598868
FDB1955	601210
FDB1956	598867
FDB196	598207
FDB1968	598919
FDB1969	598361
FDB197	598364
FDB1970	598834
FDB1970	598866
FDB1971	598997
FDB1972	598998
FDB1973	598936
FDB1974	598699
FDB1976	601031
FDB198	598208
FDB1980	601051
FDB1982	598476
FDB1985	598917
FDB1985	601172
FDB1985	601198
FDB1986	601240
FDB1988	598873
FDB1990	598821
FDB1991	601214
FDB1992	598852
FDB1997	598738
FDB1999	598871
FDB201	598148
FDB203	598592
FDB206	598212



	
FERODO	
FDB208	598185
FDB212	598120
FDB212	598166
FDB212	598212
FDB22	598088
FDB221	598093
FDB222	598125
FDB225	598123
FDB225	598379
FDB230	598220
FDB235	598081
FDB240	598168
FDB241	598612
FDB243	598110
FDB253	598150
FDB256	598080
FDB256	598104
FDB257	598162
FDB264	598090
FDB268	598163
FDB272	598149
FDB274	598118
FDB275	598217
FDB276	598120
FDB276	598335
FDB284	598817
FDB285	598131
FDB286	598168
FDB288	598921
FDB289	598169
FDB29	598603
FDB293	598278
FDB296	598103
FDB2H	598050
FDB2H	598099
FDB2H	598270
FDB300	598047
FDB308	598266
FDB316	598384
FDB317	598221
FDB318	598402
FDB328	598105
FDB340	598123
FDB346	598091
FDB346	598219
FDB347	598351
FDB348	598113
FDB349	598130
FDB350	598093
FDB350	598168
FDB357	598224
FDB359	598160
FDB361	598094
FDB363	598091
FDB363	598093
FDB363	598271
FDB365	598167
FDB368	598220
FDB370	598091
FDB370	598141

	
FERODO	
FDB370	598219
FDB372	598780
FDB375	598182
FDB375	598356
FDB385	598127
FDB391	598115
FDB392	598124
FDB392	598127
FDB393	598002
FDB393	598075
FDB393	598081
FDB393	598177
FDB393	598181
FDB393D	598081
FDB396	598021
FDB398	598240
FDB3M	598099
FDB3M	598187
FDB4001	598888
FDB4001	601269
FDB4003	598927
FDB4004	598180
FDB4014	598705
FDB402	598175
FDB4023	598893
FDB4035	601017
FDB4041	601028
FDB4042	598933
FDB4045	598996
FDB4046	601040
FDB4051	601182
FDB4051	601183
FDB4055	598995
FDB4056	598709
FDB406	598061
FDB4060	598877
FDB4061	601271
FDB4062	601223
FDB4066	598464
FDB4074	598924
FDB4076	598052
FDB4077	598878
FDB408	598121
FDB4080	598925
FDB4081	601052
FDB410	598134
FDB4110	598999
FDB4110	601225
FDB412	598214
FDB4136	601037
FDB4136	601224
FDB4148	601013
FDB415	598315
FDB4160	601178
FDB4161	601179
FDB4177	598738
FDB4178	598463
FDB4179	598999
FDB4182	601000
FDB4183	598474



 	
FERODO	
FDB4184	601014
FDB4185	601010
FDB4188	598678
FDB419	598127
FDB419	598128
FDB419	598181
FDB4191	601027
FDB4192	598752
FDB4193	598945
FDB4198	601245
FDB42	598174
FDB420	598371
FDB4201	601222
FDB4202	601211
FDB4203	601267
FDB4204	601243
FDB4207	601185
FDB4208	601177
FDB4221	598898
FDB4227	601270
FDB423	598375
FDB424	598375
FDB4241	601239
FDB4242	601175
FDB4252	601241
FDB4262	601162
FDB4265	601229
FDB4272	601181
FDB4272	601207
FDB428	598151
FDB428B	598151
FDB4295	601231
FDB4304	601220
FDB4305	601268
FDB4318	601259
FDB4322	601219
FDB4322	601227
FDB4323	601274
FDB434	598119
FDB434	598714
FDB435	598052
FDB4354	601161
FDB4355	601228
FDB440	598080
FDB440	598396
FDB441	598130
FDB442	598126
FDB445	598227
FDB448	598115
FDB454	598248
FDB455	598084
FDB455	598119
FDB455	598176
FDB455	598181
FDB456	598125
FDB456	598141
FDB470	598983
FDB471	598497
FDB472	598053
FDB472	598437



 	
FERODO	
FDB478	598540
FDB478	598984
FDB487	598293
FDB507	598964
FDB509	598271
FDB519	598271
FDB520	598129
FDB520	598497
FDB520	598498
FDB524	598095
FDB525	598183
FDB527	598406
FDB534	598082
FDB535	598030
FDB535	598156
FDB536	598102
FDB540	598179
FDB540	598353
FDB541	598180
FDB541	601247
FDB542	598006
FDB546	598289
FDB55	601016
FDB550	598296
FDB556	598597
FDB558	598158
FDB558	598396
FDB558	598570
FDB565	598010
FDB576	598250
FDB577	598231
FDB577	598440
FDB578	598259
FDB579	598335
FDB58	598362
FDB581	598186
FDB584	598184
FDB585	598047
FDB586	598183
FDB586	598253
FDB588	598666
FDB589	598043
FDB590	598355
FDB593	598003
FDB595	598135
FDB597	598268
FDB598	598248
FDB600	598051
FDB600	598786
FDB602	598266
FDB603	598254
FDB604	598054
FDB608	598019
FDB609	598183
FDB609	598243
FDB613	598022
FDB614	598029
FDB614	598385
FDB615	598292
FDB617	598172



 	
FERODO	
FDB617	598399
FDB619	598063
FDB619	598295
FDB621	598053
FDB622	598237
FDB623	598294
FDB628	598257
FDB630	598846
FDB632	598039
FDB634	598620
FDB638	598817
FDB638	601235
FDB641	598123
FDB641	598618
FDB643	598122
FDB644	598272
FDB646	598601
FDB647	598005
FDB649	598809
FDB651	598135
FDB654	598290
FDB654	598624
FDB660	598241
FDB667	598024
FDB667	598054
FDB667	598450
FDB669	598241
FDB671	598015
FDB676	598621
FDB678	598020
FDB686	598256
FDB691	598051
FDB691	598786
FDB691	598787
FDB707	598057
FDB708	598052
FDB71	598193
FDB712	598023
FDB714	598646
FDB715	598274
FDB717	598123
FDB719	598155
FDB719	598181
FDB719	601158
FDB719	601159
FDB720	598154
FDB721	598859
FDB721	598988
FDB723	598108
FDB725	598018
FDB729	598075
FDB729	598081
FDB729	598155
FDB729	598177
FDB729	598181
FDB730	598075
FDB730	598155
FDB730	598181
FDB732	598039
FDB732	598356



 	
FERODO	
FDB742	598028
FDB745	598156
FDB746	598280
FDB749	601021
FDB759	598626
FDB761	601192
FDB763	598628
FDB764	598625
FDB765	598517
FDB765	601020
FDB766	598033
FDB766	598034
FDB766	598619
FDB767	598033
FDB774	598004
FDB774	598016
FDB774	598330
FDB775	598017
FDB775	598252
FDB775	601188
FDB776	598494
FDB777	598495
FDB777	598760
FDB779	598231
FDB780	598296
FDB789	598691
FDB790	598828
FDB796	598826
FDB797	598393
FDB797	598897
FDB799	598617
FDB804	598519
FDB815	598374
FDB817	598374
FDB819	598161
FDB819	598193
FDB819	598338
FDB840	598116
FDB844	598497
FDB845	598002
FDB845	598084
FDB846	598120
FDB850	598386
FDB854	598013
FDB857	598411
FDB859	598014
FDB867	598551
FDB869	598290
FDB871	598623
FDB872	598762
FDB874	598031
FDB875	598383
FDB876	598038
FDB876	598074
FDB877	598158
FDB877	598396
FDB878	598055
FDB880	598382
FDB881	598080
FDB884	598034







	
FERODO	
FDB901	598050
FDB904	598056
FDB905	598627
FDB909	598602
FDB915	598312
FDB917	598903
FDB925	598011
FDB925	598012
FDB930	598496
FDB937	598851
FDB939	598250
FDB940	598840
FDB943	598815
FDB950	598629
FDB950	601193
FDB951	598982
FDB953	598281
FDB954	598017
FDB954	601157
FDB956	598682
FDB956	598911
FDB956	601244
FDB96	598389
FDB969	598303
FDB972	598599
FDB973	598183
FDB974	601024
FDB977	598600
FDB979	598345
FDB98	598145
FDB980	598441
FDB981	598499
FDB985	598355
FDB99	598146
FDB992	598642
FDB993	598293
FDB994	598308
FDB995	598581
FDB997	598412
FDB998	598412
FSB222	564120
FSB334	564116
FSB4014	564125
FSB4014	601246
FSB4068	564119
FSB4068	564126
FSB519	564113
FSB519	564115
FSL1337	601191
FSL1961	601202
FSL419	601155
FSL732	601194
FSS191	564109
FSS337	564112
FSS408	564110
TEXTAR	
2138217305	598859
2148217005	598476
2148217005	598691



	
TEXTAR	
2180718005	598965
2181517005	598600
2307418905	598479
2308616005	598523
2361119005	598524
19706 1797 0 5 D7113	598112
19706 1797 0 5 T016	598112
19706 1797 0 5 T088	598112
20007 15.2 0 4	598374
20008 13.0 0 4	598624
20009 15.0 0 4	598099
20009 15.0 0 4	598187
20011 15.0 0 4	598111
20011 150 0 4 T424	598111
20011 150 0 4 T424	598183
20011 150 0 4 T424	598256
20011 19.0 0 4	598106
20011 19.0 0 4	598111
2001115004T400	598111
20031 130 0 4	598780
20034 15.0 0 4	598099
20034 15.0 0 4	598113
20034 15.0 0 4	598187
20034 15.0 0 4	598270
20034 15.0 0 5	598099
20034 15.0 0 5	598113
20034 15.0 0 5	598187
20034 15.0 0 5	598270
20038 13.8 0 4	598392
2003813804T4047	598392
20073 17.3 0 4	598090
20073 17.3 0 4	598603
2007317304T468	598603
20074 10.0 0 4	598088
20076 155 0 5	598983
20076 155 0 5	598984
2007615505T4067	598983
2007615505T4067	598984
20088 14.4 0 4	598161
20088 14.4 0 4	598270
20088 14.4 0 4	598338
20098 17.0 0 4	598851
2009817004T4067	598851
20124 19.0 1 4	598025
20124 19.0 1 4	598048
20126 15.0 0 4	598099
20140 14.0 0 5	598077
20140 14.0 0 5	598078
20140 14.0 0 5	598085
20145 17.0 0 5	598174
20153 16.0 0 4	598337
20162 15.4 0 4	598292
20164 18.2 1 4	598695
20164 182 0 4	598695
20166 16.0 0 4	598405
20168 16.2 1 4	598004
20168 16.2 1 4	598016
20168 19.6 1 4	598017
20168 19.6 1 4	598252
20168 196 1 5	598982



	
TEXTAR	
20173 14.5 0 4	598099
20180 16.8 0 5	598386
20207 13.0 0 4	598144
20224 209 0 5	598808
20228 15.2 0 4	598099
20228 18.5 0 4	598099
20236 18.2 1 5	598382
20253 16.4 0 5	598193
20260 15.2 0 4	598174
20260 15.2 0 4	598375
20260 15.2 0 5	598375
20260 165 0 4	598077
20260 165 0 4	598375
20260 18.5 0 4	598375
20261 193 1 5	598553
20285 07.1 0 4	598362
20288 16.0 0 4	598145
20292 17.0 0 5	598090
20292 17.0 1 4	598090
20293 12.0 0 4	598094
2029312004T4047	598094
20297 11.7 0 4	598146
20307 10.5 0 4	598363
20315 15.0 0 4	598396
20323 165 0 4	598108
20323 165 0 5	598115
20332 17.0 2 5	598000
20332 17.0 2 5	598005
20336 14.0 0 5	598085
20341 17.5 0 4	598110
20344 15.0 0 4	598497
20356 15.5 0 4	598147
20359 18.0 0 4	598129
20359 180 0 5	598129
20359 180 1 4	598129
20361 16.5 2 5	598008
20361 16.5 2 5	598289
20364 15.0 0 5	598391
20364 150 2 5	598129
20364 150 2 5	598391
20366 15.0 0 5	598593
20366 15.0 0 5	598594
20371 08.1 0 4	598364
20373 16.5 0 5	598115
20375 16.0 0 4	598371
20379 165 0 5	598115
20380 15.6 0 4	598374
20380 15.6 0 5	598374
20387 150 0 5	598351
20389 16.0 0 4	598207
20392 15.0 0 4	598109
20392 18.5 0 4	598110
20410 15.0 0 5	598055
20410 15.0 0 5	598080
20410 15.0 0 5	598396
20421 15.0 0 4	598081
20421 15.0 0 5	598081
20422 17.5 0 4	598165
20436 15.0 0 4	598187

	
TEXTAR	
2043615004T477	598187
20437 15.0 0 4	598107
20437 19.0 0 4	598107
2043715004T476	598107
2043719004T4078	598107
20442 18.5 0 5	598086
20442 18.5 0 5	598366
20455 19.0 0 5	598178
20455 19.0 0 5	598193
20468 150 0 4	598111
20480 15.5 0 4	598076
20480 15.5 0 4	598377
20488 18.5 0 5	598366
20491 15.1 0 4	598168
20494 14.0 0 5	598077
20494 14.0 0 5	598085
20547 16.8 0 5	598039
20547 16.8 0 5	598356
20573 15.0 1 4	598592
20574 15.3 1 4	598214
20574 19.6 1 4	598205
20575 17.0 0 4	598148
20575 17.0 0 4	598292
20576 155 0 4	601016
20579 14.4 0 5	598161
20579 14.4 0 5	598187
20588 16.5 0 4	598108
2058816504T4078	598108
20594 13.0 0 4	598150
20628 165 0 4	598122
20629 20.0 0 5	598104
2062920005T476	598104
20631 18.0 0 5	598077
20631 18.0 0 5	598085
20631 18.0 0 5	598175
20634 15.0 0 4	598080
20635 18.0 0 5	598151
20652 18.2 1 5	598048
20653 180 0 5	598129
20653 180 0 5	598132
20655 19.5 0 4	598591
20660 15.6 0 4	598389
20667 155 0 4	598145
20669 162 1 4	598004
20669 19.6 1 5	598017
20669 196 1 4	598017
20671 16.5 1 5	598377
20675 17.0 0 5	598103
20675 17.0 0 5	598291
2067517005T477	598103
20687 13.5 0 4	598105
20687 15.5 0 4	598345
20690 16.0 0 4	598149
20699 15.2 0 5	598620
20699 152 0 4	598620
20708 16.5 2 4	598093
20708 16.5 2 4	598531
20708 16.5 2 5	598093
20708 16.5 2 5	598133
20708 16.5 2 5	598603



 	
TEXTAR	
2070816525T4047	598093
2070816525T4047	598133
20714 130 0 4	598144
20718 14.3 0 5	598379
20718 143 0 4	598123
20718 143 0 4	598379
2071814304T4047	598379
20719 19.6 2 5	598219
20724 15.5 0 4	598220
20729 15.0 0 5	598614
2072915005T4047	598614
20731 15.2 0 4	598185
2073115204T4047	598185
20735 15.1 0 4	598208
2073515104T4047	598208
20741 19.2 1 5	598153
20753 18.0 0 5	598166
20753 18.0 0 5	598212
2075318005T403	598166
2075318005T403	598212
20754 15.0 0 5	598116
20755 15.0 0 4	598270
20755 15.0 0 4	598621
20755 150 1 4	598270
20760 14.3 0 4	598612
20761 14.5 0 5	598117
20778 19.6 1 4	598017
20783 18.0 0 5	598166
20783 18.0 0 5	598212
20783 18.0 0 5	598334
20784 18.0 0 4	598613
20833 17.1 2 5	598093
20833 17.1 2 5	598095
20833 17.1 2 5	598141
20833 17.1 2 5	598219
20833 17.2 2 5	598006
20833 17.2 2 5	598134
20833 17.2 2 5	598219
2083317125T479	598141
2083317125T479	598219
20841 12.0 0 4	598141
20845 16.5 1 4	598163
20852 15.5 0 4	598921
2085215504T4047	598921
20857 17.5 0 5	598167
20861 17.7 1 4	598217
20861 17.7 1 5	598169
20863 17.2 0 4	598122
20863 17.2 0 4	598123
20863 17.2 0 5	598122
2086317204T4047	598122
20870 15.0 0 4	598266
20870 15.0 0 4	598402
20870 15.0 0 4	598579
2087015004T4047	598266
2087015004T4047	598402
2087015004T4047	598551
2087015004T4047	598815
20871 18.0 0 5	598162
20887 15.3 2 5	598124



 	
TEXTAR	
20887 15.3 2 5	598128
20887 17.3 2 5	598258
20887 19.7 2 5	598128
20889 17.3 2 4	598127
20894 150 0 5	598391
20895 14.5 0 5	598131
20905 18.0 0 5	598002
20905 18.0 0 5	598075
20905 18.0 0 5	598081
20905 18.0 0 5	598177
20905 18.0 0 5	598181
20905 18.0 0 5	598338
20905 18.0 2 5	598081
20905 18.0 2 5	598177
20906 18.0 2 5	598075
20906 18.0 2 5	598081
20906 18.0 2 5	598155
20906 18.0 2 5	598181
20906 18.0 4 5	598155
20906 18.0 4 5	598181
20906 180 0 5	598075
20907 18.0 0 5	598120
20907 18.0 0 5	598335
20908 180 0 5	598120
20908 180 0 5	598335
20910 15.0 0 4	598187
20910 16.5 0 4	598107
20910 16.5 0 4	598187
20911 15.0 0 5	598113
20912 15.0 0 5	598351
20913 16.5 0 4	598375
20913 16.5 0 5	598375
20915 18.0 0 5	598181
20922 15.0 0 4	598111
20926 185 0 5	598086
20937 18.2 1 5	598002
20939 15.4 0 4	598182
20941 19.3 1 4	598044
20941 19.3 1 4	598315
20941 193 1 4 T4100	598315
20944 15.0 0 4	598130
20944 15.0 0 5	598130
20946 16.5 2 5	598091
20946 16.5 2 5	598093
20950 18.0 0 5	598091
2095018005T468	598091
20955 15.0 0 4	598220
20955 15.0 0 4	598620
20955 15.0 0 4	598626
20957 16.0 0 4	598384
20957 16.0 0 5	598278
20957 16.0 0 5	598384
20958 16.0 0 4	598278
2095816004T4047	598278
20959 14.0 0 4	598047
20959 150 0 4	598047
20959 150 0 5	598047
2095915004T4047	598047
2095915005T4047	598047
20961 15.2 1 4	598180



 	
TEXTAR	
20961 15.2 3 4	598180
20961 17.2 1 4	598463
20961 17.2 3 4	598180
20961 17.2 3 4	598463
20961 17.3 1 4	598180
20961 17.3 1 4	598463
20961 174 1 4	598463
2096117215T456	598681
20968 17.5 0 5	598440
20968 20.3 0 5	598231
2096820305T476	598231
20973 11.0 0 5	598158
20973 11.0 0 5	598396
20974 110 0 4	598396
20979 19.7 1 4	598027
20981 137 1 4	598240
20989 17.7 0 5	598119
20989 17.7 0 5	598176
20989 17.7 0 5	598714
20990 20.3 0 5	598409
20995 17.3 0 5	598103
20995 17.3 0 5	598259
20995 17.3 0 5	598311
20997 16.5 0 5	598115
21000.15.0 0 5	598077
21010 15.8 1 4	598102
21012 14.0 0 4	598052
21012 14.8 0 4	598052
21012 14.8 0 5	598052
21012 14.8 0 5	598817
2101214804T4047	598052
2101214805T4047	598052
21016 170 1 4	598082
21035 15.5 0 4	598099
21041 15.0 0 5	598239
21045 150 0 4	598208
2104515004T4047	598208
21048 183 0 5	598007
21050 15.7 0 4	598183
21050 152 0 4	598183
21051 15.7 0 4	598183
21051 15.7 0 4	598243
21055 17.9 1 4	598241
21055 179 1 4 T4100	598241
21068 17.7 1 4	598237
21068 17.7 1 4	598269
21084 17.5 1 5	598118
21089 15.0 0 5	598291
21093 17.4 2 5	598133
21093 17.4 2 5	598134
21093 17.4 2 5	598135
2109317425T4078	598133
2109317425T4078	598134
21096 150 0 5	598080
21099 17.0 0 4	598112
21099 17.0 0 4	598123
21099 17.0 0 5	598123
2109917005T4047	598123
21100 17.0 2 5	598095
2110017025T479	598095



 	
TEXTAR	
21103 14.4 1 4	598142
21107 12.0 0 4	598141
21122 15.0 0 4	598817
21125 14.5 0 4	598964
21126 15.0 0 4	598224
21127 14.5 0 5	598131
21131 15.0 0 4	598126
21131 15.0 0 4	598160
21131 15.0 0 5	598126
21131 15.0 0 5	598160
21138 19.5 1 5	598230
21140 15.7 0 4	598183
21140 15.7 0 4	598253
21141 18.0 0 4	598032
21142 155 0 4	598021
21144 16.6 1 4	598016
21144 16.6 1 4	598125
21144 16.6 1 4	598142
2114416614T425	598125
2114416614T425	598142
21147 19.3 2 5	598006
21147 19.3 2 5	598985
21153 17.5 0 4	598601
21154 19.5 0 5	598269
21156 17.4 2 5	598003
21158 156 0 4	598402
21158 156 0 4	598614
21158 156 0 4	598947
21158 16.0 0 4	598402
21158 16.0 0 4	598614
2115815604T4090	598402
2115815604T4090	598947
21160 18.0 0 5	598380
21160 18.0 0 5	598391
2116018005T4047	598380
21165 165 2 5	598289
21170.17.0 1 4	598406
21171 18.0 0 5	598172
21171 180 0 4	598172
2117118004T403	598172
2117118004T403	598399
21179 16.8 0 5	598030
21179 16.8 0 5	598156
21182 19.4 2 5	598010
21182 19.4 2 5	598135
21185 19.4 2 5	598135
21188 183 0 5	598007
21188 183 0 5	598139
21188 183 0 5	598374
21190 17.5 0 5	598184
21193 18.0 0 5	598271
2119318005T4047	598271
21195 18.0 0 5	598271
21197 15.0 0 4	598272
21202 17.8 0 5	598043
21202 17.8 0 5	598171
21205 19.4 1 5	598138
21209 19.4 1 5	598179
21209 19.4 1 5	598353
21211 18.7 0 5	598281







			
TEXTAR			
21217 17.5 1 4		598015	
21217 181 1 4		598015	
21225 17.5 0 5		598186	
21225 17.5 1 5		598186	
2122517515T490		598186	
21233 16.7 1 4		598222	
21233 16.7 1 4		598257	
21237 15.0 0 5		598497	
21237 15.0 0 5		598499	
21245 17.4 0 5		598227	
21266 17.4 1 4		598221	
21267 17.6 0 5		598156	
21267 17.6 0 5		598360	
21273 19.5 0 5		598616	
2127319505TX4005		598616	
21275 16.9 0 5		598039	
21275 16.9 0 5		598502	
21275 169 1 5		598502	
21277 15.0 1 5		598293	
21277 150 0 5		598293	
21278 17.0 0 5		598063	
21278 17.0 0 5		598295	
21278 170 1 5		598063	
21280 16.0 0 4		598024	
21280 16.0 0 4		598123	
21282 17.3 0 5		598103	
21296 17.0 0 5		598029	
21296 17.0 0 5		598294	
21298 17.0 1 4		598294	
21305 15.5 0 4		598617	
21305 155 0 4 T4023		598617	
21305 155 0 4 T4140		598617	
21305 155 0 4 T4250		598617	
21305 160 0 4 T4210		598617	
21312 13.0 0 5		598053	
2131213005T4067		598053	
21322 15.0 0 5		598047	
21322 15.0 0 5		598248	
2132215005T4047		598248	
21333 15.0 0 5		598666	
21336 150 0 5		598532	
21344 16.0 0 5		598296	
21347 17.0 0 5		598123	
21347 17.0 0 5		598618	
2134717005T4047		598618	
21350 14.8 0 5		598047	
21350 14.8 0 5		598495	
21355 14.5 0 5		598268	
21358 19.8 0 5		598619	
21363 15.7 0 5		598517	
21363 15.7 0 5		601020	
21365 17.0 0 4		601021	
21366 19.6 1 4		598982	
21368 18.0 0 5		598256	
21368 18.3 1 5		598256	
2136818314T4136		598256	
21369 15.5 0 5		598496	
21370 157 1 4		601020	
21372 15.0 0 4		598266	
2137215004T4090		598266	

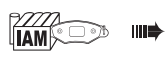

			
TEXTAR			
21373 16.5 0 5		598597	
21376 15.5 0 5		598266	
21378 15.0 0 5		598250	
21381 180 0 5		598988	
21385 13.3 1 4		598621	
21385 139 1 4		598621	
21388 18.3 1 5		598061	
21388 183 2 5		598061	
21394 18.8 0 5		598034	
21394 185 0 5		598034	
2139418505T403		598034	
21411 17.5 0 5		598050	
21414 18.0 0 5		598075	
21414 18.5 0 5		598075	
21430 17.3 0 5		598038	
21436 17.0 0 4		598012	
21436 170 1 4		598011	
21436 170 1 4		598987	
2143617004T4078		598012	
21439 20.3 2 4		598013	
21446 17.5 0 5		598056	
21446 17.5 0 5		598227	
21454 185 1 5		598483	
21459 18.5 0 5		598129	
21459 18.5 0 5		598498	
21460 18.0 2 5		598154	
21463 18.2 2 4		598002	
21463 18.2 2 4		598084	
21463 18.2 3 4		598002	
21463 18.2 3 4		598084	
21463 182 1 4		598002	
2146318224T4078		598002	
2146318224T4078		598084	
21468 15.5 0 4		598947	
2146815504T4090		598947	
21469 19.0 0 4		598037	
21469 190 1 4		598037	
2146919004T403		598037	
21470 19.0 0 4		598036	
21470 190 1 4		598036	
2147019004T403		598036	
21479 19.2 1 4		598622	
21479 192 1 5		598814	
21481 15.7 1 4		598602	
21484 20.8 0 5		598712	
2148420805T4205		598712	
21486 19.3 0 5		598412	
21486 193 0 5 T4374		598412	
21486 193 0 5 T4383		598412	
2148619305T4124		598412	
21487 17.2 0 5		598580	
21487 172 0 5 T4140		598580	
21487 173 1 5		598580	
2148717205T4001		598580	
2148717205T4147		598580	
2148717315T4071		598580	
21490 171 0 5		601023	
21491 155 0 5		601022	
2149115505T4067		601022	
21492 195 0 5		598616	

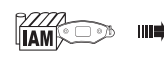

			
TEXTAR			
2149219505TX4005		598616	
21495 17.0 0 5		598691	
2149517005T4047		598915	
21497 18.0 0 5		598788	
21500 14.8 0 5		598023	
21500 14.8 0 5		598531	
21504 17.0 1 5		598028	
21504 17.0 1 5		598294	
21507 17.0 1 4		598280	
21515 18.0 0 5		598022	
21515 180 0 4		598512	
21515 180 1 5		598022	
21518 17.0 1 4		598254	
21519 18.0 0 4		598623	
21520 18.0 1 5		598019	
21526 17.0 0 5		598051	
21526 17.0 0 5		598786	
2152617005T4047		598786	
21539 15.0 0 5		598646	
21543 16.5 0 5		598020	
2154316505T4047		598020	
21545 15.6 1 4		598057	
2154515614T4047		598057	
21546 17.5 0 4		598054	
2154617504T4047		598054	
21553 14.0 0 5		598817	
21557 19.3 2 5		598010	
21557 19.3 2 5		598985	
21558 13.0 0 4		598780	
21558 13.0 0 4		598846	
21559 12.5 0 4		598624	
21559 12.5 0 4		598835	
21561 17.0 0 5		598787	
2156117005T4136		598787	
21562 17.0 0 5		601013	
21573 14.0 1 5		598000	
21573 14.0 1 5		598112	
21576 20.5 0 5		598044	
21576 20.7 0 5		541664	
21576 20.7 0 5		598044	
21576 207 1 5		598044	
21580 143 0 5		598914	
2158014305T4018		598914	
21586 157 1 4		598035	
21589 145 1 4		598180	
21592 18.8 0 5		598046	
21592 188 1 5		598046	
21595 18.3 2 5		598599	
21597 110 1 5		598158	
21601 17.6 0 5		598551	
21601 17.6 0 5		598579	
21601 17.6 0 5		598809	
2160117605T4090		598551	
2160117605T4090		598809	
21606 16.6 2 4		598581	
2160616624T4064		598581	
21607 17.3 0 5		598386	
21607 17.3 0 5		598753	
2160717305T4060		598386	
21614 18.0 0 5		598714	

			
TEXTAR			
21621 17.3 0 5		598045	
21621 173 1 5		598045	
21624 20.4 0 5		598067	
21624 20.4 0 5		598355	
21625 18.0 0 5		598120	
21626 15.8 0 4		598014	
21631 17.0 1 4		598031	
21632 16.0 1 4		598383	
21635 182 1 5		598048	
21636 19.3 0 5		598065	
2163619305T4088		598308	
21637 18.8 0 5		598308	
21637 190 0 5		598308	
2163718805T4088		598308	
21643 17.8 0 5		598018	
2164317805T4020		598018	
21647 16.0 0 5		598625	
21650 15.0 0 4		598626	
21650 150 1 4		598626	
21651 17.3 0 5		598627	
21654 15.0 0 5		598274	
21654 15.0 0 5		601018	
21654 153 1 5		598274	
21657 16.5 0 5		598628	
21662 178 1 4		598217	
21664 19.8 0 5		598357	
21670 20.3 0 5		598636	
21670 203 0 5 T4374		598636	
21674 19.3 1 5		598069	
21674 19.3 1 5		598467	
21677 20.3 0 5		598310	
21677 20.3 0 5		598409	
21677 203 0 5 T4374		598310	
21677 203 0 5 T4374		598409	
2167720305T4070		598310	
2167720305T4070		598409	
21679 15.0 0 5		598897	
2167915005T4067		598393	
2167915005T4067		598897	
21682 14.5 1 5		598903	
21691 173 0 5		598311	
21691 173 0 5 T4140		598311	
21694 17.3 0 5		598494	
2169417305T4047		598494	
21697 158 0 5		598495	
21697 158 0 5		598760	
2169715805T4047		598495	
2170018505T4047		598627	
21703 15.0 0 5		598828	
21706 15.5 0 5		598519	
21706 15.5 0 5		598834	
21713 16.4 0 5		598668	
21713 16.4 0 5		598826	
21716 15.9 0 5		598840	
21719 14.6 0 5		598682	
21719 14.6 0 5		598911	
2171914605T4067		598682	
2171914605T4067		598911	
21724 19.3 1 5		598068	
21725 156 0 5		598870	

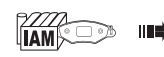
 	
TEXTAR	
21725 17.0 0 5	598051
21725 17.0 0 5	598574
21725 17.0 0 5	598786
2172517005T4047	598051
2172517005T4047	598574
21729 13.7 1 5	598121
21729 13.7 1 5	598240
21729 13.7 1 5	598312
21729 13.7 2 5	598121
21729 13.7 2 5	598312
21730 14.0 0 4	598986
21731 15.5 0 5	598250
21734 14.0 0 5	598826
2173414005T4067	598826
21738 13.0 0 5	598437
21754 16.5 0 5	598629
21759 15.3 0 5	598983
21763 15.6 0 5	598266
2176315605T819	598266
21766 13.7 1 4	598290
21766 14.8 0 4	598290
21775 15.0 0 5	598393
2177515005T4047	598393
21777 15.0 0 5	598897
21780 15.5 0 5	598496
21792 15.5 0 4	598768
2179215504T4045	598768
21797 19.7 2 5	598070
21799 19.7 2 5	598800
21801 19.3 2 5	598064
21815 19.3 0 5	598600
21820 15.5 0 5	598595
21822 17.2 0 5	598491
21827 17.3 0 5	598038
21827 17.3 0 5	598074
21829 20.3 0 5	598305
21830 15.7 0 5	598906
21833 15.5 0 5	598540
21833 15.5 0 5	598984
2183315505T4067	598540
2183315505T4067	598984
21836 15.5 0 5	598496
21840 14.0 0 5	598519
21845 16.5 0 5	598460
2184516505T4047	598460
21848 19.7 0 5	598067
21848 19.7 0 5	598303
21849 20.6 0 5	598489
21854 15.0 0 4	598476
21857 17.0 0 5	598156
21857 17.0 0 5	598360
21861 15.3 1 4	598319
2186116815T4127	598319
21862 18.0 0 5	598184
21862 18.3 0 5	598184
21866 15.3 0 5	598403
21866 17.2 0 5	598488
21866 17.3 0 5	598488
21866 19.7 0 5	598066
21868 17.2 0 5	598805

 	
TEXTAR	
21872 14.5 0 5	598844
21875 15.8 0 5	598507
21879 18.5 0 5	598056
21882 17.3 1 4	598482
21883 19.6 0 5	598675
21885 20.6 0 5	598676
21888 18.4 1 5	598470
21892 18.4 0 5	598838
21898 15.7 0 5	598447
21898 15.7 0 5 T4080	598447
21898 15.7 0 5 T4140	598447
21898 15.7 0 5 T4209	598447
21900 15.8 0 4	598763
21904 16.9 0 5	598062
21907 15.4 0 5	598533
21910 19.8 0 5	598630
2191019805T403	598630
21911 20.6 0 5	598303
21919 15.3 0 4	598444
21919 15.7 0 4	598444
21919 15.3 0 4 T4140	598444
21919 15.3 0 4 T4203	598444
21919 15.7 0 4 T4271	598444
21920 15.1 1 4	598318
21920 17.4 1 4	598318
21927 17.9 0 5	598041
21927 17.9 0 5	601003
21927 17.9 9 5	601003
21929 17.9 0 5	598040
21929 17.9 0 5	598065
21930 17.9 0 5	598040
21930 17.9 0 5	598041
21930 17.9 0 5	598607
21930 17.9 0 5	601003
21931 17.9 0 5	598607
21934 16.3 0 5	598753
21934 17.3 0 5	598753
21934 17.3 0 5 T4140	598753
2193417305T4147	598753
21937 15.5 0 4	598766
2193715504T4045	598766
21938 20.4 0 5	598483
21938 20.4 0 5	598751
21938 20.4 0 5 T4374	598483
21938 20.4 0 5 T4374	598751
21945 16.2 1 4	598330
21945 19.6 1 4	598017
21945 19.6 1 5	598484
21947 15.0 0 4	598777
2194715004T4067	598777
21948 13.6 0 5	598815
2194813605T4047	598815
21952 15.6 0 5	598850
2195215605T4067	598850
21955 16.0 0 5	601022
21957 17.0 0 5	601023
21961 15.5 1 4	598809
2196115504T4047	598809
21962 18.0 0 5	598271
21965 15.0 0 5	598328

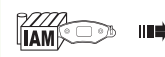
 	
TEXTAR	
21968 14.0 0 5	601024
21975 18.2 0 5	598478
2197518205T4068	598478
21980 18.0 2 5	598461
21980 18.0 2 5	598726
21980 18.0 1 5	598726
21983 16.5 1 4	598493
21983 17.3 1 4	598493
2198317314T4095	598493
21990 20.3 0 5	598409
21999 15.8 1 5	598329
23004 15.5 0 5	598071
23018 20.4 0 5	598483
23018 20.4 0 5	598751
23020 17.9 0 4	598301
23021 18.9 0 4	598300
23021 18.9 1 4	598300
23022 20.9 0 4	598299
23022 20.9 1 4	598299
23023 15.0 0 5	598449
23032 15.5 0 5	598496
2303215505T4047	598496
23034 18.6 0 1	598858
23034 18.6 0 5	598858
23042 19.0 1 4	598073
2304219014T4059	598073
23043 18.6 0 5	598556
23055 17.9 1 4	598301
23057 20.4 0 5	598454
2305720405T4097	598454
23063 17.3 0 5	598322
2306317305T4097	598322
23070 16.5 1 4	598549
23070 16.5 2 4	598549
23070 17.0 1 4	598549
23070 17.0 2 4	598549
23070 19.0 2 4	598582
23071 18.5 1 5	598033
23073 18.9 0 5	598479
2307318905TX4005	598479
23076 17.5 0 5	598480
2307617505T4067	598480
23078 15.9 0 4	598446
23080 15.1 1 4	598320
23081 19.0 0 5	598634
2308119005T4047	598634
23086 17.0 0 5	598523
23091 15.2 1 4	598183
23092 15.0 0 5	598919
23092 16.0 0 5	598309
23092 16.0 0 5	598772
23094 17.0 0 5	598436
23094 17.0 0 5	598451
2309417005T4047	598451
23095 17.0 0 4	598451
23096 17.2 0 5	598435
23099 18.4 0 5	598669
23099 18.4 0 4	598545
2309918404T424	598545
23101 17.5 0 5	598043

 	
TEXTAR	
23101 17.5 0 5	598171
2310117505T403	598043
23103 17.5 0 5	598212
23106 18.9 0 5	598481
23112 19.1 0 5	598632
2311219105T4146	598632
23115 19.6 0 5	598305
23116 19.6 0 5	598305
23116 19.6 0 5	598475
23117 20.2 0 5	598475
2311720205T4139	598475
23124 19.0 1 5	598326
23124 19.3 1 5	598326
23126 17.5 0 5	598440
23130 19.7 0 5	598332
23131 19.7 0 5	598332
23131 19.7 0 5	598408
23135 18.0 1 5	598420
23138 14.6 1 4	598583
23138 14.6 1 4 T4051	598583
23138 14.6 1 4 T4099	598583
23140 19.3 0 5	598880
2314019305T4047	598880
23144 19.4 1 5	598448
23144 19.8 1 5	598448
23144 19.8 1 5 T4374	598448
23144 19.8 2 5	598448
23144 19.8 2 5 T4374	598448
23146 17.0 1 5	598385
23146 17.0 1 4	598385
23154 19.3 0 5	598317
23157 16.0 0 4	598719
23157 16.0 0 4 T4140	598719
23168 19.3 2 5	598010
23168 19.3 2 5	598985
2316819325T4005	598010
23169 19.4 1 5	598353
23172 18.3 1 4	598473
23176 18.2 1 5	598807
23177 14.4 1 4	598142
23177 14.4 1 4	598331
23178 16.0 0 5	598907
2317816005T4047	598907
23181 17.9 0 5	598605
23183 20.3 0 5	598811
23183 20.3 0 5 T4374	598811
2318320305T4217	598811
23184 14.5 0 5	598912
23189 16.7 1 5	598443
23190 16.7 1 5	598813
23193 16.5 1 5	598442
23193 16.3 1 5	598442
23200 18.8 0 5	598563
23202 18.8 0 5	598564
23215 18.3 1 5	598566
23215 18.3 1 5	601012
23218 18.0 0 5	601019
23219 18.0 0 5	598423
2321918005T4047	598423
23222 19.0 0 5	598990







Valeo	
TEXTAR	
2322219005T4292	598990
23224 17.3 1 4	598650
23224 173 1 5	598482
23224 173 1 5	598650
23225 17.0 1 5	598456
23227 18.0 0 5	598422
23227 18.0 0 5	598424
23229 180 0 5	598006
23230 158 0 5	598528
23230 158 0 5	598988
23234 16.9 0 5	598361
23237 14.5 1 4	598902
23238 160 0 5	598575
23241 15.4 0 4	598316
23241 165 0 4	598316
23242 14.2 1 5	598854
23245 183 1 5	598471
23248 183 1 5	598471
23250 165 0 5	598661
2325016505T4047	598661
23253 15.5 0 5	598453
2325315505T4047	598453
23258 16.9 2 5	598926
2325816925T428	598926
23269 20.1 0 5	598565
23271 17.7 0 5	541655
23271 17.7 0 5	598445
23271 177 0 5 T4374	598445
23273 180 1 4	598416
23276 17.5 1 4	598417
23277 17.7 1 4	598419
23279 18.4 0 4	598433
23279 184 1 4	598433
23280 183 0 5	598992
23281 18.3 0 5	598413
23281 183 0 5 T4374	598413
23284 14.0 1 4	598457
2328414014T4131	598457
23287 17.8 0 5	598018
23287 178 0 5 T4374	598018
2328717805T4146	598018
23289 19.3 0 5	598065
23289 19.3 0 5	598308
23289 190 0 5	598065
23289 190 0 5	598308
23289 190 0 5	598990
2328919305T4088	598990
23290 155 1 4	598522
23294 165 0 4	598579
2329416504T4047	598579
23296 150 0 5	598991
23300 18.0 0 5	598399
23302 175 0 4	598490
23305 15.4 0 4	598418
2330917305T4071	598820
23312 203 0 5	598410
2331220305T4165	598410
23313 203 0 5	601027
23314 14.5 1 4	598534
2331414514T4067	598534



Valeo	
TEXTAR	
23318 159 0 5	598904
23326 17.7 1 4	601004
23326 177 2 4	598671
23329 170 0 4	598767
2332917004T4045	598767
23331 160 0 4	598944
2333116005T4146	598944
23332 180 1 5	598462
23334 16.8 0 5	598637
23334 168 0 5 T4140	598637
23340 168 1 5	598736
2334016815T4018	598736
23346 19.3 1 4	598398
2334720305T4165	598410
23348 165 0 5	598606
2334816505T4047	598606
23353 14.0 1 4	598431
23354 136 1 4	598836
23358 180 0 5	598458
23361 150 0 5	598459
23384 180 0 5	598989
2338418005T4047	598989
23387 133 1 5	598835
2338713005T4067	598835
23392 20.6 0 5	598486
23394 145 0 5	598735
2339414505T4047	598735
23395 14.5 0 5	598734
23396 18.0 1 4	598462
23397 194 1 5	598658
2339719415T4070	598658
23400 16.5 1 4	598830
2340016514T4067	598830
23402 20.6 0 5	598678
2340220605T4139	598678
23404 20.4 0 5	598678
23404 20.4 0 5	598808
23404 204 1 5	598808
23407 19.3 1 5	598500
23409 19.3 1 5	598501
23417 15.2 1 5	598584
23417 152 1 4	598584
23418 196 0 5	598801
23420 165 0 5	598452
2342016505T4047	598452
23423 178 1 4	598439
23424 178 1 4	598438
23429 150 0 4	601025
2342915004T4051	601025
23434 185 1 5	598547
2343418515T4194	598547
23435 185 1 5	541733
23440 171 0 5	598639
23440 176 0 5	598639
2344017605T4149	598639
23442 160 0 5	598511
23446 16.5 1 5	598650
23446 16.5 1 5	598681
23447 173 0 5	598411
2344717305T4166	598411



Valeo	
TEXTAR	
23452 190 1 4	598441
2345219014T4047	598441
23454 150 0 4	598642
2345415004T4067	598642
23455 130 0 5	598841
23458 150 1 4	598499
2345815014T4047	598499
23463 166 0 4	598450
2346316604T4047	598450
23470 178 1 4	598439
23471 150 0 4	598762
2347115004T4047	598762
23482 16.8 0 5	598472
23482 16.8 0 5	598783
2348216805T4140	598472
2348216805T4140	601005
23487 155 0 4	598521
2348715504T4047	598521
23488 160 1 4	598518
2348816014T4067	598518
23490 150 1 4	598548
2349015014T4067	598548
23494 140 0 5	598883
23497 155 0 5	598856
23501 172 0 5	598589
2350117205T4136	598589
23502 160 0 5	598806
23502 160 0 5	601002
2350216005T4067	598806
23507 15.0 0 5	598733
23507 15.0 0 5	598832
2350715005T4047	598453
2350715005T4047	598733
2350715005T4047	601002
23510 15.5 0 5	598737
23510 15.5 0 5	598917
2351015505T4047	598737
2351015505T4047	598917
23515 160 1 4	598515
23517 16.5 0 4	598407
23517 165 1 4	598407
2351716504T4067	598407
2351817005T4047	598504
23521 14.0 0 5	598577
23521 14.0 0 5	598737
23524 177 0 5	598535
2352417705T4067	598535
2352417705T4067	598777
2352617504T4136	598827
23527 150 1 4	598682
23527 150 1 4	598758
2352715014T4067	598682
23532 200 0 5	598543
23536 155 0 5	598908
2353615505T4047	598908
23539 175 0 4	598865
23540 165 1 4	598784
23543 150 0 5	598748
2354315005T4067	598748
23549 168 1 5	598319

Valeo	
TEXTAR	
23550 173 0 5	598885
23550 173 0 5 T4140	598885
2355017305T4191	598885
23552 180 0 5	598422
23552 180 0 5	598424
23554 152 1 4	598180
23554 152 1 4	598463
23554 152 1 4	598474
23554 17.2 1 4	598180
23554 17.2 1 4	598463
23554 172 1 4 T4140	598180
23554 172 1 4 T4140	598463
23554 172 1 5	598674
23554 172 1 5	598681
23557 169 1 4	598527
23557 172 1 4	598434
23558 170 0 5	598530
23561 170 0 5	598965
23569 17.0 0 5	598505
23569 17.0 0 5	598759
23572 138 0 5	598895
23575 160 0 5	598468
2357516005T4194	598468
23577 18.5 1 5	598432
23581 190 1 4	598667
23581 190 1 5	598720
23582 155 1 5	598520
23582 155 1 5	598852
2358215515T4067	598520
23584 160 1 4	598886
2358416014T4047	598886
23585 17.0 0 5	598536
23587 203 0 5	598635
23589 19.0 0 5	598715
23590 190 0 5	601030
2359019005T4136	601030
23593 150 0 5	598778
2359315005T4067	598778
23597 180 1 5	598461
23599 19.0 1 4	598464
23600 19.0 1 4	598465
23601 13.7 0 4	598425
23601 137 1 4	598425
23602 197 2 5	598429
23602 197 2 5	598430
2360219725T4059	598429
23603 19.7 2 5	598429
23603 19.7 2 5	598430
23604 18.8 0 5	598564
23605 15.5 1 5	598453
23608 150 0 5	598866
23613 178 0 4	598537
2361317804T4136	598537
23615 175 0 4	598514
2361517504T4136	598514
23620 16.6 0 5	598812
23620 166 1 5	598812
23623 17.4 1 5	598701
23623 174 2 5	598701
23631 178 0 5	598510

 	
TEXTAR	
23638 175 0 5	598414
23640 180 0 5	598415
23646 160 0 5	598542
23649 162 0 5	598821
23652 14.8 0 5	598682
23656 14.0 0 5	598673
23662 15.0 1 4	598843
2366215014T4067	598843
23669 16.8 1 4	598538
23671 170 1 4	598406
23692 167 0 4	598655
23693 167 0 4	598656
23694 167 0 4	598770
23698 160 0 5	598738
23705 178 1 4	598913
23705 178 1 5	598426
23705 178 1 5	598670
2370517014T4047	598913
2370517015T4047	598426
2370517015T4047	598670
23708 18.2 0 4	598698
23708 18.2 0 5	598427
23708 182 1 4	598465
23708 182 1 4	598698
23708 182 1 5	598427
23708 182 1 5	598721
23711 182 1 5	598428
23714 15.5 0 4	598633
23714 155 1 4	598633
23716 163 0 5	598643
2371616305T4047	598643
23720 170 0 5	598824
23723 182 0 5	598649
2372318205T4370	598649
23729 170 0 5	598887
2372917005T4136	598887
23730 173 0 5	598820
23730 173 0 5 T4140	598820
2373017305T4166	598820
23732 173 0 5	598754
2373217305T4161	598754
23738 20.6 0 5	598678
23743 20.5 1 5	598638
23743 205 2 5	598638
23743 205 2 5 T4374	598638
23745 177 0 5	598659
23746 180 0 5	598652
23746 201 0 5	598651
23747 201 0 5	598651
23749 188 0 5	598940
23753 180 0 5	598466
23759 170 0 4	598710
2375917004T4242	598710
23760 17.8 1 4	601029
23760 178 2 4	601029
23761 188 1 4	601001
2376118814T4136	601001
23762 19.5 0 5	598750
23762 204 0 5	598750
23763 203 0 5	598779

 	
TEXTAR	
23766 178 0 5	598679
23768 19.0 0 5	598665
23768 192 1 5	598665
23775 180 0 5	598423
2377518005T4047	598423
23776 180 0 5	601019
23777 150 0 5	598647
23777 150 0 5	598648
23780 170 0 5	598915
23793 203 0 5	598640
23794 203 0 5	598640
23794 203 0 5 T4374	598640
2379420305T4190	598640
23795 150 0 5	598697
23798 203 0 5	598475
23801 204 0 5	598863
23816 15.8 1 4	598680
23817 17.0 0 5	598848
23832 196 0 5	598860
23832 20.4 0 5	598860
23836 167 1 4	598541
2383616714T4047	598541
23842 180 0 5	598422
23845 154 1 5	598250
23845 154 1 5	598629
23863 150 0 4	598745
23864 17.0 0 4	598827
23865 164 0 5	598853
23868 16.9 0 5	598757
23868 16.9 0 5	598824
23871 138 0 5	598672
23871 138 0 5	601009
2387113805T4051	598672
23873 150 0 5	598910
23879 155 0 5	598855
2387915505T4136	598855
23881 201 1 5	598795
23885 205 0 5	598845
23891 169 0 5	598744
23896 204 0 5	598845
23901 188 1 5	598046
23904 166 0 5	598917
23912 185 0 5	598822
23912 204 0 5	598822
23914 17.2 1 4	598752
23914 172 1 4 T4140	598752
23914 172 2 4	598752
23914 172 2 4 T4140	598752
23915 17.8 1 5	598699
23916 178 1 5	598699
23917 18.3 0 5	598568
23917 191 1 5	598568
23919 18.3 0 5	598569
23919 191 1 5	598569
23921 19.1 0 4	598570
23921 201 1 4	598570
23921 201 1 5	541738
23922 210 0 5	598728
23923 180 0 5	598802
23927 17.3 0 5	598703

 	
TEXTAR	
23927 173 0 5 T4140	598703
23928 170 0 4	598862
2392817004T4136	598862
23930 18.1 1 4	598558
2393018114T4047	598558
23934 181 1 4	598557
2393418114T4047	598557
23935 17.8 0 5	598700
23945 165 0 4	601034
23950 203 0 5	598779
23954 190 1 4	598464
23959 175 1 4	598718
23960 178 0 4	598995
23960 178 0 4 T4374	598995
23961 170 0 4	598709
23966 164 0 5	598842
23970 170 0 5	598889
2397017005T4136	598889
23973 17.3 1 4	598641
23973 173 1 5	598847
2397317314T4018	598641
23974 178 0 4	598644
2397417804T4018	598644
23979 178 1 5	598426
23979 178 1 5	598913
23980 170 1 4	598546
2398017014T4018	598546
23981 192 1 5	598839
23982 178 1 5	598825
23983 178 0 4	601035
23984 180 1 5	598925
23990 207 0 5	598044
23990 207 1 5	598044
23996 18.3 0 5	598653
2399618305T4018	598653
24007 20.2 0 4	598764
24007 202 1 4	598764
24008 17.7 0 4	598765
24008 177 1 4	598765
24010 167 0 4	598770
24011 177 0 5	598829
2401117705T4051	598829
24013 15.0 1 5	598810
24014 154 1 5	598852
2401415415T4051	598852
24022 177 0 5	601026
24024 178 0 5	598857
2402417805T4051	598857
24031 16.8 0 5	598781
24036 160 0 5	598755
24039 144 0 5	598831
2403914405T4051	598831
24040 144 0 5	598831
24043 163 0 5	598643
24043 163 0 5 T4140	598643
2404316305T4047	598643
24045 130 0 4	598780
24058 158 0 5	598823
24059 166 0 5	598506
24062 176 0 5	598361

 	
TEXTAR	
2406615404T4136	598518
24071 146 0 4	598874
2407114604T4051	598874
24072 177 1 4	598696
24072 177 1 5	601015
24073 164 1 4	598761
24073 164 1 5	601031
24073 164 2 4	598761
24073 164 2 5	601031
24077 190 1 4	598704
24077 190 2 4	598704
24083 192 1 4	598833
24086 157 1 5	598849
24087 175 1 5	598803
24092 173 0 5	598654
2409217305T4018	598654
24098 160 0 4	598994
24098 171 0 4	598994
24101 190 1 4	598464
24122 192 1 5	598943
24122 192 1 5	601040
24123 203 0 5	598879
24133 177 1 5	598663
24134 187 1 5	598662
24135 17.8 1 4	598664
24137 16.8 0 5	601044
24137 167 0 5	598472
24137 167 0 5	598678
24137 167 0 5	598783
24137 167 0 5	601005
24137 167 0 5	601044
24141 198 0 5	598657
2414119805T4136	598657
24142 187 0 5	601007
24143 150 0 5	598859
24150 17.6 1 4	598702
24155 206 0 5	598678
24161 203 0 5	598898
24162 153 0 4	598861
24163 178 0 4	601033
24166 188 0 4	601032
24190 165 1 4	598438
24191 181 1 4	598741
24192 173 1 4	598742
24218 172 0 5	598705
24227 165 0 5	598738
24229 153 1 5	598873
24240 160 0 5	598730
24253 179 0 5	601051
24260 163 1 4	598740
24271 147 1 5	598929
24273 160 0 5	598772
24275 168 0 5	598707
24276 148 0 5	598706
24277 165 0 5	598708
24283 165 0 5	598999
24289 170 1 5	601041
24294 193 1 5	598793
24298 140 0 5	598746
24301 164 0 4	598878







TEXTAR	
24317 175 0 5	598868
24320 159 0 5	598867
24323 155 0 5	598888
24331 140 1 4	598875
24333 199 0 5	601036
24336 175 0 4	598943
24338 154 0 4	598819
24339 205 0 5	598729
24346 171 1 4	598877
24348 168 1 4	598727
24348 168 2 4	598727
24349 175 1 4	598722
24350 176 0 4	598890
24355 140 0 5	598755
24367 190 0 5	598946
24367 190 0 5	598967
24369 170 0 5	598739
24391 160 1 5	598804
24412 191 1 5	601046
24415 191 1 5	601047
24418 172 1 5	601048
24421 167 1 5	601049
24462 167 1 4	598939
24465 188 1 4	598892
24483 172 1 4	598752
24483 172 2 4	598752
24484 189 1 4	598816
24485 189 1 4	598818
24486 173 1 4	541736
24491 160 0 5	598945
24496 169 2 4	598928
24498 154 0 5	598941
24501 166 0 5	598934
24510 169 0 5	598942
24523 164 0 5	598894
24529 160 0 5	598893
24535 183 0 5	601012
24536 183 0 5	598993
24537 157 1 4	598935
24537 157 2 4	598935
24538 188 0 5	598997
24540 164 1 4	598936
24541 155 0 4	598768
24557 190 0 5	598998
24574 150 0 5	601028
24578 166 1 4	601039
24586 178 1 5	598744
24595 183 1 5	598899
24610 143 0 5	598933
24632 170 0 4	598738
24635 165 1 5	601038
24638 190 1 5	598901
24660 178 1 4	598927
24663 140 0 4	598531
24673 180 0 5	601017
24692 150 1 4	601011
24693 187 1 4	601010
24693 187 2 4	601010
24703 16.4 2 4	598761
24706 200 0 5	598996



TEXTAR	
24708 176 0 4	601052
24710 180 0 5	601050
24722 190 0 5	598636
24727 200 0 5	601014
24737 176 1 4	598702
24739 173 0 5	598045
24765 166 1 4	601042
24820 157 1 4	601000
24862 163 0 5	598637
24864 170 0 5	598361
29001 20.0 0 5	541641
29001 200 0 5 T456	541641
29012 180 0 5 T3078	540436
29012 180 0 5 T3078	598138
29012 180 0 5 T3078	598369
29037 183 0 5 T4047	598369
29037 183 0 5 T4047	598586
29037 183 0 5 T4047	598598
29040 180 0 5 T3078	540436
29040 180 0 5 T3078	598369
29041 183 0 5 T4047	598596
29071 170 0 5 T4047	598112
29076 20.0 1 4	541664
29076 200 1 4 T3011	541664
29076 200 1 4 T3011	598966
29121 170 0 4 T3018	541717
29121 170 0 4 T3035	541717
29121 170 1 4	541717
29121 203 0 4 T3018	541662
29121 203 0 4 T3018	541683
29121 203 1 4	541662
29121 203 1 4	541683
29121 203 1 5 T3035	541662
29121 203 1 5 T3035	541683
29123 203 0 4 T3078	541705
29123 203 1 4	541705
29123 203 1 4 T3078	541705
29139 183 0 5 T4047	598586
29140 183 0 5 T4047	598585
29153 200 1 4 T3011	541664
29160 199 0 4 T3018	541663
29160 199 1 4	541663
29190 190 0 4	541728
29190 190 1 4	541728
29190 190 1 5 T3035	541728
29192 209 1 4	598882
29192 209 1 4 T3036	598882
29192 209 2 4 T3036	598882
29200 207 1 4	598881
29200 207 1 4 T3035	598881
29200 209 2 4 T3036	598881
29217 206 1 5 T3038	598876
29217 208 1 4	598876
29217 208 1 4 T3035	598876
29229 214 1 4	541734
29229 214 1 4 T4136	541734
29229 214 1 5 T4136	541737
29232 210 1 4	541735
29232 210 1 4 T4136	541735
29706 170 0 5 T4047	598086



TEXTAR	
29984 170 0 5 T4136	598112
TRW	
GDB100	598111
GDB1003	598787
GDB1003	601176
GDB1004	598384
GDB1005	598024
GDB1008	598786
GDB1008	601187
GDB1009	601002
GDB101	598099
GDB101	598187
GDB101	598270
GDB1010	598817
GDB1012	598628
GDB1013	598840
GDB1014	598826
GDB1017	598618
GDB102	598099
GDB102	598187
GDB1020	598123
GDB1022	598589
GDB1022	598590
GDB1023	598834
GDB1023	598866
GDB1024	598274
GDB1025	598846
GDB1027	601243
GDB1029	598646
GDB1030	598061
GDB1031	598156
GDB1033	598155
GDB1033	598181
GDB1033	601158
GDB1034	598121
GDB1034	598312
GDB1035	598312
GDB1036	598239
GDB1037	598250
GDB1038	598185
GDB1039	598179
GDB1039	598353
GDB1040	598039
GDB1040	598356
GDB1041	598055
GDB1043	598496
GDB1044	598017
GDB1044	598252
GDB1044	601188
GDB1045	598000
GDB1045	598005
GDB1048	598016
GDB1049	598483
GDB1050	598125
GDB1052	598010
GDB1054	598003
GDB1054	598135
GDB1055	598463
GDB1057	598982

TRW	
GDB1058	598006
GDB1058	598010
GDB1058	598985
GDB1059	598014
GDB106	598090
GDB106	598603
GDB1060	598642
GDB1061	598056
GDB1061	598627
GDB1063	598682
GDB1064	598440
GDB1066	598338
GDB1067	598613
GDB1068	598291
GDB107	598088
GDB1071	598146
GDB1073	598180
GDB1075	598375
GDB1078	598081
GDB1078	598177
GDB1079	598080
GDB1080	598037
GDB1083	598022
GDB1084	598036
GDB1085	598028
GDB1087	598599
GDB1092	598622
GDB1093	598498
GDB1094	598013
GDB1095	598135
GDB1098	598281
GDB1099	601021
GDB1100	598018
GDB1101	598031
GDB1102	598383
GDB1103	598109
GDB1103	598110
GDB1104	598038
GDB1104	598074
GDB1105	598070
GDB1106	598800
GDB1107	598034
GDB1108	598033
GDB1108	598619
GDB1111	598598
GDB1112	598035
GDB1113	598602
GDB1114	598000
GDB1115	598011
GDB1115	598012
GDB1117	598985
GDB1118	598614
GDB1119	598103
GDB112	598375
GDB1120	598080
GDB1120	598396
GDB1121	598180
GDB1123	598617
GDB1126	598517
GDB1127	598519



 	
TRW	
GDB1128	598625
GDB1129	598626
GDB1139	598629
GDB1139	601193
GDB114	598154
GDB114	601189
GDB1140	598290
GDB1143	598551
GDB1145	598809
GDB1147	598581
GDB1148	598064
GDB1152	598374
GDB1153	598491
GDB1154	598393
GDB1155	598499
GDB1156	598441
GDB1157	598600
GDB1159	598616
GDB1160	598270
GDB1163	598125
GDB1164	598495
GDB1164	601207
GDB1166	598050
GDB1168	598540
GDB1169	598022
GDB1169	598903
GDB1170	598628
GDB1174	598533
GDB1177	598515
GDB1179	598476
GDB1179	598691
GDB118	598077
GDB118	598078
GDB118	598085
GDB1180	598056
GDB1182	598777
GDB1182	601232
GDB1183	598494
GDB1184	601023
GDB1185	601022
GDB1186	598460
GDB1187	598507
GDB1189	598386
GDB1191	598859
GDB1193	598068
GDB1194	598069
GDB1195	598496
GDB1196	598463
GDB1197	598320
GDB1198	598318
GDB1200	598303
GDB1200	598355
GDB1201	598294
GDB1203	598382
GDB1204	598067
GDB1205	598357
GDB1207	598595
GDB1208	598120
GDB1209	598762
GDB1210	598040



 	
TRW	
GDB1212	598065
GDB1212	598308
GDB1213	598630
GDB1214	598254
GDB1215	598636
GDB1216	598073
GDB1217	598396
GDB1218	598066
GDB1219	598258
GDB1220	598044
GDB1221	598043
GDB1222	598212
GDB1223	598219
GDB1234	598965
GDB1236	598556
GDB1247	598292
GDB1250	598351
GDB1251	598008
GDB1252	598113
GDB1253	598115
GDB1258	598502
GDB1259	598069
GDB1260	598326
GDB1261	598412
GDB1262	598045
GDB1263	598046
GDB1264	598310
GDB1265	598311
GDB1266	598017
GDB1267	598463
GDB127	598144
GDB1270	598470
GDB1271	598305
GDB1274	598488
GDB1275	598303
GDB1276	598063
GDB1277	598075
GDB1278	598074
GDB1279	598360
GDB1280	598217
GDB1282	598675
GDB1283	598763
GDB1284	598207
GDB1285	598712
GDB1286	598522
GDB1288	541664
GDB1288	598966
GDB1289	598062
GDB129	598146
GDB1290	598041
GDB1291	598040
GDB1292	598549
GDB1293	598549
GDB1295	598398
GDB1297	598091
GDB1299	598012
GDB1300	598184
GDB1301	598385
GDB1302	598183
GDB1304	598580



 	
TRW	
GDB1305	598396
GDB1306	598403
GDB1307	598483
GDB1307	598751
GDB1307	601195
GDB1308	598458
GDB1308	601196
GDB1309	598459
GDB1310	598125
GDB1311	598463
GDB1312	598330
GDB1313	598493
GDB1314	598319
GDB1315	598581
GDB1317	598318
GDB1319	598512
GDB1321	598726
GDB1322	598074
GDB1324	598482
GDB1325	598482
GDB1326	598650
GDB1328	598180
GDB1330	598180
GDB1330	598463
GDB1330	601255
GDB1332	598002
GDB1333	598142
GDB1333	598331
GDB1334	598447
GDB1335	598444
GDB1336	598420
GDB1337	598065
GDB1338	598880
GDB1339	598605
GDB1340	598423
GDB1341	598424
GDB1342	598475
GDB1343	598386
GDB1344	598753
GDB1345	541662
GDB1346	598183
GDB1347	598271
GDB1348	598018
GDB1349	598399
GDB1350	598454
GDB1350	598860
GDB1351	598322
GDB1352	598926
GDB1353	598328
GDB1354	598431
GDB1356	598586
GDB1357	598332
GDB1358	598317
GDB1359	598466
GDB1360	598180
GDB1361	598461
GDB1362	598308
GDB1364	598065
GDB1365	598329
GDB1366	598484



 	
TRW	
GDB1367	598814
GDB1368	598807
GDB1369	598482
GDB1369	598650
GDB1372	598463
GDB1373	598299
GDB1374	598632
GDB1375	598735
GDB1376	598355
GDB1378	598442
GDB1379	598443
GDB1380	598490
GDB1381	598992
GDB1382	598607
GDB1383	598422
GDB1383	598424
GDB1384	598425
GDB1385	598462
GDB1386	598408
GDB1386	601186
GDB1388	598479
GDB1389	598480
GDB139	598077
GDB1390	598398
GDB1391	598676
GDB1392	598988
GDB1393	601019
GDB1394	598766
GDB1395	598768
GDB1396	598407
GDB1397	598408
GDB1398	598438
GDB1399	598300
GDB1401	598439
GDB1402	598726
GDB1403	598486
GDB1403	601209
GDB1404	598409
GDB1404	598811
GDB1405	598473
GDB1406	598616
GDB1407	598086
GDB1408	598301
GDB1411	598456
GDB1412	598457
GDB1413	598448
GDB1414	598667
GDB1415	598681
GDB1416	598463
GDB1418	598563
GDB1419	598564
GDB1419	598639
GDB1420	598453
GDB1421	598447
GDB1422	598408
GDB1423	598467
GDB1424	598432
GDB1425	598429
GDB1426	598430
GDB1427	598308







 	
TRW	
GDB1429	598481
GDB1430	598753
GDB1431	598468
GDB1432	598063
GDB1433	598583
GDB1434	598433
GDB1434	601206
GDB1435	598434
GDB1436	598661
GDB1437	598330
GDB1439	598180
GDB1440	598489
GDB1441	598880
GDB1442	598537
GDB1443	598422
GDB1444	598880
GDB1445	598990
GDB1446	598406
GDB1447	598417
GDB1448	598419
GDB1449	598416
GDB145	598145
GDB1450	598418
GDB1451	598483
GDB1453	598772
GDB1454	598445
GDB1455	598446
GDB1456	598813
GDB1457	598719
GDB1459	598858
GDB146	598146
GDB1460	598565
GDB1461	598547
GDB1462	598464
GDB1463	598464
GDB1463	601159
GDB1463	601160
GDB1463	601190
GDB1463	601212
GDB1464	598465
GDB1464	601213
GDB1465	598002
GDB1466	598545
GDB1467	598180
GDB1467	598463
GDB1468	598471
GDB1469	598472
GDB1469	598783
GDB147	598085
GDB1470	598538
GDB1471	598926
GDB1472	598720
GDB1473	598514
GDB1474	598734
GDB1475	598674
GDB1476	598413
GDB1477	598643
GDB1478	598545
GDB1479	598546
GDB148	598077



 	
TRW	
GDB148	598078
GDB148	598081
GDB148	598085
GDB1480	598582
GDB1481	598583
GDB1482	598426
GDB1483	598427
GDB1484	598428
GDB1485	598633
GDB1487	601003
GDB1488	598751
GDB1489	601001
GDB149	598085
GDB1490	601029
GDB1491	598436
GDB1492	598678
GDB1495	598500
GDB1496	598501
GDB1498	598410
GDB1499	598411
GDB1500	598461
GDB1500	601184
GDB1501	598462
GDB1502	598820
GDB1503	598553
GDB1504	598463
GDB1505	598992
GDB1509	598434
GDB151	598174
GDB151	598193
GDB1510	598439
GDB1511	598438
GDB1513	598480
GDB1514	598448
GDB1515	598584
GDB1516	601004
GDB1517	598568
GDB1518	598569
GDB1519	598988
GDB1520	598407
GDB1521	598570
GDB1522	598396
GDB1525	598527
GDB1525	601257
GDB1526	598658
GDB1527	598580
GDB1528	598750
GDB1530	598580
GDB1531	598811
GDB1532	598639
GDB1533	598423
GDB1534	541717
GDB1535	541705
GDB1538	598489
GDB1538	598801
GDB154	598090
GDB1540	598566
GDB1542	598638
GDB1543	598445
GDB1543	598659



 	
TRW	
GDB1545	598444
GDB1546	598637
GDB1547	598655
GDB1548	598656
GDB1549	598770
GDB155	598094
GDB1550	598635
GDB1550	601216
GDB1551	598752
GDB1552	598558
GDB1553	598845
GDB1554	598779
GDB1555	598651
GDB1556	598652
GDB1557	598671
GDB1559	598640
GDB156	598193
GDB1560	598885
GDB1561	598643
GDB1562	598860
GDB1563	598464
GDB1565	598657
GDB1566	598829
GDB1567	598808
GDB1570	598456
GDB1571	598557
GDB1572	598036
GDB1573	598037
GDB1574	598669
GDB1576	601030
GDB1578	598463
GDB1579	598913
GDB1581	598035
GDB1582	598464
GDB1583	598649
GDB1583	601171
GDB1584	598318
GDB1586	598805
GDB1587	598463
GDB1589	598696
GDB159	598375
GDB1590	598670
GDB1590	598913
GDB1591	598698
GDB1592	598761
GDB1593	598761
GDB1594	598662
GDB1595	598663
GDB1596	598664
GDB1597	598558
GDB1600	598764
GDB1601	598765
GDB1602	598990
GDB1603	598772
GDB1604	598407
GDB1605	598715
GDB1606	598861
GDB1607	598822
GDB1609	541683
GDB1610	541663

 	
TRW	
GDB1611	598699
GDB1612	598701
GDB1613	598678
GDB1614	598641
GDB1615	598075
GDB1616	598863
GDB1617	598779
GDB1618	598619
GDB1620	598702
GDB1621	598472
GDB1621	598783
GDB1621	601044
GDB1621	601256
GDB1622	598752
GDB1622	601263
GDB1623	598464
GDB1624	598465
GDB1625	598700
GDB1626	598703
GDB1628	598795
GDB1629	598704
GDB1630	598704
GDB1631	598741
GDB1632	598742
GDB1633	598718
GDB1634	598002
GDB1635	598002
GDB1636	598793
GDB1637	598727
GDB1638	598727
GDB164	598593
GDB1642	598728
GDB1643	598802
GDB1644	598859
GDB1646	598407
GDB1647	598729
GDB1648	598772
GDB1649	601029
GDB165	598147
GDB1650	601029
GDB1651	598940
GDB1652	598770
GDB1653	598770
GDB1654	598426
GDB1655	598721
GDB1656	598722
GDB1657	598678
GDB1658	598408
GDB1659	598779
GDB166	598364
GDB1661	601004
GDB1663	598663
GDB1664	598939
GDB1665	598740
GDB1665	601258
GDB1667	598995
GDB1668	598860
GDB1669	598465
GDB1670	598994
GDB1671	598946



 	
TRW	
GDB1672	598967
GDB1673	598804
GDB1676	598465
GDB1677	598464
GDB1678	598702
GDB1678	601273
GDB1681	598891
GDB1682	598892
GDB1683	598879
GDB1683	601178
GDB1683	601218
GDB1685	598928
GDB1686	598678
GDB1687	601012
GDB1690	598997
GDB1691	598998
GDB1692	598936
GDB1693	601034
GDB1695	541655
GDB1696	598881
GDB1697	541728
GDB1698	598882
GDB1700	598825
GDB1701	598839
GDB1708	598935
GDB1708	601266
GDB1715	598942
GDB1716	598941
GDB1719	598899
GDB172	598160
GDB1723	598818
GDB1724	598816
GDB1725	541736
GDB1727	598754
GDB173	598178
GDB1747	541734
GDB1749	601017
GDB1781	601048
GDB1782	601047
GDB1782	601185
GDB1783	601177
GDB1784	601049
GDB1784	601241
GDB1784	601267
GDB1789	601045
GDB1790	601050
GDB1814	601163
GDB1844	601229
GDB185	598208
GDB194	598220
GDB197	598123
GDB197	598379
GDB199	598182
GDB233	598614
GDB238	598166
GDB238	598171
GDB238	598212
GDB238	598334
GDB240	598113
GDB241	598592



 	
TRW	
GDB242	598109
GDB243	598366
GDB251	598122
GDB252	598612
GDB253	598117
GDB254	598185
GDB255	598120
GDB255	598166
GDB255	598212
GDB259	598187
GDB261	598107
GDB262	598207
GDB263	598148
GDB264	598110
GDB265	598389
GDB267	598111
GDB269	598375
GDB270	598107
GDB271	598362
GDB272	598363
GDB276	598150
GDB277	598144
GDB278	598146
GDB279	598375
GDB280	598175
GDB282	598162
GDB284	598052
GDB284	598131
GDB287	598149
GDB288	598278
GDB294	598105
GDB296	598090
GDB297	598091
GDB297	598219
GDB298	598104
GDB299	598103
GDB300	601016
GDB301	598120
GDB303	598384
GDB3045	598844
GDB3058	598983
GDB306	598817
GDB3071	598850
GDB308	598081
GDB3086	598496
GDB3088	598780
GDB3089	598634
GDB3091	598830
GDB3092	598057
GDB3101	598786
GDB3103	598836
GDB311	598167
GDB3110	598777
GDB3111	598668
GDB3114	598071
GDB3115	598449
GDB3116	598184
GDB3123	598838
GDB3124	598523
GDB3126	601024



 	
TRW	
GDB3129	598835
GDB313	598151
GDB3130	598496
GDB3131	598476
GDB3132	598534
GDB3133	598625
GDB3134	598528
GDB3135	598854
GDB314	598591
GDB3147	598551
GDB315	598145
GDB3151	601156
GDB3154	598682
GDB3154	601248
GDB3157	598496
GDB3159	598450
GDB3160	598437
GDB3161	598020
GDB3162	598460
GDB3163	598478
GDB3164	598540
GDB3165	598575
GDB3167	598452
GDB3168	598450
GDB3169	598051
GDB317	598613
GDB3170	598817
GDB3170	601235
GDB3171	598361
GDB3172	598902
GDB3175	598682
GDB3175	601244
GDB3176	598495
GDB3177	598627
GDB3178	598212
GDB318	598123
GDB3180	598071
GDB3181	598668
GDB3181	601252
GDB3182	598533
GDB3182	598534
GDB3183	598023
GDB3184	598266
GDB3186	598436
GDB3188	598627
GDB3189	598435
GDB3190	598682
GDB3190	598758
GDB3191	598682
GDB3192	598629
GDB3193	598548
GDB3195	598316
GDB3195	601191
GDB3196	598627
GDB3197	598535
GDB3197	601166
GDB3198	598865
GDB3200	601020
GDB3201	598908
GDB3202	598531



 	
TRW	
GDB3203	598841
GDB3204	598579
GDB3205	598691
GDB3205	598915
GDB3207	598551
GDB3208	598806
GDB3209	598629
GDB3210	598021
GDB3211	598574
GDB3212	598760
GDB3213	598393
GDB3213	598897
GDB3216	598361
GDB3217	598530
GDB3218	598606
GDB3219	598883
GDB3220	598856
GDB3221	598843
GDB3222	598524
GDB3223	598895
GDB3224	598989
GDB3227	598451
GDB323	598266
GDB3231	598780
GDB3232	598504
GDB3233	601025
GDB3235	601023
GDB3236	598733
GDB3238	598784
GDB3239	598778
GDB3240	598887
GDB3240	601217
GDB3241	598511
GDB3242	598737
GDB3243	598577
GDB3243	601251
GDB3244	598759
GDB3245	598910
GDB3246	598518
GDB3247	598520
GDB3249	598542
GDB325	598047
GDB3250	598907
GDB3251	598536
GDB3255	598515
GDB3256	598574
GDB3256	601169
GDB3257	598505
GDB3258	598748
GDB3259	598574
GDB3260	598834
GDB3260	598866
GDB3261	598821
GDB3262	598274
GDB3266	598856
GDB3267	598022
GDB3268	598887
GDB3269	598682
GDB3269	601043
GDB327	598002



	
TRW	
GDB327	598075
GDB327	598081
GDB327	598177
GDB3270	598521
GDB3271	598054
GDB3273	598912
GDB3274	598668
GDB3275	598697
GDB3276	598733
GDB3276	598832
GDB3278	601242
GDB3279	598673
GDB328	598080
GDB3280	598777
GDB3282	598748
GDB3283	598574
GDB3284	598748
GDB3284	601236
GDB3285	598910
GDB3286	598944
GDB3287	598886
GDB3288	598679
GDB3289	598680
GDB3290	598848
GDB3291	598451
GDB3292	598472
GDB3293	598452
GDB3293	601183
GDB3294	598672
GDB3294	601246
GDB3296	601233
GDB3297	598505
GDB3297	598871
GDB3297	601168
GDB3298	598748
GDB3299	598506
GDB3299	601167
GDB3300	598579
GDB3301	598821
GDB3302	598745
GDB3306	598809
GDB3307	598476
GDB3308	598916
GDB3309	598647
GDB3309	601180
GDB3310	598648
GDB3311	598780
GDB3312	598452
GDB3313	598602
GDB3314	598862
GDB3315	598541
GDB3316	598827
GDB3316	601172
GDB3316	601222
GDB3317	598917
GDB332	598392
GDB3324	598736
GDB3325	598757
GDB3325	601208
GDB3327	598523

	
TRW	
GDB3328	598853
GDB3330	598644
GDB3330	601205
GDB3331	598052
GDB3332	598641
GDB3334	598810
GDB3335	598653
GDB3336	598665
GDB3337	598812
GDB3340	598889
GDB3340	601204
GDB3341	598852
GDB3342	598842
GDB3343	598654
GDB3344	598823
GDB3345	598361
GDB3346	601240
GDB3347	601197
GDB3348	598874
GDB3348	601231
GDB3348	601250
GDB3349	598919
GDB3350	598914
GDB3351	598733
GDB3352	598744
GDB3352	601173
GDB3353	598784
GDB3355	598824
GDB3357	598831
GDB3358	598873
GDB3359	598733
GDB336	598116
GDB3363	598453
GDB3364	598857
GDB3364	601165
GDB3365	598870
GDB3367	598705
GDB3368	598817
GDB3369	598707
GDB3370	598706
GDB3371	598853
GDB3373	598929
GDB3377	598708
GDB3378	598781
GDB3380	598855
GDB3383	598393
GDB3386	598744
GDB3387	598748
GDB3389	598493
GDB339	598186
GDB3390	598787
GDB3392	598738
GDB3393	598672
GDB3395	598875
GDB3396	598847
GDB3399	598888
GDB340	598391
GDB3402	598746
GDB3405	598730
GDB3407	598803

	
TRW	
GDB3408	598849
GDB341	598129
GDB3410	601035
GDB3412	598871
GDB3414	598710
GDB3418	598937
GDB3418	601164
GDB3419	598932
GDB3419	601230
GDB342	598129
GDB3420	598868
GDB3420	601210
GDB3421	598867
GDB3421	601239
GDB3422	598744
GDB3423	598589
GDB3424	601037
GDB3425	598943
GDB3426	598819
GDB3426	601264
GDB3427	598894
GDB3429	598890
GDB3429	601214
GDB343	598007
GDB343	598374
GDB3431	598739
GDB3432	598748
GDB3433	598821
GDB3435	598893
GDB3437	601225
GDB3438	601270
GDB3439	541737
GDB344	598086
GDB3445	598901
GDB3450	601175
GDB3454	598933
GDB3457	601026
GDB3459	598896
GDB3459	601221
GDB3460	601052
GDB3464	601253
GDB3467	601182
GDB3481	598943
GDB3481	601040
GDB3484	601161
GDB349	598032
GDB349	598166
GDB3493	601181
GDB350	598131
GDB3501	601223
GDB351	598402
GDB351	598614
GDB352	598921
GDB353	598130
GDB354	598239
GDB355	598220
GDB358	598047
GDB359	598371
GDB360	598125
GDB360	598141

	
TRW	
GDB362	598113
GDB364	598115
GDB365	598224
GDB367	598123
GDB371	598120
GDB371	598335
GDB373	598052
GDB374	598293
GDB383	598021
GDB384	598983
GDB386	598175
GDB391	598270
GDB392	598291
GDB394	598129
GDB395	598623
GDB397	598594
GDB399	598027
GDB400	598002
GDB4010	598906
GDB4012	598965
GDB4016	598904
GDB403	598214
GDB404	598017
GDB404	601157
GDB405	598076
GDB405	598377
GDB407	598106
GDB4091	598556
GDB4098	601249
GDB4104	598491
GDB4118	598543
GDB4119	598544
GDB4120	598510
GDB4121	598556
GDB4122	598556
GDB4124	598509
GDB4125	598905
GDB4126	598414
GDB4127	598677
GDB4128	598756
GDB4129	598415
GDB4130	598755
GDB4133	598833
GDB4135	601033
GDB4139	598755
GDB4140	601032
GDB417	598093
GDB4172	601268
GDB422	598091
GDB422	598093
GDB425	598002
GDB425	598061
GDB428	598118
GDB430	598004
GDB440	598169
GDB442	598621
GDB443	598374
GDB446	598119
GDB446	598176
GDB446	598714



BOSCH	
0 204 173 008	197070
0 986 478 010	186249
0 986 478 011	186245
0 986 478 012	186731
0 986 478 016	186113
0 986 478 017	186246
0 986 478 018	186112
0 986 478 019	186114
0 986 478 024	186884
0 986 478 029	186118
0 986 478 032	186115
0 986 478 033	186116
0 986 478 034	186117
0 986 478 036	186119
0 986 478 046	186200
0 986 478 050	186128
0 986 478 051	186142
0 986 478 052	186143
0 986 478 058	186180
0 986 478 063	186151
0 986 478 065	186520
0 986 478 066	186152
0 986 478 067	186205
0 986 478 068	186160
0 986 478 072	186158
0 986 478 079	186189
0 986 478 080	186186
0 986 478 080	197150
0 986 478 081	186187
0 986 478 081	186757
0 986 478 086	186490
0 986 478 086	197226
0 986 478 089	186197
0 986 478 090	186134
0 986 478 091	186202
0 986 478 094	186203
0 986 478 103	186226
0 986 478 105	186230
0 986 478 105	186803
0 986 478 107	186405
0 986 478 109	197069
0 986 478 112	186211
0 986 478 113	186218
0 986 478 114	186176
0 986 478 115	186433
0 986 478 121	186240
0 986 478 124	186208
0 986 478 125	186303
0 986 478 128	186291
0 986 478 130	186268
0 986 478 131	186269
0 986 478 132	186294
0 986 478 136	186771
0 986 478 140	186145
0 986 478 141	186144
0 986 478 142	186276
0 986 478 143	186256
0 986 478 144	186254
0 986 478 146	186257
0 986 478 148	186159

BOSCH	
0 986 478 160	186278
0 986 478 166	186537
0 986 478 170	186277
0 986 478 174	186438
0 986 478 186	186185
0 986 478 187	186182
0 986 478 188	186184
0 986 478 189	186692
0 986 478 190	186169
0 986 478 192	186188
0 986 478 195	186165
0 986 478 196	186424
0 986 478 198	186255
0 986 478 200	186206
0 986 478 211	186195
0 986 478 216	186292
0 986 478 218	186139
0 986 478 224	186770
0 986 478 225	186273
0 986 478 227	186457
0 986 478 228	186102
0 986 478 229	186272
0 986 478 232	186140
0 986 478 234	186136
0 986 478 235	186156
0 986 478 236	186150
0 986 478 237	186149
0 986 478 238	186146
0 986 478 239	186232
0 986 478 240	186234
0 986 478 241	186449
0 986 478 246	186130
0 986 478 252	186453
0 986 478 255	186281
0 986 478 257	186479
0 986 478 262	186298
0 986 478 265	186191
0 986 478 266	186192
0 986 478 267	186190
0 986 478 268	186198
0 986 478 270	186214
0 986 478 273	186228
0 986 478 275	186213
0 986 478 276	186229
0 986 478 277	186476
0 986 478 278	186221
0 986 478 279	186219
0 986 478 280	186224
0 986 478 283	186263
0 986 478 284	186564
0 986 478 286	186743
0 986 478 288	186300
0 986 478 289	186223
0 986 478 295	186509
0 986 478 296	186800
0 986 478 297	186311
0 986 478 299	186709
0 986 478 301	186280
0 986 478 303	186710
0 986 478 307	186776

BOSCH	
0 986 478 308	186247
0 986 478 314	186814
0 986 478 319	186124
0 986 478 321	186125
0 986 478 325	186183
0 986 478 325	186470
0 986 478 326	186625
0 986 478 327	186189
0 986 478 328	186302
0 986 478 329	186251
0 986 478 330	186177
0 986 478 331	186288
0 986 478 332	186517
0 986 478 341	186290
0 986 478 342	186155
0 986 478 342	186406
0 986 478 343	186154
0 986 478 344	186425
0 986 478 345	186168
0 986 478 346	186166
0 986 478 350	186435
0 986 478 353	186157
0 986 478 357	186178
0 986 478 358	197165
0 986 478 359	186199
0 986 478 360	186299
0 986 478 370	186194
0 986 478 371	186196
0 986 478 374	186498
0 986 478 376	197114
0 986 478 377	186374
0 986 478 384	186637
0 986 478 385	186511
0 986 478 386	186258
0 986 478 388	186264
0 986 478 390	186225
0 986 478 391	186231
0 986 478 396	186508
0 986 478 397	186696
0 986 478 415	186699
0 986 478 420	186565
0 986 478 421	186624
0 986 478 422	186628
0 986 478 424	186567
0 986 478 425	186568
0 986 478 426	186860
0 986 478 427	186401
0 986 478 429	186454
0 986 478 430	186497
0 986 478 433	187045
0 986 478 434	186418
0 986 478 435	186421
0 986 478 436	186566
0 986 478 437	186585
0 986 478 438	186875
0 986 478 442	186775
0 986 478 447	186234
0 986 478 448	186439
0 986 478 450	186827
0 986 478 451	186705

BOSCH	
0 986 478 453	186547
0 986 478 454	197056
0 986 478 458	186611
0 986 478 459	186577
0 986 478 460	186443
0 986 478 461	186294
0 986 478 464	186416
0 986 478 467	197246
0 986 478 469	186753
0 986 478 474	186783
0 986 478 475	186760
0 986 478 478	197009
0 986 478 479	186859
0 986 478 480	197032
0 986 478 481	197011
0 986 478 482	197088
0 986 478 483	197224
0 986 478 485	186563
0 986 478 486	197004
0 986 478 487	186488
0 986 478 490	186686
0 986 478 491	186874
0 986 478 492	186729
0 986 478 493	186707
0 986 478 494	186741
0 986 478 495	186841
0 986 478 496	186685
0 986 478 497	186642
0 986 478 501	186162
0 986 478 502	186163
0 986 478 503	186431
0 986 478 505	186500
0 986 478 506	186510
0 986 478 508	186519
0 986 478 511	186274
0 986 478 512	186148
0 986 478 513	186275
0 986 478 515	186153
0 986 478 517	186147
0 986 478 521	186265
0 986 478 523	186455
0 986 478 524	186446
0 986 478 525	186460
0 986 478 526	186461
0 986 478 531	186648
0 986 478 533	186482
0 986 478 534	186301
0 986 478 535	186282
0 986 478 539	186504
0 986 478 541	186652
0 986 478 542	186313
0 986 478 544	186770
0 986 478 545	186270
0 986 478 546	197222
0 986 478 547	186314
0 986 478 548	186315
0 986 478 550	186267
0 986 478 555	197059
0 986 478 556	186204
0 986 478 557	186768



BOSCH	
0 986 478 561	186295
0 986 478 564	186487
0 986 478 565	186462
0 986 478 566	186465
0 986 478 567	186485
0 986 478 568	186436
0 986 478 568	186439
0 986 478 569	186801
0 986 478 570	186861
0 986 478 571	186815
0 986 478 572	186818
0 986 478 578	186701
0 986 478 580	186638
0 986 478 582	186587
0 986 478 583	186876
0 986 478 584	197169
0 986 478 588	197226
0 986 478 590	186655
0 986 478 591	186299
0 986 478 593	197225
0 986 478 596	186488
0 986 478 598	186304
0 986 478 601	186812
0 986 478 603	186526
0 986 478 604	186586
0 986 478 605	186426
0 986 478 606	186762
0 986 478 608	186694
0 986 478 611	186306
0 986 478 613	197218
0 986 478 615	186408
0 986 478 618	186695
0 986 478 619	186521
0 986 478 620	186581
0 986 478 621	186523
0 986 478 622	197227
0 986 478 624	186467
0 986 478 624	186864
0 986 478 626	186469
0 986 478 627	186788
0 986 478 629	186640
0 986 478 632	197166
0 986 478 633	186458
0 986 478 634	186439
0 986 478 635	186653
0 986 478 638	186451
0 986 478 639	186590
0 986 478 641	186839
0 986 478 642	186559
0 986 478 643	186612
0 986 478 647	186614
0 986 478 649	187029
0 986 478 650	186576
0 986 478 652	186648
0 986 478 654	186648
0 986 478 656	186310
0 986 478 657	186286
0 986 478 664	186572
0 986 478 667	186778
0 986 478 668	186605



BOSCH	
0 986 478 669	197229
0 986 478 671	186427
0 986 478 672	186428
0 986 478 673	186440
0 986 478 674	186441
0 986 478 675	186617
0 986 478 698	186704
0 986 478 701	186452
0 986 478 704	197124
0 986 478 706	186664
0 986 478 712	186742
0 986 478 713	186691
0 986 478 716	186647
0 986 478 717	186496
0 986 478 718	186750
0 986 478 719	186220
0 986 478 721	186505
0 986 478 725	186652
0 986 478 726	197167
0 986 478 727	186777
0 986 478 728	186821
0 986 478 729	186784
0 986 478 730	186759
0 986 478 731	186791
0 986 478 732	186702
0 986 478 733	186785
0 986 478 734	186600
0 986 478 736	186110
0 986 478 740	186501
0 986 478 742	186170
0 986 478 743	197221
0 986 478 744	186718
0 986 478 745	186688
0 986 478 746	186172
0 986 478 747	186173
0 986 478 749	186135
0 986 478 751	186131
0 986 478 757	186307
0 986 478 759	186773
0 986 478 760	186103
0 986 478 761	186137
0 986 478 770	186207
0 986 478 772	197238
0 986 478 774	186823
0 986 478 776	186530
0 986 478 781	197208
0 986 478 786	186297
0 986 478 787	197161
0 986 478 793	197094
0 986 478 794	186287
0 986 478 799	186503
0 986 478 802	186665
0 986 478 810	186266
0 986 478 811	186495
0 986 478 812	186420
0 986 478 813	186613
0 986 478 819	186236
0 986 478 824	186284
0 986 478 827	186283
0 986 478 830	186532



BOSCH	
0 986 478 831	186533
0 986 478 834	186296
0 986 478 836	186564
0 986 478 837	197016
0 986 478 839	197162
0 986 478 840	186621
0 986 478 842	197228
0 986 478 843	197217
0 986 478 844	186719
0 986 478 846	186682
0 986 478 847	186599
0 986 478 848	186697
0 986 478 849	186774
0 986 478 852	186604
0 986 478 853	186603
0 986 478 854	197223
0 986 478 855	186745
0 986 478 856	186529
0 986 478 858	186822
0 986 478 859	186681
0 986 478 861	186551
0 986 478 863	197033
0 986 478 864	186305
0 986 478 865	186654
0 986 478 866	186775
0 986 478 867	197230
0 986 478 868	186597
0 986 478 869	186582
0 986 478 870	186725
0 986 478 872	186583
0 986 478 873	186552
0 986 478 874	186562
0 986 478 875	186573
0 986 478 877	186579
0 986 478 878	186571
0 986 478 879	186569
0 986 478 880	186591
0 986 478 881	186592
0 986 478 882	186594
0 986 478 883	186684
0 986 478 884	186593
0 986 478 885	187058
0 986 478 886	187040
0 986 478 887	186598
0 986 478 888	186773
0 986 478 889	186620
0 986 478 892	186560
0 986 478 893	197236
0 986 478 896	186589
0 986 478 897	186648
0 986 478 898	186647
0 986 478 963	197137
0 986 478 967	197195
0 986 478 968	197168
0 986 478 970	186740
0 986 478 970	186868
0 986 478 971	186894
0 986 478 971	197003
0 986 478 972	186804
0 986 478 973	186808



BOSCH	
0 986 478 974	186808
0 986 478 975	186883
0 986 478 976	197230
0 986 478 979	186693
0 986 478 980	197220
0 986 478 981	186736
0 986 478 982	186780
0 986 478 983	186730
0 986 478 984	197064
0 986 478 985	197198
0 986 478 986	186807
0 986 478 987	186856
0 986 478 988	186603
0 986 478 989	186810
0 986 478 990	186813
0 986 478 991	186687
0 986 478 992	186871
0 986 478 993	186442
0 986 478 996	197063
0 986 478 999	197122
0 986 479 001	186868
0 986 479 006	186743
0 986 479 007	186796
0 986 479 012	186766
0 986 479 013	197206
0 986 479 014	197103
0 986 479 020	197207
0 986 479 024	197231
0 986 479 027	186703
0 986 479 029	186734
0 986 479 030	186728
0 986 479 033	186866
0 986 479 033	197146
0 986 479 036	186888
0 986 479 037	197239
0 986 479 038	186751
0 986 479 039	186751
0 986 479 041	197035
0 986 479 042	186865
0 986 479 054	197086
0 986 479 055	186732
0 986 479 056	197084
0 986 479 057	186758
0 986 479 058	197242
0 986 479 064	186724
0 986 479 066	186708
0 986 479 068	186834
0 986 479 069	186748
0 986 479 070	197013
0 986 479 071	197060
0 986 479 076	186880
0 986 479 077	186869
0 986 479 078	186712
0 986 479 083	186893
0 986 479 084	186877
0 986 479 086	186848
0 986 479 087	186847
0 986 479 088	186755
0 986 479 094	197243
0 986 479 095	197090







	
BOSCH	
0 986 479 096	186885
0 986 479 097	186886
0 986 479 098	186754
0 986 479 099	186857
0 986 479 100	197138
0 986 479 101	186432
0 986 479 102	197022
0 986 479 103	186764
0 986 479 104	186846
0 986 479 105	186845
0 986 479 106	186854
0 986 479 107	186881
0 986 479 108	186720
0 986 479 109	197240
0 986 479 111	186765
0 986 479 113	197244
0 986 479 114	197219
0 986 479 115	197193
0 986 479 117	197233
0 986 479 119	197108
0 986 479 120	186797
0 986 479 121	186744
0 986 479 124	197172
0 986 479 126	197027
0 986 479 127	197207
0 986 479 128	197020
0 986 479 131	186851
0 986 479 132	197245
0 986 479 135	197200
0 986 479 137	186890
0 986 479 138	186858
0 986 479 139	186707
0 986 479 142	186882
0 986 479 144	186713
0 986 479 146	197062
0 986 479 149	197019
0 986 479 155	186833
0 986 479 157	197222
0 986 479 161	187148
0 986 479 162	187147
0 986 479 163	187149
0 986 479 164	186802
0 986 479 165	186803
0 986 479 166	197251
0 986 479 167	186809
0 986 479 169	186842
0 986 479 170	186843
0 986 479 171	186863
0 986 479 173	186819
0 986 479 178	197021
0 986 479 179	186872
0 986 479 185	186798
0 986 479 186	186799
0 986 479 187	197214
0 986 479 189	186757
0 986 479 190	186790
0 986 479 191	186855
0 986 479 192	197046
0 986 479 193	186746
0 986 479 194	186747



	
BOSCH	
0 986 479 195	186786
0 986 479 196	186853
0 986 479 198	186717
0 986 479 199	197079
0 986 479 200	197018
0 986 479 204	197197
0 986 479 205	197022
0 986 479 206	186879
0 986 479 207	186825
0 986 479 209	197241
0 986 479 210	186789
0 986 479 211	186756
0 986 479 213	186816
0 986 479 214	186817
0 986 479 215	197073
0 986 479 216	197234
0 986 479 218	197049
0 986 479 219	186840
0 986 479 222	197008
0 986 479 223	197044
0 986 479 224	197045
0 986 479 225	197104
0 986 479 227	197145
0 986 479 229	186829
0 986 479 230	197210
0 986 479 232	197209
0 986 479 234	197091
0 986 479 235	197036
0 986 479 236	197129
0 986 479 239	197047
0 986 479 241	197163
0 986 479 242	186849
0 986 479 243	186850
0 986 479 244	186587
0 986 479 245	197171
0 986 479 247	197031
0 986 479 248	197087
0 986 479 252	197038
0 986 479 253	186843
0 986 479 254	197101
0 986 479 255	197002
0 986 479 257	197125
0 986 479 259	197051
0 986 479 260	197142
0 986 479 261	197055
0 986 479 262	197149
0 986 479 263	197158
0 986 479 265	197176
0 986 479 266	197188
0 986 479 267	197190
0 986 479 268	197191
0 986 479 269	197092
0 986 479 270	186720
0 986 479 271	186713
0 986 479 272	186894
0 986 479 273	186718
0 986 479 274	186853
0 986 479 275	197002
0 986 479 276	186893
0 986 479 277	186720



	
BOSCH	
0 986 479 278	186796
0 986 479 279	186840
0 986 479 280	197003
0 986 479 281	186775
0 986 479 286	197096
0 986 479 287	197155
0 986 479 288	197232
0 986 479 289	197173
0 986 479 290	197130
0 986 479 291	197247
0 986 479 292	197098
0 986 479 293	197247
0 986 479 294	187141
0 986 479 295	197030
0 986 479 296	187146
0 986 479 297	186418
0 986 479 297	197043
0 986 479 299	197140
0 986 479 300	197199
0 986 479 301	197052
0 986 479 303	197139
0 986 479 304	197071
0 986 479 307	197054
0 986 479 308	197066
0 986 479 310	197143
0 986 479 311	197010
0 986 479 312	197043
0 986 479 313	197248
0 986 479 314	197131
0 986 479 316	197097
0 986 479 317	197105
0 986 479 318	197116
0 986 479 322	197057
0 986 479 324	197130
0 986 479 326	197132
0 986 479 327	197134
0 986 479 331	197201
0 986 479 338	197112
0 986 479 340	197072
0 986 479 341	197183
0 986 479 345	197121
0 986 479 348	197083
0 986 479 358	197164
0 986 479 360	197111
0 986 479 362	197106
0 986 479 363	197184
0 986 479 370	186805
0 986 479 371	197029
0 986 479 375	197156
0 986 479 377	197173
0 986 479 378	197098
0 986 479 379	197099
0 986 479 380	197133
0 986 479 381	197159
0 986 479 382	197126
0 986 479 383	197117
0 986 479 387	197117
0 986 479 388	197100
0 986 479 390	187152
0 986 479 392	197249

	
BOSCH	
0 986 479 399	197023
0 986 479 400	197100
0 986 479 402	197028
0 986 479 403	197135
0 986 479 405	186811
0 986 479 406	197203
0 986 479 407	197202
0 986 479 409	197128
0 986 479 410	197127
0 986 479 418	197110
0 986 479 420	197113
0 986 479 425	197185
0 986 479 428	197152
0 986 479 429	197194
0 986 479 430	197147
0 986 479 431	197182
0 986 479 435	186171
0 986 479 436	197178
0 986 479 437	197074
0 986 479 438	197160
0 986 479 439	197175
0 986 479 442	197179
0 986 479 443	197180
0 986 479 449	197102
0 986 479 454	197070
0 986 479 457	197212
0 986 479 459	186878
0 986 479 460	197205
0 986 479 461	197252
0 986 479 467	197213
0 986 479 470	197067
0 986 479 484	197120
0 986 479 485	197194
0 986 479 486	197065
0 986 479 488	186210
0 986 479 490	197148
0 986 479 491	186714
0 986 479 494	186295
0 986 479 497	197181
0 986 479 504	197015
0 986 479 508	197123
0 986 479 518	197107
0 986 479 519	197109
0 986 479 534	197144
0 986 479 537	197174
0 986 479 540	197204
0 986 479 548	197216
0 986 479 553	197192
0 986 479 554	197215
0 986 479 560	197187
0 986 479 743	186715
0 986 AB6 001	197302
0 986 AB6 002	197121
0 986 AB6 002	197290
0 986 AB6 003	197242
0 986 AB6 003	197384
0 986 AB6 005	197423
0 986 AB6 040	186701
0 986 AB6 047	186508
0 986 AB6 048	186652



 	
BOSCH	
0 986 AB6 051	186765
0 986 AB6 083	186699
0 986 AB6 090	186827
0 986 AB6 091	186829
0 986 AB6 092	197210
0 986 AB6 095	197027
0 986 AB6 096	197422
0 986 AB6 099	197029
0 986 AB6 102	186278
0 986 AB6 103	186537
0 986 AB6 104	186529
0 986 AB6 105	197022
0 986 AB6 109	197387
0 986 AB6 112	197052
0 986 AB6 113	197199
0 986 AB6 113	197388
0 986 AB6 114	197198
0 986 AB6 115	197142
0 986 AB6 115	197389
0 986 AB6 116	197140
0 986 AB6 117	186807
0 986 AB6 118	197125
0 986 AB6 118	197426
0 986 AB6 119	197038
0 986 AB6 120	186294
0 986 AB6 121	197124
0 986 AB6 122	186773
0 986 AB6 123	197011
0 986 AB6 124	197246
0 986 AB6 125	197088
0 986 AB6 125	197427
0 986 AB6 126	197031
0 986 AB6 127	186833
0 986 AB6 127	197429
0 986 AB6 134	197430
0 986 AB6 138	197200
0 986 AB6 140	186281
0 986 AB6 143	197096
0 986 AB6 144	186572
0 986 AB6 145	186551
0 986 AB6 147	186208
0 986 AB6 148	186884
0 986 AB6 155	186879
0 986 AB6 156	186878
0 986 AB6 157	197172
0 986 AB6 160	186130
0 986 AB6 161	186872
0 986 AB6 170	197431
0 986 AB6 171	186759
0 986 AB6 172	186163
0 986 AB6 173	186571
0 986 AB6 175	197390
0 986 AB6 185	186232
0 986 AB6 222	186188
0 986 AB6 244	186874
0 986 AB6 271	197170
0 986 AB6 282	197432
0 986 AB6 289	197433
0 986 AB6 290	197392
0 986 AB6 306	186728



 	
BOSCH	
0 986 AB6 307	186818
0 986 AB6 310	186648
0 986 AB6 316	197223
0 986 AB6 317	186235
0 986 AB6 320	186431
0 986 AB6 322	186439
0 986 AB6 323	197393
0 986 AB6 325	186437
0 986 AB6 328	186455
0 986 AB6 329	197063
0 986 AB6 333	186452
0 986 AB6 344	186547
0 986 AB6 348	197194
0 986 AB6 351	186640
0 986 AB6 352	186876
0 986 AB6 363	197018
0 986 AB6 376	186564
0 986 AB6 386	186696
0 986 AB6 392	186645
0 986 AB6 395	186866
0 986 AB6 399	186479
0 986 AB6 400	186511
0 986 AB6 403	186458
0 986 AB6 491	197394
0 986 AB6 504	186694
0 986 AB6 560	186245
0 986 AB6 594	186604
0 986 AB6 821	197397
0 986 AB6 824	186603
0 986 AB6 830	197399
0 986 AB6 832	197436
0 986 AB6 835	197400
0 986 AB6 840	197264
0 986 AB6 851	197294
0 986 AB6 857	197438
0 986 AB6 860	186194
0 986 AB6 861	197404
0 986 AB6 863	197440
0 986 AB6 864	186825
0 986 AB6 868	197406
0 986 AB6 869	197441
0 986 AB6 871	197442
0 986 AB6 874	186251
0 986 AB6 876	186695
0 986 AB6 880	186271
0 986 AB6 881	186294
0 986 AB6 882	197230
0 986 AB6 886	197412
0 986 AB6 888	186247
0 986 AB6 890	186198
0 986 AB6 896	186693
0 986 AB6 918	197267
0 986 AB6 920	186457
0 986 AB6 946	197418
0 986 AB6 964	186485
0 986 AB6 964	197420
0 986 AB6 989	197433
0 986 BB4 024	186774
0 986 BB4 039	186198
0 986 BB4 040	186200
0 986 BB4 041	186130



 	
BOSCH	
0 986 BB4 042	186251
0 986 BB4 046	186153
0 986 BB4 048	186188
0 986 BB4 054	186245
0 986 BB4 055	186155
0 986 BB4 055	186745
0 986 BB4 061	186202
0 986 BB4 063	186228
0 986 BB4 064	186288
0 986 BB4 068	186194
0 986 BB4 072	186208
0 986 BB4 075	186173
0 986 BB4 079	186304
0 986 BB4 081	186199
0 986 BB4 082	186306
0 986 BB4 083	197222
0 986 BB4 086	186229
0 986 BB4 087	197165
0 986 BB4 088	187045
0 986 BB4 091	186195
0 986 BB4 092	186533
0 986 BB4 093	197217
0 986 BB4 094	186418
0 986 BB4 096	186134
0 986 BB4 138	186603
0 986 BB4 164	186282
0 986 BB4 170	186573
0986AB6001	197302
0986AB6002	197290
0986AB6003	197384
0986AB6005	197423
0986AB6091	186829
0986AB6096	197422
0986AB6099	197029
0986AB6109	197387
0986AB6113	197388
0986AB6115	197389
0986AB6118	197426
0986AB6119	197038
0986AB6125	197427
0986AB6126	197031
0986AB6127	197429
0986AB6134	197430
0986AB6170	197431
0986AB6175	197390
0986AB6222	186188
0986AB6282	197432
0986AB6289	197433
0986AB6290	197392
0986AB6323	197393
0986AB6325	186437
0986AB6376	186564
0986AB6491	197394
0986AB6504	186694
0986AB6560	186245
0986AB6594	186604
0986AB6821	197397
0986AB6824	186603
0986AB6830	197399
0986AB6832	197436



 	
BOSCH	
0986AB6835	197400
0986AB6840	197264
0986AB6851	197294
0986AB6857	197438
0986AB6860	186194
0986AB6861	197404
0986AB6863	197440
0986AB6864	186825
0986AB6868	197406
0986AB6869	197441
0986AB6871	197442
0986AB6874	186251
0986AB6876	186695
0986AB6880	186271
0986AB6881	186294
0986AB6882	197230
0986AB6886	197412
0986AB6888	186247
0986AB6890	186198
0986AB6896	186693
0986AB6918	197267
0986AB6920	186457
0986AB6946	197418
0986AB6964	186485
0986AB6989	197420
FERODO	
DDF001	186189
DDF011	186128
DDF012	186202
DDF013	186495
DDF016	186226
DDF035	186171
DDF038	186625
DDF041	186142
DDF042	186249
DDF048	186113
DDF051	186134
DDF052	186135
DDF053	186176
DDF055	186230
DDF055	186803
DDF057	186771
DDF059	186200
DDF061	186207
DDF062	186118
DDF063	186206
DDF066	186146
DDF067	186290
DDF068	186150
DDF069	186136
DDF070	186228
DDF071	186180
DDF075	186115
DDF079	186160
DDF080	186256
DDF081	186501
DDF082	186118
DDF083	186151
DDF084	186169







	
FERODO	
DDF088	186110
DDF089	186170
DDF092	186172
DDF093	186117
DDF094	186140
DDF096	186197
DDF097	186197
DDF100	186143
DDF1000	186599
DDF1003	186582
DDF1006	186304
DDF1008	186704
DDF1009	186686
DDF1010	186682
DDF1011	186725
DDF1014	186583
DDF103	186245
DDF103	197056
DDF1030	197004
DDF1031	197056
DDF1033	186294
DDF1034	186562
DDF1035	186573
DDF1037	186753
DDF104	186186
DDF104	197150
DDF1040	186591
DDF1041	186592
DDF1042	186684
DDF1043	186594
DDF1044	186593
DDF1057	186605
DDF1058	186846
DDF1062	197229
DDF1064	186705
DDF1065	197231
DDF1066	186815
DDF1067	186688
DDF107	186211
DDF1072	186560
DDF1073	186861
DDF1076	186742
DDF1077	186777
DDF1078	186741
DDF1079	186741
DDF1080	186814
DDF1081	197016
DDF1082	197226
DDF1083	186566
DDF1084	186587
DDF1085	186811
DDF109	186152
DDF1094	186875
DDF1096	186208
DDF1097	186743
DDF1100	186687
DDF1104	197161
DDF1105	186810
DDF1106	197220
DDF1109	186719



	
FERODO	
DDF1112	186710
DDF1113	186709
DDF1114	186703
DDF1115	186785
DDF1116	197009
DDF1117	197163
DDF1118	197246
DDF1119	186780
DDF1122	186745
DDF1123	186600
DDF1124	186655
DDF1125	186750
DDF1126	186834
DDF1127	186762
DDF1128	186812
DDF1129	186757
DDF1130	186790
DDF1131	186759
DDF1132	186702
DDF1132	186746
DDF1135	186864
DDF1138	186797
DDF1139	197240
DDF1140	186695
DDF1140	186198
DDF1145	186708
DDF1148	186784
DDF1149	186766
DDF115	186257
DDF1151	186871
DDF1152	186693
DDF1154	197088
DDF1154	197427
DDF1155	197011
DDF1156	186758
DDF1157	186736
DDF1158	186801
DDF1159	197239
DDF116	186187
DDF116	186757
DDF1160	186800
DDF1161	186788
DDF1162	197137
DDF1163	186789
DDF1164	186888
DDF1165	197219
DDF1166	197198
DDF1167	186305
DDF1168	197138
DDF1169	197238
DDF117	186202
DDF117	186205
DDF1170	186418
DDF1171	197228
DDF1172	186748
DDF1173	186783
DDF1174	186731
DDF1176	197120
DDF1177	197032
DDF1178	186694



	
FERODO	
DDF1179	186744
DDF1181	186724
DDF1182	186715
DDF1183	197136
DDF1184	197252
DDF1190	197124
DDF1201	186764
DDF1202	186884
DDF1203	186890
DDF1204	186712
DDF1205	197221
DDF1210	197245
DDF1214	197069
DDF1215	186880
DDF1216	186765
DDF1217	186868
DDF1218	186755
DDF1218	197397
DDF1219	186798
DDF122	186184
DDF1220	186799
DDF1221	197230
DDF1222	186819
DDF1223	186754
DDF1223	197394
DDF1224	186857
DDF1225	186863
DDF1226	186842
DDF1227	186843
DDF1228	186816
DDF1229	186817
DDF123	186236
DDF1231	186866
DDF1231	197146
DDF1231	197420
DDF1232	186807
DDF1233	186729
DDF1234	186858
DDF1236	186869
DDF1238	197142
DDF1238	197389
DDF1239	197172
DDF124	186182
DDF1240	197140
DDF1241	186732
DDF1242	197193
DDF125	186157
DDF1252	186751
DDF1253	186756
DDF1254	186885
DDF1255	186809
DDF1256	186808
DDF1257	197406
DDF1258	197036
DDF1260	197084
DDF1261	197244
DDF1266	197144
DDF1268	197096
DDF1270	186825
DDF1271	197083

	
FERODO	
DDF1272	186740
DDF1274	197046
DDF1275	186747
DDF1276	186833
DDF1276	197429
DDF1277	197199
DDF1277	197388
DDF128	186114
DDF1280	186883
DDF1282	197162
DDF1283	186791
DDF1284	186295
DDF1286	186886
DDF1287	197064
DDF1288	186854
DDF1289	186882
DDF129	186147
DDF1290	197210
DDF1291	197052
DDF1292	186824
DDF1295	186786
DDF1296	197239
DDF1297	197251
DDF1298	197045
DDF1299	197008
DDF1302	197108
DDF1304	197044
DDF1305	197242
DDF1306	197031
DDF1307	197035
DDF1307	197426
DDF1308	197035
DDF1308	197125
DDF1309	186877
DDF131	186192
DDF1311	186872
DDF1313	186855
DDF1316	197091
DDF132	186130
DDF1346	197195
DDF135	186158
DDF1358	186432
DDF136	186254
DDF1361	186839
DDF1362	186760
DDF1363	197060
DDF1364	186718
DDF1365	197086
DDF1368	197079
DDF1369	186796
DDF137	186288
DDF1372	197233
DDF1374	186869
DDF1379	197062
DDF138	186168
DDF1380	197018
DDF1381	186720
DDF1384	186813
DDF1386	186893
DDF1386	186894

 	
FERODO	
DDF1399	197067
DDF140	186155
DDF140	186406
DDF1400	197122
DDF1401	197070
DDF1405	186804
DDF1406	186849
DDF141	186154
DDF1417	186847
DDF1417	197423
DDF1419	186848
DDF1420	197021
DDF1421	197019
DDF1423	197038
DDF1424	197145
DDF1425	186856
DDF1425	197438
DDF1426	197057
DDF1430	197155
DDF1431	197156
DDF1442	197232
DDF1443	186853
DDF1446	197168
DDF1447	197121
DDF1449	197247
DDF1450	197098
DDF1451	197247
DDF1452	197098
DDF1453	197130
DDF1454	197132
DDF1455	197130
DDF1456	197134
DDF1459	197233
DDF1461	197171
DDF1461	197400
DDF1466	197103
DDF148	186156
DDF1484	197170
DDF1486	197112
DDF1488	197015
DDF1489	186850
DDF149	186137
DDF1492	197022
DDF1493	197027
DDF1496	197267
DDF1497	186844
DDF1497	197013
DDF1498	186713
DDF1500	186851
DDF1502	186802
DDF1503	197139
DDF1508	197072
DDF1509	186805
DDF151	186188
DDF151	186790
DDF1511	186717
DDF1513	197241
DDF1514	186775
DDF1515	186775
DDF1516	186768

 	
FERODO	
DDF1517	186768
DDF1518	197017
DDF1520	197066
DDF1521	186727
DDF1522	186829
DDF1523	186840
DDF1526	186582
DDF1527	197047
DDF1529	186879
DDF1533	197092
DDF1535	197073
DDF1536	197234
DDF1537	187152
DDF154	186195
DDF1543	197209
DDF1549	197049
DDF1550	197175
DDF1554	197249
DDF1555	197054
DDF1557	197153
DDF1559	197239
DDF156	186265
DDF1560	197002
DDF1561	186840
DDF1564	197002
DDF1565	186743
DDF1566	197248
DDF1567	197055
DDF1569	186718
DDF157	186102
DDF1570	186853
DDF1571	186796
DDF1574	197097
DDF1577	186823
DDF1578	197107
DDF158	186229
DDF1580	197090
DDF1582	197200
DDF1587	197184
DDF1588	197111
DDF1589	197164
DDF159	186214
DDF1591	197087
DDF1594	197071
DDF160	186218
DDF1601	197188
DDF1602	197099
DDF1604	197050
DDF1606	197440
DDF1608	197102
DDF1615	197133
DDF1616	197101
DDF1617	197074
DDF1619	197205
DDF1620	197135
DDF1621	197214
DDF1622	197129
DDF1623	186712
DDF1623	186713
DDF1625	197190

 	
FERODO	
DDF1629	197211
DDF1632	197173
DDF1634	197176
DDF1636	186878
DDF1641	186720
DDF1644	197149
DDF1645	197109
DDF1646	197152
DDF1649	197143
DDF165	186116
DDF1653	197023
DDF1654	186893
DDF1655	186894
DDF1655	197003
DDF1656	186720
DDF1664	197196
DDF1668	197185
DDF1677	197222
DDF168	186103
DDF1687	197065
DDF1688	197203
DDF169	186139
DDF1690	197202
DDF1693	197201
DDF1707	197404
DDF172	186210
DDF174	186255
DDF175	186246
DDF176	186149
DDF177	186776
DDF178	186148
DDF180	186165
DDF181	186185
DDF182	186119
DDF1824	197387
DDF1827	197390
DDF1828	197431
DDF1829	186457
DDF183	186159
DDF1830	197430
DDF1831	197392
DDF1832	197433
DDF184	186213
DDF186	186221
DDF188	186191
DDF189	186613
DDF191	186177
DDF192	186198
DDF193	186112
DDF1938	197432
DDF194	186264
DDF1953	197436
DDF196	186263
DDF1970	197412
DDF198	186220
DDF199	186219
DDF201	186235
DDF202	186299
DDF203	186232
DDF205	186251

 	
FERODO	
DDF206	186189
DDF207	186247
DDF208	186162
DDF209	186166
DDF210	186124
DDF213	186258
DDF214	186194
DDF216	186292
DDF217	186625
DDF218	186479
DDF220	186266
DDF221	186125
DDF224	186183
DDF225	186178
DDF227	186482
DDF228	186145
DDF229	186131
DDF232	186424
DDF233	186374
DDF236	186287
DDF237	186224
DDF238	186199
DDF239	186190
DDF240	186406
DDF242	186302
DDF244	186416
DDF245	186204
DDF246	186283
DDF247	186144
DDF248	186274
DDF249	186295
DDF250	186692
DDF252	186297
DDF254	186614
DDF256	186273
DDF258	186275
DDF259	186301
DDF260	186485
DDF261	186286
DDF262	186284
DDF263	186196
DDF264	186303
DDF265	186114
DDF266	186517
DDF267	186487
DDF268	186461
DDF281	186425
DDF286	186495
DDF309	197004
DDF310	197028
DDF311	186272
DDF316	186276
DDF318	186268
DDF319	186267
DDF320	197222
DDF320	186271
DDF321	186294
DDF324	186270
DDF328	186282
DDF330	197225







FERODO	
DDF331	186490
DDF332	186313
DDF333	186768
DDF334	186775
DDF339	186519
DDF347	186637
DDF349	186267
DDF349	197165
DDF351	186504
DDF353	186223
DDF355	186498
DDF357	186665
DDF359	186530
DDF361	186567
DDF362	186306
DDF364	186277
DDF366	186570
DDF370	186159
DDF373	197114
DDF377	186431
DDF385	186488
DDF389	186441
DDF390	186440
DDF394	186446
DDF395	186455
DDF398	186500
DDF403	186509
DDF411	186508
DDF412	186510
DDF413	186511
DDF416	186696
DDF423	186427
DDF424	186770
DDF426	186314
DDF427	186315
DDF429	186454
DDF432	186311
DDF435	186428
DDF439	186231
DDF442	186300
DDF445	186768
DDF446	186140
DDF447	186433
DDF448	186234
DDF450	186436
DDF453	186235
DDF455	186446
DDF457	186460
DDF459	186664
DDF460	186653
DDF466	186508
DDF468	186435
DDF478	186225
DDF479	186426
DDF480	186611
DDF482	186617
DDF489	186296
DDF490	186586
DDF491	186496
DDF492	186438



FERODO	
DDF494	186439
DDF496	186457
DDF497	186449
DDF500	186652
DDF501	197166
DDF502	186652
DDF511	186699
DDF517	186291
DDF518	186269
DDF521	186153
DDF523	186452
DDF524	186458
DDF539	186281
DDF540	186298
DDF542	186770
DDF543	186807
DDF547	186520
DDF548	186462
DDF552	186528
DDF554	186621
DDF556	186307
DDF558	186596
DDF562	197218
DDF563	186114
DDF564	186453
DDF565	186437
DDF588	186280
DDF596	186547
DDF605	186526
DDF614	186640
DDF619	186439
DDF620	197169
DDF621	197148
DDF623	186505
DDF624	197227
DDF630	186465
DDF658	186648
DDF674	186564
DDF678	186503
DDF691	186476
DDF692	186476
DDF693	186585
DDF694	197223
DDF701	186645
DDF702	197167
DDF706	186521
DDF715	186691
DDF717	186564
DDF722	186563
DDF741	186648
DDF746	186628
DDF752	186775
DDF756	186497
DDF757	186421
DDF758	197217
DDF759	186408
DDF760	186420
DDF762	186590
DDF766	186163
DDF767	186418



FERODO	
DDF768	197228
DDF769	186638
DDF770	186299
DDF780	186514
DDF785	186435
DDF790	186654
DDF794	186701
DDF795	186581
DDF797	186643
DDF799	186822
DDF801	186401
DDF802	186443
DDF803	186442
DDF810	197226
DDF811	186566
DDF812	186523
DDF813	186714
DDF814	186565
DDF817	186467
DDF819	186470
DDF826	186572
DDF827	186644
DDF829	186778
DDF830	186773
DDF831	186559
DDF834	186697
DDF835	186568
DDF836	186860
DDF840	186569
DDF841	186533
DDF842	186589
DDF845	186529
DDF846	197236
DDF847	186624
DDF848	186278
DDF849	186537
DDF860	186551
DDF861	186552
DDF866	186576
DDF867	186577
DDF869	186579
DDF870	186532
DDF871	186286
DDF873	197224
DDF874	186642
DDF881	186511
DDF885	186648
DDF887	186163
DDF888	186571
DDF927	186603
DDF928	186604
DDF929	186597
DDF929	197442
DDF948	186874
DDF950	186432
DDF952	186773
DDF963	186469
DDF965	186839
DDF978	186827
DDF995	186598

FERODO	
DRF042	186249
DRF055	186230
DRF055	186803
DRF059	186200
DRF066	186146
DRF067	186290
DRF070	186228
DRF083	186151
DRF1003	186582
DRF1006	186304
DRF1014	186583
DRF103	186245
DRF103	197056
DRF1033	186294
DRF1035	186573
DRF104	186186
DRF104	197150
DRF1066	186815
DRF1072	186560
DRF1073	186861
DRF1078	186741
DRF1082	197226
DRF109	186152
DRF1096	186208
DRF1118	197246
DRF1122	186745
DRF1123	186600
DRF1124	186655
DRF1127	186762
DRF1128	186812
DRF1132	186702
DRF1132	186746
DRF1138	186797
DRF1140	186695
DRF1149	186766
DRF1154	197088
DRF1155	197011
DRF1156	186758
DRF116	186187
DRF116	186757
DRF1163	186789
DRF1167	186305
DRF1173	186783
DRF1174	186731
DRF1177	197032
DRF123	186236
DRF125	186157
DRF128	186114
DRF132	186130
DRF135	186158
DRF137	186288
DRF140	186155
DRF140	186406
DRF141	186154
DRF148	186156
DRF151	186188
DRF151	186790
DRF154	186195
DRF156	186265
DRF158	186229



 	
FERODO	
DRF175	186246
DRF176	186149
DRF183	186159
DRF189	186613
DRF192	186198
DRF193	186112
DRF201	186235
DRF205	186251
DRF206	186189
DRF207	186247
DRF208	186162
DRF209	186166
DRF210	186124
DRF214	186194
DRF216	186292
DRF220	186266
DRF221	186125
DRF240	186406
DRF242	186302
DRF244	186416
DRF248	186274
DRF249	186295
DRF252	186297
DRF256	186273
DRF258	186275
DRF260	186485
DRF261	186286
DRF263	186196
DRF266	186517
DRF281	186425
DRF286	186495
DRF316	186276
DRF319	186267
DRF321	186294
DRF324	186270
DRF328	186282
DRF331	186490
DRF332	186313
DRF334	186775
DRF339	186519
DRF364	186277
DRF390	186440
DRF423	186427
DRF439	186231
DRF447	186433
DRF450	186436
DRF479	186426
DRF482	186617
DRF489	186296
DRF491	186496
DRF492	186438
DRF494	186439
DRF497	186449
DRF500	186652
DRF501	197166
DRF511	186699
DRF517	186291
DRF518	186269
DRF521	186153
DRF588	186280



 	
FERODO	
DRF605	186526
DRF619	186439
DRF620	197169
DRF624	197227
DRF678	186503
DRF706	186521
DRF727S	186185
DRF752	186775
DRF756	186497
DRF759	186408
DRF762	186590
DRF766	186163
DRF794	186701
DRF795	186581
DRF797	186643
DRF798	186208
DRF799	186822
DRF801	186401
DRF810	197226
DRF812	186523
DRF817	186467
DRF829	186778
DRF830	186773
DRF831	186559
DRF834	186697
DRF841	186533
DRF845	186529
DRF870	186532
DRF927	186603
DRF928	186604
DRF929	186597
DRF952	186773
DRF995	186598
FCR104A	187029
FCR139A	187058
FCR140A	187040
FCR153A	186774
FCR154A	187045
FCR184A	187061
FCR191A	197059
FCR194A	187147
FCR195A	187148
FCR196A	187149
FCR221A	186178
FCR227A	197033
FCR228A	186774
FCR229A	187045
FCR230A	197033
FCR236A	187130
FCR310A	187141
FCR311A	197030
FCR312A	187146
TEXTAR	
407106	186140
408108	186768
410139	186226
410150	186117
410178	186114
410186	186424



 	
TEXTAR	
410190	186146
410209	186290
412126	186274
413128	186202
413166	186768
413167	186118
420111	186203
420147	186163
421102	186234
421105	186438
422141	186145
424120	186277
425100	186495
426100	186296
520128	186247
522145	186265
525105	197222
92005400	186189
92005700	197004
92009200	186142
92009200	186226
92009300	186249
92009500	186180
92010600	186245
92011400	186202
92011600	186115
92011600	186116
92011900	186160
92012100	186246
92012900	186139
92013500	186110
92014300	186140
92014400	186128
92014900	186169
92015100	186171
92016400	186142
92017200	186218
92018600	186255
92019200	186117
92019300	186151
92019900	186171
92019900	186172
92020300	186692
92020800	186186
92020900	186187
92020900	186757
92022000	186771
92022100	186143
92022800	186453
92022900	186159
92023000	186158
92025900	186113
92026000	186112
92026100	186114
92026200	186273
92026300	186292
92026400	186118
92026500	186119
92026900	186135
92027000	186152



 	
TEXTAR	
92027100	186202
92027100	186205
92027300	186166
92027400	186176
92029600	186188
92029600	186790
92029800	186199
92029800	186200
92029900	186134
92029900	186197
92031000	186257
92031300	186776
92031400	186256
92031800	186182
92031900	186185
92032000	186184
92032400	186424
92032700	186183
92032700	186470
92032703	186183
92032703	186470
92033100	186210
92033600	186103
92033800	186195
92034000	186150
92034200	186146
92034300	186156
92034300	186571
92034400	186206
92034500	186157
92035100	186299
92035600	186479
92036000	186228
92036100	186230
92036100	186803
92036200	186229
92036300	186224
92036400	186214
92036600	186374
92036800	186247
92037000	186770
92037200	186272
92037300	186114
92037900	186168
92038000	186192
92038100	186191
92038100	186192
92038200	186190
92038500	186130
92038600	186177
92038900	186178
92039100	186173
92039200	186189
92039300	186625
92040400	186223
92040600	186283
92041400	186155
92041500	186154
92041500	186155
92041700	186251







	
TEXTAR	
92041800	186288
92041803	186288
92042000	186302
92042100	186124
92042300	186125
92042303	186125
92042900	186136
92043100	186194
92043200	186196
92043500	186519
92043800	197114
92044100	186102
92044200	186149
92044400	186236
92044500	186613
92046300	186232
92046800	186265
92046900	186290
92047400	197165
92048100	186198
92048200	186199
92048500	186498
92049200	186231
92049300	186213
92049400	186219
92049500	186221
92050400	186696
92050600	186258
92050900	186162
92051000	186163
92051200	186263
92051300	186264
92051500	186225
92051600	186234
92052100	186148
92052900	186509
92053000	186770
92053200	186147
92053500	186266
92053800	186500
92054000	186131
92054200	186267
92054400	186145
92054500	186144
92054900	186208
92055000	186416
92055003	186416
92055200	186297
92055400	186289
92055500	186274
92055503	186274
92055600	186275
92055605	186275
92055700	186295
92055703	186295
92055800	186511
92055900	186314
92056000	186315
92056200	186301
92056300	186485



	
TEXTAR	
92056400	186487
92056500	186282
92056800	186465
92057000	186490
92057100	186313
92057200	186517
92057300	186460
92057400	186270
92057500	186294
92057503	186294
92057600	197222
92057605	197222
92057700	197225
92057800	186268
92057900	186461
92058000	186462
92058500	197218
92059300	186298
92059303	186298
92059400	186280
92059403	186280
92059500	186281
92059503	186281
92059600	186296
92059700	186586
92059900	186621
92060200	186185
92060400	186269
92060600	186291
92060700	186431
92060800	186435
92060900	186438
92061000	186405
92061100	186155
92061100	186406
92061103	186155
92061103	186406
92061300	186284
92061500	186449
92061600	186451
92061700	186452
92061800	186446
92061900	186455
92062000	186457
92062100	186458
92062600	186441
92062700	186617
92062800	186440
92063200	186482
92063300	186300
92063500	186277
92063600	186426
92064200	197094
92064300	186427
92064400	186428
92064500	186303
92064800	186304
92064900	186306
92065000	186305
92065100	186307



	
TEXTAR	
92065500	186510
92065600	186287
92065700	186530
92065800	186509
92066000	186504
92066200	186496
92066500	186454
92066600	186453
92066700	186526
92066703	186526
92066800	186528
92066803	186528
92067300	186276
92067700	186165
92067800	186520
92068200	186807
92068500	186153
92068600	186220
92068700	186567
92068800	186497
92068900	186652
92069000	186505
92069500	186652
92069600	186590
92069800	186299
92070000	186487
92070300	186768
92070400	186768
92070500	186285
92070600	186286
92070700	186508
92071400	197227
92071403	197227
92071600	186408
92071603	186408
92071900	186581
92071903	186581
92072000	186523
92072003	186523
92072100	186773
92072103	186773
92072300	186839
92072303	186839
92072400	186559
92072403	186559
92072500	186467
92072505	186467
92072700	186469
92072703	186469
92072800	186521
92072900	197124
92073000	186470
92073400	197033
92073600	187045
92073700	197217
92073800	186418
92073800	197043
92073900	197131
92073900	197228
92074000	186420

	
TEXTAR	
92074100	186421
92074200	197236
92074203	197236
92074300	186624
92074303	186624
92074400	186551
92074403	186551
92074500	186552
92074503	186552
92074600	186653
92074800	186653
92075000	186697
92075005	186697
92075100	186860
92075105	186860
92075300	186529
92075400	186401
92075500	186565
92075600	197226
92075700	186566
92075800	186488
92075900	186585
92076300	186547
92076300	186640
92076400	186628
92076500	186875
92076600	186568
92076603	186568
92076800	186569
92077200	186701
92077400	197169
92077500	186822
92077500	197148
92077500	197169
92077600	197167
92077700	197166
92077703	197166
92077800	186433
92077900	186432
92078000	186286
92078100	186439
92078200	186699
92078600	186532
92078700	186533
92079400	186446
92079600	186665
92079700	186476
92079800	186719
92079900	186564
92080000	186654
92080200	186564
92080400	186637
92080500	186645
92080600	186638
92080700	186579
92080800	186514
92081100	186207
92081200	186775
92081400	186596
92081500	186436



 	
TEXTAR	
92081500	186439
92081600	186439
92082000	186503
92082100	186476
92082200	186603
92082203	186603
92082300	186604
92082305	186604
92082400	197230
92082500	186597
92082503	186597
92082700	186640
92082800	186311
92082900	186648
92083100	186644
92083200	186643
92083500	186582
92083505	186582
92083600	186583
92083700	186725
92083703	186725
92083800	186682
92083803	186682
92087300	186612
92088000	186589
92088100	186278
92088200	186537
92088400	186425
92088403	186425
92088500	186773
92088503	186773
92089100	186599
92089400	186818
92089800	197059
92089803	197059
92090000	186753
92090003	186753
92090100	186620
92090200	186681
92090300	186571
92090400	186714
92090500	186511
92090800	186294
92090900	186576
92091000	186577
92091200	186582
92091203	186582
92091300	186573
92091303	186573
92091400	186585
92091400	197223
92091500	197004
92091600	186685
92091700	186591
92091800	186592
92091803	186592
92091900	186684
92091903	186684
92092000	186594
92092003	186594



 	
TEXTAR	
92092100	186593
92092103	186593
92092300	197056
92092600	186495
92092800	186598
92092803	186598
92093100	186691
92093200	186827
92093300	186704
92093500	186686
92093600	197224
92093700	186572
92093800	186442
92093900	186443
92094300	197148
92094500	186611
92094600	186503
92095000	186664
92095200	186642
92096200	186163
92096200	186560
92096203	186560
92096400	186605
92096500	186846
92096800	197063
92096900	186705
92096903	186705
92097100	197231
92097200	186815
92097205	186815
92097300	186861
92097305	186861
92097500	197229
92097600	186859
92097603	186859
92097700	186688
92097900	186874
92098100	186801
92098103	186801
92098200	186729
92098500	197246
92098600	197088
92098603	197088
92099600	186783
92099603	186783
92099700	186760
92099703	186760
92099800	186488
92100200	197009
92100300	186742
92100400	186707
92100500	186789
92100503	186789
92100600	186741
92100603	186741
92100700	186841
92100703	186841
92100900	186208
92101000	186778
92102600	186743



 	
TEXTAR	
92102800	186777
92102900	186687
92103000	197161
92103100	186810
92103200	186811
92103205	186811
92103400	186814
92103500	197016
92103600	186587
92103700	197108
92103800	186710
92103900	186648
92104100	197124
92104103	197124
92104400	197207
92105200	197033
92105300	187045
92105800	197011
92105803	197011
92105900	186467
92105900	186864
92105903	186864
92106100	186758
92106105	186758
92106200	186807
92106203	186807
92106300	186856
92106303	186856
92106400	186788
92106500	186603
92106600	197230
92106603	197230
92106700	197198
92106705	197198
92106800	186888
92106900	186731
92106905	186731
92107000	186883
92107003	186883
92107100	186884
92107105	186884
92107200	186808
92107203	186808
92107300	186808
92107400	186809
92107403	186809
92107500	186762
92107503	186762
92107600	186812
92107605	186812
92107700	186745
92107703	186745
92107800	197220
92107900	186736
92108200	197233
92108300	197069
92108400	197022
92108700	186730
92109200	186781
92109300	186821



 	
TEXTAR	
92109400	186728
92109600	186750
92109700	186834
92109800	197239
92109803	197239
92109900	186800
92109903	186800
92110000	186709
92110003	186709
92110100	186780
92110300	186866
92110300	197146
92110800	186784
92110803	186784
92110900	197244
92110903	197244
92111000	186791
92111003	186791
92111100	186759
92111103	186759
92111200	186740
92111300	186757
92111303	186757
92111400	186790
92111403	186790
92111500	186695
92111503	186695
92111600	186693
92111603	186693
92111700	186694
92111703	186694
92111800	186702
92111900	186703
92112000	186785
92112300	197240
92112700	186647
92113300	197163
92113600	197238
92113800	186600
92113900	186655
92113900	186717
92113903	186655
92114700	186797
92114900	197206
92115000	197219
92115100	186751
92115105	186751
92115200	186751
92115205	186751
92115400	197035
92115405	197035
92115500	186865
92115505	186865
92115600	186766
92115700	186871
92115800	197137
92115900	186868
92116000	186712
92116200	186708
92116600	186418



	
TEXTAR	
92116700	197228
92116800	197138
92116900	186454
92117100	197120
92117300	197032
92117303	197032
92117900	197157
92118000	186744
92118200	186724
92118300	186880
92118303	186880
92118400	186882
92118403	186882
92118500	186854
92118503	186854
92118600	186805
92118700	186881
92118703	186881
92118900	186715
92119000	197221
92119100	186718
92119200	186764
92119203	186764
92119300	186796
92119400	186804
92119500	186893
92119503	186894
92119600	197136
92119700	197252
92119800	197200
92120500	197242
92120600	197197
92120700	186754
92120705	186754
92120800	186755
92120805	186755
92120900	186857
92120903	186857
92121000	197222
92121003	197222
92121100	186833
92121103	186833
92121200	186756
92121300	186885
92121303	186885
92121400	186886
92121403	186886
92121500	197087
92121505	197087
92121900	197243
92121903	197243
92122000	197090
92122005	197090
92122300	186582
92122305	186582
92122500	186732
92122505	186732
92122600	197193
92122605	197193
92122700	197084

	
TEXTAR	
92122703	197084
92124400	186783
92124403	186783
92124500	197060
92124503	197060
92124600	186869
92124603	186869
92124700	186855
92124703	186855
92124800	186748
92124900	197013
92125000	197144
92125100	197104
92125300	197103
92125400	197014
92125500	197245
92125503	197245
92125600	186851
92125603	186851
92125800	186877
92126000	197171
92126100	186848
92126200	186847
92126300	197019
92126600	197057
92126603	197057
92128300	197086
92128500	197173
92128700	186845
92128800	186813
92129300	186869
92129303	186869
92129400	186746
92129500	197046
92129600	186747
92129700	197062
92130200	197020
92130300	186872
92130500	197021
92130800	186823
92131000	197172
92131200	197064
92131500	186774
92131503	186774
92131600	186712
92131603	186713
92131800	186798
92131803	186798
92131900	186799
92131903	186799
92132000	197091
92132003	197091
92132100	197036
92132103	197036
92132200	197052
92132205	197052
92132300	197199
92132305	197199
92132400	197142
92132405	197142

	
TEXTAR	
92132500	197125
92132503	197125
92132600	197140
92132603	197140
92132700	186816
92132703	186816
92132800	186817
92133000	197049
92133003	197049
92133200	197232
92133300	186840
92133700	186842
92133703	186842
92133800	186843
92133803	186843
92134000	197027
92134100	186879
92134500	197155
92134800	197214
92134803	197214
92134900	197129
92134903	197129
92135300	186805
92135303	186805
92135400	197166
92135403	197166
92135500	197072
92135503	197072
92135700	186849
92135703	186849
92135800	197168
92135900	186850
92135903	186850
92136400	186824
92136600	186829
92136800	197065
92137000	197038
92137003	197038
92137300	197071
92137500	197033
92137503	197033
92137600	187045
92137603	187045
92137700	197234
92137800	197073
92137900	197175
92137903	197175
92138500	197122
92138600	197015
92139700	186765
92140700	197139
92140703	197139
92140800	197031
92140803	197031
92140900	197145
92141200	186819
92141203	186819
92141300	186863
92141303	186863
92141400	186720

	
TEXTAR	
92141500	197083
92141600	197251
92141603	197251
92141900	197047
92141903	197047
92142000	186876
92142003	186876
92142200	186718
92144100	197112
92144200	197018
92144203	197018
92144700	186878
92145000	197247
92145003	197247
92145100	197130
92145200	197098
92145203	197098
92145300	197132
92145303	197132
92145303	197134
92145700	197044
92145703	197044
92145800	197045
92145803	197045
92145900	197008
92145903	197008
92146000	186295
92146003	186295
92146600	197153
92147100	197096
92147300	197210
92147400	197209
92147600	197156
92148500	197067
92148900	197066
92149100	197143
92149500	197241
92149800	197150
92149803	197150
92150600	197092
92150605	197092
92151800	197249
92151900	197054
92152000	187152
92152200	186582
92153100	186570
92153700	186712
92153700	186713
92153800	186517
92153900	186771
92154000	186768
92154100	186775
92154200	186288
92154203	186288
92154300	186773
92154500	186853
92154900	197158
92155300	197176
92156100	197147



Valeo	
TEXTAR	
92156200	197182
92156300	197113
92156400	197149
92156600	197135
92156900	197188
92157000	197133
92157100	197099
92157200	197248
92157400	197023
92157500	197097
92157600	197105
92157700	186717
92157905	197074
92158400	197070
92159200	197055
92159300	197101
92159600	197203
92160000	197196
92160100	197126
92161300	197029
92161600	197205
92161700	197123
92161900	197111
92162500	197102
92162700	197107
92163100	197128
92163103	197128
92163200	197202
92163203	197202
92163300	197127
92163700	197185
92163800	197183
92163900	197187
92164000	197109
92164100	197110
92164200	197184
92164900	197050
92165400	197190
92165500	197191
92166200	197174
92167000	197116
92167400	197164
92167500	197106
92168000	197070
92168600	197100
92168700	197117
92174100	197017
92175100	186802
92175700	186894
92175700	197003
93019400	186170
93042801	187029
93084400	186614
93089600	187040
93095100	187058
93104600	187147
93104700	187148
93104800	187149
93117600	187061
93123400	186890



Valeo	
TEXTAR	
93123500	186858
93127300	187130
93143200	187141
93143300	197030
93143400	187146
98200 0054	186189
98200 0092 0 1	186226
98200 0093 0 1	186249
98200 0095 0 1	186180
98200 0106 0 1	186245
98200 0114 0 1	186202
98200 0116 0 1	186115
98200 0116 0 1	186116
98200 0119 0 1	186160
98200 0121 0 1	186246
98200 0129 0 1	186139
98200 0135 0 1	186110
98200 0143 0 1	186140
98200 0144 0 1	186128
98200 0149 0 1	186169
98200 0151 0 1	186171
98200 0164 0 1	186142
98200 0172 0 1	186218
98200 0186 0 1	186255
98200 0192 0 1	186117
98200 0193 0 1	186151
98200 0194 0 1	186170
98200 0199 0 1	186171
98200 0199 0 1	186172
98200 0203 0 1	186692
98200 0208 0 1	186186
98200 0209 0 1	186187
98200 0220 0 1	186771
98200 0221 0 1	186143
98200 0229 0 1	186159
98200 0230 0 1	186158
98200 0259 0 1	186113
98200 0260 0 1	186112
98200 0261 0 1	186114
98200 0262 0 1	186273
98200 0263 0 1	186292
98200 0264 0 1	186118
98200 0265 0 1	186119
98200 0269 0 1	186135
98200 0270 0 1	186152
98200 0271 0 1	186205
98200 0273 0 1	186166
98200 0274 0 1	186176
98200 0296 0 1	186188
98200 0298 0 1	186200
98200 0299 0 1	186134
98200 0299 0 1	186197
98200 0310 0 1	186257
98200 0313 0 1	186776
98200 0314 0 1	186256
98200 0318 0 1	186182
98200 0319 0 1	186185
98200 0320 0 1	186184
98200 0324 0 1	186424
98200 0327 0 1	186183



Valeo	
TEXTAR	
98200 0327 0 1	186470
98200 0331 0 1	186210
98200 0336 0 1	186103
98200 0338 0 1	186195
98200 0340 0 1	186150
98200 0342 0 1	186146
98200 0343 0 1	186156
98200 0344 0 1	186206
98200 0345 0 1	186157
98200 0351 0 1	186299
98200 0356 0 1	186479
98200 0360 0 1	186228
98200 0361 0 1	186230
98200 0361 0 1	186803
98200 0362 0 1	186229
98200 0363 0 1	186224
98200 0364 0 1	186214
98200 0366 0 1	186374
98200 0368 0 1	186247
98200 0370 0 1	186770
98200 0372 0 1	186272
98200 0373 0 1	186114
98200 0379 0 1	186168
98200 0380 0 1	186192
98200 0381 0 1	186191
98200 0382 0 1	186190
98200 0385 0 1	186130
98200 0386 0 1	186177
98200 0389 0 1	186178
98200 0391 0 1	186173
98200 0392 0 1	186189
98200 0393 0 1	186625
98200 0404 0 1	186223
98200 0406 0 1	186283
98200 0414 0 1	186155
98200 0415 0 1	186154
98200 0417 0 1	186251
98200 0418 0 1	186288
98200 0420 0 1	186302
98200 0421 0 1	186124
98200 0423 0 1	186125
98200 0428 0 1	187029
98200 0429 0 1	186136
98200 0431 0 1	186194
98200 0432 0 1	186196
98200 0435 0 1	186519
98200 0441 0 1	186102
98200 0442 0 1	186149
98200 0444 0 1	186236
98200 0445 0 1	186613
98200 0463 0 1	186232
98200 0468 0 1	186265
98200 0469 0 1	186290
98200 0474 0 1	197165
98200 0481 0 1	186198
98200 0482 0 1	186199
98200 0485 0 1	186498
98200 0492 0 1	186231
98200 0493 0 1	186213
98200 0494 0 1	186219



Valeo	
TEXTAR	
98200 0495 0 1	186221
98200 0504 0 1	186696
98200 0509 0 1	186162
98200 0510 0 1	186163
98200 0512 0 1	186263
98200 0513 0 1	186264
98200 0515 0 1	186225
98200 0516 0 1	186234
98200 0521 0 1	186148
98200 0529 0 1	186509
98200 0530 0 1	186770
98200 0532 0 1	186147
98200 0535 0 1	186266
98200 0538 0 1	186500
98200 0540 0 1	186131
98200 0542 0 1	186267
98200 0544 0 1	186145
98200 0545 0 1	186144
98200 0549 0 1	186208
98200 0550 0 1	186416
98200 0552 0 1	186297
98200 0554 0 1	186289
98200 0555 0 1	186274
98200 0556 0 1	186275
98200 0557 0 1	186295
98200 0558 0 1	186511
98200 0559 0 1	186314
98200 0560 0 1	186315
98200 0562 0 1	186301
98200 0563 0 1	186485
98200 0564 0 1	186487
98200 0565 0 1	186282
98200 0568 0 1	186465
98200 0570 0 1	186490
98200 0571 0 1	186313
98200 0572 0 1	186517
98200 0573 0 1	186460
98200 0574 0 1	186270
98200 0575 0 1	186294
98200 0576 0 1	197222
98200 0577 0 1	197225
98200 0578 0 1	186268
98200 0579 0 1	186461
98200 0580 0 1	186462
98200 0585 0 1	197218
98200 0593 0 1	186298
98200 0594 0 1	186280
98200 0595 0 1	186281
98200 0596 0 1	186296
98200 0597 0 1	186586
98200 0599 0 1	186621
98200 0602 0 1	186185
98200 0604 0 1	186269
98200 0606 0 1	186291
98200 0607 0 1	186431
98200 0608 0 1	186435
98200 0609 0 1	186438
98200 0610 0 1	186405
98200 0611 0 1	186155
98200 0611 0 1	186406







	
TEXTAR	
98200 0613 0 1	186284
98200 0615 0 1	186449
98200 0616 0 1	186451
98200 0617 0 1	186452
98200 0618 0 1	186446
98200 0619 0 1	186455
98200 0620 0 1	186457
98200 0621 0 1	186458
98200 0626 0 1	186441
98200 0627 0 1	186617
98200 0628 0 1	186440
98200 0632 0 1	186482
98200 0633 0 1	186300
98200 0635 0 1	186277
98200 0636 0 1	186426
98200 0642 0 1	197094
98200 0643 0 1	186427
98200 0644 0 1	186428
98200 0645 0 1	186303
98200 0648 0 1	186304
98200 0649 0 1	186306
98200 0650 0 1	186305
98200 0651 0 1	186307
98200 0655 0 1	186510
98200 0656 0 1	186287
98200 0657 0 1	186530
98200 0660 0 1	186504
98200 0662 0 1	186496
98200 0666 0 1	186453
98200 0667 0 1	186526
98200 0668 0 1	186528
98200 0673 0 1	186276
98200 0677 0 1	186165
98200 0678 0 1	186520
98200 0682 0 1	186807
98200 0685 0 1	186153
98200 0686 0 1	186220
98200 0687 0 1	186567
98200 0688 0 1	186497
98200 0689 0 1	186652
98200 0690 0 1	186505
98200 0695 0 1	186652
98200 0696 0 1	186590
98200 0698 0 1	186299
98200 0703 0 1	186768
98200 0704 0 1	186768
98200 0705 0 1	186285
98200 0706 0 1	186286
98200 0707 0 1	186508
98200 0714 0 1	197227
98200 0716 0 1	186408
98200 0719 0 1	186581
98200 0720 0 1	186523
98200 0721 0 1	186773
98200 0723 0 1	186839
98200 0724 0 1	186559
98200 0725 0 1	186467
98200 0727 0 1	186469
98200 0728 0 1	186521
98200 0730 0 1	186470



	
TEXTAR	
98200 0734 0 1	197033
98200 0736 0 1	187045
98200 0737 0 1	197217
98200 0738 0 1	186418
98200 0738 0 1	197043
98200 0739 0 1	197131
98200 0739 0 1	197228
98200 0740 0 1	186420
98200 0741 0 1	186421
98200 0742 0 1	197236
98200 0743 0 1	186624
98200 0744 0 1	186551
98200 0745 0 1	186552
98200 0746 0 1	186653
98200 0748 0 1	186563
98200 0750 0 1	186697
98200 0751 0 1	186860
98200 0753 0 1	186529
98200 0754 0 1	186401
98200 0755 0 1	186565
98200 0756 0 1	197226
98200 0757 0 1	186566
98200 0758 0 1	186488
98200 0759 0 1	186585
98200 0763 0 1	186547
98200 0764 0 1	186628
98200 0765 0 1	186875
98200 0766 0 1	186568
98200 0768 0 1	186569
98200 0772 0 1	186701
98200 0774 0 1	197169
98200 0775 0 1	186822
98200 0776 0 1	197167
98200 0777 0 1	197166
98200 0778 0 1	186433
98200 0779 0 1	186432
98200 0780 0 1	186286
98200 0781 0 1	186439
98200 0782 0 1	186699
98200 0786 0 1	186532
98200 0787 0 1	186533
98200 0794 0 1	186446
98200 0796 0 1	186665
98200 0797 0 1	186476
98200 0798 0 1	186719
98200 0799 0 1	186564
98200 0800 0 1	186654
98200 0802 0 1	186564
98200 0804 0 1	186637
98200 0805 0 1	186645
98200 0806 0 1	186638
98200 0807 0 1	186579
98200 0808 0 1	186514
98200 0811 0 1	186207
98200 0812 0 1	186775
98200 0814 0 1	186596
98200 0815 0 1	186436
98200 0815 0 1	186439
98200 0816 0 1	186439
98200 0820 0 1	186503



	
TEXTAR	
98200 0821 0 1	186476
98200 0822 0 1	186603
98200 0823 0 1	186604
98200 0824 0 1	197230
98200 0825 0 1	186597
98200 0827 0 1	186640
98200 0828 0 1	186311
98200 0829 0 1	186648
98200 0831 0 1	186644
98200 0832 0 1	186643
98200 0835 0 1	186582
98200 0836 0 1	186583
98200 0837 0 1	186725
98200 0838 0 1	186682
98200 0844 0 1	186614
98200 0873 0 1	186612
98200 0880 0 1	186589
98200 0881 0 1	186278
98200 0882 0 1	186537
98200 0884 0 1	186425
98200 0885 0 1	186773
98200 0891 0 1	186599
98200 0894 0 1	186818
98200 0896 0 1	187040
98200 0898 0 1	197059
98200 0900 0 1	186753
98200 0901 0 1	186620
98200 0902 0 1	186681
98200 0903 0 1	186571
98200 0904 0 1	186714
98200 0908 0 1	186294
98200 0909 0 1	186576
98200 0910 0 1	186577
98200 0912 0 1	186562
98200 0913 0 1	186573
98200 0914 0 1	197223
98200 0915 0 1	197004
98200 0916 0 1	186685
98200 0917 0 1	186591
98200 0918 0 1	186592
98200 0919 0 1	186684
98200 0920 0 1	186594
98200 0921 0 1	186593
98200 0923 0 1	197056
98200 0926 0 1	186495
98200 0928 0 1	186598
98200 0931 0 1	186691
98200 0932 0 1	186827
98200 0933 0 1	186704
98200 0935 0 1	186686
98200 0936 0 1	197224
98200 0937 0 1	186572
98200 0938 0 1	186442
98200 0939 0 1	186443
98200 0943 0 1	197148
98200 0945 0 1	186611
98200 0946 0 1	186503
98200 0950 0 1	186664
98200 0951 0 1	187058
98200 0952 0 1	186642

	
TEXTAR	
98200 0962 0 1	186560
98200 0964 0 1	186605
98200 0965 0 1	186846
98200 0968 0 1	197063
98200 0969 0 1	186705
98200 0971 0 1	197231
98200 0972 0 1	186815
98200 0973 0 1	186861
98200 0975 0 1	197229
98200 0976 0 1	186859
98200 0977 0 1	186688
98200 0979 0 1	186874
98200 0981 0 1	186801
98200 0982 0 1	186729
98200 0985 0 1	197246
98200 0986 0 1	197088
98200 0996 0 1	186783
98200 0997 0 1	186760
98200 0998 0 1	186488
98200 1002 0 1	197009
98200 1003 0 1	186742
98200 1004 0 1	186707
98200 1005 0 1	186789
98200 1006 0 1	186741
98200 1007 0 1	186841
98200 1009 0 1	186208
98200 1010 0 1	186778
98200 1026 0 1	186743
98200 1028 0 1	186777
98200 1029 0 1	186687
98200 1030 0 1	197161
98200 1031 0 1	186810
98200 1032 0 1	186811
98200 1034 0 1	186814
98200 1035 0 1	197016
98200 1036 0 1	186587
98200 1037 0 1	197108
98200 1038 0 1	186710
98200 1039 0 1	186648
98200 1041 0 1	197124
98200 1044 0 1	197207
98200 1046 0 1	187147
98200 1047 0 1	187148
98200 1048 0 1	187149
98200 1052 0 1	197033
98200 1058 0 1	197011
98200 1059 0 1	186864
98200 1061 0 1	186758
98200 1062 0 1	186807
98200 1063 0 1	186856
98200 1064 0 1	186788
98200 1065 0 1	186603
98200 1066 0 1	197230
98200 1067 0 1	197198
98200 1068 0 1	186888
98200 1069 0 1	186731
98200 1070 0 1	186883
98200 1071 0 1	186884
98200 1072 0 1	186808
98200 1073 0 1	186808

 	
TEXTAR	
98200 1074 0 1	186809
98200 1075 0 1	186762
98200 1076 0 1	186812
98200 1077 0 1	186745
98200 1078 0 1	197220
98200 1079 0 1	186736
98200 1082 0 1	197233
98200 1083 0 1	197069
98200 1084 0 1	197022
98200 1087 0 1	186730
98200 1092 0 1	186781
98200 1093 0 1	186821
98200 1094 0 1	186728
98200 1096 0 1	186750
98200 1097 0 1	186834
98200 1098 0 1	197239
98200 1099 0 1	186800
98200 1100 0 1	186709
98200 1101 0 1	186780
98200 1103 0 1	186866
98200 1103 0 1	197146
98200 1108 0 1	186784
98200 1109 0 1	197244
98200 1110 0 1	186791
98200 1111 0 1	186759
98200 1112 0 1	186740
98200 1113 0 1	186757
98200 1114 0 1	186790
98200 1115 0 1	186695
98200 1116 0 1	186693
98200 1117 0 1	186694
98200 1118 0 1	186702
98200 1119 0 1	186703
98200 1120 0 1	186785
98200 1123 0 1	197240
98200 1127 0 1	186647
98200 1133 0 1	197163
98200 1136 0 1	197238
98200 1138 0 1	186600
98200 1139 0 1	186655
98200 1147 0 1	186797
98200 1149 0 1	197206
98200 1150 0 1	197219
98200 1151 0 1	186751
98200 1152 0 1	186751
98200 1154 0 1	197035
98200 1155 0 1	186865
98200 1156 0 1	186766
98200 1157 0 1	186871
98200 1158 0 1	197137
98200 1159 0 1	186868
98200 1160 0 1	186712
98200 1162 0 1	186708
98200 1166 0 1	186418
98200 1168 0 1	197138
98200 1169 0 1	186454
98200 1171 0 1	197120
98200 1173 0 1	197032
98200 1176 0 1	187061
98200 1179 0 1	197157

 	
TEXTAR	
98200 1180 0 1	186744
98200 1182 0 1	186724
98200 1183 0 1	186880
98200 1184 0 1	186882
98200 1185 0 1	186854
98200 1186 0 1	186805
98200 1187 0 1	186881
98200 1189 0 1	186715
98200 1190 0 1	197221
98200 1191 0 1	186718
98200 1192 0 1	186764
98200 1193 0 1	186796
98200 1194 0 1	186804
98200 1195 0 1	186893
98200 1195 0 1	186894
98200 1196 0 1	197136
98200 1197 0 1	197252
98200 1198 0 1	197200
98200 1205 0 1	197242
98200 1206 0 1	197197
98200 1207 0 1	186754
98200 1208 0 1	186755
98200 1209 0 1	186857
98200 1210 0 1	197222
98200 1211 0 1	186833
98200 1212 0 1	186756
98200 1213 0 1	186885
98200 1214 0 1	186886
98200 1215 0 1	197087
98200 1219 0 1	197243
98200 1220 0 1	197090
98200 1223 0 1	186582
98200 1225 0 1	186732
98200 1226 0 1	197193
98200 1227 0 1	197084
98200 1234 0 1	186890
98200 1235 0 1	186858
98200 1244 0 1	186783
98200 1245 0 1	197060
98200 1246 0 1	186869
98200 1247 0 1	186855
98200 1248 0 1	186748
98200 1249 0 1	197013
98200 1250 0 1	197144
98200 1251 0 1	197104
98200 1253 0 1	197103
98200 1254 0 1	197014
98200 1255 0 1	197245
98200 1256 0 1	186851
98200 1258 0 1	186877
98200 1260 0 1	197171
98200 1261 0 1	186848
98200 1262 0 1	186847
98200 1263 0 1	197019
98200 1266 0 1	197057
98200 1273 0 1	187130
98200 1283 0 1	197086
98200 1285 0 1	197173
98200 1288 0 1	186813
98200 1293 0 1	186869

 	
TEXTAR	
98200 1294 0 1	186746
98200 1295 0 1	197046
98200 1296 0 1	186747
98200 1297 0 1	197062
98200 1302 0 1	197020
98200 1303 0 1	186872
98200 1305 0 1	197021
98200 1308 0 1	186823
98200 1310 0 1	197172
98200 1312 0 1	197064
98200 1315 0 1	186774
98200 1316 0 1	186712
98200 1316 0 1	186713
98200 1318 0 1	186798
98200 1319 0 1	186799
98200 1320 0 1	197091
98200 1321 0 1	197036
98200 1322 0 1	197052
98200 1323 0 1	197199
98200 1324 0 1	197142
98200 1325 0 1	197125
98200 1326 0 1	197140
98200 1327 0 1	186816
98200 1328 0 1	186817
98200 1330 0 1	197049
98200 1332 0 1	197232
98200 1333 0 1	186840
98200 1337 0 1	186842
98200 1338 0 1	186843
98200 1340 0 1	197027
98200 1341 0 1	186879
98200 1345 0 1	197155
98200 1348 0 1	197214
98200 1349 0 1	197129
98200 1353 0 1	186805
98200 1354 0 1	197166
98200 1355 0 1	197072
98200 1357 0 1	186849
98200 1358 0 1	197168
98200 1359 0 1	186850
98200 1364 0 1	186824
98200 1366 0 1	186829
98200 1368 0 1	197065
98200 1370 0 1	197038
98200 1373 0 1	197071
98200 1375 0 1	197033
98200 1376 0 1	187045
98200 1377 0 1	197234
98200 1378 0 1	197073
98200 1379 0 1	197175
98200 1385 0 1	197122
98200 1386 0 1	197015
98200 1397 0 1	186765
98200 1408 0 1	197031
98200 1409 0 1	197145
98200 1412 0 1	186819
98200 1413 0 1	186863
98200 1414 0 1	186720
98200 1415 0 1	197083
98200 1416 0 1	197251

 	
TEXTAR	
98200 1419 0 1	197047
98200 1420 0 1	186876
98200 1422 0 1	186718
98200 1432 0 1	187141
98200 1433 0 1	197030
98200 1434 0 1	187146
98200 1441 0 1	197112
98200 1442 0 1	197018
98200 1447 0 1	186878
98200 1450 0 1	197247
98200 1451 0 1	197130
98200 1452 0 1	197098
98200 1453 0 1	197132
98200 1453 0 1	197134
98200 1457 0 1	197044
98200 1458 0 1	197045
98200 1459 0 1	197008
98200 1460 0 1	186295
98200 1466 0 1	197153
98200 1471 0 1	197096
98200 1473 0 1	197210
98200 1474 0 1	197209
98200 1476 0 1	197156
98200 1485 0 1	197067
98200 1489 0 1	197066
98200 1491 0 1	197143
98200 1495 0 1	197241
98200 1498 0 1	197150
98200 1506 0 1	197092
98200 1518 0 1	197249
98200 1519 0 1	197054
98200 1520 0 1	187152
98200 1522 0 1	186582
98200 1531 0 1	186570
98200 1537 0 1	186712
98200 1537 0 1	186713
98200 1538 0 1	186517
98200 1539 0 1	186771
98200 1540 0 1	186768
98200 1541 0 1	186775
98200 1542 0 1	186288
98200 1543 0 1	186773
98200 1545 0 1	186853
98200 1549 0 1	197158
98200 1561 0 1	197147
98200 1562 0 1	197182
98200 1563 0 1	197113
98200 1566 0 1	197135
98200 1569 0 1	197188
98200 1570 0 1	197133
98200 1571 0 1	197099
98200 1572 0 1	197248
98200 1574 0 1	197023
98200 1575 0 1	197097
98200 1576 0 1	197105
98200 1577 0 1	186717
98200 1579 0 1	197074
98200 1584 0 1	197070
98200 1592 0 1	197055
98200 1593 0 1	197101







TEXTAR	
98200 1596 0 1	197203
98200 1600 0 1	197196
98200 1601 0 1	197126
98200 1613 0 1	197029
98200 1616 0 1	197205
98200 1617 0 1	197123
98200 1619 0 1	197111
98200 1625 0 1	197102
98200 1627 0 1	197107
98200 1631 0 1	197128
98200 1632 0 1	197202
98200 1633 0 1	197127
98200 1637 0 1	197185
98200 1638 0 1	197183
98200 1639 0 1	197187
98200 1640 0 1	197109
98200 1641 0 1	197110
98200 1642 0 1	197184
98200 1649 0 1	197050
98200 1654 0 1	197190
98200 1655 0 1	197191
98200 1662 0 1	197174
98200 1670 0 1	197116
98200 1674 0 1	197164
98200 1675 0 1	197106
98200 1680 0 1	197070
98200 1686 0 1	197100
98200 1741 0 1	197017
98200 1751 0 1	186802
98200 1757 0 1	186894
98200 1757 0 1	197003
TRW	
DB4220	186694
DF1001	186142
DF1002	186218
DF1005	186226
DF1010	186211
DF1012	186210
DF1013	186230
DF1013BP	186230
DF1015	186228
DF1016	186229
DF1016BP	186229
DF1017	186214
DF1018	186213
DF1019	186221
DF1020	186224
DF1021	186220
DF1022	186223
DF1023	186231
DF1025	186276
DF1026	186567
DF1027	186596
DF1029	186306
DF1029	186307
DF1030	186306
DF1031	186214
DF1031	186225
DF1032	186304



TRW	
DF1032	186655
DF1032BP	186304
DF1032BP	186655
DF1033	186600
DF1036	186305
DF1104	186137
DF1107	186128
DF1109	186140
DF1113	186143
DF1114	186205
DF1115	186139
DF1117	186135
DF1118	186206
DF1119	186136
DF1120	186130
DF1122	186586
DF1123	186296
DF1203	186202
DF1209	186207
DF1210	186196
DF1210	186203
DF1215	186197
DF1216	186134
DF1217	186200
DF1218	186195
DF1220	186198
DF1220BP	186198
DF1221	186194
DF1222	186145
DF1223	186131
DF1224	186196
DF1225	186303
DF1300	186240
DF1400	186299
DF1406	186487
DF1409	186510
DF1409	186511
DF1416	186664
DF1418	186547
DF1422	186665
DF1423	186511
DF1428	186617
DF1430	197167
DF1431	197166
DF1435	186621
DF1436	186433
DF1439	186508
DF1443	186648
DF1516	186245
DF1517	186246
DF1517BP	186246
DF1518	186249
DF1521	186113
DF1524S	186771
DF1526	186114
DF1529	186288
DF1529BP	186288
DF1530	186112
DF1530BP	186112
DF1531	186273



TRW	
DF1532	186251
DF1532BP	186251
DF1533	186247
DF1533BP	186247
DF1534	186770
DF1536	186292
DF1537	186274
DF1537BP	186274
DF1538	186275
DF1539	186295
DF1540	186517
DF1540BP	186517
DF1541	186520
DF1544	186770
DF1553	186115
DF1560	186116
DF1561	186117
DF1569	186118
DF1573	186180
DF1581	186182
DF1583	186184
DF1584	186176
DF1585	186185
DF1593	186314
DF1594	186461
DF1595	186462
DF1596	186315
DF1598	186460
DF1599	186692
DF1607	186186
DF1608	186187
DF1608BP	186187
DF1609	186188
DF1612	186192
DF1613	186190
DF1614	186191
DF1619	197004
DF1620	186159
DF1621	186302
DF1622	186278
DF1624	186282
DF1625	186189
DF1627	186500
DF1630	186160
DF1642	186169
DF1647	186165
DF1648	186165
DF1649	186159
DF1651	186424
DF1652	186158
DF1653	186168
DF1654	186425
DF1655	186166
DF1658	186162
DF1662	186530
DF1669	186498
DF1674	186256
DF1679	186257
DF1683	186776
DF1683S	186776

TRW	
DF1686	186254
DF1687	186255
DF1688	186264
DF1689	186263
DF1694	186625
DF1696	186311
DF1697	186289
DF1708	186110
DF1716	186103
DF1721	186151
DF1722	186501
DF1723	186171
DF1725	186172
DF1726S	186170
DF1727	186152
DF1734	186102
DF1736	186156
DF1739	186290
DF1740	186155
DF1740	186406
DF1742	186149
DF1743	186148
DF1744	186147
DF1745	186155
DF1745	186406
DF1747	186154
DF1747BP	186154
DF1748	186173
DF1749	186265
DF1757	186297
DF1758S	186614
DF1763S	187029
DF1769	186405
DF1788	186150
DF1790	186146
DF1790	186147
DF1791	186157
DF1802	186310
DF1803	186284
DF1807	186285
DF1810	186232
DF1811	186234
DF1812	186235
DF1828	186236
DF1829	186613
DF1833	186283
DF1856	186495
DF1925	197114
DF1927	186696
DF1953	186374
DF1956	186234
DF1958	186441
DF1963	186431
DF1967	186479
DF2001	186607
DF2002	186611
DF2008S	186612
DF2011	186219
DF2012	186287
DF2024	186436



 	
TRW	
DF2024	186439
DF2550	186119
DF2550BP	186119
DF2555	186124
DF2557	186125
DF2563	186183
DF2564	186258
DF2566	186266
DF2571	186455
DF2573	186235
DF2575	186440
DF2576	186482
DF2579	186178
DF2579S	186178
DF2580	186199
DF2581	186196
DF2581	186416
DF2582	186204
DF2583	186144
DF2586	186208
DF2587	186770
DF2588	186504
DF2590	186301
DF2591	186485
DF2592	186487
DF2596	186465
DF2597	186269
DF2598	186268
DF2599	186267
DF2601	186291
DF2606	186446
DF2607	186446
DF2609	197165
DF2611	186300
DF2614	186490
DF2619	186313
DF2622	186277
DF2623	186426
DF2626	186272
DF2631	186519
DF2639	186428
DF2645	197225
DF2646	186435
DF2647	186428
DF2650	186270
DF2651	186294
DF2652	197222
DF2652	186271
DF2652BP	197222
DF2653	186281
DF2654	186298
DF2655	186807
DF2656	186280
DF2657	186432
DF2657	186435
DF2658	186701
DF2660	186528
DF2662	186454
DF2665	197218
DF2667	186114



 	
TRW	
DF2668	186453
DF2669	186437
DF2671	186526
DF2674	186640
DF2678	186570
DF2678	186730
DF2679	186439
DF2681	186496
DF2682	186427
DF2683	197169
DF2684	197148
DF2686	186153
DF2687	197227
DF2688	186497
DF2702	186451
DF2703	186452
DF2704	186457
DF2705	186458
DF2706	186768
DF2706	186775
DF2708S	186775
DF2709S	186768
DF2715	186421
DF2716	186420
DF2717	186286
DF2719	186449
DF2721	186418
DF2722	197228
DF2723	186638
DF2726	186299
DF2728	197217
DF2729S	186775
DF2730	186408
DF2734	186598
DF2742	186822
DF2751	186401
DF2752	186529
DF2753	186163
DF2753BP	186163
DF2754	186589
DF2755	186581
DF2757	186470
DF2758	186521
DF2759	186643
DF2760	186442
DF2761	186420
DF2761	186443
DF2765	186681
DF2766	197224
DF2767	186559
DF2768	186568
DF2769	186697
DF2771	186773
DF2772	186565
DF2773	186566
DF2775	186714
DF2776	197236
DF2777	186624
DF2778S	197226
DF2779	186467



 	
TRW	
DF2780	186523
DF2781	186579
DF2782	186532
DF2783	186860
DF2784	186647
DF2784BP	186647
DF2785	186537
DF2786	186278
DF2787	187040
DF2788S	187058
DF2790	186774
DF2791S	186642
DF2792	186620
DF2794	186552
DF2795	186585
DF2796	186533
DF2797	186551
DF2798	186648
DF2799	186569
DF2803	186603
DF2803BP	186603
DF2804	186604
DF2804BP	186604
DF2805	186597
DF2805	197442
DF2805BP	186597
DF2806	186582
DF2808	186599
DF2809	186314
DF2809	186682
DF2810	186725
DF2813	186469
DF2814	186177
DF2815	186598
DF3018	186564
DF3021	186438
DF3027	186645
DF3028	186514
DF3031	186653
DF3032	186505
DF3035	186637
DF3037	186509
DF3037	186696
DF3049	186488
DF3084	186439
DF3092	186503
DF3093	186652
DF3095	186476
DF3109	186699
DF3112	186563
DF3115	186652
DF3118	186719
DF3119	186572
DF3165	186628
DF4000	186564
DF4004	186435
DF4006	186654
DF4007	186875
DF4018	186577
DF4019	186576



 	
TRW	
DF4022	186818
DF4025	186605
DF4026	186773
DF4027	197230
DF4028	186778
DF4029	197223
DF4030	186685
DF4032	186648
DF4034	186562
DF4035	186573
DF4036	186560
DF4037	186571
DF4038	186294
DF4039	197032
DF4041	197004
DF4041	197392
DF4042	186592
DF4042BP	186592
DF4043	186591
DF4045	186583
DF4046	186705
DF4048	186684
DF4049	186488
DF4049	197433
DF4050	186594
DF4051	186593
DF4052	197011
DF4053S	186741
DF4054	186707
DF4054BP	186707
DF4055	186815
DF4059	197229
DF4062	186729
DF4064	197246
DF4065	197088
DF4065	197427
DF4066	186841
DF4069	186861
DF4070	197108
DF4075	186691
DF4081	186648
DF4082	186647
DF4087	197033
DF4087S	197033
DF4088S	187045
DF4089	197059
DF4089S	197059
DF4093	186686
DF4100	186876
DF4103	186687
DF4108	186781
DF4109	186600
DF4110	186655
DF4111	186688
DF4112	186587
DF4113	186874
DF4115	186704
DF4117	186827
DF4119	186810
DF4120	197161



	
TRW	
DF4121	197063
DF4122	197120
DF4122	197441
DF4123	186742
DF4126	197124
DF4130	186785
DF4131	186784
DF4132	186777
DF4133	197122
DF4135	186859
DF4141	197220
DF4142	186702
DF4147	186750
DF4151	186780
DF4152	186866
DF4152	197146
DF4152	197420
DF4153	186637
DF4155	197064
DF4156	197162
DF4158	186823
DF4159	186813
DF4160	197170
DF4161	186765
DF4163	186766
DF4163	197418
DF4164	186600
DF4165	186759
DF4166	186731
DF4168	197195
DF4169	186821
DF4170	197238
DF4172	197207
DF4173	197208
DF4179	186715
DF4180	186864
DF4182	197194
DF4182S	197194
DF4183	186693
DF4183BP	186693
DF4184	186695
DF4184BP	186695
DF4185	186694
DF4186	186807
DF4187	186808
DF4187S	186808
DF4189	186809
DF4190	186734
DF4191	186432
DF4194S	197062
DF4195	186753
DF4197	186762
DF4198	186812
DF4200	186791
DF4202	186814
DF4203	197016
DF4204	197168
DF4205	186788
DF4208	186801
DF4209	197198

	
TRW	
DF4209S	197198
DF4211	186856
DF4211	197438
DF4212	186883
DF4213	186839
DF4215	186736
DF4216	186709
DF4217	186710
DF4218	186834
DF4218	197431
DF4220	197137
DF4221	186871
DF4222	186811
DF4222S	186811
DF4223	186760
DF4224	197060
DF4225	186757
DF4226	197231
DF4227	186718
DF4227BS	186718
DF4228	186894
DF4229	197221
DF4229S	197221
DF4230	197240
DF4231	186804
DF4231S	186804
DF4232	197086
DF4233	197056
DF4234	186740
DF4235	186603
DF4236	186790
DF4237	186703
DF4237S	186703
DF4238	186789
DF4240	186845
DF4245	186708
DF4246	197244
DF4246BP	197244
DF4248	186884
DF4248S	186884
DF4249S	186868
DF4253	186888
DF4255	186655
DF4256	186724
DF4257	197219
DF4258S	197198
DF4259S	186717
DF4260S	197079
DF4261	186751
DF4262S	186758
DF4262S	197404
DF4263	197035
DF4265	186880
DF4265S	186880
DF4266	186854
DF4267	186764
DF4270	186865
DF4271	186833
DF4271	197429
DF4272	186720

	
TRW	
DF4272BS	186720
DF4273	186713
DF4273BS	186713
DF4273S	186713
DF4274	186796
DF4275S	186712
DF4276	186857
DF4277	186748
DF4278	197020
DF4279	197009
DF4280S	186804
DF4281	197121
DF4281	197290
DF4283	197302
DF4284	186882
DF4286	197422
DF4287	197027
DF4288	197144
DF4291	197172
DF4293	186881
DF4294	186754
DF4294	197394
DF4295	186755
DF4295	197397
DF4300	186258
DF4301	186311
DF4306S	197087
DF4308S	186756
DF4309S	186885
DF4310S	186800
DF4312	186886
DF4313	186863
DF4314	186819
DF4315	197163
DF4316	186728
DF4317	197400
DF4318	186869
DF4321	186774
DF4322	186783
DF4323	197239
DF4328	197264
DF4331	187061
DF4335	186847
DF4335	197423
DF4336	197022
DF4337	197050
DF4339	197057
DF4344	186855
DF4346	197233
DF4350S	197197
DF4351	186747
DF4352	197089
DF4356	186858
DF4358	197199
DF4358S	197199
DF4358s	197388
DF4359	186732
DF4360	197084
DF4361	197193
DF4362	186746

	
TRW	
DF4363	197232
DF4364	186764
DF4367	186877
DF4369	186813
DF4371	197241
DF4372	186842
DF4372	197430
DF4373	186890
DF4375	186744
DF4376	186805
DF4377	186745
DF4379	186848
DF4381	186802
DF4382	186803
DF4383	186798
DF4384	186872
DF4386	197245
DF4392S	197083
DF4393	186799
DF4394	197209
DF4395	197210
DF4401	197014
DF4402	197103
DF4404	197019
DF4407	186844
DF4407	197013
DF4409	186878
DF4412	197166
DF4413	186893
DF4413BS	186893
DF4414	186853
DF4416	197072
DF4417	186849
DF4419	197021
DF4422	186843
DF4424	186863
DF4425	186843
DF4426	186869
DF4429	197153
DF4432	197145
DF4433	197046
DF4434	197125
DF4434	197426
DF4440	186797
DF4441	197112
DF4442	186851
DF4442	197294
DF4443	186824
DF4445	197070
DF4447	186816
DF4449	186817
DF4450	197049
DF4452	186840
DF4452BS	186840
DF4453	197036
DF4454	197091
DF4457	197214
DF4458	197096
DF4459	197234
DF4460	197073

 →	Valeo
TRW	
DF4461	197175
DF4461S	197175
DF4463	197129
DF4464	197242
DF4464S	197384
DF4465	186819
DF4469	197047
DF4470	197052
DF4471	197092
DF4471S	197092
DF4474	197129
DF4476	197247
DF4477	197098
DF4478	197130
DF4479	197132
DF4480	186850
DF4486	197267
DF4487	197090
DF4494	197071
DF4496	197173
DF4505	186743
DF4508	186730
DF4531	186652
DF4534	197016
DF4542	186728
DF4547	186743
DF4548	186564
DF4550	197069
DF4554	197252
DF4558	197031
DF4561	197018
DF4573	186876
DF4690	186720
DF4690BS	186720
DF4691	186786
DF4692	197044
DF4693	197138
DF4695	197142
DF4695S	197389
DF4698	186825
DF4704	197214
DF4710	186829
DF4713	197104
DF4714	197015
DF4718	197243
DF4737	197045
DF4750	197105
DF4754	197139
DF4756	197038
DF4796	197044
DF4803	197029
DF7162	197393
DF7168	197436
DF7183	197412
DF7218	197406
DF7291	186829
DF7368	197399
DF7381	197440
DF7422	197387
DF7464	197390

 →	Valeo
TRW	
DF7489	197432

 →	Valeo
---	--------------

 →	Valeo
---	--------------

我们尽一切努力确保本产品目录中所包含的信息在印刷时是正确的，但对于这些信息的准确性我们不提供陈述和担保，并且法雷奥销售公司不承担任何由于不准确信息所造成的赔偿责任。

法雷奥销售公司有权更改规格和/或产品的最终构造，恕不另行通知。

本目录中提到的产品件号不一定在所有国家适用。

法雷奥销售公司只接受遵守法雷奥销售公司条款和条件的产品订单。

照片和图纸对法雷奥销售公司不具有约束力。本目录的版权属于法雷奥销售公司。未经法雷奥销售公司事先授权，不得对本出版物的任何部分以任何方式进行复制。

Every effort has been made to ensure that the information contained in this catalogue is correct at the time of printing, but no warranty or representation is given or made as to the accuracy of such information and Valeo Service does not accept any liability whatsoever for any inaccuracies.

Valeo Service reserves the right to alter specifications and/or the final construction of products without notice.

Product references referred to in this catalogue may not be available in all countries.

All orders for products are only accepted subject to the terms and conditions of Valeo Service.

Photographs and drawings are not binding on Valeo Service. The copyright in this publication belongs to Valeo Service exclusively. No part of this publication may be reproduced by any means without the prior authorisation of Valeo Service.

La aplicación de los productos sobre vehículos y las especificaciones de los productos que figuran en nuestros catálogos se refieren a la situación del parque de automóviles en la fecha de puesta en circulación de los productos.

Valeo Service no asume ninguna responsabilidad en caso de modificación, sustitución o supresión de dichas aplicaciones y/o especificaciones que pudieran producirse por iniciativa de los fabricantes de automóviles.

Las características técnicas de nuestros productos son susceptibles de evolucionar en cualquier momento para incorporar las mejoras técnicas y tecnológicas que se desarrollan.

Las referencias de productos mencionadas en este catalogo puede que no estén disponibles en todos los países.

Los pedidos se regiran por las condiciones generales de venta de Valeo Service.

Las fotografías y dibujos que aparecen en nuestros catálogos son meramente indicativas, por lo que no siempre coinciden exactamente con la apariencia externa de nuestros productos. Se prohíbe la reproducción de todo o parte de esta publicación sin la autorización expresa y escrita de Valeo Service.

As prescrições e recomendações relativas ao uso ou utilidade dos produtos constantes de nossos catálogos levam em consideração o estado do parque automotivo à época do lançamento desses produtos.

A Valeo Service não será responsável por quaisquer modificações, substituições ou supressões incidentes sobre as prescrições e recomendações relativas ao uso ou utilidade de nossos produtos, que sejam decorrentes de ações dos construtores de veículos.

As características técnicas de nossos produtos são suscetíveis de alteração a qualquer momento para que sejam incorporadas melhorias técnicas e/ou tecnológicas.

Certas referências podem não estar disponíveis em todos os países.

Os pedidos feitos pelos clientes são regidos pelas condições gerais de venda da Valeo Service.

Fotos e desenhos não contratuais. A reprodução do todo ou de parte desta publicação é proibida sem a autorização expressa e por escrito da Valeo Service.

Назначение и рекомендации по эксплуатации продукции, содержащиеся в наших каталогах, указываются с учетом состояния автомобильного парка на день ее появления.

Компания «Valeo Service» не несет ответственности в случае внесения изменений в рекомендации по эксплуатации продукции или их устранения, произошедших, в частности, по инициативе производителей автомобилей.

Технические характеристики нашей продукции могут претерпевать изменения в любой момент, с учетом совершенствования технических и технологических процессов.

Некоторые виды продукции могут не иметься в наличии в отдельных странах.

Заказы осуществляются согласно общим правилам торговли, применяемым в компании «Valeo Service».

Фотографии и изображения продукции могут не в полной мере соответствовать оригиналам. Воспроизведение всей или части настоящей публикации запрещено без специального письменного согласия компании «Valeo Service».

Kataloglarımızda yer alan ürünlerin kullanım ve tanımları, otomobil parkının yayın tarihindeki durumuna göredir.

Valeo Otomotiv Dağıtım AS, özellikle araç üreticilerinin inisiyatifli sonucu yapılan değişiklik, ikame veya kaldırılmalardan sorumlu tutulamaz.

Ürünlerimizin teknik özellikleri, teknik ve teknolojik gelişmelere paralel olarak geliştirilebilir.

Bazı referanslar bazı ülkelerde bulunmayabilir.

Siparişler, Valeo Otomotiv Dağıtım AS'un genel satış koşullarına uygun olarak ödenir.

Fotoğraf ve resimler akdi değildir. İşbu yayının Valeo Otomotiv Dağıtım AS'un önceden verilmiş yazılı izni olmaksızın kısmen veya tamamen çoğaltılması yasaktır.

EUROPE

FRANCE

VALEO SERVICE FRANCE
70, RUE PLEYEL
93285 SAINT-DENIS CEDEX - FRANCE
TEL : (+33) 1 49 45 32 32
FAX : (+33) 1 49 45 37 36
S.A.S. au capital de 12 900 000 e
RCS Bobigny B 306 486 408

SPAIN, PORTUGAL

VALEO SERVICE ESPAÑA, S.A.
CALLE RIO ALMANZORA, N°5
AREA EMPRESARIAL ANDALUCIA C.L.A.
28906 GETAFE (MADRID) - ESPAÑA
TEL : (+34) 91 495 85 00
FAX : (+34) 91 495 86 99
TEL. ATENCIÓN TÉCNICA :
902 011 799
TEL. ATENCIÓN AL CLIENTE :
900 122 657
Valeo Service España Sociedad Anónima
inscrita en el Registro Mercantil de Madrid,
Tomo 972 - Libro 941 de la sección 8a ,
Folio 25 - Hoja 65435 -Inscripción 1a NIF. A28772978

ITALY

VALEO SERVICE ITALIA SPA
VIA ASTI 89
10026 SANTENA (TO) - ITALIA
TEL : (+39) 011 94 95 1
FAX : (+39) 011 94 95 280
TEL. LINEA TECNICA : 800 805 046
N. iscrizione al Tribunale di Torino 2009/88 reg. soc.
C.C.I.A.A. 715107 - Capitale sociale e 2.600.000

UNITED KINGDOM

VALEO SERVICE UK LTD
HEMING ROAD - WASHFORD
REDDITCH - WORCS B98 0DZ - ENGLAND
TEL : (+44) 1527 838 300
FAX : (+44) 1527 523 732
Registration Number : 956685

GERMANY

VALEO SERVICE DEUTSCHLAND GMBH
BRANDENBURGER STRASSE 46
40880 RATINGEN - DEUTSCHLAND
TEL : (+49) 21 02 865 0
FAX : (+49) 21 02 865 142
Handelsregister Ratingen - HRB 3340

BENELUX

VALEO SERVICE BENELUX B.V.
HEIBLOEMWEG 1
5704 BS HELMOND - THE NETHERLANDS
TEL. BELGIUM (NL) : (+32) 2 366 99 17
TEL. BELGIUM (FR) : (+32) 2 355 14 46
TEL. NETHERLANDS : (+31) 492 580 894
FAX BELGIUM : (+32) 2 366 04 47
FAX NETHERLANDS : (+31) 492 580 828
K.v.k. Eindhoven 33113859

TURKEY

VALEO OTOMOTIV DAĞITIM A.Ş.
AYDINEVLER SANAYI CADDESİ
CENTRUM İS MERKEZİ N°3
KAT: 3, DAİRE N°302-303 KÜÇÜKYALI - MALTEPE
34854 İSTANBUL - TURKEY
TEL : (+90) 216 518 75 75
FAX : (+90) 216 519 93 14

POLAND, LITHUANIA, LATVIA, ESTONIA, MOLDAVIA, BELARUS, UKRAINE

VALEO SERVICE EASTERN EUROPE SP. ZO.O.
UL. POSTĘPU 13
02-676 WARSZAWA - POLSKA
TEL : (+48) 22 543 43 00
FAX : (+48) 22 543 43 05
SP. Z O.O. O KAPITALE 4,637.000 PLN
KRS 56793
Sąd Rejonowy dla m.St. Warszawy

RUSSIA

VALEO SERVICE CO LTD
RUSSIA, 105055, MOSCOW
RADIO STR, 24 - BUILD.2
TEL : (+7) 495 981-06-96
FAX : (+7) 495 787-59-92

SWITZERLAND, AUSTRIA, SWEDEN, FINLAND, NORWAY, DENMARK, ICELAND, GREECE, EASTERN EUROPE, OTHERS

VALEO SERVICE EXPORT
70, RUE PLEYEL
93285 SAINT-DENIS CEDEX - FRANCE
TEL : (+33) 01 49 45 32 32
FAX : (+33) 01 49 45 36 59

LIAISON OFFICE IN AUSTRIA
MÜHLGASSE 7
2380 PERCHTOLDSDORF - AUSTRIA
TEL : (+43) 1 480 42 46
FAX : (+43) 1 480 42 34

LIAISON OFFICE IN CZECH REPUBLIC
DEDINSKA 29
16100 PRAGUE 6 - CZECH REPUBLIC
TEL : (+420) 220 102 277
FAX : (+420) 220 102 278

LIAISON OFFICE IN HUNGARY
KOSSUTH UTCA 33
8581 BAKONYJAKO- HUNGARY
TEL : (+36) 89 350 156
FAX : (+36) 89 350 156

LIAISON OFFICE IN ROMANIA
STR.REGINA ELISABETA NR.15-19
BL.2, SC.2, EJ.3, AP.13
BUCURESTI - ROMANIA
TEL : (+40) (0)7 54 07 07 65

LIAISON OFFICE IN GREECE
18, KALAMAKIOU AVENUE
174 55 ALIMOS - GREECE
TEL : (+30) 210 45 27 447
FAX : (+30) 210 45 27 449

AMERICAS

LATIN AMERICA

valeo cibie service ltda
Rua sadae takagi, 2000
bairro Cooperativa
09852-070 - São Bernardo do Campo
São Paulo - Brasil
Tel : (+55) 11 43 93 33 54
Fax : (+55) 11 43 93 33 55
C.N.P.J. : 57.010.662/0008-36
Inscrição Estadual : 635.331.124.114

ASIA, AUSTRALIA NEW-ZEALAND

VALEO SERVICE EXPORT
70, RUE PLEYEL
93285 SAINT-DENIS CEDEX - FRANCE
TEL : (+33) 01 49 45 32 32
FAX : (+33) 01 49 45 36 59

法雷奥汽车零部件贸易(上海)有限公司
上海市徐汇区漕河泾开发区桂平路391号
新漕河泾国际商务中心B座33楼
电话 : (+86) 21 51752618
传真 : (+86) 21 51752619

AFRICA, MIDDLE EAST, DOM-TOM

VALEO SERVICE EXPORT
70, RUE PLEYEL
93285 SAINT-DENIS CEDEX - FRANCE
TEL : (+33) 01 49 45 32 32
FAX : (+33) 01 49 45 36 59
S.A.S. au capital de 12 900 000 e
RCS Bobigny B 306 486 408

LIAISON OFFICE IN TUNISIA
CENTRE D'AFFAIRES REGUS
IMMEUBLE CARTHAGE
RUE DU LAC DE CONSTANCE
1053 TUNIS - TUNISIA
TEL : (216) 71 965 002
FAX : (216) 71 965 137
MOB: (216) 98 34 91 38

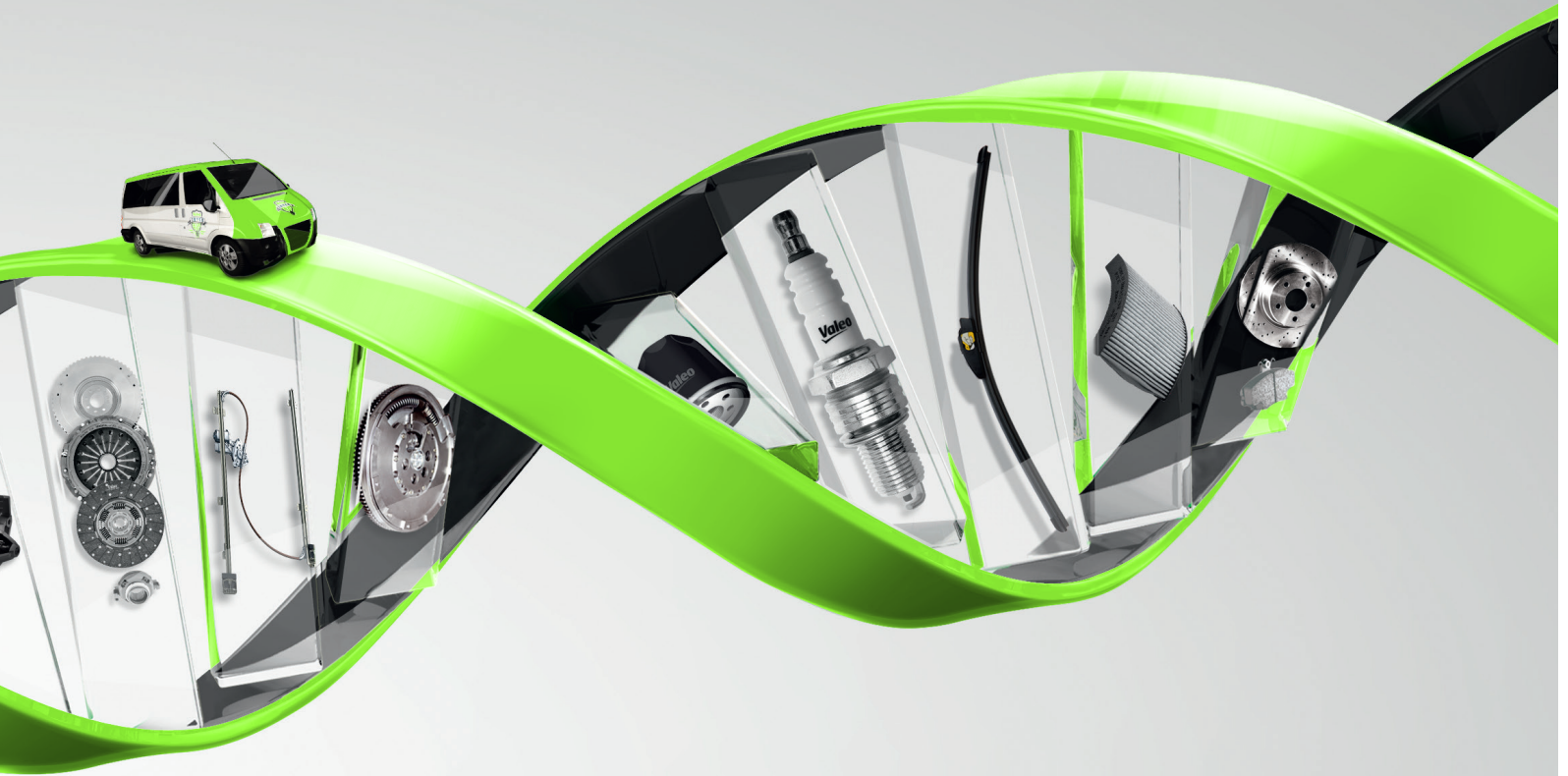

valeo added 

驶于科技，融于自然
Automotive technology, naturally

Valeo
法雷奥

Valeo