

Osburn Associates, Inc.

A Manufacturing Company

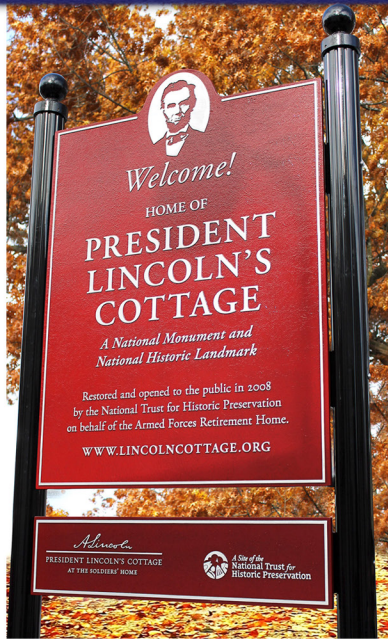
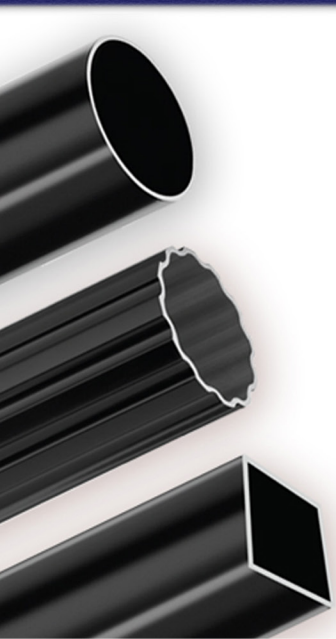

DECORATIVE STREET BLADES • TRAFFIC SIGNS • MAILBOXES • COMMERCIAL LIGHTING • ADDRESS PLAQUES • ENTRANCE & WAYFINDING SIGNAGE • CUSTOM SIGN SOLUTIONS

Streetname Sign Frames

Reflective Blade Inserts sold separately

Classic Blade Trims

Sign trims are designed to hold 36" x 6" and 36" x 9" reflective vinyl street blades. Each trim is made from a combination of extruded and cast aluminum materials with a decorative profile for a strong and attractive look. Sign trims are a cost effective way to display your street name signs with a frame while maintaining reflectivity requirements. Call one of our friendly customer service representatives for assistance with creating custom sign assemblies.



4" LETTERS



6" LETTERS



Series 6 Classic Trims	Item I.D.
36" x 6" TRIM	CT-6A
36" x 6" HIP REFLECTIVE SIGN BLADE (SEE PAGE 11)	HI-66

9" Classic Trims	Item I.D.
36" x 9" TRIM	CT-9A
36" x 9" HIP REFLECTIVE SIGN BLADE (SEE PAGE 11)	HI-69



6" Trims with Decorative Ivy	Item I.D.	9" Trims with Decorative Ivy	Item I.D.
36" x 6" w/ SORRENTO SCROLL	CT-6B1	36" x 9" w/ SORRENTO SCROLL	CT-9B1
36" x 6" w/ IVY SCROLL	CT-6B2	36" x 9" w/ IVY SCROLL	CT-9B2
36" x 6" w/ BELLFLOWER SCROLL	CT-6B3	36" x 9" w/ BELLFLOWER SCROLL	CT-9B3
36" x 6" w/ HATTERAS SCROLL	CT-6B4	36" x 9" w/ HATTERAS SCROLL	CT-9B4

Scroll Options



Above:

SIGN POLE: 4" FLUTED, 12'-0" SIGN POST (FL-0412)
 DECORATIVE BASE: 4" MINI-AMERICANA (BS-04F)
 FINIAL POST CAP: ACORN (FN-0104)
 CLASSIC BLADE TRIMS: CT-9A & HI-69
 CLASSIC PADDLE TRIMS: CT-9C & EG-09

Classic Blade & Paddle Trims

Classic Blade Paddle Trims

Paddle Trims are a compliment to the Classic Blade Trims and customizable with a variety of options including custom full color logos. Paddle Trims are designed to give the appearance that the streetblade passes through the post. We recommend a single Paddle Trim for each pole installation when being used with Classic Blade Trims. Graphics are thermal printed on durable 3M exterior vinyl and applied to an aluminum substrate.



Information

Logos

Direction

Classic Paddle Trims	Item I.D.
6" x 6" FRAME ONLY (SERIES 6)	CT-6C
9" x 9" FRAME ONLY (SERIES 9)	CT-9C
Paddle Inserts (.080)	Item I.D.
6" x 6" (SERIES 6)	EG-06
9" x 9" (SERIES 9)	EG-09



Decorative Street Sign Brackets

Turn ordinary streets into an extraordinary streetscape with our all new street blade holders

Collar Hanger Arm

The Collar Hanger Arm fits around a 3" diameter sign pole and will hold signs from 18" to 42" in length, .22" thick. Add our reflective street blades or reuse your existing signs. Choose from a standard Collar Hanger Arm, or one of four scroll options below to fit your style. Let us help you design your custom historical signs, call us today!



Collar Hanger Arm Styles	Item I.D.
COLLAR HANGER ARM - NO SCROLL	CHA-0
COLLAR HANGER ARM WITH SORENTO SCROLL	CHA-1
COLLAR HANGER ARM WITH IVY SCROLL	CHA-2
COLLAR HANGER ARM WITH BELLFLOWER SCROLL	CHA-3
COLLAR HANGER ARM WITH HATTERAS SCROLL	CHA-4

Scroll Bracket Arm

The scroll bracket arm will attach signs from 18" to 42" in length and .22" thick to any round or square sign post. Choose from one of four scroll options pictured below. Ask about our blade design services, we can help you create an elegant impression in your neighborhood. Standard and custom colors available.



Scroll Bracket Arm Styles	Item I.D.
SCROLL BRACKET ARM - NO SCROLL	SBA-0
SCROLL BRACKET ARM WITH SORENTO SCROLL	SBA-1
SCROLL BRACKET ARM WITH IVY SCROLL	SBA-2
SCROLL BRACKET ARM WITH BELLFLOWER SCROLL	SBA-3
SCROLL BRACKET ARM WITH HATTERAS SCROLL	SBA-4



SHOWN WITH "IVY SCROLL"



SHOWN WITH "BELLFLOWER SCROLL"

Decorative Scroll Options...



Post Top Mounting

Create a classic looking streetscape with this economical sign system. All components are made from rust-free aluminum. Choose your vinyl street blade on the following pages. Our "Signature" or "Classic" setup options allow for a variety of sign sizes. Recommended sign sizes listed below, or call us for custom setups and sign material thickness options.



FINIAL TOPPERS



COMPONENTS USED



SIGNATURE STACK

SIGN NOT INCLUDED IN PRICE

Signature Stack Options

	Item I.D.
1 SPIKE FINIAL TOPPER (OPTIONAL)	FT01
2 BALL FINIAL TOPPER (OPTIONAL)	FT02
3 4-WAY	4W03
4 #3 POST STACKER	PS04

SIGNATURE STACK COMPONENT KIT (CHOOSE FINIAL TOPPER)

SS-STACK



CLASSIC STACK

RECOMMENDED FOR LARGER SIGNS

SIGN NOT INCLUDED IN PRICE

COMPONENTS USED



Classic Stack Options

	Item I.D.
1 SPIKE FINIAL TOPPER (OPTIONAL)	FT01
2 BALL FINIAL TOPPER (OPTIONAL)	FT02
5 #2 POST STACKER	PS05
6 CLASSIC 2-WAY	2W06
7 CLASSIC CROSS	CC07

CLASSIC STACK COMPONENT KIT (CHOOSE FINIAL TOPPER)

CS-STACK

Wing Brackets

These brackets are made of solid rust free aluminum and powder coated with any of our standard color options. Large and small brackets are available for a variety of sign sizes. Brackets hold flat .080 or extruded aluminum vinyl street signs; see the following pages for available vinyl sign size and color options. Brackets are also available in a raw "mill finish" if you prefer to finish.



COMPONENTS USED

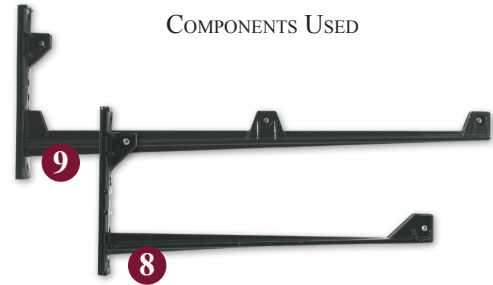

Wing Brackets

	Item I.D.
8 SMALL WING BRACKET w/ POWDER-COAT FINISH	WB-S08
SMALL WING BRACKET w/ RAW FINISH	WB-S00
9 LARGE WING BRACKET w/ POWDER-COAT FINISH	WB-L09
LARGE WING BRACKET w/ RAW FINISH	WB-L00

SIGN NOT INCLUDED IN PRICE



SMALL WING
SHOWN WITH 36" X 6"



LARGE WING
SHOWN WITH 42" X 9"

In addition to being mounted to our standard posts, Wing Brackets can also be fastened to walls, concrete, wood or existing posts with 3/4" strapping bolts, lag screws or spikes. Provide us with information on your mounting application and we can send a hardware package that suits your needs. Additional costs for hardware and fasteners may apply.

Six Street Name Styles to choose from...



Cast Aluminum

Solid “sand cast” aluminum street blades are a striking addition to any neighborhood. Each sign is finished with a 3-step urethane coating process that assures long lasting beauty and service. These dimensional signs can incorporate logos or custom coloring in addition to a variety of mounting applications. Call us for more information and we can provide you with scale drawings and specifications for presentation to your committee.



Classic Blade Trims

Sign trims are designed to hold 36” x 6” and 36” x 9” reflective vinyl street blades. Each trim is made from a combination of extruded and cast aluminum materials with a decorative profile for a strong and attractive look. Sign trims are a cost effective way to display your street name signs with a frame while maintaining reflectivity requirements. Call one of our friendly customer service representatives for assistance with creating custom sign assemblies.



Collar Hanger Arms

The Collar Hanger Arm fits around a 3” diameter sign pole and will hold signs from 18” to 42” in length, .22” thick. Add our reflective street blades or reuse your existing signs. Choose from a standard Collar Hanger Arm, or one of four scroll options below to fit your style. Let us help you design your custom historical signs, call us today!



Scroll Bracket Arm

The scroll bracket arm will attach signs from 18” to 42” in length and .22” thick to any round or square sign post. Choose from one of four scroll options pictured below. Ask about our blade design services, we can help you create an elegant impression in your neighborhood. Standard and custom colors available.



Post Top Mounting

Create a classic looking streetscape with this economical sign system. All components are made from rust-free aluminum. Choose your vinyl street blade from the following page. Our “Signature” or “Classic” setup options allow for a variety of sign sizes. Recommended sign sizes listed below, or call us for custom setups and sign material thickness options.



Wing Brackets

These brackets are made of solid rust free aluminum and powder coated with any of our standard color options. Large and small brackets are available for a variety of sign sizes. Brackets hold flat .080 or extruded aluminum vinyl street signs; see the next page for available vinyl sign size and color options. Brackets are also available in a raw “mill finish” if you prefer to finish.

Reflective Vinyl Sign Blades



Reflective Street Name Sign Blades

All our aluminum street signs are manufactured per U.S. Bureau of Public Roads Standards and are in accordance with the Federal Standard Highway Signs Manual. The aluminum substrate base for our sign blanks is chemically treated to add longer life and weather resistance. Aluminum Blanks are covered with reflective material on both sides. Choose from two grades of reflective material (High Intensity & DG3) in the five standard highway colors shown below.

High Intensity Prismatic

Type: High Intensity reflective sheeting

Best for: all applications - Highly reflective at wide angles to approaching traffic, more durable than engineer grade. Estimated lifespan 8 to 10 years

Reflectivity: Meets all MUTCD Guidelines

Diamond Grade™ DG3

Type: full cube prismatic reflective sheeting

Best for: all applications - delivers optimal performance at all sign distances, as well as all light weather conditions. Estimated Lifespan 10 to 12 years

Reflectivity: proposed ASTM Type XI



LETTER CASE CHANGES

According to new federal law, a combination of both upper and lower case letters is more legible to approaching vehicles. The new rules can be found in the Federal Highway Administration (FHA) manual. The deadline for cities and communities to phase out existing uppercase only signs is

January 22, 2018

Visit our website for updated information regarding FHA and MUTCD guidelines

Flat Reflective Blade Options

Our Flat Reflective Street Name Sign Blanks are manufactured from .080" gauge aluminum with reflective material on both sides and feature 3/4" radius corners. We overlay blanks with a 3M 3630/3680 Scotchlcal translucent film with a matte finish. Film is rated for 6 years of outdoor durability. No holes are punched in the signs.

Blade Size	High Intensity	DG3 Diamond Grade
24" x 6"	HI-46	DG-46
30" x 6"	HI-06	DG-06
36" x 6" *FITS CLASSIC TRIM	HI-66	DG-66
42" x 6"	HI-26	DG-26
30" x 9"	HI-09	DG-09
36" x 9" *FITS CLASSIC TRIM	HI-69	DG-69
42" x 9"	HI-29	DG-29



Extruded Reflective Blade Options

Our Extruded Aluminum Sign Blanks are manufactured from T-6063 aluminum extrusions. Anodized Aluminum Blanks are bare metal that has been chemically treated to meet ASTM B 499 specifications as pre-treatment for paint or sheeting applications. We overlay blanks with a 3M 3630/3680 Scotchlcal translucent film with a matte finish. Film is rated for 6 years of outdoor durability. No holes are punched in the signs.

Blade Size	High Intensity	DG3 Diamond Grade
24" x 6"	HI-46EX	DG-46EX
30" x 6"	HI-06EX	DG-06EX
36" x 6"	HI-66EX	DG-66EX
42" x 6"	HI-26EX	DG-26EX
30" x 9"	HI-09EX	DG-09EX
36" x 9"	HI-69EX	DG-69EX
42" x 9"	HI-29EX	DG-29EX

Standard Vinyl Color Options

Saginaw SE	GREEN ON WHITE
Detroit BLVD	BLACK ON WHITE
Flint LN	BLUE ON WHITE
Muskegon CT	BLACK ON WHITE
Lansing CIR	BROWN ON WHITE



Cast Aluminum Street Signs



Bracket Style	Item I.D.
MOUNTING BRACKET FOR SQUARE POST OR FLAT SURFACE	CA-BKT-SQ
MOUNTING BRACKET FOR ROUND POST	CA-BKT-RD
ADD GLO-BEAD TO YOUR STREET SIGN	GLO

Custom Cast Aluminum Street Signs

Solid “sand cast” aluminum street blades are a striking addition to any neighborhood. Each sign is finished with a 3-step urethane coating process that assures long lasting beauty and service. These dimensional signs can incorporate logos or custom coloring in addition to a variety of mounting applications. Call us for more information and we can provide you with scale drawings and specifications for presentation to your committee.

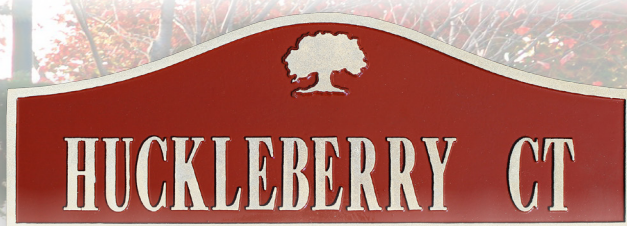

Each sign is hand crafted to your specifications. With a virtually unlimited array of colors to choose from, your custom street signs will surely be a unique addition to any community. Adding logos, custom fonts, scroll castings or other special characters are all options that allow neighborhoods to create a warm and inviting appearance.

- *Custom shapes available*
- *Add your custom logo*
- *Unlimited color options*

Check with your local authority for approval of reflectivity standards before ordering

Cast Aluminum Street Name Blades

Not your everyday ordinary street sign...



BELL

	Item I.D.
28" x 10"	CA-BL2810
35" x 12"	CA-BL3512

SCALLOP

	Item I.D.
28" x 7"	CA-SC2807
36" x 9"	CA-SC3609

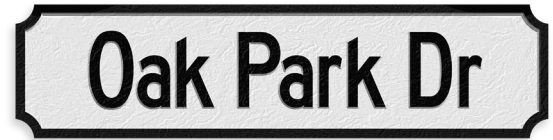

OVAL

	Item I.D.
28" x 8"	CA-OV2808
36" x 10"	CA-OV3610

CHAMFERED BELL

	Item I.D.
30" x 10"	CA-CB3010
36" x 12"	CA-CB3612



RECTANGLE

	Item I.D.
30" x 7"	CA-RT3007
36" x 9"	CA-RT3609

DOME

	Item I.D.
30" x 10"	CA-DM3010
36" x 12"	CA-DM3612



COLONIAL

	Item I.D.
22" x 14"	CA-CL2214
30" x 18"	CA-CL3018

Cast Blade Font Options

We can manufacture your street signs to your exact specifications including custom letter/number fonts. We use three standard fonts (shown to the right) to fit your needs, with the ability to produce custom fonts for a slightly higher price. Call our customer service department and we can provide you with additional details and specification drawings as needed.

ROADGEEK SERIES C

ABCDEFGabcdefg12345

CASLON BOLD EXTRA CONDENSED

ABCDEFGabcdefg12345

KABEL DEMI

ABCDEFGabcdefg12345

Traffic Signs

MUTCD approved signage, call us for more options...

Made from heavy duty .080 aluminum and high intensity prismatic reflective vinyl to meet all MUTCD codes. We stock all signs in "High Intensity Prismatic" reflective sheeting, but can also provide "DG3 Diamond Grade" - call for pricing & lead-times. Traffic signs can also have the unfinished backs coated to match your sign poles and accessories at an additional cost. Contact our customer service department for more information. For even more standard sign options, or to create a custom layout, call us directly and we can provide you with pricing and full color drawings for approval.

REFLECTIVITY REQUIREMENTS

In general terms, retroreflectivity describes the efficiency of a material to redirect light back to its source, which gives signs and pavement markings a brighter appearance at night from the driver's perspective. For more information visit the MUTCD website or contact your local authority for sign requirements.

Signature Streetscapes uses "High Intensity Prismatic" & "Diamond Grade" reflective sheeting, which meets all national requirements set by the MUTCD and FHWA. Additional reflective sheeting options are available upon request, call our customer service department for details and pricing.



Stop Sign	Yield Sign	Do Not Enter	All Way
24" (R1-1-24)	24" (R1-2-24)	24" (R5-1-24)	18" x 6" (R1-3P)
30" (R1-1-30)	30" (R1-2-30)	30" (R5-1-30)	

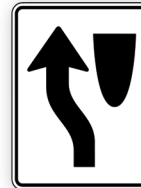

Speed Limit	One Way	Keep Left/Right	No Parking
12" x 18" (R2-1-18 #)	12" x 18" (R6-2-18 L/R)	12" x 18" LEFT (R4-8)	12" x 18" (R7-1D)
18" x 24" (R2-1-24 #)	18" x 24" (R6-2-24 L/R)	12" x 18" RIGHT (R4-7)	



Pedestrian X-ing	Cart Crossing	Reserved Parking	Fire Lane
24" (HW11A-2)	24" (W11-11)	12" x 18" (R7-8D)	12" x 18" (HR8-31)



Info Signs	Children at Play	Handicap Parking
4-WAY / 12" x 6" (HR1-3)	12" x 18" (HW9-12)	12" x 18" (HR7-128)
VAN / 12" x 6" (D9-6P)		

Our complete selection of traffic signs includes regulatory, warning, guide, and recreation signs, as well as construction, school, railroad, and bicycle signs. Whether you need a complete sign package for a comprehensive transportation plan, or just an important replacement sign, our customizable and well-made signage products not only get the job done, but adhere to all regulatory standards. All traffic signs are available in multiple grades of reflective sheeting to best serve your specific project needs.

Looking for something you don't see here? Contact Us and we'll be happy to assist you.

Decorative Sign Frames

“Extruded Frames” for the following sign sizes...

Solid extruded aluminum frames enhance and protect your signs at the same time. Frames are powder-coated to match the sign pole, and include all necessary stainless steel mounting hardware for installation of standard .080 aluminum traffic signs. We can also custom build frames to fit almost any sign, call us for more information and pricing. CUSTOM SIZES AVAILABLE, CALL FOR PRICING.



Stop:	Square	Rectangle	Yield	Diamond
24" (SF-SS02)	24" (SF-SQ02)	12" x 6" (SF-RT01)	24" (SF-YD01)	18" (SF-DM01)
30" (SF-SS03)	30" (SF-SQ03)	12" x 18" (SF-RT02)	30" (SF-YD02)	24" (SF-DM02)
36" (SF-SS04)	36" (SF-SQ04)	18" x 24" (SF-RT03)		30" (SF-DM03)
		24" x 30" (SF-RT04)		36" (SF-DM04)



Extruded Frame Front View



Extruded Frame Back View

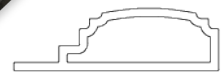

Profile View

“Faux Halo” Sign Frames for the following sign sizes...

Faux Halo frames are an economical choice for creating a 2" wide frame appearance around outside edge of your traffic sign. Made from .080 aluminum and powder-coated black. Holes are pre-punched to match standard sign hole locations.

Stop:	Square	Rectangle	Yield	Diamond
24" (FH-SS02)	24" (FH-SQ02)	12" x 6" (FH-RT01)	24" (FH-YD01)	24" (SF-DM02)
30" (FH-SS03)	30" (FH-SQ03)	12" x 18" (FH-RT02)	30" (FH-YD02)	24" (SF-DM03)
36" (FH-SS04)	36" (FH-SQ04)	18" x 24" (FH-RT03)		30" (SF-DM04)
		24" x 30" (FH-RT04)		

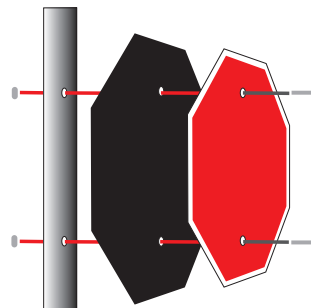

Vinyl Coated Sign Backs

Traffic sign backs come standard with a “mill finish” that shows through the backside of the open frame. We suggest covering the back of the sign with black vinyl at a small additional charge for aesthetic reasons. Not required for “Faux Halo” sign frames.

12" Wide Signs	18" Wide Signs	24" Wide Signs	> 30" Wide Signs
VC-12	VC-18	VC-24	VC-30

Decorative Sign Posts

Volume Discounts Available...



BREAKAWAY POST DEADLINE

In 2000 the MUTCD made breakaway sign supports a "shall" condition for supports within the **clear zone** of all streets and highways in the United States. FHWA intends to limit the mandate for retrofitting breakaway supports on non-National Highway System routes to those posted at 50 mph or greater, and has set a deadline of January 2013* to accomplish the retrofit of existing sign posts. Any new sign post installed after the January 2013 Breakaway Post Deadline shall be breakaway compliant on **any and all speed roads**.



3"
SMOOTH

4"
SMOOTH

3"
FLUTED

4"
FLUTED

2"
SQUARE

3"
SQUARE

4"
SQUARE

We stock all our standard post lengths and profiles in a **Tiger Drylac Bengal Gloss Black** powder-coat finish. We also inventory a large amount of mill finish product and can cut custom lengths to meet your job specification as needed. Custom powder-coat colors are available upon request, call us for more information on available powder coat color options.

Length:	3" Smooth	4" Smooth	3" Fluted	4" Fluted	2" Square	3" Square	4" Square
8'-0"	SM-0308	SM-0408	FL-0308	FL-0408	SQ-2208	SQ-3308	SQ-4408
10'-0"	SM-0310	SM-0410	FL-0310	FL-0410	SQ-2210	SQ-3310	SQ-4410
12'-0"	SM-0312	SM-0412	FL-0312	FL-0412	SQ-2212	SQ-3312	SQ-4412
14'-0"	SM-0314	SM-0414	FL-0314	FL-0414	SQ-2214	SQ-3314	SQ-4414
16'-0"	SM-0316	SM-0416	FL-0316	FL-0416	SQ-2216	SQ-3316	SQ-4416

CHOOSE YOUR POST LENGTH CAREFULLY. BE SURE TO INCLUDE ENOUGH ROOM FOR ALL SIGN/LIGHTING COMPONENTS INCLUDING A MINIMUM DIRECT BURIAL DEPTH OF 24-30"

Post installation methods...

V-Loc Breakaway

For use in clear zones to make 3" & 4" Smooth and Fluted tubing breakaway compliant

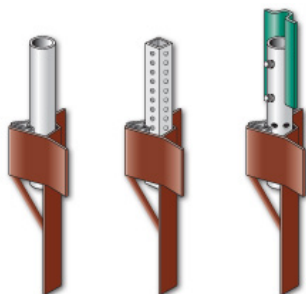

Direct Burial Posts

Designed for use with concrete installation. We recommend 24" of post burial. Size and depth of concrete varies according to local soil conditions. Concrete foundations should extend above ground level and be larger in diameter than the base, to prevent damage and ensure the finish will be protected for years to come.

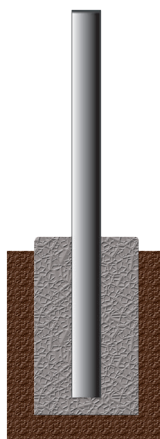

Surface Mount Posts

Designed to be used when pole is mounted above grade and fastened with anchors or "J-bolts" in concrete. Fasteners are cast integral with foundation. Call ahead and we can send a hole placement template to match the bolt patterns on our surface mounted bases for use when pouring concrete footers.

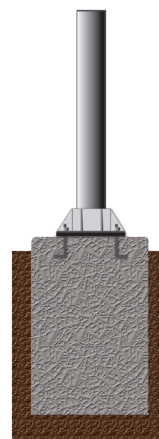

Sign Poles & Accessories

Bulk Post Pricing, call for volume discounts

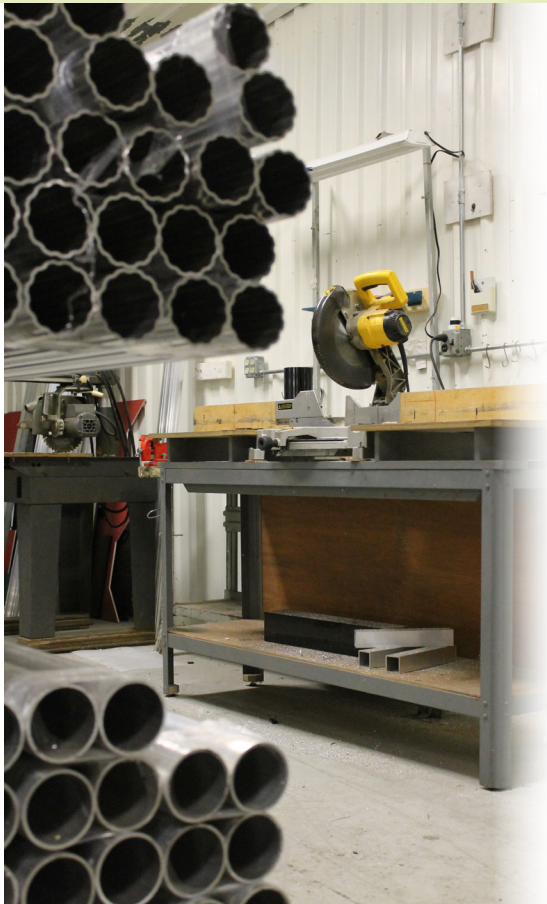

We offer significant discounts on both powder coated and mill finish (raw/uncoated) material when ordered in bulk. Call our customer service department for more information on placing high volume orders. Custom lengths also available upon request.

Length:	Wall Thickness	Lbs. / Ft.
3" SMOOTH	.120	1.300
3" FLUTED	.120	1.340
4" SMOOTH	.125	1.826
4" FLUTED	.125	1.910
2" SQUARE	.125	1.091
3" SQUARE	.125	1.673
4" SQUARE	.125	2.555

All material made from alloy 6063 aluminum

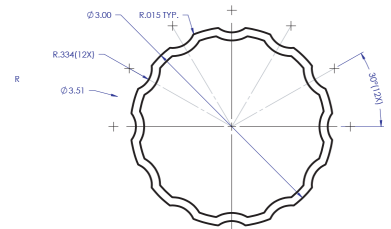

3" DIAMETER FLUTED

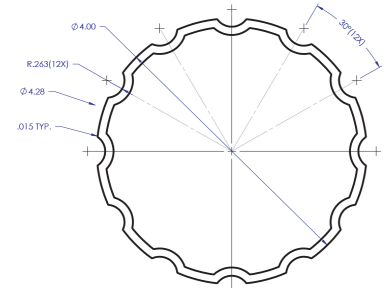

4" DIAMETER FLUTED



NEED SPECIAL HARDWARE?

We understand that when building custom sign fixtures that sometimes the standard hardware package may not always fit your needs. It is important to us that when your products arrive everything required to properly mount your sign is included in shipping. Please let us know at the time of order if you have any specific hardware or mounting style requirements. In almost all cases we can suggest and provide hardware and mounting solutions to fit your needs.

Sign Post Hardware & Accessories



J-BOLTS

Used for surface mounted poles and lighting applications



DEEP GREEN STEEL U-CHANNEL POSTS

Green enamel finish steel posts are an economical option for mounting street name and traffic signs. Can be used with a variety of hardware options.



Price per Bolt	8'-0"	10'-0"	12'-0"	10'-0"	12'-0"	Rain Cap	Dome Cap
J-BOLT	U-CHANNEL-8	U-CHANNEL-10	U-CHANNEL-12	GAL-10	GAL-12	FN-RC	FN-DC



BREAKAWAY COUPLER

Snap n' Safe breakaway hardware for 3" diameter steel posts



BREAKAWAY BOLTS

Galvanized steel bolts for creating breakaway approved surface mounted posts

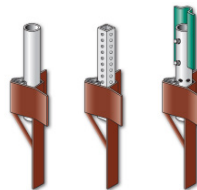

V-LOC BREAKAWAY POST ANCHOR SYSTEM

FHWA approved breakaway options for a variety of post styles including our fluted and smooth aluminum sign poles shown on page 16.



SNAP N' SAFE BREAKAWAY PRODUCTS

We carry a wide range of breakaway hardware options. Order directly from our website or call our customer service department for assistance in placing your order.

3" OD Post S300R	#4 x 6" Galvanized DENT	Earth, Asphalt & Concrete Installations CALL FOR DETAILS	For Square, Round & U-Channel Posts CALL FOR DETAILS
---------------------	----------------------------	-------------------------------------------------------------	---------------------------------------------------------

Decorative Post Finials

Popular Finials for both 3" & 4" Posts

We stock our most popular finial styles shown below in "Mill" and "Gloss Black" powder-coat finishes. Finials are secured to posts with provided stainless steel set screws. The finials shown below are available for both 3" & 4" aluminum round and square posts. Additional details on finial height, weight and other specification data can be found on our website.



ACORN



GLOBE



BALL CAP

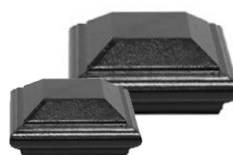

IMPERIAL



NEWEL

Fits Post / Item I.D.	Fits Post / Item I.D.	Fits Post / Item I.D.	Fits Post / Item I.D.	Fits Post / Item I.D.
3" DIAMETER / FN-0103	3" DIAMETER / FN-0203	2" SQUARE / FN-1022	3" SQUARE / FN-1233	2" SQUARE / FN-1122
4" DIAMETER / FN-0104	4" DIAMETER / FN-0204	3" SQUARE / FN-1033	4" SQUARE / FN-1244	3" SQUARE / FN-1133
		4" SQUARE / FN-1044		4" SQUARE / FN-1144

Theme Finials for 3" Diameter Poles

Theme Finials are a great way to add character to your decorative sign poles. All "Theme Finials" are designed to fit 3" diameter poles, but can be attached to 4" diameter poles with our "4x3 Reducer Cap". Additional details on finial height, weight and other specification data can be found on our website.



PINECONE



HORSE HEAD



GOLF BALL



PINEAPPLE

Item I.D.	Item I.D.	Item I.D.	Item I.D.
FN-TH01	FN-TH02	FN-TH03	FN-TH04

When mounting "Theme Finials" to 4" diameter posts a 4x3 Reducer tenon is required, see page 35.

Custom Finial Options

Our in house capabilities allow us to provide unique solutions to brand your community signage package in a variety of ways. Call us for more information and ideas on how you can incorporate your community logo on sign poles and custom street signs.



POST TOP LOGO

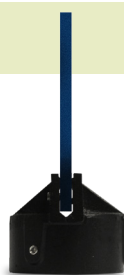

WATERJET CUT ALUMINUM

Ornamental Post Bases

Bases for 3" Diameter Poles

We manufacture cast aluminum pole bases to fit both 3" & 4" diameter posts. Each base is coated with a durable powder-coat finish and uses stainless steel hardware for securing to the post. Additional specification data on all post bases is available upon request.



Streetscape*	Colonial*	Corinthian*	Hanover	Mini Americana
BS-03A	BS-03B	BS-03C	BS-03E	BS-03F
HEIGHT: 32"	HEIGHT: 31"	HEIGHT: 24"	HEIGHT: 17.5"	HEIGHT: 10"
FOOTPRINT: 12"	FOOTPRINT: 12"	FOOTPRINT: 7.5"	FOOTPRINT: 8"	FOOTPRINT: 9"
SPLIT BASE	SPLIT BASE	SPLIT & SOLID OPTIONS	SOLID BASE	SOLID BASE

Bases for 4" Diameter Poles



Call us! We can assist in determining the base that will best suit your needs and budget.

Streetscape*	Colonial*	Legend	Mini Americana
BS-04A	BS-04B	BS-04H	BS-04F
HEIGHT: 32"	HEIGHT: 30.5"	HEIGHT: 18"	HEIGHT: 10"
FOOTPRINT: 12"	FOOTPRINT: 12"	FOOTPRINT: 13"	FOOTPRINT: 9"
SPLIT BASE	SPLIT BASE	SOLID BASE	SOLID BASE

"Solid" or "Split" Bases

Our on-site foundry casts a variety of decorative bases in two different styles, "Split" and "Solid". Bases in the above chart are noted with a (*) when they are constructed with a "Split" design. All other bases are of "Solid" one-piece construction.

Split Base

Easy to install, these bases wrap around new or existing poles and lock together with stainless steel fasteners.

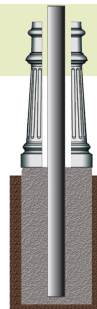

Solid Base

Slides over the top of pole and rests on the ground or concrete pad. Bases are locked to the pole with stainless steel set screws.

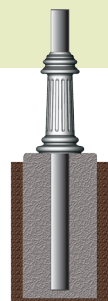



Post: 16'-0", 4" Fluted (FL-0416)
 Street Signs: 36" x 9" HIP (HI-69)
 Sign Frames: Classic Trim (CT-9A)
 Paddle Sign: 9" x 9" Insert (CT-9C)
 Paddle Trim: 9" Paddle Trim (CT-9C)
 Base: Classic (BS-04D)
 Finial: 4" Acorn Cap (FN-0104)



Post: 10'-0", 3" Fluted (FL-0310)
 Street Signs: (2) 36" x 6" (HI-66)
 Base: Corinthian (BS-03C)
 Sign Hardware: Signature Stack (SS-STACK) *see page 3*



Post: 14'-0", 3" Fluted (FL-0314)
 Traffic Sign: Pedestian (WIIA-2-30)
 Base: 3" Mini-Americiana (BS-03F)
 Finial: 3" Globe (FN-0203)



All post lengths reflect a 24" burial depth unless noted otherwise. Please consult your local authority for suggested pole burial depths based on geographic location and soil conditions

Post: 12'-0", 3" Fluted (FL-0312)
 Traffic Sign: 24" Stop Sign (R1-1-24)
 Sign Frame: 24" Faux Halo (FH-SS02)
 Base: 3" Streetscape (BS-03A)
 Finial: 3" Acorn (FN-0103)



Post: 14'-0", 3" Fluted (FL-0314)
 Street Sign: 36" x 9" HIP (HI-69)
 Wing Bracket: (WB-S08)
 Traffic Sign: 18" x 24" (R4-2R-24-L)
 Sign Frame: Faux Halo (FH-RT03)
 Base: 3" Colonial (BS-03B)
 Finial: 3" Acorn (FN-0103)





14 FT
13 FT
12 FT
11 FT
10 FT
9 FT
8 FT
7 FT
6 FT
5 FT
4 FT
3 FT
2 FT
1 FT

Post: 14'-0", 3" Fluted (FL-0314)
Street Signs: 36" x 6" HIP (HI-66)
Sign Frames: Classic Trims (CT-6A)
Base: 3" Mini-Americiana (BS-03F)
Finial: 3" Acorn (FN-0103)



Post: 16'-0", 4" Fluted (FL-0416)
Street Signs: 36" x 6" HIP (HI-66)
Frames: Classic Trims with Ivy (CT-6B)
Traffic Signs: (R1-1-30) & (HR1-3)
Traffic Sign Frame: Extruded (SF-SS03)
Base: 3" Streetscape (BS-03A)
Finial: 4" Acorn (FN-0104)



Call us today and we can send you specification drawings of your custom sign post assembly for presentation to your board or committee

Post: 12'-0", 3" Smooth (SM-0312)
Speed Limit Sign: 18" x 24" (R2-1-24-10)
Sign Frame: 18" x 24" Extruded (SF-RT03)
Base: 3" Streetscape (BS-03A)
Finial: 3" Globe (FN-0203)



Post: 8'-0", 3" Smooth (SM-0308)
Handicap Parking: (HR7-128)
Van Accessible. (D9-6P)
Base: 3" Hanover (BS-03E)
Finial: 3" Globe (FN-0203)

**Shown with 18" Burial Depth*



Post: 12'-0", 4" Smooth (SM-0412)
Street Sign: Cast Aluminum (CA-CB3010)
Base: 4" Legend (BS-04H)
Finial: 4" Acorn (FN-0104)



Cast Address Plaques

We manufacture the finest address plaques ever made...



Bell Top (14" x 9")

Material & Finish Options:	Item I.D.
BRONZE POLISHED	BLBZ-__
ALUMINUM POLISHED	BLAL-__
ALUMINUM & ROLLED GOLD	BLRG-__

Round (10")

Material & Finish Options:	Item I.D.
BRONZE POLISHED	RDBZ-__
ALUMINUM POLISHED	RDAL-__
ALUMINUM & ROLLED GOLD	RDRG-__



Oval (14" x 10")

Material & Finish Options:	Item I.D.
BRONZE POLISHED	OVBZ-__
ALUMINUM POLISHED	OVAL-__
ALUMINUM & ROLLED GOLD	OVRG-__



Rectangle (14" x 7")

Material & Finish Options:	Item I.D.
BRONZE POLISHED	RTBZ-__
ALUMINUM POLISHED	RTAL-__
ALUMINUM & ROLLED GOLD	RTRG-__



Scallop (14" x 9")

Material & Finish Options:	Item I.D.
BRONZE POLISHED	SCBZ-__
ALUMINUM POLISHED	SCAL-__
ALUMINUM & ROLLED GOLD	SCRG-__



Vertical (16" x 3")

Material & Finish Options:	Item I.D.
BRONZE POLISHED	VTBZ-__
ALUMINUM POLISHED	VTAL-__
ALUMINUM & ROLLED GOLD	VTRG-__

Square (12" x 12")

Material & Finish Options:	Item I.D.
BRONZE POLISHED	SQBZ-__
ALUMINUM POLISHED	SQAL-__
ALUMINUM & ROLLED GOLD	SQRG-__



Address Plaque Options

More styles available on our website...



MOUNTING SPIKES ARE PAINTED BLACK

Signs are available with the color options shown below, or call for custom color matching at an additional charge. Plaques are finished with satin polish raised areas, which expose the rich metal surface. Aluminum plaques can also have the raised areas painted gold. Every plaque is clear coated with our special formula, ultra hard urethane, to ensure a long lasting finish even in the harshest environments. Call our customer service department with help placing your order, or you can design and order on our website. **Additional discounts available for bulk orders, call for prices and information.**



1 GLOSS BLACK 2 DEEP GREEN 3 MEXICALI RED 4 AMERICAN BLUE 5 *ANTIQUÉ BRONZE 6 *ANTIQUÉ ALUMINUM

Lawn Mounting Spikes	
A WITH FINIALS (22")	B CONCEALED (20")
LM-A	LM-B

SEE OUR WEBSITE FOR A COMPLETE DESCRIPTION OF WHY OUR FINISHES ARE THE BEST IN THE BUSINESS!



Custom Letter & Number Fonts & Sizes...

Our standard font used on all custom home address plaques is a "Century Old Style" serif font. However, we have the capability to customize any of our plaques with custom letter/number fonts upon request. We can also accommodate special character sizes to meet your needs. Call us for more information and we will be happy to assist you with a product rendering for your approval. Additional charges may apply for custom fonts.



Room Number Signs

Small number plaques are ideal for room identification and entry ways. Each plaque is capable of holding up to four numbers, and can be finished with antique bronze or pewter aluminum as shown below. Signs are direct mounted to a flat surface, standard hardware is provided. Call for more information on custom layouts and colors.



5" x 3.75"

Rectangle

Material:	Item I.D.
ANTIQUÉ BRONZE	RN-R1
ANTIQUÉ ALUMINUM	RN-R2



5"

Circle

Material:	Item I.D.
ANTIQUÉ BRONZE	RN-C1
ANTIQUÉ ALUMINUM	RN-C2



5" x 3.75"

Oval

Material:	Item I.D.
ANTIQUÉ BRONZE	RN-O1
ANTIQUÉ ALUMINUM	RN-O2

Curbside Mailboxes



Berkshire

The Berkshire Mailbox presents an impressive face. The one-piece cast aluminum door features deeply cut details with a rich, leather grain textured panel. The stainless steel spring hinge and magnetic catch will keep the door secure to the aluminum body and creates a rust-proof weather resistant mailbox.



SHOWN WITH PAPER BOX

Berkshire Options:	Item I.D.
BERKSHIRE MAILBOX	101
BERKSHIRE WITH NEWSPAPER BOX	201

Specifications: height 10", depth 19.75", width 9", weight 18#

Tuff Body

The "Tuff Body" mailbox is made with a heavy duty steel body. These boxes have a smooth rust resistant powder-coat finish. When combined with our decorative post and mounting options, they provide an economical way for neighborhoods to achieve a uniformed look with appeal and durability.



Tuff-Body Options:	Item I.D.
TUFF BODY MAILBOX	165

Specifications: height 10", depth 20.75", width 7.5", weight 23#

Mailbox Address Toppers

Mailbox Address Toppers are made of solid cast aluminum and fit most standard mailboxes. Each address plate holds up to five numbers, and comes with hardware and instructions for mounting. Toppers come standard in gloss black with gold or polished aluminum numbers. We can also customize color or designs to fit your needs for an additional charge, call us for details.

Finish Option	Item I.D.
PEWTER FINISH / POLISHED ALUMINUM NUMBERS	MP1-A
BLACK FINISH / ROLLED GOLD NUMBERS	MP1-G



Mailbox Mounting Styles



SINGLE POST MOUNTING

Mailbox Post Style	Item I.D.
<i>SINGLE POST MOUNT</i>	MBP-1



DUEL BOX MOUNTING

Mailbox Post Style	Item I.D.
<i>DUEL BOX MOUNTING</i>	MBP-2

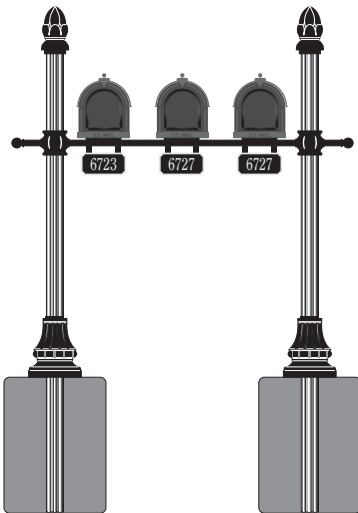

Mailbox Post Style	Item I.D.
<i>3-Box MOUNTING</i>	MBP-3

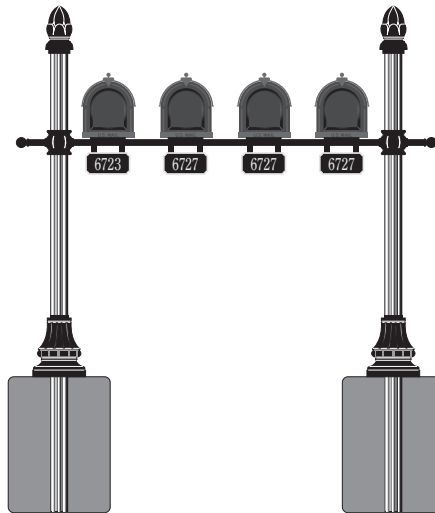

Mailbox Post Style	Item I.D.
<i>4-Box MOUNTING</i>	MBP-4

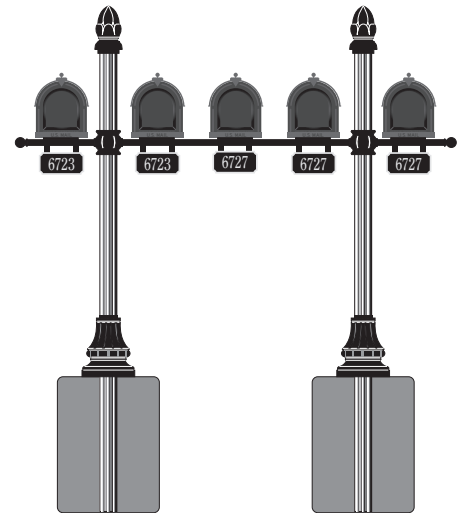

Mailbox Post Style	Item I.D.
<i>5-Box MOUNTING</i>	MBP-5



Whitehall

We are also an authorized dealer of Whitehall Products full line of decorative mailboxes and address plaques.



Cast Bronze & Aluminum Plaques



THE ROOKERY
at Marco

As an integral part of the Everglades Ecological System, The Rookery at Marco contains numerous environmentally sensitive areas as well as an abundance of wildlife including alligators and snakes.

For your safety and the well being of the Everglades Ecological System, do not enter any lakes or wetland areas and never feed any wildlife.

AUDUBON INTERNATIONAL
Paradise Naturally

In Honor of
Steven Vincent Bilyeu



Steve was a dedicated Oxmoor Country Club board member, loyal friend, devoted father and husband. Steve will be missed but never forgotten.



Cast Plaques Standard Size Chart

We have the capability to bring your vision to life in cast *bronze or aluminum*. We can help you with both concept and design by taking your ideas and rendering realistic graphics to help you better visualize the finished product before approving for production. We have helped thousands of customers create unique one of a kind cast metal plaques for a variety of special occasions and dedications. Let us help you take your ideas and bring them to life today! Call our helpful customer service department for additional details and prices.

FOR THE "ITEM I.D." CODES, USE "BZ" OR "AL" AFTER "PQ" TO SPECIFY MATERIAL OF PLAQUE WHEN ORDERING

SIZE	ITEM I.D.	SIZE	ITEM I.D.	SIZE	ITEM I.D.	SIZE	ITEM I.D.
5 x 3	PQ__- 5 x 3	9 x 7	PQ__- 9 x 7	14 x 10	PQ__- 14 x 10	22 x 12	PQ__- 22 x 12
5 x 5	PQ__- 5 x 5	9 x 8	PQ__- 9 x 8	14 x 12	PQ__- 14 x 12	24 x 4	PQ__- 24 x 4
6 x 1/2	PQ__- 6 x 1/2	9 x 9	PQ__- 9 x 9	14 x 14	PQ__- 14 x 14	24 x 6	PQ__- 24 x 6
6 x 3/4	PQ__- 6 x 3/4	9-1/2 x 2	PQ__- 9-1/2 x 2	15 x 10	PQ__- 15 x 10	24 x 8	PQ__- 24 x 8
6 x 1	PQ__- 6 x 1	10 x 1/2	PQ__- 10 x 1/2	15 x 12	PQ__- 15 x 12	24 x 10	PQ__- 24 x 10
6 x 2	PQ__- 6 x 2	10 x 3/4	PQ__- 10 x 3/4	15 x 15	PQ__- 15 x 15	24 x 12	PQ__- 24 x 12
6 x 3	PQ__- 6 x 3	10 x 1	PQ__- 10 x 1	16 x 2	PQ__- 16 x 2	24 x 14	PQ__- 24 x 14
6 x 4	PQ__- 6 x 4	10 x 1-1/4	PQ__- 10 x 1-1/4	16 x 4	PQ__- 16 x 4	24 x 16	PQ__- 24 x 16
6 x 5	PQ__- 6 x 5	10 x 1-1/2	PQ__- 10 x 1-1/2	16 x 6	PQ__- 16 x 6	24 x 18	PQ__- 24 x 18
6 x 6	PQ__- 6 x 6	10 x 2	PQ__- 10 x 2	16 x 8	PQ__- 16 x 8	24 x 20	PQ__- 24 x 20
7 x 1/2	PQ__- 7 x 1/2	10 x 2-1/2	PQ__- 10 x 2-1/2	16 x 10	PQ__- 16 x 10	24 x 24	PQ__- 24 x 24
7 x 3/4	PQ__- 7 x 3/4	10 x 3	PQ__- 10 x 3	16 x 12	PQ__- 16 x 12	28 x 18	PQ__- 28 x 18
7 x 1	PQ__- 7 x 1	10 x 4	PQ__- 10 x 4	16 x 14	PQ__- 16 x 14	30 x 4	PQ__- 30 x 4
7 x 3	PQ__- 7 x 3	10 x 5	PQ__- 10 x 5	16 x 16	PQ__- 16 x 16	30 x 6	PQ__- 30 x 6
7 x 4	PQ__- 7 x 4	10 x 6	PQ__- 10 x 6	18 x 2	PQ__- 18 x 2	30 x 8	PQ__- 30 x 8
7 x 5	PQ__- 7 x 5	10 x 8	PQ__- 10 x 8	18 x 4	PQ__- 18 x 4	30 x 10	PQ__- 30 x 10
8 x 1/2	PQ__- 8 x 1/2	10 x 10	PQ__- 10 x 10	18 x 6	PQ__- 18 x 6	30 x 12	PQ__- 30 x 12
8 x 3/4	PQ__- 8 x 3/4	10-1/4 x 2-1/2	PQ__- 10-1/4x2-1/2	18 x 8	PQ__- 18 x 8	30 x 18	PQ__- 30 x 18
8 x 1	PQ__- 8 x 1	12 x 3/4	PQ__- 12 x 3/4	18 x 10	PQ__- 18 x 10	30 x 20	PQ__- 30 X 20
8 x 1-1/4	PQ__- 8 x 1-1/4	12 x 1	PQ__- 12 x 1	18 x 12	PQ__- 18 x 12	30 x 24	PQ__- 30 X 24
8 x 1-1/2	PQ__- 8 x 1-1/2	12 x 1-1/4	PQ__- 12 x 1-1/4	18 x 14	PQ__- 18 x 14	30 x 30	PQ__- 30 x 30
8 x 2	PQ__- 8 x 2	12 x 1-1/2	PQ__- 12 x 1-1/2	18 x 15	PQ__- 18 x 15	34 x 26	PQ__- 34 x 26
8 x 3/4	PQ__- 8 x 3/4	12 x 2	PQ__- 12 x 2	18 x 16	PQ__- 18 x 16	36 x 4	PQ__- 36 x 4
8 x 4	PQ__- 8 x 4	12 x 2-1/2	PQ__- 12 x 2-1/2	18 x 18	PQ__- 18 x 18	36 x 6	PQ__- 36 x 6
8 x 5	PQ__- 8 x 5	12 x 3	PQ__- 12 x 3	20 x 2	PQ__- 20 x 2	36 x 8	PQ__- 36 x 8
8 x 6	PQ__- 8 x 6	12 x 4	PQ__- 12 x 4	20 x 4	PQ__- 20 x 4	36 x 12	PQ__- 36 x 12
8 x 8	PQ__- 8 x 8	12 x 5	PQ__- 12 x 5	20 x 5	PQ__- 20 x 5	36 x 18	PQ__- 36 x 18
9 x 1/2	PQ__- 9 x 1/2	12 x 6	PQ__- 12 x 6	20 x 6	PQ__- 20 x 6	36 x 20	PQ__- 36 x 20
9 x 3/4	PQ__- 9 x 3/4	12 x 8	PQ__- 12 x 8	20 x 8	PQ__- 20 x 8	36 x 24	PQ__- 36 x 24
9 x 1/2	PQ__- 9 x 1	12 x 9	PQ__- 12 x 9	20 x 10	PQ__- 20 x 10	36 x 30	PQ__- 36 x 30
9 x 1-1/2	PQ__- 9 x 1-1/2	12 x 10	PQ__- 12 x 10	20 x 12	PQ__- 20 x 12	36 x 36	PQ__- 36 x 36
9 x 2	PQ__- 9 x 2	12 x 12	PQ__- 12 x 12	20 x 14	PQ__- 20 x 14	40 x 28	PQ__- 40 x 28
9 x 3	PQ__- 9 x 3	14 x 2	PQ__- 14 x 2	20 x 16	PQ__- 20 x 16	40 x 30	PQ__- 40 x 30
9 x 4	PQ__- 9 x 4	14 x 4	PQ__- 14 x 4	20 x 18	PQ__- 20 x 18	42 x 36	PQ__- 42 x 36
9 x 5	PQ__- 9 x 5	14 x 6	PQ__- 14 x 6	20 x 20	PQ__- 20 x 20	48 x 24	PQ__- 48 x 24
9 x 6	PQ__- 9 x 6	14 x 8	PQ__- 14 x 8	22 x 10	PQ__- 22 x 10	48 x 36	PQ__- 48 x 36

SIGNATURE STREETSCAPES WILL PROVIDE SCALE CUSTOMER APPROVAL DRAWINGS BY E-MAIL ON ALL CUSTOM CAST PLAQUE ORDERS

How to price custom size & shape plaques...

We do not charge our customers for custom sizes or shapes. For a size not shown, use the next largest plaque size from the list above. The same applies for custom shapes and circles as shown in the examples to the right. Simply take the length and width of the plaque you require and follow the instructions shown to the right to determine the item you need. Send us files and we can help you visualize the plaque you need with full color renderings.

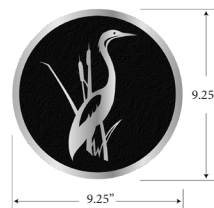

PRICE AS 10" x 10"
CAST ALUMINUM
ITEM I.D. - PQAL-10x10



PRICE AS 20" x 12"
CAST BRONZE
ITEM I.D. - PQBZ-20x12

Plaque Options



Custom Shapes

Have a strange or unique shape? No problem! No additional setup or pattern charges will be added to your order. We can even help you create the artwork required to manufacture the plaque if you do not already have it.



Etched Metal Photo

This process uses a photo-sensitive aluminum sheet, available in natural aluminum or gold-tone. The photo is produced as a permanent black image on the plate. This method can be used in both interior and exterior applications.

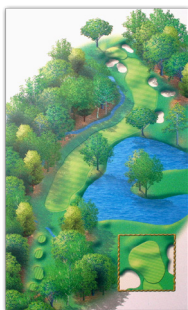

Alumicolor Photos

Alumicolor technology embeds UV resistant dyes into the anodic layer of anodized aluminum and has applications limited only by the imagination. Call us for artwork requirements and prices.



Background Textures

All our plaques are manufactured with a standard background texture. Other textures are available upon request and include: pebble, travertine & sculptured. Call for details and prices.

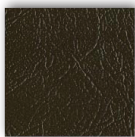

Podium Style Mount

Podium style mounted plaques allow for angled viewing. Plaques are secured to podiums with provided stainless steel hardware. A variety of post profiles and decorative options are available.

Add your Logo

Provide us with production ready artwork of your logo or special characters and we can cast them directly into your plaque, no additional charge! Our precision casting process allows for even the finest details.



Bas Relief Sculpture

The ultimate in premium photo or graphic reproduction. No other process can create the same rich detail our artists achieve by hand carving bas-relief patterns. Once completed, a sand mold is made to cast a metal version.



Raised Painted

Hand painted plaques and custom color matching is our specialty. We can paint your plaque to match exact specifications. Prices are determined by design and color requirements.



Add-Plate Plaques

Let us help you design a plaque that evolves over time. Names are cast on separate plates and added to the primary tablet as needed. Call us with your requirements and we can design it!

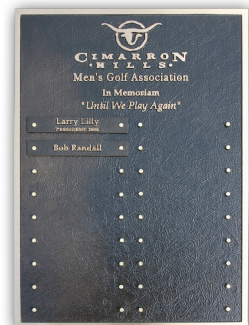

Duel Post Mounting

Duel post sign mountings provide for unique site directional and identification solutions. See our post, base & decorative cap page for options. Call us and we can design it for you!

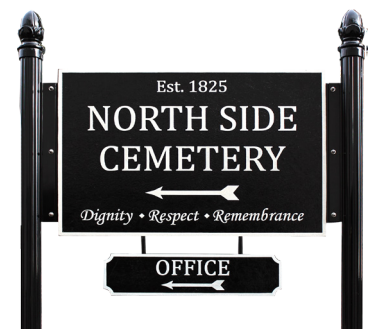

Historical Lighting

Components to build your own...



CLASSIC



ACORN



LAMP

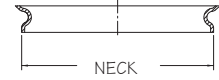
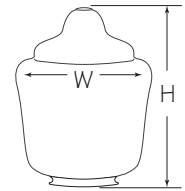

Globe Style:	Height	Width	Color	Neck	Material	Item #
CLASSIC	21"	14"	CLEAR	8"	POLYCARBONATE	88063-CL-8F
					ACRYLIC	88263-CL-8F
CLASSIC (8 INCH)	26.88"	16.60"	CLEAR	8"	POLYCARBONATE	88066-CL-8F
					ACRYLIC	88266-CL-8F
CLASSIC (9 INCH)	26.13"	16.60"	CLEAR	9"	POLYCARBONATE	88066-CL-9F
					ACRYLIC	88266-CL-9F
ACORN	23"	15.13"	CLEAR	8"	POLYCARBONATE	88064-CL-8F
					ACRYLIC	88264-CL-8F
LAMP (8 INCH)	20.69"	15.44"	CLEAR	8"	POLYCARBONATE	88060-CL-8F
					ACRYLIC	88260-CL-8F
LAMP (9 INCH)	19.88"	15.44"	CLEAR	9"	POLYCARBONATE	88060-CL-9F*
					ACRYLIC	88260-CL-9F*

Polycarbonate

Recommended for use with High Intensity Discharge lamps. Polycarbonate has a high impact resistance and durability, making it less likely to be damaged or vandalized. Over time, globes will become yellowed compared to acrylic.

Acrylic - Impact Modified

Unsurpassed resistance to weathering and aging. Acrylic has an exceptional brilliance, which does not diminish even after prolonged use. Globes are made from a harder material which makes them more prone to damage or vandalism compared to polycarbonate.

Traditional HID Light Sources



Incandescent *Standard Socket - no additional charge*

Fixtures come standard with an incandescent socket for 110 volt electricity unless otherwise specified. Incandescent bulbs are rated for up to 1,000 hours of use.

High Intensity Discharge (HID)



High Pressure Sodium

Produces a golden-pink cast, it is the most efficient commercial light source. Bulbs are rated for 24,000 hours of use. Available in the wattages shown below. Capital Fitters & Mogul style bases come with harnesses for assembling ballast kit to lamp. Consult with your electrician for proper installation or call our customer service department for details.

70 watt	100 watt	150 watt
HP-070	HP-100	HP-150

Metal Halide

Produces a pure white light with excellent color rendering. bulbs last six times longer than standard incandescent bulbs. bulbs are rated for 10,000 hours of use. Available in the wattages shown below.

70 watt	100 watt	150 watt
MH-70	MH-100	MH-150

Post Top Globe Assemblies

Historical LED Street Lighting



AVAILABLE IN BOTH
STYLE FINIALS



Standard with Spear Finial	Premium with Spear Finial	Economy Textured Globe	Ornamental Textured Globe
LENS: TYPE (III) OR (V)	LENS: TYPE (III) OR (V)	LENS: CLEAR	LENS: CLEAR
ITEM #: PB2S3SB	ITEM #: PB1P3SB	ITEM #: PV1SFB	ITEM #: PV1PFB
LED Fixture	LED Fixture	LED Fixture	LED Fixture
ITEM #: PB2S3SB-LED	ITEM #: PB1P3SB-LED	ITEM #: PV1SFB-LED	ITEM #: PV1PFB-LED

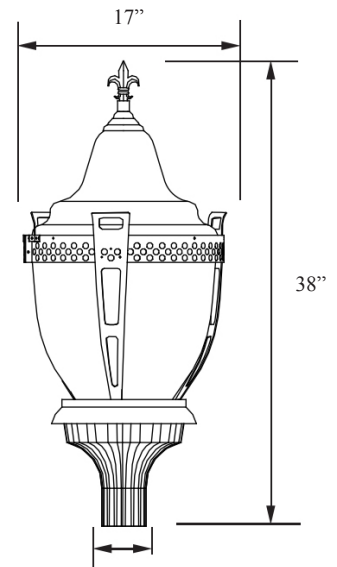

Standard with Fleur-di-lis	Deluxe with Fleur-di-lis	Premium with Fleur-di-lis
LENS: TYPE (III) OR (V)	LENS: TYPE (III) OR (V)	LENS: TYPE (III) OR (V)
ITEM #: PB2S3FB	ITEM #: PB2D3FB	ITEM #: PB2P3FB
LED Fixture	LED Fixture	LED Fixture
ITEM #: PB2S3FB-LED	ITEM #: PB2D3FB-LED	ITEM #: PB2P3FB-LED

FITS 3" DIAMETER



Choose Your LED...

Total Luminous Flux per Module	CCT	Optic Type			
		C		F	
		12w	9w	12w	9w
6500K	1288	850	1345	888	
5700K	1288	850	1345	888	
4000K	1076	710	1100	726	

LG LED Module	
COLOR TEMPERATURE	4000K, 5700K, 6500K
OPERATING TEMPERATURE	-40 TO 50 DEGREES CELCIUS
LIFESPAN	50,000 HOURS
WATTAGE	3 x 9 OR 12 WATTS
DRIVER INFO	ELECTRONIC, 120-277V, 50/60HZ, DIMMABLE

“Ring of Fire” LED Lighting

Energy efficient lighting at its best...



LUMECON ETD™ SYSTEM

The Lumecon High Output LED Light engine utilizes the Lumecon ETD™ (Enhanced Thermal Dissipation) System. The ETD System Engines are thermally bonded to provide maximum thermal dissipation to the exterior of the fixture to ensure long life. To protect the light engine panel from moisture and corrosion, the LED light engine panel is uniformly coated with a UV stabilized acrylic polymer resin that meets MIL and ASTM dielectric standards and UL and IPC standards for flammability, moisture resistance and thermal shock.

LED LIGHT COLOR / QUALITY

The High Output LEDs come standard in 4,000k Neutral White, with additional options of 2,700k Warm White and 5,700k Cool White on the Kelvin temperature scale. All are rated for a minimum of 100,000 hours of continuous operation at select ambient temperature ranges. Contact your Lumecon sales agent for product specific specifications.

20kA SURGE PROTECTION

A 20kA surge suppressor is included to provide an additional level of protection against power line disturbances in industrial and commercial applications. Complies with IEEE/ANSI C62.41.2 guidelines for “C High.”

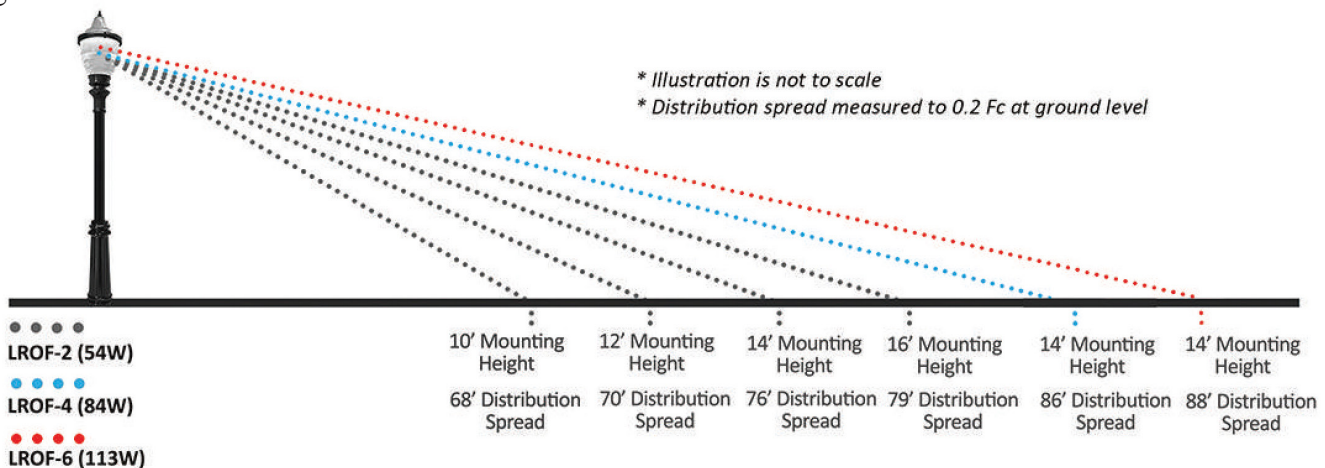

Ring & Ball of Fire

Engineered to optimally perform in "Main Street" applications



Ring of Fire



Decorative Ring of Fire



Ball of Fire

Wattage / Dist.	1 - 27W / Type III
	2 - 54W / Type V
	3 - 58W / Type III
	4 - 84W / Type V
	5 - 88W / Type III
	6 - 113W / Type V
Voltage	1 - 120v - 277v
	2 - 347v - 480v
Color Temp.	NW - Neutral
	CW - Cool
	WW - Warm
Globe Material	A - Acrylic
	P - Polycarbonate
Finial	X - None
	S - Spike
	L - Fleur-De-Lis
Paint Color *specify RAL	B - Black
	CC - Custom Color
Photocell *requires fitter	X - None
	PC1 - 120v PC
	PC2 - 277v PC
	PC3 - 347v PC
	PC4 - 480v PC
Shield	X - None
	H - House Shield
Uplight Lid *included with custom colored units	X - None
	L - Perforated
	C - Cut-Off*

Performance Data		
Watts	Equiv.	Lumens
27	175W HID	2370
54	175W HID	4692
58	250W HID	4574
84	250W HID	6809
88	250W HID	6240
113	250W HID	8426



Wattage / Dist.	1 - 54W / Type V
	2 - 84W / Type V
	3 - 117W / Type V
Voltage	1 - 120v - 277v
	2 - 347v - 480v
Color Temp.	NW - Neutral
	CW - Cool
	WW - Warm
Globe Material	A - Acrylic
	P - Polycarbonate
	W - White Acrylic
Globe Neck Size	8 - 8" Neck
	9 - 9" Neck
Fitter Base	X - None
	1 - 8" Fitter for 3" Pole
Paint Color *specify RAL	B - Black
	CC - Custom Color
Photocell *requires fitter	X - None
	PC1 - 120v PC
	PC2 - 277v PC
	PC3 - 347v PC
	PC4 - 480v PC
Uplight Shield	X - None
	C - Cut-Off
	D - Diffuser Shield

CALL US AND WE CAN ASSIST YOU WITH CHOOSING THE BEST LIGHT TO FIT YOUR NEEDS

Lighting Posts



Our aluminum surface mounted poles are constructed by combining solid cast aluminum “Bolt Bases” and our extruded aluminum posts. Our certified welders fabricate each light pole to order before applying a durable powder-coat finish. Each pole is custom built to order and can be fitted with a variety of options including electrical access doors, photo controls, decorative tenons and more.

3" Round Bolt Base LP-Base03	4" Round Bolt Base LP-Base04	4" Square Bolt Base LP-Base44
---------------------------------	---------------------------------	----------------------------------

STANDARD POST/BASE COMBINATIONS & PART NUMBERS: *SPECIFY “SMOOTH” OR “FLUTED” POSTS AT TIME OF ORDER

3" Diameter x 10'-0" (LPB-0310)*	4" Diameter x 10'-0" (LPB-0410)*	4" x 4" Square x 10'-0" (LPB-4410)
3" Diameter x 12'-0" (LPB-0312)*	4" Diameter x 12'-0" (LPB-0412)*	4" x 4" Square x 12'-0" (LPB-4412)
3" Diameter x 14'-0" (LPB-0314)*	4" Diameter x 14'-0" (LPB-0414)*	4" x 4" Square x 14'-0" (LPB-4414)

*custom lengths available call for more information and prices

THINGS TO CONSIDER WHEN BUILDING YOUR POST

- Access Door
- Decorative Base
- Reducer Tenon
- Photo Control / Outlet
- J-Bolts For Mounting
- Grounding Rod

Surface Mount Posts

Designed to be used when pole is mounted above grade and fastened with anchors or “J-bolts” in concrete. Fasteners are cast integral with foundation. Call ahead and we can send a hole placement template to match the bolt patterns on our surface mounted bases for use when pouring concrete footers.

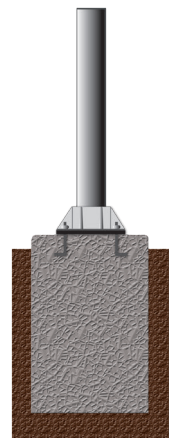

DOWNLOAD INSTALLATION INSTRUCTIONS ON OUR WEBSITE

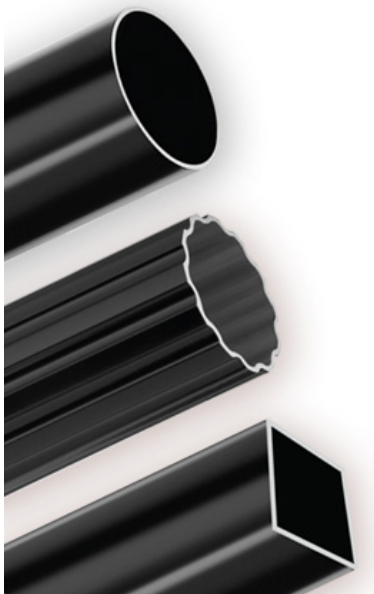

Lumecon LED Lighting & Accessories



RETROFIT SOLUTIONS

We recognize a one size solution doesn't apply for every lighting project. This is why we developed a dedicated retrofit team to design and build custom LED lighting solutions. Call us about how we can assist you with creating a custom solution to retrofitting your current lighting today!

Area



Low Bay



Canopy



Flood



Wall Pack



High Bay



Lighting Components & Accessories



9" MOGUL FITTER

Sand cast decorative aluminum housing. Fits globes with 9" neck and 3" OD poles. Includes porcelain 4KV pulse rated mogul base socket.



8" COLONNADE FITTER

Sand cast decorative aluminum housing. Fits globes with 8" neck and 3" OD poles. Includes porcelain 4KV pulse rated E40 lamp holder.



DUEL HEAD ARM & WALL MOUNT BRACKETS

Made of aluminum, and available in either raw or gloss black finishes. Accepts both "Mogul" & "Colonnade" fitters.



LUMINAIRE FINIALS

Decorative fleur-de-lis and spear finials made of cast aluminum with a powder-coat finish. Comes with mounting hardware.



DARK SKY REFLECTOR

High downlight efficiency and low uplight levels. Fits most standard globe styles. Easy to install self collapsing design ideal for retrofits.

9" Globe Necks	8" Globe Necks	Duel Head Arm	Wall Bracket	Spear / Fleur	Bottom Mount
PFCN50	PFCN10E	PADAB	PWASAB	PFINSPEB / PFINFDLB	CALL FOR PRICES
POST OUTLET	PHOTO CONTROL	4x3 POLE REDUCER	4" BASE COVER	POLE ACCESS DOOR	POLE GROUNDING KIT
Installed	Installed	Reduces 4" to 3"	10.75" x 10.75" x 4.5"	Installed	8'-0" x 5/8" Copper
OUTLET	PHOTOCONT	RED-4x3 <small>*SETSCREWS OR WELD</small>	PARF4BCB	LPB-DOOR	GRCU5808

Engraved Recycled Plastic (HDPE)

Economical maintenance free signage



BASIC ENGRAVED SIGN OPTIONS

Sign Size:	Thickness	Item I.D.
12" x 18"	1/2"	HDPE-1218
14" x 20"	1/2"	HDPE-1420
16" x 22"	1/2"	HDPE-1622
18" x 24"	1/2"	HDPE-1824
20" x 26"	1/2"	HDPE-2026
22" x 28"	1/2"	HDPE-2228
24" x 30"	1/2"	HDPE-2430
30" x 40"	3/4"	HDPE-3040
32" x 42"	3/4"	HDPE-3242
34" x 46"	3/4"	HDPE-3446
36" x 48"	3/4"	HDPE-3648
40" x 48"	3/4"	HDPE-4048

CALL FOR PRICES ON CUSTOM SIZES



CNC Routed HDPE Signage

Signs are created with HDPE (High Density Polyethylene) sign board material in 1/2" or 3/4" thickness, depending on the application. The durable textured finish resists scratches and marring. HDPE material is UV stabilized to resist deterioration in harsh outdoor environments. In addition, HDPE is impact resistant, and will not chip or dent like other materials. Signs are created by removing the skin of the outside layer to expose the core color within. Choose from our 10 standard color options on the next page. Several choices are also available for incorporating your special graphics, logo, or custom coloring, see below.



It pays to go green...

Our recycled plastic HDPE signs are made from 95% up to 100% recycled plastic materials (milk jugs, bottles, etc.). Our HDPE has also been proven to last over 20 years in harsh outdoor environments. Less maintenance and a longer lifespan, what more can you ask for!

Signs are created with HDPE (High Density Polyethylene) sign board material in 1/2" or 3/4" thickness, depending on the application. The durable textured finish resists scratches and marring. HDPE material is UV stabilized to resist deterioration in harsh outdoor environments. In addition, HDPE is impact resistant, and will not chip or dent like other materials. Signs are created by removing the skin of the outside layer to expose the core color within. Choose from our 10 standard colors below. Several options are also available for incorporating your special graphics, logo, or custom coloring, see below.

COLOR OPTIONS »



As the top layer of the material is removed by the router, the inside color shows through to expose the contrasting core color

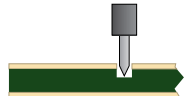

Add a logo to your sign...



INSET

Logo is printed and inset into the sign, then covered with a protective shield and sealed with crystal clear resin. UV stable design with full color graphics.



ENGRAVED

Logo is precision engraved into the sign board exposing the core color of the material. Some logos can be color filled with our resin process for an additional charge, call for details.



MEDALLION

Logos can be cast of bronze or aluminum and attached to your sign once finished. Several shape and finish options available. Call for pricing.

A-Frame Easel Signs

Easels can be custom designed to suit your specific needs. Many options are available for customization including: changeable message sliders, clocks, custom verbiage, logos and other custom graphics. Call us with your ideas and our designers can help you create a cost effective, mobile and durable HDPE easel sign today!



Duel Post Mounted Signs

Call us with your ideas and let us help you design it!

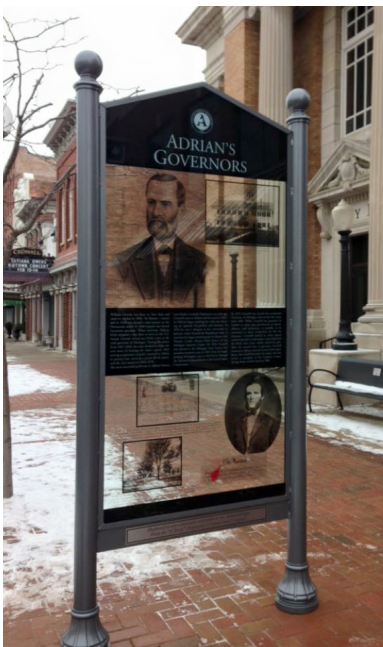
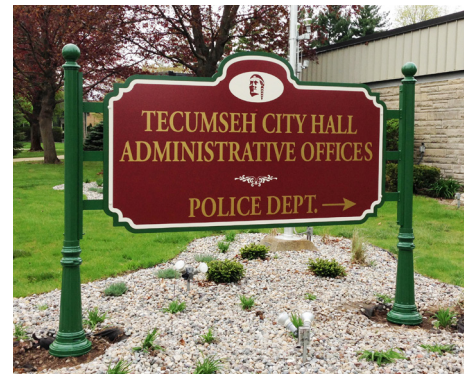
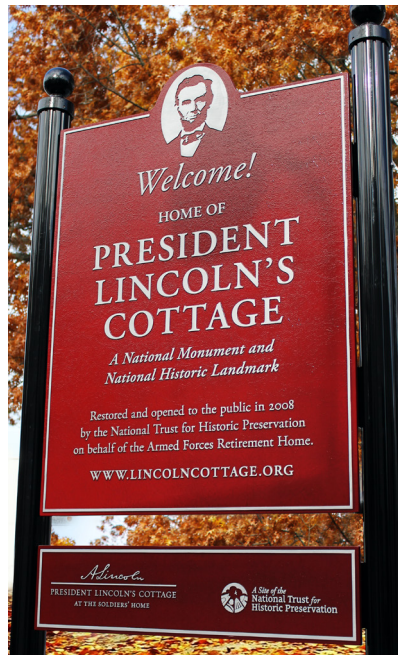

Wayfinding / Post & Panel Signs

Panel Adaptor Series

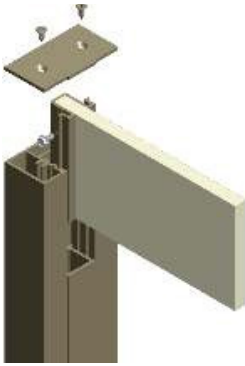

Features & Benefits:

- Pre-painted dark bronze exterior finish
- Simple to assemble
- Panel adaptor allows for choice of 1/8", 1/4" or 1/2" panels
- Three reveal settings to choose from

Panel Adaptor Series Includes:

- (2) 95" posts, choose from series 1, 2 or 3 profiles
- (2) Post Caps with mounting screws
- (1) Panel Adaptor cut to size depending on sign dimension
- (1) "Reveal" cut to size for filling below sign panel

All screws and mounting hardware required for assembly
Sign panels not included in kit prices, call for information regarding the design and size of sign panels required

Panel Adaptor Series Options	
2" SQUARE POST KIT	PP-AS-SQ
3.25" RADIUS OR RECTANGLE POST KIT	PP-AS-RR
Additional Options	
UPGRADE TO 10'-0" SQUARE POSTS	+ \$25.00
UPGRADE TO 11'-0" SQUARE POSTS	+ \$50.00
UPGRADE TO 10'-0" RADIUS/RECT. POSTS	+ \$25.00
UPGRADE TO 11'-0" RADIUS/RECT. POSTS	+ \$50.00

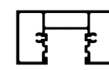

Post Profiles

Panel Adaptors

Series 2

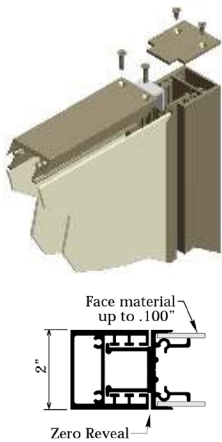

Features & Benefits:

- Pre-painted dark bronze exterior finish
- Simple to assemble
- Three reveal settings to choose from (0, 3/8" or 3/4")

Panel Adaptor Series Includes:

- (2) 95" length 2" square posts
- (2) Post Caps with mounting screws
- (4) Cut to size mitered "Slide Body" frame pieces
- (2) Cut to size series 2 reveal and "below the panel filler"

All screws and mounting hardware required for assembly
Sign panels not included in kit prices, call for information regarding the design and size of sign panels required



Series 2 Post and Panel Options

SIZE	ITEM I.D.
12" x 24"	PP-S2-1224
24" x 24"	PP-S2-2424
24" x 36"	PP-S2-2436
36" x 36"	PP-S2-3636
36" x 48"	PP-S2-3648
36" x 60"	PP-S2-3660
36" x 72"	PP-S2-3672
48" x 48"	PP-S2-4848
48" x 60"	PP-S2-4860
48" x 72"	PP-S2-4872

Series 3

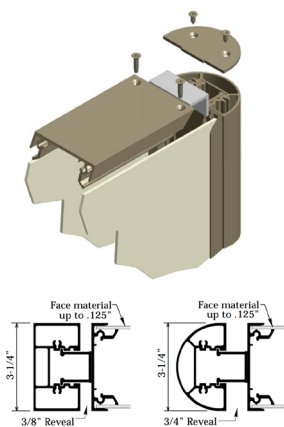

Features & Benefits:

- Pre-painted dark bronze exterior finish
- Simple to assemble
- Three reveal settings to choose from (0, 3/8" or 3/4")

Panel Adaptor Series Includes:

- (2) 95" length 3.25" Rectangle or Radius style posts
- (2) Post Caps with mounting screws
- (4) Cut to size mitered "Slide Body" frame pieces
- (2) Cut to size series 2 reveal and "below the panel filler"

All screws and mounting hardware required for assembly
Sign panels not included in kit prices, call for information regarding the design and size of sign panels required

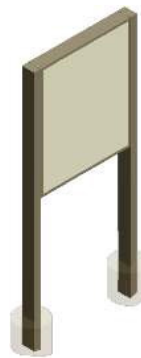

Series 3 Post and Panel Options

SIZE	ITEM I.D.
24" x 24"	PP-S3-2424
24" x 36"	PP-S3-2436
24" x 48"	PP-S3-2448
36" x 36"	PP-S3-3636
36" x 48"	PP-S3-3648
36" x 60"	PP-S3-3660
36" x 72"	PP-S3-3672
48" x 48"	PP-S3-4848
48" x 60"	PP-S3-4860
48" x 72"	PP-S3-4872

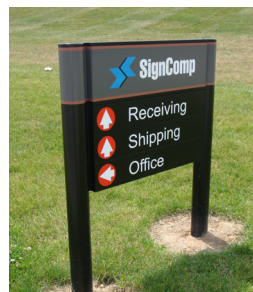

Custom Printed Signs & Banners

Custom Printed Sign Panels

We have in-house capabilities to print full color UV resistant vinyl. Our wide format thermal printers produce high quality exterior grade vinyl signs that are rated for a minimum of 5+ years of outdoor use. See below for more information on the type of substrates we use to create your custom signs.

Alupanel & Aluminum Substrates

Alupanel is a two-sided pre-finished aluminum composite panel consisting of two 0.30 mm aluminum sheets laminated to both sides of a black polyethylene core. Lightweight and strong, we can custom cut nearly any shape or size to fit your needs. A variety of vinyl cutting and printing techniques can be used to create your graphics. Aluminum sign panels are also available in a variety of thicknesses, call for information and prices.

2mm Alupanel (Series 2)	
SIZE	ITEM I.D.
12" x 24"	ALU-1224
24" x 24"	ALU-2424
24" x 36"	ALU-2436
36" x 36"	ALU-3636
36" x 48"	ALU-3648
36" x 60"	ALU-3660
36" x 72"	ALU-3672
48" x 48"	ALU-4848
48" x 60"	ALU-4860
48" x 72"	ALU-4872

3mm Alupanel (Series 3)	
SIZE	ITEM I.D.
24" x 24"	ALU-2424
24" x 36"	ALU-2436
24" x 48"	ALU-2448
36" x 36"	ALU-3636
36" x 48"	ALU-3648
36" x 60"	ALU-3660
36" x 72"	ALU-3672
48" x 48"	ALU-4848
48" x 60"	ALU-4860
48" x 72"	ALU-4872



Aluminum Sign Blanks
CALL FOR PRICES

Banner Mounting Arms

We manufacture several arm styles that accommodate a range of banners and pole sizes. We can also provide full color custom printed banners, or choose from a selection of "Ready to Print" designs shown on our website. Some banner arms are available with "Plant Holders" for use when banners are not being displayed. Call us for more information and prices on custom banners.



BannerFlex Jr.

Arm Length	Item I.D.
19"	BB-JR19
31"	BB-JR31

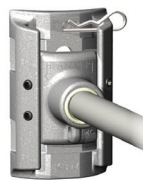

BannerFlex Metro

Arm Length	Item I.D.
25"	BB-MT25
31"	BB-MT31



Banding Buckles

Strap Diameter	Item I.D.
BANDING (8PC)	C256-P-B
BANDING (100PC)	C256-B-B



Collar Hanger Banner Arms

Collar Style:	Item I.D.
FITS 24" BANNER	CHB-24
FITS 30" BANNER	CHB-30
FITS 36" BANNER	CHB-36
CUSTOM MADE HANGER ARM	CALL FOR PRICES



Superior products require a "Signature" finish

Powder-Coat & Wet-Coat

Black is our standard finish, but you may also select from an array of colors for a slightly higher price. We use both spray painted wet coat (*Mathews Urethane Paint - Pantone System*) and powder coat (*Tiger Drylac - RAL System*) finishes depending on the product being coated. See below for our standard color offering, or specify your "Pantone" or "RAL" color to be matched. For assistance in having your products custom color matched, call our customer service department. **We can match almost any color imaginable to suit your needs!**



Gloss Black

Tiger Drylac Bengal Black



Natural White

Tiger Drylac Bengal White



Deep Green

RAL 6009



Mineral Bronze

Spraylat PPL58185



Color Charts available, call us to have one sent by mail

"Prismatic" & "Plascoat" Powder-coat finishes

Prismatic Powder textured finishes are a unique way to add rich detail to your signage, posts and components. We stock six unique powder options that simulate deep textured Hammertone and vein style finishes and are completely UV stable.

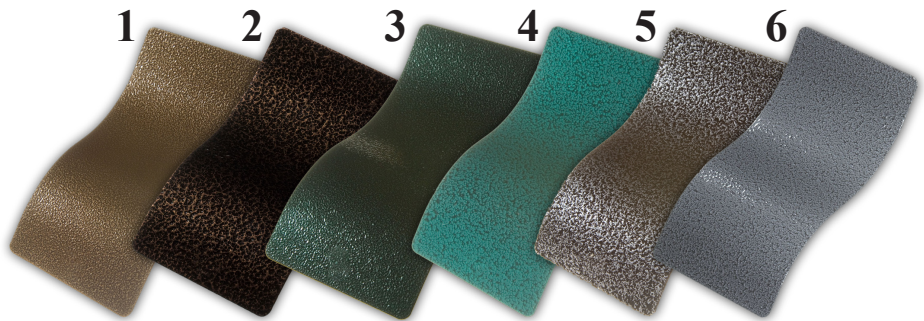

Powder Coat Color Description

- 1- **IRONSTONE GOLD** - A GOLD AND BLACK CONTRAST WITH A SMOOTH TEXTURE
- 2- **GOLDEN VEIN** - COPPER-GOLD AND BLACK CONTRAST WITH A SMOOTH AND MILD TEXTURE
- 3- **IRONSTONE MOSS** - A FOREST GREEN AND BLACK CONTRAST WITH A SMOOTH TEXTURE
- 4- **DOUBLE GREEN VEIN** - LIGHT AND DARK FOREST GREEN CONTRAST WITH A SMOOTH AND MILD TEXTURE
- 5- **BLACK FROST** - BLACK AND SILVER CONTRAST WITH A SMOOTH AND MILD TEXTURE
- 6- **SILVER VEIN** - BRIGHT SILVER WITH A HAMMERTONE TEXTURE

Simulated "Verde" & "Woodgrain" finishes

"Verde" finishes are hand applied by skilled artisans who create the look of a natural aging process. Our "Woodgrain" options are achieved with a proprietary process that imbeds graphic designs into the powder-coat for an ultra durable finish

Verde Finishes

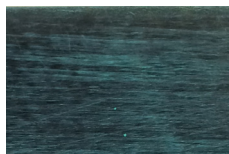

Woodgrain Options

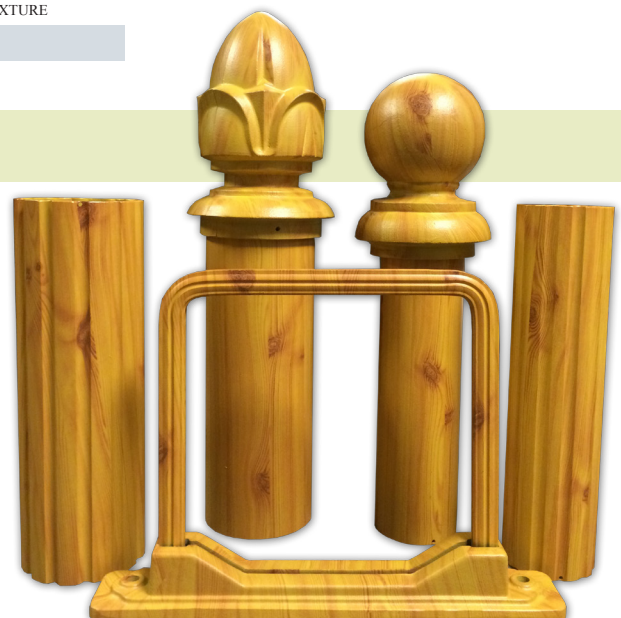

Safety Products

Traffic & Construction Safety



Traffic Safety (Cones, Barrels, etc.)



Stop / Slow Paddle

Barricades



Reflective Vests, Coats, Hoodies, Gloves, Etc.

Roll-Up Signs & Stands



Sequential Lights



U-Channel Post

- Green
- Galvanized
- Brackets



Square Post

- Pre-Punched
- Quick Punched
- Brackets

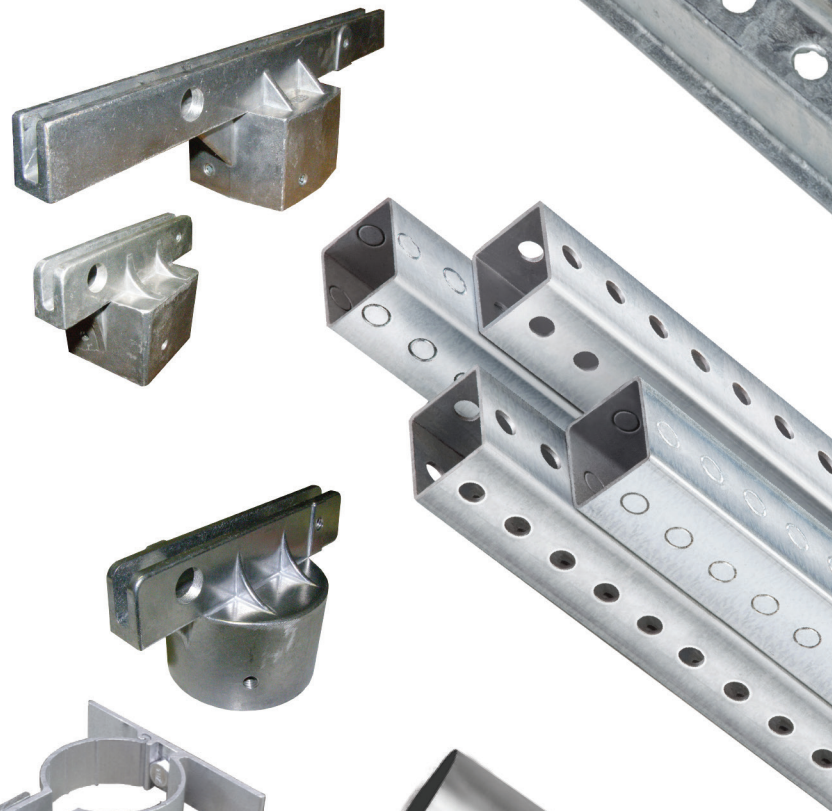

Round Post

- Brackets

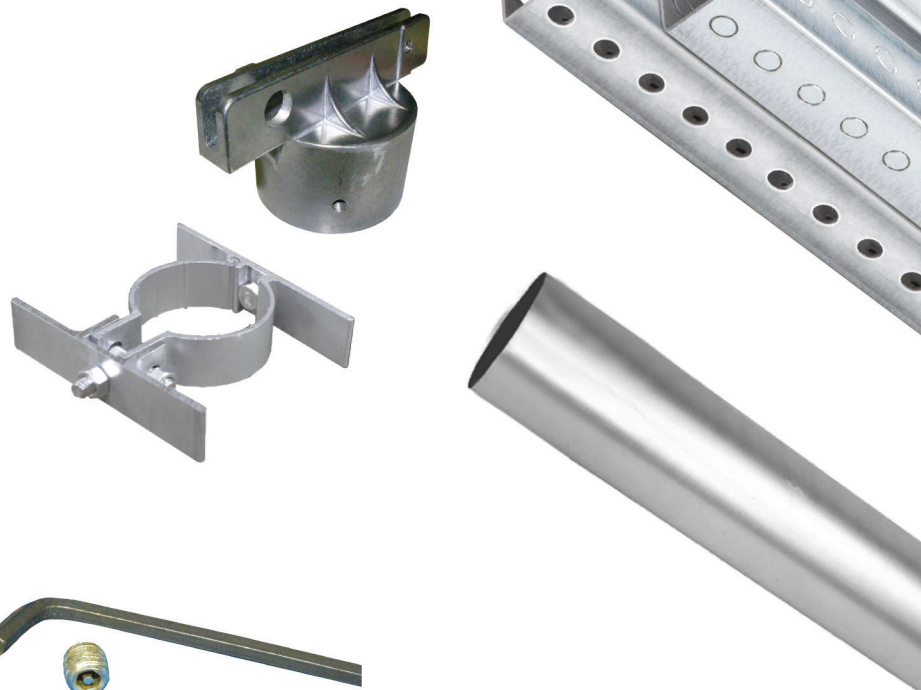

Hardware



Reflective Sheeting



Type XI (11) Omni-Cubed / Diamond Grade DG3	AVERY	3M	Size
White	T-11500	4090	24"
Yellow	T-11501	4091	30"
Blue	T-11505	4095	36"
Green	T-11507	4097	48"
Red	T-11508	4092	
Brown	T-11509	4099	
Fluorescent Yellow	T-11511	4081	
Fluorescent Yellow - Green	T-11513	4083	
Fluorescent Orange	W-11514	4084	
Type IX (9) Omni-View / Diamond Grade VIP DG	AVERY	3M	Size
White	T-9500	3990	24"
Yellow	T-9501	3991	30"
Blue	T-9505	3995	36"
Green	T-9507	3997	48"
Red	T-9508	3992	
Fluorescent Yellow	T-9511	3981	
Fluorescent Yellow - Green	T-9513	3983	
Fluorescent Orange	W-9514	N/A	
Type VIII (8) MVP	AVERY	3M	Size
White	T-7500	3940	24"
Yellow	T-7501	N/A	30"
Blue	T-7505	N/A	36"
Green	T-7507	N/A	48"
Red	T-7508	N/A	
Brown	T-7509	N/A	
Fluorescent Yellow	T-7511	N/A	
Fluorescent Yellow - Green	T-7513	N/A	
Fluorescent Orange	W-7514	3924S	

Reflective Sheeting Continued

Type IV (4) High Intensity Prismatic HIP		AVERY	3M	Size
White		T-6500	3930	24"
Yellow		T-6501	3931	30"
Blue		T-6505	3935	36"
Green		T-6507	3937	48"
Red		T-6508	3932	
Brown		T-6509	3939	
Orange		W-6504	3934	
Type I (1) Engineer Grade Prismatic EGP		AVERY	3M	Size
White		N/A	3430	24"
Yellow		N/A	3431	30"
Red		N/A	3432	36"
Blue		N/A	3435	48"
Green		N/A	3437	
Orange		N/A	N/A	
Type I (1) Engineer Grade EG		AVERY	3M	Size
White		T-1500	3290	24"
Yellow		T-1501	3271	30"
Blue		T-1505	3275	36"
Green		T-1507	3277	48"
Red		T-1508	3272	
Brown		T-1509	3279	
Orange		W-1504	CW84	
Overlay / Anti-Graffiti Film		AVERY	3M	Size
Premium Clear		1160	OL-1000	24"
				30"
				36"
				48"
ElectroCut Film		AVERY	3M	Size
Blue		OL-2005	1175C	24"
Green		OL-2007	1177C	30"
Red		OL-2008	1172C	36"
Black		OL-2003	1178C	48"
* Other colors available.				
Commercial Graphic Vinyl		AVERY	3M	Size
White		HP-700	N/A	24"
Black		HP-700	N/A	30"
				36"
				48"
* Other colors available. Visit our webstore at www.osburns.com				

Traffic Products

All MUTCD Signs

Regulatory



Warning

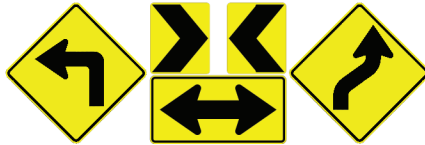

Construction



School

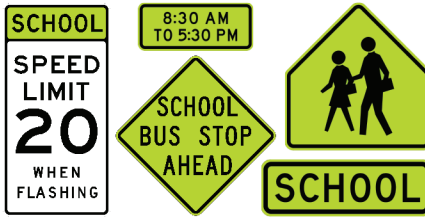

Object Markers

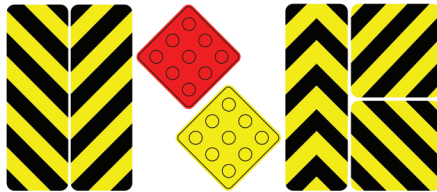

Guide Signs



Wayfinding



Street Name



Park Signs



Dating Stickers

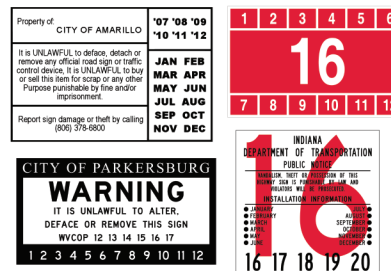

Traffic Products

Sign Blanks and Blades

Standard Blanks

- Square
- Vertical Rectangle
- Horizontal Rectangle
- Circle
- Triangle
- Octagon



- * All blanks available in .063, .080, .100 and .125 aluminum
- * 5052 - H38 Treated
- * Powder coated blanks available upon request.

Routed Blanks

- Custom shaped aluminum signs also available using an industrial router.

- * All blanks available in .063, .080, .100 and .125 aluminum, as well as other substrates.
- * Powder coated blanks available upon request.

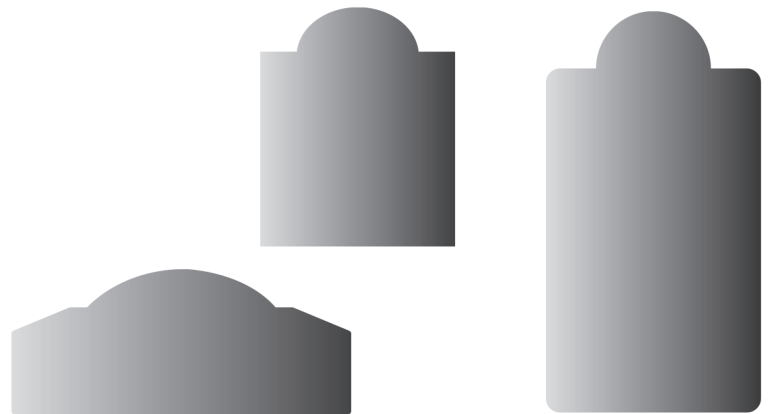

Blade Types

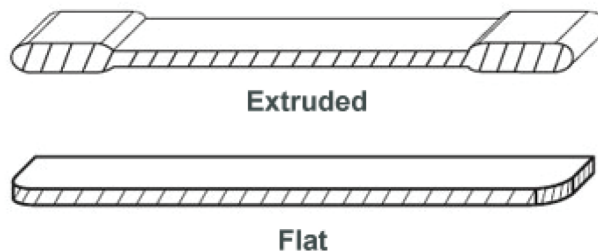
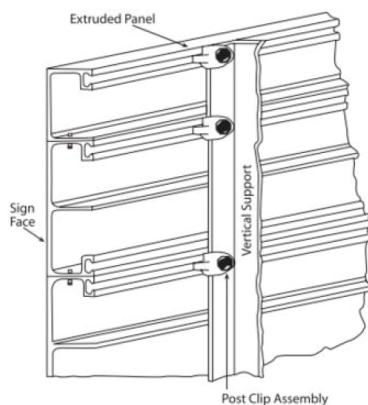

- * Custom lengths available in all types.

Osburn Associates, Inc.

A Manufacturing Company



WWW.OSBURNS.COM

TOLL-FREE 1-800-523-8917

CALL OR EMAIL TODAY FOR A QUOTE!

OSBURN ASSOCIATES, INC.

P.O. Box 912

LOGAN, OH 43138

FAX: 740-385-8016

OSBURN ASSOCIATES, INC.

1630 22ND ST. N.

ST. PETERSBURG, FL 33713

FAX: 727-800-6942

Add "curb appeal" with upscale signage and amenities