

Electrical *Direct*

MASTERS OF OUR TRADE

ISSUE 2

LOW TRADE PRICES

FOR NEXT DAY DELIVERY

CONTACTUM

13A Twin
Switch
Socket
- Pack 5

- Manufactured to BS 1363-2
- Single Pole

ONLY
£3.95
PACK



Order Code: 100936573

Cables & Flex 8

Cable Accessories 22

Cable Management 40

Wiring Accessories 64

Consumer Units &
Circuit Protection 114

Industrial Controls 138

Building Controls
& Home Electrics 148

TV, Telephone
& Network 162

Heating &
Ventilation 168

Fire & Security 196

Commercial
Lighting 236

Exterior Lighting 250

Interior Lighting 258

Lamps & Tubes 272

Sealants, Tapes
& Adhesives 288

Screws, Fixings
& Accessories 300

Issue 2 Winter 2017

FAMILY
MEMBER OF



**FREE
DELIVERY
OVER £45**
Ex VAT



FREEPHONE: 8AM-6PM, 7 DAYS A WEEK

0808 168 22 77

ONLINE: SHOP 24/7

ElectricalDirect.co.uk

EMERGENCY LIGHTING



AT LOW TRADE PRICES

Neptune 12W Downlight

4000k – colour output
5W – cutout – 85mm
7W – cutout – 95mm
12W – cutout – 130mm



SEE
PAGE
243

FROM ONLY
£18.49
EACH

WHEN YOU BUY 5+

Order Code:
179226

Emergency Exit Sign Legend

- For use with LED Exit Box



SEE
PAGE
246

FROM ONLY
£4.61
EACH

WHEN YOU BUY 5+

Order Code:
250265

NEW PRODUCTS ADDED DAILY TO OUR WEBSITE

FREEPHONE: 8AM-6PM, 7 DAYS A WEEK
0808 168 22 77

ONLINE: SHOP 24/7
ElectricalDirect.co.uk

GREAT VALUE FROM THE MASTERS



FREE Next Day Delivery

ORDER UP TO 6PM for next working day delivery. Plus, it's **FREE** on all orders over £45*. You can also order up to 7 days in advance to pick a delivery day that suits you, with weekend options available.



FREE Returns

Simply return unwanted goods via your local Post Office or Collect+ using the free returns label provided, for a full refund or exchange.



LOW **TRADE** PRICES

We keep our prices low to ensure you get the best deal. We've even got a range of bulk buy products so the more you buy, the more you save.



NEW Products Added DAILY!

Our catalogue is packed with over 4,000 products and our website has extra products added daily. Visit ElectricalDirect.co.uk to check out what's new!

*£5.95 for orders under £45 ex VAT.



FREEPHONE: 8am-6pm 7 days a week

0808 168 22 77



ONLINE: Shop 24/7

ElectricalDirect.co.uk



EASY ORDERING FROM THE MASTERS

WE'RE HERE 8AM UNTIL 6PM 7 DAYS A WEEK



FREEPHONE:
0808 168 22 77



ORDERING IS EASY ON OUR WEBSITE:
ElectricalDirect.co.uk



FREEFAX:
0808 168 22 88



EMAIL:
sales@ElectricalDirect.co.uk

**OPEN A
TRADE
ACCOUNT**

**FOR FASTER, QUICKER
ORDERING OPEN
A TRADE ACCOUNT!**

**VISIT OUR WEBSITE
OR CALL TODAY!**



CONNECT WITH US FOR GREAT OFFERS AND COMPETITIONS

HOW TO PAY

We accept all major debit
and credit cards.



ORDER BY 6PM MONDAY TO FRIDAY FOR NEXT DAY DELIVERY

ORDER TODAY!		ORDER VALUE UNDER £45*	ORDER VALUE OVER £45*
QUICK	NEXT WORKING DAY DELIVERY Between 8am – 6pm	£5.95	FREE
QUICKER	BEFORE 12PM	£8.45	£2.50
QUICKEST	BEFORE 10.30AM	£13.45	£7.50
SATURDAY & SUNDAY when ordered by 6pm Friday		£15.95	£10.00



WE DELIVER 7 DAYS A WEEK!

DELIVERY TO SUIT YOU - ORDER UP TO 7 DAYS IN ADVANCE!

A two-day service will apply to orders placed after 4pm in Scotland. Next day delivery is not available for Republic of Ireland, Scottish Highlands and some remote areas where an additional charge may apply. Please call or visit the website for details. *Excl. VAT. £5.95 on orders under £45.

↔ FREE RETURNS

We want you to be 100% satisfied with your product. If for any reason you are not, simply return your item to us using the PRE-PAID returns label provided in your order, then pop it in the post via the Post Office or Collect+. We'll either replace it or issue a full refund. Simple!



OPEN A TRADE ACCOUNT

FOR FASTER,
QUICKER ORDERING
OPEN A TRADE
ACCOUNT!
Visit our website
or call today!



NEW
PRODUCTS
ADDED DAILY



Visit ElectricalDirect.co.uk



**TAKE
A LOOK
AT THIS!**

SEE
PAGE
254

10W Floodlight with PIR

- Ideal for general indoor or outdoor use
- Waterproof IP65 rating - safe for outdoor use
- Ultra-bright energy efficient LEDs with up to 75% energy saving (compared with a halogen lamp)
- Durable construction with die cast body and toughened glass
- LED reflector for instant full brightness

Order Code: 679066

**ONLY
£14.25
EACH**

FREEPHONE: 8AM-6PM, 7 DAYS A WEEK
0808 168 22 77

ONLINE: SHOP 24/7
ElectricalDirect.co.uk



NEXT DAY DELIVERY!

WHEN YOU ORDER BY 6PM

6242Y Twin & Earth Cable - 2.5mm² - 100m - Grey

- Suitable for general domestic wiring
- Manufactured to BS 6004

Order Code: 223275



SEE
PAGE
10

FROM ONLY
£33.92
PACK
WHEN YOU BUY 5+

NEW PRODUCTS ADDED DAILY TO OUR WEBSITE

FREEPHONE: 8AM-6PM, 7 DAYS A WEEK
0808 168 22 77

ONLINE: SHOP 24/7
ElectricalDirect.co.uk

CABLES & FLEX

<u>Flat Cables</u>	<u>10</u>
<u>Double Insulated Cables</u>	<u>11</u>
<u>Single Core Cables</u>	<u>12</u>
<u>Steel Wired Armoured Cables</u>	<u>13-15</u>
<u>Round Flexible Cables</u>	<u>16-17</u>
<u>Heat Resistant Cables</u>	<u>18-19</u>
<u>Satellite, Telephone & TV Cables</u>	<u>20-21</u>

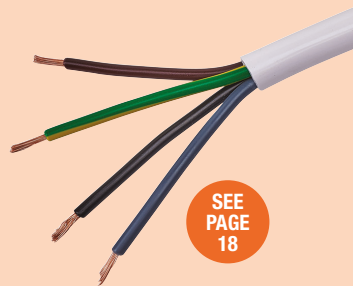

SEE
PAGE
18



SEE
PAGE
19



SEE
PAGE
11



SEE
PAGE
11

Flat Cables

6242Y Twin & Earth Cable - Grey

- Suitable for general domestic wiring
- Manufactured to BS 6004



FROM ONLY
£10.12
EACH

Code	Sq mm	Length m	Each	5+
154993	1	25	£10.63	£10.12
697132	1	50	£15.52	£14.72
168718	1	100	£19.83	£19.20
641999	1.5	25	£11.78	£11.15
654596	1.5	50	£18.97	£18.05
673691	1.5	100	£24.72	£24.63
395239	10	25	£63.82	£60.60
528101	10	50	£76.34	£73.41
692172	10	100	£155.25	£145.69
601402	16	25	£98.90	£93.95
921154	16	50	£184.00	£117.93
791568	16	100	£230.00	£218.50
357486	2.5	25	£16.67	£15.87
253687	2.5	50	£28.75	£27.37
223275	2.5	100	£35.65	£33.92
908488	4	25	£25.87	£24.61
A 142711	4	50	£32.99	£31.72
711258	4	100	£63.25	£59.71
337785	6	25	£37.95	£36.11
549596	6	50	£45.95	£44.19
328529	6	100	£92.64	£89.07

6242B LSF Twin & Earth Cable - White

- Suitable for general domestic wiring
- Manufactured to BS 7211

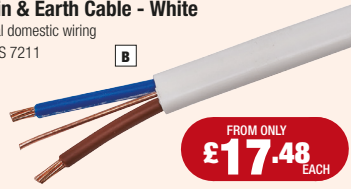

FROM ONLY
£17.48
EACH

Code	Sq mm	Length m	Each	5+
560923	1.5	25	£18.40	£17.48
753136	1.5	50	£27.60	£26.22
622279	1.5	100	£36.80	£29.88
697456	2.5	25	£21.85	£20.81
252316	2.5	50	£33.35	£31.74
370718	2.5	100	£45.94	£42.95
601255	4	25	£37.37	£35.53
786272	4	50	£56.06	£53.24
B 572218	4	100	£74.75	£65.38
800685	6	25	£52.90	£50.25
786975	6	50	£79.35	£75.44
480039	6	100	£105.80	£93.81

6243B LSF 3 Core & Earth Cable - White

- Suitable for general domestic wiring
- Manufactured to BS 7211



FROM ONLY
£15.75
EACH

Code	Sq mm	Length m	Each	5+
916103	1	25	£16.56	£15.75
810356	1	50	£24.89	£23.69
943613	1	100	£36.09	£34.70
212515	1.5	25	£22.71	£21.62
420465	1.5	50	£34.04	£32.31
C 695198	1.5	100	£45.42	£41.20

6243Y 3 Core & Earth Cable - Grey

- Suitable for general domestic wiring
- Manufactured to BS 6004

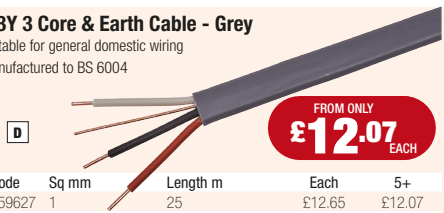

FROM ONLY
£12.07
EACH

Code	Sq mm	Length m	Each	5+
559627	1	25	£12.65	£12.07
149745	1	50	£20.70	£19.66
357320	1	100	£29.32	£27.69
772982	1.5	25	£15.52	£14.72
891521	1.5	50	£27.02	£25.64
D 604954	1.5	100	£40.25	£36.70

100m Harmonised Sleeving

FROM ONLY
£5.25
EACH

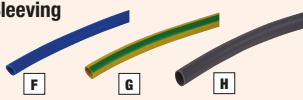

Code	Size mm	Colour	Each	5+
534683	3	Black	£5.65	£5.25
865057	3	Blue	£5.65	£5.25
839875	3	Brown	£5.65	£5.25
854152	3	Green/Yellow	£5.65	£5.25
800430	3	Grey	£5.65	£5.25
414813	4	Black	£5.65	£5.25
F 442840	4	Blue	£5.65	£5.25
754125	4	Brown	£5.65	£5.25
G 395660	4	Green/Yellow	£5.65	£5.25
H 182738	4	Grey	£5.65	£5.25
319099	6	Blue	£7.85	£7.22
946151	6	Grey	£7.85	£7.22
828910	10	Blue	£25.95	£23.87
784399	10	Brown	£51.45	£46.60
673195	10	Green/Yellow	£49.00	£46.60

100m Sleeving Reel

FROM ONLY
£4.58
EACH



Code	Colour	Each	5+
E 605244	Green/Yellow	£4.98	£4.58

Heat Shrink - 12.7mm

- Per meter

FROM ONLY
£1.43
EACH



Code	Colour	Each	5+
652354	Blue	£1.55	£1.43
I 687825	Brown	£1.55	£1.43
930356	Green/Yellow	£1.55	£1.43



To order 10/16mm cable, or any cable in more than 25m reels, please call 0808 168 2277

6181Y Double Insulated Meter Tails - Grey/Brown

- Suitable for connecting electrical meters to distribution units



A

FROM ONLY
£56.29
EACH

Code	Sq mm	Length m	Each	5+
A 796106	16	50	£58.55	£56.29
294372	25	50	£85.40	£82.11
508935	35	50	£133.06	£127.94

6181Y Double Insulated Meter Tails - Brown/Brown

- Suitable for connecting electrical meters to distribution units



B

FROM ONLY
£82.11
EACH

Code	Sq mm	Length m	Each	5+
B 456283	25	50	£85.39	£82.11

6181Y Double Insulated Meter Tails - Grey/Blue

- Suitable for connecting electrical meters to distribution units



C

FROM ONLY
£56.29
EACH

Code	Sq mm	Length m	Each	5+
C 819273	16	50	£58.54	£56.29
746410	25	50	£85.39	£82.11
537366	35	50	£133.05	£127.93

6181Y Double Insulated Meter Tails - Blue/Blue

- Suitable for connecting electrical meters to distribution units



D

FROM ONLY
£82.11
EACH

Code	Sq mm	Length m	Each	5+
D 292633	25	50	£85.39	£82.11

3m MICC PVC Sleeving

- Diameter: 1.5mm



E

FROM ONLY
£1.80

Code	Length	5+
E 470277	£1.88	£1.80

6181Y Double Insulated Meter Tails Pack

- Suitable for connecting electrical meters to distribution units
- Contains: 1 x brown tail, 1 x blue tail & 1 x 10mm² earth cables

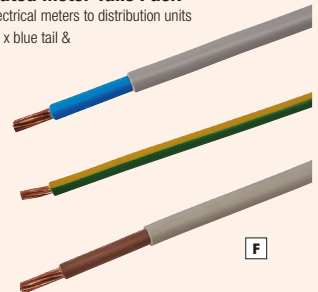

F

FROM ONLY
£7.93
EACH

Code	Sq mm	Length m	Each	5+
330381	16	1	£8.33	£7.93
880480	16	2	£18.97	£18.05
F 878116	25	1	£9.43	£8.97
260325	25	2	£22.42	£21.27

Single Core Cables

6491X Single Core Cable

- Suitable for power circuits, lighting circuits & building wiring
- Can be used in conduit or trunking



FROM ONLY
£9.89
EACH

Code	Sq mm	Length m	Colour	Each	5+
768173	1.5	100	Brown	£10.59	£9.89
788577	1.5	100	Blue	£10.59	£9.89
303315	1.5	100	Green/Yellow	£10.59	£9.89
875255	1.5	100	Black	£10.59	£9.89
585438	1.5	100	Grey	£17.00	£9.89
343125	2.5	100	Brown	£16.83	£15.71
412214	2.5	100	Blue	£16.83	£15.71
535073	2.5	100	Green/Yellow	£16.83	£15.71
418202	2.5	100	Black	£16.83	£15.71
865403	2.5	100	Grey	£16.83	£15.71
218285	4	100	Brown	£27.06	£25.26
738965	4	100	Blue	£27.06	£25.26
A 528471	4	100	Green/Yellow	£27.06	£25.26
B 955384	4	100	Black	£27.06	£25.26
447042	6	100	Brown	£38.78	£36.19
367888	6	100	Blue	£38.78	£36.19
524810	6	100	Green/Yellow	£38.78	£36.19
508077	6	100	Black	£38.78	£36.19
655212	6	100	Grey	£38.78	£36.19
894011	10	100	Green/Yellow	£34.95	£32.59
757902	10	100	Brown	£69.00	£64.44
177630	10	100	Blue	£69.00	£64.44
191057	10	100	Black	£69.00	£64.44
139126	10	100	Green/Yellow	£69.00	£64.44
106698	10	100	Grey	£69.00	£64.44
684669	16	100	Green/Yellow	£50.33	£46.97
186042	16	100	Brown	£99.25	£92.63
333779	16	100	Blue	£99.25	£92.63
698675	16	100	Green/Yellow	£99.25	£92.63
631437	16	100	Black	£99.25	£92.63
935001	16	100	Grey	£99.25	£92.63

6491B LSF Single Core Cable

- Suitable for power circuits, lighting circuits & building wiring
- Can be used in conduit or trunking
- Ideal in applications where fire, smoke, emissions & toxic fumes would create a hazard to the public

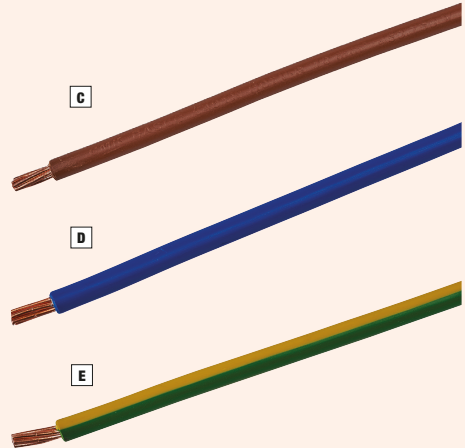

FROM ONLY
£11.40
EACH

Code	Sq mm	Length m	Colour	Each	5+
262668	1.5	100	Brown	£12.21	£11.40
141656	1.5	100	Blue	£12.21	£11.40
433129	1.5	100	Green/Yellow	£12.21	£11.40
345481	1.5	100	Black	£12.21	£11.40
669553	1.5	100	Grey	£12.21	£11.40
927605	2.5	100	Brown	£20.20	£18.85
836482	2.5	100	Blue	£20.20	£18.85
777541	2.5	100	Green/Yellow	£20.20	£18.85
791196	2.5	100	Black	£20.20	£18.85
467837	2.5	100	Grey	£20.20	£18.85
C 276457	4	100	Brown	£29.37	£27.41
D 534320	4	100	Blue	£29.37	£27.41
E 105362	4	100	Green/Yellow	£29.37	£27.41
324364	4	100	Black	£29.37	£27.41
557975	4	100	Grey	£29.37	£27.41
348322	6	100	Brown	£40.39	£39.57
493426	6	100	Blue	£40.39	£39.57
202997	6	100	Green/Yellow	£40.39	£39.57
207151	6	100	Black	£40.39	£39.57
772177	6	100	Grey	£40.39	£39.57
804948	10	100	Brown	£74.17	£69.22
983381	10	100	Blue	£74.17	£69.22
371527	10	100	Green/Yellow	£74.17	£69.22
572331	16	100	Brown	£110.47	£103.10
338440	16	100	Blue	£110.47	£103.10
696055	16	100	Green/Yellow	£110.47	£103.10

Steel Wired Armoured Cables

6943B LSF SWA Cable - 3 Core - Black

- Ideal for interior & exterior applications
- Steel wired armour provides mechanical protection & is suitable for cable ducts & underground installations
- Low smoke & fume
- Ideal where fire, smoke & toxic fumes can be hazardous to the public
- Manufactured to BS 6724 & IEC60502

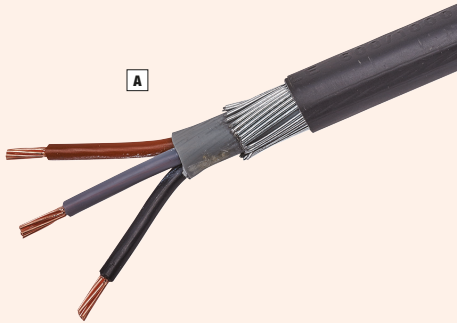

FROM ONLY
£11.30
EACH

Code	Sq mm	Length m	Each	5+
A 900227	1.5	10	£11.89	£11.30
267089	1.5	25	£27.04	£25.68
715601	2.5	10	£15.85	£15.06
483804	2.5	25	£36.03	£34.22
667403	4	10	£22.45	£21.33
711494	4	25	£51.03	£48.47
212119	6	10	£30.15	£28.64
801278	6	25	£68.54	£65.11

6944B LSF SWA Cable - 4 Core - Black

- Ideal for interior & exterior applications
- Steel wired armour provides mechanical protection & is suitable for cable ducts & underground installations
- Low smoke & fume
- Ideal where fire, smoke & toxic fumes can be hazardous to the public
- Manufactured to BS 6724 & IEC 60502

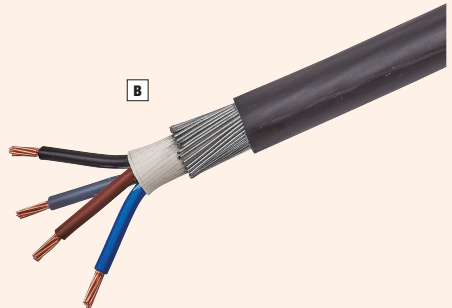

FROM ONLY
£13.84
EACH

Code	Sq mm	Length m	Each	5+
B 667160	1.5	10	£14.57	£13.84
594123	1.5	25	£33.13	£31.47
168502	2.5	10	£20.08	£19.08
150975	2.5	25	£45.65	£43.36
769153	4	10	£27.60	£26.22
669420	4	25	£62.73	£59.59
287790	6	10	£40.54	£38.51
843282	6	25	£92.14	£87.53



To order 10/16mm cable, or any cable in more than 25m reels, please call 0808 168 2277

Steel Wired Armoured Cables

6942X SWA Cable - 2 Core - Black

- Ideal for interior & exterior applications
- Steel wired armour provides mechanical protection
- Suitable for cable ducts & underground installations
- Manufactured to BS 5467

FROM ONLY
£8.01
EACH

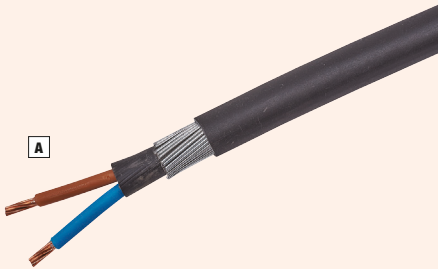

A

Code	Sq mm	Length m	Each	5+
540988	1.5	10	£8.43	£8.01
A 932324	1.5	25	£19.17	£18.21
917934	2.5	10	£11.54	£10.96
408267	2.5	25	£26.23	£24.91
155476	6	10	£20.48	£19.46
208469	6	25	£46.56	£44.23

6943X SWA Cable - 3 Core - Black

- Ideal for interior & exterior applications
- Steel wired armour provides mechanical protection
- Suitable for cable ducts & underground installations
- Manufactured to BS 5467

FROM ONLY
£9.14
EACH

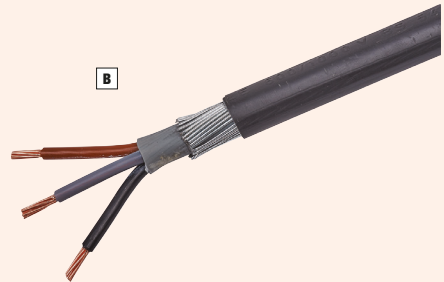

B

Code	Sq mm	Length m	Each	5+
413189	1.5	10	£9.62	£9.14
B 452891	1.5	25	£21.88	£20.78
775181	2.5	10	£13.73	£13.04
685206	2.5	25	£31.22	£29.65
576894	4	10	£18.70	£17.76
947836	4	25	£42.50	£40.37
834702	6	10	£25.38	£24.11
717389	6	25	£57.69	£54.80

6944X SWA Cable - 4 Core - Black

- Ideal for interior & exterior applications
- Steel wired armour provides mechanical protection
- Suitable for cable ducts & underground installations
- Manufactured to BS 5473

FROM ONLY
£11.12
EACH

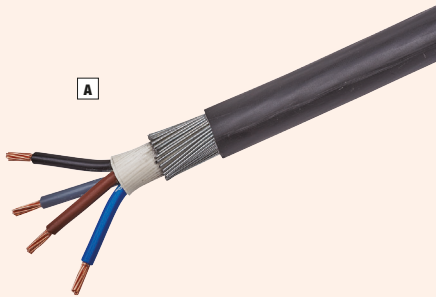

Code	Sq mm	Length m	Each	5+
613489	1.5	10	£11.71	£11.12
A 268847	1.5	25	£26.62	£25.28
637595	2.5	10	£16.88	£16.04
702754	2.5	25	£38.38	£36.46
497772	4	10	£23.10	£21.94
209716	4	25	£52.51	£49.88
797756	6	10	£34.58	£32.85
787242	6	25	£78.60	£74.67



To order 10/16mm cable, or any cable in more than 25m reels, please call 0808 168 2277

6945X SWA Cable - 5 Core - Black

- Ideal for interior & exterior applications
- Steel wired armour provides mechanical protection
- Suitable for cable ducts & underground installations
- Manufactured to BS 5473

FROM ONLY
£20.10
EACH

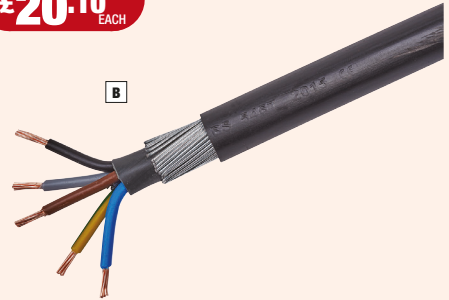

Code	Sq mm	Length m	Each	5+
B 544180	2.5	10	£21.20	£20.10
664785	2.5	25	£49.00	£46.60

6947X SWA Cable - 7 Core - Black

- Ideal for interior & exterior applications
- Steel wired armour provides mechanical protection
- Suitable for cable ducts & underground installations
- Manufactured to BS 5473

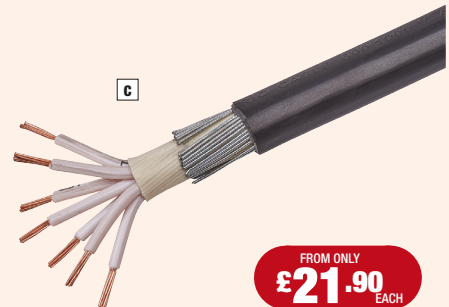

FROM ONLY
£21.90
EACH

Code	Sq mm	Length m	Each	5+
999776	2.5	10	£23.00	£21.90
C 690971	2.5	25	£53.00	£50.40

Round Flexible Cables

3182Y Round Flex - 2 Core

- Suitable for appliances such as refrigerators, washing machines, spin dryers & portable tools
- Manufactured to BS 6500

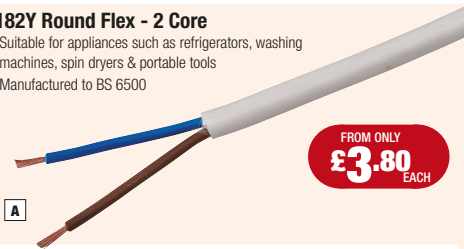

FROM ONLY
£3.80
EACH

Code	Sq mm	Length m	Colour	Each	5+
429639	0.75	10	White	£4.00	£3.80
243771	0.75	25	White	£8.00	£7.60
359725	0.75	50	White	£9.39	£9.03
607336	0.75	10	Black	£4.00	£3.80
585184	0.75	25	Black	£8.00	£7.60
574197	0.75	50	Black	£9.39	£9.03
628077	1	10	White	£5.90	£5.60
843552	1	25	White	£11.60	£11.00
908372	1	50	White	£22.14	£21.29
891129	1	10	Black	£5.80	£5.50
256141	1	25	Black	£11.70	£11.10
716812	1	50	Black	£11.41	£10.97
340318	1.5	10	White	£7.50	£7.10
606999	1.5	25	White	£15.00	£14.30
A 614135	1.5	50	White	£15.79	£15.18
857418	1.5	10	Black	£7.50	£7.10
848399	1.5	25	Black	£15.00	£14.30
390751	1.5	50	Black	£15.79	£15.18
338402	2.5	10	White	£9.50	£9.00
368307	2.5	25	White	£19.00	£18.10
308295	2.5	50	White	£50.16	£48.23

3184Y Round Flex - 4 Core - White

- Suitable for appliances such as refrigerators, washing machines, spin dryers & portable tools
- Manufactured to BS 6500

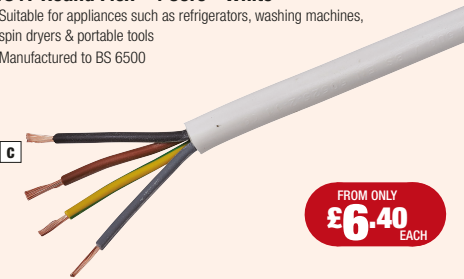

FROM ONLY
£6.40
EACH

Code	Sq mm	Length m	Each	5+
937141	0.75	10	£6.75	£6.40
469905	0.75	25	£14.00	£13.30
642185	0.75	50	£16.30	£15.68
521136	0.75	100	£31.61	£30.39
815909	1	10	£9.30	£8.80
230268	1	25	£19.40	£18.40
631363	1	50	£20.56	£19.77
758688	1	100	£39.90	£38.36
658007	1.5	10	£12.00	£11.40
706049	1.5	25	£25.00	£23.80
C 968274	1.5	50	£28.49	£27.39
573084	2.5	10	£13.75	£13.10
578242	2.5	25	£28.60	£27.20
824329	2.5	50	£46.33	£44.55

3183Y Round Flex - 3 Core

- Suitable for appliances such as refrigerators, washing machines, spin dryers & portable tools
- Manufactured to BS 6500

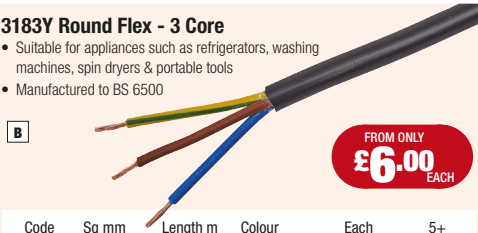

FROM ONLY
£6.00
EACH

Code	Sq mm	Length m	Colour	Each	5+
573257	0.75	10	White	£7.25	£6.90
548727	0.75	25	White	£14.50	£13.80
919216	0.75	50	White	£12.72	£12.23
634258	0.75	100	White	£24.69	£23.74
724953	0.75	10	Black	£7.25	£6.90
333780	0.75	25	Black	£14.50	£13.80
679972	0.75	50	Black	£20.50	£19.50
435667	0.75	100	Black	£24.69	£23.74
853415	1	10	White	£6.30	£6.00
905612	1	25	White	£13.10	£12.40
187645	1	50	White	£15.56	£14.97
880526	1	100	White	£30.20	£29.04
881498	1	10	Black	£10.50	£10.00
740167	1	25	Black	£21.00	£20.00
466311	1	50	Black	£23.00	£21.90
478076	1	100	Black	£30.20	£29.04
460984	1.5	10	White	£8.55	£8.10
466183	1.5	25	White	£17.80	£16.90
798330	1.5	50	White	£21.35	£20.53
124698	1.5	100	White	£54.20	£39.83
116164	1.5	10	Black	£8.55	£8.10
110168	1.5	25	Black	£17.80	£16.90
751265	1.5	50	Black	£28.50	£27.10
B 221919	1.5	100	Black	£54.20	£39.83
103865	2.5	10	White	£13.50	£12.80
645435	2.5	25	White	£28.10	£26.70
286367	2.5	50	White	£48.50	£34.24
482518	2.5	100	White	£69.24	£66.58
415650	2.5	10	Black	£13.50	£12.80
229781	2.5	25	Black	£28.10	£26.70
941686	2.5	50	Black	£48.50	£46.10
381378	2.5	100	Black	£69.24	£66.58

3185Y Round Flex - 5 Core - White

- Suitable for appliances such as refrigerators, washing machines, spin dryers & portable tools
- Manufactured to BS 6500

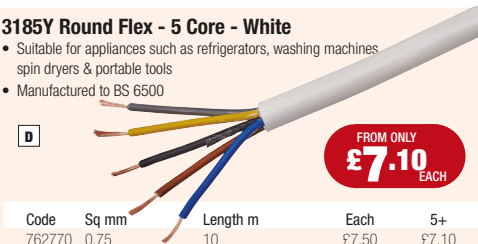

FROM ONLY
£7.10
EACH

Code	Sq mm	Length m	Each	5+
762770	0.75	10	£7.50	£7.10
251031	0.75	25	£15.60	£14.80
689114	0.75	50	£19.48	£18.73
595262	0.75	100	£39.55	£38.03
388660	1	10	£11.10	£10.50
357823	1	25	£23.10	£21.90
442061	1	50	£28.31	£27.23
957275	1	100	£46.16	£44.39
966559	1.5	10	£13.75	£13.10
336298	1.5	25	£28.70	£27.30
D 659086	1.5	50	£33.39	£32.11

3182B LSF Round Flex - 2 Core - White

- Low smoke & fume flexible cable where toxic fumes can be hazardous to the public

A

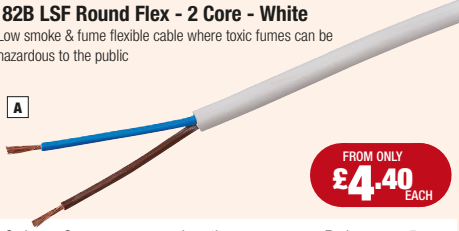

FROM ONLY
£4.40
EACH

Code	Sq mm	Length m	Each	5+
413236	1	10	£4.60	£4.40
233368	1	25	£9.20	£8.70
523046	1	50	£13.80	£13.10
A 119870	1	100	£29.17	£28.05

3184B LSF Round Flex - 4 Core - White

- Low smoke & fume flexible cable
- Toxic fumes can be hazardous to the public
- Manufactured to BS EN 50525-3-11

C

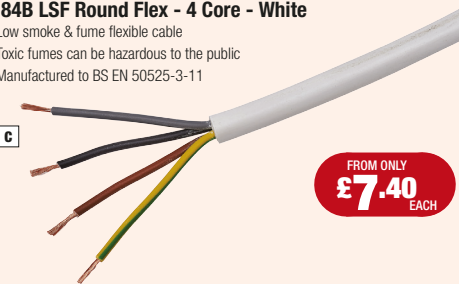

FROM ONLY
£7.40
EACH

Code	Sq mm	Length m	Each	5+
592336	0.75	10	£7.80	£7.40
539372	0.75	25	£16.15	£15.30
432784	0.75	50	£27.60	£26.20
C 908119	0.75	100	£56.63	£54.45

3183TRS Rubber Flex - 3 Core - Black

- Suitable for interior & exterior applications
- H05RR-F Approved
- Manufactured to BS 6500

E



FROM ONLY
£8.10
EACH

Code	Sq mm	Length m	Colour	Each	5+
840356	1.5	10	Blue	£8.50	£8.10
620306	1.5	25	Blue	£18.55	£17.60
984363	1.5	50	Blue	£31.00	£29.50
928444	1.5	100	Blue	£42.64	£41.00
986769	1.5	10	Yellow	£8.50	£8.10
147320	1.5	25	Yellow	£18.55	£17.60
300326	1.5	50	Yellow	£31.00	£29.50
D 125567	1.5	100	Yellow	£42.64	£41.00
109212	2.5	10	Blue	£14.60	£13.90
713538	2.5	25	Blue	£31.85	£30.30
561461	2.5	50	Blue	£48.50	£46.10
227724	2.5	100	Blue	£69.27	£66.61
343689	2.5	10	Yellow	£14.55	£13.80
331481	2.5	25	Yellow	£31.85	£30.30
154864	2.5	50	Yellow	£48.50	£46.10
334281	2.5	100	Yellow	£69.27	£66.61

3183B LSF Round Flex - 3 Core - White

- Low smoke & fume flexible cable where toxic fumes can be hazardous to the public

B



FROM ONLY
£8.00
EACH

Code	Sq mm	Length m	Each	5+
283478	0.75	10	£8.40	£8.00
271495	0.75	25	£16.70	£15.90
848503	0.75	50	£35.18	£33.83
693688	1	10	£9.40	£9.10
562614	1	25	£15.00	£14.30
272172	1	50	£42.90	£41.25
733379	1.5	10	£9.90	£9.40
607216	1.5	25	£20.50	£19.50
B 929695	1.5	50	£57.49	£55.28

3183AG Arctic Grade - 3 Core

- Suitable for tools & equipment used in cold, external environments
- Manufactured BS EN 50265

D

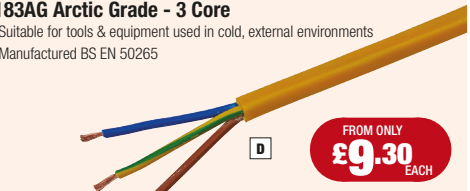

FROM ONLY
£9.30
EACH

Code	Sq mm	Length m	Each	5+
780559	0.75	10	£9.80	£9.30
299080	0.75	25	£21.35	£20.30
825889	0.75	50	£37.50	£35.60
451563	0.75	100	£39.81	£38.28
104168	1	10	£11.75	£11.20
312239	1	25	£25.55	£24.30
402399	1	50	£44.50	£42.30
225847	1	100	£48.08	£46.23
383984	1.5	10	£14.25	£13.50
688869	1.5	25	£31.15	£29.60
762049	1.5	50	£61.00	£58.00
732093	1.5	100	£66.43	£63.87
758606	2.5	10	£20.00	£19.00
575569	2.5	25	£43.75	£41.60
235625	2.5	50	£71.00	£67.50
E 297595	2.5	100	£99.17	£95.35

NYJ-J Hi-Tuf Cable - 3 Core - Black

- Suitable for interior & exterior applications
- Manufactured to BS 60332-1-2

F

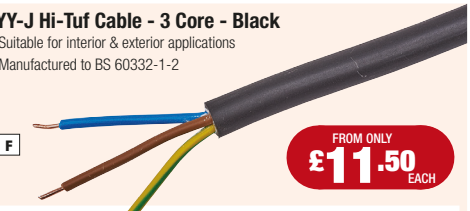

FROM ONLY
£11.50
EACH

Code	Sq mm	Length m	Each	5+
404484	1.5	10	£12.15	£11.50
270019	1.5	25	£26.60	£25.30
496877	1.5	50	£38.00	£36.10
F 725086	1.5	100	£69.30	£67.85

Heat Resistant Cables

3093Y Heat Resistant Flex - 3 Core - White

- Suitable for applications where cable is subjected to high temperatures
- Manufactured to BS 6141

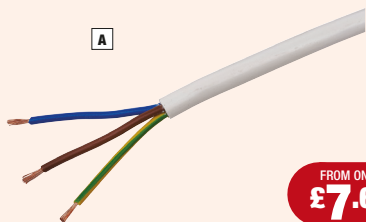

FROM ONLY
£7.60
EACH

Code	Sq mm	Length m	Each	5+
860830	0.75	10	£8.00	£7.60
336039	0.75	25	£17.50	£16.60
248466	0.75	50	£18.70	£17.99
409666	0.75	100	£34.15	£32.84
803191	1	10	£9.20	£8.70
771169	1	25	£20.10	£19.10
820984	1	50	£21.88	£21.04
368909	1	100	£42.04	£40.43
358621	1.5	10	£10.50	£10.00
229989	1.5	25	£23.10	£21.90
A 725826	1.5	50	£27.46	£26.40
429358	1.5	100	£53.20	£51.15
655180	2.5	10	£12.15	£11.50
227550	2.5	25	£26.60	£25.30
589703	2.5	50	£46.16	£44.39
856862	2.5	100	£60.90	£57.90

3094Y Heat Resistant Flex - 4 Core - White

- Suitable for applications where cable is subjected to high temperatures
- Manufactured to BS 6141

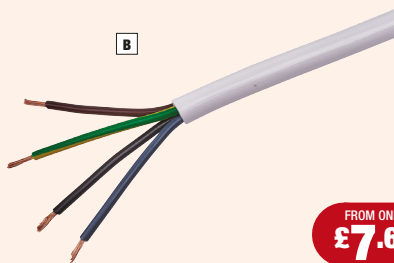

FROM ONLY
£7.60
EACH

Code	Sq mm	Length m	Each	5+
160322	0.75	10	£8.00	£7.60
599658	0.75	25	£17.50	£16.60
426303	0.75	50	£22.50	£21.62
760062	0.75	100	£43.76	£42.08
113085	1	10	£9.20	£8.70
329913	1	25	£20.10	£19.10
839615	1	50	£28.14	£27.06
750895	1	100	£46.00	£43.70
761942	1.5	10	£10.50	£10.00
359547	1.5	25	£23.10	£21.90
B 146258	1.5	50	£36.04	£34.65
466205	1.5	100	£52.90	£50.30

3095Y Heat Resistant Flex - 5 Core - White

- Suitable for applications where cable is subjected to high temperatures
- Manufactured to BS 6141

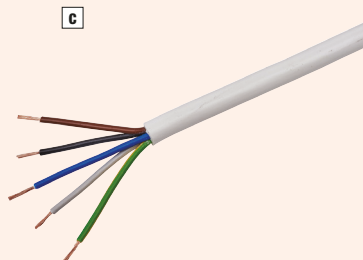

FROM ONLY
£10.60
EACH

Code	Sq mm	Length m	Each	5+
319466	0.75	10	£11.20	£10.60
900195	0.75	25	£24.50	£23.30
C 771457	0.75	50	£26.08	£25.08
859235	0.75	100	£56.00	£53.20

3183TQ HOFR Heat Resistant Cable - 3 Core - White

- Suitable for applications where cable is subjected to high temperatures
- Ideal for connecting equipment such as pumps, generators, lighting & immersion heaters
- Manufactured to BS 6500

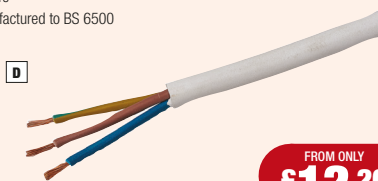

FROM ONLY
£12.20
EACH

Code	Sq mm	Length m	Each	5+
626059	0.75	10	£12.80	£12.20
514960	0.75	25	£28.00	£26.60
345876	0.75	50	£26.80	£25.77
393472	0.75	100	£52.05	£50.04
901930	1	10	£14.75	£14.00
934786	1	25	£32.20	£30.60
373283	1	50	£30.80	£29.62
487263	1	100	£73.60	£69.90
220435	1.5	10	£17.00	£16.20
569880	1.5	25	£37.00	£35.20
D 946366	1.5	50	£41.10	£39.52
418288	1.5	100	£84.80	£80.60
824587	2.5	10	£19.50	£18.50
476835	2.5	25	£42.50	£40.40
732044	2.5	50	£62.98	£60.56
663967	2.5	100	£97.30	£92.40

3183TQ HOFR Heat Resistant Cable - 3 Core - Black

- Suitable for applications where cable is subjected to high temperatures
- Ideal for connecting equipment such as pumps, generators, lighting & immersion heaters
- Manufactured to BS 6500

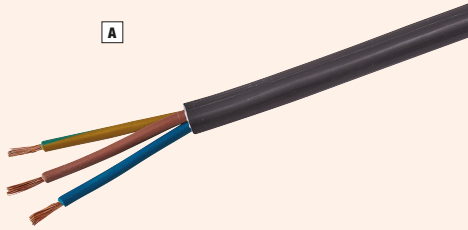

FROM ONLY
£14.30
EACH

Code	Sq mm	Length m	Each	5+
A 855666	4	5	£15.00	£14.30
757819	4	10	£90.95	£87.45
789537	6	5	£19.90	£18.90
767941	6	10	£124.41	£119.63

FP200 Gold Fire Resistant Cable

- Suitable for fire alarm & emergency lighting
- Easy to install & terminate
- Excellent data & signal transmission characteristics
- Ideal for voice alarm, addressable & networked systems
- Manufactured to BS 7629-1

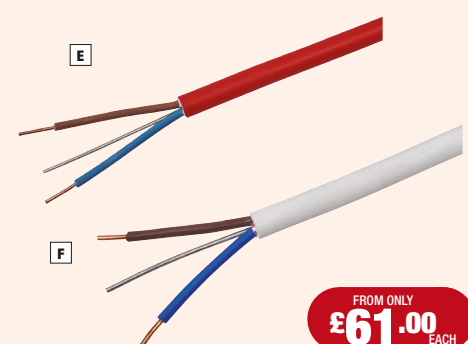

FROM ONLY
£61.00
EACH

Code	Sq mm	Colour	Cores	Each	3+
E 271088	1.5	Red	2	£64.50	£61.00
F 659565	1.5	White	3	£118.50	£114.00
669700	2.5	White	2	£112.50	£108.00

Firesure Fire Resistant Cable

- Suitable for both interior & exterior applications in suitably protected environments
- Can be buried in plaster, clipped directly to surface, tray & other installations requiring a dressable product
- Manufactured to BS EN 60228, BS EN 50363-1 & BS 7655-6.1

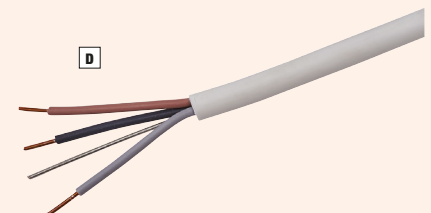
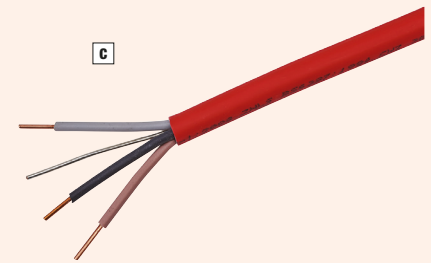
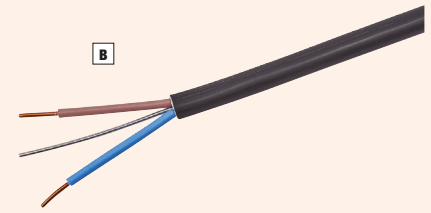

FROM ONLY
£58.37
EACH

Code	Sq mm	Colour	Cores	Each	3+
B 506275	1.5	Black	2	£60.50	£58.37
585946	1.5	Red	2	£60.50	£58.37
757115	1.5	White	2	£60.50	£58.37
C 486601	1.5	Red	3	£94.64	£91.00
D 221780	1.5	White	3	£94.64	£91.00
780669	1.5	Red	4	£112.12	£107.90
623096	1.5	White	4	£112.12	£107.90
781900	2.5	Red	2	£102.00	£98.15
601302	2.5	White	2	£102.00	£98.15

Satellite, Telephone & TV Cables

CT100 Coaxial Cable

- Standard cable for connecting TV & Satellite

A

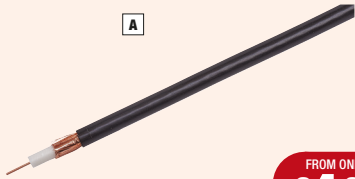

FROM ONLY
£4.00
EACH

Code	Length m	Each	5+
634019	10	£4.25	£4.00
637479	50	£12.75	£12.10
A 129693	100	£31.40	£29.84

CT100 Twin Coaxial Cable

- Standard cable for connecting TV & Satellite

B

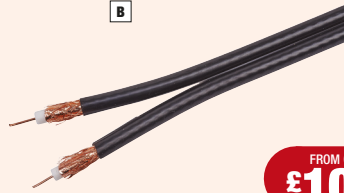

FROM ONLY
£10.50
EACH

Code	Length m	Each	5+
156729	10	£11.00	£10.50
686531	50	£33.00	£31.40
B 369696	100	£88.00	£84.60

Bell Wire - 2 Core - White

- Suitable for connecting bell push to chime

C

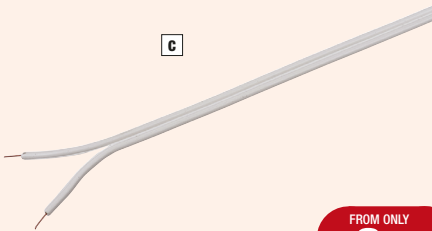

FROM ONLY
£6.20
EACH

Code	Length m	Each	5+
C 326184	100	£6.50	£6.20

Speaker Wire

- Suitable for connecting speakers to amplifiers

D

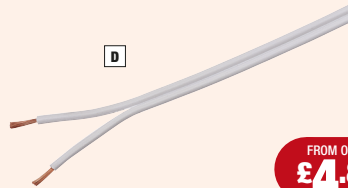

FROM ONLY
£4.80
EACH

Code	Type	Length m	Each	5+
288409	42 Strand	10	£5.00	£4.80
634154	42 Strand	50	£15.00	£14.30
D 541471	42 Strand	100	£29.40	£22.05
369916	79 Strand	10	£8.25	£7.80
500876	79 Strand	50	£24.75	£23.50
583655	79 Strand	100	£51.14	£40.32

CW1308 Telephone Cable - 100m

E

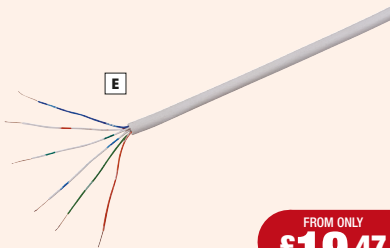

FROM ONLY
£19.47
EACH

Code	Cores	Each	5+
E 439202	3 Pair	£29.00	£19.47
186374	4 Pair	£27.28	£26.24
904691	6 Pair	£35.86	£34.49

BT IDC Plastic Insertion Tool

F



FROM ONLY
34P
EACH

Code	Each	5+
F 186533	£0.36	£0.34

CAT5e Cable - Unscreened - 305m - Grey

- 305m Fast Feed Box

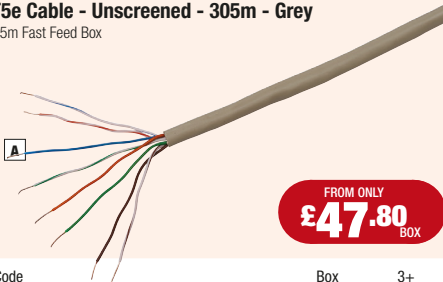

FROM ONLY
£47.80
BOX

Code	Box	3+
A 792147	£51.85	£47.80

CAT5e Cable - Screened - 305m - Grey

- High performance Cat5e cable suitable for installations where high levels of EMI and RFI could be present
- 305m fast feed box
- 100% aluminium foil tape screen
- PVC Outer Sheath

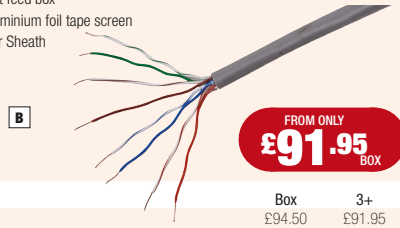

FROM ONLY
£91.95
BOX

Code	Box	3+
B 927477	£94.50	£91.95

CAT5e LSF Cable - 305m - Purple

- 305m fast feed box
- Suitable for applications where toxic fumes can be hazardous to the public

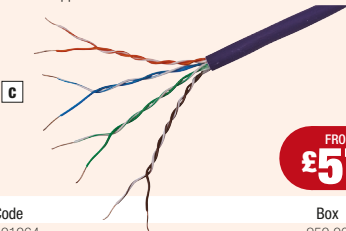

FROM ONLY
£57.35
BOX

Code	Box	3+
C 191964	£59.90	£57.35

CAT6 LSF Cable - 305m - Purple

- 305m fast feed box
- Suitable for applications where toxic fumes can be hazardous to the public

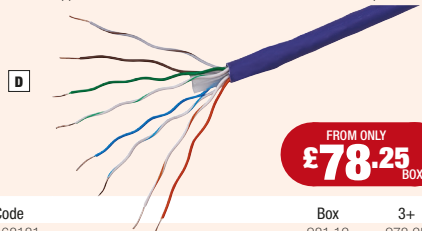

FROM ONLY
£78.25
BOX

Code	Box	3+
D 168181	£81.12	£78.25

Cat5 RJ45 Patch Lead

- Suitable for ethernet applications
- Ideal for home or office networks

FROM ONLY
84P
EACH

Code	Length m	Colour	Each	10+
770095	1	Red	£0.95	£0.84
594045	1	Blue	£0.95	£0.84
631079	1	Grey	£0.95	£0.84
E 529887	2	Red	£1.08	£0.95
616625	2	Blue	£1.08	£0.95
453484	2	Grey	£1.08	£0.95
889945	3	Red	£1.30	£1.15
795905	3	Blue	£1.30	£1.15
702012	3	Grey	£1.30	£1.15
829112	5	Blue	£1.98	£1.75
879408	5	Grey	£1.98	£1.75
F 955965	10	Grey	£4.38	£4.05
477859	20	Grey	£7.95	£7.68

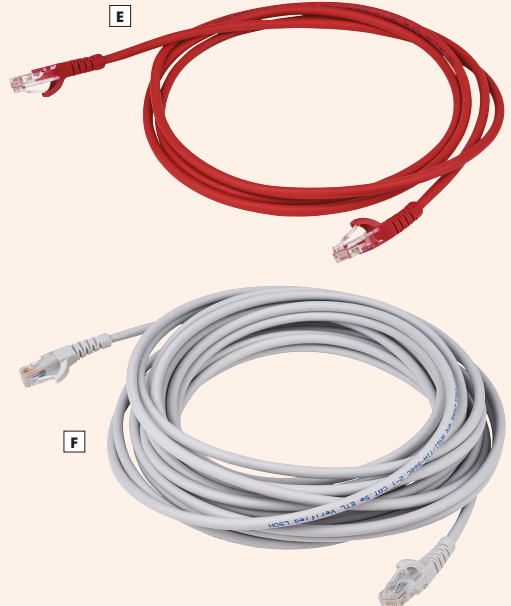



NEXT DAY DELIVERY!

WHEN YOU ORDER BY 6PM

35mm 2 Gang Knockout Box Galvanised

- Galvanised steel box with pre-pressed knockouts



**TRADE
ESSENTIAL**

Order Code: 379744

SEE
PAGE
35

FROM ONLY
53P EACH
WHEN YOU BUY 5+

NEW PRODUCTS ADDED DAILY TO OUR WEBSITE

FREEPHONE: 8AM-6PM, 7 DAYS A WEEK
0808 168 22 77

ONLINE: SHOP 24/7
ElectricalDirect.co.uk

CABLE ACCESSORIES

<u>Cable Ties, Cleats & Grommets</u>	<u>24-25</u>
<u>Glands</u>	<u>26</u>
<u>Glands & Catenary Wire</u>	<u>27</u>
<u>Copper Lugs & Insulated Grips</u>	<u>28</u>
<u>SWA Joint & Branch Kits</u>	<u>29</u>
<u>Connectors</u>	<u>30</u>
<u>Connectors & Henley Blocks</u>	<u>31</u>
<u>Earthing Accessories</u>	<u>32-33</u>
<u>Adaptable Boxes</u>	<u>34</u>
<u>Knockout Boxes</u>	<u>35</u>
<u>Dryline Boxes</u>	<u>36-37</u>
<u>Junction Boxes</u>	<u>38-39</u>



SEE
PAGE
30



SEE
PAGE
24

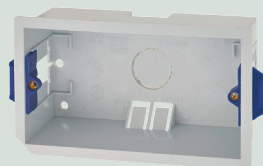

SEE
PAGE
36



SEE
PAGE
26

Cable Ties, Cleats & Grommets

Flat Twin & Earth Clips - Grey



FROM ONLY
84P
PACK

Code	Size mm	Pack 100	5+
A 785660	1	£0.88	£0.84
885130	1.5	£0.95	£0.91
338110	2.5	£1.10	£1.06
424819	4	£1.20	£1.15
821172	6	£1.82	£1.75
929730	10	£2.47	£2.37

Flat Twin & Earth Clips **TOWER**



FROM ONLY
£1.86
PACK

Code	Colour	Size mm	Pack 100	10+
445261	White	1.5	£1.94	£1.86
678874	White	2.5	£2.15	£2.07
638758	White	6	£3.14	£3.02
971751	White	10	£3.93	£3.78
374559	Grey	2.5	£2.26	£2.17
148497	Grey	4	£2.86	£2.75
469290	Grey	6	£3.14	£3.02
B 671954	Grey	10	£3.93	£3.78
418568	Grey	16	£5.49	£5.27

MICC PVC Clip



FROM ONLY
£6.05
PACK

Code	Colour	Size	Pack 50	5+
C 941367	Red	RCHL26	£7.20	£6.91
290096	Red	RCHL28	£6.30	£6.05
110042	Red	RCHL30	£6.93	£6.65
828884	Red	RCHL32	£7.20	£6.91
667231	Red	RCHL34	£7.20	£6.91
209715	Red	RCHL37	£10.13	£9.73
637024	Red	RCHL43	£10.13	£9.73
378304	Red	RCHL47	£11.25	£10.80
129339	White	RCHL26	£7.20	£6.91
961490	White	RCHL28	£6.30	£6.05
627771	White	RCHL30	£6.93	£6.65
654994	White	RCHL32	£7.20	£6.91
357784	White	RCHL34	£7.20	£6.91
234212	White	RCHL37	£10.13	£9.73
186091	White	RCHL43	£10.13	£9.73
747938	Orange	RCHL30	£6.93	£6.65
468571	Orange	RCHL37	£10.13	£9.73
640215	Orange	RCHL40	£10.13	£9.73
250224	Orange	RCHL47	£11.25	£10.80

Round Circular Clips



FROM ONLY
£1.31
PACK

Code	Colour	Size mm	Pack 100	10+
430796	White	3.5	£1.36	£1.31
239895	White	4	£1.38	£1.33
808570	White	5	£1.38	£1.33
108860	White	6	£1.38	£1.33
519253	White	7	£1.44	£1.39
420170	White	8	£1.72	£1.65
325822	White	9	£1.89	£1.81
D 982897	White	10	£2.67	£2.57
921097	White	11	£3.38	£3.25
226852	White	12	£3.83	£3.69
709760	White	14	£3.25	£3.12
178159	White	16	£3.64	£3.50
827841	Black	6	£1.38	£1.33
194042	Black	7	£1.44	£1.39
345260	Black	8	£1.72	£1.65
232547	Black	9	£1.89	£1.81
920430	Brown	6	£1.38	£1.33
563707	Brown	7	£1.44	£1.39
495768	Orange	6	£1.38	£1.33
991703	Orange	7	£1.44	£1.39
415072	Orange	8	£1.72	£1.65

MICC Double PVC Clip



FROM ONLY
£7.78
PACK

Code	Colour	Size	Pack 50	5+
809691	Red	RSFJ302	£8.10	£7.78
E 263929	Red	RSFJ342	£8.10	£7.78
288925	Red	RSFJ382	£8.10	£7.78
917161	Red	RSFJ462	£8.10	£7.78
120141	White	RSFJ302	£8.10	£7.78
603938	White	RSFJ342	£8.10	£7.78
969656	White	RSFJ382	£8.10	£7.78
523321	Orange	RSFL382	£8.10	£7.78

M.I Cable Clips - Orange



FROM ONLY
89P
PACK

Code	Cable Size mm	Pack 100	10+
668130	6.0 round	£1.18	£1.14
H 666111	7.0 round	£8.40	£8.00
642114	8.0 round	£0.93	£0.89

Bell Wire Clips - White



FROM ONLY
£1.28
PACK

Code	Pack 100	10+
F 315840	£1.33	£1.28

Double Flat Twin & Earth Clips - Grey

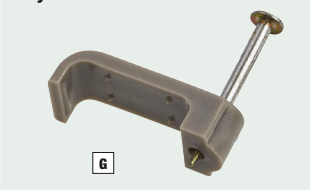

FROM ONLY
£2.88
PACK

Code	Cable Size mm	Pack 100	10+
122041	1	£2.99	£2.88
G 627564	1.5	£2.99	£2.88

6 x 30mm Masonry Mount - Lok01B HellemannTyton

FROM ONLY
£3.78
PACK



Code	Pack 100	5+
A 913754	£3.98	£3.78

Cable Tie Self Adhesive Pad

FROM ONLY
£2.80
PACK

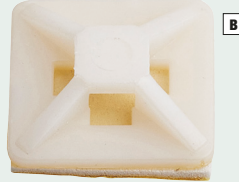

Code	Colour	Size mm	Pack 100	5+
B 835267	White	19 x 19	£3.50	£2.80
627791	Black	19 x 19	£3.50	£2.80
600439	White	28 x 28	£4.20	£3.36
565215	Black	28 x 28	£4.20	£3.36

Cable Ties



FROM ONLY
£1.04
PACK

Code	Colour	Size mm	Pack 100	5+
C 913725	Black	98 x 2.5	£1.95	£1.50
669112	Black	140 x 3.6	£1.10	£1.04
221666	Black	200 x 4.8	£2.07	£1.96
150115	Black	300 x 4.8	£3.22	£3.03
974174	Black	370 x 4.8	£3.82	£3.25
171399	Black	370 x 7.8	£5.40	£4.59
683275	Metal	150 x 4.8	£16.90	£15.20
954574	Metal	300 x 4.8	£22.15	£20.90
606588	White	98 x 2.5	£1.95	£1.50
611936	White	140 x 3.6	£1.10	£1.04
632421	White	200 x 4.8	£2.07	£1.96
792072	White	300 x 7.6	£3.22	£3.03
198913	White	370 x 4.8	£3.85	£3.27
197061	White	370 x 4.8	£3.82	£3.25
610404	White	370 x 7.8	£5.40	£4.59

Tie Wrap with Rawl Plug - White

FROM ONLY
£11.30
PACK

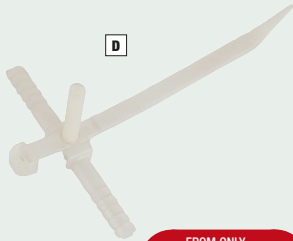

Code	Pack 100	5+
D 291149	£11.60	£11.30

S.W.A Cable Cleats

FROM ONLY
£7.00
PACK



Code	Type	Pack 100	5+
626953	5	£7.60	£7.00
127720	6	£8.40	£8.00
162236	7	£9.40	£9.00
311424	8	£11.10	£11.09
752247	9	£11.13	£11.11
890504	10	£11.50	£11.30
425059	11	£11.17	£11.15
477900	12	£11.22	£11.20
852002	14	£26.00	£24.00
332844	16	£30.00	£28.00
195372	18	£32.00	£31.00
E 765646	20	£32.00	£31.00

Snap Fit Grommets

FROM ONLY
£4.50
PACK



Code	Size mm	Pack 100
685815	20	£4.90
F 242562	25	£5.90
694835	32	£8.90

Grommet Strip - 25m

FROM ONLY
£10.75
EACH



Code	Size	Each	3+
627549	1	£11.20	£10.75
G 182835	2	£11.65	£11.18
172801	3	£12.06	£11.58

PVC Open Grommets

FROM ONLY
£2.34
PACK



Code	Size mm	Pack 100
335814	20	£2.34
812104	25	£7.30
H 143757	32	£11.30
145710	38	£15.00

PVC Blind Grommets

FROM ONLY
£5.10
PACK



Code	Size mm	Pack 100
I 576698	25	£8.90
113596	20	£5.50
354333	32	£17.80
256551	38	£19.60

Glands

Locknut - PVC



FROM ONLY
£1.10
PACK

Code	Size mm	Colour	Pack 10	10+
A 183772	20	Black	£1.30	£1.10
B 847666	20	Red	£1.30	£1.10
C 681366	20	White	£1.30	£1.10
561574	25	White	£2.20	£2.00

20mm Thread PVC TRS Gland



FROM ONLY
£6.50
PACK

Code	Size mm	Colour	Pack 10	10+
548954	4-7	Black	£7.20	£6.50
386034	4-7	White	£7.20	£6.50
F 653444	7-10	Black	£7.20	£6.50
G 564813	7-10	White	£7.20	£6.50
H 744349	7-10	Red	£7.20	£6.50

20mm Thread Skin Stop Gland



FROM ONLY
£3.70
PACK

Code	Size	Colour	Pack 10	5+
J 481202	4-9	White	£4.20	£3.70
K 609772	6-12	Black	£4.20	£3.70
245637	6-12	White	£4.20	£3.70
L 777827	6-12	Red	£4.20	£3.70

M40/32 Amend 3 Gland - PVC

- To be used with amendment 3 compliant connector unit



FROM ONLY
£3.77
EACH

Code	Each	5+
N 439525	£3.93	£3.77

25mm Thread Dome Gland



FROM ONLY
£7.80
PACK

Code	Size	Colour	Pack 10	5+
D 582042	13-18mm	Black	£9.00	£7.80
E 451189	13-18mm	White	£9.00	£7.80

TRS Gland - Brass

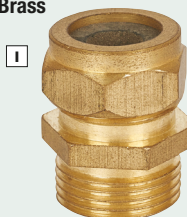

FROM ONLY
89P
EACH

Code	Size mm	Each	5+
I 480302	20	£0.94	£0.89
807688	25	£1.76	£1.68

M.I.C.C Cable Gland



FROM ONLY
£3.87
PACK

Code	Size	Quantity	Pack 10	5+
931164	RGM2H1.5	10	£33.35	£32.02
358229	RGM2H10	10	£21.06	£20.22
461600	RGM2H2.5	10	£33.35	£32.02
262272	RGM2H4	10	£33.35	£32.02
691476	RGM2L1	10	£20.19	£19.39
429353	RGM2L1.5	10	£20.19	£19.39
275281	RGM2L2.5	10	£20.19	£19.39
M 763597	RGM2L4	10	£20.19	£19.39
370059	RGM3H10	10	£21.06	£20.22
424135	RGM3L1	10	£20.19	£19.39
619631	RGM3L1.5	10	£20.19	£19.39
732719	RGM3L2.5	10	£20.19	£19.39
519459	RGM4H4	10	£33.35	£32.02
984501	RGM4L1	2	£20.19	£19.39
583639	RGM4L1.5	2	£20.19	£19.39
997254	RGM3H16	2	£21.06	£20.22

Gland Kit



HellemannTyton

Code	Description	Pack Quantity	Pack	5+
244331	20SBWK	2	£1.89	£1.65
395047	20SCW	2	£2.97	£2.59
181756	20BW	2	£2.45	£1.98
521183	20BWK	2	£3.24	£2.95
967453	20CW	2	£3.14	£2.86
497198	25BW	2	£4.57	£4.35
A 645071	25CW	2	£6.90	£6.55
589368	32BW	2	£6.90	£6.30
418028	32CW	2	£10.28	£9.45
160689	40BW	1	£7.20	£6.78
478081	40CW	1	£10.75	£9.45
333404	50BW	1	£10.85	£9.50
619236	50CW	1	£16.80	£15.45
509289	70BW	1	£20.68	£19.20
222982	20CWKLSF	2	£3.61	£3.30
679715	20SBWKLSF	2	£3.12	£2.45
179464	20SCWKLSF	2	£3.41	£2.98
669975	25BWKLSF	2	£3.98	£3.70
134132	25CWKLSF	2	£7.25	£6.90
842012	32BWKLSF	2	£7.26	£6.84
176235	32CWKLSF	2	£10.70	£9.65

FROM ONLY
£1.65
PACK

Catenary Wire Kit

- Kit Contains: 1 x 30m x 3mm wire, 4 x wire grips, 2 x wire eyes, 1 x 4" strainer, 1 x ring plate and 1 x hook plate



FROM ONLY
£23.65
EACH

Code	Each	3+
B 843369	£24.80	£23.65

Catenary Wire - Light Gauge

- 3mm gauge



FROM ONLY
£11.95
EACH

Code	Length m	Each	3+
C 419554	30	£12.50	£11.95
673838	50	£17.80	£15.20
214755	100	£25.60	£23.50

M.I.C.C Earth Type Pots & Seals



FROM ONLY
£46.30
PACK

Code	Size	Pack 10	5+
D 777219	RPSL4L2.5	£48.75	£46.30

M.I.C.C Pots, Seals & Tails



FROM ONLY
£7.33
PACK

Code	Size	Pack 10	5+
626381	2L1.5	£7.63	£7.33
E 721887	2L4.0	£19.54	£18.77
380904	4L1.5	£7.63	£7.33

M.I.C.C Pots & Seals



Code	Size	Quantity	Pack 10	5+
952061	2H1.5	10	£10.76	£10.33
845092	2H10.0	10	£9.77	£9.38
H 955288	2H2.5	10	£10.76	£10.33
569539	2H4.0	10	£10.76	£10.33
810970	2L1.0	10	£7.63	£7.33
254611	2L1.5	10	£7.63	£7.33
892421	2L2.5	10	£7.63	£7.33
697565	2L4.0	10	£7.63	£7.33
841235	3H1.5	10	£7.63	£7.33
973045	3H10.0	10	£9.77	£9.38
290529	3H16.0	10	£9.77	£9.38
933306	3L2.5	10	£7.63	£7.33
216651	4H4.0	10	£7.63	£7.33
547010	4L1.0	2	£7.63	£7.33
224259	4L1.5	2	£7.63	£7.33

M.I.C.C Shroud - 20mm

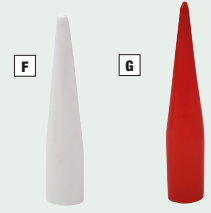

FROM ONLY
£2.00
PACK

Code	Colour	Pack 10	5+
F 835702	White	£2.08	£2.00
G 945993	Red	£2.08	£2.00
782102	Orange	£2.08	£2.00

M.I.C.C Sealing Compound



FROM ONLY
£6.74
EACH

Code	Each	5+
I 206561	£7.02	£6.74

Copper Lugs & Insulated Grips

Reducing Pin Lug

FROM ONLY
£2.85
EACH

A

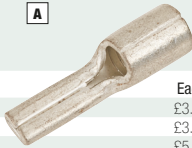

Code	Size mm	Each	5+
A 398884	25	£3.00	£2.85
450495	35	£3.80	£3.61
111539	50	£5.45	£5.18
355821	70	£6.20	£5.89
213875	95	£7.55	£7.17

Copper Crimp

FROM ONLY
£2.00
PACK

C



Code	Cable Size mm	Bolt Size mm	Pack 10	10+
928436	6	6	£2.10	£2.00
372428	10	6	£2.40	£2.30
297427	10	8	£2.40	£2.30
C 901774	10	10	£2.60	£2.50
842879	10	12	£2.60	£2.50
635049	16	6	£2.80	£2.60
159540	16	8	£2.80	£2.60
340410	16	10	£2.80	£2.60
200920	16	12	£2.80	£2.60
372379	25	6	£3.20	£3.00
661871	25	8	£3.20	£3.00
130502	25	10	£3.20	£3.00
628981	25	12	£3.20	£3.00
334419	35	6	£4.00	£3.70
559008	35	8	£4.00	£3.70
883735	35	10	£4.00	£3.70
990860	35	12	£4.00	£3.70
552374	50	6	£5.30	£5.00
497902	50	8	£5.30	£5.00
119730	50	10	£5.30	£5.00
781764	50	12	£5.30	£5.00
690177	50	14	£5.30	£5.00
686018	50	16	£5.30	£5.00
243345	70	6	£6.80	£6.40
470993	70	8	£7.40	£6.90
236426	70	10	£7.40	£6.90
539754	70	12	£8.03	£7.50
264262	70	16	£8.03	£7.50
276253	95	10	£8.20	£7.60
887139	95	12	£8.80	£8.30
779785	95	14	£8.89	£8.30
882358	95	16	£9.30	£8.60
348122	120	8	£9.90	£9.20
142543	120	10	£11.40	£10.70
835117	120	12	£12.10	£11.30
435643	150	10	£14.20	£13.30
466566	150	12	£17.00	£15.90
789991	150	14	£17.00	£15.90
443068	150	16	£19.00	£17.70
658933	185	10	£10.96	£10.83
845735	185	12	£20.79	£19.83
371156	185	14	£20.79	£19.83
379021	185	16	£20.79	£19.83
935162	240	10	£26.10	£25.80
667941	240	12	£26.80	£25.80
470204	240	16	£27.80	£27.10
448785	300	12	£29.68	£29.10
464261	300	16	£34.44	£34.10
931923	400	20	£43.40	£43.10

Butt Crimp

FROM ONLY
£2.60
PACK

B



Code	Size mm	Pack 10	10+
B 183650	10	£2.80	£2.60
624076	16	£3.60	£3.40
965795	25	£4.80	£4.50
622558	35	£6.00	£5.60
732400	50	£6.80	£6.40
317469	70	£7.10	£6.70
131291	95	£7.10	£6.70
122643	120	£11.00	£10.30

Insulated Crimps

- Red to fit 1.5m² cables
- Blue to fit 2.5m² cables
- Yellow to fit 6.0m² cables

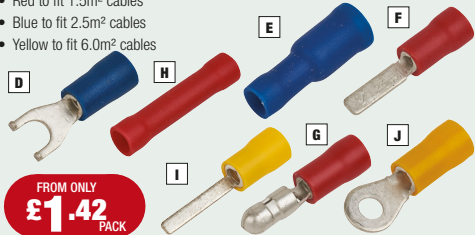

FROM ONLY
£1.42
PACK

Code	Colour	Size mm	Type	Pack 50	5+
D 975726	Blue	4	Fork	£2.54	£1.91
606087	Blue	4	Ring	£2.65	£1.99
905079	Blue	4.5	Butt	£2.96	£2.22
E 679501	Blue	5	Bullet - Female	£3.95	£2.96
177642	Blue	5	Fork	£2.54	£1.91
279162	Blue	5	Ring	£2.65	£1.99
989364	Blue	5	Bullet - Male	£4.12	£3.09
304218	Blue	6	Ring	£3.34	£2.51
632019	Blue	6.3	Insulated Spade	£4.10	£3.08
798069	Blue	6.3	Male Spade	£3.59	£2.69
679838	Blue	6.3	Spade	£3.84	£2.88
721717	Red	2	Pin	£2.68	£2.01
F 223236	Red	2.3	Flat Pin	£2.68	£2.01
937429	Red	3.5	Fork	£2.20	£1.65
884253	Red	3.5	Ring	£1.89	£1.42
504899	Red	4	Bullet - Female	£3.95	£2.96
G 907779	Red	4	Bullet - Male	£4.12	£3.09
H 706947	Red	4	Butt	£2.80	£2.10
843389	Red	4	Fork	£2.30	£1.73
870234	Red	4	Ring	£1.89	£1.42
985436	Red	5	Fork	£2.42	£1.82
714420	Red	5	Ring	£2.20	£1.65
838910	Red	6	Ring	£3.29	£2.47
376043	Red	6.3	Female Spade	£3.84	£2.88
699707	Red	6.3	Insulated Spade	£4.10	£3.08
192350	Red	6.3	Spade	£3.59	£2.69
I 128442	Yellow	2.3	Flat Pin	£5.80	£4.35
665083	Yellow	3	Pin	£5.80	£4.35
J 868154	Yellow	4	Ring	£3.80	£2.85
180467	Yellow	5	Ring	£3.74	£2.81
175423	Yellow	5	Ring	£3.80	£2.85
612198	Yellow	6	Ring	£4.65	£3.49
789701	Yellow	6.3	Male Spade	£4.46	£3.35
180388	Yellow	6.3	Spade	£4.62	£3.47
286097	Yellow	6.5	Butt	£4.12	£3.09
628009	Yellow	8	Ring	£4.96	£3.72

SWA Joint Kit & Mechanical Connectors

- SWA underground 2 way resin joint kits contain a clear PVC joint shell which snaps together with a clip-on cover for the central filling hole
- The polyurethane two part resin comes in a sealed sachet, complete with a clip separating the resin and hardener



FROM ONLY
£9.08
EACH

A



Code	Size mm	Each	3+
980358	1.5 - 4	£9.87	£9.08
A 321828	4 - 10	£17.65	£16.24
656514	10 - 25	£21.70	£19.96
757581	25 - 50	£28.85	£26.54

SWA Branch 3 Way Joint & Mechanical Connectors



B



FROM ONLY
£16.10
EACH

Code	Size mm	Type	Each	3+
718344	1.5 - 4	2 - 4 core	£17.50	£16.10
B 420337	1.5 - 10	2 - 4 core	£28.50	£26.22
655124	10 - 25	2 - 4 core	£34.50	£31.74
322102	25 - 50	2 - 4 core	£48.90	£44.99

10A 3 Terminal Inline Connection Joint Kit

FROM ONLY
£10.60
EACH

C



Code	Each	3+
C 100701	£10.95	£10.60

6A 3 Terminal Waterproof Joint

- IP68 rated

FROM ONLY
£6.10
EACH

D



Code	Each	3+
D 481648	£6.35	£6.10

10A 5 Terminal Waterproof Joint

- IP68 rated

FROM ONLY
£6.15
EACH

E



Code	Each	3+
E 453232	£6.60	£6.15

16A 5 Terminal Waterproof Joint

- IP68 rated

FROM ONLY
£14.98
EACH

F



Code	Each	3+
F 713162	£15.50	£14.98

Connectors

20A Click Push In Connector



A

FROM ONLY
£2.05
EACH

Code	Type	Each	10+
A 452552	4 pin	£3.38	£2.88
467218	3 pin	£2.65	£2.05

2 Conductor Through Connector

WAGO®



B

FROM ONLY
£1.90
PACK

Code	Pack 10	5+
B 690567	£2.10	£1.90

Lever Connector

WAGO®



C

FROM ONLY
£1.95
PACK

Code	Type	Pack 10	5+
C 305989	2W	£2.10	£1.95
831499	3W	£2.50	£2.25
268327	5W	£4.20	£3.95

Push Connector

WAGO®



D

FROM ONLY
£1.10
PACK

Code	Type	Pack 10	20+
D 896123	2W	£1.20	£1.10
331744	4W	£1.60	£1.50
467574	6W	£2.10	£2.00

Junction Box

WAGO®



E

FROM ONLY
£1.30
EACH

Code	Each	5+
E 187978	£1.39	£1.30

Conductor Loop In & Out Connector

WAGO®



F

FROM ONLY
£1.50
PACK

Code	Type	Pack 10	5+
F 130782	2 Conductor	£1.70	£1.50
160072	3 Conductor	£1.70	£1.50

75 Piece Connector Kit

WAGO®

Contains:

- 10 x 222-412 (2-way)
- 10 x 222-413 (3-way)
- 5 x 222-415 (5-way)
- 10 x 773-102 (2-way)
- 10 x 773-104 (4-way)
- 5 x 773-106 (6-way)
- 5 x 773-108 (8-way)
- 10 x 224-101 (2-way)
- 10 x 224-112 (3-way)



G

FROM ONLY
£14.38
EACH

Code	Each	3+
G 380005	£14.98	£14.38

Connector Box - Choc Box Contract

- Connectors not included

H



FROM ONLY
69P
EACH

Code	Each	10+
H 937414	£0.75	£0.69

Connector Box - Contract

- Connectors not included

I



FROM ONLY
98P
EACH

Code	Each	10+
I 324609	£1.10	£0.98

12 Way Connector Strip - White

HellemannTyton



FROM ONLY
36P
EACH

Code	Amp	Each	5+
A 699555	5	£0.38	£0.36
386726	15	£0.62	£0.60
851425	30	£1.08	£1.04
896350	60	£2.34	£2.25

12 Way Connector Strip - Black

GREEN
BROOK
ELECTRICAL LTD



FROM ONLY
£1.23
EACH

Code	Amp	Each	5+
B 367996	5	£1.28	£1.23
301550	15	£1.85	£1.78
127942	30	£2.45	£2.35

Porcelain Connector

GREEN
BROOK
ELECTRICAL LTD

C



FROM ONLY
27P
EACH

Code	Type	Amp	Each	10+
627050	1 Pole	5	£0.32	£0.27
594666	1 Pole	15	£0.55	£0.51
855347	1 Pole	30	£0.61	£0.59
514665	2 Pole	5	£0.41	£0.39
707745	2 Pole	15	£0.68	£0.64
241592	2 Pole	30	£0.79	£0.75
C 432390	3 Pole	5	£0.48	£0.44
886526	3 Pole	15	£0.84	£0.80
677341	3 Pole	30	£0.98	£0.92

Push In Connector

HellemannTyton

D



E



F



FROM ONLY
£5.00
PACK

Code	Type	Pack 50	5+
D 277689	2 Way	£6.00	£5.00
E 715802	3 Way	£8.00	£7.00
F 204190	5 Way	£10.50	£9.50

G



Connector Block

- Black urea phenolic
- Easy knockout entries
- Security sealable

FROM ONLY
£4.10
EACH

Code	Description	Type	Amp	Each	5+
149830		1 Pole	100	£4.90	£4.10
419509		1 Pole	200	£19.80	£18.85
G 621039		2 Pole	100	£7.25	£6.70
147187	5 Way	2 Pole	100	£10.25	£9.40

Earthing Accessories

Earth Clamp

- Suitable for interior installation

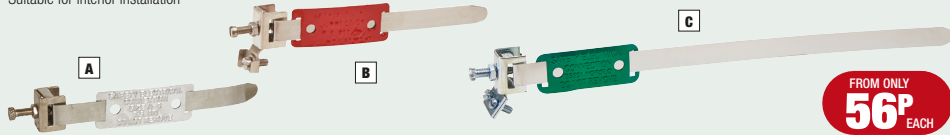

FROM ONLY
56P
EACH

Code	Description	Pipe Size mm	Each	5+
A 344586	Dry conditions	12-32	£0.65	£0.56
469381	Dry Conditions	50-75	£2.32	£2.20
B 833233	All Conditions	12-32	£1.39	£1.33
277809	All Conditions & Dual Clamp	12-32	£2.12	£1.99
C 671047	All Conditions & Dual Clamp	50-75	£4.52	£4.33

Cast Clamp For Copper Earth Rod - 5/8"

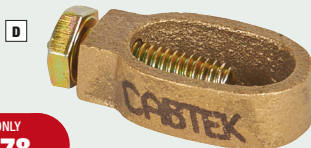

FROM ONLY
£2.78
EACH

Code	Each	5+
D 615788	£2.90	£2.78

Cast Clamp For Copper Earth Rod - 3/8"



FROM ONLY
£1.52
EACH

Code	Each	5+
E 748587	£1.58	£1.52

Copper Earth Rod - 3/8"



FROM ONLY
£3.31
EACH

Code	Each	5+
F 274709	£3.45	£3.31

Copper Earth Rod & Clamp - 3/8"



FROM ONLY
£4.83
EACH

Code	Each	5+
G 847394	£5.03	£4.83

Paxolin Sheet

- Size: 1200 x 600 x 6mm
- Offers excellent mechanical and electrical properties in low voltage installations, jigs and fixtures
- Ideal in applications such as terminal boards, mounting plates and cable supports



Code	Each	3+
H 851636	£29.80	£28.61

6 Way Earth Bar

- 10mm studs
- 35mm centres as standard



FROM ONLY
£46.66
EACH

Code	Each	3+
I 333832	£48.60	£46.66

6 Way Earth Bar with Disc Link

- 10mm studs
- 35mm centres as standard



FROM ONLY
£65.52
EACH

Code	Each	3+
J 757340	£68.25	£65.52

10 Way Earth Bar

- 10mm studs
- 35mm centres as standard



FROM ONLY
£67.00
EACH

Code	Each	3+
K 846844	£69.79	£67.00

Metal Safety Plate

• Size: 51 x 76mm

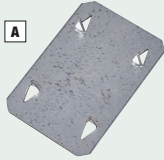

FROM ONLY
£20P
EACH

Code	Each	5+
A 678298	£0.25	£0.20

Ezyerth Earth Clamp

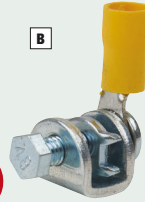

FROM ONLY
£3.00
PACK

Code	Pack 5	5+
B 733809	£3.15	£3.00

Driving Bolt For Copper Earth Rod - 5/8"



FROM ONLY
£1.11
EACH

Code	Each	5+
C 916557	£1.16	£1.11

Rod Joiner For Copper Earth Rod - 5/8"

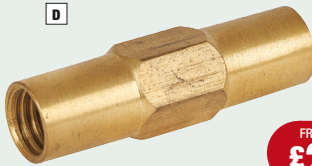

FROM ONLY
£2.78
PACK

Code	Pack 5	5+
D 353136	£2.90	£2.78

PVC Earthing Pit



FROM ONLY
£7.31
EACH

Code	Each	5+
E 553429	£7.70	£7.31

4 Way Earth Block



FROM ONLY
£1.58
EACH

Code	Each	5+
F 191083	£1.65	£1.58

8 Way Earth Block

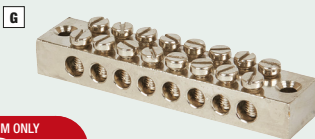

FROM ONLY
£2.69
EACH

Code	Each	5+
G 494898	£2.80	£2.69

Earth Box - Green

• Size: 81 x 81 x 67mm



FROM ONLY
£4.50
EACH

Code	Each	5+
H 362099	£4.95	£4.50

Adaptable Boxes

Adaptable Box - 80 x 80 x 40mm

- Pre moulded conduit knockout

A



FROM ONLY
£1.20
EACH

Code	Each	3+
A 838134	£1.31	£1.20

Black Enamel Adaptable Box

- Pre pressed conduit knockouts

C



FROM ONLY
£3.18
EACH

Code	Size Inches	Each	5+
C 113961	4 x 3 x 2	£3.52	£3.23
732028	3 x 3 x 3	£3.46	£3.18
428065	9 x 9 x 4	£5.88	£5.39
212471	12 x 12 x 3	£13.50	£12.95

Galvanised Adaptable Box

- Pre pressed conduit knockouts

E



FROM ONLY
£2.64
EACH

Code	Size Inches	Each	5+
692709	3 x 3 x 1.5	£2.88	£2.64
614404	3 x 3 x 2	£2.94	£2.70
869993	3 x 3 x 3	£4.78	£4.39
737390	4 x 4 x 1.5	£2.94	£2.70
144304	4 x 4 x 2	£3.18	£2.92
738388	4 x 4 x 3	£3.78	£3.47
469851	4 x 4 x 4	£3.90	£3.58
254255	6 x 4 x 2	£3.94	£3.62
444931	6 x 6 x 1.5	£3.94	£3.62
586989	6 x 6 x 2	£3.87	£3.55
445210	6 x 6 x 3	£4.40	£4.04
220685	6 x 6 x 4	£8.98	£8.24
489945	9 x 9 x 2	£6.31	£5.79
E 671796	9 x 6 x 3	£5.88	£5.39
197420	9 x 9 x 3	£6.36	£5.83
120120	9 x 9 x 4	£7.31	£6.70
240979	12 x 12 x 2	£8.31	£7.70
472372	12 x 12 x 4	£8.31	£7.70

Adaptable Box Gasket

- Maintains IP rating for outdoors use with galvanised adaptable boxes

B



FROM ONLY
36P
EACH

Code	Size Inches	Each	5+
B 992369	3 x 3	£0.38	£0.36
553822	4 x 4	£0.88	£0.84
902718	6 x 6	£1.17	£1.12

Galvanised Adaptable Box without Knockout

D



FROM ONLY
£2.92
EACH

Code	Size Inches	Each	5+
D 118692	4 x 4 x 2	£3.18	£2.92

PVC Box

F



FROM ONLY
£2.72
EACH

Code	Size Inches	Each	3+
655743	4 x 4 x 2	£2.98	£2.72
683418	5 x 3 x 2	£3.76	£3.38
438614	6 x 4 x 3	£4.79	£4.31
211919	9 x 6 x 3	£6.89	£6.20
281928	9 x 7 x 3	£9.29	£8.36
F 173568	10 x 7 x 6	£12.69	£11.42
321201	12 x 9 x 5	£14.49	£13.04
502783	15 x 12 x 5	£18.69	£16.82

Round Adaptable Box - 65 x 35mm

- Pre moulded conduit knockouts

G



FROM ONLY
82P
EACH

Code	Each	3+
G 466649	£0.98	£0.82

1 Gang Knockout Box - Galvanised

FROM ONLY
30P
EACH



Code	Size mm	Each	10+
154512	16	£0.34	£0.30
571586	25	£0.39	£0.36
A 197376	35	£0.48	£0.38
912816	47	£0.78	£0.68

2 Gang Knockout Box - Galvanised

FROM ONLY
38P
EACH



Code	Size mm	Each	5+
805569	25	£0.43	£0.38
B 379744	35	£0.58	£0.53
834730	47	£1.19	£1.04

Knockout Box - Galvanised

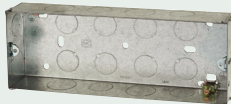

FROM ONLY
£1.04
EACH

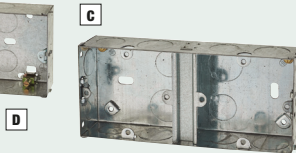

Code	No. of Gangs	Size mm	Each	5+
C 793089	1+1	35	£1.23	£1.10
420639	1+1	25	£1.19	£1.04
D 954699	3	25	£3.60	£3.13

6-8 Gang Flush Grid Box

FROM ONLY
£3.02
EACH



Code	Each	5+
E 135465	£3.39	£3.02

1 Gang Knockout Flush Box - Galvanised

FROM ONLY
£1.70
EACH

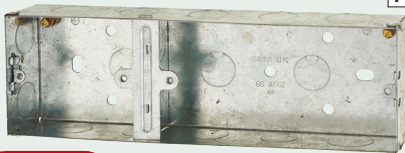

Code	Each	5+
F 365350	£1.91	£1.70

Gang Knockout - Galvanised

• Size: 35mm

FROM ONLY
£1.38
EACH



Code	Description	Each	5+
G 472917	2+1+1	£1.46	£1.38
674233	2+2+1	£2.30	£2.18

Knockout Flush Extension Box

FROM ONLY
£1.35
EACH

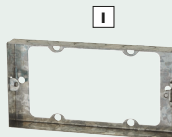

Code	No. of Gangs	Size mm	Each	5+
157260	1	16	£1.58	£1.35
H 573358	1	25	£1.79	£1.53
136456	1	35	£2.06	£1.78
I 537826	2	16	£2.96	£2.53
996571	2	25	£3.15	£2.69
997552	2	35	£3.45	£2.95

Metal Box

- Size: 41mm
- For use with MK logic plus range accessories



FROM ONLY
£2.22
EACH



Code	Type	Description	Each	5+
J 349505	1 Gang	Knockout	£2.55	£2.22
446508	2 Gang	Knockout	£3.83	£3.33
334416	1 Gang	Without Knockout	£2.84	£2.47
795447	2 Gang	Without Knockout	£4.15	£3.61

Dry Line Boxes

35mm Dry Line Box

APPLEBY

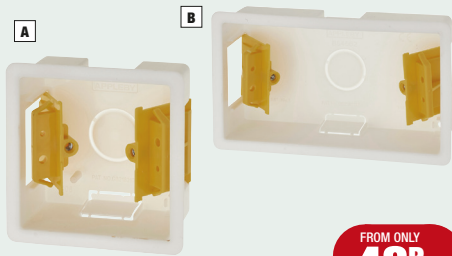

FROM ONLY
48P
EACH

Code	No. of Gangs	Each	10+
A 442407	1	£0.60	£0.48
B 638446	2	£0.98	£0.79

46mm Dry Line Box

APPLEBY

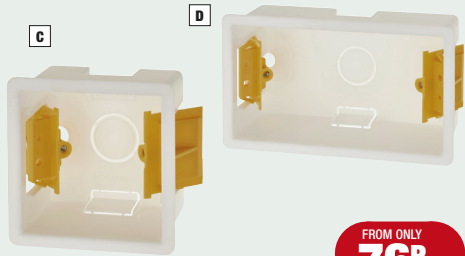

FROM ONLY
76P
EACH

Code	No. of Gangs	Each	5+
C 926525	1	£0.87	£0.76
D 462363	2	£1.48	£1.09

Dual 35mm Dry Line Box

APPLEBY



FROM ONLY
£1.35
EACH

Code	Each	3+
E 273712	£1.62	£1.35

Circular 32mm Dry Line Box

APPLEBY



FROM ONLY
74P
EACH

Code	Each	5+
F 849841	£0.82	£0.74

1 Gang 46mm Dry Line Double Skinned

**BRITISH
BG
GENERAL**



FROM ONLY
76P
EACH

Code	Each	5+
G 747307	£0.87	£0.76

2 Gang 46mm Dry Line Double Skinned

**BRITISH
BG
GENERAL**



FROM ONLY
£1.09
EACH

Code	Each	5+
H 213217	£1.48	£1.09

32mm Dry Line Box



FROM ONLY
61P
EACH

Code	No. of Gangs	Each	10+
A 504793	1	£0.64	£0.61
B 820777	2	£1.23	£1.18

2 Gang 47mm Dry Line Box



FROM ONLY
£1.52
EACH

Code	Each	10+
D 212283	£1.58	£1.52

Fire Rated Dry Line Box

- Fire & acoustic rated
- Fire tested up to 90mins
- The metal in design helps maintain the boxes in the wall with loss of structural integrity

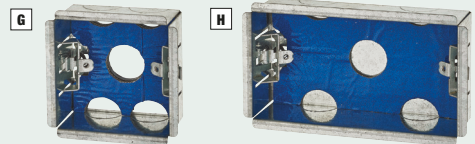

FROM ONLY
£1.73
EACH

Code	No. of gangs	Each	10+
G 768811	1	£1.80	£1.73
H 782188	2	£2.80	£2.69

1 Gang & 2 Gang 35mm Dry Line Box



FROM ONLY
£1.55
EACH

Code	Each	5+
C 568658	£1.66	£1.55

35mm Dry Line Box Flat Plate

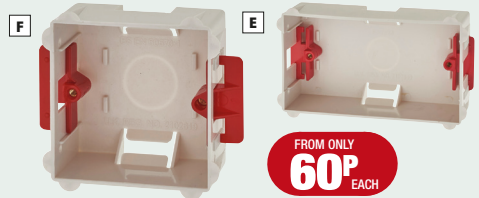

FROM ONLY
60P
EACH

Code	No. of Gangs	Each	5+
E 969948	2	£1.02	£0.98
F 902522	1	£0.62	£0.60

2 Gang Intumescent Gasket

- Expand on contact with fire, to prevent fire penetrating application



FROM ONLY
98P
EACH

Code	Each	5+
I 879219	£1.15	£0.98

1 Gang Intumescent Gasket

- Expand on contact with fire, to stop fire penetrating application

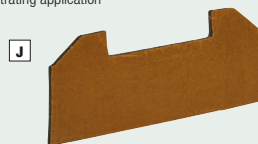

FROM ONLY
72P
EACH

Code	Each	5+
J 716365	£0.89	£0.72

**FREE
NEXT DAY
DELIVERY**



On orders over £45* *Excl. VAT. £5.95 on orders under £45.

Junction Boxes

30A Junction Box - 3 Terminal



FROM ONLY
£1.42
EACH

Code	Diameter mm	Each	10+
A 970607	80	£1.70	£1.42

20A Junction Box



FROM ONLY
£1.05
EACH

Code	Type	Diameter mm	Description	Each	20+
686323	4 Terminal	57	White	£1.25	£1.05
584333	4 Terminal	57	Brown	£1.25	£1.05
C 932111	4 Terminal	80	Brown	£1.34	£1.12
114877	6 Terminal	80	Brown	£2.88	£2.62

60A Junction Box - 3 Terminal



FROM ONLY
£3.60
EACH

Code	Each	10+
D 737175	£3.85	£3.60

Gel Filled Connector Box



- Connectors not included
- Maintains IP68 protection for outdoor connectors



FROM ONLY
£3.79
EACH

Code	Type	Each	5+
175565	3 Pole	£5.10	£4.90
B 384238	2 Pole	£3.95	£3.79

16A Downlight Junction Box



- 4 way
- Screw terminal



FROM ONLY
£2.10
EACH

Code	Each	5+
E 168550	£2.75	£2.10

IP55 4 Waterproof Connection Box

- Used for installing 4 gang extension leads to make them safe to use outside
- UV resistant construction
- Ideal for outdoor heaters, pressure washers & christmas lights

**GREEN
BROOK
TECHNICAL LTD**



A

FROM ONLY
£13.60
EACH

Code	Each	2+
A 869517	£14.50	£13.60

IP65 PVC Connection Box

HENSEL



B

FROM ONLY
£3.12
EACH

Code	Type	Size Inches	Each	5+
524603	2	3.5 x 3.5 x 2.4	£5.42	£4.98
935009	2.5	3 x 3 x 2	£3.29	£3.12
870134	6	5 x 4 x 2.5	£7.45	£6.85
B 950934	10	6 x 4 x 3	£12.50	£11.50
485480	16/25	8 x 5 x 3.5	£19.88	£18.35

PVC Adaptable Box

- IP66 protection
- Connectors not included

**Marshall
Tufflex**



C

FROM ONLY
£5.43
EACH

Code	Description	Size mm	Each	10+
753308	White	75 x 75 x 50	£5.90	£5.43
574360	White	100 x 100 x 50	£7.72	£7.10
718205	Black	75 x 75 x 50	£5.90	£5.43
C 730685	Black	100 x 100 x 50	£7.72	£7.10

IP66 Connection Box

WISKA



D

FROM ONLY
£3.55
EACH

Code	Description	Size Inches	Each	5+
141557	White	3 x 3 x 2	£3.70	£3.55
D 166686	Black	3 x 3 x 2	£3.70	£3.55



NEXT DAY DELIVERY!

WHEN YOU ORDER BY 6PM

16 x 25mm PVC Mini Trunking

- 3000mm length

SEE
PAGE
43

Order Code: 719335



FROM ONLY
£2.00
EACH
WHEN YOU BUY 5+

NEW PRODUCTS ADDED DAILY TO OUR WEBSITE

FREEPHONE: 8AM-6PM, 7 DAYS A WEEK
0808 168 22 77

ONLINE: SHOP 24/7
ElectricalDirect.co.uk

CABLE MANAGEMENT

<u>3 Compartment Dado & Skirting Trunking</u>	<u>42</u>
<u>Mini Trunking</u>	<u>43</u>
<u>Maxi Trunking</u>	<u>44-45</u>
<u>PVC Conduit & Channelling</u>	<u>46-47</u>
<u>PVC Accessories</u>	<u>48-49</u>
<u>PVC Conduit & Channeling</u>	<u>50-51</u>
<u>Steel Conduit & Accessories</u>	<u>52-55</u>
<u>Flexible Conduit</u>	<u>56-57</u>
<u>Cable Tray and Accessories</u>	<u>58-59</u>
<u>Galvanised Steel Trunking & Accessories</u>	<u>60-62</u>
<u>Steel Unistrut Accessories</u>	<u>63</u>



SEE
PAGE
58



SEE
PAGE
46



SEE
PAGE
63



SEE
PAGE
56

3 Compartment Dado & Skirting Trunking

Chamfered Dado Trunking - 50 x 170mm

- Length: 3000mm



FROM ONLY
£26.46
EACH

Code	Each	5+
A 561818	£29.40	£26.46

Chamfered Dado Trunking - Flat Tee - 50 x 170mm

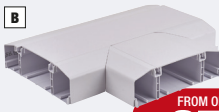

FROM ONLY
£25.70
EACH

Code	Each	5+
B 900184	£26.80	£25.70

Chamfered Trunking External Angle - 50 x 170mm

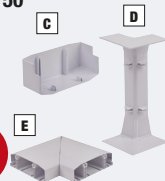

FROM ONLY
£4.30
EACH

Code	Type	Each	5+
C 597033	External Bend	£5.10	£4.30
D 551649	Internal Bend	£5.10	£4.30
E 126154	Flat Bend	£21.60	£20.46

Chamfered Dado Trunking Coupler - 50 x 170mm

- Sold per pair



FROM ONLY
£1.35
EACH

Code	Each	5+
F 292415	£1.48	£1.35

Cable Retainer

- Holds multiple cables within the compartment



FROM ONLY
50P
EACH

Code	Each	5+
G 337177	£0.55	£0.50

1 Gang 4 Pillar Outlet Box - 28mm



FROM ONLY
£1.49
EACH

Code	Each	5+
H 268214	£1.64	£1.49

Skirting Trunking - 50 x 170mm

- Skirting Trunking is a 3 compartment PVC cable management system with 3 lids

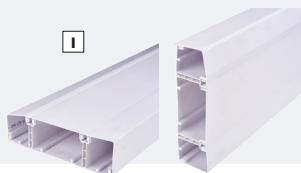

Code	Each	5+
I 723097	£29.40	£26.46

Skirting Bends - 50 x 170mm

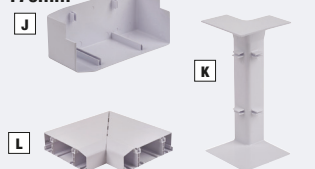

Code	Type	Each	5+
J 995168	External Bend	£5.10	£4.30
K 382139	Internal Bend	£5.10	£4.30
L 625477	Flat Angle	£20.46	£19.65

Skirting Couplers - 50 x 170mm



FROM ONLY
£1.35
PACK

Code	Pack 2	5+
M 630384	£1.48	£1.35

Chamfered Dado Stop End - 50 x 170mm



FROM ONLY
£1.35
EACH

Code	Each	5+
N 624623	£1.48	£1.35

Skirting Trunking Stop End - 50 x 170mm



FROM ONLY
£1.35
EACH

Code	Description	Each	5+
O 470032	Left	£1.48	£1.35
912559	Right	£1.48	£1.35

Dado & Skirting Socket Mounting Box - 35mm



FROM ONLY
£1.32
EACH

Code	Description	Each	5+
P 997141	1 Gang	£1.46	£1.32
Q 895114	2 Gang	£1.72	£1.58

PVC Mini Trunking - Self Adhesive - White marco cablemanagement

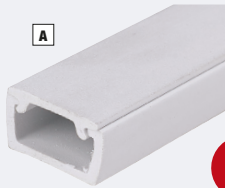

FROM ONLY
£2.65
EACH

Code	Length mm	Width mm	Height mm	Each	5+
A 543713	3000	16	10	£2.97	£2.65

PVC Mini Trunking - Self Adhesive - White marco cablemanagement

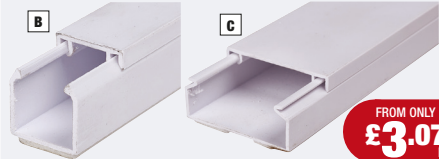

FROM ONLY
£3.07
EACH

Code	Length mm	Width mm	Height mm	Each	5+
C 601017	3000	16	16	£3.41	£3.07
314990	3000	16	25	£4.34	£3.98
760191	3000	16	40	£5.86	£5.35
271957	3000	25	40	£5.35	£4.98

Mini Trunking Flat Bend - White marco cablemanagement



FROM ONLY
59P
EACH

Code	Width mm	Height mm	Each	5+
285206	16	16	£0.64	£0.59
695792	16	25	£0.64	£0.59
548798	16	40	£0.75	£0.66
530201	25	40	£0.75	£0.66
D 739662	40	40	£1.19	£1.05

Mini Trunking Internal Angle - White marco cablemanagement



FROM ONLY
59P
EACH

Code	Width mm	Height mm	Each	5+
391716	16	16	£0.64	£0.59
805049	16	25	£0.64	£0.59
E 294843	16	40	£0.75	£0.66
431133	25	40	£0.75	£0.66
529843	40	40	£1.19	£1.05

Mini Trunking External Angle - White marco cablemanagement

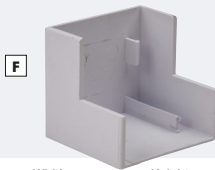

FROM ONLY
59P
EACH

Code	Width mm	Height mm	Each	5+
108361	16	16	£0.64	£0.59
800892	16	25	£0.64	£0.59
F 630177	16	40	£0.75	£0.66
137879	25	40	£0.75	£0.66
208767	40	40	£1.19	£1.05

Mini Trunking Flat Tee - White marco cablemanagement



FROM ONLY
70P
EACH

Code	Width mm	Height mm	Each	5+
627939	16	16	£0.77	£0.70
509197	16	25	£0.83	£0.75
544255	16	40	£0.95	£0.87
G 222858	25	40	£0.95	£0.87

Mini Trunking Coupler - White marco cablemanagement



FROM ONLY
50P
EACH

Code	Width mm	Height mm	Each	10+
H 559567	16	25	£0.58	£0.50

Mini Trunking End Cap - White marco cablemanagement



FROM ONLY
50P
EACH

Code	Width mm	Height mm	Each	10+
I 741282	16	16	£0.58	£0.50
113564	16	25	£0.58	£0.50
640408	16	40	£0.58	£0.50
754413	25	40	£0.72	£0.60

Maxi Trunking

PVC Maxi Trunking - 50 x 100mm - PVC

marco
cablemanagement

- Can be made into 1, 2 or 3 compartments using dividing fillet below (996083)
- Length: 3000mm



A

FROM ONLY
£13.20
EACH

Code	Each	5+
A 295443	£14.85	£13.20

Maxi Trunking Flat Tee - 50 x 100mm

marco
cablemanagement

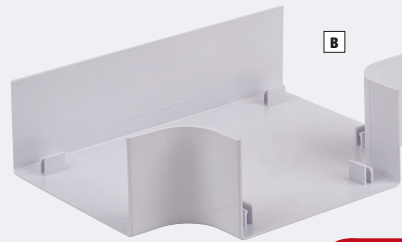

B

FROM ONLY
£5.11
EACH

Code	Each	5+
B 456640	£5.62	£5.11

Maxi Trunking Bends - 50 x 100mm - PVC

marco
cablemanagement



C

D

E

FROM ONLY
£2.66
EACH

Code	Type	Description	Each	5+
C 489671	External Bend	External	£2.92	£2.66
D 910115	Flat Angle	Flat	£3.57	£3.25
E 969256	Internal Bend	Internal	£3.57	£3.25

Maxi Trunking Dividing Fillet - 50 x 100mm - PVC

marco
cablemanagement

- Length: 1500mm
- Used to enable cable segregation

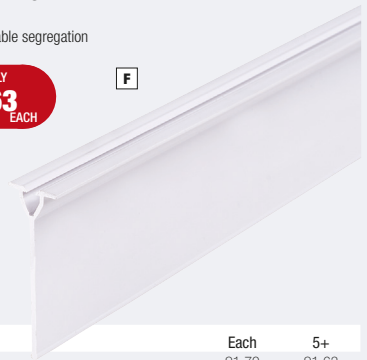

F

FROM ONLY
£1.63
EACH

Code	Each	5+
F 996083	£1.79	£1.63

Maxi Trunking End Caps - 50 x 100mm

marco
cablemanagement

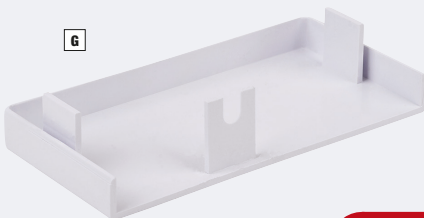

G

FROM ONLY
95P
EACH

Code	Each	5+
G 309205	£1.04	£0.95

Maxi Trunking Joint Cover - 50 x 100mm - PVC

marco
cablemanagement

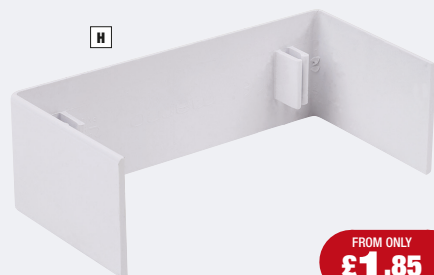

H

FROM ONLY
£1.85
EACH

Code	Each	5+
H 561986	£1.98	£1.85

PVC Maxi Trunking - White

- Anti-tamper locking lid to stop accidental removal
- Length: 3000mm

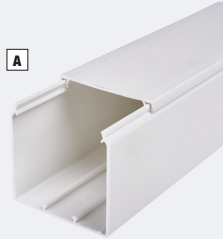

FROM ONLY
£10.40
EACH

Code	Width mm	Height mm	Each	4+
635226	50	50	£11.65	£10.40
981149	75	75	£16.60	£14.80
A 518843	100	100	£21.30	£19.00
810720	150	150	£43.50	£39.00

Maxi Trunking Flat Tee - White

- Designed to clip over trunking
- Eliminates the need for precision cutting



FROM ONLY
£6.22
EACH

Code	Width mm	Height mm	Each	4+
415758	50	50	£6.70	£6.22
401876	75	75	£9.05	£8.55
B 934700	100	100	£19.72	£18.80
998241	150	150	£25.80	£24.60

Maxi Trunking Flat Angle - White

- Designed to clip over trunking
- Eliminates the need for precision cutting



FROM ONLY
£5.35
EACH

Code	Width mm	Height mm	Each	5+
997410	50	50	£5.80	£5.35
590259	75	75	£7.99	£7.40
C 899278	100	100	£9.83	£9.10
250667	150	150	£18.15	£16.80

Maxi Trunking Internal Angle - White

- Designed to clip over trunking
- Eliminates the need for precision cutting



FROM ONLY
£5.35
EACH

Code	Width mm	Height mm	Each	5+
138429	50	50	£5.80	£5.35
326742	75	75	£7.99	£7.40
D 323766	100	100	£9.83	£9.10
869932	150	150	£18.15	£16.80

Maxi Trunking External Angle - White

- Designed to clip over trunking
- Eliminates the need for precision cutting



FROM ONLY
£5.35
EACH

Code	Width mm	Height mm	Each	5+
357409	50	50	£5.80	£5.35
612574	75	75	£7.99	£7.40
E 358240	100	100	£9.83	£9.10
907969	150	150	£18.15	£16.80

Maxi Trunking End Cap - White



FROM ONLY
95P
EACH

Code	Width mm	Height mm	Each	4+
F 588742	50	50	£0.97	£0.95
166284	75	75	£1.58	£1.50
947816	100	75	£3.25	£3.10
870192	100	100	£3.25	£3.10
874478	150	150	£4.88	£4.65

PVC Conduit & Channelling

PVC Channel - White

- Length: 2000mm

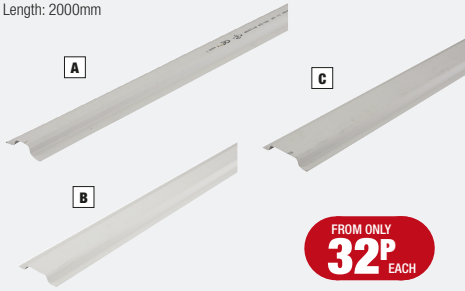

FROM ONLY
32P
EACH

Code	Diameter mm	Each	10+
A 371373	13	£0.42	£0.32
B 211485	25	£0.54	£0.42
C 555953	38	£0.90	£0.68

Oval Conduit - 3000mm - White

- Protects electrical wiring
- Surface mounted or buried in walls

FROM ONLY
82P
EACH



Code	Length mm	Diameter mm	Each	10+
D 248982	3000	16	£1.05	£0.82
E 269182	3000	20	£1.31	£1.12
F 484576	3000	25	£1.41	£1.20

Heavy Gauge PVC Conduit - 3000mm

- Durable & impact resistant to protect electrical wiring
- Surface mounted or buried in walls



FROM ONLY
£1.56
EACH

Code	Colour	Diameter mm	Each	10+
G 182232	Black	20	£1.79	£1.56
H 237856	White	20	£1.79	£1.56
152518	Black	25	£3.51	£3.13
315588	White	25	£3.51	£3.13

PVC Conduit Clip

- Open round conduit clip
- Single screw fixing point

FROM ONLY
35P
EACH



Code	Colour	Diameter mm	Each	5+
I 569858	Black	20	£0.42	£0.35
J 316432	White	20	£0.42	£0.35
719231	Black	25	£0.50	£0.40
854349	White	25	£0.50	£0.40

Spacer Bar Saddle



FROM ONLY
£3.50
PACK

Code	Colour	Size	Pack 10	5+
K 582086	Black	20mm	£4.20	£3.50
L 653467	White	20mm	£4.20	£3.50
930952	Black	25mm	£5.30	£3.50
536859	White	25mm	£5.30	£3.50

PVC Conduit Extension Ring

- Diameter: 20mm

FROM ONLY
£1.54
EACH



Code	Colour	Each	5+
M 780869	White	£1.88	£1.54

PVC Conduit Female Adaptor

- Connects conduit to square mounting boxes



FROM ONLY
£3.70
PACK

Code	Colour	Diameter mm	Pack 10	10+
257339	Black	20	£4.40	£3.70
146292	White	20	£4.40	£3.70
N 860949	Black	25	£7.40	£6.60
O 874868	White	25	£7.40	£6.60

PVC Conduit Male Adaptor

- Connects conduit to square mounting boxes



FROM ONLY
£3.70
PACK

Code	Colour	Diameter mm	Pack 10	10+
990978	Black	20	£4.40	£3.70
747373	White	20	£4.40	£3.70
A 743388	Black	25	£7.40	£6.60
B 426900	White	25	£7.40	£6.60

PVC Conduit Reducer - 25 to 20mm - White



FROM ONLY
62P
EACH

Code	Colour	Each	10+
C 880271	White	£0.75	£0.62

PVC Conduit Coupler

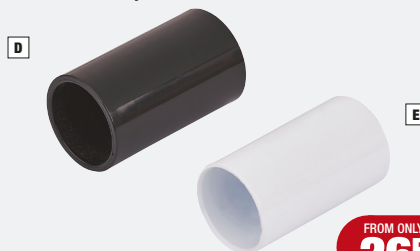

FROM ONLY
26P
EACH

Code	Colour	Diameter mm	Each	10+
885460	Black	20	£0.33	£0.26
778917	White	20	£0.33	£0.26
D 965455	Black	25	£0.44	£0.37
E 888983	White	25	£0.44	£0.37

PVC Conduit Loop In Box



FROM ONLY
72P
EACH

Code	Colour	Diameter mm	Each	5+
F 219969	Black	20	£0.88	£0.72
G 795791	White	20	£0.88	£0.72

PVC Conduit U Box



FROM ONLY
£1.98
EACH

Code	Colour	Diameter mm	Each	5+
H 357343	Black	20	£2.42	£1.98
I 482158	White	20	£2.42	£1.98

PVC Conduit Y Box



Code	Colour	Diameter mm	Each	5+
J 910524	Black	20	£2.98	£2.44
K 364955	White	25	£2.98	£2.44

PVC Conduit Terminal Box



FROM ONLY
77P
EACH

Code	Colour	Diameter mm	Each	5+
171622	Black	20	£0.87	£0.77
150607	White	20	£0.87	£0.77
A 911923	Black	25	£1.31	£1.18
B 523772	White	25	£1.31	£1.18

PVC Conduit Through Box



FROM ONLY
85P
EACH

Code	Colour	Diameter mm	Each	5+
C 181275	Black	20	£1.00	£0.85
480914	White	20	£1.00	£0.85
262053	Black	25	£1.42	£1.30
176015	White	25	£1.42	£1.30

PVC Conduit Angle Box



FROM ONLY
85P
EACH

Code	Colour	Diameter mm	Each	5+
D 341370	Black	20	£1.00	£0.85
E 757182	White	20	£1.00	£0.85
180657	Black	25	£1.42	£1.30
419200	White	25	£1.42	£1.30

PVC Conduit Tee Box



FROM ONLY
92P
EACH

Code	Colour	Diameter mm	Each	5+
F 669095	Black	20	£1.05	£0.92
724566	White	20	£1.05	£0.92
675625	Black	25	£1.55	£1.48
G 988607	White	25	£1.55	£1.48

PVC Conduit 4 Way Box



FROM ONLY
£1.36
EACH

Code	Colour	Diameter mm	Each	5+
H 394068	Black	20	£1.67	£1.36
278155	White	20	£1.67	£1.36
I 828148	Black	25	£2.50	£2.04

PVC Conduit Inspection Bend



FROM ONLY
29P
EACH

Code	Colour	Diameter mm	Each	5+
J 196961	Black	20	£0.36	£0.29
K 854547	White	20	£0.36	£0.29
618842	Black	25	£0.47	£0.39
412701	White	25	£0.47	£0.39

PVC Conduit Inspection Elbow



FROM ONLY
87P
EACH

Code	Colour	Diameter mm	Each	5+	
A	973397	White	20	£1.07	£0.87
B	882409	Black	20	£1.07	£0.87

PVC Conduit Inspection Tee Box



FROM ONLY
£1.13
EACH

Code	Colour	Diameter mm	Size	Each	5+	
C	397187	White	20	20	£1.38	£1.13
D	265271	Black	20	20	£1.38	£1.13
E	663546	White	25	25	£2.78	£2.27
F	430474	Black	25	25	£2.78	£2.27

PVC Conduit Circular Box Lid

- Lid sits flush to the edges of the conduit box



FROM ONLY
22P
EACH

Code	Colour	Diameter mm	Type	Each	5+	
G	417184	Black	50	Flush	£0.27	£0.22
H	541222	White	50	Flush	£0.27	£0.22
	724316	Black	85	Overlapping	£0.56	£0.45
	741987	White	85	Overlapping	£0.56	£0.45

PVC TRS Gland 20mm



FROM ONLY
£6.50
PACK

Code	Colour	Pack 10	10+	
I	487897	Black	£7.20	£6.50
J	201043	Red	£7.20	£6.50
K	393302	White	£7.20	£6.50

PVC Conduit Bending Spring

- Bending spring creates perfect bends at any angle without creasing

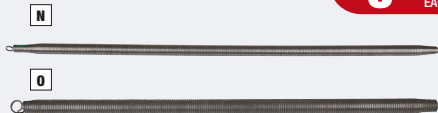

FROM ONLY
£6.17
EACH

Code	Diameter mm	Each	5+	
N	743574	20	£6.50	£6.17
O	866365	25	£9.50	£9.02

PVC Conduit Normal Bend

- Fitted with two couplers for easy conduit attachment



FROM ONLY
£1.73
EACH

Code	Colour	Diameter mm	Each	5+	
L	553863	Black	20	£1.83	£1.73
M	988584	White	20	£1.83	£1.73
	131127	Black	25	£3.11	£2.95
	210831	White	25	£3.11	£2.95

PVC Cement

- Size: 250ml



FROM ONLY
£6.50
EACH

Code	Each	5+	
P	713657	£6.85	£6.50

Steel Conduit & Accessories

Galvanised Steel Conduit - 3000mm



A

FROM ONLY
£4.88
EACH

Code	Size mm	Each	8+
A 364506	20	£5.23	£4.88
690973	25	£8.13	£7.44

Steel Conduit Terminal Box



B

FROM ONLY
£1.55
EACH

Code	Size mm	Description	Each	10+
514301	20	Galvanised	£1.60	£1.55
B 385093	25	Galvanised	£1.90	£1.85

Galvanised Steel Conduit Through Box



C

FROM ONLY
£1.45
EACH

Code	Size mm	Each	10+
215563	20	£1.62	£1.45
C 226592	25	£3.98	£3.63

Steel Conduit Angle Box



D

FROM ONLY
£1.55
EACH

Code	Size mm	Description	Each	10+
D 290975	20	Galvanised	£1.60	£1.55
713396	25	Galvanised	£1.90	£1.85

Steel Conduit 4 Way Box



E

FROM ONLY
£1.55
EACH

Code	Size mm	Description	Each	10+
E 536464	20	Galvanised	£1.60	£1.55
611846	25	Galvanised	£1.90	£1.85

Steel Conduit Back Outlet Box



F

FROM ONLY
£3.40
EACH

Code	Size mm	Description	Each	10+
F 169503	20	Galvanised	£3.59	£3.40

Steel Conduit H Box

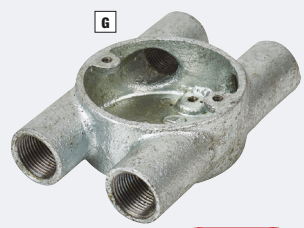

G

FROM ONLY
£3.65
EACH

Code	Size mm	Description	Each	10+
G 377361	20	Galvanised	£3.90	£3.65

Steel Conduit U Box

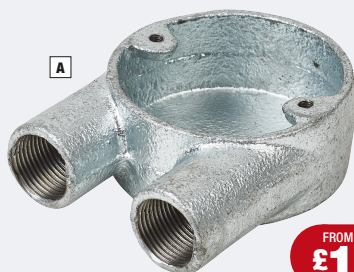

FROM ONLY
£1.54
EACH

Code	Size mm	Description	Each	10+
A 700761	20	Galvanised	£1.79	£1.54
736290	25	Galvanised	£2.30	£2.18

Steel Conduit Tangent Tee Box



FROM ONLY
£3.20
EACH

Code	Size mm	Description	Each	10+
C 299795	20	Galvanised	£3.40	£3.20

Steel Conduit Looping In Box - 20mm - Galvanised



FROM ONLY
£1.65
EACH

Code	Type	Description	Each	10+
599469	1 Hole	Galvanised	£1.90	£1.65
731385	2 Hole	Galvanised	£1.90	£1.65
F 245655	3 Hole	Galvanised	£1.90	£1.65
154030	4 Hole	Galvanised	£1.90	£1.65

Steel Conduit Y Box

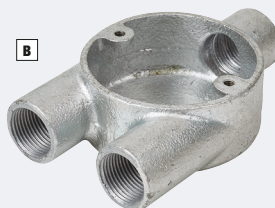

FROM ONLY
£1.68
EACH

Code	Size mm	Description	Each	10+
B 357798	20	Galvanised	£2.30	£1.68
333928	25	Galvanised	£2.68	£2.39

Steel Conduit Tee Box



FROM ONLY
£1.54
EACH

Code	Size mm	Description	Each	10+
422331	20	Galvanised	£1.79	£1.54
D 806152	25	Galvanised	£2.30	£2.18

Steel Conduit Distance Saddles



FROM ONLY
£1.35
EACH

Code	Size mm	Description	Each	10+
E 445705	20	Galvanised	£1.65	£1.35
231814	25	Galvanised	£2.16	£1.62

Steel Conduit Spacer Bar Saddles



FROM ONLY
21P
EACH

Code	Size mm	Description	Each	10+
966813	20	Galvanised	£0.26	£0.21
G 753577	25	Galvanised	£0.32	£0.26
732872	32	Galvanised	£0.86	£0.70

Steel Conduit & Accessories

Steel Conduit Inspection Bend

DETA



FROM ONLY
£3.52
EACH

Code	Size mm	Description	Each	10+
114638	20	Galvanised	£4.31	£3.52
A 738483	25	Galvanised	£6.58	£5.38

Steel Conduit Inspection Elbow

DETA



FROM ONLY
£2.85
EACH

Code	Size mm	Description	Each	10+
275064	20	Galvanised	£3.49	£2.85
B 945176	25	Galvanised	£4.74	£3.87

Steel Conduit Dome Cover

DETA

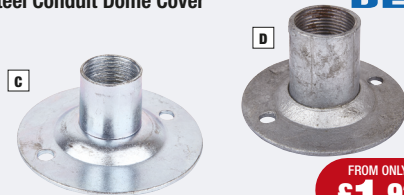

FROM ONLY
£1.92
EACH

Code	Size mm	Description	Each	10+
C 659752	20	Galvanised	£2.98	£2.44
D 988226	25	Galvanised	£2.35	£1.92

Steel Conduit Inspection Tee

DETA



FROM ONLY
£3.30
EACH

Code	Size mm	Description	Each	10+
E 474736	20	Galvanised	£4.04	£3.30
504078	25	Galvanised	£4.56	£3.73

Steel Conduit Extension Ring

DETA



FROM ONLY
£1.03
EACH

Code	Size mm	Description	Each	10+
F 161104	16	Galvanised	£1.26	£1.03
189493	20	Galvanised	£1.38	£1.13
960062	25	Galvanised	£1.65	£1.35

Steel Conduit Crampet

DETA

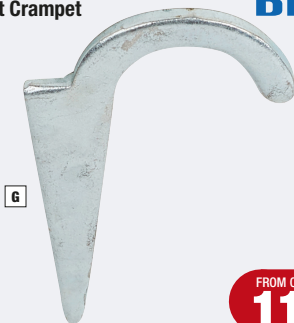

FROM ONLY
11P
EACH

Code	Size mm	Description	Each	10+
939740	20	Galvanised	£0.13	£0.11
G 195143	25	Galvanised	£0.17	£0.14

Steel Conduit Coupler

DETA



FROM ONLY
21P
EACH

Code	Size mm	Description	Each	10+
881435	20	Galvanised	£0.26	£0.21
H 842234	25	Galvanised	£0.31	£0.25
810606	32	Galvanised	£1.74	£1.42



Free Returns

Trade prices ex. VAT

Steel Conduit Nipple

DETA



FROM ONLY
£1.56
EACH

Code	Size Inches	Each	10+
A 790508	1 1/2"	£1.91	£1.56
B 178548	2"	£3.06	£2.50

Steel Conduit Locknut

DETA



FROM ONLY
12P
EACH

Code	Size mm	Description	Each	10+
977410	20	Galvanised	£0.15	£0.12
228852	25	Galvanised	£0.22	£0.18
E 805687	32	Galvanised	£0.23	£0.19

Female Brass Bush

DETA



FROM ONLY
20P
EACH

Code	Size mm	Each	10+
582794	20	£0.43	£0.35
349240	25	£0.24	£0.20
G 536775	32	£0.73	£0.59

Male Brass Bush

DETA



FROM ONLY
21P
EACH

Code	Size mm	Description	Each	10+
157022	20	Short	£0.26	£0.21
245745	20	Long	£0.33	£0.27
441856	25	Short	£0.42	£0.34
691186	25	Long	£0.59	£0.48
H 692805	32	Short	£1.13	£0.92
211883	32	Long	£1.33	£1.09

Steel Conduit Milled Edge Lockring

DETA

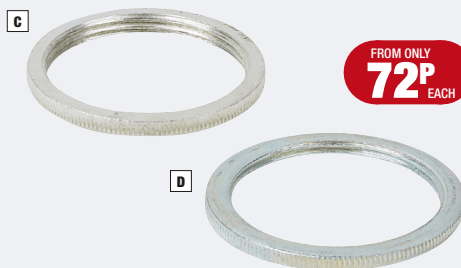

FROM ONLY
72P
EACH

Code	Size Inches	Each	10+
C 438254	1 1/2"	£0.88	£0.72
D 255757	2"	£1.55	£1.27

Brass Plug

DETA



FROM ONLY
38P
EACH

Code	Size mm	Each	10+
531525	20	£0.47	£0.38
F 298310	25	£0.62	£0.51

Tallow Tub

DETA



FROM ONLY
£5.36
EACH

Code	Type	Each	5+
I 558150	Cutting Compound	£5.65	£5.36

Galvanised Steel Conduit Nipples

DETA

A



FROM ONLY
31P
EACH

Code	Size mm	Each	10+
713495	20	£0.38	£0.31
A 586974	25	£0.45	£0.36
121285	32	£1.16	£0.95

Galvanised Steel Conduit Through Box

DETA

B



FROM ONLY
£1.45
EACH

Code	Size mm	Each	10+
215563	20	£1.62	£1.45
B 226592	25	£3.98	£3.63

Steel Conduit Reducer

DYSON

C



FROM ONLY
94P
EACH

Code	Description	Each	5+
916771	20 - 16mm	£0.99	£0.94
C 253981	25 - 20mm	£1.11	£1.06
363528	32 - 25mm	£1.80	£1.71

Galvanised Steel Conduit Flanged Coupler

D



FROM ONLY
£1.81
EACH

Code	Size mm	Each	10+
D 498113	20	£2.21	£1.81

Galvanised Steel Conduit Hexagonal Plug

E

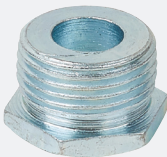

FROM ONLY
48P
EACH

Code	Type	Size mm	Each	10+
E 380125	Hook	20	£0.65	£0.48

Galvanised Steel Conduit Male Hook

F



FROM ONLY
£1.08
EACH

Code	Size mm	Each	10+
F 942071	20	£1.55	£1.08

Steel Conduit Milled Edge Lockring

G



FROM ONLY
11P
EACH

Code	Type	Size mm	Each	10+
922817	Locknut	20	£0.14	£0.11
510146	Locknut	25	£0.20	£0.17
G 263039	Locknut	32	£0.54	£0.44

Galvanised Steel Conduit Skeleton Box

H



FROM ONLY
£3.20
EACH

Code	Size mm	Description	Each	10+
H 713145	20	Terminal	£3.40	£3.20
866576	20	Through	£3.40	£3.20

Galvanised Steel Conduit Terminal Back Outlet



A

FROM ONLY
£3.20
EACH

Code	Size mm	Each	10+
A 648766	20	£3.40	£3.20

Steel Conduit Coupler



B

FROM ONLY
£1.33
EACH

Code	Description	Size Inches	Each	10+
B 901540	Galvanised	1 1/2	£1.63	£1.33
898946	Galvanised	2	£2.65	£1.95

Galvanised Steel Conduit Jack Chain - 10m



C

FROM ONLY
£5.95
EACH

Code	Each	5+
C 225927	£6.35	£5.95

Steel Conduit Locknut



D

FROM ONLY
57P
EACH

Code	Description	Size Inches	Each	10+
160407	Galvanised	1 1/2	£0.88	£0.72
D 240168	Galvanised	2	£0.70	£0.57

Female Brass Bush



E

FROM ONLY
76P
EACH

Code	Size Inches	Each	10+
973706	1 1/2	£0.93	£0.76
E 403650	2	£1.79	£1.46

Steel Conduit Box Lid



F

FROM ONLY
14P
EACH

Code	Description	Each	10+
331559	Galvanised	£0.19	£0.14
F 163260	Gasket Lid	£0.27	£0.22

Steel Conduit Hook Plate

- Base diameter 61mm



G

FROM ONLY
98P
EACH

Code	Description	Each	10+
G 712332	Galvanised	£1.36	£0.98

Steel Conduit Galvanising Spray

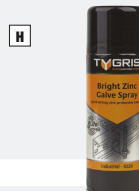

H

FROM ONLY
£8.10
EACH

Code	Each	3+
H 519238	£8.80	£8.10

Steel Conduit Triflex Cutting Compound Tin



I

FROM ONLY
£13.25
EACH

Code	Each	5+
I 634415	£13.95	£13.25

Cable Lubricant



J

FROM ONLY
£6.84
EACH

Code	Each	5+
J 136277	£7.20	£6.84

Flexible Conduit

Flexible Conduit Contractor Pack

- Contains 10 metres flexible conduit plus 10 male fixed terminations

FROM ONLY
£12.73
EACH



Code	Diameter mm	Each	5+
A 329930	20	£13.40	£12.73
325264	25	£18.50	£17.57

PVC Coated Steel Flexible Conduit

- Protects electrical wiring routes
- Price per reel

FROM ONLY
£38.80
EACH



Code	Length m	Diameter mm	Each	5+
231961	30	20	£55.80	£40.80
B 236355	30	25	£80.00	£59.10
904467	10	32	£45.40	£38.80

Bare Metal Flexible Conduit

- Bare metal flexible conduit, protects electrical wiring routes
- Price per reel



FROM ONLY
£33.00
EACH

Code	Length m	Diameter mm	Each	5+
C 942106	30	20	£40.80	£38.75
436488	30	25	£55.50	£52.75
D 580908	10	32	£34.80	£33.00

Flexible Conduit

- 20mm flexible conduit
- Protects electrical wiring routes
- Price per reel



FROM ONLY
£30.70
EACH

Code	Length m	Diameter mm	Each	5+
319078	30	20	£59.40	£54.90
E 119304	30	25	£80.70	£74.40
698923	10	32	£33.30	£30.70
601719	10	40	£36.70	£33.90
F 855281	10	50	£45.30	£41.80

LSF Flexible Conduit - 20mm - 50m - Black

- 20mm diameter
- Protects electrical wiring routes
- Price per reel

FROM ONLY
£68.40
EACH



A

Code	Each	5+
A 401412	£72.00	£68.40

Corrugated PVC Flexible Conduit - Grey

- 20mm PVC flexible conduit kit
- Protects electrical wiring routes
- Price per reel

B



C

FROM ONLY
£16.00
EACH

Code	Length m	Diameter mm	Each	5+
607028	50	20	£19.00	£16.00
978668	50	25	£33.50	£29.00
B 349119	25	32	£21.00	£18.25
C 118900	25	40	£27.00	£23.50

LSF Flexible Conduit Gland - 20mm - Black

- Black Gland to suit 20mm flexible conduit glands

D



FROM ONLY
92P
EACH

Code	Each	5+
D 846334	£0.97	£0.92

Flexible Conduit Locknut - 20mm - Black

- Hexagonal Black Locknut for use with conduit

E



FROM ONLY
10P
EACH

Code	Each	5+
E 801193	£0.11	£0.10

FREE NEXT DAY DELIVERY

*Excl. VAT. £5.95 on orders under £45.



ON
ORDERS
OVER
£45*

FREE RETURNS



MONEY
BACK
GUARANTEE

Cable Tray & Accessories

3000mm Heavy Duty Cable Tray - Galvanised

- Suited for heavy cable load applications & when covering over a large span
- Suitable for internal applications

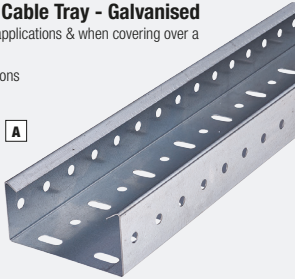

FROM ONLY
£11.50
EACH

Code	Width mm	Each	4+
A 261221	100	£12.10	£11.50
860136	150	£15.80	£15.00
186613	225	£18.95	£18.65
641729	300	£23.25	£22.00

3000mm Medium Duty Cable Tray - Galvanised

- Suited for medium cable load applications & when covering over a large span
- Suitable for internal applications



FROM ONLY
£4.75
EACH

Code	Width mm	Each	5+
711148	50	£5.55	£4.75
216483	75	£6.94	£6.49
B 729738	100	£6.77	£6.27
220745	150	£8.73	£8.08
330408	225	£10.64	£9.85
344191	300	£16.87	£15.62
975484	450	£27.47	£23.54

3000mm Light Duty Cable Tray - Galvanised

- Suited for light cable load applications & when covering over a large span



FROM ONLY
£3.41
EACH

Code	Width mm	Each	5+
371283	50	£3.68	£3.41
361489	75	£4.87	£4.51
C 679717	125	£7.77	£7.21
321833	300	£18.54	£17.16

Cable Tray Stand Off Bracket - Galvanised

- For stand-off mesh cable trays on the floor or on the wall
- Screwless fastening of the mesh cable tray on the stand-off bracket
- Perfect for outdoor use

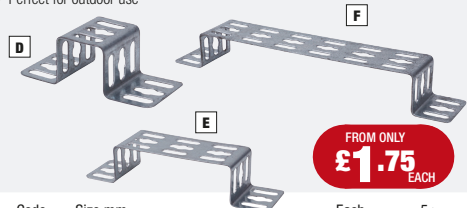

FROM ONLY
£1.75
EACH

Code	Size mm	Each	5+
D 611422	50	£1.85	£1.75
305089	75	£1.95	£1.85
E 373848	100	£2.25	£2.13
859539	150	£2.02	£1.91
F 608013	225	£2.95	£2.80
471338	300	£4.03	£3.82

Cable Tray Coupler - Galvanised

- Provides an effective means of connection between cable tray lengths
- Straight couplers are supplied as pairs with fixings

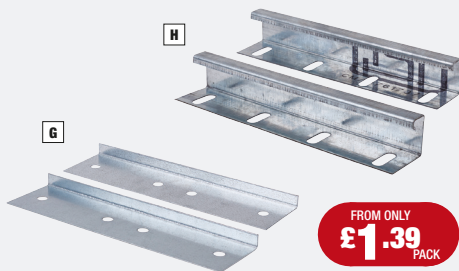

FROM ONLY
£1.39
PACK

Code	Description	Pack 2	5+
G 247071	Heavy Duty	£2.35	£2.15
H 542790	Medium Duty	£1.50	£1.39

2000mm Metal Channel

- Used for switch drops and general domestic installations
- Prevents any damage from other trades



FROM ONLY
48P
EACH

Code	Width mm	Each	10+
I 653919	25	£0.61	£0.48
J 761647	38	£0.76	£0.56

Wire Cable Tray Nut, Bolt & Clamp Assembly

marco
cablemanagement

A



FROM ONLY
£3.90
PACK

Code	Pack 10	10+
A 832920	£4.30	£3.90

Wire Basket tray

marco
cablemanagement

B

FROM ONLY
£6.19
EACH

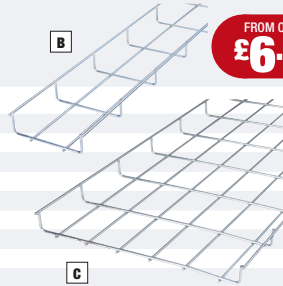

C

Code	Size mm	Each	5+
321128	30 x 50	£7.07	£6.19
B 312367	30 x 100	£7.21	£6.79
537707	30 x 150	£9.40	£8.22
713266	30 x 200	£11.25	£9.84
C 668864	30 x 300	£15.22	£13.32
875254	55 x 50	£8.97	£7.85
694733	55 x 100	£9.94	£8.69
903799	55 x 150	£11.60	£10.15
468129	55 x 200	£13.26	£11.61
512019	55 x 300	£17.88	£15.65

Wire Cable Tray Ceiling Fixing - 400mm

marco
cablemanagement

D



FROM ONLY
£7.73
EACH

Code	Each	5+
D 238747	£8.14	£7.73

Wire Cable Flexible Conduit Plate

marco
cablemanagement

E



FROM ONLY
£1.51
EACH

Code	Each	10+
E 203821	£1.80	£1.51

Wire Cable Quick Coupler

marco
cablemanagement

F



FROM ONLY
98P
EACH

Code	Each	10+
F 355502	£1.08	£0.98

Standard Threaded Rod Wire Cable Suspension Bracket

marco
cablemanagement

G



FROM ONLY
£1.32
EACH

Code	Size mm	Each	5+
G 909600	6 - 8	£1.39	£1.32

MC3050 Wire Cable Suspension Bracket

marco
cablemanagement

H



FROM ONLY
£4.25
EACH

Code	Size mm	Each	5+
H 496513	30 x 50	£4.47	£4.25

Wire Cable Suspension Hanger

marco
cablemanagement

I

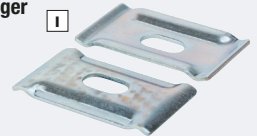

FROM ONLY
85P
EACH

Code	Each	5+
I 783672	£0.91	£0.85

Wire Cable Support Channel

marco
cablemanagement

J



K

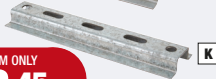

FROM ONLY
£2.45
EACH

Code	Size mm	Each	5+
J 940730	150	£2.69	£2.45
K 549769	200	£2.80	£2.56

Wire Cable Tray Wall Bracket and Mounting Plate

marco
cablemanagement

L

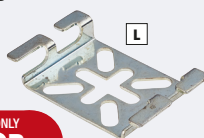

FROM ONLY
99P
EACH

Code	Each	5+
L 839423	£1.10	£0.99

Wire Cable Tray Clamp - Large

marco
cablemanagement

M

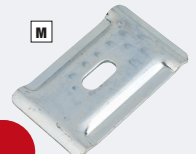

FROM ONLY
£3.70
PACK

Code	Pack 10	10+
M 411942	£4.00	£3.70

Galvanised Steel Trunking & Accessories



3m Galvanised Steel Trunking & Lid

- Fast, easy installation
- Quick-release turnbuckle fixing lid & connecting sleeve

FROM ONLY
£7.99
EACH

Code	Length mm	Width mm	Height mm	Each	4+
A 509947	3000	50	50	£8.79	£7.99

Galvanised Internal Square Bend - 45°



FROM ONLY
£4.65
EACH

Code	Width mm	Each	5+
974555	50	£5.03	£4.65
A 595445	75	£6.23	£5.76
936001	100	£7.59	£7.03
244845	150	£11.40	£10.55

Galvanised External Square Bend - 45°

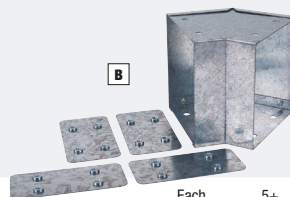

FROM ONLY
£4.65
EACH

Code	Width mm	Each	5+
223864	50	£5.03	£4.65
397550	75	£6.23	£5.76
B 250965	100	£7.59	£7.03
671743	150	£11.40	£10.55

Galvanised Internal Square Bend - 90°



FROM ONLY
£3.92
EACH

Code	Width mm	Each	5+
C 447134	50	£4.23	£3.92
626087	75	£5.24	£4.85
384380	100	£6.39	£5.92
129079	150	£9.59	£8.88

Galvanised External Square Bend - 90°

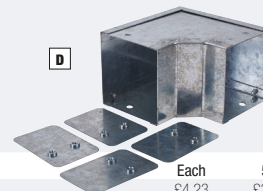

FROM ONLY
£3.92
EACH

Code	Width mm	Each	5+
396939	50	£4.23	£3.92
D 411563	75	£5.24	£4.85
434119	100	£6.39	£5.92
895339	150	£9.59	£8.88

Galvanised Steel Reducer

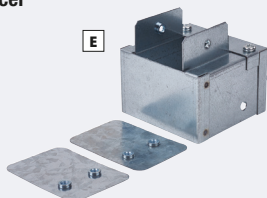

FROM ONLY
£4.95
EACH

Code	Description	Each	5+
E 647449	75 x 75mm to 50 x 50mm	£5.61	£4.95
175339	100 x 100mm to 50 x 50mm	£5.94	£5.28
581471	100 x 100mm to 75 x 75mm	£5.94	£5.28

Trunking Stirrup Hanger - 50 x 50mm



FROM ONLY
£2.32
EACH

Code	Each	5+
F 834904	£2.45	£2.32

Galvanised Steel Trunking & Accessories

Galvanised Stop End

- Specially designed to seal & close trunking sections

FROM ONLY
£1.13
EACH

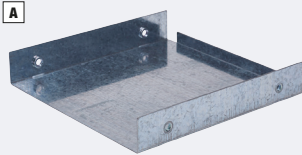

Code	Width mm	Each	5+
294059	50	£1.22	£1.13
399462	75	£1.51	£1.40
695121	100	£1.79	£1.70
A 607079	150	£2.70	£2.50

Galvanised Flange Outlet

FROM ONLY
85P
EACH

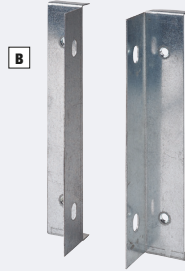

Code	Width mm	Each	5+
153099	50	£0.93	£0.85
371868	75	£1.37	£1.25
412231	100	£1.65	£1.50
B 417545	150	£2.51	£2.29

Galvanised Coupler

- Used for joining two lengths of trunking

FROM ONLY
£1.05
PAIR

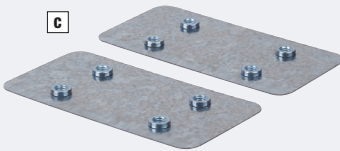

Code	Width mm	Pair	5+
146959	50	£1.13	£1.05
539145	75	£1.32	£1.22
C 966738	100	£1.61	£1.49
171026	150	£2.11	£1.96

Galvanised Coupler Screw - M5 x 6mm

- Suitable for use with all steel trunking couplers

FROM ONLY
33P
EACH



Code	Each	5+
D 736994	£0.35	£0.33

Galvanised Retainer

- Used to increase strength & rigidity for galvanised trunking

FROM ONLY
39P
EACH

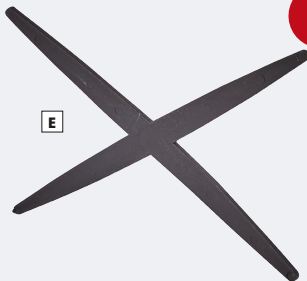

Code	Each	5+
E 606877	£0.42	£0.39

FREE NEXT DAY DELIVERY



On orders over £45* *Excl. VAT. £5.95 on orders under £45.

Galvanised Steel Trunking & Accessories

Galvanised Top Lid Bend - 90°

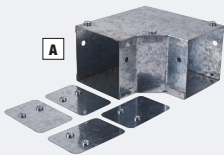

FROM ONLY
£3.92
EACH

Code	Width mm	Each	5+
192473	50	£4.23	£3.92
A 332243	75	£5.24	£4.85
207271	100	£6.39	£5.92
622119	150	£9.59	£8.88

Galvanised Top Lid Bend - 45°

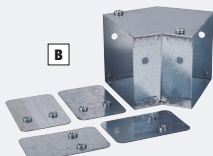

FROM ONLY
£4.65
EACH

Code	Width mm	Each	5+
445890	50	£5.03	£4.65
B 286617	75	£6.23	£5.76
953574	100	£7.59	£7.03
773928	150	£11.40	£10.55

3m Galvanised Trunking Lid



FROM ONLY
£9.33
EACH

Code	Width mm	Each	5+
140074	50	£9.83	£9.33
C 263616	75	£15.31	£14.54
871588	100	£17.14	£16.28
996780	150	£22.28	£21.16

Galvanised Top Lid Tie



FROM ONLY
£4.30
EACH

Code	Width mm	Each	5+
D 592520	50	£4.64	£4.30
652984	75	£6.43	£5.95
114084	100	£7.99	£7.40
341561	150	£12.10	£11.20

Galvanised Earth Braided Link

- Used for earth continuity by connecting trunkings, ladders & channels

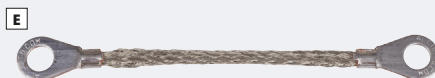

FROM ONLY
£1.28
EACH

Code	Each	10+
E 849048	£1.40	£1.28

Galvanised Earth Continuity Link

- Used to maintain earthing between trunking lengths & accessories



FROM ONLY
82P
EACH

Code	Each	10+
F 390879	£1.09	£0.82

Galvanised Bench Outlet Box - White

- 32mm deep outlet boxes allow the provision for data & power outlets in a bench application



FROM ONLY
£6.95
EACH

Code	Description	Each	5+
562993	1 Gang	£7.50	£6.95
G 349737	2 Gang	£8.95	£8.45



NEED HELP?

CALL OUR TEAM OF EXPERTS
8AM TO 6PM

Slotted Unistrut - 3000mm

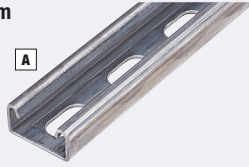

FROM ONLY
£5.56
EACH

Code	Size mm	Description	Each	5+
A 130035	41 x 21	H/Gauge	£7.95	£6.85
521572	41 x 41	H/Gauge	£8.25	£7.10

Unistrut Flat Plate



FROM ONLY
77P
EACH

Code	Description	Each	5+
B 760470	2 Hole	£0.86	£0.77
723730	3 Hole	£1.10	£0.98

Unistrut Internal 90° Bend

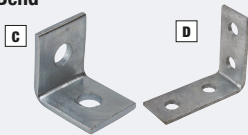

FROM ONLY
97P
EACH

Code	Description	Each	5+
C 888229	2 Hole	£1.10	£0.97
D 463640	4 Hole	£1.58	£1.26

Unistrut Flat Bend

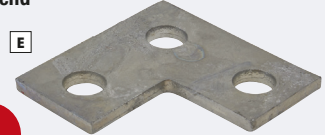

FROM ONLY
80P
EACH

Code	Description	Each	5+
E 172708	3 Hole	£0.94	£0.80

Unistrut Flat Tee

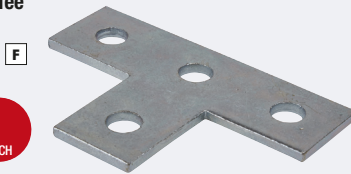

FROM ONLY
£1.26
EACH

Code	Description	Each	5+
F 871562	4 Hole	£1.58	£1.26

Unistrut Channel Spring Nut

FROM ONLY
£1.70
PACK



Code	Size	Description	Pack 10	5+
715062	M6	Short Spring	£2.10	£1.70
G 278433	M6	Long Spring	£2.20	£1.80
975773	M8	Short Spring	£2.20	£1.90
154545	M8	Long Spring	£2.30	£2.00
631822	M10	Short Spring	£2.50	£2.10
737584	M10	Long Spring	£2.60	£2.20

Unistrut Studding - 3000mm



FROM ONLY
£1.68
EACH

Code	Size	Each	5+
916619	M6	£1.98	£1.68
111296	M8	£2.32	£1.98
H 111019	M10	£2.64	£2.25

Unistrut Stud Connector



FROM ONLY
30P
EACH

Code	Size	Each	5+
768498	M6	£0.38	£0.30
I 387794	M8	£0.50	£0.41
387515	M10	£0.60	£0.51

Unistrut End Cap



FROM ONLY
34P
EACH

Code	Size mm	Description	Each	10+
211767	41 x 21	White	£0.36	£0.34
575735	41 x 41	White	£0.38	£0.36
J 198098	41 x 41	Black	£0.38	£0.36

All Round Patent Band - 10m



FROM ONLY
£6.12
EACH

Code	Colour	Width mm	Length m	Each	3+
K 907004	Black	12	10	£7.20	£6.12
251665	White	12	10	£7.20	£6.12



NEXT DAY DELIVERY!

WHEN YOU ORDER BY 6PM



**13A 2 Gang
Switched
Double Pole
Socket**

FROM ONLY
£3.31
EACH
WHEN YOU BUY 5+



• Manufactured to BS 1363 2

Order Code: 389090

SEE
PAGE
74

NEW PRODUCTS ADDED DAILY TO OUR WEBSITE

FREEPHONE: 8AM-6PM, 7 DAYS A WEEK
0808 168 22 77

ONLINE: SHOP 24/7
ElectricalDirect.co.uk

WIRING ACCESSORIES

<u>Moulded Sockets & Switches</u>	<u>66-77</u>
<u>RCD Sockets, Spurs & Converter Sockets</u>	<u>78</u>
<u>Dimmers & Timer Delay</u>	<u>79</u>
<u>Switch & Socket Surface Pattress</u>	<u>80-85</u>
<u>USB Sockets</u>	<u>82</u>
<u>Decorative Sockets & Switches</u>	<u>86-93</u>
<u>Grid Switches</u>	<u>94-99</u>
<u>Weatherproof Sockets & Switches</u>	<u>100-101</u>
<u>Metalclad Sockets & Switches</u>	<u>102-104</u>
<u>Floor Sockets & Boxes</u>	<u>105</u>
<u>Datacoms</u>	<u>106-107</u>
<u>Trailing Sockets & Extension Leads</u>	<u>108-109</u>
<u>Plug Tops & Inline Connectors</u>	<u>110</u>
<u>Hager Klik Wiring Centres</u>	<u>111</u>
<u>Industrial Plugs & Sockets</u>	<u>112-113</u>



SEE
PAGE
95



SEE
PAGE
101



SEE
PAGE
80



SEE
PAGE
104

Moulded Sockets & Switches

13A 1 Gang Switched Socket - White **DETA**



FROM ONLY
£1.56
EACH

Code	Description	Each	10+
A 800763	Double Pole	£1.86	£1.56

13A 2 Gang 2 Way Switched Socket - White **DETA**



FROM ONLY
£1.85
EACH

Code	Description	Each	10+
B 226985		£1.98	£1.85

13A 1 Gang Unswitched Socket - White **DETA**



FROM ONLY
£1.10
EACH

Code	Description	Each	10+
C 341027		£1.32	£1.10

13A 2 Gang Unswitched Socket - White **DETA**



FROM ONLY
£2.39
EACH

Code	Description	Each	10+
D 997041		£2.87	£2.39

1 Gang Flex Connection Plate - White **DETA**

- Central cord outlet
- Three pairs of terminals
- Cord grip



FROM ONLY
£1.89
EACH

Code	Description	Each	10+
E 469761		£2.26	£1.89

45A 2 Gang Cooker Switch - White **DETA**



FROM ONLY
£7.33
EACH

Code	Description	Each	10+
F 878321		£8.01	£7.33

1 Gang Fan Isolator Switch - White **DETA**

- All plate switches are X-rated
- Can be used for switching inductive or fluorescent loads without derating

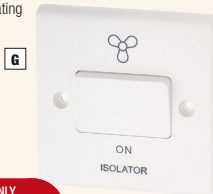

FROM ONLY
£3.18
EACH

Code	Description	Each	10+
G 727592		£3.48	£3.18

2 Gang Shaver Socket Outlet - White **DETA**

- Dual voltage outlet



FROM ONLY
£10.90
EACH

Code	Description	Each	10+
H 154483	Neon Indicator	£12.75	£10.90

1 Gang Round Pin Sockets - White **DETA**



FROM ONLY
£2.49
EACH

Code	Description	Each	10+
I 880222	2A Unswitched	£2.72	£2.49
612462	5A	£2.92	£2.68

Moulded Sockets & Switches

1 Gang Switch - White

DETA

FROM ONLY
55P
EACH

A



Code	Description	Each	10+
A 447563	1 Way	£0.65	£0.55
199887	2 Way	£0.80	£0.67

2 Gang 2 Way Plate Switch - White

DETA

FROM ONLY
£1.25
EACH

B



Code	Each	10+
B 488102	£1.49	£1.25

Multi Gang 2 Way Plate Switch - White

DETA

FROM ONLY
£1.79
EACH

C



D



Code	No. of Gangs	Each	10+
C 917288	3	£2.14	£1.79
D 222925	4	£5.42	£4.96

1 Gang 2 Way Press Switch - White

DETA

FROM ONLY
£1.91
EACH

E



Code	Each	10+
E 832460	£2.09	£1.91

20A 1 Gang Double Pole Switch - White

DETA

FROM ONLY
£3.50
EACH

F



Code	Description	Each	10+
F 124355	Switched	£3.78	£3.50
205134	Switched & Flex Outlet	£4.58	£4.24
764670	Outlet With Neon Switched With Neon	£6.15	£5.69
504633	Neon	£4.72	£4.37

45A Switch - White

DETA

FROM ONLY
£6.63
EACH

G



H



Code	Description	No. of Gangs	Each	10+
G 520053	Double Pole	1	£7.25	£6.63
H 454451	Double Pole & Neon Switch & Socket	1	£8.49	£7.77
448666	Socket	2	£10.82	£9.90

1 Gang Intermediate Switch - White

DETA

FROM ONLY
£3.51
EACH

I



Code	Each	10+
I 598633	£3.83	£3.51

13A Switch Spur - White

DETA

J



K



Code	Description	Each	10+
J 399650	Switch Spur	£3.49	£2.91
664586	Switch Spur & Bottom Flex Outlet	£5.52	£5.11
962799	Switch Spur & Front Flex Outlet	£5.31	£4.92
K 112277	Switch Spur & Neon	£4.42	£3.69
529146	Switch Spur Neon & Front Flex Outlet	£7.10	£6.57

1 Gang Unswitched Spur - White

DETA

FROM ONLY
£3.28
EACH

L



M



Code	Description	Each	10+
369934	Unswitched Spur	£3.54	£3.28
L 330996	Unswitched Spur & Flex Outlet	£4.37	£4.05
347107	Unswitched Spur & Front Flex Outlet	£4.23	£3.92
M 308959	Unswitched Spur With Neon	£4.90	£4.53

Moulded Sockets & Switches

1 Gang 2 Way Wide Rocker Switch - White

DETA

A



FROM ONLY
£3.27
EACH

Code	Each	10+
A 149751	£3.53	£3.27

1 Gang TV Connector - White

DETA

C



Code	Description	Each	10+
B 595557	TV/FM DAB Diplexer	£5.74	£5.25
C 559844	TV/FM DAB Satellite Triplexer	£6.47	£5.92

FROM ONLY
£5.25
EACH

1 Gang RJ11 Telephone Data - White

DETA

D



FROM ONLY
£3.03
EACH

Code	Description	Each	10+
851787	Master	£5.12	£4.74
D 259432	Slave	£3.27	£3.03

1 Gang TV/ Satellite Outlet - White

DETA

E



FROM ONLY
£2.97
EACH

Code	Description	Each	10+
E 616236	TV/F Type Outlet	£3.25	£2.97

2 Gang TV Connector - White

DETA

F



FROM ONLY
£13.38
EACH

Code	Description	Each	10+
	TV/FM DAB Satellite		
F 420732	x 2 Quad	£14.46	£13.38

1 Gang Coaxial Socket - White

DETA

G



FROM ONLY
£1.90
EACH

Code	Description	Each	10+
742610	Non Isolated	£2.07	£1.90
G 696790	Isolated	£2.69	£2.46

Blank Plate - White

DETA

H



FROM ONLY
36P
EACH

Code	No. of Gangs	Each	10+
760517	1	£0.43	£0.36
H 620106	2	£0.84	£0.71

6PM

ORDER BY 6PM

Get it Next Day!

13A Switched Socket - White

CONTACTUM
Make The Switch

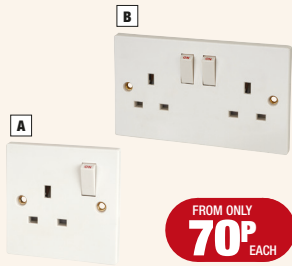

FROM ONLY
70P
EACH

Code	Description	No. of Gangs	Each	10+
A 213053	Single Pole	1	£0.84	£0.70
B 936573	Single Pole	2	£0.98	£0.75
133646	Double Pole	2	£1.15	£0.97

13A 1 Gang Switched Connection Unit - White

CONTACTUM
Make The Switch



FROM ONLY
£1.53
EACH

Code	Description	Each	10+
C 881138	Without Neon	£1.76	£1.53
D 564719	With Neon	£2.32	£2.10

10A 2 Way Switch - White

CONTACTUM
Make The Switch



FROM ONLY
39P
EACH

Code	No. of Gangs	Each	10+
E 972805	1	£0.48	£0.39
F 391178	2	£0.86	£0.64
355662	3	£1.72	£1.32

45A Double Pole Switch - White

CONTACTUM
Make The Switch



FROM ONLY
£3.01
EACH

Code	Description	No. of Gangs	Each	10+
G 167598	Square	1	£3.59	£3.01
H 144032	Vertical	2	£4.40	£3.87

45A 2 Gang Cooker Control Unit - White

CONTACTUM
Make The Switch



FROM ONLY
£4.98
EACH

Code	Each	3+
I 231203	£5.30	£4.98

1 Gang 3 Pole Fan Isolator - White

CONTACTUM
Make The Switch

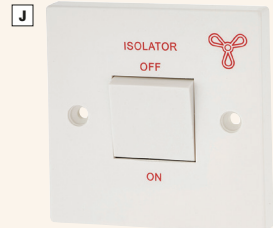

FROM ONLY
£1.60
EACH

Code	Each	10+
J 276233	£1.98	£1.60

45A 1 Gang Cooker Flex Outlet - White

CONTACTUM
Make The Switch



FROM ONLY
£1.93
EACH

Code	Each	10+
K 106546	£2.22	£1.93

1 Gang Coaxial Socket - White

CONTACTUM
Make The Switch



FROM ONLY
83P
EACH

Code	Each	10+
L 812496	£0.98	£0.83

Blank Plate - White

CONTACTUM
Make The Switch



FROM ONLY
21P
EACH

Code	No. of Gangs	Each	10+
M 402356	1	£0.28	£0.21
N 669534	2	£0.59	£0.40

Moulded Sockets & Switches

A



13A 2 Gang Single Pole Switched Socket - White



FROM ONLY
£1.25
EACH

Code	Manufacturer Code	Each	5+
A 981028	922W	£1.45	£1.25

13A 1 Gang Switched Socket - White



B



FROM ONLY
£1.34
EACH

Code	Manufacturer Code	Each	5+
B 227860	921W	£1.42	£1.34

13A Unswitched Socket - White



C



D



FROM ONLY
£1.19
EACH

Code	No. of Gangs	Manufacturer Code	Each	5+
C 169865	1	923W	£1.23	£1.19
D 190796	2	924W	£2.43	£2.34

13A 1 Gang Fused Connection Unit - White



E



F



FROM ONLY
£3.06
EACH

Code	Description	Manufacturer Code	Each	5+
E 232095	Fused Switched	950W	£3.52	£3.33
F 379231	With Neon Switched	951W	£4.65	£4.39
F 291703	Unswitched	952W	£3.25	£3.06

2 Gang Cooker Switch - White



G



Code	Description	Manufacturer Code	Each	5+
G 327755	Neon	970W	£8.34	£7.95
180090	Socket	971W	£8.35	£7.95

10A 1 Gang Plate Switch - White



FROM ONLY
80P
EACH

Code	No. of Ways	Manufacturer Code	Each	5+
A 178110	1	911W	£0.84	£0.80
397968	2	912W	£1.00	£0.94

10A 2 Gang Plate Switch - White



FROM ONLY
£1.75
EACH

Code	Manufacturer Code	Each	5+
B 416589	942W	£1.85	£1.75

10A Plate Switch - White



FROM ONLY
£1.47
EACH

Code	No. of Gangs	Manufacturer Code	Each	5+
C 718196	3	943W	£1.55	£1.47
D 331829	4	944W	£1.93	£1.82

45A Dual Cooker Outlet



FROM ONLY
£2.32
EACH

Code	Description	No. of Gangs	Manufacturer Code	Each	5+
E 981214	Dual Switch	2	880	£2.49	£2.32
154607	Outlet Plate	1	979	£4.12	£3.92

10A 1 Gang Intermediate Plate Switch - White



FROM ONLY
£1.77
EACH

Code	Manufacturer Code	Each	5+
E 266397	913W	£3.04	£1.77

Moulded Sockets & Switches

45A Double Pole Switch - White

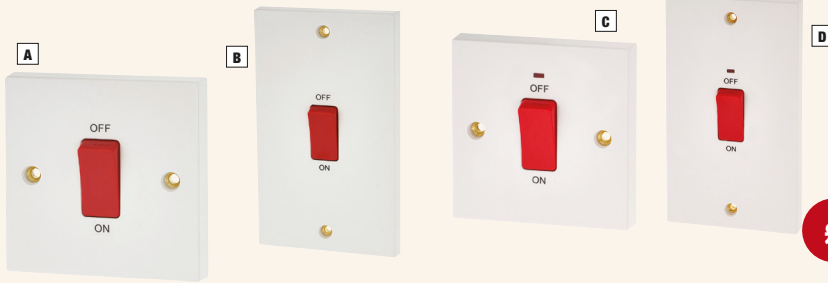

FROM ONLY
£3.39
EACH

Code	Description	No. of Gangs	Manufacturer Code	Each	5+
A 392873	Switch	1	975W	£3.62	£3.42
B 400730	Switch	2	973W	£6.02	£5.73
C 217475	Switch with Neon	1	974W	£3.59	£3.39
D 612048	Switch with Neon	2	972W	£7.13	£6.80

1 Gang Coaxial Socket - White

- Female socket
- AV installations



FROM ONLY
£1.23
EACH

Code	Manufacturer Code	Each	5+
E 261526	960W	£1.30	£1.23

Blank Plate - White



FROM ONLY
57P
EACH

Code	No. of Gangs	Manufacturer Code	Each	5+
F 460380	1	904W	£0.60	£0.57
G 287087	2	905W	£1.06	£1.01

6A 1 Gang Fan Isolator Plate Switch - White

- Colour coded terminals with captive angled screws

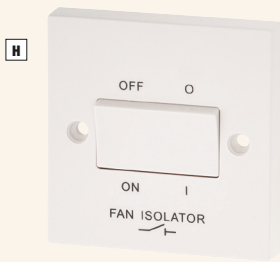

FROM ONLY
£4.10
EACH

Code	Each	5+
H 437969	£4.34	£4.10

20A 1 Gang Double Pole Switch - White

- Colour coded terminals with captive angled screws
- Flex outlet with knockout & reversible cord grip in bottom edge
- Minimum mounting box depth: 25mm



FROM ONLY
£2.32
EACH

Code	Description	Each	5+
I 219172	With Neon	£3.63	£3.43
I 673525	Bottom Flex Outlet	£2.46	£2.32

20A 1 Gang Flex Outlet Plate - White

- Cable entry at lower edge with removable reducer & reversible cord-grip
- Minimum mounting box depth: 25mm



A



FROM ONLY
48P
EACH

Code	Each	5+
A 852434	£0.51	£0.48

Surface Box 45mm - White

- Multiple knockouts & earth terminal fitted as standard



B



FROM ONLY
84P
EACH

Code	No. of Gangs	Profile Type	Each	5+
B 829834	1	Square	£1.08	£0.84
989048	2	Rectangle	£1.34	£1.23

10mm Spacer - White



C



D



FROM ONLY
73P
EACH

Code	No. of Gangs	Description	Each	5+
C 751298	1	Square Spacer	£0.76	£0.73
D 202877	2	Rectangular Spacer	£0.98	£0.94

Telephone Data Outlet - White



E



FROM ONLY
£1.21
EACH

Code	Description	Each	5+
724406	Master	£2.24	£2.12
E 134635	Slave	£1.28	£1.21

NEED HELP ?

CALL OUR TEAM OF EXPERTS
8AM TO 6PM



Moulded Sockets & Switches

13A 1 Gang Double Pole Switch Socket



A

FROM ONLY
£1.83
EACH

Code	Description	Each	10+
195755	Switch Socket	£1.93	£1.83
A 582949	Switch Socket with Neon	£7.13	£6.20
661680	Non Standard Switch Socket	£7.73	£6.72

13A 2 Gang Switch Socket



B

C

D

FROM ONLY
£3.31
EACH

Code	Description	Finish	Each	5+
389090	Double Pole Switch Socket	White	£3.56	£3.31
B 260779	Double Pole Switch Socket with Neon	White	£11.06	£9.62
C 839722	Double Pole Switch Socket Outboard	White	£4.68	£4.07
D 797660	Rockers	Red	£7.60	£6.61

13A 3 Gang Double Pole Switch Socket - White



E

FROM ONLY
£11.48
EACH

Code	Each	5+
E 540902	£13.19	£11.48

13A Unswitched Socket - White



F

G

FROM ONLY
£2.58
EACH

Code	No. of Gangs	Each	5+
F 899689	1	£2.97	£2.58
G 247688	2	£7.14	£6.22

13A 1 Gang Connection Unit - White

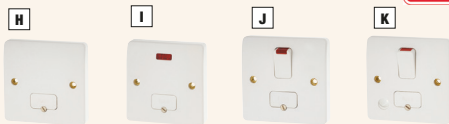

H

I

J

K

FROM ONLY
£4.04
EACH

Code	Description	Each	10+
H 848490	Base Flex	£4.64	£4.04
I 890369	Base Flex with Neon	£10.68	£9.29
209778	Switched	£6.30	£5.48
562354	Base Flex with Switch	£4.93	£4.29
J 390269	Base Flex with Neon Switch	£6.89	£6.00
376209	Flex with Neon	£10.37	£9.02
K 353458	Front Flex	£7.52	£6.54
455806	Double Pole Switched Connection Unit with Neon	£8.82	£7.67

45A Cooker Switch - White



M

L

FROM ONLY
£11.96
EACH

Code	Description	No. of Gangs	Each	5+
L 809972	Switch	2	£13.32	£12.65
784361	Control Switch	1	£13.67	£11.96
M 638070	Control Switch with Neon	2	£21.10	£18.46
728342	Metal Cooker Unit with Neon	1	£22.77	£21.69
955329	Metal Cooker Unit with Neon - Surface	1	£36.35	£34.62

10A 1 Gang Plate Switch - White



A

FROM ONLY
£1.06
EACH

Code	Description	Each	10+
233514	1 Way Single Pole	£1.21	£1.06
653827	2 Way Single Pole	£1.43	£1.25
521055	2 Way Single Pole Wide	£3.53	£3.07
A 919713	1 Way Double Pole	£6.98	£6.28

10A 2 Gang 2 Way Plate Switch - White

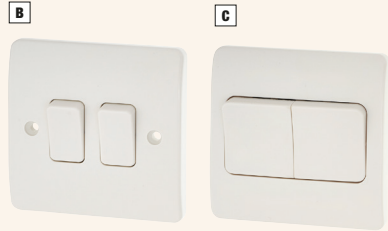

B

C

FROM ONLY
£2.16
EACH

Code	Description	Each	10+
B 924359	Plate Switch	£2.48	£2.16
C 162913	Wide Plate Switch	£6.65	£5.78

10A Multi Single Pole Switches - White

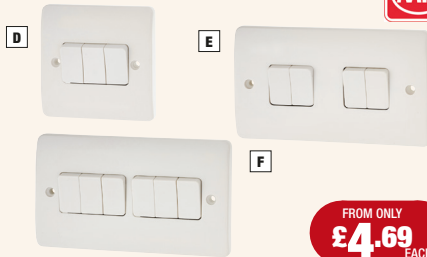

D

E

F

FROM ONLY
£4.69
EACH

Code	Description	No. of Gangs	Each	10+
D 422001	Plate Switch	3	£5.39	£4.69
750330	Wide Plate Switch	3	£13.41	£11.66
E 773483	Plate Switch	4	£11.74	£10.21
F 922926	Plate Switch	6	£27.93	£24.29

10A Single Pole Architrave Switch - White

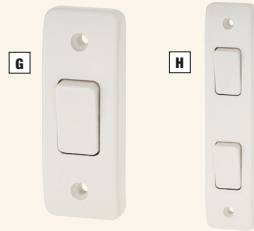

G

H

FROM ONLY
£3.11
EACH

Code	Description	No. of Gangs	Each	10+
G 542518	2 Way Architrave Switch	1	£3.58	£3.11
549499	Architrave System	1	£5.38	£4.68
H 809777	2 Way Architrave Switch	2	£7.32	£6.37

10A 1 Gang Intermediate Plate Switch - White



I

FROM ONLY
£5.53
EACH

Code	Each	10+
I 496602	£6.36	£5.53

10A 1 Gang Single Pole Push Plate Switch - White



J

FROM ONLY
£4.33
EACH

Code	Each	10+
J 658377	£4.97	£4.33

Moulded Sockets & Switches

20A 1 Gang Double Pole Switch - White



A



FROM ONLY
£3.38
EACH

Code	Description	Each	5+
374017	Base Flex without Neon	£3.88	£3.38
A 998708	Base Flex with Neon	£4.82	£4.19

32A 1 Gang Double Pole Switch - White



B



FROM ONLY
£10.71
EACH

Code	Each	5+
B 476963	£11.24	£10.71

45A 2 Gang Double Pole Switch with Neon - White



C



FROM ONLY
£8.39
EACH

Code	Each	5+
C 189222	£8.83	£8.39

13A 2 Gang RCD Protected Switch Socket - White



D

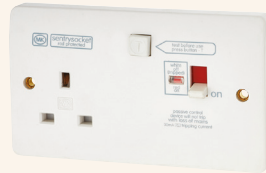

FROM ONLY
£40.87
EACH

Code	Each	5+
D 242619	£43.02	£40.87

1 Gang Round Pin Socket - White



E



F



FROM ONLY
£4.94
EACH

Code	Amp Rating	Each	5+
E 314937	2A	£5.68	£4.94
F 784655	5A	£6.63	£5.77

3 Pole Fan Isolator - White



G



FROM ONLY
£7.18
EACH

Code	Each	10+
G 940641	£8.26	£7.18



Before 12pm Delivery Available

Trade prices ex. VAT

115/230V 2 Gang Shaver Socket Outlet - White

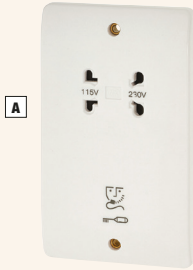

FROM ONLY
£17.99
EACH

Code	Each	5+
A 838526	£18.94	£17.99

1 Gang Blank Plate with Flex Outlet - White



FROM ONLY
£3.52
EACH

Code	Each	10+
B 161393	£4.05	£3.52

1 Gang Architrave Blank Plate - White

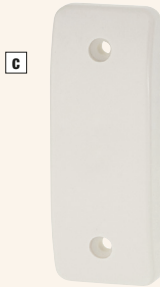

FROM ONLY
£2.07
EACH

Code	Each	10+
C 877877	£2.38	£2.07

Blank Plate - White



FROM ONLY
89P
EACH

Code	No. of Gangs	Each	10+
D 719731	1	£1.01	£0.89
E 561494	2	£2.27	£1.98

1 Gang TV Plate - White



FROM ONLY
£4.94
EACH

Code	Description	Each	5+
F 963436	Single TV - IEC: Female	£5.68	£4.94
G 568291	TV/FM/SAT Triplexer	£7.94	£6.90

1 Gang Telephone Data Socket - White



FROM ONLY
£3.81
EACH

Code	Description	Each	10+
H 523488	Master	£6.62	£5.76
354420	Secondary	£4.38	£3.81

RCD Sockets, Spurs & Converter Sockets

13A 1 Gang RCD Adaptor

- Trip current: 30mA



FROM ONLY
£7.80
EACH

Code	Each	5+
A 437996	£9.65	£7.80

13A 1 Gang RCD Spur

- Trip current: 30mA
- Fuse holder can be locked out for safety

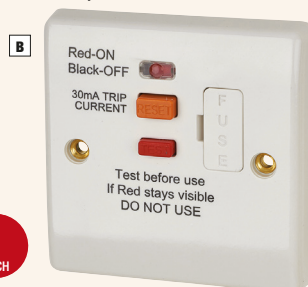

FROM ONLY
£18.91
EACH

Code	Finish	Each	5+
B 861285	Plastic	£20.90	£18.91
319633	Metal	£22.74	£20.28

13A 1 Gang RCD Socket

- Trip current: 30mA
- Supplied with surface mounting box



FROM ONLY
£12.20
EACH

Code	Finish	Each	5+
731886	Plastic	£13.95	£12.20
C 611767	Metal	£20.25	£16.95

13A 2 Gang RCD Socket

- Trip current: 30mA
- Supplied with surface mounting box

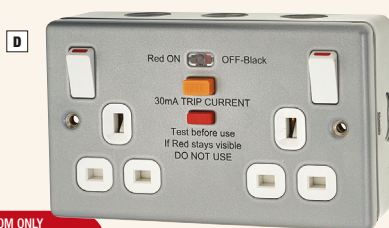

FROM ONLY
£18.91
EACH

Code	Finish	Each	5+
993332	Plastic	£19.90	£18.91
D 323970	Metal	£25.12	£23.90

1 Gang to 2 Gang Converter Socket - White

- Converts a single socket outlet into a double switched socket
- Profile type: raised square
- Material: plastic



FROM ONLY
£4.60
EACH

Code	Each	5+
E 411302	£4.85	£4.60

1 Gang to 4 Gang Converter Socket - White

- Converts a single socket outlet into a 4 switched socket
- Profile type: raised square
- Material: plastic



FROM ONLY
£7.36
EACH

Code	Each	5+
F 305863	£7.75	£7.36

1 Gang Dimmer Switch - White



A



FROM ONLY
£19.78
EACH

Code	Description	Each	5+
866832	250W	£20.82	£19.78
A 934892	500W	£24.17	£22.96

2 Gang Dimmer Switch - White



B



FROM ONLY
£17.66
EACH

Code	Description	Each	5+
251819	Tungsten Filament	£18.59	£17.66
B 741684	Tungsten Filament and Low Voltage Halogen	£33.19	£31.53

1 Gang Rotary Dimmer Switch - White



FROM ONLY
£11.76
EACH



C

Code	Description	Each	5+
C 290815	250W	£12.38	£11.76
889807	450W	£16.52	£15.70

Rotary Dimmer - White



FROM ONLY
£4.70
EACH



D

Code	Description	No. of Gangs	Each	5+
D 843157	1 Way 400W	1	£5.98	£4.70
695054	2 Way 250W	2	£6.43	£5.80

Push Dimmers - White



FROM ONLY
£5.80
EACH



E

Code	No. of Gangs	Description	Each	5+
513413	1	250W	£6.43	£5.80
502453	1	400W	£6.95	£6.18
E 943661	1	1000W	£18.75	£17.30
906400	2	250W	£6.43	£5.80
805374	3	250W	£18.25	£16.70

Trailing Edge LED Dimmer - White



FROM ONLY
£11.82
EACH



F

Code	Description	No. of Gangs	Each	5+
F 835467	400W	1	£12.45	£11.82
305213	250W	2	£19.75	£18.76

1000W 1 Gang LED Dimmer - White



- Optimises LED performance with adjustable minimum brightness and a choice of dimming modes

G



FROM ONLY
£16.04
EACH

Code	Each	10+
G 963223	£17.54	£16.04

Dimmer Knob - Brushed Steel



FROM ONLY
£1.56
EACH



H

Code	Each	5+
H 715903	£1.65	£1.56

1 Gang Grid Dimmer - White



- Low voltage

FROM ONLY
£26.21
EACH



J

Code	Description	Each	5+
I 356471	220W	£27.59	£26.21
J 786728	400W	£33.23	£31.57

400W Trailing Edge LED Grid Dimmer - White



FROM ONLY
£26.49
EACH



K

Code	Each	5+
K 794222	£27.89	£26.49

1 Gang Dimmer Module LED - White

L



FROM ONLY
£28.50
EACH

Code	Finish	Each	5+
L 776736	White	£30.00	£28.50
474630	Black	£30.00	£28.50

Pullcords, Pendants & Batten Holders

10/13W 6" Low Energy Pendant - White

- Integral control gear
- Supports a light fitting of up to 3kg



FROM ONLY
£7.85
EACH



Code	Each	5+
A 542026	£8.65	£7.85

6" Pendant Set - White

- T2 rated lampholders
- Complete with flex
- Heat resisting PVC insulated



FROM ONLY
£1.01
EACH



Code	Each	5+
B 488396	£1.25	£1.01

6" Pendant Set - White

- T2 rated lampholders
- Complete with flex
- Heat resisting PVC insulated



FROM ONLY
£2.13
EACH



Code	Each	10+
C 563654	£2.55	£2.13

Batten Holder - White

- Heat resistant to category T2



FROM ONLY
£2.51
EACH



Code	Each	10+
D 817515	£3.00	£2.51

6" Pendant Set - White

- T2 rated lampholders
- Complete with flex
- Heat resisting PVC insulated



FROM ONLY
£2.88
EACH



Code	Each	5+
E 262879	£3.31	£2.88

10/13W 6" Low Energy Pendant - White

- Integral control gear
- It supports a light fitting of up to 3kg



FROM ONLY
£22.26
EACH



Code	Each	5+
F 110010	£23.44	£22.26

10/13W 6" Low Energy Pendant - White

- Integral control gear
- It supports a light fitting of up to 3kg



FROM ONLY
£9.46
EACH



Code	Each	5+
G 403721	£9.96	£9.46

Batten Holder - White

- Heat resistant to category T2



FROM ONLY
£3.94
EACH



Code	Description	Each	5+
H 663984	Standard Batten Holder	£4.69	£4.09
I 161554	Angled Batten Holder	£4.53	£3.94

BC Straight Lampholder - White

- Heat resistant BC Lampholder

FROM ONLY
£5.25
EACH



Code	Each	5+
J 144381	£6.03	£5.25

Prewired Batten Holder

- Suitable for ceiling and wall mounting
- Current: 6A
- Rated lamp wattage: 150W

FROM ONLY
£1.25
EACH



Code	Description	Each	5+
K 239511	Batten Holder	£1.43	£1.25
L 378350	Angled Batten Holder	£2.05	£1.90

6A Pull Switch - White

- Raised slim



A

FROM ONLY
£3.93
EACH

Code	Description	Each	5+
A 391936	1 Way	£4.52	£3.93
429907	2 Way	£5.96	£5.19

6A Pull Cord Switch

- 2 way pull cord
- Profile type: raised slim

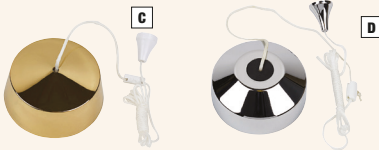

C

D

Code	Finish	Each	5+
580128	White	£2.90	£2.10
C 469173	Brass	£12.35	£11.73
D 463526	Chrome	£12.35	£11.73

FROM ONLY
£2.10
EACH

Double Pole Pull Cord - White

B



FROM ONLY
£6.78
EACH

Code	Each	5+
B 780380	£7.46	£6.78

Pull Cord with Chrome Cover

E



FROM ONLY
£7.85
EACH

Code	Each	5+
E 200763	£14.35	£7.85

Ceiling Pull Cord Switch - White

- Suitable for installation in small circular conduit boxes
- Ceiling switch cords are 1.5m minimum length
- These switches do not have to be derated when used with fluorescent or inductive loads
- Fixing centre: 50.8mm

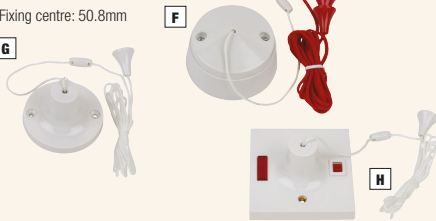

G

F

H

Code	Amp Rating	Each	5+
F 932149	6 with red cord	£9.61	£8.37
G 621662	16	£8.61	£7.49
H 899311	50	£13.04	£11.34

FROM ONLY
£7.49
EACH

10A Fan Isolator Ceiling Switch - White

- Triple pole fan isolator
- Supplied with approx.1500mm of cord



FROM ONLY
£6.01
EACH

Code	Each	5+
I 772657	£6.31	£6.01

Mounting Block for Pull Cord Switches

- Optionally used with 1 way ceiling pull cord switch
- For 6A or 16A switches
- Earth terminal riveted in base
- Diameter: 83mm
- Fixing centre: 50.8mm

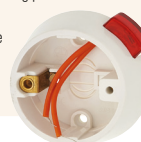

J

FROM ONLY
£1.16
EACH

Code	Description	Each	5+
637518	Without Neon	£1.32	£1.16
J 449823	With Neon	£3.06	£2.66

2A 250V Cabinet Switch - White

- Switch for cabinet lighting

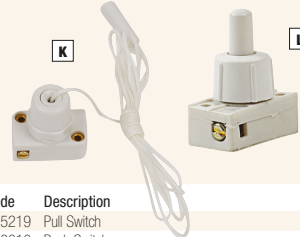

K

L

FROM ONLY
98P
EACH

Code	Description	Each	5+
K 885219	Pull Switch	£1.75	£1.60
L 188016	Push Switch	£1.15	£0.98

USB Sockets



USB Socket - White

- 2 x type A sockets - 2.1A total output 5V
- Charges iPads, iPhones, tablets, mobiles, cameras and more
- Terminal capacity: 3 x 2.5mm², 3 x 4.00mm², 2 x 6.0mm²
- Minimum mounting box depth: 25mm - ideal for retrofit



FROM ONLY
£8.55
EACH

Code	No. of Gangs	Each	5+
A 818523	1	£8.85	£8.55
B 600768	2	£10.95	£10.45



USB Socket - 2 Gang Decorative

- 2 x type A sockets - 2.1A total output 5V
- Charges iPads, iPhones, tablets, mobiles, cameras and more
- Terminal capacity: 3 x 2.5mm², 3 x 4.00mm², 2 x 6.0mm²
- Minimum mounting box depth: 25mm - ideal for retrofit



FROM ONLY
£11.95
EACH

Code	Finish	Each	5+
C 349477	Polished Chrome	£12.95	£11.95
D 406928	Stainless Steel	£12.95	£11.95

Switch & Socket Surface Pattress

Pattress - 25mm

DETA

A



FROM ONLY
67P
EACH

Code	No. of Gangs	Each	5+
A 350730	1	£0.71	£0.67
478296	2	£1.34	£1.27

1 Gang Pattress Minitrunking Knockout

B



C



Marshall Tufflex

FROM ONLY
£1.77
EACH

Code	Size mm	Description	Suitable for	Each	10+
B 782357	19	Radius	MT1/2	£2.55	£2.13
467272	19	Square	MT1/2	£2.46	£2.06
721015	32	Radius	MT1/2	£2.12	£1.77
588414	32	Square	MT1/2	£2.23	£1.87
584550	44	Radius	MT2	£3.79	£3.16
C 740119	44	Square	MT2/3	£3.19	£2.67
425292	44	Radius	MT2/3	£3.32	£2.77

Single to Twin Box

D

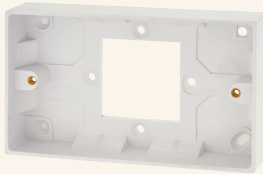

FROM ONLY
£1.18
EACH

Code	Each	5+
D 274067	£1.36	£1.18

2 Gang Pattress Minitrunking Knockout

Marshall Tufflex

E



FROM ONLY
£3.12
EACH

Code	Size mm	Description	Suitable for	Each	10+
527896	32	Radius	MT2	£3.79	£3.16
159666	32	Square	MT2	£3.93	£3.28
E 874588	44	Square	MT2	£3.78	£3.16
606283	44	Radius	MT2/3	£3.73	£3.12

Dual Pattress Box

F



FROM ONLY
£1.29
EACH

Code	Each	5+
F 521189	£1.80	£1.29

Pattress with 20mm Knockout

Marshall Tufflex

G



FROM ONLY
£1.69
EACH

Code	Size	No. of Gangs	Description	Each	10+
132760	32	1	Square	£2.02	£1.69
498310	32	1	Radius	£2.14	£1.79
G 945796	44	1	Square	£2.81	£2.35
160626	32	2	Radius	£3.74	£3.12
647379	32	2	Square	£3.74	£3.12

PVC Pattress with Knockout - MT + 20mm

H



H



FROM ONLY
75P
EACH

Code	No. of Gangs	Each	10+
H 552568	1	£0.98	£0.75
I 217332	2	£1.42	£1.20

1 Gang Architrave Flush Box 30mm

MK

J



FROM ONLY
78P
EACH

Code	Each	5+
J 373386	£0.90	£0.78

Switch & Socket Surface Pattern

Surface Box with Earth Terminal - 25mm

CONTACTUM
Made To Order

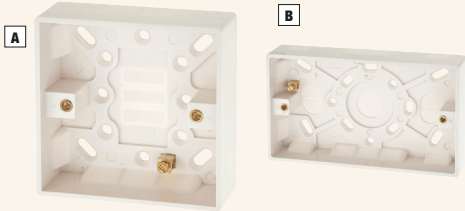

FROM ONLY
30P
EACH

Code	No. of Gangs	Each	10+
A 726452	1	£0.39	£0.30
B 163919	2	£0.74	£0.57

Surface Box

BRITISH
BG
GENERAL

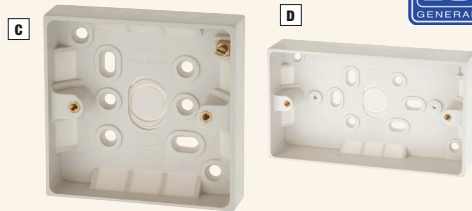

FROM ONLY
57P
EACH

Code	Description	No. of Gangs	Depth	Each	5+
C 840858	With Earth Terminal	1	19	£0.60	£0.57
428256	Without Earth Terminal	1	32	£0.60	£0.57
D 652614	Without Earth Terminal	2	32	£1.16	£1.10

Surface Box - 41mm

MK

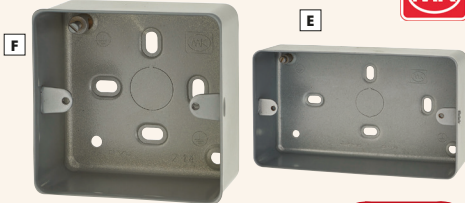

FROM ONLY
£2.63
EACH

Code	Description	No. of Gangs	Each	5+
204830	Without Knockouts	1	£4.22	£3.67
E 915416	Without Knockouts	2	£4.95	£2.63
F 903879	With Knockout	1	£3.02	£2.63
865450	With Knockout	2	£4.42	£3.84

Moulded Surface Box

MK



FROM ONLY
94P
EACH

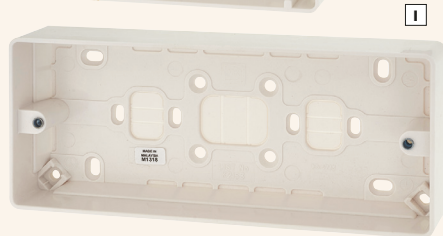

Code	Description	Depth	No. of Gangs	Each	10+
143980	With Earth Terminal	16	1	£1.08	£0.94
719007	With Earth Terminal	44	1	£1.47	£1.28
G 595306	Without Earth Terminal	30	1	£1.11	£0.97
454280	Without Earth Terminal	32	1	£1.23	£1.08
607262	With Earth Terminal	40	2	£4.01	£3.49
H 782961	Without Earth Terminal	30	2	£2.03	£1.76
142545	Without Earth Terminal	32	2	£2.12	£1.84
I 598507	Without Earth Terminal	30	3	£5.61	£4.88

Moulded Architrave Box with Earth Terminal - 16mm

MK

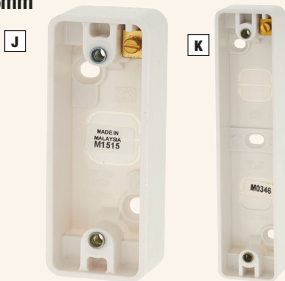

FROM ONLY
£1.30
EACH

Code	No. of Gangs	Each	5+
J 760258	1	£1.49	£1.30
K 992763	2	£4.17	£3.63

TRADE ESSENTIAL

**ORDER
BY 6PM**
GET IT NEXT DAY!

EVO-STIK

Gripfill Grab Adhesive – 350ml

- Excellent strength and fast bonding
- Solvent based – interior and exterior use
- Solvent free – interior use only

FROM ONLY

£1.80
EACH

WHEN YOU BUY 5+

**ORDER
TODAY!**

Order Code: 560181

Solvent Free

Order Code: 458984



Decorative Sockets & Switches

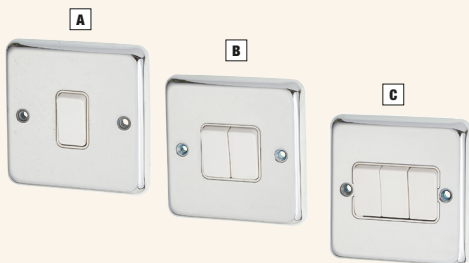

10A 2 Way Single Pole Switch - Polished Chrome



- Top access terminals for ease of wiring
- Do not have to be derated when used with fluorescent or inductive loads
- Can be wired as either one-way or two-way
- Terminal screws backed out
- White terminal markings for ease of identification

FROM ONLY
£7.06
EACH

Code	No. of Gangs	Manufacturer Code	Each	5+
A 569085	1	K4671PCR	£7.43	£7.06
B 991009	2	K4672PCR	£10.84	£10.30
C 295076	3	K4673PCR	£20.22	£19.21

13A 1 Gang Switched Fused Spur Unit - Polished Chrome



- Top access terminals for ease of wiring
- Terminal screws backed out
- White terminal markings for ease of identification
- Fitted with a 13A fuse

FROM ONLY
£12.98
EACH

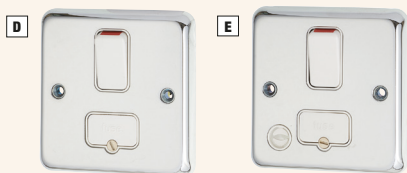

Code	Description	Manufacturer Code	Each	5+
D 699362	Without Flex Outlet	K941PCR	£13.66	£12.98
E 976881	With Flex Outlet	K931PCR	£17.68	£16.79

13A Switched Sockets - Brushed Stainless Steel



- Top access terminals for ease of wiring
- Terminal screws backed out
- White terminal markings for ease of identification
- Grade 304 stainless steel
- Durable finish and tarnish resistant
- Double pole switching
- Unique 3 pin operated safety shutter

FROM ONLY
£9.45
EACH



Code	No. of Gangs	Manufacturer Code	Each	5+
F 189009	1	K2958BSS	£9.95	£9.45
G 644564	2	K2948BSS	£19.43	£16.90

13A 1 Gang Switched Fused Spur Unit - Brushed Stainless Steel



- Top access terminals for ease of wiring
- Terminal screws backed out
- White terminal markings for ease of identification
- Grade 304 stainless steel
- Durable finish and tarnish resistant
- Fitted with a 13A fuse

H



FROM ONLY
£12.77
EACH

Code	Description	Manufacturer Code	Each	5+
H 605626	Without Flex Outlet	K941BSS	£13.44	£12.77
665604	With Flex Outlet	K5250BSS	£19.36	£18.39

1 Gang Blank Plate - Brushed Stainless Steel



- Grade 304 stainless steel
- Durable finish and tarnish resistant
- Covers unused back boxes to match existing range

I



FROM ONLY
£5.30
EACH

Code	Manufacturer Code	Each	5+
I 836067	K3330BSS	£6.09	£5.30

20A Slimline 1 Gang Double Pole Switch - Satin Chrome

- Clear terminal markings
- Colour coded terminals
- 2 earth terminals

DETA

A



FROM ONLY
£6.53
EACH

Code	Manufacturer Code	Each	5+
A 251457	SD1390SC	£6.87	£6.53

13A Slimline 2 Gang Switched Socket - Satin Chrome

- Top facing terminal screws
- Clear colour coded terminals
- Recessed earth bar with 2 terminals
- Captive & backed out terminals

DETA

B



FROM ONLY
£6.11
EACH

Code	Manufacturer Code	Each	5+
B 876920	SD1209SC	£6.54	£6.11

13A Slimline 1 Gang Fuse Spur Unit - Satin Chrome

- Captive fuse carrier
- Clear colour coded terminals
- 2 earth terminals
- Captive & backed out terminals

DETA

D



C



FROM ONLY
£6.79
EACH

Code	Description	Manufacturer Code	Each	5+
C 686300	Switched	SD1370SC	£7.15	£6.79
D 741293	Unswitched	SD1360SC	£7.37	£7.00

Slimline Dual Voltage Shaver Socket with Neon - Satin Chrome

- Clear colour coded terminals
- Dual voltage outlet for 115V or 240V
- Neon indicator
- 2 earth terminals

DETA

E



FROM ONLY
£26.33
EACH

Code	Manufacturer Code	Each	5+
E 764269	SD1305SC	£27.72	£26.33

10A Slimline 2 Way Single Pole Switch - Satin Chrome

- Can be used for switching inductive or fluorescent loads without derating
- Clear terminal markings for ease of wiring
- Captive & backed out terminals

DETA

F



G



FROM ONLY
£3.87
EACH

Code	No. of Gangs	Manufacturer Code	Each	5+
F 479387	1	SD1203SC	£4.07	£3.87
G 922263	3	SD1205SC	£6.40	£6.08

Decorative Sockets & Switches

13A Switched Sockets - Polished Chrome

- Twin earth fitted for double earth facility for installations requiring high integrity protective connection BS7671:2008



A



B



FROM ONLY
£5.84
EACH

Code	No. of Gangs	Manufacturer Code	Each	5+
A 785869	1	NPC21W	£6.30	£5.84
B 224583	2	NPC22W	£6.96	£6.45

13A 1 Gang Fuse Spur Unit - Polished Chrome



C



D



FROM ONLY
£6.25
EACH

Code	Description	Manufacturer Code	Each	5+
C 600251	Switched	NPC50W	£6.74	£6.25
D 323590	Unswitched	NPC54	£7.21	£6.68

45A Double Pole Cooker Switch - Single Plate - Polished Chrome

- Neon indicator



E



FROM ONLY
£11.31
EACH

Code	Manufacturer Code	Each	5+
E 388820	NPC74W	£12.21	£11.31

45A Double Pole Cooker Switch - Polished Chrome

- 13A Socket and Neon included



F



FROM ONLY
£18.52
EACH

Code	Manufacturer Code	Each	5+
F 435560	NPC70W	£20.00	£18.52

10A 2 Way Single Pole Switch - Polished Chrome



G



H



I



FROM ONLY
£3.89
EACH

Code	No. of Gangs	Manufacturer Code	Each	5+
G 279574	1	NPC12W	£4.20	£3.89
H 480272	2	NPC42W	£5.81	£5.38
I 577742	3	NPC43W	£7.70	£7.13

1 Gang 3 Pole Fan Isolator Switch - Polished Chrome

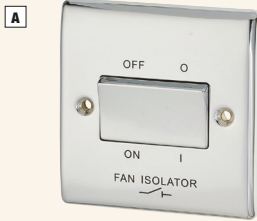

FROM ONLY
£9.35
EACH

Code	Manufacturer Code	Each	5+
A 601532	NPC15W	£10.10	£9.35

Dual Voltage Shaver Socket - Polished Chrome



FROM ONLY
£21.47
EACH

Code	Manufacturer Code	Each	5+
B 737104	NPC20W	£23.19	£21.47

400W 2 Gang 2 Way Push Dimmer Switch - Polished Chrome



- Suitable for compact fluorescent lamps (CFL) and LED Dimming
- Max LED load 40W



FROM ONLY
£18.35
EACH

Code	Manufacturer Code	Each	5+
C 165338	NPC82P	£19.81	£18.35

1 Gang Telephone Outlet - Polished Chrome



FROM ONLY
£7.66
EACH

Code	Description	Manufacturer Code	Each	5+
748111	Master	NPCBTM1	£8.73	£8.09
D 221622	Secondary	NPCBTS1W	£8.26	£7.66

1 Gang Coaxial Socket - Polished Chrome



FROM ONLY
£4.65
EACH

Code	Manufacturer Code	Each	5+
E 758591	NPC60W	£5.02	£4.65

1 Gang Blank Plate - Polished Chrome



FROM ONLY
£3.07
EACH

Code	Manufacturer Code	Each	5+
F 128852	NPC94	£3.31	£3.07

Decorative Sockets & Switches

13A Switched Sockets - Brushed Steel

- Lacquered surface to reduce fingerprints
- Angled in-line colour coded terminals
- Twin earth fitted for double earth facility for installations requiring high integrity protective connection

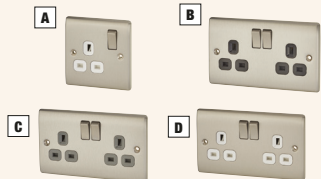

FROM ONLY
£5.84
EACH

Code	Description	No. of Gangs	Each	5+
A 593593	White Insert	1	£6.30	£5.84
B 414055	Black Insert	2	£6.96	£6.45
C 282651	Grey Insert	2	£6.99	£6.48
D 291298	White Insert	2	£6.99	£6.48

13A 1 Gang Fuse Spur Unit - Brushed Steel

- Lacquered surface to reduce fingerprints
- Angled in-line colour coded terminals

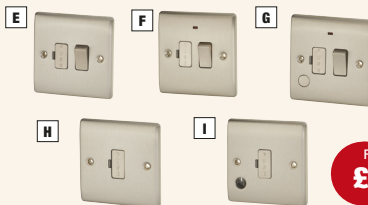

FROM ONLY
£6.25
EACH

Code	Description	Each	5+
E 670122	Switched Without Neon	£6.74	£6.25
F 632252	Switched With Neon	£7.55	£6.99
G 550714	Switched With Neon & Flex Outlet	£9.06	£8.39
H 338559	Unswitched Without Neon	£7.21	£6.68
I 429618	Unswitched With Neon & Flex Outlet	£7.71	£7.14

45A Double Pole Cooker Switch with Neon - Brushed Steel

- Lacquered surface to reduce fingerprints
- Angled in-line colour coded terminals



FROM ONLY
£18.52
EACH

Code	Each	5+
J 654689	£20.00	£18.52

45A Double Pole Cooker Switch with Neon - Brushed Steel

- Lacquered surface to reduce fingerprints
- Angled in-line colour coded terminals

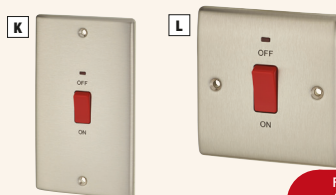

FROM ONLY
£11.31
EACH

Code	Description	Each	5+
K 298657	Double Plate	£13.44	£12.44
L 526087	Single Plate	£12.21	£11.31

10A 2 Way Single Pole Switch - Brushed Steel

- Lacquered surface to reduce fingerprints
- Angled in-line colour coded terminals

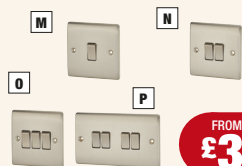

FROM ONLY
£3.89
EACH

Code	No. of Gangs	Each	5+
M 531107	1	£4.20	£3.89
N 318249	2	£5.80	£5.38
O 223691	3	£7.70	£7.13
P 402026	4	£12.55	£11.63

10A 1 Gang Intermediate Plate Switch - Brushed Steel

- Lacquered surface to reduce fingerprints
- Angled in-line colour coded terminals



Q

FROM ONLY
£6.22
EACH

Code	Each	5+
Q 767537	£6.71	£6.22

10A 1 Gang 3 Pole Fan Isolator Switch - Brushed Steel

- Lacquered surface to reduce fingerprints
- Angled in-line colour coded terminals



R

FROM ONLY
£9.35
EACH

Code	Each	5+
R 933233	£10.10	£9.35

Dual Voltage Shaver Socket - Brushed Steel

- Lacquered surface to reduce fingerprints
- Angled in-line colour coded terminals

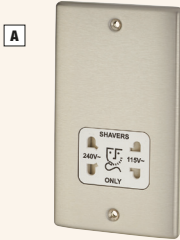

FROM ONLY
£21.47
EACH

Code	Each	5+
A 999821	£23.19	£21.47

400W 2 Way Push Dimmer Switch - Brushed Steel

- Lacquered surface to reduce fingerprints
- Angled in-line colour coded terminals
- Suitable for compact fluorescent lamps (CFL) and LED Dimming

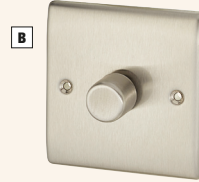

FROM ONLY
£10.74
EACH

Code	No. of Gangs	Each	5+
B 137871	1	£11.60	£10.74
944838	2	£19.81	£18.35

1 Gang Coaxial Socket - Brushed Steel

- Lacquered surface to reduce fingerprints



FROM ONLY
£4.65
EACH

Code	Each	5+
C 330210	£5.02	£4.65

1 Gang Telephone Outlet - Brushed Steel

- Lacquered surface to reduce fingerprints



FROM ONLY
£7.66
EACH

Code	Description	Each	5+
D 471272	Master	£8.73	£8.09
E 731273	Secondary	£8.26	£7.66

1 Gang 2 Euro Module Front Plate - Brushed Steel

- Lacquered surface to reduce fingerprints
- Manufactured with earth terminal



FROM ONLY
£3.83
EACH

Code	Each	5+
F 795370	£4.13	£3.83

Blank Plate - Brushed Steel

- Lacquered surface to reduce fingerprints
- Angled in-line colour coded terminals



FROM ONLY
£3.07
EACH

Code	No. of Gangs	Each	5+
G 829458	1	£3.31	£3.07
H 401723	2	£4.62	£4.28

Decorative Sockets & Switches

13A Flatplate Switched Socket Flatplates - Brushed Steel

- Lacquered surface to reduce fingerprints
- Angled in-line colour coded terminals
- Twin earth fitted for double earth facility for installations requiring high integrity protective connection



FROM ONLY
£4.69
EACH

Code	No. of Gangs	Each	5+
A 984860	1	£4.92	£4.69
B 232167	2	£6.30	£6.00

13A 1 Gang Fuse Spur Flat Plate Unit - Brushed Steel

- Lacquered surface to reduce fingerprints
- Angled in-line colour coded terminals



FROM ONLY
£4.73
EACH

Code	Description	Each	5+
C 252922	Unswitched Without Neon	£4.96	£4.73
D 331017	Switched With Neon	£5.74	£5.47

45A 2 Gang Flat Plate Double Pole Cooker Switch - Brushed Steel

- Lacquered surface to reduce fingerprints
- Angled in-line colour coded terminals



FROM ONLY
£11.59
EACH

Code	Each	5+
E 447726	£12.17	£11.59

45A Double Pole Cooker Switch Flat Plate with Neon - Brushed Steel

- Lightly lacquered surface to reduce fingerprint marks
- Angled in-line colour coded captive terminals



FROM ONLY
£8.22
EACH

Code	Description	Each	5+
F 459744	Single Plate	£8.62	£8.22
G 102459	Double Plate	£9.53	£9.08

10A 2 Way Single Pole Flat Plate Switch - Brushed Steel

- Lacquered surface to reduce fingerprints
- Angled in-line colour coded terminals

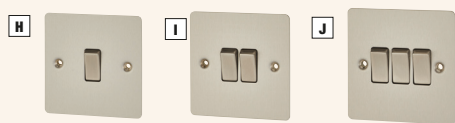

FROM ONLY
£3.12
EACH

Code	No. of Gangs	Each	5+
H 174195	1	£3.27	£3.12
I 242003	2	£4.52	£4.31
J 897999	3	£6.00	£5.72

10A 1 Gang Intermediate Flat Plate Switch - Brushed Steel

- Lightly lacquered surface to reduce fingerprint marks
- Angled in-line colour coded captive terminals



A



FROM ONLY
£4.98
EACH

Code	Each	5+
A 992920	£5.23	£4.98

10A 1 Gang 3 Pole Flat Plate Fan Isolator Switch - Brushed Steel

- Lacquered surface to reduce fingerprints
- Angled in-line colour coded terminals



B



FROM ONLY
£5.87
EACH

Code	Each	5+
B 755851	£6.16	£5.87

20A 1 Gang Double Pole Flat Plate Switch - Brushed Steel

- Lacquered surface to reduce fingerprints
- Angled in-line colour coded terminals



C



FROM ONLY
£5.85
EACH

Code	Each	5+
C 269840	£6.13	£5.85

400W 2 Way Push Flat Plate Dimmer Switch - Brushed Steel

- Lacquered surface to reduce fingerprints
- Angled in-line colour coded terminals
- Suitable for compact fluorescent lamps (CFL) & LED Dimming



D



E



FROM ONLY
£9.71
EACH

Code	No. of Gangs	Each	5+
D 505032	1	£10.19	£9.71
E 388461	2	£15.45	£14.72

1 Gang Flat Plate Coaxial Socket - Brushed Steel

- Lacquered surface to reduce fingerprints



F



FROM ONLY
£3.73
EACH

Code	Each	5+
F 131842	£3.91	£3.73

1 Gang Flat Plate Telephone Outlet - Brushed Steel

- Lacquered surface to reduce fingerprints



G



FROM ONLY
£6.14
EACH

Code	Each	5+
G 962500	£6.44	£6.14

HOT PRICES ON HAND DRYERS

• EternaPro LED

Automatic
Hand-Dryer

FROM ONLY
£49.92
EACH
WHEN YOU BUY 5+



Order Code: 207215



1.9kW Hand
Dryer

FROM ONLY
£78.60
EACH
WHEN YOU BUY 5+



Order Code: 827501

Redring
Xpelair
1.7kW Auto
Hand Dryer

FROM ONLY
£87.60
EACH
WHEN YOU BUY 5+



Order Code: 735481



1.1kW Compact
Eco Hand Dryer

FROM ONLY
£112.17
EACH
WHEN YOU BUY 5+



Order Code: 853874



2.5kW
Handy-Dryer

FROM ONLY
£184.54
EACH
WHEN YOU BUY 5+



Order Code: 534966



1.1kW Compact
Eco Hand Dryer
- Stainless Steel

FROM ONLY
£117.39
EACH
WHEN YOU BUY 5+



Order Code: 674999

FOR FULL DETAILS SEE PAGE 194

FREEPHONE: 8AM-6PM, 7 DAYS A WEEK
0808 168 22 77



ONLINE: SHOP 24/7

ElectricalDirect.co.uk

13A Fused Outlet Module - Brushed Steel

- Minimum mounting box depth: 25mm
- Clearly marked terminals with backed out captive screws for easy installation



FROM ONLY
£5.98
EACH

Code	Each	5+
A 290842	£6.27	£5.98

Grid Blank Module - Brushed Steel

- Cover any unused grid ways



FROM ONLY
£2.68
EACH

Code	Each	5+
B 572122	£2.81	£2.68

20A Switch - Brushed Steel

- Clearly marked terminals with backed out captive screws for easy installation
- 20AX inductive rated



FROM ONLY
£3.10
EACH

Code	Description	Each	5+
C 400594	2 Way Single Pole	£3.25	£3.10
602451	2 Way Double Pole	£4.32	£4.12
487033	Intermediate	£6.05	£5.77

400W 2 Way Push Dimmer Switch Module - Brushed Steel

- Suitable for tungsten lamps, low voltage transformers & mains GU10 halogen

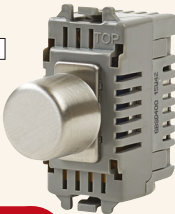

FROM ONLY
£19.57
EACH

Code	Each	5+
D 583244	£20.54	£19.57

Printed Switch Module Covers - Polished Chrome

- Switches embossed with descriptive text



FROM ONLY
61P
EACH

Code	Description	Each	5+
E 355857	Cooker Hood	£0.63	£0.61
F 221031	Microwave	£0.63	£0.61

Printed Switch Module Covers - Brushed Steel

- Switches embossed with descriptive text



FROM ONLY
61P
EACH

Code	Description	Each	5+
G 660866	Cooker Hood	£0.63	£0.61
636903	Dishwasher	£0.63	£0.61
H 242291	Fridge	£0.63	£0.61
400100	Fan	£0.63	£0.61
237327	Hob	£0.63	£0.61
230014	Microwave	£0.63	£0.61
647515	Oven	£0.63	£0.61
443900	Tumble Dryer	£0.63	£0.61
817266	Waste Disposal	£0.63	£0.61
891258	Water Heater	£0.63	£0.61
101800	Washing Machine	£0.63	£0.61

Grid Cover Plate - Brushed Steel

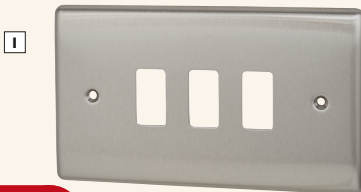

FROM ONLY
£3.71
EACH

Code	No. of Gangs	Each	5+
764869	1	£3.89	£3.71
I 473230	3	£7.67	£7.31

Grid Module Mounting Frame

- For all screwed plate versions
- Supplied with spacers for use with the Metal Clad front plates
- Metal Clad front plates require tabs to be bent along preformed indents

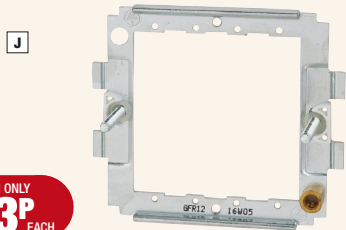

FROM ONLY
83P
EACH

Code	Description	Each	5+
J 817410	1 or 2 Modules	£0.86	£0.83
575146	3 or 4 Modules	£1.29	£1.23

Grid Switches

20A Single Pole Switch Module - White

DETA

- Curved rockers
- Front loading into grid frame
- Switches do not have to be de-rated for fluorescent loads
- Clear terminal markings
- Only one size 4mm screwdriver needed

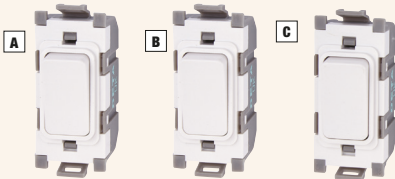

Code	Description	Each	10+
A 183320	1 Way	£1.70	£1.57
B 642173	2 Way	£2.28	£2.11
C 723746	Intermediate	£4.27	£3.96

10A Single Pole Switch Module - White

DETA

- Curved rockers
- Front loading into grid frame
- Switches do not have to be de-rated for fluorescent loads
- Clear terminal markings
- Grey font engraving
- Only one size 4mm screwdriver needed



FROM ONLY
£1.20
EACH

Code	Description	Each	10+
D 132648	1 Way	£1.29	£1.20
104805	2 Way	£1.70	£1.57

20A Double Pole Switch Module - White

DETA

- Curved rockers
- Front loading into grid frame
- Switches do not have to be de-rated for fluorescent loads
- Clear terminal markings
- Grey font engraving
- Only one size 4mm screwdriver needed



FROM ONLY
£2.33
EACH

Code	Description	Each	10+
E 649320	1W	£2.52	£2.33
F 347025	Wine Cooler	£5.47	£5.06

40-250W Dimmer Module - White

DETA

- Suitable for incandescent lamps & low voltage lighting
- Push on/push off control
- 40mm minimum deep back box recommended



FROM ONLY
£19.78
EACH

Code	Each	10+
G 966916	£21.38	£19.78

NEED HELP ?



CALL OUR TEAM OF EXPERTS
8AM TO 6PM

Grid Blank Module - White

DETA

- Blank module to cover any unused ways



FROM ONLY
78P
EACH

Code	Each	10+
H 556056	£0.84	£0.78

10A 2 Way Printed Switch Module Single Pole - White **DETA**

Pole - White

- Curved rockers
- Front loading into grid frame
- Clear terminal markings
- Grey font engraving
- Only one size 4mm screwdriver needed

A



FROM ONLY
£3.66
EACH

Code	Each	10+
A 534270	£3.95	£3.66

13A Fused Spur Module - White

- Front loading into grid frame
- Clear terminal markings

B



FROM ONLY
£4.48
EACH

Code	Each	10+
B 496980	£4.84	£4.48

20A Printed Switch Module - White **DETA**

- Curved rockers
- Front loading into grid frame
- Clear terminal markings
- Grey font engraving

C



FROM ONLY
£2.89
EACH

Code	Description	Each	10+
234716	Oven	£3.12	£2.89
352182	Hob	£3.12	£2.89
537279	Extractor Fan	£3.12	£2.89
143184	Washing Machine	£3.12	£2.89
693464	Tumble Dryer	£3.12	£2.89
551001	Dishwasher	£3.12	£2.89
301033	Fridge	£3.12	£2.89
324796	Freezer	£3.12	£2.89
565264	Boiler	£3.12	£2.89
C 226211	Cooker Hood	£3.12	£2.89
146169	Microwave	£3.12	£2.89
501777	Fridge/Freezer	£3.12	£2.89
493402	Heater	£3.12	£2.89

20A Printed Switch Module with Neon - White **DETA**

- Curved rockers
- Front loading into grid frame
- Clear terminal markings
- Grey font engraving

D



FROM ONLY
£3.19
EACH

Code	Description	Each	10+
900891	Oven	£3.45	£3.19
444127	Extractor Fan	£3.45	£3.19
908236	Washing Machine	£3.45	£3.19
D 852326	Dishwasher	£3.45	£3.19
939162	Fridge	£3.45	£3.19
796865	Microwave	£3.45	£3.19

Grid Cover Plate - White **DETA**

- Front plate for grid module system

E

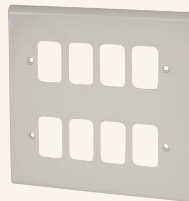

FROM ONLY
67P
EACH

Code	No. of Gangs	Each	10+
246272	1	£0.72	£0.67
698353	2	£0.72	£0.67
632270	3	£1.74	£1.62
251366	4	£1.74	£1.62
653250	6	£3.16	£2.92
E 880449	8	£3.16	£2.92
156312	12	£5.48	£5.08

Grid Module Mounting Frame **DETA**

- Large fitted earth terminals
- 415V warning label is supplied with 3 & 4 gang grid frames

F



G



FROM ONLY
73P
EACH

Code	No. of Gangs	Each	10+
F 690680	1	£0.78	£0.73
954400	2	£0.78	£0.73
G 141468	3	£1.12	£1.04
284652	4	£1.12	£1.04

Grid Switches

Grid Cover Plate - White



A

Code	No. of Gangs	Each	5+
774217	1	£1.03	£0.90
A 613639	2	£1.35	£1.15
126099	3	£2.55	£2.22
512515	4	£2.79	£2.43
467088	6	£3.96	£3.76
651223	8	£4.45	£4.25
488337	12	£7.62	£7.23

Grid Cover Plate - Polished Chrome



B



Code	No. of Gangs	Each	5+
B 501267	2	£5.29	£5.03
207694	4	£9.25	£8.79

Grid Cover Plate - Matt Chrome



C

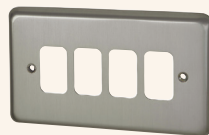

Code	No. of Gangs	Each	5+
286528	2	£4.70	£4.09
C 295223	4	£9.01	£7.84

Metalclad Grid Cover Plate - Grey

D



Code	No. of Gangs	Each	5+
930458	1	£1.73	£1.51
521635	2	£1.76	£1.54
127264	3	£2.66	£2.53
745823	4	£3.21	£2.79
D 161145	6	£6.74	£6.40
219268	8	£7.64	£7.25
479429	9	£10.81	£10.27
975682	12	£11.26	£10.69
759111	18	£18.43	£17.51
230219	24	£24.66	£23.42

Grid Module Mounting Frame



E



Code	No. of Gangs	Each	10+
446894	1	£1.13	£0.99
325284	2	£1.26	£1.10
E 586960	3	£1.64	£1.43
962877	4	£1.83	£1.59
716640	6	£4.18	£3.64

10A Switch Module - White



F



Code	Description	Each	5+
967195	1 Way Single Pole	£2.11	£1.84
F 760204	1 Way Double Pole	£3.60	£3.14
740070	2 Way Single Pole	£2.76	£2.40

10A 2 Way Single Pole Retractive Switch Module - White



G



Code	Option	Each	5+
260985	Blank	£5.82	£5.06
634728	Bell	£4.63	£4.40
G 798936	Press	£5.93	£5.16

10A 2 Way Single Pole Centre Off Switch Module



H



Code	Finish	Each	5+
674172	White	£5.18	£4.51
H 713997	Red	£6.15	£5.84

10A 1 Gang 2 Way Retractive Centre Off Switch Module - White



I



Code	Each	5+
I 626657	£9.44	£8.21

10A 1 Gang 1 Way Double Pole Push to Make Switch Module



J



Code	Finish	Each	5+
J 405348	White	£6.02	£5.24
121794	Red	£6.90	£6.01

10A 1 Gang 1 Way Double Pole Push to Break Switch Module - White



K



Code	Each	5+
K 400155	£7.37	£6.41

20A Single Pole Switch Module - White



L



Code	Description	Each	5+
L 941372	1 Way	£2.56	£2.23
955946	2 Way	£3.33	£2.90
505849	Intermediate	£6.25	£5.44

20A 2 Way Single Pole Switch Module - Red



Code	Each	5+
A 731532	£4.61	£4.01

20A 1 Way Double Pole Switch Module



Code	Finish	Each	5+
B 362199	White	£3.73	£3.25
635575	Red	£5.47	£4.76

20A Double Pole Printed Module - White



Code	Description	Each	5+
424200	Boiler	£4.41	£4.19
378216	Cooker Hood	£4.41	£4.19
569825	Dishwasher	£4.41	£4.19
856539	Fridge/Freezer	£4.41	£4.19
C 340077	Fridge	£4.41	£4.19
291687	Fan	£4.41	£4.19
290899	Hob	£4.41	£4.19

20A Double Pole Printed Module - White



Code	Description	Each	5+
237874	Blank	£4.41	£4.19
593134	Oven	£4.41	£4.19
628079	Plinth Heater	£4.41	£4.19
373644	Tumble Dryer	£4.41	£4.19
D 479151	Washing Machine	£4.41	£4.19

20A Key Switch Module - White



Code	Description	Each	5+
E 892471	1 Way Double Pole	£6.41	£5.58
905237	2 Way Single Pole	£6.85	£5.96
607044	Intermediate Key Switch	£11.53	£10.03

20A Single Pole Key Switch Module - White



Code	Description	Each	5+
F 187831	1 Way Single Pole - Emergency Lighting	£7.13	£6.20
958283	2 Way Single Pole - Emergency Lighting	£8.52	£7.41

13A Fused Spur Module - White



Code	Each	5+
G 866615	£7.25	£6.31

16A Flex Outlet Module - White



Code	Each	5+
H 562154	£7.20	£6.27

200-250V Indicator Module - White



Code	Colour	Each	5+
I 128175	Amber	£9.76	£8.49
I 199772	Green	£8.35	£7.27
J 406056	Red	£7.62	£6.63

1 Gang Grid Blank Module - White



Code	Each	5+
K 993931	£1.23	£1.08

Grid Flush Back Box



Code	No. of Gangs	Each	3+
609854	1	£1.73	£1.51
178915	2	£2.97	£2.59
L 460549	6-8	£4.94	£4.30
947378	12	£6.16	£5.85

Grid Surface Back Box



Code	No. of Gangs	Each	5+
239307	1-2	£1.53	£1.33
M 285178	3-4	£2.48	£2.16
429918	6-8	£5.01	£4.36
N 723670	9-12	£6.66	£6.33
637852	18	£14.41	£13.68
838892	24	£20.49	£19.47

Weatherproof Sockets & Switches

13A 2 Gang Switched Socket Outlet - Grey

- IP66 Rated with plug in use, cover sealed
- Earth terminals in socket & box
- Cable entries: 5 x 20mm with removable blanking caps
- See-through cover allows status of switches to be seen
- Cover can be padlocked for extra security
- Interior & exterior applications

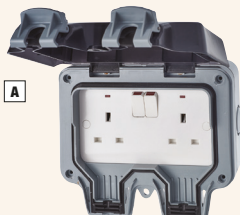

FROM ONLY
£12.50
EACH

Code	Each	5+
A 826065	£13.85	£12.50

13A 1 Gang Unswitched Socket Outlet - Grey

- IP66 Rated with plug in use, cover sealed
- Earth terminals in socket & box
- Cable entries: 5 x 20mm with removable blanking caps
- See-through cover allows status of switches to be seen
- Cover can be padlocked for extra security
- Interior & exterior applications

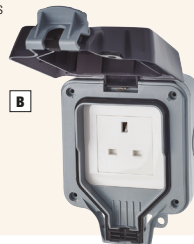

FROM ONLY
£10.50
EACH

Code	Each	5+
B 314564	£11.02	£10.50

20A Switch - Grey

- IP66 rated to protect against water & dust ingress
- Covers to seal the fixing screws
- Earth terminal in mounting box
- Cable entries: 5 x 20mm with removable blanking caps
- Neon indicator can be wired to indicate off or on
- Interior & exterior applications



FROM ONLY
£5.95
EACH

Code	No. of Gangs	Description	Each	5+
920583	1	1 Way	£6.25	£5.95
C 215425	1	2 Way	£7.37	£7.02
657305	2	2 Way	£9.91	£9.44

13A 1 Gang Switched Fused Connection Unit - Grey

- IP66 rated to protect against water & dust ingress
- LED power indicator visible through see-through cover
- Press to open or press to close lockable cover
- Cable entries: 5 x 25mm with removable blanking caps
- Drill out entry: 1 x 20/25mm in rear of mounting box
- Interior & exterior applications



FROM ONLY
£13.89
EACH

Code	Each	5+
D 575205	£14.58	£13.89

13A 2 Gang 30mA RCD Protected Switched Socket Outlet - Grey

- IP66 Rated with plug in use
- Trip Current: 30mA
- Earth terminals in socket & box
- Cover stays open to allow for easy access to sockets
- See-through cover allows power status to be seen
- Cover can be padlocked for extra security
- Interior & exterior applications



FROM ONLY
£37.79
EACH

Code	Each	5+
E 889665	£39.68	£37.79

13A 1 Gang 30mA RCD Protected Switched Fused Connection Unit - Grey

- IP66 rated to protect against water & dust ingress
- Trip Current: 30mA
- Flexible membrane allows switching without opening the unit
- Visible indication of power status through see-through cover
- Cable entries: 5 x 25mm with removable blanking caps
- Interior & exterior applications



FROM ONLY
£26.55
EACH

Code	Each	5+
F 317230	£27.88	£26.55

Order up to 6pm for Next Day Delivery

Trade prices ex. VAT

Weatherproof Sockets & Switches

13A 2 Gang Switched Socket Outlet - Grey

- IP66 rated to protect against water & dust ingress
- Seals around virtually any standard 13A plug
- Robust construction will not crack or discolour giving excellent impact protection
- Earth terminal in back box
- Cable entries: 4 x 20mm
- Interior & exterior applications

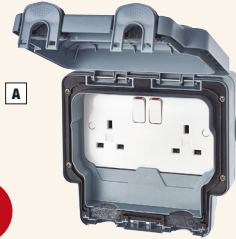

FROM ONLY
£43.25
EACH

Code	Each	3+
A 259491	£46.85	£43.25

13A Unswitched Socket Outlet - Grey

- IP66 rated to protect against water & dust ingress
- Seals around virtually any standard 13A plug
- Robust construction will not crack or discolour giving excellent impact protection
- Earth terminal in back box
- Cable entries: 4 x 20mm

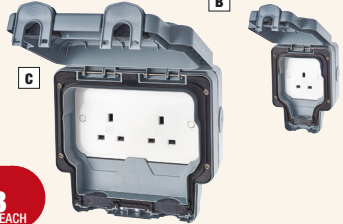

FROM ONLY
£22.28
EACH

Code	No. of Gangs	Each	3+
B 275275	1	£24.14	£22.28
C 517649	2	£41.70	£38.50

10A Switch - Grey

- IP66 rated to protect against water & dust ingress
- Robust construction will not crack or discolour giving excellent impact protection
- Earth terminal in back box
- Cable entries: 4 x 20mm
- Interior & exterior applications



FROM ONLY
£13.45
EACH

Code	No. of Gangs	Description	Each	3+
443230	1	1 Way	£14.57	£13.45
D 782579	1	2 Way	£16.43	£15.17
E 471889	2	1 Way	£18.72	£17.29

13A 1 Gang Switched Fused Connection Unit

- IP66 rated to protect against water & dust ingress
- Robust construction will not crack or discolour giving excellent impact protection
- Earth terminal in back box
- Cable entries: 4 x 20mm
- Interior & exterior applications

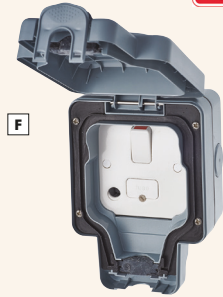

FROM ONLY
£31.93
EACH

Code	Each	3+
F 836356	£34.58	£31.93

13A 30mA RCD Protected Switched Socket Outlet - Grey

- IP66 rated to protect against water & dust ingress
- Seals around virtually any standard 13A plug
- Robust construction will not crack or discolour giving excellent impact protection
- Trip Current: 30mA
- Earth terminal in back box
- Cable entries: 5 x 20mm
- Interior & exterior applications



FROM ONLY
£76.57
EACH

Code	No. of Gangs	Each	3+
642951	1	£82.95	£76.57
G 161962	2	£92.92	£85.78

1 Gang Modular Grid Enclosure

- IP66 rated to protect against water & dust ingress
- Robust construction will not crack or discolour giving excellent impact protection
- Suitable for use with MK Grid Plus switches
- Earth terminal in back box
- Cable entries: 4 x 20mm
- Interior & exterior applications

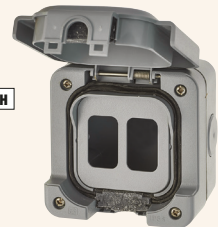

FROM ONLY
£19.28
EACH

Code	Each	3+
H 465421	£20.88	£19.28

Metalclad Sockets & Switches

13A Metalclad Switched Socket - Grey

- Front plate with smooth chamfered edge for a neat finish



FROM ONLY
£3.68
EACH

Code	No. of Gangs	Each	5+
786244	1	£4.05	£3.68
A 297742	2	£5.37	£4.88

13A 1 Gang Metalclad Spur - Grey

- Front plate with smooth chamfered edge for a neat finish



FROM ONLY
£5.40
EACH

Code	Description	Each	5+
B 803674	Switched	£5.94	£5.40
513029	Unswitched	£5.94	£5.40

13A 1 Gang Key Operated Switched Spur - Red

- Front plate with smooth chamfered edge for a neat finish
- Key operated for added security to prevent accidental operation
- Neon indicators to indicate socket is live



FROM ONLY
£10.77
EACH

Code	Each	5+
C 903713	£11.34	£10.77

6A Metalclad Plate Switch - Grey

- Front plate with smooth chamfered edge for a neat finish



FROM ONLY
£2.50
EACH

Code	No. of Gangs	Each	5+
528755	1	£3.25	£2.50
D 358064	2	£3.79	£3.45
414553	3	£5.45	£4.95

20A Double Pole Metalclad Switch - Grey

- Front plate with smooth chamfered edge for a neat finish



FROM ONLY
£4.96
EACH

Code	Each	5+
E 461136	£5.45	£4.96

45A Double Pole Metalclad Switch - Grey

- Front plate with smooth chamfered edge for a neat finish

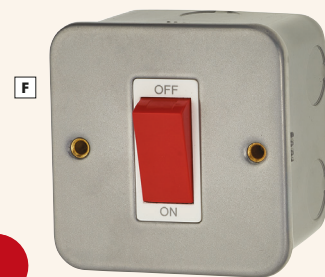

FROM ONLY
£6.40
EACH

Code	Each	5+
F 496888	£7.80	£6.40

10A 2 Way Single Pole Metalclad Switch - Grey



- Front plate fits flush with the back box for a neat finish
- Switches do not have to be derated if used with fluorescent or inductive loads

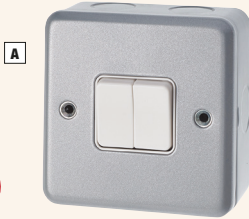

FROM ONLY
£6.03
EACH

Code	No. of Gangs	Each	5+
282248	1	£6.93	£6.03
A 312606	2	£11.41	£9.93
817712	3	£15.44	£13.43

13A Metalclad Unswitched Socket - Grey



- Front plate fits flush with the back box for a neat finish
- Shutter system to prevent access to electrical connections



FROM ONLY
£6.85
EACH

Code	No. of Gangs	Each	5+
366693	1	£7.88	£6.85
B 156431	2	£14.94	£12.99

13A Double Pole Metalclad Switched Socket - Grey



- Front plate fits flush with the back box for a neat finish
- Shutter system to prevent access to electrical connections
- Neon indicators to indicate socket is live



FROM ONLY
£8.05
EACH

Code	Description	No. of Gangs	Each	5+
946218	With Neon	1	£15.29	£13.30
C 915443	With Neon	2	£25.47	£22.15
507573	Without Neon	1	£9.24	£8.05
961651	Without Neon	2	£16.88	£14.69

32A 1 Gang Double Pole Metalclad Switch - Flex Outlet with Neon - Grey



- Front plate fits flush with the back box for a neat finish
- Neon indicators to indicate socket is live



FROM ONLY
£15.47
EACH

Code	Each	5+
D 889936	£17.79	£15.47

13A 1 Gang Metalclad Switched Fused Connection Unit - Grey



- Front plate fits flush with the back box for a neat finish
- Neon indicators to indicate socket is live



FROM ONLY
£9.21
EACH

Code	Description	Each	5+
E 699202	With Neon	£14.04	£12.21
994010	Without Neon	£10.58	£9.21

13A 1 Gang Metalclad Unswitched Fused Connection Unit - Grey



- Front plate fits flush with the back box for a neat finish
- Neon indicators to indicate socket is live



FROM ONLY
£7.78
EACH

Code	Description	Each	5+
F 151359	With Neon	£10.57	£9.19
698493	Without Neon	£8.94	£7.78

Metalclad Sockets & Switches

13A 1 Gang Metalclad Unswitched Fused Connection Unit - Flex Outlet - Grey

- Front plate fits flush with the back box for a neat finish
- Ensures critical equipment is not accidentally unplugged

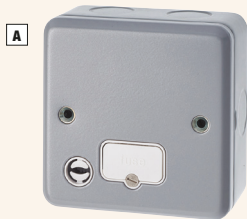

FROM ONLY
£9.72
EACH

Code	Description	Each	5+
A 960603	With Neon	£12.22	£10.63
338468	Without Neon	£11.17	£9.72

13A 1 Gang Metalclad Switched Fused Connection Unit - Flex Outlet - Grey

- Front plate fits flush with the back box for a neat finish
- Ensures critical equipment is not accidentally unplugged



FROM ONLY
£9.95
EACH

Code	Description	Each	5+
489620	Without Neon	£11.44	£9.95
B 209146	With Neon	£13.29	£11.56

20A 1 Gang Double Pole Metalclad Switch - Grey

- Front plate fits flush with the back box for a neat finish
- Switches do not have to be derated if used with fluorescent or inductive loads



FROM ONLY
£9.96
EACH

Code	Description	Each	5+
112800	Without Neon	£10.49	£9.96
C 896988	With Neon	£13.48	£12.81

Double Pole Metalclad Cooker Switch with Neon - Grey

- Front plate fits flush with the back box for a neat finish
- Neon indicators to indicate socket is live

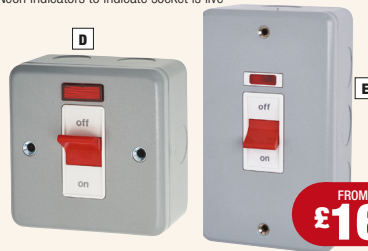

FROM ONLY
£16.92
EACH

Code	Amp Rating	No. of Gangs	Each	5+
D 546552	32	1	£17.82	£16.92
E 816561	50	2	£22.71	£21.57

Spare Metalclad Surface Box with Knockouts - Grey

- Spare back box to suit MK Metalclad Plus range
- Knockout: 8 x 20mm



FROM ONLY
£2.55
EACH

Code	No. of Gangs	Each	5+
F 414722	1	£2.92	£2.55
G 525987	2	£6.96	£6.06

Metalclad Blank Plate for Surface Boxes - Grey

- Front plate fits flush with the back box for a neat finish
- Covers back boxes where sockets are no longer required

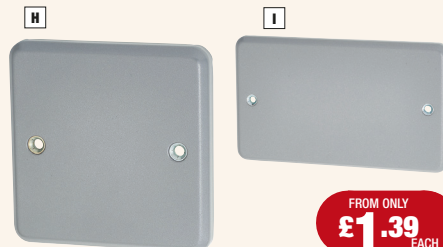

FROM ONLY
£1.39
EACH

Code	No. of Gangs	Each	10+
H 921578	1	£1.60	£1.39
I 945092	2	£2.70	£2.34

3 Compartment Commercial Floor Box

- Manufactured from galvanised steel
- 20mm & 25mm knockouts to accept flexible conduit
- Frame & lid moulded from high impact polycarbonate (RAL 7031)
- Compact design: 266 x 212mm floor cut out
- Large range of accessory plate
- Suitable for carpeted floors only with standard frame & lid
- Floor box depth: 80mm
- Plug top clearance: 30mm
- Frame lid recess: 6mm
- Accessories plates: 185 x 76mm



tass
OFFICE POWER SOLUTIONS

Code	Each	5+
A 276958	£26.05	£24.50

FROM ONLY
£24.50
EACH

4 Gang RJ45 Commercial Floor Box Blank Plate

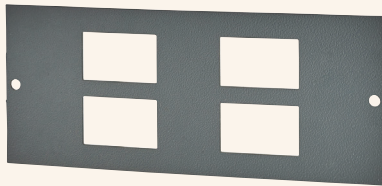

tass
OFFICE POWER SOLUTIONS

Code	Each	5+
B 256765	£2.10	£1.99

FROM ONLY
£1.99
EACH

Commercial Floor Box Blank Plate



tass
OFFICE POWER SOLUTIONS

Code	Each	5+
C 743449	£1.28	£1.21

FROM ONLY
£1.21
EACH

13A 2 Gang Commercial Floor Box



tass
OFFICE POWER SOLUTIONS

Code	Each	5+
D 682407	£5.75	£5.46

FROM ONLY
£5.46
EACH

13A Decorative Floor Socket - Brushed Chrome



FROM ONLY
£8.34
EACH

Code	No. of Gangs	Each	5+
E 913563	1	£8.67	£8.34
F 289478	2	£13.32	£12.81

13A Decorative Floor Socket - Brass

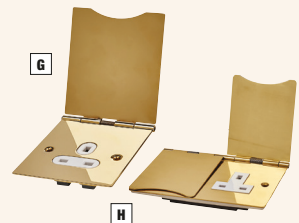

FROM ONLY
£8.34
EACH

Code	No. of Gangs	Each	5+
G 710256	1	£8.67	£8.34
H 600576	2	£13.32	£12.81

RJ11 Telephone Module - White

- Telephone modules suitable for Deta data module plates

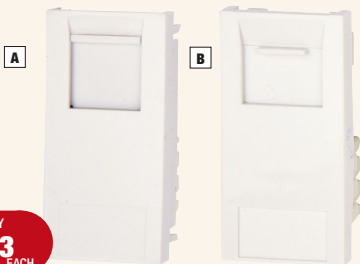

FROM ONLY
£3.53
EACH

Code	Description	Each	10+
A 102923	Master Socket	£3.86	£3.58
B 988804	Secondary Socket	£3.81	£3.53

RJ45 Data Module - White

- Data modules suitable for Deta data module plates



FROM ONLY
£5.87
EACH

Code	Each	10+
C 885434	£6.34	£5.87

TV/FM/Satellite Module - White

- Clear terminal markings
- Fixing screw attached to rear of plate
- Suitable for standard coaxial BS 3041 & F-Type satellite plugs

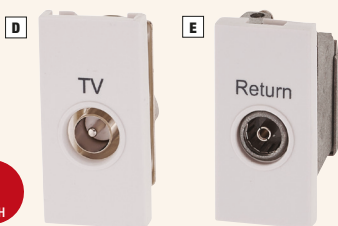

FROM ONLY
£4.46
EACH

Code	Description	Each	10+
D 301197	Coaxial Male Module	£4.82	£4.46
E 899081	Coaxial Female Module	£5.86	£5.42

1 Gang Cable Brush Flex Outlet Module - White

- 2 module plate for cable & wires ensuring no dust ingress

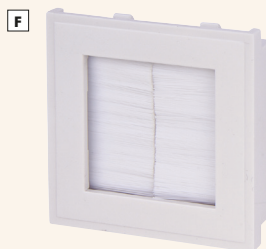

FROM ONLY
£4.30
EACH

Code	Each	10+
F 824834	£4.64	£4.30

Module Plate - White

- To suit a range of Deta slimline modules

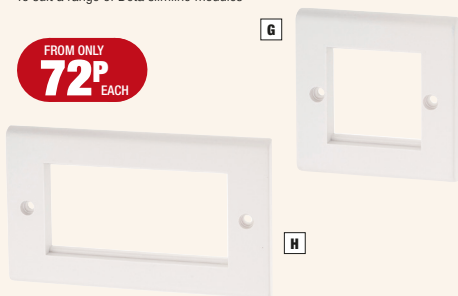

FROM ONLY
72P
EACH

Code	Description	Each	10+
G 362520	2 Module	£0.77	£0.72
H 265988	4 Module	£1.00	£0.93

Blank Module - White

- To cover spaces when not required in module plates

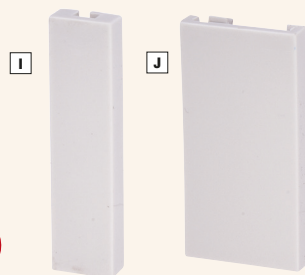

FROM ONLY
47P
EACH

Code	Description	Each	10+
I 565233	1/2 Module	£0.51	£0.47
J 914639	1 Module	£0.94	£0.88

Triplex Module - White

- Clear terminal markings
- Fixing screw attached to rear of plate
- Suitable for standard coaxial BS 3041 & F-Type satellite plugs
- 1 x TV, 1 x FM/DAB, 1 x Satellite



FROM ONLY
£8.60
EACH

Code	Each	10+
A 582588	£9.00	£8.60

Quadruplex Module - White

- Clear terminal markings
- Fixing screw attached to rear of plate
- Suitable for standard coaxial BS 3041 & F-Type satellite plugs
- 1 x TV, 1 x FM/DAB, 2 x Satellite



FROM ONLY
£12.45
EACH

Code	Each	10+
B 978611	£13.46	£12.45

Triplex Module - White

- Clear terminal markings
- Fixing screw attached to rear of plate
- Suitable for standard coaxial BS 3041 & F-Type satellite plugs
- 1 x TV, 1 x FM/DAB, 1 x Satellite



FROM ONLY
£11.14
EACH

Code	Each	5+
C 785254	£11.69	£11.14

Quadruplex Module - White

- Clear terminal markings
- Fixing screw attached to rear of plate
- Suitable for standard coaxial BS 3041 & F-Type satellite plugs
- 1 x TV, 1 x FM/DAB, 2 x Satellite



FROM ONLY
£12.69
EACH

Code	Each	5+
D 795427	£13.32	£12.69

Pop Up/ Trailing Sockets & Extension Leads

3 Gang Pop Up Socket with USB

- 3 x mains powered sockets
- 2 x USB sockets

FROM ONLY
£32.77
EACH



A

Code	Each	5+
A 535275	£34.50	£32.77

110V Extension Reels

- Non-turning socket system for comfortable working

FROM ONLY
£25.41
EACH



B

Code	Cable Reel Length M	Each	5+
B 689065	25	£26.75	£25.41
906120	50	£34.95	£33.20

13A 240V Extension Reels

- Non-turning socket system for comfortable working

FROM ONLY
£18.47
EACH



C

Code	Cable Reel Length M	Each	5+
C 486665	20	£19.45	£18.47
897825	25	£21.81	£20.71
792049	30	£23.45	£22.27

2m Handy Reel

- Easily portable reel
- 4 available sockets

FROM ONLY
£4.50
EACH



D

Code	Each	5+
D 264003	£4.75	£4.50

Trailing Sockets

- A range of trailing 1, 2 & 4 gang
- All internal component parts are retained in the base for ease of wiring



FROM ONLY
£5.12
EACH



F

G

Code	No. of Gangs	Finish	Each	5+
790457	1	Black	£6.27	£5.12
F 941374	1	White	£6.62	£5.40
788836	2	Black	£10.36	£8.45
926390	2	White	£10.92	£8.90
782283	4	Black	£22.68	£21.54
G 726765	4	White	£24.12	£22.92

13A Trailing Sockets

- A range of trailing 1, 2 gang

FROM ONLY
£1.70
EACH



E

Code	No. of Gangs	Finish	Each	5+
E 782663	1	Black	£1.78	£1.70
292240	1	White	£1.78	£1.70
135485	2	Black	£2.80	£2.67
908195	2	White	£2.80	£2.18

Trailing Sockets & Extension Leads

13A 2m Extension Lead with Surge Protection

- Surge-protected extension lead
- Protects sensitive electronic equipment from damaging surges and spikes

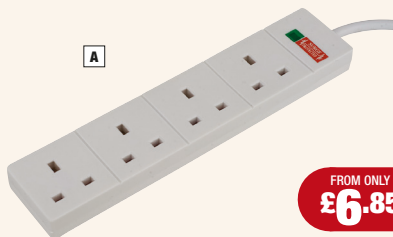

FROM ONLY
£6.85
EACH

Code	Description	Each	5+
A 758845	4 Gang	£7.60	£6.85
965782	6 Gang	£10.50	£10.00

4 Gang Extension Socket



FROM ONLY
£6.62
EACH

Code	Finish	Each	5+
B 434509	Black	£6.95	£6.62
937852	White	£6.95	£6.62

13A 4 Gang Extension Socket & Lead - White

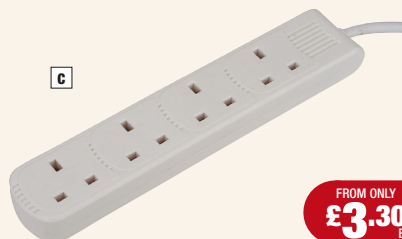

FROM ONLY
£3.30
EACH

Code	Cable Length M	Each	5+
C 759119	1	£3.50	£3.30
825605	2	£3.98	£3.50
305585	5	£5.58	£4.80

13A 6 Gang 2m Extension Socket & Lead



FROM ONLY
£4.57
EACH

Code	Each	5+
D 727039	£4.80	£4.57

13A 4 Gang 2m Extension Switched Socket



FROM ONLY
£6.75
EACH

Code	Each	5+
E 262948	£7.50	£6.75

6 Gang Power Cut Socket with Surge Protection

- Surge protected lead extension



FROM ONLY
£14.95
EACH

Code	Each	5+
F 217423	£15.70	£14.95

Plug Tops & Inline Connectors

Inline Switch



FROM ONLY
£1.14
EACH

Code	Amp Rating	Finish	Each	5+
849961	2	White	£1.20	£1.14
578363	2	Black	£1.20	£1.14
494316	10	White	£3.05	£2.89
A 691713	10	Black	£3.05	£2.89

13A Plug Adaptor Shaver Outlet



FROM ONLY
£1.50
EACH

Code	Each	5+
B 309143	£1.70	£1.50

13A 3 Pin Plug Tops



FROM ONLY
64P
EACH

Code	Each	5+
C 396654	£0.68	£0.64

13A Rubber Plug Top

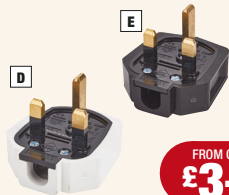

FROM ONLY
£3.15
EACH

Code	Finish	Each	5+
D 175731	White	£3.84	£3.15
E 143770	Black	£3.85	£3.15

13A Rubber Plug Top

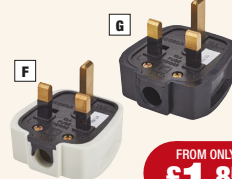

FROM ONLY
£1.85
EACH

Code	Finish	Each	5+
F 544058	White	£1.95	£1.85
G 944428	Black	£1.95	£1.85

3 Pin Round Plug Tops



FROM ONLY
£2.40
EACH

Code	Amp Rating	Each	3+
H 933786	2	£2.76	£2.40
I 858398	5	£2.83	£2.46
J 929067	15	£3.43	£2.98

2 Pin Travel Adaptor Plug



FROM ONLY
£2.20
EACH

Code	Each	5+
K 442436	£2.50	£2.20

13A 3 Way Adaptor fused



FROM ONLY
£2.35
EACH

Code	Each	3+
L 562405	£2.50	£2.35

5A Connectors



FROM ONLY
£1.74
EACH

Code	Description	Each	3+
M 244647	2 Terminal	£2.01	£1.74
N 988427	3 Terminal	£2.63	£2.28

All Continent to UK Adaptor



FROM ONLY
£2.85
EACH

Code	Each	5+
O 125720	£3.00	£2.85

BC To ES Lamp Adaptor



FROM ONLY
£2.20
EACH

Code	Each	5+
P 859831	£2.30	£2.20

Surge Protected Plug Top



FROM ONLY
£2.80
EACH

Code	Each	5+
Q 506824	£2.95	£2.80

Order up to 6pm for Next Day Delivery

Trade prices ex. VAT

16A Outlet Distribution Box - White

- Contact material: Phosphor bronze
- Current rating - outgoing: 6A
- Dual switch capability
- Terminal capacity: 5 x 4mm²



FROM ONLY
£39.23
EACH



Code	Description	Each	5+
118203	4 Way	£41.84	£39.23
A 339893	6 Way	£48.65	£45.62
215688	8 Way	£56.02	£52.52
839184	10 Way	£65.13	£61.06

6A 250VA 3 Pin Plug in Ceiling Rose - White

- Fittings can be disconnected safely in seconds for replacement or repair at ground level
- Static load: 10Kg
- Mechanical load: 5Kg
- Size: 75mm
- Diameter: 44mm
- Fixing centres: 50.8mm standard



FROM ONLY
£3.00
EACH

Code	Description	Each	10+
D 971112	Without Lead	£3.20	£3.00
E 147705	With 2000mm Lead	£4.84	£4.54
F 676996	With 3000mm Lead	£6.15	£5.77

6A 250VA 4 Pin Plug in Ceiling Rose - White

- Klik system
- Fittings can be disconnected safely in seconds for replacement or repair at ground level
- Static load: 10Kg
- Mechanical load: 5Kg
- Size: 74mm
- Diameter: 44mm
- Fixing centres: 50.8mm standard



FROM ONLY
£4.34
EACH

Code	Description	Each	5+
G 314230	Without Lead	£4.62	£4.34
H 108432	With 2000mm Lead	£7.54	£7.07
I 599204	With 3000mm Lead	£9.24	£8.67

6A 3 Terminals 3 Pin Plug - White

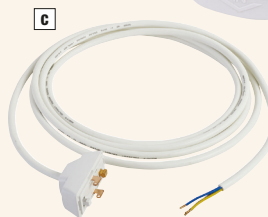

FROM ONLY
£1.75
EACH

Code	Description	Each	10+
B 415501	Without Lead	£1.86	£1.75
C 916991	With 3000mm Lead	£4.44	£4.16

6A 3 Terminals 4 Pin Plug - Red

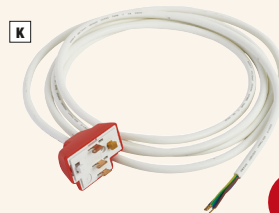

FROM ONLY
£2.37
EACH

Code	Description	Each	10+
J 530798	Without Lead	£2.52	£2.37
K 705171	With 3000mm Lead	£6.59	£6.18

Industrial Plugs & Sockets

16A Plugs IP44

A



FROM ONLY
£1.86
EACH

Code	No. of Pins	Colour	Each	5+
306835	2 Pin & Earth	Yellow	£2.35	£1.86
A 167992	2 Pin & Earth	Blue	£2.35	£1.86
742651	3 Pin & Earth	Red	£5.54	£4.97
560045	4 Pin & Earth	Red	£7.11	£6.26

32A Plugs IP44

B



FROM ONLY
£5.89
EACH

Code	No. of Pins	Colour	Each	5+
237495	2 Pin & Earth	Yellow	£7.65	£6.65
183249	2 Pin & Earth	Blue	£6.65	£5.89
B 410375	3 Pin & Earth	Red	£7.94	£6.48
786564	4 Pin & Earth	Red	£8.79	£8.02

63A Plugs IP44

C



FROM ONLY
£23.87
EACH

Code	No. of Pins	Colour	Each	5+
C 211154	3 Pin	Yellow	£25.13	£23.87
857445	3 Pin & Earth	Blue	£52.03	£49.42
	3 Pin & Neutral & Earth	Red	£36.82	£34.97

16A Surface Socket IP44

D

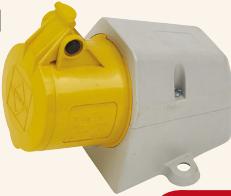

FROM ONLY
£5.77
EACH

Code	No. of Pins	Colour	Each	5+
D 964859	2 Pin & Earth	Yellow	£6.42	£5.77
397512	2 Pin & Earth	Blue	£6.42	£5.80
815714	3 Pin & Earth	Red	£8.26	£7.48
645980	4 Pin & Earth	Red	£9.48	£8.89

32A Surface Socket IP44

E



FROM ONLY
£9.27
EACH

Code	No. of Pins	Colour	Each	5+
E 818142	2 Pin & Earth	Yellow	£9.98	£9.27
175361	2 Pin & Earth	Blue	£9.98	£9.27
930882	3 Pin & Earth	Red	£10.93	£10.28
518459	4 Pin & Earth	Red	£11.52	£10.76

63A Surface Socket IP44

F



FROM ONLY
£29.00
EACH

Code	No. of Pins	Colour	Each	5+
387118	3 Pin	Yellow	£30.53	£29.00
F 933162	3 Pin & Earth	Red	£44.43	£42.20

16A Trailing Socket IP44

G



FROM ONLY
£3.15
EACH

Code	No. of Pins	Colour	Each	5+
G 830799	2 Pin & Earth	Blue	£3.54	£3.15
853204	2 Pin & Earth	Yellow	£3.54	£3.15
599874	3 Pin & Earth	Red	£7.64	£6.77
911647	4 Pin & Earth	Red	£9.24	£8.64

32A Trailing Socket IP44

H



FROM ONLY
£7.40
EACH

Code	No. of Pins	Colour	Each	5+
899858	2 Pin & Earth	Blue	£8.12	£7.40
284847	3 Pin & Earth	Red	£8.74	£7.72
H 800918	4 Pin & Earth	Red	£11.32	£10.64

63A Trailing Socket IP44

I



FROM ONLY
£29.00
EACH

Code	No. of Pins	Colour	Each	5+
I 215324	3 Pin	Blue	£67.06	£63.70
836650	3 Pin	Yellow	£30.53	£29.00
821748	3 Pin & Neutral & Earth	Red	£31.60	£30.02

16A Surface Socket & Isolator



FROM ONLY
£32.49
EACH

Code	No. of Pins	Colour	Each	5+
A 457660	2 Pin & Earth	Blue	£34.21	£32.49
371743	4 Pin & Earth	Red	£38.37	£36.45

32A Surface Socket & Isolator



FROM ONLY
£47.46
EACH

Code	No. of Pins	Colour	Each	5+
572862	2 Pin & Earth	Blue	£49.96	£47.46
B 988013	4 Pin & Earth	Red	£55.12	£52.36

16A 2 Pin & Earth Panel Socket

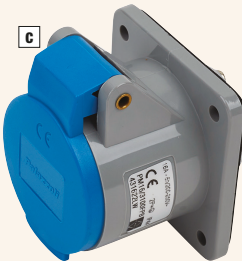

FROM ONLY
£4.51
EACH

Code	Colour	Each	5+
C 771501	Blue	£5.11	£4.51
859839	Yellow	£5.11	£4.51

63A Pin Surface Angle Socket



FROM ONLY
£53.15
EACH

Code	Description	Each	5+
D 727120	3 Pin Blue	£55.95	£53.15

2 Pin & Earth Appliance Inlet - Blue

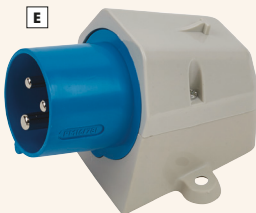

FROM ONLY
£7.56
EACH

Code	Amp Rating	Each	5+
E 790096	16A	£7.96	£7.56
188425	32A	£8.54	£8.11

Blanking Plug



FROM ONLY
96P
EACH

Code	Size mm	Each	5+
F 440147	20	£1.02	£0.96
901640	25	£1.16	£1.10
907271	32	£1.37	£1.30



NEXT DAY DELIVERY!

WHEN YOU ORDER BY 6PM

100A 10 Way Consumer Unit with 2 x 63A 30MA RCD's and 10 MCBs

- Robust metal construction
- Quick installation of MCB's
- Complies with current standards for use in domestic premises
- 17th edition amendment 3 compliant

Order Code: 950190

SEE
PAGE
117



ONLY
£53.00
EACH

NEW PRODUCTS ADDED DAILY TO OUR WEBSITE

FREEPHONE: 8AM-6PM, 7 DAYS A WEEK
0808 168 22 77

ONLINE: SHOP 24/7
ElectricalDirect.co.uk

CONSUMER UNITS & CIRCUIT PROTECTION

<u>Consumer Units</u>	<u>116-119</u>
<u>RCDs & RCCDs</u>	<u>120-121</u>
<u>Switch Fuse & Garage Units</u>	<u>122</u>
<u>Credit Meters</u>	<u>123</u>
<u>3 Phase Distribution</u>	<u>124-130</u>
<u>Fuses</u>	<u>131-133</u>
<u>Enclosures & Cabinets</u>	<u>134-137</u>



SEE
PAGE
130



SEE
PAGE
137



SEE
PAGE
124



SEE
PAGE
119

Consumer Units

63A 2 Way Main Switch Consumer Unit

- 2 useable ways



A

FROM ONLY
£16.68
EACH

Code	Each
A 100417	£16.68

63A 30mA RCD 2 Way Consumer Unit

- 3rd amendment compliant
- All metal construction
- MCB's not included



B

FROM ONLY
£23.74
EACH

Code	Each
B 811585	£23.74

80A Consumer Unit Main Switch

- 3rd amendment compliant
- All metal construction
- MCB's not included



C

FROM ONLY
£24.60
EACH

Code	No of Ways	Each
C 276693	6	£24.60
792168	10	£28.50

80A 30mA RCD Consumer Unit

- 3rd amendment compliant
- All metal construction
- MCB's not included



D

FROM ONLY
£31.50
EACH

Code	No of Ways	Each
D 790390	6	£31.50
372594	10	£37.50

100A Dual Split Load Consumer Unit with MCBs



- 3rd amendment compliant
- 2 x 63A 30mA RCD's
- Comply to 17th edition

FROM ONLY
£59.80
EACH



E

Code	No of Ways	Each
E 346893	12	£59.80
798390	16	£68.80

High Integrity Kit Split Load Board



FROM ONLY
£4.90
EACH

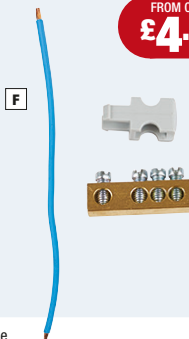

F

Code	Each
F 286194	£4.90

Single Pole Clip In Blank Module



FROM ONLY
45P
EACH

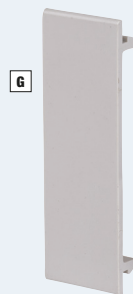

G

Code	Each	10+
G 618613	£0.49	£0.45

100A 10 Way RCD with 10 MCBs



- 3rd amendment compliant
- Comply to 17th edition
- Contains: 2 x 63A RCD's, 3 x 6A, 2 x 16A, 4 x 32A & 1 x 40A MCBs



FROM ONLY
£53.00
EACH

Code	Each
A 950190	£53.00

100A 16 Way with 12 MCBs



- 3rd amendment compliant
- Comply to 17th edition
- Contains: 2 x 80A 30MA RCD, 4 x 6A, 2 x 16A, 4 x 32A, 1 x 40A MCB's, 1 x 10A



FROM ONLY
£74.60
EACH

Code	Each
B 967083	£74.60

100A Dual Split Load High Integrity Consumer Unit with MCB's



- 3rd amendment compliant
- Comply to 17th edition
- 2 x 63A RCD's
- 30mA RCD
- 10 way board contains: 3 x 6A, 2 x 16A, 4 x 32A, 1 x 40A MCB's
- 15 way board contains: 3 x 6A, 2 x 16A, 2 x 20A, 4 x 32A, 1 x 40A MCB's

FROM ONLY
£72.67
EACH



Code	No of Ways	Each	5+
335552	10	£76.50	£72.67
211132	15	£74.60	

100A Dual Split Load with High Integrity Consumer Unit



- 3rd amendment compliant
- 2 x 63A 30mA RCD
- MCBs not included



FROM ONLY
£66.02
EACH

Code	No of Ways	Each	5+
204878	10	£69.50	£66.02
C 820446	15	£75.80	£72.01

100A Consumer Unit

- 3rd amendment compliant
- MCBs not included



FROM ONLY
£31.11
EACH

Code	No of Ways	Each	5+
880230	5	£32.75	£31.11
402714	8	£36.35	£34.53
D 979895	11	£41.15	£39.09

100A 30mA RCD Consumer Unit

- 3rd amendment compliant
- 2 x 63A 30MA RCD
- MCB's not included



FROM ONLY
£37.14
EACH

Code	No of Ways	Each	5+
733563	5	£39.10	£37.14
E 608162	8	£44.85	£42.60
166330	11	£57.50	£54.63

Consumer Units

Single Pole Type B MCB

- Suitable for ABX, BX, XL & PX boards
- Thermal-magnetic operation
- Current limiting, types B, C, D operating characteristics
- Operating dolly may be locked in either the ON or OFF position



Code	Amp Rating	Each	12+
A 934816	6A	£1.95	£1.65
912885	10A	£1.95	£1.65
192910	16A	£1.95	£1.65
819777	20A	£1.95	£1.65
613335	32A	£1.95	£1.65
474112	40A	£1.95	£1.65
906503	50A	£1.95	£1.65

FROM ONLY
£1.65
EACH

Plug In Type B MCB

- 240V AC
- 3KA breaking capacity
- DIN rail mounting



FROM ONLY
£13.50
EACH

Code	Amp Rating	Each	10+
665490	6A	£14.25	£13.50
B 863746	10A	£14.25	£13.50
604967	16A	£14.25	£13.50
175119	20A	£14.25	£13.50
211381	40A	£14.25	£13.50

Type B NH MCB

- Thermal-magnetic current limiting
- Easy to operate handle with a trip free toggle mechanism
- B curve



FROM ONLY
£2.53
EACH

Code	Amp Rating	Each	10+
883065	6A	£2.64	£2.53
C 316492	10A	£2.64	£2.53
528823	16A	£2.64	£2.53
771447	20A	£2.64	£2.53
696272	32A	£2.64	£2.53
124867	40A	£2.64	£2.53
965091	50A	£2.64	£2.53

Single Pole Type B MCB

- 230 - 400V AC
- 6kA breaking capacity
- Operating temperature: -5°C to 40°C
- Sentry range
- Trip free mechanism
- Suitable for installation in Sentry consumer units & two or four module enclosures



FROM ONLY
£2.95
EACH

Code	Amp Rating	Each	10+
205543	3A	£3.35	£2.95
107729	6A	£3.35	£2.95
975556	10A	£3.35	£2.95
985518	16A	£3.35	£2.95
943892	20A	£3.35	£2.95
290306	32A	£3.35	£2.95
888973	40A	£3.35	£2.95
D 743643	45A	£3.35	£2.95
774931	50A	£3.35	£2.95

Type C NH MCB



FROM ONLY
£4.65
EACH

Code	Amp Rating	Each	5+
E 723514	16A	£4.90	£4.65
129298	20A	£4.90	£4.65

Single Pole Type C MCB

- Type C curve MCB
- Suitable for installation in Sentry consumer units
- Positive Contact Status Indication



FROM ONLY
£3.35
EACH

Code	Amp Rating	Each	10+
F 805924	6A	£3.75	£3.35
128824	10A	£3.75	£3.35
894814	16A	£3.75	£3.35
940837	20A	£3.75	£3.35
159649	32A	£3.75	£3.35

Module Stacking Unit

- Enables 2 consumer units to be stacked to form 1 unit
- Includes nuts, bolts and earth cable
- Suitable for use with MK sentry consumer units



Code	Module	Each	3+
G 581917	12	£2.38	£2.18
199334	16	£2.46	£2.26
954604	21	£2.52	£2.32

FROM ONLY
£2.18
EACH

Cover Blanks

- Covers 1 module

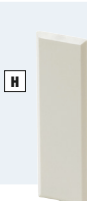

FROM ONLY
38P
EACH

Code	Each	10+
H 519280	£0.40	£0.38

Double Pole Main Switch

- Suitable for use in MK sentry consumer units



A



FROM ONLY
£10.09
EACH

Code	Amp Rating	Each	3+
551513	60	£11.00	£10.09
A 833654	100	£12.13	£11.53

Time Delay Switch

- Suitable for use with MK sentry products
- Range of 1-7 minutes, in increments of 15 seconds
- Pre programmable
- Delay range 1-7 minutes
- Rated up to 16A resistance loads



B



FROM ONLY
£49.49
EACH

Code	Each	3+
B 731295	£53.99	£49.49

7 Day Mechanical Time Switch

- 3 module
- Minimum setting 3 hours
- Rated at 16A resistance load
- Rated at 4A inductive load
- Suitable for use in MK sentry consumer units



C



FROM ONLY
£70.44
EACH

Code	Each	3+
C 496850	£76.84	£70.44

Busbar



D

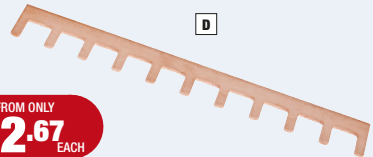

FROM ONLY
£2.67
EACH

Code	Each	3+
D 263307	£2.91	£2.67
991726	£4.06	£3.73

Split Load Kit

- Consists of 3 cables: 2 neutral & 1 live
- For use when assembling a split load arrangement



E

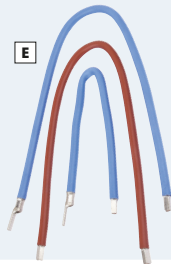

FROM ONLY
£6.77
EACH

Code	Each	3+
E 543660	£7.38	£6.77

Multi Incomer-Kit

- For use when assembling a consumer unit in a multi incomer arrangement, with separate supply to each incomer
- Pre-fitted terminal for the neutral return from switch or RCD to second or third neutral bar



F



FROM ONLY
£4.21
EACH

Code	Each	3+
F 287047	£4.59	£4.21

Split Load Kit

- 17th edition cable kit for switch & twin RCD arrangement



G



FROM ONLY
£13.54
EACH

Code	Each	3+
G 527407	£14.77	£13.54

Stacking Cable Kit

- Suitable for MK Sentry consumer units
- For use with MK cable stacking units, see page 173



H

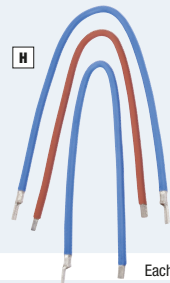

FROM ONLY
£7.22
EACH

Code	Each	3+
H 842107	£7.87	£7.22

RCDs & RCCDs

2 Pole RCD

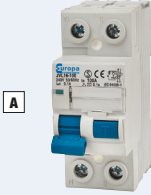

A

FROM ONLY
£16.82
EACH

Code	Amp Rating	Trip Rating (MA)	Each	3+
463976	25	30	£17.70	£16.82
234906	40	30	£19.25	£18.29
737753	63	30	£21.20	£20.14
759858	80	30	£24.35	£23.13
638101	100	30	£36.82	£34.98
570195	63	100	£24.85	£23.61
659296	80	100	£27.25	£25.89
157912	80 (Time Delay)	100	£36.50	£34.68
A 160088	100	100	£37.03	£35.18

4 Pole RCD



B

FROM ONLY
£22.85
EACH

Code	Amp Rating	Trip Rating (MA)	Each	3+
666216	40	30	£31.55	£29.97
591697	63	30	£33.25	£31.59
334451	80	30	£35.75	£33.96
678072	100	30	£33.85	£32.16
988709	63	100	£24.05	£22.85
910303	80	100	£29.35	£27.88
B 141249	100	100	£33.11	£31.45

2 Module RCD



C



FROM ONLY
£46.32
EACH

Code	Amp Rating	Trip Rating (MA)	Each	3+
627315	16	10	£82.36	£74.88
168189	30	30	£50.95	£46.32
361969	60	30	£51.36	£46.70
816969	80	30	£57.09	£51.91
C 840265	100	30	£79.14	£71.95
405445	80	100	£75.37	£68.53
606911	100	100	£88.48	£80.44

4 Module RCD



D



FROM ONLY
£71.34
EACH

Code	Amp Rating	Trip Rating (MA)	Each	3+
D 606332	25	30	£78.47	£71.34
995558	30	40	£92.04	£83.68
959698	30	63	£124.61	£113.29

1A 8V 2 Module Bell Transformer

• 220 - 240V A-C

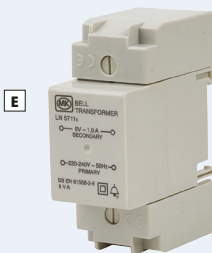

E



FROM ONLY
£21.99
EACH

Code	Each	3+
E 578259	£23.98	£21.99

FREE RETURNS

Money back guarantee!



ORDER BY 6PM

Get it Next Day!



Single Pole Type B RCBO

- Positive contact status indicator
- Lockable dolly switch
- Large terminal capacity
- Rated trip current = 30mA
- 6kA breaking capacity



FROM ONLY
£15.80
EACH

Code	Amp Rating	Each	5+
A 577144	6	£16.45	£15.80
351099	10	£16.45	£15.80
379464	20	£16.45	£15.80
540050	32	£16.45	£15.80
536322	40	£16.45	£15.80

30mA Single Pole RCBO

- Suitable for installation in Sentry consumer units
- Positive contact status indication in accordance with 16th edition IEE Wiring Regulations
- Single module
- Operating temperature: -25°C to 40°C (ambient)
- Breaking capacity: 6kA



FROM ONLY
£23.85
EACH

Code	Amp rating	Each	5+
B 760111	6	£24.95	£23.85
677867	10	£24.95	£23.85
843714	16	£24.95	£23.85
280184	20	£24.95	£23.85
783349	33	£24.95	£23.85
397956	40	£24.95	£23.85

Single Pole Type B NH RCBO

- Combined MCB/RCD device
- Breaking capacity: 6kA
- Rated trip current - 30mA
- 6kA break capacity
- Cable capacity
- Push to 16mm test button

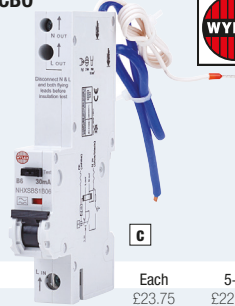

FROM ONLY
£22.60
EACH

Code	Amp Rating	Each	5+
C 133314	6	£23.75	£22.60
745147	10	£23.75	£22.60
631632	16	£23.75	£22.60
819551	20	£23.75	£22.60
524420	32	£23.75	£22.60
248834	40	£23.75	£22.60

20A Single Pole Type C NH RCBO

- Combined MCB/RCD device
- Breaking capacity: 6kA
- Rated trip current - 30mA
- 6kA break capacity
- Cable capacity
- Push to 16mm test button

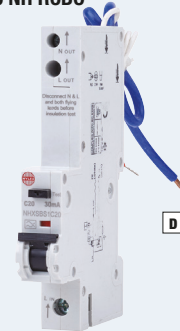

FROM ONLY
£22.60
EACH

Code	Each	5+
D 406984	£23.75	£22.60

Module Blank

- Blank module for use in MK fuseboards
- Clip on DIN rail



FROM ONLY
73P
EACH

Code	Each	3+
E 542231	£0.79	£0.73

40A Shower Unit Mini

- IP20 rated
- 40A 30mA RCD
- Suitable for showers up to 12kW

F



FROM ONLY
£22.18
EACH

Code	Each	3+
F 116989	£23.10	£22.18

Switch Fuse & Garage Units

2 Way Garage Board Amendment 3 & MCBs

- All metal construction
- MCB's included: 1 x 6A, 1 x 32A



A

FROM ONLY
£25.73
EACH

Code	Each	3+
A 512863	£26.80	£25.73

63A RCD & 6A + 32A MCB Main Switch Work/Garage Unit

- Fitted spirit level
- Easy fit & clean cover
- Flexible wiring configuration
- Backed-out & retained combi terminal screws



B

FROM ONLY
£25.46
EACH

Code	Each	3+
B 905611	£26.80	£25.46

100A Single Pole Switch Fuse Metal

- Switch fuse units for use in domestic household premises BS 7671 Amendment No. 3: 2015 IET wiring regulations
- These units have been designed, manufactured and tested to meet IEC60947-3
- Rated voltage: 415Vac
- Amps:100A
- Rated breaking capacity: 33kA



C

FROM ONLY
£48.95
EACH

Code	Each	3+
C 161476	£52.50	£48.95

80A Double Pole Fused Switch

- 2 pole fused switch ideal for the protection and isolation of incoming supplies up to 80A
- Supplied complete with 80A HRC fuse



D



FROM ONLY
£18.80
EACH

Code	Each	3+
D 324279	£19.58	£18.80

100A Single Phase Check Meter

- Single phase Bakelite casing, designed for direct connection to domestic electricity mains
- Suitable for recording electricity consumed in houses, flats, etc.

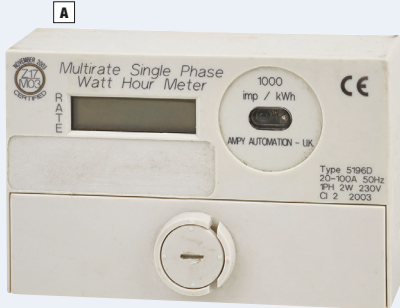

FROM ONLY
£18.24
EACH

Code	Each	3+
A 436268	£19.00	£18.24

100A 3 Phase Digital Check Meter

- 3 phase Bakelite casing, designed for direct connection to 3 phase, 4 wire electricity mains
- Suitable for recording electricity consumed in commercial and industrial installations



FROM ONLY
£62.40
EACH

Code	Each	3+
B 324867	£65.00	£62.40

M32 Gland Amendment 3 - PVC

- Single entry point for incoming tails
- Superior ingress protection mechanical grip and cable retention



FROM ONLY
£3.73
EACH

Code	Each	5+
C 981619	£3.93	£3.73

6PM

ORDER BY 6PM

Get it Next Day!

3 Phase Distribution

3 Phase TPN Distribution Board

- Unique cable trunking interface kit simplifies mounting of cable trunking & protects cables
- Improved neutral cable clamp design for simple & secure cable connection
- Additional functional earthing options & clean earth options available
- Auto-formed construction of main cover adds to board rigidity, with improved appearance
- Main switch not included (see page 168)

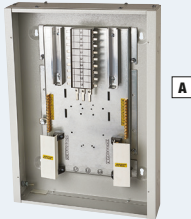

Code	No. of ways	Each	5+
A 713831	4	£79.65	£75.66
557945	6	£91.12	£86.56
195415	8	£102.88	£97.73
244516	12	£125.74	£119.45
271665	16	£179.26	£170.29

FROM ONLY
£75.66
EACH

100A 3 Phase Compact Isolator

- Suitable for use with Protecta compact distribution boards

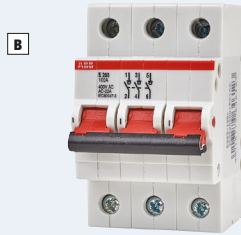

Code	Each	3+
B 327610	£31.98	£30.70

FROM ONLY
£30.70
EACH

10kA Single Pole Type B MCB

- Suitable for ABX, BX, XL & PX boards
- Thermal-magnetic operation
- Mechanical flag indicator shows ON or OFF
- Operating dolly may be locked in either the ON or OFF position
- Selected for their low electrical resistance & low propensity to weld under fault conditions



Code	Amp Rating	Each	10+
881866	6	£5.45	£4.95
C 814548	10	£5.45	£4.95
107854	16	£5.45	£4.95
789645	20	£5.45	£4.95
775571	32	£5.45	£4.95

FROM ONLY
£4.95
EACH

10kA Single Pole Type C MCB

- Suitable for ABX, BX, XL & PX boards
- Mechanical flag indicator shows ON or OFF
- Operating dolly may be locked in either the ON or OFF position
- Selected for their low electrical resistance & low propensity to weld under fault conditions



Code	Amp Rating	Each	10+
233904	6	£5.45	£4.95
D 390105	16	£5.45	£4.95
328081	20	£5.45	£4.95
721289	32	£5.45	£4.95
633319	40	£5.45	£4.95
584168	50	£5.45	£4.95
518075	63	£5.45	£4.95

FROM ONLY
£4.95
EACH

10kA Triple Pole Type C MCB

- Loadstar
- Thermal-Magnetic operation
- Mechanical flag indicator shows ON or OFF
- Operating dolly may be locked in either the ON or OFF position
- Selected for their low electrical resistance & low propensity to weld under fault conditions



Code	Amp Rating	Each	5+
E 498458	10	£23.70	£21.95
514326	16	£23.70	£21.95
552380	20	£23.70	£21.95
803551	32	£23.70	£21.95
897057	40	£23.70	£21.95
189081	63	£23.70	£21.95

FROM ONLY
£21.95
EACH

30mA 10kA 1 Module Type C RCBO

- Overcurrent protection
- Earth leakage sensitivity 30mA
- Comes with earth & neutral leads
- Test button



Code	Amp Rating	Each	3+
F 794349	6	£31.98	£30.70
620287	10	£31.98	£30.70
648573	16	£31.98	£30.70
611868	20	£31.98	£30.70
966012	32	£31.98	£30.70
370266	40	£31.98	£30.70

FROM ONLY
£30.70
EACH

2 Pole RCD

- Suitable for use with ABB Protecta compact products

A



ABB

FROM ONLY
£20.55 EACH

Code	Amp rating A	Trip Rating MA	Each	3+
555203	30	25	£21.41	£20.55
283896	30	40	£22.28	£21.39
729913	30	63	£29.10	£27.94
450916	30	100	£56.98	£54.70
376689	100	63	£32.34	£31.05
A 640945	100	100	£56.01	£53.77

4 Pole RCD

- Suitable for use with ABB Protecta compact products

B



ABB

FROM ONLY
£36.50 EACH

Code	Amp Rating	Trip rating	Each	3+
599897	40	30	£38.02	£36.50
744122	63	30	£44.85	£43.06
917639	63	100	£46.24	£44.39
727748	80	30	£64.00	£61.44
191665	80	100	£60.78	£58.35
695263	100	30	£97.57	£92.69
B 841814	100	100	£79.51	£76.33
805740	100	100	£97.57	£92.69

20A 2 Pole Contactor

- 230V
- 2 NO contacts
- Suitable for use with ABB Protecta compact products

C



ABB

FROM ONLY
£17.27 EACH

Code	Each	3+
C 942425	£17.99	£17.27

4 Pole Contactor

- 230V
- 4 NO contacts
- Suitable for use with ABB Protecta compact products

D



ABB

FROM ONLY
£28.94 EACH

Code	Amp Rating A	Each	3+
D 350001	20	£30.15	£28.94
235670	40	£39.91	£38.31
744979	63	£54.02	£51.86

RCD Connection Kit

- Required when installing RCD incomers into ABB 3 phase boards

E



ABB

FROM ONLY
£14.94 EACH

Code	Each	5+
E 549795	£15.73	£14.94

1 Module Blanking Plate

- Clip in module blank

F



ABB

FROM ONLY
65P EACH

Code	Each	10+
F 615711	£0.78	£0.65

3 Phase Distribution

3 Phase TPN Distribution Board



- Unique cable trunking interface kit simplifies mounting of cable trunking & protects cables
- Improved neutral cable clamp design for simple & secure cable connection
- Additional functional earthing options & clean earth options available
- Removable door aids installation & easy hang hinge design makes re-attachment of door simple



Code	No. of ways	Each	3+
153945	4	£94.33	£86.48
A 873067	6	£106.86	£97.96
184629	8	£124.03	£113.70
326917	12	£146.66	£134.44
739411	18	£210.04	£192.54
917485	24	£327.97	£300.64

FROM ONLY £86.48 EACH

Single Phase Type A Distribution Board



- Main busbar is removable for flexible installation
- Fully shrouded neutral busbar for increased safety
- Choice of metering option to suit application needs & aid compliance with latest Building Regulation part L2
- Door opens 180° to provide easy access & device operation
- New standard incomer switch disconnector rating of 125A provides higher rated solution for commercial buildings

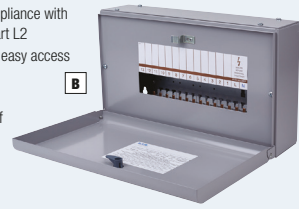

Code	No. of ways	Each	3+
106464	4	£35.72	£32.75
235565	7	£44.18	£40.50
653545	10	£49.94	£45.78
B 949100	13	£57.63	£52.83
365495	16	£68.76	£63.04

FROM ONLY £32.75 EACH

125A 3 Phase TPN Main Switch



- For use with Eaton Memshield 3 series distribution boards



FROM ONLY £35.48 EACH

Code	Each	3+
C 731248	£38.70	£35.48

3 Phase RCCB Incomer Kit



- Provides the added security of earth fault protection, covering 30mA & 100mA application



FROM ONLY £102.82 EACH

Code	Trip Rating	Each	3+
819247	30mA	£112.16	£102.82
D 815493	100mA	£116.19	£106.51

125A 3 Phase SPN Main Switch



- For use with Eaton Memshield 3 series distribution boards



FROM ONLY £10.71 EACH

Code	Each	3+
E 290909	£11.68	£10.71

125A 3 Phase SPSN Main Switch



- For use with Eaton Memshield 3 series distribution boards



FROM ONLY £32.77 EACH

Code	Each	3+
F 126900	£35.74	£32.77

3 Phase Single Pole Type B MCB



- Single pole MCBs 6kA B curve (6A to 63A)
- Breaking capacity: 6kA
- Voltage rating: 230 - 400V
- Electrical operations: 20,000
- Single pole for the protection & control of circuits against overloads & short circuits



FROM ONLY £6.48 EACH

Code	Amp Rating	Each	5+
G 997433	6	£7.13	£6.48
632215	10	£7.12	£6.48
132787	16	£7.12	£6.48
771154	20	£7.12	£6.48
903257	32	£7.12	£6.48
821669	40	£7.13	£6.48

3 Phase Single Pole Type C MCB

- Rated breaking capacity 10kA to IEC 60898 & 15kA to IEC 60947-2
- Positive contact indication
- Box clamp barrier to prevent incorrect cable/busbar insertion
- Calibrated at 40°C
- Can be used with both pin & comb type busbars



A

FROM ONLY
£6.79
EACH

Code	Amp Rating	Each	5+
A 191006	6	£7.46	£6.79
440066	10	£7.46	£6.79
264797	16	£7.46	£6.79
734011	20	£7.46	£6.79
628376	32	£7.46	£6.79
183703	40	£7.76	£7.06
881640	50	£7.76	£7.06
862054	63	£7.77	£7.06

30mA 3 Phase Single Pole Type C RCBO



- Combine the highest level of protection for both people & circuits in a single one module device
- Solid neutral
- Positive contact indication
- 30mA trip sensitivity
- 10kA rated breaking capacity



B

FROM ONLY
£36.27
EACH

Code	Amp Rating	Each	5+
B 451961	6	£39.89	£36.27
922153	10	£39.89	£36.27
575395	16	£39.89	£36.27
355929	20	£39.89	£36.27
804294	32	£39.89	£36.27
263412	40	£39.89	£36.27

3 Phase Triple Pole Type C MCB

- Positive contact indication
- Box clamp barrier to prevent incorrect cable/busbar insertion
- Calibrated at 40°C
- Can be used with both pin & comb type busbars

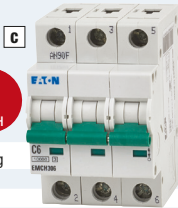

C

FROM ONLY
£27.54
EACH

Code	Amp Rating	Each	5+
C 575594	6	£30.29	£27.54
249525	10	£30.28	£27.54
991596	16	£30.28	£27.54
741711	20	£30.28	£27.54
839013	32	£30.28	£27.54
446507	40	£30.29	£27.54
141180	63	£30.29	£27.54

Busbar Clamps 100A 70mm Cable



- Capacity: 70mm²
- Nominal rating Ie 63-100A



D

FROM ONLY
£3.42
EACH

Code	Each	5+
D 924072	£3.73	£3.42

Single Pole BMS Blank

- Din rail mounted
- Designed to fill unused Busbar modules in Eaton Memshield 3 distribution board

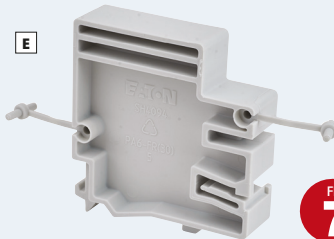

E

FROM ONLY
73P
EACH

Code	Each	5+
E 188816	£0.80	£0.73

“£2.50 pre-noon
delivery upgrade
is ideal for those
last minute jobs”



**FREE
RETURNS**



3 Phase Distribution

250A 1 - 3 Phase Distribution Board - Metal Clad

Life Is On | Schneider Electric

- Option of switching outgoing neutral on all boards using distributed neutral kit
- Single pole RCBO for new or retrofit maintaining device density
- Split neutral bars
- Removable gland plates
- Removable insulated pan assembly
- Main switch not included

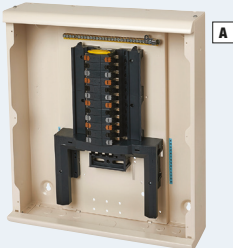

FROM ONLY
£123.19
EACH

Code	No. of ways	Each	3+
718761	4	£132.67	£123.19
392745	6	£150.75	£139.98
A 325030	8	£159.30	£147.93

TP&N 125A Switch Isolator

Life Is On | Schneider Electric

- Main switch suitable for Schneider Acti 9 3 phase distribution units



FROM ONLY
£45.73
EACH

Code	Each	3+
B 762977	£49.25	£45.73

Single Pole Type C MCB

Life Is On | Schneider Electric

- Operating cycles on load 20000
- Contact position indicator
- Thermal magnetic trip unit technology
- Voltage rating 240V - 440V AC
- Operating temperature -30°C to +70°C



FROM ONLY
£7.52
EACH

Code	Amp Rating	Each	5+
C 762852	6	£8.21	£7.52
717117	10	£8.20	£7.52
564939	16	£8.20	£7.52
529918	20	£8.20	£7.52
345510	32	£8.20	£7.52
632535	40	£8.21	£7.52

Triple Pole Type C MCB

Life Is On | Schneider Electric

- Operating cycles on load 20,000
- Protection & control of circuits against overloads & short circuits
- Tripping characteristics: BS EN 60898 type C; magnetic setting between 5 & 10 In
- 10kA breaking capacity
- Operating temperature -30°C to +70°C



FROM ONLY
£32.81
EACH

Code	Amp Rating	Each	5+
D 510301	6	£35.79	£32.81
376569	10	£35.79	£32.81
579633	16	£35.79	£32.81
959116	20	£35.79	£32.81
469996	32	£35.79	£32.81

Single Pole Type C RCBO

Life Is On | Schneider Electric

- Thermal magnetic trip unit technology
- Earth leakage protection class AC
- Earth leakage protection time delay instantaneous
- Local signalling positive break indication
- Electrical durability 20,000 cycles



FROM ONLY
£47.99
EACH

Code	Amp Rating	Each	5+
E 941220	6	£52.35	£47.99
457402	10	£52.35	£47.99
740481	16	£52.35	£47.99
396493	20	£52.35	£47.99
437520	32	£52.35	£47.99

3 Pole Blanking Plate

Life Is On | Schneider Electric

- For use with Schneider Acti 9 3 phase boards
- Designed for unused Busbar ways

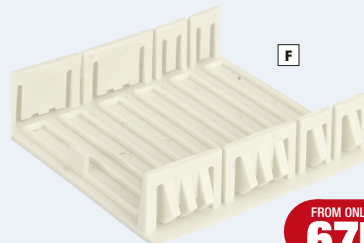

FROM ONLY
67P
EACH

Code	Each	3+
F 543053	£0.72	£0.67

3 Phase Switch Isolator

- Breaking capacity AC 22A
- Double break contacts
- Visible contact indicator



FROM ONLY
£48.75
EACH

Code	Amp rating	Each	3+
722378	32	£50.70	£48.75
A 516183	63	£71.76	£69.00
117635	100	£102.38	£98.45

TPN Switch Disconnecter

- 415V
- Exel 2 switch disconnecter
- Trip pole/neutral



FROM ONLY
£63.75
EACH

Code	Amp rating	Each	3+
376167	20	£69.54	£63.75
464904	32	£82.42	£75.56
B 310836	100	£223.16	£204.57

3 Phase Switch Fuse

- Fully rated solid neutral
- Removable back plate and door
- Fully rated AC23 on load switch disconnectors
- Total isolation for fuse link removal
- Smaller rated fuses can be fitted in fuse units



FROM ONLY
£61.10
EACH

Code	Amp rating	Each	3+
C 648714	32	£63.54	£61.10
474841	63	£92.04	£88.50
671368	100	£133.53	£128.40

TPN Switch Fuse

- Exel 2 switch disconnecter fuse
- Triple pole/neutral
- Eaton HRC fuses DC23 100SD5
- These units have dual fixings to accept SB3, SB4 and SO fuse links
- 2 x M5 screws required



FROM ONLY
£86.89
EACH

Code	Amp rating	Each	3+
425077	32	£94.78	£86.89
D 584082	100	£363.54	£333.25

SPN Switch Fuse

- Exel 2 switch disconnecter fuse
- Single pole switched neutral
- Eaton HRC fuses DC23 32SB3



FROM ONLY
£80.60
EACH

Code	Each	3+
E 330821	£87.93	£80.60

TPN Fused Switch Disconnecter

- Exel 2 switch disconnecter fuse
- Triple pole/neutral
- Eaton HRC fuses DC23 100SD5
- These units have dual fixings to accept SB3, SB4 and SO fuse links
- 2 x M5 screws required



FROM ONLY
£352.23
EACH

Code	Amp rating	Each	3+
F 572787	100	£384.25	£352.23
363099	200	£610.45	£559.58

3 Phase Distribution

400/415V TIA Motor Rated Industrial Fuse-Link with Bolt Connections



A

FROM ONLY
£3.57
EACH

Code	Motor Rating Amps	Each	5+
A 571670	32-40A	£3.89	£3.57
905132	32-50A	£3.89	£3.57
171342	32-63A	£4.14	£3.80

63-100A 400/415V TIS Motor Rated Industrial Fuse-Link with Bolt Connections



D

FROM ONLY
£7.20
EACH

Code	Each	5+
D 694422	£7.85	£7.20

400/415V TIS Offset Tag Industrial Fuse-Link with Bolt Connections

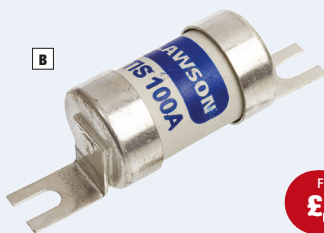

B

FROM ONLY
£4.48
EACH

Code	Amp rating	Each	5+
440401	40	£4.88	£4.48
846819	50	£4.88	£4.48
582624	63	£5.07	£4.65
308980	80	£7.91	£7.25
B 139217	100	£8.20	£7.52

400/415V TM Central Tag Industrial Fuse-Link with Bolt Connections

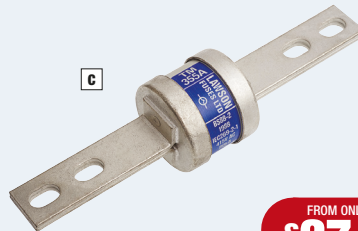

C

FROM ONLY
£27.70
EACH

Code	Amp rating	Each	5+
C 684937	355	£30.22	£27.70
335743	400	£31.39	£28.78

500mA Test Lead Fuse



E

FROM ONLY
£1.50
EACH

Code	Each	5+
E 775220	£1.58	£1.50

Bottle Fuse



F

FROM ONLY
£1.31
EACH

Code	Amp rating	Each	10+
412450	2	£1.42	£1.31
246648	10	£1.70	£1.57
F 916266	16	£1.70	£1.57
735809	25	£2.20	£2.04

6A Double Pole Street Lighting Cut Out

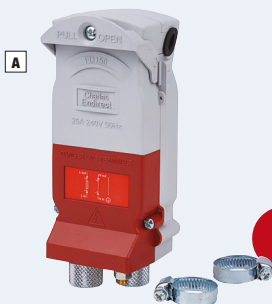

FROM ONLY
£18.00
EACH

Code	Each	5+
A 488775	£18.75	£18.00

Off-Set Tag Fuse



FROM ONLY
£4.54
EACH

Code	Amp rating	Each	10+
B 489645	16	£4.90	£4.54
169793	40	£6.00	£5.56
133434	63	£6.90	£6.39

63A-100A Motor Rated Offset Fuse



FROM ONLY
£6.85
EACH

Code	Each	10+
C 704679	£7.40	£6.85

Single Pole Clip In Blank Module

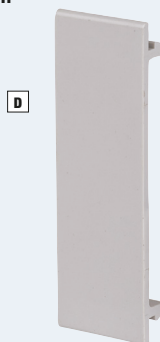

FROM ONLY
45P
EACH

Code	Each	10+
D 618613	£0.49	£0.45

5A, 15A, 30A Card Fuse Wire

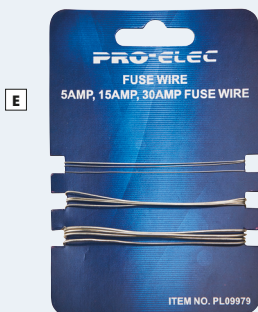

FROM ONLY
96P
PACK

Code	Pack 10	10+
E 759770	£1.04	£0.96

ORDER BY 6PM

Get it Next Day!

Fuses

32A Ceramic Fuse

A



FROM ONLY
£10.40
PACK

Code	Each	10+
A 453931	£10.40	£10.40

GTIA Industrial Fuse

FROM ONLY
£2.50
EACH

B

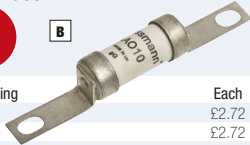

Code	Amp rating	Each	10+
831671	2	£2.72	£2.50
873880	4	£2.72	£2.50
491782	6	£2.72	£2.50
B 683884	10	£2.72	£2.50
377469	16	£2.97	£2.72
996515	20	£2.97	£2.72
954281	32	£3.03	£2.78

Consumer Unit Fuse

C



FROM ONLY
65P
EACH

Code	Amp rating	Manufacturer Code	Each	10+
C 910499	5	LA5	£0.70	£0.65
681507	5	LC5	£1.35	£1.24
684004	6	LD6	£1.54	£1.42
685344	15	LC15	£1.35	£1.24
567239	20	LC20	£1.35	£1.24
179725	30	LC30	£1.30	£1.20
118743	45	LC45	£2.40	£2.20

230/240V LST Industrial Fuse

D



FROM ONLY
£1.42
EACH

Code	Amp rating	Each	10+
649869	4	£1.54	£1.42
816595	6	£1.54	£1.42
D 476685	10	£1.54	£1.42
603981	16	£1.54	£1.42
238896	20	£1.67	£1.53
705419	32	£1.67	£1.53

22.23mm House Service Cut Out Fuse

E



FROM ONLY
£3.86
EACH

Code	Amp rating	Each	10+
512618	5	£4.20	£3.86
142361	30	£4.20	£3.86
470272	40	£4.20	£3.86
326786	60	£4.20	£3.86
793569	80	£4.20	£3.86
E 857819	100	£4.20	£3.86

30.16mm House Service Cut Out Fuse

F



FROM ONLY
£4.70
EACH

Code	Amp rating	Each	10+
775078	40	£5.13	£4.70
168302	60	£5.13	£4.70
202938	80	£5.13	£4.70
F 601800	100	£5.13	£4.70

400/415V NIT Industrial Fuse-Links with Bolt Connections

G

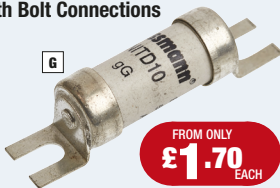

FROM ONLY
£1.70
EACH

Code	Amp rating	Each	10+
996768	2	£1.85	£1.70
284340	4	£1.85	£1.70
245298	6	£1.85	£1.70
G 518728	10	£1.85	£1.70
532723	16	£1.85	£1.70
800066	20	£2.04	£1.87
340565	32	£2.22	£2.04

400/415V NIT Motor Rated Fuse

H



FROM ONLY
£2.10
EACH

Code	Amp rating	Each	10+
H 478153	20-32	£2.29	£2.10
534772	32-63	£4.94	£4.53

240V/415V Compact Fuse

I



FROM ONLY
£1.70
EACH

Code	Amp rating	Each	10+
246673	2	£1.85	£1.70
643238	4	£1.85	£1.70
555452	6	£1.85	£1.70
I 512912	10	£1.85	£1.70
205895	16	£1.85	£1.70
848389	20	£2.04	£1.87
769101	32	£2.22	£2.04

240V/415V Motor Rated Compact Fuse



FROM ONLY
£2.10
EACH

Code	Amp rating	Each	10+
A 248323	20-32	£2.29	£2.10
873670	32-63	£4.94	£4.53

Plug Top Fuse



FROM ONLY
£2.20
PACK

Code	Amp rating	Each	10+
272921	2	£2.20	
489773	3	£2.20	
353910	5	£2.20	
380643	7	£2.20	
B 428546	10	£2.20	
411674	13	£2.20	

400/415V TC Central Tag Industrial Fuse Links with Bolt Connections



FROM ONLY
£7.43
EACH

Code	Amp rating	Each	5+
C 993789	100	£8.10	£7.43
637954	80	£8.10	£7.43

250V Slow Blow Fuse



FROM ONLY
£2.70
PACK

Code	Amp rating	Each	10+
D 428076	0.5	£3.10	£2.70
829219	0.8	£3.10	£2.70
562903	1	£3.10	£2.70
853699	1.6	£3.10	£2.70
504486	2	£3.10	£2.70
800578	3	£3.10	£2.70
944278	4	£3.10	£2.70
684263	5	£3.10	£2.70
928411	6.3	£3.10	£2.70
703620	8	£3.10	£2.70
235532	10	£3.10	£2.70

400/415V TCP Motor Circuit Protection Fuse Link



FROM ONLY
£11.96
EACH

Code	Amp rating	Each	5+
E 546460	100	£13.04	£11.96

400/415V TBC Central Tag Industrial Fuse Links with Bolt Connections



FROM ONLY
£4.93
EACH

Code	Amp rating	Each	10+
F 500611	16	£5.38	£4.93
706671	20	£5.38	£4.93
382462	32	£5.38	£4.93
740086	40	£5.44	£4.99
383784	63	£5.44	£4.99

400/415V TF Central Tag Industrial Fuse Link with Bolt Connections



FROM ONLY
£13.43
EACH

Code	Amp rating	Each	5+
G 234141	125	£14.65	£13.43
679189	160	£15.08	£13.83
200431	200	£15.45	£14.16

400/415V TFP Offset Tag Industrial Fuse Link with Bolt Connections



FROM ONLY
£13.43
EACH

Code	Amp rating	Each	5+
H 707452	125	£14.65	£13.43
744785	160	£15.08	£13.83
792409	200	£15.45	£14.16
451865	200	£21.88	£20.06

400/415V TCP Offset Tag Industrial Fuse Links with Bolt Connections



FROM ONLY
£6.80
EACH

Code	Amp rating	Each	5+
148683	32	£7.41	£6.80
950662	40	£7.41	£6.80
908618	50	£7.41	£6.80
881574	63	£7.41	£6.80
284174	80	£7.78	£7.14
I 853582	100	£7.78	£7.14

Enclosures & Cabinets

2 Module Metal Box Complete with Knockouts



FROM ONLY
£12.36
EACH

Code	Each	5+
A 867903	£12.88	£12.36

PVC Enclosure

- Internal DIN rail fixings

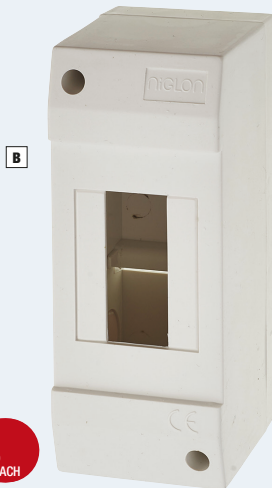

FROM ONLY
£1.98
EACH

Code	Size	Each	5+
B 745946	2 Module	£2.10	£1.98
972432	4 Module	£2.90	£2.78

4 Module Metal Enclosure

- Internally mounted DIN rail for MCB's etc



FROM ONLY
£12.36
EACH

Code	Each	5+
C 581258	£12.88	£12.36

4 Module Metal Extension Enclosure

- Offers additional room for taller applications (RCBO's)
- Internally mounted DIN rail



FROM ONLY
£13.39
EACH

Code	Each	5+
D 633011	£13.95	£13.39

Metal Enclosure

- Mounting plate not supplied, to be ordered separately
- Without gland plate
- Gutter shaped front rail
- Single piece body, cross-shaped structure
- IP66 rated

A



FROM ONLY
£29.96
EACH

Code	Size mm	Each	3+
631154	300 x 250 x 150	£31.96	£29.96
756159	300 x 300 x 150	£36.06	£33.81
214336	300 x 300 x 200	£39.52	£37.06
972913	400 x 300 x 150	£38.94	£36.51
386260	400 x 300 x 200	£43.81	£41.08
A 598907	500 x 400 x 200	£57.40	£53.82
499689	600 x 400 x 150	£54.50	£51.10
221763	600 x 400 x 200	£59.32	£55.61
907038	700 x 500 x 200	£77.66	£72.81
172216	800 x 600 x 200	£83.88	£78.64
788779	800 x 600 x 250	£99.40	£93.20

Key Lock

- Steel latch cylinder lock

B

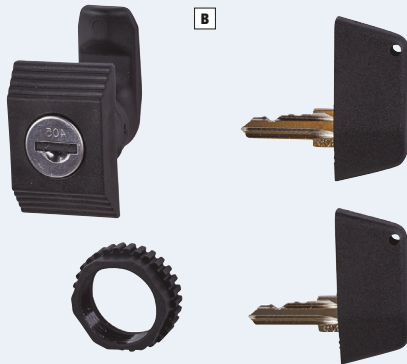

FROM ONLY
£5.71
EACH

Code	Each	3+
B 221182	£6.08	£5.71

Back Plate

- Mounting plate suitable for Schneider range of enclosures

C



FROM ONLY
£4.45
EACH

Code	Size mm	Each	3+
101290	250 x 100	£4.77	£4.48
790035	300 x 250	£4.74	£4.45
631020	300 x 300	£4.88	£4.58
C 688345	400 x 300	£4.97	£4.67
779841	500 x 400	£10.44	£9.80
546635	600 x 400	£11.07	£10.38
156255	700 x 500	£18.28	£17.14
489488	800 x 600	£25.99	£24.37



A

PVC Enclosure

Life Is On | Schneider Electric

- One-piece monoblock body
- Completely reversible
- Designed for use both indoors & outdoors
- Wide range of accessories allowing for their use in distribution, control & measurement panels for industrial & recreational installations
- Inserts located at the front of the cabinet for fixing of distribution chassis & internal door

FROM ONLY
£83.89
EACH

Code	Size mm	Each	3+
A 592232	530 x 430 x 200	£89.48	£83.89
684611	647 x 436 x 250	£98.68	£92.51



B

2 Module Insulated Enclosure



- IP30
- 2 module metal enclosure for heavier duty applications
- Designed to accommodate MCBs, RCDs, RCBOs, time switches or a switch disconnector
- MK 5502

FROM ONLY
£9.00
EACH

Code	Each	3+
B 824803	£9.45	£9.00



C

4 Module Insulated Enclosure



- IP30
- Designed to accommodate MCBs, RCDs, RCBOs, time switches or a switch disconnector
- MK 5604

FROM ONLY
£15.14
EACH

Code	Each	3+
C 743557	£16.51	£15.14

4 Module Metal Enclosure

- IP30
- 4 Module metal enclosure for heavier duty applications
- Designed to accommodate MCBs, RCDs, RCBOs, time switches or a switch disconnecter
- MK 5504

A

FROM ONLY
£22.05
EACH



Code
A 225007

Each 3+
£24.05 £22.05

IP66 8 Way PVC Enclosure

- Pre-moulded conduit knockouts

B

FROM ONLY
£11.23
EACH



Code
B 581062

Each 5+
£11.70 £11.23

IP66 4 Way PVC Enclosure

- Pre-moulded conduit knockouts

C

FROM ONLY
£8.83
EACH



Code
C 953556

Each 5+
£9.20 £8.83



NEXT DAY DELIVERY!

WHEN YOU ORDER BY 6PM

32A 4 Pole Isolator

- Padlockable
- Pre-moulded knockouts
- 415V rated

SEE
PAGE
146



FROM ONLY
£16.54
EACH
WHEN YOU BUY 3+

Order Code: 705916

NEW PRODUCTS ADDED DAILY TO OUR WEBSITE

FREEPHONE: 8AM-6PM, 7 DAYS A WEEK
0808 168 22 77

ONLINE: SHOP 24/7
ElectricalDirect.co.uk

INDUSTRIAL CONTROLS

<u>DIN Rail Connectors & Accessories</u>	<u>140</u>
<u>Contactors</u>	<u>141</u>
<u>Emergency Stop Stations</u>	<u>142-143</u>
<u>Overload Relays & Enclosures</u>	<u>144-145</u>
<u>Rotary Isolators</u>	<u>146-147</u>

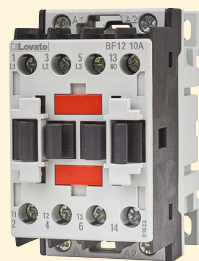

SEE
PAGE
141

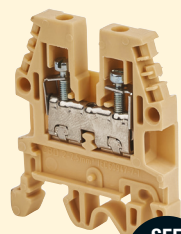

SEE
PAGE
140



SEE
PAGE
142



SEE
PAGE
143

DIN Rail Connectors & Accessories

Top Hat DIN Rail 2m

A



FROM ONLY
£2.60
EACH

Code	Each	10+
A 280206	£3.00	£2.60

G Section DIN Rail - 2m

B

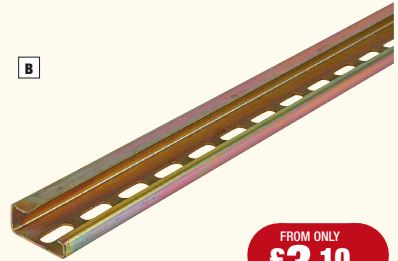

FROM ONLY
£3.10
EACH

Code	Each	5+
B 500643	£3.70	£3.10

DIN Rail Terminal Block

C

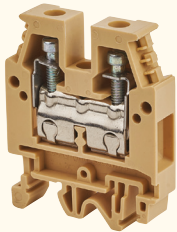

D

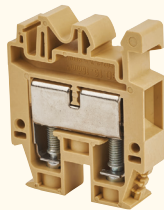

Code	Size mm	Each	10+
725247	2.5	£0.64	£0.61
549214	4	£0.71	£0.68
361610	6	£0.92	£0.88
C 960090	10	£1.17	£1.11
D 205026	16	£1.64	£1.56
770371	35	£2.81	£2.67

FROM ONLY
61P
EACH

Earth Terminal

E

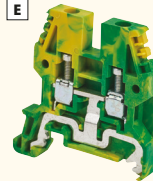

F



FROM ONLY
£1.90
EACH

Code	Size mm	Each	10+
815484	2	£2.00	£1.90
E 107137	4	£2.36	£2.24
369113	6	£3.18	£3.02
F 680024	10	£5.29	£5.03

DIN Rail Stop End

H

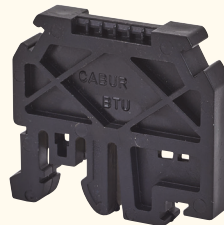

FROM ONLY
33P
EACH

Code	Size mm	Each	10+
797679	2.5	£0.23	£0.22
970319	4-6	£0.30	£0.29
G 148129	10	£0.32	£0.31
927297	16	£0.35	£0.33
916022	35	£0.38	£0.37

FROM ONLY
22P
EACH

Code	Each	10+
H 303460	£0.35	£0.33

9A Three-Pole Contactor

- IEC Operating current IE (AC3) = 9A
- AC Coil 50/60hz
- 230VAC
- 415V
- 1NO auxiliary contact

A

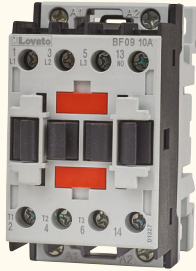

FROM ONLY
£16.08
EACH

Code	Type	Each	3+
379294	9A 230V	£17.63	£16.08
A 879242	9A 415V	£17.63	£16.08

12A Three-Pole Contactor

- IEC Operating current IE (AC3) = 12A
- AC Coil 50/60hz
- 230VAC
- 415V
- 1NO auxiliary contact

B

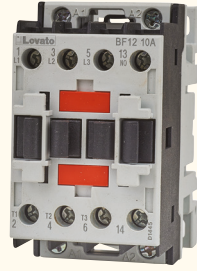

FROM ONLY
£19.77
EACH

Code	Type	Each	3+
B 691556	12A 230V	£21.67	£19.77
201046	12A 415V	£21.67	£19.77

25A Three-Pole Contactor

- IEC Operating current IE (AC3) = 25A
- AC Coil 50/60Hz
- 230VAC
- 415V
- 1NO auxiliary contact

C

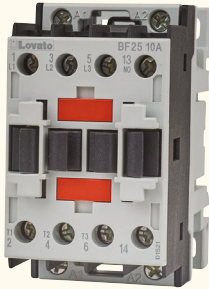

FROM ONLY
£33.56
EACH

Code	Type	Each	3+
C 602133	25A 230V	£36.80	£33.56

32A Three-Pole Contactor

- IEC Operating current IE (AC3) = 32A
- AC Coil 50/60Hz
- 230VAC
- 415V

D

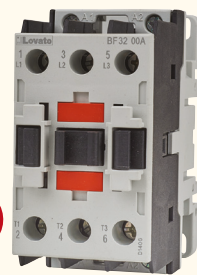

FROM ONLY
£51.46
EACH

Code	Each	3+
D 652133	£56.44	£51.46
439950	£56.44	£51.46

50A Contactor

- 50A
- 230VAC
- IEC operating current: 50A
- AC coil 50/60Hz

E

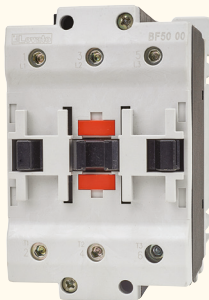

FROM ONLY
£83.84
EACH

Code	Type	Each	3+
E 196857	50A 230V	£91.95	£83.84

80A Three-Pole Contactor

- IEC operations current IE (AC3) = 80A
- AC Coil 50/60Hz
- 415 VAC

F

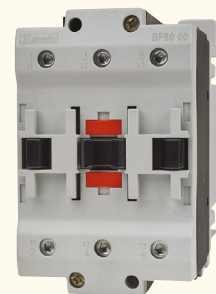

FROM ONLY
£161.65
EACH

Code	Type	Each	3+
F 658835	80A 415V	£177.28	£161.65

Emergency Stop Stations

Green Pilot Light

- 22mm LED
- Long life - high intensity
- 30,000 hours expected life



A



FROM ONLY
£1.81
EACH

Code	Each	3+
A 982765	£1.89	£1.81

Green Push Button

- Supplied with auxiliary contacts
- Ready to install
- Auxiliary contact rated at 10A thermal



B

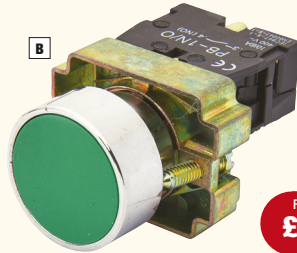

FROM ONLY
£2.29
EACH

Code	Each	3+
B 674930	£2.39	£2.29

Red Pilot Light

- 22mm LED
- Long life - high intensity
- 30,000 hours expected life



C



FROM ONLY
£1.81
EACH

Code	Each	3+
C 901745	£1.89	£1.81

Red Push Button

- Supplied with auxiliary contacts
- Ready to install
- Auxiliary contact rated at 10A thermal



D

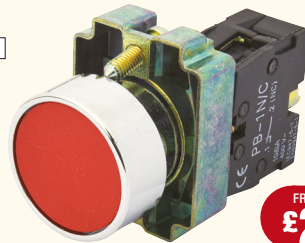

FROM ONLY
£2.29
EACH

Code	Each	3+
D 707143	£2.39	£2.29

White Pilot Light

- 22mm LED
- Long life - high intensity
- 30,000 hours expected life



E



FROM ONLY
£1.81
EACH

Code	Each	3+
E 791445	£1.89	£1.81

NEW
PRODUCTS
ADDED DAILY



Visit ElectricalDirect.co.uk

FREE
NEXT DAY
DELIVERY



Stop Button - IP55

- Height: 68mm
- Width: 68mm
- Depth: 51mm
- Push & twist mechanism



A



FROM ONLY
£9.92
EACH

Code	Each	3+
A 997147	£10.88	£9.92

Normally Closed Contact

- Rated at 10A thermal
- 400V



B



FROM ONLY
£2.30
EACH

Code	Each	3+
B 621127	£2.40	£2.30

Normally Open Contact

- Rated at 10A thermal
- 400V



C



FROM ONLY
£2.30
EACH

Code	Each	3+
C 119905	£2.40	£2.30

1 Module Enclosure - IP55

- For 22mm devices
- Height: 68mm
- Width: 68mm
- Depth: 51mm



D



FROM ONLY
£2.30
EACH

Code	Each	3+
D 252086	£2.42	£2.32

**FREE
RETURNS**

Money back
guarantee!



**ORDER
BY 6PM**
Get it Next Day!



Module Enclosure

- Height: 104mm
- Width: 68mm
- Depth: 51mm
- Suitable for 22mm devices



E



F



FROM ONLY
£2.50
EACH

Code	Modules	Each	3+
E 211893	2	£2.60	£2.50
F 732520	4	£3.10	£2.98

Rotary Isolators

Relay 8-11 Pin

- 230V rated
- 10A

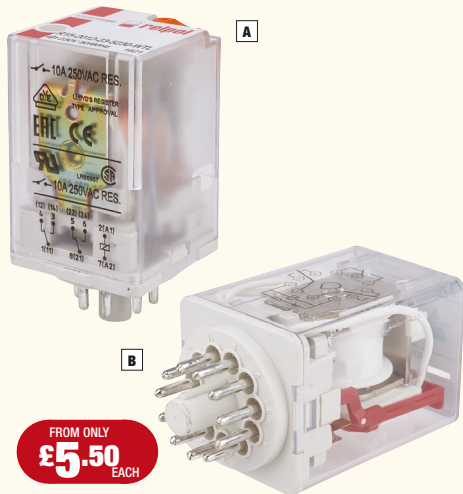

FROM ONLY
£5.50
EACH

Code	Base	Each	5+
A	8 Pin	£5.79	£5.50
B	11 Pin	£6.04	£5.74

Protected Relay Base



FROM ONLY
£2.45
EACH

Code	Base	Each	5+
C	8 Pin	£2.58	£2.45
	11 Pin	£3.47	£3.30

Plain Enclosure

- To suit lovato contactors & push buttons



FROM ONLY
£8.57
EACH

Code	Dimensions mm	Each	3+
767190	206 x 92 x 170	£9.39	£8.57
D	238 x 114 x 188	£15.66	£14.28

Start/Stop Enclosure

- To suit lovato contactors



FROM ONLY
£14.13
EACH

Code	Dimensions mm	Each	3+
261645	206 x 92 x 170	£15.49	£14.13
E	238 x 114 x 188	£21.53	£19.64

Auxiliary Contacts

- 10A



FROM ONLY
£4.73
EACH

Code	Contacts	Each	3+
924012	2 NC	£5.18	£4.73
A 276416	1NO + 1NC	£5.18	£4.73

Auxiliary Contacts

- 10A



FROM ONLY
£4.26
EACH

Code	Contacts	Each	3+
212689	2NC	£7.97	£7.27
B 675327	1NO + 1NC	£4.67	£4.26

Overload Relay

- Manual or automatic re-setting
- Direct mounting on BF09-BF38 contactors
- Frequency limit 0-400Hz

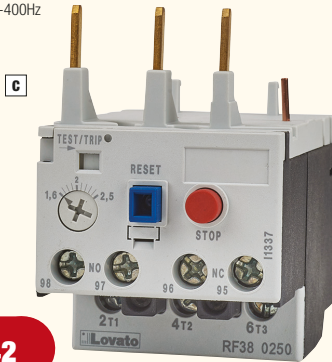

FROM ONLY
£20.42
EACH

Code	Amp Rating	Each	3+
256683	0.63 - 1.0	£22.39	£20.42
507444	1.0 - 1.6	£22.39	£20.42
C 607891	1.6 - 2.5	£22.39	£20.42
484640	2.5 - 4.0	£22.39	£20.42
492211	4.0 - 6.5	£22.39	£20.42
442375	6.5 - 10	£22.39	£20.42
789634	9 - 14	£22.39	£20.42
105265	13 - 18	£22.39	£20.42

Spare Coil

- AC spare coils for lovato contactors

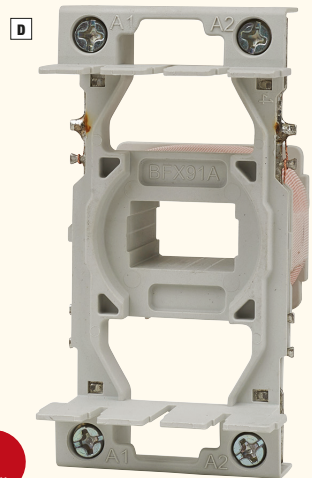

FROM ONLY
£6.94
EACH

Code	Voltage	Each	3+
D 439646	24V	£7.61	£6.94
920661	230V	£7.61	£6.94

Rotary Isolators

20A 4 Pole Isolator

- Padlockable
- Pre-moulded knockouts
- 415V rated

FROM ONLY
£14.37
EACH

A



Code	Each	3+
A 393532	£15.53	£14.37

25A 4 Pole Isolator

- Padlockable
- Pre-moulded knockouts
- 415V rated

FROM ONLY
£15.23
EACH

B



Code	Each	3+
B 850662	£16.46	£15.23

32A 3 Pole Isolator

- Padlockable
- Pre-moulded knockouts
- 415V rated

FROM ONLY
£13.87
EACH

C



Code	Each	3+
C 211563	£14.98	£13.87

32A 4 Pole Isolator

- Padlockable
- Pre-moulded knockouts
- 415V rated

FROM ONLY
£16.54
EACH

D



Code	Each	3+
D 705916	£17.86	£16.54

32A 6 Pole Isolator

- Padlockable
- Pre-moulded knockouts
- 415V rated

FROM ONLY
£17.32
EACH

E



Code	Each	3+
E 562091	£18.45	£17.32

40A 4 Pole Isolator

- Padlockable
- Pre-moulded knockouts
- 415V rated

FROM ONLY
£22.68
EACH

A



Code	Each	3+
A 307946	£24.50	£22.68

63A 4 Pole Isolator

- Padlockable
- Pre-moulded knockouts
- 415V rated

FROM ONLY
£30.40
EACH

B



Code	Each	3+
B 562049	£32.85	£30.40

80A 4 Pole Isolator

- Padlockable
- Pre-moulded knockouts
- 415V rated

FROM ONLY
£41.16
EACH

C



Code	Each	3+
C 226464	£44.47	£41.16

100A 4 Pole Isolator

- Padlockable
- Pre-moulded knockouts
- 415V rated

FROM ONLY
£49.27
EACH

D



Code	Each	3+
D 733320	£53.24	£49.27

100A C/Over Switch H410-71300-976H

- Manual mains to mains changeover switch

FROM ONLY
£130.55
EACH

E



Code	Each	3+
E 360401	£141.07	£130.55



NEXT DAY DELIVERY!

WHEN YOU ORDER BY 6PM

24 Hour Fused Spur Timeswitch

- Digital Display
- For use with immersion heaters up to 3kw
- 4 On & Off programmes
- Optional 1 or 2 hour boost

SEE
PAGE
150

Order Code: 780389

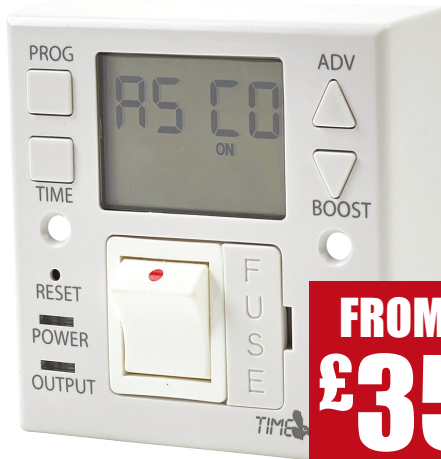

TIME GUARD
A thebelfi Group Company

FROM ONLY
£35.90
EACH
WHEN YOU BUY 3+

NEW PRODUCTS ADDED DAILY TO OUR WEBSITE

FREEPHONE: 8AM-6PM, 7 DAYS A WEEK
0808 168 22 77

ONLINE: SHOP 24/7
ElectricalDirect.co.uk

BUILDING CONTROLS & HOME ELECTRICS

<u>Central Heating & Timers</u>	<u>150-151</u>
<u>PIR Occupancy Control</u>	<u>152-157</u>
<u>Remote Wi-Fi Home Control</u>	<u>158-159</u>
<u>Time Fused Spurs / Time Lag Switches</u>	<u>160-161</u>



SEE
PAGE
160



SEE
PAGE
151



SEE
PAGE
158



SEE
PAGE
150

Central Heating & Timers

3G Remote Lighting Kit

- This kit allows you to control up to 3 separate outdoor electrical products independently, with a maximum load of 400W per channel
- Showerproof to IP55 (lid closed)
- Range 30 metres (Open Field Distance)
- Max Load: 3 x 400W
- Home Easy compatible



FROM ONLY
£45.46
EACH

Code	Each	5+
A 321680	£47.85	£45.46

4 Channel Wise Box Kit

- Wireless switching system complete with all the components required to achieve wireless lighting controls
- Complete with key fob & wall switch
- Includes receiver with 4 x 10A circuits (with a maximum ampage of 20A)
- Detection range: 200m
- IP54 rated
- The wise box connector will control lights, water features, electric shutters & gates

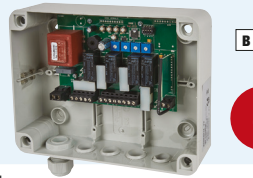

FROM ONLY
£115.90
EACH

Code	Each	3+
B 248954	£122.00	£115.90

24 Hour Fused Spur

- Up to 4 ON and OFF programmes available
- Permanent OFF and timed outputs available
- LED's up to 200W
- Energy saving

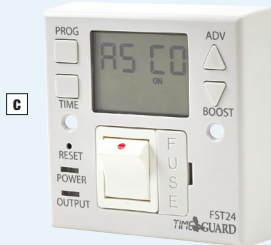

FROM ONLY
£35.90
EACH

Code	Each	3+
C 780389	£37.80	£35.90

24 Hour Time Switch

- 24 hour dial with a minimum setting of 30 minutes
- Voltage rating 220-240V
- AC 50Hz



FROM ONLY
£60.24
EACH

Code	Each	5+
D 660472	£63.71	£60.24

Digital Time Switch

- 240V
- 50-60Hz



FROM ONLY
£93.43
EACH

Code	Each	5+
E 799893	£98.82	£93.43

DIN Rail Timer



FROM ONLY
£14.25
EACH

Code	Each	5+
F 797645	£15.00	£14.25

Economy 7 Timeclock

HÖSTMANN

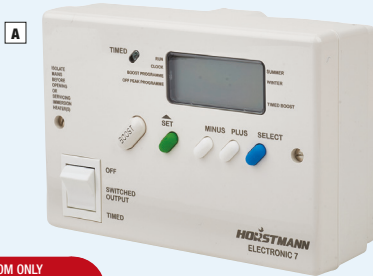

FROM ONLY
£55.63
EACH

Code	Each	5+
A 564403	£58.56	£55.63

Fused Timer Spur

B



FROM ONLY
£26.36
EACH

Code	Each	5+
B 875917	£27.75	£26.36

Time Lag 400

- Replaces existing single wall switch
- Automatically turns off lighting after a set period of time
- Adjustable from 10 seconds to 10 minutes

elkay

C



FROM ONLY
£16.25
EACH

Code	Each	5+
C 733657	£17.10	£16.25

IP66 External Time Lag Switch

- Delay function adjustable from 2 seconds to 2 hours
- ABS construction

DANLERS
Controls for Lighting & HVAC

D



FROM ONLY
£25.60
EACH

Code	Each	5+
D 635753	£26.95	£25.60

**FREE
NEXT DAY
DELIVERY**



ON
ORDERS
OVER
£45*

*Excl. VAT. £5.95 on orders under £45.

PIR & Occupancy Control

NEW

Disabled Persons Toilet Alarm Kit

- BS8300:3001 compliant
- Integral power supply with monitored rechargeable batteries
- High visibility LED indicators
- High output audible sounder
- Flush mounted Pull For Assistance cord reassurance LED
- Overdoor indicator lamp with sounder

FROM ONLY
£57.50
EACH



A



Code
A 110114

Each 5+
£61.50 £57.50

Contract Disabled Toilet Alarm

B



FROM ONLY
£41.80
EACH

Code Each 3+
B 809697 £43.90 £41.80

Disabled Toilet Alarm

C



FROM ONLY
£56.40
EACH

Code Each 3+
C 403101 £59.35 £56.40



EXCEPTIONAL QUALITY AND RELIABILITY

Logic Plus wiring devices are quick and easy to install and complement modern interiors, offering an unobtrusive and sophisticated look.

**13A 2 Gang
Double Pole
Switch Socket
- White**

**FROM ONLY
£3.31
EACH**
WHEN YOU BUY 5+



Order Code: 389090

**10A 1
Gang 2
Way Single
Pole Plate
Switch
- White**



**FROM ONLY
£1.25
EACH**
WHEN YOU BUY 5+

Order
Code:
653827

**10A 2
Gang 2
Way Single
Pole Plate
Switch
- White**



**FROM ONLY
£2.16
EACH**
WHEN YOU BUY 5+

Order
Code:
924359

**13A 1
Gang
Double
Pole Switch
Socket
- White**



**FROM ONLY
£1.83
EACH**
WHEN YOU BUY 5+

Order
Code:
195755



NEXT DAY DELIVERY!

WHEN YOU ORDER BY 6PM

**PLUS
IT'S FREE**
WHEN YOU SPEND
OVER £45
(EX VAT)



**ORDER UP TO
7 DAYS IN ADVANCE**

**PICK A
DELIVERY DAY
THAT SUITS YOU!**

154

FREEPHONE: 8AM-6PM, 7 DAYS A WEEK
0808 168 22 77



ONLINE: SHOP 24/7

ElectricalDirect.co.uk

Remote Control IR/RC

- Suitable for use with BEG Luxomat RC-Plus next range

B.E.G. LUXOMAT®



FROM ONLY
£10.16
EACH

Code	Description	Each	5+
254579	IR/RC Mini	£10.69	£10.16
A 166028	IR/RC Plus	£14.30	£13.59

Flush Mounted PIR

CP electronics
intelligent energy control



FROM ONLY
£41.04
EACH

Code	Each	5+
B 137209	£43.20	£41.04

360° PIR



FROM ONLY
£14.16
EACH

Code	Type	Each	5+
C 577327	Surface	£14.90	£14.16
D 499717	Flush	£14.90	£14.16

360° Surface Mount PIR

TIME GUARD
A theben Group Company



FROM ONLY
£20.50
EACH

Code	Each	3+
E 959181	£21.60	£20.50

Photocell

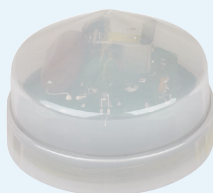

FROM ONLY
£9.17
EACH

Code	Description	Each	5+
237823	Complete with bracket	£10.75	£10.21
F 474697	Head only	£9.65	£9.17

1000W Photocell

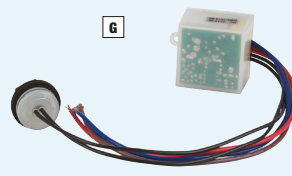

FROM ONLY
£8.82
EACH

Code	Description	Each	5+
977616	Wired	£9.80	£8.82
G 512994	Remote	£11.65	£10.49

PIR Occupancy Control

Ceiling Occupancy Switch

B.E.G. LUXOMAT®



FROM ONLY
£37.81
EACH

Code	Type	Each	5+
A	426603 Surface	£39.80	£37.81
B	776063 Flush	£39.80	£37.81
C	125252 Wallmount	£41.15	£39.09

Wall Mounted PIR - Black

- Suitable to switch LED

B.E.G. LUXOMAT®

D



FROM ONLY
£16.39
EACH

Code	Description	Each	5+
D	404808 140° angle	£17.46	£16.39
	999882 200° angle	£23.02	£21.95

Wall Mounted PIR - White

- Suitable to switch LED

B.E.G. LUXOMAT®

E



FROM ONLY
£16.39
EACH

Code	Description	Each	5+
	631328 140° angle	£17.46	£16.39
E	475387 200° angle	£23.02	£21.95

Wall Mounted 230° PIR's

- Suitable to switch LED

B.E.G. LUXOMAT®

F



FROM ONLY
£50.42
EACH

Code	Finish	Each	5+
F	838413 Black	£55.81	£50.42
	514428 White	£55.81	£50.42

150W Halogen Floodlight -140D - Black



FROM ONLY
£24.24
EACH

Code	Each	5+
A 630733	£26.93	£24.24

PD3 1 Channel

- Suitable to switch LED

B.E.G. LUXOMAT®



FROM ONLY
£33.29
EACH

Code	Description	Each	5+
B 877290	Flush	£35.89	£34.25
423192	Surface	£34.59	£33.29

180° External PIR



FROM ONLY
£10.98
EACH



Code	Colour	Each	5+
C 706649	Black	£12.35	£10.98
D 274463	White	£12.35	£10.98

270° PIR with Corner Bracket

FROM ONLY
£12.33
EACH



Code	Each	5+
E 708637	£12.98	£12.33

Remote Wi-Fi Home Control

A



3G Remote Lighting Kit

- This kit allows you to control up to 3 separate outdoor electrical products independently, with a maximum load of 400W per channel
- Showerproof to IP55 (lid closed)
- Range 30 metres (Open Field Distance)
- Max Load: 3 x 400W
- Home Easy compatible

FROM ONLY
£45.46
EACH

Code	Each	5+
A 321680	£47.85	£45.46

250W 1 Gang Dimmer

Lightwv^{RF}

B



C



FROM ONLY
£26.45
EACH

Code	Finish	Each	5+
B 538645	Stainless Steel	£27.50	£26.45
C 452132	White	£27.50	£26.45

Sockets

Lightwv^{RF}

D



E



FROM ONLY
£28.11
EACH

Code	Description	Each	5+
493156	1 Gang - Stainless Steel	£29.16	£28.11
D 287608	1 Gang - White	£29.16	£28.11
E 699304	2 Gang - Stainless Steel	£33.33	£32.28
417717	2 Gang - White	£33.33	£32.28

250W 2 Gang Dimmer

Lightwv^{RF}

F



G



FROM ONLY
£57.28
EACH

Code	Finish	Each	5+
F 981473	Stainless Steel	£58.33	£57.28
G 245413	White	£58.33	£57.28

Handheld Remote - Black

Lightwv^{RF}

H



FROM ONLY
£15.61
EACH

Code	Each	5+
H 697756	£16.66	£15.61

Remote Socket Kit

• Pack of 3

Lightw^{ve} RF



A

FROM ONLY
£26.45
EACH

Code	Each	5+
A 364375	£27.50	£26.45

Remote Magnetic Switch



B

FROM ONLY
£27.84
EACH

Code	Each	5+
B 329732	£28.84	£27.84

500W Relay

Lightw^{ve} RF

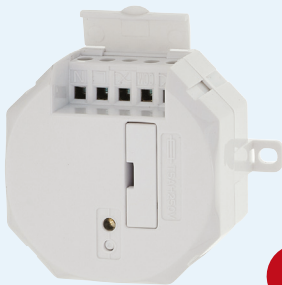

C

FROM ONLY
£32.60
EACH

Code	Each	5+
C 202135	£34.60	£32.60

RF Link

Lightw^{ve} RF



D

FROM ONLY
£73.95
EACH

Code	Each	5+
D 939032	£75.00	£73.95

1 Gang Remote Wall Switch

Lightw^{ve} RF

E



FROM ONLY
£24.16
EACH

Code	Each	5+
E 832330	£25.16	£24.16

**LOW
TRADE
PRICES**

ON
1000's
OF PRODUCTS



Time Fused Spurs / Time Lag Switches



Time lag switches available online

1 Pole 1 Throw 20A 4 Pole



FROM ONLY
£111.72
EACH

Code	Type	Each	3+
A 332625	Quartz	£127.04	£119.98
862789	Solar	£118.29	£111.72

Mounting Box

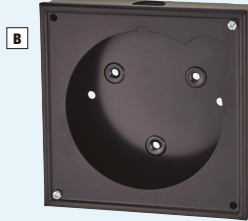

FROM ONLY
£8.49
EACH

Code	Each	3+
B 128401	£8.99	£8.49

Quartz 24 Hr



FROM ONLY
£93.52
EACH

Code	Description	Each	3+
C 448551	3 Pin	£99.02	£93.52
176582	4 Pin	£100.15	£94.59

Quartz Solar Dial



FROM ONLY
£115.75
EACH

Code	Description	Each	3+
713907	1 x On/Off	£122.56	£115.75
D 733734	2 x On/Off	£126.37	£119.35

Quartz Timer



FROM ONLY
£128.53
EACH

Code	Each	3+
E 893575	£136.09	£128.53

Synchronous 24 Hour Timer



FROM ONLY
£92.13
EACH

Code	Description	Each	3+
F 524406	2 x On/Off	£97.55	£92.13
371013	3 x On/Off	£99.96	£94.41

LOW TRADE PRICES

ON 1000'S OF PRODUCTS

Solardial Timeswitch 3P - Electro Mechanical



FROM ONLY
£106.48
EACH

Code	Each	3+
G 544528	£112.74	£106.48

HOT PRICES ON HAND DRYERS

EternaPro LED
Automatic Hand-Dryer



FROM ONLY £49.92 EACH
WHEN YOU BUY 5+

Order Code: 207215

WARNER HOWARD 1.9kW Hand Dryer



FROM ONLY £78.60 EACH
WHEN YOU BUY 5+

Order Code: 827501

Redring Xpelair 1.7kW Auto Hand Dryer



FROM ONLY £87.60 EACH
WHEN YOU BUY 5+

Order Code: 735481

airvent 1.1kW Compact Eco Hand Dryer



FROM ONLY £112.17 EACH
WHEN YOU BUY 5+

Order Code: 853874

WARNER HOWARD 2.5kW Handy-Dryer



FROM ONLY £184.54 EACH
WHEN YOU BUY 5+

Order Code: 534966

airvent 1.1kW Compact Eco Hand Dryer - Stainless Steel



FROM ONLY £117.39 EACH
WHEN YOU BUY 5+

Order Code: 674999

FOR FULL DETAILS SEE PAGE 194

FREEPHONE: 8AM-6PM, 7 DAYS A WEEK
0808 168 22 77

ONLINE: SHOP 24/7
ElectricalDirect.co.uk



NEXT DAY DELIVERY!

WHEN YOU ORDER BY 6PM

2m HDMI Cable

- 5m and 10m also available



FROM ONLY
£10.61
EACH

WHEN YOU BUY 5+

SEE
PAGE
164

Order Code: 496874

NEW PRODUCTS ADDED DAILY TO OUR WEBSITE

FREEPHONE: 8AM-6PM, 7 DAYS A WEEK
0808 168 22 77

ONLINE: SHOP 24/7
ElectricalDirect.co.uk

TV, TELEPHONE & NETWORK

TV & Satellite Accessories

164-165

Telephone & Data Accessories

166-167



SEE
PAGE
164



SEE
PAGE
165



SEE
PAGE
167

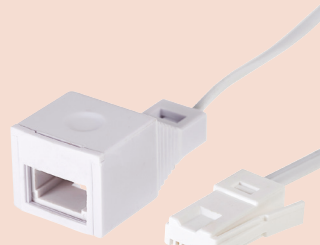

SEE
PAGE
166

TV & Satellite Accessories

TV & Satellite Outlet

- TV/SAT unscreened outlet plate flush outlet for TV and Satellite two cable in, two cable out
- Screw connections
- Size: 86 x 86 mm



FROM ONLY
£2.70
EACH

Code	Each	5+
A 586999	£3.24	£2.70

Satellite Outlet

- Designed to install satellite, cable or sky cables into a convenient fixed position
- Size: 86 x 86 mm
- Depth: 35mm



FROM ONLY
£2.18
EACH

Code	Each	5+
B 843957	£2.64	£2.18

TV/Sat/FM-DAB with Uplink and BT



FROM ONLY
£7.35
EACH

Code	Each	5+
C 611032	£8.40	£7.35

Screened Quadplexed Outlet

- SAT1, SAT2, TV, FM/DAB return & telephone outlets
- Requires 35mm mounting box



FROM ONLY
£11.31
EACH

Code	Each	5+
D 694175	£11.90	£11.31

1 Gang Satellite TV Outlet F Type

- 1 grid space
- TV F-type satellite socket for use with male F-connection plugs
- Height: 50mm
- Width: 25mm
- Depth: 15mm
- Required back box depth: 25mm

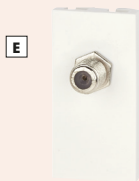

FROM ONLY
£1.95
EACH

Code	Each	5+
E 695994	£2.05	£1.95

Coaxial Surface Point

- Sleek & slim design with softly rounded edges
- Single TV socket connection
- Size: 86 x 86 mm



FROM ONLY
£1.85
EACH

Code	Each	5+
F 812884	£1.95	£1.85

Coaxial Plug

- Gender or splicer adapter for TV antenna connector
- Based on connector diameter of 9.52mm



FROM ONLY
33P
EACH

Code	Type	Each	5+
863667	Male	£0.35	£0.33
G 869958	Female	£0.66	£0.63

Coaxial Splitter

- Compatible with antenna cable/equipment
- Suitable for joining two leads or converting a coaxial plug to a socket



FROM ONLY
51P
EACH

Code	Each	5+
H 452971	£0.54	£0.51

TV/FM Coaxial Fly Lead

- Connects an aerial outlet to TV/VCR/SAT equipment



FROM ONLY
£1.16
EACH

Code	Length m	Each	5+
I 431333	1	£1.22	£1.16
491216	2	£1.22	£1.16

2 Gang Coaxial Y Coupler

- Combine 2 TV aerials into 1 lead or use to split 1 lead into 2 outlets



FROM ONLY
£3.20
EACH

Code	Each	5+
K 423682	£3.37	£3.20

1.5m Scart Lead

- RGB compatible
- Enhanced screening
- Strain relief connector
- High quality coaxial cables
- Length 1.5m



FROM ONLY
£4.70
EACH

Code	Each	5+
J 757161	£4.95	£4.70

HDMI Cable

- Integrated ethernet channel
- Supports DTS-HD master audio



FROM ONLY
£10.61
EACH

Code	Length m	Each	5+
L 496874	2	£11.17	£10.61
442044	5	£13.55	£12.87
157691	10	£21.89	£20.80

Satellite Plug

- Ideal for making satellite connections
- F plug to F plug
- F type cable

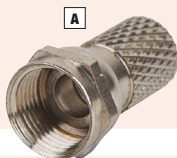

FROM ONLY
60P
EACH

Code	Each	5+
A 587108	£0.63	£0.60

Satellite Coupler

- Joins two leads with F type plugs fitted



FROM ONLY
62P
EACH

Code	Each	5+
B 292080	£0.65	£0.62

Satellite Splitter

- Feed two satellite receivers from a single LNB
- Frequency range of 5Mhz - 2400Mhz
- Screw terminals for earthing



FROM ONLY
£3.23
EACH

Code	Wattage	Each	5+
C 707740	2W - 2 Way	£3.40	£3.23
180818	4W - 3 Way	£4.84	£4.60

Satellite Finder

- Has two F-type female connectors (1 x In to 1 x Out)



FROM ONLY
£11.28
EACH

Code	Each	5+
D 128210	£11.87	£11.28

Outlet Amplifier

- 1 coaxial output
- For use with digital terrestrial, DAB, VHF & most satellite receivers, VHF & FM signals
- Key slot mounting holes



FROM ONLY
£8.88
EACH

Code	No. Outlets	Each	3+
956617	1	£9.35	£8.88
878284	2	£10.30	£9.79
E 923282	4	£14.90	£14.16
316336	6	£28.00	£26.60
483966	8	£34.60	£32.87

Link Eye For Digital Satellite

- Allows control over Sky box from second location
- 1m cable



FROM ONLY
£5.61
EACH

Code	Each	5+
F 778185	£5.90	£5.61

LCD TV Bracket

- For 13-32" screens
- Full motion wall mount
- Up to 90° swivel action depending on size of TV
- VESA size from 75 x 75mm to 200 x 200mm
- VESA 75, 100, 200 max compatible

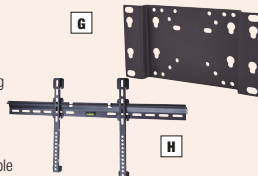

FROM ONLY
£13.07
EACH

Code	Size Inches	Each	3+
G 190968	32	£13.76	£13.07
H 735309	65	£36.34	£34.52

Chimney Lashing Kit

- Aerial bracket used when bracket is fixed to a chimney

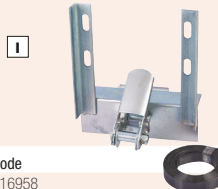

FROM ONLY
£9.69
EACH

Code	Each	3+
I 416958	£10.20	£9.69

1 Gang Knockout Box - Galvanised

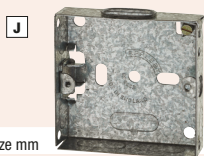

FROM ONLY
30P
EACH

Code	Size mm	Each	10+
J 154512	16	£0.34	£0.30
571586	25	£0.39	£0.36

2 Gang Knockout Box - Galvanised

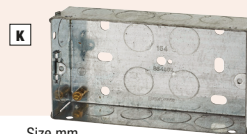

FROM ONLY
38P
EACH

Code	Size mm	Each	5+
805569	25	£0.43	£0.38
K 379744	35	£0.58	£0.53
834730	47	£1.19	£1.04

Telephone & Data Accessories

Surface Telephone Outlet Master

- For use as the first socket-outlet on a direct exchange line or PABX line
- Contains surge protectors



FROM ONLY
£2.99
EACH

Code	Each	5+
A 149123	£3.15	£2.99

Telephone Outlet Slave

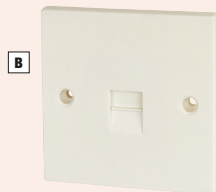

FROM ONLY
£1.89
EACH

Code	Each	5+
B 784656	£1.99	£1.89

Twin Surface Extension Socket Box

- Surface moulded
- Twin gang
- Voltage rating 220-240V



FROM ONLY
£1.77
EACH

Code	Each	5+
C 729768	£1.86	£1.77

Telephone Triple Adaptor

- 3 x socket

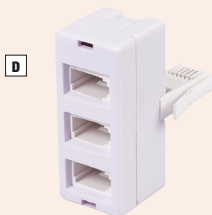

FROM ONLY
90P
EACH

Code	Type	Each	5+
D 596742	Triple	£2.98	£2.83
497059	Twin	£0.99	£0.90

Telephone Junction Box

- Grey plastic construction with a smooth face

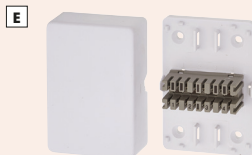

FROM ONLY
£1.85
EACH

Code	Each	5+
E 894058	£1.95	£1.85

Extension Lead - Telephone

- Telephone type plug to telephone type socket
- Plugs into an existing telephone socket



FROM ONLY
£2.28
EACH

Code	Length m	Each	5+
187090	5	£2.40	£2.28
751919	10	£2.85	£2.71
F 836233	15	£3.62	£3.44

Telephone DC Plastic Tool



FROM ONLY
34P
EACH

Code	Each	5+
G 186533	£0.36	£0.34

Telephone Jelly Filled Crimp

- Self stripping designed to be used for either 2 or 3 cables



FROM ONLY
14P
EACH

Code	Each	10+
H 304641	£0.21	£0.14

Cat 5 RJ45 Telephone Adaptor

- Adapts an RJ45 modular socket to telephone outlet
- 15cm tail cable prevents the adaptor protruding from the existing socket



FROM ONLY
£1.95
EACH

Code	Type	Each	5+
I 946975	Adaptor	£2.25	£1.95
485824	Outlet	£2.98	£2.45

Module Frames

- Front loading frame
- Grid frame has large earth terminal

A



FROM ONLY
45P
EACH

Code	Type	Each	5+
A 892703	2 Module	£0.50	£0.45
606813	4 Module	£0.85	£0.78

Cat 5 Telephone Outlet

B



FROM ONLY
£2.45
EACH

Code	Type	Each	5+
B 433477	Master	£2.98	£2.45
378185	Slave	£2.98	£2.45

1 Gang Satellite TV Outlet F Type

- 1 grid space
- TV F-type satellite socket for use with male F-connection plugs
- Height: 50mm
- Width: 25mm
- Depth: 15mm
- Required back box depth: 25mm

C



FROM ONLY
£1.95
EACH

Code	Each	5+
C 695994	£2.05	£1.95

White Brush Plates

- Size: 25 x50mm
- Ideal for passing cables through a wall to keep the outlet looking clean and tidy

D



FROM ONLY
£2.61
EACH

Code	Type	Each	5+
D 912192	1 Gang	£2.75	£2.61
105740	2 Gang	£4.00	£3.80

RJ45 Outlet

E



FROM ONLY
£2.45
EACH

Code	Each	5+
E 361124	£2.98	£2.45

Cat 5 Floor Box Blank

F



FROM ONLY
49P
EACH

Code	Each	5+
F 493967	£0.59	£0.49

Cat 5 Telephone 42461 Module Blank

G



FROM ONLY
15P
EACH

Code	Each	5+
G 990622	£0.17	£0.15

Cat 5 Management Bar

H



FROM ONLY
£4.25
EACH

Code	Each	5+
H 699191	£4.79	£4.25

Cat 5 Patch Panel

- Certified 350Mhz CAT 5e for copper ethernet

I



FROM ONLY
£33.68
EACH

Code	Type	Each	5+
985406	16 Way	£38.73	£33.68
367659	32 Way	£65.80	£58.95
I 316993	48 Way	£90.05	£78.30

5m Cat 5 Patch Lead - Red

- Unshielded twisted pair (UTP)

J



FROM ONLY
£1.75
EACH

Code	Each	5+
J 320148	£1.98	£1.75



NEXT DAY DELIVERY!

WHEN YOU ORDER BY 6PM

TOP BRAND

MANROSE
Quality Ventilation
Manufacturers of Ventilation Fans and Equipment

**100mm
4" Fan with
Timer**

- Axial fan with overrun timer
- Extracts up to 22L per second

Order Code: 748685



SEE
PAGE
172

FROM ONLY
£13.10
EACH
WHEN YOU BUY 5+

NEW PRODUCTS ADDED DAILY TO OUR WEBSITE

FREEPHONE: 8AM-6PM, 7 DAYS A WEEK
0808 168 22 77

ONLINE: SHOP 24/7
ElectricalDirect.co.uk

HEATING & VENTILATION

<u>Extractor Fans</u>	<u>170-177</u>
<u>Electric Radiators</u>	<u>178-179</u>
<u>Tubular Heaters</u>	<u>180</u>
<u>Heaters</u>	<u>181</u>
<u>Panel Heaters</u>	<u>182-185</u>
<u>Ducting</u>	<u>186-187</u>
<u>Ducting Accessories</u>	<u>188-193</u>
<u>Hand Dryers</u>	<u>194</u>
<u>Showers</u>	<u>195</u>



SEE
PAGE
194

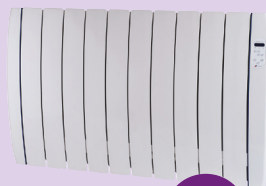

SEE
PAGE
182



SEE
PAGE
180

Extractor Fans

4 Inch Standard Fan

- Basic on/off operation



A

FROM ONLY
£9.42
EACH

Code	Each	5+
A 637647	£10.43	£9.42

4 Inch Fan & Pullcord

- Axial fan operated via pullcord



B

FROM ONLY
£10.84
EACH

Code	Each	5+
B 421453	£11.29	£10.84

4 Inch Fan & 12V Transformer

- Standard on/off operation



C

FROM ONLY
£26.88
EACH

Code	Each	5+
C 989703	£28.00	£26.88

NEW
PRODUCTS
ADDED
DAILY



Visit ElectricalDirect.co.uk

9 Inch Window & Wall Fan

- Pullcord operated
- 153 litres per second



A

FROM ONLY
£103.27
EACH

Code	Each	5+
A 698515	£112.66	£103.27

6 Inch Window & Wall Fan

- Pullcord operated
- 74 litres per second



B

FROM ONLY
£43.00
EACH

Code	Each	5+
B 723074	£46.91	£43.00

Single Fan Controller

- Suitable for GX, WX and PX fans



C

FROM ONLY
£45.51
EACH

Code	Each	5+
C 469011	£51.58	£45.51

4 Inch Toilet/Bathroom Timer Fan



D

FROM ONLY
£54.20
EACH

Code	Each	5+
D 376072	£57.00	£54.20

Extractor Fans

4 Inch Fan & Timer

- Axial fan operated via overrun timer
- Extracts up to 22L per second

MANROSE
Quality Ventilation



FROM ONLY
£13.10
EACH

Code	Each	5+
A 748685	£13.80	£13.10

4 Inch Centrifugal Fan

- Extracts up to 25L per second
- Complete with backdraught shutters

MANROSE
Quality Ventilation



FROM ONLY
£31.48
EACH

Code	Type	Size	Each	5+
B 305219	Pullicord	65 x 90	£32.79	£31.48
265969	Pullicord	185 x 260	£38.19	£36.66
298048	Pullicord	265 x 350	£110.75	£106.32
941997	Timer	65 x 90	£38.19	£36.66
297173	Timer	185 x 260	£43.58	£41.84
628583	Timer	265 x 350	£115.89	£111.25
166961	Humidistat	66 x 90	£71.19	£68.34
435351	Humidistat	185 x 260	£76.85	£73.77
274142	Humidistat	265 x 350	£144.24	£138.47

4 Inch Flat Fan

- Low profile design
- Extracts up to 26L per second

MANROSE
Quality Ventilation

FROM ONLY
£14.59
EACH



Code	Type	Each	5+
978856	Without Timer	£15.20	£14.59
C 935920	With Timer	£19.65	£18.86

4 Inch Quiet Fan & Timer

- 60°+ quieter
- Timer overrun
- Extracts up to 22L per second

MANROSE
Quality Ventilation

FROM ONLY
£29.61
EACH



Code	Each	5+
D 969546	£30.99	£29.61

4 Inch Standard Quiet Fan

- 60% quieter
- 21 litres per second

MANROSE
Quality Ventilation

FROM ONLY
£22.98
EACH



Code	Each	5+
E 406931	£24.05	£22.98

4 Inch 12V Standard Fan

- Suitable for wall or ceiling mounting
- Simple on/off operation

MANROSE
Quality Ventilation

FROM ONLY
£18.02
EACH



Code	Each	5+
F 367099	£18.86	£18.02

4 Inch Fan & Humidistat

- Axial fan
- Extracts up to 21L per second

MANROSE
Quality Ventilation

FROM ONLY
£52.57
EACH



Code	Each	5+
G 171319	£55.01	£52.57

4 Inch Fan & PIR

- Axial fan operated with motion detector
- Extracts up to 22L per second

MANROSE
Quality Ventilation

FROM ONLY
£55.02
EACH



Code	Each	5+
H 918707	£57.58	£55.02

4 Inch Showerlite Bathroom Kit & Timer

- Chrome finish
- 20 litres per second
- 12V



FROM ONLY
£41.71
EACH

Code	Each	5+
A 212155	£43.45	£41.71

4 Inch Inline Fan & Timer

- Includes indoor & outdoor grille, 3m flexiduct and timer fan



FROM ONLY
£23.68
EACH

Code	Each	5+
B 563302	£24.67	£23.68

4 Inch Standard Inline Fan

- Includes internal and external grilles, 3m flexiduct & standard fan



FROM ONLY
£20.26
EACH

Code	Each	5+
C 686218	£21.10	£20.26

Extractor Fans



A

4 Inch Duct Timer Fan

- Extracts up to 31L per second

MANROSE
Quality Ventilation

FROM ONLY
£42.10
EACH

Code	Each	5+
A 457906	£43.86	£42.10

4 Inch Timer Fan Auto Shut

- Automatic back draught shutters
- 23 litres per second

MANROSE
Quality Ventilation

B



FROM ONLY
£41.97
EACH

Code	Each	5+
B 377596	£43.92	£41.97

6 Inch Humidity Controlled Wall Fan

- 64 litres per second

MANROSE
Quality Ventilation

C



FROM ONLY
£71.11
EACH

Code	Each	5+
C 724985	£74.42	£71.11

4 Inch Chrome Fan Cover

- Suitable for XF100 range fans

MANROSE
Quality Ventilation

D



FROM ONLY
£10.58
EACH

Code	Each	5+
D 316352	£11.03	£10.58

4 Inch Centrifugal Standard Fan

- Extracts up to 31L per second
- For use with longer lengths of ductings

MANROSE
Quality Ventilation

E



FROM ONLY
£33.77
EACH

Code	Each	5+
E 179726	£35.18	£33.77

4 Inch 12V Standard Fan

MANROSE
Quality Verification

- Suitable for wall or ceiling mounting
- Simple on/off operation

A



FROM ONLY
£18.02
EACH

Code	Each	5+
A 367099	£18.86	£18.02

12V Timer Transformer

MANROSE
Quality Verification

- For use with 12V Manrose fans

B



FROM ONLY
£30.65
EACH

Code	Each	5+
B 806419	£32.08	£30.65

12V Humidity Transformer

MANROSE
Quality Verification

- For use with 12V Manrose fans

C



FROM ONLY
£62.84
EACH

Code	Each	5+
C 701769	£65.76	£62.84

4 Inch Low Profile Fan

- Auto opening shutters
- Aesthetically pleasing design
- Extracts up to 19L per second

D



FROM ONLY
£37.15
EACH

Code	Each	5+
D 914320	£40.01	£37.15

4 Inch Low Profile Centrifugal

- Auto opening shutters
- Aesthetically pleasing design
- Extracts up to 32L per second

E



FROM ONLY
£73.01
EACH

Code	Each	5+
E 572168	£78.62	£73.01

Adjustable Timer Module

AIRFLOW

- Compatible with Airflow Icon fans

F



FROM ONLY
£11.31
EACH

Code	Each	5+
F 398325	£12.18	£11.31

Pull Cord Module

AIRFLOW

- Module compatible with Airflow Icon Fans

G



FROM ONLY
£9.57
EACH

Code	Each	5+
G 337167	£10.30	£9.57

Humidistat, Pull Cord & Timer Module

AIRFLOW

- Module compatible with Airflow Icon fans

H



FROM ONLY
£24.12
EACH

Code	Each	5+
H 460059	£25.98	£24.12

Extractor Fans

4 Inch Select 100 Axial Bathroom Fan

- 20 litres per second



A



FROM ONLY
£14.87
EACH

Code	Each	5+
A 307847	£16.07	£14.87

4 Inch Select 100 Axial Bathroom Fan with Timer

- 20 litres per second



B



FROM ONLY
£22.10
EACH

Code	Each	5+
B 642270	£23.89	£22.10

4 Inch Centrifugal Recessed Fan

- Includes pullcord
- 22 litres per second



C



FROM ONLY
£30.63
EACH

Code	Each	5+
C 756792	£33.12	£30.63

4 Inch Centrifugal & Timer

- Discreet design
- Back draught shutters
- 31 litres per second



D



FROM ONLY
£38.53
EACH

Code	Each	5+
D 226316	£41.66	£38.53

4 Inch Centrifugal Humidistat

- Extracts up to 23L per second



E



FROM ONLY
£87.63
EACH

Code	Each	5+
E 980232	£94.74	£87.63

4 Inch Centrifugal Surface Fan

- Includes pullcord
- 22 litres per second



F



FROM ONLY
£30.63
EACH

Code	Each	5+
F 330950	£33.11	£30.63

4 Inch Centrifugal Humidistat & Timer Fan

- 22 litres per second



G



FROM ONLY
£87.63
EACH

Code	Each	5+
G 365829	£94.74	£87.63

4 Inch Fan, Humidistat & Pull Cord

- 20 litres per second



A

FROM ONLY
£55.22
EACH

Code	Each	5+
A 233159	£59.70	£55.22

12V 4 Inch Low Voltage with Timer & Pull Cord

- 20 litres per second



B

FROM ONLY
£52.75
EACH

Code	Each	5+
B 290562	£57.02	£52.75

6 Inch Kitchen Fan & Pull Cord

- On/Off operation
- Back draught shutters



C

FROM ONLY
£30.79
EACH

Code	Each	5+
C 211983	£33.29	£30.79

6 Inch Dual Humidistat, Timer & Pull Cord

- 71 litres per second



D

FROM ONLY
£68.14
EACH

Code	Each	5+
D 300117	£73.66	£68.14

4 Inch Low Voltage Fan & Timer & Pull Cord

- 20 litres per second
- 12V



E

FROM ONLY
£81.98
EACH

Code	Each	5+
E 622319	£88.63	£81.98

4 Inch Window/Wall Fan & Pull Cord

- 20 litres per second



F

FROM ONLY
£14.87
EACH

Code	Each	5+
F 165710	£16.07	£14.87

MAKING HEATING CALCULATIONS

Not sure which size radiators you need?

Measure the room. You will need to know the length and width of the room as well as the height of the ceiling in metres.



Recommended performance table (Watts per square metre)

Facade orientation	Not insulated		Normal insulation	
	North	South	North	South
CLIMATE ZONE				
Zone A	100	95	90	80
Zone B	105	100	95	85
Zone C	110	105	100	90
Zone D	115	110	105	95

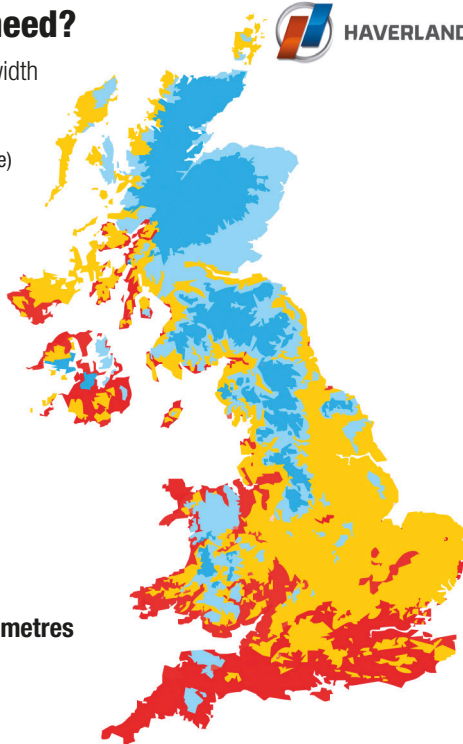

For rooms with ceilings heights up to 3 metres

Example: 5 metres x 3 metres = 15 square metres

Total sq m = 15 sq m x 100 watts = 1500 watts

Recommendation: 1 x RC12 TT = 1500 watts

For rooms with ceiling heights from 3 metres to 3.5 metres

Example: 6 metres x 5 metres = 30 square metres

Ceiling height: 3.5 metres ÷ 3 = 1.16

Multiply 30 sq m x 1.16 = 34.80 cubic metres

Total cubic metres = 34.80 sq m x 100 watts = 3,480 watts

Recommendation: 2 x RC12 Compact TTi @ 1800 watts each = 3600 watts

For rooms with ceiling height of 4 metres and above contact Haverland UK for calculation details.

Up to 3m height			3m to 3.5m height		
Model	Watts	Max sq.m room	Model	Watts	Max sq.m room
RC 4 TT	500	5	RC 4 TT	500	4.31
RC 6 TT	750	7.5	RC 6 TT	750	6.47
RC 8 TT	1000	10	RC 8 TT	1000	8.62
RC 10 TT	1250	12.5	RC 10 TT	1250	10.78
RC 12 TT	1500	15	RC 12 TT	1500	12.93
RC 8 Compact TTi	1000	10	RC 8 Compact TTi	1000	8.62
RC 10 Compact TTi	1500	15	RC 10 Compact TTi	1500	12.93
RC 12 Compact TTi	1800	18	RC 12 Compact TTi	1800	17.24

These calculations should be considered as average depending on location, orientation and insulation.

500W 4 Element

- Size: 447 x 580 x 100mm (W x H x D)
- 'State-of-the-art' energy management
- High precision, electronic chrono-thermostatic control
- Weight: 11kg



G



FROM ONLY
£181.25
EACH

Code	Each	5+
G 842332	£184.95	£181.25

750W 6 Element

- Size: 606 x 580 x 100mm (W x H x D)
- 'State-of-the-art' energy management
- High precision, electronic chrono-thermostatic control
- Weight: 68kg



H



FROM ONLY
£204.00
EACH

Code	Each	5+
H 285501	£209.00	£204.00

1000W 8 Element

- Size: 765 x 580 x 100mm (W x H x D)
- 'State-of-the-art' energy management
- High precision, electronic chrono-thermostatic control
- Weight: 19kg



I

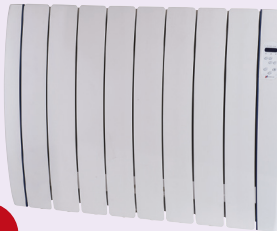

FROM ONLY
£239.02
EACH

Code	Each	5+
I 658258	£243.90	£239.02

1250W 10 Element

- Size: 924 x 580 x 100mm (W x H x D)
- 'State-of-the-art' energy management
- High precision, electronic chrono-thermostatic control
- Weight: 23kg



D

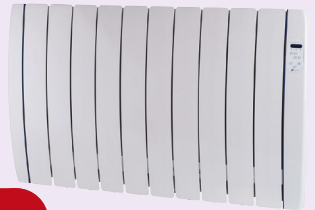

FROM ONLY
£272.45
EACH

Code	Each	5+
D 640896	£278.01	£272.45

1500W 12 Element

- Size: 1083 x 580 x 100mm (W x H x D)
- 'State-of-the-art' energy management
- High precision, electronic chrono-thermostatic control
- Weight: 27kg



E

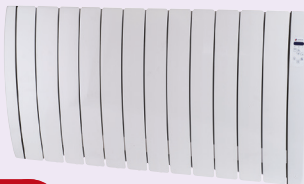

FROM ONLY
£307.38
EACH

Code	Each	5+
E 346288	£313.65	£307.38

1800W 14 Element

- Size: 1242 x 580 x 100mm (W x H x D)
- Partitioned heating systems for less frequented areas
- Weight: 31kg



F

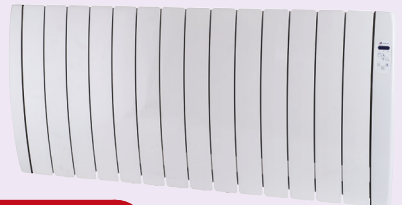

FROM ONLY
£350.33
EACH

Code	Each	5+
F 798785	£357.48	£350.33

Tubular Heaters

45W 1ft Tubular Heater

- Thermal cutout

A



FROM ONLY
£11.50
EACH

Code	Each	5+
A 484313	£12.90	£11.50

80W 2ft Tubular Heater

- Thermal cutout

B



FROM ONLY
£15.68
EACH

Code	Each	5+
B 225948	£16.20	£15.68

135W 3ft Tubular Heater

- Thermal cutout

C



FROM ONLY
£17.40
EACH

Code	Each	5+
C 968571	£18.02	£17.40

1ft Tubular Heater Guard

D

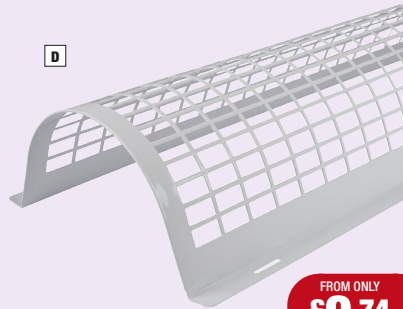

FROM ONLY
£9.74
EACH

Code	Each	5+
D 267433	£10.15	£9.74

2ft Tubular Heater Guard

E

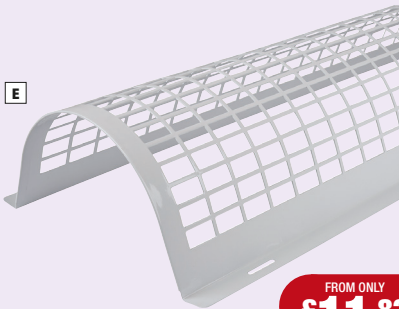

FROM ONLY
£11.82
EACH

Code	Each	5+
E 778785	£12.31	£11.82

3ft Tubular Heater Guard

F



FROM ONLY
£15.89
EACH

Code	Each	5+
F 452618	£16.55	£15.89

2kW Convector Heater - Slimline

- Sleek design
- Thermostatically controlled



FROM ONLY
£25.87
EACH

Code	Each	5+
A 442210	£26.95	£25.87

2kW Convector Heater with Turbo

- Floor standing or wall mounted
- Thermostatically controlled



FROM ONLY
£24.98
EACH

Code	Each	5+
B 647676	£26.02	£24.98

2kW Upright Fan Heater

- Floor standing
- Thermostatically controlled



FROM ONLY
£12.14
EACH

Code	Each	5+
C 754950	£12.65	£12.14

400W Frost Watch

- Wall mounted
- Thermostatically controlled
- IP20 protection



FROM ONLY
£21.79
EACH

Code	Each	5+
D 934658	£22.70	£21.79

Dimplex 2kW Fan Heater - White



- 2kW maximum output
- 2kW or 1kW output selectable on installation
- Pull cord operation
- Neon indicator
- Energy-saving thermostat switches output down to 1kW once the room is warm



FROM ONLY
£33.56
EACH

Code	Each	5+
E 818881	£34.87	£33.56

NEW
PRODUCTS
ADDED
DAILY



Visit ElectricalDirect.co.uk

Panel Heaters

1.5kW Panel Heater

- Ideal for home or office fixed heating applications
- Aesthetically pleasing design

FROM ONLY
£52.00
EACH



A



Code	Height mm	Depth mm	Width mm	Each	5+
A 725841	440	98	700	£56.00	£52.00

2kW Panel Heater

- Ideal for home or office fixed heating applications
- Aesthetically pleasing design

FROM ONLY
£53.00
EACH



B



Code	Height mm	Depth mm	Width mm	Each	5+
B 746579	440	98	855	£59.00	£53.00

1.5kW Timer Panel Heater

- Ideal for home or office fixed heating applications
- Aesthetically pleasing design
- 7 day LCD electronic timer

FROM ONLY
£61.00
EACH



C



Code	Height mm	Depth mm	Width mm	Each	5+
C 575798	440	98	700	£65.00	£61.00



2kW Timer Panel Heater

- Ideal for home or office fixed heating applications
- Aesthetically pleasing design
- 7 day LCD electronic timer

FROM ONLY
£64.00 EACH



A

	Code	Height mm	Depth mm	Width mm	Each	5+
A	816891	440	98	855	£69.00	£64.00

2kW Plinth Heater Black

FROM ONLY
£51.21 EACH



B

	Code	Height mm	Depth mm	Width mm	Each	5+
B	174362	470	240	120	£52.25	£51.21

FREE NEXT DAY DELIVERY

*Excl. VAT. £5.95 on orders under £45.



ON
ORDERS
OVER
£45*

FREE RETURNS



MONEY
BACK
GUARANTEE

Panel Heaters

DC Dimplex

A



3kW Warm Air Curtain

- Designed for single doorways
- Simple on/off control

FROM ONLY
£125.17
EACH

Code	Each	5+
A 305757	£130.05	£125.17

B



3kW Warm Air Curtain

- Suitable for wall or ceiling mounting

FROM ONLY
£62.40
EACH

Code	Each	5+
B 978969	£65.00	£62.40

HYCO
Manufacturing Ltd

C



2kW Down Flow Heater

- IP21 rated
- Pullcord operated

FROM ONLY
£24.04
EACH

Code	Each	5+
C 418143	£25.52	£24.04

FOR THE TRADE

AT A LOW TRADE PRICE



HAVERLAND®

Electric Radiator

- Dimensions: 606 x 580 x 100mm
- High precision chrono-thermostatic control
- Digital programming
- 7 Heating schedules with 1 bespoke
- Weight: 68kg
- 750W
- 6 Element

Order Code:
285501

SEE
PAGE
179

FROM ONLY
£204.00
EACH
WHEN YOU BUY 5+

SEE OUR FULL
RANGE OF ELECTRIC
RADIATORS



SEE PAGE
178-179

FREEPHONE: 8AM-6PM, 7 DAYS A WEEK
0808 168 22 77

ONLINE: SHOP 24/7
ElectricalDirect.co.uk

Ducting

Flat Ducting - 200 x 25mm

- For use with the 225mm and 300mm flat Ducting systems



FROM ONLY
£14.62
EACH

Code	Width mm	Each	5+
A 371729	225	£16.25	£14.62
135417	300	£19.94	£17.95

Insulated Ducting - 10m

- 25mm thick flexible aluminium insulation sandwich
- 1/2D radius bends can be produced
- Storage space required is also kept to a minimum with a 10 metre length being compressed to 1160mm
- Temperature Range: 30°C to 120°C
- Outer Jacket - Scuff resistant reinforced Aluminium laminate fabric



FROM ONLY
£37.39
EACH

Code	Diameter mm	Each	5+
B 357199	100	£38.95	£37.39

Flexiducting - PVC

- Lightweight, reinforced with hardened steel wire spirally wound
- Ideal for extractor fans or tumble dryers



FROM ONLY
£3.90
EACH

Code	Type	Diameter mm	Length m	Each	5+
206898	4 inch	100	3	£4.78	£3.90
C 746722	4 inch	100	6	£8.90	£7.25
D 951193	4 inch	100	15	£14.80	£14.21
327044	5 inch	125	3	£6.27	£6.02
276097	6 inch	150	3	£6.40	£5.20
748387	Rectangular			£10.10	£9.70

Solid Ducting - PVC - 2000 x 100mm

- Quick and easy fit
- Lightweight
- Flame retardant
- Ideal for long duct runs where space is unrestricted
- Designed specifically for applications requiring lower extraction rates such as bathrooms, toilets and utility rooms



FROM ONLY
£15.40
EACH

Code	Each	5+
E 968980	£16.04	£15.40

NEW
PRODUCTS
ADDED
DAILY



Visit ElectricalDirect.co.uk

C240 Flat Ducting - 1500 x 110 x 54mm

- Concealed when installed along the top of wall units due to low profile
- Fitted into ceiling voids and cavity walls providing versatility whilst remaining unobtrusive



FROM ONLY
£3.92
EACH

Code	Each	5+
F 942763	£5.70	£3.92

Plenum 90° Adaptor 125mm Spigot

• Size: 204 x 60mm

MANROSE
Quality Verification

A



FROM ONLY
£3.20
EACH

Code	Each	5+
A 602082	£3.65	£3.20

Flat Tee - 204 x 60mm

MANROSE
Quality Verification

B

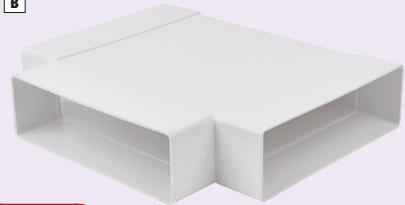

FROM ONLY
£6.36
EACH

Code	Each	5+
B 800054	£7.07	£6.36

45° Flat Bend - 204 x 60mm

MANROSE
Quality Verification

C



FROM ONLY
£3.58
EACH

Code	Each	5+
C 369326	£3.98	£3.58

Vertical Bend - 204 x 60mm

MANROSE
Quality Verification

D



FROM ONLY
£5.10
EACH

Code	Each	5+
D 256236	£6.24	£5.10

FREE NEXT DAY DELIVERY



On orders over £45* *Excl. VAT. £5.95 on orders under £45.

Connector - 204 x 60mm

MANROSE
Quality Verification

E



FROM ONLY
£3.33
EACH

Code	Each	5+
E 905626	£4.11	£3.33

Ducting Accessories

Round Connector - 225 x 25mm Straight To 100mm

MANROSE
Quality Verification



A

FROM ONLY
£4.65
EACH

Code	Each	5+
A 827659	£5.17	£4.65

Connector - 225 x 25mm

MANROSE
Quality Verification



B

FROM ONLY
£1.68
EACH

Code	Each	5+
B 953100	£1.94	£1.68

Flat Bend - 225 x 25mm

MANROSE
Quality Verification

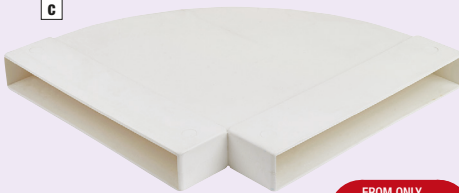

C

FROM ONLY
£4.35
EACH

Code	Each	5+
C 593718	£4.87	£4.35

Air Brick Adaptor & Grille

• Size: 225 x 25mm

MANROSE
Quality Verification



D

FROM ONLY
£6.53
EACH



E

Code	Colour	Each	5+
D 300470	Brown	£6.83	£6.53
E 437340	Sandstone	£6.83	£6.53
276841	Terracotta	£6.83	£6.53

Flat Duct Plenum - 225 x 25mm

MANROSE
Quality Verification



F

FROM ONLY
£4.99
EACH

Code	Each	5+
F 553022	£5.59	£4.99

Vertical Bend - 225mm x 25mm

MANROSE
Quality Verification



G

FROM ONLY
£4.22
EACH

Code	Each	5+
G 465493	£4.70	£4.22

Flat Duct Support Clip - 300 x 25mm

MANROSE
Quality Ventilation



A

FROM ONLY
£21^p
EACH

Code	Each	5+
A 143239	£0.26	£0.21

Connector

MANROSE
Quality Ventilation

- Size: 300 x 25mm



B

FROM ONLY
£1.92
EACH

Code	Each	5+
B 511181	£2.20	£1.92

Flat Bend 45 Degree

- Size: 300 x 25mm

MANROSE
Quality Ventilation

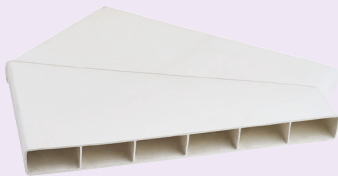

C

FROM ONLY
£6.11
EACH

Code	Each	5+
C 129644	£7.02	£6.11

Vertical Bend

- Size: 300 x 25mm

MANROSE
Quality Ventilation



D

FROM ONLY
£4.60
EACH

Code	Each	5+
D 648814	£5.24	£4.60

Flat Duct Plenum

- Size: 300 x 25mm

MANROSE
Quality Ventilation



E

FROM ONLY
£5.38
EACH

Code	Each	5+
E 393403	£6.03	£5.38

Flat Bend

- Size: 300 x 25mm

MANROSE
Quality Ventilation



F

FROM ONLY
£6.11
EACH

Code	Each	5+
F 534547	£7.02	£6.11

Ducting Accessories

Round Connector - 225 x 25mm Straight To 100mm

MANROSE
Quality Verification

A



FROM ONLY
£4.65
EACH

Code	Each	5+
A 827659	£6.17	£4.65

Flat Connector - C235

• Size: 110 x 54mm

MANROSE
Quality Verification

B



FROM ONLY
£2.90
EACH

Code	Each	5+
B 302576	£3.00	£2.90

90D Elbow Plenum - C237

• Size: 110 x 54mm

MANROSE
Quality Verification

C



FROM ONLY
£2.79
EACH

Code	Each	5+
C 454775	£3.51	£2.79

Airbrick Adaptor - C247

• Size: 110 x 54mm

MANROSE
Quality Verification

D



FROM ONLY
£1.96
EACH

Code	Each	5+
D 475229	£2.67	£1.96

Flat Bend - C238

• Size: 110mm x 54mm

MANROSE
Quality Verification

E



FROM ONLY
£2.73
EACH

Code	Each	5+
E 873308	£3.27	£2.73

**LOW
TRADE
PRICES**

ON
1000's
OF PRODUCTS

Ducting Round Reducer

MANROSE
Quality Ventilation

A



FROM ONLY
£5.12
EACH

Code	Type	Each	5+
583835	6 - 4"	£5.69	£5.12
A 645405	5 - 4"	£5.69	£5.12

Flat Duct Clip

MANROSE
Quality Ventilation

B

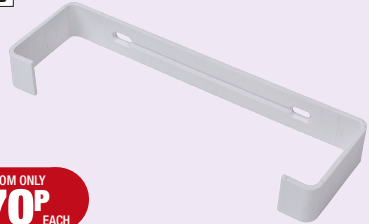

FROM ONLY
70P
EACH

Code	Size mm	Type	Each	5+
817377	110 x 54	C230	£0.86	£0.70
B 657590	204 x 60	C5610	£1.76	£1.47

PVC Connector For Ducting

MANROSE
Quality Ventilation

- Size: 4 Inch

C



FROM ONLY
£2.90
EACH

Code	Each	5+
C 107724	£3.00	£2.90

Fixed Grille - Grey

MANROSE
Quality Ventilation

D



FROM ONLY
£1.95
EACH

Code	Each	5+
D 458557	£2.20	£1.95

Tee Piece Ducting

MANROSE
Quality Ventilation

- Size: 4 Inch

E



FROM ONLY
£8.90
EACH

Code	Each	5+
E 246361	£9.50	£8.90

Soffit Grille - Brown

MANROSE
Quality Ventilation

- Size: 4 Inch

F



FROM ONLY
£1.98
EACH

Code	Each	5+
F 272719	£2.32	£1.98

ORDER BY 6PM

Get it Next Day!





TOP BRAND CCTV



**FULL
RANGE**
PAGES
206-207

Easy Fit HD Camera CCTV Kit

- View & record simultaneously
- Multi-channel playback
- 4 channel hybrid DVR to connect additional cameras
- 2 enhanced night vision cameras up to 30m/100ft
- Expand with 2 extra cameras
- 1TB hard drive
- Remote viewing

Order Code: 948640

ONLY
£249.00
EACH

Contains: 2 x Outdoor bullet cameras with IR night vision, 1 x Mouse, 1 x HDMI cable and theft deterrent stickers.



Flat Duct Airbrick with Adaptor

MANROSE
Quality Ventilation

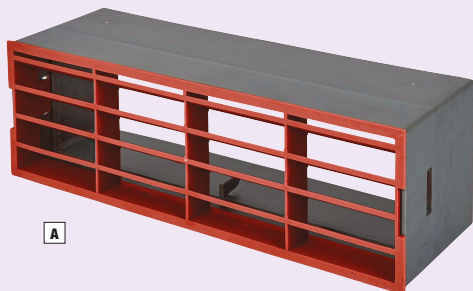

A



B

Code	Type	Each	5+
A 132517	Terracotta	£3.51	£2.81
B 435749	Brown	£3.51	£2.81

FROM ONLY
£2.81
EACH

Wall Grille - Fixed Shutter - 110mm

MANROSE
Quality Ventilation



C

FROM ONLY
£1.95
EACH

Code	Type	Each	5+
524004	White	£2.20	£1.95
C 129669	Sandstone	£2.20	£1.95
277404	Brown	£4.35	£4.10

6 Inch Wall Gravity Grille

MANROSE
Quality Ventilation



D



E

FROM ONLY
£4.10
EACH

Code	Type	Each	5+
D 468848	Brown	£4.35	£4.10
E 151862	Terracotta	£4.35	£4.10

Flat Duct Plenum

• Size: 300 x 25mm

MANROSE
Quality Ventilation



F

FROM ONLY
£5.38
EACH

Code	Each	5+
F 393403	£6.03	£5.38

Worm Drive Clip

MANROSE
Quality Ventilation



G

FROM ONLY
£1.57
EACH

Code	Type	Each	5+
G 196042	Clip	£1.66	£1.57

Hand Dryers

1.1kW Compact Eco Hand Dryer

- Economical fast hand dryer



FROM ONLY
£112.17 EACH

Code	Colour	Each	5+
A 674999	Stainless Steel	£135.00	£117.39
B 853874	White	£129.00	£112.17

1.8kW Automatic Hand-Dryer

- ABS housing
- Auto shut off after 1 minute
- Thermal cutout



FROM ONLY
£49.92 EACH

Code	Colour	Each	5+
C 207215	White	£52.00	£49.92

1.7kW Auto Hand Dryer

- ABS Housing
- Thermal cut out
- Easy clean white logo



FROM ONLY
£87.60 EACH

Code	Colour	Each	5+
D 735481	White	£90.50	£87.60

2.5kW Hand-Dryer

- Heavy duty steel construction
- Vandal resistant
- 360° nozzle



FROM ONLY
£184.54 EACH

Code	Colour	Each	5+
E 534966	White	£192.23	£184.54

1.8kW Hand-Dryer

- Die cast aluminium cover
- Vandal resistant
- Ideal for low traffic areas



FROM ONLY
£78.60 EACH

Code	Colour	Each	5+
F 827501	White	£84.10	£78.60

LOW TRADE PRICES



ON
1000'S
OF PRODUCTS

Scalemaster Shower

- Push button control
- Scale check technology to reduce limescale build up
- Low pressure neon indicator
- Fully temperature stabilised for absolute comfort



FROM ONLY
£91.91 EACH

Code	Wattage	Each	5+
216816	8.5kW	£96.55	£91.91
A 127195	9.5kW	£106.22	£101.10

8.5kW Thermostatic Power Shower

- Multi mode handset provides 5 different spray options
- 1.25m flexible hose



FROM ONLY
£133.21 EACH

Code	Each	5+
B 243697	£135.64	£133.21

8.5kW Shower - White

- Rotary controls
- 3 power settings
- Easy clean handsets
- Operating pressure 1-10 bar
- Temperature stabilisation for a comfortable and safe shower



FROM ONLY
£61.40 EACH

Code	Type	Each	5+
886653	1 spray pattern	£64.10	£61.40
C 119365	3 spray pattern	£82.11	£75.44



NEXT DAY DELIVERY!

WHEN YOU ORDER BY 6PM

ARRONE®
The Complete Range

Satin Chrome Plated Codelock

- Light duty code lock for offices & storerooms
- Interior doors only
- Suits doors 33 – 55mm thick
- Includes holdback function

SEE
PAGE
205

Order Code: 191011



ONLY
£16.50
EACH

NEW PRODUCTS ADDED DAILY TO OUR WEBSITE

FREEPHONE: 8AM-6PM, 7 DAYS A WEEK
0808 168 22 77

ONLINE: SHOP 24/7
ElectricalDirect.co.uk

FIRE & SECURITY

<u>Wireless Burglar Alarms</u>	<u>198-199</u>
<u>Alarms & Protection</u>	<u>200-203</u>
<u>Code Operated Locks</u>	<u>204-205</u>
<u>CCTV & Surveillance Systems</u>	<u>206-207</u>
<u>Access Control</u>	<u>208-213</u>
<u>Door Entry Systems</u>	<u>210-211</u>
<u>Doorbells</u>	<u>214-215</u>
<u>Fire Extinguishers</u>	<u>216-217</u>
<u>Fire Alarm Panels & Accessories</u>	<u>218-219</u>
<u>Domestic & Fire Smoke Alarms</u>	<u>220-223</u>
<u>Fire Signs</u>	<u>224-229</u>
<u>Stickered Signage</u>	<u>226</u>
<u>Yellow Warning Signs</u>	<u>227</u>
<u>Safes & Security Boxes</u>	<u>230-231</u>
<u>Padlocks, Chains & Security Devices</u>	<u>232-235</u>



SEE PAGE 218



SEE PAGE 219



SEE PAGE 217



SEE PAGE 199

Wireless Burglar Alarms

Remote Keypad

A



FROM ONLY
£32.49
EACH

Code	Each	3+
A 639227	£34.20	£32.49

Infinite Prime Wireless Alarm Kit

- 868 MHz
- Contains:
 - LED Panel
 - 3 x PIR Sensors
 - 1 x Magnetic Switch
 - 1 x Remote Keyfob

B



FROM ONLY
£204.25
EACH

Code	Each	3+
B 533143	£215.00	£204.25

Wirefree Multi Function Keyfob

- For use with infinite alarms



C



FROM ONLY
£37.24
EACH

Code	Each	3+
C 878285	£39.20	£37.24

Infinite Magnetic Contact

- For use with infinite alarms
- Used to protect doors & windows

D

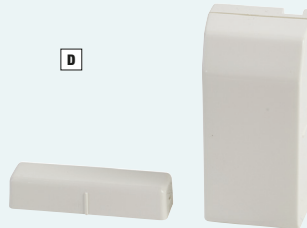

FROM ONLY
£20.14
EACH

Code	Each	3+
D 767554	£21.20	£20.14

15m Infinite PIR

- For use with infinite alarms
- 14 x 14m coverage



E



FROM ONLY
£32.87
EACH

Code	Each	3+
E 155466	£34.60	£32.87

Wirefree Pet Detector

- For use with infinite alarms
- 12 x 12m coverage
- Suitable for pets up to 22kg

F



FROM ONLY
£37.62
EACH

Code	Each	3+
F 849865	£39.60	£37.62



Wireless Burglar Alarms

YALE WIRELESS ALARMS

- 100% wire-free
- Pre-linked for quick and easy install and set-up
- Simple menu system for easy system adjustment
- Touch screen telecommunicating control panel for ease of use



Apartment



Standard



Telecommunicating

	Apartment	Standard	Telecommunicating
Ordering Code	977172	483468	144551
No of PIR Motion Detectors	1	2	2
No of Door/Window Contacts	1	2	2
Siren Box with Flashing LED	✓	✓	✓
Dummy Siren	✗	✗	✓
Remote Key Pad	✓	✓	✗
Remote Key Fob (not incl.)	✗	✗	✗
Alarm Control Panel	✗	✗	✓
Numbers contacted if activated	0	0	3
Remote Telephone Arm/Disarm	✗	✗	✓
Entry/Exit Period	20 Secs	Fixed	Adjustable
Part-Arm of System	✗	✗	✓
No of Expandable Accessories	30	30	30

Yale Wireless Alarm Accessories

- Accessories compatible with EF and SR alarm kits only
- Panic Button sounds alarm if pressed to attract attention in an emergency
- Use Pet PIR motion detector so pets do not activate the alarm
- Remote Key Pad can be used on back door or upstairs as an additional unit to arm or disarm system
- Smoke Detector will activate the alarm in the event of a fire

£105.00

£149.00

£210.00



Code	Description	Each
D	146320 Door / Window Contact	£16.60
E	179462 Keyfob	£16.60
F	187897 Remote Keypad	£28.50
G	658393 Panic Button	£19.50
H	411926 Pet Friendly PIR	£31.50
I	831206 PIR Detector	£16.60
J	498790 Smoke Detector	£35.50

TOP BRANDS AT LOW TRADE PRICES!

WAGO®

75 PIECE CONNECTOR KIT

Top brand,
easy to use
and handy
to have.



A selection of Wago 222, 224 and 773 series junction box commoning connectors including popular push-wire and cage clamp connectors.

Contains:

10 x 222-412 (2-way), 10 x 222-413 (3-way), 5 x 222-415 (5-way),
10 x 773-102 (2-way), 10 x 773-104 (4-way), 5 x 773-106 (6-way),
5 x 773-108 (8-way), 10 x 224-101 (2-way), 10 x 224-112 (3-way).

Order Code: 380005

SEE
PAGE
30

FROM ONLY
£14.38
EACH

FREEPHONE: 8AM-6PM, 7 DAYS A WEEK
0808 168 22 77



ONLINE: SHOP 24/7

ElectricalDirect.co.uk

Texcom 8 Zone Key Panel & Keypad

- 8 fully programmable zones plus tamper
- Single button quick set option
- Key switch facility
- Accepts up to 6 keypads
- Touchtone keys
- Veritas series compatible

A



FROM ONLY
£44.35
EACH

Code	Model	Each	3+
A 482876	Keypad Plus	£49.28	£44.35

8 Zone Key Panel and Keypad

- 8 fully programmable zones plus tamper

B



FROM ONLY
£42.17
KIT

Code	Kit	3+
B 743489	£46.86	£42.17

Bell Box with Strobe

FROM ONLY
£21.68
EACH

C

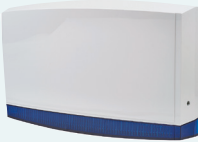

Code	Size mm	Each	3+
C 777555	318 x 201 x 66	£24.09	£21.68

Vertical Bell Box and Strobe ECO

- Sound output 109dB
- IP44 rated
- Patented safety engineer hold-off module
- Selectable SAB/SCB mode
- Strobe tube saver
- Twin alternating LEDs
- Screw & wall anti tamper

FROM ONLY
£21.68
KIT

D



Code	Kit	3+
D 353500	£24.09	£21.68

Texcom Speech And Text Dialer

- 2 programmable outputs
- Internal speaker
- Internal microphone

FROM ONLY
£71.87
EACH

E



Code	Each	3+
E 196608	£79.86	£71.87

Texcom 8 Zone Compact Key Panel

- 8 fully programmable zones plus tamper
- Single button quick set option
- Key switch facility
- Accepts up to 6 keypads

F



FROM ONLY
£33.62
EACH

Code	Each	3+
F 273190	£37.35	£33.62

Contract Internal PIR

G



FROM ONLY
£6.18
EACH

Code	Each	5+
G 470392	£6.87	£6.18

Texcom Spare 8 Zone Key Panel Keypad

- Touchtone keys
- Veritas series compatible

H



FROM ONLY
£20.95
EACH

Code	Each	3+
H 894024	£21.73	£20.95

Texcom Reflex PIR

- 104° coverage
- 1200mm coverage

I



FROM ONLY
£9.56
EACH

Code	Each	5+
I 260302	£10.62	£9.56

Alarms & Protection

Yale Easy Fit Remote Key Pad

- Remote Key Pad can be used on back door or upstairs as an additional unit to arm or disarm system



NEW

FROM ONLY
£2.50
EACH

A



Code Each
A 649291 £28.50

Yale Easy Fit Key Fob

- Remotely arm and disarm the system from a distance of 10m

FROM ONLY
£2.50
EACH

B



Code Each
B 389312 £16.50

Yale Easy Fit PIR Motion Detector

- When the alarm is set, the infrared sensor will pick up movement and activate the siren



FROM ONLY
£2.50
EACH

C



Code Each
C 694885 £16.60

Yale PIR Video Camera

- View video footage of your home direct to your Smartphone via the Yale alarm App
- No need to sync as pre-learned
- Add up to 6 PIR video cameras to a Yale alarm system



FROM ONLY
£2.50
EACH

D



Code Each
D 557206 £119.00

Yale Easy Fit Pet Friendly PIR Motion Detector

- Use a Pet PIR Motion Detector so pets do not activate the alarm
- Will not be triggered by a pet that weighs up to 27kg
- Not suitable for multiple pets



FROM ONLY
£2.50
EACH

E



Code Each
E 934944 £31.50

Yale PIR Camera

- View still images of your home direct to your Smartphone via the Yale App
- No need to sync as pre-learned
- Add up to 6 PIR camera to a Yale alarm system



FROM ONLY
£2.50
EACH

F



Code Each
F 225725 £119.00

Yale Easy Fit Smoke Detector

- Smoke Detector will activate the alarm in the event of fire



FROM ONLY
£2.50
EACH

G



Code Each
G 691036 £35.50

Yale Power Switch

- Control home appliances from your Smartphone via the Yale alarm App
- Turns lamps on and off anytime
- Appliances can be remotely turned off if accidentally left on once plugged into the connected power switch



FROM ONLY
£2.50
EACH

H



Code Each
H 776039 £33.50

Yale Easy Fit Panic Button

- Panic Button sounds alarm if pressed to attract attention in an emergency



FROM ONLY
£2.50
EACH

I



Code Each
I 604053 £19.50

Yale Easy Fit Door/Window Contact

- Should be fitted to the interior of main access point, in and around the home



FROM ONLY
£2.50
EACH

J











Code Each
J 198642 £16.60

NEW

KEYLESS CONNECTED SMART LOCK

Assured Security

The Yale Keyless Connected smart lock gives you freedom to secure your home without the need for a key. Simple to use you now have complete control on how you unlock your door.

-  4-10 digit PIN code
-  24 hour visitor PIN code
-  Mix up to 20 PIN codes, key tags and key cards
-  3 minute lock out if code entered incorrectly 5 times
-  Tamper alert
-  Unlocks up to 10,000 times on one set of 4 x AA batteries
-  Low battery indicator
-  2 year warranty

Yale Keyless Connected Ready Smart Lock

- Replaces traditional key operated rim cylinders with 60mm backset on timber or composite doors
- Lock operated by either Key Pad, Key Tag or Key Card
- Use as a standalone lock or to connect to a wider smart system. Choose the Keyless Connected Smart Lock with Yale Module to connect to a Yale system or Z-Wave Module to connect to a leading home automation system like Samsung Smart Things
- Connect to existing SmartHome Alarm or CCTV system using the Yale Module (CCTV/Alarm link adapter required)
- Connect to Samsung Smart Things system using Z-Wave Module
- 9v battery override in the event of battery failure
- Supplied with 1 x Key Tag and 1 x Key Card
- Standalone lock can be upgraded at a later date by ordering the desired Module (excludes existing Keyless locks)



i COMPATIBLE WITH LEADING SMART HOME SYSTEMS



Open your door your way

Code	Description	Each
A	783905 Standalone Lock - No Module	£99.50
	961942 Keyless Connected Smart Lock - Yale Module	£124.00
	687365 Keyless Connected Smart Lock - Z-Wave Module	£139.00

FROM ONLY £99.50 EACH

Yale Keyless Smart Lock Accessories

- A range of additional accessories to improve convenience in unlocking your Smart Lock
- Only compatible with Yale connected ready Smart Locks

FROM ONLY £2.50 EACH

Code	Description	Each
	801117 Yale Module	£24.50
	486134 Z Wave Module	£41.50
	618300 Remote Fob & Yale Module Kit	£49.50
B	575381 Remote Key Fob	£20.50
C	723851 Key Tag - Black - Pack 2	£2.50
	726253 Key Tag - White - Pack 2	£2.50
D	537009 RFID Key Card - Pack 2	£2.50
E	948327 RFID Phone Tag - Pack 2	£2.50





BL2605 External Marine Grade Code Operated Deadbolt

- Marine grade keypad & rim mount surface deadlock with Stainless Steel bolt
- Dual handed
- 25-85mm door thickness
- Suitable for external applications
- 1000 hrs Salt spray tested & 100,000 cycles



FROM ONLY
£75.10
EACH

Code	Each	5+
A 177700	£79.00	£75.10



BL3400 External Marine Grade Gate Lock

- For box section metal gate
- Marine grade keypad with external & internal side lever handles
- Anti climb housing
- Easy on site reversible handing
- Suits gate profiles of 30-60mm
- Fully adjustable spring loaded latch with throw 65 - 85mm
- Permanently clutched until correct code is entered



FROM ONLY
£113.00
EACH

Code	Type	Each	5+
B 501093	Without key override	£119.00	£113.00
472478	With key override	£129.00	£123.00



BL4409 External Marine Grade Code Operated Slam Latch

- Marine grade keypad with external lever handle
- 25-85mm door thickness
- Rim mounted slam latch
- Suitable for external applications



FROM ONLY
£61.80
EACH

Code	Each	5+
C 888723	£65.00	£61.80

Code Lock - Holdback Option - Satin Chrome Plated

- Easy code change
- Supplied with 60mm latchbolt
- Built in holdback

ARRONE
The Complete Range



A

FROM ONLY
£16.50
EACH

Code	Each	5+
A 191011	£16.50	

Code Lock Standard Option Satin Chrome

Briton

- Light duty code lock - suitable for low traffic offices & storerooms
- Use on interior doors only
- Suits doors 35-60mm thick
- Includes holdback function - ideal for areas which require the door to be left unlocked for periods as required
- Reversible for left or right hand applications



B

FROM ONLY
£32.80
EACH

Code	Each	5+
B 912789	£34.50	£32.80

Electronic Code Lock Satin Chrome

- Code Locks CL2255 Electronic Lock
- Use on interior doors only
- Suits doors 35-65mm thick
- Code free option - requires the user to enter a code to allow the door to be left unlocked for periods as required
- Reversible for left or right hand applications
- Small footprint replaces contract locks including Fort & Briton
- Up to 80 user codes 4, 5 or 6 digits
- On-door easy code change by master code
- Set up to 10 one-use codes for deliveries etc
- Can be connected to reception desk for remote release
- 80,000 operations from 2 x AA batteries



C

FROM ONLY
£75.50
EACH

Code	Each	5+
C 955818	£79.50	£75.50

Easy Code Change Code Operated Lock - Knob

- Light duty
- Knob version includes holdback function
- Left or right hand applications
- Supplied with 60mm backset latchbolt
- 40,000 code combinations



D

FROM ONLY
£30.90
EACH

Code	Type	Each	5+
274368	Knob	£32.50	£30.90
D 261725	Lever	£35.50	£33.70

CCTV & Surveillance Systems

Easy Fit HD 2 Camera CCTV Kit

- View & record simultaneously
- Multi-channel playback
- 4 channel hybrid DVR to connect additional wireless cameras
- 2 enhanced night vision cameras up to 30m/100ft
- Expand with 2 extra cameras
- 1TB hard drive
- Remote viewing
- Contains:
- 1TB Hard drive
- 2 x Outdoor bullet cameras with IR night vision
- 2 x BNC 15m camera cables
- 1 x Mouse
- 1 x Ethernet cable
- 1 x HDMI cable, screws, fittings & theft deterrent stickers
- Power adaptors

Yale®

FROM ONLY
£249.00
EACH



Code	Each
A 948640	£249.00

Easy Fit HD 4 Camera CCTV Kit

- View & record simultaneously
- Enhanced night vision up to 30m/100ft
- 1TB hard drive
- Remote viewing can be viewed live on Free Yale CCTV App
- Contains
- Hybrid DVR with pre-installed 1TB hard drive
- 4 x Outdoor bullet cameras with IR night vision up to 30m
- 4 x BNC 15m camera cables
- 1 x Mouse
- 1 x Ethernet cable
- 1 x HDMI cable
- Power adaptors
- Screws, fittings and theft deterrent

Yale®

FROM ONLY
£333.00
EACH



Code	Each
D 906289	£333.00

HD Premium 2 Camera CCTV Kit

- View & record simultaneously
- HD cameras with night vision upto 20m/65ft
- Expand with 2 extra cameras 500GB hard drive
- Remote viewing on free Yale CCTV app
- Contains
- DVR with 500GB hard drive
- 2 x Outdoor bullet cameras with IR night vision up to 20m
- 2 x BNC 15m camera cables
- 1 x Mouse
- 1 x Ethernet cable
- 1 x HDMI cable
- Power adaptors

Yale®

FROM ONLY
£199.00
EACH



Code	Each
B 867927	£199.00

Easy Fit BNC Extension Cable

- Extension cable is compatible with any Yale CCTV kit using analogue BNC connectors
- Used to extend the length of original BNC cables

Yale®

FROM ONLY
£12.87
EACH



Code	Length m	Each	5+
C 156089	15	£13.55	£12.87
726135	30	£19.90	

CCTV / Alarms Adaptor

- Allows you to control & monitor your Easy Fit Alarm system through your CCTV DVR's menu Yale CCTV App
- Arm & disarm your Yale alarm using the Yale CCTV App on your smartphone or tablet device
- To link devices simply plug in the USB Yale CCTV/Alarm link adaptor in to the USB port on the CCTV DVR & pair it with your alarm or the Keyless Smart Lock

Yale®

FROM ONLY
£39.50
EACH

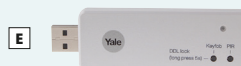

Code	Each
E 375154	£39.50

Easy Fit HD Bullet Camera - Twin Pack

- Compatible with any Yale CCTV kit using analogue BNC connectors
- Enhanced night vision of up to 30m/100ft
- 60° viewing angle
- IP55 rated

Yale®

FROM ONLY
£74.50
EACH



Code	Each
F 975211	£74.50



LOW TRADE PRICES

ON DOWNLIGHTS

12W Downlight - Cool White

- Wattage: 12W
- Cutout: 130mm
- 4000k - colour output

Order Code:
179226



**GREAT
VALUE**

SEE
PAGE
243

FROM ONLY
£18.49
EACH
WHEN YOU BUY 5+

SEE PAGE 243 FOR OUR FULL RANGE OF DOWNLIGHTS

FREEPHONE: 8AM-6PM, 7 DAYS A WEEK
0808 168 22 77



ONLINE: SHOP 24/7

ElectricalDirect.co.uk 207

Deedloċk



Standalone Access Control Kit, Keypad with Electric Strike

NEW

- Ideal for securing single timber doors
- 12VDC power supply 1.5A
- 12VDC keypad with steel buttons & chrome housing
- Kit includes mortice rim strike & 'Press to Exit' button
- Simple to install

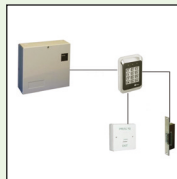

FROM ONLY
£95.50
EACH

Code	Each
A 946919	£95.50

Deedloċk



Standalone Access Control Kit, Keypad with Electromagnetic Lock

- Ideal for securing single aluminium or timber doors
- 12VDC power supply 1.5A
- 12VDC keypad with steel buttons & chrome housing
- Kit includes slimline electromagnet with 250kg holding force
- 'Press to Exit' button & green call point
- Simple to install



FROM ONLY
£114.00
EACH

Code	Each
B 647685	£114.00

Deedloċk



Standalone Access Control Kit, Proximity Controller and Reader with Electromagnetic Lock

- Ideal for securing single aluminium or timber doors
- 12VDC power supply 1.5A
- 12VDC proximity controller, reader with 10 fobs
- Easy to program with up to 998 users
- Kit includes slimline electromagnet with 250kg holding force
- 'Press to Exit' button & green call point
- Pre-wired for ease of installation

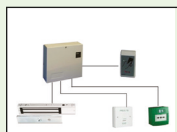

FROM ONLY
£2.75
EACH

Code	Option	Each
C 193551	Standalone Access Control Kit	£248.00
D 655684	Additional Fob	£3.15
		£2.75

Deedlock APX15 Keypad

- Cast metal housing & buttons with a polished chrome finish
- Ideal for commercial buildings
- Recommended for interior applications
- Up to 50 user codes from 2-8 digits
- Programmed via master code from keypad
- 12VAC/DC operating voltage
- Single volt-free relay to operate electric strike or electromagnet

Deedloċk



FROM ONLY
£37.50
EACH

Code	Each	5+
A 689743	£39.50	£37.50

Siemens Bewator K42 Keypad

- Cast zinc housing with stainless steel buttons
- Ideal for offices
- Recommended for interior applications
- Two 4 digit user codes
- Code change using pin & pegs
- 12-24VAC/DC operating voltage
- Single volt relay to operate electric strike or electromagnet
- Backlit buttons for ease of visibility

NEW

Deedloċk



FROM ONLY
£97.50
EACH

Code	Each	5+
B 169755	£103.00	£97.50

DEEDLOCK APX-16 VANDAL RESISTANT KEYPAD

- Strong zinc alloy electro-plated case to protect the keypad from vandalism
- IP68 rated giving total protection against dust & water ingress
- Standard 4-8 digit pin code
- 12-24V AC & DC power inputs
- Backlit keys give easy visibility in low lit areas such as porches or canopies
- Slimline design at 58mm to suit most architraves

Keypad

Deedloċk



FROM ONLY
£75.00
EACH

Code	Each	5+
C 953068	£78.00	£75.00

Keypad with Proximity

Deedloċk



FROM ONLY
£23.00
EACH



Code	Each	5+
D 228567	£87.50	£83.00
E 327104	£24.50	£23.00

Door Entry Systems

Standalone Access Control Kit with Keypad and Electric Strike

- Ideal for single timber doors
- 12VDC 1.5A power supply
- Keypad with steel buttons & chrome housing
- Contains: Mortice rim strike & egress switch



FROM ONLY
£95.50
EACH

Code
A 354458

Each
£95.50

Standalone Access Control Kit with Keypad and Electro Magnetic Lock

- Ideal for single aluminium & timber doors
- 12VDC 1.5A power supply
- Keypad with steel buttons & chrome housing
- Contains: Electromagnet, egress switch & green call point



FROM ONLY
£114.00
EACH

Code
B 642472

Each
£114.00

Standalone Access Control Kit with Proximity Controller and Reader with Electro Magnetic Lock

- Ideal for single aluminium & timber doors
- 12VDC 1.5A power supply
- Up to 998 users
- Keypad with steel buttons & chrome housing
- Contains: Electromagnet, proximity reader, egress switch & green call point
- Prewired



FROM ONLY
£248.00
EACH

Code Description
C 581866 Kit
140615 Additional Fobs

Each
£248.00
£3.15

Electric Strikes

- Rim or mortice mounting



FROM ONLY
£10.40
EACH

Code	Option	Each	5+
757965	Failed Locked 12VDC	£11.90	£11.30
A 880563	Failed Locked 12/24VDC	£10.90	£10.40
282853	Failed Unlocked 12VDC	£15.50	£14.70
443240	Rim Case	£6.20	£5.90
131969	Power Supply	£16.90	£16.10

Egress Button

- Not to be used on mains voltage
- Fits standard BESA box
- Low/medium traffic



FROM ONLY
£7.50
EACH

Code	Each	5+
B 709068	£7.90	£7.50

Stainless Steel Green Dome Egress Button

- Robust switch
- Medium/heavy use



FROM ONLY
£18.60
EACH

Code	Option	Each	5+
C 573646	Narrow Style	£19.60	£18.60
D 328038	Single Gang	£21.50	£20.40

High Impact Flush Dome Egress Switch

- Medium traffic

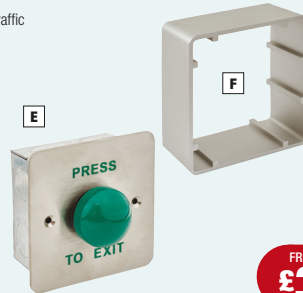

FROM ONLY
£3.10
EACH

Code	Option	Each	5+
E 987720	Single Gang	£19.50	£18.50
F 666291	Surface Box	£3.25	£3.10

Stainless Steel Equality Act Button



FROM ONLY
£18.40
EACH

Code	Option	Each	5+
G 465988	Narrow Style	£19.40	£18.40
H 840032	Large	£42.50	£40.40

Surface Door Loop

- Protect cables for electronic door closers
- Armoured suitable for high traffic



FROM ONLY
£9.30
EACH

Code	Option	Each	5+
I 276404	Contract	£9.80	£9.30
J 462515	Armoured	£13.30	£12.60



A

Deedlock APX15 Keypad

- Internal application
- Ideal for commercial buildings
- 50 user codes from 50-80 digits
- 12VAC/DC
- To operate electric strike or magnet

FROM ONLY
£37.50
EACH

Code	Each	5+
A 617346	£39.50	£37.50

Green Break Glass Unit Single Pole

- Use in an emergency to open electrically locked doors



B

FROM ONLY
£9.00
EACH

Code	Each	5+
B 426147	£9.50	£9.00

Key Switch

- Internal use
- Supplied with 3 cylinder keys
- 12 or 24V



C

FROM ONLY
£27.10
EACH

Code	Each	5+
C 892251	£28.50	£27.10

12VDC Batteries

- Used as backup for power supplies



D

FROM ONLY
£7.50
EACH

Code	Description	Each	5+
D 365429	1.2 Ah	£7.90	£7.50
312429	2.1 Ah	£8.85	£8.40
398276	3.0 Ah	£10.00	£9.50
245348	7.0 Ah	£11.90	£11.30

1 Way Audio Kit



E

FROM ONLY
£37.13
EACH

Code	Each	5+
E 259592	£39.09	£37.13

Slimline Magnets

- Internal use
- Holding force up to 250kg

A



FROM ONLY
£30.90
EACH

Code	Description	Option	Each	5+
424753	Single	Unmonitored	£32.50	£30.90
A 709058	Single	Monitored	£32.50	£30.90
781955	Double	Unmonitored	£45.50	£43.20
542448	Double	Monitored	£65.50	£62.20

Standard Magnets

- External doors
- Holding force up to 500kg

B



FROM ONLY
£32.80
EACH

Code	Description	Option	Each	5+
562857	Single	Unmonitored	£34.50	£32.80
553697	Single	Monitored	£39.50	£37.50
367567	Double	Unmonitored	£73.50	£69.80
B 882819	Double	Monitored	£105.00	£99.80

Gate Magnet

- Weatherproof for external applications
- Holding force up to 500kg

C

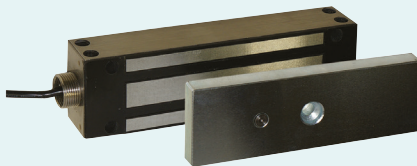

FROM ONLY
£12.30
EACH

Code	Option	Each	5+
C 968289	Magnet	£65.50	£62.20
312935	Z Bracket	£12.90	£12.30

Brackets for Electro Magnets

- L bracket for outward opening
- Z & L for inward opening

D

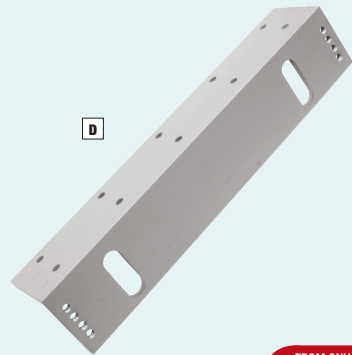

FROM ONLY
£5.80
EACH

Code	Option	Each	5+
D 832594	Standard L Bracket	£8.20	£7.80
513470	Slimline L Bracket	£6.10	£5.80
952805	Standard Z&L Bracket	£15.10	£14.30
275390	Slimline Z&L Bracket	£15.50	£14.70

Doorbells

Big Ben Chime

- Built in transformer
- 80DB
- 2 tones

A



FROM ONLY
£35.11
EACH

Code	Each	3+
A 509505	£37.31	£35.11

50m Wirefree & Plug in Chime

- 80-85DB
- 2 sounds

B



FROM ONLY
£13.83
EACH

Code	Each	3+
B 382729	£14.56	£13.83

100m Wirefree Chime & Flash

- 80-85DB
- 2 sounds

C



FROM ONLY
£18.01
EACH

Code	Each	3+
C 752952	£18.96	£18.01

150m EVO & Chime Kit

- 2 sounds

D



FROM ONLY
£29.18
EACH

E



Code	Description	Each	3+
D 173645	Plug in Chime	£31.01	£29.18
E 301688	Plug in & Portable Chime	£75.76	£71.30

30m Budget Wirefree Chime

F

FROM ONLY
£5.36
EACH



Code
F 233660

Each	3+
£5.64	£5.36

Big Ben Doorbell

• 80DB

G

FROM ONLY
£15.38
EACH



Code
G 216212

Each	3+
£16.34	£15.38

Ding Dong Doorbell

• 80DB

H

FROM ONLY
£14.26
EACH



Code
H 189572

Each	3+
£15.16	£14.26

Fire Extinguishers

Water Fire Extinguisher

A



FROM ONLY
£38.50
EACH

Code	Delivery Days	Volume	Each
A 567281 2-3		9ltr	£38.50

CO2 Fire Extinguisher

B



FROM ONLY
£46.50
EACH

Code	Delivery Days	Volume	Each
B 297286 2-3		2kg	£46.50



Indicates item shipped direct from manufacturer. Delivery to Mainland UK only and is to front door of premises only. Please note that these are working days.

Dry Powder Fire Extinguisher



FROM ONLY
£12.30
EACH

Code	Delivery Days	Volume	Each
A  705807	2-3	1kg	£12.30
B  601673	2-3	2kg	£21.50
C  261676	2-3	6kg	£39.50
C  181427	2-3	9kg	£65.50



Foam Fire Extinguisher

FROM ONLY
£26.50
EACH

Code	Delivery Days	Volume	Each
D  528968	2-3	2ltr	£26.50
E  218880	2-3	6ltr	£39.50
F  315838	2-3	9ltr	£42.50



Fire Extinguisher Brackets

FROM ONLY
£2.15
EACH

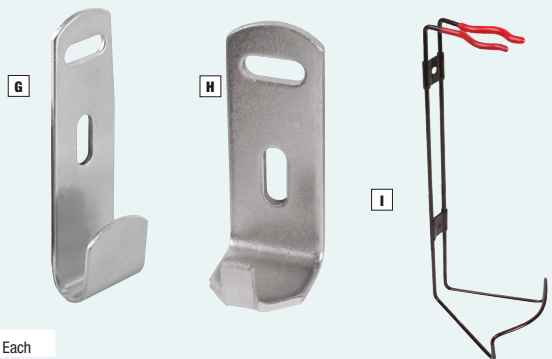

Code	Type	Each
G 683474	Water/Foam/Powder	£2.15
H 791762	CO2	£2.15
I 686473	Powder	£15.90

Fire Alarm Panels & Accessories

2 Zone Conventional Alarm Kit

Contains

- 2 zone fire panel
- 6 x Optical smoke detectors
- 2 x Resettable call points
- 2 x Banshee sounders
- 1 x 7Ah battery



esp

FROM ONLY
£156.75
EACH

Code	Each	3+
A 162934	£165.00	£156.75

Flush Call Point

B



esp

FROM ONLY
£6.00
EACH

Code	Each	3+
B 433546	£6.22	£6.00

Surface Call Point

C



esp

FROM ONLY
£6.11
EACH

Code	Description	Each	3+
C 442075	Call Point	£6.38	£6.11
383811	Spare Glass x 10	£8.90	£8.50

24V Bell - 6 Inch

D



esp

FROM ONLY
£14.31
EACH

Code	Each	3+
D 231026	£15.06	£14.31

Fire Blanket - 1200 x 1200mm

E



FROM ONLY
£10.50
EACH

Code	Each
E 720224	£10.50

Banshee Red Sounder

F



esp

FROM ONLY
£16.28
EACH

Code	Each	3+
F 961202	£17.55	£16.28

ESP Multi Alert Sounder

G



esp

FROM ONLY
£16.28
EACH

Code	Each	3+
G 101114	£17.55	£16.28

Twinflex Detector & Sounder

H



FROM ONLY
£37.10
EACH

Code	Each	5+
H 546215	£39.00	£37.10

Optical Smoke Detector

• 12V

A



FROM ONLY
£14.19
EACH

Code	Each	3+
A 514426	£16.37	£14.19

Heat Detector

B



FROM ONLY
£11.33
EACH

Code	Each	3+
B 964932	£12.63	£11.33

7Ah Battery For Alarm Panel

C



FROM ONLY
£15.85
EACH

Code	Each	5+
C 290812	£16.69	£15.85

Control Panel 4 Zone Expander

D

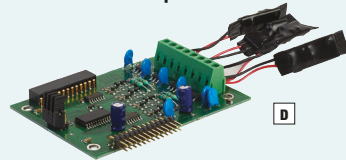

FROM ONLY
£16.97
EACH

Code	Each	3+
D 546187	£17.86	£16.97

STI Emergency Exit Stopper

E



FROM ONLY
£86.90
EACH

Code	Each	5+
E 456052	£91.50	£86.90

STI Standard Stopper Unit

F



FROM ONLY
£41.30
EACH

Code	Each	5+
F 395736	£43.50	£41.30

STI Replacement Glass for Standard Box

G



H



FROM ONLY
£15.70
EACH

Code	Description	Each	5+
G 636540	Square	£31.50	£29.90
H 801974	Round	£16.50	£15.70

STI Mini Stopper

I



FROM ONLY
£6.60
EACH

Code	Description	Each	5+
240022	Spacer	£6.90	£6.60
I 819346	Mini Stopper	£28.50	£27.10

Domestic & Fire Smoke Alarms

230V Mains Ionisation Alkaline Smoke Detector



- Responds quickly to fast flaming fires
- Easi-fit base included for ease of installation
- 4 year life Alkaline battery back up included
- Can be used with Aico radio link base (227797)

A



FROM ONLY
£16.83
EACH

Code	Each	3+
A 185910	£17.70	£16.83

230V Mains Alkaline Heat Detector Rc



- Ideal for protecting kitchens and garages or other areas prone to false alarms
- Fixed temperature fast response thermistor sensor - 58°C (+/- 4°C)
- Easi-fit base included for ease of installation
- 4 year life Alkaline battery back up included

B



FROM ONLY
£27.46
EACH

Code	Each	3+
B 749938	£28.86	£27.46

230V Mains Optical Alkaline Smoke



- More responsive to slow smouldering fires
- Fine mesh insect screen
- Easi-fit base included for ease of installation
- 4 year life Alkaline battery back up included
- Can be used with Aico radio link base (227797)

C



FROM ONLY
£21.46
EACH

Code	Each	3+
C 777908	£22.56	£21.46

230V Mains Ionisation Lithium Smoke Alarm



- Responds quickly to fast flaming fires
- Mounting plate included
- Remote control functionality
- 10 year+ rechargeable Lithium battery built in
- Can be used with Aico radio link base (227797)

D



FROM ONLY
£26.61
EACH

Code	Each	3+
D 403833	£27.97	£26.61

230V Mains Heat Alarm Easi-Fit



- Fixed temperature fast response thermistor sensor - 58°C (+/- 4°C)
- Mounting plate included
- Remote control functionality
- 10 year+ rechargeable Lithium battery built in
- Can be used with Aico radio link base (227797)

E



FROM ONLY
£39.12
EACH

Code	Each	3+
E 425662	£41.13	£39.12

230V Mains Optical Lithium Smoke Alarm



- More responsive to slow smouldering fires
- Fine mesh insect screen
- Mounting plate included
- Remote control functionality
- 10 year+ rechargeable Lithium battery built in
- Can be used with Aico radio link base (227797)

F



FROM ONLY
£37.57
EACH

Code	Each	3+
F 634746	£39.50	£37.57



Order up to 6pm for Next Day Delivery

Trade prices ex. VAT

Radio Link Base

- Radio transceiver - 868MHz band
- Easi-fit design with integral terminal block
- Interference free
- For use with all Aico detectors on page 220



FROM ONLY
£40.36
EACH

Code	Each	3+
A 227797	£42.43	£40.36

230/240V AC Mains Ionisation Detector - **DETA** DE1151

- 9V battery back up (included)
- Built in push-fit base
- Can be connected with up to 12 other alarms from the Deta range



FROM ONLY
£12.38
EACH

Code	Each	5+
C 653414	£13.93	£12.38

230/240V AC Mains Heat Detector - **DETA** DE1155

- 9V battery back up (included)
- Built in push-fit base
- Can be connected with up to 12 other alarms from the Deta range



FROM ONLY
£22.63
EACH

Code	Each	5+
E 868737	£25.46	£22.63

230V Mains RF CO Alarm

- RadioLINK wireless connection
- Simple removal and replacement
- Rechargeable battery pack



FROM ONLY
£70.36
EACH



Code	Each	3+
B 888513	£73.96	£70.36

Mains Co2 Detector - **DETA** DE1121

D



FROM ONLY
£36.20
EACH

Code	Each	5+
D 328542	£40.73	£36.20

Domestic & Fire Smoke Alarms

Smoke Detector Base

- Low profile surface mounting base for smoke and heat alarms
- Suitable for 230V smoke and heat alarm detectors
- Complete with strip connectors

FIREX

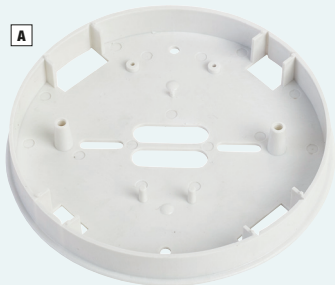

FROM ONLY
£1.89
EACH

Code	Each	3+
A 790417	£1.99	£1.89

Carbon Monoxide Mains Alarm

- These units offer a greater degree of accuracy, selectivity and stability
- Interconnect up to 12 alarms
- Manual test/hush button
- Supplied with Easi-fit surface mounting plate
- Tamper resistant cover

FIREX



FROM ONLY
£35.72
EACH

Code	Each	3+
B 390430	£37.60	£35.72

CO2 Battery Only Digital

- Digital LCD screen
- For installation on the wall or table top for added convenience
- Battery operated - 3 AAA's included
- 10 year sensor life

FIREX

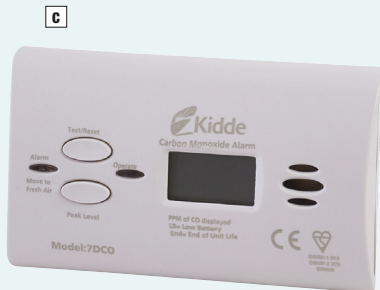

FROM ONLY
£25.10
EACH

Code	Each	3+
C 238993	£26.42	£25.10

Radio Link Base

- Mains powered with rechargeable 10 year+ lithium battery
- Radio transceiver 868.499 MHz
- Up to 12 units can be used in one system
- Interference free

FIREX



FROM ONLY
£30.21
EACH

Code	Each	3+
D 857125	£31.80	£30.21

Smoke Detector Test Spray



FROM ONLY
£8.35
EACH

Code	Each	3+
A 105332	£8.79	£8.35

Mains Smoke and Battery Back Up

- Interconnectable up to 24 units
- Push fit/snap in grip type connect
- Supplied with base plate
- Depth: 127 x 39mm
- 9V battery included



FROM ONLY
£8.95
EACH

Code	Each	3+
B 257067	£9.65	£8.95

Heat Detect and Battery Back Up

- Push fit/snap in grip type connector
- Interconnectable up to 24 units
- Supplied with base plate
- Battery included



FROM ONLY
£19.46
EACH

Code	Each	3+
C 239679	£20.80	£19.46

Battery Only Smoke Alarm

- Flashing red light to indicate unit is on
- Hush button included
- Ionisation technology



FROM ONLY
£5.65
EACH

Code	Each	3+
D 838268	£5.95	£5.65

50-75mm Fire Hood

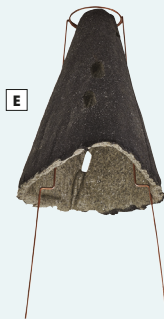

FROM ONLY
£8.60
EACH

Code	Each	5+
E 421058	£9.00	£8.60

NEW
PRODUCTS
ADDED
DAILY

Visit ElectricalDirect.co.uk

FIRE/EMERGENCY EXIT SIGNS

Legislation states that a fire exit sign must be used to clearly mark escape routes and exits. All our signs comply with BS5499 Pt1, 4 and the Health & Safety Reg 1996.

- Easy to fix - can either be screwed or stuck
- Material: rigid plastic

Double Sided Fire Exit Signs

- Size: 450 x 150mm



Code	Description	Each	5+
934392	Up	£11.50	£10.90
630157	Down	£11.50	£10.90
A 326112	Right	£11.50	£10.90
160974	Left	£11.50	£10.90

Hanging Kit for Double Sided Signs

- For use with double sided signs
- Kit contains: 1000mm brass chain; 4 x 'S' hooks



Code	Kit	5+
B 709783		£4.90

Push/Pull

- Size: 150 x 50mm

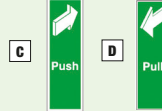

Code	Description	Each	5+
C 201988	Push	£1.65	£1.55
D 109120	Pull	£1.65	£1.55

NEW

Fire Exit - Running Man with Arrow

- Size: 150 x 450mm



Code	Description	Each	5+
466511	Up	£3.20	£2.95
709895	Down	£3.20	£2.95
178231	Right	£3.20	£2.95
376040	Left	£3.20	£2.95
508081	Down Right	£3.20	£2.95
E 721883	Down Left	£3.20	£2.95

Exit Running Man with Arrow

- Size: 150 x 450mm



Code	Description	Each	5+
982794	Up	£3.95	£3.50
F 212040	Down	£3.95	£3.50
460501	Right	£3.95	£3.50
256194	Left	£3.95	£3.50

Running Man with Arrow

- Size: 150 x 300mm



Code	Description	Each	5+
414806	Up	£2.95	£2.75
G 706588	Down	£2.95	£2.75
595753	Right	£2.95	£2.75
951687	Left	£2.95	£2.75

Fire Exit - Running Man

- Size: 150 x 300mm



Code	Description	Each	5+
H 604430	Right	£2.80	£2.45
590992	Left	£2.80	£2.45

Emergency Exit Running Man

- Size: 150 x 300mm



Code	Description	Each	5+
I 432565	Man Right	£2.95	£2.80
607192	Man Left	£2.95	£2.80

Fire Exit Keep Clear - Green/Blue

- Size: 150 x 450mm



Code	Each	5+
J 715866	£3.20	£2.95

Fire Assembly Point

- Size: 150 x 300mm



Code	Description	Each	5+
K 639510	Your Fire Assembly Point Is	£4.50	£4.25
427611	Emergency Assembly Point	£8.47	£7.90
248827	Fire Assembly Point Group	£16.70	£15.90

Push Bar To Open

- Size: 75 x 600mm

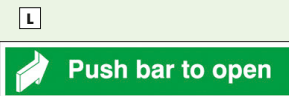

Code	Each	5+
L 853942	£3.50	£3.10

Arrow

- Size: 150 x 150mm



Code	Each	5+
M 257098	£2.15	£1.95

NITE GLO

In the event of a fire, Nite Glo signs glow in the dark to help locate exits and equipment



NEW

Fire Exit Running Man with Arrow

• Size: 150 x 450mm



Code	Description	Each	5+
415868	Up	£9.90	£9.70
967380	Down	£9.90	£9.70
317676	Right	£9.90	£9.70
704001	Left	£9.90	£9.70
A 146604	Up Right	£9.90	£9.70
777464	Up Left	£9.90	£9.70
716306	Down Right	£9.90	£9.70
470146	Down Left	£9.90	£9.70

Fire Extinguisher Signs

• Size: 300 x 100mm

B



Code	Description	Each	5+
B 337970	Co2	£7.90	£7.50
205765	Water	£7.90	£7.50
894333	Foam	£7.90	£7.50
208904	Dry Powder	£7.90	£7.50

In The Event Of Fire Do Not Use This Lift

• Size: 100 x 250mm

D



Code	Each	5+
D 780184	£6.00	£5.70

Fire Extinguisher Symbol

• Size: 200 x 200mm

C



Code	Each	5+
C 727764	£7.90	£7.50

Fire Exit Keep Clear

• Size: 150 x 450mm

F



Code	Each	5+
F 448773	£9.90	£9.70

Push Bar To Open

• Size: 75 x 600mm

G



Code	Each	5+
G 446237	£9.75	£9.25

Symbolised Fire Action Notice

• Size: 300 x 250mm

E



Code	Each	5+
E 602146	£7.00	£6.70

Stickered Signage

STICKERED SIGNAGE

- Size 80 x 80mm
- Self adhesive vinyl
- 250 stickers per roll

Fire Door Keep Shut

FROM ONLY
£28.45
EACH

A



Code	Each	5+
A 823709	£29.95	£28.45

Fire Door Keep Locked

FROM ONLY
£28.45
EACH

B



Code	Each	5+
B 392295	£29.95	£28.45

No Smoking

NEW

FROM ONLY
£28.45
EACH

C



Code	Each	5+
C 442247	£29.95	£28.45

Caution Very Hot Water

FROM ONLY
£28.45
EACH

D



Code	Each	5+
D 782536	£29.95	£28.45

Danger 230 Volts

FROM ONLY
£28.45
EACH

E



Code	Each	5+
E 475230	£29.95	£28.45

Danger 400 Volts

FROM ONLY
£28.45
EACH

F



Code	Each	5+
F 599795	£29.95	£28.45

NEW

Danger High Voltage

- Size: 420 x 297mm

FROM ONLY
£8.20
EACH

A



Code	Each	5+
A 878504	£8.60	£8.20

Danger Electric Shock Risk

- Size: 420 x 297mm

FROM ONLY
£3.05
EACH

B



Code	Description	Each	5+
B 375145	150 x 150mm	£3.20	£2.90
482087	420 x 297mm	£8.60	£8.20

Danger 400 Volts

- Size: 210 x 148mm

FROM ONLY
£3.05
EACH

C



Code	Each	5+
C 403024	£3.25	£3.05

Fire Signs

FIRE CONTROL

Legislation states that all fire fighting equipment should be clearly marked with a sign. Equipment to mark includes extinguishers, blankets & call points.

- For fire extinguishers see page 216-217



A

Your Fire Marshalls Are:

FROM ONLY
£1.80
EACH

Code	Description	Each	5+
174699	200 x 200mm	£1.90	£1.80
A 716453	210 x 148mm	£2.50	£2.30

KNOW YOUR FIRE EXTINGUISHER COLOUR CODE

B



Know Your Fire Extinguishers

- Size: 250 x 300mm

FROM ONLY
£7.70
EACH

Code	Each	5+
B 346989	£8.10	£7.70



C

Fire Alarm Symbol

FROM ONLY
£1.25
EACH

Code	Description	Each	5+
C 566829	100 x 100mm	£1.55	£1.25
118683	200 x 200mm	£4.20	£3.95

Fire Extinguisher Signs

• Size: 300 x 100mm

FROM ONLY
£1.20
EACH

Code	Description	Each	5+
951731	Foam Extinguisher	£1.50	£1.20
A 957528	CO2 Extinguisher	£1.80	£1.50
264195	Water Extinguisher	£1.80	£1.50
571294	Dry Powder - Extinguisher	£1.80	£1.50

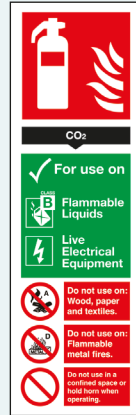

A

Fire Hose Reel

• Size: 150 x 300mm



B

FROM ONLY
£3.95
EACH

Code	Each	5+
B 803012	£4.50	£3.95

Fire Alarm

• Size: 100 x 200mm



C

FROM ONLY
£1.70
EACH

Code	Each	5+
C 138366	£1.90	£1.70

Fire Point

• Size: 200 x 400mm



D

FROM ONLY
£5.20
EACH

Code	Each	5+
D 624387	£5.50	£5.20

Fire Extinguisher

• Size: 100 x 200mm



E

FROM ONLY
£2.50
EACH

Code	Each	5+
E 200081	£2.65	£2.50

Safes & Security Boxes

Security Chest

Master Lock



FROM ONLY
£18.50
EACH

Code	Body Size mm	Each
A 331807	362 x 284 x 156	£19.50

Waterproof Fire Chest

Master Lock



FROM ONLY
£59.50
EACH

Code	Body Size mm	Each
B 152845	375 x 419 x 193	£59.50

Fire Security Chest

Master Lock



FROM ONLY
£39.50
EACH

Code	Body Size mm	Each
C 926140	363 x 391 x 168	£39.50

Waterproof Fire Chest

Master Lock



FROM ONLY
£66.50
EACH

Code	Body Size mm	Each
D 586990	351 x 421 x 359	£66.50

Compact Security Safe with Key Lock

Master Lock



FROM ONLY
£79.50
EACH

Code	Body Size mm	Each
E 372148	255 x 288 x 83	£79.50

X031 Security Safe

Master Lock



FROM ONLY
£34.50
EACH

Code	Size mm	Each
F 541203	167 x 290 x 264	£34.50

Fire & Water Resistant Safe

Master Lock



FROM ONLY
£199.00
EACH

Code	Delivery Days	Body Size mm	Each
G 504454	3-7	491 x 415 x 348	£199.00
152868	3-7	491 x 415 x 453	£245.00
498922	3-7	490 x 472 x 605	£330.00

Compact Security Safe

• With Key & Electronic Lock

Master Lock



FROM ONLY
£115.00
EACH

Code	Body Size mm	Lock	Each
H 950421	251 x 307 x 81	Electronic	£115.00
I 552798	251 x 307 x 81	Electronic & Biometric	£150.00

Portable Security Box

Master Lock



FROM ONLY
£11.90
EACH

Code	Body Size mm	Each
J 653572	66 x 150 x 203	£11.90
K 441339	74 x 254 x 102	£26.50

High Security Safe

Master Lock



Code	Delivery Days	Type	Body Size mm	Each
L 465172	3-7	T6	607 x 390 x 410	£245.00
M 411963	3-7	T8	704 x 551 x 502	£370.00
N 829133	3-7	T0	958 x 551 x 502	£396.00

Small Digital Safe

Master Lock

A



FROM ONLY
£45.50
EACH

Code	Body Size mm	Each
A 838768	290 x 264 x 194	£45.50

Home & Laptop Safe

Master Lock

B



FROM ONLY
£93.50
EACH

Code	Body Size mm	Each
B 927722	270 x 430 x 370	£93.50

Certified Laptop Safe



FROM ONLY
£145.00
EACH

C



Code	Body Size mm	Each
C 575278	200 x 480 x 350	£145.00

Certified Home Safe



D

FROM ONLY
£123.00
EACH

Code	Body Size mm	Each
D 908704	250 x 350 x 300	£123.00

Certified Office Safe



E

FROM ONLY
£149.00
EACH

Code	Delivery Days	Body Size mm	Each
E 990538	5	400 x 350 x 340	£149.00

Certified Professional Safe



F

FROM ONLY
£165.00
EACH

Code	Delivery Days	Body Size mm	Each
F 473379	5	520 x 350 x 360	£165.00

Cash Box

G



H



FROM ONLY
£6.30
EACH

Code	Finish	Size mm	Each	5+
G 283990	Black	152 x 80 x 115	£6.60	£6.30
564144	Red	152 x 80 x 115	£6.60	£6.30
686227	Black	250 x 90 x 180	£10.60	£10.10
H 606250	Red	250 x 90 x 180	£10.60	£10.10

Fire Safe



I

J



FROM ONLY
£149.00
EACH

Code	Delivery Days	Body Size mm	Each
I 210827	5	308 x 410 x 342	£149.00
J 824229	5	420 x 352 x 433	£169.00



Indicates item shipped direct from manufacturer. Delivery to Mainland UK only and is to front door of premises only. Please note that these are working days.

Group Of Master Keyed Padlocks

6 or 12 padlock sets from stock; larger master keyed padlock groups running into 1000's of padlocks can be made to special order.

- Available in 2 sizes
- 1 master key supplied per 12 padlocks
- Each padlock has 2 keys
- All padlocks are keyed to differ
- A master key will open all padlocks in the group

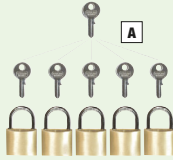

Code	Body Size	Shackle Diameter	Shackle Clearance	Each	5+
A 995993	40	6	24 x 23	£95.00	£89.50
885479	50	8	30 x 28	£59.50	£56.50

Squire Lion Open Shackle Padlock

- Steel shackle
- Solid Brass Body
- 4 Pin Tumbler On 20mm & 30mm
- 5 Pin Tumbler On 40mm, 50mm & 60mm



NEW

Code	Body Size	Shackle Diameter	Shackle Clearance	Each	5+
365492	25	4	16.5 x 13.5	£8.50	£7.90
719489	30	5.5	19.5 x 16.5	£9.90	£9.20
108573	40	6	21 x 22.5	£11.70	£10.80
B 945076	50	8.8	30 x 28	£15.90	£14.70
583156	60	9.5	35.35 x 33.5	£19.90	£18.40

Squire Lion Open Long Shackle Padlock

- Steel Shackle
- Solid Brass Body
- 5 Pin Tumbler



FROM ONLY
£12.20
EACH

Code	Body Size	Shackle Diameter	Shackle Clearance	Each	5+
563150	40	6	64 x 22.5	£13.20	£12.20
C 455198	50	8.8	65 x 28	£17.90	£16.50

Master Keyed Laminated Padlock Set

- Pack contains 6 padlocks, each with 2 keys and 2 cut master keys



FROM ONLY
£102.00
EACH

Code	Body Size	Shackle Diameter	Shackle Clearance	Each	5+
D 822871	51	9	24 x 24	£115.00	£102.00

Stronglock Laminated Padlock

- Double deadlocking and ball locking
- Hardened steel shackle
- Suitable for sheds, garages, gates, toolboxes, lockers, vans and storage areas



Code	Body Size	Shackle Diameter	Shackle Clearance	Each	5+
496253	38	7	17 x 16	£9.90	£8.50
E 894571	44	8	20 x 20	£10.20	£9.80
F 393458	51	9	24 x 24	£14.50	£13.70
G 818576	51	9	16 x 16	£14.50	£13.70

Rustproof Padlock

- Shackle clearance 25 x 20mm
- Keyed to differ
- Enhanced anti-corrosion resistance
- Hardened steel shackle to resist bolt cropping
- Solid brass lock provides high internal and external corrosion resistance
- Protected cylinder by easy use weatherproof dust cover
- Ideal for sheds, storage, vans, boats, farms, gates and bicycles



Code	Body Size	Shackle Diameter	Each	5+
H 854063	52	8	£15.50	£14.30
758433	58	10	£20.50	£18.90

Stronglock Padlock - Long Shackle

- Hardened steel shackle to resist bolt cropping
- Inner laminated steel body with corrosion resistance
- Rugged every day padlock for sheds, garages, gates and toolboxes

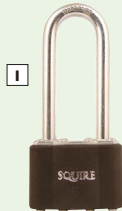

FROM ONLY
£18.10
EACH

Code	Body Size	Shackle Diameter	Shackle Clearance	Each	5+
I 143995	44	8	64 x 20	£19.90	£18.10

Squire Warrior Open Shackle Padlock

- Hardened steel shackle to resist cutting
- Armoured steel body with soft feel cover
- 5 Pin cylinder prevents picking
- Double locking for added shackle strength



FROM ONLY
£21.50
EACH

Code	Body Size	Shackle Diameter	Shackle Clearance	Each	5+
J 331525	45	8	20 x 20	£23.50	£21.50
J 776169	55	10	30 x 24	£28.50	£26.50

Padlocks, Chains & Security Devices



A

Squire Warrior Closed Shackle Padlock

- Hardened steel shackle to resist cutting
- Armoured steel body with soft feel cover
- 5 Pin cylinder prevents picking
- Double locking for added shackle strength

FROM ONLY
£24.95
EACH

Code	Each	5+
A 805178	£27.00	£24.95
588153	£31.50	£29.20

High Security Range Padlock - Open Shackle

- Hardened Boron steel shackle to resist bolt cropping
- Hardened steel body with anti-corrosion resistance
- 5 pin cylinder with up to 1500 key combinations
- Ideal for perimeter gates, garages, site equipment, commercial vehicles and storage areas

B



FROM ONLY
£23.50
EACH

Code	Each	5+
B 279487	£24.50	£23.50
482561	£29.50	£27.50

High Security Range Padlock - Closed Shackle

- Hardened Boron steel shackle to resist bolt cropping
- Hardened steel body with anti-corrosion resistance
- 5 pin cylinder with up to 1500 key combinations
- Ideal for perimeter gates, garages, site equipment, commercial vehicles and storage areas

C



FROM ONLY
£29.50
EACH

Code	Each	5+
C 151769	£31.50	£29.50

Maximum Security Padlock - Open Shackle

- Designed for maximum risk situations and harsh environments
- Hardened Boron steel shackle to resist bolt cropping
- Hardened steel body with enhanced anti-corrosion and anti chip resistance
- 6 pin anti drill cylinder with up to 25,000 key combinations
- Maximum protection for workshops and warehouses, plant and machinery, gates, shutters and commercial vehicles

D



FROM ONLY
£48.50
EACH

Code	Each	5+
D 180243	£53.50	£48.50

Maximum Security Padlock - Closed Shackle

- Designed for maximum risk situations and harsh environments
- Hardened Boron steel shackle to resist bolt cropping
- Hardened steel body with enhanced anti-corrosion and anti chip resistance
- 6 pin anti drill cylinder with up to 25,000 key combinations
- Maximum protection for workshops and warehouses, plant and machinery, gates, shutters and commercial vehicles

E



FROM ONLY
£55.50
EACH

Code	Each	5+
E 497453	£68.50	£55.50

Brass Shutter Lock

- Solid brass lock body
- Rotating hardened steel shackle to resist cutting
- 5 pin tumbler lock mechanism to resist picking

A



FROM ONLY
£24.50
EACH

Code	Each	5+
A 891014	£36.50	£33.50
392383	£26.50	£24.50

Armoured Steel Shutter Lock

- Solid brass lock body protected by armoured steel for ultra-resistance to attack
- Rotating hardened steel shackle to resist cutting
- 5 pin tumbler mechanism to resist picking

B



FROM ONLY
£37.50
EACH

Code	Each	5+
682832	£40.50	£37.50
343593	£43.00	£39.50
B 847168	£58.00	£53.50
755608	£54.50	£49.50

ABUS Steel Shutter Padlock

- Pin tumbler cylinder with anti-pick mushroom pins resists picking
- Hardened steel alloy shackle that rotates when attacked
- Solid brass body encased in hardened steel for added protection
- Nano Plated steel alloy shackle for increased corrosion protection
- Rustfree internal components increase durability

C



FROM ONLY
£27.81
EACH

Code	Each	5+
C 699041	£29.36	£27.81
639881	£37.08	£35.54

Maximum Security Shutter Padlock

- Hardened steel body with enhanced anti-corrosion resistance 6 pin anti drill cylinder with up to 250,000 key combinations
- Maximum protection shutters, workshops and warehouses, plant and machinery, gates and commercial vehicles

D



FROM ONLY
£27.50
EACH

Code	Each	5+
D 611394	£29.50	£27.50

FREE NEXT DAY DELIVERY



On orders over £45* *Excl. VAT. £5.95 on orders under £45.

Disc Padlock

- Stainless steel body for corrosion resistance
- Hardened steel shackle and steel anti drill plate for added security
- 5 pin tumbler lock mechanism to resist picking

E



FROM ONLY
£18.90
EACH

Code	Each	5+
E 516855	£20.50	£18.90
683561	£22.50	£20.50



NEXT DAY DELIVERY!

WHEN YOU ORDER BY 6PM

5ft Twin High Frequency Batten Fitting

- Flicker free
- Instant starting
- Detects failed tubes

SEE
PAGE
239

Order Code: 362974



FROM ONLY
£20.00
EACH
WHEN YOU BUY 5+

NEW PRODUCTS ADDED DAILY TO OUR WEBSITE

FREEPHONE: 8AM-6PM, 7 DAYS A WEEK
0808 168 22 77

ONLINE: SHOP 24/7
ElectricalDirect.co.uk

COMMERCIAL LIGHTING

<u>LED Batten Fittings</u>	<u>238</u>
<u>Batten Fittings</u>	<u>239</u>
<u>Non-Corrosive Fittings</u>	<u>240</u>
<u>Bulkhead Lights</u>	<u>241</u>
<u>Recessed Fittings</u>	<u>242-243</u>
<u>Ballasts & Batteries</u>	<u>245</u>
<u>Emergency Lighting</u>	<u>246-247</u>
<u>Site & Portable Lighting</u>	<u>248-249</u>



SEE
PAGE
243



SEE
PAGE
248



SEE
PAGE
239

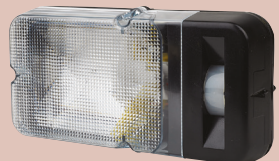

SEE
PAGE
241

Batten Fittings

LED Batten - Cool White - 4000K

- Dedicated LED Light Source With Polycarbonate Diffuser
- Traditional T8 Batten body
- Ideal Replacement/Alternative replacement/alternative to T5/T8
- 20W - lumens - 2300lm
- 26W - lumens - 3000lm
- 30W - lumens - 3450lm

A

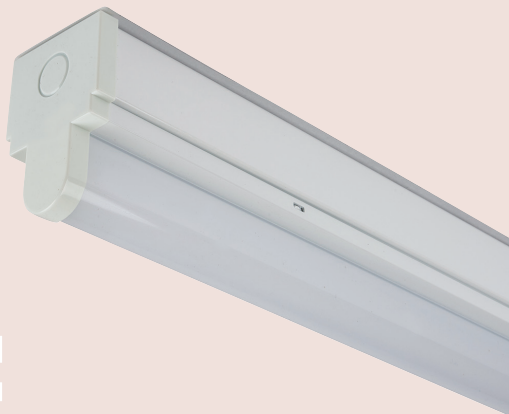

FROM ONLY
£19.49
EACH

Code	Product Length	Wattage	Each	5+
241640	4ft / 1200mm	20W	£20.30	£19.49
147036	5ft / 1500mm	26W	£29.25	£28.08
A 733800	6ft / 1800mm	30W	£42.60	£40.90

LED Smart Fitting

- Low profile
- Easy installation
- 120° beam angle
- Cool white colour render

B



FROM ONLY
£17.04
EACH

Code	Product Length	Each	5+
B 938531	2ft / 600mm	£17.75	£17.04
591417	4ft / 1200mm	£33.80	£32.45
691518	5ft / 1500mm	£38.20	£36.67

High Frequency Batten Fitting

- Flicker free & silent operation
- Instant starting
- Detects failed lamps, no more flashing on & off
- Cold starting in sub-zero temperature
- Tube included

C



FROM ONLY
£8.70
EACH

Code	Product Length	Wattage	Each	5+
C 498029	2ft / 600mm	18W	£9.30	£8.70
969862	4ft / 1200mm	36W	£11.27	£10.47
603658	5ft / 1500mm	58W	£11.78	£10.95
304009	6ft / 1800mm	70W	£15.22	£14.10

58W High Frequency Batten Fitting

- Flicker free & silent operation
- Instant starting
- Detects failed lamps, no more flashing on & off
- Cold starting in sub-zero temperature
- 3 hour maintained operation
- Tube included



FROM ONLY
£44.88
EACH

Code	Each	5+
A 949346	£47.25	£44.88

Twin High Frequency Batten Fitting

- Flicker & silent operation
- Instant starting
- Detects failed lamps, no more flashing on & off
- Cold starting in sub-zero temperatures
- Tube included

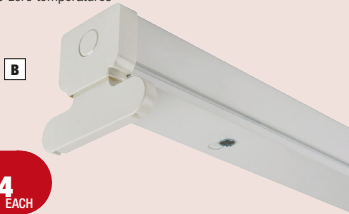

FROM ONLY
£18.44
EACH

Code	Product Length	Wattage	Each	5+
B 579907	4ft / 1200mm	36W	£19.99	£18.44
362974	5ft / 1500mm	58W	£23.09	£20.00
539551	6ft / 1800mm	70W	£27.35	£23.60

Prismatic Controller

- Clear UV stabilised styrene material
- Injection moulded push fit end caps, colour matched to body
- Secure mounting device featuring anti-lift facility

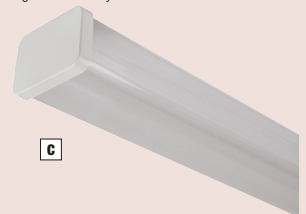

FROM ONLY
£6.90
EACH

Code	Product Length	Each	5+
807449	4ft / 1200mm	£7.50	£6.90
C 897354	5ft / 1500mm	£8.05	£7.25
862546	6ft / 1800mm	£10.35	£9.45

Twin Prismatic Controller

- Clear UV stabilised styrene material
- Injection moulded push fit end caps, colour matched to body
- Secure mounting device featuring anti-lift facility

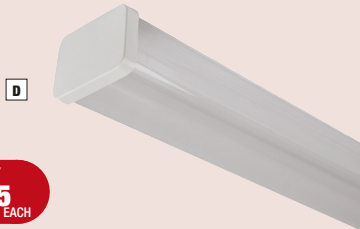

FROM ONLY
£9.45
EACH

Code	Product Length	Each	5+
508832	4ft / 1200mm	£10.35	£9.45
D 798284	5ft / 1500mm	£10.95	£10.50
180420	6ft / 1800mm	£11.28	£10.80

Metal Reflector

- Steel coated light reflector for use in factories, schools, workshops & garages

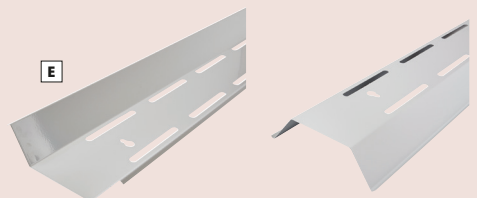

FROM ONLY
£7.65
EACH

Code	Product Length	Each	5+
E 369031	5ft / 1500mm	£8.13	£7.65
200179	6ft / 1800mm	£8.13	£7.65

Non-Corrosive Fittings

IP65 Weatherproof Fluorescent Light Fitting - Single High Frequency

- Polycarbonate diffuser
- ABS base
- Complete with stainless steel mounting clips
- Lamp not included - see page 286
- Requires either:
 - 1 x 36W T8 lamp
 - 1 x 58W T8 lamp
 - 2 x 49W T5 lamp
 - 2 x 58W T8 lamp



A

FROM ONLY
£18.75
EACH

Code	Description	Product Length	Each	5+
A 676466	1 x 36W	4ft / 1200mm	£21.89	£20.35
849212	1 x 58W	5ft / 1500mm	£21.48	£18.75
234355	1 x 70W	6ft / 1800mm	£27.00	£24.90

IP65 Weatherproof Fluorescent Light Fitting - Twin High Frequency

- Polycarbonate diffuser
- ABS base
- Complete with stainless steel mounting clips
- Integrated LED fitting



B

FROM ONLY
£23.95
EACH

Code	Description	Product Length	Each	5+
B 757114	2 x 36W	4ft / 1200mm	£25.65	£23.95
162443	2 x 49W	5ft / 1500mm	£36.85	£34.24
459699	2 x 58W	5ft / 1500mm	£27.60	£26.10
232860	2 x 70W	6ft / 1800mm	£32.90	£31.30

IP65 Emergency Weatherproof Fluorescent Light Fitting

- Polycarbonate diffuser
- ABS base
- Complete with stainless steel mounting clips
- Battery packs are designed to provide a single tube 3 hours emergency backup, with a battery life of 3 years
- Lamp not included - see page 286
- Requires either:
 - 1 x 36W T8 lamp
 - 1 x 58W T8 lamp
 - 2 x 49W T5 lamp
 - 2 x 58W T8 lamp



C

FROM ONLY
£45.60
EACH

Code	Description	Product Length	Each	5+
124287	1 x 58W	5ft / 1500mm	£49.85	£45.60
746774	2 x 49W T5	5ft / 1500mm	£69.25	£64.85
C 882492	2 x 58W	5ft / 1500mm	£57.65	£56.15

110V Non Corrosive Fitting - 5ft

- Non emergency
- 1500mm length
- Requires 1 x 58W T8 lamp
- Lamp not included - see page 286
- Requires either:
 - 1 x 36W T8 lamp
 - 1 x 58W T8 lamp
 - 2 x 49W T5 lamp
 - 2 x 58W T8 lamp

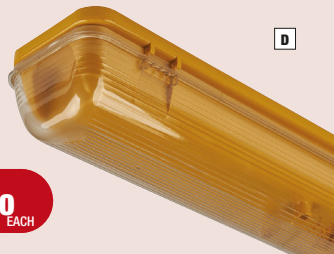

D

FROM ONLY
£26.10
EACH

Code	Each	5+
D 898368	£27.80	£26.10

FREE NEXT DAY DELIVERY



On orders over £45* *Excl. VAT. £5.95 on orders under £45.

Non Corrosive Clip

- Stainless steel



E

FROM ONLY
£2.37
EACH

Code	Each	5+
E 505881	£2.50	£2.37

Guardlite PIR Prismatic

- Slimline bulkhead
- 110° PIR range of 12m
- Weatherproof
- Total switching capacity 1000W
- Max 60W E27 lamp. Can use LED
- Lamp not included
- See page 275 for halogen lamps & LED

A

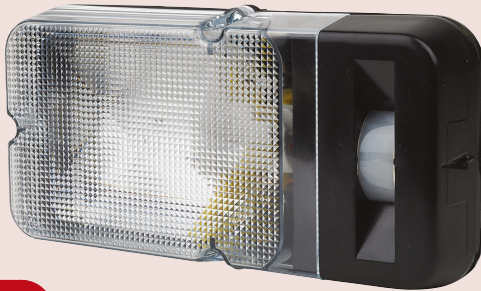

B



FROM ONLY
£16.70
EACH

Code	Finish	Each	3+
A	935867 Black	£17.40	£16.70
B	137525 White	£17.40	£16.70

100W Rectangular Bulkheads

- Lamp not included
- Requires either:
- 100W E27 lamp (GLS)
- 100W B22 lamp (GLS)
- See page 275 for halogen lamps & LED

D



C



E



FROM ONLY
£7.20
EACH

Code	Description	Each	5+
C	990814 Glass Lens	£7.70	£7.20
D	166529 Red Lens	£9.50	£8.95
E	944520 Aluminium Base	£8.20	£7.87

Recessed Fittings



A

LED Panel With Driver

- Dimensions - 600 x 600mm
- Wattage - 40W
- Lumen output - 3600lm
- Colour output - Daylight

FROM ONLY
£31.80
EACH

Code	Each	10+
A 511658	£34.86	£31.80

Emergency LED Panel Pack

- Suitable for use with LED 600 x 600mm panels - 511658
- Maintained EMS function



B

FROM ONLY
£65.55
EACH

Code	Each	5+
B 103104	£69.00	£65.55

LED Surface Frame

- Suitable for surface mounting of LED 600 x 600mm panel lights - 511658



C

FROM ONLY
£16.59
EACH

Code	Each	5+
C 247913	£18.55	£16.59

Lower CAT2 High Frequency Modular 600 x 600mm

- Requires 4 x 18W T8 lamps
- Recessed



D

FROM ONLY
£20.30
EACH

Code	Each	10+
D 945664	£21.30	£20.30

Prismatic Diffuser

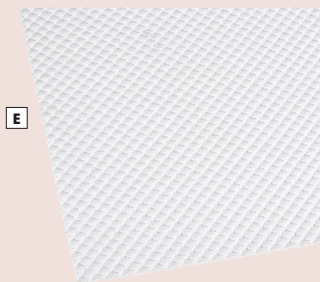

E

FROM ONLY
£3.90
EACH

Code	Wattage	Description	Each	10+
755998	18W	600 x 600mm	£4.65	£3.90
E 396171	36W	1200 x 600mm	£6.70	£5.95

12W Eterna LED Amenity Light - Cool White

- Lumen output - 800lm
- IP66 rated
- Rated 25,000 hours



FROM ONLY
£19.15
EACH

Code	Finish	Each	5+
A 919575	Black	£19.95	£19.15
B 793878	White	£19.95	£19.15

Lumilife LED Downlight - Cool White

- 8W cutout - 135mm
- 12W cutout - 155mm
- 18W cutout - 200mm



FROM ONLY
£28.90
EACH

Code	Wattage	Each	5+
519923	8W	£30.10	£28.90
C 314739	12W	£37.10	£35.62
D 405023	18W	£49.30	£47.33

Downlight - Cool White

- Wattage - 12W
- 5W - cutout - 85mm
- 7W - cutout - 95mm
- 12W - cutout - 130mm



FROM ONLY
£15.83
EACH

Code	Adjustable	Wattage	Each	5+
694712		5W	£16.66	£15.83
E 525531		7W	£18.06	£17.16
179226		12W	£19.46	£18.49

Knightsbridge LED Bulkhead - Cool White

- Low profile
- 3.5mm diameter
- 14W - Power output
- Not recessed



FROM ONLY
£26.06
EACH

Code	Each	5+
F 433181	£27.15	£26.06

HI - Spec LED Downlight - Cool White



FROM ONLY
£12.05
EACH

Code	Wattage	Each	5+
679572	6W	£12.55	£12.05
639029	12W	£24.05	£23.09
G 333769	18W	£31.75	£30.48

**FREE
NEXT DAY
DELIVERY**



On orders over £45* *Excl. VAT. £5.95 on orders under £45.

TRADE ESSENTIALS AT LOW TRADE PRICES!



Withstands high levels of torque from impact drivers.

Impact Resistant Bit Check Kit

- Contains: 1 x bit holder, 7 x PZ2, 2 x PZ3

Order Code: 595546

SEE
PAGE
316

FROM ONLY
£20.40
PACK
WHEN YOU BUY 5+

Ring Magnet Rapidaptor Bit Check

- Contains: 1 x bit holder, 1 x PZ1, 6 x PZ2, 2 x PZ3



FROM ONLY
£20.40
PACK
WHEN YOU BUY 5+

SEE
PAGE
316

Order Code: 184077

Specifically designed for use with power tools.

SEE
PAGE
316



PZ2 Pozidriv Bit

Code	Size mm	Pack Quantity	Each	5+
201296	25mm	1	£2.25	£2.10
908160	25mm	10	£19.50	£18.50
338905	50mm	1	£3.45	£3.30

2D High Frequency Ballast

- 1 x 28W
- Suits 2D Class Lamps

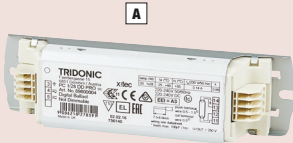

FROM ONLY
£10.17
EACH

Code	Each	5+
A 610857	£10.71	£10.17

T8 High Frequency Ballast

- Nominal life up to 50,000 hours
- Intelligent voltage guard
- Constant luminous flux
- Automatic start

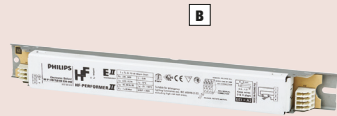

FROM ONLY
£9.01
EACH

Code	Description	Each	5+
817022	1x 36W	£9.48	£9.01
645702	1 x 58W	£9.48	£9.01
B 955599	1 x 70W	£11.22	£10.66
496608	2 x 36W	£10.68	£10.15
230901	2 x 58W	£10.68	£10.15
543992	2 x 70W	£11.79	£11.20
748782	4 x 18W	£12.81	£12.17

Tridonic 1/2 x 26W Ballast

- Nominal Life up to 50,000 hours
- Can operate either 1 or 2 lamps
- Intelligent voltage guard
- Constant luminous flux
- Automatic start after replacement of defective lamps

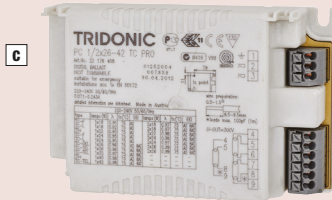

FROM ONLY
£11.26
EACH

Code	Each	5+
C 645988	£11.85	£11.26

6V Battery - Greencell GP

- Non rechargeable
- Mercury free zinc chloride chemistry
- Suitable for lanterns, road lamps and other heavy duty devices



FROM ONLY
£1.94
EACH

Code	Each	5+
D 680212	£2.05	£1.94

4 AH Cell Stick Battery

- Emergency lighting battery



FROM ONLY
£10.15
EACH

Code	Voltage	Description	Each	5+
E 853852	3.6V	3 Cell	£11.85	£11.26
271735	4.8V	4 Cell	£10.68	£10.15
593430	6V	5 Cell	£17.58	£16.70

NEW

PRODUCTS

ADDED DAILY



Visit ElectricalDirect.co.uk

Emergency Lighting

A



Emergency Legend Kit

- Contains: 2 x arrows & 2 x running men to make any desired combination

FROM ONLY
£2.00
EACH

Code	Each	5+
A 727732	£2.50	£2.00

B



Emergency LED Exit Box

- Maintained function 3 hours
- Supplied with arrow down legend

FROM ONLY
£22.56
EACH

Code	Each	5+
B 954313	£23.50	£22.56

C



Emergency Exit Sign Legends

- Replacement legend for LED Exit Box

FROM ONLY
£4.61
EACH

Code	Description	Each	5+
250265	Left Arrow	£4.80	£4.61
C 977514	Right Arrow	£4.80	£4.61

D



LED Blade Fitting

- Slim design
- Size: 310 x 230mm
- IP20
- 3 hour emergency duration

FROM ONLY
£38.16
EACH

Code	Each	5+
D 821236	£39.75	£38.16

LED TwinSpot

- 3W
- 3 hour emergency duration
- Suitable for wall mounting

FROM ONLY
£38.35
EACH

Code	Each	5+
A 566761	£39.95	£38.35

A



Emergency Downlight

- 3 hour emergency duration
- Low profile
- High output LED



FROM ONLY
£27.74
EACH

Code	Description	Each	5+
B 485493	1W	£28.90	£27.74
C 891789	3W	£28.90	£27.74

LED & CFL Emergency Pack

- 14W
- 3 hour maintained emergency

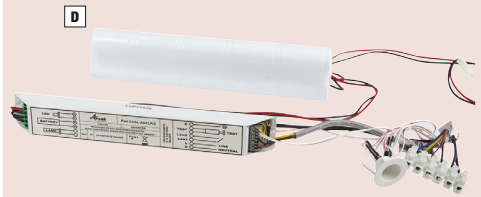

FROM ONLY
£68.25
EACH

Code	Each	5+
D 366212	£73.50	£68.25

LED Emergency Bulkhead

- 3W
- IP65



FROM ONLY
£17.90
EACH

Code	Each	5+
E 727134	£18.65	£17.90

12V Emergency Train Pack

- 50W load capacity
- 6V at 3 hours

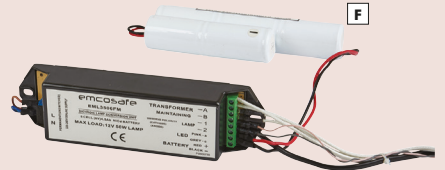

FROM ONLY
£63.00
EACH

Code	Each	5+
F 736638	£68.95	£63.00

Site & Portable Lighting

Outdoor Festoon Lights

- 100m length
- BC Lampholders
- 16A 3 pin plug supplied
- 110V 60W BC lamp required

FROM ONLY
£64.41
EACH

A



Code	Description	Each	3+
A 997211	3m spacing	£67.80	£64.41
347600	5m spacing	£74.75	£71.01

Festoon Wire Guard

FROM ONLY
£1.35
EACH

B

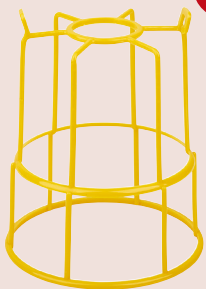

Code	Each	10+
B 274151	£1.50	£1.35

110V Briticent Gripper Light

- 1 x 60W
- 110V Bc
- Lamp required

FROM ONLY
£12.58
EACH

C



Code	Each	5+
C 629965	£13.25	£12.58

28W Task Light 110V

FROM ONLY
£16.63
EACH

D



Code	Each	3+
D 656036	£17.50	£16.63

10W LED Rechargeable Portable Hood Lamp

- 240V

FROM ONLY
£23.70
EACH

E



Code	Each	3+
E 759027	£24.95	£23.70

OPEN A TRADE ACCOUNT

FOR FASTER,
QUICKER ORDERING
OPEN A TRADE
ACCOUNT!

Visit our website
or call today!



NEW
PRODUCTS
ADDED DAILY



Visit ElectricalDirect.co.uk



NEXT DAY DELIVERY!

WHEN YOU ORDER BY 6PM

**10W LED
Square Black
Floodlight
6000k**

- IP65 rated energy saving up to 75%
- Superbright LED

FROM ONLY
£12.30
EACH
WHEN YOU BUY 5+



Order Code: 905405

SEE
PAGE
254

NEW PRODUCTS ADDED DAILY TO OUR WEBSITE

FREEPHONE: 8AM-6PM, 7 DAYS A WEEK
0808 168 22 77

ONLINE: SHOP 24/7
ElectricalDirect.co.uk

EXTERIOR LIGHTING

LED Decking & Garden Lights 252-253

LED Floodlights 254

LED Wall Lights & Brick Lights 255-257



SEE
PAGE
253



SEE
PAGE
255

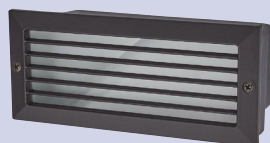

SEE
PAGE
256



SEE
PAGE
253

LED Decking & Garden Lights



FROM ONLY
£74.26
EACH

16W LED COB Light & HD Camera 4GB SD

- Passive infrared sensor detection with a range of 180° up to 10 metres
- Lamp direction adjustable horizontally to point in any required direction
- 16W LED COB energy saving, AC LED each delivering a bright 1500 lumens
- Camera records 720p resolution (1280 x 720), 20 second video & 3 x pictures for each motion detection
- Sensor range can be adjusted by moving the PIR vertically & horizontally

Code	Each	5+
A 129340	£78.17	£74.26



FROM ONLY
£22.80
EACH

1W LED Walkover Decking Light

- ID65 Rated
- Suitable for indoor and outdoor use
- 39mm cutout
- 62mm overall diameter
- Cool white colour render
-

Code	Each	5+
B 477180	£24.00	£22.80



Spike Light - 304 Stainless Steel

FROM ONLY
£18.52
EACH

Code	Wattage	Description	Each	5+
C 765012	1W	LED	£26.88	£25.53
D 232509	50W	GU10	£19.50	£18.52



Free Returns

Trade prices ex. VAT

LED Decking Kit - White

- Contains: 1 x 12V indoor inline transformer with 10m of cable, 1 outdoor rated 10-way junction box, 10 LED light fittings each with 3m of cable attached, junction box blanking plug



FROM ONLY
£37.00
PACK

Code	Fitting Diameter mm	Wattage	Pack	5+
A 134484	15	0.1	£38.95	£37.00
B 430872	30	0.3	£40.95	£38.90
C 740401	42	0.5	£43.95	£41.75

LED Decking Kit - Blue

- Contains: 1 x 12V indoor inline transformer with 10m of cable, 1 outdoor rated 10-way junction box, 10 LED light fittings each with 3m of cable attached, junction box blanking plug



FROM ONLY
£37.00
PACK

Code	Fitting Diameter mm	Wattage	Pack	5+
D 325208	15	0.1	£38.95	£37.00
E 206300	30	0.3	£40.95	£38.90
F 366921	42	0.5	£43.95	£41.75

LED GU10 Up/Down Light - 304 Stainless Steel



FROM ONLY
£32.77
EACH

Code	Each	5+
G 917387	£34.50	£32.77

PAR38 Spot Light Wall Mounted - Black



FROM ONLY
£6.08
EACH

Code	Each	5+
H 341155	£6.40	£6.08

LED Floodlights

LED Square Floodlight



FROM ONLY
£12.30
EACH

Code	Description	Wattage	Each	5+
789935	Colour Changing	10W	£27.50	£26.13
A 905405	White Light	10W	£12.95	£12.30
470578	White Light	30W	£32.95	£31.30
329962	White Light	50W	£49.65	£47.16
679066	White Light with PIR	10W	£14.25	
537383	White Light with PIR	30W	£37.65	£35.76

10W LED Square Mini Floodlight



FROM ONLY
£10.40
EACH

Code	Each	5+
B 294558	£10.95	£10.40

Adjustable Floodlight



FROM ONLY
£20.14
EACH

Code	Description	Each	5+
604017	Single Head	£21.20	£20.14
C 631732	Single Head with PIR	£26.05	£24.74
165192	Twin Head	£29.70	£28.21
D 690398	Twin Head with PIR	£34.80	£33.06

10W LED Ispot Floodlight



FROM ONLY
£22.80
EACH

Code	Finish	Each	5+
781433	Black	£24.00	£22.80
E 517893	White	£24.00	£22.80

LED Slim Floodlight



FROM ONLY
£20.75
EACH

Code	Wattage	Each	5+
624662	10	£21.85	£20.75
362535	30	£46.65	£44.31
410892	50	£60.30	£57.28
F 751601	80	£79.80	£75.81

NEW
PRODUCTS
ADDED
DAILY



Visit ElectricalDirect.co.uk

LED Wall Lights & Brick Lights

Outdoor Lantern Uplight



A



FROM ONLY
£12.07
EACH

Code	Finish	Each	5+
A 352377	Black	£12.71	£12.07
872683	White	£16.22	£15.40

Coach Lantern with Photo Cell



B



FROM ONLY
£23.89
EACH

Code	Finish	Each	5+
B 854443	Black	£25.15	£23.89
929506	White	£25.15	£23.89

Coach Lantern with PIR



C



FROM ONLY
£19.39
EACH

Code	Finish	Each	5+
931584	Black	£20.42	£19.39
C 642354	White	£29.40	£27.93

Half Coach Lantern



D



FROM ONLY
£13.07
EACH

Code	Finish	Each	5+
132163	Black	£13.76	£13.07
D 149439	White	£13.76	£13.07

9W PL9 Coach Lantern



E



FROM ONLY
£20.59
EACH

Code	Finish	Description	Each	5+
E 102829	Black	Photocell	£27.09	£26.73
478090	Black	Without Photocell	£21.68	£20.59
497685	White	Without Photocell	£21.68	£20.59

Half Coach Light With PIR



F



FROM ONLY
£27.93
EACH

Code	Each	5+
F 675021	£29.40	£27.93

LED Wall Lights & Brick Lights

24 LED Bricklight

- Cut out dimensions: 208 x 85 x 90mm
- IP54 rated
- 6500K Colour Temperature

A

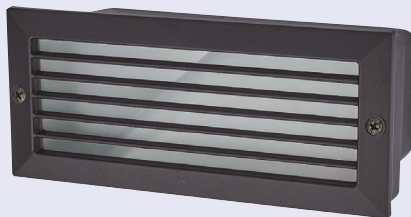

FROM ONLY
£13.87
EACH

Code	Each	5+
A 916258	£14.60	£13.87

60W Wall Light - Stainless Steel

- 201 Satin Stainless Steel & Polycarbonate
- Size: 290 x 225 x 100mm
- E27 lamp not included
- IP44 rated

B



FROM ONLY
£16.15
EACH

Code	Description	Each	5+
500448	Without PIR	£17.00	£16.15
B 502252	With PIR	£22.50	£21.37

40W Brick light

- E27 lamp not included
- Size: 235 x 100mm
- IP44 rated
- Stainless steel finish

C



FROM ONLY
£15.01
EACH

Code	Each	5+
C 618551	£15.80	£15.01

60W Brick light

- E27 lamp not included
- Size: 235 x 100mm
- IP44 rated
- Die cast finish
- Glass lense

D



FROM ONLY
£9.45
EACH

Code	Each	5+
D 424416	£9.95	£9.45

LED Wall Lights & Brick Lights

60W Up Lantern

- IP44 rated
- E27 lamp not included
- Stainless steel finish

FROM ONLY
£18.52
EACH

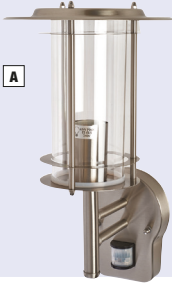

A

Code	Description	Each	5+
377638	Wall light	£19.50	£18.52
A 782746	Wall light with PIR	£25.00	£23.75

35W Up/Down Light

FROM ONLY
£14.10
EACH



B

Code	Each	5+
B 362319	£14.85	£14.10

35W Down light

- GV10 lamp holder
- IP44 rated
- Dimmable
- Lamps included (1 x 35W)
- Stainless steel finish

FROM ONLY
£13.30
EACH



C

Code	Each	5+
C 257249	£14.00	£13.30

35W PIR Twin Wall Light

- GV10 lamp holder
- IP44 rated
- Dimmable
- Lamps included (2 x 35W)
- Stainless steel finish

FROM ONLY
£23.27
EACH



D

Code	Each	5+
D 287588	£24.50	£23.27

FREE NEXT DAY DELIVERY

*Excl. VAT. £5.95 on orders under £45.

ON
ORDERS
OVER
£45*



FREE RETURNS



**MONEY
BACK
GUARANTEE**



NEXT DAY DELIVERY!

WHEN YOU ORDER BY 6PM

16W High Frequency Bulkhead



- IP44 Rated
- Ceiling or wall mounted
- Twist & lock design
- Opal diffuser

Order Code: 888349

SEE
PAGE
265

FROM ONLY
£13.77
EACH
WHEN YOU BUY 5+

NEW PRODUCTS ADDED DAILY TO OUR WEBSITE

FREEPHONE: 8AM-6PM, 7 DAYS A WEEK
0808 168 22 77

ONLINE: SHOP 24/7
ElectricalDirect.co.uk

INTERIOR LIGHTING

<u>Bathroom & Decorative Lighting</u>	<u>260</u>
<u>Decorative & Track Lighting</u>	<u>261</u>
<u>Pull Cords, Pendants & Batten Holders</u>	<u>263</u>
<u>Ceiling Lights</u>	<u>264-265</u>
<u>LED Round Bulkhead & Spotlights</u>	<u>266</u>
<u>LED Drivers & LV Transformers</u>	<u>267</u>
<u>Fire Rated Downlights</u>	<u>268-269</u>
<u>Strip & Under Cabinet Lights</u>	<u>270</u>
<u>Cabinet Link Lights</u>	<u>271</u>



SEE
PAGE
264



SEE
PAGE
267



SEE
PAGE
260



SEE
PAGE
268

Bathroom & Decorative Lighting

35W Bathroom Spot Light - Polished Chrome

- Waterproof rating: IP44
- Bulbs included

FROM ONLY
£23.75
EACH

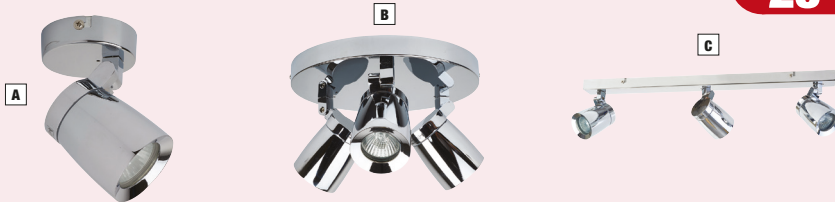

Code	Description	Outside Diameter mm	Length mm	Each	5+
A 874325	Single Spot on Rose	80		£25.00	£23.75
B 157085	Triple Spot on Rose	240		£52.00	£49.40
C 418456	Triple Spot on Bar		600	£57.00	£54.15

60W 284mm Shaver Light

FROM ONLY
£13.01
EACH

D



Code	Each	5+
D 718221	£13.70	£13.01

100W Bathroom Light

- Waterproof rating: IP44
- Outside Diameter: 320 x 95mm

FROM ONLY
£14.72
EACH

E



Code	Each	5+
E 626878	£15.50	£14.72

50W GU10 Spot - Bright Nickel

- Outside diameter: 85mm
- Bulb included

FROM ONLY
£4.89
EACH

F



Code	Description	Each	5+
F 720606	1 Spot	£5.15	£4.89
924455	2 Spot	£9.58	£9.10

GU10 On Bar Spot - Bright Nickel

- Outside diameter: 185mm
- Bulbs included

FROM ONLY
£14.70
EACH

G



Code	Description	Each	5+
727383	3 Spot	£18.17	£17.26
G 942982	4 Spot	£15.48	£14.70

Single LED Kit - Brushed Chrome

- Kit of 4
- Size: 38 x 38mm
- Cut Out: 24 x 29mm
- Depth: 28mm
- 12V

FROM ONLY
£18.81
EACH

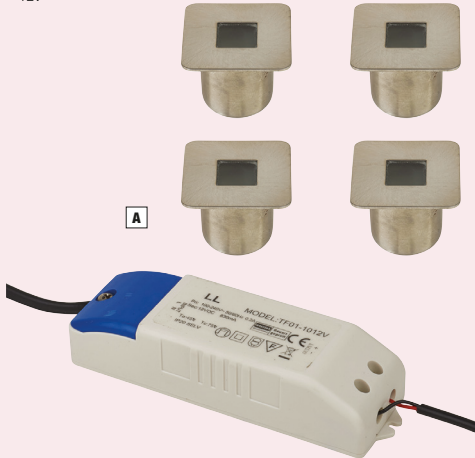

Code	Each	5+
A 734896	£19.80	£18.81

Single LED - Brushed Chrome

- Plinth light
- Size: 38 x 38mm
- Cut Out: 24 x 29mm
- Depth: 28mm
- 12V

FROM ONLY
£4.65
EACH

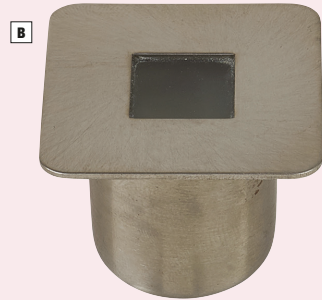

Code	Each	5+
B 531195	£4.90	£4.65

Quad LED - Brushed Chrome

- Plinth light
- Size: 38 x 38mm
- Cut Out: 10mm
- Depth: 6mm
- 12/240V
- 4 x Quad LED lights in pack

FROM ONLY
£15.96
PACK

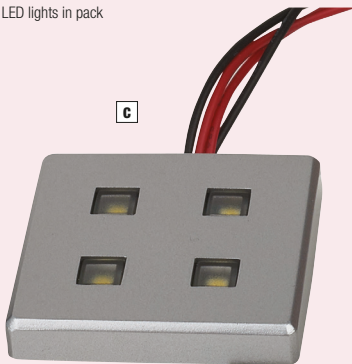

Code	Pack	5+
C 602177	£16.80	£15.96

100W Drum Fitting

FROM ONLY
£17.48
EACH



Code	Each	5+
D 663654	£18.64	£17.48

Decorative

INTERIOR LIGHTING

FROM ONLY
£49.40
EACH
WHEN YOU BUY 5+

**35W Bathroom
Spot Light -
Polished Chrome**

Order Code: 157085



SEE
PAGE
260



SEE
PAGE
261

**Single LED KIT
Brushed Chrome**

FROM ONLY
£18.81
KIT
WHEN YOU BUY 5+

Order Code: 734896

**Single LED
Brushed Chrome**

FROM ONLY
£4.65
EACH
WHEN YOU BUY 5+

Order Code: 531195



SEE
PAGE
261

Quad LED Brushed Chrome

Order Code: 602177

FROM ONLY
£15.96
EACH
WHEN YOU BUY 5+

6" Pendant Set - White

- T2 rated lampholders
- Complete with flex
- Heat resisting PVC insulated

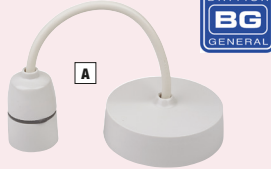

FROM ONLY
£1.01
EACH

Code	Each	5+
A 488396	£1.25	£1.01

10/13W 6" Low Energy Pendant - White

- Integral control gear
- Supports a light fitting of up to 3kg



FROM ONLY
£7.85
EACH

Code	Each	5+
B 542026	£8.65	£7.85

Batten Holder - White

- Heat resistant to category T2



FROM ONLY
£3.94
EACH

Code	Description	Each	5+
C 663984	Standard Batten Holder	£4.69	£4.09
D 161554	Angled Batten Holder	£4.53	£3.94

6" Pendant Set - White



- T2 rated lampholders
- Complete with flex
- Heat resisting PVC insulated



FROM ONLY
£2.13
EACH

Code	Each	10+
E 563654	£2.55	£2.13

Batten Holder - White

- Heat resistant to category T2



FROM ONLY
£2.51
EACH

Code	Each	10+
F 817515	£3.00	£2.51

6" Pendant Set - White

- T2 rated lampholders
- Complete with flex
- Heat resisting PVC insulated



FROM ONLY
£2.88
EACH

Code	Each	5+
G 262879	£3.31	£2.88

10/13W 6" Low Energy Pendant - White

- Integral control gear
- Supports a light fitting of up to 3kg



FROM ONLY
£22.26
EACH

Code	Each	5+
H 110010	£23.44	£22.26

10/13W 6" Low Energy Pendant - White

- Integral control gear
- Supports a light fitting of up to 3kg



FROM ONLY
£9.46
EACH

Code	Each	5+
I 403721	£9.96	£9.46

BC Straight Lampholder - White

- Heat resistant BC Lampholder



FROM ONLY
£5.25
EACH

Code	Each	5+
J 144381	£6.03	£5.25

Prewired Batten Holder

- Suitable for ceiling and wall mounting
- Current: 6A
- Rated lamp wattage: 150W



FROM ONLY
£1.25
EACH

Code	Description	Each	5+
K 239511	Batten Holder	£1.43	£1.25
L 378350	Angled Batten Holder	£2.05	£1.90

Ceiling Lights

Brass Lampholder with Switch Bar

- BC fitting

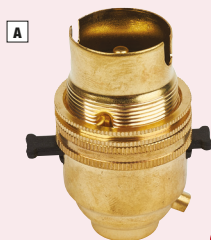

FROM ONLY
£3.54
EACH

Code	Each	5+
A 984422	£3.73	£3.54

Brass Lampholder

B

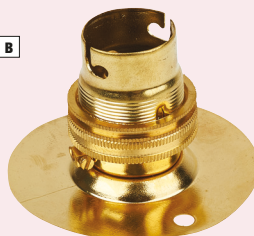

FROM ONLY
£1.58
EACH

Code	Description	Fittings	Each	5+
121618	Threaded	BC	£1.89	£1.65
133093	Threaded	SBC	£1.80	£1.58
B 393126	Batten	BC	£2.80	£2.45
993511	Batten	SBC	£2.67	£2.33

10mm Brass Adaptor

C



FROM ONLY
13P
EACH

Code	Each	5+
C 714134	£0.15	£0.13

GU10 Lamp Holder

D



FROM ONLY
£1.80
EACH

Code	Each	5+
D 667388	£1.90	£1.80

Low Voltage Lamp

E



FROM ONLY
£1.80
EACH

Code	Each	5+
E 463482	£1.90	£1.80

LED Round Luminaire

- Outside diameter: 325 x 134mm

F



FROM ONLY
£40.39
EACH

Code	Lamp Type	Description	Each	5+
721740	Emergency	20W	£55.55	£52.77
F 920812	Non Emergency	20W	£42.52	£40.39

LED Round Microwave Sensor Luminaire

- Outside diameter: 325 x 134mm

A



FROM ONLY
£52.82
EACH

Code	Description	Each	5+
601059	Emergency	£78.75	£74.81
A 660236	Non Emergency	£55.60	£52.82

GU10 Conversion Downlight Plate

- Outside diameter: 150mm
- Cut out: 70-140mm

B



FROM ONLY
£7.12
EACH

Code	Finish	Each	5+
497416	Chrome	£7.50	£7.12
990779	Stainless Steel	£7.50	£7.12
B 965451	White	£7.50	£7.12

2D High Frequency Round Light - White Opal

- Outside diameter: 330 x 110mm

C



FROM ONLY
£13.77
EACH

Code	Product Type	Description	Each	5+
888349	Non Emergency	16W	£14.50	£13.77
221930	Non Emergency	28W	£19.50	£18.52
C 596505	Non Emergency	38W	£23.75	£22.56
355100	Emergency	28W	£50.40	£47.88

16W 2D Round Screw Drum Bulkhead

- Outside diameter: 190 x 80mm

D



E



FROM ONLY
£9.31
EACH

Code	Finish	Each	5+
730607	White & Opal	£9.80	£9.31
D 404788	White & Clear	£9.80	£9.31
E 429965	Black & Opal	£9.80	£9.31
311502	Black & Clear	£9.80	£9.31

Polo LED Round Opal Bulkhead

- Outside diameter: 320 x 110mm

F



FROM ONLY
£31.91
EACH

Code	Finish	Each	5+
F 268945	Emergency	£44.95	£42.70
323244	Non Emergency	£33.59	£31.91

2D Bulkhead

G



FROM ONLY
£28.69
EACH

Code	Description	Outside Diameter mm	Each	5+
G 981207	16W	217 x 65	£30.20	£28.69
590315	28W	300 x 75	£35.60	£33.82

LED Round Bulkhead & Spotlights

LED Round Bulkhead

- Waterproof rating: IP65

A



FROM ONLY
£24.65
EACH

Code	Description	Each	5+
A 870619	Emergency	£25.95	£24.65
538507	Non Emergency	£39.60	£37.62

50W Single Spot Light - Satin Nickel

- Bulbs included

B



FROM ONLY
£4.89
EACH

Code	Each	5+
B 731177	£5.15	£4.89

2 x 50W 2 Bar Spot Light - Satin Nickel

- Bulbs included

C



FROM ONLY
£10.21
EACH

Code	Each	5+
C 590504	£10.75	£10.21

4 x 50W 4 Bar Spot Light - Satin Nickel

- Bulbs included

D



FROM ONLY
£14.72
EACH

Code	Each	5+
D 370154	£15.50	£14.72

3 x 50W Circular Spot Light - Satin Nickel

- Bulbs included

E



FROM ONLY
£13.63
EACH

Code	Each	5+
E 271432	£14.35	£13.63

4 x 50W 4 Bar Spot Light - Satin Nickel

- Bulbs included

F



FROM ONLY
£21.28
EACH

Code	Each	5+
F 532419	£22.40	£21.28



Before 12pm Delivery Available

Trade prices ex. VAT

100W 15m LED Driver Strip

A



FROM ONLY
£36.24 EACH

Code	Each	5+
A 677078	£38.15	£36.24

12W 15m LED Driver Strip

B



FROM ONLY
£11.16 EACH

Code	Each	5+
B 539347	£11.75	£11.16

36W 5m LED Strip

C



FROM ONLY
£14.72 EACH

Code	Each	5+
C 222712	£15.50	£14.72

L150E Low Voltage Electronic Transformer

E



FROM ONLY
£14.53 EACH

Code	Each	5+
E 214390	£15.80	£14.53

210E Low Voltage Electronic Transformer

F



FROM ONLY
£20.15 EACH

Code	Each	5+
F 795765	£21.90	£20.15

60A Low Voltage Electronic Transformer

G



FROM ONLY
£3.99 EACH

Code	Each	5+
G 658457	£4.25	£3.99

105VA Transformer - IP68

H



FROM ONLY
£15.96 EACH

Code	Each	5+
H 325594	£16.80	£15.96

NEW PRODUCTS ADDED DAILY



Visit ElectricalDirect.co.uk

FREE NEXT DAY DELIVERY

On orders over £45*



*Excl. VAT. £5.95 on orders under £45.

Fire Rated Downlights

LED 38° Downlight IP65 - Warm White

- Dimmable
- Outside diameter: 90mm
- Cut out: 60-70mm
- Required void depth: 100mm

HALERS RANGE



FROM ONLY
£23.66
EACH

Code	Each	5+
A 956886	£24.65	£23.66

LED 60° Downlight IP65 - Warm White

- Dimmable
- Outside diameter: 90mm
- Cut out: 60-70mm
- Required void depth: 100mm

HALERS RANGE

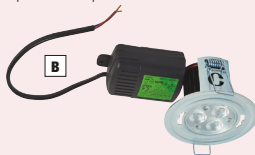

FROM ONLY
£23.66
EACH

Code	Each	5+
B 243637	£24.65	£23.66

LED 38° Downlight IP65 - Natural White

- Dimmable
- Outside diameter: 90mm
- Cut out: 60-70mm
- Required void depth: 100mm

HALERS RANGE



FROM ONLY
£23.66
EACH

Code	Each	5+
C 956204	£24.65	£23.66

LED 60° Downlight IP65 - Natural White

- Dimmable
- Outside diameter: 90mm
- Cut out: 60-70mm
- Required void depth: 100mm

HALERS RANGE



FROM ONLY
£23.66
EACH

Code	Each	5+
D 255641	£24.65	£23.66

Round Bezel



FROM ONLY
£1.58
EACH

Code	Finish	Each	5+
E 592992	Bright Steel	£1.65	£1.58
F 786889	Chrome Plated	£1.65	£1.58
G 474153	White	£1.65	£1.58

GU10 Fixed Fire Rated Downlight

- Outside diameter: 86mm
- Cut out: 76mm
- Required void depth: 145mm



FROM ONLY
£5.13
EACH

Code	Finish	Each	10+
H 111498	Chrome	£5.85	£5.49
515143	Satin Chrome	£5.85	£5.49
884215	White	£5.54	£5.13

GU10 Fixed Fire Rated Downlight - IP65

- Outside diameter: 87mm
- Cut out: 76mm
- Required void depth: 145mm



FROM ONLY
£8.00
EACH

Code	Finish	Each	10+
578885	Chrome	£9.75	£9.25
780991	Satin Chrome	£9.75	£9.26
I 980334	White	£8.50	£8.00

GU10 Adjustable Fire Rated Downlight

- Outside diameter: 100mm
- Cut out: 90mm
- Required void depth: 145mm



FROM ONLY
£5.89
EACH

Code	Finish	Each	10+
430708	Chrome	£6.85	£6.50
J 885506	Satin Chrome	£6.85	£6.50
449533	White	£6.20	£5.89

NEW
PRODUCTS
ADDED DAILY



Visit ElectricalDirect.co.uk

8W LED Downlight IP65 - Warm White

- Non dimmable
- Outside diameter: 80mm
- Cut out: 67-70mm
- Required void depth: 115mm

loxa OC
to energy lighting

FROM ONLY
£13.75
EACH

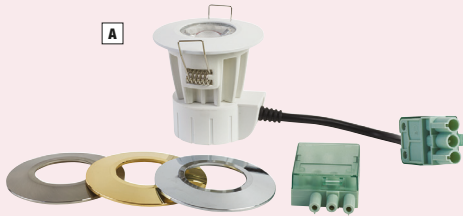

Code	Each	5+
A 569758	£15.20	£13.75

8W LED Downlight IP65 - Cool White

- Non dimmable
- Outside diameter: 80mm
- Cut out: 67-70mm
- Required void depth: 115mm

loxa OC
to energy lighting

FROM ONLY
£13.75
EACH

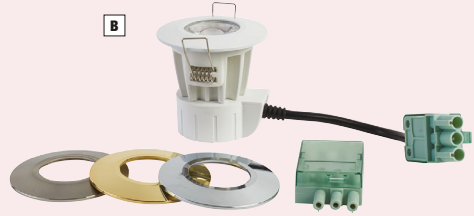

Code	Each	5+
B 821872	£15.20	£13.75

10W LED Downlight IP65 - Warm White

- Dimmable
- Outside diameter: 80mm
- Cut out: 67-70mm
- Required void depth: 115mm

loxa OC
to energy lighting

FROM ONLY
£16.40
EACH



Code	Each	5+
C 931742	£18.90	£16.40

10W LED Downlight IP65 - Cool White

- Dimmable
- Outside diameter: 80mm
- Cut out: 67-70mm
- Required void depth: 115mm

loxa OC
to energy lighting

FROM ONLY
£16.40
EACH



Code	Each	5+
D 203121	£18.90	£16.40

FREE NEXT DAY DELIVERY

*Excl. VAT. £5.95 on orders under £45.

ON
ORDERS
OVER
£45*



Strip & Under Cabinet Lights

LED Striplight

- Length: 5m
- Supplied with 2 x connectors

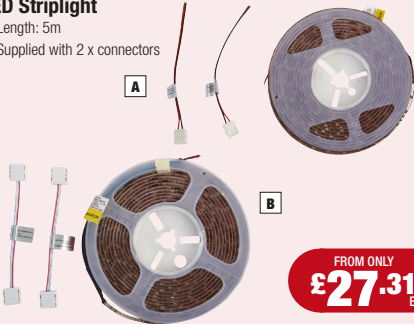

FROM ONLY
£27.31 EACH

Code	Colour	Temperature	Description	Each	5+
A 287753	2800K	Warm	White	£28.75	£27.31
256296	4500K	Cool	White	£28.75	£27.31
B 460685	6500K	Daylight		£28.75	£27.31

LED Strip Connector

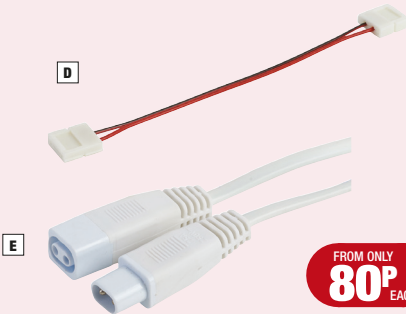

FROM ONLY
80P EACH

Code	Description	Product Length m	Each	5+
D 960229	65 Connector	5	£0.85	£0.80
E 231141	Kit		£2.10	£1.99

21 LED SMD Downlight Warm White

- Outside diameter: 65 x 15mm



FROM ONLY
£8.59 EACH

Code	Each	5+
H 258634	£9.05	£8.59

36W Striplight - Colour Changing

- Length: 5m
- Colour changing via remote control

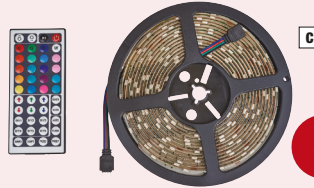

FROM ONLY
£28.31 EACH

Code	Each	5+
C 355787	£29.80	£28.31

LED Under Cabinet Striplight - Cool White

- Length: 550mm

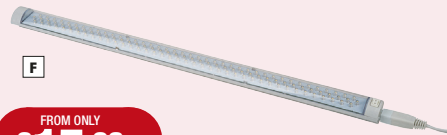

FROM ONLY
£15.96 EACH

Code	Product Type	Length mm	Each	5+
481842	47 LED	252	£16.80	£15.96
F 698656	121 LED	550	£28.85	£27.40

21 LED Under Cabinet Wedge Light - Warm White

- Length: 150 x 80mm



FROM ONLY
£8.59 EACH

Code	Each	5+
G 508402	£9.05	£8.59

12V 6W Driver

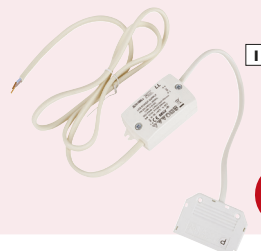

FROM ONLY
£7.29 EACH

Code	Each	5+
I 499575	£7.68	£7.29

4W LED Striplight with Link

- Length: 285mm

A



FROM ONLY
£11.86
EACH

Code	Each	5+
A 938462	£12.49	£11.86

9W LED Striplight with Link

- Length: 538mm

B



FROM ONLY
£12.58
EACH

Code	Each	5+
B 447247	£13.25	£12.58

13W LED Striplight with Link

- Length: 838mm

C



FROM ONLY
£13.15
EACH

Code	Each	5+
C 830496	£13.85	£13.15

18W LED Striplight with Link

- Length: 1138mm

D



FROM ONLY
£15.66
EACH

Code	Each	5+
D 126259	£16.49	£15.66

Link Lead

E

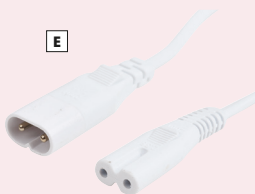

FROM ONLY
£1.42
EACH

Code	Each	5+
E 796849	£1.50	£1.42

Replacement LED Add-on - Blue

- Size: 2 x 300mm

F



FROM ONLY
£12.82
EACH

Code	Each	5+
F 770772	£13.50	£12.82

Replacement LED Add-on - White

- Size: 2 x 300mm

G



FROM ONLY
£12.82
EACH

Code	Each	5+
G 253020	£13.50	£12.82

LED Striplight Kit

- Length: 300mm

H



FROM ONLY
£18.52
EACH

Code	Finish	Each	5+
H 534432	Blue	£19.50	£18.52
304969	White	£19.50	£18.52

PIR for LED Striplight

- To activate striplights by movement

I



FROM ONLY
£9.45
EACH

Code	Each	5+
I 538952	£9.95	£9.45



NEXT DAY DELIVERY!

WHEN YOU ORDER BY 6PM



 **20,000
HOUR LIFE**

**5ft
Triphosphor
Fluorescent
Tube**

- 49W
- Cool White
- Pack of 5

Order Code: 790327

SEE
PAGE
286

FROM ONLY
£30.50
PACK
WHEN YOU BUY 10+

NEW PRODUCTS ADDED DAILY TO OUR WEBSITE

 **FREEPHONE: 8AM-6PM, 7 DAYS A WEEK**
0808 168 22 77

 **ONLINE: SHOP 24/7**
ElectricalDirect.co.uk

LAMPS & TUBES

<u>Energy Saving GLS</u>	<u>274-275</u>
<u>Energy Saving Candles</u>	<u>276</u>
<u>Energy Saving Golf Balls & Reflectors</u>	<u>277</u>
<u>Low Energy Lamps</u>	<u>278</u>
<u>Compact Fluorescents</u>	<u>279</u>
<u>Discharge Lamps</u>	<u>280-281</u>
<u>LED Filament Candle</u>	<u>282</u>
<u>LED Filament & T8 Replacement Tubes</u>	<u>283</u>
<u>Spot Lamps</u>	<u>284-285</u>
<u>Fluorescent Tubes</u>	<u>286-287</u>



SEE
PAGE
287



SEE
PAGE
286



SEE
PAGE
283



SEE
PAGE
275

FREE NEXT DAY DELIVERY

*Excl. VAT. £5.95 on orders under £45.



ON
ORDERS
OVER
£45*

LED GLS Lamp

- 15,000 hour life
- Low energy consumption



A

FROM ONLY
£4.46
EACH

Code	Wattage	Cap Type	Colour	Each	10+
A 552153	5.5	BC	Warm White	£4.95	£4.46
358048	9.5	BC	Daylight	£4.95	£4.46
523680	9.5	BC	Warm White	£4.95	£4.46
767866	9.5	ES	Daylight	£4.95	£4.46

10W LED GLS Lamp - BC Fitting - Warm White



B

FROM ONLY
£3.75
EACH

Code	Cap Type	Each	10+
B 571243	BC	£3.95	£3.75

11W LED GLS Lamp - Warm White

- 15,000 hour life
- Low energy consumption



C

FROM ONLY
£5.36
EACH

Code	Cap Type	Each	10+
778048	ES	£5.95	£5.36
C 263829	BC	£5.95	£5.36

14W LED GLS Lamp Dimmable - Warm White

- 15,000 hour life
- Opal Finish



D

FROM ONLY
£6.53
EACH

Code	Cap Type	Each	10+
D 514537	BC	£7.25	£6.53

42W GLS Halogen Lamp - BC Fitting

- Energy saving on traditional GLS lamps
- Dimmable



FROM ONLY
90P
EACH

Code	Each	10+
A 707177	£0.95	£0.90

42W GLS Halogen Lamp - ES Fitting

- Energy saving on traditional GLS lamps



FROM ONLY
90P
EACH

Code	Each	10+
B 168589	£0.95	£0.90

70W GLS Halogen Lamp

- Energy saving on traditional GLS lamps
- Dimmable



FROM ONLY
90P
EACH

Code	Description	Each	10+
C 947765	BC	£0.95	£0.90
364812	ES	£0.95	£0.90

42W GLS Halogen Lamp - ES fitting

- 2,000 hour life
- Clear finish
- UV stop glass
- Dimmable



FROM ONLY
£1.53
EACH

Code	Each	10+
D 975765	£1.82	£1.53

72W GLS Halogen Lamp

- 2,000 hour life
- Clear finish
- UV stop glass
- Dimmable



FROM ONLY
£1.53
EACH

Code	Description	Each	10+
410693	BC	£1.82	£1.53
E 773063	ES	£1.82	£1.53

30W 240V Strip Lamp



FROM ONLY
£1.30
EACH

Code	Size mm	Each	5+
781243	221	£1.56	£1.30
F 930487	284	£1.56	£1.30

60W 240V Strip Lamp



FROM ONLY
£1.30
EACH

Code	Size mm	Each	5+
901704	221	£1.56	£1.30
G 580096	284	£1.56	£1.30

Energy Saving Candles

5.5W LED Candle Lamp - Warm White

- 25,000 hour life

A



B



FROM ONLY
£3.52
EACH

Code	Cap Type	Each	10+
A 574636	BC	£3.70	£3.52
B 760577	SES	£3.70	£3.52

5.5W LED Candle Lamp - Warm White

- 15,000 hour life

C



D



E



FROM ONLY
£4.70
EACH

Code	Cap Type	Each	5+
C 576752	BC	£4.95	£4.70
D 693228	ES	£4.95	£4.70
E 171199	SES	£4.95	£4.70

18W Halogen Candle Lamp - BC Fitting - Dimmable

- 2,000 hour life
- Clear finish
- UV stop glass

F



FROM ONLY
£1.51
EACH

Code	Cap Type	Each	10+
F 530083	BC	£1.80	£1.51

28W Halogen Candle Lamp - Dimmable

- 2,000 hour life
- Clear finish
- UV stop glass

I



J



G



H



FROM ONLY
£1.51
EACH

Code	Cap Type	Each	10+
G 631419	BC	£1.80	£1.51
H 860342	ES	£1.80	£1.51
I 455155	SBC	£1.80	£1.51
J 132795	SES	£1.80	£1.51

42W Halogen Candle Lamp - Dimmable

- 2,000 hour life
- Clear finish
- UV stop glass

M



L



K



FROM ONLY
£1.51
EACH

Code	Cap Type	Each	10+
K 323466	BC	£1.80	£1.51
L 523749	ES	£1.80	£1.51
M 237111	BC	£1.80	£1.51

240V LED Candle Lamp Dimmable - Warm White

- Dimmable LED
- 15,000 hour life
- Clear finish
- For indoor use only

N



FROM ONLY
£6.41
EACH

Code	Type	Wattage	Each	5+
910969	BC	4W	£6.75	£6.41
N 664172	SES	4W	£6.75	£6.41

Energy Saving Golf Balls & Reflectors

LED Golf Ball Lamp - Warm White

- Instant full light
- 15,000 hour life



Code	Wattage	Each	10+
A 917513	3.5W	£3.70	£3.52
B 575188	3.5W	£3.70	£3.52
C 837833	4W	£3.70	£3.52
D 421412	4W	£3.70	£3.52

FROM ONLY
£3.52
EACH

28W Halogen Golf Ball Lamp - BC Fitting - Dimmable

- 2,000 hour life
- Clear finish



Code	Cap Type	Each	10+
E 307366	BC	£1.80	£1.51

FROM ONLY
£1.51
EACH

Reflector Lamp



Code	Type	Wattage	Each	10+
F 401558	R50	28W	£2.01	£1.79
G 333729	R63	42W	£2.01	£1.79

FROM ONLY
£1.79
EACH

Low Energy Lamps

11W GU10 Low Energy Lamp - Cool White



FROM ONLY
£5.00
EACH

Code	Each	5+
A 483613	£5.55	£5.00

11W GU10 Low Energy Lamp - Warm White



FROM ONLY
£4.95
EACH

Code	Each	5+
B 650001	£5.50	£4.95

Downlight Retaining Ring

- Suitable for LED or Halogen
- Will fit GU10 or MR16



FROM ONLY
32P
EACH

Code	Each	10+
C 422956	£0.35	£0.32

12V 50W Halogen Reflector Spot Lamp

- GX5.3 base
- Size: 50mm



FROM ONLY
£1.55
EACH

Code	Beam Angle	Each	10+
D 268936	38°	£1.70	£1.55

240V GU10 Halogen Lamp



FROM ONLY
£1.25
EACH

Code	Wattage	Beam Angle	Each	10+
E 565098	35	38°	£1.95	£1.60
602007	50	38°	£1.80	£1.25

20-50W Enclosed Lamps

- Glass fronted dichroic lamp
- Size: 6 x 5.3mm base



FROM ONLY
£1.05
EACH

Code	Wattage	Beam Angle	Each	10+
420385	20	36°	£1.27	£1.05
785640	35	36°	£1.27	£1.05
149998	50	10°	£1.27	£1.05
834469	50	24°	£1.27	£1.05
F 335578	50	36°	£1.27	£1.05
831346	50	60°	£1.27	£1.05

PL Compact Fluorescent Lamp - Cool White

- Single turn S type lamp
- 10,000 hour life
- Not suitable for dimming
- Colour Code 840

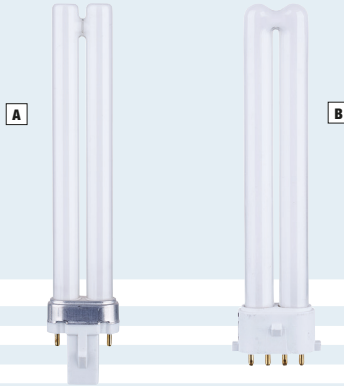

FROM ONLY
£1.98
EACH

Code	No of Pins	Wattage	Each	5+
907400	4	7	£2.31	£1.98
A 336477	2	9	£2.31	£1.98
B 319247	4	9	£2.31	£1.98
705368	2	11	£2.31	£1.98
186505	4	11	£2.31	£1.98

2 Pin PLC Compact Fluorescent Lamp - 2 Pin - Cool White

- Double turn D type lamp
- 10,000 hour life
- Not suitable for dimming
- Internally fused for safety
- Colour Code 840



FROM ONLY
£2.95
EACH

Code	Wattage	Each	10+
C 238382	10	£3.40	£2.95
815835	13	£3.40	£2.95
880481	18	£3.85	£3.40
307678	26	£3.98	£3.60

PLC-E Compact Fluorescent Lamp - 4 Pin - Cool White

- Double turn DE type lamp
- 10,000 hour life
- Not suitable for dimming
- Internally fused for safety
- Colour Code 840



FROM ONLY
£2.95
EACH

Code	Wattage	Each	10+
D 952609	10	£3.40	£2.95
860512	13	£3.65	£3.05
822201	18	£3.85	£3.40
808369	26	£3.98	£3.60
771378	32	£4.85	£4.37

PLT Compact Fluorescent Lamp - 4 Pin - Cool White

- Triple turn TE type lamp
- 10,000 hour life
- Not suitable for dimming
- Internally fused for safety
- Colour Code 840



FROM ONLY
£4.37
EACH

Code	Wattage	Each	10+
E 561971	13	£4.85	£4.37
556026	18	£4.85	£4.37
F 334384	26	£4.85	£4.37

PLL Compact Fluorescent Lamp - 4 Pin - Cool White

- Single turn L type lamp
- 10,000 hour life
- Not suitable for dimming
- Internally fused for safety
- Colour Code 840



FROM ONLY
£3.60
EACH

Code	Wattage	Each	10+
G 189574	18	£3.98	£3.60
644553	24	£3.98	£3.60
235553	36	£3.98	£3.60
100708	40	£4.45	£4.10
884738	55	£4.45	£4.10

Discharge Lamps

70W Elliptical Sodium Lamp

A



FROM ONLY
£7.29
EACH

Code	Each	5+
A 906101	£8.24	£7.29

100W Elliptical Sodium Lamp

B



FROM ONLY
£8.71
EACH

Code	Each	5+
B 501450	£9.54	£8.71

150W Elliptical Sodium Lamp

C



FROM ONLY
£8.71
EACH

Code	Each	5+
C 133292	£9.54	£8.71

250W Elliptical Sodium Lamp

D



FROM ONLY
£8.71
EACH

Code	Each	5+
D 741783	£9.54	£8.71

400W Elliptical Sodium Lamp

E



FROM ONLY
£9.36
EACH

Code	Each	5+
E 911314	£10.47	£9.36

50W Mercury Blended Fluorescent

F



FROM ONLY
£5.24
EACH

Code	Each	5+
F 188984	£6.24	£5.24

80W Mercury Blended Fluorescent

G



FROM ONLY
£5.24
EACH

Code	Each	5+
G 118356	£6.24	£5.24

125W Mercury Blended Fluorescent

H



FROM ONLY
£6.24
EACH

Code	Each	5+
H 838717	£7.18	£6.24

250W Mercury Blended Fluorescent

I



FROM ONLY
£8.06
EACH

Code	Each	5+
I 860066	£9.06	£8.06

400W Mercury Blended Fluorescent

J



FROM ONLY
£11.89
EACH

Code	Each	5+
J 804755	£13.24	£11.89

50W Tubular Sodium Lamp

- External ignitor

K



FROM ONLY
£8.71
EACH

Code	Each	5+
K 678283	£9.54	£8.71

70W Tubular Sodium Lamp

- External ignitor

L



FROM ONLY
£7.29
EACH

Code	Each	5+
L 752486	£8.24	£7.29

Compact Metal Halide Lamp G12 Ceramic Base

A



FROM ONLY
£12.30
EACH

Code	Wattage	Each	10+
109274	35W	£12.95	£12.30
A 343729	75W	£12.95	£12.30
612108	150W	£13.85	£13.16

70W Double Ended Metal Halide 4200K

B



FROM ONLY
£5.85
EACH

Code	Each	5+
B 842268	£6.50	£5.85

150W Double Ended Metal Halide Lamp

C



FROM ONLY
£6.21
EACH

Code	Each	5+
C 813746	£6.90	£6.21

250W Double Ended Metal Halide Lamp

D



FROM ONLY
£16.20
EACH

Code	Each	5+
D 784230	£18.00	£16.20

400W Double Ended Metal Halide Lamp

E



FROM ONLY
£17.87
EACH

Code	Each	5+
E 476655	£19.85	£17.87

250W Elliptical Metal Halide Lamp

F



FROM ONLY
£16.02
EACH

Code	Each	5+
F 330795	£17.80	£16.02

150W Elliptical Metal Halide Lamp

G



FROM ONLY
£16.02
EACH

Code	Each	5+
G 746798	£17.80	£16.02

100W Tubular Sodium Lamp

- External ignitor

H



FROM ONLY
£8.71
EACH

Code	Each	5+
H 480220	£9.54	£8.71

150W Tubular Sodium Lamp

I



J

FROM ONLY
£8.24
EACH

Code	Type	Each	5+
I 815806	Internal ignitor	£11.30	£9.54
J 609943	External ignitor	£9.54	£8.24

250W Tubular Sodium Lamp

- External ignitor

K



FROM ONLY
£9.36
EACH

Code	Each	5+
K 742852	£10.47	£9.36

400W Tubular Sodium Lamp

- External ignitor

L



FROM ONLY
£9.36
EACH

Code	Each	5+
L 269083	£10.47	£9.36

400W Tubular Metal Halide 4200K Lamp

M



FROM ONLY
£16.92
EACH

Code	Each	5+
M 513898	£18.80	£16.92

400W Elliptical Metal Halide Lamp

N



FROM ONLY
£16.92
EACH

Code	Each	5+
N 169705	£18.80	£16.92

70W Elliptical Metal Halide Lamp

O



FROM ONLY
£13.68
EACH

Code	Each	5+
O 216179	£15.20	£13.68

70W Elliptical Son Internal Ignitor Lamp

P



FROM ONLY
£7.29
EACH

Code	Each	5+
P 346598	£8.24	£7.29

LED Filament Candle

240V LED Filament Candle Lamp

- Decorative LED filament lamp
- Non dimmable



A

FROM ONLY
£4.04
EACH

Code	Type	Wattage	Each	10+
A 402216	BC	4W	£4.25	£4.04
687226	BC	6W	£4.25	£4.04
530095	SES	4W	£4.25	£4.04
843288	SES	6W	£4.25	£4.04

240V LED Filament Candle Lamp

- 15,000 hour life
- Non dimmable



B

FROM ONLY
£4.28
EACH

Code	Type	Wattage	Each	5+
B 814642	BC	4W	£4.51	£4.28
658792	SES	4W	£4.51	£4.28

240V LED Filament Golf Ball Lamp

- Decorative LED filament lamp
- Non dimmable



C

FROM ONLY
£4.04
EACH

Code	Type	Wattage	Each	10+
C 374108	BC	4W	£4.25	£4.04
985374	SES	4W	£4.25	£4.04

240V LED GLS Lamp With Photocell

- Auto Sensor - on at dusk, off at dawn



D

FROM ONLY
£11.35
EACH

Code	Type	Wattage	Each	5+
D 633150	BC	6.5W	£11.95	£11.35
190678	ES	6.5W	£11.95	£11.35

LED Filament & T8 Replacement Tubes

240V LED Candle Lamp Dimmable - Warm White

- Dimmable LED
- 15,000 hour life
- Clear finish
- For indoor use only

A



FROM ONLY
£6.41
EACH

Code	Type	Wattage	Each	5+
910969	BC	4W	£6.75	£6.41
A 664172	SES	4W	£6.75	£6.41

LED Replacement Tubes - 4000k

B



FROM ONLY
£5.40
EACH

Code	Length ft	Wattage	Each	5+
851956	2	10W	£6.00	£5.40
425857	4	18W	£10.78	£9.70
279820	5	24W	£13.66	£12.29
B 362029	6	40W	£21.60	£19.44

240V LED Corn Lamp

- Gives 360° illumination

C



FROM ONLY
£81.70
EACH

Code	Colour Temp	Wattage	Each	5+
C 831484	6500k	100W	£86.00	£81.70

240V LED Corn Lamp

- Gives 360° illumination

D



FROM ONLY
£75.95
EACH

Code	Colour Temp	Wattage	Each	5+
D 536130	6500k	80W	£79.95	£75.95

Spot Lamps

3W GU10 LED Colour Changing Kit

- A bright and colourful solution to lighting up a games room, child's bedroom or bar
- 16 colours
- Compatible with existing GU10 fittings
- 16 colours

FREE
CONTROLLER

A



FROM ONLY
£7.55
EACH



Code	Each	10+
A 880733	£7.95	£7.55

LED Capsule Lamp

- Replacement for G4 halogen lamps
- Warm white
- Cap fitting: G4 WW

B

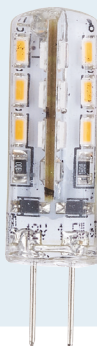

FROM ONLY
£2.95
EACH

C



Code	Wattage	Each	10+
B 469741	1.5W	£3.10	£2.95
C 418240	3W	£4.15	£3.94

ORDER BY 6PM

Get it Next Day!



5W LED GU10 Spot Lamp

A



FROM ONLY
£2.80
EACH

Code	Colour Temp	Each	10+
A 921395	3000k - Warm White	£2.95	£2.80
769129	4000k - Cool White	£2.95	£2.80

7.5W LED G x 5.3 Spot Lamp

- Will retrofit any current MR16 Halogen lamp
- 25,000 hour life

B



FROM ONLY
£4.14
EACH

Code	Colour Temp	Each	10+
B 386468	2700k - Warm White	£4.60	£4.14
532082	4000k - Cool White	£4.60	£4.14

5W LED GU10 Spot Lamp

- Will retrofit any current GU10 Halogen lamp
- 25,000 hour life



C



FROM ONLY
£3.42
EACH

Code	Colour Temp	Each	5+
C 315377	2700k - Warm White	£3.80	£3.42
220682	6000k - Daylight	£3.80	£3.42

5W LED GU10 Spot Lamp Dimmable

- Will retrofit any current GU10 Halogen lamp
- 25,000 hour life



D



FROM ONLY
£5.36
EACH

Code	Colour Temp	Each	5+
913675	2700k - Warm White	£5.95	£5.36
D 146447	6000k - Daylight	£5.95	£5.36

4W LED GU10 Spot Lamp

- Will retrofit any current GU10 Halogen lamp
- 25,000 hour life
- 4W



E



FROM ONLY
£6.20
EACH

Code	Colour Temp	Each	10+
794897	3000k - Warm White	£6.95	£6.20
E 632456	6000k - Daylight	£6.95	£6.20

6W LED GU10 Spot Lamp Dimmable

- Will retrofit any current GU10 Halogen lamp
- 25,000 hour life



F



FROM ONLY
£8.50
EACH

Code	Colour Temp	Each	10+
F 128955	2800k - Warm White	£9.25	£8.50
880831	6500k - Daylight	£9.25	£8.50

Fluorescent Tubes

T8 Triphosphor Fluorescent Tube - Box 5

- 15,000 hour life
- 4000k colour render

A



FROM ONLY
£12.00
PACK

Code	Length mm	Wattage	Pack 5	10+
443993	450	15	£12.50	£12.00
484905	730	16	£12.50	£12.00
829844	600	18	£12.50	£12.00
907912	900	30	£12.50	£12.00
A 894400	1200	36	£12.50	£12.00
357017	1500	58	£18.00	£17.10
195860	1800	70	£18.00	£17.10

T5 Triphosphor Fluorescent Tube - Box 5

- 20,000 hour life
- 4000k Colour render

B



FROM ONLY
£9.40
PACK

Code	Length mm	Wattage	Pack 5	10+
481205	550	14	£10.50	£9.40
329369	550	24	£10.50	£9.40
616835	850	21	£10.50	£9.40
331493	850	39	£10.50	£9.40
577315	1200	28	£12.00	£9.75
679265	1150	54	£12.00	£9.75
817209	1450	35	£12.00	£9.75
B 790327	1500	49	£32.50	£30.50

T8 Triphosphor Fluorescent Tube - Box 25

- 15,000 hour life

C



FROM ONLY
£37.50
PACK

Code	Pack 25	5+
770576	£85.00	£80.00
C 687295	£47.25	£44.90
949176	£68.75	£65.00
394999	£38.75	£37.50
204213	£47.50	£45.00
230060	£70.00	£67.50

T5 Triphosphor Fluorescent Tube - Box 25

- 20,000 hour life

D



FROM ONLY
£30.00
PACK

Code	Pack 25	5+
954140	£33.75	£32.50
447061	£35.00	£32.50
448963	£33.75	£32.50
278637	£65.00	£62.50
D 938237	£33.75	£32.50
646987	£45.00	£42.50
162301	£67.50	£65.00
836933	£32.50	£30.00

Mini T5 Halophosphate Fluorescent Tube

- T5 linear fluorescent tubes in lower wattages
- Suitable for use in emergency luminaires, furniture fixtures, pelmet lighting and display cabinets
- 5,000 hour life

E



FROM ONLY
£1.04
EACH

Code	Length mm	Wattage	Each	5+
307054	152	4	£1.27	£1.04
422041	229	6	£1.56	£1.30
E 640201	305	8	£1.56	£1.30
199122	533	13	£1.76	£1.46

Circular T9 Triphosphor Fluorescent Tube

- Diameter: 29mm
- 10,000 hour life

F

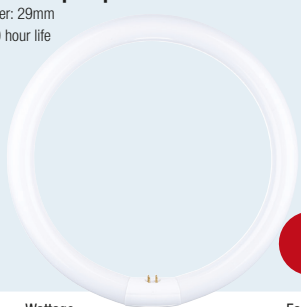

FROM ONLY
£4.84
EACH

Code	Wattage	Each	5+
455511	22	£5.08	£4.84
445527	32	£5.34	£5.08
677848	40	£6.16	£5.86
F 620489	60	£6.93	£6.59

T4 Triphosphor Fluorescent Tube

- Cool White

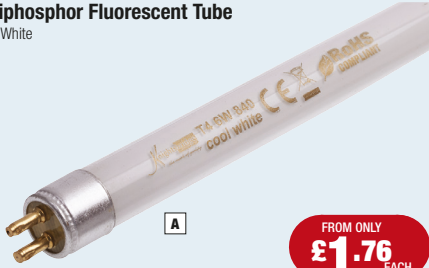

A

FROM ONLY
£1.76
EACH

Code	Length mm	Wattage	Each	5+
A 336099	220	6	£1.95	£1.76
195041	370	10	£2.10	£1.89
691008	468	16	£2.45	£2.21
995012	565	20	£2.65	£2.39
123518	765	30	£4.95	£4.46

T4 Triphosphor Fluorescent Tube

- Designed for use with Eterna brand fittings
- 10,000 hour life

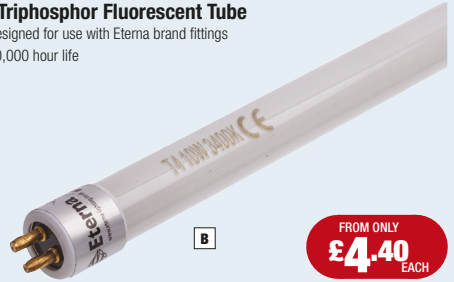

B

FROM ONLY
£4.40
EACH

Code	Length mm	Wattage	Each	5+
568896	230	6	£4.89	£4.40
B 346302	341	10	£5.44	£4.90
792729	468	16	£6.12	£5.51
302739	567	20	£6.75	£6.08

Flykiller Tube



C

FROM ONLY
£5.50
EACH

Code	Length mm	Wattage	Each	5+
C 511308	300	8	£5.95	£5.65
210222	450	15	£5.90	£5.50

Starter Switches for Fluorescent Tubes

- Starter for fluorescent fittings



F

D

E

FROM ONLY
66P
EACH

Code	Wattage	Each	10+
D 265735	4-65	£0.69	£0.66
E 322245	4-125	£2.75	£2.25
F 212814	70-125	£1.12	£1.06

**FREE
NEXT
DAY
DELIVERY**



ON
ORDERS
OVER
£45*

*Excl. VAT. £5.95 on orders under £45.



NEXT DAY DELIVERY!

WHEN YOU ORDER BY 6PM

SODAL T-Rex Solvent Free Grab Adhesive

- High initial grab & superior final bond
- Bonds almost any material
- Interior & exterior use
- Re-sealable nozzle for less wastage



Order Code: 721444

SEE
PAGE
290

FROM ONLY
£1.70
EACH
WHEN YOU BUY 5+

NEW PRODUCTS ADDED DAILY TO OUR WEBSITE

FREEPHONE: 8AM-6PM, 7 DAYS A WEEK
0808 168 22 77

ONLINE: SHOP 24/7
ElectricalDirect.co.uk

SEALANTS, TAPES & ADHESIVES

<u>Grab Adhesives</u>	<u>290</u>
<u>Adhesives</u>	<u>291</u>
<u>Sealants & Silicone</u>	<u>292-293</u>
<u>Foams & Fillers</u>	<u>294-295</u>
<u>Cleaning & Maintenance Accessories</u>	<u>296-297</u>
<u>Gloves</u>	<u>298</u>



SEE
PAGE
295



SEE
PAGE
296



SEE
PAGE
291



SEE
PAGE
296

Grab Adhesives

T-Rex Grab Adhesive - 310ml

SOUDAL

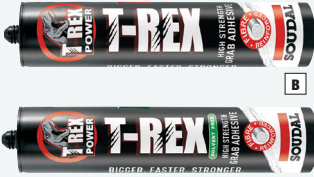

FROM ONLY
£1.70
EACH

Code	Colour	Description	Each	5+
A 343037	Beige	Solvent Based	£1.75	£1.70
B 721444	White	Solvent Free	£1.75	£1.70

Fix All High Tack - 290ml

SOUDAL



Code	Colour	FROM ONLY	Each	5+
C 771875	White	£4.65 EACH	£4.90	£4.65
723056	Grey		£4.90	£4.65
769469	Black		£4.90	£4.65

Gripfill Grab Adhesive - 350ml

EVO-STIK



Code	Description	FROM ONLY	Each	5+
D 560181	Solvent Based	£1.80 EACH	£1.90	£1.80
E 458984	Solvent Free		£1.90	£1.80

Fix All Turbo - 290ml

SOUDAL



Code	FROM ONLY	Each	5+
F 295914	£6.40 EACH	£6.50	£6.40

Fix All - X-treme Power - 290ml

SOUDAL



Code	Colour	FROM ONLY	Each	5+
G 486559	White	£5.70 EACH	£6.30	£5.70

Fix All Crystal - 290ml

SOUDAL



Code	Colour	FROM ONLY	Each	5+
H 768397	Clear	£6.60 EACH	£6.90	£6.60

Sticks Like Sh*t Grab Adhesive - 290ml

EVO-STIK



Code	Colour	FROM ONLY	Each	5+
I 972024	Clear	£4.70 EACH	£5.20	£4.90
J 874766	White		£4.90	£4.70

**ORDER
BY 6PM**



Get it Next Day!

Fix All Fills & Bonds - 750ml



FROM ONLY
£5.10
EACH

Code	Type	Each	5+
A 658389	Hand	£5.15	£5.10
B 485082	Gun Grade	£5.15	£5.10

Precision Tip Glue - 5g



FROM ONLY
£2.18
EACH

Code	Each	5+
C 825425	£2.30	£2.18

All Purpose Glue Tube - 2g



FROM ONLY
£2.18
EACH

Code	Each	5+
D 747701	£2.30	£2.18

Instant Glue Gel - 2g



FROM ONLY
£2.18
EACH

Code	Each	5+
E 238319	£2.30	£2.18

Cartridge Glue Gun - 400ml

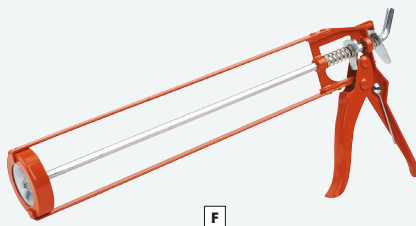

FROM ONLY
£3.56
EACH

Code	Each	5+
F 999457	£3.75	£3.56

Glue Gun



FROM ONLY
17P
EACH

Code	Type	Each	5+
G 937331	Gun	£4.89	£4.64

Sealants & Silicone

GB Pro Hybrid Silicone - 300ml

- Super strength & fast bonding
- Bonds even to damp surfaces
- Bonds to almost any surface
- Interior & exterior use

bond it

A



FROM ONLY
£4.70
EACH

Code	Colour	Each	5+
772655	Clear	£4.95	£4.70
A 161797	White	£4.95	£4.70

Low Modulus Acetoxy Silicone - 310ml

- High strength mastic adhesive

FROM ONLY
£1.85
EACH

B



C



D



Code	Colour	Each	5+
B 945150	Brown	£1.95	£1.85
C 203612	Clear	£1.95	£1.85
D 405849	White	£1.95	£1.85

Silirub 2 Neutral Silicone - 300ml

- Low modulus neutral cure professional, premium silicone
- Can be used for bedding in double glazed units
- High movement capacity
- Adheres to all common construction materials
- Full UV & weather resistance
- Interior & exterior use

SOUDAL

E



FROM ONLY
£2.70
EACH

Code	Colour	Each	5+
792918	Clear	£2.80	£2.70
829079	Brown	£2.80	£2.70
713904	White	£2.80	£2.70
952924	Black	£2.80	£2.70
E 573678	Grey	£2.80	£2.70

Silirub S Sanitary Silicone - 310ml

- Low modulus acetic cure professional silicone
- Contains a powerful fungicide for sanitary applications
- Quick cure
- Interior & exterior use

SOUDAL

F



FROM ONLY
£1.80
EACH

Code	Colour	Each	5+
F 569749	White	£1.85	£1.80
232978	Clear	£1.85	£1.80
683724	Grey	£1.85	£1.80
291520	Black	£1.85	£1.80
460955	Brown	£1.85	£1.80

Soudalead PB - 300ml

- Professional lead sealant
- Excellent adhesion
- High movement capacity
- Interior & exterior use

SOUDAL

G



FROM ONLY
£2.10
EACH

Code	Colour	Each	5+
G 202428	Grey	£2.20	£2.10

Soudaflex 40FC - 310ml

- One component high modulus polyurethane sealant
- Especially developed for concrete applications
- Full UV & weather resistance
- Interior & exterior use

SOUDAL

H



FROM ONLY
£3.10
EACH

Code	Colour	Each	5+
H 324384	Grey	£3.25	£3.10
437131	White	£3.25	£3.10

White For Life Sealant - 310ml

- Shower & bathroom sealant
- Will always look like new - won't blacken, stain or yellow
- Stop mould & fungal growth
- Gives a lifetime guaranteed seal



FROM ONLY
£6.80
EACH

A



Code	Colour	Each	5+
A 771849	White	£7.20	£6.80
472500	Clear	£7.20	£6.80

450 Builders Silicone - 310ml

- A low modulus non-corrosive neutral cure silicone sealant
- Typically used for construction joints & perimeter protection for all types of doors & window frames
- Interior & exterior use



FROM ONLY
£2.80
EACH

B



Code	Colour	Each	5+
442614	Black	£2.95	£2.80
859639	Brown	£2.95	£2.80
370449	Oak	£3.25	£3.10
369956	Translucent	£2.95	£2.80
B 353263	White	£2.95	£2.80

Gel Silicone Gel - 500ml

FROM ONLY
£9.50
EACH

C



D



Code	Description	Each	5+
C 403315	Pre mixed	£10.00	£9.50
D 620281	Separate solution	£31.40	£29.80

Webgrip Gap Filling Adhesive - 380ml

- Extremely versatile construction grab adhesive, ideal for use in a vast range of applications
- Gap filling formulation forms a strong bond even with irregular or uneven substrates
- Excellent resistance to weathering
- Interior & exterior use

FROM ONLY
£2.33
EACH

E



Code	Each	5+
E 254425	£2.46	£2.33

**FREE
NEXT DAY
DELIVERY**

On orders over £45*



**LOW
TRADE
PRICES**



ON
1000's
OF PRODUCTS

Stay Fresh Ultimate Anti-mould Sealant - 300ml

SOUDAL

FROM ONLY
£3.80
EACH

F



Code	Colour	Each	5+
760976	Ice White	£3.95	£3.80
624552	Ivory	£3.95	£3.80
F 936226	Clear	£3.95	£3.80

Foams & Fillers

Firecryl FR - 310ml

- Overpaintable
- Interior use
- Resists the passage of fire & smoke
- Intumescent in contact with fire



A



FROM ONLY
£2.00
EACH

Code	Colour	Each	5+
A 219489	White	£2.10	£2.00
331001	Grey	£2.10	£2.00

Soudafoam B3 - 750ml

- Self expanding polyurethane foam



B



FROM ONLY
£4.45
EACH

Code	Type	Each	5+
310194	Gun Grade	£6.50	£5.95
B 152912	Hand Held	£4.95	£4.45

Firecement HT - 310ml

- Interior & exterior use
- Withstands temperature of up to 1500°C



C



FROM ONLY
£3.20
EACH

Code	Colour	Each	5+
C 885039	Black	£3.35	£3.20

Soudafoam FR - 750ml

- Interior & exterior use
- Polyurethane fire filling foam
- Fire rated up to 4 hours



D



FROM ONLY
£6.10
EACH

Code	Type	Each	5+
D 392118	Hand Held	£6.40	£6.10
515608	Gun Grade	£6.40	£6.10

Decorators Caulk - 290ml

- Interior & exterior use
- Can be overpainted
- General purpose
- Sealant & filler

A



FROM ONLY
£1.00
EACH

Code	Each	5+
A 950163	£1.05	£1.00

Decorators Caulk - 300ml

- Interior & external use
- Can be overpainted
- General purpose
- Sealant & filler

B



FROM ONLY
68P
EACH

Code	Each	5+
B 397143	£0.78	£0.68

Gun and Foam Cleaner - 500ml

- Cleaning aerosol to be used with Soudal foam gun & Soudal foams
- Attaches to foam guns for cleaning through foam
- Can also be used to clean away uncured PU foam

C

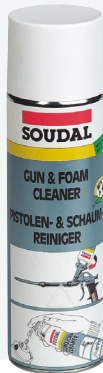

FROM ONLY
£2.80
EACH

Code	Each	5+
C 491200	£2.90	£2.80

Lightweight Filler - 500ml

- Excellent acoustic & thermal insulating properties
- Shrinkage properties and crack resistant
- Interior & exterior use

D



FROM ONLY
£4.80
EACH

Code	Each	5+
D 707426	£5.00	£4.80

Compact Foam Gun

- Professional grade applicator gun
- Designed to work with Soudal foam

E

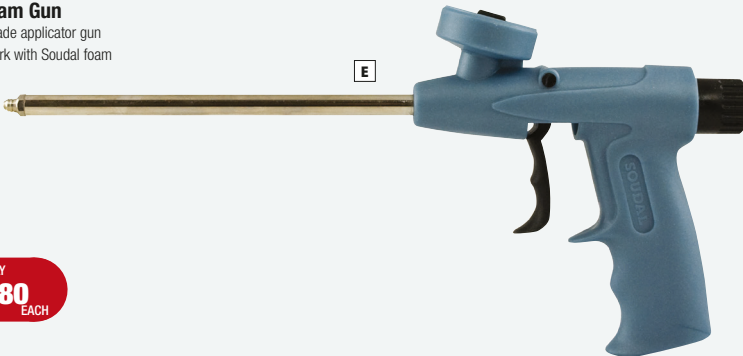

FROM ONLY
£12.80
EACH

Code	Each	5+
E 677954	£13.50	£12.80

Cleaning & Maintenance Accessories

Heavy Duty Big Wipes - 80 Tub

- Textured, scrub & clean wipes, tough enough to clean just about anything you might get on your hands during the working day
- Ideal for remote hand cleaning, has anti-bacterial protection



A

FROM ONLY
£6.70
EACH

Code	Each	5+
A 319093	£7.10	£6.70

Multi-purpose Big Wipes - 80 Tub

- Original trade wipe
- Cleans paint, adhesive & oil from hands, tools & surfaces
- Super tough absorbent wipes



B

FROM ONLY
£4.20
EACH

Code	Each	5+
B 129446	£4.45	£4.20

ProDec Multi-purpose Wipes - 100 Tub

- Removes paint, oil, grease, silicones, mastic and more from hands, tools & hard surfaces
- Anti-bacterial & anti-Well's disease
- Added aloe vera and vitamin E



C

FROM ONLY
£5.65
EACH

Code	Each	5+
C 510932	£5.95	£5.65

WD-40

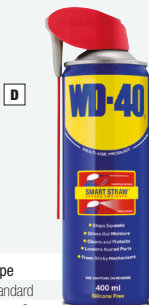

D

FROM ONLY
£3.32
EACH

Code	Volume ml	Type	Each	5+
525679	400	Standard	£3.50	£3.32
D 343169	400	Smart Straw	£4.90	£4.70
422917	250	Fast Release Penetrant	£5.25	£5.00
174176	250	High Performance Silicone Lubricant	£5.25	£5.00
739654	250	High Performance White Lithium Grease	£5.25	£5.00

Bracket for Big Wipes - 80 Tub



E

FROM ONLY
£6.00
EACH

Code	Each	5+
E 610201	£6.30	£6.00

Silicone Spray - 400ml

- Lowers friction reducing wear of mechanical parts
- Ideally suited for lubricating plastics, rubbers & sliding doors
- Prevents dirt & grease deposits collecting
- Creates a water repellent layer
- Use at any angle

SODAL



F

FROM ONLY
£3.60
EACH

Code	Each	5+
F 748003	£3.75	£3.60

Multi Spray - 400ml

- Protects metal from rust & coats in a waterproof protective layer
- Lubricates moving parts to take care of your mechanicals
- Acts as a shock spray creating a temperature difference
- Cleans & penetrates

SODAL



G

FROM ONLY
£3.60
EACH

Code	Each	5+
G 380900	£3.75	£3.60

Sealant Remover - 400ml

- Ready to use & fast working spray
- Can be applied on most surfaces including aluminium, coatings, ceramics, laminate, paint & certain plastics

A



FROM ONLY
£5.10
EACH

Code

A 498627

Each

£5.40

5+

£5.10



Cleaner and Degreaser - 400ml

- Powerful quick drying cleaner and degreaser for various maintenance and assembly jobs
- Cleans & degreases mechanical parts
- Also suitable for the preparation of surfaces for the application of sealants & adhesives
- Leaves no residue
- Aerosol can be used at any angle

B



FROM ONLY
£3.60
EACH

Code

B 912527

Each

£3.75

5+

£3.60



Multi Cleaner - 400ml

- Universal foam cleaner spray
- Suitable for glass, tiles, mirrors, laminate, PVC, kitchens, car interiors, carpets, offices
- Non-drip
- Ideal for vertical surfaces
- Does not leave residue

C



FROM ONLY
£3.60
EACH

Code

C 573356

Each

£3.75

5+

£3.60



3-IN-ONE Original Multipurpose Aerosol Oil Spray - 100ml

- Provides a specially formulated lubricant in a convenient aerosol can
- Cleans & protects surfaces from rust & corrosion
- Can be used to clean metal, lubricate moving parts or stop squeaks

D



FROM ONLY
£1.90
EACH

Code

D 365777

Each

£1.95

5+

£1.90

Degrip All Penetrating Anti Rust Oil - 400ml

- A high quality penetrating oil which dissolves rust & corrosion
- Superior penetrating characteristics
- For interior & exterior applications
- Aerosol can be used at any angle

E



FROM ONLY
£3.60
EACH

Code

E 840489

Each

£3.75

5+

£3.60



Tissue Roll - 183mm x 150m

- High quality 2 ply tissue roll

F



FROM ONLY
£3.00
EACH

Code

F 864657

Each

£3.20

5+

£3.00



Gloves

Mens Grip Gloves

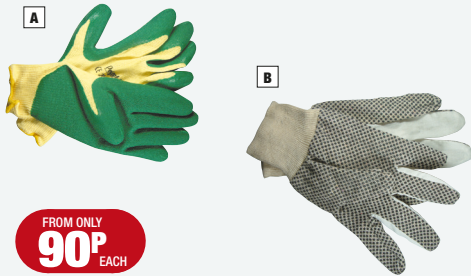

FROM ONLY
90P
EACH

Code	Type	Each	5+
A 477489	Builders Grip	£3.65	£3.50
B 262249	Cotton Grip	£0.95	£0.90

Yellow Criss Cross



FROM ONLY
£1.00
EACH

Code	Each	5+
C 233616	£1.10	£1.00

Disposable Latex Gloves



FROM ONLY
£6.70
PACK

Code	Pack 100	5+
D 773720	£7.10	£6.70

Thin Work Gloves



FROM ONLY
£1.38
EACH

Code	Size	Each	5+
283796	8 (M)	£1.46	£1.38
E 686213	9 (L)	£1.46	£1.38
335883	10 (XL)	£1.46	£1.38

Latex Builders Gloves



FROM ONLY
£1.17
EACH

Code	Each	5+
F 306282	£1.24	£1.17

Nitrile Work Gloves



FROM ONLY
£2.12
EACH

Code	Size	Each	5+
G 722262	9 (L)	£2.24	£2.12
189364	10 (XL)	£2.24	£2.12

10M ROUND FLEX FROM UNDER £4!

**SUITABLE
FOR APPLIANCES
SUCH AS**

- ✓ REFRIGERATORS
- ✓ WASHING MACHINES
- ✓ SPIN DRYERS
- ✓ PORTABLE TOOLS

**3182Y Round Flex - 2 Core
- 0.75mm² 0 10m**

SEE
PAGE
16



**BULK BUY
& SAVE**

- PVC Sheath
- Plain annealed copper wire
- Manufactured to BS 6500

Black Order Code: 607336

White Order Code: 429639

FROM ONLY

**£3.80
EACH**

WHEN YOU BUY 5+

FREEPHONE: 8AM-6PM, 7 DAYS A WEEK

0808 168 22 77



ONLINE: SHOP 24/7

ElectricalDirect.co.uk



NEXT DAY DELIVERY!

WHEN YOU ORDER BY 6PM



Solo Chippy Everyday Essentials Screws Pack - Pack 3400

Contains: 200pcs 5.0 x 100,
400pcs 5.0 x 70, 200pcs 5.0 x 50,
200pcs 5.0 x 80, 400pcs 5.0 x 40,
400pcs 4.5 x 50, 600pcs 4.5 x 30,
600pcs 4.0 x 25, 400pcs 3.5 x 25.

**3400 SCREWS
FROM ONLY
£33.30
PACK
WHEN YOU BUY 5+**

Order
Code:
388021



SEE
PAGE
305

NEW PRODUCTS ADDED DAILY TO OUR WEBSITE

FREEPHONE: 8AM-6PM, 7 DAYS A WEEK
0808 168 22 77

ONLINE: SHOP 24/7
ElectricalDirect.co.uk

SCREWS, FIXINGS & ACCESSORIES

Screws	302-305
Self-Tapping Screws	306
Electrical Screws & Fixings	307
Clips & Capping Nails	308-309
Plugs	310
Nuts, Bolts & Washers	311
Accessories	312-313
Electricians Hand Tools	314-315
Driver Bits	316
MICC Accessories	317
Anchor Fixings	318-319



SEE
PAGE
306



SEE
PAGE
304



SEE
PAGE
307



SEE
PAGE
305

Spax_Jack of all trades

- Suitable for all soft and hard woods, MDF, plywood, plastic, chipboard, thin sheets of metal - simply everything
- Extremely fast - even without pilot drill
- High precision - no wood splitting even when working close to the edge
- Self countersinking
- Yellow zinc

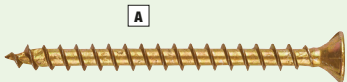

FROM ONLY
90P
PACK

Code	Size mm	Pack Quantity	Pack	5+	25+
338320	3.0 x 12	200	£2.40	£2.30	£2.10
537229	3.0 x 20	200	£2.65	£2.50	£2.30
506681	3.5 x 12	200	£2.85	£2.70	£2.50
392046	3.5 x 16	200	£3.30	£3.15	£2.85
486620	3.5 x 20	200	£3.65	£3.50	£3.20
718565	3.5 x 25	200	£3.95	£3.75	£3.45
171712	3.5 x 30	200	£4.05	£3.85	£3.50
918595	3.5 x 35	200	£4.40	£4.20	£3.80
512155	3.5 x 40	200	£4.75	£4.50	£4.15
511050	4.0 x 16	200	£3.70	£3.50	£3.20
764966	4.0 x 20	200	£3.90	£3.70	£3.40
595163	4.0 x 25	200	£4.20	£3.95	£3.65
799089	4.0 x 30	200	£4.70	£4.50	£4.10
255707	4.0 x 35	200	£4.95	£4.70	£4.30
587249	4.0 x 45	200	£5.60	£5.30	£4.90
953870	4.0 x 45	200	£6.10	£5.80	£5.30
830740	4.0 x 50	200	£7.40	£7.05	£6.40
336987	4.0 x 60	200	£9.10	£8.70	£7.90
885423	4.5 x 25	200	£4.10	£3.90	£3.60
315755	4.5 x 30	200	£4.50	£4.30	£4.00
842593	4.5 x 35	200	£4.90	£4.65	£4.25
577825	4.5 x 40	200	£5.40	£5.15	£4.70
387944	4.5 x 50	200	£7.20	£6.85	£6.25
120138	5.0 x 25	200	£6.90	£6.60	£5.95
545414	5.0 x 30	200	£7.90	£7.50	£690.00
562582	5.0 x 40	200	£9.20	£8.75	£7.90
709005	5.0 x 45	200	£9.55	£9.10	£8.30
638138	5.0 x 50	200	£9.90	£9.45	£8.60
151306	5.0 x 60	100	£6.50	£6.20	£5.65
418560	5.0 x 70	100	£7.65	£7.30	£6.65
740838	5.0 x 80	100	£9.70	£9.25	£8.45
627573	5.0 x 90	100	£12.10	£11.50	£10.50
203023	5.0 x 100	100	£13.90	£13.25	£12.10
287877	6.0 x 60	100	£9.90	£9.45	£8.60
866273	6.0 x 80	100	£13.50	£12.85	£11.75
850221	6.0 x 100	100	£16.50	£15.70	£14.35
161542	6.0 x 120	100	£35.50	£33.80	£30.90
601149	6.0 x 150	100	£42.50	£40.50	£36.90
883650	6.0 x 160	100	£34.50	£32.80	£29.90
463440	6.0 x 180	100	£64.50	£61.40	£56.00
A 968132	6.0 x 200	100	£74.50	£71.00	£64.80
415547	6.0 x 240	100	£104.50	£99.50	£90.90

Spax Trade Pack

700 Screws - Mixed Pack

- Pack contains:
200 pcs 4.0 x 40,
200 pcs 4.0 x 50,
200 pcs 5.0 x 50,
100 pcs 5.0 x 70



NEW



FROM ONLY
£26.50
PACK

Code	Pack 700
B 149550	£26.50

Spax Xpert Case

- A complete selection of the most popular screw sizes supplied in a tough metal case with pull out compartments
- Contains 200 each: 3.5 x 20, 3.5 x 25, 3.5 x 30, 4 x 20, 4 x 25, 4 x 30, 4 x 35, 4 x 50, 5 x 40, 5 x 50 and 400 - 4.0 x 40
- 2,400 screws
- Yellow Zinc



FROM ONLY
£52.50
PACK

Code	Pack
C 115875	£52.50

Spax Value Pack

- Save money by buying in bulk!
- Great value pack of the trade's favourite screws
- Available in boxes of 200, 500 and 1000
- Yellow Zinc



FROM ONLY
£11.50
PACK

Code	Size mm	Pack Quantity	Pack
884802	3.5 x 25	1000	£11.50
696236	3.5 x 30	1000	£12.50
840112	3.5 x 35	1000	£15.50
216371	3.5 x 40	1000	£17.50
761931	4.0 x 30	1000	£18.50
936956	4.0 x 40	1000	£21.50
884973	4.0 x 50	500	£15.50
D 969013	4.0 x 60	500	£22.50
238131	5.0 x 100	200	£27.50
230631	5.0 x 150	500	£24.50
800094	5.0 x 60	500	£32.50
442450	5.0 x 70	200	£15.90
682059	5.0 x 80	200	£18.90
346190	5.0 x 90	200	£22.50

Solo Chippy Screws - Yellow Zinc

- 40° deep single thread
- 25° sharp point
- Double countersunk for additional strength under the head

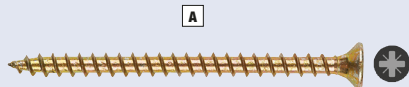

FROM ONLY
46P
PACK

Code	Size mm	Pozi No	Pack Qty	Pack	5+
755767	3.0 x 12	1	200	£0.62	£0.46
400441	3.0 x 15	1	200	£0.82	£0.62
863496	3.0 x 20	1	200	£0.95	£0.90
367669	3.0 x 25	1	200	£1.20	£1.10
983486	3.5 x 12	2	200	£0.86	£0.64
103566	3.5 x 15	2	200	£0.89	£0.66
936752	3.5 x 20	2	200	£0.95	£0.90
997284	3.5 x 25	2	200	£1.05	£1.00
752111	3.5 x 30	2	200	£1.15	£1.10
834138	3.5 x 40	2	200	£1.65	£1.60
A 653709	3.5 x 50	2	200	£2.60	£2.50
855220	4.0 x 15	2	200	£1.05	£1.00
926186	4.0 x 20	2	200	£1.20	£1.10
256302	4.0 x 25	2	200	£1.25	£1.20
330525	4.0 x 30	2	200	£1.40	£1.30
689835	4.0 x 35	2	200	£1.55	£1.50
385791	4.0 x 40	2	200	£1.80	£1.70
585371	4.0 x 45	2	200	£1.85	£1.80
929924	4.0 x 50	2	200	£2.10	£2.00
848544	4.0 x 60	2	200	£2.15	£2.00
231795	4.0 x 70	2	200	£3.35	£3.20
684397	4.5 x 30	2	200	£1.95	£1.90
336435	4.5 x 40	2	200	£2.20	£2.10
183124	4.5 x 45	2	200	£2.90	£2.80
576383	4.5 x 50	2	200	£3.30	£3.10
931026	4.5 x 60	2	200	£4.20	£4.00
434723	4.5 x 70	2	200	£4.60	£4.40
839484	4.5 x 80	2	200	£4.90	£4.70
242627	5.0 x 25	2	200	£2.20	£2.10
265598	5.0 x 30	2	200	£2.25	£2.10
585883	5.0 x 35	2	200	£2.55	£2.40
514615	5.0 x 40	2	200	£2.75	£2.60
139007	5.0 x 45	2	200	£3.10	£2.90
744358	5.0 x 50	2	200	£3.30	£3.10
351169	5.0 x 60	2	200	£3.55	£3.40
615681	5.0 x 70	2	200	£4.05	£3.80
624164	5.0 x 80	2	200	£4.15	£3.90
847100	5.0 x 90	2	100	£4.25	£4.00
947800	5.0 x 100	2	100	£4.55	£4.30
715454	6.0 x 50	3	200	£3.55	£3.40
388296	6.0 x 60	3	200	£3.65	£3.50
818355	6.0 x 70	3	200	£3.75	£3.60
143985	6.0 x 90	3	100	£5.90	£5.60
755712	6.0 x 100	3	100	£6.70	£6.40

Solo Chippy Screws - Bright Zinc

- 40° deep single thread
- 25° sharp point
- Double countersunk for additional strength under the head



FROM ONLY
56P
PACK

Code	Size mm	Pozi No	Pack Quantity	Pack	5+
954330	3.0 x 12	1	200	£0.60	£0.56
787152	3.0 x 15	1	200	£0.66	£0.62
261345	3.5 x 15	2	200	£0.70	£0.66
454343	3.5 x 20	2	200	£0.88	£0.84
334813	3.5 x 25	2	200	£1.00	£0.95
360200	3.5 x 30	2	200	£1.20	£1.10
437597	3.5 x 35	2	200	£1.40	£1.30
342606	3.5 x 40	2	200	£1.45	£1.40
B 663864	3.5 x 50	2	200	£1.80	£1.70
933173	4.0 x 15	2	200	£1.05	£0.88
210014	4.0 x 20	2	200	£1.10	£1.00
601909	4.0 x 25	2	200	£1.20	£1.10
998517	4.0 x 30	2	200	£1.35	£1.30
940516	4.0 x 35	2	200	£1.50	£1.40
667976	4.0 x 40	2	200	£1.65	£1.60
397710	4.0 x 45	2	200	£1.90	£1.80
723373	4.0 x 50	2	200	£2.20	£2.10
910487	4.0 x 60	2	200	£2.60	£2.50
381995	4.0 x 70	2	200	£3.05	£2.90
131994	5.0 x 25	2	200	£1.90	£1.80
534825	5.0 x 30	2	200	£2.10	£2.00
260962	5.0 x 40	2	200	£2.50	£2.40
312471	5.0 x 45	2	200	£2.80	£2.70
188542	5.0 x 50	2	200	£3.30	£3.10
199988	5.0 x 60	2	200	£3.80	£3.60
942438	5.0 x 70	2	200	£4.30	£4.10
133130	5.0 x 80	2	200	£4.95	£4.70
172478	5.0 x 90	2	100	£2.95	£2.80
135357	5.0 x 100	2	100	£3.30	£3.10
777459	6.0 x 50	3	200	£4.40	£4.20
243982	6.0 x 60	3	200	£5.60	£5.30
698460	6.0 x 80	3	200	£7.80	£7.40
343786	6.0 x 100	3	100	£5.10	£4.80
100168	6.0 x 150	3	100	£9.90	£9.40
563659	6.0 x 120	3	100	£6.90	£6.60

Twin Threaded Woodscrews - Mixed Box - Zinc Plated

- Contains: 85pcs 8 x 1 1/4", 180 pcs 6 x 1/2", 130 pcs 6 x 3/4", 65 pcs 8 x 1 1/2", 35 pcs 10 x 2", 100 pcs 6 x 1", 100 pcs 8 x 3/4", 110 pcs 6 x 1 1/4", 35 pcs 10 x 2 1/2", 190 pcs 6 x 5/8", 60 pcs 8 x 1", 50 pcs 8 x 2"



FROM ONLY
£12.70
PACK

Code	Pack 1140	5+
C 817363	£13.40	£12.70

Electrical Countersunk Pozi Screw

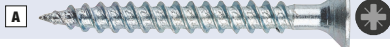

Code	Size Inches	Pack Quantity	Pack 200	5+
507815	6 x 1	200	£2.70	£2.43
475803	6 x 1 1/4	200	£3.14	£2.83
324448	6 x 1 1/2	200	£3.50	£3.15
542897	6 x 2	200	£4.18	£3.76
613178	8 x 1	200	£2.20	£2.00
626677	8 x 1 1/4	200	£3.29	£2.48
A 721520	8 x 1 1/2	200	£2.68	£2.35
636009	8 x 2	200	£2.85	£2.57
762251	8 x 2 1/2	200	£6.68	£6.01
869403	8 x 3/4	200	£2.56	£1.98
776377	10 x 1 1/4	200	£5.28	£4.75
799369	10 x 1 1/2	200	£5.65	£5.09
592010	10 x 2	200	£4.30	£3.87
485326	10 x 2 1/2	100	£4.95	£4.46
262138	10 x 3	100	£8.40	£7.56
895638	10 x 4	100	£9.10	£8.19
613053	12 x 2 1/2	100	£8.80	£7.92
322479	12 x 3	100	£9.10	£8.19
449040	12 x 4	100	£9.50	£8.55
872785	16 x 4	200	£7.40	£6.66

FROM ONLY
£1.98
PACK

Ulti-Mate II Woodscrews - Zinc and Yellow Plated

- Suitable for softwood, hardwood and MDF
- Self-countersinking ribs
- Ideal for use with wallplugs
- Quick start point



FROM ONLY
£1.90
PACK

Countersunk Twin Thread Pozi Screw - Bright Zinc

- Fully threaded up to 1 inch - partial thread thereafter
- Manufactured to BS 1210 standards

FROM ONLY
£1.00
PACK



Code	Size inches	Pozi No	Pack Quantity	Pack	5+
291679	4 x 1/2	1	200	£1.05	£1.00
842768	4 x 1	1	200	£1.25	£1.20
336030	4 x 5/8	1	200	£1.10	£1.00
656892	4 x 3/4	1	200	£1.20	£1.10
152068	6 x 1/2	2	200	£1.35	£1.30
685243	6 x 5/8	2	200	£1.40	£1.30
918522	6 x 3/4	2	200	£1.70	£1.60
483664	6 x 1	2	200	£1.85	£1.80
348135	6 x 1 1/4	2	200	£1.95	£1.90
C 755840	6 x 1 1/2	2	200	£2.15	£2.00
256039	6 x 2	2	200	£2.25	£2.10
513758	7 x 1	2	200	£1.95	£1.90
546754	7 x 1 1/4	2	200	£2.05	£1.90
507421	8 x 3/4	2	200	£2.25	£2.10
325185	8 x 1	2	200	£2.45	£2.30
263588	8 x 1 1/4	2	200	£2.55	£2.40
960201	8 x 1 1/2	2	200	£2.60	£2.50
327684	8 x 1 3/4	2	200	£2.65	£2.50
206132	8 x 2	2	200	£2.70	£2.60
669098	8 x 2 1/4	2	200	£2.75	£2.60
770976	8 x 2 1/2	2	200	£2.80	£2.70
867454	8 x 3	2	200	£2.85	£2.70
539951	10 x 1 1/4	2	200	£3.35	£3.20
839238	10 x 1 1/2	2	200	£3.45	£3.30
469129	10 x 2	2	200	£3.75	£3.60
648688	10 x 2 1/2	2	200	£3.80	£3.60
290801	10 x 3	2	100	£3.85	£3.70
697508	10 x 3 1/2	2	100	£3.90	£3.70
630572	10 x 4	2	100	£3.95	£3.80
625231	12 x 3	3	200	£4.10	£3.90
361374	12 x 3 1/2	3	100	£4.15	£3.90
521292	12 x 4	3	100	£4.25	£4.00

Code	Size mm	Pozi No	Pack Quantity	Pack	5+
B 404293	3.0 x 12	1	200	£1.95	£1.90
874748	3.0 x 20	1	200	£2.00	£1.90
915802	3.0 x 25	1	200	£2.05	£1.90
192916	3.5 x 12	2	200	£2.10	£2.00
709142	3.5 x 16	2	200	£2.15	£2.00
521482	3.5 x 20	2	200	£2.20	£2.10
457690	3.5 x 25	2	200	£2.25	£2.10
194918	3.5 x 30	2	200	£2.30	£2.20
300267	4.0 x 20	2	200	£2.35	£2.20
444011	4.0 x 25	2	200	£2.40	£2.30
302143	4.0 x 30	2	200	£3.10	£3.05
999822	4.0 x 40	2	200	£3.50	£3.45
866536	4.0 x 45	2	200	£3.85	£3.80
880655	4.0 x 50	2	200	£4.20	£4.15
294891	4.0 x 60	2	200	£6.15	£6.10
607229	4.0 x 70	2	200	£7.35	£7.30
105722	5.0 x 30	2	200	£4.65	£4.55
800583	5.0 x 40	2	200	£5.55	£5.50
444674	5.0 x 50	2	200	£6.15	£6.10
587987	5.0 x 60	2	200	£7.30	£7.25
949133	5.0 x 70	2	200	£9.10	£9.05
651132	5.0 x 80	2	200	£9.65	£9.60
662221	5.0 x 90	2	100	£6.20	£6.15
219880	5.0 x 100	2	100	£7.50	£7.45
917205	6.0 x 50	3	200	£8.20	£7.80
964664	6.0 x 60	3	100	£5.90	£5.85
412741	6.0 x 70	3	100	£6.10	£6.05
231435	6.0 x 80	3	100	£6.40	£6.35
387727	6.0 x 90	3	100	£7.40	£7.35
882324	6.0 x 100	3	100	£8.50	£8.45
596887	6.0 x 130	3	50	£8.30	£7.90
581620	6.0 x 150	3	50	£11.10	£11.00
499121	6.0 x 180	3	25	£10.70	£10.40
294207	6.0 x 200	3	25	£11.40	£10.80

Round Head Twin Thread Pozi Screw - Bright Zinc

• Manufactured to BS 1210



Code	Size Inches	Pozi No	Pack 200	5+
591625	4 x 1/2	1	£1.40	£1.30
791751	6 x 1/2	1	£1.50	£1.40
749785	6 x 5/8	1	£1.20	£1.10
102975	6 x 3/4	2	£1.75	£1.70
346471	6 x 1	2	£1.25	£1.20
659102	8 x 3/4	2	£1.45	£1.40
753782	8 x 1 1/4	2	£1.75	£1.70
A 901703	8 x 1 1/2	2	£1.90	£1.80
446186	8 x 2	2	£2.80	£2.70
475831	10 x 1	2	£2.20	£2.10
947183	10 x 1 1/2	2	£2.55	£2.40
700534	10 x 2	2	£5.50	£5.20

Raised Head Slotted Screw - Solid Brass

FROM ONLY
£3.30
PACK



Code	Size Inches	Pack 200	5+
952756	4 x 5/8	£3.50	£3.30
189805	6 x 5/8	£5.90	£5.60
885098	8 x 1	£10.90	£10.40
957046	8 x 1 1/4	£13.50	£12.80
C 626256	8 x 1 1/2	£14.90	£14.20

Solo Chippy Screws Everyday Essentials Screw Pack

• Contains: 200pcs 5.0 x 100, 400pcs 5.0 x 70, 200pcs 5.0 x 50, 200pcs 5.0 x 80, 400pcs 5.0 x 40, 400pcs 4.5 x 50, 600pcs 4.5 x 30, 600pcs 4.0 x 25, 400pcs 3.5 x 25



FROM ONLY
£33.30
PACK

Code	Pack 3400	5+
G 388021	£35.00	£33.30

Black Japanned Screws - Slotted Head

FROM ONLY
£4.17
PACK



Code	Size Inches	Pack Quantity	Pack 200	5+
786743	6 x 1 1/4	200	£4.63	£4.17
779153	6 x 1 1/2	200	£5.17	£4.65
I 767663	10 x 1 1/2	200	£5.81	£5.23
892467	10 x 2	100	£7.98	£7.18
681058	12 x 2	100	£12.30	£11.07

Slotted Countersunk Screw - Solid Brass

FROM ONLY
£4.50
PACK



Code	Size Inches	Pack 200	5+
407796	4 x 3/4	£4.70	£4.50
223512	6 x 1/2	£4.90	£4.70
839331	6 x 3/4	£5.50	£5.20
964272	6 x 1	£6.90	£6.60
913294	6 x 1 1/4	£7.90	£7.50
B 198195	8 x 1	£8.50	£8.10
752126	8 x 1 1/2	£12.50	£11.90
298002	10 x 1 1/2	£17.50	£16.60

Round Head Pozi Screw

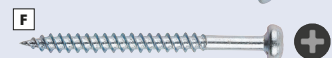

FROM ONLY
£1.84
PACK

Code	Size Inches	Pack 200	5+
D 210067	8 x 1	£2.04	£1.84
E 498855	8 x 1 1/2	£3.86	£3.47
F 523524	8 x 2	£4.56	£4.10

Roundhead Twin Thread Pozi Screw - Black Japanned

• Pozi No: 2

FROM ONLY
£2.30
PACK



Code	Size Inches	Pack 200	5+
545629	6 x 3/4	£2.45	£2.30
H 650397	6 x 1	£3.00	£2.90
954021	8 x 3/4	£3.55	£3.40
499982	8 x 1	£3.90	£3.70
858470	8 x 1 1/4	£4.70	£4.50
744686	8 x 1 1/2	£5.10	£4.80
729288	10 x 1	£5.50	£5.20
493826	10 x 1 1/2	£6.90	£6.60

Metal & Wood Screw Set

• 240 metal and wood screws

FROM ONLY
£4.70
PACK



Code	Pack	5+
J 600222	£4.95	£4.70

Self-Tapping Screws

Tapcon Hex Head - Blue

- Cuts its own thread into concrete, brick & block
- Size: 6.0 x 45mm

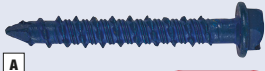

A

FROM ONLY
£8.98
PACK

Code	Pack 100	3+
A 670606	£9.98	£8.98

Self Tapping Screws

FROM ONLY
£5.00
PACK

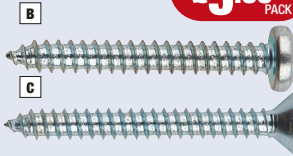

Code	Size Inches	Type	Pack 100	5+
B 255324	8 x 1 1/2	Pan Head	£5.50	£5.00
C 808498	8 x 1 1/4	Countersunk Head	£6.00	£5.50

Pan Head Self-Drilling Screws - Stainless Steel

- Pozzi No: 2

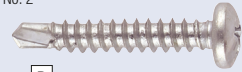

D

FROM ONLY
£18.90
PACK

Code	Size mm	Pack 1000	5+
210133	4.2 x 13	£19.90	£18.90
929985	4.2 x 16	£22.50	£21.40
451581	4.2 x 19	£24.90	£23.70
D 833238	4.2 x 25	£27.50	£26.10

Self-Tapping Screws

- Size: 3/4" x 8



E

FROM ONLY
£4.14
PACK

Code	Pack 100	5+
E 718748	£4.60	£4.14

Double Slash Point Screws

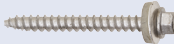

F

FROM ONLY
£6.00
PACK

Code	Size mm	Pack 100	5+
F 178347	6.3 x 32	£6.30	£6.00
153222	6.3 x 45	£8.20	£7.80
887015	6.3 x 60	£9.80	£9.30
455421	6.3 x 80	£13.90	£13.20
330633	6.3 x 100	£15.50	£14.70
629662	6.3 x 150	£27.50	£26.10

Low Profile Pancake Head Self-Drilling Screws

- Pozzi No: 2

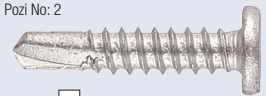

G

FROM ONLY
£9.80
PACK

Code	Size mm	Pack 500	5+
388793	5.5 x 19	£10.30	£9.80
G 856922	5.5 x 26	£12.50	£11.90

Self Drilling Screws

- For fixing sheet steel to sheet steel
- 5/16 head drive

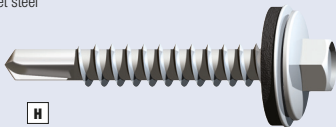

H

FROM ONLY
£3.50
PACK

Code	Type	Description	Size mm	Pack 100	5+
833917	For Light Section Steel	Without Washer	5.5 x 25	£3.70	£3.50
820928	For Light Section Steel	Without Washer	5.5 x 32	£4.20	£4.00
356335	For Light Section Steel	Without Washer	5.5 x 38	£4.45	£4.20
425864	For Light Section Steel	Without Washer	5.5 x 50	£4.90	£4.70
746980	For Light Section Steel	Without Washer	5.5 x 70	£6.45	£6.10
190722	For Light Section Steel	Without Washer	5.5 x 100	£9.80	£9.30
801100	For Light Section Steel	With Washer	5.5 x 25	£4.95	£4.70
149788	For Light Section Steel	With Washer	5.5 x 32	£5.40	£5.10
944453	For Light Section Steel	With Washer	5.5 x 38	£5.60	£5.30
371187	For Light Section Steel	With Washer	5.5 x 50	£6.60	£6.30
H 362662	For Light Section Steel	With Washer	5.5 x 70	£7.60	£7.20
235985	For Light Section Steel	With Washer	5.5 x 100	£10.90	£10.40
300891	For Heavy Section Steel	Without Washer	5.5 x 32	£5.60	£5.30
444723	For Heavy Section Steel	Without Washer	5.5 x 38	£5.90	£5.60
935622	For Heavy Section Steel	Without Washer	5.5 x 55	£7.20	£6.80
387630	For Heavy Section Steel	Without Washer	5.5 x 100	£13.90	£13.20
226118	For Heavy Section Steel	With Washer	5.5 x 32	£7.40	£7.00
838831	For Heavy Section Steel	With Washer	5.5 x 38	£7.90	£7.50
306240	For Heavy Section Steel	With Washer	5.5 x 55	£9.90	£9.40
121952	For Heavy Section Steel	With Washer	5.5 x 65	£10.90	£10.40
149752	For Heavy Section Steel	With Washer	5.5 x 80	£12.60	£12.00
198868	For Heavy Section Steel	With Washer	5.5 x 100	£18.50	£17.60

Self Drilling Screws

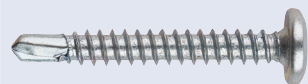

I

FROM ONLY
£7.02
PACK

Code	Size mm	Pack 100	3+
I 200022	5.5 x 40	£7.80	£7.02
223741	4.8 x 16	£8.90	£8.01

Low Profile Pan Head Self-Drilling Screw



J

FROM ONLY
£6.70
PACK

Code	Size mm	Pack 500	5+
J 398214	4.8 x 16	£7.10	£6.70

Extension Studs

- Size: 3.5mm



A

FROM ONLY
49P
PACK

Code	Pack 100	10+
A 575649	£0.56	£0.49

Multi Length Screws

- Size: M4 x 45mm
- Can be cut to size



B

FROM ONLY
£1.20
PACK

Code	Pack Quantity	Pack	5+
B 523845	4	£1.25	£1.20
749824	100	£19.90	£18.90

Electrical Socket Screws - Countersunk - Nickel Plated

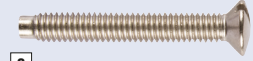

C

FROM ONLY
£1.80
PACK

Code	Size mm	Pack 100	5+
C 544037	3.5 x 25	£1.90	£1.80
326337	3.5 x 35	£2.10	£2.00
445175	3.5 x 40	£2.30	£2.20
263803	3.5 x 50	£2.40	£2.30
854890	3.5 x 75	£2.60	£2.50

Socket Extension Screws - Bright Zinc Plated

D



FROM ONLY
£4.00
PACK

Code	Size mm	Pack 1000	5+
210133	4.2 x 13	£19.90	£18.90
929985	4.2 x 16	£22.50	£21.40
451581	4.2 x 19	£24.90	£23.70
D 833238	4.2 x 25	£27.50	£26.10

Spring Toggles



Code	Size mm	Pack 50	3+
E 956146	M3 x 50	£27.50	£25.40
F 757332	M5 x 75	£29.50	£27.00
G 424467	M6 x 75	£29.50	£28.00

FROM ONLY
£25.40
PACK

Screw-Driver Plasterboard Fixing

H



FROM ONLY
£8.00
PACK

Code	Pack 100	5+
H 679946	£8.80	£8.00

Multi-Fix Bolt - Hex Head

- Replaces all traditional anchors including shield, drop-in, sleeve & throughbolts
- Heavy duty
- Ideal for use in multiple materials including: Concrete, brick, stone, block & wood



I

FROM ONLY
£6.25
PACK

Code	Size mm	Pack Quantity	Pack	5+
158095	6 x 50	64	£6.45	£6.25
214175	8 x 60	30	£6.95	£6.75
I 820702	8 x 100	20	£7.85	£7.65
350399	8 x 75	26	£7.35	£7.15
483131	10 x 75	14	£7.50	£7.30
942247	10 x 60	18	£7.10	£6.95
989066	10 x 100	12	£7.90	£7.50
544087	10 x 150	8	£8.15	£8.05
232194	12 x 75	12	£9.80	£9.60
509050	12 x 100	8	£10.15	£10.05
520492	12 x 150	6	£10.50	£10.30

Plasterboard Fixing Kit

- Contains: 200 x speed plug, 200 x screws, 1 x screw driver



J

FROM ONLY
£16.00
PACK

Code	Pack 100	5+
J 427267	£16.85	£16.00

Britclips & Capping Nails

Horizontal Beam Clip

A



FROM ONLY
£11.25
PACK

Code	Size mm	Pack 25	4+
A 942391	2-4 x 21	£11.75	£11.25
820057	5-9 x 23	£13.00	£12.25
438616	10-16 x 29	£14.00	£13.25
698400	17-20 x 34	£15.00	£14.25

2-4mm Girder Clip

B



FROM ONLY
£5.25
PACK

Code	Cable Size mm	Pack 25	4+
574732	6-7	£5.75	£5.25
583623	7-9	£6.25	£5.75
B 782826	10-11	£6.25	£5.75
151795	12-14	£6.25	£5.75
611265	15-18	£7.25	£6.50
408862	19-24	£8.50	£7.75
611476	25-30	£8.75	£8.25

4-7mm Girder Clip

C



FROM ONLY
£5.25
PACK

Code	Cable Size mm	Pack 25	4+
576995	6-7	£5.75	£5.25
472848	7-9	£6.50	£6.00
992599	10-11	£6.50	£6.00
C 851453	10-12	£7.00	£6.25
880846	15-18	£7.25	£6.50
952186	19-24	£8.75	£8.00
971190	25-30	£9.75	£8.75

8-12mm Girder Clip

D



FROM ONLY
£5.50
PACK

Code	Cable Size mm	Pack 25	4+
733523	6-7	£6.25	£5.50
284619	7-9	£6.75	£6.25
D 606547	10-11	£7.00	£6.50
767957	12-14	£7.25	£6.50
158065	15-18	£8.00	£7.00
998588	19-24	£9.25	£8.50
598302	25-30	£10.00	£9.00

14-24mm Adaptor for Girder

E

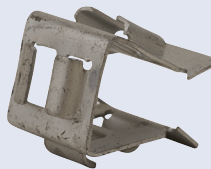

FROM ONLY
£9.50
EACH

Code	Each	4+
E 906528	£10.25	£9.50

Universal Beam Clip

F



FROM ONLY
£15.75
PACK

Code	Size mm	Pack 25	4+
F 588958	3 - 7	£17.25	£15.75
325456	8 - 12.5	£19.75	£18.00

Master Clamp

G



FROM ONLY
£10.80
PACK

Code	Size mm	Pack 10	4+
G 283576	2 - 17	£11.40	£10.80

Support Clip for 20mm Conduit

H



FROM ONLY
£19.50
PACK

Code	Description	Pack 25	4+
H 830898	M6 - M8 Rod	£20.50	£19.50

Utility Clip

- Light cable tray bracket for quick fixing to thread rods - M10 - M12

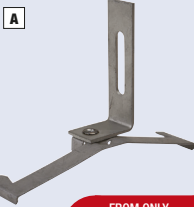

FROM ONLY
£43.00
PACK

Code	Pack 25	4+
A 662126	£47.25	£43.00

Fitting Suspension Clip (Hsc1)

- General purpose clip to support light fittings



FROM ONLY
£14.00
PACK

Code	Pack 25	4+
B 329144	£16.50	£14.00

Vertical Flange Clip

- For vertical flanges 1 - 7mm



FROM ONLY
£11.25
PACK

Code	Size mm	Pack 25	4+
C 388750	1-5	£12.50	£11.25
552621	5-7	£12.50	£11.25

Vertical Flange Rod Hanger

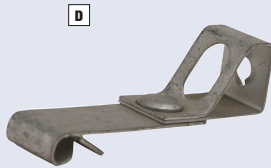

FROM ONLY
£33.25
PACK

Code	Size mm	Type	Pack 25	4+
D 695247	1-5	M6	£35.00	£33.25
732916	1-5	M8	£35.00	£33.25

Girder 10-16mm Clip & Cable Tie Fix

- For flange 2-30mm



FROM ONLY
£34.75
PACK

Code	Pack 25	4+
E 313578	£38.25	£34.75

Light Duty Flange Clip

- For vertical flanges 1-5mm

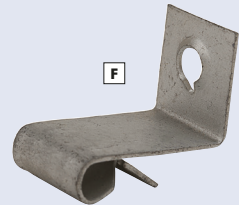

FROM ONLY
£13.50
PACK

Code	Pack 25	4+
F 427516	£15.00	£13.50

Tee Bar Hanger

- Twist on fixing for ceiling grid 15-25mm



FROM ONLY
£28.75
PACK

Code	Pack 25	4+
G 100602	£31.50	£28.75

Capping Nails

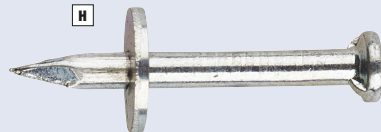

FROM ONLY
£2.60
PACK

Code	Size mm	Pack 100	5+
H 966399	2.5 x 25	£2.80	£2.60
421703	2.5 x 35	£2.95	£2.74

Plugs

Metal & Wood Screw Set

- 240 metal and wood screws



A

FROM ONLY
£4.70
PACK

Code
A 600222

Pack 5+
£4.95 £4.70

Tri Plugs



B

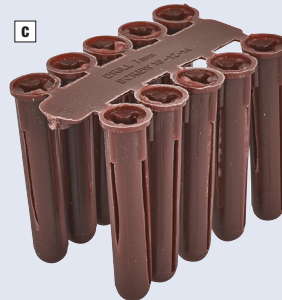

C

FROM ONLY
38P
PACK

Code	Colour
B 670980	Yellow
166272	Red
C 287878	Brown

Pack	100	5+
B	£0.49	£0.38
166272	£0.59	£0.41
C	£2.34	£2.22

6PM

ORDER BY 6PM

**GET IT
NEXT
DAY!**

FREE RETURNS

Money back guarantee!



310 Order up to 6pm for Next Day Delivery

Trade prices ex. VAT

M4 Brass Nut

A



FROM ONLY
£2.85
PACK

Code	Pack 100	3+
A 895236	£3.00	£2.85

M4 Brass Washers

B



FROM ONLY
£1.42
PACK

Code	Pack 100	3+
B 873417	£1.50	£1.42

M4 Brass Pan Head

C



FROM ONLY
£3.30
PACK

Code	Size mm	Pack 100	3+
630502	6	£4.40	£3.30
C 678089	10	£5.40	£4.30
683205	12	£5.80	£4.70
140837	16	£6.30	£5.20
441366	20	£6.80	£5.50
472217	25	£8.40	£6.70
453360	35	£12.50	£9.00
299665	50	£14.50	£9.80

Bzp Nut

D



FROM ONLY
£3.80
PACK

Code	Size mm	Pack 100	5+
269207	M6	£4.00	£3.80
D 576877	M8	£6.00	£5.80
401025	M10	£8.00	£7.60

Zinc Plated Hexagon Bolt

E

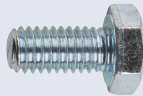

FROM ONLY
£1.04
PACK

Code	Size mm	Pack 10	5+
E 206495	M6x12	£1.10	£1.04
835435	M6x16	£1.10	£1.04
935487	M6x20	£1.10	£1.04
525793	M6x30	£1.10	£1.04
820762	M6x50	£1.10	£1.04
586518	M8x20	£1.10	£1.04
988361	M8x25	£1.10	£1.04
162490	M8x30	£1.10	£1.04
982140	M8x50	£1.10	£1.04

M10 Zinc Plated Hex Bolt

F

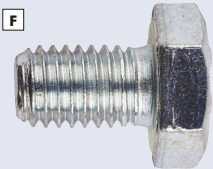

FROM ONLY
£1.99
EACH

Code	Size mm	Each	5+
F 408322	16	£2.10	£1.99
431393	20	£2.60	£2.47
913348	30	£2.90	£2.78
743359	50	£3.40	£3.23

M6 Roofing Bolts

G

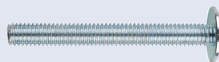

FROM ONLY
£3.14
PACK

Code	Size mm	Pack 200	3+
863026	12	£3.30	£3.14
107079	16	£3.30	£3.14
579026	20	£3.40	£3.23
263329	25	£3.52	£3.34
739151	30	£3.62	£3.44
G 231047	50	£4.28	£4.07
818943	8	£3.30	£3.14

Washers

H

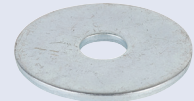

FROM ONLY
£1.90
PACK

Code	Size mm	Description	Pack 100	5+
H 870928	M6	Penny Washer	£3.50	£3.32
900207	M6	Washer	£2.00	£1.90
608352	M8	Penny Washer	£3.80	£3.45
651858	M8	Washer	£3.80	£3.45
452519	M8	Square Plate	£3.80	£3.45
415437	M10	Penny Washer	£6.00	£5.70
470701	M10	Washer	£6.00	£5.70
548400	M10	Square Plate	£6.00	£5.70

Accessories

Dry Diamond Hole Cutter

A



FROM ONLY
£59.80
EACH

Code	Size mm	Each	2+
A 839797	107	£65.00	£59.80

M3 Bi-Metal Holesaw - Variable Pitch

- For use when drilling large diameter holes in sheet metal, non-ferrous metal, plastic, wood, MDF, plywood & plasterboard
- Variable pitch tooth pattern clears dust more efficiently, & gives superior cutting performance
- High quality M3 grade HSS steel cutting edge
- 32mm saw depth

D



C



FROM ONLY
£2.10
EACH

Code	Drill Diameter mm	Each	5+
C 380215	16	£2.20	£2.10
430997	19	£2.30	£2.20
800560	20	£2.40	£2.30
435380	25	£2.70	£2.60
249510	29	£3.10	£2.90
457179	32	£3.30	£3.10
465452	35	£3.60	£3.40
992357	38	£3.85	£3.70
892568	40	£3.95	£3.80
D 115553	44	£4.10	£3.90
298993	51	£4.20	£4.00
210598	60	£4.80	£4.60
891674	64	£4.90	£4.70
274078	70	£5.10	£4.80
202976	76	£5.20	£4.90
518461	79	£5.25	£5.00
789941	86	£5.70	£5.40
456410	127	£14.30	£13.60
931459	152	£17.90	£17.00

HSS Bi-Metal Holesaw

B



FROM ONLY
£11.88
EACH

Code	Size mm	Each	3+
B 230581	102	£12.87	£11.88
880372	114	£18.82	£17.37

Alarm Panel Batteries

- 12V
- Sealed lead acid

FROM ONLY
£9.11
EACH

E



Code	Description	Each	3+
E 522496	2.1Ah	£10.12	£9.11
583507	3.0Ah	£11.29	£10.16

Duracell Batteries

FROM ONLY
£2.30
PACK



F

Code	Type	Description	Pack 2	5+
F 721909	2025	2 x 3V	£2.56	£2.30
478283	2032	2 x 3V	£2.86	£2.57
554877	AA	4 pack	£2.73	£2.46
881624	AAA	4 pack	£2.70	£2.43
562526	C	2 pack	£2.73	£2.46
117471	D	2 pack	£2.65	£2.39
492666	PP3	1 pack	£2.70	£2.43

Duracell Industrial Batteries

FROM ONLY
£3.51
PACK



G

Code	Type	Pack 10	5+
765872	AA	£3.90	£3.51
477796	AAA	£3.90	£3.51
893114	C	£7.20	£6.48
G 926615	D	£9.80	£8.82
637870	PP3	£14.00	£12.60

Conduit Bender Formers



FROM ONLY
£29.87
EACH

Code	Size mm	Each	5+
589973	20	£31.45	£29.87
A 747739	25	£43.90	£41.70

EL Conduit

- For use with Conduit Bender - 851378

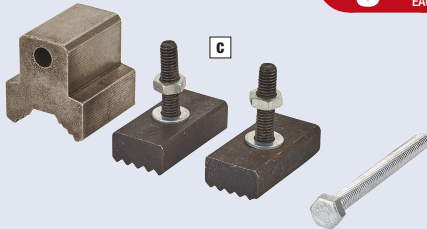

FROM ONLY
£9.92
EACH

Code	Type	Each	5+
C 402512	Jaw	£21.46	£20.38
392384	Vice	£55.67	£52.88
581037	Roller	£10.45	£9.92
290113	Stop	£12.48	£11.85

Conduit Dies and Guides



FROM ONLY
£2.51
EACH

Code	Size mm	Type	Each	5+
485859	20	Die	£6.84	£6.49
D 543804	20	Guide	£2.65	£2.51
920080	25	Die	£8.35	£7.93
608477	25	Guide	£2.65	£2.51

Conduit Bender

- Solid frame to give maximum stability which minimises the risks of sideways movement or skidding across floors
- Formers create a perfect bend for 20 or 25mm steel conduit
- Clamps support to pipe to reduce the risk of movement when bending



FROM ONLY
£199.50
EACH

Code	Each	5+
B 851378	£210.00	£199.50

Electricians Hand Tools

Cable Dispenser

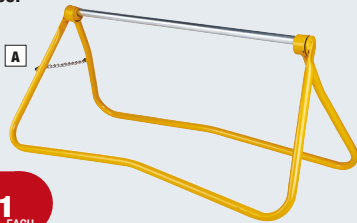

FROM ONLY
£18.81
EACH

Code	Each	5+
A 697458	£19.80	£18.81

Dust Sheets



FROM ONLY
£6.03
EACH

Code	Each	5+
B 546196	£6.35	£6.03

Chalk Lines



FROM ONLY
£1.89
EACH

Code	Description	Each	5+
C 704345	Chalk Line Chalk	£1.99	£1.89
D 610617	Chalk Line	£3.85	£3.65

Handy Rod Kit



FROM ONLY
£19.95
EACH

Code	Each	5+
E 396753	£21.00	£19.95

Telephone Wire Inserter Tool



FROM ONLY
£6.28
EACH

Code	Each	3+
F 551040	£6.98	£6.28

Ear Defenders



FROM ONLY
£6.08
EACH

Code	Each	5+
G 417277	£6.40	£6.08

Finger Saver



FROM ONLY
£2.28
EACH

Code	Each	5+
H 256326	£2.40	£2.28

Soldering Iron

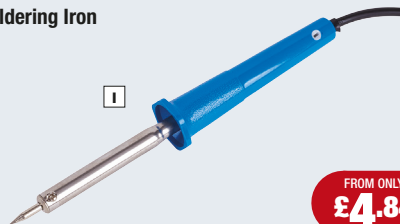

FROM ONLY
£4.84
EACH

Code	Description	Each	5+
I 729726	25W	£5.10	£4.84
282872	40W	£5.50	£5.22

Pliers



A



FROM ONLY
£18.89
EACH

Code	Size mm	Type	Each	5+
314452	180	H/L	£22.95	£21.80
A 915100	200	Combi	£19.89	£18.89

High Lever Nippers



B



FROM ONLY
£25.33
EACH

Code	Size mm	Each	5+
791339	180	£26.67	£25.33
B 141977	200	£28.62	£27.18

Cable Shears



C



FROM ONLY
£27.88
EACH

Code	Size mm	Each	5+
622080	165	£29.35	£27.88
C 739152	200	£38.75	£36.81

Combi Pliers - 200mm

D



FROM ONLY
£11.22
EACH

Code	Each	5+
D 715305	£11.82	£11.22

Sidcutters

E



FROM ONLY
£13.73
EACH

Code	Type	Stack	Each	5+
292575	Long	160	£14.46	£13.73
870056	Long	200	£14.46	£13.73
189353	High Lever	180	£18.35	£17.43
586657	Diagonal	180	£20.45	£19.42
E 812320	Diagonal	200	£19.15	£18.19

Wire Strippers

F



FROM ONLY
£14.73
EACH

Code	Size mm	Each	5+
F 529873	150	£15.51	£14.73
709902	160	£21.81	£20.71

Cable Cutters

G



FROM ONLY
£13.39
EACH

Code	Size mm	Each	5+
G 186234	210	£14.10	£13.39

Automatic Strippers

H



FROM ONLY
£13.89
EACH

Code	Each	5+
H 464928	£14.63	£13.89

Bolt Cutters - 900mm

I

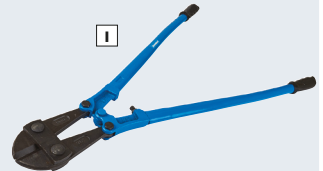

FROM ONLY
£43.13
EACH

Code	Each	5+
I 431762	£45.40	£43.13

Driver Bits

Impact Resistant Bit Check Kit

- Contains: 1 x bit holder, 7 x PZ2, 2 x PZ3

A

FROM ONLY
£20.40
PACK



Code	Pack	5+
A 595546	£21.50	£20.40

Ring Magnet Rapidaptor Bit Check

- Contains: 1 x bit holder, 1 x PZ1, 6 x PZ2, 2 x PZ3

B

FROM ONLY
£20.40
PACK



Code	Pack	5+
B 184077	£21.50	£20.40

PZ2 Pozi Bit

C

FROM ONLY
£2.10
PACK



Code	Size mm	Pack	Quantity	Pack	5+
C 201296	25mm	1		£2.25	£2.10
908160	25mm	10		£19.50	£18.50
338905	50mm	1		£3.45	£3.30

Ringmagnet Bit Holder

D

FROM ONLY
£12.80
PACK

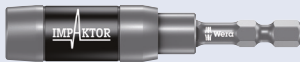

Code	Pack	5+
D 319406	£13.50	£12.80

6 piece Mini Check

- Contains: 4 x PZ2, 2 x PZ3

E

FROM ONLY
£27.60
PACK



Code	Pack	5+
E 429500	£29.00	£27.60

10 piece Bit Check

- Contains: 7 x PZ2, 2 x PZ3

F

FROM ONLY
£17.00
PACK



Code	Pack	5+
F 992640	£17.90	£17.00

PH2 x 25mm Phillips Bit Single

G

FROM ONLY
£2.10
EACH



Code	Each	5+
G 770142	£2.25	£2.10

PZ3 Pozi Bit Single - 25mm

H

FROM ONLY
£2.10
PACK



Code	Pack	5+
H 163336	£2.25	£2.10

Torx Bit Single - 25mm

I

FROM ONLY
£2.40
EACH



Code	Torx	Each	5+
I 358098	TX25	£2.50	£2.40
601495	TX30	£2.50	£2.40

Bi-Torsion Bit Box - 25mm - PZ2

J

FROM ONLY
£15.70
EACH



Code	Description	Each	5+
J 875087	Bi-Torsion	£16.50	£15.70
335797	Bi-Torsion Impact	£16.50	£15.70

MICC Crimper

- Uses a 3 point crimping plate to lock the stub cap in to the pot

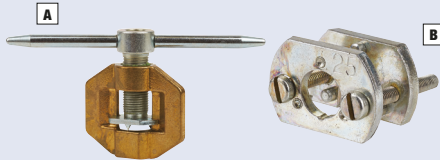

FROM ONLY
£29.99
EACH

Code	Size mm	Each	3+
A 149159	20	£37.70	£29.99
B 137094	25	£41.16	£32.74

MICC Easi Pot

- Used to thread brass pots onto copper sheathed insulated wiring cables



FROM ONLY
£8.80
EACH

Code	Size mm	Each	3+
E 436937	20	£11.07	£8.80
F 260666	25	£13.49	£10.73

MICC Ringing Tool

- Used to score a light groove round the cable sheath to neatly stop the stripping action

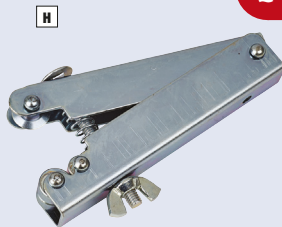

FROM ONLY
£12.86
EACH

Code	Each	3+
H 854218	£16.17	£12.86

Hand Tap

- Suitable to retap stripped threads in back boxes



FROM ONLY
£4.13
EACH

Code	Size mm	Each	5+
140022	3.5	£4.35	£4.13
147049	4.0	£5.45	£5.17
C 852785	6.0	£5.95	£5.65

MICC 40mm Pot Wrench

- Ensures quick and accurate screwing of the brass pot



FROM ONLY
£21.23
EACH

Code	Each	3+
D 693912	£26.69	£21.23

MICC Rotary Stripper

- Easy to set tool for fast and efficient stripping of MICC cable



FROM ONLY
£19.03
EACH

Code	Description	Each	3+
877157	Rotary Stripper	£82.39	£65.54
G 185858	Large Spare Blade	£23.92	£19.03
898327	Small Spare Blade	£26.12	£20.78

MICC Spare Blade

- Spare blade for use with the ZSJ Joi Stripper



FROM ONLY
£4.91
EACH

Code	Each	3+
I 124753	£6.17	£4.91

GRIPIT®

The Worlds Ultimate Plasterboard Fixing

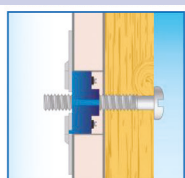

Cavity Wall

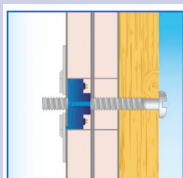

Double Thickness Plasterboard

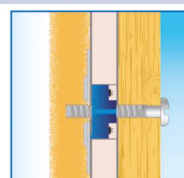

Insulated Plasterboard

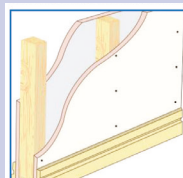

Partition Wall

HEAVY DUTY PLASTERBOARD FIXINGS

- Griptit® is a revolutionary new universal plasterboard fixing designed for all types of plasterboard & will hold very heavy weights
- Removable & reusable (no more losing fixings down the cavity!)
- Incredibly strong & secure
- Easy to install
- Fits 9.5 - 15mm plasterboard

Griptit® Plasterboard Fixing - Yellow - 15mm

- Max weight load: 142kg
- 15mm hole
- Ideal for installation of curtain rails, picture frames, mirrors, small shelving & many other applications



FROM ONLY
£2.70
PACK

Code	Size mm	Pack Quantity	Pack	5+
582766	4 x 25	4	£2.90	£2.70
305360	4 x 25	8	£5.65	£5.10
A 190254	4 x 25	25	£14.10	£13.90

Griptit® Plasterboard Fixing - Red - 18mm

- Max weight load: 148kg
- 18mm hole
- Ideal for installation of large shelf brackets, bathroom fittings, heavy duty curtain rail brackets & many other applications



FROM ONLY
£2.95
PACK

Code	Size mm	Pack Quantity	Pack	5+
B 996586	5 x 30	4	£3.30	£2.95
554014	5 x 30	8	£6.45	£6.10
506131	5 x 30	25	£14.95	£13.90

Griptit® Plasterboard Fixing - Brown - 20mm

- Max weight load: 185kg
- 20mm hole
- Ideal for installation of bathroom fittings, radiators, water heaters, cabinets & many other applications

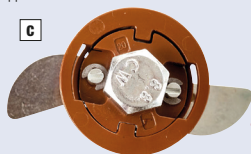

FROM ONLY
£3.50
PACK

Code	Size mm	Pack Quantity	Pack	5+
716422	M6 x 30	4	£3.70	£3.50
C 893901	M6 x 30	8	£7.30	£6.90
840943	M6 x 30	25	£16.65	£15.90

Griptit® Plasterboard Fixing - Blue - 25mm

- Max weight load: 225kg
- 25mm hole
- Ideal for installation of kitchen cupboards, water heaters, wall mounted televisions and many other applications



FROM ONLY
£3.90
PACK

Code	Size mm	Pack Quantity	Pack	5+
346342	M8 x 30	4	£4.15	£3.90
263207	M8 x 30	8	£8.15	£7.90
D 681633	M8 x 30	25	£18.30	£17.90

Gript® Ceramic Tile Saw

- Assists the fitting of Gript® fixings into tiled walls
- Allows for the cutting of two recesses opposite each other, enabling the anti rotation wings to pass through the tile into the plasterboard



FROM ONLY
£6.20
EACH

A

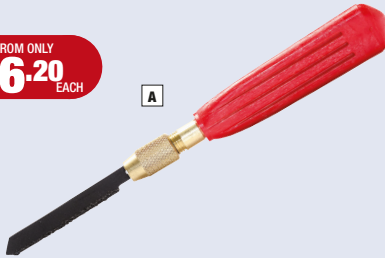

Code	Each	5+
A 790838	£6.65	£6.20

Gript® Hole Cutter



FROM ONLY
£5.50
EACH

B

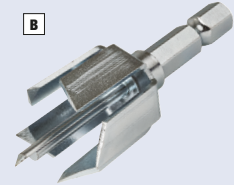

Code	Drill Diameter mm	Each	5+
540881	15	£5.80	£5.50
380787	18	£5.80	£5.50
B 902684	20	£5.80	£5.50
587907	25	£5.80	£5.50

Gript® Dot and Dab Kit

- Assists the fitting of Gript® fixings when you hit a dab in the plasterboard
- Cuts a recess for the wings to extend easily



FROM ONLY
£5.25
EACH

C

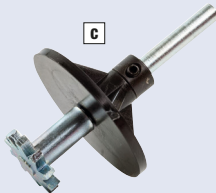

Code	Colour	Drill Diameter mm	Each	5+
269310	Yellow	15	£5.80	£5.25
119465	Red	18	£5.80	£5.25
156779	Brown	20	£5.80	£5.25
C 740870	Blue	25	£5.80	£5.25

Gript® Assortment Pack

- An assortment of the most popular sizes of Gript® plasterboard fixings



Pack contains:

- 8 x yellow fixings (15mm)
- 8 x red fixings (18mm)
- 8 x brown fixings (20mm)
- 8 x blue fixings (25mm)
- 8 screws 4 x 25mm
- 8 screws 5 x 30mm
- 8 bolts M6 x 30mm
- 8 screws M8 x 30mm
- Fixing instructions



D

FROM ONLY
£17.90
PACK

Code	Pack	5+
D 903035	£18.40	£17.90

Gript® Plasterboard Fixing - Starter Pack

Pack contains:

- 10 x yellow fixings (4 x 25mm screw, 15mm hole)
- 10 x red fixings (5 x 30mm screw, 18mm hole)
- 10 x brown fixings (M6 x 30mm bolt, 20mm hole)
- 10 x blue fixings (M8 x 30mm bolt, 25mm hole)
- 1 x each drill bit to suit (15, 18, 20 and 25mm)
- Fitting instructions

FROM ONLY
£29.90
PACK



E

Code	Pack	5+
E 384162	£33.30	£29.90

Terms

1 Definition

- 11 The "**Buyer**" means the person who buys or agrees to buy Goods from the Seller
- 12 The "**Seller**" means Electrical Direct Limited registered in England and Wales with Company Number 02646135 whose registered office is at Essex Electrical Wholesalers Ltd East Street Braintree Essex CM7 3JW VAT No 594 8182 92
- 13 "**Terms and Conditions**" means the Terms and Conditions of Sale set out in this document and any special conditions agreed in writing by the Seller
- 14 "**Order**" means the contract between the Seller and the Buyer for the sale and purchase of Goods in accordance with these Terms and Conditions
- 15 "**Goods**" means the goods (or any part of them) set out in the Order 16 A reference to writing or written includes faxes and e-mails

2 Basis of Contract

- 21 These Terms and Conditions govern the sale of Goods by the Seller to the Buyer These Terms and Conditions constitute the entire and only agreement between the parties in relation to the Seller's acceptance of the Order by delivery of the Goods constitutes a legally binding contract between the parties on these Terms and Conditions
- 22 All orders placed by the Buyer are on the basis of these Terms and Conditions and are subject to acceptance by the Seller by delivery of the Goods to the Buyer at which point a legally binding contract is constituted between the parties The processing of payment and acknowledgment of the Buyer Order does not constitute legal acceptance of the Order
- 23 These Terms and Conditions supersede all previous terms and conditions issued by the Seller and the Buyer agrees to be governed by them in all matters arising from the purchase of Goods from the Seller

3 Price and Payment

- 31 The price payable for the Goods is as set out on the Seller's website at the time the Order is placed or in order placed on one of the Seller's catalogues, as set out in the catalogue from which the order is placed (provided it is a current catalogue), plus any charges for insurance and carriage as set out in the Seller's current applicable catalogue
- 32 Subject to clause 33, the Seller shall receive payment for the whole of the price of the Goods ordered, and any applicable charges for packaging, insurance and delivery, before the Order can be accepted unless the Seller has agreed otherwise in advance in writing
- 33 If the Buyer is an account customer, payment shall be made in full at the end of the month following date of invoice Time shall be of the essence for payment The Seller may revoke credit if the Buyer fails to make payment when due If payment is not made when due, interest is payable at the rate of 4 per cent over the Royal Bank of Scotland Plc's base lending rate from time to time on the amount outstanding from the due date for payment until receipt by the Seller of the full amount (including any accrued interest) whether before or after judgment, together with any reasonable legal or other recovery costs
- 34 On occasion, the prices payable of Goods advertised on the Seller's website may differ from those prices offered in the then current catalogue, and the Seller is under no obligation to honour any web site price if there is such a difference Occasion being the Seller advertises Goods at a promotional price, the Buyer must quote the relevant promotion code otherwise the Seller will be charged the full price
- 35 The Buyer is responsible for all orders placed by its authorised employees and the Seller is not bound by any individual order limit The Buyer may impose on its authorised employees The Buyer must inform the Seller in writing as soon as a relevant employee is no longer authorised to place and receive Orders
- 36 All prices quoted are subject to VAT at the prevailing rate on the date of despatch
- 37 Occasionally an error may occur and Goods may be incorrectly priced in which circumstances the Seller will not be obliged to supply the Goods at the incorrect price, but will inform the Buyer of the correct valid price to enable the Buyer to re-order
- 38 Prices are valid as stated in Clause 15 unless the Seller requires for commercial reasons to vary any price during the current catalogue period It will notify the Buyer at the point of order or otherwise in its advertising material
- 39 No payment transaction will be completed until immediately prior to the point of despatch
- 310 Specific additional terms and conditions may apply to promotional and voucher offers These Terms can be seen on our website: <http://www.ElectricalDirect.com/information/terms>

4 Delivery and Title

- 41 Unless the Buyer tells the Seller it wishes to collect the Goods, the Seller will deliver the Goods in accordance with the Order A valid signature will be required on collection or delivery
- 42 Subject to clauses 43 and 44, title to the Goods will remain with the Seller until such time as all Goods are delivered and paid for in full
- 43 Title to the Goods shall not pass to the Buyer until the Seller has received payment in full for the Goods and all other sums which are or which will become due to the Seller for sales of Goods to the Buyer
- 44 Until title to the Goods has passed to the Buyer, the Buyer shall:
 - a) hold the Goods on a fiduciary (good faith) basis as the Seller's bailee (custodian);
 - b) store the Goods separately from all other goods held by the Buyer so that they remain readily identifiable as the Seller's property;
 - c) not remove, deface or obscure any identifying mark or packaging on or relating to the Goods;
 - d) maintain the Goods in satisfactory condition and keep them insured against all risks for their full price from the date of delivery
 - e) notify the Seller immediately if it becomes the subject to any of the events list in clause 81; and

- f) give the Seller such information relating to the Goods as the Seller may require from time to time
- but the Buyer may resell or use the Goods in the ordinary course of its business
- 45 In the unlikely event that the Buyer has not received all the Goods within 48 hours of the date of delivery for where the Buyer has requested a delayed despatch within 48 hours of the requested despatch date), the Buyer must notify the Seller immediately
- 46 The Seller will endeavour to deliver the Goods in accordance with the Order within the stated delivery time In the unlikely event that the Seller does not make the Goods available to the Buyer within 30 days of the Order the Seller will have the option of cancelling the Order by notifying the Buyer accordingly prior to delivery Before placing the Order, please refer to the delivery options set out in the Seller's website and catalogue to ensure that delivery can be made to the Buyer's address A valid signature will be required on collection or delivery The Seller reserves the right to choose to nominate the carrier in the unlikely event that the Buyer has not received all the Goods within the stated delivery time, the Buyer must notify the Seller immediately The Buyer must not schedule or commence any installation work until after the Buyer has received its Order and checked all the Goods for any defects or missing parts

5 Availability

- 51 While the Seller endeavours to hold sufficient stock to meet all orders, if the Seller has insufficient stock to supply or deliver the Goods ordered and paid for by the Buyer, the Seller may, at its discretion, supply or deliver a substituted product or refund to the Buyer the price paid for such Goods as soon as possible and in any case within 30 days of the date of the account customer, the Seller may, in its absolute discretion, as soon as possible raise a credit to offset the amount invoiced to the Buyer
- 52 Colour and finishes may vary slightly as is dependant on products supplied by manufacturers

6 Returns, Shortages, Damaged Goods & Cancellations

- 61 Goods are made available to the Buyer on a non-returnable basis to us within 30 days without any handling charge, providing the Goods, including packaging, are in a re-sellable condition subject to 64
- 62 In the unlikely event of the Order being supplied incomplete or Goods arriving damaged in transit the Buyer must notify the Seller in writing within 14 days of delivery
- 63 The Seller will refund the same method of payment used to purchase their Goods
- 64 If the Seller is unable to accept the return of any non-standard special product that has been supplied correctly in accordance with the Buyer's instructions
- 65 The Buyer may cancel its order by giving the Seller notice of cancellation within 30 days of the date of delivery to the Buyer or collection from a trade courier Such notice may be given by phone, mail, fax or email if the Buyer is cancelling because of any problem with the Goods, please notify the Seller of the problem at the time of cancellation
- 66 On cancellation for whatever reason, the Buyer must return the Goods to the Seller at the Buyer's cost unless the Seller agrees that the Buyer may dispose of them in which case please comply with the manufacturer's instructions before disposing of hazardous Goods Where the Goods are being returned because they are faulty, incorrect Goods or because of unsuitable substitution by the Seller, the Seller will meet the cost of return and the Seller can nominate a fully or damaged Goods to be returned by the Buyer as the Seller's carrier
- 67 All Electrical products are guaranteed for a minimum of 1 year, unless otherwise stated The guarantee covers these products when fitted, used and maintained as per their specifications including fair wear and tear

7 Liability

- 71 If the Buyer has notified the Seller of a problem with the Goods within 30 days of delivery, the Seller will (subject to clause 5) either make good any shortage or non-delivery; replace or repair any Goods that are damaged or defective upon delivery; or refund to the Buyer the amount paid by the Buyer for the Goods in question
- 72 The Seller shall have no liability to pay any money to the Buyer by way of compensation other than any refund The Seller makes under these Terms and Conditions The Seller's liability to the Buyer shall not in any event include losses related to any business of the Buyer, such as loss of profits or business interruption; neither will the Seller be responsible to the Buyer for any other loss which is not a foreseeable consequence of the Seller being in breach of these Terms and Conditions or its legal duties The Seller's total liability to the Buyer in respect of all other losses arising under or in connection with this agreement shall not exceed the price of the Order
- 73 This does not affect your statutory rights, nor is it intended to exclude the Seller's liability to the Buyer for fraudulent misrepresentation or for death or personal injury resulting from the Seller's negligence or any matter in respect of which it would be unlawful for the Seller to exclude or restrict liability
- 74 Goods are intended for use in the UK only and the Seller cannot confirm that the Goods comply with any laws, regulations or other standards applicable outside the UK All Goods are sold in accordance with the manufacturer's specifications and are subject to any qualifications, representations or instructions contained in the documentation associated with the Goods
- 75 Subject to Clause 73, the Seller will not be responsible to the Buyer or, in the event that the Buyer is undertaking work for another person, to any other person, for the use or installation of any Goods by the Buyer Accordingly, if the Buyer is a trade customer, the Buyer hereby agrees to hold the Seller harmless, and indemnify the Seller against any liability associated with, any claim or allegation that the Seller is responsible for any failings in the installation of: use of Goods that the Seller supplies

8 Termination

- 81 The Seller may suspend further supply or delivery, stop any Goods in transit or terminate the contract by notice in writing to the Buyer if the Buyer is in breach of an obligation hereunder or the Buyer becomes unable to pay its debts when they fall due or proceedings are commenced by or against the Buyer alleging bankruptcy or insolvency
- 82 Upon termination, the Buyer's indebtedness to the Seller becomes immediately due and payable and the Seller shall be under no further obligation to supply Goods

9 Force Majeure

- 91 In the event that the Seller is prevented or delayed from carrying out its obligations under this agreement as a result of any cause beyond its control such as but not limited to acts of God, war, strikes, lockouts, flood and failure of third parties to deliver Goods, the Seller shall be relieved of its obligations and liabilities under such agreement for as long as such fulfillment is prevented

10 Health and Safety

- 101 By purchasing from the Seller the Buyer acknowledges that it is aware of all health and safety requirements pertaining to the products and their application
- 102 By purchasing from the Seller the Buyer assumes full liability for the consequences of its actions and acknowledges that the Buyer is obliged to report any misuse or abuse of the Seller's products and/or services

11 Age Requirement for Specific Goods

- 111 Where the Buyer places an Order for age-restricted Goods such as solvents and knives, the Buyer confirms that it is over the age of 18 and that delivery will be accepted by a person over the age of 18 The Seller reserves the right to cancel the Order if the Seller reasonably believes the Buyer is not legally entitled to order certain Goods

12 Disposal of electrical and electronic equipment

- 121 The WEEE regulations 2013 (applies from 1 January 2014) ensure that the amount of waste on certain electrical and electronic equipment is reduced, separated from household waste, collected separately and ultimately disposed of in a sound environmental manner (recycled and recovered) If the Buyer is a trade customer, the Buyer agrees that the collection, recovery/treatment and disposal of non household electrical or electronic equipment purchased from the Seller will be the Buyer's responsibility In the case of household waste, please take this waste to the Buyer's nearest Designated Collection Facility (DCF) where special facilities exist for correct disposal

13 General

- 131 If in any provision of these Terms and Conditions is invalid, illegal or unenforceable (including any provision in which the Seller excludes its liability to the Buyer) that provision shall, to the extent required, be deemed to be deleted and the validity, legality or enforceability of any other part of these Terms and Conditions will not be affected
- 132 Where any terms or conditions may be valid by the inclusion or exclusion of one or more conditions it will be considered that those amendments have taken place with the minimum modification necessary
- 133 This contract and any dispute or claim arising out of or in connection with it shall be governed by and interpreted in accordance with English law, the parties irrevocably submit to the exclusive jurisdiction of the courts of England and Wales
- 134 These Terms and Conditions constitute the entire agreement between the parties The Buyer acknowledges that it has not relied on any statement, promise or representation made or given by or on behalf of the Seller which is not set out in the Order
- 135 A Person who is not a party to the contract shall not have any rights or in connection with it
- 136 By submitting the Order/requesting information the Buyer consents to the Seller retaining and using the Buyer's personal data for the purpose of advertising, marketing and its administration; this includes providing information to service providers and carefully selected third parties whose products the Seller thinks may be of interest to the Buyer The Buyer indicates its consent to receiving marketing messages from the Seller and third parties unless the Buyer notifies the Seller otherwise

14 Copyright

- 141 Drawings, photographs, part numbers, layout and style are all considered the property of the Seller Reproduction in whole, or in part, is strictly prohibited without prior written permission of the Seller Quantities and measurements are approximate All trademarks are acknowledged Exact products may vary from those shown

© Electrical Direct Ltd Registered Office: Essex Electrical Wholesalers Ltd East Street Braintree Essex CM7 3JW VAT No 594 8182 92

15 Price Validity

- 151 Subject to clause 38 prices are valid until 01/03/2017

A

Access Control	200,210-212
Adaptable Boxes	30,38
Adaptors	188,192
Adhesives	290,292
Air Curtain	184
Alarms	152,198,202,204,218,220-222
Appliance Inlets	112
Architrave Plates	77

B

Back Boxes	32,72,82,84,104,134,164,166
Batteries	244,312
Blanking Plates	68,72,76,86-90,104

C

Cable Accessories	24,28,118
Cable Ties	24
Cable Trays	58
Cables	
3 Core & Earth	10
Armoured	12-14
Bell Wire	20
Coaxial	20,164
Data	20
Fire Resistant	18
Flex	16
HDMI	164,166
Heat Resistant	18
Meter Tails	10
Single Core	12
Speaker Wires	20
Telephone	20
Twin & Earth	10
Catenary Wires	26
CCTV	206,252
Change Over Switches	146
Check Meters	122
Cleaners	296
Clips	24,190,192,308
Coaxial Plugs	68,72,164
Code Operated Locks	208
Conductors	
In & Out	30
Conduit Accessories	46-48
Conduits	50-54,56
Connectors	
Blocks	30
Chocbox	30
Contract	30
Ducting	187-191
Loop In & Out	30
Porcelain	30
Push	30
Strips	30
Through	30
Lever	30
Consumer Units	116,118,124,126,128
Contactors	124,140,144
Controllers	238
Crimps	28

D

DIN Rail	140,150
Distribution Boards	124,126,128
Doorbell	214
Ducting	186-190,192
Dust Sheets	314

E

Earthing Accessories	32
Enclosures	100,134-136
Extension Leads	108,166

F

Fans	170,172-174,176,180
Fire Extinguishers	216
Fire Signs	224,226,228
Floor Boxes	105
Fluorescent Tubes	286
Flush Back Boxes	36,98
Flykiller Tube	286
Fuses	130-132

G

Glands	26,49,122
Gloves	298
Grid Switches	94-98
Grommets	24

H

Hand Dryers	160,194
Heat Shrink	10
Heaters	180,182,184
Heating Controls	150,180

I

Industrial Plugs & Sockets	112
----------------------------	-----

J

Junction Boxes	30,38,166
----------------	-----------

K

Key Locks	134
-----------	-----

L

Lamp Adaptors	110
Lampholders	80,262,264
Lamps	
Candle	276,282
Compact Fluorescent	278
Enclosed	278
GLS	274,282
Golf Ball	276,282
GU10	284
Halogen	274,276,278
LED	282,284
Low Energy	278
Low Voltage	264
Mercury	280
Metal Halide	280
Portable	248
Reflector	276
Sodium	280
Spot	284
Lighting	
Accessories	80,158,238,252
Amenity	242
Ballast	244
Bathroom	260
Batten	80,238,262
Batten Clip	240
Bulkhead	240,242,266,246,264
Coach Lantern	254
Diffuser	242
Downlight	242,246,256,264,268,278
Downlight Fire Rated	268
Emergency	240-244
Floodlight	156,254
Gripper	248

GU10	252,268
Klik Distribution Box	110
Lantern	254,256
LED	238,242,246,252,254,256,260,264,266,270,282
LED Driver	267
Louvre	242
Non Corrosive	240
Outdoor	240,248,25-256
Pendants	80,262
Photocell	154
PIR	154-156,240
Plug in Ceiling Rose	110
Pull Cord	80
Reflector	238
Remote	150,154-156,158
Shaver	260
Spot	252,260,266
Starter Switch	286
Strip	270
Task	248
Link Leads	270

M

MCB's	118,124-128
-------	-------------

Modules

Blanks	94-98,106,116,120,134
Dimmer	78,96
Enclosures	142-144
Flex Outlet	98,106
Fused Spur	96,98
Indicator	98,142
Mounting Frame	94-98,166
Plates	90,106
Printed	98
Quadplex	106
Telephone/Television/FM/Satellite	106
Timer	174
Triplex	106

N

Nails	309
Nuts, Bolts & Washers	26,310

P

Padlocks	232-235
Patch Leads	20
Paxolin Sheets	32
Plasterboard Fixings	306,318
Plugs	78,110,112
Push Button	142, 211

R

RCBO's	120,124,128
RCD's	76,78,120,124
Relays	144

S

Safes	230
Satellite	
Coupler	164
Finder	164
Link Eye	164
Outlet	164
Plug	164
Splitter	164
Scart Leads	164
Screws	302-306,310
Sealants	292-294
Security	230-234
Shower Units	120,194

Signs	224-228
Sleeving	10
Sockets	

2A	66
Converter	78
Cut	108
Flex Outlet	72,102,104
Fused Spur	66,70,86-92,100,102
Metal Clad	102,104
Pop Up	108
Remote	158
Shaver	66,77,87,89,90
Surface	112
Switched	66,68,70,74,86-92
Telephone	88-92
Telephone Data	76
Telephone Master	68,166
Telephone Slave	68
Television/Satellite/FM	68,72,88-92
Trailing	108,112
Unswitched	66,70,74
USB	82
Weatherproof	100
Spacers	46,72

Switches

Accessories	158,160
Architrave	74
Cabinet	80
Ceiling	154-156
Cooker	66-68,70,74,88-92
Dimmers	78,88-92,94,158
Double Pole	68,72,76
Fan	66,68,72,76,80,88-92
Fused	122
Fused Disconnectors	128-130
Fused Spur	86-88
Inline	110
Lights	66-70,74,86-92
Main	118,126
Metalclad	102-104
Outdoor	100
Pull Cord	80
Remote	158
Rocker	68
Standard	66-68,72,76,86,92-94
Time	118,150,160

T

Telephone	
Accessories	166
Adaptor	166
Amplifier	164
Connection	76,166
Data Modules	106
Extension Lead	166
Outlet	166
Y Coupler	164
Television Bracket	164
Three Phase	122,124,128
Tissue Rolls	296
Tools	20,24,166,290,312,314,316
Transformers	120,174,266
Trunking	42-44,58
Trunking Accessories	60-62

V

Ventilation	170
-------------	-----

W

Wipes	296
Wire Cable Trays	58

ORDER BY 6PM GET IT NEXT DAY!



10W Floodlight with PIR

- IP65 rated energy saving up to 75%
- Super bright LED



ONLY
£14.25
EACH

Order Code:
679066

SEE
PAGE
254



Electric Radiator

- High precision chrono-thermostatic control
- Digital programming
- 7 heating schedules with 1 bespoke



ONLY
£209.00
EACH

Order Code:
285501

SEE
PAGE
179

Submersible Junction Box



- Fully submersible in salt or chlorinated water
- Rated up to 1kV
- Current rating 32A

ONLY
£3.95
EACH

Order Code:
384238

SEE
PAGE
38



Amendment 3 10 Way Consumer Unit with 2 x 63A RCD & 10 MCB's



- Amendment 3 compliant metal enclosure

ONLY
£53.00
EACH

Order Code:
950190

SEE
PAGE
117

NEW PRODUCTS ADDED DAILY TO OUR WEBSITE

FREEPHONE: 8AM-6PM, 7 DAYS A WEEK
0808 168 22 77

ONLINE: SHOP 24/7
ElectricalDirect.co.uk

