

2015



PLAQUETTES
ET DISQUES DE FREIN

BRAKE PADS
AND DISCS

PASTIGLIE
E DISCHI FRENO

PASTILLAS
Y DISCOS DE FRENO

PASTILHAS
E DISCOS DE TRAVÃO

BREMSBELÄGE
UND BREMSSCHEIBEN

REMBLOKKEN
EN REMSCHIJVEN

КЛОСКИ
И ТАРЦЕ HAMULCOWE

FREN BALATALARI
VE DISKLERI

КОЛОДКИ
И ДИСКИ

OptiPACK™



valeo added



www.valeoservice.com

Automotive technology, naturally



OptiPACK™

PERFORMANCE ET SÉCURITÉ OPTIMUM
OPTIMUM PERFORMANCE AND SECURITY

Une gamme optimisée

60 RÉFÉRENCES

pour une couverture de parc
de 92% des modèles de camions
européens

Un pack complet

UNE OFFRE TOUT-EN-UN

tous les accessoires nécessaires au
montage sont inclus dans la boîte

An optimized range

60 REFERENCES

with a 92% coverage rate
of European truck models

A complete package

ALL-IN-ONE OFFER

all necessary accessories for
mounting are included in the box



valeo added™ 

Automotive technology, naturally

Valeo



1 **OptiPACK™** >  2

2  >  5

3 **WVA** >  6

4  > **OptiPACK™** 8

5  > **OptiPACK™** 9

6 **OptiPACK™**  >  29

7  > **OptiPACK™** 61

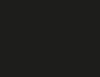

Valeo	WVA										
882200	29087	KNORR SB7	✓		MERCEDES-BENZ	Actros, Atego, Axor	0004210510	0004214310	247,4	109,5	30
882201	29087	KNORR SB7	✓	✓	IVECO	Eurocargo, Eurostar, Eurotech, Stralis, Trakker	1906439	2992348	247,4	109,5	30
882202	29087	KNORR SB7	✓	✓	SCANIA	Serie 4, P-R-T	1390428	1521979	247,4	109,5	30
882203	29087	KNORR SB7	✓	✓	BPW	SB4345	0536270020	0980102570	247,4	109,5	30
882204	29095	KNORR SB6	✓		MERCEDES-BENZ	Atego	0004210710		210,4	92,5	30
					MAN	M2000	81508205017				
882205	29095	KNORR SB6	✓	✓	IVECO	Eurocargo Tector	2992336	2996468	210,4	92,5	30
882206	29095	KNORR SB6	✓	✓	BPW	SB3745	0980102750	0980102930	210,4	92,5	30
882207	29165	KNORR SN6	✓		BPW	SB3745	0980106350	0980106430	210,4	92,5	30
882208	29167	KNORR SN7	✓		BPW	SB4345	0980106960	0980106450	247,4	109,5	30
882209	29171	KNORR SK7	✓		BPW	SB4309	0509290060	0980106440	210,2	107,8	30
882210	29115	KNORR SB5	✓		MERCEDES-BENZ	Atego	0004211010	0004211210	185/173,5	84	34/27
882211	29030	LUCAS D3	✓		IRISBUS	Heuliez, Agora	5001823000		249	118,1	28
					RENAULT TRUCKS	Magnum, Premium	5001834075				
882212	29030	LUCAS D3	✓	✓	IRISBUS	Heuliez, Agora	5001823000		249	118,1	28
					RENAULT TRUCKS	Magnum, Premium	5001834075				
882213	29030	LUCAS D3	✓	✓	IRISBUS	Heuliez, Agora	5001823000		249	118,1	28
					RENAULT TRUCKS	Magnum, Premium	5001834075				
882214	29113	LUCAS D-ELSA 1	✓	✓	MAN	F90, F2000, M2000	81508205006	81508205021	249	118,1	28
882215	29030	LUCAS D3	✓	✓	MERCEDES-BENZ	O-Series, Integro	0024205520	0034205520	249	118,1	28
882216	29113	LUCAS D-ELSA 1	✓	✓	MAN	NG, NU, NL Series	81508205066	81508206044	249	118,1	28
882217	29090	LUCAS D-LISA	✓	✓	IRISBUS	Citelis, Agora, Heuliez	5001846034	5001833114	249	109,5	28
882218	29090	LUCAS D-LISA	✓	✓	RENAULT TRUCKS	Magnum, Premium	5001846034	5001833114	249	109,5	28
882219	29131	LUCAS D-ELSA 2	✓	✓	MAN	TGA	81508205072	81508206041	249,3	117,9	30
882220	29131	LUCAS D-ELSA 2	✓	✓	RENAULT TRUCKS	Magnum, Premium	5001855646		249,3	117,9	30
882221	29125	LUCAS D-DUCO	✓		VOLVO TRUCKS	FH 12/16, FM 9/12	1078439	20768092	249,1	110,9	29,3
882222	29124	MERITOR	✓		MERITOR	DX195	MDP5076	MDP1314	205,3	102	27
882223	29088	PERROT PAN 17	✓	✓	RENAULT TRUCKS	Midlum	5010848607		175,3	82,4	26
882224	29142	PERROT PAN 19-2	✓	✓	RENAULT TRUCKS	Midlum	5001855902		204,5	97	29,9
882225	29090	LUCAS D-LISA	✓		RENAULT TRUCKS	Magnum, Premium	5001846034	5001833114	249	109,5	28



Valeo	WVA										
882226	29131	LUCAS D-ELSA 2	✓		RENAULT TRUCKS	Magnum, Premium	5001855646	5001020312	249,3	117,9	30
882227	29159	PERROT PAN 19-1	✓	✓	DAF	LF 55	1628064		210,2	79,6	30
882228	29159	PERROT PAN 19-1	✓		DAF	LF 55	1628064		210,2	79,6	30
882229	29088	PERROT PAN 17		✓	DAF	LF 45	1436901		175,3	82,4	26
					IVECO	Eurocargo Tector	1906467				
882230	29088	PERROT PAN 17			DAF	LF 45	1436901		175,3	82,4	26
					IVECO	Eurocargo	1906467				
					RENAULT TRUCKS	Midlum	5010848607				
					MAN	L2000 , M2000	81508205023				
882231	29011	BENDIX		✓	IVECO	Eurocargo, Eurostar, Eurotech	1906191	1906459	240,6	124,6	25
882232	29011	BENDIX			IVECO	Eurocargo, Eurostar, Eurotech	1906191	1906459	240,6	124,6	25
882233	29122	BREMBO		✓	IVECO	Eurocargo	1906416	1906298	175	79,5	22
882234	29122	BREMBO		✓	IVECO	Eurocargo, Eurocargo Tector	1906416	1906298	175	79,5	22
882235	29122	BREMBO			IVECO	Eurocargo, Eurocargo Tector	1906416	1906298	175	79,5	22
882236	29067	LUCAS		✓	IVECO	Eurocargo	1906043	1906297	176	78	22
882237	29011	BENDIX		✓	IVECO	Eurocargo, Eurostar, Eurotech	1906191	1906459	240,6	124,6	25
882238	29088	PERROT PAN 17		✓	MAN	L2000 , M2000	81508206006		175,3	82,4	26
882239	29835	LUCAS		✓	MERCEDES-BENZ	Vario, Medio, Sprinter	0014201520	0024205720	175	85,5	22
882240	29835	LUCAS			MERCEDES-BENZ	Vario, Medio, Sprinter	0014201520	0024205720	175	85,5	22
882241	29065	LUCAS		✓	RENAULT TRUCKS	Midliner S	5001014694	5001825638	175	85,5	22
882242	29065	LUCAS			RENAULT TRUCKS	Midliner S	5001014694	5001825638	175	85,5	22
					IVECO	Eurocargo	1906144	1906298			
882243	29173	ELSA 225-1	✓	✓	RENAULT TRUCKS	Midlum	5001864365		216	96,5	29,25
					VOLVO TRUCKS	FL II	20568712	20568715			
882244	29173	ELSA 225-1	✓		RENAULT TRUCKS	Midlum	5001864365		216	96,5	29,25
					VOLVO TRUCKS	FL II	20568712	20568715			
882245	29174	ELSA 225-3	✓	✓	RENAULT TRUCKS	Magnum DXi, Premium DXi	5001864364	5001864363	249,6	107	29,25
					VOLVO TRUCKS	FH/FE/FM	20568711	20568714			
882246	29174	ELSA 225-3	✓		RENAULT TRUCKS	Magnum DXi, Premium DXi	5001864364	5001864363	249,6	107	29,25
					VOLVO TRUCKS	FH/FE/FM	20568711	20568714			
882247	29177	VGT195	✓	✓	RENAULT TRUCKS	Magnum DXi, Premium DXi	5001864380		210,5	99,7	29,25
					VOLVO TRUCKS	FH	20568713	20765963			
882248	29177	VGT195	✓		RENAULT TRUCKS	Magnum DXi, Premium DXi	5001864380		210,5	99,7	29,25
					VOLVO TRUCKS	FH	20568713	20765963			



Valeo	WVA									
882249	29181	HALDEX DB19	✓		RENAULT TRUCKS Midlum	5001866914		210	92	30
882250	29162	PERRROT PAN 22-1	✓		SAF-SAUER	3057008400		210,5	104,3	31
882251	29143	HALDEX DB22	✓		SAF-SAUER	9291063		247,4	105	30
882254	29067	LUCAS			RENAULT TRUCKS Midliner S	5001014704		176	78	22
882255	29067	LUCAS		✓	RENAULT TRUCKS Midliner S	5001014704		176	78	22
882257	29039	LUCAS	✓	✓	FORD Cargo	6171272		175	78	22
					VOLVO TRUCKS FL 6	3090048	2709012			
882258	29067	LUCAS	✓		IVECO Eurocargo	1906043	1906297	176	78	22
882259	29181	HALDEX DB19	✓	✓	RENAULT TRUCKS Midlum	5001866914		210	92	30
882270	29137	LUCAS C-DUCO	✓		VOLVO TRUCKS FL 6	3093532	20768115	210	102.2	29.25
882271*	29246	KNORR SM7	✓		MERCEDES-BENZ Actros MP4	64201420		244.6	113.6	30
882272*	29244	KNORR SL7	✓		MERCEDES-BENZ Actros MP4	64201520		207.2	113.7	30

* Sales of this product not allowed in Germany / Vente de ce produit non autorisée en Allemagne

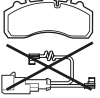

			WVA				
IVECO	1906191	1906459	29011	882231	882232	882331	Eurocargo, Eurostar, Eurotech
	1906191	1906459	29011	882237	882232	882337	Eurocargo, Eurostar, Eurotech
IRISBUS / RENAULT TRUCKS	5001823000		29030	882212	882211	882312	Heuliez, Renault Agora; Magnum AE, Premium
	5001823000		29030	882213	882211	882313	Heuliez, Renault Agora; Magnum AE, Premium
MAN	81508205006	81508205021	29030	882214	882211	882314	F 90, F 2000, M 2000
	81508205066	81508206044	29030	882216	882211	882316	NG/NL/NU Series
MERCEDES-BENZ	0024205520	0034205520	29030	882215	882211	882315	Integro (O 550), SETRA S-Series
			29039	882257	882254		
RENAULT TRUCKS	5001014694	5001825638	29065	882241	882242	882341	Midliner S
IVECO	1906043	1906297	29067	882258	882254	882333	Eurocargo
	1906043	1906297	29067	882236	882254	882334	Eurocargo
RENAULT TRUCKS	5001014704		29067	882255	882254	882341	Midliner S
BPW	0536270020	0980102570	29087	882203	882200	882303	
IVECO	1906439	2992348	29087	882201	882200	882301	Eurocargo, Eurostar, Eurotech, Stralis, Trakker
SCANIA	1390428	1521979	29087	882202	882200	882302	Series 4, Serie P-G-R-T
DAF / IVECO	1436901		29088	882229	882230	882329	LF 45; Eurocargo Tector
MAN	81508206006		29088	882238	882230	882338	L2000, M2000
RENAULT TRUCKS	5010848607		29088	882223	882230	882323	Midlum
	5001846034	5001833114	29090	882218	882225	882318	Magnum, Premium
		29090	882217	882225	882312		
BPW	0980102750	0980102930	29095	882206	882204	882306	
			29095	882205	882204	882301	
	81508205006	81508205021	29113	882214	882211	882314	
	81508205066	81508206044	29113	882216	882211	882316	
	#N/A	#N/A	29115		882210		
IVECO	1906416	1906298	29122	882233	882235	882333	Eurocargo
	1906416	1906298	29122	882234	882235	882334	Eurocargo, Eurocargo Tector
			29124		882222		
			29125		882221		
MAN	81508205072	81508206041	29131	882219	882226	882319	TGA
RENAULT TRUCKS	5001855646		29131	882220	882226	882320	Magnum, Premium
VOLVO TRUCKS	3093532	20768115	29137		882270		FL 6
RENAULT TRUCKS	5001855902		29142	882224		882324	Midlum
SAF-SAUER	9291063		29143		882251		
DAF / SAF-SAUER	1628064		29159	882227	882228	882327	LF 55; SAF-SAUER
SAF-SAUER	3057008400		29162		882250		
			29165		882207		
			29167		882208		
			29171		882209		
RENAULT TRUCKS / VOLVO TRUCKS	5001864365		29173	882243	882244	882345	Magnum DXi, Premium DXi; FH/FE/FM
	5001864364	5001864363	29174	882245	882246	882345	Magnum DXi, Premium DXi; FH/FE/FM
	5001864380		29177	882247	882248	882345	Magnum DXi, Premium DXi; FH/FE/FM
RENAULT TRUCKS	5001866914		29181	882259	882249	882359	Midlum
MERCEDES-BENZ	64201520		29244		882272*		Actros MP4
	64201420		29246		882271*		Actros MP4
	0014201520	0024205720	29835	882239	882240	882339	Vario, Medio, Sprinter

* Sales of this product not allowed in Germany / Vente de ce produit non autorisée en Allemagne



WVA





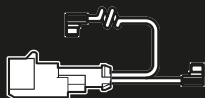

WVA						
29011	882231	882232	882331	IVECO Eurocargo, Eurostar, Eurotech	1906191	1906459
	882237	882232	882337		1906191	1906459
29030	882212	882211	882312	IRISBUS Heuliez, Renault Agora; RENAULT TRUCKS Magnum AE, Premium	5001823000	
	882213	882211	882313		5001823000	
	882214	882211	882314	MAN F 90, F 2000, M 2000	81508205006	81508205021
	882215	882211	882315	MERCEDES-BENZ Integro (O 550; SETRA S-Series	0024205520	0034205520
	882216	882211	882316	MAN NG/NL/NU Series	81508205066	81508206044
29039	882257	882254				
29065	882241	882242	882341	RENAULT TRUCKS Midliner S	5001014694	5001825638
29067	882258	882254	882333	IVECO Eurocargo	1906043	1906297
	882236	882254	882334		1906043	1906297
	882255	882254	882341	RENAULT TRUCKS Midliner S	5001014704	
29087	882201	882200	882301	IVECO Eurocargo, Eurostar, Eurotech, Stralis, Trakker	1906439	2992348
	882202	882200	882302	SCANIA Series 4, Serie P-G-R-T	1390428	1521979
	882203	882200	882303	BPW; SAF-SAUER	0536270020	0980102570
29088	882223	882230	882323	RENAULT TRUCKS Midlum	5010848607	
	882229	882230	882329	DAF LF 45; IVECO Eurocargo Tector	1436901	
	882238	882230	882338	MAN L2000, M2000	81508206006	
29090	882218	882225	882318	RENAULT TRUCKS Magnum, Premium	5001846034	5001833114
	882217	882225	882312			
29095	882206	882204	882306	BPW	0980102750	0980102930
	882205	882204	882301			
29113	882214	882211	882314			
	882216	882211	882316			
29115		882210				
29122	882233	882235	882333	IVECO Eurocargo	1906416	1906298
	882234	882235	882334		IVECO Eurocargo, Eurocargo Tector	1906416
29124		882222				
29125		882221				
29131	882219	882226	882319	MAN TGA	81508205072	81508206041
	882220	882226	882320	RENAULT TRUCKS Magnum, Premium	5001855646	
29137		882270		VOLVO TRUCKS FL	3093532	20768115

WVA						
29142	882224		882324	RENAULT TRUCKS Midlum	5001855902	
29143		882251		SAF-SAUER		
29159	882227	882228	882327	DAF LF 55; SAF-SAUER	1628064	
29162		882250		SAF-SAUER		
29165		882207				
29167		882208				
29171		882209				
29173	882243	882244	882345	RENAULT TRUCKS Magnum DXi, Premium DXi; VOLVO TRUCKS FH/FE/FM	5001864365	
29174	882245	882246	882345	RENAULT TRUCKS Magnum DXi, Premium DXi; VOLVO TRUCKS FH/FE/FM	5001864364	5001864363
29177	882247	882248	882345	RENAULT TRUCKS Magnum DXi, Premium DXi; VOLVO TRUCKS FH/FE/FM	5001864380	
29181	882259	882249	882359	RENAULT TRUCKS Midlum	5001866914	
29244		882272*		MERCEDES-BENZ Actros MP4	64201520	
29246		882271*		MERCEDES-BENZ Actros MP4	64201420	
29835	882239	882240	882339	MERCEDES-BENZ Vario, Medio, Sprinter	0014201520	0024205720

















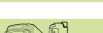
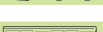

* Sales of this product not allowed in Germany / Vente de ce produit non autorisée en Allemagne







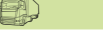







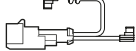







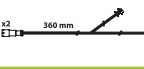

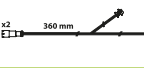

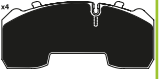

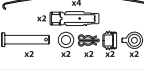
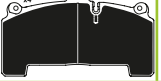

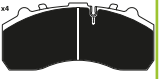
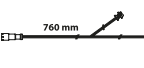
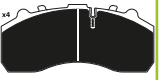
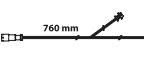
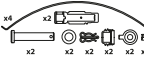



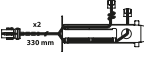

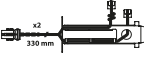

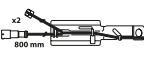

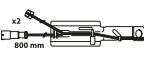
			WVA		
882301	882201	882200	29087	1903651	IVECO Eurocargo, Eurostar, Eurotech, Stralis, Trakker
882301	882205	882204	29095	1903651	IVECO Eurocargo Tector
882302	882202	882200	29087	1388953	SCANIA Series 4, Serie P-G-R-T
882303	882203	882200	29087		BPW; SAF-SAUER
882306	882206	882204	29095		BPW
882312	882212	882211	29030	5001834075	IRISBUS Heuliez, Renault Agora; RENAULT TRUCKS Magnum AE, Premium
882312	882217	882211	29090	5001834075	IRISBUS Heuliez, Renault Agora; RENAULT TRUCKS Magnum AE, Premium
882313	882213	882211	29030	68310622	IRISBUS Heuliez, Renault Agora; RENAULT TRUCKS Magnum AE, Premium
882314	882214	882211	29030	68323118	MAN F 90, F 2000, M 2000
882315	882215	882211	29030	3565400017	MERCEDES-BENZ Integro (O 550); SETRA S-Series
882316	882216	882211	29030	68323117	MAN NG/NL/NU Series
882318	882218	882225	29090	5001831161	RENAULT TRUCKS Magnum, Premium
882319	882219	882226	29131	68324072	MAN TGA
882320	882220	882226	29131	5001834075	RENAULT TRUCKS Magnum, Premium
882323	882223	882230	29088	5010848607	RENAULT TRUCKS Midlum
882324	882224		29142		RENAULT TRUCKS Midlum
882327	882227	882228	29159		DAF LF 55; SAF-SAUER
882329	882229	882230	29088		DAF LF 45; IVECO Eurocargo Tector
882331	882231	882232	29011	1907956	IVECO Eurocargo, Eurostar, Eurotech
882333	882233	882235	29122	1908825	IVECO Eurocargo
882333	882258	882254	29067	1908825	IVECO Eurocargo
882334	882234	882235	29122	1908407	IVECO Eurocargo, Eurocargo Tector
882334	882236	882254	29067	1908407	IVECO Eurocargo
882337	882237	882232	29011	1908231	IVECO Eurocargo, Eurostar, Eurotech
882338	882238	882230	29088	81508226014	MAN L2000, M2000
882339	882239	882240	29835	6695400917	MERCEDES-BENZ Vario, Medio, Sprinter
882341	882241	882242	29065	68320874	RENAULT TRUCKS Midliner S
882341	882255	882254	29067	68320874	RENAULT TRUCKS Midliner S
882345	882245	882246	29174	68325408	RENAULT TRUCKS Magnum DXi, Premium DXi; VOLVO TRUCKS FH/FE/FM
882345	882243	882244	29173	68325408	RENAULT TRUCKS Magnum DXi, Premium DXi; VOLVO TRUCKS FH/FE/FM
882345	882247	882248	29177	68325408	RENAULT TRUCKS Magnum DXi, Premium DXi; VOLVO TRUCKS FH/FE/FM
882352			29229		IVECO Daily 35C, 50C (2006 -) (Front)
882353			29232		IVECO Daily 35C, 50C (2006 -) (Rear)
882359	882259	882249	29181	5010848607	RENAULT TRUCKS Midlum
		882250	29162		SAF-SAUER
		882251	29143		SAF-SAUER

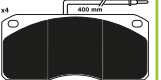

OptiPACK™

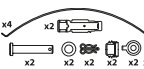
BPW 	9
DAF 	10
FORD 	10
FRUEHAUF 	10
IRISBUS 	11
GENERAL TRAILERS 	13
IVECO 	13
KNORR BREMSE 	16
MAN 	16
MAN 	18
MERCEDES-BENZ 	19
MERCEDES-BENZ 	19
MERCEDES-BENZ 	19
MERITOR 	20
RENAULT TRUCKS 	22
SAF-SAUER 	25
SCANIA 	25
VOLVO TRUCKS 	26
VOLVO TRUCKS 	27
WABCO 	27

											
BPW 											
SB 3745 	KNORR SB6	1998 >	✓	29095	882204			210,4	92,5	30	
	KNORR SB6	1998 >	✓	29095	882206			210,4	92,5	30	
	KNORR SB6	1998 >	✓	29095	882306						
	KNORR SN6	2003 >	✓	29165	882207			210,4	92,5	30	
SB 4309 	KNORR SK7	2003 >	✓	29171	882209			210,2	107,8	30	
SB 4345 	KNORR SB7	1998 >	✓	29087	882200			247,4	109,5	30	
	KNORR SB7	1998 >	✓	29087	882203			247,4	109,5	30	
	KNORR SB7	1998 >	✓	29087	882303						
	KNORR SN7	2003 >	✓	29167	882208			247,4	109,5	30	
DAF 											
LF 45  7.5t->12t	PERROT PAN 17	2001 >	✓	✓	29088	882229			175,3	82,4	26
	PERROT PAN 17	2001 >	✓	✓	29088	882329					
	PERROT PAN 17	2001 >	✓	✓	29088	882230			175,3	82,4	26
LF 55  13t, 15t	PERROT PAN 19-1	2003 >	✓	✓	29159	882227			210,2	79,6	30
	PERROT PAN 19-1	2003 >	✓	✓	29159	882327					
	PERROT PAN 19-1	2003 >	✓	✓	29159	882228			210,2	79,6	30
FORD 											
CARGO 	LUCAS	1987 >	✓	29039	882257			175	78	22	
FRUEHAUF 											
SB 4345 	KNORR SB7		✓	29087	882200			247,4	109,5	30	







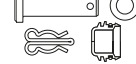
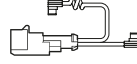



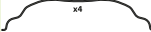

WVA

Valeo



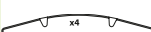

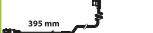
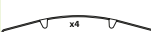





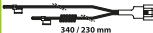

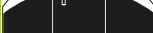

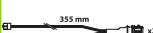
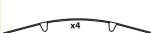

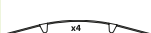







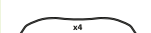

IRISBUS





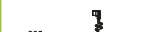









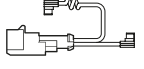
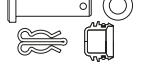







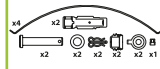

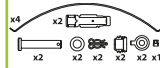







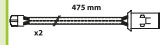

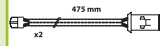

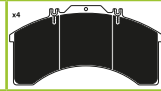
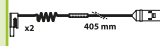

CITELIS 

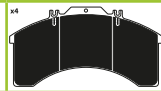
LUCAS D-LISA	2005 >	✓	29090	882217				249	109,5	28
LUCAS D-LISA	2005 >	✓	29090	882312						
LUCAS D-LISA	2005 >	✓	29090	882225				249	109,5	28
LUCAS D-ELSA 2	2005 >	✓	29131	882220				249,3	117,9	30
LUCAS D-ELSA 2	2005 >	✓	29131	882320						
LUCAS D-ELSA 2	2005 >	✓	29131	882226				249,3	117,9	30

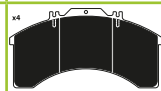

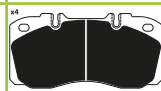

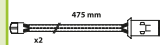
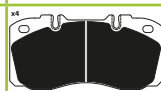
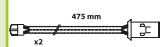









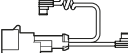









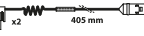





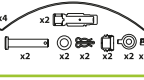
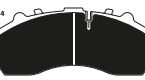

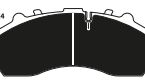

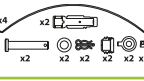

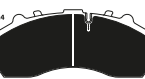

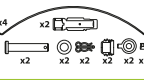



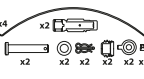

HEULIEZ 

LUCAS D3	> 1998	✓	29030	882213				249	118,1	28
LUCAS D3	> 1998	✓	29030	882313						
LUCAS D3	> 1998	✓	29030	882212				249	118,1	28
LUCAS D3	> 1998	✓	29030	882312						
LUCAS D3	> 1998	✓	29030	882211				249	118,1	28
LUCAS D-LISA	1998 >	✓	29090	882218				249	109,5	28
LUCAS D-LISA	1998 >	✓	29090	882318						
LUCAS D-LISA	1998 >	✓	29090	882225				249	109,5	28
LUCAS D-LISA	2006 >	✓	29090	882217				249	109,5	28
LUCAS D-LISA	2006 >	✓	29090	882312						
LUCAS D-LISA	1998 >	✓	29090	882225				249	109,5	28
LUCAS D-ELSA 2	2006 >	✓	29131	882220				249,3	117,9	30
LUCAS D-ELSA 2	2006 >	✓	29131	882320						
LUCAS D-ELSA 2	2006 >	✓	29131	882226				249,3	117,9	30

IRISBUS (...)																										
RENAULT AGORA	LUCAS D3	1995 > 1998	✓		29030	882213				249	118,1	28														
	LUCAS D3	1995 > 1998	✓		29030	882313																				
	LUCAS D3	1995 > 1998	✓		29030	882212				249	118,1	28														
	LUCAS D3	1995 > 1998	✓		29030	882312																				
	LUCAS D3	1995 > 1998	✓		29030	882211				249	118,1	28														
	LUCAS D-LISA	1998 >	✓		29090	882218				249	109,5	28														
	LUCAS D-LISA	1998 >	✓		29090	882318																				
	LUCAS D-LISA	1998 >	✓		29090	882217				249	109,5	28														
	LUCAS D-LISA	1998 >	✓		29090	882312																				
	LUCAS D-LISA	1998 >	✓		29090	882225				249	109,5	28														
	LUCAS D-ELSA 2	1998 >	✓		29131	882220				249,3	117,9	30														
	LUCAS D-ELSA 2	1998 >			29131	882320																				
	LUCAS D-ELSA 2	1998 >	✓		29131	882226				249,3	117,9	30														
RENAULT ILLIADE	LUCAS D3	1997 > 2000	✓	✓	29030	882213				249	118,1	28														
	LUCAS D3	1997 > 2000	✓	✓	29030	882313																				
	LUCAS D3	1997 > 2000	✓	✓	29030	882212				249	118,1	28														
	LUCAS D3	1997 > 2000	✓	✓	29030	882312																				
	LUCAS D3	1997 > 2000	✓	✓	29030	882211				249	118,1	28														
	LUCAS D-ELSA 2	2000 >	✓	✓	29131	882220				249,3	117,9	30														
	LUCAS D-ELSA 2	2000 >	✓	✓	29131	882320																				

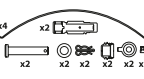
												
IRISBUS  (...)												
RENAULT ILLIADE 	LUCAS D-ELSA 2	2000 >	✓	✓	29131	882226			249,3	117,9	30	
GENERAL TRAILERS 												
	KNORR SB6	1998 >		✓	29095	882204			210,4	92,5	30	
	KNORR SB7	1998 >		✓	29087	882200			247,4	109,5	30	
IVECO 												
EUROCARGO 	6t, 6,7t, 7,5t, 10t	LUCAS	1991 >	✓	✓	29065	882242		175	85,5	22	
EUROCARGO 	7.5t, 8t, 10t	LUCAS	1991 >	✓	✓	29067	882236			176	78	22
		LUCAS	1991 >	✓	✓	29067	882334					
		LUCAS	1991 >	✓	✓	29067	882258			176	78	22
		LUCAS	1991 >	✓	✓	29067	882333					
		LUCAS	1991 >	✓	✓	29067	882254			176	78	22
EUROCARGO 	18t	BENDIX	1991 >	✓		29011	882231			240,6	124,6	25
		BENDIX	1991 >	✓		29011	882331					
		BENDIX	1991 >	✓		29011	882237			240,6	124,6	25
		BENDIX	1991 >	✓		29011	882337					
		BENDIX	1991 >	✓		29011	882232			240,6	124,6	25
EUROCARGO 	6.7t, 7.5t, 10t	BREMBO	1997 >	✓	✓	29122	882234			175	79,5	22
		BREMBO	1997 >	✓	✓	29122	882334					
		BREMBO	1997 >	✓	✓	29122	882233			175	79,5	22
		BREMBO	1997 >	✓	✓	29122	882333					
		BREMBO	1997 >	✓	✓	29122	882235			175	79,5	22

IVECO (...)														
EUROCARGO TECTOR	6.8t->12t	BREMBO	2000 >	✓	✓	29122	882234				175	79,5	22	
		BREMBO	2000 >	✓	✓	29122	882334							
		BREMBO	2000 >	✓	✓	29122	882235				175	79,5	22	
EUROCARGO TECTOR	12t	PERROT PAN 17	2000 >	✓	✓	29088	882229				175,3	82,4	26	
		PERROT PAN 17	2000 >	✓	✓	29088	882329							
		PERROT PAN 17	2000 >	✓	✓	29088	882230				175,3	82,4	26	
EUROCARGO TECTOR	13.5t, 14t, 15t	KNORR SB6	2000 >	✓	✓	29095	882204				210,4	92,5	30	
		KNORR SB6	2000 >	✓	✓	29095	882205				210,4	92,5	30	
		KNORR SB6	2000 >	✓	✓	29095	882301							
EUROCARGO TECTOR	15t, 18t	KNORR SB7	2000 >	✓	✓	29087	882200				247,4	109,5	30	
		KNORR SB7	2000 >	✓	✓	29087	882201				247,4	109,5	30	
		KNORR SB7	2000 >	✓	✓	29087	882301							
EUROSTAR Ch. N° < 4196457; Ch. N° < C044258		BENDIX	1993 > 2002	✓	✓	29011	882231				240,6	124,6	25	
		BENDIX	1993 > 2002	✓	✓	29011	882331							
		BENDIX	1993 > 2002	✓	✓	29011	882237				240,6	124,6	25	
		BENDIX	1993 > 2002	✓	✓	29011	882337							
		BENDIX	1993 > 2002	✓	✓	29011	882232				240,6	124,6	25	
EUROSTAR Ch. N° > 4196457; Ch. N° > C044258		KNORR SB7	1993 > 2002	✓	✓	29087	882200				247,4	109,5	30	
		KNORR SB7	1993 > 2002	✓	✓	29087	882201				247,4	109,5	30	
		KNORR SB7	1993 > 2002	✓	✓	29087	882301							

				WVA	Valeo						
IVECO  (...)											
EUROTECH  Ch. N° < 4196457; Ch. N° < C044258	BENDIX	1992 > 1998	✓	✓	29011	882231			240,6	124,6	25
	BENDIX	1992 > 1998	✓	✓	29011	882331					
	BENDIX	1992 > 1998	✓	✓	29011	882237			240,6	124,6	25
	BENDIX	1992 > 1998	✓	✓	29011	882337					
	BENDIX	1992 > 1998	✓	✓	29011	882232			240,6	124,6	25
EUROTECH  Ch. N° > 4196457; Ch. N° > C044258	KNORR SB7	1992 > 1998	✓	✓	29087	882200			247,4	109,5	30
	KNORR SB7	1992 > 1998	✓	✓	29087	882201			247,4	109,5	30
	KNORR SB7	1992 > 1998	✓	✓	29087	882301					
EUROTECH CURSOR 	KNORR SB7	1998 >	✓	✓	29087	882200			247,4	109,5	30
	KNORR SB7	1998 >	✓	✓	29087	882201			247,4	109,5	30
	KNORR SB7	1998 >	✓	✓	29087	882301					
EUROTRAKKER 	KNORR SB7	1993 > 2004	✓	✓	29087	882200			247,4	109,5	30
	KNORR SB7	1993 > 2004	✓	✓	29087	882201			247,4	109,5	30
	KNORR SB7	1993 > 2004			29087	882301					
STRALIS 	KNORR SB7	2002 >	✓	✓	29087	882200			247,4	109,5	30
	KNORR SB7	2002 >	✓	✓	29087	882201			247,4	109,5	30
	KNORR SB7	2002 >	✓	✓	29087	882301					
TRAKKER 	KNORR SB7	2004 >	✓		29087	882200			247,4	109,5	30
	KNORR SB7	2004 >	✓		29087	882201			247,4	109,5	30
	KNORR SB7	2004 >			29087	882301					















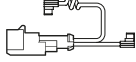
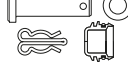



























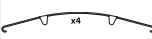

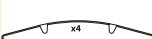



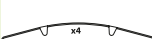

KNORR BREMSE

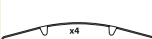
	KNORR SB5			29115	882210			185/173,5	84	34/27
	KNORR SB6			29095	882204			210,4	92,5	30
	KNORR SB6			29095	882205			210,4	92,5	30
	KNORR SB6			29095	882301					
	KNORR SB6			29095	882206			210,4	92,5	30
	KNORR SB6			29095	882306					
	KNORR SB7			29087	882200			247,4	109,5	30
	KNORR SB7			29087	882201			247,4	109,5	30
	KNORR SB7			29087	882301					
	KNORR SB7			29087	882202			247,4	109,5	30
	KNORR SB7			29087	882302					
	KNORR SB7			29087	882203			247,4	109,5	30
	KNORR SB7			29087	882303					
	KNORR SN6			29165	882207			210,4	92,5	30
	KNORR SN7			29167	882208			247,4	109,5	30
	KNORR SK7			29171	882209			210,2	107,8	30

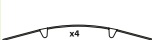
MAN

F 90	LUCAS D-ELSA 1	1990 > 1996	✓	29113	882214			249	118,1	28
	LUCAS D-ELSA 1	1990 > 1996	✓	29113	882314					
	LUCAS D-ELSA 1	1990 > 1996	✓	29113	882211			249	118,1	28

														
MAN  (...)														
F 2000 		LUCAS D-ELSA 1	1994 >	✓		29113	882214				249	118,1	28	
		LUCAS D-ELSA 1	1994 >	✓		29113	882314							
		LUCAS D-ELSA 1	1994 >	✓		29030	882211				249	118,1	28	
L 2000 		PERROT PAN 17	1996 >	✓	✓	29088	882238				175,3	82,4	26	
		PERROT PAN 17	1996 >	✓	✓	29088	882338							
		PERROT PAN 17	1996 >	✓	✓	29088	882230				175,3	82,4	26	
M 2000 	12t	PERROT PAN 17	1995 >	✓	✓	29088	882238				175,3	82,4	26	
		PERROT PAN 17	1995 >	✓	✓	29088	882338							
		PERROT PAN 17	1995 >	✓	✓	29088	882230				175,3	82,4	26	
M 2000 	14t	KNORR SB6	1995 >	✓		29095	882204				210,4	92,5	30	
M 2000 	15t, 18t, 25t	LUCAS D-ELSA 1	1995 >	✓		29113	882214				249	118,1	28	
		LUCAS D-ELSA 1	1995 >	✓		29113	882314							
		LUCAS D-ELSA 1	1995 >	✓		29113	882211				249	118,1	28	
TGA 		LUCAS D-ELSA 1	2000 > 2001	✓	✓	29113	882214				249	118,1	28	
		LUCAS D-ELSA 1	2000 > 2001	✓	✓	29113	882314							
		LUCAS D-ELSA 1	2000 > 2001	✓	✓	29030	882211				249	118,1	28	
		LUCAS D-ELSA 2	2001 >	✓	✓	29131	882219				249,3	117,9	30	
		LUCAS D-ELSA 2	2001 >	✓	✓	29131	882319							
		LUCAS D-ELSA 2	2001 >	✓	✓	29131	882226				249,3	117,9	30	
		KNORR SB7	2003 >	✓	✓	29087	882200				247,4	109,5	30	

				WVA									
MAN (...)													
NG/NU SERIES	LUCAS D-ELSA 1	1998 >	✓	✓	29113	882211				249	118,1	28	

MERCEDES-BENZ 													
ATEGO I-II	6.5t->10.5t	KNORR SB5	1998 >	✓	✓	29115	882210			185/173,5	84	34/27	
ATEGO I-II	12t->15t	KNORR SB6	1998 >	✓	✓	29095	882204			210,4	92,5	30	
ATEGO I-II	18t->26t	KNORR SB7	1998 >	✓	✓	29087	882200			247,4	109,5	30	
ACTROS		KNORR SB7	1996 >	✓	✓	29087	882200			247,4	109,5	30	
ACTROS MP4		KNORR SM7	2011 >	✓		29246	882271*			244,6	113,6	30	
		KNORR SL7	2011 >		✓	29244	882272*			207,2	113,7	30	
AXOR		KNORR SB7	2002 >	✓	✓	29087	882200			247,4	109,5	30	

MERCEDES-BENZ 													
INTEGRO (O 550)	LUCAS D3	2000 >	✓		29030	882215				249	118,1	28	
	LUCAS D3	2000 >	✓		29030	882315							
	LUCAS D3	2000 >	✓		29030	882211				249	118,1	28	
O 340/350/404	LUCAS D3	2000 >	✓	✓	29030	882215				249	118,1	28	
	LUCAS D3	2000 >	✓	✓	29030	882315							
	LUCAS D3	2000 >	✓	✓	29030	882211				249	118,1	28	

MERCEDES-BENZ 													
MEDIO	LUCAS	2002>	✓	✓	29835	882239				175	85,5	22	
	LUCAS	2002>	✓	✓	29835	882339							
	LUCAS	2002>	✓	✓	29835	882240				175	85,5	22	
SPRINTER (905)	LUCAS	2001>		✓	29835	882239				175	85,5	22	

* Sales of this product not allowed in Germany / Vente de ce produit non autorisée en Allemagne



MERCEDES-BENZ (…)

SPRINTER (905)	LUCAS	2001>		✓	29835	882339							
	LUCAS	2001>		✓	29835	882240				175	85,5	22	
VARIO	LUCAS	1996 >	✓	✓	29835	882239				175	85,5	22	
	LUCAS	1996 >	✓	✓	29835	882339							
	LUCAS	1996 >	✓	✓	29835	882240				175	85,5	22	

MERITOR







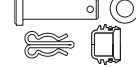
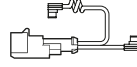





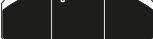



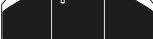



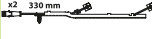
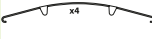

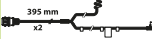

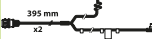

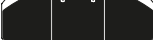
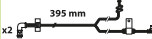

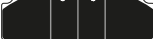
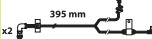

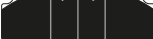



	LUCAS			✓	29065	882241				175	85,5	22	
	LUCAS			✓	29065	882341							
	LUCAS			✓	29065	882242				175	85,5	22	
	LUCAS			✓	29067	882255				176	78	22	
	LUCAS			✓	29067	882236				176	78	22	
	LUCAS			✓	29067	882334							
	LUCAS			✓	29067	882258				176	78	22	
	LUCAS			✓	29067	882333							
	LUCAS D3			✓	29030	882213				249	118,1	28	
	LUCAS D3			✓	29030	882313							
	LUCAS D3			✓	29030	882212				249	118,1	28	
	LUCAS D3			✓	29030	882312							
	LUCAS D3			✓	29030	882211				249	118,1	28	
	LUCAS D-DUCO			✓	29125	882221				249,1	110,9	29,3	

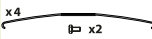

WVA

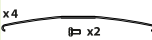

MERITOR (...)

	LUCAS D-ELSA 1		✓	29113	882214				249	118,1	28
	LUCAS D-ELSA 1		✓	29113	882314						
	LUCAS D-ELSA 1		✓	29113	882216				249	118,1	28
	LUCAS D-ELSA 1		✓	29113	882316						
	LUCAS D-ELSA 1		✓	29113	882211				249	118,1	28
	LUCAS D-ELSA 2		✓	29131	882219				249,3	117,9	30
	LUCAS D-ELSA 2		✓	29131	882319						
	LUCAS D-ELSA 2		✓	29131	882220				249,3	117,9	30
	LUCAS D-ELSA 2		✓	29131	882320						
	LUCAS D-ELSA 2		✓	29131	882226				249,3	117,9	30
	LUCAS D-LISA		✓	29090	882218				249	109,5	28
	LUCAS D-LISA		✓	29090	882318						
	LUCAS D-LISA		✓	29090	882217				249	109,5	28
	LUCAS D-LISA		✓	29090	882312						
	LUCAS D-LISA		✓	29090	882225				249	109,5	28
	DX 195 LM		✓	29124	882222				205,3	102	27
	ELSA 225-1		✓	29173	882243				216	96,5	29,25
	ELSA 225-1		✓	29173	882345						
	ELSA 225-1		✓	29173	882244				216	96,5	29,25
	ELSA 225-3		✓	29174	882245				249,6	107	29,25















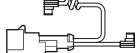





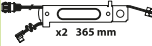
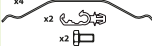

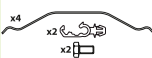

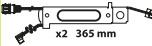

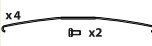















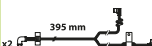

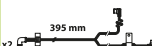







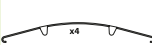



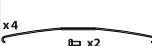

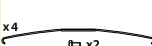







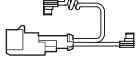







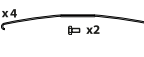

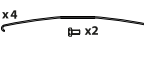







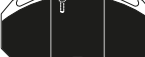



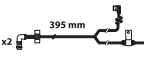
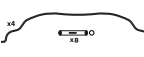

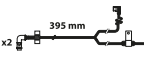

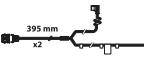

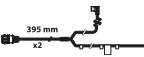

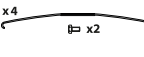

MERITOR (…)

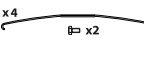
	ELSA 225-3			✓	29174	882345								
	ELSA 225-3			✓	29174	882246				249,6	107	29,25		
	VGT195			✓	29177	882247			210,5	99,7	29,25			
	VGT195			✓	29177	882345								
	VGT195			✓	29177	882248			210,5	99,7	29,25			

RENAULT TRUCKS

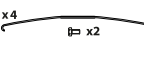
MIDLINER S	6t->6.85t	LUCAS	1990 >	✓		29065	882241				175	85,5	22	
		LUCAS	1990 >	✓		29065	882341							
		LUCAS	1990 >	✓		29065	882242				175	85,5	22	
MIDLINER S	7.5->9.5t	LUCAS	1990 >	✓		29067	882255				176	78	22	
		LUCAS	1990 >	✓		29067	882341							
		LUCAS	1990 >	✓		29067	882254				176	78	22	
MIDLUM	7.5->12t	PERROT PAN 17	2000 >	✓	✓	29088	882223				175,3	82,4	26	
		PERROT PAN 17	2000 >	✓	✓	29088	882323							
		PERROT PAN 17	2000 >	✓	✓	29088	882230				175,3	82,4	26	
MIDLUM	13->18t	PERROT PAN 19-2	2001 >	✓	✓	29142	882224				204,5	97	29,9	
		PERROT PAN 19-2	2001 >	✓	✓	29142	882324							
MIDLUM	7.5t	PERROT PAN 17	2006 >	✓	✓	29088	882223				175,3	82,4	26	
		PERROT PAN 17	2006 >	✓	✓	29088	882323							
		PERROT PAN 17	2006 >	✓	✓	29088	882230				175,3	82,4	26	

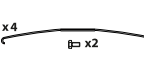
													
RENAULT TRUCKS  (...)													
MIDLUM 	10t	HALDEX DB19	2006 >	✓	✓	29181	882259		x4 	x4 	210	92	30
		HALDEX DB19	2006 >	✓	✓	29181	882249		x4 	x4 	210	92	30
		HALDEX DB19	2006 >	✓	✓	29181	882359						
MIDLUM 	12t->18t	ELSA 225-1	2006 >	✓	✓	29173	882243		x4 	x4 	216	96,5	29,25
		ELSA 225-1	2006 >	✓	✓	29173	882345						
		ELSA 225-1	2006 >	✓	✓	29173	882244		** 	x4 	216	96,5	29,25
MAGNUM AE 		LUCAS D3	1993 > 1996	✓		29030	882213			x4 	249	118,1	28
		LUCAS D3	1993 > 1996	✓		29030	882313						
		LUCAS D3	1993 > 1996	✓		29030	882212			x4 	249	118,1	28
		LUCAS D3	1993 > 1996	✓		29030	882312						
		LUCAS D3	1993 > 1996	✓		29030	882211			x4 	249	118,1	28
		LUCAS D-LISA	1996 > 2000	✓		29090	882218			x4 	249	109,5	28
		LUCAS D-LISA	1996 > 2000	✓		29090	882318						
		LUCAS D-LISA	1996 > 2000	✓		29090	882225			x4 	249	109,5	28
MAGNUM E.TECH 		LUCAS D-ELSA 2	2000 >	✓	✓	29131	882220			x4 	249,3	117,9	30
		LUCAS D-ELSA 2	2000 >	✓	✓	29131	882320						
		LUCAS D-ELSA 2	2000 >	✓	✓	29131	882226			x4 	249,3	117,9	30
MAGNUM DXi 		ELSA 225-3	2004 >	✓	✓	29174	882245		x4 	x4 	249,6	107	29,25
		ELSA 225-3	2004 >	✓	✓	29174	882345						
		ELSA 225-3	2004 >	✓	✓	29174	882246		x4 	x4 	249,6	107	29,25

												
RENAULT TRUCKS  (...)												
MAGNUM DXi 	lifting axle	VGT195	2004 >	✓	29177	882247				210,5	99,7	29,25
		VGT195	2004 >	✓	29177	882345						
		VGT195	2004 >	✓	29177	882248				210,5	99,7	29,25
PREMIUM 	LUCAS D3	1996 > 2000	✓	29030	882213				249	118,1	28	
	LUCAS D3	1996 > 2000	✓	29030	882313							
	LUCAS D3	1996 > 2000	✓	29030	882212				249	118,1	28	
	LUCAS D3	1996 > 2000	✓	29030	882312							
	LUCAS D3	1996 > 2000	✓	29030	882211				249	118,1	28	
	LUCAS D-LISA	1996 > 2000	✓	29090	882218				249	109,5	28	
	LUCAS D-LISA	1996 > 2000	✓	29090	882318							
	LUCAS D-LISA	1996 > 2000	✓	29090	882225				249	109,5	28	
	LUCAS D-ELSA 2	2000 >	✓	✓	29131	882220				249,3	117,9	30
	LUCAS D-ELSA 2	2000 >	✓	✓	29131	882320						
	LUCAS D-ELSA 2	2000 >	✓	✓	29131	882226				249,3	117,9	30
	PREMIUM DXi 	ELSA 225-3	2005 >	✓	✓	29174	882245				249,6	107
ELSA 225-3		2005 >	✓	✓	29174	882345						
ELSA 225-3		2005 >	✓	✓	29174	882246				249,6	107	29,25
PREMIUM DXi 	lifting axle	VGT195	2005 >	✓	29177	882247				210,5	99,7	29,25
		VGT195	2005 >	✓	29177	882345						
		VGT195	2005 >	✓	29177	882248				210,5	99,7	29,25



RENAULT TRUCKS (...)

R-MAJOR	LUCAS D3	1993 > 1996	✓		29030	882213				249	118,1	28
	LUCAS D3	1993 > 1996	✓		29030	882313						
	LUCAS D3	1993 > 1996	✓		29030	882212				249	118,1	28
	LUCAS D3	1993 > 1996	✓		29030	882312						
	LUCAS D3	1993 > 1996	✓		29030	882211				249	118,1	28

SAF-SAUER

SK 9019, 11019 K	KNORR SB6		✓		29095	882204				210,4	92,5	30
	KNORR SB6		✓		29095	882206				210,4	92,5	30
	KNORR SB6		✓		29095	882306						
SK 9022, 11222 K	KNORR SB7		✓		29087	882200				247,4	109,5	30
	KNORR SB7		✓		29087	882203				247,4	109,5	30
	KNORR SB7		✓		29087	882303						
	KNORR SK7		✓		29171	882209				210,2	107,8	30
SK 9019/11019 W	PERROT PAN 19-1		✓		29159	882227				210,2	79,6	30
	PERROT PAN 19-1		✓		29159	882327						
	PERROT PAN 19-1		✓		29159	882228				210,2	79,6	30
SK RB 9022 W	PERROT PAN 22-1		✓		29162	882250				210,5	104,3	31
SK RB 9022 H	HALDEX DB22		✓		29143	882251				247,4	105	30

SCANIA

SERIES 4	KNORR SB7	1996 >	✓	✓	29087	882200				247,4	109,5	30
	KNORR SB7	1996 >	✓	✓	29087	882202				247,4	109,5	30



VOLVO TRUCKS (...)











FL II	12t->18t	ELSA 225-1	2006 >	✓	✓	29173	882244				216	96,5	29,25
-------	----------	------------	--------	---	---	-------	--------	--	--	--	-----	------	-------

VOLVO TRUCKS

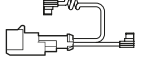
B-10	LUCAS D-LISA	1995 >	✓		29090	882218				249	109,5	28
	LUCAS D-LISA	1995 >	✓		29090	882318						
	LUCAS D-LISA	1995 >	✓		29090	882225				249	109,5	28
B-12	LUCAS D-LISA	1992 >	✓		29090	882218				249	109,5	28
	LUCAS D-LISA	1992 >	✓		29090	882318						
	LUCAS D-LISA	1992 >	✓		29090	882225				249	109,5	28
B-12 M	LUCAS D-DUCO	2001 >	✓	✓	29125	882221				249,1	110,9	29,3

WABCO

PAN 17	PERROT PAN 17				29088	882229				175,3	82,4	26
	PERROT PAN 17				29088	882329						
	PERROT PAN 17				29088	882238				175,3	82,4	26
	PERROT PAN 17				29088	882338						
	PERROT PAN 17				29088	882223				175,3	82,4	26
	PERROT PAN 17				29088	882323						
	PERROT PAN 17				29088	882230				175,3	82,4	26
PAN 19-1	PERROT PAN 19-1				29159	882227				210,2	79,6	30
	PERROT PAN 19-1				29159	882327						
	PERROT PAN 19-1				29159	882228				210,2	79,6	30
	PERROT PAN 19-2				29142	882224				204,5	97	29,9

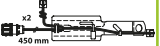
				<p>WVA</p>	<p>Valeo</p>				
<p>WABCO  (...)</p>									
	<p>PERROT PAN 19-2</p>			<p>29142</p>	<p>882324</p>				



OptiPACK™

882200	30	882230	45
882201	30	882231	45
882202	31	882232	46
882203	31	882233	46
882204	32	882234	47
882205	32	882235	47
882206	33	882236	48
882207	33	882237	48
882208	34	882238	49
882209	34	882239	49
882210	35	882240	50
882211	35	882241	50
882212	36	882242	51
882213	36	882243	51
882214	37	882244	52
882215	37	882245	52
882216	38	882246	53
882217	38	882247	53
882218	39	882248	54
882219	39	882249	54
882220	40	882250	55
882221	40	882251	55
882222	41	882254	56
882223	41	882255	56
882224	42	882257	57
882225	42	882258	57
882226	43	882259	58
882227	43	882270	58
882228	44	882271*	59
882229	44	882272*	59

* Sales of this product not allowed in Germany / Vente de ce produit non autorisée en Allemagne

882200

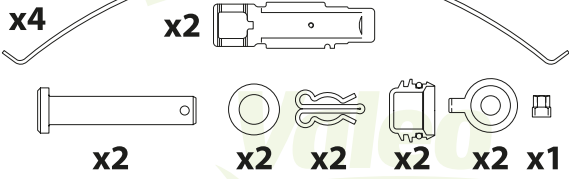
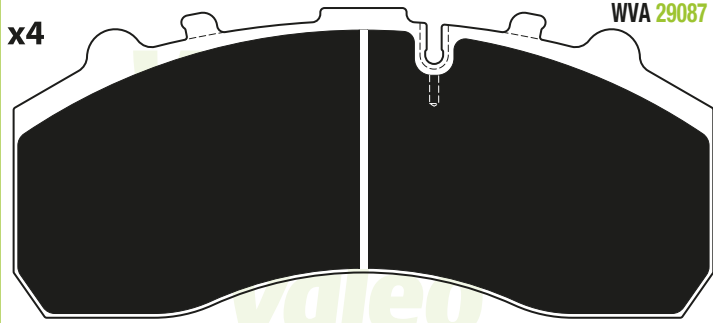

	OES
247,4 109,5 30	KNORR SB7 MERCEDES-BENZ Actros Atego Axor 0004210510 0004214310

187051

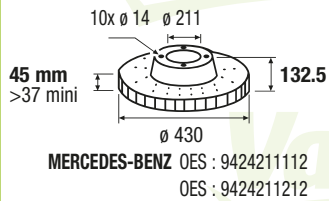

187069

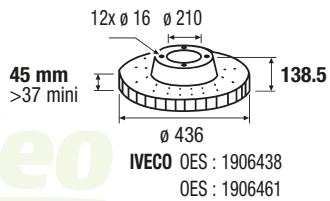

187070

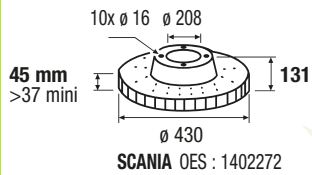

187136

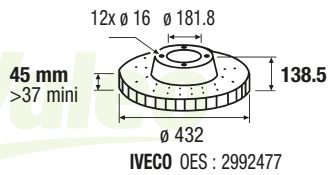

187157

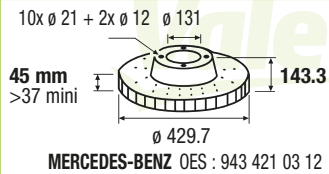

882201

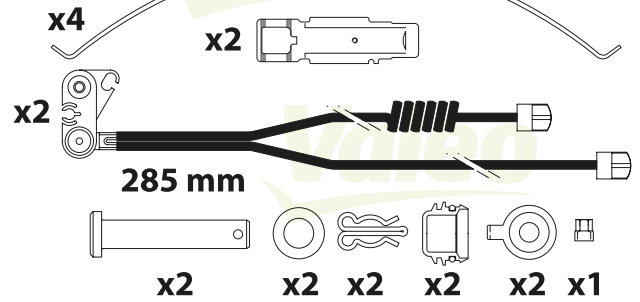
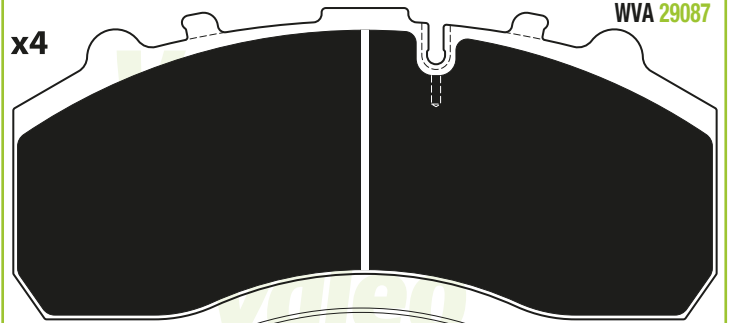

	OES
247,4 109,5 30	KNORR SB7 IVECO Eurocargo Eurostar Eurotech Stralis Trakker 1906439 2992348

882301



WVA		OES
29087	KNORR SB7	1903651

187069

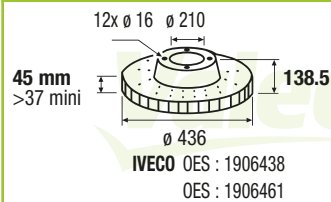

187136

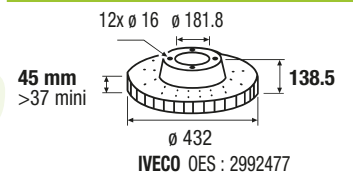

882202

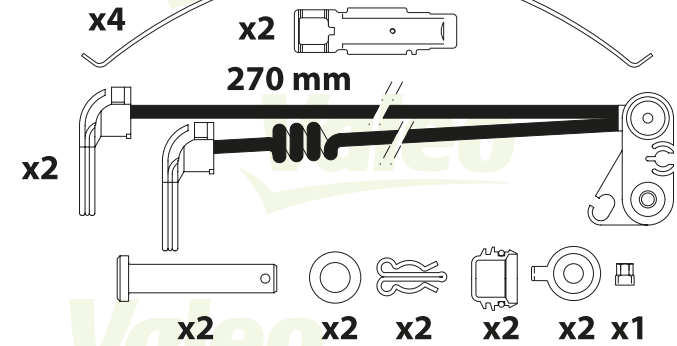
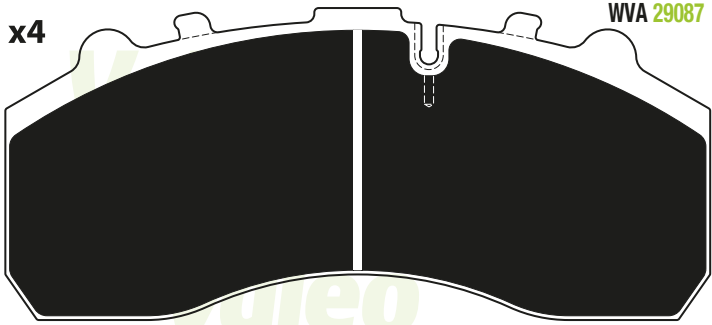

247,4	109,5	30	KNORR SB7	SCANIA	Serie 4 P-R-T	1390428	1521979
-------	-------	----	-----------	--------	------------------	---------	---------

882302

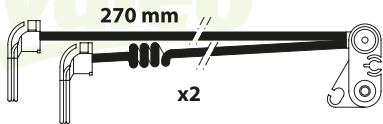

WVA	29087	KNORR SB7	OES	1388953
-----	-------	-----------	-----	---------

187070

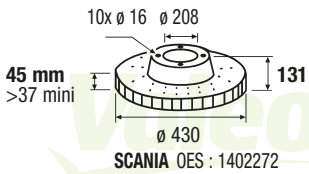

882203

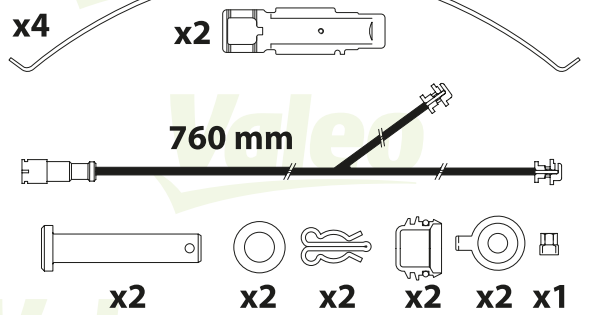
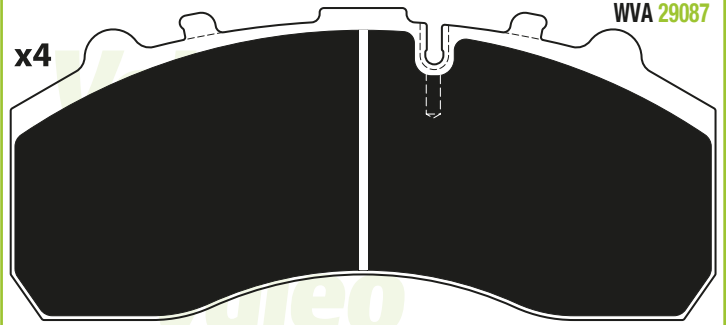

247,4	109,5	30	KNORR SB7	BPW	SB4345	0536270020	0980102570
-------	-------	----	-----------	-----	--------	------------	------------

882303



WVA	29087	KNORR SB7	OES
-----	-------	-----------	-----

187057

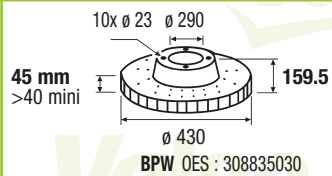

187071

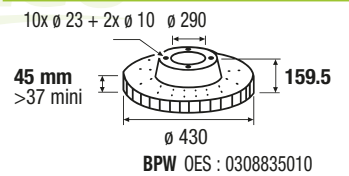

187072

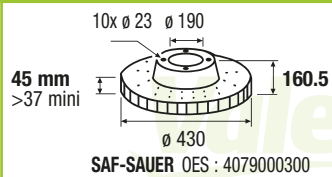

187074

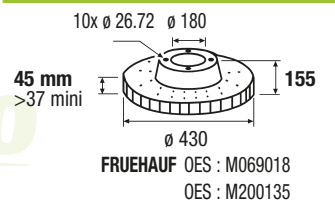

187075

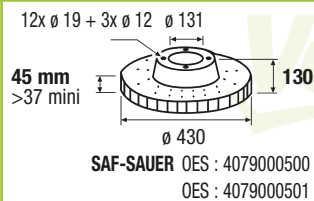

882204

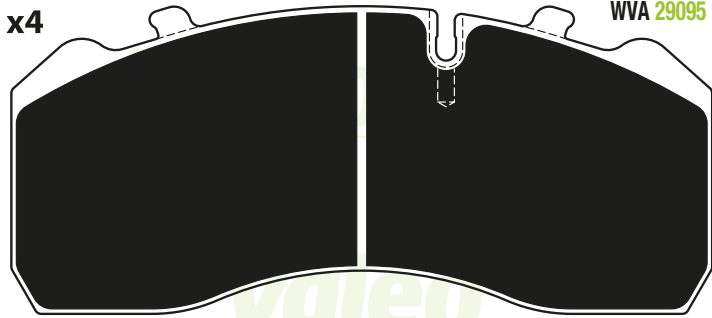

WVA 29095

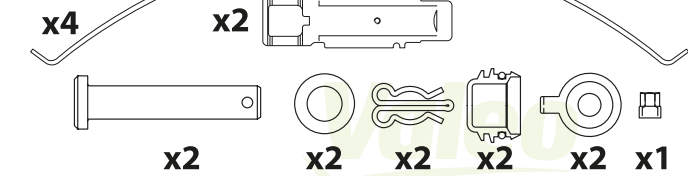

210,4	92,5	30	KNORR SB6	MERCEDES-BENZ MAN	Atego M2000	0004210710 81508205017
-------	------	----	-----------	----------------------	----------------	---------------------------

187048

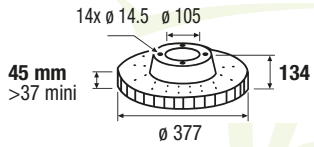

MERCEDES-BENZ OES : 9754210112

187084

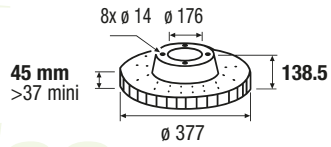

MERCEDES-BENZ OES : 9754230012
OES : 9754230312

882205

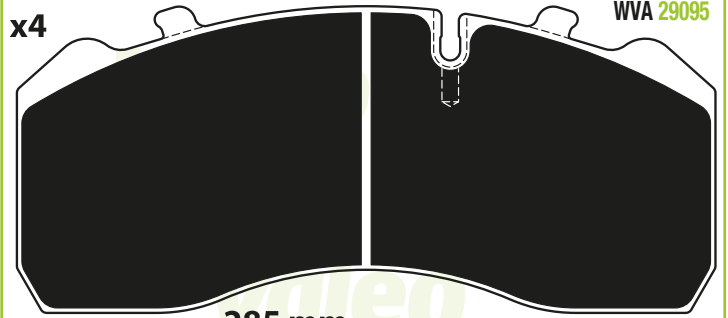

WVA 29095

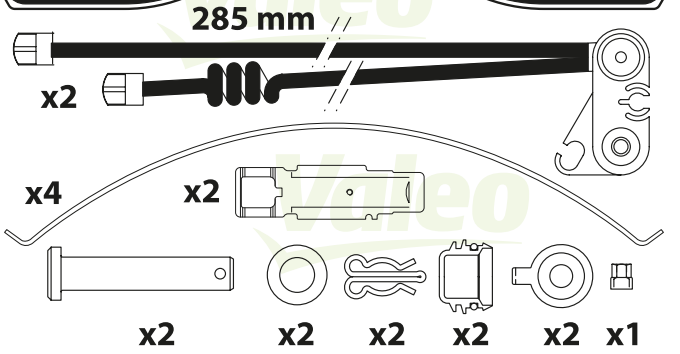

210,4	92,5	30	KNORR SB6	IVECO	Eurocargo Tector	2992336	2996468
-------	------	----	-----------	-------	------------------	---------	---------

882301



WVA OES

29095	KNORR SB6	1903651
-------	-----------	---------

187127

8x ø 22.15 + 2x ø 10 ø 159

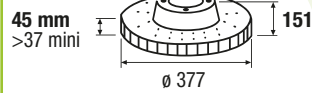

IVECO OES : 2992291

187128

8x ø 20.15 + 2x ø 10 ø 159

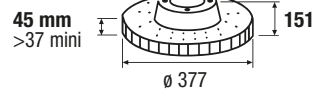

IVECO OES : 2992271

882206

WWA 29095

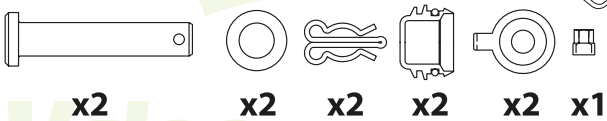
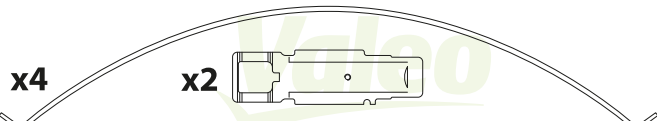
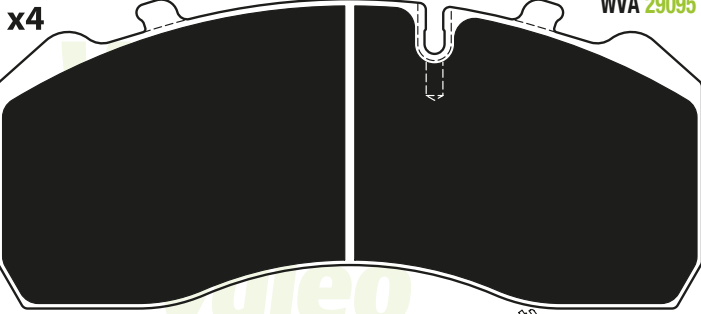

								OES
210,4	92,5	30	KNORR SB6	BPW	SB3745	0980102750	0980102930	

187064

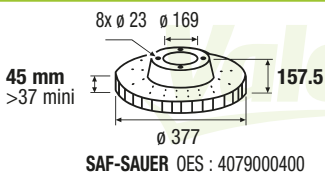

187067

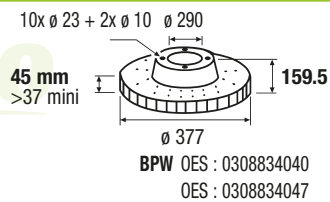

187086

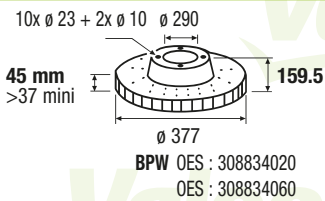

187100

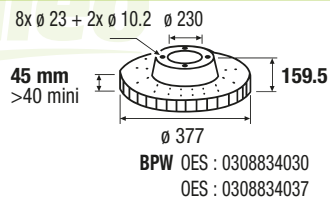

187103

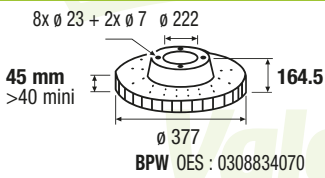

187104

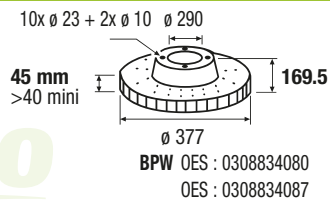

187096

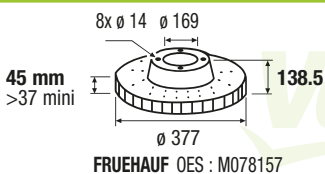

882207

WWA 29165

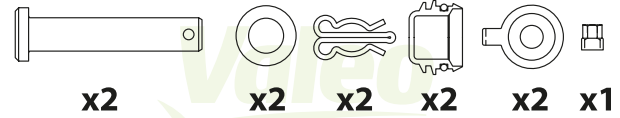
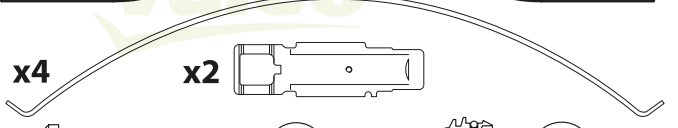
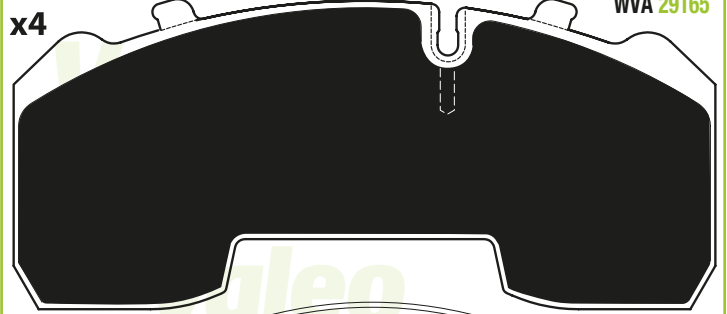

								OES
210,4	92,5	30	KNORR SN6	BPW	SB3745	0980106350	0980106430	

187100

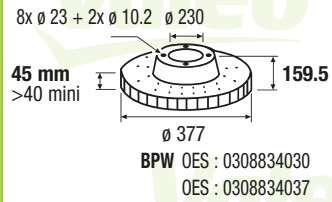

187132

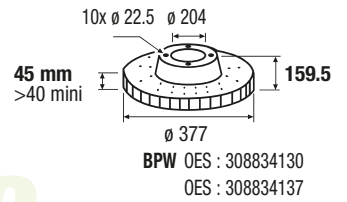

882208

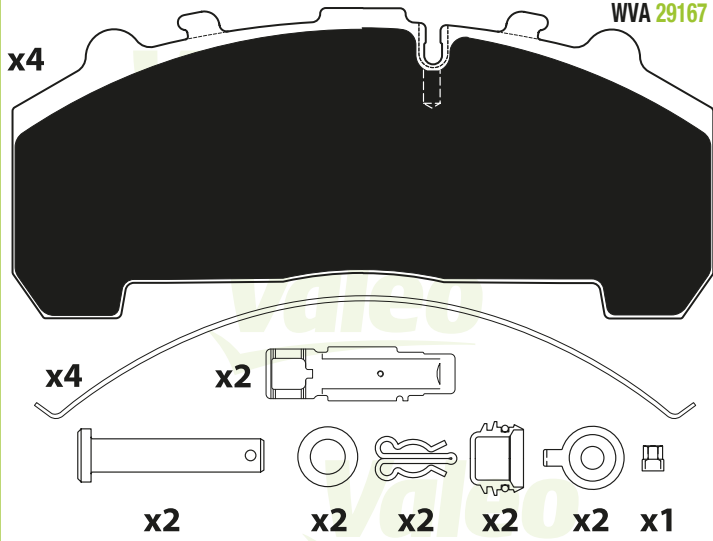

247,4 109,5 30 KNORR SN7 BPW SB4345 0980106960 0980106450 CES

187057

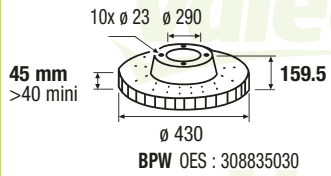

882209

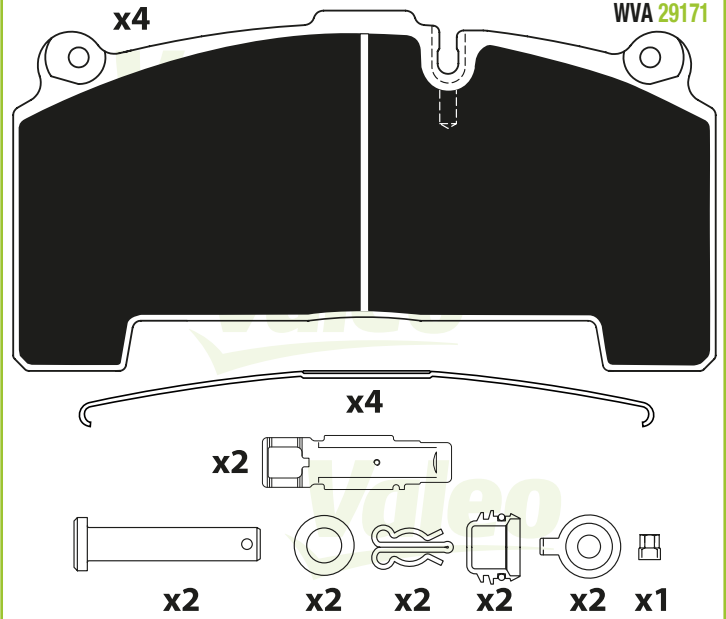

210,2 107,8 30 KNORR SK7 BPW SB4309 0509290060 0980106440 CES

882210

WVA 29115

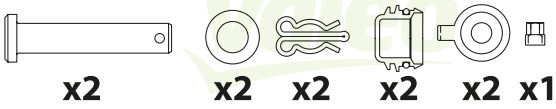
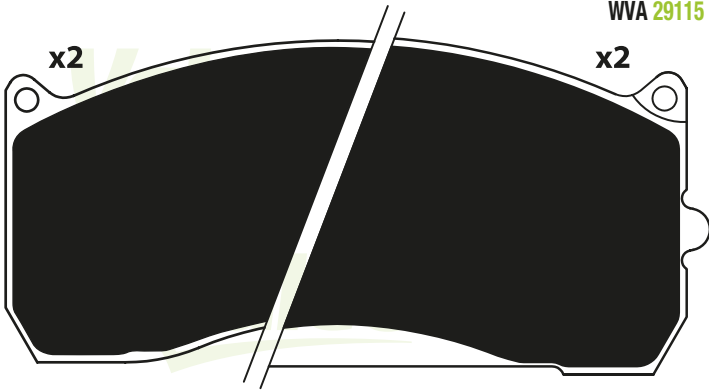

185/173,5 84 34/27 KNORR SB5 MERCEDES-BENZ Atego 0004211010 0004211210

187043

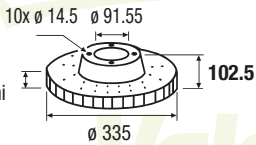

MERCEDES-BENZ OES : 9704210112
OES : 9704210612

187082

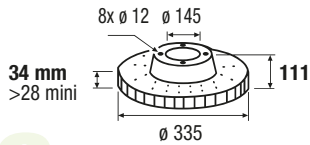

MERCEDES-BENZ OES : 9704230412
OES : 9704230612

187083

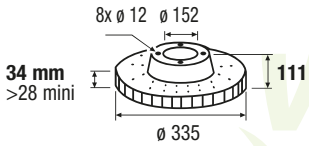

MERCEDES-BENZ OES : 9704230512

187137

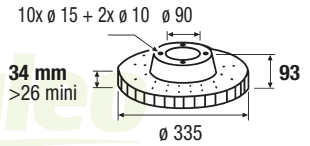

MAN OES : 81508030042

187138

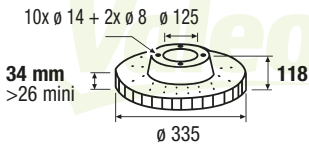

MAN OES : 81508030063

187139

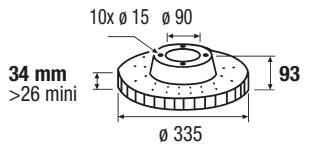

MAN OES : 81508030053

187140

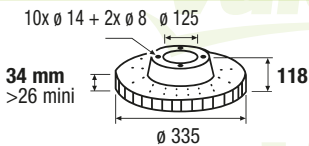

MAN OES : 81508030062

882211

WVA 29030

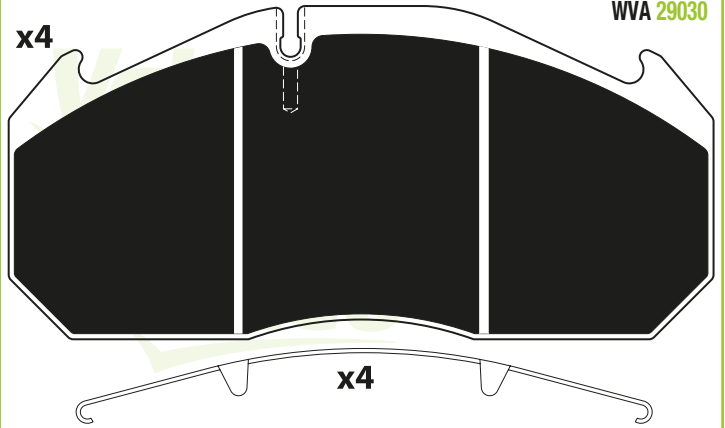

						OES
249	118,1	28	LUCAS D3	IRISBUS	Heuliez Agora	5001823000
				RENAULT TRUCKS	Magnum Premium	5001834075

187024

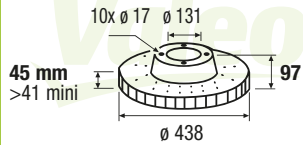

RENAULT TRUCKS OES : 5010216437

882214

WVA 29113

x4

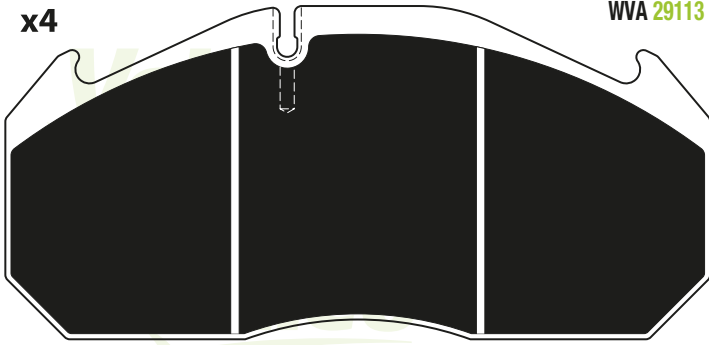

x4



x2

278 / 246 mm



249 118,1 28 LUCAS D-ELSA 1 MAN F90 F2000 M2000 81508205006 81508205021

882215

WVA 29030

x4

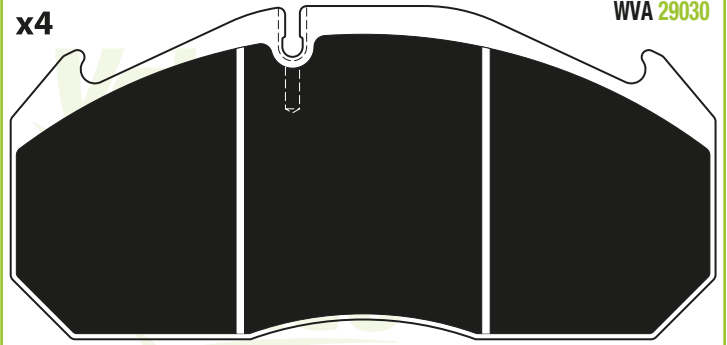

x4



x2

220 / 310 mm



249 118,1 28 LUCAS D3 MERCEDES-BENZ O-Series Integro 0024205520 0034205520

882314



x2

278 / 246 mm

WVA OES

29113 LUCAS D-ELSA 1 68323118

882315



x2

220 / 310 mm

WVA OES

29030 LUCAS D3 3565400017

187015

187052

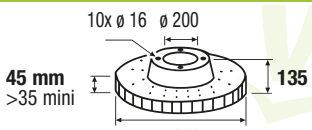

MAN OES : 81508030009
OES : 81508030014

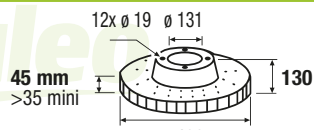

MAN OES : 81508030023
OES : 81508030031

187076

187077

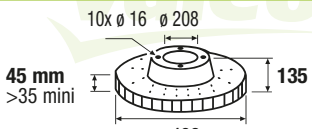

MAN OES : 81508030021
OES : 81508030041

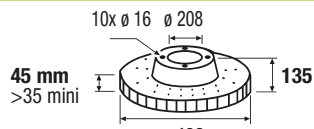

MAN OES : 81508030028

187053

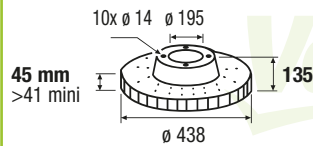

MERCEDES-BENZ OES : 3564210312
OES : 3564211012

882216

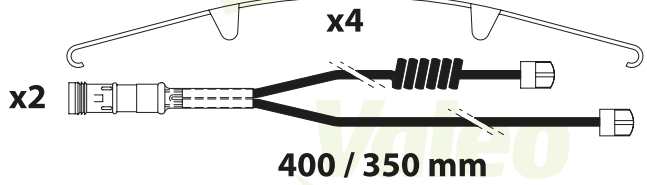
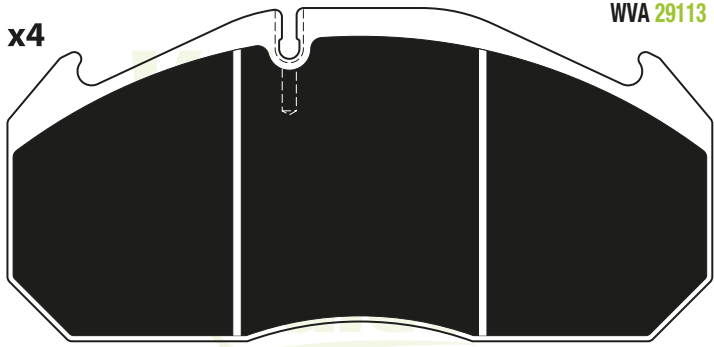

	OES
249 118,1 28 LUCAS D-ELSA 1 MAN NG NU NL Series 81508205066 81508206044	

882316



WVA	OES
29113 LUCAS D-ELSA 1 68323117	

187052

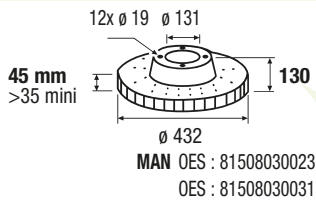

187076

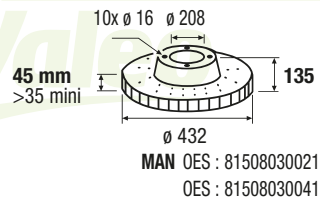

882217

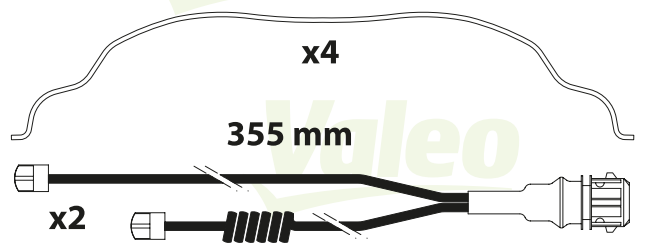
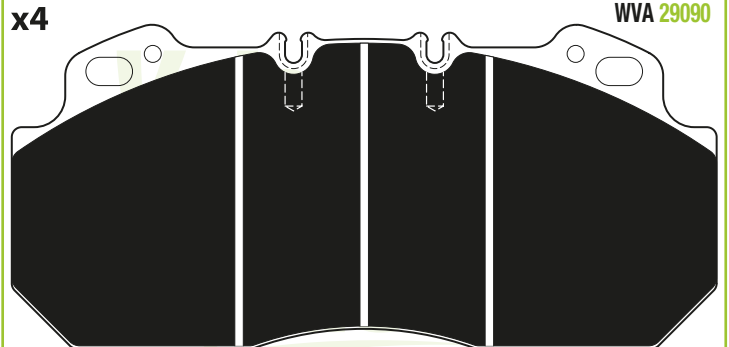

	OES
249 109,5 28 LUCAS D-LISA IRISBUS Citelis Agora Heuliez 5001846034 5001833114	

882312



WVA	OES
29090 LUCAS D-LISA 5001834075	

187024

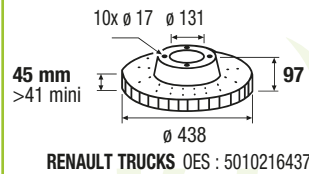

187116

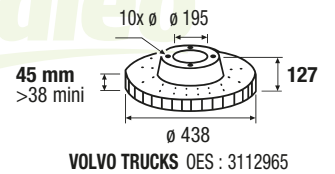

882218

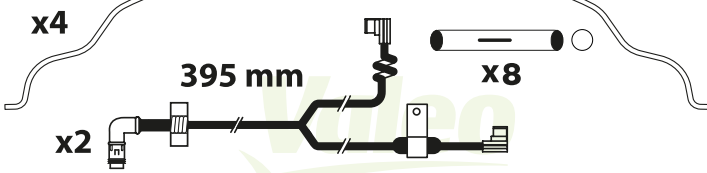
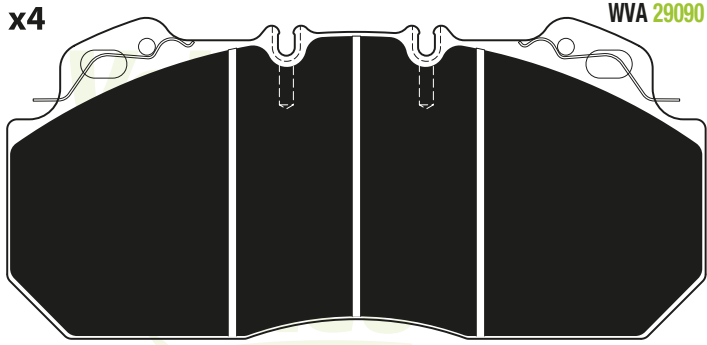

								OES
249	109,5	28	LUCAS D-LISA	RENAULT TRUCKS	Magnum	Premium	5001846034	5001833114

882318



WVA		OES
29090	LUCAS D-LISA	5001831161

187024

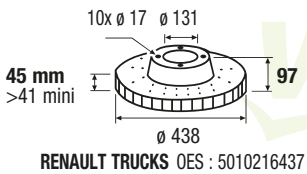

882219

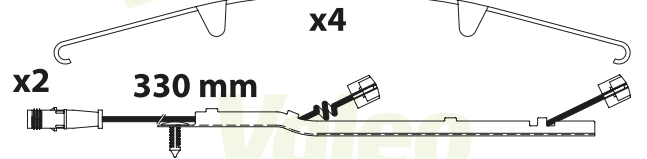
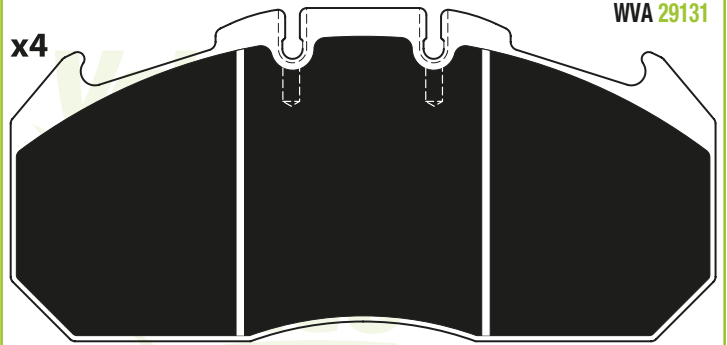

								OES
249,3	117,9	30	LUCAS D-ELSA 2	MAN	TGA	81508205072	81508206041	

882319

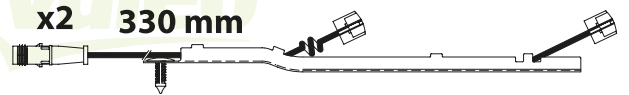

WVA		OES
29131	LUCAS D-ELSA 2	68324072

882220

x4

WVA 29131

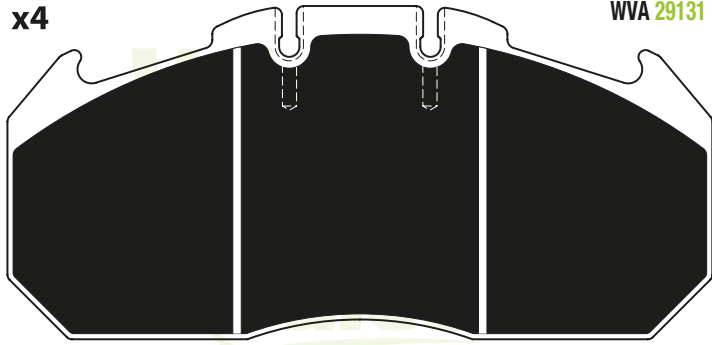

x4

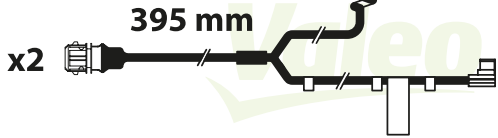

249,3	117,9	30	LUCAS D-ELSA 2	RENAULT TRUCKS	Magnum Premium	5001855646
-------	-------	----	----------------	----------------	----------------	------------

882320

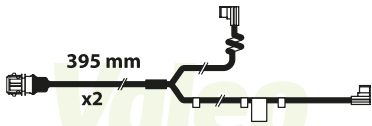

WVA						
29131	LUCAS D-ELSA 2	5001834075				

187024

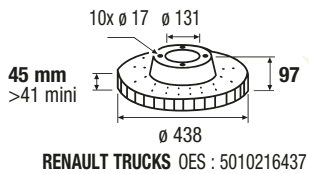

RENAULT TRUCKS OES : 5010216437

187087

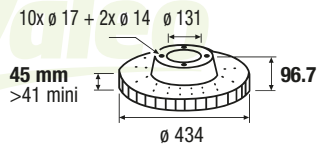

RENAULT TRUCKS OES : 5010422363

187088

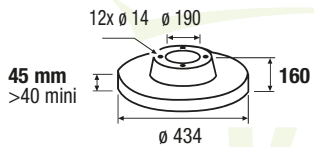

RENAULT TRUCKS OES : 5010422364

882221

x4

WVA 29125

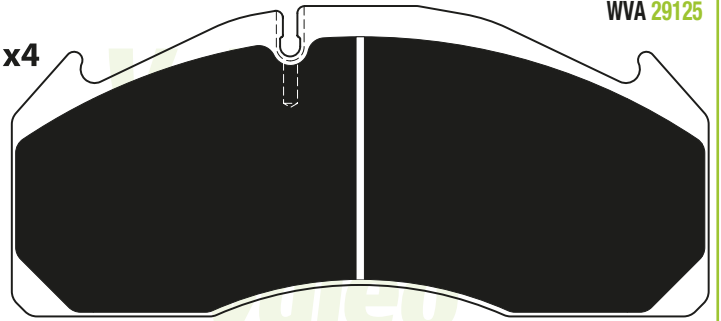

x4



249,1	110,9	29,3	LUCAS D-DUCO	VOLVO TRUCKS	FH 12/16 FM 9/12	1078439	20768092
-------	-------	------	--------------	--------------	---------------------	---------	----------

187098

8x ø 24.25 + 2x ø 12 ø 167

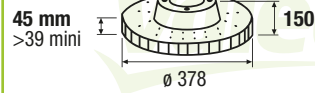

MERITOR OES : 21224263
OES : 3218H1308

882222

x4

WVA 29124

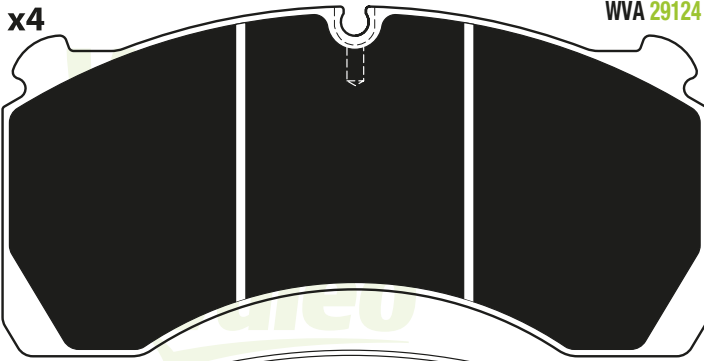

x4

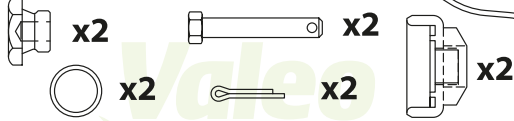

205,3 102 27 MERITOR MERITOR DX195 MDP5076 MDP1314 OES

187021

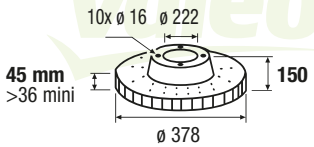

MERITOR OES : 21225115
OES : 31788700100

882223

x4

WVA 29088

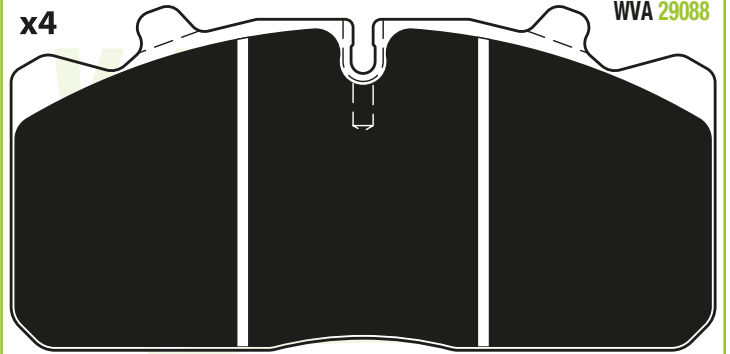

x6

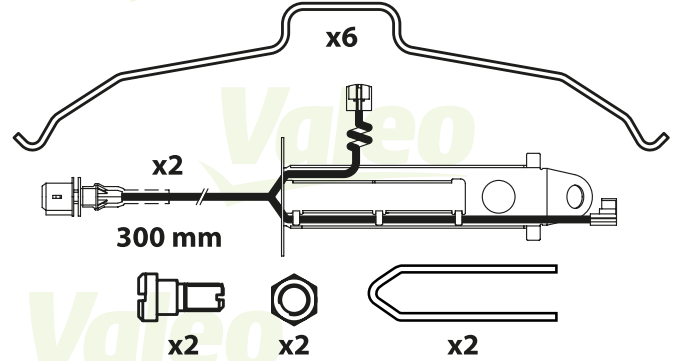

175,3 82,4 26 PERROT PAN 17 RENAULT TRUCKS Midlum 5010848607 OES

882323

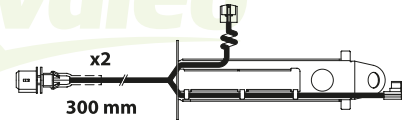

WVA OES
29088 PERROT PAN 17 5010848607

187090

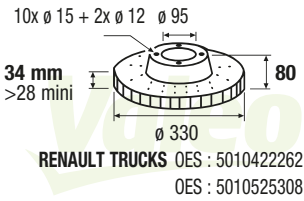

RENAULT TRUCKS OES : 5010422262
OES : 5010525308

187091

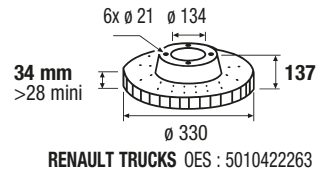

RENAULT TRUCKS OES : 5010422263

187092

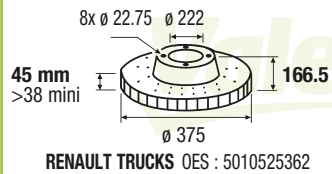

RENAULT TRUCKS OES : 5010525362

187093

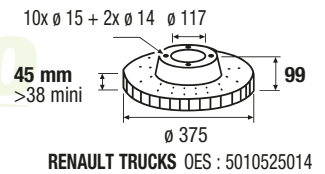

RENAULT TRUCKS OES : 5010525014

882224

x4

WVA 29142

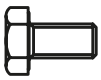
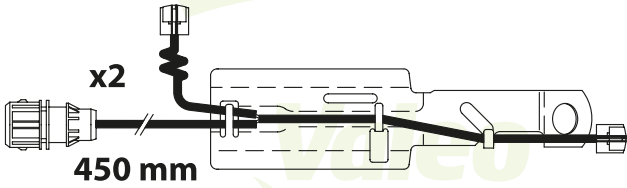
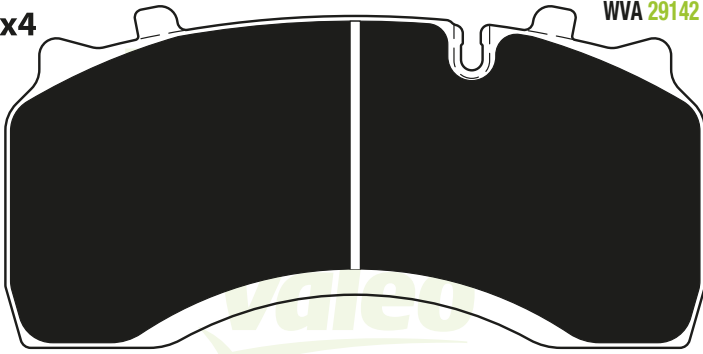

x2



x4

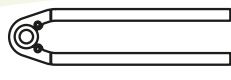

x2



204,5 97 29,9 PERROT PAN 19-2 RENAULT TRUCKS Midlum 5001855902

882324

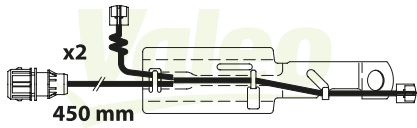

WVA OES

29142 PERROT PAN 19-2

187050

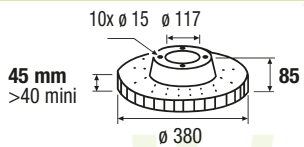

RENAULT TRUCKS OES : 5010260218

187090

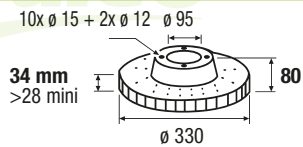

RENAULT TRUCKS OES : 5010422262
OES : 5010525308

187091

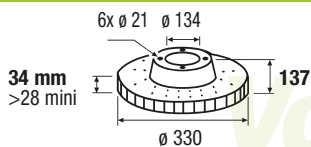

RENAULT TRUCKS OES : 5010422263

882225

x4

WVA 29090

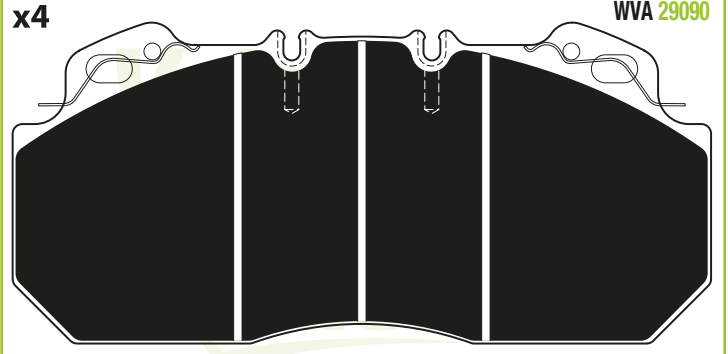

x4

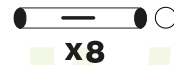

x8



249 109,5 28 LUCAS D-LISA RENAULT TRUCKS Magnum Premium 5001846034 5001833114

187024

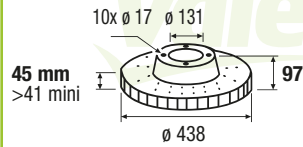

RENAULT TRUCKS OES : 5010216437

882226

x4

WVA 29131

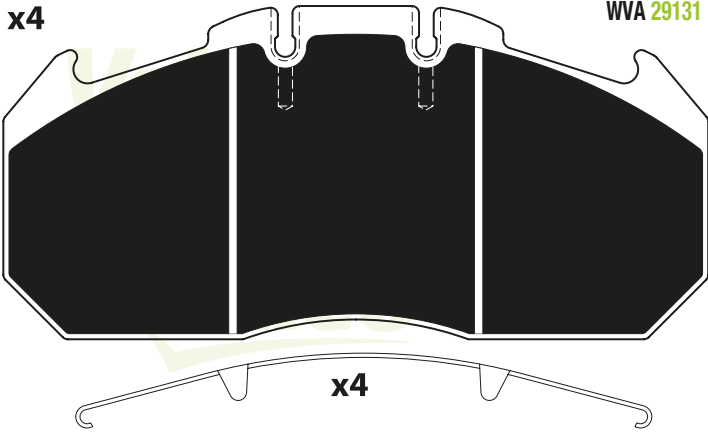

x4

249,3 117,9 30 LUCAS D-ELSA 2 RENAULT TRUCKS Magnum Premium 5001855646 5001020312

187024

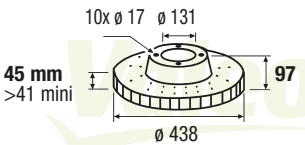

RENAULT TRUCKS OES : 5010216437

187087

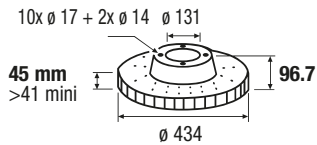

RENAULT TRUCKS OES : 5010422363

187088

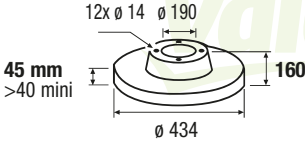

RENAULT TRUCKS OES : 5010422364

882227

x4

WVA 29159

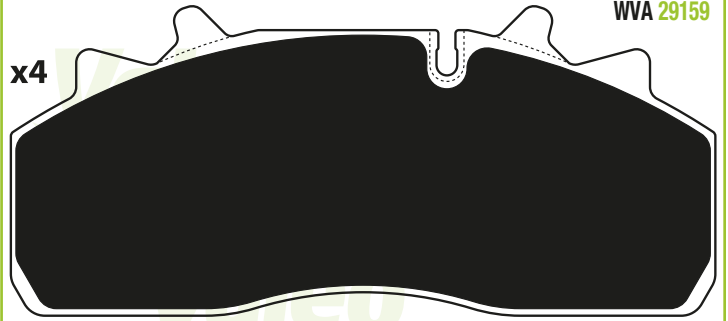

x4

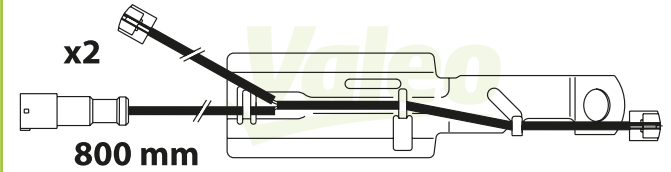

800 mm

210,2 79,6 30 PERROT PAN 19-1 DAF LF 55 1628064

882327

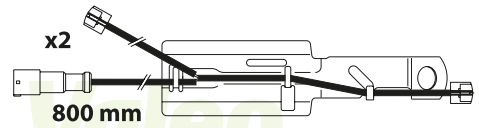

800 mm

WVA OES

29159 PERROT PAN 19-1

187117

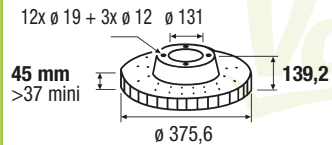

SAF-SAUER OES : 4079000700

187134

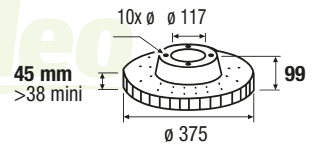

DAF OES : 1400069

187135

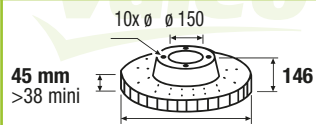

DAF OES : 1400284

882228

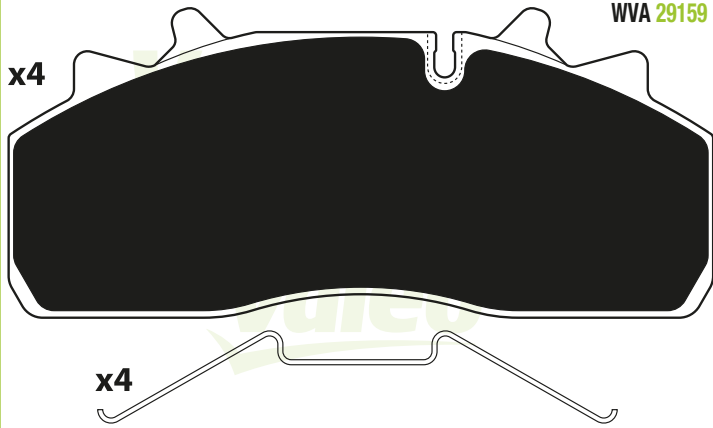

210,2 79,6 30 PERROT PAN 19-1 DAF LF 55 1628064

187117

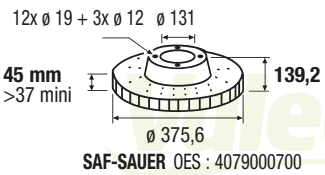

187134

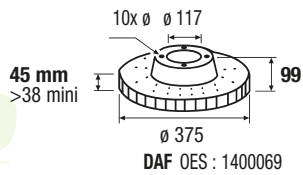

187135

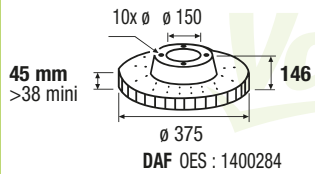

882229

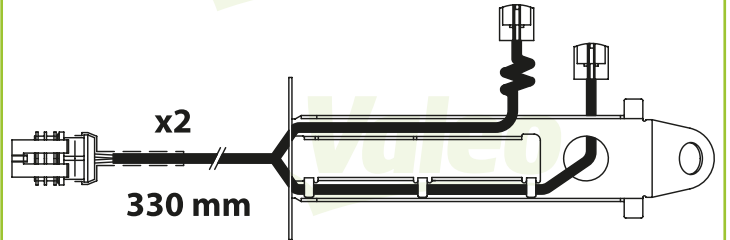
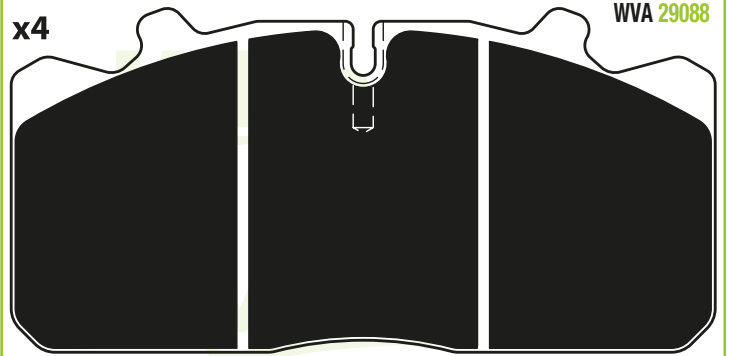

175,3 82,4 26 PERROT PAN 17 DAF LF 45 1436901 IVECO Eurocargo Tector 1906467

882329

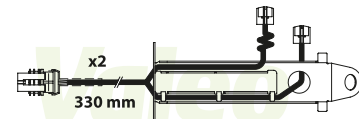

WVA OES

29088 PERROT PAN 17

187129

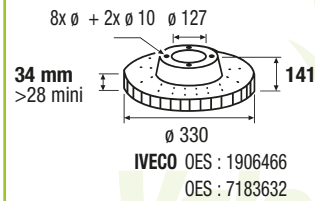

187143

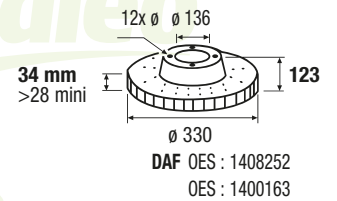

187144

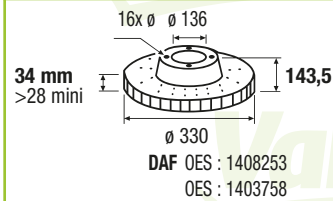

187145

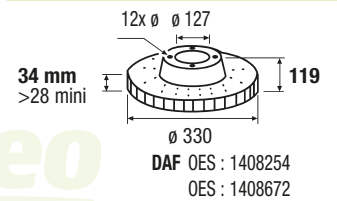

882230

WVA 29088

x4

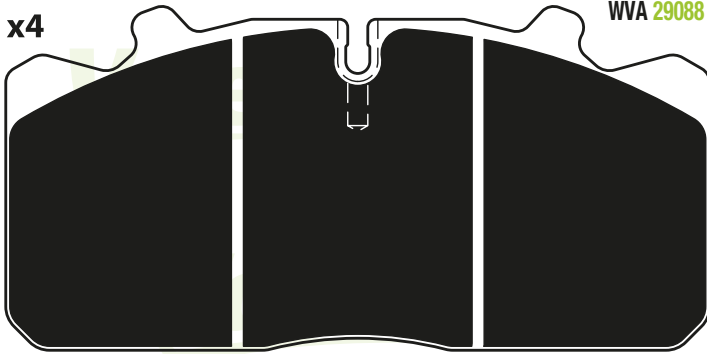

175,3	82,4	26	PERROT PAN 17	DAF	LF 45	1436901
				IVECO	Eurocargo	1906467
				RENAULT TRUCKS	Midlum	5010848607
				MAN	L2000 M2000	81508205023

187129

8x \emptyset + 2x \emptyset 10 \emptyset 127

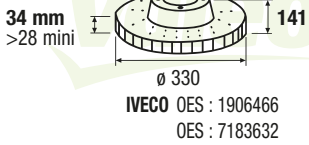

IVECO OES : 1906466
OES : 7183632

187143

12x \emptyset \emptyset 136

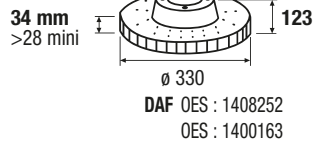

DAF OES : 1408252
OES : 1400163

187144

16x \emptyset \emptyset 136

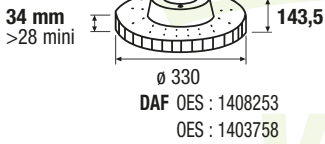

DAF OES : 1408253
OES : 1403758

187145

12x \emptyset \emptyset 127

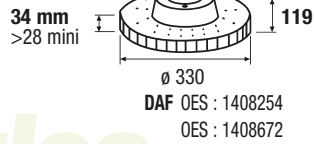

DAF OES : 1408254
OES : 1408672

882231

WVA 29011

x4

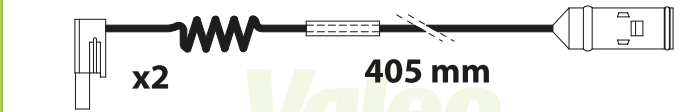
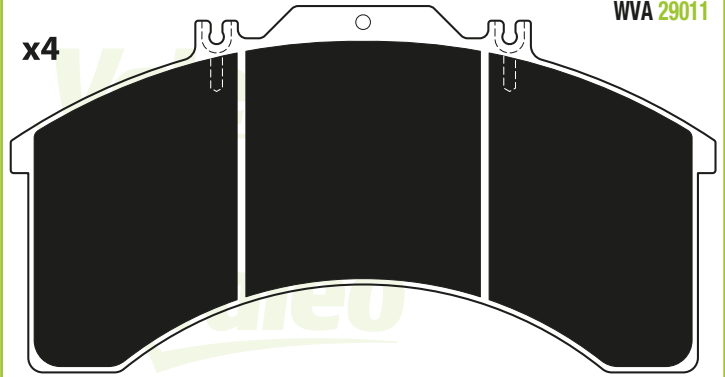

240,6	124,6	25	BENDIX	IVECO	Eurocargo Eurostar Eurotech	1906191	1906459
-------	-------	----	--------	-------	-----------------------------------	---------	---------

882331

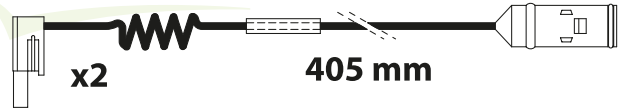

WVA OES

29011 BENDIX 1907956

187089

12x \emptyset \emptyset 170

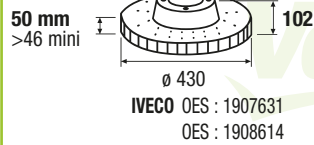

IVECO OES : 1907631
OES : 1908614

882232

x4

WVA 29011

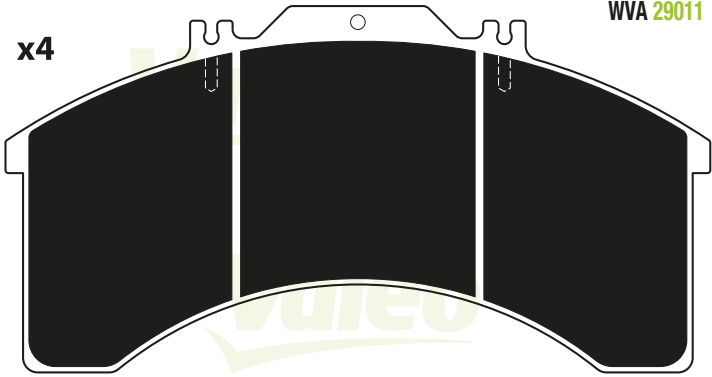

240,6 124,6 25 BENDIX IVECO Eurocargo Eurostar Eurotech 1906191 1906459

187089

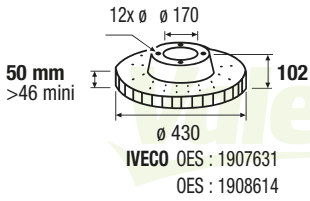

882233

x4

WVA 29122

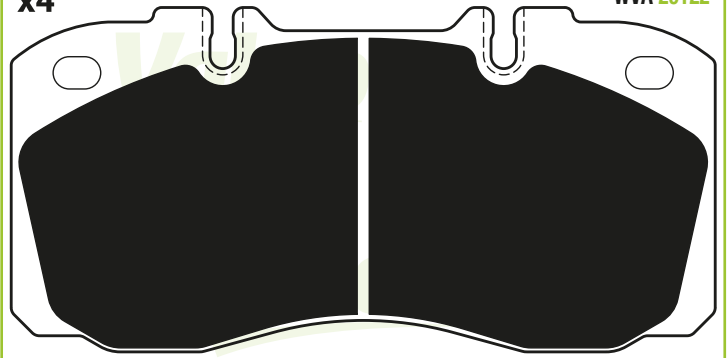

475 mm



175 79,5 22 BREMBO IVECO Eurocargo 1906416 1906298

882333

475 mm

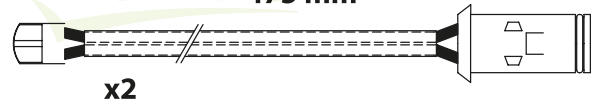

WVA BREMBO IVECO OES

29122 BREMBO 1908825

187059

6x ø 18,15 + 2x ø 10 ø 245

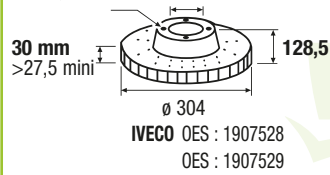

882234

x4

WVA 29122

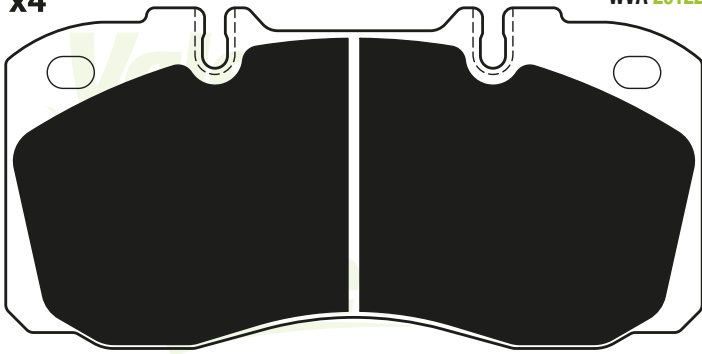

x2

295 mm



									OES
175	79,5	22	BREMBO	IVECO	Eurocargo	Eurocargo Tector	1906416	1906298	

882334

x2

295 mm



WVA		OES
29122	BREMBO	1908407

187059

6x \varnothing 18,15 + 2x \varnothing 10 \varnothing 245

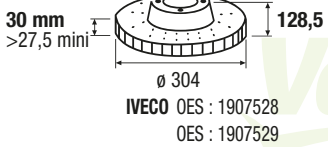

882235

x4

WVA 29122

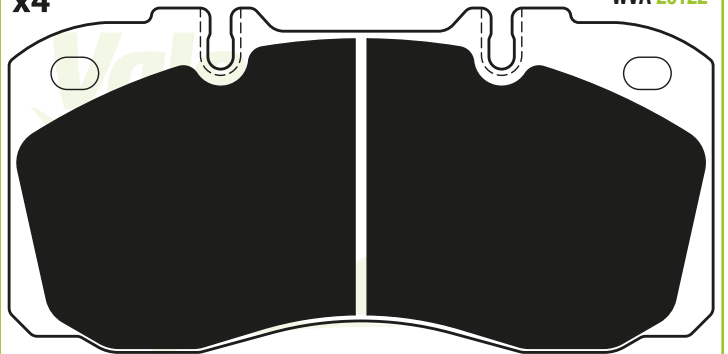

									OES
175	79,5	22	BREMBO	IVECO	Eurocargo	Eurocargo Tector	1906416	1906298	

187059

6x \varnothing 18,15 + 2x \varnothing 10 \varnothing 245

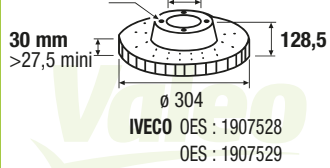

882236

x4

WVA 29067

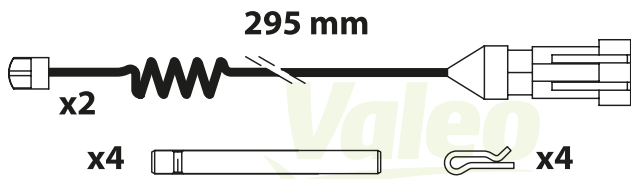
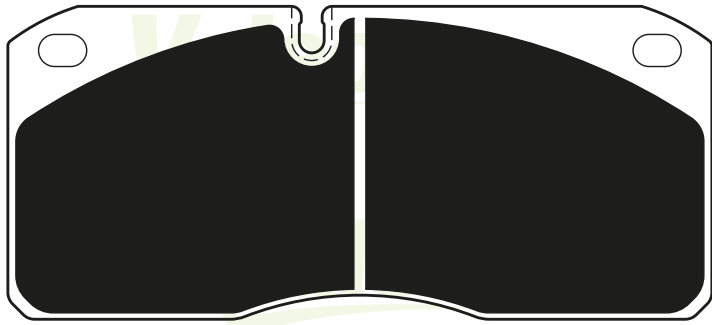

176	78	22	LUCAS	IVECO	Eurocargo	1906043	1906297
-----	----	----	-------	-------	-----------	---------	---------

882334

x2

295 mm



WVA		OES
29067	LUCAS	1906462

187005

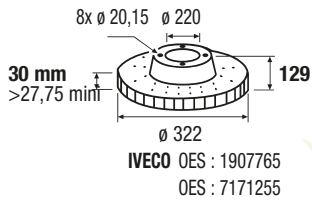

187006

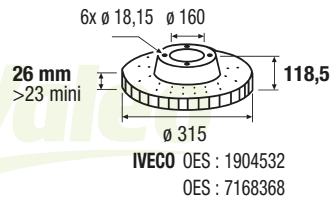

187060

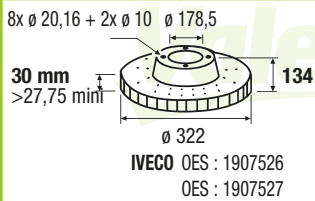

882237

x4

WVA 29011

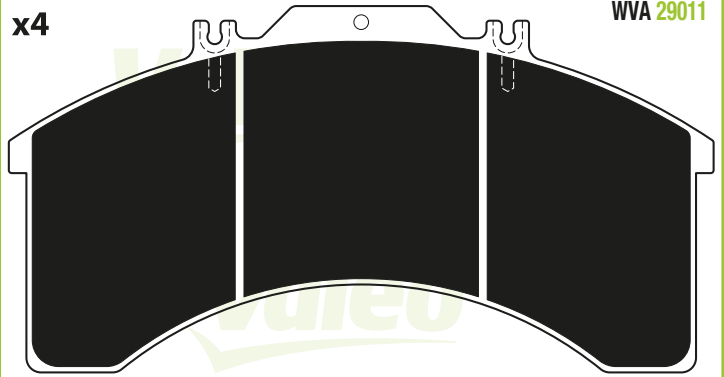

240,6	124,6	25	BENDIX	IVECO	Eurocargo Eurostar Eurotech	1906191	1906459
-------	-------	----	--------	-------	-----------------------------------	---------	---------

882337



WVA		OES
29011	BENDIX	1908231

187089

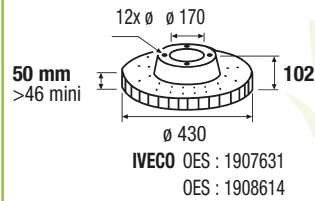

882238

x4

WVA 29088

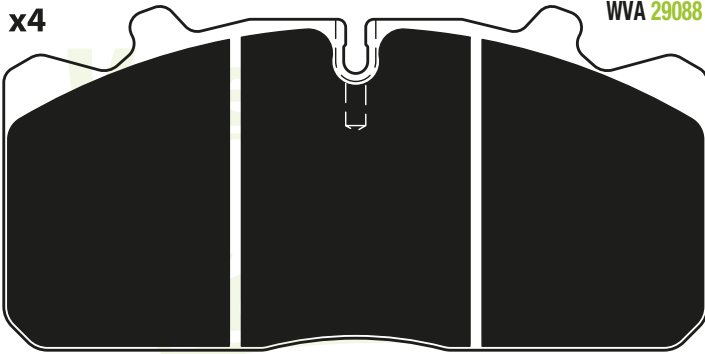

x2

295 mm

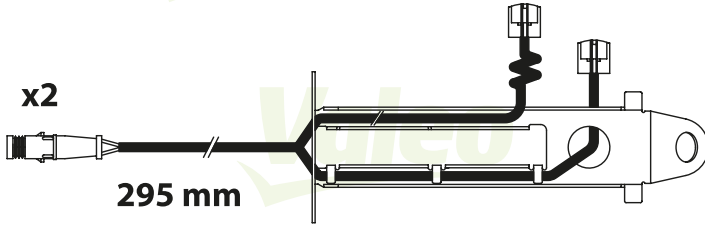

175,3	82,4	26	PERROT PAN 17	MAN	L2000 M2000	81508206006
-------	------	----	---------------	-----	----------------	-------------

882338

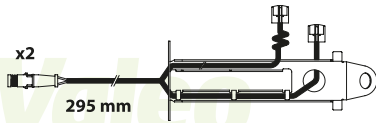

WVA	OES
29088	PERROT PAN 17 81508226014

187014

187049

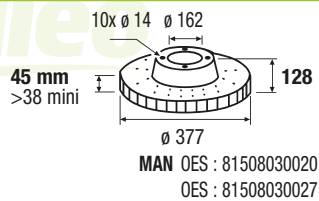
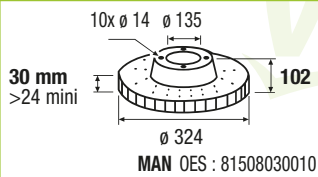

187056

187065

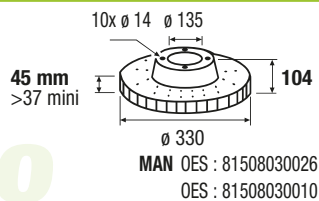
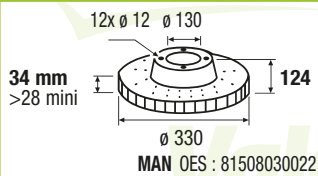

882239

x4

WVA 29835

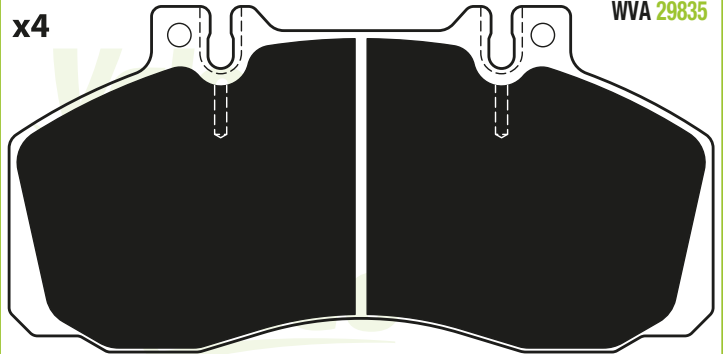

220 / 310 mm

x2



175	85,5	22	LUCAS	MERCEDES-BENZ	Vario Medio Sprinter	0014201520	0024205720
-----	------	----	-------	---------------	----------------------------	------------	------------

882339

220 / 310 mm



WVA	OES
29835	LUCAS 6695400917

187105

187106

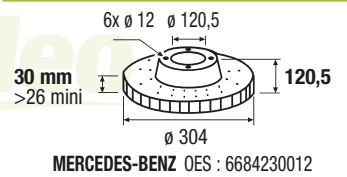
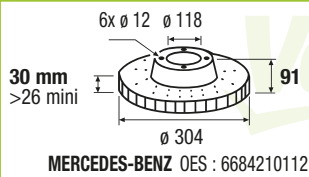

187107

187108

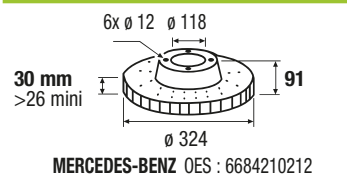
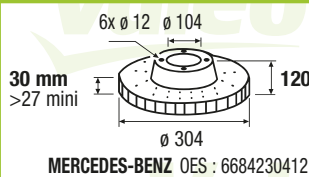

187109

187110

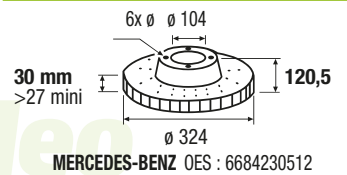
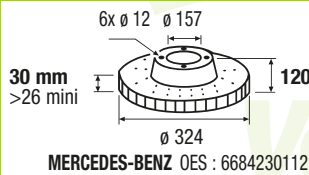

882240

x4

WVA 29835

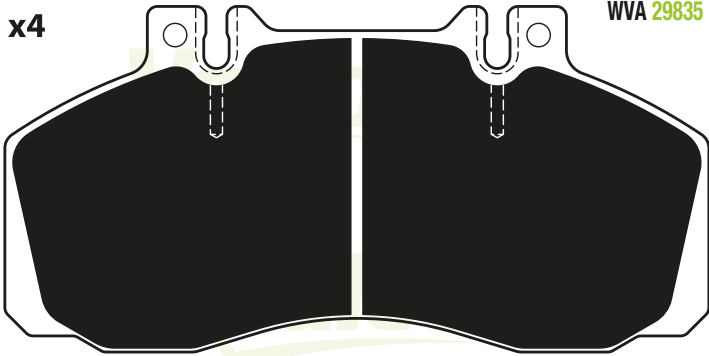

	OES
175 85,5 22 LUCAS	MERCEDES-BENZ Vario Medio Sprinter 0014201520 0024205720

187105

187106

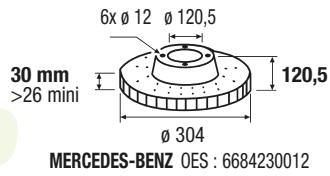
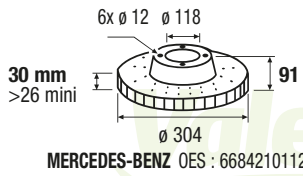

187107

187108

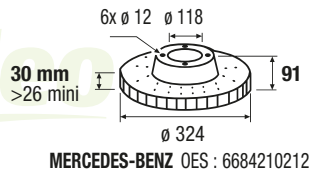
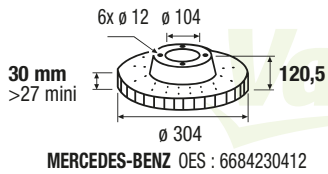

187109

187110

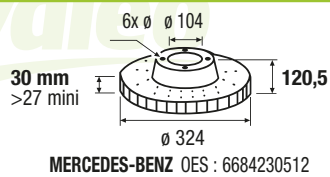
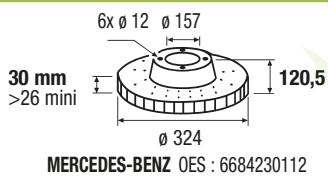

882241

x4

WVA 29065

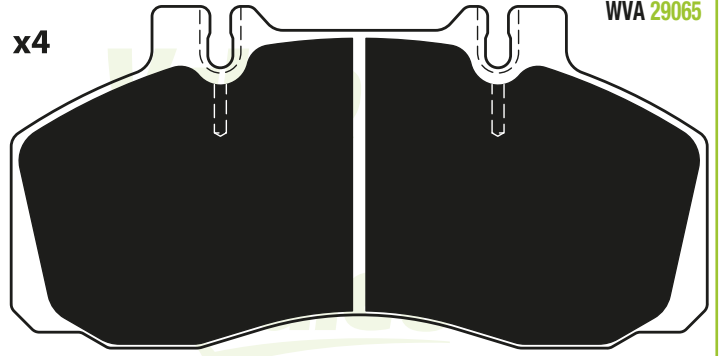

x2

885 / 780 mm

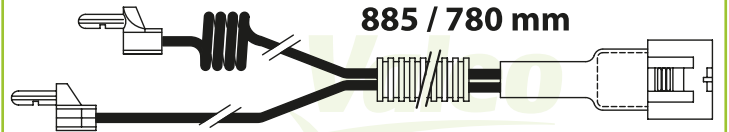

	OES
175 85,5 22 LUCAS	RENAULT TRUCKS Midliner S 5001014694 5001825638

882341



WVA	OES
29065	LUCAS 68320874

187044

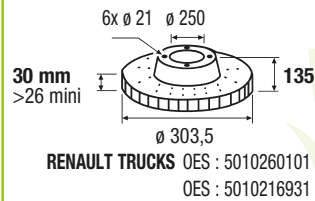

882242

WVA 29065

x4

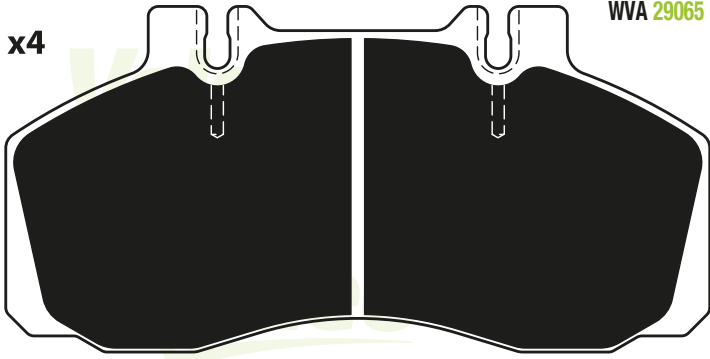

175	85,5	22	LUCAS	RENAULT TRUCKS	Midliner S	5001014694	5001825638
				IVECO	Eurocargo	1906144	1906298

187044

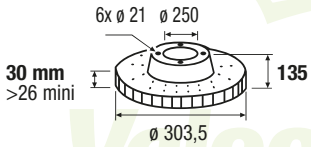

RENAULT TRUCKS OES : 5010260101
OES : 5010216931

882243

WVA 29173

x4

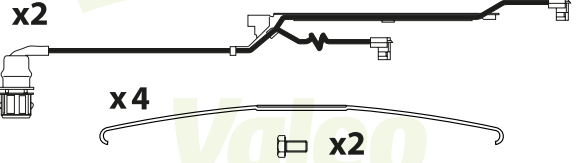
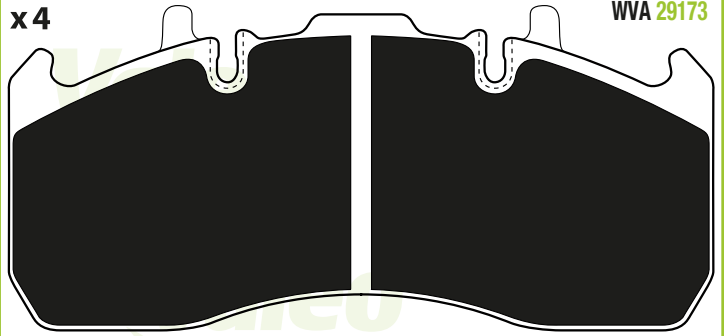

216	96,5	29,25	ELSA 225-1	RENAULT TRUCKS	Midlum	5001864365	
				VOLVO TRUCKS	FL II	20568712	20568715

882345

x2

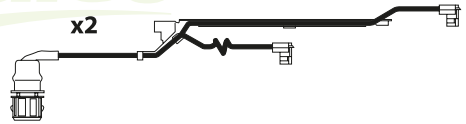

WVA OES

29173	ELSA 225-1	68325408
--------------	------------	----------

187090

10x \emptyset 15 + 2x \emptyset 12 \emptyset 95

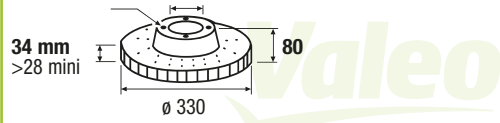

RENAULT TRUCKS OES : 5010422262
OES : 5010525308

882244

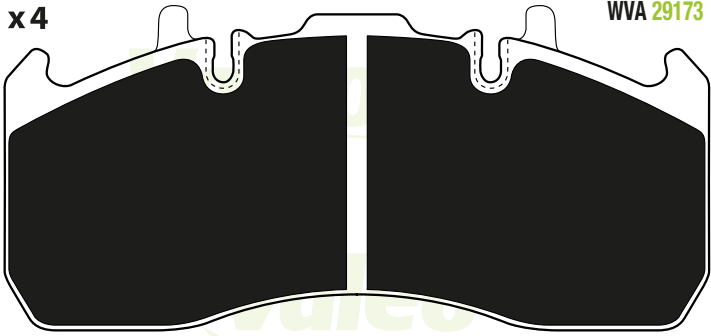

	CES
216 96,5 29,25 ELSA 225-1	RENAULT TRUCKS Midlum 5001864365 VOLVO TRUCKS FL II 20568712 20568715

187090

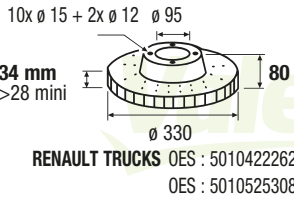

882245

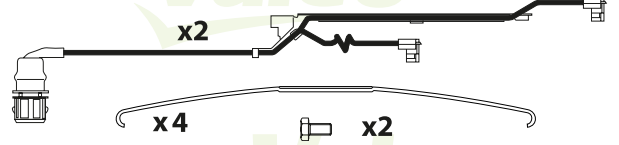
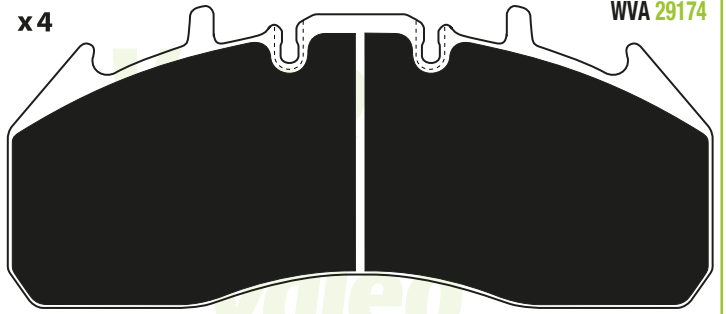

	CES
249,6 107 29,25 ELSA 225-3	RENAULT TRUCKS Magnum DXi 5001864364 5001864363 Premium DXi VOLVO TRUCKS FH/FE/FM 20568711 20568714

882345

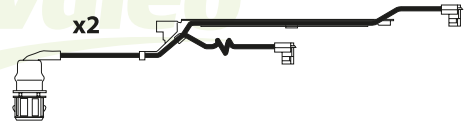

WVA		CES
29174	ELSA 225-3	5001834075

882246

x4

WVA 29174

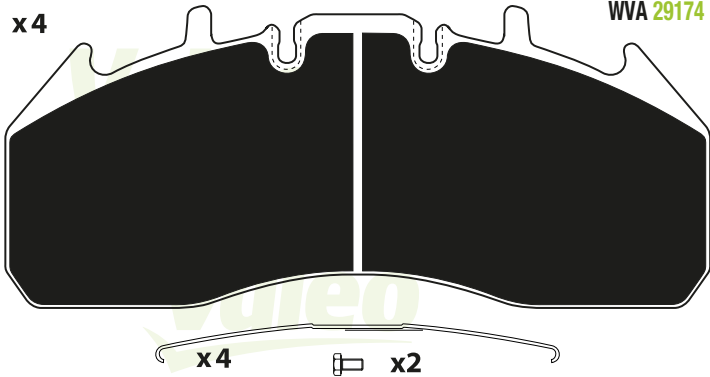

											OES
249,6	107	29,25	ELSA 225-3	RENAULT TRUCKS	Magnum DXi Premium DXi	5001864364	5001864363				
				VOLVO TRUCKS	FH/FE/FM	20568711	20568714				

882247

x4

WVA 29177

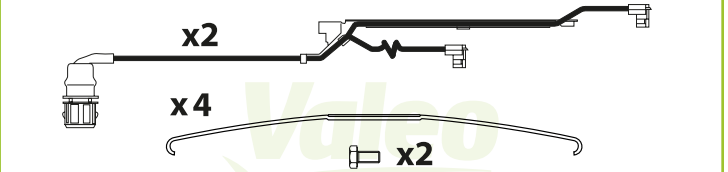
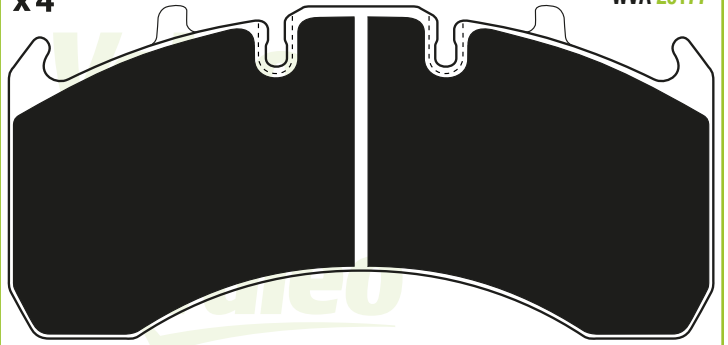

											OES
210,5	99,7	29,25	VGT195	RENAULT TRUCKS	Magnum DXi Premium DXi	5001864380					
				VOLVO TRUCKS	FH	20568713	20765963				

882345

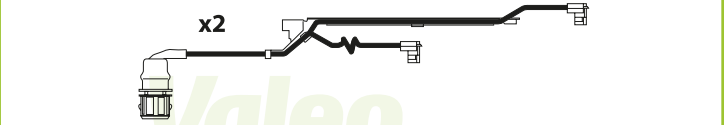

WVA		OES
29177	VGT195	5001834075

Valeo

Valeo

Valeo

Valeo

Valeo

Valeo

Valeo

Valeo

Valeo

Valeo

Valeo

Valeo

882248

x4

WVA 29177



x4



x2



OES

210,5 99,7 29,25

VGT195

RENAULT TRUCKS Magnum DXi
Premium DXi

5001864380

VOLVO TRUCKS FH

20568713 20765963



882249

x4

WVA 29181

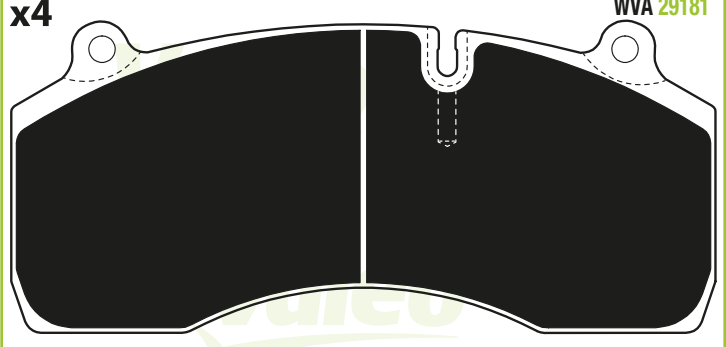

x4



x2



x2



OES

210 92 30

HALDEX DB19

RENAULT TRUCKS Midlum

5001866914



882250

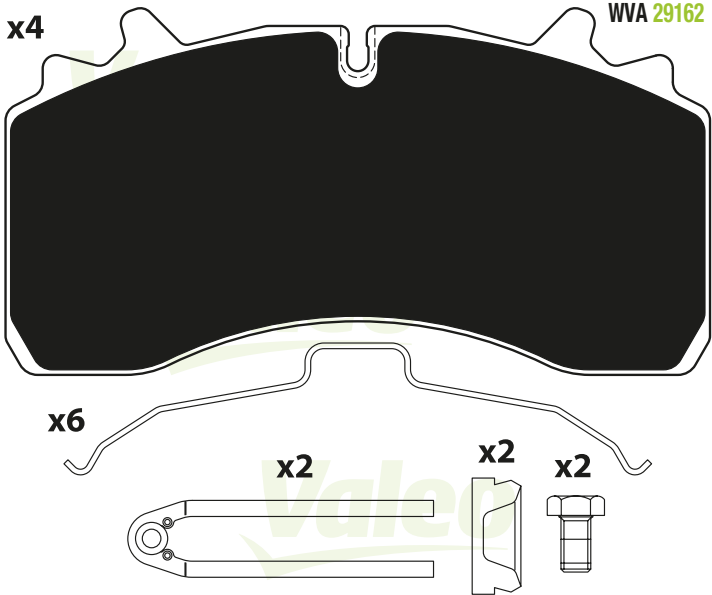

210,5 104,3 31 PERROT PAN 22-1 SAF-SAUER 3057008400

187072

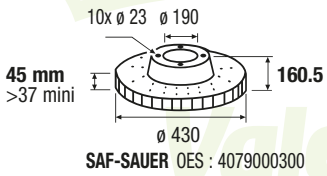

187074

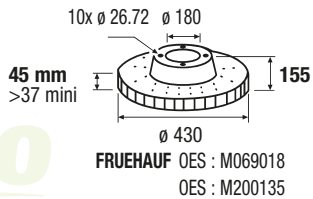

187075

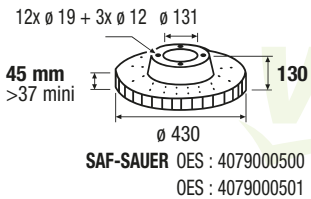

882251

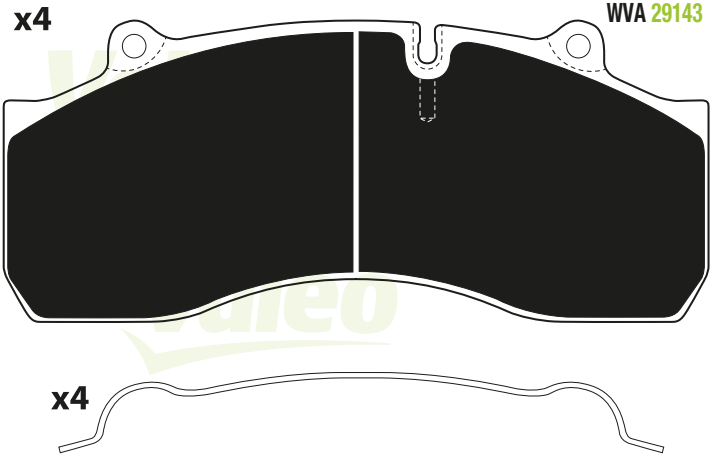

247,4 105 30 HALDEX DB22 SAF-SAUER 9291063

882254

x4

WVA 29067

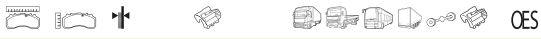
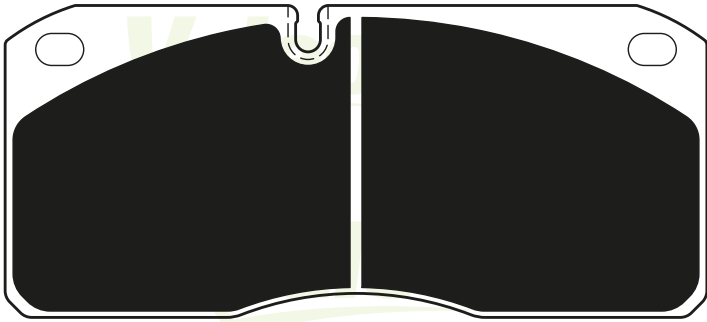

176 78 22 LUCAS RENAULT TRUCKS Midliner S 5001014704

187005

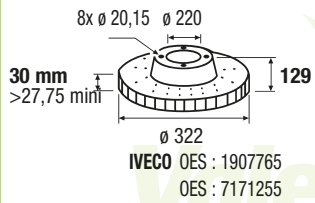

187006

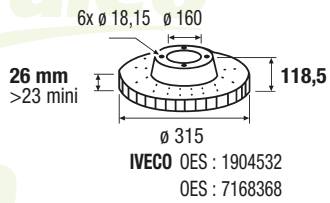

187060

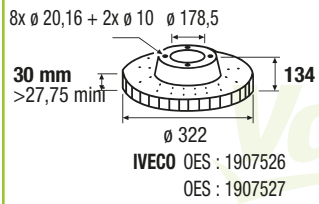

882255

x4

WVA 29067

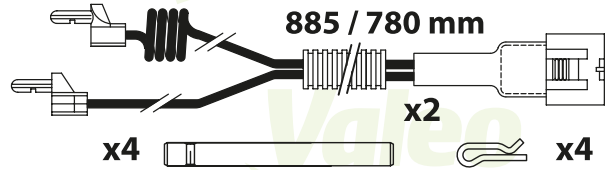
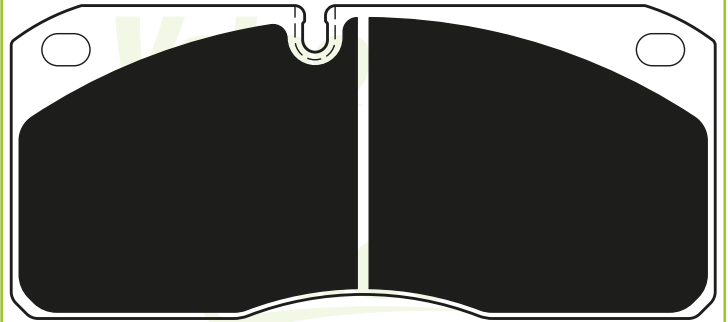

176 78 22 LUCAS RENAULT TRUCKS Midliner S 5001014704

882341



WVA LUCAS OES

29067 LUCAS 68320874

187063

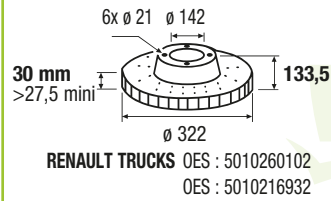

882257

WVA 29039

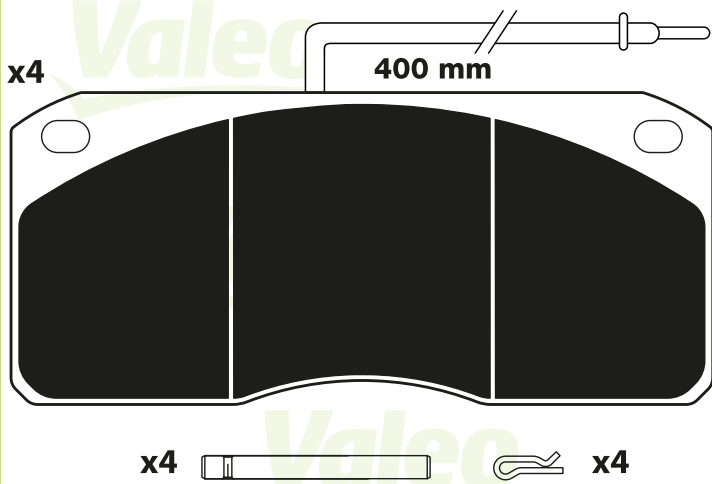

								OES
175	78	22	LUCAS	FORD	Cargo		6171272	
				VOLVO TRUCKS	FL 6		3090048	2709012

187002

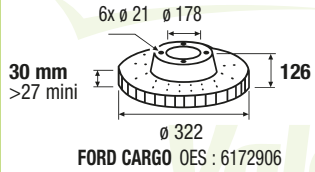

187026

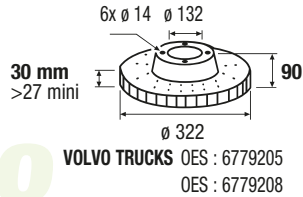

187027

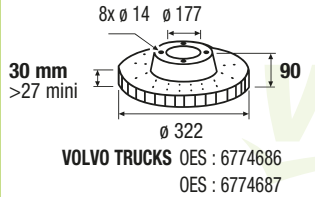

187055

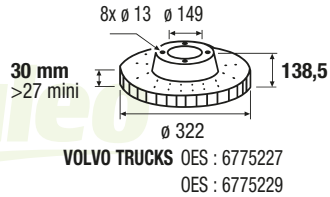

187085

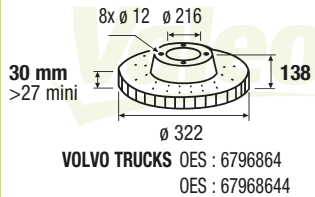

882258

WVA 29067

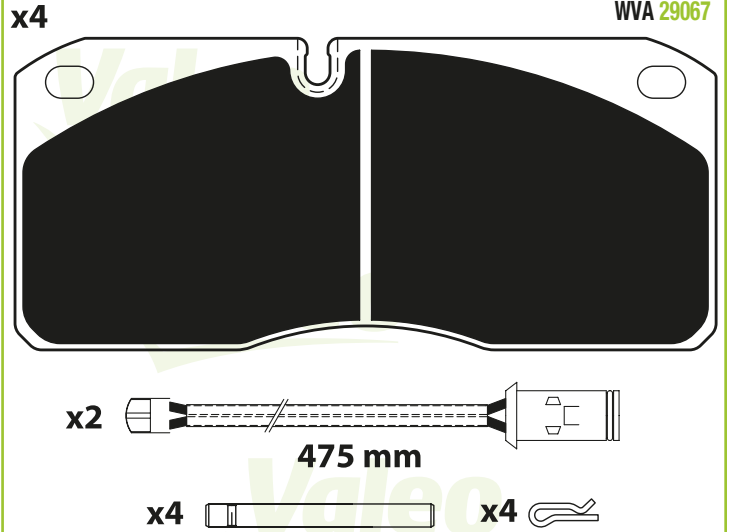

								OES
176	78	22	LUCAS	IVECO	Eurocargo		1906043	1906297

882333



WVA		OES
29067	LUCAS	

187005

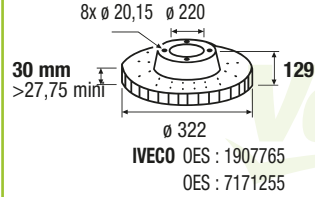

187006

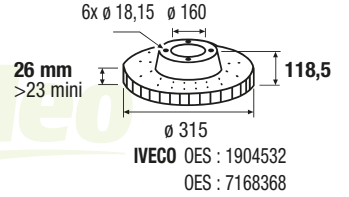

187060

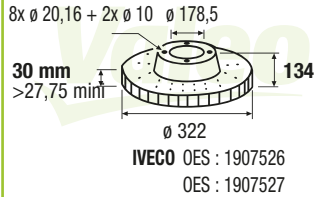

882259

x4

WVA 29181

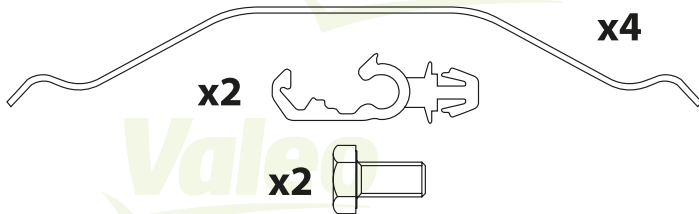
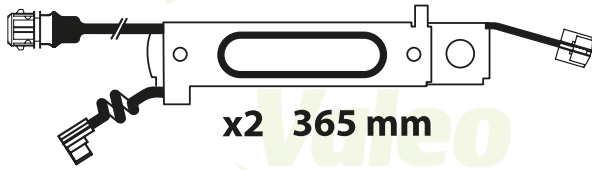
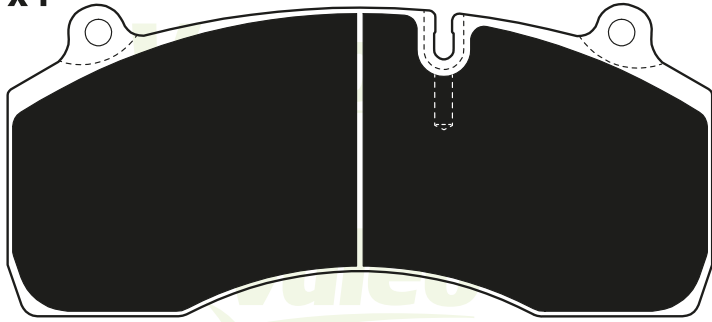

210	92	30	HALDEX DB19	RENAULT TRUCKS Midlum	5001866914
-----	----	----	-------------	-----------------------	------------

882359

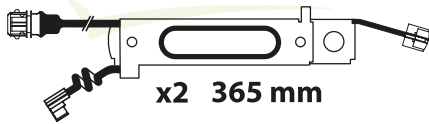

WVA		OES
29181	HALDEX DB19	5010848607

882270

WVA 29137

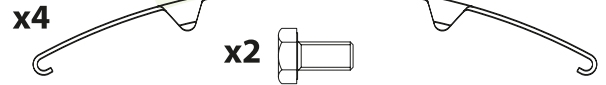
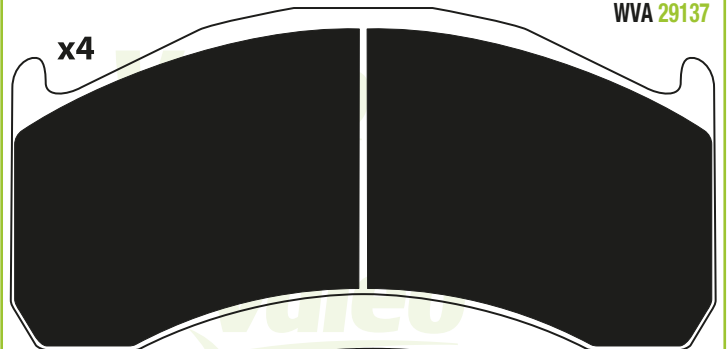

210	102.2	29.25	LUCAS C-DUCO	VOLVO TRUCKS FL 6	3093532	20768115
-----	-------	-------	--------------	-------------------	---------	----------

187026

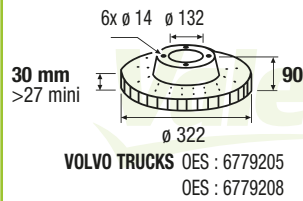

187027

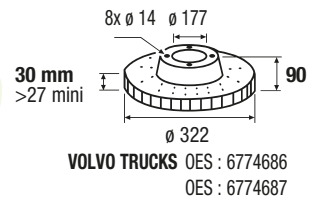

187055

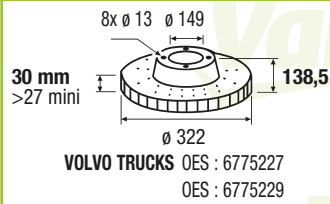

882271*

WVA 29246

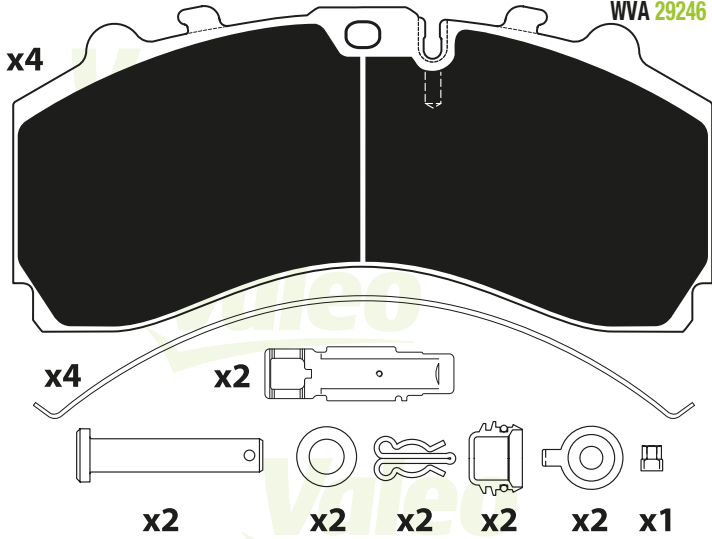

244.6 113.6 30 KNORR SM7 MERCEDES-BENZ Actros MP4 64201420 OES

Valeo

Valeo

Valeo

Valeo

Valeo

Valeo

* Sales of this product not allowed in Germany / Vente de ce produit non autorisée en Allemagne

882272*

WVA 29244

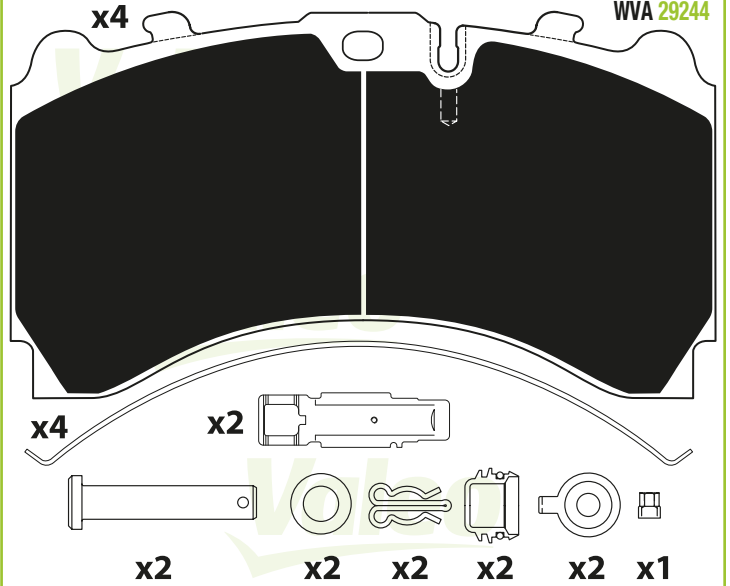

207.2 113.7 30 KNORR SL7 MERCEDES-BENZ Actros MP4 64201520 OES

Valeo

Valeo

Valeo

Valeo

Valeo

Valeo

* Sales of this product not allowed in Germany / Vente de ce produit non autorisée en Allemagne



















OptiPACK™

Valeo	WVA	TEXTAR	FERODO	ABEX	BERAL	JURID
882200	29087	2920202	FCV1373BFE	G6843FE	2917930004145504	2910815390
882201	29087	2919670	FCV1373BFE+FAI160	G6843FE+FAI160	2917930004145504+UAI160	2910815390 +
882202	29087	2920202+98025400(P8535)	FCV1373BFE+FAI141	G6843FE+FAI141	2917930004145504+UAI141	2910815390 +
882203	29087	2920202+98028900(P8548)	FCV1328BFE+FAI137	G6841FE+FAI137	2917930004145694	2910815390 +
882204	29095	2909504	FCV1275BFE	G6746FE	2919730004145504	2909305390
882205	29095	2909504+98025300(P8534)	FCV1275BFE+FAI160	G6746FE+FAI160	2919730004145504+UAI160	2909305390 +
882206	29095	2909504+98028800(P8547)	FCV1329BFE+FAI136	G6813FE+FAI136	2919730004145504+UAI136	2909305390 +
882207	29165	2916503	FCV1678B	G6938	2916530004145754	
882208	29167	2916702	FCV1677B	G6937	2916730004145754	
882209	29171	2917103	FCV1825B	G6939	2917130004145754	
882210	29115	2914812	FCV1277BFE	G6796FE	2918327004145503	
882211	29030	2903007	FCV1585BFE	G6898FE	2921028004145724	2903005390
882212	29030	2903007+98031900	FCV1585BFE+FAI101	G6898FE+FAI101	2921028004145724+UAI101	2903005390 +
882213	29030	2903071	FCV1585BFE+FAI165	G6898FE+FAI165	2921028004145724+UAI165	2903005390 +
882214	29113	2911303+98024300(P8521)	FCV1578BFE+FAI161	G6912+FAI161	2921028004145684+UAI161	2903005390 +
882215	29030	2908302+98017600(P8506)	FCV1762BFE+FAI108	G6930+FAI108	2921028004145504+UAI108	2903005390 +
882216	29113	2911303+98024300(P8521)	FCV1585BFE+FAI161	G6898FE+FAI161	2921028004145724+UAI161	2903005390 +
882217	29090	2909006+98031900	FCV1047B+FAI101	G6644+FAI101	2909028004145724+UAI101	2909005392 +
882218	29090	2909071	FCV1047B+FAI116	G6644+FAI116	2909028004145724+UAI116	2909005392 +
882219	29131		FCV1404BFE+FAI164	G6920FE+FAI164	2915630004145684+UAI164	2913109560 +
882220	29131	2913171	FCV1404BFE+FAI163	G6921FE+FAI163	2915630004145684+UAI163	2913109560 +
882221	29125	2912503	FCV1388B	G6919	2912529004145624	2912509560
882222	29124	2912405	FCV1857BFE	G6951FE	2915527004145504	2912409560
882223	29088	2908872	FCV1279B+FAI151	G6812+FAI151	2908826004145684+UAI151	2908809560
882224	29142	2914270	FCV1389 +	G6891 +	2914230004045724 +	2914209569 +
882225	29090	2909071	FCV1047B	G6644	2909028004145724	2909005392
882226	29131	2913171	FCV1404BFE	G6921FE	2915630004145684	2913109560
882227	29159	2915901 +	FCV1964 +	G6977 +		2915905390 +
882228	29159	2915901	FCV1964	G6977		2915905390
882229	29088	2908807 +	FCV4283 +	G6974 +		2908809560 +
882230	29088	2908807	FCV4283	G6974		2908809560

TRW	JURATEK	ETF	TRUSTING	EFI	LUMAG
GDB5067	JCP988+JCK509	12-5278	601.0	EDB1314	291080090110
GDB5067+GIC5016	JCP988+JCK509+JCW128	12-5278	+ 601.0W	EDB1314+EFA018	291080090110
GDB5067+GIC5014	JCP988+JCK509+JCW131	12-5278+BZ1065W	601.0	+ EDB1314+EFA017	291080090110
GDB5067	+ JCP988+JCK509+JCW134	12-5278	+ 601.0	+ EDB988	+ 290590090110
GDB5072	JCP1329+JCK509	12-5284	600.0	EDB1329	290950090110
GDB5072+GIC5016	JCP1329+JCK509+JCW128	12-5284	+ 600.0	+ EDB1329	+ 290950090110
GDB5072	+ JCP1329+JCK509+JCW135	12-5284	+ 600.0	+ EDB1329	+ 290950090110
GDB5092	JCP131+JCK509	12-5315	611.0	EFC131	
GDB5091	JCP133+JCK509	12-5314	612.0	EFC133	
GDB5093	JCP132+JCK509	12-5322	668.0	EFC132	
GDB5073	JCP1277+JCK509	12-5321	599.0	EDB1277	
GDB5065	JCP760	12-5264	602.0	EDB760	290300090110
GDB5065+GIC5011	JCP760	+ 12-5264	+ 602.0	+ EDB760	+ 290300090110
GDB5065+GIC5009	JCP760+JCW111	12-5264	+ 602.0	+ EDB760	+ 290300090110
GDB5065+GIC5012	JCP760+JCW135	12-5264	+ 602.0	+ EDB760	+ 290300090110
GDB5000+GIC5010	JCP760	+ 12-5264	+ 602.0	+ EDB760	+ 290300090110
GDB5065+GIC5012	JCP760+JCW135	12-5264	+ 602.0	+ EDB760	+ 290300090110
GDB5019+GIC5011	JCP1047	+ 12-5280	+ 605.0	+ EDB1047	+ 290900090100
GDB5019+GIC5013	JCP1047+JCW312	12-5280	+ 605.0	+ EDB1047	+ 290900090100
GDB5086	+ JCP1404+JCW124	12-5310	+ 603.1W	+ EFC124	
GDB5086+GIC5020	JCP1404	+ 12-5310	+ 603.0W	+ EFC124	
GDB5085	JCP1388	12-5317	609.0	EFC121	
GDB5082	JCP109+JCK518	12-5295	619.0	EFC109	291240090100
GDB5069+GIC5027	JCP1279+JCW123+JCK508	12-5285	+ 598.3W	EDB1279+EFA026	290880090200
GDB5084+GIC5019	JCP130+JCW127+JCK521	12-5313	606.1W	EFC130+EFA030	
GDB5019	JCP1047	12-5280	605.0	EDB1047	290900090100
GDB5086	JCP1404	12-5310	603.0W	EFC124	
GDB5095	JCP1389+JCW126+JCK510	12-5318	+ 609.0	+ EFC 113	
GDB5083	JCP1279+JCW120	12-5318		EFC 113	
GDB5069	+ JCP1279+JCW120+JCK508	598.0	+ 598.0	EDB 1279+EFA023	290880090200
GDB5069	JCP1279+JCW120	598		EDB 1279	290880090200

Valeo	WVA	TEXTAR	FERODO	ABEX	BERAL	JURID
882231	29011	2901105 + 98022400 (L300)	FCV773 +	G6502 +	2901125004034754 +	2901104240
882232	29011	2901105	FCV773	G6502	2901125004034754	2901104240 (wear sensor included)
882233	29122	2912204+98025000 (L475)	FCV1126 +	G6727 +	2912222004017214 +	2937409560 +
882234	29122	2912204+98022300 (L495)	FCV1126 +	G6727 +	2912222004017214 +	2937409560 +
882235	29122	2912204	FCV1126	G6727	2912222004017214	2937409560
882236	29067	2906705+98028400 (L150)	FCV733 +	G6487 +	2906722004034754 +	2906703342
882237	29011	2901105 + 98022400 (L300)	FCV773 +	G6502 +	2901125004034754 +	2901104240
882238	29088	2908807+98024400)				2914405390 +
882239	29835	2983506 + 98022000	FVR1522 +	G6895 +	2983521704040274 +	2983505440
882240	29835	2983506	FVR1522	G6895	2983521704040274	
882241	29065	2906504 + 98022300	FVR1522 +	G6492 +		
882242	29065	2906504	FVR1522	G6492		
882243	29173	2917301+98028200	FCV1856B +		2920329004145724 +	2917309560 +
882244	29173	2917301	FCV1856B		2920329004145724	2917309560
882245	29174	2917401+98028200	FCV1989BFE +	G6961FE +	2921829004145724 +	2917409560 +
882246	29174	2917401	FCV1989BFE	G6961FE	2921829004145724	2917409560
882247	29177	2917701+98028200	FCV4170B +	G6964 +	2917729004145724 +	2917709560 +
882248	29177	2917701	FCV4170B	G6964	2917729004145724	2917709560
882249	29181	2918101	FCV1815BFE	G6944FE	2920730004145814	
882250	29162	2916201	FCV1828	G6935		2916205390
882251	29143	2914302	FCV1367B	G6887	2914330004145504	
882254	29067	2906705	FCV733	G6487	2906722004034754	
882255	29067	2906705 +	FCV733 +	G6487 +	2906722004034754 +	
882257	29039	2903902 +	FCV70 +	G6398 +	2903922004034224 +	
882258	29067	2906705	FCV733	G6487 +	2906722004034754 +	2906703342
882259	29181	2918101 +	FCV1815BFE +	G6944FE +	2920730004145814 +	
882270	29137	291706	FCV1387B	G6889	2913729004145624	2913709560
882271*	292646		FCV4417PTS			2924605390
882272*	2926464		FCV4418PTS			2924405390

* Sales of this product not allowed in Germany / Vente de ce produit non autorisée en Allemagne

TRW	JURATEK	ETF	TRUSTING	EFI	LUMAG
GDB5024+GIC5007				EDB773+EFA008	290110090110 
GDB5024				EDB773	290110090110
GDB5068+GIC5017		12-5272 	277.0	EDB1126+EFA019	
GDB5068+GIC5017		12-5272 	277.0	EDB1126+EFA019	
GDB5068		12-5272	277.0	EDB1126	
GDB5058+GIC5002			278.0 	EDB733+EFA234	
GDB5024+GIC5007				EDB773+EFA008	290110090110 
GDB5069+GIC5018		12-5285 	598.0 	EDB 1279+EFA023	290880090200
GDB5050+GIC5004				EDB501+EFA007	298350090210 
GDB5050				EDB501	298350090210
GDB5004+GIC5004				EDB501+EFA007	290650090210 
GDB5004				EDB501	290650090210
GDB5102+senor					
GDB5102					
GDB5096 			825.0 		
GDB5096			825.0		
GDB5098 					
GDB5098					
GDB5100					
GDB5094					
GDB5090			610.0		
GDB5058			278.0		
GDB5058 			278.0 		
GDB5058 					290390090210 
GDB5058+GIC5002			278.0	EDB733	
GDB5100 					
GDB5089		12-5320	608.0		
GDB5111		12-5320	950.0		
GDB5110		12-5320	951.0		

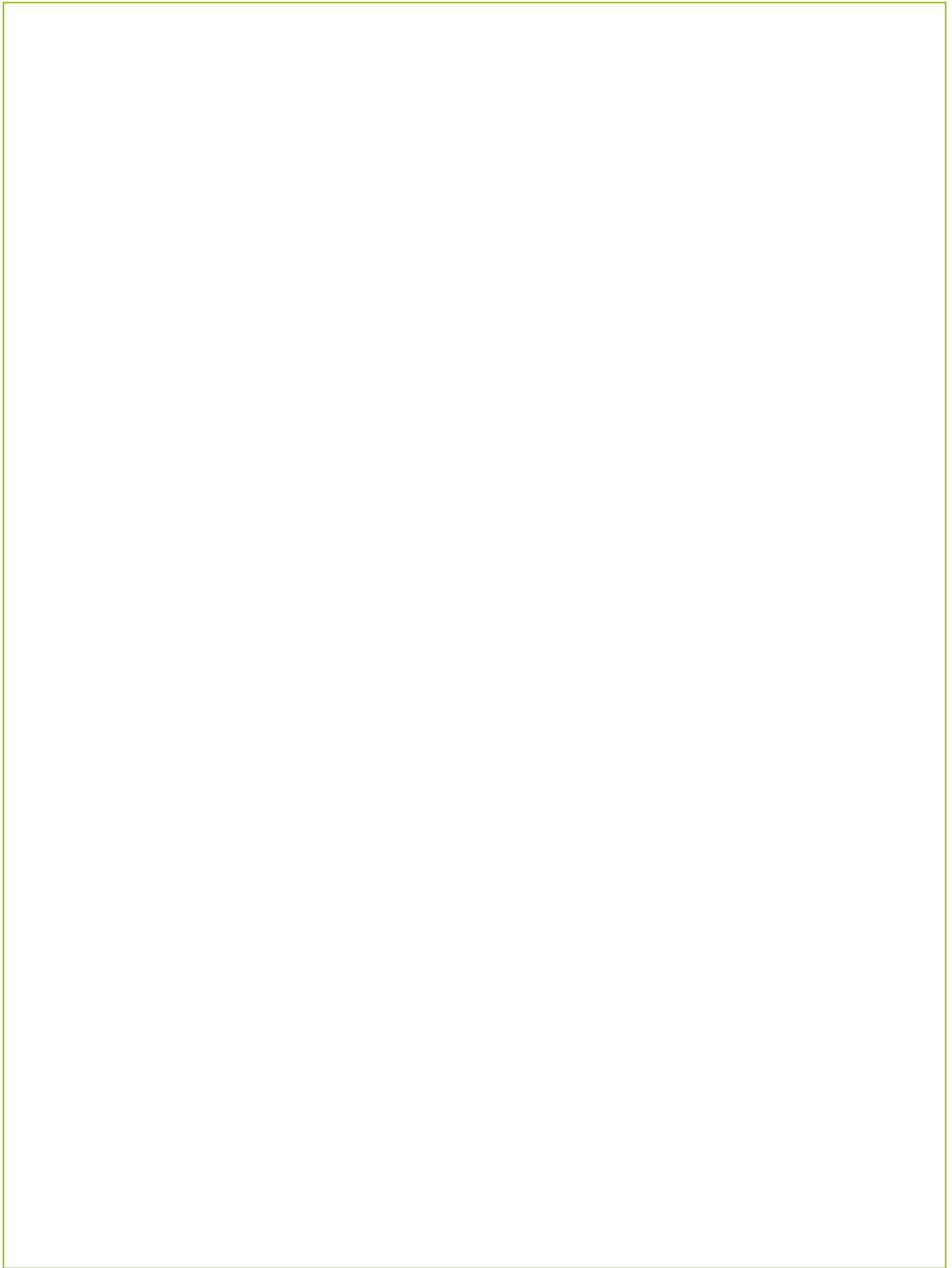

Every effort has been made to ensure that the information contained in this catalogue is correct at the time of printing, but no warranty or representation is given or made as to the accuracy of such information and Valeo Service UK Ltd does not accept any liability whatsoever for any inaccuracies.

Valeo Service UK Ltd reserves the right to alter specifications and/or the final construction of products without notice.

Product references referred to in this catalogue may not be available in all countries.

All orders for products are only accepted subject to the terms and conditions of Valeo Service UK Ltd.

Photographs and drawings are not binding on Valeo Service UK Ltd. The copyright in this publication belongs to Valeo Service UK Ltd exclusively. No part of this publication may be reproduced by any means without the prior authorisation of Valeo Service UK Ltd.

L'affectation et la préconisation des produits figurant dans nos catalogues prennent en compte l'état du parc automobile au jour de leur parution.

La responsabilité de Valeo Service ne saurait être engagée en cas de modification, substitution ou suppression des affectations ou préconisations qui pourraient intervenir notamment à l'initiative des constructeurs de véhicules.

Les caractéristiques techniques de nos produits sont susceptibles d'évoluer à tout moment pour tenir compte des

améliorations techniques et technologiques.

Certaines références peuvent ne pas être disponibles dans tous les pays.

Les commandes sont régies par les conditions générales de vente de Valeo Service.

Photos et dessins non contractuels. La reproduction de tout ou partie de cette publication est interdite sans l'autorisation expresse et écrite de Valeo Service.

La aplicación de los productos sobre vehículos y las especificaciones de los productos que figuran en nuestros catálogos se refieren a la situación del parque de automóviles en la fecha de puesta en circulación de los productos.

Valeo Service España SA no asume ninguna responsabilidad en caso de modificación, sustitución o supresión de dichas aplicaciones y/o especificaciones que pudieran producirse por iniciativa de los fabricantes de automóviles.

Las características técnicas de nuestros productos son susceptibles de evolucionar en cualquier momento para

incorporar las mejoras técnicas y tecnológicas que se desarrollen.

Las referencias de productos mencionadas en este catálogo puede que no estén disponibles en todos los países.

Los pedidos se regirán por las condiciones generales de venta de Valeo Service España SA.

Las fotografías y dibujos que aparecen en nuestros catálogos son meramente indicativas, por lo que no siempre coinciden exactamente con la apariencia externa de nuestros productos. Se prohíbe la reproducción de todo o parte de esta publicación sin la autorización expresa y escrita de Valeo Service España SA.

As prescrições e recomendações relativas ao uso ou utilidade dos produtos constantes de nossos catálogos levam em consideração o estado do parque automotivo à época do lançamento desses produtos.

A Valeo Sistemas Automotivos Ltda (Valeo Cibié Service) não será responsável por quaisquer modificações, substituições ou supressões incidentes sobre as prescrições e recomendações relativas ao uso ou utilidade de nossos produtos, que sejam decorrentes de ações dos construtores de veículos.

As características técnicas de nossos produtos são suscetíveis de alteração a qualquer momento para que sejam

incorporadas melhorias técnicas e/ou tecnológicas.

Certas referências podem não estar disponíveis em todos os países.

Os pedidos feitos pelos clientes são regidos pelas condições gerais de venda da Valeo Sistemas Automotivos Ltda (Valeo Cibié Service).

Fotos e desenhos não contratuais. A reprodução do todo ou de parte desta publicação é proibida sem a autorização expressa e por escrito da Valeo Sistemas Automotivos Ltda (Valeo Cibié Service).

Le applicazioni e le specifiche dei prodotti che figurano nei nostri cataloghi si riferiscono alla situazione del parco circolante al momento della pubblicazione.

Valeo Service Italia S.p.A. declina qualsiasi responsabilità in caso di modifica, sostituzione o soppressione di applicazioni o specifiche eventualmente apportate, senza preavviso, da parte dei Costruttori.

Le caratteristiche tecniche dei nostri prodotti sono suscettibili di modifiche in qualsiasi momento, per apportare migliorie tecniche e tecnologiche.

Alcuni riferimenti presenti in questo catalogo non sono disponibili in tutti i paesi.

Gli ordini sono regolamentati dalle condizioni generali di vendita di Valeo Service Italia S.p.A.

Le Foto ed i disegni che appaiono nel catalogo sono puramente indicativi. E' vietata la riproduzione della totalità o di una parte della presente pubblicazione senza un'esplicita autorizzazione scritta da parte di Valeo Service Italia S.p.A.

De ter zake van de producten in onze catalogi aangegeven bestemmingen en gedane aanbevelingen zijn gebaseerd op het wagenpark ten tijde van publicatie.

Valeo Service Benelux B.V. sluit elke aansprakelijkheid uit met betrekking tot wijziging, vervanging of annulering van de bestemmingen of aanbevelingen, die met name op initiatief van de autofabrikanten kunnen worden doorgevoerd.

De technische eigenschappen van onze producten kunnen te allen tijde evolueren teneinde rekening te houden met technische en technologische verbeteringen.

Bepaalde artikelen kunnen in bepaalde landen niet beschikbaar zijn.

Orders zijn onderworpen aan de algemene verkoopvoorwaarden van Valeo Service Benelux B.V.

Foto's en tekeningen zijn niet bindend.

De gehele of gedeeltelijke verveelvoudiging van deze uitgave zonder uitdrukkelijke voorafgaande schriftelijke toestemming van Valeo Service Benelux B.V. is verboden.

Die Verwendungsempfehlungen zu den in diesem Katalog aufgeführten Produkten beziehen sich auf den zum Zeitpunkt des Erscheinens dieses Katalogs existierenden Fahrzeugbestand.

Valeo Service Deutschland GmbH übernimmt keine Haftung für Änderungen, Ersetzungen oder Streichungen der Fahrzeuganwendung oder -Empfehlungen, die besonders auf Initiative der Fahrzeughersteller auftreten können.

Die technischen Eigenschaften unserer Produkte unterliegen ständiger Entwicklung, um technischen und technologischen Verbesserungen Rechnung zu tragen.

Die Fotos oder Zeichnungen in diesem Katalog dienen ausschliesslich der Veranschaulichung unserer Produkte.

Rechtliche Ansprüche können daraus nicht abgeleitet werden.

Einige Produktreferenzen sind nicht in allen Ländern verfügbar.

Lieferungen unterliegen den Allgemeinen Verkaufsbedingungen von Valeo Service Deutschland GmbH.

Die Vervielfältigung dieses Katalogs oder Teilen davon ohne die schriftliche Erlaubnis von Valeo Service Deutschland GmbH ist nicht zulässig.

Przeznaczenie i zalecenia dotyczące produktów figurujących w naszych katalogach biorą pod uwagę stan parku samochodowego w dniu ich wprowadzenia na rynek.

Spółka «Valeo Service Eastern Europe Sp.zo.o.» nie może być ponosić odpowiedzialności w przypadku zmiany, zastąpienia lub usunięcia wskazówek dotyczących przeznaczenia i zaleceń, które mogą wystąpić z inicjatyw producentów samochodów.

Dane techniczne naszych produktów mogą być w każdej chwili zmienione w celu uwzględnienia

ulepszeń technicznych i technologicznych.

Niektóre modele mogą być niedostępne w niektórych krajach.

Zamówienia podlegają ogólnym warunkom umów «Valeo Service Eastern Europe Sp.zo.o.».

Wykorzystywanie w całości lub w części zdjęć i rysunków zamieszczonych w naszych katalogach wymaga pisemnej zgody «Valeo Service Eastern Europe Sp.zo.o.».

Učinili jsme všechny kroky nezbytné k tomu, aby informace v tomto dokumentu byly přesné ke dni jeho tisku. Valeo Service Export nezodpovídá za případné neúplné či chybné informace zde uvedené.

Valeo Service Export si vyhradzuje právo úpravy specifikace a / nebo konečné formy výrobku bez předchozího upozornění.

Katalogová čísla obsažená v tomto katalogu nemusí být dostupná k prodeji na všech trzích. Konečné objednaní výrobků se řídí obchodními podmínkami Valeo Service Export.

Fotografie a technické náčrty nezávisí na Valeo Service Export. Copyright je exkluzivní Valeo Service Export. Žádná část tohoto katalogu nesmí být kopírována bez autorizace Valeo Service Export.

A VALEO teljes tudásával arra törekszik, hogy a katalógusban szereplő adatok műszaki tartalma teljesen korrekt legyen, ezért a VALEO SERVICE EXPORT nem vállal garanciát azok helyességéért, pontatlanságáért és nem terheli felelősség az esetleges hibákból eredő károkat.

A VALEO SERVICE EXPORT fenntartja a jogot a termékváltoztatásokra mellékelt termékinformáció nélkül.

A katalógusban szereplő cikkszámok között előfordulhatnak olyanok is, melyek nem minden országban kerülnek

forgalomba.

Minden termék rendelés a VALEO SERVICE EXPORT szerződés kondíciói alapján érvényes.

A katalógusban szereplő fényképek és rajzok nem a VALEO SERVICE EXPORT készítményei. A szerzői jogok a VALEO SERVICE EXPORT kizárólagos tulajdonát képezik.

A kiadvány részét nem képező reprodukciókhoz nem szükséges a VALEO SERVICE EXPORT engedélye.

Назначение и рекомендации по эксплуатации продукции, содержащиеся в наших каталогах, указываются с учетом состояния автомобильного парка на день ее появления.

Компания «Valeo Service Eastern Europe Sp.zo.o.» не несет ответственности в случае внесения изменений в рекомендации по эксплуатации продукции или их устранения, произошедших, в частности, по инициативе производителей автомобилей.

Технические характеристики нашей продукции могут претерпевать изменения в любой момент, с учетом усовершенствования технических и технологических процессов.

Некоторые виды продукции могут не иметься в наличии в отдельных странах.

Заказы осуществляются согласно общим правилам торговли, применяемым в компании «Valeo Service Eastern Europe Sp.zo.o.».

Фотографии и изображения продукции могут не в полной мере соответствовать оригиналам.

Воспроизведение всей или части настоящей публикации запрещено без специального письменного согласия компании «Valeo Service Eastern Europe Sp.zo.o.».

Kataloglarımızda yer alan ürünlerin kullanım ve tanımları, otomobil parkının yaygın tarihindeki durumuna göredir.

Valeo Otomotiv Dağıtım AS, özellikle araç, üreticilerinin inisiyatifli sonucu yapılan değişiklikler, ikame veya kaldırılmaları sorumlu tutulamaz.

Ürünlerimizin teknik özellikleri, teknik ve teknolojik gelişmelere paralel olarak geliştirilebilir.

Bazı referanslar bazı ülkelerde bulunmayabilir.

Siparişler, Valeo Otomotiv Dağıtım AS'un genel satış koşullarına uygun olarak ödenir.

Fotoğraf ve resimler akdi değildir. İşbu yayının Valeo Otomotiv Dağıtım AS'un önceden verilmiş yazılı izni olmaksızın kısmen veya tamamen çoğaltılması yasaktır.

O catálogoс έχει συσταθεί λαμβάνοντας υπόψη τη σύσταση του οτολου αυτοκινητών την ημέρα, της κυκλοφορίας του.

H Valeo δε φέρει ευθύνη σε Περίπτωση τροποποίησης, αλλαγής ή αντικατάστασης κάποιου αντίκτου που Περιεχεται στο κατάλογο, εξαιτίας Πρωτοβουλίας του κατασκευαστή του οχήματος.

Τα τεχνικά χαρακτηριστικά των Προϊόντων ενδεχεται να διαφοροποιηθούν ανά Πάσα στιγμή λογο

τεχνολογικών εξελίξεων.

Μερικοί κωδικοί αντίκων μΠορεί να μην είναι διαθέσιμοι σε κάποιες χώρες.

Οι Παραγγελίες υΠεκινται στους γενικούς ορους Πωλήσεων της Valeo.

Οι φωτογραφίες και τα σχέδια δεν είναι δεσμευτικά. Η αναΠαραγωγή ολοκληρου ή τμήματος αυτού του καταλογου αΠαγορεύεται να γίνει χωρίς τη ρητή και γραΠτή άδεια της Valeo Service.

882271 & 882272

Anglais Sales of this product not allowed in Germany
Français Vente de ce produit non autorisée en Allemagne
Spanish La venta de estos productos no está permitida en Alemania
Portugal A venda destes produtos não é permitida na Alemanha
Italian La vendita di questo prodotto non è consentita in Germania
Netherlands Verkoop uitgezonderd in Duitsland
Allemand Verkaufsverbot in Deutschland

Polish Sprzedaż tego produktu nie jest dozwolona w Niemczech
Czech Republic Prodej tohoto výrobku není dovolen na území Německa
Hungarian A termék értékesítése tilos a Német Köztársaság területén
Russian Общество с ограниченной ответственностью «Валео Сервис»
Turc Bu ürün serisinin Almanya'da satışı yoktur
Grec Οι πωλήσεις του προϊόντος αυτού δεν επιτρέπεται στη Γερμανία

EUROPE

FRANCE

VALEO SERVICE FRANCE
70, RUE PLEYEL
93285 SAINT-DENIS CEDEX - FRANCE
TEL.: (+33) 1 49 45 32 32
FAX: (+33) 1 49 45 37 36
S.A.S. au capital de 12 900 000 €
RCS Bobigny B 306 486 408

SPAIN, PORTUGAL

VALEO SERVICE ESPAÑA, S.A.
CALLE RIO ALMANZORA, N°5
AREA EMPRESARIAL ANDALUCIA C.L.A.
28906 GETAFE (MADRID) - ESPAÑA
TEL.: (+34) 91 495 85 00
FAX: (+34) 91 495 86 99
TEL. ATENCIÓN TÉCNICA:
902 011 799
TEL. ATENCIÓN AL CLIENTE:
900 122 657

Valeo Service España Sociedad Anónima
inscrita en el Registro Mercantil de Madrid,
Tomo 972 - Libro 941 de la sección 8ª,
Folio 25 - Hoja 65435 - Inscripción 1ª NIF. A28772978

ITALY

VALEO SERVICE ITALIA SPA (V.S. ADRIATIC)
VIA ASTI 89
10026 SANTENA (TO) - ITALIA
TEL.: (+39) 011 94 95 1
FAX: (+39) 011 94 95 280
TEL. LINEA TECNICA : 800 805 046
N. iscrizione al Tribunale di Torino 2009/88 reg. soc.
C.C.I.A.A. 715107 - Capitale sociale € 2.600.000

UNITED KINGDOM

VALEO SERVICE UK LTD
HEMING ROAD - WASHFORD
REDDITCH - WORCS B98 0DZ - ENGLAND
TEL.: (+44) 1527 838 300
FAX: (+44) 1527 523 732
Registration Number: 956685

GERMANY

VALEO SERVICE DEUTSCHLAND GMBH
BRANDENBURGER STRASSE 46
40880 RATINGEN - DEUTSCHLAND
TEL.: (+49) 21 02 865 0
FAX: (+49) 21 02 865 142
Handelsregister Ratingen - HRB 3340

BENELUX

VALEO SERVICE BENELUX B.V.
HEIBLOEMWEG 1
5704 BS HELMOND - THE NETHERLANDS
TEL. BELGIUM (NL): (+32) 2 366 99 17
TEL. BELGIUM (FR): (+32) 2 355 14 46
TEL. NETHERLANDS: (+31) 492 580 894
FAX BELGIUM: (+32) 2 366 04 47
FAX NETHERLANDS: (+31) 492 580 828
K.v.K. Eindhoven 33113859

POLAND, LITHUANIA, LATVIA, ESTONIA, MOLDAVIA, BELARUS, UKRAINE

VALEO SERVICE EASTERN EUROPE Sp z o.o.
WOŁOSKA 9A
02-583 WARSAW POLSKA
TEL.: (+48) 22 543 43 00
FAX: (+48) 22 543 43 05
Valeo Service Eastern Europe Sp. z o.o.; NIP 521-11-44-572
VAT UE PL5211144572 - REGON 011909673
Wysokość kapitału zakładowego: 4 637 000 PLN - KRS
56793 Sąd Rejonowy dla m. St. Warszawy w Warszawie,
XIII Wydział Gospodarczy KRS

RUSSIA

VALEO SERVICE CO LTD
107140, MOSCOW
RUSAKOVSKAYA ST. 13,
3RD FLOOR, OFFICE 6
TEL.: (+7) 495 981-06-96
FAX: (+7) 495 787-59-92

SWITZERLAND, AUSTRIA, SWEDEN, FINLAND, NORWAY, DENMARK, ICELAND, EASTERN EUROPE

VALEO SERVICE EXPORT
70, RUE PLEYEL
93285 SAINT-DENIS CEDEX - FRANCE
TEL.: (+33) 1 49 45 32 32
FAX: (+33) 1 49 45 36 59
S.A.S. au capital de 12 900 000 €
RCS Bobigny B 306 486 408

LIAISON OFFICE IN AUSTRIA
MÜHLGASSE 7
2380 PERCHTOLDSDORF - AUSTRIA
TEL.: (+43) 1 480 42 46
FAX: (+43) 1 480 42 34

LIAISON OFFICE IN CZECH REPUBLIC
DEDINSKA 29
16101 PRAGUE 6 - CZECH REPUBLIC
TEL.: (+420) 220 102 277
FAX: (+420) 220 102 278

LIAISON OFFICE IN HUNGARY
ROZSAKVARC UTCA 8
1188 BUDAPEST- HUNGARY
TEL.: (+36) 30 50 51 888
FAX: (+43) 1 480 42 34

LIAISON OFFICE IN SWEDEN
REGUS / VALEO
MASTER SAMUELSGATAN 60, 8TR
SE - 111 21 STOCKHOLM - SWEDEN
TEL.: (+46) 8 50 51 65 50

SOUTH AMERICA

LATIN AMERICA (except Mexico)

VALEO CIBIÉ SERVICE LTDA
RUA SADAÉ TAKAGI, 2000
BAIRRO COOPERATIVA
09852-070 - SÃO BERNARDO DO CAMPO
SÃO PAULO - BRASIL
TEL.: (+55) 11 43 93 33 54
FAX: (+55) 11 43 93 33 55
C.N.P.J.: 57.010.662/0008-36
Inscrição Estadual : 635.331.124.114

VALEO SERVICE ARGENTINA
RUA SADAÉ TAKAGI, 2000
BAIRRO COOPERATIVA
09852-070 - SÃO BERNARDO DO CAMPO
SÃO PAULO - BRASIL+
TEL.: (+55) 11 43 93 33 54
FAX: (+55) 11 43 93 33 55
C.N.P.J.: 57.010.662/0008-36
Inscrição Estadual : 635.331.124.114

MEXICO

LIAISON OFFICE IN MEXICO
MONTECITO 38, PISO 14 OFICINA 38.
TORRE WORLD TRADE CENTER
COLONIA NÁPOLES | 03810 | MÉXICO, D.F.
TEL.: +52 (55) 90001588

ASIA, MIDDLE EAST, AUSTRALIA, NEW-ZEALAND

VALEO SERVICE EXPORT
70, RUE PLEYEL
93285 SAINT-DENIS CEDEX - FRANCE
TEL.: (+33) 1 49 45 32 32
FAX: (+33) 1 49 45 36 59

CHINA

**VALEO AUTO PART TRADING
(SHANGHAI) CO., LTD**
201, BUILDING B, IBC TOWER (NEW
INTERNATIONAL BUSINESS CENTER)
391 GUI PING ROAD, SHANGHAI 200233, CHINA
TEL: (+86) 21 5175 2618
MP: (+86) 21 5175 2628

法雷奥汽车零部件贸易(上海)有限公司
地址: 上海市徐汇区桂平路391号新漕河泾国际商务中心B座201
电话: (+86) 21 5175 2618
传真: (+86) 21 5175 2628

**TURKEY, IRAN, IRAQ, SYRIA, LEBANON,
JORDAN, SAUDI ARABIA, UNITED ARABE
EMIRATES, KUWAIT, BAHRAIN, QATAR,
OMAN, YEMEN, EGYPT**

VALEO OTOMOTIV SISTEMLERİ ENDÜSTRİSİ A.Ş.
AYDINEVLER SANAYİ CADDESİ
CENTRUM İS MERKEZİ N°3
KAT: 3, DAİRE N°302-303 KÜÇÜKYALI - MALTEPE
34854 İSTANBUL - TÜRKİYE
TEL.: (+90) 216 518 75 75
FAX.: (+90) 216 519 93 14

AFRICA, DOM-TOM

VALEO SERVICE EXPORT
70, RUE PLEYEL
93285 SAINT-DENIS CEDEX - FRANCE
TEL.: (+33) 1 49 45 32 32
FAX: (+33) 1 49 45 36 59
S.A.S. au capital de 12 900 000 €
RCS Bobigny B 306 486 408

LIAISON OFFICE IN TUNISIA
CENTRE D'AFFAIRES REGUS
IMMEUBLE CARTHAGE RUE DU LAC DE CONSTANCE
1053 TUNIS - TUNISIA
TEL.: (216) 71 965 002
FAX: (216) 71 965 137
MOB: (216)98 34 91 38

Valeo, Your Heavy-Duty Multi-specialist**



3 276429 583005

*Valeo, votre Multispécialiste du poids-lourd

valeo added ■■■■■

Automotive technology, naturally

