



MASERATI

Levante

Levante

The Maserati of SUVs



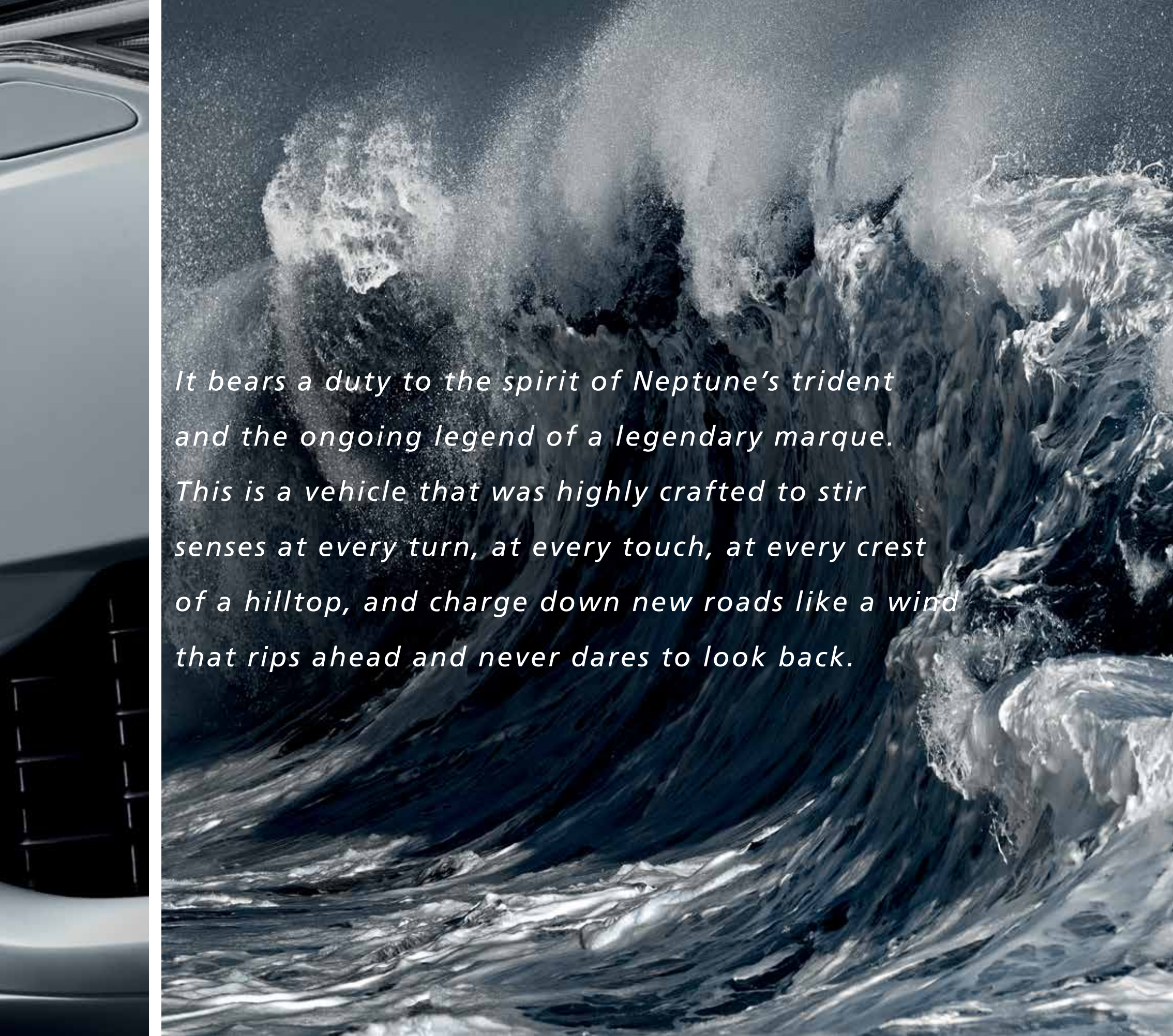

*It bears a duty to the spirit of Neptune's trident
and the ongoing legend of a legendary marque.
This is a vehicle that was highly crafted to stir
senses at every turn, at every touch, at every crest
of a hilltop, and charge down new roads like a wind
that rips ahead and never dares to look back.*





*Our vehicles are named
after exotic foreign winds.
Our vessels are propelled by them.*













*Craftsmanship is at
the helm.*

Far more than just an example of superb automotive design and craftsmanship, the Levante is underpinned by Maserati's unparalleled engineering prowess and its mastery of four-wheel-drive technology.







A close-up photograph of a red leather car seat headrest. The Maserati logo, a trident with a crown, is embossed in the center of the headrest. The leather has a fine, pebbled texture. In the background, other red leather seats are visible, also featuring the Maserati logo. The lighting is dramatic, highlighting the contours and texture of the leather.

*The lap of luxury
for tracks all your own.*

Superbly ergonomic front seats envelop their occupants in premium leather and provide excellent support, whilst all-around serenity reigns supreme in an environment of unsurpassed luxury. Only the very finest materials have been selected to grace the Levante's cabin, including high-quality leather, fine woods, platinum-effect metals and handcrafted contrast stitching. Then, for the ultimate in driving ease, there is the option of twelve-way, power-operated front seats, heated and ventilated front seats, and electrically adjustable pedals. Special sports seats are also available with twelve power-operated positions.

Passengers in the rear benefit from an asymmetrically split, leather bench seat for up to three people, complete with a fold-down central armrest that contains two cupholders. Two USB ports are located in a compartment at the end of the central console, above the rear air vents. The outer rear seats are equipped with ISOFIX attachments, the universal child seat mounting system and, for even more comfort and luxury, heated rear seats are an option. Fresh air aficionados will also appreciate the optional dual panel, full panorama electric sunroof.





It delivers its own breathtaking vista.

Sitting behind the steering wheel, the driver is aware of the fine balance between intimacy and roominess, along with a feeling of total confidence and command, as all the main controls fall immediately to hand. The smooth lines of the leather-clad dashboard provide an atmosphere of opulence, whilst in the central console is the large, display screen, along with controls for the transmission and climate control and infotainment systems. As an extra special touch of exclusivity, a dual-colour leather dashboard is an option. Ahead of the driver, the simple yet striking instrument panel is similar to that of Maserati's flagship, the Quattroporte, with a large speedometer and rev counter separated by a 7" TFT display that shows the car's dynamic data. The highly tactile, leather-clad steering wheel features controls for interacting with the main multimedia functions, and behind this are the long gearshift paddles in an elegant brushed chrome finish.





*Legendary Maserati luxury
on an entirely new scale.*

Always accommodating: Dual-Zone Climate Control.

The automatic Dual-Zone Climate Control automatically adjusts the intensity of the ventilation in relation to the outdoor temperature, and allows everyone on board, front and rear, to select their own individual heat settings.

With 13 ventilation outlets, the system is able to cool or heat the car extremely rapidly and maintains the temperature by means of the Maserati Touch Control Plus display or the control panel beneath it. The system is fitted with an anti-misting sensor that is automatically programmed to reduce the humidity content of the air as soon as the windows start to mist up. All Levante versions are equipped with Air Quality Sensor. This feature combines an intelligent sensor and a signal analysis system that calculates the external pollution levels and prevents polluted air and toxic gases from entering in the car's cabin.

As an option, the Levante can be equipped with a Four-Zone climate control system, with two more controls in the rear part of the central tunnel.



Fine points that reward your taste for the finer things.



There's pure poetry in the sculpted details. On the central console, over the glove box, and in the front and rear door panels, the standard Black Piano trim can be replaced with optional luxury trim inserts. There is a choice of finishes in wood or carbon fibre.

Two open-pore woods, with their matt surfaces, give a rich, natural and tactile feel to the interior. Radica is a natural brown wood with dark veining. The lighter Rovere Chiaro is mainly beige, with warm honey nuances. The glossy lacquered woods, Ebano and Erable, make the interiors particularly energetic and modern. As an alternative to the woods, the Levante also features Carbonio, a glossy carbon fibre finish.



Ermenegildo Zegna exclusively for Maserati.

Connect with the hand, and you will reach the heart.

The best craftsmen choose to work with only the finest materials available; how well-suited that Maserati has partnered with Ermenegildo Zegna, one of the world's leading luxury menswear brand and producer of the finest fabrics. The company, still family-owned after over 100 years, has much in common with Maserati, given their Italian tradition of excellence and innovation. The next step of their partnership is the production of the new and exclusive Ermenegildo Zegna Edition interiors, which will give a dynamic and contemporary look to the Levante.

This exclusive new product, with its irresistible style, is perfect for the most discerning drivers and passengers, a luxury bracket of precious details' lovers. They recognize luxury just by touching it, and will undoubtedly feel fully satisfied when surrounded by the truly exquisite materials of the Ermenegildo Zegna interiors. The finest leather is combined with Zegna's mulberry silk inserts on the seats, door panels, roof lining, sunshades and ceiling light fixture. The silk is embellished by a hand-stitched micro-chevron pattern while the seating features a central silk insert with a macro-chevron weave. Door panels, roof lining and sun visor are covered with Zegna silk jersey. The offering includes three different colour combinations of leather and silk with contrasting stitching. In all, the Levante Zegna Edition marks the first milestone towards the renewed, future product line-up for Maserati, further enhancing the character and aesthetic value of this iconic marque.

LEVANTE ZEGNA EDITION INTERIOR

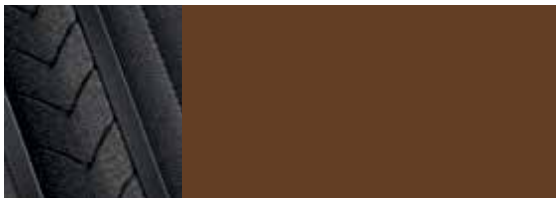

Tan Premium Leather / Dark Grey Zegna Silk
with Light Grey Contrast Stitching



Red Premium Leather / Dark Grey Zegna Silk
with Light Grey Contrast Stitching

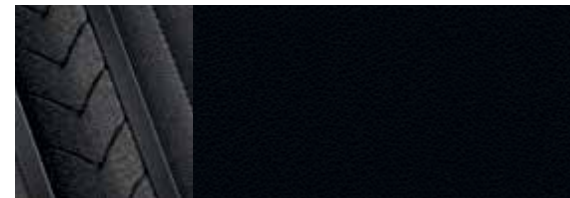

Black Premium Leather / Dark Grey Zegna Silk
with Light Grey Contrast Stitching



Unrestricted access: The convenience of Keyless Go.

In the world of Maserati, small details are everything – right down to the design of the aluminium key, which reflects the style of the Levante and incorporates Keyless Go technology. The standard keyless entry function enables the driver to open the doors or boot without ever touching the key. Once inside the car, the driver has only to press the ignition button to start the engine.

An extraordinary place for everything.

The interior of the Maserati Levante features numerous storage compartments for all the paraphernalia that accumulates in a car. Along with the spacious, illuminated, climate-controlled glove box, there are two concealed cup holders in the central tunnel, one with a 12V socket, and a handy cubbyhole with Aux-In and USB sockets for the connection of remote devices, and an SD card reader. Underneath the front armrest, there is another illuminated, soft-opening, climate-controlled compartment, with two more cupholders and a 12V power outlet. In the rear, there is a further 12V socket alongside the rear air vents, whilst the bench seat is divided by a fold-down central armrest, with two more cup holders. A fourth 12V outlet is located in the luggage compartment.





The seasoned traveller's approach to packing.

Operated via the car's remote control or internal and external buttons, the Levante's power tailgate reveals a 580-litre luggage compartment that is able to accommodate enough large suitcases for a long summer holiday – and more. As an option, the car can also be specified with 'hands free' opening, which can also be activated by simply placing a foot underneath the rear bumper when one's hands are full. Inside there is a boot light, a handy 12V power outlet and special chromed eyelets for the connection of luggage nets. The rear bench seatback can be folded down asymmetrically to take particularly large items of luggage, whilst a load-through hatch opens up to carry skis or golf clubs. As an option, special metal cargo rails with four movable rings are available to make the management of the luggage or load even easier.



The Maserati Levante is equipped with other electronic devices that have been designed to make driving safer and even more rewarding. These include the exterior electrochromic rearview mirrors that darken progressively as light intensity increases, and a power rear side sunblind to enhance privacy and screen occupants from sunlight. For greater thermal insulation and quieter journeys, the Levante can be specified with double laminated, acoustic glass windows at the rear (a standard feature of the windscreen and front windows). In addition, for additional versatility, a tow bar is available for this multi-talented vehicle. Its 2,700 kg towing capacity is ideal for boats, horseboxes, trailers and the like.



Information, control and hedonistic indulgence — all at your fingertips.

In the middle of the dashboard lies the nerve centre of the Maserati Levante: the new 8.4" Maserati Touch Control Plus (MTC Plus) system that provides user-friendly access to the car's many systems and devices. The system includes the car's radio, Bluetooth®, and satellite navigation system (where fitted), along with connections to other external sources like mobile phones, tablets and laptop computers. Using the Aux-In, USB sockets or SD card reader, the user can also play music or, when the car is stationary, watch films and view images on the screen. In addition, the MTC Plus controls the front-seat heating, as well as the car's ventilation, steering-wheel heating and glove box lock. The MTC's menus have options for configuring many of the car's main systems via the icons displayed at the bottom of the screen, whilst a new rotary control behind the gearshift adjusts the radio and other audio media settings.

The science of sound. The art of enjoyment.

The Levante features a powerful and carefully structured sound system as standard: two tweeters on the dashboard, a substantial woofer in each door and two additional tweeters in the rear doors, all powered by a head unit delivering a clear and perfectly defined audio image to all onboard.

Alternatively, the optional Premium Sound System, expertly crafted by Harman Kardon®, takes the quality of acoustic excellence to even higher levels with a 12-channel, 900-watt Class D amplifier and 14 carefully placed speakers: four tweeters, four mid-woofers, five mid-range speakers and a 20-litre bass box subwoofer. Should the recording being played feature a pin being dropped, you would undoubtedly hear it.

Audio perfection ... from the masters of sound.

For those demanding the ultimate acoustics in their Maserati Levante, we offer the high-performance Bowers & Wilkins Surround Sound system, which has been designed by the same engineers responsible for the British brand's 800 Series Diamond speakers, which are used as reference monitors by recording engineers in many of the world's most demanding professional studios.

It took these expert ears and many hours of listening to create the rich sound experience inside the Levante. The system's 17 speakers have been strategically incorporated into the car's architecture to ensure the best possible acoustics, so that everyone onboard benefits from a completely immersive audio experience.

The speaker drivers include Kevlar® mid-range units for precise, clear vocals, while the advanced aluminium tweeters capture the faintest subtleties — even the most delicate of brush strokes across the surface of a cymbal. To deliver rock-solid bass throughout the car, the engineers have used Rohacell® bass drivers: Rohacell is a stiff, highly resilient material often used in the construction of rockets and aircraft.

The speakers are powered by a highly capable 1,280-watt amplifier, with QuantumLogic™ signal processing and AuraVox equalization, while a Clari-Fi function intelligently corrects any deficiencies detected within compressed audio files.

Beyond its acoustics, the Bowers & Wilkins Surround Sound system is just as advanced and versatile in playing back your music choices, no matter how or where they are stored. It features a USB connector, so it is easy to plug in an iPhone® or any other digital music-playing device, or you can stream tracks directly via Bluetooth®.





Dare to go anywhere.

Luxurious in the extreme, and providing comfort and serenity for all onboard, the Levante can be relied on to deliver outstanding performance even in the most formidable terrain or weather conditions. Its aerodynamics and engine efficiency are unsurpassed, thanks in part to a clever air shutter behind the front air vents that controls the air flow through the radiator - improving even further its already impressive fuel consumption and exhaust emissions. One-hundred percent a Maserati, it is one-hundred percent ready for whatever lies ahead.













Power that is at once intelligent and agile.

Unparalleled in its refinement and sophistication, the Levante's 3.0 Twin Turbo V6 petrol engine achieves the seemingly impossible by delivering incredible levels of performance in conjunction with reduced fuel consumption and CO₂ emissions. A slight flexing of the right foot unleashes prodigious amounts of power, coupled with the awesome sound that is uniquely Maserati.

Designed by Maserati Powertrain and built at Ferrari's Maranello plant exclusively for Maserati, this engine features highly advanced engineering innovations that have been developed to improve its fuel efficiency. A high-pressure direct-injection system enhances combustion across the rev range by delivering atomised fuel directly into the combustion chamber, whilst in both cylinder heads there are two continuous-phase timing variators, which advance or delay the intake and exhaust valve timings. In addition, two parallel-mounted, low-inertia turbochargers help prevent turbo lag, and give greater elasticity and a faster response.

The 3.0 Twin Turbo V6 petrol engine is available with two different power outputs: 430 HP or 350 HP. With 430 HP, the Levante S accelerates from 0 to 62 mph in 5.2 seconds, and has a top speed of 164 mph, whereas the figures of the Levante 350 HP engine are 0 to 62 mph in 6.0 seconds, and a top speed of 156 mph.

The Levante Diesel innovative 3.0 V6 with Variable Geometry Turbo (VGT) is a veritable gem of an engine, boasting all the very latest in diesel technology. An impressive 275 HP and 600 NM of torque enables the Levante Diesel to surge from 0 to 62 mph in just 6.9 seconds and reach a top speed of 143 mph.

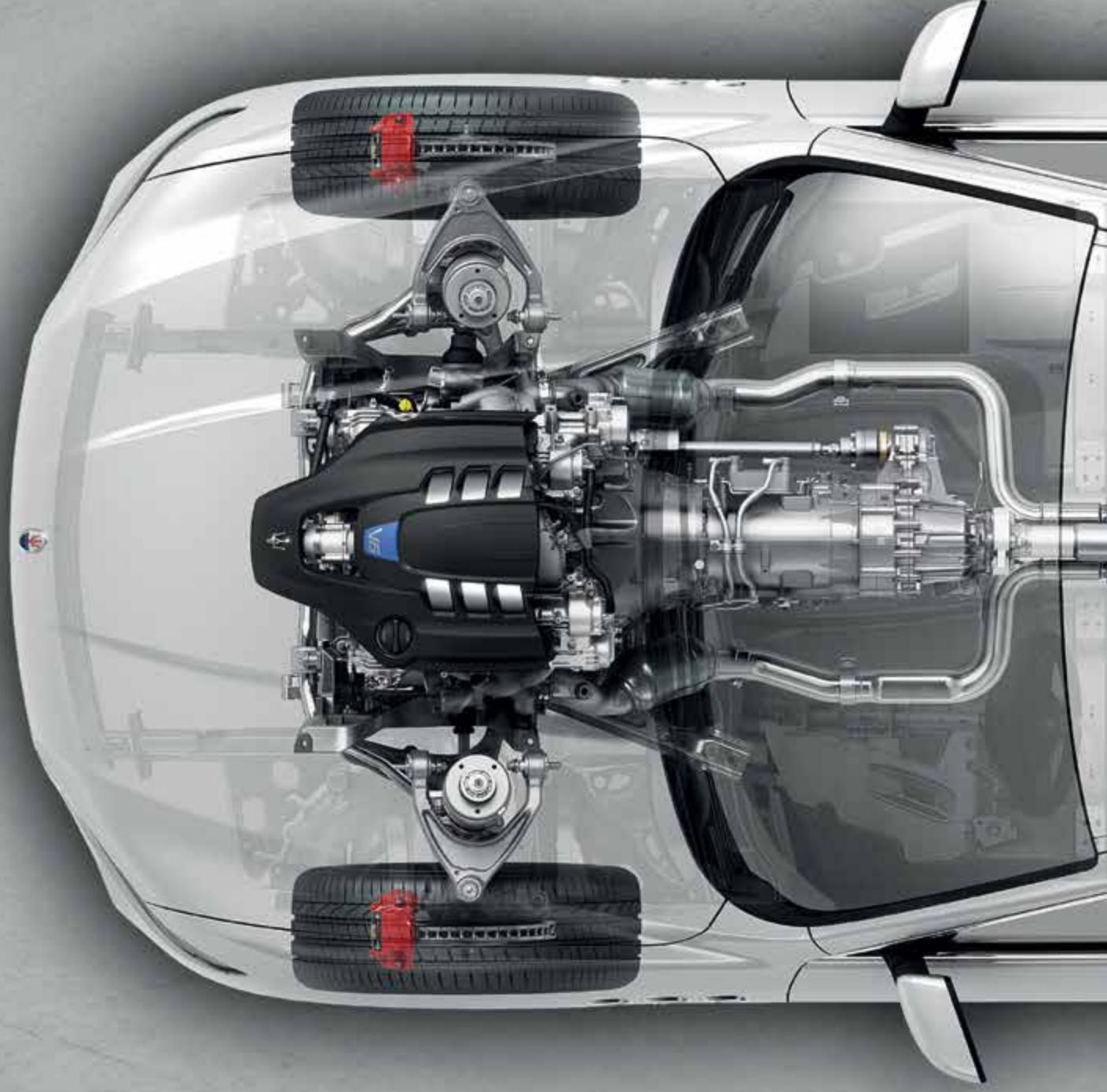

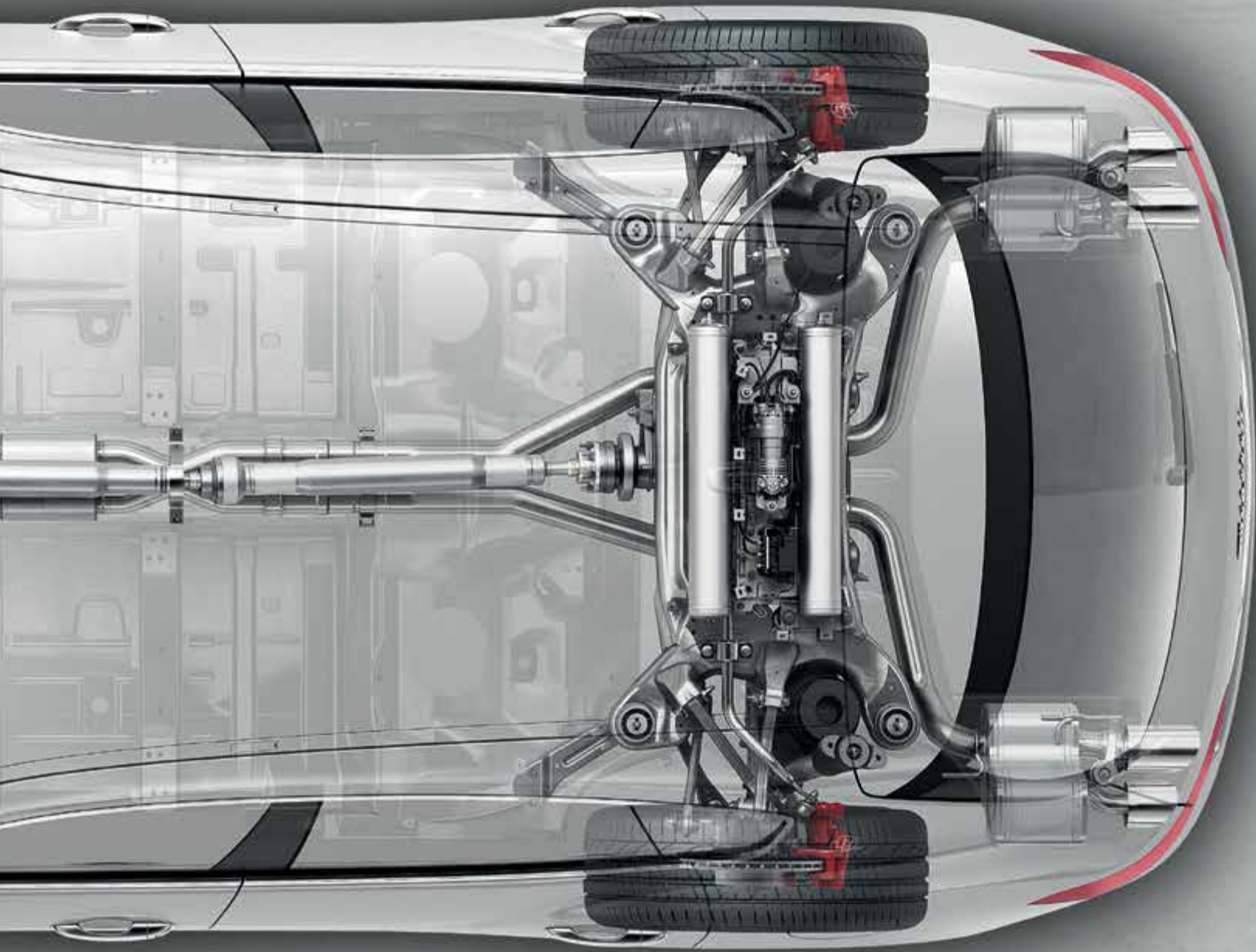

A masterpiece of technology.





*Maserati's acclaimed
Skyhook system
with continuous
damping variation:
adventure's ally.*

Clearance granted: active air suspension.

Five ride heights plus Easy Entry mode.

To ensure that it can play its dual role of luxury SUV and go-anywhere 4x4, the Maserati Levante features some of the most sophisticated engineering in the world today. Along with its groundbreaking four-wheel drive, it also benefits from an advanced active air suspension that raises or lowers the vehicle according to need or preference. With six settings to choose from (including Park), the driver can select whatever height is appropriate for the current road or terrain, from a high clearance for serious off-roading to a low setting for motorway driving.



Off-Road 2

This position provides the greatest ground clearance, raising the vehicle by 40 mm compared to the normal mode. It also provides the best approach, departure, and break-over angles enabling Levante to perform at its best even on the most challenging terrain.



Off-Road 1

This mode is automatically selected when the Off-Road button is pressed or when selected with the ride height rocker. This position provides great offroad capabilities by increasing ground clearance up 25 mm from normal, while retaining a sumptuous ride comfort.



Normal

This is the normal ride height for the vehicle, designed to provide the optimal balance of ride comfort and handling.

The height adjustments also interact with the engine operation modes for the ultimate in overall efficiency. This air suspension is then combined with Maserati's acclaimed Skyhook system, with shock absorbers featuring continuous damping variation. The basic setting prioritises comfort, whereas for a more dynamic drive, the shock absorbers stiffen and the car assumes a more sporty character.



Aero 1

This mode is automatically selected at motorway speeds. It lowers the vehicle by 20 mm compared to the normal mode, to improve aerodynamics and therefore fuel economy. It is also activated when Sport mode is selected or when set with the rocker. By lowering the vehicle's centre of gravity the handling of the Levante is more direct with reduced body roll, providing a "sportier" feel.



Aero 2

Automatically activated at even higher speeds, it reduces the vehicle's height by 35 mm compared to the normal mode to minimise aerodynamic resistance.



Easy Entry

This mode lowers the vehicle by a full 45 mm compared to normal mode, to provide easier passenger entry and exit. Therefore, also the rear cargo deck is lowered, offering better accessibility and facilitating loading and unloading.



Eight forward gears, four driving modes. All eventualities covered.

The sophisticated design of the eight-speed ZF automatic gearbox ensures precise gear changes and exceptional performance. Along with the engine, it is assisted by auto-adaptive software that is able to recognise both the way the car is being driven and the prevailing road conditions, and modifies the gear-changing mode accordingly. There are 4 different driving modes (Normal, Sport, Off Road, I.C.E.), selected using the buttons near the gear lever. They can be combined with manual or automatic transmission.

Auto Normal Mode

This default mode provides the perfect balance between luxury and sportiness in pure Maserati fashion. Smooth gearchanges at low revs to maximise ride comfort and minimise fuel consumption. When a more sporty style of driving is recognised, upshifts automatically take place at higher engine speeds.

Manual Normal Mode

In this mode the driver can experience the same benefits as in Auto Normal Mode but with the added flexibility of changing gears using the optional paddles behind the steering wheel or the lever on the central tunnel. The system automatically shifts up when approaching the rev limiter, and shifts down in order to always select the most appropriate gear for the recognized driving style.

Auto Sport Mode

The gearchanges are faster and occur at higher revs for a much sportier driving style. In this mode, exhaust valves open up in order to experience at best the iconic Maserati engine sound, the ESP is less intrusive, giving more control to the driver, moreover the accelerator pedal mapping is more aggressive and, on petrol engine versions, the overboost is activated.

Manual Sport Mode

The driver takes full control of the transmission: the overboost function is activated for maximum boost, the ESP is less intrusive, the valves in the exhaust open up giving it an even more aggressive tone, gearchanges are quicker and sharper, the accelerator pedal mapping is more aggressive and the engine can be pushed right to the rev limiter without the system intervening. The only automatic feature is downshifting if the revs drop too low.

Manual Off Road Mode

In this mode, the vehicle will rise 25mm from the normal height. The ESP mapping will change and adapt to the off road terrain driving up or downhill. This mode also changes the map for engine, transmission, and accelerator pedal to best set up the car for the terrain.

Automatic Off Road Mode

This mode retains all the benefits of the offroad mode – a setup meant for rough terrain - and adds convenience by shifting automatically. The driver can therefore fully concentrate on tackling the adventure ahead.

I.C.E. (Increased Control & Efficiency) Mode

Developed not only for use in icy or low grip conditions, this mode is intended to ensure an even quieter, smoother ride, and also a reduction in fuel consumption. In I.C.E. mode, gearchanges are almost unnoticeable and take place automatically at the optimal point to reduce consumption and increase acoustic comfort. The boost in the engine is dialed down, the exhaust valves will stay closed until 5.000 rpm and also the accelerator mapping is smoother, for unrivalled comfort.





Because there will always be forces greater than ourselves.

Keeping dangers at bay: this is a calm in the storm.

In designing the Levante, Maserati made safety the number one priority. To provide the best possible protection for its occupants, it features the latest-generation air bags and numerous state-of-the-art safety systems.

Air bags

The Maserati Levante comes equipped with six air bags. Two front air bags, both dual-stage, shield the driver and front passenger in the event of a collision, while their torsos and hips are further protected by two side air bags located in the front seats. There are also two window air bags fitted in the roof lining next to the central pillar that cushion the heads of the front and rear passengers if the car is struck from the side.

Seatbelt Pre-tensioners, Active Headrests and ISOFIX Fasteners

The front seatbelts are fitted with electronically controlled pyrotechnic pretensioners and the latest-generation load limiters. The system communicates with a sensor to determine the seriousness of a collision, and then activates with precisely the right amount of force to reel in the optimum length of belt. If the car is hit from behind, the active headrests of the two front seats automatically move in closer to the occupants' heads to reduce the risk of whiplash injury. Both side seats in the rear are fitted with ISOFIX fasteners for child seats, ensuring that the youngest passengers are properly protected, as well.

Brakes

All versions of the Maserati Levante feature powerful brakes that have been carefully matched to the performance of their engines. The Levante and the Levante Diesel are equipped with floating callipers working on 345mm ventilated discs at the front and 330mm ventilated discs at the rear.

The Levante S features an even more impressive front braking system in order to deal with the car's higher performance. The front system is derived from that used on the Quattroporte GTS: Brembo 6-piston aluminium monobloc calipers working on 380mm drilled discs. At the rear, there is the same system found on the less powerful versions, but with drilled discs. The larger size of the front discs enables better heat exchange, resulting in more efficient cooling and resistance to fade when the car is driven hard and fast over long distances.

The brake calipers of the Levante and the Levante Diesel come in Oxidised Grey, whilst those of the Levante S are Black. As an option, they can all be specified in Blue, Silver, Red, or Yellow.

Maserati Stability Programme (MSP)

The Maserati Stability Programme (MSP) is an advanced electronic stability control system that reduces torque from the engine and activates the brakes if the vehicle begins to deviate from its normal trajectory or if a skid is detected — all in a few milliseconds. The system combines a number of devices including ASR, which reduces wheelspin and improves traction, and MSR, which prevents wheels from locking up when changing down suddenly. ABS and EBD monitor the car's braking, stopping the wheels from locking and distributing the braking force between the front and rear axles. A Brake Assistance System (BAS) then recognises emergency stops and boosts the pressure in the hydraulic circuit for the ultimate in stopping power, whilst a Hill Holder prevents the car from rolling backward when starting off on a hill.

Tyre Pressure Monitoring System (TPMS)

The Tyre Pressure Monitoring System (TPMS) continuously monitors tyre pressures by means of sensors fitted inside the wheel rims. The tyre pressure is shown on the display in the centre of the dashboard, and a warning light and audio alert inform the driver if any tyre pressure drops below the optimal level, or in the event of a puncture.





Illuminating the way forward. Bi-Xenon Headlights and Adaptive Front Lighting System.

As an option, the Levante features the very latest Bi-Xenon headlights. These brilliant lights can be further enhanced by the optional Adaptive Front Lighting System, which automatically adjusts the width and depth of the beam, for driving on motorways, in the countryside, in town, and during adverse weather conditions. This is made possible by a camera mounted in the rearview mirror and sensors that monitor several different parameters, including the lights of other road users, the car's speed, and the way it is being driven. If the road ahead is empty, the beam expands to its maximum width and depth for the best visibility, with no need to switch manually to full-beam mode. In case of bad weather or for motorway or town driving, the system adjusts automatically to increase visibility and driving safety.





Electronic Parking Brake

The Levante is equipped with an Electronic Parking Brake (EPB) that is engaged via a control on the gear lever surround instead of a conventional mechanical lever. When necessary, it can be used when the car is moving: the system communicates with the stability control system and acts on all four wheels to obtain an immediate braking action (a deceleration of 0.5 g) without any loss of stability, until the control is released.



Rear Cross Path Detection

The Rear Cross Path emits a warning sound when an unseen vehicle is detected approaching from the sides while reversing out of a parking space.

Hill Descent Control

The Hill Descent Control allows a smooth and controlled downhill ride in rough terrain without the driver needing to touch the brake pedal. When activated, the vehicle will proceed by using the ABS braking system to control each wheel's speed, automatically applying the brakes as required to slow down to the desired vehicle speed.

Homelink®

The Levante is available with HomeLink® as an option. HomeLink® is a remote control device for automatically opening garage doors, gates, or security lighting systems as the vehicle approaches. It is integrated into the dome lighting unit in the ceiling above the dashboard. For people with more than one property, up to three automatic systems can be programmed in.





Surround View Camera

The Surround View Camera provides a clear 360° view around the car, as a parking aid and to help the driver see into blind zones. Two lateral cameras are housed underneath the door mirrors and display what is happening in the main display screen. Operated via the soft button, the views it provides include: Front, Front Cross (180°), Rear, Rear Cross, Top View, Open Doors and Parking Arcs.

The latest security briefings.



Front and Rear Parking Sensors and Reversing Camera

To assist with maneuvering in tight spaces, the Maserati Levante can be equipped with parking sensors housed in the front and rear bumpers. Beeping noises increase in frequency as the obstacle approaches, whilst the TFT display in the centre of the instrument panel shows the car surrounded by symbols which light up in green, yellow or red depending on the remaining distance. In addition, fitted close to the tailgate lock, there is a rear-view camera that shows a view of what is behind the car on the central console display. Dynamic grid lines illustrate the maximum width of the vehicle and its projected path, based on the steering angle of the front wheels.

Forward Collision Warning

The Forward Collision Warning monitors vehicles ahead by means of a camera, warns the driver if the car's approach could escalate into a rear-end collision, and if the driver does not take action will provide a limited level of active braking to help slow the vehicle down. This is linked to the Advanced Brake Assist system, which provides additional braking during an emergency stop.



With great power comes great responsibility.

Adaptive Cruise Control with Stop & Go function

When activated during motorway driving, the Adaptive Cruise Control with Stop & Go function constantly monitors the amount of space between the Levante and the vehicle ahead, maintaining a constant pre-set distance. If traffic slows or another vehicle moves in front, it slows the car down by coasting or engaging the brakes. Conversely, when the vehicle ahead speeds up or moves into another lane, the system accelerates up to the pre-set speed. The Adaptive Cruise Control with Stop & Go function is not affected by weather conditions, and can be particularly convenient during fog, rain and heavy spray, when visibility is reduced.



Blind Spot Alert

These valuable safety systems constantly monitor the space between the Levante and other nearby vehicles by scanning the blind spots on either side of the vehicle with radar-based sensors. When a vehicle enters one of these areas, a warning triangle appears in the door mirrors to alert the driver of the presence of a vehicle in the blind spot and if the indicator is activated to change lane a warning is sounded.



Lane Departure Warning System

Thanks to a camera located in the interior rearview mirror that monitors the road markings ahead, the Lane Departure Warning System helps the driver keep the vehicle in the chosen lane on motorways and main roads. This reduces lane drift and the possibility of lateral collisions by warning the driver when the vehicle crosses lane markings without signaling.

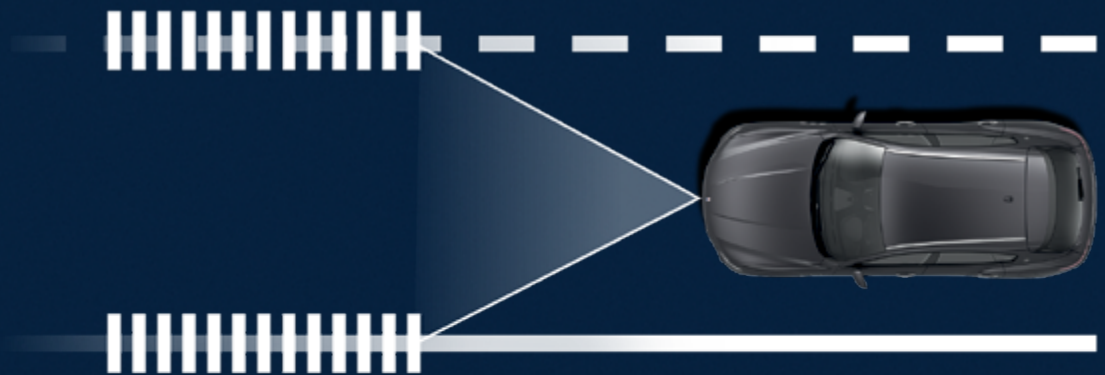

DIMENSIONS

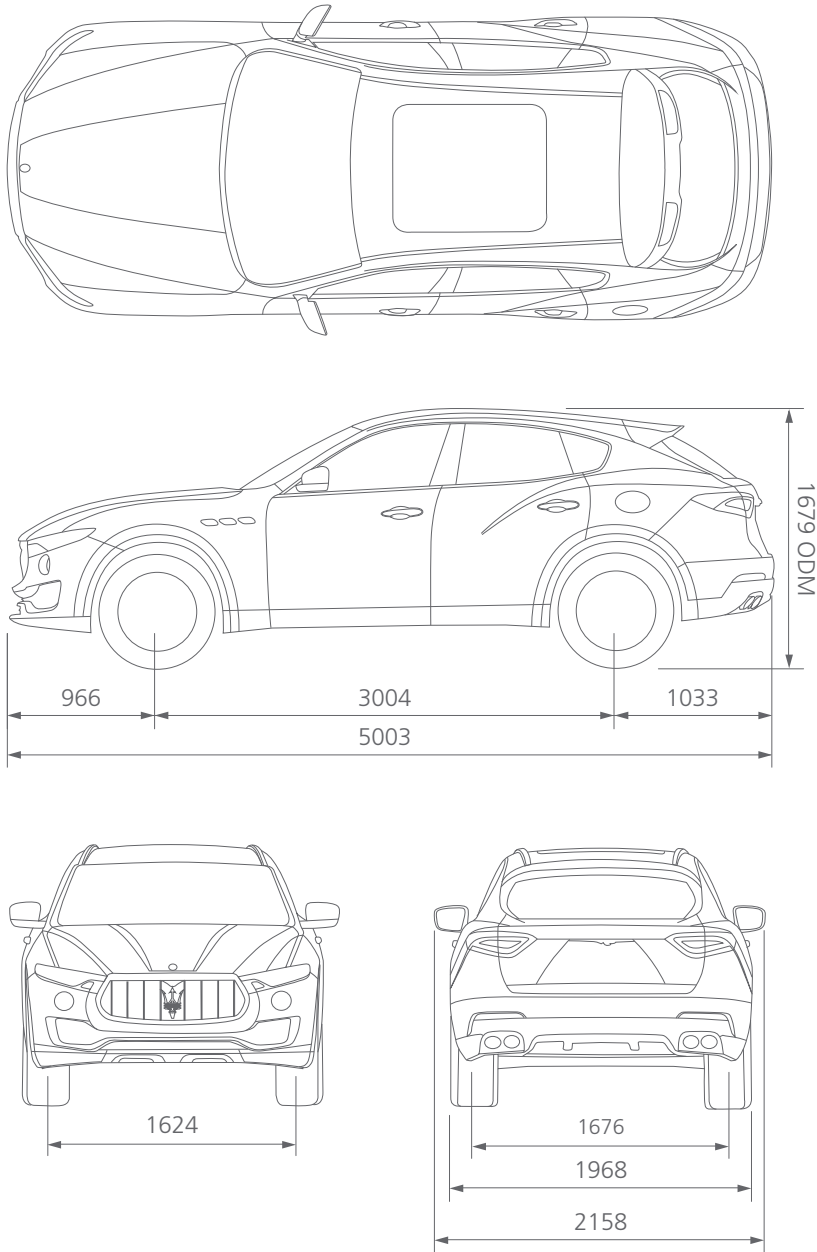

	Levante Diesel	Levante	Levante S
DIMENSIONS AND WEIGHTS			
Length	5003 mm	5003 mm	5003 mm
Width (with side mirrors)	2158 mm	2158 mm	2158 mm
Width (without side mirrors)	1968 mm	1968 mm	1968 mm
Height (Ride Height Normal)	1679 mm	1679 mm	1679 mm
Wheelbase	3004 mm	3004 mm	3004 mm
Front track	1624 mm	1624 mm	1624 mm
Rear track	1676 mm	1676 mm	1676 mm
Front overhang	966 mm	966 mm	966 mm
Rear overhang	1033 mm	1033 mm	1033 mm
Turning circle	11700 mm	11700 mm	11700 mm
Boot capacity	580 l	580 l	580 l
Fuel tank capacity	80 l	80 l	80 l
Kerb weight	2205 kg	2109 kg	2109 kg
ENGINE			
Number of cylinders and layout	V6 60°	V6 60°	V6 60°
Displacement	2987 cm ³	2979 cm ³	2979 cm ³
Bore	83 mm	86.5 mm	86.5 mm
Stroke	92 mm	84.5 mm	84.5 mm
Compression ratio	16.5:1	9.7:1	9.7:1
Max. power output	202 kW (275 CV)	257 kW (350 CV)	316 kW (430 CV)
Engine speed at max. power output	4000 rpm	5750 rpm	5750 rpm
Peak torque	600 Nm	500 Nm	580 Nm
Engine speed at peak torque	2000-2600 rpm	4500-5000 rpm	4500-5000 rpm
TRANSMISSION			
Transmission	Automatic 8 gears	Automatic 8 gears	Automatic 8 gears
All Wheel Drive ATC (Active Transfer Case)	from 0/100 to 50/50	from 0/100 to 50/50	from 0/100 to 50/50
PERFORMANCE			
Top speed	230 km/h	251 km/h	264 km/h
0 to 62 mph	6.9 s (0-100 Km/h)	6.0 s (0-100 Km/h)	5.2 s (0-100 Km/h)
Stopping distance from 100 Kph – 0	36 m	36 m	34,5 m
Fuel consumption (combined cycle)	7.2 l/100 km	10.7 l/100 km	10.9 l/100 km
Fuel consumption (urban cycle)	8.2 l/100 km	14.8 l/100 km	15 l/100 km
Fuel consumption (extra urban cycle)	6.6 l/100 km	8.3 l/100 km	8.5 l/100 km
CO ₂ emissions (combined cycle)	189 g/km	249 g/km	253 g/km
CO ₂ emissions (urban cycle)	216 g/km	343 g/km	348 g/km
CO ₂ emissions (extra urban cycle)	174 g/km	194 g/km	199 g/km

BRAKES

The Maserati Levante is a car that offers vast possibilities in terms of personalisation. In keeping with the marque's traditions of exclusivity, there is a vast array of options and a huge choice of colours and materials. Of the thirteen specially chosen colours available, three of them are unique to the Levante.



Yellow



Red



Blue



Silver



Black



BOREA

Dimensions: 18"*
 Front tyre: 255/60 R18
 Rear tyre: 255/60 R18



ZEFIRO

Dimensions: 19"
 Front tyre: 265/50 R19**
 Rear tyre: 295/45 R19***



NEREO

Dimensions: 20"
 Front tyre: 265/45 R20**
 Rear tyre: 295/40 R20***



ANTEO

Dimensions: 21"
 Front tyre: 265/40 R21**
 Rear tyre: 295/35 R21***

*Standard on Levante and Levante Diesel, not available on Levante S

**Dimension for Levante/Levante Diesel (front and rear) and Levante S (front)

***Dimension for Levante S (rear)

METALLIC PAINTS



Grigio



Verde Ossido*



Grigio Metallo

MICA PAINTS



Rame*



Blu Emozione



Rosso Rubino*



Blu Passione

*Exclusive colours for Levante only



METALLESCENT PAINTS



Nero Ribelle



Champagne



Grigio Maratea

SOLID PAINTS



Nero

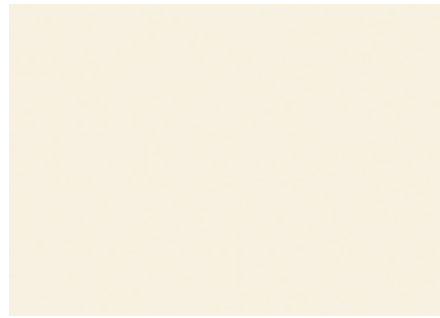

Bianco

PEARLESCENT

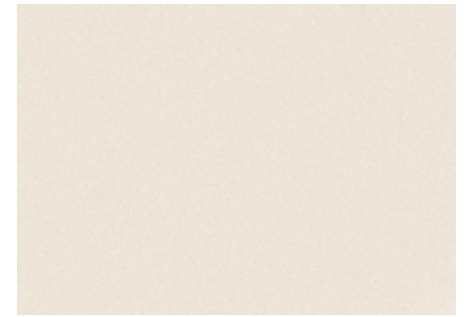

Bianco Alpi

INTERIOR TRIM



Black Piano



Rovere Chiaro



Erable



Ebano



Radica

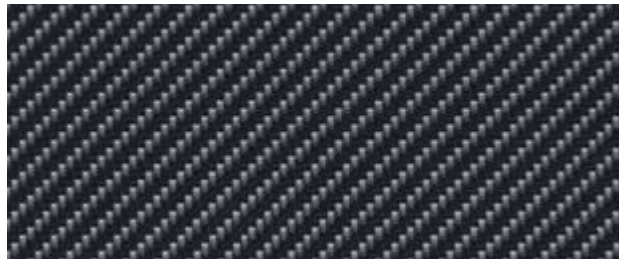

Carbonio

SEATS/DASHBOARD/DOOR PANEL



Black



Tan

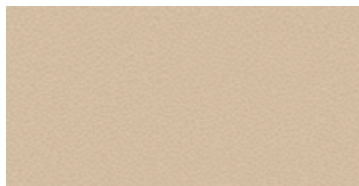

Beige



Black with Grey Stitching



Black with Red Stitching



Black with Tan Stitching

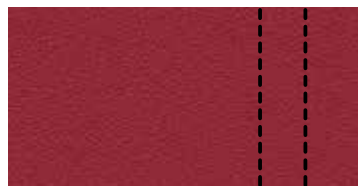

Red with Black Stitching

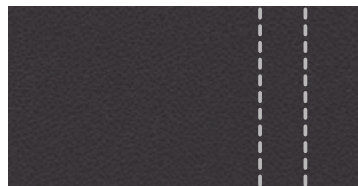

Dark Brown with Grey Stitching

CARPET/STEERING WHEEL



Black

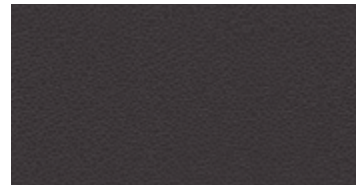

Dark Brown

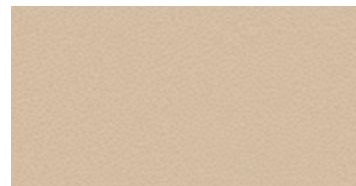

Beige

HEADLINING



Black



Beige

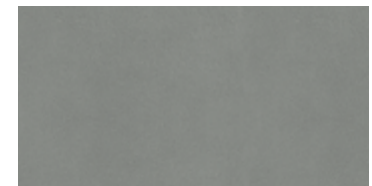

Grey

MASERATI LEVANTE Standard and Optional Equipment

Levante Diesel

Levante

Levante S

WHEELS AND CHASSIS

18" Borea Alloy Rims	●	●	—
19" Zefiro Alloy Rims	○	○	●
20" Nereo Alloy Rims	○	○	○
21" Anteo Alloy Rims	○	○	○
Brake callipers, painted Black	○	○	●
Brake callipers, painted Red	○	○	○
Brake callipers, painted Blue	○	○	○
Brake callipers, painted Silver	○	○	○
Brake callipers, painted Yellow	○	○	○
8-speed ZF automatic transmission	●	●	●
Skyhook - electronically variable active-damping suspension system	●	●	●
Air Adaptive Suspensions	●	●	●
Q4 All-Wheel-Drive Intelligent System	●	●	●

SAFETY

Blind Spot Alert	○	○	○
Bi-Xenon front headlamps	●	●	●
Bi-Xenon front headlamps with Adaptive Front Lighting System (AFS) and hi-pressure washing system	○	○	○
Surround-View Camera	○	○	○
Cruise Control	●	●	●
Adaptive Cruise Control with Stop & Go function	○	○	○
Maserati Stability Programme (MSP) includes:			
– acceleration slip regulation (ASR)			
– antilock braking system (ABS)	●	●	●
– electronic brake distribution (EBD)			
– Maserati drag torque control (MSR)			
Forward Collision Warning	○	○	○
Lane Departure Warning	○	○	○
Hill Descent Control	●	●	●
Hill holder	●	●	●
Brake Assistance System	●	●	●
Electronic Parking Brake	●	●	●
Tyre Pressure Monitoring System (TPMS) with pressure displayed on central digital cluster	●	●	●

EXTERIOR EQUIPMENT

Solid paint	●	●	●
Metallic paint	○	○	○
Metallescent paint	○	○	○
Mica paint	○	○	○
Pearlescent paint	○	○	○
Skid Plates - Metallic Finish	○	○	○
Skid Plates - Black Piano	○	○	○
Roof Rails - Metallic Finish	○	○	○
Roof Rails - Black Piano	○	○	○



	Levante Diesel	Levante	Levante S
Front Grille - Metallic Finish	●	●	●
Front Grille - Black Piano	○	○	○
Sport Rear Spoiler	○	○	○
Front and rear parking sensors with graphic display on central digital cluster	○	○	○
Rear-view camera with imaging displayed on central Maserati Touch Control Plus (MTC Plus) display	○	○	○
INTERIOR EQUIPMENT			
Fabric headlining	●	●	●
Alcantara® headlining	○	○	○
Leather interior upholstery	●	●	—
Upgraded leather interior upholstery	○	○	●
Fine-grain extended leather interior upholstery	○	○	○
Fine-grain extended and perforated leather interior upholstery	○	○	○
Zegna edition interiors: combines leather interiors with Zegna silk inserts for seats, door panels, roofline and sunvisors. Available in 3 leather colour choice: Black, Tan, Red	○	○	○
Trident stitched on the Headrests	○	○	○
Black Piano trimming for selected interior details	●	●	●
Open-pore Radica wood trim for interior details	○	○	○
Open-pore Rovere Chiaro wood trim for interior details	○	○	○
High-gloss Ebano wood trim for interior details	○	○	○
High-gloss Erable wood trim for interior details	○	○	○
High-gloss carbon fibre trim for interior details	○	○	○
Steering wheel with wood insert	○	○	○
Steering wheel with carbon fibre insert	○	○	○
Sport steering Wheel	○	○	○
Sport steering wheel with carbon fibre insert	○	○	○
Heated steering wheel	○	○	○
Heated sport steering wheel	○	○	○
Heated steering wheel with wood insert	○	○	○
Heated Front Seats	○	○	○
Heated Rear-Seat Bench	○	○	○
Rear seat bench fix&fold 60%/40%	○	○	○
Ventilated Front Seats	○	○	○
Driver seat electrically adjustable (6 ways), passenger front seat manual adjustable (4 ways)	●	●	—
Front seats electrically adjustable (6 ways)	○	○	●
Front seats electrically adjustable (8 ways + 4 ways for lumbar adjustments), with two memories for driver's side	○	○	○
Sport front seats electrically adjustable (8 ways + 4 ways for lumbar adjustments), with two memories for driver's side	○	○	○
Electrochromic Mirrors - External and Internal	●	●	●
Steel Door Sills	○	○	○
Steel Illuminated Door Sills	○	○	○
Chrome Trunk Sill	○	○	○
Floor Carpets in Velour	●	●	●
Panoramic Sunroof	○	○	○
Active Shift Paddles	○	○	○
Power foot pedals	○	○	○
Inox Sport Foot Pedals	○	○	○

● Standard ○ Optional – Not Available

	Levante Diesel	Levante	Levante S
COMFORT & FUNCTIONALITY			
Maserati Touch Control Plus (MTC Plus) unit. 8.4-inch touchscreen display	●	●	●
Maserati Touch Control Plus (MTC Plus) unit. 8.4-inch touchscreen display with Navigation System	○	○	○
Climate Dual-Zone	●	●	●
Climate Four-Zone	○	○	○
Air Quality Sensor	●	●	●
Easy Entry System	○	○	○
Front Doors Key-Less	●	●	●
Extended Key-Less	○	○	○
Power Rear Side Sunblind	○	○	○
Power Adjustable Steering Column	○	○	○
Standard audio system	●	●	●
Harman Kardon Premium Sound System with 14 speakers (900W)	○	○	○
Bowers & Wilkins Surround Sound System with 17 speakers (1,280 Watts) with Clari-Fi music restoration function	○	○	○
DAB: Digital Audio Broadcast (Digital radio)	●	●	●
SIRI (Apple® function) Smart Personal Assistant	●	●	●
Rear Privacy and Laminated Glass	○	○	○
Cargo Net for Rear Trunk	●	●	●
Cargo Rails	○	○	○
Trailer Tow	○	○	○
Power Boot Lid	●	●	●
Power Boot Lid - Hand Free function	○	○	○
Alarm system	○	○	○
HomeLink® (garage door opener)	○	○	○
Smoking kit	○	○	○

● Standard ○ Optional – Not Available



LEVANTE PACKS

An unmistakable blend of style, versatility and power makes the Maserati Levante a truly exceptional car. To ensure that it measures up to the specific needs of its highly individual customers, there is a choice of optional packs that have been specially tailored to enhance the car's comfort, style, sportiness and functionality. In addition, they represent a considerable customer benefit when compared with specifying each item individually.

LUXURY PACK. For those who require an even more elegant and luxurious interior, the Luxury Pack is the natural choice.

12 way power comfort Front Seats

Front grille - Metallic Finish

Steel Illuminated Door Sills

Chrome Trunk Sill

Lower bumper elements, wheel arches and side skirts in the car's body colour

Zefiro 19" machine-polished wheels

Brake callipers painted Black

Zegna Edition interior (specific additional option)

Three Zegna interior colour combinations:

- Tan premium leather/Dark Grey Zegna silk/Light Grey contrast stitching

- Red premium leather/Dark Grey Zegna silk/Light Grey contrast stitching

- Black premium leather/Dark Grey Zegna silk/Light Grey contrast stitching

Roof lining and sun visors in Zegna silk, pillars in Grey Anthracite Alcantara®

Headrests with stitched trident

SPORT PACK. The Sport Pack has been specially created to enhance the sporty appearance of the Levante and to reflect the racing heritage of Maserati.

Front grille in Black Piano

Skid Plates in Black Piano

Rear sport spoiler in the car's body colour

Chrome door sills

12-way power sports seats

Sport steering wheel

Black Piano roof rails (specific additional option)*

Lower bumper elements, wheel arches and side skirts in the car's body colour

Nereo 20" machine-polished wheels

Red painted brake callipers

Gear shift paddles

Inox sport pedals

Power adjustable steering column

*Content also available in Metallic Finish at no additional charge.

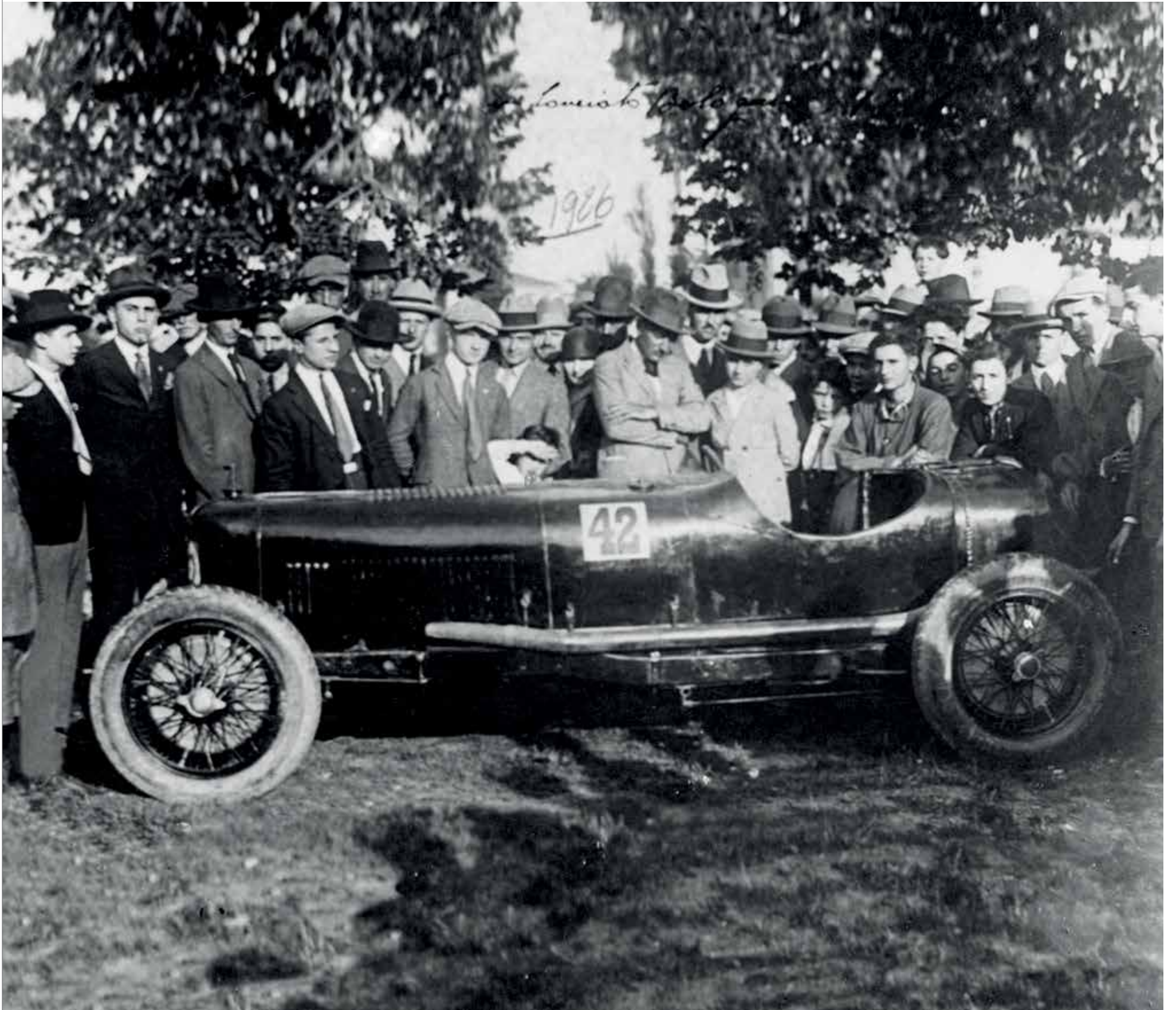

Maserati. From 1914 to the present day: a tale of determination, diligence and desire.

The Maserati story began in 1914, when three brothers, Alfieri, Ettore and Ernesto Maserati, established their engineering business in Bologna, Italy. Brilliant mechanics and devotees of motor racing, they soon began creating their own cars and, thanks to their determination, diligence and desire to succeed, their Maserati Tipo 26 won its class in the 1926 Targa Florio. Victory followed victory, as in the ensuing years Maseratis became the most feared and respected cars in the world of motorsport, setting world speed records, winning the Indianapolis 500, and taking countless chequered flags in Formula 1 and World Sportscar Championships. At the same time, the company was also building its reputation for producing some of the world's most beautiful and superbly engineered coupés, sedans and convertibles for an appreciative and very exclusive clientele.

Today, Maserati is nothing less than an Italian icon — a symbol of creativity, passion, innovation and style. Its combination of craftsmanship, technology and painstaking attention to detail creates highly desirable cars that never fail to excite and inspire. The new Levante SUV is just such an example.





Quality is all; nothing is taken for granted.

When it comes to quality and reliability, Maserati's engineers leave nothing to chance. That is why a vast fleet of prototypes Levante took part in 2.7 million kilometres of testing as part of the car's exhaustive development programme — from the intense heat of South Africa and Morocco to the extreme cold of Sweden and New Zealand, plus thousands of hours of high-speed and endurance trials in the USA and Russia. All along the production line, the car and its components are subjected to no fewer than 700 intensive checks and inspections; then, before it leaves the factory, there is a 50-kilometre road test and a thorough 30-minute examination by the strictest quality control staff.





Where high-tech manufacturing gains the personal touch.

Whilst Maserati's headquarters and manufacturing have long been based in Modena, Italy, production of the Levante SUV takes place at the recently refurbished Mirafiori plant in Turin, anticipating the high levels of skill and technology required for so advanced a vehicle. Whilst automation and the latest robotic techniques play a major role in the car's production, expert technicians man each station, keeping the assembly very much a handcrafted affair. Utilising proven practices developed through the company's World Class Manufacturing (WCM) system, the plant has a strong culture dedicated to producing the cars of the highest quality possible. Each one is built to order, and with literally millions of specification combinations possible, a document goes with each car that is signed at each station to ensure that the exact vehicle is built to the customer's personal requirements.



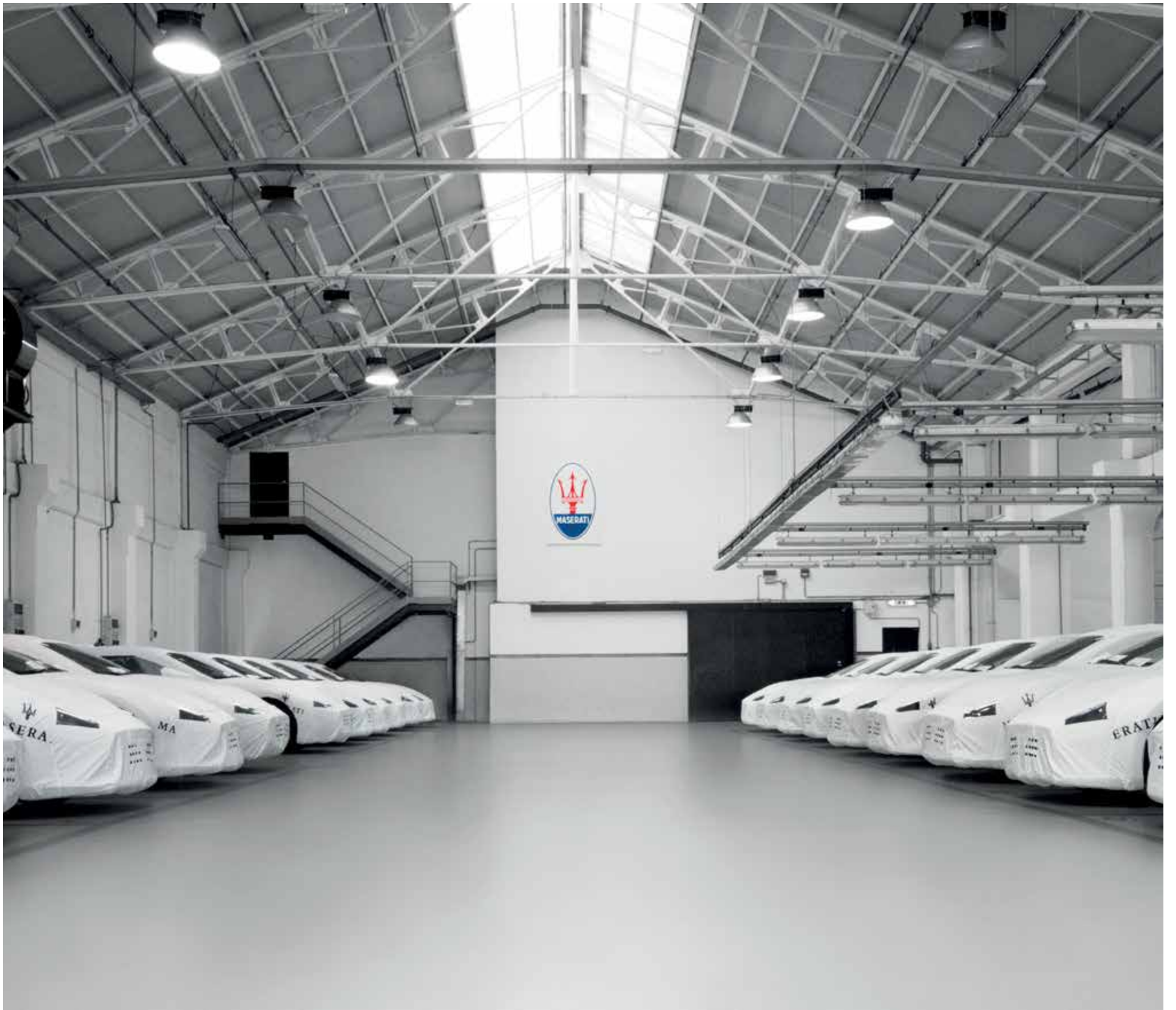



The World of Maserati. Its heart races.

Master Maserati Driving Courses

It is perhaps the ultimate driving experience: taking to the racetrack in a race-tuned Maserati. A Master Maserati Driving Course places you behind the wheel of various models in the Maserati range, so that you can learn about performance driving and other techniques.

Master Warm-Up

The Maserati Master Warm-Up offers Maserati clientele an initial taste of training in the techniques of racing-circuit driving in high-performance cars, with the support of highly qualified, expert staff. It provides the opportunity of entering the world of Maserati as a privileged guest, starting with a morning visit to the Factory where the brand's amazing cars are built, and then moving on to the Varano de' Melegari circuit, home of the Master Maserati courses. The afternoon involves a series of dynamic activities, including several on-circuit driving sessions, combined with a car-handling exercise that tests each participant's driving abilities, which can then be perfected in subsequent courses.

Master GT 1 Day

The one-day Master GT course has been designed to improve the participant's personal driving techniques at the wheel of different Maseratis. This intensive training programme comprises a number of exciting and dynamic sessions in high-performance cars, and is run by highly trained, specialist staff whose aim is to improve every delegate's driving skills in an environment that is enjoyable and challenging for all.

Master Premium

An intensive 1, 5-days program that focuses on advanced GT handling techniques and safe, yet sporty driving. In a sequence of sessions on the circuit, the driver is taught how to control the car in different simulated road conditions (e.g. quick direction changes, controlled skids and braking techniques). The ultimate aim is to use the lessons learned to maximise the enjoyment of driving a high-performance Maserati.

Master High Performance

The programme of the Master High Performance Course includes advanced high-speed driving and technically more complex exercises that build upon the fundamental skills acquired in the earlier Master GT courses. The teaching and structure of this course are adapted to



the individual needs of the participants, who can improve their driving proficiency through the analysis of Formula 1-type telemetry data.

Master Italian Lifestyle Experience

This exclusive, five-star event allows Maserati enthusiasts and their companions to experience the very best that Italy has to offer. Along with a series of Maserati racetrack sessions for the driver, both participants enjoy a programme of first-class activities and excursions in two cities steeped in history and culture: Florence and Parma.

SnowMaster Experience

Treacherous yet beautiful, maintaining full control of your car when driving on snow is always a challenging prospect. With the brand new SnowMaster Experience course, created to give you the unique experience of car control in extreme conditions on snow and ice, you can improve your driving skills and delight in impressive performance of the Maserati cars even in the most extreme situations. An enjoyable intensive-driving course, structured around thrilling and exciting teaching with complete safety guaranteed thanks to the experience and professionalism of the Master Maserati staff of driving instructors. The exclusive driving course will be held on beautiful tracks in the Swedish Lapland at Arjeplog, the ideal location for learning all the skills required for driving with confidence on the most treacherous of surfaces.

Master Maserati Incentive

Master Maserati Incentive courses last either half a day or a whole day, and include a series of highly stimulating activities. Aside from the thrilling driving sessions on the track, there are practice exercises and competitions that foster team spirit — hence they provide the perfect context for corporate incentive events and team-building exercises.

Master Levante

Master Levante is the specific driving course

organised by Maserati that combines circuit driving techniques with the most effective approach to driving on off-road terrains. The course uses the entire Maserati range, focusing in particular on the Levante model, which represents the state-of-the-art in the Sport Utility Vehicle segment. With its amazing performances, it provides the most exciting of all driving experiences, both on the circuit and on unpaved trails and uneven ground. The course programme comprises two days of activities, the first involving the dynamic programme during the afternoon, and offers full instruction in both on-track and off-road driving techniques, thanks to expert, professional input from the Master Maserati instructors. The course's logistics are the best anyone could ask for, with the ideal combination of the Varano de' Melegari circuit, corporate headquarters for the Master Maserati courses, and the surrounding off-road driving area unrivalled in size and conformation, where participants can get to grips with all the key challenges of off-road driving in complete safety.

For more information and registration, contact the Master Maserati Secretariat.

Telephone: +39 0525 551138 – Fax: +39 0525 551140.

E-mail: info@mastergt.it

www.maserati.com/MasterMaserati

Financial Services

Official Maserati dealers will be delighted to provide you with professional guidance on the various payment options available, and create a package tailored to your individual requirements.

Factory Tour*

Find out where and how the Maserati legend was born. Maserati offers you the opportunity of discovering its secrets from the inside, through a guided tour of the Modena and Grugliasco production plant. Discover how the cars are created, learn their secrets, understand their engineering and really feel part of the Maserati family.

Maserati Experience**

For those wishing to combine their factory visit with a little more insight into the company's home city of Modena, Maserati has the perfect solution. Lasting one or more days, the Maserati Experience enables you to get to know the world of Maserati first-hand via a guided tour that allows you to discover Modena, its culture, its history and its fine food. You can tailor your Maserati experience to your own personal tastes and interests by combining these with a variety of other activities:

- A visit to the Panini Museum and/or Stanguellini Museum (famous motor museums)
- A guided tour of the town
- A guided tour of a traditional balsamic vinegar manufacturer, with tastings
- A guided tour of a winery, with tastings of local wines
- Cookery school
- A day at the Modena Golf & Country Club
- And much, much more.

*Factory tours are only arranged by appointment and can be booked through official Maserati dealers worldwide

**For more information, please email us at:
maseratiexperience@maserati.com

Maserati Collection

The Maserati Collection of quality leisurewear, goods and branded merchandise has been specially created for those who share the Maserati passion, and who seek to associate with the illustrious marque. Maserati Collection items are available from all Maserati dealers, and from the Maserati Store at the Maserati showroom in Modena. Alternatively, all the articles in the collection can be purchased online at www.maseratistore.com and delivered directly to your home.

Maserati Club

Joining the exclusive Maserati Club means sharing thrills and experiences with other Maserati owners, and being invited to take part in special motoring events all over the world. Drivers of cars from every era can enjoy the pleasure of driving their Maseratis in a calendar of events created specially for Maserati Club members. The Maserati Club provides the link between the past, present and future of the company. For more information, visit www.maseraticlub.com

Maserati Genuine Accessories

Specially conceived to satisfy the varied needs of Maserati owners, the Maserati Genuine Accessories are a perfect combination of design and functionality. The attention to detail, style and quality of each individual accessory reveal the very essence of the Maserati brand, always searching for the perfect balance between comfort and performance.

The Levante Accessory range offers customers the best in transport solutions, combined with style and design.

Developed to fully enjoy the spaciousness and functionality of the car in any situation, the Maserati-branded transport systems include accessories such as the Roof Luggage Box, Bike Carrier and Luggage Compartment Mat. Added to the range are practical and safety accessories, such as the MGT (Maserati Genuine Tyres) Branded Tyres, Car Covers, Luggage Compartment Box and Mat.

These are just some of the many products available for this car, which demands the utmost attention to detail to make every experience onboard unique.

Maserati Classiche

Created for enthusiasts and owners of vintage Maserati cars, Maserati Classiche is an organisation dedicated to those who wish to engage with the marque's glorious past. The Maserati Classiche range of products includes items that celebrate the company's history: paintings of glorious events, pictures of classic Maseratis, original reproductions of parts catalogues, owners' handbooks and old brochures, clothing, scale models and much, much more. All the latest items can be found on www.maserati.com in the Maserati – Maserati Classic section. Or for more information, email maserati.classiche@maserati.com.





*There is a fluidity in the design
that starts from the first ripple
and cascades back through the sheet metal
like a wave that's been waiting a lifetime to take shape.*





EUROPE

AUSTRIA
BELGIUM
BULGARIA
CYPRUS
CZECH REPUBLIC
DENMARK
ESTONIA
FRANCE & MONACO
GERMANY
GREECE
HUNGARY
ISRAEL
ITALY
LITHUANIA

LUXEMBOURG

NETHERLANDS
NORWAY
POLAND
PORTUGAL
ROMANIA
RUSSIA
SLOVENIA
SPAIN
SWEDEN
SWITZERLAND
TURKEY
UKRAINE
UNITED KINGDOM

AFRICA & MIDDLE EAST

BAHRAIN
EGYPT
JORDAN
KUWAIT
LEBANON
MOROCCO
OMAN
QATAR
SAUDI ARABIA
SOUTH AFRICA
UNITED ARAB
EMIRATES





ASIA/OCEANIA
AUSTRALIA
AZERBAIJAN
CHINA
HONG KONG
INDIA
INDONESIA
JAPAN
KAZAKHSTAN
MALAYSIA
NEW ZEALAND
PHILIPPINES
SINGAPORE
SOUTH KOREA
TAIWAN
THAILAND
VIETNAM

NORTH AMERICA
USA
CANADA

CENTRAL/SOUTH AMERICA
ARGENTINA
BRAZIL
CHILE
COLOMBIA
COSTA RICA
DOMINICAN REPUBLIC
GUATEMALA
MEXICO
PANAMA
PUERTO RICO
URUGUAY



The illustrations and texts contained in this brochure are based on the information available at the time of production. Some models, equipment and accessories may not be available or may only become available after the car's launch on the market. Maserati reserves the right to modify colours, designs and technical features at any time and without pre-notice. Official Maserati Dealers will be glad to provide further details and updates in this regard.

Stay in touch with Maserati by visiting www.maserati.com



WWW.MASERATI.COM

MASERATI SPA · VIALE CIRO MENOTTI, 322 · 41121 MODENA · ITALY