

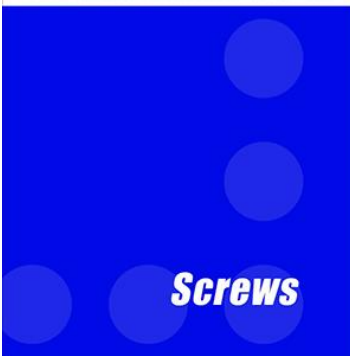

世鎧精密股份有限公司
SHEH KAI PRECISION CO.,LTD.

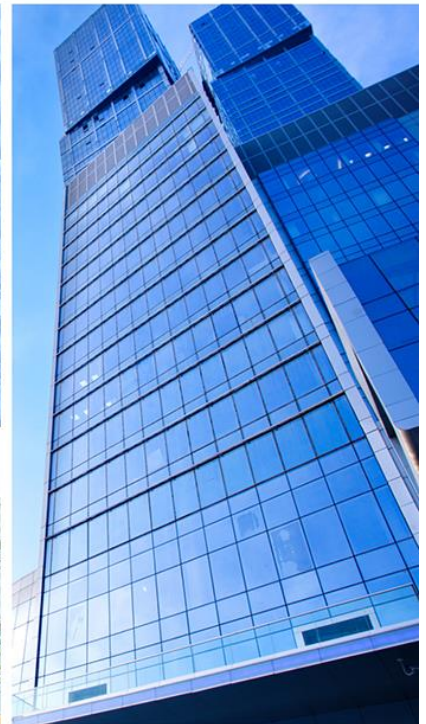

300 Series Austenitic Stainless Steel
Bi-Metal Self-Drilling Screws



Contents

01 /
Contents

02 /
Company Profile

03 /
Advantages of Using
Bi-Metal Self-Drilling
Screw

04 /
Mechanical Properties Tests

05 /
Fastener Coating

07 /
Bi-Metal Self-Drilling Screw
(304-A2) Hardened Drill Point

09 /
Bi-Metal Self-Drilling Screw
NIBS Under Head Countersunk Head
Wing Screw

10 /
Bi-Metal Self-Drilling Screw
(SUS 302) Bi-Metal Window Screw

11 /
Bi-Metal Self-Drilling Screw
Direct application on stainless steel
plate

12 /
Bi-Metal Self-Drilling Screw
(304-A2) Sharp Point/Blunt Point

13 /
Modify Self-Tapping Screw
(304-A2) Sharp Point/Blunt Point

14 /
Metric Thread Bolts / Screws
Carbon Steel / Alloy Steel /
Stainless Steel (302/304-A2/316-A4)

15 /
Double Ends Hanger Bolts
Carbon Steel / Alloy Steel /
Stainless Steel (302/304-A2/316-A4)

16 /
Special Bolts/ Screw
Carbon Steel / Alloy Steel /
Stainless Steel (302/304-A2/316-A4)

17 /
Quality Control

18 /
Project

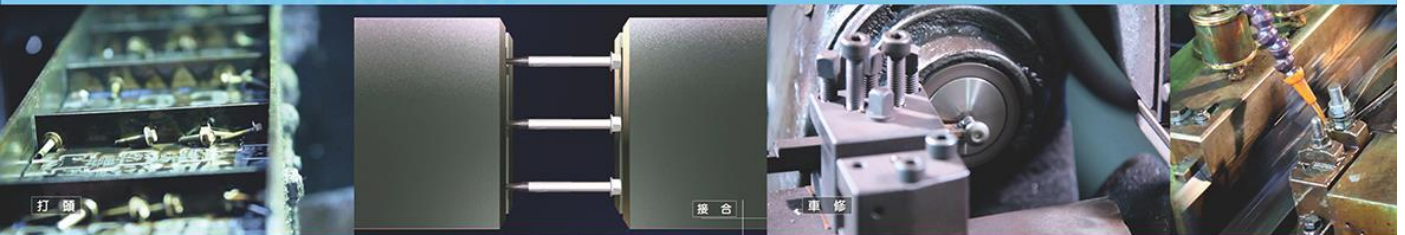

Contents



ISO 9001:2008 Certified



ISO 9001:2008 Certified



ISO 14001:2004
(CNS 14001) Certified

Company Profile

SHEH KAI PRECISION CO., LTD. was established in 1992 in Kaohsiung City. Our headquarter and main factory are currently located in Kaohsiung, Taiwan. Specialized in Bi-metal fasteners, we maintain a stainless steel wire drawing factory in Luzhu for our own raw materials to ensure their quality. As the forerunner of the bi-metal fastener industry, we constantly strive to provide our customers with innovative solutions, high quality products as well as professional service along . As an ISO 9001:2008 and 14001:2004 certified manufacturer, our devotion drives us to provide the best service to our customers for this high end product. Our products are widely used in outdoor, humidified environment where a high level of corrosion resistance is needed. Common applications include installation of roofing and cladding panels and energy-saving insulation pieces in many industrial and major government construction projects. We provide OEM services to some of the biggest construction material suppliers in the world and have distributed to all regions in Europe, North America, South America, Asia and Oceania. With more than 20 years of experience in the industry, we have great confidence in delivering the best products to our customers.

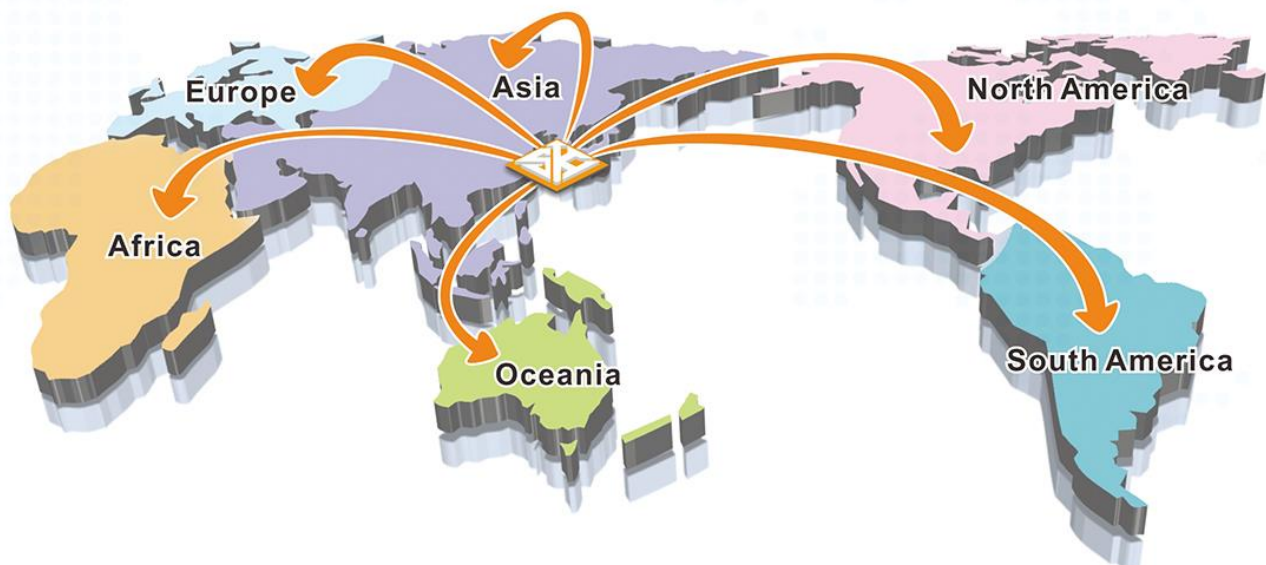



Longer Life time in outdoor environment

300 series Austenitic stainless steel
(Cold Forging, Nor Magnetic, Corrosion Resistance)

Alloy steel with induction heat treatment
(Superior Drilling Performance)

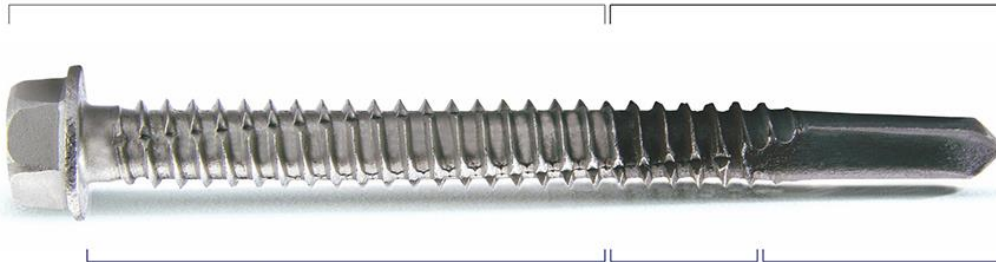

③ Fastening ② Tapping ① Drilling

One Working Process

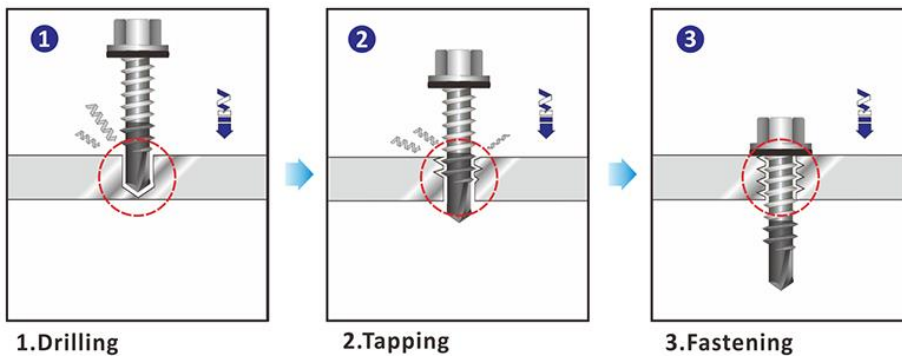

Choose The Right Screw From Dimensional Viewpoint

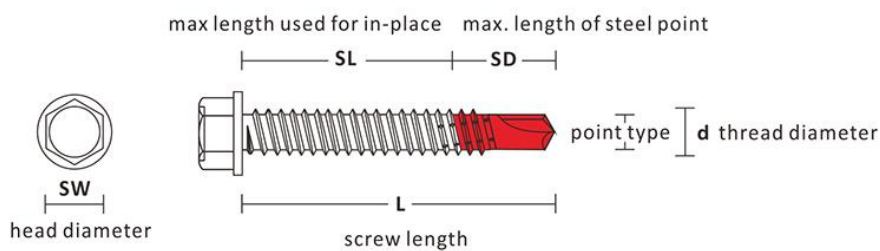

Ø12 x 25 Drill Point

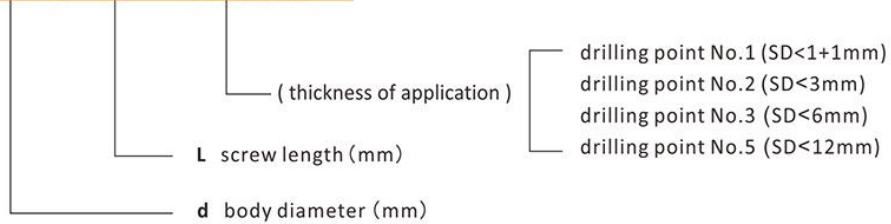

Mechanical Properties

Pull-Out Tests

	Steel Thickness (mm)	Tensile Strength kgf (min)			
		#12 (Ø5.5)		#14 (Ø6.3)	
		NO.3 Point	NO.5 Point	NO.3 Point	NO.5 Point
	2	300	—	310	—
	3	530	—	580	—
	4	780	—	800	—
	6	810	—	900	—
	10	—	920	—	1050
	12	—	920	—	1050

■ Note : For the length below 50mm, it can not apply the pull-out test for tensile. Therefore, length below 50mm will be tested per standard of torque.

■ Steel Plate for Testing : According To DIN 7504, HV110~125 (HRB62.3~69.0).

■ Tighten & Pull Test : According To ASTM F606-06 standard.

Mechanical Properties Tests

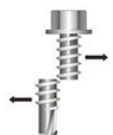
Drill Point	Size	Torque Strength kgf-cm(min)		 Tensile Strength kgf(min)	 Shear Strength kgf(min)
		SUS304 SUS316	SUS302		
NO.3 Point	#8 (Ø4.2)	45	36	—	—
	#10 (Ø4.8)	52	42	—	—
	#12 (Ø5.5)	84	68	810	620
	#14 (Ø6.3)	132	—	900	710
NO.5 Point	#12 (Ø5.5)	84	68	920	650
	#14 (Ø6.3)	132	—	1050	745

■ Note : For the length below 50mm, it can not apply the pull-out test for tensile. Therefore, length below 50mm will be tested per standard of torque.

Screws Chemical Compositions : %

Steel	C	Si	Mn	P	S	Ni	Cr	Mo	Cu
SUS XM7 (302 HQ)	Max 0.03	Max 1.00	Max 2.00	Max 0.045	Max 0.030	8.00~ 10.00	17.00~ 19.00	—	3.00~ 4.00
SUS 304 (304 M)	Max 0.08	Max 1.00	Max 2.00	Max 0.045	Max 0.030	8.00~ 10.00	18.00~ 20.00	—	—
SUS 316 (316CU)	Max 0.03	Max 1.00	Max 2.00	Max 0.045	Max 0.030	10.00~ 14.00	16.00~ 18.00	2.00~ 3.00	3.00~ 4.00

■ Note : According to DIN ISO 3506, stainless steel chemical composition requirement of Cu contain can accept 4% and below.



Corrosion of Fastener



From the past experience about the failure modes of the metal building, "Corrosion" is one major failure of the metal construction industries. Inside the interface-connection component of the Metal Building construction system, Corrosion of the screw always play a major reason for the failure. Therefore, choosing a right material for screw has been a very important issue to the designer. According to the America Uniform Building Code, the proposed product time limit of the public safety is required for at least 30-50 years. The material in which can reach its requirement is the Austenitic Stainless Steel Fastener of the SUS 300 series. It can prevent the corrosion process happened inside the panel & cladding. Not only to ensure the safety of the building and also to avoid the huge amount of the repair cost !

Salt Spray Test Comparision According to ASTM B117

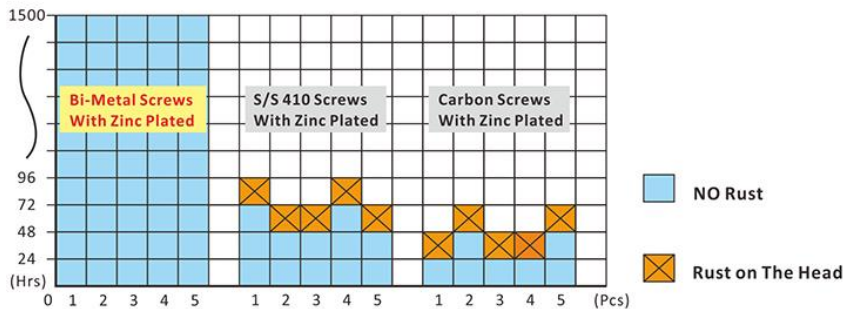

Coating of Bi-Metal Fastener

Coating	Zinc W/WAX		Ruspert		Tufcote (Ruspert)	
	24 hrs (2 μ)	72 hrs (8 μ)	500 hrs	1000 hrs	1500 hrs	2000 hrs
Salt Spray Test	24 hrs (2 μ)	72 hrs (8 μ)	500 hrs	1000 hrs	1500 hrs	2000 hrs
Kesternich Test	NO	NO	5 cycle	15 cycle	25 cycle	25 cycle
Australian Standard	NO	Class 1	Class 2	Class 3	Class 4	Class 4
Basic Characteristic	Zinc Coating Consists of 1 Layer : ① 1st layer is metallic zinc protecting the metal.		Ruspert Coating Consists of 2 Layers : ① 1st layer is metallic zinc protecting the metal. ② 2nd layer is the baked ceramic coating.		Tufcote Coating Consists of 3 Layers : ① 1st layer is metallic zinc protecting the metal. ② 2nd layer is a Ceramic Surface Coating. ③ 3rd layer is a PU modified Epoxy	
Recommend	General use in internal application.		External use in mild moderate industrial or marine environments.		External use in severe marine environment.	

Self-Drilling Screws for the building and construction industries

Corrosion Resistance Class Requirements (Australian Standard AS 3566.2-2002)

Corrosion Resistance Class	Atmosphere of Intended Use
Class 1	General use in internal application. AS 2331.3.1 (Salt Spray Test) for 72 h.
Class 2	General use in other than external applications but where significant levels of condensation occurs. AS 2331.3.1 (Salt Spray Test) for 240 h , DIN50018 (Kesternich Test) for 5 Cycles.
Class 3	External use in mild moderate industrial or marine environments. Corrosivity categories C2 and C3 classified accordance with ISO 9223. AS 2331.3.1 (Salt Spray Test) for 1000 h , DIN50018 (Kesternich Test) for 15 Cycles.
Class 4	External use in severe marine environment. Corrosivity C4 classified in accordance with ISO 9223. AS 2331.3.1 (Salt Spray Test) for 1500 h , DIN50018 (Kesternich Test) for 25 Cycles.

■ Originated as AS 3566-1988 Revised and redesignated in part as AS3566.2-2002

Fastener Coating

Bi-Metal Screw Applied With Ruspert Coating :
AS-3566 Class 3 AS 2331.3.1 for 1000h standard.

Ruspert metal finish is a high-grade metal surface processing technology that prevents corrosion. It is the tight joining of the baked ceramic surface coating and metallic zinc protection. These layers are bonded together through chemical reactions, and this unique method of combining layers results in a rigid combination of the coating films. Ruspert treatment does not attribute its anti-corrosion properties to merely a single material, but the synergy of these two layers, which combined have superb rustproof qualities. Corrosion resistance against scratches, gas, weathering and other kinds of corrosive factors including salt water. Low processing temperature, as the drying temperature below 220°C protects the products from metallographic changes. It strengthens the product by prevent embrittlement & hole corrosion after the heating treatment. Electrolytic corrosion resistance as it is less contact corrosion with other metals.

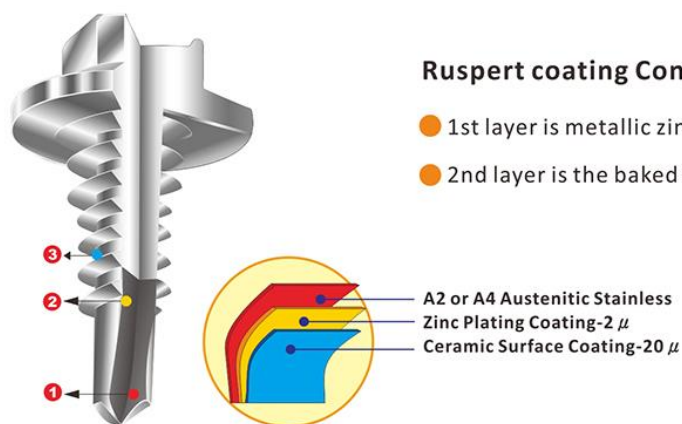

Ruspert coating Consists of 2 Layers:

- 1st layer is metallic zinc protecting the metal.
- 2nd layer is the baked ceramic coating.

A2 or A4 Austenitic Stainless
Zinc Plating Coating-2 μ
Ceramic Surface Coating-20 μ



Industrial Lightweight Construction
Austenitic Stainless Steel SUS A2-302 / A2-304 / A4-316



Drilling Point #1

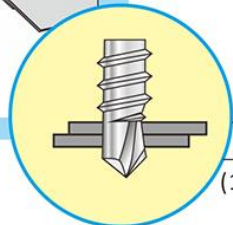
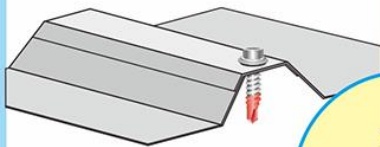

(1+1mm)

Drilling Point #2

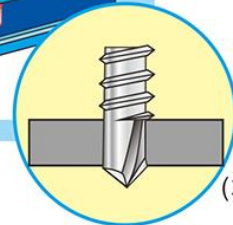
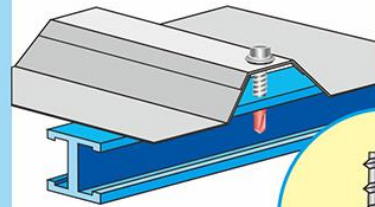

(3mm)

Drilling Point #3

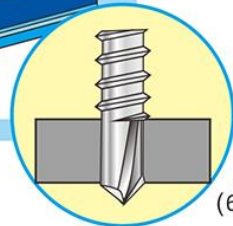
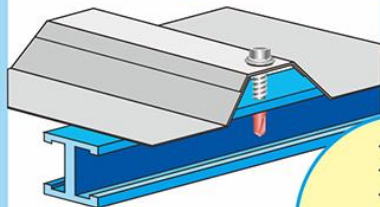

(6mm)

Drilling Point #5

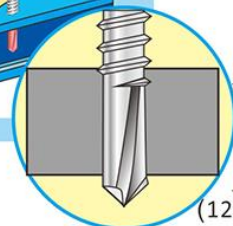
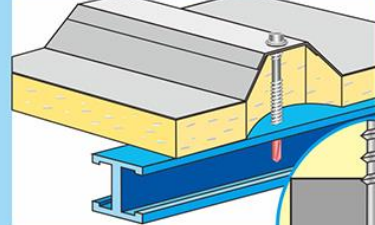

(12.5mm)

Bi-Metal Self-Drilling Screw

Industrial Lightweight Construction

Austenitic Stainless Steel SUS A2-302 / A2-304 / A4-316

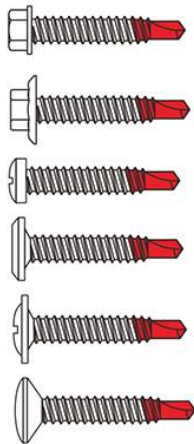

Diameter Size	Length(mm)		Point Size	Max Drilling capacity(mm)	Drive Speed (R.P.M)
	min	max			
Ø4.2	16	45	#1	1+1	1800-2500
Ø4.8	19	180	#1	1+1	1800-2500
Ø5.5	22	300	#1	1+1	1800-2500
Ø6.3	22	300	#1	1+1	1800-2500
Ø4.2	16	45	#2	2	1800-2500
Ø4.8	19	180	#2	3	1800-2500
Ø5.5	22	300	#2	3	1800-2500
Ø6.3	22	300	#2	3	1800-2500
Ø4.2	16	45	#3	3	1800-2500
Ø4.8	19	180	#3	4	1800-2500
Ø5.5	25	300	#3	6	1800-2500
Ø6.3	25	300	#3	6	1000-1800
Ø5.5	38	300	#5	12.5	1000-1800
Ø6.3	38	300	#5	12.5	1000-1800

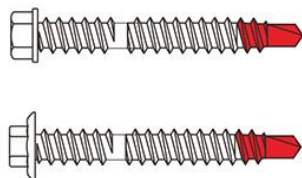

Diameter Size	Length(mm)		Point Size	Max Drilling capacity(mm)	Drive Speed (R.P.M)
	min	max			
Ø5.5/4.8	50	300	#1	1+1	1800-2500
Ø6.3/5.5	50	300	#1	1+1	1800-2500
Ø7.0/6.5	50	300	#1	1+1	1800-2500
Ø5.5/4.8	50	300	#2	3	1800-2500
Ø6.3/5.5	50	300	#2	3	1800-2500
Ø7.0/6.3	50	300	#2	3	1800-2500
Ø5.5/4.8	50	300	#2	6	1800-2500
Ø6.3/5.5	50	300	#2	6	1800-2500
Ø7.0/6.3	50	300	#3	6	1000-1800
Ø6.3/5.5	63	300	#5	12.5	1000-1800
Ø7.0/6.3	63	300	#5	12.5	1000-1800



Countersunk Head Wing Screw Austenitic Stainless Steel SUS A2-302 / A4-316

Application Example

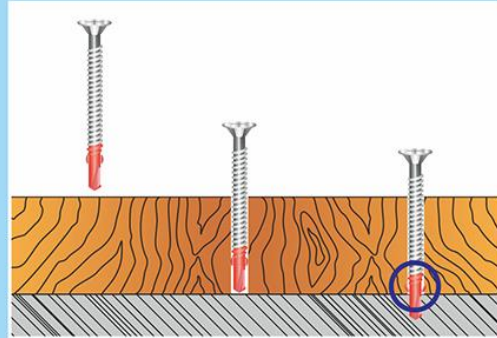

- Wing screws for fastening timber to steel rails and purlins from 6-12mm. The screw wings ream a hole through the timber, and break away before drilling into steel.

Flat Head



Diameter Size	Length(mm)		Point Size	Max Drilling capacity(mm)	Drive Speed (R.P.M)
	min	max			
Ø4.2	25	40	#3	3	1800-2500
Ø4.5	25	75	#3	4	1800-2500
Ø4.8	32	200	#3	6	1800-2500
Ø5.5	55	130	#5	6-12	1000-1800
Ø6.3	55	300	#5	6-12	1000-1800

Bi-Metal Self-Drilling Screw Austenitic Stainless Steel Flat Head Screw SUS A2-302 / A4-316

Flat Head



Diameter Size	Length(mm)		Point Size	Max Drilling capacity(mm)	Drive Speed (R.P.M)
	min	max			
Ø4.2	19	45	#2	3	1800-2500
Ø4.5	19	180	#2	3	1800-2500
Ø5.5	25	300	#2	3	1800-2500
Ø4.2	19	45	#3	3	1800-2500
Ø4.8	25	180	#3	4	1800-2500
Ø5.5	25	300	#3	6	1800-2500
Ø6.3	30	300	#3	6	1000-1800
Ø5.5	38	300	#5	12	1000-1800
Ø6.3	38	300	#5	12	1000-1800

Bi-Metal Self-Drilling Screw

Bi-Metal Window Screw Austenitic Stainless Steel SUS A2-302

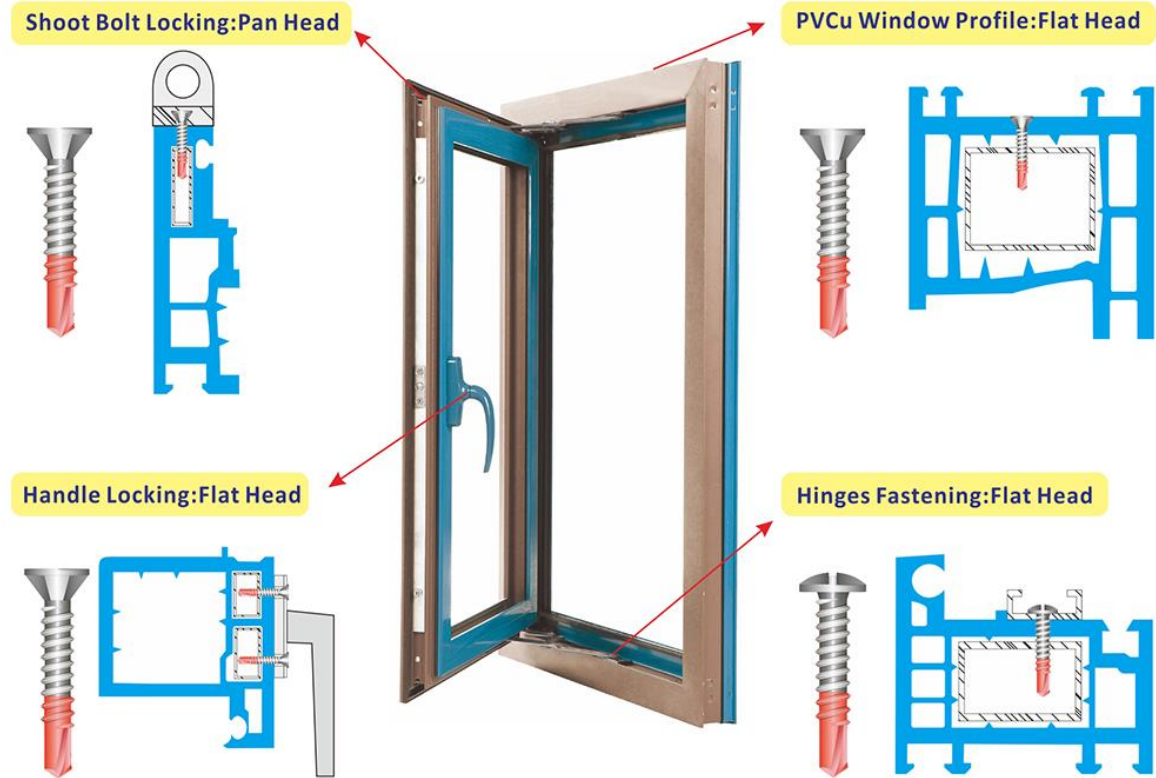

Flat Head

Diameter Size	Length(mm)		Point Size	Max Drilling capacity(mm)	Drive Speed (R.P.M)
	min	max			
Ø4.2	19	45	#3	3	1800-2500
Ø4.5	19	45	#3	3	1800-2500

Pan Head

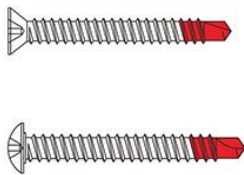

Diameter Size	Length(mm)		Point Size	Max Drilling capacity(mm)	Drive Speed (R.P.M)
	min	max			
Ø4.2	16	29	#3	3	1800-2500
Ø4.5	16	29	#3	3	1800-2500



Bi-Metal Self-Drilling Screw Austenitic Stainless Steel

- **Direct application on stainless steel plate.**
(maximum 2mm-Bi-Metal technology)

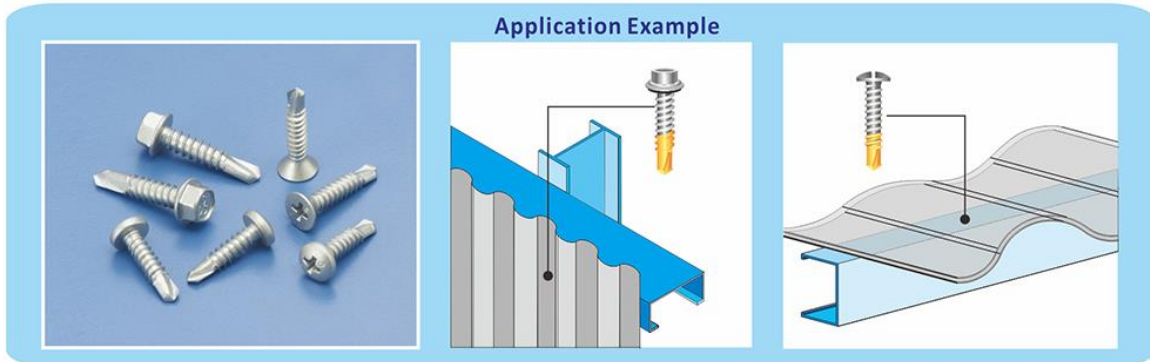

Hex Washer/Pan/Wafer/Truss Head



Diameter Size	Length(mm)		Point Size	Max Drilling capacity (mm) on S.S.plate	Max Drilling capacity (mm) on Steel plate	Drive Speed (R.P.M)
	min	max				
Ø4.2	16	25	#3	2	3	Max. 2500
Ø4.8	19	25	#3	2	4	Max. 2500
Ø5.5	19	32	#3	2	6	Max. 2500
Ø6.3	25	38	#3	2	6	Max. 2500

Flat Head



Diameter Size	Length(mm)		Point Size	Max Drilling capacity (mm) on S.S.plate	Max Drilling capacity (mm) on Steel plate	Drive Speed (R.P.M)
	min	max				
Ø4.2	16	25	#3	2	3	Max. 2500
Ø4.8	19	25	#3	2	4	Max. 2500

Bi-Metal Self-Drilling/Tapping Screw

Side Lap Screw (Special Thread, Pre-drilled unnecessary) Austenitic Stainless Steel SUS A2-304

- Designed to attach the Steel Plate or Aluminium.

Application Example

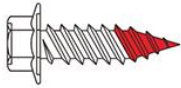
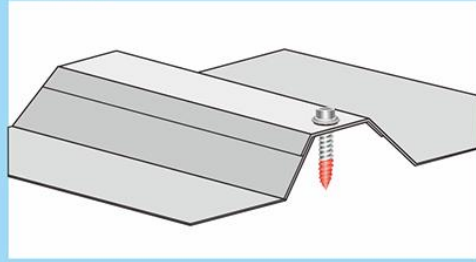

Diameter Size	Length(mm)		Point Size	Max Drilling capacity (mm) on Steel plate	Drive Speed (R.P.M)
	min	max			
Ø4.8	19	25	sharp point	0.8+0.8	Max. 1800
Ø5.5	19	25	sharp point	0.8+0.8	Max. 1800
Ø6.3	22	25	sharp point	0.8+0.8	Max. 1800

Bi-Metal Self-Tapping Screw Austenitic Stainless Steel

- Self-Tapping Screw, stainless steel(A2), type B for fastening steel sheet to steel framing profiles with or without intermediate insulation material.

- Sharp Point Drilling Capacity :

1.00+2.00mm (Pre-drilled hole 5.00mm)
0.63+0.63mm (Pre-drilled hole 3.50mm)

- Blunt Point Drilling Capacity :

1.5mm (Pre-drilled hole 4.9mm)
3.0mm (Pre-drilled hole 5.05mm)
4.0mm (Pre-drilled hole 5.35mm)
5.0mm (Pre-drilled hole 5.65mm)
6.0mm (Pre-drilled hole 5.8mm)
10 mm (Pre-drilled hole 5.85mm)

Application Example

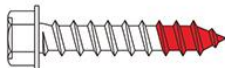
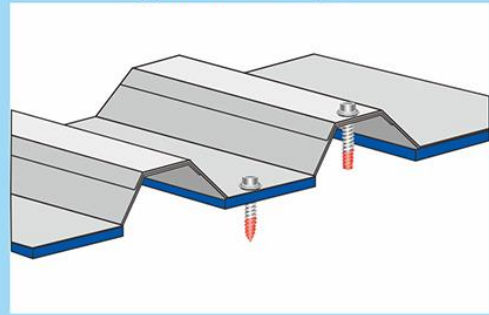

Diameter Size	Length(mm)		Point Size	Drive Speed (R.P.M)
	min	max		
Ø6.5	19 - 300		sharp / blunt	Max. 1800



High Strength A2 Stainless Steel Tapping Screw Austenitic Stainless Steel SUS A2-304

- "8-18" Stainless Steel with special treatment to improve strength characteristics.
- Easier to tapping, thread wear resistance.
- Higher torsion strength characteristics (20% improve).
- Higher pull-out strength.

Application Example

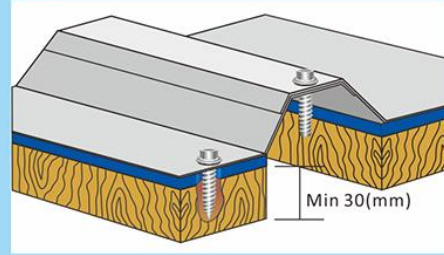

(A2-304) Modify Self-Tapping Screw Sharp / Blunt point

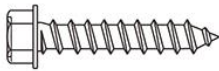

Diameter Size	Length(mm)		Point Size	Drive Speed (R.P.M)
	min	max		
Ø6.3	19	300	sharp/blunt	Max. 800

- Self-Tapping Screw, stainless steel(A2), type B for fastening steel sheet to steel framing profiles with or without intermediate insulation material.
- Sharp Point Drilling Capacity :
1.00mm+2.00mm(Pre-drilled hole 5.00mm)
0.63+0.63mm(Pre-drilled hole 3.50mm)
- Blunt Point Drilling Capacity :
1.0mm(Pre-drilled hole 4.35mm) / 1.5mm(Pre-drilled hole 4.9mm).
3.0mm(Pre-drilled hole 5.05mm) / 4.0mm(Pre-drilled hole 5.35mm)
5.0mm(Pre-drilled hole 5.65mm) / 6.0mm(Pre-drilled hole 5.8mm)
10mm(Pre-drilled hole 5.85mm)

Stainless Steel Screw Type 17 (Hex Washer Flange Head)

Application Example

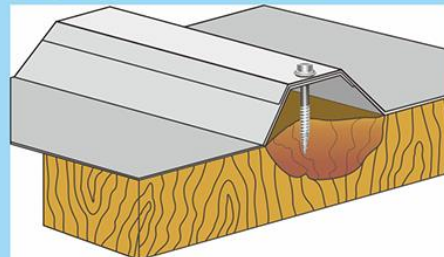

Diameter Size	Length(mm)		Point Size	Drive Speed (R.P.M)
	min	max		
Ø6.3	19	300	sharp	Max. 800

- Drilling Capacity : 1.00mm+2.00mm (Pre-drilled hole 5mm)
0.63mm+0.63mm (Pre-drilled hole 3.5mm)

Metric Thread Bolts / Screws



Size

Diameter Size		Length(mm)		Material
min	max	min	max	
M4	M36	20	300	Carbon Steel/Alloy Steel/Stainless Steel (302/304-A2/316-A4)

Standard

IFI, DIN931, DIN933, DIN603, DIN912, DIN7984, DIN 7380, DIN7991..etc.

Finish

Zinc Plated(White/ Yellow/ Blue/ Green/ Black), Nickel Plated, Zinc-Iron Alloy Plated, Geomet, Dacromet, Ruspert, Hot Dip Galvanized, Mechanical Plated, Nylon Patch, Passivation..etc.

Application Example

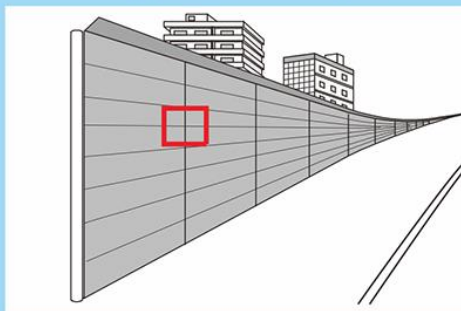

Application

Industry, Construction and Machinery. Metric Thread Bolts can be in widespread use such as fastening wood and steel, mechanical equipments, outdoor facility and other construction materials, the docks, bridges, highway structures and buildings.



Double Ends Hanger Bolts (Dowel Screw)



Size

Diameter Size		Length(mm)		Material
min	max	min	max	
M4	M36	50	300	Carbon Steel/Alloy Steel/Stainless Steel (302/304-A2/316-A4)

Standard

DIN88149

Finish

Zinc Plated (White/ Yellow/ Blue/ Green/ Black), Nickel Plated, Zinc-Iron Alloy Plated, Geomet, Dacromet, Ruspert, Hot Dip Galvanized, Mechanical Plated, Nylon Patch, Passivation..etc.

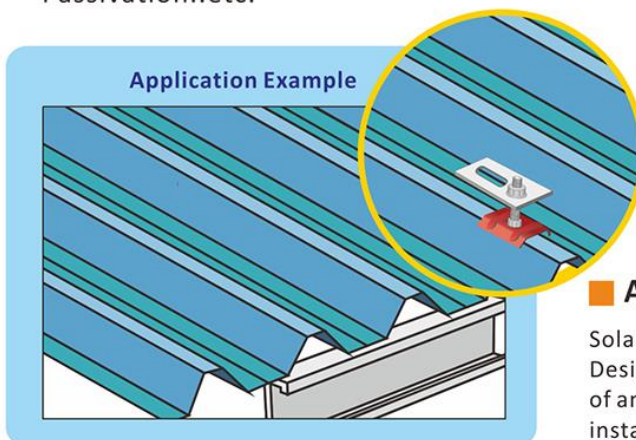

Application

Solar Panel Fastening and Overhead Installation. Designed for insertion into the pre-drilled hole of an outdoor solar panel facility or overhead installation.

Special Bolts/ Screw



Size

Diameter Size		Length(mm)		Material
min	max	min	max	
M4	M36	20	300	Carbon Steel/Alloy Steel/Stainless Steel (302/304-A2/316-A4)

Finish

Zinc Plated (White/ Yellow/ Blue/ Green/ Black), Nickel Plated, Zinc-Iron Alloy Plated, Geomet, Dacromet, Ruspert, Hot Dip Galvanized, Mechanical Plated, Nylon Patch, Passivation..etc.

Application Example

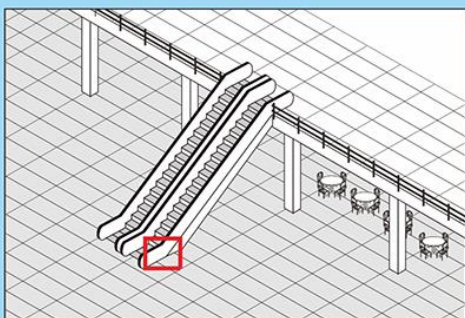

Application

Customized Design and Drawing Mostly. Special Bolts/ Screws can be used in a wide range of configurations or a specific projects such as escalator, elevator, T-extrusion track and all kinds machinery.



Quality Control

Based on the customer guidelines and continuous improvement, our company has formulated the innovative, professional, efficient and impeccable service as our quality policies. Quality control during each production process, with computerized testing and knowledgeable personnel, ensures that the highest standard is upheld. The quality of our manufacturing processes ensures us that we can meet and surpass the level of standard our customer expected.



Coating thickness testing machine

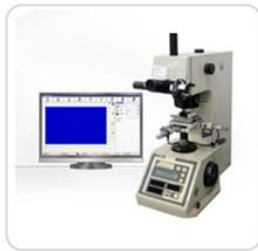

Vickers hardness testing machine

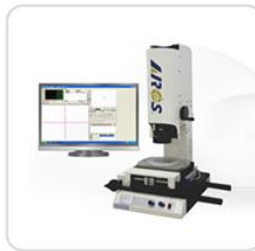

Non contact visual measuring microscope

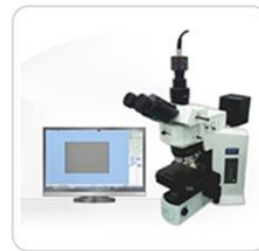

Metallographic analysis microscope



Computerized drill through testing machine



Computerized pullout testing machine



Kesternich testing machine



Salt spray testing machine



Project

Taiwan construction projects that use Bi-Metal Screw from SHEH KAI

- Taiwan High Speed Rail Platform Construction Project.
- Kaohsiung Mass Rapid Transit Project.
- Formosa Petrochemical Corp Mailiao Refinery Project.
- Taipei NeHu Mass Rapid Transit Platform Project.
- Xindian Light Weight-Steel Housing Construction Project.
- FPCC MAILIAO IEM Plant Circular Salt Storage Dome Engineering.
- Taiwan TaiChong Dragon Steel Expansion Project.
- China Steel Mill Renovation Project.
- Taipei Farglory Dome.
- Kaohsiung Wei-Wu-Ying Center for the Arts Roof Project.
- Changhua District Court Relocation Office of New Project.
- Taipei World Universiade Games Village Turnkey Project.



www.shehkai.com.tw



世鎧精密股份有限公司

SHEH KAI PRECISION CO.,LTD.

No.1,Bengong 1st Rd.,Gangshan Dist.,

Kaohsiung City 82059,Taiwan.

TEL: 886-7-622-5669

FAX: 886-7-622-6002

E-mail: info@shehkai.com.tw

Http: [//www.shehkai.com.tw](http://www.shehkai.com.tw)

