

Workshop Solutions

One call for complete peace of mind



Bodyshop Equipment



Wheel Repair – Preparation

NO HASSLE
WARRANTY

BEST PRICE
PROMISE

ALLOY WHEEL BLAST CABINET

- Quick dry blasting application for damaged alloy wheels
- Provides quick paint preparation on wheels
- Effectively removes alloy corrosion
- Can be operating either via a suction or pressure fed system

SUCTION: Scotches prior to paint- ideal for quick, smart repairs

PRESSURE: Removes layers of paint and corrosion and strips wheels back to bare metal

- Various extraction and cyclone systems are available
- Compact cabinet contains dust
- Reduces manual labour
- Internal spigot complete with pivoting arm to hold the wheel in place during the blasting process

SUCTION FEED

597 77 0950

WEEKLY
FROM ONLY **£25.43⁺**
ONLY **£5,045.00**

PRESSURE FEED

597 77 0960

WEEKLY
FROM ONLY **£32.73⁺**
ONLY **£6,495.00**



WHEEL BLAST UNIT

OPT.WHEELBLASTER-A

- Scotches the wheel prior to final preparation in minutes
- Does not strip the wheel
- Blasts, washes and scotches all in one application
- No additional washing or drying machines needed
- Ideal for quick, same day repairs
- 100% dust-free wet blasting process
- Internal spigot holds the wheel in place
- Optional pneumatic wheel lift for ease of loading
- Price includes delivery, commissioning and operator training
- Optional closed loop system

WEEKLY
FROM ONLY **£65.49⁺**
ONLY **£12,995.00**

CLOSED LOOP SYSTEM

WEEKLY
FROM ONLY **£73.56⁺**
ONLY **£14,595.00**

See in action!
goo.gl/kHHOHZ



*Finance example typically based on a 5 year lease purchase agreement. Finance subject to status, full terms and conditions available on request. Other finance options available. All prices exclude VAT at 20%. Price, availability and specification may change without prior notice. Warranty subject to manufacturers terms and conditions of use. Errors and omissions excluded. Offers valid until 28th February 2017. Prices correct at time of going to press: August 2016.

Wheel Repair – Preparation

NO HASSLE
WARRANTY

BEST PRICE
PROMISE

TRYAX TY30-VS VERTICAL DIAMOND CUT ALLOY WHEEL LATHE 597 77 8120



**SAVES TIME
MAXIMISES WHEEL THROUGHPUT**

THE TY30-VS is ushering in a new era for diamond cut alloy wheels. This CNC vertical alloy wheel lathe is characterised by its innovative purpose-built design. Built from the ground up both mechanically and electrically, the system offers an easy-to-use touchscreen interface coupled with the latest state-of-the-art real-time control software driving the latest in motion-control digital drive technology.

The CNC is equipped with 15" multi-touch screen and offers user-friendliness and precision coupled with reliability.

An ultra-fast digitiser option is capable of probing a typical 20" wheel in around 3 minutes.

- Cuts wheels from 14" to 30" in diameter.
- Fully automated and easy for staff to use.
- Intuitive, easy to use touchscreen interface.
- Automated self-plotting digitizer does all the hard work for you.
- Simple two stage process – 1 digitise wheel, 2 cut wheel.
- Compact design saves on valuable workshop space.

WEEKLY
FROM ONLY **£277.20***
ONLY **£55,000.00**

**DEMO AVAILABLE ON
APPOINTMENT**

*Finance example typically based on a 5 year lease purchase agreement. Finance subject to status, full terms and conditions available on request. Other finance options available. All prices exclude VAT at 20%. Price, availability and specification may change without prior notice. Warranty subject to manufacturers terms and conditions of use. Errors and omissions excluded. Offers valid until 28th February 2017. Prices correct at time of going to press: August 2016.



OPTIMA ALLOY WHEEL PAINT AEROSOL 500ML

- 18 colours available
- Includes genuine chrome colours
- Matched to popular OEM Colours
- Superb coverage
- No mixing required
- Ready for use
- Aerosol format
- Increase repair turnaround by repairing in-house

Felgin Silver	OPT.AWP1007-500A
---------------	------------------

Mercury Chrome	OPT.AWP0001-500A
----------------	------------------

Medium Silver	OPT.AWP2001-500A
---------------	------------------

Coarse Sparkle Silver	OPT.AWP3001-500A
-----------------------	------------------

Flat Bright Silver	OPT.AWP1001-500A
--------------------	------------------

ST Grey	OPT.AWP0048-500A
---------	------------------

Very Fine Silver	OPT.AWP1002-500A
------------------	------------------

Chrome Anthracite	OPT.AWP0003-500A
-------------------	------------------

Bright Glitter Silver	OPT.AWP3002-500A
-----------------------	------------------

Ferric Grey	OPT.AWP1013-500A
-------------	------------------

Dark Anthracite	OPT.AWP2006-500A
-----------------	------------------

Anthracite Silver	OPT.AWP2018-500A
-------------------	------------------

Carbon Charcoal	OPT.AWP2020-500A
-----------------	------------------

Light Anthracite	OPT.AWP1021-500A
------------------	------------------

Steingrau	OPT.AWP2073-500A
-----------	------------------

French Silver	OPT.AWP2087-500A
---------------	------------------

Himalayan Grey	OPT.AWP3018-500A
----------------	------------------

Grey Sparkle	OPT.AWP3027-500A
--------------	------------------

ONLY **£14.95**

OPTIMA 2K CLEARCOAT AEROSOL 500ML

OPT.AWPCLEAR-500A

Optima 2K Clearcoat is a superior high gloss, crystal clear finish that has excellent gloss retention on wheels.

- Brilliant gloss retention
- Very scratch resistant
- Gives a spray gun finish every time

ONLY **£26.95**



ALLOY WHEEL REFURBISHMENT MACHINE OPT.AWRM

Professional machine designed for repairing damage to alloy wheel rims

- Integrated Bead breaker
- Will take up to 24" wheels
- Fitted with a sanding pad attachment for quick removal of damage and unique sanding attachment for diamond cut effect
- Swivel head design and polishing arm for maximum access into difficult areas of wheels



WEEKLY
FROM ONLY **£17.01***
ONLY **£3,375.00**

4 WHEEL PAINT AND PREPARATION TROLLEY 597 77 8180

- Easy assembly wheel preparation stand of good sturdy construction with a weighty base to give stability.
- Can accommodate 4 large alloy wheels (with tyres still mounted) without them impeding on each other.
- Four castor wheels make it mobile and easily manoeuvrable.



ONLY **£445.00**

*Finance example typically based on a 5 year lease purchase agreement. Finance subject to status, full terms and conditions available on request. Other finance options available. All prices exclude VAT at 20%. Price, availability and specification may change without prior notice. Warranty subject to manufacturers terms and conditions of use. Errors and omissions excluded. Offers valid until 28th February 2017. Prices correct at time of going to press: August 2016.

The WS400 & LS400 spray guns have pre-atomizing nozzle technology, which is able to deliver a consistent droplet size when spraying. This technology also offers a long straight and even fan pattern.

In addition the WS400 & LS400 spray gun range are equipped with stainless steel fluid passages ideal for any type of material, solvent borne or waterborne. The angle of the gravity cup has been pitched to make it easier to obtain the correct gun position when spraying larger more difficult areas such as roofs and bonnets.

The larger thread pattern on the air-cap makes it easier to remove when cleaning, also this range does not have a baffle fitted between fluid tip and gun body resulting in a more precise fit with less maintenance and replacement parts needed.

IWATA WS400 SPRAY GUN

1.3mm EVO BASECOAT	IWA.13244113EP
1.3mm EVO CLEARCOAT	IWA.13244115EP
1.3mm EVO HD BASECOAT	IWA.13244121EP
1.3mm EVO HD CLEARCOAT	IWA.13244122EP
1.3mm OBS EVO BASECOAT	IWA.13244118EP
1.4mm EVO BASECOAT	IWA.13244116EP
1.4mm EVO CLEARCOAT	IWA.13244117EP
1.4mm EVO HD BASECOAT	IWA.13244123EP
1.4mm EVO HD CLEARCOAT	IWA.13244124EP
1.5mm EVO HD BASECOAT	IWA.13244125EP
1.5mm EVO HD CLEARCOAT	IWA.13244126EP

IWATA LS400 SPRAY GUN

1.2mm	IWA.13186521PL
1.3mm	IWA.13186533PL
1.4mm	IWA.13186544PL
1.5mm	IWA.13186551PL
ETS 1.2mm	IWA.13186522PL
ETS 1.3mm	IWA.13186534PL
ETS 1.4mm	IWA.13186545PL
ETS 1.5mm	IWA.13186552PL

ONLY **£279.99**

IWATA AZ3 GREEN FLASH SPRAY GUN

The Air guns Green Flash has been designed to offer the sprayer a robust, quality spray gun at an incredible price:

- New longer fan pattern
- All internal parts are stainless steel, ideal for water based and solvent paints
- Adjustable air inlet valve as standard
- New high atomisation air caps

1.2mm	IWA.W0SPG90LG12C
1.3mm	IWA.W0SPG90LG13C
1.4mm	IWA.W0SPG90LG14C
1.6mm	IWA.W0SPG90LG16C
1.8mm	IWA.W0SPG90LG18C
2.0mm	IWA.0SPG90LG20C

ONLY **£79.99**



Spray Guns – Devilbiss

NO HASSLE
WARRANTY

BEST PRICE
PROMISE

GTI PRO-LITE SPRAY GUNS

- Ergonomic gun body design
- Ultra high flow fluid tips provide superb versatility across a range of viscosities
- Revolutionary air valve design gives smoother feel for even greater air and paint control for ease of fade-outs and blend-ins
- Simplified, user friendly components provide easy cleaning and maintenance
- Precision engineered using lightweight and durable alloy components for a tough spray gun that is 25% lighter than the GTi Pro Digital
- Enhanced ergonomics combined with the GTi Pro's legendary fit and feel ensure incredible handling and balance
- A coaxial linear air valve eliminates the need for separate air and fluid control valves for a smooth, kick-free trigger action, easy cleaning and maintenance
- Four advanced atomisation technology air caps for perfect paint performance in all climatic conditions (T110, TE20, HV30, TE10)
- New for 2016 – GTi Pro Lite sprayguns are available in blue, black or gold



ONLY **£254.99**

SRI PRO-LITE SPRAY GUNS

- Designed for small repair work
- Lighter trigger control which allows more control for repair areas
- Lightweight design means improved spray gun handling
- Better fit and feel with more comfort and control
- Various air caps to suit the different and latest refinishing materials used when spraying (TE5, HV5, MC1)



ONLY **£205.99**

PRI PRO-LITE SPRAY GUNS

- Advanced technology 'Trans-Tech' compliant air cap for fast working speed
- Good transfer efficiency (paint to panel).
- Suitable for all paints including latest generation waterbase materials
- First class atomisation and material distribution
- Large spray pattern for fast and easy application
- Drop forged aluminium spray gun body, anodised Complete with airflow "cheater" valve
- Utilises new design air valve for smooth triggering control
- All new ergonomic spray gun body with improved "fit and feel"
- Five fluid tips to choose from (1.4, 1.6, 1.8, 2.0, 2.5)



ONLY **£179.99**

Contact your local LKQ Coatings branch to find out more.

*Finance example typically based on a 5 year lease purchase agreement. Finance subject to status, full terms and conditions available on request. Other finance options available. All prices exclude VAT at 20%. Price, availability and specification may change without prior notice. Warranty subject to manufacturers terms and conditions of use. Errors and omissions excluded. Offers valid until 28th February 2017. Prices correct at time of going to press: August 2016.



SATAJET 5000 B SPRAY GUNS

- Optimised nozzle concept for highest possible versatility concerning Inlet Pressure and spray distance
- Ergonomically shaped gun handle
- Pearlchrome™ surface for easy cleaning, corrosion resistant
- Easy to adjust control elements
- Safely positioned trigger sleeve – for easy, safe and quick insertion of the paint needle
- Swivel joint with new high performance seal
- Identical compact-size gun handle for non-DIGITAL and DIGITAL spray guns
- Optimised half-turn spray fan control

The “Super Saver“ SATAjet 5000 B HVLP achieves particularly high transfer rates, due to its low pressure technology.

The “Super Speed“ SATAjet 5000 B RP with its optimised high pressure technology for maximum application speed and minimum overspray.

Both versions are extremely versatile in application, meeting highest expectations concerning excellent finishes, while far exceeding 65% transfer efficiency rates in accordance with VOC legislation.

No adapter required – SATA RPS disposable cups fit directly on the SATAjet 5000 B – for reduced weight and cleaning effort

Pressure under control – the DIGITAL® option:
Integrated pressure gauge – to ensure perfect reproducibility



FROM ONLY **£399.99**

SATAMINIJET 4400 B SPRAY GUNS

- Small size – big performance
- For small surfaces and areas of difficult access
- HVLP and RP nozzle sets
- Special SR nozzle sets for the smallest spot repairs (Spot repair)
- New ergonomically shaped handle
- Easy cleaning and maintenance
- Large cup connection QCC for all RPS cup sizes
- Highly flexible in terms of atomisation pressure and spray distance
- VOC-compliant atomisation technology – optionally available as HVLP low pressure or RP optimised high pressure technology
- Adam 2 Compatible: Innovative and versatile digital retrofit air micrometer
- Perfectly suitable for the use of RPS disposable cups
- QCC Quick Cup connection for quick and clean cup changes as well as easy cleaning
- CCS Colour Code System for the convenient identification of your spray gun
- Top quality is not enough - we guarantee it: for three years

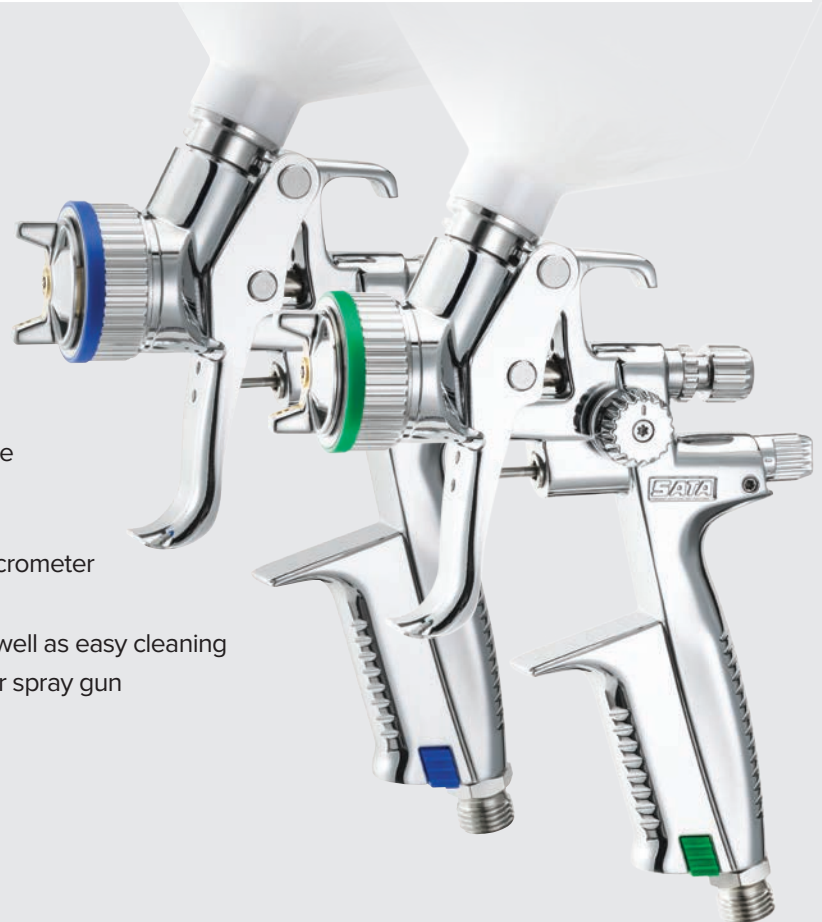

FROM ONLY **£194.99**

Contact your local LKQ Coatings branch to find out more.

*Finance example typically based on a 5 year lease purchase agreement. Finance subject to status, full terms and conditions available on request. Other finance options available. All prices exclude VAT at 20%. Price, availability and specification may change without prior notice. Warranty subject to manufacturers terms and conditions of use. Errors and omissions excluded. Offers valid until 28th February 2017. Prices correct at time of going to press: August 2016.

DEVILBISS PROVISOR COMPLETE VISOR KIT WITH WAIST DEV.PROV-600

- Disperses breathing air gently around the lightweight visor at a positive pressure
- No misting or discomfort
- Provides excellent and much wider peripheral vision than sprayers will be used to
- Removable peak reduces glare from Spraybooth lighting
- Plenty of room to cater for sprayers who wear spectacles
- Replaceable clear visor covers available in packs of 10 and 50
- Gun supply hose swivels both radially and laterally, ensuring better spray dynamics without the hose restricting the sprayers movement.
- Anti-static and anti-kink head piece supply hose.
- Anti-static head piece.



ONLY **£195.99**

IWATA KIT FULL FACE AIRFED MASK SYSTEM CLASS 3 IWA.VIUAF2010KIT

- Provides protection against airborne dusts, mists, gases and vapours
- Offers respiratory protection to class 3 and hence offers a protection factor of up to 200
- Can be used in areas where the concentration of contaminant in the workplace air is up to 200 times the Occupational Exposure Limit



ONLY **£159.99**

SATA® VISION 2000 AIR FED FACE MASK SAT.69500

- Lightweight, comfortable breathing hood thoroughly protects the face, hair and neck from over spray
- Also suitable for persons wearing glasses and persons with short beards or moustaches
- Fresh air is supplied steadily through a silencer to the hood without drafts
- Air supply has a variable adjustment according to the users requirements
- Shut-off system prevents airflow from being completely shut off.
- Compact activated charcoal filter is worn on the belt in a protective cage and removes oil vapour and gases



ONLY **£338.99**

IWATA 3 STAGE FILTER REGULATOR IWA.TSFR13603

The TSFR13603 is a high quality 3-stage filter unit providing safe, breathable air for the spraybooth. 60cfm from the first filter provides enough air to run two spray guns, plus high quality breathable air for up to two air-fed masks.

- Technical Specifications
- Max operating pressure: 0 - 10 bar
- Max operating temperature: 80°C
- Max inlet flow: 15 bar
- Drain valve, semi automatic



ONLY **£299.99**

*Finance example typically based on a 5 year lease purchase agreement. Finance subject to status, full terms and conditions available on request. Other finance options available. All prices exclude VAT at 20%. Price, availability and specification may change without prior notice. Warranty subject to manufacturers terms and conditions of use. Errors and omissions excluded. Offers valid until 28th February 2017. Prices correct at time of going to press: August 2016.

Selecting the right compressor

When selecting the right air compressor, the tank size is important. A small tank will overwork the motor. It is equally if not more important to select an air compressor that provides enough cubic feet per minute (cfm) of airflow. CFM is going to determine how many tools you can run, and whether each tool will function at its best.

TOOL/EQUIPMENT	CFM	BAR
3/8" Impact Wrench	2 – 3	6
1/2" Impact Wrench	4 – 6	6
3/4" Impact Wrench	9	6
1" Impact Wrench	14	6
3/8" Ratchet	2 – 5	6
1/2" Ratchet	5	6
3/8" Drill	12	6
DA Sander (Top Quality)	10	6
DA Sander (econ. model)	20	6
7" Sander/Polisher	25	6
Zip/Impact Cutter	4 – 5	6
Cutters Shears	4 – 8	6
4" Angle Grinder	18 – 25	6
7" Angle Grinder	25 – 35	6
Tyre Inflator	2 – 4	10 – 16
Tyre Changer (Manual)	4	10

TOOL/EQUIPMENT	CFM	BAR
Tyre Changer (Auto)	6	10
Sand Blast Cabinet	10 – 50	3.5 – 7
Sand Blast Hand Gun	8 – 12	7
Spray Gun – Airbrush	0.25	2
Spray Gun – Miniature	4 – 7	1.5 – 3.5
Spray Gun – Low Pressure	1.5 – 4	1.5 – 3
Spray Gun – Standard	7.14	3.5 – 4
Spray Gun – HVLP	14 – 20	5 – 6
HA/GEO/9000 series LVLP	7 – 9.5	2 – 2.5
Air Fed Mask	5 – 6	1.5 – 3
Oil Pump	1.5	7 – 10.5
Grease Pump	4.5	7 – 10.5
Air Water Wash	10	10.5
Car Wash	1.5 – 5	5 – 7
Blow Gun (safety nozzle)	3	7
Spark Plug Cleaner	3	7
Underseal Gun	4	7
Rivet Gun	1.5 – 3	50 – 6
2 Ton Air/Hydraulic Lift	5 – 8	9 – 10.5
Brake Tester	3 – 7	5 – 7
Plasma Cutter	6 – 8	4 – 7

ABAC PRO PISTON COMPRESSORS

Ideal for a small workshop where only single phase is available.

Belt driven, resulting in a quieter and more efficient compressor

Typically used with Tyre Inflator, Blow Gun, Spray Gun, Impact/ Ratchet wrenches



MODEL	PART NUMBER	PRICE
Pro A39B 150 FM3 13.8 cfm(dis) 10.1 cfm(FAD) 10 bar 3HP 1 Phase	572 77 0580	£475
Pro A39B 200 FM3 13.8 cfm(dis) 10.1 cfm(FAD) 10 bar 3HP 1 Phase	572 77 0560	£525

Perfect for a small workshop with three phase

Typically Used with Tyre Inflator, Blow Gun, Spray Gun, Impact/ Ratchet wrenches, low consumption shot blast cabinet

MODEL	PART NUMBER	PRICE
Pro B4900 200 FT4 18 cfm(dis) 13.8 cfm (FAD) 11 bar 4HP 3 Phase	572 77 0670	£645

Perfect for a medium workshop with three phase

MODEL	PART NUMBER	PRICE
Pro B5900B 200 FT5.5 22.9 cfm (dis) 17.7 cfm (FAD) 11 bar 5.5HP 3 Phase	572 77 0680	£695

Ideal for a small workshop where only single phase is available. Largest single phase piston compressor available.

Belt driven, resulting in a quieter and more efficient compressor

ABAC Piston compressors come with 12 months on site warranty, the pump has a further 1 year warranty when the compressor is serviced at the end of the 1st year.



MODEL	PART NUMBER	WEEKLY	PRICE
Pro A39 270 FM3 Tandem 27.6 cfm (dis) 20.2 cfm(FAD) 10 bar 3+3 HP 1 Phase	572 77 0690	£6.53*	£1,295

*Finance example typically based on a 5 year lease purchase agreement. Finance subject to status, full terms and conditions available on request. Other finance options available. All prices exclude VAT at 20%. Price, availability and specification may change without prior notice. Warranty subject to manufacturers terms and conditions of use. Errors and omissions excluded. Offers valid until 28th February 2017. Prices correct at time of going to press: August 2016.

Screw Compressors

**NO HASSLE
WARRANTY**

**BEST PRICE
PROMISE**

WILKINSON STAR SILVER AND SILVER D SCREW COMPRESSORS



**2 YEAR CONDITIONAL WARRANTY
SUPPORTED BY FACTORY-TRAINED ENGINEERS**

- For applications where there is a constantly high demand for air power
- Powerful, efficient heavy duty belt drive motors
- Low noise levels

MODEL	PART NUMBER	WEEKLY	PRICE
Silver 10 300 L 30 cfm(FAD) 10 bar 3 Phase	572 77 1870	£17.36⁺	£3,445
Silver 15 300 L 51 cfm(FAD) 10 bar 3 Phase	572 77 1890	£22.65⁺	£4,495

- Refrigerated dryer option for clean, dry air production.
- Simple-to-use control units
- Enabling manage, monitor and optimise the machine's operation

MODEL	PART NUMBER	WEEKLY	PRICE
Silver D 15 300 L 51 cfm (FAD) 10 bar 3 phase	572 77 1910	£26.69⁺	£5,295
Silver D 20 300 L 67 cfm (FAD) 10 bar 3 phase	572 77 1930	£28.95⁺	£5,745

ABAC SPINN COMPRESSORS

Typical use: Spray gun, impact wrenches, tyre machines.
Single phase, low noise.



MODEL	PART NUMBER	WEEKLY	PRICE
SPINN 2.2kW 10 200 8.5cfm (FAD) @10 bar on a 200 ltr tank 1 Phase	572 77 0270	£12.57⁺	£2,495

Typical use: Spray gun, impact wrenches, tyre machines.
Low noise, good quality air

MODEL	PART NUMBER	WEEKLY	PRICE
SPINN 4kW 10 200 16.6cfm (FAD) @10 bar on a 200ltr tank 3 Phase	572 77 0230	£13.33⁺	£2,645

Typical use: Spray guns, impact wrenches, tyre machines, sanders, air fed masks.

Low noise, good quality air

MODEL	PART NUMBER	WEEKLY	PRICE
SPINN 5.5kW 10 270 21.2cfm (FAD) @10 bar on a 270Ltr tank 3 Phase	572 77 0710	£14.59⁺	£2,895
SPINN E 5.5kW 10 270 (with dryer) 21.2cfm (FAD) @10 bar on a 270Ltr tank 3 Phase	572 77 0490	£17.36⁺	£3,445

ABAC GENESIS COMPRESSORS

Typical use: Spray guns, impact wrenches, tyre machines, sanders, air fed masks. Low noise, high output, good quality dry air, small footprint.



**2 YEARS STANDARD WARRANTY
(SUBJECT TO MANUFACTURERS TERMS OF USE)***

MODEL	PART NUMBER	WEEKLY	PRICE
GENESIS 7.5kW 08 270 40.7cfm (FAD) @ 8 bar 3 Phase	572 77 0440	£23.16⁺	£4,595

Typical use: Tyre Inflator, Blow Gun, Spray Gun, Impact/ Ratchet wrenches

Low noise, higher output for larger spray shops.

MODEL	PART NUMBER	WEEKLY	PRICE
GENESIS 11kW 08 270 58.8cfm (FAD) @ 8 bar 3 Phase	572 77 0180	£24.17⁺	£4,795
GENESIS 15kW 08 270 70.1cfm (FAD) @ 8 bar 3 Phase	572 77 0380	£25.17⁺	£4,995

*Must be commissioned and serviced by an authorised distributor

*Finance example typically based on a 5 year lease purchase agreement. Finance subject to status, full terms and conditions available on request. Other finance options available. All prices exclude VAT at 20%. Price, availability and specification may change without prior notice. Warranty subject to manufacturers terms and conditions of use. Errors and omissions excluded. Offers valid until 28th February 2017. Prices correct at time of going to press: August 2016.



HPC COMPRESSORS

HPC Compressed Air Systems is recognised as a gold standard in the industry, supplying innovative products and system solutions to quality bodyshops, commercial vehicle workshops, garages and other automotive applications. A leader in the UK market for fifty years, HPC's "yellow-box" compressed air systems are renowned for their quality, reliability and efficiency.

HPC Screw Compressors provide quality compressed air at affordable prices:

- Quiet, energy efficient & reliable
- Minimal installation required
- FREE OF CHARGE - HPC 5 years 'NO QUIBBLE' warranty (Subject to an HPC Service agreement)

HPC refrigeration dryers provide dependable drying and ensure high efficiency performance. With their compact footprint they are exceptionally versatile and are ideal for locations where space is at a premium. Removing moisture from compressed air helps to prolong the life of pipe work and air tools whilst improving compressed air quality.

Ask your branch for expert advice on HPC compressors. With HPC, you can optimise the efficiency and quality of your compressed air system.



CALL FOR A QUOTE

Do you have unwanted water and particulates within your compressed air system?

- Is water effecting your application at point of use?
- Are you tools failing and rusting due to water ingress?
- Are you tired of replacing filter elements?

The Original Dropout® is a unique, scientifically engineered, patent protected multi-stage Compressed Air Filter that removes 99.9999% of Water and 99% solid particulates down to 1 Micron. This unique multi-stage compressed air filter performance is constant regardless of the flow rate.

JUST DRAIN PERIODICALLY AND CONTINUE USING AT THE SAME HIGH EFFICIENCY

- Dropout provides a low maintenance, robust solution for unwanted water and particulates within your compressed air system
- Dropout requires no mains power to operate and can accommodate for pulsed flows or stop/start with instantaneous recovery
- Install Dropout at point of use to guarantee water free, clean air
- ISO 12500 accredited so you can be confident Dropout is as good as advertised



Match your Dropout to your compressed air output – start enjoying the benefits

ITEM DESCRIPTION	INLET/OUTLET CONNECTION	CFM MIN/MAX	BAR MIN/MAX	PART NUMBER	PRICE
DO300S	1/2" (f)	0.04 - 15	1 to 15	595 77 0250	£265
DO600S	3/4" (f)	0.04 - 30	1 to 15	595 77 0260	£315
DO900S	3/4" (f)	0.04 - 45	1 to 15	595 77 0270	£365
DO1500S	1" (f)	0.04 - 90	1 to 15	595 77 0280	£465

*Finance example typically based on a 5 year lease purchase agreement. Finance subject to status, full terms and conditions available on request. Other finance options available. All prices exclude VAT at 20%. Price, availability and specification may change without prior notice. Warranty subject to manufacturers terms and conditions of use. Errors and omissions excluded. Offers valid until 28th February 2017. Prices correct at time of going to press: August 2016.

OUR SPECIALIST EQUIPMENT SERVICE AND MAINTENANCE TEAM PROVIDES ALL INSTALLATION, SERVICING AND MOT CALIBRATION REQUIREMENTS INCLUDING PLANNED MAINTENANCE AND SCHEDULING



PLANNED MAINTENANCE

A preventative maintenance contract can provide a significant reduction in repair costs, ensuring total peace of mind for both the equipment owner and operator. Alternatively, services can be secured on 'as required' basis.

PLANNED MAINTENANCE		FROM
Vehicle Lift Maintenance & Repairs	2 Post, 4 Post, Scissor Lift Servicing and Repair	£43.75*
JACKING BEAM REPAIR		CALL
Air & Oil Pipework	Supply and installation including galvanised steel tube, Transair and John Guest aluminium	CALL
Spraybooth Servicing	Complete spraybooth service including certification and testing	£287.50
Compressor Servicing	Service support for compressed air systems excluding parts	£102.50*
Air Conditioning Machine Servicing	Service support and maintenance facility including repairs, training and F-gas assessments	£205.00
WELDING EQUIPMENT SERVICING		£30.00
Spray Gun Repairs	For a variety of spray guns regardless of manufacturer carried out in fast response time	CALL
Waste Collection		CALL

The above prices do not include any parts that may be needed.

BREAKDOWN RESPONSE

Regardless of whether or not we have been maintaining your equipment on a service contract, you can take advantage of our prompt breakdown repair service. We understand the urgency of the situation and will dispatch most efficiently.

BREAKDOWN RESPONSE		FROM
Vehicle Lifts call out and repair	2 Post, 4 Post, Scissor Lift	£120.00
Air Conditioning Machine call out and repair	All Makes call out and repair	£75.00
Welding Equipment repair	Spot and Mig Welders, Plasma Cutters, Induction Heaters, TKR Riveters, Oxy/Acet Equipment, Dent Pullers	£30.00
Compressors call out and repair	All Makes call out and repair	£102.50

The above prices do not include any parts that may be needed.

CALIBRATION SERVICES

Once you give us your calibration contract, our database tracks when your MOT equipment is due – so your calibration will always be timely. Using only suitably accredited engineers, we aim to minimise equipment down-time.

CALIBRATION SERVICES		FROM
MOT Equipment Calibration	For both Car and Motorcycle equipment	CALL
Wheel Alignment	Alignment Systems calibrations	£200.00
Emission Analyser Calibration	Scheduled calibrations	£330.00
Tools Calibration	For a wide variety of tools including tyre gauge, torque wrench, pressure gauge, paint thickness & tracking sticks	£12.50*
Paint Scales Calibration	All Makes Paint Scales calibration	£75.00

The above prices do not include any parts that may be needed. Minimum charge for tool calibrations, prices above don't include admin or travel fee. Yearly calibration (2 gas, 1 smoke).

CERTIFICATION & TESTING

We will carry out your required inspections and issue the necessary certificates.

CERTIFICATION & TESTING		FROM
LEV Exhaust Ventilation System Test & Certification		£75.00
Spraybooths Smoke Clearance Test & Certification		£56.25
Spraybooths Breathing Air Quality Test		£75.00

The above prices do not include any parts that may be needed.

*Minimum quantity applies

*Finance example typically based on a 5 year lease purchase agreement. Finance subject to status, full terms and conditions available on request. Other finance options available. All prices exclude VAT at 20%. Price, availability and specification may change without prior notice. Warranty subject to manufacturers terms and conditions of use. Errors and omissions excluded. Offers valid until 28th February 2017. Prices correct at time of going to press: August 2016.

The Junair name is synonymous with innovation in spraybooth development, providing solutions that deliver energy-savings, higher productivity, enhanced performance and, ultimately, increased profitability. The inherent design flexibility and in-house British manufacture allows any booth to be tailored to suit individual dimensions and performance requirements.



1 SERIES SPRAYBOOTH OVEN 597 77 8190

The Junair 1 Series spraybooth oven has been developed for customers who want an economical, low cost spraybooth oven, but also require a high quality construction, excellent performance and unrivalled reliability. There are many features on this spraybooth that are normally associated with higher cost equipment. There is a compact roof mounted air handling plant option for installations where space saving is critical. This is a semi downdraught spraybooth with rear extraction, requiring no floor excavation. The 1 Series spraybooth can be designed and built to any size to accommodate vans, light commercial vehicles and special vehicles.

WEEKLY
FROM ONLY **£144.64[†]**
FROM ONLY **£28,699.00**



3 SERIES SPRAYBOOTH OVEN 597 77 8210

The 3 Series is the mid-range spraybooth which can be designed and built to your individual requirements, offering enhanced features to increase the quality of your paint finish. The quality of construction and component selection make this spraybooth top in its class. Fully glazed doors improve vision into and out of the cabin. The LEVAC floor, an option on the 3 Series spraybooth, delivers excellent downdraught performance on a fully extracted floor just 140mm high, requiring no floor excavation.

WEEKLY
FROM ONLY **£165.81[†]**
FROM ONLY **£32,899.00**

[†]Finance example typically based on a 5 year lease purchase agreement. Finance subject to status, full terms and conditions available on request. Other finance options available. All prices exclude VAT at 20%. Price, availability and specification may change without prior notice. Warranty subject to manufacturers terms and conditions of use. Errors and omissions excluded. Offers valid until 28th February 2017. Prices correct at time of going to press: August 2016.

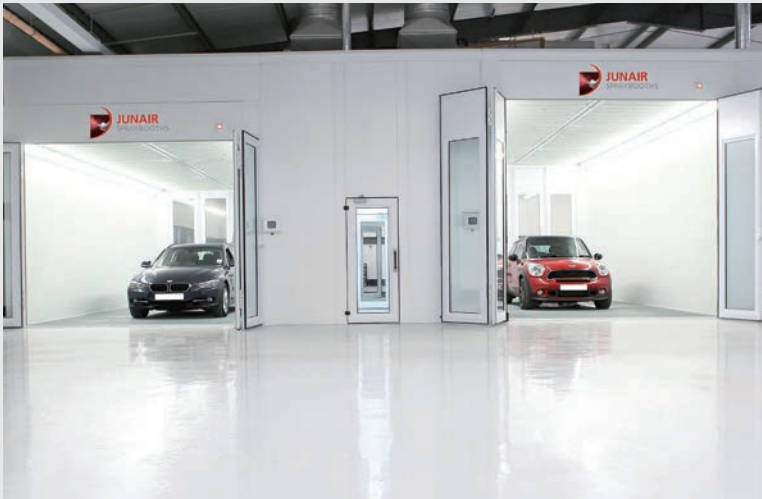

5 SERIES SPRAYBOOTH OVEN 597 77 0550

The 5 Series spraybooth oven is the flagship model. Combining state of the art technology with an outstanding build quality to offer the most advanced spraybooth on the market. With energy saving and production enhancing equipment the 5 Series spraybooth oven delivers the highest quality paint finish at the lowest cost per unit. Three leaf door set for wide opening and a LEVAC or EVAC fully extracted and balanced floor are incorporated into the 5 Series spraybooth oven as standard. In combination with the full width and full length plenum, the downdraught airflow through this cabin is second to none.

WEEKLY FROM ONLY **£227.55[†]**
FROM ONLY **£45,149.00**



DUO SPRAYBOOTH OVEN 597 77 8220

The Junair Duo spraybooth oven has been developed to meet the increasing demand for additional priming facilities and 'fast track' work. The Duo spraybooth has the option of a LEVAC floor (LEVAC is a surface mounted design, unique to Junair, requiring no builders-work excavation), pit or rear extraction. The double width cabin shares a central air handling plant making this unit very cost effective. Two vehicles can be processed at the same time, sharing a common bake cycle which also dramatically reduces energy cost per unit. Small top coat repairs can also be completed in the Duo spraybooth making it an extremely versatile addition for high throughput Bodyshops and 'fast track' work.

WEEKLY FROM ONLY **£228.31[†]**
FROM ONLY **£45,299.00**



MULTIBOOTH OVEN 597 77 8230

The Junair MultiBooth has been designed and developed to offer a flexible solution for those undertaking small to medium cosmetic repairs in a clean, controlled and safe environment.

This flexible spraybooth solution allows you to prepare, spray and fully bake a vehicle in the same cabin, eliminating vehicle movements. Each bay is designed as a combination preparation bay and full low-bake spraybooth, simply move the sliding door to the required cabin to convert it into a fully operational spraybooth.

Contact your local branch for more information.

**CALL FOR
A QUOTE**

*based on a standard 6,920 length 4 bay MultiBooth. Subject to site surveys.

[†]Finance example typically based on a 5 year lease purchase agreement. Finance subject to status, full terms and conditions available on request. Other finance options available. All prices exclude VAT at 20%. Price, availability and specification may change without prior notice. Warranty subject to manufacturers terms and conditions of use. Errors and omissions excluded. Offers valid until 28th February 2017. Prices correct at time of going to press: August 2016.



If lack of space to expand your business is holding you back, the opportunity for incremental business can be met by housing the additional equipment and operations in a Repair Qube.

Ideally suited to dedicated 'fast track', 'smart', or same-day repairs, the Repair Qube brings a new dimension to workshop Innovation, providing an instant portable repair facility that can be rapidly installed and even re-sited without too much fuss.

Repair Qube is the complete 'workshop in a box'. The pre-assembled modular units require a footprint of approximately six parking spaces and arrive equipped with load-bearing floors, two oversized repair bays, a room for ancillary equipment, reception and welfare areas, as well as parts/goods storage facilities.

It can operate as an independent site on an electrical generator or off mains electrical services, and can use directly connected or integrated LPG gas supplies.

A Repair Qube can be wrapped with any bespoke corporate identity. It can accommodate almost any equipment requirement, and complies with all legislation.

[CALL FOR A QUOTE](#)

Our Projects team have ample experience planning and installing the Repair Qube, and will be only too happy to assist you undertaking this exciting new capacity to your business. The team will assess, advise, carry out site survey work, discuss Return on Investment projections, assist on a fixed-fee basis with planning permission – and of course undertake the project implementation from beginning to completion.



Give us a call – and expand the limits of your ambitions.
One call for complete peace of mind

Repair Qube

NO HASSLE
WARRANTY

BEST PRICE
PROMISE



Based on STL's award-winning Tempo Moveable Booth, Repair Qube's unique airflow arrangement, coupled with high energy efficient fans, provides excellent overspray removal.

- High Velocity Aquadry System
- Car & LCV
- Cabin temperatures 60 degrees plus
- 85% less gas consumption
- 60% less electrical consumption
- 2000+ Lux LED lighting
- Houses full paint mixing schemes
- Less than £3.40/repair cycle running cost
- Can be run off natural or bottle gas
- Full service back up
- Can run independent of fixed services
- 2 Spraybooths
- 15000m³/hour per booth

Repair Qube is designed to work alongside:

- Bodyshops
- Dealer Groups
- Fleet Businesses
- Retail Outlets

CALL FOR A QUOTE

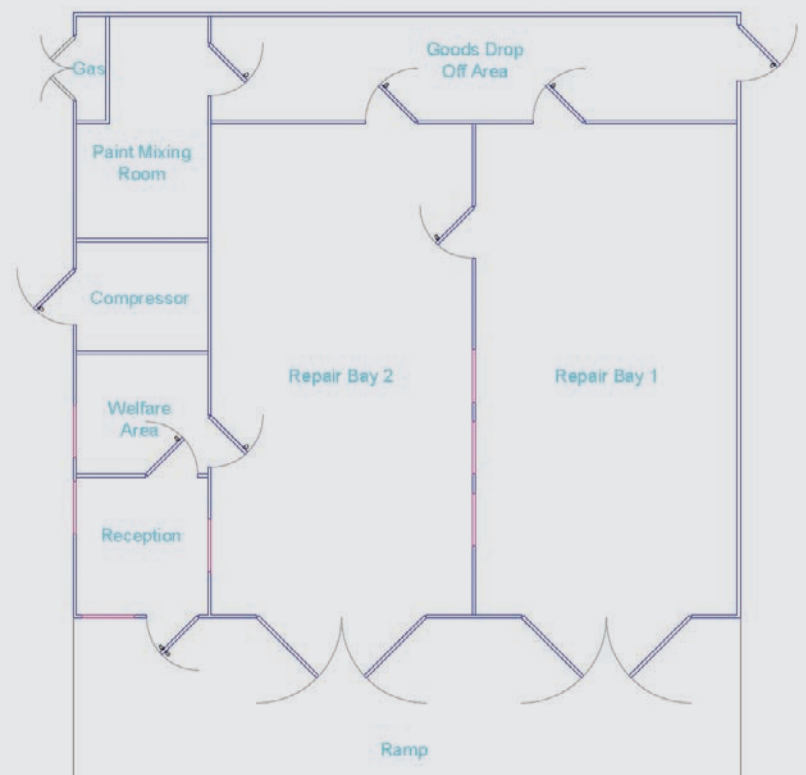

*Finance example typically based on a 5 year lease purchase agreement. Finance subject to status, full terms and conditions available on request. Other finance options available. All prices exclude VAT at 20%. Price, availability and specification may change without prior notice. Warranty subject to manufacturers terms and conditions of use. Errors and omissions excluded. Offers valid until 28th February 2017. Prices correct at time of going to press: August 2016.



Rowley Spraybooths have over forty years experience in the manufacture, installation and maintenance of Spraybooth ovens in the finishing/refinishing industry. All Rowley Spraybooth oven equipment is manufactured in the UK at their manufacturing facility located in Cannock, Staffordshire.



AERO-ECO SPRAYBOOTH OVEN 597 77 8240

Featuring dynamic air moving plant and an energy efficient control system the AERO-ECO Spraybooth oven is designed to deliver ultimate economy with ultra-low running costs. The AERO-ECO Spraybooth has a spacious cabin constructed from modular single 'skin' (or double 'skin') bright galvanised steel panels with good lighting and wide access component doors. Utilising rear chest extraction and compact air handling plant the AERO-ECO Spraybooth

provides the perfect painting environment for any type of work. The tunnel airflow design provides excellent paint over spray mist clearance during spraying operations and uniformity of air temperatures on spray and bake modes.

WEEKLY FROM ONLY **£62.97***
FROM ONLY **£12,495.00**



AERO-MAXI SPRAYBOOTH OVEN 597 77 8250

The AERO-MAXI Spraybooth oven range is a high specification Spraybooth oven that provides the highest quality environment for all types of paint application and low bake curing operations. The larger AERO-MAXI Spraybooth oven cabin is constructed using modular double 'skin' fully insulated panels to give good thermal retention, rigidity and sound dampening. Utilizing a rear chest extraction expensive underground extraction pit works are not required and this allows the

installation to be easily relocated. This tunnel airflow design provides excellent paint over spray mist clearance during spraying operations and uniformity of air temperatures on spray and bake modes. The high air flow and integral flash off mode makes the AERO-MAXI Spraybooth oven ideally suited for use with water based paint systems.

WEEKLY FROM ONLY **£78.09***
FROM ONLY **£15,495.00**



AERO-MIDI SPRAYBOOTH OVEN 597 77 8260

The spacious AERO-MIDI cabin is constructed using modular double 'skin' insulated panels to give good thermal retention, rigidity and sound dampening. Utilizing a rear chest extraction expensive underground extraction pit works are not required and this allows the installation to be easily relocated. This tunnel airflow design provides excellent paint over spray mist clearance during spraying operations and uniformity of air temperatures on spray and

bake modes. The air flow also makes the AERO-MIDI ideal for use with water based paint systems.

WEEKLY FROM ONLY **£95.73***
FROM ONLY **£18,995.00**

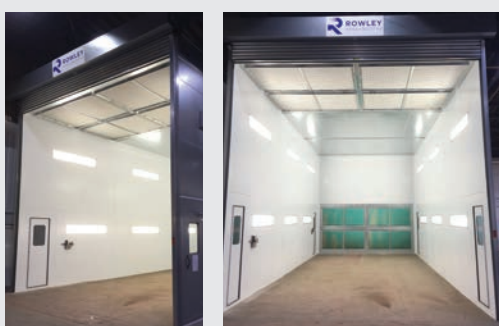

AERO-INDUSTRIAL/COMMERCIAL SPRAYBOOTH OVEN 597 77 8270

The Industrial and Commercial Spraybooth oven range can be designed to meet customer's specific requirements for Spraybooth ovens. The flexible modular design allows the cabin size and air flow

requirements to be made to suit the products being painted.

CALL FOR A QUOTE

See in action!
goo.gl/UAAf5N



*Finance example typically based on a 5 year lease purchase agreement. Finance subject to status, full terms and conditions available on request. Other finance options available. All prices exclude VAT at 20%. Price, availability and specification may change without prior notice. Warranty subject to manufacturers terms and conditions of use. Errors and omissions excluded. Offers valid until 28th February 2017. Prices correct at time of going to press: August 2016.

Choosing the Right Spraybooth



Installing a spraybooth is a huge investment and potentially very disruptive; so choosing the right booth can be as much about the right partners as the right equipment. So, what is important in choosing your biggest investment? Here are some points to consider.

PLANNING/ DESIGN

Where is the best position for the new Booth? Where the old one is [more downtime] or a different position [maybe better efficiency]? In some cases the booth can only go where the old booth was to retain the flow of work through the bodyshop – in other cases a fresh pair of experienced eyes might offer a novel and more efficient layout alternative.

Where are the services [gas & electric] in relation to the booth position – these can be expensive to connect so an accurate survey is important to avoid unpleasant surprises.

Are there any options or design developments that either improve performance or save me money?

Our Projects team carry out free site surveys and designs and will work with you to deliver the best product in the best position to suit your current and anticipated future needs.

CAPACITY

How big does the Booth need to be to handle all your current work, and to accommodate future growth?

Do you anticipate taking on vans? If so, you may need to consider a high-top booth.

For high-volume bodyshops, booth capacity can make the difference between an acceptable through-put or significant growth. For example, many bodyshops now use extended length booths that can take more than one vehicle or one vehicle and all the off-car panels, bumper etc which reduces the unit energy costs AND increases productivity.

Our Projects Team have the creative design flair that can make all the difference getting the most potential capacity from your booth.

OPERATIONAL

How much will it cost?

Cost has two elements: capital cost and running cost. Together these are often called “Whole life costs”

Over 5 years, Based on 25 jobs per week		
Capital Booth Cost	£20,000	£30,000
Running cost per Spray and Bake cycle	£12	£5
'Whole Life' Cost	£95,000	£61,250
Saving		£33,750

Example excludes VAT

In this example, the higher capital cost booth incorporates superior energy saving technology and as a result, is less than 2/3 whole life cost against the ‘cheaper’ booth. Our Projects team will advise on the best package for you including taking into account running costs and available energy saving packages. Make sure to ask our team whether and how your running costs can be improved by 65%.

AFTERSALES

What is the warranty, support and service back-up being offered?

This becomes more important over time. What is the service delivery promise given? You do not want to leave it until you need them to find out that your wait times are below your expectation. Where is the product made? Will the place of manufacture impact the availability of spares and consumables in the long term?

You can rely on the judgment of our Projects Team, gained over many years' experience, to give reliable and unbiased advice on where to set your expectations.

*Finance example typically based on a 5 year lease purchase agreement. Finance subject to status, full terms and conditions available on request. Other finance options available. All prices exclude VAT at 20%. Price, availability and specification may change without prior notice. Warranty subject to manufacturers terms and conditions of use. Errors and omissions excluded. Offers valid until 28th February 2017. Prices correct at time of going to press: August 2016.



MIRKA GLASS POLISHING SOLUTION KIT

MIR.KITGLASS125P

A complete solution for polishing a variety of glass surfaces including vehicle windows, building façades, interior doors and stairs. Designed for removing scratches on tempered or normal glass through a simple step-by-step process. Complete kit enables user to easily follow process from cleaning to sanding and polishing.

FULL KIT CONTENTS:

- Mirka PS1437 Electric Polisher
- Backing Pad for PS1437
- Dust suction hood for PS1437
- Pack of 5 Abranet® SIC NS 125mm discs P80
- Pack of 5 Abranet® SIC NS 125mm discs P120
- Pack of 5 Abranet® SIC NS 125mm discs P150
- Pack of 5 Abranet® SIC NS 125mm discs P180
- Pack of 5 Abranet® SIC NS 125mm discs P240
- Pack of 5 Abranet® SIC NS 125mm discs P320
- Pack of 5 Abranet® SIC NS 125mm discs P400
- Pack of 2 Abralon® 125mm discs P180
- Pack of 2 Abralon® 125mm discs P360
- Pack of 2 Abralon® 125mm discs P500
- Pack of 2 Abralon® 125mm discs P600
- Pack of 2 Abralon® 125mm discs P1000
- Pack of 2 white felt polishing pad
- Pack of 2 micro bre cleaning cloth
- 250ml bottle of Polarshine E3 polishing compound



ONLY **£415.99**

MIRKA DUST EXTRACTION MACHINE

915 GB 230V & HOSE – L CLASS

MIR.BMFC00049

This highly versatile industrial Dust Extractor for professional use is equipped with an automatic electric start, adjustable suction and an earthed hose connection to eliminate static electricity in the hose. A fleece dust bag and antistatic hose is also included.

Dimension LxWxH (mm)	450 x 360 x 600
Volume flow air (l/min)	3700
Weight (kg)	10
Noise level (dB)	59
Vacuum (mbar)	250
Tank volume (l)	30
Main frequency (Hz)	50/60
Power input (W)	1200
Voltage main supply (VAC)	230



ONLY **£229.99**

MIRKA RANDOM ORBITAL SANDER 650CV

CEROS – C/W POWER SUPPLY

MIR.MIM6502011UK

This Compact Electric Random Orbital Sander MIRKA® CEROS 650CV (Central Vacuum) with a 5,0 orbit is an all-round sander suitable for almost all kinds of surfaces. MIRKA® CEROS 650CV is equipped with an 150 mm backing pad.

TECHNICAL SPECIFICATIONS

Power input (W)	350
Speed (rpm)	4000 - 10000
Orbit (mm)	5
Size of pad (mm)	150
Weight (kg)	0.92
Noise Level, LpA (dB)	68
Vibration level (m/s ²)	2.82



ONLY **£235.99**

MIRKA RANDOM ORBITAL SANDER 650CV

DEROS

MIR.MID6502011UK

Mirka DEROS 650CV direct electric random orbital sander is equipped with a 150 mm (6") pad and has a 5.0 mm oscillation. Mirka DEROS 650CV is the first ever electric sanding machine with a brushless motor and no external power supply. The mains voltage is 220V - 240V. It is also the lightest electric machine on the market and suitable for general sanding purposes on almost all kind of surfaces.

TECHNICAL SPECIFICATIONS

Power input (W)	350
Speed (rpm)	4000 - 10000
Orbit (mm)	5
Size of pad (mm)	150
Weight (kg)	1
Noise Level, LpA (dB)	71
Vibration level (m/s ²)	3.4



ONLY **£275.99**

*Finance example typically based on a 5 year lease purchase agreement. Finance subject to status, full terms and conditions available on request. Other finance options available. All prices exclude VAT at 20%. Price, availability and specification may change without prior notice. Warranty subject to manufacturers terms and conditions of use. Errors and omissions excluded. Offers valid until 28th February 2017. Prices correct at time of going to press: August 2016.

RUPES VACUUM UNIT

RUP.S145EPL-GB

Mobile units for extracting dust from sanding and various types of industrial work, fitted for connection to an electro-pneumatic and also suitable for fluid extraction.

- Multifunction Intelligent Control
- Equipped with 2 large filters
- Electrostatic charge dispersion device.
- Large dust and liquid container

ONLY **£409.99**



RUPES ANGLE POLISHER 200MM WITH ELECTRIC SPEED-CONTROL

RUP.LH18ENS

- New front ergonomic grip for comfortable and safe handling
- Electrical parts insulated with special resins for greater protection and longer life of the tool
- Soft start



ONLY **£170.99**

RUPES 3MM FLATBED ORBITAL SANDER WITH DUST EXTRACTION 70X198MM

RUP.RE21AL

- Universal application for sanding and preparing sheet metals and substrates
- Excellent working capacity in inaccessible areas, such as sections, beading and large-radius curved surfaces
- Preparation of substrates and fillers
- Ideal for working in small to medium-sized areas



ONLY **£170.99**

RUPES 3MM RANDOM ORBITAL PALM SANDER WITH DUST EXTRACTION 75MM

RUP.RA75A

- The special shape and size of the pad enables a great saving of time and consumables
- Tool body designed to provide optimum visibility of parts being worked on
- Supplied with soft pad to improve the performance of micro-fine abrasives



ONLY **£165.99**

RUPES SKORPIO 6MM RANDOM ORBITAL SANDER

RUP.RH256A

- 6mm orbit is suitable for finishing applications
- Best efficiency (time/result) in plaster smothering and paint removal without diminishing the final quality
- The random orbital movement makes it an easy tool to use while offering excellent performance



ONLY **£105.99**

*Finance example typically based on a 5 year lease purchase agreement. Finance subject to status, full terms and conditions available on request. Other finance options available. All prices exclude VAT at 20%. Price, availability and specification may change without prior notice. Warranty subject to manufacturers terms and conditions of use. Errors and omissions excluded. Offers valid until 28th February 2017. Prices correct at time of going to press: August 2016.

INDASA MBX SYSTEM

IND.NCNA145

The patented MBX technology has been developed specifically for the most effective removal of rust, underbody coatings, old paintwork and bonded sealants from vehicles undergoing repair. The MBX System achieves a finish previously only available by sand/shot blasting and the in-line design allows the operator to reach those hard to access areas. Centrifugal force within the belt housing creates a cushion of air to minimize vibration through the heat treated bristle belt.

Switching from the bristle belt to the rubber eraser wheel simply converts the tool for the removal of adhesive tapes and glue residues from panels without damaging paintwork.

- Robust heavy duty motor
- 3500rpm – variable speed regulator for operator control
- Lightweight and compact design
- Low vibration and noise – versatile and safe
- Hardened steel bristles – can be easily re-sharpened
- High performance polyamide fabric belt – tension resistant up to 440kgs
- 3 belt grades to suit application (11mm & 23mm width) – colour coded for ease of identification
- 31mm rubber eraser wheel
- The MBX machine is supplied with 3 bristle belts
- Item code: NCNA-145

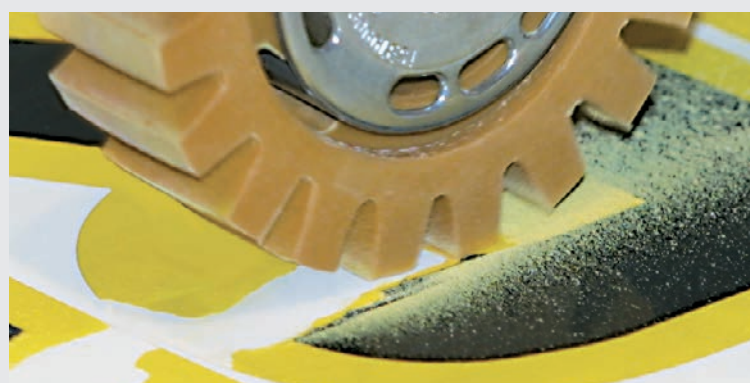

Part no	Item	Grade	Colour
IND.DCA54	23mm bristle belt	Fine	Green
IND.DCA55	23mm bristle belt	Medium	Yellow
IND.DCA56	23mm bristle belt	Coarse	Black
IND.DCA58	23mm belt housing		
IND.DCA61	Eraser wheel		
IND.DCA94	11mm bristle belt	Fine	Green
IND.DCA95	11mm bristle belt	Medium	Yellow
IND.DCA96	11mm bristle belt	Coarse	Black
IND.DCA98	11mm belt housing		



ONLY **£279.95**



*Finance example typically based on a 5 year lease purchase agreement. Finance subject to status, full terms and conditions available on request. Other finance options available. All prices exclude VAT at 20%. Price, availability and specification may change without prior notice. Warranty subject to manufacturers terms and conditions of use. Errors and omissions excluded. Offers valid until 28th February 2017. Prices correct at time of going to press: August 2016.

3M™ BELT SANDER

MMM.28366

- Great for deburring, cleaning, blending and finishing in tight or hard-to-reach areas.
- Lightweight, durable construction and 0.6HP motor helps provide an excellent power to weight ratio.
- Tool can be used with both sizes of belts giving you two tools in one – 12.7mm & 20mm belt
- Both belt head and handle rotate a full 360° to easily access hard-to-reach areas.
- Innovative belt cover allows easy access for quick belt change.
- 3M™ Greptile™ grip gives a comfortable and secure grip.
- Warm composite housing minimises vibration for less operator fatigue.
- Comes complete with one standard arm (MMM.28368), 3M™ Air Tool Lubricant (MMM.20451) and both a steel and rubber drive wheel.

ONLY **£244.95**



3M™ ORBITAL SANDER

MMM.28508

Features an alloy steel curved-throttle lever with built-in wrist support. 3M™ Hookit™ clean sanding disc pad included. Precision balanced for smooth operation. Easily attaches to your existing central vacuum system for efficient dust evacuation.

- 6" (150mm) in Central Vacuum
- 3/16" (5mm) in Orbit

ONLY **£119.95**



3M™ ORBITAL SANDER

MMM.28509

Features an alloy steel curved-throttle lever with built-in wrist support. 3M™ Hookit™ clean sanding disc pad included. Precision balanced for smooth operation. Easily attaches to your existing central vacuum system for efficient dust evacuation.

- 6" (150mm) in Central Vacuum
- 3/32" (2.5mm) in Orbit

ONLY **£119.95**



3M™ ACCUSPRAY™ PRESSURISED HGP SPRAY GUN

MMM.16587

Designed for the application of multiple high viscosity coatings including:

- Underbody Coatings
- Stone Chip protection
- Polyester and other heavy bodied primers
- Marine Gel Coats & Adhesives

ONLY **£139.95**



3M™ PPS™ COLOUR CHECK LIGHT II

MMM.16550

A valuable tool for checking and approving quality at each stage of the repair process.

- Designed to make the colour matching and refinish process faster and easier
- Reduce labour paint and material costs
- Increase productivity
- Improve customer satisfaction
- Portable, handheld and chargeable

ONLY **£354.95**



*Finance example typically based on a 5 year lease purchase agreement. Finance subject to status, full terms and conditions available on request. Other finance options available. All prices exclude VAT at 20%. Price, availability and specification may change without prior notice. Warranty subject to manufacturers terms and conditions of use. Errors and omissions excluded. Offers valid until 28th February 2017. Prices correct at time of going to press: August 2016.

MILWAUKEE M12 COMPACT JOBSITE RADIO (NAKED – NO BATTERIES OR CHARGER)

MIL416365

- Advanced technology tuner for high reception and clarity
- Weather proof aluminium speakers for rich full sound
- MP3 player compartment
- Powers from either M12™ battery or 230 V mains supply 8 hour run time on standard M12™ battery
- Digital display tuner for accurate signal selection
- 220 - 240 V power adapter, 3.5 mm jack plug for auxiliary connection i.e iPods



ONLY **£89.99**

MILWAUKEE AP12E AP12QE 150MM 240V MAINS POLISHER

MIL383925

- 1200 watt motor
- Ergonomic design for long work shifts
- Special gear for high spindle torque and ideal polishing speed
- Variable speed selection for ideal speed
- Thermal overload protection
- No load speed limitation
- 6m cable
- Flexible and soft hook and loop backing pad avoids scratches on paint work



ONLY **£169.99**

MILWAUKEE FUEL 18V ANGLE GRINDER WITH DISC BRAKE

- RAPIDSTOP™ for fastest disc brake in less than 2 seconds and best user protection
- Non lockable safety paddle switch with line-lock-out function to prevent automatic start up
- Premium gearing system – same system as used at high performance corded grinders
- 115 mm keyless guard



NAKED – NO BATTERIES OR CHARGER

MIL451007

ONLY **£169.99**

2 X 5AMP RED LITHIUM ION BATTS

MIL451008

ONLY **£339.99**

MILWAUKEE M12 SUB COMPACT POLISHER / SANDER

- Variable two speed selection (0-2800 / 0-8300 rpm) for both polishing and sanding applications
- REDLINK overload protection electronics in tool & battery pack deliver best in class system durability
- Large capacity of up to 76mm polishing sponge and 50mm sanding pad size for fast job completion
- Long run time allows frequent task completion with one battery charge
- Compact design with only 130 mm allows access to hard to reach areas
- Spindle lock allows for fast, tool free accessory change
- Detachable 2 position side handle



NAKED – NO BATTERIES OR CHARGER

MIL447791

ONLY **£94.99**

1 X 4.0AH BATTERY 1 X 2.0AH BATTERY

MIL447802

ONLY **£149.99**

*Finance example typically based on a 5 year lease purchase agreement. Finance subject to status, full terms and conditions available on request. Other finance options available. All prices exclude VAT at 20%. Price, availability and specification may change without prior notice. Warranty subject to manufacturers terms and conditions of use. Errors and omissions excluded. Offers valid until 28th February 2017. Prices correct at time of going to press: August 2016.

**KÄRCHER HDS 7/10-4 M
HOT WATER PRESSURE WASHER
240V STEAM MODE
546 77 1100**

- Superb performance for daily and deep cleaning jobs.
- Ecoefficiency mode, offers fuel savings of up to 20% without compromising cleaning performance
- 4-pole motors for high performance and long life
- On-board diagnostics, and 3-year burner coil warranty
- HDS middle class range provides toughness, cleaning power, and low running costs



WEEKLY FROM ONLY **£9.57⁺**
ONLY **£1,899.99**

**KÄRCHER HDS 6/12 C
HOT WATER PRESSURE WASHER
WITH STEAM MODE
546 77 1740**

- State-of-the-art compact hot water high-pressure cleaner
- Unique ecoefficiency mode reduces diesel consumption by 20% without compromising daily cleaning performance
- Machine Protector system prolongs component life and provides a 3-year burner coil warranty
- Easy to set-up, intuitive to operate and cheap to run



WEEKLY FROM ONLY **£7.55⁺**
ONLY **£1,499.99**

**KÄRCHER BR40/10 FLOOR
SCRUBBER
546 77 108D**

- Designed for heavy duty cleaning of small to medium floors
- Features two counter-rotating brushes and two rubber squeegees, ensuring floors are thoroughly cleaned and dried in a single pass
- With vacuum system turned off, machine can be used for deep cleaning of heavily soiled floors where more scrubbing and detergent are needed



WEEKLY FROM ONLY **£6.55⁺**
ONLY **£1,299.99**

+ FREE

**PRO NT 200 HANDY ALL-ROUNDER
546 99 1550**

The new ProNT 200 wet and dry vacuum cleaner simply provides compact dimensions, robust design and strong suction power. In short: a reliable, mobile assistant around the construction site and workshop.

WORTH £189 + VAT



*Finance example typically based on a 5 year lease purchase agreement. Finance subject to status, full terms and conditions available on request. Other finance options available. All prices exclude VAT at 20%. Price, availability and specification may change without prior notice. Warranty subject to manufacturers terms and conditions of use. Errors and omissions excluded. Offers valid until 28th February 2017. Prices correct at time of going to press: August 2016.

KÄRCHER COMPACT COLD PRESSURE WASHER

- On-board storage for nozzles, power cable, hose and lance
- New carry handle that makes the machines truly portable
- Unique lie-flat or stand up operating position

TECHNICAL DATA	HD 6/13C Plus	HD 5/12C Plus
Current type (Ph)	1 - 230 - 50	1 - 230 - 50
Flow rate (l/h)	500	590
Operating pressure (bar/MPa)	120 / 12	130 / 13
Max. pressure (bar)	175 / 17.5	190 / 19
Power rating (kW)	2.5	2.9
Power cable (m)	5	5
Weight (kg)	23.7	25.2
Dimensions (L x W x H) (mm)	380 x 360 x 930	380 x 360 x 930



HD 6/13 C PLUS COMPACT COLD PRESSURE WASHER 546 77 8000

ONLY **£399.99**

HD 5/12 C PLUS COMPACT COLD PRESSURE WASHER 546 99 0820

ONLY **£379.99**

KÄRCHER PUZZI 10/1 CARPET CLEANER KLA 1100 1320

- Powerful spray extraction unit designed for easy, efficient deep cleaning of carpets, upholstery and textile flooring
- Favourite amongst car dealers for valeting the interiors of new and used vehicles
- Powerful 1 bar spray rate means water and detergent solution is applied to the area being cleaned and picked up immediately by the vacuum nozzle



ONLY **£399.99**

KÄRCHER PUZZI 8/1 C CARPET & UPHOLSTERY CLEANER/VALETING MACHINE 546 77 8010

- Ideal for upholstery cleaning and spot cleaning of carpeted floors
- Excellent suction power leaves carpets and upholstery virtually dry to touch in minutes
- Lightweight construction allows unit to be transported easily from one place to another perfect for use in hotels, hospitals, shops and the automotive industry



ONLY **£259.99**

KÄRCHER NT 20/1 WET AND DRY VAC 546 99 0810

- Robust and powerful all-purpose vacuum cleaner designed for professional applications
- Capable of picking up wet or dry dirt and liquids in workshops and showrooms and perfect for vehicle valeting
- Easy transport and storage thanks to compact design
- Constant suction power due to semi-automatic filter cleaning system (Ap)



ONLY **£189.99**

KÄRCHER NT 27/1 COMMERCIAL WET & DRY VACUUM CLEANER 27 LITRE TANK 1380W 240V 546 77 0130

- Robust, inexpensive all-purpose vacuum cleaner perfect for the automotive industry
- Can pick up large quantities of wet or dry dirt
- Cover also designed to double up as storage area for tools and accessories
- Ergonomically designed carrying handle makes unit easy and convenient to transport



ONLY **£134.99**

*Finance example typically based on a 5 year lease purchase agreement. Finance subject to status, full terms and conditions available on request. Other finance options available. All prices exclude VAT at 20%. Price, availability and specification may change without prior notice. Warranty subject to manufacturers terms and conditions of use. Errors and omissions excluded. Offers valid until 28th February 2017. Prices correct at time of going to press: August 2016.

Spray Gun Cleaning

NO HASSLE
WARRANTY

BEST PRICE
PROMISE

DEVILBISS GUN CLEANER

DEV.DEV-FHAZ1006

- Pro Clean is faster, cleaner and more efficient than conventional gun wash machines.
- Pro Clean can be used for waterborne and solvent applications.
- Significantly reduces solvent use and wastage dramatically reducing gun cleaning costs.
- Fresh solvent is used every time ensuring no contamination and rapid colour changes.
- The compact unit can be wall mounted to maximise floor space in the mix room.
- 500ml colour coded waterborne and solvent aerosols are easily placed in the machine.
- One 500 ml can will clean up to 32 spray guns.

ONLY **£759.99**



UNIC UGC2006AUTO AUTOMATIC WATER SPRAY GUN CLEANER

597 77 8280

- Fitted with the Mini Little Blue Filter
- Increasing wash cycles up to 400 Gun washes per 25 litres
- Little Blue Filter reduces VOC Emissions
- Cleaner Solvent, cleaner Spray Guns
- Automatic Wash
- Bench or Wall mountable
- Easy Locate system Protect the air side of the gun
- Optional Stand
- 2 year parts, 5-year pump warranty
- Manufactured in the UK
- Mechanical Services, extend your warranty for FREE, Ts&Cs Apply
- Fully ATEX compliant and safe for hazardous zoned areas such as paint mixing rooms.

ONLY **£775.00**



UNIC UGC5006A WATER AND SOLVENT SPRAY GUN CLEANER WITH TWIN TANKS

597 77 8290

- Fitted with the Little Blue Filter
- Increasing wash cycles up to 400 Gun washes per 25 litres
- Little Blue Filter reduces VOC Emissions
- Cleaner solvent, cleaner spray guns
- Manufactured in the UK
- High power cleaning up to 20 ltrs per min
- Easy locate system protects the air side of the spray gun
- New ergonomic washing height
- 2 year parts, 5-year pump warranty
- Mechanical Services, extend your warranty for FREE, Ts&Cs Apply
- Fully ATEX compliant and safe for hazardous zoned areas such as paint mixing rooms.

WEEKLY FROM ONLY **£12.57***
ONLY **£2,495.00**



*Finance example typically based on a 5 year lease purchase agreement. Finance subject to status, full terms and conditions available on request. Other finance options available. All prices exclude VAT at 20%. Price, availability and specification may change without prior notice. Warranty subject to manufacturers terms and conditions of use. Errors and omissions excluded. Offers valid until 28th February 2017. Prices correct at time of going to press: August 2016.

Gun & Parts Cleaning – Safe Solvents

**NO HASSLE
WARRANTY**

**BEST PRICE
PROMISE**

The full range of Safe Solvents Parts and Spray Gun Washing Machines and Solvents is now available from Workshop Solutions.

Safe Solvents® advanced technology cleaning fluids perform as well as traditional solvents, but without the hydrocarbons, fire risk, environmental damage, or price. Safe Solvents® solutions separate from oil (like normal solvent) and can be sent down the drain without worry. Safe Solvents® fluids require no specialist service contracts or waste collection – they're just simple and effective.

Old traditional solvents are a thing of the past when it comes to spray gun cleaning or parts washing.

Welcome to the new era, say goodbye to your waste collection contract.

SAFE SOLVENTS® 25L ADVANCED GUN WASH FLUID 597 77 8150

- Suitable for ALL paint types
- Non-flammable
- Fast, effective gun cleaning
- Store & Use anywhere
- No hydrocarbons
- Safe for drains (Usage & Disposal Terms apply)



ONLY **£94.00**

SAFE SOLVENTS® 25L ADVANCED PARTS WASHING FLUID 592 77 4720

- Non-Flammable
- Contains no hydrocarbons
- No toxic smell
- Requires no specialist storage or transportation arrangements
- Safe for drains (small waste license required)
- Separates from oil



ONLY **£79.00**

SAFE SOLVENTS® TYPHOON 450 SPRAYGUN CLEANING MACHINE 597 77 8130



WEEKLY FROM ONLY **£13.60⁺**
ONLY **£2,699.00**

SAFE SOLVENTS® TYPHOON 450 PARTS WASHING MACHINE 590 01 0080



WEEKLY FROM ONLY **£7.55⁺**
ONLY **£1,499.00**

SAFE SOLVENTS® TYPHOON 650 PARTS WASHING MACHINE 590 02 0010



WEEKLY FROM ONLY **£8.56⁺**
ONLY **£1,699.00**

*Finance example typically based on a 5 year lease purchase agreement. Finance subject to status, full terms and conditions available on request. Other finance options available. All prices exclude VAT at 20%. Price, availability and specification may change without prior notice. Warranty subject to manufacturers terms and conditions of use. Errors and omissions excluded. Offers valid until 28th February 2017. Prices correct at time of going to press: August 2016.

Induction heating speeds up and simplifies the removal of bonded components (windcreens, plastic trim, bonded badges, stickers, etc), or stuck and seized metal parts such as nuts, bolts, track rod ends, bearings and gears

POWER-TEC SMART INDUCTOR 5000 LAS92363

Automatic or manual setting, quick and easy to operate, using the principle of electromagnetic induction, the innovative microprocessor-controlled self adjusting system transfers an intense quantity of heat locally with no damage to the surrounding area, whether rubber, plastic or painted surfaces.

- The flameless technology and zero set-up times assures a speedy job and excellent results.
- The Smart Inductor heats only metal objects.
- It will not burn or melt plastic or paint.
- Very safe to use. The inductor heads do not get hot to the touch.
- Digital readout and pedal control for complete control and freedom of movement



WEEKLY FROM ONLY **£13.60⁺**
ONLY **£2,699.00**

POWER-TEC HEAT INDUCTOR 3 KW LAS92405

Inductor with five accessories

- The complete tool for the bodyshop and workshop removes trim/stickers/corroded nuts mends plastic bumpers and other plastic parts
- Supplied with 5 accessories: glass remover/nut and bolt heater/heating glove/plastic stapler/plastic welding tool
- Safety and instruction leaflet provided
- 3kW
- Made in the EU



WEEKLY FROM ONLY **£10.07⁺**
ONLY **£1,999.00**

STANNER I4 INDUCTION HEATER 597 77 0150

High Quality Portable Induction Heater for heating of seized parts on vehicles of all sizes.

- Works on all steels, aluminium & copper
- Easy controls allow power control from 5 - 100%, from a 240V 13A plug
- Non contact heat source, heating only the required area protecting surrounding areas and/or parts
- Water cooled to give excellent duty cycle



WEEKLY FROM ONLY **£15.11⁺**
ONLY **£2,999.00**

PRESS-IT BUMPER KIT 597 77 7260

Kit containing different size drill bits, punches and mandrels, designed for punching holes into bumpers to mount parking sensors.

- The various drill bit sizes allow precise control over the whole size.
- The punches are designed not to flake paint from outside the whole diameter.
- The mandrels are designed to complete the parking sensor hole with millimetre precision.



ONLY **£535.00**

*Finance example typically based on a 5 year lease purchase agreement. Finance subject to status, full terms and conditions available on request. Other finance options available. All prices exclude VAT at 20%. Price, availability and specification may change without prior notice. Warranty subject to manufacturers terms and conditions of use. Errors and omissions excluded. Offers valid until 28th February 2017. Prices correct at time of going to press: August 2016.

STANNERS AS1T WELDER

597 77 0180

Dual Process Microprocessor controlled, MIG-MAG, Inverter TIG-DC LIFT and MMA welding machine.

Ideal for Vehicle Body Repair on the new UHSS/AHSS Steels and Particularly Aluminium.

All three processes can be set up at once for ease of use.

- Easy to use 1 touch "LCD Synergy Display".
- Three welding guns (processes)
- CuSi3 MIG Braze welding.
- Dip Transfer Aluminium Welding.
- Mild steel
- Compact design.
- Dual Bottle carrier
- Smooth welding arc characteristics for very thin materials.
- 230V supply



WEEKLY FROM ONLY **£6.02⁺**
ONLY **£1,195.00**

TECHNOMIG TREO 223 SYNERGIC

597 77 8340

Dual Process Microprocessor controlled, MIG-MAG, Inverter TIG-DC LIFT and MMA welding machine

Ideal for Vehicle Body Repair on the new UHSS/AHSS Steels and Particularly Aluminium.

All three processes can be set up at once for ease of use.

- Easy to use 1 touch "LCD Synergy Display".
- Three welding guns (processes)
- CuSi3 MIG Braze welding.
- Dip Transfer Aluminium Welding.
- Mild steel
- Compact design.
- Dual Bottle carrier
- Smooth welding arc characteristics for very thin materials.
- 230V supply



WEEKLY FROM ONLY **£8.29⁺**
ONLY **£1,645.00**

STANNERS AS3T WELDER

597 77 0120

- 200amp mig, fitted with 3 Euro torch adaptors to allow 3-Torches to be fitted to the machine at one time. No need to keep changing wires & liners etc; just pull the torch trigger you desire
- Synergic controlled for easy setup for material thickness
- Delivered as standard with wire for steel, aluminium & mig brazing



WEEKLY FROM ONLY **£11.47⁺**
ONLY **£2,275.00**

ELECTROMIG 230 WAVE 400V

597 77 8350

Microprocessor controlled, multiprocess MIG-MAG (continuous and pulse), FLUX/BRAZING/MMA/TIG DC-Liftinverter welder

Capable of customisation to suit customer-specific requirements, this machine's operation is traceable and analysable. Thus it offers maximum operational flexibility for use in a wide variety of application sectors - from maintenance, to installation and interventions at body shops. Can be used on steel, stainless steel, aluminium, and brazed materials.

Supplied with with MIG-MAG torch, cable and earth clamp

- Saving data via USB Full Control Synergic Settings
- Programmes for all types of welding
- CuSi3 MIG Braze welding
- Pulsed Aluminum Welding
- Double Pulsed welding (Excellent for Aluminum)



WEEKLY FROM ONLY **£9.30⁺**
ONLY **£1,845.00**

*Finance example typically based on a 5 year lease purchase agreement. Finance subject to status, full terms and conditions available on request. Other finance options available. All prices exclude VAT at 20%. Price, availability and specification may change without prior notice. Warranty subject to manufacturers terms and conditions of use. Errors and omissions excluded. Offers valid until 28th February 2017. Prices correct at time of going to press: August 2016.

STANNERS MI100 CONTROL T WELDING SYSTEM

597 77 8320

Intelligent control technology allows a spot weld quality that is comparable to the quality achieved during the production process of new vehicles

MI100 Control T takes the worry out of welding with TrueAutoMode: the Industry's First Fully Automatic Spot Welding System TrueAutoMode automates the welding process to provide perfect, OEM-approved spot welds every time.

Measuring weld resistance approximately 1,000 times per second and automatically adjusting current level, weld time and clamp pressure as needed, the MI100 provides instant feedback to the technician if there's a bad weld and can log every weld. At the end of a job, the MI100 can print out a report that includes information on the settings,

messages and actual weld parameters of every weld, enabling easy documentation that welds were made correctly.

- Lightweight Transformer C gun and 5m cable means easy manoeuvring around the job
- 14,000 Amps and Water cooled unit means no job too big
- Optional Wifi download-with-barcode scanner for Jobsheets

The modular nature of the system means the system can be easily upgraded for future requirements. Quick and easy tool change; new OEM welding programs can be added through software updates via compact flash card.



OEM-LIKE WELDING

WEEKLY FROM ONLY **£61.97⁺**
ONLY **£12,295.00**

CALL FOR A DEMO

STANNERS EXPERT SPOT WELDER

597 77 0720

Perfect for a bodyshop that doesn't need traceability on the welds.

The unique modular nature of the system secures the investment in the equipment.

This machine can be upgraded in the future to a MI 100 Control T.

- Easy to use operator panel
- High Performance transformer pliers and that means a good weld
- 5m lightweight welding cable for increased reach
- Capable of welding high strength steels such as Boron
- Upgradeable to MI-100 Control T
- Various Arms Sets available
- Exceeds spec of BSI0125



WEEKLY FROM ONLY **£47.35⁺**
ONLY **£9,395.00**

*Finance example typically based on a 5 year lease purchase agreement. Finance subject to status, full terms and conditions available on request. Other finance options available. All prices exclude VAT at 20%. Price, availability and specification may change without prior notice. Warranty subject to manufacturers terms and conditions of use. Errors and omissions excluded. Offers valid until 28th February 2017. Prices correct at time of going to press: August 2016.

Due to the high costs associated with replacing plastic panels (bumpers, inner wings, headlamp assemblies, engine covers, motorcycle bodywork etc), plastic welding equipment has been developed to offer an alternative solution. Save turnaround time, improve customer satisfaction, and increase billable labour time.

STANNERS PLASTOFUSED PLASTIC WELDER

597 77 8330

- German engineered quality and ideal for repairing broken plastic parts including cracks in bumpers or welding on broken mounting brackets etc.
- Works on many types of plastic (PP-EPDM, PP, ABS, PA), available in white or black.
- The system uses hot air to melt the plastic, the electronics controls gives a precise control of the temperature & airflow to prevent damaging the parts.



WEEKLY FROM ONLY **£8.54⁺**
ONLY **£1,695.00**

POWER-TEC NITROGEN PLASTIC WELDER

Compatible with almost every type of plastic used in the automotive industry, Allows the welding of filler material by heating with nitrogen. Heats plastic without combustion – therefore no fumes emitted. Comes complete with a set of plastic material, a scraper and a roller
230v, 50 Hz, 1600w



LAS92447
WEEKLY FROM ONLY **£10.07⁺**
ONLY **£1,999.00**

WITH TROLLEY
LAS92452
WEEKLY FROM ONLY **£16.10⁺**
ONLY **£3,195.00**

STANNERS TKR XT2 RIVETER

597 77 5830

A Pneumatic/Hydraulic Universal Tool, Specifically Developed for all Common Riveting Operations in Thin Sheet Metal.

- More & More Manufacturers are switching to bonding & riveting
- As there is no heat generated with rivets they can join UHSS/ BORON steels without weakening the steel
- Better for corrosion warranty as ecoatings are not removed or burnt away
- There is less surface preparation i.e. no removal of transport primer needed
- Unlike spot welding, Riveting does not cause sparks avoiding the risk of damage to interiors and glass



**OEM
APPROVED**

WEEKLY FROM ONLY **£31.22⁺**
ONLY **£6,195.00**

POWER-TEC SELF PIERCING RIVETING SYSTEM PLUS

LAS92386

- Self-piercing rivets are used by major manufacturers including Audi, Jaguar, Land Rover, Daimler, BMW and more.
- As there is no heat generated in the process, the self-piercing riveter can be used on OHSS/Boron steels without weakening the steel.
- Less preparation timesaver. No damage to eco-coatings therefore better corrosion warranty.
- Safer than welding, as there are no sparks produced.

**SUPPLIED
WITH KIT**



WEEKLY FROM ONLY **£12.59⁺**
ONLY **£2,499.00**

*Finance example typically based on a 5 year lease purchase agreement. Finance subject to status, full terms and conditions available on request. Other finance options available. All prices exclude VAT at 20%. Price, availability and specification may change without prior notice. Warranty subject to manufacturers terms and conditions of use. Errors and omissions excluded. Offers valid until 28th February 2017. Prices correct at time of going to press: August 2016.

Dent Repair Pullers

NO HASSLE
WARRANTY

BEST PRICE
PROMISE

POWER-TEC MIRACLE DENT REPAIR SYSTEM

The Miracle Panel Repair System offers the possibility of higher profits selling labour hours rather than simply replacing panels. Insurance companies will often prefer dent repair to replacement because the vehicle remains original.

- Increased labour with in each repair job thus reducing the need for panel replacement
- Speeds up the repair process and turns the repair around more quickly
- Improves the workshop throughput and reduces the job cycle times.
- Minimises strip and refit
- Start job immediately without waiting for panels
- Handles steel
- Repairs trucks, light commercials and cars
- Keeps vehicle original
- Increase courtesy car utilisation
- Cleaner working environment
- Reduces waste and saves the environment
- Borderline write-offs become economical repairs
- Upgrades always available

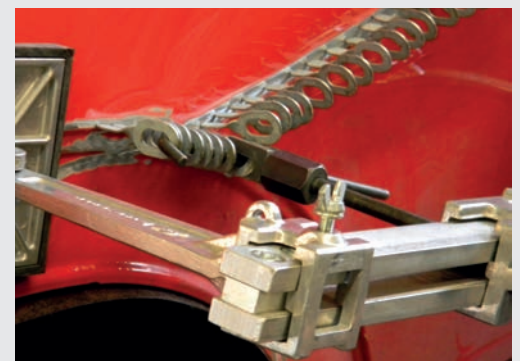
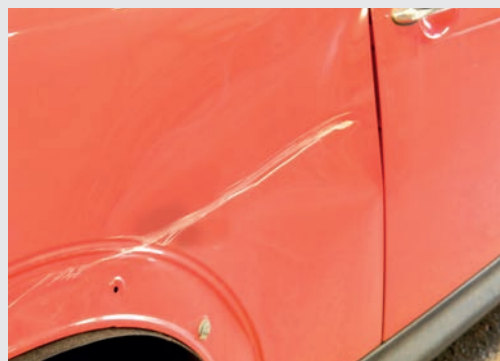

STANDARD MIRACLE SYSTEM LAS92170

WEEKLY
FROM ONLY **£15.11[†]**
ONLY **£2,999.00**

**DEMO AVAILABLE ON
APPOINTMENT**

[†]Finance example typically based on a 5 year lease purchase agreement. Finance subject to status, full terms and conditions available on request. Other finance options available. All prices exclude VAT at 20%. Price, availability and specification may change without prior notice. Warranty subject to manufacturers terms and conditions of use. Errors and omissions excluded. Offers valid until 28th February 2017. Prices correct at time of going to press: August 2016.



IWATA 1KW HAND HELD INFRA-RED + STAND IWA.VIU-100010

Technical Specifications:

- Heat T.E.C 1kW
- Minimum Static Operating Distance: 500mm (when mounted on its stand)
- Dimensions: 400 x 140 x 85mm
- Electrical Specification: 220/240V 1kW 50Hz
- Single Phase - 4.25 amps

ONLY **£109.99**

REPLACEMENT BULB IWA.VIU900300G

1KW Tube, 300mm, 220/240V

ONLY **£32.99**



STANNERS EURO 1000 & 2000

Strong Lightweight Stand with 4 swivel castor wheels making it easy to manoeuvre between vehicles
Adjustable height on trigger latch of 175 cm
The Euro 2000 can be adjusted into a variety of positions to achieve optimal surface area temperature



EURO 1000
594 77 0880

ONLY **£275.00**

EURO 2000
594 77 0760

ONLY **£395.00**

STANNERS EURO 3000 594 77 0800

Strong lightweight stand
Adjustable power, time & lamp activation



**SPECIAL OFFER – BUY A EURO3000,
GET A EURO2000 WORTH £395 FREE!**

WEEKLY
FROM ONLY **£5.52⁺**
ONLY **£1,095.00**

*Finance example typically based on a 5 year lease purchase agreement. Finance subject to status, full terms and conditions available on request. Other finance options available. All prices exclude VAT at 20%. Price, availability and specification may change without prior notice. Warranty subject to manufacturers terms and conditions of use. Errors and omissions excluded. Offers valid until 28th February 2017. Prices correct at time of going to press: August 2016.

CARTAR FL-100

597 77 0260

Free up work floor space – elevate the vehicle to a safe and comfortable working height, move the vehicle around whilst in the raised position.

Ideal for Smart Repairs, Alloy Wheel Refurb, General Repair and Damaged Vehicle Inspection

- Working at a comfortable height – max height 800mm ideal for bumper work
- Great moving damaged vehicles – 100mm low entry makes it easy to position
- Ideal for Alloy Wheel Refurbishment – remove all 4 wheels of cars / vans up to 2.8 tonnes
- Powered by Compressed Air with no installation costs – requires 50-100psi
- Heat/Weather Resistant – Can be used inside or outside, and in paint booths
- Multiple Safety Features including automatic mechanical lock when in raised position

WEEKLY FROM ONLY **£15.09⁺**
ONLY **£2,995.00**



See the Cartar in action!

CRYPTON CML3000

581 77 0320

An efficient, fully versatile and flexible mobile solution that covers 90% of all activities in the workshop for vehicles up to 3t in weight.

- Lifts vehicles to a comfortable one metre for fast refits of wheels and tyres, inspecting brakes and suspension and underbody, paint and bodywork
- Stuck for space? Easily move the lift around your workshop with no problem to create additional working space for inside and even outside the workshop
- Anti-skid lifting platforms are galvanised and can be adjusted in length
- Simple, easy and quick set-up
- Includes mobile kit



WEEKLY FROM ONLY **£13.08⁺**
ONLY **£2,595.00**

JOHN BEAN SSL 33

ELECTRO-HYDRAULIC MID-RISE LIFT

581 05 0010

Portable lift designed to lift cars and light commercial vehicles.

- Small size and portability make this a great investment for any busy garage
- Single phase operation
- 1m lifting height
- Pneumatic safety lock
- Includes mobile kit



WEEKLY FROM ONLY **£12.57⁺**
ONLY **£2,495.00**

*Finance example typically based on a 5 year lease purchase agreement. Finance subject to status, full terms and conditions available on request. Other finance options available. All prices exclude VAT at 20%. Price, availability and specification may change without prior notice. Warranty subject to manufacturers terms and conditions of use. Errors and omissions excluded. Offers valid until 28th February 2017. Prices correct at time of going to press: August 2016.

2 Post Lifts

NO HASSLE WARRANTY

BEST PRICE PROMISE

L4000 M/E 2 POST 4 TON HYDRAULIC LIFT

This value lift has a lot to offer. Symmetric arms offer wide flexibility of chassis as well as being able to accommodate vehicles driving on or reversing on. Electro-magnetic safety locks conveniently release at the push of a button. (A manual lock release version of this lift is also available)

Hydraulic hoses and balance cables are all fully concealed, providing a clean appearance.

The double hydraulic cylinders and high strength chain drive provide smooth lifting and lowering.

The two sets of arms always travel synchronously thanks to high strength balancing cables.

An emergency lowering valve can be manually operated to lower the lift safely in the event of a power failure.

Meanwhile, a flow-control valve prevents the possibility of a rapid uncontrolled descent

Door rubbers on the posts protect the car doors from direct contact, and sill protector rubbers on the upper arms perform the same function protecting the undersides of longer chassis vehicles



- Minimum pad height 110 mm
- Drive-thru width 2486 mm
- Maximum Lifting Height 1950 mm
- Lifting time 40-50 sec
- Lowering time 20-40 sec



MANUAL LOCKS 1 PHASE

577 01 0060

WEEKLY FROM ONLY **£10.05⁺**
ONLY £1,995.00

ELECTRONIC LOCKS 1 PHASE

577 01 0070

WEEKLY FROM ONLY **£11.57⁺**
ONLY £2,295.00

ELECTRONIC LOCKS 3 PHASE

577 01 0080

WEEKLY FROM ONLY **£11.57⁺**
ONLY £2,295.00

BENDPAK XPR SERIES

- Electro-Hydraulic operation
- Triple Reach arms – front and rear
- Single phase or three phase

XPR9 577 77 0020



WEEKLY FROM ONLY **£15.09⁺**
ONLY £2,995.00

XPR10 577 77 0240



WEEKLY FROM ONLY **£16.10⁺**
ONLY £3,195.00

XPR12 577 77 0030



WEEKLY FROM ONLY **£22.91⁺**
ONLY £4,545.00



*Finance example typically based on a 5 year lease purchase agreement. Finance subject to status, full terms and conditions available on request. Other finance options available. All prices exclude VAT at 20%. Price, availability and specification may change without prior notice. Warranty subject to manufacturers terms and conditions of use. Errors and omissions excluded. Offers valid until 28th February 2017. Prices correct at time of going to press: August 2016.

Liftmaster LMH Series

The LMH lifts are unique in that the design dispenses with cables or any other separate balancing mechanism between the two posts, and instead operates a Patented 'Hyperflow' system of completely hydraulic balancing. The result is faster, smoother and millimetre precise operation that is simply not possible by other means.

With the power to control the tiniest up or down movements with no slips or jerky movement; it's no wonder that this lift is a firm favourite amongst technicians!

- Single hydraulic master and slave cylinder design provides smooth and fast lifting
- The all-hydraulic system requires no electrical and pneumatic component
- Synchronising cables are not required as the hydraulic system ensures fast and safe synchronisation at any level
- The load is secured at any working height without mechanical ratchet
- Speed: 20 sec. up, 14 sec. down
- Quiet, powerful, oil submerged motor gives fast lifting and lowering times
- Low maintenance and almost wear-free cylinders
- Asymmetric arms for maximum door clearance
- Self bleeding hydraulic system
- Low lifting height
- Available in single phase or three phase
- Supplied in blue unless otherwise stated

OPTIONAL

- Height adapters to facilitate picking up of passenger cars and vans, with brand-specific pick-up points



DESCRIPTION	MODEL	PART NUMBER	WEEKLY	PRICE
Entry-level version 1 Phase 2 year warranty*	LMHS3001	577 77 7310	£15.35⁺	£3,045
Entry-level version 3 Phase 2 year warranty*	LMHS3003	577 77 7290	£14.49⁺	£2,875
3 ton 5 year warranty*	LMH3000	577 77 0680	£17.36⁺	£3,445
3 ton with 3 stage arms 5 year warranty*	LMH3000TRA	577 77 0700	£18.62⁺	£3,695
3.5 ton 5 year warranty*	LMH3500	577 77 7075	£21.24⁺	£4,215
4 ton 5 year warranty*	LMH4000	577 77 0780	£24.12⁺	£4,785
4 ton weatherproof – for outside or exposed installation 5 year warranty*	LMHW4000	577 77 0790	£38.56⁺	£7,650
5 ton 5 year warranty*	LMH5000	577 77 0810	£39.19⁺	£7,775
5 ton – with double-jointed arms – added flexibility 5 year warranty*	LMH5000DG	577 77 0820	£48.26⁺	£9,575

* Warranty is subject to manufactures terms and conditions of use

*Finance example typically based on a 5 year lease purchase agreement. Finance subject to status, full terms and conditions available on request. Other finance options available. All prices exclude VAT at 20%. Price, availability and specification may change without prior notice. Warranty subject to manufacturers terms and conditions of use. Errors and omissions excluded. Offers valid until 28th February 2017. Prices correct at time of going to press: August 2016.



LITE ALIGN 450 WALL MOUNTED 587 77 0020

Wall mounted car and light commercial four wheel laser aligner kit includes two front laser heads, two rear flag units, brake pedal depressor, steering clamp, turn discs, wall mount rack and 100mm rim buttons

MEASURES:

- Front and rear individual and total toe, to ensure correct tracking and stability on the road
- Thrust Line, to make sure the rear wheels are pointing in the straight ahead position in relation to the centre line of the vehicle
- Set back, to check front and rear wheels to ensure correct alignment across the vehicle
- Corrects steering wheel alignment. Rear flags enable the end user to adjust the alignment to achieve perfect steering wheel alignment first time.

KEY FEATURES:

- Unique tyre/wheel mounting system, resulting in more accurate measurement, reduced risk of heads becoming detached during adjustments
- Rechargeable battery operation, no cables
- Fits 12 to 22 inch wheels, cars and light commercials, XL kit available for larger wheels
- Optional digital Camber/Caster/SAI gauge available

WEEKLY FROM ONLY **£7.79⁺**
ONLY **£1,545.00**

LITE ALIGN 450 WALL MOUNTED WITH MAGNETIC CASTER CAMBER GAUGE 587 77 0640

Wall mounted car and light commercial four wheel laser aligner with magnetic caster camber gauge. Includes two front laser heads, two rear flag units, brake pedal depressor, steering clamp, turn discs, wall mount rack and 100mm rim buttons.

WEEKLY FROM ONLY **£9.55⁺**
ONLY **£1,895.00**

HOFMANN MEGAPLAN ECOLINE 58/88 – FULLY COMPUTERISED WHEEL ALIGNMENT WITH A4 PRINTER

Bridging the gap between laser alignment and fully computerised systems with printout, which traditionally made the jump too big for many workshops.

Ecoline 58 and 88 are supplied with a comprehensive vehicle database from the recognised industry name, Autodata, and offers a before and after printout. The Ecoline series – is the logical choice for anybody wanting to move into advanced vehicle geometry without the cost traditionally associated with computerised systems.

Only one alignment a week turns this investment into profit!



ECOLINE 58/88 FEATURES

- Simple to use – faster readings, saves time increasing your profit
- Supplied with PC, 19" monitor – clear impressive graphics with onscreen instructions
- Onsite training – your machine, your premises Hofmann Megaplan's specialists
- Comprehensive Vehicle Database by Autodata – over 17,000 models from 80 manufacturers
- A4 Printer – Provides before and after readings for customers
- Traditional 4-Point Clamps (58 only) – handles up to 23" rims as standard
- Front Cameras and Rear Sensors – increases accuracy and repeatability
- Zigbee® wireless communication – offers stronger and more reliable signal over Bluetooth®

ECOLINE 88 ONLY FEATURES

- 3 Point 'Grab Clamps' – even faster mounting, saves more time
- Front & Rear Cameras – ideal for advanced geometry when speed is needed

ECOLINE 58
587 77 1340

WEEKLY FROM ONLY **£20.64⁺**
ONLY **£4,095.00**

ECOLINE 88
587 77 1270

WEEKLY FROM ONLY **£27.69⁺**
ONLY **£5,495.00**

*Finance example typically based on a 5 year lease purchase agreement. Finance subject to status, full terms and conditions available on request. Other finance options available. All prices exclude VAT at 20%. Price, availability and specification may change without prior notice. Warranty subject to manufacturers terms and conditions of use. Errors and omissions excluded. Offers valid until 28th February 2017. Prices correct at time of going to press: August 2016.

Wheel Alignment

NO HASSLE WARRANTY

BEST PRICE PROMISE

JOHN BEAN ELS 3D ALIGNMENT SYSTEM WITH TILTING CAMERA

587 77 1730

The new John Bean 3D ELS alignment system has a tilted camera boom for flexible vehicle positioning, eliminating the need for a fixed position to carry out alignment checks and being able to position the camera at the touch of a button.

Running the Pro 32 software application, the ELS saves space in the workshop because everything is mounted on the support post.

The vehicle orientation directional indicator guides the technician when they are unable to see the screen, while interchangeable grippers on the wheel clamps assist work on different wheel types within a clamping range of 11" rims to 22" rims.

- AC 100 rim clamps, with a clamping range 11" – 22" rims
- Compact design everything mounted on the support post
- Tilting camera boom for working at different heights
- 3D technology for fast and accurate measurements
- Vehicle database included

WEEKLY FROM ONLY **£32.73⁺**
ONLY **£6,495.00**

SPACE SAVING DESIGN



JOHN BEAN V2200 & V2300

Offer advanced alignment service to your customers without needing specialised wheel alignment technicians.

Computerised 3D car wheel alignment with Pro 42 software for general repair shops. Liftable two-camera beam and 22" TFT flatscreen monitor. Cordless communication between targets and HD camera system.

V2200

- Comprehensive and up-to-date manufacturers' specifications
- Versatile wheel clamps provide a solid and worry-free attachment with a patented positioning procedure.
- Take a full four-wheel alignment reading in minutes.

V2300

Features as for V2200 plus

- Measurement of toe, camber, caster, maximum steering angle, rolling radius and cross diagonal
- EZ Access for measurement with demounted wheels

JOHN BEAN V2200
587 77 0050

WEEKLY FROM ONLY **£44.10⁺**
ONLY **£8,750.00**

JOHN BEAN V2300
587 77 0060

WEEKLY FROM ONLY **£65.49⁺**
ONLY **£12,995.00**



*Finance example typically based on a 5 year lease purchase agreement. Finance subject to status, full terms and conditions available on request. Other finance options available. All prices exclude VAT at 20%. Price, availability and specification may change without prior notice. Warranty subject to manufacturers terms and conditions of use. Errors and omissions excluded. Offers valid until 28th February 2017. Prices correct at time of going to press: August 2016.



JOHN BEAN BOXER BB2200 TYRE CHANGER AND BB4100 WHEEL BALANCER 583 05 0290

Tilt Back Tyre Changer and Digital Wheel Balancer newly released to provide great value for money to garages wanting to expand into tyre and wheel servicing.

TYRE CHANGER

- 20" turntable
- Pneumatic assist arm

WHEEL BALANCER

- 1D SAPE for input of wheel offset
- Maximum wheel diameter – 34"



WEEKLY FROM ONLY **£14.84⁺**
ONLY £2,945.00

HOFMANN MEGAPLAN ECOMOUNT 11XL CHANGER AND MEGASPIN 120 BALANCER 583 01 0190

Semi-automatic, side swing tyre changer with assist arm designed for anybody looking for an entry-level machine without compromising on reliability and long term support, and the first 'handspin' balancer ever to include fully-automatic (3D) data input.

CHANGER

- 10" to 24" Clamping (22" external)
- 13" rim width capability
- Semi-Automatic Operation
- Space-saving, swing arm design

BALANCER

- Can handle rims up to 30" diameter
- Automatic (3D) data input via IWA
- Dual 12v/240v operation
- 4 years PCB Warranty



UPGRADE THE CHANGER TO ECOMOUNT 22PLUS FOR ONLY £ 300.00 +VAT!

WEEKLY FROM ONLY **£13.58⁺**
ONLY £2,695.00

JOHN BEAR T5305 SINGLE SPEED TYRE CHANGER WITH ASSIST ARM AND B100 WHEEL BALANCER 583 01 0170

New package including tilt back tyre changer for all conventional tyres on the market, including helper arm and 10-20" clamping range and digital wheel balancer capable of measuring wheel offset and wheel diameter in one process (2 dimensions of semi-automatic parameter entry – 2D SAPE)

T5305 FEATURES

- Pneumatic lifting column – fast and safe wheel lifting
- Turntable has two cylinders for improved gripping of the rim
- Assist arm includes drop centre pressing tool and rim centre pushing tool – accuracy and ease of use as standard

B100 FEATURES

- Includes patented VPI system for high accuracy and repeatability
- Split weight mode – hide weights behind wheel spokes for more appealing cosmetic finish
- Tyre-matching mode – optimise tyre to rim so using fewer weights



WEEKLY FROM ONLY **£20.13⁺**
ONLY £3,995.00

*Finance example typically based on a 5 year lease purchase agreement. Finance subject to status, full terms and conditions available on request. Other finance options available. All prices exclude VAT at 20%. Price, availability and specification may change without prior notice. Warranty subject to manufacturers terms and conditions of use. Errors and omissions excluded. Offers valid until 28th February 2017. Prices correct at time of going to press: August 2016.

HELLA GUTMANN CSC MACHINE

597 77 5760

Calibration tool for camera based driver assist systems. Safety systems such as adaptive lighting, automatic distance control and lane departure warning are becoming a common feature of many mid-size and compact cars. The sensors and cameras required by these systems have to be precisely calibrated. A slight shift in the position of the radar head or the camera in relation to the geometric axle can cause the system to deliver incorrect results, or even fail completely. The CSC (Camera and Sensor Calibration) tool enables effective and accurate calibration of a wide range of camera-based driver assist systems.

The CSC Tool is an all-in-one solution for calibrating advanced driver assistance systems suitable for the whole range of vehicle manufacturers. Therefore, in connection with a diagnostic tool from Hella Gutmann Solutions, you are able to calibrate, for example, the front camera for the lane departure warning system, the radar sensor for the ACC (Adaptive Cruise Control) or the camera for adaptive headlights.

WEEKLY FROM ONLY **£28.48⁺**
FROM ONLY **£5,650.00**

(Basic machine price only. Does not include price for radar kits required)

CSC RADAR 1 KIT

597 77 7890

WEEKLY FROM ONLY **£8.37⁺**
FROM ONLY **£1,660.00**

CSC RADAR 2 KIT

597 77 7880

WEEKLY FROM ONLY **£6.27⁺**
FROM ONLY **£1,245.00**

KEEPS YOU FULLY COMPLIANT WITH THATCHAM ADAS CODE OF PRACTICE JULY 2016

- Compatible with a wide range of vehicles and camera-based driver assist systems
- A flexible, modular system which can be tailored to individual workshop requirements
- Provides accurate results with no need for a fully-equipped axle alignment station, levelled workshop floor or platform lift
- Full integration with Mega Macs diagnostic tools



HELLA GUTMANN MEGA MACS 42SE

355 77 4350

A compact, lightweight handheld diagnostic tool with comprehensive vehicle coverage and packed with features usually only found on much larger devices. Highly portable, it's no lightweight when it comes to features. The mega macs 42 SE is PassThru® compatible, enabling the latest ECU firmware to be downloaded directly from the vehicle manufacturers' websites. Combined with ECU and system data for more than 38,000 vehicle models, makes highly capable professional workshop tool.

- Compact and lightweight diagnostic tool
- Comprehensive in-depth vehicle coverage
- Equipped with PassThru® technology
- Comes complete with Bluetooth adapter for remote printing and a docking/charging cradle



WEEKLY FROM ONLY **£12.35⁺**
ONLY **£2,450.00**

HELLA GUTMANN MEGA MACS 56

355 77 4720

The stakes have just been raised with the launch of the new Mega Macs 56 – an affordable, mid-range diagnostic tool with features normally found only on much pricier models.

- 800mhz processor – finds faults fast.
- 10.4" high-resolution full colour touchscreen enables on-screen information to be easily read in low light conditions.
- Wi-Fi and Bluetooth connectivity enable wireless printing. Downloads technical data quickly and easily even whilst in use.
- PassThru® ready
- HGS Technical Data technical data included
- Optional extra – measurements package comprising 2 channel oscilloscope and multimeter

DEMO AVAILABLE ON APPOINTMENT



WEEKLY FROM ONLY **£17.61⁺**
ONLY **£3,495.00**

*Finance example typically based on a 5 year lease purchase agreement. Finance subject to status, full terms and conditions available on request. Other finance options available. All prices exclude VAT at 20%. Price, availability and specification may change without prior notice. Warranty subject to manufacturers terms and conditions of use. Errors and omissions excluded. Offers valid until 28th February 2017. Prices correct at time of going to press: August 2016.

MASTERPRO HYDRAULIC BODY REPAIR KIT 20 TONNE

538 77 4561

- 20 tonne screw type body repair kit.
- Complete with 4 sizes of threaded extension pipes.
- 3 each male and female couplers.
- 1x wedge head, 1x vee head, 1x ram toe 1x ram base.
- 20 tonne ram & hydraulic hand pump with hose.
- Supplied in 2x metal boxes.



ONLY **£229.99**

MASTERPRO HYDRAULIC BODY REPAIR KIT 10 TONNE

538 77 4601

- Includes snap connector pipe work and cast snap connector attachments for quick & easy assembly.
- Ideal for use in the garage or workshop.
- Enables bodywork structures to be returned to their original shape.



ONLY **£129.99**

FASTMOVER AIR SANDER 75 & 50MM WITH ROLL ON SYSTEM IN CASE

573 77 4110

- A great performing and very robust 75mm air orbital sander.
- Comes in a plastic carry case.
- Extremely robust steel body, making it very suitable for harsh workshop environments.



ONLY **£69.99**

MASTERPRO 7 PIECE PANEL BEATING SET

538 77 4731

- For repairing minor dents, dings and smoothing out autobody finish.
- Drop – forged striking head.
- Precision – ground surfaces.
- Fibreglass handles.
- Rugged carrying case.



ONLY **£49.99**

MASTERPRO ALUMINIUM FOLDING WORK STEP 200KG CAPACITY

538 77 4721

- Designed for up to 200kg maximum capacity.
- Robust riveted feet with ribbed tread feet for high grip slip-resistance.
- Folds virtually flat for convenient storage.
- Perfect for a wide range of odd-jobs around the home and workplace.
- Specifically designed safety locking catches located on either side.



ONLY **£29.99**

MASTERPRO 6 PIECE MINI TRIM PANEL REMOVAL SET

538 77 1481

- Tools with slim profile to simplify removal of small trim items and panels
- Ideal for removal of dash trim and internal fixtures and fittings
- Manufactured from resilient nylon to minimize panel damage and marking



ONLY **£9.99**

*Finance example typically based on a 5 year lease purchase agreement. Finance subject to status, full terms and conditions available on request. Other finance options available. All prices exclude VAT at 20%. Price, availability and specification may change without prior notice. Warranty subject to manufacturers terms and conditions of use. Errors and omissions excluded. Offers valid until 28th February 2017. Prices correct at time of going to press: August 2016.

MASTERPRO BODYSHOP PART TROLLEY

538 77 4581

- Versatile robust trolley for manoeuvring multiple parts at once
- Fitted with 5 wheels for ease of manoeuvrability
- 90Kg capacity



ONLY **£149.99**

MASTERPRO MOBILE BUMPER RACK

538 77 4641

- Portable bumper rack
- Holds up to 6 bumpers securely
- Rubberised arms



ONLY **£99.99**

FASTMOVER PANEL STAND

538 77 6031

- Features fully adjustable arms to fit many styles of bonnets, wings, doors and bumpers.
- Main frame can adjust through 180°, to give required angle.
- Fitted with two fixed Ø180mm wheels and two braked Ø125mm castors for easy manoeuvrability



ONLY **£99.99**

MASTERPRO EXTENDING PANEL STAND

538 77 6091

- Extending stand with height adjustment, ideal for a variety of applications.
- Fitted with four castors, two with brake, for maximum manoeuvrability and safe positioning.



ONLY **£84.99**

MASTERPRO MOBILE & ROTATING PANEL PAINT STAND

538 77 4591

- Allows multiple working angles
- 360° rotation-turnstile handle grip
- Easy, one-person foot pedal operation
- Includes large wheels for easy mobility



ONLY **£74.99**

FASTMOVER BUMPER TRESTLE

573 77 5300

- Includes two adjustable arms to hold the bumper in shape whilst painting it and whilst in the oven – no more distorted bumpers!
- Adjustable in height and width for maximum flexibility.
- SWL 136kg



ONLY **£24.99**

FASTMOVER TRESTLE FOLDAWAY UNIVERSAL

573 77 5310

- Economically priced fold up and portable work stand.
- Strong, sturdy and very practical.
- Ideal for resting vehicle panels on during the paint preparation stage, and also fitting them up after they have been painted.



ONLY **£19.99**

*Finance example typically based on a 5 year lease purchase agreement. Finance subject to status, full terms and conditions available on request. Other finance options available. All prices exclude VAT at 20%. Price, availability and specification may change without prior notice. Warranty subject to manufacturers terms and conditions of use. Errors and omissions excluded. Offers valid until 28th February 2017. Prices correct at time of going to press: August 2016.

LAUNCH CRP129

355 77 7450

- Retrieve vehicle information (VIN, CIN, CVN)
- Read and Clear Fault Codes
- Read & Clear 'Check Engine' Lights
- All 10 OBDII Tests
- Turn off Malfunction Indicator Lamps, and reset monitors
- Oil & Parking Brake Reset
- Print data via PC
- Fault code reader/reset machine



ONLY **£260.00**

LAUNCH CRP229

355 77 7570

All the information pertinent to a vehicle's health in an accessible, reader-friendly format. Quickly read/erase fault codes and reset service lights, also carry out specific special functions.

- Intuitive design & a user-friendly layout
- Wi-Fi enabled & compatible with mobile tethering
- Provides diagnostic information for 42 different vehicle manufacturers
- A year of free updates
- No lock-out periods
- 2 years warranty
- Touch screen



Service function diagnostic machine with 1 year warranty.

ONLY **£599.00**

VDO CHECK

355 77 8380

Easy, fast and reliable. With 10 essential service functions, this is the machine that will be in demand most of the time. Compact, easy to use and thanks to optional software updates, always up-to-date. The FastCheck application allows the testing of ABS/ESP, SRS (airbags & belt tensioners), Electronic Parking Brake, and Airconditioning systems faster than ever before.

- Electronic Parking Brake
- Service Light Reset
- Steering angle Reset
- Climate Control
- Battery Diagnostics
- DSG Gearbox ABS
- Climate Control
- Airbag
- EOBD



ONLY **£349.00**

SMOKE PRO BODY PRO COLLISION REPAIR LEAK DETECTOR

355 77 8680

The Body Pro™ is the solution to quickly solve time-consuming, impossible-to-diagnose, wind & water leaks that are a drain on profitability for body collision repair technicians.

The special patent pending adaptors, engineered just for collision repair, produce a fluffy, highly dense vapour with long hang time, that makes air disturbance leaks easy to see.

Use Body Pro to quickly test for:

- Wind/water leaks
- Body panel and door leaks
- Head/tail lamp leaks
- Testing radiators before installation
- Sunroof leaks
- Vacuum leak



ONLY **£465.00**

*Finance example typically based on a 5 year lease purchase agreement. Finance subject to status, full terms and conditions available on request. Other finance options available. All prices exclude VAT at 20%. Price, availability and specification may change without prior notice. Warranty subject to manufacturers terms and conditions of use. Errors and omissions excluded. Offers valid until 28th February 2017. Prices correct at time of going to press: August 2016.

DOES YOUR BATTERY CHARGER MATCH UP TO THE GYS 1,2,3 TEST?

MINIMUM REQUIREMENTS OF A BATTERY CHARGER

1. Must be safe to charge the battery without removing it from the vehicle
 - Protection for vehicle systems
2. Must be able to charge all the latest battery types
 - AGM / EFB / Silver / Calcium / GEL / VRLA
3. Must be able to safely charge the battery without requiring the technician to identify the battery type
 - This is a real world problem – it can be very difficult and time consuming to do this and due to the difficulty inevitable will result in potentially dangerous mistakes

THE 1, 2, 3 TEST

Consider whether battery equipment that cannot pass this test should be in use in your workshop?

NEW!

Designed for charging new generation EFB technology STOP-START batteries!

GYS STARTIUM 680E – CHARGER STARTER

355 77 8430

1. Has comprehensive protection functions
2. Has charge capability for each battery type
3. Has 'Universal Mode' for when battery type is unknown

ADDITIONAL FEATURES

- Alternator test
- Automatic start
- Battery desulphation

SPECIFICATION

- Peak power 550A
- 12V/24V
- Made in France

**DESIGNED FOR EFB
STOP/START BATTERIES**

ONLY **£475.00**



GYS DIAG STARTIUM 60:24

355 77 8440

Take a Startium and add a powerful 60A Battery Support Unit. Battery Support is now vital when carrying out extended key on engine off diagnostic work.

The Diag Startium will provide up to a massive 60A in support. Its advanced features allow adjustment of voltage 12-15V to enable use with BMW (14.8V).

- 60A Battery Support unit with adjustable voltage
- Peak power 430A
- Made in France

**DESIGNED FOR EFB
STOP/START BATTERIES**

ONLY **£599.00**



STARTIUM 480E – ADVANCED STARTER/ CHARGER

355 77 8420

- Only product on the market that offers protection for vehicle electronics AND
- Safe to charge modern battery types AND
- Universal mode for when battery type is unknown
- Starting current up to 390A, 12V and 24V

ONLY **£449.00**



*Finance example typically based on a 5 year lease purchase agreement. Finance subject to status, full terms and conditions available on request. Other finance options available. All prices exclude VAT at 20%. Price, availability and specification may change without prior notice. Warranty subject to manufacturers terms and conditions of use. Errors and omissions excluded. Offers valid until 28th February 2017. Prices correct at time of going to press: August 2016.

GT GLASS SUPERSTAR WINDSCREEN REPAIR KIT 597 77 1000

Professional windscreen repair kit with all components included within the hand carry case. System uses the latest UV curing technology and resins.

TRAINING AVAILABLE*



ONLY **£675.00**

POWER-TEC HOT SPOT 2 DENT REDUCTION SYSTEM LAS92481

Designed to remove / reduce panel damage caused by hail stones and more commonly – car park dents, it uses electromagnetic technology to rapidly create heat in panel to relieve the dent. It's very easy to use due to its power regulator which gives the operator full control of the process.

The Hot spot can be used in conjunction with other smart repair methods, such as Glue pulling and Paintless Dent Removal Kits.

- Carry case included



WEEKLY FROM ONLY **£5.01***
ONLY **£995.00**

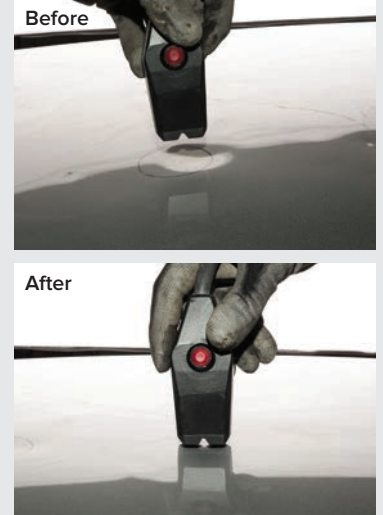

POWER-TEC PDR DENT LIFTING PRO KIT/ HOT GLUE DENT REMOVAL KIT LAS92308

Professional dent lifting kit designed for removing dents without the need to repaint. Using a HOT glue pulling PDR technique and slide hammers plus a hand lifter included. Fast and very cost effective method of dent removal. System comes in a handy carry case including a large hand puller and a wide range of tabs.

TRAINING AVAILABLE*



ONLY **£575.00**

POWER-TEC 30-PIECE PDR SYSTEM LAS92450

Essential Paintless Dent Removal Tolls to massage out minor panel damage where the paint surface has not been broken.

30 pieces includes:

- Panel punch
- Large wedge
- S Hook (10)
- Door jammer
- Mini air bag
- Carry case included

TRAINING AVAILABLE*

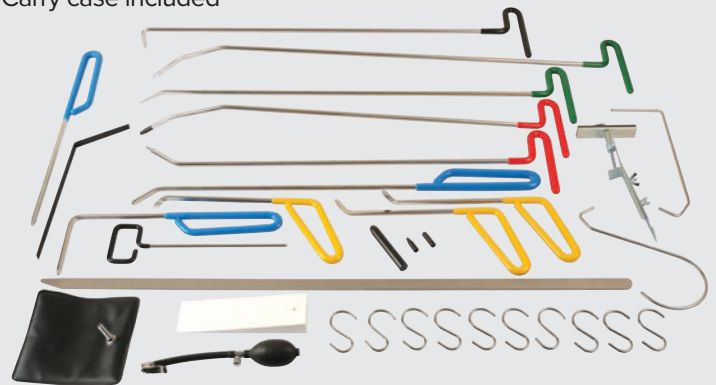

ONLY **£346.50**

*Contact a member of LKQ sales for details.

*Finance example typically based on a 5 year lease purchase agreement. Finance subject to status, full terms and conditions available on request. Other finance options available. All prices exclude VAT at 20%. Price, availability and specification may change without prior notice. Warranty subject to manufacturers terms and conditions of use. Errors and omissions excluded. Offers valid until 28th February 2017. Prices correct at time of going to press: August 2016.

SCREEN 3

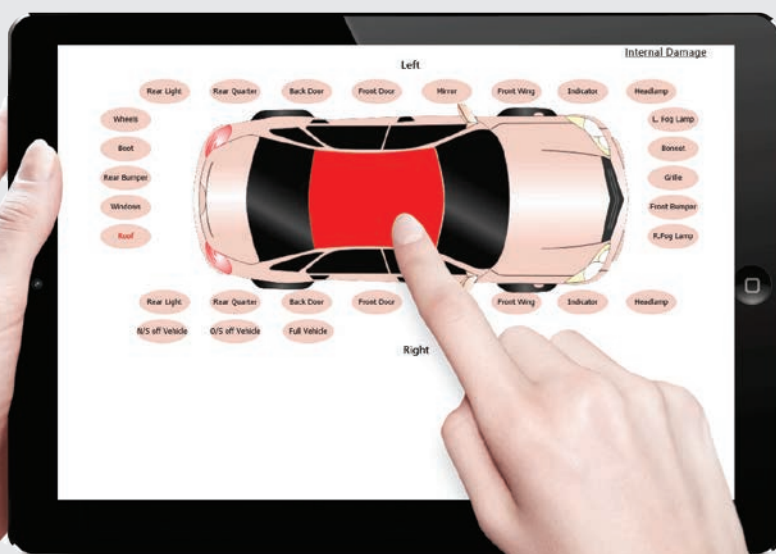

SCREEN 5

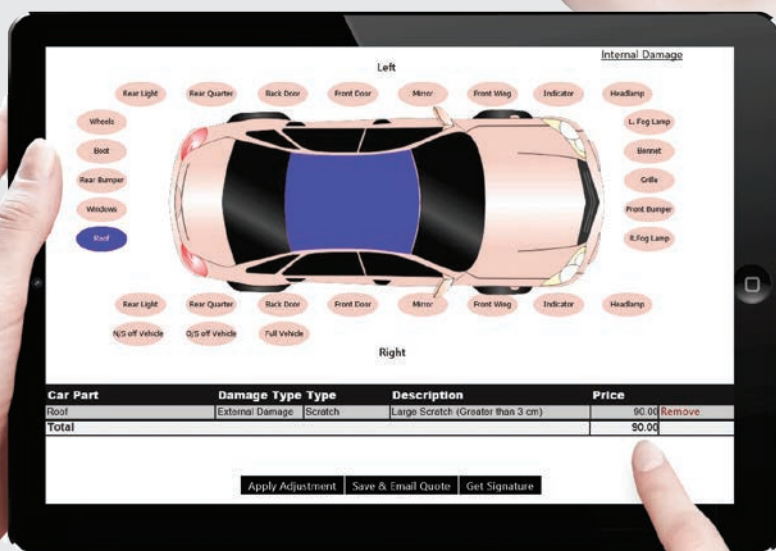

SCREEN 6

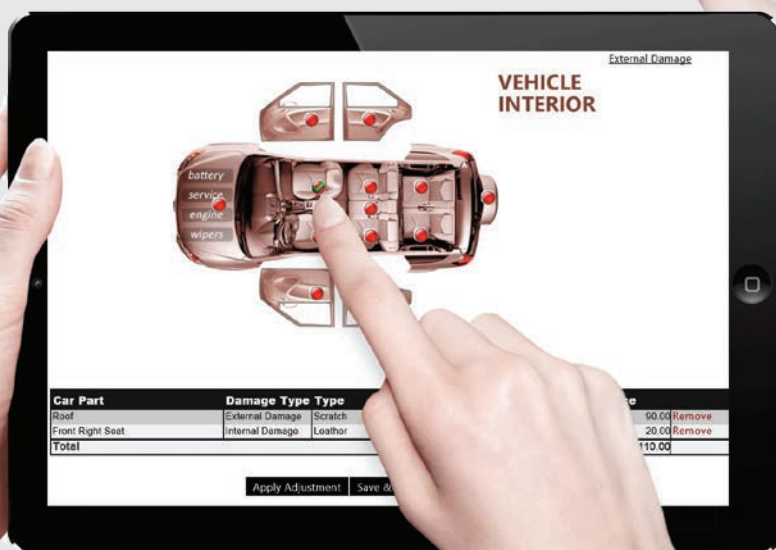

INTELLIGENT QUOTE SYSTEM

- FAST, EASY and MOBILE estimating programme.
- Designed for both experienced and inexperienced personnel.
- No special hardware required; iphone, ipad, tablet pc or android phone compatible.
- No special server access required... just internet access.
- Quick data capture
- Easy drop-box style selection
- App download

HOW TO GET YOUR QUOTE:

- SCREEN 1 Log on
- SCREEN 2 Add Customer details
- SCREEN 3 Select damage area
- SCREEN 4 Select type of damage i.e. Scratch / Dent / Chip
- SCREEN 5 Build quote
- SCREEN 6 Add any additional damage
- SCREEN 7 Apply quote discount
- SCREEN 8 Assign signature
- SCREEN 9 Send quote
- SCREEN 10 Customer email copy

BRONZE PACKAGE

Create quotes fast and easily from any Windows, iOS or Android pc, laptop, tablet or smartphone

FROM **£2.78** PER DAY (PLUS VAT)

SILVER PACKAGE

Create and email quotes and invoices. Produce reports

FROM **£5.63** PER DAY (PLUS VAT)

GOLD PACKAGE

Full quote, repair, and bodyshop management suite

FROM **£19.39** PER DAY (PLUS VAT)

Gold package includes sms and post code lookup.

All prices based on a 5.5 working day week. Set up fee applies to Bronze and Silver packages at £199.00 plus vat, Gold inclusive. Minimum 12 month rolling contract.

See how quickly and easily you can build and send a quote
goo.gl/2u7IHN



*Finance example typically based on a 5 year lease purchase agreement. Finance subject to status, full terms and conditions available on request. Other finance options available. All prices exclude VAT at 20%. Price, availability and specification may change without prior notice. Warranty subject to manufacturers terms and conditions of use. Errors and omissions excluded. Offers valid until 28th February 2017. Prices correct at time of going to press: August 2016.

MOBILE VAN CONVERSIONS OPT.VKOPLATINUM

- Full mobile repair solution
- Compliant installations – fit for purpose
- Bespoke design, not one design fits all
- Competitively priced, finance plans available
- Clients include National dealership and Franchises
- Designs include van for:
 - Alloy wheel repair
 - Cosmetic paint repair
 - Bespoke application



Before



After



CALL FOR A QUOTE

PLASTIC BUMPER REPAIR KIT TPS.408020

- Perfect starting point to undertake cosmetic repairs to 'resin' or natural coloured plastic bumpers, or other interior & exterior plastic components.



ONLY **£118.75**

FABRIC & VELOUR REPAIR KIT TPS.443100

- Self-contained kit for repairing burns, holes, snags, small tears and other damage such as weld splatter found in velour and other fabric seats, carpet and similar materials.

TRAINING AVAILABLE*

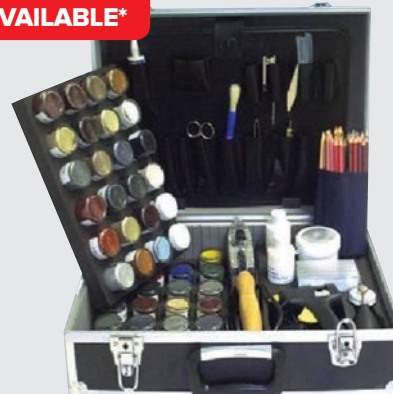

ONLY **£373.75**

LEATHER REPAIR PAINT SYSTEM TPS.470000

- Uses super concentrated water-based pigments
- Different binders for different substrates
- Excellent adhesion over leather and plastic
- Optional digital spectrometer for ultimate accuracy

TRAINING AVAILABLE*



ONLY **£333.25**

*Contact a member of LKQ sales for details.

*Finance example typically based on a 5 year lease purchase agreement. Finance subject to status, full terms and conditions available on request. Other finance options available. All prices exclude VAT at 20%. Price, availability and specification may change without prior notice. Warranty subject to manufacturers terms and conditions of use. Errors and omissions excluded. Offers valid until 28th February 2017. Prices correct at time of going to press: August 2016.



**DID YOU KNOW...?
DYNACOAT WAS LAUNCHED IN 1998
AND IS NOW SOLD IN 75 COUNTRIES**

- ✓ Simple to use.
- ✓ Best colour matching.
- ✓ Good value for money.

Three reasons why the Dynacoat paint system has all your refinishing needs covered.

DYNACOAT FOR RESULTS THAT SHINE

Introduced to the LKQ Coatings offering early last year, Dynacoat is a complete repair range designed for professional use with the pressures of today's bodyshop in mind. Essentially aimed at the professional 'Free to Choose' market, painters can be confident of a good finish with all products delivering fast, accurate and reliable results.

EXCLUSIVE TO LKQ COATINGS

Supported by AkzoNobel's worldwide product and colour tools expertise plus LKQ's technical know-how, Dynacoat assists you with all of your day-to-day bodyshop challenges from a tricky spot repair to an entire respray.

PRIMER 4100 4 LITRE (GREY) DYC.518590

Delivers excellent hiding power with impressive coverage and flow characteristics making it perfect for most substrates. Dynacoat 4100 Filler Primer is ideal for filling larger areas and surface even outs; can be baked, air-dried and wet or dry sanded offering maximum flexibility.



WATER-BASED DEGREASER 5 LITRE DYC.375737

Designed to remove most organic surface contamination including:

- Salt residue
- Sweat from hands
- Tree resin
- Waterborne contaminants



CLEARCOAT 6000 5 LITRE DYC.541191

Best in class with superior gloss finish everytime

- 2-3 minute flash off time between coats
- Flexible thinner and hardener options for all application environments
- Ability to dry as quick as 10 mins (60c)
- Air dry capabilities of 1hr 15 mins (21c)



CLEARCOAT 9000 5 LITRE DYC.518636

A VOC compliant 2k clearcoat designed for all day-to-day bodyshop needs

- Smooth and easy application
- Simple mix ratio
- Fast drying properties
- Leading spraying and polishing properties

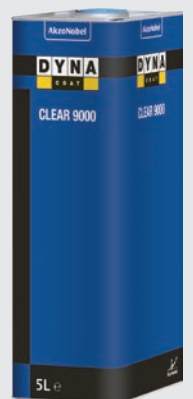

Contact your local LKQ Coatings branch to find out more.

*Finance example typically based on a 5 year lease purchase agreement. Finance subject to status, full terms and conditions available on request. Other finance options available. All prices exclude VAT at 20%. Price, availability and specification may change without prior notice. Warranty subject to manufacturers terms and conditions of use. Errors and omissions excluded. Offers valid until 28th February 2017. Prices correct at time of going to press: August 2016.

MASTERPRO 2 TON LOW PROFILE HIGH LIFT TROLLEY JACK

538 77 0581

- Min: 76mm
- Max: 508mm
- Weight: 45kg
- Max dimensions:
949mm x 365mm x 220mm



ONLY **£179.99**

MASTERPRO AIR CHASSIS JACK

538 77 4631

- Fitted with an air control valve for safely raising or lowering of loads.
- Adjustable front bumper extensions with large rubber mounting pads.
- Rear wheels mounted for easy of movement.
- Capacity: 1.25Ton
- Saddle Width Range:
254 - 838mm
- Lifting Range: 120 - 200mm



ONLY **£199.99**

MASTERPRO 2 TON 3 BAG AIR JACK

538 77 4210

- Capacity: 2Ton
- Min height: 200mm
- Max height: 560mm
- Lifting time: 4 sec
- Weight: 17Kg



ONLY **£199.99**

MASTERPRO CAR MINI LIFT PNEUMATIC

538 77 4621

- Offers fast, easy lifting, with or without an air supply
- Can be used with an air motor or the integral foot pump
- Heavy-duty steel construction
- Includes adapters to lift wheel or car body
- Capacity: 1.5Ton
- Max Height: 1100mm



ONLY **£379.99**

*Finance example typically based on a 5 year lease purchase agreement. Finance subject to status, full terms and conditions available on request. Other finance options available. All prices exclude VAT at 20%. Price, availability and specification may change without prior notice. Warranty subject to manufacturers terms and conditions of use. Errors and omissions excluded. Offers valid until 28th February 2017. Prices correct at time of going to press: August 2016.

Coil Spring Stations

NO HASSLE
WARRANTY

BEST PRICE
PROMISE

COMPAC PNEUMATIC COIL SPRING WORKSTATION

940 77 5010

- Very long stroke 330mm
- Moveable arms
- Universal swivel jaws
- Foot operated air approach and return
- Enough power to compress strong springs on vehicles such as Ducato, Jumper and Boxer
- Including 2 spring holders (78 - 125mm and 125 - 200mm)



WEEKLY FROM ONLY **£5.54⁺**
ONLY **£1,099.99**

SYKES PICKAVANT PNEUMATIC COIL SPRING COMPRESSOR STATION WITH FREE ADDITIONAL CLAMPS

SYK 385 800 SP

- Suitable for cars, 4WD's and light commercials that use McPherson strut type suspension systems
- Fitted with Extra Heavy Duty Pneumatic Cylinder Compression force (at 10 bar) = 2452 kg
- Ideal for Extra Heavy Duty applications i.e. SUV's, 4WD's etc where full spring compression is required
- Includes FREE Mercedes Bracket Set (38480100) - Upper bracket for Mercedes A, B, C, E Class and Lower bracket for Mercedes E Class – WORTH £235.00



WEEKLY FROM ONLY **£7.55⁺**
ONLY **£1,499.99**

MASTERPRO COIL SPRING COMPRESSING STATION HYDRAULIC 1000KG CAPACITY

530 77 3470

- 1000kg Foot operated hydraulic unit.
- Quicker and easier than using ratchet driven spring compressor.
- Plastic coated yokes reduce the risk of spring slippage or damage and are suitable for springs from Dia.102mm to Dia.160mm.
- 1,000kg Capacity foot-operated hydraulic unit.



ONLY **£119.99**

LASER COIL SPRING COMPRESSOR 1600KG

LAS 6050

- Suitable for spring sizes 80mm < 310mm maximum. Compression force of 1600Kg, provides sufficient power to cover ALL known standard production models (Car/Van)
- Fitted safety cage with safety valve – restricts use when in open position
- Suitable for both left and right hand wound springs and for ALL types of springs inc. Tapered, Banana and LH wound springs



WEEKLY FROM ONLY **£5.03⁺**
ONLY **£999.99**

*Finance example typically based on a 5 year lease purchase agreement. Finance subject to status, full terms and conditions available on request. Other finance options available. All prices exclude VAT at 20%. Price, availability and specification may change without prior notice. Warranty subject to manufacturers terms and conditions of use. Errors and omissions excluded. Offers valid until 28th February 2017. Prices correct at time of going to press: August 2016.



AIRCON MACHINE ECK 3500-UP

251 77 0840

- 5" Colour display with icons for easy use
- Automatic taps, no more manual valves
- Automatic leak check during vacuum phase
- Non-refillable containers, offers the advantage of eliminating contact with humidity



WEEKLY FROM ONLY **£10.88⁺**
ONLY **£2,159.00**

HFO1234YF GAS 5KG RETURNABLE CYLINDER

241 77 0130

- Low flammability, low toxicity and non-corrosive
- Zero Ozone Depletion Potential and a GWP of 4: this GWP is 99.7% lower than R134a and 97% lower than the EU's Mobile Air Conditioning (MAC) Directive requirement



ONLY **£599.00**

AIRCON MACHINE ECK 1800-HFO

251 77 0890

- Fully automatic cycle
- Refrigerant management giving usage report and archive
- Automatic leak check during vacuum phase Database for quick gas selection also allows to add new vehicle models



WEEKLY FROM ONLY **£7.86⁺**
ONLY **£1,559.00**

PORTABLE LEAK DETECTION KIT NITROGEN

248 77 3130

- 950cc "One-Shot" Nitrogen and Hydrogen Cartridge
- 200bar (in) / 0÷50bar (out) Nitrogen regulator
- Manifold gauge to run leak testing with 1/4" SAE connection & 5/16" SAE connection



ONLY **£239.00**

AIRCON MACHINE ECK TWIN-PRO

251 77 0820

- 2 Separated circuits for different gasses
- Large 7" touch screen, colour display with icons for easy use
- Automatic taps, no more manual valves
- Fully automatic cycle
- High precision



WEEKLY FROM ONLY **£18.14⁺**
ONLY **£3,599.00**

UV MINI LIGHT (12V/50 W) WITH UV GLASSES

254 77 0240

- High intensity
- 16ft. (5m) cable
- Compact and lightweight
- Includes UV enhancing safety glasses
- Instant ON



ONLY **£69.00**

R134A ELECTRONIC LEAK DETECTOR WITH BUILT-IN LED LIGHT & UV GLASSES

261 77 0010

- Ultra bright UV/blue LED light
- UV safety glasses
- 6 levels of sensitivity (15 levels of detection)
- Tri-coloured Visual Leak Level Indicator



ONLY **£172.00**

MASTERCOOL 2 IN 1 LEAK DETECTOR KIT

254 77 0010

- Light
- UV Dye Injection System
- UV Glasses



ONLY **£215.00**

*Finance example typically based on a 5 year lease purchase agreement. Finance subject to status, full terms and conditions available on request. Other finance options available. All prices exclude VAT at 20%. Price, availability and specification may change without prior notice. Warranty subject to manufacturers terms and conditions of use. Errors and omissions excluded. Offers valid until 28th February 2017. Prices correct at time of going to press: August 2016.

AIRCON MACHINE ECK 1800

251 77 0850

- Refrigerant management giving usage report and archive
- Automatic leak check during vacuum phase
- Database for quick gas selection also allows to add new vehicle models
- Fully automatic
- High precision



WEEKLY FROM ONLY **£6.30⁺**
ONLY **£1,250.00**

ROBINAIR 1234 YF-7

251 77 0740

The AC1234-7 is an automatic refrigerant management station with complete 'programme and walk-away' capability. It automatically controls the recovery, vacuum and recharging processes for oil, UV dye and refrigerant, as well as filtering the recovered refrigerant. The AC1234-7 has an integral printer.



WEEKLY FROM ONLY **£20.76⁺**
ONLY **£4,120.00**

AIRCON MACHINE AC595PRO

251 77 0710

The AC595PRO is an automatic refrigerant management station. It automatically controls the recovery, recycling, vacuum and recharging process for oil, dye and refrigerant. As an entry-level machine, the AC595PRO is simple and time efficient to use.



WEEKLY FROM ONLY **£8.06⁺**
ONLY **£1,599.00**

AIRCON MACHINE BRAIN BEE CLIMA 6000 PLUS

251 77 0980

- Extremely versatile, compact in size and lightweight
- Maintenance parts are easily reachable and accessible by non-experts/technicians, therefore minimising the machine downtime costs
- Patented Heater Lock, Eco Lock and Long Life Pump



WEEKLY FROM ONLY **£6.20⁺**
ONLY **£1,230.00**

AIRCON MACHINE AC690PRO

251 77 0720

The AC690PRO is a fully automatic refrigerant management station with complete 'programme and walk-away' capability. It automatically controls the recovery, recycling, vacuum and re-charging process for oil, dye and refrigerant. The AC690PRO has an extensive, integrated vehicle database, user database, built-in vehicle-specific diagnostics facility and integral printer.



WEEKLY FROM ONLY **£12.89⁺**
ONLY **£2,499.00**

AIRCON MACHINE ROBINAIR AC 690 PRO YF

251 77 2050

Robinair AC690PROyf Automatic Aircon Machine for HFO1234YF.

The AC690PRO is a fully automatic refrigerant management station with complete 'programme and walk-away' capability. It automatically controls the recovery, recycling, vacuum and re-charging process for oil, dye and refrigerant. The AC690PRO has an extensive, integrated vehicle database, user database, built-in vehicle-specific diagnostics facility and integral printer.



WEEKLY FROM ONLY **£16.38⁺**
ONLY **£3,175.00**

*Finance example typically based on a 5 year lease purchase agreement. Finance subject to status, full terms and conditions available on request. Other finance options available. All prices exclude VAT at 20%. Price, availability and specification may change without prior notice. Warranty subject to manufacturers terms and conditions of use. Errors and omissions excluded. Offers valid until 28th February 2017. Prices correct at time of going to press: August 2016.

DISCOVER THE WORLD OF OPTIMA

EXCLUSIVE TO
LKQ COATINGS

Re-introduced earlier this year with a fresh lick of green and blue paint, Optima is LKQ Coatings flagship bodyshop consumables range offering high quality products that deliver great cost savings compared to your typical bodyshop brands.

Consumables include adhesive & masking tapes, wipes & cloths, headlight wipe restoration kits, alloy wheel paint (see page 4), thinners and abrasive discs to name a few.



Contact your local LKQ Coatings branch to find out more.

U-POL EXPERT : THE VERY BEST FINISH STARTS WITH AN EXPERT FOUNDATION

EXCLUSIVE TO
LKQ COATINGS

The U-POL Expert range is a brand of products exclusively available to LKQ Coatings. The range consists of Premium fillers, high quality aerosols and primers utilising the latest technology and offering competitively priced products. Contact your local LKQ Coatings branch to find out more.

- Easy to use system
- Enhanced repair process
- Improved costs – save money and increase profits
- Latest technology
- Premium products made with the highest quality raw materials



Contact your local LKQ Coatings branch to find out more.

*Finance example typically based on a 5 year lease purchase agreement. Finance subject to status, full terms and conditions available on request. Other finance options available. All prices exclude VAT at 20%. Price, availability and specification may change without prior notice. Warranty subject to manufacturers terms and conditions of use. Errors and omissions excluded. Offers valid until 28th February 2017. Prices correct at time of going to press: August 2016.

Advantages of Leasing



DO YOU PAY YOUR STAFF 5 YEARS IN ADVANCE?
NO, SO WHY PAY FOR YOUR EQUIPMENT THAT WAY!
PAY FOR IT AS IT WORKS FOR YOU!

**NO HASSLE
WARRANTY**

**BEST PRICE
PROMISE**

- Fixed payments (excluding VAT)
- Tax efficient – see table
- Preserves working capital
- 1–5 year terms available
- No deposit
- Why wait? Buy the equipment your business needs now!

EQUIPMENT VALUE (EXCLUDING VAT) – £5,000

2 YEARS LEASE

Weekly Payment	£55.47
First Payment	£240.35
23 Payments	£240.35
Total Cost	£5,768.40

Tax Relief @ 20%	£5,768.40
Net Cost of Finance	£4,614.72

4 YEARS LEASE

Weekly Payment	£30.21
First Payment	£130.90
23 Payments	£130.90
Total Cost	£6,283.20

Tax Relief @ 20%	£1,256.64
Net Cost of Finance	£5,026.56

3 YEARS LEASE

Weekly Payment	£38.61
First Payment	£167.30
35 Payments	£167.30
Total Cost	£6,022.80

Tax Relief @ 20%	£1,204.56
Net Cost of Finance	£4,818.24

5 YEARS LEASE

Weekly Payment	£25.20
First Payment	£109.20
23 Payments	£109.20
Total Cost	£6,552.00

Tax Relief @ 20%	£1,310.40
Net Cost of Finance	£5,241.60

Payments shown above are subject to businesses trading more than 3 years, credit approval and VAT. New start businesses may require a higher rate. The tax relief shown is an illustration only. Euro Car Parts Ltd is regulated by the Financial Conduct Authority (FCA) reference number 559185.

*Finance example typically based on a 5 year lease purchase agreement. Finance subject to status, full terms and conditions available on request. Other finance options available. All prices exclude VAT at 20%. Price, availability and specification may change without prior notice. Warranty subject to manufacturers terms and conditions of use. Errors and omissions excluded. Offers valid until 30th September 2016. Prices correct at time of going to press: July 2016.





**Why wait until payday?
Get the tools you need, now!**

Spread the cost over weekly payments

Its 100% INTEREST FREE

INSTANT online approval

Guaranteed £600 credit limit

www.techtoolclub.co.uk