

EVERLAST

Indestructible



Signs Tags & Markers

The Only Sign System to be  **UL Tested to 30 years ... NO CHANGE!**

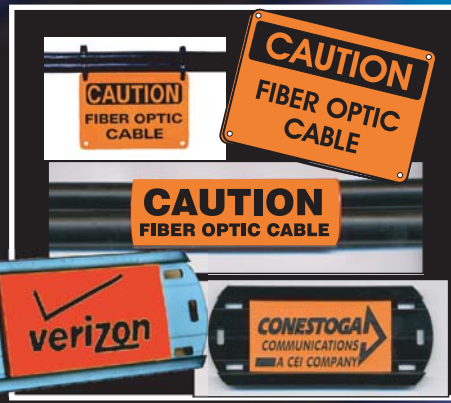

TECH
PRODUCTS, INC.

EVERLAST®

Patent#s 4835890, 5265364 & Others Pending
The Remarkable Difference!

Most signs, markers and tags have screen printed or hot stamped copy. The thickness of ink, paint or stamping foil is less than 0.002 in., offering little resistance to UV radiation, corrosion, abrasion or impact.

EVERLAST, in contrast, has copy that is deeply and solidly embedded at a thickness of the part... 0.230 inches. ... *A thickness more durable than 40 coats of paint!*

EVERLAST's "molded-in" copy is abrasion proof, unaffected by the most severe climatic conditions, and inert to environmental chemicals. **EVERLAST** withstands temperatures from -40 to 200 degrees Fahrenheit.

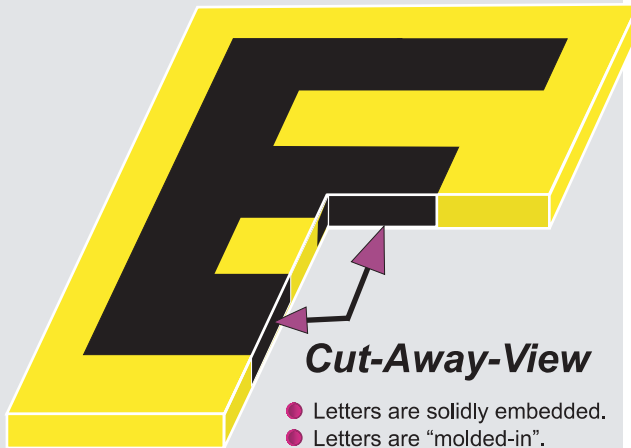

Cut-Away-View

- Letters are solidly embedded.
- Letters are "molded-in".
- Letters go Through-The-Sign.

More durable than over 40 coats of paint!

How to Specify EVERLAST®

Signs, tags or markers (as applicable) with injection molded characters, integral with locking grids. Color pigments and UV stabilizers molded throughout the thickness of the part. Characters are as thick as the part itself.



EVERLAST® Indestructible

8 Reasons To Buy EVERLAST®

- 1 The Only Solution to Long-Term-Legible Signs, Tags and Markers!**
Enormous savings! No Sign replacement costs. Huge Labor savings for the department that installs signs.
- 2 Guaranteed to cut your costs!**
*Think about it. It costs at least \$20 per hour in labor to replace a sign ... Not to mention the replacement cost of the new sign! **EVERLAST** eliminates the need to replace your signage.*
- 3 The Only Sign System to be tested by Underwriters Laboratories.** 
Test results remarkably showed ... 30 Years No Change!
- 4 FREE Holes, Corners, Color and Shape!**
*Because **EVERLAST** is injection molded, everything is done at once, holes, corners, colors and shape. Better quality, less cost!*
- 5 Legal Liability virtually eliminated!**
*Because **EVERLAST** will be legible for 30 plus years, people will always be able to read the sign... Liability and negligence issues are sharply reduced.*
- 6 EVERLAST Injection Molded with high-impact, deluxe polyolefins.**
*Not only does this mean "High Quality", it is also helpful to the environment. Unlike competitive plastic products that break down and emit toxins into the environment, **EVERLAST** does not breakdown or emit toxins.*
- 7 Withstands temperatures from -40 to 220 degrees Fahrenheit!**
***EVERLAST's** "molded-in" copy is abrasion proof, unaffected by the most severe climatic conditions, and inert to environmental chemicals. UV stabilizers are "molded-in" throughout the thickness of the sign.*
- 8 Will NEVER delaminate ... Fiberglass or other signs that have overlays, coatings or a core... will almost always delaminate in harsh environments.**
Don't be fooled by material that is sandwiched together like most fiberglass and coated signs. Water, mold, and other elements seep in, crack open the edges and make the sign look ... "cloudy".



"Why My Signs Are The Best You Can Buy!"

Ken Nelson
B.S. Industrial Engineering ... MIT
CEO Tech Products, Inc.
Inventor and Patent Holder For **EVERLAST**®



After spending 34 years in the identification products business, I'd seen laminates, adhesives, and paints fade, wear and fail. I had an epiphany one day and came up with an idea for tags and signs that could withstand the elements and extremely harsh conditions, year after year. After much testing and refining, that brainstorm developed into **EVERLAST**, a product of which I am extremely proud because it delivers what it promises.

EVERLAST products are made of thick, high impact polyolefins with copy and pictograms that are permanently embedded and impervious to sun, wind, rain, fumes, acid and alkali solutions, salt water, temperature variations or humidity.

EVERLAST is the only sign and identification product to be subjected to the rigors of UL testing to prove its extreme durability. Over the past decade, hundreds of astute companies, utilities and government entities have saved thousands of dollars in signage replacement costs by specifying **EVERLAST** for their identification and accident prevention signs.

Isn't it time you learned more about **EVERLAST**? Please give us a call at 1-800-221-1311.

Compare Our 10 x 14 inch Signs!



- Solid, Injection Molded!.
- 1/4" Thick.
- The letters go Through-The-Sign.

**Looks Good ... Always!!
Legible ... Always!**

Our **EVERLAST** Sign



Competitor's Sign



EVERLAST®...The Only
Sign System to Undergo
 UL Testing



EVERLAST withstands 30 years of Tough Conditions with no change.
Underwriters Laboratories Inc.

Test Results Prove!

UL performed numerous durability tests on **EVERLAST** signs in compliance with UL and ASTM standards. **EVERLAST** signs were subjected to 30 years worth of UV exposure, salt spray, vibration, abrasion, temperature variation, fumes and more.

Test results ... no change in color or legibility. To receive a copy of the full UL report, please call us at 800-221-1311.

What This Means To You!

1. You won't have to go out into the field and replace signs!
2. You will save ... tons of money ... Thousands of dollars.!
3. You will reduce your legal liability.

Customers Praise **EVERLAST**®

Purchasing Agent "Great product. I only wish we had started buying your signs sooner. Everlast will save us a fortune in replacement costs."

Company President "Thank you **EVERLAST**! Liability is a major concern in these litigious times. It is comforting to know that we don't have to worry about your warning signs fading or chipping."

Director of Maintenance "We've never seen anything like it. Our maintenance crew is more than happy to install your signs, because they know they won't have to do the job again every few years."

Safety Engineer "I was about to reorder some **EVERLAST** safety signs because workers splattered them with paint. Your salesperson said, just rub the paint off with sandpaper, the signs will be fine. We tried it and it worked. Amazing. Everyone should be using **EVERLAST**."

Diesel Generation Manager "You may any time have people contact me about your product. As you know, we live in a very harsh environment and have been using your tags and signs for many years. They not only hold up to the UV rays of the sun, but the constant exposure to salt and winds. Thank you for making such a great product"

Randy Jordan, Manager of Diesel Generation, NCEMC North Carolina Electric Membership Corp.

TECH
PRODUCTS, INC.



Tel: (800) 221-1311
Tel: (718) 442-4900
Fax: (718) 442-2124

www.techproducts.com

EVERLAST
Indestructible

In Stock!

Plastic Injection Molded SIGNS

Materials & Thickness	Color	Legibility
Polypropylene Plastic 1/4"	Lifetime	Lifetime

World's Most Durable Sign

EVERLAST
1/4" Thick
UL Tested! 30 Years No Change!
Underwriters Laboratories Inc.

EVERLAST
The ONLY Sign System
To Be **UL** Tested to
NO CHANGE ... 30 years!

EVERLAST
The ONLY Solution!
to Long-Term-Legible
Signs, Tags & Markers

Don't See
The Sign You Want?
Call 800-221-1311

Substation Signs ... 10x14" In Stock!

 ES10140213D	 ES10140206D	 ES10140214D	 ES10140222D	 ES10140230D
 ES10140213W	 ES10140206W	 ES10140214W	 ES10140208P	 ES10140215D
 ES10140226D	 ES10140231D	 ES10140272D	 ES10140219D	 ES10140201X
 ES10140261D	 ES1014252DP	 ES1014275DP	 ES1014282DP	 ES1014201X

Substation Signs Custom ... 10x14"

 PENNSYLVANIA LIGHT COMPANY (201) 857-6900	 ILLINOIS POWER	 ALAMEDA POWER & TELECOM 1-415-746-9092	 NORTHEASTERN REMC 244-511, 825-3700	 PUBLIC UTILITY DISTRICT NO. 1 OF DOUGLAS COUNTY
 NEVADA POWER	 Snohomish County PUD 425-783-1000 or 1-877-783-1000	 Fall River Rural Electric 208-652-7431	 B&E (410) 685-0123	 PUBLIC UTILITY DISTRICT NO. 1 OF DOUGLAS COUNTY AUTHORIZED PERSONNEL ONLY IN CASE OF EMERGENCY OR IF FOUND UNLOCKED CALL (509) 884-7191

Substation Signs ... 7 x 10"

 ES0710994D	 ES0710995D	 ES0710992W	 ES0710991D	 ES0710993D
----------------	----------------	----------------	----------------	----------------



EVERLAST®
Indestructible

In Stock!

Plastic Injection Molded SIGNS

Materials & Thickness	Color	Legibility
Polypropylene Plastic 1/4"	Lifetime	Lifetime

World's Most Durable Sign

EVERLAST®

1/4" Thick

UL Tested! 30 Years No Change!

Indestructible Letters Go Through-The-Sign

Underwriters Laboratories Inc.

ES10140289DP

EVERLAST®
The ONLY Sign System
To Be **UL** Tested to
NO CHANGE ... 30 years!

Don't See
The Sign You Want?
Call 800-221-1311

Transmission Signs ... 10x14" In Stock!

Transmission Signs Custom ... 10x14"

--	--	--	--	--

Underground Distribution Custom ... 10x14"

--	--	--	--	--

General Use Signs ... 10x14"

TECH
PRODUCTS, INC.



Tel: (800) 221-1311
Tel: (718) 442-4900
Fax: (718) 442-2124

www.techproducts.com

EVERLAST®
Indestructible

In Stock!

Plastic Injection Molded SIGNS

Materials & Thickness	Color	Legibility
Polypropylene Plastic 1/4"	Lifetime	Lifetime

EVERLAST®



1/4" Thick

UL Tested!
30 Years
No Change!



Underwriters Laboratories Inc.

Indestructible Letters Go Through-The-Sign

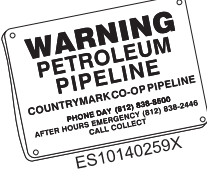

ROUND SAMPLE 18

BEFORE EXCAVATING OR IN EMERGENCY CALL
1-800-245-9399
Southern Star
CENTRAL GAS PIPELINE

Save Money!!! Half Moon
New Name & Phone #
Decal-Overlay

Pipeline Signs ... 10x14"

In Stock!

 ES10140207D	 ES10140235D	 ES10140255C	 ES10140265D	 ES10140274X
 ES10140222D	 ES10140254C	 ES10140264C	 ES10140281C	 ES10140215W
 ES10140221D	 ES10140246D	 ES10140291D	 ES10140286D	 ES10140213D
 ES10140216X	 ES1014BGPC	 ES10140001	 ES10140268D	 ES10140213W
 ES10140225W	 ES10140223X	 ES10140273W	 ES10140273N	 ES10140217N

Pipeline Signs ... 10x14" custom

custom

 CUSTOM SAMPLE 1	 CUSTOM SAMPLE 2	 CUSTOM SAMPLE 3	 CUSTOM SAMPLE 4	 CUSTOM SAMPLE 5	 CUSTOM SAMPLE 6
 CUSTOM SAMPLE 7	 CUSTOM SAMPLE 8	 CUSTOM SAMPLE 9	 CUSTOM SAMPLE 10	 CUSTOM SAMPLE 11	 CUSTOM SAMPLE 12
 CUSTOM SAMPLE 13	 CUSTOM SAMPLE 14	 CUSTOM SAMPLE 15	 CUSTOM SAMPLE 16	 SAMPLE 19	 SAMPLE 20
				 SAMPLE 21	

Don't See The Sign You Want?
Call 800-221-1311



EVERLAST®
Indestructible

In Stock!

Plastic Injection Molded SIGNS

Materials & Thickness	Color	Legibility
Polypropylene Plastic 1/4"	Lifetime	Lifetime

World's Most Durable Sign

EVERLAST®

1/4" Thick

UL Tested! 30 Years No Change!

Indestructible Letters Go Through-The-Sign

Underwriters Laboratories Inc.



ES10140277X



ES10140278D



ES10140223X



ES10140207D

Industrial and Construction Signs... 10x14"

In Stock!

 ES10140207D	 ES10140236D	 ES10140218C	 ES1014	 ES10140208P
 ES10140221D	 ES10140235D	 ES10140230D	 ES10140225W	 ES10140222D
 ES10140222D	 ES10140216X	 ES10140217N	 ES10140223X	 ES10140277X
 ES10140201X	 ES10140206D	 ES10140215D	 ES10140215W	 ES10140268D
 ES10140272D	 ES10140273W	 ES10140273N	 ES10140274X	 ES10140222D
 ES10140278D	 ES10140277X	 ES10140276X	 ES10140281C	 ES10140274X
 ES10140221D	 ES10140286D	 ES10140291D	 ES10140246D	 ES10140278D
 ES10140200X	 ES10140238W	 ES10140240D	 ES10140	 ES10140213D

Don't See The Sign You Want? Call 800-221-1311

EVERLAST
The ONLY Solution!
to Long-Term-Legible Signs, Tags & Markers

EVERLAST®
The ONLY Sign System
To Be UL Tested to
NO CHANGE ... 30 years!

TECH
PRODUCTS, INC.



Tel: (800) 221-1311
Tel: (718) 442-4900
Fax: (718) 442-2124

www.techproducts.com

EVERLAST®
Indestructible

In Stock!

Plastic Injection Molded SIGNS

Materials & Thickness	Color	Legibility
Polypropylene Plastic 1/4"	Lifetime	Lifetime

World's Most Durable Sign

EVERLAST®

1/4" Thick

UL Tested! 30 Years No Change!

Underwriters Laboratories Inc.

Indestructible Letters Go Through-The-Sign



HazMat Signs ... 10x14" In Stock!

 ES10140221D	 ES10140246D	 ES10140291D	 ES10140286D	 ES10140260X
 ES10140238W	 ES10140264C	 ES10140268D	 ES10140254C	 ES10140260X

HazMat Signs ... 10x14"

 ES10140221D	 ES10140246D	 ES10140291D	 ES10140286D	 ES10140260X
 ES10140221D	 ES10140246D	 ES10140291D	 ES10140286D	 ES10140260X
 ES10140238W	 ES10140264C	 ES10140268D	 ES10140254C	 ES10140260X
 ES10140268D	 ES10140254C	 ES10140260X	 ES10140260X	 ES10140260X

Traffic Signs ... 10x14" In Stock!

 ES10140229X	 ES10140233X	 ES10140240D ES10140237D	 ES10140004
-----------------	-----------------	--------------------------------	----------------

EVERLAST®
When You Absolutely, Positively Must Have A Sign, Tag or Marker that you'll Never Need to Replace!

EVERLAST
The ONLY Solution!
to Long-Term-Legible Signs, Tags & Markers



Tel: (800) 221-1311
Tel: (718) 442-4900
Fax: (718) 442-2124



EVERLAST®
Indestructible

In Stock!

Telecom Signs ... 10x14"

Plastic Injection Molded SIGNS

Materials & Thickness	Color	Legibility
Polypropylene Plastic 1/4"	Lifetime	Lifetime

World's Most Durable Sign

EVERLAST®
1/4" Thick
UL Tested! 30 Years No Change!
Indestructible Letters Go Through-The-Sign
Underwriters Laboratories Inc.

DANGER HARD HAT AREA ES10140207D	CAUTION Eye protection required beyond this point ES10140218C	CAUTION EYE PROTECTION REQUIRED ES10140277X	DANGER Confined Space Entry By Permit Only ES10140222D	PRIVATE PROPERTY NO TRESPASSING VIOLATORS WILL BE PROSECUTED ES10140216X
WARNING NO TRESPASSING ES10140225W	WARNING NO TRESPASSING ES10140223X	WARNING NO TRESPASSING ES10140273W	NOTICE NO TRESPASSING ES10140273N	WARNING MEN WORKING ABOVE ES10140
DANGER DO NOT ENTER AUTHORIZED PERSONNEL ONLY ES10140213D	WARNING DO NOT ENTER AUTHORIZED PERSONNEL ONLY ES10140213W	NOTICE AUTHORIZED PERSONNEL ONLY ES10140217N	WARNING DO NOT ENTER AUTHORIZED PERSONNEL ONLY ES10140274X	DANGER EMPLOYEES ONLY ES1014

EVERLAST®
Indestructible

Custom Signs

EVERLAST®
1/4" Thick
UL Tested! 30 Years No Change!
Indestructible Letters Go Through-The-Sign
Underwriters Laboratories Inc.

- Select Format (right)
- Select Your Wording
- Include Your Company Name & Phone Number.
- Select A Graphic Below



DANGER	CAUTION	WARNING	NOTICE
DANGER	CAUTION	WARNING	NOTICE
WARNING	CAUTION	WARNING	CAUTION

We will mostly MEET or BEAT ... the price of any lower quality sign (like Lexan, fiberglass or porcelain)! Call us.

Here are some samples:

DANGER Keep Out! High Voltage Georgia Transmission 800-999-9999	CAUTION AUTHORIZED PERSONNEL ONLY Duke Energy 800-999-9999	WARNING NO TRESPASSING Dole Pineapple 800-999-9999	WARNING DO NOT ENTER AUTHORIZED PERSONNEL ONLY Lucent 800-245-9999	CAUTION DO NOT DIG Call: 800-999-9499
--	---	---	---	--

Small, one-time tooling charge applies ... Call for details 800-221-1311

ITEM	25	50	100	250	500	1000
7" x 10" Sign						
10" x 14" Sign						

Call For Pricing

TECH
PRODUCTS, INC.



Tel: (800) 221-1311
Tel: (718) 442-4900
Fax: (718) 442-2124

www.techproducts.com

Numbers & Letters

1", 2", 3", 6", 8" & 12"

Mount Horizontal or Vertical
Mount in Aluminum or Poly Tag Holders

Solid Black Polypropylene characters..
Letters are "molded in" ... not simply
painted or screened.

EVERLAST withstands saltwater, acid
rain, groundwater, chemicals, alkalies &
acid solutions and temperatures from -40
to 200 degrees F.

Yellow, Orange or Black Background.
White or Black Numbers & Letters.

Other colors available!

Actual Size

3" Character

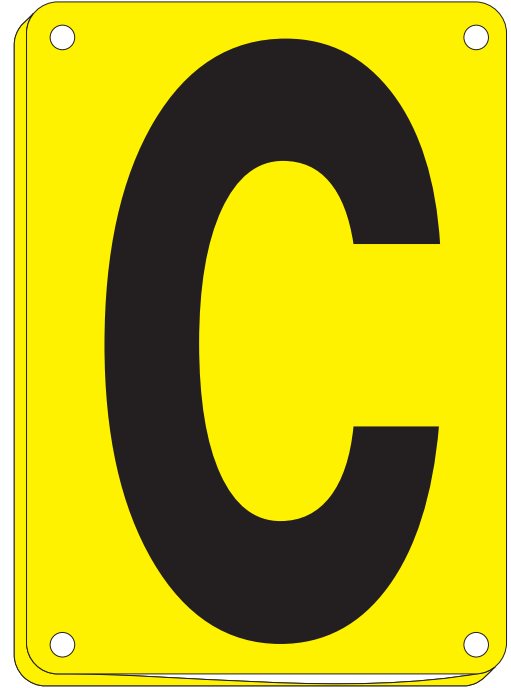

0.125" Thick

3 1/2" x 2 1/2" Size

2" Character



0.08" Thick

2.6" x 1.6" Size

1" Character



0.08" Thick

1.6" x 0.89" Size

0.70" Character



0.08" Thick

Tag Size 0.89" x 1.6" Size

Also >>

6" Character



8" Character



12" Char.



Why Does Every Major Power & Telecom Company Use **EVERLAST**?

Answer: ... It is *The Only Sign System to be UL Tested!*



EVERLAST withstands 30 years of Tough
Conditions with no significant change.

Underwriters Laboratories Inc.

Test Results Prove!

UL performed numerous durability tests on **EVERLAST** signs in compliance with UL and ASTM standards. **EVERLAST** signs were subjected to 30 years worth of UV exposure, salt spray, vibration, abrasion, temperature variation, fumes and more.

Test results ... *no change in color or legibility*. To receive a copy of the full UL report, please call us at 800-221-1311.

What This Means ... To YOU!!

1. You won't have to go out into the field and replace tags!
2. You will save ... tons of money ... Thousands of dollars.!
3. You will reduce your legal liability.



Numbers & Letters
Horizontally Mounted

1" Character



0.08" Thick

EVERLAST ... 1" Pole & Cable Tags Horizontally Mounted

Solid black polypropylene characters are permanently embedded in the bright yellow, orange or white polypropylene substrate. You can cut it, scratch it, even dig into it with little or no effect on the embedded character.

Characters are "Molded-In" See illustration on right.



ITEM ID#	10,000	5,000	1,000	<1,000
ELHKXxxx (A-Z, 0-9)	Call For Pricing			

Available in orange, or yellow.
X ... Use O or Y to designate Orange or Yellow.
xxx ... Use to designate the number or letter.

EVERLAST ... Poly or Aluminum 1" Tag Holders

Hold 1 to 30 of our 1" tall characters. Holders have holes for nails and are slotted for mounting with cable ties. For larger capacity, please call 800-221-1311.

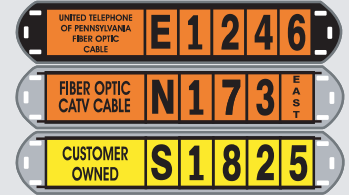

ITEM ID#	Holds 2	Holds 3	Holds 4	Holds 5	Holds 6	Holds 7	Holds 8	Holds 9	Holds 10	Holds 12-30
(POLY) PH1xx	Call For Pricing									
(ALUM) AH1xx	Call For Pricing									

xx ... Use to designate quantity to hold.

Vertically Mounted

0.70" Character



0.08" Thick

EVERLAST ... 1" Pole & Cable Tags Vertically Mounted

Solid black polypropylene characters are permanently embedded in the bright yellow, or orange polypropylene background. (Also white on black). You can cut it, scratch it, even dig into it with little or no effect on the embedded character.



Characters are "Molded-In"

ITEM ID#	10,000	5,000	1,000	<1,000
ELVXXxxx (A-Z, 0-9)	Call For Pricing			

XX ... KO =Black on Orange KY=Black on Yellow WK=White on Black
xxx ... Use to designate the number or letter.

EVERLAST ... Poly or Aluminum 1" Tag Holders

Hold 1 to 30 of our 0.70" tall characters. Holders have holes for nails and are slotted for mounting with cable ties. For larger capacity, please call 800-221-1311.

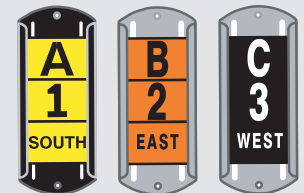

ITEM ID#	Holds 2	Holds 3	Holds 4	Holds 5	Holds 6	Holds 7	Holds 8	Holds 9	Holds 10	Holds 12-30
(POLY) PH1xx	Call For Pricing									
(ALUM) AH1xx	Call For Pricing									

xx ... Use to designate quantity to hold.



1.6" x 0.89" wide Tag



0.08" Thick



EVERLAST ... Special Tags & Symbols

Solid black polypropylene characters are permanently embedded in the bright yellow polypropylene substrate. You can cut it, scratch it, even dig into it with little or no effect on the embedded character.

Characters are
"Molded-In"

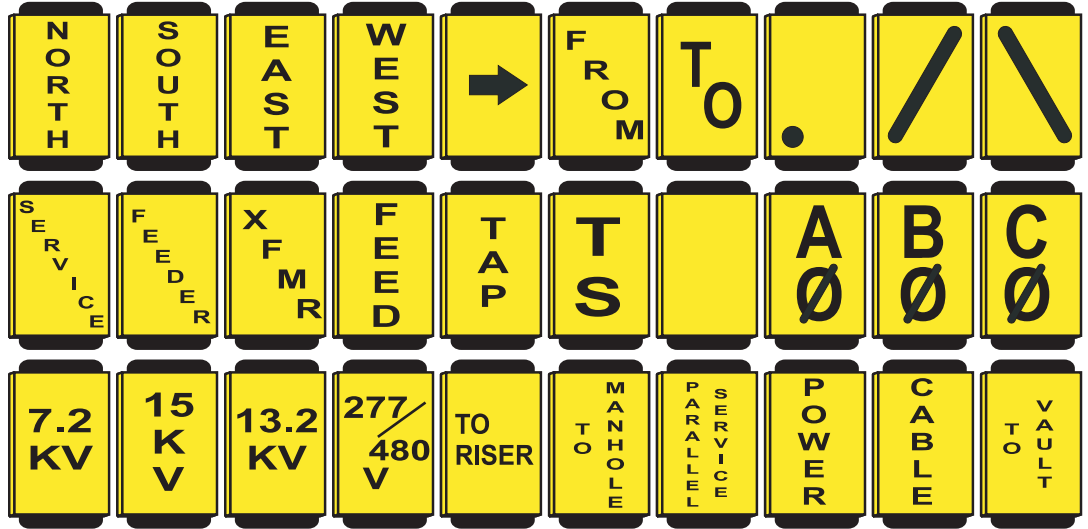

0.89" x 1.6" wide



0.08" Thick



Don't See
The Symbol You Want?
Call 800-221-1311

EVERLAST®
The ONLY Sign System
To Be **UL** Tested to
NO CHANGE ... 30 years!

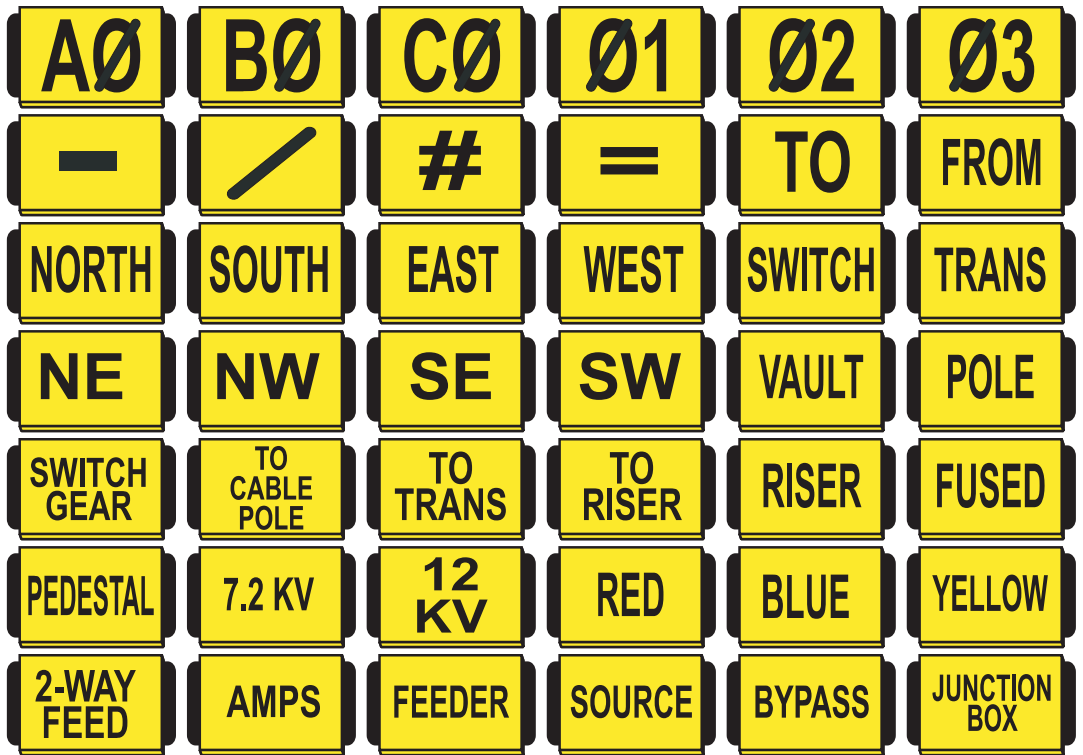

EVERLAST
The ONLY Solution!
to Long-Term-Legible
Signs, Tags & Markers



Raised Letter
Injection Molded **1"**
Numbers & Letters
Horizontally Mounted

PolyEthylene Plastic



3D 1" Pole & Cable Tags

Injection molded polyolefin tags with high-relief characters. They are hot stamped with UV stable, outdoor quality foil. Their 3-Dimensional black characters on a yellow background make them sharp, high-contrast identification markers legible even in dimly lit areas. The highly raised characters are ideal for underground applications where silt, oil or dirt may cover the markers. The tags slide into aluminum or poly holders.

ITEM ID#	10,000	5,000	1,000	<1,000
3DHYxxx (A-Z, 0-9)	Call For Pricing			

Available in yellow.
 xxx ... Use to designate the number or letter.

Poly or Aluminum 1" Tag Holders

Hold 1 to 30 of our 1" tall characters. Holders have holes for nails and are slotted for mounting with cable ties. For larger capacity, please call 800-221-1311.

ITEM ID#	Holds 2	Holds 3	Holds 4	Holds 5	Holds 6	Holds 7	Holds 8	Holds 9	Holds 10	Holds 12-30
(POLY) PH1xx	Call For Pricing									
(ALUM) AH1xx										

xx ... Use to designate quantity to hold.

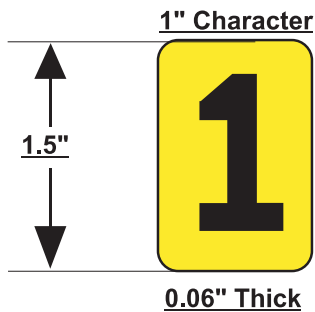

Raised Letter
Injection Molded **1"**
Numbers & Letters **Vertically Mounted**

PolyEthylene Plastic

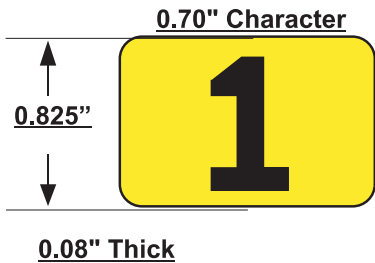

3D 1" Pole & Cable Tags.

Injection molded polyolefin tags with high-relief characters. They are hot stamped with UV stable, outdoor quality foil. Their 3-Dimensional black characters on a yellow background make them sharp, high-contrast identification markers legible even in dimly lit areas. The highly raised characters are ideal for underground applications where silt, oil or dirt may cover the markers. The tags slide into aluminum or poly holders.



ITEM ID#	10,000	5,000	1,000	<1,000
3DVIxxx (A-Z, 0-9)	Call For Pricing			

xxx ... Use to designate the number or letter.

Poly or Aluminum 1" Tag Holders

Hold 1 to 30 of our 0.70" tall characters. Holders have holes for nails and are slotted for mounting with cable ties. For larger capacity, please call 800-221-1311.

ITEM ID#	Holds 2	Holds 3	Holds 4	Holds 5	Holds 6	Holds 7	Holds 8	Holds 9	Holds 10	Holds 12-30
(POLY) PH1xx	Call For Pricing									
(ALUM) AH1xx										

xx ... Use to designate quantity to hold.



Tel: (800) 221-1311
 Tel: (718) 442-4900
 Fax: (718) 442-2124

www.techproducts.com

TECH-3D[®]
Deep Embossed

1"

Numbers & Letters
Horizontally Mounted

Stainless Steel

TECH
PRODUCTS, INC.

Stainless Steel Tagholder:



1 5/8" Height by ... Various widths.

Stainless Steel Tagholder

1 Inch Stainless Steel Embossed Characters



0.06" Thick Stainless Steel

TECH-3D[®]
Deep Embossed

Vertically Mounted

Stainless Steel Tagholder:

1 1/8" Width by Various Heights



1" Stainless Steel Embossed Character



0.06" Thick Stainless Steel

3D Stainless Steel, 1" Pole & Cable Tags

Deep Embossed, stainless steel, tags with high-relief characters. The highly raised characters are ideal for underground applications where silt, oil or dirt may cover the markers. The tags slide into stainless steel tag holders.

Now! Also in Embossed Aluminum!

ITEM ID# 10,000 5,000 1,000 <1,000

ST1SSxxx (A-Z, 0-9) *Call For Pricing*

xxx ... Use to designate the number or letter.

Aluminum Tags & Tagholders:



1 5/8" Height by ... Various widths.

Stainless Steel 1" Tag Holders

Hold 1 to 15 of our 1" tall characters. Holders have holes for nails or screws. For larger capacity, please call 800-221-1311.

ITEM ID# Holds Holds Holds Holds Holds Holds Holds Holds Holds Holds Holds

(Stainless) SS1Hxx *Call For Pricing*

xx ... Use to designate quantity to hold.

3D Stainless Steel, 1" Pole & Cable Tags

Deep Embossed, stainless steel, tags with high-relief characters. The highly raised characters are ideal for underground applications where silt, oil or dirt may cover the markers. The tags slide into stainless steel tag holders.

ITEM ID# 10,000 5,000 1,000 <1,000

ST1SSxxx (A-Z, 0-9) *Call For Pricing*

xxx ... Use to designate the number or letter.

Aluminum Tags & Tagholders:

1 1/8" Width by Various Heights

Now! Also in Embossed Aluminum!



Stainless Steel 1" Tag Holders

Hold 1 to 15 of our 1" tall characters. Holders have holes for nails or screws. For larger capacity, please call 800-221-1311.

ITEM ID# Holds Holds Holds Holds Holds Holds Holds Holds Holds Holds Holds

(Stainless) SS1Vxx *Call For Pricing*

xx ... Use to designate quantity to hold.



3M
Metal Reflective **1"**
Numbers & Letters
Horizontally Mounted

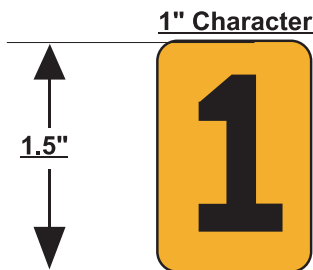

Metal, Reflective Pole & Cable Tags

Horizontally Mounted

Screen-printed, black characters on a 3M, engineer grade, yellow reflective sheeting. It has a 0.020 aluminum backing plate that can easily slide into our holders. Also great for shelf labeling and indoor areas that need to be seen with flashlights.

ITEM ID#	10,000	5,000	1,000	<1,000
SIHKYRxx (A-Z, 0-9)	Call For Pricing			

xx ... Use to designate the number or letter.



Poly or Aluminum 1" Tag Holders

Hold 1 to 30 of our 1" tall characters. Holders have holes for nails and are slotted for mounting with cable ties. For larger capacity, please call 800-221-1311.

ITEM ID#	Holds	Holds	Holds	Holds	Holds	Holds	Holds	Holds	Holds	Holds	Holds
	2	3	4	5	6	7	8	9	10	12 - 30	
(POLY) PH1xx	Call For Pricing										
(ALUM) AH1xx											

xx ... Use to designate quantity to hold.



3M
Metal Reflective **1"**
Numbers & Letters
Vertically Mounted

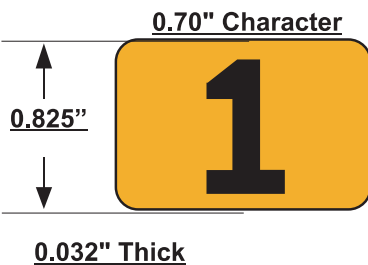

Metal, Reflective Pole & Cable Tags.

Vertically Mounted

Easy to use and forever visible, these identification tags are great for your warehouse or anywhere you need a numbering system. They slide in and out of the holders easily to reconfigure your storeroom or you can clamp them closed to keep the numbers in place.

ITEM ID#	10,000	5,000	1,000	<1,000
SIVKYRxx (A-Z, 0-9)	Call for Pricing.			

xx ... Use to designate the number or letter.



Poly or Aluminum 1" Tag Holders

Hold 1 to 30 of our 0.70" tall characters. Holders have holes for nails and are slotted for mounting with cable ties. For larger capacity, please call 800-221-1311.

ITEM ID#	Holds	Holds	Holds	Holds	Holds	Holds	Holds	Holds	Holds	Holds	Holds
	2	3	4	5	6	7	8	9	10	12 - 30	
(POLY) PH1xx	Call For Pricing										
(ALUM) AH1xx											

xx ... Use to designate quantity to hold.



Tel: (800) 221-1311
 Tel: (718) 442-4900
 Fax: (718) 442-2124

www.techproducts.com

2" Character



0.08" Thick

2.6" x 1.6" Overall Size



EVERLAST ... 2" Tall Numbers & Letters

Solid black polypropylene characters are permanently embedded in the bright yellow and orange polypropylene substrate. You can cut it, scratch it, even dig into it with little or no effect on the embedded character.

ITEM ID#	1000	500	250	100
EL2KXxxx (A-Z, 0-9)	<i>Call for Pricing</i>			

Available in orange or yellow.

X ... Use O or Y to designate Orange or Yellow

xxx ... Use to designate the number or letter.



EVERLAST ... Poly or Aluminum 2" Tag Holders

Hold 2, 3, 4, 5, 6 of our 2" tall characters. Used for tagging single or multiple cables in most any environment. Holders are slotted for mounting with a cable tie. For larger capacity, please call 800-221-1311.



Tag Holders for Horizontal Mounting

PROD#	Qty	Holds 2	Holds 3	Holds 4	Holds 5	Holds 6
(Poly) PH2xxHP (Alum) CH2xxHP	up to 99	<i>Call for Pricing</i>				
(Poly) PH2xxHP (Alum) CH2xxHP	100-249	<i>Call for Pricing</i>				
(Poly) PH2xxHP (Alum) CH2xxHP	250-499	<i>Call for Pricing</i>				

xx ... Use to designate quantity to hold.



Tag Holders for Vertical Mounting

PROD#	Qty	Holds 2	Holds 3	Holds 4	Holds 5	Holds 6
(Poly) PH2xxVP (Alum) AH2xxVP	up to 99	<i>Call for Pricing</i>				
(Poly) PH2xxVP (Alum) AH2xxVP	100-249	<i>Call for Pricing</i>				
(Poly) PH2xxVP (Alum) AH2xxVP	250-499	<i>Call for Pricing</i>				

xx ... Use to designate quantity to hold.

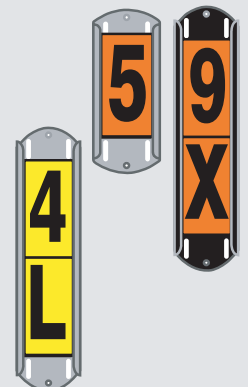

Numbers & Letters

Horizontally or Vertically Mounted

3 1/2" x 2 1/2" Size

3" Character



1/8" Thick Tags



EVERLAST ... 3" Tall Numbers & Letters

Solid black polypropylene characters are permanently embedded in the bright yellow, orange or white polypropylene substrate. You can cut it, scratch it, even dig into it with little or no effect on the embedded character.



ITEM ID#	1000	500	250	100
EL3KXxxx (A-Z, 0-9)	<i>Call for Pricing</i>			

Available in orange, or yellow.
X ... Use O or Y to designate Orange or Yellow.
xxx ... Use to designate the number or letter.

Come in boxes of 50 each.



EVERLAST ... Poly or Aluminum 3" Tag Holders

Hold 2, 3, 4, 5, 6 of our 2" tall characters. Used for tagging single or multiple cables in most any environment. Holders are slotted for mounting with a cable tie. For larger capacity, please call 800-221-1311.

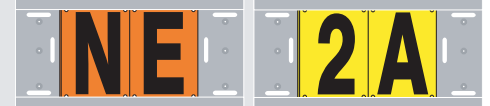

Tag Holders for Horizontal Mounting

PROD#	Qty	Holds 2	Holds 3	Holds 4	Holds 5	Holds 6	Holds 7
(Poly) PH3xxHP (Alum) AH3xxHP	up to 99	<i>Call for Pricing</i>					
(Poly) PH3xxHP (Alum) AH3xxHP	100-249	<i>Call for Pricing</i>					
(Poly) PH3xxHP (Alum) AH3xxHP	250-499	<i>Call for Pricing</i>					

xx ... Use to designate quantity to hold.



*Longer lengths available
Call for special pricing.*

Tag Holders for Vertical Mounting

PROD#	Qty	Holds 2	Holds 3	Holds 4	Holds 5	Holds 6	Holds 7
(Poly) PH3xxVP (Alum) AH3xxVP	up to 99	<i>Call for Pricing</i>					
(Poly) PH3xxVP (Alum) AH3xxVP	100-249	<i>Call for Pricing</i>					
(Poly) PH3xxVP (Alum) AH3xxVP	250-499	<i>Call for Pricing</i>					

xx ... Use to designate quantity to hold.

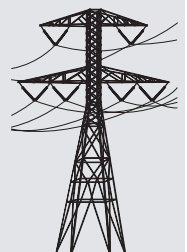

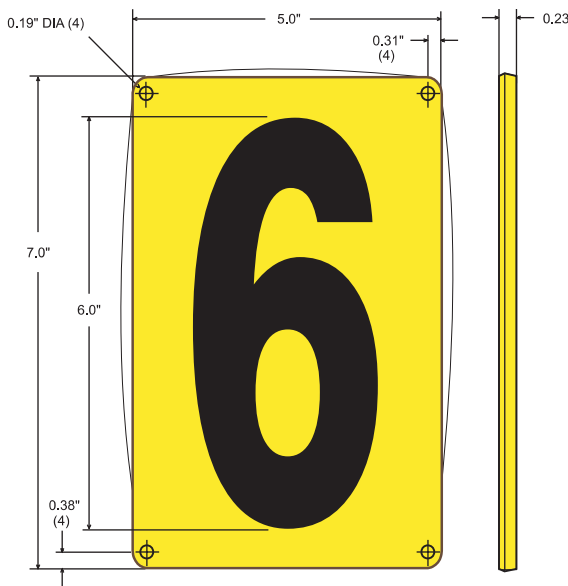

EVERLAST ... 6" Tall Numbers & Letters

For outdoor use, all numbers and letters are "molded-in" and UV protected...not simply painted or screened. Deluxe, polyolefin-plastic, **EVERLAST** signs withstand saltwater, acid rain, groundwater, chemicals, alkalies, acid solutions and temperatures from -40 to + 200 degrees F.

DEP

5R

5R

T R - 8

ITEM ID#	1000	500	250	100
EL6KYxxx (A-Z, 0-9)	Call for Pricing			

Available in yellow.
xxx ... Use to designate the number or letter.

Copy	Item	Copy	Item	Copy	Item	Copy	Item
1	EL6KY001	A	EL6KYA	K	EL6KYK	U	EL6KYU
2	EL6KY002	B	EL6KYB	L	EL6KYL	V	EL6KYV
3	EL6KY003	C	EL6KYC	M	EL6KYM	W	EL6KYW
4	EL6KY004	D	EL6KYD	N	EL6KYN	X	EL6KYX
5	EL6KY005	E	EL6KYE	O	EL6KYO	Y	EL6KYY
6	EL6KY006	F	EL6KYF	P	EL6KYP	Z	EL6KYZ
7	EL6KY007	G	EL6KYG	Q	EL6KYQ	(Blank)	EL6KY011
8	EL6KY008	H	EL6KYH	R	EL6KYR	-	EL6KY012
9	EL6KY009	I	EL6KYI	S	EL6KYS	/	EL6KY013
0	EL6KY010	J	EL6KYJ	T	EL6KYT	Ø	EL6KY014

Aluminum ... Number & Letter Holders

Hold 1, 2, 3, 4, 5, 6, 7, 8 or 9 of our 6" tall characters. Excellent for long lasting, quick change signs... especially in outdoor environments. Holders can be attached using nails, bolts, rivets, magnets or metal banding.

5R

Aluminum Tag Holders for Horizontal Mounting

ITEM ID#	Qty	Holds 2	Holds 3	Holds 4	Holds 5	Holds 6	Holds 7
AHE6xxHP	up to 99	Call for Pricing					
	100 - 249	Custom Holders & Sizes ... To Fit Your Needs!					
	250 - 499						

xx ... Use to designate quantity to hold.

Aluminum Tag Holders for Vertical Mounting

ITEM ID#	Qty	Holds 2	Holds 3	Holds 4	Holds 5	Holds 6	Holds 7
AHE6xxVP	up to 99	Call for Pricing					
	100 - 249	Custom Holders & Sizes ... To Fit Your Needs!					
	250 - 499						

xx ... Use to designate quantity to hold.

5R

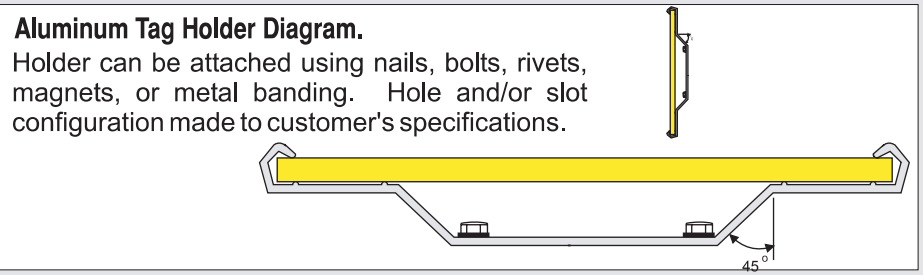



EVERLAST ... 8" Tall Numbers & Letters

For outdoor use, all numbers and letters are "molded-in" and UV protected...not simply painted or screened. Deluxe, polyolefin-plastic, **EVERLAST** signs withstand saltwater, acid rain, groundwater, chemicals, alkalies, acid solutions and temperatures from -50 to + 220 degrees F.

DEP

5R

5R

T|R-8

ITEM ID#	1000	500	250	100
EL8KYxxx (A-Z, 0-9)	Call for Pricing			

Available in yellow.
xxx ... Use to designate the number or letter.

Copy	Item	Copy	Item	Copy	Item	Copy	Item
1	EL8KY001	A	EL8KYA	K	EL8KYK	U	EL8KYU
2	EL8KY002	B	EL8KYB	L	EL8KYL	V	EL8KYV
3	EL8KY003	C	EL8KYC	M	EL8KYM	W	EL8KYW
4	EL8KY004	D	EL8KYD	N	EL8KYN	X	EL8KYN
5	EL8KY005	E	EL8KYE	O	EL8KYO	Y	EL8KYY
8	EL8KY008	F	EL8KYF	P	EL8KYP	Z	EL8KYZ
7	EL8KY007	G	EL8KYG	Q	EL8KYQ	(Blank)	EL8KY011
8	EL8KY008	H	EL8KYH	R	EL8KYR	-	EL8KY012
9	EL8KY009	I	EL8KYI	S	EL8KYS	/	EL8KY013
0	EL8KY010	J	EL8KYJ	T	EL8KYT	Ø	EL8KY014

Aluminum ... Number & Letter Holders

Hold 1, 2, 3, 4, 5, 6, 7, 8 or 9 of our 8" tall characters. Excellent for long lasting, quick change signs... especially in outdoor environments. Holders can be attached using nails, bolts, rivets, magnets or metal banding.

5R

Aluminum Tag Holders for Horizontal Mounting

ITEM ID#	Qty	Holds 2	Holds 3	Holds 4	Holds 5
AHExxHP	up to 99	Call for Pricing			
	100 - 249				
	250 - 499				

xx ... Use to designate quantity to hold.

Aluminum Tag Holders for Vertical Mounting

ITEM ID#	Qty	Holds 2	Holds 3	Holds 4	Holds 5
AHExxVP	up to 99	Call for Pricing			
	100 - 249				
	250 - 499				

xx ... Use to designate quantity to hold.

5R

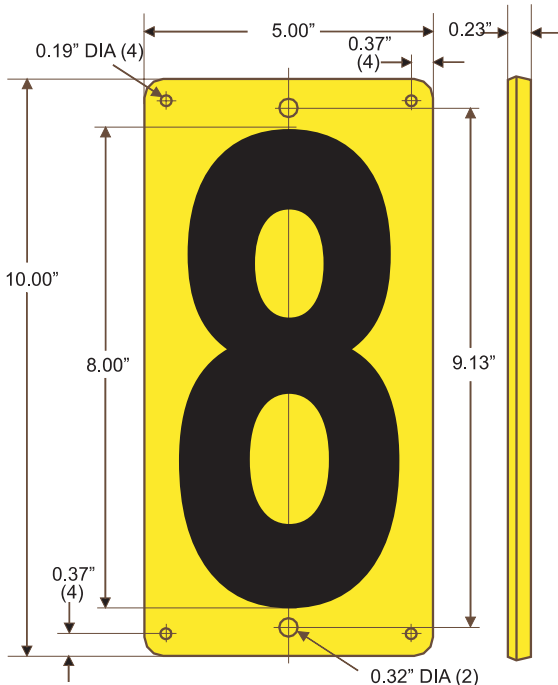

Aluminum Tag Holder Diagram.

Holder can be attached using nails, bolts, rivets, magnets, or metal banding. Hole and/or slot configuration made to customer's specifications.

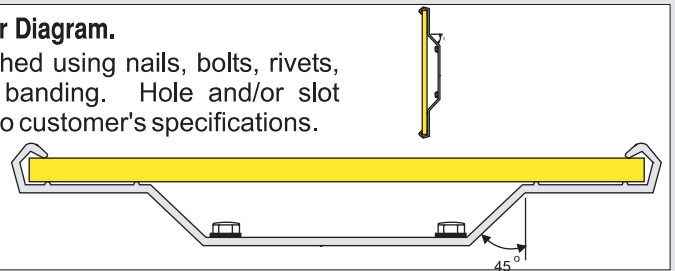

EVERLAST ... 12" Numbers & Letters

For outdoor use, all numbers and letters are "molded-in" and UV protected...not simply painted or screened. Deluxe, polyolefin-plastic, Everlast signs withstand saltwater, acid rain, sand storms, chemicals, alkalies, acid solutions and temperatures from -40 to + 220 degrees F.

PROD#	100	200	500	1000	2500
EL12KYxx	<i>Call For Pricing</i>				

Available in yellow or orange.
xx ... Use to designate the number or letter.

10" x 14"

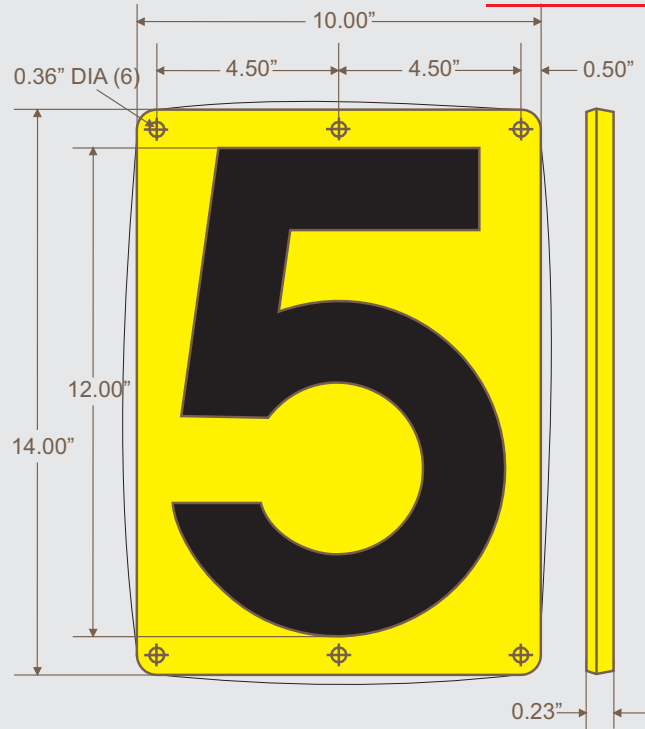
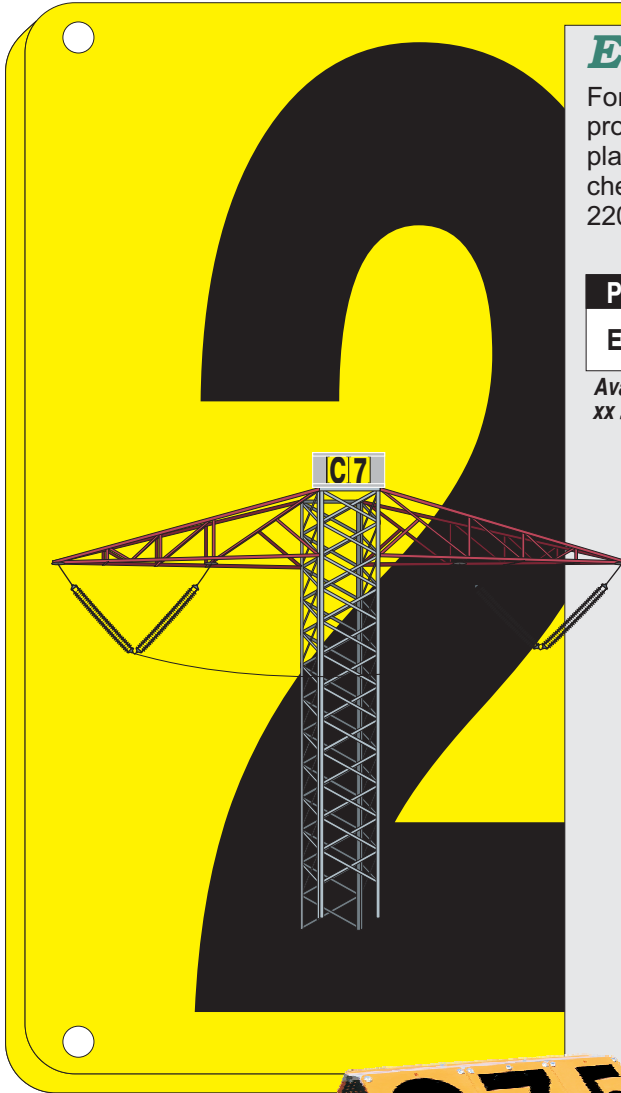

1/4" Thick!
12" Tall ... Numbers & Letters
"Molded-In" to the Plastic
Won't Wear Out!

EVERLAST ... Aerial Surveillance A-Frames

With 12" numbers and letters that won't wear out!

Our A-frames (dog houses) are made of strong, extruded aluminum parts. They have pre-punched holes and come with vandal proof nuts and bolts. They are shipped unassembled and therefore are less expensive, easier to ship and easier to carry. (Or, we can pre-assemble). Because these frames are attached to posts or stakes of various shapes & sizes, the attachment brackets will be made to fit the application.

Aerial Surveillance A-Frames only.

PROD#	Holds	25	50	100	250	500	1000
AS22	2 + 2 Tags	<i>Call For Pricing</i>					
AS33	3 + 3 Tags						



3 1/2" x 2 1/2" Size

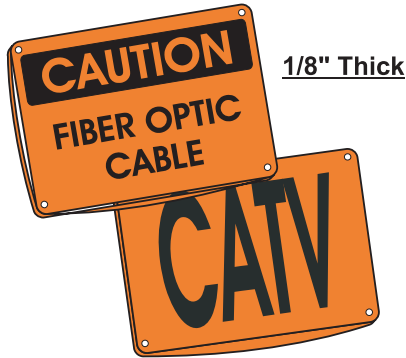

EVERLAST... Cable Tags & Markers

2 1/2" x 3 1/2"

For outdoor use, all words and logos are "molded-in" and UV protected...not simply painted or screened. Deluxe, polyolefin-plastic, **EVERLAST** signs withstand saltwater, acid rain, groundwater, chemicals, alkalies, acid solutions & temperatures from -40 to + 200 degrees



ITEM ID#	1000	500	250	100
EL3XXxxx (A-Z, 0-9)	<i>Call For Pricing</i>			

Available in orange, yellow or white..

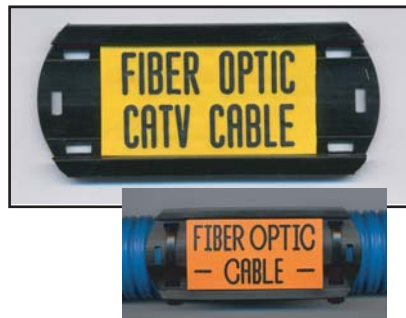

EVERLAST ... Fiber Optic Tags In Holders

For outdoor use, all words and logos are "molded-in" and UV protected...not simply painted or screened. Deluxe, polyolefin-plastic, Everlast signs withstand saltwater, acid rain, groundwater, chemicals, alkalies, acid solutions and temperatures from -40 to + 200 degrees F.



25 TAGS & HOLDERS PER BAG

PROD#	1 BAG	4 BAGS	10 BAGS	20 BAGS	40 BAGS
ELP-FOT	<i>Call For Pricing</i>				

Prices include tag and holder. Available in orange or yellow.



EVERLAST... Custom Tags

Custom-worded tags are available through special order. Call for more information and pricing. Min. qty. 1,000.



Call for custom wording & logos. 800-221-1311

Available in yellow, orange, blue.

Call for other colors & quantity pricing 800-221-1311

Calendered Vinyl ... Cable Tags & Markers

Sizes: 1 3/4" x 3 7/8"
 1 3/4" x 5 3/4"
 1 1/2" x 3"

Cable ties included. .020 Thick. Holes are .167" on each end, or oval hole on one end. Outdoor durability to 5 years. Custom printing.

ITEM ID#	1000	500	250	100
CalTag (A-Z, 0-9)	<i>Call For Pricing</i>			

Available in orange, yellow, red, white, black, blue and green backgrounds.



Metal Pole Markers



Pole Ownership / Identification

Embossed Metal Pole Markers

Rectangle-Round-End... or Circular

Unpainted, embossed aluminum or brass. Raised embossed copy last the life of the pole. The highly defined characters are legible forever. Please specify size.

Serialization available.



Product #	1000	2500	5000
Rectangle-Round End. 2 1/2" to 4"			
Rectangle-Round End 5" to 8"			
Circular 1" Diameter			
Circular 2" Diameter			
Circular 3" Diameter			

Call For Pricing
Other Shapes
& Sizes Available

3"
Inspection tags.
Any Diameter



Metal Pole Plates



Embossed Metal Plates

TECH-3D, deep embossed ... Metal Pole Plates are available in aluminum or stainless steel. Raised embossed copy will last the life of the pole. Square or round corners. Holes for mounting..

- **Warning**
- **Joint Ownership**
- **Do Not Dig**
- **Buried Fiber Optic Cable**
- **Call Before You Dig**

Embossed Materials & Thickness

Aluminum	.025", .040", .050", .063"
Stainless Steel	.030" .060"

Background & Copy Colors

Yellow	
White	
Black	
Red	
Orange	
Dk Blue	
Green	
Brown	
Peacock Blue	
Gold	
Silver Color	of Metal

Cable & Valve Tags



Embossed Metal Cable & Valve Tags

TECH-3D Embossed "UnPainted"

Cable & Valve Tags are easily read without paint or ink for contrast. Ideal for labeling or identifying: Use Tech's stamped, consecutive numbering option for your products' serial numbers, etc.

Custom Shapes Available!

Embossed Materials & Thickness

Aluminum	.025", .032", .050", .063"
Stainless Steel	.030" .060"
Brass	.032" .060"
Cold Rolled Steel	.035" .047" .059"
Tinplate	.015"
Hot Dipped Galvanized	.035"



FASTTAG

Miniature Markers

Numbers & Letters

Horizontally or Vertically Mounted

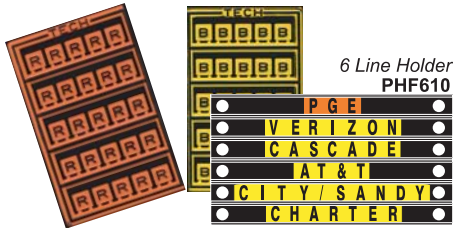

6 Line Holder
PHF610



PHF206 Two Line Holder

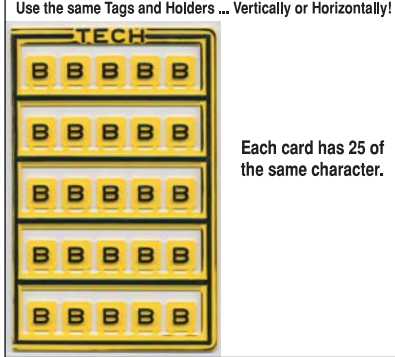

Use the same Tags and Holders ... Vertically or Horizontally!

Each card has 25 of the same character.



FastTags... Miniature Markers

The marking system with ... Endless Applications!

No matter what it is you have to identify, **FASTTAGS** can do it. These **3D-Tags** with highly-raised characters **remain legible** ... even in low light, oily or dusty environments... even if they are painted over! They are available with orange or yellow background colors. The raised characters are hot stamped with the highest quality UV stable foil.

The same tags and holders can be used both vertically or horizontally. This eliminates the need for dual inventories. The holders can be mounted using cable ties, nails, screws or adhesive.

Comes in packs of 10 Cards ... 25 letters per card.

The tags are available with yellow or orange background colors, are non conductive and non corroding. Assembling the polymer tags into the holder is a breeze, no more fumbling and frustration.

Fasttags

PROD#	Char/Card	10-49	50-99	100-249	250-499	500+
3DFYxx	25	Call For Pricing				

Poly Fasttag Holders

Call for higher quantities.

PROD#	Holds	Holds	Holds	Holds	Holds	Holds
	2	4	6	10	15	20
PHFxx	Holds One Line					
PHF2xx	Holds Two Lines					

Call For Pricing

Ask about our 6 Line Fasttag Holders.

Ask about our FASTTAG 3D Company Name Strips
Great for Joint Use projects!



NEW!
6 Line Holder
For "Joint Use" Marking

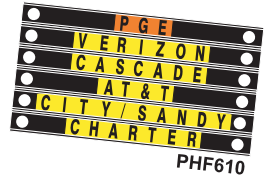

PHF610

Ask about our handy FASTTAG kits! →

Each Standard Kit Contains:

- 1 Yellow Canvas Organizer
- 50 Fasttags Cards: 2 each of: 0-9, Blank, Dash; 1 each of: A-Z
- 50 One Line - 6 Tag Capacity Poly Holders
- 100 Snap - in Plugs
- 100 Tie Straps 8 in. long (wraps around 2 in. Diameter)

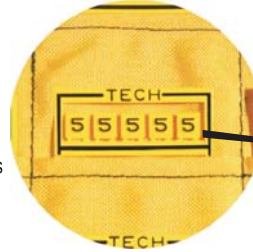

Custom Kits Available

The key feature is the flexible, tough, compact carrying case that allows the user to clip the entire kit on a cable, conduit, pipe etc., making the miniature marker system available at their fingertips.

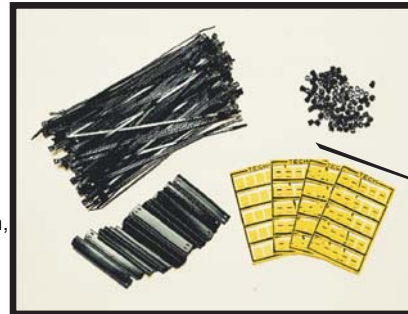

The bottom pocket neatly stores special character cards and accessories.



Call For Pricing



TECH PRODUCTS, INC.



Tel: (800) 221-1311
Tel: (718) 442-4900
Fax: (718) 442-2124

www.techproducts.com

Phase Markers

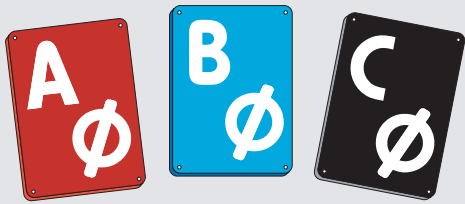

3 1/2" x 2 1/2" 1/8" Thick



PHASE MARKERS

1 1/2" x 7/8" 0.08" Thick



DEFECTIVE POLE MARKERS

3 1/2" x 2 1/2" 1/8" Thick

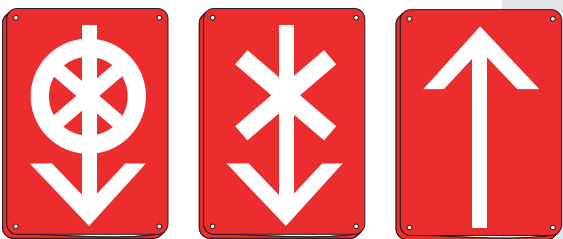

Do Not Climb
Pole To Be Replaced

Do Not Climb

Proceed With Caution

Call for custom logos. 800-221-1311

EVERLAST... 3" Tall Character ... Phase Markers

Mount in Aluminum or Poly Tag Holders or nail through pre-punched holes. Solid Polypropylene plastic. Letters are "molded in" ... not simply painted or screened.

EVERLAST withstands saltwater, acid rain, groundwater, chemicals, alkalis, acid solutions and temperatures from -40 to 200 degrees Fahrenheit

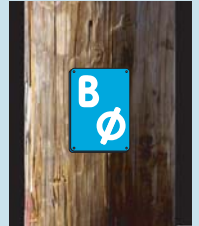

PROD#	500	1000	2500
EL3KYAO	AØ Phase Marker		
EL3KYBO	BØ Phase Marker		
EL3KYCO	CØ Phase Marker		
EL3KYA	A Phase Marker		
EL3KYB	B Phase Marker		
EL3KYC	C Phase Marker		
EL3KYAO1	Ø1 Phase Marker		
EL3KYBO2	Ø2 Phase Marker		
EL3KYCO3	Ø3 Phase Marker		

Call For Pricing

EVERLAST... 1" Tall Character ... Phase Markers

Solid black polypropylene characters are permanently embedded in the bright yellow, orange or white polypropylene substrate. You can cut it, scratch it, even dig into it with little or no effect on the embedded character.

Characters are
"Molded-In"

EVERLAST... Defective Pole Markers

Mount in Aluminum or Poly Tag Holders or nail through pre-punched holes.

Solid White Polypropylene characters.. Letters are "molded in" ... not simply painted or screened.

Everlast withstands saltwater, acid rain, groundwater, chemicals, alkalis, acid solutions and temperatures from -40 to 200 degrees F.



Proceed With Caution

PROD#	500	1000	2500
EL3WR048	Proceed With Caution		
EL3WR049	Do Not Climb		
EL3WR050	Do Not Climb Pole To Be Replaced		

Call For Pricing





Recessed Score

Lets you "breakaway" the sign into 2 separate pieces ... for alternative mounting.

EVERLAST ... High Voltage Signs

3 1/2" x 14" **EVERLAST** High Voltage Signs meet California (and some other state's) requirements.

Why pay for 2 journeymen and a bucket truck every 2 to 5 years ... to replace signs that can't be read? **EVERLAST** will remain legible at least 30 years!...we guarantee it!

Deluxe, polyolefin-plastic, **EVERLAST** signs withstand saltwater, acid rain, groundwater, chemicals, alkalis, acid solutions and temperatures from -40 to 200 degrees Fahrenheit. Letters are "molded-in" and go all the way through-the-sign!

ITEM	25	50	100	250	500	1000
ES0314001	Call for pricing & other quantities!...800-221-1311.					



EVERLAST... Ground Markers

In Sizes: 5"x 7" & 5" x 10"

High impact polypropylene with excellent cold impact resistance. UV protectors and antioxidants added to material provide complete protection and weather resistance in all climates.

PROD#	500	1000	2500
ELS5x7	Call For Pricing		
ELS5x10			

PROD#	
PSTAKE	12" PLASTIC STAKES

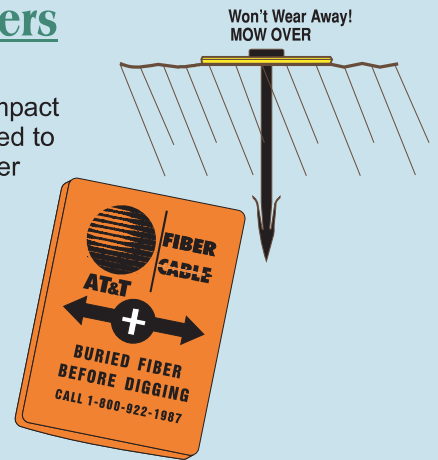

Snap around cables or pipes from 1/2" to 4" in diameter!

Wrap-Around Cable Markers

Several Colors ... Lengths from 4" to 10"

Use these wrap-around markers to mark your cables and pipes. Simply uncurl and apply. These sturdy markers hug the wire and never let go. You can also write on them with a Sharpie pen. These come in lengths of 4" to 10" and can snap around cables or pipes from 1/2" to 4" in diameter. Outdoor grade, UV stabilized, calendered vinyl.

Please specify color: Orange, Yellow, Red, Black, Green or White..

PROD#	Length	Pipe Diameter	25-99	100-249	250-499	500-999	1000-4999	5000+
SOM1x	4"	1/2" to 1"						
SOM2x	7"	1" to 2"						
SOM3x	8"	2" to 3"						
SOM4x	10"	3" to 4"						

Call For Pricing

Small setup charge applies.

3M REFLECTIVE
All Weather Decals
Reflective Decals

876544

55NE

A38

1", 1.5", 2.5", 3.75"
 Tall Characters

Standard
 Engineer Grade Reflective
 7 Year Outdoor Durable

Ask about our New "High Intensity Reflective"
 5/8" x 5/8" square, pressure sensitive. In cards of 15.

25B

High Intensity Reflective
 10 Year Outdoor Durable

87

9

9	9	9	9	9
9	9	9	9	9
9	9	9	9	9

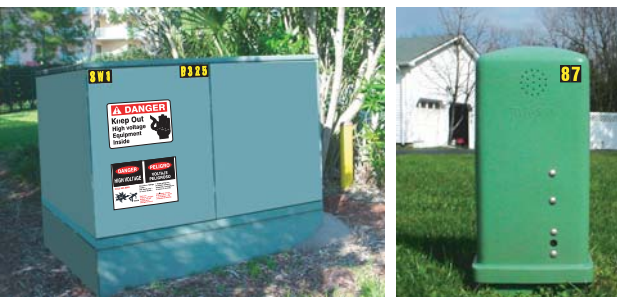

Ideal For ... Telecom Pedestals!

Reflective Decals ... 1", 1.5", 2.5", 3.75" Tall Characters
 Standard Reflective or Highly Reflective!

Use where high visibility is required ... (darkened areas or at night). All markers have a black background with brilliant reflective legend containing optical lens elements enclosed within a transparent resin. The outer surface is smooth. Stick on, pressure sensitive adhesive conforms to the adhesive requirements of FP-79 (Class 1) and LS-300C (Class 1).

These 3M decals meet all ANSI and MUTCD standards.

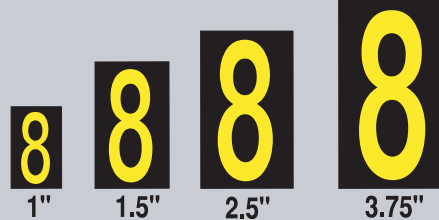

- 7 Year Outdoor Durable
- 3M Engineer Grade Material
- 7.5 mil thickness.

	PROD#	Size Character	Decal	DECALS/Pk	1 - 49	50-99	100 - 249
Standard Reflective	SR10- (0-9) (A-Z)	1"	7/8" x 1.5"	25			
	SR15- (0-9) (A-Z)	1.5"	1 3/8" x 1 7/8"	25			
	SR25- (0-9) (A-Z)	2.5"	1 3/4" x 2 7/8"	25			
	SR37- (0-9) (A-Z)	3.75"	2 7/8" x 4 5/16"	25			

Call For Pricing

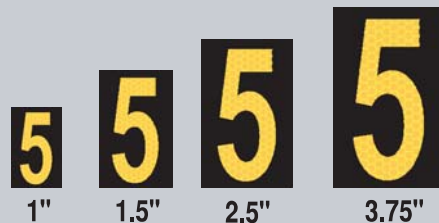

- 10 Year Outdoor Durable
- 3M High Intensity Material
- 7.5 mil thickness.

	PROD#	Size Character	Decal	DECALS/Pk	1 - 49	50-99	100 - 249
Highly Reflective	HR10- (0-9) (A-Z)	1"	7/8" x 1.5"	25			
	HR15- (0-9) (A-Z)	1.5"	1 3/8" x 1 7/8"	25			
	HR25- (0-9) (A-Z)	2.5"	1 3/4" x 2 7/8"	25			
	HR37- (0-9) (A-Z)	3.75"	2 7/8" x 4 5/16"	25			

Call For Pricing



MYLAR

All Weather Decals

Outdoor Mylar Decals



1", 2" & 3"
Tall Characters

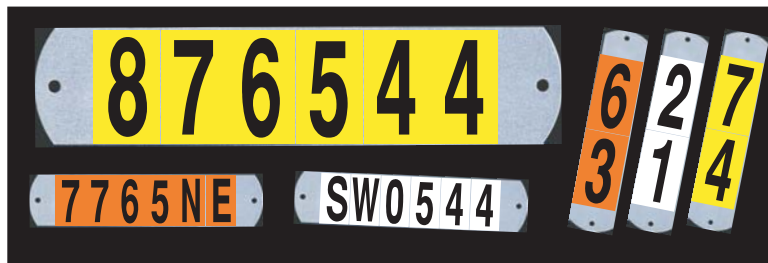
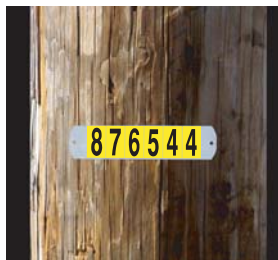

DECALS

Actual Size

1" Character
7/8" x 1.5"
Decal

2" Character
7/8" x 2.25"
Decal



3" Character

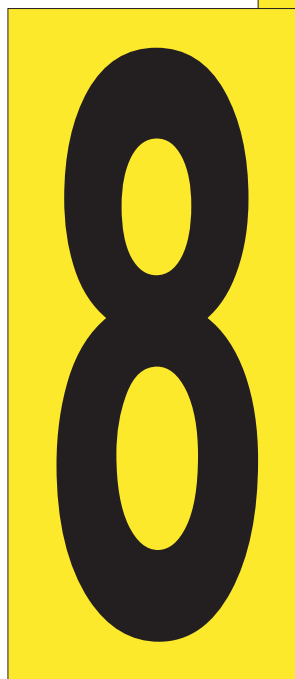

1.5" x 3.5"
Decal

Indoor / Outdoor Decals ... 1", 2" & 3" Tall Characters. All Weather Mylar ... Numbers & Letters

Tech's decals are overlaid with a clearcoat, polyester laminate. These all weather, solvent resistant decals are pressure sensitive with permanent acrylic adhesive. Clear and durable with a temperature range of -50°F to 275°F. Minimum application temperature 41°F. Excellent dimensional stability, and no measurable shrinkage.

Easy-to-handle ... Cards!



All available in numbers 0 through 9 and letters A through Z... Black letters on **Yellow, White or Orange background.**

Come in packs of 25.

	PROD#	BACKGROUND	DECALS/CARD	1 CARD	25	150	500+
1" Character 7/8" x 1.5" Decal	151BYN- (0-9)	YELLOW	10	Call For Pricing			
	151BYL- (A-Z)	YELLOW	10				
	150BWN- (0-9)	WHITE	10				
	150BWL- (A-Z)	WHITE	10				
	152BON- (0-9)	ORANGE	10				
	152BOL- (A-Z)	ORANGE	10				
2" Character 7/8" x 2.25" Decal	251BYN- (0-9)	YELLOW	10	Call For Pricing			
	251BYL- (A-Z)	YELLOW	10				
	250BWN- (0-9)	WHITE	10				
	250BWL- (A-Z)	WHITE	10				
	252BON- (0-9)	ORANGE	10				
	252BOL- (A-Z)	ORANGE	10				
3" Character 1.5" x 3.5" Decal	351BYN- (0-9)	YELLOW	6	Call For Pricing			
	351BYL- (A-Z)	YELLOW	6				
	350BWN- (0-9)	WHITE	6				
	350BWL- (A-Z)	WHITE	6				
	352BON- (0-9)	ORANGE	6				
	352BOL- (A-Z)	ORANGE	6				



3M REFLECTIVE & MYLAR

All Weather Decals



Carrier-Strip Pole Markers

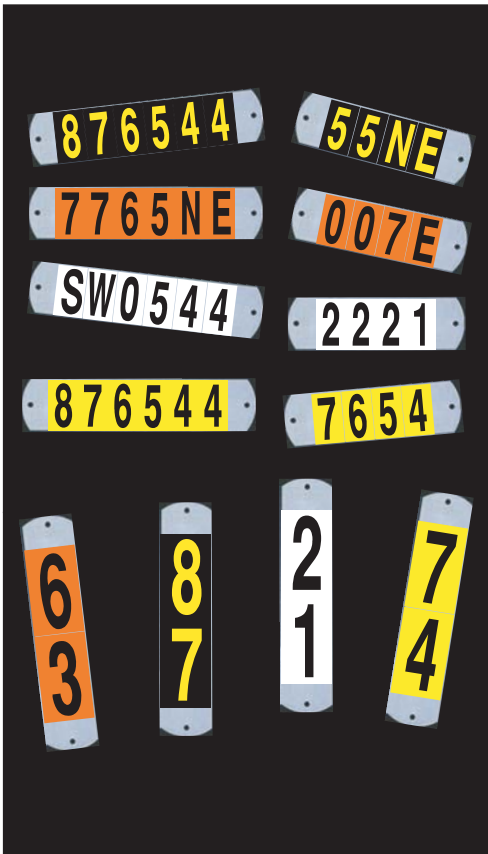

(Engineer Grade) Standard Reflective on Aluminum Carrier Strip.

All Weather, Black on Yellow Mylar on Aluminum Carrier Strip.

Carrier Strips are: 1 1/2" x ...any length.

All Weather Reflective... Decals

7/8" wide by 1 1/2" tall...with 1" tall numbers

Tech's Reflective Decals use 3M's, Engineer's grade materials to give 7-Year plus life in the field. Stick-on, pressure sensitive adhesive conforms to the adhesive requirements of FP-79 (Class 1) and LS-300C (Class Decals are 7/8" wide by 1 1/2" tall...with 1" tall numbers and letters. Decals are easily placed on Tech's aluminum carrier strips for fast, long lasting pole identification. .

Call for pricing.

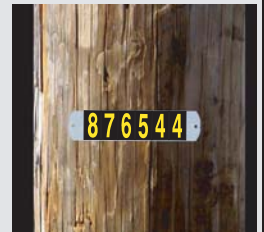

Aluminum Carrier Strips

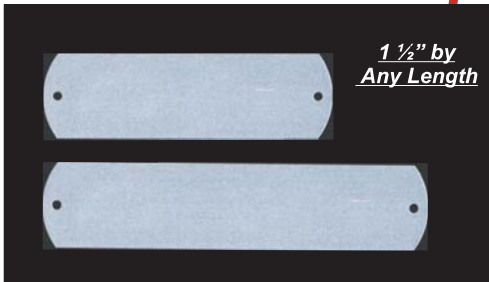

1 1/2" by Any Length

Aluminum Carrier Strips

Use Tech's, Aluminum Carrier Strips with Tech's (3M Reflective or Outdoor Mylar) "All Weather Decals.

Carrier strips are 1 1/2" by any length and can be used Horizontally or Vertically.

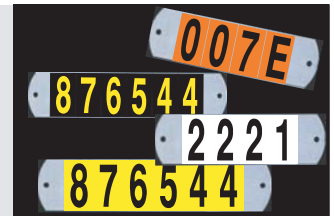

Round Reflectors

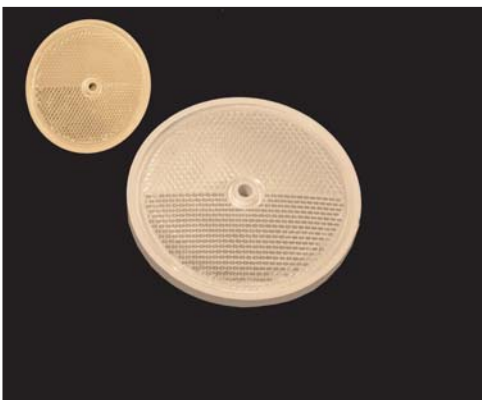

Round Reflectors

Maximize visibility of your Equipment, Poles, Trucks, Barricades, and Traffic paths with Tech's, Round Reflectors. These 3 1/4 inch reflectors come in a solid 1/4" plastic housing for long outdoor durability. 3/16" center hole for attaching with nail, screw, nut & bolt.

Call For Pricing



Vinyl, Mylar, Lexan SIGNS, LABELS, DECALS

Materials & Thickness	Color	Legibility
Vinyl .002" to .004" (2 to 4 mil)	5-7 yrs	5-7 yrs
Mylar .002" to .004" (2 to 4 mil)	5-7 yrs	5-7 yrs
Lexan .005" to .020" (5 to 20 mil)	7-10 yrs	7-10 yrs



For areas where you... Can't Drill Holes! Simply peel and stick. Self-sticking permanent acrylic adhesive. Withstands -40 degree to 180 degree F temperature with dimensional stability. Overlaminates protects signs from the sun.



Don't See The Sign or Label You Want? Call 800-221-1311

SEAL-IN-PLASTIC ... WRITE-ON, CABLE TAGS



1 3/4" x 4 "Size

- Lay Seal-In-Plastic tag on a flat surface.
- Peel back adhesive overlay.
- Write in Message and re-seal.

Write & Seal... Cable Tags

Simply peel back the plastic... Write your message and Seal!

1 3/4" x 4 "Size

Other Colors & Sizes Available!

Keep Information Protected from Oil, Dust, Dirt & Water Simply ... Write & Seal.



SEAL-IN-PLASTIC ... WRITE-ON, TAGS

3 1/4" x 5 1/2" Samples

Write-On Blank... and Seal!

Insert Your Card... and Seal!

Write-On Preprinted Tag... and Seal!

Peel & Seal-In-Plastic ... Tags

Accepts ... Handwritten information, or seal-in preprinted card, or pre-print the tag itself! Color code with 7 different colors. **Brass eyelet (standard size) on every tag.** .010 inch plastic seals with clear polyester cover laminate. Just "Peel and Seal".

Keep Information Protected from Oil, Dust, Dirt & Water Insert Your Card and Seal



PRICE PER PACK OF 25

PROD#	COLOR	Tags Per Pk	1-3 Pks	4-9	10-19	20-39	40-99	100+
1 3/4"	PAS101	White	25					
	PAS106	Green	25					
	PAS104	Red	25					
X	PAS103	Orange	25					
	PAS102	Yellow	25					
	PAS107	Lt Blue	25					
3 1/4"	PAS105	Lt Green	25					

Call For Pricing

PRICE PER PACK OF 25

PROD#	COLOR	Tags Per Pk	1-3 Pks	4-9	10-19	20-39	40-99	100+
2 1/4"	PAS201	White	25					
	PAS206	Green	25					
	PAS204	Red	25					
X	PAS203	Orange	25					
	PAS202	Yellow	25					
	PAS207	Lt Blue	25					
4 1/4"	PAS205	Lt Green	25					

Call For Pricing

PRICE PER PACK OF 25

PROD#	COLOR	Tags Per Pk	1-3	4-9	10-19	20-39	40-99	100+
3 1/4"	PAS301	White	25					
	PAS306	Green	25					
	PAS304	Red	25					
X	PAS303	Orange	25					
	PAS302	Yellow	25					
	PAS307	Lt Blue	25					
5 1/2"	PAS305	Lt Green	25					

Call For Pricing

4" x 6" Size and Other Sizes Available!

Call For: Other Sizes & "Pre-Printed" Peel & Seal Tags!



3M

Metal Reflective

TechBrite Reflector Strips



TechBrite Reflector Strips

2" x 12" or 1.5" x 12 inch sizes. These aluminum reflector strips are perfect for identifying poles at night, delineating curb sides and helping traffic flows. TechBrite reflector strips use 3M's Engineer's grade material on .020 anodized aluminum.

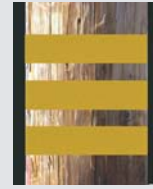
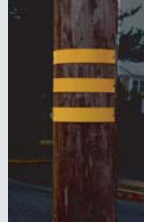

3M

Metal Reflective

2" & 3"

Numbers & Letters

Horizontally or Vertically Mounted



3M, Metal Reflective, Numbers & Letters

Durable, UV stabilized, baked enamel, black paint on 3M's highly reflective, outdoor, engineer grade material. Available in characters 0-9 and A-Z, symbols and standard or custom wordings and designs. Horizontal or vertical mounting in channel holders. Available with holes for direct mounting.

See page 15 for our 1" reflective numbers and letters.

Call for Pricing!

3M REFLECTIVE

Guy Guards

Guy Wire Markers

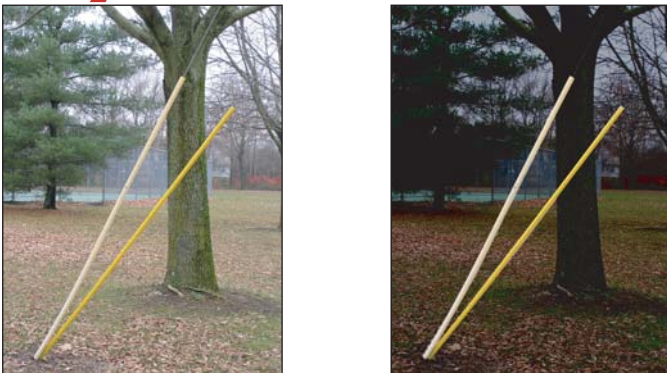

3M Reflector ... Guy Guards

Tech's, Guy Wire Guards **add to the safety of any area.** Made of high impact, UV stabilized plastic, Tech's guy wire makers are available in yellow, white, grey, orange or reflective and are REA approved. Available with several attachment options including a large stainless clamp, plastic tie wrap, poly strap with buttons, a plug option or you can order with no attachment.

Normal inside diameter is 1 1/4"

Outside diameter is 1.775"

Length 8 feet

Standard packaging is 25 per pack



Tel: (800) 221-1311

Tel: (718) 442-4900

Fax: (718) 442-2124

www.techproducts.com

Poly Dome Markers



Poly Dome Markers

Poly-Domes are mounted to white posts. Both the domes and posts are UV treated. Printing and graphics on both sides of dome. Graphics are chemically etched into the dome. Poly-Domes are 16" high with a 3 1/2" diameter. Poly dome posts come in 6', 7' and 8' lengths with a wall thickness of 0.216". (Other lengths are available)

Available in Orange, Yellow, Green or White. Print colors are black and white.



ITEM	Description	Length	25	100	500	1000
PDM0001	Dome + Post	6'		Call For Pricing		
PDM0002	Dome + Post	7'		Call For Pricing		
PDM0003	Dome + Post	8'		Call For Pricing		

Utility Markers



Cable & Pipeline Markers

Sizes: 3.75" x 66" 3.75" x 72"
Colors: Orange, Yellow, White, Red and Blue



The line marker is made from high impact fiberglass. Specially formulated for UV protection. The uniquely designed symmetrical three rib profile will flex upon impact and return to its original upright position.

We can also provide a line marker that uses a specially formulated UV plastic. This lightweight, curve-shaped marker is designed for areas with heavy traffic and/or large mowers.

Copy and graphics can be custom made and added to sign before delivery.

Call For Pricing ... 1-800-221-1311

Flexi-Guide Posts



Flexi-Guide ... Flexible Highway Delineator Posts

These "Driveable", impact resistant, posts are available with a number of standard and special options, including reflective sheeting, message decals, custom colors and lengths and various anchors.

TECHFlex-D (Double Curve) & TECHFlex-S (Single Curve) standard colors are White, Yellow & Grey. Posts and delineators are packaged in boxes of 25 pieces; 500 pieces per pallet. All TECHFlex-S posts meet U.S. DOT specifications.

Made with high performance plastic using engineering thermoplastics these markers meet the challenges of various soils, climate and traffic control requirements.

Call For Pricing ... 1-800-221-1311



Aluminum Post Reflectors ...Attach to Sign Posts!

3 1/8" Wide x 30" High. These 0.080" thick aluminum reflectors increase sign visibility day and night. Use on standard U-Channel, square or round sign posts. Installs easily with nuts and bolts. Promotes safety ... All the time!

Comes in red (Engineer Grade) reflective or fluorescent/yellow green (Diamond Grade)..one side.

**Safety
First!**



Tech's Conspicuity Tape **Reflective!**

2" Wide x 150' Long Rolls. Alternating 11" bands of red and 7" bands of white prismatic reflective. Sub surface printing protects the color from UV and solvents for superior durability. Bright red color provides excellent visibility even during daylight hours. Exceeds NHTSA requirements for marking vehicles.

**7 Year
Warranty!**



ANSI Compliant Hard Hats

Fully Adjustable! ...Squeeze Lock Suspension

Comes with Front replacement sweatband. Six point, deluxe, nylon strap suspensions. Meets ANSI Z89, 1-1997 type 1, Class E, G & C specs.



Tech's...Bird B-Gone

Bird Flight Diverter

Protects Birds from Collisions with wires.

- Fast Installation (Hot Stick available for power and telephone lines).
- Fully tested and developed by biologists to be the most effective diverter.
- Uses materials that glow at night up to 10 hours.
- Spins in the wind ... Alerting birds of obstructions.
- Rugged spring loaded clamp prevents slippage.
- Unique "Moon Shine" system reflects UV + visible light even in low light/fog conditions.

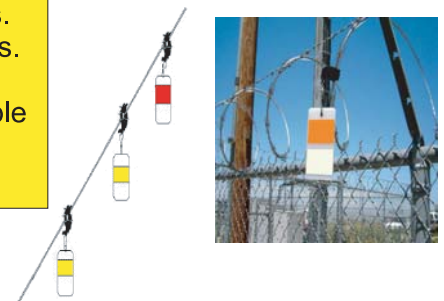

ANSI CLASS
2

Class II garments. Where traffic speeds exceed 25 mph. Suitable for railway workers, school crossing guards, parking and toll gate personnel, airport ground crews and law enforcement personnel directing traffic.

ANSI CLASS
3

Class III garments provide the highest level of visibility. Where traffic speed exceeds 50 mph. The standard recommends these garments for all roadway construction personnel and vehicle operators, utility workers, survey crews, emergency responders, railway workers and accident site investigators

This is our Standard Most Popular Vest



ANSI 107 Compliant Reflective Vests

ANSI CLASS
2

Machine washable. Bright, lightweight polyester. 2" 3M reflective tape. Two 360 degree horizontal stripes, two vertical shoulder stripes. Hook & Loop closures.

#OGVNYzz
Fluorescent Yellow or Orange.
Flr Yellow Sizes: Small to 10X
Flr Orange Sizes: Small to 6X

Plus Flame Retardant



ANSI 107 Compliant With Flame Retardant

ANSI CLASS
2

100% Modacrylic with FR 3M reflective tape. Machine washable. Two 360 degree horizontal stripes, two vertical shoulder stripes. *Flame retardant* binding, thread, hook & loop. Meets ASTM1506 requirements.

#OGVNFYzz
Fluorescent Yellow.
Fluorescent Yellow Sizes: Small to 6X



Economy Vest ... MUTCD compliant.

Mesh Safety Vest (Vinyl Coated 100% Polyester) With or without Reflective Stripe.

100% polyester mesh in DayGlow red/orange. Flat weave construction. 7 oz., Vinyl coated. 3/4"x2" front velcro closure. 3/4" x 8" elastic side straps. 1 3/8" vertical yellow strip front and back. Conforms to MUTCH Sect 6F-3, VI-60 (C) Rev. 5.

#OGVENOzz
DayGlow Orange.
DagGlow Orange Sizes: Small to 6X



ANSI 107 Compliant Reflective Vests ... Short Sleeve Our Most popular ... Short Sleeve

Bright, lightweight polyester fabric. Includes 2" 3M reflective tape. Two horizontal stripes plus two vertical shoulder stripes plus four sleeve stripes. Hook & loop closure. Machine washable.

#OGSSYzz
Fluorescent Yellow or Fluorescent Orange.
Fluorescent Yellow Sizes: Small to 6X
Fluorescent Orange Sizes: Small to 6X

ANSI CLASS
3



#OGSSOzz

- Hook & loop closure
- Four Sleeve stripes
- Reflective striping and background material compliant with Class 3 configuration.
- Lightweight material

Flame resistant under NFPA 701.

#OGSLOzz



ANSI 107 Compliant Reflective Sweatshirt

ANSI CLASS
3

#OGSLOzz
Fluorescent Yellow or Flr. Orange.
Fluorescent Yellow Sizes: Small to 6X
Fluorescent Orange Sizes: Small to 6X

Crew Neck Class 3 sweatshirt keeps wearers warm, but not too warm, and protected in high risk work environments and a wide range of weather conditions. Designed with two bands of 2" wide 3M Scotchlite reflective tape on each arm plus two vertical shoulder stripes plus one 360* reflective band that encircles the torso. Independently Certified to meet the ANSI Class 3 standard. Fabric: Made of Whisk-It(TM) treated 100% polyester, specially engineered to open up sealed fibers and create a moisture transport tunnel which continuously moves perspiration away from body. Machine washable.

#OGTSYzz



ANSI 107 Compliant Reflective T-Shirt

ANSI CLASS
3

100% polyester with Whisk-It treatment to open up sealed yarn fibers which whisk away perspiration from the body. Cooler and more comfortable than cotton.
Fluorescent Yellow or Flr. Orange.
Fluorescent Yellow Sizes: Small to 6X
Fluorescent Orange Sizes: Small to 6X

ANSI CLASS
3



ANSI 107 Compliant Reflective Bomber Jacket

Classic aviator style bomber jacket. Fluorescent Yellow PVC coated polyester plus 3M Scotchlite reflective tape. Nylon lining. Removable inner polar fleece.

#OGBLYzz
Fluorescent Yellow.
Fluorescent Yellow Sizes: Small to 6X



Warning Flags

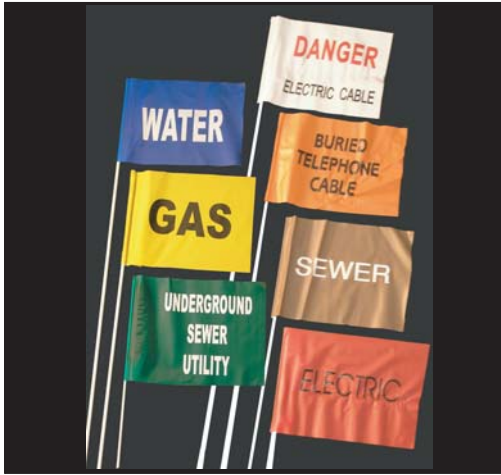

Warning Flags

Custom print your flags with the legend of your choice. 5" x 4" flag with your choice of plastic, steel or fiberglass shaft. Standard shafts are 18" long. Call for others sizes.

Available in Yellow, Blue, Green, White, Orange, Brown or Red.

Snow Poles

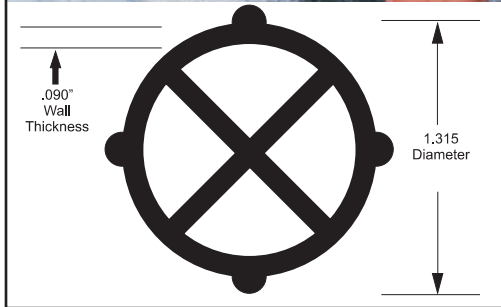

Heavy Duty... Snow Poles

Made from the strongest plastic polyolefins, Tech's snow poles withstand temperatures to as low as -76 F.

Available in standard 5, 6, 8 and 10 foot lengths. *Mount easily with our Nylon Tie Straps (up to 36" lengths).*

Colors: Fluorescent Orange, Fluorescent Yellow, Fluorescent Yellow-Green, Maintenance Orange, Yellow, Red, Blue, Green and Black.

Use to Mark

- Road snow removal
- Culverts & Drains
- Fire Hydrants
- Junction Boxes
- Snowmobile courses.
- Cross Country Ski courses.
- Snow fencing
- Walk paths

Optional Reflectors are also available. Please call 1-800-221-1311.

Shelf / Aisle Signs



EVERLAST ... Shelf, Street and Pole Signs

1 or 2 Sided. Solid black polypropylene characters are permanently embedded in the bright yellow, orange or white polypropylene substrate. You can cut it, scratch it, even dig into it with little or no effect on the embedded character.

Extruded Aluminum Tagholder.

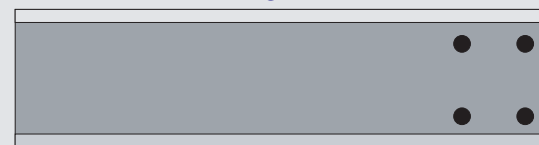

1" Tag Holders



**Mount Horizontally
or Vertically**



Nuts & Bolts



EVERLAST ... Nuts, Bolts & Washers

- 010-047000 **NBA 5/16th" Aluminum Break-A-Way Nut.** Requires a standard wrench or Vise-grip for installation. When nut is tight, keep twisting firmly to break off hex head.
- 010-036500 **BOW2 5/16th" x 2" One Way Vandal-Resistant Bolt.** Zinc plated steel head of bolt cut away for one way tightening only with straight edge screw driver. Use with NBA breakaway nut.
- 010-022501 **SAVE1 2" x 3" Square Washer.** Ribbed aluminum. One 3/8" diameter hole. mount between sign and post.
- 020-0203 **Threaded, Aluminum Wire Fence Brackets. 1 1/2"x 4".** Comes with two 5/16" x 2" one way screws.

Call
1-800-221-1311
for other shapes
& sizes!

Pole Sign-Fasteners

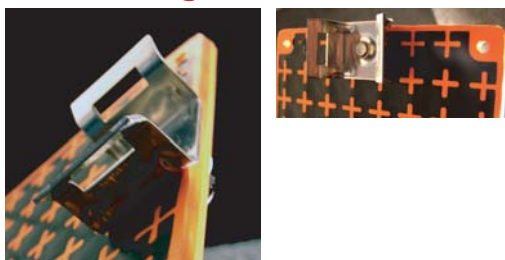

Tech Stainless Steel, Sign Fasteners & Straps

Flanged, heavy duty bolt fasteners with stainless steel bands for attaching signs, markers and reflectors to round poles.



STEEL U-Channel Posts

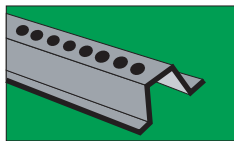
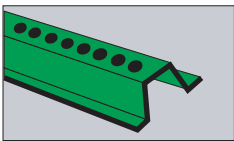

6, 7 or 8 Foot, Steel, U-CHANNEL POSTS

Our U-Channel sign posts are approved by the Federal Highway Administration (FHWA) and the American Association of State Highway and Transportation Officials (AASHTO). They comply with the mechanical requirements for grade 60 steel of ASTM A499 and the chemical requirements for grade 1080 steel of ASTM A576.

Posts are available in Green Baked enamel or Galvanized. Posts weigh approximately 2 pounds per foot.

3/8" diameter holes start 1" from top of post and are spaced every 1 inch, center to center.

Item ID#	Description	Length	25	50	100
Post-Green-6	Green Baked Enamel	6 Foot	Call For Pricing		
Post-Green-7	Green Baked Enamel	7 Foot	Call For Pricing		
Post-Green-8	Green Baked Enamel	8 Foot	Call For Pricing		
Post-Galv-8	Galvanized Steel	8 Foot	Call For Pricing		

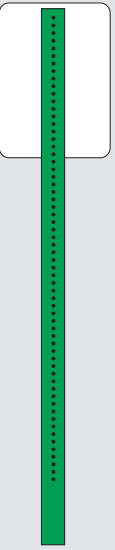

Composite U-Channel Posts

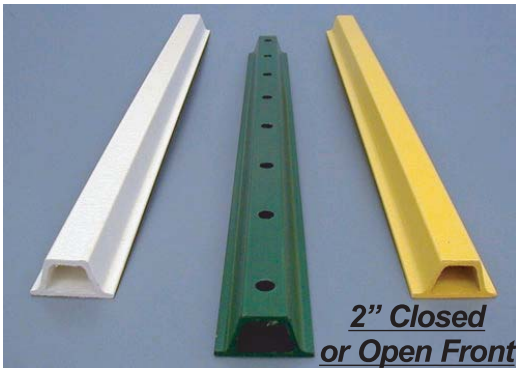

Mount Signs up to 24" x 24"

6, or 8 Foot, Composite U-Channel Posts

- 1/8" thick composite material.
- 5 times stronger than steel posts.**
- 75% lighter than steel posts.
- Maintenance free. Never rusts.
- Green, White or Yellow.
- Molded Point bottom for quick installation.

Standard sizes: 6', or 8'.
Call for other sizes and colors.

Closed U-Channel profile allows for placing Reflector-Strips on front. Posts come drilled 1" down from top every 3" to 21". Posts can be easily drilled with additional holes.

FREE with each post:
2 Steel nuts, bolts & nylon washers.

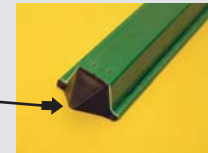

Call For Pricing!

Composite Square Post

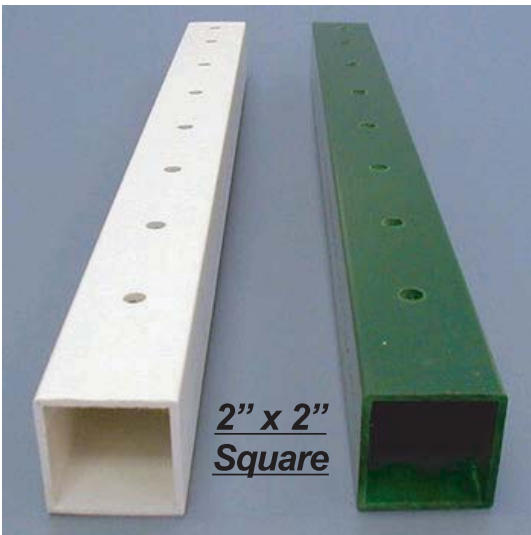

Mount Signs up to 36" x 36"

8 or 10 foot, Composite Square Posts

- 1/4" thick composite material.
- 5 times stronger than steel posts.**
- 75% lighter than steel posts.
- Maintenance free. Never rusts.
- Green or White.
- Quick Install with 2 1/4" ground sockets.
- 2 1/4" ground sockets available.

Standard sizes: 8' or 10'
Call for other sizes and colors.

Square profile allows for you to place Reflector-Strips on front of post. Posts can be easily drilled with additional holes. Will not conduct electricity or interfere with radar.

Call For Pricing!

Storage Boxes

SB3



EVERLAST ... Storage Boxes.

All steel construction with molded plastic compartments. 18" x 12" x 3" high.



SB1

ITEM ID#	Description	Capacity	1-5	6-10	11-25	26 +
SB1	For 1" and 2" char. Size Tags	21 Compartments				
SB3	For 3" char. Size Tags	20 Compartments				<i>Call for Pricing</i>
SBA	Adjustable Size Compartments	1 to 44				

Nylon Ties



Tie Straps (Cable Ties)

Heavy Duty, nylon, tie straps for all types of fastening applications.

Item Code	Overall Length	Tensile Strength	Price Each	Price Bag
TSB-6/30-100	6 in.	30lbs.	<i>Call for Pricing</i>	<i>Call for Pricing</i>
TSB-8/30-100	8 in.	30lbs.		
TSB-11/50-100	11 in.	50lbs.		
TSB-14/50-100	14 in.	50lbs.		
TSB-14/175-100	14 in.	175lbs.		
TSB-18/175-100	18 in.	175lbs.		
TSB-21/175-100	21 in.	175lbs.		
TSB-24/175-100	24 in.	175lbs.		
TSB-30-175-100	30 in.	175lbs.		

Tie Cutter... Tightener Gun



Tie Cutter & Tightener Gun

Nails & Washers

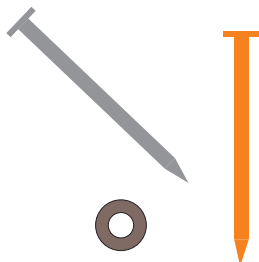

Nails & Washers

Round, square or spiral, aluminum nails. Round, copper nails. All nails are 1.5 inches long.

Neoprene washers.

Part Description	Item Code	Quant. per Box	Price per Box
Aluminum, round shank	NALRD15	580	<i>Call for Pricing</i>
Aluminum, square shank	NALSQ15	580	
Aluminum, spiral shank	NALSP15	580	
Copper, round shank	NCORD15	170	
Neoprene washers	WNEO	650	



EVERLAST®
Indestructible

6"

Numbers & Letters

Horizontally or Vertically Mounted

TECH
PRODUCTS, INC.



EVERLAST ...
6" Number & Letter ... Tower Markers

Our aerial observation tags and markers are superior to everything on the market bot for their ling lasting, high visibility and low cost to maintain. The **EVERLAST** system is designed and proven to last in the harshest environmental conditions and the transmission tower has to be among the worst of these conditions. The manpower and time lost replacing fading markers and tags is huge. Do not put up unproven tags that will fade in 10 or 20 years. Use **EVERLAST** and never worry about your transmission tower tags again.

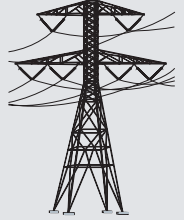

Call for pricing!...800-221-1311.

10" x 14" Size
1/4" Thick



EVERLAST ... Crossing Signs

10" x 14" **EVERLAST** Crossing Signs signal trouble areas. UL tested to last over 30 years. Will never chip, tear, corrode or delaminate. Thick 1/4" construction ... Won't bend in the wind.

Withstands saltwater, acid rain, chemicals, alkalies and acid solutions. Withstands temperatures from -40 to 220 degrees fahrenheit. UV stabilizers are "molded-in" throughout the thickness of the sign. **EVERLAST** when you absolutely, positively need a sign that you will never have to replace!

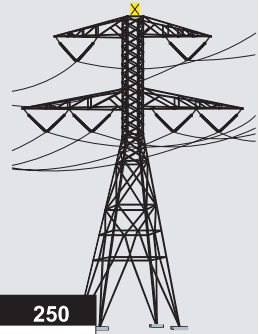

ITEM	1	10	25	50	100	250
EL12KYX	Call For Pricing					

We will mostly **MEET** or **BEAT** ... the price of any lower quality sign (like Lexan, fiberglass or porcelain)! Call us.



EVERLAST®
Indestructible

Vault Markers

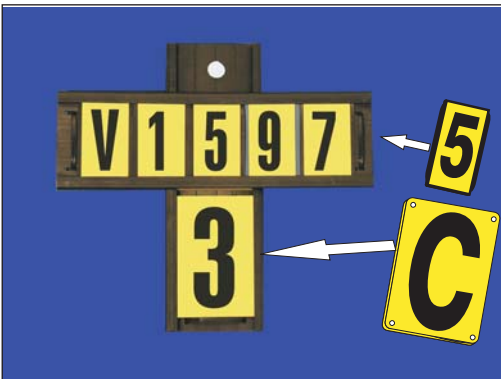

EVERLAST ... Vault Markers

EVERLAST ... Underground Vault Markers are a combination of "2-Inch" and "3-Inch" EVERLAST numbers and letters ... Inserted into a 3 inch Poly Tagholder Cross. A 3/8" diameter hole is used to attach the marker. These markers are UL tested to remain legible for a least 30 years!

TECH
PRODUCTS, INC.



Tel: (800) 221-1311
Tel: (718) 442-4900
Fax: (718) 442-2124

www.techproducts.com

1/2 " square... to 1 x 6 foot Sizes

Embossed Materials & Thickness	Legibility
Aluminum .025", .032", .050", .063"	Lifetime
Stainless Steel .030" .060"	Lifetime
Brass .032" .060"	Lifetime
Cold Rolled Steel .035" .047" .059"	Lifetime
Tin Plated Steel .015"	Lifetime
Hot Dipped Galvanized .035"	Lifetime

TECH-3D Embossed Name and Data Plates! Never wear away!!! Durable and UV resistant. Superior and more durable than aluminum foil, Mylar or Vinyl film labels. Provided with self adhesive backing or mounting holes. Holes can be .125", .22", .25", .31" or please specify. Square or rounded edges.

TECH-3D Embossed "UnPainted" Name and Data Plates are easily read without paint or ink for contrast. Ideal for labeling or identifying:

- Boilers
- Fuel Storage Tanks
- Electrical Equipment
- Motors
- Hot Water Heaters
- Refrigeration Units
- Air Conditioners
- Truck Bodies
- Trailers & Containers
- Mobile Equipment
- Chassis
- Axles
- Food Processing Equipment
- Metal Doors & Frames
- Windows & Frames

The deep embossing of **TECH-3D Embossed "UnPainted" Name and Data Plates** makes them legible for ever ... Even when painted over.

Use Tech's stamped, consecutive numbering option for your products' serial numbers, etc.

Stamping Presses Available!

1. Return Lever
2. Thickness adjust
3. Impression depth
4. Operating handle
5. Character dial

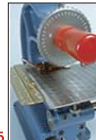
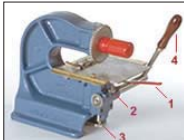

UnPainted Embossed Name Plates & Data Plates
Serialization Available



Large Name & Data Plates
Over 48 Square Inches ... To 6 foot lengths.

Embossed Materials & Thickness	Legibility
Aluminum .025", .040", .050", .063"	Lifetime
Stainless Steel .030" .060"	Lifetime
Brass .032" .060"	Lifetime

Background & Copy Colors

Yellow	
White	
Black	
Red	
Orange	
Dk Blue	
Green	
Brown	
Peacock Blue	
Gold	
Silver Color	of Metal

Custom Colors Available.

- Background Colors:**
See Above.
- Holes or Adhesive Backing**
- Square or Round Corners**
- Odd Shapes**
- Thickness of Material:**
See Above.

TECH-3D Embossed Name and Data Plates! Never wear away!!! Durable and UV resistant. **Baked enamel colors.** Superior and more durable than aluminum foil, Mylar or Vinyl film labels. Provided with self adhesive backing or mounting holes. Holes can be .125", .22", .25", .31" or please specify. Square or rounded edges.

Since 1948, we have been supplying customers with name and data plates with **cast-like**, highly raised, embossed copy. The bold, 3-dimensional letters **formed in our very high tonnage presses** cannot be destroyed by scratching, abrasion or overpainting. Printed, anodized and even etched plates cannot match the permanent legibility of **TECH-3D Embossed Name and Data Plates!**

**First Choice
For a Lasting
Impression!**

**Large Embossed
Name & Data Plates**



**Permanently legible for
the life of your product!**



TECH-3D
Deep Embossed

**Aluminum
Data Plates**

Embossed Materials & Thickness	Legibility
Aluminum .025", .040", .050", .063"	Lifetime

Background & Copy Colors

Yellow	
White	
Black	
Red	
Orange	
Dk Blue	
Green	
Brown	
Peacock Blue	
Gold	
Silver Color of Metal	

Custom Colors Available.

- Background Colors:**
See Above.
- Holes or Adhesive Backing**
- Square or Round Corners**
- Odd Shapes**
- Thickness of Material:**
See Above.

TECH
PRODUCTS, INC.

1/2 inch square to 6 feet sizes!

Aluminum Embossed Data Plates



Serialization Available

- Brilliant, baked enamel colors
- Highly raised copy & deep relief!
- 1/2" square to 6 feet!

For An Instant Quote!!!
Call 1-800-221-1311
in NY (718) 442-4900
FAX: (718) 442-2124

TECH-3D
Deep Embossed

**Aluminum
Name Plates**

Embossed Materials & Thickness	Legibility
Aluminum .025", .040", .050", .063"	Lifetime

- Brilliant, baked enamel colors
- Highly raised copy & deep relief!
- 1/2" square to 6 feet!

Permanently legible for the life of your product!

800-221-1311

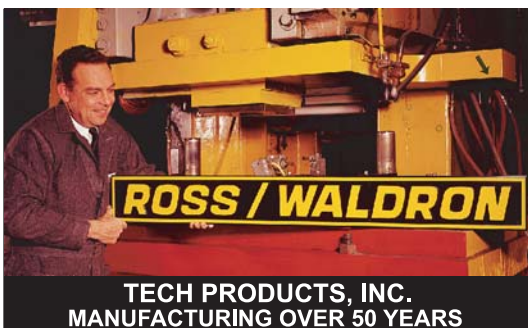

TECH PRODUCTS, INC.
MANUFACTURING OVER 50 YEARS

Aluminum Embossed Name Plates



**Brass
Data Plates**

Embossed Materials Thickness	Legibility	
Brass	.032"	.060" Lifetime

Background & Copy Colors

Yellow	
White	
Black	
Red	
Orange	
Dk Blue	
Green	
Brown	
Peacock Blue	
Gold Color	

Custom Colors Available.

- ☑ **Background Colors:**
See Above.
- ☑ **Holes or Adhesive Backing**
- ☑ **Square or Round Corners**
- ☑ **Odd Shapes**
- ☑ **Thickness of Material:**
See Above.

**Brass or
Anodized Aluminum
Name Plates**

- **Brilliant, baked enamel colors**
- **Highly raised copy & deep relief!**
- **1/2" square to 6 feet!**

Permanently legible for
the life of your product!

800-221-1311

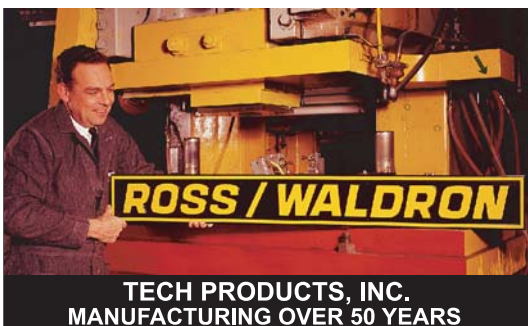

TECH PRODUCTS, INC.
MANUFACTURING OVER 50 YEARS

Brass Embossed

Data Plates

Serialization Available



- **Brilliant, baked enamel colors**
- **Highly raised copy & deep relief!**
- **1/2" to 6 feet!**

**Brass or Anodized Aluminum
Embossed**

Name Plates



TECH-3D
Deep Embossed

**Stainless Steel
Data Plates**

Embossed Materials & Thickness	Legibility
Stainless Steel .030" .060"	Lifetime

CERTIFIED BY:
Arrow TANK & ENGINEERING CO.
 CAMBRIDGE, MINN.
 MAX. ALLOWABLE WORKING PRESSURE
 PSI AT °F
 MIN. DESIGN METAL TEMPERATURE
 °F AT PSI
 MFR'S. SERIAL NO.
 YEAR BUILT
 OWNER'S SERIAL NO.
 D.O.T. SPECIFICATION MC-331
 MAT'L. SPECIFICATION
 WATER CAPACITY-LBS.
 ORIGINAL TEST DATE
 DESIGN PRESSURE P.S.I.G. TEMP. °F.
 TANK VOLUME GAL. O.D. IN.
 SURFACE AREA SQ.FT. D.R.
 MFD SHELL THK. IN. SHELL MIN. IN.
 MFD HEAD THK. IN. HEAD MIN. IN.
 OVERALL LGTH. FT. IN.
 MAX.DESIGN DENSITY OF LADING PPG.
 ABOVE GROUND SERVICE
 VAPOR PRESSURE OF CONTENTS NOT TO
 EXCEED P.S.I.G. AT °F

8" x 13"

3D Embossed, Stainless Steel Data Plate.

**Stainless Steel
Name Plates**

Background & Copy Colors

Yellow	
White	
Black	
Red	
Orange	
Dk Blue	
Green	
Brown	
Peacock Blue	
Gold	
Silver Color	of Metal

Custom Colors Available.

- ✓ **Background Colors:**
See Above.
- ✓ **Holes or Adhesive Backing**
- ✓ **Square or Round Corners**
- ✓ **Odd Shapes**
- ✓ **Thickness of Material:**
See Above.

TECH-3D
Deep Embossed
Always Legible

TECH
PRODUCTS, INC.

1/2 inch square to 6 feet sizes!

Stainless Steel Embossed Data Plates
Serialization Available

- Brilliant, baked enamel colors
- Highly raised copy & deep relief!
- 1/2" square to 6 foot sizes.

Stainless Steel Embossed Name Plates



Tel: (800) 221-1311
 Tel: (718) 442-4900
 Fax: (718) 442-2124

TECH
PRODUCTS, INC.

**Aluminum & Stainless Steel
Danger & Caution Signs**

Embossed Materials & Thickness	Legibility
Aluminum .025", .040", .050", .063"	Lifetime
Stainless Steel .030" .060"	Lifetime

- **Brilliant, baked enamel colors**
- **Highly raised copy & deep relief!**
- **1/2" square to 6 feet!**

TECH-3D Embossed Danger, Warning and Caution Signs comply with OSHA & ANSI regulations for potential hazards. They remain legible for the life of your product. The 3-dimensional legibility is unaffected by dirt, oil, grease ... Or even over-painting.

Note 1: For harsh outdoor environments and *lifetime color and legibility* see our **EVERLAST Indestructible, Injection-Molded Signs** on the following pages.

Note 2: For areas where long term legibility is not a prime consideration, we also offer Accident Prevention Signs in screen printed flat metal, Lexan, Mylar, Vinyl or foil.



**3" & 6" Numbers & Letters
Horizontally or Vertically Mounted**



Embossed ... Metal Numbers & Letters

Deep Embossed, black characters on yellow aluminum. The highly raised characters are ideal for underground applications where silt, oil or dirt may cover the markers. Can be used for both Horizontal or Vertical mounting

ITEM ID#	1000	500	250	100
SI3YExx (A-Z, 0-9) 3" Embossed Metal				Call for Pricing!
SI6YExx (A-Z, 0-9) 6" Embossed Metal				Call for Pricing!

Aluminum ... Channel Holders

Hold 1, 2, 3, 4, 5, 6, 7, 8 or 9 of our 3" tall characters. Excellent for long lasting, quick change signs... especially in outdoor environments. Holders can be attached using nails, bolts, rivets, magnets or metal banding.

Aluminum Channel Holders... For 3" Metal Tags for Horizontal or Vertical Mounting

ITEM ID#	Qty	Holds 2	Holds 3	Holds 4	Holds 5	Holds 6	Holds 7
CH30xyM	up to 99 100 - 249 250 - 499						

x ... Use to designate quantity to hold.
y ... Use to designate either Horizontal (y=H) or Vertical (y=V)

Aluminum Channel Holders... For 6" Metal Tags for Horizontal or Vertical Mounting

ITEM ID#	Qty	Holds 2	Holds 3	Holds 4	Holds 5	Holds 6	Holds 7
CH60xyM	up to 99 100 - 249 250 - 499						



Pole Tags
Anodized Aluminum

Materials & Thickness	Legibility
Anodized Aluminum .032"	Lifetime

- ✔ 1.5 x 8 inch. Anodized aluminum pole tags. These tags are one piece and sequentially numbered.
- ✔ The numbers and letters are "deep engraved" for long term, permanent legibility.
- ✔ Optional bar codes can be engraved at bottom of tag or attached using pressure sensitive labels.
- ✔ The pole tags fit snugly into Tech's aluminum tag holders.
- ✔ **Mount Horizontally or Vertically!**

Anodized Aluminum
One Piece
Sequentially Numbered

Optional Engraved or
Pressure Sensitive Bar Code Labels.

Mount Horizontally or Vertically

3M
Metal Reflective

Traffic Signs
MUTCD COMPLIANT!

Materials and Thickness	Durability & Legibility
Aluminum .063", .080"	Subject to Use

All Tech traffic signs are MUTCD compliant and are manufactured to U.S. Bureau of Public Roads Standards. Tech uses the industry standard 3105 and 5052 Alloy Grade aluminum on all its traffic control signs.

Please specify Engineer's Grade Reflective or High Intensity reflective aluminum.

See Page 37
for U-Channel
Mounting Posts



See Page 37
for U-Channel
Mounting Posts



Parking Lot Stencils



NO SMOKING

Heavy Duty ... Parking Lot Stencils Handicap Stencil

Stencils are made of 1/8" thick plastic. Paint is applied using spray, brush or roller. When finished, paint will flake off stencil for easy cleaning. Great for parking lots, warehouses, schools, etc.

Letter or Number ... Stencils

Stencils are made of 1/8" thick plastic. Paint is applied using spray, brush or roller. When finished, paint will flake off stencil for easy cleaning. Great for parking lots, warehouses, schools, etc.

Part	Letter/Number/Size
Sten01xx	1" Letter/Number
Sten02xx	2" Letter/Number
Sten03xx	3" Letter/Number
Sten05xx	4" Letter/Number
Sten06xx	6" Letter/Number
Sten08xx	8" Letter/Number
Sten10xx	10" Letter/Number
Sten12xx	12" Letter/Number
Sten18xx	18" Letter/Number
Sten24xx	24" Letter/Number
Sten30xx	30" Letter/Number
Sten36xx	36" Letter/Number
Handi1	24" x 32" Handicap Stencil
Handi2	38" x 44" Handicap Stencil

Use "xx" at end of part number to designate which number or letter you are ordering.

Embossed Metal Tape System



Features

Features a front scissor cutoff and a ***built-in hole-punching device*** that creates a hole for hanging and tacking.

Imprints 1/2" (12 mm) wide metal and vinyl tapes that withstand weather, temperature and corrosion.

Metal Tape Embossing System Embossed ... Labeling Made Easy Industrial Strength Labeler

Tapes:
Aluminum or Stainless Steel

1/2" Aluminum with /Adhesive Tape Backing

Size: 1/2" x 12'

.011" Thick.

TECH PRODUCTS INC

1/2" Aluminum Tape (No Adhesive)

Size: 1/2" x 16'

.005" Thick.

● TURN OFF ●

1/2" Stainless Steel Tape (No Adhesive)

Size: 1/2" x 21'

.005" Thick.

● A/25267 ●

Made out of tough
cast-aluminum.



Write-On Markers

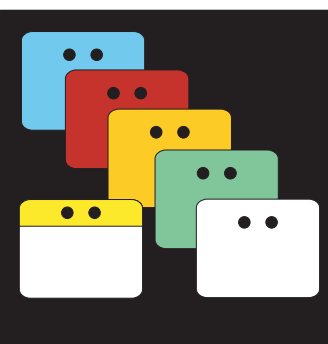

Write-On Markers 2" x 2 1/2" ... 0.030" thick

Great for fast underground marking, these flexible, write-on, polyester markers come in standard 2" x 2 1/2" sizes.

Colors are: White, Blue, Green, Yellow and Blue.

Two, 1/4" holes are standard.

See Page 38
For Nylon Tie Straps

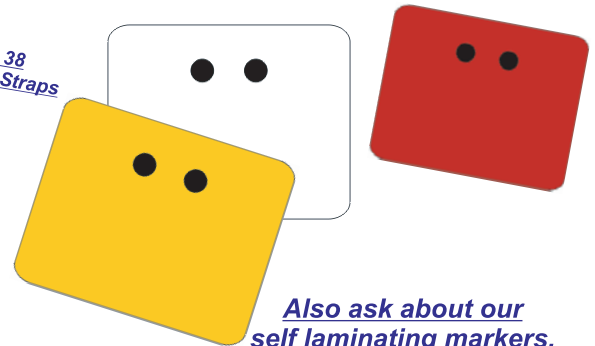

Also ask about our
self laminating markers.

EVERLAST
Indestructible



Signs Tags & Markers

The Only Sign System to be  **UL Tested to 30 years ... NO CHANGE!**



TECH
PRODUCTS, INC.

105 Willow Avenue
Staten Island, NY 10305



Tel: (800) 221-1311
Tel: (718) 442-4900
Fax: (718) 442-2124

ATTENTION MAILROOM:

If the addressee is no longer with your organization, please forward to the Standards Engineer or Purchasing Department. Thank you!

PRST STD
U. S. POSTAGE
PAID
TECH
PRODUCTS