

Digital Print Finishing



From a white paper roll to finished products

Digital printing is much more than a new way of printing on paper. It's an on-demand mindset that disrupts conventional production models. The technology allows efficient short runs, lower labor costs and faster turnarounds. And it changes the way service bureaus, commercial printers, direct mailers and book publishers process paper. Today, print production is a completely flexible process that opens up entirely new, unimagined and exciting possibilities.





Powerful systems for digital paper processing

Hunkeler develops and supplies innovative solutions for continuous feed paper processing throughout the digital print process: Modular, high-performance systems that present the paper to the digital press and then further process the printed paper through to the end product. Completely integrated systems are produced in close partnership with the leading digital press manufacturers. Centrally controlled, these systems guarantee the highest productivity, flexibility and process reliability.

Expert partnership

Success in paper processing applications requires knowledge and experience. We at Hunkeler have been continuously developing and refining this expertise together with our customers since 1922. With best-in-class engineering, machine components and control units, we have successfully mastered increasingly complex system integration.

So that everything runs perfectly

One reason for the reliability and efficiency of our systems is the high level of service support. Around the clock and worldwide. Individual service modules allow Hunkeler to ensure support that is exactly tailored to your wishes. Our service hotline with Hunkeler Remote Assist – plus our spare parts and aftersales service – guarantee the highest equipment availability. With comprehensive service and operating documentation to assure professional attention and the highest possible machine productivity.

Security becomes transparent

With the Hunkeler Control Platform we offer you hardware and software for quality control and document tracking throughout the printing process. Scalable design enables customized, user-specific solutions. Thanks to flawless web inspection and tracking, you will have good answers to these questions and more in the future. It's always better to be on the safe side, with Hunkeler as your trusted partner.



The versatile Dyna-Cut feature of Hunkeler finishing offers fully dynamic sheet length control. It allows cutting and stacking of variable sheet lengths with automatic changes on the fly, increasing the flexibility and profitability by saving unwanted waste.

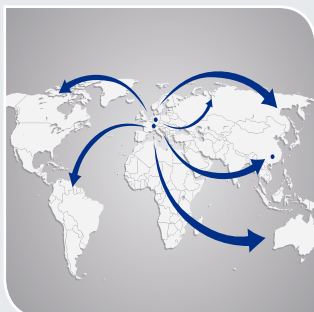

Global distribution network



Worldwide service support



Modular equipment



Security



Transactional

Roll to Roll Solution

The Hunkeler roll to roll solution with different configurations for continuous feed digital presses. High-speed Hunkeler unwinders and rewinders ensure efficient, productive downstream processing in the transactional, direct mail and print-on-demand, coupled with inserters and other finishing systems.

Technical Data* Roll to Roll			
	POPP6 (UW6-RW6)	POPP7 (UW7-RW7)	POPP8-Wide (UW8-W-RW8-W)
Max. roll diameter:	54" (1370 mm)	54" (1370 mm)	54" (1370 mm)
Web width:	6.5" – 20.5"/ 22"	6.5" – 30"	8" – 30"
Production speed:	up to 254 m/min up to 833 ft/min	up to 220 m/min up to 720 ft/min	up to 305 m/min up to 1000 ft/min
Paper weights:	40 – 300** gsm	40 – 300 gsm	40 – 350 gsm
Roll weight max.:	800 Kg (1760 lbs)	800 Kg (1760 lbs)	1500 Kg (3360 lbs)
Options:	**Heavy paper kit: 180 – 300 gsm		
	Decurler Slitter	Web Guide	Decurler, Slitter Web Guide Slitter

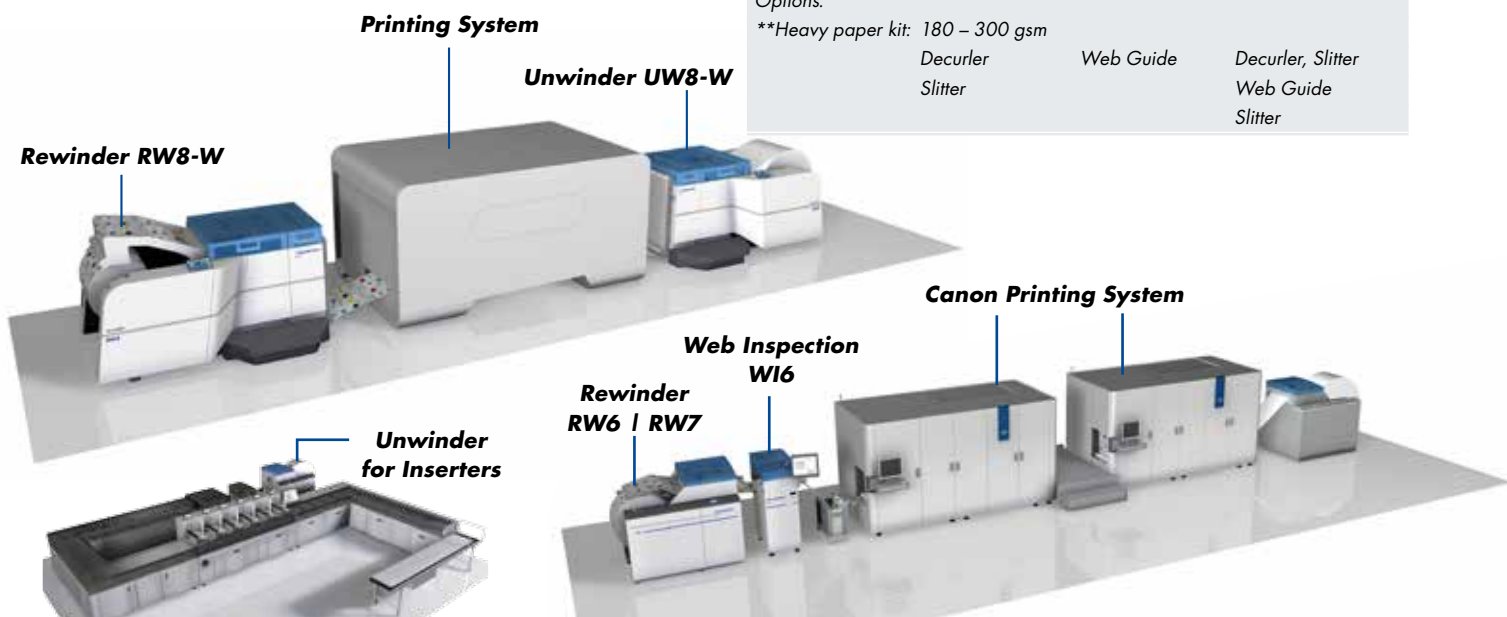

4 Roll production with center cut

Quality control with W16

Loose leaf stacks with CS6, LS6

Hole punching with PP6

Roll to Fan-Fold Solution

The modular Hunkeler roll to fan-fold solution with optional punching and perforating for in-line tractor and file hole punching and fan-fold perforating. This efficient workflow solution can reduce paper and logistic costs in digital print and mail inserting environments.

Reliable, inline high-speed operation with continuous feed printing systems in a space saving package with modular options that include a stack cart system, high capacity stacker, and web inspection.

FS6

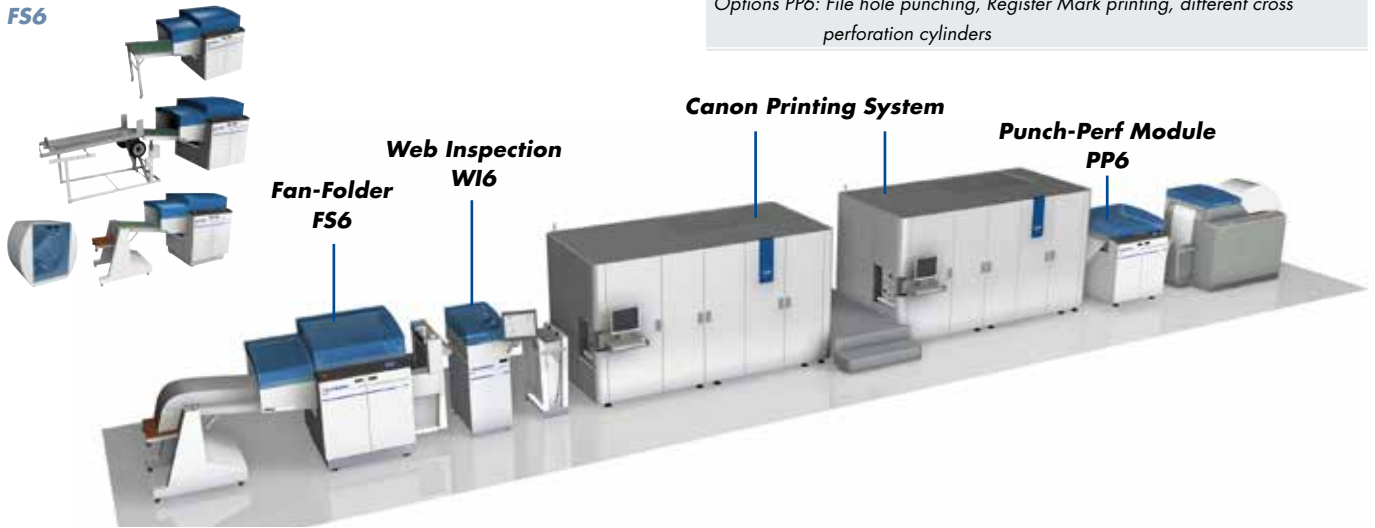

Technical Data* | Roll to Fan-Fold

Max. roll diameter:	54"	1370 mm
Web width:	8" – 20.5"	203 – 520 mm
Production speed:	up to 720 ft/min	up to 220 m/min
Paper weights:	56 – 160 gsm	16 – 40 lb bond
Stack height:	39.4"	1000 mm
Folding perforation:	7" – 14" (static)	178 – 355 mm (static)
Folding height:	7" – 17"	178 – 432 mm

Options FS6: Shingle Belt Delivery, Stack Cart System, High Capacity Stacker, Stack Turning
 Options PP6: File hole punching, Register Mark printing, different cross perforation cylinders

Roll to Stack Solution

Data center solution for 1-up / 2-up output. Roll-to-stack solution with pinless merger module PM6 for merging loose sheets. Following the longitudinal and cross cutting in the CS6 cutter, jobs with odd numbers of sheets are merged using the optional offset-on-the-fly function integrated in the PM6. Stack delivery from the LS6 for non-stop operation at a constant speed. Inline quality assurance with the WI6 Web Inspection System.

Technical Data* | Roll to Stack

Max. roll diameter:	54"	1370 mm
Web width:	16" – 18 1/3"	406 – 465 mm
Cut length:	8 – 14"	203 – 355 mm
Production speed:	up to 420 ft/min	up to 128 m/min
Paper weights:	70 – 120 gsm	18 – 32 lb bond
Stack height:	9 7/8"	250 mm
Variable chip-out:	1/4" – 2 3/4"	6.3 – 70 mm
Format length:	5 1/2" – 19"	140 – 482 mm
Applications:	1-up – 2-up	

Options: Single sheet merger, Transfer station, Cross cut with chip-out, Gutter cut, Large stack delivery 28", Web Inspection, Web Merger

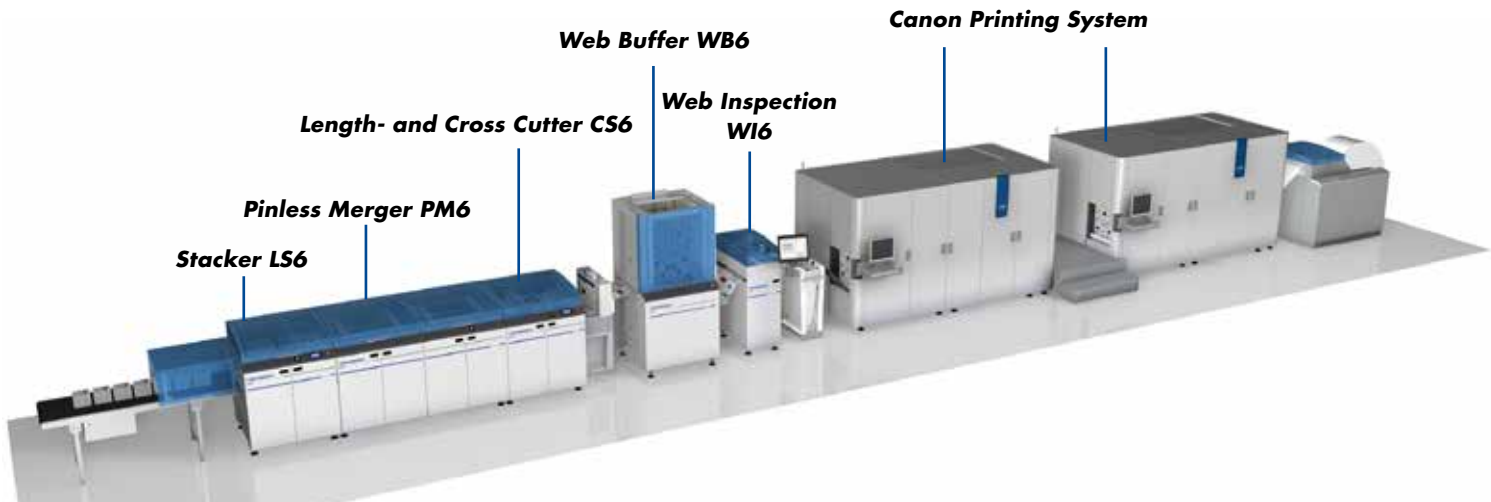

File holes with PP6, DP8



Fan-folded stacks with FS6



Web merging with WM6



Sheet merging with PM6



Transpromotional

Roll to Stack Solution with Dynamic Perforation/Punch and Web Merger

The DP8 dynamic perforation module is the first solution that combines perforation in the vertical and cross directions along with punching – all in one unit. “Dynamic” means the ability to change the punching, perforating or hole pattern from sheet to sheet. It is particularly interesting for transpromotional applications or personalized mailers. Coupons, payment slips and other elements can be integrated into practically any type of document, even those with forms that vary with each sheet.

Technical Data* | Roll to Stack with DP8 – WM6 – LS6-28

Max. roll diameter:	54"	1370 mm
Web width:	13" – 20.5"	330 – 520 mm
Production speed:	up to 420 ft/min	up to 128 m/min
Paper weights:	60 – 120 gsm	16 – 32 lb bond
Stack height:	4" – 10"	100 – 250 mm
Variable chip-out:	1/4" – 1"	6.3 – 25.4 mm
Format length:	5.5" – 28"	140 – 711 mm
File hole punching:	2-, 3-, 4 hole pattern	Ø 5,5 – 8 mm

Options: Stacker LS6, Offset separator SE6, Gutter cut, Transfer Station TS6

Dynamic Perforator/Puncher DP8

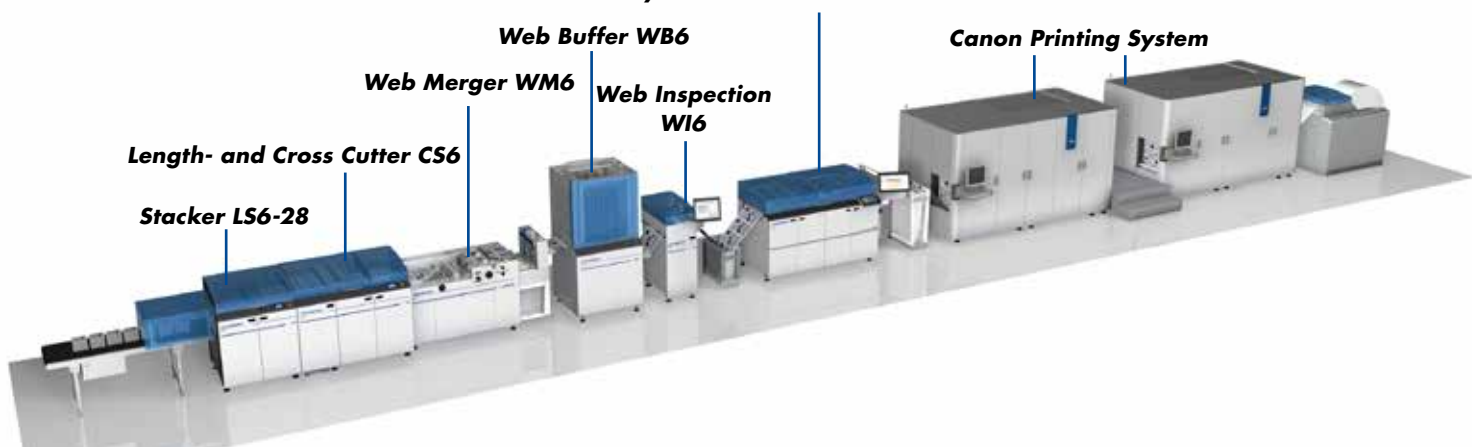

6 Vertical and cross perforations

Full bleed products with CS6-II

Quality control with WI6

Web merging with WM6

Roll to Stack Solution with Dynamic Perforation/Punch

Dynamic perforation and punching combined in a modular concept. In 2-up production individual processing of the two web halves is possible. Combined use of three different is possible in a single module (dynamic perforation in the vertical and cross direction, and dynamic file hole punching).

Technical Data* | Roll to Stack with DP8

Max. roll diameter:	54"	1370 mm
Web width:	6.5" – 20.5"	165 – 520 mm
Production speed:	up to 533 ft/min	up to 160 m/min
Paper weights:	60 – 160 gsm	16 – 40 lb bond
Stack height:	9 7/8"	250 mm
Variable chip-out:	3/16" – 2 3/4"	4.8 – 70 mm
Format length:	5 1/5" – 19"	140 – 482 mm
File hole punching:	2-, 3-, 4 hole pattern	Ø 5,5 – 8 mm

Options: Large sheet delivery LS6-28", Dyna-Cut

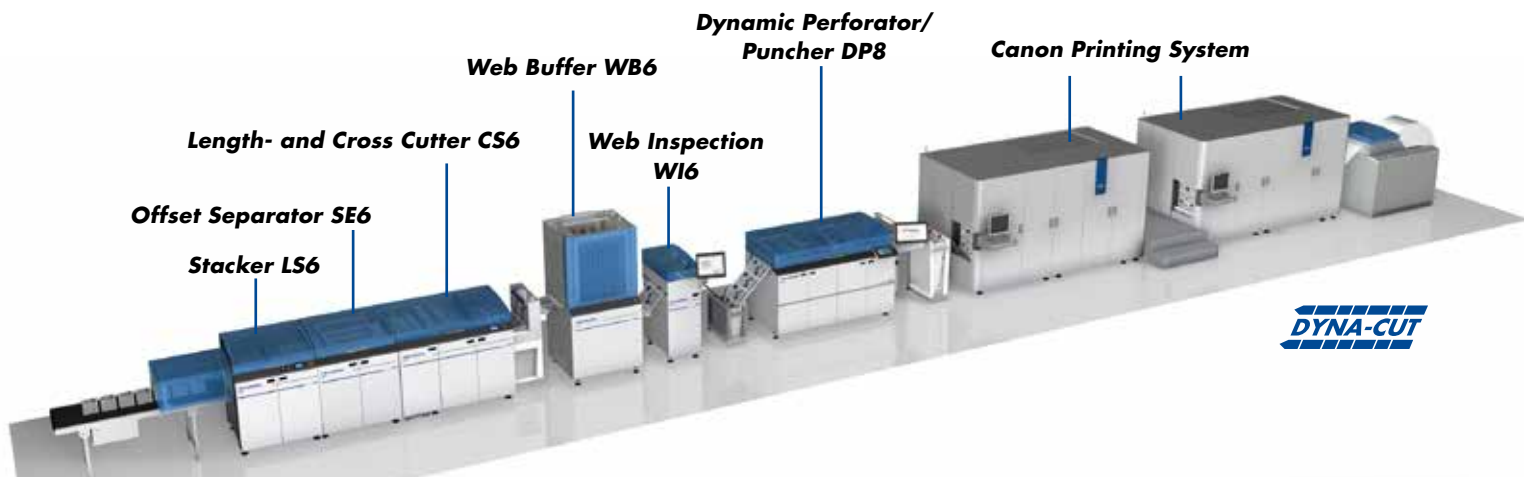

Performance DP8:

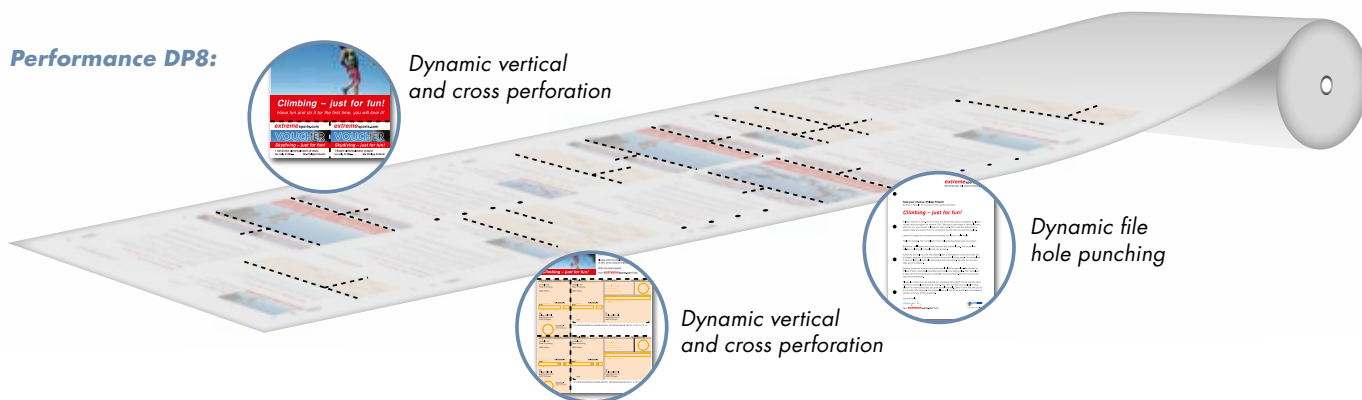

Dynamic Perforation and Punching module DP8 – Five different configuration possibilities

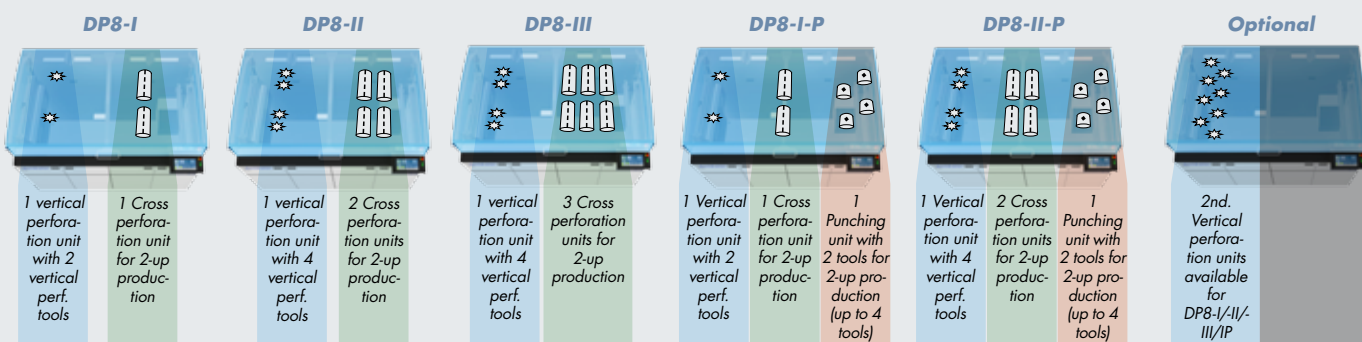

Coupon with safety features



PerfEditor: easy job setup



Perforating and Punching



Efficient 2-up production



Postcards



Selfmailers



Flyers

Direct Mail

Roll to Sheet Solution with Folder/Merger

The modular Hunkeler roll to stack solution for sheeted stack output with continuous feed digital printing systems. Innovative variable chip-out, rotary double cutter for full bleed products in the trans-promotional and direct mail markets. The line can be expanded with combined plow fold and merge functions on the FM6 folder merger to create a versatile high speed mailing system.

Technical Data* | Roll to Sheet with Folder/Merger FM6

Max. roll diameter:	54"	1370 mm
Web width:	13" – 20.5"	330 – 520 mm
Production speed:	up to 533 ft/min	up to 160 m/min
Paper weights:	60 – 120 gsm	16 – 32 lb bond
Variable chip-out:	1/4" – 1"	6.3 – 25.4 mm

Options: Cross cut with chip-out, Gutter cut, Stacker LS6, Tear-off perforation after folding, Dyna-Cut

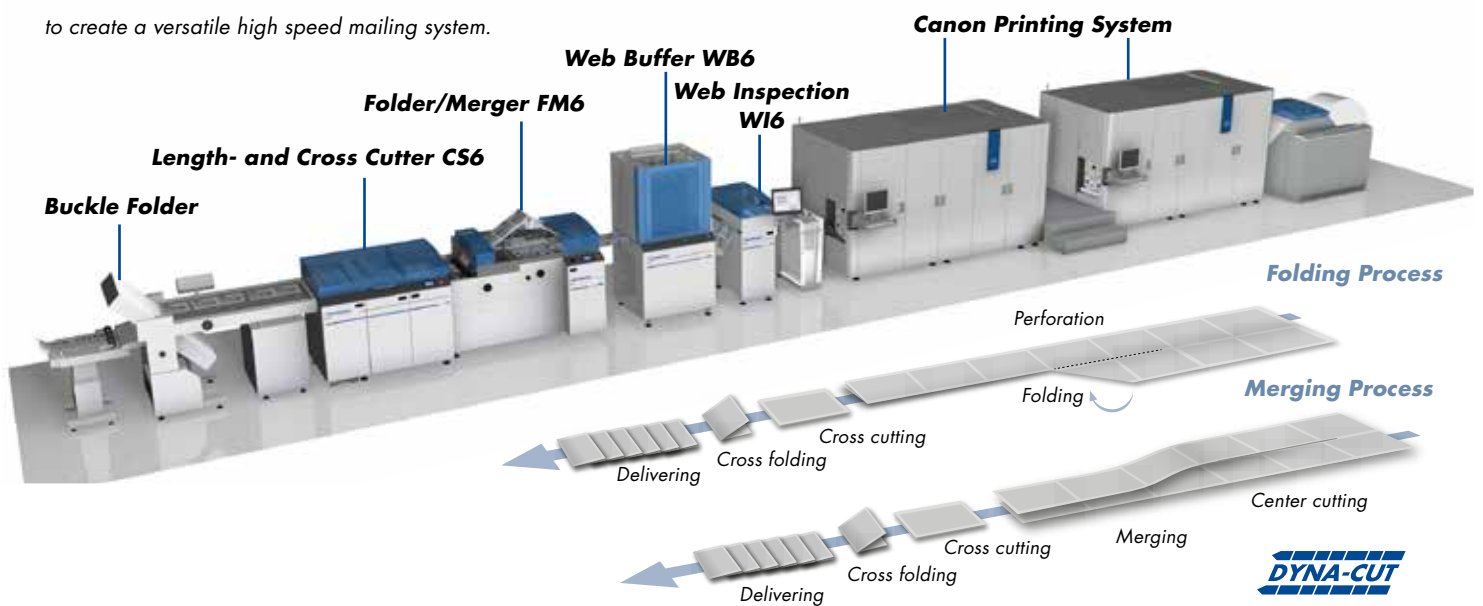

8 Full bleed products with CS6-II



Efficient direct mail production



Cross folded direct mailers



Plow-fold or slit-merge function

Roll to Stack Solution with Coater

The PC7 primer coater module brings new value to printed documents by making sheets more inkjet receptive or adding post-press gloss. This innovative solution is designed for pre-print treatment of the paper application (priming) and varnishing (coating). Depending on the intended use, the PC7 is integrated either before or after the digital printing process. Offline configurations are also possible. In coating applications, the PC7 module can be used for the full-surface coating of the paper web with a water based coating agent following the printing process. The web can be coated on one or both sides (simplex/duplex, depending on the application). Change-over is completed by the operator. The cleaning is done automatically (water).

Technical Data* Roll to Stack with Coater PC7		
Max. roll diameter:	54"	1370 mm
Web width:	8" – 20.5"	203 – 520 mm
Production speed:	up to 500 ft/min	up to 150 m/min
Paper weights:	40 – 300 gsm	27 lb offset/book – 110 lb cover
Applied quantity:	0.5 – 4.5 gsm	
Coating agent:	Water based	
Stack height:	9 7/8"	250 mm
Variable chip-out:	3/16" – 2 3/4"	4.8 – 70 mm
Options: Tank for washing water or direct connection for freshwater supply Tank for drain water or connection for external tank, Dyna-Cut		



Premium quality direct mail production with the latest generation of machines

Producing first-class, four-color printed mailings even on coated paper from the roll to the cut and folded end-product. Dynamic punching, vertical and cross perforation is performed in the DP8-II-P punching and perforation module. The double cross-cutting cylinder in the CS8 cutting module produces full-bleed documents. The cross-cutting cylinder in the CS8 can be equipped either with two knives for variable chip-out, or with one cutting knife and one perforating blade to produce dynamic folding perforations. The integrated W18 Web Inspection System based on the latest high-speed CIS technology for high-end quality and integrity control.

Technical Data* Roll to Sheet, Direct Mail CS8		
Max. roll diameter:	54"	1370 mm
Web width:	6" – 20.5"	150 – 520 mm
Production speed:	up to 600 ft/min	up to 180 m/min
Paper weights:	60 – 160 gsm	16 – 40 lb bond
Final format length:*	5.5" – 62"	140 – 1575 mm
Variable cut-out:	1/4" – 2"	6.3 – 50.8 mm
*with cut out		



300 gsm post cards



Coated products



Vertical and cross perforations



Folded mailing



Photobooks



Hard- and Softcover



Manuals

Books

Loose Leaf Book Block Production with Roll to Stack Line

The modular Hunkeler roll to stack solution for stacked sheet output with continuous feed digital printing systems. Innovative non-stop stacker with rotary single cut sheeter or variable chip-out double cutter for full bleed products. For example, cleanly offset-stacked sheets can be output for further downstream processing, such as perfect binding. Loose sheet offset stacks from 1-up to 4-up production. When connected with the Transfer Station TS6 In-line finishing can be achieved, with up to three output destinations.

Technical Data* | Loose Leaf Book Block Production

Max. roll diameter:	54"	1370 mm
Web width:	6.5" – 20.5"	165 – 520 mm
Production speed:	up to 533 ft/min	up to 160 m/min
Paper weights:	40 – 300 gsm	27 lb offset/book – 110 lb cover
Stack height:	up to 9 7/8"	up to 250 mm
Format length:	5 1/2" – 19"	140 – 482 mm
Variable chip-out:	1/4" – 2 3/4"	6.3 – 70 mm
Applications:	1up – 4up	

Options: Front/Back Verification, Transfer Station TS6, Dyna-Cut, Auto Register

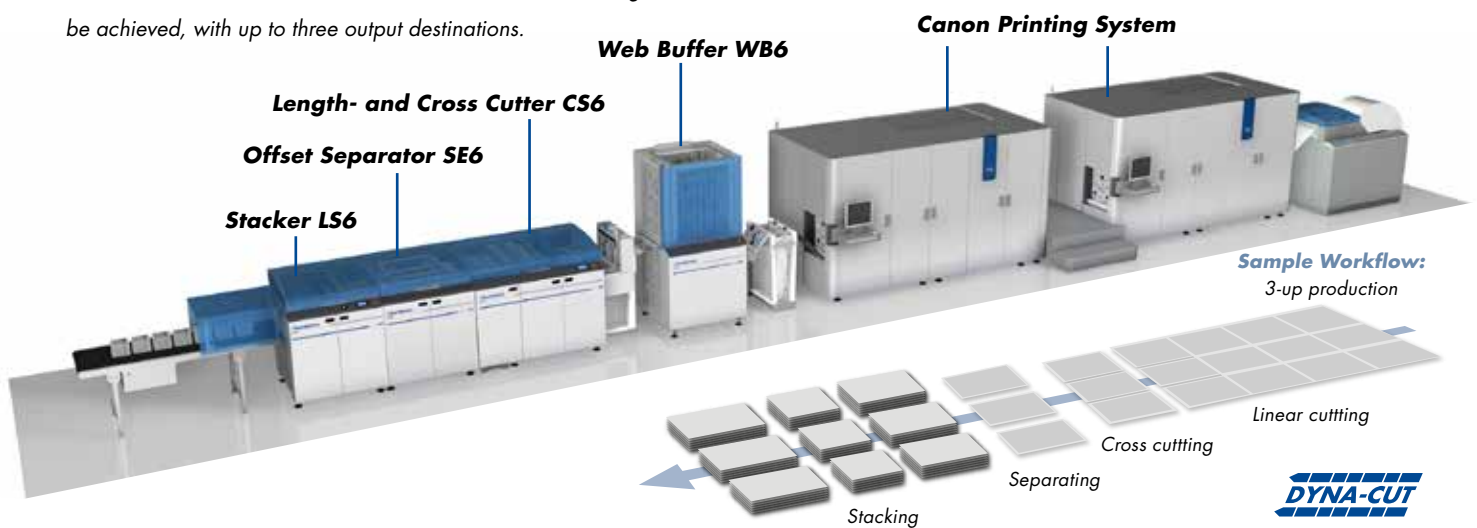

10 Premium photo book



Soft cover book



Hard cover book



Up to 4-up book production

Roll to Sheet – Book Signature Solution

Wide web roll to cut solution with integrated buckle folding systems allows different folding processes for a variety of stacked and folded signatures that are suitable for perfect binding or thread stitching. Large format sheet stacking with the Large Format Sheet Stacker LS7 is also possible, for nearline folding and finishing workflows.

Technical Data* | Roll to Sheet, Book Signature Solution

Max. roll diameter:	54"	1370 mm
Web width:	6.5" – 26"	165 – 660 mm
Production speed:	up to 600 ft/min	up to 180 m/min
Paper weights:	40 – *300 gsm	27 lb offset/book – *110 lb cover
Cut length:	5.5" – 62"	140 – 1575 mm

Options: Large format sheet stacker LS7, Dyna-Cut
*(or max. folder capacity)

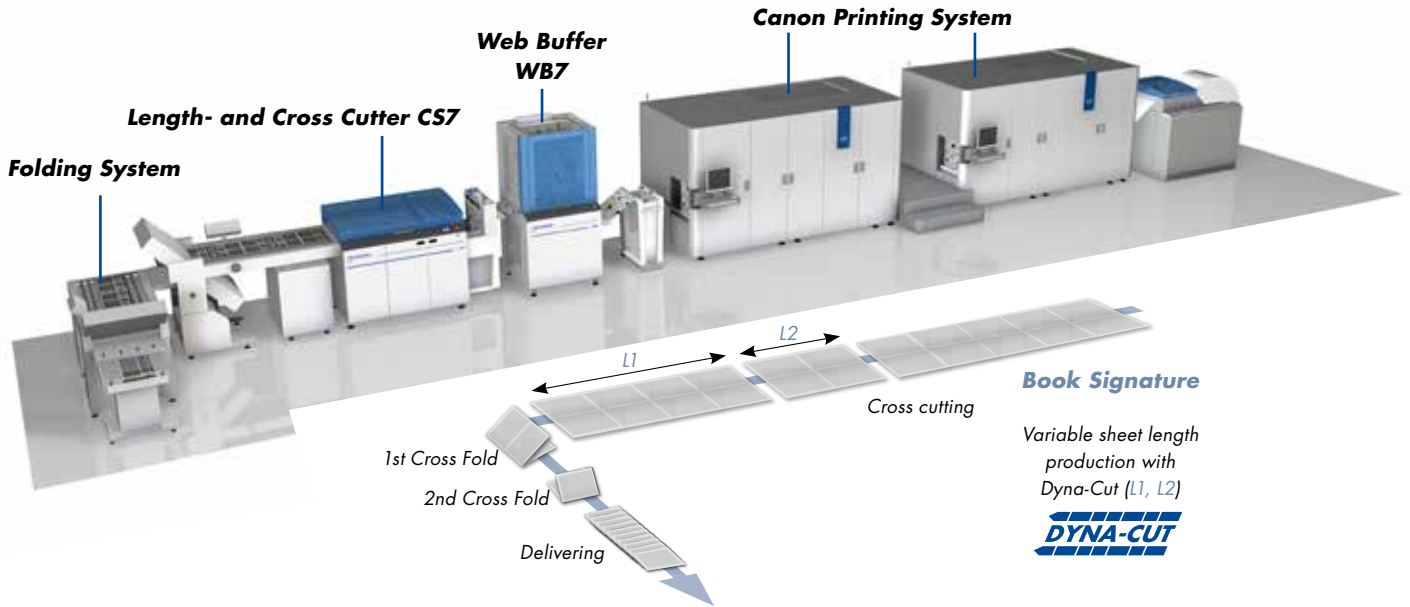

Flyfolder Book Solution

Sheets are folded into signatures by the Flyfolder. Automatic change-over between 4-page and 6-page signatures is achieved on-the-fly, avoiding any interruption in the printing process. The excellent stack quality allows for efficient finishing, especially when connected inline with a perfect binder. All signatures can be offset on-the-fly while running through the Flyfolder module (option).

The **fully automated format change-over** is done on the fly, without manual intervention or interruption of the production process.

- Length perforation (single or double)
- Book blocks can be glued for easier handling
- Folding pattern (4 or 6 pages)
- Sheet length (7" to 14")
- Offset book stacking

Technical Data* | Flyfolder Book Solution

Max. roll diameter:	54"	1370 mm
Web width:	17" – 19.5"	432 – 495 mm
Production speed:	up to 420 ft/min	up to 128 m/min
Paper weights:	60 – 120 gsm	40 – 80 lb offset/book
Cut length:	7" – 14"	178 – 356 mm
Performance:	up to 450 stacks per hour	

Options: Front/Back Verification, Book block gluing

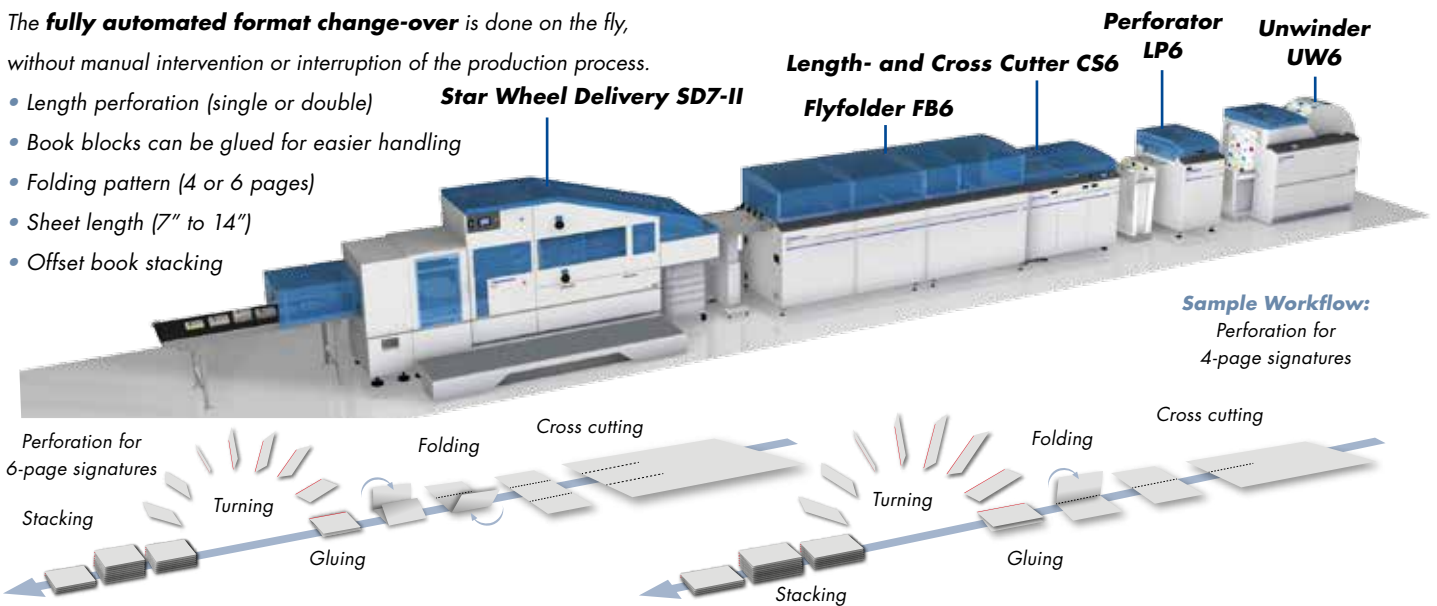

Sample Workflow:
Perforation for
4-page signatures



Folded/stacked book signatures



Thread sewn book binding



Fully automatic format changes



Optional inline perfect binding



Catalogues



Magazines



Booklets

Books

Book Block Solution with SD7-I

The modular book solution for the production of glued book blocks inline or off-line for continuous digital printing systems up to a paper web width of 30". Processing of 4, 6 or 8-page signatures with quick setups and format changes. In one stacking cycle, several book blocks are delivered. The system is characterized by modularity and flexibility coupled with simple and safe handling for further processing thanks to integrated book block gluing and perfectly flat book stacking.

Technical Data* | Book Solution with PF7 and SD7-I

Max. roll diameter:	54"	1370 mm
Web width:	up to 30"	up to 762 mm
Production speed:	up to 420 ft/min	up to 128 m/min
Paper weights:	60 – 150 gsm	40 – 100 lb offset/book
Folds:	1 to 2 plow folds (2 to 4 layers)**	
Format length:	6 – 13"	150 – 330 mm
Book block thickness:	up to 2"	up to 50.8 mm
Stack height:	max. 4 3/4	max. 120 mm
**Folding types:	Parallel fold, roll fold, double parallel fold	

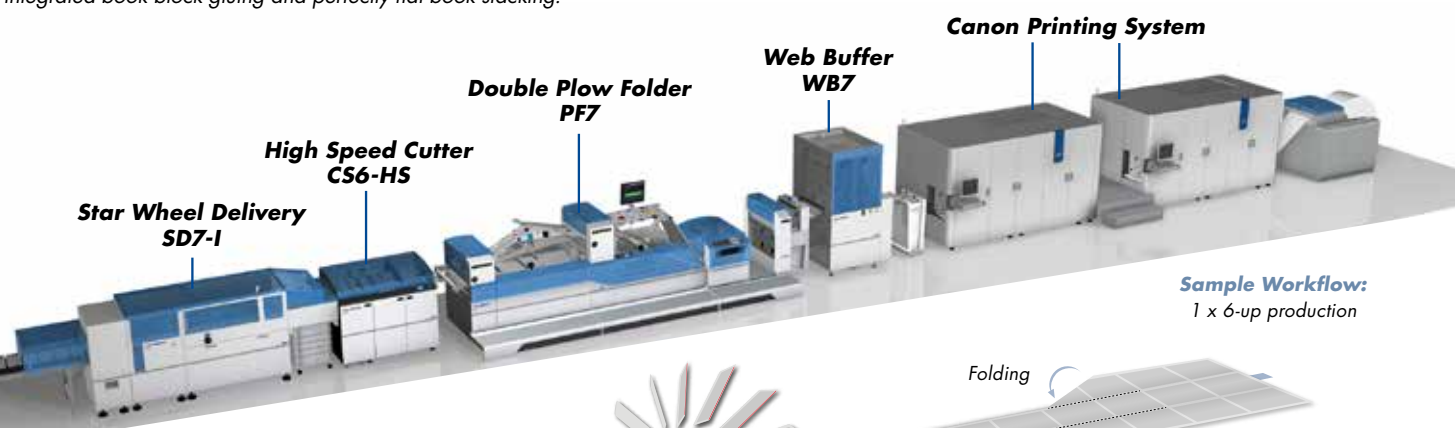

Sample Workflow:
1 x 6-up production



12 Loose-leaf bookstack with LS6



Soft cover book



Front / Back print verification



Thread-sewn book binding

High-performance Book Block Solution with Star Wheel Delivery

The modular book solution for the production of glued book blocks inline or off-line for continuous digital printing systems up to a paper web width of 30". Processing of 4, 6 or 8-page signatures with quick setups and format changes. The high-performance cross cutter CS6-HS and the new double star-wheel delivery SD7-II guarantee non-stop production at 200 m/min (656 fpm) with over 450 output cycles per hour. In one stacking cycle, several book blocks are delivered. The system is characterized by modularity and flexibility coupled with simple and safe handling for further processing thanks to integrated book block gluing and perfectly flat book stacking. The book-on-demand line can be used as a flexible near-line solution or as an in-line system and is designed for the low to medium volume segment.

Technical Data* | Book Block Solution with SD7-II

Max. roll diameter:	54"	1370 mm
Web width:	up to 30"	up to 762 mm
Production speed:	up to 656 ft/min	up to 200 m/min
Paper weights:	60 – 150 gsm	40 – 100 lb offset/book
Folds:	1 to 2 plow folds (2 to 4 layers)	
Format length:	7 – 14"	178 – 355 mm
Book block thickness:	up to 2"	up to 50.8 mm
Stack height:	up to 4 3/4"	up to 120 mm
Productivity:	up to 450 delivery cycles per hour:	
- for format 6x9":	4140 book blocks with 96 pages	
- for format DIN A5:	4500 book blocks with 96 pages	
- for format DIN A4:	2420 book blocks with 96 pages	



Options: Dyna-Cut

Inline Solution with Perfect Binder / Trimmer:

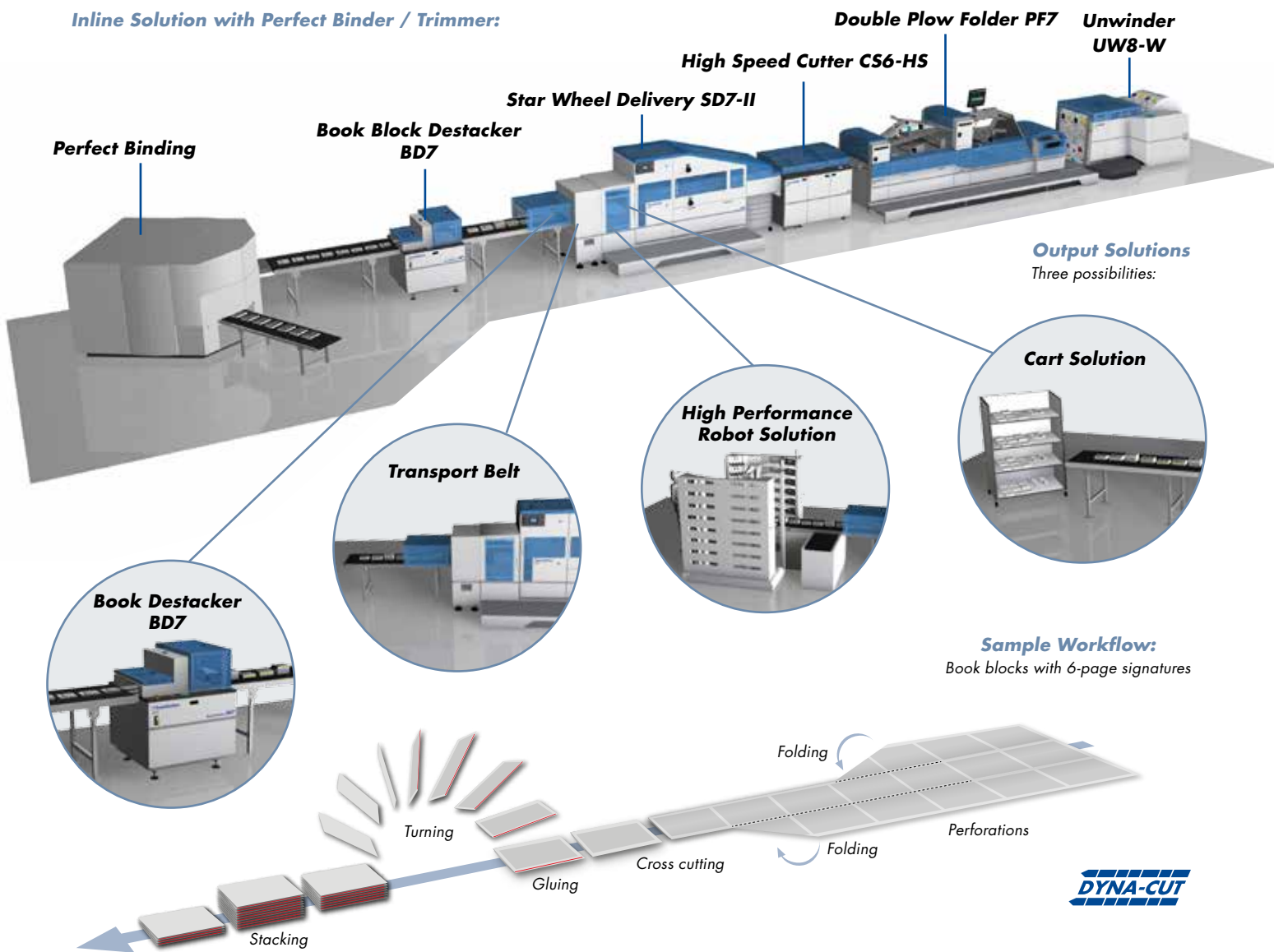

Output Solutions
Three possibilities:

Cart Solution



High Performance Robot Solution



Transport Belt



Book Destacker BD7

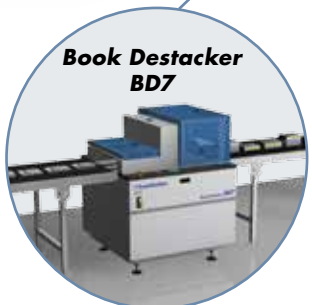

Sample Workflow:

Book blocks with 6-page signatures

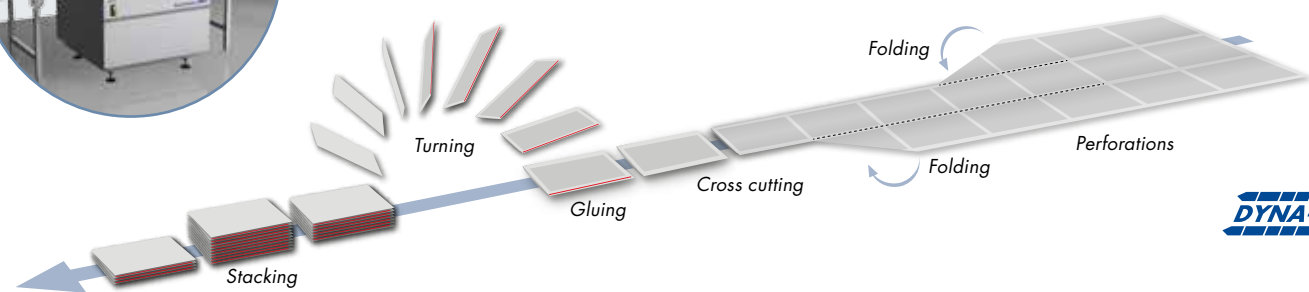

Pre-glued book blocks with SD7



Budget Binding



High performance robot system



Stack separator / Destacker



Books





Books on Demand, variable format sizes

The Hunkeler book block solution is distinguished by high flexibility, fast and easy changeover, and excellent book block quality. Books are produced on demand in variable format sizes, thanks to fully automatic longitudinal format changeover, a high-performance trimming module and a unique star wheel delivery system.

The PF7 double plow folder processes paper webs up to 30 inches web width into 4-, 6- or 8-page signatures.

Ready for integration into a JDF/JMF workflow. The glued book blocks assure simple, secure handling for post-processing. An on-board tracking system monitors for document integrity. Book blocks will be perfect bound nearline, with a barcode checking system to insure proper book block to cover matching.

The system will also support two alternative finishing processes. The PF7 will also glue "budget bound" brochures and books, a low-cost approach for short shelf-life products.

Signature folding types:	Number of pages	Signature width	Max. paper weight	Stack
Parallel fold 	4	5 – 11"	150 gsm	1-up
Roll fold 	6	5 – 10"	100 gsm	1-up
Double parallel fold 	8	5 – 7.5"	80 gsm	1-up
Gate fold 	2 x 4	5 – 7.5"	150 gsm	2-up
Loose leaf 	4	5 – 17.5"	100 gsm	1-up



14 Pre-glued book blocks with SD7

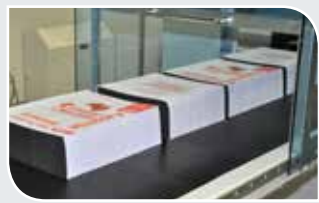

Dynamic book length



Dynamic book thickness

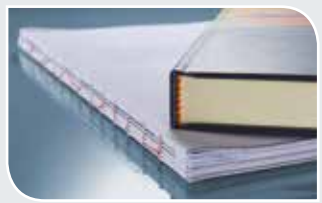

Thread-sewn book binding

Parallel fold
4-page signatures

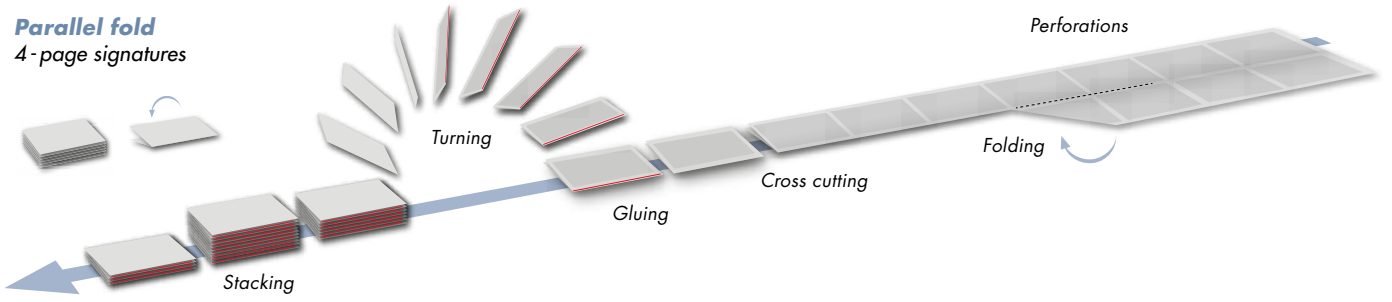

Roll fold
6-page signatures

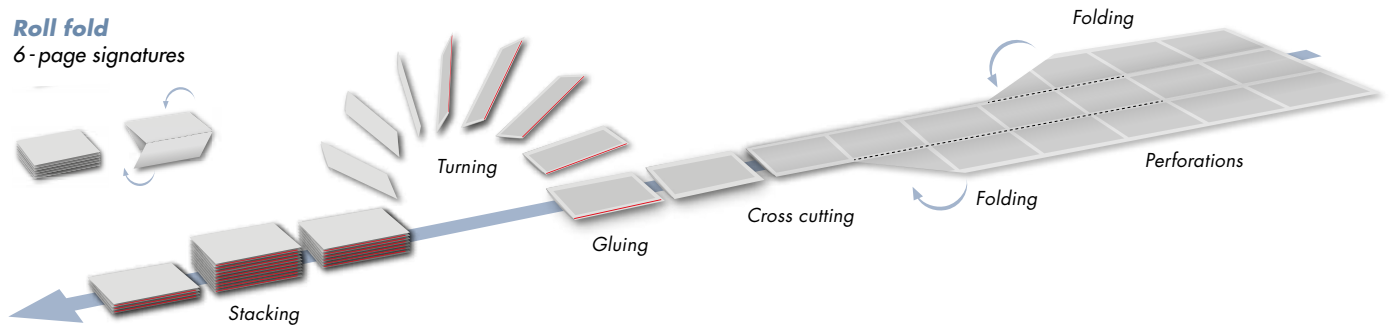

Double parallel fold
8-page signatures

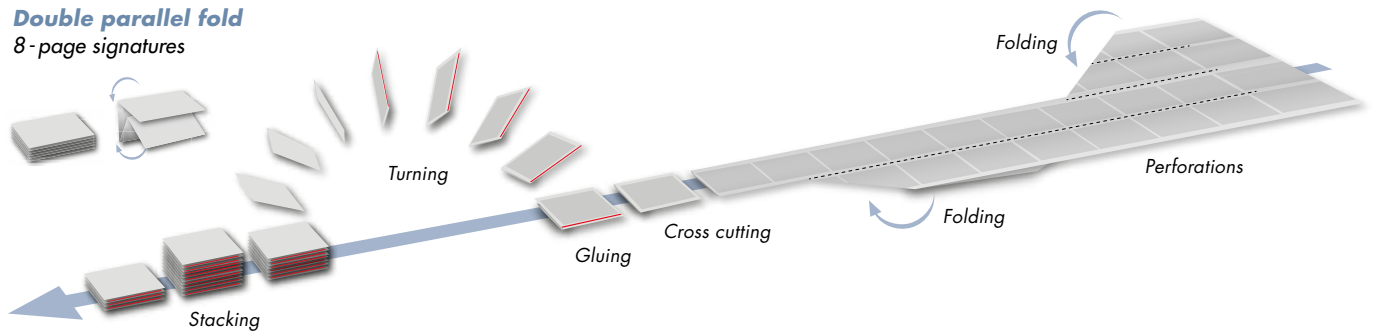

Gate fold
2 x 4-page signatures

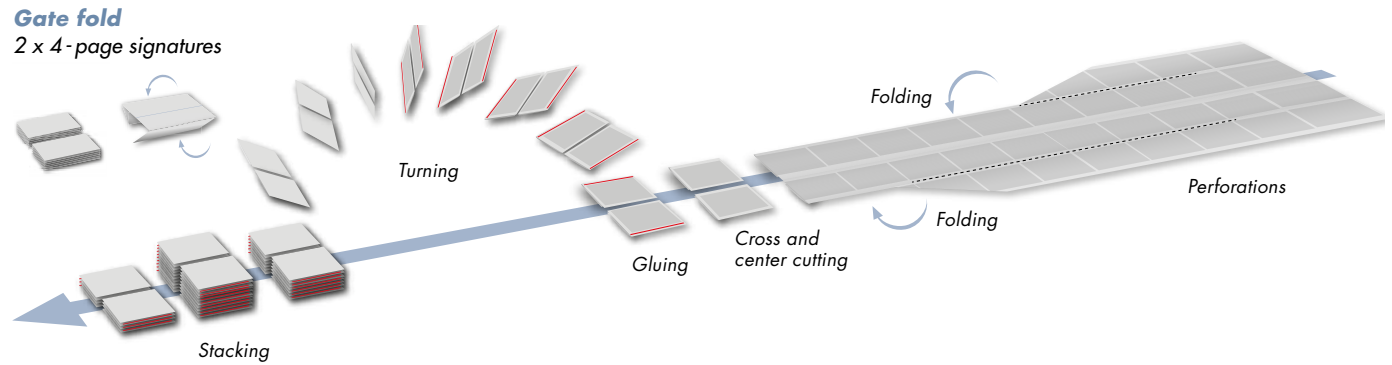

Loose Leaf
Loose sheet stacks for thread sewing or stitching

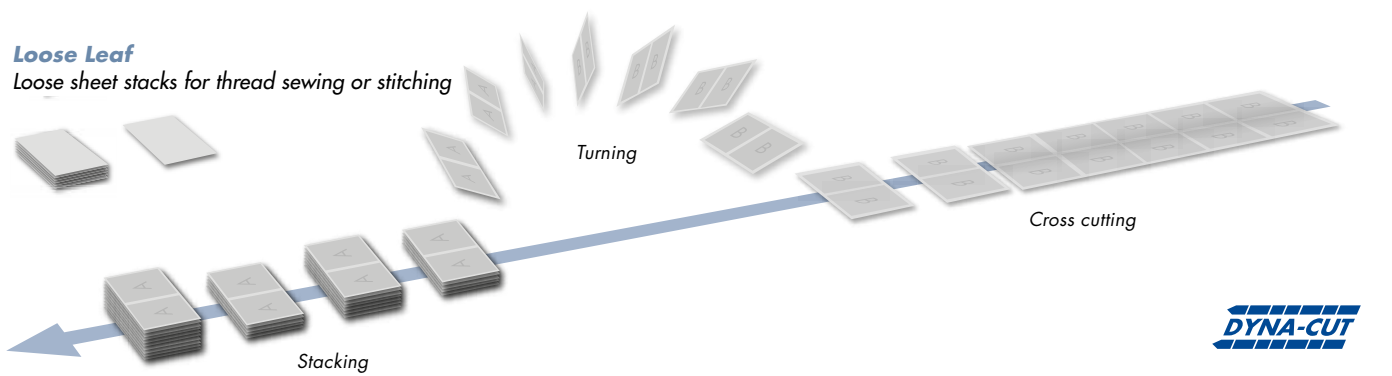

Perfect-bound books without milling



Budget Binding

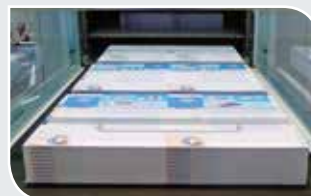

Loose leaf book stacks



Front / Back print verification



Booklet / Manuals



Examination brochures



Voucher booklets

Brochures

High Performance Booklet Production

Full-color personalized brochures with a variable number of pages. The solution for high speed production of examination brochures, leaflets, manuals, direct mailers, and other saddle-stitched products from a roll. Optionally the line can be equipped with the dynamic and vertical perforator DP8, and cover and sheet inserting. Process includes the paper web feeding from the Unwinder UW6, cross cutting in the CS6-I and gathering, folding, stitching and trimming in a saddle-stitching system.

Technical Data* UW6 - CS6 Booklet Production Line		
Max. roll diameter:	54"	1370 mm
Web width:	11" - 19.6"	279.4 - 500 mm
Cut length:	8.3 - 13.7"	210 - 350 mm
Production speed:	up to 600 ft/min	up to 180 m/min
Paper weights:	52 - 210 gsm	35 - 120 lb offset/book
Productivity:	up to 6000 booklets per hour, format A4, 24 pages	
Options: Cover and Sheet inserting unit, Dynamic vertical and cross perforator DP8, Dyna-Cut		

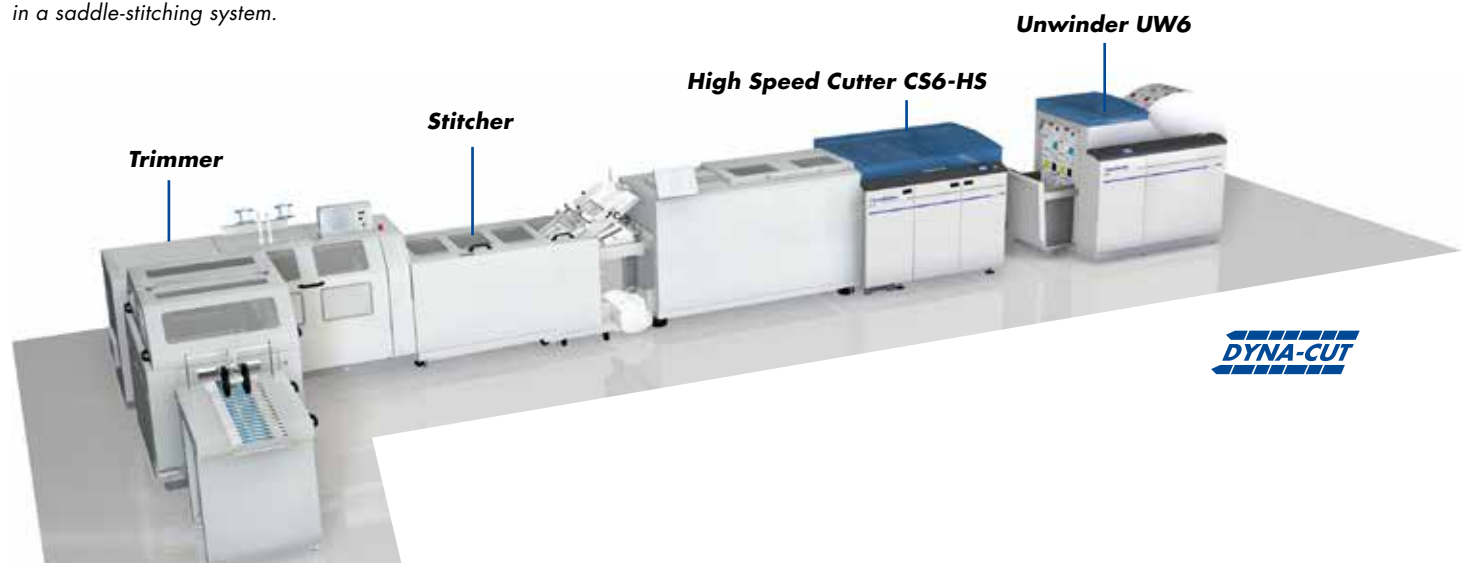

16 Stitched brochures



Dynamic glued brochures



Brochure with integrated vouchers



Inline saddle stitching / trimming

Booklets and Books Combi-Solution

With this combined solution it becomes possible to produce saddle-stitched as well as perfect bound books end products.

The centerpieces of this digital production line are the CS6 Cross Cutter and the TS6 Transfer Station. The paper web is cut into single sheets by Hunkeler's precision rotary cutting system. The TS6 Transfer Station allows quick and easy diverting of the output to the inline saddle-stitching system or nearline book block stacks directed to a perfect binder.

Technical Data* | Combi-Solution

Max. roll diameter:	54"	1370 mm
Web width:	8" – 20.5"	203 – 520 mm
Production speed:	up to 533 ft/min	up to 160 m/min
Paper weights:	52 – 210 gsm	35 – 120 lb offset/book
Stack height:	9 7/8"	250 mm

Options: Cross cut with chip-out, Dynamic vertical and cross perforator DP8, Dyna-Cut

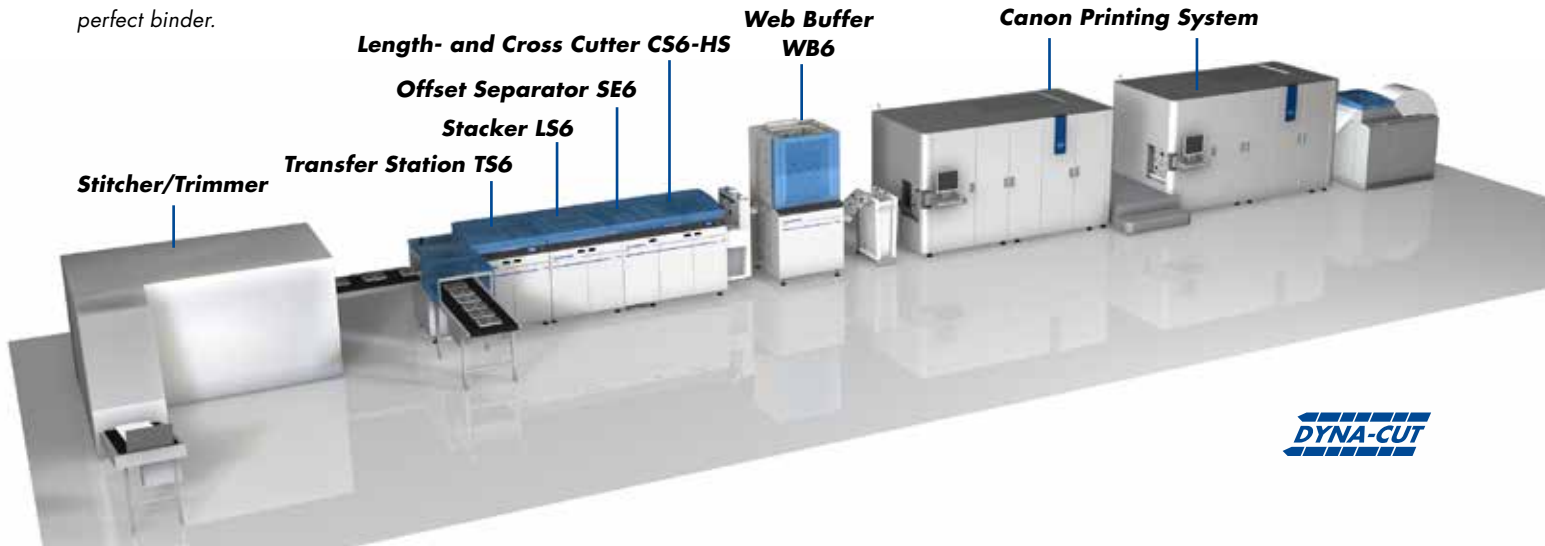

Glued Booklet Solution

The modular Hunkeler brochure solution for the production of variable on demand booklets offline or inline with continuous feed digital printing systems. Dynamic glue application in the Drum Collator DC7 enables flexible production options such as spine gluing of jobs printed in magazine and tabloid newspaper format, or producing products with several spine-glued and nested sections.

Technical Data* | Glued Booklet Solution CS6-DC7-FC7

Max. roll diameter:	54"	1370 mm
Web width:	11" – 20.5"	279 – 520 mm
Production speed:	up to 500 ft/min	up to 150 m/min
Paper weights:	40 – 90 gsm	30 – 63 lb offset/book
Cut length:	up to 32 1/4"	up to 820 mm
Number of pages:	4 – 40 Pages	
Productivity sample:	3500 ex/h, 24 pages cut length 13", 2-in 500 ft/min	

Options: Cross cut with chip-out, knife folder, Dyna-Cut

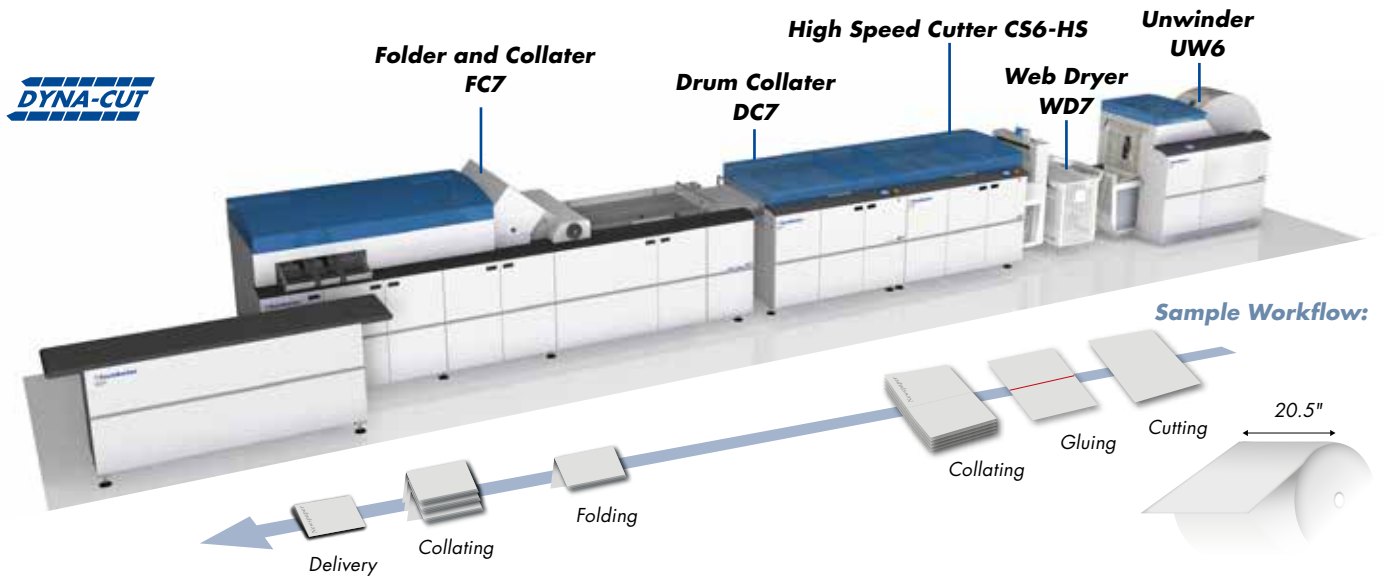

Additional books with Combi



Book signature production with DC7



Additional Newspaper production



Front / Back print verification



Tabloid



Broadsheet



Inserts

Newspaper

Newspaper Production

New production line for newspaper on demand in broadsheet and tabloid format. Production of broadsheet newspapers with multiple topic-specific sections in variable number of pages and tabloid newspapers up to 140 pages in 4 page steps. Available as an offline configuration or inline with digital printing systems.

Fully automatic change-over from broadsheet to tabloid newspapers and automatic variable cutoff length for different newspapers. That allows the production of mixed newspaper stacks based on distribution routes including stack address labeling.

The combination of flexibility and high automation allows the production of the smallest production batches of different newspapers ready to ship in the shortest time possible. No extensive mailroom is needed because the number of produced newspapers per hour can be handled and optionally bundled/packaged by the same line operator.

Beside newspapers, the system is also capable to produce spine glued inserts, newspaper supplements or booklets and with that utilize the production capacity optimally in off-peak hours.

Two different patent workflow processes for different products:

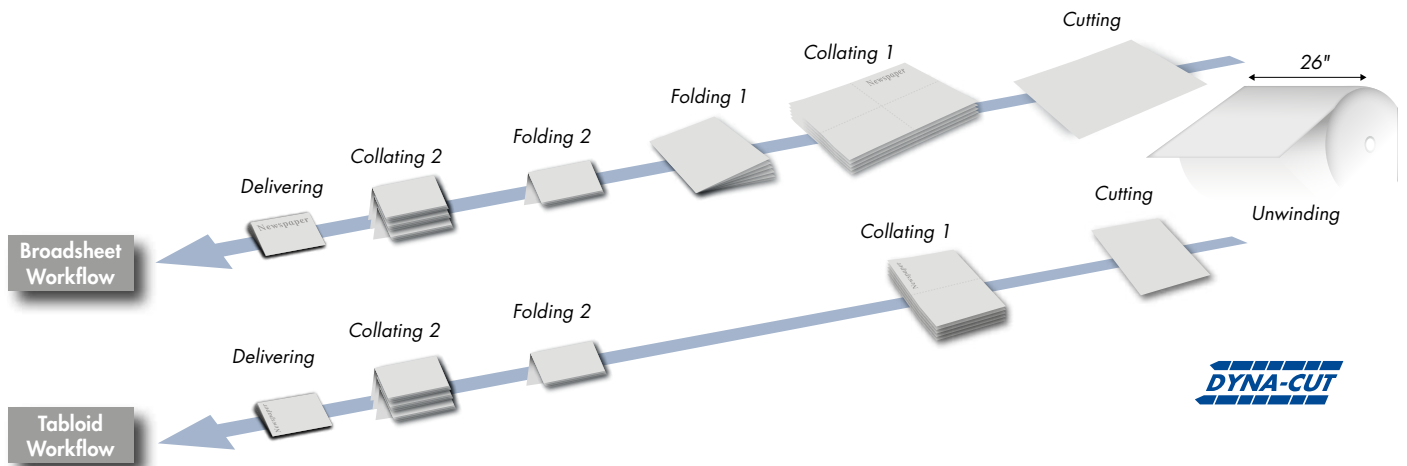

18 Tabloid or Broadsheet format



Knife folding (optional)



Production of individual editions



Electrostatic set fixing

Broadsheet and Tabloid Newspaper Solution

Newspaper line for broadsheet and tabloid products. Configuration for quickly shifting from broadsheet to tabloid, with the appropriate folding processes. Dynamic glue application in the Drum Collator enables versatile production options such as spine gluing of tabloid newspapers and job printing in magazine format or producing tabloid products with several spine-glued and nested sections.

Main features:

- Fully automatic changeover from Broadsheet to Tabloid
- Newspapers up to 140 pages
- Full variable number of pages
- Collating of sections

Technical Data* Newspaper Solution FC7		
Web width:	11" – 26"	279 – 660 mm
Format length:	up to 32.25"	up to 820 mm
Paper weight:	40 – 90 gsm	30 – 63 lb offset/book
Speed:*	up to 500 ft/min	150 m/min
Size of newspaper:		
- Tabloid:	8 – 140 pages	
- Broadsheet:	8 – 40 pages per section / max. 140 pages	
- Glued Brochures:**	4 – 40 pages (glued in DC7)	
Options:	Gluing system in DC7, Dyna-Cut	
*Depending on paper and application **Without trimming		

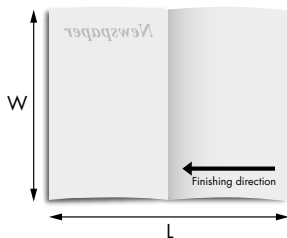
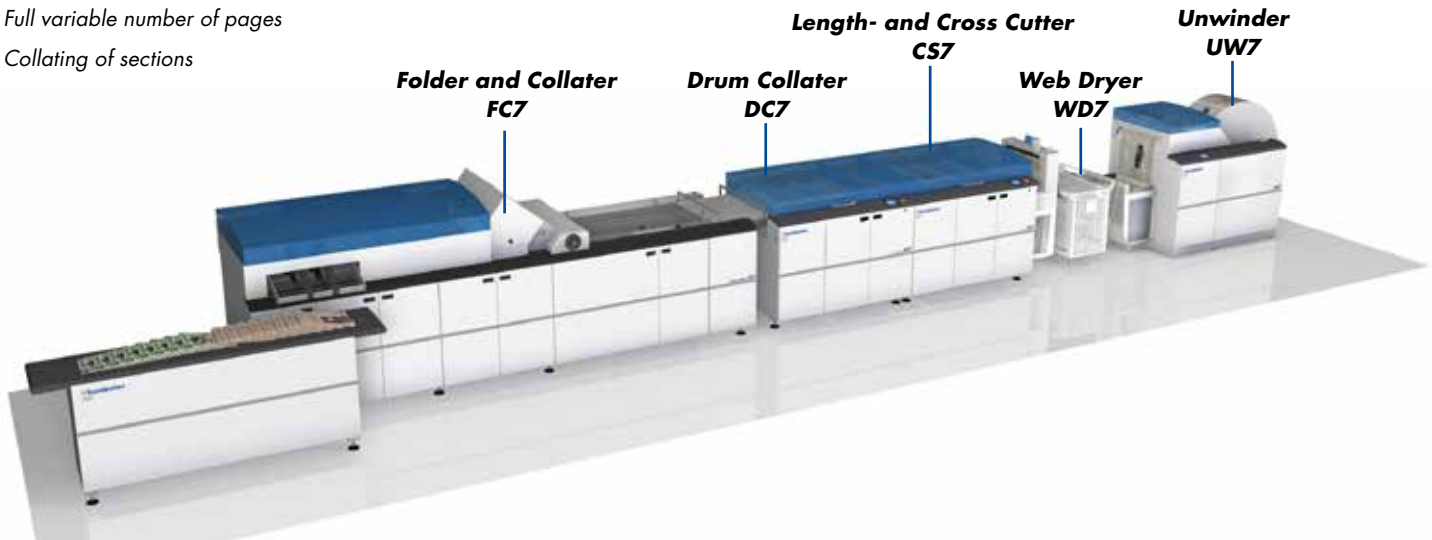

Broadsheet

width W 279 – 660 mm
length L 279 – 820 mm

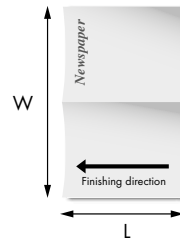

Tabloid

width W 279 – 660 mm
length L 279 – 405 mm (2-in)
279 – 450 mm (1-in)

Processing features

- Fully automatic change between broadsheet and tabloid, i.e. between different format length within the same web width
- Production of tabloid newspapers with 8 to 140 pages
- Broadsheet with variable number of sections and pages
- Gluing system for the production of inserts and brochures

Function/advantages

- Shortest set up time/high productivity
- Variable production of titles with different contents
- Ideal distribution volume/production according to the distribution tour
- Extended production and differentiation possibilities

Productivity example 24 pages 150 m/min

- 1800 copies/h Broadsheet (format length 24.8"/630mm)
- 3500 copies/h Tabloid (format length 13"/330mm, 2-in)



Glued tabloid sections



Book signature production



Dynamic glued brochures



Front / Back print verification



Vouchers



Government security



Cheques

Security print finishing

Roll to Stack Solution with Dynamic Perforation/Punch

Roll-to-stack processing including the unit for dynamic file hole punching. Individual hole and perforation patterns and shape punching as a security element in different end products. Full-color personalized direct mailers with integrated vouchers and coupons with a variable number of pages. Inline process with paper web feeding from the UW6, dynamic vertical and cross perforation in the dynamic perforation module DP8, full-bleed cutting in the CS6-II and stacking. Process control with product tracking and quality assurance.

Technical Data* | Roll to Stack with dynamic Punch/Perf

Max. roll diameter:	54"	1370 mm
Web width:	6.5" – 20.5"	165 – 520 mm
Production speed:	up to 533 ft/min	up to 160 m/min
Paper weights:	60 – 160 gsm	16 – 40 lb bond
Stack height:	9 7/8"	250 mm
Variable chip-out:	3/16" – 2 3/4"	4.8 – 70 mm
Format length:	7" – 19"	140 – 482 mm
File hole punching:	2-, 3-, 4 hole pattern	Ø 5.5 – 8 mm
Shape punching:	5.5 x 5.5 – 8 x 10 mm	
Options:	Large sheet delivery LS6-28"	

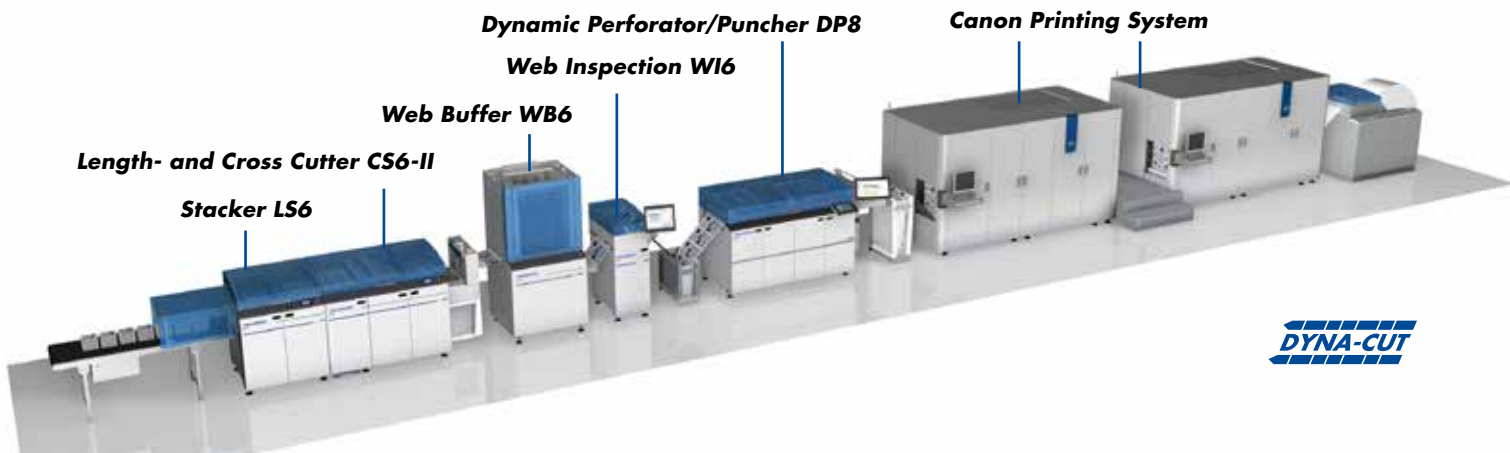

20 Coupons with shape punching



Checks with safety features



Ticket with numbers



Ticket with safety features

Security Features with Laser HL6

The HL6 laser module is certain to have a bright future in the production of checks, coupons and mail products. Patented laser technology allows the dynamic punching, cutting and engraving of customized forms, allowing simple to complex security features and an infinite variety of customized perforation patterns. The LaserEditor controller interprets native vector data and enables the simple entry of punching patterns. The laser module works at the unmatched speed of up to 150 meters per minute (500 fpm), in 1-up or 2-up mode and can be integrated into Hunkeler configurations.

Technical Data* Roll to Stack with Laser HL6		
Max. roll diameter:	54"	1370 mm
Web width:	6.5" – 20.5"	160 – 520 mm
Production speed:	up to 500 ft/min	up to 150 m/min
Paper weights:	40 – 200 gsm	27 – 120 lb offset/book
Laser type:	CO2 Laser, Class 1	
Stack height:	9 7/8"	250 mm
Variable chip-out:	3/16" – 2 3/4"	4.8 – 70 mm
Applications:	1up – 2up	
Options: Chip-out with CS6-II, second laser head HL6-II, Offset Separator SE6		

Performance HL6:

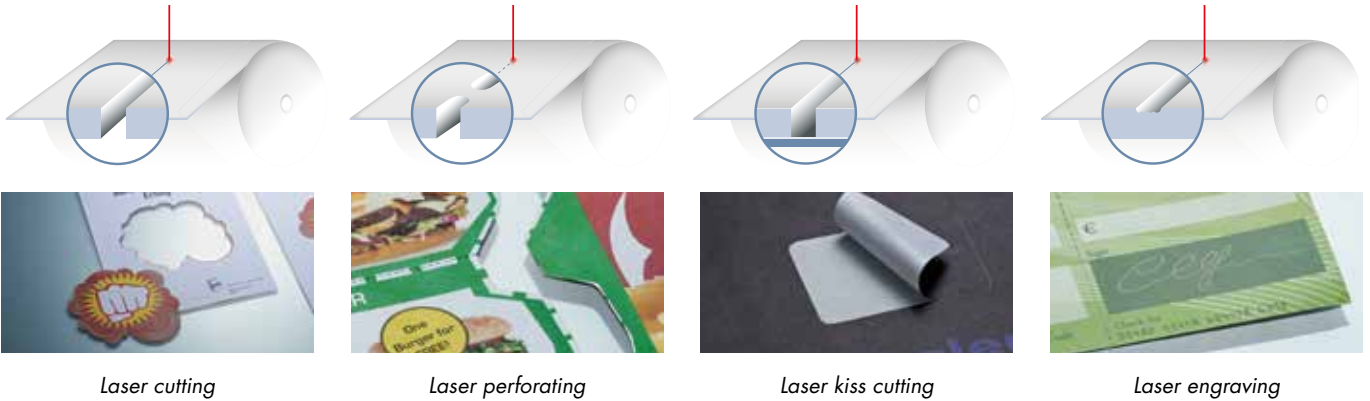

Laser cutting

Laser perforating

Laser kiss cutting

Laser engraving



Laser Head 303 – 300W

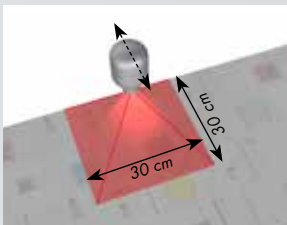

HL6-I (1 x 300W Laser)
Moveable laser head for free positioning over full paper web width

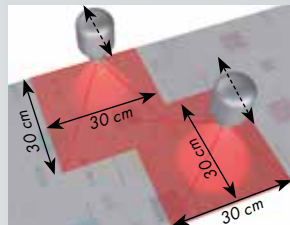

HL6-II (2 x 300W Laser)
Two moveable laser heads for free positioning over full paper web width

Laser Head 777 – 750W

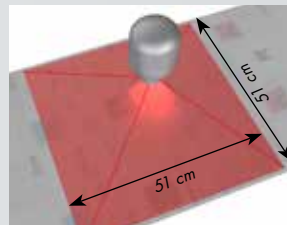

HL6-I (1 x 750W Laser)
Laser beam processing of full paper web width

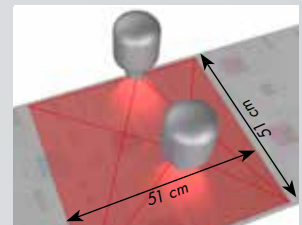

HL6-II (2 x 750W Laser)
Dual laser beam processing of full paper web width



Creative security labels



Plastified member cards



Labels



Security inspection systems



Web Inspection System

A web inspection system checks the quality and content of the printed pages in terms of colors, positions, contours, smearing, jet-outs, etc. State-of-the-art digital camera technology scans the entire width of the paper web, creates high-resolution images of the printed image and compares these with the 'golden sample' to carry out many different kinds of quality and content checks. The system ensures consistently high print quality for a diverse range of applications.

Printing and content errors are identified at an early stage to trigger immediate action, reducing both downtime and paper waste.

Web Inspection

Data package Software: Barcode reading and grading

Tests and validates the readability of fifteen Barcode symbologies.

Data matching

Reads and compares data from multiple locations to ensure a match. Capabilities include matching data anywhere within a form, including comparing data from the front-side to data on the back side.

Postal code verification

Verifies the integrity of the address Postal Barcode, supports several Postal Barcode.

Data validation

Read data and validate that it is accurate, by means of the provided matching functions.

OCR verification

Provides human readable code interpretation by OCR supported by Neural Networks interpretation, evaluates the quality of the code providing a scoring of the field against a reference dictionary.

MICR verification

Provides MICR code line interpretation for both E13B and CMC7 standards, evaluates the quality of the code line by analyzing dimensions, shapes and distortions.

Red-Point Bank
Victoria Street | 8000-Zurich | Switzerland | 062 745 6161

Peter Lehmann
31, Mountain Road
6000 Lucerne
Switzerland

Account No. 48065745
Statement: 1 Mar-31 Oct
Page No. 1 of 3
Credit Limit € 2000.00
Balance € 4428.80

Date	Description	Debits	Credits	Balance
01 Mar	Freddie's Bike Store	224.30		€ 4204.50
04 Mar	Pazza Pizza	27.20		3795.50
21 Mar	Super Petrol Station	62.25		3733.25
30 Mar	Payment receipt, ABC Corp.		743.55	4476.80
04 Apr	My Fotobook.com	66.30		4410.50
19 Apr	Super Petrol Station	59.90		4350.60
20 Apr	King Hotel Berlin	302.10		4048.50
25 Apr	Swiss Airline LX1212/1214	823.10		3225.40
29 Apr	Town Garage Lucerne	542.15		2683.25
04 May	Online Payment Received		1243.00	3926.25
17 May	Flower Power Corp.	33.70		3892.55
29 May	Swiss Driving Range	242.25		3650.30
01 Jun	Old Town Fitness Studio	120.00		3530.30
11 Jun	Pazza Pizza	35.75		3494.55
18 Jun	Freddie's Bike Store	1245.90		2248.65
27 Jun	Payment receipt, ABC Corp.		823.30	3071.95
30 Jun	Diving School Lucerne	199.90		2872.05

0123456789

Continued on next page

Voucher Show your card
Tony's Pizzeria
Safe € 5.00 !

Voucher Show your card
Online Flowers
Safe € 15.00 !

Voucher Show your card
Bike Shop
Safe € 100.00 !



22 W16 stand-alone solution



Different web width solutions



Integrated solution



Easy operation



Monitoring of smearing, forms, logos



Jet-outs

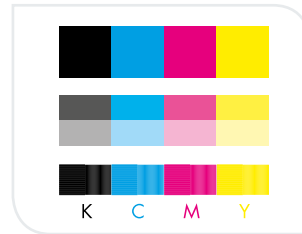

Full color monitoring

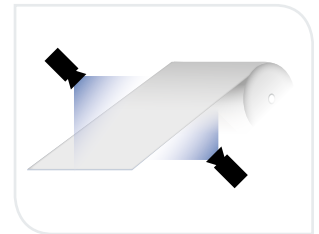

front/back verification

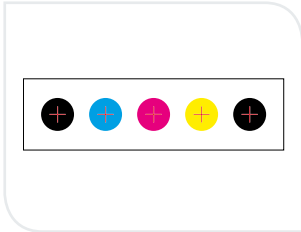

Alignment / position control (Color Registration)

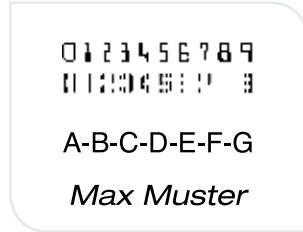

Decoding, allocation and check of information



Decoding of a diverse range of codes



Graphic package Software:

Dimensions and position measurement

Verifies proper alignment and size of a graphical object against the page reference point.

Image / Logo match

Verify that a stored image appears as required on a page, verifying and grading its shape and colors compared to the provided master.

Color measurement

Match printed output colors to a color pattern sample by means of Delta-E relative color deviation measurement following L*a*b CIE 1997 standard for typographic environment.

Density scale control

Verifies toner/ink densities to confirm their compliance with respect to a provided reference, and/or across the web to validate the consistency of color densities throughout the entire printable area.

Jet-out detection

Ensures printed lines and color blocks do not contain unwanted white space. The system checks the uniformity of the ink density on each color plane on a specifically optimized pattern.

Print registration

Verifies the alignment of the different color planes by measuring an optimized pattern, and detecting the position error in both vertical and horizontal directions.

Streak, spots and smearing detection

Look within an identified expected uniform zone (typically non-printed or in a solid homogeneous color) for streaks, spots and smearing.

Red-Point Bank
Victoria Street | 8000-Zurich | Switzerland | 062 745 6161

Account No.	Date	Description	Debit	Credits	Balance
48065745	02 Jul	Shoe Megastore	99.50		2772.55
Statement: 1 Mar-31 Oct	06 Jul	Rudy's Accessories	112.75		2659.80
Page No. 2 of 3	18 Jul	Super Petrol Station	70.05		2589.75
	22 Jul	Payment receipt, ABC Corp.		810.30	3400.05
	31 Jul	Palace Gift Shop Zurich	22.20		3377.85
	11 Aug	Super Petrol Station	65.25		3312.60
	17 Aug	Pazza Pizza	57.10		3255.50
	23 Aug	Electric Installation Inc.	1021.40		2234.10
	02 Sep	Science Museum	60.15		2173.95
	09 Sep	Online Payment Received		1440.00	3613.25
	24 Sep	Flower Power Corp.	30.10		3583.85
	30 Sep	Pazza Pizza	45.30		3538.55
	01 Oct	Online Ticket Shop	189.90		3348.65
	15 Oct	Victoria Place Jewellery	399.75		2948.90
	30 Oct	Payment receipt, ABC Corp.		799.90	3748.80
		Total Debits	6158.25		
		Total Credits		5860.05	
		Balance			3748.80

Safe € 10.00 !

Safe € 12.00 !

Free full ticket for 2 Person !



Reporting



Immediate intervention



Line scan bar



Tracking option



Tracking Solution

The tracking system monitors ongoing production in terms of completeness and accuracy. The consistency of ongoing production is constantly compared with the target data and missing pages or duplicates are identified. Defective products can be automatically fed out of the production workflow and missing documents reprinted, thereby facilitating fully automatic operation and rendering manual controls superfluous. Standardized interfaces enable communication with superordinate systems (host computer) to take place and support monitoring across multiple lines and even multiple production sites.

Control & Tracking Solutions

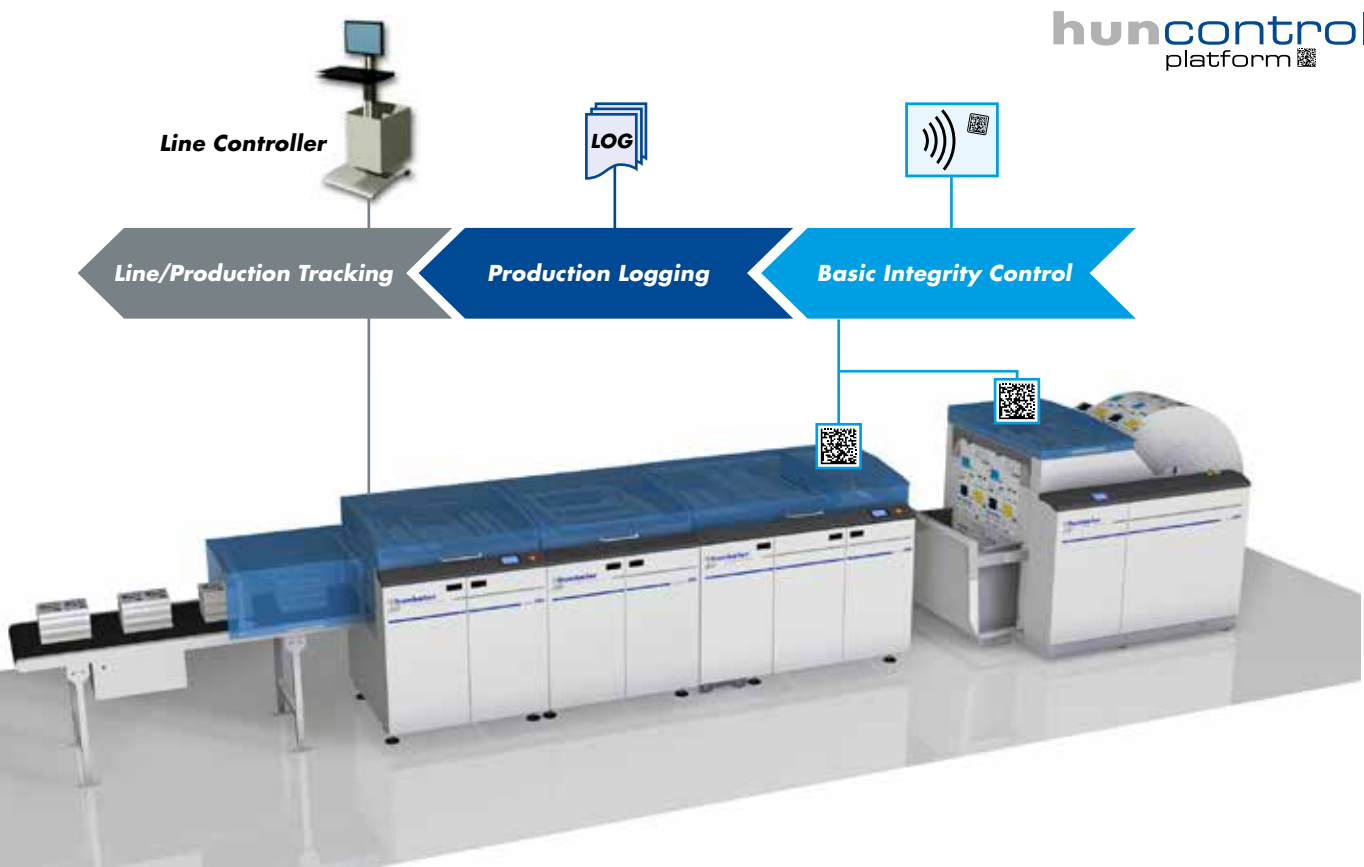

24 Check for missing pages, documents and jobs



Check for correct sequence (front-back verification)



Check for duplicates / incorrect pages, documents, jobs

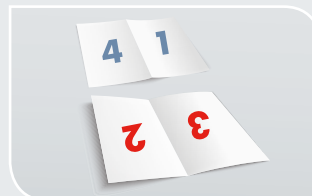

Check for correct print direction

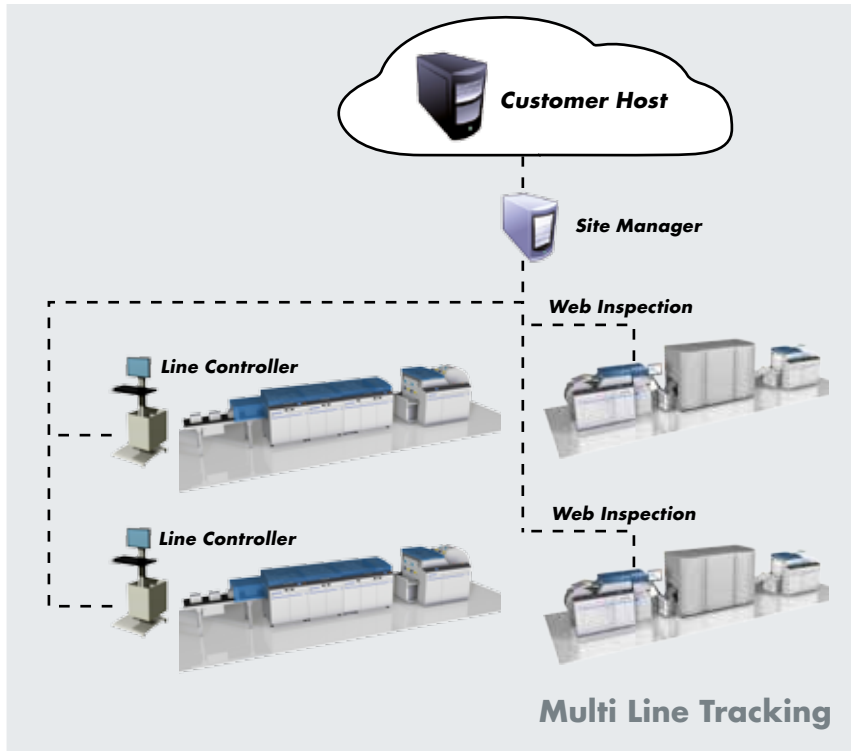
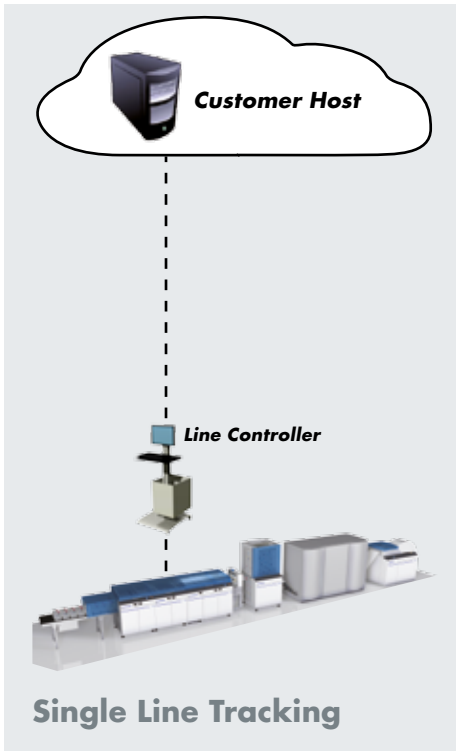

Tracking

Production Logging

Basic Integrity Control

Site Manager, tracking server with full tracking scope

Options: Stop the line, stack separation, dynamic rejects

- Duplicates detection
- Missing documents detection
- Full production tracking
- Production reporting
- Reprints generation

Production Logging

Basic Integrity Control

- Simple logging of results from Basic Integrity Control
- Share logging with external system (File based)

Basic Integrity Control

Options: Stop the line, stack separation, dynamic rejects

- Page sequence control within the document
- Document sequence control within the job
- Document completeness control
- Front to back matching
- 1-up and/or optional 2-up production handling

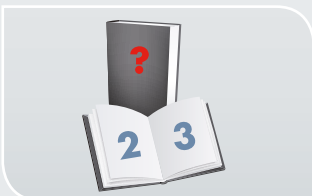

Check for correct enclosures, covers etc.



Production Logging



Document error reject



Flawless end products ready for shipment



Special-Solutions

Coating Solution

The PC7 primer coater module undoubtedly gives inkjet technology a new and interesting alternative to established printing processes. This innovative solution is designed for priming and protective coating. Depending on the intended use, the PC7 is integrated either before or after the digital printing process. Offline configurations are also possible.

In top-coating applications, the PC7 module can be used for the full-surface coating of the paper web with a water based coating agent following the printing process. The web can be top-coated on one or both sides (simplex/duplex, depending on the application). Change-over is completed by the operator. The cleaning is done automatically (water).

Technical Data* Roll to Roll with Coater PC7			
	POPP6 (UW6-RW6)	POPP7 (UW7-RW7)	POPP8-Wide (UW8-RW8)
Max. roll diameter:	54" (1370 mm)	54" (1370 mm)	54" (1370 mm)
Web width:	8" – 20.5"	8" – 30"	8" – 30"
Production speed:	up to 150 m/min	up to 150 m/min	up to 150 m/min
Paper weights:	40 – 180** gsm	40 – 300 gsm	40 – 300 gsm
Roll weight max.:	800 Kg	800 Kg	1500 Kg
Applied quantity:	0.5 – 4.5 gsm	0.5 – 4.5 gsm	0.5 – 4.5 gsm
Coating agent:	Water based		
Options:			
**Heavy paper kit:	40 – 300 gsm		
	Decurler Slitter	Web Guide	Decurler, Slitter Web Guide

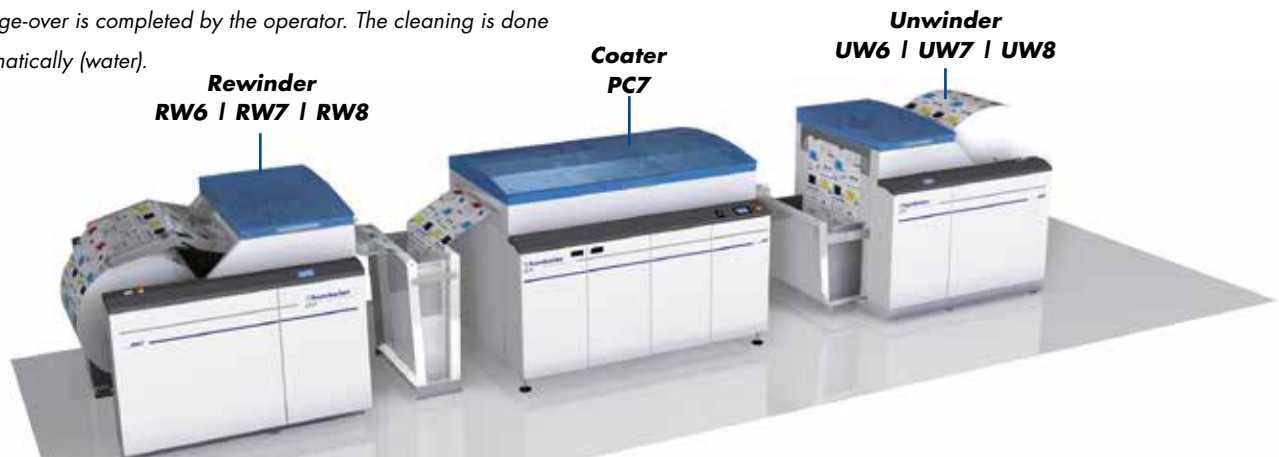

26 Patented 3-rollers coating-unit



Coating for finished products



Different applications/effects



Primer: Use of untreated offset paper



Bingo Solution

Specialty solution for customized bingo card booklets collated and glued together in the Hunkeler drum collator. A great example of the power of digital printing with individual coupons and advertisements.

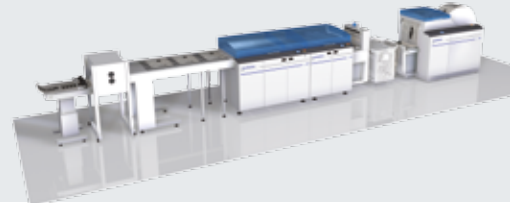

Dyna-Cut

The versatile Dyna-Cut feature of Hunkeler finishing offers fully dynamic sheet length control. It allows cutting and stacking of variable sheet lengths with automatic changes on the fly, increasing the flexibility and profitability by saving unwanted waste.

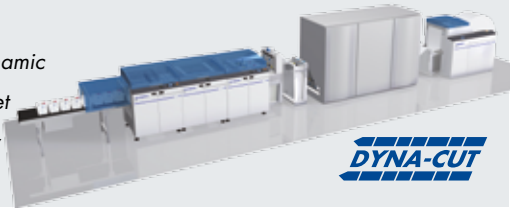

Banding Solution

Integration of economical banding solutions to hold cut sheet stacks or folded products together for further finishing or logistics reasons. A great example of Hunkeler engineering.

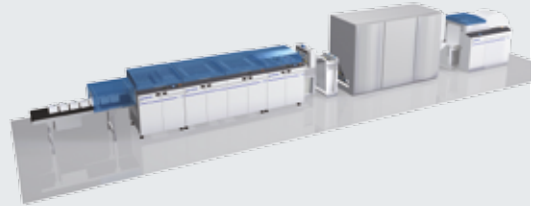

Long sheet delivery with jogger table

Jogger tables offer a very cost-effective entry level solution for the occasional yet reliable production of large format sheets.



Large format solution with UW7-CS7-LS7

Large format solution with UW7-CS7-LS7 mid-size format high pile stacking solution, roll to cut-sheet from DIN A3 all the way to DIN A1 sheets for finishing in conventional cut sheet workflows.



Pharma application: UW6-CS6-Folder

Roll to folded leaflet production lines with Hunkeler unwinder and cross cutter combine ease of use and reliable lightweight paper processing at high speeds. Almost any type of folder can be integrated into the line.



HKU Waste evacuation systems

Different Hunkeler waste evacuation solutions by Hunkeler Systeme AG. Portfolio for varying applications and waste volumes all equipped with dust filter and low noise emissions.



Remote Assist

A "remote connection" allows the external Hunkeler support person safe access to the line. Remote Assist enables faster error analysis, troubleshooting, data backup or production support to maximize availability.



Reaching the summit together



Digital: developed to meet specific needs: *Solutions from Hunkeler for pre- and post-digital printing are available for almost any imaginable application. Publishing applications for small to medium runs, computer centers, transactional and transpromo, security printing or creative direct mailing: we have high quality solutions for all of these applications. A small sample of the larger range of our potential end products are shown in this brochure.*

**All solutions and technical data subject to change. Performance depends on running configuration, application, and substrates (paper).*

Technical data will change with different running configurations like bypassing a module, different non Hunkeler post-finishing solutions, etc.



Excellence in Paper Processing

Hunkeler AG
Bahnhofstrasse 31
CH-4806 Wikon

Phone: +41-62 745 61 61
Fax: +41-62 745 62 76
info@hunkeler.ch

Hunkeler Deutschland GmbH
Bergstrasse 15
D-82024 Taufkirchen

Phone: +49-89 614 1590
Fax: +49-89 612 8400
info@hunkeler.de

Hunkeler Far East Ltd.
Room 1001, East Town Bldg.41,
Lockhart Road
Wanchai, Hong Kong
Phone: +852-2528 4082
Fax: +852-2866 2401
info@hunkeler.hk