

TapeTech[®]
PROFESSIONAL DRYWALL FINISHING TOOLS

BETTER. FASTER. EVERY TIME.



THE GOLD STANDARD

NEW EASYROLL[®] WHEELS

For Finishing Outside Corners. Standard on all TapeTech finishing boxes*, now you can finish outside corners up to two times faster than hand finishing. The wheels and blade are perfectly aligned, eliminating the need to tilt the finishing box like you must with after-market products. And the shoulder on the EasyRoll wheels is more than three times wider than after-market products, making it easier to run the finishing box down metal, paper-faced, vinyl or bullnose outside corner bead.

See More [p17](#) [p18](#) [p20](#)

NEW SP

QUICKBOX[™] QSX



The first finishing box designed specifically for use with fast-setting joint compounds. The perfect tool for contractors who embed their paper, fiber or fiberglass joint tape with chemical-set joint compounds.

See More [p22](#)

EXTRA LONG PUMP & GOOSENECK



Designed in conjunction with a major joint compound manufacturer to fit 30 gallon barrels perfectly, providing the extra length and stability you need. It is also very popular for workers who don't like to bend over when filling tools with a standard loading pump.

See More [p29](#)

*Available on all boxes manufactured after 05/15/2016.

PRODUCT OTLIGHT

CLEANING TOOLS



Clean tools perform better and last longer. Designed and manufactured to the perfect specifications for Automatic Taping & Finishing tools, TapeTech cleaning brushes make it easier than ever.

See More [p32](#)

COMPOUND TUBE FILLER ADAPTER



The Filler Adapter creates an alternative to filling finishing boxes when combined with any size Compound Tube.

See More [p31](#)

TOOL CADDY



The perfect accessory for workers who fill their finishing boxes with a compound tube instead of a loading pump. The durable design and construction securely hold any size finishing box in the perfect filling position, preventing the tool from falling or joint compound from leaking.

See More [p31](#)

ATF TOOL MAINTENANCE PRODUCTS



The first and only Tool Maintenance Kit for Automatic Taping and Finishing Tools. The 12-piece Kit contains the most common size-specific tools required to perform routine maintenance or advanced repair.

See More [p32](#)

WHY CHOOSE?

TAPETECH

For more than three decades, TapeTech has been the Industry Leader for sold Automatic Taping & Finishing Tools. Our unmatched technology and innovation help professional contractors produce superior, consistent results more efficiently than finishing by hand. TapeTech is where top-notch pros find the perfect solution to their drywall finishing needs. Choosing TapeTech means working with tools produced by a company that is dedicated to:

UNMATCHED QUALITY

We have been providing the highest quality tools for over 30 years. You can trust our tools to be the easiest to maintain and **the most dependable tools available.**

NEW INNOVATION

Our engineers strive for continual improvements and develop innovations to complement your existing TapeTech tools - innovations available only from TapeTech.

AVAILABILITY & ONGOING SUPPORT

We have more distributors, dealers and service partners around the world than any other brand. **Finding the best tools, service and support is easy and convenient.** Use the online chat on our website - we can communicate with you in nearly any language.

EDUCATION

We're dedicated to using our expertise to improve drywall finishing for every type of finisher. Whether you choose to **Ask the Expert at www.tapetech.com** or send an e-mail directly to our **dedicated Technical Support team** (techsupport@tapetech.com), there's no company that works harder to help you and your business.

INDUSTRY INVOLVEMENT

We are actively involved in more industry associations than any other ATF tool company. We participate in many industrial committees and trade seminars to constantly improve the drywall industry and provide tools to meet your needs.

 Look for the 'T' icon for exclusive TapeTech products.

In today's highly competitive workplace we have to work smart. The proper tools will help do just that by completing jobs faster and easier. That's exactly what TapeTech's Automatic Taping and Finishing (ATF) Tools are designed to do. When you use TapeTech Tools, not only will you complete jobs in record time, the work will be high quality every time.

INCREASED PRODUCTIVITY

ATF Tools help you finish drywall faster – up to 300% faster than with taping knives, pans and hawk.

Completing the job faster means more profit and the opportunity to win more jobs.

BETTER FINISH

ATF Tools are designed and calibrated to apply the proper amount of joint compound for a better finish.

ATF Tools simultaneously finish both sides of the joint requiring very little, if any sanding.

A superior finish means more satisfied customers.

CONSISTENT RESULTS

ATF Tools ensure that you get the same high quality results every time.

Consistent results on every wall will result in fewer call backs and more profit.

ENHANCED SAFETY

By using tools that can complete most of the work in a standard room without stilts or scaffolding,

ATF Tools contribute to a much safer jobsite.

Table of Contents	
Why TapeTech?	4
Why ATF Tools?	5
Automatic Taping and Finishing Tools	6
Automatic Taper	8
Corner Rollers	10
Applicator Heads	11
MudRunner	12
Corner Applicators	13
Corner Finishers	14
Nail Spotters	16
EasyClean Boxes	17
MaxxBboxes	18
Power Assist MaxxBboxes	20
QuickBox QSX	22
Premium Finishing Knives	23
Finishing Box Handles	24
EasyFinish Box Handles	25
The Wizard Compact Finishing Box Handles	26
Support Handles	27
Loading Pumps	28
Semi-Automatic Tools	30
Cleaning and Maintenance Tools	32
Tool Cases	33
Continuous Flow System	34
Maintenance Schedule	36
ProService Program	37
ProPoints Program	38

THE TAPETECH DRYWALL



p23 BXEH40TT
Extension Handle

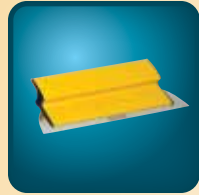

p22 BX07TT, BX10TT, BX14TT,
BX18TT, BX24TT, BX32TT,
BX40TT, BX48TT
Finishing Knives



p8 07TT
EasyClean Automatic Taper

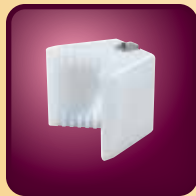

p11 16TT, 16TT90
Applicator Heads

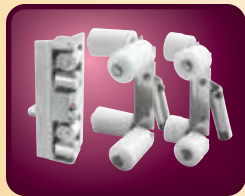

p10 15TTE, 17TT, 17TTE
Corner Rollers



p27 CFA-TT
Corner Finisher Adapter



p14 40TT, 42TT
Corner Finishers



p28 76TT, 76XLTT, 85T, 85XLTT
Pumps, Goosenecks and Adapters



p27 FHHT
Fiberglass Support Handle with Adapters



p27 XHHT
Extension Support Handle with Adapters

Taping

Embe

Automatic Taper, Corner Rollers and 2" Nail Spotter

2", 2½" or 3" Corner Finishers,

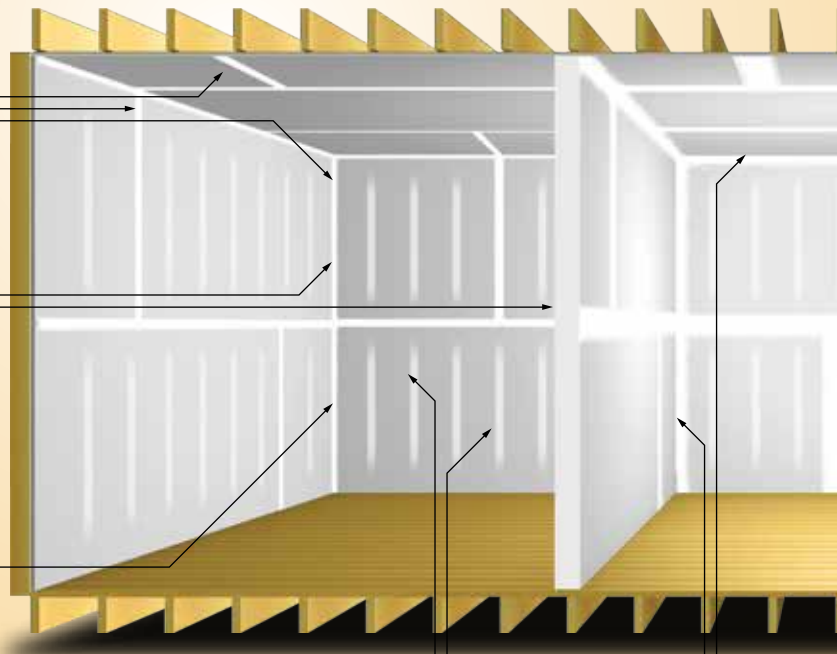

p16 NS02TT
Nail Spotter



p14 40TT, 42TT, 45TT
Corner Finishers



p27 NSA-TT, CFA-TT
Nail Spotter Adapter,
Corner Finisher Adapter



p15 48TT, 48TTX
EasyRoll Corner Finishers

Taping Finishing Handles Pumps

Visit our Learning Center at tapetech.com/learning-center/videos for more information.

LL FINISHING SYSTEM

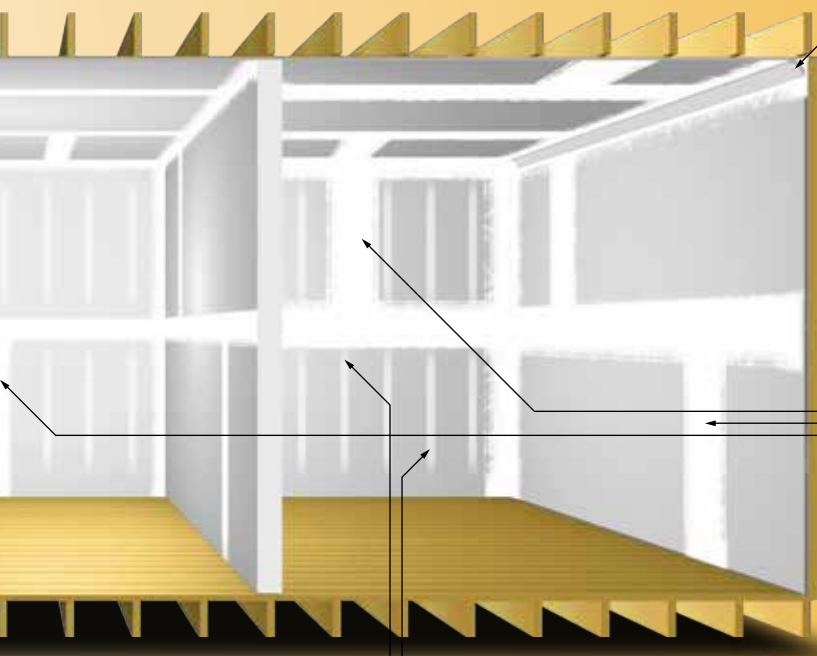

p11 CH55TT, CH75TT, CH83TT, CH90TT
Cove Applicator Heads



p17 EZ07TT, EZ10TT, EZ12TT
EasyClean Boxes



p22 QB06-QSX
QuickBox®



p18 EHC07, EHC10, EHC12
MaxxBox



p20 PAHC07, PAHC10, PAHC12
Power Assist MaxxBox



p13 CA07TT, CA08TT
Corner Applicators



p16 NS03TT
Nail Spotter



p26 The Wizard
Compact Finishing Box Handle



p28 76TT, 76XLT, 90T
Pumps



p12 14TT
MudRunner



p25 8134TT, 8142TT, 8154TT, 8172TT
EasyFinish Handles



p25 CTA01TT
Compound Tube Filler Adapter



p31 CT24TT, CT36TT, CT42TT
Compound Tubes



p24 88TTE, 8034TT, 8042TT, 8054TT, 8072TT
Box Xtender Handle and Box Handles

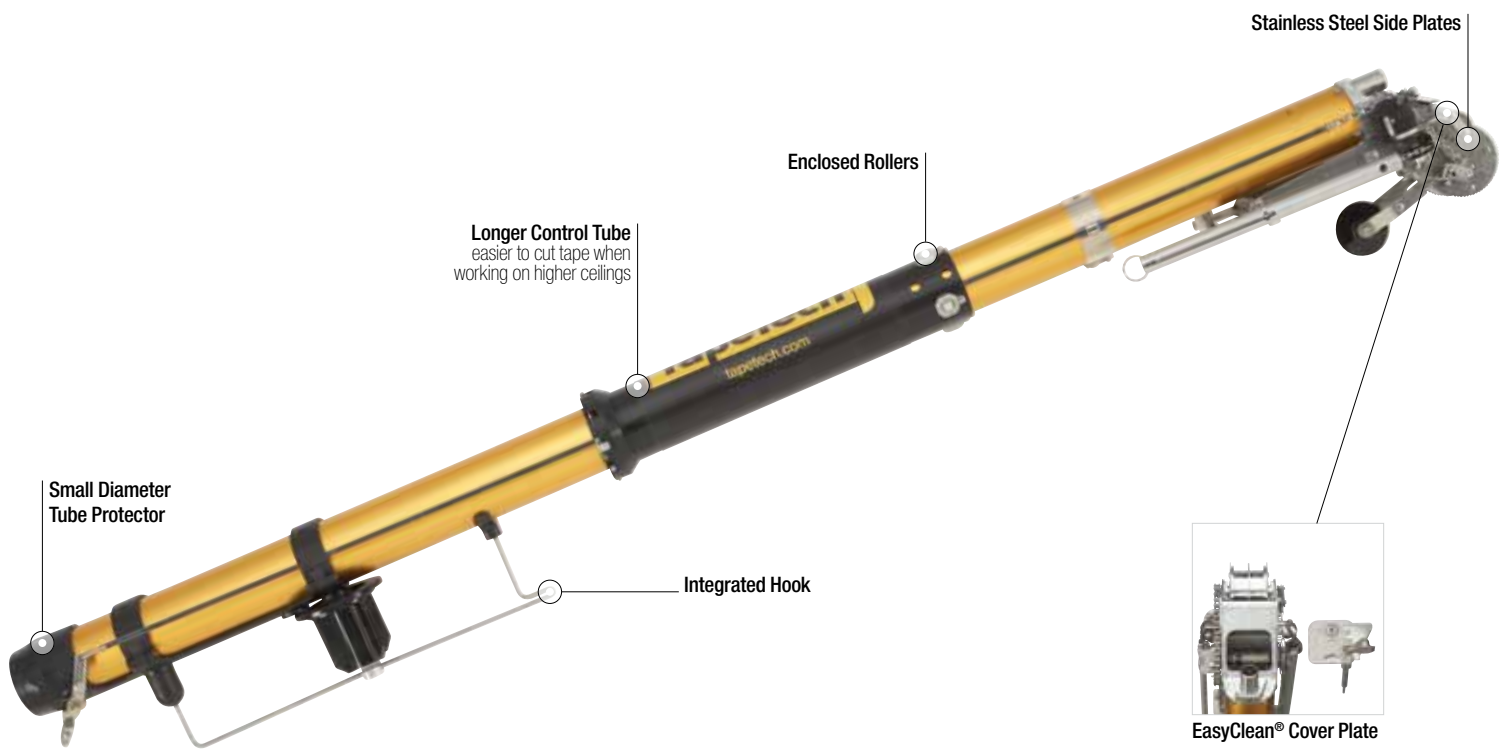

THE **SMOOTHEST TAPER** IN THE INDUSTRY

Designed to be the most durable, efficient and easy to use taper making you more productive.

Taper



The TapeTech EasyClean® Automatic Taper simultaneously applies tape and the correct amount of joint compound for all drywall joints - dramatically improving taping efficiency. The Automatic Taper applies paper joint tape and joint compound to flat and butt joints on walls, ceilings and internal corners up to 300% faster than taping by hand. TapeTech Automatic Tapers are designed to be the most durable, efficient and easy to use tapers. The result is a tool that causes less user fatigue so you can be even more productive.



07TT - EasyClean® Automatic Taper

Additional Features

- Stainless steel and gold anodized aluminum for lightweight, durability
- Reaches 10' (3m) ceilings without the need for benches, scaffolding
- Smoothest operating automatic taper available

Specifications

Empty Weight	6.25 lbs
Full Weight*	16.7 lbs
Coverage (approximate)	80' per load

*Full weight includes a 250' roll of tape.

OFF - Filling Position



ON - Taping Position



OPEN - Cleaning Position



PARTS KITS

501A - Taper Wear Parts Kit
502A - Taper Tune Up Kit
501B - Taper Cleaning Kit

200 - Gooser Assembly Replacement Kit
215 - Drive Dog Assembly Replacement Kit
335 - Piston Assembly Replacement Kit

340 - Cutter Chain Assembly Replacement Kit

COMMON WEAR PARTS

04TT, 05TT, 07TT:
059049 - Needle Gooser 056133 - Pyramid Blade
054209F - Cable 059010 - Spring

Hard Anodized Cable Drum & Push Rod

for long life and reduced wear



Adjustable Wheel Brake

maintains desired resistance as the wheels wear

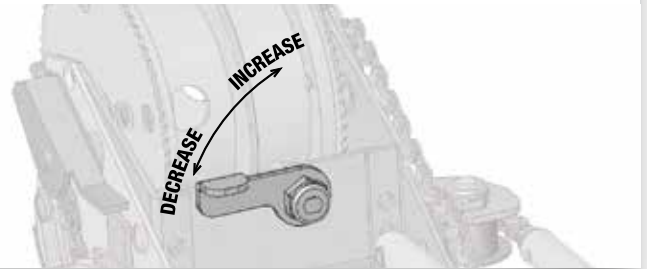

Stainless Steel Rollers
for sharp corners and long life

Standard Fasteners
do not require special
tools for maintenance

Aluminum Body
for lighter weight and durability

Industrial Quality Delrin Rollers
won't damage corner bead

TapeTech Corner Rollers apply even pressure to quickly and accurately embed paper joint tape in internal corners and paper-faced corner bead or European-style Flex Tape on outside corners. Use the Inside Corner Roller immediately after applying paper joint tape to the internal corner with the automatic taper. The inside corner roller forces excess joint compound out from behind the tape in preparation for the corner finisher or corner flusher. The TapeTech Inside Corner Roller features stainless steel rollers for crisp inside corners and long life. TapeTech Outside Corner Rollers firmly embed paper-faced corner bead or Flex Tape on external drywall corners and remove the excess joint compound from beneath it.



15TTE - Inside Corner Roller

The stainless steel rollers of the 15TTE set the paper tape into the internal corner and produce crisp, clean corners that are ready to embed with joint compound.

Use with FHTT or XHTT Handles – Not Included



17TT - Outside Corner Roller

The nylon rollers of the 17TT provide a smooth surface to prevent damage to standard paper-faced corner bead.

Use with FHTT or XHTT Handles – Not Included



17TTE - Outside Corner Roller

The 17TTE Outside Corner Roller features nylon rollers with extruded edges that are designed to embed steel reinforced paper faced corner bead, also known as flex corner tape.

Use with FHTT or XHTT Handles – Not Included

PARTS KITS

- 501RSE - Corner Roller Replacement Kit-15TTE
- 501RD - Corner Roller Replacement Kit-17TT

RELATED PRODUCTS: FHTT, XHTT (see page 27)

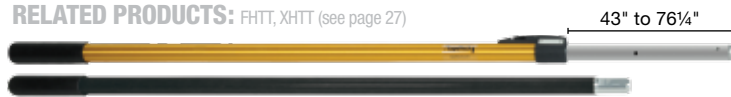

Corner Rollers

TapeTech Applicator Heads apply a consistent base coat of joint compound for the cleanest and most efficient installation of paper-faced corner bead or joint tape. The Applicator Head applies the correct amount of joint compound to maximize adhesion and reduce clean up. Attach the 16TT Applicator Head to a Corner Applicator (CA07TT or CA08TT), the 14TT MudRunner® or a Compound Tube (CT24TT, CT36TT, CT42TT) to simplify and accelerate installation of paper-faced corner bead for external (outside) drywall corners. Attach the 16TT90 Applicator Head to a Corner Applicator (CA07TT or CA08TT), the 14TT MudRunner® or a Compound Tube (CT24TT, CT36TT, CT42TT) to simplify and accelerate installation of paper-faced corner bead for internal drywall corners. TapeTech Applicator Heads feature an EasyClean design and patented locking clip for secure attachment to the MudRunner, Corner Applicators and Compound Tubes.

Patented Locking Clip
secures the applicator
head to the handle



16TT - Outside Corner

Patented Locking Clip
secures the applicator
head to the handle



16TT90 - Inside Corner

TapeTech Cove Applicator Heads apply a bead of gypsum cove adhesive in precisely the right location for optimal adhesion of gypsum cove. They are designed to work with the most common sizes of Gyprock Cornice, Gyproc Cove, GIB-Cove and other brands of gypsum cove and cornice. Cove Applicator Heads attach securely to all TapeTech Corner Applicator tools but are ideally suited to be used with the Compound Tubes.



CH55TT - Cove Applicator Head

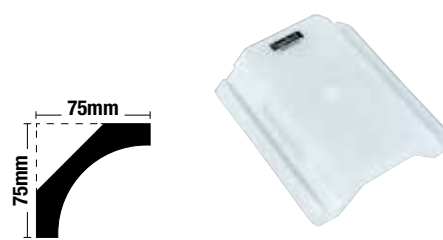

CH75TT - Cove Applicator Head



CH83TT - Cove Applicator Head



CH90TT - Cove Applicator Head

RELATED PRODUCTS: 14TT, CA07TT, CA08TT, CT24TT, CT36TT, CT42TT (see page 12, 13 & 31)



Applicator Heads

The MudRunner, available only from TapeTech, is the ultimate Corner Applicator, requiring only a twist of your wrist for effortless application. The TapeTech MudRunner® delivers joint compound to corner finishers and applicator heads with precision control and minimal effort. A simple twist of the wrist activates the piston and creates a consistent flow of joint compound. Twist it back and the flow stops immediately.

Taping - Use it with TapeTech Applicator Heads to quickly apply joint compound to internal and external corners when installing paper-faced corner bead to drywall.

Finishing - Use it with TapeTech Corner Finishers to quickly finish both sides of internal corners. The MudRunner delivers almost twice as much joint compound to the corner finisher compared to standard corner applicators, resulting in maximum coverage over the joint tape and superior results.



14TT - MudRunner®

PARTS KITS

144001 - MudRunner Tube Replacement Kit

MAXIMUM COVERAGE MINIMUM WORK

Holds 50% more compound than a 8" Corner Applicator and 70% more than a 7" Corner Applicator.



MudRunner®



D-shaped Fitting
securely positions handle
and prevents tool from
rotating during use

Gold Anodized Aluminum
for durability and long life

Stainless Steel Nose Cone

Industrial Quality Filler Valve

Corner Applicators supply joint compound to multiple tools as part of both the Taping process and the Finishing process.

Taping - If you use paper-faced corner bead products, attach TapeTech Applicator Heads to the Corner Applicator to quickly and cleanly apply a uniform amount of joint compound to inside or outside corners.

Finishing - When used with TapeTech Corner Finishers, the Corner Applicator supplies the joint compound to finish both sides of an inside corner at the same time.

Constructed of anodized aluminum with a stainless steel nose cone, TapeTech Corner Applicators provide years of dependable service and require very little maintenance. The Corner Applicator is used in conjunction with either the FHTT Fiberglass handle or the XHTT Extension handle, each sold separately.



CA07TT - 7" Corner Applicator



CA08TT - 8" Corner Applicator

COMMON WEAR PARTS

- 500028 - 7" Wiper
- 500008 - 8" Wiper

RELATED PRODUCTS: FHTT, XHTT (see page 27)



SIMPLE AND RELIABLE

EasyClean® design and very low required maintenance make TapeTech Corner Applicators the industry choice.

Corner Applicator



Patented Locking Clip secures the corner finisher to the handle

Corner Finishers are used during both the Embedding and Finishing phases to produce crisp and clean 90 degree internal corners with minimal effort. The Corner Finishers can be used for wall-to-wall internal corners or wall-to-ceiling corners.

Embedding - After using the Inside Corner Roller (15TTE) to force excess joint compound from behind the paper joint tape in the internal corners, attach a Corner Finisher to a support handle (XHTT or FHHT) to wipe down the excess joint compound. This will embed the paper joint tape in compound and smooth both edges simultaneously.

Finishing - Attach TapeTech Corner Finishers to the MudRunner or the Corner Applicator to apply joint compound to both sides of the internal corner simultaneously. Use wider Corner Finishers on successive coats to produce the best results.

TapeTech Corner Finishers feature stainless steel frames and skids plus carbide blades for durability and long life.

TapeTech Corner Finishers feature a unique, patented locking clip on the ball retainer that attaches the finisher securely to the MudRunner, Corner Applicator or support handles. This allows you to easily and confidently reach wall and ceiling corners without worrying if the Corner Finisher will detach while you are working.



40TT - 2" Corner Finisher



42TT - 2 1/2" Corner Finisher



45TT - 3" Corner Finisher

PARTS KITS

- 501F2A - 2" Corner Finisher Maintenance Kit
- 502F2 - 2" Corner Finisher Blade Change Kit
- 501F25A - 2 1/2" Corner Finisher Maintenance Kit

- 502F25 - 2 1/2" Corner Finisher Blade Change Kit
- 501F3A - 3" Corner Finisher Maintenance Kit
- 502F3 - 3" Corner Finisher Blade Change Kit

COMMON WEAR PARTS

- 40009F - 2" Carbide Blade
- 42009F - 2 1/2" Carbide Blade
- 45009F - 3" Carbide Blade

RELATED PRODUCTS: FHHT, XHTT with CFA-TT (see page 27)



Corner Finishers

Corner Finishers are used during both the Embedding and Finishing phases to produce crisp and clean 90 degree internal corners with minimal effort. The Corner Finishers can be used for wall-to-wall internal corners or wall-to-ceiling corners.

Embedding - After using the Inside Corner Roller (15TTE) to force excess joint compound from behind the paper joint tape in the internal corners, attach a Corner Finisher to a support handle (XHTT or FHHT) to wipe down the excess joint compound. This will embed the paper joint tape in compound and smooth both edges simultaneously.

Finishing - Attach TapeTech Corner Finishers to the MudRunner or the Corner Applicator to apply joint compound to both sides of the internal corner simultaneously. Use wider Corner Finishers on successive coats to produce the best results.

TapeTech Corner Finishers feature stainless steel frames and skids plus carbide blades for durability and long life.

TapeTech Corner Finishers feature a unique, patented locking clip on the ball retainer that attaches the finisher securely to the MudRunner, Corner Applicator or support handles. This allows you to easily and confidently reach wall and ceiling corners without worrying if the Corner Finisher will detach while you are working.



48TT - 3" EasyRoll® Adjustable Corner Finisher

48XTT - 3 1/2" EasyRoll® Adjustable Corner Finisher

PARTS KITS

501F4A - 3" EZ Roll Corner Finisher Maintenance Kit
502F4 - 3" EZ Roll Corner Finisher Blade Change Kit

501F4AX - 3 1/2" EZ Roll Corner Finisher Maintenance Kit
502F4X - 3 1/2" EZ Roll Corner Finisher Blade Change Kit

COMMON WEAR PARTS

45009F - 3" Carbide Blade
480209 - 3 1/2" Carbide Blade

RELATED PRODUCTS: FHHT, XHTT with CFA-TT (see page 27)

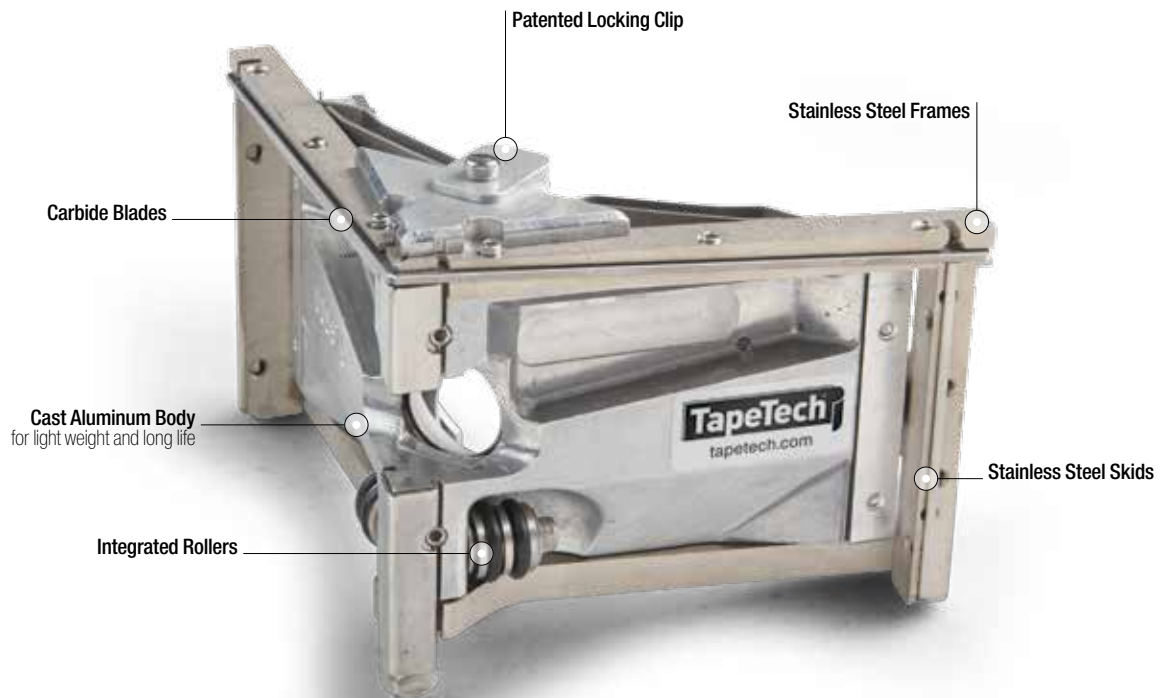

HOW TO SET SPRING ADJUSTMENT ARMS



Adjustment Arms Engaged

- one set of springs is active
- less pressure on the frames
- allows more joint compound to remain

This is the typical setting on the first coat



Adjustment Arms Disengaged

- both sets of springs are active
- more pressure on the frames

This is the typical setting for the final coat

One adjustment arm can be engaged and the other disengaged to leave more joint compound on one side of the corner only when working with uneven corners.



EasyClean® Pressure Plate Design

Stainless Steel Body

Easy Change Reversible Carbide Blade

Hardened Steel Skid Plate provides smooth operation and best protection

Tapetech Nail Spotters quickly and efficiently fill depressions left from the heads of your drywall fasteners, whether you use nails or screws. Constructed of heavy duty stainless steel, the Nail Spotter is easy to use and extremely durable. A thumb latch and EasyClean® design make access to the body and tool cleaning simple. The blade removes any excess joint compound, leaving the depressions filled for a smooth wall finish. The Nail Spotters feature a reversible carbide blade so you get double the blade life. The blade is easily changed by loosening the nuts that secure the blade holder. The industrial quality gasket provides leak-free performance. Tapetech offers Nail Spotters in two sizes, 2" and 3", to make finishing drywall easy. Nail Spotters require either the XHTT extension handle or the FHHT fiberglass handle, each sold separately.



NS02TT - 2" Nail Spotter



NS03TT - 3" Nail Spotter

COMMON WEAR PARTS

- 630015 - 2" Wiper
- 600005F - 2" Nail Spotter Blade - Carbide
- 680015 - 3" Wiper
- 650005F - 3" Nail Spotter Blade - Carbide

RELATED PRODUCTS: FHHT, XHTT (see page 27)

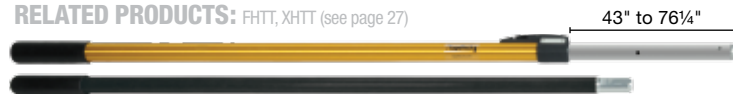

TRIANGULAR **HARDENED STEEL**
SKID PLATE

Provides the best protection for the carbide blade against protruding nail or screw heads.

Nail Spotters

TapeTech EasyClean® Finishing Boxes have been the industry standard for over 30 years. The finishing box dispenses the proper amount of joint compound over flat joints and butt joints on walls and ceilings. The adjustable crown setting dial allows the user to easily adjust the amount of joint compound applied over the tape on the drywall joint. This is very helpful when progressing from the first embedding application to the second or third finishing coat. The pivoting axle helps to compensate when the drywall or sheetrock on one side of the joint is higher than the other side of the joint. Use the EasyClean Finishing Boxes with any style of TapeTech finishing box handle.

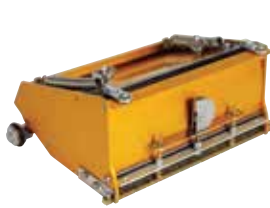

EZ07TT - 7" EasyClean® Box



EZ10TT - 10" EasyClean® Box



EZ12TT - 12" EasyClean® Box

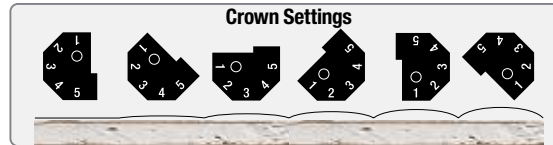

Approximate Linear Foot Coverage* - Embedding Coat (1st Coat)						
	0	1	2	3	4	5
EZ07TT	15	18	21	24	27	30
EZ10TT	16	18	20	22	24	26
EZ12TT	18	20	22	24	26	28

Approximate Linear Foot Coverage* - Finishing Coat (2nd Coat)						
	0	1	2	3	4	5
EZ07TT	44	47	50	53	56	60
EZ10TT	48	51	54	57	61	66
EZ12TT	52	55	58	62	66	70

Recommended Crown Settings			
When Using:	7"	10"	12"
7", 10" and 12"	0-1	2-3	4-5
7" and 10"	0-1	3-4	—
10" and 12"	—	0-1	3-4

* Coverage data is approximate only. Actual coverage can vary significantly based on many factors, including type of joint compound, viscosity of joint compound, quality of gypsum panel installation, quality of paper tape installation and the condition of the finishing box. There is no guarantee, written or implied, you will achieve the same coverage in all circumstances.

PARTS KITS

- 501C7 - 7" Wear Parts Kit
- 501C10 - 10" Wear Parts Kit
- 501C12 - 12" Wear Parts Kit
- 502CN - Finishing Box Wheel Replacement Kit

COMMON WEAR PARTS

- | | | |
|----------------------------------|----------------------------------|----------------------------------|
| EZ07TT: | EZ10TT: | EZ12TT: |
| 200001 - Stainless Steel Blade | 250001 - Stainless Steel Blade | 300001 - Stainless Steel Blade |
| 200026F - Box Wiper | 250026F - Box Wiper | 300026F - Box Wiper |
| 209039 - Skid Cover (left side) | 209039 - Skid Cover (left side) | 209039 - Skid Cover (left side) |
| 209006 - Skid Cover (right side) | 209006 - Skid Cover (right side) | 209006 - Skid Cover (right side) |

RELATED PRODUCTS: TC01TT Tool Caddy (see page 31)



NEW EasyRoll® Wheels for Outside Corners provides a shoulder to allow finishing of outside corners without after-market attachments or damage to the axle

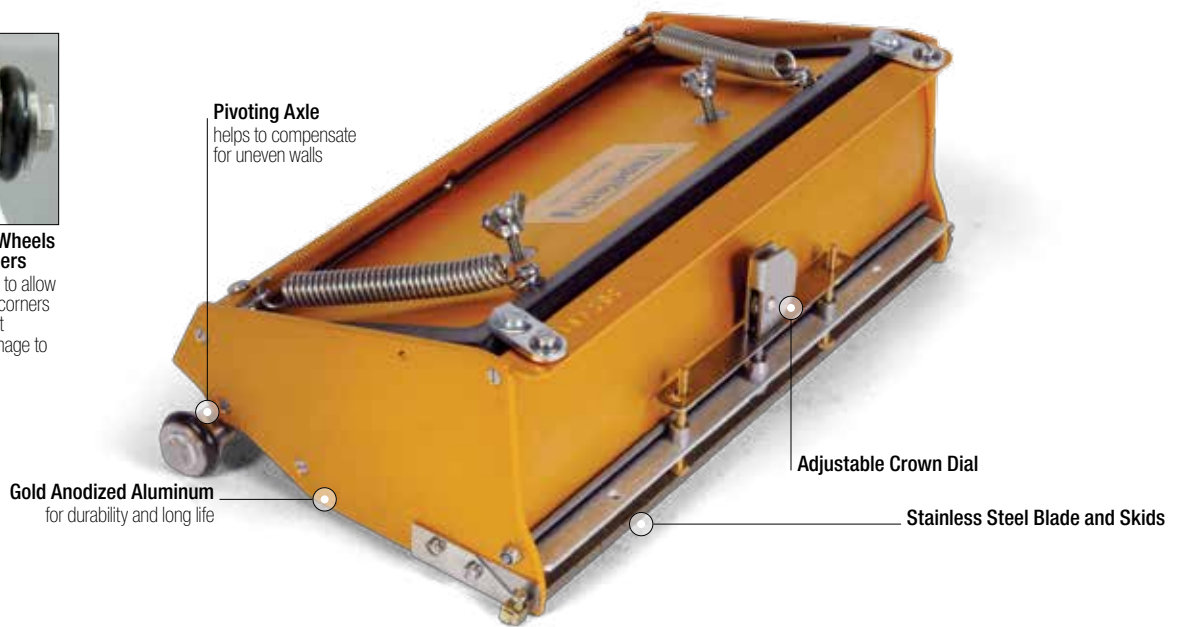

EasyClean® Boxes



NEW EasyRoll® Wheels for Outside Corners
provides a shoulder to allow finishing of outside corners without after-market attachments or damage to the axle

Pivoting Axle
helps to compensate for uneven walls



Adjustable Crown Dial

Gold Anodized Aluminum
for durability and long life

Stainless Steel Blade and Skids

MAXBOX®

Right sized for *maximum productivity*

THE RIGHT SIZE MATTERS



94% More Usable Capacity

MaxxBox®

Introducing the first high capacity finishing boxes designed to hold the right amount of joint compound when you really need it – on the first or second coat when you're filling the joint – without the unnecessary weight when you don't need it – on the finish coat. The NEW TapeTech MaxxB[®] Finishing Boxes are designed with the optimum capacity to weight ratio. This means that you get more "usable" joint compound – the amount that you can actually get out of the finishing box and onto the wall – when you actually need it, like on the first coat. The Finishing Boxes automatically dispense the proper amount of joint compound and feather the edges of butt joints and flat joints in one pass.

With a usable joint compound capacity that varies by less than 10% across the range, the TapeTech MaxxB finishing boxes hold the right amount of joint compound to keep you on the wall longer without wearing you out. The MaxxB series features TapeTech's famous EasyClean[®] design. The adjustable crown setting dial allows the user to easily adjust the amount of joint compound applied over the tape on the drywall joint. This is very helpful when progressing from the first embedding application to the second or third finishing coat. The pivoting axle helps to compensate when the drywall or sheetrock on one side of the joint is higher than the other side of the joint. Use the MaxxB Finishing Boxes with any style of TapeTech finishing box handle.



EHC07 - 7" MaxxB[®] High Capacity Box



EHC10 - 10" MaxxB[®] High Capacity Box



EHC12 - 12" MaxxB[®] High Capacity Box

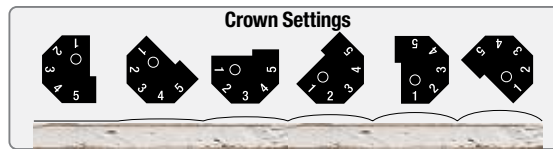

Approximate Linear Foot Coverage* - Embedding Coat (1st Coat)						
	0	1	2	3	4	5
EHC07	29	35	41	47	52	58
EHC10	26	29	32	35	38	42
EHC12	22	24	26	29	31	34

Approximate Linear Foot Coverage* - Finishing Coat (2nd Coat)						
	0	1	2	3	4	5
EHC07	85	91	97	103	109	116
EHC10	77	82	86	91	98	106
EHC12	62	66	70	74	79	84

Recommended Crown Settings			
When Using:	7"	10"	12"
7", 10" and 12"	0-1	2-3	4-5
7" and 10"	0-1	3-4	–
10" and 12"	–	0-1	3-4

* Coverage data is approximate only. Actual coverage can vary significantly based on many factors, including type of joint compound, viscosity of joint compound, quality of gypsum panel installation, quality of paper tape installation and the condition of the finishing box. There is no guarantee, written or implied, you will achieve the same coverage in all circumstances.

PARTS KITS

- 501C7 - 7" Wear Parts Kit
- 501C10 - 10" Wear Parts Kit
- 501C12 - 12" Wear Parts Kit
- 502CN - Finishing Box Wheel Replacement Kit

COMMON WEAR PARTS

- | | | |
|----------------------------------|----------------------------------|----------------------------------|
| EHC07: | EHC10: | EHC12: |
| 200001 - Stainless Steel Blade | 250001 - Stainless Steel Blade | 300001 - Stainless Steel Blade |
| 210024F - Box Wiper | 260024F - Box Wiper | 310024F - Box Wiper |
| 209039 - Skid Cover (left side) | 209039 - Skid Cover (left side) | 209039 - Skid Cover (left side) |
| 209006 - Skid Cover (right side) | 209006 - Skid Cover (right side) | 209006 - Skid Cover (right side) |

RELATED PRODUCTS: TC01TT Tool Caddy (see page 31)

USEABLE CAPACITY OF TAPETECH FINISHING BOXES



Usable Capacity is defined as the amount of joint compound that can be evacuated from the finishing box by fully depressing the pressure plate.



NEW EasyRoll® Wheels for Outside Corners
 provides a shoulder to allow finishing of outside corners without after-market attachments or damage to the axle

Pivoting Axle
 helps to compensate for uneven walls

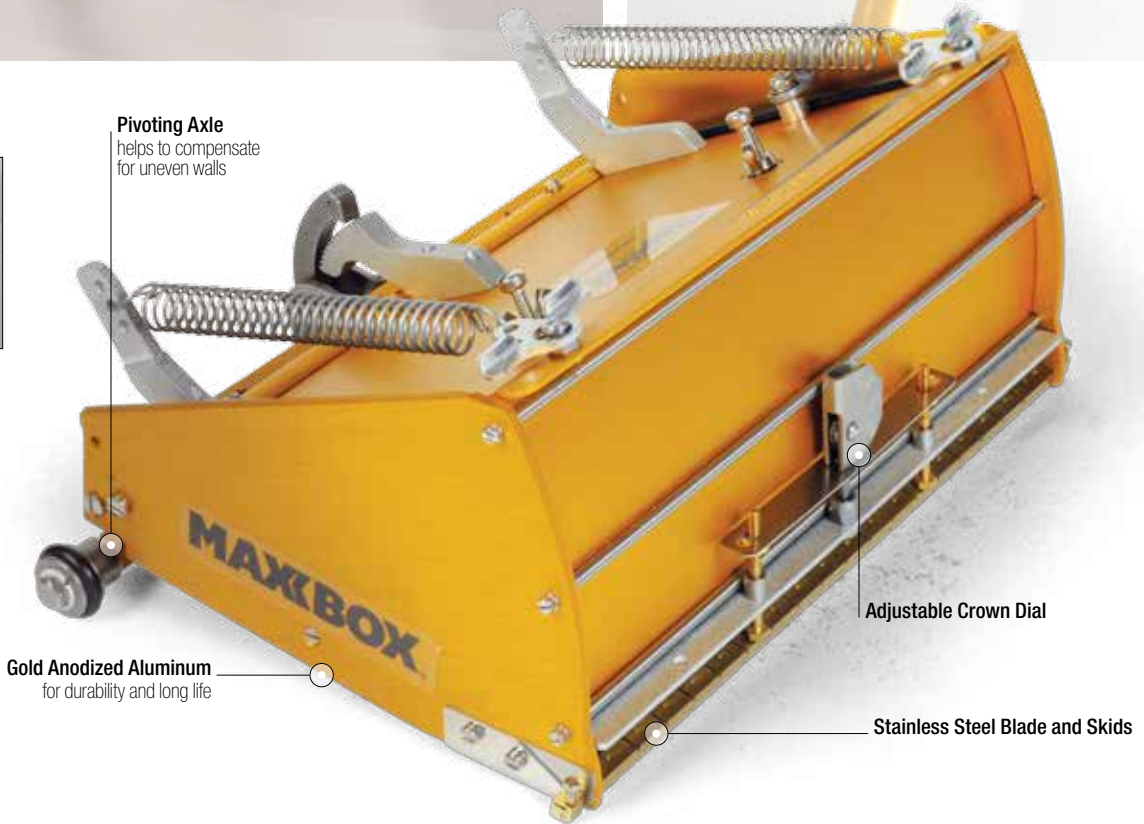

Gold Anodized Aluminum
 for durability and long life

Adjustable Crown Dial

Stainless Steel Blade and Skids

Power Assist® MAXXBOX®
Right sized for maximum productivity

THE **BEST** OF BOTH WORLDS

Same professional results with approximately 50% of the effort compared to standard finishing boxes.

Power Assist® MaxxBox®



TapeTech Power Assist® MaxxBox® finishing boxes produce professional results every time with approximately one-half of the effort required when using standard Finishing Boxes due to the patented reverse spring design. The Finishing Boxes automatically dispense the proper amount of joint compound and feather the edges of butt joints and flat joints in one pass. Power Assist® finishing boxes feature a larger capacity that holds more joint compound than the standard EasyClean® Finishing Box and the pressure plate removes easily for even faster, more efficient cleaning.

The adjustable crown setting dial allows the user to easily adjust the amount of joint compound applied over the tape on the drywall joint. This is very helpful when progressing from the first embedding application to the second or third finishing coat. The pivoting axle helps to compensate when the drywall or sheetrock on one side of the joint is higher than the other side of the joint. We highly recommend using the EasyFinish™ bent handles when using the Power Assist Finishing Boxes. The ergonomic bent handle design provides leverage and helps to activate the Power Assist mechanism.



PAHC07 - 7" Power Assist® MaxxBox®



PAHC10 - 10" Power Assist® MaxxBox®



PAHC12 - 12" Power Assist® MaxxBox®

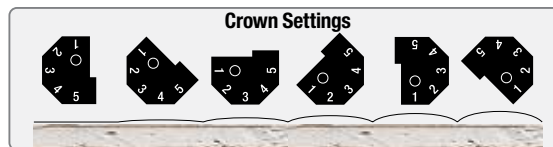

Approximate Linear Foot Coverage* - Embedding Coat (1st Coat)						
	0	1	2	3	4	5
PAHC07	24	28	33	38	42	47
PAHC10	19	21	24	26	29	31
PAHC12	15	17	19	20	22	24

Approximate Linear Foot Coverage* - Finishing Coat (2nd Coat)						
	0	1	2	3	4	5
PAHC07	69	74	79	83	88	94
PAHC10	57	61	64	68	73	79
PAHC12	44	47	49	53	56	60

Recommended Crown Settings			
When Using:	7"	10"	12"
7", 10" and 12"	0-1	2-3	4-5
7" and 10"	0-1	3-4	-
10" and 12"	-	0-1	3-4

* Coverage data is approximate only. Actual coverage can vary significantly based on many factors, including type of joint compound, viscosity of joint compound, quality of gypsum panel installation, quality of paper tape installation and the condition of the finishing box. There is no guarantee, written or implied, you will achieve the same coverage in all circumstances.

PARTS KITS

- 501C7 - 7" Wear Parts Kit
- 501C10 - 10" Wear Parts Kit
- 501C12 - 12" Wear Parts Kit
- 502CN - Finishing Wheel Replacement Kit

COMMON WEAR PARTS

- | | | |
|---|---|---|
| <ul style="list-style-type: none"> PAHC07: 200001 - Stainless Steel Blade 210024F - Box Wiper 209039 - Skid Cover (left side) 209006 - Skid Cover (right side) | <ul style="list-style-type: none"> PAHC10: 250001 - Stainless Steel Blade 260024F - Box Wiper 209039 - Skid Cover (left side) 209006 - Skid Cover (right side) | <ul style="list-style-type: none"> PAHC12: 300001 - Stainless Steel Blade 310024F - Box Wiper 209039 - Skid Cover (left side) 209006 - Skid Cover (right side) |
|---|---|---|

RELATED PRODUCTS: TC01TT Tool Caddy (see page 31)



Pressure Plate Opens Completely
accommodates filling with hand tools

Designed for Fast-Setting Joint Compound

Glass-filled Polypropylene Shell
provides a slick surface with maximum strength and durability

EasyChange™ blade system
requires no tools
Four Blade Profiles
match the application, eliminating the need for crown adjustments

QB06-QSX - 6 1/2" QuickBox® Finishing Box

The 6 1/2" QuickBox® QSX is the perfect tool for contractors who use fast-setting joint compound for the first coat over the paper or fiberglass joint tape. Constructed from advanced space age materials, fast-setting joint compound is easily removed from the finishing box, even hours or days later. Now you get all the benefits of using a finishing box without worrying if the joint compound dries in the tool. QuickBox® QSX works with all finishing box handles, including the Wizard®. It's about time someone made a finishing box for fast-setting compound!

COMMON WEAR PARTS

PB6003
Flat Finishing

PB6023
.045 Crowned Finishing

PB6033
Crowned for exterior seaming applications

PB6043
Notched for adhesive applications

RELATED PRODUCTS: 88TTE, 8034TT, 8042TT, 8054TT, 8072TT, 8134TT, 8142TT, 8154TT, 8172TT, 8000TT (see page 24, 25 & 26)



THINK OUTSIDE THE BOX

The first finishing box specifically designed to be used with fast-setting joint compounds.

QuickBox® QSX

SMOOTH AS SILK

A must when trying to achieve a level five, Q4 or other industry-recognized premium finish standard.

TapeTech premium knives are the Gold Standard for premium wipe-down and finishing knives. Featuring advanced engineering and the highest grade INOX German stainless steel, TapeTech knives produce the absolute best finish in the industry. The secret is the strong but flexible INOX blade and the precise fulcrum point designed into the grip area. This allows the blade to have up to ten times more contact area with the surface, generating a superior finish.

The ergonomic design is comfortable even with extended use and significantly reduces the wrist strain that is common when using traditional finishing knives. The knives are easy to use with one hand or two. The extendable handle securely holds any of the knives in place. The angle of the head or length of the handle can easily be adjusted to achieve the optimum results.



BX07TT - 7" Wipardown Knife

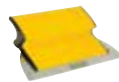

BX10TT - 10" Wipardown Knife



BX14TT - 14" Finishing Knife



BX18TT - 18" Finishing Knife



BX24TT - 24" Finishing Knife



BX32TT - 32" Finishing Knife



BX40TT - 40" Finishing Knife



BX48TT - 48" Finishing Knife



BXEH40TT - 40" Extension Handle

Superior Strength and Extreme Flexibility
the handle does the work – not your fingers

Ergonomic Grip

Blade protector included

German Stainless Steel
highest grade INOX stainless steel



Premium Finishing Knives



The TapeTech XTender® Finishing Box Handle attaches to the EasyClean®, EasyClean® High Capacity or Power Assist® Finishing Boxes and provides control to cleanly sweep the boxes off the joint for a perfect finish. The XTender is the strongest extendable finishing box handle in the industry and adjusts from 41" to 63" for increased reach and versatility. The XTender handle features a wrap-around style brake system. The wrap-around brake provides a greater working range than the quadrant brake. The ergonomic grip that controls the brake can be adjusted to accommodate different hand sizes and preferences.



88TTE - Box XTender® Handle

TapeTech Finishing Box Handles provide support and control for TapeTech EasyClean®, MaxxBow® and Power Assist® Finishing Boxes. The anodized aluminum tubes make the handles lightweight and durable. The standard straight fixed-length handles feature a quadrant style brake system. Many contractors prefer this brake style that features a set screw and detent design as it is easier to adjust due to normal wear. The control ball provides positive grip for your top hand and is easily adjusted along the entire straight grip section of any fixed length handle.

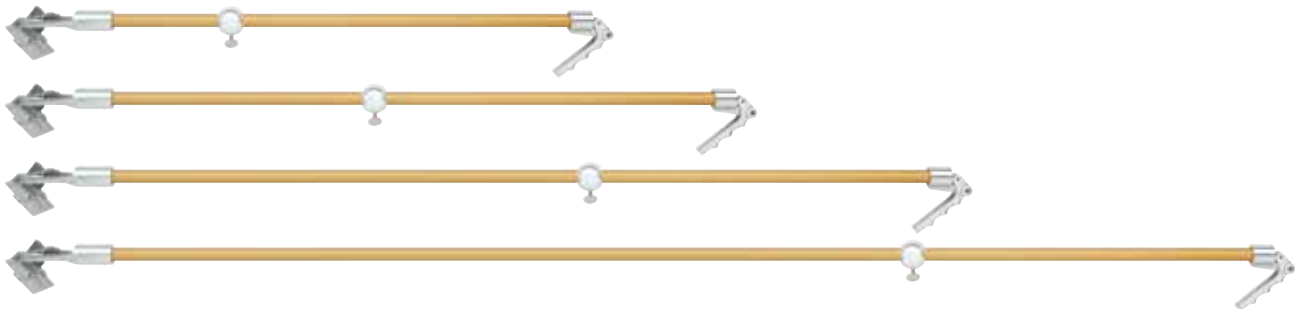

8034TT - 34" Box Handle

8042TT - 42" Box Handle

8054TT - 54" Box Handle

8072TT - 72" Box Handle

STRONG AND DEPENDABLE

TapeTech finishing box handles are the most robust handles in the industry.

Finishing Box Handles

TapeTech EasyFinish™ Box Handles provide support and control for TapeTech EasyClean®, MaxxBox® and Power Assist® Finishing Boxes. TapeTech EasyFinish box handles feature an ergonomic bent handle design for increased leverage and reduced effort. When the gypsum board panels have been installed vertically and the finishing box is starting at the top of the wall, these handles make it easier to push on the pressure plate of the finishing box. The EasyFinish handles feature a quadrant style brake system. Many contractors prefer this brake style that features a set screw and detent design as it is easier to adjust due to normal wear. The control ball provides positive grip for your top hand and is easily adjusted along the entire straight section of any fixed length handle.

EasyFinish box handles are also the preferred handle when working with the Power Assist finishing boxes. The leverage and angle created by the bent handle design help to activate the “power assist” mechanism of the finishing box.

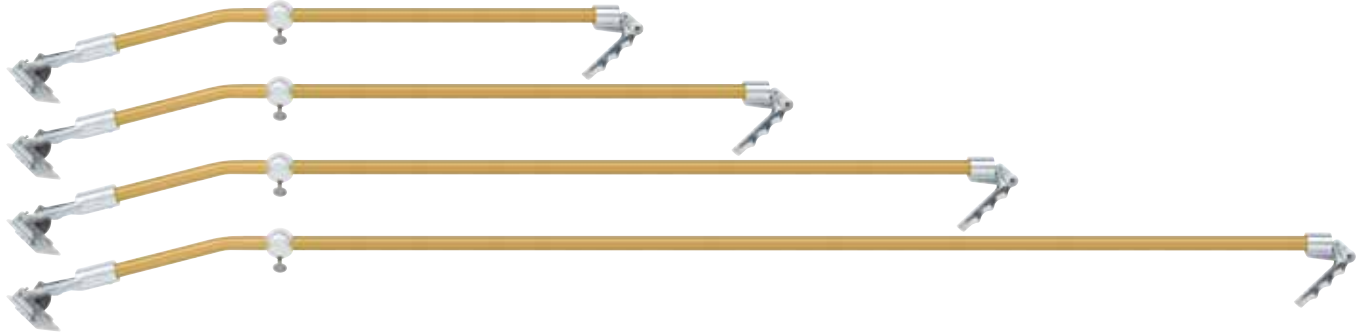

8134TT - 34" EasyFinish™ Handle

8142TT - 42" EasyFinish™ Handle

8154TT - 54" EasyFinish™ Handle

8172TT - 72" EasyFinish™ Handle

PROVIDES **THE LEVERAGE** YOU NEED

The bent handle design provides increased leverage and reduces effort for overhead and vertical applications.

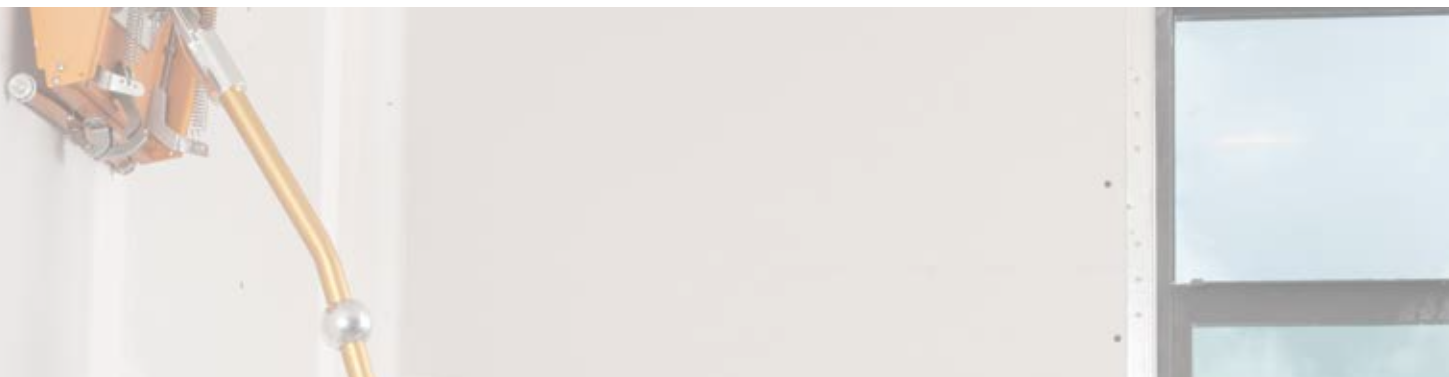
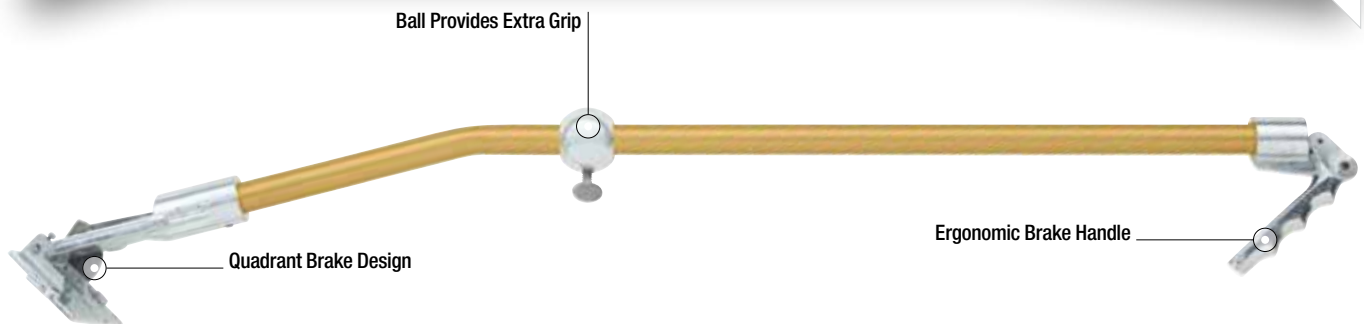

EasyFinish™ Box Handles

BIG THINGS COME IN SMALL PACKAGES

Easily fit into tight spaces you previously needed to finish by hand.

The new Wizard® Compact Finishing Box Handle from TapeTech provides unmatched control, maximum access and eliminates the learning curve of using traditional finishing box brake handles. It is the only finishing box handle that places your hand directly over the pressure plate, reducing the effort required while providing superior control. It fits into the smallest closets or under stairs and is much safer for workers on scaffolding compared to using a finishing box handle of any other length. But it isn't limited to just tight spaces or scaffolds, the Wizard® is the absolute fastest and easiest way to finish any joints, especially horizontal joints. The innovative design, including the ability to reverse the front handle, allows for multiple ergonomic hand positions to reduce worker fatigue and increase productivity. Every drywall finisher needs the Wizard® in their toolbox!



8000TT - Wizard® Compact Finishing Box Handle

8000TT-PA - Wizard® Compact Finishing Box Handle for Power Assist®

Contoured Handle
reversible for multiple
hand positions



Ergonomic Main Handle
for comfortable, secure grip

Aluminum Mounting Plate
fits most brands of finishing boxes



The Wizard®



D-SHAPE DESIGN

New handle design features a flat machined area that locks into the Corner Applicator Adapter (CAA-TT) securely positioning the handle and positively preventing the tool from rotating during use.

TapeTech is the first company to introduce an interchangeable handle system that allows one support handle to be used with every tool. And the new, optimal diameter makes TapeTech handles the most ergonomic* in the industry. The base handle fits the corner roller and corner applicator without any adapters. And the heavy duty, easy-to-change adapters connect the new handles to the nail spotters and corner finishers. Both base handles feature a D-shaped fitting that securely positions the handle in the Corner Applicator and positively prevents the tool from rotating during use.

Now your set of tools can include as little as one support handle! Or dedicate adapters to handles for larger crews. The interchangeable system also makes it easy to have both fixed and extension handles in your toolbox without the expense you would incur to do the same with other brands.

Note: If you use your current Nail Spotters with the new handle system you will need to mount the handle in the back holes of the tabs on the Nail Spotter.

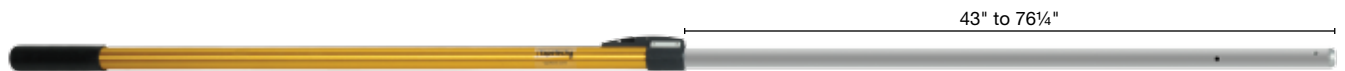

XHTT - Extension Handle

TapeTech extension handles are up to 30% longer than the previous models.



FHTT - Fiberglass Handle

TapeTech fiberglass handles are up to 35% longer than the previous models.



CAA-TT - Corner Applicator Adapter

The Corner Applicator adapter is included with the new Corner Applicators (CA07TT and CA08TT). Or you can purchase it separately to use the new handle system with your existing Corner Applicators.



NSA-TT - Nail Spotter Adapter

The Nail Spotter adapter is included with the new Nail Spotters (Models NS02TT and NS03TT). Or you can purchase it separately to use the new handle system with your existing Nail Spotters.



CFA-TT - Corner Finisher Adapter

The Corner Finisher Adapter quickly and securely attaches to the FHTT or XHTT for use with TapeTech Corner Finishers and Applicator Heads.

**Independent research at the National Institute for Occupational Safety & Health and published in the Journal of Hand Therapy found that the diameter of TapeTech support handles is the optimum size for cylindrical handles. The NIOSH study concluded that the diameter of TapeTech support handles reduces the force required for gripping a tool, protects the underlying joint structures, and reduces the risk of developing cumulative trauma associated with repetitive tasks requiring high grip forces and awkward postures.*

Support Handles



New Head Design
features shorter skirt length
for easier cylinder removal

Integrated O-ring
eliminates need
for O-ring enclosure

Integrated Gasket
provides superior seal and eliminates
the need for disposable paper gaskets

PVC Handle Wrap
for easy cleaning

Control Ball
provides secure hand
position when pumping

Easy Clean® Foot Valve
twist-lock design provides secure
attachment and quick removal

EasyClean® Pumps

TapeTech EasyClean® loading pumps combine reliability with innovation to fill all your automatic taping and finishing tools quickly and efficiently. All TapeTech pumps feature the slim tube design preferred by professional finishers and robust construction for dependable performance and long life. The pumps have a redesigned head and a new Twist-lock foot valve that provides secure attachment and easy removal for cleaning and maintenance. TapeTech pumps do not require a paper gasket for the filler adapter or gooseneck due to an innovative, integrated O-Ring that provides a perfect seal with fewer headaches from lost, worn or damaged paper gaskets you experience with competitor's pumps. Use the pumps with the appropriate filler adapter or gooseneck. TapeTech adapters are engineered to precise tolerances for leak-free performance and long life.



76TT - EasyClean® Pump

Works with most standard buckets. Use with 85T Gooseneck.

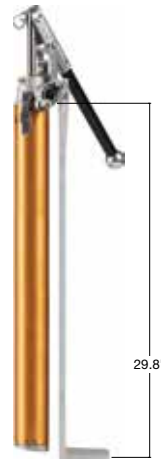

76XLTT - Extra Long EasyClean® Pump

Twice the height of the standard 76TT pump, the 76XLTT is designed for 30 gallon barrels or to reduce repetitive bending when filling tools from standard buckets. Use with 85XLTT Gooseneck.



76TT-CA - EasyClean® Pump

For Canada, with extra length for taller buckets. Use with 85T Gooseneck and GSRTT Gooseneck Riser.



85T & 85XLTT - Gooseneck

The TapeTech Gooseneck Adapter is used with the EasyClean® loading pump to fill the automatic taper. It features a heavy duty, durable design to provide years of service.

Fills TapeTech automatic tapers.

85T fits model 72TT and 73TT pumps (with 700049 gaskets, not included), and 76TT. 85XLTT fits model 76XLTT.



90T - Filler Adapter

Attaches to the TapeTech 76TT, 76XLTT or 76TT-CA EasyClean® pump to fill the MudRunner, Corner Applicators, Nail Spotters and EasyClean, MaxxBoss® or Power Assist® Finishing boxes with joint compound. New, longer design makes filling finishing boxes even easier.

Also fits model 72TT and 73TT pumps (with 700049 gaskets, not included).



GSRTT - Gooseneck Riser

The GSRTT is used with the 85T Gooseneck to provide stability when using the 76TT-CA EasyClean® Pump.

PARTS KITS

- 501H - Pump Wear Parts Kit - 72TT/73TT
- 501J - Pump Wear Parts Kit - 76TT/76TT-CA/76XLTT
- 501BH - Pump Wear Parts Kit - B74TT/B75TT

- 502H - Pump Tune Up Kit - 72TT/73TT/76TT/76TT-CA/76XLTT
- 502BH - Pump Tune Up Kit - B74TT/B75TT
- 501H1 - Pump Cleaning Kit

COMMON WEAR PARTS

- | | |
|------------------------------------|-------------------------------|
| 72TT, 73TT, 76TT, 76TT-CA, 76XLTT: | B74TT, B75TT: |
| 700032F - Screen (fine mesh) | 740032 - Screen (fine mesh) |
| 700033F - Screen (coarse mesh) | 740033 - Screen (coarse mesh) |

NEW SEMI-AUTOMATIC TOOLS !

Are you still finishing drywall with hand tools like drywall pans and knives? Are you unsure about moving up to Automatic Taping & Finishing Tools because of the cost or you think they are difficult to learn how to use? TapeTech Semi-Automatic tools can help ease the transition to ATF tools. They are the perfect entry level tools to instantly increase your productivity by making finishing internal corners significantly faster.



TapeTech Corner Flushers make quick work of wiping or finishing inside corners. Direct flushers are used to apply joint compound to internal corners. Indirect flushers simply smooth compound that has been applied by another tool. TapeTech flushers work as both a direct or indirect flusher. That means you don't have to decide which model to get, only which sizes fit your needs. The Corner Flushers fit all TapeTech corner tools (XHTT and FHTT handles, CA07TT and CA08TT Corner Applicators and 14TT MudRunner®).



CF25TT - 2 1/2" Corner Flusher



CF30TT - 3" Corner Flusher

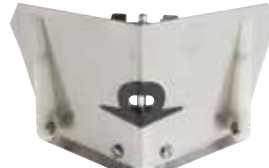

CF35TT - 3 1/2" Corner Flusher

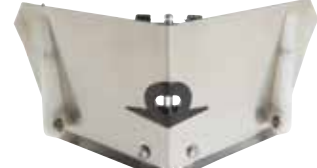

CF40TT - 4" Corner Flusher

Only TapeTech offers easy-to-install accessory kits. Easily add a creaser wheel to a flusher to set your tape into the corner and wipe it down simultaneously. Or add wheels to any flusher for smoother performance on the wall. The flexibility of the TapeTech system lets you build the tool with the features you want and change them as needed.



CFK01TT - Roller Kit



CFK02TT - Creaser Wheel Kit



Semi Automatic Tools

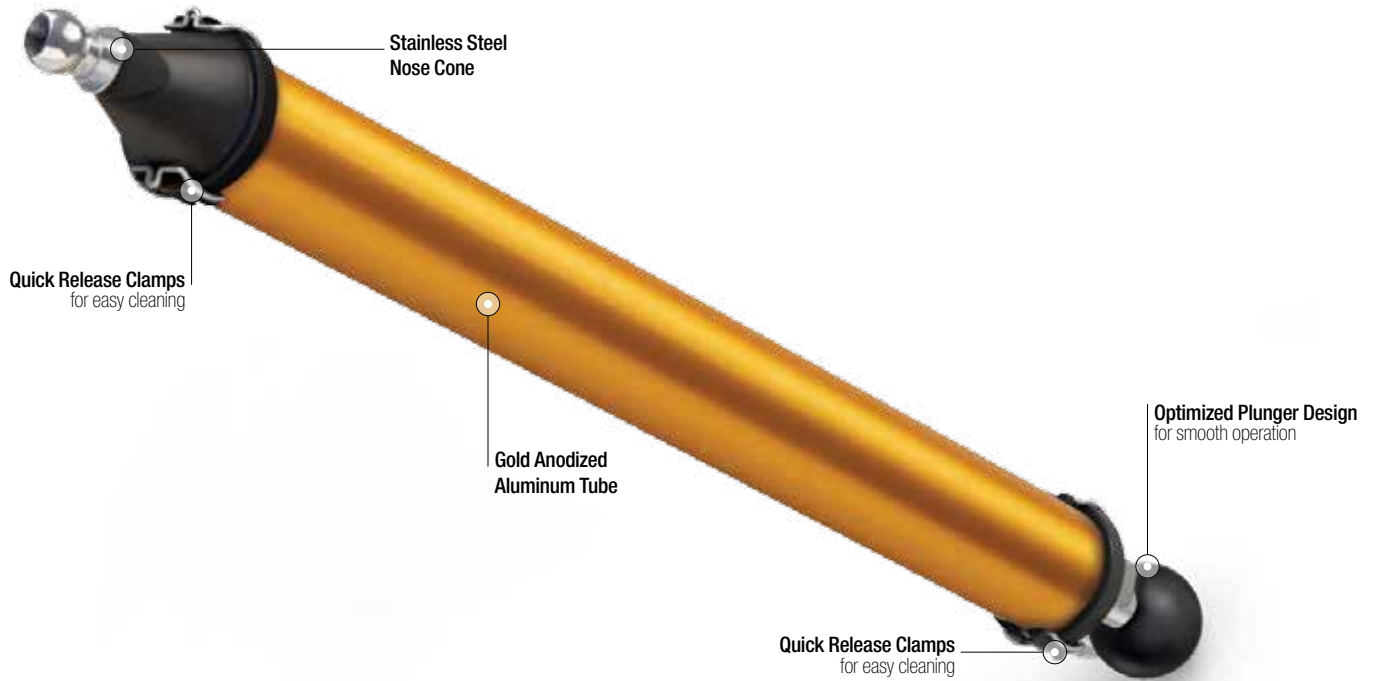

TapeTech Compound Tubes supply joint compound to Corner Flushers for finishing inside corners. Also attaches to TapeTech Corner Applicators (page 11) for applying corner bead to internal and external corners. Available in three sizes, the Compound Tubes disassemble for easy cleaning.



CT42TT - 42" Compound Tube



CT36TT - 36" Compound Tube



CT24TT - 24" Compound Tube



CTA01TT - Compound Tube Filler Adapter

Together with any size Compound Tube, is an alternative to filling finishing boxes with the loading pump. The Filler Adapter quickly attaches to TapeTech Compound Tubes by simply removing the outlet assembly, inserting the Filler Adapter and securing it with the quick-release latches.



TC01TT - Tool Caddy

The perfect accessory for workers who fill their finishing boxes with a compound tube instead of a loading pump. It securely holds any size finishing box in the perfect filling position, even with the handle attached. And it conveniently holds any length compound tube and filler adapter between fills.



IT'S **EASY** TO GET STARTED

Semi-Automatic tools are a cost-effective way to increase your productivity.

Keeping your tools clean and performing routine maintenance is the key to protecting your investment and maximizing your productivity. Only TapeTech offers everything you need to keep your tools in top condition. From brushes and cleaning adapters to lubricant and maintenance tools, TapeTech helps you keep your tools on the wall, making you money.



857355 - Gooseneck Cleaning Brush

Specifically designed to keep the Gooseneck clean for optimal operation.

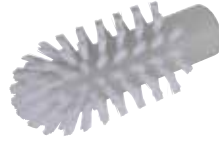

057355 - Taper Tube Cleaning Brush

Specifically designed to quickly and efficiently clean the main tube of the Automatic Taper.

Attaches to any length handle with a standard 3/4" Acme thread



057356 - Pump Tube Cleaning Brush

Specifically designed to quickly and efficiently clean the main tube of the Loading Pump.

Attaches to any length handle with a standard 3/4" Acme thread



CN-TT - Cleaning Nozzle

Connects to standard US hoses without an adapter. Metal construction with male-threaded outlet to connect to CNA-TT and traditional rear-lever design make this nozzle simple and durable – perfect for jobsite use.



CNATT - Cleaning Nozzle Adapter

Securely threads on to the Cleaning Nozzle and fits over the filler valve of the Automatic Taper to thoroughly clean the valve and the head without soaking the user.



CFSTCC - CFS Tool Cleaning Coupling

Used in conjunction with the CNA-TT to fit snugly onto the CFS tool fittings and allow for thorough cleaning.



QCA-TT - Quick Connect Adapter

Use with the CN-TT Cleaning Nozzle with quick-connect garden hose systems commonly found in Europe and other countries.



TMK01TT - ATF Tool Maintenance Kit

12 piece kit includes: 1/16" T-handle Hex Key, 5/64" T-handle Hex Key, 1/8" T-handle Hex Key, 9/64" T-handle Hex Key, .05" Flat Standard Hex Key, 1/4" Nut Driver, 5/16" Nut Driver, 11/32" Nut Driver, 3/8" Nut Driver, Calibration Gauge for Finishing Boxes (FB), Calibration Gauge for Corner Finishers (CF), Plastic Case



RTTC-TT - Taper Cable Repair Tool

Designed to easily fit in your tool box or tool bag and is the correct length for quickly pushing the plunger without damaging the main taper tube.

Cleaning & Maintenance

Lightweight Construction
up to 50% lighter than any other tool case on the market

Securely Holds Tools
four, alternating latches distribute force evenly

Custom Designed
dedicated cavities cradle the tools for optimal protection

Universal Cavities
fit all standard tools from TapeTech and most manufacturers.



The FIRST tool cases specifically designed for Automatic Taping & Finishing Tools on the way professional drywall finishers work! Finishing drywall involves taping and finishing; two phases that require time in between the application of the joint compound to dry. So, why would anyone want to carry a full set of tools in and out of the job when only half the tools are needed for each phase? TapeTech Tool Cases are designed to transport and protect the tools required for each phase, without adding unnecessary weight. So, where does the pump go? Professional drywall finishers were virtually unanimous in saying that they don't want the pump in the case with the rest of the tools. They noted that the pump does not need to be calibrated like the other tools and is just as easy to carry separately. Keeping the pump out of the cases saves weight and makes it easier to just grab the case of tools you need for that day's work along with the pump and get started!



TTCTAP - Taping Tool Case

The TapeTech Taping Tool Case is the first case specifically designed to protect and transport the Automatic Taping Tools for the Taping phase of the job. The lightweight case holds the automatic taper, corner rollers, mud heads, corner finishers and handles. The TapeTech Taping Tool Case has the features most requested by professional drywall finishers. Also holds Bazooka® CFS Taper.

TTCFIN - Finishing Tool Case

The TapeTech Finishing Tool Case is the first case specifically designed to protect and transport the Automatic Taping Tools for the Finishing phase of the job. The lightweight case holds two finishing boxes* (7" & 10", 7" & 12" or 10" & 12"), two corner finishers, finishing box handles, corner applicator, corner applicator handle and two nail spotters with handles. The TapeTech Finishing Tool Case has the features most requested by professional drywall finishers.

*Does not accommodate MaxxBox Finishing Boxes.

Tool Cases



Taper Head
New creaser wheel design for precision corners.

Endurance™ Pump
Endurance Pump features a horizontal design for easier pump loading, long life V-Max Blue™ packings and Chromex™ pump coating to create the most rugged and reliable pump on the market.

Inline Handle
Dual trigger controls the creaser wheel and positively stops joint compound flow with no oozing.

15' whip hose
Increases flexibility.

Taper
Reduced weight to 7 lbs to reduce fatigue.

Flow Control
The industry's first radio frequency (RF) controlled pump controls the flow without wires right at the tool.

No-Tool Hose connection
Makes a fast and secure connection.

Z-Swivel
Eliminates hose kinking.

Extreme-Duty Steel Frame and Flat Proof Tires
Protects critical components from job-site damage. Includes integrated tool tray for convenient storage of tools and accessories.

MaxPower Motor
The MaxPower motor is a totally-enclosed, fan-cooled design that protects the internal components from dirt, dust and joint compound. It features a powerful DC motor that never needs brushes, and Graco stands behind it with a lifetime warranty.

Max Flo™ Design
Max Flo fluid passages and large ball check valve efficiently loads thick joint compound.

25 gallon hopper
Includes air tight lid to preserve joint compound for next day use.

Internal Hopper Filter
Allows joint compound from the job-site to be recycled without wipe-down trash.

Advantage Drive™ System
The critical link between the motor and pump, the Advantage Drive System of hardened steel gears is the longest lasting drive in the industry, and Graco stands behind it with a lifetime warranty.

Quick Release Pump
Tool-free pump removal for easy lifting up stairs or in and out of vehicles.

Tool Wash Station
Power flushes all of the job site tools.

Tool Filling Station
Fills conventional taping tools even when the pump is running.

CTPMP - Bazooka Continuous Flow Pump (120V: US)
CTAPMP - Bazooka Continuous Flow Pump (230V: Australia)

CTEPM - Bazooka Continuous Flow Pump (230V: Europe)
CTUPMP - Bazooka Continuous Flow Pump (110V: UK)

All pumps include (257133) 50' hose, (223756) 15' whip hose, (16C298) hopper filter and (24D166) Z-Swivel



T05CF - Continuous Flow Taper



CF07H - 7" Continuous Flow Box
CF10H - 10" Continuous Flow Box
CF12H - 12" Continuous Flow Box



T8034 - 34" Continuous Flow Box Handle
T8042 - 42" Continuous Flow Box Handle
T8054 - 54" Continuous Flow Box Handle
T8072 - 72" Continuous Flow Box Handle



Tear-drop shape is ergonomically designed to be easier to grip and reduce fatigue. Securely locks the tear-drop handle to the finishing box.

T14CF - 42" Continuous Flow Corner Finisher Handle
T14EC - 60" Continuous Flow Corner Finisher Handle



Patent pending pivoting head to improve joint compound flow.

Use with 40TT, 42TT, 45TT, 48TT or 48XTT Corner Finishers - Not Included

257133 - 1/2" x 50' NPT Hose



223756 - 15' Whip Hose



24D166 - Z-Swivel



16C298 - Replacement Filter

For Bazooka Continuous Flow pump.



CTFILL - Fill Kit

Used to fill standard Automatic Taping and Finishing Tools from the Continuous Flow Pump.



122267 - Replacement Tire

For Bazooka Continuous Flow pump.



CTVLV - Radio Frequency Controller

For use with Taper and Corner Finisher Handles.



CTBXC - Radio Frequency Controller

For use with Finishing Box Handles.



WHY'S AND WHEN'S OF MAINTENANCE

Regular Maintenance

ATF Tools, just like a car, have parts that wear with normal use. And, just like a car, if these parts are not maintained it can lead to bigger problems. There are a number of wear parts on ATF tools. In fact, wear parts exist on ALL ATF tools.

The key to understanding wear parts is that the amount of time they last depends on three key variables:

TECHNIQUE - how you run the tools. **FREQUENCY** - how often and how long you run the tools. **MAINTENANCE** - how well you clean and lubricate the tools.

IT DOES NOT DEPEND UPON HOW LONG YOU HAVE OWNED THE TOOL.

Wear Parts MUST be changed on a regular basis. When they are not, tool performance suffers, productivity and profitability are diminished and other parts of the tool may become damaged. Which leads to the next category:

Required Service

Required service can become necessary as the result of damage to the tools in any way that is not the result of a defect in parts and workmanship or if the tool is not properly maintained. Maybe the tool was dropped. Maybe you attempted repairs the tool on your own with incorrect tools and insufficient knowledge. Or maybe you did not change wear parts when recommended, leading to premature wear of non-wear parts. You may have neglected to properly clean and lubricate the tools, leading to premature wear of wear and non-wear parts.

Here's an example of how failure to maintain the tools can lead to problems that you may think is a Warranty issue but is actually Required Service: If the Automatic Taper is not properly cleaned and lubricated, the drive dog shaft can freeze inside the cable drum. This can happen within days of purchase if the tool is not maintained! Oftentimes, tool owners will send their tools back for repair assuming this is a Warranty issue, since the tool may be only weeks or days old. But this example is not a Warranty situation. This is required service because the tool was not properly maintained.

REMEMBER: FAILURE TO PROPERLY MAINTAIN THE TOOL ALWAYS LEADS TO REQUIRED SERVICE.

What parts should be changed? And when? USE THIS TABLE AS A GUIDE. Note: These recommendations are based on regular daily use.

Daily - Clean and Lubricate all tools Every Day after use.

Monthly

TAPERS		PUMPS	CORNER FINISHERS	FINISHING BOXES
Pyramid Blade	Spring			Blades
Gooser Needle	Main Cable Assembly			

Quarterly

TAPERS		PUMPS	CORNER FINISHERS	FINISHING BOXES
Control Valve Wiper	Gooser Spring	Screens	Blades	Skid Covers
Creaser Wheel	Spring	Gasket	Skids	Repair Clips
Drive Dog Spring		Buna Gasket	Setscrews	O-Rings
Plunger Cup		O-Rings		

Yearly

TAPERS		PUMPS	CORNER FINISHERS	FINISHING BOXES
Magnet	Valve	Bushing Liner	Springs	Shoulder Screws
Cam Gooser Release	Creaser Axle	U-Cup	Blade Tension Springs	Nyliners
Chain Roller	Head Bushing	Wiper	Center Clips	Bearing Washers
Creaser Chain	Taper Wheel	Valve Disk	Center Clip Assembly	Wheels
Bearing Bracket	Head Bushing	Lock Clip		Wipers
Cup Washer	Cutter Block Tube	Pump Foot Wireform		
Control Tube Wheel	Cut Off Spring			
Roller Axle	Hub			
Brake Roller	Gooser Guide			
Brake Roller Assembly	Stopnut			
Brake Torsion Spring	Bearing Nyliner			
Insert	Drum Washer			
Side Plate Shims	Bearing Nyliner			
Anvil	Liner			



GET THE REPAIRS YOU WANT FAST!

Your TapeTech tools are important to you. They combine with your experience and skill to create perfectly finished drywall surfaces. You've invested in tools that make you money day in and day out. But your tools can only make you money when they are working properly.

Repair Packages - the easiest and quickest way to bring your tools back to life. Each Package has been specifically designed to replace all the parts that typically work together in an area of the tool. In most instances, simply replacing the one part that failed does not result in the optimal operation of the tool. This is because the part that failed is probably surrounded by other parts with significant wear on them. It's necessary to replace these other parts at the same time to keep the tool in top condition.

A la carte Repairs - Our technicians will analyze your tool and provide an itemized quote for approval. This option is recommended if you want to replace just a few parts or if you want to add a few parts to one of our packages.

Note: A la carte repairs can add time to the overall repair cycle as it requires a quote and your written approval prior to starting the repairs.

With all ProService Repair Packages or A la Carte repairs, TapeTech sends back all the parts that we replaced on your tool along with the repaired tool. This is further piece of mind that all the identified parts for your repair were replaced.

Shipping - Your tool ships to and from our facility via FedEx to reduce the amount of downtime you experience without it. You'll get the benefit of our incredibly low national shipping rates and the convenience of over 8,000 FedEx Office and Authorized ShipCenters®.

COMPLETE & EASY The TapeTech ProService program is the most comprehensive repair and maintenance program in the industry. Whether your tool needs a simple tune up or more extensive repairs due to job site damage, ProService makes it easier than ever to get your tools **fixed and back in your hands.**

OPTIMUM PERFORMANCE Over time, some parts experience natural wear and affect the performance of your tools. Professional maintenance keeps your tools up and running – **generating profit for your company.**

QUALITY ASSURANCE And now, TapeTech provides the industry's first service program performed by the same experts who built your tools. **The same technicians, quality parts and factory standards** are now available to keep your tools in top condition.

Getting Started... **Initiate Your Repair Order** - go to www.tapetech.com/ProService and fill out our online form to get your tool repair order in process. Then securely wrap and package your tool, bring it to FedEx and ship using our account.

Or... **Bring Your Tool to One of Our ProService Authorized Repair Partners** - and they will take care of the rest (process, package and ship)!

- **Tool Assessment** - a repair estimate will be provided (*a la carte repairs only*).
- **Estimate Approval** - your written approval is required (*a la carte repairs only*).
- **Tool Repair** - made by our certified technicians to factory specifications.
- **Timely Tool Return** - returned to you, good as new!

MAXpro Pricing

PEACE OF MIND TO TOOL REPAIRS

MAXpro Pricing is designed to give you peace of mind that no tool repair will exceed the stated price and in most cases it will be less. It is intended to streamline the repair process by eliminating the time-consuming repair estimate procedure. With MAXpro Pricing we can return the tool to you faster, getting you back on the job sooner.



THE EASY WAY TO EARN REWARDS!

Welcome to the TapeTech ProPoints Program! The industry's first Loyalty Rewards Program where your purchases earn points that you can redeem for cool TapeTech rewards. Now your TapeTech Tools help you earn money AND great rewards!

BUY

Buy TapeTech tools from an authorized dealer

All new, current models are eligible

Parts do not earn ProPoints

EARN

Register tools online within 14 days

E-mail or Fax the receipt within 30 days

Earn ProPoints

REDEEM

Once a minimum of 1,500 ProPoints are earned, they can be redeemed for rewards!

tapetech.com/promotions/ProPoints



1327 Northbrook Parkway, Ste 400
Suwanee, GA 30024