

OUR MOST **POPULAR**

EASILY **REFERENCE** OUR TOP SELLING DENTAL PRODUCTS.

ONE CALL GETS US ALL.

800-626-2163

www.dhpionline.com



2017-18

"Reliable, fast shipping,
always has the products we
need in stock, extremely
considerate of their
customers, personable
staff and great pricing!"

— customer response —
OHIO

**MORE
ON BACK**

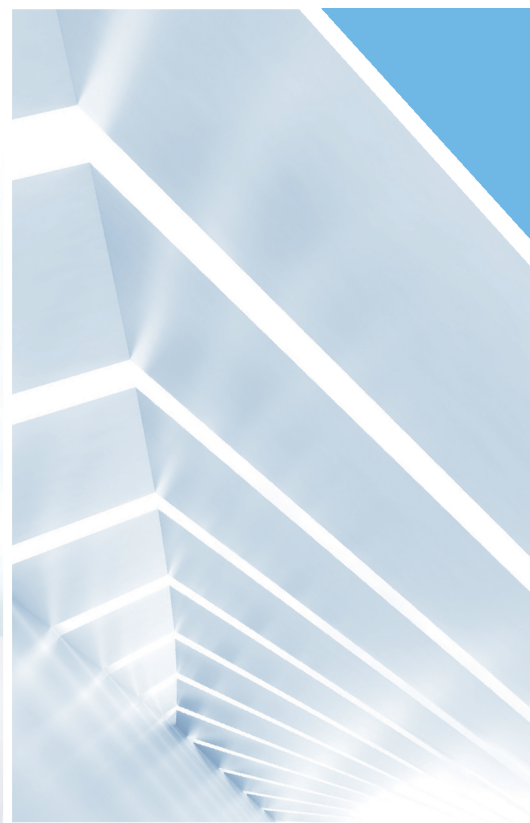

Search our full product catalog at
www.dhpionline.com



Dental Health Products, Inc.

SUPPLIES. EQUIPMENT. SOLUTIONS.



Your Equipment

Dental Health Products, Inc. (DHPI) offers many solutions for your large equipment needs. We've partnered with top equipment manufacturers to provide you the best selection available on the market. If you're looking to upgrade your equipment or convert your office to digital, we've got you covered. We also offer financing options, preventive maintenance programs and customer support to make sure your equipment is taken care of in every way possible.

Contact our Equipment & Service Team at **800-444-6410** to get started today!

Equipment



& MORE

Services



& MORE

Please see your DHPI Equipment Specialist for pricing and availability in your area.

TABLE OF CONTENTS

Acrylics & Reline.....	3-9	Infection Control	275-330
Alloys.....	10-13	Instruments	331-443
Anesthetic	14-21	Janitorial & Sanitation.....	640-641
Articulating	22-24	Lab Products	444-459
Breakroom Supplies	637-639	Matrix	460-466
Burs- Carbides & Diamonds	25-96	Office Products	590-636
Cements & Liners	97-112	Orthodontic	467-480
Core Materials	113-116	Patient Giveaways	585-589
Cosmetic Dentistry	117-153	Pharmaceuticals.....	481
Crowns	154-159	Pins & Posts	482-487
Disposables.....	160-171	Preventives	488-536
Endodontic	172-200	Retraction.....	537-541
Evacuation	201-208	Rubber Dam.....	542-549
Equipment - Small and Large	642-749	Supply Order Forms	791-792
Finishing & Polishing	209-223	Surgical Products.....	550-558
Handpieces	224-250	Uniforms.....	559-562
Impression Products	251-274	Waxes	563-565
Index & Terms & Conditions.....	750-790	X-Ray	566-584

CALL TODAY!

To Place an Order: **1-800-626-2163** 7:00-5:30 CST
 To Fax an Order: **1-888-681-5088** 24 hrs/day
 Customer Service: **1-800-626-2163** 7:00-5:30 CST
 Equipment Sales & Technical Service: **1-800-444-6410** 7:00-5:30 CST
 Handpiece and Small Equipment Repair: **1-800-209-0927** 7:00-5:30 CST
 OPTIONS Software Technical Support: ... **1-800-626-2163** 7:00-5:30 CST
 Practice Financial Services: **1-800-626-2163** 7:00-5:30 CST
 Federal & State Sales: **1-800-626-2163** 7:00-5:30 CST
 Special Market Sales: **1-800-626-2163** 7:00-5:30 CST
Order Online: **www.dhponline.com**

Full-Service Coverage	
Limited Service Coverage	
Dental Supply Coverage	
Distribution Centers	

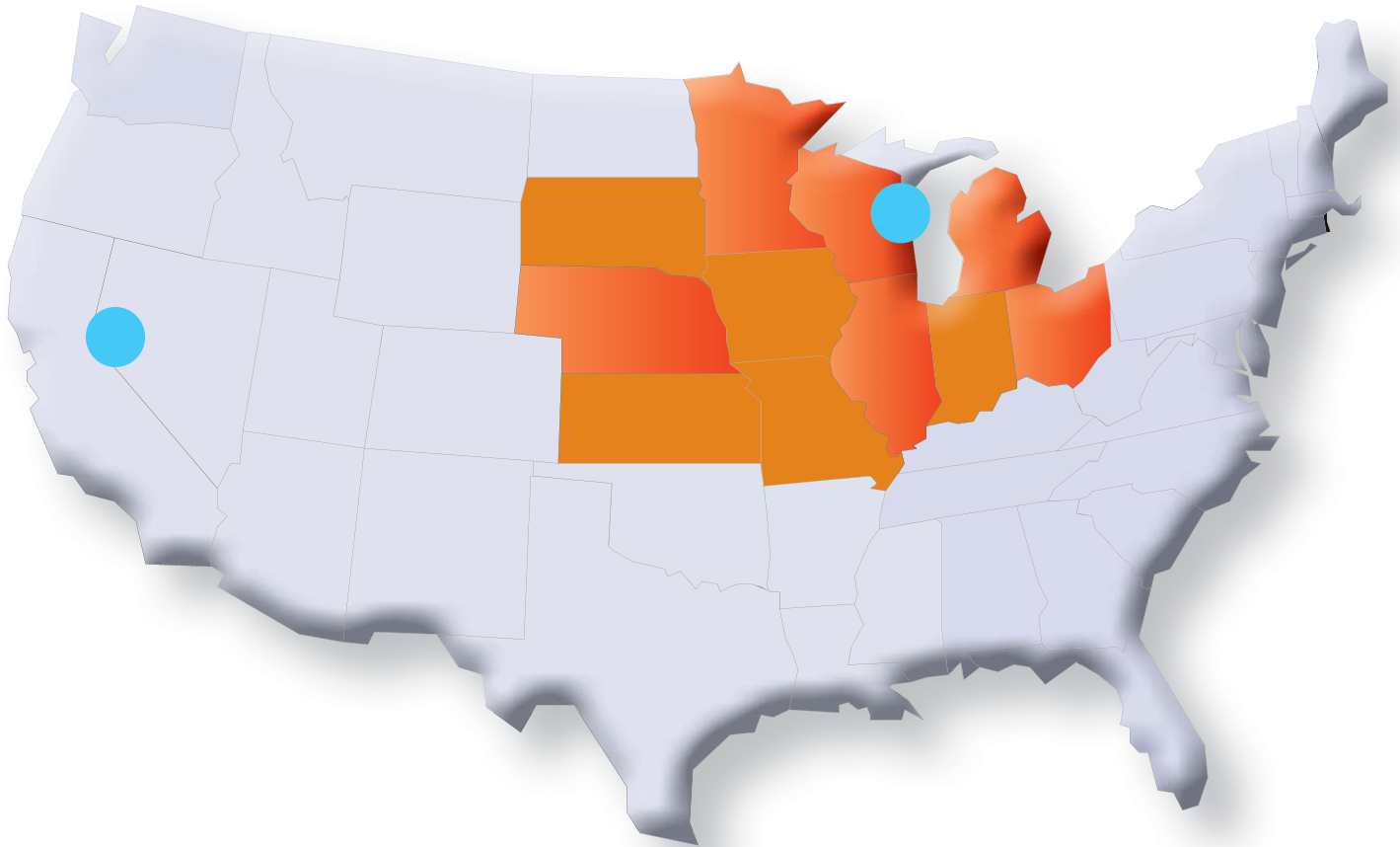

Like us.



Network with us.



Follow us.



Tweet us.



Watch us.



Add us.

FULL-SERVICE Locations in *Our Nation*

- | | | | | | | |
|---|--|--|--|---|--|---|
| <p>1. Wisconsin Office - Corporate
 2614 N. Sugar Bush Rd
 New Franken, WI 54229
 800-626-2163</p> | <p>2. Michigan Office
 3125 Pine Tree Rd
 Suite 3A
 Lansing, MI 48911
 866-910-0771</p> | <p>3. Illinois Office
 1098 Tower Lane
 Bensenville, IL
 60106-1031
 877-608-6927</p> | <p>4. Ohio Office
 812 Morrison Road
 Gahanna, OH 43230
 866-860-5040</p> | <p>5. Nebraska Office
 2200 Fletcher Ave
 Suite 101
 Lincoln, NE 68521
 866-653-1425</p> | <p>6. Minnesota Office
 1408 Northland Dr
 Suite 306
 Mendota Heights, MN 55120
 888-302-9455</p> | <p>7. Distribution Center
 205 Parr Blvd
 Reno, NV 89512</p> |
|---|--|--|--|---|--|---|

SUPPLIES.

EQUIPMENT.

SOLUTIONS.



Temporary Crown & Bridge 1:1

Easy to handle and polish, has high resistance to impact and possesses superior biocompatibility. Insertion timing is 45 seconds, timing for removal is 2-3 minutes, and end of setting process is 6-7 minutes.

Package Includes:

- 1 -50ml cartridge and 15 blue mixing tips.
- A1 110-3201
- A2 110-3202
- A3 110-3203
- Package **\$87.95**

Temporary Crown & Bridge 4:1

Offers increased flexibility and low polymerization shrinkage. There is no mixing by hand and you will get an exact dosage every time. Working time is 90 seconds, curing time in mouth is 2-3 minutes, curing time on model is 4-6 minutes. Dispenser sold separately.

Package Includes:

- 1 -50ml cartridge and 10 light blue mixing tips.
- A1 110-10001
- A2 110-10002
- A3.5 110-10003
- B1 110-10004
- Package **\$87.95**



Cartridge Dispenser

For use with all high-performance split 50ml cartridges.

- 1:1 Dispenser**
- 300-8202 Each **\$95.25**
- 4:1 with 10:1 Plunger**
- 300-8204 Each **\$95.25**



Mixing Tips 1:1 - Blue
110-4201 50/bag **\$49.95**



Mixing Tips 4:1/10:1 - Blue
300-8108 25/bag **\$23.25**



Protemp™ II - 3M Oral Care

Temporary crown and bridge material with expanded working time. Offers all the benefits of the original formulation with no technique change.

Double Pack

- Contains: 2 -28gm base paste, 1 -4.8gm catalyst, 1 syringe and mixing pad.
- A1 Extra Light 117-04609
- A3 Light 117-04610
- Each **\$341.95**

- Catalyst**
- 117-4643 4.8gm **\$59.95**

- Application Syringes**
- 117-7207 5/pack **\$39.95**



Protemp™ Plus - 3M Oral Care

Highest fracture resistance and gloss without polishing. Total set time of only five minutes. Sophisticated filler technology provides strength and esthetics.

Intro Kit

- Contains: 1 -50ml cartridge A2, 16 cartridge mixing tips, 1 cartridge dispenser, RelyX Temp NE Cement, 1 Filtek Supreme Plus Flowable syringe A2 with mixing tips, technique card and instructions.
- 117-46962 Kit **\$256.95**

Refills

- Contains: 1 -67gm cartridge and 16 Garant mixing tips.
- A1 117-46955
- A2 117-46963
- A3 117-46958
- A3.5 117-46973
- B3 117-46961
- Bleach 117-46964
- Each **\$214.95**

Garant Dispenser

- Cartridge Dispenser 4:1/10:1
- 117-77581 Each **\$163.95**

Garant Mixing Tips - Blue

- 117-071453 50/bag **\$59.95**



Access Crown® - Centrix

A bis-acryl composite that yields predictable and consistent results every time. No messy mixing, far less heat and unpleasant odor than with acrylics.

Kit

- Includes: 1 -76gm cartridge and 10 automix nozzles.
- A1 110-360035
- A2 110-360034
- A3 110-360030
- A3.5 110-360029
- B1 110-360031
- C2 110-360037
- Bleach 110-360038
- Kit **\$186.25**

DS50 Crown Nozzles - Blue

- 110-910626 50/pack **\$77.95**

TEMPORARY CROWN & BRIDGE MATERIAL



CoolTemp® Natural - Coltene

Predictable and precise temporaries. The result is an accurate provisional that can be trimmed and polished effortlessly. Low polymerization temperature does not damage or irritate the pulp to create any discomfort.

Single Pack

Contains: 1 -50ml cartridge and 10 mixing tips.
 A1 114-C5815
 A2 114-C5805
 A3.5 114-C5810
 Each **\$199.95**

CoolTemp Dispenser

Dispenser for 50ml and 75ml cartridges.
 324-C6900 Each..... **\$149.45**

CoolTemp Mixing Tips

Pointed Blue.
 114-C7774 40/pkg. **\$58.75**



Integrity Temporary Crown & Bridge Material - Dentsply Caulk

A composite resin material automatically mixed and directly dispensed from a cartridge for the fabrication of provisional restorations. Self curing. 10:1 ratio.

Complete Package available upon request.

Cartridge Refills

Contains: 1 -76gm cartridge and 20 small mixing tips.
 A1 118-666210
 A2 118-666220
 A3 110-666360
 A3.5 118-666230
 B1 118-666240
 BW 118-666245
 Each **\$221.25**

mini-Syringe Refills available upon request.

Integrity MultiCure - Dentsply Caulk

Unique dual cure formula (10:1 bisacryl material) offers improved flexural strength.

Cartridge Refills

Contains: 1 -76gm cartridge and 15 mixing tips.
 A1 118-666600
 A2 118-666610
 A3.5 118-666620
 B1 118-666630
 BW 118-666640
 Each **\$232.75**

Integrity Mixing Tips

118-666280 20/box **\$27.45**

Integrity Dispenser with Slide

118-666260 Each..... **\$213.75**



Temporary Bridge Resin - Dentsply Caulk

Powder Only

#62 - Light 118-666001
 #65 - Medium 118-666002
 42gm **\$37.95**

Liquid Only

118-666005 120ml **\$47.75**



LuxaFlow Ultra - DMG America

Specifically designed for excellent compatibility with LuxaTemp Ultra and other bisacryl provisional materials, LuxaFlow Ultra allows you to create more lifelike additions and repairs. Like LuxaFlow Fluorescence, it's perfect for blocking out undercuts and as a solution for enamel defects. It is also effective in creating a seal in gingival margin interfaces. Delivered from a high precision syringe-tip dispensing system, it provides excellent flowability in a non-slumping formula.

Intro Kit

Contains: 1 -1.5gm syringe of each LuxaFlow A1, A2, A3.5, B1 and 20 syringe tips.
 210-224000 Kit..... **\$100.95**

Refills

Contains: 2 -1.5gm syringes and 10 syringe tips.
 A1 210-224001
 A2 210-224002



A3 210-224003
 A3.5 210-224004
 B1 210-224005
 Each **\$50.95**

LuxaFlow Tips

210-211759 20/bag **\$16.45**



Luxatemp Automix Plus - DMG America

Used to create provisional restorations for placement in the patient's mouth during indirect and prosthodontic treatments. Combines approximately 30% more of the original automix provisional crown and bridge material in a new and improved cartridge delivery system.

Introductory Kit available upon request.

Refills

Contains: 76gm cartridge and 15 plus fine mixing tips.
 A1 110-110401
 A2 110-110402
 A3.5 110-110403
 B1 110-110404
 Bleach Light 110-110368
 Each **\$222.95**

Bulk Package available upon request.

Applicator Gun

110-110411 Each..... **\$170.25**

Luxatemp Automix Plus Tips - Fine

110-110351 25/bag **\$51.95**



Luxatemp Fluorescence - DMG America

Makes temporaries look as good as final restorations in all lighting conditions. It has a bisacryl composition for durable temporary restorations and low shrinkage eliminates the need to remarginate and makes provisionals easy to remove. It's neutral taste and odor with no liquid monomers provide greater patient acceptance.

Refills

Contains: 1 -76gm cartridge and 15 plus fine mixing tips.
 A1 110-110585
 A2 110-110586
 A3 110-110710
 A3.5 110-110587
 B1 110-110588
 Bleach Light 110-110589
 Each **\$222.95**

Luxatemp Automix Plus Tips - Fine

110-110351 25/bag **\$51.95**

TEMPORARY CROWN & BRIDGE MATERIAL



Luxatemp Ultra - DMG America

Temporary provisional material that sets a new standard for flexural strength and beauty. Provides unmatched stability and long-term durability for temporary crowns, bridges, inlays, onlays, and veneers. Highly accurate with incredible marginal adaptation.

Automix Refills

Contains: 1 -76gm cartridge and 15 plus fine mixing tips.

A1	110-110906
A2	110-110907
A3	110-110908
A3.5	110-110909
B1	110-110910
Bleach Light	110-110911
Each	\$222.95

Smartmix Refills available upon request.

Automix 10:1 Gun

Type 50 4:1/10:1
110-110411 Each..... **\$170.25**

Luxatemp Automix Plus Tips - Fine

110-110351 25/bag..... **\$51.95**



ALIKE™ - GC America

Temporary crown and bridge resin. Fast curing (5-6 min.) minimal shrinkage.

Professional Package

Contains: 1 -45gm powder bottle of each shade (Vita A1-B3) and 1 -4oz. liquid.
112-340501 Package..... **\$160.75**

Liquid Only

112-340591 4oz..... **\$34.25**

Powder Only

A1	112-340512
A2	112-340513
A3	112-340514
A3.5	112-340516
B1	112-340511
B3	112-340515
45gm	\$35.95



REVOTEK LC™ - GC America

Light-cured, single-component, sculptable composite resin for temporary inlays, onlays, veneers, crowns and bridges. Easy to handle and place. No mixing, no waste, no mess. B2 shade.

Intro Kit

Contains: 1 B2 putty stick, 1 light-proof storage case and 1 plastic spatula.
112-001842 Kit..... **\$100.75**



Tempsmart - GC America

Dual-cured, bis-acrylic composite temporary crown and bridge material using micro-filled resin (MFR) and nano-filler technologies. Maintains a smooth surface after polishing. Quick working and setting times for the shortest chairside time.

Contains: 48ml cartridge and 16 Mixing Tips II SSS.

A1	110-009392
A2	110-009393
A3	110-009394
A3.5	110-009395
B1	110-009396
BW	110-009397
Each	\$170.75

10ml Cartridge Syringes available upon request.

GC Cartridge Dispenser II

302-152101 Each..... **\$184.95**

Tempsmart Mixing Tips II SSS

Fits the 48ml cartridge.
110-420000 20/pkg..... **\$21.25**



Venus® Temp 2 - Heraeus Kulzer

A 10:1 auto-mix provisional material used to create temporary crowns and bridges, inlays, onlays, veneers and long-term temporaries. Offers the optimal solution in the indirect restorative process and a finished result that will meet or exceed both dentist and patient expectations.

Contains: 1 -50ml cartridge and 12 mixing tips.

A1	110-66049181
A2	110-66049182
A3.5	110-66049183
B1	110-66049184
Bleach.....	110-66049185
Each	\$217.25



Tempphase - Kerr Restoratives

Two component self-cure, bismethacryl-type composite material designed for short-and long-term provisional crown and bridge restorations. Regular and fast set, medium viscosity material has a 1:1 ratio.

Refills - Fast Set

Contains: 1 -72gm cartridge and 12 mixing tips.
A1 119-29367 || A2 | 119-28655 |
A3.5	119-28656
B1	119-28657
C2	119-28658
Each	**\$276.45**

Regular Set available upon request.

Mixing Tip Refill

119-28075 48/pack..... **\$73.45**

Extruder Gun

309-28747 Each..... **\$184.95**



Bosworth Trim® II - Keystone Industries

Identical in formula and function to Trim. Trim II is available in six multiple shades for greater diversity and in achieving the perfect shade match among patients.

Standard Kit available upon request.

Powder

#59/B1	110-0921092
#61/B2	110-0921093
#62/A2	110-0921094
#65/D3	110-0921095
#69/C2	110-0921096
#77/B4	110-0921097
1.5oz	\$23.75

Liquid Refill

110-0921091 4oz..... **\$27.75**

Trim and Trim Plus available upon request.

TEMPORARY CROWN & BRIDGE MATERIAL



Jet Tooth Shade Acrylic - Lang Dental Manufacturing Co., Inc.

Self curing acrylic resin for making stonger, more color stable provisional crowns and bridges.

6/1 Powder Kit

Contains: 6 -45gm powders, (shades #60, #62, #65, #69, #77 and #81) and 118ml liquid.
110-1493R Kit.....**\$121.25**

Powder Only

#59/B1	110-141059
#60/A1	110-141060
#61/B2	110-141061
#62/A2	110-141062
#65/D3	110-141065
#66/A3	110-141066
#67/B3	110-141067
#69/C2	110-141069
#77/B4	110-141077
#81/A3.5	110-141081
#C3	110-1410C3
#C4	110-1410C4
#D4	110-1410D4
2oz.	\$21.45

Additional shades available upon request.

Liquid Only

110-1403	4oz	\$22.45
110-1404	8oz	\$38.95



SNAP™ - Parkell, Inc.

Low shrinkage for better fitting crowns and bridges. Extraordinary marginal accuracy. Dramatically reduces polymerization shrinkage. Delivers a better fit than methyl methacrylate-based materials. Features a true doughy stage and lower heat release. Exceptional color stability and very economical to use.

Starter Kit

Contains: 1 -4oz. liquid monomer and 4 popular powder shades (A2, A3/D3, C2/D4, B3/B4).
110-S424 Kit.....**\$86.45**

Powder Refill Shades

#59/B1	110-S451
#61/B2	110-S425
#62/A2	110-S459
#65/A3/D3	110-S426
#69/C2/D4	110-S449
#77/B3/B4	110-S427
Clear	110-S429
40gm	\$24.95

#59/B1	110-S452
#62/A2	110-S447
#65/A3/D3.....	110-S443
#69/C2/D4	110-S450
170gm	\$76.75

Additional shades available upon request.

SNAP Liquid

110-S441	4oz	\$26.25
----------	-----------	----------------



TempSpan™ - Pentron Clinical

Temporary crown and bridge material specifically formulated to produce highly esthetic and durable provisional restorations in the shortest time possible. The unique dual cure ability provides clinicians with the choice to light cure to save time. Seven standard shades available.

Contains: 1 -50ml cartridge, 15 mixing tips.

AO	110-N69AA
A1	110-N69AB
A2	110-N69AC
A3	110-N69AD
A3.5	110-N69AE
B1	110-N69AF
C2	110-N69AG
Each	\$124.25

TempSpan Clear Matrix Material

Contains: 4 -50ml cartridges, 16 mixing tips.
110-Q34CB Each.....**\$84.25**



Tuff-Temp™ Plus - Pulpdent Corporation

Provisional Veneer, Crown & Bridge Resin. Dual Cure. Strong, impact resistant rubberized-urethane doesn't shrink or distort and grips the tooth tightly. Virtually eliminates fractures and debonding. Grinds and powders during trimming without softening or distorting. Faster setting time.

Automix Cartridge

Contains: 1 -50ml automix cartridge, 20 automix tips, 3ml Glaze and 1.2ml Add-on.

A1	110-TTA1
A2	110-TTA2
A3	110-TTA3
A3.5	110-TTA35
B1	110-TTB1
Bleach.....	110-TTB
Each	\$145.75

Automix Syringe available upon request.

Mixing Tips

110-FSB20	20/pack	\$23.45
-----------	---------------	----------------



Versa-Temp 2 - Sultan Healthcare

High-strength, high-esthetic temporary resin with a natural fluorescence ideal for both anterior and posterior temporaries. It provides great handling and fast polishing without compromising on strength and speed. 4 minute total set time.

Contains: 1 -50ml cartridge and 15 mixing tips.

A1	110-72051
A2	110-72056
A3	110-72061
Each	\$164.95

Bulk refills available upon request.

Mixing Tips

200-70035	50/pkg	\$72.45
-----------	--------------	----------------



Turbo Temp™ 2 - Zest Dental Solutions

Temporary crown and bridge material in a cartridge delivery system. Has up to twice the flexural strength with less than 0.44% shrinkage.

Contains: 1 -76gm cartridge and 10 mixing tips.

A1	110-90156
A2	110-90157
A3.5	110-90158
B1	110-90631
Each	\$171.75

Dispenser Gun 4:1

110-90176	Each.....	\$122.45
-----------	-----------	-----------------

Mixing Tips

110-90162	10/pkg.....	\$23.75
-----------	-------------	----------------



for something? **WE HAVE IT!**

www.dhponline.com

ACRYLIC GLAZE



LuxaGlaze® - DMG America

Light-cured varnish for glazing the surfaces of provisional crown and bridges. It light cures in 10 seconds providing a quick, easy and esthetically superior alternative to mechanical polishing. It is the perfect finishing touch for temporaries fabricated with Luxatemp but is also ideal for improving the esthetics of any provisional material.

LuxaGlaze Kit

Contains: 5ml dropper bottle, mixing pallet and 25 soft disposable application brushes.
110-212075 Kit..... **\$82.45**

ACRYLIC REPAIR



PATTERN™ RESIN LS - GC America

Fast-setting (4 minute), highly translucent, non-grainy die material which exhibits unsurpassed accuracy. Burns away completely, leaving no residue.

1:1 Package

Contains: 1 -100gm bottle powder, 1 -105ml bottle liquid, mixing cups, brush and measures.
112-335201 Package..... **\$103.75**

Liquid and Powder refills available upon request.

CUSTOM TRAY MATERIAL



COE TRAY PLASTIC™ - GC America

Economy Package

Contains: 3lb. white powder and 16oz. liquid and 2 -2oz. bottles of COE-SEP liquid.

Fast Set White..... 112-240113
Regular Set White..... 112-240013
Package **\$254.95**

Fast Set Liquid Only

112-240192 16oz..... **\$90.25**

Regular Set Liquid and Powder Refills available upon request.

Order by ☎ 800-626-2163



Bosworth Fastray™ - Keystone Industries

Dimensionally stable, radiopaque, self-curing individual tray and acrylic base plate material available in regular (5 minute) or extra-fast (3 minute) set.

Standard Kit

Contains: 1 -1lb. powder and 1 -8oz. liquid.
Blue 110-0921375
Pink..... 110-0921376
White 110-0921377
X-Fast Blue 110-0921378
Kit **\$78.25**

Powder Only

Blue 110-0921381
Pink..... 110-0921382
White 110-0921383
1lb. **\$57.75**

Blue 110-0921392
Pink..... 110-0921393
White 110-0921394
5lb. **\$140.75**

Liquid Only - Regular Set

110-0921384 8oz..... **\$40.25**
110-0921395 32oz..... **\$88.25**



Bosworth Fastray™ LC - Keystone Industries

One-component, light cured custom tray material supplied in pre-formed sheets that, when used with a separator, will not distort or stick to fingers or models. Fastray LC provides a firm, stable custom tray that is ready to use immediately after trimming and polishing.

Standard Kit

Contains: 50 sheets/box.
Blue 110-0921405
Pink..... 110-0921406
White 110-0921407
Kit **\$114.95**



Hydroplastic - TAK Systems

A unique custom formulated plastic that quickly softens in hot water to a translucent, pliable, putty-like consistency. It will harden to a tough, flexible, unbreakable plastic. There is no mixing or polymerizing and no odor or chemical hazard. Ideally suited for preformed, custom impression and bleaching trays.

Blue 110-1204
Pink..... 110-1203
White 110-1201
Yellow..... 110-1202
460gm **\$73.75**

HARD RELINE



COE-RECT™ - GC America

Self-curing, rigid denture liner for permanent hard relines and repairs you can complete at chairside in as little as 20 minutes.

Professional Package

Contains: 1 -6oz. bottle of powder, 1 -6oz. bottle of liquid, 1 -14ml repair liquid and accessories.
112-343001 Package **\$178.95**

Liquid Refill

112-343091 6oz..... **\$97.75**

Powder Refill

112-343002 6oz..... **\$133.95**



GC RELINE™ - GC America

Hard denture reline material. Methyl methacrylate-free, self-curing. Reduced exothermic heat and minimal odor. Can be cured intraorally in most cases for better adaptation and less distortion.

Standard Package

Contains: 1 -80gm powder, 1 -50ml liquid, 1 -15gm bonding agent, measure vial, spatula, brush and mixing cup.
112-346001 Package **\$201.95**

Powder

112-346002 80gm..... **\$84.45**

Liquid

112-346191 50ml..... **\$84.45**

Bonding Agent

112-346094 15gm..... **\$50.25**

☎ www.dhponline.com

☎ Fax: 888-681-5088

HARD RELINE



KOOLINER™ - GC America

A hard, permanent, chairside denture reline material that can be completely cured in the patient's mouth.

Professional Package

Contains: 1 -3oz. powder, 1 -2oz. liquid and accessories.
112-345001 Package **\$125.75**

Powder Only

112-345002 3oz **\$78.45**

Liquid Only

112-345091 2oz **\$59.45**



Rebase II - Tokuyama Dental America, Inc.

Chairside hard denture reline material. Offers better polishability, lower heat generation for in-mouth curing, higher mechanical strengths, improved handling and less odor/taste. It cures in 4 minutes 30 seconds intraorally.

Kit

Contains: 80gm powder, 50ml liquid, 15ml adhesive, 48gm Tokuso Resin Hardener II, and accessories.
110-20506 Kit..... **\$125.95**

Powder Only

110-20546 80gm **\$59.25**

Liquid Only

110-20562 50ml **\$59.25**

SOFT RELINE



Bosworth Light Liner® - Keystone Industries

A chairside light cure composite reline material. No intraoral irritation. Self-bonding.

Standard Kit

Contains: 8 -6gm single dose packs composite powder, 8 -4gm composite liquid, 1 -30cc air barrier.

Hard..... 110-0921463
Soft 110-0921464
Kit **\$234.75**



COE-SOFT™ - GC America

A resilient, soft chairside reline material for upper and lower dentures.

Professional Package

Contains: 1 -5.5oz. powder, 1 -5.5oz. liquid, 1 bottle of lubricant and accessories.
110-344011 Package **\$181.45**

Economy Package available upon request.

Powder

110-344022 5.5oz. **\$138.95**

Liquid

110-344033 5.5oz. **\$100.75**



Bosworth Truliner® - Keystone Industries

Original Truliner Standard Kit

Contains: 8oz. powder and 6oz. liquid.
Pink..... 110-0921940
Veined..... 110-0921941
Kit **\$116.25**

New Truliner Standard Kit

Contains: 8oz. powder, 6oz. liquid and 1/3oz. bonding liquid.
Pink..... 110-0921970
Veined..... 110-0921971
Kit **\$116.25**

Powder and Liquid sold separately upon request.



GC RELINE™ - GC America

Vinyl polysiloxane denture reline material, provides a soft, durable lining for partial or full dentures. Works well as a tissue toner providing a more comfortable surface while the tissue returns to a healthy state.

Introductory Package

Contains: 1 -48ml cartridge, 6 (Type 2L) mixing tips, 13ml Primer R, 1 silicone finishing point, 1 -9ml bottle of GC RELINE Modifier Parts A & B,

mixing pad, pellet sponges, spatula, scoop, primer brush and plastic case.

Extra Soft 112-346501
Soft 112-346401
Package **\$355.25**

Refill

Contains: 1 -48ml cartridge.
Soft 112-346431
Extra Soft 112-346531
Ultra Soft 112-001859
Each **\$96.75**

Primer R

Contains: 1 -13ml bottle of resin powder with built-in brush.
112-346471 Each..... **\$85.95**

GC Reline Refill Cartridge Dispenser

Contains: 1 -48ml cartridge, no mixing tips included.
302-152101 Each..... **\$184.95**



SoftLine™ - Kerr Restoratives

Soft alternative to acrylic-based liners that cures entirely in the mouth in three minutes with no heat, no odor or unpleasant taste plus no messy mixing or handling. Applied chair-side utilizing an auto-mix delivery system.

Intro Kit - Light Pink

Contains: 50ml cartridge, 6 mix tips, 5ml bonding agent, 1 bottle varnish, 5ml base, 5ml catalyst, 25 4-cavity mixing wells and 38 applicators.
110-32232 Kit..... **\$255.25**

Refill - Light Pink

Contains: 50ml cartridge, 6 mix tips, 5ml bonding agent, 25 4-cavity mixing wells and 38 applicators.
110-32234 Each..... **\$205.75**

Available in Dark Pink upon request.



Bosworth DentuSil™ - Keystone Industries

Combines the ease of cartridge dispensing with the flexibility and resilience of a soft silicone material to provide denture patients with a comfortable, reliable reline in just one office visit. Silicone base absorbs less water. Its translucent pink color provides a natural, healthy appearance.

Standard Kit

Contains: 1 -50ml cartridge, 1 -14ml liquid and mixing tips.
110-0921276 Kit..... **\$178.75**

SOFT RELINE



Bosworth Trusoft™ - Keystone Industries

Soft resilient acrylic reline. PEMA formulated, specifically designed as an intermediate liner for patients requiring a prolonged adjustment period prior to using a hard liner or denture base material. Its elasticity will ensure against pressure pain, tender ridges, sensitive areas, and irritated tuberosities. Formulated to remain resilient for up to 30 days.

Standard Kit

Contains: 3oz. powder, 4oz. liquid and 10ml bonding liquid.

110-0921250 Kit..... **\$78.45**

Bulk Kit available upon request.

Powder Only

110-0921251 3oz..... **\$46.75**
 110-0921254 1lb..... **\$159.95**

Liquid Only

110-0921252 4oz..... **\$36.75**
 110-0921255 8oz..... **\$64.45**

Bonding Liquid available upon request.



Sofreliner Tough® - Tokuyama Dental America, Inc.

An addition-cured silicone material for relining dentures on patients that require relief on upper or lower, partial or full dentures. With superb stain resistance, adhesion to the denture, and tear resistance, it ensures patient satisfaction for up to 24 months.

Sofreliner Tough S (Soft) Kit

For both short-and long-term use.

Contains: cartridge paste (base/catalyst each 26gm), primer 10ml, Drip-Cap for primer, plastic cup, mixing tip XS x 10, spatula, brush, coarse point (black), finishing wheel (brown).

110-23401 Kit..... **\$179.25**

Sofreliner Tough M (Medium) Kit

For long-term use.

Contains: Cartridge paste (base/catalyst each 27gm), primer 10ml, Drip-Cap for primer, plastic cup, mixing tip XS x 10, spatula, brush, shape adjustment point (white), finishing point (brown).

110-23351 Kit..... **\$184.45**

TISSUE CONDITIONERS



Lynal - Dentsply Caulk

Use as a tissue conditioner and temporary reliner when soft tissues have been distorted by trauma or infection. Can also be used as a functional impression material when a complete denture is to be rebased or remade. Lynal is excellent as a soft liner for aged patients.

Complete Pack

Contains: 1 -120gm powder, 1 -90ml liquid and 1 -15ml separator.
 118-653006 Pack **\$289.95**



Visco-gel - Dentsply Professional

Tissue conditioner and temporary reliner when denture bearing soft tissues have been distorted by trauma or infection.

Contains: 120gm powder, 90ml liquid and 15ml lubricant, mixture/liquid vessel and powder measure.

110-A72100 Kit..... **\$184.95**



COE-COMFORT™ - GC America

Edentulous tissue conditioner which restores form and condition to the underlying tissue at chairside.

Professional Package

Contains: 1 -6oz. powder, 1 -6oz. liquid and accessories.

112-341001 Package **\$186.25**

Powder Refills

112-341002 6oz. bottle..... **\$143.25**
 112-341004 5lb. jar..... **\$728.25**

Liquid Refills

112-341091 6oz. bottle..... **\$98.75**
 112-341092 1qt. bottle..... **\$271.25**



Bosworth Softone™ - Keystone Industries

Tissue conditioner and functional material that restores, massages and rehabilitates damaged tissue before a new denture rebase or reline. Clean, refreshing taste that will not absorb odors, generating greater patient comfort and compliance.

Standard Kit

Contains: 1 -3oz. of powder and 1 -4oz. of liquid.
 110-0921775 White..... **\$83.45**
 110-0921775P Pink..... **\$82.45**

Bulk Kit available upon request.

Powder Refills

White

110-0921776 3oz..... **\$46.45**
 110-0921779 1lb..... **\$167.45**

Pink

110-0921776P 3oz..... **\$46.45**
 110-0921779P 1lb..... **\$168.45**

Liquid Refills

110-0921777 4oz..... **\$46.45**
 110-0921780 8oz..... **\$75.25**

LOOK'in
 for something? **WE HAVE IT!**
www.dhpionline.com

DISPERSED PHASE ALLOYS

ALLOYS



Dispersed Phase Amalgam

Can use firm condensing pressure to adapt to the shape of the cavity. Clinical studies show this type of alloy lasts longer. Approximate Metal Composition: 58% Silver/ 27% Tin/ 15% Copper. Physical Properties: 1 Hour Strength 23,000 psi 24 Hour Strength 58,000 psi Static Creep: 0.21% Expansion: +/-0.5m/cm Trituration Time: Medium Speed 10+/-2 seconds.

1 Spill – 400mg Alloy/400mg Mercury

Fast Set	
50 Caps	100-UPD150..... \$72.95
500 Caps	100-UPD1500..... \$593.95

Regular Set

50 Caps	100-UPD150RS..... \$72.95
500 Caps	100-UPD1500RS..... \$593.95

2 Spill – 600mg Alloy/600mg Mercury

Fast Set	
50 Caps	100-UPD250..... \$90.95
500 Caps	100-UPD2500..... \$819.95

Regular Set

50 Caps	100-UPD250RS..... \$90.95
500 Caps	100-UPD2500RS..... \$819.95

3 Spill – 800mg Alloy/800mg Mercury

Fast Set	
50 Caps	100-UPD350..... \$119.95
500 Caps	100-UPD3500..... \$1119.95

Regular Set

50 Caps	100-UPD350RS..... \$119.95
500 Caps	100-UPD3500RS..... \$1119.95

*High Speed Amalgamator recommended for proper trituration.



Dispersalloy® - Dentsply Caulk

1 Spill Capsules - 400mg - Green

Regular Set	
50 Caps	108-6562891..... \$180.45
500 Caps	108-656291..... \$1061.25

1 Spill Capsules - 400mg - Green/White

Fast Set	
50 Caps	108-6562861..... \$180.45
500 Caps	108-656261..... \$1061.25

2 Spill Capsules - 600mg - Blue

Regular Set	
50 Caps	108-6562892..... \$221.25
500 Caps	108-656292..... \$1405.95

2 Spill Capsules - 600mg - Blue/White

Fast Set	
50 Caps	108-6562862..... \$221.25
500 Caps	108-656262..... \$1405.95

3 Spill Capsules - 800mg - Yellow

Regular Set	
50 Caps	108-6562893..... \$254.25
500 Caps	108-656293..... \$1824.95

3 Spill Capsules - 800mg - Yellow/White

Fast Set	
50 Caps	108-6562863..... \$254.25
500 Caps	108-656263..... \$1824.95



Valiant Ph.D. - Ivoclar Vivadent

Phase-dispersed amalgam with a lower mercury content and palladium enriched for higher early strengths. Fine particle size results in smoother carving, faster wetting, faster setting and a denser amalgam mass.

1 Spill Capsules - 400mg

50 Caps	100-6050410..... \$133.95
500 Caps	100-6050411..... \$914.25

2 Spill Capsules - 600mg

50 Caps	100-6050420..... \$164.95
500 Caps	100-6050421..... \$1123.25

3 Spill Capsules - 800mg

50 Caps	100-6050430..... \$203.75
500 Caps	100-6050431..... \$1294.25



Permite - SDI

The non-gamma 2 admix alloy unsurpassed by any other with its high strength, high polishability and superior handling qualities. C Capsules.

1 Spill Capsules - 400mg - Pink Plunger

ECT	100-4001101
Fast	100-4001202
Regular	100-4001303
Slow	100-4001404
50 Caps	\$142.45

1 Spill Capsules - 400mg - Pink Plunger

ECT	100-4021101
Fast	100-4021202
Regular	100-4021303
Slow	100-4021404
50 Caps	\$979.45

2 Spill Capsules - 600mg - Purple Plunger

ECT	100-4002101
Fast	100-4002202
Regular	100-4002303
Slow	100-4002404
50 Caps	\$182.45

2 Spill Capsules - 600mg - Purple Plunger

ECT	100-4022101
Fast	100-4022202
Regular	100-4022303
Slow	100-4022404
50 Caps	\$1100.95

3 Spill Capsules - 800mg - Yellow Plunger

ECT	100-4003101
Fast	100-4003202
Regular	100-4003303
Slow	100-4003404
50 Caps	\$240.45

3 Spill Capsules - 800mg - Yellow Plunger

ECT	100-4023101
Fast	100-4023202
Regular	100-4023303
Slow	100-4023404
500 Caps	\$1489.95

5 Spill Capsules - 1200mg - Green Plunger

Regular Set	
100-4005000	50 caps..... \$297.75
100-4025000	500 Caps..... \$1961.75

LOOK'in
for something? **WE HAVE IT!**
www.dhponline.com

HIGH COPPER DISPERSED PHASE ALLOY



High Copper Dispersed Phase Amalgam

Handles like dispersed phase, smooth spherical carve, and high early strength. Approximate Metal Composition: 40% Silver/30% Tin/ 30% Copper. Physical Properties: 1 Hour strength 30,000 psi 24 Hour strength 65,000 psi Static Creep: 0.05% Expansion: +/-2m/cm Trituration Time: Medium Speed 10 +/-2 seconds.

1 Spill – 400mg Alloy/400mg Mercury

Fast Set	
50 Caps	100-UTD150..... \$64.95
500 Caps	100-UTD1500..... \$601.95

Regular Set

50 Caps	100-UTD150RS..... \$64.95
---------	----------------------------------

2 Spill – 600mg Alloy/600mg Mercury

Fast Set	
50 Caps	100-UTD250..... \$84.95
500 Caps	100-UTD2500..... \$703.95

Regular Set

50 Caps	100-UTD250RS..... \$84.95
500 Caps	100-UTD2500RS..... \$703.95

3 Spill – 800mg Alloy/800mg Mercury

Fast Set	
50 Caps	100-UTD350..... \$102.95
500 Caps	100-UTD3500..... \$969.95

Regular Set

50 Caps	100-UTD350RS..... \$102.95
500 Caps	100-UTD3500RS..... \$969.95

*High Speed Amalgamator recommended for proper trituration.



Contour™ - Kerr Restoratives

Dispersed phase silver alloy offers a blend of spherical and cut particles for firm packing and smooth carving.

1 Spill Capsules - 400mg

Fast (Lt. Blue/Green).....	109-29972
Regular (Lt. Blue/Maroon).....	109-29963
50 Caps \$187.25

Fast (Lt Blue/Green)..... 109-29973

Regular (Lt. Blue/Maroon).....	109-29964
50 Caps \$1056.45

2 Spill Capsules - 600mg

Fast (Gray/Green).....	109-29975
Regular (Gray/Maroon).....	109-29966
50 Caps \$228.95

Fast (Gray/Green)..... 109-29976

Regular (Gray/Maroon).....	109-29967
50 Caps \$1257.25

3 Spill Capsules - 800mg

Fast (White/Green).....	109-29978
Regular (White/Maroon).....	109-29969
50 Caps \$265.75

Fast (White/Green)..... 109-29979

Regular (White/Maroon).....	109-29970
50 Caps \$1470.95



GS-80 - SDI

The technically advanced, non-gamma 2 spherical amalgam.

1 Spill Capsules - 400mg - Grey

Fast.....	100-4401202
Regular.....	100-4401303
Slow.....	100-4401404
50 Caps \$107.75

Fast.....	100-4421202
Regular.....	100-4421303
Slow.....	100-4421404
500 Caps \$709.95

2 Spill Capsules - 600mg - Light Green

Fast.....	100-4402202
Regular.....	100-4402303
Slow.....	100-4402404
50 Caps \$107.75

Fast..... 100-4422202

Regular.....	100-4422303
Slow.....	100-4422404
500 Caps \$709.95

3 Spill Capsules - 800mg - Burgundy

Fast.....	100-4403202
Regular.....	100-4403303
Slow.....	100-4403404
50 Caps \$107.75

Fast..... 100-4423202

Regular.....	100-4423303
Slow.....	100-4423404
500 Caps \$709.95

SPHERICAL ALLOYS



High Copper Type T Spherical Amalgam

Adapts easier to the shape of the cavity, effortless to pack, strongest type of alloy made. Approximate Metal Composition: 60% Silver/27% Tin/13% Copper. 100% Spherical. Physical Properties: 1 Hour Strength 28,000 psi 24 Hour Strength 68,000 psi Static Creep: 0.3% Expansion: +/-2m/cm Trituration Time: Medium Speed 10 +/-2 seconds.

1 Spill – 400mg Alloy/296mg Mercury

50 Caps	100-UTT150..... \$73.95
500 Caps	100-UTT1500..... \$596.95

2 Spill – 600mg Alloy/443mg Mercury

50 Caps	100-UTT250..... \$90.95
500 Caps	100-UTT2500..... \$829.95

3 Spill – 800mg Alloy/591mg Mercury

50 Caps	100-UTT350..... \$123.95
500 Caps	100-UTT3500..... \$1102.95

*High Speed Amalgamator recommended for proper trituration

ALLOYS

SPHERICAL ALLOYS



Megalloy EZ - Dentsply Caulk

A spherical amalgam alloy with its positive resistance to condensation that assures excellent margin adaptation and superior handling. Smooth and easy carving. Self-activated capsule is easy to use and virtually eliminates leakage.

1 Spill Capsules - 400mg - Red

Regular Set

50 Caps	108-603004	\$201.45
250 Caps	108-603014	\$563.45

2 Spill Capsules - 600mg - Purple

Regular Set

50 Caps	108-603005	\$228.75
250 Caps	108-603015	\$643.95

3 Spill Capsules - 800mg - Lime Green

Regular Set

50 Caps	108-603006	\$284.75
250 Caps	108-603016	\$827.25



Unison Spherical Alloy - Dentsply Caulk

1 Spill Capsules - 400mg - Brown/White

108-6572611	50 Caps	\$178.25
-------------	---------	-------	-----------------

2 Spill Capsules - 600mg - Orange/White

108-6572612	50 Caps	\$223.25
-------------	---------	-------	-----------------

3 Spill Capsules - 800mg - Beige/White

108-6572613	50 Caps	\$282.25
-------------	---------	-------	-----------------



Tytin™ - Kerr Restoratives

Spherical silver alloy. A ternary alloy with high copper content. Higher in strength and lower in creep than other types of amalgam alloys.

1 Spill Capsules - 400mg

Regular Set	109-29945	
Slow Set	109-29954	
50 Caps		\$212.45

Regular Set	109-29946	
Slow Set	109-29955	
500 Caps		\$1347.45

2 Spill Capsules - 600mg

Regular Set	109-29948	
Slow Set	109-29957	
50 Caps		\$239.75

Regular Set

Regular Set	109-29949	
Slow Set	109-29958	
500 Caps		\$1531.95

3 Spill Capsules - 800mg

Regular Set	109-29951	
Slow Set	109-29960	
50 Caps		\$290.95

Regular Set

Regular Set	109-29952	
Slow Set	109-29961	
500 Caps		\$1820.95



Tytin™ FC™ - Kerr Restoratives

Firm packing silver amalgam.

1 Spill Capsules - 400mg

Regular Set	109-29981	
Fast Set	109-29990	
50 Caps		\$218.25

Regular Set

Regular Set	109-29982	
Fast Set	109-29991	
500 Caps		\$1222.95

2 Spill Capsules - 600mg

Regular Set	109-29984	
Fast Set	109-29993	
50 Caps		\$249.25

Regular Set

Regular Set	109-29985	
Fast Set	109-29994	
500 Caps		\$1440.45

3 Spill Capsules - 800mg

Regular Set	109-29987	
Fast Set	109-29996	
50 Caps		\$304.75

Regular Set

Regular Set	109-29988	
Fast Set	109-29997	
500 Caps		\$1736.95

ACCESSORIES



Amalgam Well - Arnel Healthcare

Stainless steel with exclusive formed well to guide carrier directly to amalgam. Anti-slip ring; will not tip in use. Standard.

100-AWSTD	Each	\$12.25
-----------	------	-------	----------------



Security Capsule & Pestle - Dentsply Rinn

Wig-L-Bug Accessory.

100-0140005	Each	\$15.75
-------------	------	-------	----------------



Amalgam Squeeze Cloths - JR Rand Corporation

Made from closely woven, unbleached, unprocessed cotton, these right-sized, individual cloths offer maximum filtering for amalgam preparation. 3" round.

100-010	100/box	\$7.95
100-011	500/box	\$16.25
100-012	1000/box	\$25.95

AMALGAM WASTE MANAGEMENT



AMALGON® 1 Mail-in Amalgam Recycling - WCM

EPA, OSHA and USPS compliant recovery and disposal system for scrap amalgam, vacuum traps, filters and screens, and non-infectious teeth.

Contains: 1 container, 1 prepaid shipping container and a certificate of disposal.

370-AMALGON	1 gallon	\$178.45
370-AMALGON53	5 gallon	\$430.45

AMALGAMATORS



ProMix - Dentsply Caulk

Microprocessor controls to provide extreme accuracy for consistent mixing. Programmable, pre-set memories, touch pad controls and a sleek LED display. Spring-tensioned capsule holder adapts to fit virtually every capsule design.

778-672200 Each..... **\$1360.95**



MSDWig-L-Bug - Dentsply Caulk

Multi-Speed Digital. Compact size conveniently fits most operatories. 110v, 0.5 amps. Multi-Speeds: 3800, 4200, 4600 and 4800 rpms. Size: 4.75" W x 10.25" D x 8" H.

770-CRE0020200 Each..... **\$677.95**



OptiMix™ - Kerr Restoratives

Fully programmed microprocessor controls operation, continuously verifying cycles per minute. Preset for all Kerr amalgam capsules and offers keyboard programming for custom mixing and a message display in six languages. LED readout confirms capsule type, mixing times and speed.

770-910060 Each..... **\$1327.95**



LPDWig-L-Bug - Dentsply Caulk

Low Profile Digital Amalgamator. Fits conveniently into most operator drawers. 110v, 1.0 amps. Size: 11.5" W x 8" D x 4.5" H.

770-CREC020100 Each **\$683.25**



Silamat S6 - Ivoclar Vivadent

Features an aesthetic rounded shape and removable cover for easy cleanup. Silamat S6 uses time-tested Silamat technology with the figure-eight mixing pattern and above-average rotation speed of 4500 rpm that helps achieve reliable and homogenous mixing results.

770-602286 Each..... **\$701.45**



ultramart 2 High Speed Amalgamator - SDI

The multi-use ultramart 2 is suitable for all types of encapsulated dental materials. The one surface cover facilitates infection control cleaning and the non-porous plastic surface can be cleaned with any dental disinfectant. The micro-switch automatically halts trituration when the lid of the ultramart 2 is lifted.

770-5546004 Each..... **\$725.99**



Cut through the fat

GO DIRECTLY TO THE BEST

Manufacturers offer thousands of promotions. GO **DIRECTLY TO THE BEST.**

www.dhponline.com/promotions

BUY 1 GET 1 FREE | BUY 2 GET 2 FREE | BUY 3 GET 3 FREE | BUY 4 OR MORE GET 4 FREE | **DHPI X** EXCLUSIVE OFFERS

INJECTABLE ANESTHETIC CARTRIDGES

LIDOCAINE				
Manufacturer	Item	Description	Units/Pkg	Price
Carestream Dental	120-1559889	Cook-Waite Lidocaine 2% w/epinephrine 1:100,000 Red	50 Cart. 1.7ml	\$42.45
Carestream Dental	120-1628262	Cook-Waite Lidocaine 2% w/epinephrine 1: 50,000 Green	50 Cart. 1.7ml	\$42.45
Dentsply Pharmaceutical	120-20016	Xylocaine 2% w/epinephrine 1:100,000 Red	50 Cart. 1ml	\$47.75
Dentsply Pharmaceutical	120-22216	Xylocaine 2% w/epinephrine 1: 50,000 Green	50 Cart. 1ml	\$47.75
Septodont	120-91095	Lignospan 2% w/epinephrine 1:100,000 Red	50 Cart. 1.8ml	\$45.75
Septodont	120-91096	Lignospan 2% w/epinephrine 1: 50,000 Green	50 Cart. 1.8ml	\$45.75
MEPIVACAINE				
Manufacturer	Item	Description	Units/Pkg	Price
Carestream Dental	120-1449313	Cook-Waite Carbocaine 2% w/Cobefrin 1: 20,000	50 Cart. 1.7ml	\$57.25
Carestream Dental	120-1430735	Cook-Waite Carbocaine 3% Plain no vasoconstrictor	50 Cart. 1.7ml	\$49.95
Dentsply Pharmaceutical	120-34416	Polocaine 3% Plain no vasoconstrictor	50 Cart. 1.8ml	\$52.75
Septodont	120-A1002	Scandonest 2% w/Levonordefrin 1: 20,000	50 Cart. 1.8ml	\$55.95
Septodont	120-A1003	Scandonest 3% Plain no vasoconstrictor	50 Cart. 1.8ml	\$51.95
ARTICAINE				
Manufacturer	Item	Description	Units/Pkg	Price
Carestream Dental	120-8942831	Cook-Waite Zorcaine 4% w/epinephrine 1:100,000	50 Cart. 1.7ml	\$59.75
Dentsply Pharmaceutical	120-51116	Articadent 4% w/epinephrine 1:100,000	50 Cart. 1.8ml	\$55.25
Dentsply Pharmaceutical	120-52216	Articadent 4% w/epinephrine 1: 200,000	50 Cart. 1.8ml	\$55.25
Pierrel Pharma	120-45146110002	Orabloc 4% w/epinephrine 1:100,000	50 Cart. 1.8ml	\$42.95
Pierrel Pharma	120-45146120002	Orabloc 4% w/epinephrine 1:200,000	50 Cart. 1.8ml	\$42.95
Septodont	120-A1400	Septocaine 4% w/epinephrine 1:100,000	50 Cart. 1.8ml	\$54.75
Septodont	120-A1200	Septocaine 4% w/epinephrine 1: 200,000	50 Cart. 1.8ml	\$54.75
BUPIVACAINE				
Manufacturer	Item	Description	Units/Pkg	Price
Carestream Dental	120-1852557	Cook-Waite Marcaine 0.5% w/epinephrine 1: 200,000	50 Cart. 1.8ml	\$74.75
Septodont	120-A1600	Vivacaine 0.5% w/epinephrine 1: 200,000	50 Cart. 1.8ml	\$69.75
PRILOCAINE				
Manufacturer	Item	Description	Units/Pkg	Price
Dentsply Pharmaceutical	120-48816	Citanest Forte 4% w/epinephrine 1: 200,000	50 Cart. 1.8ml	\$49.95
Dentsply Pharmaceutical	120-46616	Citanest Plain 4% no vasoconstrictor	50 Cart. 1.8ml	\$49.95
ANESTHETIC CARTRIDGE ACCESSORIES				
Manufacturer	Item	Description	Units/Pkg	Price
Premier Dental	130-1048021	Cartridge Dispenser & Warmer - Holds up to 60 Cartridges	Each	\$72.45
Plasdent	130-1410	Cartridge Holder - Holds up to 50 Cartridges	Each	\$16.75

ANESTHETIC CARTRIDGES (INDICATIONS FOR USE)

Injectable Type	Intermediate Duration with Vasoconstrictor						Long Duration
	Mepivacaine HCl Injection, USP, Plain	Prilocaine HCl Injection, USP, Plain	Articaine HCl w/Epinephrine Injection, USP	Lidocaine with Epinephrine Injection, USP	Mepivacaine HCl w/Levonordefrin Injection, USP	Prilocaine with Epinephrine Injection, USP	
Percent	3%	4%	4%	2%	2%	4%	0.5%
Infiltration Block	20-30 Minute 34-45 Minute	10-20 Minute 45-65 Minute	60 Minute 60 Minute	55-65 Minute 80-90 Minute	40-60 Minute 60-90 Minute	35-45 Minute 50-70 Minute	Not Indicated 90-120 Minute
Maximum Dose	400mg 3.0mg/lb	600mg 4.0mg/lb	500mg 3.2mg/lb	500mg 3.2mg/lb	400mg 3.0mg/lb	600mg 4.0mg/lb	90mg 0.620mg/lb
Total Cart.	7	8	7	13	11	8	10

ASPIRATING SYRINGES



700-1880

700-1881

Aspirating Syringes

CW Type 700-1880
 A Type 700-1881
 Each **\$22.45**



Aspirating Syringe - Hu-Friedy

Precision crafted from the highest quality materials, available in two styles, the Cooke-Waite and Type A, with large diameter finger rings for enhanced control, large window for enhanced carpule visibility and sharp harpoons for easy cartridge engagement.

Type A

HF-SYRA Each..... **\$56.25**

CW Type

HF-SYRCW Each..... **\$56.25**



Aspirating Syringe - Integra® Miltex®

Type A

701-7680 Each..... **\$38.75**

Type C-W

701-7670 Each..... **\$39.75**

Petite Aspirating Syringe

Specially designed to meet the needs of dental professionals who prefer a more comfortable, form-fitting syringe.

701-7770 Each..... **\$39.75**



N-Traig Syringe

Stainless steel. Delivers precisely 0.2cc of anesthetic, has a positive ratchet action and protects against breakage of anesthesia cartridges. 30° adapter handles even the most difficult to reach injections with ease.

700-7655SS Each..... **\$338.45**



Septodont Syringes - Septodont

Septodont Standard (Bronze) - Standard sized, lightweight, durable and has no removable parts. Equipped with a larger thumb ring and offers the standard length plunger for improved comfort.

Septodont Fusion (Titanium) - The perfect in-between size, not too large, not too small comfort sized.

Septodont Petite - Designed for dentists and hygienists with smaller hands. Its compact design provides a smaller thumb ring, finger grip and shorter plunger length. This provides better control and added comfort.

Accepts 1.7ml / 1.8ml standard dental cartridges.
 Standard Bronze 130-N2110
 Fusion Titanium..... 130-N2105
 Petite Blue..... 130-N2100
 Petite Pink..... 130-N2120
 Each **\$62.95**



ECO Aspirating Syringes - Septodont

Made of durable stainless steel and contain no removable parts.

Eco Wingless 130-N2200

Eco Winged..... 130-N2210

Each **\$40.25**



Paroject® Syringe - Septodont

The Paroject intraligamental syringe is offered for use in performing PDL injections. This penstyle syringe is compact, extremely durable and comfortable to use. Designed to handle any standard dental cartridge and uses standard disposable dental needles. Click activator dispenses a calibrated .06ml dose.

130-N2040 Each..... **\$288.25**

NEEDLES



BD PrecisionGlide™ Needles - Crosstex International

The large inner diameter of thin wall needles is designed to allow the use of a smaller gauge size with increased flow rates over regular walled needles. Thin wall needles are also designed to facilitate the injection of high-viscosity fluids.

BD Regular Bevel Needles

27ga. Long 130-305136
 30ga. Extra Short 130-305106
 30ga. Short 130-305128
 100/box **\$25.95**

Variety of gauge and lengths available upon request.

NEEDLES



**Monoject™ Needles - Covidien
Products by Medtronic**

Plastic and metal hub dental needles. Self-threading hubs fit all dental syringes - Standard or Convertible Tip.

#400 Plastic Hub

25ga. Short	130-400041
25ga. Long	130-400033
27ga. Short	130-400066
27ga. Long	130-400058
30ga. X-Short.....	130-400173
30ga. Short	130-400074

#401 Metal Hub

25ga. Short	130-401049
25ga. Long	130-401031
27ga. Short	130-401064
27ga. Long	130-401056
30ga. X-Short.....	130-401171
30ga. Short	130-401072
100/box	\$12.75



**X-Tip™ Intraosseous Anesthesia
Delivery System - Dentsply Maillefer**

Easy-to-use guide sleeve provides precise injection of anesthesia into cancellous bone for greater patient comfort and faster results.

Starter System - 10 Pack

Contains: 10 X-Tip drill and guide sleeves, 10 disposable 27ga. needles, instructional video and tip card.

130-XTIP10 Starter System	\$86.75
---------------------------------	----------------

Refill - 50 Pack

Contains: 50 X-Tip drill and guide sleeves and 50 disposable 27ga. needles.

130-XTIP50 Pack	\$279.95
-----------------------	-----------------



**Accuject Needles - Dentsply
Pharmaceutical**

Accuject Sterile Disposable Needles are manufactured with a unique red dot on the hub that indicates the needle's bevel location. Needles are designed with a pre-threaded plastic hub for use with standard dental syringes.

25ga. Short	130-900505
25ga. Long	130-900605
27ga. Short	130-900705
27ga. Long	130-900805
30ga. X-Short	130-901005
30ga. Short	130-900905
100/box	\$16.95



Dental Needles - J. Morita USA

Designed for luer-lock and screw-on type syringes. Feature an indicator dot on the hub to ensure easy identification of the lancet bevel position for less insertion pain at the injection site. Universal plastic hub fits in most syringe types.

25ga. Long	130-2025GL
27ga. Short	130-2027GS
27ga. Long	130-2027GL
30ga. Short	130-2030GS
30ga. Long	130-2030GL
100/box	\$11.95



Prehema Needles - Keystone Industries

The needle is a sharp tri-bevel point for maximum comfort. Universal screw-in system that works with an inch-type of metric-type syringes. Plastic hubs are pre-threaded for an easy, straight attachment to the syringe. Siliconized for smooth motion during injection. Sterile.

27ga. Short	130-2170027
27ga. Long	130-2179927
30ga. Extra Short	130-2179930
30ga. Short	130-2170030
100/box	\$9.45



**DEFEND Plastic Hub/Self-Threading
Dental Needles - Mydent International**

Disposable, sterile needles for use on standard 1.8ml dental syringes. Triple-beveled needles feature an arrow indicator to help orient the bevel position during injections. Siliconized to help ensure a gentle insertion of needle into tissue for minimal discomfort. Prethreaded plastic hub for simple, straight attachment to the syringe perfectly and securely every time. Color coding for easy needle diameter identification.

27L Yellow	130-DN2000
27S Yellow	130-DN2100
30S Blue	130-DN3000
30XS Blue	130-DN3100
100/box	\$11.25



Septoject® Needles - Septodont

Less trauma to the tissue. Achieved through a triple bevel needle, a polished and siliconized canula and an excellent flexibility of the needle. High grade surgical stainless tubing to reduce risk of breakage.

25ga. Long (Red)	130-1252
27ga. Short (Orange)	130-1271
27ga. Long (Yellow)	130-1272
30ga. X-Short (Purple)	130-1300
30ga. Short (Blue)	130-1301
100/box	\$15.25



**Septoject® Evolution Needles
- Septodont**

Scalpel-designed bevel cuts rather than tears tissue requiring less force for the needle insertion, causing less tissue to be displaced resulting in reduced discomfort for the patient. The centered position of the bevel results in less deflection and greater control for the dentist. High grade surgical stainless steel tubing to reduce risk of breakage, and 2 bevel marks on hub for optimal use. Sterile.

Infiltration

27ga. Short	130-1600
30ga. Short	130-1630
100/box	\$20.75

Intraligamentary

30ga. X-Short.....	130-1650
100/box	\$20.75



Septoject® XL Needles - Septodont

Designed for infiltration and nerve blocks, Septoject XL eliminates the confusion of choosing a size and gauge for dental procedures. Its large bore design makes it unique from standard needles, to require less pressure resulting in a more comfortable injection. Sterile.

Infiltration	130-N1500
Block	130-N1550
100/box	\$16.75

NEEDLES



Painless Steel® Injection Needles - Transcodent

Designed to give you all the features you demand for patient comfort and convenience. Disposable and sterile. Each needle has a three-edge lancet grinding and a siliconized cannula for smooth entry and comfort to patient. Each hub has a bevel marking and is threaded to ensure easy and safe handling.

30ga. X-Short.....	130-6860
30ga. Short.....	130-6861
27ga. Short.....	130-6862
27ga. Long.....	130-6863
100/box.....	\$14.45

NEEDLESTICK PROTECTION



Pro Tector® Needle Sheath Prop - Certol International

Disposable device that can be used safely to uncap and recap needles using a one-handed technique.

710-PNS100	100/pack.....	\$14.95
710-PNS500	500/pack.....	\$57.95



Jenker™ Needle Guard - Dentsply Professional

Needlestick protector. Solid stainless steel. Autoclavable. Accepts all common brands of needles. Conical shape - low center of gravity ensures device will not topple over.

130-A87013	Each.....	\$65.95
------------	-----------	----------------



Aim Safe - Septodont

Needle Recapping Device. Helps protect against needlestick injuries.

130-N0010	4/pack.....	\$31.75
-----------	-------------	----------------



Ultra Safety Plus XL - Septodont

Needle stick injury prevention device. Engineered to allow you to cover your needle in one easy step. Slide the cover forward into its locked position and discard the injector in your sharps container.

Contains: 100 individually packed and sterilized devices and 1 autoclavable handle.

25ga. Long (Red).....	130-4252
27ga. Short (Orange).....	130-4271
27ga. Long (Yellow).....	130-4272
30ga. X-Short (Purple).....	130-4300
30ga. Short (Blue).....	130-4301
100/box.....	\$44.75

Syringe Handle

130-3000	Each.....	\$12.95
----------	-----------	----------------

Sterile Handle - Single Use

130-N3400	50/pkg.....	\$51.45
-----------	-------------	----------------



Needle Capper - Zirc

One handed capping and recapping. Syringe held ready for use, at convenient position. Base of device is secured to tabletop or tray with adhesive strip (included). Needle is uncovered at same time syringe is withdrawn from Capper. Surface Disinfect Only. Either size will fit standard base.

Standard - X-short and short needles.		
370-27R700	Each.....	\$24.95

Long - Blood-draw, long needles.		
370-27R704	Each.....	\$24.95

TOPICAL ANESTHETICS



Topical Anesthetic

No bitter aftertaste, prevents excessive salivation, and stays active with minimal wash away. Quick on-set, delivers maximum strength 20% benzocaine for fast, temporary pain relief. Gluten free. 1oz. jar.

Bubble-Gum.....	120-320052
Cherry.....	120-320012
Grape.....	120-320082
Mint.....	120-320022
Piña Colada.....	120-320042
Raspberry.....	120-320072
Strawberry.....	120-320062
Each.....	\$7.45



Endo Refrigerant Spray

Refrigerant Spray for diagnosing pulp vitality. Significantly colder than ethyl oxide or ice. Use with micro applicators or cotton pellets. Environmentally safe (no CFC or HFC). Peppermint Scented.

330-10005	6oz.....	\$13.25
-----------	----------	----------------

LOOK'in

for something? **WE HAVE IT!**

www.dhpionline.com

TOPICAL ANESTHETICS



HurriCaine® Topical Anesthetic - Beutlich® Pharmaceuticals, LLC

20% Benzocaine.

Liquid

Original Wild Cherry	120-056931
Piña Colada	120-188631
1oz.	\$10.75

Gel

Original Wild Cherry	120-087131
Fresh Mint.....	120-109831
Piña Colada	120-088631
Watermelon.....	120-029331
1oz.	\$10.75

Spray

Contains: 2oz. aerosol can with 1 disposable extension tube. Wild Cherry.

120-067902	Each.....	\$40.75
------------	-----------	----------------

Disposable Extension Tubes

130-118520	200/box	\$20.75
------------	---------------	----------------

HurriCaine® Snap-n-Go™ Swabs

20% Benzocaine in unit-dose swabs for easy application with no risk of cross contamination.

120-056972	72/box	\$31.45
------------	--------------	----------------



LolloCaine® - Centrix

20% Benzocaine Gel in convenient single-use packets. Each unit contains one single dose (0.3ml) of LolloCaine gel plus one clean swab applicator. Simply peel back the cover, dip in the swab applicator and apply.

Contains: 120 -0.3ml single use packets.

Bubblegum	120-360088
Cherry.....	120-360090
Mint.....	120-360092
Piña Colada	120-360094
Each	\$49.75



Cetacaine® Topical Anesthetic - Cetylite, Inc.

Offers three active ingredients (Benzocaine 14.0%, Butamben 2.0%, Tetracaine HCl 2.0%) to control pain and ease discomfort. Indicated for uses on all accessible mucous membrane except the eye. Has a rapid onset (approx 30 seconds); with a duration of 30-60 minutes when used as directed. Not for injection. Pleasant Banana flavor. Rx item.

Cetacaine Liquid

Well-suited for scaling and root planing.

120-0203	14gm	\$47.45
120-0211	30gm	\$71.75

Topical Liquid Clinical Kit

Contains: 1 -30gm bottle, 1 Luer-lock cap, 100 microcapillary delivery tips and 100 delivery syringes. RX item.

120-0212	Kit.....	\$224.45
----------	----------	-----------------

Topical Liquid Chairside Kit

Contains: 1 -14gm bottle, 1 Luer-lock dispenser cap, 20 microcapillary delivery tips and 20 graduated delivery syringes. RX item.

120-0218	Kit.....	\$92.75
----------	----------	----------------

Microcapillary Delivery Tips

120-0213	100/pkg.....	\$69.95
----------	--------------	----------------



Cetacaine Spray

Indicated for use to suppress the gag reflex and control pain. Included 4" autoclavable stainless steel cannula which delivers a precise, controlled spray. Malleable material can be modified to accommodate anatomical requirements or procedure. RX item.

120-0220	56gm	\$70.45
----------	------------	----------------

Replacement Cannulas

J4 - 4" Standard Autoclavable

130-0205	10/pkg,	\$50.95
----------	---------------	----------------



Cetacaine Gel

Apply directly to required site where pain control is needed, such as pre-injection sites. Pump-top jar controls amount dispensed without exposing contents to cross contaminants. Pleasant strawberry flavor. RX item.

120-0217	32gm	\$35.95
----------	------------	----------------



Hygenic® Endo-Ice® - Coltene

A diagnostic tool for the determination of pulpal health. Environmentally safe and requires no refrigeration. Fresh spearmint scent.

335-05032	6oz	\$32.25
-----------	-----------	----------------



GumNumb® Topical Anesthetic Gel - Crosstex International

Bubblegum	120-UTBG
Cherry.....	120-UTCH
Grape	120-UTG
Mint.....	120-UTM
Piña Colada	120-UTPC
Strawberry	120-UTS
1oz.	\$8.75



Oraqix® - Dentsply Pharmaceutical

Oraqix lidocaine and prilocaine periodontal gel (2.5% / 2.5%) is needle-free, patient friendly anesthesia for scaling and root planing. Features 30-second onset and can be applied to one or several periodontal pockets. Changes from a liquid to a gel at body temperature. Special Oraqix autoclavable dispenser is required.

Contains: 20 -1.8ml cartridges and blunt-tipped applicators.

120-6631211020	Each.....	\$129.95
----------------	-----------	-----------------

Oraqix Dispenser

130-66400	Each.....	\$41.25
-----------	-----------	----------------

TOPICAL ANESTHETICS



Gingicaine - Gingi-Pak

Proven safe and effective 20% benzocaine formulation delivers quick onset and virtually eliminates "down time".

Gel

Bing Cherry.....	120-20108
Banana	120-20113
Chocolate Mint.....	120-20114
Mint Julep	120-20116
Pina Colada	120-20117
Strawberry	120-20118
Cotton Candy	120-20119
1oz.	\$9.25

Gel Variety Pack

Contains: 1oz. each of Bing Cherry, Banana, Chocolate Mint, Pina Colada, Strawberry and Cotton Candy (6 total).
120-20111 Pack..... **\$48.95**



Bosworth® Cora-Caine® - Keystone Industries

Denture pain-relieving anesthetic ointment. An analgesic adhesive for use on new or intermediate dentures. Provides immediate relief from sore ridges or other sore spots. Pink. Contains: 36 -4gm tubes.

120-16621 Each..... **\$73.75**



Arctic Blast - Marie Reiko, Inc.

A refrigerant spray used primarily to test for pulp vitality. It is simpler and more efficient than using ice cubes and more comfortable than the tapping method. Just spray onto a cotton pellet and place on the tooth in question.

330-AB 10oz..... **\$26.75**



Topicale® Anesthetic Gel - Premier® Dental

Unique water-soluble base releases active ingredients on contact; permits onset of anesthesia in less than 20 seconds. Provides deeper surface anesthesia. Orange-Raspberry flavor. 18% benzocaine formulation.

127-9007151 35gm..... **\$13.25**



Topicale® GelPatch™ - Premier® Dental

Once placed in the mouth, it dissolves gradually releasing benzocaine to anesthetize surface tissue for up to 20 minutes. Ideal for denture sores, prior to injection and oral ulcer/irritations – appropriate for patient home use. 18% benzocaine. Mint.

127-9007149 25/box..... **\$58.25**



Topicale® Gel Pumps - Premier® Dental

Economical 43gm package contains up to 50% more than competitors. Reduces potential cross-contamination. 18% benzocaine formulation.

Cherry.....	127-7141
Strawberry	127-7143
Raspberry.....	127-7142
Piña Colada	127-7144
43gm	\$15.75

Assorted Package

Contains: 1 -43gm gel pump each of Cherry, Raspberry and Piña Colada.

127-7140 Package..... **\$53.75**



Topicale® Xtra Oral Anesthetic Gel - Premier® Dental

20% benzocaine formulation for rapid 10-second onset of surface anesthesia of soft tissue. No after-taste.

Jammin' Strawberry	127-9007154
Mint Freeze	127-9007153
Very Berry Cherry	127-9007152
1oz.	\$9.25

Assorted Package

Contains: 1oz. each of Very Berry Cherry, Mint Freeze and Jammin' Strawberry.

127-9007155 Package..... **\$25.25**



Lidocaine Topical Ointment - Septodont

This amide based topical is a pleasant, mint flavored white cream which can be used as a pre-injection topical. 5% lidocaine ointment.

120-T0150 50gm..... **\$29.25**



Topex® Topical Anesthetic Gel - Sultan Healthcare

Fast, effective topical anesthetic with no bitter aftertaste. 20% benzocaine.

Cherry.....	120-31001
Mint.....	120-31002
Piña Colada	120-31004
Bubble-Num'	120-31005
Strawberry	120-31006
Razzberry	120-31007
1oz.	\$11.45

Bulk Gel

Cherry.....	120-31064
Bubble-Num'	120-31068
100gm	\$31.75



Topex® HandiCaine Stix® - Sultan Healthcare

Innovative sealed container aids in asepsis control, is ideal for use with a set-up tray and same-patient reuse with no risk of cross-contamination. Handy disposable cotton swab included for mess free application. Ideal for patient home-use to relieve discomfort from oral lesions, prosthetics, orthodontic appliances and various dental procedures. Cherry flavor.

Contains: 24 -0.40gm unit dose packets.
120-31023 Each..... **\$17.25**

TOPICAL ANESTHETICS



Topex® Metered Spray - Sultan Healthcare

Delivers more than 1,000 sprays per can. Built-in safety feature allows only 50 milligrams per spray means no chance of over-spray. Great for gaggers, deep scaling and X-rays. Wild Cherry. Contains: 2oz. spray can and 25 straws.

120-31000 Each.....\$41.75

Disposable Metered Dispensing Spray Tips
130-30999 200/pkg \$23.75

ANESTHESIA REVERSAL



OraVerse® - Septodont

Allows you to bring patients back to normal sensation twice as fast. In clinical trials, the median time to recovery of normal sensation in the upper lip was 50 minutes vs. 133 minutes for the control group, and in the lower lip was 70 minutes vs. 155 minutes for the control. In clinical trials, OraVerse patients were also more quickly able to smile, speak, drink normally, and minimize drooling. Use in pediatric patients less than 3 years of age or < 15kg (33lbs) has not been established.

Contains: 10 - 1.7ml glass cartridges blister pack.
130-99210 Each..... \$86.95

NITROUS OXIDE MASKS



ClearView™ Classic Masks - Accutron, Inc.

Mask-in-mask design draws excess gas into accuum, clear outer mask shows patient "breathing through nose" and soft inner mask creates desirable nasal/ facial seal and can be seen through outer mask. Low profile expands clinical field of view and keeps patients from adjusting. Latex-free. Available in six soothing scents.

Adult
French Vanilla 130-3303514
Fresh Mint 130-3303516
Unscented Gray 130-330359
12/box \$70.25

Pedo
Sassy Strawberry..... 130-3303711
Birthday Bubble Gum..... 130-3303712
Groovy Grape 130-3303717
Unscented Gray 130-330379
12/box \$70.25

Additional scents/sizes available upon request.



P.I.P. - Personal Inhaler Plus - Accutron, Inc.

The only colored, flavored, single patient use nasal hood.

Small
Birthday Bubblegum 130-3301712
Groovy Grape 130-3301717
Outlaw Orange..... 130-3301710
Strawberry 130-3301711
24/pack \$98.95

Medium
Birthday Bubblegum 130-3301612
Whisper Gray Unscented 130-330169
Fresh Mint..... 130-3301616
Outlaw Orange..... 130-3301610
Perfect Peach..... 130-3301615
Piña Colada 130-3301613
French Vanilla 130-3301614
24/pack \$99.25

Large
Whisper Gray Unscented 130-330159
Fresh Mint 130-3301516
French Vanilla 130-3301514
24/pack \$99.25

Additional scents/sizes available upon request.

Small Variety Pack 1
Birthday Bubblegum, Outlaw Orange and Sassy Strawberry.
130-330171 Each..... \$98.95

Medium Variety Pack 1
Outlaw Orange, Sassy Strawberry and Birthday Bubblegum.
130-330161 Each..... \$99.25

Medium Variety Pack 2
Pina Colada, Vanilla and Orange.
130-330162 Each..... \$99.25

Medium Variety Pack 3
Mint, Peach and Vanilla.
130-330163 Each..... \$99.25

Large Variety Pack 3
Fresh Mint, Perfect Peach and French Vanilla.
130-330153 Each..... \$99.25



DynoMite Scented Nasal Hoods - Porter Instrument

Latex free, single-use nasal hoods that come packaged with a colorful dinosaur cartoon sticker.

Bubble Gum Small 130-91316461
Strawberry Small 130-91316462
Orange Small 130-91316463
Vanilla Small 130-91316464
Vanilla Large 130-91316478
Plain Small..... 130-91316465
Plain Medium 130-91316472
Plain Large..... 130-91316479
Variety Pack Small 130-91316466
Variety Pack Medium 130-91316473
Variety Pack Large 130-91316480
24/pack \$91.95

Additional scents/sizes available upon request.



Nitrous Scavenger - Porter Instrument

Double mask (mask within a mask) system. It features an outer mask and a flexible single use disposable, or autoclavable, easily removable inner liner. It is the soft inner liner that creates the tight, yet comfortable, seal around the patient's nose, thus assuring the unit's superior scavenging efficiency. Available in both adult and pedo sizes; the inner liners either unscented or citrus scented. The masks are autoclavable by either steam or chemical sterilizing.

Scavenger Breathing Circuits with In-Line Vacuum Control Kit
Adult 580-POR51551
Pedo 580-POR51552
Each \$694.95

Scavenger Breathing Circuits without Vacuum Control Block
Adult 580-POR51553
Each \$589.95

Scavenger Liner Kit
Adult 571-50541
Pedo 571-50542
3/pack \$54.95

NITROUS OXIDE MASKS



Silhouette Nasal Masks - Porter Instrument

Silhouette is a revolutionary new nitrous oxide nasal mask designed by a dentist for dentists. It eliminates the hassles many dentists associate with using nitrous oxide. The result is a compact and comfortable nasal mask that's nearly invisible and creates a safe and predictable experience for both the dentist and the patient.

Flowmeter Connection Kit

Contains: Cannula Adapter, Breathing Bag Cap, 6.5' fresh gas/vacuum tubing, 4 color coded sizer masks and clip.

580-PORSILCONNKIT Kit **\$54.95**

Variety Pack

Contains: 3 each of Pediatric, Adult Small, Medium and Large.

580-PORSILVAR4X3 12/pack **\$139.95**

Pediatric Pack

580-PORSILPEDO12 12/pack **\$139.95**

Adult Small Pack

580-PORSILSM12 12/pack **\$139.95**

Medium Pack

580-PORSILMED12 12/pack **\$139.95**

Large Pack

580-PORSILLG12 12/pack **\$139.95**



White Gaps™ - Salvin Dental Specialties, Inc.

Barrier device for nitrous oxide hoods. Shields direct contact of nasal hood to face during nitrous oxide and oxygen administration. Reduces micro-organism transfer from patient to patient. Disposable nasal hood liners are made of spun bonded polyester, contains no dyes or perfumes.

Adult

130-WG 50/pack **\$31.75**

Pedo

130-WGP 50/pack **\$31.75**

NEEDLE DISPOSAL



Sharps Safety RCRA Hazardous Waste Container - Covidien Products by Medtronic

Designed to segregate hazardous pharmaceutical waste under the Resource Conservation and Recovery Act. Hinged lid with snap cap, they are easily distinguished from other disposal containers. Each has a leak resistant gasket and absorbent pad to help contain liquid contents should a primary container break. Black.

370-8602RC 2 gallon..... **\$14.95**



SharpStar In-Room® System - Covidien Products by Medtronic

Sharps containers are secured in a sturdy locked enclosure. All cabinets are keyed alike for convenience. Includes a glove box dispenser.

5 Quart Wall Enclosure with Glove Dispenser

24-1/4"H x 5-1/2"D x 13"W
370-8556H Each..... **\$123.45**

5 Quart Sharps Container

For use with 370-8556H.
370-8507SA Each..... **\$8.25**



BD Sharps Containers - Crosstex International

Multi-Use One-Piece

One-way funnel valve to prevent needlesticks. Convenient, vertical point-first drop.

Regular Funnel

3.3 Quart
370-5488 Each..... **\$7.75**

6.9 Quart

370-5489 Each..... **\$11.95**

8.2 Quart

370-5490 Each..... **\$11.95**

Large Funnel

5 Gallon
370-305477 Each..... **\$27.75**

Phlebotomy

Dual access. Clear top provides visualization of collector levels.

370-5487 Each..... **\$6.45**



SMS Isolyser® Sharps Management System - WCM

Using Isolyser/SMS is a time and money saving way of managing sharps waste. Our product encapsulates sharps waste material after our proprietary catalyst packets are added to our patented, odor-free liquid, NMA base ingredient. After curing, the waste is solidified, rendered unrecognizable and unusable; making it safe to dispose of in your regular trash.

0.79 Gallon - 3.0L

370-SMS2400 Each..... **\$65.95**

Wall Mount for SMS2400

370-WMU2400 Each..... **\$49.95**

1.53 Gallon - 5.8L

370-SMS4000 Each..... **\$94.25**

2.64 Gallon - 10.0L

370-SMS10000 Each..... **\$139.95**

Isolyser/SMS Catalyst

370-10000CPEA 2oz..... **\$26.45**

Mail Back System

1.53 Gallon - 5.8L

370-SMS4000M Each..... **\$99.25**

2.64 Gallon - 10.0L

370-SMS10000M Each..... **\$146.95**

Anesthetic Carpule Disposal

Everything you need to properly dispose of full and partially full dental anesthetic carpules, including pre-paid return shipping, treatment and disposal. (Broken carpules must be, and empty carpules may be, disposed of as sharps waste.)

370-RGNM Each..... **\$93.25**

ARTICULATING PAPER



Articulating Paper

Possesses a super-sensitive surface for marking at all points of articulation and features a soft, smooth, non-sticking surface that is extremely accurate even in wet environments.

12 sheets/book, 12 books/box (144 sheets)

- Thin Blue 140-HT102B
- Thick Blue 140-HT103B
- Combo Red/Blue..... 140-HT104RB
- Each **\$8.25**

12 sheets/book, 6 books/box (72 sheets)

- Horseshoe Red/Blue ..140-HT105RB
- Each **\$10.95**



Madame Butterfly Silk - Almore International Inc.

Thinner than paper, marks clearly. 3/4" wide ribbon, 18 yards long.

- Blue 140-72001
- Green..... 140-72002
- Red 140-72003
- Each **\$25.75**



Shimstock Occlusion Foil - Almore International Inc.

Roll
8mm wide, 8 microns thick, 5 meters (6 ft.).
140-72022 Each..... **\$24.25**

Strips
2" x 3/8", 12 microns thick.
140-72070 300/box **\$23.25**

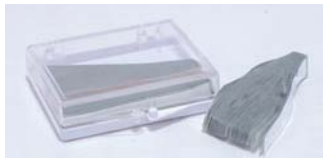

Occlusal Registration Plastic Strips - Artus Corporation
12.7 microns thick, 2" x 3/8".
830-AORS 300/box **\$14.45**



Articulating Paper - Bausch Articulating Papers

Bausch articulating papers have a progressive color transfer that highlights overall pressure distribution by means of different color shades. 200 microns.

Plastic Dispenser - 300 Strips
Blue 140-BK01
Red 140-BK02
Each **\$23.25**

Refill - 300 Strips
Blue 140-BK1001
Red 140-BK1002
Each **\$21.25**

Horseshoe Plastic Dispenser - 50 Sheets
Blue 140-BK03
Red 140-BK04
Each **\$17.45**

Booklet/Straight - 300 Strips
Blue 140-BK05
Each **\$20.95**

Arti-Check Micro-Thin
Thin and tear-resistant papers coated with liquid colors on both sides. 40 microns.

Booklet/Straight - 200 Strips
Blue 140-BK09
Red 140-BK10
Each **\$18.95**

Roll with Dispenser - 16mm Wide
Blue 140-BK13
Red 140-BK14
15m **\$13.95**

Roll with Dispenser - 22mm Wide
Blue 140-BK15
Red 140-BK16
10m **\$13.95**

Additional sizes available upon request.



Holg MARK:RITE Articulating Paper - Ched Markay, Inc.

Blue Thick Books
Contains: 72 strips (6 books of 12/book).
140-NBTK050 Each..... **\$15.45**

Blue Thin Books
144 strips in a book (12 books of 12/book).
140-NBTN050 Each..... **\$14.95**

Blue Thin Pre-Cut Tabs
140-BTNT020 600/box **\$31.95**

Red Thin Pre-Cut Tabs
140-NBTN050 600/box **\$20.95**



Surgident® dispOral™ Articulating Paper - Heraeus Kulzer

Horseshoe Red/Blue
140-99120 6/box **\$45.95**

Curved Red/Blue
140-99121 12/box..... **\$32.95**

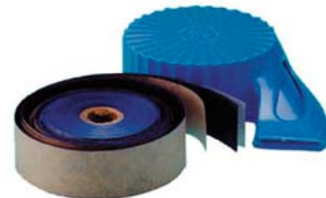

ArticoDent Articulating Paper - Integra® Miltex®

Blue Thin 146-38812
Red Thin 146-38813
Blue Thick 146-38814
25ft. **\$11.75**



AccuFilm® - Parkell, Inc.

Super thin for greater precision. Won't trigger mandibular reflexes that might skew the bite. Consistently produces sharp, easy-to-interpret marks. No false markings. It stretches, but doesn't break. There's no snap-back to distort the marks. Features the highest plastic deformation of all major brands tested.

AccuFilm I Single Sided
280 pre-cut strips.
Black..... 140-S014
Red 140-S015
Green..... 140-S016
Each **\$20.25**

AccuFilm II Double Sided
280 pre-cut strips.
Red/Black 140-S017
Black/Black 140-S018
Red/Red 140-S021
Each **\$25.45**

AccuFilm IV Marking Liquid
Contains: 10ml bottle marking liquid and 20ml bottle of solvent.
140-S020 Each..... **\$57.25**

ARTICULATING PAPER



TrollFoil - TrollDental

Framed articulation foil used when adjusting composite fillings, dentures, crowns and when doing general analytical work on articulating and occlusion. The double-sided foil is only 8 microns thick, has no problem marking wet surfaces, dry surfaces or highly polished surfaces such as cast gold or BruxZir. Frames measure 3" x 3/4".

Blue140-12000101
 Red140-12000700
 100/box **\$27.25**

Blue140-12000501
 Red140-12000600
 500/box **\$102.95**



Ardent™ Articulating Paper - Whip Mix

A superior manufacturing inking process along with the highest possible degree of quality control over the manufacturing process, guarantees clear, positive markings without smudging. These important advantages, plus the thinness of the paper, assures positive results every time in wet or dry fields.

Premium Thin Blue/Impregnated

88 microns. 140 strips.
 140-PRE101 Each..... **\$22.95**

X-Thin Blue

63 microns. 140 strips.
 140-XTB103 Each..... **\$23.25**

XX-Thin Blue

37 microns. 140 strips.
 140-XXTB104 Each..... **\$24.75**

Quadrant/Red/Blue Curved

63 microns. 144 strips.
 140-QD108 Each..... **\$25.75**

Thick Blue/Impregnated

225 microns. 70 strips.
 140-THK107 Each..... **\$23.45**

Horseshoe/Full Arch Blue/Blue

63 microns. 60 sheets.
 140-HSBB202 Each..... **\$25.25**

Horseshoe/Full Arch Red/Blue

63 microns. 72 sheets.
 140-HSRB201 Each..... **\$25.75**

Ardent Exacta-Film

Ultra thin articulating film in easy to dispense flip-top box.
 19 microns. 75 sheets.
 Red/Black140-EXRB301
 Black/Black140-EXBB302
 Red/Red140-EXRR303
 Each **\$14.45**

ARTICULATING FORCEPS



Articulating Forceps Serrated
 700-1050 Each..... **\$10.45**



Miller Articulating Paper Forceps - Hu-Friedy

Used for handling articulating paper.
 HF-APF2 Each..... **\$27.75**



Ardent™ Hold-Tight Forceps - Whip Mix

Disposable articulating paper forceps. Easy-to-use. Made of sturdy paperboard which holds paper and film firmly.
 140-HTF401 100/bag **\$18.95**

ARTICULATING INDICATORS



Arti-Spray® - Bausch Articulating Papers

Universal color indicator to test the occlusal contacts and accurate fit of crowns and bridges. Easy to handle and leaves a thin colored film which can be easily removed with water, leaving no trace of residue.
 Red140-BK285
 Green.....140-BK288
 75ml **\$27.75**

Additional colors available upon request.



Fit Checker™ Advanced - GC America Advanced 1:1 Package

Contains: 1 -50gm base and 1 -50gm catalyst.
 290-004903 Package **\$115.75**

Advanced Cartridge Package

Contains: 2 -48ml cartridges and 3 mixing tips.
 292-004904 Package **\$160.25**



Dr. Thompson's Color Transfer Applicators

For making color transfers from irritated areas under full dentures, partials, etc.
 710-CTADRT Each..... **\$12.95**



PIP Pressure Indicating Paste - Keystone Industries

PIP is a pure white silicone paste, used for seating crowns, bridges, full, immediate and partial dentures.

PIP Jar with Remover

300-0120200 1-1/4oz..... **\$35.95**
 300-0120300 2-1/4oz..... **\$57.95**

PIP Packets with Remover and Brush

300-0120550 24/pkg. **\$107.75**

PIP Pump

300-0121000 4oz. **\$101.45**

Jar Only

300-0120400 8oz. **\$174.95**

PIP Remover

300-0120700 4oz. **\$10.25**

Brushes

300-0120600 12/pack **\$10.45**

ARTICULATING INDICATORS



PIP Spray - Keystone Industries

The perfect companion product to PIP. This mint flavored wetting agent, sprayed onto teeth and soft tissue, produces smooth, accurate bubble-free surfaces on all types of impression materials. Use as a rinse to eliminate ropery saliva. Mint flavor.

300-0140100 4oz..... **\$15.45**



Hydent® - Pascal International, Inc.

Denture Indicator Paste. Apply to denture with the touch of a button. Pressure points are clearly defined. Even application with aerosol spray. Easily cleaned from denture. No chance of cross contamination. No messy brushes. Mint flavor. Contains no CFCs.

140-05100 30gm..... **\$22.25**



Occlude® - Pascal International, Inc.

Aerosol indicator marking spray. Excellent aid for seating castings. No intra-occlusal displacement during marking. Assures pinpoint location of high spots. Marks any tooth or restorative surface including gold, either wet or dry field. Highly visible.

Standard Size

Green..... 140-05300
 Red..... 140-05320
 23gm **\$20.75**

Lab Size

Green..... 140-05305
 Red..... 140-05325
 75gm **\$37.75**

Disposable Applicator Tips

140-05400 100/box **\$23.95**



Quickcheck Indicating Spray - Vacalon

Allows technicians and doctors to accurately pinpoint unwanted contact points and high spots on all dental restorations. Contains no harmful CFCs.

Green..... 140-10050
 Red..... 140-10060
 White..... 140-10070
 75gm **\$20.75**

www.dhpionline.com

NOW YOU CAN
**BROWSE ALL
 SUPPLIES**

CARBIDE BUR CROSS-REFERENCE CHART

	Health-Tec	Midwest	SS White	Coltene	Kerr Rotary	Microcopy
ROUND						
1/4	180-HTFG1/4	389201	17839	R1001/4	H0.25-FG	FG1/4
1/4S		389401		R3001/4	H0.25-FGSS	
1/2	180-HTFG1/2	389202	14961	R1001/2	H0.5-FG	FG1/2
1/2S		389402	14962	R3001/2	H0.5-FGSS	
1	180-HTFG1	389203	14964	R100001	H1-FG	FG1
1S		389403	14965	R300001		FG2
2	180-HTFG2	389204	14967	R100002	H2-FG	FG2SS
2S	180-HTFG2S	389404	15039	R300002	H2-FGSS	
3	180-HTFG3	389268	14968	R100003	H3-FG	
4	180-HTFG4	389205	14970	R100004	H4-FG	FG4
4S		389405	17654	R300004	H4-FGSS	FG4SS
5	180-HTFG5	389269	14971	R100005		
6	180-HTFG6	389206	14973	R100006	H6-FG	FG6
6S	180-HTFG6S		17657	R300006	H6-FGSS	
7		389274	14974	R100007		
8	180-HTFG8	389207	17706	R100008	H8-FG	FG8
INVERTED CONE						
33-1/2	180-HTFG33-1/2	389209	14979	R1331/2	H33.5-FG	FG331/2
33-1/2S	180-HTFG33-1/2S	389409	14980	R3331/2		
34	180-HTFG34	389210	14982	R100034	H34-FG	FG34
34S		389410	14983	R300034	H34-FGSS	
35	180-HTFG35	389211	14985	R100035	H35-FG	FG35
35S	180-HTFG35S	389411	15042	R300035	H35-FGSS	FG35SS
36		389212	14986	R100036		FG36
37	180-HTFG37	389213	14988	R100037	H37-FG	FG37
37S		389413	15026			
38			14989	R100038		
39		389215	14990	R100039		
PEAR						
1/2P			17731			
1P			17732			
1PS			17840			
2P			17733			
4P			17734			
PEAR LONG						
329		389369	14999	R100329	H329-FG	FG329
329S		389408		R300329		
330	180-HTFG330	389261	15001	R100330	H330-FG	FG330
330S	180-HTFG330S	389461	15002	R300330	H330-FGSS	FG330SS
331	180-HTFG331	389262	15004	R100331	H331-FG	FG331
331S		389462		R300331	H331-FGSS	FG331SS
331L		389264	15037			FG331L
331LS		389464				
332	180-HTFG332	389263	15005	R100332	H332-FG	FG332
332S		389463				
332L		389265	15038			
333L		389266				

Manufacturer part numbers are provided in these charts, please visit www.dhponline.com to convert or contact your DHPI Account Manager.

CARBIDE BUR CROSS-REFERENCE CHART

	Health-Tec	Midwest	SS White	Coltene	Kerr Rotary	Microcopy
FLAT FISSURE PLAIN CUT						
56	180-HTFG56	389216	14991	R100056		FG56
56S		389416	13056	R300056		FG56SS
57	180-HTFG57	389217	14994	R100057	H57-FG	FG57
57S		389417	14995	R300057		FG57SS
57L		389240	15028	R30058L		
58	180-HTFG58	389218	14996	R100058	H58-FG	FG58
957	180-HTFG957		15018			
DOMED FISSURE PLAIN CUT						
1156	180-HTFG1156	389255	17707	R101156	H1156-FG	FG1156
1156S		389455	17710	R301156		
1157	180-HTFG1157	389256	17708	R101157	H1157-FG	FG1157
1157S		389456	17711	R301157	H1157-FGSS	FG1157SS
1158	180-HTFG1158	389257	17709	R101158	H1158-FG	FG1158
1158S			17705		H1158-FGSS	
FLAT FISSURE CROSS CUT						
556	180-HTFG556	389226	15003	R100556	H556-FG	FG556
556S	180-HTFG556S	389426	15058	R300556	H556-FGSS	FG556SS
556L		389290	15059			
557	180-HTFG557	389227	15006	R100557	H557-FG	FG557
557S	180-HTFG557S	389247	15045	R300557	H557-FGSS	FG557SS
557L	180-HTFG557L	389291	15032			FG557L
558	180-HTFG558	389228	15009	R100558	H558-FG	FG558
558S	180-HTFG558S	389428	15048	R300558		
558L		389292	15033			
DOMED FISSURE CROSS CUT						
1556	180-HTFG1556	389258	15020	R101556		FG1556
1557	180-HTFG1557	389259	15021	R101557	H1557-FG	FG1557
1557S		389459	15022	R301557	H1557-FGSS	FG1557SS
1558	180-HTFG1558	389260	15024	R101558	H1558-FG	FG1558
1558S			15025	R301558	H1558-FGSS	
TAPER FISSURE PLAIN CUT						
167		389801		R100167		
168		385370		R100168		
169	180-HTFG169	389221	16884	R100169	H169-FG	FG169
169S		389419		R300169		
169L	180-HTFG169L	389245	16887	R10169L	H169L-FG	FG169L
170		389222	14997	R100170	H170-FG	FG170
170S		389422				
170L	180-HTFG170L	389246	15030	R10170L	H170L-FG	FG170L
171	180-HTFG171	389223	15000	R100171	H171-FG	
171L		389247	15031		H171L-FG	

Manufacturer part numbers are provided in these charts, please visit www.dhpionline.com to convert or contact your DHPI Account Manager.

CARBIDE BUR CROSS-REFERENCE CHART

	Health-Tec	Midwest	SS White	Coltene	Kerr Rotary	Microcopy
DOMED TAPER FISSURE CROSS CUT						
1169		389271		R101169		
1169L		389242				
1170	180-HTFG1170	389272	17712	R101170		
1170L		389243	17716			
1171	180-HTFG1171	389273	17714	R101171		FG1171
1171L		389244	17717			
1172	180-HTFG1172	389294		R101172		
TAPER FISSURE CROSS CUT						
699	180-HTFG699	389231	16890	R100669	H699-FG	FG699
699S	180-HTFG699S	389431	16891	R300669		
699L		389248	16892		H699L-FG	
700	180-HTFG700	389232	15012	R100700	H700-FG	FG700
700S	180-HTFG700S	389432	15051			
700L	180-HTFG700L	389249	16894	R10700L		
701	180-HTFG701	389233	15015	R100701	H701-FG	FG701
701S		389433	15016	R300701	H701-FGSS	
701L	180-HTFG701L	389250	15036	R10701L		FG701L
702	180-HTFG702	389234	17608	R100702	H702-FG	FG702
703		389235	15017			
AMALGAM PREP						
245	180-HTFG245	389371	15052	R100245	H245-FG	FG245
245S	180-HTFG245S	389471	15057	R300245	H245-FGSS	FG245SS
246	180-HTFG246	389372	15053	R100246		
ALL PURPOSE						
256	181-389287	389287	15054	R100256		
257	181-389288	389288	15055	R100257		
INLAY PREPARATION						
271	181-389373	389373	15066			



LOOK'in

 for something? **WE HAVE IT!**

www.dhpionline.com

Manufacturer part numbers are provided in these charts, please visit www.dhpionline.com to convert or contact your DHP Account Manager.



Our tungsten carbide burs exceed stringent ISO, FDA, BSI and CE European Standards. Tungsten carbide burs are designed, manufactured and finished for optimum strength, performance and durability. The burs are brazed in the neck as opposed to the base of the head, as found in many competitive products. Our 100% carbide neck delivers optimum concentricity and strength. Our tungsten carbide burs are engineered to cut more effectively, with a greater blade contact on the tooth surface, and reduced risk of chipping or breakage. The design ensures a fast, smooth, vibration free performance, reducing patient discomfort as well as operating time. The shank of each bur is made from stainless steel, allowing every bur to be autoclaved without risk of corrosion.

TUNGSTEN CARBIDE BURS



Round



BUR NO.	¼	½	1	2	3	4	5	6	8
DIAMETER	005	006	008	010	012	014	016	018	023
FG (19MM)	180-HTFG1/4	180-HTFG1/2	180-HTFG1	180-HTFG2	180-HTFG3	180-HTFG4	180-HTFG5	180-HTFG6	180-HTFG8
FG CLINIC	180-HTFG1/4CL	180-HTFG1/2CL	—	180-HG2CL	180-HG3CL	180-HTG4CL	—	180-HTG6CL	180-HTG8CL
FG SHORT (16MM)	—	—	—	180-HFG2S	—	—	—	180-HTFG6S	—
FG SURG (25MM)	—	180-HTFG12X	180-HTSFG1	180-HFG2X	—	180-HFG4X	—	180-HTFG6X	180-HTFG8X
FG SURG. CLINIC	—	—	—	180-HTS180	—	180-HTSFG4CL	—	180-HTSFG6CL	180-HTSFG8CL
RA (22MM)	180-HTRA1/4	180-HTRA1/2	180-HTRA1	180-HTRA2	180-HTRA3	180-HTRA4	180-HTRA5	180-HTRA6	180-HTRA8
RA CLINIC	—	—	—	180-HTR2CL	—	180-HTR4CL	—	180-HTR6CL	180-HTR8CL
RA SURG	—	—	—	180-HTSRA2	—	180-HTSRA4	—	180-HTSRA6	180-HTRA8X
HP (44.5MM)	—	180-HTHP12V	—	180-HTHP2V	—	180-HTHP4V	—	180-HTHP6V	180-HTHP8V

Amalgam Prep



BUR NO.	245	246
DIAMETER	009	011
FG (19MM)	180-HTFG245	180-HTFG246
FG CLINIC	180-HTFG245CL	—
FG SHORT (16MM)	180-HTFG245S	—
FG SHORT CLINIC	180-HTFG245SCL	—

Inverted Cone



BUR NO.	33½	34	35	37
DIAMETER	006	008	010	014
FG (19MM)	180-HTFG331/2	180-HTFG34	180-HTFG35	180-HTFG37
FG CLINIC	180-HTFG331/2CL	—	180-HTFG35CL	180-HTFG37CL
FG SHORT (16MM)	180-HTFG331/2S	—	180-HTFG35S	—
RA (22MM)	180-HTRA331/2	—	180-HTRA35	—
HP (44.5MM)	—	—	—	180-HTHP37V

Pear



BUR NO.	330	331	332
DIAMETER	008	010	012
FG (19MM)	180-HTFG330	180-HTFG331	180-HTFG332
FG CLINIC	180-HTFG330CL	180-HTFG331CL	180-HTFG332CL
FG SHORT (16MM)	180-HTFG330S	—	—
FG SHORT CLINIC	180-HTFG330SCL	—	—

FG & FG Short Shank	10/pack	\$15.95	10 @ \$14.95/ea
FG & FG Short Shank	100/pack	\$140.95	4 @ \$138.95/ea
Surgical FG	10/pack	\$16.75	10 @ \$15.75/ea
Surgical FG	100/pack	\$145.95	
Surgical RA	10/pack	\$24.95	10 @ \$23.95/ea
RA	10/pack	\$16.95	10 @ \$15.95/ea
RA	100/pack	\$148.95	
HP	5/pack	\$9.45	10 @ \$8.95/ea

STRENGTH BY DESIGN

Other manufacturers weld at the base of the head increasing the risk of breakage. Health-Tec Carbides are brazed at the base of the neck to ensure maximum strength.

Flat Fissure - Cross Cut

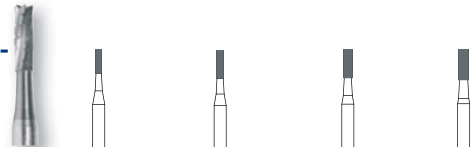

BUR NO.	556	557	558	559
DIAMETER	008	010	012	014
FG (19MM)	180-HTFG556	180-HTFG557	180-HTFG558	—
FG CLINIC	180-HTFG556CL	180-HTFG557CL	180-HTFG558CL	—
FG SHORT (16MM)	180-HTFG556S	180-HTFG557S	180-HTFG558S	—
FG SHORT CLINIC	—	180-HTFG557SCL	—	—
FG LONG	—	180-HTFG557L	—	—
FG SURG (25MM)	—	180-HTSFG557X	180-HTSFG558X	—
FG SURG CLINIC	—	180-HTSFG557CL	180-HTSFG558CL	—
RA (22MM)	—	180-HTRA557	—	—
HP (44.5MM)	—	180-HTHP557V	180-HTHP558V	180-HTHP559V

Flat Fissure - Plain Cut

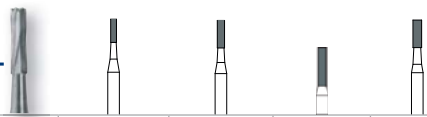

BUR NO.	56	57	957	58
DIAMETER	008	010	010	012
FG (19MM)	180-HTFG56	180-HTFG57	180-HTFG957	180-HTFG58
FG CLINIC	—	180-HTFG57CL	—	—

Taper Fissure - Cross Cut

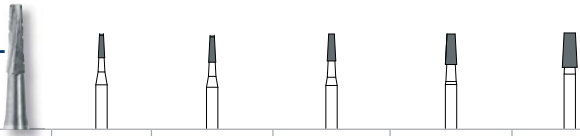

BUR NO.	699	700	701	702	703
DIAMETER	009	010	012	016	021
FG (19MM)	180-HTFG699	180-HTFG700	180-HTFG701	180-HTFG702	—
FG CLINIC	—	180-HTFG700CL	—	—	—
FG SHORT (16MM)	180-HFG699S	180-HTFG700S	—	—	—
FG SURG. (25MM)	—	180-HTSFG700X	180-HTSFG701X	180-HTSFG702X	180-HTSFG703X
FG SURG. CLINIC	—	180-HTSFG700CL	—	180-HTSFG702CL	—
HP (44.5MM)	—	—	—	180-HTHP702V	180-HTHP703V

The NEW STANDARD
in VALUE BRAND PRODUCTS.

Taper Fissure - Plain Cut

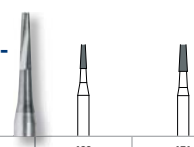

US NO.	169	171
DIAMETER	009	012
FG (19MM)	180-HTFG169	180-HTFG171

Taper Fissure - Cross Cut Long Head

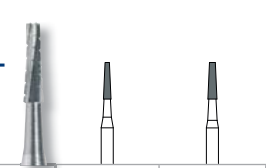

BUR NO.	700L	701L
DIAMETER	010	012
FG (19MM)	180-HTFG700L	180-HTFG701L

Taper Fissure - Plain Cut Long Head



BUR NO.	169L	170L
DIAMETER	009	010
FG (19MM)	180-HTFG169L	180-HTFG170L
FG CLINIC	180-HTFG169LCL	180-HTFG170LCL

Domed Fissure - Plain Cut

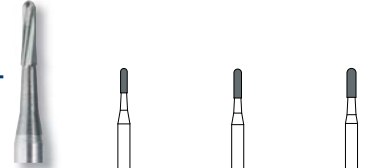

BUR NO.	1156	1157	1158
DIAMETER	008	010	012
FG (19MM)	180-HTFG1156	180-HTFG1157	180-HTFG1158
FG CLINIC	—	180-HTFG1157CL	—
FG SHORT (16MM)	—	—	—

Domed Fissure - Cross Cut

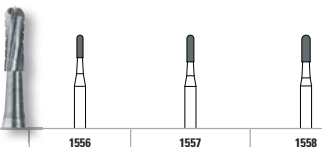

BUR NO.	1556	1557	1558
DIAMETER	008	010	012
FG (19MM)	180-HTFG1556	180-HTFG1557	180-HTFG1558
FG CLINIC	—	180-HTFG1557CL	—

Domed Taper Fissure - Cross Cut

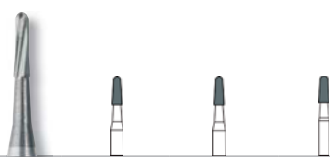

BUR NO.	1170	1171	1172
DIAMETER	010	012	016
FG (19MM)	180-HTFG1170	180-HTFG1171	180-HTFG1172

Trimming & Finishing 12 Blade

Trimming & Finishing
 FG 5/pack \$23.95
 12 @ \$22.95/ea

Flame



BUR NO.	7104	7106	7108
DIAMETER	014	018	023
HEAD LENGTH (MM)	3.5	3.7	4.5
FG (19MM)	180-HTFG71045	180-HTFG71065	180-HTFG71085

Long Taper



BUR NO.	7204	7205
DIAMETER	014	016
HEAD LENGTH (MM)	8.5	8.5
FG (19MM)	180-HTFG72045	180-HTFG72055

Taper Pointed



BUR NO.	7214
DIAMETER	010
HEAD LENGTH (MM)	5.6
FG (19MM)	180-HTFG72145

Egg

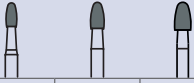

BUR NO.	7404	7406	7408
DIAMETER	014	018	023
HEAD LENGTH (MM)	3.3	3.7	3.9
FG (19MM)	180-HTFG74045	180-HTFG74065	180-HTFG74085

Bullet



BUR NO.	7801	7803
DIAMETER	009	012
HEAD LENGTH (MM)	4.0	3.4
FG (19MM)	180-HTFG78015	180-HTFG78035

Taper Flat End



BUR NO.	7702
DIAMETER	010
HEAD LENGTH (MM)	5.2
FG (19MM)	180-HTFG77025

Round

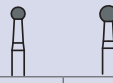

BUR NO.	7006	7008
DIAMETER	018	023
FG (19MM)	180-HTFG70065	180-HTFG70085

Needle



BUR NO.	7901	7902	7903
DIAMETER	009	010	012
HEAD LENGTH (MM)	3.8	3.8	3.9
FG (19MM)	180-HTFG79015	180-HTFG79025	180-HTFG79035

Esthetic Finishing 10-12 Blade

Esthetic Finishing
 5/pack \$29.25
 12 @ \$28.25/ea

EF Series (Safe End, 10 Blade)



BUR NO.	EF3	EF4	EF6	EF9	BUR NO.	OF1
DIAMETER	008	010	014	014	DIAMETER	023
HEAD LENGTH (MM)	3.0	4.0	6.0	9.0	HEAD LENGTH (MM)	4.3
ITEM #	—	180-HTEF4	180-HTEF6	180-HTEF9	ITEM #	180-HTOF1

OF Series (12 Blade)



Metal Cutting

Straight Domed Fissure-Cross Cut



BUR NO.	1958
DIAMETER	012
HEAD LENGTH (MM)	4
FG (19MM)	180-HTFG1958

5/pack \$18.95
 10 @ \$17.95/ea

Surgical Burs

Endo Access



BUR NO.	152
DIAMETER	016
ENDO ACCESS	180-HTFG152

5/pack \$34.95



Aluminum Bur Blocks

The attractive 5 colors allow clinicians to organize their rotary instruments by procedure. Fully autoclavable aluminum blocks hold up to 15 FG burs. The use of bur blocks minimizes damage to instruments and reduces the likelihood of injury from sharp instruments, while creating ideal procedural organization.

Red	590-10001
Silver	590-10002
Blue	590-10003
Black	590-10004
Green	590-10005

Each \$17.95
 3 @ \$16.95/ea

► Available in 10 & 100 packs

	Round				Cross Cut Fissure			Inverted Cone			Pear	
US. No.	2G	4G	6G	8G	556G	557G	558G	34G	35G	37G	330G	331G
DIA. (mm)	1.00	1.40	1.80	2.30	0.90	1.00	1.20	0.80	1.00	1.40	0.80	1.00
FG 10pk	R40002G	R40004G	R40006G	R40008G	R40556G	R40557G	R40558G	R40034G	R40035G	R40037G	R40330G	R40331G
FG 100pk		R40004GC				R40557GC						
FGSS 10pk						R40557GSS						

	Cross Cut Tapered Fissure		Round End Cross Cut Fissure		Amalgam Prep
US. No.	701G	702G	1557G	1558G	245G
DIA. (mm)	1.20	1.60	1.00	1.20	0.80
FG 10pk	R40701G	R40702G	R41557G	R41558G	R40245G
FG 100pk			R41557GC	R41558GC	R40245GC
FGSS 10pk			R41557GSS		R40245GSS

Alpen® Carbides Trimming & Finishing

► Available in 5 packs

Safe End

12 Flutes.....\$46.25
 30 Flutes.....\$83.25

	Round					Tapered									
US. No. #12	7002	7004	7006	7008	7009	7611	7612	7702	7713	7714	7114	7204	7205	7206	7214
US. No. #30	9004	9006	9008	9008	9009	9714	9714	9714	9714	9714	9714	9714	9714	9714	9214
DIA. (mm)	1.00	1.40	1.80	2.30	2.70	1.00	1.40	1.00	1.20	1.40	0.90	1.40	1.60	1.80	1.20
12 flutes	R707002	R707004	R707006	R707008	R707009	R707611	R707612	R707702	R707713	R707714	R707114	R707204	R707205	R707206	R707214
30 flutes		R909004	R909006	R909008					R909714						R909214

	Round End Taper				Parallel Bevel		Curretage		Long Pear		Composite Trimming			
US. No. #12	7642	7653	7664	7675	7283-2	7284-4	7283K6	7282K6	7303	7304	EF3	EF4	EF6	EF9
US. No. #30	9004	9006	9008	9009	9714	9714	9714	9714	9714	9714	UF3	UF4	UF6	UF9
DIA. (mm)	1.00	1.20	1.40	1.60	1.20	1.40	1.60	1.60	1.20	1.40	0.80	1.00	1.40	1.40
12 flutes	R707642	R707653	R707664	R707675	R7283-2	R7284-4	R7283K6	R7282K6	R707303	R707304	R700EF3	R700EF4	R700EF6	R700EF9
30 flutes											R9EF3UF	R9EF4UF	R9EF6UF	R9EF9UF

	Bullet				Egg Shape			Interproximal	Needle			Flame		
US. No. #12	OS3	OS2					OS1	7103	7901	7902	7903	7102	7104	7106
US. No. #30	9802	9803			9404	9406	9408		9903					
DIA. (mm)	0.70	0.90	1.00	1.20	1.40	1.80	2.30	1.20	0.90	1.00	1.20	1.20	1.40	1.80
12 flutes	R707800	R707801	R707802	R707803	R707404	R707406	R707408	R707103	R707901	R707902	R707903	R707102	R707104	R707106
30 flutes			R909802	R909803	R909404	R909406	R909408			R909903				

Manufacturer part numbers are provided in these charts, please visit www.dhponline.com to convert or contact your DHPI Account Manager.

Alpen® Carbides Operative & Surgical

▶ Available in 10 & 100 packs

Round											Amalgam Prep				Pear				End Cutting	
US. No.	1/4	1/2	1	2	3	4	5	6	7	8	245	246	256	257	329	330	331	332	956	957
DIA. (mm)	0.50	0.70	0.80	1.00	1.20	1.40	1.60	1.80	2.10	2.30	0.80	1.20	0.80	1.00	0.60	0.80	1.00	1.20	0.80	1.00
FG 10pk	R1001/4	R1001/2	R100001	R100002	R100003	R100004	R100005	R100006	R100007	R100008	R100245	R100246	R100256	R100257	R100329	R100330	R100331	R100332	R100956	R100957
FG 100pk	R1001/4C	R1001/2C	R100001C	R100002C	R100003C	R100004C	R100005C	R100006C	R100007C	R100008C	R100245C	R100246C		R100257C	R100329C	R100330C	R100331C	R100332C		
FGSS 10pk	R3001/4	R3001/2	R300001	R300002	R300003	R300004	R300005	R300006	R300007	R300008	R300245	R300246			R300329	R300330	R300331			
FGSS 100pk																				
FGOS 10pk	R5001/4	R5001/2	R500001	R500002	R500003	R500004		R500006		R500008										
RA 10pk	R2001/4	R2001/2	R200001	R200002	R200003	R200004	R200005	R200006	R200007	R200008	R200245				R200329	R200330				
RA 100pk						R200004C		R200006C		R200008C						R200330				
HP 10pk	R6001/4	R6001/2		R600002		R600004		R600006	R600007	R600008										

Inverted Cone							Round End Cross Cut Tapered Fissure			Fissure					Round End Cross Cut Fissure			
US. No.	33 1/2	34	35	36	37	38	39	1701	1702	1703	56	57	58	58L	59	1556	1557	1558
DIA. (mm)	0.70	0.80	1.00	1.20	1.40	1.60	1.80	1.20	1.60	2.10	0.90	1.00	1.20	1.20	1.40	0.90	1.00	1.20
FG 10pk	R1331/2	R100034	R100035	R100036	R100037	R100038	R100039	R101701	R101702		R100056	R100057	R100058	R10058L	R100059	R101556	R101557	R101558
FG 100pk	R1331/2C	R100034C	R100035C	R100036C	R100037C						R100056C	R100057C	R100058C					
FGSS 10pk	R3331/2	R300034	R300035								R300056	R300057						
FGOS 10pk																		
RA 10pk	R2331/2	R200034	R200035		R200037				R501702		R200056	R200057				R501557	R501558	
HP 10pk	R6331/2	R600034			R600037			R601702	R601703						R601557	R601558		

Round End Fissure				Cross Cut Fissure					Round End Tapered Fissure				Long Cross Cut Tapered Fissure			Long Tapered Fissure			
US. No.	1155	1156	1157	1158	556	557	558	559	560	1169	1170	1171	1172	700L	701L	702L	169L	170L	171L
DIA. (mm)	0.80	0.90	1.00	1.20	0.90	1.00	1.20	1.40	1.60	0.90	1.00	1.20	1.60	1.00	1.20	1.60	0.90	1.00	1.20
FG 10pk	R101155	R101156	R101157	R101158	R100556	R100557	R100558	R100559	R100560	R101169	R101170	R101171	R101172	R10700L	R10701L	R10702L	R10169L	R10170L	R10171L
FG 100pk		R101156C	R101157C	R101158C	R100556C	R100557C	R100558C		R100560C	R101169C	R101170C	R101171C					R10169LC		
FGSS 10pk		R301156	R301157	R301158	R300556	R300557	R300558												
FGOS 10pk				R501158	R500556	R500557	R500558	R500559											
RA 10pk					R200556	R200557		R600559	R600560										
HP 10pk						R600557					R601170								
FGSS 100pk						R300557C													

Cross Cut Tapered Fissure					Tapered Fissure					Safe End / Safe End				
US. No.	699	700	701	702	703	167	168	169	170	171	152EZ	219EZ	199Z	151Z
DIA. (mm)	0.90	1.00	1.20	1.60	2.10	0.70	0.80	0.90	1.00	1.20	1.40	1.40	1.60	1.60
FG 10pk	R100699	R100700	R100701	R100702	R100703	R100167	R100168	R100169	R100170	R100171	R4152EZ	R4219EZ	R40199Z	R40151Z
FG 100pk	R100699C	R100700C	R100701C	R100702C			R100168C	R100169C	R100170C	R100171C				
FGSS 10pk	R300699	R300700	R300701					R300169						
FGOS 10pk			R500701	R500702	R500703									
RA 10pk	R200699	R200700	R600701							R500171				
HP 10pk		R600700		R600702	R600703					R600171				

Alpen® Carbides Endo Access
1 @ \$47.95

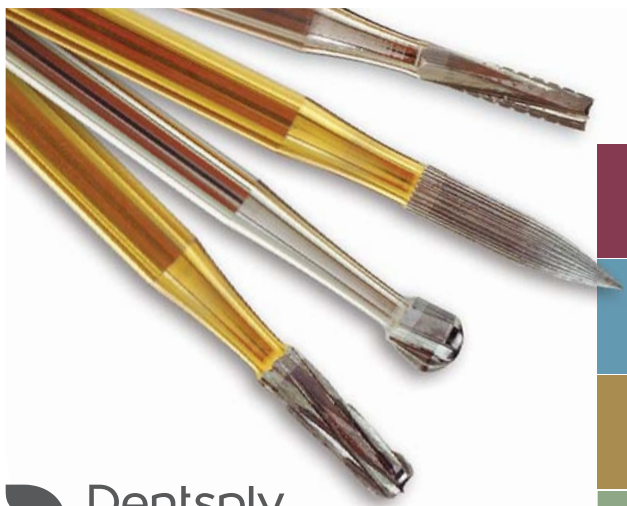

Midwest® Carbide Burs

The #1 Choice of Dentists



Convenient Packaging Options



OPERATIVE CARBIDE BURS

Exceptional cutting performance. Extensive selection of shapes and sizes in familiar configurations to meet your clinical needs.

ORAL SURGICAL CARBIDE BURS

Superior, precision ground cutting edges for efficient and consistent cutting performance. Ideal for cutting through bone and sectioning teeth.

TRIMMING & FINISHING CARBIDE BURS

Custom blended tungsten carbide, sintered and precision ground for superior cutting edges and striation-free surfaces.

ESTHETIC FINISHING CARBIDE BURS

Premium finishing burs, delivering the ultimate surface finish for great esthetic results.

MULTIPREP® PREMIUM CARBIDE BURS

Maximum density cross-cut burs for smooth and precise cutting of cavity preparations and all types of restorative materials.

Bur Shank Dimensions	Style	Length mm / inches	Diameter mm
	FGSS Friction Grip / Short Shank	16.5 / 0.65	1.60
	FG Friction Grip	19.0 / 0.75	1.60
	FGOS Friction Grip Oral Surgical	25.0 / 0.98	1.60
	LA Latch	22.0 / 0.87	2.35
	LAOS Latch Oral Surgical	26.0 / 1.02	2.35
	HP Handpiece (Straight)	44.5 / 1.75	2.35
	HPOS Handpiece Oral Surgical	65.0 / 2.54	2.35

Length includes cutting head of bur. Convert mm to inches x .039.
 "L" Series Burs offer longer head dimensions. Refer to product tables for specifications.

Round



	Shape	1/4	1/2	1	2	3	4	5	6	7
	Diameter mm	0.5	0.6	0.8	1.0	1.2	1.4	1.6	1.8	2.1
	Length mm	0.5	0.6	0.8	1.0	1.2	1.4	1.6	1.8	2.1
FG	100 Pack Bag	386201	386202	386203	386204	386268	386205	386269	386206	386274
	10 Pack	389201	389202	389203	389204	389268	389205	389269	389206	389274
FGSS	100 Pack Bag	386401	386402	386403	386404		386405		386406	
	10 Pack	389401	389402	389403	389404		389405			
LA	100 Pack Bag	386101	386102	386103	386104		386105	386169	386106	
	10 Pack	389101	389102	389103	389104		389105	389169	389106	
HP	100 Pack Bag	386301	386302	386303	386304		386305		386306	
	10 Pack	389301	389302	389303	389304		389305		389306	

Midwest® Operative Carbide Bur Pricing

Manufacturer item number listed, for conversion please visit www.dhpionline.com or contact your DHPI Account Manager.

FG, FGSS, LA & HP:
 10 Pack \$25.99
 100 Pack Bag \$229.99



		Amalgam Prep.		All Purpose		Inlay Prep	End Cutting
	Shape	245	246	256	257	271	957
	Diameter mm	0.9	1.2	0.9	1.0	1.2	1.0
	Length mm	2.7	3.7	2.7	3.7	2.7	3.7
FG	100 Pack Bag	386371	386372	386287	386288	386373	386278
	10 Pack	389371	389372	389287	389288	389373	389278
FGSS	100 Pack Bag	386471					
	10 Pack	389471					

Manufacturer part numbers are provided in these charts, please visit www.dhpionline.com to convert or contact your DHPI Account Manager.

Midwest® Operative Carbide Bur Pricing

Manufacturer item number listed, for conversion please visit www.dhponline.com or contact your DHPI Account Manager.

FG, FGSS, LA & HP:
10 Pack \$25.99
100 Pack Bag \$229.99

	Shape	 Inverted Cone						 Pear						
		33 1/2	34	35	36	37	39	329	330	331	331-L	332	332-L	333-L
	Diameter mm	0.6	0.9	1.0	1.0	1.2	1.2	0.6	0.8	1.0	1.0	1.2	1.2	1.4
	Length mm	0.4	0.6	0.7	0.8	0.8	1.3	1.6	1.6	1.6	4.1	1.6	4.1	4.1
FG	100 Pack Bag	386209	386210	386211	386212	386213	386215	386369	386261	386262	386264	386263	386265	386266
	10 Pack	389209	389210	389211	389212	389213	389215	389369	389261	389262	389264	389263	389265	389266
FGSS	100 Pack Bag	386409	386410	386411		386413		386408	386461	386462	386464	386463		
	10 Pack	389409	389410	389411		389413		389408	389461	389462	389464	389463		
LA	100 Pack Bag	386109	386110	386111	386112	386113			386161					
	10 Pack	389109	389110	389111	389112	389113			389161	389162				
HP	100 Pack Bag	386309				386313	386315							
	10 Pack	389309				389313	389315							

Diameter mm	0.9	0.9	1.0	1.0	1.2	1.2	1.6	2.1	2.1	0.9	0.9	1.0	1.0	1.2	1.2	1.6	2.1	2.1
Length mm	3.2	4.9	3.7	4.9	3.7	4.9	4.1	4.6	5.7	3.2	4.9	3.7	4.9	3.7	4.9	4.1	4.5	5.7



Straight Flat End



Straight Dome End

	Shape	Straight Flat End						Straight Dome End					
		56	57	57-L	58			1156	1157	1158			
FG	100 Pack Bag	386216	386217	386240	386218			386255	386256	386257			
	10 Pack	389216	389217	389240	389218			389255	389256	389257			
FGSS	100 Pack Bag	386416	386410					386455	386456	386457			
	10 Pack	389416	389417					389455	389456	389457			
LA	100 Pack Bag	386116											
HP	10 Pack							389356					



Straight Flat End Crosscut



Straight Dome End Crosscut

	Shape	Straight Flat End Crosscut						Straight Dome End Crosscut					
		556	556-L	557	557-L	558			1556	1557	1558		
FG	100 Pack Bag	386226	386290	386227	386291	386228			386258	386259	386260		
	10 Pack	389226	389290	389227	389291	389228			389258	389259	389260		
FGSS	100 Pack Bag	386426		386427		386428				386459	386460		
	10 Pack	389426		389427	389491	389428			389458	389459	389460		
LA	100 Pack Bag	386126		386127		386128							
	10 Pack	389126		389127		389128							
HP	100 Pack Bag			386327		386328				386359	386360		
	10 Pack			389327		389328				389359	389360		



Taper Flat End



Taper Dome End

	Shape	Taper Flat End						Taper Dome End								
		169	169-L	170	170-L	171	171-L			1169	1169-L	1170	1170-L	1171	1171-L	1172
FG	100 Pack Bag	386221	386245	386222	386246	386223	386247			386271	386242	386272	386243	386273	386244	386294
	10 Pack	389221	389245	389222	389246	389223	389247			389271	389242	389272	389243	389273	389244	389294
FGSS	100 Pack Bag	386419		386422	386446											
	10 Pack	389419		389422	389446											
LA	100 Pack Bag			38614									386189		386194	
	10 Pack	389121	389145	389122									389189		389194	
HP	100 Pack Bag													386346		386394
	10 Pack													389346		389394



Taper Flat End Crosscut



Taper Dome End Crosscut

	Shape	Taper Flat End Crosscut									Taper Dome End Crosscut						
		699	699-L	700	700-L	701	701-L	702	703	703-L					1702	1703	1703-L
FG	100 Pack Bag	386231	386248	386232	386249	386233	386250	386234	386235						386286		
	10 Pack	389231	389248	389232	389249	389233	389250	389234	389235						389286		
FGSS	100 Pack Bag	386431		386432		386433											
	10 Pack	389431		389432		389433											
LA	100 Pack Bag			386132		386133											
	10 Pack			389132		389133		389134									
HP	100 Pack Bag			386332		386333		386334	386335	386367							
	10 Pack			389332		389333	389350	389334	389335	389367					389386	389385	389376

Manufacturer part numbers are provided in these charts, please visit www.dhponline.com to convert or contact your DHPI Account Manager.

Midwest® Oral Surgical Carbide Bur Pricing

Manufacturer item number listed, for conversion please visit www.dhponline.com or contact your DHPI Account Manager.

FGOS, LAOS:	
2 Pack	\$11.29
10 Pack	\$39.49
100 Pack Box	\$366.39
HP:	
10 Pack	\$25.99
100 Pack Bag	\$229.99
HPOS:	
10 Pack	\$39.49



	Shape	1	2	4	6	8	
		Diameter mm	0.8	1.0	1.4	1.8	2.3
		Length mm	0.8	1.0	1.4	1.8	2.3
FGOS	100 Pack Box			385605	385606	385607	
	10 Pack	389603					
	2 Pack		388604	388605	388606	388607	
LAOS	100 Pack Box			385905	385906	385907	
	10 Pack	389992					
	2 Pack		388904	388905	388906	388907	
HP	100 Pack Bag	386303	386304	386305	386306	386307	
	10 Pack	389303	389304	389305	389306	389307	
HPOS	10 Pack				389706	389017	

Straight Flat End



Straight Flat End Crosscut



Straight Dome End Crosscut



Taper Flat End Crosscut



Taper Dome End Crosscut



	Shape	57	556	557	558	559	1557	1558	700	701	702	703	1702	1703
		Diameter mm	1.0	0.9	1.0	1.2	1.4	1.0	1.2	1.0	1.2	1.6	2.1	1.6
		Length mm	3.7	3.2	3.7	3.7	3.7	3.7	3.7	3.7	4.1	4.5	4.1	4.5
FGOS	10 Pack		389626						389632					389685
	2 Pack	388617	388626	388627	388628	388629	388659	388660		388632	388633	388634	388635	388686
LAOS	10 Pack			389927	389928				389932	389933	389934		389986	389985
	2 Pack			388927				389660		388933		388935		
HP	100 Pack Bag			386327	386328		386359	386360	386332	386333	386334	386335		
	10 Pack			389327	389328		389359	389360	389332	389333	389334	389335	389386	389385
HPOS	10 Pack										389609	389735		389785

Midwest® Trimming & Finishing Carbide Bur Pricing

Manufacturer item number listed, for conversion please visit www.dhponline.com or contact your DHPI Account Manager.

12 blades:
2 Pack \$22.49
10 Pack \$97.59
100 Pack Bag \$870.99

30 blades / 9000 Series:
2 Pack \$31.49

Round



Egg



Bullet



Flame



	Diameter mm	1.4	1.6	2.3	2.5	1.4	1.8	2.3	0.9	1.0	1.2	1.4	1.8	
		Length mm	1.4	1.6	2.3	2.5	3.0	3.4	3.6	2.8	2.8	3.0	3.2	3.6
12 BLADES														
FG	Shape	7004	7006	7008	7009	7404	7406	7408	7801	7802	7803	7104	7106	
	100 Pack Bag					386522	386523	386524	386507	386508	386509			
FG	10 Pack	389503	389504	389505	389506	389522	389523	389524	389507	389508	389509	389513	389514	
	2 Pack	388503	388504	388505	388506	388522	388523	388524	388507	388508	388509	388513	388514	
30 BLADES														
FG	Shape	9004	9006	9008		9406					9803			
	2 Pack	388591	388592	388593		388584					388599			

Taper Flat End



Taper Cone



Taper Dome End

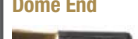

Taper T-Series



Taper Long & Extra Long



Interproximal



	Diameter mm	1.0	1.2	1.4	1.6	1.8	0.9	1.0	0.9	1.2	1.4	1.0	1.5	1.2	
		Length mm	4.9	4.9	8.8	8.8	8.8	3.4	4.0	2.9	5.1	7.6	5.7	8.6	3.4
12 BLADES															
FG	Shape	7702	7713	7204	7205	7206			7114 T-1	7214 T-2	7714 T-3	7642	7664	7103	
	10 Pack	389528	389529	389516	389517	389518			389901	389902	389903	389536	389537	389546	
FG	2 Pack	388528	388529	388516	388517	388518			388901	388902	388903	388536	388537	388546	
	30 BLADES														
FG	Shape		9713				9561	9572		9214 T-2	9714 T-3	9642		9103	
	2 Pack		388596				388594	388595		388583	388582	388585		388581	

Manufacturer part numbers are provided in these charts, please visit www.dhponline.com to convert or contact your DHPI Account Manager.

**Midwest®
Trimming & Finishing
Carbide Bur Pricing**
Manufacturer item number listed, for conversion please visit www.dhpionline.com or contact your DHPI Account Manager.



12 blades:
2 Pack \$22.49
10 Pack \$97.59
100 Pack Bag \$870.99









30 blades / 9000 Series:
2 Pack \$31.49





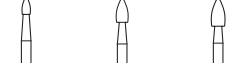

**Midwest®
Esthetic Finishing
Carbide Burs
Pricing**
Manufacturer item number listed, for conversion please visit www.dhpionline.com or contact your DHPI Account Manager.

12 Blades:
2 Pack \$23.99
10 Pack \$105.99
100 Pack Bag \$939.89

30 Blades / 9000 Series:
2 Pack \$30.49

		Needle				Inverted Taper	Straight	
								
Diameter mm		0.9	1.0	1.2	1.4	1.2	1.0	
Length mm		3.2	3.6	3.8	5.2	4.1	5.0	
12 BLADES		Shape		7901	7902	7903	7303	7572
FG	100 Pack Bag	386510	386511	386512				
	10 Pack	389510	389511	389512		389519	389525	
	2 Pack	388510	388511	388512		388519	388525	
30 BLADES		Shape		9903		9904		
FG	2 Pack			388597	388598			

		Egg			Taper Safe End		Interproximal		
									
									
									
Diameter mm		1.4	1.8	2.3	1.2	1.4	1.2		
Length mm		3.0	3.4	3.6	5.1	7.6	3.4		
12 BLADES		Shape		7404B	7406B	7408B	7214S	7714S	
FG	100 Pack	376117	376118	376119					
	10 Pack	379117	379118	379119	379105	379109			
	2 Pack	378117	378118	378119	378105	378109			
FGSS	10 Pack	379114	379115	379116	379126	379112			
	2 Pack	378114	378115	378116	378126	378112			
30 BLADES		Shape		9404B	9406B	9408B	9214S	9714S	9103
FG	2 Pack	378123	378124	378125	378106	378110		378131	
FGSS	2 Pack	378120	378121	378122	378127	378113			

		Taper			Bullet				
									
									
									
Diameter mm		1.0	1.2	1.4	0.9	1.0	1.2		
Length mm		3.9	5.9	8.8	2.8	2.8	3.0		
FG		Shape		7611	7612	7613	7801	7802	7803
FG	100 Pack				376132	376133	376134		
	10 Pack	379102	379107	379111	379132	379133	379134		
	2 Pack	378102	378107	378111	378132	378133	378134		
FGSS	10 Pack	379128	379140	379129	379136	379137	379138		
	2 Pack	378128	378140	378129	378136	378137	378138		

Midwest® MultiPrep® Premium Carbide Bur Pricing









Manufacturer item number listed, for conversion please visit www.dhponline.com or contact your DHPI Account Manager.









FG & FGSS:







10 Pack \$36.99
 100 Pack Bag \$331.79
 100 Pack Box \$331.79

FGOS:

2 Pack \$12.89
 10 Pack \$45.49
 100 Pack Bag \$414.99
 100 Pack Box \$414.99

		Round				Pear				
										
		Shape	2	4	6	8	329	330	331	332
		Diameter mm	1.0	1.4	1.8	2.3	0.6	0.8	1.0	1.2
		Length mm	1.0	1.4	1.8	2.3	1.6	1.6	1.6	1.6
FG	100 Pack Bag	396204	396205	396206	396207	396369	396261	396262	396263	
	100 Pack Box	395204	395205	395206	395207	395369	395261	395262	395263	
	10 Pack	399204	399205	399206	399207	399369	399261	399262	399263	
FGSS	100 Pack Bag						396461	396462		
	100 Pack Box						395461	395462		
	10 Pack						399461	399462		
FGOS	100 Pack Bag			396606						
	100 Pack Box			395606						
	10 Pack			399606						
	2 Pack			398606						

		Long Pear		Straight Flat End			Straight Dome End				
											
		Shape	245	246	556	557	558	1556	1557	1558	1558-L
		Diameter mm	0.9	1.2	0.9	1.0	1.2	0.9	1.0	1.2	1.2
		Length mm	2.7	3.7	3.2	3.7	3.7	3.2	3.7	3.7	4.9
FG	100 Pack Bag	396371	396372	396226	396227	396228	396258	396259	396260	396555	
	100 Pack Box	395371	395372	395226	395227	395228	395258	395259	395260	395555	
	10 Pack	399371	399372	399226	399227	399228	399258	399259	399260	399555	
FGSS	100 Pack Bag				396427					396460	
	100 Pack Box				395427					395460	
	10 Pack				399427					399460	
FGOS	100 Pack Bag				396627						
	100 Pack Box				395627						
	10 Pack				399627						
	2 Pack				398627						

		Inverted Cone			Taper Flat End	Taper Dome End		
								
		Shape	34	35	37	699	1700	1701
		Diameter mm	0.9	1.0	1.2	0.9	1.0	1.2
		Length mm	0.6	0.7	0.8	3.2	3.7	3.7
FG	100 Pack Bag	396210	396211	396213	396231	396282	396284	
	100 Pack Box		395211	395213	395231	395282	395284	
	10 Pack	399210	399211	399213	399231	399282	399284	

Manufacturer part numbers are provided in these charts, please visit www.dhponline.com to convert or contact your DHPI Account Manager.



Endo-Access™ Bur

The tip matches round bur sizes for initial penetration while its diamond shaft flares the pulp chamber. The cutting surface is 10mm. The total length is 21mm.

2.....	188-668800
4.....	188-668801
6.....	188-668802
Assorted 2, 4, 6.....	188-668803
3/pkg.	\$31.75



Endo-Z™ Bur

The rounded, non-cutting, safe-ended tip prevents penetration of the pulp chamber floor or the root canal walls. The cutting surface is 9mm and the total length is 21mm.

188-671796	3/pkg.	\$28.95
------------	-------------	----------------



LN™ Bur

Unique 1/2-round bur on a long neck. Its design allows for deep drilling alongside posts or broken instruments. Total length of 28mm.

188-671795	3/pkg.	\$15.25
------------	-------------	----------------



Multi-Purpose™ Bur

Used for initial endodontic access, sectioning of impacted molars, cutting of teeth at root level, root separation and amputation of broken roots. Cutting surface of 11mm and a total length of 23mm.

188-671797	3/pkg.	\$28.95
------------	-------------	----------------



Transmetal™ Bur

Extra-fine crosscut shape is designed to remove an old amalgam filling or to cut through porcelain fused to metal crowns without shattering the porcelain or breaking the bur. The cutting surface is 5mm and the total length is 19mm.

188-671798	3/pkg.	\$21.95
------------	-------------	----------------

Integra® Miltex®

LABORATORY BURS



"GTN" Gold Titanium Nitride Coated Lab Burs

- Longer Tool Life - The GTN coating hardens the cutting edges making the bur last longer.
- Faster, Cooler Working - The GTN coating acts as a continuous lubricant resulting in less resistance.
- Smoother Finishing - The GTN coating resists chip build-up, resulting in an extremely smooth finish.

181-DMX1 - DMX17	\$22.95
181-DMX19 - DMX23	\$17.75

Diamond Cut Laboratory Carbide Burs

Precision, diamond-shaped fluting is designed specifically to ensure smooth, fast, clean cutting of all ceramic-type and conventional gold castings.



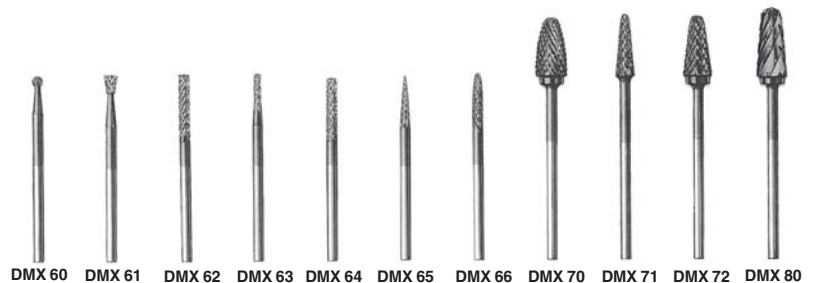









181-DMX60 - DMX66	\$16.45
181-DMX70 - DMX80	\$23.75
181-DMX31 - DMX39	\$43.75
181-DMX51 - DMX59	\$57.95



- German Quality & Technology
- Precision Ground Blades
- Wide Variety of Shapes & sizes
- Autoclavable Available in Friction Grip only. In packs of 5 only













Regular: 8 & 12 Fluted	Fine: 16 & 20 Fluted	Ultrafine: 30 Fluted
Each \$54.95	Each \$60.25	Each \$74.75

TDF™ Trim, Define, & Finish Series: Straight Blade: Safe End

												
U.S. NO.	TDF-3	TDF-3F	TDF-3UF	TDF-4	TDF-4F	TDF-4UF	TDF-6	TDF-6F	TDF-6UF	TDF-9	TDF-9F	TDF-9UF
MFG REF.	H132	H132	H132	H133	H133	H133	H134	H134	H134	H135	H135	H135
SIZE 1/10mm	008	008F	008UF	010	010F	010UF	014	014F	014UF	014	014F	014UF
LENGTH (mm)	3.0	3.0	3.0	4.2	4.2	4.2	6.0	6.0	6.0	9.0	9.0	9.0
Blade Config.	■	■	□	■	■	□	■	■	□	■	■	□
Order No.	H132-008	H132-008F	H132-008UF	H133-010	H133-010F	H133-010UF	H134-014	H134-014F	H134-014UF	H135-014	H135-014F	H135-014UF

Football













Occlusal Anatomy Series: Bullet

												
U.S. NO.	7404	7404-UF	7406	7406-UF	OA-1	OA-1F	OA1-UF	OA-3	OA-3F	OA-3UF	OA-2	
MFG REF.	H379	H379	H379	H379	H379	H379	H379	H247	H247	H247	H247	
SIZE 1/10mm	012	014	014UF	018	018UF	023	023F	007	007F	007UF	009	
LENGTH (mm)	3.5	3.5	3.5	3.5	3.5	4.2	4.2	3.2	3.2	3.2	3.2	
Blade Config.	■	■	□	■	□	■	■	■	■	□	■	
Order No.	H379-012	H379-014	H379-014UF	H379-018	H379-018UF	H379-023	H379-023F	H379-023UF	H247-007	H247-007F	H247-007UF	H247-009

Occlusal Anatomy Series: Bullet

Round

Flame

												
U.S. NO.	OA-2F	OA-2UF	7802	7802-F	7802-UF	7803	7002	7004	7006	7008	7009	7102
MFG REF.	H247	H247	H247	H247	H247	H247	H41	H41	H41	H41	H41	H46
SIZE 1/10mm	009F	009UF	010	010F	010UF	012	010	014	018	023	027	012
LENGTH (mm)	3.2	3.2	3.4	3.4	3.4	3.4	010	014	018	023	027	3.5
Blade Config.	■	□	■	■	□	■	■	■	■	■	■	■
Order No.	H247-009F	H247-009UF	H247-010	H247-010F	H247-010UF	H247-012	H41-010	H41-014	H41-018	H41-023	H41-027	H46-012













Flame

Long Flame

Flat End Cylinder

Interproximal

Modified
Flat End Cylinder















												
U.S. NO.	7104	7106	H48L	H48L	H48L	7572	7583	7602	7606	H50A	H157	H157
MFG REF.	H46	H46	H48L	H48L	H48L	H49	H49	H50	H50	H50A	H157	H157
SIZE 1/10mm	014	018	010	012	012F	010	012	010	018	010	010	012
LENGTH (mm)	3.5	3.8	8.0	8.0	8.0	5.2	5.2	6.0	6.0	6.0	6.0	6.0
Blade Config.	■	■	■	■	■	■	■	■	■	■	■	■
Order No.	H46-014	H46-018	H48L-010	H48L-012	H48L-012F	H49-010	H49-012	H50-010	H50-018	H50A-010	H157-010	H157-012















■ 8 & 12 Fluted ■ 16 & 20 Fluted □ 30 Fluted















Manufacturer part numbers are provided in these charts, please visit www.dhponline.com to convert or contact your DHPI Account Manager.

- German Quality & Technology
- Precision Ground Blades
- Wide Variety of Shapes & sizes
- Autoclavable Available in Friction Grip only. In packs of 5 only

Regular : 8 & 12 Fluted	Fine: 16 & 20 Fluted	Ultrafine: 30 Fluted
Each \$53.45	Each \$60.25	Each \$74.75

	Mod. Flat End Cylinder		Flame				Beveled Cylinder		Pointed Football	Beveled Cylinder			Curettette
													
U.S. NO.	H158	H158	7901	7902	7903	H246L	H248	H248	H274	H282	H282	H282	H281K
MFG REF.	H158	H158	H246	H246	H246	H246L	H248	H248	H274	H282	H282	H282	H281K
SIZE 1/10mm	012	014	009	010	012	012UF	009	012	016	009	010	012	012
LENGTH (mm)	8.0	8.0	3.6	3.6	3.6	5.4	2.0	2.0	3.5	6.0	6.0	6.0	5.0
Blade Config.	■	■	■	■	■	□	■	■	■	■	■	■	■
Item Code	H158-012	H158-014	H246-009	H246-010	H246-012	H246L-012UF	H248-009	H248-012	H274-016	H282-009	H282-010	H282-012	H281K-012







	Curettette						Parallel Bevel			Parallel Bevel	Chr. Tree		
													
U.S. NO.	H282K	H282K	H283K	H283K	H283K	H284K	H284K	H284K	H283	H283	H283	H284	H290
MFG REF.	H282K	H282K	H283K	H283K	H283K	H284K	H284K	H284K	H283	H283	H283	H284	H290
SIZE 1/10mm	014	016	014	016	021	014	016	018	010	012	014	014	021UF
LENGTH (mm)	6.0	6.0	8.0	8.0	8.0	10.0	10.0	10.0	10.0	8.0	8.0	10.0	5.5
Blade Config.	■	■	■	■	■	■	■	■	■	■	■	■	□
Item Code	H282K-014	H282K-016	H283K-014	H283K-016	H283K-021	H284K-014	H284K-016	H284K-018	H283-010	H283-012	H283-014	H284-014	H290-021UF

	Football	Flat End Taper						Round End Taper				
												
U.S. NO.	H369	H336	H336	H336	H336	H336	H336	H336	H336	H336	H336	H336
MFG REF.	H369	H336	H336	H336	H336	H336	H336	H336	H336	H336	H336	H336
SIZE 1/10mm	018UF	016	018	012	014	016	016	012	012	014	016	018
LENGTH (mm)	4.2	7.0	7.0	7.0	8.0	8.0	8.0	5.2	5.2	8.0	8.0	8.0
Blade Config.	□	■	■	■	■	■	■	■	■	■	■	■
Item Code	H369-018UF	H336-016	H336-018	H336-012	H336-014	H336-016	H336-016	H336-012	H336-012	H336-014	H336-016	H336-018

TRIMMING & FINISHING CARBIDES

Trimming & Finishing Carbides are designed to provide a smooth finish on composite, amalgam, or crown & bridge restorations. The new egg and needle shapes are an ideal fit in all interproximal, buccal, lingual, and occlusal areas.

T&F Carbides
5 per Pkg. @ **\$52.45**

						
MFG REF.	H7404	H7406	H7408	H7901	H7902	H7903
SIZE 1/10mm	014	018	023	009	010	012
LENGTH (mm)	3.3	3.7	3.9	3.8	3.8	3.7
Flutes	■	■	■	■	■	■
FG (31) 5-pk	H7404-MW	H7406-MW	H7408-MW	H7901-MW	H7902-MW	H7903-MW



MW Series Composite
Finishing & Polishing Set
180- LS309 Set.....**\$125.25**

■ 8 & 12 Fluted ■ 16 & 20 Fluted □ 30 Fluted

Manufacturer part numbers are provided in these charts, please visit www.dhpionline.com to convert or contact your DHPI Account Manager.

NTI® 2-Piece Operative Carbides are welded, not soldered, for added strength and a more precise cutting action.

FG	FG SS	FG SG	RA Latch	RA SG	HP
5 per Pkg. @ \$13.25	5 per Pkg. @ \$13.25	5 per Pkg. @ \$22.45	5 per Pkg. @ \$13.25	5 per Pkg. @ \$22.45	5 per Pkg. @ \$15.45
100 per Pkg. @ \$214.95	100 per Pkg. @ \$214.95		100 per Pkg. @ \$214.95		

U.S. NO. MFG REF. SIZE 1/10mm LENGTH (mm)	Round													
	1/4 H0.25 005	1/2 H0.5 006	1 H1 008	2 H2 010	2S H2S 010	3 H3 012	3S H3S 012	4 H4 014	4S H4S 014	5 H5 016	5S H5S 016	6 H6 018	6S H6S 018	7 H7 021
FG (5-pk)	H0.25-FG	H0.5-FG	H1-FG	H2-FG				H4-FG					H6-FG	
FG (100-pk)	H0.25-FG100	H0.5-FG100	H1-FG100	H2-FG100				H4-FG100					H6-FG100	
FG SS (5-pk)	H0.25-FGSS	H0.5-FGSS		H2-FGSS				H4-FGSS						
FG SS (100-pk)				H2-FGSS100				H4-FGSS100					H6-FGSS100	
FG SG (5-pk)			H1-FGSG	H2-FGSG				H4-FGSG					H6-FGSG	
RA (5-pk)	H0.25-RA	H0.5-RA	H1-RA	H2-RA	H2S-RA	H3-RA	H3S-RA	H4-RA	H4S-RA	H5-RA	H5S-RA	H6-RA	H6S-RA	H7-RA
RA (100-pk)				H2-RA100				H4-RA100					H6-RA100	
RA SG (5-pk)				H2-RASG				H4-RASG					H6-RASG	
HP (5-pk)	H1-005HP	H1-006HP	H1-008HP	H2-010HP				H1-014HP					H1-018HP	











U.S. NO. MFG REF. SIZE 1/10mm LENGTH (mm)	Round					Inverted Cone				Cylinder			Tapered Fissure	
	7S H7S 021	8 H8 023	8S H8S 023	10 H10 027	10S H10S 027	33 1/2 H33.5 006 0.6	34 H34 008 0.8	35 H35 010 1.0	37 H37 014 1.4	56 H56 009 4.2	57 H57 010 4.2	58 H58 012 4.2	169 H169 009 4.2	169L H169L 009 5.2
FG (5-pk)		H8-FG				H33.5-FG	H34-FG	H35-FG	H37-FG	H56-FG	H57-FG	H58-FG	H169-FG	H169L-FG
FG (100-pk)		H8-FG100				H33.5-FG100	H34-FG100	H35-FG100		H56-FG100		H58-FG100	H169-FG100	H169L-FG100
FG SS (5-pk)							H34-FGSS	H35-FGSS		H56-FGSS				
FG SS (100-pk)														
FG SG (5-pk)		H8-FGSG												
RA (5-pk)	H7S-RA	H8-RA	H8S-RA	H10-RA	H10S-RA		H34-RA	H35-RA	H37-RA					

U.S. NO. MFG REF. SIZE 1/10mm LENGTH mm	Tapered Fissure		Long Pear		Pear				Cross Cut Cylinder				Tapered Fissure		
	170 H170 010 4.2	171 H23L 012HP 6.0	245 H245 008 2.0	329 H329 006 1.2	330 H330 008 1.6	331 H331 010 1.7	332 H332 012 1.8	556 H556 009 4.2	557 H557 010 4.2	558 H558 012 4.2	559 H559 014 4.4	699 H699 009 4.2	699L H699L 009 5.2	700 H700 010 4.2	
FG (5-pk)	H170-FG		H245-FG	H329-FG	H330-FG	H331-FG	H332-FG	H556-FG	H557-FG	H558-FG		H699-FG	H699L-FG	H700-FG	
FG (100-pk)			H245-FG100		H330-FG100	H331-FG100	H332-FG100	H556-FG100	H557-FG100	H558-FG100			H699L-FG100		
FG SS (5-pk)	H170-FGSS		H245-FGSS		H330-FGSS	H331-FGSS		H556-FGSS	H557-FGSS					H700-FGSS	
FG SS (100-pk)					H330-FGSS100	H331-FGSS100		H556-FGSS100	H557-FGSS100						
FG SG (5-pk)								H557-FGSG	H558-FGSG	H559-FGSG				H700-FGSG	
RA (5-pk)	H170-RA							H557-FGSS100							
RA SG (5-pk)								H557-RASG	H558-RASG						
HP (5-pk)		H23L-012HP			H7-008HP		H7-012HP	H31-009HP	H31-010HP	H31-012HP				H33-010HP	







Manufacturer part numbers are provided in these charts, please visit www.dhponline.com to convert or contact your DHPI Account Manager.

NTI® 2-Piece Operative Carbides are welded, not soldered, for added strength and a more precise cutting action.

FG	FG SS	FG SG	RA SG	HP
5 per Pkg. @ \$13.25	5 per Pkg. @ \$13.25	5 per Pkg. @ \$22.45	5 per Pkg. @ \$22.45	5 per Pkg. @ \$15.45
100 per Pkg. @ \$214.95	100 per Pkg. @ \$214.95			

	Tapered Fissure					Round End Cylinder				
										
U.S. NO.	701	701L	702	703		1156	1157	1158	1557	1558
MFG REF.	H701	H33L	H702	H703		H1156	H1157	H1158	H1557	H1558
SIZE 1/10mm	012	012HP	016	021		008	010	012	010	012
LENGTH mm	4.2	6.0	4.9	4.9		4.2	4.2	4.2	4.2	4.2
FG (5-pk)	H701-FG		H702-FG			H1156-FG	H1157-FG	H1158-FG	H1557-FG	H1558-FG
FG (100-pk)	H701-FG100					H1156-FG100	H1157-FG100	H1158-FG100	H1557-FG100	H1558-FG100
FG SS (5-pk)	H701-FGSS						H1157-FGSS	H1158-FGSS	H1557-FGSS	H1558-FGSS
FG SS (100-pk)							H1157-FGSS100		H1557-FGSS100	
FG SG (5-pk)	H701-FGSG		H702-FGSG	H703-FGSG					H1557-FGSG	H1558-FGSG
RA SG (5-pk)									H1557-RASG	
HP (5-pk)	H33-012HP	H33L-012HP	H33-016HP	H33-021HP					H31R-010HP	H31R-012HP

SPECIALTY CARBIDES



	Bonding Resin Removal Series			H850: Anatomy Carbides		
						
MFG REF.	H22GK	H22AGK	H22LGK	H850.6	H850.4	H850.3
SIZE 1/10mm	016FG	016FG	016FG	010	012	014
LENGTH mm	4.7	4.7	8.0	2.5	2.5	2.5
FG (5-pk)	H22GK-016FG	H22AGK-016FG	H22LGK-016FG	H850.6	H850.4	H850.3
Price	\$67.25			\$53.45		



LS-102 Crown Removal Set



For removing crown & bridge restorations.



180-LS10..... \$125.25

	H36RS: Metal Cutter	
		
MFG REF.	1957	1958
MFG. NO.	H36RS	H36RS
SIZE 1/10mm	010	012
LENGTH mm	4.2	4.2
FG (5-pk)	H36RS-010	H36RS-012
Price	\$45.95	

	H34: Carbide Crown Remover	
		
MFG REF.	H34	H34
SIZE 1/10mm	010	012
LENGTH mm	2.1	2.1
FG (5-pk)	H34-010	H34-012
Price	\$45.95	

	H2803: Tri-Fissure Carbide
	
MFG REF.	H2803
SIZE 1/10mm	012
LENGTH mm	4.2
HP (5-pk)	H2803-012HP
Price	\$45.25

Manufacturer part numbers are provided in these charts, please visit www.dhpionline.com to convert or contact your DHPI Account Manager.

Razor Prep CARBIDE

Crown and Bridge Carbides

The RAZOR™ Carbide technology is now available in familiar diamond shapes, for use in two of the most common crown and bridge prep designs, chamfer and shoulder. The unique cross-cut design efficiently removes tooth structure, amalgam and composite restorations while staying cool and sharp. Razor Prep ensures complete reduction and smooth margin definition with a single instrument.

- Unique cross-cut blade design for smooth and accurate margin definition
- Cooler cutting reduces chance of tissue damage
- Robust head and neck design for effective bulk reduction



MFG REF.	H856RZ	H856RZ	H847RZ	H379RZ
SIZE 1/10mm	016	018	016	023
LENGTH mm	8.0	8.6	8.7	4.3
FG (5-pk)	H856-016RZ	H856-018RZ	H847-016RZ	H379-023RZ
Price	\$32.45	\$32.45	\$32.45	\$32.45

Razor Operative CARBIDE

For Rapid Reduction

The RAZOR™ Carbide by Kerr Dental is an advanced technology bur ideal for rapid reduction of materials such as amalgam, porcelain, metal and tooth structure. Its super sharp transversing tip and blade design results in powerful cutting performance, perfect for crown removal and endodontic access. Available in 10-packs or 100-packs.

- Transversing tip and blade geometry for rapid end and plunge cutting
- Concentric construction helps to eliminate vibration
- Specialty shapes and sizes perfect for multiple procedures



Razor™ Carbide
10 per Pkg. @ \$38.75
100 per Pkg. @ \$379.25



U.S. NO.	245	330	331	557	1557	1558
MFG REF.	H245RZ	H330RZ	H331RZ	H557RZ	H1557RZ	H1558RZ
SIZE 1/10mm	008	008	010	010	010	012
LENGTH mm	2.0	1.6	1.7	4.2	4.2	4.2
FG (10-pk)	H245RZ-FG	H330RZ-FG	H331RZ-FG	H557RZ-FG	H1557RZ-FG	H1558RZ-FG
FG (100-pk)	H245RZ-FG100	H330RZ-FG100	H331RZ-FG100	H557RZ-FG100	H1557RZ-FG100	H1558RZ-FG100

Razor Sculpt CARBIDE

Trim and Finish in Just One Step!

Razor Sculpt Trimming and Finishing carbides create a cutting Path of Accuracy that responds to a feather touch and carves an exceptionally smooth surface. The optimized blade profile incorporates rake and relief angles provide aggressive cutting when desired, while clearing excess materials away quickly.

- One-step finishing system – reduces chair time
- Unique cutting “Path of Accuracy” – carves an exceptionally smooth surface
- Optimized blade profile – cuts quick, clean and chatter free



MFG REF.	H379RZS	H379RZS	H134RZS	H246RZS
SIZE 1/10mm	018	023	014	009
LENGTH mm	3.4	3.9	9.0	3.6
FG (5-pk)	H379RZS-018	H379RZS-023	H134RZS-014	H246RZS-009
Price	\$78.25	\$78.25	\$78.75	\$78.75

Manufacturer part numbers are provided in these charts, please visit www.dhponline.com to convert or contact your DHPI Account Manager.

NTI® Universal Cutters incorporate sharp, precision ground tungsten carbide blades with stainless steel shanks to ensure concentricity. NTI Universal Cutters are color coded to indicate blade configuration and will cut smoothly on stone, acrylic, metals and porcelain without clogging or chattering. Sold Individually.

BURS

E : Regular Cross Cut	EF : Fine Cross Cut	SF : Superfine Cross Cut	XG : Supercoarse Cross Cut	SG : Coarse Cross Cut	GE : Bulk Cross Cut
1 per Pkg. @ \$32.75	1 per Pkg. @ \$34.75	1 per Pkg. @ \$34.75	1 per Pkg. @ \$34.75	1 per Pkg. @ \$34.75	1 per Pkg. @ \$34.75

GSQ : Coarse Straight Cross Cut	FST : Fine Straight Cross Cut	SPF : Spiral Fine Cross Cut	GTi : Coarse Titanium Toothing	Regular Straight Cut
1 per Pkg. @ \$34.75	1 per Pkg. @ \$34.75	1 per Pkg. @ \$34.75	1 per Pkg. @ \$34.75	1 per Pkg. @ \$27.95



SHAPE NO.	071	071	071	071	072	073	073	073	077	077	077
SIZE 1/10mm	023	027	040	050	060	014	023	060	023	029	040
HEAD (mm)	2.0	2.4	3.4	4.3	12.5	3.1	3.9	9.4	5.3	5.0	9.0
E	UC071E-023	UC071E-027	UC071E-040	UC071E-050	UC072E-060	UC073E-014	UC073E-023	UC073E-060	UC077E-023	UC077E-029	
EF								UC073EF-060	UC077EF-023	UC077EF-029	
SF									UC077SF-023		
SG					UC072SG-060						
GSQ											UC077GSQ-040
Regular		UC071-027		UC071-050				UC073-060			



SHAPE NO.	077	078	078	078	079	079	079	079	137	138	138
SIZE 1/10mm	060	023	040	060	031	040	045	060	023	016	023
HEAD (mm)	11.0	7.0	8.9	12.2	11.5	14.1	12.9	15.0	5.3	8.0	8.0
E	UC077E-060	UC078E-023	UC078E-040	UC078E-060	UC079E-031	UC079E-040	UC079E-045	UC079E-060	UC137E-023	UC138E-016	UC138E-023
EF	UC077EF-060		UC078EF-040		UC079EF-031	UC079EF-040	UC079EF-045	UC079EF-060		UC138EF-016	UC138EF-023
SF		UC078SF-023				UC079SF-040	UC079SF-045				UC138SF-023
SG							UC079SG-045	UC079SG-060			
FST						UC079FST-040					UC138FST-023
SPF						UC079SPF-040					
GTi						UC079GTI-040					UC138GTI-023
Regular	UC077-060			UC078-060		UC079-040	UC079-045				



SHAPE NO.	251	251	251	257	257	261	293	295	351	351	351
SIZE 1/10mm	040	060	060L	023	060	023	023	023	040	060	070
HEAD (mm)	11.5	13.9	14.2	17.0	13.6	14.0	16.0	16.0	7.8	12.2	14.2
E		UC251E-060	UC251E-060L	UC257E-023	UC257E-060	UC261E-023	UC293E-023	UC295E-023	UC351E-040	UC351E-060	
EF		UC251EF-060	UC251EF-060L	UC257EF-023		UC261EF-023	UC293EF-023	UC295EF-023	UC351EF-040	UC351EF-060	
SF				UC257SF-023		UC261SF-023	UC293SF-023	UC295SF-023			
XG		UC251XG-060									UC351XG-070
SG		UC251SG-060								UC351SG-060	
GE		UC251GE-060								UC351GE-060	
GSQ		UC251GSQ-060				UC261GSQ-023					UC351GSQ-070
SPF	UC251SPF-040	UC251SPF-060		UC257SPF-023							
Regular			UC251-060L		UC257R-060					UC351-060	

Manufacturer part numbers are provided in these charts, please visit www.dhpionline.com to convert or contact your DHPI Account Manager.

FG & SS 10 Pack **\$26.45** Bulk **\$196.95**
 RA 10 Pack **\$26.45** Bulk **\$198.95**
 HP 10 Pack **\$26.95** Bulk **\$220.25**

Reduce Breakage, Increase Efficiency

At SS White, we manufacture every carbide bur we sell. SS White carbide burs go through a series of nine quality control tests ensuring that the carbide burs we sell exceed industry standards for quality, strength and consistency.



100% Satisfaction Guaranteed*

*SS White's 100% satisfaction guarantee is on all of our products. If you are not completely satisfied with your purchase, we will issue a full refund of the purchase price through Burkhart.

	Round										Pear					
SIZE	1/4	1/2	1	2	3	4	5	6	7	8	10	1/2P	1P	2P	4P	329
FG	182-17839	182-14961	182-14964	182-14967	182-14968	182-14970	182-14971	182-14973	182-14974	182-17706		182-17731	182-17732	182-17733	182-17734	182-14999
FG (BULK)	182-13014	182-13012	182-13001	182-13002	182-13030	182-13004	182-13005	182-13006	182-1307	182-13008		182-13015	182-13011	182-13003	182-13040	182-13291
SS		182-14962	180-14965	182-15039	180-14969	182-17654		182-17657								
SS (BULK)		180-13013	180-13010	182-13022	180-13031	182-13041		182-31066					180-13009			
RA		182-14717	182-14718	182-14721	182-14724	182-14727	182-14730	182-14733	182-14736	182-14739						
RA (BULK)				182-13802		182-13804		182-1806		182-13808						
HP	182-14820	182-14821	182-14823	182-14826	182-14829	182-14832	182-14835	182-14838	182-14841	182-14844	182-14846					
HP (BULK)		182-12012	180-12001	182-12002		182-12004		182-12006		182-12008						

	Pear							Inverted Cone								
SIZE	330	330M	331	332	330L	331L	332L	33 1/2	34	35	36	37	37L	38	39	
FG	180-15001	182-15010	182-15004	182-15005	182-15008	182-15037		182-14979	182-14982	182-14985	182-14986	182-14988	182-15027		180-14990	
FG (BULK)	182-13330	182-13335	182-13331	182-13332	182-13300	182-13333		182-13033	182-13034	182-13035	182-13036	182-13037	182-13070	182-13038	182-13039	
SS	182-15002								182-14983	182-15042		182-15026				
SS (BULK)	182-13290							182-13032	182-13043	182-13053		180-13073				
RA	180-14764		180-14765			180-14768		182-14744	182-14745	182-14748	182-14751	182-14751	182-14754	182-14799	182-14760	
RA (BULK)																
HP								182-14849	182-14850	182-14853	182-14856	182-14859	180-14904		182-14865	
HP (BULK)																

	Straight/Flat End Plain					Straight/Flat End Cross Cut								Straight/Round End Plain		
SIZE	56	57	57L	58	59	556	557	558	559	560	556L	557L	558L	1156	1157	1158
FG	182-14991	182-14994	182-15028	182-14996		182-15003	182-15006	182-15009		182-15035		182-15032	182-15033	182-17707	182-17708	182-17709
FG (BULK)	182-13056	182-13057	180-13074	182-13058		182-13556	182-13557	182-13558	182-13509	182-13560	180-13507	182-13577	182-13551	182-13156	182-13157	182-13158
SS	182-16893	182-14995		180-14993		182-15058	182-15045	182-15048						182-17710	182-17711	182-17705
SS (BULK)	182-13065	182-13075		180-13085		182-13506	182-13500	182-13550						180-13155	182-13154	180-13153
RA					180-14763		182-14766	182-14769	180-14772	180-14775			180-14802		180-14798	
RA (BULK)																
HP		182-14876			182-14868		182-14871	182-14874	182-14877	182-14880			180-14907			
HP (BULK)																

FG & SS 10 Pack **\$26.45** Bulk **\$196.95**
RA 10 Pack **\$26.45** Bulk **\$198.95**
HP 10 Pack **\$26.95** Bulk **\$220.25**

Reduce Breakage, Increase Efficiency

At SS White, we manufacture every carbide bur we sell. SS White carbide burs go through a series of nine quality control tests ensuring that the carbide burs we sell exceed industry standards for quality, strength and consistency.



100% Satisfaction Guaranteed*

*SS White's 100% satisfaction guarantee is on all of our products. If you are not completely satisfied with your purchase, we will issue a full refund of the purchase price through Burkhardt.

	Straight/Round End Cross			End Cut		Taper/Flat End Plain						Taper/Round End Plain			
SIZE	1556	1557	1558	956	957	169	170	171	169L	170L	171L	1170	1171	1170L	1171L
FG	182-15020	182-15021	182-15024	180-15007	182-15018	182-16884	182-14997	182-15000	182-16887	182-15030	180-15031	182-17712	182-17714	182-17716	182-17717
FG (BULK)	182-13516	182-13559	182-13580	180-13956	182-13957	182-13169	182-13170	182-13171	182-13168	182-13172	182-13174	182-13117	182-13114	180-13119	180-13113
SS	180-15019	182-15022	182-15025					182-17660				180-17713	182-17715		
SS (BULK)	180-13515	180-13517	182-13581					182-13173				180-13118	182-13112		
RA	180-14792	182-14793	182-14796		182-14790		180-14758	180-14759				180-14789	180-14791		
RA (BULK)															
HP	180-14897		182-14901												
HP (BULK)		180-12057													

	Taper/Flat End Cross Cut							Amalgam Prep							Wheel
SIZE	699	700	701	702	703	699L	700L	701L	244	245	246	256	257	271	14
FG	182-16890	182-15012	182-15015	182-17608		180-16892		182-15036	180-15060	182-15052		182-15054	180-15055	182-15056	
FG (BULK)	182-13699	182-13707	182-13701	182-13702	180-13703	182-13697	180-13709	182-13710	180-13244	182-13245		182-13256	180-13257	180-13271	180-13140
SS	180-16891	182-15051	182-15016							182-15057					
SS (BULK)	180-13698	182-13708	182-13700							182-13243					
RA			182-14781	182-14784	180-14787			180-14805							182-14742
RA (BULK)															
HP	180-14882	182-14883	182-14886	182-14889	182-14892			182-14910							180-14847
HP (BULK)			182-12701	182-12702	182-12703										

FISSUROTOMY®
CONSERVATIVE PREPARATION & EXPLORATION BURS

10/pack - **\$44.45** 100/pack - **\$394.25**

Fissurotomy Burs			
SIZE	Original	NTF	STF
FG	182-18010	182-18014	182-18013
FG (BULK)	182-13097	182-13100	182-13099
SS	182-18011	182-18016	182-18015
SS (BULK)	182-13098		

Innovative Bur Technology!

The scientifically developed instruments for the conservative diagnosis and treatment of hidden caries. Explore, diagnose and treat suspect pit and fissure caries while preserving healthy tooth structure.

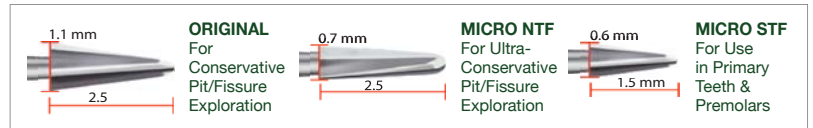

Diagnostic and Finishing Bur Kit

Kit contains 11 burs in a convenient autoclavable bur block:

- 3 - Fissurotomy® Original Burs
- 1 - #7901 Finishing Bur
- 3 - Fissurotomy® Micro NTF Burs
- 1 - #7406 Finishing Bur
- 3 - Fissurotomy® Micro STF Burs



182-18007 Kit..... **\$68.95**

simply better dentistry™



100% Satisfaction Guaranteed*

*SS White's 100% satisfaction guarantee is on all of our products. If you are not completely satisfied with your purchase, we will issue a full refund of the purchase price through Burkhart.

SPECIALTY CARBIDE BURS

FGSL - Friction Grip Surgical Length

FG - Friction Grip

SS - Short Shank

BURS



GREAT WHITE
GOLD SERIES

METAL CUTTING • CAVITY PREPARATION CARBIDE BURS



10 Pack \$40.75 Bulk \$340.25

Struggling to cut through hard materials?

Great White Burs are designed to offer optimal cutting ability through semi-precious and non-precious metals, amalgams and composite with significantly less time and chatter.

Use Great White Burs for Faster and Smoother:

- Cavity Preparations
- Restoration Removal
- Endodontic Access
- Crown/Metal Cutting

	Round						Pear						Taper Fissure		
SIZE	GW2R	GWSL2R	GW4R	GWSL4R	GW6R	GWSL6R	GW8R	GW2P	GW330	GW330S	GW1(331)	GW1S	GW245	GW701	GW702
FG	182-18202	180-182035	182-18204	180-182055	182-18206	180-182075	182-18208	182-18209	182-18201	182-18211	182-15061	182-15063	182-18212	182-18223	182-18224
FG (BULK)	182-13086		182-13087		182-13088				182-13090		182-13094	182-13089			

	Straight Fissure											Inverted Cone			
SIZE	GW556	GW557	GW557S	GWSL557	GW558	GW15	GWSL155	GW2(1558)	GW2S	GW340	GW342	GW342	GW34	GW35	GW37
FG	182-18217	182-18218	182-18219	180-182205	182-18222	182-18221	180-182255	182-15062	182-15064	182-14918	182-14919	182-14920	182-18214	182-18215	182-18216
FG (BULK)		182-13091					182-13092	182-13095	182-13096						



GREAT WHITE
ULTRA

CROWN & BRIDGE PREPARATION CARBIDE BURS



5 Pack \$34.95 (Most Shapes)

Specifically designed to offer a Faster and Smoother alternative to diamonds.

- Significantly outperforms all competitive diamonds for faster cutting while requiring less pressure and force.
- Complete the bulk reduction process with one instrument
- Smooth cutting tip helps ensure marginal integrity

	Flat End Taper						Round End Taper					Football
SIZE	847-016	847-018	847-020	845KR-016	845KR-018	845KR-025	856-016	856-018	856-020	856-023	855-025	379-023
FG	182-18200	182-18191	182-18192	182-18195	182-18196	182-18197	182-18198	182-18188	182-18189	182-18190	182-18194	182-18193
FG (BULK)	180-181865	180-181875					182-181825	182-181835	180-181845			

Great White® Ultra Crown and Bridge Preparation Kit

180-856016	180-856018	180-856020	180-379023	180-847016	180-847018

Great White® Ultra Crown and Bridge Preparation Kit

Kit Contains 11 burs in a convenient autoclavable bur block:

- 2-GWU182-856-016
- 2-GWU180-856020
- 2-GWU180-847018
- 2-GWU182-856-018
- 2-GWU180-847016
- 1-GWU180-379023
- 182-18150 Kit..... **\$94.75**



GREAT WHITE
Z
ZIRCONIA CUTTING DIAMOND INSTRUMENTS

	Round	Round End Taper	Football
SIZE	GWZ 801-014	GWZ 801-018	GWZ 856-018
FG	192-18162	192-18163	192-18161
			192-18164

5 Per Package \$45.45

Are You Burning Through Diamond After Diamond Trying to Cut Zirconia?

Designed for fast and efficient crown & bridge removal and endodontic access through aluminous oxide and zirconia copings.

Great White® Z Diamond Kit

4 diamonds in a convenient autoclavable bur block:

- 2 sizes of round diamonds
- 1 round end taper diamond
- 1 football-shaped diamond

192-18160 Kit..... **\$62.95**



Order by ☎ 800-626-2163

🌐 www.dhponline.com

☎ Fax: 888-681-5088

47



100% Satisfaction Guaranteed*

*SS White's 100% satisfaction guarantee is on all of our products. If you are not completely satisfied with your purchase, we will issue a full refund of the purchase price through Burkhart.

Faster Cutting with Less Clogging!

- Specially designed cutting blades efficiently remove bone.
- Reduce Chair Time by quickly cutting your way through third molars

FG 5 Pack - \$21.75

RA 5 Pack - \$21.75

Surgical & Endodontic Length

SIZE	1	2	4	6	8	557	558	1557	1558	700	701	702	703	1702	1703
FG	182-14001	182-14002	182-14004	182-14006	182-14008	182-14057	182-14058	182-14059	182-14060	182-14070	182-14701	182-14072	182-14073	182-14074	182-14075
RA		182-14112	182-14114	182-14116	182-14118	182-14157	182-14158	182-14159				182-14172	182-14173	180-14174	182-14175

Shanks 1-6 Sold in 10 Pack

Shank 1 - \$26.95 Shanks 2-6 - \$64.95

Sterile Packaging Available for Shanks 2-6

Shank #1 - 44.5 mm
Fits Hall & Most Standard Handpieces for Medium Bur Guard

Shank #2 - 51 mm
Fits Hall & MicroAire Handpieces with Medium Bur Guard

Shank #3 - 65 mm
Fits Hall & MicroAire Handpieces with Long Bur Guard

Shank #4 - 44.5 mm
Fits Stryker 100K & Impaction Handpiece

Shank #5 - 59 mm
Fits Stryker 100K & Impaction Handpiece

Shank #6 - 44.5 mm
Fits Stryker 50K & Osteotome Drill J-Notch

			Shank #1	Shank #2	Shank #3	Shank #4	Shank #5	Shank #6
Round	SIZE	HEAD DIA.	SSW#	SSW#	SSW#	SSW#	SSW#	SSW#
	1	1.0	182-14823					
	2	1.2	182-14826					
	4	1.4	182-14832					
	6	1.8	182-14838	182-30020	182-30035	182-30050	182-30060	180-30000
	8	2.3	182-14844	182-30021	182-30036	182-30051	182-30061	182-30001
	10	2.7	182-14871					
Cross Cut Fissure								
	557	1.0	182-14871					
	558	1.2	182-14874					
	560	1.6	182-14880			180-30052		180-3000
	1557	1.0	182-14898					
	1558	1.2	182-14901					
	700	1.0	182-14883					
	701	1.2	182-14886	182-30022		180-30053	182-3006	
	701L	1.2	182-14910					
	702	1.6	182-14889	182-30023	182-30037	182-30054	182-30063	182-30003
	702L	1.6	182-14890	182-30024		182-30055	182-30064	180-30004
	1702	1.6	182-14916	180-30029		180-30048	182-30069	182-30009
	1702L	1.6	180-14917	182-30030		180-30049	180-30070	180-30010
	703	2.1	182-14892	182-30025	182-30038	182-30056	182-30065	182-30005
	703L	2.1	182-14893	182-30026	182-30039	180-30057	182-30066	180-30006
	1703	2.1	182-14893	182-30026	182-30039	180-30057	182-30066	180-30006
	1703L	2.1	182-14915	182-30028		182-30059	182-30068	180-30008

BLUE
50/pack.....\$96.95

PURPLE
10/pack.....\$78.95
25/pack.....\$171.75

RED
10/pack.....\$65.95
25/pack.....\$164.75

GREEN
10/pack.....\$43.95

Engineered for Safety

MICROCOPY

ORANGE
10/pack.....\$33.95
25/pack.....\$78.95

PINK
10/pack.....\$38.25
25/pack.....\$81.45

TEAL
5/pack.....\$67.45

Manufacturer part numbers are provided in these charts, please visit www.dhponline.com to convert or contact your DHPI Account Manager.

FG & RA CARBIDES	ROUND	INVERTED CONE	STRAIGHT FISSURE	TAPERED FISSURE
OPERATIVE				
NeoBurr# FG SS RA	FG 1/4 FG 1/2 FG 1 FG 2 FG 4 FG 6 FG 8	FG 33 1/2 FG 34 FG 35 FG 36 FG 37	FG 56 FG 57 FG 58	FG 169 FG 169L
Head Dia. (mm)	0.5 0.6 0.8 1.0 1.4 1.8 2.3	0.6 0.8 1.0 1.2 1.4	0.8 1.0 1.2	0.9 0.9
Head Length (mm)	0.4 0.5 0.7 0.8 1.1 1.6 1.9	0.5 0.6 1.0 1.0 1.1	3.2 3.8 3.8	3.4 4.9

TAPERED FISSURE	AMALGAM PREP	PEAR	STRAIGHT FISSURE CROSSCUT	TAPERED FISSURE CROSSCUT
NeoBurr# FG	FG 245 FG 245SS	FG 329 FG 330 FG 331 FG 331L FG 332	FG 556 FG 557 FG 557L FG 558	FG 699 FG 700 FG 701 FG 701L FG 702
Head Dia. (mm)	0.8	0.6 0.8 1.0 1.0 1.2	0.8 1.0 1.0 1.2	0.9 1.0 1.2 1.2 1.6
Head Length (mm)	2.7	0.9 1.9 1.8 3.7	3.2 3.8 4.9 3.8	3.4 3.8 3.8 4.9 4.3

R.E. TAPERED FISSURE	ROUND END FISSURE	ROUND END FISSURE CROSSCUT	FGSL & RASL CARBIDES	ROUND	STRAIGHT FISSURE CROSSCUT
			SURGICAL LENGTH		
NeoBurr# FG	FG 1156 FG 1157 FG 1157SS FG 1158	FG 1556 FG 1557 FG 1558	FG 1/2 FGSL 1 RSL 2 RSL 4 RSL 6 RSL 8	FGSL 1/2 FGSL 1 FGSL 2 FGSL 4 FGSL 6 FGSL 8	FGSL 557 FGSL 558
Head Dia. (mm)	0.8 1.0 1.2	0.8 1.0 1.2	0.6 0.8 1.0 1.4 1.8 2.3	0.6 0.8 1.0 1.1 1.6 1.9	1.0 1.2
Head Length (mm)	3.2 3.8 3.8	3.2 3.8	0.5 0.7 0.8 1.1 1.6 1.9	3.8 3.8	3.8 3.8

TAPERED FISSURE CROSSCUT	FG CARBIDES	METAL/CROWN CUTTERS	FG CARBIDES	ROUND END TAPER	FLAT END TAPER	FOOTBALL (EGG)
	NEOMAX METAL CUTTERS		CROWNING HI-PERFORMANCE CROWN PREPS			
NeoBurr# FG	FG 701 FG 702	GW1/1931 MAX 1 GW2/1958 MAX 2	CK 85616 CK 85618	856-016 856-018	847-016 CK 84716	379-023 CK 37923
Head Dia. (mm)	1.2 1.6	1.0 1.2	1.6/1.2 1.8/1.5	1.6/1.2 8.0	1.6/1.2 8.0	2.3 4.3
Head Length (mm)	3.8 4.3	1.9 4.0	8.0	8.0	8.0	4.3

FG CARBIDES	EF-SERIES 10 Straight-Blades	EGG 12 Spiral-Blades	BULLET 12 Spiral-Blades	FG CARBIDES	ROUND	FLAME
ESTHETIC FINISHERS				12-BLADE TRIMMING & FINISHING		
NeoBurr# FG	EF3 EF4 EF6 EF9	OS1 OS2 OS3	(7379) (7801)	7006 7104 7106 H274 H48L10 H48L12	7006 7006	7104 7106 H274 H48L10 H48L12
Head Dia. (mm)	0.8 1.0 1.4 1.4	2.3 0.9 0.7	2.3 0.9 3.2	1.8 1.4 1.8 1.6 1.0 1.2	1.8 1.6	1.4 1.8 1.6 3.5 8.0 8.0
Head Length (mm)	3.0 4.2 6.0 9.0	4.3	4.3	3.4 3.7 8.0 8.0	3.4	3.4 3.7 8.0 8.0

EGG	LONG TAPER	BULLET	NEEDLE	FG CARBIDES	ESTH. FINISH.	INTER-PROX.	POINT. TAPER	EGG	NEEDLE
				30-BLADE FINISHING					
NeoBurr# FG	7404 7406 7408	7642 7664 7675	7802 7803	EF9UF EF9UF	9103UF 9103UF	9214UF 9214UF	9406UF 9406UF	9903UF 9903UF	7901 7902 7903
Head Dia. (mm)	1.4 1.8 2.3	1.0 1.5 1.6	1.0 1.2	1.4 1.2 1.0 1.2	1.4 1.2 1.0 1.8	1.6 1.6 1.0 1.8	1.8 1.6 1.8 1.2	1.8 1.2	0.9 1.0 1.2 3.6
Head Length (mm)	3.3 3.4 3.9	7.0 8.2 8.0	3.4 4.2	9.0 9.0 9.0 9.0	9.0 3.6	5.6	3.4 3.6	3.6	3.6

SHANK GUIDE	FG CARBIDES	151Z	SAFE-END	STRGHT BLADES	CRSSCT BLADES
	SURGICAL		ENDO ACCESS		
Surgical Diameter 1.6 mm Length 23-28 mm	NeoBurr# FG	151Z 151Z 151LZ 151LZ	152 152 152	161 161 162	161 162
HP (Oral Surgery Length) Diameter 2.35 mm Overall Length 44.5 mm	Head Dia. (mm)	1.6 1.6 1.6 1.6	1.6 1.6 1.6	1.6 1.6 1.6	1.6 1.6
HP carbides are significantly longer and wider than the Surgical Length carbides.	Head Length (mm)	11.0 11.0 11.0 11.0	9.0	10.0 10.0 10.0	10.0 10.0

HP CARBIDES	ROUND	STRAIGHT FISSURE CROSSCUT	TAPERED FISSURE CROSSCUT	ROUND END FISSURE CROSSCUT	ROUND END TAPERED FISSURE CROSSCUT
ORAL SURGERY					
NeoBurr# HP 44.5 mm	HP 2 HP 4 HP 6 HP 8	HP 557 HP 557	HP 701 HP 701	HP 702 HP 702	HP 703 HP 703
Head Dia. (mm)	1.0 1.4 1.8 2.3	1.0 2.3	1.2 1.8	1.6 2.1	2.1 2.1
Head Length (mm)	.8 1.1 1.6 1.9	3.8	3.8 4.3	4.8	3.8

DIAMOND CROSS-REFERENCE CHART- MULTI-USE

	Grit	Health-Tec	Kerr Rotary	Midwest	Premier	SS White
			NTI		Two-Striper	Revelation
ROUND						
801-009	M	190-HT801009M	M801-009	471008	--	--
801-012	M	190-HT801012M	M801-012	471010	--	91187-5
801-012	C	190-HT801012C	C801-012	471019	115C	91186-5
801-014	M	190-HT801014M	M801-014	471011	--	91189-5
801-014	C	190-HT801014C	C801-014	471020	115C	91188-5
801-016	M	190-HT801016M	M801-016	471012	--	91191-5
801-016	C	190-HT801016C	C801-016	471021	120C	91190-5
801-018	M	190-HT801018M	M801-018	471013	--	91003-5
801-018	C	190-HT801018C	C801-018	471022	125C	91004-5
801-018	SC	190-HT801018SC	SC801-018	471026	--	91193-5
801-023	M	190-HT801023M	M801-023	471014	--	91196-5
801-023	C	190-HT801023C	C801-023	471023	--	91194-5
INVERTED CONE						
805-012	C	190-HT805012C	C805-012	471050	310.1C	91010-5
805-016	C	190-HT805016C	C805-016	--	315.175C	91012-5
805-018	C	190-HT805018C	C805-018	--	318.5C	--
807-014	F	Upon Request	--	--	--	--
807-014	M	Upon Request	--	--	--	--
807-016	M	Upon Request	M807-016	471055	--	--
807-018	M	Upon Request	C807-018	471056	--	--
DOUBLE INVERTED CONE						
806-012	C	190-HT806012C	C806-012	--	390.3C	91016
806-014	M	Upon Request	M806-014	--	--	--
813-018	M	Upon Request	--	471069	1250M	--
BARREL						
811-033	C	190-HT811033C	C811-033	471060	230C	91206-5
811-037	C	190-HT811037C	C811-037	471061	234C	91208-5
811-037	SC	190-HT811037SC	SC811-037	471063	--	91210-5
PEAR						
830L-012	M	Upon Request	M830L-012	--	--	--
WHEEL						
818-030	M	Upon Request	--	--	--	--
ROUND WHEEL						
909-037	M	190-HT909037M	M909-037	--	--	--
909-037	C	190-HT909037C	C909-037	--	860C	--
909-040	C	190-HT909040C	C909-040	471383	862C	--
GROSS REDUCTION						
651-016	C	Upon Request	--	--	--	--
652-018	C	Upon Request	--	--	--	--
654-016	C	Upon Request	--	--	--	--
655-014	C	Upon Request	--	--	--	--
655-018	C	Upon Request	--	--	--	--

Manufacturer part numbers are provided in these charts, please visit www.dhpionline.com to convert or contact your DHPI Account Manager.

DIAMOND CROSS-REFERENCE CHART- MULTI-USE

	Grit	Health-Tec	Kerr Rotary	Midwest	Premier	SS White
			NTI		Two-Striper	Revelation
EGG/FOOTBALL						
368-016	F	190-HT368016F	F368-016	471409	--	91159-5
368-018	SF	190-HT368018SF	SF368-018	471408	--	--
368-018	F	190-HT368018F	F368-018	--	--	--
368-018	M	190-HT368018M	M368-018	--	--	--
368-018	C	190-HT368018C	C368-018	--	290.4C	--
368-023	SF	190-HT368023SF	SF368-023	471414	--	91169-5
368-023	F	190-HT368023F	F368-023	471415	--	91166-5
368-023	M	190-HT368023M	M368-023	471416	--	91167-5
368-023	C	190-HT368023C	C368-023	471417	285.5C	91165-5
368-023	SC	190-HT368023SC	SC368-023	471418	--	91168-5
369-023	F	Upon Request	--	--	--	--
369-023	C	Upon Request	--	--	--	--
379-016	F	190-HT379016F	F379-016	471422	--	--
379-018	F	190-HT379018F	F379-018	471423	--	91174-5
379-018	M	190-HT379018M	M379-018	471424	--	91175-5
379-018	C	190-HT379018C	C379-018	--	290.4C	91173-5
379-023	SF	190-HT379023SF	SF379-023	471399	--	91182-5
379-023	F	190-HT379023F	F379-023	471400	--	91178-5
379-023	M	190-HT379023M	M379-023	471427	--	91179-5
379-023	C	190-HT379023C	C379-023	471428	287.4C	91177-5
INTERPROXIMAL						
392-016	SF	190-HT392016SF	SF392-016	471447	--	91184-5
392-016	F	190-HT392016F	F392-016	471448	203.5F	91183-5
392-016	C	190-HT392016C	--	--	--	--
FLAT END CYLINDER						
835-008	M	Upon Request	M835-008	471493	--	--
835-010	F	190-HT835010F	F835-010	--	--	--
835-010	M	190-HT835010M	M835-010	471495	--	91219-5
835-010	C	190-HT835010C	C835-010	--	513.4C	91031-5
835-012	M	190-HT835012M	M835-012	471496	--	--
835-012	C	190-HT835012C	C835-012	--	514.3C	91032-5
835-014	M	190-HT835014M	M835-014	471497	--	91222-5
835-014	C	190-HT835014C	C835-014	--	--	91221-5
836-012	C	190-HT836012C	C836-012	471075	514.5C	91033-5
836-014	C	190-HT836014C	C836-014	471076	520.4C	91034-5
837-010	C	190-HT837010C	C837-010	--	514.7C	--
837-012	M	190-HT837012M	M837-012	471086	--	--
837-012	C	190-HT837012C	C837-012	471089	515.7C	91035-5
837-014	M	190-HT837014M	M837-014	471087	--	--
837-014	C	190-HT837014C	C837-014	471090	515.8C	91036-5
837-016	M	190-HT837016M	M837-016	471088	--	--
837-016	C	190-HT837016C	C837-016	471091	516.7C	91037-5
837-018	C	190-HT837018C	C837-018	--	--	--

Manufacturer part numbers are provided in these charts, please visit www.dhpionline.com to convert or contact your DHPI Account Manager.

DIAMOND CROSS-REFERENCE CHART- MULTI-USE

	Grit	Health-Tec	Kerr Rotary	Midwest	Premier	SS White
			NTI		Two-Striper	Revelation
CYLINDER ROUNDED SHOULDER						
836KR-014	C	190-HT836KR-014	C836KR-014	--	585.8 KS2	--
837KR-012	C	190-HT837KR012C	C837KR-012	--	575.7 KS1	--
837KR-016	C	190-HT837KR016C	C837KR-016	471098	587.8 KS3	--
ROUND END CYLINDER						
881-014	C	Upon Request	C881-014	--	550.8C	91043-5
881-016	M	Upon Request	--	--	--	--
881-016	C	Upon Request	C881-016	--	--	91044-5
FLAT END TAPER						
846-012	C	190-HT846012C	C846-012	--	721.6C	--
846-018	C	190-HT846018C	--	--	701.7C	--
847-014	C	190-HT847014C	C847-014	471128	702.8C	91055-5
847-016	M	190-HT847016M	M847-016	471125	--	91236-5
847-016	C	190-HT847016C	C847-016	471129	722.8C	91056-5
847-018	C	190-HT847018C	C847-018	471130	703.8C	91057-5
847-019	M	Upon Request	--	--	--	--
847-019	C	Upon Request	--	--	--	--
848-012	C	190-HT848012C	C848-012	--	721.10C	--
848-016	M	190-HT848016M	M848-016	471154	722.10M	--
848-016	C	190-HT848016C	C848-016	471158	722.10C	91058-5
848-018	C	190-HT848018C	C848-018	471159	700.11C	91059-5
TAPER ROUNDED SHOULDER						
845KR-018	C	190-HT845KR018C	C845KR-018	471109	708.4KRC	91226-5
845KR-025	F	190-HT845KR025F	F845KR-025	471105	--	--
845KR-025	M	190-HT845KR025M	M845KR-025	471108	--	--
845KR-025	C	190-HT845KR025C	C845KR-025	471110	712.3KRC	--
846KR-016	M	190-HT846KR016M	M846KR-016	471116	--	91231-5
846KR-016	C	190-HT846KR016C	C846KR-016	--	722.8CKR	--
847KR-016	M	190-HT847KR016M	M847KR-016	471144	--	91243-5
847KR-016	C	190-HT847KR016C	C847KR-018	471145	722.8KRC	91241-5
847KR-018	M	190-HT847KR018M	M847KR-018	--	--	--
847KR-018	C	190-HT847KR018C	C847KR-018	471146	703.8KRC	91245-5
ROUND END TAPER						
850-012	M	190-HT850012M	M850-012	471169	--	--
850-012	C	190-HT850012C	C850-012	--	781.10C	91250-5
850-014	C	190-HT850014C	C850-014	471174	781.10C	91252-5
850-016	F	190-HT850016F	F850-016	471168	--	91257-5
850-016	M	190-HT850016M	M850-016	471171	--	91258-5
850-016	C	190-HT850016C	C850-016	471175	782.10C	91256-5
850-018	F	190-HT850018F	F850-018	--	--	91261-5
850-018	M	190-HT850018M	M850-018	471172	--	91262-5
850-018	C	190-HT850018C	C850-018	471176	770.10C	91260-5
850-018	SC	190-HT850018SC	SC850-018	471180	--	91263-5
855-012	M	190-HT855012M	M855-012	471189	--	--
855-014	M	190-HT855014M	M855-014	471190	--	--

Manufacturer part numbers are provided in these charts, please visit www.dhponline.com to convert or contact your DHPI Account Manager.

DIAMOND CROSS-REFERENCE CHART- MULTI-USE

	Grit	Health-Tec	Kerr Rotary	Midwest	Premier	SS White
			NTI		Two-Striper	Revelation
ROUND END TAPER						
855-014	C	190-HT855014C	C855-014	--	799.6.5C	91067-5
855-018	C	190-HT855018C	--	--	767.7C	--
855-025	C	190-HT855025C	C855-025	--	785.7C	91279-5
856-010	C	190-HT856010C	--	--	777.8C	--
856-012	C	190-HT856012C	C856-012	471207	781.8C	91281-5
856-014	C	190-HT856014C	C856-014	471208	782.6C	91283-5
856-016	F	190-HT856016F	F856-016	471198	--	91116-5
856-016	M	190-HT856016M	M856-016	471203	--	91068-5
856-016	C	190-HT856016C	C856-016	471209	782.8C	91069-5
856-016	SC	190-HT856016SC	SC856-016	471215	--	91290-5
856-018	F	190-HT856018F	F856-018	471199	783.8F	91117-5
856-018	M	190-HT8560018M	M856-018	471204	--	91293-5
856-018	C	190-HT856018C	C856-018	471210	770.8C	91070-5
856-018	SC	190-HT856018SC	SC856-018	471216	--	91294-5
856-025	C	190-HT856025C	C856-025	471212	790.8C	91299-5
856L-016	C	190-HT856L016C	C856L-016	471241	770.9C	91305-5
856L-018	C	190-HT856L018C	C856L-018	471242	770.10C	91307-5
856L-020	C	190-HT856L020C	C856L-020	471243	--	--
NEEDLE						
858-010	F	190-HT858010F	F858-010	--	--	--
858-012	M	190-HT858012M	M858-012	--	--	91314-5
858-014	SF	190-HT858014SF	SF858-014	471249	--	--
858-014	F	190-HT858014F	F858-014	471250	--	91118-5
858-014	M	190-HT858014M	M858-014	471251	--	91071-5
858-014	C	190-HT858014C	C858-014	471253	207.7C	91072-5
858-016	M	190-HT858016M	--	471252	--	--
859-010	F	190-HT859010F	F859-010	--	797.11F	91320-5
859-010	M	190-HT859010M	M859-010	--	797.11M	91321-5
859-012	C	190-HT859012C	C859-012	--	--	--
859-014	SF	190-HT859014SF	SF859-014	--	--	91325-5
859-014	F	190-HT859014F	F859-014	--	--	91323-5
859-014	M	190-HT859014M	M859-014	--	--	91324-5
859-014	C	190-HT859014C	C859-014	--	608.9C	91322-5
859-016	SF	190-HT859016SF	SF859-016	--	--	91127-5
859-016	F	190-HT859016F	F859-016	--	--	91119-5
859-016	M	190-HT859016M	M859-016	--	--	--
859-016	C	190-HT859016C	C859-016	--	262.10C	91075-5
LONG NEEDLE						
859L-016	F	Upon Request	F859L-016	--	--	--
859L-016	M	Upon Request	M859L-016	--	--	--
FLAME						
390-018	F	Upon Request	--	--	--	--
860-010	M	Upon Request	M860-101	--	--	91078-5
861-014	SF	Upon Request	--	--	--	--
862-010	F	190-HT862010F	F862-010	471262	--	91331-5

Manufacturer part numbers are provided in these charts, please visit www.dhpionline.com to convert or contact your DHPI Account Manager.

DIAMOND CROSS-REFERENCE CHART- MULTI-USE

	Grit	Health-Tec	Kerr Rotary	Midwest	Premier	SS White
			NTI		Two-Striper	Revelation
FLAME						
862-010	C	190-HT862010C	C862-010	--	261.8C	91330-5
862-012	SF	190-HT862012SF	SF862-012	471260	--	91128-5
862-012	F	190-HT862012F	F862-012	471263	--	91121-5
862-012	M	190-HT862012M	M862-012	471267	--	91334-5
862-012	C	190-HT862012C	C862-012	471271	261.8C	91083-5
862-014	SF	190-HT862014SF	SF862-014	--	--	--
862-014	F	190-HT862014F	F862-014	471264	--	91338-5
862-014	M	190-HT862014M	M862-014	471268	--	91339-5
862-014	C	190-HT862014C	C862-014	471272	260.8C	91084-5
862-016	M	190-HT862016M	M862-016	471269	--	91343-5
862-018	C	190-HT862018C	C862-018	--	262.8C	--
863-010	F	190-HT863010F	F863-010	--	--	--
863-012	F	190-HT863012F	F863-012	471455	--	91344-5
863-012	M	190-HT863012M	M863-012	--	797.11M	91345-5
863-012	C	190-HT863012C	C863-012	--	--	91086-5
863-016	M	190-HT863016M	M863-016	--	--	--
863-016	C	190-HT836016C	C863-016	--	253.10C	91088-5
GINGIVAL CURETTAGE						
878K-014	M	190-HT878K014M	M878K-014	471320		91097-5
878K-014	C	190-HT878K014C	C878K-014	471325	764.8C	91362-5
878K-016	M	190-HT878K016M	M878K-016	471321		91098-5
878K-016	C	190-HT878K016C	C878K-016	471326	253.8C	91364-5
878K-018	M	190-HT878K018M	M878K-018	471322	--	--
878K-018	C	190-HT878K018C	C878K-018	471327	256.9C	91367-5
TORPEDO CYLINDER						
878-012	M	190-HT878012M	M878-012	471304	--	--
878-012	C	190-HT878012C	C878-012	471307	--	91354-5
878-014	M	190-HT878014M	M878-014	471305	--	
878-014	C	190-HT878014C	C878-014	471308	--	91356-5
POINTED CYLINDER						
885-010	C	190-HT885010C	--	--	248.8C	91104-5
885-012	M	190-HT885012M	M885-012	471350	--	91378-5
885-012	C	190-HT885012C	C885-012	471352	251.8C	91105-5
886-012	M	Upon Request	M886-012	--	--	91388-5
886-012	C	190-HT886012C	C886-012	--	250.9C	91387-5
886-016	C	Upon Request	C886-016	--	--	91106-5
SEPARATION						
889-008	F	Upon Request	--	--	--	91396-5
889-010	F	190-HT889010F	F889-010	471365	--	--

Manufacturer part numbers are provided in these charts, please visit www.dhponline.com to convert or contact your DHPI Account Manager.

DIAMOND CROSS-REFERENCE CHART- SINGLE-USE

	Grit	Health-Tec	Microcopy	Midwest	Premier	SS White
			NeoDiamond	Once	Solo	Piranha
ROUND						
801-009	M	--	--	--	801010M	
801-012	M	--	0112M	1801012M	801012M	801-012M
801-012	C	--	--	--	--	801-012C
801-014	M	--	--	--	--	801-014M
801-014	C	--	--	--	--	801-014C
801-016	M	--	0116M	1801016M	801016M	801-016M
801-016	C	--	0116C	--	801016C	801-016C
801-018	M	--	0118M	1801018M	801018M	801-018M
801-018	C	--	0118C	--	--	801-018C
801-018	SC	--	--	--	--	801-018SC
801-023	M	--	--	--	801023M	801-023M
801-023	C	190-HTD801023C	0123C	18010123C	801023C	801-023C
INVERTED CONE						
805-012	C	190-HTD805012C	--	1805012C	805012M	805-012C
805-016	C	190-HTD805016C	0316C	1805016C	801016C	805-016C
805-018	C	--	--	--	--	805-018C
807-014	F	--	--	--	--	807-014F
807-014	M	--	--	--	--	807-014M
807-016	M	--	--	--	807016C	807-016M
807-018	M	--	--	--	807018C	807-018M
DOUBLE INVERTED CONE						
806-012	C	--	--	--	--	806-012C
806-014	M	--	--	--	--	806-014M
813-018	M	--	--	--	813014M	813-018M
BARREL						
811-033	C	190-HTD811033C	2133C	1811033C	811033C	811-033C
811-037	C	--	2137C	1811037C	811037C	811-037C
811-037	SC	--	--	1811037SC		811-037SC
PEAR						
830L-012	M	--	--	--	830012M	830L-012M
WHEEL						
818-030	M	--	--	--	--	818-030M
ROUND WHEEL						
909-037	M	--	--	--		909-037M
909-037	C	--	--	--	909037C	909-037C
909-040	C	--	2042C	--	909040C	909-040C
GROSS REDUCTION						
651-016	C	--	--	--	--	651-016C
652-018	C	--	--	--	--	652-018C
654-016	C	--	--	--	--	654-016C
655-014	C	--	--	--	--	655-014C
655-018	C	--	2218C	--	6055018C	655-018C

Manufacturer part numbers are provided in these charts, please visit www.dhpionline.com to convert or contact your DHPI Account Manager.

DIAMOND CROSS-REFERENCE CHART- SINGLE-USE

	Grit	Health-Tec	Microcopy	Midwest	Premier	SS White
			NeoDiamond	Once	Solo	Piranha
EGG/FOOTBALL						
368-016	F	--	1916F	1368016F	368016F	368-016F
368-018	SF	--	--	--	--	368-018SF
368-018	F	--	--	--	368016M	368-018F
368-018	M	--	--	--	368016C	368-018M
368-018	C	190-HTD368018C	--	1368018C	--	368-018C
368-023	SF	--	--	1368023SF	--	368-023VF
368-023	F	190-HTD368023F	1923F	1368023F	368023F	368-023F
368-023	M	--	1923M	--	368023M	368-023M
368-023	C	190-HTD368023C	1923C	1368023C	368023C	368-023C
368-023	SC	--	--	1368023SC	--	368-023SC
369-023	F	--	--	--	--	369-023F
369-023	C	--	--	--	--	369-023C
379-016	F	--	1908F	--	--	379-016F
379-018	F	190-HTD379018F	--	1379018F	379018F	379-018F
379-018	M	--	--	--	--	379-018M
379-018	C	--	--	--	379018C	379-018C
379-023	SF	--	3900VF	1379023SF	379023EF	379-023VF
379-023	F	190-HTD379023F	1900F	1379023F	379023F	379-023F
379-023	M	--	1900M	--	--	379-023M
379-023	C	190-HTD379023C	1900C	1379023C	379023C	379-023C
INTERPROXIMAL						
392-016	SF	--	--	--	--	392-016VF
392-016	F	--	1416F	1392016F	--	392-016F
392-016	C	--	--	--	--	392-016C
FLAT END CYLINDER						
835-008	M	--	--	--	--	835-008M
835-010	F	--	--	--	--	835-010F
835-010	M	--	0710M	1835010M	835010M	835-010M
835-010	C	190-HTD835010C	0710C	1835010C	835010C	835-010C
835-012	M	--	--	1835012M	--	835-012M
835-012	C	--	0712C	--	----	835-012C
835-014	M	--	--	--	--	835-014M
835-014	C	--	--	1835014C	--	835-014C
836-012	C	--	--	--	--	836-012C
836-014	C	--	--	--	--	836-014C
837-010	C	--	--	--	--	837-010C
837-012	M	--	--	--	837012F	837-012M
837-012	C	190-HTD837012C	0712.7C	1837012C	837012C	837-012C
837-014	M	--	--	--	--	837-014M
837-014	C	--	--	--	--	837-014C
837-016	M	--	--	--	--	837-016M
837-016	C	--	0716.8C	1837016C	837016C	837-016C
837-018	C	--	--	--	--	837-018C

Manufacturer part numbers are provided in these charts, please visit www.dhpionline.com to convert or contact your DHPI Account Manager.

DIAMOND CROSS-REFERENCE CHART- SINGLE-USE

	Grit	Health-Tec	Microcopy	Midwest	Premier	SS White
			NeoDiamond	Once	Solo	Piranha
CYLINDER ROUNDED SHOULDER						
836KR-014	C	--	--	--	--	836KR-014C
837KR-012	C	--	--	--	--	837KR-012C
837KR-016	C	--	--	--	--	837KR-016C
ROUND END CYLINDER						
881-014	C	190-HTD881014C	1214.8C	1881014C	--	881-014C
881-016	M	--	--	--	--	881-016M
881-016	C	--	--	--	--	881-016C
FLAT END TAPER						
846-012	C	--	--	--	--	846-012C
846-018	C	--	--	--	--	846-018C
847-014	C	190-HTD847014C	0914.8C	1847014C	847014C	847-014C
847-016	M	--	0916.8M	--	847014M	847-016M
847-016	C	190-HTD847016C	0916.8C	1847016C	847016C	847-016C
847-018	C	190-HTD847018C	0918.8C	1847018C	847018C	847-018C
847-019	M	--	--	--	--	847-019M
847-019	C	--	--	--	--	847-019C
848-012	C	--	--	--	--	848-012C
848-016	M	--	0916.10M	--	848016M	848-016M
848-016	C	--	0916.10C	1848016C	848016C	848-016C
848-018	C	--	0918.10C	--	848018C	848-018C
TAPER ROUNDED SHOULDER						
845KR-018	C	--	0818.4C	--	845KR018C	845KR-018C
845KR-025	F	--	--	--	--	845KR-025F
845KR-025	M	--	2525M	--	--	845KR-025M
845KR-025	C	--	--	--	--	845KR-025C
846KR-016	M	--	--	--	--	846KR-016M
846KR-016	C	--	--	--	--	846KR-016C
847KR-016	M	--	0816.8M	--	--	847KR-016M
847KR-016	C	190-HTD847KR016C	0816.8C	1847KR016C	--	847KR-016C
847KR-018	M	--	--	--	847KR018F	847KR-018M
847KR-018	C	--	0818.8C	1847KR018C	847KR018C	847KR-018C
ROUND END TAPER						
850-012	M	--	1112.10M	--	--	850-012M
850-012	C	190-HTD850012C	1112.10C	1850012C	--	850-012C
850-014	C	190-HTD850014C	1114.10C	1850014C	--	850-014C
850-016	F	--	1116.10F	--	--	850-016F
850-016	M	--	1116.10M	--	850016M	850-016M
850-016	C	--	1116.10C	--	850016C	850-016C
850-018	F	--	--	--	850016F	850-018F
850-018	M	--	--	--	850018M	850-018M
850-018	C	--	--	--	--	850-018C
850-018	SC	--	--	--	--	850-018SC
855-012	M	--	--	--	--	855-012M
855-014	M	--	--	--	--	855-014M

Manufacturer part numbers are provided in these charts, please visit www.dhpionline.com to convert or contact your DHPI Account Manager.

DIAMOND CROSS-REFERENCE CHART- SINGLE-USE

	Grit	Health-Tec	Microcopy	Midwest	Premier	SS White
			NeoDiamond	Once	Solo	Piranha
ROUND END TAPER						
855-014	C	--	--	--	--	855-014C
855-018	C	--	--	--	--	855-018C
855-025	C	--	--	--	--	855-025C
856-010	C	--	--	--		856-010C
856-012	C	--	1112.7C	1856012C	856012C	856-012C
856-014	C	190-HTD856014C	1114.8C	1856014C	856014C	856-014C
856-016	F	190-HTD856016F	1116.8F	1856016F	856016F	856-016F
856-016	M	190-HTD856016M	1116.8M	1856016M	856016M	856-016M
856-016	C	190-HTD856016C	1116.8C	1856016C	856016C	856-016C
856-016	SC	--	--	--	--	856-016SC
856-018	F	--	1118.7F	--	--	856-018F
856-018	M	--	--	--	856018M	856-018M
856-018	C	190-HTD856018C	1118.7C	1856018C	856018C	856-018C
856-018	SC	--	--	1856018SC	--	856-018SC
856-025	C	--	2424C		----	856-025C
856L-016	C	--	--	1856L016C		856L-016C
856L-018	C	190-HTD856L018C	1118.9C	1856L018C	856L018C	856L-018C
856L-020	C	--	--	--	--	856L-020C
NEEDLE						
858-010	F	--	--	--	--	858-010F
858-012	M	--	--	--	--	858-012M
858-014	SF	--	3314.8VF	--	--	858-014VF
858-014	F	--	--	--	--	858-014F
858-014	M	--	1314.8M	--	--	858-014M
858-014	C	190-HTD858014C	1314.8C	1858014C	858014C	858-014C
858-016	M	--	--	--	--	858-016M
859-010	F	--	--	--	--	859-010F
859-010	M	--	--	--	--	859-010M
859-012	C	--	1312.11C	1859012C	--	859-012C
859-014	SF	--	3314.10VF	1859014SF	--	859-014VF
859-014	F	--	1314.10F	1859014F	859014F	859-014F
859-014	M	--	1314.10M	--	859014M	859-014M
859-014	C	--	1314.10C	1859014C	859014C	859-014C
859-016	SF	--	--	--	--	859-016VF
859-016	F	--	--	--	--	859-016F
859-016	M	--	--	--	--	859-016M
859-016	C	--	--	--	--	859-016C
LONG NEEDLE						
859L-016	F	--	--	--	--	859L-016F
859L-016	M	--	--	--	--	859L-016M
Flame		--	--	--	--	
390-018	F	--	--	--	--	390-018F
860-010	M	--	--	--	--	860-010M
861-014	SF	--	--	--	--	861-014VF
862-010	F		1510.8F	1862010F	862010F	862-010F

Manufacturer part numbers are provided in these charts, please visit www.dhpionline.com to convert or contact your DHPI Account Manager.

DIAMOND CROSS-REFERENCE CHART- SINGLE-USE

	Grit	Health-Tec	Microcopy	Midwest	Premier	SS White
			NeoDiamond	Once	Solo	Piranha
LONG NEEDLE						
862-010	C	--	1510.8C	1862010C	862010C	862-010C
862-012	SF	--	3512.8VF	1862012SF	--	862-012VF
862-012	F	--	1512.8F	1862012F	862012F	862-012F
862-012	M	--	1512.8M	1862012M	862012M	862-012M
862-012	C	190-HTD862012C	1512.8C	1862012C	862012C	862-012C
862-014	SF	--	--	--	--	862-014VF
862-014	F	--	--	--	--	862-014F
862-014	M	--	1514.7M	--	--	862-014M
862-014	C	--	1514.8C	1862014C	--	862-014C
862-016	M	--	1516.8M	--	--	862-016M
862-018	C	--	--	--	862016C	862-018C
863-010	F	--	--	--	--	863-010F
863-012	F	--	1512.10F	18663012F	--	863-012F
863-012	M	--	1512.10M	1863012M	--	863-012M
863-012	C	--	1512.10C	1863012C	--	863-012C
863-016	M	--	1516.8M	--	--	863-016M
863-016	C	--	1516.8C	--	--	863-016C
GINGIVAL CURETTAGE						
878K-014	M	--	1714.8M	--	--	878K-014M
878K-014	C	--	1714.8C	1878K014C	878K014C	878K-014C
878K-016	M	--	1716.8M	--	--	878K-016M
878K-016	C	190-HTD878K016C	1716.8C	1878K016C	878K016C	878K-016C
878K-018	M	--	--	--	--	878K-018M
878K-018	C	--	1718.8C	1878K018C	878K018C	878K-018C
TORPEDO CYLINDER						
878-012	M	--	--	--	--	878-012M
878-012	C	--	1800.8C	1878012C	878012C	878-012C
878-014	M	--	--	--	--	878-014M
878-014	C	--	1804.8C	--	--	878-014C
POINTED CYLINDER						
885-010	C	--	--	--	--	885-010C
885-012	M	--	1812.8M	--	--	885-012M
885-012	C	190-HTD885012C	1812.8C	1885012C	--	885-012C
886-012	M	--	1812.10M	--	--	886-012M
886-012	C	190-HTD886012C	1812.10C	1886012C	--	886-012C
886-016	C	--	--	--	--	886-016C
SEPARATION						
889-008	F	--	--	--	--	889-008F
889-010	F	--	--	--	--	889-010F

Manufacturer part numbers are provided in these charts, please visit www.dhpionline.com to convert or contact your DHPI Account Manager.

Round

CODE	801-009	801-012	801-014	801-016	801-018	801-023
DIAMETER	0.9	1.2	1.4	1.6	1.8	2.3
HEAD LENGTH	0.9	1.2	1.4	1.6	1.8	2.3
SUPER FINE	—	—	—	—	—	—
FINE	—	—	—	—	—	—
MEDIUM	190-HT801009M	190-HT801012M	190-HT801014M	190-HT801016M	190-HT801018M	190-HT801023M
COARSE	—	190-HT801012C	190-HT801014C	190-HT801016C	190-HT801018C	—
SUPER COARSE	—	—	—	—	190-HT801018SC	—

Barrel

CODE	811-033	811-037
DIAMETER	3.3	3.7
HEAD LENGTH	5.5	5.5
SUPER FINE	—	—
FINE	—	—
MEDIUM	—	—
COARSE	190-HT811033C	190-HT811037C
SUPER COARSE	—	190-HT811037SC

Inverted Cone

CODE	805-012	805-016	805-018
DIAMETER	1.2	1.6	1.8
HEAD LENGTH	1.3	1.4	1.6
SUPER FINE	—	—	—
FINE	—	—	—
MEDIUM	—	—	—
COARSE	190-HT805012C	190-HT805016C	190-HT805018C
SUPER COARSE	—	—	—

Double Inverted Cone

CODE	806-012	806-014
DIAMETER	1.2	1.4
HEAD LENGTH	3.0	2.0
SUPER FINE	—	—
FINE	—	—
MEDIUM	—	190-HT806014M
COARSE	190-HT806012C	—
SUPER COARSE	—	—

Round Wheel

CODE	909-037	909-040
DIAMETER	3.7	4.0
HEAD LENGTH	1.0	1.3
SUPER FINE	—	—
FINE	—	—
MEDIUM	190-HT909037M	—
COARSE	190-HT909037C	190-HT909040C
SUPER COARSE	—	—

Egg/Football

CODE	368-016	368-018	368-023	379-016	379-018	379-023
DIAMETER	1.6	1.8	2.3	1.6	1.8	2.3
HEAD LENGTH	3.3	4.5	5.3	3.4	3.6	4.4
SUPER FINE	—	190-HT368018SF	190-HT368023SF	—	—	190-HT379023SF
FINE	190-HT368016F	190-HT368018F	190-HT368023F	190-HT379016F	190-HT379018F	190-HT379023F
MEDIUM	—	190-HT368018M	190-HT368023M	—	190-HT379018M	190-HT379023M
COARSE	—	190-HT368018C	190-HT368023C	—	190-HT379018C	190-HT379023C
SUPER COARSE	—	—	190-HT368023SC	—	—	—

Torpedo Cylinder

CODE	878-012	878-014
DIAMETER	1.2	1.4
HEAD LENGTH	8.0	8.0
SUPER FINE	—	—
FINE	—	—
MEDIUM	190-HT878012M	190-HT878014M
COARSE	190-HT878012C	190-HT878014C
SUPER COARSE	—	—

Flat End Cylinder

CODE	835-010	835-012	835-014	836-012	836-014	837-010	837-012	837-014	837-016	837-018
DIAMETER	1.0	1.2	1.4	1.2	1.4	1.0	1.2	1.4	1.6	1.8
HEAD LENGTH	4.0	4.0	4.0	5.6	6.0	8.0	8.0	8.0	8.0	8.0
SUPER FINE	—	—	—	—	—	—	—	—	—	—
FINE	190-HT835010F	—	—	—	—	—	—	—	—	—
MEDIUM	190-HT835010M	190-HT835012M	190-HT835014M	—	—	—	190-HT837012M	190-HT837014M	190-HT837016M	—
COARSE	190-HT835010C	190-HT835012C	190-HT835014C	190-HT836012C	190-HT836014C	190-HT837010C	190-HT837012C	190-HT837014C	190-HT837016C	190-HT837018C
SUPER COARSE	—	—	—	—	—	—	—	—	—	—

Inter Proximal

CODE	392-016
DIAMETER	1.6
HEAD LENGTH	5.0
SUPER FINE	190-HT392016SF
FINE	190-HT392016F
MEDIUM	—
COARSE	190-HT392016C
SUPER COARSE	—

Flat End Taper

CODE	846-012	846-018	847-014	847-016	847-018	848-012	848-016	848-018
DIAMETER	1.2	1.8	1.4	1.6	1.8	1.2	1.6	1.8
HEAD LENGTH	6.0	7.0	8.0	8.0	8.0	10.0	10.0	10.0
SUPER FINE	—	—	—	—	—	—	—	—
FINE	—	—	—	—	—	—	—	—
MEDIUM	—	—	—	190-HT847016M	—	—	190-HT848016M	—
COARSE	190-HT846012C	190-HT846018C	190-HT847014C	190-HT847016C	190-HT847018C	190-HT848012C	190-HT848016C	190-HT848018C
SUPER COARSE	—	—	—	—	—	—	—	—

Cylinder Rounded Shoulder

CODE	836KR-014	837KR-012	837KR-016
DIAMETER	1.4	1.2	1.6
HEAD LENGTH	6.0	8.0	8.0
SUPER FINE	—	—	—
FINE	—	—	—
MEDIUM	—	—	—
COARSE	190-HT836KR014C	190-HT837KR012C	190-HT837KR016C
SUPER COARSE	—	—	—

Taper Rounded Shoulder



CODE	845KR-018	845KR-025	846KR-016	847KR-016	847KR-018
DIAMETER	1.8	2.5	1.6	1.6	1.8
HEAD LENGTH	4.0	4.0	6.0	8.0	8.0
SUPER FINE	—	—	—	—	—
FINE	—	190-HT845KR025F	—	—	—
MEDIUM	—	190-HT845KR025M	190-HT846KR016M	190-HT847KR016M	190-HT847KR018M
COARSE	190-HT845KR018C	190-HT845KR025C	190-HT846KR016C	190-HT847KR016C	190-HT847KR018C
SUPER COARSE	—	—	—	—	—

Gingival Curettage



CODE	878K-014	878K-016	878K-018	879K-018
DIAMETER	1.4	1.6	1.8	1.8
HEAD LENGTH	8.0	8.0	8.0	9.5
SUPER FINE	—	—	—	—
FINE	—	—	—	—
MEDIUM	190-HT878K014M	190-HT878K016M	—	190-HT879K018M
COARSE	190-HT878K014C	190-HT878K016C	190-HT878K018C	—
SUPER COARSE	—	—	—	—

Round End Taper



CODE	850-012	850-014	850-016	850-018	855-012	855-014	855-018	855-025
DIAMETER	1.2	1.4	1.6	1.8	1.2	1.4	1.8	2.5
HEAD LENGTH	10.0	10.0	10.0	10.0	6.3	6.3	6.4	7.0
SUPER FINE	—	—	—	—	—	—	—	—
FINE	—	—	190-HT850016F	190-HT850018F	—	—	—	—
MEDIUM	190-HT850012M	—	190-HT850016M	190-HT850018M	190-HT855012M	190-HT855014M	—	—
COARSE	190-HT850012C	190-HT850014C	190-HT850016C	190-HT850018C	—	190-HT855014C	190-HT855018C	190-HT855025C
SUPER COARSE	—	—	—	190-HT850018SC	—	—	—	—



Round End Taper (continued)



CODE	856-010	856-012	856-014	856-016	856-018	856-025	856L-016	856L-018	856L-020
DIAMETER	1.0	1.2	1.4	1.6	1.8	2.5	1.6	1.8	2.0
HEAD LENGTH	8.0	8.0	8.0	8.0	9.0	8.0	9.0	9.0	9.0
SUPER FINE	—	—	—	—	—	—	—	—	—
FINE	—	—	—	190-HT856016F	190-HT856018F	—	—	—	—
MEDIUM	—	—	—	190-HT856016M	190-HT856018M	—	—	—	—
COARSE	190-HT856010C	190-HT856012C	190-HT856014C	190-HT856016C	190-HT856018C	190-HT856025C	190-HT856L016C	190-HT856L018C	190-HT856L020C
SUPER COARSE	—	—	—	190-HT856016SC	190-HT856018SC	—	—	—	—

Separation



CODE	889-010
DIAMETER	1.0
HEAD LENGTH	4.0
SUPER FINE	—
FINE	190-HT889010F
MEDIUM	—
COARSE	—
SUPER COARSE	—

Needle



CODE	858-010	858-012	858-014	858-016	859-010	859-012	859-014	859-016
DIAMETER	1.0	1.2	1.4	1.6	1.0	1.2	1.4	1.6
HEAD LENGTH	8.0	8.0	8.0	8.0	10.0	10.0	10.0	10.0
SUPER FINE	—	—	190-HT858014SF	—	—	—	190-HT859014SF	190-HT859016SF
FINE	190-HT858010F	—	190-HT858014F	—	190-HT859010F	—	190-HT859014F	190-HT859016F
MEDIUM	—	190-HT858012M	190-HT858014M	190-HT858016M	190-HT859010M	—	190-HT859014M	190-HT859016M
COARSE	—	—	190-HT858014C	—	—	190-HT859012C	190-HT859014C	190-HT859016C
SUPER COARSE	—	—	—	—	—	—	—	—

Pointed Cylinder



CODE	885-010	885-012	886-012
DIAMETER	1.0	1.2	1.2
HEAD LENGTH	8.0	8.0	10.0
SUPER FINE	—	—	—
FINE	—	—	—
MEDIUM	—	190-HT885012M	—
COARSE	190-HT885010C	190-HT885012C	190-HT886012C
SUPER COARSE	—	—	—

Flame



CODE	862-010	862-012	862-014	862-016	862-018	863-010	863-012	863-016
DIAMETER	1.0	1.2	1.4	1.6	1.8	1.0	1.2	1.6
HEAD LENGTH	8.0	8.0	8.0	8.0	8.0	10.0	10.0	9.5
SUPER FINE	—	190-HT862012SF	190-HT862014SF	—	—	—	—	—
FINE	190-HT862010F	190-HT862012F	190-HT862014F	—	—	190-HT863010F	190-HT863012F	—
MEDIUM	—	190-HT862012M	190-HT862014M	190-HT862016M	—	—	190-HT863012M	190-HT863016M
COARSE	190-HT862010C	190-HT862012C	190-HT862014C	—	190-HT862018C	—	190-HT863012C	190-HT863016C
SUPER COARSE	—	—	—	—	—	—	—	—



ALL Multi-Use Diamonds

5/pack \$25.95
5 @ \$24.95/ea

Single-Use Diamonds

Less than Size 023 25/box **\$35.95**

023 or larger 25/box **\$43.95**

Item #	Shape	Code	Grit
190-HTD368018C	EGG/FOOTBALL	368-018	COARSE
190-HTD368023C	EGG/FOOTBALL	368-023	COARSE
190-HTD368023F	EGG/FOOTBALL	368-023	FINE
190-HTD379018F	EGG/FOOTBALL	379-018	FINE
190-HTD379023C	EGG/FOOTBALL	379-023	COARSE
190-HTD379023F	EGG/FOOTBALL	379-023	FINE
190-HTD801023C	ROUND	801-023	COARSE
190-HTD805012C	INVERTED CONE	805-012	COARSE
190-HTD805016C	INVERTED CONE	805-016	COARSE
190-HTD811033C	BARREL	811-033	COARSE
190-HTD835010C	FLAT END CYLINDER	835-010	COARSE
190-HTD837012C	FLAT END CYLINDER	837-012	COARSE
190-HTD847014C	FLAT END TAPER	847-014	COARSE
190-HTD847016C	FLAT END TAPER	847-016	COARSE
190-HTD847018C	FLAT END TAPER	847-018	COARSE

Item #	Shape	Code	Grit
190-HTD847KR016C	TAPER ROUND SHOULDER	847KR-016	COARSE
190-HTD850012C	ROUND END TAPER	850-012	COARSE
190-HTD850014C	ROUND END TAPER	850-014	COARSE
190-HTD856014C	ROUND END TAPER	856-014	COARSE
190-HTD856016C	ROUND END TAPER	856-016	COARSE
190-HTD856016F	ROUND END TAPER	856-016	FINE
190-HTD856016M	ROUND END TAPER	856-016	MEDIUM
190-HTD856018C	ROUND END TAPER	856-018	COARSE
190-HTD856L018C	ROUND END TAPER	856L-018	COARSE
190-HTD858014C	NEEDLE	858-014	COARSE
190-HTD862012C	FLAME	862-012	COARSE
190-HTD878K016C	GINGIVAL CURETTAGE	878K-016	COARSE
190-HTD881014C	ROUND END CYLINDER	881-014	COARSE
190-HTD885012C	POINTED CYLINDER	885-012	COARSE
190-HTD886012C	POINTED CYLINDER	886-012	COARSE



The **NEW STANDARD** in VALUE BRAND PRODUCTS.



Precision

Health-Tec® carbide burs have
the precision you rely on.

Manufactured for and Distributed by: **Dental Health Products, Inc.**
2614 North Sugar Bush Road | New Franken, WI 54229 | 800-626-2163 | www.dhpionline.com

The **NEW STANDARD**
in **VALUE BRAND PRODUCTS.**

Alpen® Diamonds / TurboCut™

1 @ \$71.75

▶ Available in 5 packs

	Football		Flat End Cylinder						Flat End Taper						Occlusal	Round End Taper					
Shape #	368	379	836	836	837	837	837	846	847	847	847	847	848	848	811	850	850	850-8	850-10	855	856
Head Ø (1/10 mm)	023	023	014	016	014	016	018	016	014	016	018	025	016	018	033	014	016	018	018	014	014
Head length (mm)	5.0	5.0	6.0	6.0	8.0	8.0	8.0	7.0	8.0	8.0	8.0	8.0	10.0	10.0	5.0	10.0	10.0	8.0	10.0	6.0	8.0
FG 5pk	TC	TC	TC	TC	TC	TC	TC	TC	TC	TC	TC	TC	TC	TC	TC	TC	TC	TC	TC	TC	TC

	Round End Taper		Round End Cylinder		Long Round Taper	Curettage/Beveled Taper								Beveled Cylinder							
Shape #	856-7	856-8	856	856	856	877K	877K	878K	878K	878K	878K	878K	879K	879K	879K	879K	885	880	881	881	882
Head Ø (1/10 mm)	016	016	018	021	025	014	018	014	016	018	021	021	014	016	018	021	014	014	014	016	014
Head length (mm)	7.0	8.0	8.0	9.0	7.0	6.0	6.0	8.0	8.0	8.0	8.0	10.0	10.0	10.0	10.0	8.0	6.0	8.0	8.0	10	
FG 5pk	TC	TC	TC	TC	TC	TC	TC	TC	TC	TC	TC	TC	TC	TC	TC	TC	TC	TC	TC	TC	

Alpen® Multi Use Diamonds

▶ Available in 5 & 50 packs

Prefix R Shape 132 Grit F Head 008 Shank FG

	Esthetic Finishing					Pointed Football			Football				Interproximal				Round										
Shape #	132	133	134	135	247	368	368	368	379	379	379	390	392-6	392-8	392	392	801	801	801	801	801	801					
Head Ø (1/10 mm)	008	010	014	014	009	016	020	023	016	018	023	014	016	016	018	021	009	010	012	014	016	018					
Head length (mm)	3.0	4.0	6.0	9.0	3.2	3.5	5.0	5.0	3.5	3.5	5.0	3.0	6.0	8.0	8.0	10.0											
FG 5pk	F	F	F	F	F	CSC F	CSC F	CSC F	C	F	CSC F	CSC F	C	F	C	F	C	F	C	F	C	C	C	C	F	CSC F	CSC F
SS 5pk	EF	EF UF	EF UF	EF UF		EF UF	EF UF	EF UF	EF		EF UF	EF	EF		EF	EF											
B 50pk		F	F	F			C	C F	F	F	C EF F		F														

	Round				Inverted Cone				Inverted Cone with Collar			Long Inverted Cone			Double Cone Amalgam Remover	
Shape #	801	801	801	801	805	805	805	805	806	806	806	807	807	807	813	813
Head Ø (1/10 mm)	021	023	027	029	010	012	014	016	012	014	016	012	016	018	014	018
Head length (mm)					0.8	0.9	1.4	1.4	2.2	2.2	2.5	3.5	4	5	1.5	2
FG 5pk	CSC F	CSC F	C	CSC F	C	C	C	C	C	CSC	C	C	C	C	C	C
B 50pk		C														

5/pack \$54.95
Coarse & Fine

5/pack \$62.45
Super Coarse & Extra Fine
UltraFine

GRIT GUIDE

TC = TurboCut (150µm) SC = SuperCoarse (150µm) C = Coarse (125µm) F = Fine (45µm) EF = Extra Fine (25µm) UF = Ultra Fine (15µm)

Alpen® Multi Use Diamonds

► Available in 5 & 50 packs

	Wheel	Round Wheel				Depth Marker 0.7 mm 0.3 mm 0.5 mm			Pear	Long Pear	Occlusal/Barrel				Occlusal Pointed Barrel	
Shape #	818	909-1	909-1.5	909	828	834	834	830	830L	830L	830L	811	811	811	811	899
Head Ø (1/10 mm)	050	040	040	055	030	016	021	010	012	014	016	031	033	037	048	027
Head length (mm)	0.7	1	1.5	2	1	6.8	6.8	2.7	2.7	2.7	4	4.2	5	7	8	7
FG 5pk	C	C	C SC F	C	C	C	C	C	C	C	C	C	C SC	C SC	C SC	C SC
SS 5pk								C								
B 50pk			C													

	Flat End Cylinder											Modified End Cylinder									
Shape #	835	835	835	835	836	836	836	837-7	837-8	837	837	835R	835R	835R	835R	836R	836R	836R	837R	837R	837R
Head Ø (1/10 mm)	008	010	012	014	012	014	018	012	012	014	016	008	010	012	014	010	012	014	012	014	016
Head length (mm)	3	4	4	4	6	6	6	7	8	8	8	3	4	4	4	6	6	6	8	8	8
FG 5pk	C	C	C	C	C F	C SC	C	C	C F	C SC	C SC	C	C	C	C	C	C	C F	C SC	C SC F	C
SS 5pk	C	C										C				C					
B 50pk		C																			

	Round End Cylinder									End Cutting			Flat End Taper						
Shape #	838	838	880	880	881	881	881	881	882	839	839	839	845	845	845	846-6	846-7	846	846
Head Ø (1/10 mm)	010	012	012	014	010	012	014	016	014	010	012	014	010	012	016	016	016	018	023
Head length (mm)	4	4	6	6	8	8	8	8	10				4	4	4	6	7	7	7
FG 5pk	C	C	C	C SC	C	C	C SC	C SC	C	C F	C F	C F	C	C	C	C	C	C F	C
SS 5pk																			

	Flat End Taper											Long Round End Taper							Narrow Round Taper	
Shape #	847	847	847	847	847	847	848	848	848	848	848L	850L	850L	856L-9	856L-10	856L	856L	856L	856N	856N
Head Ø (1/10 mm)	010	012	014	016	018	025	012	014	016	023	018	016	018	014	10	016	018	021	014	016
Head length (mm)	8	8	8	8	8	8	10	10	10	10	12	12	12	9	014	9	9	9	8	8
FG 5pk	C	C	C SC F	C SC F	C SC F	C SC	C	C SC	C	C SC F	C SC F	C F	C	C	C	C SC F	C	C SC F	C SC	C
SS 5pk			SC		C															

GRIT GUIDE

TC = TurboCut (150µm) SC = SuperCoarse (150µm) C = Coarse (125µm) F = Fine (45µm) EF = Extra Fine (25µm) UF = Ultra Fine (15µm)

For conversion to DHPI item number please visit www.dhpionline.com or contact your DHPI Account Manager.

5/pack **\$54.95**

Coarse & Fine

5/pack **\$62.45**

Super Coarse, Extra Fine, UltraFine



Prefix R Shape 132 Grit F Head 008 Shank FG

Alpen® Multi Use Diamonds

► Available in 5 & 50 packs

Modified End Taper

Round End Taper



Shape #	845R 016	845R 025	846R 016	847R 016	850R 014	850R 018	849-4 012	849-6 012	849 016	849 025	850 012	850 014	850 016	850-8 018	850-10 018	850 023	851 012	851 016	855 010	855 012	855 014	
Head Ø (1/10 mm)	4	4	6	8	10	10	4	6	4	4	10	10	10	8	10	10	8	8	6	6	6	
Head length (mm)	4	4	6	8	10	10	4	6	4	4	10	10	10	8	10	10	8	8	6	6	6	
FG 5pk	C	C F	C F	C F	C F	C F		C	C	C SC	C F	C SC F	C SC F	C SC	C SC F	C	C	C	C	C	C F	C SC F
SS 5pk							C					SC										C SC

Round End Taper

Flame

Shape #	855 025	856 012	856 014	856-7 016	856-8 016	856 018	856 021	856 025	852 012	852 016	853 008	858 012	858 014	858 016	859 010	859 014	859 018	859 021	859 024	860 010	860-5 012
Head Ø (1/10 mm)	7	8	8	7	8	8	8	8	6	6	3.5	8	8	8	10	10	10	10	10	4	5
Head length (mm)	7	8	8	7	8	8	8	8	6	6	3.5	8	8	8	10	10	10	10	10	4	5
FG 5pk	C SC	C F	C SC F	C F	C SC F	C SC	C SC	C SC	C F	C EF	C EF	C F UF	C F UF	C	C F UF	C F UF	C F UF	C	C UF	C	C F
SS 5pk				C	SC	C															
B 50pk					C										F	C					EF

Flame

Beveled Cylinder

Shape #	860 014	862 010	862 012	862 014	862 016	863 012	863 016	864 014	873 014	874 012	888 012	889 009	877 010	877 012	878 010	878 012	878 014	878 016	879 012	879 014	879 016
Head Ø (1/10 mm)	5	8	8	8	8	10	10	12	2	2	8	3.5	6	6	8	8	8	8	10	10	10
Head length (mm)	5	8	8	8	8	10	10	12	2	2	8	3.5	6	6	8	8	8	8	10	10	10
FG 5pk	C F	C F EF UF	C F EF UF	C SC F	C F EF	C SC F EF	C SC F EF	C F	C	C	C F EF	C F EF	C	C	C F	C F	C	C	C	C	C
SS 5pk		C				EF															
B 50pk						EF															

Beveled Cylinder

Curette/Pointed Taper

Shape #	884 012	885 012	885 014	886 012	886 014	886 016	877K 012	877K 014	877K 016	877K 018	877K 021	878K 010	878K 012	878K 014	878K 016	878K 018	878K 021	878K 023	879K 012	879K 014	879K 016
Head Ø (1/10 mm)	6	8	8	10	10	10	6	6	6	6	6	8	8	8	8	8	8	8	10	10	10
Head length (mm)	6	8	8	10	10	10	6	6	6	6	6	8	8	8	8	8	8	8	10	10	10
FG 5pk	C F	C F	C SC	C F	SC	C SC	C	C	C	C	C	C F	C SC F	C SC F	C SC	C SC F	C SC	SC	C F	C	C SC
SS 5pk																					
B 50pk							C	C				C	C								

GRIT GUIDE

TC = TurboCut (150µm) SC = SuperCoarse (150µm) C = Coarse (125µm) F = Fine (45µm) EF = Extra Fine (25µm) UF = Ultra Fine (15µm)



For conversion to DHPI item number please visit www.dhponline.com or contact your DHPI Account Manager.

Prefix R Shape 132 Grit F Head 008 Shank FG

5/pack **\$54.95**
Coarse & Fine

5/pack **\$62.45**
Super Coarse, Extra Fine, UltraFine

	Curettage/Pointed Taper			Acorn			Striated Cylinder					KS Shapes							
Shape #	879K 018	879K 021	879K 023	905 023	905 027	905 031	6051 018	6052 018	6053 018	6055 018	6056 018	KS0 010	KS1 012	KS2 014	KS3 016	KS4 024	KS5 031	KS6 025	KS7 054
Head Ø (1/10 mm)	10	10	10	2.7	2.9	3.1	6	8	10	8	10	7	7	8	8	4.2	6.2	9	1
Head length (mm)																			
FG 5pk	C SC	C SC	C	F	F	F	C SC	C SC	C	SC	C	C	SC	SC	SC	SC	SC	C	SC
SS 5pk																			
B 50pk																			

BURS



For conversion to DHPI item number please visit www.dhponline.com or contact your DHPI Account Manager.

Prefix X Shape 878K Grit C Size 021

5/pack **\$45.75**
A

5/pack **\$59.25**
B

5/pack **\$91.95**
C

Alpen® x1 Single Use Diamonds

▶ Available in 25 packs

	Curettage/Pointed Taper				Modified Beveled Cylinder		Round End Cylinder			Beveled Cylinder		Round Wheel		End Cutting		
Shape #	878K 021	879K 012	879K 014	879K 018	878 012	878 014	KS0 009	KS1 012	KS2 014	885 012	886 012	909 035	909 042	10839 012	10839 014	10839 016
Head Ø (1/10 mm)	8.0	10.0	10.0	10.0	8.0	8.0	8.0	8.0	8.0	8.0	10.0	1.3	1.5			
Head length (mm)																
FG 25pk	C	C	C	SC	C	F	C	SC	SC	C	F	C	C			
SS 25pk			M	M						M	M			M	M	M

Alpen® x1 Single Use Finishing Diamonds

Alpen® x1 Turbo Diamonds

	Football		Egg	R.E. Taper	Pointed Cone			Flame		
Shape #	368 016	368 023	379 023	856 016	858 008	858 014	859 014	862 012	862 016	863 012
Head Ø (1/10 mm)	3.5	5.0	5.0	8.0	3.0	8.0	10.0	8.0	8.0	10.0
Head length (mm)										
FG 25pk	EF	EF	EF	EF	EF	EF	EF	EF	EF	EF
SS 25pk										

	Football	Round End Taper				
Shape #	368 023	850 016	856 014	856 016	856 018	856L 018
Head Ø (1/10 mm)	5.0	10.0	8.0	8.0	8.0	11.0
Head length (mm)						
FG 25pk	TC	TC	TC	TC	TC	TC
SS 25pk						

GRIT GUIDE

TC = TurboCut (150µm) SC = SuperCoarse (150µm) C = Coarse (125µm) F = Fine (45µm) EF = Extra Fine (25µm) UF = Ultra Fine (15µm)

5/pack **\$45.75**

5/pack **\$59.25**

5/pack **\$91.95**

A

B

C

Alpen® x1 Single Use Diamonds

Available in 25 packs

BURS

	Football			Egg		Interproximal	Gross Reduction		Ball					Inverted Cone		
Shape #	368	368	368	379	379	392	6051	6055	801	801	801	801	801	805	805	807
Head Ø (1/10 mm)	016	020	023	018	023	016	017	018	010	012	016	018	023	012	016	018
Head length (mm)	3.5	5.0	5.0	3.5	5.0	6.0	8.0	8.0	0.8	1.0	1.4	1.6	2.0	0.9	1.4	5.0
FG 25pk	C	F	C	F	SC	F	C	C	M	M	C	C	C	M	C	C
SS 25pk						M					M	M				

	Occlusal Reduction		Double Cone Amalgam Remover	Pear		Depth Marker 0.5 mm	Depth Cutter 0.5 mm	Flat End Cylinder				Modified Flat End Cylinder	Modified Flat End Taper		
Shape #	811	811	813	830	830	828	834	835	835	837	837	837R	845R	847R	847R
Head Ø (1/10 mm)	033	037	014	008	012	026	021	010	012	012	016	014	018	016	018
Head length (mm)	5.0	7.0	2.2	1.6	2.7	0.5	0.5	4.0	4.0	7.0	8.0	8.0	4.0	8.0	8.0
FG 25pk	SC	SC	C	M	C	M	M	C	C	C	C	C	C	SC	SC
SS 25pk					M			M	M	M		M	M	M	

	Modified Flat End Taper Large	Flat End Taper						Round End Taper									
Shape #	845R	847	847L	847	847	848	848	850	850	85010	856	856	8567	8568	856	856L	856
Head Ø (1/10 mm)	025	014	014	016	018	016	018	012	014	016	012	014	016	016	018	018	021
Head length (mm)	4.0	8.0	9.0	8.0	8.0	10.0	10.0	10.0	10.0	10.0	8.0	8.0	7.0	8.0	8.0	9.0	8.0
FG 25pk	M	SC	F	C	SC	F	SC	SC	SC	SC	SC	SC	SC	SC	SC	SC	SC
SS 25pk		M	M	M	M	M	M	M	M	M	M	M	M	M	M	M	M

	Round End Taper Large	Pointed Cone				Flame				Curettage/Pointed Taper					
Shape #	856	858	858	859	859	862	862	862	862	862	863	862L	878K	878K	878K
Head Ø (1/10.9 mm)	024	008	014	012	014	010	012	012	014	016	012	018	014	016	018
Head length (mm)	7.0	3.0	8.0	10.0	10.0	8.0	6.5	8.0	8.0	8.0	10.0	9.0	8.0	8.0	8.0
FG 25pk	SC	F	C	F	C	F	C	F	C	F	C	F	C	C	SC
SS 25pk	SC	F				M							M	M	

GRIT GUIDE

TC = TurboCut (150µm) SC = SuperCoarse (150µm) C = Coarse (125µm) M = Medium (110µm) F = Fine (45µm) EF = Extra Fine (25µm)

**Sterile Single-Patient
Diamond Rotary Instruments**



- Improve infection control — individually packaged and sterile.
- Save time and money — no need to clean and autoclave.
- Always sharp, so you're always working at optimal cutting efficiency.
- From the most trusted name in rotary instruments, Midwest®.

**Midwest® ONCE®
Single-Patient Diamonds**

Manufacturer item number listed, for conversion please visit www.dhponline.com or contact your DHPI Account Manager.

FG unless otherwise stated

25 per pack

PRICE LEVELS

- Black** \$44.75
- Blue** \$55.95
- Purple** \$60.95
- Green** \$72.45

	Round					Inverted Cone		Pear	
Shape	801	801	801	801	801	805	805	830	830
Diameter [0.1 mm]	010	012	016	018	023	014	016	008	012
Length [mm]	1.0	1.2	1.6	1.8	2.3	1.5	1.5	1.5	3.0
● Fine					1801023F				
● Medium	1801010M	1801012M	1801016M	1801018M		1805012M		1830008M	1830012M
● Coarse	1801010C				1801023C	1805012C	1805016C		1830012C

	Needle			Interproximal		Cylinder Flat End				
Shape	858	859	859	392	835	835	835	837	837	
Diameter [0.1 mm]	014	012	014	016	010	012	014	012	016	
Length [mm]	8.0	11.5	10.0	5.0	4.0	4.0	4.0	8.0	8.0	
● Super Fine	1858014SF		1859014SF							
● Fine	1858014F		1859014F	1392016F						
● Medium					1835010M	1835012M				
● Coarse	1858014C	1859012C	1859014C		1835010C		1835014C	1837012C	1837016C	

	Cylinder Round End			Cylinder Beveled				Taper Flat End				
Shape	881	881	881	878	885	885	886	847	847	847	848	848
Diameter [0.1 mm]	009	012	014	012	012	016	012	014	016	018	016	018
Length [mm]	8.0	8.0	8.0	8.0	8.2	8.2	10.0	8.0	8.0	8.0	10.0	10.0
● Fine				1878012F								
● Medium												1848018M
● Coarse	1881009C	1881012C	1881014C	1878012C	1885012C	1885016C	1886012C	1847014C	1847016C	1847018C	1848016C	
● Super Coarse		1881012SC	1881014SC					1847014SC		1847018SC		1848018SC

Taper Round End

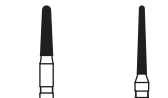

Shape	855S	856	856	856	856	856	856	850	850	850	856L	856L
Diameter [0.1 mm]	016	012	014	016	018	021	025	010	012	014	016	018
Length [mm]	6.5	8.0	8.0	8.0	8.0	8.0	8.0	10.0	10.0	10.0	9.0	9.0
FGSS ● Coarse	1855S016C											
FGSS ● S. Coarse	1855S016SC											
● Fine						1856016F						
● Medium			1856014M	1856016M								
● Coarse		1856012C	1856014C	1856016C	1856018C	1856021C	1856024C	1850010C	1850012C	1850014C	1856L016C	1856L018C
● Super Coarse			1856014SC		1856018SC							1856L018SC

Taper Round End Long



Taper Modified Bevel / Curettage



Shape	878K	878K	878K	878K	879K	879K	879K	845KR	847KR	847KR
Diameter [0.1 mm]	012	014	016	018	012	014	018	018	016	018
Length [mm]	8.0	8.0	8.0	8.0	9.5	9.5	10.0	4.0	8.0	8.0
● Medium	1878K012M		1878K016M							
● Coarse		1878K014C	1878K016C	1878K018C	1879K012C	1879K014C			1847KR016C	1847KR018C
● Super Coarse				1878K018SC			1879K018C	1845KR018SC		1847KR018SC

Taper Flat End Modified – KR



Flame



Shape	862	862	862	862	863	889S	889	368	368	368	368	379	379
Diameter [0.1 mm]	010	012	014	016	012	009	009	016	018	020	023	018	023
Length [mm]	8.0	8.0	8.0	8.0	10.0	3.0	3.5	3.25	3.6	4.7	5.2	3.4	4.25
● Super Fine		1862012SF						1368016SF			1368023SF		1379023SF
● Fine	1862010F	1862012F			1863012F	1889S009F	1889009F	1368016F		1368020F	1368023F	1379018F	1379023F
● Medium	1862010M	1862012M			1863012M								
● Coarse	1862010C	1862012C	1862014C	1862016C	1863012C			1368016C	1368018C	1368020C	1368023C		1379023C
● Super Coarse											1368023SC		1379023SC

Football/Bud



Esthetic Trimming Egg



Midwest® ONCE®
Single-Patient Diamonds

Manufacturer item number listed, for conversion please visit www.dhponline.com or contact your DHPI Account Manager.

FG unless otherwise stated

25 per pack

PRICE LEVELS

- Black \$44.75
- Blue \$55.95
- Purple \$60.95
- Green \$72.45

Barrel



Wheel, Round Edge



Gross Reduction



Shape	811	811	909	909	6051	6055
Diameter [0.1 mm]	033	037	035	042	017	018
Length [mm]	4.2	7.5	1.2	1.4	7.6	8.2
● Coarse	1811033C	1811037C	1909035C	1909042C	16051017C	16055018C
● Super Coarse	1811033SC	1811037SC				

German quality, Unimatrix® Diamond Bonding System (uniform layer diamond coating with defined grit spacing), and the micro-precise calibration of shank diameter offers: 1) optimum grinding performance with minimal heat; 2) true concentric running, extremely low vibration; 3) less wear and tear on handpiece turbine. Friction Grip only.

Coarse : Medium : Fine	Supercoarse : Superfine : Ultrafine
5 per Pkg. @ \$55.75	5 per Pkg. @ \$60.45

	Pointed Football					Football					Interproximal			
MFG REF.	368	368	368	899	369	379	379	379	379	379	833	833	392	392A
SIZE 1/10mm	016	018	023	027	025	014	016	018	023	018	031	016	016	
LENGTH (mm)	3.5	4.5	5.0	7.0	5.5	3.0	3.4	3.5	4.5	5.9	3.5	5.0	3.5	
Supercoarse	SC368-016	SC368-018	SC368-023				SC379-016	SC379-018	SC379-023					
Coarse	C368-016	C368-018	C368-023	C899-027	C369-025	C379-014	C379-016	C379-018	C379-023					
Medium	M368-016	M368-018	M368-023			M379-014	M379-016	M379-018	M379-023		M833-031	M392-016		
Fine	F368-016	F368-018	F368-023		F369-025	F379-014	F379-016	F379-018	F379-023		F833-018	F833-031	F392-016	F392A-016
Superfine	SF368-016	SF368-018	SF368-023			SF379-016	SF379-016	SF379-018	SF379-023		SF833-018		SF392-016	
Ultrafine	UF368-016	UF368-018	UF368-023				UF379-016	UF379-018	UF379-023					

	Round									Inverted Cone			Inverted Cone w/ Collar	
MFG REF.	801	801	801	801	801	801	801	801	801	805	805	805	806	806
SIZE 1/10mm	010	012	014	016	018	021	023	025	029	010	012	023	012	014
LENGTH (mm)														
Supercoarse				SC801-016	SC801-018	SC801-021	SC801-023	SC801-025	SC801-029					
Coarse		C801-012	C801-014	C801-016	C801-018	C801-021	C801-023	C801-025	C801-029		C805-012		C806-012	C806-014
Medium	M801-010	M801-012	M801-014	M801-016	M801-018	M801-021	M801-023	M801-025	M801-029	M805-010	M805-012	M805-023	M806-012	M806-014
Fine			F801-014	F801-016	F801-018		F801-023	F801-025	F801-029					
Superfine							SF801-023							

	Long Inverted Cone		Barrel			Amalgam Remover			Pear			KR Cylinder		
MFG REF.	807	807	811	811	811	813	813	813	830	830	830L	835KR	835KR	836KR
SIZE 1/10mm	016	018	033	037	047	012	014	016	010	012	014	012	014	012
LENGTH (mm)	4.0	5.0	4.2	7.0	7.0	1.5	1.6	1.6	2.5	2.2	2.5	4.0	4.0	6.0
Supercoarse		SC807-018	SC811-033	SC811-037	SC811-047									
Coarse	C807-016	C807-018	C811-033	C811-037	C811-047	C813-012	C813-014	C813-016	C830-010	C830-012	C830L-014	C835KR-012	C835KR-014	C836KR-012
Medium	M807-016	M807-018	M811-033	M811-037		M813-012	M813-014		M830-010	M830-012				M836KR-012
Fine													F835KR-014	F836KR-012

	Flat End Cylinder									KR Cylinder			End Cutting		
MFG REF.	835	835	836	836	837	837	837	837	837	836KR	837KR	837KR	839	840	840
SIZE 1/10mm	010	012	012	014	010	012	014	016	016	014	012	014	014	014	016
LENGTH (mm)	4.0	4.0	6.0	6.0	8.0	8.0	8.0	8.0	8.0	6.0	8.0	8.0	8.0		
Supercoarse	SC835-010	SC835-012	SC836-012	SC836-014		SC837-012	SC837-014	SC837-016	SC837KR-014	SC837KR-012	SC837KR-014				
Coarse	C835-010	C835-012	C836-012	C836-014	C837-010	C837-012	C837-014	C837-016	C836KR-014	C837KR-012	C837KR-014				
Medium	M835-010	M835-012	M836-012	M836-014	M837-010	M837-012	M837-014	M837-016	M836KR-014	M837KR-012	M837KR-014	M839-014	M840-014	M840-016	
Fine	F835-010		F836-012			F837-012			F836KR-014	F837KR-012	F837KR-014				

Manufacturer part numbers are provided in these charts, please visit www.dhponline.com to convert or contact your DHPI Account Manager.

German quality, Unimatrix® Diamond Bonding System (uniform layer diamond coating with defined grit spacing), and the micro-precise calibration of shank diameter offers: 1) optimum grinding performance with minimal heat; 2) true concentric running, extremely low vibration; 3) less wear and tear on handpiece turbine. Friction Grip only.

Coarse : Medium : Fine	Supercoarse : Superfine : Ultrafine
5 per Pkg. @ \$55.75	5 per Pkg. @ \$60.45

Flat End Taper



MFG REF.	845	846	846	846	847	847	847	847	848	848	848	848	848	848
SIZE 1/10mm	014	012	016	025	012	014	016	018	010	012	014	016	018	023
LENGTH (mm)	4.0	6.0	6.0	7.0	8.0	8.0	8.0	8.0	10.0	10.0	10.0	10.0	10.0	10.0
Supercoarse					SC847-012	SC847-014	SC847-016	SC847-018				SC848-016	SC848-018	SC848-023
Coarse	C845-014	C846-012	C846-016	C846-025	C847-012	C847-014	C847-016	C847-018	C848-010	C848-012	C848-014	C848-016	C848-018	C848-023
Medium		M846-012			M847-012	M847-014	M847-016	M847-018	M848-010	M848-012	M848-014	M848-016	M848-018	
Fine		F846-012	F846-016	F846-025	F847-012	F847-014	F847-016					F848-016	F848-018	

KR Taper **Christmas Tree** **Beveled Cylinder**

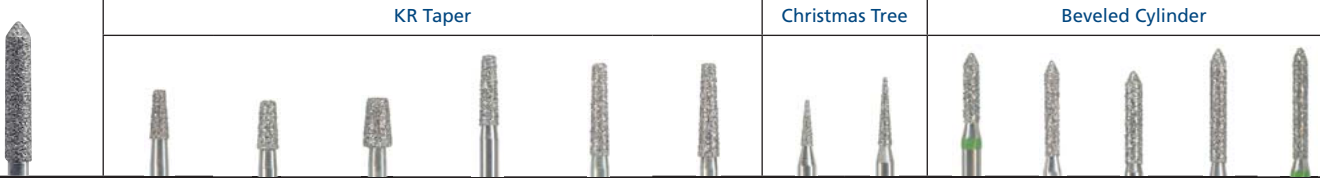

MFG REF.	845KR	845KR	845KR	846KR	847KR	847KR	852	852	884	885	885	886	886
SIZE 1/10mm	016	018	025	016	016	018	010	012	012	012	014	012	014
LENGTH (mm)	4.0	4.0	4.0	6.0	8.0	8.0	4.0	6.0	6.0	8.0	8.0	10.0	10.0
Supercoarse	SC845KR-016			SC846KR-016	SC847KR-016	SC847KR-018				SC885-012	SC885-014	SC886-012	SC886-014
Coarse	C845KR-016	C845KR-018	C845KR-025	C846KR-016	C847KR-016	C847KR-018		C852-012	C884-012	C885-012	C885-014	C886-012	C886-014
Medium	M845KR-016	M845KR-018	M845KR-025	M846KR-016	M847KR-016	M847KR-018	M852-010	M852-012		M885-012	M885-014	M886-012	
Fine	F845KR-016	F845KR-018	F845KR-025	F846KR-016	F847KR-016	F847KR-018	F852-010	F852-012	F884-012	F885-012	F885-014	F886-012	F886-014
Superfine							SF852-010	SF852-012					

Round End Taper



MFG REF.	849	849	849	849	850	850	850	850	850	850	855	855	855	856	856
SIZE 1/10mm	009	010	012	025	010	012	014	016	018	023	012	014	025	012	014
LENGTH (mm)	4.0	4.0	4.0	4.0	10.0	10.0	10.0	10.0	10.0	10.0	6.0	6.0	7.0	8.0	8.0
Supercoarse				SC849-025			SC850-014	SC850-016	SC850-018	SC850-023	SC855-012	SC855-014	SC855-025	SC856-012	SC856-014
Coarse			C849-012	C849-025	C850-010	C850-012	C850-014	C850-016	C850-018	C850-023	C855-012	C855-014	C855-025	C856-012	C856-014
Medium	M849-009	M849-010		M849-025	M850-010	M850-012	M850-014	M850-016	M850-018	M850-023	M855-012	M855-014	M855-025	M856-012	M856-014
Fine	F849-009	F849-010	F849-012		F850-010	F850-012	F850-014	F850-016	F850-018		F855-012	F855-014		F856-012	F856-014

Round End Taper **Long Round End Taper** **Long Needle** **Needle**



















MFG REF.	856	856	856	856	856L	856L	856L	856L	859L	859L	858	858	858	858	859
SIZE 1/10mm	016	018	021	025	014	016	018	020	014	016	010	012	014	016	010
LENGTH (mm)	8.0	8.0	8.0	8.0	9.0	9.0	9.0	9.0	11.5	11.5	8.0	8.0	8.0	8.0	10.0
Supercoarse	SC856-016	SC856-018	SC856-021	SC856-025	SC856L-014	SC856L-016	SC856L-018	SC856L-020		SC859L-016			SC858-014	SC858-016	
Coarse	C856-016	C856-018	C856-021	C856-025	C856L-014	C856L-016	C856L-018	C856L-020	C859L-014	C859L-016	C858-010	C858-012	C858-014	C858-016	C859-010
Medium	M856-016	M856-018	M856-021	M856-025	M856L-014	M856L-016	M856L-018	M856L-020	M859L-014	M859L-016	M858-010	M858-012	M858-014		M859-010
Fine	F856-016	F856-018		F856-025	F856L-014	F856L-016	F856L-018	F856L-020	F859L-014	F859L-016	F858-010	F858-012	F858-014	F858-016	F859-010

















Manufacturer part numbers are provided in these charts, please visit www.dhponline.com to convert or contact your DHPI Account Manager.

















German quality, Unimatrix® Diamond Bonding System (uniform layer diamond coating with defined grit spacing), and the micro-precise calibration of shank diameter offers: 1) optimum grinding performance with minimal heat; 2) true concentric running, extremely low vibration; 3) less wear and tear on handpiece turbine. Friction Grip only.

Coarse : Medium : Fine	Supercoarse : Superfine : Ultrafine
5 per Pkg. @ \$55.75	5 per Pkg. @ \$60.45

BURS

	Needle					Flame										
																
MFG REF.	859	859	859	859	859	860	860	862	862	862	862	862	862	863	863	
SIZE 1/10mm	012	014	016	018	021	012	014	009	010	012	014	016	012	014	016	
LENGTH (mm)	10.0	10.0	10.0	10.0	10.0	5.0	5.0	8.0	8.0	8.0	8.0	8.0	8.0	10.0	10.0	
Supercoarse											SC862-012	SC862-014	SC862-016	SC863-012	SC863-014	SC863-016
Coarse	C859-012	C859-014	C859-016	C859-018	C859-021	C860-012	C860-014			C862-010	C862-012	C862-014	C862-016	C863-012	C863-014	C863-016
Medium	M859-012	M859-014	M859-016	M859-018		M860-012	M860-014	M862-009	M862-010	M862-012	M862-014	M862-016	M863-012	M863-014	M863-016	
Fine	F859-012	F859-014	F859-016	F859-018		F860-012	F860-014	F862-009	F862-010	F862-012	F862-014	F862-016	F863-012	F863-014	F863-016	
Superfine	SF859-012	SF859-014	SF859-016	SF859-018		SF860-012	SF860-014	SF862-009	SF862-010	SF862-012	SF862-014	SF862-016	SF863-012			
Ultrafine	UF859-012	UF859-014	UF859-016						UF862-010	UF862-012	UF862-014		UF863-012			

	Flame			Beveled Cylinder							Curette					
																
MFG REF.	888	889	889	877	878	878	878	878	879	879		877K	877K	877K	877K	878K
SIZE 1/10mm	012	009	010	010	010	012	014	016	012	014		012	014	016	018	012
LENGTH (mm)	8.0	3.5	4.0	6.0	8.0	8.0	8.0	8.0	10.0	10.0		6.0	6.0	6.0	6.0	8.0
Supercoarse						SC878-012	SC878-014	SC878-016	SC879-012	SC879-014		SC877K-014	SC877K-016	SC877K-018	SC878K-012	
Coarse	C888-012	C889-009	C889-010		C878-010	C878-012	C878-014	C878-016	C879-012	C879-014	C877K-012	C877K-014	C877K-016	C877K-018	C878K-012	
Medium	M888-012	M889-009	M889-010	M877-010	M878-010	M878-012	M878-014		M879-012	M879-014	M877K-012	M877K-014	M877K-016		M878K-012	
Fine	F888-012	F889-009	F889-010		F878-010	F878-012	F878-014		F879-012	F879-014		F877K-014	F877K-016			

	Curette										Round End Cylinder			Donut	
															
MFG REF.	878K	878K	878K	878K	879K	879K	879K	879K	879K	879K	880	880	881	909	909
SIZE 1/10mm	014	016	018	021	012	014	016	018	021	021	012	014	014	037	040
LENGTH (mm)	8.0	8.0	8.0	8.0	10.0	10.0	10.0	10.0	10.0	10.0	6.0	6.0	8.0	1.0	2.0
Supercoarse	SC878K-014	SC878K-016	SC878K-018	SC878K-021	SC879K-012	SC879K-014	SC879K-016	SC879K-018	SC879K-021		SC880-014	SC881-014	SC909-037	SC909-040	
Coarse	C878K-014	C878K-016	C878K-018	C878K-021	C879K-012	C879K-014	C879K-016	C879K-018	C879K-021	C880-012	C880-014	C881-014	C909-037	C909-040	
Medium	M878K-014	M878K-016	M878K-018	M878K-021	M879K-012	M879K-014	M879K-016	M879K-018		M880-012		M881-014	M909-037	M909-040	
Fine	F878K-014	F878K-016			F879K-012		F879K-016	F879K-018		F880-012		F881-014		F909-040	

Manufacturer part numbers are provided in these charts, please visit www.dhponline.com to convert or contact your DHPI Account Manager.

NTI® Gold Packs are made up of 50 diamonds of the same shape and grit.
Available in 40 shapes and 3 grits: Supercoarse, Coarse, and Fine. Friction Grip only.

Coarse : Fine	Supercoarse
50 per Pkg. @ \$368.25	50 per Pkg. @ \$384.45

MFG REF.	368	379	379	801	801	801	811	835	837	837	847	847	847KR
SIZE 1/10mm	023G	018G	023G	016G	018G	023G	033G	010G	012G	014G	014G	016G	016G
LENGTH (mm)	5.0	3.5	4.5				4.2	4.0	8.0	8.0	8.0	8.0	8.0
Supercoarse	SC368-023G		SC379-023G				SC811-033G		SC837-012G		SC847-014G	SC847-016G	SC847KR-016G
Coarse	C368-023G	C379-018G	C379-023G	C801-016G	C801-018G	C801-023G	C811-033G	C835-010G	C837-012G	C837-014G	C847-014G	C847-016G	C847KR-016G
Fine	F368-023G	F379-018G	F379-023G										

MFG REF.	850	850	856	856	856	856	856	856	856L	856L	859	862
SIZE 1/10mm	016G	018G	012G	014G	016G	018G	021G	025G	014G	016G	014G	010G
LENGTH (mm)	10.0	10.0	8.0	8.0	8.0	8.0	8.0	8.0	9.0	9.0	10.0	8.0
Supercoarse	SC850-016G	SC850-018G	SC856-012G	SC856-014G	SC856-016G	SC856-018G	SC856-021G	SC856-025G	SC856L-014G	SC856L-016G		
Coarse	C850-016G	C850-018G	C856-012G	C856-014G	C856-016G	C856-018G	C856-021G	C856-025G	C856L-014G	C856L-016G		
Fine					F856-016G						F859-014G	F862-010G

MFG REF.	862	862	863	878	878K	878K	878K	885	888	909	KS1	KS2
SIZE 1/10mm	012G	014G	012G	012G	014G	016G	018G	012G	012G	040G	012G	014G
LENGTH (mm)	8.0	8.0	10.0	8.0	8.0	8.0	8.0	8.0	8.0	2.0	7.0	8.0
Supercoarse	SC862-012G	SC862-014G		SC878-012G	SC878K-014G	SC878K-016G	SC878K-018G	SC885-012G		SC909-040G	KS1G	KS2G
Coarse	C862-012G	C862-014G	C863-012G	C878-012G	C878K-014G	C878K-016G	C878K-018G	C885-012G		C909-040G		
Fine	F862-012G								F888-012G			

ZIR-CUT™ DIAMONDS

The exclusive Z-Grit diamond and bonding technology prevents micro-fractures and helps the dentist and lab technician work efficiently with zirconia, ceramic, and all of today's advanced materials. Its concentric design minimizes vibration for smooth cutting and finishing.



MFG REF.	Z368	Z390	Z801	Z807	Z856	Z856	Z878K
SIZE 1/10mm	023	018	023	018	018	025	021
LENGTH (mm)	5.0	3.0		5.0	8.0	8.0	8.0
FG	Z368-023	Z390-018	Z801-023	Z807-018	Z856-018	Z856-025	Z878K-021
Price	5 per pkg. \$67.75						

NANO | PREP™ DIAMONDS













NTI® nano | prep™ Diamonds by Kerr Dental are specifically designed for conservative and minimally invasive dentistry. The nano sized heads and slender necks allow for optical control of the working area and are perfect for tracing pits and fissures.















MFG REF.	N379	N801	N838	N838L	N860	N883	N889
SIZE 1/10mm	009	007	007	007	007	007	007
LENGTH (mm)	1.0		2.0	3.5	2.0	2.0	3.5
FG	N379-009	N801-007	N838-007	N838L-007	N860-007	N883-007	N889-007
Price	5 per pkg. \$68.75						

Manufacturer part numbers are provided in these charts, please visit www.dhponline.com to convert or contact your DHPI Account Manager.



Medium : Fine	Supercoarse : Superfine
5 per Pkg. @ \$55.75	5 per Pkg. @ \$60.45

	KS Series								MADC Series 5 Per Pkg. \$116.25			
												
MFG REF.	KS0	KS1	KS2	KS3	KS4	KS5	KS6	KS7	MADC	MADC	MADC	MADC
SIZE 1/10mm	010	012	014	016	024	031	025	054	006	010	015	020
LENGTH (mm)	7.0	7.0	8.0	8.0	4.2	6.2	8.4	1.0				
Supercoarse		KS1	KS2	KS3	KS4	KS5		KS7				
Medium	KS0						KS6		MADC-006	MADC-010	MADC-015	MADC-020

	R.A.P.T.O.R.™ Series 5 Per Pkg. \$65.75			TDF™... Trim, Define, & Finish Series					Bambino Series		
											
MFG REF.	905R	901R	902R	132	133	134	135	247	32846KR	32855	32862
SIZE 1/10mm	014	027	029	008	010	014	014	009	016	014	012
LENGTH (mm)	1.0	1.3	1.4	3.0	4.0	6.0	9.0	3.2	6.0	6.0	8.0
Supercoarse									SC32846KR-016	SC32855-014	SC32862-012
Medium											
Fine				F132-008	F133-010	F134-014	F135-014	F247-009			
Superfine	SF905R-014	SF901R-027	SF902R-029	SF132-008	SF133-010	SF134-014	SF135-014	SF247-009			







TWO-GRIT DIAMONDS

The NTI® 2-Grit Diamond is a coarse round-end diamond with fine diamonds at the tip used to create and finish a chamfer margin while producing a facial reduction for both direct and indirect veneer preparations. The "dual-grit" eliminates the need for multiple diamonds when preparing full crowns or veneers. Packaged individually.

	Round End Taper	
		
MFG REF.	FC6844	FC6844
SIZE 1/10mm	014	016
LENGTH (mm)	10	10
Fine / Coarse	FC6844-014	FC6844-016
Price	Each \$19.75	

GUIDE PIN DIAMONDS

NTI® Guide Pin Diamonds incorporate uncoated guide pins for controlled preparation, resulting in a defined and uniform cutting depth, even when vision is obstructed. Achieve optimal results of an exact and tissue-friendly chamfer or shoulder preparation.

	Beveled Cylinder	Round End Taper				Round End Cylinder
						
MFG REF.	879SE	998	998	998	998	999
SIZE 1/10mm	012	016	021	023	026	021
LENGTH (mm)	10.0	9.0	9.0	9.0	9.0	9.0
Supercoarse		SC998-016	SC998-021	SC998-023		
Coarse	C879SE-012					
Medium					M998-026	M999-021
Fine	F879SE-012	F998-016	F998-021	F998-023	F998-026	F999-021
Price		5 per pkg. \$101.95				

EXTENDED LENGTH DIAMONDS

Extended length diamonds from NTI® aide in increased intra oral visibility in the posterior section of the mouth and prevent turbine head interference during preparations of lateral and central anterior teeth.



● FGL - 21mm L x 1.60mm Ø

	Football	
		
MFG REF.	368	379
SIZE 1/10mm	023	023
LENGTH (mm)	5.0	4.5
Medium	M368-023FGL	M379-023FGL
Fine	F368-023FGL	F379-023FGL
Price	5 per pkg. \$61.95	

Manufacturer part numbers are provided in these charts, please visit www.dhponline.com to convert or contact your DHPI Account Manager.

NTI® Turbo Diamonds incorporate diamond-free cooling zones that absorb normal heat generation, resulting in fast reduction while remaining cool. Available in Friction Grip and Friction Grip Short Shank only.

- More exposed diamond surfaces on tips and edges for superior cutting ability
- Diamond-free cooling zones eliminate clogging and promote fast cool cutting

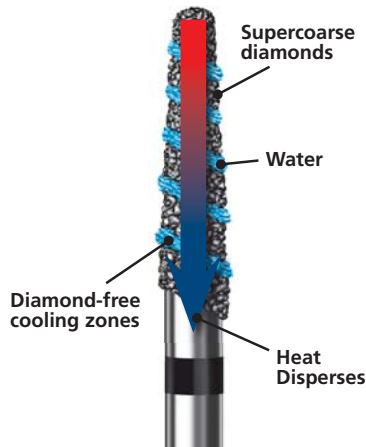

Turbo Supercoarse
5 per Pkg. @ \$70.75



MFG REF.	379T	811T	836T	836T	837T	837T	837T	837KRT	837KRT	846T	846KRT	847T	847T
SIZE 1/10mm	023	033	012	014	012	014	016	014	016	016	016	014	016
LENGTH (mm)	4.5	4.2	6.0	6.0	8.0	8.0	8.0	8.0	8.0	6.0	6.0	8.0	8.0
FG (31)	SC379-T-023	SC811-T-033	SC836-T-012	SC836-T-014	SC837-T-012	SC837-T-014	SC837-T-016	SC837KRT-014	SC837KRT-016	SC846-T-016	SC846KRT-016	SC847-T-014	SC847-T-016

MFG REF.	847T	847KRT	848T	848T	848T	850T	850T	855T	855T	856T	856T	856T	856T
SIZE 1/10mm	018	016	014	016	018	016	018	014	025	012	014	016	018
LENGTH (mm)	8.0	8.0	10.0	10.0	10.0	10.0	10.0	6.0	7.0	8.0	8.0	8.0	8.0
FG (31)	SC847-T-018	SC847KRT-016	SC848-T-014	SC848-T-016	SC848-T-018	SC850-T-016	SC850-T-018	SC855-T-014	SC855-T-025	SC856-T-012	SC856-T-014	SC856-T-016	SC856-T-018

MFG REF.	856T	862T	862T	862T	863T	863T	863T	877KT	877KT	878T	878T	878KT	878KT
SIZE 1/10mm	025	012	014	016	012	014	016	014	018	014	016	014	016
LENGTH (mm)	8.0	8.0	8.0	8.0	10.0	10.0	10.0	6.0	6.0	8.0	8.0	8.0	8.0
FG (31)	SC856-T-025	SC862-T-012	SC862-T-014	SC862-T-016	SC863-T-012	SC863-T-014	SC863-T-016	SC877KT-014	SC877KT-018	SC878-T-014	SC878-T-016	SC878KT-014	SC878KT-016

MFG REF.	878KT	879T	879T	879T	879KT	879KT	879KT	885T	886T	886T	KS1T	KS2T	KS3T
SIZE 1/10mm	018	012	014	016	014	016	018	012	012	014	012	014	016
LENGTH (mm)	8.0	10.0	10.0	10.0	10.0	10.0	10.0	8.0	10.0	10.0	7.0	8.0	8.0
FG (31)	SC878KT-018	SC879-T-012	SC879-T-014	SC879-T-016	SC879KT-014	SC879KT-016	SC879KT-018	SC885-T-012	SC886-T-012	SC886-T-014	KS1-T	KS2-T	KS3-T

Manufacturer part numbers are provided in these charts, please visit www.dhponline.com to convert or contact your DHPI Account Manager.

BluWhite Diamonds cut faster and clean easier than other leading manufacturers due to the unique grit application process, which helps reduce clogging and improves cutting efficiency. BluWhite diamonds offer a wide selection of shapes and grits which feature unique extra coarse diamond particles (40% larger than competitors.) BluWhite diamonds are a great option for any operative or prosthodontic procedure time after time.

Coarse : Medium : Fine	Supercoarse : Superfine : Ultrafine
5 per Pkg. @ \$53.95	5 per Pkg. @ \$53.95

Amalgam Remover

Ø 1/10 mm	012	014	016
LG mm	1.1	1.3	1.6

- Super Fine
- Fine
- Regular
- Coarse
- Extra Coarse

	FG470R	FG471R	FG472R
--	--------	--------	--------

Curette

Ø 1/10 mm	014	014	014	016	016	016	018
LG mm	5.8	7.8	9.8	5.8	7.8	9.8	7.8

	FG001F	FG002F	FG003F	FG004F		FG006F	FG008F
	FG001R	FG002R	FG003R	FG004R	FG005R	FG006R	FG008R
		FG002C	FG003C	FG004C	FG005C	FG006C	FG008C

Depth Cutter

Ø 1/10 mm	018
LG mm	2.8

	FG610SF
	FG610F
	FG610R
	FG610C

Flame

Ø 1/10 mm	008	012	012
LG mm	2.9	6.2	7.8

	FG201SF	FG210SF	FG216SF
	FG201F	FG210F	FG216F
	FG201R	FG210R	FG216R
		FG210C	FG216C

Flame

Ø 1/10 mm	014	014	016	012	016	016	018	014
LG mm	9.8	3.7	3.7	6.7	7.8	9.8	6.4	7.2

- Super Fine
- Fine
- Regular
- Coarse
- Extra Coarse

				FG240SF	FG250SF			
	FG217F			FG240F	FG246F	FG250F	FG252F	
	FG217R	FG220R	FG230R	FG232R	FG240R	FG246R	FG250R	FG252R
	FG217C	FG220C		FG232C	FG240C	FG246C	FG250C	FG252C

Flat End Taper

Ø 1/10 mm	014	018	016	018	018	014	016	014
LG mm	9.8	9.8	5.8	9.8	9.8	7.9	7.9	7.8

				FG713SF				
	FG703F							FG729F
	FG703R	FG713R		FG723R	FG724R	FG728R	FG729R	FG740R
	FG703C	FG713C	FG720C	FG723C			FG729C	FG740C

Flat End Taper

Ø 1/10 mm	018	018	018	018	016	023	018	021	016
LG mm	7.3	9.8	7.8	7.8	8.8	7.2	8.8	2.8	7.8

- Super Fine
- Fine
- Regular
- Coarse
- Extra Coarse

									FG431SF
				FG771F					FG431F
	FG750R	FG760R	FG770R		FG773R	FG780R	FG783R	FG410R	FG431R
	FG750C	FG760C	FG770C	FG771C	FG773C	FG780C	FG783C	FG410C	FG431C

Inverted Cone

Ø 1/10 mm	010	012	018	010	016
LG mm	0.9	1.1	1.7	2.7	4.1

	FG310R	FG320R	FG330R		FG335R
		FG320C	FG330C	FG331C	

KS

Ø 1/10 mm	016
LG mm	7.9

	FGKS1.6C
--	----------

Needle

Ø 1/10 mm	016	021
LG mm	1.3	9.9

- Super Fine
- Fine
- Regular
- Coarse
- Extra Coarse

	FG8392-016F
	FG743C

Occlusal

Ø 1/10 mm	033	035	025	023
LG mm	4.6	5.6	4.0	5.2

			FG630SF	
			FG630F	
	FG460R	FG461R	FG620R	FG630R
	FG460C	FG461C	FG620C	FG630C
			FG461XC	FG630XC

Round

Ø 1/10 mm	009	014	014	016	016	020
LG mm	0.5	0.9	0.9	1.1	1.1	1.4

			FG130SF			
			FG120F	FG130F		
	FG110R	FG120R	FG121R	FG130R		FG150R
		FG120C	FG121C	FG130C	FG131C	FG150C
				FG130XC		

Manufacturer part numbers are provided in these charts, please visit www.dhponline.com to convert or contact your DHPI Account Manager.



GREEN

25/pack\$48.25

PURPLE

25/pack\$98.95

RED

25/pack\$48.25

ORANGE

25/pack\$69.95

BLUE

25/pack\$48.25

All NeoDiamond instruments are friction grip (FG). Total instrument never exceeds 24 mm, allowing use in small or large-head handpieces.



CROWN & BRIDGE AND OPERATIVE	BALL	INVERTED CONE				DBL INV. CONE	PEAR	MOD. FL. END CYL.
Head size indicates diamond diameter's widest part. Head tip diameter is shown for tapered shapes. Instruments shown actual size. Grits indicated by color bands on shanks. Coarse grit shapes are either 150 µ (black) or 130 µ (green).								
25 of one shape per pack								
Coarse/C (150 µ, 130 µ) Medium/M (100-110 µ) Fine/F (50 µ)	Dmd. #	Dmd. #	Dmd. #	Dmd. #	Dmd. #	Dmd. #	Dmd. #	Dmd. #
Reference FG								
Head/Lgth / Tip (mm)								

FLAT END CYLINDER	ROUND END CYLINDER	MODIFIED BEV. CYL.	BEVELED CYLINDER	MODIFIED FLAT END TAPER	MOD. F. E. TPR-LGE	FLAT END TAPER

FLAT END TAPER	ROUND END TAPER

ROUND END TAPER-LARGE	POINTED TAPER	POINTED CONE	INTER-PROXIMAL	FLAME

FLAME (Continued)	EGG	FOOTBALL	WHEEL	OCCUSAL REDUCTION	GROSS REDUCTION

END CUTTER	DEPTH CUTTER	NEOSPIRAL®	ROUND END TAPER	FOOTBALL	GUIDE PIN	ROUND END TAPER

ENDO ACCESS	ROUND END TAPER	FINISHING	R.E. TAPER	POINTED CONE	FLAME	EGG	FOOTBALL

Manufacturer part numbers are provided in these charts, please visit www.dhponline.com to convert or contact your DHPI Account Manager.



← P.B.S.-bonded Two Striper[®] diamonds are guaranteed not to pull out.



← Many other diamonds are electroplated and prone to premature particle dislodgment.

Chamfer Prep

Round-End Taper	747.6	767.5	767.7	767.7	767.8	767.9	770.5	770.7	770.8	770.8	770.9	770.10	776.4	777.8	780.4	780.7	780.8
Coarse	2015058	2015452	2015453	2015652	2015454	2015455	2015456	2015458	2015457	2015650	2015460	2015459	2015461	2015972	2015462	2015463	2015464
Medium														2015930			
Fine			2015483	2015653	2015484	2015485			2015487	2015651		2015489	2015491				2015494

Round-End Taper	780.9	781.6	781.8	781.10	782.6	782.8	782.10	783.6	783.8	783.10	784.6	784.8	784.10	785.4	785.7	790.8
Coarse	2015467	2015465	2015478	2015466	2015423	2015424	2015425	2015426	2015427	2015468	2015429	2015430	2015431	2015470	2015469	2015471
Fine	2015497		2015498	2015496	2015433	2015434	2015435			2015438		2015440	2015441		2015499	2015501
Very Fine																2015529

Round-End Taper	799.6.5	799.11	Flame	290.2	KS Cylinder (Round Edge)	574.7	575.7	585.5	585.8	586.8	587.8	Parallel Cylinder Round-End	550.8	573.6	588.10
Coarse	2015473	2015475			Coarse	2015953	2015302	2015305	2015303	2015307	2015304	Coarse	2015311	2015310	2015312
Medium	2015480		Med.	2015148											
Fine	2015503	2015505			Fine	2015954	2015322		2015306						
Very Fine	2015535														

5/pack.....\$55.25

Modified Chamfer

Gold-Plated Curettage (GCP [™])	252.SA	252.SB	252.SC	253.SA	253.SB	253.SC	254.SA	254.SB	254.SC	257.SB	258.SB
Medium	2015603	2015605	2015607	2015609	2015611	2015613	2015615	2015617	2015619	2015623	2015627

Curette "K"	763.8	763.10	764.8	764.10	Modified Beveled Cylinder	510.6	510.8	511.8	511.10
Coarse	2015977	2015979	2015978	2015980	Coarse	2015973	2015974	2015975	2015976

5/pack...\$55.25

Instrument Coding

Shape → **209.10C** ← Grit
Abrasive Length ↑(mm)

Always insert diamond completely into chuck; do not short chuck.

Color Coded Stripes On Shank

Coarse (120μ) Fine (60μ)
Medium (85μ) Very Fine (45μ)

* Premier is a registered trademark of Premier Dental Products Company. / * Two Striper and PBS are registered trademarks and Luminescence Plus, TS2000, ShortCut and Skooter are trademarks of the manufacturer, Abrasive Technology, Inc. / U.S. Patent 5, 511, 718

KR Modified Shoulder Prep

Modified Shoulder	Modified Shoulder
KR Cylinder	KR Taper
515.6	703.8 KR
521.4	708.4 KR
521.6	712.3 KR
	722.8 KR
	723.6 KR
Coarse	Coarse
2015986	2015951
2015987	2015992
2015989	2015360
	2015996
Fine	Fine
2015988	2015353
	2015949
	2015995
	2015658
	2015997

5/pack.....\$55.25

All-Ceramic Guide Pin



Guide Pin	SE740.8	SE259.8
Medium	2015966	2015964
Fine	2015967	2015965

5/pack.....\$55.25



P.B.S.-bonded Two Striper[®] diamonds are guaranteed not to pull out.

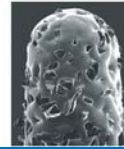

Many other diamonds are electroplated and prone to premature particle dislodgment.

Shoulder Prep

Flat-End Taper	700.5	700.6	700.8	700.9	700.11	701.5	701.7	L701.7 1.5 mm longer shank	701.9	L701.9 1.5 mm longer shank	702.8	703.8	703.9	703.10	704.9	708.3	708.4
Coarse	2015332	2015333	2015334	2015335	2015337	2015338	2015339	2015656	2015341	2015657	2015343	2015345	2015346	2015347	2015348	2015350	2015351
Medium																	2015445
Fine				2015365	2015367		2015369		2015371		2015373	2015375		2015377		2015380	
Very Fine				2015395	2015397						2015403						

Flat-End Taper	721.6	721.8	721.10	722.6	722.8	722.10	723.4	723.6	723.8	723.10	724.8	724.10	725.10	726.10	727.10	798.10
Coarse	2015354	2015355	2015356	2015357	2015358	2015359	2015254	2015255	2015256	2015257	2015259	2015260	2015446	2015448	2015450	2015442
Fine			2015386			2015389			2015262				2015447			2015443

Flat-End Cylinder	513.4	513.5	514.3	514.4	514.5	514.7	515.5	515.7	515.8	516.7	520.4
Coarse	2015271	2015272	2015273	2015274	2015276	2015278	2015275	2015277	2015279	2015985	2015281
Medium	2015288										
Fine			2015293	2015294			2015295	2015297			2015301

5/pack.....\$55.25

Bevel Shoulder Prep

Bevel-End Cylinder	244.10	248.8	250.8	250.9	250.11	251.8	255.8
Coarse	2015064	2015065	2015067	2015066	2015068	2015069	2015073
Fine		2015085	2015087	2015086		2015089	2015093

5/pack.....\$55.25

Finishing Diamonds

Skooter [™]	0	1	2
Medium	TO - 2015188	T1 - 2015190	T2 - 2015192
Very Fine	FO - 2015189	F1 - 2015191	F2 - 2015193

	MF1 (45μ)	MF2 (20μ)	MF3 (10μ)				
MFS [®] Finishing Diamonds	135	201	257	265	285	292	799
MF1 (45μ)	2015850	2015853	2015856	2015859	2015862	2015865	2015868
MF2 (20μ)	2015851	2015854	2015857	2015860	2015863	2015866	2015869
MF3 (10μ)	2015852	2015855	2015858	2015861	2015864	2015867	2015870

5/pack.....\$59.95

Composite Finishing Kit

Contains eight diamonds and two carbides for consistent, systematic finishing of all direct restorations.



197-2013557 Kit.....\$156.95



← P.B.S.-bonded Two Striper[®] diamonds are guaranteed not to pull out.



← Many other diamonds are electroplated and prone to premature particle dislodgment.

Feather Edge Prep/Break Contact

Flame	242.6	243.6	253.8	253.10	256.8	256.9	260.3	260.6.5	260.8	L260.8	260.10	261.8	262.6.5	262.8	263.8	265.6.5	265.8
Coarse	2015059	2015061	2015070	2015071	2015062	2015075	2015121	2015122	2015123	2015133	2015125	2015124	2015983	2015126	2015127	2015129	2015131
Medium	2015956																
Fine	2015060	2015090	2015091	2015095	2015152	2015153	2015163	2015155	2015154	2015157	2015159	2015161					
Very Fine	2015182									2015183	2015185						

Flame	L265.8	270.5	270.6.5	270.9	275.9	Break Contact	203.5	700.9	700.11	777.8	798.10	799.11	Interproximal Trimmer	200.3	201.3
Coarse	2015654	2015135	2015137	2015139	2015955	Coarse	2015335	2015337	2015972	2015442	2015475				
Fine	2015655	2015165	2015167	2015169			Medium	2015930					Fine	2015042	2015043
							Very Fine	2015395	2015397	2015535			Very Fine	2015052	2015053

Cone	207.7	207.10	209.6	209.10	608.9	797.11
Coarse	2015036	2015149	2015035	2015037	2015038	
Medium						2015039
Fine	2015046	2015045	2015047	2015048	2015049	
Very Fine	2015057					

5/pack.....\$55.25

Veneer Prep

D.C. Depth-Cut	DC.5	DC.75	DC1.0	DC1.5	Depth Marker	DC0.3	DC0.5
Coarse	2015776	2015785	2015802	2015803	Medium	2015970	2015971

5/pack.....\$62.25

Occlusal & Lingual Reduction (Bulk)

Football	283.4	285.5	290.4	292.3	Round	115	120	L120	125	130	L130	135	138	Occlusal Contour	204.3.5
Coarse	2015142	2015143	2015144	2015145	Coarse	2015003	2015005	2015055	2015006	2015008	2015078	2015007	2015009	Fine	2015952
Fine	2015172	2015173	2015174	2015175	Fine	2015013	2015015	2015016	2015018	2015017					
Very Fine	2015202	2015203	2015204	2015205	Very Fine	2015025									

5/pack.....\$55.25

Barrel	230	234	240	Egg	287.4	Wheel	860	862	863	866	K55	276.6.2
Coarse	2015063	2015076	2015077	Coarse	2015981	Coarse	2015543	2015544	2015545	2015546	Coarse	2015898
Fine	2015083			Fine	2015982	Fine	2015553		2015555			

5/pack.....\$55.25

Manufacturer part numbers are provided in these charts, please visit www.dhpionline.com to convert or contact your DHPI Account Manager.

Two Striper®
An abrasive technology product

Faster, Cooler,
Longer Lasting



← P.B.S.*-bonded Two Striper® diamonds are guaranteed not to pull out.

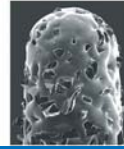

← Many other diamonds are electroplated and prone to premature particle dislodgment.

premier™

BURS

Inlay/Onlay

Flat-End Cylinder	513.4	L513.4	513.5	514.3	514.4	514.5	514.7	515.5	L515.5	515.7	L515.7	515.8	516.7	520.4
Coarse	2015271		2015272	2015273	2015274	2015276	2015278	2015275	2015279	2015277	2015298	2015279	2015985	2015281
Medium	2015288	2015289												
Fine				2015293	2015294			2015295		2015297				2015301

5/pack.....\$55.25

Specialty

5/pack.....\$59.95

Crown Cut™							Safe-End	
	SC5	SC8	SC10	ST6	ST8	ST11		S79
Coarse	2015573	2015575	2015577	2015581	2015583	2015585		2015835
Fine								

TGE™ (Tissue Guard End-Cutting)				
	1.0	1.2	1.4	1.6
Fine	2015836	2015838	2015840	2015842
Very Fine		2015839	2015841	

Endo*		
	1C RA	291.4 RA
Coarse	2013194	2013197
Fine		

*Available in single-pack only.

microprep™ Micro-Preparation Diamonds

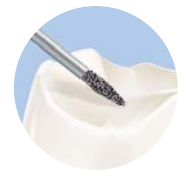

Indicated for minimally invasive cavity preps and microscope-assisted dentistry.

MicroPrep™						
	MP89	MP38	MP30R	MP30	MP53	MP53A
Medium	2015957	2015959	2015960	2015961	2015962	2015963
Fine	2015958					

5/pack.....\$55.25

Operative

Operative													
	1/4	1	2	6	35	169L	170L	245	330	556	557	558	701
Medium	2013203	2013205	2013201	2013211	2013221	2013231	2013241	2013251	2013261	2013271	2013281	2013291	2013301

Amalgam Removers					Inverted Cone							
	1210	1220	1240	1250		310.1	315.1.75	317.4	318.5	320.2	324.1	390.3
Medium	2015591	2015593	2015598	2015599		2015213	2015790	2015984	2015991	2015217	2015219	2015931
Fine						2015233				2015237		

Pear									
	351.3.75	352.4	360.2	361.2.5	362.3	L362.3	364.5	365.4	L365.4
Coarse	2015229	2015230	2015794	2015796	2015792	2015799	2015227	2015225	2015228
Fine					2015793		2015245		

5/pack.....\$55.25

Instrument Coding

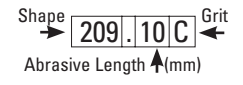

Always insert diamond completely into chuck; do not short chuck.

Color Coded Stripes On Shank

- Coarse** (120µ)
- Medium** (85µ)
- Fine** (60µ)
- Very Fine** (45µ)

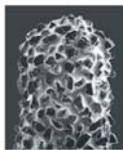

← P.B.S.[®]-bonded Two Striper[®] diamonds are guaranteed not to pull out.

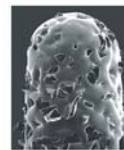

← Many other diamonds are electroplated and prone to premature particle dislodgment.

TS2000[™]

Rapid Bulk Reduction – Finished Margin
Fastest Brand!
Increased Efficiency – More Coolant

TS2000 Round-End Taper	2003.7	2003.8	2003.9	2003.10	2004.7	2004.8	2004.9	2004.10	2005.7	2005.8	2005.9	2005.10
Coarse	2000037	2000038	2000039	2000040	2000047	2000048	2000049	2000050	2000057	2000058	2000059	2000060

Two Diamonds In One



TS2000[™] Diamonds provide rapid gross reduction and a finished margin without changing burs.

Gold-Plated TS2000 Curettage (GCP [™])	2006.7GC	2006.8GC	2006.9GC	2006.10GC	2007.7GC	2007.8GC	2007.9GC	2007.10GC	2008.7GC	2008.8GC	2008.9GC	2008.10GC
Coarse	2000067	2000068	2000069	2000070	2000077	2000078	2000079	2000080	2000087	2000088	2000089	2000090

TS2000 Flat-End Taper/Cylinder	2000.7	2000.8	2000.9	2000.10	2001.7	2001.8	2001.9	2001.10	2002.7	2002.8	2002.9	2002.10	2013.7	2013.8	2013.10
Coarse	2000007	2000008	2000009	2000010	2000017	2000018	2000019	2000020	2000027	2000028	2000029	2000030	2000136	2000138	2000140

TS2000 KR Taper	2001.8KR
Coarse	2000021

TS2000 KR Cylinder	2013.8KR
Coarse	2000139

TS2000 Bevel-End Cylinder	2016.8	2016.10
Coarse	2000168	2000170

TS2000 Football	2014.5
Coarse	2000145

TS2000 Flame	2009.7	2009.8	2009.9	2010.8	2011.8
Coarse	2000097	2000098	2000099	2000108	2000118

TS2000 ShortCut[™]

	2001.8 S	2004.9 S	2005.8 S
Coarse	2000143	2000141	2000142

1) An Independent Non-Profit Dental Education and Product Testing Foundation Newsletter, May 2002. 5/pack.....\$62.25



TSZTECH[™]

Uniquely designed for efficient cutting of Lithium Disilicate and Zirconia

197-2015895 Assorted 5/pack.....\$62.25

All-ceramic Crown Cutters!

	260.8Z	285.5Z	703.8KRZ	125Z	770.8Z
5-Pack Reorder	2015893	2015891	2015894	2015892	2015890

"L" - 1.5mm longer shank:

	L260.8Z	L125Z	L770.8Z
5-Pack Reorder	2015883	2015882	2015880

These Two Striper[®] FG diamonds feature a proprietary diamond grit designed to cut quickly and safely through Lithium Disilicate and Zirconia crowns.

TSZtech[™] diamonds provide faster and cooler cutting with less trauma and no sparking. Some shapes are available in a slightly longer shank for electric handpieces with larger heads. The round and football are ideal for endodontic access.

5/pack.....\$62.25

Two Striper®
An abrasive technology product

Faster, Cooler,
Longer Lasting



← P.B.S.-bonded Two Striper® diamonds are guaranteed not to pull out.

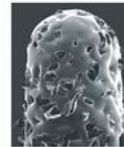

← Many other diamonds are electroplated and prone to premature particle dislodgment.

premier™

BURS



Shorter Shank For Easier Access

ShortCut™
Short Shank Diamonds



197-2015895 Assorted 5/pack\$62.25

260.8 S	285.5 S	702.8 S	767.8 S	770.8 S
Coarse	2015901	2015900	2015909	2015907
				2015905

MP89 S
Medium
2015968

767.8 S	770.8 S	780.9 S	782.8 S
Coarse	2015907	2015905	2015906
			2015928

260.8 S	261.8 S
Coarse	2015901
	2015925
Fine	2015924

Football
285.5 S
Coarse
2015900
Fine
2015923

Amalgam Removers
1250 S
Medium
2015912

Interproximal Trimmer
201.3 S
Fine
2015927

702.8 S	703.8 S
Coarse	2015909
	2015908

Modified Shoulder	703.8 KR S
Coarse	2015926

Modified Shoulder	521.8 S
Coarse	2015990

Operative	2 S	6 S	169L S	245 S	330 S	556 S
Medium	2015917	2015918	2015919	2015913	2015914	2015916
						2015915

252.SB S	253.SB S	254.SB S
Medium	2015920	2015921
		2015922

Bevel-End Cylinder
250.8 S
Coarse
2015902

Flat-End Cylinder
515.7 S
Coarse
2015910

KS1
KS Cylinder (Round Edge)
575.7 S
Coarse
2015911

Skooter™
1 S
Medium
T1 S - 2015903
Very Fine
F1 S - 2015904

5/pack....\$55.25

Manufacturer part numbers are provided in these charts, please visit www.dhponline.com to convert or contact your DHPI Account Manager.

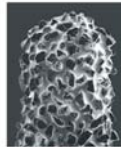

P.B.S.[®]-bonded Two Striper[®] diamonds are guaranteed not to pull out.

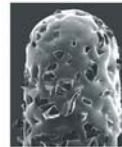

Many other diamonds are electroplated and prone to premature particle dislodgment.



Universal All-Ceramic Preparations

Ten versatile diamonds that will boost your productivity for all-ceramic Crowns, Inlays and Onlays.

Whether it's CAD/CAM Chair Side, or lab fabricated ceramic, this set contains all the tools you need to create fast, accurate preparations.

197-201355 Kit.....**\$161.95**

Item #	Shape #	Item #	Shape #
2000145	2014.5C	2015157	263.8F
2015352	703.8KRC	2015042	200.3F
2015353	703.8KRF	2015173	285.5F
2015457	770.8C	2015175	292.3F
2015487	770.8F	2015930	777.8M

5/pack.....**\$55.25**



CAD/CAM Laboratory Finishing Kit Ceramic Adjustment

Packaged in Anodized Aluminum Lab Bur Block

197-2013552 Kit.....**\$158.75**

Miniature
Muslin
Buff



16 ply x 1" No item number.
Available in kit only.

Adjust



Flame X769.10
Fine (1/pkg.) 2012730

Contour



Round-End Taper X590.12
Medium (1/pkg.) 2012681

Remove
Sprue



Thin-flex[®] Disc X929-7
Double-sided (1/pkg.) 2012657

Carve
Occlusal
Anatomy



Tri-Fissure Carbide
(5/pkg.) 9050655

Stiff
Bristle
Brush



#11 No item number.
Available in kit only.

Laboratory HP Diamonds

P.B.S.[®] Bonded - ISO Type 2 Shank 2.35mm

	X115	X118	X120	X135	X150	X261.5	X265.10	X267.10	X285.8.5	X324.1	X350.4	X535.7	X575.7
Coarse	2012699	2012700	2012701	2012703	2012705	2012707	2012708	2012738	2012709	2012711	2012713	2012719	2012728
Fine	2012747	2012746	2012731	2012733	2012789	2012737	2012787	2012786	2012739	2012741	2012743	2012749	2012758
Reference #	801-010	801-018	801-016	801-026	801-036	860-014	863-014	863-016	862-026	805-022	807-030	836-027	830-026

	X580.6	X590.12	X701.7	X701.9	X702.10	X703.12	X767.7	X769.10	X772.10	X775.10	X776.9	X884	X889
Coarse	2012720		2012721	2012723	2012759	2012724	2012725	2012762	2012765	2012766	2012726	2012770	2012727
Medium		2012681											
Fine	2012750	2012680	2012751	2012753		2012754	2012755	2012730	2012736	2012798	2012756		2012757
Reference #	836-052	842R-012	846-018	847-016	848-020	848L-025	855-018	850-018	850-025	850L-018	856-040	825-046	825-067

5/pack.....**\$15.25**

TSZTECH[™]
Laboratory
Diamonds



X590.12Z 2012847
Minor/Major Diameter 1.2

X769.10Z 2012845
Minor/Major Diameter 0.7 / 1.8



Solo
DIAMOND™

Gamma-Sterilized!
Single-Patient Use



Get a **FRESH START...**
with every **SINGLE PATIENT**

Curettage K

 Coarse 878K012C 878K012 1712.8	 Coarse 879K012C 879K012 1712.10	 Coarse 878K014C 878K014 1714.8	 Coarse 879K014C 879K014 1714.10	 Coarse 878K016C 878K016 1716.8	 Coarse 878K018C 878K018 1718.8	 Coarse 879K018C 879K018 1718.10	 Medium 879K018M 879K018 1718.10	 Medium 879K021M 879K021 1721.10
---	--	---	--	---	---	--	--	--

Most Shapes

\$46.45

Each box contains
25 individual pouches.

Flame

 Coarse 862010C 862010M 862010F 862010 1510.8	 Coarse 860012CS 860012 1512.6	 Coarse 862012C 862012M 862012F 862012 1512.8	 Coarse 863012C 863012M 863012F 863012 1512.10	 Coarse 862016C 862016F 862016 1516.8	 Coarse 862L018C 862L018F 862L018 1518.9
---	--	---	--	--	---

Pear

 Medium 830008MS 830008 0508	 Medium 830008M 830008 0508	 Medium 830012M 830012 0512
--	---	---

Instrument Coding

Coarse
Medium
Fine
Extra Fine
Solo Number
Shape Number
S - Indicates short-shank

Round End Taper

 Coarse 856012C 856012 1112.7	 Coarse 850012C 850012 1112.10	 Coarse 856014C 856014M 856014F 856014 1114.8	 Coarse 850014C 850014M 850014F 850014 1114.10	 Coarse 855016CS 855016MS 855016 1116.6	 Coarse 856016C 856016M 856016F 856016 1116.8	 Coarse 850016C 850016M 850016F 850016 1116.10	 Coarse 856018C 856018 1118.7	 Medium 850018M 850018 1118.10	 Coarse 856L018C 856L018 1118.9	 Coarse 856021C 856021 1121.8
---	--	---	--	--	---	--	---	--	---	---

Flat End Taper

 Coarse 847014C 847014F 847014 0914.8	 Coarse 847L014C 847L014 0914.9	 Coarse 847016C 847016M 847016F 847016 0916.8	 Coarse 848016C 848016F 848016 0916.10	 Coarse 847018C 847018 0918.8	 Coarse 848018C 848018 0918.10
--	---	---	---	---	--

Modified KR Taper

 Coarse 846KR016C 846KR016F 846KR016 0816.8	 Coarse 845KR018C 845KR018 0818.4	 Coarse 847KR018C 847KR018F 847KR018 0818.8
--	---	--

Pointed Cone

 Coarse 858014C 858014F 858014 1314.8	 Coarse 859014C 859014M 859014F 859014 1314.10
--	--

Ball

 Medium 801010M 801010 0110	 Medium 801012M 801012 0112	 Coarse 801016C 801016M 801016 0116	 Coarse 801018C 801018M 801018 0118	 Coarse 801023C 801023M 801023F 801023 0123
---	---	--	--	---

Inverted Cone

 Medium 805012M 805012 0312	 Coarse 805016C 805016 0316
---	---

Large Inverted Cone

 Coarse 807016C 807016 0316.4	 Coarse 807018C 807018 0318.5
---	---

Double Inverted Cone

 Medium 813014M 813014 0416

Manufacturer part numbers are provided in these charts, please visit www.dhpionline.com to convert or contact your DHPI Account Manager.

premier™

Solo™
DIAMOND

Gamma-Sterilized!
Single-Patient Use



Fast and easy tooth preparations with single-patient use, gamma-sterilized diamonds!

Your patients will appreciate fast, optimal tooth preparation with Solo single-patient use diamonds. You will love the freedom and convenience of pre-sterilized diamonds for patient-safe infection control.

BURS

Flat End Cylinder

Medium 835010MS	Coarse 835010C Medium 835010M	Coarse 837012C Fine 837012F	Coarse 837016C
835010 0710MS	835010 0710	837012 0712.7	837016 0716.8

Egg

Coarse 379018C	Coarse 379023C Fine 379023F
379018 1908	379023 1900

Football

Coarse 368016C Medium 368016M Fine 368016F	Coarse 368020C Medium 368020M Fine 368020F	Coarse 368023C Medium 368023M Fine 368023F
368016 1916	368020 1920	368023 1923

Most Shapes
\$46.45

*Each box contains
25 individual pouches.*

KS Cylinder

Coarse KS0010C	Coarse KS1012C Medium KS1012M Fine KS1012F	Coarse KS2014C
KS0010 1210.7	KS1012 1212.7	KS2014 1214.8

Modified Beveled Cylinder

Coarse 878012C
878012 1800.8

Beveled Cylinder

Coarse 885012C	Coarse 886012C
885012 1812.8	886012 1812.10

Interproximal

Medium 132008M Fine 132008F
132008 1310.3

Pit & Fissure

Fine 8889MFS
8889M 1300FS

Operative

Medium H245008M	Medium H330008M	Medium H557010M
1.1/2.8/0.9 FG245	0.9/1.6/0.8 FG330	1.0/4.2/0.9 FG557

Wheel

Coarse 909037C	Coarse 909040C
909037 2035	909040 2042

Modified KR Taper Large

Coarse 845KR025C
845KR025 2525C

Finishing

Extra Fine 132008EF	Extra Fine 134014EF	Extra Fine 135014EF	Extra Fine 862012EF	Extra Fine 379023EF	Extra Fine 368023EF
132008 3310.3	134014 3314.8	135014 3314.10	862012 3512.8	379023 3900	368023 3923

Gross Reduction

Coarse 6051017C	Coarse 6055018C
6051017 2217	6055018 2218

Round-End Taper Large

Coarse 856025C
856025 2424

Barrel

Coarse 811033C	Coarse 811037C
811033 2133	811037 2137

Acorn

Fine 905028F
905028 3028

Large & Finishing Shapes

\$59.95

*Each box contains
25 individual pouches.*

Spiral

Coarse 837T016C	Coarse 856T014C	Coarse 856T016C	Coarse 850T016C	Coarse 856T018C	Coarse 856LT018C	Coarse 368T023C
837T016 8716.8	856T014 8114.8	856T016 8116.8	850T016 8116.10	856T018 8118.7	856LT018 8118.9	368T023 8923

Spiral Shapes

\$81.45

*Each box contains
25 individual pouches.*

Manufacturer part numbers are provided in these charts, please visit www.dhponline.com to convert or contact your DHPI Account Manager.

Order by 800-626-2163

www.dhponline.com

Fax: 888-681-5088

87

100% Satisfaction Guaranteed*

*SS White's 100% satisfaction guarantee is on all of our products. If you are not completely satisfied with your purchase, we will issue a full refund of the purchase price through Burkhart.

- Designed for maximum performance, while offering great value
- Exceeds ISO standards for concentricity creating a diamond that cuts smoother with greater tactile feel
- Uniform diamond sizing combined with optimal spacing creates a remarkably consistent, precise and durable diamond instrument

Friction Grip	KS Straight Chamfer	KS-0	KS-1	KS-2	KS-3	KS-4	KS-5	KS-6	End Cutting Safe Side Margin Refinement	10839-012	10839-014	10839-016	Pointed Football Lingual Reduction	368-016
Shape														
● Supercoarse	-	-	-	-	-	-	-	-	-	-	-	-	-	-
● Coarse	-	-	-	-	-	-	-	-	-	-	-	-	-	-
● Medium	91416-5	-	-	-	-	-	-	-	-	91145-5	91146-5	91147-5	-	91161-5
● Fine	-	-	-	-	-	-	-	-	-	-	-	-	-	91158-5
● Short Shank	-	91419-5	-	-	-	-	-	-	-	-	-	-	-	91160-5
														91159-5

Friction Grip	Football Occlusal Reduction	368-020	368-023	379-014	379-018	379-023	Mosquito Nose	392-016	Round	801-010	801-012	801-014	801-016	801-018
Shape														
● Supercoarse	-	-	91168-5	-	91176-5	91180-5	-	-	-	91185-5	91186-5	91188-5	91192-5	91193-5
● Coarse	91162-5	91165-5	-	91172-5	91173-5	91177-5	-	-	-	91001-5	91187-5	91189-5	91190-5	91004-5
● Medium	91164-5	91167-5	-	91171-5	91175-5	91179-5	-	-	-	-	-	-	91191-5	91003-5
● Fine	91163-5	91166-5	-	91170-5	91174-5	91178-5	91183-5	91184-5	-	-	-	-	-	-
● Very Fine	-	91169-5	-	-	-	91182-5	-	-	-	-	-	-	-	-
○ Ultra Fine	-	-	-	-	-	91181-5	-	-	-	-	-	-	-	-

Friction Grip	Inverted Cone	801-021	801-023	801-029	801-033	805-010	805-012	805-014	805-016	Barrel	811-033	811-037	Double Inverted Cone	813-014
Shape														
● Supercoarse	-	-	91197-5	91200-5	-	-	-	-	-	-	91207-5	91210-5	-	-
● Coarse	91006-5	91194-5	91198-5	91201-5	91009-5	91010-5	91011-5	91012-5	91012-5	-	91206-5	91208-5	91211-5	91212-5
● Medium	91005-5	91196-5	91199-5	-	91202-5	91203-5	91204-5	91205-5	-	-	-	91209-5	-	-
● Fine	-	91195-5	-	-	-	-	-	-	-	-	-	-	-	-

Friction Grip	Pear	813-016	830-008	830-010	830-012	Tri-Wheel Depth Cutter Veneer Depth Cuts	834-016	834-021	Flat End Cylinder Shoulder (Straight Cylinder)	835-010	835-014	836-010	836-012	836-014
Shape														
● Supercoarse	-	-	-	-	-	-	-	-	-	91220-5	-	-	-	-
● Coarse	91213-5	-	91214-5	91020-5	91021-5	-	91217-5	91218-5	-	91031-5	91221-5	91223-5	91033-5	91034-5
● Medium	-	-	-	91215-5	91216-5	-	-	-	-	91219-5	91222-5	-	-	-

Friction Grip	Cylinder	837-012	837-014	837-016	837KR-014	845KR-018	845KR-026	846KR-016	Flat End Cone	847-012	847-014	847-016	847-018
Shape													
● Supercoarse	-	-	91224-5	-	91225-5	-	-	91232-5	-	91234-5	91235-5	91237-5	91240-5
● Coarse	91035-5	91036-5	91037-5	-	-	91226-5	-	-	-	91233-5	91055-5	91056-5	91057-5
● Medium	-	-	-	-	-	91227-5	-	91231-5	-	-	-	91236-5	91239-5
● Fine	-	-	-	-	-	-	-	-	-	-	91112-5	91113-5	-
● Short Shank	-	-	-	-	-	-	91229-5	-	-	-	-	-	91238-5
● Short Shank	-	-	-	-	-	-	-	91230-5	-	-	-	-	-
● Shorter Than Short Shank	-	-	-	-	-	91228-5	-	-	-	-	-	-	-

Manufacturer part numbers are provided in these charts, please visit www.dhponline.com to convert or contact your DHPI Account Manager.

100% Satisfaction Guaranteed*

*SS White's 100% satisfaction guarantee is on all of our products. If you are not completely satisfied with your purchase, we will issue a full refund of the purchase price through Burkhart.

- Designed for maximum performance, while offering great value
- Exceeds ISO standards for concentricity creating a diamond that cuts smoother with greater tactile feel
- Uniform diamond sizing combined with optimal spacing creates a remarkably consistent, precise and durable diamond instrument

BURS

Friction Grip	Shape	Modified Shoulder		Flat End Taper Shoulder		Round End Taper Chamfer Tapered						
		847KR-016	847KR-018	848-016	848-018	850-012	850-014	850-016	850-018	850L-016	850L-022	850L-024
● Supercoarse		91244-5	91246-5	91247-5	91249-5	91251-5	91255-5	91259-5	91263-5	-	-	-
● Coarse		91241-5	91245-5	91058-5	91059-5	91250-5	91252-5	91256-5	91260-5	91264-5	91265-5	91266-5
● Medium		91243-5	-	-	91248-5	-	91254-5	91258-5	91262-5	-	-	-
● Fine		91242-5	-	-	-	-	91253-5	91257-5	91261-5	-	-	-

Friction Grip	Shape	Christmas Tree Breaking Contact		Round End Taper Chamfer Tapered									
		852-012	855-012	855-014	855-016	855-018	855-025	856-012	856-014	856-016	856-018	856-021	856-025
● Supercoarse		91270-5	91273-5	91274-5	91276-5	-	91280-5	91282-5	91287-5	91290-5	91294-5	91298-5	91302-5
● Coarse		91267-5	91271-5	-	91275-5	-	91279-5	91281-5	91283-5	91069-5	91070-5	91296-5	91299-5
● Medium		91269-5	-	-	-	-	-	-	91286-5	91068-5	91293-5	-	91301-5
● Fine		91268-5	-	-	-	-	-	-	91285-5	91116-5	91117-5	91297-5	-
● Short Shank		-	-	-	-	91278-5	-	-	91288-5	91291-5	91295-5	-	-
● Short Shank		-	91272-5	-	-	91277-5	-	-	91284-5	91289-5	91292-5	-	91300-5

Friction Grip	Shape	Round End Taper - Long Chamfer Tapered				Needle Breaking Contact								
		856L-014	856L-016	856L-018	856L-020	858-008	858-012	858-014	858-016	859-010	859-014	859-016	859-018	
● Supercoarse		91304-5	91306-5	91308-5	-	-	-	-	-	-	-	-	-	
● Coarse		91303-5	91305-5	91307-5	91309-5	-	-	91072-5	91319-5	91074-5	91322-5	91075-5	91077-5	
● Medium		-	-	-	-	91311-5	91314-5	91071-5	-	91321-5	91324-5	91326-5	91076-5	
● Fine		-	-	-	-	91310-5	91313-5	91118-5	-	91320-5	91323-5	91119-5	91327-5	
● Very Fine		-	-	-	-	91312-5	-	-	-	-	91325-5	-	-	
● Short Shank		-	-	-	-	-	-	91315-5	-	-	-	-	-	
● Short Shank		-	-	-	-	-	-	91316-5	-	-	-	-	-	
● Short Shank		-	-	-	-	-	-	91318-5	-	-	-	-	-	

Friction Grip	Shape	Flame Feather Edge										Curtage Modified Chamfer
		860-012	862-010	862-012	862-014	862-016	863-012	863-016	868-018	868-021	868-022	877K-016
● Supercoarse		91329-5	-	91335-5	91340-5	91341-5	91346-5	91348-5	-	-	-	91353-5
● Coarse		91328-5	91330-5	91083-5	91084-5	91085-5	91086-5	-	91091-5	-	-	-
● Medium		-	91332-5	91334-5	91339-5	91343-5	91345-5	-	91349-5	-	91351-5	91352-5
● Fine		91120-5	91331-5	91121-5	91338-5	91342-5	91344-5	-	-	-	91350-5	-
● Very Fine		-	-	91128-5	-	-	91347-5	-	-	91129-5	-	-
● Ultra Fine		-	-	91137-5	-	-	-	-	-	-	-	-
● Short Shank		-	-	91336-5	-	-	-	-	-	-	-	-
● Short Shank		-	-	91333-5	91337-5	-	-	-	-	-	-	-

Manufacturer part numbers are provided in these charts, please visit www.dhponline.com to convert or contact your DHPI Account Manager.

100% Satisfaction Guaranteed*

*SS White's 100% satisfaction guarantee is on all of our products. If you are not completely satisfied with your purchase, we will issue a full refund of the purchase price through Burkhart.

- Designed for maximum performance, while offering great value
- Exceeds ISO standards for concentricity creating a diamond that cuts smoother with greater tactile feel
- Uniform diamond sizing combined with optimal spacing creates a remarkably consistent, precise and durable diamond instrument

Friction Grip	Modified Beveled Cylinder Straight Cylinder	878-012	878-014	878-016	Curettage Modified Chamfer	878K-012	878K-014	878K-016	878K-018	878K-021	879K-016	879K-018	Round End Cylinder Straight Chamfer	880-014
Shape		91355-5	-	-		91361-5	91363-5	91365-5	91368-5	91371-5	91372-5	91373-5		-
● Supercoarse		91354-5	91356-5	91357-5		91359-5	91362-5	91364-5	91367-5	91370-5	-	-		91041-5
● Coarse		-	-	91358-5		91360-5	91097-5	91098-5	-	-	-	-		91374-5
● Medium		-	-	-		-	-	91366-5	91369-5	-	-	-		-
● Short Shank		-	-	-		-	-	-	-	-	-	-		-

Friction Grip	881-012	881-014	881-016	Bevel Cylinder Bevel	885-012	885-014	885-016	886-012	886-014	886-016	Flame	888-012	889-008	889-010
Shape		-	-	91376-5		91379-5	91383-5	91385-5	-	91392-5	-	-	-	-
● Supercoarse		-	-	-		91105-5	91381-5	91384-5	91387-5	91390-5	91106-5	-	-	-
● Coarse		91375-5	91043-5	-		91378-5	91382-5	91386-5	91388-5	91391-5	-	91394-5	91397-5	91395-5
● Medium		-	-	-		91377-5	-	-	-	-	-	91393-5	91396-5	-
● Fine		-	-	-		91380-5	-	-	-	-	-	-	-	-
● Short Shank		-	-	-		-	-	-	-	-	-	-	-	-

Friction Grip	Acorn	905-018	905-023	905-027	905-031	Wheel	909-035	909-036	909-040	909-042	Micro Prep Fissurotomy®	Fiss Original	Fiss NTF	Fiss STF
Shape		-	-	-	-		91025-5	91406-5	-	91410-5		-	-	-
● Supercoarse		-	-	-	-		-	-	-	91026-5		-	-	-
● Coarse		-	-	-	-		-	-	-	-		91411-5	-	-
● Medium		-	-	-	-		-	-	-	-		91412-5	91414-5	91415-5
● Fine		-	-	-	-		-	-	-	-		-	-	-
● Short Shank		-	-	-	-		-	-	91409-5	-		-	-	-
● Short Shank		91399-5	91401-5	91403-5	91405-5		-	-	91407-5	-		-	-	-
● Short Shank		91398-5	91400-5	91402-5	91404-5		-	-	91408-5	-		-	-	-
● Short Shank		-	-	-	-		-	-	-	-		91413-5	-	-

Friction Grip	Finishing	7901-009	7404-014	Safe End	SE3	SE6	SE9
Shape		91154-5	91156-5		91148-5	91150-5	91152-5
● Fine		91155-5	91157-5		91149-5	91151-5	91153-5
● Very Fine		-	-		-	-	-

Right Angle	Round End Taper	850-014-RA	850-016-RA	Slow Speed Round	801-018-RA	801-023-RA
Shape		-	-		-	91428-5
● Coarse		-	-		91426-5	91427-5
● Medium		91424-5	91425-5		-	91429-5
● Fine		-	-		-	-



Revelation Diamonds Documented Faster Cutting and Longer Life.

Dense, uniform diamond distribution insures fast, consistent cutting.

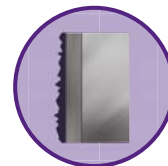

Three layer matrix results in an excellent service life and feel.

100% Satisfaction Guaranteed*

*SS White's 100% satisfaction guarantee is on all of our products. If you are not completely satisfied with your purchase, we will issue a full refund of the purchase price through DHPI.

Decrease Preparation Time,
Increase Preparation Quality

- Cut smoother and cooler due to the patented cross channel design.
- Allows for rapid gross reduction, reduces the need for final finishing.
- Tri-max matrix system increases durability maximizing service life.

5/pack.....\$84.95

BURS

	Cone, Flat End				Cone, Round End							
SHAPE	847-018	847-020	847-024	848-0202	849-012	849-018	849-022	854-018	855-014	855-018	855-023	856-016
FG	90972-5	90961-5	90962-5	90963-5	90953-5	90954-5	90956-5	90943-5	90944-5	90957-5	90958-5	90945-5

	Cone, Round End		Cylinder, Pointed End						Flame	Cylinder, Round End		
SHAPE	856-020	856-024	877-014	878-016	878K-020	879-018	885K-020	886K-023	865-018	880-014	881-016	882-018
FG	90959-5	90960-5	90945-5	90947-5	90971-5	90948-5	90964-5	90965-5	90966-5	90949-5	90950-5	90951-5

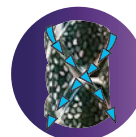

5/pack.....\$24.95

Single Use, Economical
FG - Friction Grip (Only)

100% Satisfaction Guaranteed*

Patented Dual Cross Channels

- Flush debris and reduce clogging for a faster, cooler cut.

	Flat End Taper				Round End Cylinder			Modified Beveled			Curettage			Football	Flame
SHAPE	847-018	847-020	847-024	848-020	880-014	881-016	882-018	877-014	878-016	878-018	878K-020	885K-020	886K-023	368-023	868-018
HEAD LENGTH	8.0	8.0	8.0	10.0	6.0	8.0	10.0	6.0	8.0	8.0	8.0	8.0	10.0	5.0	5.0
FG	8470182X	8470202X	8470242X	8480202X	8800142X	8810162X	8820182X	8770142X	8780162X	8780182X	878K0202X	885K0202X	886K0232X	3680182X	8680182X

	Round End Taper													
SHAPE	849-012	849-018	849-022	850-016	854-018	855-014	855-018	855-023	856-014	856-016	856-018	856L-018	856-020	856-024
HEAD LENGTH	4.0	4.0	4.0	10.0	10.0	6.0	6.0	6.0	8.0	8.0	8.0	9.0	8.0	8.0
FG	8490122X	8490182X	8490222X	8500162X	8540182X	8550142X	8550182X	8550232X	8560142X	8560162X	8560182X	856L0182X	8560202X	8560242X

Manufacturer part numbers are provided in these charts, please visit www.dhpionline.com to convert or contact your DHPI Account Manager.

100% Satisfaction Guaranteed*

*SS White's 100% satisfaction guarantee is on all of our products. If you are not completely satisfied with your purchase, we will issue a full refund of the purchase price through DHPI.

A Fresh Cut at a Fraction of the Price

Preparation quality is greatly increased when you use a new diamond for each patient.

	Pointed Football				Football			Mosquito Nose	Round							
SHAPE																
HEAD LENGTH	3.4	4.5	4.5	5.0	3.4	3.9	2.9	3.5	0.9	1.1	1.2	1.3	1.4	1.5	1.7	2.0
Super Coarse				368-023SC		379023SC										
Coarse	368016C	368020C	368021C	368023C	379018C	379023C				801012C		801014C		801016C	801018C	801021C
Medium	368016M		368021M	368023M	379018M	379023M		392016M	801010M	801012M	801013M	801014M	801015M	801016M	801018M	801021M
Fine	368016F	368020F	368021F	368023F	379018F	379023F	390014F	392016F			801013F	801014F	801015F	801016F	801018F	801021F
Very Fine	368016VF			368023VF		379023VF	390014VF	392016VF				801014VF			801018VF	
S (Short Shank)					379018CS											

	Round	Inverted Cone						Barrel		Double Inv. Cone	Depth Cutter		Tri-Wheel Depth Cutter		Depth Gauge
SHAPE															
HEAD LENGTH	2.2	1.1	1.2	1.4	1.6	4.0	5.0	5.0	7.0	1.8	0.9	0.9	6.0	6.0	0.6
Super Coarse	801023SC						811033SC	811037SC							
Coarse	801023C	805010C	805012C	805014C	805016C	807016C	807018C	811033C	813014C	801012C					
Medium	801023M	805010M	805012M	805014M	805016M					813014M	828022M	828026M	834016M	834021M	L06009M
Fine	801023F														
Very Fine	801023VF														
Ultra Fine	801023UF														

	Pear			Flat End Cylinder											Modified Flat End Cylinder	Flat End Taper	
SHAPE																	
HEAD LENGTH	2.5	3.0	3.0	3.0	3.0	3.0	4.0	4.0	6.0	6.0	8.0	8.0	8.0	8.0	4.0	4.0	
Super Coarse													837014SC				
Coarse	830008C	830010C	830012C	835008C	835009C	835010C	835012C	835014C	836012C	836014C	837012C	837014C	837016C	837KR014C	845010C	845012C	
Medium	830008M	830010M	830012M	835008M	835009M	835010M	835012M	835014M	836012M	836014M	837012M	837014M	837016M				
Fine														837KR014F			
S (Short Shank)						835010CS											
SS (Shorter than S)	830008MS	830010MS	830012MS														

	Christmas Tree		Needle								Flame				
SHAPE															
HEAD LENGTH	6.0	6.0	8.0	8.0	8.0	8.0	10.0	10.0	10.0	12.0	3.0	4.0	5.0	5.0	8.0
Super Coarse					858014SC										
Coarse	852010C				858014C	858016C	859010C	859014C		859018C	8600101C	860012C	860014C	860016C	862010C
Medium	852010M	852012M	858008M	858013M	858014M	858016M	859010M	859014M	859016M	859018M	860010M	860012M	860014M	860016M	862010M
Fine		852012F	858008F	858013F	858014F	858016F	859010F	859014F	859016F	859018F		860012F			862010F
Very Fine		852012VF	858008VF		858014VF			859014VF	859016VF	859018VF		860012VF			
SS (Short Shank)			858008FS		858014CS			859014CS		859018CS					

Manufacturer part numbers are provided in these charts, please visit www.dhponline.com to convert or contact your DHPI Account Manager.

BURS

100% Satisfaction Guaranteed*

*SS White's 100% satisfaction guarantee is on all of our products. If you are not completely satisfied with your purchase, we will issue a full refund of the purchase price through DHPI.

A Fresh Cut at a Fraction of the Price

Preparation quality is greatly increased when you use a new diamond for each patient.

Flame

SHAPE	862-012	862-014	862-016	862-017	862L-018	863-012	863-014	863-016	863-018	868-018	868-021	868-022	868-023	868-024	888-012	889-009	
HEAD LENGTH	8.0	8.0	8.0	8.0	9.0	10.0	10.0	10.0	10.0	5.0	5.0	5.0	5.0	5.0	7.0	4.0	
Super Coarse	862012SC	862014SC															888012SC
Coarse	862012C	862014C	862016C		862L018M	863012C	863014C	863016C	863018C	868018C							888012C
Medium	862012M	862014M	862016M	862017M	862L018M	863012M	863014M	863016M	863018M	868018M				868024M	888012M	889009M	
Fine	862012F	8620114F	862016F	862017F	862L018F	863012F	863014F	863016F	863018F			868022F	868023F		888012F		
Very Fine	862012VF		862016VF			863012VF					868021VF				888012VF		
S (Short Shank)	862012CS	862014CS	862016CS			863012CS		863016CS									
SS (Shorter than Short Shank)	862012CSS																
	862012MSS																

Modified Beveled Cylinder

Beveled Cylinder

Round End

SHAPE	877-010	877-012	878-012	878-014	878-016	879-012	879-014	879-016	885-012	885-014	885-016	886-012	886-014	886-016	838-010	838-012
HEAD LENGTH	6.0	6.0	8.0	8.0	8.0	10.0	10.0	10.0	8.0	8.0	8.0	10.0	10.0	10.0	4.0	4.0
Super Coarse															838010SC	838012SC
Coarse	877010C	877012C	878012C	878014C	878016C	879012C	879014C	879016C	885012C	885014C	885016C	886012C	886014C	886016C	838010C	
Medium	877010M	877012M	878012M	878014M	878016M	879012M	879014M	879016M	885012M	885014M	885016M	886012F	886014M	886016M		
Fine	8770100F	877012F	878012F	878014F	878016F	879012F	879014F	879016F	885012F	885014F	885016F	886012F	886014F	886016F		

Flat End Taper

Modified Flat End Taper

SHAPE	845-014	846-014	846-016	846-018	847-012	847-014	847-016	847-018	847L-014	847L-016	848-016	848-018	845KR-016	845KR-018	845KR-025	
HEAD LENGTH	4.0	6.0	6.0	6.0	8.0	8.0	8.0	8.0	9.0	10.0	10.0	10.0	4.0	4.0	4.0	
Super Coarse										848016SC	848018SC					
Coarse	845014C	846014C	846016C	846018C	847012C	847014C	847016C	847018C	847L014C	847L016C	848016C	848018C	845KR016C	845KR018C	845KR025C	
Medium		846014M	846016M	846018M	847012M	847014M	847016M	847018M	847L014M	847L016M	848016M	848018M		845KR018M	845KR025M	
Fine						847014F	847016F	847018F	847L014F	847L016F	848016F	848018F				
S (Short Shank)					847012CS	847014CS	847016CS	847018CS			848016CS	848018MS		845KR018CS		
SS (Shorter than Short Shank)						847014SCSS	847016SCSS	847018SCSS								

Modified Flat End Taper

Round End Taper

SHAPE	846KR-014	846KR-016	846KR-018	847KR-016	847KR-018	849-011	850-012	850-014	850-016	850-018	850-021	855-014	855-016	855-018	855-025	856-012	
HEAD LENGTH	6.0	6.0	6.0	8.0	8.0	4.0	10.0	10.0	10.0	10.0	10.0	6.0	6.0	6.0	7.0	8.0	
Super Coarse				847KR016SC	847KR018SC		850012SC	850014SC	850016SC	850018SC		855014SC	855016SC	855018SC	855025SC	856012SC	
Coarse	846KR014C	846KR016C	846KR018C	847KR016C	847KR018C		850012C	850014C	850016C	850018C	850021C	855014C	855016C	855018C	855025C	856012C	
Medium				847KR016M	847KR018M			850014M	850016M	850018M	850021M	8550114M	855016M			856012M	
Fine				847KR016F	847KR018F	849011F											
Very Fine						849011VF											
S (Short Shank)		846KR016CS		847KR016CS				850014MS	850016MS	850018MS		855014CS	855016MS	855018MS	855025MS	856012CS	
SS (Shorter than Short Shank)		846KR016CSS		847KR016CSS								855014CSS	855016CSS				
		846KR016MSS		847KR016CSS									855016MSS				

Manufacturer part numbers are provided in these charts, please visit www.dhpionline.com to convert or contact your DHPI Account Manager.

100% Satisfaction Guaranteed*

A Fresh Cut at a Fraction of the Price

Preparation quality is greatly increased when you use a new diamond for each patient.

*SS White's 100% satisfaction guarantee is on all of our products. If you are not completely satisfied with your purchase, we will issue a full refund of the purchase price through DHPI.

	Round End Taper							Round End Taper Long			Safe End Taper			Flat End Cylinder	Flat End Taper
SHAPE	856-014	856-016	856-018	856-020	856-021	856-024	856-025	856L-014	856L-016	856L-018	851-012	851-014	851-016	6051-017	6055-018
HEAD LENGTH	8.0	8.0	8.0	8.0	8.0	8.0	8.0	9.0	9.0	9.0	8.0	8.0	8.0	9.0	9.0
Super Coarse	856014SC	856016SC	856018SC		856021SC		856025SC	856L014SC	856L016SC	856L018SC					
Coarse	856014C	856016C	856018C	856020C	856021C	856024C	856025C	856L014C	856L016C	856L018C				6051017C	6055018C
Medium	856014M	856016M	856018M		856021M			856L014M	856L016M	856L018M	851012M		851016M		
Fine	856014F	856016F	856018F		856021F			856L014F	856L016F	856L018F	851012F	851014F	851016F		
Very Fine		856016VF													
S (Short Shank)		856016SCS													
	856014CS	856016CS	856018CS		856021CS		856025CS	856L014CS	856L016CS	856L018CS					
SS (Shorter than Short Shank)			856016SCSS				856024CSS								
		856016CSS													

	Round End Cylinder										Curettage			
SHAPE	880-010	880-012	880-014	881-009	881-010	881-012	881-014	881-016	881-018	882-010	877-016	878K-012	878K-014	878K016
HEAD LENGTH	6.0	6.0	6.0	8.0	8.0	8.0	8.0	8.0	8.0	10.0	6.0	8.0	8.0	8.0
Super Coarse								881016SC					878K014SC	878K016SC
Coarse	880101C	880012C	880014C	881009C		881012C	881014C		881018C		877K016C	878K012C	878K014C	878K016C
Medium	880010M	880012M	880014M		881010M	881012F	881014F	881016F			877K016M	878K012M	878K014M	878K016M
Fine	880010F	880012F	880014F		881010F	881012F	881014F	881016F			877K016F	878K012F	878K014F	878K016F
Very Fine								881016VF						
SS (Shorter than Short Shank)											877K016CSS			
											877K016MSS			

	Curettage							Acorn			Wheel				
SHAPE	878K-018	878K-021	879K-012	879K-014	879K-016	879K-017	879K-018	879K-021	905-023	905-027	905-031	909-033	909-035	909-040	909-042
HEAD LENGTH	8.0	8.0	10.0	10.0	10.0	10.0	10.0	10.0	2.5	2.9	2.9	1.4	1.5	1.23	1.2
Super Coarse	878K018SC													909040SC	
Coarse	878K018C	878K021C	879K012C	879K014C	879K016C		879K018C	879K021C				909033C	909035C	909040C	909042C
Medium	878K018M	878K021M	879K012M	879K014M	879K016M	879K017M	879K018M	879K021M	905023M	905027M	905031M			909040M	
Fine	878K018F	878K021F	879K012F	879K014F	879K016F	879K017F	879K018F	879K021F	905023F	905027F	905031F			909040F	

	KS					Finishing					Tissue Protective End		
SHAPE	KS03	KS13	KS23	KS33	KS35	SE3	SE4	SE6	SE8	SE9	10839-012	10839-014	10839-016
HEAD LENGTH	8.0	8.0	10.0	10.0	10.0	10.0	10.0	10.0	2.5	2.9	2.9	1.4	1.5
Super Coarse	KS03SC	KS13SC	KS23SC	KS33SC	KS35SC								
Medium						SE3M					18039012M	10839014M	10839016M
Fine						SE3F	SE4F	SE6F	SE8F	SE9F			
Very Fine						SE3VF	SE4VF	SE6VF	SE8VF	SE9VF			

Manufacturer part numbers are provided in these charts, please visit www.dhponline.com to convert or contact your DHPI Account Manager.



Round Bur Block, Magnetic

Autoclavable to 250°.

Small

Capacity: 7, Diameter: 1-5/8"

White	590-400BS1
Blue	590-400BS2
Yellow	590-400BS3
Green	590-400BS4
Flame	590-400BS5
Coral	590-400BS6
Beige	590-400BS7
Gray	590-400BS9
Mauve	590-400BS10
Black	590-400BS11
Aqua	590-400BS14
Each	\$6.95

Large

Capacity: 28, Diameter: 2-13/16"

White	590-400BL1
Blue	590-400BL2
Yellow	590-400BL3
Green	590-400BL4
Beige	590-400BL7
Gray	590-400BL9
Mauve	590-400BL10
Black	590-400BL11
Aqua	590-400BL14
Each	\$7.95

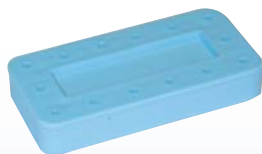

Rectangular Bur Block, Magnetic

Autoclavable to 250°.

Capacity: 14, 3" x 1-1/2" x 1/2"

White	590-400BR1
Blue	590-400BR2
Yellow	590-400BR3
Green	590-400BR4
Flame	590-400BR5
Beige	590-400BR7
Gray	590-400BR9
Mauve	590-400BR10
Black	590-400BR11
Aqua	590-400BR14
Each	\$6.95

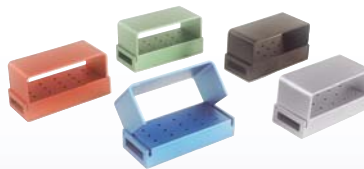

Aluminum Bur Blocks

The attractive 5 colors allow clinicians to organize their rotary instruments by procedure. Fully autoclavable aluminum blocks hold up to 15 FG burs. The use of bur blocks minimizes damage to instruments and reduces the likelihood of injury from sharp instruments, while creating ideal procedural organization.

Red	590-10001
Silver	590-10002
Blue	590-10003
Black	590-10004
Green	590-10005
Each	\$17.95



Bur Caddy - HealthSonics

Autoclavable to 325°F. Chemiclave or steam. Cover/handle swivels 360° with stops at each 45°. Staggered holes for easy viewing and access to burs/diamonds. No rinsing required when using HS Non-ionic Ultrasonic Solution.

12 FG

Beige	590-100038
Blue	590-100037
Coral	590-100040
Yellow	590-100039
Each	\$20.45

8 FG / 4 RA

Beige	590-100138
Blue	590-100137
Copper	590-50Z400U
Coral	590-100140
Yellow	590-100139
Each	\$20.45



Bur Blocks - Premier® Dental

Autoclavable, anodized aluminum. Patented design features center stabilizer plate. Secure snap-close lid.

Friction Grip - 18 Hole

Green	590-9051021
Blue	590-9051022
Each	\$31.25

Right Angle/Friction Grip - 17 Hole

Green 8 RA / 9 FG	590-9051024
Blue 8 RA / 9 FG	590-9051025
Each	\$34.45

HP Bur Block - 14 Hole

Red	590-9051030
Each	\$35.25

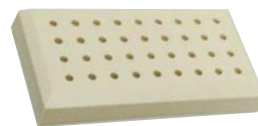

Thermo-Block - SSWhite®

Sterilization bur block with 36 holes. Made of heat resistant plastic. White.

FG	182-16392
HP/RA	182-16407
Each	\$13.95

BUR DEBRIDERS & CLEANERS



Midwest® Bur & Diamond Brush - Dentsply Midwest

Sterilizable brass wire brush ideal for debriement of carbide burs and diamonds. Features all-metal housing and a telescopic sleeve that enables adjustment of the exposed wire length.

181-380092	Each	\$32.95
------------	------------	----------------



Bur Cleaning Brushes - Grobet USA

Stainless Steel. Unique brush designed for fast and easy cleaning. Wire is firmly bound in plastic tubing which serves as a handle and can be cut away to expose more wire.

Without Handle 3" Long

760-16339	Each	\$4.75
-----------	------------	---------------

With Wood Handle 5" Long

760-16340	Each	\$6.75
-----------	------------	---------------



Clean-A-Diamond Stones - Premier® Dental

Use chairside to unclog coarse and medium grit diamonds. Extends life and restores rapid cutting. Autoclavable.

197-2014001	Each	\$19.45
-------------	------------	----------------



Clean-A-Diamond® Mini Squares - Premier® Dental

Recommended for coarse and medium grit preparation burs.

197-2014015	12/box	\$27.25
-------------	--------------	----------------

BUR HOLDERS / ORGANIZERS



Magnetic Bur Holder - Integra® Miltex®
 Made of nickel-plated steel.
 596-33810 Each..... **\$18.95**



Mesh Bur and Diamond Holder - Integra® Miltex®
 Securely holds FG, RA, HP burs, diamonds and other small items. Stainless steel design for use in all types of autoclaves.
 Small..... 711-6529
 Each **\$14.45**
 Large 711-6528
 Each **\$14.75**



Mesh Bur Holder - Palmero Health Care
 Stainless Steel. Closes tightly, allowing you to safely secure, clean and sterilize burs or any small objects during ultrasonic cleaning or sterilization. Safe for steam or dry heat. 6" long from end of handle to end of mesh cups. Mesh cup diameter is 1.75".
 710-1861 Each..... **\$7.25**



Rotary Bur Block Organizer - Palmero Health Care
 Made of clear plastic with a dome shaped cover

for visibility. Turns 360° for easy access to burs. Non-autoclavable.

60 Hole FG
 590-40 Each..... **\$49.75**
62 Hole Combo (18 FG/44 Latch)
 590-40A Each..... **\$49.75**



Bur Tray - Pascal International, Inc.
 Specially designed for cold sterilization of carbide burs and diamonds. A small opening in the lid allows you to drop in rotary and endodontic instruments without removing the lid. Lift-out basket for easy rinsing. Constructed of high impact plastic which is compatible with all sterilant disinfectant solutions. Outside dimensions: 2-5/8" H x 3" diameter.
 180-35695 Each..... **\$16.95**

BURS

ZIRC BUR BLOCKS & GUARDS

Steri-Bur Guards

- Fits FG, RA, and HP Burs
- Adjustable height for multiple-length burs (Surgical Bur Guard not adjustable)
- Holds bur in position for maximum cleaning effectiveness
- Drain holes help prevent rusting of burs



\$14.95 - 12-Hole Bur Guard
 Accommodates burs from 12mm-30mm.
 Dimensions: 7.3cm x 1cm x 3.5cm
 590-50Z406_ Available in all colors



\$15.95 - 22-Hole Bur Guard
 Accommodates burs from 12mm-30mm.
 Dimensions: 12.2cm x 1cm x 3.7cm
 590-50Z410_ Available in all colors

Magnetic Bur Blocks

- Fits FG, RA, and HP Burs
- Magnetic base holds burs securely
- Non-slip feet for stability
- Drain holes help prevent rusting of burs



\$13.45 - 8-Hole Bur Block
 Covers sold separately.
 Dimensions: 3.81cm x 3.81cm x 1.27cm
 590-50Z400_ Available in all colors

Bur Block Covers

- Covers available to maintain cleanliness of burs during storage
- 1" covers for FG and RA burs; 2" cover (14-hole only) for lab and surgical burs



\$6.45 - 8-Hole Bur Block
 Covers 1" High - Standard
 Dimensions: 4.13cm x 4.13cm x 2.54cm
 590-50Z401 Clear

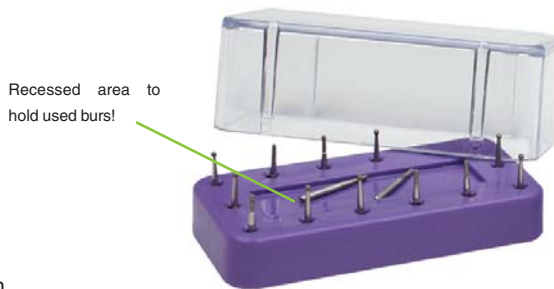

\$14.95 - 14-Hole Bur Block
 Covers sold separately.
 Dimensions: 7.46cm x 3.81cm x 1.27cm
 590-50Z403_ Available in all colors



\$6.45 - 14-Hole Bur Block
 Covers 1" High - Standard
 Dimensions: 7.94cm x 4.13cm x 2.54cm
 590-50Z404 Clear



\$6.45 - 14-Hole Bur Block
 Covers 2" High - For Surgical Burs
 Dimensions: 7.94cm x 4.13cm x 5.72cm
 590-50Z405 Clear



DENTIN SUBSTITUTE



Biodentine® - Septodont

Dentin substitute is used to treat damaged dentin in both the crown and the root with zero shrinkage. Treats permanent dentin restorations, deep cavities, pulp capping, pulpotomies, etc. in the crown and root perforations, pulpal floor perforations, internal/external resorptions in the root. In addition to treating damaged dentin, provides a number of clinical benefits including remineralization, preservation of pulp and prevention of clinical failures. 100% mineral material is close to human dentine, offering the same mechanical properties. Single dose containers.

200-01C0605 5/pack **\$91.45**
 210-C0600 15/pack **\$229.25**

CAVITY LINERS



Kerac™ Bond - 3M Oral Care

Biocompatible and radiopaque. Molecular bond to enamel and dentin for marginal integrity. High fluoride release.

Powder Refill - Yellow
 277-37330 10gm **\$100.95**

Liquid Refill
 277-37320 12ml **\$67.95**



Vitrebond™ - 3M Oral Care

A true light-cure glass ionomer that can be used as liner/base under a variety of restorations, including amalgam.

Intro Kit
 Contains: 9gm powder, 5.5ml liquid, spoon and 2 mixing pads.
 223-7510 Kit..... **\$305.95**

Refill Liquid
 223-7512L 5.5ml **\$180.95**

Refill Powder
 223-7512P 9gm **\$178.95**

Order by ☎ **800-626-2163**



Vitrebond™ Plus - 3M Oral Care

Light cure glass ionomer liner/base for use under both direct and indirect restorations.

Single Pack
 Contains: 10gm Clicker Dispenser, 1 large mixing pad and technique card.
 223-7571 Pack **\$224.95**

Double Pack
 Contains: 2 -10gm Clicker Dispensers, 1 large mixing pad and technique card.
 223-7572 Pack **\$370.95**



Dycal - Dentsply Caulk

Dycal radiopaque calcium hydroxide composition is a rigid, self-setting material useful in pulp-capping, and as a protective base/liner under dental filling materials.

Complete Package
 Contains: 13gm base, 11gm catalyst, 1 mixing pad, 1 mixing/placement instrument.
 Dentin Shade 208-623450
 Ivory Shade..... 208-623400
 Package **\$132.95**

Standard Package
 Contains: 13gm base, 11gm catalyst, 1 mixing pad.
 Dentin Shade 208-623802
 Ivory Shade..... 208-623801
 Package **\$91.25**

6 Pack
 Contains: 6 -13gm base, 6 -11gm catalyst, 4 mixing pads.
 Dentin Shade 208-623702
 Ivory Shade..... 208-623701
 Pack **\$445.95**

Placement Instrument
 208-623117 Each..... **\$43.95**



Prisma VLC Dycal - Dentsply Caulk

One component, light-cured calcium hydroxide base liner.

Standard Package
 Contains: 2 -4gm tubes and 1 transfer pad.
 208-654502 Package **\$182.45**



TimeLine - Dentsply Caulk

Visible light cure resin/liner with dentin primer. Fluoride releasing.

Refill Tube
 208-622155 4gm..... **\$192.45**



GC Fuji LINING™ LC - GC America

Offers a permanent, durable lining or base under all types of restorations with the convenience of light curing.

1:1 Package
 Contains: 10gm powder, 6.8ml liquid and accessories.
 272-434401 Package **\$259.45**

Powder
 272-000022 10gm **\$154.45**

Liquid Only
 272-434491 6.8ml **\$134.75**



GC Fuji LINING™ LC Paste Pak

Used as a liner or a base under composite resin or amalgam restorations.

Starter Kit available upon request.

Paste Pak Refill
 Contains: 7gm Paste Pak cartridge.
 272-001887 Each..... **\$185.45**

GC Paste Pak Dispenser
 272-001573 Each..... **\$96.25**



Life™ - Kerr Restoratives

A hard set calcium hydroxide base indicated for use as a direct and indirect pulp capping material and as a cement base under all restorative filling materials.

Contains: 12gm tube base, 12gm tube catalyst and 1 mixing pad.
 Regular Set..... 209-14500
 Each **\$83.75**

Fast Set available upon request.

CAVITY LINERS

**Cavitec™ - Kerr Restoratives**

Eugenol and zinc oxide liner. It can be used as a base under composite or amalgam fillings that can be completed immediately. Do not use Cavitec under self curing resin restorations. Also useful as a temporary stopping or filling agent and can be used for the temporary cementation of jacket crowns.

Standard Pack

Contains: 7gm tube accelerator, 19gm tube base and mixing pad.

209-00604 Pack **\$189.75**

**ACTIVA™ BioACTIVE BASE/LINER™ - Pulpdent Corporation**

The advantages of glass ionomers in a strong, resilient resin matrix that will not chip or crumble. Chemically bonds to teeth, seals against bacterial microleakage, releases more fluoride and is more bioactive than glass ionomers and is more durable and fracture resistant than composites. The first bioactive base/liner with an ionic resin matrix, a shock-absorbing resin component and bioactive fillers that mimic the physical and chemical properties of natural teeth. It releases and recharges with calcium, phosphate and fluoride ions delivering long-term benefits and better oral health care. No Bisphenol A, No Bis-GMA and no BPA derivatives.

Single Pack

Contains: 7gm syringe and 20 automix tips with bendable 20ga. metal cannula.

220-VB1 Pack **\$136.95**

Value Pack

Contains: 2 -7gm syringes and 40 automix tips with bendable 20ga. metal cannula.

220-VB2 Pack **\$244.95**

Automix Tips - 20ga.

230-A20N1 20/pack **\$28.45**

230-A50N1 50/pack **\$65.25**

**ACTIVA™ Kids - Pulpdent Corporation**

Esthetic, BioACTIVE resin restorative that stimulates apatite formation and the natural remineralization process with release and recharge of calcium, phosphate and fluoride. Opaque white shade ideally suited for pediatric dentistry.

Starter Kit

Contains: 8gm syringe Opaque White Shade, ACTIVA-SPENSER, 20 automix tips with bendable 20ga. metal cannula.

220-VKP Kit..... **\$185.25**

Single Refill

Contains: 8gm syringe Opaque White Shade and 20 automix tips with bendable 20ga. metal cannula.

220-VK1P Each..... **\$117.25**

Value Refill

Contains: 2 -8gm syringes Opaque White Shade and 40 automix tips with bendable 20ga. metal cannula.

220-VK2P Each..... **\$214.95**

ACTIVA-SPENSER

Dispenser for 8gm automix syringes.

230-DS05 Each..... **\$86.45**

**Lime-Lite™ - Pulpdent Corporation**

A light cure, fluoride releasing, cavity liner and base material specially formulated for use with adhesives, composites and conventional restorative materials.

Kit

Contains: 4 -1.2ml syringes and 8 applicator tips.

200-LIME Kit..... **\$52.45**

Syringe Refill

200-LIME3 3ml **\$28.95**

Applicator Tips

Prebent. 20ga. x 1/2". Pink.

230-LTL 100/pkg..... **\$22.45**

CAVITY VARNISH & SEALANT

**Bosworth Copaliner® - Keystone Industries**

Protects the dentin, penetrates, fills and seals the tubuli. Insulates against thermal and electrical shock and provides a strong bond between dentin and restoration. Prevents hyperaemia, death of pulp and discoloration, while providing an excellent marginal seal. Is scratch resistant, biologically mild and does not contain chloroform.

Varnish & Solvent Kit

Contains: 0.5oz. varnish and 0.5oz. solvent.

200-0921525 Kit..... **\$19.75**

Varnish

200-0921526 0.5oz **\$14.95**

Solvent

200-0921527 0.5oz **\$11.25**

**Copalite® Varnish - Temrex Corporation**

Cavity varnish with the deepest dentinal tubule penetration due to low viscosity and antimicrobial solvents. Hard resins protect pulp from irritating dental materials. Chemical cure.

Complete Set

Contains: 0.5oz. varnish and 0.5oz. solvent.

200-91120 Set **\$26.25**

Varnish

200-400001V 0.5oz **\$21.75**

Solvent/Thinner

200-400001S 0.5oz **\$16.95**

TEMPORARY FILLING MATERIALS

**Cavit™ - 3M Oral Care**

A self-curing, radiopaque temporary restorative with an extreme surface hardness for sealing endodontically treated preparations.

Contains: 10 -7gm tubes. Pink.

207-44351 Each..... **\$69.95**

Contains: 28gm jar. Pink.

207-44030 Each..... **\$30.25**

Cavit™ W

Reduced final hardness and increased adhesion for sealing endodontically treated preparations.

Contains: 10 -7gm tubes. White.

207-44350 Each..... **\$69.45**

Contains: 28gm jar. White.

207-44130 Each..... **\$30.25**

Cavit™ G

Quick and void-free curing in a moist environment. Slight expansion of the filling material ensures a well-seated margin.

Contains: 28gm jar.

200-44313 Each..... **\$30.25**

**Tempit - Centrix**

Premixed, ready-to-use temporary filling and sealing material in preloaded tubes. Hardens under saliva.

Contains: 30 -0.35gm prefilled tips.

200-310060 Each..... **\$66.95**

TEMPORARY FILLING MATERIALS



DuoTEMP™ - Coltene

A dual-cured, eugenol-free, temporary filling material including zinc oxide/zinc sulphate for optimal protection against infiltration of bacteria. A multi-purpose temporary filling material that can be cured by light and/or moisture. This allows the patient to immediately load the temporary filling.

Single Pack

204-C5831 5gm **\$25.75**

Eco Pack

Contains: 5 -5gm syringes.

204-C7090 Pack **\$105.25**



IRM® - Dentsply Caulk

ZOE intermediate restorative material. For intermediate restorations intended to remain in place for up to 1 year. Provides sedative-like qualities on hypersensitive tooth pulp.

IRM Package - Ivory

Contains: 38gm powder and 14ml liquid.

208-610007 Package **\$101.95**

Liquid

208-610004 14ml **\$40.75**

Powder

208-610003 38gm **\$67.45**

IRM Caps Package

Contains: 50 -0.34gm capsules.

208-610200 Package **\$148.45**



ZOE B&T - Dentsply Caulk

Polymer-reinforced zinc oxide-eugenol composition restorative material designed for intermediate restorations intended to remain in place for no longer than one year.

Standard Package

Contains: 25gm powder and 14ml liquid.

208-610103 Package **\$114.45**

Powder

208-610101 25gm **\$70.25**

Liquid

208-610102 14ml **\$47.95**



Telio CS Inlay/Onlay - Ivoclar Vivadent

Light-cured single-component materials for the temporary restoration of Class I and Class II cavities - without having to additionally use a temporary cement. Onlay offers excellent handling properties with extended working time and fast curing time. Easy and quick removal. Combines antibacterial and cariostatic agents.

Inlay

Contains: 3 -2.5gm syringes.

210-635332..... Universal

210-635335..... Transparent

Each **\$68.45**

Onlay

Contains: 3 -2.5gm syringes.

210-635339..... Universal

210-635338..... Transparent

Each **\$68.45**

Cavifil delivery format available upon request.



Cimpat S - Septodont

Can be used for the temporary restoration of cavities, in the intervals between tooth preparation and the permanent cementation of completed inlays, and as a cementing medium for all forms of temporary crowns. It is nontoxic and nonirritating to hard and soft tissue and can be used in close proximity to pulpal and gingival tissues. It adheres to dentin, expands slightly during setting and hardens rapidly to ensure a tight hermetical seal.

Contains: 4 -7.5gm syringes per package.

200-37 Package **\$66.45**



Interval - Temrex Corporation

Ideal for sealing endodontic access preparations. Quickly restores fractured or lost amalgam or composite restorations.

Contains: Syringe with 3 -6.5gm bars of material.

200-7500 Kit..... **\$18.75**

CEMENT - IMPLANT



Telio® CS Cem Implant - Ivoclar Vivadent

Dual-curing resin cement suitable for the semi-permanent cementation of crowns and bridges, as well as long-term temporaries. Offers a careful balance between retention and removability because the restoration will remain secure until removal is desired. Due to its eugenol free formula, it does not interact with materials that are used in the further treatment process.

Transparent..... 200-637510AN

Opaque 200-637509AN

Each **\$67.25**



Retrieve Implant Cement - Parkell Inc.

Provides long-term cementation of restoration to implant abutment. Allows removal of the restoration if necessary. No bonding, priming or etching required. Fully cured cement exhibits slight elasticity to reduce the chance of cracks and leakage. Convenient gel stage after two minutes for easy clean-up around the margins.

200-S250 5ml **\$61.75**



Implant Cement™ - Premier® Dental

Resin cement formulated for cementing implants. Highly retentive but easy to remove. Two-stage cure features gel-phase for removing excess cement and rigid final set for marginal seal and firm retention.

Standard Pack

Contains: 5ml automix dual-barrel syringe, 10 mixing tips, 1 mixing pad.

207-3001450 Pack **\$64.95**

Value Pack

Contains: 3 -5ml automix syringes, 25 mixing tips.

207-3001455 Pack **\$147.75**

Mixing Tips

207-3001451 Each..... **\$29.75**

PERMANENT CEMENT - COMPOMER

**PermaCem 2.0 - DMG America**

Universal, self-adhesive dual-cure composite luting cement for the permanent cementation of crowns, bridges, inlays, onlays, and root posts without the need for a separate enamel and dentin bonding agent, conditioner, or primer. Provides a strong reliable bond between enamel and dentine and all metal and ceramic substrates, particularly zirconium and aluminum oxide subs.

Contains: 9gm syringe, 15 short Smartmix tips and 5 (Endo M) Smartmix tips.

A2	110-213366
A3	110-213367
Transparent	110-213368
Each	\$140.75

PERMANENT CEMENT - COMPOSITE RESIN

**RelyX™ Unicem - 3M Oral Care**

A self-adhesive universal resin cement which uniquely combines the advantages of both conventional luting cements and resin cements. Also provides the esthetic properties required for use with all ceramic and composite restorations.

Aplicap Intro Kit available upon request.

Aplicap Capsule Trial Pack

Contains: 20 Aplicap capsules assorted, including 10 of A2 Universal, 16 of Translucent, 4 of A3 Opaque, activator/applier set for Aplicap.

223-56829 Pack **\$162.95**

Aplicap Refills

A1	223-56819
White Opaque	223-56820
20/pack	\$149.95
Translucent	223-56816
A3 Opaque	223-56817
A2 Universal	223-56818
50/pack	\$353.95

Aplicap Assorted Shades Refill

Contains: 50 Aplicap capsules: 24 of A2 Universal, 16 of Translucent, 10 of A3 Opaque.

223-56815 Each..... **\$353.95**

Aplicap Activator

223-73040 Each..... **\$79.75**

Maxicap Intro Kit available upon request.

Maxicap Refills

A2 Universal.....	223-56834
A3 Opaque.....	223-56833
Translucent	223-56832
20/pack	\$312.95

Maxicap Assorted Shades Refill

Contains: 20 Maxicap capsules: 10 of A2 Universal, 6 of Translucent and 4 of A3 Opaque.

223-56831 Each..... **\$312.95**

Applier

223-73050 Each..... **\$111.95**

**RelyX™ Unicem 2 - 3M Oral Care**

Self-Adhesive resin cement. Featuring enhancements to bond strength, mechanical properties, and esthetics; the innovative formulation delivers an even higher level of performance. The easy-to-use automix syringe provides easy handling and flexible dosing, saving treatment time.

Standard Refills

Contains: 8.5gm syringe, 10 mixing tips (regular), 5 mixing tips (wide), 5 endo tips.

Translucent	223-56848
A2 Universal	223-56846
A3 Opaque	223-56847
Each	\$152.95

Value Packs

Contains: 3 -8.5gm syringes, 30 mixing tips (regular), 20 mixing tips (wide), 15 endo tips, 5 intraoral tips.

Translucent	223-56858
A2 Universal	223-56849
Pack	\$381.95

Automix Tips - Regular

233-56851 30/pack **\$34.25**

Endo Tips

Contains: 15 automix mixing tips (endo) and 15 automix mixing tips (wide).

233-56919 Each..... **\$32.75**

**RelyX™ Unicem 2 Cement Clicker**

The easy-to-use Clicker delivery provides easy handling and reduced waste, saving treatment time.

Contains: 11gm Clicker dispenser and mixing pads.

Translucent	223-56874
A2 Universal.....	223-56875
A3 Opaque.....	223-56876
Each	\$272.95

**RelyX™ Ultimate - 3M Oral Care**

Provides ultimate high bond strength with few components. The cement offers ease of use, outstanding esthetics, tooth-like fluorescence, outstanding marginal integrity with faster and easier clean up. The easy-to-use automix syringe delivers convenience and allows for direct delivery into the crown.

Introductory Kit

Contains: 8.5gm syringe each: A3 Opaque, Bleach, A1, and Translucent cement. Mixing tips, 5ml Scotchbond Universal vial, 3ml etchant syringe, 25 dispensing tips, 50 mixing wells, 50 microbrushes, IFU and technique guide.

223-56891 Kit..... **\$639.95**

Trial Kit

Contains: 8.5gm syringe cement of A1, mixing tips, 1.5ml Scotchbond Universal adhesive vial, 3ml etchant syringe, 25 dispensing tips, 50 microbrushes, IFU and technique guide.

A1	223-56894
Translucent	223-56892
Kit	\$222.45

Refills

Contains: 8.5gm syringe, 10 regular mixing tips, 5 wide mixing tips and 5 intraoral mixing tips.

A1	223-56887
A3	223-56888
Bleach 0.5.....	223-56889
Translucent	223-56890
Each	\$188.95

Mixing Tips

Regular	233-56883
30/pack	\$40.75

Wide and Endo (10 each) 233-56885

Wide and Intraoral (10 each) ... 233-56886

20/pack
 \$40.75 |

LOOK'in

for something? **WE HAVE IT!**

www.dhponline.com

PERMANENT CEMENT - COMPOSITE RESIN



RelyX™ Veneer Cement & Try-In Paste - 3M Oral Care

A permanent light cured only resin luting material for indirect veneers. Light cure cement is stable, matching the cured final cement and provides excellent esthetic results. Clean-up is easy with both the water soluble Rely-X Try-in pastes and final light cure shades.

Intro Kit available upon request.

Trial Kit

Light cure cement is stable, matching the cured final cement and provides excellent esthetic results.

Contains: 3gm syringe in shade Translucent; 2gm syringe Try-In Paste in shade Translucent; 20 unit dose Scotchbond Universal Adhesive; 3ml syringe Scotchbond Universal Etchant; 25 etchant dispensing tips; technique cards, RelyX Veneer Shade Guide, instructions.

223-8716TK Kit..... **\$293.95**

Refills

Translucent 223-7614TR
 White Opaque 223-7614WO
 A1 Light Yellow 223-7614A1
 B0.5 White 223-7614B05
 3gm **\$95.95**

Try-In Paste Refills

Translucent 223-7614TRT
 White Opaque 223-7614WOT
 A1 Light Yellow 223-7614A1T
 B0.5 White 223-7614B05T
 2gm **\$75.95**

Additional shades available upon request.



Infinity Syringeable - DenMat

A self-adhesive, all-purpose cement that fulfills the properties necessary for cementation of porcelain-metal, zirconium, all ceramic, resin and ceramic inlay/onlays, cast metal and all types of posts. Formula syringes easily into place avoiding placement sensitivity by sealing dentin tubules, thus preventing post-operative sensitivity.

Intro Kit available upon request.

Syringeable Kit

Contains: 10gm syringe and 20 automix dispensing mixing tips.
 200-039670100 Kit..... **\$171.25**

Value Kit

Contains: 3 -10gm syringes and 60 automix dispensing tips.

200-039680100 Kit..... **\$430.45**

Mixing Tips

200-030795525 10/pack..... **\$9.25**



Comspan® - Dentsply Caulk

Composite luting cement for cast metal and resin bonded retainers.

Complete Radiopaque Package

Contains: 5gm each base and catalyst paste, 3ml self-cure bonding agent, 3ml self-cure catalyst liquid, 1 bottle Caulk 34% tooth conditioner gel and accessories.

Original 208-655100
 Opaque 208-655275
 Package **\$454.95**



Calibra Esthetic Resin Cement - Dentsply Caulk

Combines ease of use, excellent handling and Shade Stable chemistry in a versatile light cure/dual system. Perfect for inlays, onlays, veneers, crown and bridges.

Operatory Kit

Contains: 2 -2gm syringes base: 1 shade each of translucent and light, 2 -2gm syringes catalyst: 1 regular viscosity and 1 high viscosity, 4.5ml bottle Prime & Bond NT, 4.5ml bottle self cure activator, 3ml silane coupling agent, 25 disposable applicator needles, 1 mix stick, 1 brush handle, 40 disposable brush tips, 1 dispensing well, 1 mix pad, 1 light protection cover, 1 laminated directions for use.

228-607059 Kit..... **\$320.25**

Base Refills

Light..... 228-607061
 Medium..... 228-607062
 Translucent 228-607064
 Opaque..... 228-607065
 2gm **\$68.95**

Catalyst Refills

Regular Viscosity 228-607068
 High Viscosity 228-607069
 2gm **\$68.95**

Silane Coupling Agent Refill

Contains: 3ml syringe and 25 blue applicator tips.
 228-607080 Each..... **\$49.75**

Automix Syringe Refills available upon request.



Calibra UNIVERSAL - Dentsply Caulk

Two-component, dual-cure, high strength self-adhesive cement which contains fluoride. Combines esthetic shading with a self-etching adhesive, making it suitable for the permanent cementation of metal, PFM, resin/composite, ceramic and porcelain inlays, onlays, crowns and bridges and endodontic posts without application of a separate dentin/enamel adhesive bonding agent/system.

Contains: 2 -4.5gm syringes.

Light..... 228-607402
 Medium..... 228-607403
 Translucent 228-607405
 Each **\$138.75**

Additional shades available upon request.



SmartCem2 - Dentsply Caulk

Self-adhesive cement that offers excellent retentive and mechanical strengths, low film thickness, low solubility, and contains fluoride.

Introductory Kit available upon request.

Refills

Contain: 2 -5gm syringes and 20 mixing tips.
 Medium 208-669013
 Translucent 208-669015
 Each **\$172.75**

Additional shades available upon request.

Mixing Tips

208-669005 50/pkg..... **\$100.25**



Flexi-Flow - Essential Dental Systems

Patented, titanium and lanthanide reinforced, self curing, post and multi-purpose cements.

Flexi-Flow Sets

Contains: 9gm base, 9gm catalyst, 25 mixing tips, 25 intraoral tips.
 200-86000 Natural **\$139.45**
 200-85000 Cement **\$127.75**

Flexi-Flow Auto Set

Contains: 2 automix syringes (each containing 4.5gm base & 4.5gm catalyst), 20 intraoral tips.
 210-88000 Set **\$142.95**

PERMANENT CEMENT - COMPOSITE RESIN

**G-CEM™ - GC America**

Dual-cure self-adhesive resin cement in a capsule, designed for adhesive luting of all-ceramic, metal or composite indirect restorations. Saves time by eliminating steps.

Capsule Assortment Package

Contains: 50 individually packaged capsules in assortment of shades: 20 of A2, 20 of translucent shade, 5 of AO3, and 5 of BO1.

272-002588 Package **\$367.45**

Capsule Refills

A2 272-002584
AO3 272-002585
B01 272-002587
Translucent 272-002586
50/pack **\$367.45**

GC Capsule Applier III

272-437555 Each **\$114.25**

**G-CEM LinkAce™ - GC America**

High polymerization in self-cure mode. Exceptional color stability. Excess cement is easily removed in one piece after only a 1-2 second tack cure. High bond durability to zirconia restorations that actually increase over time.

Contains: 2 -4.6gm syringes, 15 regular automix tips and 5 automix tips for endo.

A2 200-004857
AO3 200-004859
Translucent 200-004858
BO1 200-004860
Each **\$147.95**

Automix Tips

272-002902 20/pkg **\$46.45**

Automix Tips for Endo

272-002903 10/pkg **\$45.25**

**Multilink® Automix - Ivoclar Vivadent**

A self-curing, luting composite with light-curing option used for the adhesive cementation of indirect restorations made of metal, all ceramics, metal ceramic and composite. Immediate bond to all surfaces, effective sealing of the dentin, universal application. Fast, easy application. Dual-Cure.

System Pack

Contains: 9gm automix syringe, 2 -3gm Primer A & B, 5gm Monobond Plus, 2.5gm Liquid Strip and accessories.

Transparent..... 220-627471
Opaque..... 220-627472
Yellow..... 220-627473
White 220-645954
Each **\$286.75**

Refills

Contains: 9gm automix syringe, and 15 mixing tips.

Transparent..... 220-615216
Yellow 220-615217
Opaque 220-615218
White 220-645952
Each **\$182.45**

Try-In Paste

Transparent 220-645956
Yellow..... 220-645957
White 220-645959
1.7gm **\$29.95**

Primer A & B

Contains: 2 -3gm A+B refill.
220-576825 50/pack **\$92.25**

Primer Refills

Refill A 220-613626
Refill B 220-613627
3gm **\$53.75**

Applicator Brushes - Regular & Endo

230-592435 50/pack **\$15.75**

Mixing Tips - Short Tapered

230-645951 15/pack **\$16.25**

Mixing Tips - Root Canal

230-645955 5/pack **\$9.95**

**Variolink Esthetic Cement - Ivoclar Vivadent**

An esthetic, light- and dual-curing luting composite for the permanent cementation of demanding ceramic and composite resin restorations. Exceptional handling and easy clean-up. Amine-free for long-term shade stability. Reliable bond strength results with a universal, easy to use bonding system.

Variolink Esthetic LC Pen System Kit available upon request.

Variolink Esthetic LC System Kit available upon request.

LC Refills

Contains: 2gm syringe and 5 application tips.
Light+ 220-666126WW
LC Warm 220-666129WW
Each **\$57.25**

DC System Kit

Contains: 3 -5gm automix syringes in Light, Neutral and Warm, 3 -1.7gm syringes Variolink Esthetic Try-In Paste In Light, Neutral and Warm, 2gm syringe Total Etch, 2ml Adhese Universal VivaPen, 5gm bottle Monobond Plus, 2.5 syringe Liquid Strip and accessories.
220-666434WW Kit..... **\$474.95**

DC Refills

Contains: 9gm syringe and 15 application tips.
Light..... 220-666122WW
Warm 220-666124WW
Neutral 220-666123WW
Each **\$192.95**

Try-In-Paste

Contains: 1.7gm syringe and 5 application tips.
Light 220-666113WW
Neutral 220-666114WW
Each **\$26.75**

Additional shades available upon request.

Mixing Tips - Short Tapered

230-645951 15/pkg. **\$16.25**

PERMANENT CEMENT - COMPOSITE RESIN



Resiment - Temrex Corporation

True dual cure chemistry with anaerobic accelerator assures complete polymerization under all restorations and in light transmitting fiber posts. Two stage curing allows easy clean-up of flash around crown margins.

Kit
 Contains: 5gm base, 5gm catalyst, 1 mixing pad and 2 mixing spatulas.
 Standard 820-RES2STD
 Fluoride 820-RES2FL
 Kit **\$119.45**



Maxcem Elite™ - Kerr Restoratives

A dual-cured self-etch/self-adhesive resin cement for indirect restorations. Refined with higher bond strengths and superior ease of use with easy cleanup, no hand mixing, and no refrigeration necessary.

Intro Kit
 Contains: 2 -5gm dual syringes clear, 5gm white, 16 -4:1 automix tips (regular), 8 -4:1 automix tips (wide), 8 intraoral tips, 8 root canal tips.
 209-34417 Kit..... **\$234.75**

Shade Refills

Contain: 2 -5gm dual syringes, 8 -4:1 automix tips (regular), 8 -4:1 automix tips (wide), 8 intraoral tips.
 Clear 209-33872
 White 209-33873
 Opaque 209-33874
 Yellow..... 209-33875
 Each **\$155.25**

Bulk Pack

Contains: 4 -5gm dual syringes clear, 16 -4:1 automix tips (regular), 8 -4:1 automix tips (wide), 8 intraoral tips, 8 root-canal tips.
 209-34418 Pack..... **\$231.95**

Automix Tips - 4:1 Wide

239-33879 10/pkg **\$10.25**

Intraoral Tips

239-33880 8/pkg **\$5.95**

Root Canal Tips

239-33881 10/pkg **\$5.95**



Maxcem Elite™ Chroma - Kerr Restoratives

Self-etch/self-adhesive resin cement offering a Color Cleanup Indicator, dispensing pink before fading at the gel state, telling you the optimal time to cleanup excess cement.

Bulk Kit available upon request.

Refills

Contains: 2 dual barrel syringes, 8 regular pink automix tips, 8 wide pink automix tips and 8 intraoral tips.
 Clear 200-36300
 White 200-36301
 Yellow..... 200-36302
 Each **\$177.75**

Mixing Tips

4:1, Regular, Pink.
 200-36303 50/pkg **\$57.45**



NX3 - Kerr Restoratives

Universally indicated for all indirect applications, a permanent resin cement with an innovative chemistry for unmatched esthetics, adhesion and great versatility. Delivery system choices include an automix syringe for dual-cure indications and a light-cure cement for multiple units where unlimited work time is needed. The automixing dual-cure cement can be used for all indirect applications, including veneers.

Intro Kit available upon request.

Automix Dual-Cure Syringe Refills

Clear 209-33643
 White 209-33644
 Yellow..... 209-33645
 Bleach..... 209-33646
 White Opaque..... 209-33647
 5gm **\$155.25**

Light-Cure Syringe Refills

Clear 209-33648
 White 209-33649
 White Opaque..... 209-33652
 1.8gm **\$81.45**

Try-In Gel

Clear 209-33656
 White 209-33657
 Bleach..... 209-33659
 3gm **\$48.45**

Additional shades available upon request.

Automix Tips

209-33655 50/pack **\$55.95**



NX3 XTR - Kerr Restoratives

Blends the versatility of NX3 Nexus 3rd Generation Universal with the adhesion superiority of OptiBond XTR Self-Etch. Delivers unrivaled clean-up and esthetics.

Contains: 5gm dual-cure syringe clear shade, 5ml OptiBond XTR Primer bottle, 5ml OptiBond XTR Adhesive bottle and 10 automix tips, 25 mix-wells, 50 Kerr applicator brushes.

209-35617 Kit..... **\$245.45**

**NOW YOU CAN
 BROWSE ALL
 CLEARANCE**

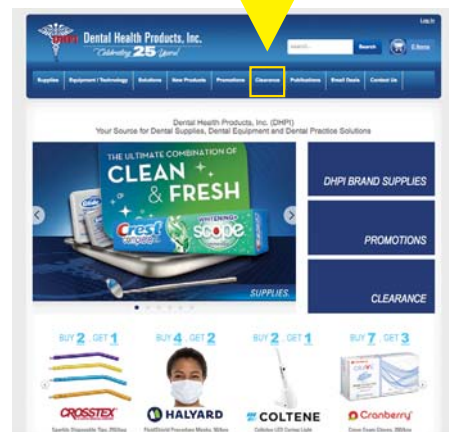

www.dhponline.com/clearance

**All Clearance
 Supplies are
 Discounted
 up to 25%,
 While Supplies Last!**

PERMANENT CEMENT - COMPOSITE RESIN



Clearfil Esthetic Cement EX - Kuraray America Inc.

Self-etch, dual-cure composite cement system developed for esthetic ceramic restorations, including veneers. The kit utilizes Clearfil DC Bond, a one-step, self-etch, dual-cure adhesive.

Standard Kit

Contains: 4.6gm syringe of paste A, 4.4gm syringe of paste B, 1.8ml Try-in Paste, 4ml Clearfil DC Bond Liquid A, 4ml Liquid B, 4ml Clearfil Ceramic primer, 4ml K-Etchant Gel, 5ml alloy primer, 20 mixing tips; 1 light-blocking plate; 1 mixing dish, 50 disposable brush tips (white); 50 disposable brush tips (black); 1 brush tip handle (white); 1 brush tip handle (black).

Universal	220-2901KA
Clear	220-2903KA
Opaque White	220-2904KA
Kit	\$382.75

Mini Kit

Contains: 2.4gm syringe of paste A, 2.3gm paste B, 1.8ml Try-in Paste, 1ml Clearfil DC Bond Liquid A, 1ml Liquid B, 2ml Clearfil Ceramic Primer, 10 mixing tips; 1 light-blocking plate; 1 mixing dish; 50 disposable brush tips (white); 1 brush tip handle (white).

Universal	220-2911KA
Clear	220-2913KA
Opaque White	220-2914KA
Kit	\$224.75

Refills

Contains: 1 double-syringe of 4.6gm Paste A, 4.4gm Paste B.

Universal.....	220-2921KA
Chroma	220-2922KA
Clear.....	220-2923KA
Opaque White	220-2924KA
Each	\$162.75



PANAVIA SA Cement Plus - Kuraray America Inc.

A self-adhesive, dual-cure, fluoride-releasing resin cement which provides an outstanding level of adhesion to enamel, dentin, metal, lithium disilicate and zirconia.

Handmix

Contains: 9.3gm syringe, 1 mixing spatula and 1 mixing pad.

Universal.....	200-3352KA
White	200-3353KA
Translucent	200-3354KA
Each	\$96.25

Automix

Contains: 8gm syringe of each Paste A & B and 20 mixing tips.

Universal	200-3382KA
White	200-3383KA
Translucent	200-3384KA
Each	\$113.95



PANAVIA™ F2.0 - Kuraray America Inc.

A self-etching, dual-cure, fluoride-releasing cement for use with metal; ceramics and metal-oxides (Zirconia) restorations.

Intro Kit available upon request.

Complete Kit

Contains: 2.3ml Panavia F2.0 A paste, 2.3ml Panavia F2.0 B paste, 4ml ED Primer II Liquid A, 4ml ED Primer II Liquid B, 4ml Clearfil Ceramic Primer, 5ml Alloy Primer, 6ml Oxyguard II and accessories.

Tooth Color Kit	210-501KA
White Kit	210-502KA
Opaque Kit.....	210-503KA
Light Kit.....	210-504KA
Kit	\$356.75

Clearfil Ceramic Primer

220-2550KA	4ml	\$106.75
------------	-----------	-----------------

Alloy Primer

220-213064	5ml	\$84.45
------------	-----------	----------------

Paste A Refill

210-493KA	2.3ml	\$80.75
-----------	-------------	----------------

Paste B Refills

Tooth Color	210-494KA
White	210-495KA
Opaque.....	210-496KA
Light.....	210-497KA
2.3ml	\$84.25

Oxyguard II

210-490KA	6ml	\$39.95
-----------	-----------	----------------

ED Primer II Liquid A

210-491KA	4ml	\$46.25
-----------	-----------	----------------

ED Primer II Liquid B

210-492KA	4ml	\$46.25
-----------	-----------	----------------



PANAVIA V5 - Kuraray America Inc.

Dual-cure, fluoride releasing, color-stable, esthetic universal cement with simplified placement. Exceptionally high bond strengths for all tooth structures in the self-cure mode. Natural fluorescence and virtually no post-cure color change.

Intro Kit

Contains: 4.2gm paste, 2ml tooth primer, 2ml Clearfil Ceramic Primer Plus, 10 mixing tips, 50 applicator brushes and 1 mixing dish.

Universal (A2)	200-3604KA
Clear	200-3605KA
Kit	\$147.95

Standard Kit available upon request.

Paste

Universal (A2)	200-3611KA
Clear	200-3612KA
4.6ml	\$162.25

Try-In Paste

Universal (A2)	200-3621KA
Clear	200-3622KA
1.8ml	\$38.75

Additional shades available upon request.

CLEARFIL Ceramic Primer Plus

200-3637KA	4ml	\$119.95
------------	-----------	-----------------

Mixing Tips

200-3626KA	20/pkg	\$16.45
------------	--------------	----------------

Endo Tips - Small

200-3629KA	20/pkg	\$20.75
------------	--------------	----------------



PANAVIA 21™ - Kuraray America Inc.

Bonds directly to metal and silanated surfaces and tooth structure.

Standard Kit

Contains: 4ml catalyst paste, 4ml universal paste, dispenser, ED Primer A & B 4ml each, 6ml Oxyguard II, 5ml Etching Agent V and accessories.

EX (White).....	210-2450
OP (Opaque)	210-2470
TC (Tooth Color)	210-2460
Kit	\$386.25

Paste Refill

Contains: 4ml catalyst and 4ml universal paste.

EX (White).....	210-2455
OP (Opaque)	210-2475
TC (Tooth Color)	210-2465
Each	\$217.75

ED Primer Liquid A

210-2121053	4ml	\$43.75
-------------	-----------	----------------

ED Primer Liquid B

210-2121054	4ml	\$43.75
-------------	-----------	----------------

Oxyguard II

230-212032	6ml	\$40.95
------------	-----------	----------------



C&B METABOND® Quick! - Parkell Inc.

Bonds several types of materials securely. Extremely versatile - ideal for dental emergency procedures and more. Features a longer working time and shorter set time, optimizing efficiency.

System

Contains: Liquid dentin activator, enamel gel etchant, Quick! Basic and Catalyst, Universal Gel Dentin Activator, Radiopaque Shade L and Clear L powders and ceramic mixing dish with temperature strip.

220-S380 System **\$480.45**

Radiopaque Tooth Shade Powder

220-S388 5gm **\$55.95**

Dentin Activator Gel

220-S394 5ml **\$24.95**

Dentin Activator Liquid

220-S393 6ml **\$26.75**

"B" Quick Base

220-S398 10ml **\$98.95**

Clear L-Powder

220-S399 3gm **\$41.45**



Breeze™ - Pentron Clinical

Specifically designed to make the cementation of crowns, bridges, inlays, onlays and posts faster and easier. Provides the strongest retention available in a self-adhesive cement with the quick and easy to use automix delivery system.

Intro Kit

Contains: 5 -4ml syringes (3 - A2, 1- Translucent, 1- Opaqueous White), 3ml bottle silane, 40 automix tips, 10 intraoral automix tips.

200-N97 Kit **\$352.25**

Refills

Contains: 4ml syringe & 12 automix tips.
 Translucent 200-N97A
 A2 200-N97B
 Opaqueous White 200-N97E
 Each **\$89.25**

Automix Tips

200-N33CA 50/pack **\$44.25**
 200-N33C 100/pack **\$80.45**



Cement-It™ Universal C&B™ - Pentron Clinical

Dual-cure resin cement designed for cementation of metal restorations, ceramic or indirect composite crowns, bridges, inlays/onlays, and posts. This system provides high strength bonding, ease of use, and reduced sensitivity.

Refills

Contains: 4ml syringe each of catalyst and base.
 A2 200-N33A
 Opaceous White 200-N33AB
 Transparent 200-N33AC
 Each **\$88.25**

Mixing Tips

200-N33CA 50/pack **\$44.25**
 200-N33C 100/pack **\$80.45**

Silane Refill

200-N04EA 3ml **\$23.25**



ACTIVA™ BioACTIVE-Cement - Pulpdent Corporation

An unparalleled combination of chemical and physical properties delivers bioactivity, toughness, resilience, durability and marginal integrity. Fracture resistant, absorbs shock. Insoluble. Releases and recharges calcium, phosphate and fluoride. No sensitivity. Safe for all your patients, its tissue compatible and contains no Bisphenol A, no Bis-GMA and no BPA derivatives.

Single Pack

Contains: 7gm syringe and 20 automix tips (15 straight black and 5 with bendable metal cannula).

Translucent 220-VC1T
 A2 Opaque 220-VC1A2
 Pack **\$117.25**



Embrace™ WetBond™ Resin Cement - Pulpdent Corporation

Dual cure, fluoride releasing, radiopaque. Unique technology bonds to the moist tooth. Margin-free, tooth integrating, eliminates microleakage. Low film thickness: 12 microns. Self-etching to dentin.

Self-adhesive: no primers, no silane, no bonding agents required. Color stable when cured.

Low Viscosity Kit available upon request.

Refill - Low Viscosity

Contains: 7gm cement and 20 automix tips.
 200-EMCAR Each **\$82.45**

Refill - Medium Viscosity

Contains: 7gm cement and 20 automix tips.
 200-EMCMR Each **\$82.45**



seT PP - SDI

Dual-cured all-in-one luting cement that etches, bonds, and fills with just one component. Does not require separate etching and washing which reduces post-operative sensitivity.

seT Capsules and Automix Syringe Assorted Kit available upon request.

Automix Syringe Refill

Contains: 2 -7gm automix syringe, 28 automix mixing tips.

A2 200-8805102
 OA3 200-8805103
 White Opaque 200-8805104
 Each **\$186.45**

Additional shades available upon request.



Adherence® DC - Septodont

Dual cure resin cement. Indicated for the final cementation of implant prosthesis, crowns and bridges, inlays and onlays, Maryland bridges and veneers. Radiopaque with high compressive and flexural strength and a low film thickness. Contains fluoride.

Syringe Kit

Contains: 5 -4gm automix syringes in shades: clear, white, yellow, brown and opaque and 25 mixing tips.
 200-C2000 Kit **\$174.95**

Automix Syringe Refills

Brown 200-C2008
 Clear 200-C2002
 White 200-C2004
 4gm **\$48.75**

PERMANENT CEMENT - COMPOSITE RESIN

**Adherence® SC - Septodont**

Permanent BIS-GMA self-curing resin cement used for many of your cementation needs. It can be used for the final cementation of crowns, including short or difficult crowns, bridges, inlays and onlays and Maryland bridges. A strong bond to metal, composite resin, enamel or dentin. Contains fluoride.

Syringe Kit

Contains: 2 -4.5gm automix syringes (1 base and 1 catalyst), 10 mixing tips, 1 mixing pad.
200-2003 Kit..... **\$113.95**

PERMANENT CEMENT - GLASS IONOMERS

**Ketac™ Cem Radiopaque - 3M Oral Care**

Radiopaque permanent glass ionomer luting cement. Fluoride releasing. Chemically bonds to enamel, dentin, gold and nonprecious metals. Excellent compressive strength 17,000 psi. Resists creep and minimizes microleakage.

Intro Kit

Contains: 33gm powder, 12ml liquid and mixing pad.
277-37201 Kit..... **\$163.95**

Triple Pack

Contains: 3 -33gm powder, 3 -12ml liquid, mixing pads.
277-37231 Pack..... **\$378.95**

Giant Pack

Contains: 10 -33gm bottles of powder, 10 -12ml vials of liquid and 5 mixing pads.
277-37251 Pack..... **\$1081.95**

Liquid Refill

277-37221 12ml..... **\$52.45**

Powder Refill

277-3721 33gm..... **\$131.95**

**Ketac™ Cem™ - 3M Oral Care**

Permanent glass ionomer luting cement that offers chemical bond to enamel and dentin. High biocompatibility. Releases Fluoride.

Aplicap Intro Kit available upon request.

Aplicap Refill

277-5606 50/box..... **\$270.95**

**Maxicap™**

Offers extended working time, predictable setting characteristics and is easy to apply. The capsule is activated, triturated for 10 seconds, then is expressed directly from the capsule into crowns and onto preparations or, if desired, onto the pad.

Intro Kit available upon request.

Maxicap Capsule Refill

277-5602 50/box..... **\$449.95**

Maxicap Applier

277-73071 Each..... **\$192.95**

Maxicap Activator

277-73060 Each..... **\$137.95**

**RelyX™ Luting Cement - 3M Oral Care**

Zero solubility combined with the benefits of a glass ionomer; sustained fluoride release, chemical adhesion, and ease of use, make this an exceptional permanent cement.

Intro Kit

Contains: 16gm powder, 9ml liquid, 2 mixing pads, spoon, technique guide and instructions.
223-3505 Kit..... **\$209.95**

Powder

223-3505P 16gm..... **\$110.95**

Liquid

223-3505L 9ml..... **\$110.95**

**RelyX™ Luting Plus Automix**

Self-mixing syringe delivery system.

Trial Kit

Contains: 8.5gm automix syringe, 12 mixing tips, technique guide.
223-3535TK Kit..... **\$91.95**

Value Pack

Contains: 3 -8.5gm automix syringes, 36 mixing tips, technique guide.
223-3535 Pack..... **\$241.95**

Automix Tips

233-3540 12/pack..... **\$12.75**

**RelyX™ Luting Plus Clicker™**

Automix delivery allows for direct delivery into the crown (no hand mixing). New tack light cure option for faster cleanup of excess cement. Sustained fluoride release for caries-prone patients. Virtually no post-operative sensitivity.

Trial Kit

Contains: 11gm Clicker Dispenser, technique guide.
223-3525TK Kit..... **\$170.95**

Refill

Contains: 2 -11gm Clicker Dispensers.
223-3525 Each..... **\$315.95**

**CeramiR® - Doxa Dental**

A new class of material called Nanostructurally Integrating Bioceramics (NIB). Creating a resilient, more natural, biocompatible luting cement that integrates with natural tooth structure, is stable in the mouth and exhibits tooth-like physical and mechanical properties.

Intro Kit

Contains: 10 -0.17ml QuikCaps and 1 applicator.
200-40031 Kit..... **\$98.95**

Capsules

200-40030 20/box..... **\$159.95**

Applicator

200-40020 Each..... **\$129.45**

**QuikMix**

Powder/liquid delivery format.

Contains: 15gm powder, 9ml liquid, 1 scoop and 1 mixing pad.
200-40032 Package..... **\$205.95**

Powder

200-40033 15gm..... **\$112.95**

Liquid

200-40034 9ml..... **\$112.95**



GC FujiCEM™ 2 - GC America

Radiopaque, fluoride-releasing, resin modified glass ionomer cement. The automix delivery system with mixing tip allows dispensing of the mixed cement directly into the restoration.

Starter Kit

Contains: 7.2ml (13.3gm) cartridge, 20 mixing tips and 1 GC FujiCEM 2 Dispenser.
270-441001 Kit..... **\$187.25**

Automix Package

Contains: 2 -7.2ml (13.3gm) cartridges and 42 mixing tips.
270-441000 Package **\$282.45**

Refill

Contains: 2 -7.2ml (13.3gm) cartridges and a #22 mixing pad.
270-441002 Each..... **\$266.45**

GC FujiCEM 2 Dispenser

272-004647 Each..... **\$32.45**

Automix Tips - White

300-431578 20/pkg **\$39.25**



GC Fuji PLUS® - GC America

Multifunctional, resin-reinforced with remarkable strength, sustained fluoride release, biocompatibility and ease of use. This translucent hybrid forms a strong chemical bond plus a micromechanical interlock between tooth structure and metal, amalgam, porcelain and composite restorations. Easy to mix, handle and place, and forgiving in a wet environment.

Powder Liquid 1:1:1 Kit

Contains: 15gm bottle powder, 7ml bottle liquid, 6.5ml bottle conditioner, mixing pad, spatula and scoop.
272-431011 Kit..... **\$199.75**

No Etch Package

Contains: 15gm bottle powder, 7ml bottle liquid, mixing pad and scoop.
272-431101 Package **\$159.45**

Powder

272-431012 15gm **\$100.25**

Liquid

272-431091 7ml **\$76.45**

Conditioner

272-433125 6.5ml **\$57.95**

Fuji PLUS Capsule Package

Contains: 48 capsules (0.36gm powder, 0.16ml liquid per capsule).
270-425030 Package **\$246.45**



GC Fuji I® - GC America

Glass ionomer luting cement for crowns, bridges, inlays and onlays, biocompatible, radiopaque, less water and absorption, smoother mixing.

1:1 Package

Contains: 20ml liquid, 35gm powder, mixing pads and scoop.
272-434011 Package **\$165.25**

Capsules

Light yellow.
270-425095 48/box **\$242.75**

Powder

270-901008 35gm **\$112.75**

Liquid

270-901009 25gm **\$56.45**



GC Fuji ORTHO™ - GC America

Self-cured bonding orthodontic cement formulated to be used in a wet field. Fluoride release for protection against enamel demineralization.

Standard Package

Contains: 40gm powder, 2 -6.8ml liquids, scoop and mixing pad.
272-439503 Package **\$394.75**

Liquid

272-439591 6.8ml **\$95.75**

Powder

272-439521 40gm **\$228.25**



GC Fuji ORTHO™ LC - GC America

The first light-cured, resin reinforced, glass ionomer for orthodontic bracket bonding. Now you can work faster and easier, and get the strength needed, without decalcification at debonding.

Intro Package

Contains: 15gm powder, 6.8ml liquid, scoop and mixing pad.
272-439401 Package **\$169.75**

Standard Package

Contains: 40gm powder, 2 -6.8ml liquids, scoop and mixing pad.
272-439403 Package **\$363.95**

Liquid

272-439409 6.8ml **\$94.75**

Powder

272-439421 40gm **\$223.75**

GC Ortho Conditioner

272-439425 25ml **\$63.45**

GC Fuji ORTHO LC Capsules

Starter Kit available upon request.

Capsule Package

272-439450 50/pkg. **\$304.95**

GC Capsule Applier III

272-437555 Each..... **\$114.25**

GC Fuji ORTHO LC Automix Cartridges

Starter Set available upon request.

Refill

Contains: 2 -13.3gm cartridges and 1 mixing pad.
272-003103 Each..... **\$334.25**

GC Fuji ORTHO Gel Conditioner

Contains: 3 -1.4gm syringes and 25 brush tips.
222-003104 Each..... **\$118.45**

Automix Tips

232-423008 20/pkg **\$53.95**



Nexus™ RMGI - Kerr Restoratives

Resin-modified glass ionomer luting cement. Provides an optimal get state and 2-3 second tack cure capability to ensure easier cleanup every time. Unique self-adhering paste/paste system delivers outstanding bond strength.

Kit

Contains: 3 -5gm dual syringes in Translucent White and 24 1:1 automix tips (Regular).
200-35640 Kit..... **\$154.25**

Automix Tips - 1:1 Wide

200-35650 8/pkg **\$8.75**

PERMANENT CEMENT - GLASS IONOMERS

**Riva Luting Plus - SDI**

A resin modified, self-curing, glass ionomer luting cement, designed for final cementation of metal, PFM and resin crowns, bridges, inlays and onlays plus ceramic inlays and crowns. Chemically bonds to dentin, enamel and all types of core material.

Powder/Liquid Kit available upon request.

Capsule Refill

200-8651008 50/pkg **\$228.45**

Liquid

200-8651900 10gm **\$68.95**

Powder

200-8651108 25gm **\$138.25**

**CX-Plus Glaslonomer - Shofu Dental Corporation**

Enhanced glass ionomer luting cement with prolonged working time. High resistance to compression. Low film thickness. High fluoride release.

Kit

Contains: 35gm powder, 17ml liquid, mixing pad, spatula and dispenser.

270-1166 Kit **\$122.45**

Triple Kit and Capsules available upon request.

Powder

270-1167 35gm **\$81.45**

Liquid

270-1168 17ml **\$47.25**

PERMANENT CEMENT - POLYCARBOXYLATE

**Durelon™ - 3M Oral Care**

With regular-set or fast-set powder, this fluoride-releasing, carboxylate luting cement attains a relatively neutral pH value that reduces post-cementation sensitivity. Low film thickness optimizes fit and marginal integrity of crowns and bridges. Adhesion to both enamel and dentin for reduced microleakage.

Intro Kit

Contains: 20gm powder, 4ml liquid, 1 measure scoop and mixing pad.

207-3801 Kit **\$125.95**

Triple Pack

Contains: 3 -20gm powder, 40ml liquid, 1 measuring scoop and 1 mixing pad.

207-38234 Pack **\$209.95**

Triple Pack Powder

Fast Set 207-38237

Regular Set 207-38236

60gm **\$100.95**

Liquid

207-38216 40gm **\$141.95**

**Durelon™ CD - 3M Oral Care**

Carboxylate Luting Cement provides strong molecular adhesion to both enamel and dentin for reduced microleakage. With regular-set or fast-set powder, this fluoride-releasing formula attains a relatively neutral pH value that reduces post-cementation sensitivity. Indications include cementing of crowns, bridges, inlays and onlays and procedures requiring cavity lining.

Intro Kit

Contains: 20gm bottle powder and 4 -14ml liquid calibrated dispensers.

207-38059 Kit **\$125.95**

Triple Pack CD

Contains: 60gm regular set powder and 4 -40ml dispensers of liquid CD and mixing pads.

207-38235 Pack **\$209.95**

Triple Pack Liquid CD

Contains: 40gm bottle of universal liquid, 12 dispensers and mixing pads.

207-3826 Pack **\$141.95**

**MASTER-DENT - Dentonics**

Permanent carboxylate type for cementation and cement base.

Kit

Contains: 60gm powder, 40gm liquid, mixing pad and scoop.

200-10300 Kit **\$33.25**

Powder and liquid available separately upon request.

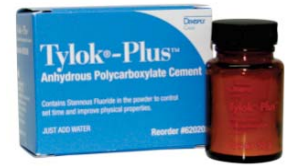
**Tylok - Plus - Dentsply Caulk**

An anhydrous polycarboxylate cement designed to be mixed with distilled water to activate the polyacrylic acid and initiate the setting reaction. It is indicated for cementation of inlays, onlays, full crown and bridges, fixed orthodontic bands and stainless steel crowns. May also be used as a restorative base or temporary restorative when mixed to a higher powder/water ratio.

Contains: 50gm powder, water dispenser, mixing pad and scoop.

208-620200 Each **\$234.95**

Powder

208-620201 50gm **\$199.95**

**HY-Bond™ Polycarboxylate Cement - Shofu Dental Corporation**

Contains tannin fluoride, which helps seal dentinal tubules, reducing post-operative sensitivity. Chemically bonds to tooth structure and metal appliance. High adhesive strength and extremely low film thickness.

Kit

Contains: 60gm powder, 33ml liquid, dispensers and instructions.

270-1160 Kit **\$124.25**

Powder and liquid available separately upon request.

PERMANENT CEMENT - ZINC PHOSPHATES

**Alpha-Dent® Zinc Phosphate Cement - Dental Technologies**

Specially formulated for superior strength, resistance to dissolution, and oral retention. They are impervious to oral fluids, and thus permanent under oral conditions.

Complete Kit

Contains: 32gm powder, 16.5ml liquid, measuring scoop and instructions.

Light Yellow 200-601000

Snow White 200-603000

Kit **\$9.45**

Powder and liquid available separately upon request.

PERMANENT CEMENT - ZINC PHOSPHATES



Fleck's Zinc Phosphate Cement - Keystone Industries

Zinc phosphate type cement ideal for permanent cementation of crowns and bridges, also used as a base liner.

Snow White.....	200-0050100
Light Yellow.....	200-0050200
Yellow.....	200-0050300
29gm	\$17.45

Ceramic Blend Powder

200-0051300	29gm.....	\$17.45
-------------	-----------	----------------

Liquid

200-0051400	15ml	\$17.45
200-0051700	35ml.....	\$23.25



HY-Bond™ Zinc Phosphate Cement - Shofu Dental Corporation

A superior zinc phosphate cement containing tannin fluoride and offering high compressive strength. Seals dentinal tubules and minimizes post-operative sensitivity. Excellent for seating permanent prostheses.

Kit

Contains: 60gm powder and 25ml liquid.		
220-1170	Kit.....	\$48.25

Powder and liquid available separately upon request.

PERMANENT CEMENT - ZOE



Fynal - Dentsply Caulk

Permanent ZOE cement for final cementation.

Complete Package

Contains: 32gm powder and 14ml liquid.		
208-609001	Package	\$158.95

Powder

208-609002	32gm.....	\$111.75
------------	-----------	-----------------

Liquid

208-609003	14ml	\$59.95
------------	------------	----------------



Bosworth SuperEBA™ Cement - Keystone Industries

An all-purpose alumina fortified material for final cementation as well as for use as a base and liner. Recognized as an excellent retro-fill material for applications during endodontic therapy.

Standard Kit

Contains: 15gm fast-set powder, 15gm regular-set powder, 6.5ml liquid, plastic measure scoop and liquid dropper.		
200-0921007	Kit.....	\$91.25

Powder and liquid available separately upon request.

TEMPORARY CEMENT



RelyX™ Temporary Cement - 3M Oral Care

Temporary cement for use in temporary luting of provisional and permanent restorations.

RelyX Temp NE Cement (Non-eugenol)

Contains: 36gm base paste, 16gm catalyst paste and 1 mixing pad.		
207-056660	Each.....	\$48.95

RelyX Temp E Cement (Eugenol)

Contains: 25gm base paste, 18gm catalyst paste and 1 mixing pad.		
223-35014	Each.....	\$53.95



NoMIX® Temporary Cement - Centrix

Single component, moisture activated, non-eugenol temporary cement designed for short-term cementation of crowns and bridges.

Starter Kit available upon request.

Syringe Refill Kit

Contains: 12 -1ml prefilled syringes and 60 syringe tips		
200-290040	Kit.....	\$118.95

Take Home Display Kit

Contains: 50 -0.50gm take home unit doses.		
200-310157	Kit.....	\$76.75



Integrity TempGrip - Dentsply Caulk

Zinc oxide non-eugenol temporary crown & bridge cement.

Refill

Contains: 2 -9gm syringes, 20 tips.		
208-666450	Each.....	\$120.25

Tips

208-666460	50/pack	\$87.25
------------	---------------	----------------



TempoCem - DMG America

Zinc oxide/eugenol temporary cement designed for use with all types of provisionals. The presence of eugenol provides a "sedative" effect on the pulp. Used for cementing a provisional restoration during the period between the tooth preparation and seating of the final crown. It is also excellent for cementing in a final restoration during a "try in" period.

Automix Refill Kit

Contains: 63gm cartridge and 40 automix tips.		
200-110300	Kit	\$164.95

TempoCem Automix Soft Refill Kit available upon request.

TempoCemNE

Non-eugenol formula used for cases where the final restoration will be cemented with a resin or resin-reinforced glass ionomer, because eugenol may inhibit resin polymerization.

Automix Refill Kit

Contains: 60gm cartridge and 40 automix tips.		
200-110302	Kit	\$164.95

Smartmix Kit

Contains: 2 -11gm syringes and 10 smartmix tips.		
200-212104	Kit.....	\$94.95

LOOK'in
for something? **WE HAVE IT!**
www.dhpionline.com

TEMPORARY CEMENT



GC TEMP Advantage® - GC America

Eugenol free zinc oxide temporary cement, contains fluoride, potassium nitrate and chlorhexidine. Used to retain provisional restorations for approximately 30 days while providing an excellent seal and maintaining low sensitivity to the patient. Working time of two minutes and a two minute self-cure. Its smooth consistency, low film thickness and quality make seating the restoration and clean-up simple.

Starter Package

Contains: 7.5gm syringe and 15 mixing tips.
202-136505 Package **\$53.75**

Bulk Package

Contains: 4 -7.5gm syringes (no tips).
202-136507 Package **\$110.25**

Mix Tips

202-136506 15/pack **\$21.75**



NOGENOL™ - GC America

Indicated for temporary cementation of plastic crowns or other provisional restorations. Possesses adequate adhesive strength to resist dislocation and leakage, yet allows for easy removal of crowns with KY pliers. Non-eugenol. Contains: 2 -30gm tubes base and 65gm tube catalyst.

292-136402 Package **\$107.25**



Telio CS Link - Ivoclar Vivadent

Dual-curing luting composite for the esthetic temporary cementation of provisional crowns, bridges, inlays, onlays and veneers. It's particularly suitable for incorporating temporary restorations in the anterior region. Eugenol-free, it's also perfectly suitable for use in conjunction with all-ceramic restorations or lab-fabricated composite restorations that are to be permanently

Contains: 2 -6gm double-push syringes and 10 mixing tips.
Transparent 210-627914
A3 210-627912
Each **\$109.75**



Temp Bond™ - Kerr Restoratives

Temporary cement for trial cementing restorations or cementing temporary crowns and bridges. Withstands mastication, seals the restoration and prevents seepage, yet affords easy removal when desired.

Automix Syringes

Contains: 2 -11.8gm syringes and 20 mixing tips.
209-33215 Pack **\$105.75**

Tubes

Contains: 50gm tube base and 15gm tube accelerator, 1 mixing pad.
209-00370 Pack **\$61.95**

Unidose

Contains: 50 -2.4gm unidose packets and 1 mixing pad.
209-31377 Pack **\$58.45**

Temp Bond NE

Non-eugenol temporary cement that will not inhibit the polymerization of permanent resin cements and acrylic temporaries.

Automix Syringes

Contains: 2 -1.7gm syringes, 20 mixing tips.
209-33217 Pack **\$105.75**

Tubes

Contains: 50gm tube base and 15gm tube accelerator, 1 mixing pad.
209-21370 Pack **\$61.95**

Unidose

Contains: 50 -2.4gm unidose packets and 1 mixing pad.
209-31973 Pack **\$58.45**

Temp Bond Clear with Triclosan

Contains: 6gm automix syringe and 10 mixing tips.

209-33351 Each **\$79.45**

Automix Tips Refill

209-33361 50/pack **\$54.25**

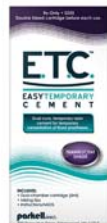

E.T.C. Easy Temporary Cement - Parkell Inc.

Strong adhesion to temporary prostheses. Low viscosity allows complete seating of temporaries. Translucent shade. Eugenol free.

Contains: 5ml automix syringe and 10 mixing tips.
200-S255 Each **\$54.25**

Mixing Tips - Brown Base

200-S292 30/pkg **\$32.45**



Embonte+ - Pentron Clinical

Features a standard zinc oxide eugenol (ZOE) formula that is rigid setting and strong. The cement can easily withstand mastication forces, but may be softened for use on long span bridges.

Automix Syringe

220-27203 5gm **\$45.45**



TempSpan™ - Pentron Clinical

Clear, dual cure, non-eugenol resin cement designed for the temporary cementation of provisional restorations in the esthetic zone. Transparent.

Contains: 6gm automix syringe with 12 mixing tips.

200-N69CB Pack **\$46.25**

Mixing Tips

200-N33CA 50/bag **\$44.25**
200-N33C 100/bag **\$80.45**



ZONE Temporary Cement - Pentron Clinical

Non-eugenol. Will not crack or craze acrylics, are non-toxic, and kind to tissue and nerve endings. Low in water solubility and are resistant to breakdown in the oral environment, thus providing long-lasting results.

Automix Syringe

A1 200-27046
Regular Shade 200-27047
4gm **\$43.45**

Dual Barrel Syringe

Regular Shade 200-27043
A1 200-27045
15gm **\$51.45**

Tubes Kit

Contains: base, catalyst and mixing pad.
200-27040 Kit **\$51.45**

Unit Dose

200-27039 25/pack **\$29.95**

TEMPORARY CEMENT



ZONEfree Temporary Cement - Pentron Clinical

Translucent zinc oxide, non-eugenol temporary dental cement. Ideal for temporary cementing of crowns, bridges, veneers, and all provisional needs. Made with color blending nanofillers which makes it ideal for esthetic cases as the cement blends easily next to any surface. 2 minute self cure set time.

Automix Syringe
200-27041 4gm \$52.25

Dual Barrel Syringe
200-27042 11.3gm \$60.25

Unit Dose available upon request.



NexTemp® - Premier® Dental

Non-Eugenol temporary resin cement. Contains fluoride, potassium nitrate and chlorhexidine. For crowns, bridges, inlays and onlays.

Standard Kit
Contains: 5ml automix dual-barrel syringe and 10 mixing tips.
207-3001471 Kit \$38.25

Bulk Pack
Contains: 4 -5ml automix dual-barrel syringes.
207-3001470 Pack \$79.75

Mixing Tips
207-3001451 25/pkg \$29.75



SensiTemp® - Sultan Healthcare

A high strength, all-purpose, non-eugenol desensitizing temporary cement for short- and long-term cementation of temporary restorations and permanent cementation of implant- retained crowns. 2-stage setting. Ninety seconds after dispensing, the material has a flexible, rubbery soft set. Within 4 to 5 minutes, it reaches its final

rigid set with a high compressive strength. It contains a potassium nitrate formula to help reduce post-operative tooth sensitivity.
Note: Do not use SensiTemp Resin with a resin based desensitizer or with a dentin bonding agent.

Automix Syringe
Contains: 5ml syringe, 10 mixing tips.
200-70010 Each \$55.25

Refill Cartridge
Contains: 25ml cartridge, 15 mixing tips.
200-70020 Each \$130.95

Blue Mixing Tips
200-70030 20/pack \$26.95
200-70035 50/pack \$72.45



TNE - Temrex Corporation

Non-eugenol temporary cement, based on diurethane dimethacrylate monomer. The chemistry imparts two important benefits: excellent biological compatibility and universal material compatibility for use with permanent cements and core build-up products.

Contains: 10gm syringe each Part A & B.
200-7700 Each \$67.75



Dual Syringe
Contains: 6gm dual syringe, 15 dispensing tips and 1 syringe of releasing agent.
200-7760 Each \$35.75

MIXING ACCESSORIES

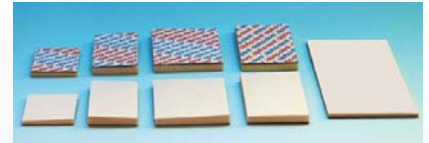

Mixing Pads
Dycal type, 1-1/2" x 2"
300-1502 Each 95¢

Durelon type, 2-3/4" x 3-3/4"
300-2343 Each \$2.25

3" x 3"
300-3030 Each \$2.25

3" x 3" Skid Resistant
300-3030SR Each \$2.25

Coe type, 3" x 4"
300-3040 Each \$2.25

3" x 6"
300-3060 Each \$2.75

3" x 6" Skid Resistant
300-3060SR Each \$2.95

Durelon Ortho type, 3-1/4" x 5"
300-3145 Each \$2.75

4" x 5"
300-4050 Each \$2.45

Impregum type, 5" x 7-1/2"
300-5075 Each \$3.75

Coe type, 6" x 6"
300-6060 Each \$3.95

Coe type, 6" x 6" Skid Resistant
300-6060SR Each \$4.25

Coe type, 6" x 9"
300-6090 Each \$4.95

6" x 9-1/2" Skid Resistant
300-6912SR Each \$4.95

Permlastic type, 7" x 8"
300-7080 Each \$4.95



Concise Mixing Pads - 3M Oral Care
2-1/2" x 3"
233-2530PAD 4/pkg \$41.25

MIXING ACCESSORIES



Impression Pads - 3M Oral Care

Durelon 3-1/2" x 2-1/2"
237-70145 Each..... \$11.75

3-1/2" x 6"
307-70129 Each..... \$8.95

4-3/4" x 7-1/2"
307-7013 Each..... \$11.75

5-3/4" x 9-1/4"
307-7018 Each..... \$19.25



Mixing Slab Glass - DiaDent®

#4 - 12mm x 5mm 75mm
Rounded edges.
300-78530 Each..... \$6.45

#10 - 150mm x 10mm x 75mm
Polished both sides, beveled edges.
300-78570 Each..... \$12.95

#10A - 150mm x 15mm x 80mm
Polished both sides, beveled edges.
300-78580 Each..... \$13.25

#2 - 76mm x 6mm x 65mm
300-78510 Each..... \$4.95

#3 - 112mm x 6mm x 76mm
300-78520 Each..... \$5.95



Mixing Pads - Pentron Clinical

Non-Slip

#0 XSmall 1-1/4" x 1-5/8"
230-1092 12/pkg..... \$27.45

#1 Small 2-9/16" x 3-1/4"
230-1093 8/pkg..... \$20.95

#2 Medium 3-1/4" x 5-1/8"
230-1094 4/pkg..... \$20.95

#3 Large 5-1/8" x 6-1/2"
230-1095 2/pkg..... \$20.95

#4 XLarge 6-1/2" x 8-1/16"
230-1096 1/pkg..... \$18.45



Jiffy Tubes - Water Pik, Inc.

Aid in the placement of cements, filling materials, and medicaments in difficult access areas.

Straight 230-51001
Curved 230-51002
30/box \$41.75

SOLVENTS



Liquid Orange Solvent - EPR Industries, LLC

With lanolin. Removes ZOE/impression material from hands and instruments.

300-OS 8oz \$7.45
300-OSQT Quart..... \$14.25



Ivoclean - Ivoclar Vivadent

Universal cleaning paste effectively cleans the bonding surfaces of prosthetic restorations after intraoral try-in and thus creates optimum prerequisites for the adhesive luting procedure.

200-637568 5gm..... \$37.25



Citrisol Orange Solvent Towelettes - Palmero Health Care

Two-ply premoistened orange solvent towelettes with lanolin. One side is abrasive to loosen dirt, the other side is smooth to wipe clean. 9.5" x 12".

300-69 70/canister \$19.95

Hold-It™ Canister Holder

Wall or cabinet mount accommodates all 5" diameter towelette containers. Mounting hardware included. Optional locking ring available separately. 6" x 5.625".

510-109 Each..... \$16.75



Cavidry™ - Parkell Inc.

Painlessly dries and degreases tooth preparations.

200-S099 4oz. \$19.25



Removalon® - I Dry Pak - Premier® Dental

Effectively removes set glass ionomer, carboxylate and zinc phosphate cements from instruments, ortho bands, crowns, inlays, facings, etc. Convenient to use and store. Environmentally friendly, biodegradable. Fills to 1/2 gallon.

207-9011005 6/pkg \$50.25



for something? **WE HAVE IT!**

www.dhpionline.com



Ketac™ Silver Glass Ionomer - 3M Oral Care

This silver glass ionomer contains no amalgam and offers high, long-term fluoride release as well as adhesion to enamel and dentin to ensure sealed, lasting restorations without the need for undercuts.

Introductory Kit available upon request.

Aplicap Refill

277-37010 50/pack**\$321.45**

Maxicap delivery format available upon request.



Vitremer™ Core Build-up - 3M Oral Care

Unique chemistry allows for bulk placement with no layering, immediate finishing, fluoride release, excellent physical properties and contrasting blue shade.

Mini Kit - Blue

Includes: 5gm blue powder, 2.5ml liquid, 2ml primer, 10 delivery tips and technique guide.

273-3303MPB Kit.....**\$261.95**

Powder - Blue

273-3303BL 9gm.....**\$181.95**

Powder - Pedo

273-3303PEDO 9gm.....**\$181.95**

Liquid Only

273-3303L 8ml**\$181.95**

Primer

273-3303P 6.5ml**\$239.95**

Finishing Gloss

273-3303FG 6.5ml**\$239.95**

Additional shades available upon request.



Encore® - Centrix

Specially designed for quick and easy C-R syringe placement. In minutes, it self-cures to a rock-solid hardness that cuts like dentin.

Contains: 25gm base, 25gm catalyst, 3ml Connexio Part A, 3ml Connexio Part B, needle tubes, micro applicators, mixing spatulas and mixing pad.

White w/fluoride 380-310070

White 380-310075

Natural w/fluoride 380-310076

Natural 380-310077

Kit**\$251.75**

Order by ☎ **800-626-2163**



Encore® D/C - Centrix

Dual-cure, for fast light-activation. Plus, the smaller size and ease of use will save you valuable chair time and reduce patient stress.

MiniMix

Contains: 36 -0.5ml cartridges and 72 mixing nozzles.

Natural 380-310254

Contrast 380-310255

Each**\$390.95**

MiniMix Nozzles

380-910630 10/pkg.**\$17.95**

Automix

Contains: 25ml cartridge, 10 mixing nozzles and 10 dispensing tips.

Natural 380-310150

Contrast 380-310152

Each**\$156.25**

Automix Nozzles

230-290025 144/pkg.**\$99.45**



RapidCore® - Centrix

Unit-dose, automix core build-up material with fluoride. This self-cure composite resin provides complete depth of cure, without light activation in only two minutes. Unit-dose dispensing provides for the fastest core build-up, without a heavy, clumsy automix syringe; and MiniMix technology virtually eliminates waste.

MiniMix

Contains: 12 -5gm cartridges with mixing nozzles.

White 380-310127

Natural 380-310126

Contrast 380-310128

Kit**\$197.95**

MiniMix Nozzles

380-910630 10/pkg.**\$17.95**

Available in automix delivery format upon request.



SuperCure® - Centrix

Light-activated composite resin core paste.

No mixing, no loading, no automix waste. Build-up your cores faster and easier. Just place a prefilled syringe tip in your C-R syringe and inject directly from package to mouth. Cures fast, cures deep, light activate in seconds.

☎ **www.dhponline.com**

Original SuperCure

Contains: 30 -0.50gm pre-filled syringe tips.

Natural Shade 380-310141

Contrast Shade 380-310143

Each**\$192.25**

C-R Snap-Fit Syringe

230-130650 Each**\$79.95**

SuperCure Q available upon request.



ParaCore® - Coltene

A dual-cured, glass reinforced composite resin, radiopaque composite system. 3-in-1 material simplifies the post & core restorative technique because it is ideal for post cementation, core build-ups and crown & bridge cementation. Use as a fixing and abutment material establishes an optimum "monoblock bond interface" between dentin, post and crown to produce a restoration with an unusually long life and very high strength.

Intro Kit

Contains: 2 -5ml syringes dentin, 2 -5ml syringes white, 3 -3ml ParaBond No Rinse Conditioner + Adhesive A & B and 20 mixing/root canal tips.

384-C5885 Kit.....**\$258.25**

Syringe Refills

Contains: 2 -5ml syringes and 20 mixing/root canal tips.

White 384-C5886

Dentin 384-C5887

Each**\$136.25**

Automix Refills

Contains: 25ml cartridge and 20 mixing/root canal tips.

White 384-C5854

Dentin 384-C5853

Each**\$216.25**

Mixing Tips - 5ml

384-C6747 40/pack**\$56.95**



Core Paste XP - DenMat

A creamy, radiopaque paste developed specifically for high-strength, reliable, core build-up. The stackable viscosity allows you to build up without a matrix or core form and the dual-cure formula gives you confidence of a self-cure with option of light curing.

Introductory Kit

Contains: 2 -2gm syringes of Core Paste XP Enamel w/fluoride, 6 mixing tips, 6 intraoral tips, Tenure A&B, Etch'N'Seal, 3 light cure test rings.

380-030657110 Kit.....**\$45.75**

Complete Kits

Contains: 4 -10gm syringes, 40 automix tips, 40 clear intraoral tips, 6 -18ga. intraoral tips, Tenure A&B bonding agent, Etch'N'Seal, 3 light cure test rings.

Enamel w/fluoride 380-030652110

Enamel 380-030653110

White w/fluoride 380-030655110

White 380-030654110

Kit**\$335.95**

☎ **Fax: 888-681-5088**

CORE MATERIALS



FluoroCore - Dentpsly Caulk

Fluoride releasing dual cure core build-up system. Enables clinicians to use one material for two consecutive parts of the same procedure. Post cementations can be immediately followed with core build-ups for an efficient and effective restorative procedure. If posts are not needed, can be used for just the core build-up prior to crown placement.

Standard Viscosity

Contains: 4.5gm syringe base and 4.5gm syringe catalyst.

- Blue Base 388-612321
- Tooth Color Base 388-612322
- Each **\$136.75**



FluoroCore 2+ - Dentpsly Caulk

Dual cure core build-up material plus fast endodontic post cement all-in-one procedure.

Syringe Intro Kit

Contains: 4 -4.75gm automix syringes (2 tooth colored, 2 blue colored), 2ml bottle of Xeno IV Adhesive, 2ml bottle of Prime & Bond NT, 2ml bottle Self Cure Activator, 25 mixing tips, 25 intraoral tips, 10 endo intraoral tips, dispensing well, 50 flocked applicator tips and 50 root canal applicator tips.

- 388-612400 Kit..... **\$207.75**

Syringe Refill Kits

Contains: 4 -4.75gm automix syringes, 25 mixing tips, 25 intraoral tips, 10 endo intraoral tips.

- Tooth Colored 388-612401
- Blue 388-612402
- Kit **\$205.75**

Mixing Tips

- 388-612500 25/pack **\$37.25**

Intraoral Tips

- 388-612501 25/pack **\$53.95**

Endo Intraoral Tips

- 388-612502 30/pack **\$53.95**



FluoroPost & Core System - Dentpsly Caulk

A 5-step, procedurally-minded treatment solution designed to efficiently complete the placement of an esthetic fiber post and core build-up.

FluoroPost Refills

Contains: 5 FluoroPost Endodontic Fiber Posts.

- Size #1 Yellow 340-611031

- Size #2 Red 340-611032
- Size #3 Blue..... 340-611033
- Size #4 Green 340-611034
- Each **\$74.45**

FluoroPost Precision Drill Refill Package available upon request.

FluoroPost Peeso Reamer Refill Package available upon request.



LuxaCore® Dual - DMG America

Choice of light-cure in as little as 20 seconds for maximum speed or allow the material to self-cure for increased working time. Radiopaque.

Automix Intro Kits available upon request.

Automix Refill

Contains: 50gm cartridge, 35 automix tips and 35 intraoral tips.

- White 380-212126
- A3 Natural..... 380-212011
- Blue 380-212012
- Each **\$216.45**

Automix Applicator Gun Type 25

For use with 25ml cartridges.

- 200-110253 Each..... **\$241.25**

Automix Tips

Contains: 35 automix tips and 35 intraoral tips.

- 380-110424 70/pack..... **\$68.75**

Smartmix

Contains: 2 -9gm syringes, 10 Smartmix tips, 10 intraoral tips.

- White 380-212064
- A3 Natural..... 380-212039
- Blue 380-212038
- Each **\$155.25**

Smartmix Tips

Contains: 50 core tips and 50 intraoral tips.

- 230-212042 100/pkg..... **\$98.95**



LuxaCore® Z-Dual - DMG America

A dual-curing composite with zirconium dioxide and nano-technology for core build-ups and endodontic post cementations.

Automix

Contains: 48gm cartridge, 30 yellow automix tips, 20 yellow intraoral tips and 10 yellow endo tips.

- A3 380-213330
- Blue 380-213331
- Light Opaque 380-213332
- Each **\$227.95**

Smartmix

Contains: 2 -9gm syringes, 10 Smartmix tips, 10 intraoral tips.

- A3 380-213334
- Blue 380-213335
- Light Opaque 380-213336
- Each **\$164.25**



Ti-Core - Essential Dental Systems

Patented, titanium and lanthanide reinforced composite material that matches the strength of dentin. Resists the ditching and grooving during preparation common to composite, glass and resin ionomer core build-up materials.

Contains: 14gm base, 15gm catalyst, mixing pad and plastic spatulas.

- Fast Set Gray 380-80500
- Gray w/fluoride 380-80000
- A3 Natural w/fluoride 380-81000
- A3 Natural Fast Set w/fluoride 380-81500
- Each **\$156.25**

Ti-Core Auto E

Flowable dual cured composite material in Shade Vita A2.

Contains: 4.5gm automix syringe base, 4.5gm automix syringe catalyst, 20 mixing tips and 20 intraoral tips.

- 210-83000 Each..... **\$139.95**

Ti-Core Flow+

Fluoride releasing, dual cured, resin composite core build-up material and post cement all in one. Shade Vita A2.

Contains: 4.5gm automix syringe base, 4.5gm automix syringe catalyst, 20 mixing tips and 20 intraoral tips.

- 210-83200 Each..... **\$153.75**

Intraoral Tips

- 210-83020 20/pkg..... **\$42.25**



Miracle Mix® - GC America

A combination of glass ionomer and spherical amalgam alloy powder. Fluoride release, chemical bonding.

Powder - Liquid Kit

Contains: 15gm powder, 8ml liquid and 17gm alloy powder.

- 272-437001 Kit..... **\$303.95**

Powder

- 272-437015 15gm **\$148.95**

Liquid

- 272-437091 8ml **\$69.75**

Miracle Mix Alloy Powder

- 272-437092 17gm **\$124.95**

Miracle Mix Capsules

- 270-452100 40/box **\$325.75**

CORE MATERIALS



MultiCore Flow - Ivoclar Vivadent

Self-curing core build-up composite. Two techniques and two curing methods provide an optimum foundation for the reconstruction of vital and non-vital teeth with part or most of the clinical crown missing.

Contains: 10gm syringe, 10 mixing tips, 10 intraoral tips and flow chart.

Light.....	380-604166
Medium.....	380-604167
White.....	380-604168
Each.....	\$96.25

Syringe Mixing Tips

380-604209	10/pkg.....	\$13.75
------------	-------------	----------------

Syringe Intraoral Mixing Tips

380-604210	10/pkg.....	\$6.25
------------	-------------	---------------

Available in cartridge delivery format upon request.



CLEARFIL DC CORE PLUS - Kuraray America Inc.

Dual-cure, radiopaque, two-component core build-up material supplied in a convenient auto-mix delivery system. Can be used for core build-up of vital and non-vital teeth.

Contains: 4.5ml automix syringe Paste A and B, 20 mixing tips; 10 guide tips (L) and 10 guide tips (S).

Dentin Shade Kit.....	380-2942KA
White Shade Kit.....	380-2943KA
Kit.....	\$171.45

Mixing Tips

380-1031KA	20/pack.....	\$30.75
------------	--------------	----------------

CLEARFIL Dispenser - 10ml

210-2832KA	Each.....	\$107.95
------------	-----------	-----------------



CLEARFIL PHOTO CORE - Kuraray America Inc.

Composite resin core material capable of light curing to a depth of 9mm, eliminates incremental build-ups. Polymerizes quickly and thoroughly to a hardness that approximates human dentin.

Syringe Kit

Contains: 3 -4.4gm syringes.

380-212355	Kit.....	\$119.25
------------	----------	-----------------

Syringe Refill

380-356KA	4.4gm.....	\$53.25
-----------	------------	----------------

CLEARFIL PHOTO CORE PLT

Contains: 30 -0.4gm compules.

380-366KA	Each.....	\$210.45
-----------	-----------	-----------------

K-etchant GEL

220-212013	6ml.....	\$16.45
------------	----------	----------------



Absolute Dentin™ - Parkell, Inc.

No BPA used in manufacturing. Cuts like dentin. Dual cure. Low viscosity. Automix. Radiopaque, 200% of aluminum. No dispensing gun needed.

Cartridge Kits

Contains: 50ml cartridge in split cartridge with mixing tips and intraoral tips.

Arctic White.....	290-S300
Tooth Shade.....	290-S301
Blue.....	290-S307
Kit.....	\$185.25

10ml cartridge delivery format available upon request.

Mixing Tips - Yellow

380-S302	30/pack.....	\$32.45
----------	--------------	----------------



Build-It™ FR Fiber Reinforced Core Material - Pentron Clinical

Formulated to flow and stack without slumping, its unique viscosity enables it to be used as a post cement. Specially treated glass fibers give it a compressive strength of 329 MPa for strong and reliable foundation for indirect restorations.

Kit

Contains: 25ml automix cartridge A2, Build-It FR Dispensing Gun, instructions and accessories.

380-N32	Kit.....	\$227.25
---------	----------	-----------------

Refills

Contains: 25ml automix cartridge, 20 mixing tips and 20 intraoral tips.

A2.....	380-N32AA
A3.....	380-N32AE
Blue.....	380-N32AC
Opaceous White.....	380-N32AD
Gold.....	380-N32AB
Each.....	\$148.45

Wastesaver Tips - Blue

380-N32E	48/pack.....	\$43.45
----------	--------------	----------------

Intraoral Tips - Yellow

380-N32D	48/pack.....	\$34.45
----------	--------------	----------------

Mini-Mix Kit

Contains: 5 -4ml syringes (A2, A3, Blue, Gold, & Opaceous White) and accessories.

380-N32F	Kit.....	\$141.75
----------	----------	-----------------

Mini-Mix Refills

Contains: 4 -4ml syringes, 20 mixing tips and 20 intraoral tips.

A2.....	380-N32FA
A3.....	380-N32FB
Blue.....	380-N32FD
Opaceous White.....	380-N32FE
Each.....	\$130.95

Mix & Intraoral Tips

380-N32GA	48/pack.....	\$49.95
380-N32GB	100/pack.....	\$91.45

Auto-Mix Syringe Dispenser Gun - 1:1

380-N75S	Each.....	\$87.95
----------	-----------	----------------



Build-It™ Light Cure Core Material - Pentron Clinical

Specifically designed for clinicians that favor the on-command cure afforded by light cure core materials. The high translucency enables a 10mm depth of cure without the need of building up incremental layers with as little as 20 seconds curing time per surface.

Syringe Kit

Contains: 2 -2.2ml syringes and instructions.

380-N32T	Kit.....	\$59.75
----------	----------	----------------

Single Dose Kit

Contains: 30 -0.25gm single doses and instructions.

380-N32U	Kit.....	\$80.45
----------	----------	----------------

Dispenser Gun - Single Dose

300-N75A	Each.....	\$74.25
----------	-----------	----------------



for something? **WE HAVE IT!**

www.dhponline.com

CORE MATERIALS



CompCore™ - Premier® Dental

Smooth flowing, syringeable, composite core build-up material with fluoride. No slumping and self-cures in only 3 minutes to save chair time. Radiopaque. Handmix.

Shade Kit

Contains: 28gm base and catalyst, mixing pads and spatulas.

White 387-3001402

Natural 387-3001405

Kit **\$119.25**

Economy Kit available upon request.



CompCore™ AF Dual-Cure - Premier® Dental

Greater translucency presents a more natural tooth appearance which minimizes the chance of shadows under ceramic crowns.

Cartridge Refills

Contains: 50gm cartridge, 10 ACCOR Matrices, 25 mix tips and 25 intraoral tips.

Shade White 387-3001432

Shade A3 387-3001433

Each **\$167.95**

Cartridge STACK Dual-Cure/Automix available upon request.

Cartridge Mix Tips & Intraoral Tips

387-3001417 35/pkg..... **\$54.45**

ACCOR Matrices - Multi-Sized

807-9048081 50/pkg..... **\$36.75**

Applicator Gun Type-25

387-3001416 Each..... **\$142.25**

SyringeMix STACK Dual-Cure/Automix

Contains: 2 -9gm automix syringes, 15 mix tips, 15 standard intraoral tips and 10 extra fine intraoral tips.

White 387-3001512

A3 387-3001513

Blue 387-3001514

Each **\$117.45**

Twist STACK Auto-Cure Syringe Hand-Mix available upon request.

SyringeMix Mix Tips & Intraoral Tips

387-3001418 35/pkg..... **\$62.45**

SyringeMix Extra-Fine Intraoral Tips

387-3001468 50/pkg..... **\$28.95**



Spee-Dee™ Build-Up - Pulpdent Corporation

Formulated for one-step post cementation and core build up, ensuring a homogenous, one-piece internal structure. Unique moisture tolerant chemistry has self-adhesive and self-etching properties.

Contains: 50ml automix cartridge and 30 automix tips.

380-SBU50 Each..... **\$168.95**

Automix Tips plus Intraoral Tips

380-FD20 20/pkg..... **\$27.95**



Getz® Blue Core Crown Build-Up Material - Water Pik, Inc.

A small particle, radiopaque, light-cured composite core material that cures to a depth of 6mm in 30 seconds.

380-41418 5gm..... **\$67.95**



Cut through the fat

GO DIRECTLY TO THE BEST

Manufacturers offer thousands of promotions. GO **DIRECTLY** TO THE BEST.

www.dhpionline.com/promotions

BUY 1	BUY 2	BUY 3	BUY 4 <small>OR MORE</small>	DHPI X <small>EXCLUSIVE OFFERS</small>
--------------	--------------	--------------	--	--



Universal Bond Refill

Light cure adhesive resin system designed to bond to enamel and dentin after acid etching.
220-HT60B 5ml**\$80.95**



Adper™ Easy Bond - 3M Oral Care

A one-step, one-coat self-etch adhesive that provides a fast and easy application, along with strong bonds. Reduces risk of post-operative sensitivity. High marginal integrity and low micro-leakage. Moisture tolerant - works well on wet or dry enamel and dentin.
223-41246 5ml **\$159.95**



Adper™ Scotchbond™ Multi-Purpose - 3M Oral Care

A light-cure system that is designed to handle difficult bonding situations, is fast and easy to apply and offers excellent bonds to a variety of surfaces.

Introductory Kit

Contains: 2 -3ml phosphoric etchant syringes, 8ml primer, 8ml adhesive, 3-well mixing well, brush tips with 3 color-coded handles.
223-7540S Kit..... **\$383.95**

Primer

223-7542 8ml **\$228.95**

Adhesive

223-7543 8ml **\$228.95**

3-Well Dispenser

Reusable, 3-well dispenser with a sliding cover designed to protect adhesive contents from exposure to light.

233-7544 4/pkg **\$24.45**

Ceramic Primer

223-2721 5ml **\$188.95**

Applicator Handles

Contains: 3 color-coded handles, 120 disposable-brush tips.

233-1919 Pack **\$68.95**

Disposable Applicator Brush Tips

233-1919B 60/pack **\$18.45**

Activator

223-7546 4ml **\$156.95**

Catalyst

223-7547 4ml **\$156.95**



Adper™ Prompt™ L-Pop™ - 3M Oral Care

Offers easier activation and improved chemistry for higher performance. The unique L-Pop delivery system is fast and easy to use, allowing you to etch, prime and bond in a single step-all in seconds.

227-41925 40/pack **\$154.95**

Giant Pack

227-41926 100/pack..... **\$325.95**

Economy Pack

227-41928 500/pack**\$1419.95**



Adper™ Single Bond Plus - 3M Oral Care

A fast, easy and convenient, total etch single-component bonding agent offering exceptional bond strength and unique, easy dispensing bottle.

Vial Introductory Kit

Contains: 6gm Adper Single Bond Plus adhesive, 2-3ml phosphoric etchant syringes, mixing wells, 1 brush handle, 60 brush tips.

223-51101 Kit..... **\$221.95**

Vial Refill

223-51102 6gm..... **\$209.95**



Scotchbond Universal - 3M Oral Care

Combined Total-Etch, Self-Etch and Selective-Etch adhesive. Consistent bond strength to both moist and dry etched dentin. Quick 35-second adhesive application time.

Vial Introductory Kit

Contains: 5ml vial, 50 mixing wells, 50 micro-brushes, 3ml etchant syringe and 25 dispensing tips.

223-41254 Kit..... **\$178.95**

Unit Dose Introductory Kit

Contains: 40 unit doses, 3ml etchant syringe and 25 dispensing tips.

223-41255 Kit..... **\$138.95**

Unit Dose Kit

Contains: 100 unit doses, 3ml etchant syringe, and 25 dispensing tips.

223-41256 Kit..... **\$308.95**

Unit Dose Bulk Pack

Contains: 200 -0.11ml unit doses, 3ml etchant syringe and 25 dispensing tips.

223-41257 Pack..... **\$552.95**

Refill Vial

223-41258 5ml **\$151.95**

Dual Cure Activator

223-41264 5ml **\$146.45**

Etch Gel

Contains: 2 -3ml syringes and 50 dispensing tips.

223-41263 Each..... **\$50.95**

Dispensing Tips

223-7523T 50/pkg **\$18.95**



Sil™ Silane - 3M Oral Care

Creates a silane layer on the silicate-coated surface of an indirect restoration to produce a chemical bond between an opaquer and a veneering material.

767-68300 8ml **\$82.45**

BONDING AGENTS



ParaBond - Coltene

Chemical curing, self-conditioning adhesive system for enamel and dentin. Ideal for post cementation, metal crowns, deep cavities or opaque ceramic.

Contains: 3ml Non-Rinse Conditioner, 3ml Adhesive A and 3ml Adhesive B.

384-C7486 Each..... **\$149.95**

A&B Refill

Contains: 3ml Adhesive A and 3ml Adhesive B.

384-C7493 Each..... **\$107.95**

Non-Rinse Conditioner

384-C7494 3ml **\$54.25**



Tenure® Multi-Purpose Bonding System - DenMat

Multi-purpose, self-cure adhesive bonds to enamel, dentin, porcelain, composite and metal.

System Kit

Contains: 6ml Tenure A, 6ml Tenure B, 6ml Tenure S Bond Enhancer, 3ml Tenure S Filled Enhancer, 3ml Etch'N'Seal, 6 - 18ga. syringe tips, 2 dappen dishes and brush-tip handle.

220-031146000 Kit..... **\$318.95**

Individual components available upon request.



Prime & Bond Elect - Dentsply Caulk

A universal dental adhesive system designed to bond resin based materials to enamel and dentin as well as to metals and ceramic. Utilize one of three techniques: selective phosphoric acid etching of enamel only, phosphoric acid etching of both enamel & dentin, or no phosphoric acid etching prior to application, ensuring outstanding bond strength and protection against microleakage.

Intro Kit

Contains: 5ml Bottle Prime&Bond Elect, 3ml Caulk 34% tooth conditioner gel, 25 blue applicator tips, 50 flocked applicator tips, 1 dispensing well.

228-634602 Kit..... **\$155.25**

Dual Cure Intro Kit available upon request.

Refill Bottle

228-634601 5ml **\$145.45**

Unit Doses

228-634604 50/pack **\$154.95**

228-634603 100/pack **\$313.45**



Prime & Bond NT - Dentsply Caulk

Total-etch adhesive. Combines primer and adhesive in a single bottle. The reduction of components and treatment steps simplifies use, maintaining superior bond strengths and protection against microleakage.

Introductory Kit

Contains: 4.5ml bottle Prime & Bond NT, 40 brush tips, 1 brush handle, 1 dispensing well, laminated directions.

228-634350 Kit..... **\$184.25**

Refill Package

Contains: 2 -4.5ml bottles Prime & Bond NT.

228-634352 Package **\$329.75**

Economy Package

Contains: 3 -4.5ml bottles Prime & Bond NT, 120 brush tips, 1 brush handle, 2 syringes 34% tooth conditioning gel, 75 disposable blue applicator tips and 1 dispensing well.

228-634351 Package **\$474.45**

Dual Cure Intro Kit available upon request.

Unit Dose Kit

Contains: 80 unit dose applications, 4 holders, 100 flocked applicator tips.

228-634356 Kit..... **\$299.75**

Self Cure Activator Refill Kit

Contains: 4.5ml Self Cure Activator.

228-634354 Kit..... **\$185.25**

Amalgam Bonding Accessory Kit

Contains: 3ml amalgam bonding base and 3ml amalgam bonding catalyst.

228-634402 Kit..... **\$184.25**



Prime & Bond XP - Dentsply Caulk

A one bottle, one coat system indicated for all direct restorations and when combined with the Self Cure Activator, becomes a universal adhesive for all indications and techniques.

220-60667281 5ml **\$155.25**

Mini Kit and Economy Kit available upon request.



ProBOND - Dentsply Caulk

Two component, no mixing total-etch bonding agent. Strong bond strengths to dentin, metals, enamel, porcelain and amalgam.

Standard Package available upon request.

Primer

228-634255 6ml **\$254.25**

Adhesive

228-634245 6ml **\$254.25**



Xeno IV - Dentsply Caulk

One bottle self etching adhesive. Single component. Available in dual cure for indirect procedures.

Intro Kit

Contains: 4.5ml, 100 flocked applicator tips and 1 dispensing well.

228-668001 Kit..... **\$209.45**

Dual Cure Intro Kit available upon request.

Bottle Refill

Contains: 2 -4.5ml bottles.

228-668004 Each..... **\$373.45**

Unit Dose Package

Contains: 100 unit doses, 100 flocked applicator tips and 3 unit dose holders.

228-668002 Package **\$393.95**

Flocked Applicator Tips

228-658012 50/box **\$11.95**



G-aenial Bond™ - GC America

Self-etch with dentin and etch-and-rinse with enamel. This selective-etch technique leads to increased bond strengths, while retaining the quick and easy application and exceptional handling professionals love.

Starter Kit available upon request.

Refill

222-004220 5ml **\$131.95**

BONDING AGENTS



G-Bond™ - GC America

Etch, desensitize, prime and bond all with one, 30 second application. Ideal for bonding light-cured composites, compomers and dual-cured cements and core build-up materials (light-cure mode) to tooth structure.

Starter Kit

Contains: 5ml bottle, 50 disposable applicators and 1 dispenser tray.
222-002277 Kit..... **\$185.75**

Unit Dose Kit

Contains: 50 -0.1ml unit doses and 50 disposable applicators.
222-002302 Kit..... **\$208.75**

GC Cavity Conditioner

Used to condition the bonding surface of the tooth prior to using glass ionomer restoratives, bases, liners or core build-up materials. 10 second application. 20% Polyacrylic Acid. Deep Blue tint.
272-430106 5.7ml **\$67.95**



G-Premio BOND™ - GC America

Light-cured adhesive. Use in all total-etch, self-etch and selective etch bonding techniques. Low pH provides effective and consistent bonding. Up to 5 minutes working time.

Syringe and Unitip Intro Kits available upon request.

Bottle Refill

220-009277 5ml **\$137.45**

Unit Dose

Contains: 50 -0.1ml unit doses and 50 fine disposable applicators.
220-009276 Each..... **\$161.45**



Gluma Comfort Bond + Desensitizer - Heraeus Kulzer

Bonding agent and Gluma Desensitizer combined to prevent hypersensitivity. The desensitizer is included in every bonded restoration without the need of the extra bottle or extra steps of applying separately. No mix application for all direct and indirect restorations. Contains 4-Meta, suitable for amalgam restorations.
220-25152 4ml **\$206.75**

Economy Pack

Contains: 3 -4ml bottles.
230-25154 Pack **\$562.75**



iBond® Self Etch - Heraeus Kulzer

All-in-one bonding agent, prime, bond and desensitize with just one application. Fast, efficient and reliable. Use for direct composite restorations and sealing of hypersensitive areas of the teeth.
220-66046242 4ml **\$171.75**

Value Pack

Contains: 3 -4ml bottles.
220-66046243 Pack **\$385.95**

Single Dose Assortment available upon request.



iBond® Total Etch - Heraeus Kulzer

An Etch & Rinse 2-step bonding system. Due to the innovative nano-filler technology, not only attains high bond strengths to both enamel and dentin, but also ensures optimal marginal adaptation— and is ideal for desensitizing hypersensitive areas.

Refill

Contains: 4ml bottle and 50 applicator tips.
220-66040094 Each **\$176.45**

Value Pack

Contains: 3 -4ml bottles.
220-66039867 Pack **\$415.75**

Single Dose Refill

Contains: 50 single doses and 50 applicator tips.
220-66040093 Each **\$221.25**

Single Dose Value Pack available upon request.



iBond® Universal - Heraeus Kulzer

A universal, light-curing adhesive for any bonding technique and all indications. Unique moisture control with easy and precise application.

220-66061411 4ml **\$126.45**

Primer

220-66061416 4ml **\$90.95**

Single Dose Intro Kit and Value Pack available upon request.



Adhese Universal - Ivoclar Vivadent

Single-component, light cured universal adhesive for direct and indirect bonding procedures. Compatible with all etching techniques: self-etch, selective enamel-etch and total-etch.

VivaPen System Pack

Contains: 100 snap-on cannulas and 20 protective sleeves.
220-664504WW Pack **\$121.25**

VivaPen Refill

220-665156WW 2ml **\$109.25**

VivaPen Snap-On Cannulas

230-627178 100/pkg **\$66.45**

VivaPen Protective Sleeves

230-627492 300/pkg **\$38.95**

Bottle Delivery format available upon request.

BONDING AGENTS



Excite F - Ivoclar Vivadent

A light-curing, fluoride releasing, single-component total-etch adhesive. It is used in the placement of direct restorations (composites, compomers) as well as in the adhesive luting of indirect restorations (all-ceramics, composites) involving light-curing.

VivaPen Introductory Pack

Contains: 2ml Excite F VivaPen, 2gm total etch, 10 total etch application tips, 100 VivaPen snap-on cannulas and 20 VivaPen protective sleeves.

220-627177 Pack **\$170.75**

VivaPen Snap-on Cannulas

230-627178 100/pkg **\$66.45**

VivaPen Protective Sleeves

230-627492 300/pkg **\$38.95**

Bottle Refills

220-630375 5gm **\$124.25**

220-630376 2-5gm **\$219.25**

Regular Applicators - Bottle

230-631699 50/pkg **\$16.25**



Soft Touch Single Dose Refill

Contains: 50 -0.1 gm pre-mounted applicators.

220-630377 Each **\$153.25**



Excite DSC

Dual-cure Single Component. Fluoride releasing, dual-curing adhesive for enamel and dentin bonding used in combination with the total-etch technique. Patented applicator, which is coated with the initiators required for the dual-curing action.

Contains: 50 -0.1 gm pre-mounted applicators.

Regular Size Brush 220-630378

Small/Endo Size Brush 220-630380

Each **\$201.95**



Heliobond - Ivoclar Vivadent

Visible, light cured, unfilled clear resin one-component enamel bonding agent.

220-6070202 6gm **\$80.25**



Monobond Plus - Ivoclar Vivadent

Universal, single-component bonding agent for all indirect restorative materials (glass and oxide ceramics, metal, composite, fibre-reinforced composite). Generates a sound bond between the restoration and the cementation material. Universal reaction time of 60 seconds.

220-626221 5gm **\$102.95**



Syntac® Single Component - Ivoclar Vivadent

Three-phase adhesive system for a sound bond between the composite restoration and the tooth.

Assortment Kit available upon request.

Primer

220-532893 3gm **\$83.25**

Adhesive

220-532892 3gm **\$81.75**



OptiBond™ All-In-One™ - Kerr Restoratives

A single-component, self-etch, light-cure adhesive, utilizes proven GPDM adhesive monomers and filler technology, delivering excellent penetration into dentinal tubules for extraordinary bond strength and protection against microleakage and post-operative sensitivity. Its unique capability delivers the most effective enamel etching of any single component adhesive, creating a deeper etched surface for higher mechanical retention.

Bottle Kit

Contains: 5ml bottle OptiBond All-In-One Adhesive, 3 Unidose samples, 50 applicators and 25 disposable mixing wells.

229-33381 Kit **\$168.75**

Unidose 100 Pack

Contains: 100 -0.18ml unidose devices and 100 Kerr applicators.

229-33533 Pack **\$347.25**



OptiBond® FL

A new two-step bonding system that provides the same structural bonding performance as Optibond, but with fewer steps for the doctor.

Bottle Kit

Contains: 8ml prime, 8ml adhesive, 3gm gel etchant, 10 syringe tips, 25 disposable mixing wells and 50 applicator tips.

229-26684 Kit **\$397.95**

Primer

229-25881 8ml **\$150.45**

Adhesive

229-25882 8ml **\$150.45**

Unidose Bulk Pack

Contains: 50 Unidose Packs (15.5gm total). Each pack contains 1 each: Unidose Prime (yellow), Unidose Adhesive (black), and applicator.

229-33352 Pack **\$364.75**



OptiBond™ Solo Plus™

Fluoride releasing bonding agent designed for bonding all direct and indirect restorative materials. 15% fluoride. Available in unidose delivery to prevent cross contamination.

Bottle Kit

Contains: 2 -5ml OptiBond Solo Plus adhesive, 3gm gel etchant syringe, 20 gel etchant syringe tips, 25 disposable mixing wells and 100 disposable applicator tips.

229-29670 Kit **\$376.45**

Bottle Refill

229-31513 5ml **\$181.45**

Unidose Kit

Contains: 100 -0.10ml unidose packets 3gm gel etchant syringe, 20 gel etchant syringe tips, and 100 disposable applicator tips.

229-29682 Kit **\$376.45**

Unidose Refill

Contains: 100 -0.10ml unidose packets (10ml total).

229-29669 Each **\$339.45**

BONDING AGENTS



OptiBond™ XTR - Kerr Restoratives

Self-etch, light-cure universal adhesive stands apart as the only bonding agent that embodies both the power and durability of a total-etch adhesive and the simplified protocol of a self-etch technique. The unique chemistry in this 2-bottle system brings outstanding bond strengths to uncut enamel and dentin.

Bottle Intro Kit

Contains: 5ml Bottle Self-Etching Primer, 5ml bottle universal adhesive, 100 applicators and 25 four-cavity mixing wells.

229-35106B Kit..... **\$204.75**

Unidose Intro Kit

Contains: 50 -0.18ml unidose self-etching primers, 50 -0.18ml unidose universal adhesives and 100 applicators.

229-35105B Kit..... **\$303.75**

Primer

229-35107 5ml..... **\$116.45**

Adhesive

229-35108 5ml..... **\$116.45**



Clearfil DC Bond - Kuraray America, Inc.

Self-etching, single step, dual-cure bonding agent. Durable bond strength for direct and indirect restorations. Low postoperative sensitivity.

Complete Kit

Contains: 4ml Bond A, 4ml Bond B, 50 disposable brush tips, 1 brush tip handle and mixing dish.

220-2510KA Kit..... **\$232.25**

Bond A

220-2512KA 4ml..... **\$119.95**

Bond B

220-2513KA 4ml..... **\$119.95**



Clearfil Liner Bond 2V

Light-cure bonding agent with dual-cure option available (Bond B). Indicated for direct or indirect restorations, composite and amalgam bonding, fractured porcelain repairs, desensitizing crown preps and cervical areas.

Complete Kit

Contains: 6ml Primer A, 6ml Primer B, 5ml Bond A, 3ml Bond B, 1 sponge pledget, 1 mixing dish, 1 light-blocking plate, 1 system tray, 1 white brush holder and 50 disposable brush tips.

220-213920 Kit..... **\$307.45**

Primer A

220-213943 6ml..... **\$65.25**

Primer B

220-213944 6ml..... **\$65.25**

Bond A

220-213930 5ml..... **\$167.45**

Bond B

220-213931 3ml..... **\$93.45**



Clearfil New Bond

Chemical-Cure Bonding Agent. Clearfil New Bond is a self-cure enamel and dentin bonding agent used with total-etch technique.

Catalyst

220-212053 6ml..... **\$100.95**

Universal

220-212054 6ml..... **\$100.95**



Clearfil Photo Bond

A dual-cure dentin, enamel, and porcelain* bonding agent developed for use with light, self or dual-cure restorative materials. *(When mixed with Clearfil Porcelain Bond activator).

Kit available upon request.

Catalyst

220-212073 6ml..... **\$93.45**

Universal

220-212074 6ml..... **\$93.45**

1:1 Set

Contains: 6ml catalyst and 6ml universal.
220-212075 Set..... **\$181.25**

Clearfil Porcelain Bond Activator

Silane coupling agent, which in combination with SE Bond Primer or Clearfil Liner Bond 2V Primer, Clearfil New Bond or Clearfil Photo Bond guarantees a strong adhesion to porcelain and composite restorations.

220-212061 4ml..... **\$95.75**

Alloy Primer

220-213064 5ml..... **\$84.45**



Clearfil® S³ Bond Plus

A light-cure, self-etching one-bottle bonding agent that provides significantly reduced postoperative sensitivity, high bond strength, along with being very easy and fast to use. Minimal technique sensitivity, and is indicated for light-cure composites, desensitizing indirect preparations, desensitizing dentin, PFM repairs, silanating porcelain, and is especially excellent for use in pedodontic restorative procedures where speed and comfort are very critical. Fluoride releasing.

Contains: 4ml Bond, 1 light blocking plate, 1 mixing dish and 50 fine applicators tips.

220-2890KA Each..... **\$147.75**

Single Dose Standard Pack

Contains: 50 -0.1ml unit dose applications.

220-2898KA Pack..... **\$173.95**

Value Pack

Contains: 3 -4ml bottles.

220-2893KA Pack..... **\$285.95**

Unit Dose Standard Pack

Contains: 50 -0.1ml unit dose applications.

220-2899KA Pack..... **\$325.95**



Clearfil SE Bond

Simple and easy, self etching, light-cured bonding agent. It soothes dentin immediately upon contact and virtually eliminates post-operative sensitivity.

Starter Kit

Contains: 6ml primer, 5ml bond, 2 brush holders, mixing dish, light-blocking plate, outer case and 100 disposable brush tips.

220-13970 Kit..... **\$222.95**

Value Kit

Contains: 3 -6ml primer, 3 -5ml bond, 2 brush holders, mixing dish, light-blocking plate, outer case and 300 disposable brush tips.

220-1972KA Kit..... **\$528.75**

Restorative Kit available upon request.

Bond

220-213981 5ml..... **\$149.95**

Primer

229-213982 6ml..... **\$64.45**

Brush Tips

220-968 50/pack..... **\$11.45**

Mixing Dish

White, 4-hole.
230-902 Each..... **\$4.95**

BONDING AGENTS



Clearfil SE BOND 2 - Kuraray America, Inc.

Universal Adhesive for direct and indirect restorations. Can now be used with CLEARFIL DC Activator to create a dual-cure bonding agent for use with all indirect restorations and core build-up composites. Excellent bond strength to enamel and dentin; new catalyst chemistry for stronger bonds. Ideal for bulk-fill composites. Low film thickness for indirect restorations. Stable & durable surface treatments for all restorations (Zirconia, etchable ceramics & metal restorations). Simple, proven procedure -no hidden steps; no shaking or scrubbing required.

Intro Kit

Contains: 6ml Primer, 5ml Bond, dispensing dish, light blocking plate, outer case and 50 applicator brushes.

220-3270KA Kit..... **\$201.95**

Value Kit

Contains: 3 -6ml primer and 3 -5ml bond.
220-3272KA Kit..... **\$497.95**

Bond

220-3281KA 5ml..... **\$142.95**

Primer

220-3282KA 6ml..... **\$61.25**

Clearfil DC Activator

220-3250KA 4ml..... **\$84.45**

Brush Tips

220-968 50/pack..... **\$11.45**



Clearfil SE Protect

Contains the same proprietary self-etching, light-cure technology of Clearfil SE Bond, plus two additional proprietary technologies: long-term Fluoride-releasing and the MDPB monomer, which has a similar level of antibacterial cavity cleansing effect as existing cavity cleansers. Very easy and fast to use, has maximum marginal leakage protection, very high dentin bond strength, and almost zero post-operative sensitivity.

Starter Kit

Contains: 6ml primer, 5ml bond, 2 brush holders, mixing dish, light-blocking plate, outer case and 100 disposable brush tips.

220-2870KA Kit..... **\$233.25**

Value Kit

Contains: 3 -6ml primer, 3 -5ml bond, 2 brush holders, mixing dish, light-blocking plate, outer case and 300 disposable brush tips.

220-2872K Kit..... **\$574.25**

Primer

220-2882KA 6ml..... **\$84.95**

Bond

220-2881KA 5ml..... **\$150.25**



Clearfil Universal Bond

A single-component, light-curing bonding agent indicated for all direct or indirect restorations in combination with all etching techniques (Total-Etch, Self-Etch or Selective Etch). It is also indicated for the surface treatment of zirconia and silica-based glass ceramics (lithium disilicate).

Standard Kit - Bottle

Contains: 5ml bond, 3ml K-Etchant, mixing dish, light-blocking plate, 50 fine applicator brushes and 20 needle tips.

220-3290KA Kit..... **\$145.95**

Value Pack - Bottle

Contains: 3 -5ml.
220-3293KA Pack..... **\$254.45**

Bond

220-3292KA 5ml..... **\$121.45**

Unit Dose delivery format available upon request.



Amalgambond® PLUS - Parkell Inc.

Chemically bonds amalgam to dentin, enamel and old amalgam.

Complete Kit

Contains: Dentin/enamel activator, adhesive agent, Amalgambond base and catalyst, high performance additive powder and accessories.

220-S370 Kit..... **\$279.75**

“C” Universal TBB Catalyst

220-S378 0.7ml..... **\$201.95**

Amalgambond B Base

220-S372 5ml..... **\$62.95**

Amalgambond AA Adhesive Agent

220-S374 8ml..... **\$8.75**

HPA Powder

220-S376 2gm..... **\$8.75**

Accessory Kit available upon request.



BluSep™ - Parkell Inc.

Anti-bonding agent. Brush onto surfaces that you don't want to bond to. Dries quickly. Forms a flexible plastic film, just 20 microns thick. Water soluble. Blue.

220-S385 5ml..... **\$52.75**



Brush & Bond® - Parkell Inc.

An easy-to-use, high-strength bonding agent that protects and desensitizes your crown preps too! Bonds direct and indirect composite restorations to all tooth surfaces. Permanently seals the tubules to prevent sensitivity. Protects the pulp against microleakage and bacterial invasion. Creates an acid- and wear-resistant shield for the tooth. Doubles the surface hardness of the preparation.

Contains: 3ml liquid, mixing well and 100 standard activator brushes.

220-S284 Pack..... **\$153.25**

Bonding Liquid

220-S285 3ml..... **\$92.95**

Initiator Brushes

220-S286 100/pkg..... **\$74.95**

Mini Endo Activator Brushes

220-S287 100/pkg..... **\$73.45**



Touch & Bond® - Parkell Inc.

Self-etching. Creates strong bonds to dentin and prepared enamel. Extraordinarily thin film -only 3 microns -ideal for direct composites and indirect restorations. No post-op sensitivity. Can be used with light-cure or self-cure composites. Requires a halogen curing light.

Contains: 5.5ml liquid, 175 activator pledgets, 50 mini-brushes and organizer.

200-S280 Kit..... **\$153.25**

BONDING AGENTS

Bond-1™ Primer/ Adhesive - Pentron Clinical

Single-bottle moist dentin total-etch bonding system, is easy to use, provides high bond strengths and helps eliminate sensitivity.

Proven to create an ideal sealed surface and interpenetrated network of the polymerized primers and unfilled resin, Bond-1 Primer/Adhesive yields high bond strengths with film thickness of only 8µm. Its ease of application, combined with its low film thickness, assures the ideal surface to bond to all types of restorative materials.

220-N011AA 4ml **\$74.75**
220-N011AB 6ml **\$102.95**

Dual Cure Activator

220-N011AC 3ml **\$33.75**



Bond-1™ SF

Solvent Free. Solvents such as acetone, alcohol, or water, are found in all bonding agents on the market. These solvents can be inadvertent contributors to weakened bond strengths and post-operative sensitivity. Bond-1 SF Solvent-Free SE Adhesive helps solve these common problems.

Contains: 2 -1ml syringes and flocked needle tips.

220-N03N Each..... **\$49.45**



Bond-IT® - Pentron Clinical

Provides a bond strength of 29.4 MPa and virtually eliminates post-operative sensitivity. The bonding system's familiar technique and chemistry assures the ideal surface to which any restorative material may be bonded to direct or indirect composite, porcelain, metal and amalgam alloy.

Bond-it System Kit available upon request.

Primer A

220-N01A 6ml **\$53.45**

Primer B

220-N01B 6ml **\$46.95**

Light-Cure Resin

220-N01D 6ml **\$40.45**

Dual-Cure Activator

220-N01E 3ml **\$27.75**



IntegraBond™ - Premier® Dental

5th generation, universal bonding agent for all bonding procedures to dentin and enamel. 10 micron film thickness for easy flow. Creates a strong chemical and mechanical bond to dentin to form and impenetrable seal between tooth and composite overlay. Can be used with Auto Cure Activator to provide anaerobic curing for post and prosthetic cementation.

Universal Bonding Agent

227-3001411 7ml **\$111.75**

Auto Cure Activator

227-3001412 7ml **\$111.75**



DenTASTIC™ UNO™ - Pulpdent Corporation

Combines the patented PMGDM adhesive primer with a hydrophilic resin and acetone solvent into a single component adhesive which bonds to tooth and restorative surfaces with exceptional strength. It is light-cured and is compatible with all restorative composites, filled and unfilled resins and resin cements.

Starter Kit

Contains: 2 -6ml bottles, 5ml Etch-Rite Gel, 20 applicator tips, 50 brush tips, brush handle.

220-UNO Kit..... **\$157.45**

Refill Bottle

220-UNOR 6ml **\$82.45**



Dry-Rite™ Drying Agent - Pulpdent Corporation

For complete chemical drying of enamel or restorative surfaces when residual moisture may affect bonding and cementation. Dispenses one drop at a time from a bottle or syringes.

Contains: 4 -1.2ml syringes, 8 dropper tips.

220-DRY Kit..... **\$16.45**

Refill

Contains: 1oz. bottle with dropper spout.

220-DRY1 Each..... **\$8.75**



Silane Bond Enhancer - Pulpdent Corporation

A single component material that increases bond strength of resin to porcelain. Apply silane to porcelain after etching with Porcelain Etch Gel and drying with Dry-Rite. Conveniently dispenses one drop at a time from the syringe.

Kit

Contains: 4 -1.2ml syringes and 8 dropper tips.
220-SIL Kit **\$44.25**

Refill

220-SIL3 3ml **\$25.95**

Silane Primer

229-23448 5ml **\$86.45**



BeautiBond - Shofu Dental Corporation

Featuring a stable, unit-dose delivery, BeautiBond is fast and easy to use. A single application of the dual adhesive monomers requires just 30 seconds for a durable, predictable bond.

Contains: 50 -0.1ml unit doses and 50 fine, pink microbrushes.

220-1782 Kit..... **\$150.45**

Bottle Refill

220-1781 6ml **\$150.45**



Copalite SnapBond® - Temrex Corporation

One-step dentin bonding agent that bonds, desensitizes and adheres to both dentin and tooth anatomy.

220-400047 6.25ml **\$79.75**

BONDING AGENTS



Bond Force - Tokuyama Dental America, Inc.

A seventh generation single component, self-etching, fluoride releasing bonding agent. With the patented SR monomer, creates a 3-D link to the tooth generating an extremely strong bond to enamel and dentin. Requires only one application, and is designed to be used on both cut/uncut enamel and dentin.

Kit
Contains: 5ml bottle, 50 disposable brushes and 1 mixing well.
220-14912 Kit..... **\$124.95**

Bottle Refill
220-14932 5ml **\$102.95**

Prelude Adhesive System - Zest Dental Solutions

Primer is water based with a methacryl phosphate and hydrophilic monomer to condition the tooth prior to restoration. The adhesive, used by itself, without the self-etching primer, serves as a superior total-etch adhesive when total etch technique is preferred.

Contains: 5ml primer and 5ml adhesive.
230-91024 Each..... **\$152.25**



ETCHANTS



Etch Gel

Viscous 40% phosphoric solution. For use on dentin and enamel. Material will stay and not flow onto surrounding tissue. Leaves no residue, rinses away clean with water.

4 -1.2gm Kit: 4 -1.2gm prefilled syringes and 20 -22 gauge blue pre-bent applicator tips.
220-10003 Kit..... **\$16.95**

12 -1.2gm Kit: 12 -1.2gm prefilled syringes and 60 -22 gauge blue pre-bent applicator tips.
220-10004 Kit..... **\$40.95**

1 -12gm Kit: 12gm prefilled syringes and 3 -22 gauge blue pre-bent applicator tips.
220-10005 Kit..... **\$12.45**

1 -60gm Kit: 60gm syringe etchant, 50 -22 gauge pre-bent applicator tips, 5 -3cc empty delivery syringes.
220-10006 Kit..... **\$38.95**



Scotchbond™ Etchant - 3M Oral Care

Used to etch enamel and/or dentin as indicated in the instructions provided with the various adhesive systems. Phosphoric acid.

35%
223-7423 9ml **\$65.75**

37%
223-1923 9ml **\$54.95**

Dispensing Tips
223-7523T 25/pkg **\$18.95**



Scotchbond™ Universal Etchant - 3M Oral Care

An etching gel for use with Scotchbond Universal Adhesive. 34% phosphoric acid with a pH of approximately 0.1.

Contains: 2 -3ml etchant syringes and 50 dispensing tips.
223-41263 Kit..... **\$50.95**



Tooth Conditioner Gel - Dentsply Caulk

Tinted blue for easy visibility. 34%.
Contains: 2 -3ml syringes and 25 disposable applicator tips.
228-646125 Each..... **\$51.45**

Syringe Tips
228-646126 25/box **\$21.75**

Bottles
Contains: 2 -6ml bottles.
228-646100 Each..... **\$34.95**

50% Tooth Conditioner Liquid
Contains: 2 -10ml bottles.
228-646009 Each..... **\$33.45**



40% Etch Gel - DMG America

With silica thickener. Viscosity prevents flow of acid into soft tissue, adjacent teeth and/or cementum and dentin. Rinses off easily and clearly.

Contains: 4 -1.2ml syringes.
220-61901 Each..... **\$59.75**



IPS Ceramic HF Etching Gel - Ivoclar Vivadent

Used for the creation of retentive bonding surfaces on all-ceramic restorations.

220-2500333 5ml **\$59.75**



Total Etch - Ivoclar Vivadent

37% phosphoric acid. Used for enamel etching and dentin conditioning in conjunction with sealants, composite restorations and the adhesive luting of indirect all-ceramic or composite restorations.

Contains: 2 -2gm syringes and 10 luer-lock applicator tips.
220-6550588 Kit..... **\$26.45**

Applicator Tips
220-6550587 20/pkg. **\$18.95**



Gel Etchant - Kerr Restoratives

37.5% phosphoric acid designed for dentin/enamel etching. Purple.

Standard Kit
Contains: 3 -3gm syringes and 30 dispensing tips.
229-25540 Kit..... **\$57.95**

Dispensing Tips - Purple
229-26909 30/pkg **\$37.25**

ETCHANTS



Seity Etchant - Keystone Industries

Specially formulated for maximum working and handling characteristics. Stays in place and will not run onto exposed tissue. Blue. 37%.

220-0700377 50ml **\$28.75**



Premier® Etch - Premier® Dental

37% phosphoric acid gel for etching tooth enamel and dentin when preparing tooth surfaces for composites.

Complete Kit

Contains: 12gm jumbo Luer Lock syringe, 10 empty 1.2ml syringes and 50 disposable tips.

227-3001422 Kit..... **\$26.25**



Etch Rite™ Dental Etching Gel - Pulpdent Corporation

38% phosphoric acid, for acid etching dentin, enamel and glass ionomer cements. A superior quality dental etching gel with a specially designed viscosity for maximum working and handling characteristics.

Standard Kit

Contains: 4 -1.2ml syringes gel and, 8 pre-bent tips.

220-ETCH Kit..... **\$19.45**

Syringe Refills

220-ET6 6ml **\$9.95**

220-ET12 12ml **\$13.75**

Bulk Syringes

Contains: 24 -1.2ml syringes.

220-ET24 Each..... **\$71.75**

Jumbo Syringe Kit

Contains: 2 -25ml syringes, 5 -3ml empty syringes and 50 pre-bent tips.

220-ET50 Kit..... **\$49.25**

Jumbo Refill

Contains: 2 -25ml syringes.

220-ET50R Each..... **\$35.75**

Pre-Bent Applicator Tips

230-ETN 20/pkg..... **\$5.95**

230-ETL 100/pkg..... **\$22.45**

Empty 3ml Refill Syringes

230-SYET3 5/pkg..... **\$5.95**



Porcelain Etch Gel - Pulpdent Corporation

9.6% Hydrofluoric Acid, for etching porcelain. Contains: 4 -1.2ml syringes and 8 dispenser tips.

220-PEG Kit..... **\$52.45**

Refill Syringe

220-PEG3 3ml **\$30.45**



Super Etch - SDI

Super Etch 37% phosphoric acid etchant for enamel and dentin. Easily controlled Super Etch gel flows under direction, not under gravity. Super Etch promotes strong bonding.

Mini Kit

Contains: 4 -1.2ml Super Etch syringes, 20 -23ga. disposable tips.

220-8100039 Kit..... **\$18.25**

Bulk Kit

Contains: 10 -2ml syringes and 50 -23ga. tips.

220-8100045 Kit..... **\$59.75**

12gm Syringe

Contains: 12gm syringe and 25 -23ga. tips.

220-8100052 Pack **\$20.75**

Syringe Tips

23ga. Blue.

230-8100050 25/pkg **\$8.95**

230-8100060 200/pkg **\$53.95**



Gel-Etch - Temrex Corporation

Washes off easily from the tooth surface.

Complete Kit

Contains: 12gm syringe and 25 tips.

220-6500 Each..... **\$29.45**

Disposable Tips

230-6550 25/pkg **\$11.95**

CARIES INFILTRATION



Icon® Caries Infiltrant - DMG America

Fills the gap between prophylaxis and filling. In addition, this treatment optically blends in the lesion with the healthy enamel. This innovative method can therefore be used for esthetic treatments of front teeth, where appearance plays an important role.

Smooth Surface - Mini Kit

Micro-invasive treatment of enamel-restricted, non-cavitated caries on smooth surfaces.

Gentle method for counteracting cariogenic white spots – with an esthetic side effect. No unnecessary loss of healthy hard tissue. User-friendly and patient-friendly application.

Contains: 2 Patient Packs which include 0.3ml syringe Icon-Etch, 0.45ml syringe Icon-Dry, 0.45ml Icon-Infiltrant and 6 smooth surface tips.

230-220402 Kit..... **\$175.75**

Proximal - Mini Kit

Micro-invasive treatment of early, non-cavitated caries in the proximal area. Tooth friendly filling by infiltration – no drilling needed. Gentle therapy approach for difficult to reach proximal lesions in just a few steps.

Contains: 2 Patient Packs which include 0.3ml syringe Icon-Etch, 0.45ml syringe Icon-Dry, 0.45ml Icon-Infiltrant, 6 proximal tips and 4 Dental Wedges.

230-220400 Kit..... **\$175.75**

7 Patient Packs available upon request.



for something? **WE HAVE IT!**

www.dhpionline.com

The Goal: to be as beautiful as nature

For 50 years, dental professionals around the world have used the VITA® classical (Lumin Vacuum) shade guide for their shade selection needs. The 16 shades in this revolutionary guide have earned a permanent home in the international lexicon of dental terminology; whenever a familiar shade from this invaluable guide is prescribed (such as A2 or C1), it is for the sole purpose of providing satisfaction to both dentist and patient.

The 3D-MASTER Shade System provides a systematic arrangement of virtually all existing natural tooth shades and integrates them into one easy-to-use shade guide.

The VITA 3D-MASTER Shade System dramatically improves the communication between the dentist and dental technician. The VITA Bleachedguide 3D-MASTER offers dental professionals an intuitive shade guide specifically designed for planning and monitoring tooth whitening regimens. This guide offers 15 3D-MASTER shades, including 7 new intermediate shade tabs that simplify the whitening prognosis.



VITA Linearguide 3D-MASTER
210-GX69913



VITA classical A1-D4 with Bleached Shades
210-G68993

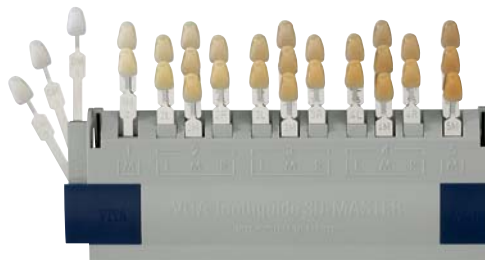

VITA Toothguide 3D-MASTER
210-V300026

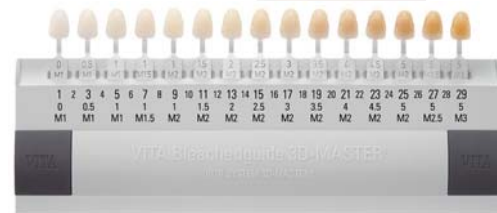

VITA Bleachedguide 3D-MASTER
210-GX69911

Explore the VITA 3D-MASTER Shade System for yourself and discover how easy it is to determine incredibly precise, natural shades.

Contact your DHPI Account Manager for details and pricing.

Filtek™ One Bulk Fill - 3M Oral Care

Designed for the posterior, its optical properties and increased opacity allow for the simplicity of one-step placement without compromising esthetics. Can be placed in a single increment up to 5mm with no need for layering or expensive dispensing devices.



- Contains: 20 -0.02gm capsules.
- A1 210-4867A1
 - A2 210-4867A2
 - A3 210-4867A3
 - B1 210-4867B1
 - C2 210-4867C2
 - Each **\$89.95**

Syringe delivery format available upon request.



Filtek Bulk Fill Flowable

Designed for use in posterior indications where time and steps can be saved by reducing the need to incrementally place layers of composite. It can be bulk placed and cured to a depth of 4mm. Offers low stress and shrinkage, great wear resistance and strength, and high radiopacity. The delivery comes in both syringe and capsule, which are colored with bright orange accents for easier identification.

Syringes

Contains: 2 -2gm syringes and 20 dispensing tips.

- A1 213-4862A1
- A2 213-4862A2
- A3 213-4862A3
- Universal 213-4862U
- Each **\$92.95**

Capsules

Contains: 15 -0.2gm capsules.

- A1 213-4861A1
- A2 213-4861A2
- A3 213-4861A3
- Universal 213-4861U
- Each **\$75.95**



Fill-Up! - Coltene

A dual curing medium viscous bulk composite applied in a single step. Faster than the conventional incremental technique and more

economical than the two layer bulk fillings. Universal Shade.

Intro Kit

Contains: 2 -4.5gm, 2.5ml etchant gel, 3ml ParaBond Adhesive A, 3ml ParaBond Adhesive B, 6 superfine short mixing tips and 8 fine short mixing tips.

- 210-60019342 Kit **\$183.75**

Economy Kit available upon request.

Refill

Contains: 4.5gm, 3 short superfine tips and 4 short fine mixing tips.

- 210-60019341 Each **\$78.95**



SureFil® SDR® flow+ - Dentsply Caulk

Low-stress flowable composite material. Bulk fill up to 4mm and cure for a faster, easier and long-lasting restoration. Self-leveling. 20-second cure time for universal shade. Radiopaque.

Intro Kit

Contains: 25 -0.25gm compula tips in Universal Shade and 1 Compules Tips Gun.

- 210-61C100 Kit **\$154.25**

Compula Tips Refills

Contains: 15 -0.25gm.

- Universal 210-61C101
- A1 210-61C106
- A2 210-61C107
- A3 210-61C108
- Each **\$91.25**

Compules Tips Gun

For use with Compules Tips and Compula Tips.

- 238-635105 Each **\$80.45**

Syringe refills available upon request.



EQUIA™ Forte - GC America

A strong bulk fill Glass Ionomer Restorative System with no polymerization shrinkage or shrinkage stress. Optimal marginal seal that offers long-term resistance to microleakage and discoloration. High fluoride release. Extends the original EQUIA indications to include stress bearing Class II Restorations.

Intro Kit

Contains: 48 capsules.

- A1 210-452001

- A2 210-452002
- A3 210-452003
- Kit **\$301.25**

Intro Kit Assorted Shades

Contains: 10 -0.14ml capsules each of Shade A2, A3, A3.5; 9 -0.14ml capsules each of Shade B1, B3; 4ml EQUIA Forte Coat and 5.7ml GC Cavity Conditioner.

- 210-452005 Kit **\$301.25**

Additional shades and refills available upon request.



Venus® Bulk Fill - Heraeus Kulzer

A light cured bulk fill flowable composite that features self adaptive handling for easy, efficient placement, low shrinkage stress, a 4mm depth of cure capability, high radiopacity for accurate diagnosis and long working time. Universal Shade.

Syringe Intro Kit with iBond available upon request.

PLT Refill

Contains: 10 -0.2gm universal shade.

- 210-66044743 Each **\$82.45**

Syringe Refill

- 210-66046795 1.8gm **\$35.75**

Pediatric Kit

Contains: 4 -1.8gm syringes universal shade, 1 -2ml iBond Self Etch and 1 of 6 finger puppets.

- 210-66057342 Kit **\$165.25**

Additional shades available upon request.



Tetric EvoFlow - Ivoclar Vivadent

Posterior flowable liner. Nano-hybrid composite, self-adapting, opacifying and cures up to 4mm in 10 seconds. Light curing. Radiopaque.

Syringes

- A 210-646472WW
- B 210-667724WW
- White/Bleach 210-667727WW
- 2gm **\$41.45**

Cavifil delivery format available upon request.

COMPOSITE - BULK FILL



SonicFill™ 2 - Kerr Restoratives

Fills cavities up to 5mm in depth in a single increment, with a single material with no liner or capping layer. Lasting marginal integrity, high depth of cure and improved esthetics.

Intro Kit

Contains: SonicFill handpiece, Getting Started Pack with 5 unidose tips and 5 tooth models, 10 -0.25gm unidose tips A1, 20 -0.25gm A2 and 30 -0.25 A3.

210-36044 Kit..... **\$1110.75**

Refill Tips

A1 210-36051
 A2 210-36052
 A3 210-36053
 20/pack **\$145.45**

SonicFill Handpiece Device

219-35215 Each..... **\$1041.95**



Microhybrid Composite

This light activated quick curing Microhybrid Composite combines excellent esthetics with superior abrasion resistance and low polymerization shrinkage. A unique combination of barium glass fillers with state-of-the-art curing agents and Bis-GMA based resin systems make our Microhybrid an ideal anterior or posterior filling material.

.30gm Refill Tips

A1 210-HT20A1
 A2 210-HT20A2
 A3 210-HT20A3
 A3.5 210-HT20A35
 B1 210-HT20B1
 B2 210-HT20B2
 C2 210-HT20C2
 C3 210-HT20C3
 20/pkg **\$61.95**

4.5gm Refill Syringe

A1 210-HT30A1
 A2 210-HT30A2
 A3 210-HT30A3
 A3.5 210-HT30A35
 B1 210-HT30B1
 B2 210-HT30B2
 C2 210-HT30C2
 C3 210-HT30C3
 Each **\$42.95**

COMPOSITE - UNIVERSAL



NanoHybrid Composite

This light activated NanoHybrid Composite contains nano-sized particles, which combined with regular silica and barium glass composes a state-of-the-art nano-filler system. It is a high viscosity composite that will resist sticking to instruments, yet will have sufficient flow to adapt to the walls of the cavity preparation. It is radio-opaque and provides high compressive and flexural strengths along with a low water uptake. This NanoHybrid Composite can be used in all classes of direct dental restorations.

.25gm Refill Tips

A1 210-HT40A1
 A2 210-HT40A2
 A3 210-HT40A3
 A3.5 210-HT40A35
 B1 210-HT40B1
 B2 210-HT40B2
 C2 210-HT40C2
 C3 210-HT40C3
 20/pkg **\$61.95**

4.5gm Refill Syringe

A1 210-HT50A1
 A2 210-HT50A2
 A3 210-HT50A3
 A3.5 210-HT50A35
 B1 210-HT50B1
 C3 210-HT50C3
 Each **\$42.95**



Filtek™ Z250 Universal Restorative - 3M Oral Care

Speed and convenience in a universal dental composite resin that provides exceptional handling, long-lasting esthetic results and is available in 15 shades.

Syringe Refills

A1 213-6020A1
 A2 213-6020A2
 A3 213-6020A3
 A3.5 213-6020A3.5
 A4 213-6020A4
 B1 213-6020B1

B2 213-6020B2
 B3 213-6020B3
 C2 213-6020C2
 D3 213-6020D3
 Incisal 213-6020I
 Universal 213-6020UD
 4gm **\$122.25**

Capsule Refills

Contains: 20 -0.2gm.

A1 213-6021A1
 A2 213-6021A2
 A3 213-6021A3
 A3.5 213-6021A3.5
 A4 213-6021A4
 B1 213-6021B1
 B2 213-6021B2
 C2 213-6021C2
 D3 213-6021D3
 Universal 213-6021UD
 Each **\$125.25**

Additional shades available upon request.



Filtek™ P60 Posterior Restorative

An easy-to-use, tooth-colored restorative material specifically designed for posterior restorations. For use in direct and indirect posterior restorations.

Syringe Refills

A3 213-4720A3
 B2 213-4720B2
 C2 213-4720C2
 4gm **\$143.45**



Filtek™ Supreme Ultra Universal Restorative

Improved polish retention-even better than a microfill-and enhanced fluorescence, it is even easier to create natural-looking esthetics. In addition, with more single-shade solutions, bold labels that are easier to read, and a wide range of shades and opacities to choose from, you will find it more user-friendly.

Syringe Refills

Dentin Shades

A1D 213-6028A1D
 A2D 213-6028A2D
 A3D 213-6028A3D
 A4D 213-6028A4D
 B3D 213-6028B3D
 C4D 213-6028C4D
 D2E 213-6028D2E
 4gm **\$123.25**

Continued

COMPOSITE - UNIVERSAL

Filtek Supreme Ultra Universal Restorative continued.

Body Shades

A1B.....	213-6028A1B
A2B.....	213-6028A2B
A3B.....	213-6028A3B
A3.5B.....	213-6028A35B
A4B.....	213-6028A4B
B1B.....	213-6028B1B
B2B.....	213-6028B2B
B3B.....	213-6028B3B
C1B.....	213-6028C1B
C2B.....	213-6028C2B
C3B.....	213-6028C3B
D2B.....	213-6028D2B
D3B.....	213-6028D3B
White.....	213-6028WB
Extra White.....	213-6028XWB
4gm.....	\$123.25

Enamel Shades

A1E.....	213-6028A1E
A2E.....	213-6028A2E
A3E.....	213-6028A3E
B1E.....	213-6028B1E
B2E.....	213-6028B2E
White.....	213-6028WE
Extra White.....	213-6028XWE
4gm.....	\$123.25

Capsule Refills

Dentin Shades

Contains: 10 -0.2gm capsules.

A1D.....	213-6029A1D
A2D.....	213-6029A2D
A3D.....	213-6029A3D
A4D.....	213-6029A4D
A6B.....	213-6029A6B
B3D.....	213-6029B3D
B5B.....	213-6029B5B
C4D.....	213-6029C4D
White.....	213-6029WD
White-D.....	213-6029WD
Each.....	\$65.45

Body Shades

Contains: 20 -0.2gm capsules.

A1B.....	213-6029A1B
A2B.....	213-6029A2B
A3B.....	213-6029A3B
A3.5B.....	213-6029A35B
A4B.....	213-6029A4B
A6B.....	213-6029A6B
B1B.....	213-6029B1B
B2B.....	213-6029B2B
B3B.....	213-6029B3B
C1B.....	213-6029C1B
C2B.....	213-6029C2B
C3B.....	213-6029C3B
D2B.....	213-6029D2B
D3B.....	213-6029D3B
White.....	213-6029WB
Extra White.....	213-6029XWB
Each.....	\$125.95

Additional kits and shades available upon request.

Enamel Shades

Contains: 10 -0.2gm capsules.

A1E.....	213-6029A1E
----------	-------------

A2E.....	213-6029A2E
A3E.....	213-6029A3E
B1E.....	213-6029B1E
B2E.....	213-6029B2E
D2E.....	213-6029D2E
White.....	213-6029WE
Extra White.....	213-6029XWE
Each.....	\$65.45

Translucent Shades available upon request.



Z100™ Restorative - 3M Oral Care

A visible light-activated, radiopaque dental composite. It is designed for use in both posterior and anterior restorations. The filler is zirconia/silica, the inorganic filler loading is 66% by volume with a particle size range of 3.5 to 0.01 micron.

Capsule Refills

Contains: 9 -0.2gm capsules.

B2.....	213-5905B2
C2.....	213-5905C2
Pedo.....	213-5907P
Each.....	\$51.95

Contains: 18 -0.2gm capsules.

A1.....	213-5905A1
A2.....	213-5905A2
A3.....	213-5905A3
A3.5.....	213-5905A3.5
A4.....	213-5905A4
Each.....	\$103.95

Syringe Refills

A1.....	213-5904A1
A2.....	213-5904A2
A3.....	213-5904A3
A3.5.....	213-5904A3.5
A4.....	213-5904A4
B2.....	213-5904B2
B3.....	213-5904B3
C2.....	213-5904C2
4gm.....	\$108.75

Syringe Refills Opaque/Dentin

Cervical Yellow.....	213-5906CY
Pedo.....	213-5906P
4gm.....	\$108.75

Additional shades available upon request.



Paradigm™ Restorative - 3M Oral Care

Paradigm Nano Hybrid Universal Restorative offers a simple solution for your everyday restorative needs. With 12 shades, great handling, strength and wear resistance, this easy-to-use composite helps you achieve your desired results.

Capsule Refills

Contains: 20 -0.2gm capsules.

A1.....	213-1481A1
A2.....	213-1481A2
A3.....	213-1481A3
A3.5.....	213-1481A35
A4.....	213-1481A4
B1.....	213-1481B1
B2.....	213-1481B2
C2.....	213-1481C2
D3.....	213-1481D3
Each.....	\$91.95

Syringe delivery format and additional shades available upon request.



Synergy® Nano Formula - Coltene

Remarkable blend properties enable the dentist to limit the shade matching to the shade intensity of the tooth. It enables the reconstruction of realistic impressions of natural tooth.

Duo Shade Tips Refill

Contains: 20 -0.25gm.

A1/D2.....	214-C7831
A2/B2.....	214-C7832
A3/D3.....	214-C7833
A3.5/B3.....	214-C7834
A4/M5.....	214-C7835
C2/C3.....	214-C7836
Each.....	\$113.25

Duo Shade Syringes and Compact Tips and Syringes available upon request.



Synergy® D6 - Coltene

A nanohybrid composite, its the ideal modern filling material: low shrinkage, optimum handling properties, fast polishability and also high resistance to operating lights. Only 6 dentin and 2 enamel shades. This small number of shades with excellent optical blend-in properties is sufficient to cover a wide range of tooth shades.

CompuTips

Contains: 10 -0.125ml tips.

Dentin White Bleach (WB).....	214-C8375
Dentin A1/B2.....	214-C8376
Dentin A2/B2.....	214-C8377
Dentin A3/D3.....	214-C8378
Dentin A3.5/B3.....	214-C8379
Dentin C2/C3.....	214-C8380
Enamel Universal.....	214-C8381
Enamel White Opalescent.....	214-C8382
Each.....	\$63.45

Syringe delivery format available upon request.

COMPOSITE - UNIVERSAL



Geristore™ - DenMat

Hybrid ionomer composite. Self-adhesive. Low polymerization shrinkage and low coefficient of thermal expansion. Contains fluoride. Radiopaque.

Syringeable Kit

Contains: 10gm syringe, 10 automix tips, 10 intra-oral tips and 3 light cure test rings.

A2	200-031457500
A3	200-031457520
Each	\$186.45

Additional shades and kits available upon request.



EsthetX HD Micro Matrix Restorative - Dentsply Caulk

Provides the ultimate combination of beauty and strength. The precise filler particle distribution of glass and nano-filler particles targets the optimal glass particle sizes and provides the ability to achieve an excellent polish with less effort and time. Ideal for all cavity classes.

Refills

Regular Body Shades

Contains: 20 -0.25gm compules tips.

A1	218-630617
A2	218-630618
A3	218-630619
A3.5	218-630620
B1	218-630622
B2	218-630623
C2	218-630627
White	218-630615
Each	\$132.95

Translucent Enamel Shades

Contains: 10 -0.25gm compules tips.

CE	218-630610
W	218-630611
YE	218-630612
AE	218-630613
GE	218-630614
Each	\$67.45

Regular Body Shades

Contains: 10 -0.25gm compules tips.

XL	218-630616
A4	218-630621
B3	218-630624
B5-DY	218-630625
C1	218-630626
C3	218-630628
C4	218-630629
C5-XGB	218-630630
D2	218-630631
D3	218-630632
Each	\$67.45

Opaque Dentin Shades

Contains: 10 -0.25g compules tips.

W-O	218-630634
A2-O	218-630635
A4-O	218-630636
B2-O	218-630637
C1-O	218-630638
C4-O	218-630639
D3-O	218-630640
Universal	218-630633
Each	\$67.45

Easy Twist Syringe Regular Body Shades

XL	218-630656
A1	218-630657
A2	218-630658
A3	218-630659
A3.5	218-630660
A4	218-630661
B1	218-630662
B2	218-630663
B3	218-630664
C1	218-630666
C2	218-630667
C3	218-630668
C4	218-630669
D2	218-630671
D3	218-630672
3gm	\$82.45



Dyract eXtra - Dentsply Caulk

Offers long lasting fluoride release for peace of mind with a restoration. Physical property performance is equal to traditional hybrid composite restorative materials. Easy finishing and polishing for a high luster restoration. Extended working time for easier placement and shortened curing time for simple and fast procedures.

Contains: 20 -0.25gm compules.

A2	218-685401
A3	218-685402
A3.5	218-685403
A4	218-685404
B1	218-685405
C2	218-685407
XL	218-685409
Each	\$161.95

Additional shades available upon request.



SureFil - Dentsply Caulk

High density posterior composite. Extraordinary wear equal to amalgam. It is precisely engineered with a mixture of particle sizes. Reduced placement time with a 5mm depth of cure and excellent handling without slumping.

Easy Twist Syringe

Shade A	218-645211
Shade B	218-645221
Shade C	218-645231
3gm	\$120.25



Quixx Posterior Restorative - Dentsply Caulk

Utilizing groundbreaking advances in technology, Quixx Restorative offers the perfect balance, a fast, efficient and clinically effective posterior restoration.

Starter Package available upon request.

Compules

Contains: 20 -0.28gm compules tips.	
218-631202	Each..... \$151.45



TPH Spectra Universal Composite - Dentsply Caulk

A direct restorative material indicated for all cavity classes. Available in 2 viscosities LV (Light Viscosity) which has a creamy, spreadable consistency and HV (High Viscosity) which is firmer and more packable. Comprised of 7 VITA based shades which cover the entire 16 VITA shades. Excellent physical properties, brilliant polish and clinical longevity.

Compules Tips Intro Kit

Contains: 55 -0.25gm compules tips; 15 shade A2, 10 shade A1, 5 each shade A3.5, A4, B1, C2 and 1 Compules Tips Gun.	
218-642600	Kit..... \$260.45

TPH Spectra LV Compules Tips

Contains: 10 -0.25gm compules tips.	
L	218-642802
LG	218-642803
LYG	218-642804
C3	218-642805
B2	218-642806
B3	218-642807
C1	218-642808
C4	218-642809
D3	218-642810
XL	218-642812
BW	218-642811
DY	218-642813
XGB	218-642814
C2-O	210-642816
CE	210-642817
Each	\$63.45

Contains: 20 -0.25gm compules tips.

A1	218-642610
A2	218-642611
A3	218-642612
A3.5	218-642613
A4	218-642616
B1	218-642614
C2	218-642615
Each	\$123.25

Continued

COMPOSITE - UNIVERSAL

TPH Spectra Universal Composite continued.

TPH Spectra LV Syringes

A1	218-642630
A2	218-642631
A3	218-642632
A3.5	210-642633
B1	218-642634
C2	218-642635
A4	218-642636
3gm	\$76.45

TPH Spectra HV Compules Tips

Contains: 20 -0.25gm compules tips.

A1	218-642650
A2	218-642651
A3	218-642652
A3.5	218-642653
A4	218-642656
B1	218-642654
C2	218-642655
Each	\$123.25

TPH Spectra HV Syringe delivery format available upon request.

Additional shades available upon request.



Gradia® Direct - GC America

Light-cured, micro-filled hybrid resin composite with microfine pre-polymer resin fillers, a unique coupling agent and urethane dimethacrylate comonomer matrix which offers significant advantages in esthetics, polishability, wear resistance and fracture toughness.

Unitips

Contains: 20 -0.16ml tips.

A1	212-001967
A2	212-001968
A3	212-001969
A3.5	212-001970
AO3	212-001971
B2	212-001977
C3	212-001979
P-A1	212-001997
P-A2	212-001998
P-A3	212-001999
P-A3.5	212-002000
P-WT	212-002041
P-NT	212-002002
Each	\$113.75

Additional shades and syringe delivery format available upon request.



Gradia® Direct X

Universal light cured esthetic composite with a new nano filler that provides improved translucency and radiopacity. Maintains the same excellent handling and esthetic properties of previous versions. The unique chameleon effect allows for 90% of restorations to be completed with one shade. Gradia Direct X is fully compatible with Gradia Direct Anterior and Gradia Direct Posterior for maximum versatility.

Unitip 10 Refills available upon request.

Unitips

Contains: 20 -0.3gm tips.

A1	212-002590
A2	212-002591
A3	212-002592
A3.5	212-002593
Each	\$128.75

Syringes

A1	212-002601
A2	212-002602
A3	212-002603
A3.5	212-002604
B1	212-002608
B2	212-002609
C2	212-002610
D2	212-002611
Bleach White	212-002795
X-Bleach White	212-002796
5gm	\$121.25

Additional shades available upon request.



G-aenial Sculpt® - GC America

Compactable, universal composite that features the same high-density, uniform dispersion nano-filler technology found in G-aenial Universal Flo. Easy to shape, sculpt and polish. Wear-resistant and radiopaque.

Syringe and Unitip Intro Kits available upon request.

Unitips

Contains: 20 -0.16ml tips.

A1	210-009169
A2	210-009170
A3	210-009171
A3.5	210-009172
Each	\$116.95

Additional shades and syringe delivery format available upon request.



Kalore™ - GC America

Combines new, revolutionary monomer technology from DuPont with unique, patented High Density Radiopaque fillers to give the lowest shrinkage stress of all leading composites. Easy polishability, high gloss and sustained luster.

Unitidose

Contains: 20 -0.16gm tips.

A1	212-003613
A2	212-003614
A3	212-003615
A3.5	212-003616
B1	212-003618
Each	\$126.75

Additional shades and syringe delivery format available upon request.



Charisma® - Heraeus Kulzer

A micro-hybrid, light cure, radio-opaque and fluoride releasing Microglass composite. Extra smooth final polish is easy with Charisma due to the grain size of the glass filler and excellent bond strengths are achieved with all bonding systems.

Syringe Assortment Kit available upon request.

Syringes

A1	210-4301
A2	210-4302
A3	210-4303
A3.5	210-4304
A4	210-4344
B1	210-4314
C2	210-4307
C4	210-4315
4gm	\$141.75

PLT

Contains: 20 -0.25gm tips.

A1	210-4361
A2	210-4362
A4	210-4369
B1	210-4365
C4	210-4368
Each	\$197.95

Additional shades available upon request.

COMPOSITE - UNIVERSAL



Venus® Diamond - Heraeus Kulzer

A universal nano-hybrid composite ideally suited for both simple and complex anterior and posterior restorations. Clinical trials affirm its unprecedented and unique handling, exceptional strength and durability, low shrinkage, long lasting polishability and perfect color adaptation.

PLT

Contains: 20 -0.25gm tips.

A1	210-66039008
A2	210-66039009
HKA2.5	210-66039010
A3	210-66039011
A3.5	210-66039012
B1	210-66039015
B2	210-66039016
C2	210-66039018
Each	\$132.95

Syringes

A1	210-66035471
A2	210-66035472
HKA2.5	210-66035473
A3	210-66035474
A3.5	210-66035475
A4	210-66035476
B1	210-66035478
C2	210-66035481
C3	210-66035482
4gm	\$108.75

Additional shades available upon request.



Venus® Pearl - Heraeus Kulzer

A universal nano-hybrid composite based on the innovative urethane monomer chemistry of Venus Diamond. Offers the same unprecedented combination of low shrinkage stress and high durability in a creamy consistency. Formulated for easy handling, it delivers high esthetic results through excellent color adaptation, sculptability and polishability.

PLT and Syringe Basic Kits available upon request.

Syringes

A1	210-66048175
A2	210-66048176
A3	210-66048178
A3.5	210-66048179
A4	210-66048180
B1	210-66048182
B2	210-66048183
C2	210-66048186
3gm	\$92.75

PLT

Contains: 20 -0.2gm tips.

A1	210-66048090
A2	210-66048141
A3	210-66048143
A3.5	210-66048144
A4	210-66048145
C2	210-66048161
C3	210-66048162
B1	210-66048147
B2	210-66048148
B3	210-66048149
C1	210-66048150
Each	\$118.45

Additional shades available upon request.



Heliomolar - Ivoclar Vivadent

Known for its outstanding resistance to wear and excellent physical properties, Heliomolar can also be used in anterior and posterior restorations.

Syringes

110/A1/20	210-6150501
140/A2/22	210-6150502
210/A3/Universal	210-6150508
340/A4/24	210-6150503
510/C3/36	210-6150507
410/D3/35	210-6150506
440/D4/32	210-6150505
110T/WE/20-T Enamel Translucent	210-6150301
420T/GE/38-T Enamel Translucent	210-6150307
3gm	\$65.95

Cavifil

Contains: 20 -0.25gm.

110/A1/20	210-6151310
140/A2/22	210-6151314
210/A3/Universal	210-6151321
510/C3/36	210-6151351
410/D3/35	210-6151341
110/WE/20-T Enamel Translucent	210-6550559
420T/GE/38-T Enamel Translucent	210-6550560
Each	\$119.45

Additional shades available upon request.

Heliomolar HB

Packable, high-viscosity version with high radiopacity, very low wear and is based on microfiller technology making it polishable to a smooth and long-lasting high-gloss finish.

Cavifil

Contains: 20 -0.25gm.

A1	210-560066
A2	210-560067
A3	210-560068
Each	\$119.45

Heliomolar Shade Guide

230-550577	Each	\$25.45
------------	------	----------------

Additional shades and syringe delivery format available upon request.



IPS Empress - Ivoclar Vivadent

Extremely homogeneous, leucite glass ceramic material that scatters light naturally and provides a balanced chameleon effect. It inspires users with its translucency and lifelike appearance.

Syringes

Enamel Shades

A1	210-627232
A2	210-627233
A3	210-627234
A3.5	210-627235
B1	210-627237
3gm	\$86.95

IPS Empress Direct Cavifil Basic Kit available upon request.

Cavifil

Enamel Shades

Contains: 10 -0.2gm.

A1	210-627270
A2	210-627271
A3	210-627272
A3.5	210-627273
Each	\$61.25

Additional shades available upon request.



Tetric® EvoCeram - Ivoclar Vivadent

A new and improved version featuring innovative nano-optimized technology, non-sticky handling and sculptability, high radiopacity levels and extended working times.

Syringes

A1	210-590312AN
A2	210-590313AN
A3	210-590314AN
A3.5	210-590315AN
A4	210-590316AN
C2	210-590320AN
C3	210-590321AN
D3	210-590322AN
T	210-590326AN
Bleach XL	210-590327AN
Bleach L	210-590328AN
Bleach I	210-590329AN
3gm	\$71.75

Cavifil

Contains: 20 -0.2gm.

A1	210-590331AN
A2	210-590332AN
A3	210-590333AN
A3.5	210-590334AN
A4	210-590335AN
B2	210-590336AN
C1	210-590338AN

Continued

COMPOSITE - UNIVERSAL

Tetric EvoCeram continued.

C2.....	210-590339AN
C3.....	210-590340AN
D3.....	210-590341AN
T.....	210-590345AN
Bleach XL.....	210-590346AN
Bleach L.....	210-590347AN
Bleach I.....	210-590348AN
Bleach M.....	210-590349AN
Each.....	\$98.95

Additional shades available upon request.



Herculite XRV® Unidose - Kerr Restoratives

A microhybrid composite with Vita shades. Anterior and posterior use of this single composite adds convenience and reduces inventory. Excellent handling properties allow anatomical shaping without composite slumping.

Syringes

Enamel Shades

A1.....	219-22859
A2.....	219-22860
A3.....	219-22861
A3.5.....	219-22862
A4.....	219-22863
B1.....	219-22864
B2.....	219-22865
B3.....	219-22866
B4.....	219-22867
C1.....	219-22868
C2.....	219-22869
C3.....	219-22870
C4.....	219-22871
D2.....	219-22872
D3.....	219-22873
5gm.....	\$111.25

Dentin Shades

A2.....	219-22875
A3.....	219-22876
A3.5.....	219-22877
B1.....	219-22878
C2.....	219-22880
D2.....	219-22881
5gm.....	\$124.25

Additional shades available upon request.

Unidose Tips

Contains: 20 -0.25gm tips.

Enamel Shades

A1.....	219-23036
A2.....	219-23037
A3.....	219-23038
A3.5.....	219-23039
A4.....	219-23040
B1.....	219-23041
B2.....	219-23042
B3.....	219-23043

C1.....	219-23045
C2.....	219-23046
C3.....	219-23047
C4.....	219-23048
D2.....	219-23049
D3.....	219-23050
Each.....	\$124.25

Dentin Shades

A2.....	219-23052
A3.....	219-23053
D2.....	219-23058

Incisal

Light.....	219-23059
Each.....	\$124.25

Unidose Guns

Original Style.....	239-21782
New Style.....	239-31569
Each.....	\$101.25



Herculite® Ultra

This universal nano hybrid composite features optimal handling and high polishability, lifelike esthetics, great wear resistance, and increased radiopacity everything a clinician needs. The resin matrix and Vita shade matching inherent in other Herculite brands are retained in Herculite Ultra.

Intro Kit available upon request.

Syringes

A1 Enamel.....	219-34337
A2 Enamel.....	219-34338
A3 Enamel.....	219-34339
A3.5 Enamel.....	219-34447
A4 Enamel.....	219-34771
B1 Enamel.....	219-34340
B2 Enamel.....	219-34772
C1 Enamel.....	219-34341
C2 Enamel.....	219-34773
D2 Enamel.....	219-34775
D3 Enamel.....	219-35155
A2 Dentin.....	219-34342
A3 Dentin.....	219-34343
Light Incisal.....	219-34344
4gm.....	\$121.25

Unidose Tips

Contains: 20 -0.2gm tips.

A1 Enamel.....	219-34347
A2 Enamel.....	219-34348
A3 Enamel.....	219-34349
A3.5 Enamel.....	219-34448
A4 Enamel.....	219-34776
B1 Enamel.....	219-34350
B2 Enamel.....	219-34777
B3 Enamel.....	219-35159
B4 Enamel.....	219-35160
C1 Enamel.....	219-34351
C2 Enamel.....	219-34778

C3 Enamel.....	219-34779
C4 Enamel.....	219-35166
D2 Enamel.....	219-34780
D3 Enamel.....	219-35161
D4 Enamel.....	219-35162
A2 Dentin.....	219-34352
A3 Dentin.....	219-34353
Light Incisal.....	219-34354
XL.....	219-34346
Each.....	\$121.25

Additional shades available upon request.



Premise™ - Kerr Restoratives

A universal nano restorative material that offers high polish, excellent mechanical strength and low polymerization all in one system. Premise utilizes three different fillers to achieve high loading (84%) and provides unmatched handling and gloss characteristics.

Syringes

Body Shades

A1.....	219-32617
A2.....	219-32618
A3.....	219-32619
A3.5.....	219-32620
A4.....	219-32621
B1.....	219-32622
B2.....	219-32623
C1.....	219-32626
C2.....	219-32627
C3.....	219-32628
4gm.....	\$124.25

Unidose

Contains: 20 -0.2gm tips.

Body Shades

A1.....	219-32650
A2.....	219-32651
A3.....	219-32652
A3.5.....	219-32653
A4.....	219-32654
B1.....	219-32655
B2.....	219-32656
B3.....	219-32657
C1.....	219-32659
C2.....	219-32660
C3.....	219-32661
C4.....	219-32662
D2.....	219-32663
D3.....	219-32664
D4.....	219-32665
Each.....	\$124.25

Bleach Shades

XL1.....	219-32666
XL2.....	219-32667

Packable Shades

A2.....	219-32871
A3.....	219-32680
Each.....	\$124.25

Additional shades available upon request.

COMPOSITE - UNIVERSAL



Point 4™ - Kerr Restoratives

Optimized particle composite which offers the strength, ease-of-polish and true vitality currently available only through the use of a combination of hybrid and microfill materials.

Syringes

A1	219-29876
A2	219-29877
A3	219-29878
A3.5	219-29879
4gm	\$130.95

Additional shades available upon request.

Unidose

Contains: 20 -0.2gm tips.

A1	219-29898
A2	219-29899
A3	219-29900
A3.5	219-29901
A4	219-29902
B1	219-29903
B2	219-29904
B3	219-29905
C1	219-29907
C2	219-29908
C3	219-29909
C4	219-29910
D2	219-29911
D3	219-29912
XL1	219-29914
XL2	219-29915
Each	\$130.95

Unidose Guns

Original Style	239-21782
New Style.....	239-31569
Each	\$101.25



Clearfil Majesty™ ES-2 - Kuraray America Inc

A light -cure, radiopaque, nano-hybrid composite resin for both anterior/posterior use.

Classic Syringes

A1	210-3020KA
A2	210-3021KA
A3	210-3022KA
A3.5	210-3023KA
B2	210-3027KA
B3	210-3028KA
3.6gm	\$95.95

Additional shades available upon request.

PLT Classic

Contains: 20 -0.25gm tip.

A1	210-3110KA
A2	210-3111KA
A3	210-3112KA
A3.5	210-3113KA
A4	210-3114KA
B1	210-3116KA
B2	210-3117KA
B3	210-3118KA
C1	210-3120KA
C2	210-3121KA
C3	210-3122KA
C4	210-3123KA
Each	\$100.95

Additional shades available upon request.



Clearfil Majesty™ Posterior

A light-cure, nano-superfilled, radiopaque restorative composite resin composed of nano and micro inorganic filler treated with a proprietary new surface coating technology. The new surface technology permits a larger quantity of nanofiller to be dispersed in the resin matrix, a matrix which consists of monomer and micro-filler. The resulting resin matrix is reinforced with a filler loading of 92wt% (82vol%).

Syringes

A1	210-2580KA
A2	210-2581KA
A3	210-2582KA
4.9gm	\$107.25

Additional shades and PLT delivery format available upon request.



EPIC® - TMPT - Parkell Inc.

Composite for Class V restorations. Flexes with the tooth to reduce stress at the margin. Reduces chances of leakage, sensitivity, staining and pop-out. Resilient and polishes beautifully.

Syringes

A1	210-S356
A2	210-S361
A3	210-S362
A3.5	210-S363
A4	210-S357
B1	210-S355
3gm	\$64.75

Additional shades and Unit Dose delivery format available upon request.



Simile™ Universal Composite - Pentron Clinical

Nano-Hybrid Composite. Combines strength and esthetics for both anterior and posterior restorations. Its nano-hybrid formula has been independently proven to deliver a superior surface for easy polishability, superior polish retention, superior wear resistance and outstanding physical properties.

10 Shade Syringe Kit available upon request.

Syringes

A1	210-N56AA
A2	210-N56AB
A3	210-N56AC
A3.5	210-N56AD
B1	210-N56AE
B2	210-N56AF
C2	210-N56AH
C3	210-N56AK
C4	210-N56AP
D3	210-N56AR
4gm	\$68.95

Single Dose delivery format available upon request.



Alert Condensable Composite - Pentron Clinical

Posterior restorative material designed to be a viable amalgam alternative. Proprietary chopped glass fiber filler that contributes to its amalgam-like handling characteristics and exceptional physical properties.

Syringes

A2	210-N15SA
A3	210-N15SB
A3.5	210-N15SC
B1	210-N15SD
C2	210-N15SE
4gm	\$58.25

Single Dose

Contains: 10 -0.25gm single dose units.	
A2	210-N15HA
A3	210-N15HB
B1	210-N15HD
Each	\$42.95

Additional shades available upon request.

COMPOSITE - UNIVERSAL



ACTIVA™ BioACTIVE - Restorative™ - Pulpdent Corporation

A highly esthetic, bioactive composite that delivers all the advantages of glass ionomers in a strong, resilient, resin matrix that will not chip or crumble. It chemically bonds to teeth, seals against bacterial microleakage, releases more fluoride and is more bioactive than glass ionomers, and is more durable and fracture resistant than composites.

Starter Kit

Contains: 8gm syringe, ACTIVA-SPENSER and 20 tips, (10 with bendable 20-gauge metal cannulas and 10 with intraoral tips).

A1	220-VRA1
A2	220-VRA2
A3	220-VRA3
Kit	\$185.25

Single Refill

Contains: 8gm syringe, 20 tips, (10 with bendable 20-gauge metal cannulas and 10 with intraoral tips).

A1	220-VR1A1
A2	220-VR1A2
A3	220-VR1A3
A3.5	220-VR1A35
Each	\$117.25

Value Refill

Contains: 2 -8gm syringes and 40 tips, (20 with bendable 20-gauge metal cannulas and 20 with intraoral tips).

A1	220-VR2A1
A2	220-VR2A2
A3	220-VR2A3
A3.5	220-VR2A35
Each	\$214.95

ACTIVA-SPENSER

Dispenser for 5ml 1:1 automix syringe.
230-DS05 Each..... **\$86.45**



Beautiful II - Shofu Dental Corporation

A fluoride releasing, highly aesthetic dental material for all classes of restorations. Appropriate for patients with a high caries index. Excellent fluorescence and light diversifying aesthetics. Eliminates shade variations associated with polymerization. High level of radiopacity. Enamel-like surface hardness.

Beautiful II Tips 6 Color Set available upon request.

Tips

Contains: 20 -0.25gm tips.

A1	210-1752
A2	210-1753
A3	210-1754
B1	210-1759
C2	210-1763
Each	\$81.45

Syringes

A1	210-1401
A2	210-1402
A3	210-1403
4.5gm	\$39.25

Additional shades available upon request.



Estelite Sigma Quick - Tokuyama Dental America Inc.

A universal, 100% spherically filled composite, with a filler weight of 82% (71% volume). Offers a reduced curing time (by one third) and an extended working time (90 seconds) under the dental light by utilizing Tokuyama's patented innovative initiator system "Radical Amplified Photopolymerization (RAP) Technology".

Syringes

A1	210-13110
A2	210-13111
A3	210-13112
A3.5	210-13113
A4	210-13114
B1	210-13116
B2	210-13117
C1	210-13120
C2	210-13121
C3	210-13122
OA2	210-13124
OA3	210-13125
3.8gm	\$86.75

PLT

Contains: 20 -0.2gm tips.

A1	210-13310
A2	210-13311
A3	210-13312
A3.5	210-13313
A4	210-13314
B1	210-13316
B2	210-13317
B3	210-13318
C1	210-13320
C2	210-13321
C3	210-13322
OA1	210-13323
OA2	210-13324
OA3	210-13325
OPA2	210-13326
CE	210-13327
BW	210-13328
Each	\$97.95

Additional shades available upon request.

COMPOSITE - FLOWABLE



Nanohybrid Flowable Composite

This Nanohybrid Flowable Composite is a light-curing BisGMA based dental restorative material. Its low viscosity and precise syringe delivery make it flowable, easy to place and finish, and adaptable to a variety of clinical situations. It is designed for use in class III and V restorations. Available in 9 Vita shades.

Introductory Kit

Kit Contains: 4 -2gm syringes and 20 tips.
Shades: A2, A3, A3.5 and B1.
210-HT10FK Kit..... **\$39.95**

Refill Kits

Contains: 2 -2gm syringes and 20 tips.

A1	210-HT10A1
A2	210-HT10A2
A3	210-HT10A3
A3.5	210-HT10A35
B1	210-HT10B1
B2	210-HT10B2
C2	210-HT10C2
C3	210-HT10C3
UO	210-HT10UO
Kit	\$40.95



Filtek™ Supreme Ultra Flowable Restorative - 3M Oral Care

Offers enhanced esthetics, excellent physical properties and flow-on-demand handling. Esthetic features including polish retention and fluorescence have been improved over our current flowable. Dentists can be confident of its dependability because of its high wear resistance and very low shrinkage. It can be used for a wide range of indications and is now available in unit dose capsules, which addresses hygienic concerns and is trusted by dentists.

Continued

COMPOSITE -FLOWABLE

Filtek Supreme Ultra Flowable Restorative continued.

Syringes

Contains: 2 -2gm syringes.

A1	213-6032A1
A2	213-6032A2
A3	213-6032A3
A3.5	213-6032A35
A4	213-6032A4
B1	213-6032B1
B2	213-6032B2
C2	213-6032C2
D2	213-6032D2
W	213-6032W
XW	213-6032XW
OA3	213-6032OA3
Each	\$94.95

Capsule delivery format available upon request.



Virtuoso Flowable - DenMat

Ideal for small restorations with difficult access. Light-cure, low viscosity. Bubble-free consistency. High radiopacity. Contains fluoride.

Custom Kits available upon request.

Contains: 4 -1gm syringes, light cure test ring and BondLink Bond Enhancer.

A1	210-032381820
A2	210-032381815
A3	210-032381825
Each	\$88.25

Additional shades available upon request.



Dyract Flow - Dentsply Caulk

Flowable compomer restorative that provides ideal handling properties and superb adaptation to tooth structure with sustained, rechargeable fluoride release.

Syringe Operatory Kit available upon request.

Syringes

A2	218-685611
A3	218-685612
A4	218-685616
A3-Opaque	218-685617
B1	218-685613
1.3gm	\$37.95

Additional shades available upon request.



Esthet-X Flow Liquid Micro Hybrid Restorative - Dentsply Caulk

Unique handling has stack and flow incorporated in one material. This material actually reacts to the movements of the dentist's instrumentation for complete control during placement.

Syringe Intro Kit available upon request.

Syringes

Contain: 2 -1.3gm syringes.

A1	218-648020
A2	218-648021
A3	218-648022
A3.5	218-648026
A4	218-648023
B1	218-648024
U/LYG (Universal)	218-648025
Each	\$66.75

Compula Tip Refills available upon request.

Syringe Tips

218-648003	60/pack	\$36.25
------------	---------------	----------------



TPH³ Flow - Dentsply Caulk

Provides an ideal viscosity for those doctors who desire a moderate flow flowable with excellent physical properties. It is a great choice for use as a Class II base/liner as it flows easily into the prep to ensure adequate marginal adaptation.

Syringe Introductory Kit available upon request.

Syringes

Contains: 2 -1.3gm and 30 gray syringe tips.

A1	218-642730
A2	218-642731
A3	218-642732
B2	218-642735
C4	218-642737
Each	\$56.75

Syringe Tips

218-648003	60/pack	\$36.25
------------	---------------	----------------

Compula Tips

Contains: 20 -0.25gm tips.

A1	218-642720
A2	218-642721
A3	218-642722
A3.5	218-642723
B2	218-642725
Each	\$113.45

Additional shades available upon request.



LuxaFlow - DMG America

Composite material formulated specifically as an add-on resin for bisacryl provisionals. Optimum flow characteristics. Non-slumping formula. Highly polishable.

Intro Package available upon request.

Contains: 2 -1.5gm syringes and 10 tips.

Light A1	210-211753
Universal A2	210-211754
Dark A3.5	210-211755
Ultra-Lite B2	210-211756
Each	\$50.95

Syringe Tips

210-211759	20/bag	\$16.45
------------	--------------	----------------



GRADIA[®] DIRECT Flo - GC America

A light-cured, highly flowable, fluoride releasing composite. Very low viscosity for easy, fluid placement as a liner, base or resin sealant, is radiopaque and contains fluoro-alumino-silicate glass (fluoride releasing).

Contains: 2 -1.5gm syringes and 4 tips.

A1	212-002278
A2	212-002279
A3	212-002280
Package	\$68.75

Additional shades available upon request.



GRADIA[®] DIRECT LoFlo

Very low shrinkage to minimize contraction stress, microleakage and sensitivity. It contains High Density Radiopaque (HDR) Pre-polymerized Filler to increase durability, polishability and radiopacity.

Contains: 2 -1.5gm syringes and 4 tips.

A1	212-002289
A2	212-002290
A3	212-002291
A3.5	212-002292
Package	\$68.75

Additional shades available upon request.



G-aenial™ Flo - GC America

A light-cured flowable nano-hybrid composite that has exceptional physical properties such as extremely high flexural strength, easy handling, and superior gloss and gloss retention. Utilizing new filler technology, this product has excellent aesthetics and radiopacity. It comes in a newly designed syringe for easy use and less waste.

Contains: 3.8gm syringe and 20 dispensing tips.

A1	212-004194
A2	212-004195
A3	212-004196
A3.5	212-004197
AO3	210-004200
Each	\$88.25



G-aenial™ Universal Flo

A light-cured composite that has the handling of a flowable (low flow) and the strength and aesthetics of a composite. Utilizing new filler technology, this product has extremely high strength, and exceptionally low-wear, making it the perfect choice for your restorative needs. It also has self-polishing characteristics. Use it from the bottom to the top of the restoration for exceptional, long-lasting results that are easy to achieve.

Contains: 3.4gm syringe and 20 dispensing tips.

A1	212-004202
A2	212-004203
A3	212-004204
A3.5	212-004205
A4	212-004206
B1	212-004207
C3	212-004210
AO2	212-004211
BW	212-004213
CV	212-004214
Each	\$93.25

Additional shades available upon request.

Dispensing Tip III - Metal

230-004635	30/pkg	\$42.45
------------	--------------	----------------

Dispensing Tip III - Plastic

232-004634	30/pkg	\$21.75
------------	--------------	----------------



Venus® Flow - Heraeus Kulzer

Flowable microhybrid composite that offers total control and greater versatility. Non-slumping and non-runny. Thixotropic, so it flows only when manipulated.

Assorted Package available upon request.

Syringes

A1	210-66014562
A2	210-66014563
A3	210-66014565
A4	210-66014567
Baseliner White	210-66014574
1.8gm	\$44.45



Venus® Diamond Flow - Heraeus Kulzer

Light-cured flowable composite based on nano-technology that is highly radiopaque with flow-on-demand behavior, low shrinkage stress and high flexural strength. The shade system is designed to match Venus Diamond to produce the highest in esthetic restorations.

Syringes

A1	210-66040354
A2	210-66040355
A3	210-66040358
A3.5	210-66040359
A4	210-66040360
B2	210-66040362
BXL	210-66040365
Baseliner	210-66041052
1.8gm	\$40.25

Additional shades available upon request.

PLT Kit and Refills available upon request.



Heliomolar Flow - Ivoclar Vivadent

Radiopaque, flowable, micro-filled resin material with high polishability and strength characteristics in a syringe delivery system.

Syringes

Contains: 1.6gm syringe and 5 tips.

110T/A1T/20T	210-6557034
105/XX/18	210-6557029
110/A1/20	210-6557030
140/A2/22	210-6557031
210/A3/U	210-6557032
410/D3/35	210-6557033
420T/XX/385T	210-6557035
Package	\$36.45

Syringe Cannulas - 0.9mm

230-6556744	20/pkg.	\$18.95
-------------	--------------	----------------



Tetric EvoFlow® - Ivoclar Vivadent

A flowable, light-curing, radiopaque nano-hybrid composite for the restorative therapy and the cementation of ceramic and composite restorations.

Cavifil Assortment Kit available upon request.

Cavifil

Enamel Shades

Contains: 20 -0.2gm.

A1	210-595987
A2	210-595988
A3	210-595989
A3.5	210-595990
B1	210-641348
Each	\$95.25

Dentin Shades

Contains: 20 -0.2gm.

A3.5	210-595994
B2 Dentin	210-641350
Bleach L	210-595996
Bleach M	210-596008
Each	\$95.25

Syringe Assortment Kit available upon request.

Syringes

A1	210-595953
A2	210-595954
A3	210-595955
A3.5	210-595956
A4	210-595978
B1	210-641358
B3	210-595957
Translucent	210-595979
A3.5 Dentin	210-595980
Bleach XL	210-595981
Bleach L	210-595982
Bleach M	210-595984
2gm	\$45.75

COMPOSITE - FLOWABLE



Herculite™ Ultra Flow - Kerr Restoratives

Nanohybrid Flowable Composite. Featuring Smart Placement Technology, flows easily when used as a base/liner and maintains its shape when used in small restorations.

Contains: 2 -2gm syringes and 20 dispensing tips.

A1	210-35392
A2	210-35393
A3	210-35394
A3.5	210-35395
A4	210-35396
B1	210-35397
B2	210-35398
C2	210-35399
D2	210-35400
XL1	210-35401
XL2	210-35402
Universal Opaque	210-35403
Each	\$84.45



Premise Flowable - Kerr Restoratives

A medium viscosity, nano-filled, light-cure composite suitable for various direct applications. Pre-polymerized filler, nano-filler and proven Point 4 technology are combined to deliver strength and durability.

Assorted Syringe Kit available upon request.

Contains: 4 -1.7gm syringes.

A1	219-33372
A2	219-33373
A3	219-33374
A3.5	219-33375
B1	219-33376
C2	219-33377
XL2	219-33380
Each	\$152.25

Tips

239-33370	50/pack	\$68.25
-----------	---------------	----------------



Revolution™ Formula 2 - Kerr Restoratives

Flowable, light-cure, hybrid resin restorative. More exact Vita Shading and expanded shade range.

Contains: 4 -1gm syringes and 20 tips.

A1	219-29493
A2	219-29494
A3	219-29495
A3.5	219-29496
A4	219-29497
B1	219-29498
B2	219-29499
B3	219-29500
B4	219-29501
C1	219-29502
C2	219-29503
C3	219-29504
C4	219-29505
D3	219-29507
XL	219-29509
Universal Opaque	219-29512
White Opaque	219-29513
Light Incisal	219-29511
Each	\$96.25

Assorted Pack Syringe Kit available upon request.

Dispensing Tips

Black, 22ga.	230-450119
Yellow, 20ga.	230-450120
100/pkg	\$80.25



Vertise™ Flow - Kerr Restoratives

A self-adhering, light-cured, resin-based flowable composite designed for direct placement. OptiBond adhesive technology greatly simplifies the direct restorative procedure by incorporating the bonding agent into the flowable.

Introductory Kit

Contains: 2gm syringe each of shades A1, A2, A3, B1, 40 tips, 40 brushes, 1 technique guide.	
210-34238B	Kit..... \$252.25

Refills

Contains: 2 -2gm syringes, 20 tips, 20 brushes.	
A1	210-34241
A2	210-34242
A3	210-34243
UO	210-34247
Each	\$157.25



Clearfil Majesty™ Flow - Kuraray America Inc.

A flowable, superfilled, light cure, radiopaque restorative composite resin with the filler particles treated with a proprietary new surface coating technology. In addition to the high filler loading, It has a low viscosity for good handling and easy placement. Exhibits high mechanical properties (strength, wear resistance, durability), high radiopacity and very low polymerization shrinkage.

Contains: 3.2gm syringe and 15 needle tips.

A1	210-2610KA
A2	210-2611KA
A3	210-2612KA
A3.5	210-2613KA
B1	210-2615KA
B2	210-2616KA
C3	210-2618KA
E2	210-2620KA
CV	210-2621KA
OA3	210-2632KA
BL2	210-2635KA
Each	\$65.25

Needle Tips

230-1015KA	20/pkg	\$12.75
------------	--------------	----------------



Flow-It ALC™ - Pentron Clinical

Flowable composite with flexural and tensile strength comparable to the best hybrid composites. Excellent handling capabilities and just the right viscosity make it easy to use in an extensive range of applications. Cures in only 3 seconds with high speed curing lights or only 10 seconds with standard halogen lights.

Syringes

A0	210-N11XA
A1	210-N11A
A2	210-N11B
A3	210-N11C
A3.5	210-N11J
A4	210-N11K
B0	210-N11XB
B1	210-N11L
B2	210-N11D
B3	210-N11E
B4	210-N11M
C1	210-N11N
C2	210-N11F
C3	210-N11G
C4	210-N11O
D2	210-N11P
D3	210-N11Q
1ml	\$23.25

Value Packs

Contains: 6 -1ml syringes and accessories.	
A1	210-N11VA
A2	210-N11VB
A3	210-N11VC

Additional shades available upon request.

COMPOSITE - FLOWABLE



Wave - SDI

Light cured hybrid, fluoride releasing, flowable composite with superior strength, polishability and handling characteristics. In its viscosity, Wave is extremely low, Wave MV is medium and Wave HV is high.

Wave Syringes

Contains: 1gm syringe and 5 applicator tips.

A1	210-7510102
A2	210-7510203
A3	210-7510304
A3.5	210-7510405
B1	210-7511101
B3	210-7511314
C3	210-7512324
Each	\$21.75

Additional shades available upon request.

Wave MV Syringe Intro Kit

Contains: 4 -1gm syringes of A2, B2, C2, OA2, 20 tips.
210-8300000 Kit..... **\$79.95**

Wave MV Syringes

Contains: 1gm syringe and 5 applicator tips.

A1	210-8310102
A2	210-8310203
A3	210-8310304
A3.5	210-8310405
B1	210-8311101
C2	210-8312223
Each	\$21.75

MV Complet delivery format available upon request.

Wave HV Syringes

Contains: 1gm syringe and 5 applicator tips.

A1	210-8210102
A2	210-8210203
A3	210-8210304
A3.5	210-8210405
C2	210-8212223
Each	\$21.75

HV Complet delivery format available upon request.

Syringe Tips

18ga.	
230-8100065	20/pkg \$13.75
20ga.	
230-7500001	20/pkg \$18.25



N'Durance® Dimer Flow - Septodont

Light cure Nano-Dimer low shrinkage, high conversion, flowable composite. Lower volumetric shrinkage. Compatible with all bonding agents. Extremely hydrophobic for better color stability. Contains: 2 -2gm syringes and 20 tips.

A1	210-C3080
A2	210-C3081
A3	210-C3082
Each	\$69.95

Additional shades available upon request.



Beautifil Flow Plus - Shofu Dental Corporation

A base, liner and final restorative all in one. Featuring Shofu's proprietary Surface Pre Reacted Glass (S-PRG) technology, It provides sustained fluoride release and recharge.

Standard Kit

Contains: 4 -2.2gm syringes: F00 (Zero Flow) A2, A3, F03 (Low Flow) A2, A3, and assorted samples from Shofu.
210-2000S Kit..... **\$113.45**

Pedo Kit available upon request.

F00 Refills (Zero Flow)

Contains: 2.2gm syringe and 20 -21ga. tips.

A0.5	210-2000
A1	210-2001
A2	210-2002
A3	210-2003
A3.5	210-2004
A4	210-2005
A10	210-2007
A20	210-2008
Bleach White	210-2011
Each	\$40.75

F03 Refill (Low Flow)

Contains: 2.2gm syringe and 20 -21ga. tips.

A0.5	210-2013
A1	210-2014
A2	210-2015
A3	210-2016
A3.5	210-2017
A20	210-2020
Bleach White	210-2024
Each	\$40.75

Needle Tips

230-1484	50/pkg \$21.25
----------	-----------------------------



Estelite Flow Quick® - Tokuyama Dental America Inc.

A universal supra-nano filled resin composite offering superior esthetics, ideal handling, and excellent gloss and polishability, all in one system. Building on the proven success of the spherical filler and the patented Radical Amplified Photopolymerization initiator technology. It provides an extended working time and quicker curing time.

Medium Flow

Contains: 3.6gm syringes and 15 tips.

A1	210-12111
A2	210-12112
A3	210-12113
A3.5	210-12114
B1	210-12116
C2	210-12121
Each	\$66.45

Available in High Flow upon request.



StarFill 2B - Zest Dental Solutions

Dual-cure flowable composite ideal where composite is inaccessible to light. Fast set with a light or self-cures intraorally in approximately 2-1/2 minutes. Radiopaque.

Contains: 10gm automix syringe and 6 tips.
210-90150 Each..... **\$95.95**

COMPOSITE - GLASS IONOMER



Ketac™ Fil Plus Aplicap™ - 3M Oral Care

Glass ionomer restorative. Provides molecular bond to enamel and dentin to guarantee a tight marginal seal. Offers high fluoride release. Radiopaque.

Intro Kit available upon request.

A1 Light	277-55020
A2 Light Yellow	277-55030
A3 Yellow	277-55040
50/box	\$293.95

Additional shades available upon request.

COMPOSITE - GLASS IONOMER



Ketac™ Molar Quick Aplicap™ - 3M Oral Care

This fluoride releasing, packable material offers short mixing and setting times and excellent handling characteristics.

Introductory Kit - Assorted Shades

277-056369 50/box **\$263.95**

Capsules

A1 277-056366
 A2 277-056363
 A3 277-056364
 50/box **\$263.95**

Ketac Conditioner

227-37470 10ml **\$35.45**

Ketac Glaze

217-37190 2.5gm **\$39.45**



Ketac™ Nano Light Curing Glass Ionomer - 3M Oral Care

The unique capsules activate by extending the capsule tip. When dispensing, the two pastes mix inside the tip allowing for easy placement directly into the prep faster and with fewer voids. High initial polish, improved wear resistance and high fluoride release make this resin-modified glass ionomer a convenient filling material.

Trial Kit

Contains: 10 -A2 quick mix capsules, 10 -A3 quick mix capsules, and 3ml primer.

277-3305TK Kit **\$177.95**

Capsules

A1 273-3305A1
 A2 273-3305A2
 A3 273-3305A3
 A3.5 273-3305A35
 20/pkg **\$122.95**

Primer

277-3304P 6.5ml **\$199.95**

Additional shades and Clicker Dispenser delivery format available upon request.



Photac™ - Fil Quick Aplicap™ - 3M Oral Care

Light-cured glass ionomer restorative. Dual cure provides light-cure control and the assurance of a complete cure. High fluoride release. Radiopaque and biocompatible.

A1 Extra Light 217-61010

A2 Light 217-61020
 A3 Universal 217-61030
 B2 Light Yellow 217-61050
 50/box **\$323.95**

Additional shades available upon request.



ChemFil Rock Advanced - Dentsply Caulk

Superior fracture and wear resistance. Bulk placement, self adhesive, self-cure setting. No cavity conditioning or surface coat needed. Non-sticky, packable formula with a sculptable consistency for excellent adaptability.

Intro Kit available upon request.

A1 278-60606591
 A2 278-60606592
 A3 278-60606593
 50/pkg **\$98.25**

Additional shades available upon request.

ChemFil Rock Capsule Extruder

278-60606596 Each **\$98.25**



GC Fuji II® Restorative - GC America

Glass ionomer restorative with high water resistance. Fluoride-releasing, radiopaque, extended working time and short set time.

1:1 Powder Liquid Package

Contains: 15gm powder, 8ml liquid, mixing cup and measuring scoop.

21 Pale Yellow 272-435021
 22 Yellow Brown 272-435022
 23 Dark Gray 272-435023
 Package **\$245.95**

Powder

21 Pale Yellow 272-435121
 22 Yellow Brown 272-435122
 23 Dark Gray 272-435123
 15gm **\$185.25**

Liquid

272-435821 8ml **\$83.95**

Capsule Assortment Package and Single Shade Packages available upon request.



GC Fuji II LC

Light-cured, resin reinforced glass ionomer restorative. Esthetics, simplicity and economy when it comes to class III and class V restorations, cervical erosions/abfraction lesions and root surface caries when used as a base or liner.

Capsules

A1 Pedo 270-425001
 A2 270-425002
 A3 270-425003
 A3.5 270-425004
 A4 270-425005
 C2 270-425009
 48/box **\$291.75**

Assorted Capsule Package - Dark Shades

Contains: 24 -0.10ml capsules; 5 each of A3.5, A4, B3 and B4; 4 of C4.

270-425020 Each **\$165.25**

Assorted Capsule Package - Light Shades

Contains: 24 -0.10ml capsules; 5 each of A1, A2, A3 and B2; 4 of C2.

270-425015 Each **\$165.25**



1:1 Powder Liquid Package

Contains: 15gm powder, 8gm liquid, mixing pad and measuring scoop.

A2 272-438021
 A3 272-438031
 Package **\$276.75**

Powder

A2 272-438022
 A3 272-438032
 15gm **\$153.25**

Additional shades available upon request.

Liquid

272-438009 6.8ml **\$143.25**

COMPOSITE - GLASS IONOMER



GC Fuji IX GP® - GC America

General purpose, self-curing ionomer designed for a wide range of applications. Ideal as an alternative to amalgam, composite and comonomers for geriatric and pediatric applications. Chemically bonds to dentin and enamel. Packable dough-like consistency, non-sticky, continual, rechargeable fluoride release, high compressive and flexural strengths.

1:1 Powder Liquid Package

Contains: 15gm powder shade A2, 8gm liquid and mixing pad.
272-439101 Package **\$222.25**

Powder - Shade A2

272-439111 15gm **\$141.25**

Liquid

272-439191 6.4ml **\$87.45**

Assorted Capsule Package

Contains: 10 of each shade A2, A3 and A3.5, 9 of each shade B2 and B3.
270-425080 Package **\$287.75**

Capsules

Contains: 50 capsules, (0.40gm powder and 0.09ml liquid per capsules).
A2 270-425081
A3 270-425082
Each **\$250.25**

Additional shades available upon request.



GC Fuji IX GP® EXTRA

Glass ionomer restorative that utilizes glass filler technology to provide a fast setting, high aesthetic restoration without sacrificing strength.

Assorted Capsule Package

Contains: 10 each of A2, A3, A3.5, 9 of each shade B1 and B3.
270-425040 Package **\$297.25**

Capsules

A1 270-425041
A2 270-425042
A3 270-425043
A3.5 270-425044
48/pkg. **\$297.25**

Additional shades available upon request.



GC Fuji IX GP® Fast

A strong, wear resistant, packable glass ionomer restorative in a fast setting formulation. Its non-sticky, dough-like consistency and simple placement make minimally invasive restorations easy. and the prep can be bulk filled because layering is not required. Finished in only 3 minutes.

Assorted Capsule Starter Pack

Contains: 48 capsules; 10 of each shade A2, A3, A3.5, 9 of each shade B2 and B3, Capsule Applier III, 5.7ml GC Cavity Conditioner and 5.2ml GC Fuji Coat LC.
270-425070 Pack **\$404.95**

Capsules

A1 270-425066
A2 270-425061
A3 270-425062
A3.5 270-425063
48/pack **\$287.75**

Assorted

Contains: 10 each: A2, A3, A3.5, 9 of each shade B2 and B3.
270-425060 Each **\$287.75**



Riva Self Cure - SDI

Glass ionomer restorative material. BPA & HEMA free. Virtually mimics dentin, no adhesive required and sensitivity is non-existent. Very high compressive strength. Does not contain resin eliminating volumetric shrinkage after curing.

Regular Set Capsules

A1 210-8600001
A2 210-8600002
A3 210-8600003
50/pkg. **\$282.95**

Fast Set Capsules

A1 210-8605001
A2 210-8605002
A3 210-8605003
50/pkg. **\$282.95**

Additional shades available upon request.



Riva Coat

210-8610001 5ml **\$68.75**

Riva Conditioner

210-8620001 10ml **\$42.75**

Riva Applicator I

270-5545009 Each **\$67.45**

Riva Applicator II

270-5545013 Each **\$170.95**

Riva Self Cure HV available upon request.

SEALERS



G-Coat Plus™ - GC America

A light-cured, protective clear coating formulated with adhesive monomer and nanofillers. One thin coat protects margins, prevents staining and provides a high gloss (comparable to intense polishing).

Starter Kit

Contains: 4ml bottle, 20 dispensing dishes, 50 micro-tips, applicator and 1 applicator holder.
272-002583 Kit **\$92.75**



GC Fuji COAT LC - GC America

Formulated from special monomers, developed to penetrate and seal glass ionomer materials. Seals the margin and surface defects, leaving an extra smooth surface on final restorations.

272-435901 5.2ml **\$91.25**



GC Fuji VARNISH™ - GC America

Ideal for use with all GC glass ionomer products where protection from moisture contamination is required.

272-435101 10.4ml **\$56.45**

SEALERS



OptiGuard™ Surface Sealant - Kerr Restoratives

A fluoride releasing composite surface sealant comprised of unfilled, light-cured resin material. Fills and strengthens the composite surface after finishing, thus guarding against premature wear and staining.

209-25880 5ml **\$82.45**

TINTS & OPAQUES



Clearfil ST Opaquer - Kuraray America Inc.

Light-cured composite resin used to mask underlying metal darkness and tooth discoloration.

Lite 220-636KA
 Universal 220-637KA
 4gm **\$83.25**



Embrace Wetbond™ Seal-n-Shine™ - Pulpdent Corporation

Seals composites and margins, finishes and polishes restorations. Saves time.

Bottle Kit

Contains: 6ml bottle, brush handle, 100 brush tips.

740-EMSNS Kit..... **\$74.25**

Syringe Kit

Contains: 2 -1.2ml syringes, 40 flocked tips.

740-EMSNY Kit..... **\$63.95**

Flocked Applicator Tips

1/2" 25ga.

230-P2520 20/pkg **\$8.45**



Pulpdent® Opaquer - Pulpdent Corporation

Masks out metal and discolored tooth structure. Bonds to dental adhesives, bonding agents, composite resins and resin cements.

Near White Shade..... 200-OP1
 Tooth Shade..... 200-OP2
 3ml **\$33.95**



Universal Masking Agent - SDI

Simulate a life like, natural tooth. Color is derived from the color saturated dentin in conjunction with light penetrating the translucent enamel and undergoing reflection, transmission and absorption.

210-7970202 1gm..... **\$21.25**

Additional shades available upon request.

WHITENING - IN-OFFICE



LUMABrite Chairside Whitening - DenMat

Used with Den-Mat's Sapphire light, achieves results of up to 12 shades.

Contains: 1 Dual barrel whitening syringe (one patient), desensitizing syringe, paint on dental dam syringe, lip moisturizer, blue mini brush applicator, 18gm syringe tip and lip expanders.

170-035359155 Kit..... **\$68.45**



Captivate by NUPRO - Dentsply Professional

Delivers up to 6 shades whiter when used alone and 9 shades whiter when used in conjunction with Hydrogen Peroxide patient take-home kits.

36% Hydrogen Peroxide System Kit

Contains: 2 -1.6gm gel syringes, 2 -0.4gm Activator Gel syringes, 1 gingival dam syringe and 3 syringe tips.

170-614062 Kit..... **\$98.25**



VenusWhite Max - Heraeus Kulzer

Provides fast results with convenient syringe-to-syringe mixing, which chemically activates the product, ensures a thorough mix and provides maximum freshness. 38% hydrogen peroxide gel. Contains potassium nitrate which helps decrease sensitivity associated with bleaching.

In Office Kit

Contains: 2 -0.96ml hydrogen peroxide syringes, 2 -0.24ml activator, 1.2ml gingival barrier, -22ga. flock tips, 2 -20ga. black mini tips.

170-40005211 Kit..... **\$60.95**



Pola Office+ - SDI

Minimal chair time is required, total treatment will take less than 30 minutes. The unique 37.5% hydrogen peroxide formula ensures fast release of the peroxide ions to begin the bleaching process.

Pola Office+ 1 Patient Kit - with Retractor

Contains: 1gm Gingival Barrier syringe, 1 Cheek Retractor and accessories.

170-7700431 Kit..... **\$75.75**

Pola Office +1 Patient Kit - no Retractor

Contains: 2.8ml syringe, 1gm Gingival Barrier syringe and accessories.

170-7700430 Kit..... **\$77.25**

Pola Office+ 3 Patient Kit - with Retractors

Contains: 3 -2.8ml syringes, 3 -1gm Gingival Barrier syringes, 3 Cheek Retractors and accessories.

170-7700416 Kit..... **\$213.45**

Pola Office+ 3 Patient Kit - no Retractors

Contains: 3 -2.8ml syringes of, 3 -1gm Gingival Barrier syringes and accessories.

170-7700415 Kit..... **\$207.75**

Pola Office+ 10 Patient Kit

Contains: 10 -2.8ml syringes and 10 mixing tips.

170-7700457 Kit..... **\$156.95**

WHITENING - IN-OFFICE



In-Office Whitening - Sinsational Smile

Clinically proven to work in just 20 minutes without sensitivity. 1 minute prep time, no gingival barrier required, designed as a maintenance procedure to be done at every 6 month patient cleaning appointment. The first and only Green Certified Teeth Whitening System in the country. Made in the USA.

Complete Sinsational Smile System

Contains: LED Accelerator light, 24 Treatment Packages (each with 1 -25% Carbamide Peroxide prefilled Whitening Tray and 2 Vitamin E oil swabs for lip moisture), 24 Take Home Whitening pens in satchels, 2 pair of eye goggles, 100 patient brochures and 2 -8x11 counter posters.
170-SINS2011 System **\$2299.95**

Refill Kits available upon request.

In-Office 25% Replacement Kit

Contains: 12 Treatment Packages (each with 1 -25% carbamide peroxide prefilled whitening tray and 2 vitamin E oil swabs) and 12 take-home whitening pens.
170-SINS12PK Kit..... **\$367.95**

WHITENING - IN-OFFICE ACCESSORIES



Perfecta® Block-Out Resin - Premier® Dental

Light-cure resin used to block out undercuts on die or to create whitening reservoirs. 20-second cure.

Contains: 2 -3cc syringes and 20 tips.
177-4008300 Pack **\$33.45**

Tray Material

.040 5"x5"
177-4008305 25/pkg. **\$39.25**



Contrast Light-Curable Block Out Resin - Spectrum Dental, Inc.

Contains: 4 -1.3gm syringes.
170-ZD1017 Each..... **\$19.25**



FastDam™ - Spectrum Dental, Inc.

Soft tissue isolation.
Contains: 4 -1.2gm syringes.
170-ZD1422 Each..... **\$27.95**



Captivate by NUPRO - Dentsply Professional

15% hydrogen peroxide take-home formula averages 5 shade changes when used just 15 minutes a day for 7 days and can whiten teeth 9 shades when used in conjunction with the in-office treatment.

Patient Kit

Contains: 3 -2.4gm 15% hydrogen peroxide gel syringes, 3 dispensing tips with cap and 1 tray case.
170-614063 Kit..... **\$54.75**

Patient Touch-Up Kit

Contains: 2 -2.4gm 15% carbamide peroxide syringes, 3 dispensing tips with cap and tray case.
170-614066 Kit..... **\$20.75**

Bulk Kit

Contains: 50 -2.4gm carbamide peroxide gel syringes and 50 dispensing tips with cap.
10%..... 170-614067
15% 170-614068
Kit **\$263.95**



Venus White Pro - Heraeus Kulzer

A high-performance, mint-flavored, take-home carbamide peroxide whitening gel for custom trays. It works gently, quickly, and with minimal sensitivity, to reveal a smile up to 7 full shades whiter.

Patient Kits

Contains: 6 -1.2ml syringes, tray case, shade guide.
16% 170-40005166
22% 170-40005167
35% 170-40005460
Kit **\$42.75**

Refill Kits

Contains: 3 -1.2ml syringes.
16% 170-40005164
22%..... 170-40005165
35% 170-40005462
Kit **\$24.75**

Bulk Kits

Contains: 50 -1.2ml syringes.
16%..... 170-40005463
22%..... 170-40005464
35% 170-40005465
Kit **\$181.45**

WHITENING - TAKE HOME



White & Brite™ Tooth Whitening System - 3M Oral Care

All strengths have a pleasant mint flavor. 22% requires refrigeration. Carbamide Peroxide.

2 Syringe Touch-Up Kit
16% 170-12177 **\$16.25**
22% 170-12178 **\$17.25**

4 Syringe Express Kit
16% 170-12174 **\$30.45**
22% 170-12175 **\$36.95**

6 Syringe Deluxe Kit
16% 170-12171 **\$51.95**
22% 170-12172 **\$55.45**



LUMIBrite Take Home Whitening - DenMat

A fast, easy-to-use, at-home whitening method that's designed to promote patient compliance.

Standard Kit
Contains: 6 -2.5ml syringes, mouthguard case, resin sheets, dentist instructions, patient instructions.
16% Mint..... 170-034359145
22% Mint..... 170-034339145
32% Mint..... 170-034139145
Kit **\$46.95**

Refill Kit

Contains: 12 -25ml syringes.
16% Mint..... 170-034358725
22% Mint..... 170-034338725
32% Mint..... 170-034138725
Kit **\$68.45**

TAKE HOME TOOTH WHITENING



Venus White Ultra - Heraeus Kulzer

Each disposable tray is pre-filled with mint-flavored, 11.2% hydrogen peroxide whitening gel. Use once a day.

Contains: 7 upper and 7 lower pre-filled trays.
170-40005210 Kit..... **\$34.45**

Venus White Ultra+

15% hydrogen peroxide with potassium nitrate to help decrease sensitivity.

Contains: 7 upper and 7 lower pre-filled trays.
170-66060672 Kit..... **\$39.95**



Venus White Touch Up Brush

A convenient, reusable pen filled with mint-flavored whitening gel, so you can brush it on anytime, anywhere. 9% hydrogen peroxide.

170-66051761 Each..... **\$15.75**



Iveri at Home - Iveri Whitening

Whitening at your patient's convenience. Customized trays.

Contains: 4 -3.5ml syringes, 2 custom tray sheets, tray carrying case and shade guide.
170-35ATHOME4PACK 35%..... **\$27.25**

Additional strengths available upon request.



Nu Radiance Classic - Nu Radiance, Inc.

Custom tray take home whitening gel available in multiple strengths: 10%, 16%, 22% and 30% carbamide peroxide. Each 3ml syringe is 5 - 6 complete treatments. Peppermint flavor.

Patient Kit

Contains: 4 -3ml syringes, dispensing tips, storage case, patient instructions, microfiber bag and the Nu Radiance reusable water bottle.
170-0233 16%..... **\$26.95**
170-0332 22%..... **\$26.95**

Maintenance Kit

Contains: 3 -3ml syringes dispensing tips patient instructions, microfiber bag and the Nu Radiance reusable water bottle.

170-0127 10%..... **\$15.95**
170-0226 16%..... **\$15.95**
170-0325 22%..... **\$15.95**



Nu Radiance Duet

For patients with sensitivity issues and/or desire a short 30 minute wear time. 8% Carbamide Peroxide, each 4ml automix syringe is 5 - 6 complete treatments.

Patient Kit

Contains: 3 -4ml syringes, dispensing tips, storage case, patient instructions, microfiber bag and the Nu Radiance reusable water bottle.
170-0622 Kit..... **\$31.95**

Maintenance Kit

Contains: 2 -4ml syringes, dispensing tips, patient instructions, microfiber bag and the Nu Radiance reusable water bottle.
170-0615 Kit..... **\$16.95**



Nu Radiance Forté

Rebuilds enamel through significant calcium uptake. With calcium peroxide that whitens with the added benefit of strengthening enamel by increasing remineralization and surface hardness. Short 30 minute wear time with 27% carbamide peroxide and virtually no sensitivity issues. Each 4ml automix syringe is 5 - 6 complete treatments.

Patient Kit available upon request.

Maintenance Kit

Contains: 2 -4ml syringes dispensing tips, patient instructions, microfiber bag and the Nu Radiance reusable water bottle.

170-0813 Kit..... **\$17.95**

Bulk Kit

Contains: 36 -4ml syringes of whitening gel, dispensing tips and patient instructions.

170-853 Kit..... **\$199.95**



Perfecta® - Premier® Dental

Carbamide peroxide based whitening system. Available in 16% and 21% strength formulas. Glycol based for minimal dehydration and sensitivity.

Patient Pak

Contains: 6 -3cc syringes of 21% whitening gel, 6 dispensing tips, cosmetic patient pouch with mirror, tray mirror and tray case.

177-4000212 Each..... **\$59.95**

Value Pak available upon request.

50-Pak

Contains: 50 -3cc syringes of 21% whitening gel, 50 dispensing tips, 8 patient instructions, 25 prescription bags and 1 doctor's instructions.

177-4004215 Each..... **\$253.75**

TAKE HOME TOOTH WHITENING



Perfecta Whitening Gel- Premier® Dental

Whitening gel in a squeeze tube. Fresh mint flavor. Glycol based for minimal dehydration and sensitivity. Ideal package for long-term cases (tetracycline) or for several members of the same family to whiten simultaneously.

Contains: 2oz. (59cc) 2-arch supply per tube.
 11% 177-4007115
 16% 177-4007165
 21% 177-4007215
 24/box **\$31.75**

Perfecta® REV!®

14% hydrogen peroxide gel delivers proven whitening results with a short wear time of only 15 minutes, once a day. Water-based to hydrate teeth to avoid sensitivity naturally. Includes refreshing finishing rinse which removes residual gel as it provides an added boost to the final whitening effect.



Patient Pak

Contains: 2 -3cc syringes of Whitening Gel, 2 dispensing tips, 4oz. bottle of finishing rinse and instructions.
 177-4000142 Each..... **\$39.25**

Refresher Pak

Contains: 3cc syringe of Whitening Gel, 1 dispensing tip, 4oz. bottle of finishing rinse and instructions.
 177-4000141 Each..... **\$17.95**



Perfecta® Bravo'

30-minutes, once-a-day tooth-whitening treatment. Patented water-based 9% hydrogen-peroxide gel. Faster results for improved compliance and superior whitening without sensitivity. Two week treatment.

Touch-Up Pak

Contains: 3cc syringe, dispensing tip and patient instructions.
 177-4000091 Each..... **\$18.95**

Patient Pak

Contains: 4 -3cc syringes, 4 dispensing tips, 6 patient instructions, doctor instructions, cosmetic patient pouch with mirror, tray material and tray case.
 177-4000092 Each..... **\$54.75**

Value Pak

Contains: 24 -3cc syringes, 24 dispensing tips, patient instructions, doctor instructions, 6 cosmetic pouches. Enough material for 6 patients.
 177-4000093 Each..... **\$200.95**

50-Pak

Contains: 50 -3cc syringes, 50 dispensing tips, 12 patient instructions, doctor instructions. Enough material for 12 patients.
 177-4000094 Each..... **\$381.75**



Crest® Whitestrips Supreme - Procter & Gamble

Provides custom tray-level whitening with 14% hydrogen peroxide-the highest concentration available in a professionally dispensed take-home whitening product. Strips are ready-made and portable enough to be used anywhere.

Contains: 84 strips (42 upper and 42 lower).
 170-80247600 Each..... **\$46.25**



Crest® 3D White Whitestrips with AdvancedSeal™ - Procter & Gamble

AdvancedSeal No Slip Technology. Stays put so patient can talk and drink water while whitening teeth. Results last up to 12 months.

Contains: 14 treatments.
 170-80252096 Each..... **\$48.95**



Pola Day CP - SDI

From just 15 minutes, once or twice per day, patients will see changes immediately. They can wear it for 30 minutes in the waiting room before they go home. Most patients see their teeth change 3 or 4 shades.

Mini Kit

Contains: 4 -1.3gm syringes of 35% carbamide peroxide.
 170-7700324 Kit..... **\$19.95**

Bulk Kit

Contains: 50 -1.3gm syringes of 35% carbamide peroxide.
 170-7700325 Kit..... **\$152.25**



Pola Day & Pola Night - SDI

The high viscosity, neutral pH tooth whitening gels ensure the greatest patient comfort in a take home kit. The unique blend of soothers, conditioners and high water content assist in reducing sensitivity. The formation of plaque and tooth decay is significantly reduced. Pola Day contains between 3% and 9.5% hydrogen peroxide, while Pola Night contains between 10% and 22% carbamide peroxide.

Pola Day 10 Syringe Kit

Contains: 10 -1.3gm Pola Day syringes, 2 tray material, 10 tips, accessories.
 3% 170-7700101
 7.5% 170-7700103
 9.5% 170-7700105
 Kit **\$44.95**

Pola Day Mini Kit

Contains: 4 -1.3gm Pola Day syringes, 8 tips, accessories.
 3% 170-7700100
 7.5% 170-7700102
 9.5% 170-7700104
 Kit **\$19.95**

Pola Day Bulk Kit

Contains: 50 -1.3gm Pola Day syringes, 50 tips, accessories.
 7.5% 170-7700026
 9.5% 170-7700034
 Kit **\$152.25**

Pola Night 10 Syringe Kit

Contains: 10 -1.3gm Pola Night syringes, 2 tray material, 10 tips, accessories.
 10%..... 170-7700107
 16% 170-7700109
 22% 170-7700111
 Kit **\$44.95**

Pola Night Mini Kit

Contains: 4 -1.3gm Pola Night syringes, 8 tips, accessories.
 10%..... 170-7700106
 16% 170-7700108
 22% 170-7700110
 Kit **\$19.95**

Pola Night Bulk Kit

Contains: 50 -1.3gm Pola Night syringes, 50 tips, accessories.
 10%..... 170-7700027
 16% 170-7700028
 22% 170-7700029
 Kit **\$152.25**

Pola Day Dispenser Pack

Contains: 50 -3gm syringes, 50 dispensing tips and accessories.
 7.5% 170-7700070
 9.5% 170-7700071
 Pack **\$290.25**

Pola Night Dispenser Packs available upon request.

TAKE HOME TOOTH WHITENING



Pola Zing - SDI

A "jump start" 35% carbamide peroxide system to accelerate the take home tooth whitening procedure.

Contains: 4 -1.3gm Pola Zing syringes, 8 tips, accessories.

170-7700112 Kit..... **\$19.95**



Pola Paint - SDI

Touch up procedure for patients who have already whitened their teeth. No trays required. No chair time used. The addition of fluoride remineralises the tooth surface and assists in reducing post-operative sensitivity. Spearmint flavor.

170-7700058 5.5ml..... **\$20.45**



ContrastPM Plus - Spectrum Dental, Inc.

The 10% and 15% carbamide peroxide gels are designed for overnight wear, while the 20% gel is for daytime wear for 1 to 2 hours. Shelf life is 2 years. Refrigeration is NOT recommended. Contains potassium nitrate to decrease sensitivity.

Mini Kits

Contains: 4 -1.2cc syringes whitening gel, patient instructions.

10%..... 170-ZD2100

15% 170-ZD2200

20% 170-ZD2300

Kit **\$15.45**

Patient Kits

Contains: 8 -1.3cc syringes whitening gel, 1 tray case, 2 sheets EVA tray material, patient instructions, 1 dentist and lab instructions.

10%..... 170-ZD2115

15% 170-ZD2215

20% 170-ZD2315

Kit **\$32.95**

2 Syringe Touch Up Kits available upon request.

APPLICATOR TIPS & BRUSHES

Bendable Applicator Needle Tips
3/4" length.

18 ga. pink	230-10010
19 ga. gray	230-10011
20 ga. yellow	230-10012
22 ga. black.....	230-10013
25 ga. blue	230-10014
100/pack	\$14.95

Bendable Brushes
One-piece disposable applicator brushes, crimped for bending at any angle for better access. Available in standard bristle (black) or fine bristle (white).

Standard Black Bristles
Red and Blue Handles..... 230-10016

Fine White Bristles
Green and Yellow Handles 230-10017

Assorted Bristles
72/ Standard - 72/ Fine..... 230-10018
144/box **\$21.95**

Composite Brush Kits

Straight black brushes	230-10020
Straight white brushes	230-10021
Tapered black brushes	230-10022
Tapered white brushes	230-10023
100/pkg.	\$9.95

Composite Brush Refills

Straight black brushes	230-10024
Straight white brushes	230-10025
Tapered black brushes	230-10026
Tapered white brushes	230-10027
100/pkg.	\$8.45

Disposable Micro - Applicators
Use with sealants, bonding agents, etchants, hemostatic solutions, cavity liners and disclosing solutions. Designed with a bendable neck that "stays-put" to facilitate the placement of materials into difficult to reach areas. Non-absorbent, non-linting fibers suspend solutions as small as 1/8 of a drop without dripping or spilling.

Superfine

White	230-10001
-------------	-----------

Fine

Mauve	230-10002
Yellow	230-10003

Regular

Blue	230-10004
Green	230-10005
Orange	230-10006
Purple	230-10007
100/tube	\$7.75



Padded Brush Delivery Tips

Plastic-hub, pre-bent needle with brush-padded end. Can be used with most types of materials such as etchant gel and hemostatic agents.

230-10030 100/pkg \$57.95



Pre-Bent Dispensing Tips

Blunt end tips designed for placing etchants, sealants, cements and other flowable materials.

18 ga. pink 230-HT18100
 19 ga. yellow 230-HT19100
 20 ga. black 230-HT20100
 22 ga. gray 230-HT22100
 25 ga. blue 230-HT25100
 100/bag \$17.25



Bendable Brushes - 3M Oral Care

One-piece disposable applicator brushes. Four colors: blue, green, yellow and red. Flip top box.
 233-3402 120/box \$34.95

Order by ☎ 800-626-2163



Brush Tips & Handles - 3M Oral Care

3 color-coded handles and 120 brush tips.

233-1919 Each \$68.95



Applicator Brush Tips

Single use brush tips for use with Applicator Handles

233-1919B 60/pack \$18.45

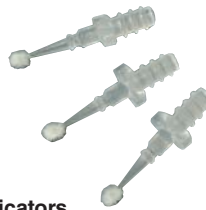

Fiber Tip Applicators

Single use fiber tips for use with Applicator Handles

233-1919F 100/pkg \$20.95



Mini-Sponge Applicator - 3M Oral Care

233-7522S 200/box \$35.25



Benda Brushes - Centrix

Disposable applicator brushes for placing etchants, bonding agents, sealer acrylic monomers and other material. Color-coded handle. Flip top box.

Mini Big Box - White Bristles

Red 230-370601
 Blue 230-370602
 Yellow 230-370603
 Green 230-370604
 576/box \$114.45

Mini Assorted

230-370111 144/box \$33.75

🌐 www.dhponline.com

Regular Assorted

230-370101 144/box \$33.75

Big Box - Black Bristles

Red 230-370501
 Blue 230-370502
 Yellow 230-370503
 Green 230-370504
 576/box \$114.45



Benda Twin

Double-ended bristle brush, regular point, snap-apart handle. Black bristles are the larger, regular point and the white bristles are smaller, fine point

Starter Kit - Blue

230-370106 200/box \$43.95

Refill Kit

Pink 230-370107
 Blue 230-370108
 400/pkg \$77.75



Benda® Micro Applicators - Centrix

The ideal applicator to place a single drop of liquid with almost no waste. Ideal for placing bonding agents and primers into post holes and small preps. Select from regular and extra-fine styles.

Single Ended, Regular Point

Blue 230-380014
 Green 230-380015
 Purple 230-380016
 Silver 230-380017
 576/box \$56.95

Assorted Colors

Contains: 100 each color
 230-380005 400/box \$37.25

Micro Fine Applicators

Single ended, fine point.
 Yellow 230-380012
 Red 230-380013
 576/box \$56.95

Assorted Colors

Contains: 100 each color.
 230-380006 400/box \$37.25

Micro X-Fine Applicators

Single ended, X-fine point.
 Light Green 230-380029
 Ivory 230-380030
 576/box \$56.95

Assorted Colors

Contains: 100 each color.
 230-380033 400/box \$37.25

🌐 Fax: 888-681-5088

APPLICATOR TIPS & BRUSHES



Mini-Sponge Applicator - Dentonics
230-37000 200/box \$14.95



Micro Applicators - Hager Worldwide
A disposable micro-applicator, specially designed for rapid application of minute amounts of materials in limited access areas. Composed of tiny, non-linting fiber tips. The plastic neck of the applicator can be bent to a suitable angle for maximum accessibility.
Quick Tips - Regular White
230-605222 100/box \$16.75



Super Quick-Tips - Regular White
Flexible tapered ends maintain desired angle for application in difficult areas.
230-605227 100/pkg..... \$21.95

Econo Tips - Fine
Bendable polypropylene. Micro fine-point tip. Comes with an easy to use dispenser.
Orange..... 230-605152
Yellow..... 230-605150
Green..... 230-605151
100/box \$12.95



Ball-Point Applicators™ - Kerr TotalCare
Longer handle for getting control and precision. The predesigned bending point holds any shape you need to get to those hard-to-reach areas. The

ball end is non-linting, non-absorbent fiber that holds solutions in amounts as small as one-eighth of a drop.

Fine Head
230-8300F 250/box \$36.45
Medium Head
230-8350M 250/box \$36.45



Pinn-Point Brushes - Kerr TotalCare
A larger, longer handle for greater control, making placement of bonding agents, etchants and sealants easier and more precise. Predesigned bending point for easy shaping to get where you need to go.
230-8200 250/box \$41.75



Microbrush Plus - Microbrush International
Package contains 400 applicators, four cartridges of 100 applicators each. Cartridges and applicators are specially designed to fit the unique dispenser.
Regular 2mm
Assorted 230-PR400
Purple 230-PR400PU
Blue 230-PR400BL
Peach..... 230-PR400PE
Green..... 230-PR400GR
400/pkg. \$45.95
Fine 1.5mm
Assorted 230-PF400
Pink..... 230-PF400PI
Yellow..... 230-PF400YE
400/pkg. \$45.95
Superfine 1mm
White 230-PSF400
400/pkg. \$45.95

Dispenser Kit
Stackable and compact dispenser is specifically designed to release one applicator at a time and features antimicrobial properties with silver technology; built-in silver ions that suppress bacteria growth.
Contains: 1 dispenser and 50 fine yellow applicators.
230-MPD Each..... \$12.75



Microbrush Tube Series
Package contains 400 applicators, four tubes of 100 applicators each.
Regular 2mm
Blue..... 230-400MB
Green..... 230-400MG
Peach..... 230-400MS
Purple 230-400MP
100/pkg \$10.95

Assorted 230-MRA400
Blue 230-MRB400
Green..... 230-MRG400
Peach..... 230-MRS400
Purple 230-MRP400
400/pkg. \$45.95

Fine 1.5mm
Assorted 230-MFA400
Pink..... 230-MFP400
Yellow..... 230-MFY400
400/pkg. \$45.95

Superfine 1mm
White 230-MSF400
400/pkg. \$45.95



Microbrush® X
Thinner, longer brush tip to simplify application for procedures involving confined spaces and allows for even placement of material. Short, stiff brush fibers hold a fraction of a drop of material for less waste and controlled application. Black.
Dispenser Kit
Contains: 1 dispenser and 100 applicators.
230-MPX Kit..... \$27.45

Refill
230-PX100 100/pkg..... \$20.95



Micro-Stix™
Disposable adhesive-tip applicators designed to securely hold and place fragile or small restorations.
Original Hold - Blue..... 230-STIX64B
64/box \$27.25

APPLICATOR TIPS & BRUSHES



TRU™ - Microbrush International

Features a double-bending tip with a longer 12 centimeter handle and Ultrafine 0.5mm tip option.

Regular 2mm

Blue 230-291159
 Green..... 230-291160
 80/pkg. **\$12.45**

Fine 1.5mm

Yellow..... 230-291161
 Pink..... 230-291162
 80/pkg. **\$12.45**

Superfine 1mm

Gold..... 230-291163
 Silver..... 230-291164
 80/pkg **\$12.45**

Ultrafine 0.5mm

Teal..... 230-291165
 Orange..... 230-291166
 80/pkg. **\$12.45**



Ultrabrush® - Microbrush International

Bends close to the tip for improved control and ease of reach. Uniquely designed to provide better spreading action and a more precise application of material.

Dispenser Kit - Regular 2mm

Contains: 1 dispenser and 100 applicators.
 230-U2D Kit..... **\$18.75**

Regular 2mm

Green/Yellow..... 230-U2R200
 200/pkg **\$31.45**

Fine 1mm

Blue/Orange 230-U1R200
 200/pkg **\$31.45**



Points - SDI

Disposable brush applicators are used to quickly transfer small amounts of materials into difficult to reach areas. Points are resistant to common solvents. The fibers will not dislodge during the procedure. The solution is suspended in the fibers until applied.

Assorted 230-8100123
 Purple - Superfine 230-8100122
 Dark Green - Fine 230-8100116
 Light Green - Fine 230-8100117
 Dark Blue - Medium 230-8100118
 Light Blue - Medium 230-8100119
 400/pkg **\$34.25**

Points Dispenser

230-8100131 Each..... **\$28.45**

MIXING WELLS



Disposable Mixing Wells - 3M Oral Care

One well mixing dispenser, plastic.
 233-3401 96/pack **\$29.45**



Scotchbond Dispenser Wells - 3M Oral Care

3 hole with light shield.
 233-7544 4/pkg. **\$24.45**



Disposable 4-Cavity Mixing Wells - Kerr Restoratives

239-27157 100/box **\$79.45**



Bondwell™ Disposable Mixing Wells - Plasdent Corporation

2-Well
 230-901MW2 200/box **\$6.95**



Disposable Mixing Wells - Pulpdent Corporation

Made from a high molecular weight polymer. Perforated sheets for convenient handling and storage. Economical bulk price.

2-Well

230-MW2B 480/box **\$49.75**

4-Well

230-MW4B 420/box **\$49.75**

DELIVERY SYSTEMS



Mark IIIIP Syringe - Centrix

For placement of composites, cements, glass ionomers and impression materials. Autoclavable plastic.

210-130600 Each..... **\$88.25**

Disposable Tubes

For all C-R syringes. Fill the tube by back loading off the mixing pad. Seal it with the plug and use in C-R syringe.



Clear Tubes

230-210001 100/pkg **\$54.25**
 230-210003 500/pkg **\$239.95**



Accudose Low Viscosity Tubes

Photobloc orange tint.
 230-210021 100/pkg **\$65.45**
 230-210023 500/pkg **\$289.45**

DELIVERY SYSTEMS



Accudose High Viscosity Tubes

Photobloc orange tint.

230-280021	110/pkg.....	\$77.25
230-280023	500/pkg.....	\$350.75



Accudose Needle Tubes

Photobloc orange tint.

230-290031	100/pkg.....	\$130.25
------------	--------------	----------



Compule Syringe Gun - Dentsply Caulk

238-635105	Each.....	\$80.45
------------	-----------	---------



C-Dent Multi-Use Dispenser - Septodont

Designed for precise placement of all types of composite resin, glass ionomers, impression materials, cements, etc.

230-40531	Each.....	\$55.45
-----------	-----------	---------

CURING LIGHTS



Elipar™ DeepCure-S - 3M Oral Care

LED Curing light. A safe, predictable and reliable cure, even at the bottom of the proximal box due to advanced optics even where perfect light positioning is not easy. One-piece durable, stainless steel housing. Unique, magnetic light guide mount

770-76976	Each.....	\$1754.95
-----------	-----------	-----------

Light Guide - 10mm

770-76981	Each.....	\$205.95
-----------	-----------	----------

Eye Shield

770-76984	Each.....	\$53.95
-----------	-----------	---------



Paradigm™ DeepCure - 3M Oral Care

Better depth of cure when perfect light positioning is difficult. 120 minutes of cure time from a full charge. Simple 2-button operation with one cure mode for all indications. Lightweight, vent-free plastic housing for easy disinfection.

770-76974	Each.....	\$833.95
-----------	-----------	----------

Light Guide - 10mm

770-76982	Each.....	\$211.25
-----------	-----------	----------

Eyeshield

770-76986	Each.....	\$51.25
-----------	-----------	---------



Coltolux® 75 - Coltene

A state-of-the-art optical system provides high powered curing energy from a conventional halogen lamp. High efficiency fan for continuously cool operation. Thermal protection against over heating. Audible trigger start and stop. Ten second beeper with auto-shutoff.

774-C7964 Each..... **\$621.45**



Eye Shield
770-60014444

Each..... **\$35.75**



Coltolux® LED - Coltene

Cordless, pen-style LED curing light with slim taperless curing probe. More powerful than high output halogen lights, with no bulbs or filters to replace. Heat-sink technology provides totally silent operation with no fan. 10 second audible signals. Auto shutoff. One year warranty. 110-115v.

Complete Unit

Contains: 1 handpiece, 1 charger base, 3 light shields, 5 extra lens, 100 barrier sleeves.

770-C7970 Each..... **\$552.45**

Light Lenses - Press On

770-C7972 25/pkg **\$44.25**

Light Shields - Snap On

770-C7990 25/pkg **\$71.95**

Barrier Sleeves

664-C7957 1000/box **\$54.95**



S.P.E.C. 3 LED - Coltene

Three distinct curing modes, offers a level of clinical flexibility that truly sets it apart from the competition. High Power Mode: 1500 mW/cm2. Plasma Emulation Mode: 3000 mW/cm2. Orthodontic Mode: Cures an entire full-arch of brackets with two 3 second intervals per bracket. Plus, lightweight construction reduces hand fatigue. Ideal for most dental composites. Plasma Emulation Mode significantly reduces procedure time.

774-60013941 Each..... **\$1376.45**

Light Shields

8mm x 11mm..... 770-60013948
11mm x 11mm 580-COL60014360
20/pkg **\$25.25**

Barrier Sleeves

660-60013949 100/box **\$13.45**



Bluephase 20i LED - Ivoclar Vivadent

The battery-operated bluephase 20i combines the highest light intensity of 2000 mW/cm2 in the Turbo program with extremely short curing times of no more than 5 seconds for light and dark composites while being gentle to the pulp and the soft tissue. The four-easy-to-use programs -Turbo maximum performance, High Power for rapid curing, Low Power for curing areas near the pulp and Soft Start for stress-reduced polymerization.

770-613735 Each..... **\$1898.25**

Anti-Glare Shield

770-592496 Each..... **\$10.75**

Anti-Glare Cones

770-551756 3/pkg **\$9.25**

Barrier Sleeves

660-608554 250/pkg **\$102.25**

Original Bluephase available upon request.

CURING LIGHTS



Bluephase® Style LED Curing Light - Ivoclar Vivadent

Curing light that uses Polywave LED technology for halogen-like wavelength output to polymerize all light-cure dental materials known to date. Light weight pen style design with cordless freedom, high-tech lithium polymer battery and inductive charging system with no contacts. "Click and Cure" provides corded backup to battery. 1,100 mW/cm² of continuous light output and 10 mm standard probe covers large tooth restorations in one use. 3-year warranty (1 year warranty on battery). 100-240v.

Contents: 1 handpiece, 1 -10mm probe, 1 power pack, 1 charging base, 1 power cord, 1 lithium polymer battery and anti-glare cones.

Gray	770-635153
Blue.....	770-642513BU
Pink.....	770-642514BU
Green.....	770-682460BU
Each	\$1440.45

Anti-Glare Shield	
770-592496	Each..... \$10.75

Anti-Glare Cones	
770-551756	3/pkg \$9.25

Barrier Sleeves	
660-636239	50/pack \$19.45

Bluephase Meter II available upon request.



Demi™ Plus - Kerr Restoratives

Lightweight, ergonomic design. Interchangeable light guides. Whisper-quiet fan. Multiple Curing Options. Periodic Level Shifting.

Contents: 1 handpiece, standard 8mm Turbo light guide, Lithium Ion Demi battery pack, battery charger, power supply and protective light shield.

779-910860	Each..... \$1648.25
------------	----------------------------

Barrier Sleeves	
660-DEMI250	250/pack \$45.45



Demi™ Ultra - Kerr Restoratives

The revolutionary U-40 ultra capacitor stores enough energy for 4 minutes of continuous use or 25 ten second cures and charges to full capacity in under 40 seconds. Revolutionary U-40 Ultra Capacitor eliminates the need for batteries and cords, while offering years of worry free service. C.U.R. E. technology delivers uniform depth of cure and industry leading low temperatures for optimal clinical outcomes. Integrated radiometer in the charging dock for convenient testing of curing light output.

Contains: 1 handpiece, 8mm light attachment, charging dock with radiometer, power supply and protective light shield.

770-35664	Each..... \$1648.25
-----------	----------------------------

Light Sleeves	
660-DEMIULTRA100	100/box \$26.95

Light Shield	
571-35668	Each..... \$75.25

Radii-cal LED - SDI

Extremely high intensity of 1200mW/cm². Ergonomic and light-weight design minimizes fatigue and maximizes comfort. Efficient energy use and ramp up mode - during the first 5 seconds, the light output power gradually increases. This soft-start polymerization minimizes stress at the junction and reduces marginal gaps. Cordless, easy to clean with a built in radiometer.

Contents: 1 handpiece, recharger, transformer, replacement lens caps and accessories.

770-5600102	Each \$588.95
-------------	----------------------------

Replacement Lens Caps	
580-5600054	25/pkg \$26.25

Light Shields	
580-5600056	5/pkg \$25.25

Barrier Sleeves	
660-5600005	1000/pkg \$59.25



CURING LIGHT ACCESSORIES



Eye Protection Shield - Dentamerica
470-664 Each..... \$13.95



Optilux Light Shield - Kerr Restoratives
779-20816 Each..... \$62.25



Pinnacle™ Vision Saver - Kerr Restoratives
660-4575 400/box \$44.95

Light Guides - Kerr Restoratives



2mm x 70mm Curved
571-20945 Each..... \$259.45



4mm x 77mm Curved Turbo
571-21185 Each..... \$292.45



8mm x 70mm Curved
571-20941 Each.....\$210.25



8mm x 70mm Curved Turbo
571-21020 Each..... \$355.75



11mm x 75mm Curved
571-20898 Each..... \$292.45



13mm x 84mm Curved
571-KER20812 Each..... \$388.25



Cure Shield - Premier® Dental
777-9006166 Each..... \$23.75



Cut through the fat

**GO DIRECTLY
TO THE BEST**

SUPPLIES UP TO
25% OFF
WHILE SUPPLIES LAST

www.dhpionline.com/clearance

3M ORAL CARE PREFABRICATED CROWN ORDER FORM

Name _____ Phone _____

Address _____

City _____ State _____ Zip _____

Instructions: This order form is formatted the same as the 3M Oral Care crown kit drawers to allow for easy ordering. Fill in spaces with the number of refill boxes for each size. If there are two sizes in a space, circle the appropriate number. Refill boxes contain 5 crowns. **Fax: 888-681-5088** or call your DHPI Account Manager at **800-626-2163**

CROWNS

Prefabricated Crowns

3M Oral Care Stainless Steel Crowns 5/box

Primary Molar

Left			Upper			Right					
<input type="radio"/> D-UL-7	<input type="radio"/> D-UL-6	<input type="radio"/> D-UL-5	<input type="radio"/> D-UL-4	<input type="radio"/> D-UL-3	<input type="radio"/> D-UL-2	<input type="radio"/> D-UR-2	<input type="radio"/> D-UR-3	<input type="radio"/> D-UR-4	<input type="radio"/> D-UR-5	<input type="radio"/> D-UR-6	<input type="radio"/> D-UR-7
<input type="radio"/> E-UL-7	<input type="radio"/> E-UL-6	<input type="radio"/> E-UL-5	<input type="radio"/> E-UL-4	<input type="radio"/> E-UL-3	<input type="radio"/> E-UL-2	<input type="radio"/> E-UR-2	<input type="radio"/> E-UR-3	<input type="radio"/> E-UR-4	<input type="radio"/> E-UR-5	<input type="radio"/> E-UR-6	<input type="radio"/> E-UR-7
<input type="radio"/> D-LL-7	<input type="radio"/> D-LL-6	<input type="radio"/> D-LL-5	<input type="radio"/> D-LL-4	<input type="radio"/> D-LL-3	<input type="radio"/> D-LL-2	<input type="radio"/> D-LR-2	<input type="radio"/> D-LR-3	<input type="radio"/> D-LR-4	<input type="radio"/> D-LR-5	<input type="radio"/> D-LR-6	<input type="radio"/> D-LR-7
<input type="radio"/> E-LL-7	<input type="radio"/> E-LL-6	<input type="radio"/> E-LL-5	<input type="radio"/> E-LL-4	<input type="radio"/> E-LL-3	<input type="radio"/> E-LL-2	<input type="radio"/> E-LR-2	<input type="radio"/> E-LR-3	<input type="radio"/> E-LR-4	<input type="radio"/> E-LR-5	<input type="radio"/> E-LR-6	<input type="radio"/> E-LR-7
Lower											

Left		Upper		Right	
<input type="radio"/> 6-UL-4	<input type="radio"/> 6-UL-3	<input type="radio"/> 6-UL-2	<input type="radio"/> 6-UR-2	<input type="radio"/> 6-UR-3	<input type="radio"/> 6-UR-4
<input type="radio"/> 6-UL-7	<input type="radio"/> 6-UL-6	<input type="radio"/> 6-UL-5	<input type="radio"/> 6-UR-5	<input type="radio"/> 6-UR-6	<input type="radio"/> 6-UR-7
<input type="radio"/> 6-LL-4	<input type="radio"/> 6-LL-3	<input type="radio"/> 6-LL-2	<input type="radio"/> 6-LR-2	<input type="radio"/> 6-LR-3	<input type="radio"/> 6-LR-4
<input type="radio"/> 6-LL-7	<input type="radio"/> 6-LL-6	<input type="radio"/> 6-LL-5	<input type="radio"/> 6-LR-5	<input type="radio"/> 6-LR-6	<input type="radio"/> 6-LR-7
Lower					

Unitek™ Stainless Steel Crowns 5/box

Primary Molar

First Primary						Second Primary					
<input type="radio"/> UR1 900121	<input type="radio"/> UR2 900122	<input type="radio"/> UR3 900123	<input type="radio"/> UR4 900124	<input type="radio"/> UR5 900125	<input type="radio"/> UR6 900126	<input type="radio"/> UR7 900221	<input type="radio"/> UR2 900222	<input type="radio"/> UR3 900223	<input type="radio"/> UR4 900224	<input type="radio"/> UR5 900225	<input type="radio"/> UR6 900226
<input type="radio"/> UL1 900111	<input type="radio"/> UL2 900112	<input type="radio"/> UL3 900113	<input type="radio"/> UL4 900114	<input type="radio"/> UL5 900115	<input type="radio"/> UL6 900116	<input type="radio"/> UL7 900211	<input type="radio"/> UL2 900212	<input type="radio"/> UL3 900213	<input type="radio"/> UL4 900214	<input type="radio"/> UL5 900215	<input type="radio"/> UL6 900216
<input type="radio"/> LR1 900141	<input type="radio"/> LR2 900142	<input type="radio"/> LR3 900143	<input type="radio"/> LR4 900144	<input type="radio"/> LR5 900145	<input type="radio"/> LR6 900146	<input type="radio"/> LR7 900241	<input type="radio"/> LR2 900242	<input type="radio"/> LR3 900243	<input type="radio"/> LR4 900244	<input type="radio"/> LR5 900245	<input type="radio"/> LR6 900246
<input type="radio"/> LL1 900131	<input type="radio"/> LL2 900132	<input type="radio"/> LL3 900133	<input type="radio"/> LL4 900134	<input type="radio"/> LL5 900135	<input type="radio"/> LL6 900136	<input type="radio"/> LL7 900231	<input type="radio"/> LL2 900232	<input type="radio"/> LL3 900233	<input type="radio"/> LL4 900234	<input type="radio"/> LL5 900235	<input type="radio"/> LL6 900236

Permanent Molar

First Molar						Second Molar		
<input type="radio"/> UR-1 900321	<input type="radio"/> UR-7 900327	<input type="radio"/> UR-7 900327	<input type="radio"/> UR-7 900327	<input type="radio"/> UR-7 900327	<input type="radio"/> UR-7 900327	<input type="radio"/> LR+1 900441	<input type="radio"/> LR+2 900442	<input type="radio"/> LR+3 900443
<input type="radio"/> UL-1 900311	<input type="radio"/> UL-7 900317	<input type="radio"/> UL-7 900317	<input type="radio"/> UL-7 900317	<input type="radio"/> UL-7 900317	<input type="radio"/> UL-7 900317	<input type="radio"/> LR+4 900444	<input type="radio"/> LR+5 900445	<input type="radio"/> LR+6 900446
<input type="radio"/> LR-1 900341	<input type="radio"/> LR-2 900342	<input type="radio"/> LR-3 900343	<input type="radio"/> LR-4 900344	<input type="radio"/> LR-5 900345	<input type="radio"/> LR-6 900346	<input type="radio"/> LL+1 900431	<input type="radio"/> LL+2 900432	<input type="radio"/> LL+3 900433
<input type="radio"/> LL-1 900331	<input type="radio"/> LL-2 900332	<input type="radio"/> LL-3 900333	<input type="radio"/> LL-4 900334	<input type="radio"/> LL-5 900335	<input type="radio"/> LL-6 900336	<input type="radio"/> LL+4 900434	<input type="radio"/> LL+5 900435	<input type="radio"/> LL+6 900436

Primary Anterior

Centrals (Black)			Laterals (Red)			Cuspids (U=Green L=Blue)		
<input type="radio"/> UL1 907001	<input type="radio"/> UL2 907002	<input type="radio"/> UL3 907003	<input type="radio"/> UL1 907021	<input type="radio"/> UL2 907022	<input type="radio"/> UL3 907023	<input type="radio"/> U1 907041	<input type="radio"/> U2 907042	<input type="radio"/> U3 907043
<input type="radio"/> UL4 907004	<input type="radio"/> UL5 907005	<input type="radio"/> UL6 907006	<input type="radio"/> UL4 907024	<input type="radio"/> UL5 907025	<input type="radio"/> UL6 907026	<input type="radio"/> U4 907044	<input type="radio"/> U5 907045	<input type="radio"/> U6 907046
<input type="radio"/> UR1 907011	<input type="radio"/> UR2 907012	<input type="radio"/> UR3 907013	<input type="radio"/> UR1 907031	<input type="radio"/> UR2 907032	<input type="radio"/> UR3 907033	<input type="radio"/> L1 907051	<input type="radio"/> L2 907052	<input type="radio"/> L3 907053
<input type="radio"/> UR4 907014	<input type="radio"/> UR5 907015	<input type="radio"/> UR6 907016	<input type="radio"/> UR4 907034	<input type="radio"/> UR5 907035	<input type="radio"/> UR6 907036	<input type="radio"/> L4 907054	<input type="radio"/> L5 907055	<input type="radio"/> L6 907056

Permanent Bicuspid

Maxillary			First Mandibular			Second Mandibular		
<input type="radio"/> UR1 900521	<input type="radio"/> UR2 900522	<input type="radio"/> UR3 900523	<input type="radio"/> LR+1 900541	<input type="radio"/> LR+2 900542	<input type="radio"/> LR+3 900543	<input type="radio"/> LR1 900641	<input type="radio"/> LR2 900642	<input type="radio"/> LR3 900643
<input type="radio"/> UR4 900524	<input type="radio"/> UR5 900525	<input type="radio"/> UR6 900526	<input type="radio"/> LR+4 900544	<input type="radio"/> LR+5 900545	<input type="radio"/> LR+6 900546	<input type="radio"/> LR4 900644	<input type="radio"/> LR5 900645	<input type="radio"/> LR6 900646
<input type="radio"/> UL1 900511	<input type="radio"/> UL2 900512	<input type="radio"/> UL3 900513	<input type="radio"/> LL+1 900531	<input type="radio"/> LL+2 900532	<input type="radio"/> LL+3 900533	<input type="radio"/> LL1 900631	<input type="radio"/> LL2 900632	<input type="radio"/> LL3 900633
<input type="radio"/> UL4 900514	<input type="radio"/> UL5 900515	<input type="radio"/> UL6 900516	<input type="radio"/> LL+4 900534	<input type="radio"/> LL+5 900535	<input type="radio"/> LL+6 900536	<input type="radio"/> LL4 900634	<input type="radio"/> LL5 900635	<input type="radio"/> LL6 900636

Iso-Form™ Crowns 5/box

Molar

Left			Upper			Right		
<input type="radio"/> U69	<input type="radio"/> U67	<input type="radio"/> U65	<input type="radio"/> U63	<input type="radio"/> U61	<input type="radio"/> U60	<input type="radio"/> U62	<input type="radio"/> U64	<input type="radio"/> U66
<input type="radio"/> U79	<input type="radio"/> U77	<input type="radio"/> U75	<input type="radio"/> U73	<input type="radio"/> U71	<input type="radio"/> U70	<input type="radio"/> U72	<input type="radio"/> U74	<input type="radio"/> U76
<input type="radio"/> L69	<input type="radio"/> L67	<input type="radio"/> L65	<input type="radio"/> L63	<input type="radio"/> L61	<input type="radio"/> L60	<input type="radio"/> L62	<input type="radio"/> L64	<input type="radio"/> L66
<input type="radio"/> L79	<input type="radio"/> L77	<input type="radio"/> L75	<input type="radio"/> L73	<input type="radio"/> L71	<input type="radio"/> L70	<input type="radio"/> L72	<input type="radio"/> L74	<input type="radio"/> L76
Lower								

Bicuspid

Left			Upper			Right		
<input type="radio"/> U49	<input type="radio"/> U47	<input type="radio"/> U45	<input type="radio"/> U43	<input type="radio"/> U41	<input type="radio"/> U40	<input type="radio"/> U42	<input type="radio"/> U44	<input type="radio"/> U46
<input type="radio"/> U59	<input type="radio"/> U57	<input type="radio"/> U55	<input type="radio"/> U53	<input type="radio"/> U51	<input type="radio"/> U50	<input type="radio"/> U52	<input type="radio"/> U54	<input type="radio"/> U56
<input type="radio"/> L49	<input type="radio"/> L47	<input type="radio"/> L45	<input type="radio"/> L43	<input type="radio"/> L41	<input type="radio"/> L40	<input type="radio"/> L42	<input type="radio"/> L44	<input type="radio"/> L46
<input type="radio"/> L59	<input type="radio"/> L57	<input type="radio"/> L55	<input type="radio"/> L53	<input type="radio"/> L51	<input type="radio"/> L50	<input type="radio"/> L52	<input type="radio"/> L54	<input type="radio"/> L56
Lower								

3M Oral Care Pediatric Strip Crown Forms 5/box

Anterior — Upper Centrals

Patient's Right		Upper Centrals		Patient's Left	
<input type="radio"/> UR 1 914011	<input type="radio"/> UR 2 914012	<input type="radio"/> UR 2 914012	<input type="radio"/> UL 1 914001	<input type="radio"/> UL 2 914002	<input type="radio"/> UL 2 914002
<input type="radio"/> UR 3 914013	<input type="radio"/> UR 3 914013	<input type="radio"/> UR 4 914014	<input type="radio"/> UL 3 914003	<input type="radio"/> UL 3 914003	<input type="radio"/> UL 4 914004

Anterior — Upper Laterals

Patient's Right		Upper Laterals		Patient's Left	
<input type="radio"/> UR 1 914031	<input type="radio"/> UR 2 914032	<input type="radio"/> UR 2 914032	<input type="radio"/> UL 1 914021	<input type="radio"/> UL 2 914022	<input type="radio"/> UL 2 914022
<input type="radio"/> UR 3 914033	<input type="radio"/> UR 3 914033	<input type="radio"/> UR 4 914034	<input type="radio"/> UL 3 914023	<input type="radio"/> UL 3 914023	<input type="radio"/> UL 4 914024

POLYCARBONATE ANTERIOR & BICUSPID CROWNS 5/box.....\$21.45									
CENTRAL		BICUSPID		LOWER ANTERIORS		UPPER AND LOWER		UPPER LATERAL	
UPPER RIGHT	UPPER LEFT	FIRST	SECOND	LONG	SHORT	RIGHT CUSPID	LEFT CUSPID	LEFT	RIGHT
P100 263-P100	P15 263-P15	P40 263-P40	P54 263-P54	P62 263-P62	P67 263-P67	P300 263-P300	P35 263-P35	P25 263-P25	P2 263-P2
P101 263-P101	P16 263-P16	P41 263-P41	P53 263-P53	P63 263-P63	P68 263-P68	P301 263-P301	P36 263-P36	P26 263-P26	P20 263-P20
P10 263-P10	P17 263-P17	P42 263-P42	P52 263-P52	P64 263-P64	P69 263-P69	P30 263-P30	P37 263-P37	P27 263-P27	P21 263-P21
P11 263-P11	P18 263-P18	P43 263-P43	P51 263-P51			P31 263-P31	P38 263-P38	P28 263-P28	P22 263-P22
P12 263-P12	P19 263-P19	P44 263-P44	P50 263-P50			P32 263-P32	P39 263-P39	P29 263-P29	P23 263-P23
P13 263-P13	P102 263-P102					P33 263-P33	P302 263-P302	P200 263-P200	P24 263-P24
P14 263-P14	P103 263-P103					P34 263-P34	P303 263-P303		

ISO-FORM MOLAR CROWNS 5/box.....\$30.25							
1ST UPPER RIGHT	1ST UPPER LEFT	1ST LOWER RIGHT	1ST UPPER LEFT	2ND UPPER RIGHT	2ND UPPER LEFT	2ND LOWER RIGHT	2ND LOWER LEFT
U-60 263-U60	U-61 263-U61	L-60 263-L60	L-61 263-L61	U-70 263-U70	U-71 263-U71	L-70 263-L70	L-71 263-L71
U-62 263-U62	U-63 263-U63	L-62 263-L62	L-63 263-L63	U-72 263-U72	U-73 263-U73	L-72 263-L72	L-73 263-L73
U-64 263-U64	U-65 263-U65	L-64 263-L64	L-65 263-L65	U-74 263-U74	U-75 263-U75	L-74 263-L74	L-75 263-L75
U-66 263-U66	U-67 263-U67	L-66 263-L66	L-67 263-L67	U-76 263-U76	U-77 263-U77	L-76 263-L76	L-77 263-L77
U-68 263-U68	U-69 263-U69	L-68 263-L68	L-69 263-L69	U-78 263-U78	U-79 263-U79	L-78 263-L78	L-79 263-L79

ISO-FORM BICUSPID CROWNS 5/box.....\$30.25							
1ST UPPER RIGHT	1ST UPPER LEFT	1ST LOWER RIGHT	1ST UPPER LEFT	2ND UPPER RIGHT	2ND UPPER LEFT	2ND LOWER RIGHT	2ND LOWER LEFT
U-40 263-U40	U-41 263-U41	L-40 263-L40	L-41 263-L41	U-50 263-U50	U-51 263-U51	L-50 263-L50	L-51 263-L51
U-42 263-U42	U-43 263-U43	L-42 263-L42	L-43 263-L43	U-52 263-U52	U-53 263-U53	L-52 263-L52	L-53 263-L53
U-44 263-U44	U-45 263-U45	L-44 263-L44	L-45 263-L45	U-54 263-U54	U-55 263-U55	L-54 263-L54	L-55 263-L55
U-46 263-U46	U-47 263-U47	L-46 263-L46	L-47 263-L47	U-56 263-U56	U-57 263-U57	L-56 263-L56	L-57 263-L57
U-48 263-U48	U-49 263-U49	L-48 263-L48	L-49 263-L49	U-58 263-U58	U-59 263-U59	L-58 263-L58	L-59 263-L59



Polycarbonate Crowns

Made of a polycarbonate resin with microglass fibers for short or long term adult anterior and bicuspid use.

Complete Set of 180

Contains: 2 of each size and mold guide.
263-C180 Set \$495.95



Iso-Form Crowns

Made of Tin-Silver alloy. Short term, molar and bicuspid use. Pre-finished, belled and contoured.

Molar Crown Complete Set

Contains: 2 of each size and 1 stackable tray.
263-MC64 64/set \$351.95



Bicuspid Crown Complete Set

Contains: 2 of each size and 1 stackable tray.
263-BC64 64/set \$349.95

Stainless Steel Crowns

Prefabricated stainless steel crowns for short or long term use. Pre-trimmed, belled and crimped.

Primary Molar Crown Complete Set

Contains: 2 of each size and 1 stackable tray.
263-ND96 96/set \$672.95

Permanent Molar Crown Complete Set

Contains: 2 of each size and 1 stackable tray.
263-PO96 96/set \$672.95

STAINLESS STEEL PRIMARY MOLAR CROWNS 5/box.....\$42.95											
1ST UPPER RIGHT	1ST UPPER LEFT	1ST LOWER RIGHT	1ST UPPER LEFT	2ND UPPER RIGHT	2ND UPPER LEFT	2ND LOWER RIGHT	2ND LOWER LEFT	UPPER RIGHT	UPPER LEFT	LOWER RIGHT	LOWER LEFT
D-UR-2 263-DUR2	D-UL-2 263-DUL2	D-LR-2 263-DLR2	D-LL-2 263-DLL2	E-UR-2 263-EUR2	E-UL-2 263-EUL2	E-LR-2 263-ELR2	E-LL-2 263-ELL2	6-UR-2 263-6UR2	6-UL-2 263-6UL2	6-LR-2 263-6LR2	6-LL-2 263-6LL2
D-UR-3 263-DUR3	D-UL-3 263-DUL3	D-LR-3 263-DLR3	D-LL-3 263-DLL3	E-UR-3 263-EUR3	E-UL-3 263-EUL3	E-LR-3 263-ELR3	E-LL-3 263-ELL3	6-UR-3 263-6UR3	6-UL-3 263-6UL3	6-LR-3 263-6LR3	6-LL-3 263-6LL3
D-UR-4 263-DUR4	D-UL-4 263-DUL4	D-LR-4 263-DLR4	D-LL-4 263-DLL4	E-UR-4 263-EUR4	E-UL-4 263-EUL4	E-LR-4 263-ELR4	E-LL-4 263-ELL4	6-UR-4 263-6UR4	6-UL-4 263-6UL4	6-LR-4 263-6LR4	6-LL-4 263-6LL4
D-UR-5 263-DUR5	D-UL-5 263-DUL5	D-LR-5 263-DLR5	D-LL-5 263-DLL5	E-UR-5 263-EUR5	E-UL-5 263-EUL5	E-LR-5 263-ELR5	E-LL-5 263-ELL5	6-UR-5 263-6UR5	6-UL-5 263-6UL5	6-LR-5 263-6LR5	6-LL-5 263-6LL5
D-UR-6 263-DUR6	D-UL-6 263-DUL6	D-LR-6 263-DLR6	D-LL-6 263-DLL6	E-UR-6 263-EUR6	E-UL-6 263-EUL6	E-LR-6 263-ELR6	E-LL-6 263-ELL6	6-UR-6 263-6UR6	6-UL-6 263-6UL6	6-LR-6 263-6LR6	6-LL-6 263-6LL6
D-UR-7 263-DUR7	D-UL-7 263-DUL7	D-LR-7 263-DLR7	D-LL-7 263-DLL7	E-UR-7 263-EUR7	E-UL-7 263-EUL7	E-LR-7 263-ELR7	E-LL-7 263-ELL7	6-UR-7 263-6UR7	6-UL-7 263-6UL7	6-LR-7 263-6LR7	6-LL-7 263-6LL7

PREFABRICATED CROWNS

CROWNS

UNITEK STAINLESS STEEL PRIMARY ANTERIOR CROWNS 5/box.....\$42.95						
	CENTRAL		LATERAL		CUSPID	
SIZE	UPPER RIGHT	UPPER LEFT	UPPER RIGHT	UPPER LEFT	UPPER	LOWER
1	907011 263-907011	907001 263-907001	907031 263-907031	907021 263-907021	907041 263-907041	907051 263-907051
2	907012 263-907012	907002 263-907002	907032 263-907032	907022 263-907022	907042 263-907042	907052 263-907052
3	907013 263-907013	907003 263-907003	907033 263-907033	907023 263-907023	907043 263-907043	907053 263-907053
4	907014 263-907014	907004 263-907004	907034 263-907034	907024 263-907024	907044 263-907044	907054 263-907054
5	907015 263-907015	907005 263-907005	907035 263-907035	907025 263-907025	907045 263-907045	907055 263-907055
6	907016 263-907016	907006 263-907006	907036 263-907036	907026 263-907026	907046 263-907046	907056 263-907056



Unitek™ Stainless Steel Crowns
 Prefabricated stainless steel crowns for short-or-long term use.
Primary Anterior Crown Complete Kit
 Contains: 2 of each size and 1 stackable tray.
 263-908100 72/kit **\$504.95**

UNITEK STAINLESS STEEL PERMANENT MOLAR CROWNS 5/box.....\$42.95								
SIZE	1ST UPPER RIGHT	1ST UPPER LEFT	1ST LOWER RIGHT	1ST LOWER LEFT	2ND UPPER RIGHT	2ND UPPER LEFT	2ND LOWER RIGHT	2ND LOWER LEFT
1	900121 263-900121	900111 263-900111	900141 263-900141	900131 263-900131	900221 263-900221	900211 263-900211	900241 263-900241	900231 263-900231
2	900122 263-900122	900112 263-900112	900142 263-900142	900132 263-900132	900222 263-900222	900212 263-900212	900242 263-900242	900232 263-900232
3	900123 263-900123	900113 263-900113	900143 263-900143	900133 263-900133	900223 263-900223	900213 263-900213	900243 263-900243	900233 263-900233
4	900124 263-900124	900114 263-900114	900144 263-900144	900134 263-900134	900224 263-900224	900214 263-900214	900244 263-900244	900234 263-900234
5	900125 263-900125	900115 263-900115	900145 263-900145	900135 263-900135	900225 263-900225	900215 263-900215	900245 263-900245	900235 263-900235
6	900126 263-900126	900116 263-900116	900146 263-900146	900136 263-900136	900226 263-900226	900216 263-900216	900246 263-900246	900236 263-900236
7	900127 263-900127	900117 263-900117	900147 263-900147	900137 263-900137	900227 263-900227	900217 263-900217	900247 263-900247	900237 263-900237



Primary Molar Crown Complete Kit
 Contains: 2 of each size and 1 stackable tray.
 263-902150 112/kit **\$719.95**

UNITEK STAINLESS STEEL PERMANENT MOLAR CROWNS 5/box.....\$42.95						
SIZE	UPPER RIGHT	UPPER LEFT	1ST LOWER RIGHT	1ST LOWER LEFT	1ST LOWER RIGHT	1ST LOWER LEFT
1	900321 263-900321	900311 263-900311	900341 263-900341	900331 263-900331	900441 263-900441	900431 263-900431
2	900322 263-900322	900312 263-900312	900342 263-900342	900332 263-900332	900442 263-900442	900432 263-900432
3	900323 263-900323	900313 263-900313	900343 263-900343	900333 263-900333	900443 263-900443	900433 263-900433
4	900324 263-900324	900314 263-900314	900344 263-900344	900334 263-900334	900444 263-900444	900434 263-900434
5	900325 263-900325	900315 263-900315	900345 263-900345	900335 263-900335	900445 263-900445	900435 263-900435
6	900326 263-900326	900316 263-900316	900346 263-900346	900336 263-900336	900446 263-900446	900436 263-900436
7	900327 263-900327	900317 263-900317	900347 263-900347	900337 263-900337		



Permanent Molar Crown Complete Kit
 Contains: 2 of each size and 1 stackable tray.
 263-902350 80/kit **\$563.95**

UNITEK STAINLESS STEEL PERMANENT BICUSPID CROWNS 5/box.....\$42.95						
SIZE	1ST UPPER RIGHT	1ST UPPER LEFT	1ST LOWER RIGHT	1ST LOWER LEFT	2ND LOWER RIGHT	2ND LOWER LEFT
00	900519 263-900519	900509 263-900509				
0	900520 263-900520	900510 263-900510	900540 263-900540	900530 263-900530	900640 263-900640	900630 263-900630
1	900521 263-900521	900511 263-900511	900541 263-900541	900531 263-900531	900641 263-900641	900631 263-900631
2	900522 263-900522	900512 263-900512	900542 263-900542	900532 263-900532	900642 263-900642	900632 263-900632
3	900523 263-900523	900513 263-900513	900543 263-900543	900533 263-900533	900643 263-900643	900633 263-900633
4	900524 263-900524	900514 263-900514	900544 263-900544	900534 263-900534	900644 263-900644	900634 263-900634
5	900525 263-900525	900515 263-900515	900545 263-900545	900535 263-900535	900645 263-900645	900635 263-900635
6	900526 263-900526	900516 263-900516	900546 263-900546	900536 263-900536	900646 263-900646	900636 263-900636



Permanent Bicuspid Crown Complete Kit
 Contains: 2 of each size and 1 stackable tray.
 263-902600 88/kit **\$563.95**

UNITEK GOLD ANODIZED BICUSPID CROWNS 5/box.....\$40.25						
SIZE	1ST UPPER RIGHT	1ST UPPER LEFT	1ST LOWER RIGHT	1ST LOWER LEFT	2ND LOWER RIGHT	2ND LOWER LEFT
00	940519 263-940519	940509 263-940509				
0	940520 263-940520	940510 263-940510	940540 263-940540	940530 263-940530	940640 263-940640	940630 263-940630
1	940521 263-940521	940511 263-940511	940541 263-940541	940531 263-940531	940641 263-940641	940631 263-940631
2	940522 263-940522	940512 263-940512	940542 263-940542	940532 263-940532	940642 263-940642	940632 263-940632
3	940523 263-940523	940513 263-940513	940543 263-940543	940533 263-940533	940643 263-940643	940633 263-940633
4	940524 263-940524	940514 263-940514	940544 263-940544	940534 263-940534	940644 263-940644	940634 263-940634
5	940525 263-940525	940515 263-940515	940545 263-940545	940535 263-940535	940645 263-940645	940635 263-940635
6	940526 263-940526	940516 263-940516	940546 263-940546	940536 263-940536	940646 263-940646	940636 263-940636



Unitek™ Gold Anodized Adult Crowns
 Gold anodized crowns are made from medium-hard aluminum for good durability.
Bicuspid Crown Complete Kit
 263-942501 80/kit **\$539.95**

UNITEK GOLD ANODIZED MOLAR CROWNS 5/box.....\$38.25						
SIZE	1ST UPPER RIGHT	1ST UPPER LEFT	1ST LOWER RIGHT	1ST LOWER LEFT	2ND LOWER RIGHT	2ND LOWER LEFT
1	940321 263-940321	940311 263-940311	940341 263-940341	940331 263-940331	940441 263-940441	940431 263-940431
2	940322 263-940322	940312 263-940312	940342 263-940342	940332 263-940332	940442 263-940442	940432 263-940432
3	940323 263-940323	940313 263-940313	940343 263-940343	940333 263-940333	940443 263-940443	940433 263-940433
4	940324 263-940324	940314 263-940314	940344 263-940344	940334 263-940334	940444 263-940444	940434 263-940434
5	940325 263-940325	940315 263-940315	940345 263-940345	940335 263-940335	940445 263-940445	940435 263-940435
6	940326 263-940326	940316 263-940316	940346 263-940346	940336 263-940336	940446 263-940446	940436 263-940436



Molar Crown Complete Kit
 263-942301 72/kit **\$520.95**

STRIP PRIMARY CROWN FORMS 5/box.....\$47.95				
SIZE	CENTRAL UPPER RIGHT	CENTRAL UPPER LEFT	LATERAL UPPER RIGHT	LATERAL UPPER LEFT
1	914011 263-914011	914001 263-914001	914031 263-914031	914021 263-914021
2	914012 263-914012	914002 263-914002	914032 263-914032	914022 263-914022
3	914013 263-914013	914003 263-914003	914033 263-914033	914023 263-914023
4	914014 263-914014	914004 263-914004	914034 263-914034	914024 263-914024



Strip Crowns
 Transparent strip crowns for primary anterior applications. The strip crowns are ideal for use with chemical or light-cured composites.
Primary Pedodontic Anterior Crown Complete Set
 263-915100 120/set **\$782.75**

PLASTIC CROWN FORMS 5/box.....\$41.25

A2	268-611564	B5	268-611546	D1	268-611535	E3	268-611504
A3	268-611563	B6	268-611545	D2	268-611534	E4	268-611503
A4	268-611562	C1	268-611520	D3	268-611533	E5	268-611502
A5	268-611561	C2	268-611519	D4	268-611532	E6	268-611501
B1	268-611550	C3	268-611518	D5	268-611531	F1	268-611571
B2	268-611549	C4	268-611517	D6	268-611530	F2	268-611570
B3	268-611548	C5	268-611516	E1	268-611506	F4	268-611581
B4	268-611547	C6	268-611515	E2	268-611505	F5	268-611580



Plastic Crown Forms - Dentsply Caulk

Can be used as a shell matrix for conventional and microfine composite resins and silicates.

Dispenser Package

Contains: 35 forms on mold guide and 105 forms in stock tray.

268-611390 Package **\$1,125.95**



Polycarbonate Replacement Crowns

Universal shade and numbering. **\$.25/Kit 180**

Contains: 180 crowns and guide.

260-51000 Kit..... **\$125.95**

POLYCARBONATE REPLACEMENT CROWNS 5/box...\$5.25

UPPER AND LOWER		UPPER LATERAL		CENTRAL		BICUSPID		LOWER ANTERIORS	
RIGHT CUSPID	LEFT CUSPID	LEFT	RIGHT	UPPER RIGHT	UPPER LEFT	FIRST	SECOND	LONG	SHORT
300 260-DPC300	35 260-DPC35	25 260-DPC25	2 260-DPC2	100 260-DPC100	15 260-DPC15	40 260-DPC40	54 260-DPC54	62 260-DPC62	67 260-DPC67
301 260-DPC301	36 260-DPC36	26 260-DPC26	20 260-DPC20	101 260-DPC101	16 260-DPC16	41 260-DPC41	53 260-DPC53	63 260-DPC63	68 260-DPC68
30 260-DPC30	37 260-DPC37	27 260-DPC27	21 260-DPC21	10 260-DPC10	17 260-DPC17	42 260-DPC42	52 260-DPC52		
31 260-DPC31	38 260-DPC38	28 260-DPC28	22 260-DPC22	11 260-DPC11	18 260-DPC18	43 260-DPC43	51 260-DPC51		
32 260-DPC32	39 260-DPC39	29 260-DPC29	23 260-DPC23	12 260-DPC12	19 260-DPC19	44 260-DPC44	50 260-DPC50		
33 260-DPC33	302 260-DPC302	200 260-DPC200	24 260-DPC24	13 260-DPC13	102 260-DPC102				
34 260-DPC34	303 260-DPC303			14 260-DPC14	103 260-DPC103				



How the best perform

Stainless Steel Pedo Crowns - Hu-Friedy

Pre-trimmed and crimped, for quick and simple placement. Accurate occlusal anatomy that mimics the natural tooth. Ideal occlusal thickness, offering superior resilience to abrasion and perforation. Soft, adaptable gingival margin and lateral areas for simpler and effortless trimming and crimping, if needed.

Introductory Kit

Contains: 48 Crowns (1 of each size).

260-SSCKIT Kit **\$251.95**



UPPER LEFT PRIMARY 5/box.....\$34.95				LOWER LEFT PRIMARY 5/box.....\$34.95			
1st #2	260-SSCULD2	2nd #2	260-SSCULE2	1st #2	260-SSCLLD2	2nd #2	260-SSCLLE2
1st #3	260-SSCULD3	2nd #3	260-SSCULE3	1st #3	260-SSCLLD3	2nd #3	260-SSCLLE3
1st #4	260-SSCULD4	2nd #4	260-SSCULE4	1st #4	260-SSCLLD4	2nd #4	260-SSCLLE4
1st #5	260-SSCULD5	2nd #5	260-SSCULE5	1st #5	260-SSCLLD5	2nd #5	260-SSCLLE5
1st #6	260-SSCULD6	2nd #6	260-SSCULE6	1st #6	260-SSCLLD6	2nd #6	260-SSCLLE6
1st #7	260-SSCULD7	2nd #7	260-SSCULE7	1st #7	260-SSCLLD7	2nd #7	260-SSCLLE7
UPPER RIGHT PRIMARY 5/box.....\$34.95				LOWER RIGHT PRIMARY 5/box.....\$34.95			
1st #2	260-SSCURD2	2nd #2	260-SSCURE2	1st #2	260-SSCLR2D2	2nd #2	260-SSCLRE2
1st #3	260-SSCURD3	2nd #3	260-SSCURE3	1st #3	260-SSCLR2D3	2nd #3	260-SSCLRE3
1st #4	260-SSCURD4	2nd #4	260-SSCURE4	1st #4	260-SSCLR2D4	2nd #4	260-SSCLRE4
1st #5	260-SSCURD5	2nd #5	260-SSCURE5	1st #5	260-SSCLR2D5	2nd #5	260-SSCLRE5
1st #6	260-SSCURD6	2nd #6	260-SSCURE6	1st #6	260-SSCLR2D6	2nd #6	260-SSCLRE6
1st #7	260-SSCURD7	2nd #7	260-SSCURE7	1st #7	260-SSCLR2D7	2nd #7	260-SSCLRE7

JAVA CROWNS, INC.

Natural Color Metal Crowns - Java Crowns, Inc.

Combine convenience with aesthetics in an affordable package. Temporary crowns have a proprietary tooth colored coating that will not chip or peel and application takes less than five minutes with minimal cleanup.

Kits available upon request.

UPPER BICUSPIDS/PREMOLARS 5/pkg.....\$24.75			LOWER BICUSPIDS/PREMOLARS 5/pkg.....\$23.75			
UB-0	260-UB0	6.00mm		LB-0	260-LB0	5.80mm
UB-1	260-UB1	6.18mm		LB-1	260-LB1	5.86mm
UB-2	260-UB2	6.50mm		LB-2	260-LB2	6.18mm
UB-3	260-UB3	6.82mm		LB-3	260-LB3	6.50mm
UB-4	260-UB4	7.14mm		LB-4	260-LB4	6.82mm
UB-5	260-UB5	7.46mm		LB-5	260-LB5	7.14mm
UB-6	260-UB6	7.78mm		LB-6	260-LB6	7.46mm
UB-7	260-UB7	8.10mm		LB-7	260-LB7	7.78mm
				LB-8	260-LB8	8.10mm
MAXILLARY MOLARS LEFT (UL) RIGHT(UR) 5/pkg.....\$23.75			MANDIBULAR MOLARS LEFT(UL) RIGHT(UR) 5/pkg.....\$23.75			
UL-1	260-UL1	9.20mm		LL-1	260-LL1	9.90mm
UR-1	260-UR1			LR-1	260-LR1	
UL-2	260-UL2	9.50mm		LL-2	260-LL2	10.40mm
UR-2	260-UR2		LR-2	260-LR2		
UL-3	260-UL3	9.80mm		LL-3	260-LL3	10.70mm
UR-3	260-UR3			LR-3	260-LR3	
UL-4	260-UL4	10.10mm		LL-4	260-LL4	11.10mm
UR-4	260-UR4			LR-4	260-LR4	
UL-5	260-UL5	10.50mm		LL-5	260-LL5	11.50mm
UR-5	260-UR5			LR-5	260-LR5	
UL-6	260-UL6	10.80mm		LL-6	260-LL6	11.90mm
UR-6	260-UR6			LR-6	260-LR6	

CROWN ACCESSORIES



Richwil Crown & Bridge Remover - Almore International, Inc.

Provides an easy, non-traumatic method of removing loose primary teeth. Use to quickly and safely remove crowns, bridges, inlays and temporary or permanent restorations.

Contains: 25 packages of 2/box.

260-33800 Each..... \$25.75



Bite Sticks - Grobet USA

Pegwood

5.75" x 2mm Round

760-23300 20/pack \$7.95

5.75" x 4mm Round

760-23303 20/pack \$11.75

7" x 6mm Round

760-23304 20/pack \$18.95

Cottonwood

8" x 0.5" Square

760-23308 12/pack \$4.45



Tooth Slooth Fracture Detector - Professional Results Inc.

An effective diagnostic device for pinpointing fractures - autoclavable.

260-477S 4/pack..... \$19.25



Tooth Slooth II Crown Seater - Professional Results Inc.

Smaller head for fracture detection of difficult-to-reach molars or for use in cementation purposes. Slot for use in seating anterior crowns, pointed end for fossa area. Autoclavable. Blue.

260-TS1104 4/pack..... \$19.25



Pic-n-Stic - Pulpdent Corporation

Use as a handle for crowns, inlays, veneers, bands, brackets, files, reamers, clasps, precision attachments, implant screws and numerous other objects.

260-PIC 60/box. \$19.95



Bite Sticks - Temrex Corporation

260-2900 80/box \$29.25

COTTON APPLICATORS

**Cotton Tipped Applicators**

Non-sterile, all wood dowels with 100% cotton bud. Comes sealed in autoclavable bag with indicator.

3"		
240-3000	1000/box	\$8.75
6"		
240-1006	1000/box	\$9.75

COTTON PELLETS

**Cotton Pellets - Richmond Dental**

Designed to provide outstanding quality and absorbency in a variety of uses.

#0	240-100105	400/box largest	\$7.75
#1	240-100106	2000/box	\$8.25
#2	240-100107	2550/box	\$7.75
#3	240-100108	2500/box	\$7.75
#4	240-100109	3000/box	\$9.25
#5	240-100110	1300/box smallest	\$16.45

Assorted

Contains: 2 -#1's, 4 -#2's, 4 -#3's and 2 -#4's.
240-100602 Each.....\$27.75

Tilt-Top Cotton Pellets

For use in tilt-top dispenser only. 12/box.

#1	240-100901	\$27.75
#2	240-100902	\$28.25
#3	240-100903	\$34.95
#4	240-100904	\$38.75

LOOK'in

for something? **WE HAVE IT!**
www.dhponline.com

COTTON ROLLS

**Ultra Cotton Rolls**

Conforms easily and maintains shape. Highly absorbent 100% long fiber, pure white cotton dental rolls. No chemical additives or whiteners.

Non-Sterile Medium #2, 1-1/2" x 3/8"
240-CR001 2000/box.....\$22.95

Cotton Rolls

Contains virgin cotton, which maintains its shape when wet and will not adhere to mucous membranes.

Non-Sterile Medium #2, 1-1/2" x 3/8"
240-CR002 2000/box.....\$20.45

**Premium Cotton Rolls - Crosstex International**

Non-Sterile Medium
1-1/2" x 3/8"
240-0100 2000/box.....\$42.95

Braided Non-Sterile

1-1/2" x 3/8"
240-0100B 2000/box.....\$45.45

**Braided Rolls - Richmond Dental**

Made of soft, pure, lengthwise fibers of cotton. A unique spirally wound, soft nylon provides flexibility for fast, positive positioning.

Non-Sterile Small

1-1/2" x 5/16"
240-201210 2000/box.....\$43.25

Non-Sterile Medium

1-1/2" x 3/8"
240-200204 2000/box.....\$37.95

Non-Sterile Medium Economy Pack

1-1/2" x 3/8"
240-200215 10,000/box.....\$152.25

Non-Sterile Medium

4" x 3/8"
240-201226 250/box.....\$29.95

Non-Sterile Medium

6" x 3/8"
240-201208 200/box.....\$25.75

Non-Sterile Large

1-1/2" x 1/2"
240-201201 1000/box.....\$48.95

Sterile Medium

1-1/2" x 3/8"
240-200206 2000/box.....\$45.95

Additional sizes available upon request.

**Wrapped Cotton Rolls - Richmond Dental**

Wrapped in a soft absorbent cover to prevent fraying and sticking.

Non-Sterile Medium

1-1/2" x 3/8"
240-200404 2000/box.....\$29.25

**TIDI Cotton Rolls - TIDI Products, LLC**

Non-linting cotton rolls are machine-rolled into soft pliable cylinders. Made in the USA.

Non-Sterile #1 Small

1-1/2" x 5/16"
240-9120 2000/box.....\$56.75

Non-Sterile #2 Small

1-1/2" x 3/8"
240-919121 2000/box.....\$37.45

Non-Sterile #2 Medium

3/8" x 6"
240-9122 500/box.....\$56.75

Non-Sterile #3 Large

1/2" x 1-1/2"
240-9123 2000/box.....\$72.75

Sterile #2 Medium

1-1/2" x 3/8"
240-9126 2000/box.....\$52.75

COTTON DISPENSERS

Cotton Roll Container - Integra® Miltex®

Round container with stainless pins embedded in weighted bottom. Holds cotton rolls in upright position. Hinged lid. Autoclavable, chemiclavable.
Beige.....240-0300
Blue.....240-0301
Each.....\$18.95



Additional colors available upon request.

COTTON DISPENSERS



Gauze Dispenser - Integra® Miltex®

Standard sponge dispenser spring loaded to hold all sterilizing and germicidal solutions along with the sponges to make your own easy and economical wipes.

2" x 2"

Blue	250-SD22BL
Beige	250-SD22BG
Mauve	250-SD22MV
White	250-SD22WH
Each	\$18.45



Isolator® - Pascal International, Inc.

Disposable cotton roll holder.

240-28110	10/pkg.....	\$5.45
240-28100	50/pkg.....	\$20.25



Cotton Roll Dispenser #220 - Richmond Dental

Plastic container with lid holds up to (50) 1-1/2" small and medium rolls and (25) 1-1/2" large rolls. Autoclavable. Includes 200 rolls.

Blue	240-200224
White	240-200424
Each	\$46.45



Temple Assorted Cotton Pellet Dispenser - Richmond Dental

Contains: 1 dispenser and 10 refills.

240-6601	Each.....	\$48.75
----------	-----------	----------------

COTTON FILLED SPONGES



Cotton-Filled Sponges

Pure white, 8-ply sponges with center fold to prevent fraying. Sponges are filled with 100% cotton and are shred resistant.

2"x 2" Non-Sterile

250-5000	5000/box	\$53.45
----------	----------------	----------------

2"x 2" Non-Sterile

250-200	200/sleeve.....	\$3.95
---------	-----------------	---------------



Exodontia Sponges - Crosstex International

Made from USP cotton gauze. Pure, virgin white cotton with 100% cotton-fiber filling. Highly absorbent.

2" x 2" Non-Sterile Advantage Plus Premium

250-ENACC	5000/case	\$71.25
-----------	-----------------	----------------

2" x 2" Non-Sterile Premium

250-ENCC	5000/case	\$91.25
----------	-----------------	----------------

2" x 2" Sterile Premium

250-ESCC	5000/case	\$119.95
----------	-----------------	-----------------



Cotton-Filled Exodontia Sponges - Richmond Dental

Inner layer of 100% cotton.

2"x 2" 8-ply Sterile

250-300405	5000/case	\$76.95
------------	-----------------	----------------

2"x 2" 8-ply Non-Sterile

250-300410	5000/case	\$69.95
------------	-----------------	----------------

4"x 4" 4-ply Non-Sterile

250-300312	2000/case	\$81.95
------------	-----------------	----------------



Venture™ Cotton-Filled Sponges - TIDI Products, LLC

Feature a woven gauze facing with an absorbent cotton fill.

2"x 2" 4-ply Non-Sterile

250-9000	5000/case	\$70.45
----------	-----------------	----------------

Additional sizes available upon request.

DRY ANGLES



Dri-Angles - DHP

Use as a cotton roll replacement in the parotid area. Can also be used as a tongue retractor when placing lingual fillings.

Plain

Small

240-0221	400/pkg.....	\$12.45
----------	--------------	----------------

Large

240-0220	320/pkg.....	\$11.75
----------	--------------	----------------

Silver Coated

Small

240-0223	400/pkg.....	\$16.25
----------	--------------	----------------

Large

240-0222	320/pkg.....	\$16.25
----------	--------------	----------------



Dri-Aids™ - Microbrush International

Ideal for use with bonding procedures, restorations, cementations, sealants and all other procedures requiring a dry field.

Standard Package

Small	240-331125
Large	240-331320
250/bag	\$23.25

Bulk Package

Small.....	240-331190
Large	240-331375
750/bag	\$58.25

Dri-Aids Silver

The laminated side prevents soak through and reflects light for improved visibility.

Standard Package

Small.....	240-332125
Large	240-332325
250/bag	\$30.95

Bulk Package

Small.....	240-332190
Large	240-332375
750/bag	\$78.45

DRY ANGLES



DryTips - Microbrush International
 Absorb and retain 30 times their own weight in moisture, keeps the parotid gland in check for 15 minutes. No loose fibers, flexible, comfortable for patient.

Small.....	240-0101	
Large.....	240-0102	
50/box		\$14.75



NeoDrys™ - Microcopy
 Maximize efficiency and procedure effectiveness by controlling the risk of parotid saliva contamination, while providing outstanding cheek protection. Inner core traps moisture quickly, keeping the working area dry for a full 15 minutes. Standard with the original white backing or Reflective featuring a light-enhancing, mirror-like finish.

Standard

Small (Yellow)	240-DYS	
Large (Blue)	240-DYL	
50/pkg.		\$15.25

Reflective

Small (Yellow)	240-DYRS	
Large (Blue)	240-DYRL	
50/box		\$18.75



Premium All Gauze Sponges - Richmond Dental
 Loose weave, giving a textured, cheese-cloth-like appearance and a slightly abrasive surface.

2"x 2" 8-ply Non-Sterile

250-300430	5000/case	\$59.95
------------	-----------------	----------------

2"x 2" 12-ply Non-Sterile

250-300420	5000/case	\$79.95
------------	-----------------	----------------

3"x 3" 12-ply Non-Sterile

250-300421	4000/case	\$117.95
------------	-----------------	-----------------

4"x 4" 12-ply Non-Sterile

250-300423	2000/case	\$109.95
------------	-----------------	-----------------

Additional sizes available upon request.



Venture™ Gauze Sponges - TIDI Products, LLC

2"x 2" 8-ply Non-Sterile

250-908282	5000/case	\$61.75
------------	-----------------	----------------

4"x 4" 8-ply Non-Sterile

250-908292	4000/case	\$105.95
------------	-----------------	-----------------

4"x 4" 12-ply Non-Sterile

250-8295	2000/case	\$99.95
----------	-----------------	----------------

Additional sizes available upon request.

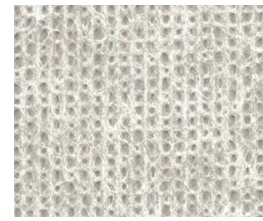

Ultra Gauze™ Sponges - Crosstex International
 Exclusive rayon/polyester formed nonwoven material provides more absorbency than traditional sponges. Ultra Gauze releases easily from incision/extraction sites. Non-Sterile.

2" x 2"

250-ENCNWUBS	200/sleeve.....	\$5.75
250-ENCNWUB	8000/case	\$176.25

3" x 2"

250-ENC3NWU	4000/case	\$172.75
-------------	-----------------	-----------------

4" x 4"

250-ENC4NWU	2000/case	\$129.95
-------------	-----------------	-----------------

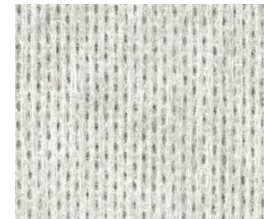

Premium Non-Woven Sponges - Crosstex International
 Offers all the advantages of traditional gauze sponges. Perfect for sustained patient use and general cleaning. Economical. Lint-free. High absorbency. Soft yet strong. 4-ply. Non-Sterile.

2" x 2"

250-ENCNW	5000/case	\$91.25
-----------	-----------------	----------------

3" x 3"

250-ENC3NW	4000/case	\$187.25
------------	-----------------	-----------------

4" x 4"

250-ENC4NW	2000/case	\$133.25
------------	-----------------	-----------------

GAUZE SPONGES

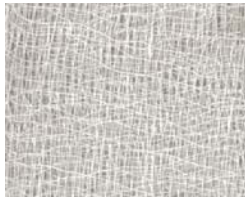

All-Gauze Sponges - Crosstex International
 Made from USP 100% gauze, these premium all-gauze sponges are highly absorbent.

2"x 2" Non-Sterile 8-ply

250-ENC2	5000/case	\$80.75
----------	-----------------	----------------

2"x 2" Non-Sterile 12-ply

250-ENC212	8000/case	\$160.25
------------	-----------------	-----------------

NON-WOVEN SPONGES



Non-Woven Sponges
 Made from a 4-ply, 32 gram rayon/polyester blend which provides for maximum absorbency and little adhesion to wounds. These are soft, smooth, strong, non-linting and non-sterile.

2" x 2"

250-5002S	200/sleeve.....	\$3.95
250-5002	5000/box	\$58.25

3" x 3"

250-4002	4000/box	\$67.95
----------	----------------	----------------

4" x 4"

250-2104S	200/sleeve.....	\$7.45
250-2002	2000/box	\$67.95



UltraPure™ Non-Woven Sponges - Crosstex International
 Eco-friendly. They're soft, lint-free and highly absorbent for the clinical results you require. Unlike typical synthetic non-woven sponges, they're biodegradable. Non-Sterile.

2" x 2"

250-ENC100	5000/case	\$113.75
------------	-----------------	-----------------

4" x 4"

250-ENC4100	2000/case	\$154.45
-------------	-----------------	-----------------

NON-WOVEN SPONGES



100% Cotton Non-Woven Sponges - Richmond Dental

Superior absorbency in a disposable and biodegradable all natural fiber. Lint-free Non-Sterile.

100% Cotton 2" x 2"

250-300631 5000/case **\$88.95**

3" x 3"

250-300632 4000/case **\$134.95**

4" x 4"

250-300633 2000/case **\$120.95**

Rayon/Poly 2" x 2"

250-300637 3000/case **\$53.95**

3" x 3"

250-300638 2500/case **\$131.95**

4" x 4"

250-300639 2000/case **\$200.95**



SteriPocket® - Richmond Dental

Perfect for dispensing to patients after an extraction. Sterile.

2" x 2" 8-ply Poly/Rayon Non-Woven

250-303120 200/pkg **\$39.95**

Cotton Filled

250-300408 300/pkg **\$19.95**



Omnisorb® Non-Woven Sponges - TIDI Products, LLC

Non-woven sponges are highly absorbent, low-linting option for prepping and packing. Also convenient for wiping down instruments and workspace. Made in USA. Closed Weave. Non-Sterile.

2" x 2"

250-2022S 200/sleeve **\$5.75**

250-2022 5000/case **\$120.95**

3" x 3"

250-2033 4000/case **\$178.75**

4" x 4"

250-2044S 200/sleeve **\$12.45**

250-2044 2000/case **\$114.45**

Order by ☎ **800-626-2163**



Venture™ Non-Woven Sponges - TIDI Products, LLC

Highly absorbent non-woven sponges, low-linting and a convenient option for prepping and packing, wiping down instruments and work space. Made in USA. Non-Sterile.

Open Weave 4-Ply

250-260002 2" x 2" 8000/case **\$103.45**

250-260003 3" x 3" 4000/case **\$109.75**

250-260004 4" x 4" 2000/case **\$105.75**

Closed Weave 4-Ply

250-912022 2" x 2" 5000/case **\$80.75**

250-912044 4" x 4" 2000/case **\$106.45**

PATIENT BIBS/TOWELS



Patient Bibs

2-ply tissue, 1-ply poly, 18" x 13".

Aqua 640-2138

Beige 640-2137

Blue 640-2133

Dusty Rose 640-2136

Green 640-2132

Lavender 640-2140

Peach 640-2139

Silver Gray 640-2135

White 640-2131

Yellow 640-2134

500/case **\$30.25**

Ultra Patient Bibs

3-ply tissue, 1-ply poly 18" x 13".

Aqua 640-3138

Beige 640-3137

Blue 640-3133

Dusty Rose 640-3136

Green 640-3132

Lavender 640-3140

Peach 640-3139

Silver Gray 640-3135

White 640-3131

Yellow 640-3134

500/case **\$35.25**



Econoback Patient Bib - Crosstex International

Traditional fold with horizontal embossing. **13" x 19" 2-ply Paper, 1-ply Poly**

Aqua 640-WEXAQ
 Beige 640-WEXBG
 Blue 640-WEXBL
 Green 640-WEXGR
 Lavender 640-WEXLV
 White 640-WEXWH
 500/case **\$37.95**

Additional colors available upon request.



Plastic Patient Barrier Apron - Crosstex International

Features two alligator clips attached to the front of the neckband to hold a disposable patient towel or bib plus a touch-tab velcro neck closure for fast and easy fastening. Can be wiped clean in seconds with any antibacterial agent.

Waist Length - 27" x 30"

Blue 480-NP3BL
 White 480-NP3WH
 Each **\$16.45**

Knee Length - 27" x 44"

Blue 480-NP4BL
 White 480-NP4WH
 Each **\$16.45**

Additional colors available upon request.



Polyback Sani-Tab® Chain-Free® Bib - Crosstex International

Exclusive adhesive tabs allow positioning anywhere on the patient. No more chains and clips. **13" x 19" 2-ply Poly**

Blue 640-WEXBLT
 Dusty Rose 640-WEXDRT
 White 640-WEXWHT
 400/case **\$37.95**

Additional colors available upon request.

PATIENT BIBS/TOWELS

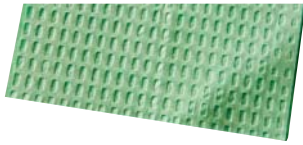

Choice Patient Bibs - TIDI Products, LLC

2-ply tissue/1-ply poly. Waffle embossed.

Regular Size - 13" x 18"

Beige	640-7467
Blue	640-7463
Gray	640-7465
Green.....	640-7462
Mauve.....	640-7466
Peach.....	640-7468
Teal.....	640-7470
White	640-7461
Lavender.....	640-7459
Yellow.....	640-7464
500/case	\$37.25

Large Size - 17" x 18"

Blue	640-7473
White	640-7471
500/case	\$51.25



Ultimate Patient Bibs

3-ply tissue/1-ply poly. Waffle embossed.

Regular Size - 13" x 18"

Beige	640-7407
Blue	640-7403
Gray	640-7405
Green.....	640-7402
Mauve.....	640-7406
Peach.....	640-7408
Teal.....	640-7410
White	640-7401
Lavender.....	640-7400
Yellow.....	640-7404
500/case	\$41.45

Large Size - 17" x 18"

Blue	640-7413
White	640-7411
500/case	\$53.45



Economy Patient Bib - TIDI Products, LLC

Provides extra protection. Tissue/poly tissue construction.

Waist Length - 29" x 21"

Blue	640-7483
Lavender	640-7480
100/case	\$38.25

Knee Length - 29" x 42"

Blue	640-7493
50/case	\$38.25



TIDI® Chainless Bib - TIDI Products, LLC

Made of a poly-backed tissue that is strong and prevents soak-through. Neck ties eliminate need for bib clips.

18" x 25"

Blue	640-7673
Mauve.....	640-7676
250/case	\$52.75



Kay-Pees® Professional Towels & Dispenser Box - TIDI Products, LLC

Lint free, low-friction, for sensitive skin. Individual dispenser boxes for portability and product protection. Super soft, highly absorbent. Edge-embossed. 10 boxes of 50 each.

13.5" x 17.5" 4-ply Tissue

White.....	640-911898
Blue.....	640-911900
500/case	\$48.25



Pediatric Bibs - TIDI Products, LLC

2-ply + poly bib.

10" x 13"

640-981410	250/case	\$28.25
------------	----------------	----------------

13" x 18"

640-981413	250/case	\$43.75
------------	----------------	----------------



Tooth Design

2-ply + poly bib.

13" x 18.

640-7490	250/case	\$52.75
----------	----------------	----------------



Adult Printed Bibs - TIDI Products, LLC

Watercolors Design

2-ply + poly bib.

13" x 18"

640-982413	500/case	\$51.45
------------	----------------	----------------



Zooby Pediatric Character Bibs - Young Dental

Each bib features the body of an animal and acts as a costume. Includes these characters: Chase the Cheetah, Zoe the Zebra, Penelope the Penguin, Talon the Tiger and Francesca the Flamingo. Non-permeable.

13.5" x 9"

640-295200	100/box	\$22.45
------------	---------------	----------------



Bib Holder - Plasdent

Acrylic bib holder. Clear.

5-5/8" W x 7-1/2" H x 6-1/4" D.

640-1205	Each.....	\$18.45
----------	-----------	----------------

Additional colors available upon request.

BIB CLIPS/CHAINS



Napkin Holders - Buffalo Dental Manufacturing

Nickle-plated. Autoclavable.

640-51451	12/pkg	\$29.75
-----------	--------------	----------------

BIB CLIPS/CHAINS



"Super" Bib Clips - Hager Worldwide

Colorful autoclavable silicone with nickel-plated clips.

Blue	640-605286	
Purple	640-605182	
1/pkg.		\$5.75
Blue	640-SBL	
Green	640-SBG	
Purple	640-SBP	
White	640-SBW	
3/pkg.		\$15.75

Additional colors available upon request.

Assortment Package

Contains: 1 each blue, green, purple, white red, yellow, orange and pink.

640-605290	8/pkg	\$39.25
------------	-------------	----------------



Bib Clips - Integra® Miltex®

Beaded Chain - Assorted Color Sleeves

641-6410	6/pkg	\$24.45
----------	-------------	----------------

Non-Chill Plastic Band - Clear

641-6415	6/pkg	\$22.45
----------	-------------	----------------



Bib-Eze - Kerr TotalCare

Disposable bib holders that simplify handling, while eliminating any need to sterilize. The self-adhesive ends secure to any bib and removal is as easy as tearing a piece of paper.

640-35053	250/box	\$15.25
-----------	---------------	----------------



Spectrum Bib Clips - Plasdent

Patient napkin holder.

Red	640-204BCRD	
Green	640-204BCGN	
Light Blue	640-204BCLB	
Pink	640-204BCPK	
Purple	640-204BCPU	
Royal Blue	640-204BCRB	
Tangerine	640-204BCTA	
White	640-204BCWT	
Yellow	640-204BCYL	
Each		\$3.25



Napkin Holders - Temrex Corporation

Sturdy, attractive and durable napkin holders are manufactured from quality materials. The quick-release clips are made of nickel-plated steel with injection-molded plastic sleeves.

Plastic Self-Adjusting Coil Type

Blue	640-226	
Black	640-230	
Green	640-231	
Red	640-227	
White	640-229	
Yellow	640-228	
Each		\$5.75

Metal Ball Chain

Blue	640-130	
Black	640-131	
Green	640-132	
Red	640-129	
White	640-134	
Yellow	640-133	
Each		\$5.25

Extruded Plastic Non-Chill

Blue	640-136	
Black	640-137	
Green	640-138	
Red	640-135	
White	640-140	
Yellow	640-139	
Each		\$5.25

CUPS



5oz. Plastic Drinking Cups

Blue	630-HT01B2	
Dusty Rose	630-HT03M2	
Green	630-HT05G2	
Lavender	630-HT06LV2	
White	630-HT04W2	
1000/case		\$31.25



Solo 3oz. Paper Cups

Treated but not waxed. Fits most dispensers.

10 sleeves of 100/sleeve.	
630-R3	1000/pkg
	\$60.75



Solo 5oz. Waxed Paper Cups

Rolled Lip. Fits most dispensers. 10 sleeves of 100/sleeve.

630-RD5N	1000pkg	\$66.95
----------	---------------	----------------



5oz. Waxed Paper Cups - TIDI Products, LLC

Tooth design.

630-9220	1000/case	\$77.25
----------	-----------------	----------------

DISPOSABLES

CUPS



6oz. Evacuation Cup Liners - TIDI Products, LLC

White paper cones, rolled rims, cut bottoms.
For Adec Unit: 3" high, 4" top opening.
630-9231 250/bag **\$19.75**



Medicine Cups - TIDI Products, LLC

Plastic 1oz. disposable cup.
630-4694 100/box **\$2.75**



Plastic Cups - TIDI Products, LLC

Leakproof construction with embossed sides.
Rolled lip for patient comfort. Fits most dispensers.

- 3.5oz.**
- White630-9241
 - Blue630-9243
 - 1000/case **\$53.75**
- 5oz.**
- Blue630-9213
 - Beige630-9217
 - Gray630-9215
 - Green630-9212
 - Lavender630-9210
 - Mauve630-9216
 - Peach630-9218
 - White630-9211
 - Yellow630-9214
 - 1000/case **\$53.75**



Cup Dispenser

Chrome. Adjustable for 3oz. or 5oz. cups.
630-9246 Each **\$41.75**



Drinking Cup Dispenser - Crosstex International

Made of clear plastic with white base. Attaches to the wall with screws or adhesives. Holds 50 -5oz. plastic cups.
630-CDIS Each **\$40.75**



Non-Woven Headrest Covers - Crosstex International

White.
Small - 10" x 10"
620-P1010 500/case **\$49.25**
Regular - 10" x 13"
620-P1310 500/case **\$65.95**



Plastic Headrest Covers - Crosstex International

Lies flat on the headrest, providing barrier protection between patient and headrest. Clear, soft 1mil thick polyethylene with a 3/8" gusset.
100/box.

- 9.5" x 11" Regular**
- 620-LOCP Clear **\$13.75**
 - 620-LOCPW White **\$59.75**
- 9.5" x 14" Jumbo**
- 620-L3CP Clear **\$15.95**





Headrest Covers - Kerr TotalCare

Disposable plastic cover for headrests.
Allrap
14" x 9-1/2".
620-250 250/box **\$19.45**
Pinnacle™
14" x 9-1/2".
620-3514 250/box **\$22.25**

HEADREST COVERS



Headrest Covers
White tissue with poly backing.

10" x 10"

- 620-HC1010 500/box **\$52.45**

10" x 13"

- 620-HC1013 500/box **\$58.95**

Plastic

11" x 9.5" x 12"

- 660-HT1195 250/box **\$13.75**

14" x 9.5" x 2"

- 660-HT1495 250/box **\$15.75**



Headrest Covers - Brixton

Protects headrest on operator chairs from damaging effects of surface disinfectants, such as cracking or fading.

- Regular Size - 10" x 11-1/4"**
- 620-501R 250/box **\$15.25**
- Jumbo Size - 10" x 14-1/2"**
- 620-501L 250/box **\$14.95**

HEADREST COVERS



Headrest Covers - TIDI Products, LLC

All poly. Latex-Free.

10" x 10" White	
620-9611	500/case \$37.95
10" x 13" White	
620-9621	500/case \$48.25
10" x 13" Clear	
620-9622	500/case \$48.25
13" x 13" White	
620-9631	500/case \$54.25

Choice Headrest Covers - TIDI Products, LLC

Tissue/Poly.

10" x 10"	
Blue	620-9713
Lavender.....	620-9719
500/case \$60.25
10" x 13"	
Blue	620-9813
Lavender.....	620-919819
500/case \$59.25

Additional colors available upon request.



Ultimate Fabricel® Headrest Covers - TIDI Products, LLC

Poly-lined to prevent leak-through. White.

10" x 10"	
620-9511	500/case \$66.25
10" x 13"	
620-9512	500/case \$80.75
10" x 20"	
620-9515	500/case \$86.95
13" x 13"	
620-9513	500/case \$94.75
11-1/2" x 15"	
620-9514	500/case \$102.75

TRAY COVERS



Tray Covers

Manufactured on high-quality paper stock. The improved moisture resistance ensures no unwanted water seepage to the surface underneath. Not made with natural rubber latex.

"B" Ritter Units 8-3/8" x 12-1/4"

Blue	650-10002
Dusty Rose	650-10003
Lavender	650-10004
Green	650-10005
Yellow	650-10006
1000/case \$27.95

White

650-10001	1000/case \$26.95
-----------	--------------------------------

"E" Midwest Units 9-1/2" x 13-1/2"

Dusty Rose	650-1003DR
Lavender	650-1003LV
1000/case \$27.95



Bracket Tray Covers - Crosstex International

Heavy-weight paper stock that impedes the flow of moisture and minimizes seep-through.

8.5" x 12.25" Size B Ritter

Lavender.....	650-FBLV
Peach.....	650-FBPE
White	650-FBWH
Beige	650-FBBG
1000/box \$34.25

9" x 13.5" Size E Midwest

Blue	650-FEBL
White	650-FEWH
1000/box \$46.95

Liquid Proof Tray Covers

Polyethylene-backed paper prevents seep through. Dual purpose paper may be used poly-side down as a moisture barrier or poly-side up for quick mixing. White.

8.5" x 12.25" Size B Ritter

650-BTCB	500/box \$35.25
----------	------------------------------



Tray Covers - TIDI Products, LLC

Standard Weight. Glazed undersurface makes them moisture resistant to liquids. Heavyweight - extra thick. Both sides are matted.

13-1/2" Diameter Circular (G)

White	650-7561
1000/case \$54.95
9" x 12-3/8"	
Blue	650-7523
White	650-7521
1000/case \$52.75

9" x 13-1/2" Certified

White	650-7581
1000/case \$46.75

8-1/2" x 12-1/4" Ritter (B)

Blue	650-7513
Green.....	650-7512
Lavender.....	650-7519
Mauve.....	650-7516
White	650-7511
Yellow.....	650-7514
1000/case \$50.25

Tooth Design

650-917520	1000/case \$56.45
------------	--------------------------------

9-1/2" x 13-1/2" Midwest (E)

White	650-7531
Blue	650-7533
1000/case \$57.75

10-1/4" x 15-3/4" S.S.White (D)

Blue	650-7543
White	650-7541
1000/case \$75.25

1" x 17-1/4" Weber (C)

Blue	650-7553
White	650-7551
1000/case \$66.25

5" x 8" Mini (F)

Blue	650-7573
White	650-7571
1000/case \$45.75



for something? **WE HAVE IT!**

www.dhpionline.com

DISPOSABLE SYRINGE TIPS



Air/Water Syringe Tips

Excellent alternative to typical metal auto-clavable tips. The disposable tips have an inner core water chamber that seats into the syringe, eliminating water contamination in the air chamber. The unique quad core design ensures instant dry air, prevents cross contamination, and delivers superior air/water spray.

Health-Tec syringes feature an O-ring groove that secures tip lock for patient safety and eliminates leakage.

- Clear.....540-HT250C
- Assorted Colors.....540-HT250A
- 250/bag **\$47.75**



Sparkle Air-Water Syringe Tips - Crosstex International

Reduce patient risk and eliminate reprocessing time. Separate chambers for air and water; no adapter required.

- Clear.....540-BCSAWSCL
- White.....540-BCSAWSWH
- Assorted Colors.....540-BCSAWS
- 250/bag **\$47.95**

Assorted Colors - Bulk

- 540-BCSAWSB 1500/bag..... **\$269.95**



Sani-Tip® - DENTSPLY Professional

Rigid, clear plastic, disposable tri-syringe tip. Central water channel and six individual air passages that offer precise separation or atomization of air and water.

- 540-122201 250/bag..... **\$85.45**

Bulk Refill

- 540-122205 1500/box..... **\$360.95**

Conversion Kits

- A - 1540-122220
- D - 1540-122240N
- E - 1540-122230
- P - 1540-122280
- 10/case **\$16.25**



BeeSure Air-Water Syringe Tips - EcoBee

Interchangeable with most water-air syringe tips. Designed without separate water core. Rounded tip end. Made from 30% recycled plastic. Green.

With Core

- 540-BE402 250/bag..... **\$22.95**

Without Core

- 540-BE401 250/bag..... **\$30.95**



Safe-Tips™ EZ - Kerr TotalCare

Metal core provides extra rigidity for cheek retraction. Rounded ends and locking retention groove for patient comfort and safety. Interchangeable with standard metal tips: no converter or other modifications needed.

- 540-44150 150/pouch..... **\$54.75**

Bulk Refill

- 540-44600 1600/box..... **\$409.95**



Seal-Tight™ - Kerr TotalCare

Disposable tips with built-in rubber O-ring seal makes syringe work like new. Fast tip changing with easy-to-install, push button converters.

Dispenser Pouch

- 540-77200 200/box..... **\$50.45**

Bulk Box

- 540-77500 1500/box..... **\$305.95**



Seal-Tight Spectrum

Assorted colors.

Dispenser Pouch

- 540-72200 200/pouch..... **\$50.45**

Bulk Box

- 540-72500 1,500/box..... **\$305.95**

Adapters

- ADEC styles540-77021
- Dental-EZ540-77023
- Engle-Macro540-77022
- Press Ring540-77024
- Each **\$23.45**



Pro-Tip Turbo - Medicom

Unique dual chamber design to separate air from water, guarantees instant dry air and perfect misted spray when and where you need it. Rounded edges. Fits most popular 3-in-1 models, wide range of con-verters available.

- 540-100702 250/bag..... **\$59.95**
- 540-100703 1500/bag..... **\$333.95**



Flash-Tips® - Sultan Healthcare

Features solid construction, with separate air and water chambers to minimize crossover and an inner tube that does not shift under pressure. Quick and easy changeover converters are not required on most common syringes. Locking indicator and wide locking groove ensure tip is in place and safe, with smooth round edges to prevent harm to patients and equipment. Five colors in each pack.

- 540-23071 250/bag..... **\$60.75**
- 540-23075 1200/bag..... **\$257.75**

TONGUE DEPRESSORS



Health-Tec
BRAND PRODUCTS

Tongue Depressors
100% wood tongue depressors are smooth and splinter free. Non-sterile and 6" in length.
240-TD06 500/box **\$11.75**

Tongue Depressors

Sterile and 6" in length.
240-5865202 100/box **\$6.95**

BIG-FOLD TOWELS



Big Fold Z® Embossed Premium Towels

Fit into existing c-fold and multi-fold dispensers without adapters. The unique fold allows for reliable dispensing. White.
680-88700 2200/case **\$61.95**

C-FOLD TOWELS



EcoSoft® C-Fold Towels

100% recycled to satisfy environmentally conscious customers. EPA compliant for minimum post consumer recycled fiber content.

EcoSoft Green Seal - Natural White
670-493 2400/case **\$39.95**

EcoSoft - White
670-495 2400/case **\$43.45**



Envision® Recycled C-Fold Towels

Made from 100% recovered materials which comply with EPA guidelines for post consumer regular fiber content.

White
670-25190 2400/case **\$42.95**

Signature White
Premium 2-ply with honey-comb emboss.
670-23000 1440/case **\$36.95**



Kleenex® C-Fold Towels

White.
670-150 2400/case **\$56.75**



Kleenex® ScottFold® Towels

Perf-embossed towel that's guaranteed to dispense one at a time. White.
680-13254 3000/case **\$65.25**



Scott C-Fold Towels

White.
670-151 2400/case **\$49.75**

MULTI-FOLD TOWELS



EcoSoft™ Multi-Fold Towels

Made from 100% recovered materials which comply with EPA guidelines for post consumer waste. White.

680-485 4000/case **\$44.45**



Envision® Multi-Fold Towels

Made from 100% recovered materials which comply with EPA guidelines for post consumer waste.

Natural
680-24990 4000/case **\$42.95**

White
680-24590 4000/case **\$47.95**



Kleenex® Multi-Fold Towels

Soft and absorbent. Meet EPA standards with a minimum of 40% post consumer waste. White.
680-1890 2400/case **\$49.25**



Scott® Multi-Fold Towels

680-1804 4000/case **\$51.25**



Signature® Multi-Fold Towels

Our unique, patented honeycomb emboss gives these towels a thick, luxurious and soft-to-the-hand feel. Strong, durable and absorbent. White.
680-24890 2000/case **\$38.45**

DISPOSABLES

NO FOLD & SINGLE-FOLD TOWELS



Envision® Single-Fold Towels

Offers dependable absorbency, thickness, and strength. EPA compliant for post consumer recycled fiber content.

- White**
680-23990 4000/case **\$46.45**
- Natural**
680-24090 4000/case **\$43.95**



Scott® Single-Fold Towels

White.
680-1700 4000/case **\$65.75**



No-Fold Qtowels

Single layer of durable paper towel made up of a unique texture that won't breakdown or pill like quilted and folded paper towels do. Size 9" x 12". White.

680-14 1500/case **\$38.45**

Qtowel Dispenser available upon request.



Durawick® Towels - TIDI Products LLC

Specially created to be used to last through several rounds of tools being placed on them from your ultrasonic cleaning. The top layer of material wicks away moisture, which is then absorbed into the middle layer of the product, keeping your sterilization area clean and sanitary.

Blue 13" x 18"
680-983914 100/pack..... **\$23.25**

ROLL TOWELS



Center Pull Towels

2-ply towels for use in Merfin Regular Center Pull Towels Dispenser. 8" x 12" perforated. White. 350 feet per roll.

680-MF730 8 rolls/case **\$43.95**

Merfin Dispenser available upon request.



Eco-Soft® Roll Towels

Made from 100% recycled paper. White, 100 sheets per roll.

680-400 30 rolls/case **\$49.75**



Envision® Hard Wound Towels

8" x 350' per roll.

680-26401 12 rolls/case **\$51.95**



Kleenex® Premier Towels

White. 70 sheets per roll.

680-13964 24 rolls/case **\$86.45**



Preference® Perforated Roll Towels

Made from 100% recycled paper. White. 100 sheets per roll, 2-ply.

680-27990 30 rolls/case **\$51.95**



Scott® Roll Towels

White, 1-ply, 128 sheets per roll.

680-1482 30 rolls/case **\$45.45**



SofPull® Centerpull Paper Towels

Used in SofPull centerpull paper towel dispensers. 320 sheets per roll. White.

680-28124 6 rolls/case **\$69.95**

SofPull Dispenser available upon request.

TOWEL DISPENSERS



Towel Dispensers - Georgia-Pacific

Complements any decor and the covered, key-lock design protects against waste and pilferage while making refilling towels quick and easy.

C-Fold

Comifold towel dispenser. Holds 400 c-folds or 600 multi-folds. Translucent Smoke.

680-56650 Each..... **\$48.95**



C-Fold

Holds up to 100 c-fold towels. White.

680-55701 Each..... **\$40.95**

TOWEL DISPENSERS



Multi-Fold

Holds up to 275 multi-fold towels or 175 2-ply multi-fold towels to provide low-cost protection from moisture and contaminants on countertops. White.

680-54701 Each..... **\$40.95**



Combination

Combi-matic towel dispenser and plate (included) holds up to 300 c-fold, 600 multi-fold, 500 senior multi-fold, or one package of big-fold towels.

680-56601 White **\$47.95**
680-56620 Chrome **\$66.95**

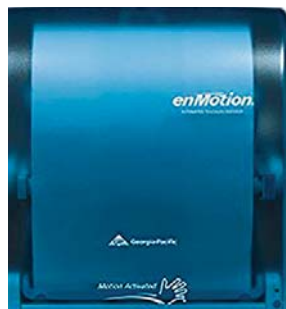

enMotion® Automated Touchless Towel Dispenser - Georgia-Pacific

The enMotion high-capacity cabinet helps reduce the number of service visits and dispenses a single towel by putting your hand in motion. This next generation of automated, touchless dispensing provides a cleaner, more hygienic environment, significantly lower waste and reduced maintenance.

Splash/White
680-59460 Each..... **\$89.95**

Smoke/White
680-59462 Each..... **\$89.95**

enMotion Large Capacity Touch Roll Towels

800 sheets per roll. White.

680-89460 6 rolls/case **\$99.45**

Wall Mount Bracket Kit
680-54019 Kit..... **\$4.75**



Tork Xpress® Towel Dispensers - SCA Multi-Fold

18.7" H x 11.9" W x 4.2" D. Black.
680-301082 Each..... **\$19.95**



Mini Towel
12" H x 11.9" W x 4.2" D. White.
680-303080 Each..... **\$19.95**

DISPOSABLES



Cut through the fat

GO DIRECTLY TO THE BEST

Manufacturers offer thousands of promotions. GO **DIRECTLY** TO THE BEST.

www.dhpionline.com/promotions

BUY 1 BUY 2 BUY 3 BUY 4 **DHPI X** EXCLUSIVE OFFERS



K-Files, Reamers & Hedstrom

(06-15-40) 1 Box (6/box) \$9.25 6 Boxes @ \$8.75			
(45-45-80) 1 Box (6/box) \$9.75 6 Boxes @ \$9.25			
K-FILES	21MM	25MM	31MM
06 Pink	334-KK1006	334-KK5006	334-KK3006
08 Gray	334-KK1008	334-KK5008	334-KK3008
10 Purple	334-KK1010	334-KK5010	334-KK3010
15 White	334-KK1015	334-KK5015	334-KK3015
20 Yellow	334-KK1020	334-KK5020	334-KK3020
25 Red	334-KK1025	334-KK5025	334-KK3025
30 Blue	334-KK1030	334-KK5030	334-KK3030
35 Green	334-KK1035	334-KK5035	334-KK3035
40 Black	334-KK1040	334-KK5040	334-KK3040
15-40 Asst.	334-KK1154	334-KK5154	334-KK3154
45 White	334-KK1045	334-KK5045	334-KK3045
50 Yellow	334-KK1050	334-KK5050	334-KK3050
55 Red	334-KK1055	334-KK5055	334-KK3055
60 Blue	334-KK1060	334-KK5060	334-KK3060
70 Green	334-KK1070	334-KK5070	334-KK3070
80 Black	334-KK1080	334-KK5080	334-KK3080
45-80 Asst.	334-KK1458	334-KK5458	334-KK3458

(08-15-40) 1 Box (6/Box) \$9.75 6 Boxes @ \$9.25			
(45-45-80) 1 Box (6/Box) \$10.75 6 Boxes @ \$10.25			
HEDSTROM	21MM	25MM	31MM
08 Gray	334-HH1008	334-HH5008	334-HH3008
10 Purple	334-HH1010	334-HH5010	334-HH3010
15 White	334-HH1015	334-HH5015	334-HH3015
20 Yellow	334-HH1020	334-HH5020	334-HH3020
25 Red	334-HH1025	334-HH5025	334-HH3025
30 Blue	334-HH1030	334-HH5030	334-HH3030
35 Green	334-HH1035	334-HH5035	334-HH3035
40 Black	334-HH1040	334-HH5040	334-HH3040
15-40 Asst.	334-HH1154	334-HH5154	334-HH3154
45 White	334-HH1045	334-HH5045	334-HH3045
50 Yellow	334-HH1050	334-HH5050	334-HH3050
55 Red	334-HH1055	334-HH5055	334-HH3055
60 Blue	334-HH1060	334-HH5060	334-HH3060
70 Green	334-HH1070	334-HH5070	334-HH3070
80 Black	334-HH1080	334-HH5080	334-HH3080
45-80 Asst.	—	334-HH5458	334-HH3458

(08-15-40) 1 Box (6/box) \$9.75 6 Boxes @ \$9.25			
(45-45-80) 1 Box (6/box) \$10.75 6 Boxes @ \$10.25			
REAMERS	21MM	25MM	31MM
08 Gray	334-RR1008	334-RR5008	334-RR3008
10 Purple	334-RR1010	334-RR5010	334-RR3010
15 White	334-RR1015	334-RR5015	334-RR3015
20 Yellow	334-RR1020	334-RR5020	334-RR3020
25 Red	334-RR1025	334-RR5025	334-RR3025
30 Blue	334-RR1030	334-RR5030	334-RR3030
35 Green	334-RR1035	334-RR5035	334-RR3035
40 Black	334-RR1040	334-RR5040	334-RR3040
15-40 Asst.	334-RR1154	334-RR5154	334-RR3154
45 White	334-RR1045	334-RR5045	334-RR3045
50 Yellow	334-RR1050	334-RR5050	334-RR3050
55 Red	334-RR1055	334-RR5055	334-RR3055
60 Blue	334-RR1060	334-RR5060	334-RR3060
70 Green	334-RR1070	334-RR5070	334-RR3070
80 Black	334-RR1080	334-RR5080	334-RR3080
45-80 Asst.	334-RR1458	334-RR5458	334-RR3458

- Special stainless steel alloy with uniform structure and flexibility for maximum resistance to fracture.
- Contoured, ribbed handle provides exceptional tactile control and reduces finger fatigue.
- Pre-applied, 1mm silicone stop.
- High separation resistance.
- Can be sterilized by autoclave or dry heat up to 390° F. Certification #3630.



HyFlex EDM

Fewer Files Required for Canal Preparation

HyFlex EDM for Straight Canals

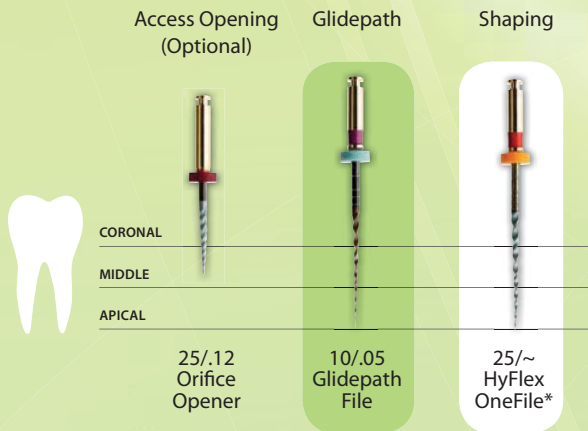

Depending on the clinical situation, use of HyFlex EDM files reduces the number of files required to 2 to 3 instruments, particularly in straight and larger canals.

HyFlex EDM + HyFlex CM for Curved Canals

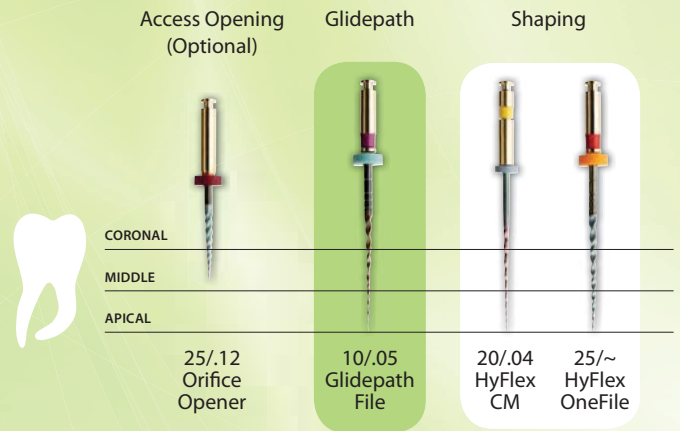

A combination of HyFlex EDM and CM files is recommended for canals with medium curvature (500 rpm; 2.5 Ncm (25 mNm)).

HyFlex EDM System

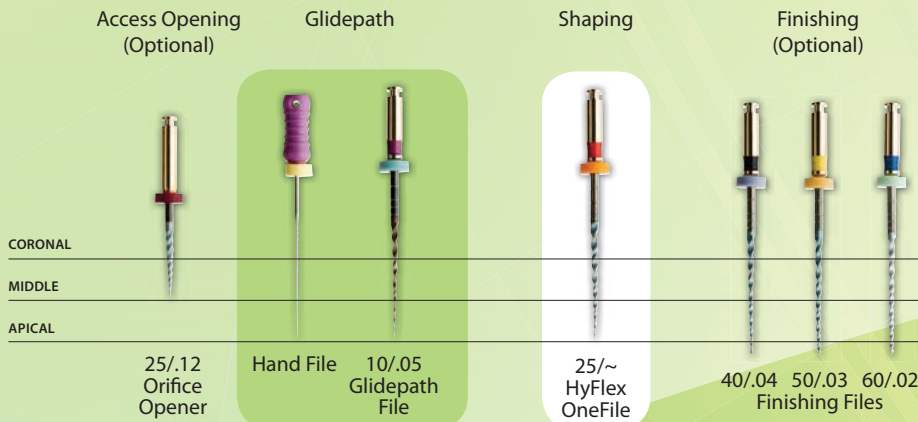

All HyFlex EDM Files can be used at 500 rpm and at a torque of up to 2.5 Ncm (25 mNm) except the glidepath files, which can be used with 300 rpm and at a torque of up to 1.8 Ncm (18 mNm).

*OneFile (25/~) is constructed with a variable taper

60019628	HyFlex EDM 10/.05 Glidepath File, 25mm	60013709	GuttaFlow2 Automix Standard Set
60019629	HyFlex EDM 25/~ OneFile, 25mm	Set\$156.75
60019630	HyFlex EDM 25/.12 Orifice Opener, 15mm	60019770	GuttaPercha SpectraPoints GT 0.03 #50
60019631	HyFlex EDM 40/.04 Finishing File, 25mm	60019771	GuttaPercha SpectraPoints OneFile
60019632	HyFlex EDM 50/.03 Finishing File, 25mm	60/pkg.\$14.75
60019633	HyFlex EDM 60/.02 Finishing File, 25mm	H08763	GuttaPercha SpectraPoints GT 0.04 #40
60019641	HyFlex EDM Shaping Set 25/.12; 25/~; 10/.05	60/pkg.\$14.45
60019642	HyFlex EDM Finishing Set 40/.04; 50/.03; 60/.02\$57.25	H08748
3/pkg.\$57.25	100/pkg.	GuttaPercha SpectraPoints 0.02 #60
H8250420	HyFlex CM 20/.04, 25mm\$74.25\$21.95
6/pack\$74.25		

1 800 221 3046 • coltene.com • info.us@coltene.com

COLTENE

Manufacturer part numbers are provided in these charts, please visit www.dhponline.com to convert or contact your DHPI Account Manager.

Order by 800-626-2163

www.dhponline.com

Fax: 888-681-5088

173

HyFlex GPF

Glide Path Files

An established glide path can reduce torsional stress and increase the lifespan of the rotary instrument used for canal preparation, decrease chance for transportation and ledging that often occurs with hand instrumentation, lessen hand fatigue and save valuable chair time. HyFlex® GPF™ will permit the clinician to negotiate working length quickly and efficiently. The HyFlex® GPF™ Controlled Memory Files track well in the apical third and allow safer, more efficient preparations. They are available in 21, 25 and 31mm lengths.



Item Code	Description	
	21mm 6-packs (taper/size,length)	\$80.75
(HGPF8211501)	HyFlex® GPF™ Navigator File 15/.01 10mm flute	
(HGPF8211502)	HyFlex® GPF™ CM K File 15/.02 16mm flute	
(HGPF8212002)	HyFlex® GPF™ CM K File 15/.02 16mm flute	
(HGPF821ASST)	HyFlex® GPF™ File Assortment 21mm	
	Contains: (2) GPF Navigator 15/.01 10mm flute (2) GPF CM K File 15/.02 16mm flute (2) CM K File 20/.02 16mm flute	

Item Code	Description	
	25mm 6-packs (taper/size,length)	\$80.75
(HGPF8251501)	HyFlex® GPF™ Navigator File 15/.01 10mm flute	
(HGPF8251502)	HyFlex® GPF™ CM K File 15/.02 16mm flute	
(HGPF8252002)	HyFlex® GPF™ CM K File 20/.02 16mm flute	
(HGPF825ASST)	HyFlex® GPF™ File Assortment 25mm	
	Contains: (2) GPF Navigator 15/.01 10mm flute (2) GPF CM K File 15/.02 16mm flute (2) CM K File 20/.02 16mm flute	

Item Code	Description	
	31mm 6-packs (taper/size,length)	\$80.75
(HGPF8311501)	HyFlex® GPF™ Navigator File 15/.01 10mm flute	
(HGPF8311502)	HyFlex® GPF™ CM K File 15/.02 16mm flute	
(HGPF8312002)	HyFlex® GPF™ CM K File 20/.02 16mm flute	
(HGPF831ASST)	HyFlex® GPF™ File Assortment 31mm	
	Contains: (2) GPF Navigator 15/.01 10mm flute (2) GPF CM K File 15/.02 16mm flute (2) CM K File 20/.02 16mm flute	

HyFlex NT

NiTi Files

HyFlex® NT™ endodontic rotary NiTi file is designed to work in specific clinical situations, such as calcified canals, straight canals, retreatments and removing Gutta-Percha. HyFlex® NT™ files are available in .06 and .04 tapers in 21mm, 25mm and 31mm lengths.



Item Code	Description	
	19 mm 6-packs (taper/size,length)	\$72.75
(HNT8190825)	HyFlex® CM™ File 08/25, 19mm	
	21mm 6-packs (taper/size,length)	
(HNT8210415)	HyFlex® NT™ File 04/15, 21mm	
(HNT8210420)	HyFlex® NT™ File 04/20, 21mm	
(HNT8210425)	HyFlex® NT™ File 04/25, 21mm	
(HNT8210430)	HyFlex® NT™ File 04/30, 21mm	
(HNT8210435)	HyFlex® NT™ File 04/35, 21mm	
(HNT8210440)	HyFlex® NT™ File 04/40, 21mm	
(HNT8210445)	HyFlex® NT™ File 04/45, 21mm	
(HNT821SML)	HyFlex® NT™ File Assortment Small 21mm	
(HNT821MED)	HyFlex® NT™ File Assortment Medium 21mm	
(HNT821LRG)	HyFlex® NT™ File Assortment Large 21mm	

	25mm 6-packs (taper/size,length)	\$72.75
(HNT8250415)	HyFlex® NT™ File 04/15, 25mm	
(HNT8250420)	HyFlex® NT™ File 04/20, 25mm	
(HNT8250425)	HyFlex® NT™ File 04/25, 25mm	
(HNT8250430)	HyFlex® NT™ File 04/30, 25mm	
(HNT8250435)	HyFlex® NT™ File 04/35, 25mm	
(HNT8250440)	HyFlex® NT™ File 04/40, 25mm	
(HNT8250445)	HyFlex® NT™ File 04/45, 25mm	
(HNT825SML)	HyFlex® NT™ File Assortment Small 25mm	
(HNT825MED)	HyFlex® NT™ File Assortment Medium 25mm	
(HNT825LRG)	HyFlex® NT™ File Assortment Large 25mm	

	31mm 6-packs (taper/size,length)	\$72.75
(HNT8310415)	HyFlex® NT™ File 04/15, 31mm	
(HNT8310420)	HyFlex® NT™ File 04/20, 31mm	
(HNT8310425)	HyFlex® NT™ File 04/25, 31mm	
(HNT8310430)	HyFlex® NT™ File 04/30, 31mm	
(HNT8310435)	HyFlex® NT™ File 04/35, 31mm	
(HNT8310440)	HyFlex® NT™ File 04/40, 31mm	
(HNT8310445)	HyFlex® NT™ File 04/45, 31mm	
(HNT831SML)	HyFlex® NT™ File Assortment Small 31mm	
(HNT831MED)	HyFlex® NT™ File Assortment Medium 31mm	
(HNT831LRG)	HyFlex® NT™ File Assortment Large 31mm	





READY•STEEL™ FLEXOFILE®

STAINLESS STEEL

Intermediate-size hand files used in combination with regular ISO files let you gradually move on to the next file size. Safeguarded non-cutting Batt® Tip reduces the chance of ledging. Made from a triangular blank for flexibility in curved canals. Pre-inserted silicone stops to save you time and money.

Size / Desc. Pkg of 6	Prod.# 18 mm	Prod.# 21 mm	Prod.# 25 mm	Prod.# 31 mm
6		6830621	6830625	6830631
8		6830821	6830825	6830831
10		6831021	6831025	6831031
12		6831221	6831225	6831231
15	6831518	6831521	6831525	6831531
17		6831721	6831725	6831731
20	6832018	6832021	6832025	6832031
22		6832221	6832225	6832231
25	6832518	6832521	6832525	6832531
27		6832721	6832725	6832731
30	6833018	6833021	6833025	6833031
32		6833221	6833225	
35	6833518	6833521	6833525	6833531
37		6833721	6833725	
12-37*			6833032	
40	6834018	6834021	6834025	6834031
15-40*		6833022	6833027	6833033
45		6834521	6834525	
50		6835021	6835025	
55		6835521	6835525	
60		6836021	6836025	
70		6837021	6837025	
80		6838021	6838025	
45-80*		6833023	6833028	
90-140*		6833024	6833029	
*ASSORTED 6/pkg.				
			 \$16.95



FlexoFile
Cutting Shape
in sizes 6, 8, 10



FlexoFile
Cutting Shape
in larger sizes



READY•STEEL™ K-FILE

STAINLESS STEEL

The READY•STEEL K-File features a twisted design and is manufactured from a square blank. This file has set the industry standard by offering superior cutting efficiency and precision handling.



K-File
Cutting
Shape

Size / Desc. Pkg of 6	Prod.# 21 mm	Prod.# 25 mm	Prod.# 31 mm
6	6840621	6840625	6840631
8	6840821	6840825	6840831
10	6841021	6841025	6841031
15	6841521	6841525	6841531
20	6842021	6842025	6842031
25	6842521	6842525	6842531
30	6843021	6843025	6843031
35	6843521	6843525	6843531
40	6844021	6844025	6844031
15-40*	6844023	6844026	6844028
45	6844521	6844525	6844531
50	6845021	6845025	6845031
55	6845521	6845525	6845531
60	6846021	6846025	6846031
70	6847021	6847025	6847031
80	6848021	6848025	6848031
45-80*	6844024	6844027	6844029
*ASSORTED 6/pkg.			
		 \$14.75

**NEW
Handle**
for better grip.



READY•STEEL™ SENSEUS® FLEXOFILE®

STAINLESS STEEL

Unique, silicone handle is as intelligently designed as its flexible file. Greater working comfort. Improved tactile feedback. X-ray visible calibration rings for accuracy and improved diagnostics. (25 mm and 31 mm only) Flexible strength for preparing even the most curved and narrow canals. Pre-inserted silicone stops save you time and money.

Size / Desc. Pkg of 6	Prod.# 21 mm	Prod.# 25 mm	Prod.# 31 mm
6	6860621	6860625	6860631
8	6860821	6860825	6860831
10	6861021	6861025	6861031
15	6861521	6861525	6861531
20	6862021	6862025	6862031
25	6862521	6862525	6862531
30	6863021	6863025	6863031
35	6863521	6863525	
40	6864021	6864025	
15-40*	6860026	6860028	6860030
45	6864521	6864525	
50	6865021	6865025	
55	6865521	6865525	
60	6866021	6866025	
45-80*	6860027	6860029	
*ASSORTED 6/pkg.			
		 \$18.25



Senseus
FlexoFile
Cutting Shape
in sizes 6, 8, 10



Senseus
FlexoFile
Cutting Shape
in larger sizes

Manufacturer part numbers are provided in these charts, please visit www.dhpionline.com to convert or contact your DHPI Account Manager.







READY•STEEL™
C+ FILE
 ULTRA STIFF



STAINLESS STEEL

Delivers superior strength for accessing difficult or calcified canals. Due to its unique taper, the C+ File features an even higher degree of ultra-stiffness to negotiate your most challenging canals. Up to 300% gain in resistance to buckling. Unique taper for ultra-stiff design. Calibration rings for easy depth determination. Pyramid-shaped tip for easy penetration. Highly polished for debris removal and smooth insertion into the canal. Square section for resistance to distortion and increased safety.

Size / Desc.	Prod.#	Prod.#	
Pkg of 6	21 mm	25 mm	
6	 6700621	6700625	C+ File Cutting Shape
8	 6700821	6700825	
10	 6701021	6701025	
15	 6701521	6701525	
6/pkg.		















READY•STEEL™
HEDSTROM FILE
 STAINLESS STEEL

The READY•STEEL Hedstrom file offers effective cutting efficiency and greater strength, provided by its thick core; this enables Maillefer to offer smaller Hedstrom file sizes starting with a #10.



Hedstrom
Cutting Shape

Size / Desc.	Prod.#	Prod.#	Prod.#
Pkg of 6	21 mm	25 mm	31 mm
10	 6851021	6851025	6851031
15	 6851521	6851525	6851531
20	 6852021	6852025	6852031
25	 6852521	6852525	6852531
30	 6853021	6853025	6853031
35	 6853521	6853525	6853531
40	 6854021	6854025	6854031
15-40*	6855023	6855024	6855027
45	 6854521	6854525	6854531
50	 6855021	6855025	6855031
55	 6855521	6855525	6855531
60	 6856021	6856025	6856031
70	 6857021	6857025	
80	 6858021	6858025	
45-80*	6855022	6855026	6855028
*ASSORTED 6/pkg.		\$14.75

NEW
Handle
 for better grip.















READY•STEEL™
K-REAMER
 STAINLESS STEEL

The READY•STEEL K-Reamer is known for its superior cutting ability, precision handling and efficient removal of dental debris.



K-Reamer
Cutting Shape

Size / Desc.	Prod.#	Prod.#	Prod.#
Pkg of 6	21 mm	25 mm	31 mm
8	 6720821	6720825	
10	 6721021	6721025	6721031
15	 6721521	6721525	6721531
20	 6722021	6722025	6722031
25	 6722521	6722525	6722531
30	 6723021	6723025	6723031
35	 6723521	6723525	
40	 6724021	6724025	
15-40*	672AS21	672AS25	672AS31
45	 6724521	6724525	
50	 6725021	6725025	
55	 6725521	6725525	
60	 6726021	6726025	
*ASSORTED 6/pkg.		\$14.75



K-Files, Reamers & Hedstrom

- Superior cutting efficiency with unsurpassed durability.
- Uniform fluting and taper.
- Numerically sized on the end of each knob.

6/BOX \$13.45								
K-FILES			REAMERS		HEDSTROM			
Size	21MM	25MM	30MM	21MM	25MM	21MM	25MM	30MM
08	339-14127	339-14128	339-14129	339-14133	339-14134			
10	339-06003	339-06062	339-06151	339-06029	339-06110			
15	339-06004	339-06063	339-06152	339-06030	339-06111	339-12766	339-11344	339-12814
20	339-06005	339-06064	339-06153	339-06031	339-06112	339-12769	339-11345	339-12817
25	339-06014	339-06065	339-06155	339-06032	339-06120	339-12772	339-11346	339-12820
30	339-06015	339-06066	339-06156	339-06033	339-06126	339-12775	339-11347	339-12823
35	339-06016	339-06067	339-06157	339-06034	339-06127	339-12778	339-11348	339-12826
40	339-06019	339-06069	339-06159			339-12781	339-11349	339-12829
15-40	339-8218021	339-8218025	339-8218030			339-12809	339-11359	339-13291

6/BOX \$20.25								
K-FILES			REAMERS		HEDSTROM			
Size	21MM	25MM	30MM	21MM	25MM	21MM	25MM	30MM
45	339-06020	339-06074	339-06160		339-13278	339-12784	339-11350	339-12832
50	339-06021	339-06075	339-06161			339-12787	339-11351	339-12835
55	339-06022	339-06076	339-06162			339-12790	339-11352	339-12838
60	339-06023	339-06077	339-06163			339-12793	339-11353	339-12841
70	339-06024	339-06085	339-06166			339-12796	339-11354	
80	339-06026	339-06099	339-06170					
45-80	339-8218121	339-8218125	339-8218130			339-12810	339-11360	339-13292



K-Flex Files

K-Flex Files

- High flute design with sharper, faster, more efficient cleaning.
- Rhomboid design provides a shorter area for greater flexibility.

6/BOX \$16.95			
K-FLEX FILES			
Size	21MM	25MM	30MM
08	339-15290	339-15122	339-15206
10	339-15294	339-15126	339-15210
15	339-15298	339-15130	339-15214
20	339-15302	339-15134	339-15218
25	339-15306	339-15138	339-15222
30	339-15310	339-15142	339-15226
35	339-15314	339-15146	339-15230
40	339-15318	339-15150	339-15234
15-40	339-8214021	339-8214025	339-8214030

6/BOX \$23.25			
K-FLEX FILES			
Size	21MM	25MM	30MM
45	339-15322	339-15154	339-15238
50	339-15326	339-15158	339-15242
55	339-15330	339-15162	339-15246
60	339-15334	339-15166	339-15250
70		339-15170	339-15254
80		339-15174	339-15258
45-80		339-8214125	339-8214130

TF® – Twisted Files

70% more flexible than other rotary NiTi files.*
The proven design of TF significantly reduces file breakage and allows you to work with greater efficiency and confidence. The TF sequence requires just 3 files for most cases. TF's helical angle design and improved surface finish ensure fast, ideal canal shaping every time. TF provides unsurpassed safety and ease of use.



TF Nickel-Titanium Files 3 per Pkg. – \$54.45

Taper	Tip	23mm	27mm
.12	25	822-2253	
.10	25	822-0253	822-0257
.08	25	822-8253	822-8257
.06	35	822-6353	822-6357
.06	30	822-6303	822-6307
.06	25	822-6253	822-6257
.04	50	822-4503	822-4507
.04	40	822-4403	822-4407

Assorted Packs 3 per Pkg. – \$54.45

Taper	Tip	23mm	27mm
.08 .06 .04	25	822-4683	822-4687
.10 .08 .06	25	822-6803	822-6807
.08 .06 .06	25 30 35	822-8663	

Procedure Packs 3 per Pkg. – \$54.45

Taper	Tip	23mm	27mm
.08 .06 .04	25 30 40	822-3864	822-7864

*Data on file, Sybron Dental Specialties, Inc. Data from Gambarini G. Cyclic fatigue and flexibility test.

TF Adaptive Files

TF Adaptive is an first of its kind innovation in the industry. Designed to work with our Elements™ Adaptive Motion technology to give you exceptional file control through the entire procedure by self adjusting to intra-canal torsional forces.



The intuitive color-coded system features a simple 3-file technique and gives you 70% greater flexibility than other NiTi files.

TF Adaptive Files: Small Canals 4 per Pkg. – \$72.75

Size	23mm	27mm
SM1	817-4203	817-4207
SM2	817-6253	817-6257

TF Adaptive Files: Medium/Large Canals 4 per Pkg. – \$72.75

Size	23mm	27mm
ML1	817-8253	817-8257
ML2	817-6353	817-6357

TF Adaptive Files: Procedure Pack 6 per Pkg. – \$72.75

Size	23mm	27mm
Small	817-3003	817-3007
Med/Large	817-4003	817-4007



TF Adaptive Starter Kit

Kit includes the Elements Motor, 8:1 contra angle, TF Adaptive files, K-files and the LA Axxess 2.0 bur kit. TF Adaptive is a simplified file technique for root canal therapy utilizing the Elements motor with Adaptive motion technology.

330-8151535..... **\$2448.25**



Elements™ Adaptive Motor and Handpiece

Used with TF Adaptive files to safely and accurately clean and shape root canals. It is also programmed for use with other SybronEndo NiTi Files and the M4 Safety Handpiece.

280-8151500..... **\$2153.75**



K3 Rotary Nickel Titanium Files

A triple-fluted, asymmetric endodontic file system designed to cut quickly, efficiently and safely, with exceptional debris removal. K3 files are available in 6 different tapers with a multitude of lengths and tip sizes. This allows you to customize your technique for any case from single, straight roots to calcified, curved molars.



K3 Nickel-Titanium Files
6 per Pkg. – \$74.95

Taper	Tip	17mm	21mm	25mm
.12	25	830-2257	830-2251	830-2255
.10	25	830-0257	830-0251	830-0255
.08	25	830-8257	830-8251	830-8255

Taper	Tip	21mm	25mm	30mm
.06	60	825-6601	825-6605	825-6600
.06	55	825-6551	825-6555	825-6550
.06	50	825-6501	825-6505	825-6500
.06	45	825-6451	825-6455	825-6450
.06	40	825-6401	825-6405	825-6400
.06	35	825-6351	825-6355	825-6350
.06	30	825-6301	825-6305	825-6300
.06	25	825-6251	825-6255	825-6250
.06	20	825-6201	825-6205	825-6200
.06	15	825-6151	825-6155	825-6150
.04	60	825-4601	825-4605	825-4600
.04	55	825-4551	825-4555	825-4550
.04	50	825-4501	825-4505	825-4500
.04	45	825-4451	825-4455	825-4450
.04	40	825-4401	825-4405	825-4400
.04	35	825-4351	825-4355	825-4350
.04	30	825-4301	825-4305	825-4300
.04	25	825-4251	825-4255	825-4250
.04	20	825-4201	825-4205	825-4200
.04	15	825-4151	825-4155	825-4150
.02	45	825-2451	825-2455	825-2450
.02	40	825-2401	825-2405	825-2400
.02	35	825-2351	825-2355	825-2350
.02	30	825-2301	825-2305	825-2300
.02	25	825-2251	825-2255	825-2250
.02	20	825-2201	825-2205	825-2200
.02	15	825-2151	825-2155	825-2150

K3XF Rotary Nickel Titanium Files

R-Phase Technology provides you a new level of flexibility and resistance to cyclic fatigue developed on the original K3 platform.



K3XF Nickel-Titanium Files
6 per Pkg. – \$71.95

Taper	Tip	17mm	21mm	25mm	30mm
.12	40	823-2407	823-2401	823-2405	823-2400
.12	30	823-2307	823-2301	823-2305	823-2300
.12	25	823-2257	823-2251		
.12	20	823-2207	823-2201	823-2205	823-2200
.10	40	823-0407	823-0401	823-0405	823-0400
.10	30	823-0307	823-0301	823-0305	823-0300
.10	25	823-0257	823-0251	823-0255	823-0250
.10	20	823-0207	823-0201	823-0205	823-0200
.08	40	823-8407	823-8401	823-8405	823-8400
.08	30	823-8307	823-8301	823-8305	823-8300
.08	25	823-8257	823-8251	823-8255	823-8250
.08	20	823-8207	823-8201	823-8205	823-8200
.06	60		823-6601	823-6605	823-6600
.06	55		823-6551	823-6555	823-6550
.06	50		823-6501	823-6505	823-6500
.06	45		823-6451	823-6455	823-6450
.06	40		823-6401	823-6405	823-6400
.06	35		823-6351	823-6355	823-6350
.06	30		823-6301	823-6305	823-6300
.06	25		823-6251	823-6255	823-6250
.06	20		823-6201	823-6205	823-6200
.06	15		823-6151	823-6155	823-6150
.04	60		823-4601	823-4605	823-4600
.04	55		823-4551	823-4555	823-4550
.04	50		823-4501	823-4505	823-4500
.04	45		823-4451	823-4455	823-4450
.04	40		823-4401	823-4405	823-4400
.04	35		823-4351	823-4355	823-4350
.04	30		823-4301	823-4305	823-4300
.04	25		823-4251	823-4255	823-4250
.04	20		823-4201	823-4205	823-4200
.04	15		823-4151	823-4155	823-4150
.04	45		823-2451	823-2455	823-2450
.04	40		823-2401	823-2405	823-2400
.04	35		823-2351	823-2355	823-2350
.04	30		823-2301	823-2305	823-2300
.04	25		823-2251	823-2255	823-2250
.04	20		823-2201	823-2205	823-2200
.04	15		823-2151	823-2155	823-2150

Manufacturer part numbers are provided in these charts, please visit www.dhponline.com to convert or contact your DHPI Account Manager.

LightSpeedLSX™

Apical and Mid-Root Shaping Rotary Instruments

Cuts only where you need to cut, and thoroughly cleans the apical third without unnecessarily removing root structure coronally or in the mid-root.



LightSpeedLSX Single Boxes

Product	21 mm	25 mm	31 mm	50 mm
Size 20	835-2021	835-2025	835-2031	
Size 25	835-2521	835-2525	835-2531	
Size 30	835-3021	835-3025	835-3031	
Size 35	835-3521	835-3525	835-3531	835-3550
Size 40	835-4021	835-4025	835-4031	835-4050
Size 45	835-4521	835-4525	835-4531	835-4550
Size 50	835-5021	835-5025	835-5031	835-5050
Size 55	835-5521	835-5525	835-5531	835-5550
Size 60	835-6021	835-6025	835-6031	835-6050
Size 65	835-6521	835-6525	835-6531	835-6550
Size 70	835-7021	835-7025	835-7031	835-7050
Size 80	835-8021	835-8025	835-8031	835-8050
Size 90	835-9021	835-9025	835-9031	835-9050
Size 100	835-0021	835-0025	835-0031	835-0050
Size 110		835-1025	835-1031	835-1050
Size 120		835-1225	835-1231	835-1250
Size 130		835-1325	835-1331	835-1350
Size 140		835-1425		
Price	6/pack - \$76.95			

LightSpeedLSX Standard Kits

Product	21 mm	25 mm	31 mm
Sizes 20 - 80	835-2801	835-2805	835-2803
Price	12/pack - \$156.95		

LightSpeedLSX Assorted Boxes

Product	21 mm	25 mm	31 mm	50 mm
Size 20 - 45 (6 pk)	835-2451	835-2455	835-2453	
Size 35 - 55 (5 pk)				835-3555
Size 50 - 80 (6 pk)	835-5801	835-5805	835-5803	
Size 60 - 90 (5 pk)				835-6090
Size 90 - 130 (5 pk)			835-9133	
Size 90 - 140 (6 pk)		835-9145		
Size 100 - 130 (4 pk)				835-1013
Size 140 - 160 (6 pk)			835-1463	835-1416
Price	Each - \$76.95			

LOOK'in

for something? **WE HAVE IT!**

www.dhpionline.com

Obturator

A gutta percha based carrier obturation system for sealing root canals. Obturators are for use with hand files or rotary files.

- Twist-off handle and built-in post space
- Thinner core for greater flexibility to navigate curved canals
- More gutta percha, fills up to .10 taper

TF Obturators

6 per Pkg. – \$52.45
36 per Pkg. – \$270.75

Tip	6 per Pkg.	36 per Pkg.
25	822-3025	822-3625
30	822-3030	822-3630
35	822-3035	822-3635
40	822-3040	822-3640
45	822-3045	822-3645
50	822-3050	822-3650

TF Adaptive Obturators

6 per Pkg. – \$57.95

Size	6 per Pkg.
SM2	815-1550
SM3	815-1551
ML1	815-1554
ML2	815-1555
ML3	815-1556

K3/K3XF Obturators

6 per Pkg. – \$53.45

Tip	6 per Pkg.
20	971-3020
25	971-3025
30	971-3030
35	971-3035
40	971-3040

Tip	6 per Pkg.
45	971-3045
50	971-3050
55	971-3055
60	971-3060



Verifiers

Used to measure the correct working length and to gauge proper obturator fit. Each verifier is precisely the same shape and taper as the obturator core. It is flexible enough to fit curved canals and radiopaque to confirm working length.

TF Verifiers

6 per Pkg. – \$23.45

Tip	6 per Pkg.
25	822-3125
30	822-3130
35	822-3135
40	822-3140
45	822-3145
50	822-3150

TF Adaptive Verifiers

6 per Pkg. – \$23.95

Size	100 per Pkg.
SM2	815-1552
SM3	815-1553
ML1	815-1557
ML2	815-1558
ML3	815-1559



K3/K3XF Verifiers

6 per Pkg. – \$23.95

Tip	6 per Pkg.
20	971-3120
25	971-3125
30	971-3130
35	971-3135
40	971-3140

Tip	6 per Pkg.
45	971-3145
50	971-3150
55	971-3155
60	971-3160

Gutta Percha

SybronEndo's radiopaque gutta percha is the time-proven fill for root canal therapies. Both Autofit and standard gutta percha cones fit seamlessly into a gutta percha wheel.

TF Gutta Percha Points

50 per Pkg. – \$28.25

Taper	Tip	50 per Pkg.
.06	30	822-0630
.06	35	822-0635
.04	40	822-0440
.04	50	822-0450

TF Adaptive Gutta Percha

50 per Pkg. – \$28.95

Size	50 per Pkg.
SM2	815-1540
SM3	815-1541
ML1	815-1543
ML2	815-1544
ML3	815-1545

K3 & K3XF Autofit Gutta Percha

50 per Pkg. – \$24.25

Taper	Tip	50 per Pkg.
.04	45	825-0445
.04	40	825-0440
.04	35	825-0435
.04	30	825-0430
.04	25	825-0425
.04	20	825-0420
.04	20-40 Asst	825-0400
.04	Feather Tip	825-0047

Asst SM2&3 50/Pk: 815-1542
Asst ML 50/Pk: 815-1546

Taper	Tip	50 per Pkg.
.06	45	825-0645
.06	40	825-0640
.06	35	825-0635
.06	30	825-0630
.06	25	825-0625
.06	20	825-0620
.06	20-40 Asst	825-0600
.06	Feather Tip	825-0048
.08	Feather Tip	971-1117
.10	Feather Tip	971-1118

Paper Points

Autofit® Paper Points are rolled to exact specifications and provide excellent absorbency for your root canal preparation.

TF Paper Points

100 per Pkg. – \$18.25

Taper	100 per Pkg.
.04	822-0004
.06	822-0006
.08	822-0008
.10	822-0010
.12	822-0012

TF Adaptive Paper Points

100 per Pkg. – \$18.25

Size	100 per Pkg.
SM2	815-1570
SM3	815-1571
ML1	815-1572
ML2	815-1573
ML3	815-1574

K3/K3XF Autofit Paper Points

100 per Pkg. – \$18.25

Taper	100 per Pkg.
.04	972-1110
.06	972-1111
.08	972-1112
.10	972-1115
.12	972-1116
Asst.04-.12	971-1113

Asst SM1&2 100/Pk: 815-1575
Asst ML 100/Pk: 815-1576



Manufacturer part numbers are provided in these charts, please visit www.dhponline.com to convert or contact your DHPI Account Manager.

Apex ID™

Apex ID is an incredibly compact unit that continually calibrates to provide stable readings and clear audio-visual cues, which enable you to focus on what's really important — providing the best care for your patients.

- “Zero point” customizing based on your clinical judgement.
- Accurate readings in almost any canal condition.
- Continuous calibration for uninterrupted readings in real-time.

Apex ID 770-9720090 \$839.45

Apex ID Stand, Lip Hook, File Holder B, File Holder A, Probe Cord, Apex ID IFU, AAA 1.5V Batteries

Individual part accessories available upon request.

More locator options can be found on pages 197



Cut through the fat

**GO DIRECTLY
TO THE BEST**

Manufacturers offer thousands of promotions. GO **DIRECTLY** TO THE BEST.

www.dhpionline.com/promotions

BUY 1	BUY 2	BUY 3	BUY 4 OR MORE	DHPI X EXCLUSIVE OFFERS
--------------	--------------	--------------	-------------------------	-----------------------------------

MiniEndo II Ultrasonic Unit

The MiniEndo II is a sleek, compact ultrasonic unit designed specifically for endodontic applications and to deliver just the right amount of power and amplitude at the tip to successfully complete endodontic procedures.

MiniEndo II Ultrasonic Unit Type S, 110v	779-9730236	\$1,775.25
Wrench for Ultrasonic Tips	770-9730096	\$14.75
MiniEndo Handpiece (M3x.6) Type S	779-9730201	\$671.45



Pulp Canal Sealer™

Pulp Canal Sealer is a zinc oxide eugenol sealer with a powder base and liquid catalyst. It is a non-toxic and non-irritating formulation that is very radiopaque. Pulp Canal Sealer EWT features a work time of greater than 6 hours on the pad.

Pulp Canal Sealer	209-24875	\$209.75
Pulp Canal Sealer- EWT	209-24746	\$214.45
Pulp Canal Sealer- Liquid Refill CS4	209-24873	\$27.95
Pulp Canal Sealer- Powder Refill CS4	209-24874	\$179.95
Pulp Canal Sealer- EWT Powder Refill CS4	209-24745	\$179.95



Xpress Sealers

Three of SybronEndo's classic sealers now boast a new delivery method to help simplify setup, delivery and cleanup. Sealapex®, Tubli-Seal™ and Tubli-Seal™ EWT are now available in automix syringes. These syringes offer easy mixing at your fingertips in a perfect 1:1 ratio without worry and without manual mixing.

Sealapex Xpress (2 – 10.5g syringes)	209-33639	\$98.45
Tubli-Seal Xpress (2 – 10.7g syringes)	209-33640	\$98.45
TubliSeal EWT Xpress (2 – 10.8g syringes)	209-33641	\$98.45
50 mixing tips	209-33680	\$50.25



SimpliSeal®

SimpleSeal™ is a paste–paste, dual component root canal sealer delivered in a convenient dual barrel syringe.

- Excellent handling characteristics
- Outstanding chemical and physical properties
- Biocompatibility

It can be used for all established and more recent root canal sealing techniques, and is suitable for the single-point method, thermoplastic methods and all condensation techniques.

SimpliSeal	330-9720082	\$97.25
-------------------	--------------------	----------------



Files & Reamers

Stainless-Steel Endodontic Instruments

- Extremely Sharp - Efficient Instrumentation
- Pre-mounted Silicone (Non-Latex) Stop
- All Sizes - Same Low Price
- Firm Grasp - Peanut Shaped Handle
- ISO Symbols on Color-Coded Handle
- Extremely Flexible - Virtually Break-Proof
- Precise to AAE and ISO Standards
- Sterilizable
- Swiss-Made

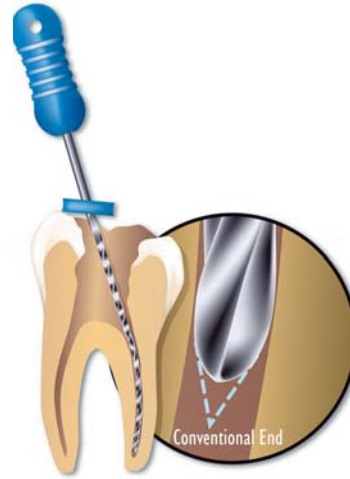

Premier®
Safe-End Files
Avoid Ledging

Standard feature on all K-Files
& Hedstrom Files, sizes 06-40

K-Files

21mm (6) per box		06-40, 15-40 asstd		\$10.95		45-110, 45-80 asstd		\$11.45					
9053200	06	9053203	15	9053206	30	9053209	45	9053212	60	9053215	90	9053219	45-80
9053201	08	9053204	20	9053207	35	9053210	50	9053213	70	9053216	100		
9053202	10	9053205	25	9053208	40	9053211	55	9053214	80	9053218	15-40		
25mm (6) per box													
9053230	06	9053233	15	9053236	30	9053239	45	9053242	60	9053245	90	9053248	15-40
9053231	08	9053234	20	9053237	35	9053240	50	9053243	70	9053246	100	9053249	45-80
9053232	10	9053235	25	9053238	40	9053241	55	9053244	80	9053247	110		
31mm (6) per box													
9053290	06	9053294	20	9053298	40	9053302	60	9053306	100	9053310	140		
9053291	08	9053295	25	9053299	45	9053303	70	9053307	110	9053311	15-40		
9053292	10	9053296	30	9053300	50	9053304	80	9053308	120	9053312	45-80		
9053293	15	9053297	35	9053301	55	9053305	90	9053309	130				

Hedstrom Files

21mm (6) per box		08-40, 15-40 asstd		\$10.95		45-90, 45-80 asstd		\$11.75					
9053399	08	9053402	20	9053405	35	9053408	50	9053411	70	9053416	15-40		
9053400	10	9053403	25	9053406	40	9053409	55	9053412	80	9053417	45-80		
9053401	15	9053404	30	9053407	45	9053410	60	9053413	90				
25mm (6) per box													
9053424	08	9053427	20	9053430	35	9053433	50	9053436	70	9053441	15-40		
9053425	10	9053428	25	9053431	40	9053434	55	9053437	80	9053442	45-80		
9053426	15	9053429	30	9053432	45	9053435	60	9053438	90				
31mm (6) per box													
9053876	08	9053879	20	9053882	35	9053885	50	9053889	80	9053894	45-80		
9053877	10	9053880	25	9053883	40	9053886	55	9053890	90				
9053878	15	9053881	30	9053884	45	9053887	60	9053893	15-40				

Reamers

21mm (6) per box		06-40, 15-40 asstd		\$11.25		45-140, 45-80 asstd		\$12.25	
9053000	06	9053003	15	9053006	30	9053009	45		
9053001	08	9053004	20	9053007	35	99053018	15-40		
9053002	10	9053005	25	9053008	40				
25mm (6) per box									
9053030	06	9053034	20	9053038	40	9053042	60		
9053031	08	9053035	25	9053039	45	9053045	90		
9053032	10	9053036	30	9053040	50	9053048	15-40		
9053033	15	9053037	35	9053041	55	9053049	45-80		
31mm (6) per box									
9053090	06	9053094	20	9053098	40	9053111	15-40		
9053091	08	9053095	25	9053099	45	9053112	45-80		
9053092	10	9053096	30	9053101	55				
9053093	15	9053097	35	9053102	60				

Rubber Stop Color Coding for Files & Reamers

Red = 21mm
Blue = 25mm
Black = 31mm

Features a Safe-End Tip
on sizes 06-40

Premier Sensipast root fillers have a miniature clutch in the mandrel that allows them to be used on any kind of right-angle handpiece without breaking.

Package of 4 - **\$17.95**

21mm

9053571	25
9053572	30

25mm

9053576	25 - \$17.95
---------	---------------------



Root Fillers

Carrier for Root Canal Sealer

Package of 4 - **\$16.75**

21mm

9053556	25
9053557	30
9053558	35
9053559	40
9053560	Assorted (25 - 40)

25mm - **\$16.75**

9053561	25
9053562	30
9053563	35
9053564	40
9053565	Assorted (25 - 40)



Gates-Glidden Drills

Shape & Taper the Canal

Package of 6 - **\$24.95**

9055001	No. 1	9055005	No. 5
9055002	No. 2	9055006	No. 6
9055003	No. 3	9055009	Assorted
9055004	No. 4		

Peeso Drills

Prepare Post Space in Endodontically Treated Teeth

To protect the integrity of the tooth and root-canal filling, gutta percha should be removed with hot pluggers to the desired depth before use of Peeso drills.

Package of 6 - **\$24.95**

9055021	No. 1
9055022	No. 2
9055023	No. 3
9055024	No. 4
9055025	No. 5
9055026	No. 6
9055029	Asst.

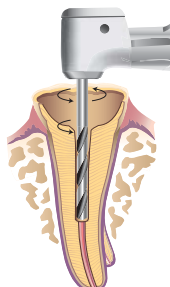

Barbed Broaches

Flexible Stainless Steel Avoids Breakage

Package of 144 - **\$118.95**

9053631	25
9053632	30
9053633	35
9053634	40
9053635	50
9053636	60
9053637	Assorted (25-60)

Individual 12 packets available through your dealer.



Finger Spreaders

For Lateral Condensation

Premier Finger Spreaders are precisely sized to provide excellent lateral condensation of gutta percha toward canal walls.

Package of 6 - **\$15.45**

21mm

9053814	15
9053816	20
9053818	25
9053820	30
9053822	35
9053824	40
9053826	Assorted (15-40)

25mm - **\$15.45**

9053830	15
9053832	20
9053834	25
9053836	30
9053838	35
9053840	40
9053842	Assorted (15-40)



Finger Pluggers

For Vertical Condensation

Package of 6 - **\$15.45**

21mm

9053771	15
9053772	20
9053773	25
9053774	30
9053788	Assorted (15-40)

25mm - **\$15.45**

9053791	15
9053792	20
9053793	25
9053794	30
9053808	Assorted (15-40)



Gutta Percha Points

Machine Rolled / Color Coded

Box of 120 - **\$15.25**

9056001	15
9056002	20
9056003	25
9056004	30
9056005	35
9056006	40
9056007	45
9056008	50
9056009	55
9056010	60
9056011	70
9056019	25-40
9056020	45-80

Box of 60 - **\$15.25**

9056021	90-140
---------	--------



Gutta Percha Accessory Points

Box of 120 - **\$15.25**

9056101	Extra Fine
9056102	Fine/Fine
9056103	Med./Fine
9056104	Fine
9056105	Fine/Med.
9056106	Medium
9056116	Asst.

Absorbent Points

Sterile - 40 cells of 5



Box of 200 - **\$14.95**

9055101	XX-Fine
9055102	X-Fine
9055103	Fine
9055104	Med
9055105	Coarse
9055106	X-Coarse
9055109	Asst.

ROYDENT™ DENTAL PRODUCTS

The boutique brand you've come to love & trust.

Roydent offers a full array of files so you have the right file for the job. Every time.

All Roydent hand files feature:

- German made with precision engineering
- Ideal tactile feedback
- Non-slip plastic handles for a firmer grip
- ISO color coded for easy identification
- Pre-inserted silicone stops



6/BOX \$15.45											
	K-FILES			REAMERS			H-FILES			C-FILES	
Size	21MM	25MM	31MM	21MM	25MM	31MM	21MM	25MM	31MM	21MM	25MM
06	330-632106	330-632506	330-633106	330-532106	330-532506	330-533106				330-652106	330-652506
08	330-632108	330-632508	330-633108	330-532108	330-532508	330-533108	330-732108	330-732508	330-733108	330-652108	330-652508
10	330-632110	330-632510	330-633110	330-532110	330-532510		330-732110	330-732510	330-733110	330-652110	330-652510
15	330-632115	330-632515	330-633115	330-532115	330-532515	330-533115	330-732115	330-732515	330-733115		
20	330-632120	330-632520	330-633120	330-532120	330-532520	330-533120	330-732120	330-732520	330-733120		
25	330-632125	330-632525	330-633125	330-532125	330-532525	330-533125	330-732125	330-732525	330-733125		
30	330-632130	330-632530	330-633130	330-532130	330-532530	330-533130	330-732130	330-732530	330-733130		
35	330-632135	330-632535	330-633135	330-532135	330-532535	330-533135	330-732135	330-732535	330-733135		
40	330-632140	330-632540	330-633140	330-532140	330-532540	330-533140	330-732140	330-732540	330-733140		
15-40	330-63211540		330-6331160	330-5321160	330-5325160	330-5331160	330-7321160	330-7325160	330-7331160		

6/BOX \$22.95									
	K-FILES			REAMERS			H-FILES		
Size	21MM	25MM	31MM	21MM	25MM	31MM	21MM	25MM	31MM
45	330-632145	330-632545	330-633145	330-532145	330-532545	330-533145	330-732145	330-732545	330-733145
50	330-632150	330-632550	330-633150	330-532150	330-532550	330-533150	330-732150	330-732550	330-733150
55	330-632155	330-632555	330-633155	330-532155	330-532555	330-533155	330-732155	330-732555	330-733155
60	330-632160	330-632560			330-532560	330-533160	330-732160	330-732560	330-733160
70	330-632170	330-632570	330-633170	330-532170	330-532570	330-533170	330-732170	330-732570	330-733170
80	330-632180	330-632580	330-633180	330-532180	330-532580	330-533180	330-732180	330-732580	330-733180
45-80	330-6321165	330-6325165	330-6331165	330-5321165	330-5325165	330-7321165	330-7321165	330-7325165	330-733165
90-110	330-6321170	330-6325170	330-6331170	330-5321170	330-5322170			330-732590110	330-7331170

FILES & REAMERS



Engine Driven K-Reamer - Dentsply Maillefer

Stainless Steel. Provides flexibility, cutting ability and engine efficiency. Fits all reciprocating handpieces. Excellent choice for cutting through calcifications. All reamers are ISO sized and color coded.

Size	21mm	25mm
10	338-671020	338-671039
15	338-671021	338-671040
20	338-671022	338-671041
25	338-671023	338-671042
30	338-671024	338-671043
35	338-671025	338-671044
40	338-671026	338-671045
15-40 Asst	338-671027	338-671046
6/box	\$15.45	

Size	21mm	25mm
45	-	338-671047
50	338-671029	338-671048
55	338-671030	338-671049
60	338-671031	338-671050
70	338-671032	338-671051
80	338-671033	338-671052
45-80 Asst	338-671034	338-671053
90	338-671035	338-671054
100	338-671036	338-671055
110	338-671037	338-671056
120	338-671038	338-671057
6/box	\$22.45	



Engine-Driven Hedstroms - Dentsply Maillefer

Stainless Steel. Hedstrom design is combined with the efficiency of engine instrumentation and ISO color identification. (The engine hedstrom must be used in a reciprocating handpiece.)

Size	21mm	25mm
15	338-671058	338-671072
20	338-671059	338-671073
25	338-671060	338-671074
30	338-671061	338-671075
35	338-671062	338-671076
40	338-671063	338-671077
15-40 Asst	338-671064	338-671078
6/box	\$15.45	

Size	21mm	25mm
45	338-671065	338-671079
50	338-671066	338-671080
55	338-671067	338-671081
60	338-671068	338-671082
70	338-671069	-
80	338-671070	338-671084
45-80 Asst	338-671071	338-671085
6/box	\$22.45	

FILES & REAMERS - PATHFINDERS



Pathfinder™ - Kerr Endodontics

For locating difficult, calcified canals. Sure-grip handle, surgical-grade stainless steel, fluted cutting edges and minimal taper.

21mm.....	339-17023
25mm.....	339-17017
6/pkg.	\$14.45



Pathfinder CS - Kerr Endodontics

For easier, improved canal navigation. Made of carbon steel for better strength. Unique, minimal taper resists buckling. Presterilized and ready-to-use. K1- Dark Brown Handle, K-2 Orange Handle.

K1- 21mm.....	339-22936
K2- 21mm.....	339-22938
K2- 25mm.....	339-23467
6/pkg.	\$22.25

NICKEL TITANIUM FILES



SureFlex® - Dentsply Maillefer

Nickel Titanium. More flexible than stainless steel alloy. Outstanding long-term sharpness and fatigue strength. No new techniques needed, you can use either balanced force or a conventional filing technique.

Size	21mm	25mm
15	338-664001	338-664012
20	338-664002	338-664013
25	338-664003	338-664014
30	338-664004	338-664015
35	338-664005	338-664016
40	338-664006	338-664017
45	338-664007	338-664018
50	338-664008	338-664019
55	338-664009	338-664020
60	338-664010	338-664021
15-40 Asst	338-664011	338-664022
6/box	\$33.95	

BARBED BROACHES



Barbed Broaches

Grade	21mm	Color
Course	330-BB100C	Black
Fine	330-BB100F	Blue
Medium	330-BB100M	Green
XFine	330-BB10XF	Red
XXFine	330-BB1XXF	Yellow
XXXFine	330-BBXXXXF	White
XXXXFine	330-BXXXXF	Purple
XXFine-Fine	330-BBXXFA	Assorted
10/pkg	\$8.25	



Barbed Broaches - Dentsply Maillefer

Designed for bulk removal of pulpal tissue and features an easy-to-grip, color-coded plastic handle. Sterile blister pack. ISO color-coded.

Size	21mm
XXXX Fine (Purple)	338-689549
XXX Fine (White)	338-689550
XX Fine (Yellow)	338-689551
X Fine (Red)	338-689552
Fine (Blue)	338-689553
Medium (Green)	338-689554
Coarse (Black)	338-689555
Assorted (XXXX Fine-Coarse) ..	338-689556
10/pkg.	\$11.75



Barbed Broaches - Kerr Endodontics

Stainless Steel. Presterilized. 22mm length.

XXX-Fine (White).....	339-17008
XX-Fine (Yellow).....	339-17009
X-Fine (Red).....	339-17010
Fine (Blue).....	339-17011
Medium (Green).....	339-17012
Coarse (Black).....	339-17013
30/pkg.	\$47.25

Assorted Package

10 of each size: XXXF (White), XXF (Yellow) and XF (Red).

339-17014	Package.....	\$47.25
-----------	--------------	----------------

Assorted Package

10 of each size: Fine (Blue), Medium (Green) and Coarse (Black).

339-17015	Package.....	\$47.25
-----------	--------------	----------------

FINGER PLUGGERS

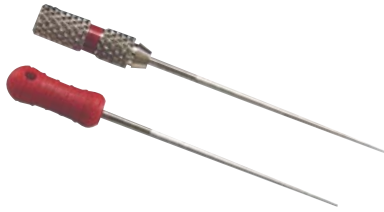

Finger Pluggers - Dentsply Maillefer

The unique design of this instrument combines a conical shape with a flat tip allowing for both lateral and vertical condensation of gutta-percha.

Plastic Handles

Size	21mm	25mm
20 A	338-671700	338-671710
25 B	338-671701	338-671711
30 C	338-671702	338-671712
35 D	338-671703	338-671713
Asst 20-35	338-671704	338-671714
4/pkg.	\$16.25	

Metal Handles

Size	21mm	25mm
20 A	338-671705	338-671715
25 B	338-671706	338-671716
30 C	338-671707	338-671717
35 D	338-671708	338-671718
Asst 20-35	338-671709	338-671719
4/pkg.	\$16.25	



Finger Pluggers - Kerr Endodontics

Standardized sizes with ISO taper designed for vertical condensation.

Size	21mm	25mm
20	339-15733	339-15740
25	339-15734	339-15741
30	339-15735	339-15742
35	339-15736	339-15743
40	339-15737	339-15744
45	339-15738	339-15745
Asst 20-45	339-15739	339-15746
6/pkg.	\$30.95	

FINGER SPREADERS



Finger Spreaders - Dentsply Maillefer

Used for lateral condensation. Each size is color-coded for easy and positive identification.

Plastic Handle

Size	21mm
10	338-671720
20	338-671721
30	338-671722
40	338-671723
Assorted	338-671724
4/pkg.	\$16.25



Finger Spreaders - Kerr Endodontics

Tapered sizes matched to Kerr Gutta Percha Points. Designed for lateral condensation.

Size		21mm	25mm
XF	White	339-15719	339-15726
FF	Yellow	339-15720	339-15727
MF	Red	339-15721	339-15728
F	Blue	339-15722	339-15729
FM	Green	339-15723	339-15730
M	Black	339-15724	339-15731
Asst	XF-Med.	339-15725	339-15732
6/pkg.	\$30.95		

GATES GLIDDEN DRILLS

Gates Glidden

	28mm	32mm
#1	330-GG7001	330-GG9001
#2	330-GG7002	330-GG9002
#3	330-GG7003	330-GG9003
#4	330-GG7004	330-GG9004
#5	330-GG7005	330-GG9005
#6	330-GG7006	330-GG9006
#1-6 Asst.	330-GG7176	330-GG9196
6/pkg.	\$16.75	



Gates Glidden Drills - Dentsply Maillefer

Can be used in any right angle handpiece to enlarge the coronal portion of the canal for bulk removal of tooth structure. Noted for easy identification. ISO color-coded to indicate cutting diameter.

Size	28mm	32mm
1	338-671530	338-671500
2	338-671531	338-671501
3	338-671532	338-671502
4	338-671533	338-671503
5	338-671534	338-671504
6	338-671535	338-671505
Asst #1-6	338-671536	338-671506
6/pkg.	\$24.95	

PASTE FILLERS



Lentulo® Spiral Fillers - Dentsply Maillefer

Stainless Steel. Consistently spaced spirals which provide outstanding flexibility in distributing root canal sealer and cement evenly throughout the root canal system. ISO color-coded. Engine Driven.

Size	21mm	25mm
1 (Red) 30-35	338-671560	338-671570
2 (Blue) 40-45	338-671561	338-671571
3 (Green) 50-60	338-671562	338-671572
4 (Black) 70-90	338-671563	338-671573
5 Asst 1-4	338-671564	338-671574
4/pkg.	\$15.75	

PEESO REAMERS

Peeso Reamers

	28mm	32mm
#1	330-PR7001	330-PR9001
#2	330-PR7002	330-PR9002
#3	330-PR7003	330-PR9003
#4	330-PR7004	330-PR9004
#5	330-PR7005	330-PR9005
#6	330-PR7006	330-PR9006
#1-6 Asst.	330-PR7176	330-PR9196
6/pkg	\$16.75	



Peeso Reamers - Dentsply Maillefer

Stainless Steel. Excellent for enlarging the cervical portion of the canal to prepare the canal entrance and to remove gutta-percha for post space. Can be used in any right angle handpiece. Notched for easy size identification.

Size	28mm	32mm
1	338-671537	338-671510
2	338-671538	338-671511
3	338-671539	338-671512
4	338-671540	338-671513
5	-	338-671514
6	338-671542	338-671515
Asst #1-6	338-671543	338-671516
6/pkg.	\$23.25	

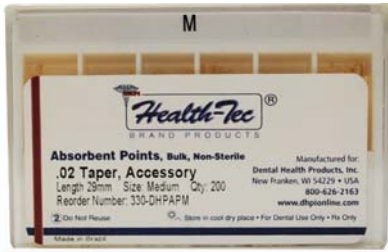

Paper Points (Bulk Package)

Uniformly machine rolled, these super absorbent points contain no starches or fillers to leave residue in the canal. Rigid for easy insertion and removal, they also feature a blunt tip for rapid absorption. Non-Sterile.

Conventional (accessory) sizes.

Size	200/box	
XX-Fine	330-DHPAPXXF	
X-Fine	330-DHPAPXF	
Fine	330-DHPAPF	
Medium	330-DHPAPM	
Coarse	330-DHPAPC	
X-Coarse (90 count)	330-DHPAPXC	
Assorted	330-DHPAPA	
Each		\$8.95



Paper Points (Sterile Cell Package)

Uniformly machine rolled, these super absorbent points contain no starches or fillers to leave residue in the canal. Rigid for easy insertion and removal, they also feature a blunt tip for rapid absorption.

Conventional (accessory) sizes.

Size	180/box
XX-Fine	330-DHPAPXXFC
X-Fine	330-DHPAPXFC
Fine	330-DHPAPFC
Medium	330-DHPAPMC
Coarse	330-DHPAPCC
Assorted	330-DHPAPAC

Size	144/box
X-Coarse	330-DHPAPXCC
Each	\$8.95



Paper Points with Color-Coded Ends (Bulk Package)

Uniformly machine rolled, these super absorbent points are available in easy to identify ISO colors. Contains no starches or fillers to leave residue in the canal. Rigid for easy insertion and removal, they also feature a blunt tip for rapid absorption. Non-Sterile.

Standardized (AAE/ISO) sizes.

Size	200/ box	
#15	330-DHPAP15	
#20	330-DHPAP20	
#25	330-DHPAP25	
#30	330-DHPAP30	
#35	330-DHPAP35	
#40	330-DHPAP40	
#45	330-DHPAP45	
#50	330-DHPAP50	
#55	330-DHPAP55	
#60	330-DHPAP60	
#70	330-DHPAP70	
#80	330-DHPAP80	
Asst. #15-40	330-DHPAP1540C	
Asst. #45-80	330-DHPAP4580C	
Each		\$8.95



PaperPoints with Color Coded Ends (Sterile Cell Package)

Uniformly machine rolled, these super absorbent points are available in easy to identify ISO colors. Contains no starches or fillers to leave residue in the canal. Rigid for easy insertion and removal, they also feature a blunt tip for rapid absorption.

Standardized (AAE/ISO) sizes

Size	180/box
#15	330-DHPAP15C
#20	330-DHPAP20C
#25	330-DHPAP25C
#30	330-DHPAP30C
#35	330-DHPAP35C
#40	330-DHPAP40C
#45	330-DHPAP45C
#50	330-DHPAP50C
#55	330-DHPAP55C
#60	330-DHPAP60C
#70	330-DHPAP70C
#80	330-DHPAP80C
#15-40	330-DHPAP1540C
#45-80	330-DHPAP4580C
Each	\$8.95



Hygienic SpectraPoint Paper Points - Coltene

Use to facilitate the removal of fluids and moisture from the canal during the process of canal preparation. Color becomes deeper when in contact with moisture. Will turn white when in contact with sodium hypochlorite or hydrogen peroxide.

15-White	335-07677	
20-Yellow	335-07678	
25-Pink	335-07679	
30-Blue	335-07680	
35-Green	335-07681	
40-Gray	335-07682	
15-40 Assorted	335-07689	
200/box		\$14.75

45-White	335-07683	
50-Yellow	335-07684	
55-Pink	335-07685	
60-Blue	335-07686	
70-Green	335-07687	
80-Gray	335-07688	
45-80 Assorted	335-07690	
120/box		\$14.75



Hygienic Paper Points - Coltene

Monitors the cleaning and drying of the root canal.

Conventional

More tapered than ISO points, ideal for more conically-shaped root canals.

	Bulk Package	Cell Package
	200/pkg.	180/pkg.
XX-Fine	335-03345	335-03201
X-Fine	335-03346	335-03202
Fine	335-03347	335-03203
Medium	335-03348	335-03204
Coarse	335-03349	335-03205
X-Coarse	335-03350	335-03206
Asst. (XF-C)	335-03351	335-03207
Bulk Package		\$15.45
Cell Package		\$20.75

White

	Bulk Package	Cell Package
	200/pkg.	180/pkg.
ISO-Size		
#15	335-02113	335-03180
#20	335-02114	335-03181
#25	335-02115	335-03182
#30	335-02116	335-03183
#35	335-02117	335-03184
#40	335-02118	335-03185
#45	335-02119	335-03186
#50	335-02120	335-03187
#55	335-02121	335-03188
#60	335-02122	335-03189
#70	335-02123	335-03190
#80	335-02124	335-03191
Asst. #15-40	335-02130	335-03198
Asst. #45-80	335-02131	335-03199
Bulk Package		\$15.45

ABSORBENT PAPER POINTS



Paper Points - Dentsply Maillefer

Hand rolled points are available in bulk and cell packages. Specially designed to match the tapered shapes created by today's instruments and techniques.

	Bulk Package 200/pkg.	Cell Package 180/pkg.
X-Fine	338-670153	338-670065
Fine	338-670154	338-670066
Medium	338-670155	338-670067
Coarse	338-670156	338-670068
X-Coarse	338-670157	338-670069
Long Size "A"	338-670158	-
Asst. (XF-C)	338-670151	-
Package	\$18.25	

ISO Sizes	Bulk Package 200/pkg.	Cell Package 180/pkg.
#15	338-670408	338-670172
#20	338-670409	338-670173
#25	338-670410	338-670174
#30	338-670411	338-670175
#35	338-670412	338-670176
#40	338-670413	338-670177
#45	338-670414	338-670178
#50	338-670415	338-670179
#55	338-670416	338-670180
#60	338-670417	338-670181
#70	338-670418	338-670182
#80	-	338-670183
Asst. #20-35	338-670420	-
Asst. #45-60	338-670421	-
Asst. #55-80	338-670422	-
Asst. #15-40	-	338-670184
Asst. #45-80	-	338-670185
Package	\$18.25	

.04 Taper	
#15 White	338-670186
#20 Yellow	338-670187
#25 Red	338-670188
#30 Blue	338-670189
#35 Green	338-670190
#40 Black	338-670191
#15-40 Assorted	338-670192
180/pkg.	\$21.45

.06 Taper	
#15 White	338-670193
#20 Yellow	338-670194
#25 Red	338-670195
#30 Blue	338-670196
#35 Green	338-670197
#40 Black	338-670198
#15-40 Assorted	338-670199
180/pkg.	\$21.45

Paper Points - DiaDent®

Made from specially formulated, highly absorbent paper. Each is individually hand jig rolled to ensure perfect size and firmness. ISO 9001 and CE Certified ensuring, a high standard of design, manufacturing and quality assurance.

Cell Pack

Contains: 5 points per cell, 40 cells per pack.

#XF	330-202302
#F	330-202303
#M	330-202304
#C	330-202305
#XC	330-202306
Pack	\$8.95

Spillproof

Contains: 200/box.

#F	330-202603
#M	330-202604
#C	330-202605
#XC	330-202606
200/box	\$7.25



Absorbent Paper Points - Kerr Endodontics

Presterilized and highly absorbent. Made to remove moisture from prepared canals and rigid enough to be easily inserted and withdrawn while keeping a firmly rolled shape.

Conventional - Bulk Package

X-Fine	339-13966
Fine	339-13967
Medium	339-13968
Coarse	339-13969
X-Coarse	339-13970
Asst (XF-C)	339-13965
200/pkg.	\$20.95

ISO Sizes - Bulk Package

#15	339-13971
#20	339-13972
#25	339-13973
#30	339-13974
#35	339-13975
#40	339-13976
#45	339-13977
#50	339-13978
#55	339-13979
#60	339-13980
#70	339-13981
#80	339-13982
200/pkg.	\$20.95

Conventional - Cell Package

XX-Fine	339-16215
X-Fine	339-16216
Fine	339-16217
Medium	339-16218
Coarse	339-16219
X-Coarse	339-16220
Asst (XF-C)	339-16221
200/pkg.	\$20.95

ISO Sizes - Cell Package

#15	339-16222
#20	339-16223
#25	339-16224
#30	339-16225
#35	339-16226
#40	339-16227
#45	339-16228
#50	339-16229
#55	339-16230
#60	339-16231
#70	339-16232
#80	339-16233
180/pkg.	\$20.95

GUTTA PERCHA POINTS



Gutta Percha Points with ISO Color-Coded Ends

High quality gutta percha is easy to identify ISO file colors. Precision machine rolled, these tapered points are clearly X-ray visible and available in easy to dispense packages.

Standardized (AAE/ISO)

Sizes .02 Taper, 28mm

Size	120/box
#15	330-DHPGP15
#20	330-DHPGP20
#25	330-DHPGP25
#30	330-DHPGP30
#35	330-DHPGP35
#40	330-DHPGP40
#45	330-DHPGP45
#50	330-DHPGP50
#55	330-DHPGP55
#60	330-DHPGP60
#70	330-DHPGP70
#80	330-DHPGP80
#15-40	330-DHPGP1540
#45-80	330-DHPGP4580

Size	60/box
#90	330-DHPGP90
#100	330-DHPGP100
#90-140	330-DHPGP140
Each	\$10.45

GUTTA PERCHA POINTS



Gutta Percha Points

Precision machine rolled, these points are made with the finest quality gutta percha. Clearly X-ray visible, featuring sharp pointed tips and available in easy to dispense packages.

Sizes .02 Taper, 28mm

Conventional (accessory) Sizes

Size	120/box
X-Fine	330-DHPGPF
Fine-Fine	330-DHPGPF
Medium-Fine	330-DHPGPF
Fine	330-DHPGPF
Fine-Medium	330-DHPGPF
Medium	330-DHPGPF

Size	60/box
Medium-Large	330-DHPGPF
Large	330-DHPGPF
X-Large	330-DHPGPF
Assorted XF-M	330-DHPGPF
Each	\$10.45



Hygienic Gutta Percha Points - Coltene

Suitable for use as accessory points for condensation technique.

Size	ADA Spec. #57	Orig Spec
X-Fine	335-01221	335-04229
Fine-Fine	335-01222	335-04230
Med.-Fine	335-01223	335-04231
Fine	335-01224	335-04232
Fine-Med	335-01225	335-04233
Medium	335-01226	335-04234
Med. Large	335-01304	-
Large	335-01305	-
X-Large	335-01306	-
100/box		\$21.95

Asst XF-M	335-01232	
200/box		\$40.75

Standardized (AAE/ISO)

Size	
#15	335-01469
#20	335-01470
#25	335-01471
#30	335-01472
#35	335-01473
#40	335-01474
#45	335-01475

#50	335-01476	
#55	335-01477	
#60	335-01478	
#70	335-01479	
#80	335-01480	
#90	335-01481	
#100	335-01482	
#110	335-01483	
#120	335-01484	
#130	335-01485	
#140	335-01486	
100/box		\$20.95



Hygienic SpectraPoint Gutta Percha Points - Coltene

Color-coded points in six pastel colors, consistent with file handle color system. Coloring agents approved and safe for endodontics. Easy identification and organization. ISO Sized and Color Coded.

#15	335-08739	
#20	335-08740	
#25	335-08741	
#30	335-08742	
#35	335-08743	
#40	335-08744	
#45	335-08745	
#50	335-08746	
#55	335-08747	
#60	335-08748	
#70	335-08749	
#80	335-08750	
100/box		\$20.95

Assorted

#15-40	335-07776	
#45-80	335-07777	
120/box		\$23.95



Gutta-Percha Points - Dentsply Maillefer

Hand-rolled. Offered in an extended range of sizes suitable for various obturation techniques.

X-Fine	338-670920	
Fine-Fine	338-670921	
Medium-Fine	338-670922	
Fine	338-670923	
Fine-Medium	338-670924	
Medium	338-670925	
Large	338-670926	
X-Large	338-670927	
Vials of 20 (6 vials/box)		\$18.75

Standardized (ISO) .02 Taper

#15	338-670928	
#20	338-670929	
#25	338-670930	
#30	338-670931	
#35	338-670932	
#40	338-670933	
#45	338-670934	
#50	338-670935	
#55	338-670936	
#60	338-670937	
#70	338-670938	
#80	338-670939	
#90	338-670940	
#100	338-670941	
#110	338-670942	
#120	338-670943	
#15-40	338-670945	
Assorted	338-670944	
Vials of 20 (6 vials/box)		\$18.75

Standardized (ISO) .04 Taper

#15 White	338-670948	
#20 Yellow	338-670949	
#25 Red	338-670950	
#30 Blue	338-670951	
#35 Green	338-670952	
#40 Black	338-670953	
#15-40 Assorted	338-670954	
120/box		\$26.25

Standardized (ISO) .06 Taper

#15 White	338-670955	
#20 Yellow	338-670956	
#25 Red	338-670957	
#30 Blue	338-670958	
#35 Green	338-670959	
#40 Black	338-670960	
#15-40 Assorted	338-670961	
120/box		\$26.25

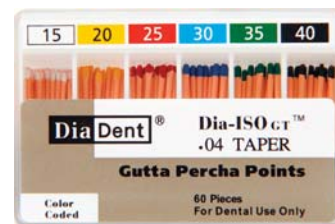

Dia-ISO GT Gutta Percha - DiaDent®

Tailor made to complement Profile ISO Rotary Files and K3 Files. .04 Taper.

#10	330-114602	
#15	330-114603	
#20	330-114604	
#25	330-114605	
#30	330-114606	
#35	330-114607	
#40	330-114608	
#45	330-114609	
#50	330-114610	
#55	330-114611	
#60	330-114612	
#70	330-114613	
#80	330-114614	
60/box		\$18.95

GUTTA PERCHA POINTS



Gutta Percha - DiaDent®

Quick and easy method for depth measurements. Eliminates apex perforations which may lead to bleeding. Completely seals the entire length of the canal.

Spillproof Pack

Size		
#15	330-101603	
#20	330-101604	
#25	330-101605	
#30	330-101606	
#35	330-101607	
#40	330-101608	
#45	330-101609	
#80	330-101614	
120/box		\$9.95



Gutta-Percha Points - Kerr Endodontics

Flexible radiopaque root canal filling. Readily softened by heat and flexible enough to be easily inserted into the canal. Sized to match corresponding size files and reamers plus taper sizes.

Taper Sizes

X-Fine	339-14376	
Fine-Fine	339-14377	
Medium-Fine	339-14378	
Fine	339-14375	
Fine-Medium	339-14379	
Medium	339-14380	
Large	339-14381	
Assorted	339-14374	
Vials of 20 (6 vials/box)		\$36.75

Standardized Sizes

#15	339-14382	
#20	339-14383	
#25	339-14384	
#30	339-14385	
#35	339-14386	
#40	339-14387	
#45	339-14388	
#50	339-14389	
#55	339-14390	
#60	339-14391	
#70	339-14392	
#80	339-14393	
Asst #15-40	339-14451	
Asst #45-80	339-14452	
Asst #90-140	339-14453	
Vials of 20 (6 vials/box)		\$36.75

Conventional Accessory Sizes

X-Fine	339-12643	
Fine-Fine	339-13985	
Medium-Fine	339-13986	
Fine	339-12644	
Fine-Medium	339-13987	
Medium	339-12645	
Large	339-12646	
Assorted	339-12647	
100/box		\$30.25

Standardized (AAE/ISO)

#15	339-12648	
#20	339-12649	
#25	339-12650	
#30	339-12651	
#35	339-12652	
#40	339-12653	
#45	339-12654	
#50	339-12655	
#55	339-12656	
#60	339-12657	
#70	339-12658	
#80	339-12659	
100/box		\$30.25

CANAL PASTES & SEALERS - TEMPORARY



Calasept® Calcium Hydroxide - Directa Dental Group

The high concentration of calcium hydroxide means long-lasting release of calcium ions. Air tight syringes eliminate the risk of incorporating air turning the material into calcium carbonate. Bactericidal effect on carious dentine. Direct, quick and easy application.

Large Kit

Contains: 4 - 1.5ml syringes, 20 luer lock needles.
334-6004U Kit..... \$65.95

Small Kit

Contains: 2 - 1.5ml syringes, 20 luer lock needles.
334-6002U Kit..... \$37.95

Luer Lock Needles

334-6003U 100/pack..... \$59.75



TempCanal™ Enhanced - Pulpdent Corporation

Enhanced with pH>12 and provides full benefits of calcium hydroxide in root canal therapy. Replaces hazardous formocresol. Flows through 27ga. x 25mm endodontic irrigation needles with 2 side-vents for controlled placement and uniform coating of canal walls and with a closed end to prevent overfills.

Kit

Contains: 3ml syringe, 12 endo irrigation needles (27ga. x 1" with 2-sided vent).

330-TEK Kit..... \$48.95

Refill

330-TE3 3ml \$35.95

Accessories available upon request.

CANAL PASTES & SEALERS - PERMANENT



MTA-FILLAPEX - Angelus Dental

Biocompatible root canal sealer with excellent radiograph visibility. Helps bone and tissues regrow. Easy handling and easy removal. Working time of 23 minutes and Setting time of 130 minutes, ideal to complete all steps of endodontic filling.

Tubes

Contains: 12gm base, 18gm catalyst and 1 mixing pad.

330-826 Each..... \$106.75

Automix

Contains: 4gm double barrel syringe, 10 automixing tips and 1 mixing pad.

330-827 Each..... \$19.45

Mixing Tips

330-158 10/pkg \$7.25



Hygenic® CRCS® Calciobiotic Root Canal Sealer - Coltene

Used along with gutta percha for permanent obturation of the root canal in accordance with ISO 6876 for Dental Root Canal Sealing Materials.

Contains: 14ml bottle of liquid with eye dropper, glass slide and 36 powder blisters.

335-03534 Each..... \$79.75

Powder

Contains: 24 powder blisters.

335-05694 Each..... \$60.25



AH 26® Root Canal Sealer - Dentsply Maillefer

This resin-based, non-acrylic, eugenol-free sealer is used with gutta-percha, Densfil obturators or silver points. It is radiopaque, has a work time of 4-6 hours, a set time of 9-15 hours and is suitable for cold and warm obturation techniques.

Complete Package

Contains: 8gm powder and 10gm liquid.
338-667000 Package **\$111.95**

Refill

Contains: 10gm tube.
338-667002 Each..... **\$49.25**



AH Plus® Root Canal Sealer - Dentsply Maillefer

Resin-based formula with excellent radiopacity, low shrinkage, low solubility and outstanding flow characteristics. It features a paste-to-paste mixing system with a 1:1 ratio for fast, easy preparation and less waste. Silver free.

Complete Package

Contains: 4ml Paste A, 4ml Paste B.
338-667003 Package **\$116.45**



AH Plus Jet®

A two component paste root canal sealer used for permanent sealing based on epoxide-amine resins. This dispenser ensures that the paste is mixed in an ideal ratio and means that the sealer can be applied directly and precisely into root canals.

Starter Kit

Contains: 4ml automix syringe, 7.5gm paste A, 7.5gm paste B and 20 intraoral tips.
338-667005 Kit..... **\$96.95**

Mixing Tips

338-667006 40/pack **\$36.45**

Syringes

Contains: 2 mixing syringes.
338-667007 Each..... **\$191.75**



Diapex® - DiaDent®

Silicone oil based calcium hydroxide and iodoform paste used for temporary or permanent root canal treatment. Pre-mixed and comes in a pre-filled syringe. Tips are pre-bent to ensure excellent canal accessibility.

Complete Kit

Contains: 2gm pre-mixed paste in a pre-filled syringe and 20 disposable tips.
200-1001301 Kit..... **\$47.95**

Intro Kit

Contains: 0.5gm pre-mixed paste and 4 disposable tips.
330-1001304 Kit..... **\$14.95**

Syringe

Contains: 2gm pre-mixed paste.
330-1001302 Each..... **\$43.95**

Irrigation Tips

330-1001316 20/pack **\$12.95**



EZ-Fill® Epoxy Root Canal Cement - Essential Dental Systems

Thoroughly coats the walls of the root canal and lateral canals without significant cement being forced apically. The reverse spirals on the apical end rotate in an unwinding direction out of the canal, helping to prevent binding. Radiopaque.

Contains: 7.5gm cement, 8gm powder and measuring scoop.
330-160800 Kit..... **\$111.75**

EZ-Fill Xpress

Same product formulation in an easy dual-barrel syringe delivery format.
Contains: 2 -9.5ml dual barrel syringes and 20 mixing tips.
330-162800 Kit..... **\$124.95**



NOGENOL™ Root Canal Sealer - GC America

This non-eugenol zinc oxide root canal sealer offers ample working time for multi-rooted teeth, yet sets quickly in the mouth. Excellent biocompatibility.

Standard Package

Contains: 3gm tube base, 6gm tube catalyst and mixing pad.
202-136301 Package..... **\$53.25**



Pulpdent Root Canal Sealer - Pulpdent Corporation

Tissue compatible, bacteriostatic and radiopaque. Resorbs with roots of deciduous teeth. Does not shrink upon setting.

Contains: 15cc powder, 7.5ml liquid, mixing pad and scoop.
200-RK Kit..... **\$47.95**



BioRoot™ RCS - Septodont

Bioactive and biocompatible permanent root canal sealer for use with cold single cone or cold lateral condensation obturation techniques. Creates a favorable alkaline environment to allow for high pH levels (>11). Pure mineral formulation will not stain teeth. Resin and eugenol-free.

Contains: 15gm bottle and 35 -0.20ml pipettes.
330-01E300 Each..... **\$153.75**



U/P Root Canal Sealer/Cement - Sultan Healthcare

Radiopaque, non-staining, non-irritating with excellent thermal insulation. Features an extended working time and excellent lubricating qualities.

Liquid

200-11435 3.5ml **\$75.25**
200-11437 15ml **\$137.75**

Powder

200-11430 15gm **\$69.45**
200-11431 60gm **\$130.95**

CANAL PREPARATION & MEDICAMENTS



Master-Dent Formo-Cresol - Dentonics
 Used primarily for the treatment of putrescent or necrotic pulps as well as temporary medicament during root canal therapy.
 330-12660 1oz **\$27.25**



Glyde File Prep® - Dentsply Maillefer Syringe Kit
 Root canal conditioner. 10% carbamide peroxide, 15% EDTA. Smooth, gel-like consistency clings to files, making precise placement in the canal easy. Effervescing action lifts dentinal shavings and debris for efficient removal.
 Contains: 5 -3ml syringes and 50 disposable tips.
 220-673021 Kit..... **\$36.25**

Disposable Tips
 230-673022 50pkg **\$21.45**



Calasept® CHX - Directa Dental Group
 2% solution. For irrigation during endodontic treatment. Bactericidal capacity. Stops the effect of sodium hypochlorite.
 330-N1270100V 100ml **\$15.95**

Calasept® EDTA
 17% solution. Specially formulated to aid in the negotiation of root canals by endodontic instruments. Forms a water soluble chelate complex that decalcifies substances and dissolves smear layers.
 200-N1260100V 100ml **\$21.75**



EDTA Plus - Essential Dental Systems
 17% ethylenediamine tetraacetic acid sodium salt. Includes a surfactant to reduce surface tension which improves penetration into the canal.
 200-77002 2oz **\$19.75**



SmearClear® - Kerr Endodontics
 Consistently removes the smear layer leaving the dentinal tubules clear of organic matter. The practitioner will recognize an increase in the efficacy of adhesives as well as an assist in the 3-dimensional obturation of the root canal system.
 200-9731002 110ml..... **\$46.95**



SlickGel™ ES - Kerr Endodontics
 Specially formulated canal lubrication used to aid in the negotiation of root canals by endodontic instruments. Contains EDTA that chelates calcifications in the root canal system. Composed of a water-soluble base containing urea peroxide and an aqueous solution of EDTA, which aids in chemically removing the smear layer. Provides a lubricating medium that helps with the negotiation of a stainless steel hand file into an endodontically treated tooth. This step is important in that it helps prevent blockage during the cleaning and shaping process.
 Contains: 12 -1ml MicroDose polytubes.
 309-9731015 Each..... **\$35.75**



RC-Prep® - Premier Dental®
 For chemo-mechanical preparation of root canals. Unique formulation of glycol, urea peroxide and EDTA in a special water-soluble base helps remove calcifications and lubricates the canal to permit more efficient instrumentation. Excellent for use with apex locators.

Syringe Kit
 Contains: 5 -3cc syringes and 50 tips.
 207-9007129 Kit..... **\$38.75**

Double Pack
 Contains: 2 -9gm filled syringes and 1 plastic tip.
 207-9007135 Pack..... **\$41.25**
 207-9007131 18gm jar **\$33.95**
 207-9007132 18gm pump **\$35.45**
 207-9007133 227gm jar **\$265.75**

RC-Prep MicroDose delivery format available upon request.



EDTA Solution, 17% - Pulpdent Corporation
 17% EDTA glycerol-based solution which has been buffered to a neutral pH is used in dentistry as a very effective calcium "binding" or "chelating" material to assist in the instrumentation of root canals.
 200-EDTA30 30ml bottle..... **\$11.45**
 200-EDTA60 60ml bottle..... **\$18.75**
 200-EDTA120 120ml bottle..... **\$23.25**
 200-EDTA480 480ml bottle..... **\$45.75**



Eugenol - Pulpdent Corporation
 730-E02 2oz **\$16.75**
 730-E04 4oz **\$29.25**
 730-E16 16oz **\$101.25**



Multi-Cal™ - Pulpdent Corporation

A smooth, creamy calcium hydroxide medication which is recommended for all clinical applications where calcium hydroxide is indicated.

Kit
Contains: 4 -1.2ml syringes and 8 applicator tips..
220-MULTI Kit..... **\$49.25**

Syringe Refill
220-MULTI3 3ml..... **\$29.95**

Applicator Tips - Prebent 22ga x 1/2"
230-22D20 20/pkg. **\$5.95**



Pulpdent® Paste - Pulpdent Corporation

Non-setting, pre-mixed calcium hydroxide paste for root canal therapy and vital pulp therapy.

Kit
Contains: 3ml syringe and 24 needles (18ga blunt, sterile).
200-PSYK Kit..... **\$46.45**

Refill Syringe
200-PSY 3ml..... **\$30.75**



Endosolv E - Septodont

Root canal filling remover for zinc-oxide eugenol-based materials. High softening potency for a time saving and efficient procedure.

200-S0260 13ml **\$27.45**



Buckley's Formo Cresol - Sultan Healthcare

19% formaldehyde, 35% cresol, 17.5% glycerin. Contains: 2 -15ml bottles.

730-10203 Each..... **\$124.25**



Calcium Hydroxide Powder - Sultan Healthcare

Mixed into paste as a dressing for apexification procedures, direct and indirect pulp capping and as a sub-base under restorations.

730-10301 2oz. **\$21.95**



Chloroform® - Sultan Healthcare

730-20390 8oz. **\$79.75**



Dry Socket Paste - Sultan Healthcare

Used to treat Alveolitis. Gives instant pain relief. Contains gualacol, balsamperu, eugenol, 1.6% chlorobutanol.

730-10404 1oz. **\$155.25**



Eucalyptol® - Sultan Healthcare

730-10501 1oz. bottle..... **\$90.75**



Sodium Hypochlorite - Sultan Healthcare

Quality controlled formula used to flush debris from root canal. Excellent for disinfecting gutta percha.

730-11507 16oz **\$47.75**



Sodium Perborate - Sultan Healthcare

Oxygenating powder mixed with Superoxol to bleach non-vital teeth.

730-11508 100gm **\$80.45**



Superoxol - Sultan Healthcare

Used to bleach non-vital teeth. 35% hydrogen peroxide.

730-11513 1oz. **\$28.95**



Xylol (Xylene) - Sultan Healthcare

Used to soften gutta percha points prior to filling.

730-21401 1oz **\$31.75**



EDTA 17% Solution - Vista Dental

Products
Specifically engineered with lower pH for optimal performance.

200-317011 16oz **\$58.95**

Unit Dose

Contains: 20 -0.6ml individually packaged pre-filled syringes and 20 -27ga side-vent irrigating tips.

200-317002 Each..... **\$27.45**

CANAL PREP ACCESSORIES



MTA Carriers - Pac-Dent International, Inc.

Disposable. Designed to deliver MTA directly to the apex of the root canal. Individually pouched.

0.80mm.....	330-MTA01
0.99mm.....	330-MTA02
1.60mm.....	330-MTA03
10/pack	\$54.45



Pulpdent® Pressure Syringe - Pulpdent Corporation

Screw syringe device for precise filling of root canals. Stainless steel construction. Sterilize by any method.

Combo Kit

Contains: Pressure Syringe, 30 assorted needles, Pulpdent Root Canal Sealer Kit and Wonder Orange.

330-PSK	Kit.....	\$165.95
---------	----------	-----------------

Pressure Syringe Needles

22ga.....	330-PSN22
25ga.....	330-PSN25
30ga.....	330-PSN30
12/box	\$15.75

IRRIGATING DEVICES



Irrigating Needle Tips

A bendable 1" needle tip designed for irrigation of canals, pockets and fistulas. Universal Luer-style design blunt-end, side-port delivery needle. Color-coded for easier identification.

23 Gauge - Blue	
130-10004	25/bag..... \$7.95

27 Gauge - Yellow	
130-10005	25/bag..... \$7.95



Utility Syringes

Disposable 12cc utility syringe. Designed for surgical site irrigation. Can be used with silicone and rubber based impression materials.

130-10001	50/box	\$24.45
-----------	--------------	----------------



Luer Lock Endo Syringes

Designed for surgical site irrigation. Non-reflective polypropylene barrel to reduce glare and eye fatigue. Textured finger grips to minimize slippage. Autoclavable, non-sterile.

Luer Lock Syringes

3cc Syringe		
130-10002	100/box	\$11.95

12cc Syringe		
130-10003	100/box	\$20.45

Luer Lock Syringes with Needles

3cc Luer Syringe with 23ga. Irrigation Needle.		
130-10006	100/box	\$40.95

3cc Luer Syringe with 27ga. Irrigation Needle.		
130-10007	100/box	\$40.95



Monoject® Endodontic Needles - Covidien Products by Medtronic

Notched tip.

23ga. x 1-1/4"	130-471232
27ga. x 1-1/4"	130-471273
25/box	\$12.45



Monoject® Irrigating Syringes - Covidien Products by Medtronic

3cc syringe with notched tip on needle for sterilizing root canals.

23ga x 1-1/4" orange cap	130-513843
27ga. x 1-1/4" yellow cap	130-513850
100/box	\$56.25

IRRIGATING DEVICES



Monoject® Syringes - Covidien Products by Medtronic

Luer Lock, disposable for irrigation. For use with endodontic needles and other types of hypo-dermic and regular hub needles.

3cc Syringe		
130-513934	100/box	\$15.95

6cc Syringe		
130-516937	50/box	\$12.95

12cc Syringe		
130-512878	80/box	\$22.95



Max-I-Probe® - Dentsply Maillefer

Fully irrigates root canals, including the apical third, in addition, probe cleanses the full gingival sulci for effective reduction of bacteria, without tissue laceration. The unique design with a well-rounded, close tip and side-port dispersal is still unmatched in effectiveness, patient comfort and safety for irrigating root canals and periodontal pockets. The luer lock connector provides a secure attachment and easy removal from any disposable syringe.

Perio-Endo Irrigating Probes

23ga. x 1"	130-MAX231
24ga. x 1"	130-MAX241
25ga. x 1"	130-MAX251
28ga. x 1"	130-MAX281
30ga. x 1"	130-MAX301
100/box	\$140.25

Perio-Endo Irrigating Probes

23ga. x 1"	130-MAXP2340
24ga. x 1"	130-MAXP2440
25ga. x 1"	130-MAXP2540
28ga. x 1"	130-MAXP2840
30ga. x 1"	130-MAXP3040
40/pkg.	\$62.95

Max-I-Probe with Syringes

23ga.....	130-MAXP231S
24ga.....	130-MAXP241S
28ga.....	130-MAXP281S
30ga.....	130-MAXP301S
100/pkg.	\$161.95

IRRIGATING DEVICES

Pocket-Probe™ Tips - Vista Dental Products

Ideal for irrigation of interdental spaces and perio pockets. Multiple perforations for thorough flushing. Closed-end, flexible 2-piece bent plastic irrigation tip. Universal luer lock style hub. 21ga tip. 130-316102 100/pkg..... **\$99.75**



Vista-Probe™ Irrigating Tips - Vista Dental Products

1" bendable with closed-end tip for side-port delivery. Luer Lock Hub. 27ga..... 130-315627 30ga..... 130-315630 100/pkg **\$100.75**

OBTURATION DEVICES & SYSTEMS



CanalPro Apex Locator - Coltene

Characterized by its brilliant, colored 3D panel and its accuracy of measurement. The ergonomic design and the easy operation make it simple to use. The CanalPro Apex Locator with rechargeable battery includes a color display with animated root canal, lip clip, file clip, power supply and test probe. The Virtual Apex Function allows marking a predetermined position at the required distance from the apex and the device will notify the user when an endodontic file reaches the apical foramen of the root canal. Other features include audio feedback with volume control, built-in demo mode, built-in self-test for a fast function control, auto-off and 2 Year Warranty. The device enables the clinician to obtain correct results in canals with different conditions – wet or dry.

CanalPro Apex Locator EU Kit

Contains: 1 CanalPro Apex Locator, 1 charger, 1 measuring cable, 2 lip clips, 2 file clips, 1 touch probe. 770-60018737 Each..... **\$974.75**



ROEKO GuttaFlow 2 - Coltene

A novel filling system for root canals that combines two products in one: gutta-percha in powder form and sealer. Works with cold free-flow gutta-percha. Excellent radiopacity and allows for precise post preparation

Intro Kit

Contains: 20 GuttaFlow 2 Capsules, 20 Canal Tips + Stops, Adapter for RotoMix 3/pcs, 1 Dispenser, 100 Retention Points ISO 30-60 and 60 gutta percha points Greater Taper 0.04 20-45. 330-60013710 Kit..... **\$443.75**

GuttaFlow 2 Canal Tips Refill

334-H08009 20/pack **\$19.45**



Densfil® Obturators - Dentsply Maillefer

Densfil's patented endodontic obturator consists of a flexible central carrier that is uniformly coated with a layer of refined and tested "alpha" phase gutta-percha. The carriers are available in bio-compatible, radiopaque medical-grade plastic or titanium.

Plastic Obturators

#20..... 338-669199 #25..... 338-669200 #30..... 338-669201 #35..... 338-669202 #40..... 338-669203 #45..... 338-669204 #50..... 338-669205 #55..... 338-669206 #60..... 338-669207 6/pkg. **\$73.45**

#20..... 338-669249 #25..... 338-669250 #30..... 338-669251 #35..... 338-669252 #40..... 338-669253 30/pkg. **\$332.45**

Assortment Package

#20-40 338-669267 #45-100..... 338-669268 20/pkg. **\$235.95**

Titanium Obturators

#20..... 338-669100 #25..... 338-669101 #30..... 338-669102 #35..... 338-669103 #40..... 338-669104 #45..... 338-669105 #50..... 338-669106 #55..... 338-669107 #60..... 338-669108 6/pkg. **\$73.45**

#20..... 338-669150 #25..... 338-669151 #30..... 338-669152 #35..... 338-669153 #40..... 338-669154 #45..... 338-669155 #50..... 338-669156 #60..... 338-669158 30/pkg. **\$332.45**



Root ZX® II Apex Locator - J. Morita USA

Ability to work in wet canals - measurement is not affected by the presence or absence of blood, other discharges, or electrolytes. Features patented technology which offers an accuracy rate evaluated at 97.5%. User friendly, its display screen is large and easy to read. The action of the meter in the display corresponds exactly to the tactile sensation of using the file. Other features include: slim, lightweight file holder, no zero-adjustment, automatic calibration, battery power indication, and automatic power off function.

330-245336392 Each **\$1242.75**

Root ZX II with OTR Handpiece Module

The OTR Module enables the unit to function as a low speed handpiece, apex locator, or a combination of both. The module snaps easily onto the back of the unit and offers a unique 90° auto torque release and file advancement feature. OTR maintains excellent cutting efficiency with less stress on the file, reducing the possibility of breakage. It offers 3 speed settings of 100, 300 and 500 rpm and 3 programmable memory modes. 1 year warranty.

330-245361257 Each..... **\$1647.95**

Probe Cord

330-24107041 Each..... **\$53.25**

File Holders

330-24107042 5/pkg **\$144.45**

Lip Clips

330-24107043 5/pkg. **\$64.45**

OBTURATION DEVICES & SYSTEMS



Elements Diagnostic Unit and Apex Locator - Kerr Endodontics

Apex locator and pulp tester featuring convenient portable satellite display with graphics. Provides accurate readings in the presence of EDTA, sodium hypochlorite, blood, saline, water and hydrogen peroxide. Adjustable volume and sound modes. Provides pain-free electric vitality testing. File clip and bifurcated probe are included.

330-9730300 Each..... **\$1720.95**



Elements Obturation Unit® - Kerr Endodontics

When you're obturating a root canal system, you want to ensure the fill is accomplished predictably, efficiently and accurately. The newly designed elements obturation unit incorporates advanced technologies involving software, metallurgy, electronics and industrial design with the best elements of system B and a patent-pending motorized extruder. From down-pack to backfill, from filling lateral canals to creating post spaces, the elements obturation unit puts the continuous wave of condensation technique in one simple-to-operate device. Consistent, reliable results made easy – all from a unit that takes up only 1/3 the space of two separate machines.

770-9730322 Each..... **\$3364.45**



ElementsFree System - Kerr Endodontics

For warm vertical obturation, the cordless ElementsFree system combines a breakthrough Downpack heat source with a world class Backfill extruder. System includes a Downpack and Backfill device, dual charging base, transformer, power cord and accessories.

ElementsFree Backfill Type B with Single Charging Base

770-9730504 Each..... **\$1664.45**

ElementsFree System Type B with Dual Charging Base

770-9730500 Each..... **\$2797.25**



Soft-Core™ - Kerr Endodontics

Carrier-based obturator. 30% thinner, allowing greater flexibility to navigate curved canals. Thinner core means more gutta percha for denser fills every time. One universal taper size to reduce and simplify your carrier inventory.

339-9723002 Each..... **\$183.45**

Soft-Core Obturators

Size	
#20.....	339-9723020
#25.....	339-9723025
#30.....	339-9723030
#35.....	339-9723035
#40.....	339-9723040
#45.....	339-9723045
#50.....	339-9723050
#55.....	339-9723055
#60.....	339-9723060
6/pkg.	\$51.45

Size	
#20.....	339-9723120
#25.....	339-9723125
#30.....	339-9723130
#35.....	339-9723135
#40.....	339-9723140
#45.....	339-9723145
#50.....	339-9723150
#55.....	339-9723155
#60.....	339-9723160
36/pkg.	\$263.45

Soft-Core Size Verifiers

Size	
#20.....	339-9723220
#25.....	339-9723225
#30.....	339-9723230
#35.....	339-9723235
#40.....	339-9723240
#45.....	339-9723245
#50.....	339-9723250
#55.....	339-9723255
#60.....	339-9723260
6/pkg.	\$23.95



Touch'N Heat - Kerr Endodontics

Conveniently and consistently puts the heat on for warm gutta percha techniques. The patented autoclavable tips are internally heated so that the heat is concentrated at the end where it's needed most.

Touch 'n Heat 5004 Unit, 110v

339-9730212 Each..... **\$1271.75**

Heat Carries and Tips

Standard Anterior Heat Carrier...	339-9730214
Standard Posterior Heat Carrier .	339-9730215
Narrow Anterior Heat Carrier	339-9730216
Narrow Posterior Heat Carrier ...	339-9730217
Spoon Tip	339-9730218
Plugger, Thick Tip (1mm)	339-9730220
Plugger, Thin Tip (.5mm)	339-9730221
Each	\$109.95

Hot PulpTest Tip

339-9730219 Each..... **\$160.25**

ORGANIZERS & ACCESSORIES



Endo-Aid Organizer Kits

Fits all finger sizes and can be used for the right or left hand. Measures files up to 30mm. Organizer ring is autoclavable. Do not reuse foam refill.

Kit

Contains: 1-Ring Organizer, 25-Lavender triangular foam refills and 25-Teal triangular foam refills.

330-10001 Kit..... **\$89.95**

Triangular Foam Refills

Lavender	330-10002
Teal.....	330-10003
50/bag	\$61.95



Endo Clean Stand - Dentsply Maillefer

Constructed of high-heat resistant, autoclavable plastic, this multipurpose mini-organizer is useful for cleaning, sterilizing and staging, or for transferring instrument from assistant to doctor. The new, thicker sponge insert can be sterilized and reused three to four times.

Round - Black
338-671682 Each..... \$17.95

Round Sponge Refill
338-671683 25/pack\$14.75

Oval - Black
338-671678 Each..... \$22.45

Oval Sponge Refill
338-671600 25/pack\$16.95



Endo Container - Dentsply Maillefer

Holds and organizes gutta-percha, paper points and Densfil obturators while easily identifying materials according to ISO standard colored tubes.

338-671395 Each..... \$42.25



Endo-M-Block™ - Dentsply Maillefer

Stainless steel measuring block with 42 depth guides.

338-671676 Each.....\$102.45



Endo Stand with Insert - Dentsply Maillefer

Keeps up to 40 files, hedstroms and reamers close at hand with a stand constructed of autoclavable aluminum with a stainless steel container.

338-671681 Each..... \$62.95



FileMate Measuring Block - Dentsply Maillefer

Plastic measuring device with 32 depth guides, including half sizes. Autoclavable.

338-671677 Each..... \$34.25



Sure-Stop® Dispenser - Dentsply Maillefer

Deposits a single stop into a specially designed well for easy placement onto the instrument shaft.

Blue 338-671673
Black..... 338-671674
Yellow..... 338-671672
200/box \$26.95



Finger & Thumb Rulers - Integra® Miltex®

Finger Ruler
Left-Handed for use on right hand.... 336-25711
Right-Handed for use on left hand.... 336-25710

Thumb Ruler
Left-Handed for use on right hand.... 336-25713
Right-Handed for use on left hand.... 336-25712
Each \$18.75



Endoring® II - Jordco, Inc.

Enables the clinician to directly place, store, measure and clean endodontic hand and rotary instruments within the operating field.

Starter Kit
Contains: 1 blue assembly, 1 e-Foam insert combo pack (48 inserts) and 2 single-use Gelwells.
330-ERK2S Kit..... \$93.25

Kit with Metal Ruler
Contains: 1 blue assembly, 1 standard metal ruler, 6 e-Foam inserts and 4 single-use Gelwells.
330-ER2S Each..... \$45.75

Endoring II Ruler
Autoclavable anodized blue aluminum detachable ruler with contrasting white laser-etched scales in 1mm and 1/2mm increments. Can be used by right and left-handed users.
330-ERRS Each..... \$32.75

Combo Pack - without Inserts
Contains: 24 yellow, 24 blue.
330-ERFS Pack\$31.45

Yellow
330-ERFYS 48/pack\$31.45

Blue
330-ERFBS 48/pack\$31.45



EndoRing - Kerr Endodontics

A convenient way to hold endodontic instruments and canal lubricant during a procedure. Features easy-to-read ruler with rubber stop port, allowing quick measurements up to 3mm for both right and left handed clinicians. Autoclavable.

Kit
Contains: 1 EndoRing measuring device w/3 sizes of rings, 1 non-disposable Gel Well, 4 disposable Gel Wells, 3 foam inserts.
339-8250049 Kit..... \$89.25

Foam Inserts
339-8250050 48/pack\$61.25

Disposable Gel Wells
339-8250051 24/pack \$43.75



Endo Stops - Integra® Miltex®

Silicone rubber. Round, sterilizable to 180° C. Assorted ISO colors.

Blue	330-ESRBU
Red	330-ESRRD
Yellow.....	330-ESRYL
100/pkg.	\$7.75

Assorted Colors	330-ESRAST
100/pkg	\$8.25

Additional colors available upon request.



Endo Clean Stand - Plasdent Corporation

Autoclavable 250°F.

White	330-400ES1
Blue.....	330-400ES2
Each	\$6.75



Endo Foam Inserts - Plasdent Corporation

Disposable foam inserts.

Triangle - White	
330-EF11	48/bag..... \$11.25

Round - Blue	
330-EFIR2	48/bag..... \$11.25

Endo Management Systems - Zirc

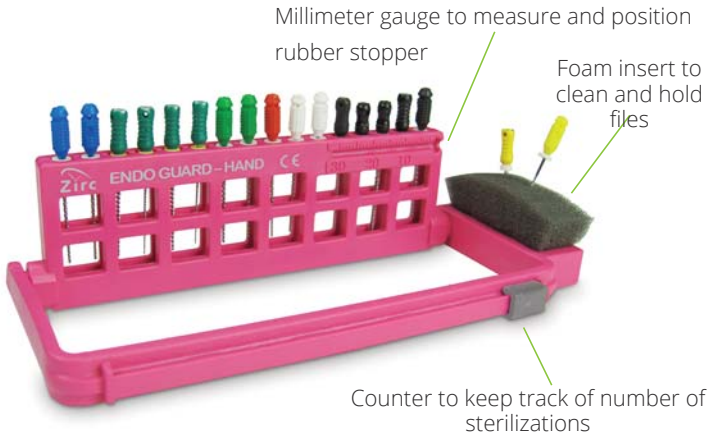

Millimeter gauge to measure and position rubber stopper

Foam insert to clean and hold files

Counter to keep track of number of sterilizations



Endo Assist™

Built-in-millimeter gauge measures files and positions rubber stopper. For right and left hand use. Small and large rings are included to accommodate most finger sizes. Designed to slide into side of the hand or engine endo guard. Single use foam insert cleans/holds files (packaged with 12). Anti-microbial protection. Autoclavable. Available in all colors.

590-50Z460_	Each	\$25.25
-------------	------------	----------------

Endo Guards

Holds most lengths for staging, cleaning, sterilizing files and reamers. Millimeter gauge measures files and positions rubber stopper. Right or left hand use. Single foam insert cleans and holds files. Sterilization counter on locking bar tracks number of times instruments have been sterilized. Contains antimicrobial protection.

Steri-Endo Guard - Engine

Organizes up to 11 engine and 5 hand files/reamers. Dimensions: 13.65cm x .95cm x 5.56cm. Available in all colors.

590-50Z452_	12/pkg.....	\$29.95
-------------	-------------	----------------

Steri-Endo Guard - Hand

Organizes up to 16 hand files/reamers. Dimensions: 13.65cm x .95cm x 5.56cm. Available in all colors.

590-50Z450_	12/pkg.....	\$29.95
-------------	-------------	----------------



Foam Inserts

Foam refills for use with Endo Guards and Endo Assist. Single use/disposable.

590-50Z451	48/pack	\$29.45
590-50Z451V	144/pack	\$59.95





High Volume Evacuation Tips

These disposable HVE tips fit all standard evacuator hose ends and have no sharp edges to maximize patient comfort. Available in vented, non-vented, and combo tip. Not made with natural rubber latex.

Vented/Combo

540-HT1050 50/bag.....\$5.95

Non-Vented

540-HT2050 50/bag.....\$3.45

Combo Tip

540-HT30100 100/bag.....\$6.75



Combo-Tip® - Crosstex International

Unique "S" tip design which eliminates any sharp edges for maximum patient comfort. Two tips in one - vented end on one side/non-vented end on the other.

White.

540-ZET 100/bag..... \$9.75



MaxVac Plus Combo Tip

Blue..... 540-ZETMVBL
 Green..... 540-ZETMVGR
 Pink 540-ZETMVPK
 Purple 540-ZETMVLV
 Yellow..... 540-ZETMVYE
 100/bag \$7.45

Assorted

540-MAXVACPLUS 1000/bag..... \$64.25



Monoject™ Evacuator Tips - Covidien Products by Medtronic

Disposable with beveled tip.
 540-443009 100/pkg..... \$23.75

Order by ☎ 800-626-2163



BeeSure Comfy High Volume Evacuator Tips - EcoBee

Cushioned edge to reduce the risk of lacerating oral tissue. Vented to cover wider evacuation area and reduce unnecessary tissue grab. Strong rigid tubing. Fits standard 11mm suction holders. Made with 30% recycled plastic.

540-BE306 100/pkg..... \$5.95



E-VacTips - Evac Corporation

Prevents plugs while evacuating near soft or loose oral tissue. Fits all standard plastic and metal evacuation tubes.

540-EVIP 100/bag\$21.45



M.A.S.S. Multi-Axis Spiral Suction HVE Tips - Ghost Mfg

Prevents tissue draw-in, allows for continuous suction even if the end of the tip is occluded and serves the function of both an HVE tip and a saliva ejector. Offers a better ergonomic hand position for assistants, a better field of view for both dentist and assistant, has a rigid barrel wall to allow for soft tissue retraction, has a rounded edge to prevent possible tissue trauma and is quieter than traditional HVE tips.

540-MAHVE2B 100/bag..... \$14.95



HVE Disposable Oral Angulated Aspirator Tips - Heraeus Kulzer

540-99100 100/pkg..... \$75.95



R-1 Reusable HVETips - Keystone Industries

Autoclavable plastic high-volume tips.
 540-R1 Each..... \$2.95



Tip-A-Dilly - Pelton & Crane Complete Kit

Contains: Tip-A-Dilly and 200 tips.
 540-TADKIT Kit.....\$118.75

Refill Tips

540-TADTIPS 200/pack \$17.50



Orajet™ Oral Evacuator Tip Inserts - Plasdent Corporation

Non-vented tip, bendable. White.
 540-8015 100/pkg \$4.75



Hi-Vac Combo Oral Evacuator Tips - Plasdent Corporation

Vented and non-vented side. 5 assorted colors: blue, green, yellow, pink and purple.
 540-8008C 100/pkg \$6.75



SPECTRUM™ Oral Evacuator Tips - Plasdent Corporation

Vented, bendable. 7 assorted neon colors.
 540-8018C 100/pkg \$11.95



Ultra-Vac™ - Young Dental

Autoclavable plastic high volume evacuator tips with vented and non-vented ends. Thick walled design provides excellent cheek retraction.
 540-076125 25/bag..... \$33.45

HIGH VOLUME EVACUATION TIPS



Vent-O-Vac™ - Young Dental

Disposable, high volume evacuator made with a soft touch plastic designed to protect soft tissue. Unique side vents and "S" curved edges minimize chance of soft tissue lock.

3-1/4" Long - One End Vented

540-078210 100/pkg..... **\$26.75**

5" Long - Both Ends Vented

540-078110 100/pkg..... **\$34.75**



Monoject™ Disposable Saliva Ejectors #450 - Covidien Products by Medtronic

Clear/blue tip.
540-450004 250/bag..... **\$22.45**



Advantage Saliva Ejectors - Crosstex International

Provides optimal suction without aspirating tissue. Soft, non-removable tip - bonded to the tube for maximum patient safety.

Blue with Blue Tip..... 540-ZBBI
Clear with Blue Tip 540-ZCBI
White with White Tip 540-ZWWI
Clear with Clear Tip..... 540-ZCCI
100/bag **\$6.45**



Comfort Plus™ Premium Saliva Ejectors - Crosstex International

Patented tip reduces patient discomfort. Optimizes fluid removal and minimizes trauma to mucosal tissue. Prevents tissue from blocking suction.

White/White 540-ZWWCP
Clear/White 540-ZCWCP
Bubblegum Scented White/Pink 540-ZWPCBG
Mint Scent White/Green 540-ZWGCPM
100/bag **\$7.45**



Premium® Saliva Ejectors - Crosstex International

Provides optimal suction without aspirating tissue. Soft, non-removable tip. Bonded to the tube for maximum patient safety.

Pink/Pink..... 540-ZPP
Clear/Blue..... 540-ZCB
Clear/White 540-ZCW
White/White 540-ZWW
Multi Color..... 540-ZCMC
100/bag **\$8.45**



BeeSure Saliva Ejectors - EcoBee

Iron wire reinforced tubing making it easily bendable and able to hold its shape. Made with 30% recycled plastic.

Green with White Tip.
540-BE201 100/bag..... **\$4.95**



Formeject - George Otis Company

Plastic formable tubes complete with cushion tips.
540-FORM 100/bag..... **\$22.95**



Mirro-Vac - IndiGreen Innovations

Combines evacuator and mirror functions into one efficient instrument. Ideal for sealants, air abrasion, bonding and other dry field procedures. Upper suction inlet relieves tissue grab and ensures anti-fog acrylic mirror stays clear—even under direct exhalation. Size 4 lens with 35° inclination delivers standard mouth mirror feel and function without compromise. 6" long, fully disposable.

540-10111 50/bag..... **\$28.95**

SALIVA EJECTORS



Disposable Saliva Ejectors

Provide optimal suction while minimizing tissue impingement and have excellent pliability to hold shape. Fits all standard saliva ejector hose ends. Available in white with white tip and clear with blue tip.

White/White

540-HT100WW2 100/bag..... **\$4.95**

Clear/Blue

540-HT100CB2 100/bag..... **\$4.95**



Comfi-Tip Foam Tips - Almore International

The simple solution to blocked suction, tissue grab, micro laceration, and unpleasant pressure.

540-15508 100/pack..... **\$35.75**



Hygoformic Saliva Ejectors - Crosstex International

Unique coil design is adjustable for maximum patient comfort. Smooth edges eliminate irritation - ideal for patients with sensitive tissue. Biodegradable.

White

540-ZFF 100/bag..... **\$9.75**

Hygoformic Adapters - Clear

540-ZFFAD 10/bag..... **\$12.25**



Total Comfort SoftTip Aspirators - IndiGreen Innovations

Feature cushioned, flexible, patient-friendly tips. Tested and proven to be gentle on soft tissue and bone, also reduces soft tissue aspiration. Elastic tips are securely bonded for safety. 100% non-latex. 6" long.

Clear Tubing

Blue Tip 540-1161CLE
Clear Tip 540-11610

White Tubing

Blue Tip 540-11611
Clear Tip 540-11610WHI
100/bag **\$10.25**



Flexo® Disposable Saliva Ejectors - Keystone Industries

Flexible hygienic saliva ejectors that will adapt to any mouth. They maintain their shape and do not collapse when bent.

Clear Removable Tip

Clear 540-1662214
100/pkg **\$9.25**

White Fixed Tip

Clear 540-1662215
Blue 540-1662216
Green 540-1662218
Red 540-1662219
Yellow 540-1662217
100/pkg **\$9.25**

Rainbow Pack

Contains: 200 fixed tip saliva ejectors of each color.

540-1662213 1000/pkg **\$73.75**



SafeBasics Saliva Ejectors - Medicom®

Provides optimal suction while maintaining its shape to help you work efficiently and easily.

Classic Clear with Blue Tip 540-700
Clear with White Tip 540-701
White with White Tip 540-703
Clear Blue with Blue Tip 540-710
Clear Pink with Pink Tip 540-711
Clear Lavender with Lavender Tip .. 540-712
105/bag **\$5.25**

Scented

Uses the latest in flavor technology through the infusion of essential oils into the plastic resin.

Mint Scented

Green w/Green Tip 540-713

Strawberry Scented

Pink w/Pink Tip 540-714
105/bag **\$6.25**



Dentapops - Primotec, Inc.

A dry field aspirator, tongue deflector and mouth prop all in one. Provides a moisture-free environment inside the mouth for almost any dental procedure. Universal fit for either side of the mouth and one size fits all.

Introductory Pack available upon request.

50 Pack

Includes: 50 Dentapops and 50 -3.5" Low-Vac Extension Tubes.

540-405 Pack **\$68.75**

100 Pack

Includes: 100 Dentapops and 100 -3.5" Low-Vac Extension Tubes.

540-410 Pack **\$108.75**

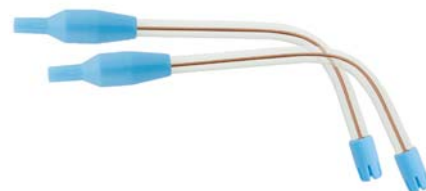

Safe-Flo Saliva Ejectors - RJC Products LLC

Made up of a flexible aspirator tip and a one-way check valve. When the On/Off vacuum switch is opened, the vacuum system sucks air through the check valve and the aspirator tip. The check valve opens in the direction of air and fluid flow. Once the suction is stopped or blocked, the check valve closes and stops air and fluid from returning to the saliva ejector or the patient.

Clear 540-M1001CLBU
White 540-M1000WHBU
100/bag **\$44.75**

Safe-Flo SE Valves

One-way check valve.
540-M1010SUSE 100/bag **\$33.25**



Saliva Ejectors - TIDI Products, LLC

Contains copper-plated wire, molded in, allowing them to bend easily and then hold their shape. Smooth tips are securely fastened. 6" long.

White with White Tip

540-9306 100/bag **\$6.45**

Clear with Blue Tip

540-9307 100/bag **\$6.45**



Lingua-Fix® Saliva Ejectors - Zirc

A disposable saliva ejector device that isolates and protects the tongue and evacuates fluids, while maintaining a dry work area. Comfortable, no sharp edges or corners. Large suction surface avoids blockage and is more comfortable. Reduces sedimentation of drilling by-products in pipes and tubing. Made in USA.

540-50Z953S 10/pack **\$14.95**
540-50Z953 50/pack **\$53.95**

SALIVA EJECTORS



SE-Cushion - Zirc

Single use only. Used in conjunction with the saliva ejector to prevent tissue grabbing and tissue irritation. Also quiets the noise of suction.

540-50Z970 100/pack..... **\$24.45**



Mr. Thirsty One-Step - Zirc

A clear and unobstructed view creating the ideal working environment. Hands-free isolation. Hygienists will be performing in a less active workspace, significantly improving their motion of economy and are able to work without stopping repeatedly to use the saliva ejector. 100% disposable. Made in USA.

Trial Kit

Contains: 5 Pedo/Small Adult and 5 Medium/Large.

540-50Z987 Kit..... **\$34.25**

Comfort Kit

Lightweight tubing and flow-control valve makes this, or existing HVE, more comfortable for the patient by reducing the amount of weight near the mouth.

Contains: 1 rotary plastic HVE Valve and 6' lightweight tubing.

540-50Z992 Kit..... **\$64.95**



25 Packs

Pedo/Small Adult..... 540-50Z986SM
Medium/Large..... 540-50Z986LG
Each **\$68.95**

100 Packs

Pedo/Small Adult..... 540-50Z986SMB
Medium/Large..... 540-50Z986LGB
Each **\$223.95**

SURGICAL ASPIRATOR TIPS

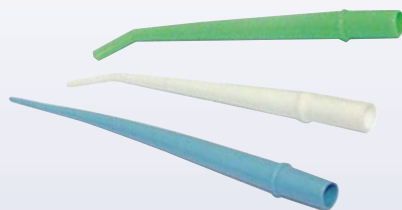

Surgical Aspirator Tips

Made of durable, high quality polyethylene with a 30° angle. Designed to fit all HVE systems. Autoclavable.

Small 1/16" Blue

540-HT5025B 25/bag..... **\$12.25**

Standard 1/8" White

540-HT5025W 25/bag..... **\$12.25**

Large 1/4" Green

540-HT5025G 25/bag..... **\$12.25**

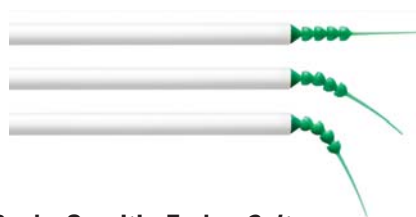

Roeko Surgitip-Endo - Coltene

Specially designed tip provides multi-directional flexibility. Tip flexibility offers fast and effective aspiration. Manufactured in clean room to EN ISO 14644. Tip inner diameter of 0.35mm for better canal access.

540-60018280 20/pkg **\$43.95**



Monoject Aspirator Tips #444 - Covidien Products by Medtronic

Surgical tips, sterile, disposable and individually packed.

540-444015 25/box **\$26.25**



OraVac Vented Evacuation Tips - Plasdent Corporation

Extra rigid HVE surgical aspirator tips. Disposable. White Plastic. 6" long.

540-8018 100/pkg **\$8.25**



Surgical Aspirators - Quality Aspirators

540-15P2A 2.5mm..... **\$32.25**
540-15P3A 3.0mm..... **\$29.95**
540-16RSA 4.0mm..... **\$29.95**



Surg-O-Vac Tips - Young Dental

Autoclavable polypropylene. Tip angled 30° 6-1/2" length. Fits all high volume evacuation systems.

White 3mm..... 540-077125
Green 6mm..... 540-077225
Blue 9mm..... 540-077325
25/pkg **\$27.75**

Vented

Blue 9mm..... 540-077425
25/pkg **\$27.75**

EVACUATION SYSTEM CLEANERS



Evacuation System Cleaner

Bacteria based cleaner works throughout the entire vacuum system – uses 6 natural bacteria. Residual bacterial action. Convenient meter dose bottle. Concentrated – 1 ounce makes 1 gallon working solution. Neutral pH so it is safe for use in amalgam separators. Virtually non-foaming. Pleasant scent. Environmentally safe.

550-00001 64oz..... **\$20.95**



Monarch™ CleanStream Evacuation System Cleaner - Air Techniques

Designed for daily cleaning, unique formulation penetrates and helps remove line buildup, increasing vacuum performance and suction. Non-foaming, highly effective, concentrated formula is environmentally friendly and completely biodegradable.

Starter Kit

Contains: 2 -120 ml (4oz.) and 1 dispenser.
Kit treats up to 12 operatories.
550-57660 Kit..... **\$77.95**

Refill

550-57850 2.5 liter bottle **\$74.95**

Dispenser System available upon request.



EZ 1-2-3™ Atomizer - Biotrol

Developed to deliver Vacusol Ultra or NeutraVAC solution by drawing a combination of air and liquid simultaneously, the way dental pumps were made to function. Simply attach the High Volume Evacuators (HVEs) onto the two HVE adapters and the saliva ejector into the remaining adapter, turn on the vacuum pump, and open the HVEs and saliva ejector valves.

550-ED592 Each..... **\$65.75**



NeutraVAC™ - Biotrol

A super-concentrated, pH balanced formula that dissolves and removes organic and inorganic debris in a dental evacuation system. Neutral formula is compatible with amalgam separators as well as your storage requirements and deodorizes with a clean mountain-fresh scent.

Starter Kit

Contains: 32oz. bottle, 1 EZ 1-2-3 Atomizer and accessories.
550-NV806 Kit..... **\$123.95**

Concentrate

550-NV800 32oz. **\$68.75**
550-NV803 96oz. **\$134.25**



Vacusol™ Ultra - Biotrol

A dental vacuum line cleaner and antimicrobial which helps prolong the life of your evacuation system. Mild, fresh scent.

Starter Kit

Contains: 32oz. solution and 1 EZ 1-2-3 Atomizer.
550-ED906 Kit..... **\$119.95**

Solution

550-ED900 32oz. bottle **\$68.95**
550-ED903 96oz. bottle **\$138.75**



SlugBuster™ - DentalEZ

Formula contains chelators, which help hold heavy metals, such as Mercury, in suspension, facilitating safer discharge to waste disposal.

Powder Pack Starter Kit

Contains: 2 -40oz. powder with scoop and one empty 2-gallon mixing jug.
550-900143 Kit..... **\$126.95**

Liquid Starter Pack available upon request.

Liquid Refill

550-900241 1 gallon..... **\$41.25**

Powder Refill

550-900146 40oz **\$41.25**



Fresh-Vac™ - Ecolab

Low foaming, enzymatic evacuation system cleaner. Loosens and helps eliminate organic material from evacuation lines keeping them free-flowing and fresh smelling. Effective in cold or warm water.

550-62410100 32oz **\$17.95**



Sani-Treet Green - Enzyme Industries, Inc.

Combines more concentrated cleaning power with new generation surfactants that biodegrade faster and more efficiently. Can be used in evacuation system cleaners, ultrasonic cleaners, for instrument pre-soak, and is compatible with amalgam separators.

550-7000 Gallon **\$73.45**

Unit Dose - Lemongrass Lavender Scent

Contains: 50 -1oz. packets.
550-7002 Each..... **\$66.45**



Sani-Treet Plus

Non-foaming, biodegradable, non-toxic, enzymatic concentrate designed for evacuation maintenance.

Mint Scent..... 550-15650
Country Meadow Scent..... 550-4200
Gallon **\$66.95**



SuperVac 40 Plus - EPR Industries LLC

Triple enzymatic, powerful, non-foaming, mint scent. Approved by Solmetex for use with their amalgam separator.

550-119536 64oz. **\$21.25**



SuperKleen 40 - EPR Industries LLC

Concentrated evacuation cleaner. Powerful, non-foaming, pleasant scent. Makes 32 gallons.
530-36 2lbs..... **\$25.45**

EVACUATION SYSTEM CLEANERS



VacuKleen E2™ Evacuation System Cleaner - Heraeus Kulzer

Protease enzyme with the convenience of a unit-dose effervescent powder. Lemon scented from real lemon extract.

Unit-Dose Pouches for Quarts

550-36100 60/box **\$79.45**
 550-36101 140/box **\$169.45**

Unit-Dose Pouches for Gallons

550-36102 25/box **\$75.75**



Turbo-Vac™ - Kerr TotalCare

Dispenser's unique design mixes air and Turbo-Vac solution to create a powerful, non-foaming, turbulent mist that dislodges debris from the walls of dental tubings, greatly improving vacuum performance.

Dispenser

550-5000 Each **\$48.25**

Line Flush

550-5050 Gallon **\$70.25**



E-VAC - L&R Ultrasonics

Premium quality, non-foaming, highly concentrated evacuation cleaner and sanitizer. Convenient premeasured pump dispensing bottle and handy E-VAC PAK is simple to use. 1oz. provides 1 quart of cleaning solution.

550-0107 Gallon **\$50.75**



Precision Cleanse Plus - Midmark Dental

Attacks and dissolves organic waste and other residue in the entire evacuation system to keep it thoroughly clean, naturally disinfected and deodorized.

550-77000570 64oz **\$63.25**



SURG Evacuation System Cleaner - Mydent International

Clinically proven to clean lines and discourage build-up. The formula is non-foaming, biodegradable, includes a germicide and has a neutral pH while maintaining the ability to dissolve organic matter and eliminate odors. Has a fresh winter-green fragrance. 128 treatments per gallon.

550-3500 Gallon **\$51.95**



Vacuum Shock - Palmero Health Care

The first stage in a 2-step tablet system. Keep vacuum lines clean and extend pump life. Only one time-released tablet every three months. Clinically proven to keep vacuum lines free of odor-causing bacteria.

550-3546 6/jar **\$38.75**



Vacuum Clean - Palmero Health Care

The second stage of a 2-step tablet system. Restores pressure, keeps vacuum lines clean, extends pump life. Use only one tablet each week. Neutral ph helps reduce dispersal of amalgam into sewer systems.

550-3547 45/jar **\$37.95**



Citrizyme® - Pascal International, Inc.

A dual enzyme solution for the cleaning of evacuation systems, instrument presoak and ultrasonic system solution. Completely dissolve organic material, getting rid of the "gray slime" that builds up in dental evacuation systems. Non-foaming. Will not damage evacuation system pumps.

Powder

Makes 35 gallons of solution.

530-15250 300gm **\$44.95**

Equals 420 treatments.

530-15270 900gm **\$96.75**

Unit-Dose Packets

Each packet makes 1/2 gallon of solution.

530-15260 50/box **\$50.25**

530-15275 250/box **\$193.45**



Vacu Blast™ - Premier® Dental

Anti-corrosive, non-foaming, phosphate and chlorine-free formula. Environmentally friendly with a neutral pH. Refreshing clean eucalyptus scent. Compatible with amalgam separators. Super concentrated formula yields 64 treatments per bottle.

550-9011107 32oz **\$54.95**



Vac Attak™ - Premier® Dental

Organic chlorine formula facilitates the immediate breakdown of protein chains found in bio-burden. Non-corrosive, non-foaming formula. Environmentally friendly. Fresh lemon scent. Provides approximately 100 uses per jar, scoop included. Made in the USA.

557-9011101 800gm **\$60.75**

EVACUATION SYSTEM CLEANERS



Bio-Pure - Sable Industries, Inc.

Restores and maintains evacuation system flow and function by actively breaking down and digesting organic waste. Non-foaming, non-corrosive neutral pH. Removes odor and sludge. Amalgam collector approved.

Restore Starter Kit available upon request.

Powder

- 550-2801002 14oz **\$89.95**
- 550-2801003 48oz **\$277.75**

Liquid

- 550-2801402 32oz **\$77.45**



Purevac® - Sultan Healthcare

Dissolves bacteria laden debris, fluoride gels and impression materials. Non-foaming, lemon scented and safe for all HVE systems.

2 Liters with Pump

- 550-21113 Each..... **\$66.95**

Clinic Pack

- 550-21115 5 liters..... **\$141.75**

Walk-about Measuring and Dispensing Unit

- 550-2116 Each..... **\$99.75**



Purevac® SC Evacuation System Cleaner - Sultan Healthcare

Formulated specifically for systems with amalgam separators with a near neutral range pH (9.4 pH at concentrate) complies with EPA and Solmetex (Amalgam Separators) specs. Provides effective daily cleaning. Non-foaming, super concentrated 1oz. per 1 quart dilution provides effective evacuation system cleaning.

- 550-21132 2 liter bottle **\$71.95**
- 550-21135 5 liter bottle w/pump..... **\$150.95**

EVACUATION TRAPS

Dispos-A-Trap™ - Kerr TotalCare

Totally disposable filter designed to replace the present trap filter in your evacuation unit. It reduces the possibility of infection and contamination. It improves the performance of your suction system and reduces infectious aerosol. It does all this while eliminating one of the most hazardous and unpleasant tasks in the dental office, cleaning the waste that is present in your filter.



Model 5500 1-1/4" diameter

- Fits Adec, Cascade and Performer models.
- 560-5500 144/box **\$74.45**



Model 5501 2-1/8" diameter

- Fits Adec models with plastic canisters.
- 560-5501 144/box **\$74.45**



Model 5502 2-1/4" diameter

- Fits Adec models with metal canisters.
- 560-5502 144/box **\$74.45**



Model 5503 1-7/8" diameter

- Fits models by Belmont, Biotec, DentalEZ, Chayes, Dentech, Pelton & Crane, Prisma and other manufacturers.
- 560-5503 144/box **\$74.45**



Model 5505 2-15/16" diameter

- Fits Pelton & Crane Spirit with white plastic canisters.
- 560-5505 144/box **\$76.45**



Model 5506 2-15/16" diameter

- Fits DentalEZ models with black plastic filters.
- 560-5506 144/box **\$73.25**



Model 5508-S Universal

- Fits all saliva ejectors.
- 560-5508S 72/box **\$33.75**



Model 5509 1-1/2" diameter

- Fits Eurodent Models.
- 560-5509 144/box **\$76.45**



Model 5512 2-3/4" diameter

- Fits A-dec 500.
- 560-5512 144/box..... **\$74.75**



Model 6100-C Universal

- Fits most cuspidor units.
- 560-6100C 144/box **\$77.75**



Model 6200-C Universal

- Fits European units, older style U.S. units with openings 1/2" and less.
- 560-6200C 144/box **\$77.75**



Model 6400-C 1-5/8"

- Fits A-DEC Cascade, Performer Cuspidors.
- 560-6400C 144/box **\$77.75**

EVACUATION TRAPS



Evac-U-Trap™ - Kerr TotalCare

Model 2200

Fits Air Techniques - VacStar models, DentalEZ-1 and 2 hp single models. Ohmeda-Matrix - all models. Turbine Industries - WhirlVac models, plus a number of other models.

560-2200 12/box **\$116.25**

Model 2300

Fits DentalEZ-Dual models made after 1978. Some Dentsply MVS models.

560-2300 8/box **\$116.25**

Model 2400

Fits Dentsply - MVS .75, 1.5, 2.0 and 4.0 models, DentalEZ Dual models made before 1978.

560-2400 8/box **\$116.25**



Defend Trap-EZ - Mydent International

Disposable filters designed to replace the trap presently in your evacuation unit or cuspidor. They reduce the possibility of infection and contamination, while improving the performance of your evacuation system.

Model DT5501

Fits Adec models with black plastic canisters, plus newer models by Ampco, Belmont, DCI, Forest, Marus, MDT. Diameter 2-1/8".

560-DT5501 144/box **\$20.75**

Model DT5502

Fits Adec models with metal canisters. Diameter 2-15/16".

560-DT5502 144/box **\$20.75**

Model DT5503

Fits Ampco, Belmont, Biotec, Chayes, Dabi-Alante, Dansereau, DCI, Dental-EZ, Dentech, Forest, Knight, Pelton & Crane, Proma and others. Diameter 1-7/8".

560-DT5503 144/box **\$20.75**

Model DT5508S

Fits all saliva ejectors. Diameter Universal.

560-DT5508S 144/box **\$16.75**

Model DT5509

Fits DCI / Belmont Reality models, System 6000 models. Diameter 1-1/2".

560-DT5509 144/box **\$26.95**

Model DT6100C

Fits most cuspidor bowls including Adec, Ampco, Belmont, Dabi-Alante, Dansereau, DCI, Dental-EZ, Forest, Knight, Marus, MDT, Proma, and Ritter. Diameter Universal.

560-DT6100C 144/box **\$26.95**



Saliva Ejector Screens - Palmero Health Care

Disposable and aseptic. Keeps debris from being aspirated and lodged in the lines.

560-1602 25/bag **\$6.45**

560-1602A 50/bag **\$6.25**

560-1602C 75/bag **\$10.25**

560-1602B 100/bag **\$12.25**



Saliva Ejector Traps - Plasdent Corporation

560-8100 72/box **\$11.25**

Dispos-A-Screen® Traps - Zirc

Color-coded for easier identification. Includes anti-microbial product protection.



Mauve

1-1/4" OD. Fits Adec, Cascade and Performer models.

560-51Z080S 25/pkg **\$20.45**



Green

1-7/8" OD. Fits Ampco, Belmont, Biotec, Chayes, DCI, DentalEZ, Dentech, Forest, Knight, Pelton & Crane and others.

560-51Z123S 25/pkg **\$20.45**



Yellow

2-1/4" OD. Fits Adec model with metal canister.

560-51Z040S 25/pkg **\$20.45**



Blue

2-1/8" OD. Fits Adec models with black plastic canisters, plus newer models by Ampco, Belmont, DCI, Forest, Marus MDT and Schein.

560-51Z045S 25/pkg **\$20.45**

Additional models available upon request.

LOOK'in

for something? **WE HAVE IT!**

www.dhpionline.com

Kerr Dental offers a variety of NTI® Diamond Discs ideally suited for use on temporary bridge acrylic, ceramic, porcelain, metal, plaster and orthodontic stripping. NTI® Diamond Discs are premounted for concentricity. Recommended speed: 20,000 RPM. Sold Individually.

Double Sided



HEAD Ø 1/16 mm	160	190	190	220	220
THICKNESS (mm)	.17	.14	.17	.14	.17
Grit	Medium	Fine	Medium	Fine	Medium
Item Number	740-D911H160	740-D911HEF190	740-D911H190	740-D911HEF220	740-D911H220
Price	\$36.25	\$36.25	\$36.25	\$36.25	\$36.25

Single Sided: Safe Side Down

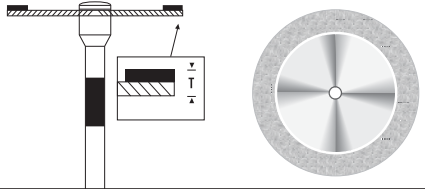

HEAD Ø 1/16 mm	220
THICKNESS (mm)	.20
Grit	Medium
Item Number	740-D911HD220
Price	\$36.25

Single Sided: Safe Side Up

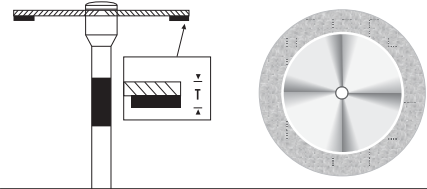

HEAD Ø 1/16 mm	220
THICKNESS (mm)	.20
Grit	Medium
Item Number	740-D911HU220
Price	\$31.45

Superflex
A super flexible diamond disc for separation and contouring of porcelain and composite veneers on anterior and posterior teeth.

Double Sided: Washer Support

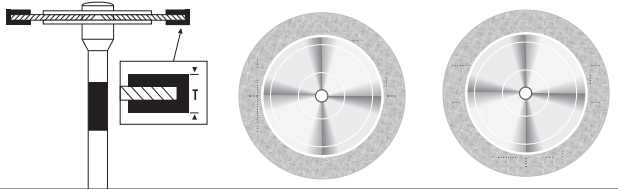

HEAD Ø 1/16 mm	220	220
THICKNESS (mm)	.17	.25
Grit	Medium	Coarse
Item Number	740-D911HF220	740-D911HF220C
Price	\$36.25	\$36.25

Double Sided: Wide

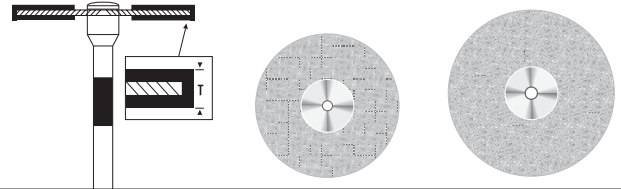

HEAD Ø 1/16 mm	190	220
THICKNESS (mm)	.15	.15
Grit	Medium	Medium
Item Number	740-D940190	740-D940220
Price	\$36.25	\$36.25

Double Sided: Perforated

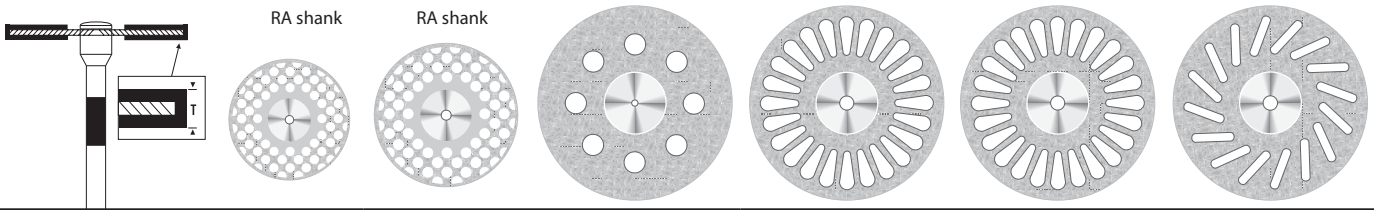

HEAD Ø 1/16 mm	160	190	220	220	220	220
THICKNESS (mm)	.15	.15	.30	.15	.25	.15
Grit	Super Fine	Super Fine	Coarse	Medium	Coarse	Medium
Item Number	740-D805EF160	740-D805EF190	740-D918PB220	740-D405220	740-D405220C	740-D605220
Price	\$30.95	\$30.95	\$39.75	\$36.25	\$36.25	\$36.25

Sold Individually.

Double Sided: Perforated

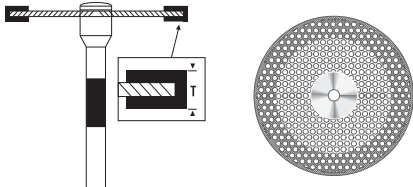

HEAD Ø 1/16 mm	220
THICKNESS (mm)	.20
Grit	Medium
Item Number	740-D934220
Price	\$39.75

Double Sided: Serrated



HEAD Ø 1/16 mm	190	220
THICKNESS (mm)	.15	.15
Grit	Medium	Medium
Item Number	740-D946190	740-D365220
Price	\$36.25	\$36.25

Turbo: Double Sided

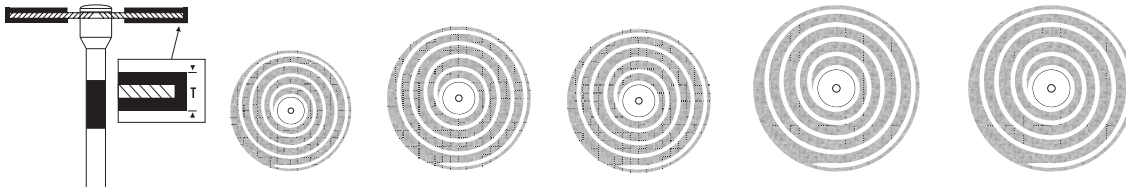

HEAD Ø 1/16 mm	160	190	190	220	220
THICKNESS (mm)	.14	.14	.17	.14	.17
Grit	Fine	Fine	Medium	Fine	Medium
Item Number	740-D911HEF160T	740-D911HEF190T	740-D940190T	740-D911HEF220T	740-D940220T
Price	\$43.95	\$43.95	\$43.95	\$43.95	\$43.95

Turbo Disc
Turbo Diamond Disc for use in a laboratory turbine for contouring interdenal spaces and cutting through ceramics.

Flex: Double Sided

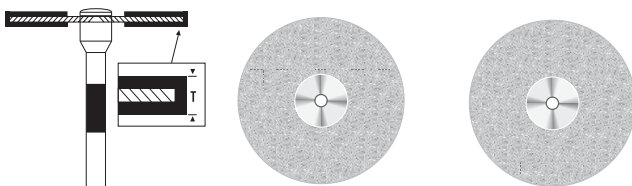

HEAD Ø 1/16 mm	220	220
THICKNESS (mm)	.20	.30
Grit	Medium	Coarse
Item Number	740-D345220	740-D9188220
Price	\$39.75	\$39.75

Disc Defender Lab Instrument Caddy

Holds up to (39) HP shank instruments or (10) diamond discs.



740-AB9101R..... **\$45.95**

Single Sided: Safe Side Down

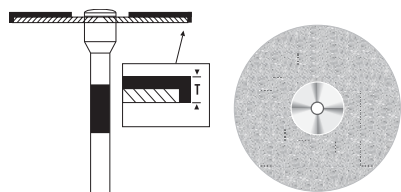

HEAD Ø 1/16 mm	220
THICKNESS (mm)	.20
Grit	Coarse
Item Number	740-D918220
Price	\$31.45

Single Sided: Safe Side Up

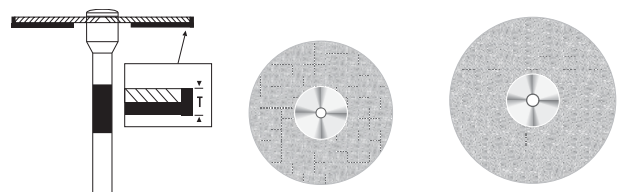

HEAD Ø 1/16 mm	190	220
THICKNESS (mm)	.20	.20
Grit	Coarse	Coarse
Item Number	740-D919190	740-D919220
Price	\$31.45	\$31.45

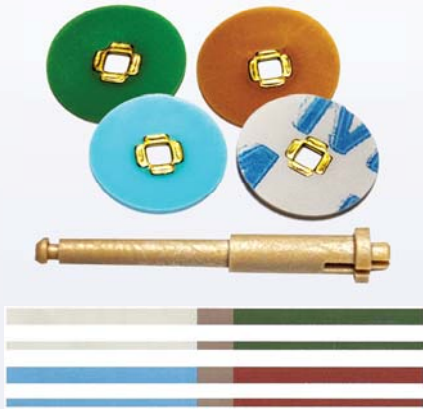

Composite Discs & Strips

Easy to use and can be used on all composites. Produces a smooth surface and gloss for natural, lifelike results.

Kit

Contains: 200 assorted discs, 50 strips, 2 mandrels.
740-10040 Kit.....\$98.95

Discs

3/8"

- Coarse - White740-10041
- Medium - Green.....740-10042
- Fine - Blue740-10043
- Superfine - Brown.....740-10044

1/2"

- Coarse - White740-10045
- Medium - Green.....740-10046
- Fine - Blue740-10047
- Superfine - Brown.....740-10048
- 100/pkg\$39.95

Mandrels

- RA740-10055
- HP740-10056
- 3/pkg\$17.45

Finishing & Polishing Strips

Regular

- Coarse/Medium.....740-10060
- Fine/Superfine.....740-10062

Narrow

- Coarse/Medium.....740-10061
- Fine/Superfine.....740-10063
- 100/pkg\$28.95



Sof-Lex™ Finishing & Polishing Systems - 3M Oral Care

Easy-to-use system allows creation of high-luster restorations that offer lifelike esthetics. Pop-on disc technology makes changing discs easier to save time and discs conform to the contours of the teeth for easier finishing and polishing.

Contains: 240 assorted contouring and polishing discs (30 of each size and grit), 240 assorted XT contouring and polishing discs (30 of each size and grit), 15 finishing strips-C/M (7" x 5/32"), 15 finishing strips narrow-C/M (7" x 5/64"), 15 polishing strips F/SF (7" x 5/32") and 1 RA Mandrel.
743-2385P Kit.....\$250.95



Sof-Lex Contouring and Polishing Kit

Contains: 240 assorted 3/8" & 1/2" discs, (30 each Coarse, Medium, Fine, and Superfine) and 1 RA Mandrel.
743-1980 Kit.....\$176.75

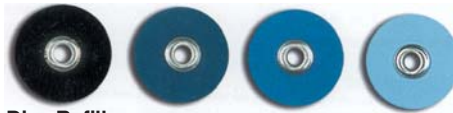

Disc Refills

3/8" Diameter

- Superfine - Light Blue.....743-1981SF
- Fine - Medium Blue743-1981F
- Medium - Dark Blue743-1981M
- Coarse - Black.....743-1981C

1/2" Diameter

- Superfine - Light Blue.....743-1982SF
- Fine - Medium Blue743-1982F
- Medium - Dark Blue743-1982M
- Coarse - Black.....743-1982C
- 85/box\$71.95



Sof-Lex Extra Thin Contouring & Polishing Kit

Allows for easier access to interproximal surfaces while offering a slightly stiffer disc. Extra thin profile for precise finishing and polishing in areas where access is a problem.

Contains: 240 assorted extra thin 3/8" & 1/2" discs (30 each Coarse, Medium, Fine, and Superfine) and 1 RA Mandrel.
743-2380 Kit.....\$176.45



Extra Thin Disc Refills

3/8" Diameter

- Superfine - Yellow.....743-2381SF
- Fine - Light Orange743-2381F
- Medium - Medium Orange ...743-2381M
- Coarse - Dark Orange.....743-2381C

1/2" Diameter

- Superfine - Yellow.....743-2382SF
- Fine - Light Orange.....743-2382F
- Medium - Medium Orange ...743-2382M
- Coarse - Dark Orange.....743-2382C
- 85/box\$75.75



Pop-On Mandrels

Low-profile mandrel design reduces risk of marring the restoration for easier use and improved results.

- Right Angle743-1983RA
- Handpiece743-1983HP
- Friction Grip743-1983FG
- 3/pkg.\$35.45



Square Eyelet Discs

Square brass centers for use with Moore-type mandrels. 0.625"

- Superfine - Light Blue.....743-1958SF
- Fine - Medium Blue743-1958F
- Medium - Dark Blue743-1958M
- Coarse - Black743-1958C
- 100/bag\$85.25



Sof-Lex Diamond Polishing System

Offers the convenience of a rubberized system while also adapting to all tooth surfaces.

The pre-polishing spiral prepares the restoration for final gloss, while the diamond-impregnated polishing spiral gives your restorations that gorgeous paste-like gloss, with no messy paste.

Unique, flexible shape adapts to all tooth surfaces. Multi-use, can be sterilized and reused.

Intro Kit

Contains: 5 beige pre-polishing spirals, 5 pink diamond polishing spirals and 1 RA mandrel.
740-50921 Kit.....\$28.95

Pre-Polishing Spiral Refills - Beige

740-5090 15/pkg\$38.45

Diamond Polishing Spiral Refills - Pink

740-5091 15/pkg.....\$51.45

RA Mandrels

743-1983RA 3/pkg\$34.95



Finishing & Polishing Discs - E.C. Moore Company

Snap on and off quickly and easily, with no screws to drop or lose. Can be used with the grit side in or out and won't come off with the reversal of the handpiece.

Coarse & X-Coarse: Gross reduction and shaping.

Medium: Less reduction, smoother finish.

Fine: Polishing, smoothing surfaces.

X-Fine: High polish, luster.

Cuttle: Gold, amalgams, proximal surfaces and wherever a satin finish polish is desired.

Garnet: Acrylic resins, general purpose.

Sand: Contouring, smoothing acrylics, gold.

Paper Disc/Brass Center

Cuttle

- 1/2"
 - Fine740-CF12
 - Medium.....740-CM12
 - Coarse740-CC12

- 5/8"
 - Fine.....740-CF58
 - Medium.....740-CM58
 - Coarse740-CC58

- 3/4"
 - Fine.....740-CF34
 - Medium.....740-CM34
 - Coarse740-CC34

- 7/8"
 - Coarse740-CC78

- Sand**
 - 1/2"
 - X-Fine740-SXF12
 - Fine.....740-SF12
 - Medium.....740-SM12
 - Coarse740-SC12

- 5/8"
 - X-Fine740-SXF58
 - Fine.....740-SF58
 - Medium.....740-SM58
 - Coarse740-SC58

- 3/4"
 - X-Fine740-SXF34
 - Fine.....740-SF34
 - Medium.....740-SM34
 - Coarse740-SC34

- 7/8"
 - Fine.....740-SF78
 - Medium.....740-SM78
 - Coarse740-SC78

- Garnet**
 - 1/2"
 - X-Fine740-GXF12
 - Fine.....740-GF12
 - Medium.....740-GM12
 - Coarse740-GC12

- 5/8"
 - X-Fine740-GXF58
 - Fine.....740-GF58
 - Medium.....740-GM58
 - Coarse740-GC58

- 3/4"
 - Fine.....740-GF34
 - Medium.....740-GM34
 - Coarse740-GC34

- 7/8"
 - Fine.....740-GF78
 - Medium.....740-GM78
 - Coarse740-GC78

- Emery**
 - 1/2"
 - Fine.....740-EF12
 - Coarse740-EC12

- 5/8"
 - Fine.....740-EF58
 - Medium.....740-EM58
 - Coarse740-EC58

- 3/4"
 - Fine.....740-EF34
 - Medium.....740-EM34
 - Coarse740-EC34

- 7/8"
 - Coarse740-EC78
 - 50/box \$3.25

Plastic Disc/Brass Center

- 1/2"
 - Fine.....740-PSF12
 - Medium.....740-PSM12
 - Coarse740-PSC12

- 5/8"
 - Fine.....740-PSF58
 - Medium.....740-PSM58
 - Coarse740-PSC58

- 3/4"
 - Fine.....740-PSF34
 - Medium.....740-PSM34
 - Coarse740-PSC34

- 7/8"
 - Medium.....740-PSM78
 - Coarse740-PSC78

- Garnet**
 - 1/2"
 - Fine.....740-PGF12
 - Medium.....740-PGM12
 - Coarse740-PGC12

- 5/8"
 - Fine.....740-PGF58
 - Medium.....740-PGM58
 - Coarse740-PGC58

- 3/4"
 - Fine.....740-PGF34
 - Medium.....740-PGM34
 - Coarse740-PGC34
 - 50/box \$5.45



Hatho Miniature Scotch Brite - Keystone Industries

Polish without ruining delicate anatomical surfaces on dental appliances. By using low speeds – around 5,000 rpm – and light pressure the acrylic should not overheat due to friction.

- Fine**
740-1670091 12/pack..... **\$24.75**
- Medium**
740-1670092 12/pack **\$24.75**
- Coarse**
740-1670016 12/pack..... **\$23.95**



Poli-Pro Discs® - Premier® Dental

Composite Polishing System, safe center protects composite surface. Thin and flexible conforms to tooth anatomy. Fast, systematic finishing and polishing. 4 color coded grits quickly slip on to supplied mandrel. Two sizes: 1/2" for greater efficiency, 5/16" for control in gingival areas.

Intro Kit
Contains: 180 discs; 20 each with 4 RA mandrels.
747-2019070 Kit..... **\$107.25**

Starter Kit
Contains: 35 assorted discs with 1 RA mandrel.
747-2019099 Kit..... **\$26.95**

- Disc Refills**
1/2"
Coarse, Black (Grit Up)747-2019071
Medium, Blue (Grit Up)747-2019073
Fine, Red (Double Sided)747-2019076
Extra-Fine, White (Double Sided) ..747-2019078
40/pack **\$21.75**

- 5/16"
Coarse, Black (Grit Up)747-2019072
Medium, Blue (Grit Up)747-2019075
Fine, Red (Double Sided).....747-2019077
Extra-Fine, White (Double Sided) ..747-2019079
40/pack **\$21.75**

RA Mandrels
747-2019090 4/pack **\$14.25**



Super-Snap Rainbow Technique - Shofu Dental Corporation

Designed for easy, fast and safe contouring, finishing and polishing of all microfilled and hybrid composites. Elastic silicone shank mount for easy placement. Manufactured without a metal center. Very flexible, ultra-thin disks allow easy access to interproximal areas.

Technique Kit
Contains: 20 disks, 20 mini-disks, 20 polystrips black/violet, 20 polystrips green/ red, 2 CA Dura-White Stones, 1 CA Composite Fine Midi-point, 2 CA mandrels.
740-0500 Kit..... **\$114.45**

Mini Kit
Contains: 32 standard disks, 16 mini disks, Composite Fine Midi-point, CA metal mandrel.
740-0505 Kit..... **\$34.75**

Refill Discs
Contouring Coarse - Black
Safe Side Down740-L506
Mini-Disk Safe Side Down.....740-L507
50/pack **\$27.75**

Finishing Medium - Violet
Safe Side Down740-L508
Safe Side Up740-L509
Mini-Disk Safe Side Down.....740-L522
50/pack **\$27.75**

Polishing Fine - Green
Double Sided740-L501
Mini-Disk Safe Side Down.....740-L519
50/pack **\$27.75**

Super Polishing Superfine - Red
Double Sided740-L502
Mini-Disk Double-Sided740-L521
50/pack **\$27.75**



Super-Snap® Singles Complete Package
Disposable, single patient use packages. Contains: 48 individual dose packages. Conveniently packaged with one disk of coarse, medium, fine and superfine grits, including mini-disks (L506, L507, L528, L522, L501, L519, L502, L521) and a Super-Snap plastic CA mandrel.
740-0501 Package **\$181.95**



Super-Snap X-Treme Ultra-Gloss
Advanced 3D semispherical surface coating. The semispherical shaped grit allows space to discharge around debris while polishing.

Performance Kits available upon request.

Disk Refills
Fine - Green740-L511
Superfine - Red740-L512
50/pack **\$26.75**

Mini Disc Refills
Fine - Green740-L531
Superfine - Red 740-L532
50/pack **\$26.95**



SuperBuff Discs - Shofu Dental Corporation
A paste impregnated disk designed for super polishing composite restorations without the use of added polishing paste. Suitable for super polishing all composite restorations.

SuperBuff Set available upon request.

Refills
740-0536 50/pack **\$44.75**

CA Mandrels
740-0439 6/pack **\$22.25**

LOOK'in
for something? **WE HAVE IT!**
www.dhpionline.com

FINISHING STRIPS



Diamond Strips

Fast cutting diamond strips are available in superfine, fine and medium grits in either perforated or non-perforated styles. 6" in length. Single-sided.

Regular

Superfine.....	740-10070
Fine.....	740-10071
Medium.....	740-10072
10/pkg.....	\$49.95

Perforated

Superfine.....	740-10073
Fine.....	740-10074
Medium.....	740-10075
10/pkg.....	\$49.95



Metal Strips - GC America

Interproximal trimming and finishing strips. Contains: 1 of each: 2.6mm extra coarse, 3.3mm extra coarse, 4.0mm extra coarse, 2.6mm coarse, 3.3mm coarse, 4.0mm coarse, 2.6mm medium, 3.3mm medium, 4.0mm medium, 2.6mm fine, 3.3mm fine and 4.0mm fine. 742-470912 12/pkg.....**\$106.25**

Refills

Extra Coarse #200 Mesh

A-Width 2.6mm Red.....	742-472112
B-Width 3.3mm Red.....	742-472212
C-Width 4.0mm Red.....	742-472312

Coarse #300 Mesh

A-Width 2.6mm Blue.....	742-473112
B-Width 3.3mm Blue.....	742-473212
C-Width 4.3mm Blue.....	742-473312

Medium #600 Mesh

A-Width 2.6mm Green.....	742-476112
B-Width 3.3mm Green.....	742-476212
C-Width 4.0mm Green.....	742-476312

Fine #1000 Mesh

A-Width 2.6mm Yellow.....	742-471112
B-Width 3.3mm Yellow.....	742-471212
C-Width 4.0mm Yellow.....	742-471312
12/pkg.....	\$106.25



Sof-Lex™ Finishing Strips - 3M Oral Care

Finishing, Coarse/Medium, Clear

7" x 5/32"	
743-1954	150/box..... \$55.75

Finishing, Coarse/Medium Narrow, Clear

7" x 5/64"	
743-1954N	100/box..... \$47.95

Finishing, Fine/Superfine, Yellow

7" x 5/32"	
743-1956	120/box..... \$53.95



EPILEX™ Finishing & Polishing Strips - GC America

No adhesive. Ensures a smooth surface finish without leaving a gummy deposit. Ultra-thin and flexible.

Introductory Package available upon request.

Refill Package - 10 Meter Reel

Extra Fine Orange.....	742-473041
Fine Gray.....	742-473031
Medium Green.....	742-473021
Coarse Blue.....	742-473011
Each.....	\$50.95

Translucent	
742-473001	Each..... \$49.25



Dual Alo #54 Strips - Integra® Miltex®

Narrow.....	746-87605
Wide.....	746-87615
Medium.....	746-87610
150/pkg.....	\$29.95



Lightning® Metal Strips - Integra® Miltex®

Made of resilient, high-strength material tough enough for the hardest porcelain or composite materials. Narrow width = 2.38mm, Medium width = 3.17mm, Wide width = 3.97mm.

Composites - Safe-Sided

Fine Narrow.....	746-81010
Fine Medium.....	746-81030
Fine Wide.....	746-81050
Medium Narrow.....	746-81070
Medium Medium.....	746-81090
Medium Wide.....	746-81110

Coarse Narrow.....	746-81130
Coarse Medium.....	746-81150
Coarse Wide.....	746-81170
Assorted.....	746-81190
10/tube.....	\$18.45

Open Center, Safe-Sided

Fine Narrow.....	746-81650
Fine Medium.....	746-81670
Fine Wide.....	746-81690
Medium Narrow.....	746-8171
Medium Medium.....	746-81730
Coarse Narrow.....	746-81770
Coarse Medium.....	746-81790
Coarse Wide.....	746-81810
Assorted Assorted.....	746-81830
Medium Assorted.....	746-81870
10/tube.....	\$20.75

Natural Dentition, Dual-Sided available upon request.



SmartStrip™ - Kerr Rotary

Easy interproximal reduction with one handed operation. Easy access to tight anterior and posterior spaces. Large grinding surface and improved working view. Autoclavable.

Single-Sided Assortment available upon request.

Single-Sided

0.08mm Superfine.....	740-SSSF
0.10mm Fine.....	740-SSF
0.14mm Medium.....	740-SSM
0.18mm Coarse.....	740-SSC
10/pkg.....	\$88.25

Double-Sided Assortment available upon request.

Double-Sided

0.18mm Superfine.....	740-SSSSF
0.20mm Fine.....	740-SSSF
0.22mm Medium.....	740-SSDSM
0.35mm Coarse.....	740-SSDSC
10/pkg.....	\$88.25

Curved Single-Sided Assortment available upon request.

Curved Single-Sided

0.08mm Superfine.....	740-SSCSF
0.10mm Fine.....	740-SSCF
0.14mm Medium.....	740-SSCM
0.18mm Coarse.....	740-SSCC
10/pkg.....	\$88.25

Serrated

0.05mm.....	740-SSSS
10/pkg.....	\$88.25

FINISHING STRIPS



HORICO Ribbon Saws One Sided - Pflingst & Company, Inc.

4mm
760-414 12/pack \$20.25

6mm
760-416 12/pack \$20.25



Compo-Strips® - Premier® Dental

One-sided diamond abrasive strips.

Assorted Strips747-2013127

100T, Blue747-2013107

150T, Blue747-2013109

100F, Red747-2013111

150F, Red747-2013113

100UF, Yellow747-2013115

150UF, Yellow747-2013117

6/tube \$33.95



Super-Snap Polystrips - Shofu Dental Corporation

Black/Violet, Coarse/Medium...740-L525

Green/Red, Fine/Superfine740-L526

100/pack \$30.95

MANDRELS



Brass Center - E.C. Moore Company

740-BC2RA #2 RA 6/pkg \$22.45

740-BC3RA #3 RA 6/pkg \$25.45



HP RA

Disc & Wheel - Integra® Miltex®

741-DM321RA RA 12/pkg..... \$19.95

741-DM321HP HP 12/pkg..... \$19.95



HP RA FG

Huey's Screw Head - Integra® Miltex®

741-DM303FG FG 12/pkg..... \$32.95

741-DM303RA RA 12/pkg..... \$19.95

741-DM303HP HP 12/pkg..... \$19.95



Large Head - Integra® Miltex®

5/16" Diameter

741-DM516HP HP 12/pkg..... \$22.75



Loma Linda Thin Head - Integra® Miltex®

741-DM350FG FG 12/pkg..... \$32.95

741-DM350HP HP 12/pkg..... \$32.95



Screw Head For Small Discs - Integra® Miltex®

741-DM3035RA RA 12/pkg..... \$19.95

741-DM3035HP HP 12/pkg..... \$19.95

LOOK'in

for something? **WE HAVE IT!**

www.dhpionline.com



Dentists' Favorite Assortment

Contains: 6 each: 0805, 0827, 0835, 4932, 4933, 4981, 5009, 5010, 5047, 5113, 5171, 5177, 5178, 5355, 5989, 5998, 5999. 2 each: 4302, 4304, 4323, 4572, 4573, 4602, 4604, 4623, 4772, 4773, 4872, 4873. 1 each: 4402, 4404, 4423, 4582, 4583, 4702, 4704, 4723, 4782, 4783, 4882, 4883, 5400, 5428, 5425. 740-1011 141/pkg.....\$112.75



MIDGETS		HP				RA				FG					
Rubberized Abrasives For Finishing & Polishing. 12/box - \$26.45															
		15		15		138		Mini		15		138		Mini	
	Brown - "long-lasting" for pre-finishing all metals	740-4862	740-4872	740-4873	740-4870	740-4882	740-4883	740-4880							
	Black - "coarsest" for carving amalgam and gold	740-4362	740-4372	740-4373	740-4370	740-4382	740-4383	740-4380							
	Green - traditional" for polishing amalgam and gold	740-4562	740-4572	740-4573	740-4570	740-4582	740-4583	740-4580							
	Blue - for final "hi-shine" polishing of all metals	740-4662	740-4672	740-4673	740-4670	740-4682	740-4683	740-4680							
	White - "Ultra-fine" for composites, enamel and gold	740-4762	740-4772	740-4773	740-4770	740-4782	740-4783	740-4780							

"GREEN GIANT" STONES															
HP								RA				FG			
12/box - \$19.95								12/box - \$24.75							
CN1	FL2	1C3	1C7	PC1	PC2	TC4	WH6	CN1	FL2	RD1	TC1	CN1	FL2	RD1	TC1
740-4223	740-4202	740-4215	740-4036	740-4040	740-4041	740-4044	740-4225	740-4323	740-4302	740-4304	740-4311	740-4423	740-4402	740-4404	740-4411

"WHITE ARKANSAS" STONES							
RA				FG			
12/box - \$24.75							
CN1	FL2	RD1	TC1	CN1	FL2	RD1	TC1
740-4623	740-4602	740-4604	740-4611	740-4723	740-4702	740-4704	740-4711

RUBBER POLISHING WHEELS			
Square-Edge		Knife-Edge	
5/8" x 1/16"	7/8" x 1/8"	5/8"	7/8"
White "Universal"			
740-7101	740-7103	740-7107	740-7109
12/box - \$12.45		12/box - \$12.45	
Green "All Purpose"			
740-5021	740-5001	740-4951	740-4950
100/box - \$26.45		100/box - \$30.95	
Blue "Hi-glaze"			
740-5024	740-5004	740-4961	740-4960
100/box - \$26.45		100/box - \$30.95	
"White Flexies"			
740-5029	740-5009	740-4981	740-4980
100/box - \$29.95		100/box - \$36.75	

SPECIALTIES FOR ACRYLIC - HP						
White Acrylic Trimmers					Touch-up Points	
5/box - \$33.25					\$34.95	12/box - \$42.95
1	2	4	5	113	Assort.	15L
740-5101	740-5102	740-5104	740-5105	740-5106	740-5100	740-5114



“HI-GLAZE” DIAMOND PORCELAIN POLISHERS

3-step diamond-filled silicone rubber system for adjusting, smoothing and brilliant “hi-glaze” polishing of porcelain, zirconium & e.max. Eliminates the need for polishing paste or reglazing.

PRE-POLISHING

HP			RA			FG				
1" Wheel 740-1101	1" Knife-Edge 740-1102	11/16" Wheel 740-1112	Point 740-1103	Knife 740-1104	Wheel 740-1105	Point 740-1106	Mini 740-1107	Cup 740-1108	Knife 740-1109	Mini 740-1110
\$53.95 Each			\$37.25 Each			\$43.25 3/box				

REFINING

HP			RA			FG				
1" Wheel 740-1121	1" Knife-Edge 740-1122	11/16" Wheel 740-1132	Point 740-1123	Knife 740-1124	Wheel 740-1125	Point 740-1126	Mini 740-1127	Cup 740-1128	Knife 740-1129	Mini 740-1130
\$53.95 Each			\$37.25 Each			\$43.25 3/box				

RESTORING “HI-GLAZE” LUSTRE

HP			RA			FG				
1" Wheel 740-1141	1" Knife-Edge 740-1142	11/16" Wheel 740-1152	Point 740-1143	Knife 740-1144	Wheel 740-1145	Point 740-1146	Mini 740-1147	Cup 740-1148	Knife 740-1149	Mini 740-1150
\$53.95 Each			\$37.75 Each			\$43.25 3/box				



DIAMOND POLISHING KITS FOR PORCELAIN & COMPOSITE

“HI-GLAZE” DIAMOND PORCELAIN POLISHING KITS

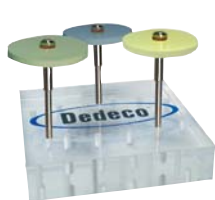

Extra oral:

For adjusting and polishing porcelain restorations, zirconium & e.max. Eliminates the need for polishing paste or reglazing.



6-piece kit: 740-1103, 740-1105, 740-1123, 740-1125, 740-1143, 740-1145

740-1181
\$215.45



Chair-side:

Specially designed for removing scratches from porcelain, zirconium & e.max. and polishing to “hi-glaze”

9-piece kit: 740-1107, 740-1108, 740-1109, 740-1127, 740-1128, 740-1129, 740-1147, 740-1148, 740-1149

740-1183
\$117.75

“HI-GLOSS” COMPOSITE KIT



Chair-side:

2-step diamond-filled silicone polishing system formulated for “hi-gloss” finishing of cured composites without paste or water.

6-piece kit: 740-1162, 740-1163, 740-1164, 740-1172, 740-1173, 740-1174

740-1182
\$83.45

3-piece kit: 740-1101, 740-1121, 740-1141

740-1180
\$165.45



DURA-GREEN® STONES

SHAPE CATEGORY	CN1	CN2	CN3	CY2	CY3	CY4	FL1	FL2	FL3	FL4	FL5
SHAPE											
ISO#	024	037	040	025	028	045	030	025	030	045	065
HP (12 PK)	PN 740-0002	-	-	740-0006	740-0007	740-0008	740-0009	740-0010	740-0011	740-0012	740-0013
HP FINE (12 PK)	PN -	-	-	-	-	-	-	-	740-011F	-	-
HP (72 PK)	PN -	-	-	-	-	-	-	740-HG10	-	-	-
CA (12 PK)	PN 740-0052	740-0053	740-0054	-	740-0057	-	740-0059	740-0060	740-0061	740-0062	-
FG (12 PK)	PN 740-0101	-	-	740-0103	-	-	-	740-0104	-	-	-

SHAPE CATEGORY	IC1	IC2	IC3	IC4	IC5	IC6	IC7	IC8	IC9	KN1	KN3
SHAPE											
ISO#	030	032	050	045	070	065	125	104	135	050	070
HP (12 PK)	PN 740-0014	740-0015	740-0016	740-0017	740-0018	740-0019	740-0020	740-0021	740-0022	740-0023	740-0025
HP FINE (12 PK)	PN -	-	-	-	-	-	-	-	740-022F	-	-
HP (72 PK)	PN 740-HG14	-	740-HG16	-	740-HG18	-	740-HG20	-	740-HG22	-	-
CA (12 PK)	PN 740-0064	-	740-0066	-	740-0068	-	-	-	-	-	-
FG (12 PK)	PN -	740-0105	-	-	-	-	-	-	-	-	-

SHAPE CATEGORY	KN4	KN5	KN6	KN7	PC1	PC2	RD1	RD2	RD3	RD4	RE1
SHAPE											
ISO#	080	060	100	125	030	050	030	024	036	050	062
HP (12 PK)	PN 740-0026	740-0027	740-0028	740-0029	740-0030	740-0031	740-0032	740-0033	740-0034	740-0035	740-0036
HP FINE (12 PK)	PN -	-	-	-	740-030F	740-031F	-	-	-	-	-
HP (72 PK)	PN -	-	-	740-HG29	-	-	-	-	-	-	-
CA (12 PK)	PN -	-	-	-	740-0080	740-0081	740-0082	740-0083	740-0084	740-0085	740-0086
FG (12 PK)	PN -	-	-	-	-	-	740-0107	740-0108	-	-	-

SHAPE CATEGORY	RE2	TC1	TC2	TC3	TC4	WH1	WH2	WH3	WH4	WH5	WH6
SHAPE											
ISO#	062	020	025	030	040	040	050	065	060	065	130
HP (12 PK)	PN 740-0037	740-0039	740-0040	740-0041	740-0042	740-0043	740-0044	740-0045	740-0046	740-0047	740-0048
HP FINE (12 PK)	PN -	740-039F	-	-	740-042F	-	-	740-045F	-	-	740-048F
HP (72 PK)	PN -	-	-	-	740-HG42	-	-	740-HG45	-	-	740-HG48
CA (12 PK)	PN -	740-0089	740-0090	-	740-0092	-	-	740-0095	740-0096	-	740-0098
FG (12 PK)	PN -	740-0109	-	-	-	740-0110	-	-	-	-	-

HP Shank (12 per pack) \$26.25
 HP Shank (72 per pack) \$138.25
 CA & FG Shank (12 per pack) \$28.45

DURA-GREEN® DIA STONES

SHAPE CATEGORY	CY5	FL3	IC5	KN7	RD2	RD3	TC2	TC4	WH6
SHAPE									
ISO#	056	030	070	125	024	036	025	025	130
HP (2 PK*/3 PK)	PN 740-0156*	740-0158	740-0162	740-0154*	-	740-0159	740-0161	740-0155	740-0157*
CA (3 PK)	PN -	740-0163	-	-	-	740-0164	740-0165	-	-
FG (3 PK)	PN -	740-0168	-	-	740-0167	-	-	-	-

HP, CA, FG Shank \$48.95



DURA-WHITE® STONES

SHAPE CATEGORY	CN1	CY2	FL1	FL2	FL3	IC2	IC4	KN1	KN3	RD1	RD2
SHAPE											
ISO#	024	025	030	025	030	032	045	050	070	030	024
HP (12 PK)	PN 740-0201	-	740-0202	740-0203	740-0204	-	740-0205	-	740-0206	740-0207	740-0208
CA (12 PK)	PN 740-0221	-	740-0222	740-0223	740-0224	-	740-0225	-	-	740-0227	740-0228
FG (12 PK)	PN 740-0241	740-0243	740-0240	740-0244	-	740-0245	-	740-0246	-	740-0247	740-0248

SHAPE CATEGORY	RE1	TC1	TC4	WH1	WH4
SHAPE					
ISO#	062	020	740-040	040	060
HP (12 PK)	PN 740-0209	740-0210	740-0211	-	740-0212
CA (12 PK)	PN 740-0229	740-0230	-	-	740-0232
FG (12 PK)	PN -	740-0249	-	740-0250	-

HP, CA, FG Shank (12 per pack) \$28.45

BROWNIE®/GREENIE®/SUPERGREENIE POLISHERS

SHAPE CATEGORY	Cup	Mini-Pt.	KN7	PC2	WH6	Floppie	Disk	Unm. Wheel
SHAPE								
ISO#	065	030	125	050	120	220	160	220
BROWNIE								
HP (12 PK)	PN -	-	740-0271	740-0272	740-0273	740-0458	-	740-0453
CA (12 PK)	PN 740-0401	740-0403	740-0281	740-0282	740-0283	-	740-0405	-
CA (72 PK)	PN 740-H401	740-H403	-	-	-	-	-	-
FG (12 PK)	PN 740-0411	740-0413	-	-	-	-	-	-
FG (72 PK)	PN 740-H411	740-H413	-	-	-	-	-	-
GREENIE								
HP (12 PK)	PN -	-	740-0274	740-0275	740-0276	740-0459	-	740-0454
CA (12 PK)	PN 740-0402	740-0404	740-0284	740-0285	740-0286	-	740-0406	-
CA (72 PK)	PN 740-H402	740-H404	-	-	-	-	-	-
FG (12 PK)	PN 740-0412	740-0414	-	-	-	-	-	-
FG (72 PK)	PN 740-H412	740-H414	-	-	-	-	-	-
SUPERGREENIE (yellow band)								
HP (12 PK)	PN -	-	740-0277	740-0278	740-0279	-	-	740-454A
CA (12 PK)	PN 740-402A	740-404B	740-0287	740-0288	740-0289	-	-	-
FG (12 PK)	PN 740-412A	740-414B	-	-	-	-	-	-

HP, CA, FG Shank (12 per pack) – KN7, PC2, WH6, Floppie & Disk \$33.75

CA, FG Shank (12 per pack) – Cup & Mini-Point \$32.25

CA, FG Shank (72 per pack) – Cup & Mini-Point \$155.25

Unmounted Wheels (12 per pack) \$22.25

COMPOSITE/COMPOSITE FINE POLISHERS

SHAPE CATEGORY	Bullet	Knife	Wheel	Disk	Cup	Pear-Point	IC	Midi-Point
SHAPE								
ISO#	040	090	090	160	080	033	-	040
REGULAR (no band)								
CA (12 PK)	PN 740-0191	740-0192	740-0193	740-0194	740-0195	740-0196	740-0197	740-0198
FG (12 PK)	PN -	-	-	-	-	740-196B	-	740-0199
FINE (white band)								
CA (12 PK)	PN 740-0291	740-0292	740-0293	740-0294	740-0295	740-0296	740-0297	740-0298
FG (12 PK)	PN -	-	-	-	-	740-296B	-	740-0299

CA, FG Shank (12 per pack) \$35.75

MOUNTED POINTS & STONES



Astropol® Finishing & Polishing - Ivoclar Vivadent

For interdental and occlusal applications. Step 1, finishing with Astropol F, for the removal of excess material and pre-polishing. Step 2, polishing with Astropol P, ensures a smooth surface finish and Step 3, high gloss polishing with Astropol HP, results in extremely smooth, high gloss surfaces.

Astropol Assortment Package available upon request.

Astropol F - Gray

Small Flame.....	740-557615
Large Flame.....	740-557616
Cup.....	740-557617
Disk.....	740-557618
6/pkg.	\$33.95

Astropol P - Green

Small Flame.....	740-557613
Large Flame.....	740-557621
Cup.....	740-557619
Disk.....	740-557620
6/pkg.	\$23.95

Astropol HP - Pink

Small Flame.....	740-557613
Large Flame.....	740-557622
Cup.....	740-557623
Disk.....	740-557624
3/pkg.	\$23.95



Ceramiste' - Shofu Dental Corporation

Systematic polishing up to a high gloss of porcelain and tooth enamel in three steps: Ceramisté Standard (without band): prepolishing Ceramisté Standard (yellow band): polishing Ceramisté Ultra II (white band): high gloss polishing.

Standard

KN7.....	740-0261
WH6.....	740-0263
PC2.....	740-0262
12/box	\$35.75

Ultra

KN7.....	740-0264
WH6.....	740-0266
PC2.....	740-0265
12/box	\$35.75

Ultra II

KN7.....	740-0267
WH6.....	740-0269
PC2.....	740-0268
12/box	\$35.75



OneGloss® - Shofu Dental Corporation

One-step finisher and polisher that provides the ideal finish for all types of composite restorations, simply by altering the contact pressure as you go from finishing to polishing.

Complete Set

Contains: 20 of each shape Cup, Midi and IC; and 3 stainless steel CA mandrels.

740-0180 Set	\$91.95
--------------------	----------------

Refills

Cup	740-0181
IC	740-0183
Midi Pt.....	740-0182
50/pack	\$75.45

Mandrel

1-1/2" x .032"	
740-0435 6/pack	\$19.95

Mini Point Refill

740-0186 12/pack	\$30.95
------------------------	----------------

OneGloss PS Assortment Kit

Contains: 15 cups, 20 Midi Points and 15 IC.	
740-0175 Kit.....	\$112.25

PS Refills

Cup	740-0176
IC	740-0178
Midi Pt.....	740-0177
50/pack	\$112.25

POLISHING GEL & PASTE



Prisma® Gloss™ Polishing Paste - Dentsply Caulk

X-Fine	748-631450
Fine.....	748-631400
4gm	\$74.75



Diamond Twist SCL™ - Premier® Dental

Extra-oral polishing. Glaze-like, multi-surface polishing. Unflavored.

747-2019001 6gm	\$67.75
-----------------------	----------------

Diamond Twist SCL Kit available upon request.



Diamond Twist SCO™ - Premier® Dental

Intra-oral Polishing. After permanent seating and adjustments, polish crowns, inlays, onlays and nano-hybrid composites intra-orally in one easy step. Mint flavored.

747-2019003 3gm	\$50.45
-----------------------	----------------

Diamond Twist SCO Kit available upon request.



Luminescence® - Premier® Dental

Single-gel diamond polishing system, contains an optimal concentration of micron sized diamond. For use with composites, porcelain, amalgam, glass ionomers, precious metals and tooth enamel. Applied with felt applicators that provide access to multiple surfaces without generating heat. Particularly effective for intraoral polishing of CEREC/CAD/CAM restorations.

Intro Kit

Contains: 3gm syringe of gel, 50 applicators and 2 RA mandrels.

747-2014200 Kit.....	\$86.95
----------------------	----------------

Refill

747-2014202 3gm	\$50.75
-----------------------	----------------

Applicators

747-2014206 50/box	\$38.25
--------------------------	----------------



Luminescence PLUS!

Contains potassium nitrate topical desensitizer for patient comfort. Improved viscosity eliminates waste.

747-2014208 3gm	\$47.45
-----------------------	----------------

Applicators

747-2014206 50/box	\$38.25
--------------------------	----------------

RA Mandrels

747-2014204 2/pkg	\$11.45
-------------------------	----------------



Sparkle™ Diamond Polishing Paste - Pulpdent Corporation
 Creates a glaze-like lustrous finish on porcelain, gold and composite. Washes off easily.
 Contains: 4 -1.2ml syringes.
 740-SPARK Each..... **\$35.25**



Diamond Polishing Paste - Temrex Corporation
 Restores the original smooth finish. Polishes resin and porcelain surfaces.
 220-6800 3gm..... **\$40.75**



Polishing Paste - Temrex Corporation
 For final stage polishing on all composite and paint-on restoratives. Creates a high lustre, enamel-like finish.
 Contains: 5 -5gm syringes.
 740-5200 Each..... **\$51.95**

LOOK'in
 for something? **WE HAVE IT!**
www.dhpionline.com



Composite Polishing System
 Disposable diamond polishers for the finishing and polishing of all composites including the last generation of composites.
Single-Use Diamond Composite Kit
 Contains: 10 Discs, 10 Cups and 10 Points in coarse and fine grits.
 740-10030 Kit..... **\$119.95**

Single-Use Diamond Composite Polishers Coarse

Disc RA	740-10031
Cup RA	740-10032
Point RA	740-10033
48/pkg	\$89.95

Fine

Disc RA	740-10035
Fine Cup RA	740-10036
Fine Point RA	740-10037
48/pkg	\$139.95



Enhance® Finishing & Polishing System - Dentsply Caulk Complete Kit
 Contains: 20 finishing discs, 10 finishing cups, 10 finishing points, 25 polishing cups, 4gm syringe Prisma Gloss, 4gm syringe Extrafine Prisma Gloss and 1 metal mandrel.
 748-624075 Kit..... **\$160.75**

Finishing Disc Refill
 748-624045 40/pkg..... **\$113.45**

Finishing Cup Refill
 748-624055 40/pkg..... **\$113.45**

Finishing Point Refill
 748-624065 40/pkg..... **\$113.45**

Polishing Paste System
 Contains: 25 polishing cups, 4gm Prisma Gloss syringe, 4gm Extrafine Prisma Gloss Syringe and 1 metal mandrel.
 748-624005 Each..... **\$93.75**

Polishing Cup Refill
 Contains: 100 polishing cups and 1 mandrel.
 748-624020 Each..... **\$64.95**

Metal Mandrels
 748-624025 3/pkg..... **\$15.75**



Enhance® & PoGo® Micro-Polishers - Dentsply Caulk
 After finishing with the one-component Enhance system, polish with the one-step PoGo Diamond Micro-Polishers to create the ultimate luster. Start with a light pressure and decrease to a "feather-like" touch to bring out the highest luster.
Enhance & PoGo Complete Kit
 Contains: 10 of each Enhance Finisher Discs, Cups and Points; 10 of each PoGo Polisher Discs, Cups and Points.
 748-662020 Kit..... **\$183.45**

PoGo Refills Discs

748-662010	40/pkg	\$170.75
------------	--------------	-----------------

Points

748-662022	40/pkg	\$170.75
------------	--------------	-----------------

Cups

748-662023	40/pkg	\$170.75
------------	--------------	-----------------



Jazz® Polishers - SS White®
 Composite polishing system. Diamond impregnated to achieve high gloss on all direct esthetic materials which eliminates the need for multiple polishing systems.

C1S available upon request.

C2S

Fine Flame	742-89026
Fine Knife Edge.....	742-89027
Fine Cup	742-89028
Medium Flame	742-89022
Medium Knife Edge.....	742-89023
Medium Cup	742-89024
3/pkg.	\$42.95

8-Piece Kit with Autoclavable Bur Block available upon request.

Supreme

Small Flame.....	742-89034
Flame.....	742-89031
Knife Edge	742-89032
Cup	742-89033
3/pkg	\$49.25

4-Piece Kit with Autoclavable Bur Block available upon request.



A remarkable diamond-impregnated polishing system used to restore a natural high shine to porcelain and eliminate the need for re-firing. Handpiece sold individually. Friction Grip & RA/Latch available in packs of 3. HP & RA/Latch recommended speed: 5,000-7,000 rpm. Autoclavable. ***FG polishers should be used at minimum speed allowed by your electric handpiece, and with light pressure.**

Pre-Polishing : Porcelain - opt. 16,000 rpm



HEAD Ø 1/16mm	250	250	055	145	050	030	060	100
LENGTH (mm)	3.0	2.0	15.5	2.5	10.0	6.0	9.0	4.7
FG shank - 3 pk						740-P3533		740-P3553
RA shank - 3 pk					740-P3323		740-P3353	740-P3633
HP shank - 1 pk	740-P301	740-P310	740-P344	740-P343				
Price	\$73.75			\$51.45		\$56.25		

Refining : Porcelain, Precious / Semi-Precious Metals - opt. 12,000 rpm



HEAD Ø 1/16mm	250	250	055	150	145	050	030	060	100
LENGTH (mm)	3.0	2.0	15.5	1.0	2.5	10.0	6.0	9.0	4.7
FG shank - 3 pk							740-P30533	740-P30553	
RA shank - 3 pk						740-P30323	740-P30333	740-P30353	740-P30363
HP shank - 1 pk	740-P3001	740-P3010	740-P3044	740-P3042	740-P3043				
Price	\$73.75			\$51.45		\$56.25			

High Shine : Porcelain, Precious / Semi-Precious Metals - opt. 6000 rpm



HEAD Ø 1/16mm	250	250	055	150	145	050	030	060	100
LENGTH (mm)	3.0	2.0	15.5	1.0	2.5	10.0	6.0	9.0	4.7
FG shank - 3 pk							740-P300533	740-P300553	
RA shank - 3 pk						740-P300323	740-P300333	740-P300353	740-P300363
HP shank - 1 pk	740-P30001	740-P30010	740-P30044	740-P30042	740-P30043				
Price	\$73.75			\$51.45		\$56.25			

CeraGlaze® Ultimate Porcelain Polishing Set

This Logic Set is a three-step set for making minor adjustments and polishing porcelain/ceramic restorations. This diamond impregnated polisher is what is needed on today's "new age" porcelain and ceramic materials. 740-LS506..... **\$205.45**



CeraGlaze® Extra-oral Porcelain Adjusting & Polishing Set

This set contains the 17mm square edge wheels and points in all three steps for extra-oral adjusting and polishing on all porcelain restorations. Used chair side, this set doesn't require polishing paste or reglazing. 740-LS911 **\$345.45**



Zirconia Polishers

The ZIR-CUT™ Polisher utilizes a unique diamond-abrasive mixture to bring zirconia materials to a high shine. This two-step system removes scratches, smoothes rough surfaces, and creates a high gloss surface on all zirconia crowns, bridges, substructures and abutments. Available in a point, cup and disk, the ZIR-CUT Polisher is mounted to a latch mandrel for intra-oral use.



MFG. NO.	P901	P902	P903	P9001	P9002	P9003
Item Code	740-P901	740-P902	740-P903	740-P9001	740-P9002	740-P9003
Price	\$61.95					
Shank	RA / Latch (21)					
Package	3 Per Pkg.					



Zirconia Polisher Set

Contains 1 each of the Zir-Cut™ Polishers. Specifically designed for use on Zirconia restorations, contains the unique two-step system that efficiently removes scratches and polishes to a high gloss shine every time.

740-LS517..... **\$162.95**

DiaGloss® Composite Polishers

Diamond-impregnated polishers that achieve an aesthetic high gloss finish on cured composites. Use pink to adjust and pre-polish followed by white to achieve the desired finish. No paste or water required.

Pink Pre-Polishing



MFG. NO.	P1932-3	P1933-3	P1935-3	P1938-3	P1953-3
Item Code	740-P19323	740-P19333	740-P19353	740-P19383	740-P19533
Price	\$16.75				\$43.95
Shank	RA / Latch (21)				FG (31)
Package	3 Per Pkg.				

White High Shine



MFG. NO.	P19032-3	P19033-3	P19035-3	P19038-3	P19053-3
Item Code	740-P190323	740-P190333	740-P190353	740-P190383	740-P190533
Price	\$16.75			\$43.95	
Shank	RA / Latch (21)				FG (31)
Package	3 Per Pkg.				

ProGloss™ Composite Polishers

The ProGloss Polisher one-step system is designed for use with all types of composite restorations. With the new ProGloss Polishers, you can consistently achieve a higher surface luster, faster. Designed for either wet or dry applications. Available in packs of 12, assortment kit contains 4 of each shape.



MFG. NO.	P8001	P8002	P8003	P8000A
Item Code	740-P8001	740-P8002	740-P8003	740-P8000A
Price	\$89.75			\$87.25
Shank	RA / Latch (21)			
Pack	12 per pack			4 of each

ProGloss Ultimate Composite Polishing Set

This Logic Set combines the ProGloss™ Single-Step Composite Polishers and the PDQ™ Composite Polishing Brush for achieving the desired high shine on the new "hard setting" composites.

740-LS516..... **\$88.95**



Health-Tec® High-Speed Handpieces

4-Hole: Non Fiber-Optic



Standard Head

Description	Item#	Price
4-Hole Standard Head	280-10001	\$145.95
Turbine Cartridge Replacement	280-10015	\$58.95
Bur Tool	280-10025	\$18.95
End Cap	280-10027	\$7.95
End Cap Wrench	280-10029	\$5.25
Handpiece Chuck	280-10030	\$16.45
Gasket 4-Hole	280-10032	\$4.95



Mini Head

Description	Item#	Price
4-Hole Mini Head	280-10003	\$145.95
Turbine Cartridge Replacement	280-10017	\$60.95
Bur Tool	280-10026	\$18.95
End Cap	280-10027	\$7.95
End Cap Wrench	280-10029	\$5.25
Handpiece Chuck	280-10031	\$16.45
Gasket 4-Hole	280-10032	\$4.95

4-Hole: Non Fiber-Optic > Push Button



Standard Head

Description	Item#	Price
4-Hole Standard Head Push Button	280-10002	\$195.95
Turbine Cartridge Replacement	280-10016	\$102.95
End Cap	280-10028	\$24.95
End Cap Wrench	280-10029	\$5.25
Gasket 4-Hole	280-10032	\$4.95



Mini Head

Description	Item#	Price
4-Hole Mini Head Push Button	280-10004	\$195.95
Turbine Cartridge Replacement	280-10018	\$102.95
End Cap	280-10028	\$24.95
End Cap Wrench	280-10029	\$5.25
Gasket 4-Hole	280-10032	\$4.95

5-Hole: Fiber Optic



Standard Head

Description	Item#	Price
5-Hole Standard Head	280-10005	\$331.95
Turbine Cartridge Replacement	280-10015	\$58.95
Bur Tool	280-10025	\$18.95
End Cap	280-10027	\$7.95
End Cap Wrench	280-10029	\$5.25
Handpiece Chuck	280-10030	\$16.45
Gasket 5-Hole	280-10033	\$4.95

5-Hole: Fiber Optic > Push Button



Standard Head

Description	Item#	Price
5-Hole Standard Head Push Button	280-10006	\$362.95
Turbine Cartridge Replacement	280-10016	\$102.95
End Cap	280-10028	\$24.95
End Cap Wrench	280-10029	\$5.25
Gasket 5-Hole	280-10033	\$4.95

*1 year warranty on all High Speed Handpieces (handpiece body and fiberoptics). 3 month warranty on all High Speed HP Turbines and High Speed HP Swivels.

Health-Tec® High-Speed Handpieces

4 Hole: Non Fiber-Optic > Quick Disconnect > Push Button



*Quick Disconnect not included.

Standard Head

Description	Item#	Price
4-Hole Standard Head Push Button Quick Disconnect Style	280-10009	\$184.95
Turbine Cartridge Replacement	280-10016	\$102.95
End Cap	280-10028	\$24.95
End Cap Wrench	280-10029	\$5.25
Gasket 4-Hole	280-10032	\$4.95
4-Hole Handpiece Quick Disconnect (Swivel Only)	280-10010	\$50.95

Health-Tec® Low-Speed Motors



Low Speed Motor

Description	Item#	Price
E-Type Low Speed Motor (0-20,000 RPM)	280-10060	\$249.95



Straight Nose Cone

Description	Item#	Price
Straight Nose Cone 1:1 (Blue)	280-10065	\$104.95
Straight Nose Cone 4:1 (Green)	280-10066	\$169.95

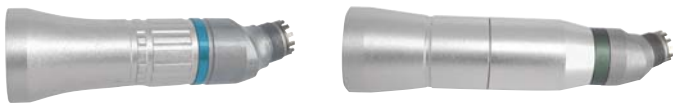

Angle Sheath

Description	Item#	Price
Contra Angle Sheath 1:1 (Blue)	280-10070	\$66.95
Contra Angle Sheath 4:1 (Green)	280-10071	\$142.95

*6 month warranty on all Low Speed Motors.

Health-Tec® Accessories



Handpiece Lubricant Spray

Multi-use for lubricating, cleaning and degreasing handpieces. Contains high temperature silicone to prevent damage to bearings during autoclaving.

Description	Item#	Price
6oz	770-10001	\$14.95



Latch Type Heads

Description	Item#	Price
1. Swing Latch Head	280-10072	\$49.95
2. Spring Latch Head	280-10073	\$77.95
3. Push Button Latch Head	280-10074	\$127.95

Friction Grip Head



Description	Item#	Price
Push Button FG Head	280-10075	\$169.95



Prophy Heads

Description	Item#	Price
1. E-Type Prophy Head Snap On	280-10078	\$48.95
2. E-Type Prophy Head Screw Type	280-10079	\$48.95
3. Standard Prophy Head Snap On	280-10076	\$13.95
4. Standard Prophy Head Screw Type	280-10077	\$13.95



U-Type Contra Angle

Description	Item#	Price
20,000RPM	280-10080	\$27.95

*3 month warranty on all Low Speed Accessories

HIGH SPEED FIBER OPTIC

DENSPLY
MIDWEST



Stylus™

The Midwest Stylus offers dentists all of the features that are required out of the ideal handpiece - best-in-class performance, power, durability, light, noise, maintenance options and ergonomics. The EasyCare option is designed with factory-lubricated ball bearings for easier maintenance conveniently freeing up staff, and no oil on the tooth prep means better composite retention.

Stylus Standard

281-790300 Each.....\$1441.45



Stylus™ Lite

The Midwest Stylus Lite offers dentists all of the features that are required out of the ideal handpiece, but with a tapered rear sheath making it 15 grams lighter than the current Stylus.

Stylus Lite 361S Standard

Compatible with MULTIflex LUX Coupler.

281-791330 Each.....\$1441.45

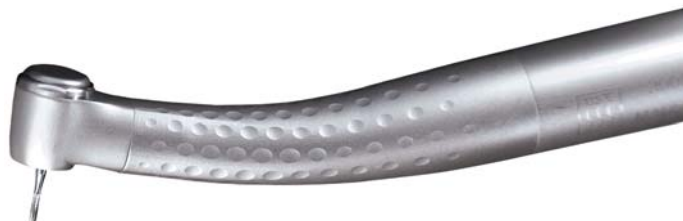

Stylus™ ATC

Speed-Sensing Intelligence (SSI) delivers more consistent power for improved cutting performance.

890

281-881300 Each.....\$1560.75

990 Mini

281-882300 Each.....\$1560.75



Stylus™ Mini

The Midwest Stylus Mini offers dentists all of the power, performance and reliability you expect from Midwest Stylus packed into a mini head for superior intra-oral access, visibility, and power - 15 watts. Stylus Mini accepts both Short Shank and Regular Shank burs.

Stylus Mini 540S Standard

281-792300 Each.....\$1441.45

Stylus Mini 540E EasyCare™

281-792500 Each.....\$1488.95

DENSPLY
MIDWEST



Tradition®

Tradition Standard with Conventional Wrench chuck

281-750045 Each.....\$1056.45

Tradition L with Power Lever Chuck

281-780045 Each.....\$1051.45

Tradition PB with Push Button Chuck

281-790045 Each.....\$1051.45

MORITA



TwinPower Turbine Standard

The standard model delivers up to 22 watts for smooth, efficient cutting even under high load conditions. Clinically evaluated by several institutions, TwinPower has earned high marks for its fit to hand ergonomics, balance, visibility, power output, and braking ability.

Unit Includes: Lubricant spray nozzle, chuck grip tester, spray hole wire, screwdriver, cap tool.

4H PAR-4HEX-O

280-165340888 Each.....\$1177.25



TwinPower Turbine 45

The TwinPower Turbine 45 model offers maximum access and visibility with a 45° angle and an overall head size smaller than competitive units. Extremely powerful, it delivers up to 20 watts for smooth, efficient cutting. Rear-facing exhaust vents direct air flow away from the surgical site for patient protection. With zero suck back in the air line, TwinPower also provides excellent contamination control, especially important in surgical procedures such as sectioning of 3rd molars.

Unit Includes: Lubricant spray nozzle, chuck grip tester, spray hole wire, screwdriver, cap tool.

4H PAR-4HEX-O-45

280-165344670 Each.....\$1177.25

HIGH SPEED FIBER OPTIC



TwinPower UltraM

UltraM delivers 18 watts of power, twice the power of some other popular mini handpieces. It also offers the smallest head of the TwinPower Turbine product line with a height of just 10.6mm. Due to its very compact size, UltraM offers exceptional access. It accepts burs up to 20mm. Unit Includes: Lubricant spray nozzle, chuck grip tester, spray hole wire.

PAR-4HUMX-O

280-165356989 Each..... **\$1177.00**



EXPERTtorque LUX E679 L

Ceramic bearing; standard head (18 watt); MULTIflex LUX connection; push button auto w/chuck; 4-port spray; replaces 659 BR; 3rd generation cellular optics with 5 year warranty; 36 psi (2.5 bar); 380,000 rpm.

283-10069200 Each..... **\$1214.95**



MASTERtorque™ M8900 L

Most powerful (23 watts) KaVo High Speed with ceramic bearing. Direct Stop Technology (DST) that stops the bur in one second, increasing efficiency and improving safety during treatment. DST reduces drawback of particles into the ball bearings for improved durability and hygiene. Quietest KaVo air high speed at 57 decibels. 5 year warranty.

280-10087800 Each..... **\$1598.95**



MASTERtorque™ Mini M8700 L

Mini head KaVo high speed with ceramic bearing. Quietest KaVo mini head air high speed at 59 decibels, push button auto chuck. MULTIflex LUX connection, 440,000rpm. 3rd generation cellular optics with 5 year warranty.

280-30010000 Each..... **\$1598.95**



EXPERTtorque Mini LUX E675L

Ceramic bearing; miniature head (15 watts); MULTIflex LUX connection; push button auto-chuck; 3-port spray; replaces 635BR; 3rd generation cellular optics with 5 year warranty; 33 psi (2.3 bar); 420,000 rpm.

283-10066400 Each..... **\$1214.95**



SMARTtorque™ LUX S619 L

Standard head (15 watts); optimum balance between speed and torque; MULTIflex LUX connection; push-button auto chuck; 4-port spray; 40 psi (2.8 bar); 1 year warranty.

283-10081641 Each..... **\$764.95**



SMARTtorque™ Mini LUX S615 L

Fiber optic miniature head (13 watts); optimum balance between speed and torque; MULTIflex LUX connection; push-button auto chuck; 1-port spray 40 psi (2.8 bar); 1 year warranty.

283-10081643 Each..... **\$764.95**



SURGtorque™ LUX S459 L

Unique head angle for improved access to molar region (45°). Fiber optic, powerful 19W turbine for increased efficiency. MULTIflex connection; ceramic bearings; exhaust port directs excess exhaust away from the cutting area; single port water with no spray; push button auto chuck; accepts standard and surgical length burs; 1 year warranty. 380,000 rpm.

280-30004808 Each..... **\$998.95**



Ti-Max X Series

Premium quality high performance turbine handpiece that is designed to be in total harmony with the human hand. Integrated shaft bearings provide higher rigidity and reduced vibration and guarantees more accurate and consistent cutting. Offers NSK's patented clean head system, quattro (4) water spray, cellular glass LED optics, and dual air jet turbines, which generate an unrivaled 22 watts of power. Additional features include a solid titanium body, which is 30% lighter than stainless steel and DURACOAT scratch resistance surface. 2 year warranty.

Mini Head Handpiece

- Power: 17W
- Speed: 390,000~450,000 min-1
- Head size: 10.3 x H11.7 mm
- Short shank burs only



X500L (for NSK Coupling)

280-P495 Each..... **\$1048.95**

HIGH SPEED FIBER OPTIC



X500KL (for KaVo MULTiflex Coupling)
280-P857 Each..... **\$1048.95**

Standard Head

- Power : 21W
- Speed : 380,000-440,000 min-1
- Head Size : 11.2 x H13.6 mm



X600L (for NSK Coupling)
280-P496 Each..... **\$1048.95**



X600KL (for KaVo MULTiflex Coupling)
280-P858 Each..... **\$1048.95**



S-Max Pico Series

The NSK S-Max Pico series has been developed for the operation of Minimal Intervention (M.I). The ultra mini head and super slim handpiece design is the result of fine NSK precision engineering allowing a wider view of the operational field, and greater flexibility for dexterity.

S Max Pico

Innovative air turbine with an “ultra” mini head 9mm and super slim body shape offering 9W of power. The design delivers expanded operational visibility and better access while increasing patient comfort. Use with short shank burs or S-Max Pico burs only. 1 year warranty.

Specify:

For NSK coupling.....280-P1140
For KaVo MULTiflex LUX coupling280-P1142
Each **\$848.95**

S-Max Pico MWL

- Ultra Mini Head
- Midwest Coupling
- Single Spray
- Stainless
- Max Speed 450,000 min-1

280-P1179 Each..... **\$848.95**



S-Max Pico STL

- Ultra Mini Head
- Star Coupling
- Single Spray
- Stainless
- Max Speed 450,000 min-1

280-P1180 Each..... **\$848.95**



S-Max M Series

Features unrivalled cutting performance, a slim ergonomically designed body and excellent visibility. It has been developed to realize what dentists need in their practice. NSK ‘ISB’ (Integrated Shaft Bearings) reduce vibration and guarantee more accurate and consistent cutting. For easy maintenance of S-Max M air turbines, cartridges can be replaced easily in your practice helping you to control cost and down-time.

S-Max M500L

- Power:16W
- Mini Head
- Quattro Spray
- Stainless
- Max Speed 450,000 min-1

280-P1001 Each..... **\$748.95**



S-Max M600L

- Power: 20W
- Standard Head
- Quattro Spray
- Stainless
- Max Speed 430,000 min-1

280-P1002 Each..... **\$748.95**



S-Max M500KL

- Power: 17W
- Mini Head
- Quattro Spray
- Stainless
- Max Speed 450,000 min-1

280-P1005 Each..... **\$748.95**



S-Max M600KL

- Power: 17W
- Standard Head
- Quattro Spray
- Stainless
- Max Speed 430,000 min-1

280-P1006 Each..... **\$748.95**

HIGH SPEED FIBER OPTIC



IMPACT AIR 45®

The IMPACT AIR 45 has a unique 45° angled head that allows maximum access and visibility. The IMPACT AIR 45 is also designed for use in peri-odontal and endodontic procedures. A water or saline line inside the handpiece handle directs a pure water jet (not a mist) directly onto the cutting area. Air is exhausted through the back of the handpiece.

- Fully autoclavable (all stainless steel)
- Minimizes downtime (office-replaceable turbine)
- Uses standard friction grip burs (push-button bur release)



IMPACT AIR 45® (5-Hole)
280-401 Each.....\$1048.95



IMPACT AIR 45® Quick Disconnect
280-407 Each.....\$1115.00



Access S4500KL

Sable Access Handpieces are manufactured to meet and exceed ISO 7785-1 Handpiece Standards. All Sable Handpieces include push button chuck operation and a Quick Connect, 360 degree swivel feature. All supplied with a comprehensive manufacturers 12 month warranty.

KaVo Style Fiber Optic High Speed Mini Head
280-2000015 Each..... \$621.50



Rotamax S6500KL

Sable Rotamax Handpieces are manufactured to meet and exceed ISO 7785-1 Handpiece Standard. All Sable Handpieces include push button chuck operation and a Quick Connect, 360 degree swivel feature. All product is supplied with a comprehensive manufacturers 12 month warranty.

KaVo Style Fiber Optic High Speed Torque Head
280-2000016 Each..... \$621.50

StarDental® Instruments

A DentalEZ® Integrated Solutions brand

430 Series

Ceramic autochuck turbine contains long lasting ceramic bearings. Improves efficiency and saves time with quick bur changing feature. Bifurcated solid cellular glass rod fiber optics offer greater light output for superior coverage and less bur shadow than single beam units. Small head. High torque design with low noise levels. Autoclavable.



430 SWL® Satin
High speed fiber optic handpiece with ceramic bearing autochuck turbine, elegant satin finish.
280-268840 Each.....\$1253.95



430 SWL®
High speed fiber optic handpiece with ceramic bearing autochuck turbine.
430SWL Lubefree
280-264450 Each.....\$1253.95

430SWL Lubricated
280-264451 Each.....\$1441.95



430 Torque Series
Ergonomically designed with a stylish satin finish, the 430 Torque is the newest member of the StarDental family: delivering power and choice. 27 Watts of power, enough for all procedures.

430SWL® Torque Lubefree
280-265890 Each.....\$1358.95

430SWL® Torque Lubricated
280-265892 Each.....\$1486.95



Velocity Extreme Vx9
Access head, 3-port water spray, push button autochuck bur release.
Fits KaVo Multiflex
280-VX9SLK Each.....\$849.95

Fits NSK
280-VX9SLN Each.....\$849.95



Velocity Extreme Vx10
Torque head, 4-port water spray, push button autochuck bur release.
Fits KaVo Multiflex
280-VX10SLK Each.....\$849.95

Fits NSK
280-VX10SLN Each.....\$849.95

HIGH SPEED NON FIBER OPTIC

**DENTSPLY
MIDWEST**



Tradition®
Midwest Tradition with Conventional Wrench Chuck
281-750044 Each.....\$637.25

Tradition® L with Power Lever Chuck
281-780044 Each.....\$762.95

Tradition® PB with Push Button Chuck
281-790044 Each.....\$762.95



Tradition® Plus
Smartly engineered and constructed, the Midwest Tradition Plus is ideal for each cutting procedure, providing easy, confident handling and consistent, uncompromised power. Built to deliver surefire performance day in and day out, the Tradition Plus expands on Midwest's legacy of handpiece technology.

Fixed Back End
280-770044 Each.....\$849.95

Coupler Back End
280-770244 Each.....\$1234.95



Quiet-Air®
Midwest Quiet-Air Standard
281-464004 Each.....\$599.45

Midwest Quiet-Air L® with Power Lever Chuck
281-484004 Each.....\$780.95

MORITA



TwinPower 45 Basic
Fiber optics were removed, thus offering a more economical option for clinicians using loops or a microscope. The non-optic model also offers a ceramic coated surface. It is compatible with Morita and KaVo MULTIflex LUX connections and comes with a 2 year warranty. The basic model features a chrome body and a fixed, 4-hole connection with a 1 year warranty.

Unit Includes: Lubricant spray nozzle, chuck grip tester, spray hole wire, screwdriver, cap tool.

PAR-4HEX-B-45
280-165606322 Each.....\$799.00

MORITA



TwinPower Turbine 45
The TwinPower Turbine 45 model offers maximum access and visibility with a 45° angle and an overall head size smaller than competitive units. Extremely powerful, it delivers up to 20 watts for smooth, efficient cutting. Rear-facing exhaust vents direct air flow away from the surgical site for patient protection. With zero suck back in the air line, TwinPower also provides excellent contamination control, especially important in surgical procedures such as sectioning of 3rd molars.

Unit Includes: Lubricant spray nozzle, chuck grip tester, spray hole wire, screwdriver, cap tool.

4H PAR-4HEX-45
280-165361087 Each.....\$999.00

KAVO
Dental Excellence



SMARTtorque™ 619 C
Standard head (15 watts); optimum balance between speed and torque; MULTIflex connection; push-button auto chuck; 4-port spray; 40 psi (2.8 bar); 1 year warranty.
283-10081642 Each.....\$674.95



SMARTtorque™ S609 C
Standard head (15 watts); optimum balance between speed and torque; standard 4-hole connection; push-button auto chuck; 4-port spray; 40 psi (2.8 bar); 1 year warranty.
283-10081644 Each.....\$578.95



SMARTtorque™ Mini S605 C
Miniature head (13 watts); optimum balance between speed and torque; standard 4-hole connection; push-button auto chuck; 1-port spray; 40 psi (2.8 bar); 1 year warranty.
283-10081645 Each.....\$578.95



SURGtorque™ S459 C
Unique head angle for improved access to molar region (45°). Powerful 19W turbine for increased efficiency. Standard 4-hole connection; ceramic bearings; exhaust ports direct excess exhaust away from the cutting area; single port water with no spray; push button auto chuck; accepts standard and surgical length burs; 1 year warranty. 420,000 rpm.
280-30005063 Each.....\$858.95

HIGH SPEED NON FIBER OPTIC



Pana-Max Plus/Pana-Max

High performance reliable fixed back handpiece. Precision engineered to offer the power and reliability required to perform clinical procedures. The stainless steel body is comfortable in the hand and is angulated at the optimum degree for excellent visibility. Ceramic bearings, NSK's patented clean head system, and push button chuck are also included.

Pana-Max Plus

- Stainless steel body
- Ceramic bearings
- ISB turbine
- Clean head system
- Push button chuck
- Quattro spray
- 1 year warranty

Standard Head.....	280-P1022	
Mini Head.....	280-P1021	
Each		\$498.95



Pana-Max

- Stainless steel body
- Ceramic bearings
- Clean head system
- Push button chuck
- Single spray
- 6-month warranty

Standard Head	280-P560	
Torque Head	280-P561	
Each		\$398.95



Ti-Max X450

The slim-form Ti-Max X450 series possesses a unique 45-degree angled head specially designed to access hard-to-reach areas for sectioning and extraction of third molars and other impacted teeth. The X450's robust 21 watts of cutting power and effective cooling system - featuring triple water jets - ensure safe and effective treatment during a variety of surgical procedures.

- 45° Angle Head
- Triple Water Jet
- Titanium
- Max Speed 450,000 min-1

280-P1088	Each	\$748.95
-----------	------------	-----------------



S-Max M Series

S-Max M series features unrivaled cutting performance, a slim ergonomically designed body and excellent visibility. It has been developed to realize what dentists need in their practice. NSK 'ISB' (Integrated Shaft Bearings) reduce vibration and guarantee more accurate and consistent cutting. For easy maintenance of S-Max M air turbines, cartridges can be replaced easily in your practice helping you to control cost and down-time.

S-Max M500

- Power: 16W
- Mini Head
- Quattro Spray
- Stainless
- Max Speed 450,000 min-1

280-P1003	Each	\$649.00
-----------	------------	-----------------



S-Max M600

- Standard Head
- Quattro Spray
- Stainless
- Max Speed 430,000 min-1

280-P1004	Each	\$649.00
-----------	------------	-----------------



S-Max M500K

- Power: 17W
- Mini Head
- Quattro Spray
- Stainless
- Max Speed 450,000 min-1

280-P1007	Each	\$649.00
-----------	------------	-----------------



S-Max M600K

- Power: 17W
- Standard Head
- Quattro Spray
- Stainless
- Max Speed 430,000 min-1

280-P1008	Each	\$648.95
-----------	------------	-----------------

HIGH SPEED NON FIBER OPTIC

HANDPIECES



IMPACT AIR 45®

The IMPACT AIR 45 has a unique 45° angled head allows maximum access and visibility. The IMPACT AIR 45 is also designed for use in periodontal and endodontic procedures. A water or saline line inside the handpiece handle directs a pure water jet (not a mist) directly onto the cutting area. Air is exhausted through the back of the handpiece.

- Is fully autoclavable (all stainless steel)
- Minimizes downtime (office-replaceable turbine)
- Uses standard friction grip burs (push-button bur release)



IMPACT AIR 45® (2 hole)

280-402 Each **\$879.00**



IMPACT AIR 45® (4 hole)

280-403 Each **\$879.00**

IMPACT AIR 45® Quick Disconnect

280-408 Each **\$905.00**



Access II

Sable Access Handpieces are manufactured to meet and exceed ISO 7785-1 Handpiece Standard. All Sable Handpieces include push button chuck operation and a Quick Connect, 360 degree swivel feature. All product is supplied with a comprehensive manufacturers 12 month warranty.

Non Fiber Optic High Speed Mini Head

280-2000003 Each **\$344.50**



Rotamax II

Sable Rotamax Handpieces are manufactured to meet and exceed ISO 7785-1 Handpiece Standard. All Sable Handpieces include push button chuck operation and a Quick Connect, 360 degree swivel feature. All product is supplied with a comprehensive manufacturers 12 month warranty.

Non Fiber Optic High Speed Torque Head

280-2000004 Each **\$344.50**

StarDental® Instruments

A DentalEZ® Integrated Solutions brand

Concentrix®

Durable stainless steel construction with high gloss finish. Lubricated steel bearing turbine for smooth, high-torque operation. Single glass rod optics for shadow-free illumination. Improved unique water spray flushes site and keeps tooth and bur cool.



Concentrix® SW

Lubricated steel bearing autochuck turbine. Uses either 4-line or 2/3-line StarDental swivel. 1 year warranty.

280-265633 Each **\$420.95**



Concentrix® FX

4-line fixed back-end with lubricated steel bearing autochuck turbine. 1 year warranty.

280-265634 Each **\$382.95**



Concentrix® FB

Fixed back-end 4-line with manual chuck. 1 year warranty.

280-265635 Each **\$245.95**

430 Series

Ceramic autochuck turbine contains long lasting ceramic bearings. Improves efficiency and saves time with quick bur changing feature. Bifurcated solid cellular glass rod fiber optics offer greater light output for superior coverage and less bur shadow than single beam units. Small head. High Torque Design with low noise levels. Autoclavable.



430SW™ Lubefree

280-62057 Each **\$826.95**

430SW™ Lubricated

280-64951 Each **\$971.95**



430K Lubefree

280-62052 Each **\$826.95**

HIGH SPEED NON FIBER OPTIC

StarDental® Instruments

A DentalEZ® Integrated Solutions brand



430SW® 45

45 degree angled head provides access to posterior area of the oral cavity. Engineered for removal of impacted third molars as well as other endodontic and periodontal procedures. Specially designed side ports exhaust air away from surgical site, reducing risk of embolism and protecting integrity of the site.

430SW® 45 Lubefree

280-265822 Each..... **\$795.95**



430SW™ Torque Series

Ergonomically designed with a stylish satin finish, the 430 Torque is the newest member of the StarDental family: delivering power and choice. 27 Watts of power, enough for all procedures.

430SW™ Torque Lubefree

280-265891 Each..... **\$891.95**

430SW™ Torque Lubricated

280-265893 Each..... **\$1019.95**



Alpha Air Professional Series

Super economical and value priced high speed. Accepts standard canister turbines. Quiet, lightweight and fully autoclavable. 400,000 rpm. Available in standard bur tool type or with push button autochuck bur release. Compare to competitors' house brand handpieces.



4-hole standard fixed back end

280-HAS4 Each..... **\$94.95**



Velocity Extreme Vx9

Access head, 3-port water spray, push button autochuck bur release.

Fits KaVo Multiflex

280-VX9SK Each..... **\$574.95**

Fits NSK

280-VX9SN Each..... **\$574.95**



Velocity Extreme Vx10

Torque head, 4-port water spray, push button autochuck bur release.

Fits KaVo Multiflex

280-VX10SK Each..... **\$574.95**

Fits NSK

280-VX10SN Each..... **\$574.95**

HIGH SPEED TURBINES & CARTRIDGES

**DENTSPLY
MIDWEST**

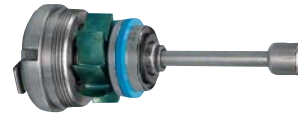

XGT Tradition PB Fiber Optic & Non Fiber Optic

Cartridge kit with cap wrench.

281-790118 Each..... **\$341.45**



Tradition L Fiber Optic & Non Fiber Optic

Cartridge kit with cap wrench.

281-780118 Each..... **\$341.45**



Tradition Fiber Optic & Non Fiber Optic

Cartridge kit with cap wrench.

281-750118 Each..... **\$321.95**



Quiet Air-L Fiber Optic & Non Fiber Optic

Cartridge kit with cap wrench.

281-484300 Each..... **\$321.95**



Quiet Air Standard/Quiet Air In Sight II Fiber Optic

Cartridge kit with cap wrench.

281-464300 Each..... **\$321.95**



MORITA



TwinPower Turbine 4HUEX

280-16501147 Each..... **\$399.25**

HIGH SPEED TURBINES & CARTRIDGES



NL95T Turbine
280-P059001 Each.....\$260.00



PanaMax Turbine
280-Y900213 Each.....\$209.00



NL75T Turbine
280-P046 Each.....\$238.95



NL95S Turbine
280-P058001 Each.....\$270.00



IMPACT AIR 45° Replacement Turbine
280-603 Each.....\$280.00



Star Lube Free Ceramic Turbine
280-1000162 Each.....\$225.00



KaVo 6500B Steel Turbine
280-1000173 Each.....\$225.00



KaVo 642/632 Steel Turbine
280-SAB1000101 Each.....\$215.00

KaVo 4500BR Ceramic Turbine
280-1000171 Each.....\$225.00

StarDental® Instruments

A DentalEZ® Integrated Solutions brand



Ceramic Bearing Turbines

Ceramic handpiece ball bearing turbines are offered in both our lubricated and LubeFree handpieces. Ceramic is the hardest, yet lightest material of any ball bearing used today, for extended handpiece turbine life. StarDental is the originator of utilizing ceramic ball bearings in handpiece turbines.

LubeFree Ceramic Bearing Autochuck Turbine
280-263739 Each.....\$458.95

LubeFree Ceramic Bearing Turbine
280-264184 4/pack.....\$1372.95



LubeFree E6 Turbine
280-265807 Each.....\$287.95

LubeFree Ball Bearing Autochuck Cartridge
280-264096 Each.....\$222.95



For Midwest Quiet Air Standard
280-TMQS Each.....\$94.95



For Star 430 Push Button
280-TS430 Each.....\$197.95



For Midwest Tradition Push Button
280-TMTP Each.....\$197.95



For F4, F7, V8, V9 Highspeeds
280-TF4 Each.....\$204.95



Alpha-Air Standard Canister Turbine
280-RPST Each.....\$39.95



Alpha-Air Autochuck Canister Turbine
280-RPAT Each.....\$94.95

HIGH SPEED ELECTRIC ATTACHMENTS

DENTSPLY
MIDWEST



Midwest® E Plus

Offers a 20% smaller head, 4-port water spray, ceramic head bearings, stronger chuck, and titanium shell for improved performance and ergonomics.

280-875205 Each..... \$1396.95

KAVO
Dental Excellence



COMFORTdrive 200 XDR Handpiece

High speed contra angle handpiece features precise performance, superior comfort, and allows for seamless integration into dental units. Speed range 30,000 to 200,000 rpm. Integrated micro-motor with 30W power, cellular optic, ceramic ball bearings, exchangeable micro-filter. Only connects to the KaVo COMFORTbase coupling.

283-10073570 Each..... \$1698.95

MASTERmatic™ LUX

KaVo Triple Gear System: Unique gear system worldwide, quiet and low-vibration, extremely hardwearing.

- 1:5 transmission: The highest power on the tooth
- Maximum operating speed 200,000 rpm
- Ceramic ball bearing, for uniquely long life
- KaVo Plasmatec hygienic coating
- With push button auto chuck
- Washable in thermal disinfectant
- Sterilizable up to 135°C (275°)



M25 L
280-10093630 Each..... \$1684.95



M05 L Mini
280-10093640 Each..... \$1684.95



M07
280-10093610 Each..... \$1198.95

KAVO
Dental Excellence



M20 L
280-10093620 Each..... \$959.95



M29 L
280-10093580 Each..... \$1324.95



M10 L
280-10093570 Each..... \$1384.95



20E Low Speed Handpiece

1:1 transmission. 100° head angle for superior access. Push button auto chuck for latch burs. Durable hygienic coating with textured surface for easy grip. Speed up to 20,000 rpm.

283-10031107 Each..... \$624.95



31E Low Speed Handpiece

Reduction 4:1. Speed range up to 5,000 rpm. For use with snap-on/screw-in cups and brushes. Extremely small head with 100° for superior access. Durable hygienic coating with textured surface for easy grip. Comes with prophy cup holder.

283-10036976 Each..... \$614.95



10E Low Speed Handpiece

1:1 transmission. For use with handpiece burs. Durable hygienic coating with textured surface for easy grip. Speed up to 20,000 rpm.

283-10036977 Each..... \$554.95

HIGH SPEED ELECTRIC ATTACHMENTS



HANDPIECES

Ti-Max X Series

Latest electric attachment technology combined with an elegant ergonomic design. Best possible access to the operating field and maximum visibility of the instrument body causes reliability and superior operator and patient comfort. Internal gearing system reduces noise and vibration. Additional features include ceramic bearings, quattro (4) spray; and NSK's patented clean head system; solid titanium body, which is 30% lighter than stainless steel and scratch resistant DURACOAT surface. 2 year warranty.



Fiber Optic Attachments

X95L Standard Head

- 1:5 increasing
- Quattro spray
- Max speed 200,000 min-1
- For FG burs

280-C600 Each..... \$1298.95



X85L Mini Head

- 1:5 increasing
- Single
- Mini head
- Max speed 200,000 min-1
- Short shank burs only

280-C604 Each..... \$1298.95



Ti-Max Z45L Series

The world's first 45-degree contra-angle electric handpiece, Ti-Max Z45L provides effortless access to hard-to-reach molars that a standard contra-angle simply can't match. The slim-form also offers excellent visibility and high operability, creating more space between adjacent teeth and the handpiece body. Powerful and consistent cutting shortens treatment time for time-consuming sectioning and third-molar extractions compared to standard contra-angles, dramatically reducing stress for both clinicians and patients. Two-way spray function, making it suitable for a wide range of procedures such as third-molar preparation and clarifications of the root canal orifice.

- 1:4.2 Increasing
- Quattro spray (water jet / mist)
- Max speed: 168,000 min-1
- For FG burs (01.6)

280-C1064 Each..... \$1598.95



X25L Direct Drive

- 1:1 Direct Drive
- Single spray
- Max speed 40,000 min-1
- For CA burs

280-C601 Each..... \$1048.95



X65L Straight Handpiece

- 1:1 Direct Drive
- Single spray
- Max speed 40,000
- For HP and CA burs

280-H273 Each..... \$1048.95

S-Max M Series

Push Button Chuck is NSK's original push button auto-chuck mechanism that tensions the bur grip during rotation. It allows one-touch bur insertion and removal without tools. The bur lock mechanism is designed so that bur retention strength increases when high loads are applied to the bur. The patented NSK Clean Head System is a special mechanism designed to automatically prevent the entry of oral fluids and other contaminants into the handpiece head prolonging the life of the bearings. The NSK Quattro Water Spray effectively cools the entire surface of the bur with a high cooling effect, leaving no areas untreated.



M95L 1:5 Fiber Optic

280-C1023 Each..... \$1048.95



M95 1:5 Non Fiber Optic

280-C1026 Each..... \$848.95



M25L 1:1 Fiber Optic

280-C1024 Each..... \$798.95



M25 1:1 Non Fiber Optic

280-C1027 Each..... \$598.95

HIGH SPEED ELECTRIC ATTACHMENTS



Ti-Max Z Series

Light and very strong pure titanium is used for the body. Microfilter to prevent particles from entering the water spray system to guarantee optimum water spray cooling at all times. NSK's latest surface enhancement technology takes advantage of the non-allergic and bio-compatible properties of titanium to further improve durability. DURACOAT creates a smooth, scratch resistant surface which is comfortable to hold. The patented NSK Clean Head System is a special mechanism designed to automatically prevent the entry of oral fluids and other contaminants into the handpiece head prolonging the life of the bearings.



Z25L 1:1 Fiber Optic
280-C1038 Each..... **\$1348.95**



Z95L 1:5 Fiber Optic
280-C1034 Each..... **\$1598.95**



Z85L 1:5 Fiber Optic Mini Head
280-C1062 Each..... **\$1598.95**

LOW SPEED MOTOR SYSTEMS



Midwest E

The Midwest E Electric Handpiece System features a touch screen interface with separate menu screens for both preparatory and endodontic procedure settings and the ability to view and customize the attachment operation directly from that screen.

280-876000 Each..... **\$3675.25**



Dental Excellence



ELECTROtorque TLC Torque Limit Control LUX Brushless Motor Kit

Brushless electric motor for ALL your high-speed, low-speed and torque control endodontic needs. Endo operation is available with a push of a button - no more searching and set up of a separate endo motor. Performs exact rotary endo procedures safely with torque control, auto-reverse and cellular optic advantages. Audible beep and flashing light notifies operator of automatic auto-reverse when preselected endo torque limit if reached. Remote mountable faceplate for convenient mounting options and easy to access controls. Motor speed range 100-40,000 rpm (with various attachments 2-200,000 rpm). Endodontic torque 0.4 - 8.0 Ncm. Motor torque 3 Ncm. KL703 Motor is sterilizable. 3 year warranty (includes motor, tubing and control box). One of the world's shortest and lightest electric motors. Superior power & torque. Unique brushless motor (no brushes to exchange - no downtime). Quieter than brush motors. Water spray can be adjusted at motor. Integrated light and coolant. Unit can be calibrated to existing air pressure for optimized performance.

Contains: ELECTROtorque TLC module with 6.5' cable, ELECTROtorque TLC transformer with connector, electric tubing, KL703 brushless electric motor (sterilizable), and mounting bracket with hardware.

283-10035840 Each..... **\$3498.95**



NLX Nano

Brushless LED electric micromotor portable system covers a wide speed range, 100 - 200,000 min-1, torque: 3.4 Ncm. The overall length of the instrument and NLX Nano micromotor are almost the same length as an air turbine and coupling. Use in multiple clinical applications and is compatible with existing optic and non fiber optic attachments. 3 year warranty.

Contains: NLX Nano control unit, NLX Nano motor, NLX Nano cord, NLX Nano A/C adapter.

280-Y1001361 Each..... **\$2,599.00**

LOW SPEED MOTOR SYSTEMS

StarDental® Instruments

A DentalEZ® Integrated Solutions brand



NuTorque®

The NuTorque electric handpiece system features an easy-to-use touch screen to make every procedure more efficient and productive. The NuTorque micromotor is designed to deliver consistent speed and powerful torque for both low and high speed uses. The NuTorque attachments feature lightweight, durable and corrosion-resistant titanium housings that provide a firm, tactile grip. The light weight gives the handpiece exceptional balance and helps reduce hand and wrist fatigue.

NuTorque System

Contains: Control unit, tubing, electric motor and A/C adapter.

280-265199 Each **\$3611.95**



NuTorque Lite

The NuTorque Lite electric handpiece system is not only economical, but it is the go-to in dental care. Its push button control panel allows all procedures to be completed with ease and precision. Similar to NuTorque, the NuTorque Lite is more compact than existing electric motors as well as being whisper quiet and free of vibration. With a wide speed range of 100-200,000 RPMs, it's easy to see how NuTorque Lite can meet all of your procedural needs.

280-265289 Each **\$2144.95**

LOW SPEED ELECTRIC ATTACHMENTS

**DENTSPLY
MIDWEST**

Midwest® E Plus

The new Midwest E Plus line of attachments offers a 20% smaller head, 4-port water spray, ceramic head bearings, stronger chuck, and titanium shell for improved performance and ergonomics.



1:1 FO Low Speed Attachment

280-875210 Each **\$1325.95**

280-875220 Each **\$1194.95**



1:1S FO Straight Attachment

280-875230 Each **\$1194.95**

**DENTSPLY
MIDWEST**



Contra Angle Sheath for Shorty and Rhino XP

281-710074 Each **\$295.95**



Straight Attachment for Shorty and Rhino XP

281-720005 Each **\$460.75**



Prophy Right Angle Head

Lower speed range only. Triple-Seal, Screw-in type. (Includes Head Wrench).

281-720445 3/pkg **\$219.75**



Push Button Contra Angle Heads for Shorty and Rhino XP

Recommended for upper and lower speed ranges.

Push Button Friction Grip Head

281-720475 Each **\$400.45**

Push Button Latch Type Head

281-720485 Each **\$400.45**



U-Style Adapter

Universal Style Adapter for use with Shorty and Rhino XP. Accepts disasposable prophy angles.

281-760020 Each **\$151.25**



Prophy Contra Angle Head

Recommended for Lower Speed Range only. Triple-Seal Prophy Contra Angle Head. Screw-in type.

281-720446 Each **\$146.25**

LOW SPEED ELECTRIC ATTACHMENTS



L68 B Latch Head
Transmission 1:1 for latch burs. Push Button auto chuck.
283-10081834 Each.....\$594.95



L67 H Reduction Latch Head - Operative
Transmission 2:1 for latch burs. Push Button auto chuck.
283-10081832 Each.....\$614.95



EX Series Low Speed Attachments
EC-30 1:1 Direct Drive
280-C100008 Each.....\$98.95



FPB-Y Non Fiber Optic
280-C875 Each.....\$188.95



FFB-Y Non Fiber Optic
280-C884 Each.....\$188.95



EX-5B Non Fiber Optic
280-H262001 Each.....\$188.95



NSK Style E Type 1:1 Contra Angle
280-1600210 Each.....\$53.75



Midwest Style 1:1 Contra Angle 14 Tooth
280-1600204 Each.....\$109.95



Midwest Style Ball Bearing Swing Latch Head
280-1600507 Each.....\$85.75



NSK Style Standard Swing Latch Head
280-1600403 Each.....\$32.95



NSK Style Ball Bearing Push Button Latch Head
280-1600421 Each.....\$80.25



KaVo Style Ball Bearing Push Button Latch Head
280-1610810 Each.....\$158.25



KaVo Style 1:1 Ball Bearing Contra Angle
280-1610210 Each.....\$172.25



NSK Style E Type Straight Nose Cone
280-1600310 Each.....\$131.95



NSK Style E Type 20K Air Motor
280-1600110 Each.....\$167.50

LOW SPEED ELECTRIC ATTACHMENTS

StarDental® Instruments

A DentalEZ® Integrated Solutions brand

StarDental® Instruments

A DentalEZ® Integrated Solutions brand

HANDPIECES

Low Speed Handpiece Attachments

Titan-T Straight Nose Cone

280-63942 Each.....\$508.95



Titan 3 Straight Nose Cone

280-57506 Each.....\$499.95



Titan 3 Endodontic Auto Latch Angle

For standard files. Lubricated.

280-62570 Each.....\$452.95



Titan-T Motor-To-Angle Adapter

280-63970 Each.....\$255.95

Titan 3 Motor-To-Angle Adapter

280-264073 Each.....\$259.95



Titan-T Ball Bearing Manual Latch Angle

Lubricated.

280-63947 Each.....\$302.95



Titan 3 Lube Free Ball Bearing Manual Latch Angle

280-62738 Each.....\$297.95

Titan 3 Ball Bearing Manual Latch Angle

Lubricated.

280-259005 Each.....\$297.95



Titan-T Lube Free Ball Bearing Autochuck Friction Grip Angle

280-63954 Each.....\$426.95

Titan 3 Lube Free Ball Bearing Autochuck Friction Grip

280-64151 Each.....\$420.95



Titan 3 Torque Multiplier

280-58443 Each.....\$257.950



RA Latch Type Head Attachment

280-TTLAP Each.....\$174.95



Contra Angle Sheath to fit Shorty™ and Rhino™ Type Motors

280-CAMW Each.....\$114.95



Latch Grip - Push Button

280-TTLAPMW Each.....\$179.95



Deluxe Propfy Angle - Screw Type

For Midwest type contra angle sheath.

280-DPSMW Each.....\$49.95



Straight Nose Cone to fit Shorty™ and Rhino™ Type Motors

280-SNMW Each.....\$204.95



Straight Nose Cone to fit: StarTitan™ “T-Style” Motors

280-SNST Each.....\$279.95



Turbo Torque Straight Nose Cone Attachment 1:1

Fits all standard E-type connections. Will accept any 3/16” shaft lab bur or “straight handpiece” bur or any “doriot” style prophy or contra angle.

280-TTSN1 Each.....\$204.95

LOW SPEED ELECTRIC ATTACHMENTS



Turbo Torque Straight Nose Cone Attachment 4:1
 4:1 reduction gear generates 5,000 rpm from a 20,000 rpm motor. Fits all standard E-type connections. Will accept any 3/16" shaft lab bur or "straight handpiece" bur or any "doriol" style prophyl or contra angle.
 280-TTSN4 Each..... **\$349.95**



Turbo Torque 1:1 Contra Angle Attachment
 Standard no reduction contra angle. Accepts all NSK fitment contra angle heads and attachments. Will fit any standard E-type motor.
 280-TTEC Each..... **\$124.95**



Turbo Torque 4:1 Reduction Contra Angle Attachment
 Fits all standard E-type connections. Will accept any "NSK" threaded contra angle head.
 280-TTE4R Each..... **\$224.95**



Friction Grip - Push Button
 280-TTFGPMW Each..... **\$179.95**

LOW SPEED MOTORS



Rhino XP Single Speed Air Motor
 0-8,000 RPM (4-hole connection)
 281-760034D Each..... **\$1100.95**



Shorty Single Speed Air Motor
 0-6000 RPM (4-hole connection)
 281-710027 Each..... **\$1231.95**



Shorty Two Speed Air Motor
 0-30,000 RPM and 0-6000 RPM (4-hole connection)
 281-710024D Each..... **\$1231.95**



181K Air Motor
 Speed range from 5,000-20,000 rpm. Forward/reverse speed adjustment. Standard 4-hole connection. Non Optic, sterilizable, with 1 year warranty.
 283-05355260 Each..... **\$788.95**

INTRAfLEX Air Motors

This gear-driven system is ergonomic and compact with high torque and it fits on KaVo's unique MULTIflex system. The slow speed air handpiece's lighting system uses fused glass rods versus fiber bundle technology, resulting in no degradation of light quality after repeated sterilization.



2307LN
 Reduction 2.7:1. Speed range up to 13,000rpm. Internal air/water coolant. 1 year warranty.
 283-05356190 Each..... **\$1698.95**

2320LN

Transmission 1:1. Speed range up to 35,000rpm. Internal air/water coolant. 1 year warranty.
 283-05356180 Each..... **\$1648.95**



2325LN

Transmission 1:4 speed increasing. Speed range up to 140,000rpm. Internal air/water coolant. 1 year warranty.
 283-05356210 Each..... **\$1998.95**



L68 Latch Heads

1:1 B latch head with push button auto chuck. 100-40,000 rpm. Blue dot.
 283-10081834 Each..... **\$594.95**

LOW SPEED MOTORS

StarDental® Instruments

A DentalEZ® Integrated Solutions brand



Titan-T™ and Titan® 3 Motors

The Lube Free performance and incredible versatility you have come to know with the stainless steel Titan 3 is now also available in the 25% lighter titanium Titan-T. Both systems come in two speed ranges 5K and 20K, and feature chairside repairable Lube Free angles for reduced downtime and increased efficiency. 360° quick-connect swivels, sold separately, are available in 2 or 4 hole configuration.

Titan-T 5,000 RPM Motor

280-263940 Each \$1194.95

Titan-T 20,000 RPM Motor

280-63941 Each \$1074.95



Titan 3 - 5,000 RPM Motor

280-62261 Each \$1121.95



Titan 3 - 20,000 RPM Motor

280-62262 Each \$977.95

ENDODONTIC HANDPIECES

Kerr™
ENDODONTICS



Elements™ Adaptive Motor and Handpiece

Used with TF Adaptive files to safely and accurately clean and shape root canals. It is also programmed for use with other SybronEndo NiTi Files and the M4 Safety Handpiece.

280-8151500 Each \$2153.75

Kerr™
ENDODONTICS



Endo-Touch TC2 Cordless Handpiece

The next generation in cordless motors. Designed to replace the EndoTouch TC, TC2 has a large LCD display, simple 5-key operation and a lightweight, ergonomic design to assure comfort and ease of use during even the most delicate endodontic procedures. The autoreverse and alarm functions indicate the load is about to reach the pre-set torque level, allowing you to unload the file even before the auto reverse sets in. Contains: Motor handpiece, EndoTouch swing latch head 16:1, 110V power cord, battery charger, F-type spray nozzle, motorcap.

339-8159140 Each \$1558.45



M4 Safety® Handpiece and M4TC2 Handpiece

Before using any NiTi rotary file, it is important to establish a glide path using hand files. Hand filing can cause fatigue, especially when canals are calcified. SybronEndo's M4 Safety and M4 TC2 Handpieces have been designed to navigate canals quickly, efficiently and effectively with hand files.

M4 Safety Handpiece E-Type

289-25846 Each \$1120.45

M4 TC2 Handpiece

339-8159142 Each \$529.25



for something? **WE HAVE IT**

www.dhponline.com

ENDODONTIC HANDPIECES

COLTENE



CanalPro CL Cordless Handpiece

Thin, ergonomic design for better access to hard-to-reach areas. Large, user-friendly LCD panel. Memory for up to 5 programs. Auto-reverse modes. 6 head positions allow contra angle to be adjusted to your preferred position. Operates continuously for approximately 90 minutes. Non-contact charger prevents improper charging due to deterioration of metallic terminal. Energy-saving; turns off when not used for 10 minutes. Contra angle head is autoclavable at 135°C. Rotation Speed (min-1): 140~550. Torque Level (N-cm): 0.3~3.0.

334-H8CPCLINTRO Each.....\$1383.45



Tri Auto ZX

Cordless Endodontic Handpiece. The cordless Tri Auto ZX is the only endodontic handpiece with a built-in apex locator, giving the clinician the capability and convenience to electronically monitor the root canal before, during and after instrumentation. Combined with the technology and accuracy of the Root ZX II apex locator, Tri Auto ZX significantly increases accuracy and safety. Tri Auto ZX also offers greater control and flexibility with adjustable torque settings. Choice of automatic or manual mode operation provides versatility. Automatic functions include: Auto start/stop, auto apical reverse, and auto torque reverse.

330-5316227 Each.....\$2455.25



Endo-Mate DT

Push Type Ultra mini head allows fast and easy exchange of files during procedures. Compact head offers excellent visibility of treatment spots. Quick release system allows for easy head exchange. 120V.

280-Y141120 Each.....\$1248.95



Endo-Mate TC2

Mini head and slim neck assure higher visibility. Two kinds of alarms sound for safer and more efficient treatment. Suitable for use with most major brands of NiTi files. Features a large LCD panel and access friendly key.

280-Y1001036 Each.....\$1248.95

HYGIENE HANDPIECES



ProphyPal™

The ProphyPal Hygiene Handpiece is designed with an extended Sure-fit nosecone with a 360° swivel for maximum control and easy transfer between buccal and lingual surfaces. Its lightweight and balanced construction is ergonomic with a grip that fits all hand sizes. This autoclavable, no-stall handpiece is whisper-quiet and backed by a 2 year warranty.



Prophy Pink280-751001
 Classic Silver280-750001
 Wild Thing Green280-752001
 Each\$643.25



Prophy Pink280-751003
 Classic Silver280-750003
 Wild Thing Green280-752003
 Variety280-753003
 3/pack\$1855.75

ProphyPal Nosecone

280-754001 Each.....\$31.75

HYGIENE HANDPIECES

DENTSPLY
MIDWEST



Midwest® RDH®

A lightweight hygiene handpiece system designed with your comfort in mind. Midwest RDH Hygiene Handpieces offer exceptional ergonomics and a lightweight design. The handpiece is designed to neutralize hand position during procedures with specifically designed contours. The Midwest RDH Hygiene Handpiece and the Featherweight Hose are exclusively designed to work together to reduce cord drag. Includes handpiece, featherweight hose, hose installation kit. 2 year warranty.

Gray	
281-740050	Each \$768.45
Beige	
281-740060	Each \$753.25



Midwest® RDH® Hygienist Handpiece with Proply Right Angle

281-740020	Each \$822.75
281-740030	3/pack \$2164.25



Nupro Freedom™ Cordless Proply System

Provides enhanced control, comfort and freedom. SmartMode Technology provides the latest advance in handpiece speed control, without the need for buttons or foot pedals. The electric motor and high quality NUPRO Freedom Disposable Proply Angles reduce noise and vibration, providing a more pleasant polishing experience for both the patient and the clinician. Provides 25% more speed and power than previous Freedom models. Sterilizable outer sheath and fully compliant with the CDC Sterilization Guidelines.

System

Contains: 1 outer sheath.	
280-90741L01	System \$949.95

Package

Contains: 3 outer sheaths and 200 disposable proply angles.	
280-90741L03	Package \$1499.95

KAVO
Dental Excellence



PROPHYwiz

Lightweight hygiene handpiece that features 360° swivel for accessing hard to reach areas while providing superb fingertip control. Runs smoothly and quietly to optimize patient comfort while eliminating operator wrist and hand stress.

283-10032278	Each \$864.95
283-10039882	3/pack \$1828.95

NSK



iProply Air

360° Swivel - The iProply Air swivels at your fingertips, providing excellent maneuverability during polishing procedures. NSK ultra-precision micro machining technology has been applied to all parts of iProply Air that remarkably reduce vibration and noise to the lowest level. Designed using NSK's ergonomic method. This slim, short and light handpiece provides good balance and less fatigue.

280-M1020	Each \$728.95
-----------	----------------------------

StarDental® Instruments

A DentalEZ® Integrated Solutions brand



iStar Cordless Prophylaxis Handpiece

Cordless handpiece designed to make dental hygiene procedures easier, faster and less stressful. Accepts any standard disposable proply angle (excluding RDH freedom and Preventech ESA) and has a 3 hour running time. Lightweight, cordless design uses no foot pedal. 18 month warranty on handpiece, charger and A/C adapter.

280-265993	Each \$1044.95
------------	-----------------------------

HYGIENE HANDPIECES

StarDental® Instruments

A DentalEZ® Integrated Solutions brand



Propphy Star 3

The lightweight anodized aluminum Propphy Star 3 offers less stress and fatigue for operator. Sterilizable silicone replacement grips allow color coding. 4" in length and features a longer 360° swivel.

Propphy Star 3

Contains: 1 handpiece and 4 grips; one each Aqua, Blue, Lavender and Pink.

280-264422 Each..... **\$908.95**

Nosecone with 4 Grips

280-264434 Each..... **\$140.95**

Replacement Grips

Contains: One each color - Aqua, Blue, Lavender and Pink.

280-264441 4/pack..... **\$51.95**

YOUNG



Young Hygiene Handpiece

Designed to fit the contours of the hygienist's hand, The Reverse Radius silhouette allows the handpiece to fit comfortably in the dental hygienist's hand, while the contra-angled hose connector reduces drag aggravation. The nosecone, which easily detaches for easier preparation and sterilization, features a 360-degree rotation and matte grip for maximum maneuverability. Manufactured in the USA and comes with a 2 year warranty.

Silver

280-410001 Each..... **\$743.25**

Purple

280-295249 Each..... **\$743.25**

LAB HANDPIECES



M35 Electric Laboratory Handpiece

The M35 provides excellent cutting power and smooth performance. Provides fully variable speed from 0-35,000 rpm via the console or foot control.

Contains: M35 System Complete, 120/220 V control console, one handpiece with HP collet, variable speed foot control, spare carbon brushes, and accessories.

770-BUF38120 Each..... **\$549.95**



X50 Brushless Electric Laboratory Handpiece

Brushless high torque motor and control system provide brute-strength power and smooth control through the 1,000 to 50,000 rpm speed range and eliminate carbon brush maintenance. New intelligent microprocessor controls provide fully variable speed via console or foot control, protect the handpiece from damage, and display precise rotational speed. Automatic cruise control simplifies foot control speed operation.

Contains: X50 Brushless Handpiece system complete, 120 V AC, including brushless handpiece with HP collet, variable speed foot control, and accessories.

770-37800 Each..... **\$1141.95**

SURGICAL SYSTEMS

KAVO
Dental Excellence



EXPERTSurg LUX

Operate safely with high precision thanks to one of the world's lightest and smallest surgical motor and auto-calibration. Rely on high performance with 80 Ncm torque at the instrument. Save time with intuitive programming and easy hygiene.

Contains: Foot control, instrument holder, INTRA LUX S600 motor, sterilizable motor cable, power cord, and 5 sterile irrigation tubes. Handpiece not included.

280-10083500 Each **\$4198.95**



MASTERSurg LUX

Comfort features such as touchscreen, wireless foot control and data documentation come as standard. Can be customized with up to 10 programs, each with 10 individually programmable steps. High performance thanks to the S600 LED - one of the world's lightest surgical motors.

Contains: Wireless foot control, instrument holder, INTRA LUX S600 motor, sterilizable motor cable, power cord, and 5 sterile irrigation tubes. Handpiece not included.

280-10091200 Each **\$5698.95**

INTRAmatic LUX KL703

Replacement motor.

280-10070150 Each **\$2478.95**

NSK



Surgic Pro

This new surgical micromotor is 16.2mm shorter and weighs 42g less compared to the conventional optic surgical micromotor. LED illumination helps the clinicians to focus more easily on the treatment area and contributes to precise surgery. Use NSK Surgic Pro AHC to calibrate micromotor and handpiece to the rotational resistance of each individual handpiece prior to operation. AHC guarantees extremely accurate speed and torque for maximum safety during operation. The Foot Control is user friendly and allows operation of all functions within the preset parameters without touching the control panel to avoid accidental activation of the micromotor outside the preset limits. The Surgic Pro/Surgic Pro+ is certificated according to IPX8.

Surgic Pro+ OPT-D Fiber Optic (120V)

280-Y1002095 Each **\$6698.95**

Surgic Pro OPT Fiber Optic (120V)

280-Y1001949 Each **\$5598.95**

Surgic Pro OPT Non Fiber Optic (120V)

280-Y1001950 Each **\$4598.95**

COUPLERS & SWIVELS

**DENTSPLY
MIDWEST**



Stylus™ Fiber Optic Couplers

5-Hole

281-790245 Each **\$290.45**



6-Pin

281-790246 Each **\$364.95**

COUPLERS & SWIVELS



460 LED MULTiflex LUX Coupler

6-pin fiber optic coupler with LED bulb in coupler. Use with LCM illuminator and tubing. Anti-retraction valve. Non-Optic.

283-10073201 Each \$374.95



457 MULTiflex Coupler

4-hole. Anti-retraction valve. Use with LS2 Illuminator and Tubing.

283-05531210 Each \$264.95



1390 MULTiflex LUX Coupler

5-hole connection. Use with KaVo standard 5 hole fiber optic tubing or standard 5 hole tubing. Anti-retraction valve.

283-05531390 Each \$364.95



465LRN MULTiflex LUX Coupler L

6-hole connection. Spray regulator. Light bulb in coupler. Anti-retraction valve. Use with LCM illuminator and tubing.

283-05531550 Each \$424.95



LED Coupling

Stainless steel body, with a titanium coating. Non-retraction valve. LED incorporated in coupling. For use with NSK model handpieces.

280-P1001600 Each \$358.95



Fiber Optic Coupling

Stainless steel body with titanium coating. Non-retraction valve. Light bulb. For Midwest 5-Hole coupling.

280-P380081 Each \$248.95

StarDental® Instruments

A DentalEZ® Integrated Solutions brand



Swivel Assembly ISO 4-Line Non Fiber Optic

280-61547 Each \$222.95



HiFlo Swivel Assembly

4-hole fiber optic for 5 hole tubing.

280-263758 Each \$325.95



HiFlo Swivel Assembly

Use with 6 pin 3.3V fiber optic StarBright system.

280-263772 Each \$454.95



StarBright® LED Swivel

Cool white neutral daylight color. 1/3 the weight of your current LED handpiece coupler or swivel. More than 10 times the life of a halogen bulb. Compatible with any 6-pin ISO type C tubing. Autoclavable.

280-265400 Each \$515.95



StarBright Plug n' Play™ LED Swivel

New internal circuitry designed to work on most delivery units without modification. Non autoclavable. Cool white light.

280-265646 Each \$533.95



ISO-C 6 Pin Swivel with Bulb

280-VKS6LE Each \$234.95



5-Hole Fiber Optic Swivel

280-VKS5 Each \$204.95

HANDPIECE MAINTENANCE SYSTEMS



Midwest® Automate - Dentsply Professional

Enhances efficiency and complements the way you work by effectively removing debris to promote lasting handpiece turbine life, reducing downtime to keep your staff moving and creating less mess than traditional handpiece maintenance for quick cleanup.

Contains: Maintenance System, absorbent pads, air tube with wall connection, power connection, Midwest Tradition/Quiet-air Quick Connect maintenance adapter, Midwest lowspeed attachment adapter, Midwest Automate E-Type Maintenance Coupler, Midwest Plus aerosol spray can.

770-380200 Package **\$2850.95**

Absorption Pad Refill

280-380520 6/pack **\$50.95**

Midwest Plus Aerosol Spray Can

Without nozzle.

571-380080 16oz. **\$68.45**



Lubrina - J. Morita USA

Fully automatic, highly efficient cleaning, purging, and lubrication for a wide variety of equipment. Service up to 4 handpieces in just 100 seconds, accommodating contra-angles, straight handpieces, air driven handpieces, and air scalers. Accepts multiple brands of spray lubricant. Additionally, up to two different lubrication sprays can be used in the same cycle. Equipped with an air suction system to help eliminate odor and a return circuit to absorb excess lubricant for a clean operating area.

770-245343054 Each..... **\$2477.25**



QUATTROcare Plus - KaVo Dental

Designed to clean, lubricate and purge your instruments with the simple push of a button. Loading and operation is easy as are the automatic care and maintenance procedures. Less wear, fewer repairs, less staff down time, smoother operation, and increased longevity of your handpieces. Can be used for virtually all manufacturer's high-speeds, low-speed contra-angles, straight handpieces, air driven scalers, and air motors. Complete handpiece maintenance is available with the new chuck care feature. Once per week cleaning and care of handpiece chucks maintains their gripping force, reliability and long service life. Unit comes with one can of QUATTROcare Plus spray.

770-10083805 Each **\$3268.95**



iCare - NSK

Automatically cleans and lubricates up to 4 handpieces at once. The proper solution volume is preset based on high and low speed handpiece type, ensuring precise and thorough lubrication at the touch of a button. A chuck-cleaning function removes dirt and cutting powder from the chuck. Purging select mode ensures complete removal of excess oil. The iCare uses liquid oil in an integrated tank that holds up to 1.2 liters and provides up to 2,800 cycles before refilling is needed.

C2 120V

280-Y1002796 Each..... **\$2798.95**

C3 120V

280-Y1002797 Each..... **\$2798.95**



STATMATIC 31 - SciCan

Automatic handpiece maintenance unit cleans and lubricates straight to the bottom line. Quick and thorough. Automatically cleans and maintains up to three handpieces. Cycle time is only 15 seconds per handpiece. Unique chuck care system. Chemical/physical cleaning with foaming care agent. Optimal lubricant coverage throughout the handpiece. Compressed-air connection for excess lubricant purging. Automated reproducible quality of care. Easy spray can insertion. Can coupling with unique safety valve. Absorption pad for excess lubricant.

570-SCIS3000NA Each..... **\$2829.95**

HANDPIECE LUBRICANT



Midwest Plus Aerosol Spray - Dentsply Midwest

Spray Can without Nozzle

571-380080 16oz. **\$68.45**

Aerosol Nozzle

281-380085 Each..... **\$22.45**

HANDPIECE LUBRICANT



Midwest® Plus Handpiece Cleaner - Dentsply Midwest Maintenance Kit

Contains: 2 oz. lube and 8 oz. cleaner.
571-380145 Kit..... **\$76.25**

Lubricant
571-380130 2oz. dropper bottle... **\$50.25**

Lubricant Refill
571-380131 8oz **\$161.95**

Cleaner
571-380140 8oz spray bottle **\$40.45**

Cleaner Refill
571-380141 1liter **\$105.75**



Handpiece Lubricant - Integra® Miltex®

Non-toxic formula lube comes in easy-to-use bottle with tapered applicator tips. Requires only 2-3 drops per application. 0.50oz.
571-7538 4/pkg..... **\$80.25**



AR Spray - J.Morita USA Spray Can

280-245010212 420ml **\$35.95**

AR Spray Nozzle for TwinPower Turbine

280-245010307 Each **\$32.00**

KaVo Spray - KaVo Dental

Designed specifically to withstand sterilization. Relubrication after sterilization is unnecessary, eliminating the risk of recontaminating sterilized handpieces. Nozzles sold separately.
571-04119660 500ml..... **\$65.75**



MULTiflex Nozzle - KaVo Dental

For maintenance of all KaVo MULTiflex handpieces, INTRAfLEX LUX motors, SONICflex scalers and the 181 M Air Motor.
571-04119921 Each **\$24.95**

Quick Nozzle - KaVo

For all INTRA & INTRAfLEX LUX heads, 4-hole fixed back handpieces, all KaVo air motors (except 181 M), all handpieces with universal "E" type connection and surgical handpieces.
571-04119931 Each **\$24.45**

QUATTROcare Plus Spray - KaVo Dental

High-quality universal maintenance for all KaVo handpieces (high speeds, low speeds, heads and air motors). Designed specifically to withstand sterilization. Relubrication after sterilization is unnecessary, eliminating the risk of recontaminating sterilized handpieces. For cleaning and care in the KaVo QUATTROcare Plus.
571-10054524 500ml **\$62.45**



Pana Spray Plus - NSK

Lubricant spray for high and low speed handpieces, and air motors.
770-Z182600 10.5oz. **\$48.95**



Once-A-Day - Palmero Health Care

Cleaner and lubricant directions on the container. Used in air turbines and all hinged instruments. Non-flammable, non-corrosive and non-conductive. Sterilize to 450°.
571-702 8.8oz. **\$12.75**



STATMATIC Spray - SciCan

One-step, pre-sterilization handpiece maintenance spray. Provides lubrication to help prolong the working life of your dental handpieces. Simple, convenient spray can loading.
571-STM5006NA 500ml **\$45.15**



Bio Lube - Southland Distribution & Sales Lubricant

Advanced synthetic handpiece lubricant. Eliminates metal-to-metal contact, reduces friction and wear, runs smoother and quieter, withstands temperatures up to 572°F, extends turbine life, ceramic and steel, restores bearing cages and O-rings, eliminates costly repairs, biodegradable, non-flammable aerosol, non-toxic, no hazardous shipping.

For Automatic Handpiece Station

571-BIOAL 1000ml **\$89.75**

Cleaner

Advanced handpiece cleaner. Extend the life of your handpiece: evaporates old oil, strips away blood and saliva, frees gummed-up turbines, leaves no residue, non-flammable, environmentally friendly, contains no carbon tetrachloride.
571-BIOC12 7oz. **\$31.45**

For Automatic Handpiece Station

571-BIOAC 1000ml **\$35.25**

Bio Lube Introductory Kit

Contains: 7oz. cleaner and 7oz. lubricant.
571-BIOC24 Kit..... **\$123.95**

HANDPIECE LUBRICANT



DentaLube II - StarDental® Instruments
Advanced high-speed handpiece lubricant.
Non-Aerosol.
571-62539 1oz..... **\$27.95**



Vector Spray - Vector Research & Development Inc.

Will not break down in your sterilizer. One spray prior to sterilization is all that is needed. The highest quality handpiece lubricant available today. Interchanges with KaVo spray attachments.

Manual
571-VLS 500ml..... **\$36.95**

Automatic
571-VLAQ 500ml..... **\$36.95**

HANDPIECE ACCESSORIES



Autoclavable Rubber Gasket 4-Hole - DCI
580-DCI0123 Each..... **\$3.25**



Gaskets & Couplers - Dentsply Midwest
5-H Fiber Optic Gasket - Blue
281-773018 Each..... **\$17.75**



5-H Fiber Optic Gasket - Red
Quick connect adapter.
281-753342 Each..... **\$21.25**



4-Hole Gasket
Midwest connector.
281-773002 Each..... **\$17.75**



6-Pin Gasket
Quick connect tubing.
281-790258 Each..... **\$17.75**



5-H Coupler
281-790255 2 sets..... **\$17.75**

6-Pin Coupler
281-790256R 2 sets..... **\$17.75**



Tradition Standard Bur Changer - Dentsply Midwest
281-750119 Each..... **\$38.45**



MULTI LED Bulb - KaVo Dental
For all your 6 pin MULTIflex couplers. An LED that can easily replace your existing halogen lamp. MULTI LED offers efficient and superior light, with color temperature similar to daylight (5,500 K and 25,000 LUX) at the bur tip. Operating voltage range 3.0 - 3.6 V DC. Nominal voltage 3.4 V DC. Current < 120 mA.
283-10075372 Each..... **\$124.95**



MULTIflex Coupler Bulbs - KaVo Dental
For the 465LRN, 459AN, 181L and 460LE.
283-10022928 2/pack..... **\$104.95**



O-Ring Kit for Swivel - 430 Series - StarDental® Instruments
2 large and 2 small.
280-59884 Each..... **\$18.95**



O-Ring - Vector Research & Development Inc.
Fits all KaVo MULTIflex type swivel connectors. Contains: 2 white, 3 black.
280-RP008 5/pack..... **\$9.95**



Spray Adapters - Vector Research & Development Inc.
A) For KaVo MULTIflex..... 571-VLAK
B) For Star Type..... 571-VLAT
C) For NSK Type..... 571-VLAN
D) For E-Type Lowspeeds..... 571-VLAE
E) Universal pointed..... 571-VLAU
Each..... **\$9.95**



Alginate

A very smooth, creamy alginate that provides consistent, accurate, bubble-free impressions. Spearmint flavored with reduced gag reflex for increased patient comfort.

Regular Set: Working Time: 1 minute / Setting Time: 3 minutes.

Fast Set: Working Time: 45 seconds / Setting Time: 2-1/2 minutes.

Regular Set 290-HTRS101
Fast Set 290-HTFS101
1lb. can **\$13.45**

Scoop & Vial

300-HTMEASURE Each **\$1.95**



Cavex ColorChange - Cavex

9 days dimensional stability (without shrinking in a well closed plastic bag). Innovative reaction mechanism. Rapid, complete hardening reaction. Highly elastic. Good tear and deformation resistance. Detail reproduction at least 25 µm. Smooth surface, optimum gypsum compatibility. Dustfree. Setting time: 1 minute in mouth.

290-AA323 500gm **\$12.95**



Alpha-Dent - Dental Technologies

Designed to produce consistent impressions. Each can includes powder scoop and vial.

Regular Set

Mint..... 290-000MRR
Bubble Gum..... 290-000BRR
Cherry..... 290-000CRR
Strawberry 290-000SRR
1lb. can **\$10.45**

Fast Set

Mint..... 290-000MFR
Bubble Gum..... 290-000BFR
Cherry..... 290-000CFR
Strawberry 290-000SFR
1lb. can **\$10.45**



Jeltrate - Dentsply Caulk

For consistently accurate and reliable impressions. Contains proper flow characteristics and has great ability to register oral detail. Includes scoop.

Regular Set..... 298-608503
Fast Set..... 298-608522
1lb. can **\$19.45**

Regular Set..... 298-608058
Fast Set..... 298-608247
22lbs. **\$337.45**



Jeltrate Dustless

Easy-to-store pouches.

Fast Set..... 298-605200EACH
1lb. pouch **\$138.75**

Value Pack

Contains: 8 -1lb. pouches, 1 empty canister, 1 scoop and 1 water measure.

Regular Set.....298-605100
Fast Set.....298-605200
Each **\$138.75**

Measuring Scoop & Vial

308-608015 Each..... **\$1.75**



Jeltrate Chroma Dustless

Formulated to change colors for each preparation phase: fuchsia during mixing, lavender during tray loading and seating to light blue during setting in the mouth. Fast setting time of 2 minutes and is five day dimensionally stable when stored in a hermetically sealed plastic bag.

Intro Kit

Contains: 1lb. pouch with reusable canister and 1 measuring scoop.
298-605710 Kit..... **\$22.45**

Refill

298-605700 1lb. pouch..... **\$22.45**



Jeltrate Plus

Dispenses easily with no annoying dust when fluffing or mixing. Antimicrobial, smoother, creamier and more algin for increased tear strength.

Regular Set..... 298-605502
Fast Set..... 298-605602
1lb. can **\$20.95**

Regular Set..... 298-605503
Fast Set..... 298-605603
22lbs. **\$355.25**



Coe Alginate™ - GC America

Commonly used for edentulous and study model impressions for orthodontics and prosthodontics. Contains enough powder for 24 full arch impressions. Scoop included.

Fast Set/Mint..... 292-120101
Fast Set/Cherry..... 292-121101
1lb. pouch **\$24.25**



Identic™ Dust Free - Kerr Restoratives

Achieves four results: easy mixing, excellent stone surface, smoothness and fine detail. Identic Singles are convenient, easy to use and ensure consistent mixes every time. Identic Fast Set and Regular Set have a cinnamon scent. The Extra Fast Set Hypo-Allergenic is unscented.

Regular Set..... 290-7480
Fast Set..... 290-7476
1lb. pouch **\$17.45**

Extra Fast Set 290-7493
1lb. pouch **\$20.75**

Value Pak

Contains: 8 -1lb. bags, 1 canister, 1 scoop and 1 water vial.

Regular Set..... 290-7481
Fast Set..... 290-7477
Pack **\$128.75**

Extra Fast Set
290-7492 Pack **\$139.95**

Singles - Fast Set

Contains: 125 pre-measured single-use packets.
290-27434 Each..... **\$100.95**

ALGINATE



Integra™ - Kerr Restoratives

A very smooth, creamy alginate that provides a quick oral record. Dust-free. Provides great detail for model reproduction. Packaged in poly-aluminum bags to eliminate moisture contamination. Cinnamon scented.

Introductory Package - Fast Set

Contains: 6 -1lb. pouches, water measure, powder measure and canister.

299-26755 Package **\$140.45**

Refill - Fast Set

299-267571 1lb. pouch **\$20.95**



KromaFaze - Kerr Restoratives

Color change, dust-free alginate offers a visual guide for consistent impression making. Purple FAZE: mix, Pink FAZE: load, White FAZE: set. Remove the tray 30 seconds after set.

Regular Set..... 290-27453
Fast Set..... 290-27466
1lb. pouch **\$177.25**

Singles - Fast Set

Contains: 125 pre-measured single-use packets.
290-27444 Each..... **\$100.95**

Value Pak

Contains: 8 -1lb. pouches, 1 plastic canister, scoop and water vial.

Regular Set..... 290-7497
Fast Set..... 290-27467
Each **\$147.75**



Bosworth Supergel - Keystone Industries

Premium blended alginate material that mixes readily to a smooth, creamy consistency. Its slow dehydration and low surface tension provide consistent, accurate, bubble-free detailed reproductions every time. Pleasing saffras flavor, controlled flow, heavy body, and gag reflex

reduction provide greater patient acceptance.

Regular Set

1lb. can..... 290-0921825
1lb. pouch..... 290-0921818

Fast Set

1lb. can..... 290-0921826
1lb. pouch..... 290-0921819
Each **\$16.95**



Bosworth Supergel Fresh

Has all the benefits of our traditional Supergel alginate but is a dust-controlled formula for less airborne particles when opening and mixing. Berry-Cherry flavored. 1lb can.

Regular Set..... 290-0921822
Fast Set..... 290-0921823
1lb. can **\$16.95**



Kromopan 100 - Kromopan USA

After mixing water and powder, the compound color turns to purple, it is time to mix. Pink indicates the time to pour the compound in the impression tray. The white color indicates the time to insert the tray in the oral cavity. The minimum in-mouth setting time is just 30 seconds. Dust-free, fast set, and mint flavored.

Kit

Contains: 1lb. pouch with resealable plastic tub.
290-KROMOCAN Kit..... **\$23.95**
290-KROMOP 1lb. pouch **\$12.25**



Image Dust Free - Pentron Clinical

Dust free and bubble free, glass-like results. Green, mint scented.

Contains: 1lb. pouch, canister, scoop and vial.

Regular Set..... 290-27426
Fast Set..... 290-27416
Each **\$19.95**

Value Pack

Contains: 10 -1lb. pouches, canister, scoop and vial.

Regular Set..... 290-27427
Fast Set..... 290-27417
Each **\$154.75**

Bulk Pack available upon request.



Plastalgin - Septodont

Impression for case study and orthodontic models, fabrication of models for mouthguards, provisional restorations, bleaching trays, partial denture frameworks and occlusal splint appliances. Class A alginates for accurate impressions. Fruit-flavored dust-free formula.

Normal Set Type II..... 290-C1100
Quick Set Type I 290-C1000
1lb. bag **\$17.75**



Key-To® - Water Pik, Inc.

Quick mixing for smooth handling and fast cleanup. Includes scoop and water vial. Spearmint flavored.

Regular Body - Regular Set..... 290-13111
Regular Body - Fast Set 290-13113
Heavy Body - Fast Set..... 290-13112
1lb. can **\$17.95**



Hydrogum - Zhermack

Elastic, quick-setting (45 seconds - in the mouth), dust-free alginate. Indicated for denture impressions including chromes, orthodontic, opposing arches, study models, temporary crown and bridge impressions. Setting time 2:10. Green. Mint flavored.

290-C302025 1lb. bag **\$16.25**

Continued

ALGINATE

Hydrogum continued.



Hydrogum Soft

Fast setting extra-elastic dust free alginate. Indicated for removable prosthesis and chromes, study models, antagonists in fixed prostheses. Time in mouth, 60 seconds. Set time, 2:10. Light Blue. Mint flavored.

290-C302060 1lb **\$13.25**



Hydrogum 5

5 Days stability, extra fast setting - dust free. Recommended for: temporary crown & bridges, removable protheses and chromes, study models, antagonists in fixed and removable prosthesis. Time in mouth, 45 seconds. Set time, 1:50 minutes. Lilac. Exotic fruit flavored.

290-C302072 1lb. canister **\$21.95**
290-C302070 1lb. bag **\$16.25**



Tropicalgin - Zhermack

Chromatic 3-phase alginate with a fast set (60 seconds in the mouth). Indicated for denture impressions including chromes, orthodontic, surgery models, opposing arches, temporary crown and bridge impressions. Setting time 2:35. Dust free. Mango flavored.

290-C302240 1lb. bag **\$16.25**



Orthoprint - Zhermack

Rapid setting, highly elastic, dust-free alginate. Yellow. Vanilla flavored.

290-C302145 1lb. bag **\$16.25**

Order by ☎ **800-626-2163**

ALGINATE MIXING BOWLS



Flexible Mixing Bowls

Small
8 cm/150 cc, 3-1/4" Dia, 2-1/2" H
760-HT904S Each **\$7.95**

Medium
10 cm/350 cc, 4-1/4" Dia, 2-3/4" H
760-HT904M Each **\$8.45**

Large
13 cm/600 cc, 4-3/4" Dia, 3-1/2" H
760-HT904L Each **\$8.95**



Flexibole® - Coltene

Material will not stick. Self-cleaning. More flexible than rubber. 150cc capacity.

Small - 3-1/4" diameter x 2-1/4" height.
765-00563 Each **\$11.25**

Medium - 4-1/4" diameter x 2-3/4" height.
350cc capacity.
765-00564 Each **\$16.75**

Large - 4-3/4" diameter x 3-1/2" height.
600cc capacity.
765-00565 Each **\$18.25**



Mixing Bowls - Kerr Restoratives

Alginate Type
Medium, 3-5/8" x 5" Gray.
300-25236 Each **\$24.75**

Stone Type
Large, 4-1/2" x 5-3/8" Gray.
300-25252 Each **\$28.75**



Candeez Flexible Mixing Bowls - Palmero Health Care

Manufactured in an extremely pliable PVC that allows for easier and more efficient mixing of impression materials. With a large stabilizing base and an ultra smooth surface. The unique flexible design allows inside-out folding. All bowls can be used with most automatic alginate mixers. Latex-free. Non-Autoclavable.

Medium 4" wide x 2-1/2" deep - 350cc
Red 300-1530R
Purple 300-1530P
Blue 300-1530B
Green 300-1530G
Each **\$7.75**

Large 4-1/2" wide x 3" deep - 600cc
Red 300-1531R
Purple 300-1531P
Blue 300-1531B
Green 300-1531G
Each **\$9.75**

Scented available upon request.



Mighty Mixer Bowl - Zirc

Insert the self-standing plastic, disposable liner into your mixing bowl. The liner is smooth surfaced and as pliant as the mixing bowl. 4-7/8" x 3-1/4".

Freestanding White
760-50Z505 36/pkg **\$22.75**

Assorted Colors
760-50Z505ASTD 36/pkg **\$20.95**



Clean and Lube Spray - Kerr Restoratives

Effectively removes alginate and stone residue from bowls. Also contains an emollient to keep bowls from drying out while reducing bowl abrasion. Will not discolor your alginate bowls and is completely safe.

760-3070 4oz. **\$12.25**

ALGINATE MIXING PADS

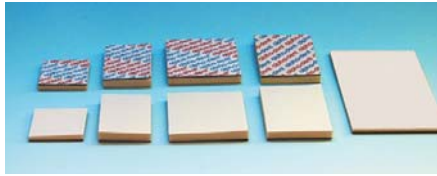

Mixing Pads

Polyethylene coated. 100 sheets per pad.

- Dycal Type 1-1/2" x 2"**
300-1502 Each..... **95¢**
- Durelon Type 2-3/4" x 3-3/4"**
300-2343 Each..... **\$2.25**
- 2-3/4" x 3-3/4" Skid Resistant**
300-2343SR Each..... **\$2.75**
- 3" x 3"**
300-3030 Each..... **\$2.25**
- 3" x 3" Skid Resistant**
300-3030SR Each..... **\$2.25**
- Coe Type 3" x 4"**
300-3040 Each..... **\$2.25**
- 3" x 6"**
300-3060 Each..... **\$2.75**
- 3" x 6" Skid Resistant**
300-3060SR Each..... **\$2.95**
- Durlone Ortho Type 3-1/4" x 5"**
300-3145 Each..... **\$2.75**
- 4" x 5"**
300-4050 Each..... **\$2.45**
- Impregum Type 5" x 7-1/2"**
300-5075 Each..... **\$3.75**
- Coe Type 6" x 6"**
300-6060 Each..... **\$3.95**
- Coe Type 6" x 6" Skid Resistant**
300-6060SR Each..... **\$4.25**
- Coe Type 6" x 9"**
300-6090 Each..... **\$4.95**
- 6" x 9-1/2" Skid Resistant**
300-6912SR Each..... **\$4.95**
- Permlastic Type 7" x 8"**
300-7080 Each..... **\$4.95**



Mixing Pads - 3M Oral Care

- Universal 2-1/2" x 3-1/2"**
Disposable, coated sheets.
237-70145 Each..... **\$11.75**
- Small 3-1/2" x 6"**
307-70129 Each..... **\$8.95**

- Large 4-3/4" x 7-1/2"**
307-7013 Each..... **\$11.75**
- X-Large 5-3/4" x 9-1/4"**
307-7018 Each..... **\$19.25**



Mixing Pads - GC America
6" x 6"

Designed for materials to be easily mixed and kneaded.
302-159112 12/pkg **\$13.75**



Non-Slip Mixing Pads - Pentron Clinical
Non-slip, waterproof backing. Each sheet is plastic coated on both sides.

- #0 X-Small 1-1/4" x 1-5/8"**
230-1092 12/pkg..... **\$27.45**
- #1 Small 3-1/4" x 2-9/16"**
230-1093 8/pkg..... **\$20.95**
- #2 Medium 3-1/4" x 5-1/8"**
230-1094 4/pkg..... **\$20.95**
- #3 Large 6-1/2" x 5-1/8"**
230-1095 2/pkg..... **\$20.95**
- #4 X-Large 6-1/2" x 8-1/16"**
230-1096 1/pkg..... **\$18.45**

ALGINATE SPATULAS



Mixing Spatula - Dentamerica, Inc.

White plastic.
300-910 Each..... **\$3.95**



Alginate Spatula - Kerr Restoratives

Autoclavable.
300-25234 Each..... **\$17.95**



Alginate Spatula - Palmero Health Care

A white plastic, broad blade spatula with medium flex and short, straight handle. Autoclavable up to 270°. Latex free. 7.5"

300-1519 Each..... **\$4.75**



Ergonomic Jumbo Spatula - Palmero Health Care

For use with cements, porcelains, acrylics and other materials. They are specially designed with an ergonomic handle. Autoclavable to 270°. Latex-free. 11"

- White 300-1520W
- Gray 300-1520GY
- Blue 300-1520B
- Purple 300-1520P
- Mauve 300-1520M
- Each **\$5.25**

Additional colors available upon request.

ALGINATE ALTERNATIVES



Algin-X Ultra - Dentsply Caulk

VPS-based dimensional stability allows you to pour your model whenever you want, and repour if necessary, for up to two weeks. Automix cartridge provides a consistent mix. Fast Set. Spearmint flavored.

4-Pack Refill

Contains: 4 -50ml cartridges and 6 mixing tips.
298-61E800 Each..... **\$61.45**
Case refill available upon request.

Bulk Refill

Contains: 24 -50ml cartridges.
298-61E801 Each..... **\$290.95**

DECA Standard Pack

Contains: 2 -380ml cartridges, 20 dynamic mixing tips, and 1 bayonet locking ring.
298-61E810 Each..... **\$135.25**

ALGINATE ALTERNATIVES



StatusBlue - DMG America

A-silicone situation impression material for use with the MixStar machine. Use it for impressions, temporaries, model-cast dentures, orthodontic models and opposing jaw models. 100% dust-free and can be cold disinfected, allowing for clean, neat and safe impression taking. StatusBlue cartridges will also fit in Pentamix machines. (Pentamix is a registered trademark of 3M Oral Care).

StatusBlue MixStar

Contains: 38ml cartridge and 10 MixStar Tips.
290-909693 Each.....\$118.45

AutoMix Economy Tub

Contains: 8 -50ml cartridges and 16 automix tips.
290-909826 8/pkg.....\$152.25

MixStar Mixing Tips

300-993334 50/pkg.....\$99.25

StatusBlue Automix Tips

290-909797 25/pkg.....\$54.95

Type 50 Automix Gun

4:1/10:1 Ratio
110-110411 Each.....\$170.25



AlgiNot - Kerr Restoratives

A high-quality material that delivers exceptional accuracy and performance. Simple to use, and it saves a tremendous amount of time.

Cartridge Intro Kit

Contains: 6 -50ml cartridges and 12 mixing tips.
299-33034 Kit.....\$94.25

Cartridge Refill

Contains: 24 -50ml cartridges.
299-33035 Each.....\$309.45

Volume Intro Kit available upon request.

Volume Refill

Contains: 6 -380ml base and 3 bayonet rings.
299-34680 Each.....\$309.45

Alginot FS - Fast Set Cartridge Intro Kit

Contains: 6 -50ml cartridges and 12 mixing tips.
299-33816 Kit.....\$94.25

FS Cartridge Refill

Contains: 24 -50ml cartridges.
299-33817 Each.....\$309.45

FS Volume Intro Kit available upon request.

Order by ☎ 800-626-2163

FS Volume Refill

Contains: 6 -380ml cartridges and 3 bayonet rings.

299-34682 Each.....\$309.45

Mix Tips - Large

309-29333 48/pkg.....\$62.45

Dynamic Mixing Tips for Volume

Contains: 50 tips and 2 bayonet rings.
309-34746 Each.....\$57.95



Silgimix™ - Sultan Healthcare

A VPS material for study models, orthodontic models, temporary crown and bridge models, and other procedures in the dental office. Fast Set (2:10) with a mint flavor.

8-Pack

Contains: 8 -50ml 1:1 cartridges.
290-79020 Pack.....\$92.75

Bulk Pack

Contains: 4 -380ml cartridges and 1 bayonet ring.
290-79015 Pack.....\$217.95

Contains: 60 -50ml 1:1 cartridges.
290-79025 Pack.....\$529.95

Dynamic Mixing Tips

300-78840 50/pkg.....\$94.95

ALGINATE FLAVORING



Alginote Flavoring - Dental Technologies

Bubble Gum.....300-451003
Cherry.....300-451004
Fruit Punch.....300-451007
Grape.....300-451008
Orange.....300-451010
Peppermint.....300-451011
Root Beer.....300-451015
Strawberry.....300-451016
Watermelon.....300-451018
2oz. bottle.....\$5.45

Additional flavors available upon request.

BITE REGISTRATION



Bite Registration Material

A blue thixotropic material with "mousse-like" properties for increased accuracy and non-slumping consistency. Available in Regular 2 minute work time /1 minute set time, or in Fast 30 second work time /1 minute set time, or in Super Fast 30 second work/30 second set time.

Contains: 2 -50ml cartridges and 6 mixing tips.

Unflavored

Regular Set.....150-101
Fast Set.....150-102
Super Fast Set.....150-103
Each.....\$26.75

Cool Mint

Fast Set.....150-202
Super Fast Set.....150-203
Each.....\$26.75

Bulk Packs

Contains: 25 -50ml cartridges.
Unflavored
Fast Set.....150-102B
Super Fast Set.....150-103B
Each.....\$27.45

Cool Mint

Fast Set.....150-202B
Each.....\$27.45

50ml Dispenser

300-8202 Each.....\$27.45

Mixing Tips - 6.5mm Green

300-8104 48/pkg.....\$27.45



Express Bite - 3M Oral Care

Hand-mixed putty system designed to mix easily without streaking. Offers 15-20 seconds mixing time, up to 30 seconds seating time and 1.5 minutes oral set time for fast results.

Contains: 2 -305ml jars and 1 bag of spacers.
153-6160J Each.....\$327.95

BITE REGISTRATION



Imprint 4 Bite - 3M Oral Care

Delivers fast & accurate bite registrations. Short intra-oral setting time of only 60 seconds enhancing patient comfort and reducing inaccuracies. Easy to cut, trim and position due to material hardness and low flexibility after setting. Can also be scanned for occlusal recording and registration with CAD/CAM systems.

Contains: 2 -50ml cartridges, 5 Garant mixing tips (green) and 5 Garant Intraoral tips.
150-71529 Kit..... **\$49.95**

Garant Mixing Tips - Green

307-71450 50/pkg. **\$55.95**



Temporary Crown Matrix Buttons - Advantage Dental Products, Inc.

For making temporary crowns, splints or bridges. Hard-yet-flexible thermoplastic softens in hot water or microwave and easily form the button around the tooth to be prepped. Blow air to harden and remove.

290-100 72/box **\$58.25**



Jet Bite - Coltene

Gives the perfect occlusal fit without the adjustments on the first try. Smooth mousse-like consistency - no resistance to closure, no rebound, sets rock hard. Fast 70 second total working time: Working time max 20 seconds and oral setting time minimum 50 seconds. Yellow.

Refills

Contains: 2 -50ml cartridges, 12 mixing tips, 20 spreader tips.
154-C6400 Each..... **\$55.45**

Bulk Pack available upon request.

Dispenser - 50ml HP

324-C6900 Each **\$149.45**

Mixing Tips - Pink Medium

304-C6551 40/pkg. **\$41.75**

Spreader Tips

304-C6223 100/pkg..... **\$34.45**

microSystem Refill

Contains: 4 -25ml cartridges, 20 mixing tips, 20 spreader tips.

154-C6440 Each..... **\$55.45**

microSystem 25ml Dispenser

304-C6270 Each **\$55.25**

Universal Mixing Tips

300-60019663 40/pkg **\$39.25**



Jet Blue Bite - Coltene

Flows with a smooth whipped-cream consistency exactly where you want it in a predictable quantity and ideal ribbon pattern. The superior handling characteristics are the key for a perfect occlusal fit on the first try.

Refills

Contains: 4 -50ml cartridges, 12 mix tips and 12 spreader tips.

Fast..... 154-C6495

Superfast 154-C6497

Each **\$98.75**

Single Pack available upon request.



Regisil - Dentsply Caulk

Vinyl polysiloxane bite registration material. No unpleasant odor or taste. Color gives a sharp, clear impression.

Standard Package

Contains: 90ml tube base and 90ml tube catalyst.

158-619130 Package **\$92.75**



Regisil 2x

Accurately records occlusal details. Easily seat models with a slight amount of elasticity. Minimizes interferences from convex tooth sur-

faces. Enables low resistance to patient's jaw closure to minimize deviation of the mandible and aids in producing consistently accurate centric relation records.

Contains: 4 -50ml cartridges and 12 teal mixing tips.

158-619500 Each..... **\$145.45**

Regisil PB available upon request.

50ml Dispenser

308-678351 Each..... **\$175.75**

Mixing Tips - Teal

308-678212 48/pkg **\$70.45**

Intraoral Tips - White

308-626382 100/pkg..... **\$75.45**



Regisil Rigid

Mousse-like. Light, stackable viscosity. Super-fast rigid final set, 30 second work time and 30 second set time.

Intro Kit available upon request.

Contains: 4 -50ml HP cartridges and 12 mixing tips.

158-619425 Each..... **\$138.75**

Mixing Tips - Yellow

308-619451 12/pkg..... **\$23.75**

Regisil Rigid digit available upon request.



EXABITE II NDS - GC America

Developed especially for occlusal registration, extrudes easily and sets hard very quickly.

2-Pack

Contains: 2 -48ml cartridges and 12 mixing tips.
152-132412 Pack..... **\$51.25**

8-Pack

Contains: 8 -48ml cartridges and 48 mixing tips.
152-132418 Pack..... **\$175.75**

Mixing Tips - Aqua

302-153248 48/pkg **\$68.45**



Memosil® 2 - Heraeus Kulzer

A transparent A-silicone for special indications. Its transparency allows optical control when positioning aids (e.g. X-ray pellets). Light-curing is possible for filling and fixative materials through placeholders.

Contains: 2 -50ml cartridges and 12 mixing tips.
290-35018 Each..... **\$107.95**

Dispensing Gun

For use with Memosil and Flexitime or any 50ml cartridges with a 1:1 or 2:1 ratio.

300-66001970 Each..... **\$224.95**

Mixing Tips - Green

300-34809 48/pkg **\$66.95**



Virtual Bite - Ivoclar Vivadent

Fast setting material offers a rock hard set creating excellent occlusal records. 30 second working time, 1 minute time in mouth. Orange.

2-Pack Refills

Contains: 2 -50ml cartridges and 8 large mixing tips.

150-562842 Each..... **\$49.25**

16-Pack available upon request.



Take 1 Advanced Bite - Kerr Restoratives

Offers superior handling and great physical properties, no resistance to closure and is easy to trim.

Cartridge Refill Package

Contains: 2 -50ml cartridges, 6 mixing tips and 6 intraoral tips.

159-33975 Package **\$60.95**

Extruder Dispenser - 50ml HP

309-28747 Each..... **\$184.95**

Mixing Tips

309-29363 Small 48/pkg..... **\$55.25**

309-29333 Large 48/pkg..... **\$62.45**

Order by ☎ **800-626-2163**



Blu-Mousse - Parkell Inc.

Exceptional accuracy. Dependable, no slump consistency. Plaster-like hardness.

Classic 2-Minute Set

Contains: 2 -50ml split cartridges and mixing tips.
290-S438S Each..... **\$47.75**

Contains: 2 -50ml standard cartridges and mixing tips.
290-S438 Each..... **\$48.25**

60-Second Set

Contains: 2 -50ml split cartridges and mixing tips.
290-S440S Each..... **\$47.75**

Super-Fast 30-Second Set

Contains: 2 -50ml split cartridges and mixing tips.
290-S457S Each..... **\$48.25**

Contains: 2 -50ml standard cartridges and mixing tips.
290-S457 Each..... **\$47.75**

Peppermint Blu-Mousse and Green-Mousse available upon request.



Futar D Occlusion - Roydent

Pink, non-brittle bite registration material with mousse-like qualities and a final set Shore D43 hardness. 30-second work time and 90-second set time.

Contains: 2 -50ml cartridges and 12 mixing tips.
153-11931 Each..... **\$74.95**



Genie™ Bite - Sultan Healthcare

Mousse consistency that stays where you put it and approaches zero resistance to closure. Once set, it won't compress or flex, giving your model positioning exceptional precision. Sets to a Shore hardness of 90+ in 90 seconds and Super Fast sets in 60 seconds. Can be used as a quick die for temporary inlays and onlays. Mint flavored.

Fast Set

Contains: 2 -50ml cartridges and 6 green mixing tips.
150-0077640FG Each..... **\$40.95**

Super Fast Set

Contains: 2 -50ml cartridges and 6 green mixing tips.

150-0077645FG Each..... **\$40.95**

Dispensing Gun Type S-50

300-70051 Each..... **\$173.25**

Mixing Tips - Green

300-72001 48/pkg **\$55.45**



Occlufast Rock - Zhermack

Maximum intercuspation registration with rigid 95 Shore A hardness. 30 second working time with 60 second set time. Purple.

Contains: 2 -50ml cartridges and 12 mixing tips.
150-C200726 Each..... **\$46.45**

Mixing Tips - Green

300-C202080 48/pkg **\$49.45**

IMPRESSION COMPOUND



Impression Compound - Kerr

Restoratives

Cakes - 1/2lb.

Green..... 839-00441
Gray..... 839-00452
Red..... 839-00429
8/pkg **\$41.25**

Sticks - 1/4lb.

Green..... 839-00444
Gray..... 839-00455
Red..... 839-00432
15/pkg **\$41.25**

IMPRESSION PASTE



Opotow Standard Zoe Impression Paste - Water Pik, Inc.

Designed for use with full denture impressions in a custom tray or as a wash in a denture base. Blue color; Type 1. Heavy body. Blue.

Complete Package

Contains: 80gm accelerator, 65gm base, mixing pad and tube keys.

290-12200 Package **\$62.95**

☎ **www.dhponline.com**

☎ **Fax: 888-681-5088**

257

HYDROCOLLOIDS



AccuDent® XD - Ivoclar Vivadent

Dual-phase alginate materials for more accuracy and precision. Premeasured and packaged for predictable and precise mixing. Fast set time for optimum productivity. Thermoplastic heat moldable impression trays to accommodate all arch forms. A single Tray and Syringe Alginate for both dentate and edentulous impressions. Tray alginate with Color Changing properties for precise timing of impression taking.

Edentulous and Dentate Trial Kits available upon request.

Syringe Material

Contains: 12 -9gm syringes.
290-673470 Each..... **\$13.95**

Tray Material

Contains: 12 -24gm packets.
290-673471 Each..... **\$26.75**

AccuDent XD Impression Trays available upon request.



CartriLoids Reversible Hydrocolloid Syringe Material - Pentron Clinical

Blue - Heavy 290-11038
Pink - Light..... 290-11040
White - Ultralight..... 290-11043
48/box **\$84.25**



VanR Reversible Hydrocolloid Tray Materials - Pentron Clinical

The most consistently accurate and proven impression-making system for crowns, bridges, partials, inlays, and onlays. The color identifies and differentiates each formulation as to its characteristics and the technique it best serves. Made from water and the ocean's agar, contains no toxic materials and does not require mixing. 60gm tubes.

Heavy Bodied - Green
290-11012 12/pkg..... **\$100.95**

AccuLoid - Lavender
Extra Strength.
290-11110 12/pkg..... **\$105.45**

EconoPak
290-11111 144/pkg **\$1045.25**

AgarLoid - Blue
Fast tempering.
290-11501 12/pkg..... **\$100.95**

EconoPak
290-11502 144/pkg **\$965.25**

Slate - Pacific Blend
Special blend of Pacific agars. Strongest available.

EconoPak
290-11302 144/pkg **\$1045.25**

Qwik Tray Brown - Chocolate Blend
3 minute gel and a pleasing cocoa scent.
290-11401 12/pkg **\$103.95**

Qwik Wash - Periwinkle Blue
One-step technique.
290-11070 12/pkg **\$100.95**



Identic Syringeable Reversible Hydrocolloid - Pentron Clinical

Unites by physical and chemical bonds to all alginate tray materials.

Contains: 48 -1.8cc glass vials.
290-21580 Each..... **\$84.25**

POLYETHER



Impregum™ Penta™ Polyether - 3M Oral Care

The "original" polyether precision impression material that is ideal for use in the monophasic technique. Hydrophilic before, during and after the set for unsurpassed accuracy, even when moisture is present. Thixotropic: flows smoothly under pressure. Working time (including mixing) is 2:45 minutes, setting time (from start of mix) is 6:00 minutes.

P2 and P3 Penta Medium Body Intro Kits available upon request.

Impregum Penta Medium Body
Includes: 2 -300ml base and 2 -60ml catalyst.
297-3164 Each **\$359.95**



Impregum™ Soft Polyether

Better initial hydrophilicity than any VPS - provides void-free impressions in moist conditions. "Snap-set behavior" of soft polyether is ultra-forgiving and results in precise-fitting restorations without distortion. Less rigid, easier to remove, great for dual-arch trays. Suggested applications include: Crown and bridge impressions, inlay and onlay impressions, functional impressions, implant abutments and denture and partial denture impressions. Quick-setting materials especially suited for single-unit and two-unit impressions. Mint Flavor.

Penta Soft and Penta Soft Quick Set Intro Kits available upon request.

Impregum Penta Soft Heavy Body - Dark Purple

Contains: 2 -300ml base and 2 -60ml catalyst.
297-031741 Each..... **\$391.95**

Impregum Penta Soft Quick Step Heavy Body - Dark Purple

Contains: 2 -300ml base and 2 -60ml catalyst.
297-31769 Each..... **\$391.95**

Impregum Penta Soft Medium Body - Purple

Contains: 2 -300ml base and 2 -60ml catalyst.
297-031731 Each..... **\$391.95**

Impregum Penta Soft Quick Step Medium Body - Purple

Contains: 2 -300ml base and 2 -60ml catalyst.
297-31765 Each..... **\$391.95**

Impregum Penta Soft Light Body - Light Pink

Contains: 300ml base and 60ml catalyst.
297-031746 Each..... **\$291.95**

Impregum Soft Tray Material

Contains: 4 -50ml cartridges, 10 purple mixing tips.
297-31785 Each..... **\$135.95**

Impregum Soft Quick Step Tray Material

Contains: 4 -50ml cartridges, 10 purple mixing tips.
297-31788 Each..... **\$135.95**

Impregum Soft Light Body - Pink

Contains: 4 -50ml cartridges, 20 white mixing tips.
297-031752 Each..... **\$135.95**

Impregum Soft Quick Step Light Body - Pink

Contains: 4 -50ml cartridges, 20 white mixing tips.
297-31767 Each..... **\$136.45**

Accessories

Polyether Tray Adhesive
307-30600 17ml **\$27.45**

Cartridge Dispenser 1:1/2:1 with Plunger
307-077580 Each..... **\$174.95**

Intraoral Syringes - Purple
300-71508 50/pkg **\$76.95**

Continued

POLYETHER

Impregum Soft Polyether continued.

- Penta Mixing Tips - Red**
300-77949 50/pkg **\$68.45**
- Garant Polyether Mixing Tips - White**
307-071451 50/pkg **\$55.95**
- Garant Polyether Intraoral Tips - White**
307-071461 50/pkg **\$34.45**
- Garant Mixing Tips - Purple**
303-71454 50/pkg **\$55.95**



Penta Elastomer Syringe Set

For use with the Pentamix 3 Automatic Mixing Unit.

Contains: 1 syringe, 4 tips, 4 barrels and 1 brush.

307-7121 Each..... **\$108.95**

Penta Elastomer Syringe Knurbled Hub Cap

For use with the Penta Elastomer Syringe (not compatible with the Impregum F Elastomer Syringe).

307-77720 Each..... **\$16.25**



Impregum Penta Cartridges

P3 Medium Body Cartridge - Purple
297-P3792 Each..... **\$61.25**

P3 Impregum Penta Soft Quick Step Heavy Body Cartridge - Dark Purple
307-P3774 Each..... **\$61.25**

P3 Soft Quick Step Medium Body Cartridge - Medium Purple
307-P3776 Each..... **\$61.25**

P3 Soft Medium Body Cartridge - Medium Purple
297-P3788 Each..... **\$61.25**

P3 Soft Heavy Body Cartridge - Dark Purple
303-P3794 Each..... **\$61.25**

Universal Cartridge for Pentamix 2
300-76994 Each..... **\$61.25**



Pentamix 3 Automatic Mixing Unit

Saves counter space with the smallest footprint on the market. Easy handling with push-button control on both sides. Homogeneous mixing for void-free impressions. Less waste – dispenses only the amount of material needed. Can be used with polyether, VPS and alginate replacement materials

777-77876 Each **\$2204.95**



Impregum™ F (Handmix) Polyether

A polyether precision impression material (medium body) for the one-step monophasic technique (hand-mixing version). Ideal for implant and functional impressions as well as crown and bridge inlay/onlay impressions. Working time (including mixing) 2:45 minutes, setting time (from start of mix) 6:00 minutes.

Intro Kit

Includes: 2 -120ml tubes base and 2 -15ml tubes catalyst, 1 mixing pad.

297-031711 Kit..... **\$167.95**

Base Refill

297-IMPREBAS 120ml **\$97.95**

Catalyst Refill

297-IMPRECAT 5ml **\$30.75**

Polyether Tray Adhesive

307-30600 17ml **\$27.45**



Impregum F Elastomer Syringe with Filling Device

For use with polyether and vps impression materials.

Contains: 1 syringe with 3 replacement tips, 1 cleaning brush and 1 filling device.

307-71199 Each..... **\$142.95**

Impregum F Elastomer Syringe Filling Device Refill

307-71217 Each..... **\$20.45**



Permadyne™ Polyether - 3M Oral Care

2:1 Light Body, polyether tray impression material. Intended for use in the one-step/two viscosity technique. For Crown and bridge impressions, inlay and onlay impressions. functional impressions and denture and partial denture impressions. Working time: Penta 2:30 minutes, cartridge 2:00 minutes. Set Time: Penta 6:00 minutes, cartridge 5:30 minutes.

Contains: 4 -50ml cartridges and 20 polyether white mixing tips.

297-030413 Each..... **\$342.95**

Available in Penta refills and Heavy Body upon request.



Permadyne™ Handmix Polyether

Handmix version. Working time, including mixing is 3 minutes. Setting time, from start of mix, is 6 minutes.

Light Body

Contains: 2 -120ml tubes base, 2 -15ml tubes catalyst and 1 mixing pad.

297-3020DP Each..... **\$237.95**

Heavy Body/Tray

Contains: 2 -120ml tubes base, 2 -15ml tubes catalyst and 1 mixing pad.

297-03071 Each..... **\$237.95**



Polyjel® NF™ - Dentsply Caulk

Suitable for the single-phase technique for a variety of crown and bridge and partial or complete edentulous impression techniques. It may also be used for precise duplication of models in the laboratory. Working time 2:45 minutes, time in the mouth 6:00 minutes.

Single Pack

Contains: 115ml base, 15ml catalyst and mixing pad.

298-618110SP Each..... **\$138.75**

10 Pack

Contains: 10 -115ml base and 10 -15ml catalyst.

298-618110 Each..... **\$1296.95**

Tray Adhesive

308-618104 17ml **\$55.95**

Catalyst and Base available separately upon request.

IMPRESSION PRODUCTS

RUBBER BASE



COE-FLEX® Lead-Free - GC America

Lead-free, all-purpose rubber base impression material for inlays, crowns, bridges, full and partial dentures, rebasing and relining. High elasticity, excellent tear strength, patented copper catalyst system. Blue-green color. Mint flavor.

Standard Package

Contains: 90ml base, 45ml catalyst and 15ml adhesive.

Regular Body	292-131002
Injection Type Light	292-131003
Heavy Body	292-131004
Fast Set Regular Body	292-131005
Package	\$57.25

Refill Package

Contains: 90ml base and 45ml catalyst.

Regular Body	292-131102
Injection Type Light	292-131103
Heavy Body	292-131104
Fast Set Regular Body	292-131105
Package	\$49.75



OMNIFLEX - GC America

All-purpose, rubber base impression material for crowns, bridges, inlays

and temporary denture relines. Unique consistency- single-mix is suitable for the syringe and tray. Excellent tear strength, high elasticity and removes easily from the stone. Fast Set: 2-1/2 minutes work time with 3-minute set.

Contains: 90ml base, 45ml catalyst, 1 mixing pad and adhesive.

Standard Package - Fast Set

292-137301	Package	\$79.45
------------	---------------	----------------

Bulk Package available upon request.

Base

292-137321	90ml	\$50.75
------------	------------	----------------

Catalyst

292-137311	45ml	\$46.25
------------	------------	----------------



Permlastic™ - Kerr Restoratives

Polysulfide, condensation-cured, elastomeric impression material in three viscosities.

Regular is recommended for partial- or full denture impressions because it has a high degree of

flow that will register the finest detail. While usually used in single-mix, it can be used with Light-Bodied Permlastic for crown and bridge impressions. It will not tear when being removed from undercuts.

Light-Bodied is the most free-flowing. It is excellent for inlay and fixed bridge impressions usually used with Heavy-Bodied Permlastic. Light Body bonds completely with both Regular and Heavy Bodies, resulting in impressions with great accuracy and fine definition.

Heavy-Bodied is formulated for use whenever a stiffer material is indicated. The heavy body consistency results in optimum compression of the Light-Bodied Permlastic in a double-mix, copper-band impression.

Light Bodied

Contains: 95gm tube base, 130gm tube catalyst and 1 mixing pad.	
299-00678	Package

Regular Bodied

Contains: 100gm tube base, 130gm tube catalyst and 1 mixing pad.	
299-00677	Package

Regular Bodied Base

299-00493	100gm	\$64.45
-----------	-------------	----------------

Regular Bodied Catalyst

299-00494	130gm	\$64.45
-----------	-------------	----------------

Heavy Bodied

Contains: 2 -100gm tubes base, 70gm tube catalyst and 1 mixing pad.	
299-00675	Package

Bulk Packages available upon request.

SILICONE



Lab Putty - Coltene

Polysiloxane laboratory modeling material with 62 - 67 Shore A.

Contains: 900ml base, 40ml activator and 1 measuring scoop.

294-C8805	Each	\$86.25
-----------	------------	----------------



FIT CHECKER™ ADVANCED - GC America

Vinyl Polyether Silicone (VPES) material ideal for fit-checking dentures, PFM (Porcelain-Fused-to-Metal) Restorations, ceramic prosthetics and occlusal contact. Ideal for fit-checking dentures and PFM Restorations. Provides optimal flowability, excellent detail and accuracy that is not affected by saliva. Minimal film thickness provides excellent transparency for easy fit-checking and peel away easily, leaving a clean, residue-free fitting surface.

1:1 Package

Contains: 50ml base and 50gm catalyst.	
290-004903	Package

Cartridge Package

Contains: 2 -48ml cartridges and 3 mixing tips.	
292-004904	Package

FIT CHECKER ADVANCED BLUE

Ideal for fit-checking ceramic prosthetics and occlusal contact.

Cartridge Package

Contains: 2 -48ml cartridges and 3 mixing tips.	
290-004905	Package



CutterSil Light - Heraeus Kulzer

The combination of CutterSil products (Light and Putty Plus), along with a choice of both liquid and paste hardeners, offer the dentist a wide variety of products depending on individual requirements and techniques. Can be customized to individual dentist techniques or patient situations. Produces sharp detail reproduction. Retains accuracy for an extended period of time-up to seven days. Can be used with CutterSil Putty Plus and mixed with gloves on.

290-35511	140ml tube	\$87.25
-----------	------------------	----------------

Universal Liquid Hardener

290-35162	25ml	\$68.75
-----------	------------	----------------

Universal Paste Hardener

290-35527	60ml	\$68.75
-----------	------------	----------------

CutterSil Putty Plus

290-35507	900ml tub	\$216.75
-----------	-----------------	-----------------



CutterSil Mucosa - Heraeus Kulzer

For use in endentulous procedures. Border molding can be especially easy using CutterSil Putty Plus in combination with Mucosa. Produces consistently accurate impressions both in narrow cleft and flabby ridge areas. Provides optimal working conditions during endentulous procedures. Non-slumping. Simplifies full and partial dental relines.

290-35514	140ml tube	\$89.95
-----------	------------------	----------------



Sil-Tech - Ivoclar Vivadent

Precision putty designed for laboratory use. High shore hardness. Fast setting. Elastic. Heat resistant.

Standard Package with Gel

760-2050103	Package	\$110.45
-------------	---------------	-----------------

Gel Hardener

760-563193	40ml	\$25.45
------------	------------	----------------



**Vinyl Polysiloxane Impression Material
Unflavored Refill 4 -50ml Cartridges
Regular Set**

Light Body	290-00005
Medium Body	290-00007
Monophase	290-00009
Heavy Body	290-00011

**Unflavored Refill 4 -50ml Cartridges
Fast Set**

Light Body	290-HT9000
Medium Body	290-HT9001
Monophase	290-HT9002
Heavy Body	290-HT9003
Each	Each.....\$32.45



Putty Kits

Contains 300ml base and 300ml catalyst.
Scoops included.

Unflavored

Regular Set	290-00001
Fast Set	290-00002

Mint

Regular Set	290-00003
Fast Set	290-00004
Kit.....	\$52.45



**Dimension™ Garant L Quick - 3M Oral
Care**

Fast Set. Low viscosity (light body) vinyl polysiloxane syringe material. Used for the one or two-step tray/syringe technique, as well as crown, bridge, inlay and only impressions.

Contains: 4 -50ml cartridges, 20 mixing tips.
297-036954 Each..... **\$156.95**

Universal Penta Cartridge

For Use with Pentamix 2 300-76994
For Use with Pentamix 3 300-71545
Each **\$63.75**

See pg 259 for the Pentamix 3 Mixing Machine.

Cartridge Dispenser 1:1 / 2:1 with Plunger
307-077580 Each..... **\$174.95**

Mixing Tips - Yellow
307-071452 50/pkg **\$55.95**



Dimension™ Penta™ H

High viscosity (heavy body) vinyl polysiloxane tray material for automatic mixing and dispensing. Normal setting time and high precision.

Contains: 2 -300ml base and 2 -60ml catalyst.
297-036715 Each..... **\$510.95**

Dimension Penta H Quick Tray available upon request.

Pentamix 3 Dispenser

See page 259 for the Pentamix 3 Mixing Machine.



Express™ - 3M Oral Care

A vinyl polysiloxane impression material with superior tear strength and outstanding dimensional stability. Regular Set: working time 1 minute, set time 5 minutes. Fast Set: working time 30 seconds, set time 3-1/2 minutes.

Introductory Kit available upon request.

Refills

Contains: 4 -50ml cartridges, 20 mixing tips.
Light Body / Fast Set 293-7301
Light Body / Regular Set 293-7302
Regular Body / Regular Set..... 293-7322
Each **\$165.95**

Bulk Refills

Contains: 10 -50ml cartridges.
Light Body / Fast Set 293-7301T
Light Body / Regular Set 293-7302T
Regular Body / Regular Set..... 293-7322T
Each **\$318.95**

Putty

Contains: 305ml base and 305ml catalyst.
293-7312 Pack **\$181.95**

Cartridge Dispenser 1:1 / 2:1 with Plunger
307-077580 Each..... **\$174.95**

Mixing Tips - Yellow

307-071452 50/pkg **\$55.95**

Putty Spoons

303-7314 2/pkg **\$20.95**



Imprint™ 3 - 3M Oral Care

Designed to resist distortion better than any other VPS to help reduce costly retakes, remakes and adjustments. For crown and bridge impressions, inlay and onlay impressions, functional impressions, implant abutments, clear aligner impressions, study model impressions, quick-setting materials especially suited for single-unit and two-unit impressions and removable denture and partial denture impressions.

Introductory Kits available upon request.

Heavy Body - Maroon

Contains: 4 -50ml cartridges, 10 mixing tips green.
293-10771 Each..... **\$119.45**

Heavy Body Jumbo - Maroon

Contains: 30 -50ml cartridges.
293-10771J Each..... **\$659.95**

Penta Heavy Body - Burgundy

Contains: 2 -300ml base paste , 2 -60ml catalyst paste.
293-10771PH Each..... **\$403.95**

Quick Step Heavy Body - Blue/Green

Contains: 4 -50ml cartridges,10 mixing tips green.
293-10971 Each..... **\$118.95**

Continued

VINYL POLYSILOXANE (VPS)

Imprint 3 VPS continued.

Quick Step Heavy Body Jumbo - Blue/Green

Contains: 30 -50ml cartridges.
293-10971J Each..... **\$659.95**

Penta Quick Step Heavy Body - Blue/Green

Contains: 2 -300ml base paste, 2 -60ml catalyst paste.
293-10971PH Each..... **\$403.95**

Penta Putty - Frog Green

Contains: 2 -300ml base paste, 2 -60ml catalyst paste.
293-10771PP Each..... **\$403.95**

Monophase Medium Body - Aqua

293-10781 Each..... **\$122.45**

Light Body - Yellow

Contains: 4 -50ml cartridges, 10 yellow mixing tips.
293-10778 Each..... **\$119.45**

Quick Step Light Body - Pink

Contains: 4 -50ml cartridges and 10 mixing tips yellow.
293-10978 Each..... **\$119.45**

Regular Body - Yellow

Contains: 4 -50m cartridges, 10 mixing tips yellow.
293-10779 Each..... **\$119.45**

Quick Step Regular - Pink

Contains: 4 -50ml cartridges, 10 mixing tips yellow.
293-10979 Each..... **\$119.45**



Imprint™ 4VPS - 3M Oral Care

The fastest intraoral setting time of 75 seconds. Its active self-warming technology allows for real time savings, without compromising working time. Truly hydrophilic in the unset state, which helps capture the finest details for highly accurate impressions, and a stress-free procedure.

Intro Kits available upon request.

Heavy Body - Sky Blue

Contains: 4 -50ml cartridges, 10 mixing tips (green).
290-71492 Package..... **\$120.25**

Heavy Body Economy - Sky Blue

Contains: 10 -50ml cartridges.
290-71531 Pack..... **\$239.95**

Penta Heavy Body - Sky Blue

Contains: 2 -300ml base, 2 -60ml catalyst.
290-71484 Kit..... **\$396.95**

Super Quick Heavy Body - Yellow

Contains: 4 -50ml cartridges, 10 mixing tips (green).
290-71493 Package..... **\$120.25**

Super Quick Heavy Body Economy

Contains: 10 -50ml cartridges.
290-71532 Pack..... **\$239.95**

Penta Super Quick Heavy Body - Yellow

Contains: 2 -300ml base and 2 -60ml catalyst.
290-71485 Each..... **\$396.95**

Penta Putty - Green

290-71486 Each..... **\$396.95**

Regular Body - Lime Green

Contains: 4 -50ml cartridges, 5 yellow mixing tips and 5 green intraoral tips.
290-71487 Package..... **\$120.25**

Super Quick Regular Body - Royal Blue

Contains: 4 -50ml cartridges, 5 mixing tips (yellow), 5 Intra-Oral Syringes (green).
290-71489 Package..... **\$120.25**

Light Body - Rose Pink

Contains: 4 -50ml cartridges, 5 yellow mixing tips and 5 green intraoral tips.
290-71488 Package..... **\$120.25**

Super Quick Light Body - Lavender

Contains: 4 -50ml cartridges, 5 yellow mixing tips and 5 green intraoral tips.
290-71490 Package..... **\$120.25**

Imprint 4 Monophase VPS available upon request.

Accessories

Tray Adhesive
303-7307 17ml..... **\$28.75**

Cartridge Dispenser 1:1/2:1 with Plunger

307-077580 Each..... **\$174.95**

VPS Mixing Tips - Green

307-71450 50/pkg..... **\$55.95**

VPS Mixing Tips - Yellow

307-071452 50/pkg..... **\$55.95**

Intraoral Syringes - Green

300-71506 50/pkg..... **\$76.95**

VPS Intraoral Tips - Bite Clear

307-71460 50/pkg..... **\$34.45**

VPS Intraoral Tips - Yellow

307-071462 50/pkg..... **\$34.95**

Penta Mixing Tips - Red

300-77949 50/pkg..... **\$68.45**

Universal Penta Cartridges

For Use with Pentamix 2 300-76994
For Use with Pentamix 3 300-71545
Each **\$63.75**

P3 Penta Heavy Body Cartridge - Sky Blue

290-77784 Each..... **\$61.45**

P3 Penta Super Quick Heavy Body - Yellow

290-77785 Each..... **\$61.45**

P3 Penta Putty Cartridge - Green

290-77786 Each..... **\$61.45**

See page 259 for the Pentamix 3 Mixing Machine.



Paradigm™ - 3M Oral Care

Easy extrusion and easy-to-use. Hydrophilic. Great flow, yet does not drip or slump. Good tear strength. Great for all indications.

Heavy Body - Burgundy

Contains: 2 -50ml cartridges.
293-5313 Each..... **\$32.95**

Heavy Body Jumbo Pack - Burgundy

Contains: 30 -50ml cartridges.
293-5313J Pack..... **\$302.95**

Heavy Body Fast Set - Pale Green

Contains: 2 -50ml cartridges.
293-5513 Each..... **\$32.95**

Heavy Body Fast Set Jumbo Pack - Pale Green

Contains: 30 -50ml cartridges.
293-5513J Pack..... **\$302.95**

Medium Body Monophase - Royal Blue

Contains: 2 -50ml cartridges.
290-5312 Each..... **\$32.95**

Light Body - Yellow/Green

Contains: 2 -50ml cartridges.
293-5311 Each..... **\$32.95**

Light Body Fast Set - Orange

Contains: 2 -50ml cartridges.
293-5511 Each..... **\$32.95**



Access® BLUE - Centrix

Sets hard like laboratory plaster in 30 seconds when taking bite registrations, provisional crown pre-op impressions, and so many other "quick" techniques. Allows you to cut and trim the impression without it crumbling.

Contains: 2 -50ml S-50 cartridges and 6 mixing nozzles.
290-360006 Kit..... **\$45.95**

VINYL POLYSILOXANE (VPS)



Affinis® - Coltene

These wash and tray materials wet the tooth and gingiva extremely quickly and effectively. Its hydrocolloid-like property ensures that the material flows into the narrowest areas without applying pressure. Has a very low contact angle thanks to its structure-breaking property of the surfactant agent. The mixed material provides adequate stability and does not drip from the tooth. Final impressions can be autoclaved. Regular Set, 3-minute set time. Fast Set, 2:10 minute set time.

Contains: 2 -50ml cartridges and 12 mixing tips.
 Light Body 294-C6501
 Regular Body 294-C6511
 Fast Light Body 294-C6601
 Fast Regular Body 294-C6611
 Each **\$62.75**

Full line available upon request.



Affinis Precious

The unique colors – silver and gold – facilitate readability of the impression detail. Wash materials have an application time of one minute. The thermo-active formula accelerates the setting process as soon as the impression tray is placed in the patient's mouth.

Light Body Silver

Contains: 2 -50ml cartridges, 12 mixing tips (Yellow).
 294-C6775 Each **\$62.75**

Full line available upon request.

Use with AFFINIS Black Edition for excellent readability of the impression, available upon request.

LOOK'in
 for something? **WE HAVE IT!**
www.dhpionline.com



Aquadil Smart Wetting Impression Material - Dentsply Caulk

Refills

Quadrafunctional vinyl polysiloxane material designed to minimize the problems of voids, bubbles, pulls and drags. An elastomeric impression material designed for optimum viscosity at each stage of the impression technique, delivered as both a free-flowing syringe viscosity and a more viscous and thixotropic tray material. Mint flavor. Contains: 4 -50ml cartridges impression material and 12 mixing tips.

Monophase Regular - Set Purple 298-678250
 Rigid Regular Set - Lt Green 298-678350
 Rigid Fast Set - Lt Green 298-678355
 LV Regular Set - Teal 298-678425
 LV Fast Set - Teal 298-678415
 Each **\$143.75**

Bulk Refills upon request.

Cartridge Dispenser - 50ml

308-678351 Each **\$183.25**

Mixing Tips - Teal

308-678212 48/pkg. **\$70.45**

Intraoral Tips - White

308-626382 100/pkg **\$75.45**



Aquadil Ultra

Ultra-low contact angle to minimize voids and bubbles combined with constant flow characteristics to minimize pulls and drags. High tear strength. Mint-flavored for patient comfort.

2 Pack Refills

Contains: 2 -50ml cartridges and 6 mixing tips.
 Heavy Super Fast Set 298-678865
 XLV Super Fast Set 298-678885
 Each **\$66.25**

4 Pack Refills

Contains: 4 -50ml cartridges and 12 mixing tips.
 XLV Regular Set - Orange 298-678768
 XLV Fast Set - Orange 298-678770
 LV Regular Set - Teal 298-678771
 LV Fast Set - Teal 298-678772
 Monophase Reg. Set - Purple .. 298-678773
 Monophase Fast Set - Purple ... 298-678774
 Heavy Regular Set - Lt Green .. 298-678775
 Heavy Fast Set - Lt Green 298-678776

Rigid Regular Set - Lt Green.... 298-678777
 Rigid Fast Set - Lt Green 298-678778
 Each **\$125.95**

Bulk Refills

Contains: 8 4-pack Refills.
 XLV Regular Set - Orange 298-6787688
 XLV Fast Set - Orange 298-6787708
 LV Regular Set - Teal 298-6787718
 LV Fast Set - Teal 298-6787728
 Heavy Regular Set - Lt Green .. 298-6787758
 Heavy Fast Set - Lt Green 298-6787768
 Rigid Fast Set - Lt Green 298-6787788
 Each **\$1008.75**

Monophase

Standard Refill - Purple

Contains: 90ml tube each base and catalyst.
 298-678100 Each **\$96.25**



Aquadil Ultra with B4 Surface Optimizer

Designed to be used as pre-impression conditioning solution. When applied to substrates such as sulcular tissue, tooth preparations, ceramic, composite or metal core buildup material or implant abutments or copings, it provides a uniform surface condition with reduced surface tension prior to the application of Aquasil Ultra Impression Material.

Contains: 4 -50ml Cartridges, 6ml bottle B4 Pre-Impression Surface Optimizer, 12 mixing tips, 50 flocked applicator tips and 1 dispensing well.
 LV Regular Set Teal 298-678130
 LV Fast Set Teal 298-678150
 XLV Regular Set Orange 298-678140
 XLV Fast Set Orange 298-678160
 Each **\$151.45**

Introductory Kits available upon request.

Bulk Refills available upon request.

Accessories

Cartridge Dispenser - 50ml
 308-678351 Each **\$183.25**

Mixing Tips - Teal

308-678212 48/pkg **\$70.45**

Intraoral Tips - White

308-626382 100/pkg **\$75.45**

VINYL POLYSILOXANE (VPS)



Aquasil Ultra DECA - Dentsply Caulk

A universal use, quadrifunctional hydrophilic addition reaction silicone, elastomeric impression material with excellent hydrophilic properties, dimensional accuracy, high tear strength, and resistance to permanent deformation. Improves both wetting on the tooth surface and model detail reproduction.

Standard Packs

Contains: 2 -380ml cartridges, 20 Dynamic mixing tips and 1 bayonet locking ring.
 Monophase Regular Set 298-678782
 Heavy Fast Set..... 298-678784
 Heavy Regular Set 298-678786
 Heavy Super Fast Set 298-678895
 Each **\$446.25**

Bulk Packs

Contains: 3 Standard Packs.
 Heavy Fast Set..... 298-6787843
 Each **\$1323.95**

Bayonet Ring

308-678900 2/pkg **\$16.75**

Dynamic Mixing Tips - 380ml

308-678950 50/box **\$81.75**



Aquasil Ultra Digit

Easier access allows for precise placement. Minimizes waste. Available in two unit dose sizes: small cartridge is ideal for single-unit crowns, and large cartridge contains enough material for multiple-unit cases.

Digit Small Cartridge Refills with B4 available upon request.

Digit Small Cartridge Refills without B4

Contains: 50 small unit doses, 50 mixing tips and 50 intraoral tips.
 LV Regular Set Small - Blue298-678040
 LV Regular Set Large - Blue298-678041
 LV Fast Set Small - Blue298-678042
 XLV Regular Set Small - Orange .298-678043
 XLV Regular Set Large - Orange .298-678044
 XLV Fast Set Small - Orange.....298-678045
 Each **\$183.45**

Syringe Dispenser

308-678020 2/pkg. **\$24.25**

Mixing Tips

308-678003 50/box **\$70.45**

Intraoral Tips

308-678006 50/box **\$31.75**



Aquasil Ultra Cordless Tissue Managing Impression System

A revolutionary retractionless impression system with digit power pneumatic dispenser technology. Less traumatic way to record impressions doesn't use retraction cord or paste.

Intro Kits available upon request.

Tray Material Refills

Contains: 4 -50ml cartridges and 12 teal mixing tips.
 290-678056 Each..... **\$125.25**

The following Aquasil Ultra Cordless Tray and Wash Material Refills require a digit power Dispenser Kit. Compatible kit options are available for ISO Threaded Connector, Midwest, KaVo MULTIflex, and StarDenal HiFlo.

digit power Single

Contains: 50 -0.68ml digit power wash material cartridges, 50 digit power mixing tips with Intraoral tips, 6ml B4 pre-impression surface optimizer, 1 dispensing well, 50 flocked applicator tips.
 290-678050 Each..... **\$359.95**

digit power Multi

Contains: 15 -0.68ml digit power wash material cartridges, 15 digit power mixing tips with intraoral tips, 6ml B4 Pre-Impression Surface Optimizer, 1 dispensing well, 25 flocked applicator tips.
 290-678053 Each..... **\$146.45**

Tray Material Standard Pack

Contains: 2 -380ml DECA cartridges, 20 mixing tips, 1 bayonet ring.
 290-678059 Pack **\$469.25**

Bayonet Rings

308-678900 2/pack **\$16.75**

Dynamic Mixing Tips - 380ml

308-678950 50/pkg **\$81.75**



Aquasil Ultra Xtra

Ideal for large, multi-unit impressions with faster mouth removal time , 5-1/2 minutes.

Intro Kits available upon request.

Aquasil Ultra Xtra DECA Intro Kit with B4 available upon request.

Tray Material Refills

Contains: 4 -50ml cartridges and 12 mixing tips.
 298-678710 Each..... **\$141.95**

Wash Material with B4 Refills

Contains: 4 -50ml cartridges, 6ml bottle of B4, 12 mixing tips, 50 flocked applicator tips and 1 dispensing well.
 298-678705 Each..... **\$157.95**

DECA Tray Material with B4

Contains: 2 -380ml cartridges, 20 dynamic mixing tips and 1 bayonet locking ring.
 298-678715 Each..... **\$446.25**

Bulk Refills available upon request.



Aquasil EasyMix Smart Wetting Putty

High viscosity material consisting of two pastes that harden to form a base for final impressions. This elastomeric impression material is Smart Wetting, which improves both wetting on the tooth surface and model detail reproduction.

Contains: 320ml base, 320ml catalyst and 2 scoops.
 298-678120 Each..... **\$193.95**

Reposil - Dentspy Caulk

Hydrophilic vinyl polysiloxane impression material that provides excellent dimensional accuracy and stability for a variety of crown, bridge and edentulous impressions. It may also be used for precise duplication of models in a laboratory setting.

Contains: 4 -50ml cartridges, 12 mixing tips.
 Light Body - Orange 298-626600
 Regular Body - Blue 298-626210
 Heavy Body - Green..... 298-626220
 Each **\$176.45**



Cartridge Dispenser - 50ml

308-678351 Each..... **\$183.25**

Mixing Tips - Teal

308-678212 48/pkg **\$70.45**

Intraoral Tips - White

308-626382 100/pkg..... **\$75.45**

Tube Refills

Contains: 90ml base and 90ml catalyst.
 Light Body - Orange 298-626170
 Regular Body - Blue 298-626175
 Heavy Body - Green..... 298-626180
 Each **\$105.75**

Putty Refills

Contains: 260gm base and 260gm catalyst and spacers and 14ml VPS adhesive.
 298-626110 Each..... **\$208.75**

Contains: 1075gm base and 1075gm catalyst.
 298-626118 Each..... **\$705.45**

VPS Adhesive

308-626155 14ml **\$43.75**

VINYL POLYSILOXANE (VPS)



EXAMIX™ NDS - GC America

A fast-setting VPS impression material developed for improved accuracy, increased productivity and maximized patient comfort.

Introductory Kits available upon request.

2-Pack Refills

Contains: 2 -48ml cartridges, 6 mixing tips.
 Regular 292-137007
 Injection 292-137107
 Heavy Body 292-137207
 Monophase..... 292-137407
 Each **\$35.25**

Bulk Pack Refills available upon request.

GC Cartridge Dispenser II - 48ml

302-152101 Each..... **\$184.95**

Mixing Tips - Pink

302-153148 48/pkg. **\$68.45**

Mixing Tips - Green

302-153248 48/pkg. **\$68.45**

Small Mixing Tips - Purple

302-153048 48/pkg **\$68.45**

Intraoral Tips - White

302-150100 100/pkg..... **\$63.25**

Putty

Contains: 500gm blue base, 500gm yellow catalyst, measures and instructions.
 292-137307 Each..... **\$98.95**



EXAFLEX® - GC America

Addition reaction silicone (platinum catalyzed) with outstanding physical properties, optimum handling and accuracy characteristics. The reaction silicone also has a unique combination of innovative, clinical advantages for impression taking. Produces crisp, extraordinarily smooth and precise impressions for models, crowns, bridges and dentures.

Standard Package

Contains: 74ml base, 74ml catalyst and 1 mixing pad.
 Heavy Body Yellow 292-138201
 Injection Pink 292-138101
 Monophase Purple..... 292-138401
 Regular Body Blue 292-138901
 Package **\$68.25**

Clinic Package available upon request.

Putty

Contains: 500gm blue base, 500gm yellow catalyst, and 2 measuring scoops.
 292-138301 Pack **\$118.75**

Universal VPS Adhesive

302-138906 7ml..... **\$16.75**

Order by ☎ **800-626-2163**



EXAMIX™ NDS - GC America

Advanced, addition reaction (platinum catalyzed) Vinyl Polysiloxane. Produces crisp, extraordinary smooth and highly precise impressions for models, crown and bridge, dentures and inlays and onlays. Non-slumping, virtually tasteless and odorless, unsurpassed dimensional stability, patented hydrogen scavenger formula, excellent elastic recovery and tear strength, thixotropic, ideal consistency and flow under pressure.

2-Pack Refills

Contains: 2 -48ml cartridges, 6 mixing tips.
 Regular Body 292-137016
 Injection 292-137106
 Heavy Body 292-137206
 Monophase..... 292-137406
 Pack **\$35.25**

Bulk Packs available upon request.

Manual Cartridge Dispenser II - 48ml

302-152101 Each..... **\$184.95**

Mixing Tips - Pink

302-153148 48/pkg. **\$68.45**

Mixing Tips - Green

302-153248 48/pkg. **\$68.45**

Small Mixing Tips - Purple

302-153048 48/pkg. **\$68.45**

Intraoral Tips - White

302-150100 100/pkg..... **\$63.25**



Flexitime® - Heraeus Kulzer

The high quality VPS impression solution offering reliable impressions even in adverse conditions. Working time: 60-seconds to 2:30 minutes; Total set time: 3:30 to 5 minutes. Creating excellent detail reproduction with superior hydrophilicity on a polyether level. Resists tearing and distortion upon removal. Read impressions easily with high-contrast colors.

Trial Kits available upon request.

Refills

Contains: 2 -50ml cartridges with mixing tips.
 Heavy Tray 290-34804
 Correct Flow..... 290-34806
 Monophase..... 290-34811
 Light Flow 290-40005040
 Medium Flow 290-40005041
 Each **\$56.75**

Bulk Refills

Contains: 12 -50ml cartridges with mixing tips.
 Heavy Tray 290-34805
 Correct Flow..... 290-34807
 Monophase..... 290-34812
 Each **\$308.95**

Easy Putty Single Refill

Contains: 300ml base and 300ml catalyst.
 290-34802 Each..... **\$155.25**

Easy Putty Bulk Refill

Contains: 4 -300ml base and 4 -300ml catalyst.
 290-34803 Each..... **\$605.45**

Flexitime Dynamix Trial Kits available upon request.

Dynamix Refills

Contains: 2 -380ml, 2 dynamix tips and 1 dynamix fixation ring.
 Heavy Tray 290-40003991
 Monophase..... 290-40003990
 Each **\$417.25**

Flexitime Xtreme 2

Increased hydrophilicity with improved tear strength. 30 to 90 seconds working time allows for greater efficiency.

Trial Kit available upon request.

Contains: 6 -50ml cartridges and 18 mixing tips.
 Heavy Tray 290-66044885
 Correct Flow..... 290-66050334
 Each **\$169.75**

Dispensing Gun - 50ml

300-66001970 Each..... **\$224.95**

Large Mixing Tips - Green

300-34809 48/pkg. **\$66.95**

Small Mixing Tips - Yellow

300-66001988 48/pkg. **\$66.95**

Intraoral Tips - Yellow

300-34424 96/pkg. **\$91.25**



PerfectIM Systems® - J.Morita USA

Two-step vinyl polysiloxane impression system eliminates packing retraction cord and any possible posttraumatic discomfort. Materials are hydrophobic, radiopaque, resistant to fluid absorption, tasteless and odorless. 30 second Blue Velvet has a whipped cream texture, eliminating running, dripping, and gagging. The high durometer (80) of 90 second Blue Velvet produces a hard, plaster-like set and eliminates the need for retraction cord when used with Flexi-Velvet or SnoWhite in the H&H cordless technique.

Blue Velvet Kit

Contains: 3 -50ml cartridges and 12 mixing tips.
 30 second 290-300500
 90 second 290-300550
 Kit **\$44.45**

Flexi-Velvet Kit

Contains: 3 -50ml cartridges and 12 mixing tips.
 30 second 290-300625
 90 second 290-300650
 Kit **\$44.45**

☎ **www.dhponline.com**

☎ **Fax: 888-681-5088**

VINYL POLYSILOXANE (VPS)



Extrude™ - Kerr Restoratives

VPS impression system available in four viscosities. Extra is a thixotropic, non-slumping tray material that minimizes distortion while providing a flexible-firm set that promotes easy tray and die removal. Medium provides excellent flow as well as sufficient body for use as a tray material. Wash is a very low viscosity and is used in conjunction with Putty for the putty/wash technique or with Extrude Extra for the double-mix technique. M.P.V. is a unique material that can be used for both the tray and syringe material. It is very thixotropic, so it will not slump or run out of the tray, but it also exhibits superior flow under pressure and high tear strength. XP (Putty) is used for both simultaneous and two-step putty/wash techniques. It drives syringe material subgingivally for ideal tissue displacement and accurate details.

Cartridge Refills

Contains: 2 -50ml cartridges, 6 mixing tips.
 Medium - Green 299-205152
 Wash Light Body - Blue 299-201472
 MPV Monophase - Dark Green 299-28420
 Extra Heavy Body - Mauve 299-28414
 Each **\$56.25**

24 - 50ml Cartridge Value Packs

Wash Light Body - Blue 299-29036
 Extra Heavy Body - Mauve 299-29034
 Pack **\$509.25**

Extruder Gun

309-28747 Each **\$184.95**

Mixing Tips - Large Green

309-29333 48/pkg **\$62.45**

Intraoral Tips - Large White

309-20731 100/pkg **\$64.25**

Extrude Extra

Contains: 32 -50ml cartridges.
 Extra Heavy Body - Purple
 299-28415 Each **\$854.45**

Additional packaging formats available upon request.



Extrude XP Putty

Contains: 2 -520ml jars, 2 volume scoops and 18 spacers.
 299-27877 Each **\$172.75**

Putty Spacers

309-09526 18/pkg **\$11.45**



Take 1 Advanced™ - Kerr Restoratives

A high-performance VPS impression material that has the optimum combination of physical properties: strength, elasticity, dimensional stability, and the ability to register detail in any environment.

Cartridge Intro Kit available upon request.

Cartridge Refills

Contains: 2 -50ml cartridges and 6 mixing tips.
 Light Body Wash FS - Orange299-33953
 Light Body Wash RS - Orange.....299-33951
 Light Body Wash SFS - Orange
299-33955
 Reg. Body Wash FS - Light Green.....299-33971
 Reg. Body Wash RS - Light Green...299-33969
 Reg. Body Wash SFS - Light Green
299-33973
 Med. FS - Light Blue299-33959
 Med. RS - Light Blue299-33957
 Med. SFS - Light Blue299-33961
 Tray FS - Dark Blue299-33965
 Tray RS - Dark Blue.....299-33963
 Tray SFS - Dark Blue.....299-33967
 Each **\$63.25**

Value Packs

Contains: 24 -50ml cartridges.
 Light Body Wash RS - Orange.....299-33952
 Light Body Wash FS - Orange299-33954
 Med. SFS - Light Blue299-33962
 Tray FS - Dark Blue299-33966
 Tray RS - Dark Blue.....299-33964
 Tray SFS - Dark Blue299-33968
 Each **\$594.75**

Unidose syringes available upon request.

Volume Hard Cartridges

Contains: 2 -380ml hard cartridges.
 Volume Tray FS299-34696
 Volume Tray RS.....299-34695
 Volume Tray SFS299-34697
 Each **\$356.95**

Volume Hard Cartridges in Medium/Monophase and Rigid available upon request.

Putty

Contains: 400gm base and 400gm catalyst.
 299-34070 Each **\$109.75**

Extruder Gun - 50ml

309-28747 Each **\$184.95**

Mixing Tips

309-29363 Small - Yellow 48/pkg **\$55.25**
 309-29333 Large - Teal 48/pkg **\$62.45**

Intraoral Syringe Tips - Small

309-27517 100/pkg **\$57.95**

Intraoral Syringe Tips - Large

309-20731 100/pkg **\$64.25**

VPS Adhesive

309-16622 15ml bottle **\$36.75**
 309-25777 60ml bottle **\$72.25**



Correct Plus™ Impression Material - Pentron Clinical

Versatile impression material designed to accommodate all impression techniques. A low contact angle of 30° outstanding detail in the presence of fluids. Exceptional tear strength ensures your detailed impression will remain intact.

Trial Kit

Contains: 50ml Thick'n Thin light body cartridge fast set, 50ml Universal body cartridge fast set, 50ml auto-mix putty cartridge fast set, 50ml 1:1 dispenser gun, 12 mixing tips (4 each pink, green, purple) and 8 intraoral tips.
 290-Q34T Kit **\$96.95**

Standard Pack

Contains: 4 -50ml cartridges, 16 mixing tips, 16 intraoral tips.

Regular Set Unflavored

Light Body 290-Q34BA
 Universal Body 290-Q34DA
 Thick'n Thin Light Body 290-Q34GA
 Auto-Mix Putty 290-Q34HA
 Bite Superfast Material 290-Q34IA
 Tray Material 290-Q34JA
 Each **\$65.95**

Regular Set Flavored

Berry Tray Material 290-Q34JAA
 Berry Auto-Mix Putty 290-Q34HAA
 Each **\$65.95**

Fast Set Unflavored

Auto-Mix Putty 290-Q36A
 Universal Body 290-Q36B
 Thick'n Thin Light Body 290-Q36C
 Each **\$65.95**

Bulk Pack available upon request.

Putty

Contains: 230ml jar base and 230ml jar catalyst.
 Unflavored 290-Q34H
 Berry Flavored 290-Q34HCA
 Each **\$81.75**

Tray Adhesive

290-Q12A 1oz **\$41.95**

Automix Putty

Contains: 32 -50ml cartridges.
 Regular Set Unflavored 290-Q34HC
 Regular Set Berry Flavored 290-Q34HAC
 Fast Set Unflavored 290-Q36AA
 Each **\$422.95**

Additional packaging formats and accessories available upon request.

VINYL POLYSILOXANE (VPS)



Genie VPS - Sultan Healthcare

Chemically engineered to produce remarkable detailed and precise impressions. It actually exceeds the requirements of ISO 7380, and eliminates the need for expensive remakes. Not merely hydrophilic, it's ultra hydrophilic, so it's forgiving in clinical oral environments. It effectively removes concerns about moisture compromising your results.

2 Pack - Berry Flavored

Contains: 2 -50ml cartridges, 6 mixing tips (XLB & LB) varieties include an additional 6 intraoral tips. Set times are 2:10 for Rapid Set and 4:30 for Standard Set.

- X-Light Rapid Set..... 290-0077600FG
- X-Light Standard Set..... 290-0077605FG
- Light Rapid Set 290-0077610FG
- Light Standard Set 290-0077615FG
- Regular Rapid Set 290-0077620FG
- Regular Standard Set 290-0077625FG
- Heavy Rapid Set 290-0077630FG
- Heavy Standard Set..... 290-0077635FG
- Pack **\$36.25**

Bulk Refills - Berry Flavored

- Contains: 60 -50ml cartridges.
- Light Body Rapid Set 290-0077720FG
 - Regular Body, Rapid Set..... 290-0077700FG
 - Regular Body, Standard Set..... 290-0077705FG
 - Heavy Body Rapid Set..... 290-0077710FG
 - Heavy Body Standard Set..... 290-0077715FG
 - Each **\$637.25**

Genie Putty

Berry flavored, Rapid Set 2.30 minutes, Standard Set 4.30 minutes.
Contains: 2 -300ml jars and 2 scoops.

- Rapid Set..... 290-0077650FG
- Standard Set..... 290-0077655FG
- Each **\$637.25**

Genie Magic Mix

Disposable 380ml cartridges have 5% more material than foil bag systems and can be used with automix dispensing.

- Regular Body Standare Set.....290-78805
- Regular Body Rapid Set.....290-78800
- Heavy Body Standard Set.....290-78815
- Heavy Body Rapid Set.....290-78810
- Each **\$146.75**



Elite HD+ Soft Putty - Zhermack

Very high viscosity A-Silicone for fixed prostheses. Suggested technique: two-stage with standard tray. High deformation strength. Excellent elastic recovery. High dimensional stability.

Contains: 2 -250ml tub (base and catalyst).

Order by 800-626-2163

- Regular Set..... 290-C203000
- Fast Set..... 290-C203010
- Each **\$58.25**

Elite HD+ Maxi Tray

Contains: 6 -380ml cartridges.

Heavy Body Fast Set

- 290-C202330 Each..... **\$515.45**



Freealgin® - Zhermack

Ideal for preliminary and orthodontic impressions, removable prosthesis, antagonist models and temporaries. 1:1 mixing ratio.

Trial Kit - Medium Body

- Contains: 2 -50ml cartridges and 4 Lilac mixing tips.
- 290-C300110 Kit..... **\$24.45**

Bulk Pack available upon request.

SYRINGES



Utility Syringes
Disposable 12cc utility syringe. Designed for surgical site irrigation. Can be used with silicone and rubber based impression materials.

- 130-10001 50/box **\$24.45**



Intraoral Syringes - 3M Oral Care

Used to dispense polyether impression materials and provide precise application for a more accurate final restoration.

- Purple 300-71508
- Green..... 300-71506
- 50/pkg **\$76.95**



Monoject™ CurvedTip Syringes - Covidien Products by Medtronic

- 12ml capacity, ungraduated. Non-Sterile.
- 300-412012 50/box **\$30.45**



COE Aluminum Syringe - GC America

Contains: Barrel, plunger, 12 plastic tips and cleaning brush.

- 302-159001 Kit..... **\$127.75**

Type A Plastic Syringe Tips

- 302-159225 25/pkg..... **\$50.75**

Cleaning Brush

- 302-159021 Each..... **\$15.25**

Replacement Aluminum Hub

- 302-159031 Each..... **\$15.25**



Surgident DispOral Disposable Syringe - Heraeus Kulzer

For use with rubber or silicone materials. Tip angles when depressed.

- 540-99104 50/box **\$77.45**

Free-Flo™ Syringe - Kerr Restoratives

Places impression materials into cavity preparations. The all-plastic syringe is easy to load and can be autoclaved or immersed in most cold disinfectant solutions.

- 309-00126 Each..... **\$79.75**

Plastic Cap Nut

- 309-15808 Each..... **\$3.95**

O-Rings Red Silicone

- 309-25153 10/pack..... **\$24.45**

Fine Point Tips - Clear

- 309-01844 6/pkg..... **\$21.45**



Disposable Impression Syringes - Sultan Healthcare

Extended, tight-fitting plunger provides better leverage and reduces waste. Seamless construction prevents splitting during extrusion. Syringe tips are adjustable by cutting or bending to reach all areas.

- 300-36001 50/bag..... **\$30.45**



Impression Syringe - Vista Dental Products

Tip is bendable up to 45 degrees. Seamless barrel construction eliminates splitting. Preassembled.

- 300-313001 50/box **\$19.75**

Health-Tec® IMPRESSION MIXING TIPS

Universal Mixing Tips

Compatible with all 50ml dual-barrel impression material cartridges. The *ULTRA T-Mixer* design offers up to a 30% reduction in material waste.



Small - Yellow (4.2mm) 300-8105



ULTRA (T-Mixer) 300-8103T
Save Money. Waste less material.



Medium - Pink (5.4mm) 300-8106



ULTRA (T-Mixer) 300-8106T
Save Money. Waste less material.



Large - Green (6.5mm) 300-8104



ULTRA (T-Mixer) 300-8104T
Save Money. Waste less material.



X-Large - Purple (7.5mm) 300-8107

48/bag

\$40.95

Temporary Cement Mixing Tips

Compatible with regular, monophasic and heavy body materials with 50ml impression cartridges (bayonet style connector). The *ULTRA T-Mixer* design offers up to a 30% reduction in material waste.



Brown 1:1 300-10001



ULTRA (T-Mixer) 300-10001T
Save Money. Waste less material.

25/pkg

\$17.95

Intraoral Mixing Tips



Small - Yellow
Compatible with Yellow HP mixing tips

300-8103

100/pkg

\$36.95



Small - Clear
Compatible with Pink, Green or Purple HP Mixing Tips

300-101

100/pkg

\$36.95



Cartridge Dispenser 1:1

For use with all high-performance split 50ml cartridges, 1:1 base to catalyst, units.

300-8202

Each

\$97.95



Dynamic Mixing Tips

Designed to be used in automated impression mixing machines. Can be used with most VPS, polyether or alginate materials.

Yellow

300-10006

Green

300-10007

50/pack

\$53.95

BITE TRAYS



Bite Trays

Accurate impressions result from the undercut support ribs, along with the thin non-tear mesh. Easy-to-grip ergonomic handles make removal from the mouth easier.

Anterior	35/pkg.....	310-HT001
Posterior	50/pkg.....	310-HT002
Sideless Posterior	50/pkg.....	310-HT003
Quadrant	35/pkg.....	310-HT004
Wide Posterior	50/pkg.....	310-HT005
Each		\$28.45



President Disposable Impression Tray System - Coltene

A patented system of intersecting ribs and rails provides unprecedented rigidity in a plastic tray. Perforated.

Size 1 Upper Large	314-C6901
Size 2 Lower Large	314-C6902
Size 3 Upper Medium	314-C6903
Size 4 Lower Medium	314-C6904
Size 5 Upper Small	314-C6905
Size 6 Lower Small	314-C6906
Size 7 Quadrant UL/LR	314-C6907
Size 8 Quadrant UR/LL	314-C6908
Size 9 Anterior Universal	314-C6909
12/pkg.		\$17.25



Polybite™ Disposable Bite Trays - Dentamerica Inc.

For impression, bite registration, counterimpression. 3-in-1 disposable tray.

Anterior	310-885	35/box	\$20.95
Full Arch	310-888	30/box	\$20.95
Posterior	310-886	50/box	\$20.95
Quadrant	310-887	35/box	\$20.95
Sideless	310-889	50/box	\$20.95



COE® Triple Function Disposable Impression Trays - GC America

Assure accurate working impressions and counter impressions of the opposing arch, as well as a precise bite registration in one easy procedure. Check-Bite Trays cover more than half the arch area, resulting in multiple bite registration points for more accurate articulation.

#75D Anterior 2-5/8" x 1-1/2" x 3/4"	
312-257540	40/pkg. \$69.75
#73D Posterior 2-3/8" x 2-3/16" x 3/4"	
312-257350	50/pkg. \$69.75
Sideless 2-1/2" x 3"	
312-150001	50/pkg. \$72.95



Mini Tray - Hager Worldwide

Quadrant - plastic. Cold Sterilizable.
310-101102 50/box \$58.25



Kwik Tray - Kerr Restoratives

Adjustable, perforated, aluminum trays for crown, bridge and inlay quadrant impressions.
319-09244 24/pack \$61.45



Neo Tray™ Impression Trays - Premier® Dental

The strongest, rigid, disposable triple bite impression tray in its class.

Intro Kit

Contains: 10 each of Wide Posterior, Sideless Posterior; 5 each of Anterior, Posterior, Full Arch, Quadrant and Extended Quadrant.

310-2206NT Kit..... \$51.95

Anterior - Pink
310-2204NT 30/box \$51.95

Posterior - Orange
310-2201NT 48/box \$51.95

Quadrant - Green
310-2203NT 40/box \$51.95

Sideless - Purple
310-2202NT 48/box \$51.95

Full Arch - Yellow
310-2205NT 30/box \$51.95

Extended Quadrant - Pink
310-2207NT 35/box \$51.95

Wide Posterior - Green
310-2208NT 48/box \$51.95

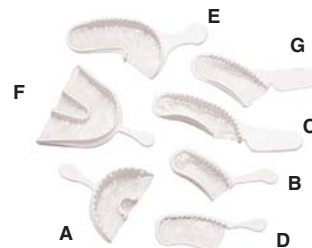

Triple Tray® - Premier® Dental

Very thin, loose webbing which will not distort when the patient bites down.

Anterior (A)
317-1006213 35/box \$50.45

Posterior (B)
317-1006203 48/box \$50.45

Quadrant (C)
317-1006223 40/box \$50.45

Sideless Posterior (D)
317-1006243 48/box \$50.45

Extended Quadrant (E)
317-1006253 35/box \$50.45

Three-Quarter Arch (F)
317-1006273 35/box \$48.75

Wide Body Posterior (G)
317-1006283 48/box \$50.45

Assorted
Contains: 5 of each tray.
317-1006233 35/box \$50.45

BITE TRAYS



T-LOC™ Triple Tray® - Premier® Dental

An adhesive-free dual-arch impression tray whose large, ergonomic handles simplify loading of the tray, enable easy transfer between assistant and dentist. Greater rigidity in posterior.

Posterior	310-1006204	35/box	\$44.25
Anterior	310-1006214	28/box	\$40.95
Three-Quarter Arch	310-1006274	22/box	\$40.95



Alfa™ Triple Tray® - Premier® Dental

A full-arch, closed mouth alginate triple tray. Unique palate-free design engages the patient's tongue to restrict the overflow of impression material and eliminate gagging.

Small - Purple	317-1006313	24/box	\$39.25
Medium - White	317-1006323	24/box	\$39.25
Large - Green	317-1006333	24/box	\$39.25
Assorted	317-1006343	24/box	\$39.25

Contains: 5 small, 14 medium, 5 large.

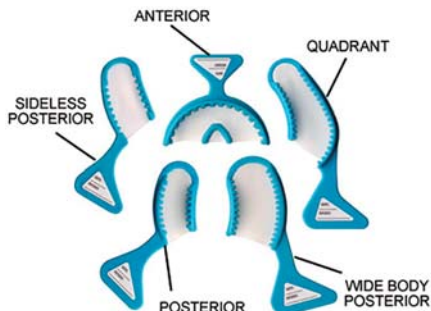

3-Way® Disposable Impression Trays - Sultan Healthcare

Ergonomically designed handles for easier placement and removal. Well-defined access

ledges, thin non-tear mesh; patented undercut wall grooves and rigid plastic frames save chair time and improve the accuracy of impressions.

Assorted Kit

Contains: 8 of each tray (40 total).
310-33000 Kit..... **\$66.75**

Anterior
310-33001 35/box **\$66.75**

Posterior
310-33002 50/box **\$66.75**

Quadrant
310-33003 35/box **\$66.75**

Sideless Posterior
310-33004 50/box **\$66.75**

Wide Body Posterior
310-33005 50/box **\$66.75**



Bite Relator 2000 Dual Arch - Temrex Corporation

It takes 3 impressions simultaneously: the occlusal relationship, the prepared teeth and the opposing dentition- all the information the dentist needs to fabricate a prosthesis accurately and easily.

Contains: 1 tray frame and 12 disposable tray inserts.

Standard Size
310-710 Each..... **\$39.75**

Xi Extended Size
310-760 Each..... **\$44.25**

Additional sizes available upon request.

Rite-Bite Disposable Tray Inserts

Use with Temrex Bite Relator for accurate 3-in-1 impressions. Can also be used for supporting occlusal bite registrations.

Standard Size
For Bite Relator 2000 standard frame.
310-620 100/box **\$42.75**

Xi Extended
For Bite Relator 2000 standard and extended frame.
310-640 100/box **\$40.25**

PLASTIC IMPRESSION TRAYS



Plastic Impression Trays

Rigid, distortion-free design with smooth edges for patient comfort. Not made with natural rubber latex and impact resistant.

Perforated Trays

#1 - Large Upper	310-10001
#2 - Large Lower.....	310-10002
#3 - Medium Upper.....	310-10003
#4 - Medium Lower.....	310-10004
#5 - Small Upper.....	310-10005
#6 - Small Lower.....	310-10006
#7 - UL/LR	310-10007
#8 - UR/LL	310-10008
#9 - Anterior Upper	310-10009
#10 - Anterior Lower	310-10010

Solid Trays

#7 - UL/LR	310-10015
#8 - UR/LL	310-10016
#9 - Anterior Upper	310-10017
#10 - Anterior Lower	310-10018
12/bag	\$8.25



Directed Flow Impression Tray - 3M Oral Care

Eliminate the need for a tray adhesive and simplify both preliminary and final impressions with this

innovative, single-use tray. Revolutionary self-retentive fleece strip eliminates the need for a tray adhesive for fewer handling steps, and features striations that act as a barrier to avoid tooth/tray contact and occlusal flat-spots for better impression results.

Upper Refills

Small	313-71615
Medium.....	313-71616
Large	313-71617
10/pack	\$25.25

Lower Refills

Small.....	313-71618
Medium.....	313-71619
Large	313-71620
10/pack	\$25.25



Crystal Disposable Impression Trays - Affordable Dental Products, Inc.

Allows visualization for underlying anatomy for molding and re-insertion for fabrication of temps and wash techniques. No unpleasant metallic taste.

Full Arch Upper

- Small Perforated 310-04P
- Small Solid..... 310-04S
- Medium Perforated..... 310-05P
- Medium Solid 310-05S
- Upper Large Perforated..... 310-06P
- Upper Large Solid 310-06S

Full Arch Lower

- Lower Small Perforated..... 310-07P
- Lower Small Solid 310-07S
- Lower Medium Perforated 310-08P
- Medium Solid 310-08S
- Large Perforated 310-09P
- Large Solid..... 310-09S

LL, UR Quadrant

- Perforated 310-02P
- Solid..... 310-02S

LR, UL Quadrant

- Perforated 310-01P
- Solid..... 310-01S

Universal Anterior

- Perforated 310-03P
- Solid..... 310-03S
- 12/bag **\$8.25**

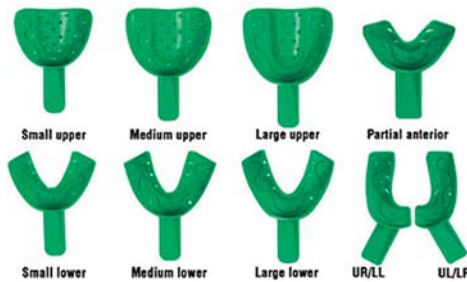

Disposable SpacerTrays - GC America

Unique zigzag spacer bar designed into the occlusal surface allows you to seat loaded impression trays to the correct depth, time after time.

Uppers

- Small #7D 312-250071
- Medium #4D 312-250041
- Large #1D 312-250011

Lowers

- Small #22D 312-250221
- Medium #21D 312-250211
- Large #20D 312-250201

Quadrant

- LR/UL #30D 312-250301
- LL/UR #31D 312-250311
- Anterior #32D..... 312-250321
- 12/bag **\$14.25**

Single Units and Master Packs available upon request.



MiraTray Advanced Implant - Hager Worldwide

Clean and precise impression, no overflow of impression material at the abutments. Compatible with all impression material and implant systems.

Introductory Kit

- Contains: Six sizes; one piece each (upper lower jaw - small, medium & large).
- 310-101250 Kit..... **\$55.75**

Refill Packs

- Upper S1 (Small) 310-101251
- Upper S2 (Medium)..... 310-101252
- Upper S3 (Large) 310-101253
- Lower I1 (Small) 310-101254
- Lower I2 (Medium) 310-101255
- Lower I3 (Large) 310-101256
- 6/pack **\$55.75**



Bosworth Edentulous Tray Aways - Keystone Industries

Disposable, perforated edentulous impression

trays that can easily be modified for implant impressions. Patient friendly, high impact styrene trays provide excellent precision and outstanding details, allowing for a perfect fit. No adhesive material needed.

- #1 Upper Small 310-0921600
- #2 Lower Small 310-0921599
- #3 Upper Medium..... 310-0921700
- #4 Lower Medium 310-0921701
- #5 Upper Large 310-0921702
- #6 Lower Large 310-0921703
- 12/bag **\$28.95**

Extra Large size available upon request.

Assorted Sizes

- Contains: 2 of each size.
- 310-0921704 12/bag **\$27.95**



BosworthTray Aways - Keystone Industries

High impact nylon with combination slots, keyways and holes for adhesion. Reinforced handle. Posterior rim lock to minimize secondary flow. Disposable.

Perforated

- #1 Large Upper 310-0921884
- #2 Large Lower 310-0921887
- #3 Medium Upper 310-0921885
- #4 Medium Lower 310-0921888
- #5 Small Upper 310-0921886
- #6 Small Lower 310-0921889
- #7S UR/LL 310-0921894
- #8S UL/LR 310-0921895
- #9S Lower Anterior 310-0921896
- #10S Upper Anterior..... 310-0921897

Solid

- #7 UR/LL 310-0921890
- #8 UL/LR..... 310-0921891
- #9 Lower Anterior 310-0921892
- #10 Upper Anterior 310-0921893
- 12/bag **\$11.25**

PLASTIC IMPRESSION TRAYS

DuraLock PLUS - Ortho Technology

By eliminating the extra step of coating the tray with adhesive and waiting for it to dry, the impression process is simplified and accelerated. Eliminate inadequate coverage and/or tissue impingement and ensures an accurate fit every time by offering more size choices than competing trays. Manufactured with an advanced medical-grade polystyrene plastic which is designed to be either disposable or cold sterilizable.

Introductory Kit

Contains: 60 trays, 5 trays of each size upper and lower.

310-501000 Kit..... **\$52.95**



Pedo - Red

Upper 310-501001U
Lower..... 310-501001L
50/pkg **\$45.45**



Extra Small - Orange

Upper 310-501002U
Lower..... 310-501002L
50/pkg **\$49.25**



Small - Blue

Upper 310-501003U
Lower..... 310-501003L
50/pkg **\$49.25**



Medium - Green

Upper 310-501004U
Lower..... 310-501004L
50/pkg **\$49.25**



Large - Yellow

Upper 310-501005U
Lower..... 310-501005L
50/pkg **\$49.25**



Extra Large - Purple

Upper 310-501006U
Lower..... 310-501006L
50/pkg **\$49.25**



DenTray® II Disposable Impression Trays - Sultan Healthcare

Made of high impact polystyrene. They feature a rigid design that captures detailed impressions without distortion. These thermoplastic trays can be customized by flame or trimming if desired and can be cold sterilized with most leading solutions if necessary.

Perforated

Size 1P Large Upper 310-33051
Size 2P Large Lower 310-33052
Size 3P Medium Upper 310-33053
Size 4P Medium Lower 310-33054
Size 5P Small Upper 310-33055
Size 6P Small Lower 310-33056
Size 7P LR/UL 310-33057
Size 8P LL/UR 310-33058
Size 9P Upper Anterior..... 310-33059
Size 10P Lower Anterior..... 310-33060
12/pkg. **\$12.95**

Assorted

Contains: 1 of each perforated tray, plus 2 each of 3P and 4P.
310-33050 12/pkg **\$13.25**



MasterTray® Impression Trays - Water Pik, Inc.

Reinforced cross-section, trays offer rigid metal tray performance for your most critical crown and bridge cases and implant cases. Peripheral locking rim aids in retention. Easy to adjust and trim.

Large Upper 310-11211
Large Lower 310-11212
Medium Upper 310-11213
Medium Lower 310-11214
Small Upper 310-11215
Small Lower 310-11216
Partial UL, LR..... 310-11217
Partial UR, LL 310-11218
Anterior 310-11219
12/pkg. **\$13.75**



Sani-Trays® Impression Trays - Water Pik, Inc.

Rigid to insure precise alginate, crown and bridge and edentulous impressions. Extra thick side-walls.

Perforated

#1 Large Upper 310-11511
#2 Large Lower 310-11512
#3 Medium Upper 310-11513
#4 Medium Lower 310-11514
#5 Small Upper 310-11515
#6 Small Lower 310-11516

Non-Perforated

#7 Partial UL, LR..... 310-11517
#8 Partial UR, LL..... 310-11518
#9 Anterior 310-11519
#11 Large Upper 310-11521
#12 Large Lower 310-11522
#13 Medium Upper..... 310-11523
#14 Medium Lower..... 310-11524
#15 Small Upper 310-11525
#16 Small Lower 310-11526
12/box **\$12.25**

Dual Arch available upon request.

PLASTIC IMPRESSION TRAYS



Tra-Tens® Impression Trays - Water Pik, Inc.

Fully perforated tray pattern helps ensure consistent impressions.

#1 Small Upper	310-13451
#2 Medium Upper	310-13452
#3 Large Upper	310-13453
#4 Small Lower	310-13454
#5 Medium Lower	310-13455
#6 Large Lower	310-13456
#7 Anterior	310-13457
#8 Bilateral UL, LR	310-13458
#9 Bilateral UL, LL	310-13459
12/bag	\$12.95

METAL IMPRESSION TRAYS



Stainless Steel Perforated Impression Trays

Item #	Dot Color	Size
Upper Full Mouth		
310-00001	White	XX-Small
310-00002	Yellow	X-Small
310-00003	Red	Small
310-00004	Blue	Medium
310-00005	Green	Large
310-00006	Purple	X-Large
Lower Full Mouth		
310-00007	White	XX-Small
310-00008	Yellow	X-Small
310-00009	Red	Small
310-00010	Blue	Medium
310-00011	Green	Large
310-00012	Purple	X-Large
Partial		
310-00013	Yellow	UR/LL.....Small*
310-00014	Blue	UR/LL.....Medium*
310-00015	Purple	UR/LL.....Large*
310-00016	Yellow	UL/LRSmall*
310-00017	Blue	UL/LRMedium*
310-00018	Purple	UL/LR.....Large*
Anterior		
310-00019	White	Upper
310-00020	White	Lower
Each		\$18.95

*Embossed position orientation on the partial tray handles reflect the dental professional's perspective.



Rim-Lock® Trays - Dentsply Caulk

Recommended for the putty wash technique and for alginate impressions. Trays feature a unique locking design that assures retention of material.

Regular

Contains: Uppers and lowers in sizes 11, 12, 13, 14 and 15.

318-661697	10/set	\$393.95
------------	--------------	-----------------

Edentulous

Contains: Uppers and lowers in sizes 21, 22, 23 and 24.

318-661699	8/set	\$333.25
------------	-------------	-----------------

Regular Individual Trays

U11	318-661675
U12	318-661676
U13	318-661677
U14	318-661678
U15	318-661611
U16	318-661612
U17	318-661613
U21	318-661661
U22	318-661662
U23	318-661663
U24	318-661664
L11	318-661680
L12	318-661681
L13	318-661682
L14	318-661683
L15	318-661620
L16	318-661621
L17	318-661622
L18	318-661623
L21	318-661666
L22	318-661667
L23	318-661668
L24	318-661669
Each	\$42.45

Individual Partial Impression Trays

#41 UL/LR	318-661636
#42 Lower Anterior	318-661637
#43 UR/L	318-661638
#44 Large Swivel	318-661639
#45 Small Swivel	318-661640
#46 Upper Anterior	318-661641
Each	\$38.95



COE Check-Bite™ Trays - GC America
Unilateral #70 Bite Registration Water Cooled
 312-267001 Each..... **\$72.95**

Unilateral #72 Non-Water Cooled
 312-267201 Each..... **\$68.45**

Occlusal Inserts
 302-262025 25/pkg. **\$27.95**



COE® Nickel Plated Trays - GC America

Full Set available upon request.

Full Denture available upon request.

Perforated Regular Trays

#1 Large Upper	312-260011
#3 Med.-Large Upper	312-260031
#4 Med. Upper	312-260041
#5 Narrow Med. Upper	312-260051
#7 Small Upper	312-260071
#20 Large Lower	312-260201
#21 Med. Lower	312-260211
#22 Small Lower	312-260221
#X1 X-Large Upper	312-260911
#X20 X-Large Lower	312-260921
#30 Quadrant UL/LR	312-260301
#31 Quadrant UR/LL	312-260311
Each tray	\$40.45

Additional sizes and Stainless Steel version available upon request.

TRAY ADHESIVE



Tray Adhesive - 3M Oral Care

For use with Polyether Impression Materials.
307-30600 17ml bottle..... **\$27.45**

For use with VPS Impression Materials.
303-7307 17ml bottle..... **\$28.75**



Alpha-Dent® Tray Adhesive - Dental Technologies Inc.

Contains: 2 -1/2 oz bottles (14ml).
300-5400103001 Pack **\$10.95**



VPS Tray Adhesive - Dentsply Caulk

308-626155 14ml..... **\$43.75**



Tray Adhesives - GC America Adhesive

302-133911 13ml **\$17.95**

Universal VPS Adhesive

302-138906 7ml **\$16.75**



Universal Silicone Adhesive - Heraeus Kulzer

300-35257 10ml **\$32.45**



Permlastic Rubber Adhesive - Kerr Restoratives

309-00674 2oz..... **\$37.95**



V.P.S. Tray Adhesive - Kerr Restoratives

309-16622 0.5oz. **\$36.75**
309-25777 2oz. **\$72.25**



Bosworth Tac - Keystone Industries

Use with alginate impression material to securely hold the alginate in the tray when the impression is removed from the patient's mouth.

300-0921880 3.5oz. spray can **\$28.75**
300-0921882 4oz. bottle **\$38.75**
300-0921881 2 -0.5oz. bottles **\$18.75**



DEFEND Vinyl Adhesive - Mydent International

300-8300 10ml **\$14.75**



Genie VPS Tray Adhesive - Sultan Healthcare

300-77100 14ml **\$31.45**



Hold™ Tray Adhesive - Water Pik, Inc.

Not recommended for use with elastomeric impression materials.

Liquid

Contains: 2 -0.5oz. bottles.
300-11460 Each..... **\$26.75**

Contains: 2 -4oz. bottles.
300-11462 Each..... **\$111.25**

Aerosol Spray

300-11461 2.7oz. can..... **\$32.95**

TRAY CLEANERS



Coe Tray Cleaner - GC America

Dustless, bacteriostatic, ultrasonic bath powder cleaner. mixes easily with water to remove alginate, wax, and material compounds from metal trays and instruments. This product cleans in as little as 15 minutes. Mild to skin; does not contain phosphates.

302-250010 575gm **\$42.75**



Tray Cleaner - EPR Industries LLC

Removes Zoe and Alginate from impression trays.
300-TC 1lb. **\$15.75**



Health-Tec
BRAND PRODUCTS

Health-Tec PRO-TEC
Latex Exam Gloves

• Disposable Single Use
• Non-Sterile
• Ambidextrous
• Made of Natural Rubber Latex

Pro-Tec Exam Gloves
Micro-Textured
Polymer-Coated
White

X-Small	410-PPFXS2
Small	410-PPFS2
Medium	410-PPFM2
Large	410-PPFL2
X-Large	410-PPFXL2
100/box	\$8.95
10@	\$8.45



M Latex Powder Free Medical Examination Gloves

NextStep

Ansell Protects

MICROTOUCH
NextStep

Micro-Touch® NextStep® - Ansell Healthcare
Textured
Glycerol coated inner surface
Green

X-Small	410-3200
Small	410-3201
Medium	410-3202
Large	410-3203
X-Large (80/box)	410-3204
100/box	\$11.45
10@	\$10.95



Refresh
Latex Powder Free Mint Examination Gloves

M

Honeycomb Textured
• Polymer-Coated
• Ambidextrous
• 100 Gloves by Weight

AURELIA

Refresh® - Aurelia® Gloves by Supermax
Honeycomb Textured
Polymer-Coated
Mint Scent
Teal

X-Small	410-99225
Small	410-99226
Medium	410-99227
Large	410-99228
X-Large	410-99229
100/box	\$11.25
10@	\$10.95



Health-Tec
BRAND PRODUCTS

Powder Free Latex Exam Gloves

• Disposable
• Non-Sterile
• Ambidextrous

One Size Use Only
100 Gloves by Weight

Powder Free Latex Exam Gloves
Fully Textured
Chlorinated
White

X-Small	410-HTPFXS
Small	410-HTPFS
Medium	410-HTPFM
Large	410-HTPFL
X-Large	410-HTPFXL
100/box	\$9.95
10@	\$8.45



Distinct
Latex Powder Free Exam Gloves

L

Honeycomb Textured
• Polymer-Coated
• Ambidextrous
• 100 Gloves by Weight

AURELIA

Distinct® - Aurelia® Gloves by Supermax
Honeycomb Textured
Polymer-Coated
White

X-Small	410-29225
Small	410-29226
Medium	410-29227
Large	410-29228
X-Large	410-29229
100/box	\$11.25
10@	\$10.75



Velocity
Latex Powder Free Examination Gloves

S

Smooth
• Chlorinated
• Ambidextrous
• 100 Gloves by Weight

AURELIA

Velocity® - Aurelia® Gloves by Supermax
Smooth
Chlorinated
White

X-Small	410-28225
Small	410-28226
Medium	410-28227
Large	410-28228
X-Large	410-28229
100/box	\$10.45
10@	\$9.95



M Latex Powder Free Medical Examination Gloves

PLUS

Ansell Protects

MICROTOUCH
Plus

Micro-Touch® Plus - Ansell Healthcare
Textured
Polymer-Coated
Cream

X-Small	410-6015300
Small	410-6015301
Medium	410-6015302
Large	410-6015303
X-Large	410-6015304
150/box	\$14.25
10@	\$13.75



Luminance
Latex Powder Free Examination Gloves

M

Fully Textured
• Polymer-Coated
• Ambidextrous
• 100 Gloves by Weight

AURELIA

Luminance® - Aurelia® Gloves by Supermax
Fully Textured
Polymer-Coated
White

X-Small	410-29885
Small	410-29886
Medium	410-29887
Large	410-29888
X-Large	410-29889
100/box	\$11.25
10@	\$10.95



Vibrant
Latex Powder Free Examination Gloves

XL

Textured
• Chlorinated
• Ambidextrous
• 100 Gloves by Weight

AURELIA

Vibrant® - Aurelia® Gloves by Supermax
Textured
Chlorinated
Beige

X-Small	410-98225
Small	410-98226
Medium	410-98227
Large	410-98228
X-Large	410-98229
100/box	\$9.95
10@	\$9.45



Cyntek - Cranberry

Textured
Coated with lanolin & vitamin E
Citrus - Peppermint Scent
Winter Green
X-Small 410-7835
Small 410-7836
Medium 410-7837
Large 410-7838
X-Large 410-7839
100/box **\$11.45**
10@ **\$10.95**



Aloe PRO - DASH Medical Gloves Inc.

Textured
Inner coating with lanolin & vitamin E
White
X-Small 410-AP100XS
Small 410-AP100S
Small/Medium 410-AP100SM
Medium 410-AP100M
Large 410-AP100L
X-Large 410-AP100XL
100/box **\$12.75**
10@ **\$12.25**



VitalGard - DASH Medical Gloves Inc.

Textured
Chlorinated
White
X-Small 410-VPF100XS
Small 410-VPF100S
Medium 410-VPF100M
Large 410-VPF100L
X-Large 410-VPF100XL
100/box **\$9.75**
10@ **\$9.25**



Sigma - Cranberry

Micro-Textured
Polymer-Coated
White
X-Small 410-5815
Small 410-5816
Medium 410-5817
Large 410-5818
X-Large 410-5819
100/box **\$11.45**
10@ **\$10.95**



Black Maxx - DASH Medical Gloves Inc.

Textured
Black
Small 410-BMX100S
Medium 410-BMX100M
Large 410-BMX100L
X-Large 410-BMX100XL
100/box **\$11.45**
10@ **\$10.95**



BeeSure - EcoBee

Micro-Textured
Polymer-Coated
White
X-Small 410-2815
Small 410-2816
Medium 410-2817
Large 410-2818
X-Large 410-2819
100/box **\$10.25**
10@ **\$9.75**



Silkcare - Cranberry

Micro-Textured
Inner coating with lanolin & vitamin E
White
X-Small 410-7815
Small 410-7816
Medium 410-7817
Large 410-7818
X-Large 410-7819
100/box **\$11.45**
10@ **\$10.95**



MicroPRO - DASH Medical Gloves Inc.

Textured
Chlorinated
White
X-Small 410-TPF100XS
Small 410-TPF100S
Medium 410-TPF100M
Large 410-TPF100L
X-Large 410-TPF100XL
100/box **\$11.75**
10@ **\$11.25**



BeeSure Green - EcoBee

Micro-Textured
Polymer-Coated
Citrus Mint Scent
Green
X-Small 410-2835
Small 410-2836
Medium 410-2837
Large 410-2838
100/box **\$10.45**
10@ **\$9.95**



Aloetouch Professional - Medline

Textured
 Inner coating with lanolin & vitamin E
 Green
 X-Small 410-MDS198153
 Small 410-MDS198154
 Medium 410-MDS198155
 Large 410-MDS198156
 X-Large 410-MDS198157
 100/box **\$13.25**
 10@ **\$12.75**



Diamond Grip™ - Microflex® Gloves by Ansell

Textured
 Chlorinated
 White
 X-Small 410-300XS
 Small 410-300S
 Medium 410-300M
 Large 410-300L
 X-Large 410-300XL
 100/box **\$15.45**
 10@ **\$15.45**



Evolution One® - Microflex® Gloves by Ansell

Fully Textured
 Polymer-Coated
 White
 X-Small 410-2050XS
 Small 410-2050S
 Medium 410-2050M
 Large 410-2050L
 X-Large 410-2050XL
 100/box **\$17.75**
 10@ **\$17.25**



ColorTouch® Pink - Microflex® Gloves by Ansell

Textured
 Polymer-Coated
 Pink
 X-Small 410-CTP233XS
 Small 410-CTP233S
 Medium 410-CTP233M
 Large 410-CTP233L
 100/box **\$12.45**
 10@ **\$11.95**



Diamond Grip Plus™ - Microflex® Gloves by Ansell

Fully Textured
 Polymer-Coated
 White
 X-Small 410-DGP350XS
 Small 410-DGP350S
 Medium 410-DGP350M
 Large 410-DGP350L
 X-Large 410-DGP350XL
 100/box **\$12.95**
 10@ **\$11.45**

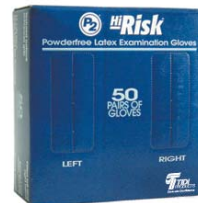

Hi-Risk Gloves - TIDI Products LLC

Thick and Textured
 12" Long
 Blue
14ml
 Small 410-BS04501
 Medium 410-BS04601
 Large 410-BS04701
 X-Large 410-BS04801
 50/box **\$29.95**
18ml
 Small 410-9324771
 Medium 410-9324801
 Large 410-9324831
 X-Large 410-9324861
 50/box **\$62.95**



Comfort Grip® - Microflex® Gloves by Ansell

Fully Textured
 Polymer-Coated
 White
 X-Small 410-CFG900XS
 Small 410-CFG900S
 Medium 410-CFG900M
 Large 410-CFG900L
 X-Large 410-CFG900XL
 100/box **\$12.45**
 10@ **\$11.95**



for something? **WE HAVE IT!**

www.dhponline.com



Pure Touch 100

Micro-Textured
White

Small	430-30022
Medium	430-30032
Large	430-30042
X-Large	430-30052
100/box	\$8.45
10@	\$7.95



Amazing® - Aurelia® Gloves by Supermax

Textured
Violet

X-Small	430-92885
Small	430-92886
Medium	430-92887
Large	430-92888
X-Large	430-92889
300/box	\$19.95
10@	\$19.45



Perform® - Aurelia® Gloves by Supermax

Textured
Teal

X-Small	430-92395
Small	430-92396
Medium	430-92397
Large	430-92398
X-Large	430-92399
200/box	\$14.45
10@	\$13.95



Pure Touch 200

Micro-Textured
Blue

X-Small	430-200XS
Small	430-200S
Medium	430-200M
Large	430-200L
X-Large	430-200XL
200/box	\$15.45
10@	\$14.95



Blush® - Aurelia® Gloves by Supermax

Textured
Pink

X-Small	430-78885
Small	430-78886
Medium	430-78887
Large	430-78888
200/box	\$16.45
10@	\$15.95



Robust® - Aurelia® Gloves by Supermax

Textured
Blue

Small	430-93896
Medium	430-93897
Large	430-93898
X-Large	430-93899
100/box	\$10.25
10@	\$9.75



Pure Touch 300

Micro-Textured
Dark Blue

X-Small	430-N300XS
Small	430-N300S
Medium	430-N300M
Large	430-N300L
X-Large (250/box)	430-N300XL
300/box	\$18.95
10@	\$18.45



Protégé™ - Aurelia® Gloves by Supermax

Textured
Sky Blue

X-Small	430-93995
Small	430-93996
Medium	430-93997
Large	430-93998
X-Large	430-93999
100/box	\$9.45
10@	\$8.95



Sonic® - Aurelia® Gloves by Supermax

Textured
Indigo

X-Small	430-93775
Small	430-93776
Medium	430-93777
Large	430-93778
X-Large (250/box)	430-93779
300/box	\$20.95
10@	\$20.45



Quest® - Aurelia® Gloves by Supermax

Textured
White

X-Small	430-92895
Small	430-92896
Medium	430-92897
Large	430-92898
X-Large	430-92899
100/box	\$8.45
10@	\$7.95



Crave - Cranberry

Fully Textured
Inner coating with lanolin & vitamin E
Ice Blue

X-Small	430-CR3555
Small	430-CR3556
Medium	430-CR3557
Large	430-CR3558
X-Large	430-CR3559
200/box	\$12.45
10@	\$11.95



Evolve 300 - Cranberry

Textured
Dark Blue

X-Small	430-CR3305
Small	430-CR3306
Medium	430-CR3307
Large	430-CR3308
X-Large (250/box)	430-CR3309
300/box	\$21.45
10@	\$20.95



Transform® - Aurelia® Gloves by Supermax

Textured
Blue

X-Small	430-98895
Small	430-98896
Medium	430-98897
Large	430-98898
X-Large	430-98899
200/box	\$14.95
10@	\$14.45



Contour - Cranberry

Textured
Blue

X-Small	430-3115
Small	430-3116
Medium	430-3117
Large	430-3118
X-Large	430-3119
100/box	\$11.75
10@	\$11.25



Luv - Cranberry

Textured
Tangerine Mint Scent
Tangerine

X-Small	430-CR3335
Small	430-CR3336
Medium	430-CR3337
Large	430-CR3338
200/box	\$18.95
10@	\$18.45



Aqua Source - Cranberry

Textured
Inner coating with lanolin & vitamin E
Aqua

X-Small	430-3445
Small	430-3446
Medium	430-3447
Large	430-3448
X-Large	430-3449
200/box	\$17.45
10@	\$16.95



Contour Plus - Cranberry

Textured
Inner coating with lanolin & vitamin E
White

X-Small	430-3225
Small	430-3226
Medium	430-3227
Large	430-3228
X-Large	430-3229
100/box	\$10.95
10@	\$10.45



R200 - Cranberry

Textured
Dark Blue

X-Small	430-CR3205
Small	430-CR3206
Medium	430-CR3207
Large	430-CR3208
X-Large	430-CR3209
200/box	\$16.75
10@	\$16.25



Truly 200 - Cranberry

Textured
Low Dermatitis Potential
Light Blue

X-Small	430-CR3215
Small	430-CR3216
Medium	430-CR3217
Large	430-CR3218
X-Large	430-CR3219
200/box	\$16.45
10@	\$15.95



Alasta - DASH Medical Gloves Inc.

Textured
Blue

X-Small	430-ALS100XS
Small	430-ALS100S
Medium	430-ALS100M
Large	430-ALS100L
X-Large	430-ALS100XL
100/box	\$8.75
10@	\$8.25



Alasta White - DASH Medical Gloves Inc.

Textured
White

X-Small	430-AW100XS
Small	430-AW100S
Medium	430-AW100M
Large	430-AW100L
X-Large	430-AW100XL
100/box	\$8.75
10@	\$8.25



Xlim - Cranberry

Textured
Dark Blue

X-Small	430-3125
Small	430-3126
Medium	430-3127
Large	430-3128
X-Large	430-3129
100/box	\$9.95
10@	\$9.45



Alasta 200 - DASH Medical Gloves Inc.

Textured
Blue

X-Small	430-ALS200XS
Small	430-ALS200S
Medium	430-ALS200M
Large	430-ALS200L
X-Large	430-ALS200XL
200/box	\$16.45
10@	\$15.95



Black Maxx - DASH Medical Gloves Inc.

Textured
Black

Small	430-BMN100S
Medium	430-BMN100M
Large	430-BMN100L
X-Large	430-BMN100XL
100/box	\$11.45
10@	\$10.95



Ambi-ance - Crosstex International

Textured
Blue

X-Small	430-19010
Small	430-19011
Medium	430-19012
Large	430-19013
X-Large	430-19014
200/box	\$19.75
10@	\$19.25



Alasta with Aloe - DASH Medical Gloves Inc.

Textured
Aloe Vera Coated
Green

X-Small	430-AA100XS
Small	430-AA100S
Medium	430-AA100M
Large	430-AA100L
X-Large	430-AA100XL
100/box	\$12.25
10@	\$11.75



Halo - DASH Medical Gloves Inc.

Textured
Blue

X-Small	430-HAL100XS
Small	430-HAL100S
Medium	430-HAL100M
Large	430-HAL100L
X-Large	430-HAL100XL
100/box	\$9.95
10@	\$9.45



Nitrile PF with Aloe - DASH Medical Gloves Inc.

Textured
Aloe Vera Coated
Green

Small	430-NA100S
Medium	430-NA100M
Large	430-NA100L
X-Large	430-NA100XL
100/box	\$14.75
10@	\$14.25



BeeSure Naturals Forest - EcoBee

Smooth
Green

X-Small	430-BE2945
Small	430-BE2946
Medium	430-BE2947
Large	430-BE2948
300/box	\$16.45
10@	\$15.95



BeeSure Slim - EcoBee

Textured
White

X-Small	430-1125
Small	430-1126
Medium	430-1127
Large	430-1128
200/box	\$16.75
10@	\$16.25



VitalGard - DASH Medical Gloves Inc.

Textured
Blue

X-Small	430-VNPF100XS
Small	430-VNPF100S
Medium	430-VNPF100M
Large	430-VNPF100L
X-Large	430-VNPF100XL
100/box	\$9.95
10@	\$9.45



BeeSure Naturals Glacier - EcoBee

Smooth
Light Blue

X-Small	430-BE2925
Small	430-BE2926
Medium	430-BE2927
Large	430-BE2928
300/box	\$16.45
10@	\$15.95



BeeSure SuperSlim - EcoBee

Smooth
Cobalt Blue

X-Small	430-BE1145
Small	430-BE1146
Medium	430-BE1147
Large	430-BE1148
300/box	\$18.95
10@	\$18.45



True Advantage - Dynarex

Smooth
Lilac

X-Small	430-6501
Small	430-6502
Medium	430-6503
Large	430-6504
X-Large	430-6505
100/box	\$11.45
10@	\$10.95



BeeSure - EcoBee

Textured
Light Blue

X-Small	430-1115
Small	430-1116
Medium	430-1117
Large	430-1118
X-Large	430-1119
100/box	\$8.95
10@	\$8.45



Aquasoft - Halyard Health

Textured
Blue

X-Small	430-43932
Small	430-43933
Medium	430-43934
Large	430-43935
X-Large (250/box)	430-43936
300/box	\$18.95
10@	\$23.45



Lavender - Halyard Health

Textured	
Lavender	
X-Small	430-52816
Small	430-52817
Medium	430-52818
Large	430-52819
X-Large (230/box)	430-52820
250/box	\$21.95
10@	\$21.45



Purple Dental Exam - Halyard Health

Textured	
Purple	
X-Small	430-52000
Small	430-52001
Medium	430-52002
Large	430-52003
X-Large (90/box)	430-52004
100/box	\$12.95
10@	\$12.45



FreeForm® SE - Microflex® Gloves by Ansell

Textured	
Blue	
X-Small	430-FFS700XS
Small	430-FFS700S
Medium	430-FFS700M
Large	430-FFS700L
X-Large	430-FFS700XL
100/box	\$14.45
10@	\$13.95



Sterling - Halyard Health

Textured	
White	
X-Small	430-50705
Small	430-50706
Medium	430-50707
Large	430-50708
200/box	\$20.45
10@	\$19.95



Optimum - Hedy Canada

Textured	
Blue	
X-Small	430-120NVB10
Small	430-120NVB20
Small/Medium	430-120NVB30
Medium	430-120NVB50
Large	430-120NVB60
X-Large	430-120NVB70
250/box	\$19.95
10@	\$19.45



MidKnight® - Microflex® Gloves by Ansell

Textured	
Black	
X-Small	430-MK296XS
Small	430-MK296S
Medium	430-MK296M
Large	430-MK296L
X-Large	430-MK296XL
100/box	\$16.25
10@	\$15.75



Purple Exam - Halyard Health

Textured	
Purple	
X-Small	430-55080
Small	430-55081
Medium	430-55082
Large	430-55083
X-Large (90/box)	430-55084
100/box	\$13.95
10@	\$13.45



Caress COATS - Hedy Canada

Textured	
Colloidal Oatmeal Therapeutic Skincare Inner	
Coating	
White	
X-Small	430-110NOW10
Small	430-110NOW20
Medium	430-110NOW50
Large	430-110NOW60
100/box	\$9.95
10@	\$9.45



Soft White - Microflex® Gloves by Ansell

Textured	
White	
X-Small	430-TQ601XS
Small	430-TQ601S
Medium	430-TQ601M
Large	430-TQ601L
X-Large	430-TQ601XL
100/box	\$10.95
10@	\$10.45



Ultraform® - Microflex® Gloves by Ansell

Textured
Cobalt Blue
X-Small/ Small 430-UF524XSS
X-Small 430-UF524XS
Small 430-UF524S
Small/ Medium 430-UF524SM
Medium 430-UF524M
Medium/ Large 430-UF524ML
Large 430-UF524L
X-Large (250/box) 430-UF524XL
300/box **\$24.95**
10@ **\$24.45**



UltraSense® EC - Microflex® Gloves by Ansell

Textured
Blue
Small 430-USE880S
Medium 430-USE880M
Large 430-USE880L
X-Large 430-USE880XL
100/box **\$14.95**
10@ **\$14.45**



Allogel - Preventive Care, Inc.

Textured
AlloGel Inner Coating
Magenta
X-Small 430-ALLOGENAXS
Small 430-ALLOGENAS
Medium 430-ALLOGENAM
Large 430-ALLOGENAL
X-Large (90/box) 430-ALLOGENAXL
100/box **\$11.95**
10@ **\$11.45**



UltraSense® - Microflex® Gloves by Ansell

Textured
Blue
X-Small 430-US220XS
Small 430-US220S
Medium 430-US220M
Large 430-US220L
X-Large 430-US220XL
100/box **\$12.25**
10@ **\$11.75**



Xceed® - Microflex® Gloves by Ansell

Textured
Light Blue
X-Small 430-XC310XS
Small 430-XC310S
Medium 430-XC310M
Large 430-XC310L
X-Large 430-XC310XL
250/box **\$21.45**
10@ **\$20.95**



Cut through the fat

GO DIRECTLY TO THE BEST

Manufacturers offer thousands of promotions. GO **DIRECTLY** TO THE BEST.

www.dhpionline.com/promotions

BUY 1 BUY 2 BUY 3 BUY 4 OR MORE **DHPI X** EXCLUSIVE OFFERS



Softouch - Cranberry

Vinyl
Smooth
Clear

X-Small	420-3015
Small	420-3016
Medium	420-3017
Large	420-3018
X-Large	420-3019
100/box	\$7.95
10@	\$7.45



True Comfort - DASH Medical Gloves Inc.

Neoprene
Textured
Green

X-Small	430-TC100XS
Small	430-TC100S
Medium	430-TC100M
Large	430-TC100L
X-Large	430-TC100XL
100/box	\$11.75
10@	\$10.95



Flexaprene Green - Halyard Health

Chloroprene
Textured
Green

X-Small	430-44792
Small	430-44793
Medium	430-44794
Large	430-44795
X-Large (180/box)	430-44796
200/box	\$18.25
10@	\$17.75



Aloe PRO - DASH Medical Gloves Inc.

Synthetic
Aloe Vera Coated
Green

X-Small	430-APS100XS
Small	430-APS100S
Small/ Medium	430-APS100SM
Medium	430-APS100M
Large	430-APS100L
X-Large	430-APS100XL
100/box	\$13.25
10@	\$12.75



Vinyl PF - DASH Medical Gloves Inc.

Vinyl
White

Small	420-SPF100S
Medium	420-SPF100M
Large	420-SPF100L
X-Large	420-SPF100XL
100/box	\$8.45
10@	\$7.95



NeoGard® - Microflex® Gloves by Ansell

Neoprene
Textured
Green

X-Small	430-C520
Small	430-C521
Medium	430-C522
Large	430-C523
X-Large	430-C524
100/box	\$13.25
10@	\$12.75



Nuvo Vinyl - DASH Medical Gloves Inc.

Vinyl
White

Small	420-NV100S
Medium	420-NV100M
Large	420-NV100L
X-Large	420-NV100XL
100/box	\$8.45
10@	\$7.95



Durasafe - Lifeguard Medical

Vinyl
Clear

Small	420-DSVPFS
Medium	420-DSVPFM
Large	420-DSVPFL
X-Large	420-DSVPFXL
100/box	\$7.95
10@	\$7.45



NeoPro® - Microflex® Gloves by Ansell

Neoprene
Textured
Approved for use with Chemotherapy Drugs
Green

X-Small	430-NPG888XS
Small	430-NPG888S
Medium	430-NPG888M
Large	430-NPG888L
X-Large	430-NPG888XL
100/box	\$15.25
10@	\$14.75

NON-STERILE FITTED GLOVES

GLOVE SIZING CHART

X-Small	5-5-1/2
Small	6-6-1/2
Medium	7-7-1/2
Large	8-8-1/2
X-Large	9

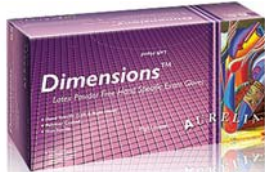

Dimensions® - Aurelia® Gloves by Supermax

Latex
Textured
Polymer-Coated
White

6.5.....	410-699265
7.....	410-699270
7.5.....	410-699275
8.....	410-699280
8.5.....	410-699285
50 pair/box	\$11.45
10@	\$10.95



Curve® - Cranberry

Nitrile
Textured
White

6.....	430-3424
6.5.....	430-3425
7.....	430-3426
7.5.....	430-3427
8.....	430-3428
8.5.....	430-3429
50 pair/box	\$9.95
10@	\$9.45



Silkcare® - Cranberry

Latex
Textured
Polymer-Coated
White

6.....	410-7824
6.5.....	410-7825
7.....	410-7826
7.5.....	410-7827
8.....	410-7828
8.5.....	410-7829
50 pair/box	\$13.95
10@	\$13.45



Left/Right Fitted - Crosstex International

Nitrile
Textured
Polymer-Coated
Blue

7.5.....	430-19095
8.....	430-19096
8.5.....	430-19097
50 pair/box	\$24.75
10@	\$24.25



Neolon® 2G - Medline Industries, Inc.

Neoprene
Polymer-Coated
Textured
Brown

6.5.....	430-MSG6065Z
7.0.....	430-MSG6070Z
7.5.....	430-MSG6075Z
8.0.....	430-MSG6080Z
50 pair/box	\$136.25

STERILE SURGICAL GLOVES



Gammex® - Ansell Healthcare

Synthetic
Smooth
Green

6.....	430-8512	7.5.....	430-8515
6.5.....	430-8513	8.....	430-8516
7.....	430-8514	8.5.....	430-8517
50 pair/box	\$157.25		

FINGER COTS



Nitrile Finger Cots - Tech-Med Services

Small.....	430-4404S
Medium.....	430-4404M
Large.....	430-4404L
X-Large.....	430-4404XL
144/box	\$9.95

GLOVE HOLDERS



Aloetouch 12" - Medline Industries, Inc.

Nitrile
Textured
Green

Small	430-194085
Medium	430-194086
Large	430-194087
50 pair/box	\$50.75

Pinnacle™ Glove Dispenser - Kerr TotalCare

Two-compartment glove dispenser.
12-1/4" W" x 7" H x 4" D
White
 400-1050 || Box-loading glove dispenser. 12" W x 7" H x 4-1/2" D Almond | 400-1500 |
| Each | **\$43.95** |

GLOVE HOLDERS



Hold-It Single/Double Glove Box Holder - *Palmero Health Care*

Designed to accommodate one or two boxes so that a variety of glove styles and sizes can be stored in the same convenient location. Mounting hardware included. 11" x 4" x 4"

400-1858 Each..... **\$16.45**



Hold-It Triple Glove Box Holder - *Palmero Health Care*

Designed to accommodate one, two or three boxes so that a variety of glove styles and sizes can be stored in the same convenient location. Mounting hardware included. 12.25" x 4.5" x 15"

400-1858T Each..... **\$26.95**



Acrylic Glove Box Holders - *Unimed Corp.*

Clear acrylic allows easy identification of glove type and size.

Single

Dimensions: 11" W x 4.75" H x 3.5" D

400-1061004 Each..... **\$22.75**

Double

Dimensions: 11" W x 9.5" H x 3.5" D

400-2061281 Each..... **\$25.75**

Triple

Dimensions: 11" W x 14.5" H x 3.5" D

400-3061282 Each..... **\$29.95**

Quadruple

Dimensions: 11" W x 19.25" H x 3.5" D

400-4061284 Each..... **\$41.95**

OVERGLOVES



Plastic Embossed Overgloves

Reduce your cost of replacing expensive gloves during patient exams. Use an overglove when leaving a patient to answer the phone, pick-up records / files, etc. One size fits all.

430-BDG601 100/bag **\$2.95**



Glove/Gloves - *Biotrol*

Clear, textured polyethylene glove protectors that preserve exam gloves while performing non-clinical tasks, such as handling patient charts. One size fits all.

430-GG551 100/bag **\$10.95**



Latindo® Disposable Plastic Overgloves - *Plasdent Corporation*

Small..... 430-900S
 Medium..... 430-900M
 Large 430-900L
 100/box **\$5.25**

UTILITY GLOVES



Nitrile Utility Gloves - *HealthSonics*

For use in the sterilization area, and for operatory disinfection. Puncture and abrasion resistant nitrile compound. Flocked-lined for easier hand insertion and removal. Mold embosses for improved tactile feel and handling of instruments. Heat sterilizable in Chemiclave or steam heat to 270°.

Green.
 Small 430-300012
 Medium 430-300013
 Large 430-300014
 3 pair/pack **\$23.50**



Lilac Utility Gloves - *Hu-Friedy*

Flock-lined utility gloves for use when cleaning and processing instruments. Puncture and chemical resistant with a non-slip grip. Steam autoclavable to 250°F/121°C up to five times.

Small (Size 7) 430-40060
 Medium (Size 8)..... 430-40062
 Large (Size 9) 430-40064
 X-Large (Size 10) 430-40066
 3 pair/pack **\$21.95**



Nitrile Decontamination Gloves - *Saf-T-Gard International, Inc.*

Give yourself extra protection when sterilizing instruments and handling decontamination chemicals. Highly puncture-resistant and autoclavable up to 300°. Reusable, ambidextrous.

Small..... 430-SG133S
 Medium..... 430-SG133M
 Large 430-SG133L
 2/pack **\$2.95**

MASKS - CONE



Cone Masks

Fluid resistant cone mask. Not made with natural rubber latex. Cool and comfortable with a soft inner lining. Fiberglass free. Pink mask is 10% smaller. BFE/PFE greater than 99%

Blue 460-10001
 Pink (Petite) 460-10002
 50/box **\$9.95**

Molded Face Masks - 3M Oral Care

Utility mask for procedures that do not produce fluid, spray or aerosols. Soft and lightweight for comfortable wear. Collapse-resistant design. Non-fiberglass.

Blue 463-1942FB
 Rose 463-1942FR
 50/box **\$48.45**



Triple Layer Molded Face Mask - 3M Oral Care

Fluid resistant to help reduce potential exposure of the wearer to blood and body fluids. Greater than 99% Bacterial Filtration Efficiency (BFE) when challenged with a mean particle size of approximately 2.7 microns. The soft inner layer absorbs moisture.

White 463-2042F
 Petite- White 463-2042FP
 50/box **\$58.95**



Surgical Molded Masks - Crosstex International

Splash repellent barrier with flared edge for added

comfort with soft, flexible nose-piece. Latex free.

Blue 460-GCBL
 Pink (slightly smaller) 460-GCPK
 50/box **\$14.95**



Standard Cone Masks - Halyard Health

Appropriate for situations where exposure to blood and/or bodily fluids is not a risk. Headband. Blue.

460-50601 50/box **\$17.95**



Form Fit Masks - Mydent International

Contoured design eliminates need for aluminum nose guard. Non-fogging. Fiberglass free. BFE 99%.

Blue 460-1206
 Pink (slightly smaller) 460-1216
 50/box **\$14.75**

MASKS - EARLOOP



Earloop Exam Masks

Rated for Level 1 protection. It's 4-pleat design provides 15% more breathing area for added comfort. Adjustable nose and chin pieces give a more secure fit. The soft inner layer is free from chemicals, inks and dyes. Latex/Fiberglass free.

Blue 450-10020
 Pink 450-10021
 50/box 50/box **\$7.75**



Ultra Earloop Exam Masks

3-ply downward pleat design provides an exact fit. Longer, rounded earloops will not irritate ears. Made from water repellent SMS material. Not made with natural latex. Made in U.S.A.

LEVEL 1 Fluid Resistance 80mm Hg, BFE - >95%, PFE - >99%, Delta P - <2.0, Flame Spread - Class I

Blue 450-7000B2
 Pink 450-7000P2
 Lavender 450-7000LV2
 50/box **\$9.95**

LEVEL 2 Fluid Resistance 120mm Hg, BFE - >99%, PFE - >99%, Delta P - <2.0, Flame Spread - Class I

Blue 450-8000B2
 Pink 450-8000P2
 50/box **\$10.45**

LEVEL 3 Fluid Resistance 160mm Hg, BFE - >99%, PFE - >99%, Delta - <5.0, Flame Spread - Class I

Blue 450-9000B2
 50/box **\$10.95**



Sensitive Skin Earloop Exam Masks

Fluid resistant white outer layer with white, extra soft, hypoallergenic cellulose inner layer. Designed specifically for people with sensitive skin - no inks, dyes or chemicals. Designed not to tear, shred or lint. ASTM Level 1. White.

450-10001 50/box **\$9.95**

MASKS - EARLOOP



Earloop Face Mask - 3M Oral Care

Features slip-on convenience, and provides fluid resistance and >99% Bacterial Filtration Efficiency (BFE) at a mean particle size of 4.0 microns. Soft and lightweight for comfortable wear. Blue.
453-2000F 50/box **\$51.95**



Critical Cover® PFL® - Alpha ProTech

PFL (Positive Facial Lock) masks feature our exclusive Twist-Seal chin piece which allows a custom fit to any size face, reducing potential for small particles to be inhaled around the borders of the face mask. This unique design virtually eliminates gaps at the border of the mask. Blue.
Headband
450-108 50/box **\$26.95**

Earloops

450-115 50/box **\$29.25**



Critical Cover® PFL® with MagicArch® - Alpha ProTech

The integrated Magic Arch prevents the mask from coming in contact with the user's nose and mouth thereby making it easier to breathe while enhancing filtration efficiency. Hypoallergenic.

Headband

Blue 450-608

Earloops

ASTM Level 1.

Blue 450-615
Pink 450-617P
50/box **\$28.75**



Repel 4 Ply Face Masks - Cranberry

4-ply HydroGuard layer that provides superior fluid resistance. ASTM level 3 protection exceeds

the most stringent ASTM F1862 standards for synthetic blood penetration at 160mmHg. Latex and fiberglass free, inner layer is dye-free, chemical-free, and lint-free.

Amber/ Gold 450-R2960G
Sapphire 450-R2960SA
Pearl/ Silver 450-R2960SI
50/box **\$11.95**



Repel Anti-Fog 4 Ply Face Masks - Cranberry

Exclusive non-woven anti-fog cushion across inner layer greatly reduces fogging of eye wear. 4-ply HydroGuard layer that provides superior fluid resistance. ASTM level 3 protection exceeds the most stringent ASTM F1862 standards for synthetic blood penetration at 160mmHg. Latex and fiberglass free, inner layer is dye-free, chemical-free, and lint-free

Sapphire 450-R2970SA
Pearl/ Silver 450-R2970SI
50/box **\$12.95**



S3 - Cranberry

Earloop face masks designed with healthy skin in mind with exclusive S3 features that provide skin soothing benefits. S3 offers ASTM Level 2 protection and exceptional breathing efficiency with its exclusive Breath EZ filter.

Blue 450-S3060B
White 450-S3060W
50/box **\$10.45**



S3 ACE

Earloop face masks with proprietary inner layer enriched with Aloe Vera, Vitamin C, and Vitamin E. ASTM Level 2 protection and exceptional breathing efficiency with its exclusive Breath EZ filter.

Blue 450-S3080B
White 450-S3080W
Pink 450-S3080P
Lavender 450-S3080L
50/box **\$11.45**



S3 Mint

Earloop face masks with proprietary inner layer with a refreshing mint scent. ASTM Level 2 protection and exceptional breathing efficiency with its exclusive Breath EZ filter.

Blue 450-S3090B
Green 450-S3090G
Lavender 450-S3090L
Yellow 450-S3090Y
50/box **\$11.45**



S3 C2

Earloop face masks with proprietary inner layer enriched with cucumber extract and a mild cucumber scent. ASTM Level 2 protection and exceptional breathing efficiency with its exclusive Breath EZ filter.

Blue 450-S3070B
Pink 450-S3070P
Lavender 450-S3070L
50/box **\$11.45**



Isofluid® - Crosstex International

Fluid resistant outer layer with white, facial tissue inner layer. Extra long, aluminum nose piece. Latex free, ASTM Level 1.

Blue 450-GCIBL
Green 450-GCIGR
Lavender 450-GCILV
Pink 450-GCIPK
Sapphire 450-GCISA
Teal 450-GCITE
Turquoise 450-GCITQ
Topaz 450-GCITZ
50/box **\$14.45**

Blue 450-GCIBL100
100/box **\$28.75**



Isofluid Fog Free®

Fluid resistant outer layer with white, facial tissue inner layer. Unique FogFree barrier on inner layer and extra long, aluminum nose piece. Latex free, ASTM Level 1.

Blue 450-GCICXB
Topaz 450-GCIPWZ
Turquoise 450-GCICXT
Sapphire 450-GCICXS
40/box **\$16.25**

MASKS - EARLOOP



Isofluid® Plus - Crosstex International

Fluid resistant outer layer with white, extra soft, hypoallergenic cellulose inner layer. Void of all inks, dyes and chemicals - will not lint, tear or shred. Designed specifically for people with sensitive skin. Latex free, ASTM Level 1.

- Blue 450-GPLUSB
- Kaleidoscope 450-GPLUSKA
- Pink..... 450-GPLUSPK
- 50/box **\$13.25**



Isolite® Face Masks - Crosstex International

Facial tissue outer layer with white, facial tissue inner layer. Extra long, aluminum nose piece. Latex free, ASTM Level 1.

- Blue 450-GCLBL
- Pink..... 450-GCLPK
- 50/box **\$14.45**



Le Petit Masque - Crosstex International

Three-quarters of an inch shorter than standard masks to help eliminate gapping and provide a more comfortable, protective fit for smaller faces. Latex free, ASTM Level 1. Pink.

- 450-GCAPTPK 50/box **\$11.45**



Procedural Earloop - Crosstex International

Order by ☎ 800-626-2163

Fluid resistant outer layer with white fluid resistant inner layer. Latex free, ASTM Level 2.

- Blue.....450-GCPBL
- Pink.....450-GCPPK
- Yellow.....450-GCPYL
- 50/box **\$15.25**

- Blue 450-GCPBL100
- 100/box **\$29.45**



SecureFit® Face Masks - Crosstex International

Creates a tight, custom fit for enhanced facial protection. Fluid resistant outer layer with white, facial tissue inner layer. Extra long, aluminum nose piece. Enclosed aluminum strip under the chin – the wearer pinches the aluminum strip to create a custom fit with a tight seal at the bottom and sides of the mask. Latex free.

Isofluid (ASTM Level 1)

- Blue 450-GCIBLSF
- Pink..... 450-GCIPKSF
- 50/box **\$15.95**

Isofluid Fog Free (ASTM Level 1)

- Blue 450-GCICXBSF
- 40/box **\$18.25**

Isofluid Plus Pure (ASTM Level 1)

- White 450-GPLUSWHSF
- 50/box **\$16.45**

Procedural (ASTM Level 2)

- Blue 450-GCPBLSF
- Pink..... 450-GCPPKSF
- Lavender..... 450-GCPLVSF
- 50/box **\$14.95**

Ultra (ASTM Level 3)

- Blue 450-GCFCXUSF
- 50/box **\$19.75**

Ultra Sensitive (ASTM Level 3)

- White 450-GCFCXSSF
- 50/box **\$20.25**

Ultra Sensitive Fog Free (ASTM Level 3)

- White 450-GCFCXSF
- 40/box **\$23.25**



Ultra Earloop Masks - Crosstex International

Fluid resistant outer layer with white fluid

resistant inner layer. Extra long, aluminum nose piece. PFE 99.9% @ 0.1 Micron. Latex free, ASTM Level 3.

- Blue 450-GCFCXU
- 40/box **\$15.95**

Fog Free

- Blue 450-GCFCX
- 40/box **\$23.25**

Sensitive

- White 450-GCFCXS
- 50/box **\$18.75**



BeeSure Face Masks - EcoBee

Dye-free, chemical-free and soft comfort cellulose inner layer. Latex-free and fiber glass-free. ASTM Level 2.

- Blue 450-2100B
- Yellow..... 450-2100Y
- White 450-2100W
- 50/box **\$8.95**



BeeSure Masks with Floral Design

Printed with floral designs on the mask. 100% Latex Free with CoolSilk lint- and dye-free inner layer. Proprietary RoundEdge corners and cushioned ear loops. Breathe smoothly without moisture buildup. 98% particle filtration provide secure protection. Quad-fold design for exact fit. ASTM Level 2.

- Plumeria 450-2310
- Orchid 450-2320
- Fern 450-2340
- Hibiscus 450-2300
- Daisy..... 450-2330
- 50/box **\$10.25**



BeeSure Naturals Face Masks

More than 60% earth-friendly cellulose components. Unique cellulose layers deliver cool easy breathability. Exclusive Quad-Fold design offers 15% more breathing volume. 100% latex-free and fiber glass-free filter layers. ASTM Level 2.

- Canyon Red 450-BE2410
- Glacier Blue 450-BE2420
- Cloud White 450-BE2430
- 50/box **\$11.95**

Continued

MASKS - EARLOOP

BeeSure Masks continued.



BeeSure Face Masks with Peppermint Scent

Greater than 98% particle filtration efficiency gives you secure protection. Dye-free, chemical-free and soft comfort cellulose inner layer. Light peppermint scent. Latex-free and fiber glass-free. ASTM Level 2.

- Green..... 450-2200G
- Lavender..... 450-2200L
- Pink..... 450-2200P
- Blue 450-2200B
- 50/box **\$9.45**



Procedure Masks - Halyard Health

Pleat style with earloops. Protective three-layer construction. Appropriate for situations where exposure to blood and/or bodily fluids is not a risk. Latex free.

- Blue 450-50102
- Green..... 450-50105
- Pink..... 450-50104
- White with Pink/ Blue Teddy Bears
..... 450-50511
- Yellow..... 450-50103
- 50/box **\$11.45**

Fog Free

- White 450-50500
- Blue 450-50512
- 50/box **\$16.45**



FluidShield Procedure Masks - Halyard Health

Designed with unique So Soft bicomponent fabric technology to provide comfort to users. ASTM Level 1.

- Yellow 450-25867
- Lavender 450-25868
- Blue 450-25869
- 50/box **\$10.95**



THE LITE ONE Procedure Masks - Halyard Health

Designed with extra lightweight materials to improve breathability and provide a cooler, more comfortable earloop mask. Appropriate where exposure to blood and/or bodily fluids are not a risk. Blue, Latex free.

- 450-50515 50/box **\$10.95**



SafeMask® Premier Earloop Masks - Medicom®

Low Barrier mask for oral exams of low-risk patients and procedures involving lowest levels of spray and spatter such as fluoride treatments, minor orthodontics and basic lab work. ASTM Level 1.

- Lavender..... 450-2011
- Blue 450-2015
- Pink..... 450-2016
- Yellow..... 450-2017
- Teal..... 450-2018
- 50/box **\$13.25**



SafeMask® Premier Plus

Moderate Barrier mask for oral exams of known higher-risk patients and procedures involving moderate levels of spray, spatter and airborne particles such as endo or periodontic procedures, bleaching and lab work with exposure to blood or contaminated materials. ASTM Level 2.

- 450-2040 50/box **\$14.45**



SafeMask® Premier Elite

High Barrier mask ideal for oral exams of high-

risk patients and procedures involving high levels of spray, spatter, moisture and airborne particles. Perfect for ultrasonic scalers, high-speed aerosols, air polishers and oral surgeries. ASTM Level 3.

- Blue 450-2042
- Pink..... 450-2046
- White 450-2047
- 50/box **\$15.25**



SafeMask® Master Series®

Constructed from the same high quality materials found in the SafeMask Premier line. ASTM Level 1.

- Augusta Sky Royal Blue..... 450-2050
- Azalea Festival Fuschia 450-2051
- Georgia Sun- Orange Burst . 450-2053
- Lush Lawn Vibrant Green..... 450-2052
- Southern Bell Flower Purple 450-2054
- 50/box **\$13.25**



SafeMask® SofSkin®

Designed with sensitive skin in mind. It's soft, lightweight and highly breathable inner layer is gentle, non-irritating and remains cool on the skin for ultimate ease and comfort. ASTM Level 1.

- Blue 450-2081
- Pink..... 450-2082
- Lavender..... 450-2083
- White 450-2080
- 50/box **\$15.45**



BARRIER Earloop Surgical Mask - Molnlycke Health Care

Pleated. 3-layer design. Sure fit nose clip 0.5mm thickness. Latex free, ASTM Level 1. Blue.

- 450-4228 50/box **\$15.25**

Anti-Fog

- 450-4229 50/box **\$17.95**

MASKS - EARLOOP



DEFEND "Diffuser" Fog-Free Masks - Mydent International

Contains an antifog foam nose piece which absorbs moisture to prevent the fogging of eye-wear. Fluid resistant. Fiberglass free. BFE 99%.
 Blue 450-1046
 Pink..... 450-1056
 50/box **\$13.95**



Ear Loop Face Masks - Septodont

Soft, light weight, non-irritating, latex free masks. Meets current ASTM F2100 safety standards, Level 1.
 Blue 450-25515
 Pink..... 450-25510
 White 450-25505
 50/box **\$14.75**



com-fit® Easy Breathe™ Face Masks - Sultan Healthcare

Keep you cool, allow you to breathe with minimal moisture, and are more comfortable without sacrificing protection. Hypoallergenic and latex free, components will not irritate skin. 97% PFE filtration at 0.1 micron. Blue.
 450-20340 40/box **\$19.45**



com-fit® Fluid Resistant Procedural Masks

Soft comfortable design. Contains a fluid resistant outer layer. Economical. Ear Loop design.
 Blue 450-20324
 Pink..... 450-20325
 50/box **\$15.25**



com-fit® Groovy Masks

Comforting color that will not alarm patients and a fog-free strip to keep glasses fog free. 99.9% BFE at 3 micron. ASTM Level 3.
 450-20350 50/box **\$22.25**



com-fit® Plush Face Masks

Hypoallergenic. Silky soft on skin. Curved nose-band for a correct fit. Soft ear loops ultrasonically bound to the outside of the mask so they won't cause skin irritation. White.
ATSM Level 1
 450-20352 40/box **\$15.95**
ASTM Level 2
 450-20353 40/box **\$16.75**
ASTM Level 3
 450-20354 40/box **\$17.95**



com-fit® Plush Natural Fit Masks

Elastic chin strip that is designed to conform to the users' natural facial structure. Plus, it's softer and more breathable than leading brands. Better fit. Powerful protection. Hypoallergenic comfort.
ASTM Level 1
 450-20355 40/box **\$15.95**
ASTM Level 2
 450-20356 40/box **\$16.95**
ASTM Level 3
 450-20357 40/box **\$19.45**



com-fit® Super High Filtration Face Masks

Features two-way DELNET film barrier that provides fluid resistance with excellent breathability. Foam strip keeps glasses fog free. 99% PFE at 0.1 micron. ASTM Level 3. Blue.
 450-20326 40/box **\$18.45**



com-fit® Super Sensitive Face Masks

These masks provide excellent protection for those with sensitive skin. Latex Free with no inks, dyes, perfumes or scratchy surfaces to irritate skin. PFE 99% at 0.1 micron. White.
 450-20346 50/box **\$18.45**



Zooby Character Masks - Young Dental

Pliable nose piece. Sensitive cellulose material to help provide comfort and protection with character designs featuring Penelope the Penguin and Francesca the Flamingo. Latex free. ASTM Level 1.
 450-295404 30/box **\$13.95**

MASKS - EARLOOP WITH SHIELD



Repel Face Masks with Shield - Cranberry

Resistant to fluid and synthetic blood penetration at 160 mm Hg (exceed ASTM- F1862). 4-Ply protection for greater than 99% BFE and PFE. New advance ClearView filmed shield reduces glare and ensures clear vision with longer lasting anti-fog properties. Black UV proof outer strip delivers optimal glare preventions. Ideal for users with sensitive skin, made from non-irritant and odorless materials, 100% Latex Free and fiberglass free. First Touch Enhanced. ASTM Level 3.
 Sapphire..... 450-R2980SA
 Pearl/ Silver..... 450-R2980SI
 25/box **\$28.25**

MASKS - EARLOOP WITH SHIELD



Isofluid FogFree® Face Masks with Shield - Crosstex International
 Fluid resistant outer layer with white, facial tissue inner layer. Unique FogFree non-woven barrier on inner layer to prevent fogging with an optically clear, distortion free wrap-around shield. ASTM Level 1. Blue.

450-GCIPWB 25/box **\$38.25**



Ultra No Fog Masks with Splash Visor - Crosstex International

All the benefits of fog-free plus an optically clear wraparound visor shield. ASTM Level 3.

Blue 450-GCPW
 Sensitive- White 450-GCPWS
 25/box **\$54.25**



Fluidshield Masks - Halyard Health

Resists fluid penetration. Large, clear visor for visual clarity. Protects face and eyes from fluid splash and possible contamination. Eliminates need for separate protective eyewear. Charcoal binding reduces glare reflecting on visor. ASTM Level 3.

Wrap-Around Splashguard Visor

Blue 450-57080
 Peach..... 450-47080080
 25/box **\$37.95**

MASKS - RESPIRATOR



PFL N-95 Particulate Respirator Masks - Alpha ProTech

Designed specifically for use in healthcare settings and is NIOSH approved. It uses the exclusive Positive Facial Lock (PFL) design, which permits the respirator to "custom fit" virtually any face.

460-695 35/box **\$36.45**



Isolator Plus® N95 Particulate Respirator - Crosstex International

A NIOSH approved N95 Particulate Respirator that meets guidelines for TB exposure control. Indicated for use when treating patients with airborne diseases such as TB or Influenza. Fluid Resistance – 160 mm Hg. PFE = 99.9% @ 0.1 Micron. BFE = 99.9% @ 3.1 Micron. Dual elastic headband. Malleable aluminum nose and chin pieces. Fluid resistant inner and outer layers. Chin pocket construction for secure fit. Blue/White stripe outer layer. White inner layer.

460-GPRN95 28/box **\$37.45**

MASKS - TIE-ON



Tie-On Surgical Masks - 3M Oral Care

Soft rayon and poly fibers is an excellent filtration material for sensitive skin. Form-fitting nose band adjusts to bridge. Fluid resistant, fiberglass free. Blue.

443-1818 50/box **\$61.95**



Surgical Masks - Halyard Health

Protective three-layer construction. Appropriate for situations where exposure to blood and/or bodily fluids is not a risk. Tie on.

Blue 440-47123010
 50/box **\$19.95**



Fluidshield Fog-Free Surgical Masks with Wraparound Visor - Halyard Health

Meets ASTM F2100-11 Level 3 standards. Anti-fog, anti-glare wrap-around visor. Foam band. SO SOFT lining.

Orange..... 440-48247
 25/box **\$39.45**



DEFEND Tie-On Masks - Mydent International

Anti-fog. Fluid resistant. Cool breathing and fiberglass free. BFE of greater than 99%. 3 pleat. Blue.

440-1076 50/box **\$13.95**

GOWNS - DISPOSABLE



Protection Plus™ Fluid Resistant Disposable Gowns

The most economical way of providing maximum protection against potentially infectious fluids. Comfortable, lightweight and air permeable with a closed back design for complete protection. Ties at neck and waist. Neatly folded and packaged. Available with elastic cuff or 3-inch knit cuff.

Gown with Elastic Cuff

Blue	480-6000B
Blue XL	480-6000BXL
Yellow.....	480-6000Y
White	480-6000W
50/case	\$52.25

Gown with 3" Cuff

Blue	480-7000B
Blue XL	480-7000BXL
Yellow.....	480-7000Y
50/case	\$58.95



Impervious Gowns

This gown is designed for more intense invasive procedures and is plastic lined to be completely impervious to all infectious fluids. Open back design.

Blue	480-8000B
White	480-8000
50/case	\$86.75



Kendall™ Splash Resistant Protective Gowns - Covidien Products by Medtronic

Large Blue	480-CT5100
X-Large Blue	480-CT5101
30/case	\$154.25

HEAD & FOOT WEAR



Surgical Cap - Halyard Health

4-ply tissue with polyester reinforcements. No potential fluid contact. Universal size. Tie Fastener. Blue KAYCEL fabric.

480-69240	100/box	\$41.45
-----------	---------------	----------------



Bouffant Caps

For extra protection against potentially infectious fluids. Excellent for perio and oral surgery practices.

21" - White.....	480-21W
21" - Blue	480-21B
24" - White.....	480-24W
24" - Blue	480-24B
100/box	\$8.95



Non-Slip Shoe Covers

Non-absorbent spunbound material that is ideal for use in your lab or other work environments. Latex Free material provides maximum protection against spills without sacrificing comfort or mobility. Non-skid pattern, elastic top for snug fit. Comes with dispenser box.

Regular

480-SC300	150 pairs/case	\$53.75
-----------	----------------------	----------------

X-Large

480-SC300XL	150 pairs/case	\$52.25
-------------	----------------------	----------------

LOOK'in
for something? **WE HAVE IT!**
www.dhpionline.com



Medium	
Blueberry	480-3630BBM
Ceil Blue	480-3630CBM
Light Pink	480-3630LPM
Purple	480-3630PPM
Raspberry	480-3630RBM
Sky Blue	480-3630SBM
Teal	480-3630TEM
White	480-3630WHM
10/pkg	\$30.25

Large	
Blueberry	480-3630BBL
Ceil Blue	480-3630CBL
Light Pink	480-3630LPL
Purple	480-3630PPL
Raspberry	480-3630RBL
Sky Blue	480-3630SBL
Teal	480-3630TEL
White	480-3630WHL
10/pkg	\$30.25

X-Large	
Blueberry	480-3630BBXL
Ceil Blue	480-3630CBXL
Light Pink	480-3630LPXL
Purple	480-3630PPXL
Raspberry	480-3630RBXL
Sky Blue	480-3630SBXL
Teal	480-3630TEXL
White	480-3630WHXL
10/pkg	\$30.25

Extra-Safe™ Disposable Jackets - Valumax International

Quality protective jackets with a snap front, three pockets, and knit cuffs and collar. Fluid resistant, yet they are breathable due to soft three-layer "SMS" fabrics. They meet OSHA protective requirements.

Small	
Blueberry	480-3630BBS
Ceil Blue	480-3630CBS
Light Pink	480-3630LPS
Purple	480-3630PPS
Raspberry	480-3630RBS
Sky Blue	480-3630SBS
Teal	480-3630TES
White	480-3630WHS
10/pkg	\$30.25



Medium	
Blueberry	480-3660BBM
Ceil Blue	480-3660CBM
Light Pink	480-3660LPM
Purple	480-3660PPM
Raspberry	480-3660RBM
Sky Blue	480-3660SBM
Teal	480-3660TEM
White	480-3660WHM
10/pkg	\$30.25

Large	
Blueberry	480-3660BBL
Ceil Blue	480-3660CBL
Light Pink	480-3660LPL
Purple	480-3660PPL
Raspberry	480-3660RBL
Sky Blue	480-3660SBL
Teal	480-3660TEL
White	480-3660WHL
10/pkg	\$30.25

X-Large	
Blueberry	480-3660BBXL
Ceil Blue	480-3660CBXL
Light Pink	480-3660LPXL
Purple	480-3660PPXL
Raspberry	480-3660RBXL
Sky Blue	480-3660SBXL
Teal	480-3660TEXL
White	480-3660WHXL
10/pkg	\$30.25

Extra-Safe™ Disposable Lab Coats - Valumax International

Have all the quality features of the Extra-Safe jackets but in knee length.

Small	
Blueberry	480-3660BBS
Ceil Blue	480-3660CBS
Light Pink	480-3660LPS
Purple	480-3660PPS
Raspberry	480-3660RBS
Sky Blue	480-3660SBS
Teal	480-3660TES
White	480-3660WHS
10/pkg	\$30.25



DEFEND+ PLUS Jackets - Mydent International

Made of a soft, breathable fabric, these fluid-resistant jackets and lab coats meet OSHA requirements for blood-borne pathogens. Static free - no clinging. Soft 3-layer SMS fabrics. Fluid resistant, breathable. Snap front, knit cuffs & collar. 1 Breast pocket & 2 hip pockets. Autoclavable and washable. Latex Free.

Small

Ceil Blue	480-SJ3630CBS
Sky Blue	480-SJ3630SBS
Light Pink	480-SJ3630LPS
Purple	480-SJ3630PPS
10/pkg	\$22.45

Medium

Ceil Blue	480-SJ3630CBM
Sky Blue	480-SJ3630SBM
Light Pink	480-SJ3630LPM
Purple	480-SJ3630PPM
10/pkg	\$22.45

Large

Ceil Blue	480-SJ3630CBL
Sky Blue	480-SJ3630SBL
Light Pink	480-SJ3630LPL
Purple	480-SJ3630PPL
10/pkg	\$22.45

X-Large

Ceil Blue	480-SJ3630CBXL
Sky Blue	480-SJ3630SBXL
Light Pink	480-SJ3630LPXL
Purple	480-SJ3630PPXL
10/pkg	\$22.45



DEFEND+ PLUS Full Length Lab Coats - Mydent International

Made of a soft, breathable fabric, these fluid-resistant lab coats meet OSHA requirements for blood-borne pathogens. Static free - no clinging. Soft 3-layer SMS fabrics. Fluid resistant, breathable. Snap front, knit cuffs & collar. 1 Breast pocket & 2 hip pockets. Autoclavable and washable. Latex Free.

Small

Ceil Blue	480-SG3660CBS
Light Pink	480-SG3660LPS
10/pkg	\$27.95

Medium

Ceil Blue	480-SG3660CBM
Light Pink	480-SG3660LPM
10/pkg	\$27.95

Large

Ceil Blue	480-SG3660CBL
Light Pink	480-SG3660LPL
10/pkg	\$27.95

X-Large

Ceil Blue	480-SG3660CBXL
Light Pink	480-SG3660LPXL
10/pkg	\$27.95

EYE PROTECTION



Safety Glasses
Clear with side shields.
470-001C Each..... **\$7.25**



Outback Eyewear - Hager Worldwide

Contain an anti-scratch coating on both the inside and outside lens surfaces. The nasal bridge design creates superior air flow over the rear of the lens. Eliminates fogging. Clear wrap around lens provides a 6 dioptre base curve. Edge to edge vision without distortion. Soft non-latex nose bridge fitting, UV protection, and constructed of medium velocity polycarbonate impact resistant lenses.

Clear Lens

Gold Frame	470-100700
Red Frame	470-100701
Black Frame	470-100702
Hot Pink Frame	470-100703
Pink Frame	470-100704
Purple Frame	470-100705
Blue Frame	470-100706
Green Frame	470-100707
Silver Frame	470-100710
Blue Frame - Child Size.....	470-100708

Tinted Lens

Black Frame	470-100709
Each	\$40.25



Uvex Genesis - Hager Worldwide

Wrap around lens provides exceptional vision and protection. Flexible fingers adjust to most nasal profiles. Elastomer browguard deflects impact. Adjustable temples and lens inclination.

Clear Lens

Black Frame	470-355810
Earth Frame	470-355812
Vapor Blue Frame	470-355816
Mercury Red Frame	470-355822

Tinted Lens

Black Frame	470-355811
Earth Frame	470-355813
Vapor Blue Frame	470-355817
Each	\$21.95

Replacement Lenses

Clear	470-355820
Tinted	470-355821
10/pkg	\$107.75

Continued

EYE PROTECTION

Hager Worldwide Eye Protection continued.



Uvex Ignite
Sleek wrap-around unilens provides close to the face protection and superior protection.
Clear Lens
Black & Silver Frame 470-355825
Metallic Red & Silver Frame . 470-355826
Each **\$20.95**



Googles™ Eye Shields - Kerr TotalCare
These OSHA-compliant safety goggles have side-shield protection and are made of distortion-free, optical-grade plastic lenses. The frames are reusable and can be autoclaved.
Office Pack
Contains: 10 assorted color frames, 1 Yikes neck-strap, and 20 clear lens.
470-GOP10 Each..... **\$36.45**
Clear Lens Refills
470-GDLR100 100/pack..... **\$89.25**
Single color packs available upon request.



Pinnacle™ Side Shields - Kerr TotalCare
Disposable, clear side shields that fit all sizes and types of prescription eyewear.
470-4700 250/box **\$44.95**



Bad Dogs Eyewear - Palmero Health Care
Wraparound lens provides an uninterrupted peripheral view while providing ultimate protection. Featherweight, fog-free and scratch-

resistant. scratch-resistant. Meets the new ANSI Z87.1-2003 standard for safety eyewear. Polycarbonate lens and temples are impact resistant but not unbreakable. Over 95% UVA and UVB protection. Clear frame/clear lens.
470-3620 Each..... **\$16.25**



Bonding Wraps Eyewear - Palmero Health Care
Sleek styling and clinically proven to provide excellent protection from blue light frequencies used in dental bonding and bleaching procedures.
470-3600 Each..... **\$11.75**



Contour Wraps - Palmero Health Care
Lightweight, stylish safety glasses that offer telescoping arms to ensure a great fit. Fog-free and scratch resistant. Meets the new ANSI Z87.1-2003 standard for safety eyewear.
Gray Lens with Black Frame.....470-3552
Clear Lens with Gray Frame.....470-3553
Each **\$13.25**



Dynamic Disposables Eyewear - Palmero Health Care
Latex Free disposable face shield with an ergonomically engineered frame that fits flush against the forehead and a wraparound lens. Fog-free, anti-static, anti-glare and optically clear, these shields meet the OSHA "no-holes" standard.
Office Pack
Contains: 10 frames, 20 clear lenses and 1 cord.
470-3900 Pack **\$29.45**

Clear Replacement Lenses
470-3903 25/pack **\$21.25**
470-3902 100/pack..... **\$72.45**

Gray Replacement Lenses
470-3905 25/pack **\$28.95**

Bonding Replacement Lenses
470-3906 10/pack..... **\$31.75**

Replacement Frames
470-3901 10/pack..... **\$10.75**



Econo Bonding Eyewear - Palmero Health Care
One piece plastic lens design with detached side shields. Optically correct, non-distorting and lightweight. Filters over 95% of blue, UVA and UVB light. Impact and stress resistant material. Meets the ANSI Z87.1-2003 standard for safety.
470-1100 Each..... **\$15.75**



Econo Wraps - Palmero Health Care
Feather-weight, eye protection that offers a universal fit, superior optical quality and unsurpassed protection. Features a sleek, compact design. Perfect for patient and staff use. Fog-free and scratch-resistant. Meets the new ANSI Z87.1-2003 standard.
Gray Frame/Gray Lens..... 470-3601G
Clear Frame/Clear Lens..... 470-3601C
Each **\$6.45**

Mini
Gray Frame/Gray Lens..... 470-3607G
Clear Frame/Clear Lens..... 470-3607C
Each **\$6.75**



End-Fog Safety Eyewear - Palmero Health Care
Extra anti-fog coating. Features a secure, snug fit and optically correct, crystal-clear lenses for those special procedures. Meets the new ANSI Z87.1-2003 standard for safety eyewear. Blocks up to 95% of UVA and UVB rays.
Blue 470-3556B
Clear 470-3556C
Purple 470-3556P
Red 470-3556R
Each **\$9.25**



EyeSavers - Palmero Health Care

Features an ultra-light frame. Blocks up to 95% of UVA and UVB rays. Meets the new ANSI Z87.1-2003 standard for safety. Impact-resistant polycarbonate lenses. Hinged temples allow for convenient storage.

- Gray 470-3S
- Green 470-18S
- Yellow 470-19S
- Each **\$6.75**



ProVision Bifocal Safety Eyewear - Palmero Health Care

Magnifying eyewear with a dual curvature mono-lens and integrated side shields. The temples adjust to four different lengths and have panoscopic angle adjustments to ensure a perfect fit. They are also fog-free and scratch resistant. Meets the ANSI Z87.1 standard.

- 1.0 Diopter 470-3701A
- 1.5 Diopter 470-3701B
- 2.0 Diopter 470-3701C
- 2.5 Diopter 470-3701D
- 3.0 Diopter 470-3701E
- Each **\$24.45**



See-Breez Protection Eyewear - Palmero Health Care

Stylish glasses offering the protection you need. Ultra-lightweight frames, sculptured dual lens and telescopic temples for comfort. Meets the ANSI 278.1-2003 standards. Fog-free. Clear Lens.

- Black Frame 470-3560BK
- Blue Frame 470-3560B
- Platinum Frame 470-3560PL
- Each **\$16.95**



Safety Side Shields - Palmero Health Care

Slip onto your glasses to provide side protection.

- 470-3611 Pair **\$4.25**



Tech Spec Eyewear - Palmero Health Care

This eyewear has exceptional styling in a light-weight design that provides excellent protection and comfort. Fog free and scratch resistant. Meets the ANSI Z87.1-2003 standard for eye-wear safety. Contoured design and rubberized (non-latex) attachments on the nosepiece and ear rests. Blocks up to 95% of UVA and UVB rays.

- Gray Frame/Clear Lens 470-3710C
- Gray Frame/Gray Lens 470-3710G
- Each **\$16.95**



Tech Spec Bifocal

The lightweight design and rubberized nosepiece make them extremely comfortable to wear while the integrated side shields provide safety. They are also fog-free and scratch resistant. Meets the ANSI Z87.1-2003 standard.

- 1.0 Diopter 470-3720A
- 1.5 Diopter 470-3720B
- 2.0 Diopter 470-3720C
- 2.5 Diopter 470-3720D
- 3.0 Diopter 470-3720E
- Each **\$20.95**

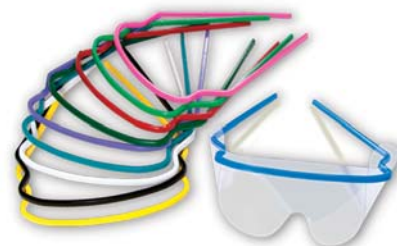

TIDIShield Assemble'n Go - TIDI Products LLC

Autoclavable frames can be reused with economical disposable lenses to provide high protection at a low cost. Lightweight 0.3 oz. Wrap-around design; front and side protection. Optical-grade lenses.

Combo Pack

Contains: 5 assorted color frames, 25 clear replacement lenses, one size fits most.

- 470-945210 Pack **\$35.95**

Pink

Contains: 5 pink frames, 25 replacement lenses. One size fits most.

- 470-9452P10 Pack **\$37.45**

Clear Lens Refill

- 470-921050 50/pack **\$38.45**



TIDIShield Flip'n Go - TIDI Products LLC

Protect both the patient and provider from splatter. 5 assorted color frames/clear lens. One size fits most. Packed flat for compact storage. Optical grade, anti-static and fog-resistant lens. No assembly required just flip to wear. Extremely lightweight and comfortable. Wrap-around design with front and side protection.

- 470-9300FE 25/box **\$59.25**

EYEWEAR DISINFECTANT



See Clear® Eyeglass Wipes - Crosstex International

Anti-static, anti-fog wipes for safety glasses. Will not scratch lenses.
470-SEEC 120/box **\$9.75**



Kimtech Science Lens Cleaning Station - Kimberly-Clark

Lens cleaning station that features dry KIMWIPES delicate task 1-ply wipers and a spray bottle containing an anti-static, anti-fog, and silicone-free cleaning solution.
Contains: 560 1-ply tissues, 4.4" x 8.4", and 8 oz. cleaning spray.
680-34622 Each..... **\$34.45**



DisClens Lens Cleaning Station - Palmero Health Care

Wall mountable station is designed to be easily accessible wherever and whenever the need should arise to clean your eyewear.
Contains: Station, 8oz. pump spray bottle and 600 dry optical wipes.
470-3535 Each..... **\$14.95**



ProVision Crystal Clear Optical Cleaning Wipes - Palmero Health Care

Convenient wipes premoistened with anti-fog, anti-static lens cleaning and polishing solution.

Cleans dirt, grease, oils and blood-borne pathogens from eyewear.

6" x 6.75"
470-3534 160/canister **\$17.75**

Hold-It Wall Mount Canister Holder

6" x 5.625"
510-109 Each **\$16.75**

FACE SHIELDS - DISPOSABLE



Disposable Face Shields - Crosstex International

Clear visor with Soft Strap 13" impenetrable foam barrier provides complete protection against splash and splatter.
470-GCFS 24/box **\$80.45**



ABS Visor Shields - Op-d-Op

Shields are reusable and replaceable.
Contains: 1 visor, 3 shields, 1 mini-shield and 1 light-cure filter.

White	470-308DKWT
Blue	470-308DKBL
Royal Blue.....	470-308DKRB
Pink.....	470-308DKPK
Violet.....	470-308VT
Peach.....	470-308PE
Teal.....	470-308DKTL
Burgundy	470-308DKBR
Misty Jade.....	470-308DKMJ
Purple	470-308DKPR
Each	\$53.75

Replacement Face Shields

470-308SS3 3/pkg	\$27.95
470-308SS12 12/pkg	\$62.45

Replacement Mini Shields

470-308MS6 6/pkg	\$12.75
------------------------	----------------

Replacement Mini Shields - Shaded

470-355MS6 6/pkg	\$21.45
------------------------	----------------

Replacement Foam Bumpers

470-308FB6 6/pkg	\$9.75
------------------------	---------------



Op-d-Op II Adjustable Dental Visor Shield - Op-d-Op

The push-button design provides a perfect fit and eliminates pressure points. Increased ventilation eliminates fogging. Excellent fit with loupes and glasses.

Contains: 1 visor, 3 shields, 1 mini-shield and 1 light-cure filter.

Cloud White	470-355DKCW
Blue	470-355DKBL
Royal Blue.....	470-355DKRB
Periwinkle	470-355DKPW
Violet.....	470-355DKVT
Each	\$63.95

Replacement Face Shields

470-308SS3 3/pkg	\$27.95
470-308SS12 12/pkg.....	\$80.45

Replacement Mini Shields - Shaded

470-355MS3 3/pkg	\$19.75
------------------------	----------------



Disposable Face Shields - Palmero Health Care

Disposable, lightweight face shields offer complete facial coverage that protects from aerosols, sprays and splatters. Covers below the chin, approx 8" in length. Soft elastic band, foam forehead band. Latex-free.

470-1964 24/pkg	\$55.95
-----------------------	----------------



TIDIShield Assemble 'n Go Face Shields - TIDI Products LLC

Weighs less than 1.5 ounces. Designed to maximize airflow and prevent fogging. Visors are autoclavable and reusable. Includes a clear, snap-in nosepiece for support. Latex-free, Meets requirements for both OSHA and EEC mandates.

Combo Pack

Contains 3 assorted visors and 25 face shields
470-24526 25/pack **\$49.95**

Replacement Shields

470-2210406 40/box	\$79.95
470-22101005 100/box	\$194.95

HAND LOTIONS



Glove 'n Care Hand Cream - Essential Dental Systems

Nature's secret of rejuvenation for long-term care of damaged, dry, chapped or irritated hands. It is fortified with the richest essential minerals found on earth: sodium chloride, calcium chloride, sulfate, potassium and magnesium, mined from the dead sea.

Tube		
350-120000	3.4oz.....	\$8.25
Pump Bottle		
350-120400	8.5oz.....	\$25.75



Hand Essentials Moisturizing Lotion - Hu-Friedy

Nurtures and soothes skin with colloidal oatmeal, Aloe Vera and Vitamin E. Non-greasy and fragrance free. Contains dimethicone and allantoin to help retain moisture on skin. CHG and latex-friendly. Perfect for end of the day moisturizing.

350-IMS1503	33.8oz pump	\$25.25
-------------	-------------------	----------------



Hand Essentials Skin Repair Cream - Hu-Friedy

Moisturizing cream that helps to restore the skin's natural moisture balance. Contains Olivamine that aids in the skin's repair process.

Pump Bottle		
350-IMS1500	32oz	\$51.45
Tube		
350-IMS1502	2oz	\$9.25
350-IMS1501	4oz	\$25.75



Hand Cream - Septodont

Penetrates easily and leaves no greasy residue. Specially formulated to permeate superficial layer of epidermis and replenish the moisture lost due to frequent washing. Forms an effective barrier against the irritating components of gloves without effecting their integrity. Pleasant scent.

350-200	3.5oz tube.....	\$12.25
---------	-----------------	----------------



Moist SURE™ Lotion - Sultan Healthcare

Blend of surfactants, enhanced emollients and skin conditioners. Leaves hands soft and moisturized with a pleasant, light fragrance.

Pump Bottle		
350-95731	15oz	\$14.95

HAND SANITIZERS



Avagard™ D Instant Hand Antiseptic Sanitizer with Moisturizers - 3M Oral Care

Broad-spectrum activity kills 99.999% of harmful bacteria, including antibiotic-resistant strains (in vitro) Proven efficacy - meets CDC, AORN and WHO Guidelines. Helps prevent skin breakdown. Dries quickly without leaving hands sticky.

350-2317	5000ml	\$15.95
----------	--------------	----------------



Avant Instant Hand Sanitizer - B4 Brands

Clinically proven to kill 99.99% of the most common germs that may cause illness. Fragrance- Free. 95% bio-based. Hydrates skin

with natural glycerin. Powered by 60% grain-based ethanol, a renewable natural resource, leaves hands feeling clean and refreshed without the strong smell of perfume or alcohol. Free of irritating dyes or colorants CHG and latex compatible.

350-12089275	2.75oz	\$2.45
350-1208985	8.5oz. pump	\$5.25
350-1208916	16.9oz. pump	\$7.25
350-12086	Gallon	\$35.75



Citrus II Instant Hand Sanitizing Lotion - Beaumont Products, Inc.

A moisture-rich gel that kills 99.99% of most common disease-causing germs on the hands in seconds. So gentle, repeated use will not dry skin.

Pump Bottle		
350-632712949	32oz	\$17.75



SaniTize™ Waterless Moisturizing Antimicrobial Gel - Crosstex International

Contains 62% Ethyl Alcohol, meeting CDC recommended guidelines. Contains Aloe Vera, Vitamin E, Keratin and Liposomes to moisturize, condition and soften skin while combating dryness - keeping hands silky soft and smooth. Petroleum free.

Pump Bottle		
350-JWG8	8oz	\$8.75
350-JWGP	18oz	\$17.95

Pouch		
350-JWGEL	800ml	\$23.45
350-JWGEL1	1000ml	\$19.75

Promo Pack		
Contains: 2 dispensers and 6 -1000ml pouches.		
350-JWGPRO1	Pack	\$110.75

Wall-Mounted Dispenser		
For 800ml and 1000ml pouches.		
350-PGEL1	Each.....	\$22.75

HAND SANITIZERS



Advanced Gel Hand Sanitizer - Ecolab
Formulated with emollients and moisturizers to condition and protect the skin and contains 62% ethyl alcohol to provide fast, proven antimicrobial efficacy against a wide range of microorganisms.
350-61430370 540ml pump **\$14.95**



Quik-Care™ Aerosol Foam Hand Sanitizer - Ecolab
Waterless, foaming antimicrobial hand sanitizer formulated with 62.5% ethyl alcohol as well as skin conditioners and emollients to help moisturize and improve skin health with continued use.
350-61032713 7oz. can.....**\$10.95**
350-61032729 15oz. can..... **\$15.45**



PURELL® Advanced Instant Hand Sanitizer Foam - GOJO Industries, Inc.
Kills 99.9% of most common disease causing germs on hands. A supplement to hand washing routine. Nontoxic, dermatologist tested, dye free. Formulated with emollients for exceptional mildness.
Pump Bottle
350-965212 8oz.**\$10.75**
350-579204 4- 18oz **\$113.25**

PURELL® NXT® Refill 1000ml
350-GJ215608 Each..... **\$17.25**

NXT® Dispenser
350-GJ212006 Each..... **\$12.95**

TFX Refill 1200ml
350-539202 2/pack**\$105.95**

TFX Touch Free Dispenser
350-GJ272012 Each..... **\$69.95**



PURELL® Advanced Hand Sanitizer Aloe Gel - GOJO Industries, Inc.
Kills more than 99.99% of most common germs that may cause illness. 12oz pump bottles.
350-363912 12/case**\$108.45**



GBG AloeGel® Instant Hand Sanitizer - Healthlink
Formulated with moisturizers and skin conditioners to help increase skin hydration and maintain the skin's health. Kills 99.9% of harmful microorganisms in 15 seconds. Contains vitamin E, Aloe Vera, glycerin and isopropyl myristate.
350-7773 7oz. can..... **\$11.75**
350-7776 18oz. pump..... **\$14.95**
350-7777 800ml bag-in-box **\$14.45**



Hand Essentials Instant Hand Antiseptic - Hu-Friedy
Contains 70% ethyl alcohol to disinfect hands of most common disease-causing germs. Also contains aloe vera and vitamin E to moisturize and soothe skin.
350-IMS1505 16oz. pump..... **\$11.25**



VioNex™ No-Rinse Gel - Kerr TotalCare
Provides a convenient and economical way to cleanse and kill germs on your hands when soap and water are not available. It is formulated with cleansers, skin conditioners and the active ingredient chloroxylenol.
359-101628 18oz. pump..... **\$16.25**

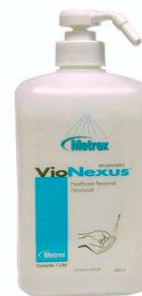

VioNexus™ No Rinse Spray - Kerr TotalCare
A moisturizing waterless skin sanitizer. The 65.8% ethanol, 0.10% benzalkonium chloride formula contains emollients and is recommended for repeated use. When dispensed using the No-Touch Dispenser, it virtually eliminates cross-contamination while relieving and moisturizing over-stressed hands. Latex compatible. 1 liter bottle.
359-101800 2/pack **\$69.25**

No-Touch Dispenser
Requires 4 D-size batteries (not included).
359-101810 Each..... **\$113.95**



Moist SURE™ Liquid Hand Sanitizer - Sultan Healthcare
63% isopropyl alcohol. Contains enhanced emollients to moisturize your hands like a lotion. It keeps your skin hydrated and soft for up to two hours after each use.
Pump Bottle
350-95741 15oz **\$19.75**

Dispenser Refill
350-95742 33.8oz. Cartridge..... **\$37.45**

Automatic Dispenser for 33.8oz Cartridges
350-95762 Each..... **\$69.45**



Foaming Sanitizer
350-95751 9oz. bottle..... **\$17.95**

Foaming Sanitizer Wall Bracket
350-95763 Each..... **\$7.25**

HAND SANITIZERS



Preference Liquid Hand Sanitizer - Whip Mix

Kills 99.9% of the most common germs associated with cross-contamination. Dries very fast, usually less than 10 seconds. Surgical gloves slide on and off easily.

- 350-11451 16oz **\$16.25**
- 350-11452 2 -32oz. bottles **\$68.25**
- 350-11453 5 -20ml **\$33.95**

HAND SOAPS



Aterra Eco-Premium Foaming Hand Soap - B4 Brands

Combines thick, rich lather to clean hands with natural glycerin and panthenol (provitamin B5) to soften and condition the skin. USDA Certified Biobased Product and EcoLogo certified Hand Cleaner CCD-104.

- Pump Bottle**
350-2200018 18oz **\$6.75**



SaniSept® Antimicrobial Soap - Crosstex International

Effective against gram-negative and gram-positive bacteria. Contains 0.3% Triclosan, proven effective against resident microbes hidden in skin layers as well as transient microbes. Gentle, non-drying formula contains Aloe Vera, Vitamin E, Liposomes and Keratin to moisturize, condition and soften skin while combating dryness. Petroleum free.

- Pump Bottle**
350-JSOD 18oz. **\$13.75**



Dial Liquid - Dial Corporation

Antibacterial Soap. Non-irritating; added skin moisturizers. Prevents regrowth of bacteria. 0.2% Triclosan.

- Pump Bottle**
350-80761 7.5oz..... **\$8.45**
- Gallon**
350-08047 Each..... **\$32.25**



Bacti-Foam™ - Ecolab

Antimicrobial foam. Bacti-Foam's 0.3% Triclosan formula meets FDA requirements for Healthcare Personnel Handwash. It contains aloe vera and emollients to help moisten and soothe the skin.

- Pump Bottle**
350-61039202 500ml **\$13.75**



Bacti-Stat® - Ecolab

0.3% Triclosan formula meets FDA requirements for Healthcare Personnel Handwash. Lathers quickly, rinses freely which minimizes residual lather than can cause irritation. Contains Aloe Vera which helps protect against irritation and dry, cracked skin.

- Pump Bottle**
350-61048722 540ml **\$10.45**
- Gallon**
350-61017285 Each..... **\$42.95**



Medi-Stat™ - Ecolab

Mild Healthcare Personnel Hand Wash containing 0.5% Chloroxylenol (PCMX) as an antimicrobial active. Contains aloe vera to help moisten and soothe skin during frequent use..

- Pump Bottle**
350-61048532 540ml **\$7.95**



Micrell® Lotion Soap - GOJO Industries, Inc.

Cleans hands and kills 98% of germs as you wash with a quick-acting antimicrobial agent (PCMX). Gentle on hands even after repeated daily washes. Non-irritating, non-sensitizing formulation. Lightly citrus scented, amber liquid with moisturizers.

- Pump Bottle**
350-975212 8oz **\$7.75**
- Gallon**
350-975504 Each..... **\$23.25**
- Bag-in-Box**
350-975606 80ml **\$14.45**

- Micrell NXT Lotion Soap**
350-GJ215708 1000ml **\$12.45**

Micrell NXT Dispenser available upon request.

HAND SOAPS



PROVON® Foaming Medicated Handwash - GOJO Industries, Inc.
 Antimicrobial foam formulation with moisturizers. Fresh dispensing valve with each refill.
Dispenser Refill - 2-Pack
 350-GJ538802 2000ml **\$81.75**
Dispenser
 350-GJ274512 Each..... **\$69.95**



AloeGuard® Antimicrobial Soap - Healthlink
 Specially formulated with soothing, moisturizing Aloe Vera to protect your skin's delicate balance, and Chloroxylenol to provide the high antimicrobial activity necessary for personal protection and reduction of cross contamination.
Pump Bottle
 350-7760 18oz **\$12.95**



Hand Essentials™ Lotion Soap - Hu-Friedy
 pH-balanced formula that is gentle on hands. Rich feeling with a clean, light scent.
Pump Bottle
 350-IMS1507 16oz **\$12.75**



VioNex™ Antimicrobial Liquid Soap - Kerr TotalCare
 Effective germ reduction in 30 seconds. Lotion-based formula for extra softness.
Pump Bottle
 359-101518 18oz **\$15.45**
Gallon
 359-101500 Each..... **\$41.75**
302



VioNex™ Antimicrobial Foaming Soap - Kerr TotalCare
 Protection against germs without being harsh on hands. It is recommended for repeated use. It helps reduce bacteria that can cause disease with the active ingredient chloroxylenol. It is recommended for use between routine patient contact, procedures, after exposure to potential pathogens and after removal of personal protective equipment. 1 liter bottle.
 359-101900 2/pack **\$64.75**



VioNex™ Foaming Soap with Vitamin E
 Gentle foaming with a refreshing plumeria-apple fragrance. The formula is non-irritating, pH-balanced, and leaves hands feeling soft. The product is specifically designed for healthcare professionals and recommended for repeated use. 1 liter bottle.
 359-102001 2/pack **\$39.95**
No-Touch Dispenser
 Provides a pre-measured application over the surface of the hands. Battery operated.
 359-101810 Each..... **\$113.95**



Dyna-Hex CHG Scrub - Medline Industries, Inc.
 Chlorhexidine gluconate (CHG), 2% or 4% concentration. Water-aided surgical scrub. Also useful for patient preoperative skin prep, wound cleansing and healthcare personnel hand wash.
2%
 350-DYNG2 Gallon **\$33.25**
4%
 350-DYNG4 Gallon **\$50.75**



HiBiClen's® - Molnlycke Health Care
 Effectively kills clinically relevant MRSA strains in one minute (99.99% log reduction) and is effective against a broad spectrum of Gram-positive and Gram-negative bacteria, enveloped viruses and many fungi and molds. Provides persistent and residual effects. The solution kills germs on contact and with repeated use it binds to the skin, reducing hand microbial counts further with each use. The solution is not neutralized by blood or other organic matter, making the chlorhexidine gluconate the most effective active antiseptic ingredient on the market.
 350-580016 16oz. bottle **\$17.45**
 350-580128 Gallon **\$69.25**



Naturally Hydrating Lotion Soap - Mydent International
 Specifically blended with Aloe Vera Gel and "BioStructure™"- a blend of 7 natural ingredients devised to moisturize and preserve. Pleasant baby powder scent. Contains PCMX.
Pump Bottle
 350-9310 16oz **\$18.95**
Gallon
 350-9300 Each..... **\$39.95**



DisCide Effect Professional Hand Asepsis Soap - Palmero Health Care
 Contains PCMX, a broad spectrum antimicrobial agent effective against germs, bacteria, yeast and fungal microorganisms. Viscous formula removes stubborn dirt, grease and transient bacteria without irritating sensitive skin. Contains aloe vera, vitamin E. Fresh almond scent.
 350-3543 Quart..... **\$16.75**
 350-3542 Gallon **\$28.25**

HAND SOAPS



Moist SURE Hand Soap - Sultan Healthcare

Kills MRSA, VRE and other pathogenic organisms. Meets the FDA proposed performance standards for a healthcare personnel handwash. Lotion Soap contains .5% triclosan—an antibacterial agent with documented efficacy for both gram-positive and gram-negative bacteria.

Foaming Soap Pump Bottle

350-95720 15oz **\$16.45**

Lotion Soap Pump Bottle

350-95726 15oz **\$15.75**

Dispenser Refill

350-95727 33.8oz **\$20.75**

Gallon

350-95728 Each **\$50.45**

PATIENT TOWELETTES



Refreshing Patient Facial Towelettes - Palmero Health Care

Lightly scented facial wipe to refresh either the patient or staff after exams and procedures. Specially formulated with lanolin to moisturize skin as it cleans. 5.9" x 6.8".

350-3515 120/canister **\$9.95**



Versi-Wipe Towelettes - Palmero Health Care

Just add the solution of your choice to this dry towelette and create your own moist towelette. OSHA compliant label attached. 6" x 6-3/4".

510-3516 160/canister **\$13.25**

HEAT SEALERS & ACCESSORIES



Heat Sealer - Mydent International

This ETL certified and ultra durable heat sealer will seal nylon sterilization tubing within 1-2 seconds and then turn off automatically. Strong stainless steel, 8" heating elements resist breaking.

110 Volt Unit

770-3000 Each **\$123.25**

Replacement Heating Elements

590-3001 3/pack **\$17.45**

Replacement Insulating Cloth

Upper 590-3002
Lower 590-3003
3/pack **\$14.75**



Nyclave® Impulse Heat Sealer - Young Dental

115 Volt Unit

770-110101 Each **\$270.45**

Teflon Cover

590-110301 Each **\$12.45**

Heating Element

590-110401 Each **\$12.45**

Teflon Insulator

590-110501 Each **\$12.45**

STERILIZATION INDICATOR TAPE



Sterilization Tapes

For use in sealing sterilization wraps, tubing and autoclave bags. Indicates temperature has been achieved.

1/2"
590-10006 60 yards **\$5.25**

3/4"
590-10007 60 yards **\$6.95**

1"
590-10008 60 yards **\$8.45**



Latex-Free, Lead-Free Process Indicator Tape - Crosstex International

3/4" tape effectively seals tubing, autoclave bags and CSR wraps. Indicates specific temperature has been achieved during the sterilization cycle.

590-STMF 60yds **\$19.45**



IMS® Lead & Latex Free Autoclave Monitor Tape - Hu Friedy

3/4" tape. Secures wrapped cassettes prior to sterilization and provides a visual indicator that the cassette has been processed in an autoclave.

590-IMS1460 60 yds..... **\$17.75**



IMS® MonitorTape - Hu-Friedy

3/4" tape can be written on and visually differentiates processed from non-processed cassettes. Tape is available with specific procedural set-ups, color-coded or blank.

Blank 590-IMS1250
Each **\$13.75**

By Procedure

Ortho 590-IMS1243
Archwire 590-IMS1244
Banding 590-IMS1245
Bonding 590-IMS1246
Restorative 590-IMS1247
Surgery 590-IMS1248
X-Ray 590-IMS1249
Amalgam 590-IMS1251
C&B 590-IMS1252
Cement 590-IMS1253
Composite 590-IMS1254
Endo 590-IMS1255
Exam 590-IMS1256
Extraction 590-IMS1257
Perio 590-IMS1258
Prophy 590-IMS1259
Pedo 590-IMS1260
Each **\$13.75**

Continued

STERILIZATION INDICATOR TAPE

IMS Monitor Tape continued.

By Color

Gray.....	590-IMS1262
Orange.....	590-IMS1263
Purple.....	590-IMS1264
Yellow.....	590-IMS1265
Red.....	590-IMS1266
Green.....	590-IMS1267
Blue.....	590-IMS1268
Black.....	590-IMS1269
Each.....	\$22.95

4 Roll Mini Tape Dispenser

590-IMS1270H Each.....	\$85.75
------------------------	----------------

9 Roll Tape Dispenser

590-IMS1270 Each.....	\$91.45
-----------------------	----------------

IMS® I.D. Marker

Permanent indelible ink marker ideal for identifying procedural set ups. For use on I.D. Labels or Monitor Tape.

530-IMS1235 Each.....	\$10.45
-----------------------	----------------

STERILIZATION POUCHES



**Sterilization Pouches
Self-Sealing with Dual Indicators**

Made with lead-free indicator inks, medical grade paper with a thumb notch for easier opening and have built in internal and external indicators. They are made with a triple seal to prevent tearing as well as a reinforced bottom to help prevent instrument push through. Not made with natural rubber latex.

2-1/4" x 4"	
600-10003	200/box \$7.75
2-3/4" x 10"	
600-10004	200/box \$10.75
3-1/2" x 5-1/4"	
600-10005	200/box \$10.75
3-1/2" x 10"	
600-10006	200/box \$10.75
3-1/2" x 10"	
600-10007	500/box \$23.75
5-1/4" x 10"	
600-10008	200/box \$13.75
7-1/2" x 13"	
600-10009	200/box \$23.75

**ULTRA Sterilization Pouches
Self-Sealing with Dual Indicators**

High quality porous medical grade paper. Lead free high quality ink is compatible with a large number of commonly used disinfectants and assures easy confirmation of sterilization process. Not made with natural rubber latex. Made in the U.S.A.

2-1/4" x 4"	
600-ULT2254	200/box \$8.75
2-3/4" x 9"	
600-ULT2759	200/box \$11.45
3-1/2" x 5-1/4"	
600-ULT35525	200/box \$11.25
3-1/2" x 9"	
600-ULT359	200/box \$11.45
5-1/4" x 10"	
600-ULT52510	200/box \$15.95



ProView® Plus - Certol International

Self-sealing sterilization pouches. Provides dependable quality and verification with Class 4 internal and external chemical indicators.

2-3/4" x 9"	
600-2790	200/box \$21.25
3-1/2" x 5-1/4"	
600-3554	200/box \$21.75
3-1/2" x 9"	
600-3590	200/box \$21.75
5-1/4" x 10"	
600-5410	200/box \$31.75



SteriSure Dry Heat Self Sealing Bags - CPAC

Medical grade paper construction. Azure strip turns brown when exposed to high temperature.

2.5" x 1.5" x 10.5"	
600-ST5	250/box \$42.75



Duo-Check Sterilization Pouches - Crosstex International

Self-sealing, see-through pouches have easy-to-read color indicators for vapor, steam or gas sterilization to assure that sterile conditions have been achieved. Blue tinted film.

2" x 8"	
600-SCZ	200/box \$17.25
2-1/4" x 4"	
600-SCXX	200/box \$13.45
2-3/4" x 9"	
600-SCX	200/box \$16.95
3-1/2" x 5-1/4"	
600-SCXS	200/box \$15.95
3-1/2" x 9"	
600-SCS	200/box \$16.95
4-1/4" x 11"	
600-SCB1X	200/box \$21.45
5-1/4" x 10"	
600-SCM	200/box \$24.25
Pink with Purpose	
3-1/2" x 9"	
600-SCSPP	200/box \$16.95
5-1/4" x 10"	
600-SCMPP	200/box \$24.25



Sure-Check® Sterilization Pouches - Crosstex International

Gives you the assurance of confirming all 3 sterilization parameters: time, temperature and presence of steam with an internal/external multi-parameter steam indicator printed directly on the pouch.

2-1/4" x 4"	
600-SCXX2	200/box \$14.75
2-3/4" x 9"	
600-SCX2	200/box \$18.45
3-1/2" x 5-1/4"	
600-SCXS2	200/box \$18.45
3-1/2" x 9"	
600-SCS2	200/box \$16.45
5-1/4" x 6-1/2"	
600-SCW2	200/box \$18.45
5-1/4" x 10"	
600-SCM2	200/box \$24.25
7-1/2" x 13"	
600-SCL2	200/box \$42.25
10" x 15"	
600-SCL1015	100/box \$54.95
12" x 15"	
600-SCL12152	100/box \$58.25
12" x 18"	
600-SCL12182	100/box \$57.45

STERILIZATION POUCHES



Paper Sterilizing Bags - Fox Converting, Inc.

An affordable, reliable paper bag with no compromise to quality. Indicator turns brown during steam autoclaving only, but can be used in chemical or dry heat autoclaves.

Self Sealing

2-1/2" x 10"

600-0203 1000/box **\$86.95**

Tape Sealing

Economical white paper pouch with indicator.

2-1/2" x 1-1/2" x 7-1/2"

600-0101 1000/box **\$55.25**

2-1/2" x 1-1/2" x 10-1/2"

600-0103 1000/box **\$62.45**



Bagette™ Self-Sealing Sterilization Pouches - Hu-Friedy

Constructed with durable materials and thick seals. The unique design optimizes instrument cassette fit, reducing bulky storage while simplifying packaging time. Built-in external and internal sterilization indicators.

3-1/2" x 9"

600-IMS1236 200/box **\$17.25**

7-1/2" x 13"

600-IMS1237 100/box **\$25.95**

10" x 14"

600-IMS1238 100/box **\$45.75**

12" x 17"

600-IMS1239 100/box **\$61.95**



PeelVue+ Sterilization Pouches - Kerr TotalCare

Feature patented internal multi-parameter indicators and patented 'Closure Validators' that provide a guide for creating a proper seal which confirms the items inside will remain sterile once they have been properly sterilized. Peelvue also works with Gravity Steam Sterilizers or Chemiclave Sterilizers.

Orange 3-1/2" x 9"

600-1612 200/box **\$20.25**

Red 3-1/2" x 5-1/4"

600-1610 200/box **\$23.95**

Green 2-3/4" x 9"

600-1611 200/box **\$18.25**

Blue 5-1/4" x 6-1/2"

600-1614 200/box **\$28.75**

Pink 8-1/2" x 15"

600-1615 200/box **\$67.25**

Purple 3-1/4" x 12"

600-1616 200/box **\$24.95**

Gold 4-1/4" x 12"

600-1617 200/box **\$29.95**

Black 8" x 12"

600-1618 200/box **\$48.25**

Brown 5-1/4" x 12"

600-1619 200/box **\$34.45**

Silver 2-1/4" x 4"

600-1623 200/box **\$13.75**

Teal 7-1/8" x 13-13/16"

600-31655 200/box **\$48.25**

Baby Blue 10-1/2" x 16"

600-1643 200/box **\$87.25**

Forest Green 13-1/4" x 20"

600-31647 200/box **\$139.45**



DEFENDLoc Sterilization Pouches - Mydent International

Constructed with a built-in, lead-free Internal Indicator, giving you peace of mind when it comes to the sterilization of your instruments. External indicator will still change color when the optimal temperature is reached.

2.25" x 4"

600-SP0150 200/box **\$8.45**

2.75" x 10"

600-SP0550 200/box **\$12.95**

3.5" x 5.25"

600-SP1500 200/box **\$10.75**

3.5" x 10"

600-SP2500 200/box **\$11.95**

5.25" x 10"

600-SP3500 200/box **\$18.25**

7.5" x 13"

600-SP4500 200/box **\$46.95**

9" x 15"

600-SP5500 200/box **\$45.25**

13" x 20"

600-SP8000 200/box **\$75.95**



Sterilization Self Seal Pouches - Septodont

Self-seal sterilization pouches for dental instruments after cleaning and before final sterilization. All nylon film with imprinted sterilization indicator. Compatible with steam, dry heat or chemical vapor sterilization.

2" x 9-1/2"

600-I0032 100/box **\$20.95**

3" x 10"

600-I0033 100/box **\$24.25**

4" x 10"

600-I0034 100/box **\$29.45**

6" x 11"

600-I0036 100/box **\$35.45**



Assure Plus™ Sterilization Pouches - Sultan Healthcare

The only sterilization pouch with a built in peel-off internal indicator, as recommended by the CDC.

3-1/4" x 6-1/2"

600-83000 200/box **\$20.95**

2-3/4" x 10"

600-83003 200/box **\$19.95**

3-1/2" x 10"

600-83005 200/box **\$18.75**

5-1/2" x 7-1/2"

600-83075 200/box **\$37.95**

5-1/2" x 11"

600-83010 200/box **\$34.75**

11" x 16"

600-83080 200/box **\$57.25**

STERILIZATION TUBING



Sani-Roll® Sterilization Tubing - Crosstex International

Cut only the length you need. Easy-to-read indicator. Blue tinted transparent plastic film, white paper.

2" x 100'	600-SCT2	\$10.75
3" x 100'	600-SCT3	\$12.45
4" x 100'	600-SCT4	\$12.45
6" x 100'	600-SCT6	\$19.95



Sani-Tube™ with Process Indicators - Crosstex International

Manufactured from clear, puncture-resistant, 1½ mil nylon. Seal with process indicator tape or heat sealer. Use in steam up to 425°F/218°C.

2" x 100'	610-S12	\$11.75
3" x 100'	610-S13	\$15.25
4" x 100'	610-S14	\$18.75
6" x 100'	610-S16	\$24.45



DEFEND Nylon Sterilization Tubing - Mydent International

Manufactured from transparent nylon for easy viewing of contents, the sterilization tubing will remain pliable after heat sterilization (up to 425°F / 218°C). The tubing is for use in autoclave, dry heat or chemical sterilizers and may be sealed with a heat sealer.

2" x 100'	610-1018	\$12.45
3" x 100'	610-1019	\$14.45
4" x 100'	610-1020	\$17.25
6" x 100'	610-1021	\$22.95



Nyclave® Sterilization Tubing - Young Dental

An ideal wrap for instruments prior to autoclaving. Tough, transparent and economical. Specifically for use in dry heat and chemical vapor sterilization.

No Indicator

3" x 100'	610-112310	\$27.45
4" x 100'	610-112410	\$34.25
6" X 100'	610-112610	\$42.45

With Indicator

3" x 100'	610-113310	\$33.25
4" x 100'	610-113410	\$38.95
6" X 100'	610-113610	\$46.95

Dry Heat Tubing No Indicator

2" x 100'	610-114210	\$19.25
3" x 100'	610-114310	\$26.25
4" x 100'	610-114410	\$33.45

Indicator Labels

590-111212	125/pkg.....	\$18.25
------------	--------------	----------------

STERILIZATION WRAP



Sterilization Wraps

For use in EtO and steam sterilizers. Liquid resistant. Exceptional tensile strength either wet or dry. Environmentally friendly. Irritant-free materials eliminates sensitivity.

12" x 12"		
590-10009	100/pack.....	\$10.95
15" x 15"		
590-10010	100/pack.....	\$15.95
20" x 20"		
590-10011	100/pack.....	\$25.95
24" x 24"		
590-10012	100/pack.....	\$32.95

C.S.R. Wraps - Fox Converting, Inc.

White in color. Made of a non-woven fabric.

15" x 15"		
590-1205	1000/box	\$124.45
20" x 20"		
590-1206	500/box	\$120.75



Sequential Sterilization Wrap - Halyard Health

Features patented Powerguard Technology for enhanced microbial barrier protection. Strength and resistance to tearing. Flame resistance and resistance to linting and abrasion. Microbial barrier. Effective sterilant penetration.

590-37046	12" x 12"	100/bag	\$11.95
590-37047	15" x 15"	100/bag	\$15.95
590-37049	18" x 18"	100/bag	\$16.95
590-37050	20" x 20"	100/bag	\$25.95
590-37051	24" x 24"	100/bag	\$34.95



IMS Autoclave Wrap - Hu-Friedy

Compatible with all sterilization methods except dry or rapid heat.

12" x 12"		
590-IMS1213	1000/pack.....	\$138.45
15" x 15"		
590-IMS1211	1000/pack.....	\$186.25
20" x 20"		
590-IMS1212	500/pack	\$170.25
24" x 24"		
590-IMS1210	500/pack	\$225.25



IMS Universal Autoclave Wrap - Hu-Friedy

Low-lint wrap that is compatible with several sterilization methods (steam, ETO, gamma) while maintaining optimal product integrity.

12" x 12"		
590-IMS1217	1000/pack.....	\$126.25
15" x 15"		
590-IMS1215	1000/pack.....	\$159.45
20" x 20"		
590-IMS1216	500/pack	\$151.45
24" x 24"		
590-IMS1214	500/pack	\$181.95



Biological Monitoring System

This mail-in biological monitoring system involves the use of bacterial spore test strips for measuring the effectiveness of steam, dry heat, chemical vapor and ethylene oxide gas sterilization processes. CDC guidelines recommend weekly monitoring of all practice autoclaves! These test strips also provide an effective way to biologically monitor both mechanical function and operator technique for steam and dry heat sterilizers. Postage not paid.

- 12 Envelopes/box**
590-HT12BMS Each\$85.95
- 52 Envelopes/box**
590-HT52BMS Each\$194.95



Attest™ Biological Monitoring System- 3M Oral Care

14-vial capacity to meet the needs of both small and large offices. Readout in 24-28 hours. Indicators are self-contained with dry-spore strip and ampule of growth medium.

Complete System

Contains: Incubator, biological indicators 25 each, Attest record book.

- 593-116K System \$524.95

Incubator Only

- 593-116 Each..... \$342.25

48 Hour Indicator Refills

- 593-1262P 25/box \$225.45

24 Hour Indicator Refills

- 593-1261P 25/box \$225.45



Comply™ SteriGage™ Integrators - 3M Oral Care

Integrators respond to all steam (i.e., time, temperature, and saturated steam) to assure

accuracy. Test packs provide immediate Accept/Reject results to allow you to respond more quickly to sterilizer problems. Can provide early readout of equipment performance prior to biological indicator results and/or in between biological indicator-monitored loads for faster detection of sterilization process failures.

- 590-4133 100/pkg..... \$25.75



ConForm® 10 In-Office Biological Monitoring System - Crosstex International

Results in just 10 hours. Meet daily biological monitoring requirements for steam sterilizers in less than half the time. Easy to use – Simply process indicator in a normal sterilizer cycle at the end of the day. Activate the indicator, place it in the incubator, then see and record the results the next morning. Easy to read results – If any bacterial spores survive the process, the indicator media will turn yellow.

Incubator

- 590-NDB601 Each..... \$260.75

Biological Indicators

- 590-C10BI25 25/box \$143.25



ConForm® 24 In-Office Biological Monitoring System - Crosstex International

In-office system for monitoring steam sterilizers. Easy to use and interpret, with results in 24-48 hours. Simply process vial in a normal sterilizer cycle, then activate the vial, incubate and record the results. If any spores survive the process, the vial medium will turn yellow. Incubator is 24 volt and holds up to 14 indicators.

Starter Kit

Contains: 1 box of 25 indicators, 1 incubator, 1 crusher and 1 record keeper.

- 590-CBMS10 Kit..... \$355.95

Steam Biological Indicators

- 590-CSBI25 25/box \$126.25



ConForm® Mail-in Sterilizer Monitoring Service - Crosstex International

Test results in 24 hours. Your choice of immediate test failure notification by telephone, fax or e-mail. Complete sterilization test results are faxed or e-mailed quarterly. Check results online with our secure, confidential web site. Free reminder program helps you keep on your regular testing schedule. Compatible with steam, dry heat, chemical and EtO. Postage not included.

6 Tests

- 590-CST060 Each.....\$71.45

12 Tests

- 590-CST120 Each.....\$131.95

48 Tests

- 590-CST480 Each..... \$370.75

52 Tests

- 590-CVT520 Each..... \$248.45



Sure-Check® Strips - Crosstex International

For use in pouches, tubing, autoclave bags, CSR Wraps. Meets OSHA & CDC guidelines of sterilization monitoring. Simple, convenient to use.

- 590-SCK 100/box \$15.45



SporeCheck™ 24 Hour In-Office Biological Monitoring - Hu-Friedy

A quick and accurate approach to in-office steam sterilizer monitoring, providing reliable results in 24 hours while being in compliance with local, state and federal guidelines.

Starter Kit

Contains: Dry Block Incubator with built-in vial crusher, 1 record notebook, and 25 box Biological Indicators.

- 590-IMS1376 Kit..... \$324.75

Steam Biological Indicators

- 590-IMS1373 25/box \$135.75

Record Notebook

- 590-IMS1375 Each..... \$30.25

Vial Crusher

- 590-IMS1377 Each.....\$10.25

BIOLOGICAL MONITORING



Sterilization Steam Indicators - Hu-Friedy

Indicator strips are a chemical monitor used to monitor the steam sterilization process.
 590-IMS1240 250/box **\$36.45**



Steam Sterilization Integrators - Hu-Friedy

Class 5 sterilization monitor designed to react to all critical variables in the sterilization cycle: time, temperature and presence of steam. Lead and Latex Free.
 590-IMS1241 100/pack..... **\$32.45**



Steam Indicator Strips - Integra® Miltex®

Strips turn brown when sterilization conditions have been met and are certified for use with all steam sterilization processes. Strips can be maintained as a permanent record of sterilization.
 590-STDIND 250/box **\$36.95**



EMS Sterilizer Monitoring System - SPS Medical Supply Corp.

Economical mail-in system for quarterly lab reports (individual reports available upon request). Recommended by most sterilizer manufacturers. Includes a toll-free help line service. Postage is required.
 590-EMS012 12 test pack **\$88.75**
 590-EMS052 52 test pack **\$192.95**



PassPort® and PassPort Plus® - SPS Medical Supply Corp.

Certified for use with steam, EtO gas, dry heat and chemical vapor process sterilizers. Each kit includes: spore tests (2 test and 1 control), instructions for use and prepaid return mailer envelope. A test report is provided with every test; an immediate and confidential phone call if the test fails.
 590-PS012 12 tests..... **\$130.95**
 590-PS052 52 tests..... **\$475.25**

PassPort Plus

Includes: prepaid envelope, lab report with every test, 1 test and 1 control spore strip and 1 Steam Plus Integrator.
 590-PP012 12 tests..... **\$130.95**
 590-PP052 52 tests..... **\$449.25**

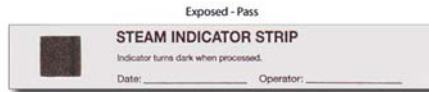

Steam Indicator Strips - SPS Medical Supply Corp.

For use as an internal monitor. Can be written on and kept as a permanent record.
 590-SIS250 250/box **\$23.75**



STEAMPlus™ Type 5 Integrators - SPS Medical Supply Corp.

Used with steam sterilization cycles to provide a distinct pass or fail result, which allows for the release of all nonimplant loads before the results of the spore test are received.
 590-SS1100 100/pack..... **\$53.95**

AIR FRESHENERS



Citrus II® - Solid Air Freshener - Beaumont Products, Inc.

Using a unique, non-toxic, and biodegradable formula that utilizes baking soda. Quickly absorbs odors, and freshens the air with a fresh scent. Ideal for doctors' and dentists' offices, hospitals, nursing homes, and home care. Provides convenient, continuous odor control that lasts 6 to 8 weeks. Effective in areas up to 350 square feet. Citrus scent.
 890-636471430 8oz. **\$6.25**



Citrus II® Air Fragrance and Odor Eliminator - Beaumont Products, Inc.

100% natural and contains only the pure essential oils of tree ripened citrus fruit specially formulated to preserve their distinctive fragrance in an environmentally safe, non-aerosol container.
 Lemon..... 890-172528
 Citrus Blend 890-77000
 7oz. **\$10.95**

STERILANTS



Tec-Cide Plus®

3.0% glutaraldehyde is a, higher strength formulation with accelerated kill times for faster, high level disinfection of instruments. Has a minimal surfactant level to protect lensed instruments and a new solid activator to assure a mild pleasant smell at the higher glutaraldehyde concentration and to maintain a consistent efficacy level through 28 days of continuous use. Includes activator. High level disinfection time: 25 minutes, Sterilization time: 10 hours.
 500-0001 Gallon **\$30.95**



Biocide G30™ - Biotrol

Ready-to-use, 2.65% glutaraldehyde. 30 day, reusable sterilizing and disinfectant solution. Requires no activator. When used full strength, provides high level disinfection of dental instruments in 45 minutes and complete sterilization in 10 hours. Effective against spores, vegetative organisms, fungi and enveloped and non-enveloped viruses. Contains a non-ionic surfactant, a silicone antifoam agent, a corrosion inhibitor and a lemon scent.

510-BIOG30 Gallon\$51.45



Cetyl-G® Concentrate and Diluent - Cetylite, Inc.

Pleasantly-scented glutaraldehyde-based sterilant/high-level disinfectant in an easy-measure tip-and-pour bottle allows you to mix just the amount needed. Each quart of concentrate yields 15 quarts (3.75 gallons) of 3.2% strength use-solution, that may be reused for up to 28 days. Anti-corrosion formula.

Contains: 32oz. Cetyl-G and 8oz. bottle Diluent.

500-0122 Each.....\$104.25

Diluent Refill

500-00146 8oz\$27.95



Rapicide® OPA/28 High-Level Disinfectant - Crosstex International

Provides a superior way to reprocess heat-sensitive, semi-critical medical devices that are unsuitable for sterilization. A powerful,

ready-to-use disinfectant that is FDA cleared carrying an active ingredient of 0.575% ortho-phthalaldehyde (OPA). Tested to provide 84 reuse cycles along with a reuse period of up to 28 days—twice the reuse period of other OPA brands. 10-minute manual disinfection time. Easy to use. Less toxic than glutaraldehyde. No activation required. Compared to glutaraldehyde it is less likely to irritate the eyes, nose and throat.

500-ML020127 Gallon..... \$43.95

Rapicide OPA/28 Test Strips

500-ML020137 50/Pack \$69.95



SANI Glut® Glutaraldehyde 3% Solution - Crosstex International

Reusable sterilizing and high-level disinfection solution. Non-corrosive and is compatible with immersible, heat sensitive instruments and devices. Once activated, it can be used up to 28 days. Fast acting and useful against a variety of microorganisms. It is readily biodegradable, formaldehyde-free and performs more effectively than products that use formaldehyde, glyoxal or other corrosive materials

590-JGLUT Gallon \$39.95



CoeCide™ XL - GC America

2.5% alkaline glutaraldehyde has broad spectrum sporicidal, tuberculocidal, virucidal, bacterial, pseudomonacidal, and fungicidal activity. Corrosion inhibitors protect instruments. Includes activator. Sterilization: 10 hours at 25°C, High Level Disinfection: 90 minutes at 25°C. Intermediate Level Disinfection: 10 minutes at 25°C.

502-551128 Gallon \$65.25



CoeCide™ XL Plus

3.4% alkaline glutaraldehyde.

502-550128 Gallon \$65.75



Cidex® OPA Solution - Johnson & Johnson

Near neutral pH allowing for excellent materials compatibility. 12 minute immersion for high level disinfection including TB. Low-level ortho-phthalaldehyde formulation (0.55%), glutaraldehyde free. Requires no activation or mixing. Low odor. Used for high-level disinfection only.

500-20390 Gallon \$69.95



Compliance™ Disinfectant/Sterilant - Kerr TotalCare

Reusable for up to 14 days. Hydrogen peroxide/peracetic acid formula that offers a superior alternative to glutaraldehyde formulas. Does not require activation or test strips. Achieves high-level disinfection in 15 minutes at 20° C. Achieves sterilization in 3 hours at 20° C.

500-102500 Gallon \$65.25



ProCide-D™ - Kerr TotalCare

2.4% glutaraldehyde. Long life, activated 28 day, buffered glutaraldehyde solution. Recommended for the sterilization of heat sensitive, immersible dental equipment and instruments, except hand-pieces. No dilution required / Activation Required. Achieve sterilization after soaking items for 10 hours at 25° C. Not designed to be used as a holding solution. Includes activators.

500-PC1032 Quart..... \$15.95

500-PC1128 Gallon \$39.75

STERILANTS



ProCide-D™ Plus
3.4% glutaraldehyde.
500-103265 Quart..... **\$19.25**
500-PP128 Gallon **\$42.45**



WAVICIDE®-01 - Medical Chemical Corp
2.65% glutaraldehyde sterilant / high level disinfectant soaking solution that has been tested and approved for use with endoscopes and stainless steel surgical instruments. Requires no activator. At a pH of about 6.3, it is very stable and noncorrosive. Mild fresh scent.
500-0112 Quart..... **\$11.95**
500-0104 Gallon **\$37.25**



Banicide® Plus - Pascal International, Inc.
3.4% glutaraldehyde. Full sterilization in 10 hours at 25° C. Kills HIV AIDS, and Tuberculosis. Pleasant mint scent. Includes activator.
500-15200 Gallon **\$44.75**



Sporox® II - Sultan Healthcare
Sterilizing and disinfecting solution. 7.5% hydro-

gen peroxide solution without glutaraldehyde. Odorless, clear liquid, no mixing. Ready-to-use. 30 minute, high level disinfection, 6 hour sterilization at 20°C/68° F, no activation necessary.
500-74596 Gallon **\$46.45**

STERILANT ACCESSORIES



C-Tub® Receptacle - Cetylite, Inc.
Holds up to 1 gallon of solution and requires limited counter space. Embossed measuring markers for mixing and transparent lid reduces technician exposure to chemicals.
Dimensions:
Tub: 13.5" L x 7.5" W x 6.25" H
Inner Basket: 13.5" L x 5" W x 4" H
Mini Basket: 5" L x 1.9375" W x 1.4375" H
710-0106 Each..... **\$75.75**



Germicide Trays - Integra® Miltex®
100% guaranteed against material breakdown when used with accepted germicides including phenols. Perforated inner tray automatically lowers into the solution when the lid is closed. Heavy duty, easy flip handle and free bur tray included.

Stainless Steel Cover
Beige 500-GTSBG
Blue 500-GTSBU
Gray 500-GTSGY
Each **\$38.95**

Plastic Cover
Beige 500-GTPBG
Blue 500-GTPBU
Each **\$40.75**



MetriTest Strips - Kerr TotalCare™
A quick and easy-to-use way to determine if the minimum effective concentration (MEC) of 1.8% glutaraldehyde is present during the life of the active glutaraldehyde sterilant solution.
590-PCG660 60 strips/bottle **\$83.75**



WAVICIDE® MEC Indicator Strips - Medical Chemical Corp
To ensure the level of glutaraldehyde is at least 1.7%. Provides test results in 5 minutes.
590-0306 50 strips/bottle..... **\$63.75**



Tap & Slide® Tray - Pascal International, Inc.
Holds 1 quart. Recommended for use with glutaraldehyde solutions. The inner plastic instrument tray automatically raises out of the solution when the lid is opened. Swing-out handle allows removal of instruments without user coming in direct contact with solution.
Outside dimensions: 10" W x 3" H x 5" D
Interior Tray dimensions: 9" L x 4" W x 1" D
500-35697 Each..... **\$58.95**



Steri-Soaker - Zirc
Holds one gallon liquid. Calendar on lid conveniently reminds staff when to change solution. Safe to use chemicals: enzymes, detergents/disinfectants (phenols)/cold sterilants for glutaraldehyde and chlorines. Transfer basket is ribbed and perforated design allows quick drain off and easy pick-up of instruments.
Dimensions: 13-7/8" x 9-5/8" x 5-1/8"
590-50Z805B Each..... **\$92.75**

Additional colors available upon request.

STERILIZER CLEANERS



V-Cide® - Certol International

For use in Chemiclave sterilizers. Improved formula reduces odor-causing agents. Gentle and does not corrode, rust or dull instruments. 1 liter bottle.

590-VC338 4/pack \$49.95



AutoClean Autoclave Cleaner & Enhancer - L&R Ultrasonics

Removes hard water scale and lime deposits that accumulate in the autoclave chamber during normal use. Concentrated.

530-239 Quart \$42.95



Speed-Clean - Midmark Dental

A slightly alkaline, multi-purpose solution used to remove grease and grime from sterilizers. Will also retard scale deposits.

580-MID002039600 16oz. \$14.75

SURFACE CLEANERS & DISINFECTANTS



Surface Disinfectant

Hospital-level dual quaternary ammonium surface disinfectant in a pleasant smelling, ready-to-use formula. Alcohol-free formula will not crack, fade or discolor most vinyl office equipment. Broad spectrum microbial kill, effective against TB, hepatitis B, hepatitis C, HIV, polio, staphylococcus, salmonella, pseudomonas and streptococcus.

510-0024 32oz spray bottle \$13.95
510-0001 Gallon \$27.95



Monarch Surface Disinfectant - Air Techniques

Fast and effective, 1-step surface disinfectant for use on non-porous surfaces. 1 minute broad-spectrum kill of 25 microorganisms, including TB, MRSA, HIV and Hepatitis B & C.

510-H6110N 32oz spray bottle \$18.95

Wipes - 7" x 9"

Unscented.
510-H6171 100/canister \$9.95



BirexSE® - Biotrol

EPA-approved, one-step cleaner and broad-spectrum, anti-microbial disinfectant. It is effective against TB Mycobacterium, HIV-1, staphylococcus, salmonella, pseudomonas,

with OSHA's Blood Borne Pathogens Standard and the CDC guidelines for dental disinfection.

Introductory Kit - 4 Pack

Contains: 4 - 1/8oz. packets, 32oz. spray bottle, 1 sprayer and 1 cup.

510-B1004IK Kit \$32.95

Introductory Kit - 24 Pack

Contains: 24 - 1/8oz. packets, 1 - 32oz spray bottle, funnel and squirt cap.

510-B1024 Kit \$155.25

Operatory Pack

Contains: 48 - 1/8oz. packets.

510-B1048 Pack \$272.75

Clinic Pack

Contains: 144 - 1/8oz. packets.

510-BC144 Pack \$710.25

Refills Packets - 1/8oz.

510-B1004 4/pack \$27.95

510-BI025 24/pack \$146.45

Super Pack Introductory Kit

Contains: 12 - 1/2oz. packets, one gallon mixing container, 4 - 16oz. spray bottles, funnel and 4 squirt caps.

510-B1013 Kit \$258.95

Super Pack Refills

Contains: 12 - 1/2oz. packets.

510-BI012 Each \$235.75

Empty Spray Bottles

510-SC203 16oz. \$10.95

510-SC103 32oz. \$11.95



Birex® Quat Disinfectant Wipes - Biotrol

EPA-approved 2-minute Tuberculosis kill claim with low-alcohol content.

**Please note: Birex SE and Birex Quat contain different chemical formulations. The concentrate and wipes are meant to be used separately. When switching between different hard, non-porous surface disinfectants, surfaces should be lightly washed with a mild detergent and water.

6" x 6.75"
510-295507 160/canister \$17.95

SURFACE CLEANERS & DISINFECTANTS



Opti-Cide3® - Biotrol

Ready-to-use cleaner and broad spectrum dental office disinfectant effective against TB in 2 minutes. It sanitizes hard, non-porous surfaces in 10 seconds and maintains broad pathogen kill claims.

Spray Bottle

510-OCS12024 24oz\$16.25

Gallon

510-OCP04128 Each..... \$43.75

5 Gallon Pack

Contains: 2-1/2 gallon containers and spigot.
510-OCP02320 Pack\$188.25

Surface Wipes - 6" x 10"

510-OCW06100 100/canister\$16.95



ProSpray® Surface Disinfectant - Certol International

Broad spectrum disinfecting power in one minute: including HIV-1 and Herpes simplex virus type 1 & 2, negetative bacteria including Staphylococcus aureus, Methicillin-resistant Staphylococcus aureus, Salmonella enterica and Pseudomonas aeruginosa. Kills TB in 5 minutes. Lemon scent.

510-PSC240 24oz. spray bottle\$10.95
510-128 Gallon\$30.95
510-PSC050 5 Gallon w/Spigot.....\$96.95

Concentrated

510-PSC6032 32oz.....\$39.95

Wipes

3 minute kill time: M. tuberculosis var. bovis (TB), Staphylococcus aureus, MDROs such as staphylococcus MRSA - HA, Salmonella aeruginosa, Fungi (Trichophyton mentagrophytes), HIV-1, and enterica, Pseudomonas Herpes simplex virus types 1 & 2. Lemon Scent.

Soft Pack - 9" x 10"

510-PSW 72/pack\$8.45

Canister - 6" x 6.7"

510-PSWC 240/canister\$13.75



Cetylciide-II® Hard Surface Disinfectant - Cetylite, Inc.

Kills 140+ pathogenic organisms including HIV, Influenza A, Hepatitis B and C, VRE, MRSA & Influenza A / Brazil Virus (H1N1). 1 quart makes 16 gallons. Safe to use on all water-safe surfaces. No alcohol or phenol. Pleasant lemon scent. 32oz. makes 16 gallons.

500-0152 32oz spray bottle..... \$102.25
500-0159 12 -0.5oz bottles.....\$47.25

Empty Quart Bottle

500-0109 Each\$4.75



BioSonicWIPEOUT - Coltene

1 minute kill time, 25 pathogens, one-step cleaning and disinfecting, fragrance free. Low toxicity rating, compatible with common materials in the dental suite.

Wipes 6" x 6.75"

510-60019366 160/canister \$12.75

Wipes 8" x 14"

510-60019367 65/canister \$15.25

Disinfectant Spray

510-60019368 32oz. \$16.95



Sani-Cloth® AF3 Germicidal Wipes - Crosstex International

Effective against 44 microorganisms in 3 minutes, including 12 relevant multi-drug resistant organisms (MDROs) and TB. Fragrance, alcohol, bleach, acid, phenol, acetone, and ammonia free. Meets CDC, OSHA and CMS Tag F441 guidelines. Bactericidal, tuberculocidal, virucidal.

Large 6" x 6.75"

510-SANAFL3 160/canister\$11.95

X-Large 7.5" x 15"

510-SANAFXL23 65/canister\$14.25



Sani-Cloth® Plus Germicidal Wipes

Kills HBV, HCV & MRSA in 2 minutes. Active ingredients: Quaternary Ammonium & alcohol. Low alcohol content (14.85%). Use for both cleaning and disinfecting steps on hard, non-porous surfaces and patient care equipment.

Large 6" x 6.75"

510-Q77272 160/canister\$11.95

X-Large 7.5" x 15"

510-Q33872 65/canister\$13.45



Sani-Cloth® HB Germicidal Wipes

Dual chain quaternary solution impregnated in a wiping cloth. Kills the hepatitis B virus in 10 minutes and over 100 other microorganisms including HIV, staph, E coli, salmonella, MRSA and VRE. Alcohol-free and can be used on most hard surfaces to reduce the risk of cross-contamination.

Large 6" x 6.75"

510-Q08472 160/canister\$11.95

X-Large 8" x 14"

510-Q24272 65/canister\$14.45



Super Sani-Cloth® Germicidal Wipes

Kills Influenza A2/HK, Rhinovirus, HBV, HCV, MRSA & VRE in 2 minutes. Active ingredients: Quaternary Ammonium & alcohol. Alcohol content (55%) - very rapid (1 min.) TB kill. Use on pre-cleaned hard, non-porous surfaces and patient care equipment. X-Large size moist wipe is "fold-less" for immediate, easy use.

Large 6" x 6.75"

510-Q55172 160/canister\$11.95

X-Large 7.5" x 15"

510-Q43472 65/canister\$13.95



Sanitex Plus® Spray and Wipes - Crosstex International

Kills HBV in 3 minutes, HIV in 30 seconds. Active ingredients: Quaternary Ammonium & alcohol. Low alcohol content (21%) provides excellent cleaning with rapid TB kill. Use for both cleaning and disinfecting steps on hard, non-porous surfaces and patient care equipment.

- 510-JSSDP Quart **\$24.45**
- 510-JSSGP Gallon **\$46.45**

Wipes

Large 6" x 6.75"

- 510-SANLC 160/canister **\$13.45**

X-Large 8" x 14"

- 510-SANXLC2 65/canister **\$15.95**



Asepticare™ TB+II - Ecolab

Dual-quaternary ammonium/alcohol germicidal disinfectant. Powerful, broad spectrum kill, including TB. Microbiological efficacy in a convenient, ready-to-use form.

- 510-61121521 32oz spray bottle..... **\$17.95**



COE SPRAY™ II "THE PUMP" - GC America

Dual-phenolic, ethanol-based surface disinfectant effective against Herpes 1 & 2, Tuberculosis and HIV-1 (AIDS). EPA registered. Deodorizing floral scent. Trigger spray pump.

- 512-554128 Gallon **\$111.25**



COE FOAM™ II - GC America

Rinseless, dripless foaming germicidal cleanser and deodorant suitable for cleaning wood, stainless steel, porcelain and chrome. It effectively penetrates grease, grime and dirt. This ozone-friendly aerosol also cleans and sanitizes hard, washable surfaces. EPA compliant.

Demonstrates effective disinfection against Legionelle Pneumophila and is virucidal against HIV-1 (AIDS Virus), Herpes Simplex Virus Type 1 and 2, Canine Parvovirus and Influenza A H1N1.

- 512-551222 18oz. can..... **\$24.95**



Clorox Healthcare® Citrace® Hospital Disinfectant & Deodorizer - Healthlink

Kills bacteria on soft surfaces in 30 seconds. Eliminates odors instantly. Disinfects hard surfaces in 5 minutes or less. Prevents mold and mildew on fabrics. Citrus scent.

- 510-49100 14oz..... **\$9.95**



Clorox® Hydrogen Peroxide Disinfecting Cleaners - Healthlink

Kills bacteria and viruses in as fast as 30 seconds. Registered to kill germs of high concern. Contains hydrogen peroxide, an active ingredient that breaks down into water and oxygen after use. Quickly removes soap scum, grease & grime.

- 510-30828 32oz spray bottle..... **\$6.95**

Gallon

- 510-30829 Each **\$16.95**

Wipes 6.75" x 9"

- 510-30824 95/canister **\$7.75**

Wipes 6.75" x 5.75"

- 510-30825 155/canister **\$9.25**



Clorox Healthcare® Bleach Germicidal Cleaners - Healthlink

EPA registered to kill C.difficile spores in 5 minutes. Kills norovirus in 1 minute. Formulated with 1:10 bleach solution strength that is recommended by CDC guidelines for effective disinfecting. Meets OSHA bloodborne pathogen standards. Cleans and disinfects in one step.

- 510-68967 22oz. spray bottle **\$15.45**
- 510-68973 Gallon **\$26.75**



CaviCide™ - Kerr TotalCare

Fast Action: kills TB in 3 minutes and MRSA, HIV-1, HBV and HCV in 2 minutes. Non-carcinogenic. 3 in 1 cleaner, disinfectant and decontaminant. Satisfies OSHA's Bloodborne Pathogen Standard.

- 510-MWPC1224 24oz. spray bottle **\$15.95**
- 510-4128 Gallon **\$39.45**

5 Gallon Pack with Spigot

- 510-1640 2 -2.5 gallons **\$148.95**

CaviCide AF Alcohol Free

- 510-138000 Gallon **\$38.95**



CaviCide1™

The only low alcohol surface disinfectant offering a 1-minute TB kill claim, materials compatibility, plus over 25 other clinically relevant organism kill claims, including Norovirus and A. baumannii. Bleach-free.

- 510-135024 24oz. spray bottle **\$16.75**
- 510-135000 Gallon **\$40.45**
- 510-135025 2 -2.5 gallons **\$157.95**



CaviWipes™ - Kerr TotalCare

Fully saturated wipe designed to drench surfaces with the power of CaviCide. Non-abrasive: For use on nonporous surfaces.

Large 6" x 6.75"
510-131100 160/canister **\$13.45**

X-Large 9" x 12"
510-131150 65/canister **\$17.45**

Flat Pack 7" x 9"
Wipes in a convenient flat package.
510-131224 45/pack **\$10.95**



CaviWipes1™

Fully saturated wipe designed to drench surfaces with the power of CaviCide 1.

Large 6" x 6.75"
510-135100 160/canister **\$15.45**

X-Large 9" x 12"
510-135150 65/canister **\$18.45**

X-Large 9" x 12" - Singles
Convenient individual 1-wipe packets.
510-135155 50/box **\$45.95**

Flat Pack 7" x 9"
Wipes in a convenient flat package.
510-135224 45/pack **\$12.95**

Canister Wall Brackets
510-131175 12/case **\$274.95**



DEFEND+ Plus Wipes - Mydent International

2 minute kill time, contains a stable, low pH formulated disinfectant and deodorant for use on hard, non-porous surfaces, in hospitals, emergency medical settings, laboratories, medical offices, dental offices – where control of cross contamination is required. Containing a dual chain quaternary ammonium/alcohol formula.

Large 6" x 6.75"
510-SO9000 160/canister **\$12.45**

X-Large 10" x 10"
510-SO9001 60/canister **\$15.45**



DisCide Ultra - Palmero Health Care

Hospital-level, one-step, ready-to-use quaternary ammonium, high-level alcohol-based disinfectant that is laboratory-proven to kill deadly pathogens in one minute. It is one of the fastest kill times on the market. Non-corrosive and non-staining, leaves behind a pleasant herbal scent with no unsightly residue. EPA-registered and meets the disinfection requirements of OSHA's Blood-borne Pathogen Standard. TB, MRSA, HIV, H1N1, HBV, HBC, VRE, RSV, H3N2, influenza A, adenovirus, HSV-2, coronavirus, Pseudomonas aeruginosa, salmonella, staph, E. coli, among others.

510-3565Q 32oz spray bottle **\$17.75**
510-3565G Gallon **\$38.75**

Towelettes 6" x 6.75"
510-60DIS 160/canister **\$12.25**

Towelettes XL 10" x 10"
510-10DIS 60/canister **\$14.95**

Canister Wall Mount
510-109 Each **\$16.75**



Optim 33TBWipes - SciCan

Fast contact time: 1 minute bactericidal & virucidal claim. 30 second sanitizer. 5 minute TB claim. Has the lowest toxicity category assigned of which precautionary warning label is not required.

510-OPT3341 Gallon **\$30.45**

Wipes 6" x 7"
510-OPT33W12E 160/canister **\$13.75**



LYSOL® Brand I.C.™ Foaming Disinfectant Cleaner - Sultan Healthcare

Ready to use quaternary formula provides hospital-grade germicidal activity. Effective against HIV-1 (AIDS virus), Poliovirus Type 1,

Staphylococcus, Salmonella, and Pseudomonas on hard nonporous surfaces. Rich foam lather spreads easily for effective cleaning. Contains no harsh acids, abrasives or bleach. Ideal for fiberglass, porcelain, synthetic marble, tile, plastic and vinyl.

510-95524 24oz. **\$9.45**

LYSOL® Brand III I.C.™ Disinfectant Spray - Sultan Healthcare

Kills harmful microorganisms such as Tuberculosis, Poliovirus, HIV-1, Hepatitis A, Herpes Simplex Type 1 and Herpes Simplex Type 2. Kills 99% of germs on hard, non-porous surfaces in 30 seconds. Ideal for countertops, door handles, waiting rooms, sick rooms, laboratories, sinks and other hard non-porous surfaces.

510-95029 19oz. **\$16.25**



VoloWipes™ - Sultan Healthcare

Tuberculocidal, virucidal and bactericidal in just two minutes. Ideal for hard, non-porous surfaces. Alcohol and quaternary ammonium formula makes it an effective disinfectant, cleaner and deodorizer all in one. 19% larger than standard wipes.

Wipes 6" x 8"
510-90100 150/canister **\$14.75**



70% Isopropyl Alcohol

510-33127EACH 16oz. **\$2.95**

510-40548 Gallon  **\$23.75**



Alcohol Dispensers - Palmero Healthcare

Plastic Menda Type Brown
510-47 8oz. **\$12.45**

Opaque Plastic
510-48 8oz. **\$12.75**



Enzymatic Tablets

For use as a general purpose ultrasonic cleaner, evacuation system cleaner and an instrument presoak. Biodegradable and non-toxic. Non-corrosive to protect your equipment. 2 tablets make 1 gallon of solution.

530-10003 64 tablets/pack..... \$46.95



Tartar and Stain Remover

Ready to use. Used in a beaker in the ultrasonic unit. Effectively removes tartar and stains from dentures, crowns, bridges and ortho appliances

530-10002 Gallon \$21.45



Ultrasonic General Purpose Cleaner

Effectively cleans blood, tissue and compounds from instruments, burs, diamonds, appliances and more. Concentrated solution 10:1. Non-corrosive to protect your equipment. Non-sudsing.

530-10001 Gallon \$21.45



Monarch Enzymatic Cleaner - Air Techniques

Instrument pre-soak and cleaning detergent for ultrasonic and holding baths formulated with 5 enzymes. Effectively removes blood, tissue and other difficult debris. Neutral pH, non-corrosive. Concentrated, mixes instantly.

Contains: 50 -0.34oz packets.
530-H6310N Each \$89.75



Biozyme-LT™ - Biotrol

Enzyme detergent that works in both room temperature and warm water to dissolve blood and tissue on contaminated instruments in 2 to 5 minutes.

530-BLT900 32oz..... \$64.45



No-Ionic Ultrasonic Multi-Purpose Solution - Biotrol

Does not need to be rinsed. Contains a rust inhibitor which makes this solution ideal for carbide tools and burs. Contains no harmful chemicals such as phosphates and chlorine, which are aggressive/corrosive to stainless steel tanks. Formulated to protect equipment and is environmentally safe and biodegradable.

530-350050 Quart \$55.95
530-350060 4 gallons/case \$521.95

Purit™ Cide-it™ - Biotrol

Premium ultrasonic solution and presoak for cleaning and decontaminating instruments. Its EPA-approved germicidal, fungicidal, virucidal and tuberculocidal claims protect your staff from exposure to residual biohazards during instrument processing.

530-PI016 16oz..... \$94.75



Purit™ Clean-it - Biotrol

This biodegradable ultrasonic solution is formulated with non-ionic surfactants to protect dental instruments. This unique surfactant blend rapidly lifts soil, blood, tissue and mucus from dental instruments.

530-PC016 16oz..... \$38.45



Purit™ Enz-it - Biotrol

Enzymatic ultrasonic solution and presoak that is pH buffered with non-ionic surfactants for superior compatibility with dental instruments. The powerful dual enzyme formulation is designed for the effective removal of blood, tissue and mucus.

530-PE016 16oz..... \$38.45

Powder

Contains: 24 -1 oz. packets.
530-PE024 Each \$56.95

Purit™ Remuv-it - Biotrol

High performance Tartar and Stain Remover powder for use on removable dental prostheses such as dentures, partials and bridges. Brightens and shines all stainless steel as well as partials. Safe for porcelain, metals, rubber, plastics and glass. Ammonia-free, biodegradable, non-corrosive.

530-PR024 24/box..... \$71.45



Restore™ Daily - Biotrol

Concentrated liquid detergent for use in ultrasonic machines or diluted as a pre-soak for badly stained stainless steel instruments. Designed to clean stainless steel dental instruments and laboratory glassware.

530-RD016 16oz..... \$62.45

ULTRASONIC/ENZYMATIC SOLUTIONS



Good Vibrations™ - Certol International
 Non-foaming formula with effective cleaning action. Concentrated formula; one ounce makes one gallon of solution.

- 1oz. Tubes**
 530-GVUS24 24/pack **\$21.95**
 530-GVUS128 Gallon w/pump **\$29.95**



ProEZ Foam™ - Certol International
 Ready-to-use foaming enzymatic spray. Four powerful enzymes (protease, amylase, cellulase and lipase) work to dissolve the broadest range of common surgical soils including proteins, starches, indigestible bioburden and fats.

- 530-PREZF240 24oz **\$19.45**



BioSonic Ultrasonic Solutions - Coltene
 Exclusive MeterDose bottles eliminate spills and waste. Space saving, easy handling, super concentrated BioSonic cleaning solutions are extensively tested for optimum cleaning efficiency. All BioSonic concentrates dilute 1oz. to 1 gallon of usable solution.

Enzymatic Ultrasonic Cleaner
 Metered 8oz. dose bottle. Makes 8 gallons.
 534-UC32 Each **\$45.95**

Disinfectant Ultrasonic Cleaner
 Metered 8oz. dose bottle. Makes 8 gallons.
 534-UC38 Each **\$50.75**

Disinfectant Ultrasonic Cleaner Concentrate
 Metered 16oz. dose bottle. Makes 16 gallons.
 534-UC42 Each **\$89.95**

General Purpose Solution
 Metered 16oz. dose bottle. Makes 8 gallons.
 534-UC30 Each **\$47.75**

Cement Remover
 Metered 16oz. bottle. Yields 32 applications.
 534-UC39 Each **\$68.25**



CrossZyme® Concentrated Enzyme Ultrasonic Cleaner - Crosstex International

Neutral pH formula will not damage or harm instruments/endoscopes. Contains no harsh alkaline components - non-corrosive. Safe for use on plastics, stainless steel, glass and aluminum. Contains rust inhibitors. Enhances the dissolving of organic materials. Balanced detergent system for effective cleaning and easy rinsing over a wide range of concentrations and temperatures. Powerfully chelated to improve performance in hard water conditions. May be used as an ultrasonic cleaning solution or an instrument presoak.

- 530-JEZ Gallon **\$35.25**



EfferZyme® - Crosstex International

Made from a biodegradable, non-chlorine formulation that contains fast acting protease enzymes. Enhances removal of blood and other soils that may be resistant to chemical detergents. Simply place tablets in warm water. 2 tablets makes 1 gallon.

- 530-JET 52/box **\$60.95**



Asepti-Zyme™ - Ecolab

Effective instrument presoak and detergent that can be used for manual cleaning, in scope washers/disinfectors, ultrasonic cleaners, and automatic instrument washers. Enzyme-formulated to remove and dissolve proteinacious matter. Safe for use on endoscopes, fiber optics and other medical instruments. Neutral pH, low foaming, non-staining, and leaves no residue.

- 530-61023175 Gallon **\$47.45**



Blood Buster - Enzyme Industries, Inc.

A premium, ready-to-use, blood and organic stain remover formulated for dental, sports, veterinary and medical industries. Its enzymes and surfactants rapidly convert water insoluble stains into water soluble stains. Effective on blood, saliva, vomit, urine, fecal, wine, coffee and grass stains.

- 370-4194 32oz. spray bottle **\$36.25**



Sani-Soak® Ultra - Enzyme Industries, Inc.

Superior anti-corrosion qualities will not rust stainless steel instruments or dental burs. This specially formulated, state-of-the art enzyme formulation is designed to clean and brighten dental instruments in just minutes. Fresh citrus flavor, is biodegradable and non-toxic. Convenient "tip & measure" container. 1/2oz. of concentrate makes one gallon of solution. Lemongrass Lavender Scent.

- 530-5199 Quart **\$49.95**
 530-5198 Gallon **\$145.45**

Available in Cool Mint and 0.5oz Packettes upon request.



Sani-Treet Plus - Enzyme Industries, Inc.

A non-foaming, biodegradable, non-toxic, enzymatic concentrate designed for evacuation maintenance. It cleans and deodorizes filters keeping lines clear of debris and may be used as an instrument pre-soak and ultrasonic cleaner. Pump included for accurate product dispensing.

- Mint Scent**
 550-15650 Gallon **\$65.45**

- Country Meadow Scent**
 550-4200 Gallon **\$65.45**



Concentrated Ultrasonic Powder - EPR Industries LLC

Light weight powder. Add water to make concentrated ultrasonic solution further diluted 10:1.

General Purpose

Cleans blood and debris from instruments, burs and dentures.

530-0103 Gallon **\$21.45**

Tartar & Stain

Removes permanent cement from instruments.

530-0101 Gallon **\$21.95**



Temporary Cement Remover - EPR Industries LLC

Ready-to-use ultrasonic solution to remove temporary cement.

530-CR Gallon **\$30.45**



COEZYME™ - GC America

Formulated as a neutral pH formula to guard against instrument discoloration. Contains two proteolytic enzymes in a powerful detergent base. Efficiently dissolves organic solids and protein, allowing the detergent to carry contaminants away. Low foaming, provides non-corrosive cleaning of hard to reach surfaces, reducing need for manual cleaning. As a presoak solution, prevents solidification of organic substances on instruments. If used as an ultrasonic cleaner, low sudsing, removes debris in less than three minutes. One ounce makes one gallon of cleaner.

530-557064 Gallon **\$74.75**



Dri-Clave Ultrasonic Cleaning Solutions - Heraeus Kulzer

VK-1 General Purpose Cleaner:

Concentrated solution specially formulated for the removal of buffing compounds, pumice, rouge, tripoli, food particles, foreign matter and soils of all types from dentures, bridges, crowns, orthodontic appliances, instruments, burs, reamers, diamonds, aspirator tips & glass slabs.

530-36202 Gallon **\$78.45**

VK-3 Plaster and Stone Remover:

Ready to use and specially formulated for removal of plaster and stone from bridges, crowns, dentures, inlays, impression trays and spatulas.

530-36206 Gallon **\$62.25**

VK-4 Tartar and Stain Remover:

Ready to use and specially formulated for removal of calculus, tartar, tobacco and food stains from dentures, bridges and orthodontic appliances.

530-36208 Gallon **\$62.25**

VK-6 Temporary Cement Remover:

Ready to use and specially formulated for removal of temporary cement from bridges, crowns, inlays, splints, acrylic dentures, orthodontic appliances and instruments.

530-36212  Gallon **\$62.25**



VibraKleen E2 - Heraeus Kulzer

Enzyme ultrasonic cleaner effervescent tablets. 20 tablets dilute to 10 gallons. Drop directly into ultrasonic cleaner. Contains fast-acting protease enzymes. Non-ionic, low-foaming, biodegradable. Clean mint scent.

530-37100 20/box **\$38.95**

530-37101 80/box **\$110.25**

Enzymax® Spray Gel - Hu-Friedy

Prevents blood, fat, saliva and other body fluids from drying onto instruments. Replaces the need for presoaking. Fast-acting dual enzyme cleaning; Corrosion inhibitor; Biodegradable, pH-neutral formula; Can be used as a linen spot remover.

530-IMS1229 24oz. bottle **\$21.25**



 HAZARDOUS MATERIAL SYMBOL



IMS Daily Clean - Hu-Friedy

Concentrated powder detergent specifically formulated for efficient ultrasonic cleaning or presoaking of cassettes and instruments. 1.1lb container makes 35 gallons, 5lbs makes 160 gallons.

530-IMS1220 1.1 lbs. **\$31.95**

530-IMS1218 5 lbs. **\$92.75**



Enzymax® Concentrated Ultrasonic Detergent - Hu-Friedy

Specifically formulated for efficient ultrasonic cleaning or pre-soaking of cassettes and instruments. Contains Steelgard agents to protect instruments from harmful minerals naturally found in water that contribute to buildup, spotting and corrosion. Can also be used as an evacuation system cleaner.

530-IMS1224 Quart **\$41.25**

530-IMS1226 Gallon **\$83.75**

Liquid Packets

Each packet makes 1 gallon.

530-IMS1222 40/box **\$87.25**

Powder

1.76lbs (800gm) makes 50 gallons.

530-IMS1230 Each **\$54.75**

Powder PAX

Dissolvable single-use powder packets. Each makes 1 gallon.

530-IMS1232 32/pack **\$56.95**



EZ-Zyme All Purpose Enzyme Cleaner - Integra® Miltex®

Neutral pH multi-enzyme liquid concentrate ideal for instrument presoak, ultrasonic cleaning, laundry presoak, and evacuation system cleaner. Ideal for cleaning hard to remove proteinaceous (mucous & tissue) and lipid (fatty) materials from the surfaces of surgical/dental instruments, linen, water submersible equipment, or where mechanical scrubbing is impractical.

Contains: 32 -22ml packets in a dispenser box; makes 32 gallons of solution.

531-3750 Each **\$69.25**

ULTRASONIC/ENZYMATIC SOLUTIONS



EmPower™ Dual Enzymatic Detergent - Kerr TotalCare

Quickly removes blood, protein and other proteinaceous debris. Neutral pH formula. Less corrosive than distilled water. Contains two proteolytic enzymes for more effective cleaning. Low-foaming.

530-060801 Gallon **\$44.75**



EmPower™ Foam

Ready-to-use foaming dual enzymatic spray perfect for the pre-cleaning of instruments. The thick foaming spray effectively cleans away blood, tissue, mucous and other protein-rich body fluids.

530-104224 24oz. spray bottle **\$23.95**



Diamond Zyme™ Cleaning Solution - Kerr Rotary

A concentrated enzymatic cleaning solution with anti-corrosive agents that helps to prevent dull or corroded dental burs and prolong the life of hand instruments and everything else.

530-EC1200 Quart **\$64.45**



UltraDose® Single-Dose Cleaning Powders and Solutions - L&R

Ultrasonics

Replaces bulky, heavy liquids and allow you to use one packet at a time, as needed. No more measuring.

Ultrasonic Cleaning Solution

A cleaner of instruments, burs and orthodontic appliances, this solution removes blood, organic debris, buffing compounds, soils, oxides, rouges and tripoli in an ultrasonic cleaning machine. Each 1 ounce packet makes one gallon of cleaning solution.

530-012 24/pack **\$58.75**

General Purpose Cleaner

This powder cleans instruments, burs, general equipment, orthodontic appliances, gold and porcelain. Effectively removes blood, tissue, debris, buffing compounds, rouge, tripoli and oxides when used in an ultrasonic cleaning machine. One packet makes one gallon of cleaning solution.

530-030 24/pack **\$59.75**

Tartar & Light Stain Remover

This powder cleans dentures, partials and bridges when used with a beaker in an ultrasonic cleaning machine. Biodegradable. Use one packet per cleaning.

530-028 24/pack **\$50.25**

Beakers

571-40005 400ml **\$19.95**

571-LR40006 600ml **\$20.95**



UltraDose® Bulk UltraDose Germicidal

This Hospital Grade Ultrasonic Cleaner Concentrate cleans and disinfects inanimate, non-porous instrument and appliance surfaces, eliminating residual micro-organisms in one step. Performs as an ultrasonic cleaner, disinfectant, deodorant, germicidal, fungicidal, virucidal and tuberculocidal all-in-one. Fragrance-free solution. 1oz. makes 1 gallon.

530-UD036 16oz **\$69.45**

Tartar, Light Stain and Permanent Cement Remover

Removes tartar and light stains from dentures, partials and permanent cements. Can also be used to clean solder flux, oxide, investment, calcium hydroxide, some temporary cements and hard water scale.

530-232 Gallon **\$42.25**

Advanced Formula Temporary Cement Remover

Removes most of today's most popular temporary cements and, replaces manual removal.

530-293 Gallon **\$58.45**

Plaster and Stone Remover

Removes tough-to-clean plaster and stone from dentures, partials, flasks and articulators.

530-230 Gallon **\$53.25**



MEDIZIME® LF - Medical Chemical Corp

Facilitates lower suds production in automatic cleaning devices. 100% bio-degradable and phosphate free. Gentle on the environment.

530-3304LF Gallon **\$56.75**



DEFEND Ultrasonic Enzymatic Tablets - Mydent International

Convenient general purpose ultrasonic solution in tablet form. Dissolves in 45-60 seconds. Non-corrosive and biodegradable. May also be used as a pre-soak for instruments.

530-UT1000 64/box **\$59.95**



Citrzyme® - Pascal

An excellent instrument pre-soak and ultrasonic cleaning solution. Fast-acting dual enzyme formula quickly removes proteins and carbohydrates. Leaves no residue. Premium non-foaming formula dissolves instantly in warm tap water – no mixing required. Fresh citrus scent & color.

Powder

530-15250 300gm **\$44.95**
530-15270 900gm **\$96.75**

Undose Packets

530-15260 50/pkg **\$50.25**



Brite Shield™ - Premier® Dental

Instrument cleaner and protectant. Versatile – debrides clogged dental burs, removes alginate and stone from impression trays. Removes set glass ionomer, carboxylate, zinc phosphate cements and bio-burden from hand instruments. Polishes and protects – a protective shield coats the instrument through a unique passivation process to restrict rust and corrosion while imparting a lustrous surface to remove - stainless-steel instruments. Environmentally friendly. One jar makes up to 34 gallons.

537-9011100 Each **\$60.95**



Pro Clean™ - Premier® Dental

Easy to mix and dispense without waste, and environmentally friendly. Professional strength tartar and stain remover for dentures, partials, retainers and night guards. Dispense for patient home use - ideal for retainers and night guards (one box lasts six months).

537-9011103 25/box **\$45.45**



Cleanlets General Purpose - Sultan Healthcare

Easily removes common soils such as blood, tissue, plaster, pumice, buffing compounds, etc. Fully water soluble, will not leave a residue on instruments or in the tank like enzyme tablets and solutions. Effective in all water temperatures, hot or cold. 1 tablet makes 1 gallon.

530-21500 32/box **\$73.45**



Pro-Portion Ultrasonic Cleaning Solution - Sultan Healthcare

General purpose cleaning solution. Super concentrated 1oz. packets eliminate lifting, mixing, storage and handling problems. Each packet makes 1 gallon of solution.

530-21360 20/box **\$71.95**



ReSURGE™ Instrument Cleaning Solution - Sultan Healthcare

Formula helps protect your instruments' passive layer (outer coating), reducing the potential for stains, spots and even rust. Neutral pH, biodegradable and environmentally friendly.

Self-Measuring Bottle

Makes 67 gallons.

530-21521 33.8oz. **\$93.25**

Packets

Each 0.5oz. packet makes 1 gallon.

530-21520 24/box **\$63.45**



Clean & Simple - Tuttnauer

Ultrasonic/enzymatic solution dispensed in tablet form. Dissolves in 45-60 seconds producing a non-ammoniated enzymatic general purpose solution. Non-toxic, biodegradable and non-caustic. Two tablets make 1 gallon.

Single Pack

530-CS0064 64/box **\$59.95**

Econo Pack

530-CS0144 144/box **\$107.95**



Omni Cleaner Plus - Pelton & Crane

Concentrated autoclave cleaner to maintain and service all makes of sterilizers. Breaks down chamber deposits.

710-OMNI 16oz. **\$14.95**



Chamber Brite™ - Tuttnauer

Powdered sterilizer cleaner in premeasured packets. Cleans and descales the reservoir, chamber and copper tubing of steam sterilizers.

590-CB0010 10/box **\$59.95**



Harvey Chemiclave Chamber Cleaner - Thermo Fisher Scientific Inc.

550-32010101 Quart **\$28.00**

BARRIER FILM



Barrier Film

Provides a universal infection control barrier with a low tack adhesive backing that leaves behind no residue. Perfect for use in areas that are difficult to clean, disinfect or sterilize. Perforated 4" x 6" sheets are easy to apply and remove. Not made with natural rubber latex.

Clear	660-HT46C
Blue	660-HT46B
1200/roll	\$20.95



Barrier Film With Finger Lift Edge - Crosstex International

Easy-to-grasp for quick removal even when wearing gloves. Attractive dispenser package. 4" x 6".

Blue	660-BFBL
Clear	660-BFCL
1200/roll	\$24.25



Pinnacle™ Cover-All™ - Kerr TotalCare

Easily placed on any surface, then removed without leaving any residue. Perforated 4" x 6" sheets.

Blue	660-3710B
Clear	660-3700C
1200/roll	\$29.75

Dispenser

660-1600	Each	\$58.95
----------	------------	----------------



Barrier Film - Palmero HealthCare

Polyethylene film with a low-tack adhesive that adheres to most operatory surfaces. Leaves no residue. Makes cleanup between patients fast and easy. 4" x 6".

Blue	660-1803B
Clear	660-1803C
1200/roll	\$37.25

BARRIERS - CHAIR COVERS



Half Chair Sleeves

Durable clear plastic and designed to fit easily over most chairs. They are easy to use and even easier to dispose of. 27.5" x 24".

660-HT27524	225/box	\$29.25
-------------	---------------	----------------



Brixton® Disposable Chair Covers - Filmtech, Inc.

Protects the top half of operatory chairs including the headrest and controls from surface disinfectants. Tapered top for customized fit.

27.5" x 24"		
660-505	200/box	\$30.95
660-504	225/roll	\$27.95



Pinnacle™ Chair Sleeves - Kerr TotalCare

Tapered design conforms neatly to your chair. It is disposable, no chair clean up is required. Eliminates the need for a headrest cover and with the reduced usage of disinfectant it extends the life of your chair. This extra wide sleeve is made with a special copolymer plastic, its gripping bottom surface keeps the sleeve in place, while your patient easily slides in.

27.5" x 24"		
660-3800	225/pack	\$43.45
29" x 79"		
660-3850XL	125/pack	\$55.25
32" x 32" (Fits A-Dec's Cascade)		
660-3825	200/pack	\$53.95
48" x 56"		
660-3870	150/pack	\$45.75



Slip-N-Grip Chair Covers - Kerr TotalCare

Disposable two-sided dental chair covers that are manufactured from two distinctly different plastics laminated together to produce a slippery top surface and a gripping bottom surface.

Half Cover		
33" x 37"		
660-SGSC125	125/box	\$42.95
Full Chair		
29" x 80"		
660-SNG2980	125/box	\$65.95
48" x 56"		
660-SNG150	150/box	\$60.45

BARRIERS - CHAIR COVERS



Full Chair Covers - Pac-Dent

29" x 80"
660-50130 125/box\$44.25



Chair Protectors - Palmero Health Care

Protects the operatory chair from infectious splatters, drying-out, cracking, fading or changing colors from use of disinfectants. For faster and easier clean-up between patients. Latex free.

Half Chair

14" x 13.75" x 23"
660-1901 225/roll\$59.75

Full Chair

39" x 84"
660-1902 175/roll\$96.75

BARRIERS - SYRINGE SLEEVES



Air/Water Syringe Sleeves

Fits most 3-way air/water syringes. Perfect for handpieces, saliva ejectors, ultrasonic scalers and more.

Sealed End 660-HT2510C
Slide Through..... 660-HT2510H
500/box\$17.45



Disposa-Shield® Universal Air/Water Syringe Covers - Dentsply Professional

Disposable covers for high-touch dental equipment and surfaces. Shaped for better fit and to reduce excess material. Saves clean-up time between patients. Easy on - easy off. Easy to dispense packaging.

660-A88007 500/box\$45.75



Brixton® Air/Water Syringe Sleeves - Filmtech Inc.

Pre-punched for easy slide-through covers. The 3-way syringe helps reduce cross-contamination. 500 ties included to secure sleeves in place and eliminate sliding during use.

Blue660-507B
Clear660-507C
500/box\$19.95



Syringe Sleeves - Kerr TotalCare

Syringe sleeves cover syringes and most instruments to act as an asepsis barrier and reduce cross-contamination.

2-1/2" x 10"
660-SS500 500/box\$24.45

2-1/2" x 20"
660-SS500XL 500/box\$26.45



Pinnacle™ Syringe Sleeves - Kerr TotalCare

Made to cover 3-way syringes, handpieces, saliva ejector valves, HVE and jet polishers.

2-1/2" x 10"
660-3760 500/box\$23.45
2-1/2" x 20" - with Adhesive
660-3763 500/box\$39.75
2-1/2" x 10" - with Opening
660-3767 500/box\$22.95

BARRIERS - SYRINGE TIP COVERS



Syringe Tip Covers - Palmero Health Care

Designed to fit virtually all air/water syringes. No need for conversions, modifications or adapters. Aerates water spray without restricting the pattern of air flow. Hub-design provides for easy, one-handed rotation. Latex free.

540-1950 100/bag\$20.25



Syringe Tip Covers - Vista Dental Products

For infection control with metal syringe tips. Autoclavable. Requires no conversion adapters. Will not impede air or water flow. Hydrophobic filter adds "suck-back" protection. Meets OSHA and CDC Standards.

540-STP1 100/bag\$23.25
540-STP 250/box\$58.25

BARRIERS - TRAY SLEEVES



Tray Sleeves

Made of highly durable clear plastic, and covers the entire instrument tray. Easy to apply.

10-1/2" x 14"

660-HT1014 500/box\$20.95

11-5/8" x 16"

660-HT1116 500/box\$25.75

BARRIERS - X-RAY SLEEVES



X-Ray Head Sleeves

Designed to fit over most X-ray heads. Made of a clear plastic and easy to apply.

15" x 26"

660-HT1526 250/box\$28.25



Bite Block Covers - Palmero Health Care

Ideal for your Pano X-ray machine bite blocks. Place over bite block for barrier protection and dispose after each patient. Boxed in convenient dispenser with self-adhesive wall mount to save counter space. 1" x 2".

660-1850 1000/box\$23.25

Siemens Bite Block Cover

1-1/2" x 3"

660-1850S 500/box\$23.25



Tray Sleeves - Kerr TotalCare

Use of these plastic sleeves reduces the possibilities of cross-contamination.

10-1/2" x 14"

660-TS10514 500/box\$32.75

11-5/8" x 16"

660-TS11516 500/box\$43.45



Pinnacle™ Tray Sleeves - Kerr TotalCare™

Instruments are placed directly on top of the disposable plastic. Tray sleeve covers the entire tray.

10-1/2" x 14"

660-3000B 500/box\$31.25

11-5/8" x 14-1/2"

660-3100A 500/box\$36.25

11-1/2" x 16"

660-3200E 500/box\$36.25

7-1/2" x 10-1/2"

660-3300F 500/box\$36.25

14" x 19-1/2"

660-3500M 500/box\$55.25



Pinnacle™ Panoramic X-Ray Barriers - Kerr TotalCare

Disposable plastic covers that protect the head-positioning guide or the chin rest on panoramic machines.

Temple Guard Covers

660-7300 200/box\$37.25

Chin Guard Covers

660-7200 100/box\$37.25



Pinnacle™ X-Ray Sleeves - Kerr TotalCare Universal 15" x 26"

660-3900 250/roll\$39.45

Extra Long 23" x 31"

660-3950XL 200/roll\$47.25



Universal X-Ray Sleeves - Kerr TotalCare

This sleeve will fit both large, old style and small, new style heads. 14" x 13" x 24.5".

660-XRS225 225/box\$52.25

BARRIERS - CURING LIGHTS



Cure Sleeve™ - Kerr TotalCare

Eliminates the problem of the composite adhering to the end of the light tip.

Fits 7mm and 8mm Curing Light Tips

660-4500 400/box\$52.25

Fits 11mm Curing Light Tips

660-4511 400/box\$52.25

Fits 13mm Curing Light Tips

660-4513 400/box\$52.25



Pinnacle™ Complete Barrier Sleeves - Kerr TotalCare

Cover entire curing light from handle to top.

Fits Demetron LED660-LED250
250/box\$41.75

Fits Demetron, Caulk Max, Efos, 3M Visilux I, and others.

Fits Demi660-DEMI250
250/box\$45.45

Fits Demetron, Caulk Max, Efox, 3M Visilux I and others

660-CLS250 250/box\$41.75



TIDIShield™ Curing Light Sleeves - TIDI Products LLC

Unique individually wrapped, easy-peel outer wrapping protects inner sleeve from contamination. Prevents composite build-up on curing light tip. Reduces the need for using harmful disinfectants on your curing light. Prevents contamination/bacteria build-up on curing light surfaces. Latex free.

- Kerr Demi Ultra 660-21100
- 3M Elipar S10 660-21101
- Ivoclar Vivadent Bluephase 660-21102
- DENTSPLY SmartLite Max 660-21103
- Ultradent Valo 660-21105
- SDI Radium Plus..... 660-21106
- Coltene SPEC3 660-21109
- 100/box \$15.95



Digital Sensor Sleeves - Crosstex International

Smooth seams - eliminating the patient discomfort. Manufactured from soft, clear polyethylene. Small 1.375" x 8.25" 660-BCXSS
 Large 1.625" x 8.25"..... 660-BCXSL
 500/box \$18.25

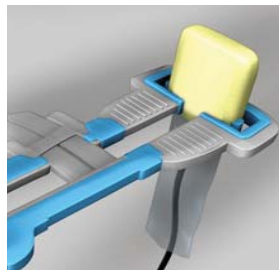

Sensor Slippers® - Crosstex International

The cushioned sensor sleeve built for use with gripping-style holders, such as Rinn Uni-Grip and Eezee-Grip. Foam cushion stabilizes sensor in the holder and prevents slippage. Creates a softer edge that won't abrade corners of the mouth. Seamless sleeve won't split open. Yellow. **Large - Fits Most Size #2**
 660-BWSSL 50/box \$454.75



Bite Block Baggies™ - Flow Dental

Eliminate the need to autoclave. Covers film, PSP, sensor, bite block and alignment arm. Use just one bag per patient, discard after use, and prevent cross-contamination. Self-dispenser box makes compliance a breeze. Save set-up, clean-up and autoclaving time and hassle.
 660-70104 500/box..... \$18.25



Comfee Econo-Pak Sensor Sleeves - Flow Dental

Soft, rounded corners and easy tear-away seams. Will keep your sensors clean through the entire procedure without coming apart. Medium. Fits Most Size #0 & #1 660-80201
 Large. Fits Most Size #2 660-80211
 500/box \$26.45

BARRIER SLEEVES - DIGITAL IMAGING



Digital X-Ray Sensor Sleeves

Made from LLDPE and LDPE, non-sterile, provides protection from cross-contamination.

- Size 1 1-3/8" x 8" 660-13758500
- Size 2 1-5/8" x 8" 660-16258500
- 500/box \$15.95



Wrap-Ease® - Crosstex International

A fully adjustable, all-in-one seamless barrier sleeve, comfort cushion and positioning aid that fits all brands of sensors. Converts autoclavable film holders into sensor holders. Great for vertical bitewings. Eliminates the need for disposable sensor holders.

- Large White 930-BWWEL
- Small Blue 930-BWWES
- 50/box \$37.75



Perfect Fit Adjustable Camera Sleeves - Flow Dental

Universal fit. Just slide over your camera head, fold over the excess material and use the blue tab to cinch tight. You'll achieve a tight, form-fitting wrap and a clean, crisp image.
 660-80125 150/box \$24.45



ULTRA Digital X-Ray Sensor Sleeves with Paper Backing

Made from EMA film and medical paper, non-sterile, provides protection from cross contamination, fits respective sizes of Gendex and XDR sensors.

- Size 1 660-918500
- Size 2 660-92500
- 500/box \$62.95



Digital Sensor Covers - Dentsply Rinn

Universal fit.
 660-550500 500/box..... \$68.45



Snuggies Custom-Fit Sensor Sleeves - Flow Dental

Simply peel, stick, and go. Works with sensors of any size, shape and thickness. Less loose plastic for patients to gag on. Eliminates the need to buy and stock sleeves of many sizes.
 660-80222 500/box..... \$56.75

BARRIER SLEEVES - DIGITAL IMAGING

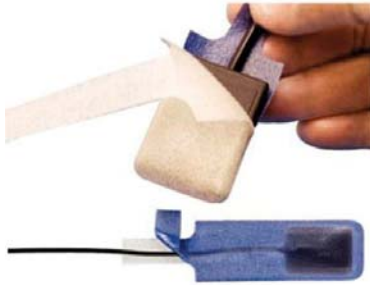

Salibag - Hager Worldwide

A disposable and economical soft pouch to separate digital sensors from the patient's oral fluid.

Small/Medium CCD Sensors

660-656232 320/box..... \$50.45

Large CCD Sensors

660-656233 240/box..... \$50.45



Pinnacle™ Sensor Covers - Kerr

TotalCare

Disposable plastic covers for digital X-ray sensors that help protect the patient from cross-contamination. Fits Trophy and Gendex systems.

1-3/8" x 8"

660-3735 500/pack.....\$37.25

1-5/8" x 8"

660-3736 500/pack.....\$44.95

X-Ray Sensor Sheaths for DEXIS Platinum

660-PSS3100 100/box.....\$20.25



R.S. Barrier™ - Steri-Shield

For use with radiological sensors, these snug fitting elastic barriers fit all popular sensors on the market. Perfect infection control for your patients while protecting your equipment from corrosive wipes or sterilizing solutions.

Non-Latex Green

660-088088 250/box.....\$67.95

Latex Blue

660-088089 250/box.....\$55.95



TIDiShield™ Digital X-Ray Sensor Sheaths - TIDI Products LLC

Soft, rounded edges for greater patient comfort. Unique individually wrapped, easy-peel outer wrapping protects inner sleeve from contamination. Reduces the need for using harmful disinfectants on your X-ray sensors. Latex free. Instructions for use printed directly on packaging. Reorder part number printed on the sleeve.

Carestream 6100 Size 0 Sensor Sheath

660-20977 500/box..... \$108.25

Carestream 6100 Size 1 Sensor Sheath

660-20978 500/box.....\$102.95

Carestream 6100 Size 2 Sensor Sheath

660-20979 500/box..... \$108.25

CygnusRay MPS Size 1 Sensor Sheath

660-20841 500/box.....\$79.25

Dexis Universal Sensor Sheath

660-20999 500/box..... \$108.25

Palodex Size 1 Sensor Sheath

660-20957 500/box..... \$104.25

Progeny Size 1 Sensor Sheath

660-21041 500/box.....\$132.25

Progeny Size 2 Sensor Sheath

660-21040 500/box.....\$132.25

Regam Size 2 Sensor Sheath

660-20861 500/box.....\$79.25

Suni Size 1 Sensor Sheath

660-20819 500/box.....\$79.25

Suni XL X-Ray Over Bag

660-20997 500/pack..... \$108.25

Schick Size 0 Sensor Sheath

660-20998 500/box..... \$108.25

Schick Size 1 Sensor Sheath

660-20824 500/box..... \$79.25

Schick Size 2 Sensor Sheath

660-20825 500/box.....\$79.25



IntraOral Camera Sheaths - TIDI Products LLC

Snug fitting, easy-on disposable camera covers maintain image clarity while providing a cross-contamination film barrier.

Carestream 1500

660-21001 500/box.....\$185.25

DMD Telicam

660-20810 500/box..... \$106.25

Dentsply Gendex AcuCam Plus, Polo

660-20816 500/box..... \$106.25

Dent-X Pro Scope 1000, Easy Doc (ICS)

660-20831 500/box..... \$106.25

Digital Doc Iris

660-21013 500/box.....\$124.95

Digital Doc Net Design

660-20968 500/box..... \$106.25

Gendex Insight 900 Lens (Long Window)

660-20856 500/box.....\$106.25

Gendex AcuCam Concept III

660-20893 500/box..... \$106.25

Schick USB

660-20808 500/box.....\$195.75

Siemens Cera cam/Minicam Ultra

660-20855 500/box..... \$106.25

Trophy STV Pro

660-20829 500/box..... \$106.25

Video Dental Concepts Toothpicks, Quickcam 4.1, Quickcam DDS, & Compucam

660-20840 500/box..... \$106.25

Video Dental Miniscope & TD-2000

660-20909 500/box..... \$106.25

Welch Allyn Reveal

660-20852 500/box..... \$106.25

Win US Tech WIND

660-20932 500/box..... \$106.25

BARRIER SLEEVES - HANDPIECES



Handpiece Sleeves - Kerr TotalCare

Straight 4.25" x 10"

660-4000 500/box.....\$50.25

Contra Angle 2" x 10"

660-4050 500/box.....\$50.45

Tube Sleeves 2" Diameter

660-3720 1200'/roll.....\$40.75

BARRIER SLEEVES - LIGHT HANDLES



Light Handle Sleeves

Made to fit most light handles, these sleeves are made of highly durable clear plastic. 4" x 5.75"

660-HT4575 500/box.....\$19.45



Disposa-Shield® T-Bar Light Handle Sleeves - Dentsply Professional

3-1/2" x 6-3/4".
660-A88008 500/box \$45.75

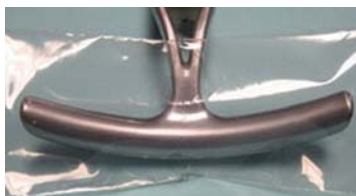

Brixton® Disposable "T" Light Handle Sleeves - Filmtech, Inc.

Slides over "T" style light handles quickly and easily. Unique design provides a neat fit on handle. Reduces possibility of cross contamination. Clear.
660-511 500/box \$15.95



Pinnacle™ Light Sleeves - Kerr TotalCare 1-1/2" x 8" - L Style

660-3650 500/pack \$35.25

5-3/4" x 4" - T Style

660-3600 500/pack \$31.75



T-Style Light Sleeves - Kerr TotalCare

Disposable to protect high-touch dental T-Style light handles from contamination. They have a patented design that keeps the sleeve from falling off while in use, yet it is easily removed when finished.

660-TLC500 500/box \$31.25



C-Bar Barrier™ - Steri-Shield

Extra large elastic barrier, one size fits a wide variety of closed and unusual shaped dental lamp handles. Also used to cover doorknobs and tray handles.

Latex Blue 660-088022
Nitrile Green 660-088072
25/box \$32.45



T-Bar Barrier™ - Steri-Shield

Form-fitting, T-style dental light handle barrier with easy on, easy off elasticity.

Latex Blue 660-088015
Nitrile Green 660-088175
250/box \$26.95

BARRIER PROTECTION - MISCELLANEOUS



ProBarrier™ Tube Sox - Certol International

Easy-on, lip-guided entry to facilitate quick loading. Adhesive strip tacks barrier in place. 3" x 12" with 1" lip.

660-BB0312H 500/box \$30.75



iBarrier - Crosstex International

Made specifically to fit the iPad, but will fit multiple tablets currently on the market. Simply insert the iPad/tablet into the sleeve, remove the adhesive strip and seal.

660-BCIB 100/box \$30.25



Denta Sleeves - Denta Sleeve

Provides complete contact of your disinfectant with dental device surfaces to ensure no bare spots. Also keeps sterilized instruments covered until use. Covers suction controls, saliva ejectors, low-speed and high-speed handpieces, intraoral scopes and other sensitive instruments. It provides a wet disinfecting environment over a period of time without discharging the dental device.

6" Sleeves

590-DENT6 100/pkg. \$12.25

9" Sleeves

590-DENT9 100/pkg. \$14.75



Disposable Barriers - Denticator Inc.

Low-Speed Handpiece Sleeves 1-3/8" x 8"

660-801LL 500/box \$35.95

Short Pen Sleeves 1" x 6"

660-801HS 500/box \$26.25

Air/Water Syringe Sleeves 3" x 8"

660-801US 500/box \$33.25

Light Handle Sleeves 5.75" x 4.5"

660-600802H 500/box \$37.25



Disposa-Shield® Covers - Dentsply Professional

Contra Angle Handpieces 8.5"

660-A88005 500/box \$45.75

Low Speed Long Handpieces 1-1/4" x 7-3/4"

660-A88006 500/box \$45.75

BARRIER PROTECTION - MISCELLANEOUS



Disposa-Shield® Standard Syringe Covers - Dentsply Professional

Ideal for sealant or etchant syringes.

Dimensions: 1- 3/8" x 7.5"

660-A88013 500/box **\$35.25**



Simplistic® Sleeves - Keystone Industries

Instrument sleeve protects curing lights, three way syringes and evacuation tubes. Easily dispensed from the uni-bag handles. 4" x 16"

660-0921660 1000/pkg. **\$58.25**

660-0921671 2000/pkg. **\$97.25**



Curelastic™ - Steri-Shield

For use on all curing lights and curing lasers, this snug fitting, latex free, translucent, elastic barrier allows 95%+ light transmission.

Small fits guides 8-10mm 660-088065

Large fits guides 11-13mm 660-088066

500/box **\$51.45**



Multi-Use Barrier™ - Steri-Shield

Single barrier easily rolls on a wide spectrum of dental instruments with a snug fit. Use on pens, prophy jets, bite blocks and ultrasonic scalers.

660-088058 500/box **\$34.95**

OSHA COMPLIANCE



CPR Pocket Microshield Kit - HPTC Inc.

Microshield with a soft barrier membrane that conforms to the face and has a unique antiflex one-way valve to prevent contact with oral secretions. Also has a bite block valve that allows a positive airway in the head-tilt/chin-lift CPR technique.

Contains: 1 microshield, 1 pair nitrile safety gloves and antiseptic towelettes.

370-CPM Kit **\$21.45**

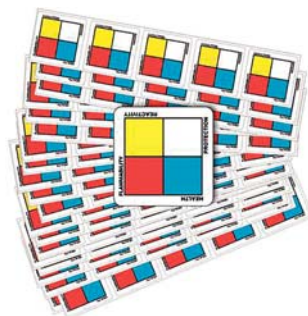

Chemical Labels - Medical Safety Systems

1.25" x 1.25"

370-51051040100 100/pkg **\$13.75**



GHS Chemical Product Labels - HPTC Inc.

These water resistant GHS chemical labels are color coded and allow for compliance with the new Globally Harmonized System for Hazard Communication.

4" x 4"

370-GHCL 25/pack **\$25.95**

370-GHCL100 100/pack **\$69.95**

2.5" x 2.5"

370-GHSC 25/pack **\$18.95**

370-GHSC100 25/pack **\$49.95**



Emergency Spill Response Kits - Medical Safety Systems

Master Spill Response Kit

Contains: One biological SRK, one mercury SRK, one universal/Chemical SRK, and one Glutaraldehyde SRK.

370-SKM Kit **\$148.95**

Biological Spill Response Kit

Blood and body fluid spills. Includes one RED Z fluid control solidifier (5-oz shaker), 1 bio-clean scoop with scraper, two absorbent towels, one 10-gal. biohazard bag, one ziplock biohazard bag, one poly protection gown, one earloop face mask, one pair of safety glasses, one pair of nitrile exam gloves, one pair of shoe covers, two antimicrobial hand wipes, one disinfectant wipe, and instructions.

370-SKBIO Kit **\$36.25**

Mercury Spill Response Kit

Includes one MercZORB absorbent/solidifier powder (175 gram bottle), one MercZORB scrubber pad, one 2-oz spray bottle, 1 Bio-Clean Scoop with scraper, one magnetic pick-up tool, two absorbent towels, one amalgam disposal jar with lid and label, one 10-gal. clear trash bag, one clear ziplock bag, one poly protection gown, one N95 respirator mask, one pair of splash goggles, one pair of Nitrile exam gloves, one pair of shoe covers, two antimicrobial hand wipes, two surface cleaning wipes, and instructions.

370-SKMERC Kit **\$51.45**

Universal/Chemical Spill Response Kit

Common chemical spills, such as fixer, developer, disinfectants, and corrosives. Includes one OmniZORB safety absorbent powder (350 gram shaker), 1 Bio-Clean scoop with scraper, two absorbent towels, one 10-gal. clear trash bag, one clear Ziplock bag, one hazardous waste label, one poly protection gown, one N95 respirator mask, one pair of splash goggles, one pair of nitrile exam gloves, one pair of shoe covers, two antimicrobial hand wipes, two surface cleaning wipes, and instructions.

370-SKCHEM Kit **\$36.25**

Glutaraldehyde Spill Response Kit

Includes one GlutaZORB safety absorbent powder (350 gram shaker), 1 Bio-Clean scoop with scraper, two absorbent towels, one 10-gal. clear trash bag, one clear ziplock bag, one biohazard trash bag, one hazardous waste label, one poly protection gown, one N95 respirator mask, one pair of splash goggles, one pair of nitrile exam gloves, one pair of shoe covers, two antimicrobial hand wipes, two surface cleaning wipes, and instructions.

370-SKGLUT Kit **\$49.95**



Dental Enhancements.com



ALL-IN-ONE OSHA / GHS & HIPAA OMNIBUS FEDERAL Rules Training Compliance Package - Dental Enhancements, Inc.

Includes: Federal Annual OSHA Employee Training Certification, International OSHA / GHS (Global Harmonization System) Certification Requirements & HIPAA Omnibus Rule Training Module. This Expert-Guided Compliance Solution has everything you need for complete Federal & International Compliance. Included in this package is a 90-Minute Employee Training Private Webinar, Customized Employee Required Forms, Current OSHA & HIPAA Manuals written to new standards (with HIPAA Hi-Tech Law & Red Flag Rule Packets), all required HIPAA eForms & Annual Data Back Up / Contingency & Risk Assessment Reports (in Microsoft WORD & PDF formats) accessible via our HIPAA Omnibus Rule On-line Portal, Dental Product Labeling Supplies & SDS/GHS Guidebook, 72-Point OSHA Safety Facility Report customized per location, 90-Minute Guided Session to personally guide you through the materials, and OSHA & HIPAA Expert On-Call Support for 1 Full Year.

OSHA / GHS Complete Compliance Package

Includes current OSHA/GHS Manual written to Global Harmonization System Standards, 45-Minute Employee Training Video, Customized Employee Required Forms, Dental Product Labeling Supplies & GHS/SDS Guidebook, all required OSHA/GHS forms in Electronic Format, and 30-Minute OSHA/GHS Expert Phone Consult for Guided Assistance in navigation of the materials. Also, includes OSHA Expert On-Call for 1 Full Year.

INITIAL ANNUAL OSHA EMPLOYEE TRAINING PACKAGE (Employee Training Webinar & Customized Facility Report)

Federal Annual OSHA Employee Training – Infection Control and Bio Medical Waste Training (includes Bloodborne Pathogens) - Fulfill your Federal Annual OSHA Employee Training by scheduling your private 1-hour Instructor-Led Webinar Session. Also, includes a post-webinar, customized 72-Point OSHA Facility Safety Report which will provide proper protocol set-up for your dental office setting. Report is instantly emailed to you upon completion of a phone interview. A printable Sign-In Sheet that will certify your team is also emailed pre-webinar. This package includes 1-year support with our OSHA Experts! After completion of this training, you will be auto-enrolled in our OSHA Auto-Renewal Training Program. This program provides a 20% savings on all future OSHA Annual Federal Employee Training Renewals. Never worry about falling short with your annual OSHA training obligations again. OSHA Renewal Fee with 20% savings.

HIPAA OMNIBUS Rule Complete Compliance Package

Includes a current HIPAA Manual written to Omnibus Rules Standards, Hi-Tech & Red Flag Law Packets, Access to all HIPAA eForms (in both Microsoft WORD & PDF formats) via our password protected HIPAA On-Line Portal, Employee Training Video, Comprehensive Checklist of Requirements, HIPAA Risk Assessment & Annual Data Back- Up Report Templates, and 30-Minute HIPAA Expert Phone Consult for Guided Assistance in navigation of the materials. Also, includes HIPAA Expert On-Call for 1 Full Year.

To inquire more about pricing and these services, please contact your DHPI Account Manager or visit, www.dentalenhancements.com

OSHA COMPLIANCE



Emergency Eyewash Station - Nevin Laboratories

Replaces aerator on existing faucet. Faucet operates normally until button on front of Eyewash Station is pulled. Delivers copious amount of fresh water to eyes. Easy to install. Constructed of brass with chrome plating. Two adapters (part #'s 1M & 20M) are included which will permit usage with many standard faucets.

370-630 Each **\$133.95**



OSHA Compliance Labels - Palmero Health Care

Easily identify all hazardous substances, waste and radiation areas. Must be placed on trash receptacles in each operatory identifying them as biohazard material.

BioHazard Warning Label 3" x 3"

370-1960 100/roll **\$13.75**



Caution Radiation Label 3" x 3"

Radiographic equipment must be labeled with a recognizable, Caution Radiation label.

370-1957 5/pack **\$5.25**



Disinfected Sticker 1.625" x 1"

Let your patients know items are being disinfected in your office. Place disinfected stickers on trays and other areas that are thoroughly disinfected between patients.

590-1951 250/roll **\$17.95**



Hazardous Material Label 2.25" x 4"

Use information on manufacturer's MSDS sheet for proper product labeling. Color-coded to correspond to the NFPA rating code system.

370-1959 100/roll **\$12.25**



Hazardous Waste Label 2-1/4" x 3-1/4"

Label the hazardous waste collected in the operatory with the date filled and contents.

370-1958 100/roll **\$14.45**



First Aid Kit - Pro Advantage

Meets federal OSHA regulation 1910.151b (states may vary) and ANSI Z308.1-2003 when minimum fill is maintained. Wall mountable.

Contains: Plastic case (9" x 8-3/8" x 2-1/2") w/ dividers; 100 - 1" x 3" adhesive plastic bandages; 3 - knuckle fabric bandages; 3 - fingertip fabric bandages; 1 set 40" x 40" x 56" triangular sling/bandage, w/2 safety pins; 4 - 3" x 3" gauze dressing pads, 5 - 2" x 3" non-stick pads; 5" x 9" trauma pad; 3" conforming gauze roll bandage; 2" conforming gauze roll bandage; 2 - sterile eye pads; 15 - Antiseptic cleansing wipes; 3 - ammonia inhalant ampoules; 6 - First aid/burn packs, 0.9 gm; 4" x 5" instant cold compress; 1 - 1/2" x 10 yd. first aid tape roll; 4-1/2" scissors, nickel plated; 4" tweezers, plastic, one time use; 4 - exam quality vinyl gloves, 2 pairs; Eye wash, 1/2 oz.; and First Aid Guide.

880-P440025 Kit **\$18.95**

SHARPS DISPOSAL



Sharps Collectors - Covidien Products by Medtronic

Containers lock for final disposal. Red.

1 Pint - Hinged

370-8901 Each **\$2.95**

1 Quart - Hinged

370-8900 Each **\$3.45**

2 Quart - Rotor Lid

370-8920 Each **\$4.25**

Gallon

370-8950 Each **\$6.25**

2 Gallon - Rotor Lid

370-8970 Each **\$6.75**



Sharps-A-Gator™ Sharps Containers

Vertical drop lid. Safe to autoclave. Red with chimney top.

Small - 4qt.

370-676236 Each **\$3.75**

Medium - 8qt.

370-676285 Each **\$3.75**

Large - 14qt.

370-676434 Each **\$9.25**



Hazardous Pharmaceutical Waste Containers - Covidien Products by Medtronic

Designed to segregate hazardous pharmaceutical waste under the Resource Conservation and Recovery Act. Hinged lid with snap cap, they are easily distinguished from other disposal containers. Each has a leak resistant gasket and absorbent pad to help contain liquid contents should a primary container break. Black with hinged lid.

370-8602RC 2 gallon **\$14.95**

SHARPS DISPOSAL



SharpSafety™ In Room Sharps System - Covidien Products by Medtronic

Sharps containers are secured in a sturdy locked enclosure. All cabinets are keyed alike for convenience. Includes a glove box dispenser.

5 Quart Wall Enclosure with Glove Dispenser
24-1/4"H x 5-1/2"D x 13"W
370-8556H Each..... **\$123.45**

5 Quart Sharps Container
For use with 370-8556H
370-8507SA Each..... **\$8.25**



QuickSmart® BladeFlask - MYCO Medical

Holds 100 blades. Compatible with most brands of general surgery blades (#10, #11, #12, #12B, #15, #15C, #20-25) and flat blade handles (sizes 3, 4, 5, 7, 9)

370-QFRGEN Each..... **\$43.75**

BladeFlask Bracket
370-QBRGEN Each..... **\$8.45**



Isolyser®/SMS® Sharps Management System - Waste & Compliance Management, Inc.

Our product encapsulates sharps waste material after our proprietary catalyst packets are added to our patented, odor-free liquid. After curing, the waste is solidified, rendered unrecognizable and unusable; making it safe to dispose of in your regular trash.

3.3 Liters
370-SMS2400 Each..... **\$65.95**

5.8 Liters
370-SMS4000 Each..... **\$94.25**

10 Liters
370-SMS10000 Each..... **\$139.95**

Isolyser/SMS Catalyst
370-10000CPEA 2oz..... **\$26.45**

Order by ☎ 800-626-2163

Mail Back System

Convenient mail-back disposal for sharps and other approved waste. Includes sharps container, mailing carton, prepaid return postage, treatment and disposal.

3.3 Liters
370-SMS2400M Each **\$143.25**

5.8 Liters
370-SMS4000M Each **\$99.25**

10 Liters
370-SMS10000M Each **\$146.95**

Wall Mount for 3.3 Liter
370-WMU2400 Each..... **\$49.95**

BIOHAZARD WASTE BAGS



Biohazard Waste Stick - On Bags - CareTek

Convenient adhesive strip adheres to most clean, dry surfaces without damaging. Easy clean up. A second adhesive strip seals the full bag. Universal biohazard symbol printed on bag. 2 mil thickness for extra protection. Red.

1.4 Quarts - 9"x10"
370-IW0910 200/box..... **\$34.95**

2.6 Quarts - 12"x14"
370-IW1214 200/box..... **\$45.95**

33 Gallons - 33"x 39"
Infectious waste, low density liner.
370-HBA6639PR 150/case..... **\$90.45**



Rack and Bag Waste Disposal System - Unimed Corp.

Infectious waste rack can be mounted on wall or inside cabinets. Each bag has "Infectious Waste" and "Biohazard" label printed on it. Red bags and racks are sold separately.

1 Gallon Bags
10 rolls of 20 bags.
370-4796 200/case..... **\$34.95**

1 Gallon Bag Rack
11" W x 15-1/2" H x 7 1/4"D.
371-BGRS004001 3/case..... **\$67.45**



Handi Hopper Liners - Zirc

Small plastic waste liners for disposal of contaminated items. Red.

370-20Z405 100/box **\$23.75**

☎ www.dhponline.com

WATERLINE CLEANING & TESTING



Monarch™ Lines Cleaner - Air Techniques

Once-a-week solution for cleaning dental unit waterlines. Neutral pH formula helps attack accumulated deposits in tubing lines without the use of harsh chemicals. Ready-to-use, no mixing or diluting required. Non-corrosive. Fresh Minty scent.

530-H6340 16.9oz **\$12.45**



Mint-A-Kleen - Anodia Systems

A 16 oz. bottle will clean waterlines in one operator for an entire month, with no need for supplementary products. Ingredients do not corrode, clog or leave residue in waterlines, bottles or equipment. A mint blue, liquid solution with a convenient three-step, once-per-week process.

530-2000500 16oz **\$12.75**



DentaPure® - Crosstex International

Delivers uninterrupted water treatment to dental waterlines, substantially reducing patient and staff exposure to harmful bacteria for a year. Reliable, simple to use and easy to install. NO tablets, NO hazardous Silver, NO distilled water requirement, NO concern about use with amalgam separators, NO allergenic iodine proteins, NO special disposal requirements.

Water Bottle Cartridge
571-DP365B Each **\$244.95**

Municipal Water Supply Cartridge
571-DP365 Each **\$244.95**

☎ Fax: 888-681-5088

WATERLINE CLEANING & TESTING



Team Vista™ Dental Unit Waterline Cleaner - Hu-Friedy

For use in independent water bottle systems. Provides continuous cleaning of waterlines for up to one week. Non-corrosive – gentle and safe on equipment. One year supply per operator.

Contains: 1oz. of VistaClean Irrigant Solution and 15 VistaTab Cleaner Tablets.
530-IMS1450 Each\$214.75



BluTab Waterline Tablets - ProEdge Dental Corporation

Simply add an effervescent tablet to your self-contained water bottle each time it is refilled. Tablet is specially formulated to be continuously present in your water system. Remains effective for up to 28 days, so there is no need to purge waterlines at the end of the work day. It is tasteless, odorless, and has no effect on bonding.

For 700 - 750ml bottles
530-BT50 50/box\$37.25

For 2L bottles
530-BT20 50/box\$54.45



Waterline Testing Kits - ProEdge Dental Corporation

Simply collect water samples from each dental unit in a separate vial and place in the provided mailer (postage not included). Results are faxed to you after 7 days of incubation. Provides third-party documentation of water quality.

4 Vial Test Kit
Contains: 1 styrofoam mailer, 4 collection vials, 1 refrigerant pack.
530-80401 Kit..... \$114.45

6 Vial Test Kit

Contains: 1 styrofoam mailer, 6 collection vials, 1 refrigerant pack.
530-80601 Kit.....\$148.45

16 Vial Test Kit

Contains: 2 styrofoam mailers, 16 collection vials, 2 refrigerant packs.
530-81601 Kit.....\$372.45



Citrisil All-In-One Tablets - Sterisil, Inc.

Produces a light blue tint for usual compliance. EPA registered to produce less than or equal to 10 CFU per ml HPC purity; 50 times below the ADA and CDC Guidelines.

Contains: 20 maintenance tablets and 1 Citrisil shock tablet, for 0.7-1 liter bottles.
530-C20B Each\$16.25



Sterisil Straw - Sterisil, Inc.

Works 365 days to continuously disinfect dental unit water lines while providing safe and clean water for your patients, staff, and dental unit. A built-in shock treatment is released upon initial install for optimum control of bacteria.

For Use with Distilled Water
530-S365 Each\$222.95

For Use with Municipal Water
530-S365M Each\$222.95

WATER DISTILLERS



AQUASTAT - SciCan

A patented distillation technology kills harmful bacteria and viruses by flash vaporizing water and then reconstituting it through condensation. The result is water that's 99% pure. AquaStat purifies soft or hard water from any source including those that are spring fed or municipally piped. Limited one year warranty. 16" x 9 5/8" x 15" 1/8".

770-W10120S Each\$668.95

Filters

580-SCIW8010 Each\$94.75



Water Distiller Model 9000 - Tuttnauer

This distiller uses a highly effective process that removes up to 99% of most substances from the water. Limited one year warranty.

770-TUT9000 Each\$713.95



Model 9000 Water Distiller - Waterwise, Inc.

Effectively removes contaminants such as arsenic, bacteria, chemicals, heavy metals, nitrates, pesticides and viruses. Limited one year warranty.

Model 9000: Reservoir size 1 gallon.
770-WW9000 Each\$489.00

COLLEGE PLIERS



College Plier 6" Self-Locking, Serrated

700-1802

\$8.25



College Plier 6" Serrated

700-1800

\$7.25



College Plier 6" Serrated, Narrow

700-1801

\$7.25



College Plier Self-Locking, Serrated, Narrow

700-1804

\$8.25

EXPLORERS



Explorer DE2

700-1302

\$10.95



Explorer DE5

700-1303

\$10.95

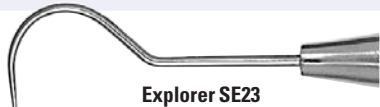

Explorer SE23

700-1301

\$10.25

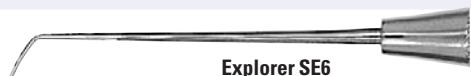

Explorer SE6

700-1300

\$10.25

EXPROS



Expro #23/CP11 Color Coded

700-1352

\$13.25

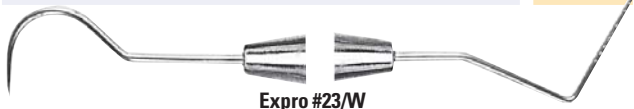

Expro #23/W

700-1350

\$13.25



Expro #23/W Color Coded

700-1351

\$13.25

PROBES



Probe Williams Round

700-1603

\$12.95



Probe # CP11 Color Coded

700-1600

\$13.95



Probe # CP12 Color Coded

700-1601

\$13.95



Probe Michigan "O" Round

700-1602

\$12.95

MOUTH MIRRORS



Round Mirror Handle



Octagonal Mirror Handle

Mirror Handles

	Round		Octagonal
Simple Stem	700-HT01SS	Simple Stem	700-HT02SS
Cone Socket	700-HT01CS	Cone Socket	700-HT02CS

Each \$4.75



Mouth Mirrors

A full gasket, chrome metal mirror capable of withstanding all forms of sterilization as well as indefinite cycling through steam or dry heat autoclaves. Stainless steel.

Front Surface Mirrors

	#4	
Simple Stem		700-FS4SS
Cone Socket		700-FS4CS

	#5	
Simple Stem		700-FS5SS
Cone Socket		700-FS5CS

12/box \$19.95

Rhodium-Coated Front Surface Mirrors

	#4	
Simple Stem		700-RH4SS
Cone Socket		700-RH4CS

	#5	
Simple Stem		700-RH5SS
Cone Socket		700-RH5CS

12/box \$26.75



AMERICAN EAGLE INSTRUMENTS[®] INC
better DENTISTRY by DESIGN[™]

Single End Handles



1/4" Stainless Steel Single End



3/8" EagleLite Single End (X)

Double End Handles



7/32" Stainless Steel Double End



3/8" EagleLite Double End (X)

EXPLORERS



23 Single End

**Code
Price**

Stainless Steel
AEXP23
\$15.25

EagleLite Handle
AEXP23X
\$16.75



2 Double End

**Code
Price**

Stainless Steel Handle
AEXP2
\$21.95

EagleLite Handle
AEXP2X
\$22.95



3 CH

**Code
Price**

Stainless Steel Handle
AEXP3CH
\$21.95

EagleLite Handle
AEXP3CHX
\$22.95



5

**Code
Price**

Stainless Steel Handle
AEXP5
\$21.95

EagleLite Handle
AEXP5X
\$22.95



11-12

**Code
Price**

Stainless Steel Handle
AEXP11-12
\$21.95

EagleLite Handle
AEXP11-12X
\$22.95

EXPOS



Explorer 23 Black Probe 1

**Code
Price**

Stainless Steel Handle
AEEP23/1B
\$31.95

EagleLite Handle
AEEP23/1BX
\$32.75



Explorer 23 Black Probe 12

**Code
Price**

Stainless Steel Handle
AEEP23/12B
\$31.95

EagleLite Handle
AEEP23/12BX
\$32.75



Explorer 23 Yellow Probe 1

**Code
Price**

Stainless Steel Handle
AEEP231Y
\$34.45

EagleLite Handle
AEEP23/1YX
\$36.25

PROBES



Probe SE 1 Black (1-2-3-5-7-8-9-10mm)

**Code
Price**

Stainless Steel Handle
AEP1-2B
\$25.75

EagleLite Handle
AEP1BX
\$27.25



Probe SE 4 Black (3-6-9-12mm)

**Code
Price**

Stainless Steel Handle
AEP12B
\$25.75

EagleLite Handle
AEP12BX
\$33.95



Probe SE OW Black (1-2-3-5-7-8-9-10mm)

**Code
Price**

Stainless Steel Handle
AEP0WB
\$25.75

EagleLite Handle
AEP0WBX
\$27.25



Probe SE WHO Black Ball Tip (3.5-5.5-8.5-11.5mm)

**Code
Price**

Stainless Steel Handle
AEPWHOB
\$28.75

EagleLite Handle
AEPWHOBX
\$29.95



AMERICAN EAGLE INSTRUMENTS® INC
better DENTISTRY by DESIGN™

PROBES



Probe SE 4 Yellow (3-6-9-12mm)
Stainless Steel Handle EagleLite Handle
AEP12Y AEP4YX
\$28.75 \$28.95

Code
Price



Probe SE SD4 Yellow (3-6-9-12mm)
Stainless Steel Handle EagleLite Handle
AEPD12Y AEPD12YX
\$28.75 \$29.95

Code
Price



Probe SE UNC 15 (1-2-3-5-6-7-8-9-10-11-12-13-14-15mm)
Stainless Steel Handle EagleLite Handle
AEPUNC15RB AEPUNC15RBX
\$25.75 \$27.25

Code
Price

MIRRORS & HANDLES

High-quality, front surface, rhodium coated, stainless steel, cone socket mirrors assure you distortion-free images.



1/4" C.S. Round Handle AEMHR.....\$16.75



3/8" C.S. Round Handle AEMHRX\$18.75



1/4" C.S. Tapered Handle AEMHT\$16.75



AEM4 NO. 4 Front Surface 7/8" Diameter 22mm
Each.....\$8.45



AEM5 NO. 5 Front Surface 15/16" Diameter 24mm
Each.....\$8.45



Cut through the fat

**GO DIRECTLY
TO THE BEST**

SUPPLIES UP TO
25% OFF
WHILE SUPPLIES LAST

www.dhponline.com/clearance



PLIERS



How the best perform



18L Locking
| DP18L
\$48.75



1 Perry
| DP1
\$30.45



2 College
| DP2
\$30.45



3
| DP3
\$30.45



17
| DP17
\$30.45



18
| DP18
\$30.45



19
| DP19
\$30.45



Utility Pick-Up
Dressing Pliers
| DPU17
\$18.25



317 Smooth
Beak
| DP317
\$24.75



318 Foil/Meriam
Serrated Beak
| DP318
\$24.75

Manufacturer part numbers are provided here, please visit www.dhponline.com to convert or contact your DHPI Account Manager.



HANDLE OPTIONS



How the best perform

DOUBLE END

#8 ResinEight
\$38.45



#7 Satin Steel
Colours
\$40.45



#6 Satin Steel
\$38.45



#31 Round
STARTING AT \$19.45



SINGLE END

#8 ResinEight
\$38.45



#7 Satin Steel
Colours
\$40.45



#6 Satin Steel
\$38.45



#30 Round
STARTING AT \$15.45



SINGLE-END EXPLORERS

Satin Steel® XTS® explorers feature a non-stick Aluminum Titanium Nitride (AlTiN) coating.



3
| EXS36

Handle options:
#30, #6

3A
| EXS3A6

Handle options:
#30, #6, #7, #8

6
6.5 mm
| EXS66

Handle options:
#30, #6, #8

6L
9 mm
| EXS6L6

Handle options:
#30, #6, #8

9
| EXS96

Handle options:
#30, #6, #8

17
| EXS176

Handle options:
#30, #6

23
Shepherd's
Hook
| EXS236

Handle options:
#30, #6, #7, #8

54
| EXS546

Handle options:
#30, #6

TU17
Wilkins/
Tufts
| EXTU176

Handle options:
#30, #6, #8

Manufacturer part numbers are provided here, please visit www.dhponline.com to convert or contact your DHPI Account Manager.



EXPLORERS



How the best perform

DOUBLE-END EXPLORERS



1
| **EXD16**
Handle options:
#31, #6



2
| **EXD26**
Handle options:
#31, #6, #7, #8

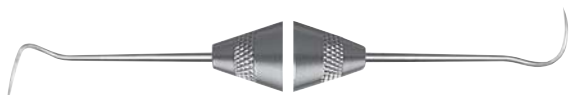

2A Pigtail
| **EXD2A6**
Handle options:
#31, #6

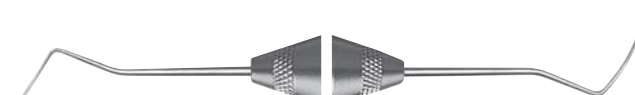

2H
| **EXD2H6**
Handle options:
#31, #6



3
| **EXD36**
Handle options:
#31, #6



2R/2L
| **EXD2R/2L6**
Handle options:
#31, #6, #7



3ES
| **EXD3ES6**
Handle options:
#31, #6, #7, #8



**3CH
Cowhorn**
| **EXD3CH6**
Handle options:
#31, #6, #7, #8



5
| **EXD57**
Handle options:
#31, #6, #7, #8

Combination of #17 end for subgingival calculus detection and #23 end for caries detection



**TU17/23
Wilkins/Tufts**
| **EXTU17/237**
Handle options:
#31, #6, #7, #8

Combination of #TU17 end for subgingival calculus detection and #23 end for caries detection; the #TU17 end features a balanced tip design for ease and comfort.

Manufacturer part numbers are provided here, please visit www.dhpionline.com to convert or contact your DHPI Account Manager.

DOUBLE-END EXPLORERS**6/3****| EXD66**Handle options:
#31, #6Combination
of #6 and #3
explorers.**11/12****Old Dominion
University****| EXD11/126**Handle options:
#31, #6, #7, #8Ideal for posterior
calculus detection
in deep pockets,
especially on
proximal surfaces.
Designed to
explore an entire
dentition with a
single instrument.**11/12AF****After Five®****| EXD11/12A6**Handle options:
#31, #6, #7, #8Similar to the
EXD11/12 but
3 mm longer
at the terminal
shank for better
access in deeper
pockets.**3CH****Cowhorn****| EXD3CHXTS**

Handle: #6

**5****| EXD5XTS**

Handle: #6

**TU17/23****Wilkins/Tufts****| EXTU1723XT**

Handle: #6

Manufacturer part numbers are provided here, please visit www.dhponline.com to convert or contact your DHPI Account Manager.



EXPROS



How the best perform

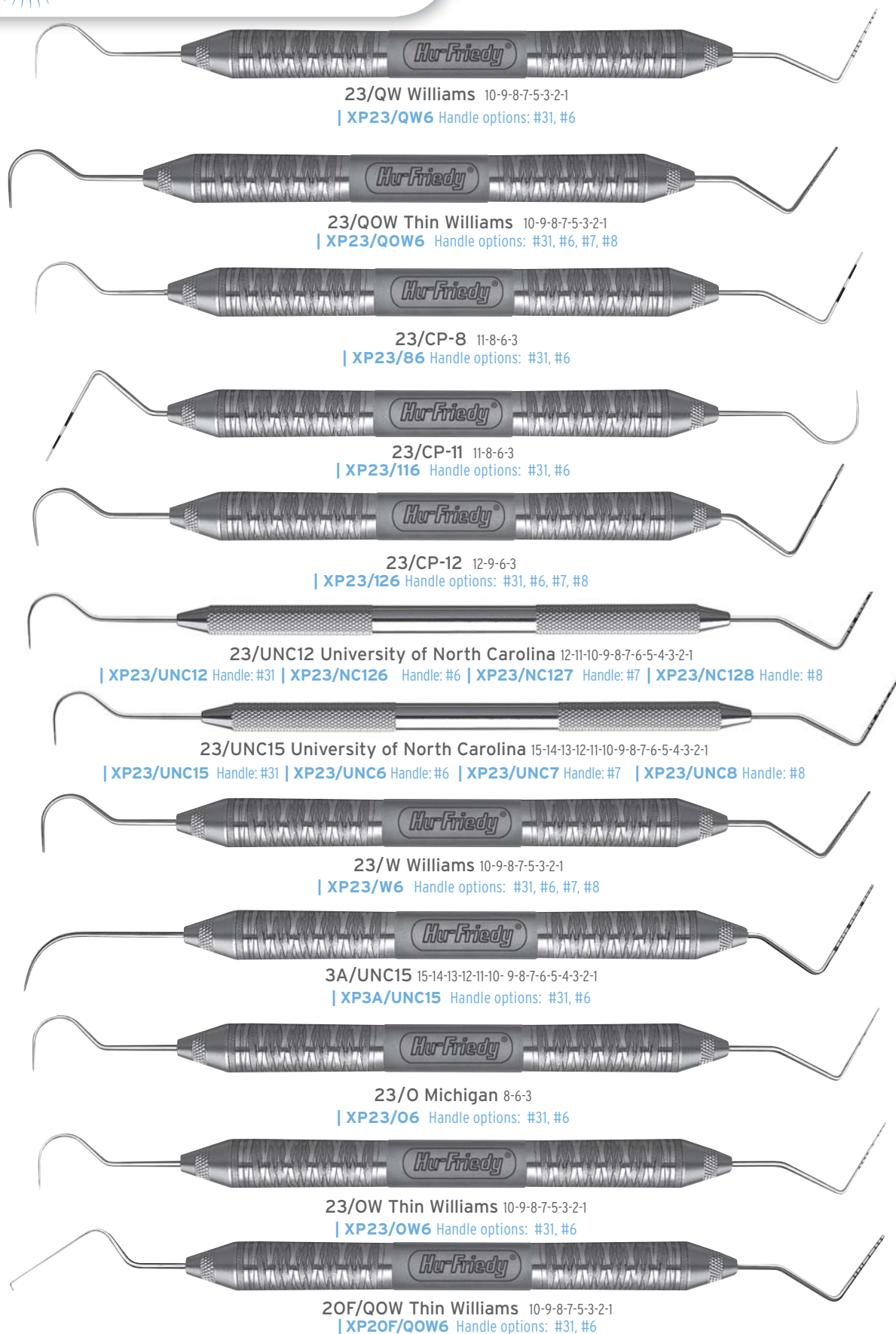

23/QW Williams 10-9-8-7-5-3-2-1
| XP23/QW6 Handle options: #31, #6

23/QOW Thin Williams 10-9-8-7-5-3-2-1
| XP23/QOW6 Handle options: #31, #6, #7, #8

23/CP-8 11-8-6-3
| XP23/86 Handle options: #31, #6

23/CP-11 11-8-6-3
| XP23/116 Handle options: #31, #6

23/CP-12 12-9-6-3
| XP23/126 Handle options: #31, #6, #7, #8

23/UNC12 University of North Carolina 12-11-10-9-8-7-6-5-4-3-2-1
| XP23/UNC12 Handle: #31 | XP23/NC126 Handle: #6 | XP23/NC127 Handle: #7 | XP23/NC128 Handle: #8

23/UNC15 University of North Carolina 15-14-13-12-11-10-9-8-7-6-5-4-3-2-1
| XP23/UNC15 Handle: #31 | XP23/UNC6 Handle: #6 | XP23/UNC7 Handle: #7 | XP23/UNC8 Handle: #8

23/W Williams 10-9-8-7-5-3-2-1
| XP23/W6 Handle options: #31, #6, #7, #8

3A/UNC15 15-14-13-12-11-10-9-8-7-6-5-4-3-2-1
| XP3A/UNC15 Handle options: #31, #6

23/O Michigan 8-6-3
| XP23/O6 Handle options: #31, #6

23/OW Thin Williams 10-9-8-7-5-3-2-1
| XP23/OW6 Handle options: #31, #6

20F/QOW Thin Williams 10-9-8-7-5-3-2-1
| XP20F/QOW6 Handle options: #31, #6

Manufacturer part numbers are provided here, please visit www.dhponline.com to convert or contact your DHPI Account Manager.



PLASTIC PROBES



How the best perform

COLORVUE® PROBES

Colorvue probes feature a vivid yellow tip with black markings for enhanced contrast to intraoral structures in both natural and implant dentition. Optimal flexibility and a rounded tip provide greater patient comfort and acceptability. The probe tips are safe for use with implants and feature a twist-on design for easy replacement of worn tips.



11
3-6-8-11

| **PCV11PT**

12 Replacement Tips

| **PCV11KIT6**

6 Pack,
1 handle + 7 tips

| **PCV11KIT12**

12 Pack,
2 handles + 12 tips



12
3-6-9-12

| **PCV12PT**

12 Replacement Tips

| **PCV12KIT6**

6 Pack,
1 handle + 7 tips

| **PCV12KIT12**

12 Pack,
2 handles + 12 tips



Williams
1-2-3-5-7-
8-9-10

| **PCVWPT**

12 Replacement Tips

| **PCVWKIT6**

6 Pack,
1 handle + 7 tips



UNC12
1-2-3-4-5-6-7-
8-9-10-11-12

| **PCVUNC12PT**

12 Replacement Tips

| **PCVNCKIT6**

6 Pack,
1 handle + 7 tips

| **PCVNCKIT12**

12 Pack,
2 handles + 12 tips



Colorvue's vibrant markings provide superior contrast to gingival tissue and exposed root surfaces, making it easy to assess pocket depth and recession.

EXPRO HANDLES



Colorvue
Oxford Probe

| **PCVOKIT6**

Colorvue Oxford Starter Kit
with 1 UNC15 probe/PH6 handle
and 6 Colorvue UNC15 tips

| **PCV012PT**

Refill Pack of Colorvue
Oxford Tips



17 Expro
and Handle

| **XP17/PH6**



23 Expro
and Handle

| **XP23/PH6**

TU17 Expro
and Handle

| **XPTU17/PH6**

Manufacturer part numbers are provided here, please visit www.dhpionline.com to convert or contact your DHPI Account Manager.



METAL PROBES



COLORVUE® PERIOSCREEN® PROBES

Hu-Friedy's Colorvue PerioScreen probe provides a fast and easy-to-use method of screening periodontal pocket depth prior to definitive probing. A universally understood color-coding of green and red indicates the absence or presence of periodontal disease.



#10 Markings
3-5-7-10

| PPS10PT

12 Replacement Tips

| PPS10KIT6

6 Pack, 1 handle + 7 tips

| PPS10KIT12

12 Pack, 2 handles + 12 tips

| PPSPROMO10

Intro Kit: 1 handle + 1 tip

#12 Markings
3-6-9-12

| PPS12PT

12 Replacement Tips

| PPS12KIT6

6 Pack, 1 handles + 7 tips

| PPS12KIT12

12 Pack, 2 handles + 12 tips

| PPSPROMO12

Intro Kit: 1 handle + 1 tip

Colorvue
Goldstein
Probe

| PPSGKIT6

Kit 1 Handle + 7 Tips

| PPSG12PT

12 Replacement Tips

Colorvue
| PH6

EXPRO HANDLES

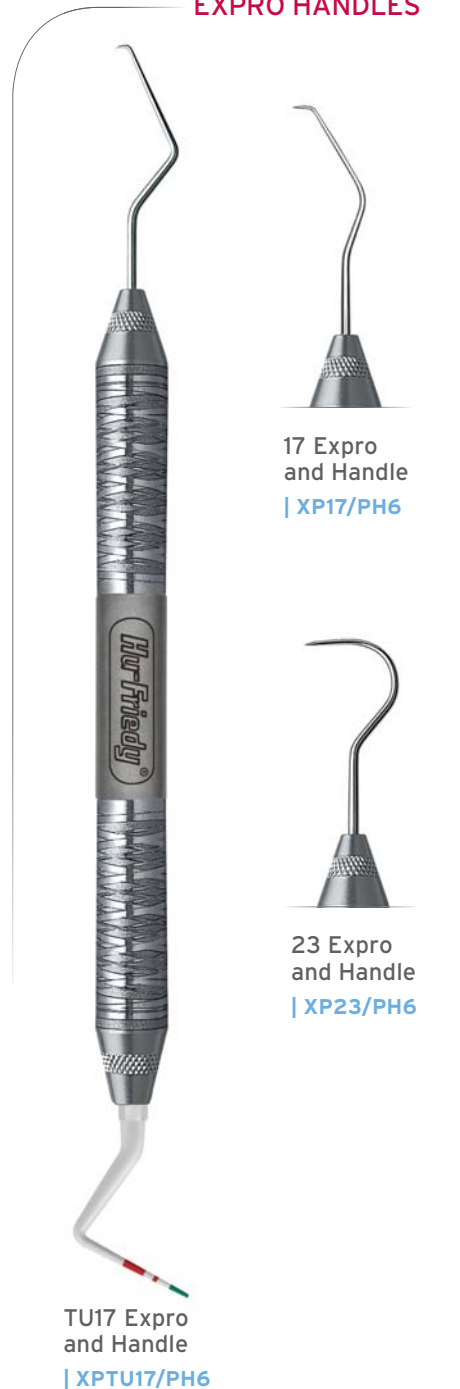

17 Expro
and Handle
| XP17/PH6

23 Expro
and Handle
| XP23/PH6

TU17 Expro
and Handle
| XPTU17/PH6

Manufacturer part numbers are provided here, please visit www.dhponline.com to convert or contact your DHPI Account Manager.

QULIX™ COLOR-CODED PROBES

Qulix™ probes are color-coded with accurate, smoothly finished black markings which will not chip, flake or fade.

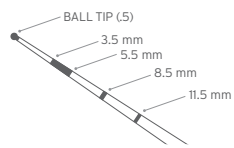

3-6-8-11

1-2-3-5-7-8-9-10

3-6-8-11

3-6-9-12

1-2-3-4-5-6-7-8-9-10-11-12

1-2-3-4-5-6-7-8-9-10-11-12-13-14-15

3.5-5.5-8.5-11.5



CP-8

| **PCP86**

Handle options: #30, #6

CP-10

| **PCP106**

Handle options: #30, #6, #7, #8

CP-11

| **PCP116**

Handle options: #30, #6, #7, #8

CP-12

| **PCP126**

Handle options: #30, #6, #7, #8

CP-12

University of North Carolina

| **PCPUNC126**

Handle options: #30, #6, #7, #8

CP-15

University of North Carolina

| **PCPUNC156**

Handle options: #30, #6, #7, #8

CP-11.5B

Screening Probe

| **PCP11.5B6**

Handle options: #30, #6, #7, #8

Manufacturer part numbers are provided here, please visit www.dhpionline.com to convert or contact your DHPI Account Manager.



MIRRORS



How the best perform

CONE SOCKET MIRROR HANDLES

SIMPLE STEM MIRROR HANDLES



#24
Cone
Socket
Mirror
Handle
| MH24
\$16.45

#1
Cone
Socket
Mirror
Handle
| MH1
\$16.45

#6
Cone
Socket
Mirror
Handle
| MH6
\$17.95

#7
Cone
Socket
Mirror
Handle
| MH7
\$18.95

#8
Cone
Socket
Mirror
Handle
| MH8
\$17.95

#6
Simple
Stem Mirror
Handle
| MHE6
\$16.75

#7
Simple
Stem Mirror
Handle
| MHE7
\$18.75

Round
Simple
Stem Mirror
Handle
| MH0175E
\$15.75

Manufacturer part numbers are provided here, please visit www.dhpionline.com to convert or contact your DHPI Account Manager.

HIGH DEFINITION MIRRORS

Scratch resistant and feature a proprietary coating that provides superior brilliance and color for increased visibility in all dental procedures.

CONE SOCKET



#3 Single-Sided
| **MIR3HD**
Single



#4 Single-Sided
| **MIR4HD**
Single
| **MIR4HD3**
Box of 3
| **MIR4HD12**
Box of 12



#5 Single-Sided
| **MIR5HD**
Single
| **MIR5HD3**
Box of 3
| **MIR5HD12**
Box of 12



#4 Double-Sided
| **MIR4DSHD**
Single
| **MIR4DSHD6**
Box of 6



#5 Double-Sided
| **MIR5DSHD**
Single
| **MIR5DSHD6**
Box of 6

EUROPEAN SIMPLE STEM



#3 Single-Sided
| **MIR3HDE**
Single



#4 Single-Sided
| **MIR4HDE**
Single
| **MIR4HDE3**
Box of 3
| **MIR4HDE12**
Box of 12



#5 Single-Sided
| **MIR5HDE**
Single
| **MIR5HDE3**
Box of 3
| **MIR5HDE12**
Box of 12



#4 Double-Sided
| **MIR4DSHDE**
Single
| **MIR4DSHDE6**
Box of 6



#5 Double-Sided
| **MIR5DSHDE**
Single
| **MIR5DSHDE6**
Box of 6

Manufacturer part numbers are provided here, please visit www.dhponline.com to convert or contact your DHPI Account Manager.

How the best perform

EUROPEAN SIMPLE STEM



Single-Sided #4
7/8" (22 mm)
Diameter
| M4C
Box of 12



#4 Double-Sided
| M4DC
Box of 6



Single-Sided #5
15/16" (24 mm)
Diameter
| M5C
Box of 12



#5 Double-Sided
| M5DC
Box of 6

PHOTOGRAPHY MIRRORS



1-1/2" Exam Mirror
with Handle
| M7H



2" Exam Mirror
with Handle
| M8H

RHODIUM MIRRORS

Rhodium-coated to resist scratching, they provide sharp and distortion free images with a smooth finish for patient comfort.

CONE SOCKET MIRRORS



Single-Sided #4
7/8" (22 mm)
Diameter
| MIR4/3
Box of 3
| MIR4/12
Box of 12



Double-Sided #4
7/8" (22 mm)
Diameter
| MIR4DS/3
Box of 3
| MIR4DS/6
Box of 6



Single-Sided #5
15/16" (24 mm)
Diameter
| MIR5/3
Box of 3
| MIR5/12
Box of 12



Double-Sided #5
1-5/16" (24 mm)
Diameter
| MIR5DS/3
Box of 3
| MIR5DS/6
Box of 6

Manufacturer part numbers are provided here, please visit www.dhponline.com to convert or contact your DHPI Account Manager.

PLIERS



701-66317 **\$28.75**
317 Dental Cotton (College) Pliers, Serrated Tips



701-66652 **\$43.25**
Cotton Pliers with Lock, Serrated Tips



701-66656 **\$44.75**
Cotton Pliers with Lock, Grooved Tips



701-66318 **\$28.45**
318 MERIAM Pliers, Serrated Tips



701-66312A **\$28.25**
312A Dental Cotton (Perry) Pliers, Angled, Serrated Tips



701-V966317 **\$7.95**
VANTAGE College Pliers with Pin, Serrated Tips



701-V966652 **\$10.25**
VANTAGE Self-Locking College Pliers, Serrated Tips

MIRRORS & HANDLES



		Octagonal	
Cone Socket	701-67680	12/box	\$49.95
Simple Stem	701-67684	12/box	\$49.75



		Deluxe	
Cone Socket	701-67685	12/box	\$38.45



		Octagonal with Millimeter Rule	
Cone Socket	701-67688	Each	\$7.95



		Front Surface Mirrors 12/box	
		Cone Socket	Simple Stem
#3	701-676963	\$40.95	701-676983 \$40.75
#4	701-676964	\$38.75	701-676984 \$40.75
#5	701-676965	\$38.75	701-676985 \$38.75

		Regular Mirrors 12/box	
		Cone Socket	Simple Stem
#4	701-676644	\$26.75	701-676724 \$26.25
#5	701-676645	\$26.45	701-676725 \$26.45



Front Surface Indian Head Mirrors 12/box
Front surface mirrors will withstand dry heat, autoclave and cold as well. Made of highly polished stainless steel.

		Cone Socket	
#4	706-24693	\$38.45
#5	706-24694	\$38.45



PLIERS



700-08220 **\$9.75**
College Plier, Self-Locking, Grooved



700-08255 **\$9.75**
Meriam Pliers 6.25" Serrated



700-08262 **\$7.75**
Perry Pliers 5" Serrated



Single End Handle



Double End Handle



EXPLORERS



#7 Single End

700-04918 \$9.75



#3 Double End

700-04830 \$8.45



#6 Double End

700-04860 \$8.45



DG16 Double End

700-04996 \$8.45

PROBES



Michigan "OW" Probe

700-16532 \$12.75



Probe #12

700-16512 \$11.25



WHO Probe Color-Coded, Ball Tip

700-16555 \$15.25



Cut through the fat

GO DIRECTLY TO THE BEST

Manufacturers offer thousands of promotions. GO **DIRECTLY** TO THE BEST.

www.dhpionline.com/promotions

BUY 1	BUY 2	BUY 3	BUY 4 OR MORE	DHPI X EXCLUSIVE OFFERS
--------------	--------------	--------------	-------------------------	-----------------------------------



MONTANA EXPLORER R170 \$20.45



Explorer 5 R166 \$20.45



WRS ACE™ - UNC 12 R215 \$35.75
(left:3-6-9-12mm) (right:1-2-3-4-5-6-7-8-9-10-11-12mm)



Explorer 11-12 R167 \$20.45



ACE™ 12 Short R216 \$35.75
(left: 3-6-9-12mm) (right: 3-6-9-12mm)



Explorer 23 R183 \$17.25



Explorer 23/Probe 12 R223 \$29.25



Probe 12 R195 \$25.75
(3-6-9-12mm)



Explorer 23/Probe Who R225 \$29.25



Mirror #5 (15/26") T050 with Cone Socket Mirror Handle R245 \$17.25



Mirror #5 (15/16") T050 \$4.75
Front Surface Rhodium Coated



Mirror #4 (7/8") T051 \$4.75
Front Surface Rhodium Coated



Cone Socket Mirror Handle R245 \$17.25
Available In Simple Stem R248



Cotton Pliers T043 \$17.75
Single-Piece Construction - No Joints To Fail!



EasyView™ Probe T212 \$13.25
(3-6-9-12mm)



EasyView™ Probe T214 \$13.25
(3-5-7-10mm)

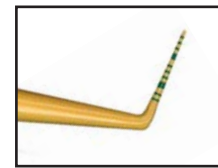

EasyView™ Probe T216 \$13.25
(1-2-3-4-5-6-7-8-9-10-11-12mm)

Manufacturer part numbers are provided here, please visit www.dhponline.com to convert or contact your DHPI Account Manager.



Single End Round Handle



Double End Round Handle

EXPLORERS - DOUBLE END



707-1003527 Cavity Finder 3 CH \$17.45



707-1003529 Cavity Finder 11/12 CF \$17.45

PROBES - SINGLE END



707-1003670 Probe SE YO 9 CC (3-6-12mm) \$22.25

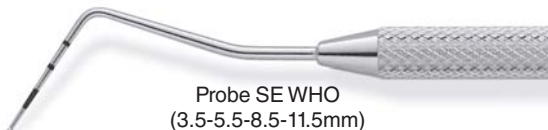

707-1003675 Probe SE WHO (3.5-5.5-8.5-11.5mm) \$22.25

PerioWise® Periodontal Probes



3-6-12mm
 3 Pack 707-9006108 \$38.75
 6 Pack 707-9006104 \$80.75
 12 Pack 707-9006106 \$118.45



3-5-7-10mm
 3 Pack 707-9006107 \$38.75
 6 Pack 707-9006102 \$80.75
 12 Pack 707-9006105 \$118.45

UNC 12 PerioWise® Probes



3 Pack 707-9006120 \$38.75
 6 Pack 707-9006121 \$80.75
 12 Pack 707-9006122 \$118.45

NOW YOU CAN
BROWSE ALL
CLEARANCE

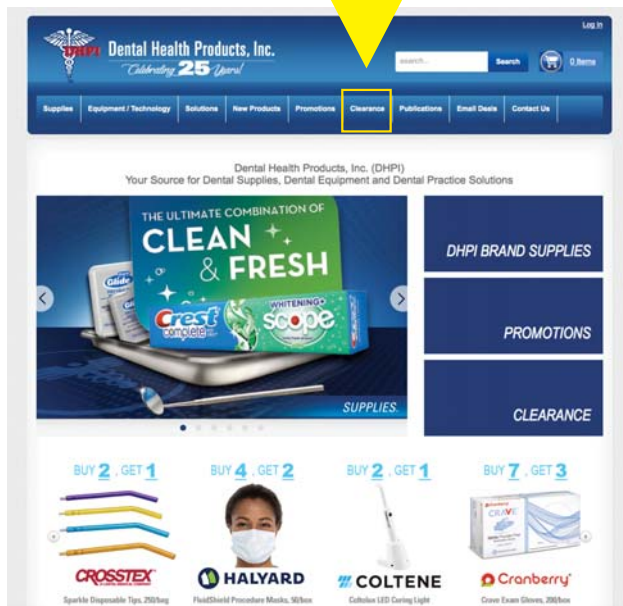

www.dhponline.com/clearance

All Clearance
 Supplies are
Discounted
 up to **25%**,
While Supplies Last!



Crystal HD

The Crystal HD[®] lens produces a 99% true color reflection across the entire color spectrum, significantly dominating the average 75% reflection that a Rhodium lens provides. With a 40% brighter reflection than Rhodium, the Crystal HD[®] mouth mirror lens helps illuminate the oral cavity significantly, bringing more value to this commonly-used dental tool.



\$75.45 - Assorted Thin Grip 12pk

Vibrant Assorted #4 700-50Z353NEON
#5 700-50Z354NEON
2 of each color:
N, O, P, Q, R and S

Jewel Assorted #4 700-50Z353JWL
#5 700-50Z354JWL
2 of each color:
E, J, T, I, M and U



\$15.25 Each - Ergo Grip Handle

700-50Z342_ Available in all colors



700-50Z340_ Available in all colors



Black/Gray Soft Grip

\$27.95 - 4pk #4 700-50Z361
\$75.45 - 12pk #4 700-50Z363
#5 700-50Z362 #5 700-50Z364



\$75.45 - Resin Screw-on Heads 12pk

Flush surface, no debris build-up can occur.

1-Color - #4 700-50Z371_ #5 700-50Z372_ Available in All Colors

Vibrant Assorted #4 700-50Z371NEON
#5 700-50Z372NEON
2 of each color:
N, O, P, Q, R and S

Jewel Assorted #4 700-50Z371JWL
#5 700-50Z372JWL
2 of each color:
E, J, T, I, M and U

Classic Assorted #4 700-50Z371PSTL
#5 700-50Z372PSTL
2 of each color:
A, B, D, G, I and K (black)



\$75.45 - Assorted Soft Grip 12pk

Vibrant Assorted #4 700-50Z363NEON
#5 700-50Z364NEON
2 of each color:
N, O, P, Q, R and S

Jewel Assorted #4 700-50Z363JWL
#5 700-50Z364JWL
2 of each color:
E, J, T, I, M and U



\$41.45 - Double-Sided Mirror Head 4pk

Gray Only
#4 700-50Z374I

Vibrant Assorted
#4 700-50Z374NEON
1 of each color: N, O, R and S



\$75.45 - 12pk Stainless Steel Head

#3 700-50R379
#4 700-50R380
#5 700-50R381



\$11.95 Each Stainless Steel Head #0
#0 700-50R388



Flush surface, no debris build-up can occur



Resin

Gap where debris build-up occurs



Stainless Steel

	RESIN	STAINLESS
Autoclavable	X	X
Antimicrobial Protection	X	
Lens flush with mirror frame	X	
No galvanic shock on patient	X	
Rust-free	X	

Why Use Zirc's Resin Mirrors?



With an efficient and unique application system, mirror magic[®] assists the practitioner in combating fog and debris by using an anti-fog solution combined with an adhesive swipe pad placed on the glove or patient bib. One swipe prior to starting the procedure provides long-term protection against fogging and is accessible for debris removal at any time. The compact size of the anti-fog solution bottle and swipe pads allows this system to be easily accessible and manageable in the dental sterilization area or in the operatory, right next to chairside.



\$24.95 - mirror magic[®] Trial Kit

710-50R200
2 6ml bottles of Anti-Fog Solution
24 Swipe Pads.



\$16.95 - mirror magic[®] Organizer

710-50R201
Holds 48 Swipe Pads & 1 6ml bottle of Anti-Fog Solution.



\$24.95 - Swipe Pads 96pk

710-50R210
Removes debris from mirror.



\$73.95 - Anti-Fog Solution 10pk

710-50R205
Each bottle is 6ml. 1 bottle lasts approx. 50 patients.



MISC. MOUTH MIRRORS

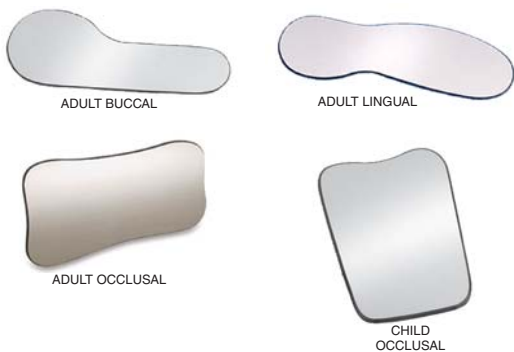

Riofoto Intra-Oral Photography Mirrors - EMF Corporation

Riofoto mirrors for intraoral photography are used by dentists and orthodontists around the world to provide sharp, clear images when used with either 35mm or digital cameras. These glass mirrors are coated with Rhodium for the highest reflectance available and are mirrored on both sides. Riofoto mirrors withstand repeated steam autoclave cycles.

- Child Buccal..... 690-1CB
- Child Occlusal..... 690-3CO
- Child XLong Occlusal..... 690-4XLCO
- Adult Buccal..... 690-1AB
- Adult Occlusal..... 690-3A0
- Adult Lingual..... 690-2AL
- Adult XLong Occlusal..... 690-4XLAO
- Each **\$61.75**



MirrorLite™ Illuminated Mouth Mirror - Mydent

Coated in titanium which resists corrosion and tarnishing. Ideal for: oral diagnosis, oral cancer exams, restorative dentistry, air abrasion and transillumination. Ergonomic and compact. Uses LED light which allows you to see in true color. Portable and autoclavable.

Introductory Kit

Contains: 1 MirrorLite, 50 disposable mirrors, 50 barrier sleeves and 6 batteries.
700-IN7003 Kit..... **\$112.95**

#5 Mirror Refills

Contains: 50 mirrors, 50 barrier sleeves and 2 batteries.
700-IN7004 Pack..... **\$24.75**

DISPOSABLE MOUTH MIRRORS



Flecta Disposable Mirrors - Pulpdent Corporation

No more scratches and blotches. Double-sided with backside light reflector. Lightweight, comfort handle reduces stress and fatigue. Offset handle design is a better tongue guard and cheek retractor.

700-FLEC 200/box **\$51.25**



Disposable Mouth Mirrors - Vista Dental Products

Highly reflective ultra-thin plated glass surface enhances imaging. Light weight with ergonomic handle.
700-307001 60/pkg. **\$33.45**

MIRROR ACCESSORIES



Dee Fog - Cetylite, Inc.

Mirror defogger, specially formulated for clear, undistorted vision. Also prevents fogging and bubbling on glass and front surface mirrors.

710-0504 2oz. spray..... **\$7.75**



Fog Free - EPR Industries LLC

Mirror defogger. Eliminates water and fog distortion on mouth mirrors. Mint scent.

710-FF Quart..... **\$10.75**



Butler Clear Dip - Sunstar Americas, Inc.

Prevents fogging, bubbling and image distortion on mouth mirrors. Works in presence of water. Pleasant tasting and non-toxic.

710-716P 16oz. **\$13.25**



Mirror Gear Mirror Covers - MirrorGear USA

Specially designed medical grade material that protects the mirror surface while allowing disinfectant solution to wash over the mirror head and flush debris out of the slots on the sides. Flexible, durable and heat and chemical-resistant up to 450°. Latex free.

Intro Pack

Contains: 16 covers (2 of each color: Red, Green, Orange, Blue, Yellow, Purple, Pink and White).

Size 4..... 710-MG16S4
Size 5..... 710-MG16S5
Pack **\$44.95**

Individual colors available upon request.

EXCAVATORS



Excavator #17

700-1251

\$13.95



Excavator #18

700-1252

\$13.95



Excavator #38/39

700-1253

\$13.95

PLUGGERS



Plugger #0/1 Serrated

700-1552

\$13.95



Plugger #0/1 Smooth

700-1553

\$13.95



Plugger #1/2 Serrated

700-1550

\$13.95



We know you'll find value and quality when ordering any product carrying the *Health-Tec* Brand. 100% satisfaction of your purchase, guaranteed!

Visit our website for more details.



1/4\"

CONDENSERS/PLUGGERS - DOUBLE END



0

700-AECP0

\$31.95



1/2

AECP12

\$31.95



3/4

AECP34

\$31.95

EXCAVATORS



E-2

AEEXCE2

\$32.75



38/39

AEEXC38-39

\$32.75



40/41

AEEXC40-41

\$32.75



42/43

AEEXC42-43

\$32.75



70/71

AEEXC70-71

\$32.75



74/75

AEEXC74-75

\$32.75

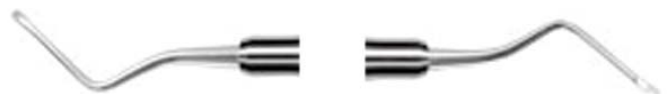

Endodontic Excavator 31L

AEEM31LEXC

\$32.75

Continued



AMERICAN EAGLE INSTRUMENTS® INC

better DENTISTRY by DESIGN™

American Eagle Instruments continued



ROOT CANAL PLUGGERS

<p>3 - 5 AEE3-5P</p>		<p>Each.....</p>	<p>\$31.95</p>
<p>5 - 7 AEE5-7P</p>		<p>Each.....</p>	<p>\$31.95</p>
<p>9 - 11 AEE9-11P</p>		<p>Each.....</p>	<p>\$31.95</p>

SPREADERS

<p>D 11 - 21 AEED11-21S</p>		<p>Each.....</p>	<p>\$26.75</p>
<p>D 11T - 21 AEED11T-21S</p>		<p>Each.....</p>	<p>\$26.75</p>
<p>D 11T - 25 AEED11T-25S</p>		<p>Each.....</p>	<p>\$26.75</p>

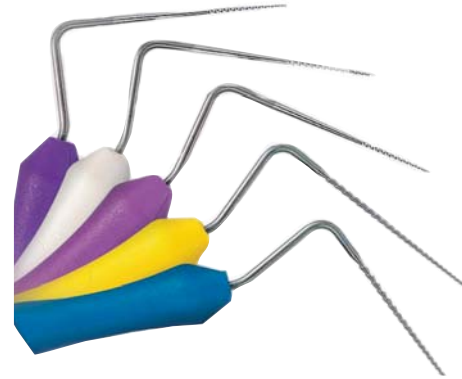

Micro-Openers & Micro-Debriders - Dentsply Maillefer

Stainless steel hand instruments for use in the location and initial negotiation of root canals. Specially designed flexible handle allows a firm yet sensitive grip. The offset handle offers an unobstructed view of the canal when used with or without magnification.

10/.04.....	338-671687	
15/.04.....	338-671688	
10/.06.....	338-671689	
3/pkg.		\$46.25

Micro-Debrider

20/.02.....	338-671690	
30/.02.....	338-671691	
3/pkg.		\$48.25

Kit #1

Contains: 1 Micro-Opener 15/.04, 1 Micro-Opener 10/.04 and 1 Micro-Debrider 30/.02.
338-671684

Kit..... **\$47.25**

Kit #2

Contains: 1 Micro-Opener 10/.06, 1 Micro-Opener 10/.04 and 1 Micro-Debrider 20/.02.
338-671685

Kit..... **\$47.25**

Kit #3

Contains: 1 Micro-Opener 15/.04, 1 Micro-Opener 10/.04 and 1 Micro-Debrider 10/.06.
338-671686

Kit..... **\$47.25**



EXCAVATORS/PLUGGERS



How the best perform



ENDODONTIC EXCAVATORS \$34.25



2 Glick
| EXCGL2

31L
| EXC31L
Handle options:
#6, #41

31W
Oval Spoon
| EXC31W
Handle options:
#6, #41

32L
| EXC32L
Handle options:
#6, #41

33L
| EXC33L
Handle options:
#6, #41

ISO SIZED PLUGGERS

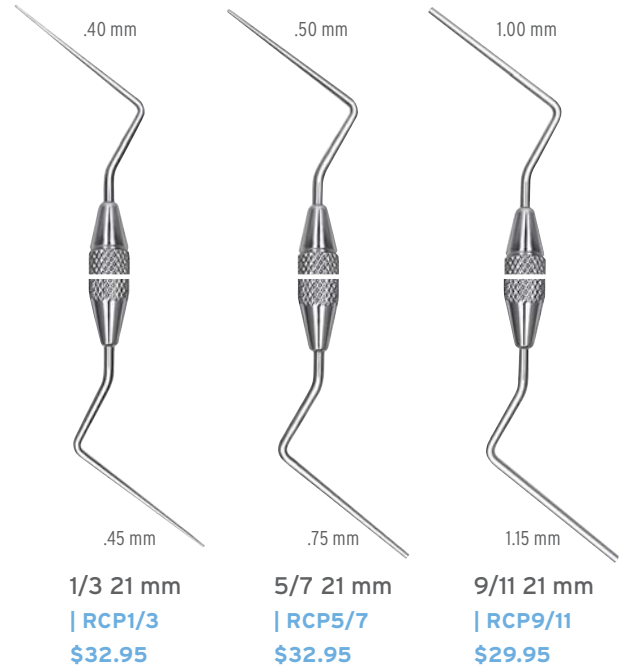

1/3 21 mm
| RCP1/3
\$32.95

5/7 21 mm
| RCP5/7
\$32.95

9/11 21 mm
| RCP9/11
\$29.95

BLADE/PLUGGERS



1 Glick Blade/Plugger
| RCPGL1
\$36.75
Handle options: #6, #7, #41

Popular instrument combines a plugger on one end with a blade for cutting off gutta percha on the other. Plugger working end has a 1.10mm diameter.

Manufacturer part numbers are provided here, please visit www.dhponline.com to convert or contact your DHPI Account Manager.



PLUGGERS



How the best perform

ANTERIOR \$29.95

Anterior condensers are 7 mm longer than posterior condensers.

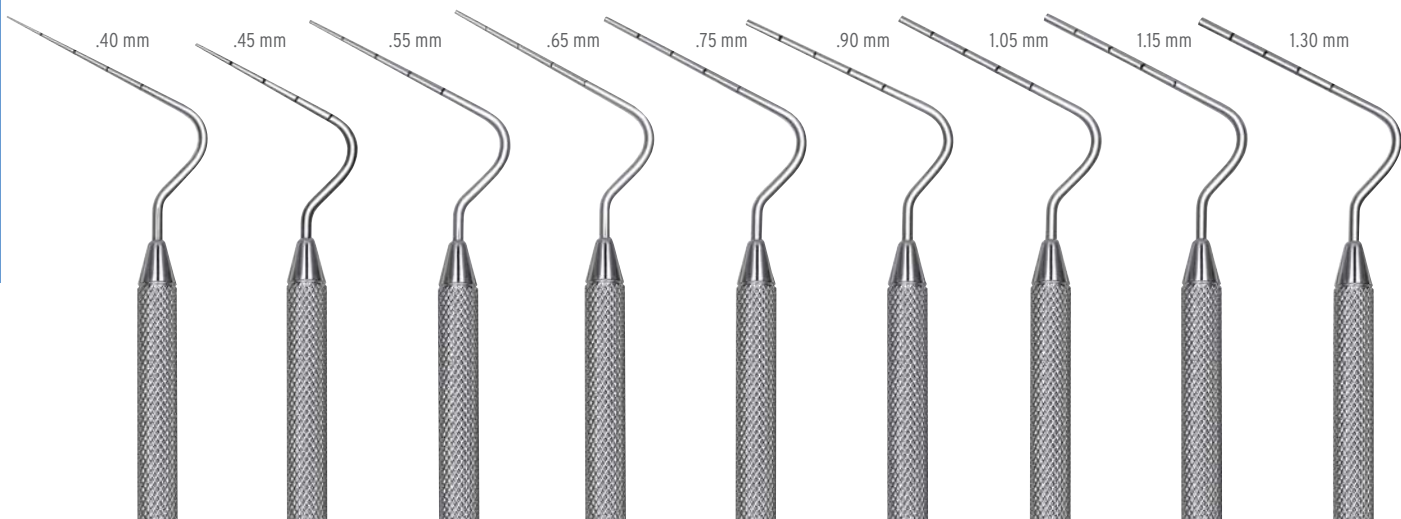

- | | | | | | | | | |
|------------------------|---------------------------------|------------------------|---------------------------------|--------------------------|----------------------------------|--------------------------|----------------------------------|--------------------------|
| 8A
29 mm
 RCP8A | 8-1/2A
29 mm
 RCP8-1/2 A | 9A
29 mm
 RCP9A | 9-1/2 A
29 mm
 RCP9-1/2A | 10A
29 mm
 RCP10A | 10-1/2A
29 mm
 RCP10-1/2A | 11A
29 mm
 RCP11A | 11-1/2A
29 mm
 RCP11-1/2A | 12A
29 mm
 RCP12A |
|------------------------|---------------------------------|------------------------|---------------------------------|--------------------------|----------------------------------|--------------------------|----------------------------------|--------------------------|

POSTERIOR \$29.95

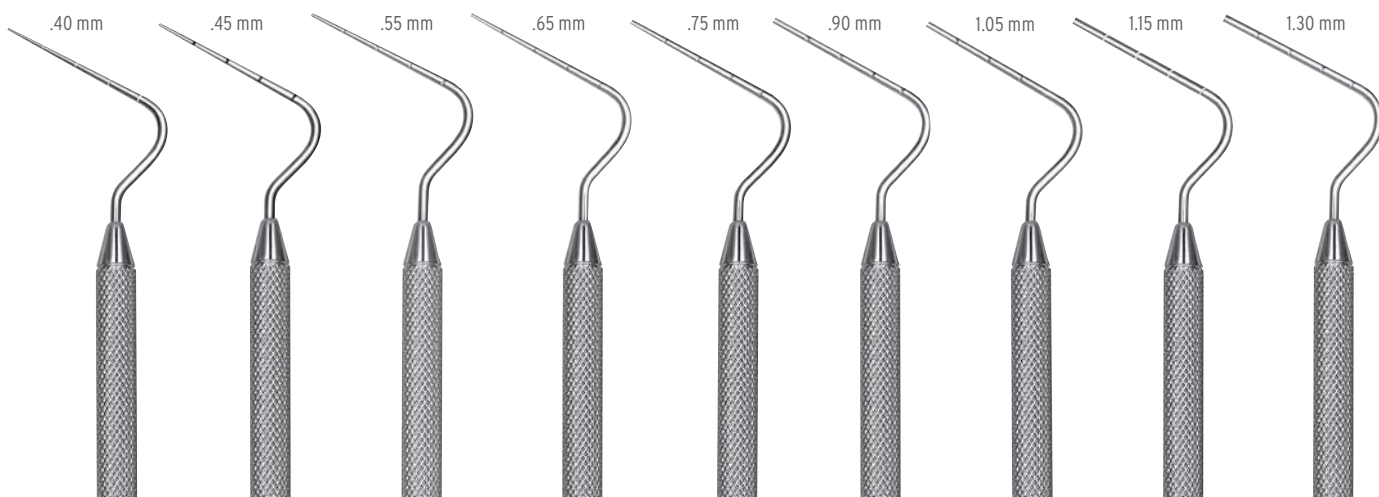

- | | | | | | | | | |
|----------------------|------------------------------|----------------------|------------------------------|------------------------|--------------------------------|------------------------|--------------------------------|------------------------|
| 8
22 mm
 RCP8 | 8-1/2
22 mm
 RCP8-1/2 | 9
22 mm
 RCP9 | 9-1/2
22 mm
 RCP9-1/2 | 10
22 mm
 RCP10 | 10-1/2
22 mm
 RCP10-1/2 | 11
22 mm
 RCP11 | 11-1/2
22 mm
 RCP11-1/2 | 12
22 mm
 RCP12 |
|----------------------|------------------------------|----------------------|------------------------------|------------------------|--------------------------------|------------------------|--------------------------------|------------------------|

Manufacturer part numbers are provided here, please visit www.dhponline.com to convert or contact your DHPI Account Manager.



Octagonal Double End Handle

EXCAVATORS

		#5	
700-04705		\$16.25
		#14	
700-04714		\$16.25
		#19	
700-04719		\$16.25
		#22	
700-04722		\$16.25
		#24	
700-04724		\$16.25
		#38/39	
700-04738		\$16.25

PLUGGERS

		1/2	
Code Price	Serrated	700-01220	\$16.25
	Smooth	700-01225	\$16.25
		2/3	
Code Price	Serrated	700-01240	\$16.25
	Smooth	700-01245	\$16.25
		1	
Code Price	Serrated	700-01255	\$16.25
	Smooth	700-01250	\$16.25
		2	
Code Price	Serrated	700-01265	\$16.25
	Smooth	700-01260	\$16.25



Double End Round Handle



Double End Octagon Handle

EXCAVATORS

		12	
Code Price	Round Handle	707-1003447	\$23.95
	Octagon Handle	707-1003422	\$23.95
		13	
Code Price	Round Handle	707-1003448	\$23.95
	Octagon Handle	707-1003423	\$23.95
		14	
Code Price	Round Handle	707-1003449	\$23.95
	Octagon Handle	707-1003424	\$23.95
		17	
Code Price	Round Handle	707-1003452	\$23.95
	Octagon Handle	707-1003427	\$23.95

REAL WORLD ENDO EXPLORERS

		Anterior	
707-1003891		\$24.75
		Posterior	
707-1003892		\$24.75
		#16	
707-1003844		\$18.95



ULTRA Instruments

GRACEY - DOUBLE END



Lightweight 3/8" hollow stainless steel handle



1-2

700-DHP016

\$18.75



3-4

700-DHP018

\$18.75



5-6

700-DHP020

\$18.75

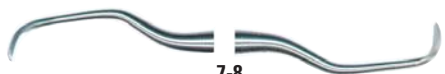

7-8

700-DHP022

\$18.75

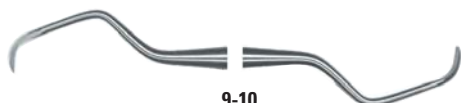

9-10

700-DHP024

\$18.75



11-12

700-DHP026

\$18.75



13-14

700-DHP028

\$18.75



15-16

700-DHP030

\$18.75

BARNHART - DOUBLE END



1-2

700-DHP060

\$18.75



5-6

700-DHP061

\$18.75

COLUMBIA - DOUBLE END



13-14

700-DHP064

\$18.75



4L-4R

700-DHP067

\$18.75



We know you'll find value and quality when ordering any product carrying the *Health-Tec* Brand. 100% satisfaction of your purchase, guaranteed!

Visit our website for more details.



Health-Tec
BRAND PRODUCTS

ULTRA
Instruments

MCCALLS - DOUBLE END



13-14

700-DHP069

\$18.75



13S-14S

700-DHP070

\$18.75



17-18

700-DHP071

\$18.75



17S-18S

700-DHP072

\$18.75

YOUNGER/GOOD - DOUBLE END



7-8

700-DHP077

\$18.75

LANGER - DOUBLE END



3-4

700-DHP080

\$18.75

SCALERS - DOUBLE END

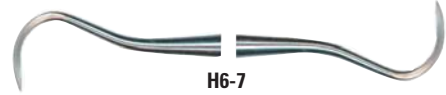

H6-7

700-DHP110

\$18.75



H5-33

700-DHP111

\$18.75



U15-33

700-DHP113

\$18.75

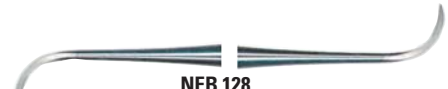

NEB 128

700-DHP114

\$18.75



204S

700-DHP135

\$18.75



204SD

700-DHP136

\$18.75



EagleLite XP
X-treme Performance

Sharpen Free

Not all patterns are represented. All instruments also available in Talan Tough™ stainless steel unless otherwise noted.



EagleLite Resin Double End (3/8" Dia.)



EagleLite Stainless Steel Double End (3/8" Dia.)

EAGLELITE XP GRACEY - DOUBLE END



1/2

Code
Price

EagleLite Resin 3/8"
AEG12XPX
\$55.95

EagleLite Stainless Steel 3/8"
AEG12XPZ
\$55.95



5/6

Code
Price

EagleLite Resin 3/8"
AEG56XPX
\$55.95

EagleLite Stainless Steel 3/8"
AEG56XPZ
\$55.95



7/8

Code
Price

EagleLite Resin 3/8"
AEG78XPX
\$55.95

EagleLite Stainless Steel 3/8"
AEG78XPZ
\$55.95



11/12

Code
Price

EagleLite Resin 3/8"
AEG112XPX
\$55.95

EagleLite Stainless Steel 3/8"
AEG112XPZ
\$55.95



EagleLite XP

X-treme Performance

EAGLELITE XP GRACEY - DOUBLE END



13/14

Code	EagleLite Resin 3/8" AEG1314XPX	EagleLite Stainless Steel 3/8" AEG1314XPZ
Price	\$55.95	\$55.95



15/16

Code	EagleLite Resin 3/8" AEG1516XPX	EagleLite Stainless Steel 3/8" AEG1516XPZ
Price	\$55.95	\$55.95



17/18

Code	EagleLite Resin 3/8" AEG1718XPX	EagleLite Stainless Steel 3/8" AEG1718XPZ
Price	\$55.95	\$55.95

EAGLELITE XP GRACEY +3 ACCESS - DOUBLE END

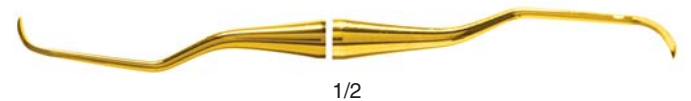

1/2

Code	EagleLite Resin 3/8" AEGA12XPX	EagleLite Stainless Steel 3/8" AEGA12XPZ
Price	\$55.95	\$55.95



3/4

Code	EagleLite Resin 3/8" AEGA34XPX	EagleLite Stainless Steel 3/8" AEGA34XPZ
Price	\$55.95	\$55.95



5/6

Code	EagleLite Resin 3/8" AEGA56XPX	EagleLite Stainless Steel 3/8" AEGA56XPZ
Price	\$55.95	\$55.95

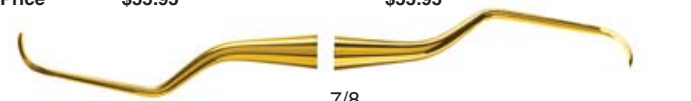

7/8

Code	EagleLite Resin 3/8" AEGA78XPX	EagleLite Stainless Steel 3/8" AEGA78XPZ
Price	\$55.95	\$55.95



11/12

Code	EagleLite Resin 3/8" AEGA1112XPX	EagleLite Stainless Steel 3/8" AEGA1112XPZ
Price	\$55.95	\$55.95



13/14

Code	EagleLite Resin 3/8" AEGA1314XPX	EagleLite Stainless Steel 3/8" AEGA1314XPZ
Price	\$55.95	\$55.95

EAGLELITE XP GRACEY +3 DEEP POCKET - DOUBLE END



11/12

Code	EagleLite Resin 3/8" AEGDP1112XPX	EagleLite Stainless Steel 3/8" AEGDP1112XPZ
Price	\$55.95	\$55.95



13/14

Code	EagleLite Resin 3/8" AEGDP1314XPX	EagleLite Stainless Steel 3/8" AEGDP1314XPZ
Price	\$55.95	\$55.95

EAGLELITE XP BARNHART - DOUBLE END

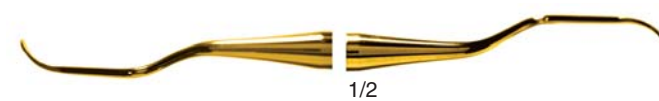

1/2

Code	EagleLite Resin 3/8" AECB12XPX	EagleLite Stainless Steel 3/8" AECB12XPZ
Price	\$55.95	\$55.95



5/6

Code	EagleLite Resin 3/8" AECB56XPX	EagleLite Stainless Steel 3/8" AECB56XPZ
Price	\$55.95	\$55.95

EAGLELITE XP COLUMBIA - DOUBLE END



13/14

Code	EagleLite Resin 3/8" AECC1314XPX	EagleLite Stainless Steel 3/8" AECC1314XPZ
Price	\$49.95	\$42.95

EAGLELITE XP RULES - DOUBLE END



3/4

Code	EagleLite Resin 3/8" AECR34XPX	EagleLite Stainless Steel 3/8" AECR34XPZ
Price	\$55.95	\$55.95

GOLDEN EAGLE KIT



Eagle Claw and Eagle Talon. Talon is a combination of the Jacquette 3 and the Nebraska 128. Claw is the ideal universal posterior scaler, for tight, interproximal areas.

AEGEKXPX Kit \$55.95

DOUBLE GRACEY KIT



AEDGAXP and AEDGXPX. Surface engineered with XP Technology.

700-AEDGKXPX Kit \$138.45



AMERICAN EAGLE INSTRUMENTS® INC
better DENTISTRY by DESIGN™



3/8" EagleLite Single End (X)



Stainless Steel Double End (3/8" Dia.)



EagleLite Double End (3/8" Dia.)

BARNHART - DOUBLE END



1/2

3/8" Stainless Steel
Code AECB12Z
Price \$38.75

EagleLite
Code AECB1-2X
Price \$38.75



5/6

3/8" Stainless Steel
Code AECB56Z
Price \$38.75

EagleLite
Code AECB5-6X
Price \$38.75

COLUMBIA - DOUBLE END



13/14

3/8" Stainless Steel
Code AECC1314Z
Price \$38.75

EagleLite
Code AECC13-14X
Price \$38.75



2L/2R

3/8" Stainless Steel
Code AECC2L2RZ
Price \$38.75

EagleLite
Code AECC2L2RX
Price \$38.75



4L/4R

3/8" Stainless Steel
Code AECC4L4RZ
Price \$38.75

EagleLite
Code AECC4L-4RX
Price \$38.75

GRACEY - DOUBLE END



1/2

3/8" Stainless Steel
Code AEG12Z
Price \$38.75

EagleLite
Code AEG1-2X
Price \$38.75



3/4

3/8" Stainless Steel
Code AEG34Z
Price \$38.75

EagleLite
Code AEG3-4X
Price \$38.75



11/12

3/8" Stainless Steel
Code AEG1112Z
Price \$38.75

EagleLite
Code AEG11-12X
Price \$38.75



13/14

3/8" Stainless Steel
Code AEG1314Z
Price \$38.75

EagleLite
Code AEG13-14X
Price \$38.75



15/16

3/8" Stainless Steel
Code AEG1516Z
Price \$38.75

EagleLite
Code AEG15-16X
Price \$38.75



17/18

3/8" Stainless Steel
Code AEG1718Z
Price \$38.75

EagleLite
Code AEG17-18X
Price \$38.75

GRACEY +3 ACCESS - DOUBLE END



1/2

3/8" Stainless Steel
Code AEGA12Z
Price \$38.75

EagleLite
Code AEGA1-2X
Price \$38.75



3/4

3/8" Stainless Steel
Code AEGA34Z
Price \$38.75

EagleLite
Code AEGA3-4X
Price \$38.75



5/6

3/8" Stainless Steel
Code AEGA56Z
Price \$38.75

EagleLite
Code AEGA5-6X
Price \$38.75



7/8

3/8" Stainless Steel
Code AEGA78Z
Price \$38.75

EagleLite
Code AEGA7-8X
Price \$38.75

Continued



AMERICAN EAGLE INSTRUMENTS® INC
better DENTISTRY by DESIGN™

11/12

Code Price	3/8" Stainless Steel AEGA1112Z \$38.75	EagleLite AEGA11-12X \$38.75
---------------	--	------------------------------------

13/14

Code Price	3/8" Stainless Steel AEGA1314Z \$38.75	EagleLite AEGA13-14X \$38.75
---------------	--	------------------------------------

15/16

Code Price	3/8" Stainless Steel AEGA1516Z \$38.75	EagleLite AEGA15-16X \$38.75
---------------	--	------------------------------------

GRACEY +3 DEEP POCKET - DOUBLE END

1/2

Code Price	3/8" Stainless Steel AEGDP12Z \$38.75	EagleLite AEGDP1-2X \$38.75
---------------	---	-----------------------------------

3/4

Code Price	3/8" Stainless Steel AEGDP34Z \$38.75	EagleLite AEGDP3-4X \$38.75
---------------	---	-----------------------------------

5/6

Code Price	3/8" Stainless Steel AEGDP56Z \$38.75	EagleLite AEGDP5-6X \$38.75
---------------	---	-----------------------------------

7/8

Code Price	3/8" Stainless Steel AEGDP78Z \$38.75	EagleLite AEGDP7-8X \$38.75
---------------	---	-----------------------------------

11/12

Code Price	3/8" Stainless Steel AEGDP1112Z \$38.75	EagleLite AEGDP11-12X \$38.75
---------------	---	-------------------------------------

13/14

Code Price	3/8" Stainless Steel AEGDP1314Z \$38.75	EagleLite AEGDP13-14X \$38.75
---------------	---	-------------------------------------



15/16

Code Price	5/16" Stainless Steel AEGDP1516Z \$38.75	EagleLite AEGDP15-16X \$38.75
---------------	--	-------------------------------------

JACQUETTE - DOUBLE END

U15/30

Code Price	3/8" Stainless Steel AESU1530Z \$38.75	EagleLite AESU15-30X \$38.75
---------------	--	------------------------------------

U15/33

Code Price	3/8" Stainless Steel AESU1533Z \$38.75	EagleLite AESU15-33X \$38.75
---------------	--	------------------------------------

J3/4

Code Price	3/8" Stainless Steel AESJ34Z \$38.75	EagleLite AESJ3-4X \$38.75
---------------	--	----------------------------------



J14/15

Code Price	3/8" Stainless Steel AESJ1415Z \$38.75	EagleLite AESJ14-15X \$38.75
---------------	--	------------------------------------

J3/U5

Code Price	3/8" Stainless Steel AESJ3U5Z \$38.75	EagleLite AESJ3-U5X \$38.75
---------------	---	-----------------------------------

MCCALLS - DOUBLE END

13/14S

Code Price	3/8" Stainless Steel AECM1314SZ \$38.75	EagleLite AECM13-14SX \$38.75
---------------	---	-------------------------------------

13/14

Code Price	3/8" Stainless Steel AECM1314Z \$38.75	EagleLite AECM13-14X \$38.75
---------------	--	------------------------------------



AMERICAN EAGLE INSTRUMENTS® INC

better DENTISTRY by DESIGN™

MCCALLS - DOUBLE END



17/18S

Code
Price

3/8" Stainless Steel
AECM1718SZ
\$38.75

EagleLite
AECM17-18SX
\$38.75



17/18

Code
Price

3/8" Stainless Steel
AECM1718Z
\$38.75

EagleLite
AECM17-18X
\$38.75



H5/33

Code
Price

3/8" Stainless Steel
AESH533Z
\$38.75

EagleLite
AESH5-33X
\$38.75



204S

Code
Price

3/8" Stainless Steel
AES204SZ
\$38.75

EagleLite
AES204SX
\$38.75



204SD

Code
Price

3/8" Stainless Steel
AES204SDZ
\$38.75

EagleLite
AES204SDX
\$38.75

SCALERS



NEB 128 - Single End

Code
Price

1/4" Stainless Steel
X
X

EagleLite
AESN128X
\$27.75



H6/7

Code
Price

3/8" Stainless Steel
AESH6-7Z
\$38.75

EagleLite
AESH6-7X
\$38.75



Bates 7/8

Code
Price

3/8" Stainless Steel
AESB78Z
\$38.75

EagleLite
AESB7-8X
\$38.75



107/108

Code
Price

3/8" Stainless Steel
AES107108Z
\$38.75

EagleLite
AES107-108X
\$38.75



Cut through the fat

**GO DIRECTLY
TO THE BEST**

SUPPLIES UP TO
25% OFF
WHILE SUPPLIES LAST

www.dhpionline.com/clearance

EVEREDGE® SCALER HANDLES

#9 EverEdge 2.0 \$46.25



#9 EverEdge \$41.75



#C8 Resin 8 Colors \$46.25
for EverEdge & EverEdge 2.0



IMMUNITY STEEL® SCALER HANDLES

DOUBLE END

#8 ResinEight \$38.45



#7 Satin Steel Colours \$40.45



#6 Satin Steel \$38.45



#4 Round \$38.45



#2 Octagonal \$38.45



SINGLE END

#8 ResinEight \$38.45



#7 Satin Steel Colours \$40.45



#6 Satin Steel \$38.45



#24 Round \$29.75



#1 Octagonal \$29.75



SICKLE SCALERS



H6/H7 Hygienist

| SH6/79E2

Handle options: #2, #4, #6, #7, #8, #C8, #9

Super-thin, contra-angle design is for interproximal areas. Shank angulation provides accessibility to all anterior and premolar surfaces.



U15/30 Towner-Jacquette

| SU15/309E2

Handle options: #2, #4, #6, #7, #8, #C8, #9



H5/33 Hygienist-Jacquette

| SH5/339E2

Handle options: #2, #4, #6, #7, #8, #C8, #9

Super-thin sickle scaler combined with a straight sickle blade. For scaling interproximal and cervical areas of anterior teeth.



U15/33 Towner-Jacquette

| SU15/339E2

Handle options: #2, #4, #6, #7, #8, #C8, #9



How the best perform

Manufacturer part numbers are provided here, please visit www.dhponline.com to convert or contact your DHPI Account Manager.

SICKLE SCALERS

204
| **S2046**

Handle options:
#2, #4, #6



204IUFW
| **SIUFW2049E2**

Handle options:
#2, #4, #6, #7, #8,
#C8, #9



204S
| **S204S9E2**

Handle options:
#2, #4, #6, #7, #8,
#C8, #9

For posterior
supra-gingival
interproximal
scaling



204SD
| **S204SD9E2**

Handle options:
#2, #4, #6, #7, #8,
#C8, #9

Contra angle
design offers
greater access
to distal surfaces



135
| **SN1359E2**

Handle options: #4,
#6, #7, #8, #C8, #9



137
| **SN1379E2**

Handle options: #4, #6, #7,
#8, #C8, #9

Small anterior sickle
paired with an anterior
universal curette

Manufacturer part numbers are provided here, please visit www.dhponline.com to convert or contact your DHPI Account Manager.

NEVI® SCALERS



How the best perform



JACQUETTE SCALERS



THE CURVED SICKLE SCALER
Two cutting edges on a curved blade that end in a sharp point



THE STRAIGHT SICKLE SCALER
Two cutting edges on a straight blade that end in a sharp point (also known as a Jacquette Scaler)



Nevi 1 Anterior

| SCNEVI19E2

Handle options: #6, #7, #8, #C8, #9

An elongated disk end for anterior lingual stain and calculus removal paired with a super thin, anterior curved sickle.

Nevi 2 Posterior

| SCNEVI29E2

Handle options: #6, #7, #8, #C8, #9

A super thin posterior curved sickle scaler, the unique contra-angle design is great for interproximal reach and ergonomic hand positioning.

Nevi 3 Posterior

| SCNEVI39E2

Handle options: #C8, #9

Ultra slender, dual cutting blades provide effective placement in tight, narrow contacts and interproximal areas and precise access for effective removal of light to moderate deposits.

Nevi 4 Posterior

| SCNEVI49E2

Handle options: #C8, #9
Tapered dual cutting blades provide precise access for effective deposit removal and increased shank rigidity provides for effective removal of burnished, heavy and tenacious deposits.

30/33 Jacquette

| SJ30/339E2

Handle options: #2, #4, #6, #7, #8, #C8, #9

Combination standard and miniature anterior Jacquette

31/32 Jacquette

| SJ31/329E2

Handle options: #2, #4, #6, #7, #8, #C8, #9

Posterior standard Jacquette

34/35 Jacquette

| SJ34/359E2

Handle options: #2, #4, #6, #7, #8, #C8, #9
Posterior miniature Jacquette

LANGER CURETTES



1/2 Langer
(shown)

| **SL1/29E2**

Handle options:
#4, #6, #7, #8, #C8, #9

1/2 Langer
Rigid

| **SL1/2R6**

Handle options:
#4, #6, #7, #8

1/2 Langer
After Five

| **SL1/2AF9E2**

Handle options:
#4, #6, #9

1/2 Langer
Mini Five

| **SL1/2MF6**

Handle options:
#4, #6, #9

Langer 1/2 for
mandibular posterior



3/4 Langer
(shown)

| **SL3/49E2**

Handle options:
#4, #6, #7, #8, #C8, #9

3/4 Langer
Rigid

| **SL3/4R6**

Handle options:
#4, #6, #7, #8

3/4 Langer
After Five

| **SL3/4AF9E2**

Handle options:
#4, #6, #9

3/4 Langer
Mini Five

| **SL3/4MF9E2**

Handle options:
#4, #6, #9

Langer 3/4 for maxillary
posterior



5/6 Langer
(shown)

| **SL5/69E2**

Handle options:
#4, #6, #7, #8, #C8, #9

5/6 Langer
Rigid

| **SL5/6R6**

Handle options:
#4, #6

5/6 Langer
After Five

| **SL5/6AF6**

Handle options:
#4, #6

5/6 Langer
Mini Five

| **SL5/6MFPE2**

Handle options:
#4, #6, #9

Langer 5/6 for
maxillary and
mandibular anterior



17/18 Langer
(shown)

| **SL17/189E2**

Handle options:
#4, #6, #7, #8, #C8, #9

17/18R Langer
Rigid

| **SL17/18R6**

Handle options:
#4, #6

Langer 17/18 for maxillary and
mandibular posterior

LANGER APPLICATION CHART

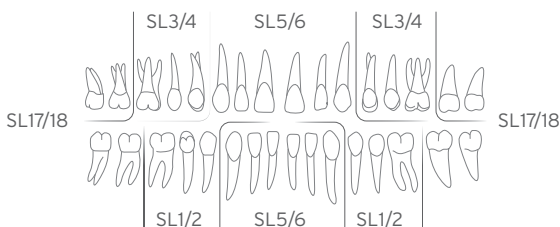

Standard
Langer
Curette

After Five®
Curette

Mini Five®
Curette

- After Five and Mini Five terminal shanks are elongated by 3 mm for access into deep periodontal pockets and root surfaces of 5 mm or more.
- Blade is 10% thinner than standard Langer to ease gingival insertion and reduce tissue distention.
- Mini Five has a reduced blade, half the length of the After Five or standard Langer, for better adaptation in narrow pockets and furcations.

Manufacturer part numbers are provided here, please visit www.dhponline.com to convert or contact your DHPI Account Manager.

COLUMBIA



2R/2L Columbia

| **SC2R/2L9E2**

Handle options: #8, #C8, #9

Anterior application



4R/4L Columbia

| **SC4R/4L9E2**

Handle options: #2, #4, #6,
#7, #8, #C8, #9

Posterior application



13/14 Columbia
(shown)

| **SC13/149E2**

Handle options: #2, #4,
#6, #7, #8, #C8, #9

Universal application

13/14 Columbia Rigid

| **SC13/14E2**

Handle options: #2, #4, #6, #7, #8

Universal application

13/14 Columbia Curved Tip

| **SC13/14C**

Handle options: #2, #4

Universal application



IU13/14 Indiana University

| **SIU13/146**

Handle options: #2, #4, #6

Anterior



IU17/18 Indiana University

| **SIU17/186**

Handle options: #2, #4, #6, #7, #8

Posterior



1/2 Bunting

| **SBN1/2**

Handle options: #2, #4, #6

Curette-Chisel combination



5/6 Bunting

| **SBN5/6**

Handle: #2



YG7/8 Younger-Good

| **SYG7/89E2**

Handle options: #2, #4, #6, #7, #8, #C8, #9

BARNHART



1/2 USC Barnhart

| **SBH1/2USC9E2**

Handle: #9



1/2 Barnhart
(shown)

| **SBH1/29E2**

Handle options: #2, #4,
#6, #7, #8, #C8, #9

1/2 Barnhart Rigid

| **SBH1/2R9E2**

Handle options: #2, #4,
#6, #7, #8, #C8, #9



5/6 USC Barnhart

| **SBH5/6USC9E2**

Handle: #9



5/6 Barnhart
(shown)

| **SBH5/69E2**

Handle options: #2, #4,
#6, #7, #8, #C8, #9

5/6 Barnhart Rigid

| **SBH5/6R9E2**

Handle options: #2, #4,
#6, #7, #8, #C8, #9

UNIVERSAL CURETTES



How the best perform



Blade angulation of a Universal Curette

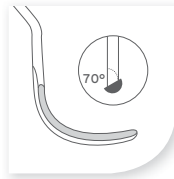

Blade angulation of a Gracey Curette

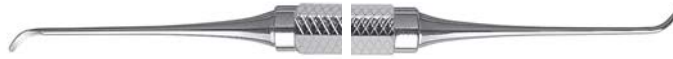

HU1/2 Hutchinson
| SHU1/2
Handle: #2



UC3/4 Ratcliff
| SUCR3/49E2 Handle options: #6, #8, #9



10/11 Loma Linda Rigid
| SLL10/11R6
Handle options: #6, #8



1/2 Mallery
| SMAL1/2 Handle options: #2, #4

10/11 Loma Linda Slim
| SLL10/11S6
Handle options: #6, #8



ME-1 [10-11]
| SME1 Handle: #2

STANDARD GRACEY CURETTES

- Area-specific allows for deep scaling, root planing and periodontal debridement.
- Offset blade provides a perfect working angulation for the tooth surface.
- Offset blade angulation means only the lower cutting edge of each blade is used.



1/2 Rigid
| SG1/2R9E2
Handle options: #2, #4, #6, #7, #8, #C8, #9

Slight contra-angle for anterior incisors and canines



3/4 Rigid
| SG3/4R9E2
Handle options: #2, #4, #6, #7, #8, #C8, #9

Short contra-angle for anterior incisors and canines



5/6 Extra Rigid
| SG5/6ER6
Handle options: #2, #4, #6, #7, #8

Medium contra-angle for anteriors and premolars



7/8 Extra Rigid
| SG7/8ER6
Handle options: #4, #6, #7, #8

Medium contra-angle for premolars and molars, facial and lingual surfaces

Manufacturer part numbers are provided here, please visit www.dhponline.com to convert or contact your DHPI Account Manager.

STANDARD GRACEY CURETTES



How the best perform



GRACEY 1/2



GRACEY 7/8



GRACEY 11/12



GRACEY 13/14



GRACEY 15/16



GRACEY 17/18



9/10 (shown)

| **SG9/109E2**

Handle options: #2, #4, #6, #7, #8, #C8, #9

9/10 Rigid

| **SG9/10R9E2**

Handle options: #2, #4, #6, #7, #8

Long contra-angle for molar buccal and lingual surfaces and a more pronounced angle than 7/8 for less accessible root surfaces.



11/12 (shown)

| **SG11/129E2**

Handle options: #2, #4, #6, #7, #8, #C8, #9

11/12 Rigid

| **SG11/12R9E2**

Handle options: #2, #4, #6, #7, #8, #C8, #9

11/12 Extra Rigid

| **SG11/12ER8**

Handle options: #4, #6, #7, #8

Angulated to reach mesial surfaces of posterior teeth



13/14 (shown)

| **SG13/149E2**

Handle options: #2, #4, #6, #7, #8, #C8, #9

13/14 Rigid

| **SG13/14R9E2**

Handle options: #2, #4, #6, #7, #8, #C8, #9

13/14 Extra Rigid

| **SG13/14ER8**

Handle options: #4, #6, #7, #8

Angulated to reach distal surfaces of posterior teeth



15/16 (shown)

| **SG15/169E2**

Handle options: #2, #4, #6, #7, #8, #C8, #9

15/16 Rigid

| **SG15/16R9E2**

Handle options: #2, #4, #6, #7, #8, #C8, #9

Same shank bends as 13/14, but blade positioned to reach mesial posterior surfaces



17/18

| **SG17/189E2**

Handle options: #2, #4, #6, #7, #8, #C8, #9

17/18 Rigid

| **SG17/18R9E2**

Handle options: #2, #4, #6, #7, #8, #C8, #9

Accentuated angles improve access to distal posterior surfaces. The 17/18 also has smaller blade and slightly longer terminal shank.



1/2

| **SG1/29APE2**

Handle options: #9

Modified Gracey 1/2 with a rigid shank and a face angle offset at 60 degrees featuring a thinner, shorter blade for easier subgingival access.



7/8

| **SG7/89APE2**

Handle options: #9

Modified Gracey 7/8 with a rigid shank and a face angle offset at 60 degrees featuring a thinner, shorter blade for easier subgingival access.



11/12

| **SG11/129APE2**

Handle options: #9

Modified Gracey 11/12 with a rigid shank and a face angle offset at 60 degrees featuring a thinner, shorter blade for easier subgingival access.



13/14

| **SG13/149APE2**

Handle options: #9

Modified Gracey 13/14 with a rigid shank and a face angle offset at 60 degrees featuring a thinner, shorter blade for easier subgingival access.

Manufacturer part numbers are provided here, please visit www.dhponline.com to convert or contact your DHPI Account Manager.

AFTER FIVE

Designed to adapt to a specific area or tooth surface.

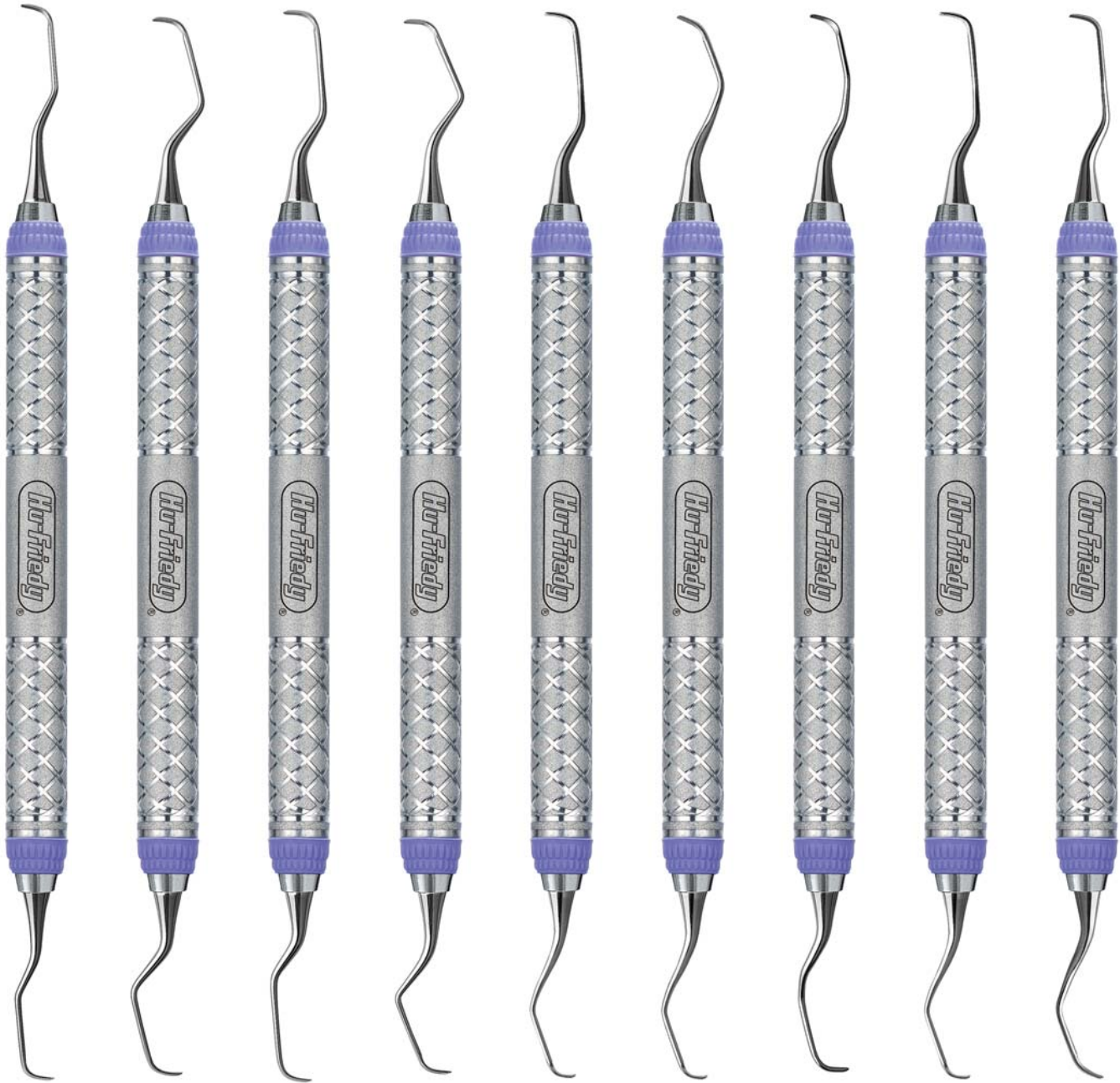

1/2	3/4	5/6	7/8	11/12	13/14	15/16	11/14 Mesial/ Distal	12/13 Mesial/ Distal
SRPG1/29E2	SRPG3/49E2	SRPG5/69E2	SRPG7/89E2	SRPG11/129E2	SRPG13/149E2	SRPG15/169E2	SRPG11/149E2	SRPG12/139E2

Handle options: #2, #4, #6, #7, #8, #C8, #9 on all After Five patterns

Rigid	Rigid	Rigid	Rigid	Rigid	Rigid	Rigid	Rigid	Rigid
SRP1/2R9E2	SRP3/4R9E2	SRP5/6R9E2	SRP7/8R9E2	SRP11/12R9E2	SRP13/14R9E2	SRP15/16R9	SRP11/14R4	SRP12/13R4E2
Handle options: #2, #4, #6, #7, #8, #C8, #9 on all After Five Rigid patterns except where noted							Handle: #4	Handle: #4

Extra Rigid	Extra Rigid	Extra Rigid	Extra Rigid
SRP5/6E6	SRP7/8E6	SRP11/12E6	SRP13/14E6
Handle options: #6, #7, #8 on all After Five Extra Rigid patterns			

Manufacturer part numbers are provided here, please visit www.dhponline.com to convert or contact your DHPI Account Manager.

MINI FIVE

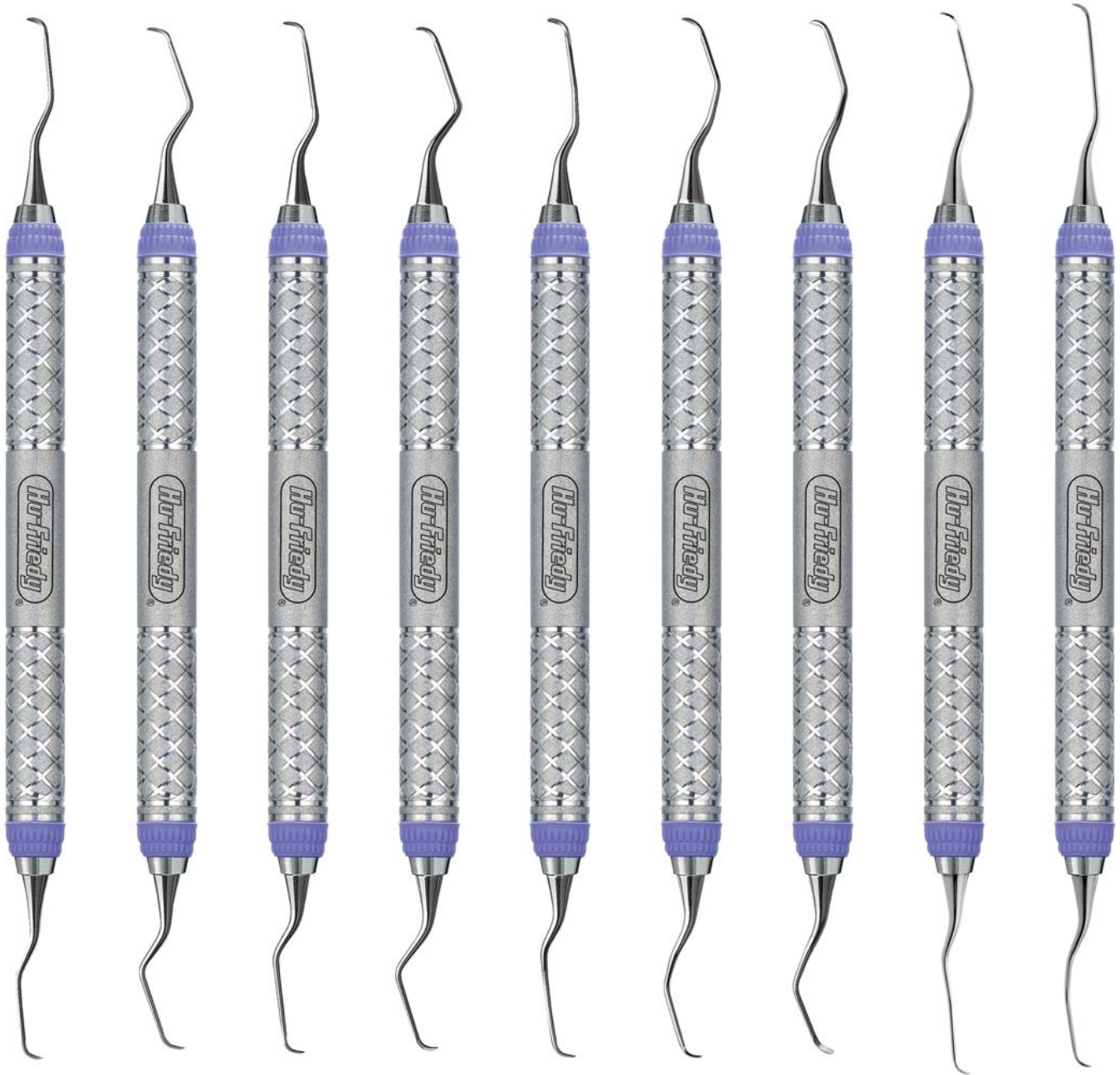

1/2	3/4	5/6	7/8	11/12	13/14	15/16	11/14 Mesial/Distal	12/13 Mesial/Distal
SAS1/29E2	SAS3/49E2	SAS5/69E2	SAS7/89E2	SAS11/129E2	SAS13/149E2	SAS15/169E2	SAS11/149E2	SAS12/139E2

Handle options: #2, #4, #6, #7, #8, #9 on all Mini Five patterns. #C8 on all Mini Five Patterns except 11/14 and 12/13 Mesial/Distal Gracey Curettes

Rigid	Rigid	Rigid	Rigid	Rigid	Rigid	Rigid
SAS1/2R9E2	SAS3/4R9E2	SAS5/6R9E2	SAS7/8R9E2	SAS11/12R9E2	SAS13/14R9E2	SAS15/16R9E2

Handle options: #2, #4, #6, #7, #8, #C8, #9 on all Mini Five Rigid patterns

MICRO MINI

- Longer terminal shank designed to access deep periodontal pockets
- Compared to the standard Gracey curette, blade is 50% shorter for better adaptation in narrow pockets and furcations
- Blade is 20% thinner than a Mini Five Gracey to help reduce tissue distension and ease gingival insertion



How the best perform



Micro Mini Five 1/2

| SMS1/29E2

Handle: #9



Micro Mini Five 7/8

| SMS7/89E2

Handle: #9



Micro Mini Five 11/12

| SMS11/129E2

Handle: #9



Micro Mini Five 13/14

| SMS13/149E2

Handle: #9

Manufacturer part numbers are provided here, please visit www.dhponline.com to convert or contact your DHPI Account Manager.



Octagonal Double End Handle

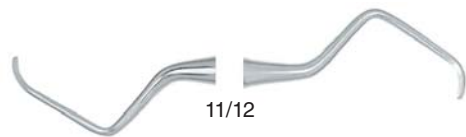

700-11694

11/12

.....\$15.25

GRACEY - DOUBLE END

COLUMBIA - DOUBLE END



1/2

700-11612

.....\$15.25



5/6

700-11656

.....\$15.25



7/8

700-11678

.....\$15.25



2R/2L

700-11740

.....\$15.25



4R/4L

700-11741

.....\$15.25





13/14





700-11742

.....\$15.25



JACQUETTE - DOUBLE END

	1S/1S	\$15.25
700-11600		
	2S/3S	\$15.25
700-11603		
	2/3	\$15.25
700-11605		



SCALERS - DOUBLE END



	S/533	\$15.25
700-11533		
	H6/H7	\$15.25
700-11067		
	15/33	\$15.25
700-11714		
	204S	\$15.25
700-11204		

COLUMBIA SCALERS

	4R/4L	\$25.45
700-95741		
	13/14	\$25.45
700-95742		

MCCALL CURETTES

	13/14	\$25.45
700-95750		
	13S/14S	\$25.45
700-95750		

	17/18	\$25.45
700-95752		
	17S/18S	\$25.45
700-95753		



PDT SAVER KITS



PDT 3 Saver Kit-1
 Contains: 1 of each: Columbia Barnhart 5-6 universal scaler, HL/5 mini anterior scaler/curette & Montana Jack posterior scaler.
 700-R903 Kit..... **\$92.25**



PDT 3 Saver Kit-2
 Contains: 1 of each: Columbia 13-14 universal scaler, HL/5 mini anterior scaler/curette & Montana Jack posterior scaler.
 700-R904 Kit..... **\$92.25**



PDT 3 Saver Kit-3
 Contains: 1 of each: Columbia 4L-4R universal scaler, HL/5 mini anterior scaler/curette & Montana Jack Posterior Scaler.
 700-R905 Kit..... **\$92.25**

LOOK'in

for something? **WE HAVE IT!**

www.dhpionline.com



Queen of Hearts R144 \$41.75

UNIVERSAL CURETTES \$35.75



Barnhart 1-2 R060



Younger-Good 7-8 R077



Barnhart 5-6 R061



Langer 1-2 R079



Columbia 13-14 R064



Langer 3-4 R080



Columbia 4L-4R R067



Langer 5-6 R081



McCalls 13-14 R069



Langer 17-18 R087



McCalls 17-18 R071



Mini Me™ R089



Rules 3-4 R076



23A R099

ANTERIOR SCALERS \$35.75



H5-L5 R090



H6-7 R110



NEB 128-L5 R091



H5-33 R111



H5-L5 Mini R092



U15-33 R113



N128-L5 Mini R093



NEB 128 R114



N1 R096



Jack B. Nimble® Slim R130S



Jack B. Nimble® R130

Manufacturer part numbers are provided here, please visit www.dhponline.com to convert or contact your DHPI Account Manager.



POSTERIOR SCALERS \$35.75

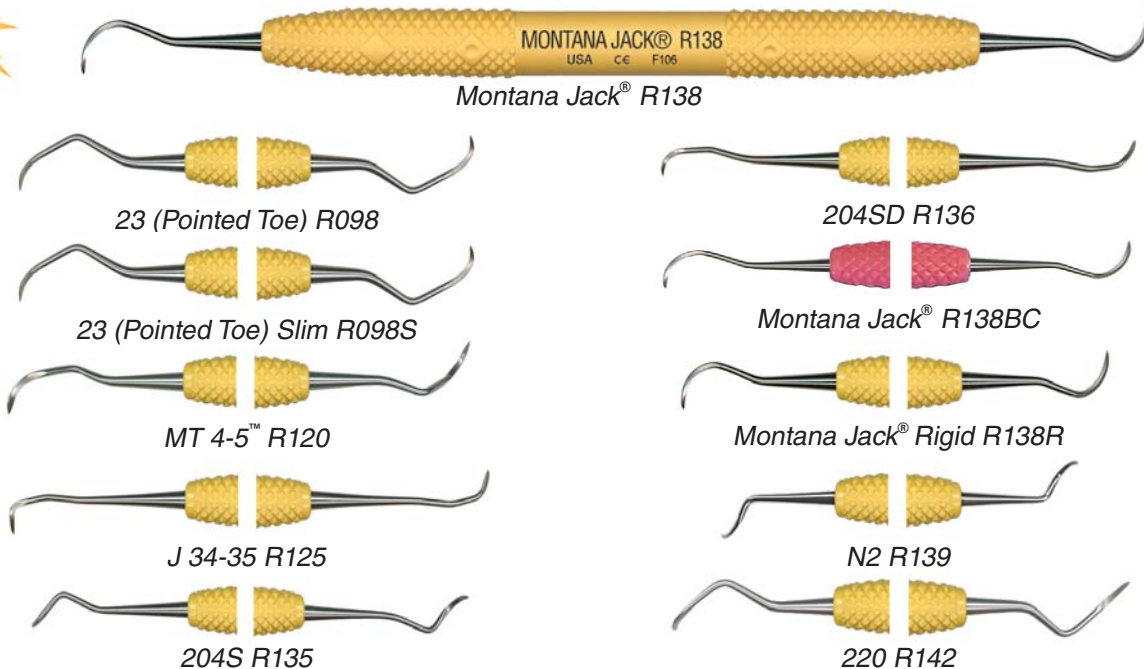

AMAZING GRACEYS™ \$35.75

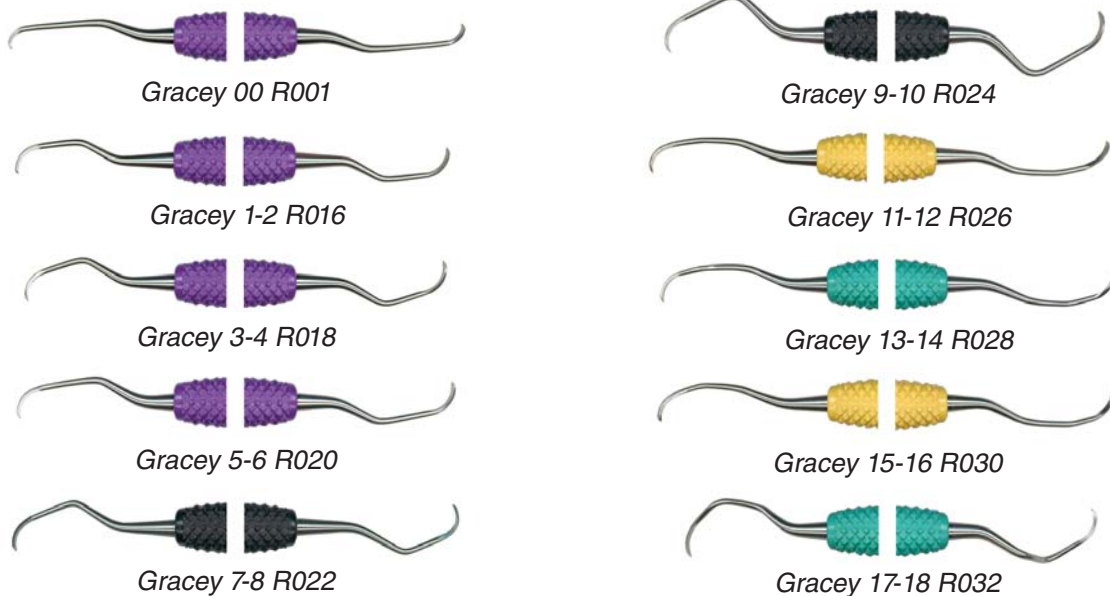

Manufacturer part numbers are provided here, please visit www.dhpionline.com to convert or contact your DHPI Account Manager.

EXTENDED REACH MINI GRACEYS

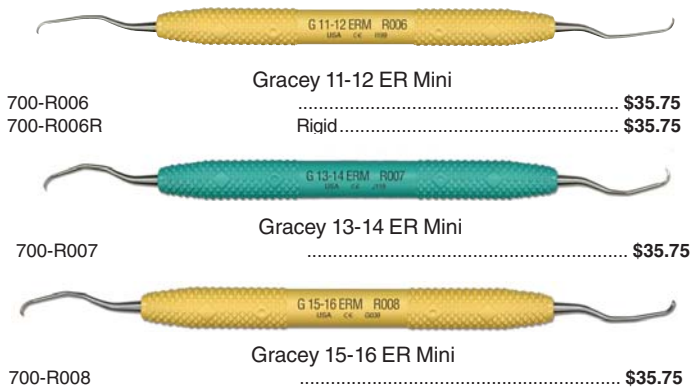

O'HEHIR CURETTES



POSTERIOR GRACEYS

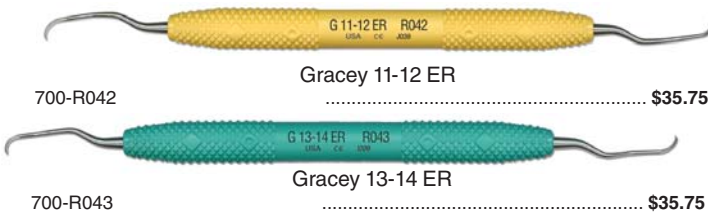

QUADRANT SPECIFIC GRACEY

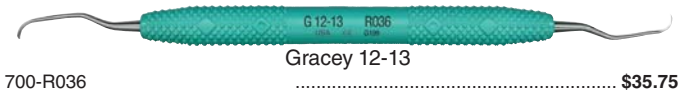



Big Easy 1/2" diam. Handle (BEUL)

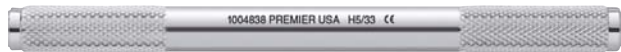

Big Easy 7/16" diam. Handle (BE)

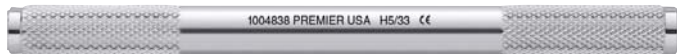

Light Touch Round 5/16" diam. Handle (LT)

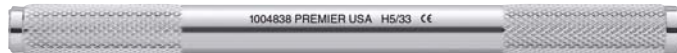

Light Touch Octagon 1/4" diam. Handle (LTO)

204 SERIES - DOUBLE END



204 S

	BEUL	BE	LT	LTO
Code	707-05623	707-1005045	707-1004837	707-1004587
Price	\$35.25	\$37.95	\$33.25	\$33.25



H-204 S

	BEUL	BE	LT	LTO
Code	707-05625	707-1005050	707-1004846	707-1004596
Price	\$35.25	\$37.95	\$33.25	\$33.25



H-204 SD

	BEUL	BE	LT	LTO
Code	707-05627	707-1005055	707-1004847	707-1004597
Price	\$35.25	\$37.95	\$33.25	\$33.25

BARNHART - DOUBLE END



5/6

	BEUL	BE	LT	LTO
Code	707-05643	707-1005110	707-1004829	X
Price	\$35.25	\$37.95	\$33.25	X

COLUMBIA - DOUBLE END



2L/2R

	BEUL	BE	LT	LTO
Code	X	707-1005028	707-1004800	X
Price	X	\$37.95	\$33.25	X

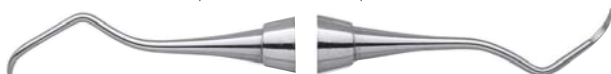

4L/4R

	BEUL	BE	LT	LTO
Code	707-05615	707-1005030	707-1004801	X
Price	\$35.25	\$37.95	\$33.25	X



13/14

	BEUL	BE	LT	LTO
Code	707-05617	707-1005035	707-1004802	707-1004552
Price	\$35.25	\$37.95	\$33.25	\$33.25

GRACEY - DOUBLE END



1/2

	BEUL	BE	LT	LTO
Code	707-05601	707-1005001	707-1004810	707-1004560
Price	\$35.25	\$37.95	\$33.25	\$33.25



3/4

	BEUL	BE	LT	LTO
Code	707-05603	707-1005005	707-1004811	707-1004561
Price	\$35.25	\$37.95	\$33.25	\$33.25



5/6

	BEUL	BE	LT	LTO
Code	707-05605	707-1005010	707-1004812	707-1004562
Price	\$35.25	\$37.95	\$33.25	\$33.25



7/8

	BEUL	BE	LT	LTO
Code	707-05607	707-1005015	707-1004813	707-1004563
Price	\$35.25	\$37.95	\$33.25	\$33.25



9/10

	BEUL	BE	LT	LTO
Code	707-05609	707-1005018	707-1004814	X
Price	\$35.25	\$35.25	\$33.25	X



11/12

	BEUL	BE	LT	LTO
Code	707-05611	707-1005020	707-1004815	707-1004565
Price	\$35.25	\$37.95	\$33.25	\$33.25



13/14

	BEUL	BE	LT	LTO
Code	707-05613	707-1005025	707-1004816	707-1004566
Price	\$35.25	\$37.95	\$33.25	\$33.25

JACQUETTE - DOUBLE END



34/35

	BEUL	BE	LT	LTO
Code	X	707-1005100	707-1004830	707-1004586
Price	X	\$37.95	\$33.25	\$33.25

Continued



MCCALL - DOUBLE END



13/14

	BEUL	BE	LT	LTO
Code	707-05635	707-1005075	707-1004823	X
Price	\$35.25	\$37.95	\$33.25	X



13S/14S

	BEUL	BE	LT	LTO
Code	707-05639	707-1005085	707-1004821	X
Price	\$35.25	\$37.95	\$33.25	X



17/18

	BEUL	BE	LT	LTO
Code	707-05637	707-1005080	707-1004824	X
Price	\$35.25	\$37.95	\$33.25	X



17S/18S

	BEUL	BE	LT	LTO
Code	707-05641	707-1005090	707-1004822	707-1004572
Price	\$35.25	\$37.95	\$33.25	\$33.25

SICKLE SCALERS - DOUBLE END



H6/H7

	BEUL	BE	LT	LTO
Code	707-05621	707-1005040	707-1004839	707-1004589
Price	\$35.25	\$37.95	\$33.25	\$33.25



H5/33

	BEUL	BE	LT	LTO
Code	707-05629	707-1005060	707-1004838	707-1004588
Price	\$35.25	\$37.95	\$33.25	\$33.25



U15/30

	BEUL	BE	LT	LTO
Code	707-05631	707-1005065	707-1004842	707-1004592
Price	\$35.25	\$37.95	\$33.25	\$33.25



U15/33

	BEUL	BE	LT	LTO
Code	707-05633	707-1005070	707-1004843	707-1004593
Price	\$35.25	\$37.95	\$33.25	\$33.25



Morse 0/00

Big Easy Ultralite	700-05695	\$35.25
Big Easy	700-1005855	\$37.95
Light Touch	700-1004855	\$33.25



NV1

Big Easy Ultralite	707-05690	\$35.25
Big Easy	700-1005850	\$37.95
Light Touch	700-1004850	\$33.25



NV2

Big Easy Ultralite	707-05691	\$35.25
Big Easy	700-1005851	\$37.95
Light Touch	700-1004851	\$33.25



NV4

Big Easy Ultralite	707-05684	\$35.25
Big Easy	700-1005854	\$37.95
Light Touch	700-1004854	\$33.25



135

Big Easy Ultralite	700-05694	\$35.25
Big Easy	700-1005853	\$37.95
Light Touch	700-1004853	\$33.25



137

Big Easy Ultralite	707-05692	\$35.25
Big Easy	700-1005852	\$37.95
Light Touch	700-1004852	\$33.25



Nebraska 128

Big Easy Ultralite	707-05680	\$35.25
Big Easy	707-1005125	\$37.95
Light Touch	707-1004876	\$33.25



Athena

Titanium Implant Scalers \$48.75

- Color-coded handles
- Tips made from 6AL-4V titanium alloy
- Fully autoclavable
- Guaranteed sharpness
- Made in America

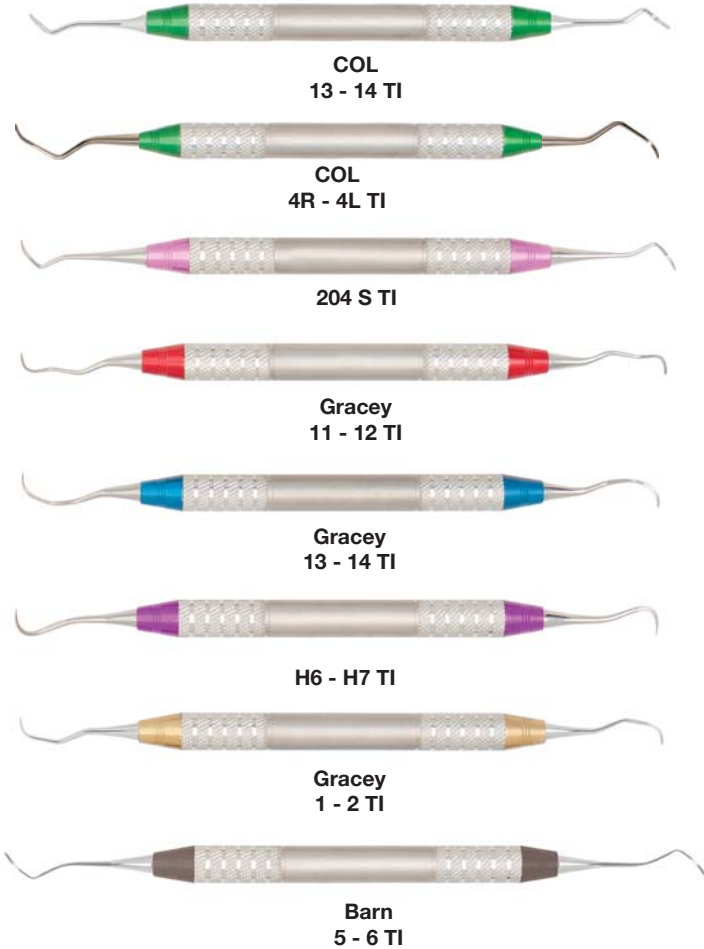

COL
13 - 14 TI

COL
4R - 4L TI

204 S TI

Gracey
11 - 12 TI

Gracey
13 - 14 TI

H6 - H7 TI

Gracey
1 - 2 TI

Barn
5 - 6 TI

Titanium Implant Explorers and Probes

- Used to find soft spots and holes around implant and abutment.
- D-Lite blue color coded handle.



Expl 5 TI \$29.75

- Single Ended, 15mm
- Used to measure pocket depths around implant & abutment.
- D-Lite blue color coded handle.



Expl 23 TI \$24.75



UNC 15 TI \$34.45

Manufacturer part numbers are provided here, please visit

www.dhpionline.com to convert or contact your DHPI Account Manager.

IMPLANT SURGERY



Adjustable Torque Wrench

Minimizes risk of implant screw working loose. Improves precision during bridge fabrication. No lubrication needed. Ratchet mechanism. 9 torque settings. Wrench head accepts the standard 4mm square connection. Autoclavable.

700-TWA Each **\$509.95**



Bone Funnels

Comfort grip thumb ring. Graft material loads at both ends to prevent clogging. 100% Stainless Steel. Made in America.

Curved

3.5mm/1.5cc 700-BFC35
 4.5mm/2.0cc 700-BFC45
 6.0mm/2.6cc 700-BFC60
 Each **\$96.95**

Straight

3.5mm/1.5cc 700-BFS35
 4.5mm/2.0cc 700-BFS45
 6.0mm/2.6cc 700-BFS60
 Each **\$96.95**



Implantation/Explantation Trephines

Trephine Drills create a defined space in the bone enabling precision implant placement. Fast removal of "bone core." Reduces number of drills used for implant site preparation. Depth markings at 9.0mm, 11.0mm and have an overall length of 14mm.

Implantation Trephine Kit

Contains: 5 implantation trephines and a sterilization block for storage.
 700-K363 Kit **\$449.95**

Explantation Trephine Kit

Contains: 5 explantation trephines and a sterilization block for storage.
 700-K369 Kit **\$449.95**



Osseous Collector

Sterile disposable bone collector. Harvest valuable autogenous bone. Correct small defects around implant sites and periodontal compromised teeth. Shut off valve cuts off suction eliminating the chance of drying out bone. Single patient use, includes 2 filters.

700-BC100 10/pack **\$149.95**



Osseous Glider

Sterile, disposable bone scraper. Always has a fresh blade. 360° blade is marked in 4 sections. Expose new cutting surface with the twist of any .050 hex driver.

Straight

Recommended for ramus, symphysis and tuberosity areas of the mouth.
700-BG200 Each **\$43.75**

Angled

Recommended for the external oblique ridge. Hold at a 35° angle on the ridge.
700-BG205 Each **\$43.95**



Osteotomes

100% stainless steel. Made in America. Lifetime guarantee.

Osteotome Kit - Concave

Contains: 6 straight and 6 angled osteotomes with concave tips, 1 mallet and a custom sterilization tray T-20.
700-K310 Kit **\$1192.95**

Osteotome Kit - Convex

Contains: 6 straight and 6 angled osteotomes with convex tips, 1 mallet and a custom sterilization tray T-20.
700-K320 Ki **\$1192.95**

Available individually upon request.



Universal Drivers

Long and short-handled drivers work with all major implant systems. Color-coded for easy identification. Fully autoclavable.

Short

Designed for anterior mandible cases. 1.75" long.

- Straight Screwdriver..... 700-ID535
- SCS Screwdriver..... 700-ID536
- Unigrip Driver..... 700-ID534
- Hex 1.3/0.50"..... 700-ID524
- Hex 1.2mm/.048"..... 700-ID537
- Hex 0.9/0.35"..... 700-ID529
- Square 1.3/.050"..... 700-ID525
- Each **\$57.25**

Short Handled Kit available upon request.

Long

Provide outstanding access between teeth and are specifically designed for maxillary cases. 4.25" long.
Straight Screwdriver..... 700-ID530

- SCS Screwdriver..... 700-ID533
- Unigrip Driver..... 700-ID527
- Hex 1.3/0.50"..... 700-ID531
- Hex 1.2mm/.048"..... 700-ID532
- Hex 0.9/0.35..... 700-ID528
- Square 1.3/.050"..... 700-ID526
- Each **\$57.25**

Long Handled Kit available upon request.



Right Angle Driver

Ability to rotate the head to the exact angle you need, maximizing access and comfort. Pre-set torque adapters allow you to achieve a specific torque value.

- 280-RAD Each **\$393.45**

Torque Adaptor

Easily connects. 7 torque values. Autoclavable.

- 280-ATA Each **\$459.95**



Right Angle Driver Bits

Compatible with all implant systems. Ideal for posterior abutments and cover screws in the mandible and maxilla. Each bit is laser etched for quick identification.

- 700-BITSKIT 7/set **\$262.45**



Sinus Lift Instruments

Tips are extremely smooth to ensure the sinus wall isn't punctured when separating the sinus lining from the wall. Light-weight, color-coded handles with stainless steel tips.

Sinus Lift Complete Kit

Contains: Sinus 0, Sinus 1, Sinus 2, Sinus 3, Sinus 4, Sinus 5, Sinus 7S and the stainless steel sterilization cassette.
700-K7000 Kit **\$727.45**

RCSLK Sinus Lift Kit

Developed by Dr. Ronald Cardoso, includes 5 instruments arranged in a surgical tray. Each instrument is numbered and each side of the instrument is labeled A or B.
700-KRCSLK Kit **\$437.25**

Each sinus lift instrument available individually upon request.



BONE CHISELS

Used for splitting teeth.



7 Chandler
| CC7
4.7 mm
\$55.25



9 Chandler
| CC9
7.1 mm
\$55.25



18 McFarland
| CM18
4.2 mm
\$55.25



1W Wakefield
| CW1
2.7 mm
\$55.25



2W Wakefield
| CW2
3 mm
\$72.95



3 Kramer-Nevins
| CKN3
7.5 mm
Sharp, mono-beveled, long chisels are designed to widen the split bone.
\$72.95



55 Kramer-Nevins
| CKN55
5.5 mm
\$72.95



75 Kramer-Nevins
| CKN75
7.5 mm
\$72.95

Hu-Friedy
How the best perform

IMPLANT INSTRUMENTS



SINUS LIFTERS

BLACK LINE SERIES



2/4 Molt Curette, Double-Ended
| CM2/4X \$99.95



86 Lucas Surgical Curette, Double-Ended
| CL86X \$77.95



87 Lucas Surgical Curette, Double-Ended
| CL87X \$77.95



Kramer-Nevins, Obtuse
| IMP6578SX \$105.95



Kramer-Nevins, Acute
| IMP6577SCX \$105.95



Sinus Curette 1
| SINC1X \$102.95
Handle: Black Line
| SINC1SX \$102.95
Handle: Short



Sinus Curette 2
| SINC2X \$102.95
Handle: Black Line
| SINC2SX \$102.95
Handle: Short

Manufacturer part numbers are provided here, please visit www.dhponline.com to convert or contact your DHPI Account Manager.

Order by 800-626-2163

www.dhponline.com

Fax: 888-681-5088



OSTEOTOMES



How the best perform



Bone Spreading Osteotome Kit
| BONEKIT
\$999.95



Interchangeable Osteotome Handle
| OSTMGRIF
\$94.25

Osteotomes - Tapered Convex Tip, Straight

Developed for the lateral bone condensation of the closed sinus elevation technique. The tip design allows for the insertion of rotationally symmetrical implants (3.3 - 6.5 mm) in soft bone structures. The rounded tip minimizes the risk of perforation when lifting the Schneiderian membrane.

\$33.95

2.7 mm 3.2 mm 3.7 mm 4.2 mm 5.0 mm



2.7 mm | OSTMSP27

3.2 mm | OSTMSP32

3.7 mm | OSTMSP37

4.2 mm | OSTMSP42

5.0 mm | OSTMSP50

Osteotomes - Tapered Convex Tip, Angulated

Specially designed for closed sinus elevation procedures in the lateral upper jaw region or in difficult-to-access maxillary areas.

\$33.95

2.7 mm 3.2 mm 3.7 mm 4.2 mm 5.0 mm



2.7 mm | OSTMSP27A

3.2 mm | OSTMSP32A

3.7 mm | OSTMSP37A

4.2 mm | OSTMSP42A

5.0 mm | OSTMSP50A

Manufacturer part numbers are provided here, please visit www.dhponline.com to convert or contact your DHPI Account Manager.

Osteotomes - Bone Pushers, Slightly Convex Tip, Straight \$33.95

Designed to condense bone material and/or autogenous bone under the sinus. Minimizes the risk of perforation of the mucous membrane in sinus elevation procedures.



- 2.7 mm | **OSTMPU27**
- 3.2 mm | **OSTMPU32**
- 3.7 mm | **OSTMPU37**
- 4.2 mm | **OSTMPU42**
- 5.0 mm | **OSTMPU50**

Osteotomes - Bone Pushers, Angled \$33.95

Designed to condense bone material and/or autogenous bone under the sinus. Minimizes risk of perforation of the mucous membrane in sinus elevation procedures.



- 2.7 mm | **OSTMPU27A**
- 3.2 mm | **OSTMPU32A**
- 3.7 mm | **OSTMPU37A**
- 4.2 mm | **OSTMPU42A**
- 5.0 mm | **OSTMPU50A**

Osteotomes - Tapered Concave Tip, Straight \$33.95

Allows for the transport of bone graft chips from the implant cavity or for condensing them apically.



- 2.7 mm | **OSTMSH27**
- 3.2 mm | **OSTMSH32**
- 3.7 mm | **OSTMSH37**
- 4.2 mm | **OSTMSH42**
- 5.0 mm | **OSTMSH50**

Osteotomes - Tapered Concave Tip, Angulated \$33.95

Allows for the transport of bone graft chips from the implant cavity or for condensing them apically.



- 2.7 mm | **OSTMSH27A**
- 3.2 mm | **OSTMSH32A**
- 3.7 mm | **OSTMSH37A**
- 4.2 mm | **OSTMSH42A**
- 5.0 mm | **OSTMSH50A**

Manufacturer part numbers are provided here, please visit www.dhponline.com to convert or contact your DHPI Account Manager.

Integra® Miltex®

BONE CHISELS



Gardner #2 Chisel
701-624 Each\$71.45

Graduated Chisels

Used to widen ridges and have reference graduation marks.



Straight 3.8mm (7-10-13-15-18mm markings)
700-6220 Each\$52.25



Curved 3.8mm (7-10-13-15-18mm markings)
700-6221 Each\$52.25



Straight 7.5mm (7-10-13-15-18mm markings)
700-6222 Each\$52.25



Curved 7.5mm (7-10-13-15-18mm markings)
700-6223 Each\$52.25

Freer Chisels

Extremely sharp tips make it possible to incise and widen ridges.

Single Cut Blade



700-6240 2mm\$49.95



700-6241 4mm\$50.25



700-6242 6mm\$50.25

Double Cut Blade



700-6243 2mm\$50.25



700-6244 4mm\$50.25



700-6245 6mm\$50.25

BONE CURETTES



2/4 Molt Curved
701-6120 Each\$79.95



85 Lucas Curved
701-614 Each\$66.75



86 Lucas Curved
701-616 Each\$66.75

IMPLANT SURGERY

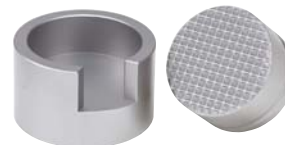

Bone Grinder

Used with mallet to reduce bone to desired particle size.

701-6270 Each\$157.25



Bone Basin

Deep dish with weighted bottom to prevent tipping. Holds 20gm of wetted material. Autoclavable, chemically compatible.

701-6271 Each\$54.25



Bone Compactor

Serrated tips, excellent in difficult to access sites.

3/4mm861-6260

6/8mm861-6261

Each\$39.95

IMPLANT OSTEOTOMES

Concave Osteotomes with Stops

Break the floor of the maxillary sinus through the implant cavity prepared beneath the floor. Also allows for introduction of graft material.



Straight

2.0mm700-62148

3.0mm700-62149

3.3mm700-62150

4.0mm700-62151

Each\$63.25



Curved

2.0mm700-62152

3.0mm700-62153

3.3mm700-62154

4.0mm700-62155

Each\$70.45



Concave Progressive Osteotomes

Used to prepare the implant site in maxillary areas with bone densities 3 or 4.

1.6mm700-62120

1.9mm700-62121

2.8mm700-62122

3.1mm700-62123

3.9mm700-62124

5.5mm700-62125

Each\$49.75

Integra® Miltex®



Convex Osteotomes with Stops

Raise the floor of the maxillary sinus after fracturing.



Straight

2.0mm.....	700-62140	
3.0mm.....	700-62141	
3.3mm.....	700-62142	
4.0mm.....	700-62143	
Each		\$63.25



Curved

2.0mm.....	700-62144	
3.0mm.....	700-62145	
3.3mm.....	700-62146	
4.0mm.....	700-62147	
Each		\$68.75

SINUS LIFT INSTRUMENTS



Sinus Lift Elevator #1

700-62180	Each	\$43.95
-----------	------------	----------------



Sinus Lift Elevator #2

700-62181	Each	\$43.75
-----------	------------	----------------



Sinus Lift Elevator #3

700-62182	Each	\$43.95
-----------	------------	----------------



Elevator #B1

700-62183	Each	\$45.45
-----------	------------	----------------



Elevator #B2

700-62184	Each	\$45.45
-----------	------------	----------------



Elevator #B3

700-62185	Each	\$45.45
-----------	------------	----------------



Sinus Lift Curette #1

700-62190	Each	\$49.75
-----------	------------	----------------



Sinus Lift Curette #2

700-62191	Each	\$49.75
-----------	------------	----------------



Sinus Lift Curette #3

700-62192	Each	\$49.75
-----------	------------	----------------

IMPLANT SCALERS



Wingrove Go-To Set R900

Comes in the PDT 5 FlipTop Cassette and includes three specifically designed Wingrove titanium instruments; Wingrove B5-6 Ti R661, Wingrove L3-4 Ti R680 and Wingrove N128B-L5 mini Ti R693, a ceramic stone for sharpening and UNC 12 plastic perio probe.

700-R900	Kit.....	\$258.95
----------	----------	-----------------



B5-6 Titanium

700-R661	\$50.75
----------	-------	----------------



L 3-4 Titanium

700-R680	\$50.75
----------	-------	----------------



N128B-L5M Titanium

700-R693	\$50.75
----------	-------	----------------



Montana Jack B Titanium Implant Scaler

700-R138T	\$44.95
-----------	-------	----------------



UNIVERSAL IMPLANT SCALERS - DOUBLE END



137 Anterior Implant Scaler

2/pack	700-9061421	\$66.75
5/pack	700-9061420	\$140.75



204 Posterior Implant Scaler

2/pack	700-9061423	\$66.75
5/pack	700-9061422	\$140.75



IMPLANT ORGANIZER

The arch shape of the organizer matches the arch shape of the mouth for implant placement. Cover prevents instruments or implants from falling out. Contains anti-microbial product protection. Lubricated plastic enables tooth number to be written in the designated area. Base is autoclavable.



710-20Z490B	Each	\$24.95
-------------	------------	----------------

THE ORTHODONTIC SLIM LINE COLLECTION



How the best perform

Ortho Slim Line Features:

- 10% to 50% smaller working ends than original designs
- More intraoral adaptation and maneuverability
- More patient comfort



SLIM MICRO CUTTER | HF-678500
13% SMALLER, WIRE SIZE <= .012"
Each - \$188.25



ULTRA SLIM WEINGART PLIERS | HF-678501
Each - \$163.25



SLIM HAMMERHEAD® NiTi PLIERS | HF-678502
WIRE SIZE >= .025"
Each - \$163.25



SLIM FLUSH CUT & HOLD DISTAL END CUTTER | HF-678113
Each - \$224.75



SLIM BAND REMOVING PLIERS | HF-678503
WIRE SIZE <= .012" x .021" x .025"
21% THINNER AND MORE TAPERED THAN 678-207
Each - \$163.25



SLIM DIRECT BOND BRACKET TWEEZERS | HF-678504
50% THINNER AND MORE TAPERED THAN 678-212
Each - \$62.25



SLIM BUCCAL TUBE BONDER TWEEZERS | HF-678505
Each - \$62.25



DISTAL CINCH BACK HAND INSTRUMENT | HF-678506
WIRE SIZE <= .021" x .025"
Each - \$51.75

SLIM FLUSH CUT & HOLD DISTAL END CUTTER



DISTAL END CUTTERS



UNIVERSAL CUT & HOLD DISTAL END CUTTER | HF-678101
WIRE SIZE <= .012" x .021" x .025"
Each - \$167.95
LONG HANDLE | HF-678101L
Each - \$188.25



FLUSH CUT DISTAL END CUTTER | HF-678102
WIRE SIZE <= .021" x .025"
Each - \$188.25



FLUSH CUT & HOLD DISTAL END CUTTER | HF-678111
WIRE SIZE <= .020"
Each - \$224.75



HARD WIRE CUTTER, 15° | HF-678103
WIRE SIZE <= .022" x .028"
Each - \$188.25



HARD WIRE CUTTER | HF-678104
WIRE SIZE <= .022" x .028"
Each - \$188.25

HARD WIRE CUTTER

PIN & LIGATURE CUTTERS



MULTI-USE CUTTER | HF-678105
WIRE SIZE <= .015"
Each - \$188.25



MINI PIN & LIGATURE CUTTER | HF-678106
WIRE SIZE <= .012"
Each - \$188.25



MICRO-MINI PIN & LIGATURE CUTTER | HF-678107
Each - \$188.25
LONG HANDLE | HF-678107L
WIRE SIZE <= .012"
Each - \$188.25



MICRO CUTTER | HF-678110
WIRE SIZE <= .012"
Each - \$188.25

UTILITY PLIERS



WEINGART PLIERS | HF-678201
Each - \$163.25
LONG HANDLE | HF-678201L
Each - \$163.25



SLIM WEINGART PLIERS | HF-678202
Each - \$163.25



HOW PLIERS STRAIGHT | HF-678203
Each - \$163.25



HOW PLIERS, OFFSET | HF-678204
Each - \$163.25



BAND SEATING PLIERS | HF-678205
Each - \$163.25

ACCESSORIES FOR 678-206

REPLACEMENT BLADE | HF-678001
Each - \$13.75

1/4" (6.3MM) REPLACEMENT PADS (PACK OF 6) | HF-678014A
Each - \$14.95

ACCESSORIES FOR BOTH

1/4" (6.3MM) REPLACEMENT PADS (PACK OF 6) | HF-678014
Each - \$14.95

3/16" (4.8MM) REPLACEMENT PADS (PACK OF 6) | HF-678036
Each - \$14.95



ADHESIVE REMOVING PLIERS | HF-678206
Each - \$163.25



POSTERIOR BAND REMOVING PLIERS, LONG | HF-678207
Each - \$163.25



POSTERIOR BAND REMOVING PLIERS, SHORT | HF-678208
Each - \$163.25



FORCE MODULE SEPARATING PLIERS | HF-678210
Each - \$163.25



COON STYLE LIGATURE TYING PLIERS | HF-678211
WIRE SIZE <= .015"
Each - \$163.25



BRACKET REMOVING PLIERS | HF-678219
Each - \$163.25



ANGULATED BRACKET REMOVING PLIERS | HF-678220L
Each - \$163.25



BAND CRIMPING PLIERS | HF-678225
Each - \$163.25



BAND CRIMPING PLIERS WITH SPRING | HF-678225M
Each - \$163.25



CROWN & BAND CONTOURING PLIERS | HF-678221
Each - \$163.25
SLIM CROWN | HF-678221M
Each - \$163.25

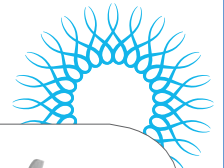

WIRE BENDING PLIERS



BIRD BEAK PLIERS
| HF-678304
WIRE SIZE <= .030"
Each - \$163.25



LIGHT WIRE BIRD BEAK
PLIERS WITH GROOVE
| HF-678305
WIRE SIZE <= .020"
Each - \$163.25



TWEED LOOP FORMING
PLIERS
| HF-678306
WIRE SIZE <= .022" x .025"
Each - \$163.25



ARCH BENDING PLIERS
| HF-678307
WIRE SIZE <= .022" x .025"
Each - \$163.25



TWEED PLIERS, SLIM
| HF-678307S
WIRE SIZE <= .022" x .025"
Each - \$163.25



JARABAK PLIERS
| HF-678301
WIRE SIZE <= .020"
Each - \$163.25



THREE JAW PLIERS
| HF-678302
WIRE SIZE <= .030"
Each - \$163.25



OMEGA LOOP
FORMING PLIERS
| HF-678303
WIRE SIZE <= .022" x .025"
Each - \$163.25

ACCESSORIES FOR HF-678303

REPLACEMENT BLADE
| HF-678002
Each - \$8.45

REPLACEMENT SCREW
WITH HEX KEY | HF-678018
Each - \$3.75



GENERAL CONTOURING
PLIERS
| HF-678315
WIRE SIZE <= .021" x .025"
Each - \$163.25



RECTANGULAR ARCH
BENDING PLIERS
| HF-678308
WIRE SIZE <= .022" x .025"
Each - \$163.25



LINGUAL ARCH FORMING
PLIERS
| HF-678309
WIRE SIZE <= .036"
Each - \$163.25



HOLLOW CHOP
CONTOURING PLIERS
| HF-678310
WIRE SIZE <= .030"
Each - \$163.25



O'BRIEN PLIERS
| HF-678311
WIRE SIZE <= .020"
Each - \$163.25



MINI THREE JAW PLIERS
| HF-678312
WIRE SIZE <= .030"
Each - \$163.25



MARCOTTE
LOOPING PLIERS
| HF-678316
WIRE SIZE <= .022" x .025"
Each - \$163.25



HOLLOW CHOP PLIERS
| HF-678317
WIRE SIZE <= .030" (SAME AS
678-310 WITH REDUCED RADIUS)
Each - \$163.25



LIGHT WIRE BIRD BEAK
PLIERS WITH GROOVE
| HF-678318
WIRE SIZE <= .020"
Each - \$163.25



NITI THREE-PRONG PLIERS
| HF-678322
WIRE SIZE <= .020"
Each - \$163.25



OPTICAL PLIERS
| HF-678323
WIRE SIZE <= .022" x .025"
Each - \$163.25



OLD STYLE LOOP PLIERS
| HF-678324
WIRE SIZE <= .022" x .025"
Each - \$163.25

HAND INSTRUMENTS



BIRD BEAK PLIERS
WITH CUTTER
| HF-678325
WIRE SIZE <= .022" x .025"
Each - \$188.25



LONG-TAPERED BIRD
BEAK PLIERS
| HF-678326
WIRE SIZE <= .022" x .025"
Each - \$163.25



HAMMERHEAD® NITI
TIE-BACK PLIERS
| HF-678327
WIRE SIZE <= .025"
Each - \$163.25



SCALER/BAND
PUSHER
| HF-678904
Each - \$51.75



How the best perform

HAND INSTRUMENTS

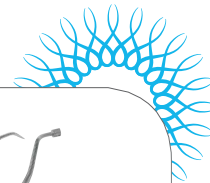

LIGATURE DIRECTOR/
SCALER | HF-678905
Each - \$51.75



DULL SCALER/
BAND PUSHER | HF-678906
Each - \$51.75



SMALL PLUGGER/
PICKER | HF-678907
Each - \$51.75



LIGATURE DIRECTOR/
BAND PUSHER | HF-678908
Each - \$51.75



LARGE PLUGGER/
PICKER | HF-678909
Each - \$51.75



DULL SCALER | HF-678910
Each - \$51.75



DULL SCALER | HF-678911
Each - \$51.75



LIGATURE DIRECTOR/
BAND PUSHER | HF-678912
Each - \$51.75



DULL SCALER | HF-678913
Each - \$51.75



SCALER/PICKER | HF-678914
Each - \$51.75



PICKER/LIGATURE
DIRECTOR | HF-678916
Each - \$51.75



LIGATURE DIRECTOR | HF-LDG2
Each - \$64.45



LIGATURE DIRECTOR
PLUGGER | HF-LDP
Each - \$37.25



TUCKER LIGATURE
DIRECTOR | HF-LDT
Each - \$64.45



FILLION EXPLORER/LIGATURE
DIRECTOR | HF-FELD
Each - \$37.75



BAND PUSHER
|HF-BP300
Each - \$64.45
SHORT TIP | HF-BP300S
Each - \$64.45



BAND PUSHER SCALER
| HF-BPS1
Each - \$43.25
SHORT TIPS | HF-BPS2
Each - \$43.25



DIRECT BOND BRACKET
HOLDER | HF-678212
Each - \$63.25
SLIM | HF-678212M
50% SLIMMER
Each - \$63.25



MATHIEU NARROW TIP
PLIERS | HF-678330
Each - \$163.25



ORTHO MATHIEU WIDE TIP
PLIERS | HF-678331
Each - \$166.25



ORTHO MATHIEU PERMA
SHARP® | HF-678332
Each - \$227.75

LOOK'in

for something? **WE HAVE IT!**

www.dhpionline.com



Orthodontic Instrument Organizers

Durable construction, designed for easy access.

Organizers only, contents sold separately.

A. Combination Organizer

6-1/2" W x 3-7/8" H x 9'-1/4" D.

690-PDW001 Each **\$50.25**

B. Covered Plier Organizer

7-1/4" W x 7-1/2" H x 6" D.

690-56146 Each **\$87.45**

C. Upright Plier Organizer

4-7/8" W x 5-1/4" H x 9" D.

White 690-OTIHW

Black 690-OTIHB

Clear 690-OTIHC

Each **\$28.75**

D. Round Plier Organizer

4-3/32" H x 4" D.

690-PDW002 Each **\$33.75**

Falcon Orthodontic Instruments®

Falcon pliers and cutters are made of surgical stainless steel and hard chrome plated to withstand all accepted methods of sterilization.



15 Degree Pin and Fine Wire Cutter
690-OT1000 Each **\$123.95**



Hard Wire Cutter
690-OT7001 Each **\$123.95**



Posterior Band Remover, Long
690-OT347L Each **\$123.95**



Pin and Ligature Cutter
690-OT1001 Each **\$123.95**



Weingart Utility Plier
690-OT158 Each **\$123.95**



Keat Buccal Tube Tweezers
690-OT209 Each **\$42.25**



Distal End Cutter, Safety Hold
690-OT1016 Each **\$123.95**



Direct Bond Remover, Wide
690-OT346RT Each **\$123.95**



Direct Bond Ortho Tweezers
690-OT203 Each **\$36.75**



High Heat Height Gauge
.018" 690-OT2118HH
.022" 690-OT2122HH
Each **\$9.75**



AMALGAM CARRIERS



Lever type amalgam carriers in a choice of stainless steel or delrin (plastic) tips.

Single End

Stainless Steel

Regular	700-10010
Large	700-10011
Jumbo	700-10012

Delrin

Regular	700-10015
Large	700-10016
Jumbo	700-10017

Each \$15.95

Double End

Stainless Steel

Regular/Large	700-10001
Regular/Jumbo	700-10002
Mini/Regular	700-10003
Jumbo/Jumbo	700-10004

Delrin

Regular/Large	700-10007
Regular/Jumbo	700-10008

Each \$18.95

AMALGAM PLUGGERS



Plugger #0/1 Serrated

700-1552 **\$51.95**



Plugger #0/1 Smooth

700-1553 **\$51.95**



Plugger #1/2 Serrated

700-1550 **\$51.95**

BURNISHERS

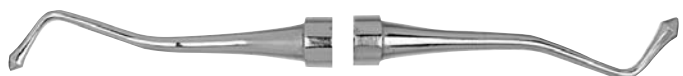

Burnisher Acorn #21B

700-1072 **\$13.95**



Burnisher DE #26/27

700-1070 **\$13.95**



Burnisher DE #27/29

700-1071 **\$13.95**

CARVERS



Carver 3 Hollenback

700-1101 **\$13.95**



Carver 3S Hollenback

700-1100 **\$13.95**



Carver Cleoid Discoik 89/92

700-1102 **\$13.95**

CORD PACKERS

Cord Packer Circular - Serrated

700-1191 **\$18.45**

Cord Packer Standard - Non-Serrated

700-1192 **\$18.45**



Cord Packer Standard - Serrated

700-1190 **\$18.45**

Cord Packer Circular - Non-Serrated

700-1193 **\$18.45**

CROWN REMOVERS

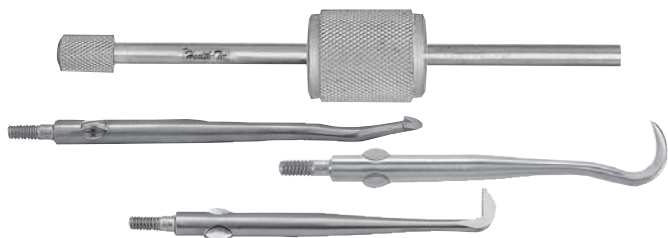

Crown Remover with Tips

700-1850 **\$43.95**

PLASTIC FILLING INSTRUMENTS



Plastic Filling Instrument #13

700-1154

\$13.95



Plastic Filling Instrument #4

700-1151

\$13.95



Plastic Filling Instrument Woodson #2

700-1155

\$13.95

SPATULAS



Cement Spatula #22

700-1700

\$10.95



Cement Spatula #24

700-1701

\$10.95



Cement Spatula - Flexible #24A

700-1702

\$10.95



Wax Spatula #7

700-1703

\$10.95



CROWN PLIERS & SCISSORS



Crown Crimping Pliers

Small Crown Crimping Pliers

Crown Contouring Pliers



Deluxe Straight Crown Scissors

Deluxe Straight Curved Crown Scissors

Deluxe Straight Curved Crown Scissors

Crown Contouring Pliers

A crown contouring pliers for enhancing crown-form contours to improve interproximal contacts and gingival margins for stainless steel and temporary crowns.

703-800112 Each..... **\$229.95**

Crown Crimping Pliers

A crown pliers specially designed to crimp the gingival margin of stainless steel and temporary crowns.

703-800417 Each..... **\$229.95**

Small Crown Crimping Pliers

A crown pliers specially designed to crimp the gingival margin of stainless steel and temporary crowns. Smaller size to meet your procedural needs.

703-800421 Each..... **\$229.95**

Deluxe Straight Crown Scissors

Straight crown scissors designed for trimming the margins of 3M pre-formed crowns.

703-801201 Each..... **\$109.95**

Deluxe Curved Festooning Scissors

Curved crown scissors designed for trimming the margins of 3M pre-formed crowns.

703-801202 Each..... **\$109.95**

Deluxe Curved Festooning Scissors

Curved festooning crown scissors designed for trimming the margins of 3M pre-formed crowns.

703-801203 Each..... **\$115.45**



AMERICAN EAGLE INSTRUMENTS™ INC

better DENTISTRY by DESIGN™



1/4" Stainless Steel Sure Grip Double End Handle

BURNISHERS



PFI 18B

AEBPFI18B \$33.45



PFI 21A

AEBPFI21A \$33.45



PFI 21B

AEB21BA \$33.45



26/27

AEB26-27B \$33.45



26/29

AEB2629BF \$33.45

CARVERS - DOUBLE END



Hollenback 1/23

AECAH1/23 \$30.25



Interproximal IPC

AECAIPC \$33.45



Interproximal IPC-T

AECAIPCTT \$38.75



IPC 1 (Minn)

AECAIPC1M \$33.45



Discoid-Cleoids 1/2

AECADC12 \$33.45



Discoid-Cleoids 3/6

AECADC36 \$33.45



Discoid-Cleoids 4/5

AECADC4-5 \$33.45

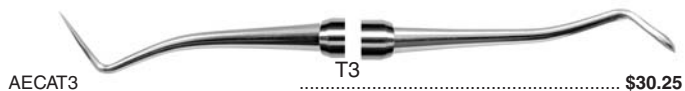

T3

AECAT3 \$30.25

CAVITY PREP - HATCHET DOUBLE END



8/9

AEHA89 \$32.75



10/11

AEHA1011 \$32.75

COMPOSITE MANIPULATION - DOUBLE END



8A

AECA8A \$30.25



4 TNT

AEC4TN \$36.25



5 TNT

AEC5TN \$36.25



6 TNT

AEC6TN \$36.25



7 TNT

AEC7TN \$36.25



9 TNT

AEC9TN \$36.25

CONDENSERS/PLUGGERS - DOUBLE END



0

AEC/P0 \$31.95



1/2

AECP12 \$31.95



3/4

AECP34 \$31.95



AMALGAM CARRIERS



How the best perform

CF® II AMALGAM CARRIERS \$71.75

SYNCOTE™ coating eliminates clogging. It prevents abrasion of the barrel's inner surface and keeps amalgam particles from interfering with dispensing action

DISTAL

1.5 mm



Mini Distal
| AC5301

2.0 mm



Regular Distal
| AC5302

SINGLE-END

1.5 mm



Mini Single-End
| AC5101

2.0 mm

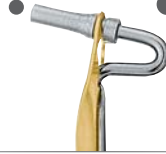

Regular Single-End
| AC5102

2.8 mm



Large Single-End
| AC5103

DOUBLE-END

2.0 mm



Mini/
Regular
| AC5201

2.0 mm



Large/
Regular
| AC5202

2.0 mm



Jumbo/
Regular
AC5203

1.5 mm

2.8 mm

3.2 mm

Improves visibility and access to posterior regions.

DISTAL

SINGLE-END

DOUBLE-END



Amalgam Well
| WA \$29.25

Stainless steel, with removable non-slip base ring. Designed for easy amalgam handling.

STANDARD AMALGAM CARRIER \$71.75

Shown at 75% size.

Amalgam Carrier DE

| 23690

Regular/Large

2.0 mm

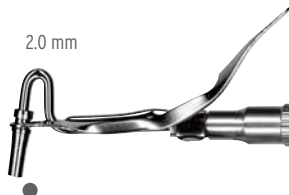

2.8 mm

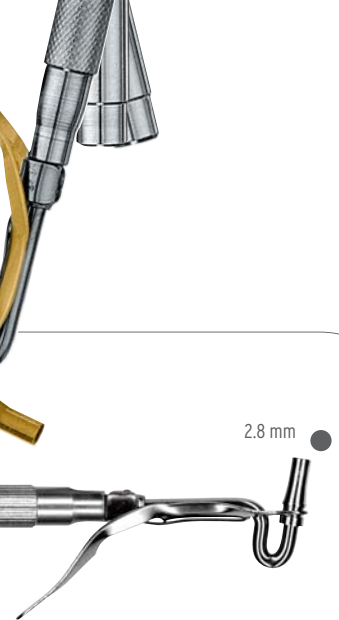

Manufacturer part numbers are provided here, please visit www.dhponline.com to convert or contact your DHPI Account Manager.



HANDLE OPTIONS



How the best perform

SINGLE END



#8 ResinEight \$38.45



#7 Satin Steel Colours \$40.45



#6 Satin Steel \$38.45



#40 Round Starting at \$30.45

DOUBLE END



#8 ResinEight \$38.45



#7 Satin Steel Colours \$40.45



#6 Satin Steel \$38.45



#41 Round Starting at \$29.25



6S Smooth Satin Steel \$38.75



EverEdge (#9 Handle) \$41.75



BURNISHERS



21B
| TNBB21B

Acorn-shaped instrument for forming occlusal anatomy in posterior restorations.



27/29
| TNBB27/29

Used to blend material for final contouring, to achieve sculpting of areas like grooves, fissures or pits. Can also be used to form occlusal anatomy.



2
Ladmore
| TNBBL2

Medium to large rounded tips for condensing composite materials.



3
Ladmore
| TNBBL3

Small to medium slightly rounded tips for condensing composite materials.

FREEDMAN BURNISHERS



Freedman
"Duckhead"
| TNPCCI

Used to contour the convexity of the cusp ridge, developing the anatomy in a single motion.



Freedman
Small
Contact
Forming
| TNFCIS

Oval-shaped paired instrument designed to provide improved contact forming for small Class II Restorations.



Freedman
Large
Contact
Forming
| TNFCIL

Oval-shaped paired instrument designed to provide improved contact forming for large Class II Restorations.

Manufacturer part numbers are provided here, please visit www.dhpionline.com to convert or contact your DHPI Account Manager.



CARVERS



How the best perform



3 Tanner
| CV3T



4 Tanner
| CV4T



5 Tanner
| CV5T



6 Tanner
| CV6T



1 Wall
| CVWL1



3 Wall
| CVWL3



1 Ward
| CVWR1



2 Ward
| CVWR2

DISCOID-CLEOIDS



1/2
| CD1/2



4/5
| CD4/5
#41, #6, #7



3/6
| CD3/6
#41, #6, #7, #8

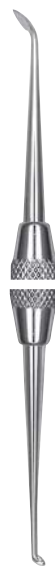

89/92
| CD89/92
#41, #6, #7, #8



90B
| CD90B



W-A-C-D
| CDWACD

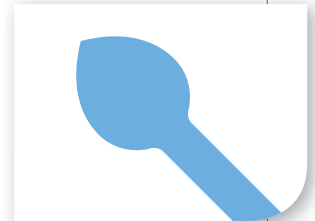

CLEOID
Spade shape with point for carving occlusal anatomy

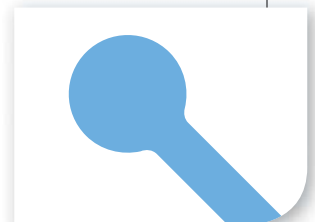

DISCOID
Round shape for removing excess material

Manufacturer part numbers are provided here, please visit www.dhpionline.com to convert or contact your DHPI Account Manager.

CARVERS



1 Andrew
| CVA1



2 Andrew
| CVA2



3 Andrew
| CVA3



4 Clappison
| CVCL4



2/3 Frahm
| CVFR2/3
Handle options:
#41, #6



104
| CV104



1 Hollenback
2 Modified
Cleoid Small
| CVH1/MC2



1 Hollenback
3 Modified
Cleoid Large
| CVH1/MC3



1 Hollenback
| CVHL1



2 Hollenback
| CVHL2



L7 Levy
| CVL7



SHO-A
Shoshan
| CVSA



18 Sprengel
| CVSPR18
Handle options:
#41, #6



1 Tharp
| CVTH1



2 Tharp
| CVTH2

Manufacturer part numbers are provided here, please visit www.dhponline.com to convert or contact your DHPI Account Manager.

COMPOSITE/PLASTIC FILLING INSTRUMENTS



The #1 (CIGFT1) on an anterior preparation



The thin blade of the Mini 4 (CIGFT4) working interproximally



How the best perform

GOLDSTEIN FLEXI-THIN COMPOSITE INSTRUMENTS



#1

| CIGFT1

Handle options:
#41, #6, #8

Small universal style with rounded plugger tip and a narrow paddle for initial placement and contouring of Class I, II and III restorations.



#2

| CIGFT2

Handle options:
#41, #6

Larger universal style for final placement and contouring of Class I, II, and III restorations.



#6

Flexi-Thin

| CIGFT6

Large reverse angle tips make it easy to place fissures, grooves and pits creating the ideal occlusal anatomy in hard to reach posterior areas.

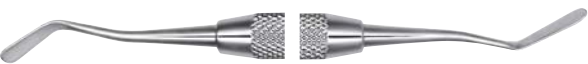

#3

Extra-Flex

| CIGFT3

Handle options:
#41, #6, #8

Flexible, reversed, flared paddle design for shaping and placement of Class III and IV restorations.



Mini 1

| CIGFTMINI1

Handle options:
#41, #6

Mini version of the CIGFT1 for small pits and fissures, tunnel preparations or minor tooth defects on lower anteriors.



#4

Extra-Flex

| CIGFT4

Handle options:
#41, #6

Flexible, paired, offset, paddle-shaped blades for placing and shaping material on posterior, mesial and distal surfaces. Reverse angle is also useful for placing and shaping anterior bonded restorations.



Mini 3

Extra-Flex

| CIGFTMINI3

Handle options:
#41, #6, #8

Mini version of the CIGFT3. Can also be used for packing gingival retraction cord.



#5

Flexi-Thin

| CIGFT5

Small reverse angle tips make it easy to place fissures, grooves and pits creating the ideal occlusal anatomy in hard to reach posterior areas.



Mini 4

Extra-Flex

| CIGFTMINI4

Handle options:
#41, #6, #8

Mini version of the CIGFT4 for placing and shaping material in difficult to access mesial and distal posterior restorations.

Manufacturer part numbers are provided here, please visit www.dhponline.com to convert or contact your DHPI Account Manager.

COMPOSITE/PLASTIC FILLING INSTRUMENTS



How the best perform



ABI Boghosian (PFIAB1) knife-shaped blade applying composite veneer



ABI Boghosian

| PFIAB1

Handle options:
#41, #6

Unique combination of thin, knife-shaped blade with standard angled blade. Knife blade allows controlled, efficient manipulation of composite even in gingival areas.
Application: Class III, IV, V



Interproximal Carver

| CVIPC

Handle options:
#41, #6, #7, #8

Extremely thin flexible blades are opposed for easy handling of composite materials and interproximal contouring.
Application: Class III, IV, V



AB2 Boghosian

| PFIAB2

Used for measuring composite layers and shaping occlusal anatomy.



3 Tufts

| C16001

Combination of medium-sized blade with small condenser tip for universal adaptability. Ideal for placement, layering, and general contouring. Application: Class I, II, III, IV, V



W3

| PFIW3

Handle options:
#41, #6, #8

Combination of medium-sized blade with small condenser tip for universal adaptability. Ideal for placement, layering, and general contouring. Application: Class I, II, III, IV, V



A6 (156)

| PFIA6

Handle options:
#41, #6, #7, #8

Large, thin blades are opposed for adaptability to any situation, including veneers, where broad contouring or carving strokes are needed. Application: Class II, III, IV, V

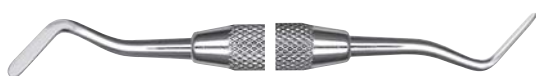

4F Tufts

| C16056

Reverse double-end blades with ideal width and length for initial placement and carving of composite. Can also be used for packing gingival retraction cord. Application: Class III, IV



4/5 Gregg

| PFI4/5

Off-angled blades allow easy adaptability to mesial and distal surfaces of posterior teeth, providing increased interproximal access and better visibility of the working area. Application: Class II, V

Manufacturer part numbers are provided here, please visit www.dhponline.com to convert or contact your DHPI Account Manager.

COMPOSITE/PLASTIC FILLING INSTRUMENTS



How the best perform

ANTERIOR

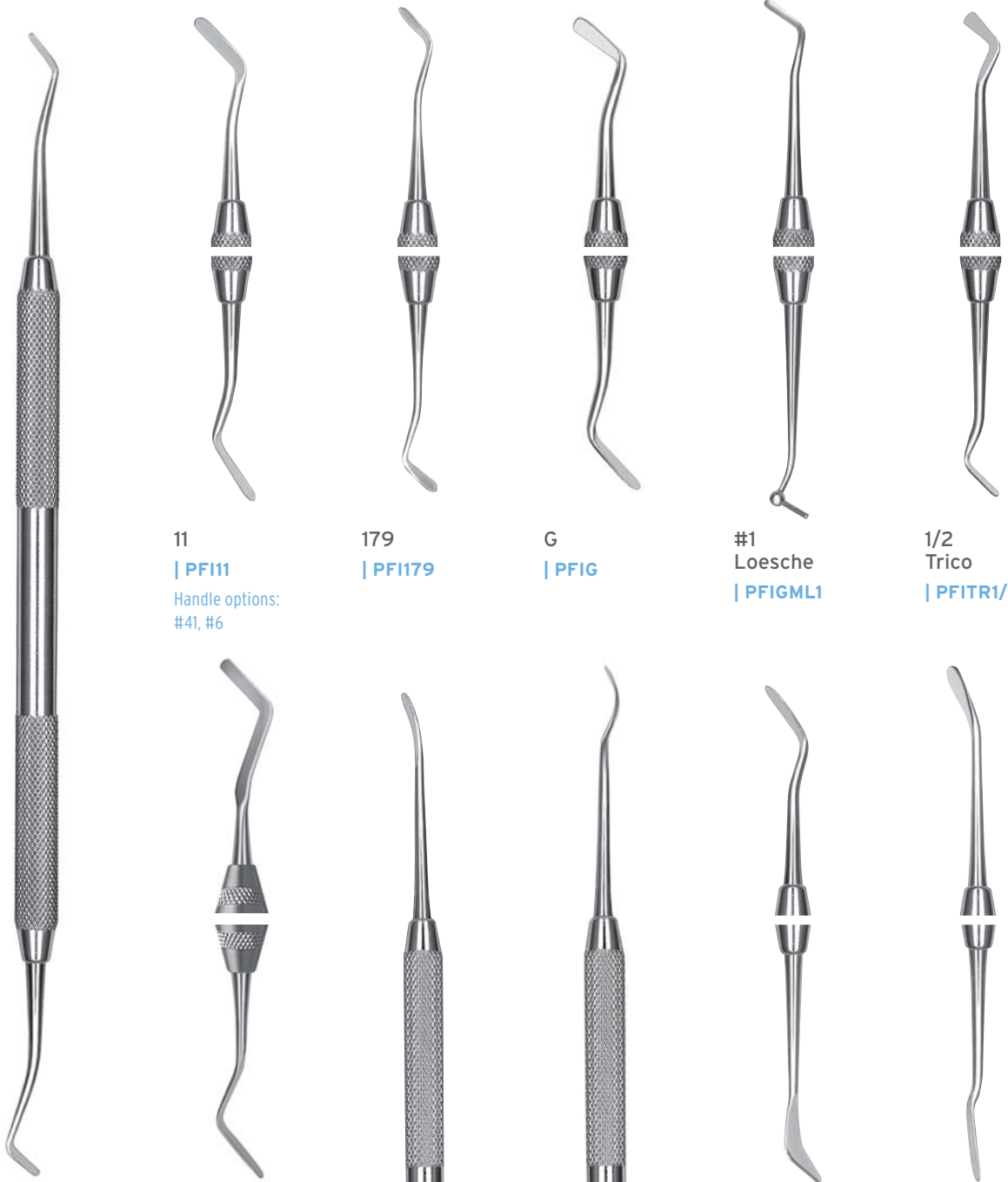

8A
| PFI8A
Handle options:
#41, #6

11
| PFI11
Handle options:
#41, #6

179
| PFI179

G
| PFIG

#1
Loesche
| PFIGML1

1/2
Trico
| PFITR1/2

PFI #1
Heidmann
Spatula
| PFIHS16

DPT6 SE
Darby Perry
Trimmer
| PFIDP6

DPT6 SE
Trimmer
Plastic
| PFIDPT6

W1
| PFIW1

1
Woodson
| PFIWDS1
Handle options:
#41, #6

Manufacturer part numbers are provided here, please visit www.dhponline.com to convert or contact your DHPI Account Manager.

COMPOSITE/PLASTIC FILLING INSTRUMENTS

Hu-Friedy®

How the best perform

GOLDFOGEL INSTRUMENTS

A
Cosmetic
Contouring

| CCIA

Identical, opposing, large, flexible, oval-shaped blades, straight and angled, for contouring composite material on larger facial surfaces of central incisors.

B
Cosmetic
Contouring

| CCIB

Identical, opposing, spear-shaped blades, straight and angled, used for contouring composite material on smaller facial surfaces of central incisors.

F
Cosmetic
Contouring

| CCIF

Uniquely-shaped blades with curved and rounded tips for adding and shaping composite material on desired areas of facial incisors.

C
Cosmetic
Contouring

| CCIC

Flexible, oval-shaped blades - one slightly larger - for interproximal contouring on central incisors.

G
Marginal Ridge
& Embrasure
Shaping
Instrument

| CCIG

Allows formation of marginal ridges along with buccal and lingual embrasures while composite is uncured.

D
Cosmetic
Contouring

| CCID

Used when working near or at interproximal areas. Straight end compacts composite material, while sharp knife edge cuts composite to avoid bonding to adjacent tooth.

H
Occlusal
Anatomy
Instrument

| CCIH

Designed to help attain proper occlusal form, function and improve marginal seal.

E
Cosmetic
Contouring

| CCIE

Small and medium curved blades for thinning and shaping composite material at the gingival areas.

I
Composite
Packing
Instrument

| CCII

Aids in forming a properly filled axial box and occlusal portion.

 Manufacturer part numbers are provided here, please visit www.dhponline.com to convert or contact your DHPI Account Manager.

POSTERIOR



Interproximal
Off Angle
| CVIPCOA



2
Hu-Friedy
| PFIHF2



49
Baldwin
| PFI49



21
Burnisher
| BB21

Handle options:
#41, #6



21B
Burnisher
| BB21B

Handle options:
#41, #6, #8



PKT-3R
Rounded Cone
| PKT3R

Handle options:
#41, #6

UNIVERSAL



1
Woodson
| PFIWDS1

Handle options:
#41, #6



2
Woodson
| PFIWDS2

Handle options:
#41, #6



3
Woodson
| PFIWDS3



1
Loesche
| PFIGML1



2
Loesche
| PFIGML2

Handle options:
#41, #6



1
| PF11



BEQ1
Quétin
| PFIBEQ1

Handle options:
#41, #7



1
Hu-Friedy
| PFIHF1



3T
Tufts
| CI6001

Manufacturer part numbers are provided here, please visit www.dhponline.com to convert or contact your DHPI Account Manager.



PLUGGERS/CONDENSERS



How the best perform



1/2 Andrew
| **PLGA1/2**

1/2 Black [15-7-12] [25-7-12]
| **PLG1/2NS**
Handle options: #41, #6

1/2 Serrated
| **PLG1/2**
Handle options: #41, #6, #8

H1 Hollenback
| **PLGH1**
Handle options: #41, #6, #8

H2 Hollenback
| **PLGH2**
Handle options: #41, #6

H3 Hollenback
| **PLGH3**

H4 Hollenback
| **PLGH4**

O/1 Serrated Marquette Condenser
| **PLGO/1**
Handle options: #41, #6

O/1 Marquette
| **PLGO/1NS**
Handle options: #41, #6

Manufacturer part numbers are provided here, please visit www.dhpionline.com to convert or contact your DHPI Account Manager.



How the best perform

PLUGGERS/CONDENSERS

0.6 mm	1.0 mm	0.6 mm	0.5 mm	1.1 mm	1.0 mm	1.5 mm
1.2 mm	1.5 mm	0.76 mm	0.5 mm	0.66 mm	1.0 mm	2.8 mm
2 Mortonson PLGM02	2 Serrated Smith PLGS2	SPO Serrated PLGSP0	1M Markley PLG1M	2M Markley PLG2M Handle options: #2, #6	3M Markley PLG3M	4M Markley PLG4M Handle options: #2, #6

Manufacturer part numbers are provided here, please visit www.dhponline.com to convert or contact your DHPI Account Manager.



EXCAVATORS

For removal of carious dentin.



How the best perform

SPOONS

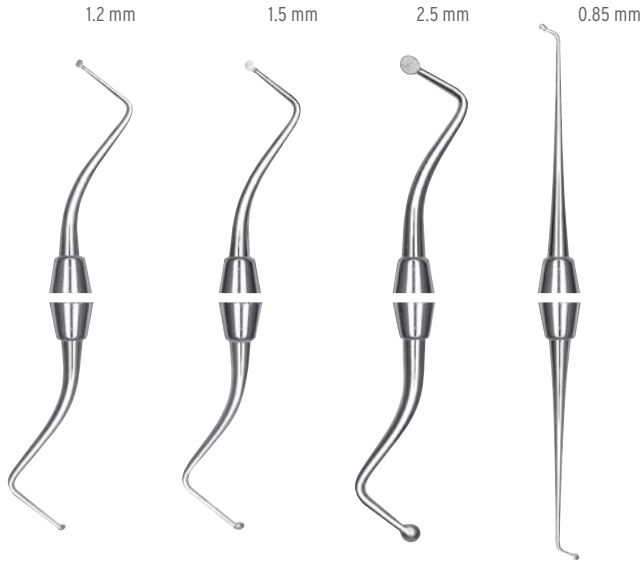

E1
[12-9-15]
| EXCE1
Handle options:
#41, #6

E2
[15-9-15]
| EXCE2
Handle options:
#41, #6

E3
[25-9-15]
| EXCE3

6
| EXC6

The following spoons are available heavy:

| EXC17H

Handle options:
#41, #6, #7

| EXC17WH

Handle options:
#41, #6

| EXC18H

Handle options:
#41, #6, #7

| EXC18WH

Handle options:
#41, #6

| EXC19H

Handle options:
#41, #6, #7

| EXC19WH

Handle: #41

OVAL SPOONS



17W
| EXC17W

18W
| EXC18W

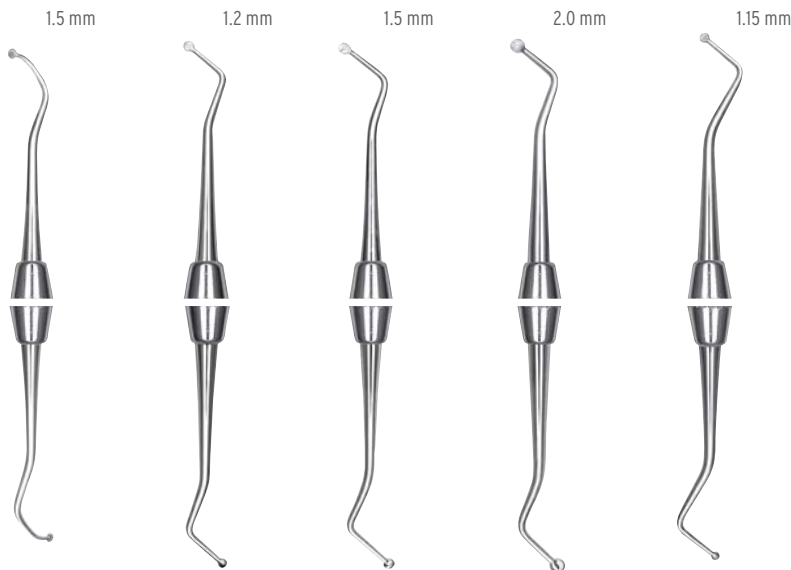

14
| EXC14

17
| EXC17
Handle options:
#41, #6, #7,
#8, #9

18
| EXC18
Handle options:
#41, #6, #7,
#8, #9

19
| EXC19
Handle options:
#41, #6, #7, #8

38/39
[11.5-7-14]
| EXC38/39
Handle options:
#41, #6, #7

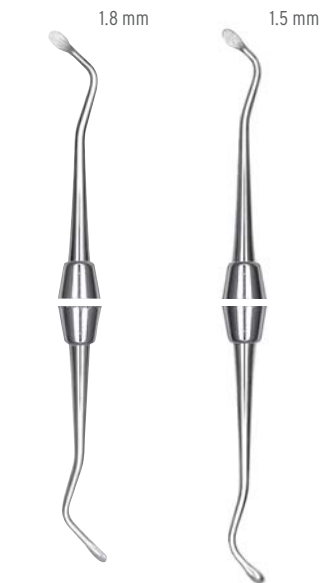

19W
| EXC19W

220/221
Darby-Perry
| EXC220/1
Handle options:
#41, #6

Manufacturer part numbers are provided here, please visit www.dhponline.com to convert or contact your DHPI Account Manager.

EXCAVATORS

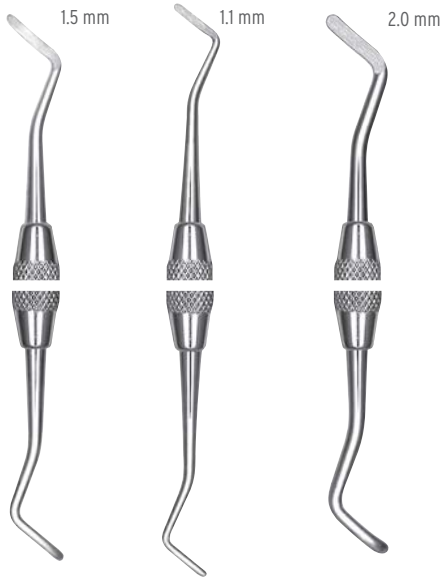

36/37
[15-8-14]

| EXC36/37

Handle options:
#41, #6

40/41
[11-7-14]

| EXC40/41

44/45
[20-9-14]

| EXC44/45

Handle options:
#41, #6

ENGLISH PATTERNS

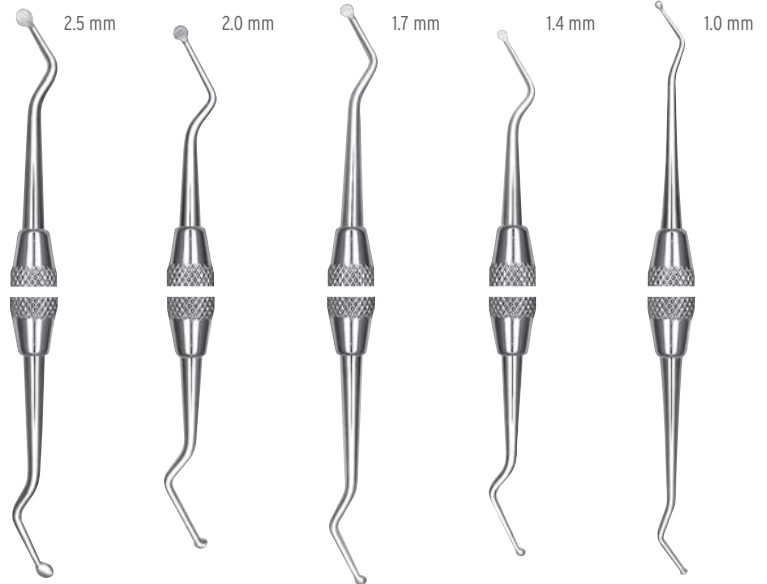

125/126

| EXC125/6

127/128

| EXC127/8

129/130

| EXC129/0

Handle options:
#41, #6

131/132

| EXC131/2

153/154

| EXC153/4

Handle options:
#41, #6

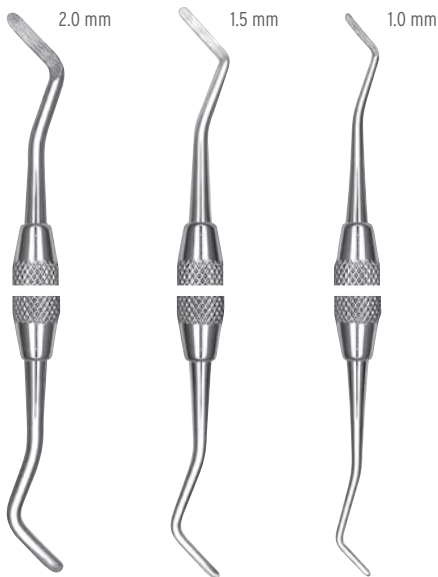

61/62
[20-9-12]

| EXC61/62

63/64
[15-8-12]

| EXC63/64

Handle options:
#41, #6

65/66
[10-6-12]

| EXC65/66

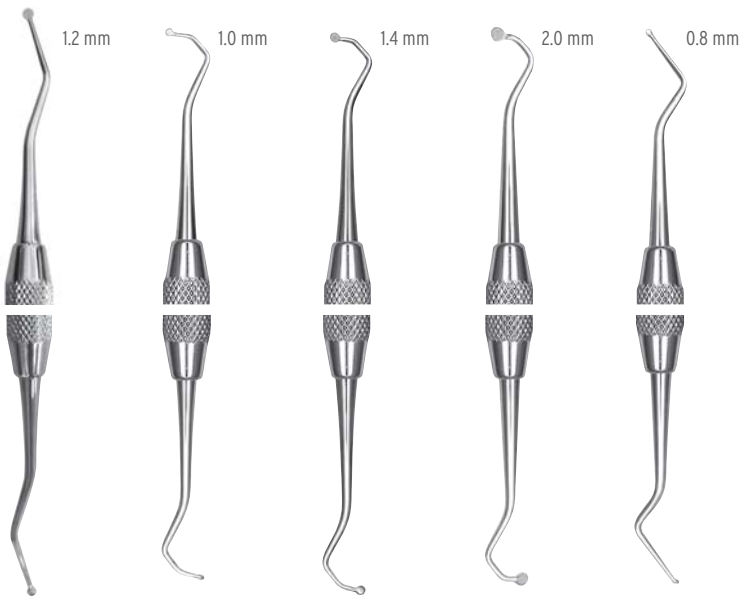

Goldstein
Interproximal
Excavator

| EXC242

Handle options:
#41, #9

243

| EXC243

244

| EXC244

245

| EXC245

246

| EXC246

Handle options:
#41, #6, #9

Manufacturer part numbers are provided here, please visit www.dhponline.com to convert or contact your DHPI Account Manager.

Integra® Miltex®

AMALGAM CARRIERS



Color-coded: Medium-White, Large-Yellow, Jumbo-Red.

Single End Steel

Medium.....	701-7150	
Large.....	701-7152	
Each.....		\$39.75

Double End Steel

Medium/Large.....	701-7162	
Medium/Jumbo.....	701-7164	
Large/Jumbo.....	701-7166	
Each.....		\$62.75

Double End Delrin

Medium/Large.....	701-7163	
Medium/Jumbo.....	701-7165	
Each.....		\$64.25



SCT Amalgam Carriers - Double End

Medium/Large.....	701-7162TC	
Medium/Jumbo.....	701-7164TC	
Large/Jumbo.....	701-7166TC	
Each.....		\$98.45

CALCIUM HYDROXIDE PLACEMENT



701-7135	Each.....	\$11.95
----------	-----------	---------

WYNMAN CROWN GRIPPER



Carb-N-Sert Jaws

701-7210TC	Each.....	\$213.75
------------	-----------	----------



COMPOSITE MANIPULATION

OptraSculpt®Pad - Ivoclar Vivadent

Innovative modeling instrument designed for the intra-oral adaptations shaping, and contouring of uncured packable composite and compomer materials in Class III, IV and V restorations and direct laminate veneers. Non-stick surface of the foam pad prevents adhesion of composite resins. Instrument does not leave any marks and



ensures creation of even surfaces. Reference scales on the instrument handle ensure professional esthetic results. Consists of an autoclavable handheld instrument and single-use disc-shaped attachments (pads) in diameters ranging from 4 to 6mm.

Assortment Kit

Contains: 1 instrument, 1 refill (4mm/60), 1 refill (6mm/60).	
700-639791AN	Kit..... \$124.75



Octagonal Double End Handle

AMALGAM PLUGGERS - DOUBLE END



	1/2	
	Serrated	Smooth
Code	700-01220	700-01225
Price	\$16.25	\$16.25



	2/3	
	Serrated	Smooth
Code	700-01240	700-01245
Price	\$16.25	\$16.25



	1	
	Serrated	Smooth
Code	700-01255	700-01250
Price	\$16.25	\$16.25



	2	
	Serrated	Smooth
Code	700-01265	700-01260
Price	\$16.25	\$16.25

BURNISHERS



	#1	
700-02610	\$16.25

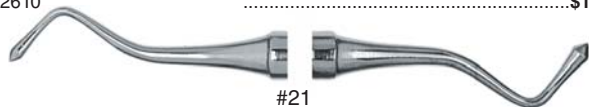

	#21	
700-02522	\$16.25



	#21B	
700-02600	\$16.25



	#21C	
700-02601	\$16.25







	#28/29	
700-02500	\$16.25









Octagonal Double End Handle

COMPOSITE FILLING

	PFI #5	\$16.25
700-08050	
	PFI #11	\$16.25
700-08055	
	Woodson #1	\$16.25
700-08101	
	Woodson #3	\$16.25
700-08103	

EXCAVATORS

	#5	\$16.25
700-04705	
	#14	\$16.25
700-04714	
	#19	\$16.25
700-04719	
	#22	\$16.25
700-04722	
	#24	\$16.25
700-04724	
	#38/39	\$16.25
700-04738	

CROWN REMOVER



#N134 DuraLite [®] Hex	\$50.75
700-CRN134

CROWN ADAPTING PLIERS





#2709 with Rubber Inserts	\$198.75
700-CRN2709



COMPOSITE MANIPULATION - DOUBLE END

Gold Line™ Composite Sculpting System

Titanium nitride coating. Ultralight, ergonomically designed handles that allow for superior torque control and require less pinch force.

	CSS-2	R514	\$37.45
700-R514		
	CSS-3	R518	\$37.45
700-R518		
	CSS-5	R526	\$37.45
700-R526		



Octagonal Double End Handle

BURNISHERS



707-1003027 26/27 \$24.75



707-1003028 27/29 \$24.75

CARVERS



707-1003050 Acorn 21 \$27.25



707-1003051 Acorn 51 \$27.25



707-1003057 Hollenback 3 \$27.25

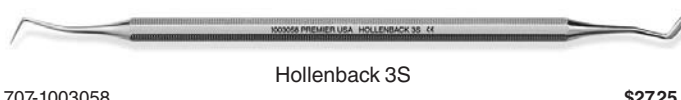

707-1003058 Hollenback 3S \$27.25



707-1003045 Large Cleoid/Discoïd \$27.25



707-1003049 Cleoid/Discoïd 7C \$27.25



707-1003064 Cleoid/Discoïd Tanner 5T \$27.25



707-1003092 Interproximal \$29.25

COMPOSITE FILLING

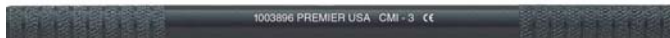

Manipulation Double End Handle

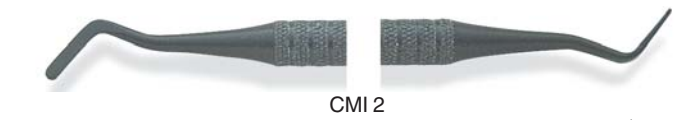

707-1003895 CMI 2 \$30.95



707-1003896 CMI 3 \$30.95



707-1003897 CMI 4 \$30.95



707-1003898 CMI 5 \$30.95

Slix™

Features tips that are treated with a protective coating that provides superior non-stick properties for composite placement. Autoclavable.



707-05700 DE11 \$35.45



707-05705 DE W3 \$35.45



707-05702 IPC \$35.45

PLASTIC FILLING



707-1003694 PFI 13A \$25.45

ASPIRATING SYRINGES



Aspirating Syringe A Type

700-1881

\$22.45



Aspirating Syringe CW Type

700-1880

\$22.45

CHEEK RETRACTORS



University of Minnesota Cheek Retractor

700-1750

\$17.25

ELEVATORS

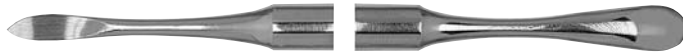

Elevator Molt Periosteal #9

700-1217

\$19.95



Elevator Heidbrink #3

700-1212

\$19.95



Elevator Heidbrink #2

700-1211

\$19.95



Apical Elevator Handle



Apical #301

700-1206

\$19.75



#302



#303

700-1207

Apical 302

700-1208

Apical 303

\$19.75

FORCEPS



Articulating Forceps Serrated

700-1050

\$10.45



Extracting Forceps #23

700-1406

\$65.95



Extracting Forceps #150

700-1400

\$65.95



Extracting Forceps #150S Pedro

700-1404

\$65.95



Extracting Forceps #151

700-1401

\$65.95



Extracting Forceps #151S Pedro

700-1405

\$65.95

HEMOSTATS



Kelly 5.5" Straight

700-1450

\$10.95

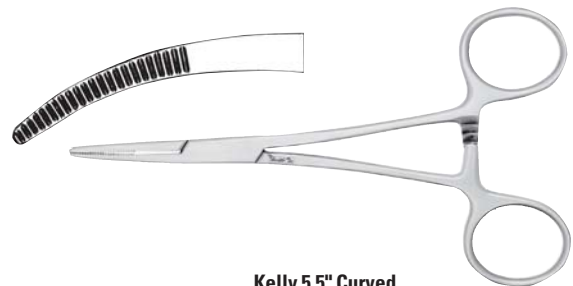

Kelly 5.5" Curved

700-1451

\$10.95



HEMOSTATS

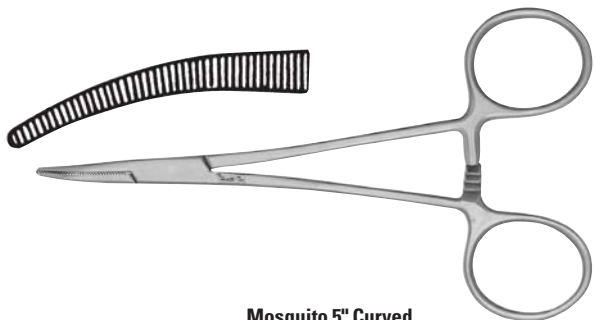

Mosquito 5" Curved

700-1453

\$10.95



Mosquito 5" Straight

700-1452

\$10.95

RUBBER DAM INSTRUMENTS



IV Type Rubber Dam Punch

700-1760

\$85.95



IV Type Rubber Dam Clamp Forceps

700-1761

\$51.95

SCISSORS



Iris Scissor 4.5" Curved

700-1654

\$14.95



Iris Scissor 4.5" Straight

700-1653

\$14.95



Kelly Scissor 6.25"

700-1652 Straight

\$15.95

700-1651 Curved

\$15.95



Crown Scissor 4.5" Curved

700-1656

\$11.95



Dean 7" Angled Scissor

700-1650

\$22.45

NEEDLE HOLDERS



Needle Holder Crile - Wood 6"

700-1500

\$13.95

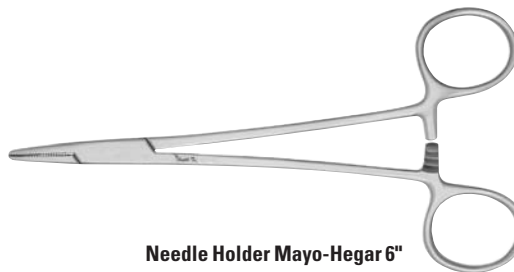

Needle Holder Mayo-Hegar 6"

700-1502

\$13.95



Atraumatic Extracting Forceps \$229.95

Unique Beak Designs

- Preserve bone
- Provide an exceptional grip of the tooth

Exclusive Handle Designs:

- Make forceps 25% lighter
- Offer great ergonomic comfort
- Provide increased tactile sensitivity



X-TRAC® Root Tip Kit K4000 \$476.95

Includes: Upper Root Tip Forceps 5115, Lower Root Tip Forceps 4515, and Bone Preservation Elevator 63

Also sold individually



Upper Universal Forceps
0700



Upper Anterior Forceps-Notched
3400



Upper Universal Forceps-Notched
3500



Lower Anterior Forceps-Notched
3600



Lower Universal Forceps-Notched
2190



Lower Anterior Forceps
3608



Upper Universal Forceps
3508



Lower Universal Forceps
7990



Upper Molar Left Forceps
1700



Upper Molar Right Forceps
1800



Lower Cowhorn Forceps
2300



Upper 3rd Molar Forceps
6701



3-Prong Upper Left Molar Forceps
6717



3-Prong Upper Right Molar Forceps
6718



Lower Molar Forceps
7301



Lower 3rd Molar Forceps
7900



Universal Maxillary Root Forceps
4415



Upper Root Forceps
5115



Lower Root Forceps
4515



Upper Narrow Root Fragment
5197



Lower Narrow Root Fragment
4507

Manufacturer part numbers are provided here, please visit www.dhponline.com to convert or contact your DHPI Account Manager.



\$184.25 - Pedo \$234.75 - Adult
Plus Series Adult & Pedo Forceps

- Lightweight and balanced handle maximizes grip and tactile sensation.
- Beveled and serrated beaks allow for more tooth and root surface contact and operator control
- The most advanced design using CAD CAM technology and experienced Board Certified Consultants
- Crafted in Germany from 100% stainless steel



Upper Root 51+



Upper Anterior 1+



Upper Universal 150+



Lower Universal 151+



Upper Molar 210+



Upper Anterior - Pedo 1P+



Upper Root - Pedo 51P+



Upper Molar- Pedo 210P+



Upper Universal - Pedo 150P+



Lower Universal - Pedo 151P+

Apical Retention Forceps \$175.95

- Serrated beaks to enhance forceps performance
- Tapered beaks slide below the gum line giving an excellent purchase on the crown and root while causing less trauma.



Upper Universal Forceps 1107



Upper Universal Forceps, narrow 1107N



Lower Anterior Forceps, narrow 1174XN



Cowhorn 23



Upper Anterior Forceps 1102



Lower Universal Forceps 1274



Lower Universal Forceps, narrow 1274N



Bone Preservation Elevators \$71.45

- Minimize bone loss.
- Create space between the bone and root for all atraumatic extractions.
- Thin sharp tip of the elevator slides between the bone and the root creating space without removing any bone.
- Fast and easy removal of roots and fragments without a surgical procedure.



K5000 \$279.95

Bone Preservation Elevator Kit

Includes: #63, #60B, #60R and #60L



K3000 \$142.95

Molar Elevator Kit

Includes: #60R and #60L

Also sold individually



Spade Tip, Straight
63



Spade Tip, Angled
60B



Spade Tip, Right Molar
60R



Spade Tip, Left Molar
60L



Spade Tip, Back Action
60U



Small, Straight - 2.5mm
301



Medium, Straight - 3.5mm
304



Large, Straight, Thin - 4.5mm
34S Thin



Large, Straight - 3.75mm
34S



Large, Straight - 5.0mm
34



Angled, Serrated Molar Region
46R



Angled, Molar Region
77R

Manufacturer part numbers are provided here, please visit www.dhponline.com to convert or contact your DHPI Account Manager.



Needle Holders \$152.95

- Tungsten-Carbide tips eliminates needle rotation
- Fully Autoclavable
- German-made
- 100% stainless steel

Mayohegar 6"
M6



Mayohegar 7"
M7

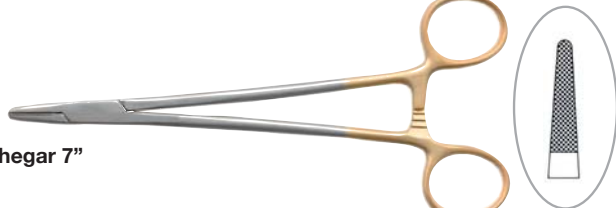

Crilewood 6"
C6C



Baumgartner 5.5"
B5



Scissors Starting at \$61.95

- Fully Autoclavable
- German-made
- 100% stainless steel

Curved Kelly, Serrated Blade 6.25"
859

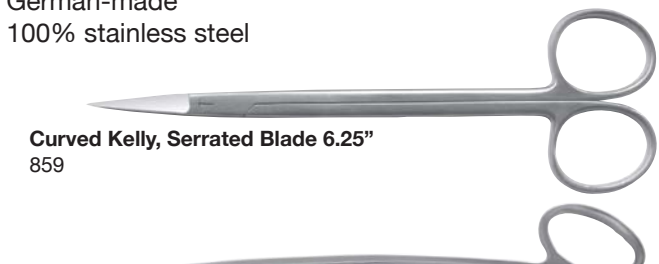

Dean scissor with Serrated blades 7"
861



Iris Curved, Extra Fine 4.5"
840



Iris Curved 4.5"
865



Iris Straight 4.5"
869



Goldman Fox Serrated 5"
808



Curved LaGrange 4.5"
877



Closed handle, Locklin Serrated Blades 6.25"
880



Crown & Bridge 4"
378



Straight suture scissor with Loop Suture 6"
899



Scissors Starting at \$91.95

- One blade is serrated to provide a smooth cut and stay sharper longer
- Excellent for trimming tissue and suture material



Iris Curved, Extra Fine 4.5"
840SC



Iris Curved 4.5"
865SC



LaGrange 4.5"
877SC



Manufacturer part numbers are provided here, please visit www.dhponline.com to convert or contact your DHPI Account Manager.

X-Otomes \$122.75

- Made in the America
- Hybrid instrumentation, a cross between an Elevator and a Periostome
- Custom sure-grip handle for controlled luxation
- Honed narrow tips to disrupt the periodontal fibers
- Preserves tissue structures
- Eliminates bone fracture and promotes minimally invasive exodontia
- 100% stainless steel



XO-10 Straight Small



XO-20 Curved Small



XO-30 Curved Angled Mesial



XO-40 Angled Distal



XO-50 Angled Mesial



XO-60 Angled Distal



XO-70 Straight Universal



XO-77 Straight Universal



XO-77AR Angled Universal



XO-77AL Angled Universal



XO-77D Beveled Spade Angled Distal



XO-77M Beveled Spade Angled Mesial



XO-90 Straight Micro



XO-100 Angled Mesial Large



XO-100 Angled Distal Large



XO-110 Notched Tip X-Otome

Periostomes P1 - P5 \$52.95 P100 - P500 \$89.95

- Available individually and in 2 styles or kits
- 4 different blade shapes for all areas of the mouth
- Blades are all slightly rounded on the end and paper thin
- Slide easily below the gumline
- 100% Stainless Steel

K6000 \$219.95

Fixed Tip Periostome Kit
Includes #P-100, #P-200 and #P-300

K6100 \$219.95

Interchangeable Periostome Kit
Includes #P0, #P1, #P2 and #P3



P100
Wide Blade Universal



P200
Narrow Blade Anterior



P300
Angled Blade Posterior



P500
Angled Blade Interproximal



P5
Angled Blade Interproximal

P0
Interchangeable Handle



P3
Tip Angled



P2
Tip Narrow



P1
Tip Wide



K3300 \$364.95

Elemental Kit
Includes: XO-10, XO-20, XO-77 and a sterilization cassette

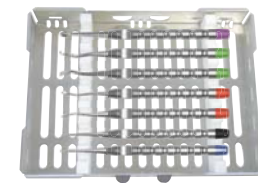

K6600 \$835.95

X-Otome Kit
Includes one of each: XO-10, XO-20, XO-30, XO-40, XO-50, XO-60, XO-77 and a sterilization tray

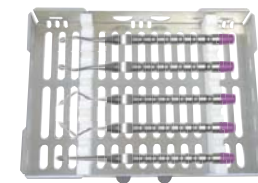

K7700 \$624.95

X-Otome Kit
Includes one of each: XO-77, XO-77AL, XO-77AR, XO-77M, XO-77D and a sterilization tray

Manufacturer part numbers are provided here, please visit www.dhponline.com to convert or contact your DHPI Account Manager.



ELEVATORS

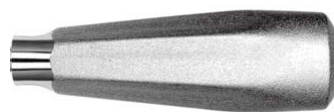

How the best perform

Ergo Dynamic handle



34S Seldin
Thinner tip and more narrow than the 34 shank
| E34S
Handle: #510
| E34SSM
Handle: Ergo Dynamic



77R Hu-Friedy Serrated
Upper posterior roots and upper 3rd Molars
| E77R
Handle: #510
| E77RSM
Handle: Ergo Dynamic



301 Apexo
For displacement of deeply seated roots
| E301
Handle: #510
| E301SM
Handle: Ergo Dynamic



B Cogswell
| EB
Handle: #510
| EBSM
Handle: Ergo Dynamic

CRYER

Suggested Pair



21 Cryer Mini | **22 Cryer Mini**
| E21 | E22

Suggested Pair



44 Cryer Small | **45 Cryer Small**
| E44 | E45

Suggested Pair



25 Cryer Medium | **26 Cryer Medium**
| E25 | E26

Suggested Pair



31 Cryer Large | **32 Cryer Large**
| E31 | E32

Suggested Pair



A30 Cryer | **A31 Cryer**
| EA30 | EA31

HEIDBRINK



1 Heidbrink Straight
| E1



2 Heidbrink Straight
| E2



40 Heidbrink Straight
| E40



41 Heidbrink Straight
| E41

English Patterns

Upper and lower anterior teeth and roots

Manufacturer part numbers are provided here, please visit www.dhponline.com to convert or contact your DHPI Account Manager.

APEXO

Suggested Pair		Suggested Pair		Suggested Pair			
4 Schmeckeber Apexo	5 Schmeckeber Apexo	71 Miller Apexo	72 Miller Apexo	73 Miller Apexo	74 Miller Apexo	302 Apexo	303 Apexo
E4	E5	E71	E72	E73	E74	E302	E303

Schmeckeber and Miller designs used for displacement of broken or deep-seated root tips.

For displacement of deeply seated roots

Manufacturer part numbers are provided here, please visit www.dhponline.com to convert or contact your DHPI Account Manager.



Cut through the fat

**GO DIRECTLY
TO THE BEST**

Manufacturers offer thousands of promotions. GO **DIRECTLY** TO THE BEST.

www.dhponline.com/promotions

BUY 1	BUY 2	BUY 3	BUY 4 <small>OR MORE</small>	DHPI X <small>EXCLUSIVE OFFERS</small>
--------------	--------------	--------------	--	--



**EXTRACTION
FORCEPS**



How the best perform

UPPER MOLARS Starting at \$176.75

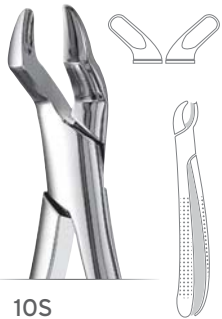

10S
| F10S
Upper Molars

Suggested Pair



18L Harris
| F18L
1st & 2nd Upper Molars; left. Pointed beak for engaging bifurcated buccal root.

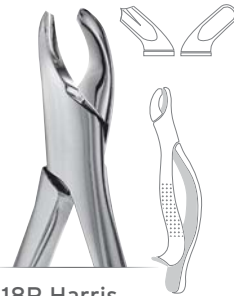

18R Harris
| F18R
1st & 2nd Upper Molars; right. Pointed beak for engaging bifurcated buccal root.

Suggested Pair



53L
| F53L
1st & 2nd Upper Molars; left. Pointed beak for engaging bifurcated buccal root.

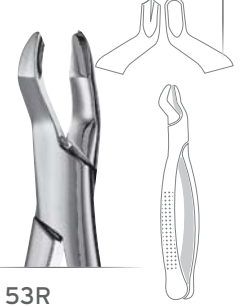

53R
| F53R
1st & 2nd Upper Molars; right. Pointed beak for engaging bifurcated buccal root.

Suggested Pair



88L Nevius
| F88L
1st & 2nd Upper Molars. Split beak for engaging palatal root.

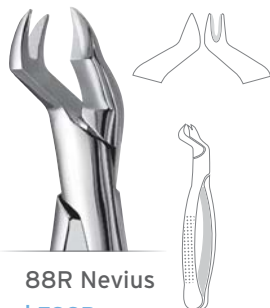

88R Nevius
| F88R
1st & 2nd Upper Molars. Split beak for engaging palatal root.

Suggested Pair

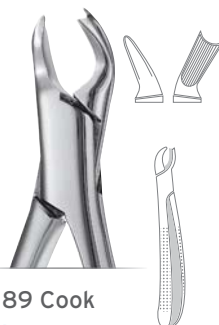

89 Cook
| F89
Upper Molars; Right

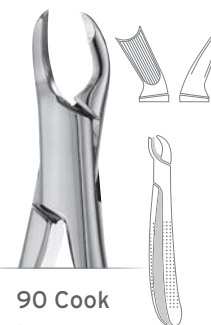

90 Cook
| F90
Upper Molars; Left

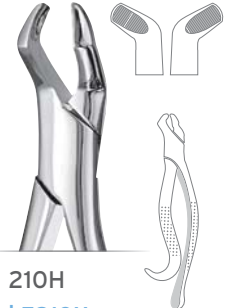

210H
| F210H
3rd Upper Molars

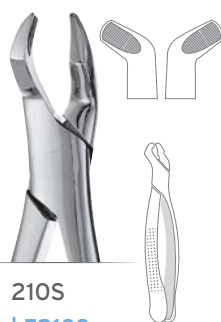

210S
| F210S
3rd Upper Molars



MD2 Mead Serrated
| FMD2
Upper 1st, 2nd, & 3rd Molars, Universal

Suggested Pair



17 European Style Serrated
| FX17
| FX17E
Matte Finish
Upper Molars; Right



18 European Style Serrated
| FX18
| FX18E
Matte Finish
Upper Molars; Left

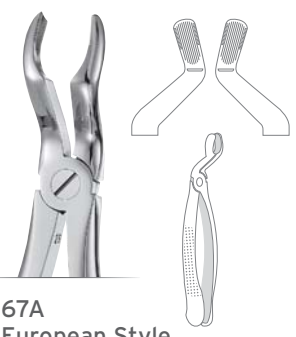

67A European Style Serrated
| FX67A
Upper 3rd Molars

Manufacturer part numbers are provided here, please visit www.dhponline.com to convert or contact your DHPI Account Manager.

EXTRACTION FORCEPS



How the best perform

LOWER ANTERIORS AND PREMOLARS Starting at \$176.75



151 Cryer Universal
| F151
Lower Incisors, Canines, Premolars & Roots; Universal

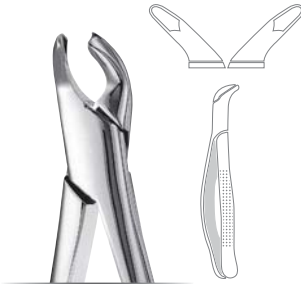
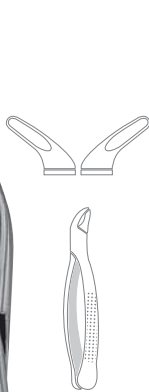

151A Cryer Parallel Beaks
| F151A
Lower Incisors, Canines, Premolars & Roots; Universal

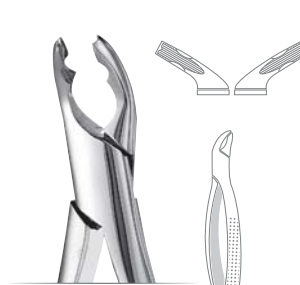

151A Split Beaks Serrated
| F151AS
Lower Incisors, Canines, Premolars & Roots; Universal

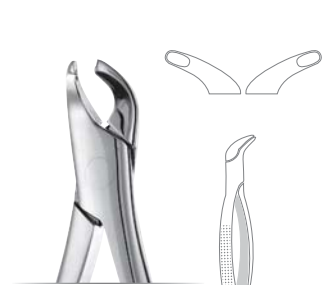

203
| F203
Lower Incisors, Canines, Premolars, and Roots



13 European Style Serrated
| FX13
| FX13E
Matte Finish
Lower Premolars



MD3 Mead Serrated
| FMD3
Lower Incisors & Roots

UPPER AND LOWER ANTERIORS \$176.75

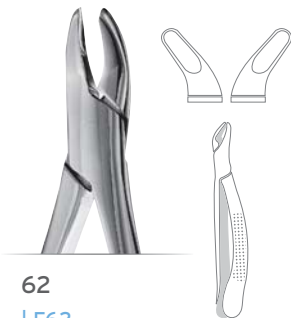

62
| F62
Upper & Lower Incisors, Canines, Premolars, and Deciduous; Universal



101 Hull
| F101
Upper & Lower Premolars, and Deciduous; Universal



Manufacturer part numbers are provided here, please visit www.dhponline.com to convert or contact your DHPI Account Manager.

EXTRACTION FORCEPS



How the best perform

LOWER MOLARS Starting at \$176.75

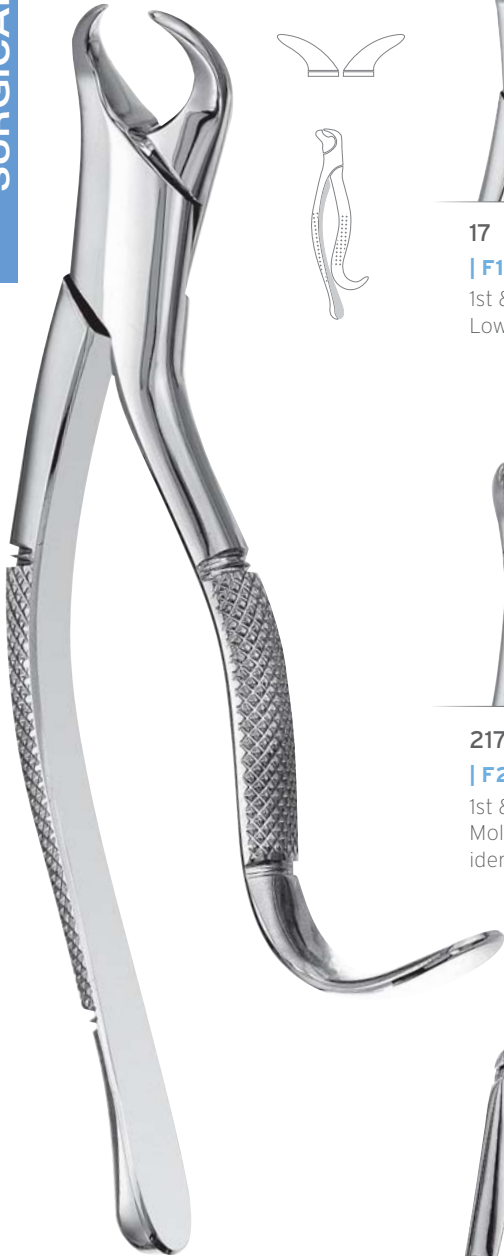

16 Cowhorn
1st & 2nd Lower
Molars

| **F16**
| **F16M**
Handle: Straight



17
| **F17**
1st & 2nd
Lower Molars



23 Cowhorn
| **F23**
1st & 2nd
Lower Molars



3FS Woodward
| **F3FS**
Lower Molars



217 Hu-Friedy
| **F217**
1st & 2nd Lower
Molars Beaks
identical to #17

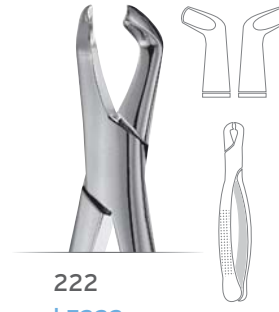

222
| **F222**
3rd Lower
Molars



MD4 Mead Serrated
| **FMD4**
Lower 1st, 2nd,
& 3rd Molars



22 European Style Serrated
| **FX22**
| **FX22E**
Matte Finish
Lower Molars



73 European Style Serrated
| **FX73**
Lower Molars



79 European Style Serrated
| **FX79**
| **FX79E**
Matte Finish
Lower 3rd Molars

Manufacturer part numbers are provided here, please visit www.dhponline.com to convert or contact your DHPI Account Manager.

EXTRACTION FORCEPS

How the best perform

UPPER ANTERIORS AND PREMOLARS Starting at \$176.75

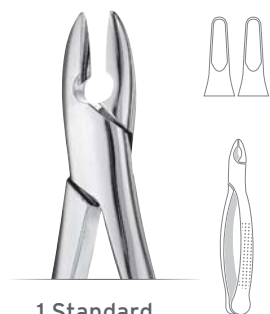

1 Standard
| F1
Standard Upper Incisors & Canines

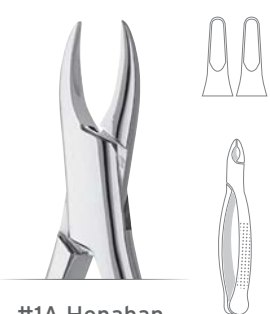

#1A Henahan
| F1A

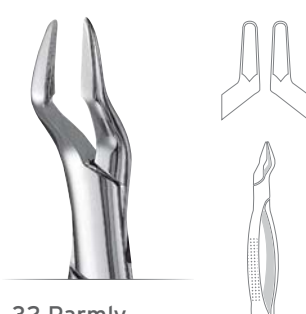

32 Parmly Alveolar
| F32
Upper Canines, Premolars, & Molars; Universal. Sharp edged beaks for breaking the alveolar process and trimming it after extraction.

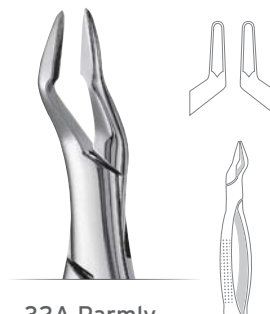

32A Parmly Alveolar
| F32A
Same as No. 32, but with more slender beaks.



99C Kells
| F99C
Upper Incisors, Canines & Premolars



150 Cryer Universal
| F150
Upper Incisors, Canines, Premolars & Roots; Universal



150A Cryer Parallel Beaks
| F150A
Upper Incisors, Canines & Premolars; Universal



150AS Split Beaks Serrated
| F150AS
Upper Incisors, Canines, & Premolars; Universal

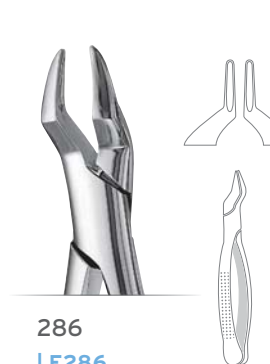

286
| F286
Upper Roots, Incisors, Premolars



MD1 Mead Serrated
| FMD1
Upper Incisors, Canines, Premolars & Roots

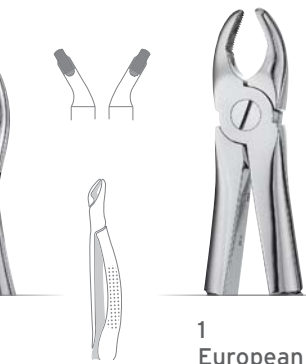

35
| FX35E
Matte Finish
Upper Incisors, Canines, Premolars and Roots



1 European Style Serrated
| FX1
| FX1E
Matte Finish
Upper Anteriors

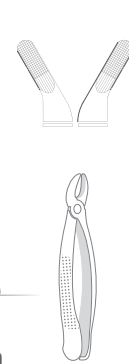

7 European Style Serrated
| FX7
| FX7E
Matte Finish
Upper Premolars

Manufacturer part numbers are provided here, please visit www.dhponline.com to convert or contact your DHPI Account Manager.

SURGICAL INSTRUMENT CROSS-REFERENCE CHART



CALIPERS



700-06800
\$31.95

HF-BG
\$134.95

701-68694
\$59.25



700-06841
\$30.95

HF-CLP1
\$134.95

ELEVATORS



700-1206
\$19.75

HF-E301
\$82.75

701-DEL301
\$73.25

707-1003360
\$56.95



700-1207
\$19.75

HF-E302
\$82.75

701-DEL302
\$73.25

707-1003361
\$56.95



700-1208
\$19.75

HF-E303
\$82.75

701-DEL303
\$73.25

707-1003362
\$56.95



700-04944
\$22.25

HF-E44
\$82.75

701-DEL44
\$73.25



700-04945
\$22.25

HF-E45
\$82.75

701-DEL45
\$73.25



700-04925
\$22.25

HF-E25
\$82.75

701-DEL25
\$73.25



700-04926
\$22.25

HF-E26
\$82.75

701-DEL26
\$82.75



700-04210
\$18.25

HF-EHB1
\$60.25

701-DELH1
\$57.45



700-1211
\$19.95













HF-EHB2
\$60.25

701-DELH2
\$57.45

SURGICAL INSTRUMENT CROSS-REFERENCE CHART



ELEVATORS

 HEIDBRINK 3 ROOT TIP PICK	700-1212 \$19.95		HF-EHB3 \$60.25	701-DELH3 \$57.45	
 HEIDBRINK DE 13/14			HF-EHB1314 \$65.25		707-1003396 \$34.45
 HEIDBRINK STRAIGHT 1			700-04901 \$22.25	HF-E1 \$82.75	
 HEIDBRINK STRAIGHT 2			700-04902 \$22.25	HF-E2 \$82.75	
 HEIDBRINK STRAIGHT 40			700-04940 \$22.25	HF-E40 \$82.75	
 MOLT 9	700-1217 \$19.95		HF-P9 \$63.25	701-DELM9 \$63.25	707-1003661 \$40.25
 POTTS T-BAR 1 (6X)		700-04591 \$24.45	HF-E6X \$82.75	701-DEL6X \$73.25	707-1003394 \$56.95
 POTTS T-BAR 2 (7X)		700-04592 \$24.45	HF-E7X \$82.75	701-DEL7X \$73.25	707-1003395 \$56.95
 ROOT TIP 80		700-04980 \$22.25	HF-E8 \$82.75	701-DEL80 \$73.25	
 SCHMECKEBIER 4		700-04964 \$22.25	HF-E4 \$82.75		
 SCHMECKEBIER 5		700-04965 \$22.25	HF-E5 \$82.75		
 SELDIN 34S		700-04335 \$21.25	HF-E34S \$82.75	701-DEL34S \$73.25	701-DEL34S \$73.25
 SELDIN STRAIGHT 34		700-04334 \$21.25	HF-E34 \$82.75	701-DEL34 \$73.25	707-1003372 \$56.95

SURGICAL INSTRUMENT CROSS-REFERENCE CHART



ELEVATORS

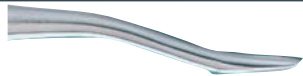

SERRATED 77R

HF-E77R
\$82.75

701-DEL77R
\$73.25

FORCEPS



1 UPPER ANTERIOR STANDARD

700-05001
\$58.45

HF-F1
\$176.75

701-DEF1STD
\$169.45



150 UPPER ANTERIOR

700-1400
\$65.95

HF-F150
\$176.75

701-DEF150
\$169.45

707-9065030
\$123.25



150A UPPER ANTERIOR

700-06152
\$58.45

HF-F150A
\$176.75

701-DEF150A
\$169.45

707-9065032
\$123.25



150S PEDO

700-1404
\$65.95

HF-F150S
\$176.75

701-DEF150S
\$169.45

707-9065057
\$123.25



151 LOWER ANTERIOR

700-1401
\$65.95

HF-F151
\$176.75

701-DEF151
\$169.45

707-9065031
\$123.25



151A LOWER ANTERIOR SERRATED

700-06153
\$58.45

HF-F151A
\$176.75

701-DEF151A
\$169.45

700-9065033S
\$124.45



151S LOWER ANTERIOR PEDO

700-1405
\$65.95

HF-F151S
\$176.75

701-DEF151S
\$169.45

707-9065058
\$123.25



53 UPPER LEFT

700-05530
\$58.45

HF-F53L
\$176.75

701-DEF53L
\$169.45

707-9065015
\$123.25



53 UPPER RIGHT

700-05535
\$58.45

HF-F53R
\$176.75

701-DEF53R
\$169.45

707-9065016
\$123.25



88 UPPER MOLAR LEFT

700-05880
\$58.45

HF-F88L
\$176.75

701-DEF88L
\$169.45

707-9065024
\$123.25



88 UPPER MOLAR RIGHT

700-05885
\$58.45

HF-F88R
\$176.75

701-DEF88R
\$169.45

707-9065025
\$123.25

SURGICAL INSTRUMENT CROSS-REFERENCE CHART



FORCEPS



16 LOWER MOLAR

700-05160
\$58.45

HF-F16
\$176.75

701-DEF16
\$169.45

707-9065006
\$123.25



17 LOWER MOLAR SERRATED

700-05170
\$58.45

HF-FX17
\$188.25

701-DEF17
\$169.45

707-9065008
\$123.25



23 LOWER 1ST AND 2ND MOLAR

700-1406
\$65.95

700-05230
\$58.45

HF-F23
\$176.75

701-DEF23
\$169.45

707-9065011
\$123.25



69 UPPER AND LOWER ROOTS

700-05690
\$58.45

HF-F69
\$176.75

701-DEF69
\$169.45

707-9065019
\$123.25



74 ENGLISH PATTERN SERRATED

700-05745
\$58.45

HF-FX74
\$188.25

701-DEF74N
\$201.45

707-9065021
\$123.25

HEMOSTATS

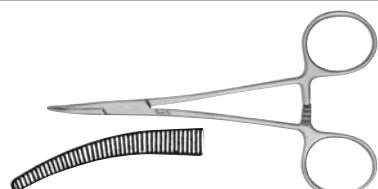

HALSTED MOSQUITO 5" CURVED

700-1453
\$10.95

HF-H3
\$60.75

701-716
\$69.25

07-9065127
\$64.25



HALSTED MOSQUITO 5" STRAIGHT

700-1452
\$10.95

HF-H4
\$60.75

701-714
\$69.25

707-9065126
\$64.25



KELLY 5-1/2" CURVED

700-1451
\$10.95

HF-H2
\$60.75

701-738
\$54.75

707-9065129
\$64.25



KELLY 5-1/2" STRAIGHT

700-1450
\$10.95

HF-H1
\$60.75

701-736
\$52.25

707-9065128
\$64.25

SURGICAL INSTRUMENT CROSS-REFERENCE CHART



MALLETS



MEAD

700-02360
\$44.75

HF-MAL1
\$167.75

701-19796
\$157.25

NEEDLE HOLDERS



CASTROVIEJO 5-1/2" STRAIGHT

700-257850
\$55.45

HF-NHCV
\$330.45

701-181828
\$425.95

TUNGSTEN INSERTS
700-657850
\$111.45

TUNGSTEN INSERTS
HF-NH5020
\$424.25

TUNGSTEN INSERTS
701-181828TC
\$606.25

TUNGSTEN INSERTS
707-9085159
\$332.25



CRILE-WOOD 6"

700-1500
\$13.95

TUNGSTEN INSERTS
700-656420
\$68.25

HF-NHCW
\$103.95

TUNGSTEN INSERTS
HF-NH5038
\$165.75

701-850
\$88.45

TUNGSTEN INSERTS
701-850TC
\$167.25

707-9085163
\$66.25

TUNGSTEN INSERTS
707-9085153
\$146.95



DERF 5"

TUNGSTEN INSERTS
700-656000
\$63.75

HF-NHD
\$103.95

TUNGSTEN INSERTS
HF-NH5032
\$165.75

707-9085165
\$66.25

TUNGSTEN INSERTS
707-9085155
\$146.95



MATHIEU 5-1/2"

700-257650
\$25.45

HF-NHM
\$154.95

701-828
\$151.25

TUNGSTEN INSERTS
700-657650
\$84.95

TUNGSTEN INSERTS
HF-NH5076
\$215.25

TUNGSTEN INSERTS
701-828TC
\$260.45

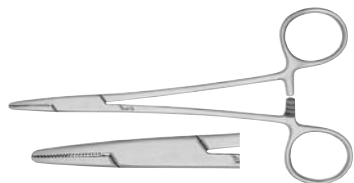

MAYO-HEGAR 5"

700-256290
\$15.25

701-842
\$80.45

707-9085161
\$72.45

TUNGSTEN INSERTS
701-842TC
\$174.45



MAYO-HEGAR 6"

700-1502
\$13.95

HF-NMH
\$103.95

TUNGSTEN INSERTS
HF-NH5042
\$165.75

701-844
\$81.25

TUNGSTEN INSERTS
701-844TC
\$166.95

707-9085162
\$72.45

TUNGSTEN INSERTS
707-9085151
\$146.95

INSTRUMENT CROSS-REFERENCE CHART



PLIERS



#200

700-09200
\$31.95

701-7475
\$154.95



CONTOUR JOHNSON

700-09114
\$31.95

HF-678221
\$163.25

701-7430
\$151.25



WIRE CUTTER 5-1/2"

700-09177
\$58.45

701-74115
\$92.75

SCISSORS



COLLAR & CROWN CURVED 4-1/4"

700-1656
\$11.95

701-9D135
\$69.25

SHARP
707-9085344
\$60.25
BLUNT
707-9085345
\$60.25



DEAN 7" ANGLED

700-1650
\$22.45

TUNGSTEN INSERTS
700-62100
\$103.25

HF-S9
\$112.25
TUNGSTEN INSERTS
HF-S5009
\$257.95

701-5264
\$132.25

707-9065110
\$95.45



GOLDMAN-FOX 5"

HF-S16
\$102.75
TUNGSTEN INSERTS
HF-S5080
\$226.75

701-5320
\$86.95
TUNGSTEN INSERTS
701-5320TC
\$179.25

707-9065105
\$56.95



IRIS CURVED 4-1/2"

700-1654
\$14.95



IRIS STRAIGHT 4-1/2"

700-1653
\$14.95



KELLY 6-1/4" CURVED

700-1651
\$15.95

HF-S1
\$89.75
TUNGSTEN INSERTS
HF-S5001
\$226.75

701-5252
\$104.75



SURGICAL INSTRUMENT CROSS-REFERENCE CHART





SCISSORS

 KELLY 6-1/4" STRAIGHT	700-1652 \$15.95		HF-S2 \$89.75 TUNGSTEN INSERTS HF-S5002 \$226.75	701-5250 \$98.75	
 LAGRANGE DC 4-1/2"		700-221540 \$11.75	HF-S14 \$112.25	701-5D324 \$117.25	707-9065115 \$95.45
 LITTAUER		700-233040 \$10.75		701-9102 \$77.95	707-9085114 \$37.75
 OPERATING 5-1/2" SHARP/BLUNT		700-221110 \$11.75	HF-S22 \$78.25	701-516 \$51.95	
 SUTURE 6"		700-233070 \$12.75	HF-S13 \$89.75		707-9085116 \$50.95
 WAGNER 4-3/4" CURVED		700-12345 \$17.25	HF-S6 \$78.25	701-5277 \$85.25	
 WAGNER 4-3/4" STRAIGHT		700-12339 \$16.45	HF-S5 \$78.25	701-5271 \$84.25	

TOWEL CLAMPS

 BACKHAUS 3-1/4"			HF-TC3 \$67.25		
 BACKHAUS 3-1/2"		700-311000 \$10.75		701-V97504 \$16.45	

WAXING

 SPATULA 7			HF-WS7 \$30.75	701-7362 \$31.25	707-1004375 \$21.25
 SPATULA 31		700-13310 \$9.75		701-7358 \$48.45	707-1004379 \$24.25

CHEEK RETRACTORS



Health-Tec
BRAND PRODUCTS

Cheek Retractor
University of Minnesota
700-1750 Each\$17.25



Lip Retractors - Integra Miltex
Positions lips away from teeth and gums to increase visibility and accessibility. Single-sided.
Child 706-31621
Adult 706-31620
2/pkg..... \$20.45



Spandex - Hager Worldwide
Comfortable for the patient and warm to the touch. Easy to snap into place. Allows clear view and work area. Autoclavable to 130° C-270° F. Non-reflective, ideal for photography, oral surgery, restorative bonding, etc.
Mini 700-605455
Standard 700-605454
2/pkg. \$43.45



Cheek Retractor - Hu-Friedy
University of Minnesota
HF-CRM Each \$39.45



Lip Retractor #164 - Integra® Miltex®
6" length, double end, 25mm and 36mm wide.
701-22200 Each \$50.25



OptraGate - Ivoclar Vivadent
Auxiliary aid that enables the treatment field to be enlarged easily, effectively and comfortably. It allows lips and cheeks to be retracted completely and ensures relative isolation.

Assortment
Contains: 40 regular and 40 small.
700-577275 80/pack \$138.45

Regular
700-590850 80/pack \$138.45

Small
700-590851 80/pack \$125.25



Cheek Retractors - Plasdent Corporation
Translucent Blue, Autoclavable to 275° F.
Hand-free Adult
700-EX9000 2/pack \$10.25

Hand-free Child
700-EX9001 2/pack \$10.25

Hand-free Teen
700-EX9001T 2/pack \$7.25

Hand-hold Adult
700-EX9002 2/pack \$7.25

Hand-hold Child
700-EX9003 2/pack \$7.25

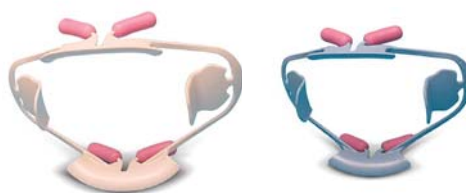

ComfortView™ Lip and Cheek Retractor - Premier® Dental
Retracts lips and cheeks for optimal buccal and gingival access. Maximum visibility and patient comfort. Suitable for use in diagnostic, preventative, therapeutic dental applications and digital impression scanning, in-office tooth whitening and intra-oral photography. Autoclavable, Latex-Free.

Universal - White
700-9061381 2/box \$47.95

Small - Blue
700-9061383 2/box \$47.95

NOW YOU CAN
BROWSE ALL CLEARANCE

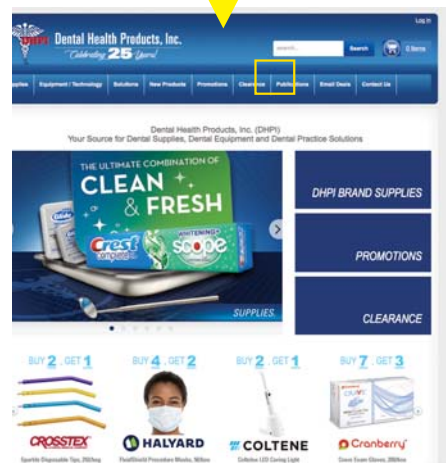

www.dhpionline.com/clearance

All Clearance
Supplies are
Discounted
up to **25%**,
While Supplies Last!



Nola Dry Field System

Achieve Total Bonding Success...

- Full Arch Access for Bonding
- Adjustable to Arch Length
- Maximum Patient Comfort
- Excellent Soft Tissue Retraction
- Fully Autoclavable to 280°F/135°C
- Reduces Bond Failure
- Prevents Treatment Delays

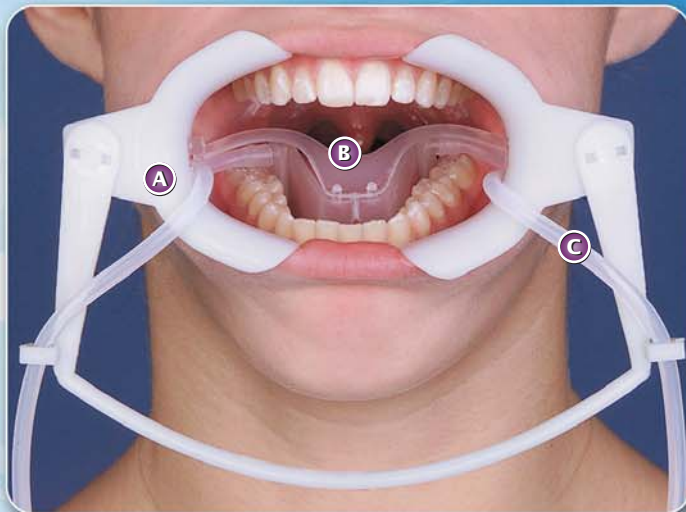

The Nola Dry Field System completely eliminates saliva and fully exposes both arches making it ideal for all bonding applications.

The system is easy to assemble, be inserted, and used by a single operator. The entire system is completely autoclavable making clean-up easy.

Dry Field Systems

- Small (Red)690-300400
- Large (White)690-300401
- System..... **\$89.75**

System Includes: 1x cheek retractor, 1x flexible connector, 1x tongue guard, 2x bilateral suction tubes, 1x central suction "Y" connector with low-volume adapter

Dry Field System Separate Components

- | | |
|--|--|
| <p>A Cheek Retractor
 <i>Assembly with flexible connector</i>
 Small (Red) 690-300414
 Large (White) 690-300406
 1 retractor \$27.95</p> | <p>Adjustable Cheek Retractor
 Keeps the cheeks back and fully exposes both dental arches</p> |
| <p>B Tongue Guards
 Small (Red) 690-300413
 Large (Translucent)690-300403
 2/pack..... \$59.75</p> | <p>Tongue Guard
 Holds the tongue in place and allows the patient to continue swallowing</p> |
| <p>C Bilateral Suction Tubes
 <i>Silicone Tubing</i>
 Item #: 690-300412
 10/pack..... \$33.45</p> | <p>Bilateral Silicone Tubing
 Precisely directs saliva flow and ensures unrestricted evacuation for a totally dry environment</p> |
| <p>D "Y" Connectors
 Item #: 690-300408
 4/pack..... \$18.25</p> | <p>Central Suction
 "Y" connector adapter (low-volume and high volume also available)</p> |
| <p>E Low-Volume Adapters
 Item #: 690-300409
 1 pack \$30.95
 4x Adapters and 4x "Y" connectors</p> | <p>G Connecting Arm Inserts
 Used for connecting Tongue Guards to Cheek Retractor.
 Item #: 690-300402
 10/pack..... \$19.75</p> |
| <p>F High-Volume Adapters
 Item #: 690-300411
 1 pack \$41.25
 4x Adapters and 4x "Y" connectors</p> | |



RUBBER DAM FORCEPS



IV Type Rubber Dam Clamp Forceps
700-1761 Each \$51.95



Ivory Dental Dam Forceps - Coltene
Stainless steel.
815-01262 Each \$128.25



Ivory Rubber Dam Clamp Forceps - Heraeus Kulzer
810-57220 Each \$89.25



Rubber Dam Clamp Forceps - Hu-Friedy®
HF-RDF Each \$115.95

RUBBER DAM PUNCH



IV Type Rubber Dam Punch
700-1760 Each \$85.95



Ivory Rubber Dam Punch - Heraeus Kulzer
810-57225 Each \$188.75



Ainsworth Type Rubber Dam Punch - J&J Instruments
700-11500 Each \$74.25

LOOK'in

for something? **WE HAVE IT!**

www.dhpionline.com



IMS SIGNATURE SERIES® CASSETTES



Exam Cassette - 5 Instruments \$92.25

Exterior Dimensions 3" x 8" x 1.25"
(76 mm x 203 mm x 32 mm) Holds 5 instruments.

Red	■	IM6050
Gray	■	IM6051
White	□	IM6052
Orange	■	IM6053
Yellow	■	IM6055
Lavender	■	IM6056
Blue	■	IM6058
Green	■	IM6059



Small Cassette - 8 and 10 Instruments \$122.75

Exterior Dimensions 5.5" x 8" x 1.25" (140 mm x 203 mm x 32 mm) Holds 8 instruments with an accessory area.

	8 Instrument	10 Instrument
Red	■ IM5080	IM5100
Gray	■ IM5081	IM5101
White	□ IM5082	IM5102
Orange	■ IM5083	IM5103
Yellow	■ IM5085	IM5105
Lavender	■ IM5086	IM5106
Blue	■ IM5088	IM5108
Green	■ IM5089	IM5109

8 instrument cassette shown above. Also available in 10 instrument cassette.



Signa-Stat Cassette - 12 Instruments \$143.75

Exterior Dimensions 6.5" x 10.5" x 1.25" (165 mm x 267 mm x 32 mm) Holds 12 instruments with an accessory area. Fits in SciCan® STATIM® or the Midmark M3 autoclave.

Red	■	IM8120
Gray	■	IM8121
White	□	IM8122
Orange	■	IM8123
Yellow	■	IM8125
Lavender	■	IM8126
Blue	■	IM8128
Green	■	IM8129

Manufacturer part numbers are provided here, please visit www.dhponline.com to convert or contact your DHPI Account Manager.



How the best perform



Large Cassette-12, 16 and 20 Instruments \$147.25
 Exterior Dimensions 8" x 11" x 1.25" (203 mm x 280 mm x 32 mm)
 Holds 16 instruments with an accessory area.
 Also available in 8" x 10.5" x 1.25" size (IM416xQ) to fit unique ultrasonic tanks.

	12 Instrument	16 Instrument	20 Instrument
Red	■ IM4120	IM4160	IM4200
Gray	■ IM4121	IM4161	IM4201
White	□ IM4122	IM4162	IM4202
Orange	■ IM4123	IM4163	IM4203
Yellow	■ IM4125	IM4165	IM4205
Lavender	■ IM4126	IM4166	IM4206
Blue	■ IM4128	IM4168	IM4208
Green	■ IM4129	IM4169	IM4209



Small Ultrasonic Insert/Handpiece Cassette

Ultrasonic Insert/Handpiece Cassette \$82.75/\$92.25

Small: Exterior Dimensions 1.5" x 8" x 1.25"
 (38 mm x 203 mm x 32 mm)
 Large: Exterior Dimensions 3" x 8" x 1.25"
 (76 mm x 203 mm x 32 mm)

	Small Cassette	Large Cassette
Red	■ IM30HU0	IM60H0
Gray	■ IM30HU1	IM60H1
White	□ IM30HU2	IM60H2
Orange	■ IM30HU3	IM60H3
Yellow	■ IM30HU5	IM60H5
Lavender	■ IM30HU6	IM60H6
Blue	■ IM30HU8	IM60H8
Green	■ IM30HU9	IM60H9



Large Ultrasonic Insert/Handpiece Cassette

Small holds 2 Ultrasonic Inserts or 1 handpiece.
 Large holds up to 3 high-speed handpieces or 5 ultrasonic inserts.



Double Symmetry IQ[®] Handpiece Cassette

Symmetry IQ[®] Handpiece Cassette \$92.25

Small: Exterior Dimensions 1.5" x 8" x 1.25"
 (38 mm x 203 mm x 32 mm)
 Large: Exterior Dimensions 3" x 8" x 1.25"
 (76 mm x 203 mm x 32 mm)

Single	IM30IQ8
Double (pictured)	IM60IQ8

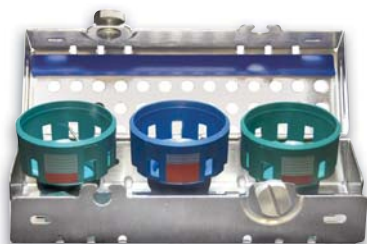

Symmetry IQ Wrench Cassette

Exterior Dimensions 5.63" x 1.95" x 1.77"
 (143 mm x 50 mm x 45 mm)

Blue	■ IMIQ38
------	------------

Wrench not included.

IMS Infinity Series Cassettes by Popular Procedure are available upon request.

Manufacturer part numbers are provided here, please visit www.dhpionline.com to convert or contact your DHPI Account Manager.

Order by 800-626-2163

www.dhpionline.com

Fax: 888-681-5088

431



IMS RESIN CASSETTES



How the best perform

Hu-Friedy Resin Cassettes are constructed of high-grade medical resin. Soft silicone instrument rails gently hold instruments in place. Cools down quickly after sterilization and are lightweight.



Small Cassettes \$160.75

Exterior Dimensions 4.5" x 8" x 1.5" (114 mm x 203 mm x 38 mm)

Small Resin 7 Instruments | [IMS-3107](#)

Holds up to 7 instruments. The cassette is perfect for exam and prophylactic procedures.

Small Resin 12 Instruments | [IMS-3112](#)

Holds up to 12 instruments

Small Resin 16 Instruments | [IMS-3116](#)

Holds up to 16 instruments in a compact space (pictured)



Large Cassettes - No Accessory Area \$168.75

Exterior Dimensions 8" x 11" x 1.5" (203 mm x 279 mm x 38 mm)

Large Resin 18 Instruments | [IMS-1118](#)

Holds up to 18 instruments (pictured)

Large Resin 24 Instruments | [IMS-1124](#)

Holds up to 24 instruments



Large Cassettes - with Accessory Area \$168.75

Exterior Dimensions 8" x 11" x 1.5" (203 mm x 279 mm x 38 mm)

Large Resin 12 Instruments | [IMS-1112](#)

Holds up to 12 instruments (pictured)

Large Resin 16 Instruments | [IMS-1116](#)

Holds up to 16 instruments

BLEACH CLEANING RECOMMENDATIONS FOR RESIN CASSETTES

The resin cassettes should be bleach cleaned on a six month basis. They may be submerged in a solution of two cups bleach to one gallon of water (0.5 liters bleach to 4 liters of water) for 5 to 30 minutes. If staining has occurred, use less water and more bleach. If bleach does not break through the stain, wipe cassettes with isopropyl alcohol prior to bleaching. Be sure to remove instruments before placing cassettes in bleach solution as bleach is destructive to metal. This cleaning procedure is only recommended with resin cassettes. If staining does occur on stainless steel cassettes, wipe clean with soap and water. DO NOT use bleach process described for resin cassettes on stainless steel cassettes.

Manufacturer part numbers are provided here, please visit www.dhponline.com to convert or contact your DHPI Account Manager.



SIGNATURE SERIES™ TUBS



How the best perform

Together, procedure tubs and cassettes create the most efficient and organized system for managing instruments and consumable products. The time savings achieved by using IMS (Instrument Management System) cassettes and procedure tubs will allow the staff to spend time on more value added activities in the dental office.

Signature Series Tubs are designed to match IMS cassette rail colors and feature antimicrobial product protection.

Signature Series™ Complete Tub \$62.45

12-3/4" x 11-3/16" x 4"

Includes:

- Signature Series Tub
- Tub Liner
- Tub Divider (package of 8)
- Single Tub Cup w/Cover
- Double Tub Cup w/Cover
- Divided Slide Tray
- Locking Tub Cover

Red	IMS-1400
Gray	IMS-1401
White	IMS-1402
Orange	IMS-1403
Purple	IMS-1404
Yellow	IMS-1405
Lavender	IMS-1406
Black	IMS-1407
Blue	IMS-1408
Green	IMS-1409
Ocean Blue	IMS-14011



Signature Series Tub \$20.75

12-1/4" x 10-7/8" x 2-3/4"

Red	■	IMS-1410
Gray	■	IMS-1411
White	□	IMS-1412
Orange	■	IMS-1413
Purple	■	IMS-1414
Yellow	■	IMS-1415
Lavender	■	IMS-1416
Black	■	IMS-1417
Blue	■	IMS-1418
Green	■	IMS-1419
Ocean Blue	■	IMS-14111



Divided Slide Tray

9-3/4" x 5-3/8" x 11/16"

Can be used to store cotton rolls, cotton squares, clamps,

\$11.75 | IMS-1421



Flat Slide Tray

9-3/4" x 5-3/16" x 1-3/8"

Can be used to store discs, strips, toffelmeil, articulating paper, etc.

\$11.75 | IMS-1422



Locking Tub Cover

12-3/4" x 11-3/16" x 2-3/4"

Protects items from airborne materials during transportation and storage

\$23.75 | IMS-1420



Tub Insert

9-3/4" x 10-3/4" x 11/32"

The insert features 10 compartments for easy organization of tub materials

Sits on rim of tub allowing for storage underneath

\$17.25 | IMS-1423



Tub Dividers

Tub Liner

Dividers

12-3/4" x 11-3/16" x 1-3/8"

\$14.45 | IMS-1427

Includes 8 dividers

Tub Liner

9-5/8" x 8-7/8" x 1/8"

\$7.75 | IMS-1428

Non-slip liner prevents small items from slipping under divider sections

Manufacturer part numbers are provided here, please visit www.dhponline.com to convert or contact your DHPI Account Manager.



How the best perform

SIGNATURE SERIES TUB CUPS & COVERS

Signature Series Tub cups and covers can be used to store brushes, clamps, cotton pellets, syringe tips, prophylactic paste, prophylactic angle tips, pumice, implant tools, etc.



Single Tub Cup with Cover

2-1/4" x 1-5/8" x 1-1/8" \$7.75

Double Tub Cup with Cover

3-3/8" x 2-1/4" x 1-1/8" \$7.75 | [IMS-1425](#)

Long Tub Cup with Cover

8-1/3" x 2-1/4" x 1-1/8" \$14.45 | [IMS-1426](#)

- Provides 5 storage compartments
- Dividers are removable for customization
- Perfect for storing capsules, discs, abrasive strips, wedges, matrix bands, etc.

SIGNATURE SERIES RACKS



Adjustable 3 Tub Rack

Adjustable 4 Tub Rack

Adjustable 3 Tub Rack

MIN 7-1/2" - MAX 15-1/2" x 10-1/2" x 13" \$101.45 | [IMS-1433](#)

Adjustable 4 Tub Rack

MIN 7-1/2" - MAX 15-1/2" x 10-1/2" x 18-3/4" \$91.45 | [IMS-1434](#)

- Holds a maximum of 4 tubs with lids or 8 cassettes
- Non-slip feet
- Sturdy metal construction

SIGNATURE SERIES CLIP-ON HOLDERS

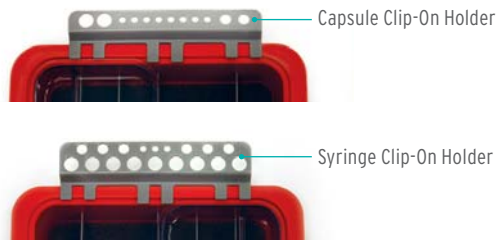

Capsule Clip-on Holder

8" x 2-1/2" x 3/4" \$14.45 | [IMS-1429](#)

- Allows quick access to composite material during procedure
- Conveniently clips on any side of tub
- Holds up to 8 capsules, 4 syringe tubes and capsule/gun dispenser

Syringe Clip-on Holder

8" x 2-5/8" x 3/4" \$14.45 | [IMS-1430](#)

- Allows quick access to composite material during procedure
- Conveniently clips on any side of tub
- Holds up to 15 syringe tubes and 3 applicator tips

SIGNATURE SERIES SYRINGE STANDS



20-Unit Syringe Stand

9" x 4-3/4" x 2 1/2" \$32.25 | [IMS-1431](#)

- Stands up for easy access to syringes
- Lays flat to fit inside a tub or drawer
- Holds up to 20 syringe tubes

10-Unit Syringe Add On

8-1/2" x 2-3/8" x 3/4" \$14.45 | [IMS-1432](#)

- An add-on for the Syringe 20 Unit Stand
- Provides additional space for syringe storage
- Holds up to 10 syringe tubes

ANTIMICROBIAL PROTECTION

*Antimicrobial protection is integrated into the tub and tub components during the manufacturing process. This technology works by interrupting key cell functions that allow the microorganisms to function, grow and reproduce. Antimicrobial protection begins to work as soon as the microorganism comes into contact with the product surface and works continuously to inhibit the growth of microbes that can cause stain, odors and product degradation - for the lifetime of the product.



How the best perform



How the best perform

IMS COLOR CODE INSTRUMENT RINGS

\$26.45

IMS Color Code Instrument Rings are silicone rubber rings used for identifying and organizing instruments. Useful for maintaining proper instrument order in cassettes and identifying instruments by procedure; can withstand all heat sterilization methods.



	Reglar Use on #2 and 4 Handles	Large Use on #6, 7, 8 and 9 Handles
Assorted Colors	IMS-1280	IMS-1280L
Gray	■ IMS-1281	IMS-1281L
White	□ IMS-1282	IMS-1282L
Orange	■ IMS-1283	IMS-1283L
Brown	■ IMS-1284	IMS-1284L
Yellow	■ IMS-1285	IMS-1285L
Red	■ IMS-1286	IMS-1286L
Green	■ IMS-1287	IMS-1287L
Blue	■ IMS-1288	IMS-1288L
Black	■ IMS-1289	IMS-1289L
Pink	■ IMS-12810	IMS-12810L
Lavender	■ IMS-12811	IMS-12811L

All single color packages contain 50 pieces. The assorted color package contains 90 pieces.

SIGNATURE SERIES™ GRIPS

\$9.75

Signature Series grips can only be used with Satin Steel Colours®, EverEdge® technology and ResinEight® instruments, and are used for identifying and organizing instruments. They're useful for maintaining proper instrument order in cassettes and identifying instruments by procedure. Grips will withstand all approved heat sterilization methods.



Gray	■	SSG1	Blue	■	SSG8
White	□	SSG2	Black	■	SSG9
Orange	■	SSG3	Pink	■	SSG10
Brown	■	SSG4	Lavender	■	SSG11
Yellow	■	SSG5	Ocean Blue	■	SSG12
Red	■	SSG6	16 Assorted		SSG0
Green	■	SSG7	80 Assorted		SGMULTI

All single color packages contain 16 pieces. The assorted color packages contain your choice of either 16 or 80 pieces.

RESIN 8 COLORS GRIPS

\$9.45

Red	■	SSGREDB8
Orange	■	SSGORANGE8
Yellow	■	SSGYELLOW8
Purple	■	SSGPURPLE8
Lavender	■	SSGLAVNDR8
Green	■	SSGGREEN8
Blue	■	SSGBLUE8
Gray	■	SSGGRAY8

All single color packages contain 16 pieces.

IMS COLOR TABS

\$14.75

Silicone tabs that fit on cassette lid for identifying cassette procedure by color.



All single color packages contain 5 pieces. The assorted color package contains 9 pieces.

Red	■	IMS-1290N
Gray	■	IMS-1291N
White	□	IMS-1292N
Orange	■	IMS-1293N
Purple	■	IMS-1294N
Yellow	■	IMS-1295N
Lavender	■	IMS-1296N
Black	■	IMS-1297N
Blue	■	IMS-1298N
Green	■	IMS-1299N
Pink	■	IMS-12910N
Ocean Blue	■	IMS-12911N
Assorted		IMS-12912N

IMS CASSETTE I.D. LABELS AND I.D. MARKER

Specially designed polyester pressure-sensitive labels for cassette identification.



IMS Cassette I.D. Labels | **IMS-1234**
\$34.95

50 per package

IMS I.D. Marker | **IMS-1235**
\$10.45

Permanent indelible ink marker is ideal for identifying procedural set-ups. For use on I.D. Labels or Monitor Tape.

Manufacturer part numbers are provided in these charts, please visit www.dhponline.com to convert or contact your DHPI Account Manager.

WHY USE Zirc's Cassettes?

A low-cost investment with a quick return! Individual instrument handling takes time away from treating patients and increases overall processing time. Zirc's cassettes will prolong your instrument's life and save you time without breaking the bank. In a 2014 Implementation of Cassettes Case Report, Marie T. Fluent, DDS, writes how the dental office benefited from the transition from no cassettes to using them with every procedure: "Drs. Dale and Thomas were both grateful that they chose to implement ... an Instrument Management System for the organization, processing, and handling of their instruments within their practice. They agreed that cassettes improved all aspects of instrument management... Initially, their opinions were varied; however, at the conclusion of the one-year anniversary, no clinical staff could imagine processing instruments in any other fashion. Cassette usage had become organized, efficient, safe, and routine." Read the article in its entirety at: www.dentaleconomics.com.



Size comparison with the 8-Place E-Z Jett® Cassette.

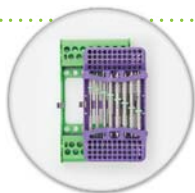

\$29.75 - E-Z Jett® Compact 8-place Slim

Holds 8 instruments. Covers stay attached to the cassette and fold back easily. Compact size. Fits the Statim. Stackable in Ultrasonic. Syringe Tip Holder included.

Dimensions: 7-1/16" x 4-1/16" x 1-5/16"

710-50Z911_ Available in all colors

Provide pleasing presentation chairside. Minimize stress for patients.

Sterilization Pouch Size

Cassette	Pouch Size
E-Z Jett® 5-Place	5-1/4" x 12"
E-Z Jett® 8-Place	7-1/8" x 13-13/16"
E-Z Jett® 8-Place Slim	7-1/8" x 13-13/16"
E-Z Jett® 10-Place	10" x 15"



Syringe Tip Holder

Syringe Tip Holder 5pk

Dimensions: 1" x 3/8" x 3/8"

\$4.95 710-50Z926

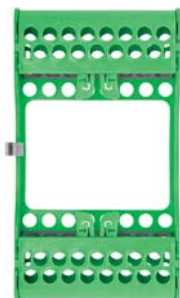

\$24.95 - E-Z Jett® Cassette 5-place

Holds 5 instruments.

Great for a basic exam set up!

Syringe Tip Holder included.

Covers stay attached to the cassette and fold back easily.

Fits Statim Sterilizer.

Dimensions: 8" x 3-1/8" x 1-3/16"

710-50Z925_ Available in all colors

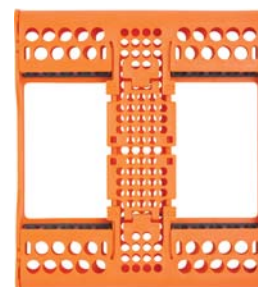

\$34.95 - E-Z Jett® Cassette 8-place

Holds 8 instruments.

Covers stay attached to the cassette and fold back easily. Syringe Tip Holder included.

Dimensions: 7-15/16" x 4-7/16" x 1-1/8"

710-50Z927_ Available in all colors

\$39.95 - E-Z Jett® Cassette 10-place

Holds 10 instruments.

Accessory compartment in the middle for extra storage. Covers stay attached to the cassette and fold back easily.

Dimensions: 7-15/16" x 7" x 1-1/8"

710-50Z930_ Available in all colors



\$10.75 - Steri-Container

Holds 10-14 instruments.

Keep instrument setups together through sterilization processes.

Dimensions: 8-1/8" x 1-7/8" x 1-7/8"

710-50Z900_ Available in all colors



\$10.75 - Compact Steri-Container

Holds 8-12 instruments.

Easy open latch, just push down.

Statim 2000 holds 7 Compact Steri-Containers.

Dimensions: 7-1/8" x 1-1/2" x 1-1/2"

710-50Z905_ Available in all colors





Zirc's Tub Kits and Accessories are designed to store and organize materials and keep your inventory under control. In addition, they are easily portable for transportation between procedures and your centralized location for sterilization, disinfecting, and restocking.

\$63.95 - Complete Tub

Includes: Procedure Tub, Tub Liner, Tub Dividers, Cup/Cover Single, Cup/Cover Double, Divided Slide Tray, Safe-Lok Cover for Tub.
 Dimensions: 12-5/8" x 11-1/4" x 4"
 710-20Z455_ Available in all colors



\$50.95 - Syringe Composite Kit

Syringe holder allows you to store up to 40 syringe tubes. Kit includes: Syringe 20-Unit Stand, 1 Long Tub Cup/Cover, 1 Divided Slide Tray, 1 Syringe Clip-On Holder, Shade Label Sheet 2pk.
 230-20Z489



\$50.95 - Capsule Composite Kit

Long Tub Cups provide a total of 20 compartments for capsule storage. Includes: Tub Liner, 4 Long Tub Cup/Cover, 1 Divided Slide Tray, 1 Capsule Clip-On Holder, Shade Label Sheet 2pk.
 230-20Z479



\$18.45 - Procedure Tub

Allows you to "build" your own setup.
 Dimensions: 12-1/4" x 10-7/8" x 2-3/4"
 710-20Z463_ Available in all colors



\$17.95 - Safe-Lok® Tub Cover

Locking cover for securing materials. Keep materials protected during storage and transportation.
 Dimensions: 12-5/8" x 11-1/4" x 1-7/16"
 710-20Z459 Clear



\$14.75 - Tub Insert

10 compartments for easy organization. Sits on rim of Tub, allowing for storage underneath.
 Dimensions: 10-3/4" x 9-11/16" x 1"
 710-20Z465 Gray Only



Tub Cups with Covers

Fill Tub Cups with brushes, clamps, cotton pellets, prophylaxis angle tips, prophylaxis paste, pumice, syringe tips, implant tools, etc. Can be used in procedure tubs, drawers, on trays, etc. for small, easy-to-lose items. Covers are transparent.

\$7.95 - Single Tub Cup with Cover
 Dimensions: 2-1/4" x 1-5/8" x 1-1/8"
 710-20Z471 Gray Only

\$12.95 - Long Tub Cup with Cover
 Dimensions: 8-3/8" x 2-5/16" x 1-1/8"
 710-20Z473 Gray Only

\$7.95 - Double Tub Cup with Cover
 Dimensions: 3-3/8" x 2-1/4" x 1-1/8"
 710-20Z472 Gray Only



Slide Trays

Sits on rim of Tub and allows for storage underneath.

\$10.75 - Divided Slide Tray
 Dimensions: 9-3/4" x 5-3/8" x 1-1/16"
 710-20Z466 Clear

\$10.75 - Flat Slide Tray
 Dimensions: 9-3/4" x 5-3/8" x 1-1/16"
 710-20Z467 Clear

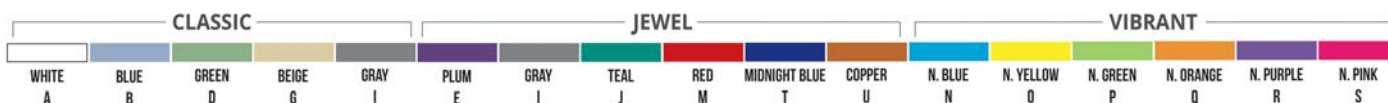



The Safe-Lok® Tray Cover helps prevent cross-contamination and provide safe transportation back to the sterilization area.

Zirc's exclusive Safe-Lok® tray cover provides an excellent method of infection control and safety that allows for two benefits other trays do not:

1

Prevents any contaminated items from falling off of the used tray during transportation from operator to central sterilization. The contaminated items stay enclosed until you are ready for the cleaning and sterilization process.

2

Set up your procedure trays ahead of time with all instrumentation needed. The Safe-Lok cover securely locks to the tray, not only keeping items clean, but also allowing for safe transportation to chairside. The cover is removed once the patient is in the chair and the procedure begins.



\$11.95 - B-Lok Flat Tray

Wide edges for secure grip.
Non-slip feet for stability.
Self-lubricating, high-gloss surface helps prevent staining.
Dimensions: 13-3/8" x 9-5/8" x 7/8"
710-20Z401_ Available in all colors



\$14.95 - B-Lok Divided Tray

Holds 12 hand instruments.
Bur holder for 9 FG, RA, or HP burs.
Comes with Insti-Grip.
Non-slip feet for stability.
Self-lubricating, high-gloss surface helps prevent staining.
Holder for Syringe Tip or Saliva Ejector.
Dimensions: 13-3/8" x 9-5/8" x 7/8"
710-20Z451_ Available in all colors



\$16.95 - B-Size Safe-Lok® Tray Cover

Fits B-Lok Flat and Divided Trays only.
Side locking mechanism securely locks cover to tray.
Dimensions: 13-7/8" x 9-7/8" x 3/4"
710-20Z445



\$10.95 - Mini Tray

Self-lubricating, high-gloss surface helps prevent staining.
Non-slip feet for stability.
Wide edges for secure grip.
Mini Trays are great for hygiene/exam setup.
Dimensions: 9-3/8" x 6-3/8" x 7/8"
710-20Z101_ Available in all colors



\$14.95 - Mini-Lok Tray Cover

Side locking mechanism securely locks cover to tray.
Dimensions: 9-7/8" x 6-5/8" x 1"
710-20Z103

SAVE ON SPACE & Organize Your Office

\$91.75 - Multi-Mod Rack 8-Place

Holds 8 Trays or 4 Tubs with covers. Adjustable to hold Trays, Tubs, and Cassettes. Sturdy metal construction; chrome-plated. Non-slip feet.
710-21Z410

\$91.75 - Multi-Mod Rack 6-Place

Holds 6 Trays or 3 Tubs with covers. Adjustable to hold Trays, Tubs, and Cassettes. Sturdy metal construction; chrome-plated. Non-slip feet.
710-21Z105



Adjustable to fit your needs!



Can adjust to hold Mini Trays and Cassettes



How to effectively identify your instrument setup.

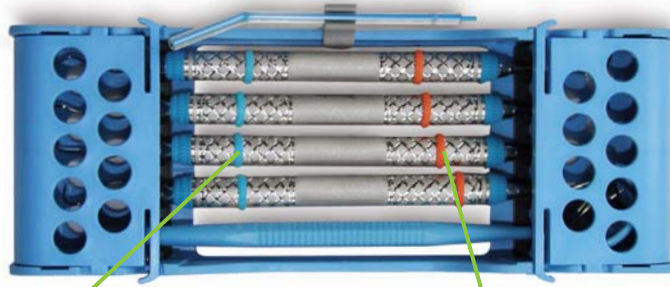

1 color for procedure:
Neon Blue is for identifying the procedure.

1 color for practitioner:
Neon Orange shows ownership to the practitioner.

E-Z ID Rings

- Prepackaged in an easy-to-use dispenser
- Available in Small, Large, and XL sizes to fit all instrument handles

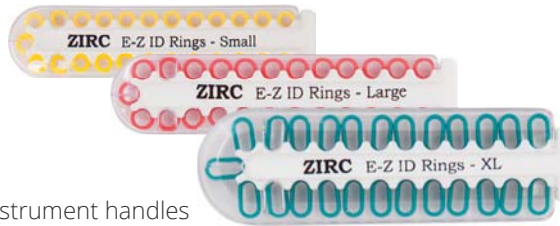

25pk

Available in all colors.

- SM 710-70Z100 **\$6.95**
- LG 710-70Z200 **\$7.45**
- XL 710-70Z000 **\$7.95**

Jewel System 200pk

Assorted colors (E, J, T, I, M, and U).

- SM 710-70Z115 **\$48.95**
- LG 710-70Z215 **\$50.95**
- XL 710-70Z015 **\$53.75**

Vibrant System 200pk

Assorted colors (N, O, P, Q, R, and S).

- SM 710-70Z110 **\$48.95**
- LG 710-70Z210 **\$50.95**
- XL 710-70Z010 **\$53.75**

Classic System 200pk

Assorted colors (A, B, D, G, and I).

- SM 710-70Z105 **\$48.95**
- LG 710-70Z205 **\$50.95**
- XL 710-70Z005 **\$53.75**

E-Z ID Tape

- Tape dispenser has built-in tape cutter.
- Dispenser roller prevents tape from twisting.



E-Z ID Tape Roll

Available in all colors.
10' roll.

710-70Z300_ **\$10.25**

Label Containers!
Keep containers organized by labeling them per content.

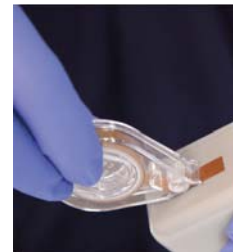

E-Z ID Tape System - Jewel

Assorted colors (E, J, T, I, M, and U).
Includes : 3 ft. rolls.

710-70Z315 **\$41.75**

E-Z ID Tape System - Vibrant

Assorted colors (N, O, P, Q, R, and S).
Includes : 3 ft. rolls.

710-70Z310 **\$41.75**

E-Z ID Tape System - Classic

Assorted colors (A, B, D, G, and I).
Includes : 3 ft. rolls.

710-70Z305 **\$41.75**



CODE RINGS



Code Rings - Integra® Miltex®

Silicone. For hand instrument handles sizes 2-6. Sterilizable by standard table top sterilizer: Temperature 250° F; Exposure Time: 30 minutes.

Small

Baby Blue	710-50BB
Beige	710-50BG
Black	710-50BK
Blue	710-50BU
Brown	710-50BR
Dusty Rose	710-50DR
Gray	710-50GY
Green	710-50GN
Mauve	710-50MV
Orange.....	710-50OR
Pink-Coral	710-50PK
Red	710-50RD
White	710-50WH
Yellow	710-50YL
50/box	\$6.95

Baby Blue	710-100BB
Black	710-100BK
Blue	710-100BU
Dusty Rose	710-100DR
Gray	710-100GY
Green	710-100GN
Mauve	710-100MV
Orange.....	710-100OR
Pink-Coral	710-100PK
Red	710-100RD
Teal	710-100TL
White	710-100WH
Yellow	710-100YL
100/box	\$10.45

Assorted Small

710-120AS	120/box	\$12.45
-----------	---------------	----------------

Medium

Black	710-CM100BK
Blue	710-CM100BU
Pink-Coral	710-CM100PI
Red	710-CM100RD
White	710-CM100WH
100/box	\$13.45

Assorted Medium

710-CM120AST	120/box.....	\$13.95
--------------	--------------	----------------

Additional colors available upon request.



Silicone Color Code Rings - Plasdent Corporation

Autoclavable to 250° F.

Blue	710-202CD2
Flame.....	710-202CD5
Green.....	710-202CD14
Mauve.....	710-202CD10
Yellow.....	710-202CD3
White	710-202CD1
60/box	\$5.45

Assorted

710-202CDA	80/box.....	\$5.45
------------	-------------	---------------



Code Rings - Pulpdent Corporation

Highest quality, long-lasting silicone rings for color-coding dental instruments. Can be sterilized by any method. Will not gum up or crack in the autoclave.

Black	710-CR6
Blue	710-CR3
Green.....	710-CR5
Orange.....	710-CR9
Pink.....	710-CR11
Yellow.....	710-CR2
100/box	\$14.75

Assorted

710-CRAS	100/box	\$13.25
----------	---------------	----------------

Additional colors available upon request.

INSTRUMENT TAPE & TIES



Pro-Ties - DenMat

Helps you safely sort, scrub, presoak, ultrasonic, sterilize, and keep instruments together. Durable silicone construction withstands repeat cycles in all sterilizers up to 400°F. Compatible with all existing sterilizer systems, bags and wraps. 4" long.

Red	710-310051
Green	710-310052
Blue	710-310053
Yellow	710-310054
6/pkg	\$16.75



Tape-N-Tell - E.C. Moore Company

Adhesive tape for color-coding instruments. Unaffected by autoclaving or cold sterilization.

Black.....	710-BKTT
Blue	710-BLTT
Brown	710-BRTT
Green	710-GRTT
Orange.....	710-ORTT
Red	710-RD TT
White	710-WHTT
Yellow.....	710-YWTT
Roll	\$7.95

Assortment Kit

Contains: 8 rolls; 1 each color.

710-ASSTT	Kit	\$18.95
-----------	-----------	----------------

TUBS, TRAYS & LIDS



ProTray™ Disposable Instrument Trays - Certol International

Rigid and disposable with a smooth glossy finish made of polystyrene foam. Sturdy enough to hold a full setup of instruments. Most materials can be mixed or dispensed right from the surface. Free of CFCs. White

Divided Setup Tray

9-1/2" x 13-1/4"

710-DT00W	200/box.....	\$102.95
-----------	--------------	-----------------

Flat Hygiene Tray

8-3/8" x 10"

710-DT01A	125/box.....	\$60.25
-----------	--------------	----------------

Flat Utility Tray

9" x 12-3/4"

710-DT03W	125/box.....	\$71.95
-----------	--------------	----------------



Procedure Tub, Lids & Inserts - Kerr TotalCare

Portable drawer for organization, storage and transport of support materials used with procedure tray set-ups. Sturdy plastic construction. All tubs accommodate an F (Mini) tray as an accessory tray on top of tub. Can be autoclaved or chemically. Easily attach color clips or adhesive labels to match all set-up tray colors.

S Tub

Standard size and depth tub. Fits Adec, Biotec, Clive Craig, Dental-EZ, Celebrity, Pelton & Crane, etc. tub racks. Dimensions: 11-1/2" W x 9-3/8" D x 2-1/4" H.

Beige	710-31930
Gray	710-31935
Each	\$18.95

Continued

TUBS, TRAYS & LIDS

Procedure Tubs, Lids & Inserts by Kerr
TotalCare continued.



S Tub Lid

Highly durable, transparent, impenetrable barrier against airborne contaminants. Elevated design increases tub storage capacity and accommodates taller items. Top of lid provides convenient work surface or lid can be placed under for out-of-the-way storage. Specifically designed to fit Kerr TotalCare S Tubs. Clear autoclavable/chemiclavable plastic.

710-31526 Each **\$14.75**



S Tub Divided Insert

Fits inside S tub only. Sturdy construction with a standard 10-compartment design. Autoclavable/chemiclavable. Plastic.

Dimensions: 11-3/8" W x 9-1/4" D x 1-1/4" H.
710-31990 Each **\$14.25**



Size B Flat Trays

Most versatile. Adapts well to individual set-up configurations. To achieve consistent infection control, a flat tray set-up with a separate sterilizable steri-mat and bur block is recommended. Can be auto/chemiclaved.

Dimensions: 13-1/2" W x 9-5/8" D x 7/8" H.
Baby Blue 710-32130
Grey 710-32122
Light Mauve 710-32127
Lilac 710-32129
Mauve 710-32121
Seafoam 710-32128
Sky Blue 710-31121
Each **\$11.75**

Additional colors available upon request.



Size B Divided Trays

Designed for easier handling of instruments. Can be auto/chemiclaved.

Dimensions: 13-1/2" W x 9-5/8" D x 7/8" H.
Beige 710-31158
Lilac 710-32159
Seafoam 710-32158
Teal 710-32153
Each **\$13.95**

Additional colors available upon request.



Size F Mini Tray

Ideal for proph procedures. Half the size of B Trays. Can be auto/chemiclaved.

Dimensions: 9-5/8" W x 6-5/8" D x 7/8" H.
Baby Blue 710-32149
Sand 710-32145
Teal 710-32143
Each **\$11.45**

Additional colors available upon request.



Tray Racks

Sturdy chromed steel. Stackable or freestanding, can be assembled without tools. All racks will accommodate a minimum of 8 trays.

Short Side Loading

Accommodates 8 Size B Trays or up to 16 Size F Mini Trays. Requires minimum cabinet space of 10-3/4" W x 13-1/2" D x 14-1/8" H.
710-31312 Each **\$95.25**

Long Side Loading

Accommodates 8 B Trays with the ability to easily pass-through. Requires minimum cabinet space of 14-1/2" W x 9-3/4" D x 14-1/8" H.
710-31302 Each **\$95.25**

Size F Mini Tray

Accommodates 8 Size F Mini Trays and requires minimum cabinet space of 7-1/2" W x 9-3/4" D x 14-1/8" H.
710-31304 Each **\$95.25**



**Setup Trays - Plasdent Corporation
Divided Tray Size A (Chayes)**

Blue 710-300AD2
Flame 710-300AD5
White 710-300AD1
Each **\$6.75**

Flat Tray Size B (Ritter)

Dimensions: 13-3/8" x 9-5/8" x 7/8"
Aqua 710-300BF14
Beige 710-300BF7
Black 710-300BF11
Blue 710-300BF2
Coral 710-300BF6
Flame 710-300BF5
Gray 710-300BF9
Green 710-300BF4
Mauve 710-300BF10
White 710-300BF1
Yellow 710-300BF3
Each **\$5.75**

Divided Tray Size B (Ritter)

Dimensions: 13-1/2" x 9-5/8" x 7/8"
Beige 710-300BD7
Blue 710-300BD2
Green 710-300BD4
Mauve 710-300BD10
Each **\$6.75**

Flat Tray Size D (Adtec, DentalEZ)

Dimensions: 12-3/8" x 7-3/4" x 3/4"
White 710-300DF1
Blue 710-300DF2
Each **\$5.75**

Flat Tray Size E (Midwest) available upon request.

Divided Tray Size E (Midwest) available upon request.

Flat Tray Size F Mini available upon request.

Additional colors available upon request.

CLEANERS & LUBRICANTS



LubeCube - Centrix

Clean and lubricate your sculpting instrument by simply running it through the slit on top. Put an end to composite stickiness, pull-back and unnecessary voids. Simply peel off the adhesive back, stick it to a surface and slide your instrument tip through the slit. The cleaning and lubricating action will allow you to shape with ease.

200-310108 72/pack..... **\$50.25**



IMS® Instrument Daily Clean - Hu-Friedy

Virtually eliminates hand scrubbing, saves time and minimizes cross-infection. Specifically formulated for efficient ultrasonic cleaning or presoaking of cassettes and instruments.

530-IMS1220 1.1lbs..... **\$31.95**
530-IMS1218 5lbs..... **\$92.75**



IMS® Instrument Lubricant Spray - Hu-Friedy

Keeps hinged instruments moving freely.

710-ILS 8oz. **\$22.95**



IMS® Instrument Penetrating Oil - Hu-Friedy

Removes light rust and corrosion to loosen problem joints.

710-IPS 8oz. **\$22.25**



IMS® Shine reNEW Stain & Rust Remover - Hu-Friedy

Effectively removes stain and rust, restoring the luster to stainless steel and tungsten carbide instruments. Keeps hinged instruments moving freely eliminating the need for abrasive scrubs. Quick and simple to use.

530-IMS1453 Gallon..... **\$56.95**

Wipes

Can also be used on copper, brass and anodized aluminum. 5.5" x 7.9".

HF-IMS1455 20/canister..... **\$13.95**



Instrument Care System - Integra® Miltex®

Designed to help practitioners and staff properly care for instruments. Including a 25 minute instructional DVD that offers step-by-step guidance on handling, cleaning, rinsing, inspecting, lubricating and sterilizing all surgical and dental instruments.

Instrument Care Kit

Contains: 8oz. spray lube, 3oz. stain remover, 1 Nylon Bristle Brush, 1 Stainless Steel Bristle Brush and instructional DVD.

711-3800 Kit..... **\$84.95**

Spray Lube

Pre-mixed, non-silicone, anti-corrosive formula. Steam permeable and water soluble. Helps prevent rusting, spotting and staining. Lubricates instrument box locks, screw locks, scissor blades and any other metal to metal moving parts.

711-3700 8oz..... **\$12.95**

Surgical Instrument Cleaner

Neutral pH and phosphate free liquid concentrate formula for manual and ultrasonic cleaning or soaking. Biodegradable and rinses free. 8oz makes 32 gallons of solution.

711-3720 8oz. **\$14.45**

Instrument Cleaning Brushes Nylon Bristles

Ideal for cleaning hard to reach places without scratching or harming delicate instrument surfaces. 7-1/4".

711-31000 3/pkg..... **\$21.25**

Stainless Steel Bristles

Ideal for cleaning rasps, files and burs. 7-1/4".
711-31001 3/pkg..... **\$21.95**



Barrier Milk - L&R Ultrasonics

Protects instruments against rust and corrosion when used regularly before sterilization.

530-00139 8oz. **\$22.45**

530-076 Gallon..... **\$60.75**



Sparkl - Star Dental

Cleans all makes and types of diamond instruments, perforated and hollow instruments, carbide and steel burs, root canal files, reamers and broaches and hand instruments. Dissolves dental debris, blood and serous exudate.

Concentrate, 1 quart makes 10 quarts of solution.

710-5472 Quart..... **\$57.75**



Lorvic™ Surgical Milk - Young Dental

Extends the life of your valuable instruments. Inhibits rusting. Non-toxic, environmentally safe and odor-free.

710-192132 Quart..... **\$36.45**

710-192101 Gallon..... **\$63.75**

SHARPENING



Sharpening Stones - Hu-Friedy

#3 Ceramic

3" x 1-1/4" x 1/4" Medium Grit

HF-SS3C Each **\$31.75**



#4 Arkansas Flat

4" x 1" x 1/4" Fine Grit

HF-SS4 Each **\$33.25**

#6 India Wedge

4-1/2" x 1-7/8" x 3/8" Medium Grit

HF-SS6 Each **\$31.75**



#6A Arkansas Wedge

4" x 1-7/8" x 3/8" down to 1/8" Fine Grit

HF-SS6A Each **\$31.75**

#299 Arkansas Conical

3-1/2" x 5/16" Base Fine Grit

HF-SS299 Each **\$31.75**



#309 India

4" x 1/2" to 1/4" x 1/4" to 1/8" Fine Grit

HF-SS309 Each **\$31.75**



Sharpen-Ez - Hu-Friedy

Sharpening stone oil. Medical-grade oil floats away metal particles, prevents damaging build-up on stone and decreases friction heat.

HF-SSO 1.05oz. **\$14.45**



Sidekick™ - Hu-Friedy

Designed for routine maintenance sharpening of scalers and curettes. Cordless, lightweight and portable, can be used anywhere. Reciprocating stone does the work so you don't have to. Easy to use guide channels and vertical backstops allow simple positioning of scaler and curettes to provide consistent sharpening results every time. Contains: 1 Sidekick Unit, user manual and CD-ROM, ceramic sharpening stone, plastic test stick, magnifying lens, and 2 AA batteries.

710-SDKKIT Kit **\$391.95**

Replacement Stone - Medium Grit

HF-SDKSTONEC Each **\$27.75**

Coarse Grip Replacement Stone available upon request.

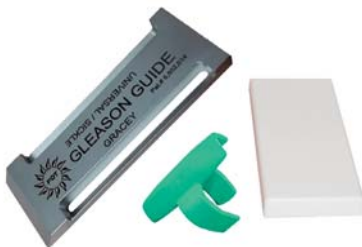

Sharpening Kits & Stones - PDT, Inc.

Reduces instrument sharpening time and insures the "perfect" blade every time.

Ultimate Edge Kit

Contains: Gleason Guide, ultra-fine stone and a PingRing sharpness tester.

710-T066 Kit **\$186.75**

Gleason Guide

3 beveled edge guides, one side Gracey, one Universal/Sickle and the other to shape the toe and sharpen O'Hehirs, Chisels and Hoes.

710-T065 Each **\$162.25**

Diamond Head Stone

Fine ceramic stone that will not pit or groove. No need to use oil or water to sharpen. This stone is designed to maintain the shape and edge of your instruments. White.

710-T061 Each **\$34.45**

Transformation Stone

Coarse ceramic stone that will not pit or groove. No need to use oil or water. This stone is designed to reshape the edge of your instruments. Brown.

710-T062 Each **\$35.25**

NOW YOU CAN
**BROWSE ALL
CLEARANCE**

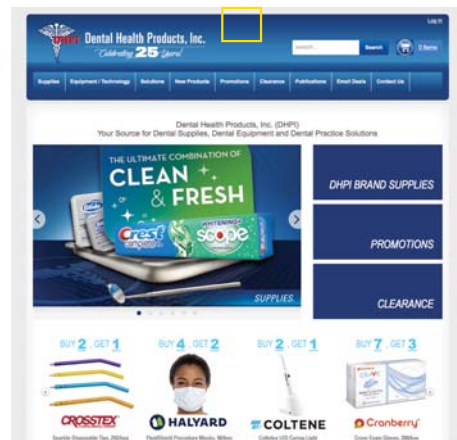
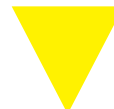

www.dhpionline.com/clearance

All Clearance
Supplies are
Discounted
up to **25%**,
While Supplies Last!

ABRASIVE WHEELS & DISCS



Lathe Wheels - Dedeco International, Inc
Green Soft
 "Soft" for fast, heatless, chip-free grinding of porcelain teeth - the "traditional favorite."
 740-5123 3" x 3/8" **\$16.75**



Green Medium
 "Medium" rubber-bonded wheel for rapidly removing scratches from porcelain and metals.
 760-5148 3" x 3/8" **\$18.75**



White "Knock-Down"
 Specially formulated for rapid trimming of plaster and stone models. Plastic center.
 740-5162 3" x 3/8" **\$16.75**

AIR ABRASION



Paasche Style Etching Pencil - Handler Mfg Co
 Easy set-up; comes with 6oz. canister of aluminum oxide, air tubing and connection.
 770-52PAB Each..... **\$225.95**



PrepStart - Zest Dental Solutions
 PrepStart air abrasion system offers all the performance and controllability of more expensive systems for as little as one-quarter the cost.
 770-20025900 Each..... **\$3186.95**



MicroEtcher IIA - Zest Dental Solutions
 MicroEtcher IIA Intraoral Sandblaster improves bond strength by increasing the surface area and simultaneously activating the surface, all mechanical bonding procedures are improved. Etching all metals, composites and amalgam for maximum bond strength. Intraoral porcelain repair. Pit and fissure prep. Cleaning dark grooves to reveal decay. Prepping incipient lesions and minor Class I and V. Debriding bur preps for best esthetics and bonds.
 Contains: Unit, rounded nozzle, 9' air line, O-ring Kit and 2 abrasive jars.
 770-DAN22005 Each..... **\$343.25**

ARTICULATORS



Crescent Articulator - Dentsply Caulk
 Model "A"
 760-005000A Each..... **\$63.25**



Crown & Bridge K-Chrome Articulator - Keystone Industries
 Chrome articulator used for crown and bridge procedures.
 760-1050140 Each..... **\$14.75**



Deluxe Articulator - Keystone Industries
 Teflon-coated articulator features removable pins for fast mounting and removal of models.
 760-1050095 Each..... **\$37.45**



K-Chrome Articulator - Keystone Industries
 Chrome articulator used for dentures and general purpose.
 760-1050145 Each..... **\$15.25**



Plastic Crown & Bridge Disposable Articulator - Keystone Industries
 Holds models accurately. Permits full lateral and protrusive excursions. Heavy-duty plastic. No need to break off models or to waste time cleaning articulators. Lightweight.
 760-1050165 50/box..... **\$47.45**



W.O.W. Articulators - Premier® Dental
 Single use articulator for all types of cases. Fixed hinge creates positive occlusal relationship and appropriate lateral movement.

Posterior
 Contains: 50 articulators and 300 dowel pins.
 760-0072 Each..... **\$64.25**

Anterior/Full Arch
 Contains: 50 articulators and 300 dowel pins.
 760-0065 Each..... **\$73.25**

W.O.W. 2 available upon request.



Hanau™ 96H2 Articulator - Whip Mix
 Series 96H2 Articulator is a semi-adjustable non-arcon type, which simulates the multiple functions of the Glenoid Fossa in centric, protrusive and right and left lateral positions.
 760-00330200 Each..... **\$972.95**

Mounting Plates
 Zinc.
 760-005057000 2/pack **\$16.75**

Disposable Mounting Plates
 With metal inserts.
 571-110002610 10/pack..... **\$32.75**
 760-110002650 50/pack **\$117.25**

ARTICULATORS



Hanau™ Wide-Vue Articulator - Whip Mix

Semi-adjustable. Unobstructed lingual access. Closed tracking fossa and fixed upper member are ideal for fabricating prosthetic appliances.



Magnetic Mounting System - Whip Mix

Articulator converter plates used to convert existing Denar and Hanau Articulators to a magnetic mounting system.

Magnetic Converter Plates

760-20002367 2/pack..... **\$96.95**

Disposable Mounting Plates

760-20002368 20/pack..... **\$57.25**

760-20002369 100/pack..... **\$201.95**

BRUSHES



No. 11

No. 12

Abbott-Robinson Bristle Brushes - Buffalo Dental Manufacturing

Classic, high quality natural bristle brushes ideal for cleaning and polishing denture acrylic. Durable design with permanently attached bristles for extended life without flaring.

#11 Soft

740-06061 12/pkg..... **\$14.25**

#11 Standard Stiff

740-06081 12/pkg..... **\$13.75**

#12 Soft

740-06141 12/pkg..... **\$14.25**

#12 Standard Stiff

740-06161 12/pkg **\$13.75**

Additional sizes available upon request.

Order by ☎ 800-626-2163

BUFFS



Chamois Buffs - Buffalo Dental Manufacturing

Tough durable chamois wheels excellent for application of polishing materials and for final polishing. Leather center.

1" 4-Ply

740-07600 Each..... **\$4.75**

2" 10-Ply

740-07610 Each..... **\$12.75**

2.5" 10-Ply

740-07620 Each..... **\$14.75**

3" 10-Ply

740-07630 Each..... **\$17.95**



Muslin Buffs - Grobet USA

Shellac-hardened centers for easy threading and durability.

3" x 24-ply 760-17575 **\$1.95**

3" x 30-ply 760-17576 **\$2.45**

3" x 35-ply 760-17578 **\$2.45**

4" x 30-ply 760-17580 **\$2.45**

4" x 42-ply 760-17581 **\$2.95**

BURNERS & TORCHES



Alcohol Torch - Buffalo Dental Manufacturing

Needle Flame

760-82440 Each..... **\$8.95**

Wick for Torch

760-575601 Each..... **95¢**

Bunsen Burner - Grobet USA

Needle valve gas control adjustment to provide flame from very hot brush to needle with intense heat.

#2N

For artificial or natural gas. 3" base diameter.
760-14260 Each..... **\$51.25**

#5N

For use with natural gas. 2" diameter black enamel base.
760-14271 Each..... **\$18.75**

#100

For use with natural gas. Nickel-plated with tapered, serrated stems for use with 5/16" tubing. 3" base diameter.
760-14266 Each..... **\$30.25**



APT III Portable Butane Burner - Hager Worldwide

Allows comfortable one-handed operation. With its reliable spark ignition and adjustable flame, it is ideal for warming bite wax, instruments, etc.

571-401025 Each..... **\$168.95**

Butane Refill

760-605141 6oz. ♦ **\$13.95**



Micro Torch - Select Dental Manufacturing Company

Model ES1000

760-ES1000 Each..... **\$61.95**

Butane Refill

760-RF300 5.3oz. ♦ **\$5.95**

BURNERS & TORCHES

Lenk Laboratory Burner - Wall Lenk Corporation

Burner with refill canister.  760-65 Each \$43.45



Refill Canister Only

760-65F Each \$10.75

DENTURE & RETAINER ACCESSORIES



Denture Boxes

Lightweight, strong and protective for dentures.

Traditional

Bright Pink 760-10016
 Beige 760-10017
 Dark Blue 760-10014
 Light Blue 760-10011
 Mauve 760-10013
 White 760-10012
 Yellow 760-10015
 Assorted 760-10010
 12/pkg \$11.45

New Age

Aqua 760-10021
 Lavender 760-10022
 Lime 760-10019
 Orange 760-10020
 Pink 760-10023
 Purple 760-10024
 Assorted 760-10018
 12/pkg \$11.45



Night Guard Box

Dimensions: 3" W x 2.5" L x 1.5" H

Black 760-HT200DB11
 Blue 760-HT200DB2
 Beige 760-HT200DB7
 Gray 760-HT200DB9
 Neon Yellow 760-HT200DB3
 Neon Green 760-HT200DB4
 Neon Pink 760-HT200DB6
 Neon Tangerine 760-HT200DB12
 Neon Red Orange 760-HT200DB13
 Purple 760-HT200DB10
 Red 760-HT200DB5
 White 760-HT200DB1
 Assortment 760-HT200DBA
 12/bag \$9.45



Retainer Boxes

Dimensions: 3" W x 2.5" L x 1" H

Beige 760-HT200RT7
 Black 760-HT200RT11
 Blue 760-HT200RT2
 Gray 760-HT200RT9
 Neon Green 760-HT200RT4
 Neon Pink 760-HT200RT6
 Neon Red/ Orange 760-HT200RT13
 Neon Tangerine 760-HT200RT12
 Neon Yellow 760-HT200RT3
 Purple 760-HT200RT10
 Red 760-HT200RT5
 White 760-HT200RT1
 Assortment 760-HT200RTA
 12/bag \$9.45



Denture Maintenance Kit - Archtek, Inc

Designed to attractively store and clean dentures by filling with water and adding a denture cleaning tablet. Lid securely snaps in place. Kit includes an ergonomically designed denture cleaning brush.

Contains: 3 piece case with cleaning brush, soaking basket, base and lid.

760-405 Kit \$4.45



Den-Shur-Cup - Modalities Research Inc.

Keep dentures fresh and white. Holds one or two dentures. Spill proof and unbreakable. Assorted colors.

760-DSC12 12/pkg \$12.95



Denture Boxes - Zirc

One piece construction. No drain holes. Solid locking mechanism. 4-3/8" x 3-3/8" x 2"

 **HAZARDOUS MATERIAL SYMBOL**

Midnight Blue 760-30R800T
 Copper 760-30R800U
 Plum 760-30R800E
 Gray 760-30R800I
 Teal 760-30R800J
 Red 760-30R800M
 Assorted 760-30R800AS
 12/pack \$14.45

Imprinting available upon request.

DENTURE MATERIAL

Wonderfill - Dental Creations Ltd.

Used as a tongue filler when pouring models. First, remove a palmful and form a domed bridge in the tongue area. Next, pour the plaster or stone and allow to fully set. Then pop out the non-sticky Wonderfill for a clean model, using only water and brush to remove any residue.



300-30200 2.5lbs \$76.25

Dentsply Repair Material Lab Powder - Dentsply Trubyte

High quality, self-cure acrylic for repairing all types of resin base dentures. Accurate, stable color match.

Ensures a strong, long-lasting repair. Pink fibered.

110-680006 1lb \$70.25



Dentsply Repair Material - Liquid

To be used with either Lucitone 199 Repair Material or Dentsply Repair Material.

110-680007 175ml \$25.25

Lucitone 199® Denture Base Resin - Dentsply Trubyte

An acrylic whose ultra-high impact strength has set the industry standard for denture resins. Cadmium-free. Powder/liquid ratio: 21gm (32 cc)/10ml.

Original Shade

11-Unit Package

Contains: 231gm powder, 120ml liquid, 2 measuring vials, and heat seal bags.

110-688103 Package \$53.25

30-Unit Package

Contains: 630gm powder, heat seal bags.

110-688106 Package \$105.45

120-Unit Package

Contains: 4 -630gm powders, 3 -430ml liquids, measuring vials, and heat seal bags.

110-688105 Package \$454.25



Additional shades available upon request.



Lucitone® Clear Resin - Dentsply Trubyte

A quality resin with excellent physical strength properties. Requires Lucitone liquid. Powder/liq-uid ratio: 21gm (32 cc)/10ml.

30-Unit Powder

110-688506 630gm.....**\$61.75**

4lb. Powder

110-688542 Each..... **\$122.45**

Lucitone Liquid

110-684309 430ml..... **\$29.75**

110-684315 1 gallon..... **\$145.75**



Triad Denture Base Material - Dentsply Trubyte

Used for denture base fabrication, relines, repairs, orthodontic, appliances, custom trays, implant applications and more.

6 Sheet Package

Light Pink Fibered 760-95742
Regular Pink Fibered 760-9574202
Regular Pink Unfibered..... 760-9574203
Dark Pink Fibered 760-89935
Package **\$56.75**

6 Rope Package available upon request.

30 Sheet Package

Light Pink Fibered 760-95750
Regular Pink Fibered 760-95751
Package **\$168.95**



Triad Original Flow 6 Sheet Package

Firmer viscosity, especially suited for lower or partial denture intraoral relines. May be used to extend inadequate overdenture flange extensions.

Light Pink Fiber 760-9574501
Regular Pink Fiber 760-9574502
Package **\$58.25**

30 Sheet Package available upon request.



Triad Hi-Flow

Increased flow reduces time needed for in-mouth muscle molding and trimming. Thixotropic qualities allow it to move easily under pressure, yet hold its shape when pressure is released so the reline impression does not shift before curing.

6 Sheet Package

Light Pink Fiber 760-88975
Regular Pink Fiber 760-88977
Package **\$109.75**

Triad Transheet Material

Ideal for orthodontic appliances of all types, removable prosthodontic appliances and many removable placement and fixation devices used in implant prosthodontics.

Clear 760-89271
Pink..... 760-89273
4/pkg. **\$39.75**

Colorless..... 760-89272
24/pkg **\$188.25**



Triad DualLine®

A dual-cure full or partial reline material which combines the accuracy of self-cure and the strength and dimensional stability of light cure.

Introductory Package

Contains: 2 -56gm cartridges, 8 mixing tips, 20ml bottle bonding agent, 15ml bottle air barrier coating, 25 brushes and instructions.

760-905530 Package **\$164.25**

Refill Package

Contains: 2 -56gm cartridges and 8 mixing tips.
760-905537 Package **\$117.75**

Cartridge Mixing Tips

860-905538 16/pkg..... **\$24.75**

Cartridge Dispenser

760-89821 Each.....**\$91.75**



Trubase Baseplates

Single Thickness (0.050")

Upper..... 760-870970201
Lower..... 760-870970202
50/pkg. **\$49.95**

Double Thickness (0.1000")

Upper..... 760-872970101
Lower..... 760-872970102
25/pkg. **\$49.95**



Triad Custom Tray Material

Convenient uniform sheets provide superb adaptation and easy handling. Original Blue.

760-95746 6/pkg **\$33.25**
760-95752 30/pkg **\$98.95**

Triad TruTray Custom Tray Material

Translucency gives a visible benefit when adapting to a marked cast. Firmer, thicker and slightly larger than blue Custom Tray sheets.

760-89902 4/pkg **\$23.95**
760-89904 30/pkg **\$119.95**
760-89905 100/pkg **\$364.95**



Triad Gel

A ready-to-use, flowable VLC material available in four shades for orthodontic, implant, patient ID, bleaching tray spacers, and other removable appliances.

Contains: 4 -22gm tubes per pack.

Clear Colorless 760-88859
Clear Pink 760-88860
Clear Blue 760-88850
Assortment 760-88762
Each **\$125.25**

Continued

DENTURE MATERIAL

Triad by Dentsply Trubyte continued.



Triad 2000 Visible Light Curing Unit

Create custom trays, provisional bridges, denture relines or repairs easily and immediately. Material options include: Denture relines, repair material, denture base, trays, provisional materials, retainers, nightguards, implant placement appliances and other accessories.

Contains: 1 -115v unit and 1 techniques and procedures CD.

770-70210 Unit **\$1183.25**

Replacement Lamp for Triad 2000 unit

250 watt bulb, 120v.

780-70353 Each..... **\$53.25**

Replacement Lamp for Triad I and Triad II

200 watt bulb, 41v.

780-95775 Each..... **\$53.25**

Air Barrier Coating

760-95759 5oz. bottle..... **\$17.25**

760-95760 32oz. bottle..... **\$72.25**

Model Release Agent

760-95762 4oz. bottle..... **\$16.25**

VLC Bonding Agent

760-95765 20ml bottle..... **\$16.95**

VLC Modeling Instrument

760-95779 Each..... **\$16.25**



Pala® Digital Dentures - Heraeus Kulzer

Extremely accurate dentures with faster processing time, 10 days start to finish, in just 3 patient visits. Captures impressions, vertical dimension and centric relations for precision fit and comfort.

Starter Kit

Contains: 2 sizes of each tray size (S, M, L, XL), 2 lip rulers, 2 jaw gauges, 10 Pala Tracers and 2 sizes of single arch attachment (S/M and L/XL).
760-66061720 Kit..... **\$269.95**

Full product line available upon request.



Jet Repair Acrylic - Lang Dental Manufacturing Co., Inc.

Self-curing/fast-setting - 6 to 8 minutes.

Small Professional Package

Contains: 100gm powder and 236ml liquid.

21..... 110-1223CP
Clear..... 110-1223C
Fibred Pink..... 110-1223FP
Meharry..... 110-1223M
Pink..... 110-1223P
Each **\$50.45**

Pound Package

Contains: 454gm powder and 236ml liquid.

Clear..... 110-1234C
Fibred Pink..... 110-1234FP
Meharry..... 110-1234M
Pink..... 110-1234P
Each **\$77.75**

Powder

21..... 110-1220CP
Clear..... 110-1220C
Fibred Pink..... 110-1220FP
Meharry..... 110-1220M
Pink..... 110-1220PNK
4oz. **\$33.75**

21..... 110-1230CP
Clear..... 110-1230C
Fibred Pink..... 110-1230
Meharry..... 110-1230M
Pink..... 110-1230PNK
16oz. **\$56.95**

Liquid

4oz. 110-1403..... **\$21.75**
8oz. 110-1404..... **\$37.75**

DOWEL PINS



Dowel Pins-Brass - Buffalo Dental Manufacturing

Regular for anteriors.

760-34600 100/box..... **\$6.95**

Ney Dowel Pins

Ney brand brass dowel pins with highly polished tapered surfaces for easy removal and accurate placement. Knurled head improves retention. Flat side assists in accurate placement every time die is reinserted.

Small

340-9995118 100/pkg..... **\$15.75**

Medium

340-9995115 100/pkg..... **\$15.75**



DUST COLLECTORS



Optiblast Workstation - Buffalo Dental Manufacturing

This ideal lab workstation for the Optiblast with built-in dust collection. Can be used with electric handpieces and other dust producing devices. 120 volts and has an additional power outlet to plug in your electric handpiece unit.

770-BUF36560 Each..... **\$442.45**



52CSU Etcher Catcher - Handler Mfg Co

Collects dusts created by the use of aluminum oxide blasting pencils. Constructed to be ergonomically accommodating when used with hand-held blasting pencils, preventing dusts from collecting on table tops and surrounding areas. Scratch resistant shield that lasts up to 4 times longer and more powerful suction fan to remove more dust.

Unit Dimensions: 11" W x 16" D x 9" H.

770-52CSU Each..... **\$378.75**



550 Porta Vac Bench Top Dust Collector - Handler Mfg Co

40% more suction power, compact in-line suction design, removable resin clean out tray, replaceable clear acrylic shield and reusable and replaceable pleated rear filter. Comes with a fluorescent light for hours of cool, bright operation and will collect 0.5 microns of dust and larger particles. Easy operation. The durable white powder coated heavy gauge steel frame is built to last. Made in the USA.

770-550 Each..... **\$398.95**

DUST COLLECTORS



62 Super Sucker - Handler Mfg Co

Develops 225 cfm suction capacity through two top inlets. Dust and grindings are entrapped in a removable, disposable paper filter. A secondary polyester filter entraps finer dusts. A third filter made of activated charcoal removes up to 80% of acrylic monomer odors.

Unit dimensions: 14-3/4" W x 8-1/2" D x 17-3/8" H.
570-HAN62 Each..... **\$674.95**



62-II Super Sucker II - Handler Mfg Co

Designed to provide excellent suction to a single bench top work position. Develops 110 CFM (cubic feet / minute) at a static pressure of 63" of H2O double walled disposable filter bag is easily removed through the front access door with the removal of two thumb screws. A rear internal activated charcoal filter aids in the removal of acrylic monomer odors. Includes the dust collector with variable speed controlled suction motor, 4 feet of 2-1/2" flex hose and a fishmouth. This unit is not recommended for collection of ALO dusts.

Unit Dimensions: 10" W x 15-1/2" D x 13" H.
770-62II Each..... **\$610.15**

LAB ADHESIVE



Permabond 910 Adhesive - Buffalo Dental Manufacturing

Cyanoacrylate adhesive used for cementation of pins, repair of models and dies, and for positioning work prior to soldering. Ready to use and requires no catalyst. Extremely high bonding strength, can also be used for sealing/hardening dies.

220-00671 3gm..... **\$6.75**
220-00680 1oz. **\$23.25**

LAB KNIVES & SPATULAS

Green Line Plaster Knives - Buffalo Dental Manufacturing



700-55500 #3 2-1/2" Blade Each..... **\$14.25**



700-55590 #7 1-1/2" Blade Each..... **\$14.25**



700-55630 #8 2" Blade Each..... **\$14.25**

Impression Material Spatulas - Buffalo Dental Manufacturing



2R 4"
Flexible. Used for impression material and plaster.
700-79340 Each..... **\$16.75**

Rosewood Knives - Buffalo Dental Manufacturing



6R 1-5/8" Blade - Plaster
700-55570 Each..... **\$15.95**



7R 1-1/2" Blade - Plaster
700-55600 Each..... **\$14.25**



12 Gritman 2" x 3/4" Full Tang - Plaster/Compound
End of knife for flasks.
700-55700 Each..... **\$22.25**

Spatulas - Buffalo Dental Manufacturing



3R 4"
Stiff.
700-79350 Each..... **\$16.45**



8R 4"
Stiff.
700-79390 Each..... **\$16.45**



10R 4-1/4"
Stiff.
700-79410 Each..... **\$16.75**

Stone/Plaster & Alginate Spatulas - Buffalo Dental Manufacturing



11R 3-1/2"
Flexible.
700-79420 Each..... **\$16.45**



16R 3-1/2"
Extra stiff.
700-79500 Each..... **\$16.75**

Cement Spatulas - Vista Dental Products

Premium grade stainless steel tool for use with waxes, cements, resins and other materials. Maintains color and resists abrasion over time.



2R
700-PS2R Each..... **\$17.95**



11R 2" Gritman Blade
700-PS11R Each..... **\$17.45**

Plaster Knives - Vista Dental Products

Designed for a lifetime of use, this premium quality, rosewood handle knife is ground from premium grade carbon steel. Can be resharpened if necessary.



6R
700-LK6R Each..... **\$15.25**



7R 1-1/2" Blade
700-LK7R Each..... **\$15.25**



12R 2" Gritman Blade
700-LK12R Each..... **\$15.25**

LAB PANS



Lab Pans with Metal Clip

These lab pans are a great way to organize your laboratory. As cases arrive, sanitize the impressions or appliances and place them in the lab pans to protect them from contamination. They are available in a variety of colors so they can be used to organize lab work by incoming and outgoing, or by days of the week. Measures 7" x 5" x 2-1/2". Sold individually.

- Green..... 760-HT7375
- Yellow..... 760-HT7373
- Red..... 760-HT7372
- Blue 760-HT7371
- Beige 760-HT7370
- White 760-HT7374
- Each **\$1.95**



Lab Pans - Plasdent Corporation

Organizes and transports impressions, models, dentures, and crown and bridge appliances from operatory to lab on a daily basis. Color-coded.

- Blue 760-205LPB
- Purple 760-205LPPL
- White 760-205LPW
- Each **\$2.75**

Additional colors available upon request.

LAB POLISHING - ALUMINUM OXIDE



Sil Silane Primer - 3M Oral Care

A silane material that creates a silane layer on the silica-coated surface of an indirect restoration to produce a chemical bond between the opaquer material and the veneering material.

- 767-68300 8ml **\$82.45**

450



Aluminum Oxide - Deldent
White - 50 Micron

- 760-12300 2lbs..... **\$29.25**

White - 90 Micron

- 760-12400 2lbs..... **\$29.25**



Aluminum Oxide - Keystone Industries

Dental grade abrasive. 100% dependable cleaning action.

White - 50 Micron

- 760-1010002 15lbs..... **\$88.95**



Aluminum Oxide - Zest Dental Solutions

White - 27 Micron

- 760-80042 1lb. **\$30.75**

White - 50 Micron

- 760-15301 1lb. **\$18.25**

Tan - 90 Micron

- 760-15201 1lb. **\$18.25**

LAB POLISHING COMPOUND



Fabulastre - Grobet USA

Provides a high luster finish on all types of precious metals. Special formulation removes light scratches and produces a mirror-bright final finish without discoloration.

- 760-47312 1/4lb. tube..... **\$5.25**



Pumice - Integra® Miltex®

Used for prophy treatments, denture cleanings and a polisher for stone models.

- Flour 746-70870
- Fine..... 746-70690
- Medium..... 746-70750
- Coarse 746-70810
- 1lb. **\$8.95**
- Coarse 746-70830
- 4lbs. **\$20.75**
- Flour 746-70890
- Fine..... 746-70710
- Medium..... 746-70770
- 5lbs. **\$28.25**

LATHES



Red Wing Lathes - Handler Mfg Co
Model 16B

The 16B Chuck/Changer is factory installed on the right side of a 26A low base Red Wing lathe. This combination provides the technician with the ultimate in chuck changing at both high and low lathe speeds. All chuck and maintenance accessories.

- 770-HAN16B Each **\$723.75**



Model 26A

A full 1/4 HP 1725/34350 rpm lathe for use on top of laboratory bench. Shipped with standard tapered shafts, each lathe includes a right and left chuck remover, which provides easy chuck removal.

- 770-26A Each **\$330.15**

MISCELLANEOUS



Bioform Shade Guide - Dentsply Trubyte

Comprehensive shade selector for both denture teeth and porcelain C&B materials.

Style A - Light to Dark

Porcelain..... 210-89350
 IPN Plastic 230-89566
 Each **\$99.95**

Style B - Groups by Hue

Porcelain..... 230-89351
 IPN Plastic 230-89557
 Each **\$99.95**



Denatured Burning Alcohol - EPR Industries LLC

510-00099C 4 -32oz./case **\$36.75**



3% Hydrogen Peroxide - Hydrox Laboratories

510-13 Gallon **\$11.75**



Alcohol Dispensers - Palmero Health Care

Plastic Menda Type Brown
 510-47 Each **\$12.45**

Opaque Plastic
 510-48 Each **\$12.75**

MIXING BOWLS

Health-Tec
 BRAND PRODUCTS

Flexible Mixing Bowls
Small (8cm/ 150cc)
 3-1/4" diameter, 2-1/2" Height
 760-HT904S Each **\$7.95**

Medium (10cm/ 350cc)
 4-1/4" diameter, 2-3/4" Height
 760-HT904M Each **\$8.45**

Large (13cm/ 600cc)
 4-3/4" diameter, 3-1/2" Height
 760-HT904L Each **\$8.95**



Flexiboles - Coltene

Small - 150cc
 765-00563 Each **\$11.25**

Medium - 350cc
 765-00564 Each **\$16.75**

Large - 600cc
 765-00565 Each **\$18.25**

Extra Large - 850cc
 765-00566 Each **\$23.25**

Jumbo - 1700cc
 765-00566 Each **\$23.25**



Suction Base Mini Bowls - Pulpdent Corporation

Non-stick silicone bowls with suction base for acrylics.

Small
 300-BMS3 Set of 3 **\$23.45**

Medium
 300-BMM2 Set of 2 **\$23.45**

Large
 300-BML Each **\$16.45**

MODEL BASE FORMERS

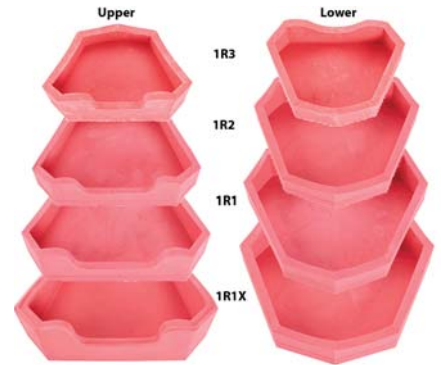

Model Formers - Columbia Dentoform®

These bases are soft and flexible for perfect models.

Pedo/Small Set

Length 2-1/4", Width 1-1/2", Depth 3/4"
 760-R3 Each **\$60.45**

Adult Medium Set

Length 2-1/2", Width 3-1/2", Depth 1"
 760-R2 Each **\$59.25**

Adult Large Set

Length 3", Width 4", Depth 1"
 760-R1 Each **\$63.75**

Adult X-Large Set

Length 3-1/2", Width 4-1/2", Depth 1-1/4"
 760-R1X Each **\$66.95**



Model Formers - Plasdent Corporation

Available in three sizes.
 Contains: 3 upper and 3 lower per box.

Small

760-MFS Each **\$7.25**

Medium

760-MFM Each **\$8.25**

Large

760-MFL Each **\$9.25**

Assorted

760-MFA Each **\$8.25**

MODEL TRIMMER WHEELS



Carborundum Wheels - Buffalo Dental Manufacturing

Aggressive cutting wheels cut fast and smooth. Coarse Grit with 1" Center Hole
 740-61990 10"..... **\$26.95**
 740-62030 12"..... **\$34.45**



Model Trimmer Wheels - Dedeco International, Inc.

Fibreglass reinforced for perfect balance and superior durability.

Coarse 36 Grit
 740-7010 10" coarse..... **\$32.75**
 740-7012 12" coarse..... **\$35.75**



Carbo-Dent Model Trimmer Wheels - Handler Mfg Co.

Reversible and reinforced. 1/4" thick.

Standard Coarse
 580-HAN31AC 10"..... **\$33.95**
 770-32AC 12"..... **\$40.95**



31 Model Trimmer - Handler Mfg Co.

Standard with a reversible, reinforced 1/4" thick Carbo-Dent wheel for long lasting use and improved safety, as well as a pair of rubber suction cup feet to lift the front of the trimmer for better water flow and more stable operation for safety.

Model 31
 10" wheel, 1/3 HP, 110 volts.
 770-31 Each..... **\$607.45**

Model 31X
 10" wheel, 1/4 HP, 110 volts.
 770-31X Each..... **\$571.55**



Model Trimmer - Whip Mix

10" Model. Offers a two-position work table and many features of the larger models but at a lower cost. 10" coarse abrasive wheel and 1/3 HP motor.
 770-09474 Each..... **\$933.95**

Complete Kit

Contains: Sealed trap bucket, 2 hoses and sewer tail pipe adapter fitting.

560-62100 3-1/2 Gallon **\$46.95**
 560-62110 5 Gallon..... **\$53.95**

Refill

Contains: Trap and 2 plastic caps for sealing full trap.

560-62106 3-1/2 Gallon **\$19.95**
 560-62112 5 Gallon..... **\$23.95**

Bottle Trap and Self-Sanitizing Trap available upon request.



Crescent® Plaster Trap - Dentsply Caulk

Eliminates cleaning problems, odors and mess. It has a disposable vinyl liner with a built-in drain attached to disposable liner. 8 quart capacity and brushed aluminum canister.
 770-CRE0350100 3-1/2 Gallon **\$329.75**

Replacement Liners

560-0350225 Each..... **\$28.75**

MODEL TRIMMERS



Model Trimmer - Buffalo Dental Manufacturing

Engineered for greater visibility, plus efficient trimming of models without splashing or plaster build-up. Quiet and smooth running, ideal for any requirement. Heavy-duty bearing motor for low noise and smooth running. Optional solenoid valve controls water and motor simultaneously.

Model 61790A
 10" wheel, 1/3 HP, 110 volts.
 770-61790A Each **\$593.25**

Model 61792
 10" wheel, 1/2 HP, 110 volts.
 770-61792 Each **\$674.95**

PLASTER TRAPS



Trap-Eze™ Disposable Plaster Traps - Buffalo Dental Manufacturing

The sanitary, convenient, odor-resistant solution for the capture and disposal of messy wet model trimming waste.

Original Classic
 Requires minimum 9" clearance between bottom of sink tail pipe and top of trap bucket for easy installation without tools.



Dispos-a-trap - Keystone Industries

Combines convenience with economy. Translucent color allows for easy monitoring of the waste level. Safe, reliable and sanitary.

Complete Set

560-7000365 3-1/2 Gallon **\$53.25**
 560-7000366 5 Gallon..... **\$59.45**

Bucket Only

560-7000367 3-1/2 Gallon **\$34.95**
 560-7000368 5 Gallon..... **\$33.75**

Hose Set

560-7000369 Each..... **\$48.45**

PLASTER TRAPS



Gleco Plaster Trap - Practicon, Inc.
 Invented by a plumber, the trap makes changing your plaster trap a clean, effortless task. Install the pre-assembled trap once, then replacing the bottle takes less than one minute start to finish without tools. Adapts easily to existing plumbing.

Gleco Trap Packages available upon request.

32oz.
 770-GT32C 12/pack **\$2.75**

Replacement Jars - 128oz.
 770-GLE10015 4/pack **\$7.75**

PRESSURE POTS



448PP Pneumatic Curing Vessel/Pressure Pot - Handler Mfg Co
 8 quart. Made of sturdy cast aluminum, will hold up to 22PSI to cure acrylic while doing denture repairs and relines. Can hold one Handler 61B two flask compress with one Handler 44U upper flask and one Handler 44L lower flask.
 770-448PP Each..... **\$267.45**

SAW FRAMES & BLADES



Ceri-Saw™ - DenMat
 Used for interproximal finishing. Handle prevents accidental slips and injury while allowing interproximal finishing with one hand.
Kits
 Contains: 1 holder with blade and 10 replacement blades.
 Posterior 740-031336600
 Anterior 740-031336500
 Kit **\$79.25**

Order by ☎ 800-626-2163

Replacement Blades

Posterior 740-13371
 Anterior 740-031336520
 10/pkg **\$46.25**



Saw Kit & Blades - Dentsply Ceramco
 Designed for hand cutting operations of stone and acrylic. The skip tooth blade permits a quick, clean and narrow cut. Blade is held in place by tension of the one-piece frame and is free of any locking or tightening devices which might interfere with the cutting surface. Blades are quickly and easily changed.

Saw Frame w/10 Blades
 760-9995112 Each..... **\$27.75**

Blades
 760-9995113 10/pack..... **\$13.45**



Wheel Saw - Keystone Industries
 High quality cutting wheel used for hard sheet resins and dual laminates. The cutting surface is on the edge that contacts the plastic. Fits most slow speed handpieces.
 760-9630100 Each..... **\$18.25**

SEPARATING AGENT



Al-Cote Separating Agent - Dentsply Trubyte
 Ideal replacement for tinfoil in the processing of acrylics. Chemically reacts with gypsum to form a film that is insoluble in water or monomer.
 760-652500 65ml..... **\$11.45**
 760-652502 Gallon..... **\$90.25**

☎ www.dhponline.com

SEPARATING AGENT



COE-SEP - GC America
 Tinfoil substitute that provides smooth, glossy and tough film on stone models. Prevents denture resins from sticking to stone models during processing. Uniform film thickness permits closer adaptation of acrylic resin to model.
 762-343591 2oz **\$11.45**
 762-343592 1 quart..... **\$41.25**
 762-343593 1 gallon..... **\$81.75**



Super-Sep - Kerr Laboratory
 An alcohol-based die separating fluid that dries on contact. Plastics, stone or investment can be poured against it immediately.
 759-22325 8oz. bottle **\$41.95**
 759-22326 32oz. bottle **\$82.25**

SILICONE SPRAY



Sta-Lube Silicone Spray - Buffalo Dental Manufacturing
 This silicone lubricant prevents mouthguard materials from adhering to the model, vacuum plates and frames. Assures easy cleanup of flasks and trays. Ideal separating medium for dies when making copings. Environmentally safe.
 571-80015 16oz..... **\$16.25**

☎ Fax: 888-681-5088

SILICONE SPRAY



Silicone Spray - Dentsply Trubyte

An all purpose food-grade release agent. Can be used on metals, many plastics, plaster, stone, amalgam and compounds. Does not contain petroleum oil.

760-98929 16oz \$19.45



Silicone Emulsion - Keystone Industries

Produces smooth, accurate, bubble-free surfaces on all impression materials and models.

760-0140400 4oz \$16.45

16oz. Concentrate

Makes 32oz.

760-0140500 Each \$45.75

SPLASH HOODS



Model 83NLS - Handler Mfg Co.

770-HAN83NL Each \$89.95



Model 86D - Handler Mfg Co.

770-HAN86D Each \$99.95



Model 86RHL - Handler Mfg Co.

Resin splash hood with light and shield. Insert pan is dishwasher safe and can last a lifetime.

770-HAN86RHL Each \$92.95

Sta-Kleen Shield #86B

Protective clear acrylic shield.

580-HAN86B Each \$27.95

Packets - 120gm

Green 750-46507
24/pkg \$64.45

Green 750-46578
Pink 750-46560
Blue 750-46565
Ivory 750-46615
25lbs. \$82.25

Green 750-46580
Pink 750-46590
Blue 750-46585
Ivory 750-46635
50lbs. \$105.75



Vel-Mix - Kerr Laboratory

High strength, low expansion crown and bridge die stone. Produces accurate surfaces.

Pink 759-31006
Classic Pink 759-31008
White 759-31007
33lbs. \$65.45

DIE STONE



Modern Materials® Die Stone - Heraeus Kulzer

Type IV die stone. Specially formulated for fixed and removable bridges, cast partials, crowns and inlays. Peach.

750-46674 25lbs \$57.45



Modern Materials® Die-Keen - Heraeus Kulzer

Type V. High strength and optimum expansion for dies and crown and bridge work. Compatible with all impression materials.

Packets - 60gm

Green 750-46502
24/pkg \$48.75



Jade Stone - Whip Mix

ISO type 5. Compatible with all types of impression materials. Color provides excellent contrast to casting waxes. Green.

750-18570 25lbs \$79.75
750-31739 55lbs \$96.95



Silky Rock - Whip Mix

ISO Type 4. Low-expansion die stone.

Characterized by exceptional hardness and density throughout and an unusual "silky-smooth" pouring quality that makes it flow freely into any type of impression.

25lbs.

750-02070 White \$72.75
750-01910 Violet \$72.75
750-01996 Yellow \$72.75
750-33163 Ivory \$95.75

55lbs.

750-27219 White \$95.75
750-33162 Yellow \$95.75

GYPSUM



Modern Materials Plaster - Heraeus Kulzer

Lab Plaster

Type II model plaster. White.

Regular Set.....	750-48472
Fast Set.....	750-48512
25lbs.	\$35.75
Regular Set.....	750-48452
Fast Set.....	750-48552
50lbs.	\$59.95

Orthodontic Plaster

Type II. Velvet-smooth. Sets harder and denser. Ideal for ortho casts and study models. Extremely Snow White.

750-48170	25lbs.....	\$44.95
750-48180	50lbs.....	\$65.95



Snow White™ Plaster - Kerr Laboratory #1 Type II Model Plaster

A high grade model plaster excellent for study models, ortho study models and general work because of its durability, smooth surface and easy mixing. Natural Set. White.

759-31001	33lbs.....	\$83.95
-----------	------------	----------------

#2 Type I Impression Plaster

A quick setting, reliable impression plaster. Commonly used for impressions, soldering transfers, labial and occlusal indexes. Rapid Set. White.

Mint.....	759-31003
Unflavored.....	759-31002
33lbs.	\$83.95



Orthodontic Stone - Whip Mix

Hard, accurate dental stone of super-white color for optimal esthetics. Smooth mixing and easy flowing with ample working time.

750-31801	25lbs.....	\$67.45
-----------	------------	----------------



Snap-Stone - Whip Mix

Fast setting stone with an early high compressive strength, allowing separation of the cast from the impression in 5 minutes. Compatible with all impression materials. Hand-mixing is recommended. Pink.

750-23690	11lbs.....	\$63.25
750-23698	25lbs.....	\$68.45
750-33219	50lbs.....	\$123.75

MODEL STONE



Castone - Denstply Trubyte

ADA Type III. Used for dental casts, investing and articulator mounting. Cream.

750-99043A	25lbs.....	\$51.45
------------	------------	----------------

White available upon request.



COECAL™ - GC America

Hard, quick setting and accurate. Minimum processing change. Excellent for study and working models and flasking procedures.

Buff	750-310125
White	750-310225
25lbs.	\$56.95
Buff	750-310150
White	750-310250
50lbs.	\$76.75



Modern Materials® Model Stone - Heraeus Kulzer Denstone

Type III model stone formulated for processing full or partial acrylic dentures and counter models.

Golden.....	750-46175
White	750-46172
25lbs.	\$44.45

Golden.....	750-46185
White	750-46182
50lbs.	\$57.95

Pink available upon request.

Labstone

Type III all purpose model stone for articulating flasking and master models.

Buff

750-46277	25lbs.....	\$46.95
750-46287	50lbs.....	\$51.45

Blue and Green available upon request.

Ortho Stone 0-67

Type III. Specifically formulated for orthodontic casts where whiteness, accuracy and durability are essential. Snow white.

750-46972	25lbs.....	\$52.75
750-46952	50lbs.....	\$77.45

StatStone

Ideal for fabricating bleaching trays, custom trays, mouth guards, mounting casts, temporaries and denture repairs. Working models in 5 minutes. Pink.

750-46860	25lbs.....	\$71.75
-----------	------------	----------------



Hydrock™ Model Stone - Kerr Laboratory

Type III. Used primarily for full or partial denture models. 10 minute set time. The Rapid set formula (7 minutes) can be used for articulations requiring a bit more accuracy than using plasters.

Rapid White	759-30997
Rapid Yellow.....	759-30996
33lbs.	\$58.25
White	759-30993
Yellow.....	759-30994
Ivory.....	759-30995
33lbs.	\$58.25



Mounting Stone - Whip Mix

ISO Type 3. A very hard fast setting gypsum material formulated expressly for mounting casts to articulators.

White

750-02917	25lbs.....	\$49.45
750-33197	50lbs.....	\$98.25

Blue

750-18740	25lbs.....	\$49.45
-----------	------------	----------------

SURFACTANT/DEBUBLIZER



Surfactant Debubblizer - Almore International, Inc.

Reduces surface tension and eliminates bubbles. Spray lightly on any impression material such as alginate, rubber or silicone. Does not contain alcohol. Avoids repouring and distortion of models. May also be directly added to stone or plaster mix.

- 760-62801 8oz \$18.25
- 760-62800 32oz \$40.75

VACUUM FORMERS



Econo-Vac - Buffalo Dental Manufacturing

Premium features and performance at a budget friendly price. 110 volts.

- 770-80186 Each \$455.95

The Machine III - Keystone Industries

Aluminum construction is long-lasting, eliminating the possibility of rust. Heating element is symmetrically engineered for even heat distribution throughout the thermoplastic material. Use with 5" x 5" resin sheets. Made in the USA with a 5-year guarantee on parts and labor. 110 volts.



- 770-NATM31 Each..... \$415.75

Machine IV - Keystone Industries

Super strong, lightweight thermoplastic material. Plastic housing dampens vibrations resulting in a quieter running unit. Vented heater cover allows heat to quickly dissipate. Locking handle allows you to vary the height of the material plate to control the heating rate of various materials. Contoured vacuum platform allows full air flow under the model. Reliable touch pad control with several safety features: Built-in safety timer that shuts down the heater if not used for 15 minutes. Built-in tilt-switch that powers down the unit if it is knocked over or tilted more than 45 degrees. Made in the U.S.A. with a 5-year warranty on parts and labor. 110 volts.



- 770-7000338 Each..... \$492.95

Stalite Special Solution - Buffalo Dental Manufacturing

Unique solution helps make harder, smoother and more accurate stone models and dies. No significant setting expansion. Can be used with all gypsums.



- 760-80151 Gallon..... \$38.95



Sta-Vac - Buffalo Dental Manufacturing

High performance, premium vacuum forming machine with a dual stage vacuum motor, which provides highly accurate adaptations. 110 volts.

- 770-80190 Each \$662.45

Debubblizer - Kerr Laboratory

A surface tension reducing agent that allows investment to flow uniformly to all portions of the wax pattern. For use when hand mixing.



- 769-22320 8oz \$42.75
- 769-22321 32oz \$55.95



Tray-Vac - Buffalo Dental Manufacturing

Features a high velocity air flow system, a new quick lock frame and a gasket free design. 110 volts.

- 770-80165 Each \$381.95

Pro-Line Air Vac 2000 - Keystone Industries

Provides superior adaptation for dental plastics. Utilizes the laboratory's or operator's internal air compressor to provide the maximum amount of air pressure to adapt thermoplastics. No motor means the unit is very compact and very quiet. The vacuum pressure from an office compressor is greater than that generated from smaller vacuum units. Greater pressure means it works on all types of plastics and all types of appliances. Can be used to layer appliances. Made in U.S.A. with a 5-year warranty on parts and labor. 120 volts.



- 770-7000470 Each..... \$612.75

Model Glow (Model Soap) - Whip Mix

High luster to gypsum models. Its special formulation does not yellow or flake and seals the pores to provide a protective coating. Its thin consistency does not affect occlusal accuracy. Long lasting and can be used full strength or diluted. Models can be buffed wet or dry.



- 760-29009 Gallon..... \$51.75



iNTERRA™ In Office Nightguard - Dentsply Caulk

Clinician can, in one visit, offer the patient a lab quality, custom fit, comfortable, long lasting durable and esthetically pleasing appliance, without the need for an impression. It offers a unique wedge shape that allows easier lateral excursions.

Starter Kit

Contains: 1 small arch, 2 medium arches, 1 large arch, 1 Regisil Rigid super fast set cartridge (50ml), 6 mixing tips.

760-61D010 Kit **\$212.95**

Refills

Small 6/pkg 760-61D020
 Medium 5/pkg 760-61D030
 Large 6/pkg 760-61D040
 Each **\$353.75**

Curing Unit

iNTERRA VLC Curing Unit - 120V
 770-61D100 Unit..... **\$4,055.45**

iNTERRA Replacement Bulbs

760-91D400 Each **\$93.25**



Base Plate Material - Keystone Industries

Used for denture base or wax bite plates. Made of pure high-impact styrene, the material melts at a low temperature and is easy to work with. Pink. 5" x 5" sheets.

.060
 760-9616210 25/box **\$25.25**

.080
 760-9616230 25/box **\$17.45**

.100
 760-9616140 100/box **\$61.25**

Tray Material - Keystone Industries

Ideal for impression trays. Made of high-impact styrene. Spacer foam is included. 5" x 5" sheets.

.150
 760-9617410 25/box **\$26.75**

Additional thickness and sizes available upon request.



Bleaching Laminates - Keystone Industries

Ideally suited for making bleaching trays and withstanding bleaching products. Only .020" thick once it's formed over the model. Foam liner to absorb bleach. Clear. 5" x 5" sheets.

760-P150000 50/pkg. **\$86.75**



Coping Material - Keystone Industries

These cloudy, stiff polypropylene sheets are excellent for fabricating temporary crowns, bridges and copings. The material gives good definition and will not adhere to acrylics.

.020 Coping
 760-9613470 50/box **\$15.45**

.030 Coping
 760-9613480 50/box **\$16.45**

Additional thickness and sizes available upon request.



Crown & Bridge Material - Keystone Industries

A thin, clear rigid material that works great for temporary bridges. The material is easy to work with, does not bond to acrylic. 5" x 5" sheets, .020 thick.

760-9613680 50/box **\$25.95**



Dual Laminates - Keystone Industries

Unique combination of two materials formed into a single laminated sheet, made with bruxing cases in mind. Soft liner assures patient comfort and the hard surface assures long-lasting wear. Acrylic will bond to the hard surface to allow the technician to modify the occlusal surface. 5" x 5" sheets.

760-P130000 12/pkg..... **\$76.75**

Additional thickness and sizes available upon request.

Pro-Form Niteguard Laminates - Keystone Industries

Layered with soft/soft material, made specifically for the making of niteguards. Layering gives the thermoplastic a more abrasion resistant characteristic that will withstand grinding better than traditional soft sheet materials. 5" x 5" sheets.

0.120
 760-P120000 12/box **\$76.75**



Pro-Form Soft EVA - Keystone Industries

Great for the fabrication of custom fluoride trays, bleaching trays and model duplication. The material is soft, clear and easily forms, can be trimmed effortlessly. Ideal for soft bruxing patients. Clear. 5" x 5" sheets.

.040
 760-9596980 25/box **\$19.95**

.060
 760-9597090 25/box **\$31.25**

.080
 760-9597150 25/box **\$27.25**

.120
 760-9611240 25/box **\$32.95**

.160
 760-9597940 25/box **\$33.75**



Splint Material - Keystone Industries

This stiff clear material is ideal for hard splints, thin splints, surgical trays, orthodontic retainers and bleaching trays. The material sticks to acrylics for various dental appliances. 5" x 5" sheets.

Clear .020 Splint
 760-P221003 50/box **\$23.25**

Clear .030 Splint
 760-P221A04 25/box **\$22.95**
 760-P221004 50/box **\$25.45**

Clear .040 Splint
 760-P221A06 25/box **\$14.45**
 760-9614830 50/box **\$24.25**

Clear .060 Splint
 760-9614960 25/box **\$20.75**
 760-9614780 50/box **\$30.75**

Clear .080 Splint
 760-P221A02 25/box **\$23.45**
 760-9614790 50/box **\$39.25**





Pro-Form Fun Guards

Diagonal

Red/Green/Blue/Yellow

760-9600006 12/pack **\$74.25**



Dripping Blood

Black with Blood Image.

760-9599077 12/pack **\$74.25**

Polka Dots

Red Background 760-9600929

Blue Background..... 760-9598079

White Background..... 760-9601039
12/pack **\$74.25**

The Fangs

Black & White Fangs

760-9599075 12/pack **\$74.25**

Tie-Dye

Midnight..... 760-7944000

Assorted 760-7974000

6/pack **\$38.95**

Solid Colors 4mm 12/pack \$78.95							
	760-P110000 Clear		760-9600800 Green		760-9600870 Purple		760-9600820 Maroon
	760-P110RE0 Red		760-9601040 Yellow		760-9600850 Orange		760-P110C02 Assorted
	760-P110BK0 Black		760-P110B00 Blue		760-9600886 Pink		760-9601020 White

Two-Color Combinations 4mm 12/pack \$78.95							
	760-9598360 Green/Blue		760-9598280 Orange/White		760-9598110 Black/Yellow		760-9598340 Purple/Yellow
	760-9598210 Blue/Red		760-9598320 Black/Orange		760-9598400 Blue/Orange		760-9598420 Red/Yellow
	760-P110BD10 Blue/White		760-9598240 Black/White		760-9598380 Green/White		760-9598300 Maroon/Yellow
	760-9598150 Blue/Yellow		760-9598090 Black/Red		760-9598190 Green/Yellow		760-P110BD50 Assorted

Two-Color Combinations 4mm 12/pack \$78.95	
	760-9598900 Red/White/Red/ Canada
	760-9600170 Assorted

Pro-form can make colored mouthguards that have up to three colors in one sheet. Take above colors and mix them however you like.

X-Tra Pro Laminates 5mm 12/pack \$73.25			
	760-9601515 Red		760-9601535 Yellow
	760-9601485 Green		760-9601280 Red/White/Blue
	760-9601215 Clear		760-9601275 Black
	760-9601225 Blue		760-9601350 Assorted

VACUUM FORMING ACCESSORIES



Block-Out Compound - Buffalo Dental Manufacturing
760-05240 Each..... \$12.95



ThermaKnife - Buffalo Dental Manufacturing
Quickly and easily trim bleaching trays, mouthguards and many other thermoplastic materials. Adjustable temperature control makes it easy to customize. Lightweight pen features an ergonomic design and sharp, permanent tip for improved comfort and control. 120 volts.

Intro Kit
Contains: Unit and Knife Edge Pen.
770-BUF80500 Kit..... \$220.95

Additional Pens available upon request.



Pro-form Electric Knife - Keystone Industries
Useful in trimming and cutting a variety of thermoplastic dental materials. Solid state circuitry, and interchangeable handpiece with up to four other replacement handpieces available, 2 outlet stations to accommodate more than one person. 10 amps allow you to cut most materials easily and smoothly by providing extra heat at the tip. Excellent for bleaching trays, impression trays, splints, mouthguards and more. Can also double as a waxer.
770-9144730 Each \$385.95



Pressure Dome - Keystone Industries
Uses positive pressure during vacuuming, allowing for a form-fitting mold of thermoplastics. Hooks into any existing air compressor lines to provide extra pressure when adapting thermoplastics over an existing model.
770-9594050 Each \$124.75

VIBRATORS



1A Vibrator - Buffalo Dental Manufacturing
Durable 4" diameter rubber cover and suction cup feet improve stability and ensure quiet operation. 120 Volt, 3 speed.
770-84350 Each..... \$96.75



200 Extra H.D. Vibrator - Buffalo Dental Manufacturing
Our largest vibrator for multiple flasks and dense castings. 10-1/8" x 7-1/2" rubber covered work platform for convenience and spill control. Beige enameled housing. 110 volts.
770-84500 Each..... \$324.75



78-RK Atlas Heavy Duty Tri-Speed Vibrator - Handler Mfg Co
Built for durability and rugged use. Two frequencies each with variable speed. The HIGH and LOW are variable to allow a technician to vibrate a mixing bowl or flask at the correct speed for the plaster, stone or viscous solution to de-bubble. The fully covered larger rubber table is built to hold larger flasks and mixing bowls. The rubber top is removable for easy cleaning and replacement. Four soft rubber feet hold the 78-RK in place during the heaviest vibrating cycles. The unit is coated with a baked enamel finish.
Unit Dimensions: 8" W x 6 1/2" D x 4 1/2" H
770-HAN78RK Each..... \$215.95



78-1 Atlas Junior Vibrator - Handler Mfg Co
A three speed vibrator for use by the dentist or smaller laboratory. This is designed for compactness, longevity and intermittent use. Its 4" [10cm] diameter, removable, rubber covered table top makes it an ideal addition to any small lab workbench where a vibrator will be utilized for short periods. Finished in a durable, baked coating with resista-move rubber suction cupped feet. Unit Dimensions: 4 1/2" W x 4 1/2" D x 4" H.
770-HAN781 Each..... \$115.95



ContactPro® Sectional Matrix System - Microbrush® International

The ContactPro Sectional Matrix System by Microbrush International provides you a solution for Class II Restorations. The system is reliable, consistent and easy to use. The ContactPro Ring provides consistent clamping force throughout the lifecycle of the product which helps achieve minimal flash and great contact. This ring was designed to allow for great visibility in your working area and better access for light curing. Pair the ContactPro Ring with the coated or uncoated Smartbands for a snug fit at the gingival margin, the ContactPro Wedge, and DryTips for advanced moisture control for a successful Class II Restoration.



Expert Kit

ContactPro Expert Kit

Contains: 2 ContactPro Rings; 2 SmartView Clips; 150 ContactPro SmartBands - 50 of each size: 3.5mm, 4.5mm, 5.5mm; 150 ContactPro Wedges - 50 of each size: X-Small, Small, Med; 40 DryTips - 20 of each size: Small & Large; 15 Microbrush Applicators; 1 ContactPro Band Forcep; 1 ContactPro Ring Forcep

800-291698 Uncoated ContactPro SmartBands \$600.00
 800-291699 Coated ContactPro SmartBands..... \$650.00



Primary Kit

ContactPro Primary Kit

Contains: 2 ContactPro Rings; 1 SmartView Clip; 75 ContactPro SmartBands - 25 of each size: 3.5mm, 4.5mm, 5.5mm; 75 ContactPro Wedges - 25 of each size: X-Small, Small, Med; 1 ContactPro Band Forcep; 1 ContactPro Ring Forcep

800-291700 Uncoated ContactPro SmartBands \$475.00
 800-291701 Coated ContactPro SmartBands..... \$525.00



Intro Kit

ContactPro Intro Kit

Contains: 2 ContactPro Rings; 30 ContactPro SmartBands - 10 of each size: 3.5mm, 4.5mm, 5.5mm; 30 ContactPro Wedges - 10 of each size: X-Small, Small, Med; 1 ContactPro Ring Forcep

800-291702 Uncoated ContactPro SmartBands \$325.00
 800-291703 Coated ContactPro SmartBands..... \$375.00



ContactPro SmartBands

3.5mm 4.5mm 5.5mm 6.5mm 7.5mm

**SmartBands Refills
3.5mm**

Contains: 100 ContactPro SmartBands
 800-291707 Uncoated ContactPro SmartBands ..\$60.00
 800-291704 Coated ContactPro SmartBands.....\$110.00

4.5mm

Contains: 100 ContactPro SmartBands
 800-291590 Uncoated ContactPro SmartBands ..\$60.00

5.5mm

Contains: 100 ContactPro SmartBands
 800-291592 Uncoated ContactPro SmartBands ..\$60.00
 800-291593 Coated ContactPro SmartBands.....\$110.00

6.5mm

Contains: 25 ContactPro SmartBands
 800-291708 Uncoated ContactPro SmartBands ..\$20.00
 800-291705 Coated ContactPro SmartBands.....\$30.00

7.5mm

Contains: 25 ContactPro SmartBands
 800-291709 Uncoated ContactPro SmartBands ..\$20.00
 800-291706 Coated ContactPro SmartBands.....\$30.00



ContactPro Ring Refill

ContactPro Ring Refill

800-291710 2/pkg\$220.00



SmartView Clip Refill

SmartView Clip Refill

800-291600 3/pkg\$90.00



ContactPro Wedges

ContactPro Wedges Refill

X-Small..... 800-291746
 Small..... 800-291747
 Medium..... 800-291748
 Large 800-291749
 100/pkg\$33.00

X-Small Small Medium Large

Assorted

Contains: 100 each size.
 800-291750 400/pkg.....\$44.00



ContactPro Ring Forceps

ContactPro Ring Forceps

800-291712 Each\$85.00



ContactPro Band Forceps

ContactPro Band Forceps

800-291711 Each\$85.00

waterpik® ClearView Sectional Matrix System



ClearView Trial Kit

800-20020224 ClearView Trial Kit.....\$141.95

Trial Kit Includes:

- 1 - Universal Ring
- 1 - Ring Forceps
- 5 - 5.5mm (dark blue) non-stick matrices
- 5 - 6.4mm (green) non-stick matrices
- 10 - Small Wedges (light blue)

ClearView Complete Kit

800-20020223 ClearView Complete Kit.....\$554.95

Complete Kit Includes:

- 2 - Universal Rings
- 1 - Ring Forceps
- Non-stick Matrices:

20 - 4.6mm (light gray)	Wedges:
20 - 3.8mm with extension (light blue)	25 - Extra Small (white)
20 - 5.5mm (dark blue)	25 - Small (light blue)
20 - 6.4mm with extension (purple)	25 - Medium (dark blue)
20 - 6.4mm (green)	25 - Large (purple)



ClearView Ring

The unique hourglass shape allows you to see and access the site to help you achieve outstanding restorations with tighter contacts, and it retains its strength for consistent and predictable restorations over time.

Either one ring may be used for the restoration or two rings may be stacked one over the other for performing M.O.D.'s and multiple-tooth restorations.

800-20020225 2 - Universal Rings.....\$224.95

ClearView Sectional Matrices

The Waterpik®ClearView Sectional Matrices have a non-stick coating, plus a centralized gripping tab for easier placement and removal of the matrix. The matrices are anatomically shaped to produce the best contour and contact for the range of Class II restorations. They are color-coded for quick and accurate selection of the desired size.



- 800-20020226** 50 - Bicuspid 4.6mm (lt gray).....\$72.95
- 800-20020227** 25 - Bicuspid 3.8mm with extension (lt blue).....\$72.95
- 800-20020228** 50 - Bicuspid and Small Molars 5.5mm (dk blue).....\$72.95
- 800-20020229** 25 - Molars 6.4mm with extension (purple).....\$72.95
- 800-20020230** 50 - Molars 6.4mm (green).....\$72.95

CV Anatomical Wedges

The anatomical shape of the Waterpik®CV Wedge produces a comfortable and secure fit for optimal contour, gingival seal, and tooth separation.



- 800-20020231** 100 - Extra-small (white).....\$48.95
- 800-20020232** 100 - Small (lt blue).....\$48.95
- 800-20020233** 100 - Medium (dk blue).....\$48.95
- 800-20020234** 100 - Large (purple).....\$48.95



ClearView Ring Forceps

The autoclavable Waterpik®ClearView Ring Forceps are specifically designed to provide secure gripping of the ClearView ring for placement and removal.

800-20020235 1 ClearView Ring Forceps.....\$92.95

Palodent® Plus Sectional Matrix System

- Nickel-titanium retaining rings provide consistent tooth separation force and exceptional stability
- Matrices are shaped to commonly encountered cavity form
- Wedges are designed for easy placement, stacking, and minimized impingement of soft tissue
- WedgeGuards protect the adjacent tooth from bur damage during prep
- Ring placement forceps locking function and angled grip arms hold the ring securely for placement
- Pin Tweezers grip matrices, wedges, and wedgegards for placement and removal control
- Visit www.PalodentPlus.com for more information

808-659700 INTRO KIT \$547.95

100 Matrices
25 each: 3.5mm, 4.5mm, 5.5mm, 6.5mm
75 Wedges
25 each: Small, Medium, Large
30 WedgeGuards
10 each: Small, Medium, Large
1 Universal Ring; 1 Narrow Ring
1 Forceps; 1 Pin Tweezers

800-659670 EZ COAT INTRO KIT \$596.95

100 Matrices
20 each: 3.5mm, 4.5mm, 5.5mm, 6.5mm, 7.5mm
75 Wedges
25 each: Small, Medium, Large
30 WedgeGuards
10 each: Small, Medium, Large
1 Universal Ring; 1 Narrow Ring
1 Forceps; 1 Pin Tweezers

808-659880 TRIAL KIT \$275.25

10 Matrices – Size 5.5mm
10 Medium Wedges
10 Medium WedgeGuards
1 Universal Ring
1 Forceps
1 Pin Tweezers
5 SureFil® SDR® flow+ Compula® Tips
Universal Shade (0.25g ea)

MATRIX REFILL (50 pack) \$64.75

808-659710 3.5mm
808-659720 4.5mm
808-659730 5.5mm
808-659740 5.5mm (100 pack)
808-659750 6.5mm
808-659860 7.5mm



RING REFILL (2 pack) \$218.25

808-659760 Universal
808-659770 Narrow



WEDGE REFILL (100 pack) \$54.45

808-659780 Small – Dark Blue
808-659790 Medium – Medium Blue
808-659800 Large – Light Blue



EZ COAT MATRIX REFILL (50 pack) \$79.45

800-659610 3.5mm
800-659620 4.5mm
800-659630 5.5mm
800-659640 5.5mm (90 pack)
800-659650 6.5mm
800-659660 7.5mm



WEDGE GUARD REFILL (50 pack) \$64.75

808-659830 Small – Dark Blue
808-659840 Medium – Medium Blue
808-659850 Large – Light Blue



808-659810 Forceps Refill (1) \$64.75

808-659820 Pin Tweezers Refill (1) \$64.75



AutoMatrix® Retainerless Matrix System

- Ideal for larger preparations and buccal or lingual extensions
- Pre-loaded bands save time and require fewer steps
- Multiple matrix heights and gauges are available for varied clinical solutions
- Automate® III tightening device limits over-tensioning, and provides easier shaping of contact

808-663032 INTRO KIT \$607.25

96 Bands – 24 each: Medium Regular, Narrow Regular, Wide Regular, Medium Thin
1 Automate III Tightening Device
1 AutoMatrix Snippers+
6 AutoMatrix Snippers+ Catch Trays

BANDS REFILL PACKAGE (72/box) \$96.25

808-663001 Medium Thin 1/4" x .0015"
808-663002 Narrow Regular 3/16" x .002"
808-663003 Medium Regular 1/4" x .002"
808-663004 Wide Regular 5/16" x .002"

Accessories

800-62422601 **SNIPPERS+ REFILL \$186.75**
(for removal of AutoMatrix bands)
1 AutoMatrix Snippers+
1 Catch Tray
800-62422605 **CATCH TRAY REFILL for Snippers+ \$27.75**
808-663016 **EXTRA SHAFT ASSEMBLY (For AutoMate III) \$104.75**
808-663100 **AUTOMATE III TIGHTENING DEVICE \$359.95**

MATRIX BANDS



Matrix Bands

Tofflemire-type matrix bands in .0015" and .002" gauges plus .001" Ultra-Thin stainless steel.

.0015"

#1	800-10001
#2	800-10002
#3	800-10003
#13	800-10004

.002"

#1	800-10010
#2	800-10011
#3	800-10012
#13	800-10013
12/pkg	25¢

.0015"

#1	800-10021
#2	800-10022
#3	800-10023
#13	800-10024

.002"

#1	800-10030
#2	800-10031
#3	800-10032
#13	800-10033
144/pkg	\$8.45

.001" - Ultra Thin

Regular	800-10040
Dead Soft	800-10041
12/pkg	\$2.25



Pro-Matrix™ - Medicom®

Single-use and pre-assembled, with a sliding band deflector and smooth tightening mechanism. Saves valuable preparation time. Circumferential band acts as one solution for both large and small restorations.

Wide, Blue 6mm	800-30010
Narrow, Green 4.5mm	800-30020
50/box	\$61.95

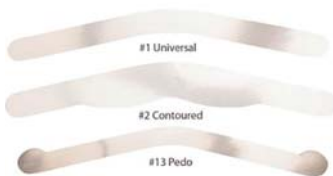

HO Bands™ - Microbrush International

Stainless steel and .001" thick. The dead soft bands are particularly easy to contour and adapt to any tooth structure. Also have a unique, one-handed dispensing box that makes them more user-friendly than other choices.

#1 Regular Universal

800-350110	100/pack	\$39.25
------------	----------	---------

#1 Dead Soft Universal

800-351110	100/pack	\$44.45
------------	----------	---------

#2 Regular MOD Wide

800-350210	100/pack	\$39.25
------------	----------	---------

#2 Dead Soft MOD Wide

800-351210	100/pack	\$44.45
------------	----------	---------

#13 Regular Pedo

800-350310	100/pack	\$39.25
------------	----------	---------

#13 Dead Soft Pedo

800-351310	100/pack	\$44.45
------------	----------	---------



Pre-Contoured Metal Bands - Premier® Dental

Anatomical shape achieves better contact points. Ideal for large Class II restorations with incremental curing technique. 0.035mm thickness.

807-9061070	30/pkg	\$24.45
-------------	--------	---------

Cure-Thru Clear Cervical Matrices - Premier® Dental

Compress restorative material as you light cure. Flexible to the exact contour of the tooth for dense restorations with excellent marginal integrity.



Assorted Package available upon request.

719CT	807-9061012
720CT	807-9061013
722CT	807-9061015
Molar/Universal	807-9061018
150/box	\$92.75

Blue Cure-Thru Matrix Bands

The blue color increases the contact between the matrix and tooth without compromising polymerization of the composite. Thin, yet strong enough to pack against. Simplifies posterior composite placement. 0.075mm.

Premolar	807-9061231
Molar	807-9061233
100/pkg	\$86.75



T-Bands - Pulpdent Corporation

Self-contained matrix bands that do not require matrix retainers. Will not break or tear when condensing amalgam.

Stainless Steel 0.0002"/0.05mm

Straight Narrow	
800-BTSSN	100/pkg \$16.95

Straight Assorted

800-BTSSA	100/pkg \$16.95
-----------	-----------------

Brass 0.002"/0.05mm

Curved Narrow	
800-BTBCN	100/pkg \$16.95

Additional configurations available upon request.

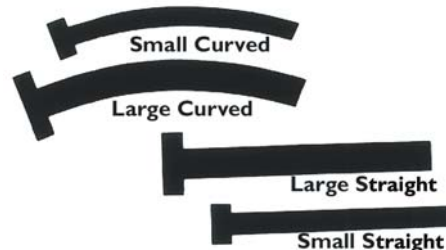

T-Bands - Temrex Corporation

Brass-Straight

Small	800-091
Large	800-092
Assorted	800-093
100/box	\$10.95

Brass-Curved

Small	800-094
Large	800-095
Assorted	800-096
100/box	\$10.95



Getz® Contour Matrix Bands "Dixieland Band" - Water Pik, Inc.

Pre-contoured band made of high tensile strength stainless steel and will not tear under stress.

Regular .002"	800-61081
Ultra-Thin .0015"	800-61080
50/pkg	\$47.25

MATRIX BANDS



Original Tofflemire® Matrix Bands - Water Pik, Inc.

This surgical grade stainless steel band is carefully stamped for consistently smooth (burr-free) edges that keep your patient comfortable and reduce risk of gingival trauma.

Stainless Steel

- # 1 Adult Universal- .002" 800-345770
- # 1 Adult Universal- .0015" 800-345789
- # 2 Adult MOD Wide- .002" 800-345797
- # 2 Adult MOD Wide- .0015" 800-345800
- # 3 Adult MOD Narrow- .0015" . 800-345826
- # 13 Pedo Universal- .002" 800-345842
- # 13 Pedo Universal- .0015" 800-345850
- 36/pkg **\$8.25**

Stainless Steel

- #1 Adult Universal - .0015" 800-61032
- 1000/pkg. **\$138.45**



Original Tofflemire® "Dead Soft" Matrix Band - Water Pik, Inc.

The micro-thin "dead soft" band is .001 inch gauge, making it more flexible than thicker bands. Ideal for use with posterior composites.

- #1 Adult Universal 800-346036
- #2 Adult MOD Wide 800-346044
- #13 Pedo Universal 800-346052
- 36/pkg. **\$10.75**



Contact Matrices - Zest Dental Solutions

Unique resilience that won't crush during placement. Ideal contour for a perfect restoration.

Clinical Kit available upon request.

- Thin Flex Small 800-89432
- Thin Flex Large 800-89434
- Stiff Flex Small 800-90070
- Stiff Flex Large 800-90071
- 100/pkg. **\$58.75**

MATRIX RETAINERS



Matrix Retainers

- Tofflemire-type stainless steel matrix retainers.
- Universal 800-10050
- Contra Angle 800-10051
- Junior Contra Angle 800-10052
- Each **\$12.45**



Tofflemire Retainers - Integra® Miltex®

Secure locking mechanism and instant release enable the retainers to tighten and release with precise, effortless action. Fully autoclavable.

- Junior Contra Angle 800-099
- Contra Angle 800-098
- Universal 800-097
- Each **\$31.95**



Original Tofflemire® II Retainers - Water Pik, Inc.

Secure locking mechanism and instant release enable the retainers to tighten and release with precise, effortless action. The clean, smooth surface is free of burrs and sharp edges that can cause gingival trauma. Easy insertion and adjustment; handles any width band. Contra-Angle model can be used buccally and lingually. Fully autoclavable.

- Contra Angle 800-61102
- Universal 800-61100
- Each **\$35.75**



MatrixTape - 3M Oral Care

Polyester matrix tape and dispenser. 3/8".
800-1939 23.3yds **\$51.95**



Mylar Matrix Strips - Palmero Health Care

Made of Dupont .002 mylar polyester film which can be used for composite restorations. Far stronger than acetate. 5.8 microns, 3/8" x 4".

Straight

800-57 1000/box **\$9.95**

Curved

800-58 1000/box **\$11.95**



Stop Strip - Premier® Dental

Anterior matrix band, transparent and self attaching. Unique stopper secures the band between adjacent teeth.

- 8mm (Red) Straight 807-9061380
- 10mm (Blue) Straight 807-9061375
- 100/box **\$28.25**

Assorted

Contains: 75 -8mm and 75 -10mm. 150 total.
807-9061370 Package **\$41.75**

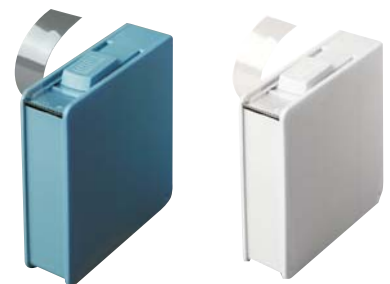

MatrixTape with Dispenser - Zirc

Allows matrix to be contoured, U-shaped, as it dispenses. Stainless steel cutter allows for desired length.

Contains: 1 roll of 3/8" x 12 yds. clear matrix tape, 0.002 ga. in plastic dispenser 2" x 2-1/8"

- Blue 800-55Z200B
- White 800-55Z200A
- Each **\$24.45**

MATRIX WEDGES



WonderWedges® Interproximal Wooden Wedges - Keystone Industries

Anatomically conformed wedge made of sycamore wood. Available in Natural, Non-staining colors or non-bleach white.

Natural

- Small 12mm 800-0921480
- Medium 13mm 800-0921481
- 100/box **\$16.75**

Additional colors and sizes available upon request.



Cure-Thru® Reflective Curing Wedges - Premier® Dental

The clear acrylic body and white core reflect up to 90% of the curing light towards the restoration, resulting in a better contact.

Intro System available upon request.

- Small 807-9061221
- Medium 807-9061223
- Ultra Thin 807-9061225
- 100/pack **\$86.75**

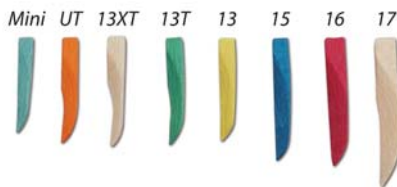

Sycamore Wedges - Premier® Dental

Anatomically carved for function. The rounded tip easily passes over the gingiva while the concave sides conform the matrix band to the anatomy of the tooth. Slightly compressible yet will not splinter in thin sections. Ultra thin is half the width of regular wedges yet high through the embrasure. Number designates length in mm.

- 13T Green 807-9061101
- 13 Yellow 807-9061102
- 13XT Neutral 807-9061100
- 15 Blue 807-9061103
- 16 Red 807-9061104
- 17 Neutral 807-9061105
- Ultra Thin Orange 807-9061106
- Mini Light Blue 807-9061109
- Assorted (UT, 13, 13T, 15) 807-9061108
- 400/box **\$44.45**

Organizer - 6 Compartments

- 807-9061115 Each **\$17.75**



Wizard Wedges® Matrix Wedges - Water Pik, Inc.

Wizard Wedges help provide access to tight contact areas and help hold matrix systems in place during procedures. Made from birch wood for greater tooth separation and faster, better tooth position recovery upon removal.

- Small 800-61211
- Large 800-61212
- Slim Jim 800-61213
- Wide Base 800-61214
- 500pkg. **\$49.95**

Assorted

- 800-61205 100/pkg. **\$15.25**
- 800-61215 500/pkg **\$49.95**



Wizard Wedges® Anatomical Matrix Wedges - Water Pik, Inc.

These anatomically shaped wedges employ an exclusive multi-plane contour that firmly engages adjoining teeth to hold the matrix in position.

- Small Natural 800-61306
- Medium Yellow 800-61307
- Large Purple 800-61308
- X-Large Red 800-61309
- 400/pkg **\$44.25**

Assorted

- 800-61315 100/pkg. **\$16.45**
- 800-61310 400/pkg **\$44.25**

LOOK'in

for something? **WE HAVE IT!**

www.dhpionline.com



Marquis Bracket System, Roth-Style Prescription Color Coded ID System

Removable identification dot assures accurate selection.

Stainless Steel Direct Bond Brackets

Marquis stainless steel bracket system is pre-programmed with technical specifications for straight wire that has all the features you're looking for in a precise and versatile bracket system:

- A state-of-the-art base design with micro-etched pylons that act as miniature anchorage points to embed firmly into the adhesive.
- Made of the finest 17-4 surgical stainless steel to ensure durability and dimensional stability.
- Contoured edges for increased patient comfort. Tie wings are parallel to tooth anatomy.
- Defined center scribe line for easy and accurate bracket placement.
- Dependable integrated ball hooks.
- Offset Bicuspids available.
- An identification system with a removable color-coded dot.

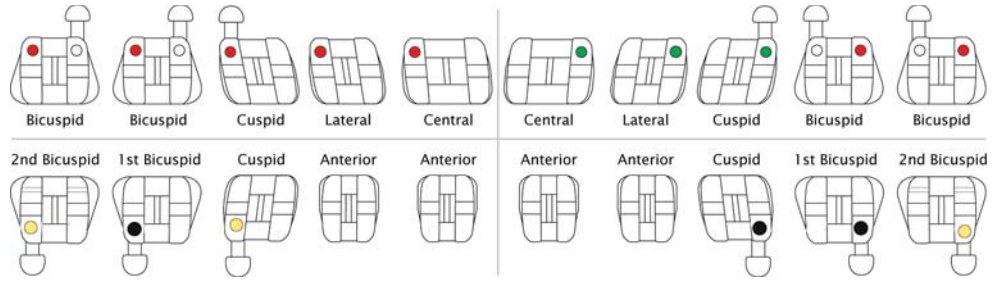

Single Patient Kits



Single Patient Kit Upper/Lower 5x5

1 kit (20 brackets) \$48.95

Upper/Lower 5x5 no hooks .018" slot
690-M181000

Upper/Lower 5x5 no hooks .022" slot
690-M221000

Upper/Lower 5x5 hooks on cuspids .018" slot
690-M181300

Upper/Lower 5x5 hooks on cuspids .022" slot
690-M221300

Upper/Lower 5x5 hooks on 3, 4, 5, .018" slot
690-M181345

Upper/Lower 5x5 hooks on 3, 4, 5, .022" slot
690-M221345

* Marquis™ Ortho Technology's version of the Roth Prescription 10/pack.....\$28.45

Maxillary Arch	Torque	Angulation	Width	L/R	.018 Slot	.022 Slot
Central	+12	+5	.155"	R	690-M18001	690-M22001
				L	690-M18002	690-M22002
Lateral	+8	+9	.125"	R	690-M18011	690-M22011
				L	690-M18012	690-M22012
Cuspid with Hook	0	+11	.130"	R	690-M18021	690-M22021
				L	690-M18022	690-M22022
Cuspid	0	+11	.130"	R	690-M18023	690-M22023
				L	690-M18024	690-M22024
Bicuspid with Hook	-7	0	.125"	R	690-M18031	690-M22031
				L	690-M18032	690-M22032
Bicuspid	-7	0	.125"	U	690-M18030	

Mandibular Arch	Torque	Angulation	Width	L/R	.018 Slot	.022 Slot
Lower Anterior	0	0	.100"	U	690-M18040	690-M22040
Cuspid with Hook	-11	+5	.125"	R	690-M18051	690-M22051
				L	690-M18052	690-M22052
Cuspid	-11	+5	.125"	R	690-M18053	690-M22053
				L	690-M18054	690-M22054
1st Bicuspid with Hook	-17	0	.125"	R	690-M18061	690-M22061
				L	690-M18062	690-M22062
1st Bicuspid	-17	0	.125"	U	690-M18060	
2nd Bicuspid with Hook	-22	0	.125"	R	690-M18071	690-M22071
				L	690-M18072	690-M22072
2nd Bicuspid	-22	0	.125"	U	690-M18070	

Ortho Technology's version of the Roth Rx is not implied to be an exact version of any other system.

ORTHO TECHNOLOGY®

PURE®

Sapphire Bracket System

The Ultimate in
Crystal Clear Aesthetics™



Smooth, strong and contoured tie-wings for added patient comfort.

Archwire slot design diamond and heat polished for superior sliding mechanics.

Highest Quality Material
Made from high quality monocrystalline sapphire

Unique bonding base.
Zirconia spheres provide superior shear bond strength and predictable debonding.

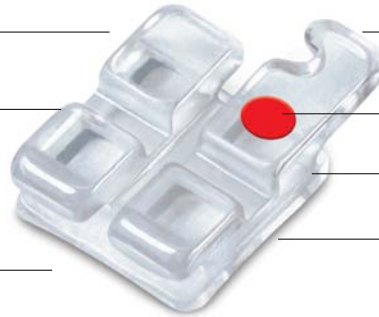

Ultra-smooth, strong hooks
For added patient comfort and secure engagement of elastics.

Removable color coded ID dot.
For easy bracket selection.

Ample tie-wing area
for easy bracket ligation.

Contour base
provides simplified and accurate bracket placement.

Identification System

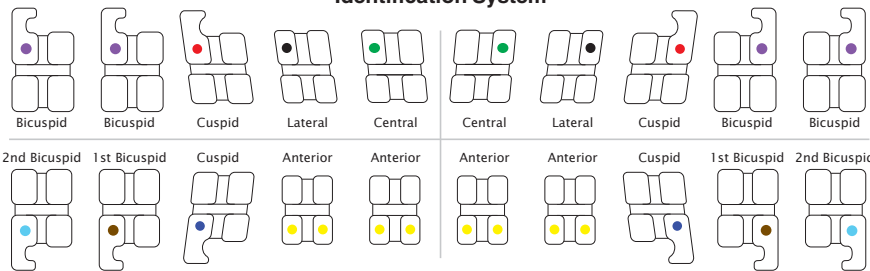

Pure Sapphire Bracket System is made from pure monocrystalline sapphire for a bracket system with the highest transparency available for outstanding aesthetics. Nearly invisible against any tooth shade and stays crystal clear without staining. Each Pure bracket has been diamond and heat polished to produce rounded, smooth corners for uncompromised patient comfort. Tie-wings are easy to ligate, exceptionally strong and highly fracture resistant.

Patient Kits 10/pack.....\$122.95

Item Numbers

	.018" Slot	.022" Slot
Upper/Lower 3x3 No Hooks	690-S18100	690-S22100
Upper/Lower 3x3 Hooks on Cuspids	690-S18300	690-S22300
Upper/Lower 5x5 No Hooks	690-S18310	690-S22310
Upper/Lower 5x5 Hooks on Cuspids	690-S18330	690-S22330
Upper/Lower 5x5 Hooks 3, 4, & 5	690-S18340	690-S22340
Upper 5-5 No Hooks	690-S18320	690-S22320
Upper 5-5 Hooks on Cuspids	690-S18360	690-S22360
Upper 5-5 Hooks 3, 4, & 5	690-S18370	690-S22370

Roth Prescription* 10/pack.....\$123.25

▲ Maxillary Arch	Torq.	Ang.	Width	R/L	.018" Slot	.022" Slot
1 1 Central	+12°	+5°	.126"	R	690-S18001	690-S22101
				L	690-S18002	690-S22102
2 2 Lateral	+8°	+9°	.116"	R	690-S18011	690-S22111
				L	690-S18012	690-S22112
3 3 Cuspid w/hook	0°	+11°	.126"	R	690-S18021	690-S22121
				L	690-S18022	690-S22122
4/5 4/5 Bicuspid	-7°	0°	.126"	U	690-S18030	690-S22130
4/5 4/5 Bicuspid w/hook	-7°	0°	.126"	R	690-S18031	690-S22131
				L	690-S18032	690-S22132

*Ortho Technology's version of the Roth Rx is not implied to be an exact version of any other system

▼ Mandibular Arch	Torq.	Ang.	Width	R/L	.018" Slot	.022" Slot
1/2 1/2 Lower Anterior	0°	0°	.112"	U	690-S18041	690-S22141
3 3 Cuspid with hook	-11°	+5°	.126"	R	690-S18051	690-S22151
				L	690-S18052	690-S22152
4 4 1st Bicuspid	17°	0°	.126"	U	690-S18060	690-S22160
4 4 Bicuspid w/hook	-17°	0°	.126"	R	690-S18061	690-S22161
				L	690-S18062	690-S22162
5 5 2nd Bicuspid	-22°	0°	.126"	U	690-S18070	690-S22170
5 5 2nd Bicuspid with hook	-22°	0°	.126"	R	690-S18071	690-S22171
				L	690-S18072	690-S22172

TruFit[™] 2.0 Bondable Buccal Tubes ORTHO TECHNOLOGY[®]

- Available in the most popular prescriptions
- The first molar gingival ball hooks hold elastics and springs securely
- Designed with the latest technology for patient comfort



Maxillary Single Convertible

DHPI Part #: 690-_____

	Slot Torque	Distal Offset	Headgear Tube	Slot Size	Bondable	
					Left	Right
R	-10°	+10°	-	.018"	492-11-2610	492-11-1610
	-10°	+10°	-	.022"	492-12-2610	492-12-1610
R	-14°	+14°	-	.018"	492-91-2610	492-91-1610
	-14°	+14°	-	.022"	492-92-2610	492-92-1610
M	-14°	+10°	-	.018"	492-21-2610	492-21-1610
	-14°	+10°	-	.022"	492-22-2610	492-22-1610
\$7.25/tube						



Maxillary Combination Convertible Occlusal Headgear Tube

DHPI Part #: 690-_____

	Slot Torque	Distal Offset	Headgear Tube	Slot Size	Bondable	
					Left	Right
R	-10°	+10°	.045"	.018"	492-11-2672	492-11-1672
	-10°	+10°	.045"	.022"	492-12-2672	492-12-1672
R	-14°	+14°	.045"	.018"	492-91-2672	492-91-1672
	-14°	+14°	.045"	.022"	492-92-2672	492-92-1672
M	-14°	+10°	.045"	.018"	492-21-2672	492-21-1672
	-14°	+10°	.045"	.022"	492-22-2672	492-22-1672
S	0°	0°	.045"	.018"	492-51-2672	492-51-1672
	0°	0°	.045"	.022"	492-52-2672	492-52-1672
					\$11.25/tube	



Maxillary Double Convertible

.018" x .025" Auxiliary Tube

DHPI Part #: 690-_____

	Slot Torque	Distal Offset	Headgear Tube	Slot Size	Bondable	
					Left	Right
R	-10°	+10°	-	.018"	492-11-2631	492-11-1631
	-10°	+10°	-	.022"	492-12-2631	492-12-1631
R	-14°	+14°	-	.018"	492-91-2631	492-91-1631
	-14°	+14°	-	.022"	492-92-2631	492-92-1631
\$11.25/tube						



Mandibular Single Convertible

DHPI Part #: 690-_____

	Slot Torque	Distal Offset	Headgear Tube	Slot Size	Bondable	
					Left	Right
R	-25°	+4°	-	.018"	492-91-4610	492-91-3610
	-25°	+4°	-	.022"	492-92-4610	492-92-3610
M	-20°	0°	-	.018"	492-21-4610	492-21-3610
	-20°	0°	-	.022"	492-22-4610	492-22-3610
					\$7.25/tube	

R The Ortho Technology version of the Roth Rx*

M The Ortho Technology version of the McLaughlin, Bennett, & Trevisi Rx*

S Standard Edgewise Rx

*The Ortho Technology versions of these prescriptions are not implied to be an exact version of any other system, nor do we claim any endorsement of the respective doctors.

Bondable Attachments Loose

MADE IN THE USA



Direct Bond Eyelets Round Base

Item #: 690-025100
3.5 mm diameter two piece flat base.
10/pack..... **\$36.75**



Direct Bond Eyelets Rectangle Base

Item #: 690-025000
3.75 mm x 3.0 mm one piece curved base.
10/pack..... **\$36.75**



Direct Bond Buttons Round Base

Item #: 690-49400110
Micro-etched
3.5 mm diameter curved one piece base.
10/pack..... **\$15.25**



Direct Bond Buttons Rectangle Base

A. Oval Flat..... 690-400201
B. Oval Curved.... 690-400202
3.88 mm x 2.48 mm one piece base.
10/pack..... **\$18.75**

TruEase™ Bondable Buccal Tubes



MADE IN THE USA

Designed With the Latest Technology for Patient Comfort



- **Stainless Steel Construction**
- **Molded Compound Contour Base with 80 Gauge Indented Mesh Pad** provides an anatomically correct fit that conforms to the tooth ensuring maximum bond strength
- **The Indented Pad** assists in easy and accurate placement to conform into the buccal groove
- **The Extended Base** provides maximum coverage for greater bond strength and control
- **4.2 mm Mesial/Distal Dimension** for full rotational control



Single Non-Convertible

DHPI Part #: 690-_____

Quadrant	Slot Torque	Distal Offset	Color Code	Extended Base Slot Size	
				.018"	.022"
R Upper Right	-10°	8°	●	460-11-1020	460-12-1020
Upper Left	-10°	8°	●	460-11-2020	460-12-2020
R Lower Right	-25°	5°	■	460-11-3020	460-12-3020
Lower Left	-25°	5°	■	460-11-4020	460-12-4020
M Upper Right	-14°	10°	●	460-21-1020	460-22-1020
Upper Left	-14°	10°	●	460-21-2020	460-22-2020
M Lower Right	-20°	0°	▲	460-21-3020	460-22-3020
Lower Left	-20°	0°	▲	460-21-4020	460-22-4020
S UR/LL	0°	0°	◆	460-51-7020	460-52-7020
UL/LR	0°	0°	◆	460-51-8020	460-52-8020
				\$5.25/tube	

R The Ortho Technology version of the Roth Rx*

M The Ortho Technology version of the McLaughlin, Bennett, & Trevisi Rx*

S Standard Edgewise Rx

TruEase™ Low Profile Mini Bondable Buccal Tubes

MADE IN THE USA

Specifically Designed for Partially Erupted Second Molars



- **Stainless Steel Construction**
- **Mesially Placed Compound Contour Base** is designed to fit easily and precisely on the second molar mesial cusp to provide an anatomically correct fit
- **Pylon Base** with Electrical Discharge Machining (EDM) offers retention superior to mesh bonding pads
- **Torque in Base** allows easier alignment for optimal functional occlusion and case finishing
- **2.5 mm Mesial/Distal Dimension**

DHPI Part #: 690-_____

Quadrant	Slot Torque	Distal Offset	Color Code	Slot Size	
				.018"	.022"
R Upper Right	-10°	0°	●	470-11-1720	470-12-1720
Upper Left	-10°	0°	●	470-11-2720	470-12-2720
R Lower Right	-25°	0°	■	470-11-3720	470-12-3720
Lower Left	-25°	0°	■	470-11-4720	470-12-4720
M UR/LL	-14°	0°	●	470-21-7723	470-22-7723
UL/LR	-14°	0°	●	470-21-8723	470-22-8723
S UR/LL	0°	0°	◆	470-51-7720	470-52-7720
UL/LR	0°	0°	◆	470-51-8720	470-52-8720
				\$5.25/tube	

R The Ortho Technology version of the Roth Rx*

M The Ortho Technology version of the McLaughlin, Bennett, & Trevisi Rx*

S Standard Edgewise Rx

*The Ortho Technology versions of these prescriptions are not implied to be an exact version of any other system, nor do we claim any endorsement of the respective doctors.



TruEase Buccal Tubes Mini Typodont

Item #: 690-G50000
Includes: 1x TruEase Buccal Tube and 1x TruEase Low Profile Mini Buccal Tube.

Each.....**\$135.00**

TruFit™ 2.0

Assembly ORTHO TECHNOLOGY® Starter Kits

We've Pre-Selected the Most Popular Sizes with the Most Popular Buccal Tubes to Get You Started!

Ask your DHPI Account Manager for Details



Maxillary Single Convertible with Lingual Cleats

DHPI Part # : 690-_____

	Slot Torque	Distal Offset	Headgear Tube	Slot Size	Starter Kit
R	-10°	+10°	-	.018"	493-11-1910-080
	-10°	+10°	-	.022"	493-12-1910-080
M	-14°	+10°	-	.018"	493-21-1910-080
	-14°	+10°	-	.022"	493-22-1910-080
1 kit (80 assemblies)					\$486.95



Maxillary Combination Convertible with Lingual Cleats

DHPI Part # : 690-_____

	Slot Torque	Distal Offset	Headgear Tube	Slot Size	Starter Kit
R	-10°	+10°	.045"	.018"	493-11-1970-080
	-10°	+10°	.045"	.022"	493-12-1970-080
M	-14°	+10°	.045"	.018"	493-21-1970-080
	-14°	+10°	.045"	.022"	493-22-1970-080
1 kit (80 assemblies)					\$486.95



Mandibular Single Convertible with Lingual Cleats

DHPI Part # : 690-_____

	Slot Torque	Distal Offset	Headgear Tube	Slot Size	Starter Kit
R	-25°	+4°	-	.018"	493-11-1010-080
	-25°	+4°	-	.022"	493-12-1010-080
M	-20°	0°	-	.018"	493-21-1010-080
	-20°	0°	-	.022"	493-22-1010-080
1 kit (80 assemblies)					\$486.95

R The Ortho Technology version of the Roth Rx* **M** The Ortho Technology version of the McLaughlin, Bennett, & Trevisi Rx*

*The Ortho Technology versions of these prescriptions are not implied to be an exact version of any other system, nor do we claim any endorsement of the respective doctors.

MADE IN THE USA



Each Starter Kit Includes 40 Left and 40 Right Assemblies

TruFit™ 2.0

Band and Tube Assembly Starter Kits

Includes: 40 left and 40 right band & tube assemblies with lingual cleats, 2x band tray organizers dimensions 11 1/4" W x 1 1/2" H x 8 1/4" D

1 kit.....**\$486.95**

- 2 Stackable Band Organizers included with your purchase

Starter Kits Included Sizes	34.5	35	35.5	36	36.5	37	37.5	38	38.5	39	39.5	40
Left Side	2	2	2	4	4	5	5	5	4	3	2	2
Right Side	2	2	2	4	4	5	5	5	4	3	2	2

Plain Molar Bands

DHPI Part # : 690-_____

Quadrant	1st Molars	2nd Molars
UR	495-00-1600-000	495-00-1700-000
UL	495-00-2600-000	495-00-2700-000
LR	495-00-3600-000	495-00-3700-000
LL	495-00-4600-000	495-00-4700-000
1 band		\$2.95

© 2016 Ortho Technology, Inc. TruFit is a trademark of Ortho Technology. Due to our ongoing efforts to update and improve our buccal tube designs, the product you receive may vary slightly from those depicted.

TruFit™ 2.0

ORTHO TECHNOLOGY®

Prewelded Band and Tube Assemblies w/Lingual Cleat

DHPI Part # : 690-_____



Maxillary Combination Convertible
Occlusal Headgear Tube

	Slot Torque	Distal Offset	Headgear Tube	Slot Size	With Lingual Cleat	
					Left	Right
R	-10°	+10°	.045"	.018"	493-11-2672-000	493-11-1672-000
	-10°	+10°	.045"	.022"	493-12-2672-000	493-12-1672-000
R	-14°	+14°	.045"	.018"	493-91-2672-000	493-91-1672-000
	-14°	+14°	.045"	.022"	493-92-2672-000	493-92-1672-000
M	-14°	+10°	.045"	.018"	493-21-2672-000	493-21-1672-000
	-14°	+10°	.045"	.022"	493-22-2672-000	493-22-1672-000
S	0°	0°	.045"	.018"	493-51-2672-000	493-51-1672-000
	0°	0°	.045"	.022"	493-52-2672-000	493-52-1672-000
Individual Assemblies					\$6.95 ea.	

Rolled Edges
No sharp edges for maximum patient comfort

Straight Interproximal Wall
Makes band seating easy

Permanent Marking
For easy identification

Micro-Etched Interior Surface
Ensures maximum retention
No Extra Charge!

MADE IN THE USA

DHPI Part # : 690-_____



Maxillary 1st Molar Single Non-Convertible

	Slot Torque	Distal Offset	Headgear Tube	Slot Size	With Lingual Cleat	
					Left	Right
R	-10°	+10°	-	.018"	493-11-2620-000	493-11-1620-000
	-10°	+10°	-	.022"	493-12-2620-000	493-12-1620-000
R	-14°	+14°	-	.018"	493-91-2620-000	493-91-1620-000
	-14°	+14°	-	.022"	493-92-2620-000	493-92-1620-000
M	-14°	+10°	-	.018"	493-21-2620-000	493-21-1620-000
	-14°	+10°	-	.022"	493-22-2620-000	493-22-1620-000
S	0°	0°	-	.018"	493-51-2620-000	493-51-1620-000
	0°	0°	-	.022"	493-52-2620-000	493-52-1620-000
Individual Assemblies					\$6.95 ea.	

Precision Preweld Position Buccal Attachments to Molar Bands



Upper Molar

Entrance to buccal tube will bisect the mesial/buccal cusp

DHPI Part # : 690-_____



Maxillary Double Convertible

.018" x .025" Auxiliary Tube

	Slot Torque	Distal Offset	Headgear Tube	Slot Size	With Lingual Cleat	
					Left	Right
R	-10°	+10°	-	.018"	493-11-2631-000	493-11-1631-000
	-10°	+10°	-	.022"	493-12-2631-000	493-12-1631-000
R	-14°	+14°	-	.018"	493-91-2631-000	493-91-1631-000
	-14°	+14°	-	.022"	493-92-2631-000	493-92-1631-000
Individual Assemblies					\$6.95 ea.	

Lingual Cleat Attachments Centered on Molar Bands

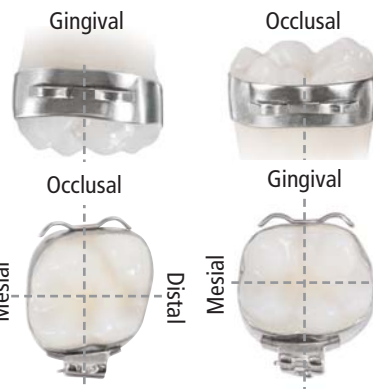

DHPI Part # : 690-_____



Mandibular 1st Molar Single Non-Convertible

	Slot Torque	Distal Offset	Headgear Tube	Slot Size	With Lingual Cleat	
					Left	Right
R	-25°	+4°	-	.018"	493-91-4620-000	493-91-3620-000
	-25°	+4°	-	.022"	493-92-4620-000	493-92-3620-000
M	-10°	0°	-	.018"	493-21-4620-000	493-21-3620-000
	-10°	0°	-	.022"	493-22-4620-000	493-22-3620-000
S	0°	0°	-	.018"	493-51-4620-000	493-51-3620-000
	0°	0°	-	.022"	493-52-4620-000	493-52-3620-000
Individual Assemblies					\$6.95 ea.	

BITE STICKS



Color Coded Bite Sticks - Ortho

Technology

Molded high impact plastic with metal serrated triangle tip.

Cold Sterilizable

- Teal..... 690-600201T
- Purple..... 690-600201P
- Blue..... 690-600201B
- Each **\$6.25**

Autoclavable

Up to 250°F/121°C. Do not cold sterilize.

- Teal..... 690-600A201T
- Purple..... 690-600A201P
- Blue..... 690-600A201B
- Each **\$9.25**



High Heat Bite Stick - Ortho Technology

Metal serrated triangle tip. White, molded high impact plastic. Safe for dry heat sterilizers.

- 690-OT600199 Each..... **\$15.45**

BONDING SUPPLIES



GC Fuji ORTHO™ - GC America

Self-cured, resin reinforced glass ionomer cement ideally suited for bonding orthodontic brackets and bands. Its placement in a wet field simplifies application and bonding procedures. It can be used with a non-etch or etch technique. Because it's a true glass ionomer cement, it releases fluoride to protect against decalcification and decay.

Intro Package

Contains: 2 -6.8ml bottles of liquid, 40gm powder and accessories.

- 272-439503 Pack..... **\$394.75**

Liquid Only

- 272-439591 6.8ml..... **\$95.75**

Powder Only

- 272-439521 40gm **\$228.25**



GC Fuji ORTHO™ Band

Blue-colored resin modified glass ionomer for bonding orthodontic bands with sustained fluoride release to reduce white spot lesions. Mixes within 15 seconds and has about 3½ minutes working time with final set after 3 minutes (in the mouth).

Starter Package

Contains: 2 -13.3gm cartridges, 1 mixing pad, 1 Paste Pak Dispenser and 1 GC Fuji Spatula.
272-439460 Package **\$269.25**

Refill Package

Contains: 2 -13.3gm cartridges and 1 mixing pad.
272-001888 Each..... **\$174.45**

Paste Pak Dispenser

272-001573 Each..... **\$96.25**



GC Fuji ORTHO™ LC

Light-cured, resin reinforced glass ionomer ideally suited for bonding orthodontic brackets, bands and appliances. A continual fluoride release reduces the risk of decalcification, which helps maintain the soundness of enamel. Additionally, debonding can be accomplished faster with less risk of damaging the enamel than with composite resin bonding systems. Light cures within 10 seconds.

Introductory Package

Contains: 15gm powder, 6.8ml liquid, scoop and mixing pad.
272-439401 Package..... **\$169.75**

Standard Package

Contains: 40gm powder, 2 -6.8ml liquids, scoop and mixing pad.
272-439403 Package..... **\$363.95**

Liquid Only

272-439409 6.8ml..... **\$94.75**

Powder Only

272-439421 40gm **\$223.75**

GC ORTHO LC Conditioner

272-439425 25ml..... **\$63.45**

Capsule Starter Kit

Contains: 50 capsules, capsule applicator and GC ORTHO conditioners.
272-439451 Kit **\$433.75**

Capsule Package

272-439450 50/box..... **\$304.95**

GC Capsule Applier III

272-437555 Each..... **\$114.25**



Heliosit Orthodontic - Ivoclar Vivadent

Light-cured, highly translucent single-component material for luting orthodontic brackets (made either of metal or ceramic material). After the enamel has been etched with phosphoric acid (37%), Heliosit Orthodontic is applied to establish a sound bond (metal and ceramic surfaces have to be pre-treated according to manufacturer's directions).

Standard Kit

Contains: 3 -2.5gm syringes.
220-532629 Kit **\$108.25**



Orthogap Disposable Bonding Pads - Ortho Technology

The adhesive backing holds the brackets firmly in place. Liquid impermeable surface is perfect for mixing adhesives.

690-600370 25 sheets **\$16.75**



Ortho-Coat™ - Pulpdent Corporation

Coats brackets and teeth. Prevents decalcification, staining and discoloration under orthodontic brackets. Light cure, bonds to self-cure and light cure orthodontic adhesives.

Contains: 2 -5ml syringes and 20 applicator tips.
690-OC Kit **\$55.95**

ELASTOMERIC PRODUCTS



Maximum Power Chain - Ortho Technology

Manufactured from medical grade polyurethane, these elastomeric ligatures are fade resistant and feature high elasticity and excellent rebound. Not made with natural rubber latex.



Closed/Continuous

- Black..... 690-430110
- Clear (Stain Resistant)..... 690-430102
- Cobalt Blue 690-430133
- Light Blue..... 690-430105
- Metallic Silver..... 690-430120
- Pink..... 690-430113

- Red 690-430108
- Royal Blue..... 690-430104
- Sky Blue 690-430170
- 15/spool **\$19.75**



Short

- Blue Pearl 690-440172
- Black..... 690-440110
- Clear (Stain Resistant)..... 690-440102
- Cobalt Blue 690-440133
- Light Blue..... 690-440105
- Metallic Silver..... 690-440120
- Pink..... 690-440113
- Red 690-440108
- Royal Blue..... 690-440104
- Sky Blue 690-440170
- 15/spool **\$19.75**



Long

- Black..... 690-450110
- Clear (Stain Resistant)..... 690-450102
- Cobalt Blue 690-450133
- Light Blue..... 690-450105
- Metallic Silver..... 690-450120

- Pink..... 690-450113
- Red 690-450108
- Royal Blue..... 690-450104
- Sky Blue 690-450170
- 15/spool **\$19.75**



Radiopaque Separators - Ortho Technology

Smooth injection molded non-latex plastic.

- Posterior Blue 690-480302
- Posterior White..... 690-480304
- Anterior White 690-480308
- 1000/pack **\$18.75**



Power Sticks - Ortho Technology

Superior color stability, fade resistant. High elasticity and excellent rebound. Medical grade polyurethane. Not made from natural rubber latex.

Full Size - Holds 50

- .115" ligatures 1000/pack..... **\$19.75**

Mid-Size - Holds 24

- .115" ligatures 1008/pack..... **\$15.45**

Mini - Holds 10

- .115" ligatures 1000pack..... **\$25.25**



Elastomeric Organizers

Product not included with organizers.

Combination

- 6-3/4" W x 5-1/2" H x 9" D.
- 690-OTCDW Each..... **\$79.25**

Power Chain

- 3-7/8" W x 4-1/4" H x 9-7/8" D.
- 690-OTPCD Each..... **\$70.45**

Power Sticks

- 10-1/2" W x 5-1/2" H x 5-1/4" D.
- 690-OTPSD Each..... **\$81.25**

Colors	Power Stick	Mid Size	Mini Power Stick
Assorted Colors	690-404000		
Gray	690-404001	690-405001	690-407001
Clear (Stain Resist.)	690-404002	690-405002	690-407002
Tooth	690-404003	690-405003	690-407003
Royal Blue	690-404004	690-405004	690-407004
Light Blue	690-404005	690-405005	690-407005
Purple	690-404006	690-405006	690-407006
Lavender	690-404007	690-405007	690-407007
Red	690-404008	690-405008	690-407008
Maroon	690-404009	690-405009	690-407009
Black	690-404010	690-405010	690-407010
White	690-404011	690-405011	690-407011
Yellow	690-404012	690-405012	690-407012
Pink	690-404013	690-405013	690-407013
Aqua	690-404014	690-405014	690-407014
Neon Green	690-404015	690-405015	690-407015
Kelly Green	690-404016	690-405016	690-407016
Dark Green	690-404017	690-405017	690-407017
Orange	690-404018	690-405018	690-407018
Teal	690-404019	690-405019	690-407019
Fuchsia	690-404026	690-405026	690-407026
Turquoise	690-404027	690-405027	690-407027
Violet	690-404029	690-405029	690-407029
Navy Blue	690-404030	690-405030	690-407030
Cobalt Blue	690-404033	690-405033	690-407033
Sky Blue	690-404070	690-405070	690-407070
Blue Pearl	690-404072	690-405072	690-407072
Pearl	690-404071	690-405071	690-407071
Metallic Silver	690-404020	690-405020	690-407020
Metallic Gold	690-404021	690-405021	690-407021
Fluorescent Pink	690-404060	690-405060	690-407060
Glow "Classic"	690-404050	690-405050	690-407050

FIXED APPLIANCE



Bite-Builder® - Ortho Technology

Opens deep bites with immediate results. Bonds lingually to upper anteriors. Eliminates occlusal interference. Reduces bond failure on lower brackets.

690-OT2350 10/pack **\$62.95**



Bondable Lingual Retainers - Ortho Technology

For lower Cuspid to Cuspid (3x3). Foil mesh bonding pads. Anatomical form and offset pads.

22mm..... 690-68285
 24mm..... 690-68281
 26mm..... 690-68282
 28mm..... 690-68283
 30mm..... 690-68284
 5/pack **\$49.45**



Braided Retainer Wire - Ortho Technology

Used to make permanent fixed lingual retainers following orthodontic treatment, features a very thin rectangular wire that can be adapted with no occlusal interference while ensuring patient comfort. It prevents inadvertent tooth movement associated with active force wires. Can be used as semi-permanent orthodontic splinting of the upper or lower incisors. To maintain difficult extraction sites. 6" lengths, .010" depth x .028" width.

690-68292 10/pack **\$57.75**



OrthoFlex Composite Buttons - Ortho Technology

Aesthetically pleasing appearance. Durable stain resistant material. Secure dovetail base design. 2.85mm x 2.05mm one piece base.

690-OT2344 10/pack **\$49.45**



Tongue Tamers - Ortho Technology

Eliminates detrimental forces. Discourages over active muscle activity. Bonds to upper or lower arches. 80ga. foil mesh bonding base. High quality 17-4 stainless steel. Curved base perfect for lingual placement.

690-034001 10/pack **\$56.25**

WIRED PRODUCTS



Archwire - Dentsply Glenroe Stainless Steel

Corrosion resistant, heat treated archwires that are long enough to accommodate bends and loops.

Round Natural Arch Form

Upper .014 690-PO14U
 Upper .016 690-PO16U
 Upper .018 690-PO18U
 Upper .020 690-PO20U
 Lower .014 690-PO14L
 Lower .016 690-PO16L
 Lower .018 690-PO18L
 Lower .020 690-PO20L
 100/pack **\$30.25**

Rectangular and Square Natural Arch Form

Upper .016 x .016 690-P616U
 Upper .016 x .022 690-P622U
 Upper .017 x .025 690-P725U
 Upper .018 x .018 690-P818U
 Upper .018 x .025 690-P825U
 Upper .019 x .025 690-P925U
 Upper .021 x .025 690-P215U
 Lower .016 x .016 690-P616L
 Lower .016 x .022 690-P622L
 Lower .017 x .025 690-P725L
 Lower .018 x .018 690-P818L
 Lower .018 x .025 690-P825L
 Lower .019 x .025 690-P215L
 10/pack **\$6.75**

Nickel Titanium Archwire

A super elastic alloy that uses shape memory effect to produce the ideal orthodontic wire. Highly polished surface and midline marked.

Round Natural Arch Form

Upper .012 690-M12U
 Upper .014 690-M14U
 Upper .016 690-M16U
 Upper .018 690-M18U
 Upper .020 690-M20U
 Lower .012 690-M12L
 Lower .014 690-M14L
 Lower .016 690-M16L
 Lower .018 690-M18L
 Lower .020 690-M20L
 10/pack **\$10.95**

Rectangular and Square Natural Arch Form

Upper .016 x .016 690-M616U
 Upper .016 x .022 690-M622U
 Upper .017 x .025 690-M725U
 Upper .018 x .025 690-M825U
 Upper .019 x .025 690-M925U
 Upper .021 x .025 690-M215U
 Lower .016 x .016 690-M616L
 Lower .016 x .022 690-M622L
 Lower .017 x .025 690-M725L
 Lower .018 x .025 690-M825L
 Lower .019 x .025 690-M925L
 Lower .021 x .025 690-M215L
 10/pack **\$15.95**

Thermal Nickel Titanium

Soft and flexible wire at room temperature (or colder) but once in the mouth returns to its original natural arch shape. Midline marked.

Round Natural Arch Form

Upper .012 690-TM12U
 Upper .014 690-TM14U
 Upper .016 690-TM16U
 Upper .018 690-TM18U
 Lower .012 690-TM12L
 Lower .014 690-TM14L
 Lower .016 690-TM16L
 Lower .018 690-TM18L
 10/pack **\$15.95**

Rectangular and Square Natural Arch Form

Upper .016 x .022 690-TM622U
 Upper .017 x .025 690-TM725U
 Upper .018 x .025 690-TM825U
 Lower .016 x .022 690-TM622L
 Lower .017 x .025 690-TM725L
 Lower .018 x .025 690-TM825L
 10/pack **\$20.25**

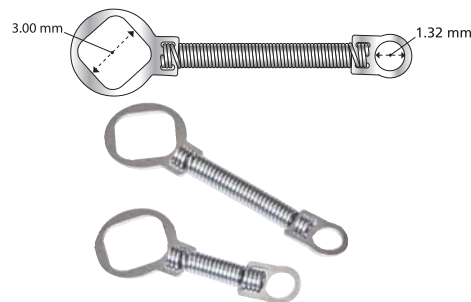

Closed Coil Spring Spools - Ortho Technology

Closed wound stainless steel wire designed to hold spaces.

.010" x .030" 690-908102
 3'/spool **\$8.75**



Crimpable Bi-Directional Ball Hooks w/ Split Archwire Opening - Ortho Technology

Easily place onto any size archwire inside of the mouth. Secure anchor for any auxiliary attachment. Bi-directional hook for easy ligation. Smooth for patient comfort. High quality stainless steel. Fits archwires up to .022" x .025".

Short: 1.6mm Tall
690-20102 20/pack..... \$42.25

Long: 3.3mm Tall
690-20103 20/pack..... \$50.75



Crimpable Mini Stops - Ortho Technology

Extremely low profile and small in size, making them more aesthetically pleasing. Stainless steel. Slides easily onto the archwire for customized placement. Crimps easily into place with Weingart style utility pliers. 2mm in length.

Small
For wire sizes .012" through .018".
690-020200 25/pack..... \$38.25

Large
For Rectangular Wires .014" x .025" through .019" x .025" and Square Wires up to a maximum of .020" x .020".
690-020300 25/pack..... \$38.25



Open Coil Spring Spools - Ortho Technology

Open wound stainless steel wire designed to open spaces.
.010" x .030" 690-908101
.010" x .036" 690-908103
3'/spool \$8.75



Orthogap Disposable Archwire Markers - Ortho Technology

Protect against cross contamination when marking archwires. Each marker is machine dipped in special thick wax that will not crack or melt. A dispenser is available to keep the working area organized by dispensing one marker at a time.

Markers
690-600401 100/pack \$15.45

Dispenser
690-600400D Each \$20.95



Split Ball Hooks - Ortho Technology

Easily crimps to archwires. Slide on ball hooks for placement outside of the mouth. Split ball hooks provide convenient positioning without removing archwires. 3.2mm tall.

Fits up to .018" x .025" 690-014114
Fits up to .021" x .025" 690-014115
20/pack \$95.25



Tooth Tone Coated Crimpable Ball Hooks - Ortho Technology

Split archwire opening, for total aesthetic treatment. Very comfortable to the patient. Crimps securely to archwire. 3.3mm tall. Fits archwires up to .022" x .025"
690-907002 20/pack..... \$77.75



Tooth Tone Coated Kobayashi Shorty Ties - Ortho Technology

.012" wire (.014" coated). Stainless steel. Durable plastic coating.
690-907115 100/pack..... \$36.75



Tooth Tone Coated Nickel Titanium Open Coil Springs - Ortho Technology

Consistent force level. Coated for superior aesthetics. 7" Lengths.
.012" x .030" (.014" x .027" coated).
690-907003 3/pack \$72.45



Tooth Tone Coated Preformed Ligature Ties - Ortho Technology

.010" wire (.012" coated). Stainless steel.
690-907102 100/pack..... \$30.95



Tooth Tone Coated Preformed Shorty Ties - Ortho Technology

.010" wire (.012" coated). Stainless steel.
690-907105 100/pack..... \$36.75

WIRED PRODUCTS



TruFlex Nickel Titanium Closed Coil Springs - Ortho Technology

Delivers constant force levels. Active until the spring is closed. Super elastic nickel titanium quality. Provides comfortable, predictable forces during treatment. Stainless steel key-end eyelets for easy attachment.

Light Force 100gm

9mm (.010" x .030") 690-700104L
12mm (.010" x .030") 690-700105L

Medium Force 150gm

9mm (.011" x .030") 690-700104M
12mm (.011" x .030") 690-700105M

Heavy Force 200gm

9mm (.012" x .030") 690-700104H
12mm (.012" x .030") 690-700105H
10/pack **\$54.95**

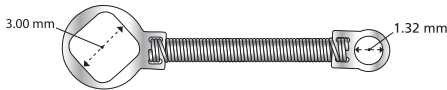

TruFlex Nickel Titanium Distalizing Springs - Ortho Technology

Distalize molars without the use of headgear. Achieve 1.0 mm to 1.5 mm distalization per month. Fits over any size wire. Delivers approximately 1240 grams of force when 3 segments are used. Force level decreases as the length of spring increases. (.010" x .045".)

690-700100 3/pack..... **\$66.95**

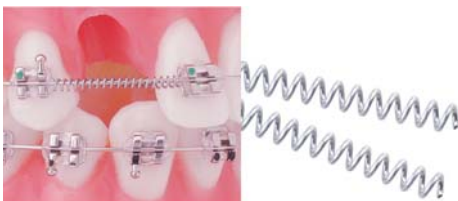

TruFlex Nickel Titanium Open Coil Springs - Ortho Technology

Delivers continuous force for opening or holding

of spaces between teeth.

7" Lengths

10 x 30 690-700101
12 x 30 690-700102
14 x 36 690-700103
3/pack **\$25.25**

15" Spools

10 x 30 690-700000
12 x 30 690-700001
Each **\$16.75**



De-Impacting Springs Separating Springs

TruFlex Nickel Titanium De-Impacting and Separating Springs - Ortho Technology

Designed to effectively separate or de-impact posterior teeth with minimal patient discomfort. Offset leg design and rectangle nickel titanium wire provides the most efficient method of separating and de-impacting. Looped over safety ends ensure patient comfort.

De-Impacting Springs

.017" x .025" Long.
690-600434 15/pack **\$74.45**

Separating Springs

.016" x .022" Narrow.
690-600436 15/pack **\$74.45**

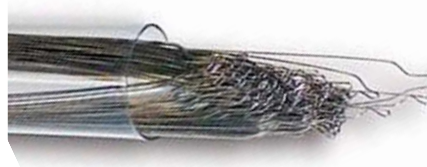

TruForce Stainless Steel Kobayashi Ties - Ortho Technology

Used for quick placement of retraction hooks on brackets without hooks. High quality dead soft 304 medical grade stainless steel.

.010" 690-905100
.012" 690-905101
.014" 690-905102
100/pack **\$18.75**



TruForce Stainless Steel Preformed Ligature Ties - Ortho Technology

High quality dead soft 304 medical grade stainless steel.

.009" 690-906101
.010" 690-906102
.011" 690-906103
.012" 690-906104
1000/pack **\$29.75**



TruForce Stainless Steel Retainer Wire - Ortho Technology

302SS Stainless Steel. High tensile strength. Smooth bright finish.

Round - 14" Lengths

.022" 690-900105
.025" 690-900106
.026" 690-900107
.028" 690-900108
.030" 690-900109
.032" 690-900110
.036" 690-900111
.040" 690-900112
.045" 690-900113
25/pack **\$12.95**

TruForce Stainless Steel Straight Lengths

Round - 14" Lengths

.014" 690-900101
.016" 690-900102
.018" 690-900103
.020" 690-900104
25/pack **\$9.75**

Rectangle - 14" Lengths

.016" x .016" 690-900114
.016" x .022" 690-900115
.017" x .025" 690-900116
.018" x .018" 690-900117
.018" x .025" 690-900118
.019" x .025" 690-900119
.021" x .025" 690-900120
25/pack **\$18.75**

HEADGEAR



Cervical Neckpads - Ortho Technology

Poly/cotton blend cervical neckpads for maximum comfort. Washable with two hook-up tabs for use with any style module.

Royal Blue 690-550200
Assorted Colors 690-550500
5/pack **\$50.25**

HEADGEAR

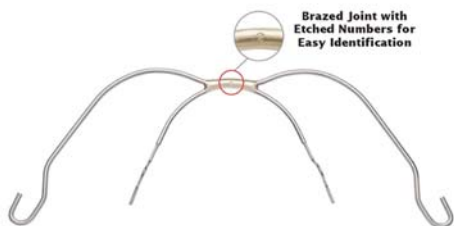

Full Form Extraoral Facebows - Ortho Technology

High quality stainless steel. Wide inner bow size measurement. For accurate selection of the proper size, measurements are based on distal side of loop to distal side of opposite loop of the inner bow. Improved laser welded joint - strong, durable.

- #1 Yellow 83mm 690-431111
- #2 Red 90mm 690-431112
- #3 Pink 97mm 690-431113
- #4 Blue 104mm 690-431114
- #5 Green 111mm 690-431115

White Universal (Inner bow without loops)

- Full Form 690-431110
- Standard 690-441110
- Each **\$14.75**



High Pull Head Caps - Ortho Technology

Woven/poly/cotton blend for maximum comfort. Washable with two hook-up tabs for use with any style module.

- Royal Blue 690-550755
- Assorted Colors 690-550650
- 5/pack **\$41.75**



Multi-Adjustable Facemask - Ortho Technology

Fully adjustable reverse pull facemask that is ergonomically designed for maximum patient comfort. Each kit includes two sets of pads and a hexagon key to adjust the pads and horizontal bar. The vertical mainframe is made of stainless steel.

- Blue 690-550400
- Clear 690-550403
- Pearl White 690-550404
- Red 690-550401
- Teal 690-550405
- American Pride 690-550406
- Pink Camo 690-550412
- Green Camo 690-550413
- Each **\$56.75**

PATIENT TAKE HOME CARE



Deep Retainer Box

Dimensions: 3"W x 2-1/2"L x 1-1/2"H

- Black 760-HT200DB11
- Blue 760-HT200DB2
- Beige 760-HT200DB7
- Gray 760-HT200DB9
- Neon Yellow 760-HT200DB3
- Neon Green 760-HT200DB4
- Neon Pink 760-HT200DB6
- Neon Tangerine 760-HT200DB12
- Neon Red Orange 760-HT200DB13
- Purple 760-HT200DB10
- Red 760-HT200DB5
- White 760-HT200DB1
- Assorted 760-HT200DBA
- 12/pack **\$9.45**



Orthodontic Patient Kits

Imprinting available, 4 assorted colors. Contains: V Trim Toothbrush, Travel V Trim Toothbrush, 12yds waxed dental floss, 10 floss threaders, ortho wax, interproximal brush, 2 minute timer and dental mirror.

- 950-10018 36 kits/box **\$99.95**



Retainer Box

Dimensions: 3" W x 2-1/2" L x 1" H

- Beige 760-HT200RT7
- Black 760-HT200RT11
- Blue 760-HT200RT2
- Gray 760-HT200RT9
- Neon Green 760-HT200RT4
- Neon Pink 760-HT200RT6
- Neon Red/ Orange 760-HT200RT13
- Neon Tangerine 760-HT200RT12
- Neon Yellow 760-HT200RT3
- Purple 760-HT200RT10
- Red 760-HT200RT5
- White 760-HT200RT1
- Assortment 760-HT200RTA
- 12/pack **\$9.45**

LOOK'in
 for something? **WE HAVE IT!**
www.dhpionline.com



Amber Elastic Bands - Dentsply Glenroe

Manufactured from prime medical grade latex, every package is checked to assure all cuts are consistent and that the forces are correct. Packed in color-coded resealable plastic bags for easy patient use.

Light 2.5oz.

- 1/8" Diameter (A).....690-G731
- 3/16" Diameter (B).....690-G741
- 1/4" Diameter (C).....690-G751
- 5/16" Diameter (D).....690-G761
- 3/8" Diameter (E).....690-G771

Medium 3.5oz.

- 1/8" Diameter (A).....690-G733
- 3/16" Diameter (B).....690-G743
- 1/4" Diameter (C).....690-G753
- 5/16" Diameter (D).....690-G763
- 3/8" Diameter (E).....690-G773

Heavy 4.5oz.

- 1/8" Diameter (A).....690-G735
- 3/16" Diameter (B).....690-G745
- 1/4" Diameter (C).....690-G755
- 5/16" Diameter (D).....690-G765
- 3/8" Diameter (E).....690-G775

X-Heavy 6oz.

- 1/8" Diameter (A).....690-G736
 - 3/16" Diameter (B).....690-G746
 - 1/4" Diameter (C).....690-G756
 - 5/16" Diameter (D).....690-G766
 - 3/8" Diameter (E).....690-G776
- 50 bags of 100/box..... **\$28.95**



Non-Latex Elastic Bands - Dentsply Glenroe

These bands have the same features as the amber elastic bands, but are not made with natural rubber latex. 100 bands/bag.

Assorted Neon Colors

Medium 3.5oz.

- 3/16" Diameter (B).....690-G902
- 1/4" Diameter (C).....690-G912
- 5/16" Diameter (D).....690-UNLN763

Heavy 4.5oz.

- 3/16" Diameter (B).....690-G904
 - 1/4" Diameter (C).....690-G914
 - 5/16" Diameter (D).....690-G924
- 50 bags/box **\$27.95**

Clear

Medium 3.5oz.

- 3/16" Diameter (B).....690-UNL743
- 1/4" Diameter (C).....690-UNL753
- 5/16" Diameter (D).....690-UNL763

Heavy 4.5oz

- 3/16" Diameter (B).....690-UNL745
 - 1/4" Diameter (C).....690-UNL755
 - 5/16" Diameter (D).....690-UNL765
- 50 bags/box **\$30.75**



Comfort Cover - Ortho Technology

Shields the patient's lips and cheeks from the discomfort often associated with orthodontic treatment or activities where the risk of oral laceration could occur, such as playing musical instruments or light contact sports where mouth guards are excessive. Individually packaged. Not made from natural rubber latex.

- 690-98165 5/pack..... **\$31.25**



Patient Relief Wax - Ortho Technology

Plain wax in scented cases.

- Grape..... 690-600001
 - Orange..... 690-600002
 - Cherry..... 690-600003
 - Mint..... 690-600005
 - Bubble Gum..... 690-600007
 - Plain (Silver)..... 690-600010
- 50/pack **\$36.75**



Retainer Brite - Ortho Technology

Cleans and brightens retainers, nightguards, mouthguards, splints and most other removable dental appliances. Kills germs and bacteria, keeping appliances minty fresh.

- 690-18160 36/box..... **\$11.25**
- 690-18159 96/box..... **\$20.75**



ULTRA-GUARD Mouthguards - Ortho Technology

Specially designed for athletes with braces. Helps protect lips and cheeks from laceration. No boiling or impressions needed. Includes helmet strap.

- Black..... 690-24005
 - Blue..... 690-24004
 - Clear..... 690-24006
 - Pink..... 690-24007
 - Green..... 690-24002
 - Red..... 690-24001
 - Yellow..... 690-24003
 - Assorted..... 690-24000
- 12/pack **\$45.45**



Chroma Retainer Boxes - Plasdent Corporation

- Dark Blue..... 760-CR2000DB
 - Dark Green..... 760-CR2000DG
 - Dark Gray..... 760-CR2000DGy
 - Light Pink..... 760-CR2000LP
 - Mint Green..... 760-CR2000MG
 - Orange..... 760-CR2000O
 - Purple..... 760-CR2000P
 - White..... 760-CR2000W
 - Yellow..... 760-CR2000Y
- Each **75¢**

Assorted

- 760-CR2000A 12/box..... **\$9.25**



Platypus Orthodontic Flossers - Platypus Co.

Easy and effective orthodontic flosser with unique design which increases patient compliance.

950-T130 30/bag \$5.95

Sample Box

3 flossers/pkg.

950-T103 75/box \$49.95



GUM® Premium Ortho Kit - Sunstar Americas, Inc.

Gives your patient the proper care for their orthodontics with a complete assortment of products. Contains: Orthodontic Toothbrush, Clear, Vented Bag with Business Card Pocket, 12yds Butler-Weave Minted Waxed Floss, Go-Between Cleaners, Orthodontic Wax - unflavored, Antibacterial Toothbrush Travel Cap, Eez-Thru Floss Threaders, Go-Betweens Proxabrush Cleaners and Soft Picks.

690-ORTHOKITPR 12/pack \$96.25



Retainer Boxes - Zirc

High impact plastic. One-piece construction. Solid locking mechanism. Patient identification label. Imprinting available.

1" Deep

Assorted 760-25R500AS
 Neon Blue 760-25R500N
 Neon Green 760-25R500P
 Neon Pink 760-25R500S
 Neon Purple 760-25R500R
 Neon Yellow 760-25R500O
 Teal 760-25R500J
 12/pkg. \$13.25

1.5" Deep

Assorted 760-25R550AS
 Neon Blue 760-25R550N
 Neon Green 760-25R550P
 Neon Pink 760-25R550S
 Neon Purple 760-25R550R
 Neon Yellow 760-25R550O
 Teal 760-25R550J
 12/pkg \$14.25

ORTHO LAB



Orthodontic Resin - Dentsply Caulk Regular Package

Contains: 605gm powder, 430ml liquid, 65ml separator, 1 liquid dispenser (empty) and accessories.

Pink 118-651007
 Clear 118-651011
 Package \$281.25

Powder

118-651006 605gm \$172.75

Liquid

Pink 118-651002
 Clear 118-651003
 430ml \$79.45



Modern Materials O-67 Snow White Orthodontic Stone - Heraeus Kulzer

Type III. Specifically formulated for orthodontic casts where whiteness, accuracy, and durability are essential.

750-46972 25lbs \$54.45
 750-46952 50lbs \$79.95

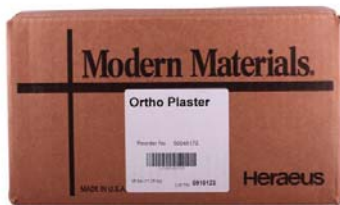

Modern Materials Orthodontic Plaster - Heraeus Kulzer

Type II, Extremely Snow White. Ideal for orthodontic casts and study models.

750-48170 25lbs \$45.45
 750-48180 50lbs \$67.95



Ortho-Jet - Lang Dental Manufacturing Co., Inc.

A self-curing acrylic resin for fabrication of orthodontic appliances.

Pound Package

Contains: 1 lb powder, 8oz. liquid.

Clear 110-1334CL

Pink 110-1334PT

Package \$80.45

Powder - Clear

110-1320C 4oz. \$32.75
 110-1330C 1lb. \$57.25

Powder - Pink

110-1303PT 4oz. \$22.45
 110-1304PT 8oz. \$35.95
 110-1306PT 1qt. \$71.45

Liquid

110-1303C 4oz. \$22.45
 110-1304CLR 8oz. \$35.95

NOW YOU CAN
**BROWSE ALL
 CLEARANCE**

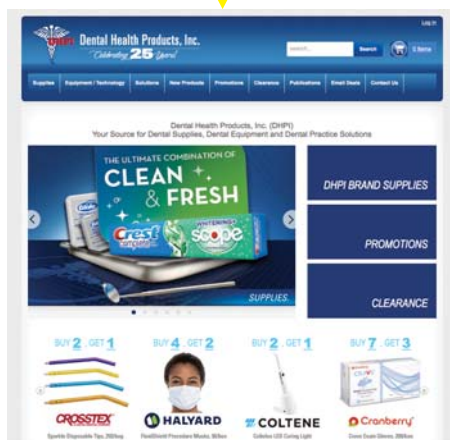

www.dhpionline.com/clearance

All Clearance
 Supplies are
Discounted
 up to **25%**,
While Supplies Last!

GENERIC PRODUCTS

Item Code	Generic Name	Brand Equivalent	Strength	Unit
880-995216	Amoxicillin Capsules	Amoxil®	250mg	100 Caps
880-4230660	Amoxicillin Capsules	Amoxil®	500mg	100 Caps
880-997193	Amoxicillin Capsules	Amoxil®	500mg	500 Caps
880-401210	Amoxicillin Suspension	Amoxil®	125/mg, 5ml	80ml
880-4035234	Aspirin Tablets Enteric Coated	Ecotrin®	325mg	100 Tabs
880-800210	Butalbital/Apap/Caffeine Tablets	Fioricet®	50/325/40mg	100 Tabs
880-997822	Cephalexin Capsules	Keflex®	500mg	100 Caps
880-889630	Cephalexin Capsules	Keflex®	500mg	500 Caps
880-999722	Clindamycin Capsules	Cleocin®	150mg	100 Caps
880-500209	Diphenhydramine Capsules	Benadryl®	25mg	100 Caps
880-996957	Doxycycline Hyclate Tablets	Vibramycin	100mg	50 Tabs
880-996505	Ibuprofen Tablets	Advil®	200mg	100 Tabs
880-2220382	Ibuprofen Tablets	Advil®	200mg	500 Tabs
880-10027230	Ibuprofen Tablets	Motrin®	400mg	100 Tabs
880-998289	Ibuprofen Tablets	Motrin®	400mg	500 Tabs
880-800252	Ibuprofen Tablets	Motrin®	600mg	100 Tabs
880-601245	Ibuprofen Tablets	Motrin®	800mg	100 Tabs
880-998287	Ibuprofen Tablets	Motrin®	600mg	500 Tabs
880-998288	Ibuprofen Tablets	Motrin®	800mg	500 Tabs
880-999863	Minocycline HCL Capsules	Minocin®	100mg	50 Caps
880-601441	Naproxen Tablets	Naprosyn®	500mg	100 Tabs
880-203773	Penicillin V Tablets	Pen Vee K®	250mg	100 Tabs
880-996827	Penicillin V Tablets	Pen Vee L®	500mg	100 Tabs

BRAND PRODUCTS

*Practitioner's License Number is required to purchase pharmaceuticals, anesthetics and drugs.
Please furnish your Practitioner's License Number with Expiration Date to your Dental Health Products, Inc.
Account Manager when ordering. We appreciate your compliance.*

Advil® Gel Caplets 200mg
880-045904 100/pack

Multi-Use Vial
880-902201 1.5ml

Vaseline® Petroleum Jelly
880-2538510 13oz. jar

Advil® Tablets 200mg
2-pack foil pack.
880-4404422 50/pack

Efferdent®
880-2435451 44 tablets

Zilactin® Medicated Gel
880-350000 0.25oz.

Ammonia Inhalants .33ml
880-2390847 10/pack

Epinephrine Injection, USP
Auto-injector. Rx. 2/pack.
880-995276 0.15mg
880-995277 0.30mg

Benzodent®
Denture pain cream
880-2903300 0.25oz.

Tums® Tablets
Assorted Flavors
880-2656833 150 tablets

Debactoral
Topical pharmaceutical used for treatment of
ulcerating oral mucosal lesions (canker sores).
Rx. Single Use Swab
880-902112 12/pack

Tylenol® Extra Strength Caplets 500mg
2-pack foil pack.
880-2735348 50/box



PINS



Max® Restorative Pins - Coltene

Parapulpal pins. Self-threading retention pins with shoulder stop and rounded head design for good adaptation. Corrosion-free, titanium alloy. Self-alignment during placement.

Complete Kit

Contains: 20 restorative pins, 2 max drills and 1 universal hand driver.

MAX017 0.017"/0.425mm Blue.....	344-M11
MAX021 0.021"/0.525mm Purple...	344-M21
Kit	\$202.95

Refills

MAX017 0.017"/0.425mm.....	344-M13
MAX021 0.021"/0.525mm.....	344-M23
50/pkg.	\$305.75

Max Drills - Depth Limiting

Purple 0.021" x 0.095"	344-M92
Blue 0.017" x 0.075"	344-M91
5/pkg.	\$186.45

Additional sizes available upon request.



TMS® Pins - Coltene

Thread Mate System. Self-threading parapulpal retention pins conceived for manual insertion that provide a reliable link between restorative filling material and dentine.

TMS Complete Kit

Contains: 20 self-threading pins, 1 color-coded Kodex drill, 1 hand wrench.

Regular .675mm/.027" K97.....	344-T01
Minim .525mm/.021" K93.....	344-T04
Kit	\$168.95

Refills

Regular .675mm/.027"	344-T02
Minim .525mm/.021"	344-T05
50/pkg.	\$252.25

TMS Bulk Kit available upon request.

TMS Two-in-One available upon request.

TMS Regular Self-Shearing Pins available upon request.



TMS® Link Series - Coltene

Self-threading parapulpal pins, made of alpha-beta titanium alloy or gold-plated stainless steel. Shoulder stop. Smooth self alignment during placement.

Gold-Plated Stainless Steel Single Shear Complete Kit

Contains: 20 self-threading pins, 1 color-coded Kodex drill, 1 hand driver.

Minuta 0.0135"/0.350mm K89	344-L501
Minikin 0.017"/0.425mm K91.....	344-L511
Minim 0.021"/0.525mm K92.....	344-L521
Kit	\$200.75

Single Shear Bulk Kit

Contains: 50 self-threading pins.

Minikin 0.017"/0.425mm K91.....	344-L512
Minim 0.021"/0.525mm K92.....	344-L522
Kit	\$389.75

Double Shear Complete Kit

Contains: 20 self-threading double pins, 2 color-coded Kodex drills, 1 hand driver.

Minim 0.021"/0.525mm K92.....	344-L531
Kit	\$231.95

Double Shear Bulk Kit

Contain: 50 self-threading double pins.

Minim 0.021"/0.525mm K92.....	344-L532
Kit	\$389.75

Titanium Alloy

Single Shear Complete Kit

Contains: 20 pins, 1 color-coded Kodex drill, 1 hand driver.

Minikin 0.017"/0.425mm K91.....	344-L811
Kit	\$200.75

Single Shear Bulk Kit

Contains: 50 self-threading pins.

Minikin 0.017"/0.425mm K91.....	344-L812
Minim 0.021"/0.525mm.....	344-L822
Kit	\$389.75

Full product line available upon request.



TMS Link Plus® Series

Includes a buttress thread for better retention and rapid insertion.

Gold-Plated Stainless Steel

Single Shear Complete Kit

Contain: 20 self-threading pins, 1 color-coded Kodex drill, 1 hand driver.

Minim 0.021"/0.525mm K92.....	344-L721
Regular 0.027"/0.675mm K96.....	344-L741
Kit	175.75

Single Shear Bulk Kit

Contains: 50 self-threading pins.

Minim 0.021"/0.525mm	344-L722
Kit	\$298.75

Double Shear Complete Kit

Contains: 20 self-threading pins, 1 color-coded Kodex drill, 1 hand driver.

Minim (.525mm/.021" K92)	344-L731
Kit	\$225.95

Double Shear Bulk Kit

Contains: 50 self-threading pins.

Minim 0.021"/0.525mm	344-L732
Regular 0.027"/0.675mm	344-L752
Kit	\$378.75

Titanium Alloy

Single Shear Complete Kit

Contains: 20 self-threading pins, 1 color-coded Kodex drill, 1 hand driver.

Minim 0.021"/0.525mm K92.....	344-L821
Kit	\$225.95

Single Shear Bulk Kit available upon request.

Double Shear Complete Kit

Contains: 20 self-threading double pins, 2 color-coded Kodex drills, 1 hand driver.

Minim 0.021"/0.525mm K92.....	344-L841
Kit	\$225.95

Double Shear Bulk Kit

Contains: 50 self-threading double pins.

Minim 0.021"/0.525mm	344-L842
Kit	\$378.75

Kodex Twist Drills

Color-coded for use with Minuta, Minikin, Minim and Regular TMS pins.

Depth Limiting

Minim - Silver 0.021" x 0.079"	344-K92
Minuta - Pink 0.0135" x 0.051"	344-K89
Regular - Gold 0.027" x 0.079".....	344-K96
6/pkg.	\$118.25

Without Depth Limiting

Minim - Silver 0.021" x 0.079"	344-K93
Regular - Gold 0.027" x 0.179"	344-K97
6/pkg.	\$118.25

Long Shank

Minikin - Red 0.017" x 0.059".....	344-K91
6/pkg.	\$118.25

Short Shank

Minikin - Red 0.017" x 0.059".....	344-K90
6/pkg.	\$118.25

TMS Hand Wrenches

Regular and Minikin	344-B593
Minim	344-B595
Each	\$22.25

TMS Bending Tools

Regular	344-B61R
Minim	344-B61M
Each	\$31.75

Full product line available upon request.

PINS



Stabilok - Fairfax Dental Ltd.

Provide extra mechanical retention for restorations in both anterior and posterior teeth. They can be reduced in length and/or bent into desired position. The pin is securely held in a contra-angle shank until it is ready to automatically shear off in the tooth at the correct depth.

Standard Kit

Contains: 20 pins and 1 drill.

Stainless Steel

- Blue 0.021" 340-SSS
- Green 0.027" 340-SG
- Kit **\$33.45**

Titanium

- Yellow 0.021" 340-SST
- Orange 0.027" 340-MST
- Kit **\$33.45**

Economy Kit

Contains: 100 pins and 5 drills.

Stainless Steel

- Blue 0.021" 340-ESS
- Green 0.027" 340-EG
- Kit **\$136.75**

Titanium

- Yellow 0.021" 340-EST
- Orange 0.027" 340-EMT
- Kit **\$136.75**



Filpin System - Filhol Dental

99.8% pure titanium. Biocompatible, will not corrode. Self-shears, self-threading, self-aligning shaft. Easy to bend after insertion without breaking the pin or tooth.

Standard Package - Universal

- Contains: 35 red 0.60mm / 0.021" Filpins and 1 universal twist drill.
- 340-PIN101 Package **\$96.95**

Twist Drill - Universal

- 340-DR123 Each **\$41.95**

METAL POSTS

Size		Color
3	0.036"	Brown
4	0.040"	Yellow
4.5	0.045	Blue
5	0.050	Red
5.5	0.055	Purple
6	0.060	Black
7	0.070	Green



ParaPost® System - Coltene

Universal endodontic post system for direct post and core buildups and all casting techniques.

Stainless Steel Refills

- Size 3 344-P443
- Size 4 344-P444
- Size 4.5 344-P4445
- Size 5 344-P445
- 10/pkg **\$135.75**

Stainless Steel Bulk Refills

- Size 3 344-P443B
- Size 4 344-P444B
- Size 5 344-P445B
- 25/pkg **\$311.25**

Titanium Alloy Refills

- Size 3 344-P843
- Size 4 344-P844
- Size 5 344-P845
- 10/pkg **\$135.75**

Plastic Impression Posts

- Size 3 344-P433
- Size 4 344-P434
- Size 5 344-P435
- 20/pkg **\$61.25**

Titanium Alloy Temporary Posts available upon request.



ParaPost Plus®

Cylindrical, passively cemented endodontic post system for direct post and core build-up technique. Spiral flutes provide excellent venting of excess cement and resistance to rotation. Available in stainless steel and titanium alloy.

Stainless Steel Refills

- Size 3 344-P2443
- Size 4 344-P2444
- Size 4.5 344-P24445
- Size 5 344-P2445
- Size 6 344-P2446
- 10/pkg **\$135.95**

Stainless Steel Bulk Refills

- Size 3 344-P2443B
- Size 4 344-P2444B
- 25/pkg **\$329.75**

Titanium Alloy Refills

- Size 3 344-P2843
- Size 4 344-P2844
- Size 5 344-P2845
- Size 5.5 344-P28455
- 10/pkg **\$135.95**

Titanium Alloy Bulk Refills available upon request.



ParaPost® XH™

Parallel-sided, passively cemented, titanium alloy post with undercut slotted head design. Used for glass ionomer or composite cores.

Introductory Kit

Contains: 25 posts, 7 X-drills, 1 universal hand driver.

- 344-P880 Kit **\$420.25**

Titanium Alloy Refills

- Size 3 344-P883
- Size 4 344-P884
- Size 4.5 344-P8845
- Size 5 344-P885
- Size 5.5 344-P8855
- Size 6 344-P886
- 10/pkg **\$120.45**

Titanium Alloy Bulk Refills available upon request.



ParaPost® XP™

Parallel-sided, passively cemented titanium alloy or stainless steel post with flat head design for amalgam cores and multi-rooted teeth.

Introductory Kit available upon request.

Stainless Steel Refills

- Size 3 344-P7443
- Size 4 344-P7444
- Size 4.5 344-P74445
- Size 5 344-P7445
- Size 5.5 344-P74455
- Size 6 344-P7446
- Size 7 344-P7447
- 10/pkg **\$107.25**

Continued

METAL POSTS

ParaPost XP continued.

Stainless Steel Bulk Refills available upon request.

Titanium Alloy Refills

Size 3	344-P7843
Size 4	344-P7844
Size 4.5	344-P78445
Size 5	344-P7845
Size 5.5	344-P78455
Size 6	344-P7846
Size 7	344-P7847
10/pkg	\$116.25

Titanium Alloy Bulk Refills available upon request.

Casting Technique components available upon request.



ParaPost® XT™

Parallel-sided, actively threaded titanium alloy post with rounded, under-cut head design for extra retention and safety.

Introductory Kit available upon request.

Titanium Alloy Refills

Size 3	344-P6830
Size 4	344-P6840
Size 4.5	344-P6845
Size 5	344-P6850
Size 5.5	344-P6855
Size 6	344-P6860
10/pkg	\$140.95

Titanium Alloy Bulk Refills available upon request.

ParaPost X Drills

Size 3	344-P423
Size 4	344-P424
Size 4.5	344-P4245
Size 5	344-P425
Size 5.5	344-P4255
Size 6	344-P426
Size 7	344-P427
3/pkg	\$74.95

ParaPost XT Drills

Size 3	344-P6230
Size 4	344-P6240
Size 5	344-P6250
3/pkg	\$94.75

Universal Hand Driver

344-L590	Each.....	\$8.75
----------	-----------	---------------

ParaPost XT Metal Wrench A

For sizes 3, 4, 4.5.

344-L594	Each.....	\$50.75
----------	-----------	----------------

ParaPost XT Metal Wrench B

For sizes 5, 5.5, 6.

344-L595	Each.....	\$50.75
----------	-----------	----------------

ParaPost XT Metal Wrench Set

344-L596	2/pack	\$98.25
----------	--------------	----------------



Surtext - Dentatus

Square crosscut head for core material adaptation and retention. Parallel sides for passive insertion with thread pitch for secure retention to all cements. Anatomical geometry for safe extra length of posts and for tapered roots.

Gold Plated

Short 7.8mm	
1.05mm	340-RRAS1
1.20mm	340-RRAS2
1.80mm	340-RRAS6
12/pkg	\$90.75

Medium 9.3mm

1.05mm	340-RRAM1
1.20mm	340-RRAM2
1.35mm	340-RRAM3
1.50mm	340-RRAM4
12/pkg	\$90.75

Long 11.8mm

1.05mm	340-RRAL1
1.20mm	340-RRAL2
1.35mm	340-RRAL3
1.50mm	340-RRAL4
1.65mm	340-RRAL5
12/pkg	\$90.75

Stainless Steel available upon request.



Screw Posts - E.C. Moore Company

Standard screw posts, available in gold plated or titanium.

Gold Plated Assortment

Contains: 60 assorted sizes.

340-PT60GK	Pack.....	\$41.95
------------	-----------	----------------

Gold Plated Refills

Short 1	340-PTS1GR
Short 2	340-PTS2GR
Short 3	340-PTS3GR
Short 4	340-PTS4GR
Short 5	340-PTS5GR
Short 6	340-PTS6GR
Medium 1	340-PTM1GR
Medium 2	340-PTM2GR
Medium 3	340-PTM3GR
Medium 4	340-PTM4GR
Medium 5	340-PTM5GR
Medium 6	340-PTM6GR
Long 1	340-PTL1GR
Long 2	340-PTL2GR
Long 3	340-PTL3GR
Long 4	340-PTL4GR
Long 5	340-PTL5GR
Long 6	340-PTL6GR
XLong 4	340-PTXL4GR
XLong 6	340-PTXL6GR
12/pkg	\$7.45

Titanium Assortment

Contains: 60 assorted sizes.

340-PT60TK	Pack.....	\$98.95
------------	-----------	----------------

Titanium Refills

Short 1	340-PTS1TR
Short 2	340-PTS2TR
Short 3	340-PTS3TR
Short 4	340-PTS4TR
Short 5	340-PTS5TR
Short 6	340-PTS6TR
Medium 1	340-PTM1TR
Medium 2	340-PTM2TR
Medium 3	340-PTM3TR
Medium 4	340-PTM4TR
Long 1	340-PTL1TR
Long 2	340-PTL2TR
Long 3	340-PTL3TR
Long 4	340-PTL4TR
6/pkg	\$10.25

Reamers - Assorted Long

340-PTALRR	6/pkg	\$40.95
------------	-------------	----------------

Hollow Key

340-PTHK	Each.....	\$2.75
----------	-----------	---------------

Cross Key

340-PTCK	Each.....	\$2.75
----------	-----------	---------------

LOOK'in
for something? **WE HAVE IT!**
www.dhpionline.com

METAL POSTS



Flexi-Flange® - Essential Dental Systems

Incorporates a countersunk flange to provide stability in situations where there is inadequate coronal dentin and excessive occlusal forces. Cuts in to dentin rather than pushing it away. Closes upon insertion to deliver maximum retention with minimal stress.

Stainless Steel Intro Kit - 0, 1, 2 available upon request.

Stainless Steel Refills

Contains: 10 posts and 1 drill.

00.....	340-43000
01.....	340-43001
02.....	340-43002
03.....	340-43003
Each	\$187.75

Titanium Intro Kit - 0, 1, 2 available upon request.

Titanium Refills

Contains: 10 posts and 1 drill.

0.....	340-4350
1.....	340-43501
2.....	340-43502
3.....	340-43503
Each	\$194.95



Flexi-Post® - Essential Dental Systems

The original patented prefabricated split shank post. The split shank closes during insertion, absorbing insertional stress. Parallel-sided and threaded. Proven maximum retention and minimal stress.

Stainless Steel Assorted Kit

Contains: 4 posts of each size (12 total), 3 primary reamers, 3 secondary drills, 1 extender, 2 wrenches and 1 gauge.

Sizes 0, 1, 2	340-11000
Sizes 1, 2, 3	340-11001
Kit	\$292.25

Stainless Steel Refills

Contains: 10 posts, 1 reamer and 1 drill.

00.....	340-13000
0.....	340-1300
01.....	340-13001
02.....	340-13002
03.....	340-13003
Each	\$187.75

Stainless Steel Economy Refill Package

Contains: 30 posts, 1 reamer and 1 drill.

00.....	340-14000
0.....	340-1400
01.....	340-14001
02.....	340-14002
03.....	340-14003
Package	\$469.75

Titanium Assorted Kit available upon request.

Flexi-Post Sterilization Box

Holds 50 posts (not included).

340-19700	Each.....	\$145.75
-----------------	-----------	-----------------

Primary Reamers

00.....	340-19100
02.....	340-19102
0.....	340-1910
01.....	340-19101
Each	\$25.75

Secondary Drills

0.....	340-1920
01.....	340-19201
Each	\$25.75

External Wrench

340-19300	Each.....	\$25.75
-----------------	-----------	----------------

Internal Wrench

340-19301	Each.....	\$24.25
-----------------	-----------	----------------

Drill Extender

340-19400	Each.....	\$25.75
-----------------	-----------	----------------

Depth Gauge

340-19500	Each.....	\$3.25
-----------------	-----------	---------------



Flexi-Overdenture - Essential Dental Systems

Ball and socket attachment for highest retention and ideal distribution of stresses of full or partial dentures. Provides a simple, inexpensive overdenture at chairside.

Stainless Steel Introductory Kit available upon request.

Stainless Steel Refills

Contains: 6 posts, 1 reamer, 1 drill.

1.....	340-23001
2.....	340-23002
3.....	340-23003
Each	\$216.25

Flexi-Overdenture Wrench

340-29002	Each.....	\$38.25
-----------------	-----------	----------------



Precision Post - Integra® Miltex®

Designed as a parallel sided/flute style for maximum retention when placed into a root canal. Vented to reduce pressure and stress during placement. Available in a medical grade stainless steel or a high strength corrosion resistant titanium. Compatible with the ParaPost system. Posts are color-coded to match the Precision drills.

Precision Post Kit available upon request.

Stainless Steel Post Refills

#3	340-SVP3
#4	340-SVP4
#4.5	340-SVP45
#5.....	340-SVP5
#5.5.....	340-SVP55
10/pkg.	\$31.25

Titanium Post Refills

#3	340-TVP3
#4	340-TVP4
#4.5	340-TVP45
#5.....	340-TVP5
#5.5.....	340-TVP55
10/pkg.	\$30.25

Stainless Steel Drills

#3	340-D3
#4	340-D4
#4.5	340-D45
#5.....	340-D5
2/pkg.	\$24.95



for something? **WE HAVE IT!**

www.dhpionline.com

METAL POSTS



IntegraPost® - Premier® Dental

Core build-up post system with a patented Flow-Thru-Head and micro-knurled shank that assures a secure, stress-free anti-rotational core. Midflange and shoulder are designed to dissipate stress away from canal. Safe, nonthreaded parallel shank minimizes potential root fracture. Made from bio-compatible titanium alloy.

Mini Introductory Kit

Contains: 6 posts, 2 each #3, #4, #4.5, 3 drills each #3, #4, #4.5, IP carrier and lucite block.
347-3001001 Kit..... **\$102.75**

IntegraPost Refills

Size 3.....347-3001105
Size 4.....347-3001110
Size 4.5.....347-3001115
Size 5.....347-3001125
Size 6.....347-3001130
10/pkg**\$103.75**

Integra Drills

Size 3 Yellow.....347-3001205
Size 4 Red.....347-3001210
Size 4.5 Purple.....347-3001215
Size 5 Blue.....347-3001225
Size 6 Green.....347-3001230
3/pkg.....**\$48.45**

NON-METAL POSTS



RelyX™ Fiber Posts - 3M Oral Care

Feature elasticity similar to natural dentin, meaning a lower risk of root fracture than rigid metal/ceramic posts. Radiopaque. Available in a combination kit with RelyX Unicem Cement.

RelyX Fiber Posts Intro Kit

Contains: 5 posts each of sizes: 1 -1.3mm dia, 2 -1.6mm dia and 3 -1.9mm dia; 4 drills in sizes: 1, 2, 3, universal; 20 elongation tips.
343-56860 Kit..... **\$301.95**

RelyX Fiber Post/RelyX Unicem Cement Kits available upon request.

Post Refills

Contains: 10 posts and 10 elongation tips.
Size 0/White.....343-56872
Size 1/Yellow.....343-56861
Size 2/Red.....343-56862
Size 3/Blue.....343-56863
Each.....**\$136.95**

Drill Refills

Size 0/White.....343-56873
Size 1/Yellow.....343-56864
Size 2/Red.....343-56865
Size 3/Blue.....343-56866
Reamer.....343-56867
Each.....**\$27.45**

Elongation Tips

223-77550 10/bag..... **\$23.95**

RelyX Fiber Post 3D

Higher mechanical retention to the core build-up material due to coronal 3D macro retentions. Strong bond in the root canal due to its microporous surface without a silanating step.

Size 1/Yellow.....340-56949
Size 2/Red.....340-56950
10/pkg.....**\$138.95**

Additional sizes available upon request.



ParaPost® Fiber Lux™ - Coltene

Made of translucent fiber resin material that gives it excellent esthetic qualities and the convenience of being able to be used with dual, self and light-cured materials. Ideal for normal shaped root canals.

Introductory Kit

Contains: 15 posts: 2 of each size 3, 5.5 and 6; 3 of each size: 4, 4.5 and 5; 6 drills: 1 of each size 3, 4, 4.5, 5, 5.5 and 6; 1 universal hand driver.
344-PF170 Kit..... **\$284.75**

Refills

3.....344-PF1713
4.....344-PF1714
4.5.....344-PF17145
5.....344-PF1715
5.5.....344-PF17155
6.....344-PF1716
5/pkg.....**\$69.75**

Starter Drill and Universal Hand Driver

344-TEDC1 Set..... **\$24.95**



ParaPost® Fiber White™

White translucent color minimizes the possibility of shadowing in restorations where the dentin walls are thin.

Introductory Kit

Contains: 10 posts: 3 of each size 4.5 and 5, 2 of each size 5.5 and 6; 4 drills: 1 each size 4.5, 5, 5.5 and 6; 1 universal hand driver.
344-PF160 Kit..... **\$258.75**

Refills

4.5.....344-PF16145
5.....344-PF1615
5.5.....344-PF16155
6.....344-PF1616
5/pkg.....**\$87.95**



ParaPost® Taper Lux™

The tapered post design is best for narrow canals. Three head design for easy post length adjustment.

Introductory Kit

Contains: 15 posts: 5 of each size 4.5 and 5, 3 of size 5.5 and 2 of size 6; 4 drills: 1 of each size 0.045"/1.14mm, 0.050"/1.25mm, 0.055"/1.40mm and 0.060"/1.50mm and 1 universal hand driver.
344-PF180 Kit..... **\$284.75**

Refills

Size 4.5.....344-PF18145
Size 5.....344-PF1815
Size 5.5.....344-PF18155
Size 6.....344-PF1816
5/pkg.....**\$69.75**

NON-METAL POSTS



**FibreKleer 4X Fiber Post - Pentron
Clinical**

Feature outstanding radiopacity of up to 400% of aluminum to help ensure that they are instantaneously identified on a radiograph. Translucent glass fibers bundled in a proprietary clear resin matrix provide outstanding flexural strength and help to preserve the natural lifelike esthetics. A dentin-like flexural modulus results in a post that flexes with the tooth and transmits stress more evenly to help minimize the instance of root fractures.

Original Kit available upon request.

Original Refills

1.00mm Red.....	380-N83CA
1.25mm Yellow.....	380-N83CB
1.50mm Blue.....	380-N83CC
10/pack	\$111.45

1.00mm Red.....	340-N83CD
1.25mm Yellow.....	340-N83CE
1.50mm Blue.....	340-N83CF
30/pack	\$290.25

Parallel Kit

Contains: Parallel posts: 5 ea. of size 1.00mm red, 1.25mm yellow, 1.50mm blue, 3 drills - (1 each of sizes 1.00mm, 1.25mm, 1.50mm).
340-N83A Kit..... **\$212.95**

Parallel Refills

1.00mm Red.....	340-N83AA
1.25mm Yellow.....	340-N83AB
1.50mm Blue.....	340-N83AC
10/pack	\$111.45

Tapered Kit available upon request.

FiberKleer 4XFiber Post available upon request.

Tapered Refills

1.25mm Black.....	340-N83BA
1.375mm Purple.....	340-N83BB
1.50mm Green.....	340-N83BC
10/pack	\$111.45

1.25mm Black.....	340-N83BD
1.375mm Purple.....	340-N83BE
1.50mm Green.....	340-N83BF
30/pack	\$290.25



**FibreKor™ Post System - Pentron
Clinical**

Prefabricated endodontic posts in various sizes to accommodate large, medium and small canals. Posts are easily bonded to tooth structure via resin cements and bonding agents.

Intro Kit available upon request.

Refills

1.00mm.....	340-N18BA
1.125mm.....	340-N18BD
1.25mm.....	340-N18BB
1.375mm.....	340-N18BE
1.50mm.....	340-N18BC
10/pack	\$114.75

Refill Combo Pack

Contains: 10 each of size 1.00mm, 1.25mm, 1.50mm.
340-N18A Pack..... **\$310.25**

Drill Refills

1.00mm.....	340-N18DA
1.125mm.....	340-N18DD
1.25mm.....	340-N18DB
1.375mm.....	340-N18DE
1.50mm.....	340-N18DC
Each	\$29.95



**Cure-Thru® IntegraPost® - Premier®
Dental**

Utilizes the strength of longitudinal Zirconia glass fibers in a composite resin matrix for superior fatigue resistance, translucency and radiopacity. This esthetic glass fiber post is factory-silanated for more secure adhesion and ease of use. Color-coded by size to match current Integra drills.

Introductory Kits available upon request.

Refills

Size 4 Red.....	347-3001610
Size 4.5 Purple.....	347-3001611
Size 5 Blue.....	347-3001612
Size 6 Green.....	347-3001613
10/pack	\$105.95



Cut through the fat

**GO DIRECTLY
TO THE BEST**

Manufacturers offer thousands of promotions. GO **DIRECTLY** TO THE BEST.

www.dhpionline.com/promotions

BUY 1

BUY 2

BUY 3

BUY 4
OR MORE

DHPI X
EXCLUSIVE OFFERS

CARIES DETECTION

Caries Detector - Kuraray America Inc.

A simple solution that detects carious dentin enamel. Aids in the excavation of the outer decalcified and infected carious dentin layer, permitting optimal caries removal.

Contains: 2 -6ml bottles.

950-212220 Each..... **\$54.95**



Snoop™ - Pulpdent Corporation

Propylene glycol caries detecting dye. Dark blue color that provides strong contrast with both dentin and pulp. Stains infected carious dentin in 10 seconds and helps preserve vital dentin that should not be removed.

950-SNOOP 12ml **\$44.25**



Caries Indicator - Vista Dental Products

Facilitates the identification of carious dentin with a glycol based solution using a 19 gauge Sol-U-Flow brush tip. Ensures maximum inner dentin is preserved and infected dentin is removed.

Contains: 4 -1.2ml syringes and 20 Sol-U-Flow brush tips.

Red 950-502700

Green..... 950-502750

Each **\$33.75**

Sol-U-Flow Brush Tips

19ga tip with adjustable brush fiber length. Curved cannula for optimal entry.

230-312202 20/pkg. **\$18.25**



Caries Finder™ - Zest Dental Solutions

Caries detection dye that isolates decay precisely. Stains only carious dentin or enamel a brilliant red or green and helps to prevent recurrent decay and unnecessary pulp intrusion.

Green..... 950-80004

Red 950-80010

10ml **\$48.25**

CHEWING GUM, MINTS & LIP BALM

TheraMints 100% Xylitol Sweetened Mints - 3M Oral Care

Provide excellent therapy that may reduce the risk of caries and help fight oral malodor. Can be an important part of daily oral hygiene for many patients and is especially beneficial for xerostomic patients.

Mint..... 950-12119M

520/bottle **\$21.25**



Xylitol Dry Mouth Drops - Hager Worldwide

Low calorie sugar substitute. Reduces plaque forming bacteria and aids in saliva production.

Display Box

Contains: Counter top display box.

Melon..... 950-630185

Cherry..... 950-630186

Mint..... 950-630187

Assortment (4 each flavor)..... 950-630182

12 bags/box **\$46.75**

Individual Assortment

950-630188 156/box **\$25.45**



Miradent Xylitol Chewing Gum - Hager Worldwide

Contains Xylitol which has an active anti-caries/ cariostatic effect by reducing plaque forming bacteria. Low caloric value. 30/tube.

Peppermint 950-630053

12 tubes/box **\$38.45**

Additional flavors available upon request.

Assorted Flavors - Dispenser Box

Contains: Dispenser box with 200 individual packs of 2 pieces each.

950-635069 200/box **\$33.45**

Chap-Ice Mini Lip Balm Assortment - OraLabs, Inc.

Place display at the front desk for post-op dry lips and patient take-a-ways. Each mini stick weighs 3 grams. Assorted flavors.

792-840FB 100/pack..... **\$46.95**



Mouth Kote® Dry Mouth Spray - Parnell Pharmaceuticals Inc

The first and only dry mouth (xerostomia) product containing Yerba Santa in an exclusive, patented formulation. Also contains xylitol, which has been documented in scientific literature to prevent tooth decay. No sugar or alcohol, and has a pleasant lemon-lime flavor. It relieves dry mouth conditions caused by medications, disease, surgery, irradiation, Sjogren's Syndrome and aging.

880-09808 Each..... **\$16.95**



Spry Chewing Gum - Xlear

All natural, sweetened with Xylitol. Combines the tooth friendly properties of xylitol with a great taste that helps improve salivation and overall oral health. All natural ingredients that moisturize the mouth and strengthen tooth enamel.

Available in Peppermint, Spearmint, Fruit, Green Tea or Cinnamon.

Cinnamon

950-GC100 100ct **\$8.75**

Sample Dispenser

2-piece sample packs, assorted flavors.

950-GFM225 225ct **\$40.75**

Mints available upon request.

CHLORHEXIDINE GLUCONATE



**Peridex® Chlorhexidine Gluconate
0.12% Oral Rinse - 3M Oral Care**

Specially-formulated to help reduce gingival inflammation and bleeding and has more than 20 years of clinical proof. Herbal Mint flavor.

- 950-12134 4oz. \$5.45
- 950-PERIDEX 16oz. \$10.45
- 950-12133 64oz. \$30.95

**NUPRO Chlorhexidine
Gluconate 0.12% Oral Rinse
- Dentsply Professional**

Indicated for use between dental visits as part of a professional program for the treatment of gingivitis. Mint.

- 950-130059 16oz. \$8.75



**Paroex™
Chlorhexidine
Gluconate Oral
Rinse - Sunstar
Americas, Inc.**

The only FDA Approved Alcohol Free CHX rinse that is designed to be used as part of a professional program to treat gingivitis, leading to better gum health without the irritation of alcohol. Alcohol-free Chlorhexidine Gluconate Oral Rinse USP, 0.12% from GUM helps all your patients gain from their gingivitis treatment-without alcohol.

- 950-1788P 4oz. \$4.75
- 950-1789P 16oz. \$8.95



**Chlorhexidine Gluconate - Xttrium
Laboratories**

- Oral rinse 0.12%.
- 950-PET04 4oz. \$3.95
- 950-CHG 16oz. \$6.95

Order by ☎ 800-626-2163

DESENSITIZERS



Desensitizer with Fluoride

Desensitizing agent which eliminates post-op sensitivity and discomfort. It can be placed under dental cements and temporary, provisional and permanent restorative materials as well as amalgam. HEMA formulation to plug tubules. Glutaraldehyde based and contains fluoride. Compatible with all bonding systems, cements and amalgam. Helps kill bacteria.

- 220-10001 10ml \$40.95



**Hemaseal & Cide Desensitizer -
Advantage Dental Products**

Eliminates post-op sensitivity, precluding the need to do remakes. Superior disinfection of preparations. Enhanced and prolonged bond strength. Reduction of microleakage.

- 220-170 10ml \$87.95

Unidose available upon request.



**HurriSeal® - Beutlich® Pharmaceuticals,
LLC**

Acts as a wetting agent in bonding procedures. Treat or prevent dentinal hypersensitivity associated with: Cervical erosion/toothbrush abrasion, exposed root surfaces/recession, before and after tooth whitening procedures, after periodontal scaling and root planing treatment (applied after soft tissue healing), and permanent and temporary restorations. No mixing or light curing.

- 200-069782 12ml \$51.25



Zarosen® - Cetylite, Inc.

Provides immediate relief from hypersensitivity caused by thermal shock to exposed cementum or dentin from gum recession, erosion, post-prophy sensitivity, and/or tooth restorations. Instantly forms a hard protective film which protects, reduces acid diffusion from cement, minimizes marginal leaks, and acts as a thermal insulator.

- 200-0800 14gm \$45.25



Calm-it™ Desensitizer - Dentsply Caulk

A desensitizer that treats and prevents dentinal hypersensitivity immediately by creating cross-linked protein precipitates which form barriers within the dentinal tubules, greatly reducing painful fluid movement, a main cause of post operative sensitivity. A glutaraldehyde-based & resin-based formula meant to compete directly with Gluma.

- 228-61A002 6ml \$134.95

Unit Dose Refill

- 228-61A004 40/pack \$120.45



Seal & Protect™ - Dentsply Professional

Protective sealant for exposed dentin. Seals exposed dentinal tubules from the external environment, resists erosion and abrasion, reduces dentinal hypersensitivity fro up to 12 months.

Refill Package

Contains: 40 unit doses, 50 flocked applicator tips and 2 unit dose holders.

- 208-658010 Package \$114.25

DESENSITIZERS



Gluma® Desensitizer - Heraeus Kulzer

An ideal long-lasting desensitizing barrier under all types of restorative materials. Gluma can also be applied topically without a restoration to hypersensitive eroded areas using a simple one step procedure for long term treatment relief.

220-25142 5ml **\$145.45**

Clinic Pack

Contains: 3 -5ml bottles.

220-25143 Pack **\$378.25**

Single Dose Pack

Contains: 40 -0.075ml.

220-25131 Pack **\$101.75**

Gluma Power Gel

One-step gel formula desensitizer that allows for greater control and accuracy during application. Unique green-color indicator provides visual ease of placement and rinse-clean capability. Used with all bonding and restorative materials, in any situation. No-drip formula, so it stays where you place it, minimizing contact with soft tissues. No agitation or light curing required.

Gluma PowerGel Syringe Kit

Contains: 4 -1gm syringes and 20 cannulas.

220-66043451 Kit..... **\$159.95**

Brush Cannulas

230-66044334 60/pack **\$22.95**



Telio CS Desensitizer - Ivoclar Vivadent

Pre-treating and desensitizing exposed or cut dentin surface. To prevent and minimize dentinal hypersensitivity dentin surfaces can be treated prior to seating the temporary restoration. The desensitizing agent is suitable for the following fields of application: temporary restorations, luting/ cementation of indirect restorations, direct restorative treatment and treatment of sensitive tooth necks. Total working time of 10 seconds. No light-curing required.

Refill

220-627911 5gm **\$105.45**

Single Dose Unit Refill

Contains: 50 -0.1gm single doses.

220-627916 Each **\$107.95**



Teethmate™ Desensitizer - Kuraray America Inc.

A revolutionary new natural material designed to create the human body's hardest mineral, hydroxyapatite (HAp). It is created exactly where you need it, closing dentinal tubules and enamel cracks. And because it is natural, it is also tissue-friendly. So from now on, you can treat sensitivity with confidence. This can be used in a wide variety of treatment approaches for treating sensitivity: Exposed dentin (cervical hypersensitivity), scaling/root planing, before/ after bleaching and dentin prepared for prosthesis.

Contains: 6gm powder, 4.8ml liquid, 1 mixing dish, 1 measuring spoon, 50 superfine applicator brushes.

950-1210KA Package. **\$112.25**



Crest® Sensi-Stop™ Strips - Procter & Gamble

Thin, flexible strips that contain oxalate gel on one side. The unique strip is designed to cover the outer gumline of sensitive teeth. This gives the key ingredient time to form a lasting barrier that blocks dentinal tubules to help relieve sensitivity. Just 1 strip, applied for 10 minutes, can give patients up to 1month of protection against dentinal sensitivity.

950-80249760 6/box **\$13.45**



Shield Force Plus - Tokuyama Dental America, Inc.

Provides immediate relief from sensitivity, a strong coating layer for long-term relief and tough resistance to long-term reduction through abrasion and erosion. Green color provides accurate visibility of placement, then cures clear.

Kit

Contains: 3ml bottle, 25 disposable superfine applicators and dispensing well.

220-15111 Kit..... **\$118.95**

Refill

220-15121 3ml **\$96.25**



MicroPrime - Zest Dental Solutions

Eliminates post-op sensitivity and discomfort from cervical erosions. Proven HEMA formula which reliably desensitizes tubules.

MicroPrime B

220-87001 10ml **\$83.45**

MicroPrime G

Ideal as an antimicrobial when used with self-etch adhesives.

220-90814 10ml **\$83.45**

DISCLOSING AGENTS



HurriView® Plaque Indicating Snap-n-Go™ Swabs - Beutlich Pharmaceuticals, LLC

Highlights plaque in the mouth by staining it pink, making removal a snap. No messy rinses or tablets to chew, just unwrap, snap and apply.

950-01472 72/box..... **\$31.45**



GUM Red-Cote - Sunstar Americas, Inc

Highlights harmful plaque on tooth surfaces to show patient where more brushing and flossing are needed.

Tablets

950-800CQA 248/pkg **\$23.25**

DISCLOSING AGENTS



2Tone Disclosing Agent - Young Dental

A specialized multi-colored disclosing agent to increase patient compliance. Older plaque stains blue while newer plaque stains red.

Liquid

950-233102 2oz \$13.25

Unit Dose

950-233120 200/pack \$69.45

Tablets

950-234225 250/pack \$34.25



Trace Disclosing Agent - Young Dental

A dramatically red disclosing agent that stains plaque without a bitter aftertaste.

Tablets

950-232225 250/pack \$27.75

Liquid

950-231102 2oz \$27.75

Unit Dose Packs available upon request.

LOOK'in
for something? **WE HAVE IT!**
www.dhponline.com

FLOSS



Dental Floss

Nylon shred resistant floss.

Dental tape, 100 yds. 950-DFD
Mint waxed, 200 yds. 950-DFM
Unwaxed, 200 yds. 950-DFU
Waxed, 200 yds. 950-DFW
Each \$4.45

Patient Size - 12yd

Nylon shred resistant floss.

Mint Waxed 950-PDFM
Unwaxed 950-PDFU
Waxed 950-PDFW
Bubblegum 950-PDFB
72/box \$24.95



PTFE Floss

Teflon coated to slide easily into interproximal spaces.

Plain, 200m 950-10008
Mint, 200m 950-10007
Each \$5.95

Patient Size -10m

Plain 950-10006
Mint 950-10007
72/box \$45.95

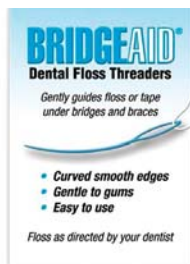

BRIDGE AID® Dental Floss Threader - FLOSSAID Corporation

Used for flossing under bridges and gums. Easy to thread and gentle to gums. Endorsed by oral hygienists worldwide. Precision molded with collapsible eye. 10 threaders/pkg.

950-FLTH 100/box \$39.75

Listerine & Reach Dental Floss - Johnson & Johnson

Floss products designed to address oral care needs and provide the clean mouth feeling you love.



Listerine Cool Mint

Cleaner, fresher mouth. Soft, woven floss gently cleans the gum-line. Polypropylene air-entangled multi-filament. Classic Clean. Waxed. 5yds. 950-44037 144/box \$46.95



Listerine Gentle Gum Care

Cushioned design for sensitive gums. Nylon textured multi-filament. Waxed. Cinnamon. 5yds. 950-44022 144/box \$46.95



Listerine Ultraclean

Shred resistant technology to stretch, flex and glide for an ultimate clean. Multi-rib mono-filament. Waxed. Mint.

950-44032 90yds \$3.95

5yds

950-44026 72/box \$21.45



REACH Floss

Twisted nylon floss for regularly spaced teeth. Air-entangled multi-filament. Waxed. 5yds.

Mint 950-9864
Plain 950-9863
144/box \$47.95

Mint 950-2733

Plain 950-2749
200yds \$3.75



REACH Dentotape

Plaque removal for wide spaced teeth. Unflavored. Waxed.

950-9221 100yds \$3.75

FLOSS

Oral-B® Glide Floss - Procter & Gamble

Slides up to 50% more easily in tight spaces for a superior clean at and below the gum line.



Glide Pro-Health Original

Silky smooth texture slides easily between teeth. Gently stimulates gums and helps prevent gingivitis. Light Wax coating.

4m
950-8483393 72/box **\$28.95**

15m
950-80271104 72/box **\$56.95**

200m - Font Refills
950-84843401 2/box **\$14.95**

200m - Vial Dispenser
950-84843402 Each..... **\$7.95**



Glide Pro-Health Deep Clean

Up to 90% more micro textured surface area than Glide Original. Light Wax coating. Cool Mint.

4m
950-84836592 72/box **\$28.95**

15m
950-84843404 72/box **\$56.95**



Glide Pro-Health Advanced

Clinically proven to help reverse gingivitis in 2 weeks as part of a comprehensive dental health routine. Tension control design allows floss to surround the tooth surface. Light Wax Coating. Fresh Mint.

15m
950-80282477 72/box **\$56.95**



Glide Threader Floss

For use in cleaning around fixed bridges, orthodontic appliances, and implants. One-piece floss with built-in threader tip inserts easily under appliances. Silky smooth texture slides easily between teeth. Great for operator tray set-ups. Reduces risk of cross-contamination.

950-84843426 150/box **\$25.45**



Oral-B® Complete Satin Floss

Satin-like texture for comfortable flossing. Mint. **5.5yds**

950-84860307 144/box **\$57.95**

10yds
950-84860306 144/box **\$59.95**



Oral-B® Super Floss

Ideal for cleaning braces, bridges and wide gaps. Three unique components, a stiffened-end dental floss threader, spongy floss and regular floss, work together for maximum benefits. Allows flossing under appliances. Pre-measured strands.

Trial Pack - 10 Strands/box

Regular 950-13265221
Mint..... 950-13265220
100/box **\$99.95**

Office Pack - 50 Strands/box

Mint
950-84855870 **\$89.95**



ProxySoft Floss - ProxySoft Worldwide, Inc.

3-in-1

Everyday floss with built-in threader, brush and floss section all on one strand. Unflavored.

Trial Pack

Contains: 5 -27" pre-cut nylon strands.
950-685450648134 100/pkg..... **\$110.45**

Periodontal

Special-use floss that features a built-in ultra-stiff threader, floss and extra-thick brush section to clean large spaces between teeth that are caused by gum recession. Useful for every day care of periodontal disease, cleaning under bridges and around braces. Unflavored.

Trial Pack

Contains: 5 -27" pre-cut nylon strands.
950-685450648196 100/pkg..... **\$112.45**

ProxySoft Bridge & Implant Cleaners available upon request.



Floss Singles - Single Use Dental, Inc

Individually packaged mint waxed dental floss. 20" of floss in each package. Convenient, efficient and sanitary.

950-D180F 180/box **\$18.95**
950-B1200F 1200/bag..... **\$92.95**

GUM Dental Floss - Sunstar Americas, Inc.

Clinically proven products to make food and plaque removal as effortless as possible.



ButlerWeave

Patented interlaced weave construction is strong and virtually eliminates shredding. Thin, flat design allows floss to glide easily between tight spaces and helps to avoid gingival irritation. Spreadability covers like dental tape providing more surface area to clean teeth and carry away plaque.

Patient Size - 4yds

Mint Waxed 950-1815A
Waxed..... 950-1115A
Tutti Frutti Waxed..... 950-1415A
144/box **\$51.45**



EasyThread

Double-ended, threader sections are designed with the ideal stiffness to easily navigate around braces, bridges and implants without irritating the gums. Innovative, hygienic packaging reduces tangles and waste. Designed for patients with braces, bridges and implants.

Sample Packs

Contains: 50 envelopes per box, 5 strands per envelope.
950-3200D 2 boxes..... **\$85.95**



Dispenser - 5yds

950-3210D 6/box **\$25.75**

Continued

FLOSS

GUM Dental Floss continued.



Fine

Special "S" twist fibers give durability and spreadability to disrupt plaque deposits and carry them away. Helpful where teeth are tightly positioned.

4yds - Unwaxed

950-515A 144/box **\$47.75**

200yds - Unwaxed Mint

950-540RYB 6/box **\$46.45**



Expanding

Innovative floss that expands to thoroughly and gently remove plaque from between both tight spaces and wide gaps. Made of texturized nylon fibers that are soft and gentle on gingival tissue.

4yds

950-2030A 144/box **\$62.45**

32.8yds

950-2031 12/box **\$20.45**



Eez-Thru

Special PTFE floss slides easily between teeth and below the gumline for effective plaque removal.

Patient Size - 4yds

Plain 950-2010A

Mint 950-2014A

144/box **\$62.45**



Eez-Thru Floss Threaders

Helps patients to thread floss under bridges, between connected crowns and around orthodontic appliances. 5/envelope.

950-840P 100/box **\$34.45**

Order by ☎ **800-626-2163**

FLOSS ACCESSORIES



SafeDispense Floss Dispenser - Almore International, Inc

Provides easy single-handed dispensing of dental floss. Computer machined from aluminum stock, clear anodized, and can be sterilized by chemical vapor or steam. Holds up to 300 yards of waxed or unwaxed dental floss. Silver.

950-56100 Each **\$69.45**



FLOSSAID® Floss Holder - Flossaid

Holds floss securely for easier flossing.

950-FADFHW Each **\$2.95**



Plastic Floss Dispenser - Johnson & Johnson

Refillable floss dispenser, equipped with a short blade for customizable length.

950-2736 Each **\$5.95**



Floss Dispenser - Plasdent

Fits all 200 yard spools of dental floss. Beige.

950-207FSD Each **\$4.25**



GUM® Flossmate® Floss Handles - Sunstar Americas, Inc.

Helps patients insert floss between teeth. Longer, curved fingers have an angled design that allows for easy access to posterior teeth.

950-845P 12/pkg **\$26.75**

FLOSSERS

Flossers
Single-use flosser and gum stimulator combination. Effectively removes plaque between teeth. Unwaxed nylon fiber.
950-10009 20 - 25/pkg **\$29.95**



Floss and Toss Flossers - 3M Oral Care

Tough, yet soft, floss is supported firmly in a flexible flosser with a convenient pick at the opposing end. 30 flossers/pkg.

950-12130 48/pack **\$89.95**



Comfort Clean - DenTek

Specially designed for tight teeth and sensitive gums. 3 picks/pkg.

950-01002 48/box **\$14.95**

950-01006 144/bag **\$36.95**



Comfort Clean Easy Angle

Combine premium floss with an improved angle to floss all teeth including those hard-to-reach back teeth. 3 picks/pkg.

950-01003 48/box **\$14.95**

950-01007 144/bag **\$38.95**

Continued

FLOSSERS

Den Tek Flossers continued.



Triple Clean

The mint waxed floss effectively removes plaque, the unique tongue scraper freshens breath, and the textured pick removes food and stimulates gums. 3 picks/pkg.

950-01001 48/box **\$14.95**
 950-01005 144/bag **\$36.95**



Fun Flossers for Kids

Encourage healthy oral hygiene habits at an early age. Ergonomically designed to comfortably fit into kid's or parent's hands, easily reaching all teeth. 3 flossers/pkg.

950-01004 48/box **\$14.95**
 950-01008 144/bag **\$42.25**



Listerine® Ultra Clean Access™ Flosser - Johnson & Johnson

Toothbrush style handle makes flossing as easy as brushing. Comes with 4 replacement heads.

950-44028 48/box **\$44.95**

Replacement Head Refills - Mint

950-44019 28/pack **\$4.95**



Wild Flossers™ - Johnson & Johnson

Easy to hold and maneuver, makes flossing fun. Unique dinosaur shapes in yellow, green, orange and purple colors.

950-2755 144/dispenser **\$44.95**



Platypus Orthodontic Flossers - Platypus Co.

Easy and effective orthodontic flosser with unique design which increases patient compliance.

950-T130 30/bag **\$5.95**

Sample Box

3 flossers/pkg. 75/box **\$49.95**



Plackers® Gentle Fine Flossers - Ranir, LLC

Made with Super Tuffloss, revolutionary, patented, high performance dental floss that's engineered not to stretch, shred or break during use.

Singles
 950-135999 1000/pkg..... **\$89.25**

10-Pack
 950-135009 144 packs/box **\$116.45**



GUM® Eez-Thru® Flossers - Sunstar Americas, Inc.

Special floss slides easily between teeth without shredding, breaking or sagging. Easy-grip handle with thumb pad creates better control, while the long handle and angled neck allows easier access to posterior teeth. 3/pkg, Mint flavored.

950-891PA 48/box **\$16.95**

With Fluoride and Vitamin E

950-888P 48/box **\$16.95**



Angled Flosser

Angled design effectively reaches back teeth to remove plaque from hard-to-reach places.

950-898P 48/pack **\$16.95**



GUM® Crayola Children's Flossers - Sunstar Americas, Inc.

Colorful crayon shapes kids recognize and love. Easy to hold in kid-sized hands. 3 flossers/pkg.

950-895PY 48/box **\$17.95**

FLOSSERS - INTERDENTAL CLEANERS



Interproximal Brushes

Our interproximal brushes are made with soft nylon bristles on coated wire for patient comfort. They have a flexible handle with cap and are individually wrapped.

Blue (Cylinder)..... 950-10015
 Green (Tapered) 950-10016
 72/box **\$29.95**



Pick-A-Dent - Denticator Inc.

Flexible, reusable plastic toothpick. Excellent for removing food particles and interdental plaque. Unbreakable and can be sterilized by boiling. Handy pouch makes it ideal for travel.

950-111 36/pkg **\$18.45**



Tip-A-Dent

Compact interproximal brush and gum stimulator. Helps control bacterial plaque and remove food particles. Tips snap on/off for easy replacement. Pouch makes it ideal for travel.

950-11636 36/pkg **\$91.25**

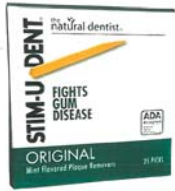

Stim-U-Dent® Plaque Removers - Emerson Healthcare, LLC

Made of soft, porous basswood. Clinically shown to reverse severity of gingivitis with daily use. Unique flat-bottomed wedge shape contours to fit comfortably into interproximal spaces. 25 cleaners per pack. Mint.

950-00005 144/pkg **\$44.95**



Oral-B® Interdental Brushes - Procter & Gamble

Provides effective cleaning around bridges, braces and wide interdental spaces. Using an angled head and brush refills, the interdental brush system helps you to keep your teeth clean and healthy.

Brush Handles

950-84861876 36/box **\$30.45**



Brush Refills

X-Fine Tapered - 2/pack

950-84861873 36/box **\$30.95**

Compact Tapered

Tapered.
950-84862518 36/box **\$30.95**

GUM® Proxabrush® System - Sunstar Americas, Inc.

All GUM Proxabrush refills now feature new triangular-shaped bristles that penetrate and remove up to 25% more plaque compared to conventional round bristles (in lab study). The bristles incorporate a patented antibacterial agent. For added comfort, a light nylon coating is applied to each brush to help prevent galvanic shock.



Handles

Single End 950-611P
Dual End 950-605P
12/box **\$12.75**



GUM® Proxabrush® Snap-Ons

Snap-Ons load directly from their dispenser, no fumbling with refill packaging or threading a tiny wire through a tiny hole. More comfortable handle with soft grip for better control.

Single End Starter Pack

Contains: 12 handles and 2 refills per package.
Cylindrical 950-627
Tapered 950-626
Pack **\$22.95**

Refills 2/pkg.

Cylindrical 950-622PA
Tapered 950-624PA
18/bag **\$15.95**

Ultra Fine Cylindrical 950-422C
Ultra Fine Tapered 950-424C
12/bag **\$18.45**

Single End Handle

950-625P 12/pkg **\$12.75**

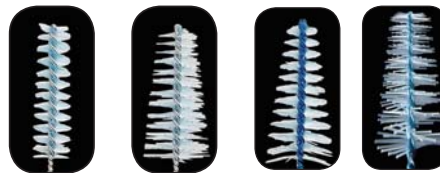

414PA 612PA 614PA 618PA

Proxabrush® Go Between Refills - 2/pack

Tight Tapered 950-414PA
Moderate Tapered 950-612PA
Wide Tapered 950-614PA
Ultra Wide Tapered 950-618PA
18/box **\$18.45**



GUM® Proxabrush® Go-Between® Tapered Cleaners

Better comfort, control and grip with flexible handle and cleans back teeth easily with bendable neck. Coated wire and antibacterial bristles on all sizes. 1 box contains 36 individually wrapped brushes.

Moderate 950-3612A
Tight 950-872PA
Ultra Tight 950-871PA
Wide 950-3614A
Variety 950-3615A
36/pkg **\$31.75**
Moderate 950-612BC
Wide 950-614BB
200/box **\$82.25**



GUM® Proxabrush® Go-Between® Angle Cleaners

Angled design is ideal for cleaning around bridges, crowns, orthodontics and other hard-to-reach spaces. Bristles incorporate a patented antibacterial agent. Nylon-coated for added comfort and to help prevent galvanic shock.

950-3014PYA 36/pkg **\$31.95**



GUM® Proxabrush® Go-Between® Ultra Cleaners

Easy access to both front and back teeth. The head easily pivots and snaps into place at 90 degrees to the handle for back teeth and in the direction of the handle for front teeth. Cylindrical brush head is made of nylon bristles and can reach into smaller spaces. Includes a protective case.

950-878P 36/pkg **\$40.95**



GUM® Proxabrush® Trav-Ler®

Ideal for patients with interproximal spaces, furcations and bridges, as well as for patients with orthodontic appliances or implants. Cylindrical 940-1612PN
Tapered 940-1614PN
36/pkg **\$35.75**



GUM® Soft-Picks - Sunstar Americas, Inc.

The only soft pick on the market today. Soft, flexible bristles, not hard wood or plastic. Tapered design to work with appliances such as bridges, pontics, implants and orthodontic appliances. Tissue friendly, more comfortable and effective than wooden or plastic picks. 5 picks/pack.

Original 950-632PYA
For Wider Spaces 950-634P
72/box **\$54.95**

FLOSSERS - INTERDENTAL CLEANERS



GUM® Soft-Picks Advanced- Sunstar Americas, Inc.

Flexible, comfortable bristles to gently remove plaque, dislodge food and massage gums. Flexible synthetic rubber bristles fit easily between most teeth. Curved design allows the pick to reach difficult back teeth. Longer handle gives an improved grip. 2 picks/pack.

950-650P 110/box..... **\$54.95**



GUM® Stimulator - Sunstar Americas, Inc.

Designed for gingival massage and interproximal cleaning.

Handle and Tip

940-600P 12/pkg **\$20.25**

Refill Tips

940-600PB 36/pkg **\$14.95**

FLOSSERS - POWER



Aquarius™ Professional Water Flosser (WP-660) - Water Pik, Inc.

Compact design includes on/off water control on the handle, an LED information panel and 7 water flosser tips. Pulse-modulation technology provides maximum plaque control in Floss Mode and enhanced gum stimulation and improved circulation in Hydro-Pulse Massage Mode. One minute timer with a 30 second pacer. 3 year warranty.

950-20018355 Each..... **\$57.25**



Classic Professional Water Flosser - Water Pik, Inc.

Six water pressure settings let you customize gentle-to-deep cleansing, while a spacious reservoir reduces the need for refills. Unique Pik Pocket Tip for gentle delivery of antimicrobials and special rinses below the gumline. 2 year warranty.

950-20018209 Each..... **\$38.75**



Cordless Professional Care Water Flosser + Nano Sonic Toothbrush - Water Pik, Inc.

Rechargeable and portable, perfect for smaller spaces and travel. Advanced dual water pressure control system allows you to personalize water pressure intensity. The Nano-Sonic Toothbrush features vibrating bristles that break up plaque and the high-low bristle pattern accesses plaque in hard to reach areas. 4 Tips included with 360-degree tip rotation. 2 year warranty.

950-20018255 Each..... **\$49.25**



Power Flosser - Water Pik, Inc.

Rechargeable flosser. Flexible nylon tip slips easily between teeth 10,000 strokes per minute flossing action.

Comes with 15 disposable replacement tips. Ergonomic handle. Includes 1 replaceable AA battery.

Model FLA-220

950-20007140 Each..... **\$7.95**

FLUORIDE FOAM



Kolorz Sixty Second Fluoride Foam - DMG America

Acidulated Phosphate formula contains 1.23% Fluoride ion. Smooth foam consistency for better patient acceptance. Contains Xylitol. Gluten free. 4.4oz can.

Triple Mint 950-766201

Cherry Cheesecake 950-766202

Cotton Candy 950-766203

Blue Raspberry 950-766204

2/pkg. **\$47.25**

Kolorz Neutral Fluoride Foam

Neutral pH formula contains 2% sodium fluoride. Smooth consistency. Contains Xylitol. Gluten free.

Triple Mint 950-766205

4.4oz **\$47.25**



PUFF™ Fluoride Foam - Pascal International, Inc.

Uptake equal to APF gel. Low pH of 3.75 promotes fast, effective uptake in one minute. Excellent interproximal coverage.

Cotton Candy 950-10300

Peppy Mint 950-10310

Verry Berry 950-10330

Wild Strawberry - Neutral 950-10350

7.4oz. pump **\$33.75**



PCxx® One Minute APF Foam - Ross Healthcare

1.23% fluoride Ion 3.8 pH. Approximately 120 applications/bottle. Non-aerosol foam is stable, does not continue to expand, giving you more working time and increased patient comfort with no spillage or leakage. Gluten free.

Cool Peppermint 950-FL210FMPT

Screamini' Strawberry 950-FL210FMST

Vanilla Orange 950-FL210FMVO

7.4oz. **\$32.75**

Additional flavors available upon request.

FLUORIDE FOAM



Topex® 60-Second™ APF Fluoride Foam - Sultan Healthcare

An effective 60 second fluoride treatment. The 1.23% acidulated phosphate fluoride 3.5 pH formula provides comfort and efficacy. Foam remains in tray even under bite pressure to eliminate patient gagging.

Bubble Fun.....	950-31152
Grape.....	950-31153
Orange Dream.....	950-31154
Spearmint.....	950-31151
Strawberry.....	950-31150
Mixed Berry - Neutral.....	950-31165
4.4oz.	\$40.75



Oral B® Minute-Foam® - Young Dental

1.23% APF Foaming Solution. Aspartame and Saccharin free. Contains Xylitol. Gluten free. Each bottle contains approximately 120 full mouth tray treatments.

BubbleGum.....	950-75074548
Mellow Mint.....	950-75074561
Orang-A-Tangy.....	950-75074563
Strawberry.....	950-75074567
5.8oz.	\$44.95



Oral B® Neutra-Foam® 2% Sodium Fluoride - Young Dental

Topical neutral fluoride foaming solution for patients with crowns, bridges, or complete restorations. Also for use in replacement of acidic-type fluorides for patients with reduced salivary flow or glass-filled resin sealants. Gluten free. Mint.

950-75074639	5.8oz.	\$44.95
--------------	-------------	----------------



Zooby Fluoride Foam - Young Dental

1.23% APF Fluoride Foam. Available in 6 great tasting foam flavors that match Zooby prophylaxis pastes. Patient friendly, dense formula that dispenses easily without mess.

Spearmint Safari.....	950-611001
Growlin' Grrrape.....	950-612001
Happy Hippo Cake.....	950-613001
Chocolate Chow.....	950-614001
Gator Gum.....	950-615001
Turtle Melon.....	950-616001
4.4oz.	\$33.95

FLUORIDE GEL



Patient's Choice Zap™ Fluoride Gels - Crosstex International

APF Gel with 1.23% Fluoride Ion. Flows easily and remains inside the tray for easier placement, assuring closer adherence to enamel and interproximal surfaces with minimal risk of ingestion. Contains Xylitol to enhance the effect of fluoridation and prevent new caries.

Bubble Gum.....	950-UFGABG
Cotton Candy.....	950-UFGACC
Mint-Dye Free.....	950-UFGADFM
Strawberry.....	950-UFGAS
16oz. bottle	\$17.75



Kolorz Sixty Second Fluoride Gel - DMG America

Acidulated Phosphate formula contains 1.23% Fluoride ion. Thixotropic, so it will not run under bite pressure. Contains Xylitol. Gluten free. 16oz. bottles.

Triple Mint.....	950-777301
Cherry Cheesecake.....	950-777302
Cotton Candy.....	950-777303
Blue Raspberry.....	950-777304
Piña Colada.....	950-777305
2/pkg.	\$41.75



NUPRO® Fluoride Gel - Dentsply Professional

Available in a 2% neutral sodium fluoride oral solution and a 1.23% acidulated phosphate fluoride topical gel for professional application as a fluoride treatment to aid in the protection against dental caries.

Acidulated Phosphate

Bubble Gum.....	950-13007201
Wild Cherry.....	950-13007001
12oz. bottle	\$35.25

Neutral Sodium

Mandarin Orange.....	950-13007401
Mint.....	950-13007601
Apple Cinnamon.....	950-13007801
12oz. bottle	\$35.25



Gelato Fluoride APF 60 Second Gels - Keystone Industries

60 second Acidulated Phosphate Fluoride Gel. Smooth and creamy fluoride gel contains 1.23% Fluoride Ion. Its thixotropic formula will not run; it thickens during treatment to prevent the patient from gagging.

Cherry.....	950-2408277
Strawberry.....	950-2403377
Grape.....	950-2401877
Bubble Gum.....	950-2408677
Mint.....	950-2400577
Orange Vanilla.....	950-2411077
Cotton Candy.....	950-2410177
Mango Smoothie.....	950-2410677
Marshmallow.....	950-2409977
Dye-Free Mint.....	950-2404477
16oz. bottle	\$20.25

Gelato Neutral pH Fluoride Gels

60 second acidulated phosphate fluoride that contains 2% fluoride ion. Smooth, creamy gel with no bitter aftertaste.

Strawberry.....	950-2401677
Bubble Gum.....	950-2401777
16oz. bottle	\$23.75

Additional flavors available upon request.

FLUORIDE GEL



60 Second Taste® Fluoride Gel - Pascal International, Inc.

Acidulated phosphate fluoride formula. Contains 1.23% fluoride ion at pH 3.5. Unique flow-set characteristics allow the gel to flow easily during tray placement; yet thickens during treatment.

- Bubble Gum 950-10020
- Chocolate Vanilla Dye-Free 950-10021
- Groovy Grape 950-10025
- Marshmallow Dye-Free 950-10027
- Mint 950-10030
- Strawberry 950-10040
- Orange Twist 950-10022
- 16oz. bottle **\$23.25**



PCxx® One Minute APF Gel - Ross Healthcare, Inc.

1.23% fluoride ion. 3.5 pH. Approximately 80 applications per bottle. One minute application.

- Banana Berry 950-PCXXBB
- Bazooka Bubble Gum 950-PCXXPB
- Cool Peppermint 950-PCXXPM
- Grape Explosion 950-PCXXGR
- Marshmallow Float 950-PCXXCM
- Raspberry Blast 950-PCXXRB
- Screamin' Strawberry 950-PCXXSB
- Vanilla Orange 950-PCXXVO
- Watermelon Splash 950-PCXXWM
- Wild Cherry 950-PCXXCH
- 16.6oz. bottle **\$16.95**

PCxx® Neutral Gel

- Neutral pH, 2% Sodium Fluoride Topical Gel.
- Creme de Menthe 950-FL500NMT
- Raspberry Blast 950-FL500NRS
- Vanilla Orange 950-FL500NVO
- Watermelon Splash 950-FL500NWT
- 16.6oz. bottle **\$16.95**

Additional flavors available upon request.



Topex® 60-Second APF Gel - Sultan Healthcare

Thixotropic formula liquifies when tray is placed on teeth and returns to gel once the tray is seated, reducing gagging and ingestion. 60 second application. Enhances fluoride uptake in the enamel.

- Cherry 950-31111
- Mint 950-31112
- Orange Cream 950-31117
- 16oz. bottle **\$30.45**



Topex® Neutral pH™ 2% Neutral Sodium Office Topical

2% Sodium Fluoride, ideal for patients with cosmetic restorations or intolerance to acidic fluoride. Four minute application for optimal fluoride uptake.

- Mint 950-31130
- 16oz. bottle **\$34.95**



Zooby Perfect Choice® 1.23% APF Gel - Young Dental

One minute application, delivers 1.23% fluoride ion to tooth enamel.

- Happy Hippo Cake 950-APF203MM
- Growlin' Grrrape 950-APF204JG
- Striped Peppermint Stick 950-APF205PS
- Gator Gum 950-APF206PB
- Tickled Pink Strawberry 950-APF208SD
- Roarin' Vanilla Orange 950-APF209VO
- Turtle Melon 950-APF210WW
- 17.5oz. bottle **\$34.75**

FLUORIDE - HOME CARE



OMNI Gel™ - 3M Oral Care

0.4% Stannous Fluoride brush-on gel. For patients who prefer a brush-on fluoride treatment. Reduces caries, enhances remineralization. Protects from decalcification for ortho patients. Mint.

- 950-12106M 4.3oz Tube **\$8.75**



Just For Kids™ - 3M Oral Care

0.4% Stannous Fluoride Brush-on gel. Designed for young, caries prone patients.

- Bubble Gum 950-12107B
- Grapey Grape 950-12107G
- 4.3oz Tube **\$8.75**



Act® Anticavity Fluoride Treatment Rinse - Chattem, Inc

Reduces root caries up to 71% more than brushing with fluoride dentifrice alone. Daily use can reverse active carious lesions by 38%. ACT for children reduces coronal caries up to 40%. Reduces white spot lesions during orthodontic therapy. Alcohol free. 1oz.

- Bubble Gum 950-9406
- Mint 950-9420
- Strawberry 950-004505
- 48/case **\$28.95**



Alpha-Dent Home Care Fluoride Gel - Dental Technologies

Ideal product for those patients suffering from sensitivity caused from tooth whitening procedures. Intended for home use by simply brushing on and rinsing. It provides the benefits of stannous fluoride, inhibits plaque growth, helps eliminate hypersensitivity, and aids in the prevention of dental caries. Reduces the possibility of de-calcification and band marks for orthodontic patients. 4.3oz. tubes.

- Bubble Gum 950-462003
- Mint 950-461001
- Strawberry 950-464007
- 12/box **\$64.95**

FLUORIDE - HOME CARE



GC Dry Mouth Gel - GC America

Designed to ease the symptoms of dry mouth for patients who may be suffering from impaired production of saliva due to medications, radiation treatment or diseases that can damage the salivary glands. Sugar free.

Contains: 10 -40gm tubes; two each flavor of Fruit Salad, Lemon, Mint, Orange and Raspberry.
950-002526 Each..... **\$76.95**



MI Paste - GC America

Contains Recaldent (CCP-ACP). Binds calcium and phosphate to tooth surfaces, plaque and surrounding soft tissue. The Recaldent (CCP-ACP) technology releases the calcium and phosphate when a patient's saliva is acid challenged by the normal digestive process. Indicated for post-bleaching sensitivity, root planing and scaling, as well as during prophylaxis. Water based, sugar-free paste. 40gm tubes.

MI Paste

Assorted 950-002265
Mint..... 950-003679
Strawberry 950-004505
10/pack **\$158.75**

MI Paste Plus

Contains fluoride.

Assorted 950-002614
Mint..... 950-002621
Strawberry 950-002886
Vanilla 950-002888
10/pack **\$158.75**



NeutraGard® Advanced Gel - Pascal International, Inc.

1% neutral sodium fluoride. Indicated for adults and children over 6 years old. Non-staining formula perfect for patients with recurrent decay around restorations and for those at risk for root caries.

Wintermint 950-11710
Mixed Berry..... 950-11713
2oz. **\$10.25**

Order by ☎ 800-626-2163



NeutraGard® Gel - Pascal International, Inc.

1.1% neutral sodium fluoride. Brush-on gel for home use. Neutral pH makes it safe on porcelain crowns, bridges and composite restorations. Use once a day to increase enamel resistance to acid dissolution for caries reductions.

Mint 950-11715
Tropical Blast 950-11718
2oz. **\$8.45**



Enamelon® Preventive Treatment Gel - Premier® Dental

Exclusive formula combines stabilized stannous fluoride with ACP technology. Helps to prevent caries, gingivitis and treat sensitivity. Features Ultramulsion, a patented saliva-soluble coating that moisturizes and soothes oral soft tissues. Great tasting mint flavor, no Sodium Lauryl Sulfate (SLS), abrasive-free, gluten-free and dye-free. Clean Mint.

950-9007285 4oz. tube **\$12.25**



Topex® Take Home Care® 0.4% Stannous Fluoride Gel - Sultan Healthcare

Reduces sensitivity and plaque biofilm, while inhibiting cariogenic microbial process. Thick, clear gel can be easily applied using a toothbrush or fluoride tray. No food or drink restrictions after application. Alcohol free with no color additives. Contains: 4.3oz. tubes.

Bubble Gum 950-30210
Berry 950-30211
Mint..... 950-30212
12/box **\$116.45**

☎ www.dhponline.com



Oral-B® Neutra-Care® Home Treatment 1.1% Sodium Fluoride - Young Dental

A fluoride home treatment for patients with crowns, bridges, or composite restorations. Safe to use in place of acidic-type gels for patients with reduced salivary flow, glass filled sealants, orthodontics or high caries susceptibility.

950-75074570 2oz **\$7.45**

FLUORIDE RINSE



PerioMed® Oral Rinse - 3M Oral Care

0.63% Stannous Fluoride provides antimicrobial activity for up to 8 hours. Helps inhibit plaque build-up, prevent demineralization, and reduce gingival inflammation.

Mint..... 950-12105SM
2.75oz 24/case **\$136.95**

Mint..... 950-12105M
Tropical Fruit 950-12105F
10oz. **\$9.95**



NUPRO® Fluoride Rinse - Dentsply Professional

2% neutral sodium fluoride. In-office fluoride delivery system that is an alternative to fluoride tray delivery systems, yet offers the clinician the convenience of a ready-to-use rinse. Safe for patients with porcelain, composite restorations, sealants and xerostomia. Pump included.

Tropical 950-130034
Mint 950-130036
Berry Cherry 950-130038
Peach 950-130040
64oz. **\$59.25**

☎ Fax: 888-681-5088

FLUORIDE RINSE



60:60 Rinse® - Pascal International, Inc.

Two-part system of stannous fluoride and APF solution. Metered pumps measure and dispense the two parts into the supplied mixing vial. Kit contains sufficient solution for 256 patient treatments. Combines the benefits of stannous fluoride and APF in one quick and easy treatment. Precludes the need for gel trays - patient simply swishes and expectorates.

Kit
 Contains: 4 -64oz. Part A (APF Solution), 64oz Part B (Stannous Fluoride), 2 metered pump dispensers and 1 graduated mixing vial.

Bubble Gum..... 950-11360
 Mint..... 950-11400
 Kit **\$196.75**

Part A - APF Solution

Bubblegum 950-11415
 Mint..... 950-11420
 64oz. **\$63.45**

Part B - Stannous Fluoride

Bubblegum 950-11416
 Mint..... 950-11421
 64oz. **\$143.25**

Pump

Part A..... 950-65601
 Part B..... 950-65602
 64oz. **\$9.75**



PCxx® Neutral Fluoride Rinse - Ross Healthcare

2.0% Sodium Fluoride in a single bottle; no mixing! Compatible with composite and porcelain dental work. Added protection for patients at risk of tooth decay.

Cool Peppermint..... 950-FLOFCNMT
 Screamin' Strawberry..... 950-FLOFCNST
 Grape Explosion..... 950-FLOFCNGR
 64oz. **\$89.95**

FLUORIDE TRAYS



Fluoride Trays

An anatomically enhanced tray for greater fluoride coverage and patient fit. Rigid, yet flexible enough to adapt to the contour of all arches and teeth. Trays are color-coded for easier size identification. The dual arch tray features a unique hinge design for extra convenience in "folding over" the tray.

Single Arch

50 lowers, 50 uppers
 Small - Yellow950-10050
 Medium - White950-10051
 Large - Blue950-10052
 100/bag **\$17.45**

Dual Arch

Child - Green.....950-10053
 Small - Yellow950-10054
 Medium - White950-10055
 Large - Blue950-10056
 100/bag **\$40.95**



Discovery Trays - Kerr TotalCare

Patented disposable trays for topical fluoride application are designed for greater patient fit and comfort. The foam matrix ensures total fluoride coverage to all tooth surfaces without a separate insert and the tray construction permits simultaneous fluoride application to both maxillary and mandibular arches. The Dual Foam ability provides a harder outer shell bonded to a closed cell soft lining that pumps fluoride interproximally during mastication.

Child - Aqua 959-16188
 Small - Yellow 959-16189
 Medium - Lime 959-16190
 Large - Blue 959-16191
 100/pkg. **\$151.25**



Topex® Dual Arch Fluoride Trays - Sultan Healthcare

Interlocking handles for easy placement and removal. Contoured shape creates a distal lock. Anatomically correct for comfort and interproxi-

mal placement of fluoride. Fill-lines offer guide to help eliminate over-fill and waste. Color-coded for convenience.

Pedo - Aqua 950-32010
 Small - Yellow 950-32011
 Medium - White 950-32012
 Large - Blue 950-32013
 50/pkg **\$43.95**



Topex® Single-Arch Fluoride Trays - Sultan Healthcare

Detailed occlusal anatomy on the biting surface, which forces gel to contact interproximal regions for total vertical coverage. Color coded with arch ID. Deep distal dam, prevents fluoride overflow, eliminates gagging and ingestion.

Small 950-32101
 Medium 950-32102
 Large 950-32103
 100/pkg. **\$37.95**



Oral-B® Centrasys® - Young Dental

Disposable single arch applicator trays used for fluoride treatment applications. Naturally contoured fit, deep distal dam and high walls inhibit overflow, stable foam design keeps fluoride in the tray and moisture out. Anatomical contours force fluoride into contact with all tooth surfaces. Closed-cell foam prevents fluoride absorption.

Small..... 950-13226939
 Medium..... 950-13226940
 Large 950-13226941
 100/bag **\$35.75**



Oral-B® Centwins® - Young Dental

Stable, non-flimsy foam design keeps fluoride in the tray and moisture out. Deep distal dam and high walls improve patient comfort and inhibit overflow. Anatomical contours force fluoride into contact with all tooth surfaces. Closed cell foam precludes fluoride absorption into the tray. Rounded arch and smooth ridge provide natural fit and comfort. Hide-a-hinge folds out of the way to help prevent gag reflex.

Small..... 950-13226936
 Medium..... 950-13226937
 Large 950-13226938
 50/bag **\$42.45**

FLUORIDE VARNISH



Fluoride Varnish

Clear 5 % sodium fluoride varnish in a convenient single-dose package. Each unit contains 0.5ml fluoride varnish with a microapplicator.

Mint	950-10070	
Melon	950-10071	
50/box		\$61.95
Mint	950-10080	
Melon	950-10081	
200/box		\$204.95



CavityShield® - 3M Oral Care

Unit-dosed 5% neutral sodium fluoride varnish. The unit-dose feature provides the ability to mix fluoride varnish, which naturally settles, prior to application.

Unit Dose - 0.25ml

950-12142	32/pkg	\$39.95
950-12140	200/pkg	\$189.95

Unit Dose - 0.40ml

950-12143	32/pkg	\$45.95
950-12141	200/pkg	\$219.95



Vanish 5% Sodium Fluoride White Varnish with TCP - 3M Oral Care

Tri-Calcium Phosphate (TCP) is a proprietary formula that contains fluoride, calcium and phosphate—components naturally found in saliva. It delivers targeted and sustained fluoride and calcium release. Flows better and reaches areas traditional varnishes may miss. Relieves hypersensitivity. 0.5ml unit dose packets.

Trial Pack

Cherry.....	950-12149C	
Melon.....	950-12149L	
Mint.....	950-12149M	
50/pkg		\$127.95

Standard Pack

Cherry.....	950-12150C	
Melon.....	950-12150L	
Mint.....	950-12150M	
100/pkg		\$212.75

Bulk Pack

Contains: 10 -100 unit dose packets, 100 applicator brushes, 2 patient pads and 108 dosage stickers.

Cherry.....	950-12151C	
Cherry & Melon.....	950-12151CL	
Melon.....	950-12151L	
Mint.....	950-12151M	
1000/pkg		\$219.95



Vanish XT Extended Contact Varnish

The 6 month protective barrier that immediately relieves sensitivity and provides a long-term release of fluoride, calcium and phosphate.

950-12148	10gm Clicker	\$214.95
-----------	--------------------	-----------------



FluoroDose Fluoride Varnish with Xylitol - Centrix

5% sodium fluoride. Dries in seconds upon contact with saliva. Remains on the tooth for 6-8 hours for optimum fluoride uptake. Contains Xylitol and Sucralose powder. Convenient single use Lollipack.

Unit Dose - 0.3ml

Mint.....	950-360086	
Bubble Gum.....	950-360087	
Melon.....	950-360107	
Caramel	950-360137	
120/pkg		\$139.75

Available in 600 and 1200ct upon request.



ProGuard™ 5% Sodium Fluoride Varnish - Crosstex International

Pleasant flavors, visually clear formula, easy and efficient application so patient's can resume normal activities immediately. Smooth consistency with good flow characteristics, aiding in the application of a thin layer to all surfaces, including hard-to-reach areas. High substantivity allows the fluoride to be retained on the tooth for optimal release.

Melon.....	950-UFVPML	
Mint.....	950-UFVPM	
50/box		\$107.75



Sparkle V 5% Sodium Fluoride Varnish with Xylitol - Crosstex International

Delivers maximum allowable fluoride dosage, with consistent fluoride level in every application. Dries to a natural tooth shade on contact. FDA approved for treating dentinal sensitivity. Gluten free.

Bubble Gum.....	950-UFVBG	
Mint.....	950-UFVM	
120/box		\$167.95



NUPRO® 5% Sodium Fluoride White Varnish - Dentsply Professional

Features a unique formulation with rapid fluoride release to aid in tubuleocclusion, can be applied to wet tooth surface and is uniquely formulated for no dripping or stringing so that clinicians can deliver comprehensive protection with ease.

Unit Dose - 0.25gm

Grape.....	950-130226	
Bubblegum.....	950-130221	
50/box		\$98.25

Unit Dose - 0.4gm

Grape.....	950-130210	
Raspberry.....	950-130213	
Bubblegum	950-130219	
Mint.....	950-130222	
50/box		\$103.75

Grape.....	950-130211	
Raspberry.....	950-130214	
Bubblegum	950-130219	
Mint.....	950-130223	
100/box		\$181.45

Grape.....	950-130212	
Raspberry.....	950-130215	
Bubblegum	950-130220	
Mint.....	950-130224	
500/box		\$773.25

FLUORIDE VARNISH



Kolorz ClearShield™ 5% Sodium Fluoride Varnish - DMG America

Goes on clear. Provides improved treatment acceptance and patient satisfaction. Does not create yellow discoloration on teeth. Contains no Saccharin or Aspartame. Gluten free, contains Xylitol and natural sweeteners. 0.40ml unit dose.

Watermelon	950-799501
Bubblegum	950-799503
Cookie Dough	950-799512
Mint	950-799506
Caramel	950-799516
35/pkg.	\$56.75
Watermelon	950-799502
Bubblegum	950-799504
Cookie Dough	950-799513
Mint	950-799507
Caramel	950-799517
200/pkg.	\$281.25



MI Varnish™ - GC America

Topical fluoride varnish with Calcium and Phosphate and contains NaF 5% in a fresh Strawberry Flavor, with Recaldent (CPP-ACP). It enhances enamel acid resistance and boosts salivary fluoride levels. Remains on the teeth longer than other fluoride varnishes with higher levels of fluoride and calcium released in the oral cavity. 0.5ml unit dose packages.

Mint	950-005265
Strawberry	950-004274
50/box	\$124.95



Duraflor® - Medicom®

In-office 5% sodium fluoride varnish. Ideal for hypersensitive patients. Fast and easy to use; sets in contact with saliva. Bubble Gum flavor, sweetened with Xylitol.

950-MO11011	10ml tube	\$30.95
-------------	-----------------	----------------

Unit Dose - 0.25ml

Bubble Gum	950-1011BG32
32/box	\$45.95
Bubble Gum	950-1011BG200
200/box	\$205.95

Unit Dose - 0.4ml

Raspberry	950-1011RB32
32/box	\$48.95

Raspberry	950-1011RB200
200/box	\$212.25



Duraflor® Halo 5% Sodium Fluoride White Varnish - Medicom®

Dries to a natural white tooth color. Pre-measured, "peel and apply" one-step package. Dries quickly on contact with saliva and has the highest allowable fluoride concentration (22,600 ppm F). Includes 0.5ml of varnish with disposable brushes.

Unit Dose - 0.5ml

Spearmint	950-1015SM32
Wild Berry	950-1015WB32
MelonMint	950-1015MM32
32/box	\$69.95

Available in 250/box upon request.



Enamel Pro® Varnish - Premier® Dental

5% NaF. Optimized to provide valuable tooth building ions of calcium and phosphate. Independent studies show the ACP formula delivers more enamel fluoride uptake and greater fluoride release than varnish with TCP. Gluten free.

Unit Dose - 0.25ml

Bubblegum	957-9007542
35/box	\$68.25

Unit Dose - 0.40ml

Bubblegum	957-9007541
Strawberries 'n Cream	957-9007540
VanillaMin	957-9007547
35/box	\$70.75

Bubblegum	957-9007544
Strawberries 'n Cream	957-9007543
VanillaMint	957-9007545
200/box	\$358.95



Vella Varnish - Preventech®

5% sodium fluoride varnish with Xylitol. Clear, thin layer formula applies easy, with no clumps, lumps or stringy mess. Quickly sets in saliva with great fluoride uptake at two hours. n-Hexane free.

Unit Dose - 0.5ml

Strawberry	950-770023
Spearmint	950-770013
Melon	950-770073
Bubblegum	950-770103
Caramel	950-770143
35/box	\$68.25

Strawberry	950-770043
Spearmint	950-770033
Melon	950-770083
Bubblegum	950-770113
Caramel	950-770143
100/box	\$171.75



Embrace™ Varnish - Pulpdent Corporation

5% Sodium Fluoride with CXP. Incorporates xylitol-coated calcium and phosphate in a permeable resin matrix that does not separate. No mixing required. Ensures predictable, uniform dose.

Unit Dose - 0.4ml

950-FV50	50/box	\$76.45
950-FV200	200/box	\$265.75

Available in 12ml tube upon request.



DuraShield 5% Sodium Fluoride Varnish - Sultan Healthcare

Desensitizing agent used to relieve hypersensitivity on areas of teeth where dentin or cementum is exposed, but can also be used to line amalgam cavity preparations. Sets on contact with saliva and remains on contact for up to eight hours for enhanced fluoride uptake. Bubble Fun Flavor. Sweetened with xylitol.

Unit Dose - 0.4ml

950-31101	32/box	\$69.75
950-31102	200/box	\$299.75

FLUORIDE VARNISH



DuraShield CV Varnish - Sultan Healthcare

5% sodium fluoride clear varnish. Colorless, no yellow discoloration following application. 2 hour wear and patient can return to normal eating 2 hours after application. Unique unit dose design. Thin application. Non-drip formulation. Applies smoothly and easily.

Unit Dose - 0.4ml

Watermelon 950-31103
 Strawberry 950-31104
 50/box **\$87.25**

Watermelon 950-31105
 Strawberry 950-31106
 200/box **\$291.95**



D-Lish® 5% Sodium Fluoride Varnish - Young Dental

Offers sensitivity relief and protection. Made with the highest varnish fluoride concentration available in a smooth, translucent formula. Single-dose packages are uniquely shaped for easy handling. Gluten free. Contains Xylitol.

Unit Dose - 0.4ml

Orchard Cherry 540-211450
 Spearmint Surprise..... 540-213450
 Fresh Melon 540-212450
 Vanilla Cupcake 540-214450
 Assorted 540-218450
 50/box **\$107.45**

Orchard Cherry 540-211420
 Spearmint Surprise..... 540-213420
 Fresh Melon 540-212420
 Vanilla Cupcake 540-214420
 Assorted 540-295484
 200/box **\$381.25**



Oral-B® 5% Sodium Fluoride Varnish - Young Dental

Treats hypersensitive dentin. Thin, smooth formula dries clearly and is easily applied to moist teeth. Contains Xylitol. Gluten free.

Strawberry 950-295097
 Bubble Gum 950-295100
 Mellow Mint 950-295103
 50/box **\$101.95**

Strawberry 950-295098
 Bubble Gum 950-295101
 Mellow Mint 950-295104
 100/box **\$180.95**

Available in 500/box upon request.



UltraThin Varnish - Water Pik, Inc.

5% sodium fluoride. Treats dental hypersensitivity and for use as a cavity liner. Dries Clear. Contains Xylitol.

Unit Dose - 0.4ml

Melon 950-20011179
 Bubblegum 950-20014133
 Strawberry 950-20014135
 Mint 950-20014137
 30/box **\$64.25**

Melon 950-20011180
 Bubblegum 950-20014134
 Strawberry 950-20014136
 Mint 950-20014138
 Variety Pack (25 each flavor) 950-20014139
 100/box **\$185.95**

MOUTHWASH / ORAL RINSE



Protexin® Mouthwash Concentrate - Cetylite, Inc.

Zinc chloride formula. Cleans the mouth of debris and ropy saliva leaving a fresh, long-lasting taste making for more perfect impressions. Can dispense a few drops directly into a chair-side cup of water or mix the entire 1oz bottle with water to create ready-to-use solution. Fresh Mint flavor.

Patient Sized - 0.4oz.

360-0304 6/pack **\$35.95**

Kit

3 -2oz. spray bottles and 1 -4oz. personal sized bottle.
 360-0321 Kit **\$54.25**

3 -1oz bottles, each makes 2 gallons

360-0307 Pack **\$22.75**



Protexin Breath Freshener Spray - Cetylite, Inc.

May be used to refresh taste and breath after operative procedures and offers fast convenient single-hand use. Can also be sprayed on x-ray holders, N20 nose pieces, rubber dam material, on dental appliances prior to insertion and on clinicians gloved fingertips. Mint.

360-0320 2oz. **\$20.95**



Listerine® - Johnson & Johnson

Shown in a clinical study to reduce 52% more plaque and 21% more gingivitis than brushing and flossing alone. The only nationally branded antimicrobial mouthwash to receive the ADA Seal of Acceptance for fighting plaque and gingivitis.

Original

360-70153 1.5 liter **\$7.25**
 360-42795 3.2oz. 24/case **\$21.95**
 360-42755 1.5 liter **\$6.95**
 360-42750 1 gallon with pump... **\$27.95**

FreshBurst

360-42855 1.5 liter **\$6.95**

Soft Mint

360-52155 1.5 liter **\$6.95**



Listerine® PocketPaks™ Oral Care Strips - Johnson & Johnson

Dissolve instantly to kill over 99.9% of bad breath germs in 30 seconds. Discreetly and quickly releases powerful Cool Mint Listerine germ-killing ingredients for fresh breath. Sugar free. No calories.

950-43310 24 strips/pack **\$2.95**

FLUORIDE VARNISH



Listerine® Smart Rinse - Johnson & Johnson

A post-brush rinse for kids which helps prevent cavities, kills bad breath germs and cleans by removing bacteria. Alcohol free with fluoride.

Mint Shield Avengers Assemble

950-11329 16.9oz \$5.45



Listerine® Total Care - Johnson & Johnson

Helps prevent cavities, restores minerals to enamel, strengthens teeth, kills bad breath germs, freshens breath, and fights unsightly plaque above the gum line. Fresh Mint.

3.2oz.

360-30695 24/case \$21.95

8oz.

360-94480 6/case \$15.75

1 Liter

360-30635 6/case \$30.45



Listerine® Total Care Zero - Johnson & Johnson

Zero alcohol and less intense choice with all the healthy mouth benefits of Listerine Total Care. Helps prevent cavities, restores enamel, and strengthens teeth. Kills bad breath germs and freshens breath. Mint.

3.2oz.

360-30668 24/case \$21.95

1 Liter

360-30671 6/case \$30.45



Listerine® Zero - Johnson & Johnson

A low intensity, alcohol-free mouthwash that provides a deep clean by killing germs that cause bad breath for a cleaner, fresher mouth. Contains signature 4 Essential Oils found in Listerine for a cleaner, fresher mouth. No other alcohol-free mouthwash has been proven more effective at killing bad breath germs.

3.2oz.

360-42830 24/case \$21.95

1.5 Liter

360-42834 Each \$6.95

Pump for 1.5 Liter

360-70809 Each \$2.75



Crest® PRO-HEALTH® Advanced Extra Deep Clean - Procter & Gamble

Gives you six benefits in one rinse, for a more complete way to get better dental checkups. It provides anticavity protection with fluoride, rebuilds teeth enamel, cleans teeth and gums, kills bad breath germs, freshens breath and has no burn of alcohol. Alcohol Free. Fresh Mint.

1 Liter

950-80272831 6/box \$24.95



Crest® PRO-HEALTH® Multi-Protection - Procter & Gamble

Formulated with CPC to provide 12-hour protection against plaque and gingivitis. It kills 99% of germs that cause plaque, gingivitis, and bad breath, without the burn of alcohol. The CPC remains in the mouth for long periods after use to inhibit bacterial growth, even with eating and drinking. Refreshing Clean Mint.

36ml

950-80276535 48/case \$24.95

1 Liter

950-94853262 6/case \$24.95



Crest® Scope® Classic - Procter & Gamble

A classic rinse that leaves your breath feeling clean, and you feeling confident enough to get close. Kills 99% of bad breath germs (in lab tests). Mint.

1 Liter

950-80279698 6/case \$19.95



CloSYS® Oral Rinse - Rowpar Pharmaceuticals

Kills 99.9% of the bacteria that cause bad breath. Gentle formula ideal for sensitive mouths. Original unflavored. Alcohol-free.

360-2C1612M 16oz. bottle \$8.25

360-2C3212M 32oz. bottle \$12.75



Biotene Dry Mouth Oral Rinse - GlaxoSmithKline

An adjusted pH level closer to neutral and a new combination of moisturizers, for optimal dry mouth symptom management.

360-00592 2oz \$2.95

360-00445 16oz \$8.75

MOUTHWASH / ORAL RINSE



GUM® PerioShield™ - Sunstar Americas, Inc.

A proprietary active ingredient (delmopinol 0.2%) breaks down plaque, making it easier to remove and also creates an invisible barrier that blocks plaque from forming on your teeth and gums. It is clinically proven to help reduce plaque build-up and bleeding gums by up to 36%.

950-1775P 10oz. bottle**\$10.25**

PIT & FISSURE SEALANT



Pit & Fissure Sealant

Used for sealing pits and fissures on posterior teeth to help in the prevention of caries. This light cure sealant is low viscosity, opaque material and easy to apply. Contains fluoride and is BPA free.

Contains: 4 -1.2ml syringes, 20 placement brushes, 20 -22ga. tips. Opaque.
950-10060 Each.....**\$31.95**



Clinpro™ Sealant - 3M Oral Care

Goes on pink for easy-to-see application, and cures to a natural white. Applied with our convenient ultra-fine syringe tip, its low viscosity formula flows easily into pits and fissures.

Introductory Kit Syringe

Contains: 2 - 1.2ml Clinpro sealant syringes, 3ml 3M ESPE Scotchbond etchant syringe, 20 sealant syringe tips (black) and 24 etchant syringe tips (blue).

953-12626 Kit.....**\$81.95**

Order by **800-626-2163**

Refill Syringe

Contains: 1.2ml Clinpro sealant syringe and 10 sealant syringe tips (black).

953-12627 Pack **\$25.75**

Refill Bottle

953-12622 6ml **\$81.95**

Dispensing Tips

953-12626T 10/pack..... **\$5.75**

Adper Prompt L-Pop Trial Kit

Ideal for pediatric sealant applications. Contains: 1.2ml Clinpro Sealant Syringe; 10 syringe tips (Black); 20 L-Pop Applicators.

953-12626TP Kit..... **\$78.95**



Delton® Pit & Fissure Sealants - Dentsply Professional

Light Cure. High wetting ability for maximum coverage and the low viscosity permits sealant to flow freely into pits and fissures to improve protection.

Regular Kit

Contains: 2 -2.7ml bottle of sealant, 7ml bottle of etchant, applicator with tubes and disposable mixing trays.

Clear 950-2796
Opaque..... 950-2797
Kit **\$146.45**



Delton® DDS

Direct Delivery System in unit dose cartridges. Unfilled, light cured, low viscosity sealant. Flows into deep pits and fissures. Brush tip cartridge provides easy application and works to thin the material for penetration into deep pits and fissures.

Refill Kit

Contains: 50 -0.8ml cartridges.
Clear 950-2695
Opaque..... 950-2696
Kit **\$150.45**



DELTON DDS Plus

38% filled, contains 2 sources of releasable fluoride. Single unit dose cartridges require no mixing or measuring and address infection control issues. Adjustable tip allows more accurate placement of sealant. Opaque.

Introductory Package available upon request.

Refill Kit

Includes: 50 -0.08ml cartridges of sealant.
950-2896 Kit..... **\$212.45**

Delton DDS Applicator

950-2000 Each..... **\$12.25**



Fluroshield Pit & Fissure Sealant - Dentsply Professional

VLC with fluoride. Preventive pit and fissure sealant that creates a combined chemical and mechanical bond to etched enamel when light cured.

Kit

Contains: 2 -5gm tubes, 40 disposable tips, 1 brush handle, 10ml bottle tooth conditioner and 1 transfer/mix pad.

Opaque White 958-643300
Tooth Color 958-643350
Kit **\$281.25**



Alpha-Dent LC Pit & Fissure Sealant - Dental Technologies

This hard-setting wear resistant material has an ideal flowable viscosity for maximum coverage and protection to seal pits and fissures of teeth susceptible to caries. The fluoride releasing, unfilled, resin-based material fights against recurring caries.

Liquid Etch Kit - Opaque

Contains: 2 -3ml sealant, 7ml liquid etch and dispensing pad.
220-191001 Kit..... **\$26.95**

PIT & FISSURE SEALANT



GC Fuji Triage™ - GC America

A simple-to-use glass ionomer sealant and surface protection material. The glass ionomer sealant coats and barricades pit and fissures from the oral environment with a self-bonding ion exchange and a high fluoride release to create a strong fused layer.

Starter Package

Contains: 50 -0.13ml capsules, 1 GC Cavity Conditioner, 1 GC Fuji Coat LC and 1 GC Caspule Applier III.

Pink	950-439990
White	950-439991
Package	\$287.75

Capsule Package

Contains: 50 -0.13ml capsules.

Pink	950-001946
White	950-002269
Package	\$236.75



Helioseal® - Ivoclar Vivadent

ADA accepted light-cured pit & fissure sealant. Provides long-term, effective caries protection in occlusal areas. White-shaded. Easy to check retention. Without fluoride, without fillers. Low viscosity.

Assortment Kit available upon request.

Liquid Refill

950-6170102	8ml	\$100.95
-------------	-----------	-----------------

Cannulas - Black

230-533669	20/pkg.	\$20.95
------------	--------------	----------------



Helioseal® Clear

Clear, transparent version of the sealant supplied in syringes. Without fluoride, without fillers, low viscosity. Changes under the sealant are easily detected.

Standard Pack

Contains: 5 -1.25gm syringes and 6gm enamel preparator.

950-558520	Pack	\$96.95
------------	------------	----------------

Syringe Refill

950-558521	1.25gm	\$21.75
------------	--------------	----------------



Helioseal® F

Fluoride releasing, supplied in syringes and cavifils. Pigmented. 40% filler content, higher viscosity, easy to check retention.

Standard Pack

Contains: 5 -1.25gm syringes and 6gm enamel preparator.

950-6558518	Pack	\$96.45
-------------	------------	----------------

Syringe Refill

950-558519	1.25gm	\$21.75
------------	--------------	----------------

Unit Dose

Contains: 50 -0.1gm Cavifils.

950-6170104	Each.....	\$113.75
-------------	-----------	-----------------

Cavifil Injector

230-627882	Each.....	\$45.25
------------	-----------	----------------



Seal-Rite™ Pit & Fissure Sealant - Pulpdent Corporation

Fluoride releasing, visible light-cured, radiopaque. Releases fluoride with an initial burst that is followed by a slow and sustained rate of fluoride ion release for many years.

Standard Kit

Includes: 4 - 1.2ml syringes and 8 applicator tips.

950-SEAL	Kit.....	\$63.95
----------	----------	----------------

Syringe Refill

950-SEAL3	3ml	\$35.95
-----------	-----------	----------------



Embrace™ Pit & Fissure Sealant - Pulpdent Corporation

Wet-bonding resin technology, bonds to moist tooth. Remarkable sealing ability and adaptation to tooth structure. Margin-free, no chipping, no

staining. No drying or bonding agents required. Releases and recharges phosphate and fluoride with long lasting antibacterial activity.

Kit

Contains: 4 -1.2ml syringes and 20 applicator tips.

Natural Shade	950-EMS
Off-White Shade	950-EMSW
Kit	\$87.25

Refills

Natural Shade	950-EMS3
Off White Shade	950-EMS3W
3ml	\$44.25

Bulk Packs

Contains: 20 -1.2ml syringes and 100 applicator tips.

Natural Shade	950-EMSB
Off White Shade	950-EMSWB
Pack	\$357.95

PROPHY ANGLES - AUTOCLAVABLE



Autoclavable Prophy Angle

Worry-free prophy angles at an economical price. Fits all standard handpieces.

Screw Type

280-10077	Each.....	\$13.95
-----------	-----------	----------------

Snap-On

280-10076	Each.....	\$13.95
-----------	-----------	----------------



Vantage Economy Autoclavable Prophy Angles - Integra® Miltex®

Gears and shaft are made of hardened stainless steel. Can be oiled without disassembling head. Phosphor bronze cup and head bearings.

Screw-On

961-7528	5/pkg	\$153.75
----------	-------------	-----------------

Snap-On

961-7530	5/pkg	\$148.75
----------	-------------	-----------------

PROPHY ANGLES - AUTOCLAVABLE



Young™ Care-Free® Autoclavable Propphy Angles - Young Dental

Easily maintained by wiping with a disinfectant before sterilizing. 1 year warranty when used exclusively with Young Cups and Brushes.

960-018005 5/pack **\$260.95**



Young™ TS2® Autoclavable Propphy Angles - Young Dental

Forms a patented seal to prevent fluids and abrasives from entering internal parts, allowing for consistent, long-lasting performance. Easily maintained with steam sterilization and lubricate only once every 40 prophies. 3 year warranty when used exclusively with Young Cups and Brushes.

960-013001 Each.....**\$166.95**

PROPHY ANGLES - DISPOSABLE



Disposable Propphy Angles

Synchronized gearing for smooth, vibration-free operation. Webbed cup for quick efficient cleaning. Fits all doriot-style slow speed handpieces. Available in soft gray or firm white cups.

Not made with natural rubber latex.

Standard Cup

Gray Soft Cup 970-522014
White Firm Cup 970-522114

Long Cup

Purple Soft..... 970-522414
Blue Firm 970-522514
144/pack **\$56.95**

Standard Cup - 500

Gray Soft 970-10001
White Firm 970-10002
500/pack **\$179.95**



Clinpro™ Propphy Angles - 3M Oral Care

Non-latex cups. Designed with input from dental hygienists for quality construction and performance. Soft Gray.

973-12600 144/box **\$98.95**



BeeSure 90° Right Angles - BeeSure

Fits all standard straight handpieces. Ribbed and webbed propphy cups. Unique gearing for smooth operation. Latex free. Made from 50% recycled plastic.

Regular Cup - White 970-BE601RA
Soft Cup - Green 970-BE602RA
100/box **\$23.45**



BeeSure 105° Steady Angles - BeeSure

Allows better access in hard to reach areas. Latex free and fit all standard size hand pieces. Made from 50% recycled plastic.

Regular Cup - White 970-BE605SA
Soft Cup - Green 970-BE606SA
100/box **\$26.95**



Sparkle Propphy Angles - Crosstex International

Dark colored soft cups for better contrast of teeth. Better cup flares for improved subgingival access. 100% Latex-Free Cups.

Soft Cup - Purple..... 970-TPASSC1
Firm Cup - White 970-TPASFC1
100/box **\$50.95**

Soft Cup - Purple..... 970-TPASSC5
Firm Cup - White 970-TPASFC5
500/box **\$299.95**

Tapered Brush
970-TPATBC1 100/box **\$71.75**



Twist Propphy Angles - Crosstex International

Unique, patented oscillating motion. Ideal for applying dental medicaments, and preparing teeth for etchants and bleaching procedures. Effective propphy angle brush for orthodontic cases - use on and in between brackets, wires and bands. Latex-Free.

Soft Cup 970-TPASC
Firm Cup 970-TPAFC
100/box **\$75.75**

Flat Brush 970-TPAFB
Tapered Brush 970-TPATB
100/box **\$102.95**



Brush Tip Propphy Angles - Denticator Inc.

Specially designed for hard-to-reach areas. Ideal for patients with orthodontic appliances and for removing stains in pit and fissures prior to sealants. Latex free.

Flat Brush
970-500514 144/pkg **\$142.45**

Tapered Brush
970-500572 72/pkg **\$83.45**



Denticolors Propphy Angles - Denticator Inc.

Smooth performance for maximum comfort with stylish colors. Individually wrapped. Superior torque, strength and reliability. Designed to fit all standard nose cones. Latex free. 4-webbed cup.

Assorted Colors - Soft Cup
970-502814 144/pkg **\$90.25**
970-502850 500/pkg **\$277.45**

PROPHY ANGLES - DISPOSABLE



Diamond Prophy Angles - Denticator Inc.

Patented prophy cup with exclusive diamond design that virtually eliminates past splatter. Longer and deeper prophy cup holds more paste, reducing the number of times the clinician interrupts polishing to re-apply.

- Soft Cup - Pink 970-337S
- Regular Cup - White 970-337
- 144/box **\$93.25**

- Soft Cup - Pink 970-337SB
- Regular Cup - White 970-337B
- 500/box **\$290.95**



Emerald™ Contra Disposable Prophy Angles - Denticator Inc.

Provides enhanced polishing benefits, Latex-Free cup featuring external ribbing for improved interproximal access and flare. 17-degree back-bend that facilitates a neutral wrist position and improved posterior access.

Gray Web Cup with Outer Ridges

- 970-580014 144/box **\$96.95**
- 970-580050 500/box **\$298.75**



Original Green Prophy Angles - Denticator Inc.

Smooth, efficient performance. Individually wrapped for maximum safety. Four-webbed cup. Latex-Free.

Original Green

- Soft Cup - Green 970-336S
- Regular Cup - White 970-336
- 144/box **\$90.25**

- Soft Cup - Green 970-336SB
- Regular Cup - White 970-336B
- 500/box **\$277.45**



NUPRO® Freedom® Prophy Angles - Dentsply Professional

Prophy angles designed to allow the hand and wrist to operate with less effort, leading to improved clinician comfort. Contra Spiral is ergonomic for improved comfort during polishing; Soft Cup is for light to moderate stain removal, Spiral has improved interproximal cleaning and splatter control, Firm is for heavy stain removal, Pedo is for small tooth polishing, Tapered Brush for removal of pit and fissure stain before sealant placement and the Pointed Tip is ideal for cleaning around orthodontic appliances.

Contra - Spiral Cup

- Lavender..... 970-965670
- Pink..... 970-965673
- 200/box **\$138.75**

Soft Cup

- Lavender..... 970-965750
- Pink..... 970-965752
- 200/box **\$128.25**

Firm Cup

- Lavender..... 970-965754
- Pink..... 970-965756
- 200/box **\$128.25**

Spiral Cup

- Lavender..... 970-965758
- Pink..... 970-965760
- 200/box **\$128.25**

Pedo Cup

- Lavender..... 970-965762
- Pink..... 970-965764
- 200/box **\$128.25**

Available in Econo 1200/box upon request.

Pointed Tip

- Lavender 970-965766
- Pink..... 970-965767
- 100/box **\$62.45**

Tapered Brush

- Lavender..... 970-965768
- Pink..... 970-965769
- 100/box **\$97.25**

Exclusively for use with the NUPRO® Cordless Prophy System.



NUPRO® revolv® Prophy Angles - Dentsply Professional

- Latex-free, soft cup disposable prophy angle.
- Tapered Brush 970-965259
- Pointed Tip 970-965258
- 100/box **\$100.25**

- Soft Cup 970-965250
- Firm Cup 970-965252
- Spiral Cup 970-965254
- Pedo Cup 970-965256
- 200/box **\$139.75**

- Soft Cup 970-965251
- Firm Cup 970-965253
- Spiral 970-965255
- 1200/box **\$780.95**

- Contra - Spiral Cup
- 970-965212 200/box **\$149.45**
- 970-965213 1200/box **\$830.45**



PerfectPearl™ Prophy Angles - Kerr TotalCare

Classic

Spiral grooves on the inside of the patented cup design holds the prophy paste and pushes it towards the tooth as the angle rotates, reducing splatter. Spiral grooves on the outside of the cup allow you to use both inside and outside of the cup to polish. Excellent visibility. Minimal vibration. Patented Hawe cup design.

Standard Cup

- Dark Blue 970-109510
- 200/box **\$145.45**

Soft Cup

- Dark Blue 970-109514
- 200/box **\$145.45**



Midnight

Stylish looks that offer a sleek black shell with pink, teal and purple stomp pad and cup options.

Standard Cup

- Blue..... 970-109514
- Purple..... 970-109517
- Pink..... 970-109518
- Teal..... 970-109519
- 200/box **\$145.45**

Soft Cup

- Pink..... 970-109522
- Purple 970-109521
- Teal..... 970-109523
- 200/box **\$145.45**

PROPHY ANGLES - DISPOSABLE



ProAngle® Ergo Contra Propy Angles - Pac-Dent International, Inc.

Allows hand and wrist to operate with less effort. Quiet operation. Produces less daily micro-traumas on hand and arm muscles. Latex free.

- Soft Green Cup 970-144
- Firm Purple Cup..... 970-188144
- 144/box **\$90.75**

- Soft Green Cup 970-168500
- Firm Purple Cup..... 970-188500
- 500/box **\$297.95**

Additional options available upon request.



2pro® Disposable Propy Angles - Premier® Dental

Cleans and polishes all tooth surfaces with its unique cup and tip design. Use the cup to polish all tooth surfaces. Remove the cup and use the tip for better access to gingival and proximal areas, occlusal surfaces, veneer margins, and around implants and orthodontic brackets. Latex-Free.

- Soft/Short Cup - Purple 970-5500101
- Firm/Short Cup - Blue 970-5500102
- Soft/Long Cup - White 970-5500103
- Firm/Long Cup - Green 970-5500104
- 144/bag **\$90.25**

Available in 1000/bag upon request.



esaprophy Angles - Preventech®

Extended straight attachment is 50% lighter than traditional connections, reducing hand and wrist fatigue. Connects quickly and easily to the handpiece motors listed below, reducing chatter and vibration for a smoother, quieter-running disposable prophy angle.

For Midwest Shorty and Midwest Rhino

- Soft Cup 970-330001
- Firm Cup 970-330002
- Soft Cup Non-Latex..... 970-330004
- 100/box **\$66.95**

- Soft Cup 970-3300117
- Firm Cup 970-3300127
- Soft Cup Non-Latex 970-3300147
- 1000/box **\$625.75**

For Star Titan

- Soft Cup 970-330011
- Firm Cup 970-330012
- Soft Cup Non-Latex 970-330014
- 100/box **\$67.95**



Pivot™ Disposable Propy Angles - Preventech®

Designed to fit all slow speed, doriot-style handpieces. Smooth and quiet.

Latex

- Firm Cup 970-110002
- Soft Cup 970-110001
- 144/box **\$75.95**

- Firm Cup 970-1100027
- Soft Cup 970-1100017
- 1200/box **\$541.95**

Latex Free

- Tapered Brush 970-110003
- Firm Cup 970-110005
- Soft Cup 970-110004
- 144/box **\$75.95**

- Firm Cup 970-1100057
- Soft Cup 970-1100047
- 1200/box **\$541.95**



Disposable Propy Angles - Propy Perfect

Individually packaged plastic disposable prophy angle available with either firm or soft prophy cups that are both ribbed and webbed. Assorted colors.

- Firm Cup 970-01002
- Soft Cup 970-01001
- 144/box **\$65.95**



Butler® Eez-Touch Propy Angles - Sunstar Americas, Inc.

Unique soft grip designed to provide greater control, reduce vibration and lessen hand and finger

fatigue. Dimpled housing makes applying and removing to hand piece faster and easier.

- Soft Cup 970-1201P
- Firm Cup 970-1202P
- 200/box **\$129.45**

- Tapered Brush 970-1203P
- 50/box **\$49.45**



GUM® Duropro Propy Angles - Sunstar Americas, Inc.

Individually wrapped, Latex-Free, textured, 4 web cup. Fits all slow speed, doriot-style handpieces.

- Firm Cup 970-1205P
- Soft Cup 970-1207P
- 200/box **\$113.25**

- Tapered Brush 970-1209P
- 50/box **\$44.75**



Upgrade® Propy Angles - Sultan Healthcare

Feature a patented compact, ergonomic design with a non-slip grip for enhanced tactile sensitivity. Beveled gears providing smooth vibration/chatter-free operation. It provides easier subgingival access and readily adapts to tooth contour with its exclusive non-latex, odor-free, splatter control prophy cup.

- Firm cup 970-30100
- Soft cup 970-30101
- 100/pkg. **\$68.75**

- Firm cup 970-30503
- Soft cup 970-30502
- 1200/pkg. **\$705.25**



Multi-Color Soft Cup

- 970-30106 100/pack **\$68.75**
- 970-30506 1200/pack **\$705.25**

PROPHY ANGLES - DISPOSABLE



Butler® Prophy Angles™ - Sunstar Americas, Inc.

Clean and polish without using paste. No need to refill the cup, no paste splatter, no mess. Better visibility during cleaning. Patient does not have to rinse. Easier cleanup between patients. Featuring ButlerBloom Contouring Cup designed to: clean and polish effectively interproximally, subgingivally and on all facial and lingual tooth surfaces. Adapts better to follow contours on all tooth surfaces.

Clean and Polish

970-1215P 50/box **\$44.95**
 970-1211P 200/box **\$178.95**

Polish

970-1217P 200/box **\$178.95**



Densco® Prophy Angles - Water Pik, Inc.

Designed for safety, durability, convenience and performance. Minimizes splatter and are designed for use on any doriot handpiece. Latex free.

Tapered Brush

Removes heavy stains from occlusal surfaces and interproximal spaces.

970-18175 100/box **\$107.45**

Soft Blue

For contoured cleaning and comfort.

970-18100 125/box **\$80.45**
 970-1810001M 1000/box **\$634.75**

Firm Yellow

Combination webbed and ribbed design for heavy stain.

970-18150 125/box **\$80.45**
 970-1815001M 1000/box **\$634.75**

Dynamo Green

Unique rib design to reduce splatter, webbed and ribbed design for heavy stain.

970-18125 125/box **\$80.45**
 970-1812501M 1000/box **\$634.75**

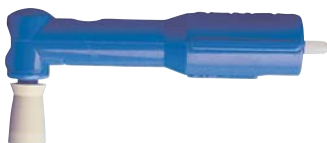

Classic Prophy Angles - Young Dental

Guaranteed to last through entire prophy. Ability to change cups and brushes. Lubricated for smooth and quiet operation. Individually wrapped and tested.

Classic Traditional Web

Gray Webbed Soft 970-131120
 Gray Turbo Soft 970-132120
 White Webbed Firm 970-131320
 White Turbo Firm 970-132320
 Purple Soft Latex Free 970-131620
 Blue Soft Latex Free 970-131720
 200/box **\$168.75**

Gray Webbed Soft 970-131112
 Gray Turbo Soft 970-132112
 White Webbed Firm 970-131312
 White Turbo Firm 970-132312
 Purple Soft Latex Free 970-131612
 1200/pkg. **\$900.25**

Classic Petite Web

Blue Firm Latex Free 970-134720
 Purple Soft Latex Free 970-134620
 200/box **\$168.75**
 Blue Firm Latex Free 970-134712
 Purple Soft Latex Free 970-134612
 1200/box **\$900.25**

Classic Junior

Gray Webbed Soft 970-131420
 Gray Webbed Firm 970-131520
 200/box **\$168.75**



Classic Pointed Polisher

Distinguishable pointed tip with outer ridges that work similarly to a brush, designed for heavy stain removal but is more gentle on gums than a brush. The flexible tip provides better access for orthodontic cleanings under the wires and around brackets.

970-137710 100/pkg **\$95.95**



Contra Prophy Angles - Young Dental Contra Turbo Plus

Features the Turbo Plus Cup designed to follow the natural contours of the teeth for maximum surface contact, minimal splatter and effective stain removal.

Latex

Gray Soft 970-153120
 White Firm 970-153320
 200/pkg. **\$176.75**

Latex Free

Purple Soft 970-153620
 Blue Firm 970-153720
 200/pkg. **\$176.75**

Available in 1200/pkg upon request.

Contra Petite Web

Designed to flex and flare around tooth contours to expertly remove biofilm. Latex free.

Blue Firm 970-154720
 Purple Soft 970-154620
 200/box **\$176.75**

Blue Firm 970-154712
 Purple Soft 970-154612
 1200/box **\$921.45**



Elite Series Prophy Angles - Young Dental

Designed to provide exceptional stain removal, allow better interproximal cleaning, and reduce splatter. Ribbed exterior. All Elite cups are soft, petite, and Latex-Free.

Classic Elite Original

970-135620 200/pkg. **\$168.75**
 970-135612 1200/pkg **\$900.25**

Contra Elite Original

970-155620 200/pkg. **\$176.75**
 970-155612 1200/pkg **\$921.45**



Classic Elite Flex

Contra Elite Flex

Elite Flex Prophy Angles - Young Dental

25% softer and more flexible than the original Elite cup. Its enhanced softness is optimal for improved flair and flexibility. Great benefits of interproximal stain removal and exceptional splatter control with the Elite's exterior and interior spiral ridge design. The Elite Extend Flex prophy cup is 19% longer than the Elite Original and the Elite Flex.

Classic Elite Flex - Soft Short

970-138920 200/pkg. **\$168.75**
 970-138912 1200/pkg **\$900.25**

Contra Elite Flex - Soft Short

970-156820 200/pkg. **\$176.75**
 970-156812 1200/pkg **\$921.45**

Classic Elite Extend Flex - Soft Long

970-139020 200/pkg. **\$168.75**
 970-139012 1200/pkg **\$900.25**

PROPHY ANGLES - DISPOSABLE



Oral-B® SUPA® Prophyl Angles - Young Dental

Latex-free single use DPA with a slender shank and low profile cup designed for easy access and visibility to enter proximal surfaces, gingival margins and posterior areas. Easy flaring soft webbed or improved soft Performax cups. Smooth, quiet operation due to lubricated drive components, which reduce vibration and noise.

Soft Performax Cup..... 970-13226221
Soft Webbed Cup 970-13225055
100/bag **\$52.45**

SUPA Slim

Designed without any unnecessary bulk, making it one of the smallest disposable prophyl angles.

Soft Four-Webbed Cup..... 970-295330
Soft Exterior Ribbed Cup..... 970-295332
110/bag **\$81.95**



Vera Prophyl Angles - Young Dental

Eases maneuverability and access during polishing with its compact head and slim neck design. Enhanced grip features. Latex free.

Classic Elite Original

Features the Elite Classic Cup which has external ridges for advanced stain removal and minimal splatter

970-121025 25/pkg. **\$110.75**
970-121075 750/pkg. **\$658.75**

Classic Petite Web - Soft Short

Features the Petite Web Cup designed to flex and flare around the tooth contours to expertly remove biofilm.

970-120025 125/pkg..... **\$121.25**
970-120075 750/pkg. **\$658.75**

Contra Elite Original - Soft Short

17° back bend for reduced wrist strain. Features the Elite Original Cup which has external ridges for advanced stain removal and minimal splatter.

970-161025 125/pkg **\$121.25**
970-161075 750/pkg **\$658.75**

Contra Petite Web - Soft Short

17° back bend for reduced wrist strain. Features the Petite Web Cup designed to flex and flare around tooth contours to expertly remove biofilm.

970-160025 125/pkg **\$121.25**
970-160075 750/pkg **\$658.75**



Zooby™ Prophyl Angles - Young Dental

5 fun animal characters with a soft web, Latex-Free cup. Fits all slow speed handpieces.

970-575010 100/box **\$71.25**
970-575050 500/box **\$319.25**

PROPHY ANGLES - STERILE



Sterile Mini Prophyl Angles - Pac-Dent International, Inc.

Gamma radiated for patient safety, reducing the risk of infection. Under independent lab testing, the surface was shown to be completely free of pathogens. Small powerful head and slim profile for increased visibility and improved access. 100% Latex free.

Sterile Mini 90™ - 90° Angle

Gray Soft Cup - Turquoise 970-S16390144
Gray Pedo Cup - Turquoise 970-S16590144
White Firm Cup - Champagne. 970-S16490144
144/pack **\$104.95**

Sterile Mini Ergo™ - Contra Angle

Gray Soft Cup - Turquoise 970-S163144
Gray Pedo Cup - Turquoise 970-S165144
White Firm Cup - Champagne. 970-S164144
144/pack **\$104.95**

Available in 500/pack upon request.

PROPHY BRUSHES



Disposable Prophyl Brushes - Dentamerica Inc.

For cleaning interproximally and gingival areas. High elasticity with head protection.

Latch Prophyl Brush..... 980-415
Screw Prophyl Brush..... 980-416
144/box **\$41.75**



Prophy Brushes - Denticator Inc.

Nylon bristles provide for safe and effective cleaning. Flexible to reach into occlusal fissures and grooves to remove debris without injury. Excellent for polishing composite restorations. Latex free.

Snap On

Flat 980-560014 **\$102.45**
Tapered 980-561014 **\$102.45**

Screw Type

Flat 980-560214 **\$113.95**



Crescent Disposable Prophyl Brushes - Dentsply Rinn

Standard or pointed brushes in popular mounting styles and in soft or stiff bristle horsehair or nylon to polish and remove stains. Horsehair.

Screw Type - Black

980-0100005 36/pkg **\$21.95**

Pointed Screw Type - Black

980-0100025 36/pkg **\$32.95**

RA - Black

980-0100205 36/pkg **\$24.95**

Pointed RA - Black

980-0100225 36/pkg **\$160.25**

Additional configurations available upon request.



Prophy Brushes - Young Dental

Ideal for removing stains from occlusal pits and fissures and for preparing tooth surfaces prior to sealant and orthodontic applications.

Screw Type

Firm Long - Black

980-090101 144/box **\$128.95**

Soft Short - White

980-090701 144/box **\$128.95**

Firm Standard Pointed Brush - Black

980-090201 144/box **\$145.25**

Additional options available upon request.

PROPHY BRUSHES



Densco® Prophy Brushes - Water Pik, Inc.

Effectively remove stains and clean occlusal pits and fissures, around orthodontic appliances, and in hard-to-reach interproximal spaces.

Screw Shank - Tapered Brush

980-85177 36/box **\$35.75**

Snap On - Tapered Brush

980-85077 36/box **\$35.75**



Prophy Cups - Dentamerica Inc.

For cleaning and polishing. High elasticity, effective polishing and removal of stains. White 6 web, 144/pkg.

Snap-On 980-403 **\$10.95**

Latch 980-401 **\$25.75**

Screw 980-402 **\$17.45**



Young™ Pointed Polisher - Young Dental

Pointed tip with outer ridges that help remove tough stains. Flexible enough to polish around brackets and under the wires of orthodontic appliances without damaging tissue.

Screw Type

Pointed, ribbed exterior. Latex free.

Soft 980-059101

Firm 980-059701

144/pkg. **\$70.45**



Young™ Prophy Cups - Young Dental

Designed to deliver more prophy paste to the tooth surface for efficient stain and biofilm removal.

Traditional Web - Screw Type

Long; webbed interior. Smooth exterior.

Soft 980-051101 144/pkg **\$79.45**

980-051105 720/pkg **\$310.45**

Firm 980-051301 144/pkg **\$79.45**

980-051305 720/pkg **\$310.45**

Latex free Soft 980-054101

Firm 980-054201

144/pkg **\$79.45**

Petite Web LF - Screw Type

Short; webbed interior. Smooth exterior. Latex free.

Soft 980-054601 144/pkg **\$79.45**

980-054605 720/pkg **\$318.25**

Turbo Cup - Screw Type

Long; ribbed interior. Smooth exterior.

Soft 980-052101 144/pkg **\$87.25**

980-052105 720/pkg **\$337.45**

Firm 980-052301 144/pkg **\$87.25**

980-052305 720/pkg **\$337.45**

Latex free Soft 980-053601 144/pkg **\$87.25**

980-053605 720/pkg **\$337.45**

Firm 980-053801 144/pkg **\$87.25**

980-053805 720/pkg **\$337.45**

Traditional Web - Snap-On

Long; webbed interior. Smooth Exterior. Latex free.

Soft 980-051801

Firm 980-051201

144/pkg **\$64.25**

Traditional Web - Latch Cup

Long; webbed interior. Smooth exterior.

Soft 980-055401

Firm 980-055601

144/pkg **\$99.95**

Ribbed - Latch Cup

Long; ribbed interior. Smooth exterior.

Soft 980-056401

Firm 980-056601

144/pkg **\$99.95**



Densco - Water Pik, Inc.

Minimizes splatter and fits most prophy angles.

Screw Shank - Blue

Soft with skirt, ribs and recessed webs.

980-85132 144/pkg **\$54.25**

980-8513201M 1000/pkg **\$314.25**

Snap-On - Blue

Soft with ribs and recessed webs.

980-85032 144/pkg **\$51.95**

950-8513201M 1000/pkg **\$314.25**

Right Angle Latch - Blue

Soft with skirt, ribs and recessed webs.

980-85232 144/pkg **\$83.95**

Screw Shank - Yellow

Firm with skirt, ribs and recessed webs.

980-85133 144/pkg **\$54.25**

980-8513301M 1000/pkg **\$314.25**

Dynamo Latex-Free

Features a reverse helix rib design for reduced splatter. Soft.

Screw Shank - Light Green

980-85148 144/pkg **\$54.25**

980-8514801M 1000/pkg **\$314.25**

PROPHY CUPS



Prophy Cups

Designed to reduce splatter and easily fit into subgingival areas to remove plaque. Divided, webbed interior provides a fast and effective cleaning. Not made with natural rubber latex.

Screw Type

Soft Purple 980-00001

Firm Blue 980-00002

144/pkg **\$18.45**



Crescent Prophy Cups - Dentsply Rinn

All Crescent webbed cups are permanently mounted and made of finest quality white rubber. Cups have increased polishing surface. Webs reinforce the cups, conform to the teeth and retain the polishing material without splashing. Snap-on cups are easy to place and remove from the angle. 144/pkg.

R.A. Webbed 980-0200030 **\$56.75**

Snap-on Webbed 980-0200100 **\$35.25**

Webbed Screw 980-0200005 **\$56.75**

Ribbed Screw 980-0200015 **\$56.75**

PROPHY PACKS



NUPRO® revolv® Disposable Propphy Pack - Dentsply Professional

One convenient package for a complete prophylaxis. Each packet includes a revolv Disposable Propphy Angle with a soft cup and a cup of NUPRO Propphy Paste.

Bubble Extreme Medium.....	970-96553BM
Bubble Extreme Coarse	970-96553BC
Mint Fine	970-96553MF
Mint Medium	970-96553MM
Mint Coarse	970-96553MC
Mint Plus	970-96553MP
Razzberry Medium	970-96553RM
Razzberry Coarse	970-96553RC
Orange Vanilla Swirl Med.	970-965530M
Orange Vanilla Swirl Coarse ...	970-965530C
100/box	\$97.95

Additional flavors and grits available upon request.

Econo Box

Mint Medium	970-96554MM
Mint Coarse	970-96554MC
1000/box	\$872.95



PIVOT® Disposable Propphy Pack - Preventech®

A great PIVOT disposable prophylaxis angle and Next prophylaxis paste in one convenient package. Makes tray setup quicker and more aseptic.

Mint Medium	970-1100073
Mint Coarse	970-1100083
100/box	\$75.95

Additional flavors and grits available upon request.

PROPHY PASTE

Propphy Paste

Our propphy paste is the perfect blend of polishing and cleaning agents with 1.23% Fluoride Ion. Splatter free formula with excellent washability leaving no gritty residue. Disposable unit dose cups eliminate cross contamination. Great tasting flavors. Each box contains an autoclavable propphy ring. Gluten free.

Mint Coarse	990-331010
Mint Medium	990-331011
Cherry Coarse	990-331012
Cherry Medium	990-331013
Raspberry Coarse	990-331014
Raspberry Medium	990-331015
Bubblegum Coarse.....	990-331016
Bubblegum Medium.....	990-331017
Bubblegum Fine	990-331018
200/box	\$25.45



Clinpro™ Propphy Paste - 3M Oral Care

Clean and polish in one paste. Propphy paste starts out coarse for cleaning, then breaks down to a fine paste for polishing. Patented perlite particles are less abrasive to both enamel and dentin. Neutral pH value.

Mint	993-12611
200/box	\$75.95



Propphy Gems - Biotrol

1.23% fluoride ion with phosphate. Low splatter, great taste and rinses easily. Paste has excellent consistency and the ring is even recyclable after sterilization.

Bubblegum Fine.....	990-133BG
Cool Mint Fine.....	990-101CM
Cool Mint Medium	990-102CM
Cool Mint Coarse	990-103CM
Cool Mint X-Coarse.....	990-104CM
Cinnamon Medium.....	990-112CI
Cinnamon Coarse.....	990-113CI
Vanilla Orange Medium.....	990-152VO
Vanilla Orange Coarse.....	990-153VO
Wild Berry Medium.....	990-122WB
Wild Berry Coarse.....	990-123WB
100/box	\$32.95

Assorted Medium

Mint, Cinnamon, Wild Berry	
990-142AS	100/box \$32.95

Assorted Coarse

Mint, Cinnamon, Wild Berry	
990-143AS	100/box \$32.95



Sparkle® Propphy Paste - Crosstex International

1.23% active fluoride ion. Splatter free formula with optimum rinsability, leaves no residual grit. Aspartame free. Gluten free. Contains Xylitol.

Bubble Gum Fine	990-UPFBG
Bubble Gum Medium	990-UPMBG
Bubble Gum Coarse.....	990-UPCBG
Mint Medium	990-UPMM
Mint Coarse	990-UPCM
Orange Vanilla Medium	990-UPMOV
Orange Vanilla Coarse	990-UPCOV
200/pkg	\$40.95

Additional flavors and grits available upon request.



NUPRO® Extra Care Propphy Paste - Dentsply Professional

The only propphy paste powered by NovaMin. It contains fluoride, calcium and phosphate ions for improved oral health. NovaMin calcium phosphate technology releases the natural building blocks of teeth to help build an enamel-like mineral layer. The paste can also be applied before or after scaling to relieve sensitivity, and is available in two different grits: Polish, which is a fine to medium grit, and Stain Removal, which is a medium to coarse grit. Dye-free, gluten-free and SLS-free.

Spearmint

Polish Fine-Med.....	990-801600
Stain Removal Med. Coarse....	990-801601

Peppermint

Polish Fine-Med	990-801602
Stain Removal Med-Coarse	990-801603

Citrus Mint

Polish Fine-Med	990-801604
Stain Removal Med-Coarse	990-801605

Orange

Polish Fine-Medium	990-801606
Stain Removal Med-Coarse	990-801607
175/box	\$65.95

Non-Fluoride Spearmint

Polish Fine-Med	990-801608
175/box	\$65.95

PROPHY PASTE



NUPRO® Prophylaxis Paste - Dentsply Professional

Designed to deliver consistent, splatter-free performance. Rinses easily and completely. Color-coded grits. Contains fluoride. Gluten free. 2gm unit dose cups.

Fine

Bubblegum Extreme	990-801302
Cookie Dough	990-801308
Fruit Punch	990-801332
Grape	990-801225
Mint	990-801232
Orange	990-801231
Orange Vanilla	990-801317
Orange w/out Fluoride	990-801235
Razzberry	990-801311
Strawberry Vanilla	990-801326
Zinnamon	990-801314
200/pkg	\$59.95

Medium

Bubblegum Extreme	990-801301
Cherry Blast	990-801321
Chocolate Bliss	990-801330
Cookie Dough	990-801307
Fruit Punch	990-801333
Grape	990-801226
Mint	990-801222
Mint w/out Fluoride	990-801223
Orange	990-801221
Orange Vanilla	990-801318
Pina Colada	990-801335
Razzberry	990-801310
Strawberry Vanilla	990-801327
Zinnamon	990-801313
200/pkg	\$59.95

Coarse

Bubblegum	990-801300
Cherry Blast	990-801322
Chocolate Bliss	990-801331
Cookie Dough	990-801306
Fruit Punch	990-801334
Grape	990-801227
Mint	990-801212
Mint w/out Fluoride	990-801213
Orange	990-801211
Orange Vanilla	990-801319
Pina Colada	990-801336
Razzberry	990-801309
Strawberry Vanilla	990-801328
Zinnamon	990-801312
200/pkg	\$59.95

Variety Pack

Contains: 200 single dose cups, 1 prophy grip, 1 prophy ring.

Adult Coarse	990-638028
Child Medium	990-638027
200/pkg.	\$59.95

Plus

Mint Fluoride	990-801299
200/pkg.	\$59.95

Prophy Paste Jars

Cherry Blast Coarse	990-801171
Grape Coarse	990-801127
Mint Medium	990-801122
Mint Coarse	990-801112
Orange Coarse	990-801111
12oz.	\$43.45



Kolorz™ Prophyl Paste - DMG America

Premium splatter-free fluoride formulas with flavors developed in consultation with food industry professionals. 1.23% fluoride sweetened with Xylitol. Gluten free.

Bubblegum Fine	990-788417
Triple Mint Fine	990-788401
Triple Mint Medium	990-788402
Triple Mint Coarse	990-788403
Triple Mint Xtra-Coarse	990-788404
Cherry Burst Medium	990-788406
Cherry Burst Coarse	990-788407
Carnival Pak Fine*	990-788408
Carnival Pak Medium*	990-788409
200/box	\$67.95

*Carnival Paks include 100 cups Cotton Candy and 100 cups Blue Raspberry.



Gelato Prophyl Paste - Keystone Industries

Smooth, pliable and spatter free application. 1.23% fluoride ion. Gentle for minimal enamel loss. Gluten free.

Mint Coarse	990-2403077
Mint Extra Coarse	990-2405177
Bubble Gum Coarse	990-2407577
200/box	\$25.95

Available in additional flavors and grits upon request.



Enamel Pro® Prophyl Paste - Premier® Dental

Formulated to release ACP (Amorphous Calcium Phosphate) to stimulate remineralization of tooth

enamel. Contains 1.23% fluoride ion. cleans quickly, less splatter, easy to rinse and smooth consistency. Gluten free.

Bubblegum Fine	997-9007614
Bubblegum Medium	997-9007615
Bubblegum Coarse	997-9007616
Cinnamon Fine	997-9007604
Cinnamon Medium	997-9007605
Cinnamon Coarse	997-9007606
Grape Fine	997-9007610
Grape Medium	997-9007611
Grape Coarse	997-9007612
Raspberry Mint Fine	990-9007620
Raspberry Mint Medium	990-9007621
Raspberry Mint Coarse	990-9007622
Strawberry Fine	997-9007607
Strawberry Medium	997-9007608
Strawberry Coarse	997-9007609
Mint Fine	997-9007600
Mint Medium	997-9007601
Mint Coarse	997-9007602
Mint Extra Coarse	997-9007603
VanillaMint Fine	997-9007617
VanillaMint Medium	997-9007618
VanillaMint Coarse	997-9007619
200/pkg.	\$60.25

Without Fluoride

Mint Coarse	997-9007613
200/pkg.	\$60.25



Glitter® Prophyl Paste - Premier® Dental

Glitter is smooth, pliable and splatter-free to clean teeth quickly. Easy to rinse off teeth and Gluten free.

Bubble Gum Fine	997-9007430
Bubble Gum Medium	997-9007432
Cherry Fine	997-9007410
Cherry Medium	997-9007412
Cherry Coarse	997-9007414
Mint Fine	997-9007400
Mint Medium	997-9007402
Mint Coarse	997-9007404
Mint X-Coarse	997-9007406
Strawberry Fine	997-9007420
Strawberry Medium	997-9007422
Strawberry Coarse	997-9007424
200/box	\$35.75

Without Fluoride

Mint-Coarse	997-9007440
Mint Medium	997-9007442
200/box	\$35.75

Next
PROPHY PASTE



Next® Propy Paste - Preventech®

Low splatter formula, great tasting, excellent stain removal. Fresh, flavorful flavors, appropriate grits and superior polishing properties.

Bubble Gum Fine	990-220083
Bubble Gum Medium	990-220093
Bubble Gum Coarse.....	990-220103
Cherry Medium	990-220063
Cherry Coarse	990-220073
Chocolate Mint Medium	990-220143
Chocolate Mint Coarse.....	990-220153
Cinnamon Burst Medium	990-220163
Cinnamon Burst Coarse.....	990-220173
Mint Fine	990-220013
Mint Medium	990-220023
Mint Coarse	990-220033
Mint Extra Coarse	990-220043
Tropical Fruit Medium.....	990-220123
Tropical Fruit Coarse	990-220133
Watermelon Fine	990-220183
Watermelon Medium	990-220193
Watermelon Coarse	990-220203
Vanilla Medium	990-220223
Vanilla Coarse	990-220233
Wintergreen Medium	990-220253
Wintergreen Coarse	990-220263
Wintergreen Xtra Coarse	990-220273
200/box	\$46.95

Additional flavors and grits available upon request.



Nada™ Pumice Paste - Preventech®

No fluoride, no flavor, no flavor oils, leaves no residue. Ideal prior to sealants, composite bonding, and orthodontic bracket application. More acceptable to flavor-intolerant patients. Medium grit.

990-223313 200/box **\$46.95**



Topex® Prep & Polish® Paste - Sultan Healthcare

Delivers a consistent pumice blend that's free of flavors, oils, colors and fluoride for use when the tooth surface must be free of an inhibiting layer. Ideal for prepping a variety of dental procedures. Also great for cleaning and/or polishing heavily stained teeth, amalgam and composite restorations. Perfect for highly sensitive or homeopathic patients intolerant of dyes, flavors and fluoride. Contains: 100 -2gm cups and 1 autoclavable prophy ring.

990-30045 Each **\$40.45**



Topex® Propy Paste - Sultan Healthcare

Blend of polishing and cleaning agents with 1.23% fluoride ion. Leaves no gritty residue. Splatter-free formula.

Cherry Medium	990-30031
Cherry Coarse	990-30021
Mint Medium	990-30032
Mint Coarse	990-30022
Piña Colada Medium.....	990-30034
Piña Colada Coarse	990-30024
12oz. jar	\$25.75

Unit Dose Cups

Contains: 2 Upgrade angles and 1 autoclavable prophy ring.

Assorted Medium.....	990-30015
Assorted Coarse	990-30000
Bubble Gum Fine	990-30025
Cherry Medium	990-30011
Cherry Coarse	990-30001
Chocolate Mint Coarse.....	990-30007
Mint Medium	990-30012
Mint Coarse	990-30002
Mint X-Coarse	990-30042
Piña Colada Medium.....	990-30014
Piña Colada Coarse	990-30004
FunPak Medium*.....	990-30018
FunPak Coarse*	990-30008
200/box	\$45.45

**FunPak includes Really Raspberry, Root Beer Float, and CinnaMint.*

Additional flavors and grits available upon request.



Propy Paste - Water Pik, Inc.

Smooth and splatter free. Excellent stain and plaque removal. Contains Xylitol plus fluoride. Gluten free.

Melon Coarse	990-20015784
Strawberry Medium.....	990-20015785
Mint Extra Coarse	990-20015789
Mint Medium	990-20015841
Mint Coarse	990-20015790
Variety Pack Medium	990-20015791
200/box	\$43.25

Additional flavors and grits available upon request.



Pumice Preppies - Whip Mix

Specially formulated for dental professionals requiring a cleaning agent that contains no flavoring agents, oils or fluoride. Gluten free. 2gm unit dose cups.

740-03400 100/pkg..... **\$45.95**



Preppies Plus® - Whip Mix

Pumice paste with 2% Chlorhexidine. Specifically formulated for clinicians requiring a cleaning and disinfecting agent. Contains no fluoride, oils or added flavoring agents. 1.3gm unit dose cups.

740-03410 100/pkg..... **\$58.75**



Coral Propy Paste with Fluoride - Young Dental

Phosphate fluoride prophy paste. Cleans quickly and easily leaving a high luster finish after polishing. Non-drying and splatter free formula.

Bubblegum Fine.....	990-033309
Bubblegum Coarse	990-033409
Mint Fine	990-033109
Mint Coarse	990-033209
9oz. jar	\$25.95

Available without fluoride upon request.

PROPHY PASTE



D-Lish™ Propy Paste - Young Dental

Pumice based formula for reduced splatter and better stain removal. Smooth, creamy texture for excellent rinsability. Paste colored by grit for easier identification. 1.23% fluoride. Contains Xylitol

Mint Coarse	990-300010
Mint Medium	990-300120
Mint Fine	990-300220
Cinnamon Coarse	990-301020
Cinnamon Medium	990-301120
Cherry Coarse	990-302020
Cherry Medium	990-302120
Dreamsicle Orange Coarse	990-305020
Dreamsicle Orange Med.	990-305120
Dreamsicle Orange Fine	990-305220
Grape Coarse	990-303020
Grape Medium	990-303120
Grape Fine	990-303220
Assorted Coarse	990-304320
Assorted Medium	990-304120
Assorted Fine	990-304220
200/box	\$59.45

Additional flavors and grits available upon



Oral-B® Propy Paste - Young Dental

Offers an optional balance of abrasive and adhesive properties designed for splatter and maximum stain removal. Formulated with 1.23% fluoride ion and xylitol. Gluten-Free

Mellow Mint Coarse	950-295189
Mellow Mint Medium	950-295190
Mellow Mint Fine	950-295191
Cinnamon Coarse	950-295192
Cinnamon Medium	950-295193
Orang-A-Tangy Coarse	950-295194
Orang-A-Tangy Medium	950-295195
Bubblegum Fine	950-295196
200/box	\$60.25

Assorted

Contains: Mellow Mint, Cinnamon and Orang-A-Tangy.

Coarse	950-295187
Medium	950-295188
200/box	\$60.25



SmartSelect™ Selective Polishing Paste - Young Dental

2-in-1 polishing system that promotes enamel health through customized care. A single-dose cup includes a coarser paste for stain removal and a finer paste for a smooth polish. Includes a custom gripper. 1.23% fluoride ion. Contains Xylitol. Gluten free.

Mint	990-295230
125/pkg	\$43.25

Assorted

Contains: Mint, Cinnamon and Clementine.

990-295231	125/pkg	\$43.25
------------	---------	----------------



Vera® Advanced Bright Propy Paste - Young Dental

Powered by baking soda, a time-honored ingredient known for its ability to whiten, brighten and neutralize pH. 1.23% fluoride ion. Contains Xylitol. Gluten free.

Arctic Mint - Polish	990-295386
Arctic Mint - Stain Remover	990-295387
125/pkg	\$36.25

Assorted

Contains: Arctic Mint, Cinnaburst and Berryblast.

Polish	990-295388
Stain Remover	990-295389
125/pkg	\$36.25



Zooby™ Propy Paste - Young Dental

1.23% fluoride. Optimal formulation of abrasive and adhesive properties designed for minimal splatter and stain removal. Includes a special autoclavable Zooby Propy Paste Animal Gripper with a wide base; Turtle, Hippo and Gator. Gluten free.

Spearmint Safari Coarse	990-601010
Spearmint Safari Medium	990-601110
Spearmint Safari Fine	990-601210
Growlin Grape Coarse	990-602010
Growlin Grape Medium	990-602110
Growlin Grape Fine	990-602210
Happy Hippo Cake Coarse	990-603010
Happy Hippo Cake Medium	990-603110
Happy Hippo Cake Fine	990-603210
Chocolate Chow Coarse	990-604010
Chocolate Chow Medium	990-604110

Chocolate Chow Fine	990-604210
Gator Gum Coarse	990-605010
Gator Gum Medium	990-605110
Gator Gum Fine	990-605210
Turtle Melon Coarse	990-606010
Turtle Melon Medium	990-606110
Turtle Melon Fine	990-606210
Animal Pack Assortment Coarse	990-600010
Animal Pack Assortment Medium	990-600110
Animal Pack Assortment Fine	990-600210
100/pkg	\$29.95

PREVENTIVE - MEDICAMENTS / ANALGESICS



GUM® Canker-X™ Oral Pain Reliever Gel - Sunstar Americas, Inc.

For fast, long-lasting pain relief. Does not numb or sting the mouth. Does not contain benzocaine or alcohol. Provides a protective coating to soothe tissues and promote healing, in a site specific gel. 4ml sachets.

950-1773P	36/box	\$26.95
-----------	--------	----------------



GUM® Rincinol P.R.N.™ - Sunstar Americas, Inc.

First non-Rx protective bio-adherent mucosal coating that provides rapid, long-lasting pain relief. Works for up to six hours, promotes healing, hydrates tissue without numbing, stinging or burning. Applications include: Aphthous ulcers and other oral lesions. Irritation from orthodontic appliances and removable prostheses. Post-oral surgery and other soft tissue management procedures such as root planing, scaling and prophylaxis treatment. Oral tissue trauma from a variety of other causes. 10ml sachets.

120-1771P	36/box	\$31.45
-----------	--------	----------------



Disposable Dappen Dishes

Disposable dappen dishes used for composite materials, bonding agents, cements, acrylics and more. Made of high quality plastic that is impervious to most dental products.

950-10170 1000/pack.....\$33.75



NUPRO® Propy Grips - Dentsply Professional

Autoclavable.

990-801207 3/pkg.\$11.75



SofScale Calculus Scaling Gel - Dentsply Professional

Helps prevent periodontal disease. Compatible with dental restorations and won't harm enamel, dentin or cementum.

Standard Package

Contains: 5 -2ml syringes and 5 applicator tips.

950-A9005 Package\$51.25

Refill Tips

950-A900525 25/pkg\$33.75

Bulk Package available upon request.



Dappen Dish - DiaDent®

Glass mixing dish.

Amber 950-3019A

Blue..... 950-3019B

Clear..... 950-3019C

Green..... 950-3019G

Each\$3.25

Order by ☎ 800-626-2163



Dapdish Dappen Dishes - Plasdent Corporation

Disposable dappen dishes in assorted colors.

950-901DD 200/box\$12.45

950-901DDBA 1000/box.....\$37.75



Dapper Dan Disposable Dappen Dishes - Temrex Corporation

Use with prophy paste or resin. Includes finger ring.

980-2620 1000/box\$68.25

TONGUE CLEANERS



Professional Tongue Cleaner - Pureline Oralcare

Scientifically designed to effectively clean the tongue. Made from a durable, FDA approved, bio-compatible material. Assorted colors.

950-PTC01 12/pkg.....\$45.95



GUM® Dual-Action Tongue Cleaners - Sunstar Americas, Inc

Two rows of soft, sturdy bristles on one side and two rows of scalloped scrapers on the other. Both work to gently dislodge, remove and clean the tongue of harmful bacteria. Long, ergonomic handle that comfortably reaches the posterior region of the tongue.

950-760P 6/pkg.\$9.95



Travel Caps - Tess Oral Health

Protect bristles while carrying brush. These bright colored caps fit most toothbrushes.

940-1500 Each..... 45c



Tongue Cleaners - Vista Dental Products

Effectively treat halitosis. Multi-tier cleaning ridges enhance the removal of surface plaque and odor causing bacteria. Assorted colors.

950-309001 72/pkg.....\$89.25

TOOTHBRUSHES - DENTURE



Denture Brushes

Ergonomic double sided brush. Individually cello wrapped. Available in 4 assorted colors: blue, green, purple and red.

950-10011 12/box\$10.45



Denture Brushes - Lactona

Smaller tapered head effectively cleans lower plate and between teeth. Larger flat head efficiently cleans tooth surfaces.

4.5" Handle

940-55229 12/pkg\$12.45

6" Handle

940-55230 12/pkg\$18.95

TOOTHBRUSHES - DENTURE



Oral-B® Denture Brushes - Procter & Gamble

Dual purpose brush with two sets of bristles on one head. One set to clean denture surfaces and one angled set for cleaning removable partial appliances. Large, easy grip handle.

940-75048450 6/box **\$8.95**



GUM® Denture Brushes - Sunstar Americas, Inc.

Consists of two brush heads; flat bristled head for smooth surfaces and a single-tufted head with tapered bristles for hard to reach areas. Ergonomic handle with lever-grip adapted for people with limited dexterity.

5 row, 39 tufts, Ultra soft.
940-201R 12/pkg..... **\$17.45**

Without Toothpaste

940-605403 100/box **\$43.45**

Trial Pack

Contains: 20 brushes with paste, 1 molar mug and 1 display case.

940-605404 Each..... **\$35.75**



Scope Outlast Minibrushes - OraLabs, Inc.

Get fresh on-the-go with Scope Outlast Minibrush. No water needed. Each brush contains gel with Scope Outlast technology, multi-ridge tongue cleaner and premium interdental pick. Packaged in convenient fish bowl container, 60 brushes per bowl.

940-PG0013FB Each..... **\$31.95**



Oral-B® Genius Professional Exclusive Power Toothbrush - Procter & Gamble

Features 5 brushing modes, Position Detection technology and SmartPhone holder. SmartRing on handle allows color customization of the ring. Includes Bluetooth technology and Oral-B app. Contains: Oral-B Genius Professional Exclusive Power Toothbrush, battery & charger, travel case with SmartPhone Holder and brush head refills; 1 each CrossAction, FlossAction, Deep Sweep, Sensitive Gum Care and Interproximal Care.

940-80296501 Each..... **\$103.95**

TOOTHBRUSHES - DISPOSABLE



PRO Disposable Toothbrushes

Assorted colors. Pre-pasted option uses USA formulated toothpaste.

Individually wrapped.

Adult Pre-Pasted - 39 Tufts

940-HT10917 100/box **\$19.95**

Adult Regular - 39 Tufts

940-HT10918 100/box **\$17.95**

TOOTHBRUSHES - ELECTRIC



Oral-B® Black 8000 Genius Power Toothbrush - Procter & Gamble

Features multiple brushing modes, pressure indicator light, Bluetooth technology and Oral-B app compatibility plus customizable SmartRing, Position Detection technology and Smartphone holder. 2 year warranty.

Contains: Oral-B Black 8000 Genius Power Toothbrush, battery charger, smartphone holder and USB travel case.

940-80286890 Each..... **\$145.45**

Brush Head Refills

CrossAction 940-80269486
FlossAction 940-80286878
Deep Sweep 940-80243929
Interproximal Clean..... 940-80286873
Ortho 940-80243934
Precision Clean..... 940-80286869
6/pkg **\$41.95**

Sensitive Gum Care..... 940-80243936
12/pkg **\$82.95**



Oral-B® PRO-HEALTH Jr. Vitality Kids Rechargeable Toothbrush - Procter & Gamble

The distinct shape of the PRO-HEALTH Jr. Disney Frozen Vitality Rechargeable Electric Toothbrush allows the head to surround each tooth for individual cleaning, resulting in amazing, tooth-by-tooth clean. Waterproof handle. Uses a Sensitive Clean toothbrush head that can be replaced when its indicator bristles fade halfway (about every 3 months).

940-80280597 Each..... **\$22.95**

Happy Morning Disposable Toothbrushes - Hager Worldwide

Bristles impregnated with pleasant mint flavored toothpaste. Hygienically, individually sealed. Ideal for patient use before treatment. Each box includes a display card for the waiting room.

With Toothpaste

940-605401 100/box **\$44.75**



TOOTHBRUSHES - ELECTRIC



Oral-B® Vitality Floss Action Electric Toothbrush - Procter & Gamble

Has oscillating-rotating technology that removes more plaque than a regular manual toothbrush. Its timer encourages patients to brush longer by signaling after 2 minutes.

Contains: 1 Ergonomic Handle, 1 Brush Head, 1 Charging Station, 1 Rechargeable Battery, 2-Year Limited Warranty.

940-80230351 Each..... **\$22.95**

FlossAction Brush Head Refill

High density bristles precisely angled at 16degrees to perfectly adapt to each tooth.

940-80286878 6/pkg..... **\$41.95**



Oral-B® Vitality Sensitive Clean Electric Toothbrush - Procter & Gamble

Rechargeable electric toothbrush uses oscillating, rotating technology to surround each tooth for better overall cleaning than a manual brush. Extra soft bristles provide gentle yet thorough cleaning.

Contains: 1 Ergonomic Handle, 1 Oral-B Sensitive Brush Head, 1 Charging Station, 1 Rechargeable Battery, 2-Year Limited Warranty. 940-80286467 Each **\$22.95**

Oral-B® Sensitive Gum Care Brush Head Refill

Extra soft bristles made of a soft, crimped filament. Use to gently clean sensitive teeth and inflamed gums.

940-80243936 12/pkg..... **\$82.95**



Sensonic® Professional Plus Toothbrush - Water Pik, Inc.

Features state-of-the-art sonic technology. The advanced brush head design, with extra soft, end-rounded bristles gently targets those hard to reach areas between teeth. Powerful, yet gentle plaque removal for a healthy and attractive smile.

Ergonomic handle, three unique brush heads, two speed settings for gentle cleaning or maximum plaque removal and a deluxe recharge indicator gauge. 2 minute brushing timer with 30 second intervals to ensure adequate brushing time throughout the mouth, hygienic brush head covers and a premium travel case.

940-20014289 Each..... **\$61.25**

Brush Head Refills

Standard

940-20016397 3/pack **\$16.25**

Compact

940-20016398 3/pack **\$16.25**

TOOTHBRUSHES - ELECTRIC BUNDLES



Crest® Oral-B® PRO-HEALTH Jr. Power Bundle - Procter & Gamble

Contains: Backpack with PRO-HEALTH Jr Toothbrush, Crest PRO-HEALTH JR Disney Frozen 4.2oz. Toothpaste, Crest PRO-HEALTH Jr Star Wars 4.2oz. Toothpaste, Crest PRO-HEALTH Advanced with Extra Deep Clean 500ml Mouthwash, Oral-B Glide Complete 75ct Floss Picks and 2 Sensitive Gum Care brush head refills.

940-83507978 Each..... **\$92.95**



Crest® Oral-B® Daily Clean System - Procter & Gamble

Contains: Tote bag with Oral-B PRO 1000 Power Toothbrush, 2 brush heads (1 CrossAction, 1 Deep Sweep); Crest Complete Multi-Benefit Whitening + Scope 4.4oz. Toothpaste, Scope Classic 500ml Mouthwash and Oral-B Glide PRO-HEALTH Deep Clean 15m Floss.

940-83501977 3 bundles..... **\$149.95**

Oral-B CrossAction Brush Head Refill

940-80269486 6/pkg..... **\$41.95**



Oral-B® Gingivitis Power System Bundle - Procter & Gamble

Contains: Tote bag with Oral-B Genius Professional Exclusive Power Toothbrush, Crest PRO-HEALTH Advanced Extra Gum Protection 3.5oz. Toothpaste, Crest PRO-HEALTH Multi-Protection 250ml Mouthwash, Oral-B Glide PRO-HEALTH Advanced 15m Floss and 1 each brush head refill; CrossAction, FlossAction, Sensitive Gum Care and Interproximal Clean.

940-83514493 3/pkg..... **\$324.75**



Crest® Oral-B® Whitening System - Procter & Gamble

Contains: Tote bag with Oral-B PRO 3000 Power Toothbrush with Bluetooth Technology, 3 brush heads (1 CrossAction, 1 ProWhite, 1 Deep Sweep), Crest 3D White Brilliance 4.1oz. Toothpaste, Crest 3D White Whitestrips Professional Supreme (14ct), Crest 3D White 237ml Mouthwash.

940-83501834 3 bundles..... **\$247.75**

Oral-B® Pro White Brush Head Refill

940-80243928 6/pkg..... **\$41.95**

TOOTHBRUSHES - ELECTRIC BUNDLES



Oral-B® Genius Sensitive System Power Bundle - Procter & Gamble

Contains: Tote bag with Oral-B Genius Professional Exclusive Power Toothbrush, Crest Sensi-Repair & Prevent 3.5oz. Toothpaste, Oral-B Glide PRO-HEALTH Advanced 15m Floss, Crest PRO-HEALTH Advanced with Extra Deep Clean 250ml Mouthwash, 1 each brush head refill; CrossAction, FlossAction, Sensitive Gum Care and Interproximal Care.
940-83514499 3/pkg **\$324.75**

TOOTHBRUSHES - MANUAL



Toothbrushes

Designed with a tapered head to help brush hard-to-reach areas. The contoured handle is ergonomically designed. The soft .007 Dupont Tynex nylon bristles are end-rounded and polished to be gentle on gums and tooth enamel. Each box contains 72 brushes in an assortment of 7 bright colors. Imprinting available for additional cost. 6 case minimum for imprint.

Adult Toothbrushes

940-HTA42 72/box **\$36.95**

Junior Toothbrushes

940-HTC28 72/box **\$30.95**

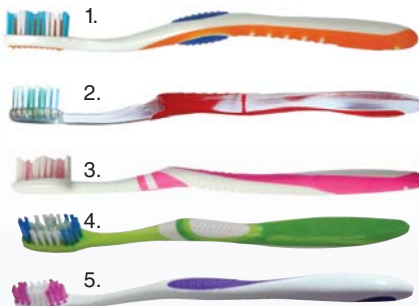

MAX Toothbrushes

Adult toothbrushes. Assorted colors. Imprinting available on most styles for an additional cost..

1. Full Head Stimulator - 36 Tufts

940-HT16990 72/box **\$35.95**

2. Classic Full Head - 34 Tufts

9400-HT16991 72/box **\$35.95**

3. Offset Compact - 32 Tufts

940-HT16888 72/box **\$29.95**

4. Compact Whitener - 32 Tufts

940-HT16890 72/box **\$35.95**

5. Curve Compact - 28 Tufts

940-HT16401 72/box **\$23.95**



PRO Toothbrushes

Assorted colors. Imprinting available on most styles for an additional cost.

1. Adult Cleargrip w/indicator - 38 Tufts

940-HT10420 72/box **\$35.95**

2. Youth w/sparkles - 32 Tufts

940-HT10950 72/box **\$24.95**

3. Child Stage 3 soft - 27 Tufts

940-HTUC 72/box **\$36.95**

4. Child Stage 2 extra-soft - 28 Tufts

940-HT10751 72/box **\$29.95**

5. Infant Stage 1 extra-soft - 22 Tufts

940-HT10750 72/box **\$29.95**

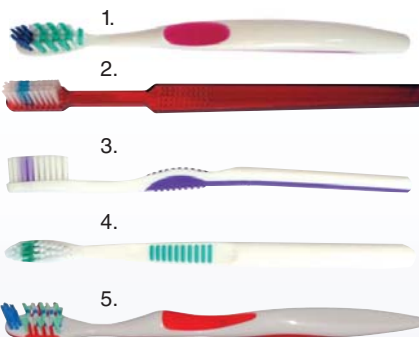

PLUS Toothbrushes

Adult toothbrushes. Assorted colors. Imprinting available on most styles for an additional cost.

1. Active Full Head - 39 Tufts

940-HTUA 72/box **\$36.95**

2. Full Head - 39 Tufts

940-HT10050 72/box **\$29.95**

3. Interdental Compact - 37 Tufts

40-HT16793 72/box **\$31.95**

4. Classic Compact - 35 Tufts

940-HT16659 72/box **\$31.95**

5. Compact Stimulator - 32 Tufts

940-HT16996 72/box **\$35.95**

Reach® Barbie Toothbrushes - Dr. Fresh

Kids remove plaque from hard to reach places with Barbie's help. Soft bristles, small head and thick handle designed for a child. Bi-Level bristles, cleaning tip, and angled neck to clean hard to reach places.



940-109583 12/pkg..... **\$13.45**



Reach® Advanced Design Toothbrushes - Dr. Fresh

Raised rubber ridges on the handle help patients control the brush for effective cleaning. Tapered head to comfortably clean hard-to-reach back teeth. Polished end-rounded bristles help prevent gingival abrasion.

Compact Size, Soft 940-7219
Compact Size, Extra Soft 940-7213
Full Size, Soft 940-7212
12/box **\$10.45**

TOOTHBRUSHES - MANUAL



Reach® Total Care Floss Clean Toothbrushes - Dr. Fresh

An ergonomically-designed handle. Unique touchpoint thumb grip for better control. Floss-like bristles to clean deep between teeth and around the gumline, with a tongue scraper. This toothbrush has everything you need to remove more plaque from the hardest-to-reach places. 940-9223 12/pkg..... **\$6.95**

vent gingival abrasion.
Compact Size, Soft 940-7219
Compact Size, Extra Soft 940-7213
Full Size, Soft 940-7212
12/box **\$10.45**



Junior Toothbrushes - OraLine®

This 32 Tuft Junior Toothbrush comes in three handle varieties: red/yellow, blue/orange and yellow/green. Soft bristles. Designed for adolescents.

940-10772 72/pkg **\$37.95**



Kids Caterpillar Toothbrushes - OraLine®

This 27 Tuft Kids toothbrush comes in three colorful handle varieties, with soft bristles. Designed for ages 3-5.

940-10771 72/pkg **\$37.95**



Kids Dinosaur Suction Cup Toothbrushes - OraLine®

26 tufts of extra soft 2 color bristles. Suction cup on bottom, individually cello wrapped. 4 color assortment only. Length 6". Extra soft.

940-16230 72/box **\$29.45**



Kids Neon Toothbrushes - OraLine®

27 tufts. Toothbrushes come in a variety of 4 vibrant neon handle colors and 4 assorted bristle colors.

940-10927 72/box **\$14.45**

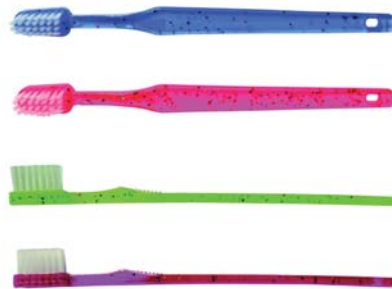

Kids Sparkle Toothbrushes - OraLine®

Tapered head helps clean back teeth. Extra-soft bristles, individually cello wrapped. 4 color assortment only.

Stage 1, 28 tufts
940-10940 144/box **\$17.95**

Stage 2, 29 tufts
940-10930 144/box **\$19.45**



Premium OraFlex Adult Toothbrushes - OraLine®

Inter-dental cut of the bristles and a flexible neck. Tapered head for easy access and color coded bristles and handle. Elastomeric handle grip. Individually cello wrapped. 4 color assortment only. 40 tuft.

940-10780 72/box **\$49.25**



Oral-B® 20 Series Toothbrushes - Procter & Gamble

Comes in a range of patterns for the young and young at heart. Exceptional gentleness with high-quality end-rounded bristles. Blue indicator bristles encourage compliance and signal when it's time to replace the brush. Available in assorted colors: Passion Purple, Minty Green, Cool Blue & Neon Pink.

940-80250656 12/box **\$12.95**



Oral-B® Cavity Defense Toothbrushes - Procter & Gamble

Unique dual cup-shaped bristles feature powerful inside bristles and soft outside bristles that clean between teeth and along the gumline. Indicator bristles tell you when to replace your brush. 40 soft.

940-80238579 6/box **\$5.45**



Oral-B® Complete Sensitive Toothbrushes - Procter & Gamble

Extra-soft Oral-B ComfortClean bristles that are easy on sensitive gums. The Oral-B ExtendAngle brush head and the Power Tip bristles are designed for hard-to-reach areas. Available in 5 Colors: Green, Pink, Dark Blue, Orange & Light Blue. 35 X-Soft.

940-80286457 12/box **\$13.95**



Oral-B® Complete 123 Toothbrushes - Procter & Gamble

Offers 3 oral care benefits in one brush. It cleans teeth for outstanding plaque removal, cleans the tongue to freshen breath, and stimulates and massages gums. Available in 4 Colors: Pink, Raspberry, Green & Blue. 35 Soft, textured tongue cleaner.

940-75062268 12/box **\$13.95**



Oral-B® Complete 3D White Vivid Toothbrushes - Procter & Gamble

Ergonomic, nonslip handle provides comfortable and secure handling. Cleans and whitens teeth by gently removing surface stains. Available in 5 Colors: Teal, Violet, Lime Green, Citrus Orange & Blue. 35 Soft.

940-80250652 6/box **\$6.95**

TOOTHBRUSHES - MANUAL



Oral-B® Complete Control Grip Toothbrushes - Procter & Gamble

The V-shaped Action Cup bristles of the Oral-B Complete Control Grip toothbrush contour to each tooth's unique surface for a more comfortable and secure cleaning. The Multisection Power Tip bristles facilitate enhanced penetration to clean hard-to-reach, high-risk areas for plaque buildup while being gentle on enamel. Available in 5 Colors: Green, Yellow, Blue, Red & Orange.

35 Soft 940-84860370
 30 Soft 940-80286454
 12/box **\$13.95**



Oral-B® Complete® Deep Clean Toothbrushes - Procter & Gamble

Power tip bristles designed to reach deep and clean hard-to-reach areas. Longer gum-massaging bristles that gently clean and stimulate the gum line. Available in 5 Colors: Green, Pink, Dark Blue, Red & Light Blue. 35 Soft.

940-84862506 12/box **\$13.95**



Oral-B® CrossAction® PRO-HEALTH Gentle Clean Toothbrushes - Procter & Gamble

Delivers superior performance with an unexpected softness your patients will appreciate. The extra soft bristles are gentle on enamel yet still remove up to 90% of plaque in hard-to-reach areas. The precise 16°-angle CrissCross bristles optimize interproximal cleaning. Available in 4 colors: Blue, Aqua, Green and Magenta. 35 X-Soft.

940-80236010 12/box **\$15.45**



Oral-B® CrossAction® PRO-HEALTH Advanced Pro-Flex Toothbrushes - Procter & Gamble

Up to 34% more plaque reduction along gum line. Significantly reduces gingival bleeding in 2 weeks. Two flexing sides with criss cross bristles removes 93% of plaque in hard-to-reach areas. One superior clean vs a regular manual toothbrush. 38 Soft.

940-80242564 72/box **\$93.95**



Oral-B® End-Tufted Brushes - Procter & Gamble

Perfect for cleaning specific, difficult-to-reach areas between crowns, bridgework and crowded teeth. Gently removes plaque from your mouth. Allows you to pinpoint small, hard-to-reach spaces. Gives you great control. X-Soft.

940-13243558 6/box **\$7.75**



Oral-B® Indicator Toothbrushes - Procter & Gamble

Innovative blue bristles inform patients when their brush has lost its optimum effectiveness, reminding them it's time to change their toothbrush. Polished, end-rounded bristles effectively clean along the gumline. Oval brush head enables access to posterior teeth. Available in 5 Colors: Green, Dark Blue, Purple, Light Blue & Pink.

30 Soft 940-84860374
 Sensitive, 35 X-Soft..... 940-80209881
 35 Soft 940-80209882
 12/box **\$12.95**



Oral-B® Orthodontic Brushes - Procter & Gamble

Uses V-shaped bristles to remove plaque from braces and teeth. It can be used as a braces toothbrush or as a brush to clean wires and brackets associated with retainers, headgear and other types of orthodontic work. 35 Soft, Ergo Grip Handle.

940-80211624 12/box **\$12.95**



Oral-B® PRO-HEALTH® All-In-One with CrossAction Bristles Toothbrushes - Procter & Gamble

Significantly reduces gingivitis after just 4 weeks of use while remaining gentle on enamel and gingival. Precise, 16°-angle CrissCross bristles penetrate 31% deeper within proximal areas vs a flat-trim brush to remove up to 99% of plaque biofilm in hard-to-reach areas. Multisection Power Tip bristles clean hard-to-reach areas. Outer extra-soft gingival stimulators massage gums. Textured tongue cleaner removes odor-causing bacteria from the tongue. Available in 4 colors: dark blue, turquoise, charcoal, and red. 35 Soft.

940-80214236 12/box **\$15.45**



Oral-B® Stages® 1 Toothbrushes - Procter & Gamble

4-24 months. Baby-soft bristles gently clean and massage baby teeth and tender gums. Cushioned head also designed to protect baby's gums. Nonslip handle designed for a parent's hand. Available in fun Disney Baby character graphics. 940-80234065 6/box **\$7.45**



Oral-B® PRO-HEALTH® Stages® Toothbrushes - Procter & Gamble

Easy to hold handle to help children learn to brush. Narrow head for small mouths. Small Power Tip bristles help clean hard-to-reach back teeth and lingual surfaces. Squeezable, nonslip grip enables small hands with limited dexterity to brush competently. Added tongue cleaner feature.

2-4 yrs, Mickey & Minnie, X-Soft.. 940-80286469
 5-7 yrs, Princess Jewels, Soft..... 940-80234084
 5-7 yrs, Cars & Planes, Soft..... 940-80253047
 5-7 yrs, Princess, Cars & Planes, Soft
 940-80253049
 5-7 yrs, Dory/Nemo, Soft..... 940-80286471
 5-7 yrs, Marvel Avengers, Soft..... 940-80234099
 6/box **\$7.45**



Oral-B® Frozen PRO-HEALTH Jr. CrossAction Toothbrushes - Procter & Gamble

For kids 8-12 years. Soft, angled, crossing bristles that clean between gaps in kids' changing teeth, or teeth with braces, and remove plaque in hard to reach areas.

940-80279976 6/box **\$7.45**



GUM® Adult Classic Toothbrushes - Sunstar Americas, Inc.

Latex-Free rubber tip stimulator for gingival massage and between teeth cleaning. Flat trim bristles remove plaque and improve gingival health of patient's teeth. With stimulator tip for gingival massage.

Small Head, Soft 940-407P
 Compact Head, Soft..... 940-409P
 Full Head, Soft 940-411P
 Slender Head, Soft..... 940-311P
 12/pkg. **\$12.75**

TOOTHBRUSHES - MANUAL



GUM® Children's Toothbrushes - Sunstar Americas, Inc.

End-rounded bristles provide a safe and gentle toothbrush for young teeth and gums. Youth Soft. 940-211P 12/pkg\$13.25



GUM® Crayola Neon Marker Toothbrushes - Sunstar Americas, Inc.

Comes in 5 vibrant colors. Ultra Soft bristles are gentle on young gums. Suction cup base reduces counter clutter and helps keep the brush head clean. 940-227Q 12/pkg\$12.95



GUM® Crayola Timer Light Toothbrushes - Sunstar Americas, Inc.

Toothbrush with built in timer flashes colored LED lights for 60 second intervals to help kids increase brushing time. Light increases brushing time resulting in more plaque removal. Suction cup base for fun storage. 940-202RG 12/pack \$27.75



GUM® Crayola Pip-Squeaks™ Toothbrushes - Sunstar Americas, Inc.

Ultra soft bristles on a narrow, tapered head. Available in four different Pip-Squeaks faces and fun colors. Suction cup base that reduces bathroom counter clutter and keeps the brush head clean between uses. Great for both boys and girls. 940-232RG 12/box\$12.95



GUM® Delicate Post-Surgical Toothbrush - Sunstar Americas, Inc.

Ultra gentle 0.004 bristles are ideal for post-surgical cleaning, mouth irritations, extractions, implants and grafts. 940-317M 12/pkg.....\$15.95



GUM® Dome Trim Toothbrushes - Sunstar Americas, Inc.

Raised center bristles have been trimmed to form a dome shape that provides greater contact with the tooth surface and reaches under the gum line. Modern Comfort-Grip Handle with wide thumb support.

Compact Soft
940-457P 12/box.....\$12.45



GUM® End Tuft Toothbrushes - Sunstar Americas, Inc.

Seven tufts, small head fits well in areas such as orthodontic bands, implants, etc. Tapered Trim. 940-308P 12/pkg\$13.45



GUM® Implant Care Kit - Sunstar Americas, Inc.

Contains: Clear, vented bag with business card pocket, delicate post-surgical toothbrush, Micro Tip Toothbrush (compact head/sensitive bristles), End-Tuft Brush, tongue cleaner, Proxabrush Trav-Ler Tapered Head, Post-Care floss aids, patient care handbook. 950-IMPKIT Kit.....\$108.75



GUM® Monsterz Toothbrushes - Sunstar Americas, Inc.

Cushioned brush heads protect gums and the Unique Dome Trim bristles are clinically proven to clean below the gum line. Thumb pad provides a comfortable grip and suction cup base holds the toothbrush upright.

Kids 2+ 940-901A
Junior 5+ 940-902A
12/pack\$13.25



GUM® Micro Tip™ Toothbrushes - Sunstar Americas, Inc.

Increase contact with the tooth surface by 70%. Thousands of bristle tips contact the tooth surface to provide soft, gentle cleaning with minimized pressure. Clear handle with comfort grip will provide better control of brush. Compact Size, Soft 940-471P
Full Size, Soft 940-470P
Full Size, Sensitive 940-474P
Compact Size, Sensitive 940-475P
12/pkg.\$12.45



GUM® Orthodontic Toothbrushes - Sunstar Americas, Inc.

This "V" trim brush facilitates cleaning around orthodontic appliances such as brackets, arch wires, buttons and ligatures. 4 row, 34 tufts. 940-124P 12/pkg.....\$13.45



GUM® Orthodontic Travel Toothbrushes - Sunstar Americas, Inc.

This "V" trim facilitates cleaning around orthodontic appliances such as brackets, arch wires, buttons and ligatures. Gentle tongue cleaner helps to gently remove odor-causing bacteria. 940-125P 12/pkg.....\$17.45



GUM® Razzle Dazzle® Girl's Youth Toothbrushes - Sunstar Americas, Inc.

Offers fun and effective teeth cleaning for ages 5-10 yrs, with colorful decals, Super Tip bristles and comfort grip handle. 940-217PA 12/pkg.....\$12.95

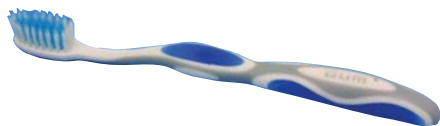

GUM® SUMMIT+ Toothbrushes - Sunstar Americas, Inc.

Toothbrush with ETB (Extremely Tapered Bristles) as well as conventional bristles arranged in a Bi-Level bristle design. Scientifically tested superior cleaning and plaque removal subgingivally, along gingival margin and intradentally. Exceptionally gentle on tissue.

Compact, Soft 940-505P
 Compact, Sensitive 940-509P
 12/pkg. **\$13.95**



GUM® Super Tip Toothbrushes - Sunstar Americas, Inc.

Improved cleaning in hard-to-reach areas. Raised bristles at the tip provide greater access to posterior regions and clean hard-to-reach surfaces.

Compact Size, Soft 940-461P
 Full Size, Soft 940-460P
 Full Size, Sensitive 940-464P
 Compact Size, Sensitive 940-465P
 Subcompact Size, Soft 940-468C
 12/pkg. **\$12.45**



GUM® Sulcular Toothbrushes - Sunstar Americas, Inc.

2 row, 20 tufts allows easy access to gum line, Ultra soft.

940-210 12/pkg..... **\$12.95**



GUM® Technique® Toothbrushes - Sunstar Americas, Inc.

Four angled thumb pads naturally guide the bristles at the optimal 45° angle to the gumline. Effortlessly achieves the dental recommended "Bass" brushing method. Clinically-proven to reduce gingivitis and early forms of gum disease.

Adult
 Full Head, Soft 940-490P
 Compact Head, Soft 940-491P
 Compact Head, Sensitive 940-495P
 12/box **\$12.45**

Youth
 Compact Head, Ultra Soft 940-221P
 12/box **\$12.95**



GUM® Technique Complete Care Toothbrushes - Sunstar Americas, Inc.

Patented Quad-Grip design guide the bristles at a 45° angle to the gumline and special interdental trim and Dome Trim bristle design enhance the complete cleaning abilities.

Soft Full 940-590
 Soft Compact 940-591
 12/box **\$13.95**



GUM® Technique Deep Clean Toothbrushes - Sunstar Americas, Inc.

Design features extremely tapered bristles that clean 2.8 mm below the gum line. Scientifically tested to provide superior cleaning and plaque removal along the gingival margin, subgingivally and interdently. Features patented quad grip thumb pad, designed to guide the hand to hold the brush at a 45 degree angle in all quadrants.

Full Head, Soft 940-524P
 Compact Head, Soft 940-525P
 Sensitive Compact 940-527P
 12/pkg **\$13.95**



GUM® Technique Sensitive Care Toothbrushes - Sunstar Americas, Inc.

Patented Quad-Grip design guide the sensitive bristles at a 45° angle to the gumline and sensitive bristles are exceptionally gentle on gums and tissue.

Full Head 940-516PG
 Compact Head 940-517PG
 12/box **\$13.95**



GUM® Travel Toothbrushes - Sunstar Americas, Inc.

Travel brush with Dome Trim features antibacterial protected bristles to keep brush cleaner between uses and a snap-lock cap/handle extension. Gentle tongue cleaner helps to gently remove odor-causing bacteria.

940-153P 12/pkg..... **\$16.45**



Concept Perio X-Soft Toothbrushes - Tess Oral Health

Made with colorful handles and black .005 bristles. Great for oral hygiene instruction since the patient can more clearly see how to brush due to the contrast between the black bristles and tooth enamel and gum line. Individually cello-wrapped.

940-3810 72/box **\$37.95**



Pre-School Toothbrushes - Tess Oral Health

Contoured handle with tapered head. 8 assorted colors. Extra Soft .006" white bristles.

940-1900 72/box **\$29.95**



Junior Hot Tropics Toothbrushes - Tess Oral Health

Brightly colored bristles on a contoured tapered head and bright colored handle. Soft .007". 16 assorted colors.

940-2830 72/box **\$37.95**



Signature Classic Toothbrushes - Tess Oral Health

Tapered head brush with soft .007" white and color coordinated bristles. Soft 42. Pearlescent handle colors.

940-4220 72/box **\$37.95**

TOOTHBRUSHES - MANUAL BUNDLES



Crest® Oral-B® Manual Toothbrush Bundle for Kids 2 to 4 - Procter & Gamble

Contains: Oral-B PRO-HEALTH Stages Toothbrush with Mickey & Minnie graphics, Kids Crest Cavity Protection 0.85oz. Toothpaste, Oral-B Glide PRO-HEALTH Original 4m Floss and kids patient bags.
940-83512365 72 bundles.....\$76.25



Crest® Oral-B® Basics Solution - Procter & Gamble

Contains: Oral-B Indicator Toothbrush (35 Soft), Crest 3D White Brilliance 0.85oz. Toothpaste, Oral-B Glide PRO-HEALTH Original 4m Floss and patient bags.
940-83511466 144 bundles.....\$135.95



Crest® Oral-B® Whitening Solution Bundle - Procter & Gamble

Contains: Oral-B Complete 3D White Vivid Toothbrush (35 Soft), Crest 3D White Brilliance 0.85oz. Toothpaste, Oral-B Glide PRO-HEALTH Deep Clean 4m Floss and patient bags.
940-83512366 72 bundles..... \$72.95



Crest® Oral-B® Solution for Kids Ages 5-7 - Procter & Gamble

Contains: Oral-B PRO-HEALTH Stages Toothbrushes in mixed cases of Disney Princess and Planes and Disney/Pixar Cars, Kids Crest Cavity Protection 0.85oz. Toothpaste, Oral-B Glide PRO-HEALTH Original 4m floss and kids patient bags.
940-84875737 72 bundles..... \$72.95



Crest® Oral-B® Daily Clean Solution Bundle - Procter & Gamble

Contains: Oral-B Deep Clean Toothbrush (35 Soft), Crest 3D White Brilliance 0.85oz. Toothpaste, Oral-B Glide PRO-HEALTH Deep Clean 4m Floss and patient bags.
950-83513026 72 bundles..... \$72.95



Crest® Oral-B® Complete Sensitive Solution Bundle - Procter & Gamble

Contains: Oral-B Complete Sensitive Toothbrush (35 Extra Soft), Crest Sensi-Repair & Prevent 0.85oz. Toothpaste, Oral-B Glide PRO-HEALTH Advanced 4m Floss and patient bags.
940-83511562 72 bundles..... \$72.95



Crest® Oral-B® PRO-HEALTH Jr. Solution for Kids Ages 8-12 - Procter & Gamble

Contains: Oral-B PRO-HEALTH Disney Frozen Toothbrush, Crest PRO-HEALTH Jr. 0.85oz Toothpaste with Disney Frozen graphics, Oral-B Glide PRO-HEALTH Original 4m Floss and kids patient bags.
940-83508111 72 bundles.....\$76.25



Crest® Oral-B® PRO-HEALTH Gingivitis Solution - Procter & Gamble

Contains: Oral-B PRO-HEALTH All-in-One Toothbrush (35 Soft), Crest PRO-HEALTH Advanced Extra Gum Protection 0.85oz. Toothpaste, Oral-B Glide PRO-HEALTH Advanced 4m Floss and patient bags.
940-83512372 72 bundles..... \$82.45



Clear Plastic Zipper Pouch - OraLine®

Clear vinyl with cloth zipper closure. Used for kits. Standard business card pocket on front. 4 5/8" x 8 5/8"
870-20405C 100/box..... \$34.95

TOOTHBRUSHES - POWER



Oral-B® PRO-HEALTH Clinical Precision Clean - Procter & Gamble

Battery operated. Better at plaque removal than a regular manual toothbrush. Electronically controlled drive system provides more consistent power throughout the battery life. Light Blue Handle.

Contains: 1 Oral-B Precision Clean Brush Head, 2 replaceable AA Batteries.
940-84853200 Each.....**\$13.95**



Oral-B® Stages Kids Battery Operated Toothbrush - Procter & Gamble

Kids 3 years of age and up. Oscillating power head and cup-shaped stationary bristles effectively remove plaque.

Contains: Stages Power Toothbrush in choice of character graphics and replaceable Duracell battery.

Disney Princess 940-80259300
Star Wars 940-80264762
Each **\$5.95**

TOOTHPASTE



Clinpro™ 5000 1.1% Sodium Fluoride Anti-Cavity Toothpaste - 3M Oral Care

Delivers more fluoride, helps strengthen enamel and helps reverse white spot lesions better than conventional 5000 ppm prescription fluoride toothpastes and a 900 ppm fluoride topical crème containing calcium phosphate.

Vanilla Mint 950-12115
Spearmint 950-12115SM
Bubblegum 950-12115BG
4oz tube **\$13.95**

AquaFresh® Infant Training Paste - GlaxoSmithKline

Fluoride free toothpaste designed for toddlers 3-24 months. Contains all natural ingredients, no artificial colors or preservatives. Natural apple/banana flavor.

1.5oz.
950-31025 Each..... **\$4.45**



Sensodyne® Fresh Impact Toothpaste - GlaxoSmithKline

A refreshing combination of paste and gel that keeps your breath feeling fresh for hours. Relieves sensitive teeth by building a protective barrier that blocks the pain caused by hot, cold, sweet and other triggers and keeps it from coming back. Great-tasting mint flavor.

0.8oz.
950-08351 Each..... **\$1.95**
4oz.
950-08356 Each..... **\$8.45**



Sensodyne® ProNamel® Gentle Whitening Toothpaste - GlaxoSmithKline

Specially formulated to help protect against the effects of acid erosion. Helps gently whiten and re-harden acid softened enamel, contains fluoride.

0.8oz.
950-83040 Each..... **\$1.95**
4oz.
950-83065 Each..... **\$8.45**



Sensodyne® ProName® Fresh Breath Toothpaste - GlaxoSmithKline

Specially designed to re-harden acid softened enamel. Helps protect against the effects of acid erosion. Contains fluoride for cavity protection and potassium nitrate for sensitivity. Specially formulated for people with sensitive teeth. Freshens breath.

0.8oz.
950-83075 Each..... **\$1.95**
4oz.
950-83081 Each..... **\$8.25**



Sensodyne® Repair & Protect Toothpaste - GlaxoSmithKline

Proven relief and daily protection for sensitive teeth. Contains stannous fluoride which helps to build a repairing layer over sensitive areas. Provides cavity protection and fresh breath.

3.4oz.
950-84040 Each..... **\$8.75**



CloSYS Toothpaste - Rowpar Pharmaceuticals, Inc.

Unique combination of ingredients that kill the harmful bacteria that cause plaque buildup, help prevent cavities and neutralize odor-causing compounds.

Fluoride - 3.4oz.
950-1C3424F 24/pkg **\$156.95**
Without Fluoride - 3.4oz.
950-1C3424R 24/pkg **\$156.95**



Bubble Gum Fluoride Toothpaste - OralLine®

Accepted by the ADA. 0.85oz. tube.
950-42109 144/pkg **\$69.95**

TOOTH PASTE



Mint Fluoride Toothpaste - OraLine®
Accepted by the ADA. 0.85oz. tube.
950-42102 144/pka **\$69.95**



Enamelon® Toothpaste - Premier® Dental
Exclusive formula combines stabilized stannous fluoride with ACP technology. More protection with less fluoride. Mint Breeze.

0.75oz.
950-9007290 24/case **\$75.25**
4.3oz.
950-9007280 Each..... **\$12.25**



Crest® 3D White Brilliance Toothpaste - Procter & Gamble
Illuminating complex to leave your smile dazzlingly white and brilliantly clean by reaching areas between teeth with its gently foaming action. Micro-cleansing teeth whiteners polish away surface stains. Fluoride to help prevent caries. Enamel Safe.

0.85oz.
950-80280382 72/case **\$24.25**



Crest® Cavity Protection Toothpaste - Procter & Gamble
Cavity protection for teeth and exposed roots. With regular brushing will help fight cavities and leave you with fresh breath. Wintergreen Mint.

0.85oz.
950-80233969 72/case **\$23.95**



Kids Crest® Cavity Protection Toothpaste - Procter & Gamble
Offers kids protection from caries with clinically proven Fluoristat that's gently on tooth enamel. Sparkle fun flavor.

0.85oz.
950-84839310 72/case **\$23.95**



Crest® Complete Multi-Benefit Whitening Plus Scope® Toothpaste - Procter & Gamble
Remineralizes weakened enamel. Protects against demineralization due to plaque acid attack. Whitens teeth by gently removing surface stains. Freshens breath with a blast of Scope.

0.85oz.
950-80236221 72/case **\$23.95**
4.4oz.
950-80272883 24/case **\$40.95**



Crest® PRO-HEALTH® Advanced Extra Gum Protection Toothpaste - Procter & Gamble
Clinically proven to help reverse gingivitis in just 4 weeks. Formulated with stabilized stannous fluoride. Mint.

0.85oz.
950-80274092 36/case **\$12.95**
3.5oz.
950-80273522 24/case **\$40.95**



Crest® PRO-HEALTH® Jr. Toothpaste - Procter & Gamble Oral Health
Specially designed for kids 8 years of age and older. Fights cavities with sodium fluoride, strengthens enamel, and freshens breath. Disney Frozen character graphics. Cool Minty Breeze.

0.85oz.
950-80276288 72/case **\$23.95**
4.2oz.
950-80273668 24/case **\$40.95**



Crest® PRO-HEALTH® SensiRepair™ & Prevent Toothpaste - Procter & Gamble
Blocks dentinal tubules to help prevent sensitivity pain. Helps repair and prevent by building a therapeutic and protective layer. Formulated with stabilized stannous fluoride. Smooth Mint.

0.85oz.
950-80268559 36/case **\$12.95**
3.5oz.
950-80249427 24/case **\$40.95**



Crest® Sensi-Relief™ Whitening Plus Scope® Toothpaste - Procter & Gamble
Combines potassium nitrate with our longest-lasting Scope technology, providing maximum strength sensitivity relief that tastes great.

0.85oz.
950-80236221 72/case **\$23.95**
4.1oz.
950-80245431 24/case **\$40.95**

ULTRASONICS & AIR SCALERS



Newtron P5 B.LED - ACTEON North America
Introducing the PURE NEWTRON range of ultrasonic scalers from ACTEON North America including the Newton Booster. The exclusive Cruise Control System adapts the ultrasonic power depending on the resistance encountered by the tip in real time. This generates unmatched power for the clinician and painless treatments for the patient. The Color coded power dial makes power selection simple. The refined curves of the Newton Slim handpiece enhance its handling and accessibility in any patient's mouth. Compatible with over 80 tips, each Pure Newtron device can perform the most applications such as scaling, periodontics, endodontics, and restorative procedures. Tips not included.

770-F61116 Each..... **\$2420.25**



Newtron Booster - ACTEON North America
Introducing the PURE Newtron range of ultrasonic scalers from ACTEON North America including the Newtron P5. The exclusive Cruise Control System adapts the ultrasonic power depending on the resistance encountered by the tip in real time. This generates unmatched power for the clinician and painless treatments for the patient. The LED lit, glowing color coded power dial makes power selection simple. The refined curves of the Newtron Slim B.LED handpiece enhance its handling and accessibility in any patient's mouth while producing bright, LED light for better visibility. Compatible with over 80 tips, each Pure Newtron device can perform the most applications such as scaling, periodontics, endodontics, and restorative procedures. Tips not included.

770-F60216 Each..... **\$1715.50**



P5XS B.LED - ACTEON North America

Introducing the Pure Newtron range of ultrasonic scalers from ACTEON North America. The exclusive Cruise Control System adapts the ultrasonic power depending on the resistance encountered by the tip in real time. This generates unmatched power for the clinician and painless treatments for the patient. The LED lit, glowing color coded power dial makes power selection simple. The refined curves of the Newtron Slim B.LED handpiece enhance its handling and accessibility in any patient's mouth while producing bright, LED light for better visibility. Devices also come available with or without independent irrigation tanks for delivery of different solutions. Compatible with over 80 tips, each Pure Newtron device can perform the most applications such as scaling, periodontics, endodontics, and restorative procedures. Tips not included.

770-F62118 \$2964.95



ProphyBrite Air Polishing Unit - Keystone Industries

Air polisher connects to most quick connect couplings for quick and gentle patient care. This unit delivers a fine sodium bicarbonate and water spray for easy removal of plaque and stains. Offers chairside convenience for cleaning and preparing teeth prior to placement of orthodontic brackets, sealants, bleaching and fluoride treatments. No installation needed, unit connects directly onto most air and water tubing. Light and ergonomic. Autoclavable nozzle. Nozzle rotates 360 degrees for easy access.

Air Polisher Unit Kit

Contains: Nozzle (2), air polisher, powder chamber cap (2), cleaning files (2.5cm, 8cm, and 10cm), o-rings (cap, powder and water), Prophy Powder (3oz, 85gm sample).

Red 770-16670R

- Black..... 770-16670B
- Blue 770-16670LB
- Orange..... 770-16670N
- Each\$1020.95

Spearmint Prophy Powder Refill

950-16691 10oz \$21.25

Handpiece Adapters available upon request.



BioSonic® Ultrasonic Scaler US100R - Coltene

BioSonic magnetostrictive ultrasonic scaler system automatically adjusts to work with any manufacturers 25KHz or 30KHz inserts. Faster hard calculus removal with on-demand maximum power turbo boost button. Ergonomic handpiece improves operators comfort during extended scaling. Ergonomically designed grip for operators comfort and reduced hand stress. 770-COLUS100R115T 115V\$1203.45

Use with Biosonic Inserts on page 531

Pro proves an economical choice in ultrasonic scaling. BOBCAT Pro is compatible with Cavitron Dual Select medicament delivery system.

770-81201 Unit \$940.95



Cavitron Select SPS Ultrasonic Scaler - Dentsply Professional

Cavitron Select SPS Ultrasonic Scaler provides maximum clinical efficiency and patient comfort. Accepts all 30K Inserts and 30K PEC Endosonic Inserts. Dimensions: 2"H x 4"W x 7"D Weight: 15oz. Contains: Steri-Mate sterilizable handpiece, one detachable cable assembly with in-line water control, and swivel connection, foot control and instruction manual.

30K Cavitron Select without Reservoir
770-DPC81302 Unit \$1997.99

30K Cavitron Select with Reservoir
770-81308 Unit \$2654.45

Cavitron JET-Fresh Prophy Powder with Aluminum Trihydroxide Sodium Free Refill
950-130203 13oz \$31.45

PROPHY-JET Prophy Powder with Sodium Bicarbonate Refill
950-13000201 13oz \$29.95

Shop Cavitron Inserts beginning on page 532-534



Cavitron® Bobcat® Pro - Dentsply Professional

The Cavitron BOBCAT Pro, 25kHz ultrasonic scaler, provides quality and performance along with a contemporary look. Equipped with a modern enclosure, versatile vertical or horizontal orientation, universal control graphics, and a user-friendly weighted foot pedal, the BOBCAT



Cavtron JET Plus Ultrasonic Scaler and Air Polishing Prophylaxis System with Tap-On Technology Package - Dentsply Professional

Tap-On Technology is designed to reduce leg and ankle discomfort associated with continued foot pedal usage – A single tap activates scaling, allowing you to rest your foot during the procedure. Prophy Mode auto cycles- short, medium, long - automatically alternate between air polish and rinse without a need to touch the foot pedal. Additional power option include single-push turbo mode for up to 25% greater power and hands-free boost activation by pressing the pedal to the floor.

Contains:(1) Cavtron JET Plus Ultrasonic Scaler and Air Polishing System (3) JET-Mate Sterilizable, Detachable Handpiece, (1) Tap-On Technology Wireless Foot Pedal, (4) Ultrasonic Inserts (package contains 1 Fitgrip focused spray) (2) Cavtron Air Polishing/Inserts/Nozzles (1) Prophy Jet Sodium Bicarbonate Prophy Powder (1) Jet Fresh Aluminum Trihydroxide Prophy Powder, 3 year warranty, 3 year Cavtron Care maintenance plan.

770-8161428 Package **\$6920.00**
770-8187501 Unit Only **\$5714.25**



Cavtron JET-Fresh Prophy Powder with Aluminum Trihydroxide Sodium Free Refill
Aluminum trihydroxide powder (Na-free) For use in Cavtron JET Plus and PROPHY-JET Systems. Refreshing mint flavor.
950-130203 13oz **\$31.45**

PROPHY-JET Prophy Powder with Sodium Bicarbonate Refill
Sodium bicarbonate powder for use in Cavtron JET Plus and PROPHY-JET Systems. Refreshing mint flavor.
950-13000201 13oz **\$29.95**

Shop Cavtron Inserts beginning on page 532-534



Cavtron Plus Ultrasonic Scaler System with Tap-On Technology Package - Dentsply Professional

Tap-On Technology is designed to reduce leg and ankle discomfort associated with continued foot pedal usage – A single tap activates scaling, allowing you to rest your foot during the procedure. Additional power option include single-push turbo mode for up to 25% greater power and hands-free boost activation by pressing the pedal to the floor. Finer water control allows for more precise and convenient adjustment of lavage on the handpiece to the preferred setting.

Contains: (1) Cavtron Plus Ultrasonic Scaler with Tap-On Technology, (1) Steri-Mate Detachable, Sterilizable Handpiece, (4) Ultrasonic Inserts (1 Fitgrip Focused Spray Slimline - 10S Insert and an Insert redemption form for 3 additional Ultrasonic Inserts), 3 year warranty, 2 year Cavtron Care Maintenance plan.

770-8161425 Package **\$3520.95**
770-8184001 Unit Only **\$2872.25**

Shop Cavtron Inserts beginning on page 532-534



Cavtron Touch and Steri-Mate 360° Ultrasonic Scaling System - Dentsply Professional

The Cavtron Touch Ultrasonic Scaling System is designed to be user friendly, while providing options for an improved scaling experience.

Digital touch screen technology provides an easy to use interface. Smaller footprint to maximize available counter space. The wireless Tap-On Technology foot pedal is designed to reduce leg and ankle discomfort associated with continued foot pedal usage. The Steri-Mate 360° Handpiece offers features that provide a new scaling experience. Fully rotating handpiece allows for free flowing movement of an ultrasonic insert within

the oral cavity. The detachable and autoclavable handpiece provides the highest assurance of control against cross-contamination. The Featherweight Handpiece cable is designed to provide ergonomic benefits by reducing cable drag.

System Contains: (1) Cavtron Touch Ultrasonic Scaler, (1) Steri-Mate 360° Sterilizable Detachable Handpiece, (1) Tap-On Technology Wireless Rechargeable Foot Pedal and 2 Year Warranty. *Package contains similar contents with additional 2 handpieces and 4 inserts.

770-8250001 System **\$3998.00**
770-8161426 Package **\$4940.00**

Shop Cavtron Inserts beginning on page 532-534



Piezon® 150 - Hu-Friedy

The new refined and versatile Piezon 150 serie features the intuitive EMS "Original Piezon Method" technology, offering dental professionals with more effectiveness and efficiency in all means.

Attaches to water system and has a unique external water filter and clear water line for biofilm detection. Large, ergonomic interface with fingertip control allows the clinician to easily select or change the desired power setting during use. Illuminated handpiece remains lit for 20 seconds after the foot control is released for continued visibility of the treatment site and easire diagnosis. Exceptionally low noise level during operation provides a more peaceful patient experience.

770-FT223HFA001 Unit Only **\$2071.25**



Piezon® 250 - Hu-Friedy

The Piezon 250 is based on the EMS Original Piezon Method. It offers dental scaler users an exceptional treatment experience that boosts their productivity while increasing their overall comfort - and that of their patients - through the low operating noise and the outstanding quality of both the equipment and the accessories.

This powerful and compact ultrasonic dental scaler offers precise power and irrigation control within a highly ergonomic system and a uniquely sophisticated and refined authentic Swiss design. Large, ergonomic interface with fingertip control allows the clinician to easily select or change the desired power setting during use. Illuminated handpiece remains lit for 20 seconds after the foot control is released for continued visibility of the treatment site and easier diagnosis. Instantaneous tip amplitude adjustment offers smooth treatment and ultimate patient comfort.

770-FT224HFA001 Unit..... **\$2851.95**



Piezon® Master 700 - Hu-Friedy

Combines power, precision, design and function in a self-contained package with an irrigant bottle. The LED handpiece ensures enhanced visibility while the fingertip control delivers 35 individual power increments for the exact power you need. Smooth touch panel surface for simple cleaning and disinfection. Ergonomic handpieces for working comfort and precision. Intelligent feedback control technology senses when higher power is needed to remove deposit and adjusts accordingly.

770-FT194HFA001 Unit **\$4490.25**



The Original Autoscaler® - Southeast Instruments

The Original Autoscaler is American made for high quality. Over 40 years of design experience is incorporated into the Autoscaler.

Features include a detachable handpiece assembly, precision automatic tuning and water pressure flow regulation to ensure precise delivery of water during procedures. The Autoscaler is a great value! It is designed to accept and function efficiently with Leading Manufacturers magnetostrictive insert tips. 25K and 30K models available. The Autoscaler® is made with a durable aluminum cabinet that will not crack or turn yellow in color like plastic.

Contains: (1) 8.0' Detachable handpiece assembly, (1) 8.0' Foot Switch Attached (not supplied when ordered with Air Microswitch), (1) Power Cord Attached (Hospital Grade), (1) 8.0' Water Tubing with 1/4 Male Shut Off style quick release ~ Attached, (1) Complete instructions and internet web support.

25K 770-SEIAW25C **\$794.95**

30K 770-SEIAW30C **\$794.95**



Titan® Blis-sonic™ Scaler - StarDental Instruments

The clinically proven sonic scaler design effectively removes hard calculus deposits and stains. Lightweight- only 50 grams. Relieves wrist and finger fatigue. Both motor and grips are autoclavable.

Contains: SW Scaler, 5 patented scaling tips; Universal, Sickle, Perio, Perio Right & Left.
280-264563 Kit..... **\$997.95**

K Scaler 4 Line

280-264565 Each..... **\$1074.95**



Universal Tip

571-61668 Black **\$97.95**



Sickle Tip

571-61667 Blue..... **\$97.95**



Perio Tip

571-61669 Natural/Tan..... **\$97.95**

Spare Rotor Kit

Includes: (4) O-rings and 1 rotor.
280-56715 Kit..... **\$106.95**

Clean-Out Wire

571-56719 2/pack **\$10.95**

BioSonic®

BioSonic Inserts are available with ergonomically designed handles to reduce finger fatigue, or with SuperSoft™ cushion grips to enhance tactile sensitivity and rotational control. Many popular tip styles are available, including the BioSonic OptiMist® with through-the-tip water delivery for contact point lavage.

- Popular tip configurations at both 25 kHz and 30 kHz
- Patented stack-soldering process increases durability
- OptiMist design for improved water spray control
- Interchangeable for use with other scalers

Pricing Starting
as Low as
\$149.95

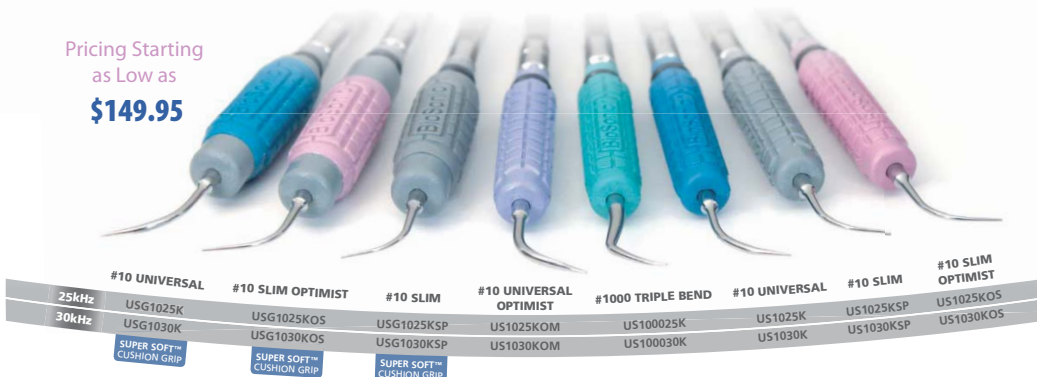

BioSonic® Suvi® ScalerTips - Coltene

Scaling is precision work. Proper ultrasonic instrument selection is of primary importance in achieving complete periodontal debridement. Our wide variety of tips gives you the freedom to choose.



PE-31 PE-32



PE-39 PE-41A

Heavy Calculus Removal

Used for lingual, buccal and approximal supragingival scaling.

PE-31 770-60014265
PE-32 770-60014266
Each **\$126.45**

Used for universal, lingual and buccal supragingival scaling.

PE-39 770-60014267
PE-41A 770-60014268
Each **\$126.45**



PE-37 PE-37L PE-37R



PE-41P PE-41AF PE-41PF

Universal

Developed for subgingival scaling, furcations, supragingival fine scaling and spot removal.
PE-37..... 770-60014269

Universal tip for subgingival scaling, furcations, supragingival fine scaling and spot removal. Tip angled to left for better access to furcations.

PE-37L..... 770-60014270

Universal tip for subgingival scaling, furcations, supragingival fine scaling and spot removal. Tip angled to right for better access to furcations.

PE-37R 770-60014271

Used for universal, lingual and buccal supragingival scaling. Can also be used for shallow pockets.

PE-41P 770-60014272

Used for approximal supragingival scaling. Also suitable for lingual and buccal scaling.

PE-41AF 770-60014273

Used for lingual, buccal and approximal supragingival scaling

PE-41PF 770-60014274
Each **\$126.45**



PE-33 PE-333L PE-33R



PE-38 PE-38L PE-38R

Periodontics

Used for subgingival scaling and furcations.

PE-33 770-60014275

Used for subgingival scaling and furcations. Tip angled to left for better access to furcations.
PE-33L 770-60014276

Used for subgingival scaling and furcations. Tip angled to right for better access to furcations.
PE-33R 770-60014277

Used for lingual and buccal subgingival scaling and furcations. Also suitable for supragingival fine scaling and spot removal.

PE-38 770-60014278
Suitable for supragingival fine scaling and spot removal. Tip angled to left for better access to furcations.

PE-38L 770-60014279

Suitable for supragingival fine scaling and spot removal. Tip angled to right for better access to furcations.

PE-38R 770-60014280

Each **\$126.45**



PE-40L PE-40R



PE-41 PE-40H PE-41PS

Scaling

Used for deeper lingual and buccal subgingival scaling. Also suitable for supragingival fine scaling and spot removal.

PE-40 770-60014281

Used for deeper subgingival scaling and molar furcations. Tip angled to left for better access to furcations.

PE-40L 770-60014282

Used for deeper subgingival scaling and molar furcations. Tip angled to right for better access to furcations.

PE-40R 770-60014283

Used for deeper subgingival scaling. Especially suitable for lingual scaling of incisors.

PE-40H 770-60014284

Used for deeper lingual and buccal subgingival scaling. Also suitable for supragingival fine scaling and spot removal.

PE-41PS 770-60014285

Each **\$123.25**

ULTRASONICS INSERTS



Cavitron FSI® Focused Spray Powerline® Ultrasonic Inserts - Dentsply Professional

For gross deposit removal. Patented internal water delivery system delivers water directly to the insert tip and “focuses” the water where it’s needed most.

30K Powerline Inserts

Dark Blue Grip - Power Setting: Low - High.

3 Beavertail.....	571-80797
10	571-80294
100	571-80798
1000 Triple Bend	571-80799
Each	\$179.95

25K Powerline Inserts

Light Blue Grip - Power Setting: Low - High.

3 Beavertail	571-80794
10	571-80293
100	571-80795
1000 Triple Bend	571-80796
Each	\$179.95



Bellissima™ FSI® Focused Spray Powerline®

Dimple grip design offers an easy-to-clean, ergonomic design. Offers better grip and easy rotation in the clinician’s hands and fingers for increased comfort and decreased fatigue. Bright Purple Grip Power Setting: Low - High.

30K FSI-3 Beavertail

571-81500	Each	\$220.25
-----------	------------	-----------------

30K FSI-10

571-81501	Each	\$220.25
-----------	------------	-----------------

30K FSI-100

571-81502	Each	\$220.25
-----------	------------	-----------------

30K FSI-1000 Triple Bend

571-81503	Each	\$220.25
-----------	------------	-----------------



Cavitron® FITGRIP™ 30K FSI® Focus Spray Powerline®

Ergonomically designed with clinician’s fingers in mind, the hygienist’s grip naturally conforms to the insert’s unique one piece design. The large diameter silicone soft grip lessens muscle load and pinch force to help maintain tactile sensitivity. The rippled grip is designed to lessen chance of slipping.

FSI-PWR-3	770-82001
FSI-PWR-10	770-82002
FSI-PWR-100	770-82003
FSI-PWR-1000	770-82004
Each	\$179.25



Cavitron® FSI® -SLI Focused Spray Slimline® Ultrasonic Inserts - Dentsply Professional

For fine periodontal debridement. Extra thin design provides maximum subgingival access. Patented focused spray water delivery system eliminates external water tube and increases clinical visibility. Designed to remove light to moderate deposits.

Dark Green Grip - Power Setting: Low - Medium

30K 10S Straight.....	571-80395
30K 10L Left	571-80396
30K 10R Right	571-80397
30K 1000 Triple Bend	571-81570
Each	\$179.95

Assorted 2-pack (10L, 10R)

571-80401	2/pack.....	\$336.25
-----------	-------------	-----------------

Assorted 3-pack (10S, 10L, 10R)

571-80399	3/pack.....	\$494.75
-----------	-------------	-----------------

Light Green Grip - Power Setting: Low - Medium

25K 10S Straight	571-80392
25K 10L Left	571-80393
25K 10R Right	571-80394
25K 1000 Triple Bend	571-81569
Each	\$179.95

Assorted 2-pack (10L, 10R)

571-80400	2/pack.....	\$336.25
-----------	-------------	-----------------

Assorted 3-pack (10S, 10L, 10R)

571-80398	3/pack.....	\$494.75
-----------	-------------	-----------------



Bellissima™ FSI® Focused Spray Slimline®

Dimple grip design offers an easy-to-clean, ergonomic design. Offers better grip and easy rotation in the clinician’s hands and fingers for increased comfort and decreased fatigue. Bright Pink Grip - Power Setting: Low - Medium

30K 10S Straight

571-81510	Each.....	\$220.25
-----------	-----------	-----------------

30K 10L Left Curve

571-81511	Each.....	\$220.25
-----------	-----------	-----------------

30K 10R Right Curve

571-81512	Each.....	\$220.25
-----------	-----------	-----------------

Assorted 2-pack (10L, 10R)

571-81514	2/pack	\$416.75
-----------	--------------	-----------------

Assorted 3-pack (10S, 10L, 10R)

571-81513	3/pack	\$604.95
-----------	--------------	-----------------



Cavitron® FITGRIP™ 30K Focus Spray Slimline®

Ergonomically designed with clinician’s fingers in mind, the hygienist’s grip naturally conforms to the insert’s unique one piece design. The large diameter silicone soft grip lessens muscle load and pinch force to help maintain tactile sensitivity. The rippled grip is designed to lessen chance of slipping.

FSI-SLI-10S	770-82005
FSI-SLI-10L	770-82006
FSI-SLI-10R	770-82007
FSI-SLI-1000	770-82008
Each	\$179.25

Cavitron® FITGRIP™ 30K Focus Spray® THINsert®

THINsert.....	770-82009
Each	\$179.25



Cavitron® SLI® Slimline® Ultrasonic Metal Inserts - Dentsply Professional

For fine definitive debridement. Slimline inserts are 40% thinner than standard inserts, allowing for maximum subgingival access. External spray system for a gentle, effective sulcular lavage.

30K Slimline Inserts

Metal Grip - Power Setting: Low - Medium.

30K 10S Straight	571-79611
30K 10R Right.....	571-79612
30K 10L Left	571-79613
Each	\$197.45

Assorted 3-pack (10S, 10L, 10R)

571-79610	3/pack.....	\$551.25
-----------	-------------	-----------------

25K Slimline Inserts

Metal Grip - Power Setting: Low - High.

25K 10S Straight	571-79290
25K 10L Left	571-79291
25K 10R Right	571-79292
Each	\$186.45

Assorted 3-pack (10S, 10L, 10R)

571-79293	3/pack.....	\$522.25
-----------	-------------	-----------------

Steri-Mate® Handpieces - Dentsply Professional

To be used with the Cavitron Select SPS and the Steri-Mate 360.



Steri-Mate Grey

770-8183001	Each.....	\$274.95
770-8183003	3/pack	\$715.45



Steri-Mate 360

770-8183201	Each.....	\$360.00
770-8183203	3/pack	\$1080.75



Cavitron® SofTip™ Ultrasonic Implant Insert - Dentsply Professional

The Cavitron SofTip Implant Insert removes plaque and calculus around titanium implants and abutments, allowing you to save time during an implant maintenance procedure and providing the convenience of lavage delivery. The Cavitron SofTip Implant Insert is only used with a SofTip disposable prophylaxis tip attached. The SofTip disposable prophylaxis tip is a single-use, plastic tip that is safe for implant maintenance.

30K Yellow Grip

571-90411	Each.....	\$192.75
-----------	-----------	-----------------

Replacement Tips

571-380059	100/pack.....	\$128.45
------------	---------------	-----------------

Prophy Tip Wrench

571-380060	Each.....	\$26.95
------------	-----------	----------------



Cavitron® THINsert® Ultrasonic Insert - Dentsply Professional

Cavitron THINsert is 47% thinner than current FSI Slimline inserts and allows access to areas such as misalignments, interproximal areas and areas of tight tissue attachment.

9 degree back bend allows easier access and adaptation. 30K.

571-81551	Each	\$179.95
-----------	------------	-----------------



Cavitron® Thru Flow® Inserts - Dentsply Professional

30K - For use in Cavitron 3000, Cavitron Jet, Cavitron SPS and Cavitron Jet SPS. Black Grip - Power Setting: Low - High.

25K - For use in Bobcat, Cavitron Select, Cavitron Med and Cavitron Endosonic. Gray Grip - Power Setting: Low - High.

TFI-3 Thin Beavertail

For effortless removal of heavy black tar stain and calculus.

25K	571-6121702
-----------	-------------

TFI-10 Straight

30K	571-6374106
25K	571-6121708

TFI-1000 Triple-Bend

30K	571-6374110
25K	571-6122001
Each	\$186.45



Cavitron® Classic 'P' Series Inserts - Dentsply Professional

For supragingival scaling.

P-10

For use in all areas supra and subgingivally.

571-6120108	25K	\$202.45
-------------	-----------	-----------------



Air Polishing Nozzle Steri-Pak™ - Dentsply Professional

For use with Prophy-Jet 30 and all discontinued models. Includes 3 nozzles and 1 cleaning tool.

571-7760205	Pack.....	\$366.95
-------------	-----------	-----------------



Cavitron™ JET Air Polishing Insert Nozzle - Dentsply Professional
 For use with Cavitron PROPHY-JET Air Polishing Units and 30 kHz Cavitron JET systems.
 571-63740 Each..... **\$195.95**



Cavitron® Inserts O-Rings - Dentsply Professional
 For all Cavitron Jet Air Polishing Nozzles, Slimline, P-Style, Cavitron MED and PEC Inserts. Green.
 580-DPC62605 12/pack..... **\$18.25**
 For all FSI, FSI-SLI, and TFI 25K an 30K Inserts. Black.
 580-DPC62351 12/pack..... **\$18.25**



How the best perform

SWIVEL DIRECT FLOW INSERTS



	#10 Universal	#100 Thin	#1000 Triple Bend
25 kHz:	HF-UI25SD10	HF-UI25SD100	HF-UI25SD1000
30 kHz:	HF-UI30SD10	HF-UI30SD100	HF-UI30SD1000
	Each: \$175.75	Each: \$175.75	Each: \$175.75

SWIVEL™ INSERTS



	#10 Universal	#100 Thin	#1000 Triple Bend	Swivel XT
25 kHz:	HF-UI25SS10	HF-UI25SS100	HF-UI25SS1000	HF-UI25SSXT
30 kHz:	HF-UI30SS10	HF-UI30SS100	HF-UI30SS1000	HF-UI30SSXT
	Each: \$175.75	Each: \$175.75	Each: \$175.75	Each: \$175.75



How the best perform

ULTRASONIC SCALING



Hu-Friedy ultrasonic inserts give you the power, efficiency, and comfort you need to treat a wide range of patients.

POINTS OF PERFORMANCE

- Swivel inserts offer 360° rotation for efficient adaptation.
- Swivel Direct Flow inserts deliver water from the tip, which targets water directly to the area of treatment.
- Streamline inserts offer colorful resin handles, allowing easy identification of tip designs.

streamline INSERTS

ORIGINAL PROPHY INSERT



	#10 Universal	#100 Thin	#3 Beavertail	#1000 Triple
25 kHz:	HF-UI1025K	HF-UI25K100S	HF-UI325K	25 kHz: HF-UI100025K
30 kHz:	HF-UI1030K	HF-UI30K100S	HF-UI330K	30 kHz: HF-UI100030K
	Each: \$145.75	Each: \$145.75	Each: \$145.75	Each: \$145.75

ORIGINAL PROPHY PLUS INSERT

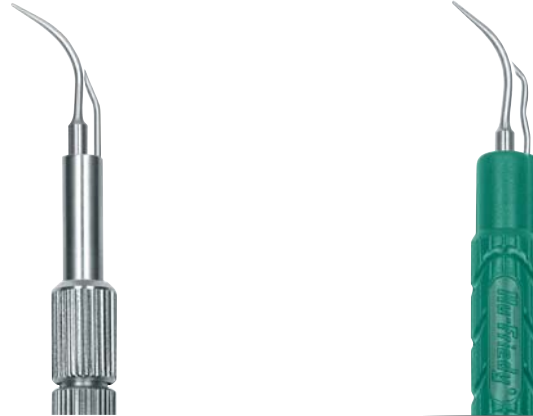

HF-UI25KP10	25 kHz: HF-UI25KP10P
HF-UI30KP10	30 kHz: HF-UI30KP10P
Each: \$155.75	Each: \$182.75

AFTER FIVE® SWIVEL DIRECT FLOW INSERTS

Set of Three
HF-UI25SDSET
HF-UI30SDSET
Each: \$472.25



	Left	Straight	Right
25 kHz:	HF-UI25SDL	HF-UI25SDS	HF-UI25SDR
30 kHz:	HF-UI30SDL	HF-UI30SDS	HF-UI30SDR
	Each: \$181.25	Each: \$181.25	Each: \$181.25

AFTER FIVE® PLUS INSERTS

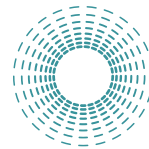

Set of Three
HF-UI25KSFSET
HF-UI30KSFSET
Each: \$484.25



	Left	Straight	Right
25 kHz:	HF-UI25KSF10L	HF-UI25KSF10S	HF-UI25KSF10R
30 kHz:	HF-UI30KSF10L	HF-UI30KSF10S	HF-UI30KSF10R
	Each: \$168.75	Each: \$168.75	Each: \$168.75



Big Easy® Ultrasonic Inserts - Premier® Dental

Ergonomically designed large 0.43" diameter cushion-grip handle for maximum comfort and decreased fatigue. Compatible with most magnetorestrictive hand pieces. PEEK tip is permanently attached, no special tool or replacement tips are required. Effectively removes biofilm and calculus. Safe for use on implants and orthodontic brackets. Ideal for sensitive patients.

Universal 25K	577-1005300
Triple Bend 25K	577-1005305
Universal 30K	577-1005310
Triple Bend 30K	577-1005315
Each	\$128.25



Big Easy Ultrasonic Implant Insert - Premier® Dental

No scratch tip will safely and quickly clean around implant surfaces and is ideal for sensitive patients. Features a permanently attached tip made from PEEK polymer. Autoclavable.

25K	
770-1005326	Each..... \$169.95
30K	
770-1005336	Each..... \$169.95



Resin Handle Ultrasonic Inserts - Premier® Dental

Complete line of internal flow ultrasonic inserts featuring resin handles to complement the ergonomic Big Easy line. You can choose from Universal, Triple Bend or the Thin-tip designs. Made in the USA. Compatible with most magnetorestrictive handpieces.

#100 30K (Red)	770-1006920
#10 25K (Orange)	770-1006800
#10 30K (Yellow)	770-1006900
#1000 25K (Red)	770-1006802
#1000 30K (Purple)	770-1006901
Each	\$103.95



Cut through the fat

GO DIRECTLY TO THE BEST

Manufacturers offer thousands of promotions. GO **DIRECTLY** TO THE BEST.

www.dhpionline.com/promotions

BUY 1 GET	BUY 2 GET	BUY 3 GET	BUY 4 GET OR MORE	DHPI X EXCLUSIVE OFFERS
--	--	--	---	-----------------------------------

HEMOSTATIC SOLUTIONS



Gingi-Aid® - Gingi-Pak

Epinephrine-free. 25% buffered aluminum chloride solution for gingival retraction and hemostasis. Easily absorbed and can be applied by cord, cotton, paper point and mini-sponge or syringe for effective bleeding control.

- 320-12114 15ml **\$18.95**
- 320-12115 40ml **\$40.95**



Orostat® - Gingi-Pak

A specially buffered formulation of 8% epinephrine which controls hemorrhaging while delivering a debris-free field.

- 320-10145 15ml **\$19.45**



Stasis® - Gingi-Pak

21% ferric sulfate hemostyptic formulation that offers superior hemorrhage control versus other non-epinephrine solutions. Recommended for use with Gingi-Plain cotton pellets.

- 120-13114 15ml **\$18.45**
- 120-13115 40ml **\$41.45**



Hemogin L - Kerr Restoratives

25% aluminum chloride in a lubricating glycerin base. An eye dropper is provided to eliminate cross-contamination. Applied with cotton pellets to the gingival tissue, or pre-saturate retraction cord.

- 320-13057 10ml **\$21.45**
- 320-13058 20ml **\$32.45**
- 320-13052 35ml **\$55.95**



Hemodettes - Kerr Restoratives

20% buffered aluminum chloride lubricating hemostatic gel with saturated cotton pellets packaged in unique plastic cups with attached finger ring. Light blue color indicates area of placement. The gel viscosity enhances placement and eliminates migration from the site. Cranberry flavor.

- 320-13150 25/box **\$26.25**



Hemostasyt™ - Kerr Restoratives

15% aluminum chloride paste. Stops bleeding and controls fluids without the chance of staining common to other hemostatic agents. Adheres well to tissue for a more efficient use of material. Bright turquoise color offers sharp contrast to easily see placement. Strawberry scent.

- Contains: 2 -2gm syringes.
- 329-34723 Each **\$50.25**

Curved Applicator Tips

- 329-34724 40/pkg **\$29.45**



Styptin - Kerr Restoratives

A fast-acting, 20% buffered aluminum chloride hemostatic solution in a lubricating base. Blue coloring helps you see where the solution has been placed. Increased viscosity prevents the solution from migrating from the site. Squeeze bottle allows easy dispensing and minimizes the possibility of cross-contamination. Cranberry flavor.

- 320-13157 15ml **\$26.25**
- 320-13156 30ml **\$48.95**



Gel Cord™ - Pascal International, Inc.

Stays where you place it. Will not run or dilute as liquid astringents do. 25% aluminum sulfate gel with pleasant flavor. Can be used with any type of cord and is compatible with all impression materials. Light Blue.

Pro Pack 12

- Contains: 12 -0.75gm syringes and 14 tips.
- 320-15540 Kit **\$51.45**

MicroPoint Kit

- Contains: 25 -0.32gm cartridges and applicator syringe.
- 320-15505 Kit **\$69.45**

Bulk Kit available upon request.

Applicator Syringe

- 320-35900 Each **\$34.25**



FS Hemostatic® - Premier® Dental

A 15.5% ferric sulfate liquid solution offers instantaneous coagulation for difficult hemostatic control. It contains no epinephrine so it is safe for use on all patients.

- 327-9007057 1oz. dropper bottle... **\$24.45**
- 327-9007058 2oz. **\$36.45**



Hemodent® Liquid - Premier® Dental

Effectively stops minor gingival bleeding. It contains no epinephrine to help avoid cardiac reactions. Stable and offers a long shelf life.

- 327-9007071 10cc **\$16.95**
- 327-9007072 20cc **\$32.25**
- 327-9007073 40cc **\$55.25**

RETRACTION

HEMOSTATIC SOLUTIONS

**Racegel® - Septodont**

25% aluminum chloride for optimal and fast control of bleeding. Thermogelifiable properties to ensure no mechanical trauma to the periodontium to control application without excessive hand pressure to facilitate placement and rinsing. Orange color to easily see placement. Raspberry flavor.

Contains: 3 -1.4gm syringes and 30 pre-bent tips.
320-C0500 Each..... **\$98.45**

**Racestyptine Solution - Septodont**

Topical hemostatic and astringent that rapidly and temporarily retracts the gingiva. Contains aluminum chloride and oxyquinol sulfate.

320-S0350 13ml bottle..... **\$33.45**

**Hemoban - Sultan Healthcare**

Controls superficial bleeding during restorative procedures, placement of metal bands, cervical matrixes and crown preparations. 25% aluminum chloride, no epinephrine.

320-10801 30ml..... **\$48.25**

**Quick-Stat™ FREE - Vista Dental Products**

25% aluminum chloride clear hemostatic gel. Will not stain. Controls bleeding fast. Viscous gel will not flow onto surrounding tissue. Surfactant lowers surface tension for better wound penetration.

Standard Kit available upon request.

Value Pack

Contains: 40 -1.2ml syringes and 50 Stat-Flo tips.
330-504640 Kit..... **\$121.45**

Bulk Syringe Kit

Contains: 30ml syringe, 20 Stat-Flo tips, 20 -1.2ml empty syringes and 1 docking port.
330-504650 Kit..... **\$61.25**

Bulk Refill

Contains: 30ml syringe and 1 docking port.
330-504660 Each..... **\$35.45**

**Quick-Stat™ FS**

15.5% ferric sulfate hemostatic gel. Provides effective tissue management when completing impressions, restorations, crown and bridge procedures. Will not flow onto surrounding tissue.

Standard Kit

Contains: 4 -1.2ml syringes and 8 Stat-Flo Tips.
330-502804 Kit..... **\$20.75**

Value Pack

Contains: 40 -1.2ml syringes and 50 Stat-Flo Tips.
330-502800 Pack..... **\$111.25**

Bulk Syringe Kit

Contains: 30ml syringe, 1 docking port, 20 Stat-Flo Tips, 20 -1.2ml empty syringes.
330-503550 Kit..... **\$46.75**

Bulk Refill

Contains: 30ml syringe and 1 docking port.
330-503555 Each..... **\$34.25**

Bulk Procedure Complete Kit available upon request.

Basic Bulk Complete Procedure Kit

Contains: 30ml syringe, 20 -1.2ml empty syringes, 40 Stat-Flo applicator tips, 1 docking port, 2 Stat-Pak cords: 0, 1.

320-503558 Kit..... **\$92.75**

Stat-Flo Brush Tips

19ga. curved cannula and padded-end brush tip.
230-312102 20/pkg..... **\$16.95**

RETRACTION CORD

**Magic FoamCord - Coltene**

Expanding PVS material designed for easy and fast retraction of the sulcus without the potentially traumatic and time-consuming packing of retraction cord.

Intro Kit

Contains: 2 -50ml cartridges, Comprecap Anatomic Set (10 each size 1 and 3), 30 small yellow mix tips and 30 yellow oral tips.
324-C6735 Kit..... **\$194.95**

Refill Kit

Contains: 2 -5ml cartridges.
324-C6737 Kit..... **\$162.95**

Universal Mixing Tips

300-60019663 40/pkg..... **\$39.25**

Oral Tips (yellow)

294-C6555 100/pkg..... **\$65.75**

Comprecap Anatomic Compression Caps**Size 1 Small 7mm**

324-RE531201 120/pkg..... **\$32.95**

Size 3 Medium 10mm

324-RE531203 120/pkg..... **\$36.75**

Size 5 Large 12.5mm

324-RE531205 60/pkg..... **\$26.95**

**ROEKO Stay-Put - Coltene**

Pliable retraction cord with the adaptability of a fine metal filament. Easy to place, no overlapping necessary.

Non-Impregnated

#0 X-Fine	320-R52100
#1 Fine.....	320-R521001
#2 Medium	320-R521002
#3 Thick	320-R521003
72"	\$21.25

GingiBRAID⁺ - Kerr

Restoratives

Braided together for quick absorption. Cotton fiber that will not split or collapse in the sulcus. Can be used with any type of packing instrument. ShortCut is an all-in-one delivery system with a built in cord cutter. Each click of the dial delivers 1cm of cord.



Epinephrine/Alum

- 0e, Fine: Blue320-13170
- 1e, S: Blue w/Purple Strand320-13171
- 2e, M: Blue w/Green Strand320-13172
- 3e, L: Blue w/Pink Strand320-13173
- 72" (6 feet) **\$16.45**

ShortCut

- 0e Fine:Blue.....320-13720
- 1e Small: Blue w/Purple Strand.....320-13721
- 2e Medium: Blue w/Green Strand ..320-13722
- 72" (6 feet) **\$22.95**

Aluminum Potassium Sulfate

- 0a, Fine: Yellow.....320-13210
- 1a, S: Yellow w/Purple Strand.....320-13211
- 2a, M: Yellow w/Green Strand.....320-13212
- 3a, L: Yellow w/Pink Strand.....320-13213
- 72" (6 feet) **\$16.45**

ShortCut

- 0a Fine:Yellow320-13730
- 1a Small: Yellow w/Purple Strand ...320-13731
- 2a Medium: Yellow w/Green Strand 320-13732
- 72" (6 feet) **\$22.95**

Non-Impregnated

- 0n, Fine: White320-13217
- 1n, S: White w/Purple Strand.....320-13214
- 2n, M: White w/Green Strand.....320-13215
- 3n, L: White w/Pink Strand320-13216
- 72" (6 feet) **\$16.45**

ShortCut

- Fine:White.....320-13740
- Small: White w/Purple Strand320-13741
- Medium: White w/Green Strand.....320-13742
- 72" (6 feet) **\$22.95**



UniBRAID⁺

GingiBRAID+ in a Unit Dose delivery format. Pre-cut and individually packaged for single use. Contains: 50 -2" pre-cut lengths.

Epinephrine/Alum

- 0e.....320-13370
- 1e.....320-13371
- 2e.....320-13372
- Each **\$18.95**

Aluminum Potassium Sulfate

- 0a.....320-13360
- 1a.....320-13361
- 2a.....320-13362
- Each **\$18.95**



GingiKNIT⁺ - Kerr Restoratives

Constructed by knitting many tiny loops together to form a long interlocking chain. Places easily without fraying or memory. Conforms to the sulcus with a gentle, outward force and will cut cleanly if touched by a high-speed cutting instrument.

Aluminum Potassium Sulfate

- 000a Extra Fine: Yellow320-13508
- 72" (6 feet) **\$17.25**

Aluminum Potassium Sulfate

- 00a Fine: Yellow w/Black Strand320-13509
- 0a Small: Yellow w/Orange Strand..320-13510
- 1a Medium: Yellow w/Orange-Black Strand320-13511
- 2a Large: Yellow w/Red Strand320-13512
- 72" (6 feet) **\$13.45**

Non-Impregnated

- 000n Extra Fine: White320-13498
- 72" (6 feet) **\$16.25**

Non-Impregnated

- 00n Fine: White w/Black Strand.....320-13499
- 0n Small: White w/Orange Strand...320-13500
- 1n Medium: White w/Orange-Black Strand320-13501
- 2n Large: White w/Red Strand320-13502
- 72" (6 feet) **\$12.95**

GingiCORD - Kerr Restoratives

Traditional retraction cord made of a twisted, long-strand cotton fiber. Ideal when placed last for absorbency or to accommodate a lot of space. Impregnated with epinephrine/aluminum.



- 1 Small: Blue320-13021
- 72" (6 feet) **\$19.95**



GingiGEL - Kerr Restoratives

Gel-coated braid made of synthetic fiber and packaged in hemostatic gel containing 20% buffered aluminum chloride. Completely saturated for easy placement and immediate hemostatic results. Extra layer of medicament coating. Soft and flexible.

- Small320-13165
- Medium320-13166
- 72" (6 feet) **\$18.25**



Gingi-Pak MAX[®] - Gingi-Pak

100% cotton braided weave blends strength and durability while eliminating stiffness and rebound. Easily visible braid provides excellent handling characteristics. Easy to pack, resists penetration and with no memory remains in place. Exclusive Kutter Kap saves time and prevents cross-contamination.

Gingi-Pak MAX Z-Twist

Easily visible Green Braid. Impregnated with Epinephrine.

- Very Thin #00320-10170M
- Thin #1320-10171M
- Medium #2320-10172M
- Thick #3320-10173M
- 108" **\$13.45**

Gingi-Aid MAX Z-Twist

Consistent and effective hemostatic properties without the use of epinephrine. Easily visible Teal Braid. Impregnated with Aluminum Sulfate.

- Very Thin #00320-12170M
- Thin #1320-12171M
- Medium #2320-12172M
- Thick #3320-12173M
- 108" **\$13.45**

Gingi-Plain MAX Z-Twist

Easily visible Purple Braid. Non-Impregnated. Ultra Thin #000.....320-1117TM

- 108" **\$13.45**
- Very Thin #00320-11170M
- Thin #1320-11171M
- Medium #2320-11172M
- Thick #3320-11173M
- 108" **\$12.95**

Gingi-Pak MAX Soft-Twist

100% cotton soft-twist cord suitable for all retraction techniques, including the 2-cord technique. Firmly twisted for easy packing, absorbent and pliable; remains where it's placed. Impregnated with epinephrine.

- Thin #1320-10105M
- Medium #2320-10110M
- Thick #3320-10115M
- 108" **\$13.25**

Non-Impregnated

- Thin #1320-11105M
- Medium #2320-11110M
- Thick #3320-11115M
- 108" **\$11.95**

Gingi-Pak MAX 2 Ply

Loosely wound so that the strands may be separated, twisted or combined to make them ideal for use in the gingival sulcus regardless of the size or condition. Impregnated with epinephrine.

- 320-10120M 108" **\$13.25**

Non-Impregnated

- 320-11120M 108" **\$11.95**

Gingi-Pak Crown-Pak 4 Ply is available upon request.

RETRACTION CORD



KnitTrax™ - Pascal International, Inc.

100% cotton cord is knitted into interlocking chains to facilitate easy packing into sulcus. Will not entangle diamond burs. Can be soaked in hemostatic of choice. No memory.

#00.....	320-07570
#0.....	320-07575
#.....	320-07580
100"	\$16.45

Additional sizes available upon request.



Racord® TWO

Combination vasoconstrictor and astringent action. Impregnated with a solution containing both racemic epinephrine hydrochloride and zinc phenolsulfonate, then dried by a special process to assure optimal retraction. Epinephrine strength is 55% - 70% less than Racord.

#7 Ultra Thin	320-07797
#8 Thin	320-07800
#9 Medium	320-07810
#10 Thick.....	320-07820
6'	\$16.75



Knit-Pak+ - Premier® Dental

Impregnated retraction cord created from unique knitted microfibers. The fibers have very low moisture content with high durability and retention properties. Easily packs into sulcus. Will not entangle in burs. Fray resistant and pliable. Lint and particle free.

000.0 Dark Green	320-9007560
000 Green.....	320-9007561
00 Brown.....	320-9007562
0 Purple	320-9007563
1 Blue.....	320-9007564
2 Orange.....	320-9007565
100"	\$14.45

RETRACTION PASTE



Pascord® - Pascal International, Inc.

100% cotton cord. For patient situations where gingival retraction material containing epinephrine is contraindicated. Impregnated with a solution of aluminum sulfate, then dried by a special process, assures consistent aluminum sulfate content and hemostatic retraction properties.

#7 Ultra Thin	320-07597
#8 Thin	320-07600
#9 Medium	320-07610
#10 Thick.....	320-07620
6'	\$16.45



SilTrax® - Pascal International, Inc.

100% cotton cord. Memory free for precise placement and retraction in the sulcus. Unique packaging prevents cord tangles and cord will not fall back into the bottle.

SilTrax Plain

Non-medicated retraction cord, may be soaked in hemostatic of choice.

#7 Ultra Thin.....	320-07397
#8 Thin	320-07400
#9 Medium	320-07410
#10 Thick.....	320-07420
100"	\$12.75

SilTrax EPI

Impregnated with a solution of stabilized epinephrine hydrochloride.

#7 Ultra Thin.....	320-07197
#8 Thin	320-07200
#9 Medium	320-07210
#10 Thick.....	320-07220
6'	\$17.25

SilTrax AS

For patient situations where gingival retraction material containing epinephrine is contraindicated. Impregnated with a solution of aluminum sulfate.

#7 Ultra Thin	320-07097
#8 Thin	320-07100
#9 Medium	320-07110
#10 Thick.....	320-07120
6'	\$16.45

SilTrax Plus

Combination vasoconstrictor and astringent action in one cord. Impregnated with a solution containing both epinephrine hydrochloride and zinc phenolsulfonate.

#7 Ultra Thin.....	320-07297
#8 Thin	320-07300
#9 Medium	320-07310
#10 Thick.....	320-07320
6'	\$16.45



Racord® - Pascal International, Inc.

100% cotton cord saturated with a solution of stabilized racemic epinephrine hydrochloride, then dried by a special process, assuring both consistent racemic epinephrine content and excellent hemostatic retraction properties. Memory free.

#7 Ultra Thin	320-07697
#8 Thin	320-07700
#9 Medium	320-07710
#10 Thick.....	320-07720
6'	\$17.25



Retraction Capsules - 3M Oral Care

Patented extra fine tip. The retraction paste dispenses easily using common composite dispensers and effectively deflects marginal gingiva. Hygienic unit-dose capsule, convenient and time-saving retraction process: Up to 50% faster and gentle on tissue for improved patient comfort. Compatible with most composite dispensers.

323-56941	25/pkg	\$93.95
-----------	--------------	----------------

Value Pack

323-56942	100/pack.....	\$298.95
-----------	---------------	-----------------

**Expasyl™
Gingival
Retraction
System -
Acteon North
America**

Rigid paste for gingival retraction that not only opens the sulcus but also leaves the field dry and ready for impression taking or cementation. Holds its rigidity when in the sulcus to create space between the tooth and the tissue. Safe and painless with no risk of rupturing the epithelial attachment. Original and Strawberry flavor.



Intro Kits available upon request.

Refill

Contains: 20 - 1gm capsules.		
320-261030	Original	\$352.25
320-261001	Strawberry	\$273.75

Manual Applicator

320-260900	Each.....	\$404.95
------------	-----------	-----------------

Applicator Tips

320-261040	40/pkg.	\$107.25
320-261005	100/pkg.....	\$195.75

RETRACTION PASTE



GingiTrac™ - Centrix

1:1 Vinyl Polysiloxane formula. Contains aluminum sulfate astringent to control bleeding and oozing, while the flowable vps material gently pushes the gingiva. No tissue trauma or ligament damage. Sets in 2 minutes in the mouth.

Standard Kit available upon request.

Refill Kit

Contains: 2 -50ml cartridges, 10 mixing nozzles and 10 dispensing tips.

320-360100 Kit.....\$114.45

MiniMix Automix 1:1 Nozzles

Clear hub.

380-910630 10/pkg \$17.95



Dryz® - Parkell Inc.

Gingival hemostatic retraction paste. Stops gingival bleeding and seepage that may interfere with impression taking. Fast-acting. Light green color.

Contains: 7 syringes and 15 applicator tips.

320-S180 Each..... \$79.25

Value Pack

Contains: 25 syringes and 55 applicator tips.

320-S182 Each..... \$247.25

Unit Dose

Contains: 30 -0.24gm capsules.

320-S183 Each.....\$102.95

Luer Lock Applicator Tips

300-S181 40/pkg \$33.25



Traxodent™ - Premier® Dental

15% aluminum chloride retraction paste packed in 0.7gm syringes with bendable tips for easy access. The absorbent paste displaces soft tissue and works synergistically with the astringent properties of aluminum chloride to create retraction.

Starter Pack

Contains: 7 -0.7gm syringes and 15 tips.

327-9007093 Pack \$97.95

Value Pack

Contains: 25 -0.7gm syringes and 50 tips.

327-9007091 Pack \$259.95

Applicator Tips

327-9007092 50/box \$41.25

Unit Dose available upon request.

RETRACTION PELLETS & COTTON



Roeko Comprecap - Coltene

Opens the sulcus and holds the retraction cord in place. Ensures a dry, clean area for impression taking. Exerts pressure on the gingiva to stop bleeding, ensuring a clean, dry and open sulcus.

Introductory Kit

Contains: 150 caps; 50 each of size 1, 3 and 5.

320-R530000 Kit..... \$36.45

Refills

#1 Small 7mm
320-R530008 120/box \$29.45

#3 Medium 10mm
320-R530010 120/box \$33.95

#5 Large 12.5mm
320-R530014 60/box \$25.45



Gingi-Pak® Pellets - Gingi-Pak

100% cotton. Impregnated with epinephrine for hemostatis.

320-10135 560/box \$19.95

Available Non-Impregnated upon request.



Gingi-Plain® Cotton Coil - Gingi-Pak

100% cotton. Impregnated with epinephrine for hemostatis. May be shaped to the sulcus depth and width to be used as a substitute for retraction cord.

320-10140 15ml \$19.95

Available Non-Impregnated upon request.



EpiDri® Pellets - Pascal International, Inc.

Cotton pellets with epinephrine. Normal tissue moisture will activate the pellet. For rapid activation, dip in water, just prior to application. Supplied in a spring loaded, self dispensing, weighted plastic container. Counts per box are approximated. 1.9mg racemic epinephrine HCl per pellet. Color-coded yellow.

240-12100 350/box \$35.95



Racellet® Pellets - Pascal International, Inc.

Used to control light bleeding and seepage along gingival margins. Soft pellets are activated by normal tissue moisture. For rapid activation, dip in water just prior to application. Supplied in a spring loaded, self-dispensing, weighted plastic container. Counts per box are approximated. Color-coded green.

#2 Pellets

1.15mg Racemic Epinephrine HCl per pellet.
240-12150 200/box \$35.95

#3 Pellets

0.55mg Racemic Epinephrine HCl per pellet.
240-12200 350/box \$35.95



Retraction Caps - Premier® Dental

Hollow cotton caps designed to enhance gingival retraction and assist hemostasis. Works synergistically with Traxodent hemodent paste retraction system.

#1 Small

327-9048251 120/box..... \$26.45

#3 Medium

327-9048253 120/box..... \$32.45

#5 Large

327-9048255 60/box. \$26.25

Assorted

Contains: 15 small, 15 medium and 30 large.
327-9048260 60/box \$22.45

RUBBER DAMS



Hygenic® Latex Dental Dams - Coltene

Made of pure, natural rubber latex. Tough and hard to tear, used as a barrier during operative and endodontic procedures.

5" x 5"

Thin

Green.....	815-02141
Light.....	815-00523
52/box	\$22.45

Medium

Blue.....	815-03529
Dark.....	815-00529
Green.....	815-02142
Light.....	815-00524
52/box	\$25.25

Heavy

Blue.....	815-07314
Dark.....	815-00530
Green.....	815-02143
Light.....	815-00525
52/box	\$26.95

Extra Heavy

Dark.....	815-00531
Green.....	815-02144
Light.....	815-00526
52/box	\$28.45

6" x 6"

Thin

Dark.....	815-00538
Green.....	815-02146
Light.....	815-00533
36/box	\$22.45

Medium

Blue.....	815-03530
Dark.....	815-00539
Green.....	815-02147
Light.....	815-00534
36/box	\$25.25

Heavy

Blue.....	815-07315
Dark.....	815-00540
Green.....	815-02148
Light.....	815-00535
36/box	\$26.95

Extra Heavy

Dark.....	815-00541
Green.....	815-02149
Light.....	815-00536
36/box	\$28.45

Convenience Dam Packs 5" x 5"

Thin

Green.....	815-04240
Light.....	815-04236
364/box	\$123.95

Medium

Pastels.....	815-07316
Dark.....	815-04239
Green.....	815-04241

Light.....	815-04237
364/box	\$143.75

Convenience Dam Packs 6" x 6"

Thin

Green.....	815-04246
Light.....	815-04242
360/box	\$170.75

Medium

Pastels.....	815-07317
Dark.....	815-04245
Green.....	815-04247
Light.....	815-04243
360/box	\$214.45



Hygenic® Non-Latex Dental Dam - Coltene

Latex-Free with similar tear resistance to natural rubber latex without any patient/staff reactions. It is easy to apply and used for improved patient comfort.

Medium 5" x 5"

Teal Green.....	815-09928
15/box	\$34.95

Medium 6" x 6"

Teal Green.....	815-09105
15/box	\$38.95



Hygenic® Elasti-Dam - Coltene

Considerably more elastic and tear resistant than standard latex dams making application much easier.

5" x 5"

Medium Green.....	810-H11624
Medium Blue.....	810-H11626
Heavy Green.....	810-H11675
Heavy Blue.....	810-H11677
52/box	\$25.25

6" x 6"

Medium Green.....	810-H11625
Medium Blue.....	810-H11627
Heavy Green.....	810-H11676
Heavy Blue.....	810-H11678
36/box	\$25.25



Hygenic® Fiesta® Dam - Coltene

Natural rubber latex dam is fresh fruit scented for greater patient and staff comfort.

Assorted Colors

5" x 5" - 52/box

Thin.....	815-04640	\$23.25
-----------	-----------	----------------

Medium.....	815-04641	\$26.25
Heavy.....	815-04643	\$28.95

6" x 6" - 36/box

Thin.....	815-04639	\$23.25
Medium.....	815-04642	\$26.25
Heavy.....	815-04644	\$28.95



Hygenic® FlexiDam® Non Latex Dental Dam - Coltene

Feature a low modulus of elasticity for extra strength and flexibility. No offensive odor.

6" x 6"

Medium.....	
Purple.....	815-09945
Green.....	815-09946
30/box	\$50.25



Smart Dam - Cranberry

Low modulus elasticity and uncompromising tear resistance. Studies have proven that Smart Dam has a 950% elongation at break with 98% less latex protein and 80% less powder. Offers a high color contrast for optimal visual acuity.

Latex Unscented - Blue

5" x 5".....	810-8155
52/box	\$10.25
6" x 6".....	810-8166M
36/box	\$10.25

Latex Spearmint Scented - Green

5" x 5".....	810-8055
52/box	\$10.25
6" x 6".....	810-8066
36/box	\$10.25

Non Latex Spearmint Scented - Purple

6" x 6".....	810-8366M
15/box	\$17.25



Latex Dental Dams - Crosstex International

Manufactured from premium latex. Powder-free with less than 5mg/sheet. 100% non-chlorinated. Excellent tensile and tear strength.

5" x 5"

Thin

Blue - Unflavored.....	812-19102
Green - Mint Flavored.....	812-19202
52/box	\$16.95

Continued

RUBBER DAMS

Latex Dental Dams continued.

Medium

Blue - Unflavored 812-19100
 Green - Mint Flavored..... 812-19200
 52/box **\$16.95**

Heavy

Blue - Unflavored 812-19101
 Green - Mint Flavored..... 812-19201
 52/box **\$16.95**

6" x 6"

Thin

Blue - Unflavored 812-19302
 Green - Mint Flavored 812-19402
 36/box **\$16.95**

Medium

Blue - Unflavored 812-19300
 Green - Mint Flavored..... 812-19400
 36/box **\$16.95**

Heavy

Blue 812-19301
 Mint Green 812-19401
 36/box **\$16.95**



Isodam® Dental Dams - Hedy Canada

Keeps operatory field dry. Tear resistant. Blue.

Non-Latex

5" x 5"
 Medium 810-320DNB5MU
 Heavy 810-320DNB5HU
 20/box **\$20.25**

6" x 6"

Medium 810-320DNB6MU
 Heavy 810-320DNB6HU
 15/box **\$20.25**

Economy Pack

5" x 5"
 Medium 810-321DNB5MU
 100/box **\$75.75**

6" x 6"

Medium 810-321DNB6MU
 75/box **\$75.75**

Latex

5" x 5"
 Thin - Blue..... 810-310DB5TU
 Medium - Blue..... 810-310DB5MU
 Heavy - Blue 810-310DB5HU
 Thin - Green 810-310DG5TU
 Medium - Green 810-310DG5MU
 Heavy - Green..... 810-310DG5HU
 52/box **\$11.25**

6" x 6"

Thin - Blue 810-310DB6TU
 Medium - Blue..... 810-310DB6MU
 Heavy - Blue 810-310DB6HU
 Thin - Green..... 810-310DG6TU
 Medium - Green..... 810-310DG6MU
 Heavy - Green..... 810-310DG6HU
 36/box **\$11.25**



Relaxed-Fit Insti-Dam - Zirc

Relaxed dam works well for hard to reach posterior teeth. Folds easily to the side so radiographs may be taken without removal of the dam. Compact design fits outside patients lips, non-threatening and comfortable for patients. 4-1/4" diameter, purple, latex-free.

810-50Z457 20/pack **\$67.25**

PRE-FRAMED RUBBER DAMS



HandiDam® Dental Dams - Aseptico, Inc.

Pre-framed rubber dams. Easily isolate a single tooth or groups of teeth for endodontics or other dental treatments.

Latex - Blue
 810-170BM 20/box **\$38.95**
 810-170BM100 100/box **\$148.75**

Latex Free - Purple
 810-170LF 20/box **\$55.95**
 810-170LF100 100/box **\$257.25**



Hygenic® Framed Non-Latex FlexiDam® - Coltene

The smooth surface of the plastic frame helps to maximize patient comfort when positioned on their skin. 6" x 6", purple.

815-00750 20/box **\$72.25**



Insti-Dam - Zirc

Built-in flexible frame. 1/2" offset pre-punched hole makes positioning easy. Compact design fits outside patients lips, non-threatening and comfortable for patients. Radiographs may be taken without removing the rubber dam by folding it to the side. Single use only. Comes pre-assembled. Dimensions: 4-1/4" diameter.

Latex - White
 810-50Z455 20/pack **\$54.75**

Latex Free - Blue
 810-50Z459 20/pack **\$54.75**

Insti-Dam Dispensers

Holds 35 Insti-Dams.
 White 810-50Z471A
 Blue 810-50Z471N
 Each **\$20.45**

RUBBER DAM ACCESSORIES



Hygenic® Dental Dam Stamp - Coltene

Used to mark standard tooth positions on dental dam. Works with most office ink pads.

5" x 5" 815-01442
 6" x 6" 815-01443
 Each **\$32.25**



Hygenic® Wedjets® - Coltene

Eliminates tedious clamp selection and application. Packaged in a dispenser containing seven continuous feet. An attached cutting blade enables the dentist to choose desired length. Made of natural latex, disposable. No chance of tissue or enamel trauma.

X-Small Blue **815-08040**
 Small Yellow **815-06522**
 Large Orange..... **815-06523**
 Each **\$27.75**

Available in non-latex upon request.

RUBBER DAM

RUBBER DAM ACCESSORIES



Ora-Shield® Dam Napkins - Coltene

Napkins - 50/box
 Frame size 815-01415 **\$24.75**
 Holder size 815-00841 **\$31.25**



MiniDam - DMG America

Silicone-based gingival protection device that protects the proximal area during treatment - quickly, easily and most importantly, comfortably for the patient. Can be placed in just a few seconds and stabilizes itself without the use of clamps, while still allowing open access to the treatment area.

810-220381 20/pack **\$31.95**



FastDam™ Soft Tissue Isolation - Spectrum Dental, Inc.

A fast, easy and effective way to isolate the soft tissue for a variety of procedures. The resin material is syringed onto the soft tissue and cured. Once polymerized, provides a solid, protective, leak-proof barrier.

Contains: 4 -1.3ml syringes.
 170-ZD1422 Each..... **\$27.95**

RUBBER DAM FRAMES



Hygenic® Dental Dam Frames - Coltene

Autoclavable.
Ostby plastic frame – radiolucent
 6" 815-00560 **\$25.95**

Plastic U-shaped – radiolucent
 5" 815-01416 **\$18.95**
 6" 815-01414 **\$18.95**

Metal U-shaped
 5" 815-07082 **\$33.75**
 6" 815-07083 **\$33.75**



Rubber Dam Frames - Hu-Friedy Steel Frame.

5" HF-RDCF5 **\$31.45**
 6" HF-RDAF6 **\$31.45**

Rubber Dam Frames - Young Dental

Easy-to-use and more comfortable for patients.



2 Button Regular - 7 Tines
 810-177101 Each..... **\$25.25**



Contoured Adult Frame - 7Tines 5 1/16" x 4 1/8"
 810-177601 Each..... **\$34.45**



Contoured Pedo - 7 Tines 4 9/16" x 3 3/4"
 810-177801 Each..... **\$34.45**

Hook & Ball Type - 9 Tines 5 1/16" x 4 1/8"
 810-179201 Each..... **\$31.25**



Nylon Radiolucent Frame - 11 Tines 4 3/8" x 3 7/8"
 810-171401 Each..... **\$16.95**



Original Frame - 7 Tines 4 1/8" x 3 1/5"
 810-177001 Each..... **\$18.25**



Dental Dam Clamps

Hygenic Fiesta Color Coded Matte Finish Winged Clamps \$17.95 Each

#2	● Premolars and upper incisors	815-09957
#2A	● Premolars and upper incisors	815-09958
#4	● Small upper molars, deciduous teeth	815-09959
#7	● Flat jawed, general purpose, lower molar clamp	815-09960
#8A	● Downward sloped jaws for small, partially erupted molars	815-09961
#9	● Anterior teeth	815-09962
#12A	● Serrated jaw clamp, upper left molars	815-09963
#13A	● Serrated jaw clamp, upper right molars	815-09964
#14A	● Downward sloped jaws for large, partially erupted molars	815-09965

Hygenic Fiesta Color Coded Matte Finish Wingless Clamps \$17.95 Each

#W2	● Premolars and upper incisors	815-02794
#W2A	● Premolars and upper incisors	815-02795
#W3	● Flat jawed, small molar clamp	815-02795
#W7	● Flat jawed, general purpose, lower molar clamp	815-02797
#W8	● General purpose, upper molar clamp	815-02798
#W8A	● Downward sloped jaws for small, partially erupted molars	815-02799
#W9	● Anterior teeth	815-02800
#W14A	● Downward sloped jaws for large, partially erupted molars	815-02802
#W56	● Universal molar clamp	815-02803



Hygenic Gloss Finish Winged Clamps \$15.25 Each

#00	For upper and lower premolar and anterior teeth	815-02762
#1	General purpose, upper premolar clamp	815-02703
#2	Premolars and upper incisors	815-02761
#2A	Premolars and upper incisors	815-05688
#3	Flat jawed, small molar clamp	815-05689
#4	Small upper molars, deciduous teeth	815-02704
#7	Flat jawed, general purpose, lower molar clamp	815-02758
#8	General purpose, upper molar clamp	815-02760
#8A	Downward sloped jaws for small, partially erupted molars	815-02759
#9	Anterior teeth	815-02763
#14	For partially erupted or irregularly shaped molars	815-05690
#14A	Downward sloped jaws for large, partially erupted molars	815-02757



Hygenic Gloss Finish Wingless Clamps \$15.25 Each

#212	Anterior teeth	815-07792
#W00	For upper and lower premolar and anterior teeth	815-02769
#W2	Premolars and upper incisors	815-02768
#W2A	Premolars and upper incisors	815-02775
#W3	Flat jawed, small molar clamp	815-03814
#W7	Flat jawed, general purpose, lower molar clamp	815-02765
#W8	General purpose, upper molar clamp	815-02767
#W8A	Downward sloped jaws for small, partially erupted molars	815-02766
#W9	Anterior teeth	815-02770
#W14	For partially erupted or irregularly shaped molars	815-02774
#W14A	Downward sloped jaws for large, partially erupted molars	815-02764
#W56	Universal molar clamp	815-03815

Hygenic Brinker Clamps - Tissue Retractors \$15.25 Each

Brinker Universal Clamp Set	815-01054 Set.\$78.25	#B-1	Lower molars/pedo	815-01048
(one of each B-1, B-2, B-3, B-4, B-5, B-6)		#B-2	Upper left molar	815-01049
		#B-3	Upper right molar	815-01050
		#B-4	Bicuspid, anterior	815-01051
		#B-5	All bicuspid & incisors	815-01052
		#B-6	All bicuspid & incisors	815-01053



Hygenic® Dental Dam Clamp Sets....\$102.25

Contains the following clamps:
1, 2, 4, 7, 8A, 9, 12A, 13A, 14A

System-9 Winged-Clamp-Pak 815-02701

ANTERIOR



How the best perform

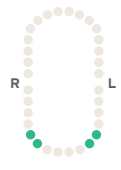

00
| HF-RDCM00

Flat jaws and high bow for small lower canines and first premolars.

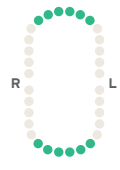

6
| HF-RDCM6

Slightly offset jaws for labial caries on anterior teeth.

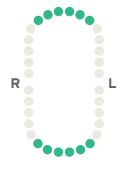

9
| HF-RDCM9

Offset flat jaws and stiff bow for anterior teeth.

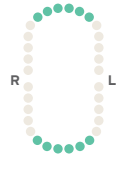

9S
| HF-RDCM9S

Offset flat serrated jaws for anterior teeth.

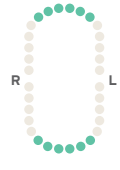

212
| HF-RDCM212

Flat jaws for labial caries on anterior teeth.

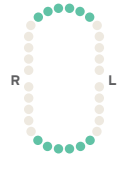

212SA
| HF-RDCM212SA

Slightly offset staggered jaws for odd shaped anteriors.

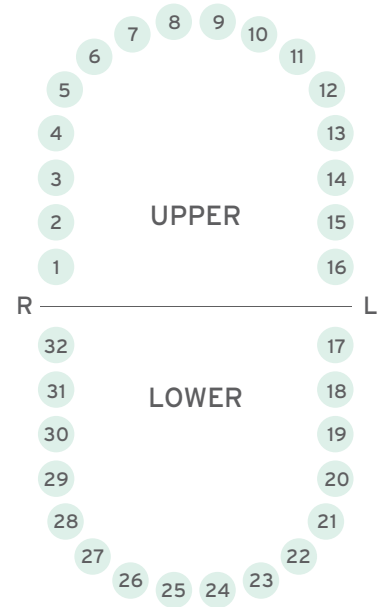

\$14.25 Each

PREMOLARS

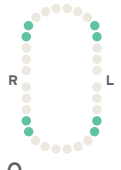

0
| HF-RDCM0

Flat jaws and high bow for longer premolars.

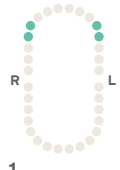

1
| HF-RDCM1

Slightly festooned jaws for upper premolars.

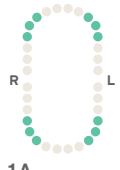

1A
| HF-RDCM1A

Deeply festooned jaws for canines and premolars.

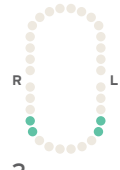

2
| HF-RDCM2

Flat jaws for premolars.

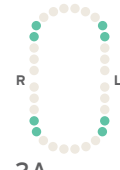

2A
| HF-RDCM2A

Flat jaws for larger premolars.

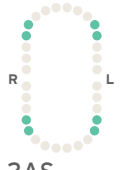

2AS
| HF-RDCM2AS

Flat serrated jaws for larger premolars.

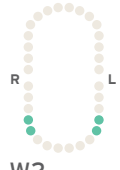

W2
| HF-RDCMW2

Flat jaws for premolars.

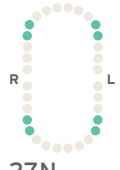

27N
| HF-RDCM27N

Slightly festooned jaws for premolars.

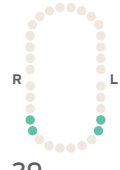

29
| HF-RDCM29

Flat jaws for lower premolars.

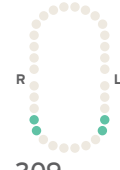

209
| HF-RDCM209

Small, flat jaws with stiff bow for lower premolars.

\$14.25 Each

MOLARS (GENERAL)



How the best perform

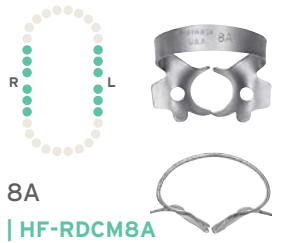

8A
| HF-RDCM8A
Deeply festooned four-point jaws for molars.



8AD
| HF-RDCM8AD
Deeply festooned jaws and extended bow for distal access to molars.



W8A
| HF-RDCMW8A
Slightly festooned jaws for molars.

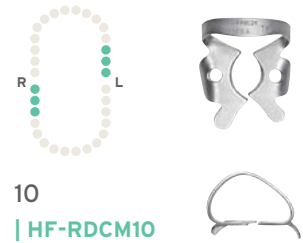

10
| HF-RDCM10
Flat jaws designed for small upper left and lower right molars; paired with RDCM11.

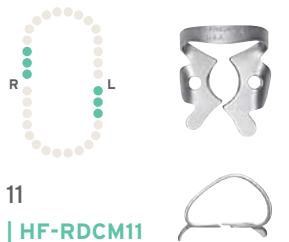

11
| HF-RDCM11
Flat jaws designed for small upper right and lower left molars; paired with RDCM10.

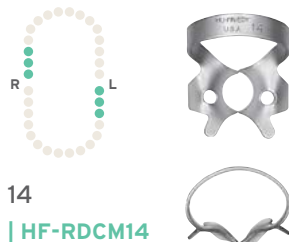

14
| HF-RDCM14
Deeply festooned jaws for partially erupted or irregularly shaped molars.



14A
| HF-RDCM14A
Deeply festooned jaws for partially erupted or irregularly shaped molars; larger than RDCM14.



W14A
| HF-RDCMW14A
Deeply festooned jaws for partially erupted or irregularly shaped molars.



18
| HF-RDCM18
Flat jaws and stiff bow for molars.



24
| HF-RDCM24
Flat jaws for upper right and lower left molars; paired with RDCM25.



25
| HF-RDCM25
Flat jaws for upper left and lower right molars; paired with RDCM24.



27
| HF-RDCM27
Flat jaws for large molars.



56
| HF-RDCM56
Slightly festooned jaws for large molars.



56S
| HF-RDCM56S
Slightly festooned serrated jaws for large partially erupted or irregularly shaped molars.

\$14.25 Each

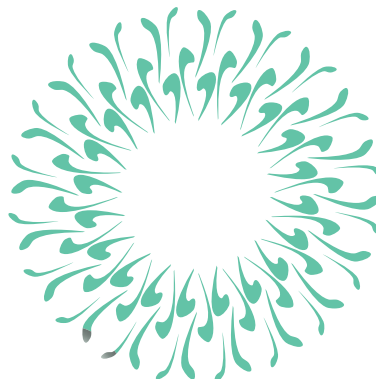



UPPER MOLARS

How the best perform



4
| HF-RDCM4
Flat narrow jaws for small upper molars.



W4
| HF-RDCMW4
Flat narrow jaws for small upper molars.



5
| HF-RDCM5
Slightly festooned jaws for large upper molars.

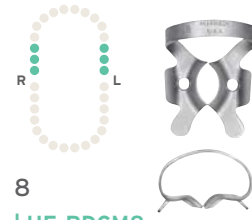

8
| HF-RDCM8
Deeply festooned jaws for upper molars.



26N
| HF-RDCM26N
Flat jaws for upper molars.

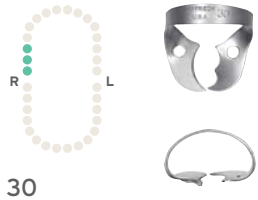

30
| HF-RDCM30
Offset jaws for upper right molars; paired with RDCM31.

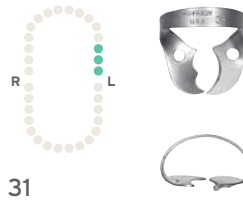

31
| HF-RDCM31
Offset jaws for upper left molars; paired with RDCM30.

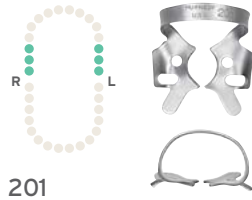

201
| HF-RDCM201
Slightly festooned jaws for upper molars.

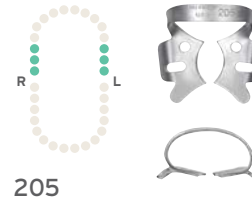

205
| HF-RDCM205
Slightly festooned jaws for large upper molars.

\$14.25 Each

LOWER MOLARS

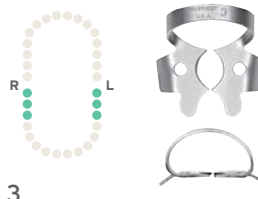

3
| HF-RDCM3
Flat narrow jaws for small lower molars.

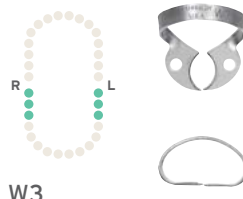

W3
| HF-RDCMW3
Flat narrow jaws for small lower molars.

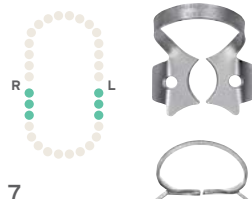

7
| HF-RDCM7
Flat jaws for lower molars.

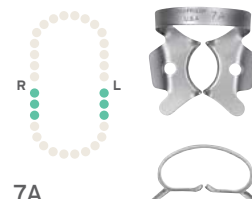

7A
| HF-RDCM7A
Slightly reversed festooned jaws for large lower molars.



W7
| HF-RDCMW7
Flat jaws for lower molars.

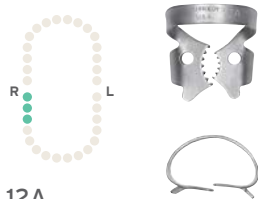

12A
| HF-RDCM12A
Serrated offset jaws for lower right molars; paired with RDCM13A.

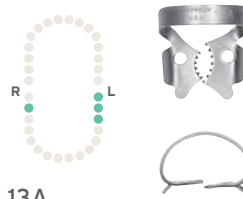

13A
| HF-RDCM13A
Serrated offset jaws for lower left molars; paired with RDCM12A.

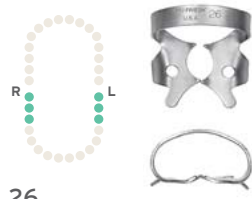

26
| HF-RDCM26
Slightly reversed festooned jaws for small lower molars.

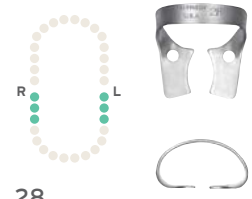

28
| HF-RDCM28
Flat jaws for lower molars.

\$14.25 Each



How the best perform

Rubber Dam Kit

| **HF-RDKIT Kit.....\$511.25**

Basic items needed for rubber dam procedures conveniently packaged in a kit (also available individually).

Rubber Dam Clamp Forceps	RDF
Rubber Dam Punch	RDP
Rubber Dam Frame-Adult	RDAF6
Universal Rubber Dam Template	RDTUNIV
FDI Rubber Dam Template	RDTFDI
Rubber Dam Clamp Organizing Board	RDCOB
#0 Satin Steel Rubber Dam Clamp	RDCM0
#1 Satin Steel Rubber Dam Clamp	RDCM1
#2 Satin Steel Rubber Dam Clamp	RDCM2
#7 Satin Steel Rubber Dam Clamp	RDCM7
#8 Satin Steel Rubber Dam Clamp	RDCM8
#8A Satin Steel Rubber Dam Clamp	RDCM8A
#14A Satin Steel Rubber Dam Clamp	RDCM14A
#212 Satin Steel Rubber Dam Clamp	RDCM212

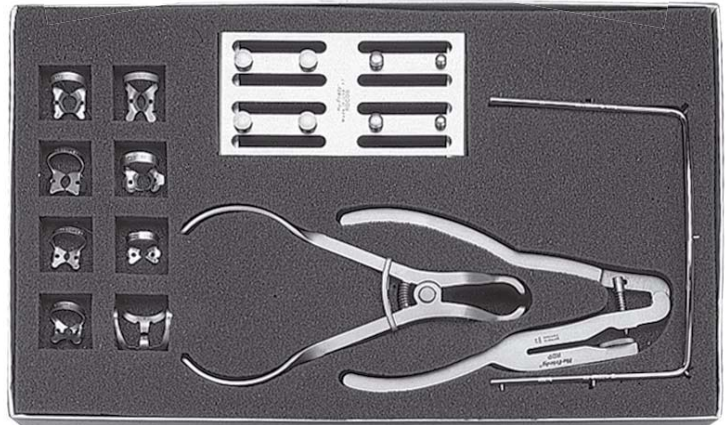
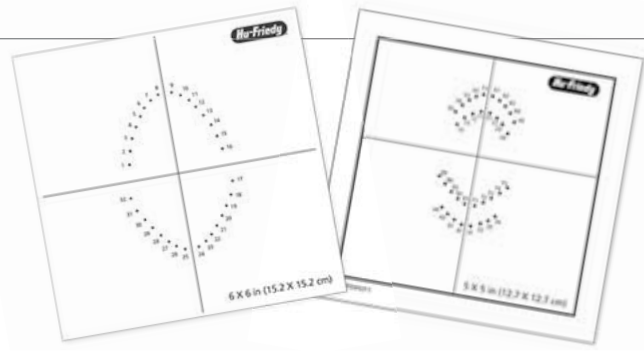

Rubber Dam Clamp 7 Pack

| **810-RDCSET7 Pack.....\$86.75**

#00 Satin Steel Rubber Dam Clamp	RDCM00
#2 Satin Steel Rubber Dam Clamp	RDCM2
#7 Satin Steel Rubber Dam Clamp	RDCM7
#8 Satin Steel Rubber Dam Clamp	RDCM8
#8A Satin Steel Rubber Dam Clamp	RDCM8A
#9 Satin Steel Rubber Dam Clamp	RDCM9
#14A Satin Steel Rubber Dam Clamp	RDCM14A















Rubber Dam Clamp 8 Pack

| **810-RDCSETPack.....\$93.95**

#0 Satin Steel Rubber Dam Clamp	RDCM0
#1 Satin Steel Rubber Dam Clamp	RDCM1
#14A Satin Steel Rubber Dam Clamp	RDCM14A
#2 Satin Steel Rubber Dam Clamp	RDCM2
#212 Satin Steel Rubber Dam Clamp	RDCM212
#7 Satin Steel Rubber Dam Clamp	RDCM7
#8 Satin Steel Rubber Dam Clamp	RDCM8
#8A Satin Steel Rubber Dam Clamp	RDCM8A



Needle Cross Reference Guide

Needle	Health-Tec	Hu-Friedy	Look	Ethicon	Other Brands
C-1  10.7mm 3/8 Circle Reverse Cut		C-1	C-1	P-1	
C-3  13mm 3/8 Circle Reverse Cut	C3	C-3	C-3	P-3, PS-3	BO-2, C-3, P-13, PRE-2
C-6  18.7mm 3/8 Circle Reverse Cut	C6	C-6	C-6	FS-2, PS-2	C-13, CE-4, PC-31, PF-12, PRE-4
C-7  24.3mm 3/8 Circle Reverse Cut	C7	C-7	C-8	FS-1, PS-1	C-14, C-15, CE-6, DS-26, DSS-2, PRE-6
C-9  23mm 1/2 Circle Reverse Cut	C31	C-9	C-20	X-1	C-21, C-23, C-30, C-31, M-1
C-17  12mm 3/8 Circle Reverse Cut		C-17	C-17	C-3	C-1, C-2, C-16, C-17, CE-2
C-19  18.3mm 1/2 Circle Reverse Cut		C-19	C-19	J-1	C-19
C-22  16.2mm 3/8 Circle Reverse Cut		C-22	C-22	FS-3, PS-3	C-12, C-22, CE-3, PC-34, PRE-3, J-1
C-43  16.2mm 1/2 Circle Reverse Cut		C-43	C-19	X-8	C-26
D-14  17.5mm 1/2 Circle Cutting End Taper		D-14	D-14	V-5	CV-332, D-14, DT-31, CV-332, Y-5
T-28  17.5mm 1/2 Circle Taper Point		T-28	T-28	RB-1	CV-331, T-31
T-4  22.2mm 1/2 Circle Taper Point		T-4	T-4	SH-1	T-16

Images may vary slightly from actual.



Suture Materials Comparison Chart

Chromic Gut - Absorbable, (P)= Precision or Premium Indicating Finer Point Needle								
Suture Size	Length (mm)	Needle Type	Length (mm)	Shape	Health-Tec 12/box	Hu-Friedy 12/box	Look 12/box	Ethicon 12/box, 36/box*
2-0	27"	C-8	24	3/8			850-561B	
3-0	18"	C-6	19	3/8	850-CG3018C6		850-525B	
	27"	C-6	19	3/8	850-CG3027C6	850-PSN636C	850-560B	850-636H*, (P)850-1638H*
4-0	18"	C-3	13	3/8	850-CG4018C3	(P) 850-PSN1654C	(P) 850-595B	(P) 850-1654G
	18"	C-6	19	3/8	(P) 850-CG4018C6		850-558B	(P) 850-1637G
	27"	C-6	19	3/8	850-CG4027C6	850-PSN635C	850-559B	850-635H*
5-0	18"	C-3	13	3/8	(P) 850-CG5018C3	(P) 850-PSN687C	(P) 850-1248B	(P) 850-687G
	18"	PS-3 Prime	16	3/8				(P) 850-1636G
	18"	C-17	12	3/8		850-PSN385C	850-563B	
	18"	C-19	15	1/2			850-598B	
	27"	C-6	19	3/8		850-PSN634C	850-557B	
6-0	18"	C-1	11	3/8		(P) 850-PSN1816C		
Plain Gut - Absorbable, (P)= Precision or Premium Indicating Finer Point Needle								
Suture Size	Length (mm)	Needle Type	Length (mm)	Shape	Health-Tec 12/box	Hu-Friedy 12/box	Look 12/box	Ethicon 12/box, 36/box*
2-0	27"	C-8	24	3/8			850-555B	
3-0	18"	C-6	19	3/8	850-PG3018C6		850-592B	
	18"	C-31	23	3/8	850-PG3018C31			
	18"	C-31	24	1/2	850-PSN612A		850-594B	850-612G
4-0	27"	C-6	19	3/8	850-PG3027C6	850-PSNH822A	850-554B	850-H822H*
	27"	C-7	24	3/8	850-PG3027C7		850-553B	850-H810H*
	18"	C-3	13	3/8			(P) 850-1241B	(P) 850-1644G
5-0	18"	C-6	19	3/8	850-PG4018C6	850-PSN7771A	(P) 850-591B	
	18"	C-20	24	1/2			850-599B	
	27"	C-6	19	3/8	850-PG4027C6	850-PSNH821A	850-551B	850-H821H*
6-0	18"	C-3	13	3/8			(P) 850-596B	(P) 850-686G
	27"	C-6	19	3/8			850-550B	
Braided Polyglycolic (PGA) - Absorbable, (D)= Dyed, (U)=Undyed, (P)= Precision or Premium Indicating Finer Point Needle								
Suture Size	Length (mm)	Needle Type	Length (mm)	Shape	Health-Tec 12/box	Hu-Friedy 12/box	Look 12/box	Ethicon 12/box, 36/box*
3-0	18"	C-6	19	3/8		(D) 850-PSN393V	(UP) 850-497B	(UP) 850-J497G
	27"	C-6	19	3/8			(U) 850-423B	(U) 850-J423H*
4-0	18"	C-3	13	3/8			(UP) 850-494B	(DP) 850-J464G
	18"	C-6	19	3/8		(D) 850-PSN392V		(D) 850-J392H*
	27"	C-6	19	3/8		(U) 850-PSN422V	(U) 850-422B	(U) 850-J422H*
5-0	18"	C-3	13	3/8		(UP) 850-PSN493V	(UP) 850-493B	(UP) 850-J493G, (DP) 850-J463G
	27"	C-6	19	3/8			(U) 850-421B	(U) 850-J421H*
6-0	18"	P-3	13	3/8				(UP) 850-J492G



Suture Materials Comparison Chart

Braided Black Silk - Nonabsorbable, (P)= Precision or Premium Indicating Finer Point Needle								
Suture Size	Length (mm)	Needle Type	Length (mm)	Shape	Health-Tec 12/box	Hu-Friedy 12/box	Look 12/box	Ethicon 12/box, 36/box*
2-0	18"	C-8	26	3/8			(P) 850-770B	
3-0	18"	C-6	19	3/8	850-S3018C6	850-PSN7772S	(P) 850-784B	
	18"	C-7	24	3/8	850-S3018C7	850-PSN684S	(P) 850-786B	850-684G
	18"	C-19	18	1/2		850-PSN632S	850-783B	
	18"	C-20	22	1/2			(P) 850-785B	850-632G
	18"	C-26	15	1/2			850-778B	
	18"	C-31	23	3/8	850-S3018C31			
	18"	C-43	16	1/2		850-PSN7762S		
4-0	18"	C-3	13	3/8		(P) 850-PSN641S	(P) 850-792B	
	18"	C-6	19	3/8	850-S4018C6	850-PSN683S	(P) 850-781B	850-683G
	18"	C-8	24	3/8			(P) 850-776B	
	18"	C-17	13	3/8		850-PSN736S	850-787B	
	18"	C-22	17	1/2			850-780B	
5-0	18"	C-3	13	3/8		(P) 850-PSN640S	(P) 850-1265B	850-640G
	18"	C-6	19	3/8			(P)850-754B	850-682G
	18"	C-17	12	3/8			(P) 850-774B	
6-0	18"	C-22	16	3/8		850-PSN681S	850-750B	
Nylon Monofilament - Nonabsorbable, (B)=Blue, (BK)=Black, (P)= Precision or Premium Indicating Finer Point Needle								
Suture Size	Length (mm)	Needle Type	Length (mm)	Shape	Health-Tec 12/box	Hu-Friedy 12/box	Look 12/box	Ethicon 12/box, 36/box*
4-0	18"	C-6	19	3/8		(BK) 850-PSN662N	(BKP) 850-922B	(BK) 850-662G
5-0	18"	C-6	19	3/8		(B) 850-PSN8661P	(BKP) 850-918B	(BKP) 850-1668G
6-0	18"	C-6	11	3/8			(BKP) 850-1279B	

SURGICAL BLADES



Bard-Parker® Surgical Blades - Crosstex International

Stainless Steel Sterile Blades

Size 10	860-371210	
Size 11	860-371211	
Size 15	860-371215	
50/pack		\$55.45

Size 15C	860-1716	
10/pack		\$34.75

Size 12	860-371212	
50/ pack		\$180.75

Carbon Steel Rib-Back Sterile Blades

Size 15	860-371115	
50/pack		\$57.75

Size 12	860-371112	
50/pack		\$193.75

Carbon Steel Rib-Back Non-Sterile Blades

Size 25	860-1325	
10/pack		\$12.45

Surgeon's Special Stainless Steel Blades

Size 12B	860-1712	
10/pack		\$72.45



Sterile Surgical Blades - Integra® Miltex®

Razor-sharp cutting edges for superior cutting and clean incisions. Individually packaged in foil peel packs. Sizes clearly marked on each blade. Single use. 100 blades per box.

Stainless Steel

Size 12	861-4312	\$76.45
Size 12B	861-4312B	\$108.75
Size 15	861-4315	\$57.25
Size 15C	861-4315C	\$108.75

Carbon Steel

Size 12	861-4112	\$78.95
Size 12B	861-4112B	\$108.75
Size 15	861-4115	\$57.25
Size 15C	861-4115C	\$108.75

Additional sizes available upon request.



GLASSVAN® Sterile Surgical Blades

- MYCO Medical

Produced from high quality, high durability Swiss Carbon and Stainless steel. Computerized grinding and proprietary polishing processes ensure consistent, clean, sharp cutting edges and two VCI strips ensure product and packaging integrity.

Stainless Steel

10	860-300110	
11	860-300111	
12	860-300112	
15	860-300115	
20	860-300120	
21	860-300121	
22	860-300122	
23	860-300123	
25	860-300125	
12B	860-300112B	
15C	860-300115C	
100/box		\$30.25

Carbon Steel

10	860-200110	
11	860-200111	
12	860-200112	
15	860-200115	
20	860-200120	
21	860-200121	
22	860-200122	
23	860-200123	
25	860-200125	
12B	860-200112B	
15C	860-200115C	
100/box		\$27.25

SURGICAL BLADE HANDLES



Knife Handle #3

Fits blades 10 through 15, X-fine. Non-sterile.

Bard-Parker® Handle - Crosstex International

860-1030	Each	\$28.75
----------	------------	----------------

Handle - Hu-Friedy

HF-1013003	Each	\$27.95
------------	------------	----------------

Stainless Steel - Integra® Miltex®

711-47	Each	\$18.95
--------	------------	----------------

Nickel Plated, Rustless - Integra® Miltex®

711-47R	Each	\$9.75
---------	------------	---------------



Siegel Round Knife Handle - Integra® Miltex®

861-417	Each	\$35.75
---------	------------	----------------

SURGICAL SCALPELS & BIOPSY PUNCHES



Bard-Parker® Disposable Scalpels - Crosstex International

Sterile, stainless steel.

#10	860-1610	
#11	860-1611	
#15	860-1615	
10/box		\$19.95

#12		
860-1612	10/box	\$57.45

#12B		
860-1613	10/box	\$79.25



Short Handled Biopsy Punch - Integra® Miltex®

Designed to take tissue samples in all areas of the mouth. Features a razor-sharp blade with a shorter handle to allow access to posterior areas of the mouth. Total length is 1-1/16". Sterile, individually wrapped packets.

3.5mm	860-3333SH	
4mm	860-3334SH	
5mm	860-3335SH	
6mm	860-3336SH	
50/box		\$116.45

Technocut® Disposable Scalpels - MYCO Medical

Superior sharpness and sharpness retention. High quality raw materials obtained from Switzerland. Each blade is individually wrapped in foil and hermetically sealed. ISO9001 based quality control systems assure uniform cutting edges and a perfect fit with scalpel handles. With integrated metric ruler.

10	860-600810	
11	860-600811	
12	860-600812	
12B	860-600812B	
15	860-600815	
22	860-600822	
10/box		\$8.45

Additional sizes available upon request.

SURGICAL SCALPELS & BIOPSY PUNCHES



Technocut® Plus Disposable Safety Scalpels - MYCO Medical

Features top activated retractable blade to minimize chance of injury when passing the scalpel from assistant to doctor. Audible clicks indicate blade position. Final lock after use to prevent injuries and re-use.

- #10..... 860-6008TR10
- #11..... 860-6008TR11
- #12..... 860-6008TR12
- #15..... 860-6008TR15
- #20..... 860-6008TR20
- 10/box **\$11.95**

Additional sizes available upon request.



Uni-Punch - Premier® Dental

Seamless razor-sharp stainless steel blade for exact excisions. The handle is ribbed for superior control and also hollow for easy specimen removal. Individually packaged in sterile peel-pouches.

- 1.5mm..... 867-9033509
- 2.0mm..... 867-9033502
- 2.5mm..... 867-9033511
- 3.0mm..... 867-9033503
- 3.5mm..... 867-9033510
- 4.0mm..... 867-9033504
- 5.0mm..... 867-9033505
- 6.0mm..... 867-9033506
- 8.0mm..... 867-9033508
- 25/box **\$40.45**

SURGICAL BLADE ACCESSORIES



Blade-Safe - Integra® Miltex®

An instrument for the safe removal of scalpel blades from the handles. Protects hands against cuts. Stainless steel. Autoclavable.

- 861-4100 Each **\$19.95**



Qlicksmart® BladeFLASK - MYCO Medical

Scapel blade removal system. Removes all common blades from most sizes: No. 3, No. 4, No. 5, No. 7 and No. 9 scalpel handles in a single action. Immediate containment of blade upon removal. Holds 100 blades. Bracket required with initial purchase; reuse bracket with subsequent Qlicksmart removers.

- 370-QFRGEN Each **\$43.75**

Bracket

- 370-QBRGEN Each **\$8.45**

SURGICAL DRESSINGS & BONE AUGMENTATION



ActCel Hemostatic Gauze - Coreva Health Sciences

Collagen-like natural substance created from chemically treated cellulose. Effective, patented, hemostatic agent to help control bleeding from open wounds. Contains no chemical additives and is hypoallergenic. Does not cause delay to healing. Effectively cuts down on clotting time, helps stabilize new clots by accelerating the formation of fibrin cross-linkages, and increases blood viscosity.

- 860-HG020022 Each **\$118.95**



Curity™ Iodoform Packing Strip - Covidien Products by Medtronic

100% cotton, fine mesh gauze ideal for wet-to-dry packing. Sterile.

- 1/4" x 15'**
250-7831 Each **\$7.75**
- 1/2" x 15'**
250-7832 Each **\$7.25**



Barricaid® - Dentsply Caulk

Visible, light-cure periodontal wound dressing that gives total control over placement and setting, and is tinted for superior esthetics. Easy to use syringes which can be used outside the mouth or intra-orally for dispensing the material directly to the wound site. 4gm syringes.

- 728-639050 4/box..... **\$112.45**



Surgicel® Original Absorbable Hemostat - Ethicon

Absorbable Hemostat, assists in control of bleeding and clot formation. Conforms readily to irregular gingival contours. .05" x 2"

- 860-101955 12/box **\$674.25**



SURGIFOAM® Absorbable Gelatin Sponges - Ethicon

Sterile, water-insoluble, malleable, porcine gelatin absorbable sponge intended for hemostatic use by applying to a bleeding surface. Compressible, does not require cutting, and can absorb up to 40 times its own weight.

- 1cm x 1cm x 1cm**
860-1969 24/box..... **\$154.75**

- 2cm x 6cm x 7mm**
860-1972 12/box **\$141.25**



COE-PAK™ Automix NDS - GC America

A noneugenol surgical dressing and periodontal pack that has no burning sensation, no unpleasant taste, no disagreeable odor, and offers proven protection to surgical sites. Promotes cleanliness and healing. Plastic and cohesive; ropes of any length or thickness can be formed.

Continued

SURGICAL DRESSINGS & BONE AUGMENTATION

Coe-Pak Automix NDS continued.

Smooth texture allows to adapt closely to teeth and tissue to protect the wound. Sets with resilient, non-brittle hardness. The NDS version (New Delivery System) eliminates manual mixing and provides a consistent mix for immediate placement.

Pack

Contains: 2 -50ml double barrel cartridges with 12 mixing tips.

722-135003 Pack..... **\$125.45**

Regular Set - 3 Minutes

722-135001 Each **\$103.25**

Hard and Fast Set - 1 Minute

722-135301 Each **\$103.25**

Mixing Tips - Aqua

302-153248 48/pkg..... **\$68.45**

Dispenser

302-152101 Each **\$184.95**



HeliCote® - Integra® Miltex®

Collagen wound dressing. For use in palatal donor sites, in mucosal flaps and larger wounds. Measures 3/4" x 1-1/2" (2cm x 4cm) with a resorption time of 10-14 days. Sterile.

860-62201 10/box **\$134.95**



HeliMend® - Integra® Miltex®

Absorbable collagen membrane- white, compressed, non-friable matrix fabricated from collagen derived from bovine deep flexor (Achilles) tendon. Creates space deep during guided tissue regeneration procedures where a longer absorption rate is desired. Each membrane is supplied sterile and in an easy-to-open package. Absorbed in 4 to 8 weeks

860-62203 15x20..... **\$107.95**
 860-62204 20x30..... **\$134.75**
 860-62205 30x40..... **\$212.25**

Absorbed in 18 weeks

860-62206 15x20..... **\$129.25**
 860-62207 20x30..... **\$152.25**
 860-62208 30x40..... **\$216.75**



HeliPlug® - Integra® Miltex®

Collagen wound dressing. Used to control bleeding and develop blood clots in extraction and biopsy sites. Measures 3/8" x 3/4" (1cm x 2cm) with a resorption time of 10-14 days. Sterile.

860-62202 10/box..... **\$124.75**



HeliTape® - Integra® Miltex®

Collagen wound dressing. Used for dressing minor oral wounds, closure of graft sites and to help repair sinus tears. Measures 1" x 3" (2.5cm x 7.5cm) with a resorption time of 10-14 days. Sterile.

860-62200 10/box..... **\$186.45**



Foundation® - J. Morita USA

A revolutionary bone augmentation material for use after teeth extractions. Collagen-based, it provides support for implants, bridges, and dentures. Immediately following an extraction, place into the socket, the surrounding cells and capillaries gradually infiltrate Foundation. As the extraction socket heals, it is filled with new augmented bone. "Bullet" form for easy placement. **Small**

860-27500100 10/box..... **\$459.95**

Medium

860-27500200 5/box..... **\$459.95**

Assorted Pack

Contains: 3 small and 3 medium.

860-27500150 Pack..... **\$459.95**



Bioplant - Kerr Restoratives

A unique combination of biocompatible polymers which form a non-resorbable, radiopaque, porous matrix which fosters new bone growth. HTR Synthetic Bone offers a broad spectrum of applications including ridge preservation, repair of periodontal and bony defects, sinus lifts, api-

coectomies, use with implants, and ridge augmentation.

0.125gm Syringe

860-216110 6/box **\$441.25**

0.25gm Syringe

860-H216112 6/box **\$694.45**

0.50gm Syringe

860-H216114 6/box **\$1205.45**



SockIt! Oral Wound Dressing Gel - M.C.M.P

A hydrogel wound dressing approved by FDA for management of any and all oral wounds. SockIt! is drug-free, non-toxic and provides three important benefits to oral wounds: 1) fast, constant pain relief without causing a numb sensation, procedures, as well as mucosal ulcers, lesions and all injuries to the mouth. After professional application in the office, it is sent home with the patient to use as often as needed for safe, continuous pain relief and wound management.

950-SI Each..... **\$12.75**

950-SI25 25/pack..... **\$275.95**



SafeGauze® HemoStyp™ Topical Hemostatic Dressing - Medicom®

Sterile fabric prepared by the chemical treatment of regenerated cellulose. It is a safe and effective product used in dental practices for the control of bleeding applied to extractions, periodontal surgery and other selected procedures. When contacting blood or fluids the product expands and transforms to a clear, viscous gel which fills and adheres to the conformation of the extraction socket. Precut .75" x .75", 4-ply.

320-4900 20/box **\$69.95**



SureStop Hemostatic Dressing - MedRedi

Sterile, soluble cellulose-based dressing that transforms quickly into a clear, viscous gel upon contact with blood or fluids. It is indicated for the topical management of wounds and to temporarily control bleeding. Appropriate dental indications include extraction sites, dental trauma, biopsy sites, periodontal surgery, and oral surgery. Comes in pre-cut 1.9cm squares. Individually sealed in blister packs. It has two unique features – it is bacteriostatic and is very effective in stopping bleeding on patients who use anticoagulants.

320-SSSBGD 20/box **\$75.95**

SURGICAL DRESSINGS & BONE AUGMENTATION



Gelfoam® Absorbable Dental Sponges - Pfizer, Inc.

Sterile, surgical sponges prepared from a specially treated and purified gelatin solution and are absorbable. In oral and dental surgery, Gelfoam Dental Sponges are an aid in providing hemostasis. May be used either dry or moistened, depending upon conditions present at operation and preference of the surgeon. Isotonic saline is suitable for use with Gelfoam. Although not necessary, Gelfoam can be used either with or without thrombin to obtain hemostasis.

- Size 4 cm/2**
720-9039601 12/box **\$248.45**
- Size 7 cm/2**
720-31503 12/box **\$165.95**
- Size 50 cm/2**
720-288811 4/box **\$192.95**
- Size 100 cm/2**
720-2446557 6/box **\$428.95**



PerioCare® Periodontal Dressing - Pulpdent Corporation

A two paste, highly elastic periodontal dressing which sets resiliently hard and does not chip or fall apart in the mouth. PerioCare assists in tissue placement after periodontal surgery and provides durable protection of tissue. PerioCare is ready to pick up with wet fingers in about 90 seconds. Neutral odor and taste. Contains no eugenol. Contains: 3oz. tube paste and 3oz. tube gel with mixing pad.

720-PC Each **\$48.95**



R.T.R Syringe - Septodont

Made of β-tricalcium phosphate granules of synthetic origin. Sterile and gradually resorbable bone substitute. Releases calcium and phosphate ions that help promote new bone formation. Osteoconductive micro and macroporous structure that fosters dense new bone growth. Helps renew bone integrity within 3-6 months. Curved Syringe.

860-S0500 0.8cc **\$118.95**



Dry Socket Paste - Sultan Healthcare

Used to treat Alveolitis. Gives instant pain relief. Contains: Gualacol, balsamperu, eugenol, 1.6% chlorobutanol.

730-10404 1oz **\$155.25**



GUIDOR® easy-graft® CLASSIC Alloplastic Bone Grafting System - Sunstar Americas, Inc.

Designed to be syringed directly into a bone defect, hardening into a stable, porous scaffold in approximately one minute and eliminating the need for a dental membrane in many cases. 100% synthetic, fully resorbable and unit-dose application. Complete system that eliminates the need to guess with which liquid (e.g. blood, saline) to mix the granules. Ideally suited for filling voids around immediate implant placements and ridge preservation after tooth extraction. Each unit contains three systems. A system of GUIDOR easy-graft includes one syringe of coated granules and one ampule of BioLinker.

Large, Purple 500 - 1000µm, 0.4ml
860-C11008 **\$271.95**

Medium, Blue 500 - 1000µm, 0.25ml
860-C11078 **\$272.25**

Small, Green 500 - 630µm, 0.15ml
860-C110118 **\$222.45**



GUIDOR® Bioresorbable Matrix Barrier - Sunstar Americas, Inc.

A line of translucent, resorbable barrier membranes with a unique, multi-layer design that facilitates periodontal tissue integration. 100% synthetic with predictable resorption. Can be cut and shaped to precisely cover the defect site. Becomes malleable within seconds at body temperature, making it easy to handle and control. Each unit contains one dental membrane.

Guided Bone
P6 – Rectangle, 20.0 x 28.0 mm
860-5081 Each **\$221.25**

P3 – Rectangle, 15.0 x 20.0 mm
860-5090 Each **\$136.25**

Tissue Regeneration
MC – Molar Curved, 19.8 x 15.0 mm
860-50000 Each **\$181.95**

DC – Double Curved, 16.1 x 22.6 mm
860-5020 Each **\$249.95**

PPS-R – Perio Plastic Regular, 10.0 x 12.7 mm
860-5050 Each **\$181.95**

MSL – Molar Straight Large, 15.0 x 14.2 mm
860-5060 Each **\$204.25**



AmnioMTM™ Amniotic Multipotential Tissue Matrix - Surgical Esthetics™

An injectable dynamic bone and wound healing system that contains osteoinductive, osteoconductive, and osteogenic elements to enhance wound, bone healing, and regeneration. Indicated for: Elevation of maxillary sinus in use with a bone graft, Ridge augmentation combined with bone graft, for enhanced bone and periodontal healing on patients with compromised health, recession defects in conjunction with membranes, periodontal defects and TMJ. 0.25ml.

860-AG010025 Each **\$545.25**



OSSIF-i sem™ Mineralized Cancellous Bone Allograft - Surgical Esthetics™

Extraction sockets. Periodontal defects. In conjunction with the placement of dental implants. Apicoectomy, cystectomy, root-resection.

.25-1.0mm particle size
860-BG010050 0.5cc **\$89.25**
860-BG010100 1.0cc **\$125.25**
860-BG010200 2.0cc **\$219.25**

1.0-2.0mm particle size
860-BG011050 0.5cc **\$89.25**
860-BG011100 1.0cc **\$125.25**
860-BG011200 2.0cc **\$219.25**

OSSIF-i sem Mineralized Cortical Cancellous Bone Allograft

Ridge augmentation. Elevation of the maxillary sinus. Large extraction sockets. Whenever volume maintenance is desired. 0.6-1.25mm or 1.0-2.0mm particle size.

860-BG013050 0.5cc **\$89.25**
860-BG013100 1.0cc **\$125.25**
860-BG013200 2.0cc **\$219.25**

OSSIF-i sem Demineralized Cortical Bone Allograft

The filling of periodontal defects. Extraction sockets. Ridge augmentation. Elevation of the maxillary sinus. Apicoectomy, cystectomy, and root resection. As a graft expander. In combination with numerous graft materials. 0.25-1.0mm particle size.

860-BG020050 0.5cc **\$68.95**
860-BG020100 1.0c **\$94.95**
860-BG020200 2.0cc **\$125.25**

SURGICAL DRESSINGS & BONE AUGMENTATION



OSSIF-i sem™ Demineralized Sponge Filler - Surgical Esthetics™

Internal or osteotome sinus lifts, especially when combined with mineralized grafts. Extraction sockets. Periodontal defects. In conjunction with the placement of implants. Generally as a versatile graft expander. 1.0-4.0mm particle size.

860-BG025075 0.75cc..... **\$138.95**
 860-BG025100 1.0cc **\$154.95**



OSSIF-i sem™ Demineralized Sponge Strip - Surgical Esthetics™

Horizontal ridge augmentation. Vertical ridge augmentation. In conjunction with the placement of dental implants. Extraction sockets. Periodontal defects, especially non-surrounded. Recession defects.

860-BG024010 10 x 6 x 7mm..... **\$148.95**
 860-BG024020 20 x 6 x 7mm..... **\$298.95**

SURGICAL DIAGNOSTIC SUPPLIES



ProSphyg™ 775 Sphygmomanometer - ADC

Black enamel 300 mm Hg no-pin stop manometer and a latex inflation bladder and bulb. Navy blue nylon cuff with range markings to facilitate selection of correct cuff size. Includes leatherette zippered carrying case and operating instructions.

Adult
 860-775 Each **\$37.75**

Additional sizes available upon request.



Advantage™ 6012 Semi-Automatic BP Monitor - ADC

Compact and easy-to-use blood pressure monitor. Measures systolic, diastolic pressure and pulse. Manual inflation. Latex-free cuff. Automatic shut-off.

860-6012 Each **\$39.95**



Advanced Wrist Blood Pressure Monitor - Graham Field

4 user memory with averages. WHO risk indicator with 6 color LED. Irregular heartbeat detector. Accurate vital health information in seconds. Features: 396 reading memory with 4 memory zones (99 readings each). Automatic time & date stamp. 5 average modes: hour, day, week, month, and total. 4 alarm settings.

Contains: Monitor, 2 AAA batteries, storage case, instruction manual (English & Spanish), quick start guide, limited lifetime warranty.

860-1147 Each **\$42.45**



Dual Head Stethoscope - Graham Field

Anodized aluminum rotating chestpiece with recessed non-chill ring and adjustable chrome-plated brass binaurals. 22" latex-free "Y" tubing.

890-400 Each **\$8.25**



Stethoscope - Graham Field

Single head stethoscope with 22" non-latex "Y" tubing.

890-2867300DLX Each..... **\$6.95**

SURGICAL MISC. SUPPLIES



Sodium Chloride 0.9% Irrigation - Baxter

250ml Plastic Bottle
 860-2F7122 Each **\$5.45**

500ml Plastic Bottle
 860-BAX2F7123 18/pack..... **\$98.95**

1000ml Plastic Bottle
 860-2F7124 12/pack..... **\$68.95**

1500ml Plastic Bottle
 860-2F7125 Each **\$9.95**

Sodium Chloride 0.9% - Baxter
250ml Plastic Bag
 860-2B1322Q 36/pack..... **\$257.95**

500ml Plastic Bag
 860-2B1323Q 24/pack..... **\$185.95**

1000ml Plastic Bag
 860-2B1324 14/pack..... **\$126.95**

SURGICAL MISC. SUPPLIES



Dextrose 5% in Lactated Ringers - Baxter
 500ml Plastic Bag
 860-2B2073Q 24/pack.....\$233.95

Sterile Water for Irrigation - Hospira
 860-061390 500ml.....\$12.95
 860-5000 1000ml.....\$13.25

Sterile Water for Injection - Baxter
 860-0799009 1000ml.....\$12.95



WEBCOL® Alcohol Preps - Covidien Products by Medtronic
 Sterile, non-woven, 2-ply sponges designed for moderate cleansing. 70% isopropyl alcohol.
 860-B33901 200/box.....\$4.75



Cold Pack - Graham Field
 Instant, one-time use. 6" x 8.5"
 860-9102 24/pkg.....\$22.25



Hot/Cold Pack - Graham Field
 Reusable, microwavable, stays flexible. 4.5" x 7"
 860-9123A 24/pkg.....\$31.75



Ammonia Inhalants - Young Dental
 Individual 0.4cc ampules containing ammonium hydroxide, ammonium carbonate and 35% alcohol by volume. Crush between fingers to use.
 730-1101 10/box.....\$12.25



AED Plus Defibrillator Package #2 - ZOLL Medical Corporation
 Unique graphical interface – pictures combined with text displays and voice prompts – helps the rescuer every step of the way!
 Contains: AED cover for public safety, one CPR-D Padz, set of Pedo Padz and one sleeve of batteries. Includes LCD screen showing voice prompt messages, device advisory messages, elapsed time, shock count and chest compression graph. Also contains operators guide and a 5-year limited warranty.
 571-ZOLL2010 Each.....\$1895.95



Cut through the fat

GO DIRECTLY TO THE BEST

SUPPLIES UP TO
25% OFF
 WHILE SUPPLIES LAST

www.dhpionline.com/clearance

All Fashion Seal Healthcare item numbers need the desired size following the item number. Example: 480-78734XL

UNISEX WARM-UPS

65/35 Fashion Poplin®

- Raglan sleeves
- Snap front closure
- Two lower pockets
- Coordinating knit cuffs
- Scissor holder in right pocket

Sizes: XS - XL **\$21.75**

2XL - 5XL extra charge, contact your DHPI Account Manager for details.

Black
480-7673_



Burgundy 480-7691_



Ciel Blue 480-7690_



Cobalt 480-7675_



Dark Teal 480-7692_



Eggplant 480-7693_



Navy 480-7696_



Pewter 480-7607_



White 480-7699_

Fashion Seal Healthcare®

Other Colors and Embroidery Options Available
Contact your DHPI Account Manager for details and pricing.

Order by  800-626-2163

 www.dhponline.com

 Fax: 888-681-5088

559

All Fashion Seal Healthcare item numbers need the desired size following the item number. Example: 480-78734XL

Coordinating Solid Unisex Warm-ups Available

Other Colors and Embroidery Options Available

UNIFORMS

UNISEX FASHION SCRUB SHIRTS

65/35 Fashion Poplin®

- Extra long cap sleeves
- Left breast pocket
- Reinforced, bartacked V-neck
- Non-reversible
- Classic fit

Sizes: XS - XL **\$19.95**

2XL - 5XL extra charge, contact your DHPI Account Manager for details.

Burgundy
480-78741_



Black 480-78729_ Dark Teal 480-78734_ Ciel Blue 480-78737_ Navy 480-78744_ Cobalt 480-78720_ Pewter 480-78785_



Black 480-78829_ Dark Teal 480_78834_ Ciel Blue 480-78837_ Navy 480-78844_ Cobalt 480-78851_ Pewter 480-78877_

UNISEX FASHION SCRUB PANTS

65/35 Fashion Poplin®

- Drawstring closure with easy glide coordinating webbing
- Right back pocket
- Non-reversible
- Classic fit

Sizes: XS - XL **\$13.75**

2XL - 5XL extra charge, contact your DHPI Account Manager for details.

Burgundy
480-78841_

WOMEN'S FASHION SLACKS

65/35 Fashion Poplin®

- Multi-stitched elastic wasitband
- Two side slant inset pockets
- Classic Fit

Sizes: XS - XL **\$14.75**

2XL - 5XL extra charge, contact your DHPI Account Manager for details.

Eggplant
480-7450_

Pewter
480-7529_



Fashion Seal
Healthcare

WOMEN'S DOUBLE V-NECK TUNICS

65/35 Fashion Poplin®

- Set-in sleeves
- Contrasting V-neck placket
- Modern fit
- Two lower pockets with contrasting trim
- Princess seams
- Flattering slim fit

Sizes: XS - XL **\$16.75**

2XL - 5XL extra charge, contact your DHPI Account Manager for details.

Ciel Blue w/Navy
480-7575_

Eggplant w/Plum
480-7576_

Pewter w/Black
480-7579_



Navy w/Ciel Blue
480-7578_

Other Colors and Embroidery Options Available

UNIFORMS

WOMEN'S DRAWSTRING FLARE PANTS

65/35 Fashion Poplin®

- Coordinating easy glide webbed drawcord
- Elastic waist back
- Two side inset pockets
- Right back pocket
- Natural waist
- Flared legs with side slit
- Modern fit

Sizes: XS - XL **\$16.75**

2XL - 5XL extra charge, contact your DHPI Account Manager for details.



Ciel Blue
480-7080_

Black
480-7077_

Navy
480-7082_

Pewter
480-7084_

WOMEN'S CARDIGAN WARM-UP

65/35 Fashion Poplin®

- Set-in sleeves
- Two lower pockets
- Scissor holder in right pocket
- Snap front closure
- Center back half belt
- Classic fit

Sizes: XS-XL **\$21.25**

2XL - 5XL extra charge, contact your DHPI Account Manager for details.



White
480-7364_

Fashion Seal Healthcare



Mulberry
480-60199_

Other Colors and Embroidery Options Available

WOMEN'S WAFFLE KNIT SHIRTS

Cotton/Polyester

- Short Sleeve
- Double-ridged knit collar
- Side vents
- Two button "Y" placket
- Hemmed sleeves

Sizes: XS - XL **\$20.75**

2XL - 5XL extra charge, contact your DHPI Account Manager for details.



Black
480-64506_



Cobalt
480-64504_



Deep Navy
480-64511_



Hunter Green
480-64558_



White
480-64514_

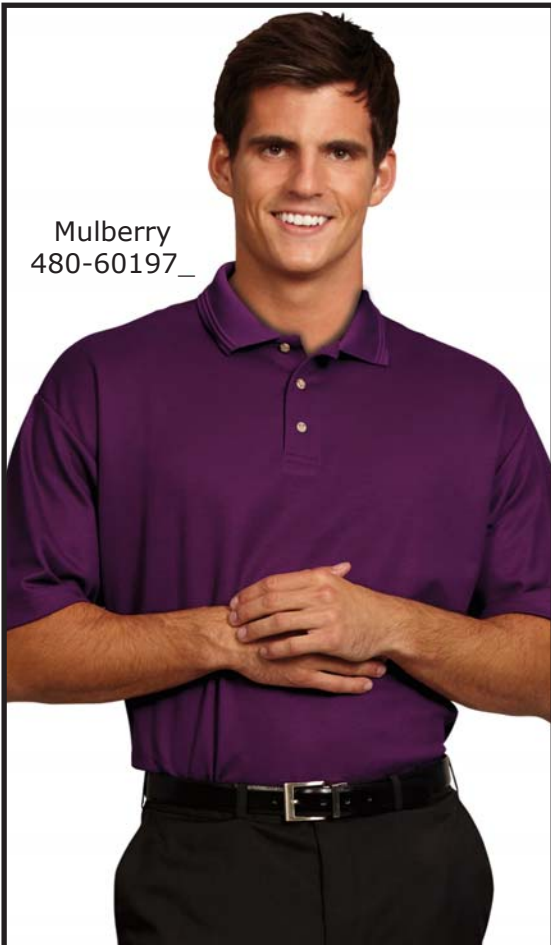

Mulberry
480-60197_

MEN'S WAFFLE KNIT SHIRTS

Cotton/Polyester

- Short Sleeve
- Double-ridged knit collar
- Three button placket
- Hemmed sleeves

Sizes: XS - XL **\$20.75**

2XL - 5XL extra charge, contact your DHPI Account Manager for details.



Black
480-61076_



Cobalt
480-61069_



Deep Navy
480-61077_



Hunter Green
480-61025_



White
480-61067_

Fashion Seal
Healthcare

BASE PLATE & BITE WAX



Bite Registration Wax - Almore International, Inc.

Dimensionally stable, will not shrink or distort and are ideal for checking and maintaining accurate occlusal records. Conform to every detail and set by water or room temperature. Blue.
830-42600 1lb. **\$26.75**



Hygenic® Base Plate Wax - Coltene

Red 835-00805
Medium Soft #3 Pink 835-00806
Extra Tough Pink 835-00803
Yellow Bite..... 835-00807
1lb. **\$19.45**

Red 835-00811
Medium Soft #3 Pink 835-00812
Extra Tough Pink 835-00809
Yellow Bite..... 835-00813
5lbs **\$72.45**



Hygenic® Beeswax - Coltene

Pure, natural beeswax with no additives. Softens easily under hot water.

1/2lb. 835-00832..... **\$21.95**
1lb. 835-00833..... **\$39.45**



NeoWax® Flexible Baseplate Wax - Dentsply Trubyte

Popular all-season, all-purpose, high grade synthetic wax that is tough, pliable and boils out cleanly. Bright Pink.

0.050" Thick 830-140101
0.070" Thick 830-140102
5lbs **\$55.75**



TruWax® Baseplate Wax - Dentsply Trubyte

High quality wax that carves easily at room temperature and boils out cleanly. Pink.

Regular 830-7709002
Extra Hard..... 830-7708902
1lb. **\$29.25**

Regular 830-7709003
Extra Hard..... 830-7708903
5lbs **\$25.25**



Modern Materials Waxes - Heraeus Kulzer

Made from natural organic waxes. Carves clean, won't chip and break at try-in. Boils out without oily residue.

Base Plate Wax

Medium Soft #3 Modern Pink.
830-93312 1lb **\$25.25**



Shur Wax®

For setups, occlusal rims and final waxups. An extra tough yet pliable all-purpose wax. Shaded pink to resemble gum tissue.

Regular 830-93112
Extra Hard..... 830-93212
1lb. **\$25.45**

Regular 830-93152
Extra Hard..... 830-93252
5lbs **\$91.45**



Yellow Bite Wax

Sheets made primarily of beeswax. Softens in warm water and tempers in the patient's mouth so it's harder after the bite is taken than when it was in the box.

1lb. 830-93614..... **\$31.95**
5lbs 830-93654..... **\$118.45**



10X Light Pink Wax - Integra® Miltex®

Used for taking accurate bites and waxing setup. It is thin, pliable and soft.

836-55500 1lb **\$33.95**
836-55520 5lbs **\$151.75**



Beauty Pink Dental Wax - Integra® Miltex®

Used to make extremely accurate impressions and bite registrations. Excellent for carving. Hard and extra hard should be softened in hot water so the wax is heated throughout the sheet. Melting temperature is approximately 140°.

Soft 836-56450
Hard 836-56570
Medium 836-56510
Extra Hard..... 836-56630
1lb. **\$21.25**

Extra Hard..... 836-56650
5lbs **\$97.45**



Mizzy Allcezon Base Plate Wax - Keystone Industries

Composed of general, all-purpose wax for bites, registration and impressions. Pink.

1lb. 830-0160100..... **\$18.25**

BITE WAX - PREFORMED



ALUWAX™ Waxes - Aluwax Dental Products Company

Sophisticated composite material which contains powdered aluminum to increase the integrity of the compound and provide the heat retention properties needed for efficient modeling. Available in wax only or waxed cloth form which contain coarse cloth at the center of the material. Scored wax allows easy use in small quantities.

Denture Wax

830-DENT 15oz **\$19.95**

Scored

830-SCOR 15oz **\$19.95**

Waxed Cloth

830-WCS 15oz **\$20.45**

Waxed Cloth Forms

830-WCF 11oz **\$21.45**

Denture Forms

830-DENTF 11oz **\$20.95**

U-Shaped Bite Wafers

830-USBW 40/box **\$21.95**



Hygienic® U-Shaped Occlusal Rim Wax - Coltene

Pink wax formulated for bite rims. Recessed base aids adoption to base plate. Can be reshaped at room temperature to fit individual arch.

835-04030 21/box **\$21.25**
835-00822 100/box **\$95.25**



Coprwax Bite Wafers - Heraeus Kulzer

Horseshoe shaped bite wafers made from wax with copper particles distributed throughout. Soften wafer in warm water and the copper holds the heat so the wax is softer. Foil laminated to prevent bite through, yet thin enough not to open the bite. Tempers in the patient's mouth.

830-92178 84/box **\$94.95**



Hygienic® Bite Wafers - Coltene

U-shaped, soft bite registration wax slips; designed for fast, precise impressions.

Blue Foil Laminated Double Thickness

Lessens distortion and prevents patients from biting through wafer.

835-00825 24/box **\$24.95**

Yellow Soft No Foil Single Layer

Adapts to dental arch; provides quick, precise bite-checks.

835-00839 50/box **\$24.95**

Green Extra Hard

Nonbrittle. Will not shatter when chilled; softens quickly in warm water; shaped for full arch coverage.

835-03365 50/box **\$24.95**



Modern Materials® Check Bite Wafers - Heraeus Kulzer

Easy horseshoe shape minimizes trimming. Ideal for a quick bite. Won't stain models. Yellow.

830-95094 48/box **\$28.25**
830-95194 192/box **\$89.45**



Modern Materials® Boxing Wax - Heraeus Kulzer

Sticky enough to adhere but not too sticky to remove cleanly without softening.

Regular .96" Thick

830-94693 1lb **\$25.25**

X-Thin .040" Thick

830-94793 1lb **\$30.95**

Boxing Wax - Integra® Miltex®

Soft, pliable and cohesive at room temperature, yet firm enough to maintain its form during handling. Used for boxing impressions in the pouring of casts. Red.

Thin

830-57630 1lb **\$27.45**

Thick

836-57550 1lb **\$25.75**

ORTHO WAX



Hygienic® Orthodontic Tray Wax Strips - Coltene

Used for peripheral lining of trays, increasing tray height and postdamming. Soft and sticky, they may be adapted without heating. Pure white color, unscented. 6" long by 1/4" diameter.

835-00827 48/box **\$19.95**

BOXING WAX



Hygienic® Boxing Wax - Coltene

Designed for boxing impressions; withstands the extreme heat given off by dental stones during setting. Red.

Regular 835-00815
Extra Thin 835-00816
1lb. **\$35.75**



Orthodontic Tray Wax - Kerr Laboratory

A soft, white plastic wax strip for orthodontic use in extension of periphery, post damming and stops for impression trays.

839-09246 48/box **\$37.45**

STICKY WAX



Sticky Wax - Integra® Miltex® Sticks

Brown	836-58291	
Red	836-58351	
24/box		\$18.25

Tin

Brown	836-58310	
Red	836-58370	
3oz.		\$8.75



StickyWax - Kerr Laboratory

A hard, fast-setting wax. Repairs wax patterns, and welds waxes together. It is excellent for joining sprues to sprue bases. Light Amber.

839-00623	15/box	\$15.25
839-00625	120/box	\$50.45

UTILITY WAX



Hygenic® UtilityWax - Coltene

For preserving the periphery roll, extending and building up impression trays and post-damming. Both strips and ropes are 3/16" by 11" long.

Round Strips

Red	835-00817	
White	835-00818	
80/box		\$19.25

Square Ropes

Red	835-00819	
White	835-00820	
44/box		\$19.25



Modern Materials® Wax Bite Blocks - Heraeus Kulzer

Made from natural organic waxes, so it carves out clean, won't chip and break at try in, and boils out without oily residue. Easy to form and carve. Polishes to high shine. Teeth don't shift due to shrinkage. Natural tissue color.

Soft Pink

830-95592	12/box.....	\$23.95
830-95992	120/box	\$86.45

Hard Pink

830-95492	12/box	\$23.95
830-95892	120/box	\$86.45



Modern Materials® UtilityWax Strips - Heraeus Kulzer

Wax for protecting the soft tissue from the periphery of the impression tray, to extend or post dam impression trays. Sticky enough to adhere. Great for patients to keep without softening in pocket or purse. White for Ortho, won't discolor model. Red for general purpose and visibility.

Round Strips

Red Small	830-94293	
White Small.....	830-94291	
114/box		\$19.95

Red Large	830-94193	
White Large.....	830-94191	
75/box		\$19.95

Square Ropes

Red	830-94493	
White	830-94491	
55/box		\$19.95

MISCELLANEOUS WAX



Surgident® PeripheryWax - Heraeus Kulzer

Wax for protecting soft tissue from the periphery of the impression tray, to extend or post dam impression trays. Can be used to post dam a tray or as a stop. Sticky enough to adhere without softening. Can be used with hydrocolloid higher melting range. Pleasant scent. Blue for visibility.

830-92189	60/box	\$27.25
-----------	--------------	----------------



DisclosingWax - Kerr Laboratory

A creamy wax used to repair wax pattern defects. Also used to determine the fit of full and partial dentures in relation to the supporting tissue. Ivory.

839-00610	57gm jar	\$36.95
-----------	----------------	----------------



Occlusal IndicatorWax - Kerr Laboratory

A superior indicator to define occlusal prematurities with a positive reading of contacting surfaces.

839-00655	180/box	\$80.45
-----------	---------------	----------------



Carestream Dental intraoral films capture high-resolution periapical, bite-wing and occlusal images with a wide range of film speeds and sizes for maximum patient comfort and confident diagnoses.



Ultra-Speed - Carestream Dental
D-speed film that generates the high quality, detailed images you need to make accurate diagnoses.

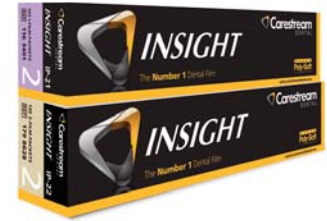

INSIGHT - Carestream Dental
A true F-speed film that delivers excellent and consistent image quality through exclusive T-Grain emulsion technology and 60% less radiation per exposure.

POLYSOFT
No. 2 Standard Super Poly Soft Packets

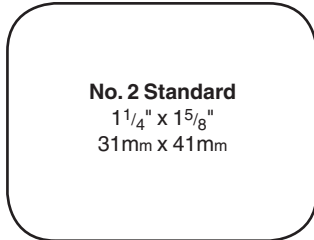

No. 2 Standard
1 1/4" x 1 5/8"
31mm x 41mm

SureSoft™ Packets
PAPER
No. 2 Standard Paper Packets

DF-58 900-DF58	1 Film Packets 150/box	\$77.45
DF-58C 900-DF58C	1 Film Barrier Packets Clinasept 100/box	\$83.95
DF-57 900-DF57	2 Film Packets 130/box	\$99.25
DF-57C 900-DF57C	2 Film Barrier Packets Clinasept 100/box	\$111.95
DF-58P 900-DF58P	1 Film Packets 150/box	\$107.95
DF-57P 900-DF57P	2 Film Packets 150/box	\$142.95

IP-21 900-IP21	1 Film Packets 150/box	\$88.75
IP-21C 900-IP21C	1 Film Barrier Packets Clinasept 100/box	\$86.95
IP-22 900-IP22	2 Film Packets 130/box	\$109.95
IP-22C 900-IP22C	2 Film Barrier Packets Clinasept 100/box	\$108.45
IP-21P 900-IP21P	1 Film Packets 150/box	\$88.75
IP-22P 900-IP22P	2 Film Packets 150/box	\$156.95

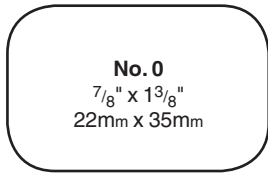

No. 0
7/8" x 1 3/8"
22mm x 35mm

POLYSOFT
No. 0 Super Poly Soft Packets

DF-54 900-DF54	1 Film Packets 100/box	\$65.95
DF-54C 900-DF54C	1 Film Barrier Packets Clinasept 75/box	\$84.95
DF-53 900-DF53	2 Film Packets 100/box	\$82.45

IP-01 900-IP01	1 Film Packets 100/box	\$71.45
IP-01C 900-IP01C	1 Film Barrier Packets Clinasept 75/box	\$83.95
IP-02 900-IP02	2 Film Packets 100/box	\$93.45

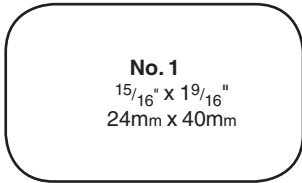

No. 1
1 5/16" x 1 9/16"
24mm x 40mm

PAPER
No. 1 Paper Packets

DF-56 900-DF56	1 Film Packets 100/box	\$80.95
DF-55 900-DF55	2 Film Packets 100/box	\$109.95

IP-11 900-IP11	1 Film Packets 100/box	\$86.95
IP-12 900-IP12	2 Film Packets 100/box	\$108.45

Posterior No. 3 .. 2 1/8" x 1 1/16" (27mm x 54mm)
Paper Packets

DF-42 900-DF42	1 Film Packets 100/box	\$158.95
--------------------------	---------------------------------	-----------------

IB-31 900-IB31	1 Film Packets 100/box	\$176.95
--------------------------	---------------------------------	-----------------

Posterior No. 2 .. 1 5/8" x 1 1/4"
Paper Packets

DF-40 900-8393043	1 Film Packets 50/box	\$105.95
-----------------------------	--------------------------------	-----------------

IB-21 900-IB21	1 Film Packets 50/box	\$117.95
--------------------------	--------------------------------	-----------------

Occlusal Type
No. 4 2 1/4" x 3" (57mm x 76mm)
Paper Packets

DF-50 900-DF50	1 Film Packets 25/box	\$101.95
--------------------------	--------------------------------	-----------------

IO-41 900-IO41	1 Film Packets 25/box	\$111.95
--------------------------	--------------------------------	-----------------



X-OMAT 2 Dental Duplicating - Carestream Dental

X-Omat dental duplicating film is used to produce duplicate radiographs. Designed for automatic processing in dental processors, this film can be processed manually in emergency situations. Unlike X-ray film, this is a direct-reversal film where longer exposure times produce lighter images and shorter exposure times produce darker images.

Extraoral Film - Carestream Dental

T-MAT G/RA: The standard for extraoral film in the industry, T-MAT G/RA is a Green sensitive, high-contrast, 400-speed system when used with LANEX Regular or EV Screens.

X-OMAT DBF: X-OMAT DBF is a Blue sensitive film with medium contrast that can be used with other manufacturers' blue/UV screens. When used with X-OMATIC Regular Screen, this provides a 200-speed system.

T-MAT L/RA: T-MAT L/RA provides wide latitude for capturing detailed images of soft tissue of facial profile as well as bone and tooth structure. This film acts as a 400-speed system when used with LANEX Regular Screens.

T-MAT H/RAL: T-MAT H/RA provides high-contrast images with very short exposure times. Excellent for capturing images quickly, T-MAT H/RA is an 800-speed system when used with LANEX Regular Screens. When used in the double load mode to create two identical radiographs with a single exposure, it acts as a 400-speed system with LANEX Regular Screens.

Extraoral Film EVG: EVG is a Green sensitive, high contrast, "zero-crossover" film, and is a 400-speed system when used with either EV screens or LANEX Regular Screens.

CARESTREAM DENTAL DUPLICATING FILM		
Item No.	Size	Price
900-1215821	5" x 12" 50/box	\$210.95
900-1493691	6" x 12" (15 x 30cm) 50/box	\$181.45
900-1586460	1-1/4" x 1-5/8" For intraoral film duplication 150/box	\$111.95

X-RAY

CARESTREAM EXTRAORAL FILM				
PANORAMIC				
Item No.	Type	Size	Ref. No.	Price
900-1477405	Ektavision G	5" x 12" (13cm x 30cm) 50/box	EVG-5	\$136.95
900-8372716	Ektavision G	6" x 12" (15cm x 30cm) 50/box	EVG-15	\$136.95
900-5216742	T-Mat E	5" x 12" (13cm 30cm) 100/box	TME-5	\$159.95
900-1987627	T-Mat G	5" x 12" (13cm x 30cm) 50/box	TMG-5	\$119.95
900-1869080	T-Mat G	6" x 12" (15cm x 30cm) 50/box	TMG-15	\$137.45
900-DF75	X-Omat DBF	5" x 12" (13cm x 30cm) 50/box	XDBF-75	\$139.95
900-DF76	X-OMAT DBF	6" x 12" (15cm x 30cm) 50/box	XDBF-76	\$139.95
CEPHALOMETRIC & TMJ FILMS				
900-8453938	T-Mat G	8" x 10" 50/box	TMG-1	\$148.95
900-1589852	T-Mat L	8" x 10" 50/box	TMI-1	\$149.95
900-8021933	X-Omat DBF	8" x 10" 50/box	XDBF-1	\$198.95















FLOW X-RAY FILM			
Item. No.	Description	Flow Ref. No.	Price
900-18200	Polysoft Single Films, D Speed 150/box	DV-58	\$54.25
900-18201	Polysoft Double Films, D Speed 130/box	DV-57	\$71.45
900-18310	Polysoft Single Films, F Speed 150/box	FV-58	\$65.25
900-18410	Polysoft Double Films, F Speed 150/box	FV-57	\$82.95
900-18204	Econo-Pak 4 boxes DV-58 600/box	DV-58	\$202.95
900-18235	DV-54: Pedo Pak D Speed Child 100/box	DV-54	\$52.75
900-18035	Paper Single Film, D Speed Child 100/box	DX-54	\$44.95
900-18060	Paper Bitewing Film, D Speed	DX-42	\$93.25
900-18095	X-Omat Pan Film, 5" x 12" Blue Sensitive 50/box	HC-512	\$78.45
900-18096	X-Omat Pan Film, 6" x 12" Blue Sensitive 50/box	HC-612	\$90.75
900-18095G	Tmat-G Pan Film, 5" x 12" Green Sensitive 50/box	HC-512-G	\$78.45
900-18096G	Tmat-G Pan Film, 6" x 12" Green Sensitive 50/box	HC-612-G	\$101.45
900-18070	Kopy Kat 512 Duplicating Film, 5" x 12" 50/box	-	\$98.25

FILM MOUNTS

X-RAY



	CARDBOARD	OPAQUE PLASTIC	TRANSPARENT PLASTIC		OPAQUE PLASTIC	
50/box* or 100/box	EZ-Mount Gray Paperboard	EZ-Tab Open Window Gray	Transview Notched Translucent	EZ-View Vinyl Pocket Clear	EZ-View Masked Pocket Black	EZ-View Masked Pocket Green
 1H #2	10-0101 910-100101 \$32.95	30-6011 910-306011 \$44.95	25-0178 910-250178 \$38.75	20-1018 910-201018 \$32.95	121-6011 910-216011 \$41.95	22-6011 910-226011 \$41.95
 1V #2		30-6012 910-306012 \$44.95				
 2H #0 Pedo		30-4021 910-304021 \$37.95	25-0811 910-250811 \$36.95	20-1024 910-201024 \$40.95	21-4021 910-214021 \$37.45	22-4021 910-224021 \$37.45
 2H #1	10-0105 910-100105 \$35.45	30-5021 910-305021 \$34.95				
 2H #2		30-6021 910-306021 \$44.95	25-0179 910-250179 \$38.75	20-1020 910-201020 \$44.25	21-6021 910-216021 \$43.45	22-6021 910-226021 \$43.45
 2H #3	10-0131 910-100131 \$40.25	30-7021 910-307021 \$38.75	25-0180 910-250180 \$45.45	20-1023 910-201023 \$38.95	21-7021 910-217021 \$46.75	22-7021 910-227021 \$46.75
 H #0 Pedo	10-0846 910-100846 \$56.25	30-4040 910-304040 \$84.75		20-1044 910-201044 \$52.95		
 4H #2	10-0142 910-100142 \$58.75	30-6040 910-306040 \$60.45		20-1048 910-201048 \$52.25	21-6040 910-216040 \$56.45	22-6040 910-226040 \$52.75
 4H #2	10-0141 910-100141 \$54.45	30-6045 910-306045 \$52.95	25-0815 910-250815 \$57.25	20-1040 910-201040 \$48.75	21-6045 910-216045 \$54.25	22-6045 910-226045 \$54.25
 4V #2	10-0162 910-100162 \$51.95	30-6042 910-306042 \$60.45	25-0814 910-250814 \$56.75	20-1048 910-201048 \$52.25	21-6042 910-216042 \$43.95	22-6042 910-226042 \$43.95
 4H 2V #2	10-0161 910-100161 \$65.45	30-6062 910-306062 \$58.95	25-0161 910-250161 \$66.95	20-1062 910-201062 \$58.95		
 6H #2	10-0144 910-100144 \$67.95	30-6061 910-306061 \$58.95	25-0182 910-250182 \$67.45	20-1060 910-201060 \$50.25	21-6061 910-216061 \$69.95	22-6061 910-226061 \$58.95
 8H #2	10-0156 910-100156 \$78.95	30-6081 910-306081 \$74.95	25-0825 910-250825 \$85.45	20-1088 910-201088 \$58.25	21-6081 910-216081 \$111.75	22-6081 910-226081 \$111.75

FILM MOUNTS

X-RAY



	CARDBOARD	OPAQUE PLASTIC	TRANSPARENT PLASTIC		OPAQUE PLASTIC	
50/box* or 100/box	EZ-Mount Gray Paperboard	EZ-Tab Open Window Gray	Transview Notched Translucent	EZ-View Vinyl Pocket Clear	EZ-View Masked Pocket Black	EZ-View Masked Pocket Green
 8H 6V #2	10-0136 910-100136 \$133.75	30-6141 910-306141 \$103.25	25-0184 910-250184 \$120.45	20-1142 910-201142 \$73.75		
 8H 6V 2BW #2	10-0138 910-100138 \$136.25	30-6162 910-306162 \$117.95				
 8H 6V 4BW #2	10-0140 910-100140 \$136.25	30-618 910-306180 \$139.45	25-0187 910-250187 \$135.75	20-118250 910-20118250* \$87.45 910-201182 \$117.25	21-618050 910-21618050* \$99.45 910-216180 \$136.75	22-6180 910-226180 \$136.75
 8H #2 8V 4BW	10-0129 910-100129 \$163.75	30-6200 910-306200 \$144.25	25-0838 910-250838 \$235.45	20-1208 910-201208 \$99.75	21-6200 910-216200 \$134.25	22-6200 910-226200 \$134.25
BITEWING HISTORY MOUNTS						
 10BW #0		30-0123 910-300123 \$93.45				
 10BW #2	10-0805 910-100805 \$98.25	30-2345 910-302345 \$94.95	25-0821 910-250821 \$98.95	20-1108 910-201108 \$66.25	21-2345 910-212345 \$88.45	22-2345 910-222345 \$87.25
 10BW #3	10-0806 910-100806 \$98.25	30-3456 910-303456 \$93.45	25-0820 910-250820 \$107.45		21-3456 910-213456 \$120.25	22-3456 910-223456 \$120.25
 16BW #2					21-816350 910-21816350* \$88.45 910-218163 \$120.25	22-8163 910-228163 \$110.45
 20BW #2	10-0905 910-100905 \$165.75	30-4567 910-304567 \$220.95		20-0138 910-200138 \$164.45	21-456750 910-21456750* \$140.45 910-214567 \$192.95	22-4567 910-224567 \$192.95

FILM MOUNTS



Universal X-Ray Film Mounts

Perforated, clear vinyl 2-window pocket mounts with white matte surface for writing. Protects film from damage. Each box contains 1000 windows.

910-10001 1000/box **\$95.95**



EZ-View FasTear Mount - Dentsply Rinn

Perforated for easy removal. Fan-folded for easy dispensing. Comes with Name/Date labels. Pull out the desired number of pockets and tear into your desired configuration. The clear vinyl pocket style offers maximum protection, visibility and convenience.

910-200500 1000/box **\$95.95**



EZ-View Universal Cut-Apart Mounts - Dentsply Rinn

Flexible windows hold #0, #1 and #2 films. Fan-folded for easy dispensing. Comes with Name/Date labels. Pull out the desired number of pockets and cut into your desired configuration. The clear vinyl pocket style offers maximum protection, visibility and convenience.

910-200102 1000/box **\$134.45**

AUTOMATIC PROCESSING CHEMICALS



Developer & Fixer - Air Techniques

Every batch of chemistry receives continual quality inspection. Our developer has superior anti-oxidation properties for longer life. Our fixer easily washes off the film surface extending the life of radiographs. For roller processors only.

Developer & Fixer

920-40270 2 gallons each **\$127.45**

Developer Only

920-40240 1 gallon **\$27.75**

Fixer Only

920-40245 1gallon **\$27.75**

Starter Solution

For use with Air Techniques Developer.

920-40280 12oz **\$13.25**



Peri-Pro Chemistry - Air Techniques

Developer & Fixer

920-90800 3 quarts each **\$62.75**

Developer Only

920-90801 1 quart **\$15.95**

Fixer Only

920-90802 1 quart **\$15.95**



Rapid Access - Carestream Dental

These ready-to-use solutions require no mixing. Radiographs are suitable for viewing in 30 seconds (15-second development, 15-second fix).

Developer & Fixer

920-1838374 1 pint each **\$23.25**



Readymatic - Carestream Dental

Designed for use in all automatic roller-transport dental x-ray film processors. They deliver clear, consistent results for all intraoral and extraoral radiographs. For your convenience, our chemicals are available in ready-to-use form.

Developer & Fixer

920-1028869 2 gallons each **\$89.95**

Developer Only

920-8777534 4 gallons **\$101.95**

Fixer Only

920-8712879 4 gallons **\$116.95**



Readypro Chemicals - Carestream Dental

Specially formulated for use in rollerless processors.

Developer & Fixer

920-1176262 1 quart each **\$25.95**



Redi-Chem - Fujifilm USA

Ready-to-use (no dilution required) chemicals, designed for use in all brands and types of automatic roller type processors.

Developer A & Fixer B

920-27270 2 gallons each **\$56.45**

Developer Only

920-27272 4 gallons **\$72.45**

Fixer Only

920-27274 4 gallons **\$58.45**

AUTOMATIC PROCESSING CHEMICALS



Peri-Chem Pre-Mixed - Fujifilm USA

For rollerless type automatic film processors.

Developer & Fixer

920-27271 3 quarts each \$36.75



Peri-Sol® - Solutek Corporation

Ready-to-use developer & fixer formulated for use in roller-less processors. They produce optimum film quality, high contrast and definition, low fog. One bottle fills a tank in the Peri-Pro processor. Peri Sol chemistry contains special ingredients that retard oxidation, produce consistent results, and minimize the formation of sludge.

Developer & Fixer

920-23879 3 quarts each \$20.95

Developer Only

920-23879A 1 quart \$4.25

Fixer Only

920-238792 1 quart \$3.95



SoluDent Developer & Fixer - Solutek Corporation

Ready-to-use processing solutions provide consistent results, long shelf life and exceptional quality. Pre-mixed chemistry prevents solution mixing errors and time consuming retakes. Assures high quality films with less handling time and fewer problems. Suitable for use in all automatic roller type dental X-Ray film processors.

Developer & Fixer

920-20629 2 gallons each \$31.95

Developer Only

920-20624 4 gallons \$33.95

Fixer Only

920-20824 4 gallons \$27.95



PanoPro™ Developer & Fixer - Southland Distribution & Sales

Formulated for use in roller type automatic processors. All temperature formula works in machines with or without heaters, specifically developed for "Peri-type" processors, less oxidation, stays fresher longer, archival quality X-rays, quick drying formula, sharper images.

Developer & Fixer

920-FM8004 2 gallons each \$105.25

Developer Only

920-FM8005 4 gallons \$100.95

Fixer Only

920-FM8006 4 gallons \$100.95



ABX® Premixed Developer & Fixer - White Mountain Imaging

Color-coding system specially formulated to help eliminate possible cross contamination. Fixscent, no odor formulation, completely eliminates chemical odors and provides a fresh pleasant floral fragrance.

Developer & Fixer

920-324 2 gallons each \$51.95

Developer Only

920-204 4 gallons \$64.75

Fixer Only

920-304 4 gallons \$54.75



Excel Ready-to-Use Chemistry - White Mountain Imaging

High quality chemistry ensures better looking films with fewer processor problems. Pre-diluted, simply open the bottle and add it to your film processor.

Developer & Fixer

920-9926020 2 gallons each \$81.45

Developer Only

920-992602DV 4 gallons \$78.75

Fixer Only

920-992602FX 4 gallons \$78.75



Peri-Dent Developer & Fixer - White Mountain Imaging

Easy to use. High resistance to oxidation which provides a longer active life. Special emulsion hardeners to protect the film as it goes through the processor.

Developer & Fixer

920-401 3 quarts each \$40.75

MANUAL PROCESSING CHEMICALS



GBX - Carestream Dental

Liquid chemical concentrates designed to manually process all of our intraoral and extraoral dental film. Both the developer and fixer are single-solution concentrates, which provide mixing convenience, chemical stability, and identical mixing and dilution procedures for tank and replenishment solutions.

Developer & Fixer Twin Pack

920-1901859 28oz each \$34.45

Developer & Replenisher

920-1900943 1 quart \$33.25

920-1900984 1 gallon \$77.25

Fixer & Replenisher

920-1901875 1 quart \$29.45

920-1902485 1 gallon \$62.45

MANUAL PROCESSING CHEMICALS



Insta-Neg & Insta-Fix - Microcopy

These solutions give not only speed but great diagnostic quality with archival permanence. In addition, many users indicate a greater active tank life compared to conventional and other high-energy solutions. Insta-Neg and Insta-Fix are premixed for use in either standard developing tanks for total X-ray processing (including panoramic film), or in small containers for endodontic and emergency processing.

Developer & Fixer

920-NEGFIXQT 4 quarts each **\$115.45**
 920-NEGFIXGL 2 gallons each **\$150.75**

Insta-Neg 920-NEGDEV
 Insta-Fix 920-NEGFIX
 1 quart **\$15.45**

Insta-Neg 920-NEGDEVG
 Insta-Fix 920-NEGFIXG
 1 gallon **\$31.25**



SoluDent SDX Concentrate - Solutek Corporation

SoluDent SDX is a special two-part formulation designed for processing X-ray films, packaged in twin-paks. One bottle of developer and one bottle of fixer, each makes one gallon..

920-26009 26oz each **\$8.95**

X-RAY PROCESSING CLEANERS



Peri-Pro Transport Cleaning Kit - Air Techniques

Contains: All items needed to chemically clean

572

a Peri-Pro Transport along with cleaning tub, 1 brush, and 1 Twin-Pack of Formula 2000.
 930-43975 Kit **\$147.95**

Formula 2000 PLUS Tank & Transport Cleaner

Use for roller-type processors, manual processing tanks & Peri-Pro transports.

Twin Pack - 1 Liter

Contains: 2 bottles, 2 sponges and 1 spatula.
 920-43945 Pack **\$53.95**



Spray 2000 PLUS - Air Techniques

For roller-type film processors only; not for Peri-Pro.

Contains: 1 liter Spray 2000 Plus, 1 spray attachment, 4 cleaning webs (non-abrasive scrubbing pads for cleaning roller transports).

920-43965 Kit **\$57.95**



Clean-Up Film - Carestream Dental

This film is designed for convenient cleaning of the transport mechanism in roller transport processors. (8" x 10" Roller Transport).

900-1039205 100/box **\$246.95**



Rapid-Klene - Premier® Dental

Effectively and safely cleans automatic film processors in as little as 20 minutes without scrubbing. After draining all sections, one Rapid-Klene pouch is emptied into each section to be cleaned and hot tap water is added. The transports are inserted and the machine is turned on. 63gm pouches.

927-9018101 12/pack **\$122.75**



Clear Image Radiographic Weekly Cleaner - Southland Distribution & Sales

No acids or hazardous chromate chemicals. One step and easy to use. Safe for all processors. 100% biodegradable and nontoxic. No hazardous shipping charges, EPA safe. Cleans rollers and tank in 3 to 5 minutes.

920-CI3212 1 quart **\$40.25**
 920-CI1284 1 gallon **\$122.75**



Pro-32 - Southland Distribution & Sales

A professional strength monthly or quarterly cleaner for all processors. Removes silver build-up and oxidation from rollers, webs, transports and tanks. Ten cleanings per bottle. Includes gloves and safety glasses.

920-P32 1 quart **\$116.95**



Sharp Image Clean Up Sheets - Southland Distribution & Sales

Eliminates retakes due to build-up. Process a new Sharp Image Clean Up Sheet as the first film of the day to remove artifacts that build up on the processor rollers. Fifty 8"x10" sheets per pack.

900-CI0810 Each **\$76.45**

X-RAY PROCESSING CLEANERS



Easy Clean - White Mountain Imaging
 This environmentally safe cleaner is a water-soluble powder. Simply drop your racks, rollers or tanks into the solution and leave them overnight or over the weekend. Easy Clean removes silver and other residues from the parts, minimizing the chances of film slippage in the rollers while decreasing artifacts on the films .25 lbs each.
 920-99260260 12/pack **\$67.45**



LH System Cleaner - White Mountain Imaging
 Concentrated powder cleaner can be used full strength, dissolves silver oxide deposits and other stains. 1 quart.
 920-701 6/box..... **\$42.75**

FIXER WASTE MANAGEMENT



All Ways Recycle - Fixer Treatment Systems
 Safely recycles hazardous fixer for one year in the dental office. For use with manual and automatic processors. Meets EPA regulations. Price includes UPS pickup of the old recycling unit.
 770-FTS100 Each **\$342.75**



CHEMGON® 5 - Waste & Compliance Management
 Chemistry treatment and disposal product for used X-Ray processing chemicals. On the basis of Toxicity Characteristic Leaching Procedures (TCLP), CHEMGON processed graphic arts, photo processing fluids, and X-ray fluids are converted to a non-hazardous solid waste safe for regular trash disposal; silver levels are well below the acceptable parts per million (ppm's) established by the EPA. CHEMGON converts hazardous liquids into non-hazardous solid waste.
 370-CHG5 5 gallons **\$107.75**



FOILGON® - Waste & Compliance Management
 Mail-back lead foil recycling. A FOILGON container is provided; prepaid shipping documents and a recycler ready to accept your lead foil waste. You simply attach the prepaid shipping label and give your full (no more than 7 lbs.) container to the UPS driver that delivers your supplies or drop the container off at a convenient UPS drop off location.
 370-FOILGON Each..... **\$89.45**

X-RAY FILM DUPLICATORS & VIEWERS



Slimline Duplicator - Dentsply Rinn
 Quickly and easily duplicate your radiographs, great for referrals and claims. Position films in darkroom with built-in safelight. Accurate exposure control with "instant-on" ballast and pre-settable timer. Exceptionally durable chemical-resistant polyethylene housing. 5-7/8" x 12-5/8" duplicating area.
 770-721212 Each **\$1157.45**



Kopy Kat - Flow Dental
 Duplicators for intraoral/extraoral films.
6" x 12"
 770-21520 Each **\$549.75**
10" x 12"
 770-21522 Each **\$598.25**



Classic X-Ray Viewers - Kerr Restoratives
 All plastic construction (wet films will not rust viewer). Roller clip secures film or film mount. Viewing area: 12 7/8" W x 4 7/8" H. Actual Size: 15 1/4" W x 6 3/4" H.
Desk Model
 930-31332 Each **\$132.25**
Wall Model
 930-31342 Each **\$132.25**



Luminator Slim-Line X-Ray Viewer - Kerr Restoratives
 Modern Slim-Line styling accepts panoramic films and intra-oral mounts. Functions as a desk viewer or as a wall mount. Viewing area: 13-1/2" wide x 6" high.
 930-31323 Each **\$186.45**

SOOTHE-GUARD AIR®
LEAD-FREE X-RAY APRONS

SOOTHE-GUARD®
LEAD-LINED X-RAY APRONS

Choose the right apron for the job!

APRON GUIDE

The NCRP (National Council on Radiation Protection and Measurements) requires thyroid shielding for all children and highly recommends it for all adults as well.¹

INTRAORAL IMAGING

BITEWINGS – PERIAPICALS – FULL-MOUTH SERIES

COLLARED APRONS

Provide protection in front from thyroid to gonadal area. Velcro closure at neck ensures snug fit.

EXCLUSIVE!

EXTENDED COLLAR APRONS

Adjustable closure fits necks sizes SMALL thru 6X-LARGE.

Premium leather grain Soothe-Guard® material.

COLLARS

For use with non-collared aprons for thyroid protection.

NON-COLLARED APRONS

Provide protection in front from shoulders to gonadal area. Not for use with Extraoral Imaging (no protection in back).

EXTRAORAL IMAGING

PANORAMIC – CEPHALOGRAPHIC – CONE-BEAM CT

PANOVEST

Provides light-weight protection from the shoulders and chest as well as down the back. Front closure for easy on-and-off.

PANO-CAPE

Provides protection from the shoulders and features a back closure. Light-weight option.

PANO-DUAL

Provides protection from the shoulders to the gonadal area in both front and back, with Velcro closure at the shoulder. Most protective option.

**DENTSPLY
RINN**



Studies show that protective collars reduce radiation dosage to the thyroid by 26-33%

SOOTHE-GUARD® Brand Aprons

EASY TO CLEAN

- Both sides will not crack, chalk or fade when cleaned with soap and water or VoloWipes™ disinfecting wipes**
- Comfortable Soothe-Guard® material

SOOTHE-GUARD AIR®

25% LIGHTER

THAN LEAD-LINED APRONS*

- Innovative lead-free alloy lining provides protection equal to lead*

EVERY APRON HAS A BIRTH DATE — WHAT'S YOURS?

According to the ADA:

“All protective shields should be evaluated for damage (ie. tears, folds, and cracks) monthly using visual and manual inspection.”*

Note: A crack in the outer layer could expose the lead inside, which could transfer to the patient. We recommend replacing your aprons every 3-5 years.



Apron Hanger

Heavy-duty, white epoxy-coated steel. Mounting hardware is included.

Dimensions: 1.25" high x 14.875" wide x 1.375" deep (32 x 378 x 35mm)

930-662052 Each.....\$43.25

- A** Adult with Extended Thyroid Collar
- B** Adult with Thyroid Collar
- C** Child with Thyroid Collar
- D** Protective Thyroid Collar
- E** Pano-Cape
- F** Adult Pano-Dual
- G** Child Pano-Dual
- H** PanoVest
- I** Adult (No Collar)

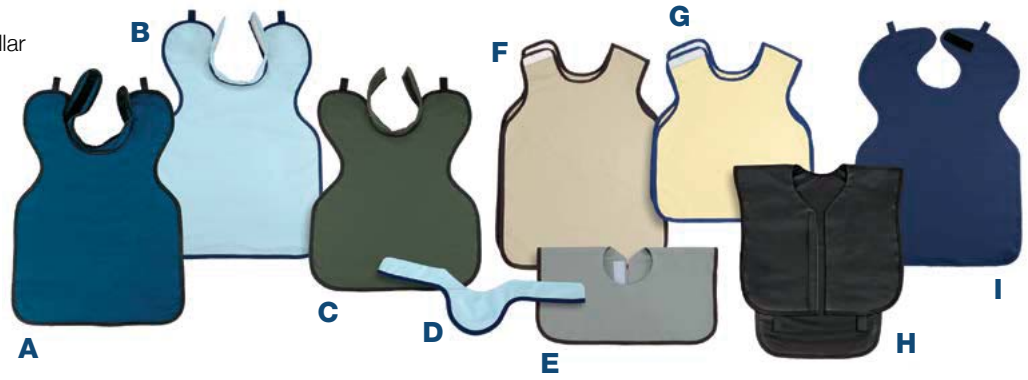

X-RAY

SOOTHE-GUARD AIR® Lead-Free *25% Lighter than Lead-Lined Aprons* | *Easier Handling for the Dental Professional* | *Environmentally Friendly*

.3MM LEAD EQUIVALENCY

Model	Weight (Lbs.)	Sapphire Blue	Dark Olive	Taupe	Black	Buttercup	Navy	Dove Grey	Light Blue	Tan/Beige	Price
A Adult Apron with Extended Collar	4.15	930-8616060	930-8617060	930-8614060	930-8615060						\$352.25
B Adult Apron with Collar	4.05					930-868050	930-869050	930-8610050	930-8611050	930-8612050	\$337.75
C Child Apron with Collar	2.70	930-8616047	930-8617047	930-8614057	930-8615057	930-868047	930-869047	930-8610047	930-8611047	930-8612047	\$289.25
D Protective Thyroid Collar	0.5					930-868051	930-869051	930-8610051	930-8611051	930-8612051	\$102.95
I Adult Apron (no collar)	3.80					930-868049	930-869049	930-8610049	930-8611049	930-8612049	\$251.25
H PanoVest	4.60	930-8616059	930-8617059	930-8614059	930-8615059		930-869059			930-8612059	\$461.75
E Pano-Cape Apron	2.60					930-868053	930-869053	930-8610053	930-8611053	930-8612053	\$384.45
F Adult Pano-Dual Apron	6.75					930-868054	930-869054	930-8610054	930-8611054	930-8612054	\$482.45
G Child Pano-Dual Apron	4.25					930-868055	930-869055	930-8610055	930-8611055	930-8612055	\$429.25

.5MM LEAD EQUIVALENCY

B Adult Apron with Collar	6.60						930-879050				\$444.95
C Child Apron with Collar	4.00						930-879047				\$368.95
F Adult Pano-Dual Apron	10.00						930-879054				\$552.25

SOOTHE-GUARD® Lead-Lined *Extended Collars* | *Comfortable Material* | *Variety of Colors*

.3MM LEAD EQUIVALENCY

Model	Weight (Lbs.)	Sapphire Blue	Dark Olive	Taupe	Black	Buttercup	Navy	Dove Grey	Light Blue	Tan/Beige	Price
A Adult Apron with Extended Collar	5.60	930-6616060	930-6617060	930-6614060	930-6615060						\$211.45
B Adult Apron with Collar	5.50					930-668050	930-669050	930-6610050	930-6611050	930-6612050	\$211.45
C Child Apron with Collar	3.60	930-6616047	930-6617047	930-6614057	930-6615057	930-668047	930-669047	930-6610047	930-6611047	930-6612047	\$169.25
D Protective Thyroid Collar	0.60					930-668051	930-669051	930-6610051	930-6611051	930-6612051	\$69.95
I Adult Apron (no collar)	4.90					930-668049	930-669049	930-6610049	930-6611049	930-6612049	\$179.75
E Pano-Cape Apron	3.60					930-668053	930-669053	930-6610053	930-6611053	930-6612053	\$256.75

.5MM LEAD EQUIVALENCY

B Adult Apron with Collar	8.80						<i>930-569050</i>				\$285.25
C Child Apron with Collar	5.70						<i>930-569047</i>				\$211.25
D Protective Thyroid Collar	0.90						<i>930-569051</i>				\$106.95
I Adult Apron (no collar)	8.20						<i>930-569049</i>				\$204.75
E Pano-Cape Apron	5.70						<i>930-569053</i>				\$330.95

Light Italic Part Numbers: Made-to-order (non-returnable).



X-RAY

Lead Free protection that's both beautiful and affordable!

Flow lead free aprons come in a variety of beautiful, stain resistant fabrics your patients will love! Made from environmentally friendly, non-toxic materials that are both long lasting and flexible, Flow aprons are healthier for you and for our environment. Available in Adult, Adult with attached color, Child with attached color, or Panoramic (poncho) styles. Thyroid collars can also be bought separately.



All Flow Dental Aprons are available in the following colors and patterns...



How to order your Flow No-Lead Apron

To order, select from any of the patterns shown above. Use the stock number and add a fabric number after it. **Example:** If you want a Bib Apron, without a thyroid collar, in the Tye Dye fabric, the correct product number is 930-75050NL-30.

Description	Size	Stock Number	Price
Adult Bib Apron without Thyroid Collar	24" x 26"	930-75050NL (+ color #)	\$252.75
Adult Bib Apron with Sewn-on Thyroid Collar	24" x 26"	930-75051NL (+ color #)	\$295.95
Child Size Bib Apron with Sewn-on Thyroid Collar	20" x 20"	930-75053NL (+ color #)	\$227.25
Adult Panoramic Apron	24" x 27"	930-75061NL (+ color #)	\$370.75
Child Panoramic Apron	20" x 20"	930-75062NL (+ color #)	\$308.75
Thyroid Collar	5" x 27"	930-75056NL (+ color #)	\$53.25

Lead-Free X-ray Apron with thyroid collar

Lead-Free X-ray Aprons with thyroid collars provide protection for patients during intra-oral radiography without the weight of lead.



Child, Blue microfiber	930-31351	\$184.80
Child, Charcoal microfiber	930-31354	\$309.25
Adult, Reversible Violet/Charcoal	930-31359	\$386.95
Adult, Charcoal microfiber	930-31389	\$333.75
Adult, Blue microfiber	930-31459	\$333.75

Lead-Free X-ray Apron without collar

The lead-free X-ray aprons are made of proprietary alloy sheeting that provides the same protection as lead but are up to 30% lighter.



Adult, Charcoal microfiber	930-31388	\$297.75
Adult, Blue microfiber	930-31458	\$297.75

Lead-Free Panoramic Poncho

Lead-Free X-ray Panoramic Ponchos provide protection for patients during panoramic radiography without the weight of lead.



Child, Charcoal microfiber	930-31355	\$464.25
Adult, Reversible Violet/Charcoal	930-31360	\$627.25
Adult, Charcoal microfiber	930-31390	\$485.25
Adult, Blue microfiber	930-31460	\$485.25

Lead X-ray Aprons with thyroid collar

Each lead X-ray apron drapes comfortably over patient. Adult size measurements: 23" width x 26" length.



Blue	930-31461	\$170.75
Beige	930-31464	\$170.75
Gray	930-31465	\$170.75
Mauve	930-31485	\$170.75

Lead X-ray Apron without collar

These lead X-ray aprons are easy to clean with a vinyl front and durable stain-resistant binding. Adult size measurements: 23" width x 26" length.



Blue	930-31401	\$175.95
Beige	930-31404	\$175.95
Gray	930-31405	\$175.95

Lead Panoramic Poncho

Adult size measurements: Front 19 1/4" width at shoulder x 19" length
Back 30" length measured from the neckline, tapered to 13 1/4" width



Blue	930-31490	\$244.25
Beige	930-31491	\$244.25
Gray	930-31492	\$244.25
Mauve	930-31493	\$244.25



CLING SHIELD™ Petite/Child Protectall Apron

Neck collar permanently attached. Covers from thyroid to below the gonadal area. Sized for petite adults or children. Velcro clasp on neck collar. Loops attached for easy hanging and storage. 20" x 20"

Product No.	Type	Price
930-27	Dental .3mm	\$119.75
930-27M	Medical .5mm	\$180.25
930-27U	Unleaded	\$201.25

CLING SHIELD™ Adult Protectall Apron

Neck collar permanently attached. Covers from thyroid to below the gonadal area. Velcro clasp on neck collar. Loops attached for easy hanging and storage. 22¼" x 25½"

Product No.	Type	Price
930-24	Dental .3mm	\$136.25
930-24M	Medical .5mm	\$203.95
930-24U	Unleaded	\$234.25

CLING SHIELD™ Adult Patient Apron

Covers from over the shoulders to below the gonadal area. Loops attached for easy hanging and storage. 22¼" x 24¼"

Product No.	Type	Price
930-20	Dental .3mm	\$119.95
930-20M	Medical .5mm	\$180.25
930-20U	Unleaded	\$198.25

CLING SHIELD™ Petite/Child Patient Apron

Covers from over shoulders to below the gonadal area. Loops attached for easy hanging and storage 20" x 19½"

Product No.	Type	Price
930-22	Dental .3mm	\$101.95

CLING SHIELD™ Pano-Adult Dual Apron

Covers in front from shoulders to below gonadal area. Back is the same length as front. Velcro clasp at shoulder. 22½" x 26½"

Product No.	Type	Price
930-26	Dental .3mm	\$220.45
930-26U	Unleaded	\$404.95

CLING SHIELD™ Neck Collar

For the protection of the thyroid area. Velcro closing. One size fits all. Use in conjunction with Adult Patient Apron. 22⅝" x 4¼"

Product No.	Type	Price
930-25	Dental .3mm	\$53.25
930-25M	Medical .5mm	\$74.75
930-25U	Unleaded	\$74.75

Vinyl Colors
Black Binding





Bite Wing Loops

Bite Wing loops are made of heavy-duty paper board, and designed to accommodate any dental film.

- Child size 0 930-HTBWL0
- Adult size 2 930-HTBWL2
- 500/box **\$5.95**



Bite Wing Tabs

Self Adhesive Bite Wing Tabs easily fold down and stick to any size film.

- 930-HTBWT 500/box **\$7.95**



Bite Wing Tabs - Crossex International

Self-adhesive bite wing tabs attach to adult and children's X-ray film - hold securely in place. Convenient pop-out dispenser box.

- 930-YBT 500/box **\$9.25**



Bite Wing Tabs - Dentsply Rinn

Self-adhesive tabs affix to film packet. For use horizontally or vertically. Handy dispenser box included.

- 930-140500 500/box **\$14.95**



Stabe Bite-Blocks - Dentsply Rinn

Holds #0, 1 or 2 film firmly, comfortably at the correct angle for long or short cone technique. End of block snaps off for tight situations.

- 930-600870 100/box **\$46.45**



XCP Disposable Bite-Blocks - Dentsply Rinn

For size 0, 1 or 2 film. Break off front section for Pedo applications.

- 930-540870 100/box **\$51.25**

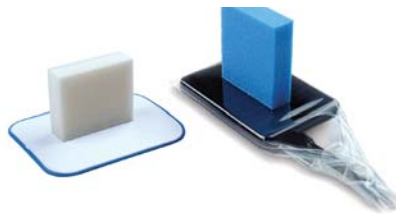

FLAPS Digital Sensor Film Tabs - Microcopy

Made of soft plastic foam. "Flaps" are so comfortable patients accept them better with less gagging.

- Original - White**
- 930-FLAPS 500/box **\$41.25**

- Long - Blue**
- 930-FLS 375/box **\$43.45**



SoftX Foam Bite Wing Loops - ProEdge Dental Corp

Cushion and protect the susceptible surfaces of the mouth during bite wing X-rays. Soft edges and corners comfortably cushion tissue to eliminate the pain of Bite Wing X-rays in seconds, for pennies per patient.

- #0 Pediatric 930-BWL250
- #2 Pediatric 930-BWL252
- #2 Vertical 930-VBWL252
- 250/box **\$31.25**



Bite Wing Tabs - Temrex Corporation

The box is self-dispensing, convenient pop-up as the carrier strip is advanced. This eliminates the individual peeling off of protecting paper on individual tabs.

- 930-2450 550/box **\$12.75**



Bite Wing Tabs - Vista Dental Products

A self-adhesive tab that can be applied to both adult or child X-ray film. For added convenience, can be affixed either vertically or horizontally. The unique dispenser box eliminates the need to individually peel each tab while providing a convenient pop-up dispenser.

- 930-308001 500/box **\$10.25**

PANORAMIC POSITIONING

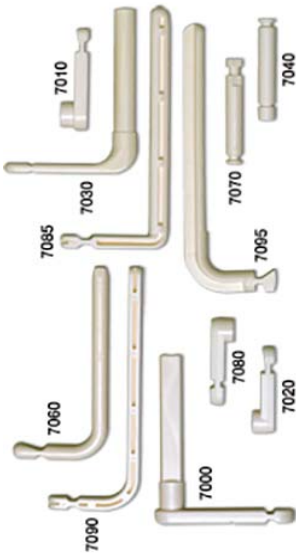

Dispos-A-Bite - Kerr TotalCare

Disposable bite blocks for panoramic X-ray machines. Individually wrapped to reduce the risk of cross contamination.

- Fits Midwest, Ritter Panorol, J. Morita, Versview 660-7000
- Fits Siemens OP10 660-7010
- Fits Siemens OP, OP5, DentalEZ, Panolite, Soredex 660-7020
- Fits Phillips 660-7030
- Fits GE, Gendex and Panolipse 660-7040
- Fits Planmeca 660-7060
- Fits Panorex by Keystone 660-7070
- Fits Belmont Autopan 660-7080
- Fits Yoshida, Kaycor Panoura, FIAD-Rotograph 660-7085
- Fits Belmont X-Caliber 660-7090
- Fits Panoramic 660-7095
- 100/box **\$57.95**

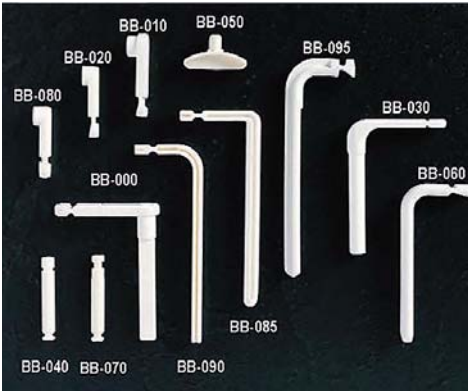

Block-4-Bite - Plasdent Corporation

Disposable bite blocks for panoramic X-ray machines.

- Fits Midwest, Ritter Panorol, J. Morita Versview 930-BB000
- Fits Siemens OP10 and Instrumetarium 930-BB010
- Fits Siemens OP3, OP5 930-BB020
- Fits Phillips, DentalEZ, Panolite, Soredex 930-BB030
- Fits GE Panolipse, Gendex 930-BB040
- Fits Yoshida, Kaycor Panoura 930-BB050
- Fits Planmeca 930-BB060
- Fits Panorex by Keystone 930-BB070
- Fits Belmont Autopan, FIAD Rotograph 930-BB080

- Fits Yoshida, Kaycor Panoura 930-BB085
- Fits Belmont X-Caliber 930-BB090
- Fits Panoramic 930-BB095
- 100/box **\$26.75**

SENSOR, FILM & PSP HOLDERS



Edge-Ease Comfort Cushions - Crosstex International

Developed by a dental hygienist to allow for easier film and sensor placement and provide a more comfortable edge on intraoral film packets and digital sensors. Patients will bite harder on your film holder, which positions the X-ray more periapically for better diagnostic X-rays.

- Large - Blue 930-EEB
- Small - White 930-EEW
- 300/box **\$48.95**



Eezee-Grip Digital Sensor Holder - Dentsply Rinn

Save time on digital radiographs. Simply insert the sensor, squeeze and you're ready to go. The Eezee-Grip has patented flexible grips for patient comfort and accommodates most popular sensor brands. Autoclavable.

- 930-550293 Each **\$35.75**
- 930-550294 3/pack **\$90.25**



Snap-A-Ray DS - Dentsply Rinn

Allows you to quickly load and place digital sensors for accurate periapical radiographs. Autoclavable. Use with the optional 2-in-1 Arm and Ring kit for easy alignment.

- 930-550321 Each **\$48.75**
- 930-550323 3/pack **\$127.95**

Endo

- 930-550421 Each **\$48.75**
- 930-550423 3/pack **\$127.95**

Arm & Ring Kit

- 930-550322 Each **\$92.75**



Snap-A-Ray Film Holder - Dentsply Rinn

Used with e2v (CCD) and Schick CDR Sensors. Posterior radiographs made simple with the modified Snap-A-Ray Film holder. Note: Not for Schick CDR Elite or other CMOS sensors. For e2v (CCD) and Schick CDR sensors.

- 930-550295 Each **\$34.45**



Snap-A-Ray Xtra Film and PSP Holder - Dentsply Rinn

Autoclavable film and PSP holder with cushioned holder grips to minimize potential of scratching PSP. Its anterior bite block is angled to assist with Bisecting Angle Instrumentation (BAI) while allowing for easier patient placement of X-ray media.

- 930-540501 Each **\$30.75**
- 930-540503 3/pack **\$73.75**



Uni-Grip 360 Universal Sensor Holders - Dentsply Rinn

Holder is designed to produce an entire full mouth series using only one holder. Sliding the bitepiece along the channels enables you to take anterior, posterior and bitewing x-rays. One per procedure is all you need.

Starter Kit

- Contains: 50 Holders & 50 Sensor Covers.
- 930-550052 Kit **\$69.75**

Combo Pack

- Contains: 100 Holders, 100 sensor covers and 1 Uni-GripAR Positioning Arm and Ring.
- 930-550252 Pack **\$143.45**

Kit for Film and Phospor Plates

- 930-550055 50/pack **\$69.75**

Combo Kit for Film and Phospor Plates

- Contains: 2 (930-550055) and 1 Uni-Grip AR.
- 930-550255 Kit **\$136.75**

Uni-Grip AR Positioning Arm and Ring

Accurately align your X-ray cone with the universal positioning arm and ring for Uni-Grip Holders. Color-coded for quick assembly. Autoclavable.

- 930-550100 Each **\$58.25**

SENSOR, FILM & PSP HOLDERS



X-Ray Holders - Precision Dental

Holds X-ray film for anterior and posterior X-rays. Both ends securely hold film without bending. Available with an angulated end or with a straight end. Sterilizable by standard table top sterilizer.

Beige Angled

930-XFH3 3/pkg. **\$13.95**

Blue Straight

930-XFH5BU 3/pkg. **\$14.45**



Wing-A-Ray® - Steri-Shield

Fits all digital sensors on the market. Can be cold or heat sterilized (105° C max.).

930-088050 Each **\$33.95**

Use with Wingers, see page 583



Endo Ray II - Dentsply Rinn

Greater control with addition of an aiming ring. Fits over files clamps and rubber dams without touching the subject tooth.

930-540303 2/pack **\$111.95**

930-540307 4/pack **\$221.25**



XCP® Evolution 2000 Film and PSP Holding Systems - Dentsply Rinn

Quickly align the x-ray cone to media and prevent cone cutting. Easily assemble with color coded XCP components. Guide PID for proper alignment with short arms and light rings that accommodate intraoral units. Steam autoclavable.

Kit with Bitewing Holder

Contains: 4 arms and rings: 1 anterior, 2 posterior, 1 bitewing; 17 bite blocks: 4 anterior, 8 posterior and 5 bitewings (2 H#2, 2 V#2, 1H #0/1, (1V #1); instructional poster.

930-542001 Kit **\$199.45**

Kit Without Bitewings

Contains: 3 arms and rings: 1 anterior, 2 posterior; 12 biteblocks: 4 anterior, 8 posterior; instructional poster.

930-540928 Each **\$151.95**

Kit with Bitewings and Endodontic

Contains: All contents of 930-542001, plus 1 endo arm and ring and 4 endo biteblocks.

930-542045 Kit **\$63.45**

Kit for Endodontic Film/ PSP

Contains: 1 endo arm and ring, 3 endo biteblocks.

930-542045 Kit **\$63.45**

XCP® Evolution 2000 Kit Replacement Parts



XCP Aiming Rings

Anterior (Blue)..... 930-540865

Posterior (Yellow) 930-540860

Bitewing (Red) 930-540934

Endo (Green) 930-550598

Each **\$13.75**



XCP Stainless Steel Indicator Arms

Anterior Arm (Blue) 930-540857

Posterior Arm (Yellow) 930-540858

Bitewing Arm (Red) 930-540927

Endo Arm (No Pins) 930-550597

Each **\$44.25**



XCP Color-Coded Bite Blocks

XCP Anterior (Blue).....930-540867

XCP Posterior (Yellow).....930-540868

6/pkg **\$22.95**

XCP Anterior (Blue)..... 930-540861

XCP Posterior (Yellow) 930-540862

BAI Anterior (White) 930-540919

BAI Posterior (White)..... 930-540920

25/pkg **\$34.45**

XCP Anterior & Posterior ..930-540863

10/pkg. **\$34.45**

BAI Anterior & Posterior....930-540864

10/pkg. **\$38.95**

Endo (Green).....930-540935

2/pkg. **\$26.45**



XCP Bitewing Blocks

#0/1 Film horizontal..... 930-540933

#1 Film vertical..... 930-540922

#2 Film horizontal..... 930-540929

#2 Film vertical..... 930-542041

#3 Film horizontal..... 930-540931

6/pkg. **\$26.45**

XCP Disposable Bite-Blocks

For size 0, 1 or 2 film. Break off front section for Pedo applications.

930-540870 100/box **\$51.25**



XCP-DS FIT® Universal Sensor Holder System - Dentsply Rinn

Fits any size, any brand sensor. Self-adjusting clip stretches to fit Size 0, 1, 1.5 and 2. Easy to load. Rigid sensor support – keeps sensor accurately positioned. Less clutter – one holder fits multiple sizes. Autoclavable.

Hygiene Kit

Contains: XCP-ORA Arm and Ring, 2 each XCP-DS Bite Blocks (anterior, posterior, horizontal bitewing, vertical bitewing).

930-559900 Kit **\$274.45**

Endodontic Kit

Contains: 1 Endo Aiming Ring, 1 Endo Arm, 2 XCP-DS Endo Bite Blocks.

930-559908 Kit **\$97.75**

Complete Kit

Contains: XCP-ORA Arm and Ring, 2 each XCP-DS Bite Blocks (anterior, posterior, horizontal bitewing, vertical bitewing, endo), Endo Ring and Arm and 50 Universal Sensor Holders.

930-559909 Kit **\$302.75**

Continued

XCP-DS FIT Universal Sensor Holder System continued.



XCP-DS FIT® Bite Blocks

Anterior.....	930-559901	
Anterior Thin	930-559906	
Posterior	930-559902	
Horizontal Bitewing	930-559903	
Vertical Bitewing	930-559904	
Endodontic.....	930-559905	
2/box		\$48.25

Anterior.....	930-559921	
Anterior Thin	930-559926	
Posterior	930-559922	
Horizontal Bitewing	930-559923	
Vertical Bitewing	930-559924	
10/pack		\$193.25

Replacement Silicone Bands

Short (Posterior, VBW, Endo, Size1)		
930-559913	6/pack.....	\$36.75
Long (Anterior, Anterior- Thin, HBW)		
930-559914	6/pack	\$36.75



XCP-DS FIT® Bitepieces

Connects the holder basket to the XCP device.

Anterior (Blue).....	930-550567	
Posterior (Yellow)	930-550568	
Bitewing (Red)	930-550570	
Endo (Green).....	930-550562	
3/pkg.		\$193.25



XCP-DS® (Digital Sensor) Holder Kits by Sensor Type - Dentsply Rinn

Kit for Gendex VisualiX/GX-S/HDI, Accent, Acteon Sopro, Cyber Medical XDR, Cygnus, Dextrix, Dürr, HDX, Mediadent, Progeny MPD/MPSe, Visident

Contains: 5 Arms & Rings: 1 Ant., 2 Post., 1 BW, 1 Endo; 10 Bitepieces: 2 Ant., 4 Post., 2 BW, 2

Endo; 8 Baskets - 2 each: #1H, #1V, #2H, #2V.
930-551001 Kit **\$272.75**

Kit for Sirona, Instrumentarium, Planmeca

Contains: 4 Arms & Rings: 1 Ant., 1 Post., 1 BW, 1 Endo; 4 Bitepieces: 1 Ant., 1 Post., 1 BW, 1 Endo; 18 Baskets -2 each: Ant. Full Size, Ant. Universal, Post. Univ., Post. Full Size, Post. Vert. Univ., BW Full Size, Endo Hor. Full Size, Endo Vert. Univ., Endo Vert. Full Size.
930-551150 Kit **\$272.75**

Kit for Schick CDR

Contains: 5 Arms & Rings: 2 Post., 1 Ant., 1 BW, 1 Endo; 20 biteblocks - 2 each: #1 Post., #2 Post., #1 Ant., #2 Ant., #1 HBW, #2 HBW, #1 VBW, #2 VBW, #1 V Endo, #2 H Endo; 50 Disposable Cord Holders.
930-551900 Each **\$272.75**

Replacement Baskets for Schick CDR

#1 Horizontal Posterior	930-550619	
#2 Horizontal Posterior	930-550620	
#1 Vertical Anterior	930-550621	
#2 Vertical Anterior	930-550622	
#1 Horizontal Bitewing	930-550623	
#2 Horizontal Bitewing	930-550624	
#1 Vertical Bitewing	930-550625	
#2 Vertical Bitewing	930-550626	
#1 Vertical Endo	930-550627	
#2 Horizontal Endo	930-550628	
3/pack		\$29.45

Kit for Gendex eHD Digital Sensors

Contains: 5 Arms & Rings: 1 Ant., 2 Post., 1 BW, 1 Endo; 10 Bitepieces: 2 Ant., 4 Post., 2 BW, 2 Endo; 8 Baskets - 2 each: #1V, #1H, #2V, #2H.
930-551002 Kit **\$272.75**

Replacement Baskets for Gendex eHD

Universal #1 Vertical	930-550614	
Universal #1 Horizontal	930-550615	
Large #2 Vertical	930-550616	
Large #2 Horizontal	930-550617	
3/pack		\$27.45

Kit for DEXIS PerfectSize and Platinum

Contains: 5 Arms & Rings: 1 Ant., 2 Post., 1 BW, 1 Endo; 10 Biteblocks - 2 each: Ant., Post., HBW, VBW, Endo.
930-552500 Each **\$272.75**

Replacement Baskets for DEXIS Sensors:

Horizontal Posterior	930-552501	
Vertical Anterior.....	930-552502	
Vertical Bitewing	930-552504	
Horizontal Bitewing	930-552503	
Vertical Endo	930-552505	
3/pack		\$29.45

Kit for Carestream 5100/6100/6500

Contains: 5 Arms & Rings: 1 Ant., 2 Post., 1 BW, 1 Endo; 20 biteblocks - 2 each: #1 Post., #2 Post., #1 Ant., #2 Ant., #1 HBW, #2 HBW, #1 VBW, #2 VBW, #1V Endo, #2H Endo; 50 Disposable Cord Holders.
930-553001 Each **\$272.75**

Replacement Baskets for Carestream 5100/6100/6500 Sensors:

Size 1 Horizontal Posterior.....	930-553011	
Size 2 Horizontal Posterior	930-553012	
Size 1 Vertical Anterior	930-553013	
Size 2 Vertical Anterior	930-553014	
Size 1 Horizontal Bitewing	930-553015	
Size 2 Horizontal Bitewing	930-553016	

Size 1 Vertical Bitewing	930-553017	
Size 2 Vertical Bitewing	930-553018	
Size 1 Vertical Endo	930-553019	
Size 2 Horizontal Endo	930-553020	
3/pack		\$29.45



XCP-ORA (One Ring & Arm) Positioning System - Dentsply Rinn

One ring. One arm. One goal: Faster and easier radiographic accuracy. Autoclavable for low cost-per-use. For film, digital sensor and PSP. Ideal for use with rectangular collimators. Unique Arm & Ring design simplifies your positioning procedure with fewer parts.

1 Pack

930-550771	Each	\$129.95
------------	------------	-----------------

2 Pack

930-550772	Each	\$237.45
------------	------------	-----------------

Ring Only

930-550773	Each	\$52.75
------------	------------	----------------

Arm Only

930-550774	Each	\$86.45
------------	------------	----------------

Complete Kit With Bite Blocks

Contains: 1 XCP-ORA ring, 1 XCP-ORA arm, and a full complement of anterior, posterior and bite-wing bite blocks.

For Film.....	930-542071	
For Gendex eHD.....	930-551071	
For Schick CDR	930-551971	
For Schick CDR Elite.....	930-552971	
For Sirona XIOS Plus.....	930-552160	
For DEXIS.....	930-552571	
For Kodak 6100.....	930-553071	
Kit		\$254.75

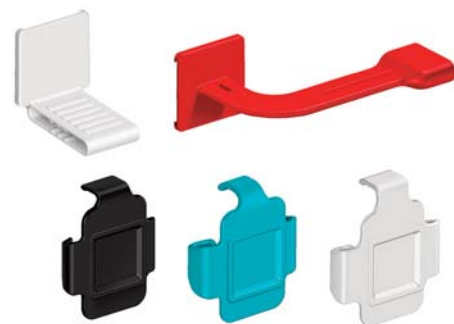

XCP-QT® Universal Disposable Sensor Holders - Dentsply Rinn

Disposable quick-tabs grip your sensor securely without need for a tight sensor cover. This makes use easier with less risk of cord pull. The white bitepiece attaches vertically or horizontally to perform anterior and posterior periapicals; the red bitepiece is for both horizontal and vertical bitewings; the blue is for DEXIS.

Continued

SENSOR, FILM & PSP POSITIONING SYSTEMS

XCP-QT Universal Disposable Sensor Holders continued.

Intro Kit for Size 1 & Size 2 Sensors

Contains: 2 XCP-ORA One Ring & Arm Positioners, 25 Size 1 Bases, 75 Size 2 Bases, 50 Periapical Bitepieces, 50 Bitewing Bitepieces and 50 Universal Sensor Covers.
930-554900 Kit **\$265.95**

Intro Kit for Size 1.5 Sensors (DEXIS)

Contains: 2 XCP-ORA One Ring & Arm Positioners, 100 Size 1.5 Bases, 50 Periapical Bitepieces, 50 Bitewing Bitepieces and 50 Universal Sensor Covers.
930-554905 Kit **\$265.95**

Refill Kits

Contains: 75 bases and 75 bitepieces.
Size 1 Periapical 930-554901
Size 2 Periapical 930-554902
Size 1 Bitewing 930-554903
Size 2 Bitewing 930-554904
Size 1.5 (Dexis) Periapical 930-554906
Size 1.5 (Dexis) Bitewing 930-554907
Kit **\$42.75**



RaPiD™ X-Ray Positioning System - Flow Dental

Can be used for anterior, posterior and bitewing exams. Color-coded parts for easy assembly. Bite blocks are soft and pliable for easy film insertion for added patient comfort. Fully autoclavable for over 100 uses. All parts are interchangeable with Rinn's XCP system.

Contains: 4 aiming rings: 2 anterior and 2 posterior; 4 indicator arms: 1 anterior, 2 posterior and 1 bitewing, 16 bite blocks: 4 anterior, 8 posterior and 4 bitewing.
930-40856 Kit **\$116.25**

Aiming Ring

Anterior and Bitewing 930-40859
Posterior 930-40860
Each **\$9.25**

Anterior Arm

930-40857 Each **\$28.95**

Posterior Arm

930-40858 Each **\$33.25**

Bitewing Arm

930-40927 Each **\$28.25**

Bite Blocks

Anterior - Blue 930-40861
Posterior - Purple 930-40862
25/box **\$29.75**

Bitewing Blocks

#0/1 horizontal 930-40933
#2 horizontal 930-40929
#3 horizontal 930-409310
6/box **\$14.25**

RaPiD Shorty Positioning Kits and Refills available upon request.

Order by ☎ **800-626-2163**



Sensibles™ Universal Sensor Holders - Flow Dental

Sensibles Deluxe Kit with Bite-Wing
Contains: Bite Blocks (4 Large, 8 Medium, 2 Large Bite-Wing, 2 Medium Bite-Wing), Positioning Arms (2 Anterior, 2 Posterior, 2 Bite-Wing), Aiming Rings (2 Anterior/Bite-Wing, 2 Posterior), 50 Comfees Deluxe Sensor Sleeves.
930-40915 Kit **\$185.45**

Sensibles Deluxe Starter Kit

Contains: 4 Large and 8 Medium Bite Blocks, Positioning Arms (2 Anterior, 2 Posterior), Aiming Rings (2 Anterior, 2 Posterior), 50 Comfees Deluxe Sensor Sleeves.
930-40900 Kit **\$115.45**

Sensibles Econo Starter Kit

Contains: 2 Large and 2 Medium Bite Blocks, Positioning Arms (1 Anterior, 1 Posterior), Aiming Rings (1 Anterior, 1 Posterior), 25 Comfees Deluxe Sensor Sleeves.
930-40901 Kit **\$45.45**



Bite-Wing Bite Blocks - Large

430-40910 12/pack **\$56.45**

Bite-Wing Bite Blocks - Medium

430-40909 12/pack **\$56.45**

Bite-Wing Positioning Arm

430-409150 Each **\$29.75**

Wingers® Positioning System - Steri-Shield

Disposable radiological sensor holders fit all popular digital X-ray systems. Made of super soft plastic for ultimate patient comfort and designed to produce technically perfect anterior, posterior and bite-wing images. Wingers sensor holders are disposable.
Use with Wing- A-Ray on page 581.



Horizontal Bitewing

Large 930-088024
Small 930-088026
125/pkg **\$39.95**



Posterior Holder

Large 930-088034
125/pkg **\$41.95**



Anterior Holder

Large 930-088030
Small 930-088028
125/pkg **\$41.95**



Bitewing Sensor Holder

Large (Size 2) 930-088124
125/pkg **\$41.45**



Paralleling Aiming Ring and Bar Set

930-088046 Each **\$49.45**

COIN ENVELOPES



X-Ray Envelopes - Dentsply Rinn

Heavy-duty, end-opening gray paper envelopes for filing or mailing X-ray mounts.

No. 1 - 2-1/2" x 3-1/2" - Manila.
930-500250 100/box **\$20.75**

No. 5 - 3-1/8" x 5-1/2" - Manila.
930-500251 100/box **\$29.45**

No. 21 - 5-1/4" x 12-1/4" - Gray.
930-500945 100/box **\$75.45**

No. 20 - 6" x 12" - Gray.
930-500849 100/box **\$79.45**

☎ Fax: **888-681-5088**

583

X-RAY

☎ www.dhpionline.com

COIN ENVELOPES



Coin Envelopes - EPR Industries LLC
 2-1/4" x 3-1/2" - White. Size #1.
 930-04060 500/box..... **\$19.95**



Coin Envelopes - Kerr TotalCare
 Size: 2-1/4" x 3-1/4" - White. Size #1.
 930-31041 500/box..... **\$27.75**



Coin Envelopes - Temrex Corporation
 2-1/2" x 4-1/4" - Yellow.
 930-3300 500/box..... **\$24.75**

PHOSPHOR PLATE BARRIER ENVELOPES



PSP Barrier Envelopes

Used with phosphor plates to prevent cross-contamination. Side loading envelopes are made of soft vinyl with rounded corners for patient comfort. Easy to use adhesive and notches for easily unloading. Double black sides to ensure plates are not exposed to light.

Envelopes

Size 0..... 930-10001
 100/box **\$14.95**
 Size 1..... 930-10002
 100/box **\$14.95**
 Size 2..... 930-10003
 300/box **\$38.95**

Envelopes with Inserts

Cardboard inserts are included for easy loading of plates.

Size 0..... 930-10004
 Size 1..... 930-10005
 Size 2..... 930-10006
 200/box **\$44.95**



ScanX Barrier Envelopes - Air Techniques

Features transparent side for accurate plate positioning. Patented envelope prevents ambient light from reaching the sensitive side of the imaging plate. Made with rounded corners and soft edges to maximize patient comfort.

Size 4..... 930-732484
 50/pack **\$30.95**

Size 0 930-732480
 Size 1 930-732481
 Size 3 930-732483
 100/pack **\$24.75**

Size 2 930-732482
 300/pack **\$59.95**

Size 2 930-732482K
 1000/pack **\$159.95**



Econo Safe 'n' Sure PSP Envelopes with Thumb Notch - Flow Dental

Non-transparent sided envelope with an easy thumb notch removal tab.

Size 0..... 930-80100
 Size 1..... 930-80110
 Size 2..... 930-80120
 Size 3..... 930-80130
 300/bag **\$55.75**



Deluxe Safe "n" Sure PSP - Flow Dental

Features our unique EZ-GLIDE loader / sealer. The E-Z GLIDE tab that makes loading quick and effortless and has a butterfly seam to unload without touching the plates.

Size 0..... 930-80101
 Size 1..... 930-80111
 Size 2..... 930-80121
 Size 3..... 930-80131
 300/box **\$58.75**

X-RAY MONITORING



Instadose Radiation Badge Service - IC Care, Inc.

The traditional radiation badge service is provided through NVLAP accredited passive dosimeters. Exchange frequencies range from monthly to quarterly. Subscribers to our service will automatically receive shipments, along with a pre-printed envelope used to send the dosimeters back for processing. Before the end of the frequency subscribers will receive a new set of badges. Our traditional radiation badge service includes automatic exchange of dosimeters each wear period, processing and analysis of dosimeters, archival storage of exposure results, and standard dosimetry reports with data management, customer service and technical support programs.

Monthly Service

Includes twelve shipments of a badge and a monthly dosimetry report for one year, price per person.

930-ICC3835303 **\$151.95**

Quarterly Service

Includes four shipments of a badge and a quarterly dosimetry report for one year, price per person.

930-ICC3835311 **\$108.95**



@ease Personalized X-ray Monitoring Badges - ProEdge Dental Corp

Personalized X-ray badges measure exposure at 3 tissue levels and include quick reports from an accredited laboratory. Quarterly reports are updated for the current wear period, plus YTD and lifetime history. One super-low price includes everything: free control badges, automatic replacement badge shipments, online reports with no hidden fees for set-up, or changes. Every quarter, you'll automatically receive a new set of badges, along with a pre-printed envelope for returning the previous badges for analysis. Our service includes analysis, personalized reports with results archiving, data management, and technical support. No-hassle service - no account maintenance or set-up fees. 24/7 access to your secure online results. Automated reports sent with your exposure history. Automatic renewal option.

Annual Subscription - 4 quarters of service
 930-RB401 **\$106.75**

Annual Service - 12 monthly badges
 930-RB1201 **\$122.25**

NOVELTIES



Action Tops

Just spin these with your fingers and watch them go. Tops are 2" diameter and come in assorted fun designs.

870-NTY233 48/pkg \$20.95



Confetti Bouncing Balls

Sparkle when they bounce. Each ball features a rainbow of metallic star-shaped confetti floating inside. 33mm.

870-BL62 48/pkg \$24.75



Dental Stampers

1-3/8" tall. Assorted designs.

870-DEN60 24/pkg. \$10.75



Dinosaurs

Plastic dinosaur toys in assorted designs and colors. 1" to 3" in size.

870-SDIN 72/pkg \$26.25



Fish Print Sunglasses

Assorted styles. Individually wrapped. 5" wide.
870-NTY373 24/pkg \$21.95



Flashlight Backpack Pulls

Transparent assorted colors show the inner parts of these 1" x 1-1/2" flashlights. Individually wrapped.

870-PUL44 24/pkg \$14.25



Frog Squeakers

Assorted cute designs that children love. 2" tall.

870-TOY403 36/pkg \$29.25



Fun Color Brushing Timers

Create healthy habits. Assorted Blue, Pink and Yellow with matching colored sand. 3-1/2"

Three Minutes..... 870-BTCS
Two Minutes..... 870-DEN10
40/pkg \$25.25



Glitter Sticky Hands

Classic sticky hands covered in glitter. Individually wrapped. Assorted colors. 2-1/4" hands.

870-SCK76 48/pkg \$16.25



Glow in the Dark Springs

Assorted fun shapes. 1-1/2", each stretch to 12"

870-NTY95 36/pkg \$21.75



Glowing Eye Balls

Glow in the dark bouncy balls with eyeball graphics. Assorted vibrant colors. 32mm.

870-GWBE 48/pkg \$21.75



Happy Tooth Stress Relievers

Your patients will enjoy squeezing these colorful stress relievers during their visits. Assorted colors. 2" x 1-3/4"

870-DEN264 24/pkg \$21.75



Mini Butterfly Gliders

Beautiful varied designs. Individually wrapped. 3-3/4" x 3-1/2".

870-PLN58 144/pkg \$19.45

NOVELTIES



Mini Glider Assortment

Variety of styles, colors and designs. 5"x 4". Individually wrapped.

870-PLN26 144/pkg **\$21.75**



Sticky Chameleons

Sticky chameleons can be pulled up to 5 feet. 2-3/4" with a 5-3/4" long tail. Individually wrapped. Assorted colors.

870-SKCA 48/pkg **\$16.25**



Neon Puffer Balls

Bright and wiggly air-filled designs. Assorted neon colors. 5" diameter.

870-TOY489 24/pkg **\$28.25**



Pull Back Cars

Assorted pull back vehicles. 2 - 2-1/2" long. Individually wrapped.

870-NTY547 36/pkg **\$21.25**



Sensational Ball Sampler

An assortment of balls 32mm or larger in size.

870-BALS 140/pkg **\$69.75**



Smiling Teeth Pencils

870-4TA 50/pkg **\$15.95**



Pencil Sampler

Assorted popular styles in a reusable canister with flip-up lid for easy storage.

870-PSAM 250/pkg **\$79.95**



Toothbrush Erasers

2" long. Assorted colors.

870-TBE 72/pkg **\$16.25**



Yo-Yo's

Perfect for small hands. 1-1/2" in diameter. Assorted bright colors.

870-DY 72/pkg **\$17.45**

STICKERS



Brave at Dentist Sticker

2-1/2" stickers. Five designs.

870-ST076B 100/box **\$9.95**

870-ST076R 100/roll **\$9.95**

PENCILS



Dancing Teeth Pencils

870-PCL341 50/pkg **\$15.95**

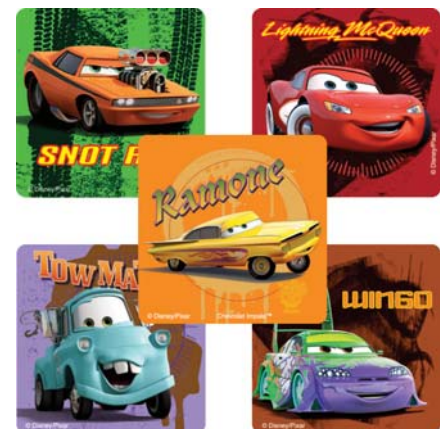

Disney Cars Supercharged Stickers

2-1/2" stickers. Five designs.

870-CSUP 100/roll **\$9.95**

STICKERS



Dora the Explorer Dental Stickers

2-1/2" stickers. Five designs.
870-DORD 100/roll \$9.95



Disney Princess Stickers

2-1/2" stickers. Five designs.
870-PNCS 100/box \$9.95



Fluoride Shower Stickers

2-1/2" stickers. Five designs.
870-FRSW7 100/box \$9.95



Fluoride Treatment Stickers

2-1/2" stickers. Five designs.
870-FLOR 100/roll \$9.95



Fruity Scratch 'N Sniff Stickers

2-1/2" stickers with a yummy fruity scent. Five designs.
870-FRU 100/roll \$9.95



No Cavities Stickers

2 1/2" stickers. Five designs.
870-SNTC 100/roll \$9.95



PAW Patrol Patient Stickers

5 assorted designs featuring pups Marshall, Chase, Rubble and more. 2-1/2" stickers.
870-ST1257R 100/roll \$9.95



Penguins of Madagascar Stickers

2-1/2" stickers. Five designs.
870-ST1037R 100/roll \$9.95

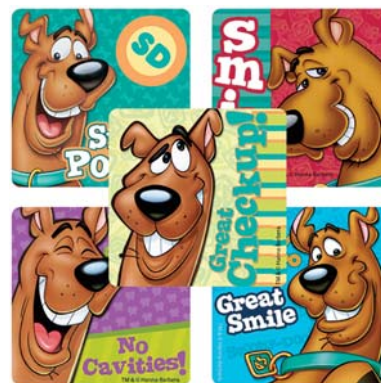

Scooby-Doo Dental Stickers

2-1/2" stickers. Five designs.
870-SCDD7 100/box \$9.95



Silly SpongeBob Stickers

2-1/2" stickers. Five designs.
870-ST160B 100/box \$7.25



Spider-Man Stickers

2 1/2" stickers. Five designs.
870-SPDY 100/roll \$9.95



Tooth Shaped Sparkle Stickers

2-1/2" stickers. 1 design.
870-STOT 100/roll \$9.95

TATTOOS



Dinosaur Tattoos

An assortment of different dinosaurs that are easy to apply and remove. 1-1/2" x 2"

870-NTY199 144/pkg \$17.75

TOY ASSORTMENT



Ultimate Treasure Chest

100 of the most popular toys and prizes. Colorful cardboard treasure box easily converts to a display. 6" x 9" x 13"

870-KCTC Each..... \$85.95

Refill available upon request.



Value Treasure Chest

250 toys and prizes in a cardboard treasure box perfect for your little patients. 16" x 8-3/4" x 6"

870-NLTC Each..... \$82.45

Refill available upon request.

TOOTH KEEPERS



Goofy Tooth Holders

Assorted colors. 1-3/4" size.

870-DEN143 72/pkg \$29.95



Lucky Tooth Treasure Chest

Perfect for keeping little lost teeth! Assorted Colors. 3/4" x 1/2"

870-TC 200/pkg \$12.45



Rainbow Tooth Holders

Assorted bright tooth holders with closeable lids. 1-1/4" tall.

870-DEN144 72/pkg \$15.75



Tooth Saver Necklaces

24" long necklace cord with a 1-3/4" tooth holder that will stay closed. Each comes individually tied.

870-TN 144/pkg \$16.25

WEARABLES



Birthstone Rings

36 adjustable double band rings resist breaking. Looks like real jewelry. 3 rings for each month in a beautiful display.

870-BSR Each..... \$21.75



Happy Tooth Clip Bracelets

Assorted bright designs printed on a woven bracelet. 1/4" x 8-1/2"

870-DEN233 48/pkg \$14.25



Happy Tooth Fun Cord Bracelets

Stretchy. 2" when not stretched.

870-DEN536 48/pkg \$17.95



Parachute Bands

Durable parachute material. Assorted colors. 2-1/2" diameter.

870-JL539 24/pkg \$35.25

PATIENT TAKE-HOME BAGS

Customization available with black imprinting up to 6 lines, contact your DHPI Account Manager for details.



Brush, Floss, Smile Bear Bags
 870-BSML4 7-1/2" x 9" 100/box \$21.45
 870-BSML2 9" x 12" 100/box \$23.25



Tooth Shaped Patient Bags
 870-TSHP 9" x 12" 100/box \$33.25



Floss Block Bags
 870-B039S 100/box \$21.45



Brush, Floss, Smile Monkey Bags
 870-BSFL4 7-1/2" x 9" 100/box ... \$21.45
 870-BSFL2 9" x 12" 100/box.. \$23.25



Tooth, Brush, Floss, Paste Bags
 870-B072S 7-1/2" x 9" 100/box \$21.45
 870-B072L 9" x 12" 100/box ... \$23.25



Large Tooth Brush, Floss, Smile Bags
 870-TOOT 100/box \$21.45



Healthy Habits Bag
 870-HEHA4 7-1/2" x 9" 100/box.... \$21.45
 870-HEHA2 9" x 12" 100/box... \$23.25

Scatter Print Patient Bags - 7-1/2" x 10"
 Perfect for goodies and supplies sent home from the dentist. Additional designs available.



Multi Teeth Print Bags
 870-BWTO 100/box \$21.45



Monkeys Spotlight Bags
 870-B030S 7-1/2" x 9" 100/box \$21.45
 870-B030L 9" x 12" 100/box \$23.25

Brush, Floss, Smile Bags
 870-BSMF 100/box \$21.45



Smile! Bags
 870-SMIE 100/box \$21.45



Smile Supplies Bag
 870-SPLE4 7-1/2" x 9" 100/box.... \$21.45
 870-SPLE2 9" x 12" 100/box... \$23.25

Brush, Floss, Smile Monkeys Bags
 870-KEYS 100/box \$21.45



Dental Care Bags
 870-B049S 100/box \$21.45



Smile Ribbon Bags
 870-B041S 100/box \$21.45



Smile Supply Bags
 870-B036S 100/box \$21.45

BALL POINT PENS

● ● ● Feather-light, flexible barrel



Round Stic® Ballpoint Pens . Feather-light, polypropylene barrel provides added comfort. Produces clean, smooth writing on just about any type of surface. Ventilated cap. Pocket clip. Nonrefillable.

No.	Ink	Point Size	Qty.	Unit	Price
790-BICGSF11BK	Black	Fine	12	DZ	\$2.45
790-BICGSF11BE	Blue	Fine	12	DZ	\$2.45
790-BICGSM11BK	Black	Medium	12	DZ	\$2.75
790-BICGSM11BE	Blue	Medium	12	DZ	\$2.25
790-BICGSM11RD	Red	Medium	12	DZ	\$2.25
790-BICGSM609BK	Black	Medium	60	PK	\$9.75
790-BICGSM609BE	Blue	Medium	60	PK	\$10.75

HIGHLIGHTERS



Sharpie, ACCENT
HIGHLIGHTER

A Liquid Pen Style Highlighters Features a loop that attaches to three-ring binders, planners and bags. Visible ink supply, so you know before you run out. Smooth ink flow for consistent highlighting. Micro chisel tip lets you highlight both wide and narrow lines of text. Quick-drying, odorless and nontoxic ink. SMEAR GUARD™ ink resists smearing—even on inkjet printer and ball pen documents. (Based on consumer surveys. Let ink dry before highlighting.)

Five-Color Set—Fluorescent orange, fluorescent blue, fluorescent yellow, fluorescent green and fluorescent pink.
790-SAN24555 Assorted Colors 5/PK EA \$12.95



B Brite Liner® + Rubber grip for added comfort and control. Contemporary design with visible ink supply. Ink delivery system provides smooth, even flow of brilliant fluorescent ink.

Five-Color Set—Fluorescent yellow, fluorescent pink, fluorescent blue, fluorescent green and fluorescent orange.
790-BICB4P51ASST Assorted Colors 5/PK EA \$8.25

PERMANENT MARKERS



● ● ●



Sharpie

Retractable Fine Tip Permanent Markers Just click and mark for easy one-handed operation. Safety Seal™ valve design prevents dry out. Quick-drying, fade and water-resistant ink in AP Certified nontoxic. ♻️

No.	Color	Tip	Marker Qty.	Unit	Price
790-SAN32701	Black	Fine	1	EA	\$3.45

Three Color Set—Black, blue, and red.
790-SAN32726PP 3/PK EA \$9.75

LOOK'in

for something? **WE HAVE IT!**
www.dhponline.com

CORRECTION SUPPLIES



A



B



C



A Wite-Out® Brand EZ Correct Correction Tape

No.	W x L	Qty.	Unit	Price
790-BICWOTAPP21	1/6 x 473	2	PK	\$8.75
790-BICWOTAP10	1/6 x 473	10	PK	\$38.75



B DryLine® Grip Correction Tape

No.	W x L	Qty.	Unit	Price
790-PAP662415	1/5 x 472	2	PK	\$9.95

C DryLine® Correction Film

No.	W x L	Qty.	Unit	Price
790-PAP6137206	1/5 x 472	2	PK	\$10.45
790-PAP6137406	1/5 x 472	10	PK	\$40.45

GLUES & ADHESIVES



Permanent Glue Sticks Washable, nontoxic, acid-free for use on paper, cardboard, photos, fabric. Glue dries clear, wrinkle-free. Ideal for archival materials. ACMI/AP Certified.

No.	Application Color	Size	Qty.	Unit	Price
790-UNV75748	Clear	.28 oz.	12	PK	\$7.25
790-UNV75750	Clear	.77 oz.	12	PK	\$12.45



A



B



For metal, wood, rubber, glass, ceramic and other surfaces.

A Advanced Formula Glue Advanced formula provides an extra strong, durable shock resistant bond. The precision tip applicator has an extended, no-clog tip with an easy-open, easy-seal hanger cap. Dries clear.

No.	Size	Qty.	Unit	Price
790-EPIKG483	.18 oz.	1	EA	\$5.95

B All Purpose Glue All-purpose formula is great for everyday household repairs. Forms an extra-strong bond. The airtight, leak-proof cap keeps glue from drying out. Dries clear.

No.	Size	Qty.	Unit	Price
790-EPIKG58548R	.07 oz.	1	EA	\$2.75

TAPE & DISPENSERS



Magic™ Office Tape Value Pack Dependable tape for a convenient solution to daily home and office situations. * \$



No.	Description	Qty.	Unit	Price
790-MMM810K24	3/4" x 1000	24	PK	\$86.75
790-MMM810P10K	3/4" x 1000	10	PK	\$36.95

Magic™ Office Tape with 1" Core Fits 1" core dispensers. *

No.	Description	Qty.	Unit	Price
790-MMM810341296	3/4" x 1296	1	RL	\$3.95
790-MMM8106PK	3/4" x 1296	6	PK	\$24.25



Invisible Tape The matte finish of this tape becomes invisible on contact, making it great for protecting labels. Plus, because it accepts ballpoint pen, it's perfect for organizing boxes and other items.

No.	Description	Qty.	Unit	Price
790-UNV83410	3/4" x 1000	6	PK	\$8.95
790-UNV83412	3/4" x 1000	12	PK	\$20.25
790-UNV83436	3/4" x 1296	1	RL	\$1.45

PAPER CLIPS



Paper Clips with Magnetic Dispenser Magnetic clear plastic clip dispenser with black magnetic top keeps up to 100 paper clips close at hand. Value pack includes twelve 100-count boxes of No. 1, smooth finish clips. Includes 1200 paper clips and magnetic dispenser. Silver.

No.	Finish	Size	Qty.	Unit	Price
790-UNV72211	Smooth	No. 1	1,200	PK	\$5.95

Smooth Paper Clips Smooth finish helps resist tearing. Silver.

No.	Finish	Size	Qty.	Unit	Price
790-UNV72210	Smooth	No. 1	1,000	PK	\$3.25
790-UNV72220	Smooth	Jumbo	1,000	PK	\$9.25
790-UNV72230	Nonskid	No. 1	1,000	PK	\$5.25
790-UNV72240	Nonskid	Jumbo	1,000	PK	\$13.25

RUBBER BANDS

SAMPLE BANDS SHOWN ACTUAL SIZE

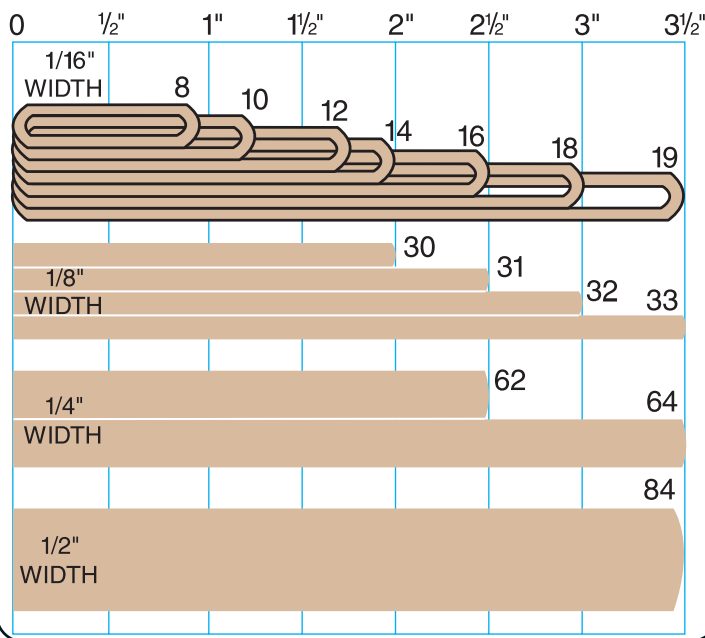

Now in resealable plastic bags.



Rubber Bands General purpose rubber bands for home or office use.

No.	Size	L x W x Gauge	Pack Size	Unit	Price
790-UNV00416	16	2 1/2 x 1/16 x 1/32	535/4 lb.	PK	\$2.25
790-UNV00418	18	3 x 1/16 x 1/32	400/4 lb.	PK	\$2.45
790-UNV00433	33	3 1/2 x 1/8 x 1/32	158/4 lb.	PK	\$2.45
790-UNV00464	64	3 1/2 x 1/4 x 1/32	88/4 lb.	PK	\$1.95
790-UNV00114	14	2 x 1/16 x 1/32	2,360/1 lb.	PK	\$7.75
790-UNV00119	19	3 1/2 x 1/16 x 1/32	1,420/1 lb.	PK	\$6.95
790-UNV00132	32	3 x 1/8 x 1/32	740/1 lb.	PK	\$6.25
790-UNV00164	64	3 1/2 x 1/4 x 1/32	350/1 lb.	PK	\$6.95

All rubber bands are designed to meet Federal Guideline Specifications.

STAPLERS & STAPLES



A



B



DESIGNED FOR THE WAY YOU WORK™

A LightTouch® Reduced Effort Stapler It's all about ease and convenience with this stapler. The exceptional design means 50% less effort is required than with a conventional stapler. Manufacturer's limited one-year warranty. ✚

No.	Sheet Capacity	Color	Unit	Price
790-SWI66402	20	Black	EA	\$34.75
790-SWI66404	20	Blue	EA	\$34.45

B Full Strip Stapler All-metal with floating channel mechanism. Nonskid base. 3½" throat depth. Loads a full strip (210) of standard staples. Manufacturer's limited one-year warranty.

No.	Sheet Capacity	Color	Unit	Price
790-UNV43128	15	Black	EA	\$8.45

All sheet capacities are based on 20-lb. bond.



Universal® Staples For standard staplers. Chisel point.

No.	Strip Count	Staples Per Unit	Unit	Price
790-UNV79000	210	5,000	BX	\$1.25

SCISSORS



Eversharp® Scissors with Microban® Protection These corrosion-resistant, stainless steel scissors come with an enhanced level of cleanliness with their built in antimicrobial protection by Microban® which controls the growth of microbes and bacteria. In addition to fighting stains and odor-causing bacteria, they also feature contoured RibGrip® handles and an adjustable pivot to set optimal blade tension. Manufacturer's lifetime warranty.

No.	Length	Style	Cut	Color	Unit	Price
790-ACM14648	7"	Straight, Pointed	3"	Blue	EA	\$11.75
790-ACM14643	8"	Straight, Pointed	3½"	Blue	EA	\$11.95
790-ACM14739	8"	Bent, Blunt	3½"	Blue	EA	\$11.95

SELF-STICK NOTES



A



B



A Yellow Color Note Pads

No.	Size	Plain/Lined	Pads/Pack	Unit	Price
Regular Size					
790-UNV35668	3 x 3	Plain	12	PK	\$6.95
790-UNV35688 ✚	3 x 3	Plain	18	PK	\$9.95
Large Size					
790-UNV35672	3 x 5	Plain	12	PK	\$10.25
790-UNV35692 ✚	3 x 5	Plain	18	PK	\$19.25
Jumbo Size					
790-UNV35673	4 x 6	Lined	12	PK	\$27.45

B Fan-Folded Self-Stick Pop-Up Notes Notes pop-up one at a time from specially designed dispensers (sold separately). 100 sheets per pad.

No.	Size	Plain/Lined	Pads/Pack	Unit	Price
790-UNV35611	3 x 3	Plain	12	PK	\$10.25

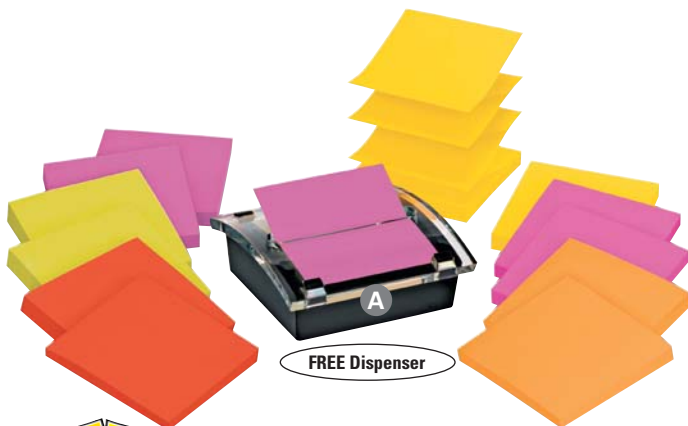

FREE Dispenser



Stick practically anywhere!

Pop-Up Dispensers & Notes Accordion-style notes pop up, one by one, keeping notes right at your fingertips. 90 sheets per pad, except as noted. *

A Super Sticky Pop-Up Dispenser Value Pack Clear top designer dispenser with assorted Neon Fusion and Ultra Notes.

No.	Size	Plain/Lined	Pads/Pack	Unit	Price
790-MMMDS330SSVA	3 x 3	Plain	12	PK	\$38.45

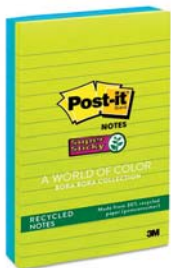

B



Stick practically anywhere!

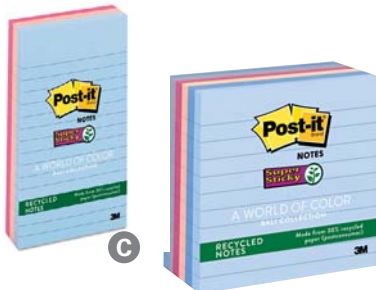

C

B Tropical

No.	Size	Plain/Lined	Pads/Pack	Unit	Price
790-MMM65412SST	3 x 3	Plain	12	PK	\$32.25
790-MMM6756SST	4 x 4**	Lined	6	PK	\$24.75
790-MMM6603SST	4 x 6	Lined	3	PK	\$17.45

C Recycled "Nature's Hues" Notes—Earth-friendly notes now available in Super Sticky! Assorted. *

No.	Size	Plain/Lined	Pads/Pack	Unit	Price
790-MMM6756SSNRP	4 x 4	Plain	6	PK	\$27.25
790-MMM6603SSNRP	4 x 6	Lined	3	PK	\$21.25

** 180 sheets per pad.



Polypropylene Sheet Protector Three-hole punched for unpunched 11 x 8½ inserts. No photocopy transfer; archival quality.

No.	Color	Gauge	Load Type	Qty.	Unit	Price
790-UNV21126	Semi-Clear	Standard	Top	50	BX	\$5.95
790-UNV21128	Clear	Heavy*	Top	50	BX	\$9.95

*Ideal for presentation use

BINDERS



Vinyl Round Ring View Binders

Create the perfect title page, then place it inside the clear plastic overlay. Wide base rings lock pages in place to hold securely. Concealed rivets on spine for a clean professional appearance. Two inside pockets for additional storage of loose documents. Included card stock spines are easy to remove, reverse and re-use.



Deluxe Vinyl Round Ring View Binder

Extra-deep 4½" inside pockets. Sheet lifters included in 2" capacity and larger. Holds 11 x 8½ sheets. Post-consumer recycled content: 42%.

No.	Ring Size	Sheet Capacity	Color	Unit	Price
790-UNV20711	1"	175	Black	EA	\$6.75
790-UNV20712	1"	175	White	EA	\$6.25
790-UNV20721	1½"	280	Black	EA	\$7.25
790-UNV20722	1½"	280	White	EA	\$7.25
790-UNV20753	3"	480	Light Blue	EA	\$8.45



Economy Vinyl Round Ring View Binder

Extra-deep 3½" inside pockets. Holds 11 x 8½ sheets. Post-consumer recycled content: 42%.

No.	Ring Size	Sheet Capacity	Color	Unit	Price
790-UNV20951	½"	100	Black	EA	\$3.25
790-UNV20952	½"	100	White	EA	\$3.45
790-UNV20961	¾"	175	Black	EA	\$2.95
790-UNV20961CT	¾"	175	Black	CT	\$30.45
790-UNV20962	1"	175	White	EA	\$2.95
790-UNV20962CT	1"	175	White	CT	\$30.45
790-UNV20971	1½"	280	Black	EA	\$4.25
790-UNV20972	1½"	280	White	EA	\$4.95
790-UNV20981	2"	375	Black	EA	\$4.95
790-UNV20982	2"	375	White	EA	\$5.45
790-UNV20991	3"	480	Black	EA	\$6.25
790-UNV20992	3"	480	White	EA	\$7.25

CLIPBOARDS



Hardboard Clipboard Get a grip on large stacks of paper with the high-capacity clip.

No.	Holds Forms (W x H)	Clip Capacity	Color	Unit	Price
790-UNV40304	8½ x 11	1¼"	Brown	EA	\$2.45
790-UNV40305	8½ x 14	1¼"	Brown	EA	\$2.45

COMPUTER CLEANING SUPPLIES



Nonflammable!



Dust-Off® Disposable Compressed Gas Dusters Blows away harmful dust and lint. 100% ozone safe; no CFCs, HCFCs, butane or propane. Trigger controls spray power. Slip-on extender offers greater reach.

A Dust-Off®

No.	Size	Qty.	Unit	Price
790-FALDPSJC	3½ oz.	1	EA	\$8.25
790-FALDSXLPW	10 oz.	2	PK	\$22.25
790-FALDPSJMB	17 oz.	1	EA	\$16.95
790-FALDPSJMB2	17 oz.	2	PK	\$32.25

B Nonflammable Dust-Off® Specially developed for use in environments such as scientific research labs where flammability is a concern.

No.	Size	Qty.	Unit	Price
790-FALDPNXL	10 oz.	1	EA	\$15.45
790-FALDPNXL2	10 oz.	2	PK	\$29.25

BATTERIES

High Tech

Longest lasting!



Energizer e2® Rechargeable NiMH Batteries

POWERS THOUSANDS OF PICTURES IN DIGITAL CAMERAS. Designed for today's high-tech devices such as digital cameras, portable CD players and personal digital assistants. Cadmium free.

Size	No.	mAh	Qty.	Unit	Price
AA	790-EVENH15BP4	2500	4	PK	\$23.25
AAA	790-EVENH12BP4	900	4	PK	\$23.25
C	790-EVENH35BP2	2500	2	PK	\$17.45
D	790-EVENH50BP2	2500	2	PK	\$17.45
9V	790-EVENH22NBP	175	1	PK	\$17.45



Energizer e2® Rechargeable NiMH 15-Minute Battery Charger

Charges one to four AA or AAA NiMH size batteries in 15 minutes for maximum convenience. Illuminated LED monitoring light keeps you aware of charge status. Includes car adapter. Energizer Star® Compliant. Manufacturer's limited lifetime warranty.

No.	Unit	Price
790-EVECH15MNCP4	EA	\$69.95

Everyday



Energizer MAX® Alkaline Batteries THE BATTERY THAT HAS THE POWER TO KEEP YOU GOING. Date coded and 100% mercury free. Long-life alkaline batteries.

Size	No.	Unit	Price
AA	790-EVEE91SBP36H	36PK	\$53.95
AAA	790-EVEE92FP12	12PK	\$16.95
C	790-EVEE93FP8	8PK	\$23.95
D	790-EVEE95FP8	8PK	\$26.95
9V	790-EVE522FP4	4PK	\$23.25

A



B



U.S. STAMP & SIGN®

A ADA Signs Universally and easily recognizable white graphics. Raised tactile graphics with grade 2 braille. Meets Americans with Disabilities Act (ADA) requirements. Includes double-side adhesive tape for mounting to door or wall.

No.	Color	Message(s)	Size	Unit	Price
790-USS4725	Blue	Wheelchair Accessible	6 x 9	EA	\$12.75
790-USS4726	Gray	Employees Must Wash Hands	6 x 9	EA	\$12.75
790-USS4811	Gray	Restroom (Man/Woman/Wheelchair)	6 x 9	EA	\$12.75
790-USS4812	Gray	Restroom (Man/Woman)	6 x 9	EA	\$12.75
790-USS4813	Gray	No Smoking	6 x 9	EA	\$12.75
790-USS4814	Gray	Women (with Wheelchair)	6 x 9	EA	\$12.75
790-USS4815	Gray	Men (with Wheelchair)	6 x 9	EA	\$12.75
790-USS4816	Gray	Women	6 x 9	EA	\$12.75
790-USS4817	Gray	Men	6 x 9	EA	\$12.75

HEADLINE SIGN

B Century Series Office Signs Get the message out with these stylish commonly used signs that will complement most office décors. Includes easel for countertop display and double-sided adhesive tape for mounting to door or wall.

No.	Color	Message(s)	Size	Unit	Price
790-USS4782	Black/Silver	Employees Must Wash Hands	9 x 3	EA	\$12.25
790-USS4758	Black/Silver	No Soliciting	9 x 3	EA	\$12.25
790-USS4762	Black/Silver	Office	9 x 3	EA	\$12.25
790-USS4760	Black/Silver	Employees Only	9 x 3	EA	\$12.25
790-USS4763	Black/Silver	Visitors Must Sign In	9 x 3	EA	\$12.25
790-USS4761	Black/Silver	Private	9 x 3	EA	\$12.25
790-USS4757	Black/Silver	No Smoking	9 x 3	EA	\$12.25
790-USS4759	Black/Silver	Cell Phones Must Be Turned Off	9 x 3	EA	\$12.25



Compatible Inkjet Cartridges

No.	Description	Replaces Cartridge	Approx. Page Yield*	Qty.	Unit	Price
For HP Deskjet 460c, 5740, 5740xi, 5743, 5745, 5748, 5940, 5940i, 6520, 6520xi, 6940, 6940dt, 6980, 6980dt, 6988, 9800, 9800d; OfficeJet H470, 6200, 6210vA10, 6210A10, 6210x1A10, 7210, 7210v, 7210xi, 7310A10, 7310xiA10, 7410, 7410xi; PhotoSmart 2600, 2610, 2610v, 2610xi, 2710, 2710xi, 325, 325xi, 335, 335v, 375, 385, 422, 425, 475, 8050, 8150, B8350, 8450, 8750; PSC 1600, 1610, 2350, 2355						
790-IVR63WN	Color	#97	285	1	EA	\$25.45
For HP Deskjet 460c, 460cb, 460wbt, 460wfi, 5740, 5740xi, 6520, 6520xi, 6540, 6540dt, 6540xi, 6620, 6620xi, 6830v, 6840, 6840df, 6840xi, 9800; Officejet H470, 6200, 6210, 7210, 7310, 7410; Photosmart 2610, 2710, 7850, 8150, B8350, 8450; PSC 1600, 1610, 2350, 2355						
790-IVR65WN	Black	#94	290	1	EA	\$21.75
For HP Deskjet 5440, 5440v, 5440xi; PhotoSmart 7850, C3140, C3150, C3180A10; PSC1507, 1510, 1510v, 1510xi						
790-IVR62WN	Black	#92	160	1	EA	\$15.75
790-IVR61WN	Tri-Color	#93	130	1	EA	\$25.45
For HP Deskjet 460C, 5740, 5740xi, 5940, 6520, 6520xi, 6540, 6540dt, 6540xi, 6620, 6830, 6840, 9800; OfficeJet H470, 6200, 6210, 6310, 7210, 7310, 7410; Photosmart 325, 335, 375, 385, 422, 425, 428, 475, 2570, 2575, 2610, 2710, C4140, C4150, C4180, D5060, D5065, D5069, D5145, D5155, D5160, 7850, 8050, 8150, B8350, 8450; PSC 1600, 1610, 2350, 2355						
790-IVR66WN	Color	#95	215	1	EA	\$26.95
For HP Deskjet 5740, 5740xi, 5743, 5745, 5748, 5940, 5940xi, 6520, 6520xi, 6540, 6540dt, 6540xi, 6620, 6830v, 6840, 6840dt, 6840xi, 6940, 6940dt, 6980, 6980dt, 9800, 9800d; OfficeJet 7210, 7210v, 7210xi, 7310A10, 7310xiA10, 7410, 7410xi; PhotoSmart 2600, 2610, 2610v, 2610xi, 2710, 2710xi, 8050, 8050v, 8150, 8150v, 8150xi, B8350, 8450, 8450xi, 8750; PSC 2610, 2710						
790-IVR67WN	Black	#96	450	1	EA	\$24.75
For HP Deskjet 600, 600C, 660, 670, 672C, 680C, 682C, 690C, 692C, 693C, 697C, 695C, 694C Series; DeskWriter 600, 660, 660C, 680, 680C, 694C Series; FAX 920 Series, 910; Officejet 500, 520, 570, 580, 590 Series, 600, 620, 630, 700, 710, 720; Printer/Scanner/Copier 370, 380 Series						
790-IVR2029A	Black	#29	570	1	EA	\$30.95
For HP Deskjet 610C, 610CL, 612C, 630C, 640, 656C Series; Fax 1010, 1020, 1040, 1050; Apollo P-1200U, 9-2150U, P2200, P2250 Series						
790-IVR20014	Black	#20	500	1	EA	\$28.25
For HP Deskjet 640C, 710C, 712C, 720C, 722C, 820, 820C, 830, 830C, 832, 850C, 855, 855C, 870, 870C, 880, 880C, 822, 882C, 890, 890C, 895 Series, 895C, 930, 930C, 932, 932C, 935C, 950, 950C, 952, 952C, 955C, 960, 970, 990, 990Cxi, 995C, 1000, 1000C, 1000Cxi, 1100, 1100C, 1120, 1120C, 1125, 1220, 1220Cxi, 1220C/PS, 1600 Series, 1600C Series, 9300; Designjet 700, 750C Series; OfficeJet G55, D85, G95, K60, K80, R40, R60, R80, T45, T65, 1170C, 1175C; Photosmart P1000, P1100, 1115, 1215, 1218, 1315; Fax 1220; Color Copier 110, 120, 140, 145, 150, 155, 160, 170, 180, 190, 210, 260, 270, 280, 290						
790-IVR20045	Black	#45	600	1	EA	\$33.45
For HP Deskjet F335, F340, F350, F380, D1330, D1360, D1341, D1420, D1430, D1455, F2110, F2140, F2180, D2320, D2445, D2460, 3910, 3915, 3930, 3940, F4135, F4140, F4180; Fax 1250; Officejet 4315, J3680, PSC 1410.						
790-IVR9351AN	Black	#21	365	1	EA	\$17.45
790-IVR9352AN	Tri-Color	#22	293	1	EA	\$20.75
For HP Photosmart C5180, C6180, C7180, D6160, D7145, D7155, D7160, D7345, D7355, D7360, 3110, 3210, 3310, 8250						
790-IVR21WN	Black	#02	1,752	1	EA	\$16.75
790-IVR71WN	Cyan	#02	973	1	EA	\$10.25
790-IVR72WN	Magenta	#02	708	1	EA	\$10.25
790-IVR73WN	Yellow	#02	823	1	EA	\$10.25
790-IVR74WN	Light Cyan	#02	17,133	1	EA	\$10.25
790-IVR75WN	Light Magenta	#02	16,862	1	EA	\$10.25
For HP Deskjet 700, 710C, 712C, 720C, 722C, 810C, 815, 830C, 832C, 880, 882, 890C, 895, 1120, 1125 Series; Color Copier 140, 145, 150, 155, 160, 170, 260, 270 Series; Officejet T45, T65 Series; R40, R60, R80, 1170, 1175 Series						
790-IVR1823D	Tri-Color	#23	575	1	EA	\$25.25
For HP Deskjet 810, 810c, 812, 812c, 815, 825, 825c, 840, 840c, 842, 842c, 843c, 845c, 940, 3280 Series; Officejet v30, v40, v45 Series; Officejet K60, K80, V40 Series; Printer-Scanner-Copier 500, 750, 950 Series						
790-IVR20015	Black	#15	300	1	EA	\$38.75



No.	Description	Replaces Cartridge	Approx. Page Yield*	Qty.	Unit	Price
For HP Deskjet 920, 930, 932, 935, 935C, 940, 950 Series, 952, 960, 970, 990, 995C, 1220, 3820 Series; Color Copier 180, 190, 280, 290 Series; Fax 1220 Series; Officejet G55, G85, G95, K60, K80, V30, V40 Series; Photosmart 1000, 1100, P1000, P1100, 1115, 1215 Series, 1218, 1315 Series; Printer-Scanner-Copier 750, 950 Series						
790-IVR20078	Tri-Color	#78	650	1	EA	\$40.95
For HP Deskjet 3320, 3420, 3425, 3520 Series; 3550, 3620v, 3650, 3651, 3740, 3745, 3843, 3844, 3845, 3847 Series; PSC 1311, 1315 Series						
790-IVR2027A	Black	#27	200	1	EA	\$22.75
790-IVR2028A	Tri-Color	#28	350	1	EA	\$26.25

LEXMARK COMPATIBLE SUPPLIES

For Lexmark™ P315, P915						
790-IVRC0033	Tri-Color	#33 (18C0033)	200**	1	EA	\$28.75
For Lexmark™ Z816, P915, P4350, X3350, X5250, X5270, X5470, X7170, X7350, X8350						
790-IVRC0032	Black	#32 (18C0032)	252	1	EA	\$22.75
For Lexmark™ Z13, Z23, Z25, Z33, Z35, Z515, Z605, Z615, Z75, X1150, X1185, X2250						
790-IVRN0016	Black	#16 (10N0016)	262	1	EA	\$24.75
790-IVRN0026	Color	#26 (10N0026)	380	1	EA	\$28.45

*Approximate page yield based on 5% coverage
 **Approximate page yield based on 4" x 6" borderless photos
 ♦Remanufactured



• Innovera delivers quality imaging supplies at a great price!
 • Product support available at 1-866-756-4676



Copier Supplies The compatibility chart below makes it easy to find the copier supplies you need. The list is in alphabetical sequence by manufacturer and then by machine model. Supplies from the Original Equipment Manufacturer (OEM) as well as cost-effective compatible alternatives are listed in the chart.

FOR BROTHER MODELS

No.	Description	Approx. Page Yield*	Qty.	Unit	Price
For Brother® DCP-1000; MFC 4800, 6800					
790-DPSDPCTN250	Black Toner Cartridge	2,200	1	EA	\$21.45
790-IVRDR250	Drum Cartridge	12,000	1	EA	\$140.95
For Brother® DCP-1200,1400; MFC-P2500, 8300, 8500, 8600, 8700, 9600, 9700, 9800					
790-BRTTN430	Black Toner Cartridge	3,000	1	EA	\$97.25
790-BRTTN460	Black Toner Cartridge	6,000	1	EA	\$133.25
790-DPSDPCTN430	Black Toner Cartridge	3,000	1	EA	\$86.95
790-DPSDPCDR400	Drum Cartridge	20,000	1	EA	\$122.95
790-BRTDR400	Drum Cartridge	20,000	1	EA	\$267.45
790-IVRDR400	Drum Cartridge	20,000	1	EA	\$124.25
For Brother® DCP-7020; Fax 2820, 2920; HL-2040, 2070N; MFC-7220, 7225N, 7420, 7820N					
790-BRTTN350	Black Toner Cartridge	2,500	1	EA	\$99.95
790-DPSDPCTN350	Black Toner Cartridge	2,500	1	EA	\$56.25
790-BRTDR350	Drum Cartridge	12,000	1	EA	\$199.25
790-IVRDR350	Drum Cartridge	12,000	1	EA	\$94.25
For Brother® DCP-7040; MFC-7440CN, 7840W					
790-BRTTN330	Black Toner Cartridge	1,500	1	EA	\$66.95
790-BRTTN360	Black Toner Cartridge, High-Yield	2,600	1	EA	\$103.75
790-BRTDR360	Drum Cartridge	12,000	1	EA	\$143.25
For Brother® DCP-8020, 8025D; MFC-8420, 8820D, 8820DN					
790-BRTTN530	Black Toner Cartridge	3,300	1	EA	\$108.45
790-BRTTN560	Black Toner Cartridge, High-Yield	6,500	1	EA	\$145.75
790-BRTDR500	Drum Cartridge	20,000	1	EA	\$286.25
790-IVRDR500	Drum Cartridge	20,000	1	EA	\$105.45

No.	Description	Approx. Page Yield*	Qty.	Unit	Price
For Brother® DCP-8040, 8045D; MFC-8220, 8440, 8840D, 8840DN					
790-BRTTN540	Black Toner Cartridge	3,500	1	EA	\$125.45
790-BRTTN570	Black Toner Cartridge, High-Yield	6,700	1	EA	\$159.75
790-IVRTN540	Black Toner Cartridge	3,500	1	EA	\$78.95
790-DPSDPCTN540	Black Toner Cartridge	3,500	1	EA	\$75.45
790-DPSDPCTN570	Black Toner Cartridge, High-Yield	6,700	1	EA	\$109.75
790-BRTDR510	Drum Cartridge	20,000	1	EA	\$286.45
790-DPSDPCDR510	Drum Cartridge	20,000	1	EA	\$104.95
For Brother® DCP-8060, 8065DN; MFC 8460N, 8860DN, 8870DW					
790-BRTTN550	Black Toner Cartridge	3,500	1	EA	\$125.45
790-BRTTN580	Black Toner Cartridge, High-Yield	7,000	1	EA	\$180.25
790-IVRTN550	Black Laser Cartridge	3,500	1	EA	\$97.25
790-IVRTN580	Black Laser Cartridge, High-Yield	7,000	1	EA	\$96.45
790-DPSDPCTN550	Black Toner Cartridge	3,500	1	EA	\$92.75
790-DPSDPCTN580	Black Toner Cartridge, High-Yield	7,000	1	EA	\$97.25
790-BRTDR520	Drum Cartridge	25,000	1	EA	\$371.45
For Brother® DCP-9040CN, 9045CDN; MFC-9440CN, 9840CDW					
790-BRTTN110BK	Black Toner	2,500	1	EA	\$97.45
790-BRTTN110C	Cyan Toner	1,500	1	EA	\$113.95
790-BRTTN110M	Magenta Toner	1,500	1	EA	\$113.95
790-BRTTN110Y	Yellow Toner	1,500	1	EA	\$113.95
790-BRTTN115BK	Black Toner, High-Yield	5,000	1	EA	\$138.95
790-BRTTN115C	Cyan Toner, High-Yield	4,000	1	EA	\$212.45
790-BRTTN115M	Magenta Toner, High-Yield	4,000	1	EA	\$212.45
790-BRTTN115Y	Yellow Toner, High-Yield	4,000	1	EA	\$212.45
790-BRTDR110CL	Drum Cartridge	17,000	1	EA	\$371.45

*Approximate page yield based on 5% coverage
 ♦ Remanufactured

Remanufactured Cartridges Conserve Oil

The manufacture of a single new toner cartridge burns approximately three quarts of oil. Many can be remanufactured up to four times for a potential conservation of twelve quarts of oil! Remanufactured cartridges keep tons of plastic and metal out of our landfills each year because they are restored multiple times before entering the waste stream.



We can customize your prescription pads. Ask your DHPI Account Manager for details.

EXCUSE SLIP

Date _____

This is to certify that

(has/had) an appointment at this office for professional attention

on _____

at _____ o'clock.

Please excuse this absence.

Dr. _____

FORM #3373 DENTAL HEALTH PRODUCTS, INC.

Front

Family Dental Center
444 South Monroe
Fremont, Wisconsin 54222
555-222-0000

NAME _____

ADDRESS _____ DATE _____

R_x

REFILL _____ TIMES _____, DDS,SC

FORM #3374 DENTAL HEALTH PRODUCTS, INC.

Front

Excuse Slips and Prescription Pads

Concerned over the problems associated with counterfeiting and forgery of prescription forms? Several state health agencies outline specific guidelines for issuance of prescription forms for Schedule II controlled substances. 4-1/4" x 5-1/2", 50# blue offset copy proof paper.

Excuse Pads

Contains: 3 pads of 50 sheets per pad.
792-3373*

Prescription Pads

Contains: 5 pads of 50 sheets per pad.
792-NOTEPAD*

* Call for pricing.



Printed on security watermark paper to prevent fraud

WELCOME to our practice!

Please take a few minutes to answer the following questions so we can better assist you with your health care needs.



PATIENT INFORMATION

Date _____ Soc. Sec. # _____ Birthdate _____
 Name _____
 Address _____ Email _____ Phone _____
 City _____ State _____ Zip _____
 Sex: M F Minor Single Married Long Term Partner Divorced Widowed Separated
 Employer _____ Business Phone _____
 Business Address _____ Occupation _____
 Who should we thank for referring you? _____
 In case of emergency, who should we contact? _____ Phone _____

PRIMARY INSURANCE

Person Responsible for Account _____
 Relationship to Patient _____ Birthdate _____ Soc. Sec. # _____
 Address _____ Email _____ Phone _____
 City _____ State _____ Zip _____
 Responsible Party Employed By _____ Business Phone _____
 Business Address _____ Occupation _____
 Insurance Company _____
 Insurance Address _____
 Subscriber I.D. # _____ Group # _____

ADDITIONAL INSURANCE

Insured Name _____
 Relationship to Patient _____ Birthdate _____ Soc. Sec. # _____
 Address _____ Email _____ Phone _____
 City _____ State _____
 Insured Employed By _____ Business Phon _____
 Insurance Company _____
 Insurance Address _____
 Subscriber I.D. # _____ Group # _____

PLEASE COMPLETE REVERSE SIDE

Front

REASON FOR VISIT

Please list your present health concerns, problems or symptoms _____

MEDICAL HISTORY

When was your last physical exam? _____
 Physician's Name _____ Phone _____

1. Are you currently under medical treatment?..... <input type="checkbox"/> Yes <input type="checkbox"/> No Please describe: _____	7. Have you had any allergic reactions to the following: <input type="checkbox"/> Yes <input type="checkbox"/> No Local Anesthetics (eg. novocaine) <input type="checkbox"/> <input type="checkbox"/> Penicillin or other Antibiotics <input type="checkbox"/> <input type="checkbox"/> Sulfa Drugs <input type="checkbox"/> <input type="checkbox"/> Barbiturates (sleeping pills) <input type="checkbox"/> <input type="checkbox"/> Sedatives <input type="checkbox"/> <input type="checkbox"/> Iodine <input type="checkbox"/> <input type="checkbox"/> Aspirin <input type="checkbox"/> <input type="checkbox"/> Other <input type="checkbox"/> <input type="checkbox"/> Please describe: _____
2. Have you ever had any serious illnesses or operations? <input type="checkbox"/> Yes <input type="checkbox"/> No Please describe: _____	7. <i>Women Only:</i> <input type="checkbox"/> Yes <input type="checkbox"/> No Do you have regular periods <input type="checkbox"/> <input type="checkbox"/> Are you taking birth control pills <input type="checkbox"/> <input type="checkbox"/> Have you ever been pregnant <input type="checkbox"/> <input type="checkbox"/> Number of Pregnancies: _____
3. Are you currently taking any medication?..... <input type="checkbox"/> Yes <input type="checkbox"/> No Please describe: _____	
4. Do you smoke?..... <input type="checkbox"/> Yes <input type="checkbox"/> No	
5. Do you use alcohol?..... <input type="checkbox"/> Yes <input type="checkbox"/> No	
6. Do you use cocaine or other drugs?..... <input type="checkbox"/> Yes <input type="checkbox"/> No	

Have you ever had the following:		Yes	No	Yes	No	Yes	No
Anemia (low blood count)	<input type="checkbox"/> <input type="checkbox"/>	<input type="checkbox"/>	<input type="checkbox"/>	Heart Murmur	<input type="checkbox"/> <input type="checkbox"/>	Polio	<input type="checkbox"/> <input type="checkbox"/>
Anorexia (no appetite)	<input type="checkbox"/> <input type="checkbox"/>	<input type="checkbox"/>	<input type="checkbox"/>	Heart Disease	<input type="checkbox"/> <input type="checkbox"/>	Prostate Problem	<input type="checkbox"/> <input type="checkbox"/>
Arthritis	<input type="checkbox"/> <input type="checkbox"/>	<input type="checkbox"/>	<input type="checkbox"/>	Hepatitis-Type	<input type="checkbox"/> <input type="checkbox"/>	Psychiatric Care	<input type="checkbox"/> <input type="checkbox"/>
Asthma	<input type="checkbox"/> <input type="checkbox"/>	<input type="checkbox"/>	<input type="checkbox"/>	Hernia	<input type="checkbox"/> <input type="checkbox"/>	Respiratory Disease	<input type="checkbox"/> <input type="checkbox"/>
Back Problems	<input type="checkbox"/> <input type="checkbox"/>	<input type="checkbox"/>	<input type="checkbox"/>	Herpes	<input type="checkbox"/> <input type="checkbox"/>	Rheumatic Fever	<input type="checkbox"/> <input type="checkbox"/>
Bleeding Tendency	<input type="checkbox"/> <input type="checkbox"/>	<input type="checkbox"/>	<input type="checkbox"/>	High Blood Pressure	<input type="checkbox"/> <input type="checkbox"/>	Scarlet Fever	<input type="checkbox"/> <input type="checkbox"/>
Blood Disease	<input type="checkbox"/> <input type="checkbox"/>	<input type="checkbox"/>	<input type="checkbox"/>	HIV/AIDS	<input type="checkbox"/> <input type="checkbox"/>	Shortness of Breath	<input type="checkbox"/> <input type="checkbox"/>
Cancer	<input type="checkbox"/> <input type="checkbox"/>	<input type="checkbox"/>	<input type="checkbox"/>	Jaundice	<input type="checkbox"/> <input type="checkbox"/>	Sinus Trouble	<input type="checkbox"/> <input type="checkbox"/>
Chemical Dependency (Addiction to drugs)	<input type="checkbox"/> <input type="checkbox"/>	<input type="checkbox"/>	<input type="checkbox"/>	Kidney Disease	<input type="checkbox"/> <input type="checkbox"/>	Skin Rash	<input type="checkbox"/> <input type="checkbox"/>
Chemotherapy	<input type="checkbox"/> <input type="checkbox"/>	<input type="checkbox"/>	<input type="checkbox"/>	Latex Sensitivity	<input type="checkbox"/> <input type="checkbox"/>	Stroke	<input type="checkbox"/> <input type="checkbox"/>
Chicken Pox	<input type="checkbox"/> <input type="checkbox"/>	<input type="checkbox"/>	<input type="checkbox"/>	Liver Disease	<input type="checkbox"/> <input type="checkbox"/>	Thyroid Problems	<input type="checkbox"/> <input type="checkbox"/>
Chronic Fatigue Syndrome	<input type="checkbox"/> <input type="checkbox"/>	<input type="checkbox"/>	<input type="checkbox"/>	Low Blood Pressure	<input type="checkbox"/> <input type="checkbox"/>	Tonsillitis	<input type="checkbox"/> <input type="checkbox"/>
Circulatory Problems	<input type="checkbox"/> <input type="checkbox"/>	<input type="checkbox"/>	<input type="checkbox"/>	Measles	<input type="checkbox"/> <input type="checkbox"/>	Tuberculosis	<input type="checkbox"/> <input type="checkbox"/>
Congenital Heart Lesions	<input type="checkbox"/> <input type="checkbox"/>	<input type="checkbox"/>	<input type="checkbox"/>	Migraine Headaches	<input type="checkbox"/> <input type="checkbox"/>	Ulcer	<input type="checkbox"/> <input type="checkbox"/>
Cough - persistent or bloody	<input type="checkbox"/> <input type="checkbox"/>	<input type="checkbox"/>	<input type="checkbox"/>	Mitral Valve Prolapse	<input type="checkbox"/> <input type="checkbox"/>	Venereal Disease	<input type="checkbox"/> <input type="checkbox"/>
Diabetes	<input type="checkbox"/> <input type="checkbox"/>	<input type="checkbox"/>	<input type="checkbox"/>	Mumps	<input type="checkbox"/> <input type="checkbox"/>	Any Other Condition	<input type="checkbox"/> <input type="checkbox"/>
Emphysema	<input type="checkbox"/> <input type="checkbox"/>	<input type="checkbox"/>	<input type="checkbox"/>	Multiple Sclerosis	<input type="checkbox"/> <input type="checkbox"/>	Please describe: _____	
Epilepsy	<input type="checkbox"/> <input type="checkbox"/>	<input type="checkbox"/>	<input type="checkbox"/>	Pacemaker	<input type="checkbox"/> <input type="checkbox"/>		
Glaucoma	<input type="checkbox"/> <input type="checkbox"/>	<input type="checkbox"/>	<input type="checkbox"/>	Pneumonia	<input type="checkbox"/> <input type="checkbox"/>		

MEDICAL HISTORY

I hereby authorize payment directly to _____ for all insurance benefits otherwise payable to me for services rendered. I understand that I am financially responsible for all charges, whether or not paid by insurance, and for all services rendered on my behalf or my dependents.

I authorize the above doctor and/or any provider or supplier of services in this office to release the information required to secure the payment of benefits. I authorize the use of this signature on all insurance submissions.

Signature of Responsible Party _____ Date _____

Back

New Patient Form

8-1/2" x 11" form, printed on 70# white paper in full color. Shrink wrapped in 100 sheets per package.

792-5067 1 @\$12.45 2 @\$24.95 5 @\$21.45

HIPAA Peel-able Privacy Sign-In Sheets - IFS Filing Systems LLC

Removable labels for added security. Meet the needs of your patient's privacy expectations. Patients fill in information line on the removable strip, the carbon sheet transfers that information to the back sheet so other patients don't see the previous person's information. 8-1/2" x 11".

Patient Sign-In Date: _____

Please sign in and notify us if:
you are a new patient, your insurance, telephone number or address have changed.

NO.	Please Print Name Sign-in on next available line	Arrival Time	Appt. Time	Appointment with	New Patient (✓)	Any change in address/phone/ insurance since last visit?
1	1					
2	2					
3	3					
4	4					
5	5					
6	6					
7	7					
8	8					
9	9					
10	10					
11	11					
12	12					
13	13					
14	14					
15	15					
16	16					
17	17					
18	18					
19	19					
20	20					
21	21					
22	22					
23	23					

Pink
790-14037
250/box.....\$76.75

Patient Sign-In Date: _____

Please sign in and notify us if:
you are a new patient, your insurance, telephone number or address have changed.

NO.	Please Print Name Sign-in on next available line	Arrival Time	Appt. Time	Appointment with	New Patient (✓)	Any change in address/phone/ insurance since last visit?
1	1					
2	2					
3	3					
4	4					
5	5					
6	6					
7	7					
8	8					
9	9					
10	10					
11	11					
12	12					
13	13					
14	14					
15	15					
16	16					
17	17					
18	18					
19	19					
20	20					
21	21					
22	22					
23	23					

Blue
790-18228
250/box.....\$76.75

Patient Sign-In Date: _____

Please sign in and notify us if:
you are a new patient, your insurance, telephone number or address have changed.

NO.	Please Print Name Sign-in on next available line	Arrival Time	Appt. Time	Appointment with	New Patient (✓)	Any change in address/phone/ insurance since last visit?
1	1					
2	2					
3	3					
4	4					
5	5					
6	6					
7	7					
8	8					
9	9					
10	10					
11	11					
12	12					
13	13					
14	14					
15	15					
16	16					
17	17					
18	18					
19	19					
20	20					
21	21					
22	22					
23	23					

Green
790-18229
250/box.....\$76.75

 **Patient Sign-In**

Please sign in and notify us if:
you are a new patient, telephone number, address or insurance have changed. Date: _____

NO.	Please Print Name	Appt. Time	Time Seen	Appointment with	Note if first visit, new phone, address or insurance change.
1	1				
2	2				
3	3				
4	4				
5	5				
6	6				
7	7				
8	8				
9	9				
10	10				
11	11				
12	12				
13	13				
14	14				
15	15				
16	16				
17	17				
18	18				
19	19				
20	20				
21	21				
22	22				
23	23				

Smile Sign-In
790-17008
100/box.....\$67.45

 **Patient Sign-In**

Please sign in and notify us if:
you are a new patient, telephone number, address or insurance have changed. Date: _____

NO.	Please Print Name	Appt. Time	Time Seen	Appointment with	Note if first visit, new phone, address or insurance change.
1	1				
2	2				
3	3				
4	4				
5	5				
6	6				
7	7				
8	8				
9	9				
10	10				
11	11				
12	12				
13	13				
14	14				
15	15				
16	16				
17	17				
18	18				
19	19				
20	20				
21	21				
22	22				
23	23				

Toothbrush Graphic Sign-In
790-17014
100/box.....\$67.45

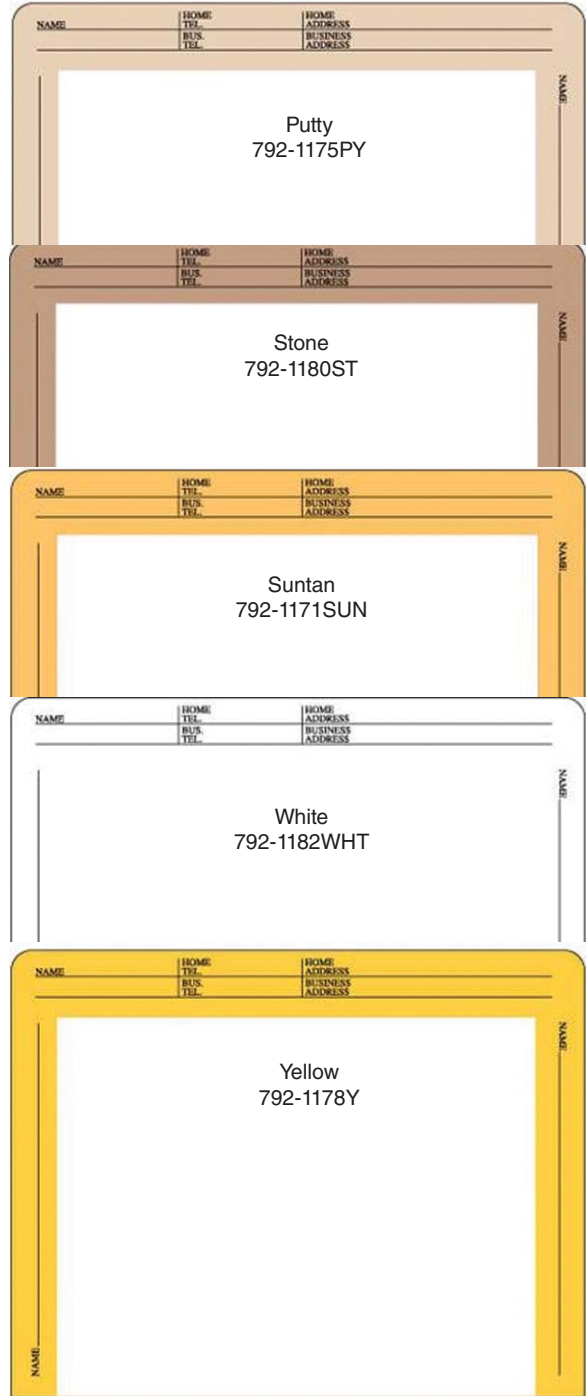
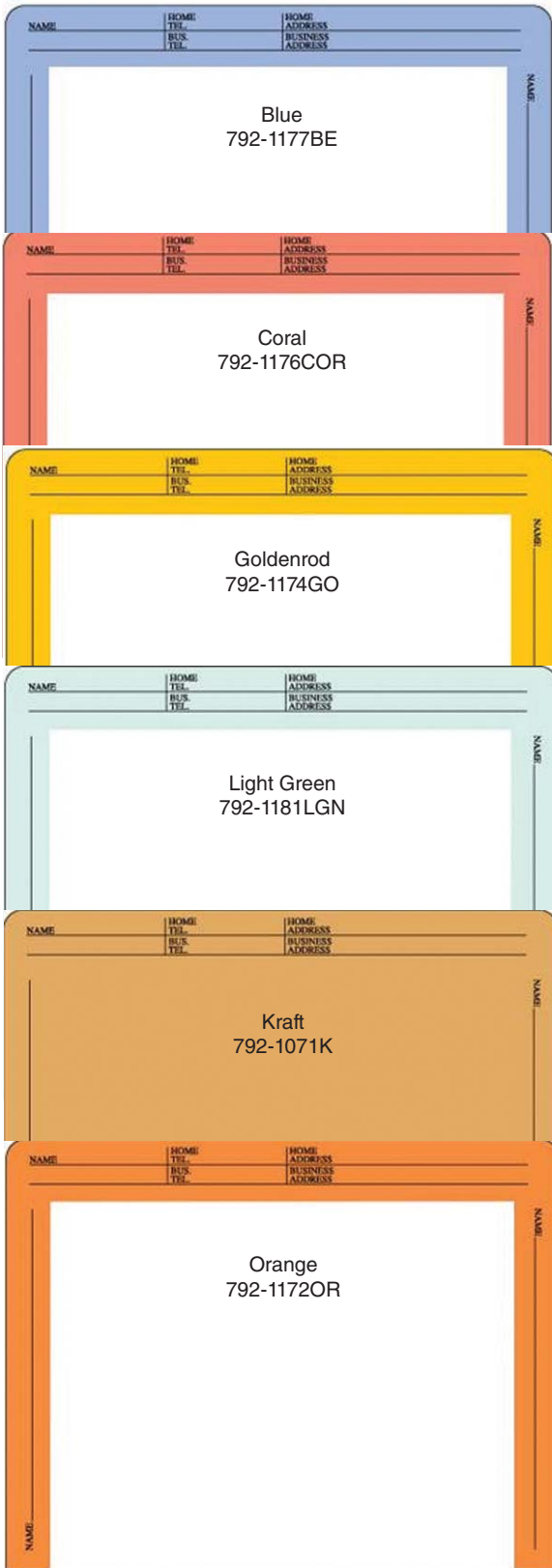

Economy File Envelopes - Integrated Filing Solutions

28 lb. kraft colors. Perfect filing envelopes if you access a patient's file only a few times a year. Closed on three sides. Front is printed with spaces for a patient's name, home and business phone numbers plus addresses.

Size: 8-3/34" H x 11-1/4" W .

100/box \$21.45

Manila Single Ply Non-Reinforced End Tabs

MS-100 - Integrated Filing Solutions

Fasteners 1

1-2" Sem-Clip in position 1, Folder Wt: 95 lb. per thousand

792-MS10021	50/box.....	\$14.95
	5 @	\$14.45
	10 @	\$13.95

Fasteners 1 & 3

2-2" Sem-Clips in position 1 & 3, Folder Wt: 100 lb. per thousand

792-MS100213	50/box.....	\$16.95
	5 @	\$16.45
	10 @	\$15.95

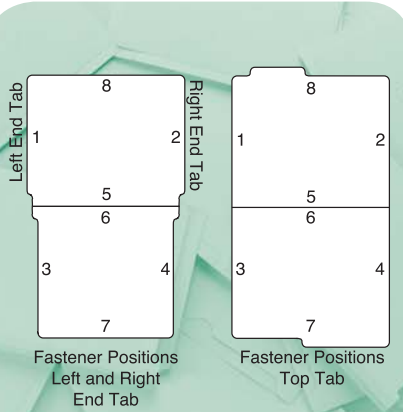

Fasteners or Clips can be ordered in any position. Please refer to the charts for clip and fastener position numbers. When ordering, state the folder item number, size of the fastener, type of the fastener and the desired position(s).

Example: MRS-10, 1" Sem-Clips, position #1 and #3.

- 11 pt. Manila
- Overall Size: 9-1/2" x 12-1/4"
- Front Size: 9-1/2" x 11-3/4" undercut to 11-3/8"
- Overall Tab Length: 8-1/2"
- Scored for 3/4" expansion
- Single ply end tab, right side
- 8 scored tick marks on end tab

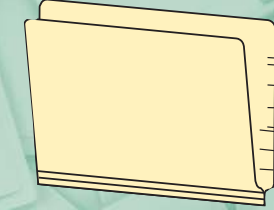

Manila Single Ply Non-Reinforced End Tabs

MS-200 - Integrated Filing Solutions

792-MS200	100/box.....	\$17.95
	5 @	\$17.45
	10 @	\$16.95

Fasteners 1 & 3

2-2" Sem-Clips in position 1 & 3, Folder Wt: 120 lb. per thousand

792-MS200213	50/box.....	\$18.95
	5 @	\$18.45
	10 @	\$17.95

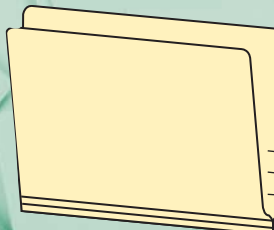

- 14 pt. Manila
- Overall Size: 9-1/2" x 12-1/4"
- Front Size: 9-1/2" x 11-3/4" undercut to 11-3/8"
- Overall Tab Length: 8-1/2"
- Scored for 3/4" expansion
- Single ply end tab, right side
- 8 scored tick marks on end tab

Manila Reinforced End Tabs MRSD-10 - Integrated Filing Solutions

792-MRSD10	100/box.....	\$14.45
	5 @	\$13.95
	10 @	\$12.95

Fasteners 1

1-2" Sem-Clip in position 1
Folder Wt: 100 lb. per thousand

792-MRSD1021	50/box.....	\$21.95
	5 @	\$21.45
	10 @	\$20.95

Fasteners 1 & 3

2-2" Sem-Clips in position 1 & 3
Folder Wt: 105 lb. per thousand

792-MRSD10213	50/box.....	\$16.95
	5 @	\$16.45
	10 @	\$15.95

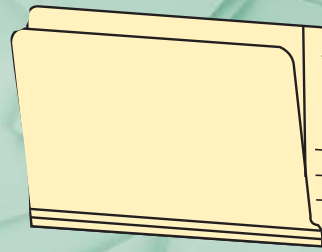

- 11 pt. Manila
- Overall Size: 9-1/2" x 12-1/4"
- Front Size: 9" x 11-3/4" undercut to 11-3/8"
- Overall Tab Length: 8-1/2"
- Scored for 3/4" expansion
- Full undercut end tab, reinforced, right side
- 10 scored tick marks on tab

DHPI can customize patient file charts to fit your needs. Call for a competitive price quote.

Colored Folders

11 Point End-Tab Pockets with Colored Border - Integrated Filing Solutions

More economical than colored stock, these manila pockets have printed borders.

100/box.....\$36.95

792-M11PK_

- O.....Brown
- G.....Green
- Y.....Gray
- H.....Orange
- B.....Blue

- E.....Pink
- V.....Violet
- I.....Tan
- C.....Yellow
- D.....Red

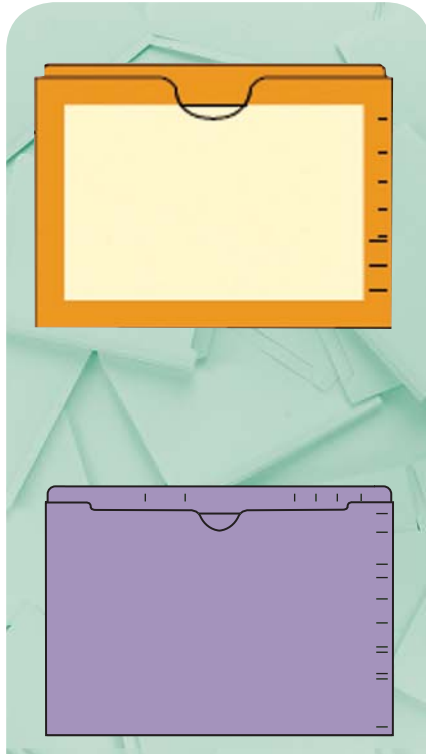

- 11 pt. Pulp Dyed Colored Stock.
- Overall Size: 9-1/2" x 12-1/4"
- Thumbcut front
- Flat pocket with side seam on outside back.
- Folder Wt: 100 lb per thousand

Colored Folders

FP11X - Integrated Filing Solutions

792-FP11X_

- DKBDark Blue
- GGreen
- L.....Lavender
- YGray

100/box.....\$37.95
 5 @\$36.95
 10 @\$35.95

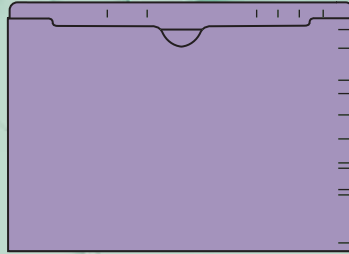

- 11 pt. Pulp Dyed Colored Stock
- Overall Size: 9-1/2" x 11-3/4"
- Front Size: 9" x 11-3/4"
- Flat pocket with side seam on outside back
- Reinforced top tab
- Thumbcut front
- Folder Wt: 100 lb per thousand

COLOR CHART
 Colors may vary.

A	C	D	DKRO	G	H	L	P	DKH
B	CAN	DKB	E	GL	I	O	Y	DKG

MFC-1 - Integrated Filing Solutions

792-MFC1

25/box.....\$50.45
 5 @\$49.45
 10 @\$47.45

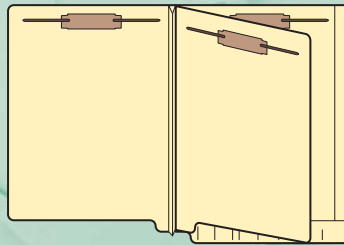

- 14 pt. Manila stock
- Overall Size: 9-1/2" x 12-1/4"
- Front Size: 9-1/2" x 11-3/4" undercut to 11-3/8"
- Reinforced top tab and end tab
- 8 scored tick marks on tab
- Two 14 pt. folders laminated together to form 1 divider

Manila Pocket Folders

MRSP-10 - Integrated Filing Solutions

792-MRSP10

100/box.....\$19.95
 5 @\$19.45
 10 @\$18.95

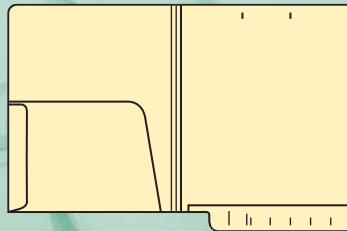

- 11 pt. Manila stock
- Overall Size: 9-1/2" x 12-1/4"
- Front Size: 9-1/2" x 11-3/8"
- Overall tab length 8-3/8"
- 1 piece construction pocket inside front, 5-3/4" x 8-7/8" seamed on the inside left

Manila Pocket Folders

MTTPK - Integrated Filing Solutions

792-MTTPK	50/box.....	\$18.95
	5 @	\$18.45
	10 @	\$17.95

Fasteners 1

1-2" Sem-Clip in position 1
Folder Wt: 115 lb. per thousand

792-MTTPK21	50/box.....	\$22.95
	5 @	\$22.45
	10 @	\$21.95

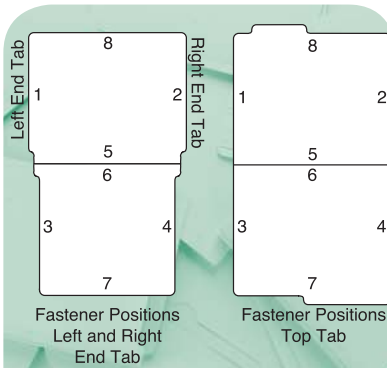

- 11 pt. Manila stock
- Overall Size: 9-1/2" x 11-3/4"
- Front Size: 9" x 11-3/4"
- Overall tab length 11-3/4"
- 1 piece construction pocket inside front, 5-3/4" x 9" seamed at left open of fold
- Reinforced top tab, straight cut top tab
- 5 scored tick marks
- Folder Wt: 110 lb per thousand

AJ-11 - Integrated Filing Solutions

Comparable to Jeter.

792-AJ11	100/box.....	\$36.25
	5 @	\$35.25
	10 @	\$34.25

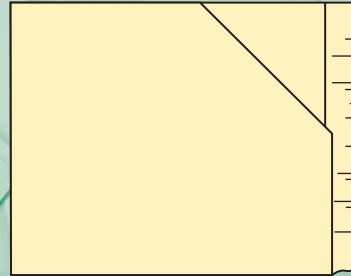

- 11 pt. Manila
- Overall Size: 9-1/2" x 12-1/4"
- Front Size: 9-1/2" x 11-3/8" with angle cut front panel
- Overall tab length 9-3/8"
- Left side seam outside back
- Continuous reinforced end tab with tick marks printed in gray ink
- Folder Wt. 100 lb per thousand

FPDT12 - Integrated Filing Solutions

792-FPDT12	100/box.....	\$25.95
	5 @	\$25.45
	10 @	\$24.95

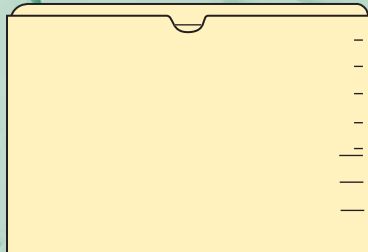

- 11 pt. Manila
- Overall Size: 9-1/2" x 12-1/4"
- Front Size: 9" x 12-1/4"
- Reinforced top tab
- 8 scored tick marks in gray ink on right side
- Flat pocket with side seams on outside back
- Thumb cut front
- Folder Wt. 100 lb per thousand

MXP11 - Integrated Filing Solutions

Comparable to Smead.

792-MXP11	50/box.....	\$30.45
	5 @	\$29.45
	10 @	\$28.45

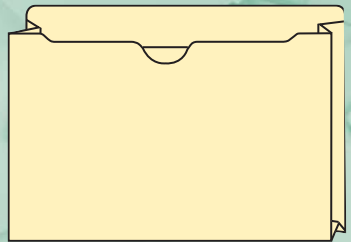

- 11 pt. Manila
- Overall Size: 9-1/2" x 11-3/4"
- 1-1/2" paper gusset expansion
- Front Size: 9" x 11-3/4" with undercut
- Double ply top tab
- Seams meet at the gusset, closed corners
- Thumb cut front
- Folder Wt. 150 lb per thousand

MRSP-14 - Integrated Filing Solutions

Comparable to Barkley.

792-MRSP14	100/box.....	\$20.95
	5 @	\$20.45
	10 @	\$19.95

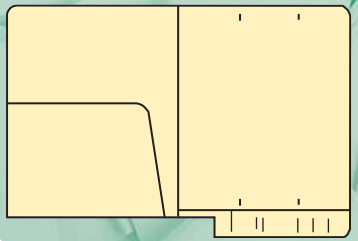

- 14 pt. Manila stock
- Overall Size: 9-1/2" x 12-1/4"
- Front Size: 9-1/2" x 11-3/8"
- Overall tab length 8-3/8"
- 1 piece construction pocket inside front, 5-3/4" x 8-7/8" seamed on the inside left
- Scored for 1/2" expansion
- Reinforced end tab, right side
- 8 scored tick marks on tab
- Folder Wt: 150 lb per thousand

Manila Pocket Folders

MPFA-10 - Integrated Filing Solutions

792-MPFA10	100/box	\$19.95
	5 @	\$19.45
	10 @	\$18.95

Fasteners 1

1-2" Sem-Clip in position 1

Folder Wt: 135 lb. per thousand

792-MPFA1021	50/box	\$25.95
	5 @	\$25.45
	10 @	\$24.95

MPF-10 - Integrated Filing Solutions

792-MPF10	50/box	\$19.95
	5 @	\$19.45
	10 @	\$18.95

Fasteners 1

1-2" Sem-Clip in position 1

Folder Wt: 135 lb. per thousand

792-MPF10021	50/box	\$25.95
	5 @	\$25.45
	10 @	\$24.95

Fasteners 1 & 3

2-2" Sem-Clips in position 1 & 3

Folder Wt: 140 lb. per thousand

792-MPF10213	50/box	\$30.95
	5 @	\$29.95
	10 @	\$28.95

TopTab Reinforced Folders

M9518L Left Top Tab - Integrated Filing Solutions

792-M9518L	100/box	\$14.95
	5 @	\$14.45
	10 @	\$13.95

M9518C Center Top Tab - Semco

792-M9518C	100/box	\$15.45
	5 @	\$14.95
	10 @	\$14.45

M9518R Right Top Tab - Semco

792-M9518R	100/box	\$14.95
	5 @	\$14.45
	10 @	\$13.95

MR-50 - Integrated Filing Solutions

792-MR50	100/box	\$14.75
	5 @	\$14.25
	10 @	\$13.75

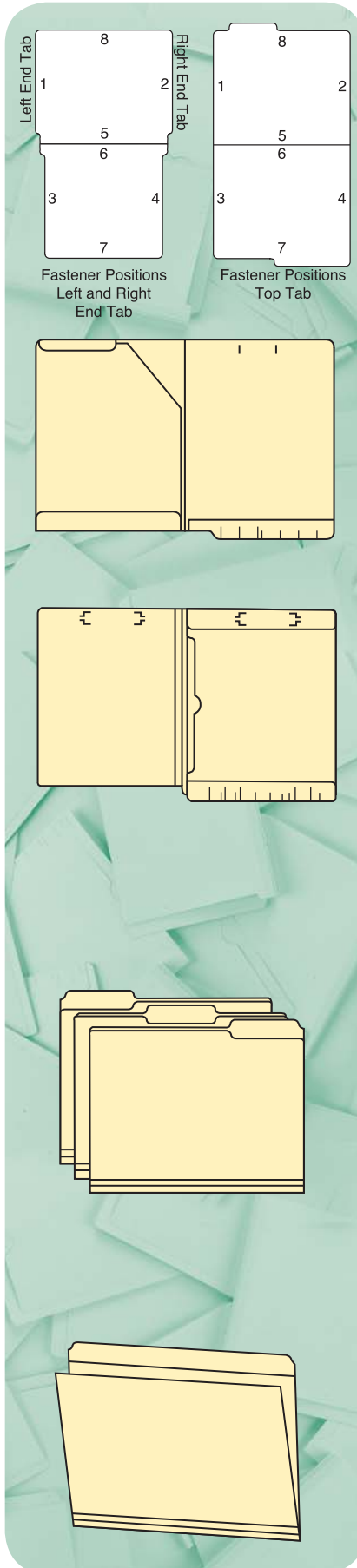

- 11 pt. Manila stock
- Overall Size: 9-1/2" x 12-1/4"
- Front Size: 9-1/2" x 11-3/4"
- Overall tab length 8-3/8"
- 1 piece construction pocket inside front, 9-3/8" x 11-3/4"
- Reinforced end tab, right side
- Scored tick marks on tab
- Folder Wt: 130 lb per thousand

- 11 pt. Manila stock
- Overall Size: 9-1/2" x 12-1/4"
- Front Size: 9-1/2" x 11-3/8"
- Overall tab length 9-1/2"
- Pocket size: 9-3/8" x 12-1/4"
- 1 piece construction full inside back panel pocket
- Reinforced end tab, right side
- Printed tick marks on end tab
- Thumb cut on pocket for easy access
- Printed clip position marks

- 11 pt. Manila
- Overall Size: 9-1/2" x 11-3/4"
- Front Size: 8-7/8" x 11-3/4" undercut to 8-3/8"
- Overall top tab size 3-3/4"
- Scored for 3/4" expansion
- Reinforced top tab in left, center or right positions
- 1/3 cut undercut style
- Folder Wt. 90 lb per thousand

- 11 pt. Manila
- Overall Size: 9-1/2" x 11-3/4"
- Front Size: 8-7/8" x 11-3/4"
- Overall top tab size: 11-3/4"
- Scored for 3/4" expansion
- Straight cut reinforced top tab
- Folder Wt. 90 lb per thousand

Vinyl & Poly Pockets

- 792-WV64 Heavy Duty Vinyl for Card Size 6" x 4"
Opening on 6" dimension
100/box**\$38.95**
5 @**\$37.95**
10 @**\$36.95**

- 792-WV85 Heavy Duty Vinyl for Card Size 8" x 5"
Opening on 8" dimension
100/box**\$46.75**
5 @**\$45.75**
10 @**\$44.75**

- 790-7225S 5 mil. Poly for Card Size 6" x 4"
Opening on 6" dimension
100/box**\$15.75**

- 790-7250S 5 mil. Poly for Card Size 8" x 5"
Opening on 8" dimension
100/box**\$27.75**

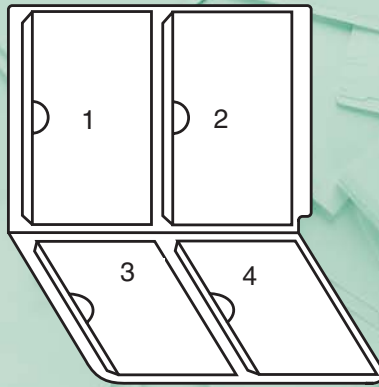

Pocket Positions

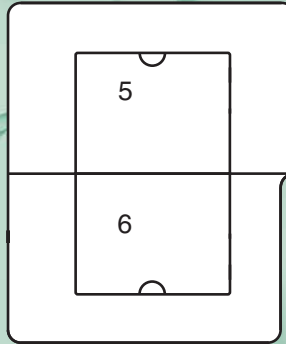

11700 / 51700 / 81700 series
Original Col'R'Tab®

3/4"H x 1-1/2"W – Label size
1,000 labels per roll • 500 labels per roll • 250 labels per pkg.

stock no. 500/roll	stock no. 250/pkg	item	color
790-51717	81717	17	Blue
790-51718	81718	18	Orange
790-51719	81719	19	Black
790-51720	81720	20	Yellow

500/roll	250/roll
1 @	1 @
\$5.25	\$8.25



51717 – Roll • 81717 - Pkg.



51718 – Roll • 81718 - Pkg.



51719 – Roll • 81719 - Pkg.



51720 – Roll • 81720 - Pkg.

70200 series
Original Tabbies®

3/4"H x 1-1/2"W – Label size
500 labels per roll

stock no.	item	color
790-70217	17	Red
790-70218	18	Light Blue
790-70219	19	Pink
790-70220	20	Black

1 @\$5.45



70217 - Roll



70218 - Roll



70219 - Roll



70220 - Roll

71700 series
Original Col'R'Tab®

1-1/2"H x 3/4"W (Top Tab) – Label size
1,000 labels per roll

stock no.	item	color
790-71717	17	Blue
790-71718	18	Orange
790-71719	19	Black
790-71720	20	Yellow

1 @\$14.75



71717 - Roll



71718 - Roll



71719 - Roll



71720 - Roll

90500 series
Jeter® compatible series

3/4"H x 1-1/2"W – Label size
500 labels per roll

stock no.	item	color
790-90517	17	White
790-90518	18	Aqua
790-90519	19	Gray
790-90520	20	Blue

1 @\$6.95

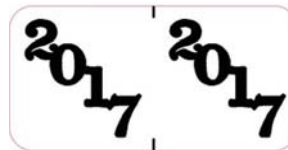

790-90517 - Roll



790-90518 - Roll

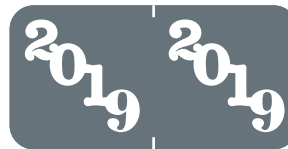

790-90519 - Roll



790-90520 - Roll

14400 series
Colwell® compatible series

3/4"H x 1-1/2"W – Label size
500 labels per roll

stock no.	item	color
790-14417	17	Light Green
790-14418	18	Purple
790-14419	19	Orange
790-14416	20	Yellow

1 @\$8.95



790-14417 - Roll



790-14418 - Roll



790-14419 - Roll



790-14420 - Roll

94600 series
GBS®/VRE® compatible series

3/4"H x 1-1/2"W – Label size
500 labels per roll

stock no.	item	color
790-94617	17	Gray
790-94618	18	Red
790-94619	19	Black
790-94620	20	Yellow

1 @\$5.25



790-94617 - Roll



790-94618 - Roll



790-94619 - Roll



790-94620 - Roll

12900 series
SFI® compatible series

3/4"H x 1-1/2"W – Label size
1,000 labels per roll
Original Col'R® Tab® construction

stock no.	item	color
790-12917	17	Black
790-12918	18	Pink
790-12919	19	Green
790-12920	20	Orange

1 @\$14.25



790-12917 - Roll



790-12918 - Roll



790-12919 - Roll



790-12920 - Roll

21800 / 90800 series
Smead® compatible series

1/2"H x 1"W – Label size
500 labels per roll • 250 labels per pkg.

stock no.	item	color
790-90817	17	Gray
790-90818	18	Red
790-90819	19	Black
790-90820	20	Yellow

500/roll 250/roll
1 @\$4.95 1 @\$2.95



21817-Pkg • 90817 - Roll



21818 -Pkg • 90818 - Roll



21819 -Pkg • 90819 - Roll



21820 -Pkg • 90820 - Roll

92000 series
Tab Products® compatible series

3/4"H x 1-1/2"W – Label size
500 labels per roll • Laminated

stock no.	item	color
790-92017	17	Purple
790-92018	18	Lilac
790-92019	19	Brown
790-92020	20	Pink

1 @\$4.75



92017 - Roll



92018 - Roll



92019 - Roll



92020 - Roll

91200 series
Tab Products® compatible series

1/2"H x 1-1/8"W – Label size
500 labels per roll • Kimdura

stock no.	item	color
790-91217	17	Purple
790-91218	18	Lilac
790-91219	19	Brown
790-91220	20	Pink

1 @\$5.75



91217 - Roll



91218 - Roll



91219 - Roll



91220 - Roll

70800 series
Smead® compatible series

1"H x 1/2"W (Top Tab) – Label size
500 labels per roll

stock no.	item	color
790-70817	17	Gray
790-70818	18	Red
790-70819	19	Black
790-70820	20	Yellow

1 @\$3.25



70817 - Roll



70818 - Roll



70819 - Roll



70820 - Roll

Holographic series
PMA

3/4"H x 1-1/2"W (Top Tab) – Label size
Polylaminated
500 labels per roll

stock no.	item	color
790-0717HV	17	Holographic Violet
790-0717HRD	17	Holographic Red
790-0717HAQ	17	Holographic Aqua
790-0717HGN	17	Holographic Green
790-0717HOR	17	Holographic Orange

1 @\$7.95



2017 - 790-0717HV
2018 - 790-0718HV



2017 - 790-0717HRD
2014 - 790-0718HRD



2017 - 790-0717HAQ
2018 - 790-0718HAQ



2017 - 790-0717HGN
2018 - 790-0718HGN



2017 - 790-0717HOR
2018 - 790-0718HOR

month labels

Month labels are time-saving, self-adhesive labels that are color coded for efficient filing of due dates, pay dates and follow-up work.

Labels are 1/2" high and are printed horizontally and vertically for side or top placement.

*Assorted package includes 300 labels, 25 of each month January–December - 70243.

70230 series Original Tabbies®

1/2" H x 1" W – Label size
PACK / 100 labels per pkg.
25 labels per sheet
Sheet size: 5-5/8" x 3-1/8"

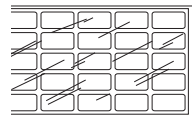

*791-70243 JAN-DEC (assorted)
25 ea. – 300/Pkg.

1 @ \$3.25
5 @ \$2.95
10 @ \$2.45

791- + stock no.

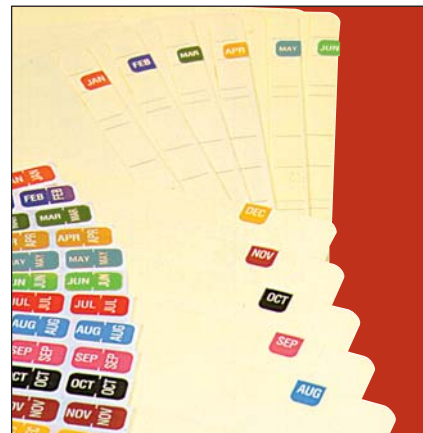

11880 series Original Col'R'Tab®

1/2" H x 1-1/2" W – Label size
PACK / 100 labels per pkg.
20 labels per strip
Sheet size: 10" x 1-1/2"

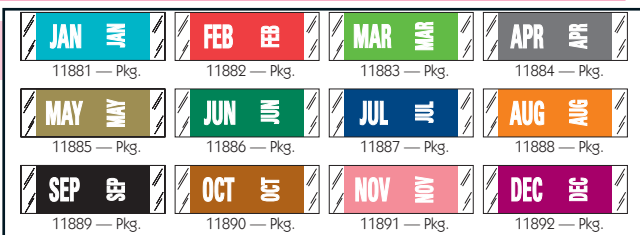

791- + stock no.

1 @ ... \$4.95
5 @ ... \$4.75
10 @ .. \$4.25

Original Col'R'Tab® color code labels provide the best value of any label system in the industry. The unique hinged construction allows for consistent and quick application to file folders, pockets, or even pressboard folders. The clear, outside skirt offsets any tendency for the labels to "hook" onto one another when pulled from the shelf. Made with heavy duty paper and fade-resistant inks. Do not settle for inexpensive color matches – realize the value and savings by using only original Col'R'Tab products!

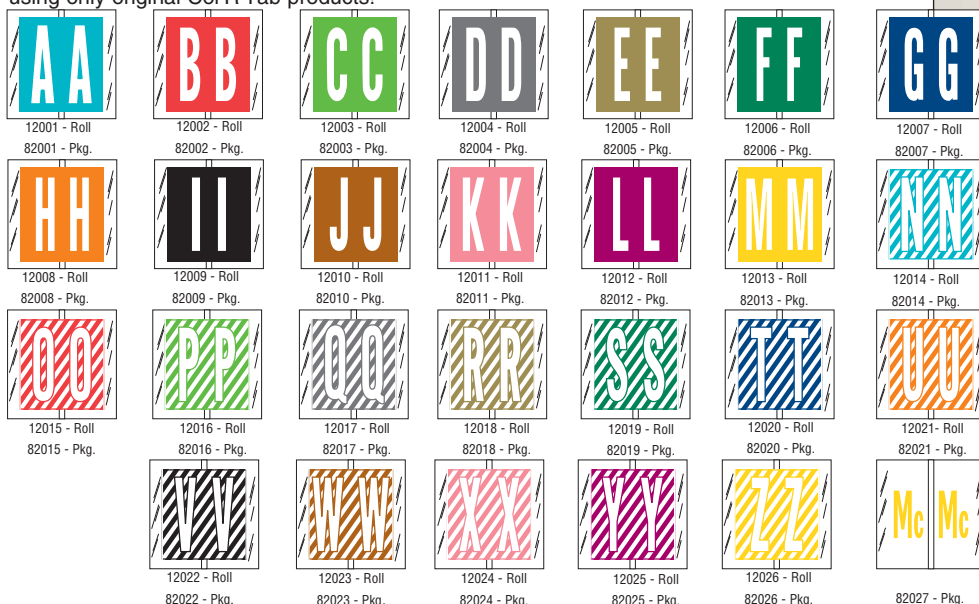

12000 / 82000 series Original Col'R'Tab®

1" H x 1-1/2" W – Label size

ROLL / 500 labels per roll
Roll Unit
791-42000 (28 rolls) **\$280.75**

PACK / 100 labels per pkg.
10 labels per strip
Sheet size: 10" x 1-1/2"
Desktop Kit
791-32000 (3,200 labels) **\$123.75**

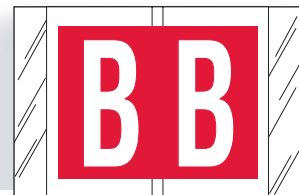

Dispenser Container only – 791-12000
(Holds 30 Rolls)
\$19.95

791- + stock no. 500/roll 1 @ ... \$9.95 5 @ ... \$9.75 10 @ .. \$9.25
100/pkg. 1 @ ... \$3.75 5 @ ... \$3.45 10 @ .. \$3.25



COLOR CODED LABELS

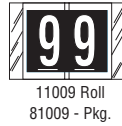
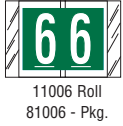
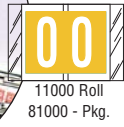

**11000 / 81000 series
Original Col'R'Tab®**

1"H x 1-1/2"W – Label size
ROLL / 500 labels per roll
Roll Unit – 791-41000 (10 rolls) **\$98.45**
PACK / 100 labels per pkg.
10 labels per strip
Sheet size: 10" x 1-1/2"
Desktop Kit – 791-31000 (4,000 labels) **\$148.45**

Dispenser Container only – 791-12000 - **\$19.95**
(Holds 30 Rolls)

791-+ stock no. 500/roll 1 @ .. **\$9.25** 5 @... **\$8.95** 10 @ .. **\$8.45**
100/pkg. 1 @ .. **\$3.25** 5 @... **\$2.95** 10 @ .. **\$2.45**

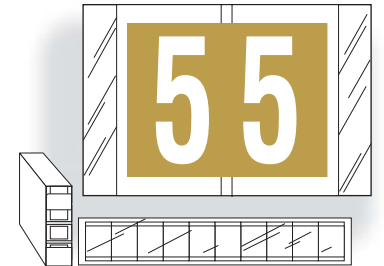

LABELS



Dispenser Container only – 791-11015 - **\$4.45**
(Holds 10 Rolls)

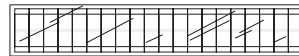

**81950 series
Original Col'R'Tab®**

1/2"H x 1-1/2"W – Label size
PACK / 100 labels per pkg.
20 labels per strip
Sheet size: 10" x 1-1/2"
Desktop Kit – 791-31950 (3,100 labels) **\$116.45**



791-+ stock no. 100/pkg. 1 @ .. **\$3.75** 5 @... **\$3.45** 10 @ .. **\$3.25**

**11850 series
Original Col'R'Tab®**

1/2"H x 1-1/2"W – Label size
ROLL / 500 labels per roll

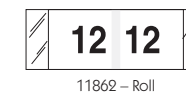
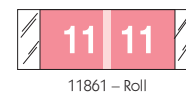
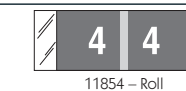
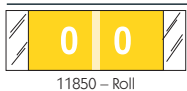

791-+ stock no. 500/pkg. 1 @ .. **\$7.75** 5 @... **\$7.45** 10 @ .. **\$6.95**

91720 / 61720 series
Jeter® 0200 compatible series

15/16"H x 1-5/8"W – Label size
 ROLL / 500 labels per roll

Dispenser Container only – 791-90150 - **\$6.95**
 (Holds 28 Rolls)

RINGBOOK / 240 labels per pkg.
 10 labels per sheet – 7 drill holes
 Sheet size: 8-1/2" x 6"

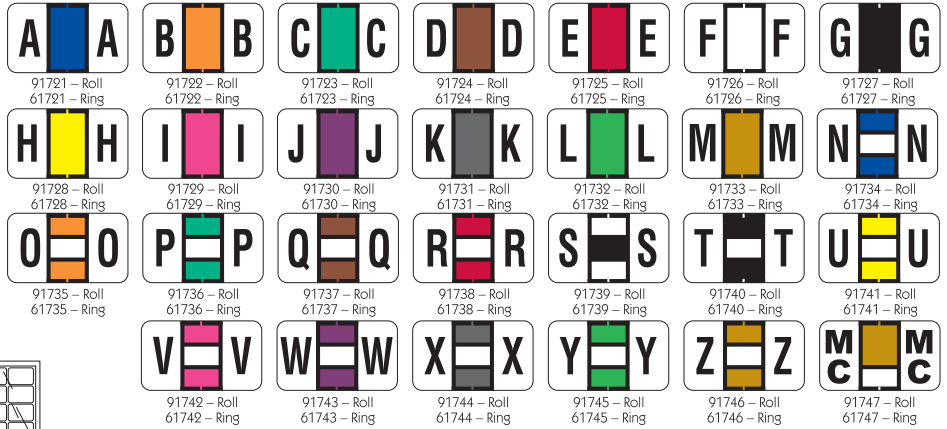
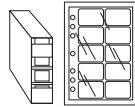

791+ stock no. 500/roll 1 @ ... **\$11.45** 5 @ ... **\$10.95** 10 @ . **\$10.45**
 240/ring 1 @ ... **\$10.25** 5 @ ... **\$9.95** 10 @ .. **\$9.45**

93020 / 63020 series
Safeguard® compatible series

15/16"H x 1-5/8"W – Label size

ROLL / 500 labels per roll

Dispenser Container only – 791-90150 - **\$6.95**
 (Holds 28 Rolls)

RINGBOOK / 240 labels per pkg.
 10 labels per sheet – 7 drill holes
 Sheet size: 8-1/2" x 6"

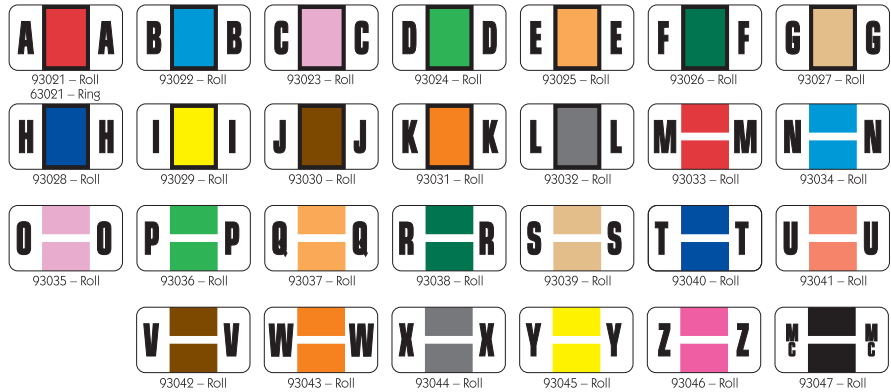
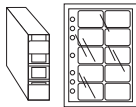

791+ stock no. 500/roll 1 @ ... **\$11.95** 5 @ ... **\$11.45** 10 @ . **\$10.95**
 240/ring 1 @ ... **\$10.25** 5 @ ... **\$9.95** 10 @ .. **\$9.45**



Cut through the fat

**GO DIRECTLY
 TO THE BEST**

SUPPLIES UP TO
25% OFF
 WHILE SUPPLIES LAST

www.dhponline.com/clearance

COLOR CODED LABELS

12700 series
Acme Visible® compatible series
 4"H x 1-1/2"W – Label size
 PACK / 100 labels per pkg.
 3 labels per strip
 Sheet size: 12" x 1-1/2"
 Original Col'R'Tab® construction

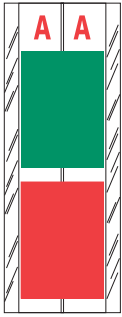

12701 – Pkg.

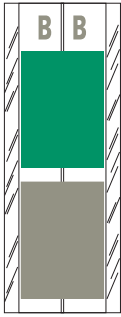

12702 – Pkg.

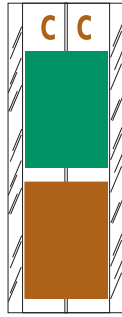

12703 – Pkg.

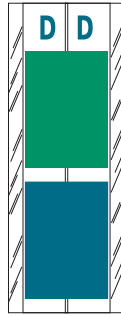

12704 – Pkg.

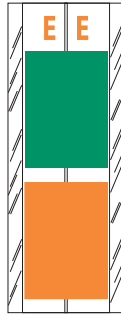

12705 – Pkg.

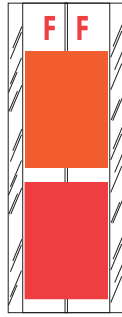

12706 – Pkg.

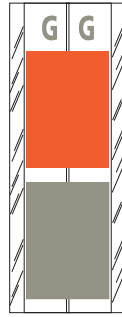

12707 – Pkg.

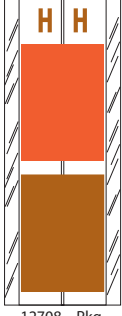

12708 – Pkg.

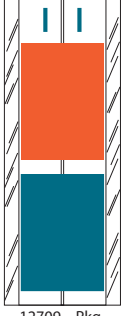

12709 – Pkg.

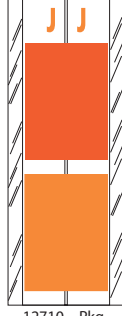

12710 – Pkg.

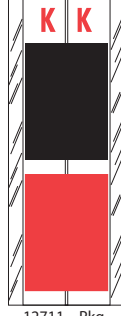

12711 – Pkg.

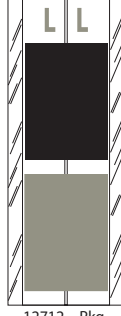

12712 – Pkg.

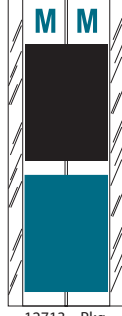

12713 – Pkg.



12715 – Pkg.

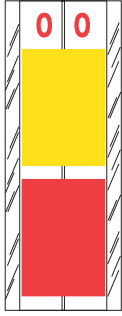

12716 – Pkg.

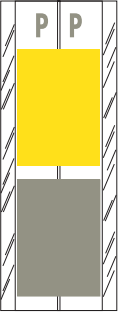

12717 – Pkg.

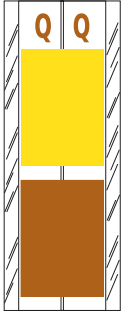

12718 – Pkg.

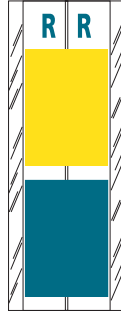

12719 – Pkg.

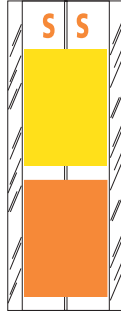

12720 – Pkg.

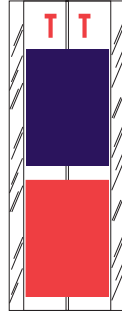

12721 – Pkg.

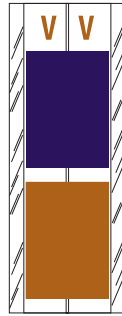

12723 – Pkg.

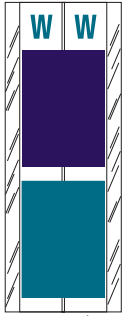

12724 – Pkg.

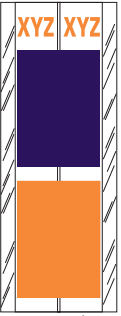

12725 – Pkg.

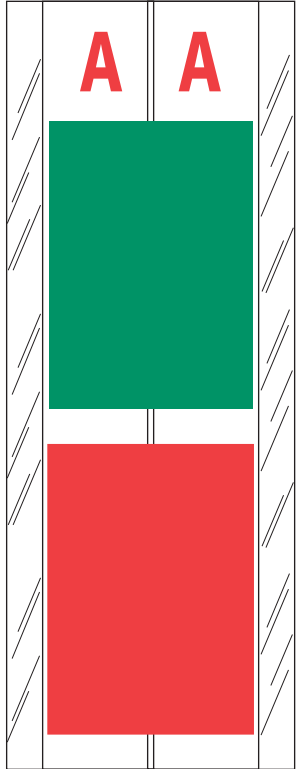

791- + stock no.

- 1 @ \$12.25
- 5 @ \$11.95
- 10 @ \$11.45



COLOR CODED LABELS

LABELS



791- + stock no. 500/roll 1 @ ... \$10.25 5 @ \$9.95 10 @ \$9.45
 240/ring 1 @ ... \$10.25 5 @ \$9.95 10 @ \$9.45

91420 / 61420 series
Colwell® Jewel-Tone compatible series

1" H x 1-1/2" W – Label size
 ROLL / 500 labels per roll
 Roll Unit – 791-91420 (28 rolls)
\$268.25

RINGBOOK / 240 labels per pkg.
 24 labels per sheet / 3 drill holes
 Sheet size: 5-1/2" x 9"

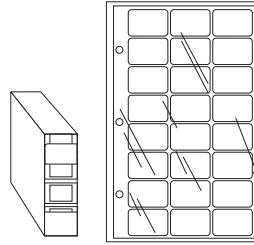

791- + stock no. 550/roll 1 @ \$9.75 5 @ \$9.45 10 @ \$9.25
 220/ring 1 @ \$6.75 5 @ \$6.45 10 @ \$5.95

91320 / 61320 series
GBS®/VRE® 8848/8850 compatible series

1-5/16" H x 1-1/4" W – Label size
 ROLL / 550 labels per roll
 Roll Unit – 791-91320 (27 rolls)
\$312.45

RINGBOOK / 220 labels per pkg.
 10 labels per sheet / 6 drill holes
 Sheet size: 3-1/4" x 6-3/4"

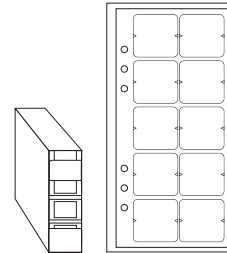

791- + stock no. 1 @ ... \$11.95 5 @ ... \$11.75 10 @ .. \$11.25

91300 series
GBS®/VRE® compatible series

1-5/16" H x 1-1/4" W – Label size
 ROLL / 550 labels per roll
 Roll Unit – 791-91310 (10 rolls)
\$97.95



COLOR CODED LABELS

LABELS

**91120 / 71120 series
Tab Products® & Jeter® 5100
compatible series**

15/16"H x 1-1/2"W – Label size
Laminated finish

ROLL / 500 labels per roll
Roll Unit – 791-31120 (28 rolls) **\$253.75**
PACK / 252 labels per pkg.
9 labels per sheet
Sheet size: 5" x 3-1/2"
Desktop Kit – 791-71120 (2,016 labels) **\$59.75**

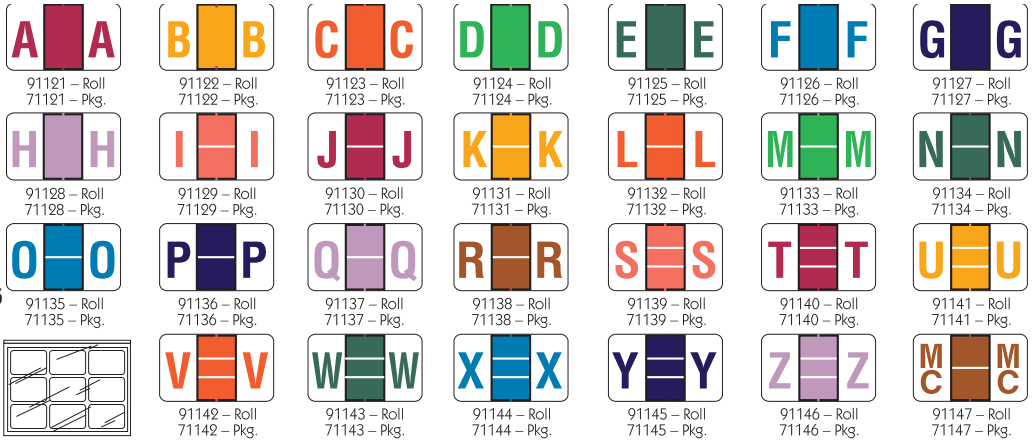

791- + stock no. 500/roll 1 @ . . . **\$9.25** 5 @ **\$8.95** 10 @ **\$8.45**
252/pkg. 1 @ **\$5.95** 5 @ **\$5.75** 10 @ **\$5.45**

Dispenser Container only – 791-90150 – **\$5.95** (Holds 28 Rolls)

**91100 / 71100 series
Tab Products® & Jeter® 6100
compatible series**

15/16"H x 1-1/2"W – Label size
Laminated finish

ROLL / 500 labels per roll
Roll Unit – 791-31100 (10 rolls) **\$90.75**
PACK / 252 labels per pkg.
9 labels per sheet
Sheet size: 5" x 3-1/2"
Desktop Kit – 791-71110 (2,016 labels) **\$59.75**

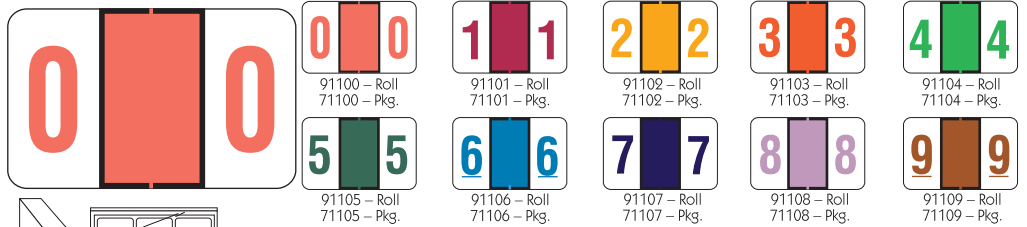

791- + stock no. 500/roll 1 @ **\$9.25** 5 @ **\$8.95** 10 @ **\$8.45**
252/pkg. 1 @ **\$5.95** 5 @ **\$5.75** 10 @ **\$5.45**

Dispenser Container only – 791-90110 – **\$2.25** (Holds 10 Rolls)

**91520 / 71520 / 61520 series
Jeter® 5800, 7100, 7200
compatible series**

15/16"H x 1-5/8"W – Label size

ROLL / 500 labels per roll
Roll Unit – 791-91520 (28 rolls) **\$268.25**
Dispenser Container only – 791-90150 – **\$6.95**
(Holds 28 Rolls)
PACK / 252 labels per pkg.
9 labels per sheet
Sheet size: 5-1/4" x 3-1/4"
Desktop Kit – 791-71520 (2,016 labels) **\$63.75**

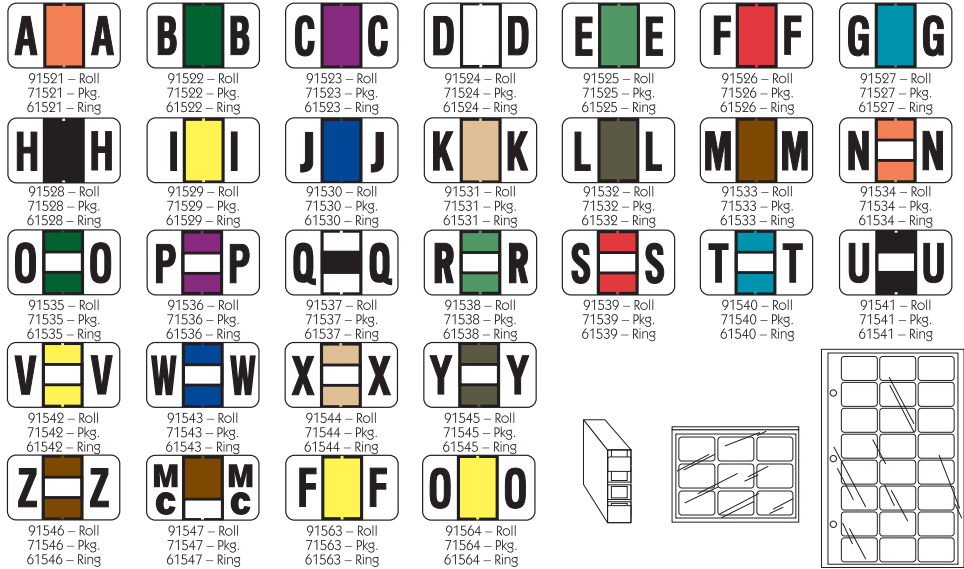

791- + stock no. 500/roll 1 @ . . **\$10.25** 5 @ . . . **\$9.95** 10 @ . . **\$9.45**
252/pkg. 1 @ . . . **\$7.95** 5 @ . . . **\$7.75** 10 @ . . **\$7.25**
240/ring 1 @ . . **\$9.25** 5 @ . . . **\$8.95** 10 @ . . **\$8.45**

**62230 multi-letter series
POS® 3700 compatible series**

1-1/2"H x 1-1/2"W – Label size

RINGBOOK / 150 labels per pkg.
15 labels per sheet / 3 drill holes
Sheet size: 5-1/2" x 8-1/2"

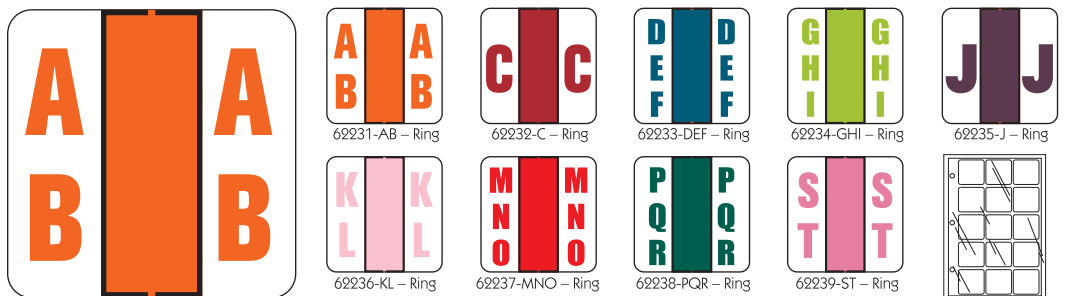

791- + stock no. 150/ring 1 @ . . . **\$11.25** 5 @ **\$10.75** 10 @ **\$10.25**

COLOR CODED LABELS

LABELS

**91920 series
Smead® NCC compatible series**

1-5/32"H x 3-5/8"W – Label size

PACK / 100 labels per pkg.

5 labels per sheet

Sheet size: 3-3/4" x 5-7/8"

Desktop Kit – 791-31920 - **\$55.75** (1,500 labels)

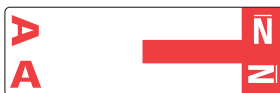
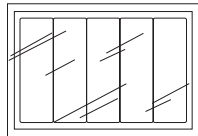

91921 (A-N) – Pkg.



91922 (B-O) – Pkg.



91923 (C-P) – Pkg.

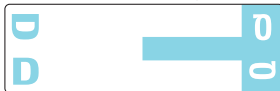

91924 (D-Q) – Pkg.



91925 (E-R) – Pkg.



91926 (F-S) – Pkg.

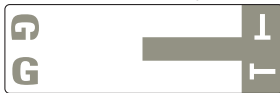

91927 (G-T) – Pkg.

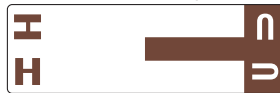

91928 (H-U) – Pkg.

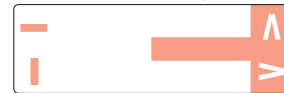

91929 (I-V) – Pkg.



91930 (J-W) – Pkg.



91931 (K-X) – Pkg.

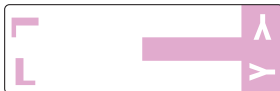

91932 (L-Y) – Pkg.



91933 (M-Z) – Pkg.

791- + stock no. 100/pkg. 1 @ **\$3.95** 5 @ **\$3.75** 10 @ **\$2.95**

**91820 / 71820 series
Smead® ACC & ACCS compatible series**

1-5/8"H x 1"W – Label size

ROLL / 250 labels per roll

Roll Unit – 791-41820 - **\$161.75** (26 rolls)

Dispenser Container only – 791-90150 - **\$6.95**
(Holds 28 Rolls)

PACK / 108 labels per pkg.

9 labels per sheet

Sheet size: 5-1/4" x 3-3/8"



91821 – Roll
71821 – Pkg.



91822 – Roll
71822 – Pkg.



91823 – Roll
71823 – Pkg.



91824 – Roll
71824 – Pkg.



91825 – Roll
71825 – Pkg.



91826 – Roll
71826 – Pkg.



91827 – Roll
71827 – Pkg.



91828 – Roll
71828 – Pkg.



91829 – Roll
71829 – Pkg.



91830 – Roll
71830 – Pkg.



91831 – Roll
71831 – Pkg.



91832 – Roll
71832 – Pkg.



91833 – Roll
71833 – Pkg.



91834 – Roll
71834 – Pkg.



91835 – Roll
71835 – Pkg.



91836 – Roll
71836 – Pkg.



71837 – Pkg.



91838 – Roll
71838 – Pkg.



91839 – Roll
71839 – Pkg.



91840 – Roll
71840 – Pkg.



91841 – Roll
71841 – Pkg.

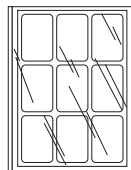

91842 – Roll
71842 – Pkg.



91843 – Roll
71843 – Pkg.



71844 – Pkg.



91845 – Roll
71845 – Pkg.



71846 – Pkg.

791- + stock no. 250/roll 1 @ **\$6.95** 5 @ **\$6.75** 10 @ **\$5.95**
108/pkg. 1 @ **\$3.95** 5 @ **\$3.75** 10 @ **\$2.95**

**14000 series
Tab Products® compatible series**

1"H x 1-1/2"W – Label size

Original Col'R'Tab® construction

ROLL / 500 labels per roll



14000 – Roll



14001 – Roll



14002 – Roll



14003 – Roll



14004 – Roll



14005 – Roll



14006 – Roll



14007 – Roll

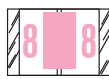

14008 – Roll



14009 – Roll





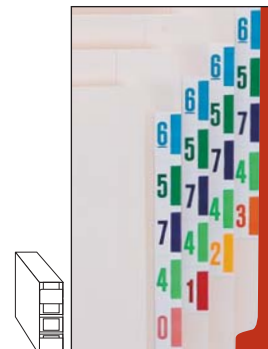





















791- + stock no. 500/roll 1 @ **\$10.95** 5 @ **\$10.45** 10 @ **\$9.95**

Dispenser Container only 791-11015 **\$4.45**
(Holds 10 Rolls)



COLOR CODED LABELS

LABELS

 71021 - Roll 91021 - Roll TP240-A - Pkg. 61021 - Ring	 71022 - Roll 91022 - Roll TP240-B - Pkg. 61022 - Ring	 71023 - Roll 91023 - Roll TP240-C - Pkg. 61023 - Ring	 71024 - Roll 91024 - Roll TP240-D - Pkg. 61024 - Ring	 71025 - Roll 91025 - Roll TP240-E - Pkg. 61025 - Ring	 71026 - Roll 91026 - Roll TP240-F - Pkg. 61026 - Ring	 71027 - Roll 91027 - Roll TP240-G - Pkg. 61027 - Ring	 71028 - Roll 91028 - Roll TP240-H - Pkg. 61028 - Ring	
 71029 - Roll 91029 - Roll TP240-I - Pkg. 61029 - Ring	 71030 - Roll 91030 - Roll TP240-J - Pkg. 61030 - Ring	 71031 - Roll 91031 - Roll TP240-K - Pkg. 61031 - Ring	 71032 - Roll 91032 - Roll TP240-L - Pkg. 61032 - Ring	 71033 - Roll 91033 - Roll TP240-M - Pkg. 61033 - Ring	 71034 - Roll 91034 - Roll TP240-N - Pkg. 61034 - Ring	 71035 - Roll 91035 - Roll TP240-O - Pkg. 61035 - Ring	 71036 - Roll 91036 - Roll TP240-P - Pkg. 61036 - Ring	
 71037 - Roll 91037 - Roll TP240-Q - Pkg. 61037 - Ring	 71038 - Roll 91038 - Roll TP240-R - Pkg. 61038 - Ring	 71039 - Roll 91039 - Roll TP240-S - Pkg. 61039 - Ring	 71040 - Roll 91040 - Roll TP240-T - Pkg. 61040 - Ring	 71041 - Roll 91041 - Roll TP240-U - Pkg. 61041 - Ring	 71042 - Roll 91042 - Roll TP240-V - Pkg. 61042 - Ring	 71043 - Roll 91043 - Roll TP240-W - Pkg. 61043 - Ring	 71044 - Roll 91044 - Roll TP240-X - Pkg. 61044 - Ring	
 71045 - Roll 91045 - Roll TP240-Y - Pkg. 61045 - Ring	 71046 - Roll 91046 - Roll TP240-Z - Pkg. 61046 - Ring	 71047 - Roll 91047 - Roll TP240-Mc - Pkg. 61047 - Ring						

791- + stock no. 500/roll 1 @ . \$10.25 5 @ . \$9.95
 500/roll 1 @ . \$9.45 5 @ . \$9.45
 250/ring 1 @ . \$8.25 5 @ . \$7.95

71020 series (Kimdura) rolls
 91020 series (Paper laminated) rolls
 TP240 series (Paper laminated) pack
 Tab Products® 1283, 1286 &
 Smead® BCCS & BCCR compatible series
 61020 series (Kimdura) ringbook sheets

1"H x 1-1/4"W - Label size









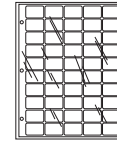
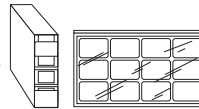

Roll Unit - 791-71020 - \$305.45 - Kimdura (28 rolls)

Roll Unit - 791-41020 - \$266.75 - Laminated (28 rolls)

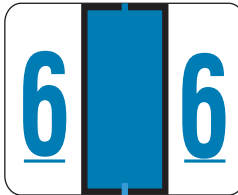
RINGBOOK / 250 labels per pkg.
 50 labels per sheet / 3 drill holes
 Sheet size: 7-1/4" x 11-1/4"

Dispenser Container only 791-90150\$6.95
 (Holds 28 Rolls)



 71000 - Roll 91000 - Roll	 71001 - Roll 91001 - Roll	 71002 - Roll 91002 - Roll	 71003 - Roll 91003 - Roll	 71004 - Roll 91004 - Roll	
 71005 - Roll 91005 - Roll	 71006 - Roll 91006 - Roll	 71007 - Roll 91007 - Roll	 71008 - Roll 91008 - Roll	 71009 - Roll 91009 - Roll	

791- + stock no. 500/roll 1 @ . . . \$9.25 5 @ . . . \$8.95 10 @ . . . \$8.45
 500/roll 1 @ . . . \$9.75 5 @ . . . \$9.45 10 @ . . . \$9.25

























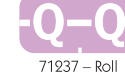

71000 series (Kimdura)
 91000 series (Paper laminated)
 Tab Products® 1282 &
 Smead® BCCRN compatible series

1"H x 1-1/4"W - Label size

ROLL / 791-71000 - \$9.25 Series - 500 labels per roll
 Roll Unit - 791-71010 - \$106.45 - Kimdura (10 rolls)

ROLL / 791-91000 - \$9.75 Series - 500 labels per roll
 Roll Unit - 791-91010 - \$95.25 - Laminated (10 rolls)

Dispenser Container only 791-90110\$3.95
 (Holds 10 Rolls)

 71221 - Roll	 71222 - Roll	 71223 - Roll	 71224 - Roll	 71225 - Roll	 71226 - Roll	 71227 - Roll
 71228 - Roll	 71229 - Roll	 71230 - Roll	 71231 - Roll	 71232 - Roll	 71233 - Roll	 71234 - Roll
 71235 - Roll	 71236 - Roll	 71237 - Roll	 71238 - Roll	 71239 - Roll	 71240 - Roll	 71241 - Roll
 71242 - Roll	 71243 - Roll	 71244 - Roll	 71245 - Roll	 71246 - Roll		

791- + stock no. 500/roll 1 @ . . . \$7.95 5 @ . . . \$7.75 10 @ . . . \$7.25

71220 series
 Tab Products® compatible series

1/2"H x 1"W - Label size
 (Laminated)

ROLL / 500 labels per roll

Dispenser Container only

791-90150\$6.95
 (Holds 28 Rolls)



71200 series
Tab Products® compatible series

1/2"H x 1"W – Label size
(Laminated)
ROLL / 500 labels per roll
Dispenser Container only
791-90110 **\$3.95**
(Holds 10 Rolls)

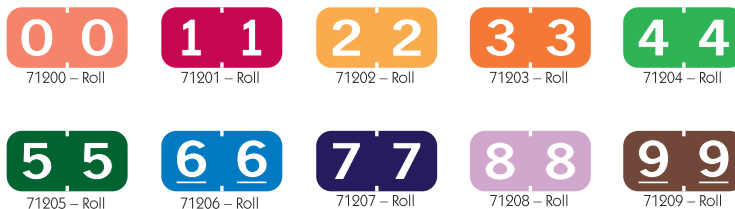

791- + stock no. 500/roll 1 @ **\$7.95**

90120 / 70120 series
Original Tabbies®

15/16"H x 1-1/2"W – Label size
ROLL / 500 labels per roll
PACK / 252 labels per pkg.
9 labels per sheet
Sheet size: 5" x 3-3/8"



Dispenser Container only
791-90150 **\$6.95**
(Holds 28 Rolls)

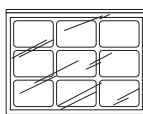

791- + stock no.

500/roll 1 @ .. **\$10.45** 5 @ ... **\$10.25**
252/pkg. 1 @ ... **\$9.95** 5 @ ... **\$9.75**
10 @ ... **\$9.75** 10 @ ... **\$9.25**

90100 / 70100 series
Original Tabbies®

15/16"H x 1-1/2"W – Label size
ROLL / 500 labels per roll
PACK / 252 labels per pkg.
9 labels per sheet
Sheet size: 5" x 3-3/8"

Dispenser Container only
791-90110 **\$3.95**
(Holds 10 Rolls)

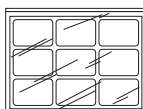

791- + _____ 500/roll 1 @ .. **\$10.45** 5 @ ... **\$10.25** 10 @ ... **\$9.75**
stock no. 252/pkg. 1 @ ... **\$9.95** 5 @ ... **\$9.75** 10 @ ... **\$9.25**

COLOR CODED LABELS

LABELS



94900 - Roll 94901 - Roll 94902 - Roll 94903 - Roll 94904 - Roll



94905 - Roll 94906 - Roll 94907 - Roll 94908 - Roll 94909 - Roll

791- + stock no. 500/roll 1 @ ...\$12.45 5 @ ...\$11.95 10 @ ...\$11.45

**94900 series
Ames® compatible series**

1-7/8"H x 1-7/8"W - Label size
ROLL / 500 labels per roll

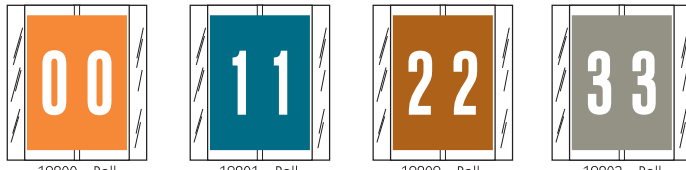

12800 - Roll 12801 - Roll 12802 - Roll 12803 - Roll

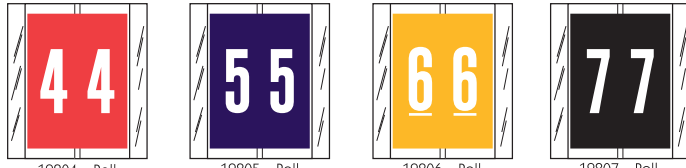

12804 - Roll 12805 - Roll 12806 - Roll 12807 - Roll

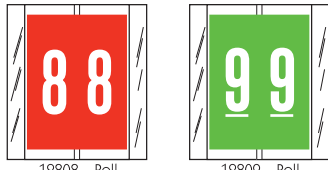

12808 - Roll 12809 - Roll

791- + stock no. 500/roll
1 @ \$15.75
5 @ \$15.25
10 @ \$14.75

call for availability on
double digit labels

**12800 series
SFI® compatible series**

1-2/3"H x 1-1/2"W - Label size
Original Col'R'Tab® construction
ROLL / 500 labels per roll

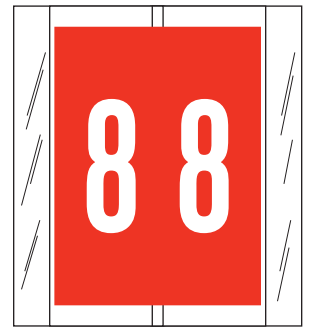

**70520 series
Original Tabbies®**

1"H x 1-1/2"W - Label size
PACK / 252 labels per pkg.
9 labels per sheet
Sheet size: 5" x 3-1/4"

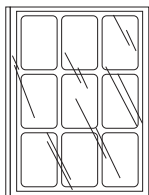

791- + stock no. 252/roll
1 @\$9.45
5 @\$9.25
10 @\$8.75



70521 - Pkg. 70522 - Pkg. 70523 - Pkg.



70524 - Pkg. 70525 - Pkg. 70526 - Pkg.

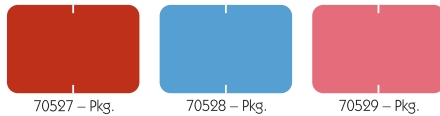

70527 - Pkg. 70528 - Pkg. 70529 - Pkg.



70530 - Pkg. 70531 - Pkg.



70532 - Pkg. 70533 - Pkg.

**91980 series
Jeter® 9500 compatible series**

3/4"H x 1-1/2"W - Label size
ROLL / 500 labels per roll



791- + stock no. 500/roll
1 @ .. \$10.75
5 @ .. \$10.25
10 @ .. \$9.75



91981 - Roll



91982 - Roll



91983 - Roll



91984 - Roll



91985 - Roll

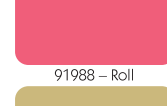

91988 - Roll

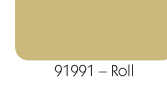

91991 - Roll



91986 - Roll



91989 - Roll



91992 - Roll



91987 - Roll



91990 - Roll



91993 - Roll



A. 791-UL927 White/Red 240/roll 5-1/2"W x 1"H
 1 @ \$13.75 3 @ \$13.45 6 @ \$13.25

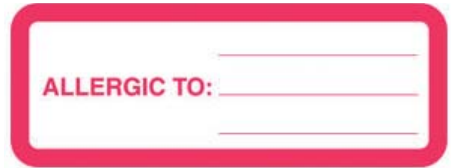

B. 791-UL702 White/Red 320/roll 3"W x 1-1/8"H
 1 @ \$13.75 3 @ \$13.45 6 @ \$13.25



791-SS16 FI-Red
 500 / Roll – 1-7/8"W x 3/4"H
 1 @ \$11.95
 3 @ \$11.75
 6 @ \$11.25



791-UL808 FI-Red
 420 / Roll – 2-1/4"W x 7/8"H
 1 @ \$13.75
 3 @ \$13.45
 6 @ \$13.25



791-40525 FI-Red
 250 / Roll – 1-1/2"W x 3/4"H
 1 @ \$4.45
 3 @ \$4.25
 6 @ \$3.95



791-MAP496 FI-Orange
 300 / Roll – 2-1/2"W x 3/4"H
 1 @ \$9.25
 3 @ \$8.95
 6 @ \$8.45



791-UL439 FI-Red
 500 / Roll –
 1-1/4"W x 5/16"H
 1 @ \$10.45
 3 @ \$10.25
 6 @ \$9.75

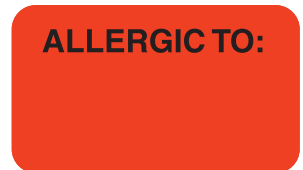

791-MAP3390 FI-Red
 250 / Roll – 1-1/2"W x 7/8"H
 1 @ \$6.75
 3 @ \$6.45
 6 @ \$6.25

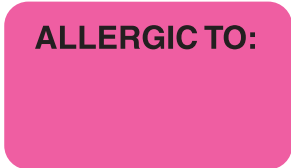

ALLERGIC TO: _____

791-MAP3350 FI-Pink
 250 / Roll – 1-1/2"W x 7/8"H
 1 @ \$6.75
 3 @ \$6.45
 6 @ \$6.25



791-MAP500 FI-Green
 300 / Roll – 2-1/2"W x 3/4"H
 1 @ \$9.25
 3 @ \$8.95
 6 @ \$8.45



ALLERGIC TO: _____

791-MAP3290 White/Red
 250 / Roll – 3"W x 1"H
 1 @ \$8.95
 3 @ \$8.75
 6 @ \$7.95



ALLERGIC TO: _____

791-MAP497 FI-Pink
 300 / Roll – 2-1/2"W x 3/4"H
 1 @ \$9.25
 3 @ \$8.95
 6 @ \$8.45



ALLERGIC TO: _____

791-MAP4950 FI-Pink 250 / Roll – 3"W x 1"H
 1 @ \$9.25
 3 @ \$8.95
 6 @ \$8.45



NO KNOWN ALLERGIES

791-MAP1510 Lt-Blue
 250 / Roll – 1-1/2"W x 7/8"H
 1 @ \$8.95
 3 @ \$8.75
 6 @ \$8.25



ALLERGIC TO: _____

791-MAP3240 FI-Red
 250 / Roll – 3"W x 1"H
 1 @ \$8.95
 3 @ \$8.75
 6 @ \$7.95



ALLERGIC TO: _____

ALLERGY

*791-40562 White/Red
 500 / Roll – 3"W x 1"H
 1 @ \$10.75
 3 @ \$10.45
 6 @ \$9.75

*791-MAP6430 White/Red
 250 / Roll – 3"W x 1"H
 1 @ \$8.95
 3 @ \$8.75
 6 @ \$7.95

*Wrap-around labels are designed to alert you to view important information whether file is open or closed.

ALLERGIC TO:

791-MAP1000 White/Red
250 / Roll – 1-1/2"W x 7/8"H
1 @ \$5.95
3 @ \$5.75
6 @ \$5.45

ALLERGY ALERT

791-MAP4930 FI-Red
250 / Roll – 1-1/2"W x 7/8"H
1 @ \$6.75
3 @ \$6.45
6 @ \$6.25

ALLERGIC TO:

791-MAP3320 FI-Orange
250 / Roll – 1-1/2"W x 7/8"H
1 @ \$6.75
3 @ \$6.45
6 @ \$6.25

ALLERGIC TO LATEX

791-MAP6260 Red
250 / Roll
1-1/2"W x 7/8"H
1 @ \$6.75
3 @ \$6.45
6 @ \$6.25

ALLERGIES

791-MAP1630 FI-Red – 250 / Roll – 3-1/4"W x 1-3/4"H
1 @ \$8.75 3 @ \$8.45 6 @ \$8.25

ALLERGIES/DRUG REACTIONS

NO KNOWN ALLERGIES

791-MAP1730 FI-Pink – 250 / Roll – 3-1/4"W x 1-3/4"H
1 @ \$9.25 3 @ \$8.95 6 @ \$8.75

ALLERGIES

LATEX PENICILLIN
 DYE CODEINE
 TAPE SULFA
 OTHER ERYTHROMYCIN

NO KNOWN ALLERGIES

791-MAP3250 FI-Red – 250 / Roll – 3-1/4"W x 1-3/4"H
1 @ \$10.75 3 @ \$10.45 6 @ \$10.25

ALLERGIES/DRUG REACTIONS

NO KNOWN ALLERGIES

791-MAP3230 FI-Red – 250 / Roll – 3-1/4"W x 1-3/4"H
1 @ \$10.75 3 @ \$10.45 6 @ \$10.25

ALLERGIC TO:

791-MAP3300 White/Red – 250 / Roll – 3-1/4"W x 1-3/4"H
1 @ \$10.75 5 @ \$10.45 10 @ \$10.25

 **ALLERGIES**

A.

ALLERGIC TO:

PENICILLIN
 CODEINE
 SULFA

B.



ALLERGIES

C.

ALLERGIC TO:

PENICILLIN
 CODEINE
 SULFA

D.

ALLERGIES

E.

ALLERGY

ALLERGIC TO:

F.

- | | | | |
|----|---------------------------|--------------------------------|----------------------------------|
| A. | 791-MAP486
1 @ \$10.45 | FL-Red 100/roll
3 @ \$10.25 | 4"W x 2-1/2"H
6 @ \$9.75 |
| B. | 791-MAP488
1 @ \$10.45 | FL-Red 100/roll
3 @ \$10.25 | 4"W x 2-1/2"H
6 @ \$9.75 |
| C. | 791-UL926
1 @ \$17.45 | FL-Red 390/roll
3 @ \$16.75 | 2-1/2"W x 2-1/2"H
6 @ \$16.45 |
| D. | 791-MAP4890
1 @ \$6.45 | FL-Red 250/roll
3 @ \$6.25 | 2"W x 2"H
6 @ \$5.95 |
| E. | 791-MAP3220
1 @ \$6.45 | FL-Red 250/roll
3 @ \$6.25 | 2"W x 2"H
6 @ \$5.95 |
| F. | 791-MAP3330
1 @ \$6.25 | FL-Red 250/roll
3 @ \$6.25 | 2"W x 2"H
6 @ \$5.95 |

ALLERGY WARNING LABELS

ALLERGIC TO:

PENICILLIN

CODEINE

SULFA

791-MAP1550 FI-Chartreuse – 250 / Roll – 3-1/4"W x 1-3/4"H
1 @ \$8.75 3 @ \$8.45 6 @ \$8.25

MEDICATION ALLERGY

791-MAP5140 White/Red – 250 / Roll
3-1/4"W x 1-3/4"H
1 @ \$10.75 3 @ \$10.45 6 @ \$10.25

ALLERGIC TO:

791-UL180 FI-Red – 500 / Roll
1-5/8"W x 7/8"H
1 @ \$13.75 3 @ \$13.45 6 @ \$13.25

ALLERGIC TO:

ALLERGY

*791-MAP6440 250 / Roll-White/Red
3-1/4"W x 1-3/4"H
1 @ \$10.75 3 @ \$10.45 6 @ \$10.25

ALLERGIC TO:

PENICILLIN

CODEINE

SULFA

791-MAP4900 FI-Red – 250 / Roll
3-1/4"W x 1-3/4"H
1 @ \$10.75 3 @ \$10.45 6 @ \$10.25

INSURANCE LABELS

INSURANCE

791-UL007 FI-Chartreuse
500 / Roll – 1-5/8"W x 7/8"H
1 @ \$13.75 3 @ \$13.45 6 @ \$13.25

INSURANCE

791-MAP2830 FI-Pink
250 / Roll – 3-1/4"W x 1-3/4"H
1 @ \$10.75 3 @ \$10.45 6 @ \$10.25

INSURANCE

791-MAP1570 FI-Red
250 / Roll – 3-1/4"W x 1-3/4"H
1 @ \$8.75 3 @ \$8.45 6 @ \$8.25

INSURANCE PROVIDER:

791-MAP1110 White/Red
250 / Roll – 1-1/2"W x 7/8"H
1 @ \$5.95
3 @ \$5.75
6 @ \$5.45

INSURANCE

INSURANCE

*791-MAP6420 FI-Pink – 250 / Roll – 3"W x 1"H
1 @ \$10.95 3 @ \$10.75 6 @ \$9.95

INSURANCE

INSURANCE

*791-MAP3140 FI-Orange – 250 / Roll – 3"W x 1"H
1 @ \$8.95 3 @ \$8.75 6 @ \$7.95

MEDICAID

MEDICAID

*791-MAP3090 FI-Pink – 250 / Roll – 3"W x 1"H
1 @ \$10.95 3 @ \$10.75 6 @ \$9.95

MEDICAID

791-MAP120 FI-Pink – 500 / Roll
1-1/4"W x 5/16"H
1 @ \$10.45 3 @ \$10.25 6 @ \$9.75

MEDICARE

791-MAP113 FI-Orange – 500 / Roll
1-1/4"W x 5/16"H
1 @ \$10.45 3 @ \$10.25 6 @ \$9.75

MEDICAID

791-MAP1340 FI-Pink 250 / Roll
1-1/2"W x 7/8"H
1 @ \$5.95
3 @ \$5.75
6 @ \$5.45

ATTENTION OFFICE STAFF:

CO-PAY

\$ _____

Collect at time of visit

CO-PAY

*791-MAP6410 FI-Red
250 / Roll – 3-1/4"W x 1-3/4"H
1 @ \$10.75 3 @ \$10.45 6 @ \$10.25

ATTENTION OFFICE STAFF:

CO-PAY

\$ _____

Collect at time of visit

791-MAP1310 FI-Red
250 / Roll – 1-1/2"W x 7/8"H
1 @ \$5.95
3 @ \$5.75
6 @ \$5.45

Medicare Worker Comp.

Medicaid Self Pay

BC/BS Auto

United Healthcare Kaiser

Aetna CIGNA

Other _____

791-MAP2940 FI-Chartreuse
250 / Roll – 3-1/4"W x 1-3/4"H
1 @ \$10.95 3 @ \$10.75 6 @ \$9.95

BC/BS

791-MAP1650 Lt-Blue
250 / Roll – 1-1/2"W x 7/8"H
1 @ \$5.95
3 @ \$5.75
6 @ \$5.45

Due to catalog printing processes, colors may vary slightly on product from colors illustrated.

* Wrap-around labels are designed to alert you to view important information whether file is open or closed

CHART LABELS

MINOR

791-MAP3550 FI-Green
250 / Roll
1-1/2"W x 7/8"H
1 @ \$9.95
3 @ \$9.75
6 @ \$9.45

Spanish
is preferred by
the patient

791-MAP3540 Lt-Blue
250 / Roll
1-1/2"W x 7/8"H
1 @ \$6.75
3 @ \$6.45
6 @ \$6.25

DECEASED
Date _____

791-MAP3560 Lt-Blue
250 / Roll
1-1/2"W x 7/8"H
1 @ \$6.75
3 @ \$6.45
6 @ \$6.25

PRE-MEDICATE

791-40526 FI-Red
250 / Roll
1-1/2"W x 3/4"H
1 @ \$4.45
3 @ \$4.25
6 @ \$3.95

DIABETIC

791-40528 FI-Red
250 / Roll
1-1/2"W x 3/4"H
1 @ \$4.45
3 @ \$4.25
6 @ \$3.95

ADVANCE DIRECTIVE

Living Will _____
Health Care Proxy _____
Durable Power of Attorney
for Health Care _____
Other _____

791-UL851 FI-Green
390 / Roll – 2-1/2"W x 2-1/2"H
1 @ \$17.45
3 @ \$16.75
6 @ \$16.45

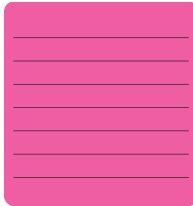

791-UL849 FI-Pink
45 / Pkg
2-1/4"W x 2-3/8"H
1 @ \$8.95
3 @ \$8.75
6 @ \$7.95

CHART INACTIVATED

- Moved/Unable to Contact
- Transferred to Another Doctor
- Non-Payment
- Missed Appointments
- No Response To Scheduling Attempts
- Patient Deceased
- Other _____

791-MAP1540 White
250 / Roll – 3-1/4"W x 1-3/4"H
1 @ \$8.75
3 @ \$8.45
6 @ \$8.25

ATTENTION / ALERT LABELS

MEDICAL ALERT

791-MAP5180 FI-Red
250 / Roll – 3-1/4"W x 1-3/4"H
1 @ \$10.75
3 @ \$10.45
6 @ \$10.25

NAME ALERT

Birthdate _____

791-MAP1180 FI-Red
250 / Roll
1-1/2"W x 7/8"H
1 @ \$5.95
3 @ \$5.75
6 @ \$5.45

MEDICAL ALERT

791-40524 FI-Red
250 / Roll
1-1/2"W x 3/4"H
1 @ \$4.45
3 @ \$4.25
6 @ \$3.95

NAME ALERT

791-40543 FI-Red
250 / Roll
1-1/2"W x 3/4"H
Removable Adhesive
1 @ \$4.45
3 @ \$4.25
6 @ \$3.95

NAME ALERT

791-MAP345 FI-Chartreuse
500 / Roll – 1-1/4"W x 5/16"H
1 @ \$10.45
3 @ \$10.25
6 @ \$9.75

NAME ALERT

Two patients with
same name

*791-MAP6470 FI-Chartreuse
250 / Roll – 3"W x 1"H
1 @ \$8.95
3 @ \$8.75
6 @ \$7.95

NAME ALERT

Two patients
with same name

791-MAP1050 FI-Chartreuse
250 / Roll – 1-1/2"W x 7/8"H
1 @ \$5.95
3 @ \$5.75
6 @ \$5.45

PATIENT RESPONSIBILITY LABELS

YOUR INSURANCE COMPANY
has paid its share of your bill.

This statement is for the amount
payable directly by you.

791-MAP4200 FI-Pink
250 / Roll – 3-1/4"W x 1-3/4"H
1 @ \$10.75
3 @ \$10.45
6 @ \$10.25

REMINDER

- Your insurance has paid its share.
- This is the amount that you owe.
- Please remit TODAY!

791-MAP5620 FI-Green
250 / Roll – 3-1/4"W x 1-3/4"H
1 @ \$10.75
3 @ \$10.45
6 @ \$10.25

YOUR INSURANCE COMPANY
has paid its share of your bill. This
statement is for the amount payable
directly by you. *Please Remit.*

791-UL1423 FI-Red – 320 / Roll – 3"W x 7/8"H
1 @ \$13.75 3 @ \$13.45 6 @ \$13.25

**WE HATE TO KEEP
HOUNDING YOU,
BUT YOUR BILL
IS PAST DUE.**

791-UL520 FI-Pink – 420 / Roll – 2-1/4"W x 7/8"H
1 @ \$13.75 3 @ \$13.45 6 @ \$13.25

* Wrap-around labels are designed to alert you to view important information whether file is open or closed

INSURANCE CARRIER LABELS

<div style="background-color: #f080f0; padding: 5px; border: 1px solid black;"> <p>RESUBMISSION: This is not a duplicate billing. This claim has either been denied or never received. Please consider for benefits.</p> <p>791-MAP2670 FI-Pink 250 / Roll – 1-1/2"W x 7/8"H 1 @ \$6.75 3 @ \$6.45 6 @ \$6.25</p> </div>	<div style="background-color: #ffa500; padding: 5px; border: 1px solid black;"> <p>MEDICARE EOB ATTACHED</p> <p>791-MAP2690 FI-Orange 250 / Roll – 1-1/2"W x 7/8"H 1 @ \$5.75 3 @ \$5.45 6 @ \$5.25</p> </div>	<div style="background-color: #90ee90; padding: 5px; border: 1px solid black;"> <p>PRIMARY EOB ATTACHED</p> <p>791-MAP1480 FI-Green 250 / Roll – 1-1/2"W x 7/8"H 1 @ \$5.95 3 @ \$5.75 6 @ \$5.45</p> </div>	<div style="background-color: #90ee90; padding: 5px; border: 1px solid black;"> <p>DOCUMENTATION ATTACHED DO NOT SEPARATE FROM CLAIM</p> <p>791-MAP2650 FI-Green 250 / Roll – 1-1/2"W x 7/8"H 1 @ \$6.75 3 @ \$6.45 6 @ \$6.25</p> </div>	<div style="background-color: #f080f0; padding: 5px; border: 1px solid black;"> <p>CORRECTIVE CLAIM</p> <p>791-MAP1460 FI-Pink 250 / Roll – 1-1/2"W x 7/8"H 1 @ \$5.95 3 @ \$5.75 6 @ \$5.45</p> </div>
<div style="background-color: #00ced1; padding: 5px; border: 1px solid black;"> <p>INSURANCE</p> <p>This office has not received an explanation, payment or denial on this claim. We respectfully request one. Thank you.</p> <p>791-MAP6200 Teal/Black 250 / Roll – 1-1/2"W x 1-1/2"H 1 @ \$8.95 3 @ \$8.45 6 @ \$7.95</p> </div>	<div style="background-color: #fff9c4; padding: 5px; border: 1px solid black;"> <p>RESUBMISSION This is not a duplicate billing. This claim has either been denied or never received. Please consider for benefits or instruct if patient owes.</p> <p>791-MAP2610 FI-Chartreuse 250 / Roll – 3-1/4"W x 1-3/4"H 1 @ \$10.75 3 @ \$10.45 6 @ \$10.25</p> </div>	<div style="background-color: #ffeb3b; padding: 5px; border: 1px solid black;"> <p>SECOND SUBMISSION ORIGINAL CLAIM WAS SENT ON:</p> <p>791-MAP6220 Orange/Black 250 / Roll – 1-1/2"W x 1-1/2"H 1 @ \$10.95</p> </div>		

BILLING COLLECTION LABELS

<div style="background-color: #ff4500; color: white; padding: 10px; border: 1px solid black;"> <p>FINAL NOTICE</p> <p>If we do not hear from you within 10 days, this account will be turned over to our collection agency.</p> </div> <p>791-MAP4790 FI-Red – 250 / Roll – 3-1/4"W x 1-3/4"H 1 @ \$10.75 3 @ \$10.45 6 @ \$10.25</p>	<div style="background-color: #fff9c4; padding: 5px; border: 1px solid black;"> <p>WE ACCEPT MAJOR CREDIT CARDS</p> <p>To pay with your credit card please complete:</p> <p>Acct. No. _____ VISA <input type="checkbox"/> MasterCard <input type="checkbox"/> American Ex <input type="checkbox"/> Discover <input type="checkbox"/> Exp. Date _____ Signature _____</p> </div> <p>791-MAP5790 FI-Chartreuse – 250 / Roll – 3"W x 1"H 1 @ \$9.25 3 @ \$8.75 6 @ \$7.95</p>	<div style="background-color: #fff9c4; padding: 5px; border: 1px solid black;"> <p>To pay with your credit card please complete:</p> <p> Acct. No. _____ Exp. Date _____ <input type="checkbox"/> VISA <input type="checkbox"/> MasterCard Signature _____</p> </div> <p>791-MAP4680 FI-Chartreuse – 250 / Roll – 3"W x 1"H 1 @ \$8.95 3 @ \$8.75 6 @ \$7.95</p>	
<div style="background-color: #ff4500; color: white; padding: 5px; border: 1px solid black;"> <p>ACCOUNT SERIOUSLY OVERDUE</p> <p>Remit payment in full to prevent collections</p> </div> <p>791-MAP1400 FI-Red 250 / Roll – 1-1/2"W x 7/8"H 1 @ \$5.95 3 @ \$5.75 6 @ \$5.45</p>	<div style="background-color: #90ee90; padding: 5px; border: 1px solid black;"> <p><i>Just a friendly reminder</i> that your account is overdue. Won't you please mail your remittance?</p> </div> <p>791-MAP4220 FI-Green 250 / Roll – 1-1/2"W x 7/8"H 1 @ \$6.75 3 @ \$6.45 6 @ \$6.25</p>	<div style="background-color: #ff4500; color: white; padding: 5px; border: 1px solid black;"> <p>PAST DUE</p> <p>Please remit TODAY!</p> </div> <p>791-MAP1350 FI-Red 250 / Roll – 1-1/2"W x 7/8"H 1 @ \$5.95 3 @ \$5.75 6 @ \$5.45</p>	<div style="background-color: #fff9c4; padding: 5px; border: 1px solid black;"> <p><i>Thank You!</i></p> </div> <p>791-MAP4300 FI-Chartreuse 250 / Roll – 1-1/2"W x 7/8"H 1 @ \$6.75 3 @ \$6.45 6 @ \$6.25</p>

X-RAY LABELS

<div style="background-color: #90ee90; padding: 5px; border: 1px solid black;"> <p>ORIGINAL PLEASE RETURN</p> </div> <p>791-UL806 FI-Green – 420 / Roll 2-1/4"W x 7/8"H 1 @ \$13.75 3 @ \$13.45 6 @ \$13.25</p>	<div style="background-color: #ffff00; padding: 5px; border: 1px solid black;"> <p>X-RAY COPIES DO NOT RETURN</p> </div> <p>791-UL807 FI-Chartreuse – 420 / Roll 2-1/4"W x 7/8"H 1 @ \$13.75 3 @ \$13.45 6 @ \$13.25</p>	<div style="background-color: #ff4500; padding: 5px; border: 1px solid black;"> <p>X-RAYS Handle with Care</p> </div> <p>791-MAP2410 FI-Red – 250 / Roll 1-1/2"W x 7/8"H 1 @ \$5.95 3 @ \$5.75 6 @ \$5.45</p>
--	---	--

END TAB



NAME LABEL PROTECTORS

Name label protectors eliminate dirty, worn, dog-eared file folders and file folder labels. Clear, wrap-around, self-adhesive protectors keep file folders and labels clean and prevent them from falling off, extending the life of the folder. Name label protectors can also be used "flat" to attach miscellaneous materials to any surface.

stock no.	size	qty. per pkg.	qty. per box	qty. per roll	price
791-58385	3-1/2" x 2"	100	5 pkgs.	—	\$18.25
791-58485	4" x 2"	100	5 pkgs.	—	\$23.75
791-58385B*	3-1/2" x 1-3/4"	—	500	—	\$14.75
791-88385 (roll)	3-1/2" x 2"	—	—	500	\$18.45
791-88485 (roll)	4" x 2"	—	—	500	\$22.75

*500 single protectors per box

OR



FULL END TAB PROTECTORS

End tab protectors are an ideal solution for extending the life of shelf file folders. Clear protectors wrap around folder end tabs, preventing labels from cracking or popping off, and protect against wear and tear. Self-adhesive, 8" x 2" protectors can be easily applied to all types of end tab file folders to keep them looking neat and clean longer.

stock no.	size	qty. per pkg.	price
791-68386	8" x 2"	100	\$8.95



SPINE EDGE PROTECTORS

Edge protectors keep heavily used file folders looking good longer by protecting edges from cracking or splitting. The 11" x 2" clear, wrap-around protector is easily applied to the bottom edge of a file folder, where the most wear and tear occurs as the folder is moved in and out of shelf file cabinets.

stock no.	size	qty. per pkg.	price
791-68387	11" x 2"	100	\$12.75



LASER - INK NAME LABELS

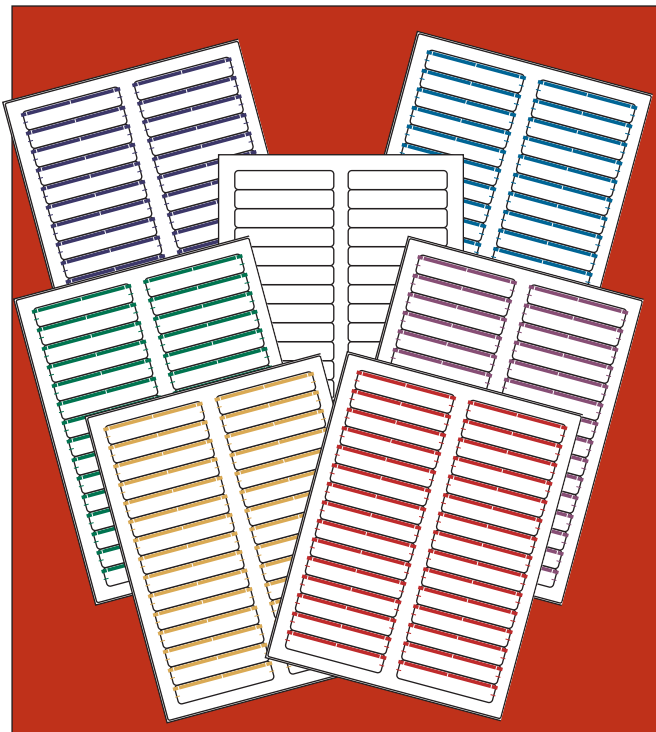

Laser/inkjet name labels are easy to use with most label software. The paper and adhesive are formulated specifically for use in laser or inkjet printers. 30 labels per sheet, 25 sheets per package, 750 labels per package.

Overall sheet size: 8-1/2" x 11"
Label size: 3-7/16" x 2/3" – Color bar or White



stock no.	color	1 @	5 @	10 @
791-49437	Dark Blue	\$14.25	\$13.75	\$13.25
791-49436	Green	\$14.25	\$13.75	\$13.25
791-49431	Blue	\$14.25	\$13.75	\$13.25
791-49443	Purple	\$14.25	\$13.75	\$13.25
791-49432	Red	\$14.25	\$13.75	\$13.25
791-49441	Tan	\$14.25	\$13.75	\$13.25
791-49430	White	\$14.25	\$13.75	\$13.25

1-UP NAME LABELS

Self-adhesive file folder labels attach permanently to file folders, cards, etc. Color coded for easy identification and smudge proof for legibility. Available in convenient sheets, in white and 6 colors ready for typing or writing. Labels are 3-7/16" x 9/16" in size, 248 labels per package.



stock no.	color	1 @	5 @	10 @
791-59437	Dark Blue	\$4.45	\$4.25	\$3.45
791-59436	Green	\$4.45	\$4.25	\$3.45
791-59431	Blue	\$4.45	\$4.25	\$3.45
791-59443	Purple	\$4.45	\$4.25	\$3.45
791-59432	Red	\$4.45	\$4.25	\$3.45
791-59441	Tan	\$4.45	\$4.25	\$3.45
791-59430	White	\$4.45	\$4.25	\$3.45

WRAP AROUND NAME LABELS

Use Microsoft Word® and any laser/inkjet printer to create wrap-around name labels for file folders, pockets, jackets, etc. Easy set-up instructions for both drawer and shelf filing applications in each package. 12 labels per sheet, 240 labels per package. 8-1/2" x 11" sheets.

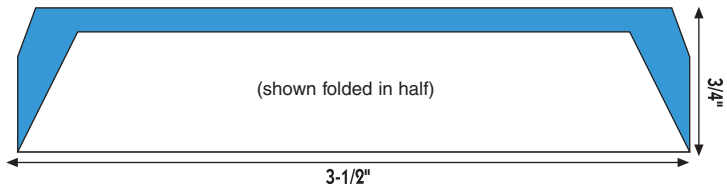

Acme® Abgor Name Labels compatible series



stock no.	color	1 @	5 @	10 @
791-49401	Blue	\$12.75	\$12.25	\$11.75
791-49402	Brown	\$12.75	-	\$12.25
791-49403	Green	\$12.75	-	-
791-49404	Orange	\$12.75	\$12.25	\$11.75
791-49405	Red	\$12.75	-	-
791-49406	White	\$12.75	-	-

Create the perfect message for your practice! It's simple!

LaDeana DeClark, D.D.S.
 234 Somewhere Street
 Anytown, WI 54321
 Phone: 555-555-1212

Because your dental health is important to us, we'd like to remind you that it's time for your examination. We look forward to seeing you!

Please call today to schedule an appointment

Your appointment is on _____ at ____:____.

Thank You.

Dental Health Products, Inc. • 800-626-2163

PLACE STAMP HERE

PERSONALIZE WITH YOUR PRACTICE INFORMATION

ADD A MESSAGE HERE

STANDARD MESSAGE ORDERING

1. Choose the version number from below.
2. Indicate your personalization. Five lines maximum for name and address area. Available in black ink only.

CUSTOM MESSAGE ORDERING

1. Create your own message. Postcard accommodates up to 50 words, plus postcard mailing area.
2. Indicate your personalization. Available in black ink only.

Version 1

As you requested we are sending you a friendly reminder that it's time to schedule an appointment. Please call us today for a time that's convenient for you. *Thank you.*

Version 5

Because your dental health is important to us, we'd like to remind you that it's time for your examination. We look forward to seeing you!

Please call today to schedule an appointment

Your appointment is on _____ at ____:____.

Version 9

It's time for your dental checkup and cleaning. Please call today for an appointment. *Thank You.*

Version 2

Your health is important to us! This is a reminder that we have reserved an appointment for you on _____ at ____:____. If you are unable to keep this appointment, please call to reschedule as soon as possible. We look forward to seeing you.

Version 6

It's time for your examination.

Please call today to schedule an appointment

Your appointment is at ____:____ on _____.

Thank You.

Version 10

As a new patient, you deserve a special thank you! We are pleased to welcome you to our practice and thank you for choosing us. We look forward to seeing you again. If you ever need anything, just let us know.

Version 3

This is a reminder that your next appointment is on _____ at ____:____.

Thank You.

Version 7

Because your dental health is important to us, we'd like to remind you that it's time for your examination. We look forward to seeing you!

Please call today to schedule an appointment

Your appointment is on _____ at ____:____.

Thank You.

Version 11

We moved! We're pleased to announce the new location of our office. We're conveniently located to serve you even better. We look forward to showing you around on your next visit.

Version 4

We missed you! Please call our office today to reschedule your appointment.

Thank You.

Version 8

Good dental health is important! Please call us today for an appointment. *Thank You.*

Version 12

A new Office! We're pleased to announce the opening of our new office. We look forward to seeing you at the address shown above.



Animated Dental Cards

Animated Dental Postcards
Assorted

Animated Dental Cards

DHPI Office Products now brings you Postcards, Appointment Cards and Business Cards! Four dazzling animated styles that are a perfect fit for your dental practice! Postcards, Appointment Card and Business Cards are perforated for your convenience. All postcards are sold 4 up for laser printing. Postcard Size: 5-1/2" x 4-1/2"



Appointment Reminder Assorted Postcards

65 lb. white stock, 4-cards per sheet (100/pkg.)

792-1091	1 @	\$17.95
	2 @	\$16.95
	4 @	\$15.95

Each 8 1/2" x 11" sheet has four perforated postcards, 4 1/4" x 5 1/2". 25 sheets, 100 cards per package.
 1@\$18.95 2@\$18.45 4@\$17.95



790-RCL759



792-RCL861



790-RCL1297

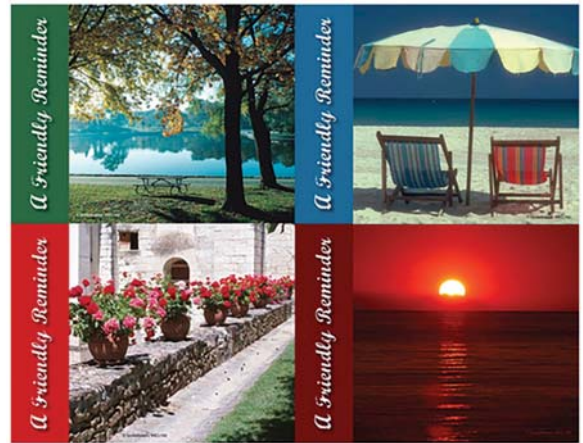

790-RCL740



790-RCL1032

Each 8 1/2" x 11" sheet has four perforated postcards, 4 1/4" x 5 1/2". 25 sheets, 100 cards per package.
 1 @ \$18.95 2 @ \$18.45 4 @ \$17.95



790-RCL742



790-RCL745



790-RCL1159



790-RCL761



790-RCL1168



790-RCL1158



Bring the great outdoors indoors. These panels bring the vibrant look of the outdoors, inside your office. Experience the calming and pleasant effect our beautiful panels bring to any application. The applications are only limited by your imagination! Sky-Scapes transforms your existing fluorescent lighting with a smooth, calming and beautiful outdoor scene. They are beautiful translucent panels that replace your existing diffuser and reduce harsh glare. Installation is easy and can be completed in a few minutes with minimal effort. Durastrong material is flexible, easy to cut and will last 10+ years without yellowing! Panels measure 23-3/4"W x 47-3/4"L. **Contact your DHPI Account Manager for pricing.**

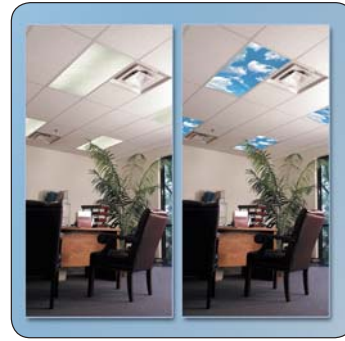

795-FLUFFYCLOUD



795-BIRDS



795-HOTAIR



795-PALMTREE

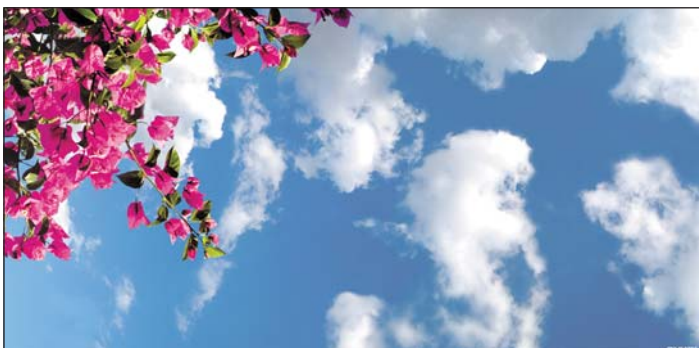

795-FLOWERS

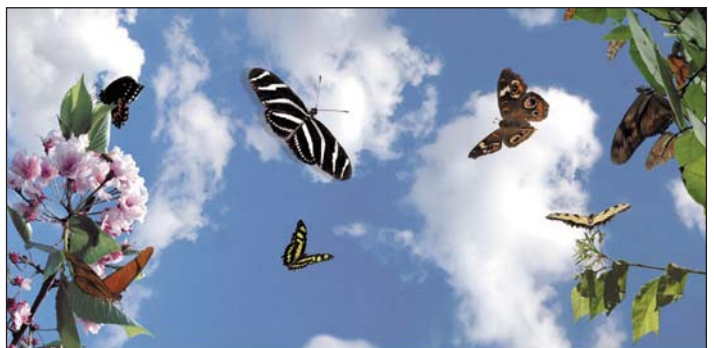

795-BUTTERFLIES



795-CURIOUSANIMALS



795-OCEANVIEW

Your perfect cup, made simple!

Keurig® single cup brewers make a perfect cup of individually brewed beverages – in under a minute. With over 200 varieties of coffee, tea and hot cocoa, plus nothing to pour, measure or clean up, Keurig is the new way coffee gets made, at home or at the office.



CHOOSE • BREW • ENJOY



Keurig® K140 Brewer

Perfect for offices of 15 or less. Features three brew sizes of 6oz., 8oz. and 10oz. Just press the Auto-Off feature to automatically turn the brewer off in two hours. Travel mug friendly.
770-K140 - Call for pricing.



Keurig® K150 Brewer

Perfect for offices of 30 or less. Features three brew sizes of 6oz., 8oz., 10oz. & 12oz. This feature-rich brewing system will satisfy all your employees' coffee, tea, hot cocoa or iced beverage preferences. Ideal for the waiting room.
770-K150 - Call for pricing.

Wire Display Rack - 4 Sleeve

- Black wire frame display rack
- Holds 4 x 25 K-Cup® pack sleeves
- Pre-assembled, ready to use out of the box
- Includes removable single section condiment tray

Dimensions: 9.25"W x 12.5"D x 17.5"H

790-5066..... Each



Wire Display Rack - 8 Sleeve

- Black wire frame display rack
- Holds 8 x 25 K-Cup® pack sleeves
- Pre-assembled, ready to use out of the box
- Includes removable 3 section condiment tray

Dimensions: 18.25"W x 12.5"D x 17.5"H

790-5065..... Each

Paper Hot and Multi-Use Cups - Green Mountain Coffee®

These cups use a resin lining made from plants, 100% natural and annually renewable resource.

Eco Paper Hot Cup 10oz. 790-GMT93767PK 50/Pack

Eco Paper Hot Cup 12oz. 790-GMT93766PK 50/Pack

Eco Multi-Use Beverage Cup 12oz. 790-GMT93766..... 1000/Case

Eco Multi-Use Beverage Cup 16oz. 790-GMT93768..... 1000/Case

Plastic Lids - Green Mountain Coffee®

Designed to fit Paper Hot Cups listed above.

Lock Tab/Flat/White 790-GMT93782..... 1000/Ctn

Domed/White 790-GMT93783..... 1200/Ctn

K-Cup® Pack

For use in Keurig® brewing systems. Enjoy your choice of acclaimed beverages one perfect cup at a time.



To learn more about K-Cup® pack coffee, tea and hot cocoa varieties, contact your DHPI Representative, today!

Regular



The Original Donut Shop™ K-Cup® Coffee - Coffee People®

All-American roast is quickly becoming one of this roaster's most popular varieties. Medium-roasted, premium Arabica beans deliver a slightly bright, smooth flavor with sweet overtones.

790-DIE60052101

24-Pack



Italian Roast Coffee - Tully's®

For an intense, full-bodied cup with a slightly more pronounced zippy bite than may be found in other robust roasts, Italian roast coffee is the perfect choice. When you sip this Southern European dark roast, sophisticated hints of caramel and spice will bring your palate to life. Extra Bold.

790-GMT193019

24-Pack



Newman's Own® Special Blend Extra Bold - Newman's Own® Organics

These singles are an extra bold blend of medium-roasted Central American and dark-roasted Indonesian coffees. Rich in taste with notes of dried fruit and dark chocolate while mild in finish with a slightly astringent berry bite, they're a study in contrasts that satisfies an extremely wide range of coffee drinkers. Fair Trade Certified™ organic coffee.

790-GMT4050

24-Pack

Regular



Colombian Fair Trade Select Coffee - Green Mountain Coffee®

Each sip of this bold, complex, single-origin Fair Trade coffee bursts with ripe fruit notes and sweet walnut tones. A medium body and a smooth finish with 100% Colombian beans.

790-GMT6003

24-Pack



Breakfast Blend Coffee - Green Mountain Coffee®

Always rich, balanced and smooth, never too weak, never too strong, gourmet Green Mountain Coffee® Breakfast Blend will please anyone. A wakeful harmony of crisp, citrusy Central American and sweet, full-bodied Indonesian beans.

790-GMT6520

24-Pack



Dark Magic® Extra Bold Coffee - Green Mountain Coffee®

Dark Magic® is sweet, intense and vibrant with a pleasing, lingering finish. A traditional cup of coffee that features the rich aromatics and flavor qualities of espresso. This syrupy Indonesian, Latin American blend is tailored to fit like a Savile Row suit.

790-GMT4061

24-Pack

Regular



Mahogany Coffee - Caribou Coffee®

Fans of rugged, robust dark roasts must try this blend. Its flavor tones of molasses, spice and semi-sweet chocolate provide a wonderfully complex experience. This Sumatran-Central American bean blend hits all the notes as well as a fine mahogany musical instrument.

790-GMT6990

24-Pack



Emeril's® Big Easy Bold Coffee - Emeril's®

Classic deep, dark Parisian roast captures the essence of the "most unique" city in America. Thick and hearty with an invigorating aroma, even those born and bred on the bayou confuse Big Easy Bold for their mother's fresh brew. Rainforest Alliance Certified coffee.

790-TWCPB4137

24-Pack

Decaf



French Roast Decaf Coffee - Tully's®

The powerful, intense flavor and smoky, decadent finish of these decaf singles have made it this roaster's most popular variety. This carefully roasted Guatemalan and Ugandan 100% Arabica, decaffeinated coffee blend more than deserves its acclaim.

790-GMT192419

24-Pack

Decaf



Breakfast Blend Decaf Coffee - Green Mountain Coffee®

Green Mountain Coffee® provides this naturally decaffeinated variety. Providing the same blend of crisp, citrusy Central American and sweet, full-bodied Indonesian beans, this coffee always brews with the perfect balance of vibrancy and smoothness.

790-GMT7522

24-Pack



Special Decaf - Newman's Own® Organics

This water-process decaffeinated coffee is a special blend of medium-roasted Central American and dark-roasted Indonesian beans. Rich in taste with notes of red wine and chocolate while mild in finish with a shallow but quiet persistence, they're a study in contrasts that satisfies an extremely wide range of coffee drinkers.

790-GMT4051

24-Pack



Dark Magic® Decaf Extra Bold Coffee - Green Mountain Coffee®

Dark Magic® is sweet, intense and vibrant with a pleasing, lingering finish. If you've been searching for a traditional cup of decaffeinated coffee that features the rich aromatics and flavor qualities of espresso, look no farther. This syrupy Indonesian, Latin American blend is tailored to fit like a Savile Row suit.

790-GMT4067

24-Pack

K-Cup® Pack

Flavored



Caramel Vanilla Cream Coffee - Green Mountain Coffee®

Delicious blend of caramel, toasty brown sugar and vanilla cream flavors caress the palate. Premium, medium-roasted beans brew a classic American city-style cup.

790-GMT6700 24-Pack



French Vanilla Coffee - Green Mountain Coffee®

If you love vanilla, you have to try this lusciously rich, flavored coffee. Inspired by the aromas and tastes of an artisan bakery, it's both sweet and creamy. This premium 100% Arabica coffee is an absolute treat.

790-GMT6732 24-Pack



Hazelnut Coffee - Green Mountain Coffee®

People, who prefer a very light, aromatic coffee with a flavored creamy body and smooth finish, love this coffee. Buttery and sweet with the essence of Piedmont hazelnuts, it's a coffee that promises to please.

790-GMT6792 24-Pack

Flavored



Fair Trade Wild Mountain Blueberry Coffee - Green Mountain Coffee®

A subtle berry-sweet, slightly buttery aroma underscores the special nature of this Fair Trade Certified coffee. The light roasted beans brew a lively, eye-opening cup with the flavor of sun-kissed blueberries in a buttery crust.

790-GMT6783 24-Pack

Tea



English Breakfast Black Tea - Celestial Seasonings®

Drinking this soothing, invigorating all-natural tea is a true pleasure. Made with only the highest quality black teas from Assam and Kenya, this robust English breakfast variety is guaranteed to tantalize your senses.

790-GMT14731 24-Pack



Green Tea - Celestial Seasonings®

People from around the world drink green tea to lift their spirits and to savor the smooth, full-bodied flavor. Green tea, a natural source of antioxidants (free radical neutralizers) offers many of the same health benefits as eating fruits and vegetables. Enjoy this delicious, 100% natural tea any time of the day or night.

790-GMT14734 24-Pack

Tea



Tea K-Cup® Pack Sampler, Assorted Flavors - Celestial Seasonings®

Four delectable varieties, including English Breakfast, Green Tea, Lemon Zinger® and Sleepy-time®, provide an ideal match for just about any occasion. Premium, 100% natural tea and herbs are an excellent alternative to coffee.

790-GMT6505 22-Pack



India Spice Tea - Celestial Seasonings®

Enjoy the health benefits of antioxidant-rich tea and savor an intriguing, delicious flavor that stands apart from the crowd. This tea features a fusion of meticulously blended premium black teas and natural, exotic spices that can't be beat.

790-GMT14738 24-Pack

Iced Beverage



Southern Sweet Perfect Iced Tea - Celestial Seasonings®

A sweet, Southern summer tradition. Bold, black tea with added natural sugar cane.

790-GMT6825 22-Pack

Cocoa/Other



Milk Chocolate Hot Cocoa - Café Escapes®

Developed with expert European chocolatiers to provide a sophisticated take on a traditional classic.

790-GMT6801 24-Pack



Chai Latte Specialty - Café Escapes®

Transport yourself with this aromatic blend of black tea and exotic spices. An added touch of milk and sugar completes the latte.

790-GMT6805 24-Pack



Hot Apple Cider - Green Mountain Naturals®

Made with real apples, brown sugar and cinnamon. Contain no artificial flavors or preservatives.

790-GMT6201 24-Pack



CLEANING PRODUCTS



A Formula 409® Glass & Surface Cleaner Ideal for glass, stainless steel, aluminum and other hard surfaces. Unique formula cuts dirt and grease without streaking. Ready-to-use, no-rinse formula leaves no residue. Biodegradable and phosphate-free.

No.	Size	Qty.	Unit	Price
790-COX35293EA	32oz., Trigger Bottle	1	EA	\$7.95
790-COX35293CT	32oz., Trigger Bottle	9	CT	\$56.25

B Free & Clear™ Natural Glass & Surface Cleaner Natural glass and surface cleaner leaves no streaks and is 100% VOC free. This nontoxic, hypo-allergenic cleaner creates no harsh, unpleasant fumes and will not leave harmful residues. It's vegetable-based, not made with alcohol- or petroleum-based solvents and contains no dyes or fragrances. Biodegradable and not tested on animals.

No.	Size	Qty.	Unit	Price
790-SEV22713	32oz., Trigger Bottle	1	EA	\$9.95

C Windex® Powerized Formula™ Glass & Surface Cleaner Fast, easy cleaning with Ammonia-D®. Won't streak or leave a film. Also cleans chrome, stainless steel, Plexiglas® and other hard surfaces.

No.	Size	Qty.	Unit	Price
790-DRA90135EA	32 oz., Trigger Bottle	1	EA	\$8.45
790-DRA90135CT	32 oz., Trigger Bottle	12	CT	\$96.25
790-DRA90940CT	1 gal., Bottle	4	CT	\$78.95
790-DRA90129EA	20 oz., Aerosol	1	EA	\$7.75
790-DRA90129CT	20 oz., Aerosol	12	CT	\$82.95

D Misty® Glass & Mirror Cleaner with Ammonia Readily lifts soil and grease from windows, glass counters, windshields, mirrors and more; dries quickly without streaking or hazing.

No.	Size	Scent	Qty.	Unit	Price
790-AEPA12120EA	19 oz., Aerosol	Mint	1	EA	\$5.25
790-AEPA12120CT	19 oz., Aerosol	Mint	12	CT	\$48.25
790-AEPR1214EA	1 gal., Bottle	Mint	1	EA	\$13.95
790-AEPR1214CT	1 gal., Bottle	Mint	4	CT	\$45.25

E Pledge® Multi-Surface Cleaner Cleans many surfaces, including wood, glass, stainless steel, granite and electronics.

No.	Size	Qty.	Unit	Price
790-DRACB214599EA	16 oz., Trigger Bottle	1	EA	\$9.45
790-DRACB214629EA	25 count Wipes	1	EA	\$9.45
790-DRACB214629CT	25 count Wipes	12	CT	\$98.95

F Whistle® All-Purpose Cleaner Tackles the toughest grease and grime. Use on washable hard surfaces, walls, floors, cabinets, appliances, fixtures. No rinsing, no streaking, no dulling residue and no phosphates.

No.	Size	Qty.	Unit	Price
790-DRA91218CT	1 gal., Bottle	4	CT	\$122.95

AIR FRESHENERS



A Neutra Air® from the Makers of Lysol® Provides a triple-action benefit. Neutralizes odors in the air from odor-causing bacteria; helps reduce airborne contaminants; leaves crisp, clean fragrance.

No.	Scent	Size	Qty.	Unit	Price
790-RAC76938EA	Fresh	10oz.	1	EA	\$7.45
790-RAC76938CT	Fresh	10oz.	12	CT	\$68.95
790-RAC76940EA	Citrus	10oz.	1	EA	\$6.45
790-RAC76940CT	Citrus	10oz.	12	CT	\$63.75

B Lysol® Neutra Air® FreshMatic® Starter Kit Designed to automatically neutralize odors in the air from odor-causing bacteria—making sure your bathroom, kitchen and office smell fresh and clean. Three automatic settings—9-, 18- and 36-minute intervals. For immediate action press the express button to deliver an extra boost of freshness. Lasts up to 60 days. Kit includes one dispenser, one 6.17oz. aerosol can and two AA batteries.

No.	Scent	Size	Qty.	Unit	Price
790-RAC79830	Fresh	6.17oz.	1	KT	\$25.25

C Lysol® Neutra Air® FreshMatic® Refill Don't allow your Neutra Air® freshener unit to run out of product—simply keep this refill on hand.

No.	Scent	Size	Qty.	Unit	Price
790-RAC79831	Fresh	6.17oz.	1	EA	\$12.45

FACIAL TISSUE



Eco-Soft™ - Bay West

Made from 100% recycled paper. 100 2-ply tissues per box. White.
680-130 30 boxes/case\$41.45



Angel Soft™ Facial Tissue - Georgia-Pacific

Cube Box
680-46560 36 boxes/case\$79.95

Flat Box
680-48560 30 boxes/case\$67.95



Kleenex™ Facial Tissue - Kimberly-Clark

Polyshield dispensing protects each tissue. Soft and strong. 2-ply tissues. White.

100 tissues per box
680-21400 36 boxes/case.....\$64.95

125 tissues per box
680-21600 48 boxes/case.....\$97.25



Anti-Viral Kleenex™ Facial Tissue

Moisture-activated middle layer that is scientifically proven to kill cold and flu viruses. When moisture from a runny nose, cough or sneeze comes in contact with Kleenex Anti-Viral Tissue's special middle layer, cold and flu viruses are trapped and killed. 68 sheets/cube.
680-25836 27/case\$116.25



Surpass Facial Tissue

Convenience case. 100 2-ply tissues per box. White.
680-2365 30 boxes/case.....\$47.45

TOILET TISSUE



Angel Soft White Bath Tissue - Georgia-Pacific

Two lush plies of the thickest tissue available and our unique quilted emboss combine to offer maximum softness, thickness, strength and absorbency. 2-ply.
680-16580 80 rolls/case\$84.95



Cottonelle® - Kimberly-Clark

Cottony soft 2-ply. 505 sheets/roll. White.
680-7713 60 rolls/case\$72.95



Scott® Tissue - Kimberly-Clark

Made from 100% recycled paper. 2-ply. 605 sheets/roll. White.
680-04460 80 rolls/case\$83.25

TRASH LINERS



Economy Liners Linear Low Density

Poly - Belson
Lightweight, twist ties included. Ideal for office use.

7-10 Gallon - 15" x 9" x 23"
Clear370-2410C
500/case\$43.25

12-16 Gallon - 24" x 32"
Black.....370-3310B
Clear.....370-3310C
500/case\$52.25

20-30 Gallon - 30" x 37"

Clear370-3715C
250/case\$51.25

33 Gallon - 33" x 40"

Black.....370-4015B
Clear.....370-4015C
250/case\$60.75



High Density Poly - Belson

Lightweight but strong, twist ties included. Star design bottom seal. Ideal for office use. Translucent.

10 Gallon 6 microns - 24" x 24"
370-24240 1000/case.....\$54.45

30 Gallon 10 microns - 30" x 37"
370-6037 500/case\$51.25

30 Gallon 12 microns - 30" x 37"
370-30372 500/case\$89.25

33 Gallon 16 microns - 33" x 40"
370-33403 250/case\$37.25

44 Gallon 13 microns - 40" x 48"
370-40483 250/case.....\$98.75



Super Heavyweight Refuse Liners

Heavy-duty bag on a roll. Tough. Resistant to splitting, tearing and puncture.

10 Gallon White
370-2424 500/case.....\$69.95

15 Gallon White
370-2433 500/case.....\$94.95

30 Gallon Black
370-3037 200/case.....\$72.95

33 Gallon Black
370-3340 200/case\$87.95

40 Gallon Black
370-4048 100/case.....\$95.95

55 Gallon Black
370-3660 100/case.....\$98.95



SOPRO 717 First

The Sopro 717 First allows you to go beyond the limits of human vision while casting off bulky accessories. This is MacroVision.

As a result, you can film a cavity preparation, make a surface state, acquire images of micro-fissures, cervical lesions – while fully appreciating the exceptional image quality of the SOPRO 717 First. The focusing ring of the SOPRO 717 First allows great depth of field, whichever operating mode you choose (extraoral, intraoral and macro). This camera fits in perfectly with your dental practice environment and can be perfectly integrated into all dental units.

Features

- High sensitivity 1/4" CCD.
- Resolution:(752x582) PAL;(768x494) NTSC.
- Definition: 470 lines.
- Sensitivity: 2 lux.
- Lighting: 8 LED.
- Adjustment: 3 pre-set positions (Extra-oral, Intraoral, Macro).
- Non-inverted image.
- Freeze Frame with SoproTouch or pedal (option).
- Angle of view: 70°.
- Cable length: 2,5 m.
- Dimensions of the handpiece in mm: L. 200 x W. 28 x H. 24.
- Dimensions of the distal part in mm: l. 13 x H. 8.
- Weight: 75 gm



CamX® Elara

- Designed with all ergonomic demands in mind, this sophisticated intraoral camera will improve patient communication, leading to higher case acceptance and better tracking of treatment.
- Excellent Image Quality: 8 White Light LEDs positioned around the lens provide bright homogeneous image quality
- Always in focus from 5-35mm making the camera easy to use and eliminating the need for further adjustments

Please see your DHPI Equipment Specialist for pricing and availability in your area.



CamX Triton HD

CamX Triton HD Interchangeable Head System - caries detection and intraoral imaging with autofocus and real HD image quality. From communication and caries diagnostics to documentation and tracking progress, we've got you covered. The CamX Triton HD system from Air Techniques provides valuable support in dental treatments and fosters patient understanding of your treatment recommendations

NEW



Iris HD

The new IRIS HD USB 3.0 brings the smallest details into brilliant full-screen high-resolution focus. With dual capture buttons and one-touch focus, control is always within reach. IRIS HD even knows to turn itself on and off when you pick it up or set it down. Extreme clarity in HD is obtained with the IRIS HD precision optical lens array and Sony's advanced HD sensor for the finest picture quality. A touch of the button and the newly designed electronic focus will advance automatically to the next focus mode, all five positions are shown onscreen. Equipped with a motion sensor, it will Auto-On when lifted and Auto-Off after ten minutes of inactivity. The streamlined soft-tip has brilliant 8-point LED lighting and a new tapered USB 3.0 connector that fits in a standard delivery unit.



Please see your DHPI Equipment Specialist for pricing and availability in your area.

CAMERAS

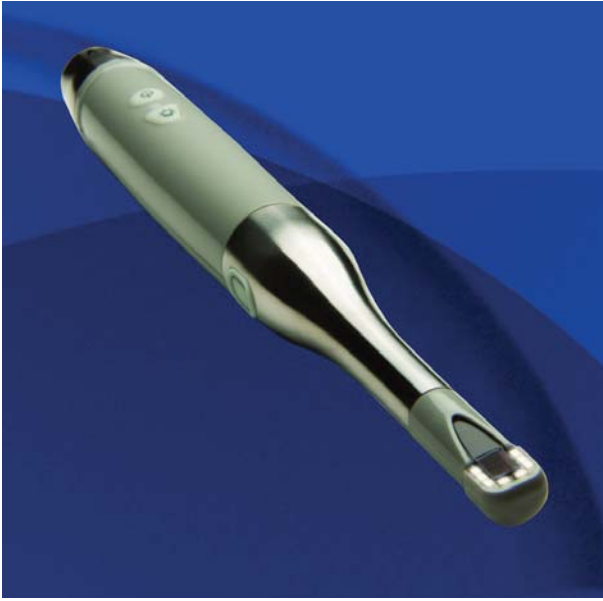
**Iris LTE**

Bring the power of the new IRIS LTE Intraoral Camera into every operator. This precision optical instrument features an easy to use fixed focus system with dual capture buttons and a unique USB connector that fits in a standard delivery unit.

The elegantly streamlined profile has a smaller, specially designed soft-tip with brilliant 8-point LED lighting and with Sony's Hi-Resolution CCD, it produces the finest picture quality.



futudent»

EduCam HD

Futudent EduCam is the world's leading dental video solution created by top dentists for daily use in your practice. Capture everything you see, handsfree without interrupting your work. Take HD video and images and share your findings with patients and other dental professionals. It's the most easy-to-use, highest quality camera on the market and probably the only camera you will ever need.

Please see your DHPI Equipment Specialist for pricing and availability in your area.

NEW



Wired & Wireless Cameras

Our goal is to make powerful technology more accessible, relevant and personal. The Polaroid Wired & Wireless Intraoral Cameras represent a new chapter in this relationship. Refine your case presentation and improve your patient education capabilities. Practical functions of our ultramodern intramural camera include angle rotation, a detachable head, caries detection and more. Take oral care to the next level.



Claris i4D

The award winning Claris i4D Intraoral Camera is the highest quality intraoral camera in the dental market. Designed and manufactured in Southern California by SOTA Imaging, the Claris i4D boasts a unique high end lens, hand control focus, and compatibility with almost all dental imaging software.

Features

- Precision optics with focal range of 1 mm-infinity for macro to full facial shots
- Precision controlled sliding focus
- 8 white LED lights
- Ergonomic hand-piece that weighs only 2.4 oz
- Silicon capture button for image stability
- Integrates seamlessly with almost all dental imaging software.
- Secure Monster® USB cable connection
- Light ON/OFF capability available with special order



Please see your DHPI Equipment Specialist for pricing and availability in your area.

Order by 800-626-2163

www.dhponline.com

Fax: 888-681-5088

645

CAMERAS



sun*i*

ImageMaster

The Suni ImageMaster intraoral camera continues Suni's commitment to providing high-quality digital imaging tools that help practitioners maximize their practices' diagnostic capabilities and workflow efficiency. With precision optics that produce crisp, high-quality images and an easy-to-use plug-and-play direct USB interface, Suni ImageMaster is designed to seamlessly integrate into your practice, allowing you to capture incredible images to educate your patients.



DrQuickLook™
DENTAL VIEWER

DrQuickLook SD

HD Camera with 6 super bright LEDs, choose from 3 resolutions with a simple TOUCH of the screen! Live survey, capture, zoom, and save countless "time-date" stamped images. Patient holds the viewer and will easily SEE what you SEE! Touch the screen and INSTANTLY review ALL saved images, zoom, move with your finger or delete unwanted images. Patients get involved and say yes to treatment, without the hassles that integrated intraoral camera's with USB cord can create. Drawn and undrawn images can both be saved, submit with insurance claim, transfer to electronic chart, or print. Reusable SD memory card, permanently save Time and Date stamped images in seconds. With a "single touch on the screen", do complete composite with occlusal views, lateral dental shots, anterior overjet, facial and more, then SAVE. Provides a LARGE image for patients to "see what you see". Great for Patient Education video's and slides. Charging SD PLUS with Rechargeable Li-Ion Battery. SD PLUS can charge overnight in countertop/wall mounted charger, plug in to any wall outlet. Up to 8 hours of continuous use. Battery life is up to 4 years and replacement is easy.

Please see your DHPI Equipment Specialist for pricing and availability in your area.



SOPROCARE®

The SOPROCARE concept was developed to assist the dental professional during prophylaxis and periodontal treatment in the dental office. The camera utilizes unique fluorescence technology (SOPRO patent - 2003) to illuminate dental tissue to reveal caries, as well as plaque and tartar. In addition, SOPROCARE is the first product on the market to reveal gingival inflammation. In Daylight Mode, SOPROCARE can also be used as a camera, providing aUJ of the necessary tools to perform a complete and time efficient oral examination. The dental professional can now achieve complete prophylactic treatment with one device.



SOPROLIFE

ACTEON Group introduces SOPROLIFE, a new imaging fluorescence device aiding in the diagnosis and treatment of caries. The latest generation in dental imagery solutions, SOPROLIFE provides unsurpassed image quality.

SOPROLIFE functions "live" in three modes (Diagnosis, Treatment and DAYLIGHT) and are free from ultraviolet or ionizing rays. The auto fluorescence technology in SOPROLIFE allows you to detect occlusal or interproximal decay, even in its earliest stages, which can often be missed by the eyes or by x-rays. SOPROLIFE even allows you to differentiate healthy from infected tissue in order to excavate only the tissue which is diseased.

And thanks to its versatility (can be used with a simple monitor or any imaging software), sleek profile, and ease of use it will fit naturally into your dental practice.



CamX Spectra

- The only caries detection aid that uses fluorescence technology to visualize and discover caries earlier, as well as plaque and calculus.
- 4 Violet LEDs stimulate metabolic products found in cariogenic bacteria, causing them to glow red while healthy enamel glows green
- Caries and plaque filters in the imaging software show caries activity by means of a color scale and numeric evaluation
- Repeatable and reliable documentation for monitoring progress of caries due to the 8mm spacer



Please see your DHPI Equipment Specialist for pricing and availability in your area.

DIGITAL PROCESSORS



ScanX® Digital Radiography Systems

Digital Imaging Without Limits.

Your complete digital X-ray solution that works with ALL image sizes: 0, 1, 2, 3 and 4; Panoramic; Cephalometric; and TMJ. ScanX utilizes photo stimuable phosphor (PSP) technology. These wafer-thin, flexible and wireless PSP imaging plates provide ample comfort for every patient. Dentists are choosing PSP as their digital option due to its many advantages over film, including: faster image development; better clarity; greater convenience; no costly chemicals or processor maintenance; and paperless efficiency. Best of all, there is no need for special training, as workflow and placement technique are identical to film.

ScanX is available in 4 models to meet the needs of your practice

Classic

This do-everything four track system can read images simultaneously from 4 PSPs in seconds. ScanX Classic accepts intraoral PSP sizes 0, 1, 2, 3 and 4 and extraoral Pan, Ceph, and TMJ PSPs.

Duo

This small and efficient two track system is capable of reading images simultaneously from 2 PSPs. ScanX Duo accepts intraoral PSP sizes 0, 1, 2, 3 and 4 for patients of all ages and anatomies.

Intraoral

Centralized intraoral workhorse capable of reading images simultaneously from 4 PSPs. Accepts intraoral sizes 0, 1, 2, 3 and 4.

Swift

Chairside Imaging- this quick and efficient one track system is capable of reading intraoral PSP sizes 0, 1, and 2 for patients of all ages and anatomies.

Please see your DHPI Equipment Specialist for pricing and availability in your area.



PSPIX Personal Imaging Plate Scanner

Combining revolutionary size, modern design and remarkable ease-of-use, the PSPIX represents the next level of PSP design, technology and function.

The PSPIX features a very small footprint, high quality and contrasted images, incredibly fast acquisition times and removable parts for easy sterilization. Tightly integrated with Sopro Imaging software, the PSPIX is available for both the Windows and OS X operating systems and can be shared across a local area network.



Because we care.

ClearVision® CR Digital Radiography Reader

Whether you are looking for a central reader or an affordable exam room based solution, the Midmark ClearVision® CR Digital Radiography Reader is the right choice for any practice. With its small footprint and elegant design, the reader fits seamlessly into even the smallest dental offices and exam rooms.

- LCD Screen—intuitively guides users through operations and offers image preview
- Magnetic Feeding Tray—push and go functionality is designed to ensure ease-of-use and perfect plate positioning
- Built-in Erase Function
- Full range of reusable plates come standard—including size 4C
- Progeny® Imaging Software is included with purchase to optimize acquisition, processing and image management



NEW

Please see your DHPI Equipment Specialist for pricing and availability in your area.

Order by 800-626-2163

www.dhponline.com

Fax: 888-681-5088

649



SOPIX²

The Sopix², digital x-ray system integrates the best of modern technology, including fibre-optic based CMOS, which ensures exceptional image quality. The ACE technology is a Sopro exclusive process that makes it possible to control the amount of x-rays accumulated by the sensor. It protects each image from overexposure and ensures that all your images are always clear. User friendly and compatible Sopix² will easily fit your practice whatever the configuration. Two sensor sizes have been proposed. In order to improved patient comfort, the corners of the sensor are rounded for easier placement inside the mouth.



DentiMax Dream

Affectionately termed the Dream Sensor, the DentiMax boxless sensors represent the latest in CMOS digital radiography, producing incredibly crystal-clear, film-like x-ray images. The DentiMax sensors' rounded corners and smooth edges make them the ideal sensor for patient comfort and patient compliance. Sensors are offered in adult and in youth sizes so as to provide the best fit for varying mouths. The adult size #2 sensor takes a large x-ray "footprint" while the youth size #1 sized sensor is the perfect fit for the smaller mouth. The sensors excel in every area, including: (1) Image Quality (2) Patient Comfort and (3) Hardware/Software Compatibility.

Please see your DHPI Equipment Specialist for pricing and availability in your area.



GXS-700

The GXS-700, designed to make migrating from film, or upgrading a digital system, easier than ever. As the eighth generation digital sensor from Gendex, the GXS-700 system comes from a strong lineage of imaging excellence, raising the performance bar for other digital sensors.

- High quality image capture provides brilliant diagnostic results
- Advanced CMOS sensor technology enhances image quality, elevating technical and diagnostic capabilities
- High-performance sensor captures high resolution images, providing more than 20 visible line pairs per millimeter
- Two ergonomically designed sensors improve patient comfort
- Direct hi-speed usb 2.0 connectivity offers optimum portability
- Software integration and "always ready" image capture improves workflow



Because we care.

ClearVision®

ClearVision makes digital practice integration simple while delivering high quality images in a durable, patient friendly design. With direct USB 2.0 connection, there is no need for docking stations or adapters. Advanced CMOS technology optimizes resolution producing sharp, detailed images for immediate diagnosis.



Please see your DHPI Equipment Specialist for pricing and availability in your area.



NEW

 **Polaroid**

Keren Sensors

Polaroid is proud to introduce its imaging product line the Keren & Keren HD intra-oral sensor. Superior image quality is guaranteed via high-definition, a theoretical resolution of >25lp/mm associated to 14 bit grey levels. Accompanying software further lends itself to image perfection as a color gauge on the finished image allows you to determine your optimal x-ray parameters. Additionally, image modification through standard software for the Keren HD, enables you to refine images through contrast, brightness and gamma values to your preference.



sota
 IMAGING

Clio

The Clio Digital X-ray Sensors are designed and manufactured in the world's leading facility of CCD and CMOS technology for guaranteed highest-grade imaging. These dental sensors have all the features and benefits that ensure a highly reliable product and deliver the best images in the industry.

Features:

- Direct Integration Technology
- Thin sensor hardware with rounded corners for maximum comfort
- Direct USB cable with no docking station
- Repairable USB cable for longevity of sensors
- Fiber optic plate sensors for low-noise ratio
- Largest active area for maximum coverage
- Fully waterproof sensor head with sealed cable and housing design
- USB connector: USB 2.0, USB 3.0
- Sensor Technology - Next Generation CMOS Fiber optic Sensors
- Maximum Gray Levels - 4096 (12-bit)

Please see your DHPI Equipment Specialist for pricing and availability in your area.

suni

Dr. Suni Plus

Dr. Suni Plus was designed to make the diagnostic process easy for doctors and comfortable for patients. The thinnest digital sensor in the world, Dr. Suni Plus is durably built—with an ultrasonically-sealed outer casing and reinforced cable attachment—without sacrificing patient comfort. Its versatile design and reliable performance allow Dr. Suni Plus to adapt to a variety of practice configurations making it the most flexible digital imaging system on the market. And as one of the few sensors available in a size 0 pedo-application, Dr. Suni Plus is the ideal solution for any practice.

- Patient Comfort. The thinnest digital sensor in the world, Dr. Suni Plus was designed for superior comfort with rounded corners that make positioning easy and allow the sensor to fit comfortably in the patient's mouth.
- Durability. A Bite Pressure Plate and Reinforced Cable Attachment make Dr. Suni Plus highly durable, allowing it to reliably withstand daily mechanical stresses. Dr. Suni Plus sensors also come with a full three-year warranty.
- Pedo Application. Dr. Suni Plus is one of the few intraoral digital sensors on the market that comes in a size 0—perfect for pediatric use. The rounded corners and industry-leading thin sensor design were crafted with younger patients in mind, for an easy and comfortable fit.
- Portability. Dr. Suni Plus was designed to take full advantage of its separate optical and electrical components. And because Dr. Suni Plus can be connected to each docking station without having to load the drivers each time a sensor is swapped, it's perfect for capturing full-mouth series where different sensor sizes are required.



HD Sensor

The HD Sensor is clinically usable at a wide range of exposure settings and is more consistent than all of the other sensors in the market. Practitioners benefit from a reduction of time consuming and exposure-related retakes. Also, patients benefit from the reduction of radiation exposure. With our high sensitivity sensor, you can capture diagnosable images under any condition, even when using an old X-ray source



Please see your DHPI Equipment Specialist for pricing and availability in your area.

X-RAY INTRAORAL

**XMind Unity™**

Discover X-MIND UNITY™, successor of X-MIND DC™, the famous bullet proof intraoral unit. With its elegant style coupled to the cutting edge patented ACE technology, X-MIND UNITY brings the standard of X-ray generator to a very new level. Perfect accuracy and patient protection are what no other X-ray system has been able to reach so far. With SOPIX Inside, the digital sensor connects seamlessly and effortlessly into the X-Mind Unity. SOPIX Inside digital sensors feature the patented ACE Technology and with ACE Technology, overexposed images are eliminated. Your patient will only receive the necessary and adapted dose to their dental morphology. The dose received by the patient after each exposure appears on the timer's screen. When used with SOPRO Imaging software, this dose is also recorded in the patient's file in SOPRO Imaging ensuring permanent traceability and recordkeeping. You can also single-handedly position and stabilize X-Mind Unity making adjustments effortless. The anti-vibration and anti-movement mechanism ensures drift free positioning during an exposure. This assures a perfect image every time, eliminating unnecessary retakes and further acquisitions. Both staff and patient are now protected from unnecessary radiation exposure.

**ProVecta HD**

ProVecta HD Intraoral X-Ray Perfect in function & design

- DC tube features a 0.4 mm focal point for maximum image sharpness
- The smaller the focal spot, the greater the contrast resolution, which provides sharper edge definition and finer details of internal structures
- ProVecta HD works with wired sensors, cordless flexible phosphor sensors (PSPs) and film
- Generator head handle allows precise positioning that stays in place
- Right-angle/parallel technology for precise alignment
- Adjustable mA and kV and exposure time
- Optional rectangular radiation field collimator
- DC technology allows constant radiation levels to ensure reliable image quality
- Our special generator head handle not only allows precise positioning, it makes the process more comfortable for both the clinician and the patient
- Choose from 3 Extended arm lengths: short (68"), medium (74"), and long (86")
- The DC tube reduces the patient radiation dose by more than 25% in comparison to conventional AC units, ensuring greater safety for your patients and staff
- This state-of-the-art unit's small footprint, coupled with its right-angle/parallel technology, allows it to work its magic in less space than less-advanced units
- Factory programmed dosage specifically set for each view of teeth when using ScanX flexible phosphor sensors (PSP)



Please see your DHPI Equipment Specialist for pricing and availability in your area.



NOMAD® Pro 2

Building upon the successes of previous innovation and design, the NOMAD Pro 2 provides the same mobile convenience and cost savings as previous models while also significantly increasing durability and performance. The Pro 2's newly designed battery handset, with infrared connectors, together with a new charging cradle improves the system's durability and boosts battery performance. Durability is further enhanced by a re-engineered user interface that is more scratch and moisture resistant.



PHOT-xlls

The PHOT-xlls DC Intraoral X-ray systems produces crystal clear radiographic images, while minimizing patient exposure to radiation.

- High frequency X-ray generator minimizes patient exposure to radiation
- Small, lightweight X-ray head facilitates easy positioning
- Individual and cumulative air kerma display settings aides operator staff with monitoring exposure radiation for patient safety
- Easy to use and compact microprocessor control module includes kV, mA, patient type, tooth type, cone type, film speed, exposure time and digital-ready selection switches
- Automatic and manual modes for optimal selection of parameters for each patient and tooth type
- 36 programmable time settings
- PHOT-xlls Intraoral X-rays include standard wall mounting plate or can be ordered with optional 4x4 stud/pass-thru mounting plate
- NEW Holder for digital imaging sensors



Please see your DHPI Equipment Specialist for pricing and availability in your area.



MaxRay

MaxRay offers a lightweight, truly portable, FDA-approved alternative to traditional x-ray machines. Weighing only 4.4lbs you can easily take x-rays anywhere and everywhere you go! MaxRay is 100% FDA-approved and meets all FDA standards for hand-held use. MaxRay features a permanently attached, extra long cone to protect the operator and the patient from unnecessary radiation exposure and a lead infused back scatter shield to protect the operator from potential back scatter.

Iridium Dental puts safety first, which is why the MaxRay was designed with patient and operator safety in mind. The MaxRay produces significantly less radiation than wall-mount units. This is particularly ideal for instances such as Pedo, Endo or Oral Surgery, where the operator may need to be in the room to position the sensor or secure the patient.

Add the optional rolling stand and remote switch and your MaxRay hand-held becomes a full-featured mobile x-ray machine.



Because we care.

Preva DC

Preva DC is a high frequency intraoral X-ray system that provides exceptional image quality. The smooth, drift-free arm is balanced in the factory, and a proprietary braking system provides drift-free positioning. The Preva's 0.4 mm focal spot allows for visibly higher resolution images when using digital receptors, phosphor plates or film. Only Preva DC offers such a powerful combination of features designed to provide incredible flexibility, razor-sharp images and years of productivity.

Please see your DHPI Equipment Specialist for pricing and availability in your area.



RXDC HyperSphere

RXDC HyperSphere Plus incorporates an ergonomically advanced touch-activated positioning technology and the freedom of wireless control.

HyperSphere technology: Locked and unlocked by 2 touch-sensitive areas, the tube head revolves freely around the spherical ball-joint, enabling freedom and precision in terms of positioning.

Easy controls: The wireless control device, which can be attached to any available surface in the surgery, offers a full range of intuitive exposure scenarios designed to make correct X-ray acquisition a straightforward process.

MyRay Multi-Mode: The most appropriate combination of technical factors (kV, mA and exposure time) is automatically determined according to patient size and anatomic region of interest.

Precision imaging: Excellent parallelism ensured by the incorporated 30 cm (12") collimation, combined with a 0.4 mm focal spot, places RXDC at the top for image definition quality.



EzRay

The Efficient functionality Intra Oral X-Ray for All Dental Specialists

- Make your practice extraordinary
- Secure Clear Image
- Intuitive & Easy to use operating panel
- Reliable Design for Easy & Stable use
- Sophisticated Design



Please see your DHPI Equipment Specialist for pricing and availability in your area.

X-RAY 2D/3D PANORAMIC

NEW

The ACTEON logo, featuring the word 'ACTEON' in a bold, sans-serif font with a blue swoosh underline.

X-MIND® TRIUM

ACTEON® presents its new X-MIND® TRIUM panoramic dental unit which can be upgraded to 3D (CBCT) and/or cephalometry. It has a full range of medium FOV sizes to facilitate 2D and 3D examinations. X-MIND® TRIUM is equipped with an acquisition and reconstruction algorithm which ensures a perfectly uniform and high quality image on all visual axes.



The AIR TECHNIQUES logo, featuring the words 'AIR TECHNIQUES' in a bold, sans-serif font with 'equipped for life™' in a smaller font above 'TECHNIQUES'.

ProVecta S-Pan

The Air Techniques ProVecta S-Pan revolutionary technology delivers unmatched sharpness with unmatched ease. The S-Pan automatically selects the sharpest areas, resulting in sharper images and faster, easier diagnosis. From a single exposure, the S-Pan acquires 20 layers of images and slices them into 20,000 fragments. The best are selected and compiled to generate a single, exceptionally sharp panoramic image--automatically!

- Diagnostic information is sharply displayed, including the mandibular canal and bone structure
- Uses a CsI sensor for better image quality and reduced radiation
- Panoramic images for adults within 7 seconds
- 17 X-ray programs for ease of diagnosis, including 2 sinus for paranasal sinuses
- The child modes reduce the dose by 45-56% and shortens the scan time
- Face-to-face positioning uses 3 positioning laser lines and X-ray transparent temple holders
- Audio announcements for staff and patients
- 7" touch-display for intuitive operation
- Long vertical path accommodates tall patients and wheelchair users

» pricing and availability in your area.



ProVecta S-Pan Cephalometric X-Ray

Quick cephalometric X-ray images with excellent image quality are achieved with the new ProVecta S-Pan Ceph and with the lowest possible dose. The two high-end CsI sensors – for panoramic X-ray and Ceph projection – already integrated in the unit eliminate the time consuming switching of the sensor, and thus the risk of damage. All this makes ProVecta S-Pan Ceph the ideal X-ray solution for your practice.

- Low X-Ray Dose – High Efficiency
- Very fast scan in 4.1 seconds (lat. head)
- Excellent image quality
- Low radiation dose
- 17 panoramic programs + 5 cephalometric programs for Head lateral L, PA head, SMV, Waters view and Hand



Bel-Cypher N

Simple to use and affordable, the Bel-Cypher Digital X-Ray System produces outstanding panoramic, TMJ, and bitewing imaging.

- Digital panoramic (child, adult), 4 view lateral, and bitewing (child, adult) imaging.
- High frequency X-Ray generator minimizes patient exposure to radiation
- Three-laser beam alignment system for correctly positioning patients mid-sagittal, frankfort, and focal-trough planes
- Sharp images can be obtained, even with mild positioning errors
- Fast 10 second scan time



Please see your DHPI Equipment Specialist for price

X-RAY 2D/3D PANORAMIC

**GXDP-300 & 700™ Pan Series**

The GXDP-300 incorporates the features you are looking for with the most commonly-used imaging modes: a simple, three-step pan process. With the GXPD-300 panoramic x-ray system, you get exactly what your practice needs—great-looking images at a competitive price.

The GXDP-700 is a modular system, upgradable from 2D panoramic to Cephalometrics or 3D Cone Beam with flexible field-of-view, or both. As you need it, you can increase your imaging capabilities to complement general preventative care, extractions, implants, endodontics, and orthodontics. You have the freedom to upgrade on your timeline and within your budget for seamless and affordable expansion.

**Veraviewepocs 3D R100**

J. Morita's new completely unique full arch field of view (FOV) abandons the typical cylinder with a new convex triangle shape. By more closely matching the natural dental arch form, this groundbreaking FOV reduces dosage by excluding areas outside the region of interest. And, as with all Morita X-ray units, you won't believe the image clarity and diagnostic capability.

Features:

- 3D, panoramic, and cephalometric capabilities
- New 3D Reuleaux Full Arch FOV offers a full arch scan
- New Dose Reduction Feature lowers X-ray exposure 30% to 40%

Please see your DHPI Equipment Specialist for pricing and availability in your area.

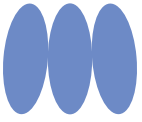

MORITA

Veraview IC5 HD

Veraview IC5 HD offers high speed, exceptional clarity, and low dosage. The new 10 second panoramic scan captures an even higher resolution image with a 25% reduction in pixel size. Additionally, it features a 5.5 second panoramic for a quick examination. Digital Direct Auto Exposure automatically sets kV and mA and provides continuous, real-time adjustment of the parameters throughout the pass to compensate for varying densities. The result is exceptionally clear images with the best possible contrast.

Features

- NEW 10 second panoramic for exceptional detail & clarity
- High speed 5.5 second panoramic
- Low dosage
- Fully automatic, simplified operation
- Digital Direct Auto Exposure provides real-time adjustment of exposure levels
- Pediatric function offers 4.8 second panoramic with further reduced dosage
- Compact, lightweight & energy efficient



MORITA

Veraviewepocs 2D

Morita's cutting edge technology features extremely high quality images with low exposure. Veraviewepocs 2D is completely upgradeable to our Veraviewepocs 3D model. This unit also features the NEW High Definition (HD) cephalometric update.

Veraviewepocs 2D offers crystal clear panoramic and cephalometric images with low effective dose. Designed for versatility, the 2D model can be upgraded to 3D at a later date.

With fully automatic settings, Veraviewepocs 2D is easy to operate. This unit features a variety of options and specialized programs such as the Orthoradial Panoramic projection, which reduces the overlapping of neighboring teeth, and the Shadow Reduction Panoramic projection, which reduces obstructing shadows. Patient positioning is also easy with AF Automatic Positioning – a light beam sensor automatically positions the C-arm without requiring the patient to move.

For accurate diagnosis and analysis, Veraviewepocs 2D offers high definition, refined imaging processing with multi-plane observation.



Please see your DHPI Equipment Specialist for pricing and availability in your area.



Because we care.

Progeny Vantage®

The Progeny Vantage Digital Panoramic System has been designed to improve the way you work. With a full featured, Windows computer integrated into the VantageTouch operator panel, Vantage gives you the flexibility to prepare and deliver diagnostic images chairside, allowing you more time with the patient for consultation and image review. Vantage boasts an exceptional array of features, from ease of exam set up to positioning assistance with VantageTrust, to support efficient imaging work flow in your practice and to provide better patient care.

- Preview image on the VantageTouch operator panel
- Five pre-programmed exam choices including bitewing
- Open, compact design optimizes space requirements
- Ceph upgradeable for expanded extra-oral exam capability



Because we care.

Progeny Vantage® C

The Progeny Vantage® C is designed to meet your practice needs. Progeny Vantage® C is available with two sensors—panoramic and cephalometric for optimal examination efficiency, or with one sensor when the clinic requires occasional cephalometric exams. Purchase a Progeny Vantage® Panoramic System knowing that you can add the cephalometric option in the future. Enhanced by the exclusive Clarity Enhanced Imaging Filter Set, Vantage C provides soft tissue visualization for the detailed patient profiles necessary to identify the bony and soft tissue landmarks. These critical points of reference are essential for accurate measurement in orthodontic patient treatment care planning.

Please see your DHPI Equipment Specialist for pricing and availability in your area.



Hyperion X5

Hyperion X5 needs a minimum operational space, the same as an intraoral X-Ray. The captivating form and the elegant lines make it an agreeable element capable of adding value to your practice. Hyperion X5 does not clutter and blends into your environment.

- Smallest unit available on the market
- User friendly interface allows 15 HD, 2D images in just a few steps
- Installation is both time & cost efficient
- MRT feature eliminates exposure parameters



Hyperion X9 3D CBCT Scanner

The X9's 3D CBCT module is available with 11x8 or 11x5 cm image detector and a variety of fields of view including 5x5cm. SafeBeam technology automatically calculates the lowest possible dosage based on patient anatomy and scan modality. A 16bit detector and 75µm voxels allow for unmatched detail and clarity. Hyperion's super-charged NNT 4.0 clinical software comes with pre-stocked implant library to simulate implant placement. High-speed processing, specialty-specific user interfaces, and DICOM exporting for third party applications will please users regardless of their specialty.



Please see your DHPI Equipment Specialist for pricing and availability in your area.



Excelsior 3D CBCT

The PreXion Excelsior advances all CBCT core technologies including the X-Ray Tube and FPD. The Excelsior couples the smallest focal spot (0.3 mm) with the following: voxel size of 0.1 – 0.2; 1024 volume size; 360° gantry rotation; 16 bit grayscale; and advancements in the PreXion software – resulting in unprecedented diagnostic clarity. In addition, the PreXion Excelsior can deliver 30% lower patient dose without compromising the image quality.

The PreXion Excelsior has 4 fields of view (FOV), 48 preset scan mode options, bitewing capture, TMJ capture, and the optional Cephalometric. Direct applications include relevancy in implantology, orthodontics, oral surgery, periodontics, endodontics, TMJ, airway analysis, and ENT.

The PreXion software flawlessly integrates into the office network without any specialized hardware. The PreXion3D Viewer can be installed on any Windows PC on the network, allowing scans to be viewed from any computer (with no additional or annual viewer licensing fees). The PreXion Excelsior Pro has a 7 year parts warranty available.



PaX-i3D Green

- Real Low dose with high quality images
- 5.9 second Rapid Scan time produces superb image quality
- Optimized multi FOV: 15x15, 16x10, 12x9, 10x8, 8x8, 8x5, 5x5
- Easy and simple Software : Intuitive user-interface and powerful consulting tools

Please see your DHPI Equipment Specialist for pricing and availability in your area.



PaX-i

PaX-i : Digital Pano ONLY

PaX-i SC/OP: Digital Pano + Ceph

- Scan Type: Scanning Type (LAT/Full LAT) & One Shot Type (Small/Medium/Large)
- Superb Image Quality
- 2 Dedicated Sensors for Pano & Ceph
- Various Capture Modes
- Stable & Easy to Use
- Simple & Compact Design



PaX-i3D

- 3 Dedicated Sensors: True Pano + True Ceph + CT
- Optimized multi FOV: 12x9, 8x8, 8x5, 5x5
- Scan Type: Scanning Type (LAT/Full LAT) & One Shot Type (Small/Medium/Large)
- Analyze 3D images with advanced tools and functions. Ez3D supports effective and efficient communication with your patients
- Various 16 Capture Modes in panoramic including bitewing



Please see your DHPI Equipment Specialist for pricing and availability in your area.



K66 Rear Treatment Console

The K66 Left/Right Rear Treatment Consoles offer open accessibility to the cabinet central work area and a 2-way left-right sliding work surface. All doors are hinged to open away from operators to permit unobstructed access to storage.

Standard Features

- Interchangeable panel fronts for Delivery System Controls and Analgesia
- Central upper storage compartment with ventilation grill for CPU
- Left-right sliding monitor mount on upper section
- LED task lighting with dimmer control
- Stainless steel covered base with leveling feet
- Soft-close hinges
- Stainless steel hardware
- (2) Duplex electrical outlets with (1) grommet
- Utility Column front panel for easy access
- Space for LR Delivery System (BDS2561 Doc/Asst or BDS2563 Asst. Instrumentation)
- Options include: Stainless Steel Toe Base and Additional Upper Storage Glass Shelf



Please see your DHPI Equipment Specialist for pricing and availability in your area.



D4RH Split Entry Console

The D4RH Center Island Cabinets provide privacy, plenty of accessible storage space and cost savings by reducing construction expenses and allowing a single intraoral X-ray to be shared between adjacent operatories. Cabinetry height measures 86".

- Round end section with sink
- Stainless steel covered base with leveling feet
- Door noise reduction system
- Stainless steel hardware
- Laminated pass-thru upper storage with windows
- Dual flip down door storage with duplex outlet
- Paper cup, towel dispenser, single or dual glove dispenser
- Sink with soap dispenser
- Waste receptacle with basket
- Dual Knee Activated Faucet
- Pull out writing surface
- ITS/ETL pre-wire"



Please see your DHPI Equipment Specialist for pricing and availability in your area.



N7220 Central Divider

Standard Features

- Sink & waste module featuring oval integral sink, foot activated faucet, white faucet & soap dispenser and waste ring
- 4 drawer module to assistant's side
- Metal x-ray wall frame with 2 outlets
- 4 drawer appliance module to doctor's side
- Pass-thru storage cabinet with adjustable shelf
- Cup and towel cabinet with cup and towel dispenser, adjustable shelf and 2 glove dispensers in door
- Upper storage pass thru with adjustable shelf
- Bi-fold x-ray enclosure
- Water resistant base assembly
- Fully customizable

BIOTEC

Please see your DHPI Equipment Specialist for pricing and availability in your area.



Platinum Collection

Biotec's Platinum Collection of cabinets gives you a premium style cabinet, without the premium price. Highly stylish and efficient cabinets do not have come at a high price. Biotec is best known for durable custom cabinets at a budget price level. The Platinum Collection of cabinets give an efficient environment for the provider. The features give an elegance to any operatory setting.

- Water Resistant 6" Base Assembly, guaranteed against water damage
- New Grohe fixtures all knee activated faucets.
- ETL Listed product with Pre-wired hospital grade outlets and USB outlets
- Integrated doctors and assistants controls are available
- Illuminated work surface is standard
- Beveled Upper doors with options for CPU storage
- Center Console with hidden storage and room for nitrous flowmeter and room for cable drops
- Solid Corian worksurfaces

BIOTEC

Please see your DHPI Equipment Specialist for pricing and availability in your area.

Order by  800-626-2163

 www.dhponline.com

 Fax: 888-681-5088

669



DentaleZ® Equipment Solutions

NextGen® Elite Team Workstation

The heart of the dental operator is the NextGen® Elite Team Workstation and its pivoting work surface that holds both doctor and assistant instrumentation. NextGen® Elite Team Workstation 42" wide by 20" deep. Quality dental cabinets designed specifically for you!

Standard Features

- Upper storage module with glass panels for quick viewing of contents with optional pass-through.
- Clock timer for display of time-of-day and date and ability to time multiple procedures.
- (2) Duplex outlets built-in to internal powder-coated aluminum trim to accommodate ancillary devices.
- Drop-down pull-out front drawers for storage and easy access.
- Center nitrous storage area for easy access to rubber goods.
- Workstations available in any color choices and solid surface countertop options.
- Stylish powder-coated aluminum trim provides durability
- Sub-base with adjustable feet for leveling cabinets

Please see your DHPI Equipment Specialist for pricing and availability in your area.



DentaleZ® Equipment Solutions

NextGen® Elite Dual Access Workstation

Elite Dual Access Workstation with X-Ray bi-fold door (Model C) laminate tops, stainless steel round sink, standard lever faucet, 109" long. The dental cabinet choice for your open bay operator, the Dual Access Workstation offers the following benefits:

- Aesthetically pleasing rounded sink with solid surface dome.
- Numerous storage areas including doctor/assistant readily used accessory item drawers, customized storage area for any combo of doors and drawers, X-ray apron area and X-ray accessory items area.
- Shared upper storage area for trays, tubs, or operator supplies with glass door panels for easy viewing.
- Standard with tapmaster foot-activated faucet or optional infrared controls on faucet and soap for hands-free on/off eliminate spreading of germs.

Please see your DHPI Equipment Specialist for pricing and availability in your area.



Beckenridge Center Console

The center consoles come standard with glove, cup and towel dispensers, a sink base cabinet for additional storage, upper storage pass through cabinets, base storage cabinets, a concealed x-ray cabinet, and equipment area storage under the x-ray cabinet. Shown below is our standard unit. There are over 1000 laminate colors available to suit your needs.

Please see your DHPI Equipment Specialist for pricing and availability in your area.



Boulder Rear Delivery

The rear delivery units come standard with pass-through upper cabinets, three base cabinet sections - each customizable to your needs. Shown below is our canyon model followed by several other rear delivery units we have to offer. These samples show some of the color options available from the over 1000 laminate colors available.

Dentist's Choice
Cabinetry

Please see your DHPI Equipment Specialist for pricing and availability in your area.

Order by  800-626-2163

 www.dhponline.com

 Fax: 888-681-5088

673



Artizan® Expressions Treatment Stations

- Available in three design series, each with their own configurable options
- A slim midsection, floating glass shelf and cantilever forward upper profile, give the treatment station shape while freeing up valuable countertop space
- Adding the option of resin allows the upper cabinet face to become an expressive focal point
- Ultraleather and stainless steel accents complement the cabinetry's stylish appearance, giving it a high-end feel
- Monitor mounts, USB, ample electrical outlets and dedicated CPU storage options are available to help accommodate equipment or technology needs



Because we care.

Please see your DHPI Equipment Specialist for pricing and availability in your area.



Artizan® Expressions Central Stations

- Available in 72" and 90" heights
- Multiple storage options available for each cabinet zone to match your operatory support requirements
- Vanity front feature mirror, soft accent lighting, a sleek touch/proximity faucet and a recessed cantilevered sink
- Ultraleather™ and stainless steel accents complement the cabinetry's stylish appearance, giving it a high end feel



Because we care.

Please see your DHPI Equipment Specialist for pricing and availability in your area.

Order by  800-626-2163

 www.dhponline.com

 Fax: 888-681-5088

675



Rear Console Francis Park Collection

The Francis Park 400 Collection is designed to be both smart and beautiful. All of the high tech practical features essential in a dental office have been incorporated with the sleek artful look of high quality furniture. This extremely well engineered and manufactured modular system allows it to integrate with the dental equipment of your choice all without breaking your budget.

Please see your DHPI Equipment Specialist for pricing and availability in your area.



Central Console Francis Park Collection

The engineered storage solutions, equipment integration, dispensing features, and overall quality make the Francis Park 500 Collection the ideal choice to divide your treatment rooms. The extra tall unit provides essential privacy while still maintaining an open feel. High end manufacturing methods assure that your practice will look great for years to come.



Please see your DHPI Equipment Specialist for pricing and availability in your area.

Order by  800-626-2163

 www.dhponline.com

 Fax: 888-681-5088

677



HANDLER

RED WING INTERNATIONAL

Pro Tech Lite Work Station PTL-211

The PTL-211 CAD/CAM is the newest family member of Handler's Pro Tech Lite platform of work stations. PTL-211 CAD/CAM is a sensible and elegant design that combines art & engineering. It is a compact, stylish and affordable CAD/CAM computer operator work station that enables the technician to use a computer efficiently and comfortably. PTL-211 CAD/CAM is manufactured in the USA of sturdy oven cured powder coated steel with solid Resistop work surface. Color options are colonial white, eagle white, designer beige, warm gray, merlot and blue heaven.

Features and Benefits

- Solid steel construction for years of efficient use in the lab.
- Compact design can fit almost any space.
- Affordable price fits any budget.
- Two 2" drop holes to keep electrical wiring off the work surface.
- Three separate storage drawers.
- Wrap around back splash to help keep prosthetics and other items from falling off the bench.
- Leg levelers.
- No installation required.
- Several color options available to match any lab design.
- Monitor mounting bracket.



HANDLER

RED WING INTERNATIONAL

Pro Tech Lite Petite Plaster Bench PTL-231

Pro Tech Lite is a sensible design that combines art & engineering. It is a compact, stylish and affordable plaster bench that provides adequate work space for the dentist or lab technician to pour models and trim models using a model trimmer. The installed sink and gooseneck lab faucet is convenient and necessary for plaster operations. PTL-231 is manufactured in the USA of sturdy oven cured powder coated steel with solid Resistop work surface. Color options are Colonial White, Eagle White, Designer Beige, Warm Gray, Merlot and Blue Heaven.

Features and Benefits

- Solid steel construction for years of efficient use in the lab
- Compact design can fit almost any space
- Affordable price fits any budget
- Factory installed Resistop sink and gooseneck lab faucet with paddles
- Leg levelers
- Several color options available to match any lab design
- Optional in drawer plaster bin
- Optional hands free kick plate for water activation
- Model Trimmer sold separately
- No assembly required, simple plumbing installation required

Please see your DHPI Equipment Specialist for pricing and availability in your area.

NevinLabs™ Workstation Solutions

ErgoTech™ Workstation

Features

- Dependable, steel construction with powder coated finish
- Personal bench height options of 34", 32", and 30"
- Adjustable arm rests that move side to side
- Variable speed dust collector with automatic or manual settings
- Modern, removable dust hood with shield
- Motor control panel with illuminated power switch and indicator lights
- Stainless steel scrap drawer
- Choice of 3 drawer sizes
- Gas valve and retractable air blowgun
- Single, back to back, side to side, and custom
- Shipped partially assembled, pre-piped for gas/air, pre-wired for electric, does not include final hook-up
- Task lighting and magnifying lens*
- Solid ½" work surface*
- Lab handpiece*

*Optional features



NevinLabs™ Workstation Solutions

Freedom™ Workstation

Functional features to make your work easier and more precise

- Individual dust collecting system with removable suction hood and safety shield
- 1/2" Solid Surface (Shown but quoted separately)
- Removable, stainless steel scrap drawer
- All steel construction with durable scratch and chip resistant powder coating finish
- Single workstations, pre-piped for gas and air, pre-wired for electricity
- AGA approved gas valve for Bunsen burner
- OSHA compliant air blowgun
- Drawer storage cabinet with steel roller bearings
- Case pan shelf
- 2X magnifying lens*
- Generous size magnetic stainless steel top saver*
- Removable, adjustable arm boards*

* Optional Features



Please see your DHPI Equipment Specialist for pricing and availability in your area.



Quolis™ Q5000

The Quolis® Q5000 chair has a sleek and fluid appearance, incorporating a seat positioning system that gently glides patients into treatment position. The thin and narrow backrest design allows doctors and assistants to work comfortably and efficiently.

- Quolis® shockless seat movement hydraulic system smoothly and gently glides patients into desired treatment position, reducing patient stress and anxiety
- Synchronous movement of backrest and seat perfectly fits the patient's natural body motion
- Built-in armrest seat positioning controls
- Articulating dual axis headrest accommodates the anatomy of each patient
- 60° left-to-right seat rotation with electronic lock
- Swing out armrests
- Wide backrest or slinged armrest models available
- Option of seamless or plush upholstery
- Slinged armrest upholstery available
- Choice of Standard Vinyl or Ultraleather®



X-Calibur B50N

The B50N Dental Chair carries forward the Belmont traditions of excellence in reliability, durability and patient comfort.

- Dual axis articulating headrest accommodates the anatomy of each patient
- Swing-Away Armrests
- Built-in Chair Back Membrane Controls on Doctor's and Assistant's Side: Programmable Positions for Base Up/Down, Backrest Forward/Recline, and Programmable Auto-return Position
- Option of Seamless or Plush Upholstery
- Slinged Armrest Model Available with Upholstery Choices
- Choice of Standard Vinyl or Optional Ultraleather®
- Narrow, thin backrest for excellent access to the patient oral cavity

Please see your DHPI Equipment Specialist for pricing and availability in your area.



PRO II 037N

The PRO II Dental Chairs incorporates a unique folding legrest feature that permits doctors to communicate with, and access seated patients face-to-face. The PRO II is ideal for obtaining accurate and consistent occlusal records, prosthetic dentistry, cosmetic dentistry and general dental procedures. Its compact footprint makes it suitable for both small and large operatories, with easy accessibility for patients with disabilities.

- Roll out/folding legrest
- Patient sits with feet on floor & with backrest upright for assessment of jaw alignment
- Wide backrest design for improved patient comfort and support
- Articulating Dual Axis Headrest accommodates the anatomy of each patient
- Swing-Out Armrest delivers easy accessibility for patients with disabilities
- 220° Left-to-Right Seat Rotation with Locking Foot Pedal
- Choice of Standard Vinyl or Ultraleather®



NEW

DCI edge

Series 5

Get comfortable, stay healthy

- Thin, narrow back of the Series 5 chair combined with low height adjustment allows operator to be in proper working position regardless of patient size.
- Unique back rest features a deep scoop that allows the headrest to be positioned lower to support smaller patients or children while comfortably supporting larger patients shoulder and head.
- Series 5 dental chair comes in 3 back styles: Wide, Narrow and Narrow with slings – All styles are offered in plush or seamless versions
- 5 Year Warranty to support your investment



Please see your DHPI Equipment Specialist for pricing and availability in your area.



DentalEZ® Equipment Solutions

NuSimplicity™ Chair

Ergonomics: Minimize Twisting & Reaching

- Thin tapered back.
- Slim 12-3/4" width at top of chair back.
- Integrated touch pads located on both sides of upper backrest.
- Simple chair controls include Auto Return, Last Position, 3 pre-sets and manual settings.

Flexibility: Positioning Made Easy

- Height from 15" -35.5" accommodates sit down and stand up dentistry.
- 60 degree rotation for positioning.
- Optional IV Armboard, IV Bag stand and body straps for oral surgery.

Technology: Meet the Demands of Today's Practices

- Optional "exclusive" airglide for ease of movement.
- Optional USB Port for today's technology needs.
- Optional Wireless controls – eliminates clutter from touch pad and foot control.



DentalEZ® Equipment Solutions

CORE Chair

Our new CORE chair provides great support and helps patients stay relaxed for a positive dental experience. Featuring an extremely strong baseplate and stable footprint, the CORE Chair situates patients in an ideal position with a durable hydraulic lift cylinder. The chair is quiet yet powerful with smooth operation.

Features

- Fully Hydraulic
- Emergency Shut-Down
- Double Articulating Headrest
- Flip Down Armrests
- Touch Pad Control
- Quality Upholstery with Wide Back

NEW

Please see your DHPI Equipment Specialist for pricing and availability in your area.



300 Chair

Features

- Thin Back With Lumbar Support
- Anatomically Correct Back Pivot Point
- 5 Programmable Positions/4 Manual
- Touch Pad (Specify Location – Lt or Rt Side)
- Synchronized Back & Toe Board Recline
- Smooth, Quiet All Hydraulic System
- 60° Seat Rotation Without 360 Lt/Rt Light Delivery
- 30° Seat Rotation With 360 Lt/Rt Light Delivery
- Vinyl Contour Upholstery
- Quick Release Double Articulating Headrest
- Left/Right Swing Down Upholstered Arms
- Programmable Exit
- 10 Year Electronic System Limited Warranty



300 Traverse Chair

Features

- Thin Back With Lumbar Support
- Anatomically Correct Back Pivot Point
- 5 Programmable Positions/6 Manual
- Touch Pad (Specify Location – Lt or Rt Side)
- Synchronized Back & Toe Board Recline
- Smooth, Quiet All Hydraulic System
- 60° Seat Rotation Without 360 Lt/Rt Light Delivery
- 30° Seat Rotation With 360 Lt/Rt Light Delivery
- Vinyl Contour Upholstery
- Quick Release Double Articulating Headrest
- Left/Right Swing Down Upholstered Arms
- Programmable Exit
- 10 Year Electronic System Limited Warranty
- 10" Hydraulic Traverse Movement



Please see your DHPI Equipment Specialist for pricing and availability in your area.

CHAIRS



Because we care.

Elevance®

Sophisticated styling, optimal patient access and exceptional patient comfort come together in a dental chair that is a genuine departure from any chair on the market today.

Features

- Cantilever Forward design to accentuate styling and deliver an unsurpassed range of travel for greater flexibility
- SerenEscape optional heat and massage system to relax anxious patients
- Advanced hydraulic system supports patients weighing up to 450 lbs with soft start/stop



Because we care.

UltraComfort®

With its full contoured back and specially designed lumbar support, the UltraComfort Chair will keep patients supported and comfortable through even the lengthiest of procedures.

Standard Features

- Hydraulic, cantilever system
- Automatic armrests
- Seamless, silhouette upholstery
- Double articulating headrest
- Programmable foot switch/control
- Two, hip-post mounted, programmable controls
- Chair swivels 60 degrees (30 degrees each side of center)
- Concept L/R chair swivels 30 degrees (15 degrees each side of center)

Options

- Ultra leather upholstery
- Adjustable headrest w/magnetic contoured pillow
- Delete foot switch

Models

- 153592-001 Midmark UltraComfort Dental Chair
- 153592-002 Midmark UltraComfort Dental Chair w/Internal Umbilical (4 ft.) and Console Mount
- 153592-003 Midmark UltraComfort Dental Chair w/Internal Umbilical (4 ft.) and L/R Mount

Please see your DHPI Equipment Specialist for pricing and availability in your area.



Because we care.

641 Barrier-Free® Oral Surgery

The Midmark 641 offers the positioning, accessibility and patient comfort you require in order to complete procedures in your office.

Features

- Narrow patient support surface, slim back section and tuck away side rails provide maximum patient accessibility, allowing for closer access to the patient to support proper posture for a long, injury-free career.
- Powered seat, back, foot and tilt offer multi-positioning capabilities, improving comfort and reducing likelihood of injury.
- Premium Comfort System enhances patient comfort for a “chair-like” feel.
- Optional wireless controls allow for placement of hand and foot controls anywhere in the room, while removing cords and eliminating obstacles.
- Options and accessories that improve functionality of any office.



Pelton & Crane

Spirit 1700 Dental Chair

The Spirit 1700 dental chair combines innovative technology with quality components resulting in an easy to use, durable dental chair. Standard features such as embossed membrane touchpads for the doctor and assistant, a dual articulating headrest and swing away armrests coupled with the Spirit 1700's powerful hydraulic lift mechanism provide a quality seating experience.

Pelton & Crane offers an extensive selection of dental delivery units for various styles. Pelton & Crane's chair mounted delivery systems facilitate a balanced, ergonomic design and allow integration of today's modern dental equipment.



Please see your DHPI Equipment Specialist for pricing and availability in your area.

Order by 800-626-2163

www.dhponline.com

Fax: 888-681-5088

685



Royal®

Alliant 2260

The Royal Alliant chair features a sleek design providing excellent ergonomic features including a chair base that places the seat of the chair at 13.5 inches from the floor at its lowest position. Mirror image touch pad controls are conveniently located on the armrests. The smooth, thin and narrow backrest is excellent for operator access. The comfortable magnetic headrest pillow allows for optimal patient positioning. There is an easily removable umbilical chase to hide unit tubings. Integrated junction box.



Royal®

GP2 Pediatric & Adult

Standard Features

- Automatic return
- Swing up/down armrests
- Replaceable upholstery
- Easy-care upholstery
- Basic headrest standard
- Extendable headrest
- Switches on back panel - one side

Please see your DHPI Equipment Specialist for pricing and availability in your area.

Royal®

RS1 Oral Surgery

Standard Features

- Oral surgery magnetic headrest
- Extendable headrest
- 6-Way foot control
- Automatic return and position
- Solid-state electronics
- Adjustable 8-way IV arm board
- Body and arm straps
- Adjustable backrest accessory rails on both sides
- Easy-care upholstery
- Swing up and down sling arm rests



TPC *Advanced Technology, Inc.*
 "On budget.... On time!"

Laguna

Articulating dual axis headrest rotation allows for optimum positioning of the oral cavity without the need to reposition the chair. Reinforced seat upholstery provides extra comfort and durability. Optional armrests pivot up and down for patient entry & exit from the chair.

Features

- Two Programable positions
- One preset exit position
- Electronic foot control with auto return function
- Built-in fuse/surge protection
- Toe guard protection to prevent scuffing
- All-metal construction
- Double articulating headrest, adjustable for height and wheelchair positioning
- Seamless upholstery
- Input voltage 110V or 220V



Please see your DHPI Equipment Specialist for pricing and availability in your area.



Belmont

Evogue Delivery System

The EVOGUE Delivery System maximizes patient treatment productivity through efficient positioning of the delivery head and unhindered line-of-sight access to handpiece controls; even when working around patients in the twelve and one o'clock positions.

- Delivery head rotation gives practitioners the ability to fine-tune access to handpiece instruments, in relation to where they are seated, for more ergonomic & stress free patient treatment
- 3 Handpiece control
- Integrated Belmont chair seat positioning control touchpad is centrally located on the delivery head, so left-handed or right-handed practitioners have easy, line-of-sight access to controls during patient treatment
- Individual handpiece air and water coolant adjustment controls
- Optional integrated accessories such as a micromotor, handpiece fiberoptics & scaler can be attached & controlled from the delivery head, reducing typical operatory clutter associated with multiple stand-alone accessories



Belmont

QDU Delivery System

The Quolis® Delivery Systems are beautiful, rugged and jam-packed with features to optimize operatory efficiency and provide enhanced utilization of Quolis® Q5000 chairs.

- 3 Handpiece control
- Foot control
- Delivery head rotation gives practitioners the ability to fine-tune access to handpiece instruments, in relation to where they are seated, for more ergonomic & stress free patient treatment
- Digital display with integrated multi-control function panel reduces typical operatory clutter associated with multiple stand-alone accessories
- Individual handpiece air and water coolant adjustment controls
- Handpiece flush switch
- Individually adjustable handpiece holder angle provides a dimension of flexibility for assistants, so they can comfortably set instrument positions within convenient and easy reach



Belmont

BDU Delivery System

The BDU Series delivery systems focus on providing superb value for the growing dental practice that requires high quality and feature-rich dental units for their operatories.

- 3 Handpiece control
- Wet/dry foot control
- Individual handpiece water coolant and master air coolant adjustment controls
- Handpiece flush switch
- Individually adjustable handpiece holder angle
- Oil mist separator
- Master On/Off switch
- Air/Water Syringe (on Doctor's & Hygienist's delivery systems)
- Balance arm with pneumatic brake
- Pre-wired delivery system for adding optional accessory devices
- Bottled water system with bottle quick disconnect & City/Bottle selector switch
- Safety break-away telescoping assistant instrument arm with 4 position holder (Cuspidor/PMU models)
- Assistant syringe, HVE and SE (on Cuspidor/PMU)
- Air and water quick disconnects with outlet flow control (on Cuspidor/PMU models)

Please see your DHPI Equipment Specialist for pricing and availability in your area.

*DCI Edge***NEW****Series 5 Delivery System**

DCI's Series 5 delivery system integrates technology to improve operator efficiency and eliminate workspace clutter. Enjoy the flexibility of integrating the devices you use today as well as what you might need in the future. Swing mount or post mount, the Series 5 delivery system features reliable pneumatic components. Dual integrated touchpads provide ergonomic access to control your equipment easily and comfortably.

*DCI Edge***NEW****Series 4 Delivery System**

The Series 4 delivery system combines design simplicity with style at a price that fits any budget. The DCI Edge Series 4 delivery system is a unique combination of flexibility and value. Available in post mount, swing mount or cart systems. If you are looking to change your delivery system and keep an existing chair then the Series 4 is the perfect choice. The Series 4 is the only delivery system that can retrofit to most dental chairs.

*DCI Edge***Series 4 Doctor Cart****Features**

- Sturdy All-Metal Control Head
- Automatic control for 3 handpieces
- Individual drive air & water coolant controls
- Deluxe Clean Water System
- Water Quick Disconnect
- Asepsis Junction Box and Utilities Included
- 5 Year Warranty to support your investment



Please see your DHPI Equipment Specialist for pricing and availability in your area.

DELIVERY SYSTEMS



DentalEZ® Equipment Solutions

Simplicity Delivery System®

- Doctors control & assistant's instrumentation
- Stable H-frame base with four dual wheel caster
- Powder coated finish
- Power assisted vertical height adjustment from 28 to 36.5 inches
- Clean water/city water
- Optional duplex electrical outlet
- Optional camera, scaler, curing light
- Optional fiber optics

Keep your new or existing delivery system clean and trouble-free with our BluTab Waterline Maintenance System. Order online at www.dhpionline.com



DentalEZ® Equipment Solutions

CORE Delivery Unit

Designed with simplicity in mind, the CORE product line provides a straightforward, easy to use delivery unit with common components, simple integrated holders and an easy-to-read pressure gauge. Choose from a left/right Magellan-style mount or a fixed-console mount, both positioning StarDental® handpieces and ancillaries within easy, comfortable reach.

- Tray
- Pressure Monitoring
- Handle
- Quick Maintenance
- Aluminum Flex Arm
- Dual-Access Touch Pads



DentalEZ® Equipment Solutions

NextGen® Carts

Accommodate your needs with our convenient mobile dental delivery units.

Available in Duo and Assistant's only styles

- Left/Right handpiece control
- Stable H-frame base with 4 dual wheel casters
- Powder coated finish
- Power assisted vertical height adjustment from 32.75" to 42"

Doctor's Control Features – Duo Cart Only

- Pre-wired for fiber optics
- Clean water system
- Optional integrated products
- 3 handpiece positions
- Bio-Free water & handpiece tubing

Please see your DHPI Equipment Specialist for pricing and availability in your area.



Because we care.

Elevance®

- Integration Control Module®
- Automatic Kink Valve® handpieces
- Straight 4-hole handpiece tubing
- Syringe with autoclavable tip
- Individual water volume needle valve ad-justment
- Individual air pressure needle valve ad-justment
- Handpiece exhaust oil collector
- Handpiece flush system
- Self-contained water system with 1 liter bottle
- Counter balanced flex arm
- Contoured junction box
- Instrument tray (9" x 13") and autoclava-ble instrument pad
- Powered USB port (1A @ 5VDC)
- Software upgradeable display



Because we care.

Procenter

- Three automatic Kink Valve® handpieces
- Straight 4-hole handpiece tubing
- Syringe with autoclavable tip
- Individual water volume needle valve ad-justment
- Individual air pressure needle valve ad-justment
- Handpiece exhaust oil collector
- Handpiece flush system
- Self-contained water system
- City water/bottle water selector
- Counter balanced flex arm with on-way position air lock
- Dual air lock release integrated into the handles
- Instrument tray (9" x 13") and autoclava-ble instrument pad



Because we care.

Asepsis 21®

The Midmark Asepsis 21® Delivery System provides quality and reliability in a sleek, compact, value-priced package.

- Air and water controls are protected from contamination beneath an easily removable top
- Smooth, easy-to-clean surfaces
- Midmark's patented Kink-Valve technology
- Available in cart, console mount or left/right delivery



Please see your DHPI Equipment Specialist for pricing and availability in your area.

Order by ☎ 800-626-2163

🌐 www.dhponline.com

☎ Fax: 888-681-5088

691



Pelton & Crane

Spirit 1585 Delivery System

Flexible Positioning

Ellipse mount facilitates easy left/right conversion. Add ellipse assistant's instrumentation and cuspidor if desired.

Control Head

The Spirit 1585 dental delivery system has a die-cast metal control head to support long-term durability. Equipment utility center with asepsis housing.

Water System

Self-contained water system with city/bottled water selector. Individual non-retracting water coolant adjustments.

Doctor's Instrumentation

4 positions accommodate 3 handpieces and 1 syringe. Optional 5th position holder available.



Pelton & Crane

Alliance 1258 Delivery System

The Alliance 1258 series dental delivery system includes rotating system design quickly and easily converts from left-to-right hand position and quick clean syringe and straight asepsis tubing for 3 handpieces is standard. Pre-wired with 8 conductor cable for accessory addition, floor utility center with regulators and shut-off valves, wet/dry foot control (with signal relay), self-contained water system with city water/bottled water selector, individual water coolant adjustment valves, handpiece tubing flush system and Contoured junction box.



Pelton & Crane

Spirit 1540/1550 Carts

Vertically Adjustable

Spirit 1500 series dental delivery carts have a chrome plated u-frame, height is adjustable from 25.5" to 34.5".

Durable Design

Durable die-cast metal control head and dual wheel casters.

4 Instrument Positions

4 position doctor's instrumentation accommodates 3 handpieces and 1 syringe; a 5th position holder is optional. Spirit 1540 is configured for the doctor and assistant, Spirit 1550 is configured for the doctor only.

Integration

A duplex electrical outlet enables use of ancillary equipment. Equipped with wet/dry foot control with signal relay.

Please see your DHPI Equipment Specialist for pricing and availability in your area.

Proma

Alliant Unit Line A6210

The Alliant Unit Line by Proma reveals a high tech design at an affordable price. The unit line has all new styling as well as the Piston Valve control system that carries a lifetime warranty. The new handpiece water spray system introduces a new precision adjustment feature. Alliant control head cast aluminum design has more space for accessory equipment.

- Precise fine water spray control for the handpiece.
- Easily removable umbilical chase to hide unit tubings.



Proma

A5410 North Mounted Hygiene Unit

Standard Features

- Two automatic Piston Valve handpiece controls.
- Air / water syringe with Quick-change sterilizable tip.
- Disc foot control, wet / dry with 7' of tubing.
- Self-contained patient water system.
- Coolant air valve and adjustment.
- Stainless steel instrument tray with non-skid pad.
- Rear mount vacuum arm.
- Utility center with 5' umbilical.
- ProValve Plus HVE, autoclavable.
- Saliva ejector valve, autoclavable.
- Chair adapter for rear delivery.



Proma

A6552 Dual Universal Delivery Floor Mounted Unit

Standard Features

- Selector with three automatic handpiece controls
- Water flush system for handpieces
- Self-contained patient water system with quick connect
- Air/Water syringe with quick-change seri-alizable tip
- Disc foot control, wet/dry toggle with 7' tubing
- Air regulator with mounting bracket
- Vertically adjustable corian work surface
- Air/Water syringe for assistant



Please see your DHPI Equipment Specialist for pricing and availability in your area.



S-4250 Mobile Cart

Beaverstate Dental System's mobile units provides reliability for trouble free operation in many different configurations. All mobile systems feature a steel H frame base for stability and durability. Internal features include simplicity in configuration, highly cycled valves and lifetime warranty on the handpiece control block, and foot control.

Standard Features

- Doctor's side = Three-handpiece automatic with air/water controls
- Side mount, recessed controls
- System Purge feature flushes entire water system and replaces with clean water
- Assistant's side = Three-way syringe, autoclavable
- S/E and HVE valves
- Plastic storage organizer assembly
- 16" x 22" Star Board ST work surface



AS-1 Dual Purpose Table Top Cart

Features

- AS-1 Control Head
- 3-Position Automatic Hand-Piece Holders
- Individual Water Coolant Controls
- Asepsis Hand-Piece Tubing
- Wet/Dry Foot Control
- Hand-Piece Flush/Purge System
- 3-Way Air/Water Syringe
- Assistant's 3-Way Air/Water Syringe
- Master On/Off Switch
- Solids Collector
- H.V.E.
- Saliva Ejector
- Bottled Water System (Bottled Or City Water Selector Switch)



MC-500 Mirage Mobile Cart

Features

- Automatic control for three handpieces
- Master On/Off
- Individual handpiece pressure controls
- Individual air & water coolant controls
- Three way syringe
- Easy-clean work surface
- Adjustable height mobile frame 30"-38"

Please see your DHPI Equipment Specialist for pricing and availability in your area.

FOOT CONTROL



Standard
Model 1200
580-PWF1200 Each..... **\$67.95**

WET/DRY FOOT CONTROL



Model 1210
w/Wet Dry
580-PWF1210 Each..... **\$124.75**

Model 1210 Repair Kit
580-PWF1225 Each..... **\$11.45**

TRADITIONAL SYRINGE



Air Water Syringe
Trim, lightweight head reduces fatigue. Cross-pin allows easy button exchange. Each syringe comes with one autoclavable tip.
Syringe w/ 1 tip
580-AWS01 Each..... **\$62.95**
Autoclavable tip
580-AWT01 5/pkg..... **\$28.95**



Contour Syringe Spool Valve
580-PWC1700 Each..... **\$68.95**

PRESS RING SYRINGE



Quick Clean Standard Syringe
580-DCI3430 Each..... **\$70.95**

Quick Clean Standard Syringe
w/Straight Gray Tubing
580-DCI3439 Each..... **\$79.95**



Precision Comfort Syringe
580-DCI3600 Each..... **\$70.95**

DELIVERY SYSTEM PARTS

REPAIR PARTS



Syringe Tips - Autoclavable
ADEC Style
580-DCI3055 5/pack..... **\$23.95**

Syringe Tip O-Rings
580-DCI2201 12/pack..... **\$2.95**



Foot Control Repair Kit
580-PWF1225 Kit..... **\$11.45**



Toggle Only - Gray
580-PWV1550 Each..... **\$1.75**



Quick Change Tips
580-DCI3060 Each..... **\$4.75**
580-DCI3061 5/pack..... **\$23.45**
580-DCI3059 50/pack..... **\$199.95**

Please see your DHPI Equipment Specialist for pricing and availability in your area.

Order by ☎ 800-626-2163

🌐 www.dhponline.com

☎ Fax: 888-681-5088

695

DELIVERY SYSTEM PARTS

BUTTONS



Syringe Button w/Spring, Quick Clean
580-DCI3085 Each.....\$8.95



Syringe Button w/Spring, Precision Comfort
580-DCI3625 Each.....\$9.25



A-dec Syringe Button Assembly
580-DCI9186 Each.....\$13.95

SYRINGE TUBING



Straight Asepsis 2-Hole
580-DCI232 Per Foot 75¢

SALIVA EJECTOR TUBING



Vinyl Saliva Ejector Tubing
3/16" Gray
580-DCIS601 Per Foot..... 95¢



Vinyl Saliva Ejector Tubing
13/64" Gray
580-DCIS611 Per Foot 75¢

DRAIN TUBING



Smooth Drain Tubing
1/2" I.D.
580-DCISV05 Per Foot \$1.95

HVE TUBING



Asepsis HVE Vacuum Tubing
1/2" I.D.
580-DCI733 Per Foot\$2.45



Asepsis Sheathed Corrugated Tubing
1/2" I.D. Gray
580-DCI721 Per Foot \$7.45
1" I.D. Gray
580-DCI722 Per Foot\$5.45

FOOT CONTROL TUBING



Aseptic Foot Control
4-Hole Gray
580-DCI426 Per Foot\$2.95



Spirolock Vacuum Tubing
1/2" ID
580-DCI701 Per Foot \$2.25
5/8" ID
580-DCI703 Per Foot \$2.45
3/4" ID
580-DCI704 Per Foot \$2.75

HANDPIECE TUBING



Aseptic Ultraflex Straight
4-Hole w/Connector
580-PWT1741G Gray.....\$21.95
580-PWT1741B Black.....\$21.95

Aseptic Straight

4-Hole w/Connector
580-DCI432T Gray.....\$21.95
580-DCI431T Black.....\$21.95



Standard Straight

4-Hole w/Connector - Gray
580-PWT1729 Each..... \$18.75



Aseptic Ultraflex

4-Hole Bulk - Gray
580-PWT1785G Per Foot \$1.25

SOURCE FOR VACUUM TUBINGS & ACCESSORIES



Mini Vac Saliva Valve
580-BF22257 Each..... \$75.75



Autoclavable QD Saliva Ejector
580-PWS1200 Each..... \$28.95



Saliva Ejector w/QD
580-PWS1805 Gray..... \$19.75



Rotary Saliva Ejector w/QD
580-PWS1360G Gray..... \$17.95
580-PWS1360B Black..... \$17.95

Please see your DHPI Equipment Specialist for pricing and availability in your area.



Precision Comfort Premium Autoclavable Saliva Ejectors w/Quick Disconnect
580-DCI5222 Each..... **\$42.95**



Replacement Lever - Saliva Ejector
540-11122 3 pack..... **\$7.45**



Disposable Plastic S.E. Screens
580-DCI5755 10/pack..... **\$5.95**



Snap-On Tip
580-DCI5754 Gray..... **\$2.95**

580-DCI5750 Black..... **\$2.95**

Screw Type
580-DCI5742 Gray..... **\$21.25**

HVE ACCESSORIES



Autoclavable HVE Valve
Anodized aluminum w/swivel.
580-PWS1100 Each..... **\$36.95**



Universal QD Lever Valve
580-PWS1340G Gray..... **\$39.95**



IC Lever QD Lever Valve
580-DCI5148 Each..... **\$36.95**



Precision Comfort Premium Autoclavable Extended Vacuum Values w/Quick Disconnect
580-DCI5112 Each..... **\$48.95**



Standard HVE Lever Valve w/Swivel
580-BEA112192 White..... **\$29.95**
580-PWS1320G Gray..... **\$29.95**
580-PWS1320B Black..... **\$29.95**



QD Swivel Base
580-BEA112170 Each..... **\$6.45**

O-Ring HVE QD
580-DCI2243 12/pack..... **\$8.25**

O-Ring HVE Tip
580-DCI2254 12/pack..... **\$8.25**

O-Ring HVE Valve
580-DCI2253 12/pack..... **\$8.25**



Replacement Lever - HVE
540-11113 3/pack..... **\$7.75**

HVE ACCESSORIES



Vacuum Canisters - Bottom and Side Mount - Side Port
Solids collector with removable screen.
580-DCI5872 Each..... **\$33.95**

VACUUM ACCESSORIES



Includes mounting bracket and hardware. Bottom drain.



Vacuum Canister Kit, Gray
Used with central vacuum system. Solids collector with removable screen. Accepts 2 HVE & 1 SE. Hydrocolloid drain provision. 1/2" OD drain. Includes both vertical & horizontal mounting brackets.
580-DCI5860 Kit..... **\$29.95**



6oz. Evacuation Cup Liner
White paper cones, rolled rims, cut bottoms. For Adec Unit: 3" high, 4" top opening.
630-9231 250 cups..... **\$19.75**



Dry Oral Cup
580-DCI5840 Each..... **\$11.45**



Solids Collector Disposable Covered Screen
Covered disposable vacuum trap. For use with 5872 & 5873 vacuum canister.
1-7/8
580-DCI5820 Each..... **75¢**
580-DCI5832 100/pack..... **\$45.45**
2-1/8
580-DCI5889 Each..... **75¢**
580-DCI5887 100/pack..... **\$45.45**

Please see your DHPI Equipment Specialist for pricing and availability in your area.

DELIVERY SYSTEM PARTS

ASEPSIS WATER SYSTEMS

**Asepsis Self-Contained Water Systems**

Asepsis self-contained water systems have a metal cover with white powder coat finish, air purge toggle, water pressure is controlled by adjustable regulator.

Models for 750 ml and 2 liter bottles standard 28 mm thread for water bottle. Features pressure gauge and on/off toggle to release bottle pressure. Mounts to vertical surface, optional 2" post mounting. Deluxe models have a selector toggle allowing a switch between city and bottled water.

Dual Bottle Systems**Dual Bottle Systems**

580-DCI8177 750 ml Std.....	\$283.95
580-DCI8178 750ml Dlx.....	\$319.95
580-DCI8179 2 Liter Std.....	\$293.95
580-DCI8180 2 Liter Dlx.....	\$229.95

Single Bottle Systems

580-DCI8181 750 ml Std.....	\$213.95
<i>(Includes Extra Bottle)</i>	

580-DCI8182 750 ml Dlx.....	\$249.95
<i>(Includes Extra Bottle)</i>	

580-DCI8183 2 Liter Std.....	\$218.95
580-DCI8184 2 Liter Dlx.....	\$254.95

ECONOMY WATER SYSTEMS

**Economy Self-Contained Water Systems****Features:**

Water regulator-adjustable. Heavy-duty water bottles 750ml or 2 liters. Water pressure gauge. Vertical surface mount. On/Off toggle releases bottle pressure. Optional post mount available. White polyester powder coat finish.

Standard System

With extra bottle

580-DCI8145 750ml.....	\$154.95
------------------------	-----------------

Deluxe System

With extra bottle

580-DCI8139 750ml.....	\$184.95
------------------------	-----------------

Standard System

580-DCI8144 2liter.....	\$159.95
-------------------------	-----------------

Deluxe System

580-DCI8143 2liter.....	\$189.95
-------------------------	-----------------

WATER SYSTEM REPLACEMENT BOTTLES

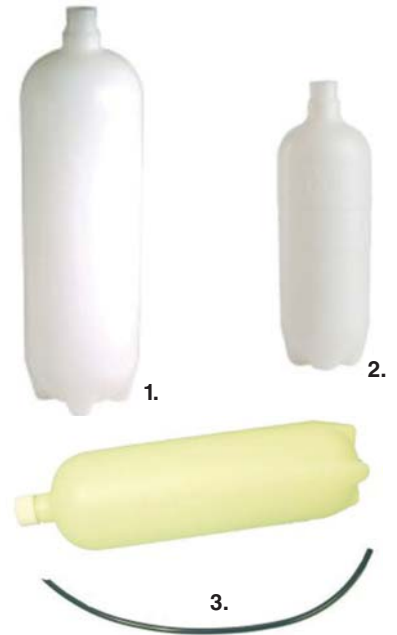
**Heavy-Duty Bottles for Dental Unit Water Systems Standard Bottles**

Plastic Bottle w/Cap & Pick-up Tube

1. 580-DCI8128 750 ml.....	\$6.95
2. 580-DCI8669 1 Liter.....	\$7.45
3. 580-DCI8164 2 Liter.....	\$11.95

**Quick-Switch Water Bottle System**

Kit (Includes Converter & Adapter)

580-DCI8941 Each.....	\$69.95
-----------------------	----------------

Manifold Converter With O-Ring

580-DCI8942 Each.....	\$45.95
-----------------------	----------------

Bottle Adapter With Washer

580-DCI8943 Each.....	\$31.95
580-DCI8944 5/Pack.....	\$124.95

Buna-n O-Ring

580-DCI2297 12/Pack.....	\$2.95
--------------------------	---------------

Integrated Quick-Switch Manifold

580-DCI8946 Each.....	\$22.45
-----------------------	----------------

**Washers For Water Bottle Cap**

580-DCI8136 Each.....	\$2.95
-----------------------	---------------

Please see your DHPI Equipment Specialist for pricing and availability in your area.



HYDRIM C61w G4

- Countertop or under the counter, steri-center installation.
- G4 web portal includes data storage, service logs and remote access capabilities
- Validated cycles to ensure repeatable washing performance
- Improved serviceability, reliability and minimal maintenance requirements
- Vivid color touch screen
- Robust stainless steel exterior
- USB port for data storage
- Active hot air drying

Hydrim Cleaning Solutions

For use with the C61wG4
 571-CSHIPCU 8-750mL/case..... **\$151.95**



HYDRIM L110w G4

Hydrim L110w is an instrument washer specifically designed for larger dental practices. The Hydrim L110w automatically removes debris from instruments, reducing the time, effort and risk associated with manual and ultrasonic cleaning.

The Hydrim L110w is designed to get instruments clean - very clean - as any residual debris left on instruments may impair sterilization. By virtually eliminating debris on instruments, the Hydrim L110w effectively promotes sterilization.

Hydrim Cleaning Solutions

For use with the L110w.
 571-CSHIPL 2 Gallons **\$175.45**



Please see your DHPI Equipment Specialist for pricing and availability in your area.



AdvErL Evo Er:YAG

AdvErL Evo is ideal for periodontal treatment. As an Er:YAG laser, the wavelength is readily absorbed by water and efficiently vaporizes soft tissue. Versatile, this unit offers a wide variety of tip options with an extensive selection for perio procedures. Its lightweight and flexible cable and powerful settings are also ideal for this specialty. Applications include removal of subgingival calculus, diseased, infected, inflamed and necrosed soft tissue within the periodontal pocket, subgingival calculus, and granulation tissue from bony defects. It may also be applied for soft tissue curettage, sulcular debridement, and osseous crown lengthening.

Please see your DHPI Equipment Specialist for pricing and availability in your area.



Photon

The Photon 3 Watt is the ideal Dental Laser, boasting 810nm diode flexibility, complete portability, built-in tutorials and the best multi-lingual interface on the market. Enjoy the flexibility of the 20 Pre-Set programs which may be tailored to fit your personal needs.

- 20 Customizable Programs
- Large LCD Screen and Long Battery Life
- Digital Password Protection
- Wireless Foot Pedal
- Disposable Tips
- Adjustable Aiming Beam
- Continuous or Pulse Mode
- Easy to Carry and Store

The Photon Laser was designed to be your surgical dental device of choice to perform a wide range of oral soft tissues and tooth whitening procedures. The use of Dental Lasers for curing gum inflammation and infection is highly recommended and is also a reliable and instant cure for a number of other periodontal ailments.



Photon Plus

The Photon Plus 10 Watt immaculate dental laser with 980nm diode versatility and complete portability has built-in tutorials and the best multi-lingual interface.

The large LCD touch screen for ease of navigation and a menu containing several programs that are both pre-set and customizable, makes the new Photon Plus dental diode laser unparalleled. It is perfect for tooth whitening or bleaching without any menace of cross infection.

- Portable power module can work wirelessly 4 hours
- Password protected feature provides great security
- 3 year warranty
- Touch interface and Wireless Foot Pedal highlight just a few of the advanced features
- More than 20 Preset Procedures and Multiple Customized Programs
- 3 levels of aiming beam intensity
- Continuous or Pulse Mode

Intended uses

Excision, Incision, Coagulation, Removal of Fibroma, Granulation Tissue, Soft Tissue Crown Lengthening, Canker Sores, Bleaching, Tooth Decay, Discolorations and Oral Soft Tissue dental procedures!



Please see your DHPI Equipment Specialist for pricing and availability in your area.



Bel-Halo LED

The Bel-Halo LED Operatory Light produces cool, natural light with high color rendering performance for correct tooth shade matching and for differentiation of soft tissue. Stepless light intensity can be adjusted to fit operatory ambient light conditions.

- Unique circular LED array provides cool white light that is excellent for tooth shade matching and differentiation of soft tissues
- Easy on the eyes - stepless intensity control adjusts oral cavity illumination to fit ambient lighting conditions within the operatory
- Shadowless illumination - even with 50% obstruction between light and patient
- 5000°K color temperature approximates natural daylight at all intensity settings
- Long LED life and low power consumption add to operatory efficiency
- Touchless On/Off and Composite Safe Mode controls minimize the potential for operator cross-contamination, by reducing physical contact with the light surfaces
- Smooth, 3-axis light head rotation for easily directing illumination where it is needed
- Special mirror option provides dental staff with a means of providing patients with a visual communication of oral cavity conditions
- Available in post mount, swing mount, ceiling mount, track mount, cabinet mount, wall mount and curved post models



Clesta LED

The Clesta LED Operatory Light perfectly blends the technology of the award winning Bel-Halo LED Operatory Light with the proven, long-term success of the Clesta Halogen Light to provide a powerful new tool for every dental practice.

- Five LED array provides cool white light that is excellent for tooth shade matching and differentiation of soft tissues
- Step-less light adjustment provides operators with the ability to fine-tune illumination to fit individual operatory lighting conditions
- Shadowless illumination - even with 50% obstruction between light and patient
- Touchless On/Off and Composite Safe Mode controls minimize the potential for operator cross-contamination, by reducing physical contact with the light surfaces
- 5000°K color temperature approximates natural daylight at all intensity settings
- Long LED life and low power consumption add to operatory efficiency
- 3-Axis light head rotation provides operators with the flexibility to direct illumination precisely where it is needed within the patient's oral cavity
- Available in post mount, swing mount, post mount, ceiling mount, track mount, and curved post models



Please see your DHPI Equipment Specialist for pricing and availability in your area.

DCI Edge

Series 4 LED Light

New LED light features an innovative, durable design & breakthrough LED technology to delivery next level lighting performance. The brand new design blends innovation with beauty on every level, redefining what you should expect from an operator light. DCI's heavy-duty metal structure and handle design along with high quality components demonstrate a strong commitment to building the highest quality dental equipment.

Standard Features

- Available in both white & gray to match your existing operator equipment
- Available in multiple mounting options including track, ceiling, and post mount
- 3rd Axis Rotation for improved positioning
- Dual Membrane Integrated Touch Controls allow you to easily access and control three intensity settings of 17,500, 26,000 and 35,000 lux



NEW

DCI Edge

Series 5 LED Light

Affordable LED Technology

- The reflective technology of DCI's LED Light provides uniform light pattern, less eye fatigue and accurate shade matching.
- Available in both white and gray colors to match existing operator equipment
- Mounting configurations include: post mount, track mount, ceiling mount and system mount.
- 5 Year Warranty to support your investment

Advanced Features

- No Cure Setting
- 3 Intensity Level Settings
- Programmable No-Touch Sensors



Please see your DHPI Equipment Specialist for pricing and availability in your area.



DentalEZ® Equipment Solutions

EverLight® LED Operatory Light

- Operatory light with 100% true direct LED technology using no reflectors or fans
- Consumes 70% less energy than halogen; lowers bills
- Lasts 10 times longer than halogens
- Natural daylight illumination provides clearer oral cavity visibility
- 9 color/intensity settings to meet all your operative needs, including color matching and composite modes
- Cool, white, direct lighting at 6,000K
- Choose your light intensity: 15,000 – 25,000 – 30,000 LUX



DentalEZ® Equipment Solutions

CORE LED Light

The Core LED light is equipped with three light intensity settings (10,000, 20,000 or 30,000 LUX) and no-touch operation. The handles can be repositioned 360° and can be autoclaved.

- Pattern
- Magnetic Handles
- Hands-Free
- Programmable Sensor
- Kelvin Color Temperature
- Easy Cleaning

NEW

Please see your DHPI Equipment Specialist for pricing and availability in your area.



Because we care.

LED Operatory Light

Features

- Cool, quiet operation - efficient design eliminate the need for noisy cooling fans
- Soft feathered edge on light pattern de-signed to help reduce eye fatigue
- True composite safe setting: Midmark uses filters to remove the 470 nm blue light known to cure composites
- Touchpad control designed to offer three intensity settings as well as composite safe mode
- Available as chair mount, ceiling mount, cabinet mount, wall mount or track mount configurations



Because we care.

Dual Track Light & Monitor

Features

- Monitor positioning designed to allow for overhead viewing during procedures or chair side viewing for consultation
- Designed to allow for seamless integra-tion of PC, TV, and DVD with inputs in-cluding VGA, HDMI, coaxial, 3.5 mm au-dio, S-video, and RCA composite.
- Dual trolleys and counterbalanced flex arm designed to offer uncompro-mised positioning
- Dental grade monitor optional
- Can mount with Midmark halogen or LED operatory lights



Please see your DHPI Equipment Specialist for pricing and availability in your area.



Proma

5100 Series LED

Proma lighting technology has taken a dramatic step forward with the inception of LED. The safest, most beneficial application of LED for dentistry is indirect, reflected light.

Minimal Shadowing

The light's 516 facets work to greatly reduce shadows. Dual parabolic lenses are engineered to produce the perfect elliptical pattern, bright in the center with a feathered edge.

Relieve Eye Strain

Relieve eye strain by using precisely the most comfortable light level. Continuous intensity adjustment from 3,000 to 35,000 LUX range is achieved by the simple one-touch control.

The Ideal color rendering temperature of 5,000K, matching that of natural indirect daylight, is consistent at all intensities. When using light-cured resins, a filter is simply placed over the light source.

Upgrade existing Proma 5100 Series lights to the new LED version with an upgrade kit.



Proma

5152 LED HD Track Mounted LED Light & Monitor

Light Features

- Light head with three axes of rotation
- Auto on/off microswitch
- Counter-balanced drift-free arm Proma LED
- Reflected LED light with dual parabolic lenses for safe indirect, shadow-free illumination
- Cool and efficient - silent operation (no fan)
- Infinite intensity adjustment
- Color temperature is 5000°K at all intensities

Monitor Features

- 22" LED HD Wide Screen
- 12-volt power supply
- High definition 1920 x 1080 picture resolution
- Single remote control selects between different video sources, and operates the monitor functions (on/off, volume, brightness, etc.)
- Comes standard with internally routed cables for USB, Composite Video/Audio, HDMI, SVGA and Coaxial Video/Audio
- Integrated digital TV tuner

Please see your DHPI Equipment Specialist for pricing and availability in your area.

Pelton & Crane

Helios 1800 Series LED Light

The Helios 1800 is the newest member of the Helios family of LED dental lights. Features like reflective technology and a crisp 3" x 6" light pattern mean enhanced performance over traditional halogen dental lights. This dental light also offers optimal efficiency to help you save energy and lifecycle costs. Leverage technology and enjoy increased performance from halogen lighting at a similar price point.



TPC Advanced Technology, Inc.

"On budget.... On time!"

Radiant LED Operatory Light

Features

- Two axis light head rotation for optimal positioning.
- The contoured handles are conveniently located for operator positioning and asepsis protection and easily removed for cleaning. (Serializable)
- Constant color temperature at every level of brightness.
- Superior color rendering index allowing real color matching and accurate examination of tissues.
- Light intensity is dimmable.
- 2-year warranty



Please see your DHPI Equipment Specialist for pricing and availability in your area.

OVERHEAD OPERATORY BULBS

	BULB CODE	WATTS/ VOLTS	FITS MODELS:	ITEM NO.	PRICE
	FCS, 64640, 041-179-01	150W/24V	DentalEz Ecs Light, Eurodent Light, Faro Original Sunlight 70, J Morita Light, Plan Meca Delight, Seimans A1/E1	780-54444LMD	\$8.95
	L-6 H-3 64151- 041-513-00	55W/12V	Belmont, Chayes Virginia, Healthco Aristocrat, Healthco Celebrity, SDS Fantastic, Fiad, Adec Performer, Apco Contender, Celux, Dabi Atlante, Summit Dental System 1300 Light	780-20001LMD	\$5.95
	4079 Q75T3/CL	75W/28V	Ritter (Model "J" Starlite)	780-20002LMD	\$20.95
	150W/24V	150W/25V	Adec, Knight Model L, FARO Sunlight 70, SDS 1350, Siemens, A1/E1 Sirona, Eurodent, J. Morita, Plan Meca Delight, Yoshita Kay Cor	580-DCI8696	\$11.50
	125T10PL	125W/120V	Castle Panovision, Ritter "H" Weber Panovision	780-23640LMD	\$15.95
	DZE/FDS 4074	150W/24V	Koolbeam Light, S-90 Sunlight, Sunlight 70, S2000 Light, Forest 9000 Light, Knight (Examination Light #152616), LuxStar 1000 Series, Daystar S-90B, Model "K" Super, Starlight, UL1000 Light, Crusader, Star Brite, Vacudent Light	780-54755LMD	\$10.95
	Q150T4/CL	150W/25V	Pelton & Crane LF+, LF I, LF II, LF III	780-20003LMD	\$15.95
	501074	60W/24V	Clesta	780-L6ABEL	\$79.95
	EJA	150W/21V	Fotofil, Perspective Dental Imaging, Retrospective Treatment, Spectaview Intraoral & Extra Oral Camers, Stylus 240 & 2000, Trophy IntraOral Camera	780-54753LMD	\$24.95

Please see your DHPI Equipment Specialist for pricing and availability in your area.

PHOTO CURING BULBS

	BULB CODE	WATTS/ VOLTS	FITS MODELS:	ITEM NO.	PRICE
		35W/14V	Aristocrat I, EFOS 35, Elcelux, Heliolux, Heliolux 2, MaxLite, Optilux (50, 150), Faro P287, Optilux 35, Patterson TCL 390	780-20010LMD	\$29.95
	EFR 3014	150W/15V	Fotofil, Perspective Dental Imaging, Retrospective Treatment, Spectaview Intraoral & Extra Oral Camers, Stylus 240 & 2000, Trophy IntraOral Camera	780-54920LMD	\$29.95
	64617 JCRM 20437 3016	75W/12V	Aristocrat I, Cotolux II, 3, & 4, Degulux, Executor, Heliolux GT, Hilux 200, Litex 660, Penn Med 300 & 301, Super-Dent 2001 & 2500, Visilux & II, Apollo CP, Litex 680, Ortholux & Ortholux XT, VCL 100, 200 & 300, Heliolux DLX, Hilux 350, Omega 750 PowerPower	780-64617LMD	\$29.95
	64624, 644358 3021	100W/12V	Efox Lite, Focus, Prismetics Lite, Profile VCS, Sunspot, Translux CL Ceri-Light	780-64624LMD	\$29.95
		80W	Optilux	789-21237	\$89.95
	EJV	150W/21V	Triad TCU11	780-54732LMD	\$20.95
	ETJ 490874	250W/120V	Triad 2000	780-54928LMD	\$21.95

Please see your DHPI Equipment Specialist for pricing and availability in your area.





LIGHT ACCESSORIES

FIBER OPTIC HANDPIECE & INTRAORAL IMAGING SYSTEM BULBS

	FITS MODELS:	ITEM NO.	PRICE
	Handpiece Illuminator System-Krypton 3.5V	281-790257	\$38.00
	5-Hole ISO Lamp Module	580-DCI8813	\$65.00
	Optica Fiber Optic Unit	780-62962STA	\$22.95
	Excellence (1988-Newer) Brass Pins	780-20040LMD	\$32.95
	KaVo LUX Coupler, MK-Dent Coupler	580-CH1606100	\$48.50
	COLORight System	780-60986STA	\$138.95
	StarBright 6-Pin Swivel 3.3V	780-62522STA	\$125.75
	Fotofil, Perspective Dental Imaging, Retrospective Treatment, Spectaview Intraoral & Extra Oral Camers, Stylus 240 & 2000, Trophy IntraOral Camera	780-54158LMD	\$29.95
	Fotofil, Perspective Dental Imaging, Retrospective Treatment, Spectaview Intraoral & Extra Oral Camers, Stylus 240 & 2000, Trophy IntraOral Camera	780-54928LMD	\$21.95

Please see your DHPI Equipment Specialist for pricing and availability in your area.

X-RAY VIEWING BOX FLUORESCENT TUBES

	BULB CODE	FITS MODELS:	ITEM NO.	PRICE
	F4T12/D12	Clive Craig Desktop Mount 1-1/2" x 15"	780-25926LMD	\$13.95
	F14T8/D15 14W	Star DE100, DE120, DE150, DE160, DE200, & SW100, DUX Dental Wall Mount, Healthco,	780-21488LMD	\$11.95
	F8T5/D	Rinn (Viewer 67-0400, 0440, 0440, 1000, 1020, 6000, 6020, 8001), Star X-Ray (Endo Viewer 5/8" x 12" TR 130 Cephalometric 5/8" x 9")	780-33249LMD	\$6.95
	F14T8/D 14W	X-Ray Viewing Bulb	780-21488LMD	\$11.95

LENS SPLASH SHIELDS

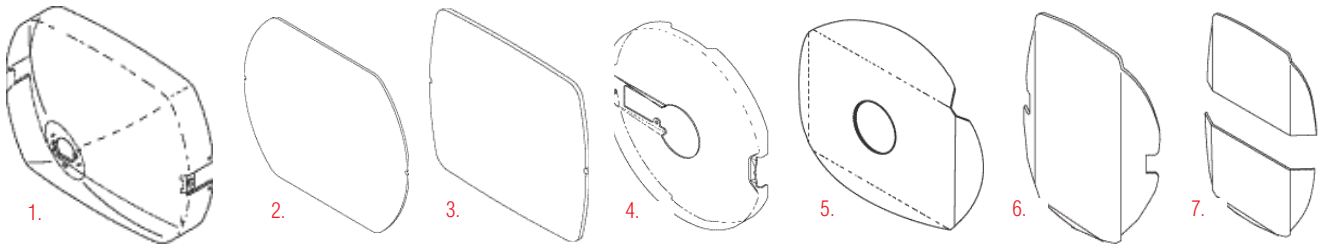

Brand	Model	OEM#	DHPI#	Price
1. A-Dec	6300	28.0503.01	580-DCI9390	\$21.00
2. Belmont	X-Calibur/ECO-Sys (Oval Handles)	8000-02005	580-DCI8603	\$7.95
3. Belmont	X-Calibur/ECO-Sys (Square Handles)	HLU2005	580-DCI8631	\$8.00
4. Belmont	Clesta	501701	580-DCI8959	\$57.95
5. Marus	LuxStar (CL1000, UL1000, TL1000)	52R430	580-DCI8602	\$14.00
6. Pelton	Light Fantastic: LF & LF+	006777	580-DCI8600	\$ 7.50
7. Pelton	Light Fantastic: LF-II (2 Piece)	3321598	580-DCI8601	\$12.75

Please see your DHPI Equipment Specialist for pricing and availability in your area.



Digital Ultra Flushmount

The Digital Ultra Flushmount is the right choice for clinicians who prefer to work in a digital environment but want critical parameters displayed both numerically and as electronic flow tubes. The ease of color-coded, fingertip controls is an additional feature of the flowmeter. Options include a remote control, a printer for recording gas delivery during patient treatment and an automatic vacuum system. The unit's design complements aseptic, contemporary operatory environments.

Features

- Automatic Calibration – adjust total flow while gas % remains constant, adjust gas % and total flow remains constant.
- Digital and electronic gas flow displays.
- Microprocessor technology; color-coded fingertip controls.
- N2O ratio control – min. 30% O2 total flow.
- Oxygen fail-safe; oxygen flush.
- Audible and visual (LED) low O2 alarms.
- Sealed membrane switch technology – easy to clean and disinfect or barrier protect.



Newport Flowmeter System

The Newport Flowmeter System offers a practical solution to the challenges associated with operatory space planning and ready availability of conscious sedation equipment. A totally integrated mobile unit with a stabilizing low center of gravity, it glides easily between operatories and can be positioned discreetly under standard-height counter space when not in use. The system's enclosed design provides convenient, yet out-of-sight, storage for both the manifold and gas tanks. A floor supports the weight of the unit's four cylinders to simplify the task of changing tanks.

Features

- Enclosed 4-cylinder portable system.
- Single-knob on/off and total flow control.
- N2O ratio control - min. 30% oxygen.
- Flow tubes at 15° angle.
- Always-ready oxygen flush.
- O2 resuscitation connector.
- Oxygen fail-safe.

Please see your DHPI Equipment Specialist for pricing and availability in your area.



PC7 Flowmeter System

Available on Mobile Stand Or Cylinder Yoke Block. Scavenger Rubber Goods Included.

Flowmeter Head Dimensions
8.75"H x 3.75"W x 10.25"D

Weight of Flowmeter Head
5 lbs.

Bag and Outlet Diameter
22mm (Approx. 7/8".)

Oxygen Flow Range
3-10 LPM.

Nitrous Oxide Flow Range
0-7 LPM.

Fail-Safe Type
Proportional.

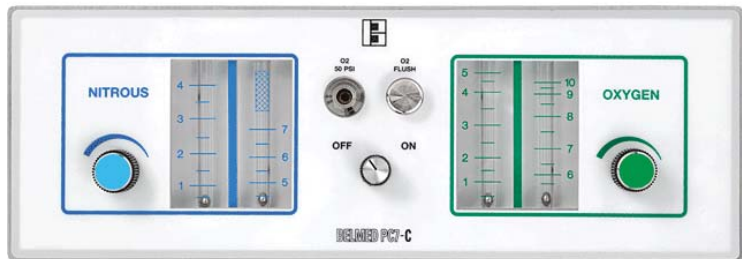

PC7-C Flushmount Flowmeter

The PC7-C has been reconfigured to fit flush into today's cabinetry and provides the same time-proven precision and dependability as our standard PC-7 unit.

- On off control. simple 1/4 turn, establishes a 3 liter minimum O2 flow.
- Oxygen flush. Provides rapid flow of oxygen directly into patient breathing circuit.
- Micrometer needle valves. Allow quick, responsive flow adjustments. needle valve design prevents seat damage.
- Minimum 30% O2. is achieved by limiting flows to a minimum of 3 liters for O2 and a maximum of 7 liters for N2O.
- Dual cascading flowmeter tubes. O2 and n2o are calibrated in liters per minute.
- Oxygen fail-safe. automatically and proportionally reduces N2O in the event O2 is reduced or shut off.
- Solid gas control block. Designed to eliminate internal gas leaks.
- O2 quick connect. Provides connection of auxiliary resuscitation equipment.
- NRB check valve. Prevents the rebreathing of expired gases and guards against CO2 build-up.
- Emergency air valve. Entrain ambient air into the breathing circuit in the event flow from the machine is lost for any reason.

Please see your DHPI Equipment Specialist for pricing and availability in your area.



PORTER

MXR Flowmeter

- Porter Flowmeter Tubes - Provide accurate, visual flow readings the standard of the industry.
- Dual Seal Fail-Safe - Automatically reduces and eliminates N₂O if O₂ is shut off or the pressure is reduced.
- Gas Control Block - Virtually eliminates internal gas leaks. One piece, solid aluminum construction.
- Gas Flow Adjustment Knobs - Throttle-type knobs allow quick, accurate, one-hand adjustment of gas flows.
- Emergency Air In-Take Valve - Automatically provides patient with ambient air if gas flow is interrupted.
- Check Valve. - Prevents rebreathing of used gases and guards against CO₂ build-up in the breathing bag.
- Positive ON-OFF Switch - On all models, the on-off switch eliminates the possibility of accidentally leaving the machine on.
- Oxygen Flush Button - Provides an easily accessible override of all other gas flows and delivers 100% O₂.
- Posi-Stop Needle Valves - Spring washer design prevents over turn of needle stems and resulting damage to seats and valves.
- Oxygen Quick Connect - Facilitates connection of resuscitation equipment to the central system.
- Total Flow Adjustment Knob - Controls flow of both N₂O and O₂ at any desired concentration. Total flow can be adjusted without affecting concentration. Total flow can be adjusted without affecting concentration. Low flow capability means economy of operation Available only on MXR model.

Please see your DHPI Equipment Specialist for pricing and availability in your area.

PORTER

MXR-D Digital Flowmeter

The MXR-D is the only digital flowmeter with both a digital display and calibrated glass indicator tubes for accurate real flow display.

The MXR-D features ergonomic total-flow and percentage adjustment knobs, advanced needle valve technology, visual and audible alarms, on/off switch, and oxygen flush button. The MXR-D is also the only digital flowmeter with an oxygen quick-connect built into the flowmeter for fast connection of emergency oxygen equipment. Easily mounted into your cabinets, walls or pediatric benches.



PORTER

Digital MDM

Porter's newest nitrous oxide flowmeter has the smallest footprint in the industry. At just under 8" long and 2 3/4" high the mounting options are limitless including: flush mount, surface mount, under counter, and top of counter. As cabinet spaces are shrinking and becoming more restrictive - the Digital MDM makes installation as easy as it gets.



PORTER

MXR-1 Cabinet-Mounted Flowmeter

Easily mounted to your cabinet or wall- the MXR-1 allows for ergonomic control and precision delivery with Porter glass indicator tubes. Convenience, accuracy, and reliability- built right into your cabinets or wall.

The MXR-1 is equipped with easy-to-read flow indicator tubes, on/off switch, oxygen flush button, and oxygen quick connect for fast connection of emergency oxygen equipment. Ergonomic single motion control knobs allow for easy flow and percentage adjustment. This space-saving cabinet-mounted flowmeter comes standard with a NIOSH recommended interconnect between the delivery unit and the vacuum system for dual failsafe operation.



Please see your DHPI Equipment Specialist for pricing and availability in your area.



Enhanced Oral Assessment



VELscope® Vx

It is time to take a closer look at the Enhanced Oral Assessment of the VELscope Vx system. Fast becoming the Professionals Choice; this easy to use, portable hand held device is guaranteed to elevate the standards of oral health assessment and patient care.

No rinsing or staining is required for bright clear mucosal visualization when you use the VELscope Vx system. It is used to conduct more oral tissue examinations than any other adjunctive device making it the number one choice for the early detection of oral disease and infection. The VELscope Vx system supports the early detection of:

- Viral, fungal and bacterial infections
- Inflammation from numerous causes
- Cancer and pre-cancer
- Various other oral conditions

770-42001 **\$2,888.95**

Please see your DHPI Equipment Specialist for pricing and availability in your area.

NEW



BioScreen

Bio/Screen uses 5 powerful violet LEDs that shows biofluorescence in the oral cavity without turning off the room lights. It is powered by an internal, rechargeable lithium ion battery. An on/off push button is located on the viewing side. An eyepiece and an optical viewing filter increases contrast between healthy and abnormal tissue. A battery charge indicator is located on the viewing side of the handle.

770-BS7000..... **\$2,094.95**



StarDental® Instruments

A DentalEZ® Integrated Solutions brand

Identafi® Oral Cancer Screening System

Information You Can't Live Without!

Features and Benefits

- Only screening system of its kind using narrow band reflectance (green-amber light).
- Enhances perception of practice as delivering the "highest standard of care."
- Variety of educational and marketing tools including FREE patient brochures and practice marketing tools.

770-RT300371 **\$3,108.95**



Please see your DHPI Equipment Specialist for pricing and availability in your area.

Order by ☎ 800-626-2163

🌐 www.dhponline.com

☎ Fax: 888-681-5088

STERILIZERS

**CoxRapidHeat**

Modernize your sterile processing with the fastest total cycle time. Incorporating Cox RapidHeat sterilization means a lower total cost of ownership (TCO) while also providing faster instrument turnaround! Because there is no water involved, you can place your COX RapidHeat Sterilizer anywhere. No water means that your instruments come out dry and ready to use.

**SteriSure**

The perfect low-cost alternative to steam sterilization. Purchasing a SteriSure delivers the lowest total cost of ownership (TCO) in a microprocessor controlled sterilizer. Requiring no routine cleaning, no harsh chemicals, and no water means lower operating costs while also providing sterilized instruments without pitting, dulling, or corrosion.

**SteriDent**

Cut costs without sacrificing quality. SteriDent sterilizers have a low purchase and operating cost. Requiring no routine cleaning, no harsh chemicals, and no water means operating costs remain low while also providing sterilized instruments without pitting, dulling, or corrosion.

Please see your DHPI Equipment Specialist for pricing and availability in your area.



Because we care.

M3 Ultrafast®

Features

- Sterilizes unwrapped Instruments and handpieces in just 6 minutes and pouched instruments in just over 10
- Easy-to-use, one-step loading operation, push-button cycle selection and automatic-opening door
- 3 pre-programmed cycles, programmable dry cycle and warm-up cycle
- Chamber size 7.6" x 12.1" x 1.6"
- ASME certified



Because we care.

M9 UltraClave®

Features

- Designed to be the most reliable and easiest to use autoclave in healthcare
- Exclusive automatic-opening door design allows for a quick dry time
- 4 pre-programmed cycles create convenience, flexibility and increase confidence
- M9 has 9" x 15" chamber with 3.5 gal usable volume
- ASME certified



Because we care.

M11 UltraClave®

Features

- Designed to be the most reliable and easiest to use autoclave in healthcare
- Exclusive automatic-opening door design allows for a quick dry time
- 4 pre-programmed cycles create convenience, flexibility and increase confidence
- M11 has 11" x 18" chamber with 6.5 gal usable volume
- ASME certified



Please see your DHPI Equipment Specialist for pricing and availability in your area.

SciCan



Statim 2000 G4

SciCan's innovative G4 Technology, now WiFi enabled, automatically records and monitors every cycle 24/7 so the tedious task of manually logging cycle data can now be done automatically and error-free.

Logging accurate cycle information has never been so effortless, simple and efficient. STATIM G4 Technology detects human or mechanical error before it costs time and money.

Specs

- Unit size (L x W x H): 19.5" x 16.25" x 6"
- Cassette internal dimensions: 11" x 7" x 1.4"
- Weight without water: 46 lbs/21 kg
- Air Drying Only

SciCan



Statim 5000 G4

SciCan's innovative G4 Technology, now WiFi enabled, automatically records and monitors every cycle 24/7 so the tedious task of manually logging cycle data can now be done automatically and error-free.

Logging accurate cycle information has never been so effortless, simple and efficient. STATIM G4 Technology detects human or mechanical error before it costs time and money.

Specs:

- Unit size (L x W x H): 23.6" x 16.1" x 7.5"
- Cassette internal dimensions: 15" x 7" x 3"
- Weight without water: 73 lbs/33 kg

SciCan



Bravo

The BRAVO fractionated vacuum chamber autoclave continues the SciCan tradition of being at the forefront of innovation and technology. BRAVO incorporates both pre-vac (to remove air) and post-vac (to help drying) cycles to ensure perfect steam penetration for any load. BRAVO is true to the STATIM reputation for speed, providing rapid cycles for all types of instrument loads.

Please see your DHPI Equipment Specialist for pricing and availability in your area.



EZ9 and EZ10 Autoclaves

Tuttnauer fully automatic autoclaves fill, sterilize, exhaust and dry at the touch of a button. Innovative closed door drying cycle circulates warm, filtered fresh air through the chamber to maintain sterility and ensure efficient drying of packs and pouches.

Features

- Pre-loaded cycles for: unwrapped instruments; wrapped/packs; liquid and additional drying cycle.
- All program parameters can be customized and stored.
- Power outage recovery system.
- Hepa filtered air circulated in chamber drying.
- Chamber door remains closed during entire cycle.
- One touch fully automatic operation; forget it once you set it.
- Optional printer available.

9" and 10" fully automatic machines are also available in a fast cycle model (KWIKLAVE) which reduces total sterilization time by 50%.

Available Units

- 9" x 18"
- 10" x 18"
- 10" x 19"

Keep your sterilizer running clean and trouble-free with regular use of a chamber cleaner. DHPI also carries replacement gaskets and other parts for your sterilizer.



Please see your DHPI Equipment Specialist for pricing and availability in your area.

Order by 800-626-2163

www.dhpionline.com

Fax: 888-681-5088

721



EZ9Plus & EZ11Plus

At Tuttnauer, our single focus on sterilization and infection control enables us to offer products to help practitioners meet today's challenging workloads and regulatory requirements. Our newly designed, ergonomically friendly EZGlide door features effortless opening and closing with an automatic double safety locking mechanism. Glide the door closed with a gentle push to close and lock it. The door remains closed through the dry cycle to maintain sterility and ensure efficient drying. High efficiency air pump circulates filtered air through the chamber for fast drying. Also includes a rear Network Port for connection to a local network, making remote monitoring of your system possible. Available in 9" and 11" chamber sizes and includes a 2 year parts and labor and 10 year chamber warranty.



The Only
**7" ON THE
MARKET**



Valueklave 1730

The Valueklave 1730 will satisfy all of your basic sterilization needs at an economical price. The compact size (7" chamber) makes it a perfect primary unit for small offices or a second autoclave for larger practices. The fast cycle time and heated drying delivers a quick turnaround for wrapped or unwrapped instruments. The simple controls and easy closing door make this unit a breeze to operate. High speed and reliability are built into every Valueklave 1730.

Features

- Fast Cycle Time. 11 minutes from a hot start (Standard Unwrapped Cycle time).
- Automatic shut off at the end of both the sterilization and dry cycles.
- A long life electro polished chamber and door.
- Double safety locking device prevents door from opening while chamber is pressurized.
- Drain valve is located on the front, allowing for quick and easy draining of water reservoir.
- Dual safety to protect against overheating.
- International certifications.
- 1 year parts and labor warranty.
- 316L grade stainless steel with electro-polish finish.

Please see your DHPI Equipment Specialist for pricing and availability in your area.

STERILIZER GASKETS

Brand	Model	Description	OEM#	DHPI Part #	Price	
Scican	Statim 2000 Statim 2000 G4	Seal & Lube Kit	01-100028S	580-SCI01100028S	\$112.95	
		Seal & Lube Kit		580-RPISCS001	\$58.95	
	Statim 5000 Statim 5000 G4	Seal & Lube Kit	01-101649S	580-SCI01101649S	\$129.95	
		Seal & Lube Kit		580-RPISCS029	\$61.45	
Midmark	M3	Door Seal Gasket	053-1635-00	580-MID053163500	\$30.45	
		Door & Dam Gasket Kit	002-0361-01	580-MID002036101	\$131.95	
	M9	Door & Dam Gasket Kit		580-RPIMIK072	\$93.75	
		Door & Dam Gasket Kit		580-DCI2194	\$89.95	
		Door Gasket	053-0366-00	580-MID053036600	\$64.95	
		Door Gasket		580-RPIMIG027	\$43.75	
		Dam Gasket	053-0903-00	580-MID053090300	\$28.25	
		Dam Gasket		580-RPIMIG035	\$22.75	
	M11	Door & Dam Gasket Kit	002-0504-00	580-MID002050400	\$142.95	
		Door & Dam Gasket Kit		580-RPIMIK080	\$98.25	
		Door & Dam Gasket Kit		580-DCI2195	\$94.95	
		Door Gasket	053-0527-00	580-MID053052700	\$74.95	
		Door Gasket		580-RPIMIG028	\$47.95	
		Dam Gasket	053-0904-00	580-MID053090400	\$31.95	
	M7	Dam Gasket		580-RPIMIG036	\$24.25	
		Door Gasket	002-0243-00	580-MID002024300	\$56.25	
	Pelton	Delta-Q 8"	Door Gasket	4014	580-PC004014	\$82.25
			Door Gasket		580-RPIPCG014	\$33.75
Door Gasket				580-DCI2100	\$40.95	
Door Seal & Dam Kit			1539241	580-PC1539241	\$72.75	
Door Seal & Dam Kit				580-RPIPCG065	\$32.25	
Door Seal & Dam Kit				580-DCI2102	\$44.95	
Delta-Q 10"		Door Gasket	4341	580-PC004341	\$97.95	
		Door Gasket		580-RPIPCG015	\$39.45	
		Door Gasket		580-DCI2101	\$47.25	
		Door Seal & Dam Kit	1539407	580-PC1539407	\$107.95	
		Door Seal & Dam Kit		580-RPIPCG066	\$39.75	
		Door Seal & Dam Kit		580-DCI2103	\$51.95	
Tuttnauer	EZ9 & EZ9Plus	Door Gasket	2610118	580-TUT02610118	\$53.95	
		Door Gasket		580-RPITUG021	\$45.75	
	EZ10 & EZ10Plus	Door Gasket	2610023	580-TUT02610023	\$66.25	
		Door Gasket		580-RPITUG003	\$40.95	
	2540 Series	Door Gasket	2610023	580-TUT02610023	\$66.25	
		Door Gasket		580-RPITUG003	\$40.95	
		Door Gasket		580-DCI2107	\$51.95	
	1730 Series	Door Gasket	2610020	580-TUT02610020	\$54.95	
		Door Gasket		580-RPITUG001	\$33.75	
		Door Gasket		580-DCI2105	\$41.95	
	2340 Series (S/N 8805 & Below)	Door Gasket		580-RPITUG002	\$42.25	
		Door Gasket		580-DCI2106	\$51.95	
2340 Series (S/N 8806 & Above)	Door Gasket	2610118	580-TUT02610118	\$53.95		
	Door Gasket		580-RPITUG021	\$45.75		

Please see your DHPI Equipment Specialist for pricing and availability in your area.



Quolis E155

The Quolis® E155 Sterilization Center delivers improved staff safety and work flow efficiency for the processing of contaminated instruments.

- Modular design easily accommodates the integration of key technologies, such as ultrasonic cleaners with cold sterilization, instrument dryers and handpiece lubrication
- Stainless steel sink
- Soft close tandembox drawer system
- Red Light storage for soiled instrument cassettes
- Slide-out shelves for sterilization offer convenient temporary storage and keep work surfaces clear
- Upper towel, glove, and cup dispenser module
- Tapmaster foot control
- Optional foot activated upper door opening system minimizes the potential of cross contaminated surfaces
- Built-in sharps and bio-waste disposal permits immediate disposal of contaminated items to minimize risk to staff
- Built-in LED puck lighting provides optimal lighting of countertop work surface area
- Built-in countertop HVE located next to sink for fast removal of liquids from work surfaces
- Cabinet height is designed for easy access to upper sections
- Stainless Steel laminated backsplash and base panels for durability and convenient hygienic wipe down

Please see your DHPI Equipment Specialist for pricing and availability in your area.

BIOTEC



(Optional equipment and accessories shown)

N7410 Steri Center

Attention to detail ensures Biotec Steri-Centers enhance productivity, and withstand the rigors of a busy practice. Biotec uses superior materials, such as Gibraltar countertops to ensure quality.

Please see your DHPI Equipment Specialist for pricing and availability in your area.

Order by  800-626-2163

 www.dhponline.com

 Fax: 888-681-5088

725

DentalEZ® Equipment Solutions

**NextGen® Sterilization Center**

The efficient design of the DentalEZ® NextGen® Sterilization Center provides the dental team with a system that allows working in a single instrument process flow.

Features include:

- Upper storage with task lighting
- Dispenser:
 - Glove
 - Soap dispenser
 - Towels
- Equipment tower with pull out shelves and wrapped storage
- Drop in deep sink with faucet/spray
- Tapmaster
- Stainless steel waste drop with basket
- 2 Equipment Pull Outs / Wrap station

The DentalEZ NextGen Sterilization Centers are available in 4 Single Flow Centers or we can customize the center that fits your specific needs.

- 72" Sterilization Center
- 96" Sterilization Center
- 120" Sterilization Center
- 144" Sterilization Center

Please see your DHPI Equipment Specialist for pricing and availability in your area.

Dentist's Choice

Cabinetry



Aspen Sterilization Unit

This sterile center was developed to compete with a national manufacturer. Although it is not an exact duplicate it performs as well but sells for half the price. It can also be configured to the customers needs. Sterilization Units come standard with Hospital-grade electrical outlets and under cabinet lighting.

Standard Features

Lifetime warranty • Serial numbered • Dowel Pin Constructed using only 3/4" materials for sides, tops, bottoms, doors and drawers • 3mm edging on all doors and drawers • Customer configured cabinetry • Choice of door pulls • Powder coated steel toe kick • Over 1000 colors to choose from

Optional Features

Inlaid glass doors • Glass shelves • Cup and towel dispenser • Glove dispenser • 15" round stainless steel sink • Single lever and cold faucet • Solid surface counter tops • Hands free faucet • 4" trash drop

Please see your DHPI Equipment Specialist for pricing and availability in your area.



Because we care.



Artizan® Expressions Streamline Center

- Designed to work in a single direction, the flow of instruments follow the recommended CDC guidelines
- Slide-out waste module features available Airglide foot activated open/close system
- Red illuminated windows indicate contaminated material and blue illuminated windows indicate clean environment
- Wrap station includes two full-size wrap drawers, tape alcove and instrument drawers
- The clean storage tower swivels 180 degrees and has adjustable racks

Please see your DHPI Equipment Specialist for pricing and availability in your area.



Because we care.



Integra™ Steri-Center

- Durable steel construction, internal and external modularity and asepsis-friendly design creates a unique IP solution
- Designed to work in a single direction, the flow of instruments follows the recommended CDC guidelines
- Distinct flow and separation from dirty to sterile eliminates inefficiencies and the risk of cross-contamination
- Available in 8', 10' or 12' standard configurations and custom configurations to meet your specific office requirements
- Combined with our market leading sterilizers and quality ultrasonic cleaners creates an all-inclusive system that addresses all your critical sterilization needs

Please see your DHPI Equipment Specialist for pricing and availability in your area.



Belmont

080 Doctor's Stool

- Contoured seat cushion minimizes pressure points to the back of the leg
- Five-spoke, aluminum base with polished top
- Metal hooded casters with dual wheels™
- Coordinated seat & backrest tilt and height adjustment optimizes user comfort and promotes good working posture
- Seamless with the choice of Standard Vinyl or Ultraleather®

081 Assistant's Stool

- Seat height and backrest adjustment for user comfort and for promoting good working posture
- Adjustable seat height range 20"-26"
- Horizontal backrest adjustment with 0° tilt
- Armrest for left- or right-handed users
- Five-spoke aluminum base with polished top
- Metal hooded casters with dual wheels™
- Seamless with the choice of Standard Vinyl or Ultraleather®

Belmont

090 Doctor's Stool

- Standard foam cushions minimizes pressure points to the back of the leg
- Adjustable seat height range 18"-24" (Optional short cylinder for seat height range 16.5"-21" available)
- Coordinated seat & backrest tilt adjustment, seat height adjustment, backrest height adjustment optimizes user comfort and promotes good working posture
- Five-spoke, brushed aluminum base
- Metal hooded casters with dual wheels
- Seamless with the choice of Standard Vinyl or Ultraleather®

091 Assistant's Stool

- Standard foam cushions alleviate pressure points and adjusts for user comfort and for promoting a good working posture
- Adjustable seat height range 20"-26" (Optional long cylinder for seat height range 21"-31" available) & horizontal backrest adjustment with 0° tilt
- Five-spoke, brushed aluminum base
- Adjustable height tubular footing
- Armrest for left- or right-handed users
- Metal hooded casters with dual wheels
- Seamless with the choice of Standard Vinyl or Ultraleather®



Stools looking a little worn and tattered? DHPI can match stool colors to your existing operatory upholstery.

Please see your DHPI Equipment Specialist for pricing and availability in your area.

William "Buffalo Bill" Cody

His production in the saddle
made him a legend...

Now it's your turn!

Discover the exclusive back-pain-relieving
advantages of Brewer's innovative Dynamic,
Split-Saddle-Seat Technology!

Data shows that profit-robbing lower back pain affects 81% of dental professionals, which can lead to shortened work hours, leaves of absence and shortened careers.

So what can you do to help safeguard yourself and your team?

Optimize posture and production with
Brewer's latest patented breakthrough!

- **Unique 360° circular movement:**
 - Actively strengthens the core muscles supporting the spine
 - Allows natural movement while maintaining a neutral posture
 - Lessens lower back pain and spinal muscle degeneration
- **Patented split-saddle-seat design:**
 - Eases load on muscles by putting weight on the "sit-bones"
 - Lessens pressure on upper legs when moving side-to-side
 - Offers superior cooling comfort, improved circulation and reproductive health



Brewer

Visit www.brewercompany.com to learn more!

Brewer

135DSS

- Three height ranges for optimum neutral posture with 135° knee angle
- Unique 360° tilt for dynamic and natural movement
- Exclusive split-saddle seat design
- 23" diameter cast aluminum base
- Large casters for easy rolling
- Locking casters available
- 250lb weight capacity
- Standard 5 year warranty
- Numerous standard color options available
- Premium Ultraleather upholstery available
- Manufactured in the USA



Please see your DHPI Equipment Specialist for pricing and availability in your area.

Order by ☎ 800-626-2163

🌐 www.dhponline.com

☎ Fax: 888-681-5088

731



Brewer

9500 Premium Ergonomic Series

- Seat and backrest feature 3rd generation Dynamic Motion Technology
- Separate, independent backrest control
- Flexible waterfall seat front for added comfort as you move
- Less deep, saddle-style seat dimensions: 18" x 16"
- Includes the new exclusive HybriGel foam, a gel-infused memory foam that gives advanced pressure management and superior cooling comfort
- Wrap-around backrest with ratcheted height adjustment
- 25" diameter powder-coated, 5-leg cast aluminum base with hooded, dual wheel, polyurethane-tread casters
- 250 lb weight capacity
- Standard 5 year warranty
- Made in the USA



Brewer

EG-9000 Series

- Features HybriGel foam.
- Pneumatic height adjustment 18.5" – 24.5".
- Contoured, adjustable lumbar backrest.
- Layered, high density foam in seat and backrest.
- Floating synchronized back and seat tilt.
- 5 year warranty.

Your patients are only in the chair for about an hour, but you are seated all day long. Make an investment in the health of your back and take advantage of the ergonomic developments our manufacturers offer.

Please see your DHPI Equipment Specialist for pricing and availability in your area.



Aurora Series Operator (C140D) & Assistant (C140A) Stools

Standard Features

- Stool: Triple Lever, Independent Adjustment
- Seat: Advanced Molded Contour
- Arm: Ratcheting (Assistant Stool Only)
- Cylinder: Medium - Metal Base
- Doctor Stool Base: Fully Polished
- Assistant Stool Base: Metal
- Casters: 65mm, Two Tone Grey, Hard Floor
- Cushioning: Closed Cell Injection Molded Foam
- Upholstery: Standard Vinyl



Keystone C40D

Standard Features

- Stool: Dual lever adjustment.
- Back: Oval back.
- Seat: Contoured.
- Cylinder: Standard - metal base.
- Base: metal - fully powder coated.
- Casters: Carpet - beige.
- Cushioning: Standard foam.
- Upholstery: Standard vinyl.



C90SB

Standard Features

- Stool: Dual Lever Adjustment
- Seat: Western Style Saddle
- Cylinder: Tall - Metal Base
- Base: metal Base
- Casters: Carpet - Beige
- Cushioning: Standard Foam
- Upholstery: Standard Vinyl



Please see your DHPI Equipment Specialist for pricing and availability in your area.

NEW

DCI edge

Doctor & Assitant Stools

Good posture has a significant effect on your overall health and well-being. Sitting properly takes pressure off your joints and spine reducing stress and allowing you to perform at your best without neck or back pain.

DCI's Doctor's Stool features four adjustment points that allow you to optimally position your stool for proper ergonomics and comfort.

DCI's Assistant's Stool facilitates proper ergonomic positioning.

Please see your DHPI Equipment Specialist for pricing and availability in your area.

DentalEZ® Equipment Solutions

Generation™ Stools

- Broad caster base and five casters to improve stability during position changes.
- Complete mobility to allow movement around the patient's head, minimizing stressful positions.
- Adjustable back support on doctor's stools to facilitate balanced posture (back support is optional on premium assistant's stools).
- Easy height adjustment allowing relaxed positions for multiple operators while maintaining visual access to the oral cavity.
- Side body support on assistant stools to allow comfortable, stable positioning during activities such as suctioning or retracting.
- The DentalEZ system approach can eliminate Class IV and V movements for optimum ergonomic benefit.



DentalEZ® Equipment Solutions

Simplicity™ Stools

Quality & Value for Less!

- Broad caster base and five casters to improve stability during position changes.
- Complete mobility to allow movement around the patient's head, minimizing stressful positions.
- Adjustable back support on doctor's stool to facilitate balanced posture.
- Easy stool height adjustment allowing proper positions for multiple operators while maintaining visual access to the oral cavity.
- Side body support on assistant stools to allow comfortable, stable positioning during activities such as suctioning or retracting.
- Height adjustment foot ring on assistant's stool.



Please see your DHPI Equipment Specialist for pricing and availability in your area.

STOOLS

**Model 2012**

- Contoured backrest follows natural shape of the user's back.
- Ergonomic seat is designed specifically for spending long hours seated.
- 4-way adjustment includes seat tilt, seat height, backrest tilt, and backrest height.
- High Resilience foam, hand cut plastic back, powder coated base, twin wheel black casters.
- 2012 height adjustment is approx. 18" to 23". 2022 height adjustment is approx. 23" to 30".
- 2022 also has a footring and body support arm. Ratcheting mechanism is available upon request

**Model 1067R**

- Round seat is 16" in diameter and 3.5" in thickness.
- High Resilience foam, chrome base, twin wheel black casters.
- Seat height adjusts from approximately 23" to 30".
- Height adjustable footring and body support arm.
- Ratcheting mechanism is included.

**Model 1150 Hygienist**

Hygienist still with back support. Anti-fatigue design helps keep pressure off legs while working. Two-way adjustable height and back tilt support. Adjusts from approximately 18" to 23" high.

Please see your DHPI Equipment Specialist for pricing and availability in your area.



Bambach Saddle Stools

Bambach Saddle Stool will make a dramatic difference in your sitting/working position and visibility, which can result in marked health benefits. Improving Performance & Job Satisfaction. Fluid movement is created with natural, relaxed Bambach sitting even while working on posterior teeth, doing extractions, viewing X-rays, performing oral surgery or reaching out to handpieces or instruments.

Bambach Saddle Stool has been designed for health, comfort and productivity: relieves pain, reduces fatigue, corrects posture, increases mobility, improves circulation.



Because we care.

Dentist & Dental Technician Stools

Features

- Contoured seat with raised front
- Waterfall front edges
- Up to twelve degrees of forward tilt
- One lever adjustment for locking seat and backrest tilt
- Ratcheted backrest for height adjustment without knobs
- Cylinder height: standard - 16.5" to 22"; short - 15.25" to 18.3"; tall - 20.9" to 28.7"
- Seat size: standard - 17.5" x 16.5"; small - 16.25" x 16"
- Vinyl upholstery standard



Please see your DHPI Equipment Specialist for pricing and availability in your area.

Order by ☎ 800-626-2163

🌐 www.dhponline.com

☎ Fax: 888-681-5088

737

STOOLS



Pelton & Crane

Spirit 2000 Series Dental Stools

Comfort while practicing can only enhance your effectiveness – enjoy support and style while treating each patient throughout the day. Pelton & Crane Dental Stools and Dental Assistant Stools provide support for every dental application. Various colors and finishes allow you to select a dentist stool that complements each operatory design aesthetic.



Royal®

D2110 Domain

Standard Features

- Contoured Seat
- Premium vinyl upholstery
- Seat height 16" - 21" (40-53 cm)
- Backrest moves in and out for lumbar support
- Seat can be tilted

Please see your DHPI Equipment Specialist for pricing and availability in your area.

Royal®

A2160 Assistant

Standard Features

- Adjustable footrest
- Ratcheting abdominal support
- Premium vinyl upholstery
- Backrest moves in and out for lumbar support
- Seat height 19" - 26.5" (48-67 cm)



TPC *Advanced Technology, Inc.*
 "On budget.... On time!"

Mirage

Features

- Three seat function.
- Seat pan tilt.
- Six-way lumbar support.
- Two height ranges.
- Height, back and seat adjustment levers.
- Durable tile/carpet casters.



Please see your DHPI Equipment Specialist for pricing and availability in your area.



TRI-CLEAN®
by BrandMax



From Dirty to Clean and Everything In Between... It's BrandMax Clean!®

Ultrasonic Cleaners

Tri-Clean ultrasonic cleaners by BrandMax provide superior cleaning power which results in cleaner instruments. All Tri-Clean ultrasonic units come standard with heating element, cycle time controller and stainless steel basket, there is no need to pay extra for these valuable options when *BrandMax provides them for free!*

Take the *Tri-Clean* Challenge ...

FEATURE	<i>Tri-Clean</i>	Competitor	BENEFIT
All stainless steel construction	✓	?	Scratch resistant, durable and easy to clean
Stainless steel drain valve	✓	?	Easy and effective draining of soiled cleaning solution
Digital timer	✓	?	Control time for worry free cleaning cycles
Superior acoustic pulse generators	✓	?	Powerful cavitations loosen bio-burden from instruments
Heating element included	✓	?	Expensive option included for free!
Stainless steel basket included	✓	?	Expensive option included for free!
Works with all popular cassette systems	✓	?	Supports instrument management
1 year warranty on unit & electronics / 2 year warranty on transducers	✓	?	Comprehensive protection for your investment
Superior customer service	✓	?	"Best in Class" product support

Model #	Cleaning Tank Capacity Gallons/Liters	Temp Range	Timer Setting	Power Sonic/Heat	Tank Dimensions L x W x H (in.)	Basket Dimensions L x W x H (in.)	Overall Dimensions L x W x H (in.)	Unit Weight (lbs.)	Shipping Weight (lbs.)	Shipping Dimensions L x W x H (in.)
U-5LH	1.05 gal / 4L	68-120 °F 20-60 °C	1 - 99 min.	120W / 200 W	9.5 x 5.5 x 6 in.	8.25 x 4.25 x 4.25 in.	11 x 7 x 10.75 in.	11 lbs.	13 lbs.	15 x 10 x 13 in.
U-5LHREC	1.05 gal / 4L	68-120 °F 20-60 °C	1 - 99 min.	120W / 200 W	9.5 x 5.5 x 6 in.	8.25 x 4.25 x 4.25 in.	16.625 x 12.625 x 11 in.	15 lbs.	25 lbs.	21 x 16 x 15 in.
U-10LH	2.64 gal / 10L	68-120 °F 20-60 °C	1 - 99 min.	220W / 350 W	12 x 9.5 x 6 in.	10.5 x 8.25 x 4.25 in.	13.5 x 11 x 11.5 in.	17 lbs.	22 lbs.	18 x 15 x 15 in.
U-10LHREC	2.64 gal / 10L	68-120 °F 20-60 °C	1 - 99 min.	220W / 350 W	12 x 9.5 x 6 in.	10.5 x 8.25 x 4.25 in.	18.6 x 16.2 x 11.5 in.	26 lbs.	34 lbs.	21 x 19 x 15 in.
U-13LH	3.43 gal / 13L	68-120 °F 20-60 °C	1 - 99 min.	300W / 450 W	13 x 11.8 x 6 in.	11.6 x 10.6 x 4.25 in.	14.75 x 13.75 x 13 in.	25 lbs.	32 lbs.	20 x 17 x 15 in.
U-13LHREC	3.43 gal / 13L	68-120 °F 20-60 °C	1 - 99 min.	300W / 450 W	13 x 11.8 x 6 in.	11.6 x 10.6 x 4.25 in.	19.25 x 18.10 x 13 in.	33 lbs.	41 lbs.	23 x 21 x 15 in.
U-20LH	5.06 gal / 20L	68-120 °F 20-60 °C	1 - 99 min.	430W / 650 W	20 x 12 x 6 in.	18.85 x 11.25 x 4.25 in.*	21.75 x 13.75 x 13 in.	36 lbs.	42 lbs.	28 x 17 x 15 in.
U-20LHREC	5.06 gal / 20L	68-120 °F 20-60 °C	1 - 99 min.	430W / 650 W	20 x 12 x 6 in.	18.85 x 11.25 x 4.25 in.*	26.75 x 18.6 x 13 in.	44 lbs.	53 lbs.	29 x 21 x 15 in.

* New 20L basket size, SN 3498 and higher

Supporting Oral Health For Better Health.™

www.BrandMax.us



Please see your DHPI Equipment Specialist for pricing and availability in your area.



Ag 200 SweepZone

SweepZone technology uses "Smart Circuit," a custom-engineered electronic component that creates Constant Power Output (CPO) for consistent, uniform cleaning. SweepZone Ag cleaning systems automatically adjust to different conditions to create uniform cleaning power – eliminating hot spots and weak areas.

- Capacity: 4.25 quarts
- Tank Size: 11.75" x 6" x 4"
- Digital Timer & Drain
- Stainless steel cover
- Basket not included

770-LRAG902

Accessory Kit

Includes one 3/4 size solid side basket, one positioning cover, 2-60 ml beakers, 1 bur box, 1 bur tray.

771-LR659



Quantrex 140

- Capacity: 3.2 liters.
- Tank Size: 10-3/8" x 6-3/8" x 8".
- 60 Minute Timer
- Stainless steel cover.
- 117 volts, 270 watts.
- Basket not included

770-LR311

Accessory Kit

Includes: 1 solid side basket, 1 positioning cover, 2-600 ml beakers, 1 bur tray, 1 basket suspension bracket.

771-LR454



Quantrex 310

The Quantrex Ultrasonic Cleaning System line provides super-strength cleaning every time. Versatile enough for a variety of cleaning applications. When used with L&R's specialty formulated solutions, the self-contained, compact unit offers efficient trouble-free cleaning. Each Quantrex machine comes standard with increased power... strength you can see as soon as you turn the unit on.

- Capacity: 12.3 Liters
- Tank Size: 15.5" x 9" x 6"
- 60 Minute Timer
- Stainless steel cover
- 117V 300W

Basket Not Included

770-LR725

Accessory Kit

Includes: 1/2 Size Solid Side Basket, 1/2 Size Positioning Cover, 2-600 ML Beakers Complete, Bur Box, Bur Tray

770-535



Please see your DHPI Equipment Specialist for pricing and availability in your area.

ULTRASONIC CLEANERS

COLTENE
BioSonic® UC150

With its sleek, Swiss design, the BioSonic UC150 is built for versatility, efficiency and convenience. The 1.5 gallon stainless steel tank offers a small footprint but generous capacity, holding up to 4 instrument cassettes. The UC150 can be used as a countertop or recessed unit, allowing flexibility in any sterilization center setting.

Includes: Unit, Display, Bakset, Power Cord, Drain Tube, Recess Template & Recess Gasket

Tank Size: 1.58 Gallon

BioSonic UC150 Unit
770-60021987

BioSonic UC150 Accessory Kit
Includes Cassette Basket, Beakers (2), Covers (2), Positioning Rings (2), Beaker Holders (2)

770-60022042

COLTENE
BioSonic UC300

- 115 volts.
- Tank Size: 3.8 gallons with cover.
- Enzymatic cleaner and manual.

770-COLUC300115B

SciCan
StatClean

StatClean's 1.6 gallon tank and convenient self docking lid, holds a variety of instruments in the unique hands free drying basket, making it the perfect ultrasonic to complete your reprocessing needs.

Features

- Minimize noise level with StatClean's 4.5mm thick wall housing and tank lid.
- Made from engineering grade plastic making it quieter than most steel housing ultrasonic units.
- 3 color LED touch screen conveniently displays the 1-30 minute timer and 5 temperature settings with advanced power off memory capability memorizing last timer and temperature setting.
- Easy to access drainage valve – Eliminates manual emptying and potential spills.
- Two ceramic heaters are mounted under StatClean's tank for even heating.
- Independent control circuits for each transducer increasing up to 40% higher cleaning efficiency.

770-SCP4862

Please see your DHPI Equipment Specialist for pricing and availability in your area.

Sultan SultanHealthcareInc.

Resurge

The new Resurge Ultrasonic Cleaner will provide you with the confidence of better, safer and faster instrument reprocessing. Both new units feature flexible loading of trays and cassettes while the powerful transducers clean fast and effectively. Combined with Resurge Instrument Cleaning Solution, the new system introduces the next level of instrument cleaning

2 Gallon 770-60200

0.8 Gallon 770-60100



TPC Advanced Technology, Inc.
"On budget... On time!"

Dentsonic

Features

- Powerful 40 KHz of cavitation for thorough, quieter cleaning.
- Stainless steel cover and tank with welded drain.
- Durable vinyl clad steel housing is scratch resistant and easy to clean.
- Digital timer for quick and easy process.
- Sweep technology ensures exceptional cleaning efficiency.
- 1 Year Warranty
- Included basket and lid.

.95 Gallon 770-UC400

2.65 Gallon 770-UC1000



Tuttnauer
Your Sterilization & Infection Control Partners

Clean & Simple Ultrasonic Cleaner

Tuttnauer's Clean & Simple Ultrasonic Cleaning Systems are manufactured with only the highest quality components. The machines provide 60 kHz of quiet cleaning power which is less aggressive to instruments while still removing all surface contamination. The contemporary design and quiet operation compliment any office environment. Clean & Simple Ultrasonic Systems are available in 2 sizes and with a full selection of accessories to meet your specific needs. The 1 gallon holds a standard selection of instruments or 2 half size cassettes. The 3 gallon holds 3 full size cassettes.

1 Gallon 771-CSU1TUT

3 Gallon 771-CSU3TUT



Please see your DHPI Equipment Specialist for pricing and availability in your area.



Oil-Less Air Compressor

Deliver the highest quality of air to your staff and patients without loud, annoying machinery. Our unit is so quiet, you won't even know it's running. Throughout the day, this revolutionary equipment will sense the number of users and adapt to the number of handpieces in use at any one time. Our integrated air dryer also helps extend the life of your handpieces. And because our compressor is 70% smaller than the competition, our unit allows you to reduce your Utility footprint without sacrificing ease of access to service items. In larger installations, multiple stacked units communicate to operate in the most energy efficient pattern while balancing running hours on each compressor. Product comes with a five-year, 10,000 hour warranty, so you can worry about your practice, not your equipment.



Dry Vacuum System

Reduce maintenance costs, green your practice, deliver a higher quality of air and clean up your mechanical room with our Dry Vacuum System. Thanks to variable speed technology and an energy efficient dry vacuum pump, power consumption can be reduced by as much as 70% over wet systems. Add in the elimination of water and sewage costs, and this system can pay for itself in as little as three years. Because you'll also reduce your electric costs, our technology can save your business around \$20,000 over a ten-year period. Our direct driven vacuum motor is built to last up to 20,000 operating hours without maintenance. No other manufacturer can match that. Our system also has the smallest footprint in the industry to help reduce your Utility footprint. Product comes with a five-year, 10,000 hour warranty, so you can worry about your practice, not your equipment.

Please see your DHPI Equipment Specialist for pricing and availability in your area.



Because we care.

ClassicSeries Wet-Ring Vacuum

The Midmark ClassicSeries Wet-Ring Vacuums bring together the highest standard of quality and most proven technologies into one uniform offering. The ClassicSeries Wet Ring Dental Vacuums come standard with many of the same value-driven features as their Apollo and Matrix brand predecessors including:

Features

- High output, proven performance.
- Exclusive internal water recycling uses over 60% less water than standard wet-rings.
- Durable aluminum bronze construction and a stainless steel motor shaft.
- NFPA 99C level 3 compliant and UL/CUL classified.
- Backed by an industry leading full 5 year product warranty



Because we care.

PowerAir® Oil-less Air Compressor

The Midmark PowerAir Oil-less Dental Air Compressors bring together the highest performance and most proven oil-less compressor head technologies into one powerful offering. PowerAir oil-less compressors satisfy the high standards demanded by today's dental professionals including:

Features

- Unrivaled power and performance – up to 66% more CFM than competitive products.
- .01 micron coalescent filter (500 times greater filtration than the industry standard) eliminates common contaminants that other systems can't catch.
- Ultra quiet operation
- Unmatched 5 year/3,500 hour full product warranty
- NFPA 99C level 3 compliant and UL/CUL classified
- Backed by an industry leading full 5 year product warranty



Our Service Technicians are factory trained and certified by the top manufacturers in the dental industry, like Midmark!



Because we care.

PowerVac® G Dry Vacuum

Introducing the next generation in dental vacuum technology – the PowerVac G. The Midmark PowerVac G uses an intelligent energy management system that creates a new standard for all dental vacuums by offering:

- Efficient energy control – uses up to 83% less electricity than competitive systems
- Significant heat reduction – reduces heat emissions by up to 30%
- Whisper quiet operation – as low as 48 dBA
- Consistent performance – up to 18" Hg
- Upgradable flexibility – can accommodate 1 – 20 users
- Unmatched product warranty – 5 year/10,000 hour full product; 10 year/20,000 hour pump warranty
- Backed by an industry leading full 5 year product warranty



Please see your DHPI Equipment Specialist for pricing and availability in your area.



RAMVAC® Utility Solutions

Badger LF LubeFree Dry Vacuum

- High efficiency positive displacement pump runs at only 6.2 amps even at full load, saving money and the environment.
- Connects to pre-existing plumbing, making an easy switch from your wet-vac system .
- Auto shut down ensures longevity of rotary vanes
- 5 Year / 10,000 Hour Warranty on pump, whichever comes first.
- LubeFree and open frame design for quick, easy maintenance.
- 100% water free, saving water and money
- Integrated tank and control unit, saving space in the utility room



RAMVAC® Utility Solutions

Osprey™ Compressor

For any practice looking to increase productivity and decrease downtime servicing their compressors. These new Osprey compressors provide clean, dry, oil-free air even in the busiest dental office! RAMVAC heads are 100% duty cycle rated and run at 115 PSI, helping produce more useable air than any other dental compressor. The Osprey also utilizes a dual column desiccant dryer to provide a 100% continuous supply of dry, clean air. Inquire about our industry leading RAMVAC compressor warranty – 6 years/4200 hours!!!

*Vacuum pump or air compressor need servicing?
Call DHPI and ask about our Preventive Maintenance
Program. Customized to fit your office's needs!*



RAMVAC® Utility Solutions

Bulldog® QT Dry Vacuum

- Easy install features include vertical inlet and exhaust with built-in exhaust check valve.
- One year service interval from a space saving oil reservoir recirculating synthetic oil.
- Compact, space saving flat sides with footprint matching standard twin water ring pump.
- Exclusive gravity and vacuum driven oiling system with no moving parts.
- Oversized pump shaft and bearings for maximum service life.
- 10 year no-fail, no-wear out warranty, high efficiency low speed oil-sealed positive displacement pump.
- Exclusive patented RAMVAC Filtrol features positive protection from foam and liquids; air filters you only need to check once a year; and dust protected vacuum controller.
- Washable long-life main air filter with stainless steel back-up screen.
- S1 Electrols with state-of-the-art micro controller keeps you informed of the equipment status. LEDs identify "faults" and announce time for maintenance.

Please see your DHPI Equipment Specialist for pricing and availability in your area.

NEW

HG Containment Series

Anterior Quest is a Michigan based company that contains and recycles 100% of chair side dental waste that contains amalgam. The HG Containment System is the simplest, safest and most effective mercury and amalgam separator on the market. This patented close looped system eliminates the liability for the office, by ensuring that no one comes into contact with the harmful material. There are no filters to change, no office shutdown required to maintain the HG Containment System. Anterior Quest has preset routes that evacuate the system for the offices every 2 months. They also do all of the paperwork, handling and provide software for each office to monitor their system. The HG Containment System is the only hands-off system on the market today. Anterior Quest is the only company World Wide that contains 100% of all chair side waste and recycles it back to clean mercury free water. The HG Containment System produced by Anterior Quest does not allow any mercury to pass to the local wastewater treatment plant and is contained, evacuated and recycled; this exempts offices with the Anterior Quest System from regulations. The HG Containment System is the most cost effective, maintenance free and environmentally friendly Amalgam Separator on the market.



Amalised Green

The Silver Service by medentex is your one-stop shop solution for amalgam recycling! You receive a box with everything you need: one amalised® Silver separator cartridge – which can be fitted to many existing separator systems, one amalgam waste container, one toothbox and a bag for amalgam capsules. We take care of the exchange intervals and the collection safe and trouble-free!

- ISO 11143:2008 Certified at 99.7%
- Universal, industry-standard connection
- Easy to install, easy to maintain
- Most offices need only 1 exchange per year!
- Separator, waste containers & recycling included for 1 price



Please see your DHPI Equipment Specialist for pricing and availability in your area.

Order by 800-626-2163

www.dhponline.com

Fax: 888-681-5088

747



Eco II Amalgam Separator

Features

- Services up to 6 chairs (or 12 chairs with tandem unit)
- ISO 11143 certified, >99% effective For wet or dry vacuum systems, adaptable to all thickness hoses
- Centrally installed before the main vacuum, zero maintenance
- Includes a pre-paid UPS return shipping label
- Online compliance portal with automatic recycling e-certificates
- Lasts 6-12 months depending on practice size with quick “plug-in, plug-out” replacement canister exchange process



Hg5 Amalgam Separator

We’ve got amalgam separation down to a science. Removing mercury from the dental practice (and the environment) is a good thing - and we’re way ahead of the game. When it comes to Amalgam Separation, no one knows more than Solmetex. 21 years ago, our experience in water science led us to create a system that easily and affordably removes amalgam waste from dental practices. Our signature product the Hg5 is the industry standard and has won more awards than all competitors combined. As a ‘total solution provider,’ Solmetex takes care of waste handling and recycling so you don’t have to. Good for you and good for the environment. Solmetex – clearly the leader in amalgam separation

Please see your DHPI Equipment Specialist for pricing and availability in your area.



Sterisil® System Microbiological Dental Office/Clinic Water Treatment System

Sterisil has simplified the means for producing treated dental water. This turnkey Sterisil System eliminates the inconvenience and added cost of buying secondary water disinfection products. It also provides continuous autoclave water and final rinse water for instrument washers. Gone are the days of corrosive, toxic and expensive waterline disinfection products as well as costly and untimely trips to obtain distilled water.

The Sterisil System is available in two different versions: Bottle Fill and Direct Feed. The Bottle Fill Sterisil System comes with a chrome faucet that conveniently provides EPA registered dental water for your bottle reservoirs. The Direct Feed Sterisil System is typically installed in a new build, remodel or configured in a pre-existing office that has directly plumbed water lines to the operatories.

Main Features

- EPA registered dental water for any size office. 1 to 100+ chairs
- Produces distilled quality water to 0ppm TDS for autoclaves
- Final rinse water for instrument washers

Product Highlights

- No more tablets & additives for daily dental water use
- Fully automated monitoring with visual and audible alarms
- Class B Ultraviolet (UV) Irradiation water disinfection
- Cartridge replacement only takes 10 minutes per year!
- Does not adversely affect composite bond strength
- Contains no iodine or chlorine and prevents hard water deposits
- Non-toxic, non-corrosive and safe for patients and dental equipment

530-SSB **\$6,303.75**

Please see your DHPI Equipment Specialist for pricing and availability in your area.

3M Oral Care

Adper Easy Bond	117
Adper Prompt L-Pop Self-Etch.....	117
Adper Scotchbond Multi-Purpose Adhesive	117
Adper Single Bond Plus Adhesive.....	117
Attest Biological Monitoring	307
Avagard D Hand Antiseptic.....	299
Cavit	98
CavityShield Varnish.....	501
Clinpro 5000	526
Clinpro Disposable Prophy Angles	507
Clinpro Prophy Paste	513
Clinpro Sealant.....	505
Comply Sterigage Integrators	307
Crown Pliers	389
Crown Scissors.....	389
Dimension VPS	261
Directed Flow Impression Trays.....	270
Durelon.....	108
Elipar DeepCure-S LED Curing Light....	150
Express Bite Registration	255
Express VPS	261
Filtek Bulk Fill Flowable	127
Filtek One Bulk Fill	127
Filtek P60.....	128
Filtek Supreme Ultra.....	128-129
Filtek Supreme Ultra Flowable	135-136
Filtek Z100.....	129
Filtek Z250.....	128
Floss and Toss.....	493
Gold Anodized Crowns.....	157
Impregum Impression Material.....	258-259
Impregum Penta Cartridges	259
Impregum Syringe	259
Imprint 3 VPS	261
Imprint 4 Bite Registration	256
Imprint 4 VPS	262
Intraoral Syringes	267
Ion Iso-Form Crowns.....	155
Iso-Form Crowns	155
Just for Kids Stannous Fluoride	498
Ketac-Bond.....	98
Ketac-Cem Aplicap	106
Ketac-Cem Maxicap	106
Ketac-Cem Radiopaque	106
Ketac-Fil Plus.....	139
Ketac-Molar Quick Aplicap	140
Ketac-Nano	140
Ketac-Silver	113
Matrix Tape.....	465

Molded Face Masks	287
Omni Gel Fluoride Gel	498
Paradigm DeepCure LED Curing Light .	150
Paradigm Restorative	129
Paradigm VPS	262
Pentamix 3.....	259
Peridex Oral Rinse	489
Periomed Oral Rinse	499
Permadyne	259
Photac-Fil Quick Aplicap.....	140
Polycarbonate Crowns.....	155
ProTemp II	3
Protemp Plus	3
RelyX Fiber Posts.....	486
RelyX Luting Cement.....	106
RelyX Luting Plus	106
RelyX Temporary Cement	109
RelyX Ultimate.....	100
RelyX Unicem	100
RelyX Unicem 2.....	100
RelyX Veneer Cement	101
Retraction Capsules	540
Scotchbond Dispenser Wells.....	149
Scotchbond Etchants	124
Scotchbond Universal Adhesive	117
Scotchbond Universal Etchant	124
Sil Silane Material	117, 450
Sof-Lex Discs	211
Sof-Lex Finishing & Polishing Strips	214
Sof-Lex Pop-On Mandrels	211
Sof-Lex Spiral Finishing & Polishing Wheels.....	211
Stainless Steel Crowns.....	155-156
Strip Crowns	157
TheraMints.....	488
Triple Layer Molded Face Masks.....	287
Unitek Crowns	156-157
Unitek Gold Anodized Temporary Crowns	157
Vanish Fluoride Varnish.....	501
Vitrebond	97
Vitrebond Plus	97
Vitremer Core Buildup	113
White & Brite	143

A. Titan Instruments

Implant Bone Funnels.....	377
Implantation/Explantation Trephines.....	377
Osseous Collector	377
Osseous Glider.....	378
Periotomes.....	413

Universal Implant Drivers	378
X-Otomes	413

Accutron, Inc.

Clearview Classic Nasal Masks	20
Digital Ultra Nitrous Oxide System	712
Newport Flowmeter Nitrous Oxide System	712
Personal Inhaler Plus Nasal Hoods.....	20

Acteon North America

Expasyl.....	540
Newtron Ultrasonic Scalers	527
P5XS B.LED Ultrasonic Scaler.....	528
PSPIX Imaging Plate Scanner	649
Sopix2 Sensors	650
Sopro 717 First Camera	642
SoproCare Caries Detection.....	647
SoproLife Caries Detection.....	647
XMind Trium X-Ray 2D/3D	658
XMind Unity Intraoral X-Ray.....	654

Advantage Dental Products, Inc.

Hemaseal & Cide	489
Temporary Crown Matrix Buttons	256
Crystal Impression Trays	271

Air Techniques

Air Techniques Developer & Fixer	570
Cam-X Elara IntraOral Camera	642
Cam-X Spectra Caries Detection	647
Cam-X Triton HD Camera.....	643
Formula 2000 Plus	572
Monarch CleanStream Evacuation Cleaner	205
Monarch Enzymatic Cleaner	315
Monarch Surface Disinfectant	311
Monarch Waterlines Cleaner	329
Peri-Pro Developer & Fixer	570
Peri-Pro Transport Cleaning Kit	572
ProVecta HD IntraOral X-Ray	654
ProVecta S-Pan Ceph X-Ray.....	659
ProVecta S-Pan Panoramic X-Ray	658
ScanX Barrier Envelopes	584
ScanX Digital Radiography.....	648
Spray 2000 Plus	572

Almore International, Inc.

Bite Registration Wax	563
Comfi-Tip Foam Tips	202
Madame Butterfly Articulating Paper.....	22

Richwil Crown & Bridge Remover	159
SafeDispense Floss Dispenser	493
Shimstock Occlusion Foil	22
Surfactant Debubbler	456

AlphaProTech

Ctical Cover PFL Earloop Masks	288
PFL N95 Particulate Respirator Mask	292

Aluwax Dental Products Company

Aluwax	564
--------------	-----

American Eagle Instruments, Inc.

American Eagle Explorers	332
American Eagle Expos	332
American Eagle Probes	332-333
American Eagle Scalers & Curettes	357-361

Angelus Dental

MTA-Fillapex	192
--------------------	-----

Anodia Systems

Mint-A-Kleen	329
--------------------	-----

Ansell Healthcare

Gammex Sterile Surgical Gloves	285
Micro-Touch NextStep Gloves	275
Micro-Touch Plus Gloves	275

Anterior Quest

HG Containment System (Amalgam Separator)	747
--	-----

Aribex, Inc.

NOMAD Pro 2	655
-------------------	-----

Aseptico, Inc.

Handi-Dam	543
-----------------	-----

Aurelia® Gloves by Supermax

Amazing Nitrile Gloves	278
Blush Nitrile Gloves	278
Dimensions Latex Fitted Gloves	285
Distinct Latex Gloves	275
Luminance Latex Gloves	275
Perform Nitrile Gloves	278
Protégé Nitrile Gloves	278
Quest Nitrile Gloves	279
Refresh Latex Gloves	275
Robust Nitrile Gloves	278
Sonic Nitrile Gloves	278

Transform Nitrile Gloves	279
Velocity Latex Gloves	275
Vibrant Latex Gloves	275

B4 Brands

Aterra Foaming Hand Soap	301
Avant Hand Sanitizer	299

Bausch Articulating Papers

Arti-Spray	23
Bausch Articulating Paper	22

Bay West

EcoSoft Facial Tissue	641
EcoSoft Hand Towels	169-170

Beaumont Products, Inc.

Citrus II Hand Sanitizer	299
Citrus II Odor Eliminator	308
Citrus II Solid Air Freshener	308

Beaverstate Dental Systems

Beaverstate S-4250 Mobile Cart	694
--------------------------------------	-----

Belmed Inc.

PC7 Flowmeter System	713
----------------------------	-----

Belmont

BDU Delivery System	688
Bel-Cypher N X-Ray	659
Bel-Halo LED Operatory Light	702
Belmont Cabinetry	666-667
Belmont Delivery Systems	688
Belmont Dental Chairs	680-681
Belmont Lights	702
Belmont Sterilization Center	725
Belmont Stools	730
Belmont X-Ray	655
Clesta LED Operatory Lights	702
D-4RH Cabinetry	667
Evogue Delivery System	688
PHDT-xlIs Intraoral X-Ray	655
PRO II Dental Chair	681
Quolis 5000 Dental Chair	680
Quolis Delivery Systems	688
Quolis Sterilization Center	725
X-Calibur B50 Dental Chair	680

Beutlich® Pharmaceuticals, LLC

Hurricane	18
HurriSeal	489
HurriView Swap-n-Go Swabs	490

Biotrol

Biocide G30	309
Biozyme LT	315
Birex Disinfecting Wipes	311
BirexSE	311
EZ 1-2-3 Atomizer	205
Glove/Gloves	286
NeutraVAC	205
Opti-Cide 3	312
Opti-Cide 3 Wipes	312
Prophy Gems	513
Purit Cide-it	315
Purit Clean-it	315
Purit Enz-it	315
Purit Remuv-it	315
Restore Daily	315
Vacusol Ultra	205

BrandMax

Tri-Clean Ultrasonic Cleaners	740
-------------------------------------	-----

Brewer Company

Brewer Stools	731-732
---------------------	---------

Buffalo Dental Manufacturing

Abbott-Robinson Brushes	445
Alcohol Torch	445
Bib Clips	164
Block-Out Compound	459
Chamois Buffs	445
Econo-Vac Vacuum Former	456
M35 Electric Handpiece	245
Optiblast Workstation	448
Permabond 910 Adhesive	448
Robinson Bristle Brushes	445
Stalite Special Solution	456
Sta-Lube Silicone Spray	453
Sta-Vac Vacuum Former	456
ThermaKnife Trimming Knife	459
Trap-Eze Plaster Trap	452
Tray-Vac Vacuum Former	456
X50 Electric Handpiece	245

Carestream Dental

Carbocaine	14
Cook-Waite Injectable Anesthetics	14
Ektavison G Film	567
GBX Developer & Fixer	571
Insight Film	566
Lidocaine	14
Marcaine	14

Rapid Access Process Developer & Fixer570

Ready Pro Developer & Fixer570

Readymatic Developer & Fixer570

T-Mat ExtraOral Film.....567

Ultra-Speed Film.....566

X-Omat ExtraOral Film567

Zorcaine..... 14

Cavex

Cavex Alginate251

Cefla North America (MyRay)

Hyperion X5 Panoramic X-Ray.....663

Hyperion X9 3D CBCT Scanner663

RXDC HyperSphere Intraoral X-Ray657

Centrix

Access Blue.....262

Access Crown.....3

Accudose Tubes & Plugs..... 149-150

Benda Brushes.....147

Benda Micro Applicators.....147

C-R Syringes149

Encore/Encore DC..... 113

FluoroDose Fluoride Varnish501

Gingitrac541

Lollicaine..... 18

LubeCube442

Mark IIIP Syringe.....149

NoMIX Temporary Cement109

RapidCore 113

SuperCure 113

Tempit.....98

Tubes & Plugs 149-150

Certol International

Good Vibrations.....316

ProBarrier Tube Sox325

ProEZ Foam316

ProSpray Surface Disinfectant.....312

Protector Needle Sheath Prop.....17

ProTray Foam Set-Up Trays.....440

ProView Plus Pouches304

V-Cide 311

Cetylite, Inc.

Cetacaine 18

Cetylcide II.....312

Cetylcide-G.....309

C-Tub.....310

Dee-Fog.....350

Protexin Oral Rinse & Spray.....503

Zarosen489

ACT Anticavity Fluoride Rinse.....498

Ched Markay, Inc.

Holg Mark Rite Articulating Paper22

Coltene

Affinis Precious VPS263

Affinis VPS263

Alpen Burs31-32

Alpen Multi Use Diamonds..... 64-67

Alpen x1 Single Use Diamonds.....67-68

Biosonic Optimist Inserts.....531

Biosonic Super Soft Inserts.....531

Biosonic Suvi Scaler Tips531

BioSonic Ultrasonic Solutions316

BioSonic Ultrasonic Units742

Biosonic US100R Scaler528

Biosonic WipeOut312

Bite Wafers564

Brinker Rubber Dam Clamps545

CanalPro Apex Locator.....197

CanalPro CL Cordless Endo Handpiece
.....243

Coltolux 75 Curing Light.....151

Coltolux LED Curing Light.....151

Comprecap541

CoolTemp4

CRCS Calciobiotic Root Canal Sealer ..192

DuoTEMP99

Elasti-Dam542

Endo-Ice 18

Fiesta Dental Dam542

Fiesta Rubber Dam Clamps545

Fill-Up!127

Flexiboles 253, 451

Flexi-Dam 542-543

GuttaFlow 2197

HyFlex CM Files173

Hyflex EDM Files173

Hyflex GPF Files.....174

Hyflex NT Files174

Hygenic Absorbent Paper Points.....189

Hygenic Gutta Percha Points.....191

Hygenic Rubber Dam542

Hygenic Waxes 563-565

Jet Bite.....256

Jet Blue Bite256

Kodex Drills482

Lab Putty260

Link Pins.....482

Magic FoamCord538

Max Pins.....482

ParaBond..... 118

ParaCore 113

ParaPost 483-484

ParaPost Fiber Lux486

ParaPost Fiber White.....486

ParaPost Plus483

ParaPost Taper Lux486

ParaPost XH483

ParaPost XP 483-484

ParaPost XT484

President Impression Trays.....269

Rubber Dam Napkins544

Rubber Dam Stamp.....543

SPEC 3 LED Curing Light.....151

Spectra Absorbent Points.....189

Spectra Gutta Percha Points191

Speedster Burs (Alpen)31

Stay-Put Retraction Cord538

SurgiTip-Endo Aspirator Tips.....204

Synergy D6 Composites.....129

Synergy Nano Composites.....129

TMS Pins.....482

Wedjets.....543

Covidien Products by Medtronic

Curity Packing Strip.....554

Iodoform Packing Strip554

Monoject Aspirator Tips204

Monoject Endo Needles & Syringes.....196

Monoject Evacuator Tips201

Monoject Needles.....16

Monoject Saliva Ejectors202

Monoject Sharps Containers...21, 327, 329

Monoject Syringes.....196

Sharpstar Sharps Containers.....21

CPAC Environmental Solutions

Cox Rapid Heat Sterilizer718

Dry Heat Sterilizers718

SteriDent Sterilizer.....718

SteriSure Dry Heat Sterilization Bags ..304

SteriSure Sterilizer.....718

Cranberry

Aqua Source Nitrile Gloves279

Contour Nitrile Gloves279

Contour Plus Nitrile Gloves279

Crave Nitrile Gloves.....279

Curve Fitted Nitrile Gloves.....285

Cyntek Latex Gloves.....276

Evolve 300 Nitrile Gloves279
 Luv Nitrile Gloves279
 R200 Nitrile Gloves279
 Repel 4-ply Mask with Shield291
 Repel 4-ply Masks288
 S3 ACE Earloop Masks288
 S3 C2 Earloop Masks288
 S3 Earloop Masks288
 S3 Mint Earloop Masks288
 Sigma Latex Gloves276
 Silkcare Fitted Latex Gloves285
 Silkcare Latex Gloves276
 Smart Dam542
 Softouch Vinyl Gloves284
 Truly 200 Nitrile Gloves280
 Xlim Nitrile Gloves280

Crosstex International

Advantage Saliva Ejectors202
 All-Gauze Sponges162
 Ambiance Nitrile Gloves280
 BD Luer-Lok Needles15
 BD Sharps Containers21
 Combi-Tip HVE Tips201
 Comfort Plus Saliva Ejectors202
 Confirm 10 In Office Monitoring307
 Confirm 24 In-Office Biological Monitoring
307
 Confirm Main-In Monitoring Service307
 Cotton Rolls160
 CrossZyme316
 Cup Dispenser166
 DentaPure329
 Duo-Check Sterilization Pouches304
 Econoback Patient Bibs163
 Edge-Ease Comfort Cushions580
 Efferzyme Tablets316
 Exodontia Sponges161
 Finger Lift Edge Barrier Film320
 GumNumb18
 Headrest Covers166
 Hygoformic Saliva Ejectors202
 iBarrier325
 Isofluid Earloop Masks288
 Isofluid Fog Free Earloop Masks288
 Isofluid Fog Free Earloop Masks with
 Shield292
 Isofluid Plus Earloop Masks289
 Isofluid Plus Earloop Masks with SecureFit
289
 Isolator Plus N95 Particulate Masks292
 Isolite Procedure Mask289

LaPetit Masque289
 Left/Right Fitted Nitrile Gloves285
 MaxVac Plus HVE Tips201
 Patient Apron163
 Patient's Choice Zap Fluoride Gel497
 Premium Saliva Ejectors202
 Procedural Earloop Masks289
 Proguard Fluoride Varnish501
 Rapicide OPA 28309
 Sani-Cloth AF3312
 Sani-Cloth HB312
 Sani-Cloth Plus312
 SaniGlut Glutaraldehyde309
 Sani-Roll Sterilization Tubing306
 SaniSept Soap301
 Sani-Tab Bibs163
 Sanitex Plus Spray313
 Sani-Tube Sterilization Tubing306
 Sanitize Antimicrobial Gel299
 SecureFit Face Masks289
 SeeClear Eyeglass Wipes296
 Sparkle Air/Water Syringe Tips168
 Sparkle Disposable Prophyl Angle507
 Sparkle Prophyl Paste513
 Sparkle V Fluoride Varnish501
 SporeCheck In-Office Monitoring307
 Super Sani-Cloth Plus312
 Sure-Check Sterilization Pouches304
 Sure-Check Strips307
 Surgical Molded Mask287
 Tray Covers167
 Twist Disposable Prophyl Angle507
 Ultra Earloop Masks289
 Ultra Earloop Masks with SecureFit289
 Ultra Fog Free Earloop Masks289
 Ultra Gauze Sponges162
 Ultra No Fog Mask with Splash Visor292
 Ultra Pure Non Woven Sponges162
 Ultra Sensitive Earloop Masks289
 Ultra Sensitive Earloop Masks with
 SecureFit289
 Ultra Sensitive Fog Free Masks289
 Ultra Sensitive NoFog Mask with Shield
292
 Wrap-Ease323

Crown Seating

Crown Seating Stools733

DASH Medical Gloves Inc.

Alasta Nitrile Gloves280
 Alasta White Nitrile Gloves280

Alasta with Aloe Nitrile Gloves280
 aloePRO Latex Gloves276
 aloePRO Synthetic Gloves284
 Black Maxx Latex Gloves276
 Black Maxx Nitrile Gloves280
 Halo Nitrile Gloves280
 MicroPro Latex Gloves276
 Nitrile PF with Aloe Gloves281
 Nuvo Vinyl Gloves284
 True Comfort Neoprene Gloves284
 Vinyl PF Gloves284
 VitalGard Latex Gloves276
 VitalGard Nitrile Gloves281

DCI Equipment

DCI Edge Delivery Systems689
 DCI Edge Dental Chair681
 DCI Edge Operatory Lights703
 DCI Edge Stools734

DEAN Dental Systems

Dry Vacuum System744
 Oil-Less Air Compressor744

Dedeco International, Inc.

Green Giant Stones216
 Lathe Wheels444
 Midgets216

DenMat

Ceri-Saw453
 Core Paste XP113
 Geristore130
 Infinity Syringeable101
 LumiBrite Chairside Whitening142
 LumiBrite Take Home Whitening143
 Pro-Ties440
 Tenure Multi-Purpose Bonding System . 118

Dental Enhancements

OSHA & HIPAA Compliance Packages.327

DentalEZ

CORE Delivery System690
 CORE Dental Chair682
 CORE LED Light704
 Dental EZ Cabinetry670-671
 Dental EZ Delivery Systems690
 Dental EZ Dental Chairs682
 Dental EZ Operatory Lights704
 Dental EZ Stools735
 EverLight Operatory Light704

- Generation Stools.....735
 NextGen Delivery System690
 NextGen Sterilization Center726
 NuSimplicity Dental Chair.....682
 Simplicity Delivery System690
 Simplicity Stools735
- DentalEZ (Nevin Labs)**
 ErgoTech Lab Workstation679
 Eye Wash Stations327
 Freedom Lab Workstation679
- DentalEZ (RamVac)**
 Badger LubeFree Dy Vacuum746
 Bulldog QT Vacuum.....746
 Osprey Compressors.....746
 SlugBuster.....205
- DentalEZ (Star Dental)**
 430-series Handpieces.....229, 232-233
 Blissonic Scaler530
 Ceramic Bearing Turbines234
 Concentrix Handpieces232
 Dentalube II250
 Identafi Oral Cancer Screeing System ..717
 iStar Cordless Prophy Handpiece.....244
 NuTorque Electric Handpieces238
 Prophy Star 3 Handpieces.....245
 Sparkl442
 Star High Speed Handpiece Accessories
234
 Star Hygiene Handpieces.....244-245
 Star Low Speed Handpiece Accessories
240
 Titan Blissonic Scaler530
 Titan Motors & Accessories240, 242
- Dentamerica Inc.**
 Eye Protection Shield153
 Polybite Trays.....269
- Dentatus**
 Surtex Posts484
- DenTek**
 Comfort Clean Floss Picks493
 Easy Angle Floss Picks493
 Fun Flossers494
 Triple Clean Floss Picks494
- Denticator Inc.**
 Denticolors Prophy Angles.....507
- Diamond Prophy Angles508
 Emerald Disposable Prophy Angles508
 Pick-A-Dent.....494
 ProphyPal Handpieces243
 Tip-A-Dent494
- DentiMax**
 DentiMax Dream Digital Sensor650
 DentiMax Dream Sensors650
- Dentist's Choice Cabintery**
 Aspen Sterilization Center.....727
 Dental Cabinets672-673
- Dentsply Caulk**
 Algin-X Ultra254
 Aquasil Ultra263-264
 Aquasil Ultra Cordless264
 Aquasil Ultra DECA264
 Aquasil Ultra Digit.....264
 Aquasil Ultra with B4263
 Aquasil Ultra Xtra264
 Automatrix463
 Barricaid554
 Calibra Esthetic Resin Cement.....101
 Calibra Universal Self-Adhesive Resin
 Cement.....101
 Calm-It489
 ChemFil Rock Advanced140
 Clear Crown Forms156
 Compule Syringe Gun150
 Comspan101
 Crescent Plaster Trap452
 Dispersalloy10
 Dycal.....97
 Dyract eXtra.....130
 Dyract Flow.....136
 Enhance Finishing & Polishing.....221
 Enhance PoGo221
 Esthet-X Flow136
 Esthet-X HD.....130
 Fluopost.....114
 FluoroCore.....114
 FluoroCore 2+.....114
 FluroShield505
 Fynal.....109
 Integrity.....4
 Integrity Multi-Cure4
 Integrity TempGrip109
 iNTERRA In-Office Nightguard.....457
 IRM99
 Jeltrate Alginates251
- Lynal9
 Megalloy EZ.....12
 Orthodontic Resin.....480
 Palodent Matrix.....463
 Palodent Plus EZ Coat Matrices463
 Palodent Plus Matrix463
 Polyjel NF259
 Prime & Bond Elect118
 Prime & Bond NT118
 Prime & Bond NT Amalgam Bonding
 Accessory Kit.....118
 Prime & Bond XP118
 Prisma Gloss220
 Prisma VLC Dycal.....97
 ProBond.....118
 ProMix Amalgamator13
 Quixx Posterior Composite.....130
 Regisil256
 Regisil 2X256
 Regisil Rigid.....256
 Reprosil264
 Rim-Lock Trays273
 SmartCEM2.....101
 SureFil130
 SureFil SDR Flowable + Composite127
 Temporary Bridge Resin.....4
 TimeLine.....97
 Tooth Conditioner Gel.....124
 TPH Spectra Universal Composite.130-131
 TPH3 Flow.....136
 Tylok-Plus108
 Unison Alloy.....12
 Xenon IV.....118
 ZOE B&T99
- Dentsply Glenroe**
 Archwire, Orthodontic.....475
 Elastic Bands.....479
- Dentsply Maillefer**
 AH Plus Jet Root Canal Sealer193
 AH Plus Root Canal Sealer.....193
 AH26 Root Canal Sealer193
 Densfil Thermal Endodontic Obturators 197
 Endo Clean-Stand199
 Endo Container.....199
 Endo Stand.....199
 Endo-Access Bur.....38
 Endo-M-Block199
 Endo-Z Bur38
 Filemate.....199
 Glyde File Prep194

LN Bur38
 Max-I-Probe 196
 Micro-Openers & Micro-Debridors352
 Multi-Purpose Bur.....38
 Ready-Steel C-Files / C+ Files 176
 Ready-Steel Flexofiles175
 Ready-Steel Hedstrom Files..... 176
 Ready-Steel K-Files.....175
 Ready-Steel K-Reamers.....176
 Ready-Steel Senseus Flexofiles175
 SureFlex Files.....187
 Sure-Stop Dispenser199
 Transmetal Bur38
 X-Tip 16

Dentsply Midwest

Carbide Burs..... 33-37
 Esthetic Finishing Carbide Burs36
 Finishing Carbide Burs 35-36
 Midwest Burs 33-37
 MultiPrep Burs37
 Once Single Use Diamonds 69-70

Dentsply Pharmaceutical

Accuject Needles..... 16
 Artica dent 14
 Citanest 14
 Oraquix 18
 Polocaine 14
 Xylocaine 14

Dentsply Professional

Automate Handpiece Maintenance System
248
 Bobcat Pro Ultrasonic Scaler.....528
 Captivate In-Office Whitening142
 Captivate Take-Home Whitening.....143
 Cavitron Bellissima Inserts532
 Cavitron Bobcat Pro.....528
 Cavitron Fitgrip Ultrasonic Inserts532
 Cavitron Inserts O-Rings534
 Cavitron Jet Air Polishing Insert534
 Cavitron Jet Plus Ultrasonic Scaler529
 Cavitron Jet-Fresh Prophy Powder529
 Cavitron Plus Ultrasonic Scaler with
 Tap-On.....529
 Cavitron Powerline Inserts.....532
 Cavitron Select SPS.....528
 Cavitron Slimline Inserts..... 532-533
 Cavitron SofTip Implant Insert.....533
 Cavitron THINsert Ultrasonic Insert.....532
 Cavitron Thru Flow Inserts533

Cavitron Touch with Steri-Mate529
 Cavitron Ultrasonic Inserts 532-534
 Delton Pit & Fissure Sealant505
 Disposa-Shield Barriers. 321, 325, 325-326
 Jenker Needle Stick Protection..... 17
 Midwest Automate Maintenance System
248
 Midwest E Electric Handpiece System
237-238
 Midwest E Plus Electric High-Speed
 Handpiece 235, 238
 Midwest High-Speed Handpieces 226, 230
 Midwest Hygiene Handpieces244
 Midwest Low Speed Motors & Accessories
238
 Midwest Plus Cleaners & Lubricants
 248-249
 Midwest RDH Handpieces244
 Nupro Chlorhexidine Gluconate Rinse .489
 Nupro Extra Care Prophy Paste513
 Nupro Flouride Gel.....497
 Nupro Fluoride Rinse499
 Nupro Fluoride Varnish.....501
 Nupro Freedom Cordless Prophy System
244
 Nupro Freedom Disposable Contra Prophy
 Angle508
 Nupro Prophy Grips517
 Nupro Prophy Paste.....513-514
 Nupro revolV Disposable Prophy Angle .508
 Nupro revolV Disposable Prophy Pack...513
 Prophy Jet Powder.....529
 Quiet-Air Handpieces230
 RDH Hygienist Handpieces244
 Rhino XP Motors241
 Sani-Tip 168
 Seal & Protect.....489
 Shorty Motors241
 Sofscale Calculus Scaling Gel517
 Steri-Mate Handpiece.....533
 Stylus ATC Handpiece.....226
 Stylus Couplers246
 Stylus Fiber Optic Handpiece.....226
 Stylus Lite Handpiece.....226
 Stylus Mini Handpiece.....226
 Tradition Handpieces 226, 230
 Visco-Gel9

Dentsply Rinn

Eezee-Grip Digital Sensor Holder580
 Eezeemount 568-569
 Endo-Ray II.....581

EZ-Tab Mounts 568-569
 EZ-View Mounts 568-570
 FasTear Mounts.....570
 LPD Wig-L-Bug Amalgamator..... 13
 MSD Wig-L-Bug Amalgamator..... 13
 Security Capsule & Pestle..... 12
 Slimline Duplicator.....573
 Snap-A-Ray580
 Snap-A-Ray DS580
 Snap-A-Ray Xtra.....580
 Soothe-Guard X-Ray Aprons.....574-575
 Stabe Bite-Blocks579
 Transview Mounts..... 568-569
 Uni-Grip 360 Universal Sensor Holder .581
 Wig-L-Bug Amalgamators 13
 XCP Bite Blocks 579, 581
 XCP Evolution 2000 Positioning Kit.....581
 XCP/BAI Replacement Parts.....581
 XCP-DS Digital Sensor Holder582
 XCP-DS FIT Sensor Holder581-582
 XCP-ORA Positioning System582
 XCP-QT Universal Disposable Sensor
 Holders 582-583

Dentsply Trubyte

Al-Cote.....453
 Bioform Shade Guide.....451
 Castone455
 Lucitone446
 Lucitone 199446
 Neowax.....563
 Reapir Material446
 Silicone Spray.....454
 Triad 2000 VLC Curing Light448
 Triad Air Barrier Coating448
 Triad Custom Tray Material447
 Triad Denture Base Material.....447
 Triad Dualine Reline Material447
 Triad Gel.....447
 Triad Model Release Agent448
 Triad Reline Material Hi Flow447
 Triad Reline Material Original447
 Triad Transheet Material447
 Triad TruTray Custom Tray Material447
 Triad VLC Bonding Agent448
 Triad VLC Modeling Instrument448
 TruBase Baseplates447
 TruWax563

DHPI Brand Supplies

'U' Contra Angles225
 Absorbent Paper Points..... 189

Air/Water Syringe Tips.....	168	Diamonds - Single-Use	62	Mirror Handles.....	331
Air/Water Syringes.....	695	Digital X-Ray Sensor Sleeves	323	Mirrors	331
Alginate.....	251	Dispersed Phase Amalgam Alloy	10-11	Mixing Bowls	253, 451
Alloys	10-11	Disposable Prophy Angles.....	507	Mixing Pads.....	111, 254
Amalgam Carriers.....	388	Disposable Toothbrushes	518	Mixing Tips	268
Anesthetic Syringes.....	15	Drinking Cups.....	165	Motors-Low Speed	225
Applicator Tips.....	146	Dynamic Mixing Tips	267	Mouth Mirrors	331
Articulating Paper Forceps	23	Earloop Masks.....	287	Nanohybrid Composite.....	128
Articulating Paper	22	Elevators.....	407	Needle Holders.....	408, 424
Aspirating Syringe	15, 407	Endo Refrigerant Spray.....	17	Night Guard Boxes	446
Autoclave Pouches	304	Endo Syringes & Needles	196	Nitrile Gloves	278
Barbed Broaches.....	187	Endo-Aid Organizer	198	Non-Woven Sponges	162
Barrier Envelopes.....	584	Enzymatic Tablets.....	315	Orthodontic Patient Kits.....	478
Barrier Film.....	320	Etch Gel.....	124	Padded Brush Delivery Tips.....	147
Bendable Brushes	146	Evacuation System Cleaner	204	Peeso Reamers	188
Bibs.....	163	Excavators	351	Phosphor Plate Barrier Envelopes	584
Biological Monitoring System	307	Explorers	331	Pit & Fissure Sealant.....	505
Bite Registration	255	Explos	331	Plastic Filling Instruments.....	389
Bite Trays	269	Extracting Forceps.....	407	Plastic Impression Trays	270
Bite Wing Loops	579	Files & Reamers.....	172	Pluggers	351, 388
Bite Wing Tabs.....	579	Finishing Strips.....	211	Pre-Bent Dispensing Tips	147
Bonding Agent.....	117	Flexible Mixing Bowls	253, 451	Probes	331
Bur Blocks	30, 95	Floss.....	491	Procedural Masks.....	287
Burnishers	388	Flossers	493	Prophy Angles - Autoclavable	506
Carbide Burs.....	28-30	Flowable Composites	135	Prophy Angles - Disposable	507
Cartridge Dispenser	3, 268	Fluoride Trays	500	Prophy Cups.....	512
Carvers	388	Fluoride Varnish.....	501	Prophy Paste	513
Cement Spatulas.....	389	Forceps.....	407	Pro-Tec Powder Free Gloves	275
Chair Sleeves	320	Gates Glidden Drills	188	PSP Barrier Envelopes.....	584
College Pliers	331	General Purpose Ultrasonic Solution	315	PTFE Floss.....	491
Composite Brushes	146	Gloves	275, 278	Pure Touch Nitrile Gloves	278
Composite Discs & Strips.....	211	Gutta Percha Points.....	190-191	Reamers	172
Composite Polishers.....	221	Handpiece Lubricant Spray	225	Retainer Boxes	446, 478
Composites.....	128	Handpieces.....	224-225	Retraction Cord Packing Instruments.....	388
Cone Masks	287	Headrest Covers.....	166	Rubber Dam Clamp Forceps.....	408
Contra Angles.....	225	Hedstrom Files	172	Rubber Dam Punch.....	408
Cord Packers	388	Hemostats	407-408, 423	Safety Glasses	295
Cotton Filled Sponges	161	HVE Tips	201	Saliva Ejectors.....	202
Cotton Pliers	331	Impression Cartridge Dispenser.....	268	Scalers & Curettes.....	356-357
Cotton Rolls	160	Impression Syringes.....	267	Scissors.....	408
Cotton Tipped Applicators.....	160	Impression Trays.....	269, 270, 273	Sensor Sheaths.....	323
Crown Remover.....	388	Interproximal Brushes.....	494	Sensor Sleeves	323
CSR Sterilization Wrap.....	306	Irrigating Needle Tips	196	Spherical Alloy.....	11
Cups	165	K-Files	172	Stainless Steel Impression Trays.....	273
Curettes & Scalers.....	356-357	Lab Pans	450	Sterilants.....	308
Dappen Dishes-Disposable	517	Latex Exam Gloves.....	275	Sterilization Indicator Tape	303
Dental Floss	491	Light Handle Sleeves.....	324	Sterilization Pouches	304
Denture Boxes.....	446	Masks	287	Sterilization Wrap.....	306
Denture Brushes	517	Matrix Bands	464	Surface Disinfectant	311
Desensitizer.....	489	Matrix Retainers	465	Surgical Aspirator Tips.....	204
Diamond Strips.....	214	Micro-Applicators	146	Surgical Burs	28-30
Diamonds - Multi-Use.....	60-61	Microhybrid Composite.....	128	Sutures	551-552

Syringe Sleeves.....	321
Tartar & Stain Remover.....	315
Tec-Cide Plus.....	308
Temporary Crown & Bridge Material.....	3
Tongue Depressors.....	169
Toothbrushes - Pre-Pasted.....	518
Toothbrushes.....	520
Topical Anesthetics.....	17
Tray Covers.....	167
Tray Sleeves.....	322
Trimming & Finishing Burs.....	30
Ultrasonic Cleaning Solutions.....	315
Ultrasonic Enzymatic Tablets.....	315
Universal Bond.....	117
Utility Syringes.....	196, 267
Varnish, Fluoride.....	501
Vinyl Polysiloxane Impression Material.....	261
Wax Spatulas.....	389, 426
X-Ray Mounts.....	570
X-Ray Sleeves.....	322

DiaDent®

Dappen Dishes-Glass.....	517
Dia-ISOGT Gutta Percha.....	191
Diapex.....	193
Glass Mixing Slab.....	112

Digital Doc

Iris HD Camera.....	643
Iris LTE Camera.....	644

Directa Dental Group

Calasept.....	192
Calasept CHX.....	194
DMG America.....	
Icon Caries Infiltrant.....	125
Kolorz ClearShield Fluoride Varnish.....	502
Kolorz Fluoride Foam.....	496
Kolorz Fluoride Gel.....	497
Kolorz Prophy Paste.....	514
LuxaCore Dual.....	114
Luxacore Z Dual.....	114
Luxaflow Composite.....	136
LuxaFlow Ultra.....	4
LuxaGlaze.....	7
Luxatemp Automix Plus.....	4
Luxatemp Fluorescence.....	4
Luxatemp Ultra.....	5
MiniDam.....	544
PermaCem 2.0.....	98
StatusBlue.....	255
TempoCem.....	109

Doxa Dental

Ceramir.....	106
--------------	-----

Dr QuickLook, Inc.

Dr. QuickLook Viewer.....	646
---------------------------	-----

Dr. Fresh

Barbie Toothbrushes.....	520
Reach Toothbrushes.....	520-521

E.C. Moore Company

Brass Center Snap-On Discs.....	212
Screw Posts.....	484
Tape-N-Tell.....	440

EcoBee

BeeSure Naturals Nitrile Gloves.....	281
BeeSure Air/Water Syringe Tips.....	168
BeeSure Comfy HVE Tips.....	201
BeeSure Disposable Prophy Angles.....	507
BeeSure Earloop Face Masks.....	289
BeeSure Latex Powder Free Gloves.....	276
BeeSure Nitrile Gloves.....	281
BeeSure Saliva Ejectors.....	202
BeeSure Scented Earloop Masks.....	290
BeeSure Naturals Earloop Masks.....	289
BeeSure Slim Nitrile Gloves.....	281
BeeSure SuperSlim Nitrile Gloves.....	281

Ecolab

Fresh-Vac.....	205
Advanced Gel Hand Sanitizer.....	300
Asepticare TB+II.....	313
Asepti-Zyme PreSoak.....	316
Bacti-Foam Soap.....	301
Bacti-Stat Soap.....	301
Medi-Stat Soap.....	301
Quick-Care Foam Sanitizer.....	300

Emerson Healthcare, LLC

Stim-U-Dent.....	495
------------------	-----

Engle Dental

Engle 300 Dental Chairs.....	683
Engle AS-1 Delivery System.....	694

Enzyme Industries, Inc.

Blood Buster.....	316
Sani-Soak Ultra.....	316
Sani-Treet Green.....	205
Sani-Treet Plus.....	316

EPR Industries LLC

Fog-Free Mirror Defogger.....	350
Super Kleen 40.....	205
Super-Vac 40.....	205
Temporary Cement Remover.....	317
Ultrasonic Concentrate Powder.....	317

Essential Dental Systems

EDTA Plus.....	194
EZ-Fill Epoxy Root Canal Cement.....	193
Flexi-Flange Posts.....	485
Flexi-Flow.....	101
Flexi-Overdenture.....	485
Flexi-Post.....	485
Glove 'n Care Hand Cream.....	299
Ti-Core.....	114
Ti-Core Auto E.....	114
Ti-Core Flow+.....	114

Ethicon

Ethicon Sutures.....	551-552
Surgicel.....	554
Surgifoam.....	554

Fairfax Dental Ltd.

Stabilok Pins.....	483
--------------------	-----

Fashion Seal Healthcare®

Fashion Seal Scrubs.....	559-562
--------------------------	---------

Filhol Dental

Filpin System.....	483
--------------------	-----

Filmtech, Inc.

Brixton Chair Covers.....	320
Brixton Light Handle Sleeves.....	325
BrixtonSyringe Sleeves.....	321

Fixer Treatment Systems

AllWays Recycle.....	573
----------------------	-----

FLOSSAID Corporation

Bridge Aid Dental Floss.....	491
Flossaid Floss Holder.....	493

Flow Dental

Bite Block Baggies.....	323
Comfee's Sensor Sleeves.....	323
Flow X-Ray Film.....	567
Kopy Kat Duplicator.....	573
Perfect Fit Camera Sleeves.....	323
RAPD X-Ray Positioning.....	583

Safe 'n' Sure.....	584
Sensibles Sensor Holders	583
Snuggies Sensor Sleeves	323

Fox Converting Inc.

Autoclave Envelopes	306
---------------------------	-----

Fujifilm USA

Peri-Chem Developer & Fixer.....	571
Redi-Chem Developer & Fixer.....	570

Futudent

EduCam HD Camera.....	644
-----------------------	-----

Galaxy

Galaxy Stools	736
---------------------	-----

GC America

Alike Temporary C&B Resin	5
Check-Bite Trays.....	273
Coe Adhesive	274
Coe Alginate	251
Coe Check-Bite Trays	273
Coe Foam II.....	313
COE Impression Trays.....	269, 271, 273
Coe Spray II.....	313
COE Syringe	267
Coe Tray Cleaner.....	274
Coe Tray Plastic.....	7
Coe Triple Function Bite Trays	269
COECAL.....	455
CoeCide XL.....	309
CoeCide XL Plus	309
Coe-Comfort.....	9
COE-FLEX.....	260
Coe-Pak Automix	554-555
Coe-Rect	7
Coe-Soft.....	8
CoeZyme	317
Dry Mouth Gel.....	499
Epitex Finishing/Polishing.....	214
Equia Forte Bulk Fill	127
Exa Tray Adhesive	274
Exabite II NDS.....	256
Exafast NDS.....	265
Exaflex	265
Examix NDS	265
Fit Checker Advanced.....	23, 260
Fuji Coat LC.....	141
Fuji I Luting Cement	107
Fuji II.....	140
Fuji II LC	140

Fuji IX GP	141
Fuji IX GP Extra.....	141
Fuji IX GP Fast	141
Fuji Lining LC.....	97
Fuji Ortho Band	473
Fuji Ortho Bonding	473
Fuji Ortho LC	107, 473
Fuji Ortho Self Cure.....	107
Fuji Plus.....	107
Fuji Triage	506
Fuji Varnish.....	141
FujiCEM 2.....	107
G-aenial Bond	118
G-aenial Flo.....	137
G-aenial Sculpt.....	131
G-aenial Universal Flo.....	137
G-Bond	119
GC Cavity Conditioner.....	119
GC Fuji Coat LC.....	141
GC Reline	7
GC Reline Soft/Extra Soft.....	8
G-Cem.....	102
G-Cem LinkAce	102
G-Coat Plus.....	141
G-Premio Bond.....	119
Gradia Direct	131
Gradia Direct Flo	136
Gradia Direct LoFlo	136
Gradia Direct X.....	131
Kalore	131
Kooliner	8
Metal Strips	214
MI Paste	499
MI Varnish.....	502
Miracle Mix	114
Nogenol Root Canal Sealer.....	193
Nogenol Temporary Cement.....	110
Omniflex.....	260
Pattern Resin LS.....	7
Revotek LC	5
Spacer Trays.....	271
Temp Advantage.....	110
Tempsmart.....	5

Gendex

GXDP 300 & 700 Panoramic X-Ray.....	660
GXS-700 IntraOral Sensors	651

Georgia-Pacific

Angel Soft Facial Tissue	641
Angel Soft White Bath Tissue	641
Big-Fold Z Towels	169

enMotion Roll Towels.....	171
enMotion Touchless Towel Dispenser....	171
Envision Hand Towels.....	169-170
Preference Roll Towels	170
Signature Hand Towels.....	169
SofPull Centerpull Paper Towels	170

Ghost Mfg.

M.A.S.S. HVE Tips.....	201
------------------------	-----

Gingi-Pak

Gingi-Aid.....	537, 539
Gingicaine.....	19
Gingi-Pak Retraction Cords.....	539
Gingi-Plain Cotton Coil & Pellets	541
Orostat.....	537
Stasis Solution.....	537

GlaxoSmithKline

Aquafresh Infant Training Toothpaste	526
Biotene Dry Mouth Oral Rinse	504
Sensodyne Fresh Impact Toothpaste	526
Sensodyne ProNamel Toothpaste	526
Sensodyne Repair & Protect Toothpaste	526

GOJO Industries, Inc.

Micrell Lotion Soap.....	301
Provon Foaming Soap	302
Purell Instant Hand Sanitizer	300

Hager Worldwide

Apt II Dental Burner.....	445
Bambach Saddle Stool.....	737
Happy Morning Toothbrushes.....	518
Micro Applicators	148
Mini-Tray	269
Miradent Gum.....	488
MiraTray Implant Impression Trays	271
Outback Eyewear	295
Salibag.....	324
Spandex Cheek Retractor	427
Super Bib Clips.....	165
Super Quick Tips	148
Uvex Genesis Glasses	295
Uvex Ignite Glasses.....	296
Xylitol Dry Mouth Drops.....	488

Halyard Health

Aquasoft Nitrile Gloves	281
Flexaprene Chloroprene Gloves.....	284

- Fluidshield Fog Free Tie-On Mask with
Visor292
- Fluidshield Mask with Visor292
- Fluidshield Masks290
- KC100 Lavender Nitrile Gloves282
- KC100 Procedure Masks290
- KC300 Sterling Nitrile Gloves282
- KC500 Purple Nitrile Gloves282
- Lavender Nitrile Gloves282
- Lite One Masks290
- Purple Nitrile Gloves282
- Sequential Sterilization Wrap306
- Sterling Nitrile Gloves282
- Surgical Caps293
- Handler Mfg. Co.**
- Etcher Catcher448
- Paasche Style Etching Pencil444
- Pneumatic Pressure Pot453
- Porta Vac448
- Pro Tech Lab Work Stations678
- Red Wing Lathes450
- Splash Hoods454
- Super Sucker Dust Collector449
- HealthSonics**
- Non-Ionic Multi-Purpose Ultrasonic Solution
.....315
- Healthlink**
- AloeGuard Soap302
- Citrace313
- Clorox Bleach Germicidal Cleaner313
- Clorox Hydrogen Peroxide Cleaner313
- GBG AloeGel Hand Sanitizer300
- Hedy Canada**
- Caress COATS Nitrile Gloves282
- Isodam Rubber Dam543
- Optimum Nitrile Gloves282
- Heraeus Kulzer**
- Charisma131
- Check Bite Wafers564
- Copr wax Bite Wafers564
- CutterSil260
- Denstone455
- Die Stone454
- Die-Keen454
- DispOral Angulated Aspirator Tips201
- DispOral Articulating Paper22
- DispOral Disposable Syringes267
- Flexitime Dynamix265
- Flexitime VPS265
- Gluma Comfort Bond + Desensitizer119
- Gluma Desensitizer490
- Gluma PowerGel490
- iBond Self Etch119
- iBond Total Etch119
- iBond Universal119
- Lab Plaster455
- Labstone455
- Memosil 2257
- Modern Materials Gypsums454-455
- Modern Materials Waxes563-565
- O-67 Snow White Ortho Stone455, 480
- Ortho Stone O-67455, 480
- Pala Digital Dentures448
- Periphery Wax565
- Shur Wax563
- StatStone455
- Surgident Articulating Paper22
- Surgident DispOral Disposable Syringes
.....267
- VacuKleen E2206
- Venus Bulk Fill127
- Venus Diamond132
- Venus Diamond Flow137
- Venus Flow137
- Venus Pearl132
- Venus White Max142
- Venus White Pro143
- Venus White Touch Up Brush144
- Venus White Ultra144
- VenusTemp 25
- Vibrakleen E2317
- VK Ultrasonic Solutions317
- HPTC Inc.**
- CPR Pocket Microshield Kit326
- GHS Chemical Product Labels326
- Hu-Friedy**
- After Five Ultrasonic Inserts535
- Bagette Sterilization Pouches305
- Colorvue Probes339
- Enzymax Spray Gel317
- Enzymax Ultrasonic Detergent317
- GoldFogel Composite Instruments398
- Goldstein Composite Instruments395
- Hand Essentials Instant Hand Antiseptic
.....300
- Hand Essentials Lotion299
- Hand Essentials Lotion Soap302
- Hand Essentials Skin Repair Cream299
- Hu-Friedy College Pliers334
- Hu-Friedy Explorers336-337
- Hu-Friedy Expos338
- Hu-Friedy Mirrors & Handles342-344
- Hu-Friedy Probes339-341
- Hu-Friedy Scalers & Curettes362-371
- Hu-Friedy Ultrasonic Inserts535
- IMS Autoclave Wrap306
- IMS Daily Clean317, 442
- IMS Enzymax317
- IMS Instrument Cassettes430-432
- IMS Instrument Code Rings435
- IMS Instrument Lubricating Spray442
- IMS Instrument Penetrating Spray442
- IMS Lilac Utility Gloves286
- IMS Monitor Tape303
- IMS Shine reNEW442
- IMS Steam Sterilization Indicators308
- Lilac Utility Gloves286
- Orthodontic Pliers384, 387, 425
- Pedo Crowns158
- Sharpen-Ez Oil443
- Shine reNEW442
- Sidekick Instrument Sharpener443
- Signature Series Cassettes430-431
- Signature Series Grips435
- Signature Series Procedure Tubs & Trays
.....433-434
- Steam Sterilization Integrators308
- Streamline Inserts535
- Team Vista Waterline Cleaner330
- Piezon Master Scalers529-530
- IC Care, Inc.**
- Instadose Online Radiation Badge584
- IndiGreen Innovations**
- Gleco Plaster Trap453
- Mirro-Vac202
- Total Comfort SoftTip Aspirator203
- Integra® Miltex®**
- 10X Wax563
- Articodent22
- Beauty Pink Wax563
- Bib Clips165
- Biopsy Punch553
- Blade-Safe554
- Bone Basin382
- Bone Compactor382
- Bone Grinder382
- Dual Alo #54 Strips214

EZ-Zyme.....317
 Finger & Thumb Rulers 199
 GTN Gold Titanium Nitride Burs.....38
 HeliCote.....555
 HeliMend555
 HeliPlug555
 HeliTape.....555
 Instrument Care System.....442
 Lab Burs38
 Lightning Metal Finishing Strips214
 Mesh Bur and Diamond Holder.....96
 Micro Diamond Supreme Strips485
 Precision Posts485
 Pumice.....450
 Vantage Prophy Angle506
 Wynman Crown Gripper404

Iridium Dental

MaxRay Portable X-Ray656

Ivoclar Vivadent

Accu-Dent XD.....258
 Adhese Universal 119
 Astropol Finishing & Polishing220
 bluephase 20i LED Curing Light 151
 bluephase Style LED Curing Light 152
 ExcITE DSC Adhesive 120
 ExcTE F Adhesive 120
 Heliobond 120
 Heliomolar 132
 Heliomolar Flow.....137
 Heliomolar HB132
 Helioseal.....506
 Heliosit Orthodontic.....473
 IPS Ceramic Etching Gel.....124
 IPS Empress.....132
 Ivoclean 112
 Monobond.....120
 Multicore Flow 115
 Multilink Automix Next Generation..... 102
 OptraGate427
 OptraSculpt Pad404
 Silamat S6 Amalgamator 13
 Sil-Tech.....260
 Syntac Adhesive 120
 Telio CS Cem Implant.....99
 Telio CS Desensitizer490
 Telio CS Inlay & Onlay.....99
 Telio CS Link 110
 Tetric EvoCeram 132
 Tetric EvoFlow137
 Tetric EvoFlow Bulk Fill127
 Total Etch.....124

Valiant - Ph.D 10
 Variolink Esthetic Cement102
 Virtual Bite Registration.....257

J. Morita USA

AdvErL Evo Laser700
 AR Spray249
 Foundation.....555
 Lubrina Handpiece Maintenance System
248
 PerfectIM VPS265
 Root ZX II Apex Locator 197
 Tri Auto ZX.....243
 TwinPower Handpieces 226-227, 230
 Veraview IC5 HD X-Ray661
 Veraviewepocs 2D X-Ray661
 Veraviewepocs 3D R100 X-Ray660

Java Crowns, Inc.

Crowns - Natural Color Metal 159

Johnson & Johnson

Cidex OPA309
 Dentotape491
 Gentle Gum Care Floss.....491
 Listerine 503-504
 Listerine Floss491
 Listerine Pocket Paks503
 Listerine Smart Rinse504
 Listerine Total Care.....504
 Listerine Zero.....504
 Reach Floss491
 Ultra Clean Access Flossers494
 Ultra Clean Floss.....491
 Wild Flossers494

Jordco, Inc.

Endoring II 199

KaVo Dental

COMFORTdrive Handpiece235
 Electrotorque TLC Handpieces.....237
 EXPERTsurg LUX System246
 EXPERTorque Handpieces227
 INTRAFlex Motors241
 KaVo High-Speed Handpieces..... 230, 235
 Kavo Low Speed Motors and Accessories
 239, 241
 KaVo Spray.....249
 MASTERsurg LUX System.....246
 MASTERtorque Handpiece227
 MULTIflex Nozzle.....249

PROPHYwiz Handpieces248
 QUATTROcare Plus Maintenance System
248
 QUATTROcare Plus Spray249
 SMARTtorque Handpiece..... 227, 230
 SMARTtorque LUX Handpiece.....227
 SurgTorque Handpieces 227, 230

Kerr Laboratory

Debubblizer.....456
 Disclosing Wax565
 Hydrock.....455
 Snow White Plaster455
 Super-Sep.....453
 Vel-Mix.....454

Kerr Restoratives

AlgiNot.....255
 Bioplant.....555
 Cavitec.....98
 Clean & Lube Spray253
 Contour Alloy 11
 Demi Plus Curing Light 152
 Demi Ultra Curing Light..... 152
 Discovery Trays.....500
 Extrude Extra VPS266
 Extrude VPS266
 Free-Flo Syringe267
 Gel Etchant.....124
 GingiBraid.....539
 Gingi-Gel539
 Gingi-Knit +.....539
 Hemodettes537
 Hemogin-L.....537
 HemostasyL.....537
 Herculite Ultra133
 Herculite Ultra Flow138
 Herculite XRV133
 Identic Alginate251
 Integra Alginate.....252
 Kromafaze Alginate.....252
 Kwik-Tray269
 Life Calcium Hydroxide.....97
 Luminator X-Ray Viewers573
 Maxcem Elite103
 Maxcem Elite Chroma103
 Nexus RMGI107
 NX3 Cement.....103
 NX3 XTR Cement.....103
 OptiBond All-In-One120
 OptiBond FL120
 OptiBond Solo Plus120

Optibond XTR..... 121
 Optiguard Surface Sealant 142
 Optilux Light Shield 153
 Optimix Amalgamator 13
 Permlastic.....260
 Permlastic Adhesive 274
 Point 4 134
 Premise Composite 133
 Premise Flowable 138
 Revolution Formula 2 138
 Shortcut Retraction Cord.....539
 Softline.....8
 SonicFill 2 128
 Styptin 537
 Take 1 Advanced Bite257
 Take 1 Advanced VPS266
 Temp-Bond 110
 Tempphase5
 Tytin Alloy..... 12
 Tytin FC Alloy..... 12
 UniBraid +.....539
 Vertise Flow..... 138

Kerr Rotary

Apex ID Digital Apex Locator..... 182
 Axis Burs 39-44
 Axis NTI Diamond Discs209-210
 Axis NTI Diamonds..... 71-76
 Axis NTI Polishers 222-223
 BluWhite Diamonds77
 CeraGlaze Porcelain Polishing222
 DiaGloss Composite Polishing223
 Diamond Zyme 318
 Elements Adaptive Motor..... 178, 242
 Elements Apex Locator 198
 Elements Diagnostic Unit 198
 Elements Free Obturation Unit..... 198
 Elements Obturation Unit 198
 EndoRing 199
 Endotouch TC2 Cordless Endo Handpiece
 242
 Hedstrom Files 177
 K3 NiTi Files 179
 K3/K3XF Gutta Percha 181
 K3/K3XF Obturators 181
 K3/K3XF Paper Points..... 181
 K3XF NiTi Files..... 179
 K-Files 177
 K-Flex Files..... 177
 LightSpeed LSX NiTi Files 180
 M4 Safety Handpiece242
 MiniEndo II 183

NTI Burs 39-44
 NTI Diamond Discs209-210
 NTI Diamonds 71-76
 NTI Polishers 222-223
 Pathfinder & Pathfinder CS 187
 ProGloss Composite Polishers223
 Pulp Canal Sealer..... 183
 Pulp Canal Sealer EWT 183
 Razor Burs.....43
 Reamers 177
 Sealapex..... 183
 SimpliSeal..... 183
 SlickGel ES..... 194
 SmartStrip 214
 SmearClear 194
 Soft-Core Classic Obturators..... 198
 TF Adaptive Files..... 178
 TF Adaptive Obturators 181
 TF Adaptive Unit..... 178
 TF Gutta Percha 181
 TF Obturators 181
 TF Paper Points..... 181
 TF Twisted Files..... 178
 Touch 'N Heat..... 198
 Tubli-Seal..... 183
 Twisted Files 178
 Verifiers..... 181
 Xpress Sealers 183
 Zirconia Polishers223

Kerr TotalCare

Ball-Point Applicators..... 148
 Bib-Eze 165
 CaviCide 313
 CaviCide 1 313
 CaviWipes..... 314
 CaviWipes 1 314
 Compliance Disinfectant/Sterilant.....309
 Cover-All Barrier Film320
 Dispos-A-Bite.....580
 Dispos-A-Trap.....207
 Empower Enzymatic Solution.....318
 EmPower Foam..... 318
 Evac-U-Trap.....208
 Googles Eye Shields296
 Headrest Covers..... 166
 MetriTest Strips..... 310
 Peel-Vue+ Pouches305
 Perfect Pearl Disposable Prophyl Angles
 508
 Pinn-Point Brushes..... 148
 ProCide-D309

ProCide-D Plus 310
 Safe-Tips EZ..... 168
 Seal-Tight Air/Water Syringe Tips..... 168
 Side Shields 296
 Slip-N-Grip.....320
 Turbo-Vac 206
 Vionex Liquid Soap 302
 Vionex No-Rinse Gel300
 Vionexus Foaming Soap 302
 Vionexus No-Rinse Spray 300
 Vision Saver 153

Keystone Industries

Allcezon Wax563
 Base Plate Material457
 Bleaching Laminate457
 Bosworth Copaliner98
 Bosworth Cora Caine 19
 Bosworth Dentusil8
 Bosworth Fastray7
 Bosworth Fastray LC7
 Bosworth Flexo Saliva Ejectors203
 Bosworth Light Liner.....8
 Bosworth ProphylBrite Air Polisher.....528
 Bosworth Simplastc Sleeves326
 Bosworth Softone9
 Bosworth SuperEBA..... 109
 Bosworth Supergel Alginate252
 Bosworth TAC Tray Adhesive 274
 Bosworth Tray-Aways.....271
 Bosworth Trim II.....5
 Bosworth Truliner.....8
 Bosworth TruSoft9
 Bosworth Wonder Wedges466
 Coping Material457
 Dispos-a-trap Plaster traps.....452
 Fleck's Zinc Cement 109
 Gelato Fluoride Gel497
 Gelato Prophyl Paste..... 514
 Hatho Scotch Brite Wheels213
 PIP Pressure Indicator Paste.....23
 PIP Spray 24
 Prehma Dental Needles 16
 Pressure Dome.....459
 Pressure Indicating Paste 23
 Pro-form ElectricKnife.....459
 Pro-Form Vacuum Forming Materials
457-458
 Pro-Line Air Vac 2000.....456
 R-1 HVE Tips - Reusable 201
 Seity Etchant 125
 Silicone Emulsion454

Splint Material.....457
 The Machine Vacuum Formers456

Kimberly-Clark

Anti-Viral Kleenex Facial Tissue641
 Cottonelle Bath Tissue.....641
 Hard Wound Towels..... 170
 Kimtech Lens Cleaning Station298
 Kleenex Facial Tissue.....641
 Kleenex Hand Towels 169
 Scott Hand Towels 169
 Scott Toilet Tissue.....641

Kromopan USA

Kromopan 100 Alginate252

Kuraray America Inc.

Caries Detector.....488
 Clearfil Ceramic Primer & Primer Plus .. 104
 Clearfil DC Bond..... 121
 Clearfil DC Core Plus 115
 Clearfil Esthetic Cement EX 104
 Clearfil Liner Bond 2V 121
 Clearfil Majesty ES-2..... 134
 Clearfil Majesty Flow 138
 Clearfil Majesty Posterior..... 134
 Clearfil New Bond..... 121
 Clearfil Photo Bond 121
 Clearfil Photo Core 115
 Clearfil Porcelain Bond Activator 121
 Clearfil S3 Bond Plus 121
 Clearfil SE Bond 121
 Clearfil SE Bond 2 122
 Clearfil SE Protect 122
 Clearfil ST Opaquer.....142
 Clearfil Universal Bond..... 122
 Oxyguard II 104
 Panavia 21 104
 Panavia F2.0 104
 Panavia SA Cement Plus 104
 Panavia V5 104
 Teethmate Desensitizer490

L&R Ultrasonics

Autoclean.....311
 Barrier Milk442
 E-Vac Evacuation Cleaner206
 Quantrex140 Ultrasonic Unit.....741
 SweepZone Ultrasonic Units 741
 UltraDose Ultrasonic Solutions.....318

Lang Dental Manufacturing Co., Inc.

Jet Repair Acrylic.....448
 Jet Tooth Shaded Acrylic6
 Ortho Jet Acrylic480

LED Dental

VELscope Vx.....716

Marie Reiko, Inc.

Arctic Blast..... 19

MCMP

SocketIt!.....555

Medentex LLC

amalsed max Amalgam Separators 747

Medical Chemical Corp

Medizime LF318
 Wavicide310
 Wavicide MEC Indicator Strips.....310

Medical Safety Systems

Biological Spill Response Kit.....326
 Chemical Spill Response Kit326
 Emergency Spill Response Kits326
 Glutaraldehyde Spill Kit326
 Mercury Spill Response Kit326

Medicom®

Duraflor Halo Varnish502
 Duraflor Varnish502
 Pro-Matrix464
 Pro-Tip Turbo Syringe Tips 168
 Safe+Mask Master Series Earloop Masks
290
 Safe+Mask Premier Earloop Masks290
 Safe+Mask Premier Elite Earloop Masks
290
 Safe+Mask Premier Plus Earloop Masks
290
 Safe+Mask SofSkin Earloop Masks290
 Safebasics Saliva Ejectors203
 SafeGauze HemoStyp Dressing.....555

Medline Industries, Inc.

Aloe Touch 12" Sterile Gloves285
 AloeTouch Latex Gloves277
 Dyna-Hex CHG Scrub32
 Neolon 2G Surgical Gloves285

MedRedi Solutions

SureStop Hemostatic Dressing555

Microbrush International

ContactPro Sectional Matrix 460-461
 Dry Tips 162
 HO Bands.....464
 Microbrush Plus..... 148
 Microbrush Tube Series..... 148
 Microbrushes 148
 Micro-Stix Applicators 148
 SmartBands.....461
 TRU Applicators..... 149
 Ultrabrush 149

Microcopy

Flaps Film Tabs579
 Insta-Neg & Insta-Fix.....572
 NeoBurr49
 NeoDiamond.....78
 NeoDrys 162

Microflex® Gloves by Ansell

Color Touch Pink Latex Gloves.....277
 Comfort Grip Latex Gloves277
 Diamond Grip Latex Gloves277
 Diamond Grip Plus Latex Gloves277
 Evolution One Latex Gloves277
 FreeForm SE Nitrile Gloves.....282
 Midnight Nitrile Gloves.....282
 NeoGard Neoprene Gloves284
 NeoPro Synthetic Gloves.....284
 Soft White Nitrile Gloves.....282
 Ultraform Nitrile Gloves283
 UltraSense Nitrile Gloves283
 Xceed Nitrile Gloves.....283

Midmark Dental

641 Barrier-Free Oral Surgery Chair685
 Artizan Expressions Cabinetry674-675
 Artizan Streamline Steri-Center.....728
 Asepsis 21 Delivery System.....691
 Elevance Delivery System.....691
 Elevance Dental Chair.....684
 Integra Steri-Center729
 M11 Ultraclave719
 M3 Ultrafast Automatic Sterilizer719
 M9 Ultraclave.....719
 Midmark Autoclaves.....719
 Midmark Compressors/Vacuums..... 745
 Midmark Delivery Systems.....691
 Midmark Dental Chairs..... 684-685

Midmark Operatory Lights705
 Midmark Sterilization Center 728-729
 Midmark Sterilizers719
 Midmark Stools.....737
 PowerAir Compressor..... 745
 PowerVac G Vacuum 745
 Precision Cleanse Plus.....206
 Procenter Delivery Systems.....691
 Speed-Clean..... 311
 UltraComfort Dental Chair684

Midmark Dental (Progeny)

ClearVision Digital Sensor System.....649
 ClearVision Digital Sensors.....651
 Preva DC IntraOral X-Ray656
 Vantage Digital Panoramic System662

Midmark Dental (Proma)

Alliant Delivery System.....693
 Proma Delivery Systems693
 Proma Operatory Lights706

Molnlycke Health Care

Barrier Earloop Masks.....290
 Hibiclens HandWash302

MYCO Medical

Glassvan Surgical Blades.....553
 Qlicksmart 329, 554
 TechnoCut Scalpels..... 553-554

Mydent International

Defend Cone Masks287
 Defend Dental Needles 16
 Defend Diffuser Fog-Free Masks.....291
 Defend Loc Sterilization Pouches.....305
 Defend Plus Jackets.....295
 Defend Plus Lab Coats295
 Defend Plus Wipes 313
 Defend Sterilization Tubing.....306
 Defend Tie-On Masks.....292
 Defend Trap-EZ208
 Defend Tray Adhesive 274
 Defend Ultrasonic Tablets.....318
 MirrorLite350
 Naturally Hydrating Lotion Soap.....302
 SRG Evacuation Cleaner206

NSK

Endo-Mate DT/TC2243
 iCare Handpiece Maintenance System .248
 iProphy Air Hygiene Handpieces244

NLX Nano Electric System237
 NSK Handpieces
227-228, 231, 236-237, 239, 243-244
 Pana Spray Plus.....249
 Pana-Max High Speed Handpieces231
 S-Max Handpieces 228, 231, 237
 Surgic Pro Surgical Micromotor246
 Ti-Max Electric Handpieces..... 236-237
 Ti-Max High-Speed Handpieces
227-228, 231
 Ti-Max X High Speed Handpieces236
 Ti-Max Z High Speed Handpieces237

Nu Radiance, Inc.

Nu Radiance Classic Whitening 144
 Nu Radiance Duet Whitening 144
 Nu Radiance Forte' Whitening..... 144

Odin Technologies

BioScreen Oral Exam Light.....717

Op-d-Op

Op-d-Op Protective Eyewear.....298
 Op-d-Op Visor Shields.....298

OraLabs, Inc.

Chap-Ice Lip Balm.....488
 Scope Outlast Minibrush518

OraLine®

Caterpillar Toothbrushes.....521
 OraFlex Toothbrushes521
 Oraline Toothbrushes521

Ortho Technology

Archwire Markers.....476
 Ball Hooks476
 Bite-Builder.....475
 Brackets, Orthodontic.....467-468
 Buccal Tubes 469-470
 Cervical Neckpads477
 Coil Springs 475-477
 Comfort Cover479
 Composite Buttons475
 Crimpable Ball Hooks.....476
 Crimpable Mini Stops476
 DuraLock Plus Trays.....272
 Elastomeric Chain474
 Elastomeric Ligatures.....474
 Elastomeric Organizers474
 Facebows478
 Falcon Ortho Pliers and Cutters387

Headgear.....477-478
 Ligature Ties476
 Ligatures, Elastomeric474
 Lingual Retainers.....475
 Marquis Brackets.....467
 Mini-Stops, Crimpable476
 Nola Dry Field System.....429
 Orthodontic Bite Sticks473
 Orthodontic Brackets.....467-468
 Orthodontic Buccal Tubes 469-470
 Orthodontic Molar Band Assemblies
471-472
 OrthoFlex Composite Buttons475
 Orthogap Archwire Markers.....476
 Orthogap Bonding Pads473
 Patient Relief Wax479
 Power Sticks & Chains474
 Pure Sapphire Brackets.....468
 Relief Wax479
 Retainer Brite.....479
 Retainer Wire.....475
 Separators474
 Tongue Tamer.....475
 ToothTone Preformed Shorty Ties.....476
 ToothTone Ball Hooks.....476
 ToothTone Kobayashi Shorty Ties476
 ToothTone Ligature Ties476
 ToothTone NiTi Open Coil Springs476
 TruEase Buccal Tubes.....470
 TruFit 2.0 Buccal Tubes469
 TruFit 2.0 Molar Bands471-472
 TruFlex Niti De-Impacting and Separating
 Springs477
 TruFlex NiTi Springs477
 TruForce Stainless Steel Retainer Wire.477
 Tubes, Buccal 469-470
 Ultra-Guard Sports Mouthguards479

Pac-Dent International, Inc.

MTA Carriers..... 196
 ProAngle Ergo Contra Disposable Prophy
 Angle508
 Sterile Mini Prophy Angles..... 511

Palisades Dental LLC

ImpactAir Handpieces 229, 232

Palmero Health Care

Alcohol Dispenser314
 Bad-Dogs Eyewear.....296
 Biohazard Warning Labels327
 Bite Block Covers322

Bonding Wrap Eyewear.....	296
Candeez Flexible Mixing Bowls	253
CitriSol Towelettes.....	112
Cling Shield X-Ray Aprons	578
Contour Wraps Eyewear	296
Discide Effect Asepsis Soap	302
DisCide Ultra.....	314
DisCide Wipes	314
DisClens Lens Cleaning Station	298
Disinfected Label	327
Dynamic Disposables Eyewear	296
EconoWraps Eyewear.....	296
EnFog Safety Eyewear	296
Eye Savers Eyewear.....	297
Glove Box Holders.....	286
Hazardous Waste Labels.....	327
Hold-It Glove Box Holder	286
Once-A-Day Cleaner & Lubricant	249
Pro-Vision Eyewear.....	297
Pro-Vision Optical Cleaning Wipes	298
Radiation Warning Labels.....	327
Refreshing Patient Towelettes	303
Safety Side Shields.....	297
See-Breez Eyewear	297
Tech-Specs Eyewear	297
Vacuum Clean.....	206
Vacuum Shock	206
Versi-Wipes	303

PDT, Inc.

Easyview Probes.....	347
Gold Line Composite Sculpting Instruments	405
Jack B. Nimble Scalers	373
Montana Jack Implant Scalers.....	383
Montana Jack Scalers.....	374
PDT Explorers.....	347
PDT Probes.....	347
PDT Scalers and Curettes	372-374
Queen of Hearts Curettes.....	373
Transformation Sharpening Stone	443
Wingrove Implant Scalers	383

Parkell, Inc.

Absolute Dentin.....	115
Accufilm	22
Amalgambond Plus.....	122
Blu-Mousse	257
BluSep	122
Brush & Bond	122
C&B Metabond	105
Cavidry.....	112

Dryz Retraction Paste	541
E.T.C. Easy Temporary Cement.....	110
Epic - TMPT	134
Retrieve Implant Cement	99
Snap Acrylic.....	6
Touch & Bond	122

Parnell Pharmaceuticals

Mouth Kote Dry Mouth Spray	488
----------------------------------	-----

Pascal International, Inc.

60 Second Taste Fluoride Gel	498
60:60 Rinse.....	500
Banicide Plus	310
Citrizyme.....	206, 318
Epidri Pellets.....	541
Gel-Cord	537
Hydent.....	24
Isolators	161
NeutraGard Gel.....	499
Occlude.....	24
Pascord.....	540
Puff Fluoride Foam.....	496
Racellet Pellets	541
Racord	540
Sil-Trax Retraction Cords	540
Tap-n-Slide Sterilant Tray	310

Pelton & Crane

Alliance 1258 Delivery System	692
Helios 1800 Series LED Light.....	707
Omni Cleaner Plus.....	319
Spirit 1540/1550 Delivery Carts	692
Spirit 1585 Delivery System.....	692
Spirit 1700 Dental Chair.....	685
Spirit 2000 Dental Stools	738
Tip-A-Dilly HVE Tips.....	201

Pentron Clinical

Acculoid	258
Agarloid.....	258
Alert Condensable Composite	134
Bond-1	123
Bond-1 SF.....	123
Bond-IT	123
Breeze Resin Cement.....	105
Build-It	115
Build-It FR.....	115
Cartriloids.....	258
Cement-It	105
Correct Plus	266
Embonte 2	110

FibreKleer Posts.....	487
FibreKor Posts.....	487
Flow-It ALC	138
Identic Syringe Material	258
Image Alginate	252
Simile	134
TempSpan Temporary C&B Material	6
TempSpan Temporary Cement	110
Van R Hydrocolloids.....	258
ZONE/ZONE Free Temporary Cement	110-111

Pfizer, Inc.

Gelfoam	556
---------------	-----

Pierrel Pharma

Orabloc	14
---------------	----

Plasdent Corporation

Bib Holder	164
Block-4-Bite.....	580
Bondwell Mixing Wells	149
Dapdish.....	517
Endo Foam Inserts	200
Latindo Overgloves	286
OraJet Evacuator Tips	201
OraVac Evacuator Tips	204
Spectrum Bib Clips	165
Spectrum Oral Evacuator Tips.....	201

Platypus Co.

Platypus Orthodontic Flosser	480, 494
------------------------------------	----------

Polaroid Digital Imaging

Keren Sensors	652
Polaroid Wired & Wireless Cameras	645

Premier® Dental

2Pro Disposable Prophylaxis Angle.....	509
Alfa Triple Tray.....	270
Big Easy Ultrasonic Inserts.....	536
Brite Shield	319
Clean-A-Diamond.....	95
ComfortView Lip & Cheek Retractor	427
CompCore.....	116
CompCore AF	116
Compo-Strips	215
Cure Shield	153
Cure-Thru Cervical Matrices.....	464
Cure-Thru IntegraPost	487
Cure-Thru Matrix Bands	464
Cure-Thru Wedges.....	466
Diamond Twist SCL.....	220

Diamond Twist SCO220
 Enamel Pro Prophyl Paste.....514
 Enamel Pro Varnish502
 Enamelon Preventive Treatment Gel499
 Enamelon Toothpaste527
 FS Hemostatic537
 Glitter Prophyl Paste 514
 Hemodent.....537
 Implant Cement99
 IntegraBond 123
 IntegraPost486
 Knit-Pak+540
 Laboratory HP Diamonds85
 Luminescence220
 Luminescence Plus220
 Microprep Diamonds82
 NeoTray Impression Trays269
 NexTemp 111
 Perfecta 144-145
 Perfecta Block-Out Resin 143
 Perfecta Bravo 145
 Perfecta Rev! 145
 PerioWise Periodontal Probes348
 Poli-Pro Disks213
 Pre-Contoured Metal Bands464
 Premier Etch 125
 Premier Explorers348
 Premier Probes348
 Premier Scalers and Curettes.....375-376
 Premier Ultrasonic Inserts536
 Pro Clean.....319
 Rapid-Klene.....572
 RC-Prep.....194
 Removalon I Dry Pak 112
 Retraction Caps.....541
 Sensipast Root Fillers.....185
 Slix Composite Placement Instruments...406
 Solo Diamonds 86-87
 Stop Strips.....465
 Sycamore Wedges.....466
 T-Loc Triple Tray270
 Topicale Anesthetic.....19
 Traxodent.....541
 Triple Tray269
 TSZtech Diamonds..... 83, 85
 Two Striper Diamonds 79-85
 Two Striper TS2000 Diamonds.....83
 Uni-Punch.....554
 Vac Attak.....206
 VacuBlast.....206
 W.O.W. Articulators444

Preventech®
 esa Disposable Prophyl Angle.....509
 Nada Pumice Paste.....515
 Next Prophyl Paste515
 Pivot Disposable Prophyl Angle.....509
 Pivot Disposable Prophyl Pack.....513
 Vella Varnish.....502

Prexion
 Excelsior 3D CBCT X-Ray.....664

Procter & Gamble
 Crest 3D White Brilliance Toothpaste ...527
 Crest 3D White WhiteStrips 145
 Crest Cavity Protection Toothpaste.....527
 Crest Complete Multi-Benefit Whitening
 Toothpaste527
 Crest Pro-Health Advanced Toothpaste.527
 Crest Pro-Health Jr. Toothpaste527
 Crest Pro-Health Mouthwash.....504
 Crest Pro-Health SensiRepair Toothpaste
527
 Crest Sensi-Relief Whitening Toothpaste
527
 Crest Sensi-Stop Strips490
 Crest Toothpaste.....527
 Crest WhiteStrips Supreme 145
 Glide Pro-Health Deep Clean Floss492
 Glide Pro-Health Floss492
 Glide Pro-Health Threader Floss492
 Glide SatinFloss492
 Oral-B Basics Solution525
 Oral-B Black 800 Genius Power
 Toothbrush.....518
 Oral-B Cavity Defense Toothbrushes ...521
 Oral-B Complete 123 Toothbrushes521
 Oral-B Complete 3D White Vivid
 Toothbrushes521
 Oral-B Complete Control Grip
 Toothbrushes522
 Oral-B Complete Deep Clean
 Toothbrushes522
 Oral-B Complete Sensitive Toothbrushes
521
 Oral-B Cross-Action Pro-Health Pro-Flex
 Toothbrushes522
 Oral-B Cross-Action Pro-Health
 Toothbrushes522
 Oral-B Daily Clean System.....519
 Oral-B Electric Toothbrush Bundles..519-520
 Oral-B Electric Toothbrushes.....519-520
 Oral-B End Tufted Brush.....522

Oral-B Frozen Pro-Health Jr. Toothbrushes
522
 Oral-B Genius Professional Exclusive
 Power Toothbrush.....518
 Oral-B Genius Sensitive System Power
 Toothbrush Bundle520
 Oral-B Gingivitis System Power Toothbrush
 Bundle519
 Oral-B Glide Pro-Health Deep Clean Floss
492
 Oral-B Glide Pro-Health Floss492
 Oral-B Glide Pro-Health Threader Floss ..492
 Oral-B Glide SatinFloss492
 Oral-B Indicator Toothbrushes522
 Oral-B Interdental Brushes494
 Oral-B Manual Toothbrushes.....521-522
 Oral-B Orthodontic Brushes522
 Oral-B Power Toothbrushes.....518-520
 Oral-B Pro-Health All-In-One Toothbrushes
522
 Oral-B Pro-Health Battery Toothbrush...518
 Oral-B Pro-Health Clinical Precision Clean
 Battery Toothbrush526
 Oral-B Pro-Health Stages Toothbrushes .522
 Oral-B Stages Kids Battery Toothbrush ...526
 Oral-B Stages Toothbrushes522
 Oral-B SuperFloss492
 Oral-B Toothbrush Bundles ... 519-520, 525
 Oral-B Vitality Floss Action Electric
 Toothbrush.....519
 Oral-B Vitality Sensitive Clean Electric
 Toothbrush.....519
 SatinFloss.....492
 Scope Mouthwash504
 SuperFloss492

ProEdge Dental Corp.
 @ease X-Ray Monitoring Badge.....584
 Blu-Tab Waterline Tablets330
 Dental Unit Waterline Testing330
 SoftX Bite Wing Loops.....579

Professional Results Inc
 Tooth Slooth159

Pulpdent Corporation
 Activa BioActive Base/Liner.....98
 Activa BioActive Cement105
 Activa BioActive Restorative135
 Activa Kids.....98
 DenTASTIC UNO.....123
 Dry-Rite Drying Agent.....123
 Embrace Pit & Fissure Sealant506

Embrace Varnish	502
Embrace WetBond Resin Cement.....	105
Embrace WetBond Seal-n-Shine.....	142
Etch Rite Dental Etching Gel.....	125
Eugenol	194
Flecta Disposable Mirrors.....	350
Lime-Lite.....	98
Mini Bowls	451
Multi-Cal	195
Ortho-Coat.....	473
PerioCare Periodontal Dressing	556
Pic-n-Stic	159
Porcelain Etch Gel.....	125
Pulp Capping Paste.....	195
Pulpdent Opaquer	142
Root Canal Pressure Syringe	196
Root Canal Sealer	193
Seal-Rite Pit & Fissure Sealant.....	506
Silane Bond Enhancer.....	123
Snoop caries Detecting Dye.....	488
Sparkle Diamond Polishing Paste	221
Spee-Dee Build-Up	116
TempCanal	192
Tuff-Temp Plus.....	6

Pureway

Eco II Amalgam Separator	749
--------------------------------	-----

Quality Aspirator

Surgical Aspirators.....	204
--------------------------	-----

Ranir, LLC

Plackers Flossers	494
-------------------------	-----

Richmond Dental

Braided Cotton Rolls.....	160
Exodontia Sponges	161
Gauze Sponges.....	162
Non-Woven Sponges	163
SteriPocket Sterile Sponges.....	163
Temple Cotton Pellets	161
Tilt-Top Cotton Pellets.....	160
Cotton Pellets	160

RJC Products LLC

Safe-Flo Saliva Ejectors	203
PCXX Fluoride Foam	496
PCXX Fluoride Gel.....	498
PCXX Fluoride Rinse	500

Rowpar Pharmaceuticals, Inc

CloSYS Oral Rinse	505
Closys Toothpaste	526

Royal Dental Group

Alliant Dental Chair 2260	686
GP2 Dental Chair	686
Royal Dental Chairs.....	686-687
Royal Stools.....	738-739
RS1 Oral Surgery Chair	687

Royal Dental Group (Biotec)

Biotec Cabinetry	668-669
Biotec Sterilization Center	725

Royal Dental Group (Porter Instrument)

Dynamite Nasal Hoods.....	20
MXR Flowmeter.....	714-715
Nitrous Scavenger	20
Silhouette Nasal Masks.....	21

Roydent Dental Products

Futar D Occlusion.....	257
Roydent Files & Reamers.....	186

Sable Industries Inc.

Access High Speed Handpieces..	229, 232
Bio-Pure.....	207
Rotamax High Speed Handpieces	229

SciCan

AquaStat Distiller.....	330
Bravo Sterilizer	721
Hydrim Instrument Washers	699
Optim 33TB Wipes	314
StatClean Ultrasonic Unit	742
Statim G4 Autoclaves	721
StatMatic 31 Handpiece Maintenance System.....	248
Statmatic Handpiece Spray	249

Septodont

Adherence DC Dual Cure Resin Cement	105
Adherence SC Self Cure Resin Cement..	106
Aim-Safe	17
Biodentine.....	97
BioRoot RCS Sealer.....	193
Cimpat S.....	99
ECO Aspirating Syringe.....	15
Endosolv E	195
Hand Cream	299
Lidocaine Ointment	19
Lignospan	14
N'Durance Dimer Flow	139
N-tralig Syringe.....	15

OraVerse.....	20
Paroject Syringe	15
Plastalgin Alginate	252
R.T.R. Syringe.....	556
Racegel	538
Racestypine Solution.....	538
Scandonest.....	14
Septocaine.....	14
Septodont Aspirating Syringes	15
Septodont Hand Cream.....	299
Septodont Injectable Anesthetics	14
SeptoJect Evolution Needles.....	16
SeptoJect Needles	16
SeptoJect XL Block Needles	16
Ultra Safety Plus XL	17
Vivacaine	14

Shofu Dental Corporation

BeautiBond.....	123
Beautifil Flow Plus	139
Beautifil II.....	135
Brownie Points & Wheels	219
Ceramiste Points	220
CX-Plus Glaslonomer Cement.....	108
Dura Green Abrasive Stones.....	218
Dura White Abrasive Stones.....	219
Greenie Points & Wheels.....	219
Hy-Bond Polycarboxylate Cement	108
Hy-Bond Zinc Phosphate Cement.....	109
OneGloss.....	220
SuperBuff Discs.....	213
Supergreenie Points	219
Super-Snap Polystrips	215
Super-Snap Rainbow.....	213
Super-Snap Singles.....	213
Super-Snap X-Treme Ultra-Gloss Discs...	213

Single Use Dental, Inc.

FlossSingles	492
--------------------	-----

Sinsational Smile

Sinsational Smile In-Office Whitening....	143
---	-----

Solmetex

Hg5 Amalgam Separator	749
-----------------------------	-----

Solutek Corporation

Peri-Sol Developer & Fixer	571
Soludent Developer & Fixer.....	571-572

Sota Imaging

Claris i4D Camera	645
Clio Sensors	652

South East Instruments, LLC

Autoscaler.....530

Southern Dental Industries (SDI)

GS-80 Alloy..... 11

Permite Alloy.....10

Points Applicators149

Pola Day145

Pola Night.....145

Pola Office +142

Pola Paint146

Pola Zing146

Radii-Cal LED Curing Light.....152

Riva Coat.....141

Riva Luting Plus108

Riva Self Cure141

seT Cement.....105

Super-Etch.....125

Ultram 2 Amalgamator.....13

Universal Masking Agent.....142

Wave Flowable Composite139

Southland Distribution & Sales

Bio Lube249

Clear Image Cleaner572

PanoPro Developer and Fixer.....571

Pro-32 Processor Cleaner572

Sharp Image Clean Up Sheets572

Spectrum Dental, Inc.

Contrast Light Curable Resin143

Contrastpm146

FastDam143, 544

SPSmedical Supply Corp

EMS Sterilizer Monitoring.....308

PassPort Biological Monitoring.....308

SteamPlus Type 5 Integrators.....308

SS White®

Fissurotomy Burs46

Great White Gold Series Burs47

Great White Ultra Burs.....47

Great White Z Diamonds.....47

Jazz Polishers.....221

Piranha 2X Diamonds91

Piranha Diamonds..... 92-94

Revelation Diamonds..... 88-90

SS White Burs45-48

TDA Diamonds91

Thermo-Block.....93

Steri-Shield

C-Bar Barriers325

Curelastic Barriers.....326

R.S. Barrier.....324

Steri-Shield Barriers 324, 326

T-Bar Barriers325

Wing-A-Ray581

Sterisil, Inc.

Citrisil Blue330

Sterisil Straw/Cartridge.....330

Sterisil Water Treatment System.....749

Sultan Healthcare

3-Way Bite Trays.....270

Assure Plus Pouches305

Buckley's Formo Cresol.....195

Calcium Hydroxide Powder.....195

Chloroform.....195

Cleanlets.....319

COM-FIT Easy Breathe Earloop Masks...291

COM-FIT Groovy Earloop Masks291

COM-FIT Masks291

COM-FIT Plush Earloop Masks291

COM-FIT Super High Filtration Earloop
Masks291COM-FIT Super-Sensitive Earloop Masks
.....291

Dentray II Impression Trays272

Dry Socket Paste.....195, 556

DuraShield CV Varnish.....502

Durashield Varnish502

Eucalyptol195

Flash Tips168

Genie Bite Registration.....257

Genie VPS.....267

Genie VPS Tray Adhesive.....274

Handicaine Stix19

Hemoban538

Lysol I.C. Disinfecting Spray314

Lysol I.C. Foaming Disinfectant Spray...314

MoistSURE Hand Sanitizer300

MoistSURE Hand Soap.....303

MoistSURE Lotion.....299

Prep & Polish Paste.....515

Pro-Portion Ultrasonic Cleaning Solutions
.....319

Purevac.....207

Purevac SC.....207

ReSURGE319

Resurge Ultrasonic Cleaner743

SensiTemp.....111

Silgimix255

Sodium Hypochlorite195

Sodium Perborate.....195

Sporox II310

Superoxol.....195

Topex Fluoride Foam.....497

Topex Fluoride Gels498

Topex Fluoride Trays.....500

Topex Handicaine Stix.....19

Topex Metered Spray.....20

Topex Neutral pH.....498

Topex Prep & Polish Paste515

Topex Propy Paste.....515

Topex Take Home Care499

Topex Topical Anesthetics19-20

U/P Root Canal Cement.....193

Upgrade Disposable Propy Angle.....509

VersaTemp 2.....6

Volo Surface Disinfectant Wipes.....314

Xylol (Xylene).....195

Suni Medical Imaging, Inc.

Dr. Suni Plus Sensor653

ImageMaster Intraoral Camera.....646

Sunstar Americas, Inc.

Butler Dental Floss492

Butler Prophycency Disposable Propy
Angles510

ButlerWeave Floss.....492

Canker-X Oral Pain Reliever.....516

Clear Dip350

Crayola Flossers.....494

Duropro Disposable Propy Angles.....509

EasyThread Floss Office Dispensers492

EasyThread Floss Sample Packs.....492

EEZ Touch Disposable Propy Angles ..509

Eez-Thru Floss493

Eez-Thru Floss Threaders.....493

Eez-Thru Flossers494

Expanding Floss.....493

Flossmate Floss Handle.....493

Go-Betweens Angle Cleaners495

Go-Betweens Interdental Cleaners495

GUIDOR Bioresorbable Matrix Barrier ..556

GUIDOR easy-graft Classic.....556

GUM Butler Weave Floss492

GUM Canker-X Oral Pain Reliever516

GUM Crayola Flossers494

GUM Crayola Pip-Squeaks Toothbrushes 523

GUM Crayola Timer Light Toothbrushes..523

GUM Crayola Toothbrushes523

GUM Delicate Post-Surgical Toothbrushes523

GUM Dental Floss 492-493

GUM Denture Brushes518

GUM Dual Action Tongue Cleaners.....517

GUM Duropro Disposable Prophy Angles509

GUM Easy Thread Floss492

GUM Eez-thru Floss/Flossers493

GUM Expanding Floss493

GUM Go-Betweens Angle Cleaners.....495

GUM Go-Betweens Proxabrush Cleaners495

GUM Implant Care Kit523

GUM Micro Tip Toothbrushes523

GUM Monsterz Toothbrushes523

GUM Orthodontic Toothbrushes.....523

GUM Paroex489

GUM PerioShield.....505

GUM Post-Surgical Toothbrushes523

GUM Premium Ortho Kit480

GUM Proxabrush495

GUM Razzle Dazzle Toothbrushes.....523

GUM Red-Cote Tablets.....490

GUM Rincinol P.R.N.516

GUM Soft-Picks 495-496

GUM Stimulators496

GUM Sulcular Toothbrushes.....524

GUM Summit + Toothbrushes524

GUM Super Tip Toothbrushes524

GUM Technique Toothbrushes524

GUM Toothbrushes..... 522-524

Paroex Chlorhexidine Gluconate489

Prophycency Disposable Prophy Angles .510

Proxabrush Go-Betweens.....495

Proxabrush Snap-Ons495

Proxabrush Trav-ler.....495

Red-Cote Tablets490

Rincinol P.R.N.....516

Soft-Picks..... 495-496

Surgical Esthetics™

AmnioMTM556

OSSIF-I sem 556-557

Symmetry Dental, LLC

Francis Park Collection Cabinetry .676-677

Temrex Corporation

Aidaco Bite Sticks..... 159

Amalgam Squeeze Cloths..... 12

Resiment 103

Bite Relator Trays.....270

Copalite98

Copalite SnapBond.....123

Gel-Etch.....125

Interval Temp Filling Material.....99

Napkin Holders.....165

Rite Bite Trays.....270

TNE Temporary Cement..... 111

Tess Oral Health

Tess Toothbrushes.....524

TravelCaps.....517

TIDI Products LLC

Chainless Bibs..... 165

Cotton Rolls160

Durawick Towels170

Evacuation Cup Liners166

Fabricel Headrest Covers167

Headrest Covers.....167

Hi-Risk Latex Gloves277

Kay-Pees Towels.....164

Omnisorb II Non-Woven Sponges.....163

Patient Bibs164

Pediatric Bibs.....164

Q-Towels.....170

Tidi Intraoral Camera Sheaths.....324

Tidi Tooth Bibs164

Tidi Tooth Cups.....165

TidiShield Assemble'n Go Eyewear.....297

TidiShield Assemble'n Go Face Shields...298

TidiShield Camera Sheaths.....324

TidiShield Curing Light Sleeves323

TidiShield Digital Sensor Sheaths324

TidiShield Flip'n Go297

TidiShield Sensor Sheaths324

Tray Covers.....167

Venture Cotton-Filled Sponges.....161

Venture Gauze Sponges162

Venture Non-Woven Sponges163

Tokuyama Dental America, Inc.

Bond Force124

Estelite Flow Quick139

Estelite Sigma Quick135

Shield Force Plus490

Sofreliner Tough.....9

Tokuyama Rebase II.....8

TPC Advanced Technology, Inc.

Dentsonic Ultrasonic Unit.....743

Laguna Dental Chair687

Mirage Operatory Stools739

Radiant LED Operatory Light707

TPC MC-500 Mobile Cart.....694

TrollDental

TrollFoil23

Tuttner

Chamber Brite319

Clean & Simple.....319

Clean & Simple Ultrasonic Cleaner.....743

EZ Plus Sterilizer.....722

EZ9 / EZ10 / EZ10K Autoclaves721

Tuttner Autoclaves.....721-722

Valueklave 1730 Autoclave722

Valumax International

Extra-Safe Disposable Jackets294

Extra-Safe Disposable Lab Coats294

Vatech America

HD Sensor.....653

Pax-i Panoramic X-Ray.....665

PaX-i3D Panoramic X-Ray 664-665

Vector Research & Development Inc.

Alpha Air High Speed Handpieces.....233

Vector Handpiece Spray.....250

Velocity Handpieces 229, 233

Vista Dental Products

Caries Indicator488

Pocket-Probe Tips.....197

Quick-Stat FREE538

Quick-Stat FS538

Vista-Probe Irrigating Tips197

Water Pik, Inc.

Aquarius Water Flosser496

Clearview Sectional Matrix System462

Contour Matrix Bands.....464

Cordless Professional Care Water Floss & Toothbrush.....496

Dead Soft Matrix Bands465

Densco Disposable Prophy Angles510

Densco Prophy Cups & Brushes.....512

Getz Blue Core Build Up116

Hold Tray Adhesive274

Jiffy Tubes.....112

Key-To-Alginate.....252

Master Trays272

Opotow ZOE Impression Paste257

Power Flossers496
 Sani-Trays272
 Sensonic Professional Plus Toothbrush...519
 Tofflemire Matrix Bands465
 Tofflemire Retainers465
 Tra-Tens273
 UltraThin Fluoride Varnish503
 Wizard Wedges466

Waste & Compliance Management, Inc.

Amalgon112
 Chemgon573
 Foilgon573
 SMS Sharps Management System .. 21, 329

Whip Mix

Ardent Articulating Paper23
 Exacta-Film Articulating Paper23
 Hanau Articulators 444-445
 Hold-Tight Articulating Forceps23
 Jade Stone454
 Magnetic Mounting System445
 Model Glow456
 Mounting Stone455
 Preference Liquid Hand Sanitizer301
 Preppies Plus515
 Pumice Preppies515
 Silky Rock454
 Snap-Stone455

White Mountain Imaging

ABX Developer & Fixer571
 Easy Clean573
 Excel Developer & Fixer571
 LH System Cleaner573
 Peri-Dent Developer & Fixer571

Xlear Inc.

Spry Chewing Gum & Mints488

Young Dental

2-Tone Disclosing Solution491
 Contra-Disposable Prophy Angle510
 Coral Prophy Paste515
 D-Lish Prophy Paste516
 D-Lish Varnish503
 Dri-Aids161
 Elite Disposable Prophy Angles510
 Elite Flex Disposable Prophy Angles510
 Lorvic Surgical Milk442
 Nyclave Heat Sealer & Accessories303

Nyclave Tubing306
 Oral-B Centrays500
 Oral-B Centwins500
 Oral-B Denture Brushes518
 Oral-B Fluoride Varnish503
 Oral-B Minute Foam497
 Oral-B Neutra-Care Home Fluoride499
 Oral-B Neutra-Foam497
 Oral-B Prophy Paste516
 Oral-B SUPA Disposable Prophy Angles .511
 SmartSelect Selective Prophy Paste516
 SUPA Disposable Prophy Angles511
 Surgical Milk442
 Surg-O-Vac Tips204
 Trace Disclosing Solution491
 Ultra-Vac HVE Tips201
 Vent-O-Vac HVE Tips202
 Vera Advanced Bright Prophy Paste516
 Vera Disposable Prophy Angles511
 Young Disposable Prophy Angles... 510-511
 Young Hygiene Handpiece245
 Zooby Character Masks291
 Zooby Disposable Prophy Angle511
 Zooby Flouride Foam497
 Zooby Fluoride Foam497
 Zooby Pediatric Bibs164
 Zooby Perfect Choice Fluoride Gel498
 Zooby Prophy Paste516

Zest Dental Solutions (Danville)

Caries Finder488
 Contact Matrices465
 Microetcher IIA444
 MicroPrime Desensitizer490
 Prelude Adhesive124
 PrepStart Air Arasion System444
 StarFill 2B Flowable139
 TurboTemp 26

Zest Dental Solutions (Iveri)

Iveri At Home Whitening144

Zhermack

Elite HD+267
 Freealgin267
 Hydrogum Alginate 252-253
 Occlufast Rock257
 OrthoPrint Alginate253
 Tropicalgin Alginate253

Zirc

B-Lok Trays438

Compact Cassette436
 Crystal Mirrors349
 Denture Boxes446
 Dispos-A-Screen Traps208
 Endo Assist200
 EZ ID Rings439
 EZ ID Tape439
 E-Z Jett Cassette436
 Handi-Hopper Liners329
 Implant Organizer383
 Insti-Dam542
 Lingua-Fix203
 Matrix Dispenser465
 Mighty Mixer Bowl253
 Mirror Magic349
 Mr Thirsty One-Step204
 Needle Capper17
 Safe-Lok Covers438
 SE Cushion204
 Steri-Bur Guard96
 Steri-Containers436
 Steri-Endo Guard200
 Steri-Soaker310

ZOLAR Technology & Mfg Co. Inc.

Photon Lasers701

ZOLL Medical Corporation

AED Plus Defibrillator558

@ease X-Ray Monitoring Badge.....	584
'U' Contra Angle, Health-Tec.....	225
'U' Contra Angles.....	225
10X Wax.....	563
2Pro Disposable Prophy Angle.....	509
2-Tone Disclosing Solution.....	491
3-in-1 Floss.....	492
3-Way Bite Trays.....	270
430-series Handpieces.....	229, 232-233
60 Second Taste Fluoride Gel.....	498
60:60 Rinse.....	500
641 Barrier-Free Oral Surgery Chair.....	685
70% Isopropyl Alcohol.....	314

A

Abbott-Robinson Brushes.....	445
Abrasive Discs & Accessories.....	211-213
Absolute Dentin.....	115
Absorbent Paper Points.....	181, 185, 189-190
Absorbent Paper Points, Health-Tec.....	189
ABX Developer & Fixer.....	571
Access Blue.....	262
Access Crown.....	3
Access High Speed Handpieces.....	229, 232
Accu-Dent XD.....	258
Accudose Tubes & Plugs.....	149-150
Accufilm.....	22
Accuject Needles.....	16
Acculoid.....	258
Acrylic Glaze.....	7
Acrylic Repair.....	7

ACRYLICS & RELINE 3-9

ACT Anticavity Fluoride Rinse.....	498
ActCel Hemostatic Gauze.....	554
Activa BioActive Base/Liner.....	98
Activa BioActive Cement.....	105
Activa BioActive Restorative.....	135
Activa Kids.....	98
Adherence DC Dual Cure Resin Cement.....	105
Adherence SC Self Cure Resin Cement.....	106
Adhese Universal.....	119
Adper Easy Bond.....	117
Adper Prompt L-Pop Self-Etch.....	117
Adper Scotchbond Multi-Purpose Adhesive.....	117
Adper Single Bond Plus Adhesive.....	117
Advanced Gel Hand Sanitizer.....	300
Advanced Wrist BP Monitor.....	557
Advantage Blood Pressure Monitor.....	557
Advantage Saliva Ejectors.....	202
AdvErL Evo Laser.....	700
Advil.....	481
AED Plus Defibrillator.....	558
Affinis Precious VPS.....	263
Affinis VPS.....	263
After Five Ultrasonic Inserts.....	535
Agarloid.....	258
AH Plus Jet Root Canal Sealer.....	193
AH Plus Root Canal Sealer.....	193
AH26 Root Canal Sealer.....	193
Aidaco Bite Sticks.....	159
Aim-Safe.....	17
Air Abrasion.....	444

Air Compressors.....	744-746
Air Fresheners.....	308
Air Fresheners.....	640
Air Techniques Developer & Fixer.....	570
Air/Water Syringe Tips.....	168
Air/Water Syringe Tips, Health-Tec.....	168
Air/Water Syringes.....	695
Air/Water Syringes, Health-Tec.....	695
Alasta Nitrile Gloves.....	280
Alasta White Nitrile Gloves.....	280
Alasta with Aloe Nitrile Gloves.....	280
Alcohol Dispenser.....	314
Alcohol, Isopropyl.....	314
Alcohol Preps.....	558
Alcohol Torch.....	445
Al-Cote.....	453
Alert Condensable Composite.....	134
Alfa Triple Tray.....	270
Alginate.....	251-253
Alginate Flavoring.....	255
Alginate Mixing Pads & Spatulas.....	254
Alginate Replacement Material.....	254-255
Alginate, Health-Tec.....	251
AlgiNot.....	255
Algin-X Ultra.....	254
Alike Temporary C&B Resin.....	5
All Gauze Sponges.....	162
Allcezon Wax.....	563
Allergy Warning Labels.....	625-627
All-Gauze Sponges.....	162
Alliance 1258 Delivery System.....	692
Alliant Delivery System.....	693
Alliant Dental Chair 2260.....	686
Allogel Nitrile Gloves.....	283

ALLOYS..... 10-13

Alloys, Health-Tec.....	10-11
AllWays Recycle.....	573
Aloe Touch 12" Sterile Gloves.....	285
AloeGuard Soap.....	302
aloePRO Latex Gloves.....	276
aloePRO Synthetic Gloves.....	284
AloeTouch Latex Gloves.....	277
Alpen Burs.....	31-32
Alpen Multi Use Diamonds.....	64-67
Alpen x1 Single Use Diamonds.....	67-68
Alpha Air High Speed Handpieces.....	233
Alpha-Dent Alginate.....	251
Alpha-Dent Home Fluoride.....	498
Alpha-Dent LC Pit & Fissure Sealant.....	505
Alpha-Dent Zinc Phosphate Cement.....	108
Aluminum Oxide.....	450
Aluwax.....	564
Amalgam Carriers.....	388, 391, 404
Amalgam Carriers, Health-Tec.....	388
Amalgam Disposal.....	12
Amalgam Separators.....	747-748
Amalgam Squeeze Cloths.....	12
Amalgam Well.....	12
Amalgamators.....	13
Amalgambond Plus.....	122
Amalgon 1.....	12
amalsed max Amalgam Separators.....	747

Amazing Nitrile Gloves.....	278
Ambiance Nitrile Gloves.....	280
American Eagle Explorers.....	332
American Eagle Expos.....	332
American Eagle Probes.....	332-333
American Eagle Scalars & Curettes.....	357-361
Ammonia Inhalants.....	481, 558
AmnioMTM.....	556
Amoxicillin.....	481
Anesthesia Reversal.....	20
Anesthetic Syringes.....	15
Anesthetic Syringes, Health-Tec.....	15

ANESTHETICS 14-21

Anesthetics, Injectable.....	14
Anesthetics, Needles.....	15-17
Anesthetics, Topicals.....	17-20
Angel Soft Facial Tissue.....	641
Angel Soft White Bath Tissue.....	641
Anti-Viral Kleenex Facial Tissue.....	641
Apex ID Digital Apex Locator.....	182
Applicator Tips.....	146-149
Applicator Tips, Health-Tec.....	146
Apron Hangers.....	574
Aprons, X-Ray.....	574-578
Apt II Dental Burner.....	445
Aqua Source Nitrile Gloves.....	279
Aquafresh Infant Training Toothpaste.....	526
Aquarius Water Flosser.....	496
Aquasil Ultra.....	263-264
Aquasil Ultra Cordless.....	264
Aquasil Ultra DECA.....	264
Aquasil Ultra Digit.....	264
Aquasil Ultra with B4.....	263
Aquasil Ultra Xtra.....	264
Aquasoft Nitrile Gloves.....	281
AquaStat Distiller.....	330
AR Spray.....	249
Archwire Markers.....	476
Archwire, Orthodontic.....	475
Arctic Blast.....	19
Ardent Articulating Paper.....	23
Articadent.....	14
Articaine.....	14
Articodent.....	22

ARTICULATING PAPER 22-24

Articulating Paper Forceps.....	23
Articulating Paper Forceps, Health-Tec.....	23
Articulating Paper, Health-Tec.....	22
Articulators.....	444-445
Arti-Spray.....	23
Artizan Expressions Cabinetry.....	674-675
Artizan Streamline Steri-Center.....	728
Asepsis 21 Delivery System.....	691
Asepticare TB+II.....	313
Asepti-Zyme PreSoak.....	316
Aspen Sterilization Center.....	727
Aspirating Syringe, Health-Tec.....	15, 407
Aspirating Syringes.....	15
Aspirator Tips.....	204
Aspirin.....	484

Assure Plus Pouches	305	BeeSure Latex Powder Free Gloves.....	276	Bite Sticks.....	159, 473
Astropol Finishing & Polishing	220	BeeSure Nitrile Gloves	281	Bite Trays	269-270
Aterra Foaming Hand Soap.....	301	BeeSure Saliva Ejectors.....	202	Bite Trays, Health-Tec	269
Attest Biological Monitoring	307	BeeSure Slim Nitrile Gloves	281	Bite Wafers	564
Autoclave Cleaners.....	311	BeeSure SuperSlim Nitrile Gloves	281	Bite Wax	564
Autoclave Envelopes	306	BeeSure Scented Earloop Masks	290	Bite Wing Loops	579
Autoclave Pouches	304-305	BeeSure Scented Gloves	784	Bite Wing Loops, Health-Tec	579
Autoclave Pouches, Health-Tec	304	Beeswax	563	Bite Wing Tabs.....	579
Autoclave Steam Indicator Tape	303-304	Bel-Cypher N X-Ray.....	659	Bite Wing Tabs, Health-Tec.....	579
Autoclave Tubing.....	306	Bel-Halo LED Operator Light.....	702	Bite-Blocks (X-Ray)	579
Autoclaves	718-722	Bellissima Ultrasonic Inserts	532	Bite-Builder	475
Autoclean.....	311	Belmont Cabinetry.....	666-667	Black Maxx Latex Gloves	276
Automate Handpiece Maintenance System	248	Belmont Delivery Systems.....	688	Black Maxx Nitrile Gloves.....	280
Automatic X-Ray Processing Chemicals	570-571	Belmont Dental Chairs	680-681	Blade-Safe.....	554
Automatrix	463	Belmont Lights.....	702	Bleaching Laminate.....	457
Autoscaler.....	530	Belmont Sterilization Center.....	725	Bleaching Products.....	142-146
Avagard D Hand Antiseptic.....	299	Belmont Stools	730	Blissonic Scaler	530
Avant Hand Sanitizer.....	299	Belmont X-Ray	655	Block-4-Bite	580
Axis Burs	39-44	Benda Brushes.....	147	Block-Out Compound	459
Axis NTI Diamond Discs	209-210	Benda Micro Applicators.....	147	B-Lok Trays.....	438
Axis NTI Diamonds.....	71-76	Bendable Brushes, Health-Tec.....	146	Blood Buster.....	316
Axis NTI Polishers	222-223	Benzodent	481	Blood Pressure Monitors	557
B					
Bacti-Foam Soap.....	301	Bib Clips & Chains	164-165	bluephase 20i LED Curing Light	151
Bacti-Stat Soap	301	Bib Holder.....	164	bluephase Style LED Curing Light	152
Bad-Dogs Eyewear.....	296	Bib-Eze	165	Blu-Mousse.....	257
Badger LubeFree Dy Vacuum	746	Bibs	163-164	BluSep.....	122
Bagette Sterilization Pouches.....	305	Bibs, Health-Tec	163	Blush Nitrile Gloves	278
Bags, Dental Design.....	589	Big Easy Ultrasonic Inserts	536	Blu-Tab Waterline Tablets	330
Ball Hooks	476	Big-Fold Z Towels	169	BluWhite Diamonds	77
Ball-Point Applicators.....	148	Binders	594	Bobcat Pro Ultrasonic Scaler.....	528
Bambach Saddle Stool.....	737	Bio Lube	249	Boley Gauge	420
Banicide Plus.....	310	Biocide G30.....	309	Bond Force.....	124
Barbed Broaches.....	187	Biodentine.....	97	Bond-1	123
Barbed Broaches, Health-Tec.....	187	Bioform Shade Guide	451	Bond-1 SF	123
Barbie Toothbrushes.....	520	Biohazard Warning Labels	327	Bonding Agent, Health-Tec.....	117
Bard Parker Surgical Blades & Scalpels	553	Biohazard Waste Bags	329	Bonding Agents	117-124
Barricaid	554	Biological Monitoring System, Health-Tec	307	Bonding Eyewear	296
Barrier Earloop Masks.....	290	Biological Monitors	307-308	Bonding Wrap Eyewear	296
Barrier Envelopes, Health-Tec.....	584	Biological Spill Response Kit.....	326	Bond-IT.....	123
Barrier Film	320	Biopant.....	555	Bondwell Mixing Wells.....	149
Barrier Film, Health-Tec.....	320	Biopsy Punch.....	553	Bone Basin	382
Barrier Milk	442	Bio-Pure.....	207	Bone Compactor.....	382
Barrier Products.....	320-326	BioRoot RCS Sealer.....	193	Bone Curettes.....	379, 382
Base Plate Material	457	BioScreen Oral Exam Light.....	717	Bone Grafting Materials.....	554-557
Base Plate Wax	563	Biosonic Optimist Inserts	531	Bone Grinder.....	382
Batteries.....	595	Biosonic Super Soft Inserts.....	531	Bone Liner	98
Bausch Articulating Paper	22	Biosonic Suvi Scaler Tips.....	531	Bosworth Copaliner	19
BD Luer-Lok Needles	15	BioSonic Ultrasonic Solutions	316	Bosworth Cora Caine	8
BD Sharps Containers.....	21	BioSonic Ultrasonic Units	742	Bosworth Dentusil	8
BDU Delivery System	688	Biosonic US100R Scaler	528	Bosworth Fastray	7
BeautiBond.....	123	Biosonic WipeOut.....	312	Bosworth Fastray LC	7
Beautiful Flow Plus	139	Biotec Cabinetry	668-669	Bosworth Flexo Saliva Ejectors	203
Beautiful II.....	135	Biotec Sterilization Center	725	Bosworth Light Liner.....	8
Beauty Pink Wax	563	Biotene Dry Mouth Oral Rinse	504	Bosworth PropyBrite Air Polisher.....	528
Beaverstate S-4250 Mobile Cart	694	Biozyme LT	315	Bosworth Simplastic Sleeves	326
BeeSure Naturals Nitrile Gloves.....	281	Birex Disinfecting Wipes	311	Bosworth Softone	9
BeeSure Air/Water Syringe Tips	168	BirexSE.....	311	Bosworth SuperEBA.....	109
BeeSure Comfy HVE Tips	201	Bite Block Baggies	323	Bosworth Supergel Alginate	252
BeeSure Disposable Propy Angles.....	507	Bite Block Covers	322	Bosworth TAC Tray Adhesive.....	274
BeeSure Earloop Face Masks.....	289	Bite Blocks (Wax)	565	Bosworth Tray-Aways.....	271
		Bite Registration	255-257	Bosworth Trim II.....	5
		Bite Registration Wax	563	Bosworth Truliner.....	8
		Bite Registration, Health-Tec.....	255	Bosworth TruSoft	9
		Bite Relator Trays.....	270	Bosworth Wonder Wedges	466
				Bouffant Caps	293

Boxing Wax.....564
 Brackets, Orthodontic.....467-468
 Braided Cotton Rolls.....160
 Brass Center Snap-On Discs.....212
 Bravo Sterilizer.....721

BREAKROOM SUPPLIES.....637-639

Breeze Resin Cement.....105
 Brewer Stools.....731-732
 Bridge Aid Dental Floss.....491
 Brinker Rubber Dam Clamps.....545
 Brite Shield.....319
 Brixton Chair Covers.....320
 Brixton Light Handle Sleeves.....325
 Brixton Syringe Sleeves.....321
 Brownie Points & Wheels.....219
 Brush & Bond.....122
 Brush Tips.....146-149
 Buccal Tubes.....469-470
 Buckley's Formo Cresol.....195
 Buffs.....445
 Build-It.....115
 Build-It FR.....115
 Bulbs, Replacement.....708-711
 Bulk-Fill Composites.....127
 Bulldog QT Vacuum.....746
 Bunsen Burners.....445
 Bur Accessories.....93
 Bur Blocks.....30, 95-96
 Bur Blocks, Health-Tec.....30, 95
 Bur Caddy.....95-96
 Bur Cleaning Brushes.....95
 Bur Cross-Reference Chart.....25-27
 Bur Holder.....95-96
 Bur Tray.....96
 Burners & Torches.....445-446
 Burnishers.....388, 390, 392, 404, 406
 Burnishers, Health-Tec.....388

BURS-CARBIDES & DIAMONDS.....25-96

Burs, Health-Tec.....28-30
 Butalbital.....481
 Butler Dental Floss.....492
 Butler Prophylaxis Disposable Prophylaxis Angles.....510
 ButlerWeave Floss.....492

C

C&B Metabond.....105
 Cabinetry.....666-679
 Calasept.....192
 Calasept CHX.....194
 Calcium Hydroxide Placement Instruments.....404
 Calcium Hydroxide Powder.....195
 Calibra Esthetic Resin Cement.....101
 Calibra Universal Self-Adhesive Resin Cement.....101
 Calipers.....420
 Calm-It.....489
 Cameras.....642-646

Cam-X Elara IntraOral Camera.....642
 Cam-X Spectra Caries Detection.....647
 Cam-X Triton HD Camera.....643
 Canal Preparation & Medicaments...194-195
 CanalPro Apex Locator.....197
 CanalPro CL Cordless Endo Handpiece.....243
 Candeez Flexible Mixing Bowls.....253
 Canker-X Oral Pain Reliever.....516
 Captivate In-Office Whitening.....142
 Captivate Take-Home Whitening.....143

CARBIDE BURS.....25-49

Carbide Burs, Health-Tec.....28-30
 Carbocaine.....14
 Caress COATS Nitrile Gloves.....282
 Caries Detection (Equipment).....647
 Caries Detector.....488
 Caries Detectors.....488
 Caries Finder.....488
 Caries Indicator.....488
 Cartridge Dispenser, Health-Tec.....3, 268
 Cartriloids.....258
 Carvers.....388, 390, 393-394, 406
 Carvers, Health-Tec.....388
 Cassettes, Instrument.....430-432, 436
 Castone.....455
 Caterpillar Toothbrushes.....521
 Cavex Alginate.....251
 CaviCide.....313
 CaviCide 1.....313
 Cavidry.....112
 Cavit.....98
 Cavitec.....98
 Cavitron Bellissima Inserts.....532
 Cavitron Bobcat Pro.....528
 Cavitron Fitgrip Ultrasonic Inserts.....532
 Cavitron Inserts O-Rings.....534
 Cavitron Jet Air Polishing Insert.....534
 Cavitron Jet Plus Ultrasonic Scaler.....529
 Cavitron Jet-Fresh Prophy Powder.....529
 Cavitron Plus Ultrasonic Scaler with Tap-On.....529
 Cavitron Powerline Inserts.....532
 Cavitron Select SPS.....528
 Cavitron Slimline Inserts.....532-533
 Cavitron SoftTip Implant Insert.....533
 Cavitron THINsert Ultrasonic Insert.....532
 Cavitron Thru Flow Inserts.....533
 Cavitron Touch with Steri-Mate.....529
 Cavitron Ultrasonic Inserts.....532-534
 Cavity Liners.....97-98
 Cavity Varnish & Sealants.....98
 CavityShield Varnish.....501
 CaviWipes.....314
 CaviWipes 1.....314
 C-Bar Barriers.....325
 C-Dent Multi-Use Dispenser.....150
 Cement Spatulas.....389
 Cement Spatulas, Health-Tec.....389
 Cement-It.....105

CEMENTS & LINERS.....97-112

Centerpull Paper Towels.....171
 Cephalixin.....481
 CeraGlaze Porcelain Polishing.....222
 Ceramic Bearing Turbines.....234
 Ceramir.....106
 Ceramiste Points.....220
 Ceri-Saw.....453
 Cervical Neckpads.....477
 Cetacaine.....18
 Cetylclde II.....312
 Cetylclde-G.....309
 C-Fold Towel Dispensers.....170-171
 C-Fold Towels.....169
 Chainless Bibs.....165
 Chair Covers.....320-321
 Chair Sleeves.....320-321
 Chair Sleeves, Health-Tec.....320
 Chairs.....680-687
 Chamber Brite.....319
 Chamber Cleaner.....319
 Chamois Buffs.....445
 Chap-Ice Lip Balm.....488
 Charisma.....131
 Check Bite Wafers.....564
 Check-Bite Trays.....273
 Cheek Retractors.....407, 427-428
 ChemFil Rock Advanced.....140
 Chemgon.....573
 Chemical Spill Response Kit.....326
 Chewing Gum.....488
 Chlorhexidine Gluconate Oral Rinse.....489
 Chlorhexidine Oral Rinse.....489
 Chloroform.....195
 Cidex OPA.....309
 Cimpat S.....99
 Citanest.....14
 Citrace.....313
 Citrisil Blue.....330
 CitriSol Towelettes.....112
 Citrzyme.....206, 318
 Citrus II Hand Sanitizer.....299
 Citrus II Odor Eliminator.....308
 Citrus II Solid Air Freshener.....308
 Claris i4D Camera.....645
 Clean & Lube Spray.....253
 Clean & Simple.....319
 Clean & Simple Ultrasonic Cleaner.....743
 Clean-A-Diamond.....95
 Cleaners & Lubricants, Instrument.....442
 Cleaning Supplies, Office.....540
 Cleanlets.....319
 Clean-Up Film.....572
 Clear Crown Forms.....156
 Clear Dip.....350
 Clear Image Cleaner.....572
 Clearfil Ceramic Primer/Primer Plus.....104
 Clearfil DC Bond.....121
 Clearfil DC Core Plus.....115
 Clearfil Esthetic Cement EX.....104
 Clearfil Liner Bond 2V.....121
 Clearfil Majesty ES-2.....134

Clearfil Majesty Flow	138	COM-FIT Masks	291	Cordless Professional Care Water Floss & Toothbrush	496
Clearfil Majesty Posterior.....	134	COM-FIT Plush Earloop Masks	291	Core Build-Up Material	113-116
Clearfil New Bond.....	121	COM-FIT Super High Filtration Earloop Masks	291	CORE Delivery System	690
Clearfil Photo Bond	121	COM-FIT Super-Sensitive Earloop Masks	291	CORE Dental Chair	682
Clearfil Photo Core	115	Comfi-Tip Foam Tips	202	CORE LED Light	704
Clearfil Porcelain Bond Activator	121	Comfort Clean Floss Picks	493	CORE MATERIALS	113-116
Clearfil S3 Bond Plus	121	Comfort Cover	479	Core Paste XP	113
Clearfil SE Bond	121	Comfort Grip Latex Gloves	277	Correct Plus	266
Clearfil SE Bond 2	122	Comfort Plus Saliva Ejectors	202	Correction Supplies	591
Clearfil SE Protect	122	COMFORTdrive Handpiece	235	COSMETIC DENTISTRY	117-153
Clearfil ST Opaquer.....	142	ComfortView Lip & Cheek Retractor	427	Cotton & Dressing Pliers 331, 334, 345, 347	
Clearfil Universal Bond.....	122	Communication Labels	628-629	Cotton Filled Sponges	161
ClearShield Fluoride Varnish	502	Compact Cassette	436	Cotton Filled Sponges, Health-Tec	161
Clearview Classic Nasal Masks	20	CompCore	116	Cotton Pellets.....	160
Clearview Sectional Matrix System	462	CompCore AF.....	116	Cotton Pliers	331, 334, 345, 347
ClearVision Digital Sensor System.....	649	Compliance Disinfectant/Sterilant.....	309	Cotton Pliers, Health-Tec	331
ClearVision Digital Sensors.....	651	Comply Sterigage Integrators	307	Cotton Roll Alternatives	161-162
Cleoid Discoids.....	388, 390, 393, 406	Composite Brushes	146-149	Cotton Roll Dispensers	160-161
Clesta LED Operatory Lights.....	702	Composite Brushes, Health-Tec.....	146	Cotton Rolls	160
Clindamycin	481	Composite Buttons	475	Cotton Rolls	160
Cling Shield X-Ray Aprons	578	Composite Delivery Systems.....	149-150	Cotton Rolls, Health-Tec	160
Clinpro 5000	526	Composite Discs & Strips, Health-Tec.....	211	Cotton Tipped Applicators, Health-Tec.....	160
Clinpro Disposable Prophyl Angles	507	Composite Plastic Filling Instruments	389, 390, 395-399, 405-406	Cottonelle Bath Tissue.....	641
Clinpro Prophyl Paste	513	Composite Polishers, Health-Tec.....	221	Cover-All Barrier Film	320
Clinpro Sealant.....	505	Composites	127-141	Cox Rapid Heat Sterilizer	718
Clio Sensors	652	Composites, Health-Tec	128	CPR Pocket Microshield Kit.....	326
Clipboards	595	Compo-Strips.....	215	C-R Syringes	149
Clorox Bleach Germicidal Cleaner	313	Comprecap	541	Crave Nitrile Gloves.....	279
Clorox Hydrogen Peroxide Cleaner	313	Compressors and Vacuums.....	744-746	Crayola Flossers.....	494
CloSYS Oral Rinse	505	Compule Syringe Guns	150	CRCS Calciobiotic Root Canal Sealer	192
Closys Toothpaste	526	Computer Cleaning Supplies	595	Crescent Plaster Trap	452
Code Rings.....	435, 440	Comspan	101	Crest 3D White Brilliance Toothpaste	527
Coe Adhesive	274	Concentrix Handpieces	232	Crest 3D White WhiteStrips	145
Coe Alginate	251	Cone Masks.....	287	Crest Cavity Protection Toothpaste.....	527
Coe Check-Bite Trays	273	Cone Masks, Health-Tec	287	Crest Complete Multi-Benefit Whitening Toothpaste	527
Coe Foam II.....	313	Confirm 10 In Office Monitoring.....	307	Crest Pro-Health Advanced Toothpaste...527	
COE Impression Trays.....	269, 271, 273	Confirm 24 In-Office Biologocal Monitoring	307	Crest Pro-Health Jr. Toothpaste	527
Coe Spray II.....	313	Confirm Main-In Monitoring Service.....	307	Crest Pro-Health Mouthwash.....	504
COE Syringe	267	Contact Matrices	465	Crest Pro-Health SensiRepair Toothpaste ..527	
Coe Tray Cleaner.....	274	ContactPro Sectional Matrix	460-461	Crest Sensi-Relief Whitening Toothpaste ..527	
Coe Tray Plastic.....	7	Contour Alloy	11	Crest Sensi-Stop Strips	490
Coe Triple Function Bite Trays	269	Contour Matrix Bands.....	464	Crest Toothpaste.....	527
COECAL.....	455	Contour Nitrile Gloves	279	Crest WhiteStrips Supreme	145
CoeCide XL	309	Contour Plus Nitrile Gloves	279	Crimpable Ball Hooks.....	476
CoeCide XL Plus	309	Contour Wraps Eyewear.....	296	Crimpable Mini Stops	476
Coe-Comfort	9	Contouring Pliers	425	CrossZyme	316
COE-FLEX.....	260	Contra Angles	225, 239-240	Crown Accessories	159
Coe-Pak Automix	554-555	Contra Angles, Health-Tec.....	225	Crown Adapting Pliers	405
Coe-Rect	7	Contra-Disposable Prophyl Angles.....	510	Crown and Bridge, Temporary Material... 3-6	
Coe-Soft.....	8	Contrast Light Curable Resin	143	Crown Matrix Buttons	256
CoeZyme	317	Contrastpm	146	Crown Order Forms.....	154
Coffee	637-639	Cook-Waite Injectable Anesthetics	14	Crown Pliers	389
Coil Springs	475-477	CoolTemp	4	Crown Remover, Health-Tec.....	388
Coin Envelopes	583-584	Copalite	98	Crown Removers	388, 405
Cold Packs.....	558	Copalite SnapBond.....	123	Crown Scissors.....	389
College Pliers, Health-Tec	331	Copier Toner	598	Crown Seating Stools.....	733
Color Touch Pink Latex Gloves.....	277	Coping Material	457		
Colorvue Probes.....	339	Coprwx Bite Wafers	564		
Coltolux 75 Curing Light.....	151	Coral Prophyl Paste	515		
Coltolux LED Curing Light.....	151	Cord Packers, Health-Tec.....	388		
Combi-Tip HVE Tips.....	201	Cord Packing Instruments	388		
Comfee's Sensor Sleeves.....	323				
COM-FIT Easy Breathe Earloop Masks	291				
COM-FIT Groovy Earloop Masks	291				

- CROWNS154-159**
- Crowns, Natural Color, Metal..... 159
- Crowns, Iso-Form..... 155
- Crystal Impression Trays271
- Crystal Mirrors349
- CSR Sterilization Wrap.....306
- CSR Sterilization Wrap, Health-Tec.....306
- Ctical Cover PFL Earloop Masks288
- C-Tub.....310
- Cup Dispenser.....166
- Cups, Disposable165-166
- Cups, Health-Tec..... 165
- Cure Shield..... 153
- Curelastic Barriers.....326
- Cure-Thru Cervical Matrices464
- Cure-Thru IntegraPost.....487
- Cure-Thru Matrix Bands.....464
- Cure-Thru Wedges466
- Curettes & Scalers.....356-376
- Curettes & Scalers, Health-Tec Ultra ..356-357
- Curing Light Probes..... 153
- Curing Light Sleeves 322-323
- Curing Lights & Accessories150-153, 709
- Curity Packing Strip.....554
- Curve Fitted Nitrile Gloves.....285
- Custom Tray Material.....7
- CutterSil260
- CX-Plus Glaslonomer Cement.....108
- Cyntek Latex Gloves.....276
- D**
- D-4RH Cabinetry667
- Dapdish517
- Dappen Dishes-Disposable517
- Dappen Dishes-Disposable, Health-Tec..517
- Dappen Dishes-Glass.....517
- DCI Edge Delivery Systems689
- DCI Edge Dental Chair.....681
- DCI Edge Operator Lights703
- DCI Edge Stools.....734
- Dead Soft Matrix Bands465
- Debactoral481
- Debubbler.....456
- Dee-Fog.....350
- Defend Cone Masks287
- Defend Dental Needles16
- Defend Diffuser Fog-Free Masks.....291
- Defend Loc Sterilization Pouches.....305
- Defend Plus Jackets.....295
- Defend Plus Lab Coats295
- Defend Plus Wipes313
- Defend Sterilization Tubing.....306
- Defend Tie-On Masks.....292
- Defend Trap-EZ208
- Defend Tray Adhesive274
- Defend Ultrasonic Tablets.....318
- Defibrillator558
- Defogger, Mirror.....350
- Delivery Units 688-694
- Delton Pit & Fissure Sealant505
- Demi Plus Curing Light152
- Demi Ultra Curing Light.....152
- Denatured Alcohol451
- Densco Disposable Prophy Angle510
- Densco Prophy Cups/Brushes512
- Densfil Thermal Endodontic Obturators ..197
- Den-Shur-Cups.....446
- Denstone455
- Dental Cabinets..... 672-673
- Dental Chairs..... 680-687
- Dental Dam..... 542-543
- DentalEZ Cabinetry 670-671
- DentalEZ Delivery Systems.....690
- DentalEZ Dental Chairs.....682
- DentalEZ Operatory Lights.....704
- DentalEZ Stools.....735
- Dental Floss, Health-Tec491
- Dental Needles.....15-17
- Dental Stools 730-739
- Dental Unit Water Line Products 329-330
- Dental Unit Waterline Testing330
- Dentalube II250
- Dentapops203
- DentaPure.....329
- Denta-Sleeve.....325
- DenTASTIC UNO.....123
- Denticolors Prophy Angles.....507
- DentiMax Dream Sensors650
- Dentin Substitute97
- Dentotape491
- Dentray II Impression Trays272
- Dentsonic Ultrasonic Unit743
- Denture Boxes446
- Denture Boxes, Health-Tec.....446
- Denture Brushes 517-518
- Denture Brushes, Health-Tec517
- Denture Maintenance Kit.....446
- Denture Materials 446-448
- Desensitizer, Health-Tec.....489
- Desensitizers 489-490
- Developer & Fixer 570-572
- Developer/Fixer Disposal.....573
- Dextrose 5%.....558
- DiaGloss Composite Polishing223
- Diagnostic Instruments331-350
- Dia-ISOGT Gutta Percha.....191
- Dial Liquid Soap301
- DIAMOND BURS 50-96**
- Diamond Cross-Reference Chart 50-59
- Diamond Grip Latex Gloves277
- Diamond Grip Plus Latex Gloves277
- Diamond Prophy Angles508
- Diamond Strips, Health-Tec.....214
- Diamond Twist SCL220
- Diamond Twist SCO220
- Diamond Zyme318
- Diamonds, Multi-Use, Health-Tec 60-61
- Diamonds, Single-Use, Health-Tec62
- Diamonds, Health-Tec 60-62
- Diapex193
- Die Stone.....454
- Die-Keen.....454
- Digital Processors..... 648-649
- Digital Sensor Barriers 323-324
- Digital Sensors 650-653
- Digital Ultra Nitrous Oxide System712
- Digital X-Ray Sensor Sleeves 323-324
- Digital X-Ray Sensor Sleeves, Health-Tec323
- Dimension VPS261
- Dimensions Latex Fitted Gloves285
- Diphenhydramine.....481
- Directed Flow Impression Trays.....270
- Discide Effect Asepsis Soap.....302
- DisCide Ultra314
- DisCide Wipes314
- DisClens Lens Cleaning Station.....298
- Disclosing Solutions & Tablets.....491
- Disclosing Wax565
- Discovery Trays.....500
- Disinfectants, Surface..... 311-314
- Disinfected Label327
- Dispersalloy 10
- Dispersed Phase Alloys..... 10-11
- Dispersed Phase Amalgam Alloy, Health-Tec 10-11
- DispOral Angulated Aspirator Tips.....201
- DispOral Articulating Paper22
- DispOral Disposable Syringes.....267
- Dispos-A-Bite.....580
- Disposable Prophy Angles..... 507-511
- Disposable Prophy Angles & Prophy Paste Packs.....513
- Disposable Prophy Angles, Health-Tec...507
- Disposable Toothbrushes518
- Disposable Toothbrushes, Health-Tec518
- DISPOSABLES160-171**
- Dispos-A-Screen Traps208
- Disposo-Shield Barriers... 321, 325, 325-326
- Dispos-a-Trap207
- Dispos-a-Trap Plaster traps.....452
- Distillers330
- Distinct Latex Gloves275
- D-Lish Prophy Paste516
- D-Lish Varnish503
- Dowel Pins-Brass448
- Doxycycline481
- Dr. QuickLook Viewer646
- Dr. Suni Plus Sensor653
- Dr. Thompson's Color Transfer Applicators...23
- Dri-Aids.....161
- Dri-Angles.....161
- Drinking Cups..... 165-166
- Drinking Cups, Health-Tec.....165
- Dry Heat Sterilizers718
- Dry Mouth Gel499
- Dry Socket Paste.....195, 556
- Dry Tips162
- Dry Vacuum System744
- Dry-Rite Drying Agent.....123
- Dryz Retraction Paste.....541
- Dual Alo #54 Strips.....214
- Duo-Check Sterilization Pouches304
- DuoTEMP99
- Dura Green Abrasive Stones.....218
- Dura White Abrasive Stones.....219
- Duraflor Halo Varnish.....502
- Duraflor Varnish502
- DuraLock Plus Trays272

Durasafe Vinyl Gloves	284	Elite HD+	267	Epitex Finishing/Polishing	214
DuraShield CV Varnish	502	Embonte 2	110	Equia Forte Bulk Fill	127
Durashield Varnish	502	Embrace Pit & Fissure Sealant	506	EQUIPMENT - SMALL & LARGE ...642-749	
Durawick Towels	170	Embrace Varnish	502	ErgoTech Lab Workstation	679
Durelon	108	Embrace WetBond Resin Cement	105	esa Disposable Prophyl Angles	509
Duropro Disposable Prophyl Angles	509	Embrace WetBond Seal-n-Shine	142	Estelite Flow Quick	139
Dust Collectors	448-449	Emerald Disposable Prophyl Angles	508	Estelite Sigma Quick	135
Dycal	97	Emergency Eye Wash Station	324	Esthetic Finishing Carbide Burs	36
Dyna-Hex CHG Scrub	32	Emergency Spill Response Kits	326	Esthet-X Flow	136
Dynamic Disposables Eyewear	296	Empower Enzymatic Solution	318	Esthet-X HD	130
Dynamic Mixing Tips, Health-Tec	267	EmPower Foam	318	Etch Gel, Health-Tec	124
Dynomite Nasal Hoods	20	EMS Sterilizer Monitoring	308	Etch Rite Dental Etching Gel	125
Dyract eXtra	130	Enamel Pro Prophyl Paste	514	Etchants	124-125
Dyract Flow	136	Enamel Pro Varnish	502	Etcher Catcher	448
E		Enamelon Preventive Treatment Gel	499	ETHICON Sutures	551-552
E.T.C. Easy Temporary Cement	110	Enamelon Toothpaste	527	Eucalyptol	195
Earloop Face Masks	287-292	Encore/Encore DC	113	Eugenol	194
Earloop Masks, Health-Tec	287	Endo Access Burs	30, 38	E-Vac Evacuation Cleaner	206
Easy Angle Floss Picks	493	Endo Assist	200	E-Vac Tip	201
Easy Clean	573	Endo Clean-Stand	199	EVACUATION	201-208
EasyThread Floss Office Dispensers	492	Endo Container	199	Evacuation Cups & Liners	697
EasyThread Floss Sample Packs	492	Endo Foam Inserts	200	Evacuation Cup Liners	166
Easyview Probes	347	Endo Handpieces	242-243	Evacuation System Cleaner, Health-Tec	204
ECO Aspirating Syringe	15	Endo Needles	196-197	Evacuation System Cleaners	204-207
Eco II Amalgam Separator	749	Endo Organizers	198-200	Evacuation Traps	207-208
Econoback Patient Bibs	163	Endo Pluggers	351-355	Evac-U-Trap	208
Econo-Vac Vacuum Former	456	Endo Refrigerant Spray, Health-Tec	17	EverLight Operatory Light	704
EconoWraps Eyewear	296	Endo Stand	199	Evogue Delivery System	688
EcoSoft Facial Tissue	641	Endo Stops	200	Evolution One Latex Gloves	277
EcoSoft Hand Towels	169-170	Endo Syringes	196	Evolve 300 Nitrile Gloves	279
Edge-Ease Comfort Cushions	580	Endo Syringes & Needles, Health-Tec	196	Exa Tray Adhesive	274
EDTA Plus	194	Endo-Access Bur	38	Exabite II NDS	256
EDTA Solution	194-195	Endo-Aid Organizer, Health-Tec	198	Exacta-Film Articulating Paper	23
EduCam HD Camera	644	Endodontic Instruments	351-355	Exafast NDS	265
EEZ Touch Disposable Prophyl Angles	509	ENDODONTICS	172-200	Exaflex	265
Eeze-Grip Digital Sensor Holder	580	Endo-Ice	18	Exam Record Forms	600-602
EezeMount	568-569	Endo-Mate DT/TC2	243	Examix NDS	265
Eez-Thru Floss	493	Endo-M-Block	199	Excavators	351, 353, 355, 402-403, 405
Eez-Thru Floss Threaders	493	Endo-Ray II	581	Excavators, Health-Tec	351
Eez-Thru Flosser	494	EndoRing	199	Excel Developer & Fixer	571
Efferdent	481	Endoring II	199	Excelsior 3D CBCT X-Ray	664
Efferzyme Tablets	316	Endosolv E	195	Excite DSC Adhesive	120
Ektavison G Film	567	Endotouch TC2 Cordless Endo Handpiece	242	ExcTE F Adhesive	120
Elastic Bands	479	Endo-Z Bur	38	Excuse Slips	599
Elasti-Dam	542	EnFog Safety Eyewear	296	Exodontia Sponges	161
Elastomeric Chain	474	Engine Files	187	Expanding Floss	493
Elastomeric Ligatures	474	Engine Reamers	187	Expasyl	540
Elastomeric Organizers	474	Engle 300 Dental Chairs	683	EXPERTSurg LUX System	246
Electric Handpieces	235-242	Engle AS-1 Delivery System	694	EXPERTtorque Handpieces	227
Electric Toothbrushes	518-520	Enhance Finishing & Polishing	221	Explorers	331-332, 336-337, 346, 347-348
Electrotorque TLC Handpieces	237	Enhance PoGo	221	Explorers, Health-Tec	331
Elements Adaptive Motor	178, 242	enMotion Roll Towels	171	Express Bite Registration	255
Elements Apex Locator	198	enMotion Touchless Towel Dispenser	171	Express VPS	261
Elements Diagnostic Unit	198	Envision Hand Towels	169-170	Expres	331-332, 338
Elements Free Obturation Unit	198	Enzymatic Tablets, Health-Tec	315	Expres, Health-Tec	331
Elements Obturation Unit	198	Enzymatic Ultrasonic Cleaning Solutions	315-319	Extracting Forceps	407, 409-410, 416-419, 422-423
Elevance Delivery System	691	Enzymax Spray Gel	317	Extracting Forceps, Health-Tec	407
Elevance Dental Chair	684	Enzymax Ultrasonic Detergent	317	Extraoral Film	567
Elevators	407, 411, 414-415, 420-422	Epic - TMPT	134	Extra-Safe Disposable Jackets	294
Elevators, Health-Tec	407	Epidri Pellets	541		
Elipar DeepCure-S LED Curing Light	150				
Elite Disposable Prophyl Angle	510				
Elite Flex Disposable Prophyl Angles	510				

Extra-Safe Disposable Lab Coats	294	Fissurotomy Burs	46	FreeForm SE Nitrile Gloves.....	282
Extrude Extra VPS.....	266	Fit Checker Advanced.....	23, 260	Fresh-Vac	205
Extrude VPS.....	266	FitGrip Ultrasonic Inserts.....	532	FS Hemostatic.....	537
Eye Protection	295-298	Flaps Film Tabs	579	Fuji Coat LC.....	141
Eye Protection Shield	153	Flash Tips	168	Fuji I Luting Cement	107
Eye Savers Eyewear	297	Fleck's Zinc Cement	109	Fuji II.....	140
Eye Wash Stations	327	Flecta Disposable Mirrors.....	350	Fuji II LC	140
Eye Wear Disinfectant	298	Flexaprene Chloroprene Gloves.....	284	Fuji IX GP	141
EZ 1-2-3 Atomizer.....	205	Flexible Mixing Bowls, Health-Tec ..	253, 451	Fuji IX GP Extra.....	141
EZ ID Rings.....	439	Flexiboles	253, 451	Fuji IX GP Fast.....	141
EZ ID Tape.....	439	Flexi-Dam	542-543	Fuji Lining LC.....	97
E-Z Jett Cassette	436	Flexi-Flange Posts	485	Fuji Ortho Band	473
EZ Plus Sterilizer.....	722	Flexi-Flow	101	Fuji Ortho Bonding	473
EZ9, EZ10, EZ10K Autoclaves	721	Flexi-Overdenture	485	Fuji Ortho LC	107, 473
EZ-Fill Epoxy Root Canal Cement.....	193	Flexi-Post	485	Fuji Ortho Self Cure.....	107
EZ-Tab Mounts	568-569	Flexitime Dynamix	265	Fuji Plus.....	107
EZ-View Mounts	568-570	Flexitime VPS	265	Fuji Triage	506
EZ-Zyme.....	317	Floss & Accessories	491-494	Fuji Varnish.....	141

F

Fabricel Headrest Covers	167	Floss and Toss.....	493	Floss Dispenser.....	493	Floss, Health-Tec.....	491	Flossaid Floss Holder.....	493	Flossers & Floss Picks	494-496	Flossers, Health-Tec.....	493	Flossmate Floss Handle.....	493	FlossSingles	492	Flow X-Ray Film	567	Flowable Composites	135-139	Flowable Composites, Health-Tec	135	Flow-It ALC	138	Flowmeters	712-715	Fluidshield Fog Free Tie-On Mask with Visor	292	Fluidshield Mask with Visor	292	Fluidshield Masks.....	290	Fluopost.....	114	Fluoride, Home Care	498-499	Fluoride Foams.....	497	Fluoride Gels	497-498	Fluoride Rinse	499-500	Fluoride Trays	500	Fluoride Trays, Health-Tec	500	Fluoride Varnish	501-503	FluoroCore.....	114	FluoroCore 2+.....	114	FluoroDose Fluoride Varnish.....	501	FluroShield	505	Fog-Free Mirror Defogger.....	350	Foilgon.....	573	Foot Controls	695	Forceps, Extracting	407, 409-410, 416-419, 422-423	Forceps, Health-Tec.....	407	Forceps, Rubber Dam Clamp	408, 429	Formeject.....	202	Formocresol.....	194-195	Formula 2000 Plus	572	Foundation.....	555	Framed Dental Dams	543	Francis Park Collection Cabinetry	676-677	Freealgin.....	267	Freedom Lab Workstation	679	Free-Flo Syringe	267	G-aenial Bond	118	G-aenial Flo.....	137	G-aenial Sculpt.....	131	G-aenial Universal Flo.....	137	Galaxy Stools	736	Gammex Sterile Surgical Gloves.....	285	Garbage Bags	641	Gates Glidden Drills	185, 188	Gates Glidden Drills, Health-Tec	188	Gauze Sponge Dispensers	161	Gauze Sponges	162	GBG AloeGel Hand Sanitizer	300	G-Bond	119	GBX Developer & Fixer	571	GC Cavity Conditioner.....	119	GC Fuji Coat LC	141	GC Fuji I Luting Cement.....	107	GC Fuji II	140	GC Fuji II LC.....	140	GC Fuji IX GP.....	141	GC Fuji IX GP Extra	141	GC Fuji IX GP Fast.....	141	GC Fuji LINING LC.....	97	GC Fuji Ortho LC	107	GC Fuji Ortho Self Cure	107	GC Fuji Plus	107	GC Fuji Triage	506	GC Fuji Varnish	141	GC FujiCEM 2	107	GC Reline.....	7	GC Reline Soft/Extra Soft.....	8	GC Temp Advantage.....	110	G-Cem	102	G-Cem LinkAce	102	G-Coat Plus.....	141	Gel Etchant.....	124	Gelato Fluoride Gel	497	Gelato Prophy Paste.....	514	Gel-Cord	537	Gel-Etch.....	125
--------------------------------	-----	---------------------	-----	----------------------	-----	------------------------	-----	----------------------------	-----	------------------------------	---------	---------------------------	-----	-----------------------------	-----	--------------------	-----	-----------------------	-----	---------------------------	---------	---------------------------------------	-----	-------------------	-----	------------------	---------	---	-----	-----------------------------------	-----	------------------------	-----	---------------	-----	---------------------------	---------	---------------------	-----	---------------------	---------	----------------------	---------	----------------------	-----	----------------------------------	-----	------------------------	---------	-----------------	-----	--------------------	-----	----------------------------------	-----	-------------------	-----	-------------------------------	-----	--------------	-----	---------------------	-----	---------------------------	--------------------------------	--------------------------	-----	---------------------------------	----------	----------------	-----	------------------	---------	-------------------------	-----	-----------------	-----	--------------------------	-----	---	---------	----------------	-----	-------------------------------	-----	------------------------	-----	---------------------	-----	-------------------	-----	----------------------	-----	-----------------------------	-----	---------------------	-----	-------------------------------------	-----	--------------------	-----	----------------------------	----------	--	-----	-------------------------------	-----	---------------------	-----	----------------------------------	-----	--------------	-----	-----------------------------	-----	----------------------------	-----	-----------------------	-----	------------------------------	-----	------------------	-----	--------------------	-----	--------------------	-----	---------------------------	-----	-------------------------	-----	------------------------	----	------------------------	-----	-------------------------------	-----	--------------------	-----	----------------------	-----	-----------------------	-----	--------------------	-----	----------------	---	--------------------------------	---	------------------------	-----	-------------	-----	---------------------	-----	------------------	-----	------------------	-----	---------------------------	-----	--------------------------	-----	----------------	-----	---------------	-----

G

FINISHING & POLISHING..... 209-203

Finishing Carbide Burs	35-36
Finishing Strips.....	214-215
Finishing Strips, Health-Tec.....	211
First Aid Kit	327

Gelfoam.....	556	GP2 Dental Chair.....	686	Hand Essentials Lotion Soap.....	302
GelPatch.....	19	G-Premio Bond.....	119	Hand Essentials Skin Repair Cream.....	299
General Purpose Ultrasonic Solution, Health-Tec.....	315	Gradia Direct.....	131	Hand Lotion.....	299
Generation Stools.....	735	Gradia Direct Flo.....	136	Hand Sanitizers.....	299-301
Genie Bite Registration.....	257	Gradia Direct LoFlo.....	136	Hand Soaps.....	301-303
Genie VPS.....	267	Gradia Direct X.....	131	Handicaine Stix.....	19
Genie VPS Tray Adhesive.....	274	Great White Gold Series Burs.....	47	Handi-Dam.....	543
Gentle Gum Care Floss.....	491	Great White Ultra Burs.....	47	Handi-Hopper Liners.....	329
Geristore.....	130	Great White Z Diamonds.....	47	Handpiece Bulbs.....	250, 710
Germicide Trays.....	310	Green Giant Stones.....	216	Handpiece Couplers & Swivels.....	246-247
Getz Blue Core Build Up.....	116	Greenie Points & Wheels.....	219	Handpiece Lubricant Spray, Health-Tec.....	225
GHS Chemical Product Labels.....	326	GS-80 Alloy.....	11	Handpiece Lubricants & Cleaners... ..	249-250
Gingi-Aid.....	537, 539	GTN Gold Titanium Nitride Burs.....	38	Handpiece Maintenance Systems.....	248
GingiBraid.....	539	GUIDOR Bioresorbable Matrix Barrier.....	556	Handpiece Swivels & Couplers.....	246-247
Gingicaine.....	19	GUIDOR easy-graft Classic.....	556	Handpiece Turbines.....	233-234
Gingi-Gel.....	539	GUM Butler Weave Floss.....	492	HANDPIECES.....	224-250
Gingi-Knit +.....	539	GUM Canker-X Oral Pain Reliever.....	516	Handpieces, Health-Tec.....	224-225
Gingi-Pak Retraction Cords.....	539	GUM Crayola Flossers.....	494	Happy Morning Toothbrushes.....	518
Gingi-Plain Cotton Coil & Pellets.....	541	GUM Crayola Pip-Squeaks Toothbrushes.....	523	Hard Reline Materials.....	7-8
Gingitrac.....	541	GUM Crayola Timer Light Toothbrushes.....	523	Hard Wound Towels.....	170
Glass Ionomer Cements.....	106-108	GUM Crayola Toothbrushes.....	523	Hatho Scotch Brite Wheels.....	213
Glass Ionomer Restoratives.....	139-141	GUM Delicate Post-Surgical Toothbrushes.....	523	Hazardous Waste Label.....	327
Glass Mixing Slab.....	112	GUM Dental Floss.....	492-493	HD Sensor.....	653
Glasses, Safety.....	295-297	GUM Denture Brushes.....	518	Headgear.....	477-478
Glassvan Surgical Blades.....	553	GUM Dual Action Tongue Cleaners.....	517	Headrest Covers.....	166-167
Gleco Plaster Trap.....	453	GUM Duropro Disposable Prophy Angles.....	509	Headrest Covers, Health-Tec.....	166
Glide Pro-Health Deep Clean Floss.....	492	GUM Easy Thread Floss.....	492	Heat Sealers.....	303
Glide Pro-Health Floss.....	492	GUM Eez-thru Floss & Flossers.....	493	Hedstrom Files.....	172, 176-177, 184, 186
Glide Pro-Health Threader Floss.....	492	GUM Expanding Floss.....	493	Hedstrom Files.....	177
Glide Satin Floss.....	492	GUM Go-Betweens Angle Cleaners.....	495	Hedstrom Files, Health-Tec.....	172
Glitter Prophy Paste.....	514	GUM Go-Betweens Proxabrush Cleaners.....	495	HeliCote.....	555
GLOVES.....	275-285	GUM Implant Care Kit.....	523	HeliMend.....	555
Glove Accessories.....	285-286	GUM Micro Tip Toothbrushes.....	523	Heliobond.....	120
Glove Box Holders.....	285-286	GUM Monsterz Toothbrushes.....	523	Heliomolar.....	132
Glove Dispensers.....	285-286	GUM Orthodontic Toothbrushes.....	523	Heliomolar Flow.....	137
Glove 'n Care Hand Cream.....	299	GUM Paroex.....	489	Heliomolar HB.....	132
Glove/Gloves.....	286	GUM PerioShield.....	505	Helios 1800 Series LED Light.....	707
Gloves.....	275-285	GUM Post-Surgical Toothbrushes.....	523	Helioseal.....	506
Gloves, Fitted Non-Sterile.....	285	GUM Premium Ortho Kit.....	480	Heliosit Orthodontic.....	473
Gloves, Fitted Sterile.....	285	GUM Proxabrush.....	495	HeliPlug.....	555
Gloves, Health-Tec.....	275, 278	GUM Razzle Dazzle Toothbrushes.....	523	HeliTape.....	555
Gloves, Latex.....	275-277	GUM Red-Cote Tablets.....	490	Hemaseal & Cide.....	489
Gloves, Nitrile.....	278-283	GUM Rincinol P.R.N.....	516	Hemoban.....	538
Gloves, Synthetic/Vinyl.....	284	GUM Soft-Picks.....	495-496	Hemodent.....	537
Glues & Adhesives, Office.....	591	GUM Stimulators.....	496	Hemodettes.....	537
Gluma Comfort Bond + Desensitizer.....	119	GUM Sulcular Toothbrushes.....	524	Hemogin-L.....	537
Gluma Desensitizer.....	490	GUM Summit + Toothbrushes.....	524	HemostasyL.....	537
Gluma PowerGel.....	490	GUM Super Tip Toothbrushes.....	524	Hemostatic Solutions.....	537-538
Glutaraldehyde Spill Kit.....	326	GUM Technique Toothbrushes.....	524	Hemostats.....	407-408, 423
Glutaraldehyde Sterilants.....	308-310	GUM Toothbrushes.....	522-524	Hemostats, Health-Tec.....	407-408, 423
Glyde File Prep.....	194	GumNumb.....	18	Herculite Ultra.....	133
Go-Betweens Angle Cleaners.....	495	Gutta Percha Points.....	181, 185, 190-192	Herculite Ultra Flow.....	138
Go-Betweens Interdental Cleaners.....	495	Gutta Percha Points, Health-Tec.....	190-191	Herculite XRV.....	133
Gold Anodized Crowns.....	157	GuttaFlow 2.....	197	HG Containment System (Amalgam Separator).....	747
Gold Line Composite Sculpting Instruments.....	405	GXDP 300 & 700 Panoramic X-Ray.....	660	Hg5 Amalgam Separator.....	749
GoldFogel Composite Instruments.....	398	GXS-700 IntraOral Sensors.....	651	Hibiclens HandWash.....	302
Goldstein Composite Instruments.....	395	H		High Volume Evacuation Tips.....	201-202
Good Vibrations.....	316	Halo Nitrile Gloves.....	280	Highlighters.....	590
Googles Eye Shields.....	296	Hanau Articulators.....	444-445	Hi-Risk Latex Gloves.....	277
Gowns.....	293	Hand Cream.....	299	HO Bands.....	464
		Hand Essentials Instant Hand Antiseptic.....	300	Hold Tray Adhesive.....	274
		Hand Essentials Lotion.....	299		

- Hold-It Glove Box Holder.....286
 Hold-Tight Articulating Forceps23
 Holg Mark Rite Articulating Paper22
 Hoods, Nitrous..... 20-21
 Hu-Friedy College Pliers.....334
 Hu-Friedy Explorers..... 336-337
 Hu-Friedy Expos.....338
 Hu-Friedy Mirrors & Handles..... 342-344
 Hu-Friedy Probes..... 339-341
 Hu-Friedy Scalars & Curettes..... 362-371
 Hu-Friedy Ultrasonic Inserts.....535
 Hurracaine 18
 HurriSeal.....489
 HurriView Swap-n-Go Swabs490
 HVE Tips.....201-202
 HVE Tips, Health-Tec201
 HVE Tubing.....696
 HVE Valves.....696-697
 Hy-Bond Polycarboxylate Cement 108
 Hy-Bond Zinc Phosphate Cement..... 109
 Hydent24
 Hydrim Instrument Washers699
 Hydrock.....455
 Hydrocolloid Impression258
 Hydrogen Peroxide451
 Hydrogum Alginate252-253
 Hydroplastic.....7
 HyFlex CM Files173
 Hyflex EDM Files173
 Hyflex GPF Files.....174
 Hyflex NT Files174
 Hygenic Absorbent Paper Points.....189
 Hygenic Gutta Percha Points.....191
 Hygenic Rubber Dam542
 Hygenic Waxes.....563-565
 Hygiene Handpieces243-245
 Hygiene Instruments356-376
 Hygoformic Saliva Ejectors.....202
 Hyperion X5 Panoramic X-Ray.....663
 Hyperion X9 3D CBCT Scanner.....663
-
- iBarrier325
 iBond Self Etch.....119
 iBond Total Etch.....119
 iBond Universal119
 Ibuprofen.....481
 iCare Handpiece Maintenance System ...248
 Icon Caries Infiltrant125
 Identafi Oral Cancer Screeing System717
 Identic Alginate251
 Identic Syringe Material.....258
 Image Alginate.....252
 ImageMaster Intraoral Camera.....646
 ImpactAir Handpieces229, 232
 Implant Bone Chisels379, 382
 Implant Bone Curettes.....379, 382
 Implant Bone Funnels.....377
 Implant Cement99
 Implant Cements99
 Implant Explorers & Probes.....377
 Implant Organizer.....383
 Implant Osteotomes378, 380-383
- Implant Scalars.....377, 383
 Implant Sinus Lift Instruments .378-379, 383
 Implant Ultrasonic Inserts.....533, 536
 Implantation/Explantation Trephines.....377
 Impregum Impression Material258-259
 Impregum Penta Cartridges259
 Impregum Syringe259
 Impression Cartridge Dispenser, Health-Tec
268
 Impression Compound257
 Impression Mixing Accessories267-268
- IMPRESSION PRODUCTS.....251-274**
- Impression Syringes267
 Impression Syringes, Health-Tec.....267
 Impression Tray Adhesive274
 Impression Trays.....270-273
 Impression Trays, Health-Tec..269, 270, 273
 Impression Trays, Metal.....273
 Imprint 3 VPS261
 Imprint 4 Bite Registration.....256
 Imprint 4 VPS262
 IMS Autoclave Wrap306
 IMS Daily Clean.....317, 442
 IMS Enzymax317
 IMS Instrument Cassettes430-432
 IMS Instrument Code Rings.....435
 IMS Instrument Lubricating Spray.....442
 IMS Instrument Penetrating Spray442
 IMS Lilac Utility Gloves.....286
 IMS Monitor Tape303
 IMS Shine ReNEW.....442
 IMS Steam Sterilization Indicators.....308
 Indicator Strips307-308
 Indicator Tape303-304
- INFECTION CONTROL275-330**
- Infectious Waste Bags329
 Infinity Syringeable101
 Injectable Anesthetics.....14
 Inkjet Printer Supplies.....597
 In-Office Tooth Whitening.....142-143
 Insight Film566
 Instadose Online Radiation Badge.....584
 Insta-Neg & Insta-Fix.....572
 Insti-Dam542
- INSTRUMENT ACCESSORIES430-443**
- Instrument Care System.....442
 Instrument Cassettes.....430-432, 436
 Instrument Cleaners & Lubricants.....442
 Instrument Cleaning Brushes.....442
 Instrument Code Rings.....435, 440
 Instrument Sharpening.....443
 Instrument Tape.....439-440
 Instrument Washers.....699
- INSTRUMENTS.....331-443**
- Integra Alginate.....252
 Integra Steri-Center729
- IntegraBond123
 IntegraPost486
 Integrity.....4
 Integrity Multi-Cure4
 Integrity TempGrip109
 Interdental Cleaners494-496
 Interproximal Brushes, Health-Tec494
 iNTERRA In-Office Nightguard.....457
 Interval Temp Filling Material.....99
 INTRAFlex Motors241
 Intraoral Camera Sheaths324
 Intraoral Cameras.....642-646
 Intraoral Films.....556-557
 Intra-Oral Photography Mirrors.....350
 Intraoral Syringes267
 Intraoral X-Ray Equipment654-657
 Intraosseous Needles.....16
 Iodoform Packing Strip554
 Ion Iso-Form Crowns.....155
 iProphy Air Hygiene Handpieces244
 IPS Ceramic Etching Gel.....124
 IPS Empress.....132
 Iris HD Camera.....643
 Iris LTE Camera.....644
 IRM99
 Irrigating Needle Tips, Health-Tec196
 Irrigating Needles196-197
 Irrigating Solutions.....557-558
 Irrigating Syringes.....196
 Isodam Rubber Dam543
 Isofluid Earloop Masks288
 Isofluid Fog Free Earloop Masks.....288
 Isofluid Fog Free Earloop Masks with Shield
292
 Isofluid Plus Earloop Masks289
 Isofluid Plus Earloop Masks with SecureFit
289
 Iso-Form Crowns.....155
 Isolator Plus N95 Particulate Masks.....292
 Isolators161
 Isolite Procedure Mask289
 Isolyser Sharps.....21, 329
 Isopropyl Alcohol314
 iStar Cordless Prophy Handpiece.....244
 IV Solutions557-558
 Iveri At Home Whitening.....144
 Ivoclean112
 Iwanson Calipers420
-
- J**
- Jack B. Nimble Scalars.....373
 Jackets.....294-295
 Jade Stone454
 Jazz Polishers.....221
 Jeltrate Alginates251
 Jenker Needle Stick Protection.....17
 Jet Bite.....256
 Jet Blue Bite256
 Jet Repair Acrylic.....448
 Jet Tooth Shaded Acrylic6
 Jet-Fresh Prophy Powder.....529
 Jiffy Tubes.....112
 Just for Kids Stannous Fluoride498

K

K3 NiTi Files	179
K3 & K3XF Gutta Percha.....	181
K3 & K3XF Obturators.....	181
K3 & K3XF Paper Points.....	181
K3XF NiTi Files.....	179
Kalore	131
KaVo High-Speed Handpieces.....	230, 235
KaVo Low Speed Motors and Accessories	239, 241
KaVo Spray.....	249
Kay-Pees Towels.....	164
KC100 Lavender Nitrile Gloves	282
KC100 Procedure Mask.....	290
KC300 Sterling Nitrile Gloves.....	282
KC500 Purple Nitrile Gloves.....	282
K-Cups.....	637-639
Keren Sensors	652
Ketac-Bond	98
Ketac-Cem Aplicap	106
Ketac-Cem Maxicap	106
Ketac-Cem Radiopaque	106
Ketac-Fil Plus.....	139
Ketac-Molar Quick Aplicap	140
Ketac-Nano	140
Ketac-Silver	113
Keurig Brewers	637
Keurig K-Cups.....	537-639
Key-To-Alginate.....	252
K-Files	172, 175, 177, 184, 186
K-Files, Health-Tec	172
K-Flex Files.....	177
Kimtech Lens Cleaning Station	298
Kleenex Facial Tissue.....	641
Kleenex Hand Towels	169
Knit-Pak+.....	540
Kodex Drills	482
Kolorz ClearShield Fluoride Varnish.....	502
Kolorz Fluoride Foam	496
Kolorz Fluoride Gel.....	497
Kolorz Prophy Paste	514
Kooliner	8
Kopy Kat Duplicator	573
Kromafaze Alginate.....	252
Kromopan 100 Alginate	252
Kwik-Tray	269

L

Lab Burs	38, 44
Lab Coats	294-295
Lab Equipment	678-679
Lab Handpieces	245
Lab Jackets	294-295
Lab Knives	449
Lab Pans	450
Lab Pans, Health-Tec	450
Lab Plaster	455

LAB PRODUCTS..... 444-459

Lab Putty	260
Lab Spatulas	449
Labels, Office, Color Coded	611-624
Laboratory HP Diamonds	85

Labstone.....	455
Laguna Dental Chair	687
LaPetit Masque.....	289
Lasers.....	700-701
Latex Exam Gloves, Health-Tec	275
Latex Gloves.....	275-277
Lathe Wheels.....	444
Lathes	450
Latindo Overgloves.....	286
Lavender Nitrile Gloves	282
LED Curing Lights	150-153
Left/Right Fitted Nitrile Gloves	285
Lenk Laboratory Burner	446
Lentulo Spiral Fillers	188
LH System Cleaner	573
Lidocaine	14
Lidocaine Ointment	19
Life Calcium Hydroxide.....	97
Ligature Ties	476
Ligatures, Elastomeric	474
Light Handle Covers	324-325
Light Handle Sleeves, Health-Tec	324
Light Shields (Operator)	711
Lightning Metal Finishing Strips	214
Lights, Operator.....	702-707
LightSpeed LSX NiTi Files	180
Lignospan.....	14
Lilac Utility Gloves	286
Lime-Lite.....	98
Lingua-Fix.....	203
Lingual Retainers.....	475
Link Pins.....	482
Listerine	503-504
Listerine Floss	491
Listerine Pocket Paks	503
Listerine Smart Rinse.....	504
Listerine Total Care.....	504
Listerine Zero.....	504
Lite One Masks	290
LN Bur	38
Lollicaine.....	18
Look Sutures	551-552
Lorvic Surgical Milk	442
Lotions.....	299
Low Speed Handpiece Attachments ..	235-237
Low Speed Handpiece Systems.....	237
LPD Wig-L-Bug Amalgamator.....	13
LubeCube	442
Lubrina Handpiece Maintenance System ..	248
Lucitone	446
Lucitone 199	446
LumiBrite Chairside Whitening	142
LumiBrite Take Home Whitening	143
Luminance Latex Gloves	275
Luminator X-Ray Viewers	573
Luminescence	220
Luminescence Plus	220
Luv Nitrile Gloves	279
LuxaCore Dual	114
Luxacore Z Dual	114
Luxaflow Composite	136
LuxaFlow Ultra.....	4
LuxaGlaze	7
Luxatemp Automix Plus	4

Luxatemp Fluorescence	4
Luxatemp Ultra	5
Lynal	9
Lysol I.C. Disinfecting Spray	314
Lysol I.C. Foaming Disinfectant Spray	314

M

M.A.S.S. HVE Tips.....	201
M11 Ultraclave	719
M3 Ultrafast Automatic Sterilizer	719
M35 Electric Handpiece	245
M4 Safety Handpiece	242
M9 Ultraclave.....	719
Madame Butterfly Articulating Paper	22
Magic FoamCord	538
Magnetic Mounting System	445
Mallets	424
Mandrels.....	211, 215
Manual X-Ray Processing Chemicals	571-572
Marcaine.....	14
Mark IIP Syringe.....	149
Marquis Brackets.....	467

MASKS.....287-292

Masks, Earloop with Shield.....	291-292
Masks, Health-Tec.....	287
Masks, Procedural.....	287-292
Master Trays	272
Master-Dent Polycarboxylate Cement	108
MASTERSurg LUX System.....	246
MASTERTorque Handpiece	227

MATRIX..... 460-466

Matrix Bands	464-465
Matrix Bands, Health-Tec	464
Matrix Dispenser	465
Matrix Retainers	465
Matrix Retainers, Health-Tec	465
Matrix Tape	465
Matrix T-Bands.....	464
Max Pins.....	482
Maxcem Elite	103
Maxcem Elite Chroma	103
Max-I-Probe	196
MaxRay Portable X-Ray	656
MaxVac Plus HVE Tips.....	201
Medicine Cups.....	166
Medi-Stat Soap.....	301
Medizime LF.....	318
Megalloid EZ.....	12
Memosil 2	257
Mepivacaine	14
Mercury Spill Response Kit	326
Mesh Bur and Diamond Holder.....	96
Metal Strips	214
MetriTest Strips.....	310
MI Paste	499
MI Varnish.....	502
Micrell Lotion Soap.....	301
Micro Applicators	148
Micro Diamond Supreme Strips	485

- Micro Torch445
- Micro-Applicators146-149
- Micro-Applicators, Health-Tec.....146
- Microbrush Plus.....148
- Microbrush Tube Series.....148
- Microbrushes148
- Microetcher IIA444
- Microhybrid Composite, Health-Tec.....128
- Micro-Openers & Micro-Debriders.....352
- Microprep Diamonds82
- MicroPrime Desensitizer.....490
- MicroPro Latex Gloves.....276
- Micro-Stix Applicators.....148
- Micro-Touch NextStep Gloves275
- Micro-Touch Plus Gloves.....275
- Midgets.....216
- Midnight Nitrile Gloves.....282
- Midmark Autoclaves.....719
- Midmark Compressors/Vacuums.....745
- Midmark Delivery Systems.....691
- Midmark Dental Chairs.....684-685
- Midmark Operatory Lights.....705
- Midmark Sterilization Center728-729
- Midmark Sterilizers719
- Midmark Stools.....737
- Midwest Automate Maintenance System.....248
- Midwest Burs33-37
- Midwest E Electric Handpiece System
.....237-238
- Midwest E Plus Electric High-Speed
Handpiece235, 238
- Midwest High-Speed Handpieces ..226, 230
- Midwest Hygiene Handpieces244
- Midwest Low Speed Motors & Accessories
.....238
- Midwest Plus Cleaners & Lubricants .248-249
- Midwest RDH Handpieces244
- Mighty Mixer Bowl253
- Mini Bowls451
- MiniDam544
- MiniEndo II183
- Mini-Sponge Applicators.....147-148
- Mini-Stops, Crimpable476
- Mini-Tray269
- Minocycline.....481
- Mint-A-Kleen.....329
- Miracle Mix114
- Miradent Gum.....488
- Mirage Operatory Stools739
- MiraTray Implant Impression Trays271
- Mirror Defogger350
- Mirror Handles, Health-Tec.....331
- Mirror Magic.....349
- MirrorLite.....350
- Mirrors & Handles.....
.....331, 333, 342-345, 347, 349-350
- Mirrors, Disposable.....350
- Mirrors, Health-Tec331
- Mirrors, Intra-Oral Photography350
- Mirro-Vac202
- Mixing Bowls253, 451
- Mixing Bowls, Health-Tec253, 451
- Mixing Pads, Health-Tec.....111, 254
- Mixing Slab Glass.....112
- Mixing Tips, Health-Tec268
- Mixing Wells.....149
- Model Formers451
- Model Glow.....456
- Model Plaster.....455
- Model Stone455
- Model Trimmer Wheels452
- Model Trimmers452
- Modern Materials Gypsums454-455
- Modern Materials Waxes563-565
- MoistSURE Hand Sanitizer300
- MoistSURE Hand Soap.....303
- MoistSURE Lotion.....299
- Molar Bands471-472
- Molded Face Masks287
- Monarch CleanStream Evacuation Cleaner
.....205
- Monarch Enzymatic Cleaner315
- Monarch Surface Disinfectant311
- Monarch Waterlines Cleaner329
- Monobond.....120
- Monoject Aspirator Tips204
- Monoject Endo Needles & Syringes.....196
- Monoject Evacuator Tips201
- Monoject Needles.....16
- Monoject Saliva Ejectors202
- Monoject Sharps Containers21, 328
- Monoject Syringes.....196
- Montana Jack Implant Scalars383
- Montana Jack Scalars374
- Motors-Low Speed, Health-Tec.....225
- Mounted Points & Stones.....216-220
- Mounting Stone455
- Mounts, Cut-Apart570
- Mouth Guard Material.....457-458, 479
- Mouth Kote Dry Mouth Spray.....488
- Mouth Mirrors, Health-Tec331
- Mouthguards.....457-458, 479
- Mouthwashes503-505
- Mr Thirsty One-Step204
- MSD Wig-L-Bug Amalgamator.....13
- MTA Carriers.....196
- MTA-Fillapex192
- Multi-Cal195
- Multicore Flow115
- MULTIflex Nozzle.....249
- Multi-Fold Towels169
- Multi-Fold Towels Dispenser.....171
- Multilink Automix Next Generation.....102
- MultiPrep Burs37
- Multi-Purpose Bur.....38
- Muslin Buffs445
- MXR Flowmeter.....714-715
- Mylar Matrix Strips465
- Naturals Earloop Masks289
- N'Durance Dimer Flow139
- Needle Capper17
- Needle Holders.....408, 412, 424
- Needle Holders, Health-Tec.....408, 424
- Needles, Anesthetic.....15-17
- Needlestick Protection17
- NeoBurr49
- NeoDiamond.....78
- NeoDrys.....162
- NeoGard Neoprene Gloves284
- Neolon 2G Surgical Gloves285
- NeoPro Synthetic Gloves.....284
- NeoTray Impression Trays269
- Neowax.....563
- NeutraGard Gel499
- NeutraVAC.....205
- New Patient Forms603
- Newport Flowmeter Nitrous Oxide System
.....712
- Newtron Ultrasonic Scalars527
- Next Prophy Paste515
- NexTemp111
- NextGen Delivery System690
- NextGen Sterilization Center726
- Nexus RMGI.....107
- Night Guard Boxes, Health-Tec.....446
- NiTi Files.....173-174, 178-179, 187
- Nitrile Gloves278-283
- Nitrile Gloves, Health-Tec.....278
- Nitrile PF with Aloe Gloves.....281
- Nitrile Utility Gloves286
- Nitrous Hoods.....20-21
- Nitrous Oxide Systems20, 712-715
- Nitrous Scavenger.....20
- NLX Nano Electric System237
- Nogenol Root Canal Sealer.....193
- Nogenol Temporary Cement.....110
- Nola Dry Field System.....429
- NOMAD Pro 2.....655
- NoMIX Temporary Cement.....109
- Non-Ionic Multi-Purpose Ultrasonic Solution
.....315
- Non-Metal Posts486-487
- Non-Woven Sponges.....162-163
- Non-Woven Sponges, Health-Tec162
- Note Pads.....593-594
- NSK Handpieces
...227-228, 231, 236-237, 239, 243-244
- NTI Burs39-44
- NTI Diamond Discs209-210
- NTI Diamonds71-76
- NTI Polishers222-223
- N-tralig Syringe.....15
- Nu Radiance Classic Whitening144
- Nu Radiance Duet Whitening144
- Nu Radiance Forte' Whitening144
- Nupro Chlorhexidine Gluconate Rinse489
- Nupro Extra Care Prophy Paste513
- Nupro Flouride Gel497
- Nupro Fluoride Rinse499
- Nupro Fluoride Varnish.....501
- Nupro Freedom Cordless Prophy System
.....244

N

Nupro Freedom Disposable Contra Prophy Angles.....508
 Nupro Prophy Grips.....517
 Nupro Prophy Paste.....513-514
 Nupro revolv Disposable Prophy Angles..508
 Nupro revolv Disposable Prophy Pack....513
 NuSimplicity Dental Chair.....682
 NuTorque Electric Handpieces.....238
 Nuvo Vinyl Gloves284
 NX3 Cement.....103
 NX3 XTR Cement.....103
 Nyclave Heat Sealer & Accessories.....303
 Nyclave Tubing.....306
 Nylon Tubing.....306

O

O-67 Snow White Ortho Stone..... 455, 480
 Obturation Devices & Systems..... 197-198
 Occlude24
 Occlufast Rock.....257
 Occlusal Registration Strips22

OFFICE PRODUCTS 590-641

Office Signs596
 Oil-Less Air Compressor 744
 Omni Cleaner Plus319
 Omni Gel Fluoride Gel498
 Omniflex.....260
 Omnisorb II Non-Woven Sponges.....163
 Once Single Use Diamonds 69-70
 Once-A-Day Cleaner & Lubricant.....249
 OneGloss.....220
 Op-d-Op Protective Eyewear298
 Op-d-Op Visor Shields.....298
 Operative Instruments 388-406
 Operatory Light Bulbs.....708
 Operatory Light Shields.....711
 Operatory Lights.....702-707
 Opotow ZOE Impression Paste257
 Optiblast Workstation.....448
 OptiBond All-In-One120
 OptiBond FL120
 OptiBond Solo Plus120
 Optibond XTR.....121
 Opti-Cide 3312
 Opti-Cide 3 Wipes312
 Optiguard Surface Sealant142
 Optilux Light Shield153
 Optim 33TB Wipes314
 Optimix Amalgamator13
 Optimum Nitrile Gloves282
 OptraGate427
 OptraSculpt Pad404
 Orabloc14
 OraFlex Toothbrushes521
 OraJet Evacuator Tips201
 Oral Cancer Screening.....716-717
 Oral-B Basics Solution525
 Oral-B Black 800 Genius Power Toothbrush518
 Oral-B Cavity Defense Toothbrushes521
 Oral-B Centrays.....500
 Oral-B Centwins500

Oral-B Complete 123 Toothbrushes521
 Oral-B Complete 3D White Vivid Toothbrushes521
 Oral-B Complete Control Grip Toothbrushes.....522
 Oral-B Complete Deep Clean Toothbrushes522
 Oral-B Complete Sensitive Toothbrushes...521
 Oral-B Cross-Action Pro-Health Pro-Flex Toothbrushes522
 Oral-B Cross-Action Pro-Health Toothbrushes.....522
 Oral-B Daily Clean System.....519
 Oral-B Denture Brushes518
 Oral-B Electric Toothbrush Bundles .519-520
 Oral-B Electric Toothbrushes.....519-520
 Oral-B End Tufted Brush.....522
 Oral-B Fluoride Varnish503
 Oral-B Frozen Pro-Health Jr. Toothbrushes522
 Oral-B Genius Professional Exclusive Power Toothbrush.....518
 Oral-B Genius Sensitive System Power Toothbrush Bundle520
 Oral-B Gingivitis System Power Toothbrush Bundle519
 Oral-B Glide Pro-Health Deep Clean Floss492
 Oral-B Glide Pro-Health Floss492
 Oral-B Glide Pro-Health Threader Floss..492
 Oral-B Glide SatinFloss.....492
 Oral-B Indicator Toothbrushes.....522
 Oral-B Interdental Brushes494
 Oral-B Manual Toothbrushes.....521-522
 Oral-B Minute Foam497
 Oral-B Neutra-Care Home Fluoride.....499
 Oral-B Neutra-Foam497
 Oral-B Orthodontic Brush.....522
 Oral-B Power Toothbrushes.....518-520
 Oral-B Pro-Health All-In-One Toothbrushes522
 Oral-B Pro-Health Battery Toothbrush518
 Oral-B Pro-Health Clinical Precision Clean Battery Toothbrush526
 Oral-B Pro-Health Stages Toothbrushes .522
 Oral-B Prophy Paste516
 Oral-B Stages Kids Battery Toothbrush...526
 Oral-B Stages Toothbrushes522
 Oral-B SUPA Disposable Prophy Angles .511
 Oral-B SuperFloss.....492
 Oral-B Toothbrush Bundles 519-520, 525
 Oral-B Vitality Floss Action Electric Toothbrush.....519
 Oral-B Vitality Sensitive Clean Electric Toothbrush.....519
 Oraline Toothbrushes521
 Orange Solvent.....112
 Oraqix18
 OraVac Evacuator Tips.....204
 OraVerse.....20
 Organizers, Elastomeric474
 O-Rings, Cavitron Inserts534
 Orostat.....537
 Ortho Jet Acrylic.....480

Ortho Stone O-67 455, 480
 Ortho Tray Wax.....564
 Ortho-Coat.....473
 Orthodontic Bite Sticks473
 Orthodontic Brackets.....467-468
 Orthodontic Buccal Tubes 469-470
 Orthodontic Instruments.....384-387
 Orthodontic Molar Band Assemblies 471-472
 Orthodontic Patient Kits, Health-Tec478
 Orthodontic Plaster.....455, 480
 Orthodontic Pliers.....384, 387, 425
 Orthodontic Resin.....480
 Orthodontic Wax.....564

ORTHODONTICS467-480

OrthoFlex Composite Buttons475
 Orthogap Archwire Markers.....476
 Orthogap Bonding Pads473
 OrthoPrint Alginate253
 OSHA Compliance Material 326-328
 Osprey Compressors.....746
 Osseous Collector377
 Osseous Glider.....378
 OSSIF-I sem 556-557
 Osteotomes 378, 380-383
 Outback Eyewear295
 Overgloves.....286
 Oxyguard II104

P

P.I.P. - Personal Inhaler Plus.....20
 P5XS B.LED Ultrasonic Scaler.....528
 P60 Filtek Restorative.....128
 Paasche Style Etching Pencil.....444
 Padded Brush Delivery Tips, Health-Tec. 147
 Pads, Mixing 111-112
 Painless Needles17
 Pala Digital Dentures.....448
 Palodent Matrix.....463
 Palodent Plus EZ Coat Matrices463
 Palodent Plus Matrix463
 Pana Spray Plus.....249
 Pana-Max High Speed Handpieces231
 Panavia 21104
 Panavia F2.0104
 Panavia SA Cement Plus104
 Panavia V5104
 PanoPro Developer and Fixer.....571
 Panoramic X-Ray Units (2D/3D)..... 658-665
 Paper Clips592
 Paper Drinking Cups165
 Paper Points181, 185, 189-190
 ParaBond.....118
 ParaCore113
 Paradigm DeepCure LED Curing Light ...150
 Paradigm Restorative129
 Paradigm VPS262
 ParaPost.....483-484
 ParaPost Fiber Lux486
 ParaPost Fiber White.....486
 ParaPost Plus483
 ParaPost Taper Lux486
 ParaPost XH483

- ParaPost XP 483-484
 ParaPost XT 484
 Paroex Chlorhexidine Gluconate 489
 Paroject Syringe 15
 Pascord..... 540
 PassPort Biological Monitoring..... 308
 Paste Fillers 188
 Pathfinder / Pathfinder CS..... 187
 Patient Apron 163
 Patient Bags 589
 Patient Bibs 163-164
 Patient Bibs, Health-Tec 163
 Patient File Chart Folders..... 606-610
- PATIENT GIVEAWAYS..... 585-589**
- Patient Napkins 163-164
 Patient Napkins, Health-Tec 163
 Patient Recall Postcards..... 632-635
 Patient Relief Wax 479
 Patient Sign-In Forms..... 604
 Patient's Choice Zap Fluoride Gel..... 497
 Pattern Resin LS..... 7
 Pax-i Panoramic X-Ray..... 665
 PaX-i3D Panoramic X-Ray 664-665
 PC7 Flowmeter System 713
 PCXX Fluoride Foam 496
 PCXX Fluoride Gel 498
 PCXX Fluoride Rinse 500
 PDT Explorers 347
 PDT Probes 347
 PDT Scalers and Curettes..... 372-374
 Pediatric Bibs..... 164
 Pedo Crowns 158
 Peel-View+ Pouches 305
 Peeso Reamers 185, 188
 Peeso Reamers, Health-Tec..... 188
 Penicillin..... 481
 Pens 590
 Pentamix 3..... 259
 Perfect Fit Camera Sleeves..... 323
 Perfect Pearl Disposable Prophy Angles .508
 Perfecta 144-145
 Perfecta Block-Out Resin 143
 Perfecta Bravo 145
 Perfecta Rev! 145
 PerfectIM VPS 265
 Perform Nitrile Gloves 278
 Peri-Chem Developer & Fixer..... 571
 Peri-Dent Developer & Fixer..... 571
 Peridex Oral Rinse 489
 PerioCare Periodontal Dressing 556
 Periodontal Dressing 554-556
 Periodontal Probes 100-109
 Periomed Oral Rinse 499
 PerioShield 505
 Periotomes..... 413
 PerioWise Periodontal Probes..... 348
 Periphery Wax 565
 Peri-Pro Developer & Fixer 570
 Peri-Pro Transport Cleaning Kit 572
 Peri-Sol Developer & Fixer 571
 Permabond 910 Adhesive..... 448
 PermaCem 2.0 98
- Permadyne 259
 Permanent Cements..... 100-108
 Permanent Markers 590
 Permite Alloy..... 10
 Permlastic..... 260
 Permlastic Adhesive 274
 Personal Inhaler Plus Nasal Hoods..... 20
 PFL N95 Particulate Respirator Masks ..292
- PHARMACEUTICALS 481**
- PHDT-xlIs Intraoral X-Ray..... 655
 Phosphor Plate Barrier Envelopes 584
 Phosphor Plate Barrier Envelopes,
 Health-Tec 584
 Photac-Fil Quick Applicap..... 140
 Photon Lasers 701
 Pick-A-Dent..... 494
 Pic-n-Stic 159
 Piezon Master Scalers..... 529-530
 Pinn-Point Brushes..... 148
- PINS & POSTS 482-487**
- PIP Pressure Indicator Paste..... 23
 PIP Spray 24
 Piranha 2X Diamonds 91
 Piranha Diamonds..... 92-94
 Pit & Fissure Sealant, Health-Tec..... 505
 Pit & Fissure Sealants..... 505-506
 Pivot Disposable Prophy Angles..... 509
 Pivot Disposable Prophy Packs 513
 Plackers Flossers 494
 Plastalgin Alginate 252
 Plaster 455
 Plaster Knives..... 449
 Plaster Spatula 449
 Plaster Traps..... 452-453
 Plasters & Stone..... 454-455
 Plastic Drinking Cups 165-166
 Plastic Filling Instruments, Health-Tec ... 389
 Plastic Impression Trays 270-273
 Plastic Impression Trays, Health-Tec..... 270
 Platypus Orthodontic Flosser..... 480, 494
 Pliers, College 331, 334, 345, 347
 Pliers, Cotton & Dressing 331, 334, 345, 347
 Pliers, Orthodontic 384-387
 Pluggers 351-355, 388-389, 400-401, 404
 Pluggers, Endo 351-355
 Pluggers, Health-Tec 351, 388
 Pneumatic Pressure Pot..... 453
 Pocket-Probe Tips..... 197
 Point 4 134
 Points Applicators 149
 Pola Day 145
 Pola Night 145
 Pola Office + 142
 Pola Paint 146
 Pola Zing 146
 Polaroid Wired & Wireless Cameras..... 645
 Poli-Pro Disks 213
 Polishing Paste 220-221
 Polocaine 14
 Polybite Trays..... 269
- Polycarbonate Crowns..... 155
 Polycarbonate Crowns 155, 158
 Polycarboxylate Cements 108
 Polyether Impression 258-259
 Polyjel NF 259
 Porcelain Etch Gel..... 125
 Porta Vac 448
 Post-It Pads 594
 Pouches, Autoclave 304-305
 Pouches, Sterilization 304-305
 Power Flossers 496
 Power Sticks & Chains 474
 PowerAir Compressor..... 745
 PowerVac G Vacuum..... 745
 Pre-Bent Dispensing Tips, Health-Tec.... 147
 Precision Cleanse Plus..... 206
 Precision Posts 485
 Pre-Contoured Metal Bands 464
 Preference Liquid Hand Sanitizer 301
 Preference Roll Towels 170
 Prehma Dental Needles 16
 Prelude Adhesive 124
 Premier Etch..... 125
 Premier Explorers 348
 Premier Probes 348
 Premier Scalers and Curettes..... 375-376
 Premier Ultrasonic Inserts 536
 Premise Composite 133
 Premise Flowable 138
 Premium Saliva Ejectors..... 202
 Prep & Polish Paste 515
 Pre-Pasted Toothbrushes..... 518
 Preppies Plus..... 515
 PrepStart Air Arasion System 444
 Prescription Pads..... 599
 President Impression Trays..... 269
 Pressure Dome..... 459
 Pressure Indicating Paste 23
 Preva DC IntraOral X-Ray 656
- PREVENTIVES 488-536**
- Prime & Bond Elect 118
 Prime & Bond NT 118
 Prime & Bond NT Amalgam Bonding
 Accessory Kit..... 118
 Prime & Bond XP 118
 Printer Supplies 597-598
 Prisma Gloss 220
 Prisma VLC Dycal..... 97
 Pro Clean..... 319
 PRO II Dental Chair..... 681
 Pro Tech Lab Work Stations 678
 Pro-32 Processor Cleaner 572
 ProAngle Ergo Contra Disposable
 Prophy Angles..... 508
 ProBarrier Tube Sox 325
 Probes 331-332, 339-341, 346-348
 Probes, Health-Tec 331
 ProBond..... 118
 Procedural Earloop Masks 289
 Procedural Masks, Health-Tec..... 287
 Procedure Masks..... 287-292
 Procedure Tubs..... 433-434, 437, 440

Procenter Delivery Systems.....691
 ProCide D309
 ProCide D Plus310
 ProEZ Foam316
 Pro-form ElectricKnife459
 Pro-Form Vacuum Forming Materials .457-458
 ProGloss Composite Polishers223
 Proguard Fluoride Varnish501
 Pro-Line Air Vac 2000456
 Proma Delivery Systems693
 Proma Operatory Lights706
 Pro-Matrix464
 ProMix Amalgamator13
 Prophy Angles, Autoclavable..... 506-507
 Prophy Angles, Autoclavable, Health-Tec..506
 Prophy Angles, Disposable..... 507-511
 Prophy Angles, Disposable, Health-Tec...507
 Prophy Brushes 511-512
 Prophy Cups512
 Prophy Cups, Health-Tec.....512
 Prophy Gems.....513
 Prophy Jet Powder.....529
 Prophy Packs, DPA & Paste513
 Prophy Paste513-516
 Prophy Paste, Health-Tec513
 Prophy Star 3 Handpieces.....245
 Prophyiciency Disposable Prophy Angles.510
 ProphyPal Handpieces243
 PROPHYwiz Hygiene Handpiece.....244
 Pro-Portion Ultrasonic Cleaning Solutions .319
 ProSphyg Sphygmomanometer.....557
 ProSpray Surface Disinfectant.....312
 Pro-Tec Powder Free Gloves, Health-Tec...275
 Protection Plus Gowns293
 Protector Needle Sheath Prop.....17
 Protégé Nitrile Gloves.....278
 ProTemp II3
 Protemp Plus3
 Protexin Oral Rinse & Spray.....503
 Pro-Ties440
 Pro-Tip Turbo Syringe Tips168
 ProTray Foam Set-Up Trays.....440
 ProVecta HD IntraOral X-Ray654
 ProVecta S-Pan Ceph X-Ray659
 ProVecta S-Pan Panoramic X-Ray658
 ProView Plus Pouches304
 Pro-Vision Eyewear297
 Pro-Vision Optical Cleaning Wipes.....298
 Provon Foaming Soap302
 Proxabrush.....495
 Proxabrush Go-Betweens.....495
 Proxabrush Snap-Ons495
 Proxabrush Trav-ler.....495
 PSP Barrier Envelopes.....584
 PSP Barrier Envelopes, Health-Tec584
 PSPIX Imaging Plate Scanner649
 PTFE Floss, Health-Tec491
 Puff Fluoride Foam496
 Pulp Canal Sealer.....183
 Pulp Canal Sealer EWT183
 Pulp Capping Paste195
 Pulpdent Opaquer142
 Pumice.....450
 Pumice Preppies.....515

Pure Sapphire Brackets.....468
 Pure Touch Nitrile Gloves, Health-Tec....278
 Purell Instant Hand Sanitizer300
 Purevac.....207
 Purevac SC.....207
 Purit Cide-it.....315
 Purit Clean-it.....315
 Purit Enz-it.....315
 Purit Remuv-it.....315
 Purple Nitrile Gloves.....282

Q

Qlicksmart 329, 554
 Q-Towels.....170
 Quantrex140 Ultrasonic Unit.....741
 QUATTROcare Plus Maintenance System.248
 QUATTROcare Plus Spray249
 Queen of Hearts Currettes373
 Quest Nitrile Gloves279
 Quick-Care Foam Sanitizer300
 Quickcheck Indicating Spray24
 Quick-Stat FREE538
 Quick-Stat FS538
 Quiet-Air Handpieces230
 Quixx Posterior Composite.....130
 Quolis 5000 Dental Chair680
 Quolis Delivery Systems.....688
 Quolis Sterilization Center.....725

R

R.S. Barrier324
 R.T.R. Syringe.....556
 R-1 HVE Tips - Reusable201
 R200 Nitrile Gloves279
 Racegel538
 Racellet Pellets.....541
 Racestyptine Solution.....538
 Racord.....540
 Radiant LED Operatory Light707
 Radiation Monitoring.....584
 Radiation Warning Labels327
 Radii-Cal LED Curing Light152
 RAPD X-Ray Positioning583
 Rapicide OPA 28309
 Rapid Access Process Developer & Fixer .570
 RapidCore.....113
 Rapid-Klene.....572
 Razor Burs.....43
 RC-Prep.....194
 RDH Hygienist Handpieces.....244
 Reach Barbie Toothbrushes520
 Reach Floss491
 Reach Toothbrushes.....520-521
 Ready Pro Developer & Fixer570
 Readymatic Developer & Fixer.....570
 Ready-Steel C-Files & C+ Files.....176
 Ready-Steel Flexofiles175
 Ready-Steel Hedstrom Files.....176
 Ready-Steel K-Files.....175
 Ready-Steel K-reamers.....176
 Ready-Steel Senseus Flexofiles175
 Reamers172, 176-177, 184, 186
 Reamers177

Reamers, Health-Tec.....172
 Reapir Material446
 Red Wing Lathes450
 Red-Cote Tablets490
 Redi-Chem Developer & Fixer.....570
 Refresh Latex Gloves275
 Refreshing Patient Towelettes.....303
 Regisil256
 Regisil 2X256
 Regisil Rigid.....256
 Relief Wax479

RELINES & ACRYLICS 3-9

RelyX Fiber Posts486
 RelyX Luting Cement.....106
 RelyX Luting Plus106
 RelyX Temporary Cement.....109
 RelyX Ultimate.....100
 RelyX Unicem100
 RelyX Unicem 2.....100
 RelyX Veneer Cement101
 Removalon I Dry Pak.....112
 Repel 4-ply Mask with Shield291
 Repel 4-ply Masks.....288
 Reprosil264
 Resiment103
 Respirator Masks.....292
 Restore Daily315
 ReSURGE319
 Resurge Ultrasonic Cleaner743
 Retainer Boxes446, 478-480
 Retainer Boxes, Health-Tec.....446, 478
 Retainer Brite.....479
 Retainer Wire.....475

RETRACTION537-541

Retraction Caps.....541
 Retraction Capsules540
 Retraction Cord Packing Instruments.....388
 Retraction Cord Packing Instruments,
 Health-Tec388
 Retraction Cords.....538-540
 Retraction Cottons & Pellets.....541
 Retrieve Implant Cement.....99
 Revelation Diamonds.....88-90
 Revolution Formula 2138
 Revotek LC5
 Rhino XP Motors241
 Ribbon Saws215
 Richwil Crown & Bridge Remover159
 Rim-Lock Trays273
 Rincinol P.R.N.....516
 Riofoto Mirrors350
 Rite Bite Trays.....270
 Riva Coat.....141
 Riva Luting Plus108
 Riva Self Cure141
 Robinson Bristle Brushes.....445
 Robust Nitrile Gloves.....278
 Roll Towels.....170
 Roller Clean Up Film572
 Root Canal Pastes & Sealers.....192-193

Root Canal Pluggers	351-355	Sani-Tube Sterilization Tubing	306	Sharpstar Sharps Containers	21
Root Canal Pressure Syringe	196	Sanitize Antimicrobial Gel.....	299	Sheet Protectors	594
Root Canal Sealer	193	SatinFloss.....	492	Shield Force Plus	490
Root Canal Spreaders	352	Saw Frames & Blades	453	Shimstock Occlusion Foil	22
Root ZX II Apex Locator	197	Scalers & Curettes.....	356-376	Shine reNEW.....	442
Rotamax High Speed Handpieces	229	Scalers & Curettes, Health-Tec Ultra ..	356-357	Shoe Covers	293
Royal Dental Chairs.....	686-687	Scalpels	553-554	Shofu Finishing & Polishing.....	218-220
Royal Stools.....	738-739	Scandonest.....	14	Shortcut Retraction Cord.....	539
Roydent Files & Reamers.....	186	ScanX Barrier Envelopes	584	Shorty Motors	241
RS1 Oral Surgery Chair	687	ScanX Digital Radiography.....	648	Shur Wax	563
Rubber Bands.....	592	Scavenger Hoods	20-21	Side Shields	296
Rubber Base Impression.....	260	Scissors	408, 412, 425-426	Sidekick Instrument Sharpener	443
RUBBER DAM	542-549	Scissors (Office)	593	Sigma Latex Gloves	276
Rubber Dam Clamp Forceps.....	408, 429	Scissors, Health-Tec.....	408	Signature Hand Towels.....	169
Rubber Dam Clamp Forceps, Health-Tec	408	Scope Mouthwash.....	504	Signature Series Cassettes	430-431
Rubber Dam Clamps	545-549	Scope Outlast Minibrush	518	Signature Series Grips	435
Rubber Dam Frames	544	Scotchbond Dispenser Wells.....	149	Signature Series Procedure Tubs & Trays	433-434
Rubber Dam Napkins	544	Scotchbond Etchants	124	Signs.....	596
Rubber Dam Punches	408, 429	Scotchbond Universal Adhesive	117	Sil Silane Material	117, 450
Rubber Dam Punch, Health-Tec.....	408	Scotchbond Universal Etchant	124	Silamat S6 Amalgamator.....	13
Rubber Dam Stamps	543	Scott Hand Towels	169	Silane Bond Enhancer.....	123
RXDC HyperSphere Intraoral X-Ray	657	Scott Toilet Tissue.....	641	Silgimix	255
S					
S3 ACE Earloop Masks.....	288	SE Cushion	204	Silhouette Nasal Masks.....	21
S3 C2 Earloop Masks	288	Seal & Protect.....	489	Silicone Emulsion	454
S3 Earloop Masks	288	Sealants, Pit & Fissure	505-506	Silicone Impression	260
S3 Mint Earloop Masks	288	Sealapex.....	183	Silicone Spray.....	454
Safe 'n' Sure.....	584	Seal-Rite Pit & Fissure Sealant.....	506	Silkcare Fitted Latex Gloves	285
Safe+Mask Master Series Earloop Masks	290	Seal-Tight Air/Water Syringe Tips.....	168	Silkcare Latex Gloves.....	276
Safe+Mask Premier Earloop Masks	290	SecureFit Face Masks	289	Sil-Tech.....	260
Safe+Mask Premier Elite Earloop Masks	290	Security Capsule & Pestle.....	12	Sil-Trax Retraction Cords.....	540
Safe+Mask Premier Plus Earloop Masks	290	Sedation Dentistry	712-715	Simile.....	134
Safe+Mask Sof Skin Earloop Masks	290	See-Breez Eyewear.....	297	Simplicity Delivery System	690
Safebasics Saliva Ejectors	203	SeeClear Eyeglass Wipes	296	Simplicity Stools	735
SafeDispense Floss Dispenser	493	Seity Etchant	125	SimpliSeal.....	183
Safe-Flo Saliva Ejectors	203	Self-Contained Water Systems.....	698	Sinsational Smile In-Office Whitening.....	143
SafeGauze HemoStyp Dressing.....	555	Sensibles Sensor Holders	583	Sinus Lift Instruments.....	378-379, 383
Safe-Lok Covers	438	Sensipast Root Fillers.....	185	Sky-Scapes Light Diffusers	636
Safe-Tips EZ.....	168	SensiTemp.....	111	SlickGel ES.....	194
Safety Glasses, Health-Tec	295	Sensodyne Fresh Impact Toothpaste	526	Slimline Duplicator.....	573
Safety Side Shields	297	Sensodyne ProNamel Toothpaste	526	Slimline Ultrasonic Inserts.....	532-533
Salibag.....	324	Sensodyne Repair & Protect Toothpaste	526	Slip-N-Grip.....	320
Saliva Ejector Screens	208-209	Sensonic Professional Plus Toothbrush ..	519	Slix Composite Placement Instruments..	406
Saliva Ejector Traps	208-209	Sensor Sheaths, Health-Tec.....	323	SlugBuster	205
Saliva Ejector Tubing	696	Sensor Sleeves, Health-Tec	323	Smart Dam	542
Saliva Ejector Valves	696-697	Separators	474	SmartBands.....	461
Saliva Ejectors.....	202-204	Septocaine.....	14	SmartCEM2.....	101
Saliva Ejectors, Health-Tec.....	202	Septodont Aspirating Syringes	15	SmartSelect Selective Prophy Paste	516
Sani-Cloth AF3	312	Septodont Hand Cream.....	299	SmartStrip	214
Sani-Cloth HB.....	312	Septodont Injectable Anesthetics	14	SMARTtorque Handpiece.....	227, 230
Sani-Cloth Plus.....	312	SeptoJect Evolution Needles.....	16	SMARTtorque LUX Handpiece.....	227
SaniGlut Glutaraldehyde.....	309	SeptoJect Needles	16	S-Max Handpieces	228, 231, 237
Sani-Roll Sterilization Tubing	306	SeptoJect XL Block Needles	16	SmearClear	194
SaniSept Soap.....	301	Sequential Sterilization Wrap.....	306	SMS Sharps Management System ..	21, 329
Sani-Soak Ultra	316	seT Cement.....	105	Snap Acrylic.....	6
Sani-Tab Bibs	163	Set-Up Tray Racks.....	438, 441	Snap-A-Ray	580
Sanitex Plus Spray	313	Set-Up Trays	438, 440-441	Snap-A-Ray DS	580
Sani-Tip	168	Sharp Image Clean Up Sheets	572	Snap-A-Ray Xtra.....	580
Sani-Trays.....	272	Sharpen-Ez Oil.....	443	Snap-Stone.....	455
Sani-Treet Green	205	Sharpening Stones.....	443	Snoop Caries Detecting Dye	488
Sani-Treet Plus	316	Sharpening, Instrument.....	443	Snow White Plaster	455
		Sharps Containers & Collectors	21, 328	Snuggies Sensor Sleeves	323
		Sharps Disposal	21, 328	Soaps, Hand.....	301-303

Socket!	555	SporeCheck In-Office Monitoring	307	Sticky Wax	565
Sodium Chloride 0.9%	557	Sporox II	310	Stim-U-Dent	495
Sodium Hypochlorite	195	Spray 2000 Plus	572	Stools	730-739
Sodium Perborate	195	Spry Chewing Gum & Mints	488	Stop Strips	465
Sof-Lex Discs	211	Squeeze Cloths	12	Streamline Inserts	535
Sof-Lex Finishing & Polishing Strips	214	SRG Evacuation Cleaner	206	Strip Crowns	157
Sof-Lex Pop-On Mandrels	211	SS White Burs	45-48	Stylus ATC Handpiece	226
Sof-Lex Spiral Finishing & Polishing Wheels	211	Stabe Bite-Blocks	579	Stylus Couplers	246
Sof-Lex XT	211	Stabilok Pins	483	Stylus Fiber Optic Handpiece	226
SofPull Centerpull Paper Towels	170	Stainless Steel Crowns	155-156	Stylus Lite Handpiece	226
Sofreliner Tough	9	Stainless Steel Impression Trays	273	Stylus Mini Handpiece	226
Sofscale Calculus Scaling Gel	517	Stainless Steel Impression Trays, Health-Tec	273	Styptin	537
Soft Reline Materials	8-9	Stalite Special Solution	456	SUPA Disposable Prophy Angles	511
Soft White Nitrile Gloves	282	Sta-Lube Silicone Spray	453	Super Bib Clips	165
Soft-Core Classic Obturators	198	Staplers	593	Super Kleen 40	205
SofTip Ultrasonic Insert	533	Staples	593	Super Quick Tips	148
Softline	8	Star High Speed Handpiece Accessories	234	Super Sani-Cloth Plus	312
Softouch Vinyl Gloves	284	Star Hygiene Handpieces	244-245	Super Sucker Dust Collector	449
Soft-Picks	495-496	Star Low Speed Handpiece Accessories	240	SuperBuff Discs	213
SoftX Bite Wing Loops	579	StarFill 2B Flowable	139	SuperCure	113
Solo Diamonds	86-87	Stasis Solution	537	Super-Etch	125
Solo Paper Cups	165	StatClean Ultrasonic Unit	742	SuperFloss	492
Soludent Developer & Fixer	571-572	Statim G4 Autoclaves	721	Supergreenie Points	219
Sonic Nitrile Gloves	278	StatMatic 31 Handpiece Maintenance System	248	Superoxol	195
SonicFill 2	128	Statmatic Handpiece Spray	249	Super-Sep	453
Soothe-Guard X-Ray Aprons	574-575	StatStone	455	Super-Snap Polystrips	215
Sopix2 Sensors	650	StatusBlue	255	Super-Snap Rainbow	213
Sopro 717 First Camera	642	Sta-Vac Vacuum Former	456	Super-Snap Singles	213
SoproCare Caries Detection	647	Stay-Put Retraction Cord	538	Super-Snap X-Treme Ultra-Gloss Discs	213
SoproLife Caries Detection	647	Steam Indicator Strips	307-308	Super-Vac 40	205
Spacer Trays	271	Steam Sterilization Integrators	308	Sure-Check Sterilization Pouches	304
Spandex Cheek Retractor	427	SteamPlus Type 5 Integrators	308	Sure-Check Strips	307
Sparkl	442	Steri-Bur Guard	96	SureFil	130
Sparkle Air/Water Syringe Tips	168	Steri-Containers	436	SureFil SDR Flowable + Composite	127
Sparkle Diamond Polishing Paste	221	SteriDent Sterilizer	718	SureFlex Files	187
Sparkle Disposable Prophy Angles	507	Steri-Endo Guard	200	Sure-Stop Dispenser	199
Sparkle Prophy Paste	513	Sterilants	308-310	SureStop Hemostatic Dressing	555
Sparkle V Fluoride Varnish	501	Sterilants, Health-Tec	308	Surface Disinfectant, Health-Tec	311
Spatulas, Impression	254	Sterile Mini Prophy Angles	511	Surface Disinfectants	311-314
Spatulas, Waxing	389, 426	Sterile Surgical Gloves	285	Surfactant Debubbler	456
SPEC3 LED Curing Light	151	Sterilization Cassettes	430-432, 436	Surgic Pro Surgical Micromotor	246
Spectra Absorbent Points	189	Sterilization Centers	724-729	Surgical Aspirator Tips	204
Spectra Gutta Percha Points	191	Sterilization Indicator Tape	303-304	Surgical Aspirator Tips, Health-Tec	204
Spectrum Bib Clips	165	Sterilization Indicator Tape, Health-Tec	303	Surgical Aspirators	204
Spectrum Oral Evacuator Tips	201	Sterilization Pouches	304-305	Surgical Blades	553
Speed-Clean	311	Sterilization Pouches, Health-Tec	304	Surgical Burs, Health-Tec	28-30
Spee-Dee Build-Up	116	Sterilization Tubing	306	Surgical Caps	293
Speedster Burs, Alpen	31	Sterilization Wrap	306	Surgical Carbide Burs	28-29, 32, 35, 48
Spherical Alloy, Health-Tec	11	Sterilization Wrap, Health-Tec	306	Surgical Gown	293
Spherical Alloys	11-12	Sterilizer Gaskets	723	Surgical Milk	442
Sphygmomanometers	557	Sterilizers	718-722	Surgical Molded Mask	287
Spill Response Kits	326	Steri-Mate Handpiece	533		
Spirit 1540/1550 Delivery Carts	692	SteriPocket Sterile Sponges	163	SURGICAL PRODUCTS	550-558
Spirit 1585 Delivery System	692	Steri-Shield Barriers	324, 326	Surgical Sterile Gloves	285
Spirit 1700 Dental Chair	685	Sterisil Straw & Cartridge	330	Surgical Tray Material	457
Spirit 2000 Dental Stools	738	Sterisil Water Treatment System	749	Surgicel	554
Splash Hoods	454	Steri-Soaker	310	Surgident Articulating Paper	22
Splint Material	457	SteriSure Dry Heat Sterilization Bags	304	Surgident DispOral Disposable Syringe	267
Sponges	161-163	SteriSure Sterilizer	718	Surgifoam	554
Sponges, All Gauze	162	Sterling Nitrile Gloves	282	SurgiTip-Endo Aspirator Tips	204
Sponges, Cotton Filled	161	Stethoscopes	557	Surg-O-Vac Tips	204
Sponges, Non-Woven	162-163	Stickers	586-587	SurgTorque Handpieces	227, 230
Sponges, Sterile	163			Surpass Facial Tissue	641

Surtex Posts	484	TF Adaptive Files	178	ToothTone Ball Hooks.....	476
Sutures	550-552	TF Adaptive Obturators	181	ToothTone Kobayashi Shorty Ties	476
Sutures, Health-Tec	551-552	TF Adaptive Unit.....	178	ToothTone Ligature Ties	476
SweepZone Ultrasonic Units	741	TF Gutta Percha	181	ToothTone NiTi Open Coil Springs	476
Swivel Direct Flow Ultrasonic Inserts	534	TF Obturators	181	Topex Fluoride Foam.....	497
Swivel Ultrasonic Inserts	534	TF Paper Points.....	181	Topex Fluoride Gels	498
Sycamore Wedges.....	466	TF Twisted Files.....	178	Topex Fluoride Trays.....	500
Synergy D6 Composites.....	129	The Machine Vacuum Formers	456	Topex Handicaine Stix.....	19
Synergy Nano Composites.....	129	TheraMints.....	488	Topex Metered Spray.....	20
Syntac Adhesive	120	ThermaKnife Trimming Knife	459	Topex Neutral pH.....	498
Synthetic Bone Material	555-557	Thermo-Block	93	Topex Prep & Polish Paste	515
Syringe Sleeves.....	321	Ti-Core	114	Topex Prophyl Paste	515
Syringe Sleeves, Health-Tec	321	Ti-Core Auto E	114	Topex Take Home Care	499
Syringe Tip Covers	321	Ti-Core Flow+	114	Topex Topical Anesthetics	19-20
Syringe Tips, Air/Water	168	Tidi Intraoral Camera Sheaths.....	324	Topical Anesthetics	17-20
Syringes, Anesthetic	15	Tidi Tooth Bibs	164	Topical Anesthetics, Health-Tec.....	17
Syringes, Aspirating.....	15	Tidi Tooth Cups.....	165	Topicale Anesthetic.....	19
T					
Take 1 Advanced Bite	257	TidiShield Assemble'n Go Eyewear.....	297	Tork Xpress Towel Dispenser	171
Take 1 Advanced VPS	266	TidiShield Assemble'n Go Face Shields	298	Total Comfort SoftTip Aspirator.....	203
Take-Home Whitening Systems.....	143-146	TidiShield Camera Sheaths.....	324	Total Etch.....	124
Tape-N-Tell	440	TidiShield Curing Light Sleeves	323	Touch & Bond	122
Tapes & Dispensers (Office).....	592	TidiShield Digital Sensor Sheaths.....	324	Touch 'N Heat	198
Tap-n-Slide Sterilant Tray.....	310	TidiShield Flip'n Go	297	Towel Clamps	426
Tartar & Stain Remover, Health-Tec	315	TidiShield Sensor Sheaths	324	Towel Dispensers	170-171
T-Bands	464	Tie-On Masks	292	Towels, C-Fold.....	169
T-Bar Barriers	325	Tilt-Top Cotton Pellets.....	160	Towels, Hand.....	169-170
TDA Diamonds	91	Ti-Max Electric Handpieces.....	236-237	Towels, Multi-Fold	169
Team Vista Waterline Cleaner	330	Ti-Max High-Speed Handpieces.....	227-228, 231	Towels, Paper	169-170
Tec-Cide Plus, Health-Tec	308	Ti-Max X High Speed Handpieces	236	Toy Chest Assortment	588
TechnoCut Scalpels.....	553-554	Ti-Max Z High Speed Handpieces	237		
Tech-Specs Eyewear	297	TimeLine.....	97	TOYS	585-589
Teethmate Desensitizer	490	Tip-A-Dent	494	TPC MC-500 Mobile Cart.....	694
Telio CS Cem Implant.....	99	Tip-A-Dilly HVE Tips	201	TPH Spectra Universal Composite... 130-131	
Telio CS Desensitizer	490	Tissue Conditioners.....	9	TPH3 Flow.....	136
Telio CS Inlay & Onlay.....	99	Tissue, Bath.....	641	Trace Disclosing Solution	491
Telio CS Link	110	Tissue, Facial	641	Tradition Handpieces	226, 230
Temp Advantage	110	Tissue, Toilet.....	641	Transform Nitrile Gloves	279
Temp-Bond	110	Tissue/Poly Headrest Covers, Health-Tec	166	Transformation Sharpening Stone.....	443
Temp-Bond Clear	110	Titan Blissonic Scaler	530	Transmetal Bur	38
Temp-Bond NE	110	Titan Motors & Accessories.....	240, 242	Transview Mounts	568-569
TempCanal	192	T-Loc Triple Tray.....	270	Trap-Eze Plaster Trap	452
TempPhase	5	T-Mat ExtraOral Film.....	567	Trash Liners	641
Tempit.....	98	TMS Pins.....	482	Tra-Tens.....	273
Temple Cotton Pellets	161	TNE Temporary Cement.....	111	TravelCaps	517
TempoCem	109	Tofflemire Matrix Bands	465	Traxodent.....	541
Temporary Bridge Resin.....	4	Tofflemire Retainers	465	Tray Adhesive	274
Temporary Cement Remover	317	Toilet Tissue.....	641	Tray Cleaner	274
Temporary Cements	109-111	Tokuyama Rebase II.....	8	Tray Covers.....	167
Temporary Crown & Bridge Material, Health-Tec	3	Tongue Cleaners	517	Tray Covers, Health-Tec	167
Temporary Crown & Bridge Resin.....	3-6	Tongue Depressors	169	Tray Racks.....	438, 441
Temporary Crown Matrix Buttons	256	Tongue Depressors, Health-Tec	169	Tray Sleeves	322
Temporary Filling Material	98-99	Tongue Tamer.....	475	Tray Sleeves, Health-Tec	322
Temporary Splint Material.....	457	Tooth Conditioner Gel.....	124	Trays, Set-Up.....	438, 440-441
Tempsmart.....	5	Tooth Slooth	159	Tray-Vac Vacuum Former	456
TempSpan Temporary C&B Material	6	Tooth Whitening, In-Office.....	142-143	Treasure Chest Toy Assortment.....	588
TempSpan Temporary Cement.....	110	Tooth Whitening, Take-Home Systems	143-146	Tri Auto ZX.....	243
Tenure Multi-Purpose Bonding System ...	118	Toothbrushes, Pre-Pasted, Health-Tec ...	518	Triad 2000 VLC Curing Light.....	448
Tess Toothbrushes.....	524	Toothbrushes, Manual	520-525	Triad Air Barrier Coating	448
Tetric EvoCeram	132	Toothbrushes, Power	518-520	Triad Custom Tray Material.....	447
Tetric EvoFlow	137	Toothbrushes, Health-Tec.....	520	Triad Denture Base Material.....	447
Tetric EvoFlow Bulk Fill	127	Toothbrushes, Pre-Pasted	518	Triad DualLine Reline Material	447
		Toothpaste	526-527	Triad Gel.....	447
		ToothTone Preformed Shorty Ties	476	Triad Model Release Agent	448

Triad Reline Material Hi Flow447
 Triad Reline Material Original447
 Triad Transheet Material447
 Triad TruTray Custom Tray Material447
 Triad VLC Bonding Agent448
 Triad VLC Modeling Instrument448
 Tri-Clean Ultrasonic Cleaners..... 740
 Trimming & Finishing Burs, Health-Tec30
 Trimming & Finishing Burs.. 30, 35-36, 39-40
 Triple Clean Floss Picks494
 Triple Layer Molded Face Masks.....287
 Triple Tray269
 TrollFoil23
 Tropicalgin Alginate.....253
 TRU Applicators.....149
 TruBase Baseplates.....447
 True Comfort Neoprene Gloves.....284
 TrueAdvantage Gloves281
 TruEase Buccal Tubes470
 TruFit 2.0 Buccal Tubes469
 TruFit 2.0 Molar Bands471-472
 TruFlex Niti De-Impacting and Separating
 Springs477
 TruFlex NiTi Springs477
 TruForce Stainless Steel Retainer Wire...477
 Truly 200 Nitrile Gloves280
 TruWax563
 T-Style Light Handle Covers 324-325
 TSZtech Diamonds..... 83, 85
 Tubes & Plugs149-150
 Tubes, Buccal469-470
 Tubli-Seal.....183
 Tuff-Temp Plus6
 Tums481
 Turbines 233-234
 TurboTemp 26
 Turbo-Vac206
 Tuttnauer Autoclaves.....721-722
 TwinPower Handpieces226-227, 230
 Twist Disposable Propy Angle.....507
 Twisted Files178
 Two Striper Diamonds 79-85
 Two Striper TS2000 Diamonds.....83
 Tylenol481
 Tylok-Plus108
 Tytin Alloy.....12
 Tytin FC Alloy.....12

U

U/P Root Canal Cement.....193
 Ultra Clean Access Flossers494
 Ultra Clean Floss.....491
 Ultra Earloop Masks289
 Ultra Earloop Masks with SecureFit289
 Ultra Fog Free Earloop Masks289
 Ultra Gauze Sponges162
 Ultra No Fog Mask with Splash Visor.....292
 Ultra Pure Non Woven Sponges.....162
 Ultra Safety Plus XL17
 Ultra Sensitive Earloop Masks289
 Ultra Sensitive Earloop Masks with
 SecureFit289
 Ultra Sensitive Fog Free Masks289
 Ultra Sensitive NoFog Mask with Shield .292

Ultrabrush149
 UltraComfort Dental Chair684
 UltraDose Ultrasonic Solutions.....318
 Ultraform Nitrile Gloves283
 Ultra-Guard Sports Mouthguards479
 Ultramat 2 Amalgamator..... 13
 UltraSense Nitrile Gloves283
 Ultrasonic Cleaning Solutions315-319
 Ultrasonic Cleaning Solutions, Health-Tec
315
 Ultrasonic Concentrate Powder317
 Ultrasonic Enzymatic Tablets.....315-319
 Ultrasonic Enzymatic Tablets, Health-Tec .315
 Ultrasonic Equipment 740-743
 Ultrasonic Inserts.....531-536
 Ultrasonic Scalers.....527-530
 Ultra-Speed Film.....566
 UltraThin Fluoride Varnish.....503
 Ultra-Vac HVE Tips.....201
 UniBraid +.....539

UNIFORMS 559-562

Uni-Grip 360 Universal Sensor Holder...581
 Uni-Punch.....554
 Unison Alloy.....12
 Unitek Crowns156-157
 Unitek Gold Anodized Temporary Crowns.157
 Universal Bond, Health-Tec.....117
 Universal Implant Drivers378
 Universal Masking Agent.....142
 Upgrade Disposable Propy Angles509
 Utility Gloves.....286
 Utility Syringes, Health-Tec196, 267
 Utility Wax.....565
 Uvex Genesis Glasses295
 Uvex Ignite Glasses.....296

V

Vac Attak.....206
 VacuBlast.....206
 VacuKleen E2206
 Vacusol Ultra205
 Vacuum & Compressors.....744-746
 Vacuum Clean206
 Vacuum Formers456
 Vacuum Forming Materials.....457-458
 Vacuum Shock.....206
 Valiant - Ph.D10
 Valueklave 1730 Autoclave722
 Van R Hydrocolloids258
 Vanish Fluoride Varnish.....501
 Vantage Digital Panoramic System662
 Vantage Propy Angle506
 Variolink Esthetic Cement.....102
 Varnish, Fluoride501-503
 Varnish, Fluoride, Health-Tec501
 Vaseline481
 V-Cide311
 Vector Handpiece Spray.....250
 Vella Varnish.....502
 Vel-Mix.....454
 Velocity Handpieces229, 233
 Velocity Latex Gloves275

VELscope Vx716
 Vent-O-Vac HVE Tips202
 Venture Cotton-Filled Sponges.....161
 Venture Gauze Sponges162
 Venture Non-Woven Sponges163
 Venus Bulk Fill.....127
 Venus Diamond132
 Venus Diamond Flow.....137
 Venus Flow137
 Venus Pearl132
 Venus White Max.....142
 Venus White Pro143
 Venus White Touch Up Brush144
 Venus White Ultra144
 VenusTemp 2.....5
 Vera Advanced Bright Propy Paste.....516
 Vera Disposable Propy Angles511
 Veraview IC5 HD X-Ray661
 Veraviewepocs 2D X-Ray661
 Veraviewepocs 3D R100 X-Ray.....660
 Verifiers.....181
 VersaTemp 2.....6
 Versi-Wipes.....303
 Vertise Flow138
 Vibrakleen E2317
 Vibrant Latex Gloves275
 Vibrators459
 Vinyl Gloves.....284
 Vinyl PF Gloves284
 Vinyl Polysiloxane Impression261-267
 Vinyl Polysiloxane Impression Material,
 Health-Tec261
 Vionex Liquid Soap302
 Vionex No-Rinse Gel.....300
 Vionexus Foaming Soap302
 Vionexus No-Rinse Spray300
 Virtual Bite Registration.....257
 Virtuoso Flowable136
 Visco-Gel.....9
 Vision Saver153
 Vista-Probe Irrigating Tips197
 VitalGard Latex Gloves.....276
 VitalGard Nitrile Gloves281
 Vitrebond97
 Vitrebond Plus97
 Vitremer Core Buildup113
 Vivacaine14
 VK Ultrasonic Solutions.....317
 Volo Surface Disinfectant Wipes.....314
 VPS Tray Adhesive274
 W.O.W. Articulators444

W

Water Distillers.....330
 Water Flosser - Cordless.....496
 Water System Replacement Bottles698
 Waterline Cleaning & Testing329-330
 Wave Flowable Composite139
 Wavicide310
 Wavicide MEC Indicator Strips.....310
 Wax Spatulas389, 426
 Wax Spatulas, Health-Tec389, 426

WAXES..... 563-565

Wedges466
 Wedjets.....543
 Wheels, Model Trimmer.....452
 White & Brite.....143
 White Gaps.....21
 WhiteGaps.....21
 Whitening & Bleaching142-146
 Wig-L-Bug Amalgamators.....13
 Wild Flossers.....494
 Wing-A-Ray.....581
 Wingrove Implant Scalers.....383
 Wire Cutter.....384, 387, 425
 Wizard Wedges466
 Wonderfill.....446
 Wrap-Ease.....323
 Wraps, CSR Sterilization306
 Wynman Crown Gripper.....404

X

X50 Electric Handpiece.....245
 X-Calibur B50 Dental Chair.....680
 Xceed Nitrile Gloves.....283
 XCP Bite Blocks579, 581
 XCP Evolution 2000 Positioning Kit.....581
 XCP/BAI Replacement Parts.....581
 XCP-DS Digital Sensor Holder582
 XCP-DS FIT Sensor Holder581-582
 XCP-ORA Positioning System582
 XCP-QT Universal Disposable
 Sensor Holders.....582-583
 Xenon IV.....118
 Xlim Nitrile Gloves.....280
 XMind Trium X-Ray 2D/3D658
 XMind Unity Intraoral X-Ray.....654
 X-Omat ExtraOral Film.....567
 X-Otomes413
 Xpress Sealers183

X-RAY..... 566-584

X-Ray Apron Hanger574
 X-Ray Aprons574-578
 X-Ray Chemistry570-572
 X-Ray Envelopes.....583-584
 X-Ray Film.....566-567
 X-Ray Film Duplicators.....573
 X-Ray Film Viewers573
 X-Ray Mounts.....568-570
 X-Ray Mounts, Health-Tec.....570
 X-Ray Positioners.....579-583
 X-Ray Processor Chemicals.....570-572
 X-Ray Processor Cleaners572-573
 X-Ray Radiation Monitoring.....584
 X-Ray Sensor Sleeves.....323-324
 X-Ray Sleeves.....322
 X-Ray Sleeves, Health-Tec.....322
 X-Ray Units654-665
 X-Ray Viewers573
 X-Tip16

Xylitol Chewing Gum488
 Xylitol Dry Mouth Drops.....488
 Xylocaine14
 Xylol (Xylene).....195

Y

Young Disposable Prophy Angles.....510-511
 Young Hygiene Handpieces245

Z

Z100 Filtek Restorative129
 Z250 Filtek Restorative.....128
 Zarosen489
 Zilactin481
 Zinc Phosphate Cements108-109
 Zirconia Polishers223
 ZOE B&T.....99
 Zoe Pastes257
 Zoll Defibrillator573
 ZONE & ZONE Free Temporary Cement
 110-111
 Zooby Character Masks291
 Zooby Disposable Prophy Angle.....511
 Zooby Fluoride Foam497
 Zooby Pediatric Bibs.....164
 Zooby Perfect Choice Fluoride Gel498
 Zooby Prophy Paste516
 Zorcaine.....14
 Z-Twist Retraction Cord539

Our Dental Reference Guide represents the industry's top selling supplies and equipment. If you are not able to locate items within this guide, please visit our webstore to shop our full product offering, www.dhpionline.com.

One Call Gets Us All...

When you call Dental Health Products, Inc. (DHPI) and speak to an experienced Account Manager, they will work with you and our entire team of professionals to select the best SUPPLIES, EQUIPMENT and SOLUTIONS for your practice. Our sales team is continually trained by industry top dental supply and equipment manufacturers to provide you with current product information and answers to any questions you may have about a product or promotion. If you have a specific question on a product or simply would like a quote for your supply needs, contact us today at 800-626-2163.

Ready to Ship...

We have a large selection of quality dental supplies and equipment – over 50,000 items from over 400 top manufacturers in the industry. Our broad product selection offers you the most popular brand name dental supplies, along with our own high quality line of Health-Tec® Brand Products.

Pricing Stability...

All prices in this catalog are current at the time of publication. While it is our policy to maintain everyday low prices for the duration of the catalog, market conditions and manufacturer price increases may make it necessary to adjust our prices without notice. We may also need to adjust prices that are incorrect due to typographical errors. Prices are exclusive of applicable sales, use and other taxes relating to the sale. Costs associated to the purchase or delivery of the product shall be paid by the buyer. Pricing in this catalog supersedes all previously published prices.

Ordering Products...

It's fast! It's easy! Choose your DHPI Shopping Experience:

- Phone in your order, 800-626-2163.
- Fax in your order 24/7, 888-681-5088. A fax order form is located at the back of this catalog. Photocopy before use to have additional copies for future orders.
- Order online, www.dhpionline.com. It's safe and secure!
- Order using OPTIONS Inventory Management Software.

Regulatory requirements may apply to the use or the installation of certain products. Please be sure to understand and comply with any such requirements prior to purchase. Please note that all business transactions may be conducted by electronic means, including the use of electronic signatures and are subject to Wisconsin Statutes Chapter 137. Phone calls may be monitored for training purposes.



Exclusive Distributor of...

OPTIONS Inventory Management Software; the only inventory management software program that allows you to order your entire practice's inventory – dental products to office supplies – from several different suppliers. The system automatically generates orders based on your stocking level requirements. Please contact your Account Manager for more details.

Government and Special Markets Accounts...

To service the unique needs of these customers, we have dedicated, professionally trained personnel to answer your questions and assist you in the supply procurement process. Requests for bids and proposals may be sent to: info@dhipi.net or call, 800-626-2163.



Payment...

For your convenience, we accept Visa, MasterCard, American Express and Discover at point of sale and for online payment of invoices. We also accept Check by Phone and ACH Debit. Qualified customers may establish an open account with the completion and approval of a credit application. Payments on open accounts are due on all orders within 7 days after receipt of the product. Balances left unpaid after 30 days from invoice date will incur a 1.5% finance charge per month (18% APR). Disputed items on an invoice are the exception. If we find it necessary to place an account in collection, fees and other costs associated with the collection will be assessed.

Equipment...

A deposit is required on all large equipment orders over \$10,000. Balance of payment is due when the equipment is installed. Please note we cannot provide long-term storage of customer's equipment purchases, therefore equipment must be installed within a reasonable amount of time. All equipment orders are non-returnable and cannot be cancelled. Architectural and design services are available for a fee and are refundable with equipment purchase. We honor manufacturer warranties and provide a 90-day labor warranty. Please read and return all warranty information required immediately upon taking delivery of your new equipment. Open or defective equipment will be covered by manufacturer warranty. Ask your Equipment Specialist about financing options and other details on equipment purchases today!

Financing Solutions...

In order to provide you with the best financing options, DHPI has partnered with the most reliable financial companies in the industry. Through our established partnerships, you can rely on our many years of experience and knowledge to help guide you through every step of the process. We're here to help you find the right plan, with the right terms, for your needs. Get the financing you deserve. Contact your DHPI Equipment Specialist, 800-626-2163, for more information today!

Service & Repair...

Our technical service consultants are reliable and manufacturer-trained. Take advantage of our annual preventive maintenance program designed to keep your practice running at peak efficiency. DHPI offers new equipment installation as well as old equipment teardown and disposal. All service is backed by DHPI and complete warranties. Our Service Dispatchers are available during normal business hours. To schedule a Service Technician visit for your office, please call 800-444-6410. After-hours service is available in select areas.

Shipping & Handling...

All orders within the continental U.S. are subject to a handling charge. A fuel surcharge may apply to all orders. Bulk items and liquids may incur additional freight charges. Expedited freight is available at an additional cost.

◆ Hazardous Materials...

The hazardous materials symbol is used to identify products classified as hazardous by the Department of Transportation (DOT). All hazardous materials are subject to a hazardous materials surcharge. This charge will be added to your invoice or credit card transaction. DOT regulations prohibit the shipment of hazardous materials by air freight.

Returns...

Need to return an item for credit or exchange?

- Call our Customer Service Department within 30 days of the invoice date for a RMA number.
- Please note, returns past 30 days from invoice date are subject to a restocking charge.
- Only items listed on the RMA form will be processed for credit. If additional items are added, a restocking fee will be applied.
- We will provide a return label and return instructions via email, fax or postal mail.
- Enclose a copy of the original invoice, the reason for the return, along with the item being returned.
- The customer is responsible for all freight; shipping charges will apply on all returns.
- For your own protection, we suggest you insure the package for the full value of the item being returned. Should the items be lost or damaged in transit, carriers require you to file a claim directly with them.
- Items must be returned in unmarked, unopened, and original sealed packages making certain the item being returned is in resalable condition.

Exceptions...

The following items are NOT returnable under any circumstance:

- Opened handpieces, small equipment, large equipment, their accessories, and custom-ordered equipment.
NOTE: Before opening a sealed item, please examine the label to determine you have received the correct item ordered. These items will be replaced according to the manufacturer's warranty as directed by federal regulations.
- Special ordered items for products we do not ordinarily stock.
- Personalized, customized, imprinted items or government-regulated items.
- Opened computer hardware and software.
- Hazardous items.
- Short dated or expired product.
- Discontinued merchandise.
- Items marked as non-returnable.
- Items that cannot be returned to the manufacturer.
- For X-ray film you believe to be defective, please call the manufacturer's help line directly. Defective X-ray film cannot be returned to Dental Health Products, Inc.
- Certain Health-Tec® items such as bulk items, alloy, or imprinted product. Please see our Health-Tec® Brand Products Guarantee below for more information.

Claims for shortages or errors in shipments MUST be reported within 48 hours of receipt of delivery. NO claim for shortages will be allowed after 48 hours of receipt of delivery. We will only grant full credit on items we can return to the manufacturer for full credit or are in resalable condition. Re-stocking fees and other restrictions may apply. We reserve the right to refuse any unauthorized returns following inspection. Please call our Customer Service Department for more details.

Health-Tec® Guarantee...

We stand behind our DHPI private label Health-Tec® Brand Products by offering you a 100% satisfaction guarantee. If you have tried a Health-Tec® Brand Product and it is defective or doesn't perform up to your expectations we will provide a credit, refund or exchange. It's your choice. Please call our Customer Service Department toll-free, 800-626-2163, to explain the reason for the return and to receive proper return authorization. We have a few simple conditions that apply:

- Product(s) can only be returned within 60 days of the invoice date with the exception of handpieces which must be returned within 30 days of the invoice date and must be unopened.
- Discontinued or personalized merchandise.
- Opened products must be returned in their original, unmarked packaging.
- Hazardous, personalized, or special ordered items are not returnable under any circumstance.
- DHPI will assume responsibility for any common-carrier ground shipping or restocking charges that may apply.
- Your account will be credited, a refund issued or an exchange made once the return has been received, inspected and approved for final return by DHPI.

Regulatory Requirements...

Local regulatory requirements may apply to use or installation of certain products. Be sure to understand and comply with any such requirements prior to purchase, use or installation of products. Any "transfers of value" made to you by Dental Health Products, Inc. or other distributors or manufacturers of dental care products may need to be reported to the Center for Medicare & Medicaid Services (CMS). This information will then be posted by CMS.

Important Notice...

We reserve the right to modify or change our Terms and Conditions at any time for any reason without notice. Please visit our website to review the most current DHPI Policies, www.dhponline.com.



Dental Health Products, Inc.

SUPPLIES. EQUIPMENT. SOLUTIONS.

Supply Order Form

Date _____

Check Here If First Order

Ordered By _____

Office Name _____ Phone (_____) _____

Fax Number: _____

Address _____

City _____ State _____ Zip _____

Salesperson _____

Order, Pricing and Product Questions:

Toll Free: **800-626-2163**

Toll Free Fax: 888-681-5088

Account #: _____

Payment Method Choose One: <input type="checkbox"/> Bill My Account <input type="checkbox"/> Check-by-Phone	<input type="checkbox"/> Credit Card Please call the Dental Health Products, Inc. Billing Department with your credit card information. (800-626-2163)
---	---

Qty	Item#	Size/Color	Product Name/Description	Unit Price	Extended Price

Check-by-Phone Has Replaced C.O.D.'s
 Our customers are enthusiastic about our Check-by-Phone service. Check-by-Phone is faster than C.O.D. and saves you the \$10.00 or \$10.50 fee. To use Check-by-Phone just tell your Account Manager or Customer Service Representative your check information. It's that easy! No C.O.D., no extra charge; it's all taken care of!

Sub Total:	
Shipping:	
Fuel Surcharge: <small>(This fuel charge will be monitored and adjusted on a regular basis.)</small>	\$0.00
Handling Fee:	TBD
TOTAL:	



Practice Solutions

Officite

Dental Websites

sesame

Patient Communication



Dental Enhancements.com

**OSHA & HIPAA
Compliance Training**

**Dental
Exchange**

Employment Opportunities

VIVA LEARNING™
interactive web-based training

FREE CE Credits

INVENTORY MANAGEMENT
OPTIONS®
SOFTWARE

Inventory Management

Request more information or a FREE demo at:

www.dhpionline.com/solutions



WHEN ASKED...

...91% of our customers' responses state they would refer DHPI to colleagues

...our customers agreed — DHPI's Top 4 Qualities:

“Reliable, Responsive, Knowledgeable and Resourceful”

— 2017 customer survey —

**"VERY FRIENDLY,
RELIABLE CUSTOMER
SERVICE. RECEIVE
ORDERS IN A TIMELY
MANNER. QUALITY!"**

— customer response —
MICHIGAN

**"Our DHPI Service Tech is
a HUGE factor... an asset
to the DHPI team."**

— customer response —
NEBRASKA

**"The reason we choose to stay
with DHPI is because of our
Sales rep. She is extremely
knowledgeable of all the
products and goes above and
beyond to ensure that we
are well taken care of. She
has a wonderful personality,
and because of that, makes
ordering and obtaining quotes
through DHPI a breeze!"**

— customer response —
TEXAS

**"Being busy with patients,
I'm not able to call several
times a day to try to get
ahold of my supplier.
Sometimes I have questions
about products that I need
to know ASAP. I am able
to get ahold of my DHPI
Account Manager all of the
time, and it's the best!"**

— customer response —
MINNESOTA

**"We continue to do business
with DHPI because they
have everything we need and
at a good price. Our sales
representative is very kind
and easy to work with."**

— customer response —
CALIFORNIA

**"You understand the
business end and work
with us to make our
office profitable."**

— customer response —
WISCONSIN