

# 2017

## CABIN AIR FILTER | FILTRE HABITACLE

FILTRO HABITACULO | FILTRO ABITACOLO

INTERIEUR LUCHTFILTER | INNENRAUMLUFTFILTER

FILTR KABINOWY | KABINOVÉ FILTRY

POLLEN SZŰRŐ | FILTERI KABINE

САЛОННЫЙ ФИЛЬТР | KABIN FILTRESI

φίλτρο καμινάς

[valeoservice.com](http://valeoservice.com)



WANT TO  
KNOW MORE?\*



\*en savoir plus

**Valeo**

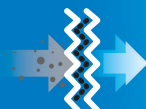

**Particle Filter**  
Particules/pollen

**Filtre à Particule**  
Particules/pollen

**Filtro de Partículas**  
Partículas/polen

**Filtro Particellare**  
Particelle/polline

**Filtro de Partículas**  
Partículas/polen

**Partikelfilter**  
Partikel/pollen

**Deeltjesfilter**  
Deeltje/pollen

**Filtr zwykły**  
Cząstki/pyłki

**Parçacık Filtresi**  
Parçacık/polen

**Угольный фильтр**  
Частицы/пыльца



**Combined filter with active carbon**

Particules/pollen + Harmful gases + Unpleasant odours

**Filtre combiné avec charbon actif**

Particules/pollen + Gaz nocifs + Odeurs désagréables

**Combinado con carbón activo**

Partículas/polen + Gases nocivos + Olores desagradables

**Combinato con carboni attivi**

Particelle/polline + Gas nocivi + Odori sgradevoli

**Combinado com carvão ativo**

Partículas/polen + Gases nocivos + Odores desagradáveis

**Kombifilter mit Aktivkohle**

Partikel/pollen + schädliche Gase + unangenehme Gerüche

**Gecombineerd filter met actieve koolstof**

Deeltje/pollen + Schadelijke gassen + Onaangename geuren

**Filtr przeciwpyłkowy z aktywnym węglem**

Cząstki/pyłki + Szkodliwe gazy + Nieprzyjemne zapachy

**Aktif karbonlu birleşik filtre**

Parçacık/polen + Zararlı gazlar + Kötü kokular

**Комбинированный фильтр  
с активированным углем**

Частицы/пыльца + Вредные газы + Неприятные запахи

## 33

Part numbers



### Polyphenol with active carbon

Particules/pollen + Harmful gases + Unpleasant odours + Allergen neutralization

### Polyphénol avec charbon actif

Particules/pollen + Gaz nocifs + Odeurs désagréables + Neutralisation des allergènes

### Polifenol con carbón activo

Partículas/polen + Gases nocivos + Olores desagradables + Neutralización de alérgenos

### Polifenoli con carboni attivi

Particelle/polline + Gas nocivi + Odori sgradevoli + Neutralizzazione degli allergeni

### Polifenol com carvão ativo

Partículas/polen + Gases nocivos + Odores desagradáveis + Neutralização de alergias

### Polyphenol mit Aktivkohle

Partikel/pollen + schädliche Gase + unangenehme Gerüche + Neutralisierung der Allergene

### Polyfenolfilter met actieve koolstof

Deeltje/pollen + Schadelijke gassen + Onaangename geuren + Neutraliseert Allergieën

### Polifenol z aktywnym węglem

Cząstki/pyłki + Szkodliwe gazy + Nieprzyjemne zapachy + Neutralizacja alergenów

### Aktif karbonlu Polifenol

Parçacık/polen + Zararlı gazlar + Kötü kokular + Alerji yapan maddelerin nötrleştirilmesi

### Полифенол с активированным углем

Частицы/пыльца + Вредные газы + Неприятные запахи + Нейтрализация действия аллергенов

# Multi-protection Air Quality

Concept to improve air quality in the cabin.

One of the most complete Cabin Air Filter ranges on the market combined with 2 purifying solutions.



Protects against:



Particles and pollution



Harmful gases



Unpleasant odours



Allergen neutralization



COMFORT

## FR Programme qualité de l'air.

Un concept pour améliorer la qualité de l'air dans l'habitacle: l'une des gammes les plus complètes de filtres habitacle disponible sur le marché combinant 2 solutions purifiantes.

**Protection contre:**

- Particules & pollution.
- Gaz nocifs.
- Odeurs désagréables.
- Allergènes.

## DE Multi-protection Air Quality Program.

Ein Konzept, um die Luftqualität zu verbessern: eines der komplettesten Sortimente im Bereich Innenraumluftfilter auf dem Markt.

**Schützt vor:**

- Partikel & Abgase.
- Schädliche Gase.
- Unangenehme Gerüche.
- Neutralisierung der Allergene.

## ES Programa de multiprotección para la Calidad de aire.

Un concepto para mejorar la calidad del aire en el habitáculo: una de las gamas de filtros de habitáculo más competas del mercado combinada con 2 soluciones de purificación.

**Protección contra:**

- Partículas & contaminación.
- Gases nocivos.
- Olores desagradable.
- Neutralización de alérgenos.

## PT Programa multi-proteção para a qualidade do ar.

Um conceito para melhorar a qualidade do ar no habitáculo: uma das gamas mais completas de filtros de habitáculo do mercado combinada com 2 soluções de purificação.

**Proteção contra:**

- Partículas & contaminação.
- Gases nocivos.
- Cheiros desagradáveis.
- Neutralização de alérgenos.

## IT Programma di multi-protezione della qualità dell'aria.

Un concetto per migliorare la qualità dell'aria nell'abitacolo: una delle più complete gamme di Filtri per abitacolo sul mercato che combina due soluzioni di purificazione dell'aria.

**Protegge da:**

- Particelle & inquinamento.
- Gas nocivi.
- Odori sgradevoli.
- Neutralizzazione allergeni.

## NL Programma luchtzuiveringsproducten met meervoudige bescherming.

Een concept dat de luchtkwaliteit in het interieur verbetert: een van de meest complete interieurfilterprogramma's op de markt, gecombineerd met 2 luchtzuiveringstechnologieën.

**Beschermt tegen:**

- Roetdeeltjes & Uitlaatgassen.
- Schadelijke gassen.
- Onaangename geuren.
- Hyposensibilisati.

# program



**PROTECT**



**SUPREME**

## PL Program Valeo - Jakości Powietrza.

Koncepcja poprawy jakości powietrza w kabinie: jedna z najbardziej kompletnych gam filtrów kabinowych na rynku w połączeniu ze środkami do czyszczenia klimatyzacji i powietrza w kabinie.

### Chroni przed:

- Cząsteczkami & zanieczyszczeniami.
- Szkodliwymi gazami.
- Nieprzyjemnymi zapachami
- Neutralizuje alergeny.

## RU Комплексное предложение по очистке воздуха от Valeo.

Уникальная концепция для улучшения качества воздуха в салоне: широкий ассортимент салонных воздушных фильтров, дополненный двумя позициями очищающих жидкостей.

### Защищает от:

- Микрочастиц & загрязнений.

- Вредоносных газов.
- Неприятных запахов.
- Нейтрализует аллергены.

## CZ Ochrana kvality vzduchu v kabině.

Koncept ke zlepšení kvality ovzduší v kabině: nejkomplesnější nabídka pylových filtrů na trhu a dvě formy čištění.

### Pro:

- Částice & Spaliny.
- Škodlivé plyny.
- Nepříjemnými zápachy.
- Neutralizace alergenů.

## TR Çoklu koruma içeren Hava Kalitesi programı.

Araç içi hava kalitesini mükemmelleştirmek için eşsiz çözümler: Eksiksiz kabin hava filtre serisi ve üstün özellikli iki arındırıcı sunumu.

### Geniş koruma:

- Parçacıklar & Kirlilik.
- Zararlı gazlar.
- Kötü kokular.
- Alerji yapan maddelerin nőtürleştirilmesi.

## GR Πρόγραμμα πολύ-προστασίας Ποιότητας Αέρα.

Ενα μοναδικό σχέδιο βελτίωσης της ποιότητας αέρα εντός της καμπίνας: μία από τις πιο ολοκληρωμένες σειρές Φίλτρων Καμπίνας στην αγορά, που συνδυάζει 2 λύσεις καθαρισμού.

### προστατεύει ενάντια:

- Σωματίδια & Ρύπανση.
- Επιβλαβή αέρια.
- Δυσάρεστες οσμές.
- Εξουδετέρωση των αλλεργιογόνων.

# Multi-protection Air Quality

## Allergen neutralization.

To protect against entrance of the inhalation allergen into the cabin.



### FR Programme multi-protection sur la qualité de l'air.

**Neutralisation des allergènes.**  
Pour protéger contre l'entrée des pneumallergènes dans l'habitacle.

#### ClimFilter™ Supreme

- Une solution combinant les avantages du charbon actif et du polyphénol (**neutralisation des allergènes**).
- Couverture de la gamme ClimFilter™ Supreme: 90 millions de véhicules en Europe.

### DE Multi-protection Air Quality Programm.

**Neutralisierung der Allergene.** Schützt vor Gelangen des Allergens in den Fahrzeuginnenraum.

#### ClimFilter™ Supreme

- Eine Lösung, welche die Vorteile von Aktivkohle und Polyphenol-Beschichtung (**dient der Neutralisation von Allergene**) verbindet.
- Die gesamte ClimFilter™ Supreme Produktpalette deckt: 90 Millionen Fahrzeuge in Europa ab.

### ES Programa de multiprotección para la Calidad de aire.

**Neutralización de alérgenos.**  
Para proteger contra entrada del alérgeno al interior del habitáculo.

### PT Programa multi-proteção para a qualidade do ar.

**Neutralização de alergias.**  
Para proteger contra entrada de alérgeno no interior do habitáculo.

#### ClimFilter™ Supreme

- Uma solução que combina os benefícios do carvão activo e uma capa de polifenol (**neutralização de alérgenos**).
- Cobertura da gama ClimFilter™ Supreme: 90 milhões de veículos na Europa.

### ClimFilter™ Supreme

- Una solución que combina los beneficios del carbón activo y una capa de polifenol (**neutralización de alérgenos**).
- Cobertura de la gama ClimFilter™ Supreme: 90 millones de vehículos en Europa.

# program

## ClimFilter™ Supreme

A solution which combines the advantages of active carbon and polyphenol coating (**allergen neutralization**).

Total ClimFilter™ Supreme range covering:  
90 million vehicles in Europe.

### IT Programma di multi-protezione della qualità dell'aria.

Neutralizzazione degli allergeni. Protegge da ingresso dell'allergene da inalazione nell'abitacolo.

#### ClimFilter™ Supreme

- Una soluzione che combina i vantaggi del carbone attivo e i polifenoli (**neutralizzazione degli allergeni**).
- Gamma completa ClimFilter™ che copre: 90 milioni di veicoli in Europa.

### NL Programma luchtzuiverings-producten met meervoudige bescherming.

Neutraliseert Allergieën. Beschermt tegen buitenlucht met allergenen stroomt het interieur binnenw.

#### ClimFilter™ Supreme

- Een oplossing die de voordelen van actieve koolstof en een polyphenol coating (**neutralisatie van allergenen**) combineert.
- Het volledige ClimFilter™ Supreme programma dekt 90 miljoen voertuigen in Europa.

### PL Program Valeo - Jakość Powietrza.

Neutralizacja alergenów. Chroni przed wnikaniem wziewnych alergenów do kabiny pojazdu.

### ClimFilter™ Supreme

- Rozwiązanie które łączy zalety stosowania aktywnego węgla i polifenolu (**neutralizacja alergenów**).
- Całkowite pokrycie rynku przez ClimFilter™ Supreme: 90 milionów pojazdów w Europie.

### RU Комплексное предложение по очистке воздуха от Valeo.

Нейтрализация действия аллергенов. Защищает от попадания аллергенов в салон.

#### ClimFilter™ Supreme

- Уникальное запатентованное решение Valeo сочетает преимущества активированного угля и полифенольного покрытия (**нейтрализация аллергенов**).
- Весь ассортимент ClimFilter™ Supreme покрывает 90 миллионов транспортных средств в Европе.

### CZ Ochrana kvality vzduchu v kabině.

Neutralizace alergenů Ochrana proti vniknutí alergenů do kabiny.

#### ClimFilter™ Supreme

- Řešení, které kombinuje výhody aktivního uhlí s polyfenolovou vrstvou (**neutralizace alergenů**).
- ClimFilter™ Supreme pokrývá 90 milionů vozů v Evropě.

### TR Çoklu koruma içeren Hava Kalitesi programı.

Alerji yapan maddelerin nütürleştirilmesi. Geniş koruma Solunabilen alerjenlerin kabine girişi.

#### ClimFilter™ Supreme

- Valeo patentli alerji yapan maddelerin nütürleştirilmesini sağlayan aktif karbon ve polifenol korumalı eşsiz çözüm.
- ClimFilter™ Supreme ürün serisi Avrupa'da 90 milyon aracı kapsamaktadır.

### GR Πρόγραμμα πολύ-προστασίας Ποιότητας Αέρα.

#### Εξουδετέρωση αλλεργιογόνων.

Προστατεύει ενάντια είσοδο του αλλεργιογόνου από την καμπίνα.

#### ClimFilter™ Supreme

- Μια μοναδική πατενταρισμένη λύση της Valeo που συνδυάζει τα πλεονεκτήματα του ενεργού άνθρακα και του στρώματος πολυφαινόλης (**εξουδετέρωση αλλεργιογόνων**).
- Η πλήρης σειρά ClimFilter™ Supreme καλύπτει: 90 εκατομμύρια οχήματα στην Ευρώπη.

# Multi-protection Air Quality

## 2 purifying solutions.

To protect against bacteria and unpleasant odours.

Conform to: EN1040, EN1275, EN1276, EN1650, EN13697.



To clean  
the A/C circuit



Valeo  
ref. 698984



To purify  
the cabin



Valeo  
ref. 698899

### FR Programme multi-protection sur la qualité de l'air.

#### 2 solutions purifiantes.

Pour protéger contre  
les bactéries et les odeurs  
désagréables:

- Pour nettoyer le circuit  
de climatisation.
- Pour purifier l'habitacle.
- Conforme aux normes :  
EN1040, EN1275, EN1276,  
EN1650, EN13697.

### DE Multi-protection Air Quality Programm.

#### 2 Reinigungslösungen.

Schützt vor Bakterien &  
unangenehmen Gerüchen:

- Zur Reinigung des  
Klimakreislaufs.
- Zur Reinigung des Innenraums.

- Adaptado a: EN1040, EN1275,  
EN1276, EN1650, EN13697.

### ES Programa de multiprotección para la Calidad de aire.

#### 2 soluciones de purificación.

Para proteger contra bacterias  
y malos olores:

- Para limpiar el circuito  
de climatización.
- Para purificar el habitáculo.
- Conforme a: EN1275, EN1276,  
EN1650, EN13697.

### PT Programa multi-protecção para a qualidade do ar.

#### 2 soluções de purificação.

Para proteger contra bactérias  
e maus odores:

- Para limpar o circuito de  
climatização.

- Para purificar o habitáculo.

- Conforme a: EN1275, EN1276,  
EN1650, EN13697.

### IT Programma di multi-protezione della qualità dell'aria.

Due soluzioni di purificazione  
dell'aria.

Sgradevoli e spiacevoli odori:

- Per pulire il circuito A/C.
- Per purificare l'abitacolo.
- Conforme a: EN1275, EN1276,  
EN1650, EN13697.

### NL Programma luchtzuiverings- producten met meervoudige bescherming.

2 luchtzuiveringstechnologieën.

Beschermt tegen bacteriën en  
onaangename geuren:



# program



- Reinigt het aircoircuit.
- Zuivert de interieurlucht.
- Voldoet aan: EN1040, EN1275, EN1276, EN1650, EN13697.

## PL Program Valeo - Jakość Powietrza.

**Dwa rodzaje preparatów czyszczących w celu ochrony przed bakteriami i nieprzyjemnymi zapachami:**

- Do czyszczenia układu klimatyzacji.
- Do czyszczenia powietrza w kabinie.
- Zgodny z: EN1040, EN1275, EN1276, EN1650, EN13697.

## RU Комплексное предложение по очистке воздуха от Valeo.

**Два решения по очистке воздуха от бактерий и неприятного запаха:**

- Очищает и освежает воздух, уничтожает неприятные запахи в салоне Вашего автомобиля за 15 минут.
- Очищает воздух в салоне.
- Соответствуют: EN1275, EN1276, EN1650, EN13697.

## CZ Ochrana kvality vzduchu v kabině.

**Dvě formy čištění.**

- Ochranu proti bakteriím i nepříjemnému zápachu:
- Čištění obvodu klimatizace.
  - Čištění kabiny vozidla.
  - V souladu s: EN1040, EN1275, EN1276, EN1650, EN13697.

## TR Çoklu koruma içeren Hava Kalitesi programı.

**İki arındırıcı sunumu.**

**Bakteri ve kötü kokulara karşı güçlü etki:**

- Klima çevriminde üstün temizlik.
- Arındırılmış kabin içi atmosfer.
- Uyumluluk: EN1275, EN1276, EN1650, EN13697.

## GR Πρόγραμμα πολύπροστασίας Ποιότητας Αέρα.

**2 λύσεις καθαρισμού.**

**Προστατεύει ενάντια στα βακτήρια & στις δυσάρεστες οσμές:**

- Καθαρίζει το κύκλωμα κλιματισμού.
- Καθαρίζει την καμπίνα.
- Σύμφωνα με: EN1275, EN1276, EN1650, EN13697.

# Valeo know-how

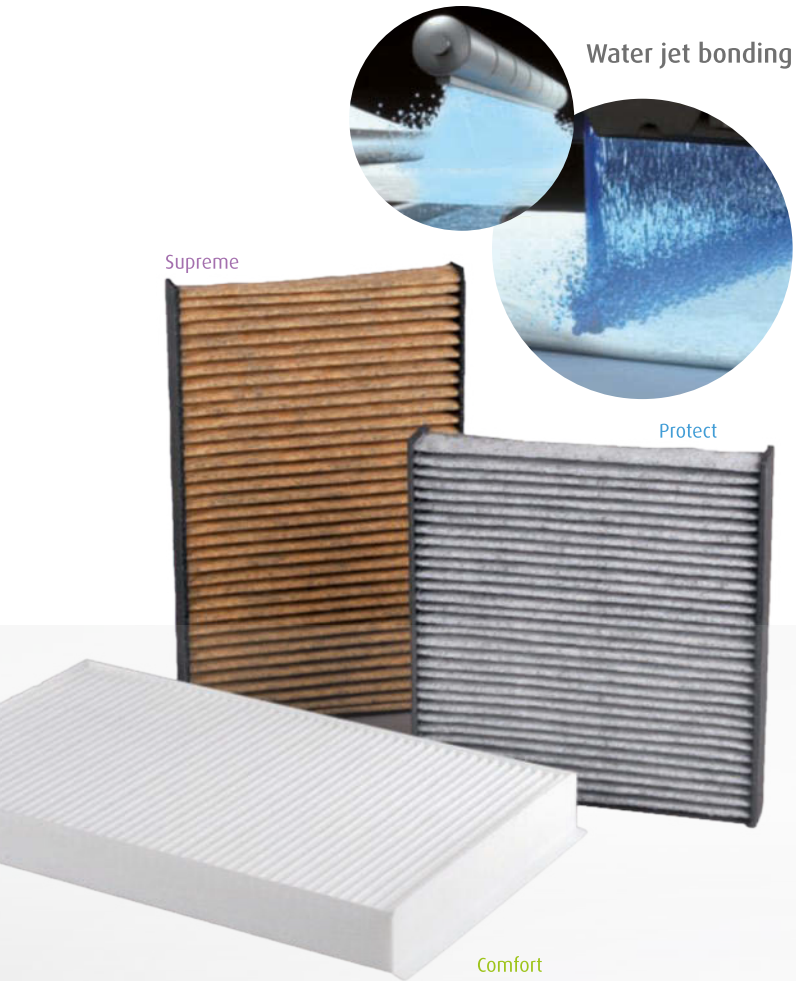

- Manufacturing high quality media.
- A non chemical Valeo specific assembling process, the water jet bonding, (the media layers are assembled under high water pressure), with 2 advantages:
  - Air flow disturbance reduction,
  - Environmental friendly.
- High filtration precision without reducing the air flow.
- Adopted by car manufacturers (OE supplier).

#### **FR** Le savoir-faire Valeo

- Un média de haute qualité fabriqué dans notre usine.
- Un procédé d'assemblage non chimique propre à Valeo, le « collage par jet d'eau » (les couches de médias sont assemblées grâce à de l'eau sous haute pression), ayant 2 avantages :
  - Réduction de la perturbation dans le flux de l'air,
  - Respect de l'environnement.
- Filtration haute précision sans réduction du flux d'air.
- Qualité Premium adoptée par les constructeurs.

#### **DE** Valeo Know-how

- Hochqualitatives Filtermaterial aus eigener Herstellung.
- Ein nicht chemischer Valeo spezifischer Prozess, die Wasserstrahlbindung (die Filtermedien werden unter hohem Wasserdruck verbunden), der zwei Vorteile hat:
  - Reduktion von Störungen des Luftflusses,
  - Umweltfreundlich.
- Hohe Filterpräzision ohne Verringerung der Luftdurchlässigkeit.
- Akzeptiert durch Fahrzeughersteller Premium Qualität.

#### **SP** El saber hacer de Valeo

- Medio filtrante de alta calidad y de producción propia.
- Un exclusivo proceso de fabricación libre de químicos (las capas de medio filtrante son ensambladas mediante la proyección de agua a alta presión), con 2 ventajas:
  - Reducción de ruido en el flujo de aire,
  - Respetuoso al medio ambiente.
- Alta precisión de filtrado sin reducir el flujo de aire.
- Calidad Premium adoptado por los fabricantes de automóviles.

#### **PT** O know-how da Valeo

- Meio filtrante de alta qualidade e de produção própria.
- Um processo de fabricação exclusivo livre de produtos químicos (camadas do meio filtrante são montadas através da projecção de água sob alta pressão), com 2 vantagens:
  - Redução de ruído de fluxo de ar,
  - Respeitando o meio ambiente.
- Alta precisão de filtrado sem reduzir o fluxo de ar.
- Prémio de Qualidade adotado pelo fabricante de automóveis.

#### **IT** Esperienza Valeo

- Produzione interna di alta qualità della media.
- Uno specifico processo Valeo di assemblaggio non chimico, il getto d'acqua legante (gli strati di carta sono uniti con un getto d'acqua ad alta pressione), con 2 vantaggi :
  - Riduzione del disturbo del flusso d'aria,
  - Rispettoso dell'ambiente.
- Elevata precisione di filtrazione senza ridurre il flusso dell'aria.
- Qualità superiore adottato dai principali costruttori.

#### **NL** Valeo knowhow

- Hoogwaardig filtermateriaal uit eigen productie.
- Een niet-chemisch Valeo specifiek assemblageproces «Water jet bonding» (waarbij de verschillende lagen worden geassembleerd onder hoge druk van water), met 2 voordelen:
  - Beter doorstroming van lucht,
  - Milieuvriendelijk.
- Hoge filterprecisie; hindert de luchtstroom niet.
- Hoogwaardige kwaliteit, overgenomen door autofabrikanten.

#### PL Specjalizacja Valeo

- Produkcja wysokiej jakości mediów filtracyjnych.
- Niechemiczny proces łączenia wkładów filtracyjnych - klejenie za pomocą strumienia wody (media filtracyjne są łączone pod wysokim ciśnieniem wody) ma dwie główne zalety:
  - Redukcja oporów przepływu powietrza,
  - Przyjazny dla środowiska.
- Wysoka dokładność filtracji bez zmniejszenia przepływu powietrza.
- Jakość premium doceniana przez producentów samochodów.

#### RU Ноу-хау Валео

- Высококачественное производство.
- Нехимический процесс запрессовки волокон от VALEO - обработка фильтрующего материала водой под давлением - имеет 2 преимущества:
  - Снижение помех при проходимости воздушного потока,
  - Экологическая безопасность.
- Высокий уровень фильтрации без сокращения воздушного потока.
- Премиум качество утверждено автопроизводителями.

#### CZ Valeo know - how

- Vlastní výroba vysoce kvalitní filtrační látky.
- Speciální výrobní proces Valeo bez použití chemikálií, spojování vodním paprskem, (vrstvy filtračního média jsou spojeny vysokým tlakem vody) s 2 výhodami:
  - Snížení omezení průtoku vzduchu,
  - Šetrnost k životnímu prostředí.
- Vysoká přesnost filtrace bez snížení průtoku vzduchu.
- Prémiová kvalita přijaté výrobcí automobilů.

#### RO Experiența Valeo

- Element filtrant de calitate ridicată.
- Proces de producție non-chimic, specific Valeo, prin lipire cu jet de apă, care oferă 2 avantaje:
  - Reduce perturbațiile fluxului de aer,
  - Protejează mediul inconjurător.
- Precizie ridicată de filtrare fără reducerea debitului de aer.
- Furnizor de primă echipare (O.E.).

#### TU Valeo bilgi birikimi

- Yüksek kalite filtre elemanı.
- Su jeti bağlantısı, Valeo'ya özel kimyasal olmayan birleştirme süreci (medya tabakaları yüksek su basıncı altında toplanır), iki avantajı vardır:
  - Hava akışındaki rahatsızlığı azaltma,
  - Çevre dostu.
- Hava akış hızını düşürmeden yüksek filtreleme.
- Kabul edilen araç üreticileri tarafından yüksek kalite.

#### GR Τεχνονγνωσία Valeo

- Κατασκευή μέσων υψηλής ποιότητας.
- Μια ειδική διαδικασία συναρμολόγησης Valeo, χωρίς χρήση χημικών, συγκόλληση με εκτόξευση νερού, (τα στρώματα των μέσων ενημέρωσης συναρμολογούνται υπό υψηλή πίεση νερού), με 2 πλεονεκτήματα:
  - μείωση της διαταραχής της ροής του αέρα,
  - φιλικό προς το περιβάλλον.
- Υψηλή ακρίβεια φιλτραρίσματος χωρίς μείωση της ροής του αέρα.
- Ανώτερη Ποιότητα εγκεκριμένη από κατασκευαστές αυτοκινήτων.



## GENERAL SYMBOLS & ABBREVIATIONS

Vehicle  
Véhicule  
Fahrzeug  
Vehículo  
Viatura  
Veicolo  
Voertuig  
Pojazd  
Автомобиль  
Vozidlo  
Vozilo  
Gépjármű  
Vehicul  
Превозно средство  
Araç  
**Οχημα**



Vehicle  
Véhicule  
Fahrzeug  
Vehículo  
Viatura  
Veicolo  
Voertuig  
Pojazd  
Автомобиль  
Vozidlo  
Vozilo  
Gépjármű  
Vehicul  
Превозно средство  
Araç  
**Οχημα**



From the Chasis N°  
A partir du Châssis N°  
Ab Fahrgestellnummer  
A partir del N° de chasis ->  
A partir de n° de chasis  
A partire dal telaio N°  
Vanaf chassisnummer  
Od numeru nadwozia  
От шасси №  
Od čísla karoserie  
Od broja karoserije  
Alvázszámától  
Începând cu Şasiul Nr.  
От номер на рама  
... şasi numarásından sonra  
Από σασί ΝΓ



► N°

Until chasis N°  
Jusqu'au Châssis N°  
Bis Fahrgestellnummer  
-> Hasta N° de chasis  
Até n° de chasis  
Fino al telaio N°  
Tot chassisnummer  
Do numeru nadwozia  
До шасси №  
Do čísla karoserie  
Do broja karoserije  
Alvázszámig  
Până la Şasiul Nr.  
До номер на рама  
... şasi numarásina kadar  
μέχρι σασί ΝΓ



N° ►

Images  
Abbildungen  
Foto/esquemas  
Foto/Esquema  
Immagini  
Afb.  
Ilustracja  
Рисунки  
Zobrazení  
Slike  
Képek  
Imagini  
Снимки  
Resim  
ικόνες



## AC

With  
Avec  
Mit  
Con  
Com  
Con  
Met  
Z  
c  
S  
sa  
Van  
Cu  
C  
Birlikte  
µε

+

Without  
Sans  
Ohne  
Sin  
Sim  
Senza  
Zonder  
Bez  
без  
Bez  
bez  
Nincs  
Fără  
Без  
Ayn olarak  
χωρίς

-

M+

Manual air conditioning  
Climatisation manuelle  
Manuelle Klimaanlage  
Climatización manual  
Climatização manual  
AC manuale  
Manuele Klimaatregeling  
Klimatyzacja manualna  
Кондиционер ручного  
управления  
Mechanická klimatizace  
Ručni klima uređaj  
Manuális klíma  
Climatizare manuală  
Климатик  
Manuel klima  
Χειροκίνητος κλιματισμός

**A+**

Auto air conditioning  
 Climatisation automatique  
 Klimaautomatik  
 Climatización automática  
 Climatização automática  
 AC automatica  
 Elektronische Klimaatregeling  
 Klimatyzacja automatyczna  
 Климат контроль  
 Automatická klimatizace  
 Automatski klima uređaj  
 Automata klima  
 Climatizare automată  
 Климатроник  
 Otomatik klima  
 Αυτόματος κλιματισμός

**PA**

Particle Filter  
 Filtre à particules  
 Partikelfilter  
 Filtro de partículas  
 Filtro de partículas  
 filtro particellare  
 Deeltjesfilter  
 Filtr przeciwpyłkowy  
 Угольный фильтр  
 Částicový filtr  
 Filter čestica  
 Részecske szűrő  
 Filtru de particule  
 Поленов фильтр  
 Parçacık filtresi  
 φίλτρα σωματιδίων

## DRIVE SIDE

Right Hand Drive  
 Conduite à droite  
 Rechtslenker  
 Conducción a Derechas  
 Condução a direita  
 Guida a destra  
 Rechts gestuurd  
 Kierownica z prawej strony  
 Автомобили с рулем справа  
 Volant v pravo  
 volan desno  
 Jobbkormányos jármű  
 Conducere pe dreapta  
 С дясна кормилна уредба  
 Sağdan direksiyon  
 Δεξιότιμονο



Left Hand Drive  
 Conduite à gauche  
 Linkslenker  
 Circulación a Izquierdas  
 Condução a esquerda  
 Guida a sinistra  
 Links gestuurd  
 Kierownica z lewej strony  
 Автомобили с рулем слева  
 Volant v levo  
 volan lijevo  
 Balkormányos jármű  
 Conducere pe stânga  
 С лява кормилна уредба  
 Soldan direksiyon  
 ριστεροτίμονο



## TECHNOLOGY

Particle Filter  
 Filtre à particules  
 Partikelfilter  
 Filtro de partículas  
 Filtro de partículas  
 filtro particellare  
 Deeltjesfilter  
 Filtr przeciwpyłkowy  
 Угольный фильтр  
 Částicový filtr  
 Filter čestica  
 Részecske szűrő  
 Filtru de particule  
 Поленов фильтр  
 Parçacık filtresi  
 φίλτρα σωματιδίων

**PA****CA**

Combined with active carbon  
 Filtre combiné  
 Kombifilter mit Aktivkohle  
 Combinado con carbón activo  
 Combinado con carvão ativo  
 Combinato con carboni attivi  
 Gecombineerd filter met actieve koolstof  
 Filtr przeciwpyłkowy z aktywnym węglem  
 Комбинированный фильтр с активированным углем  
 Kombinovaný filtr s aktivním uhlím  
 Kombinirani filter s aktivnim ugljenom  
 Aktiv szénrel kombinált  
 Filtru combinat cu carbon activ  
 Фильтр с активен въглен  
 Aktif karbonlu birleşik filtre  
 φίλτρα ενεργού άνθρακα



**PCA**

Polyphenol with active carbon  
 Polyphénol avec charbon actif  
 Polyphenol mit Aktivkohle  
 Polifenol con carbón activo  
 Polifenol com carvão ativo  
 Polifenoli con carboni attivi  
 Polyfenolfilter met actieve koolstof  
 Polifenol z aktywnym węglem  
 Полифенол с активированным углем  
 Polyfenol s aktivním uhlím  
 Polifenol s aktivnim ugljenom  
 Polyphenol aktiv szénrel  
 Polifenol cu carbon activ  
 Aktif karbonlu Polifenol  
 Πολυφαινόλη με ενεργό άνθρακα

## APPLICATION DETAILS

100% Activated Carbon Filter  
 100% Filtre à Charbon Actif  
 100% Aktivkohlefilter  
 100% Filtro de Carbón Activo  
 100% filtro de carbaio activo  
 100% Filtro a carbone attivo  
 100% Aktieve koolstoffilter  
 Filtr z aktywnym węglem  
 Фильтр со 100% активированным углем  
 Filtr se 100% aktivním uhlíkem  
 Filter sa 100% aktivnim ugljikom  
 100% aktiv szenes szűrő  
 100% Filtru cu cărbune activ  
 Фильтр 100% активен въглен  
 100% Aktif karbon Filtre  
 Φίλτρο 100% ενεργού άνθρακα

**100% ACT. CARBON**

Ultrafine	Ultrafine Ultrafin Ultrafein Ultrafina Ultrafina Ultrafine Ultrafijn Ultrafine Задержки Сверхмелких Частиц Ultrajemná Ultra Fino Ultrafinom Ultrafin Yüksek Filtreleme Υπερβολικά Λεπτό	KIT	Kit kit Kit Kit Kit kit Set Komplet комплект Sada kit Készlet Kit Комплект Kit Σετ
(-)	Except Sauf Ohne Sin Sim Ad eccezione d Zonder Z wyjątkiem Кроме S vyjimkou Osim Kivéve Fără С исключение Hariç Εκτός α		
Prefilter	Prefilter Pré-filtre Vorfilter Pre-filtro Pré-Filtro Pre-filtro Voorfilter Filtr wstępny предфильтр S předfiltrováním Előszűrővel Prefiltru Предфилтър Ön filtre Προφίλτρο	Quick 	Quick ≤ 15 min. Rapide ≤ 15 min. schnell ≤ 15 Min. Rápido ≤ 15 min. Rápido ≤ 15 min. Veloce ≤ 15 min. Snel ≤ 15 min. Krótki ≤ 15 min. Быстрое ≤ 15 мин. Rychlá ≤ 15 min. brzo ≤ 15 min. Gyors ≤ 15 perc. Rapid ≤ 15 min. 15 dakikadan çabuk Μικρός ≤ 15 λεπτά
		Medium 	Medium 16-25 min. Moyen 16-25 min. mittel 16-25 Min. Medio 16-25 min. Medio 16-25 min. Medio 16-25 min. Gemiddeld 16-25 min. Średni 16-25 min. Среднее 16-25 мин. Střední 16 - 25 min. srednje 16-25 min. Közepes 16-25 perc. Mediu 16-25 min. 16-25 dakika arası Μεσαίος 16-25 λεπτά
Without plastic frame	Without plastic frame Sans cadre plastique Ohne Kunststoffrahmen Sin marco de plástico Sem marca de plástico Senza cornice in plastica Zonder plastic frame Bez obudowy plastikowej без пластикового элемента Bez plastového rámcu Műanyag keret nélkül Fara cadru de plastic без пластмасова рамка Plastik çerçevesiz Χωρίς πλαίσιο	Long 	Long ≥ 26 min. Long ≥ 26 min. lange ≥ 26 Min. Largo ≥ 26 min. Longo ≥ 26 min. Lungo ≥ 26 min. Langzaam ≥ 26 min. Długi ≥ 26 min. Долгое ≥ 26 мин. Dlouhá ≥ 26 min. dugo ≥ 26 min. Hosszú ≥ 26 perc Lung ≥ 26 min. 26 dakikadan fazla Μεγάλος ≥ 26 λεπτά

## FITTING TIME





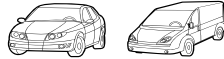
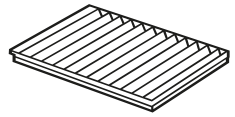

**NEW** New Nouveau Neu Nuevo Novo Nuovo Nieuw Nowy **Новый** Nové Nou Nouă Нов Yeni 11

 → **Valeo** 13

 53

 → **Valeo** 57

**Valeo** →  139

 → **Valeo** 159

 → **Valeo** 170



**NEW** New Nouveau Neu Nuevo Novo Nuovo Nieuw Nowy **Новый** Nové Nou Nouă Нов Yeni 199

 → **Valeo** 201

ROLL MEDIA  207

 → **Valeo** 209

 VT01 VT02 VT03 VT04 VT05 VT06 221

**Valeo** →  229

 → **Valeo** 232

 → **Valeo** 234

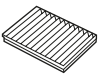

# EN

## Function

The cabin air filter prevents harmful pollutants from the surrounding air entering the cockpit via the air-conditioning and ventilation shafts.

There are 3 different technologies of cabin air filters:

- particle filters for solid pollutants: dust, tar, pollen..
- combined filters for solid pollutants + other pollution: exhaust fumes, bad odours...
- polyphenol filters for allergen (pollen) neutralization, solid pollutants, harmful gases, bad odours

## Replacement

**Essential for safety and comfort as well as the efficiency of the air-conditioning system, cabin air filters must be replaced regularly - every year or every 15.000 km (10000 miles).**

The Cabin air filter can be located near the air entry or the evaporator. Typical problems with cabin air filters

- Lack of air blown into the cabin (less air-conditioning, slower defogging...)
- Allergic reactions (sneezing, irritations...)
- Poor air quality in the cabin (bad odours, pollution...)

## Repair recommendations

- Choose the right cabin air filter according to the vehicle.
- For the highest driver & passengers protection the polyphenol filter is recommended.
- Specific fitting instructions are included with all Valeo cabin air filters to promote efficient replacement.
- Valeo's recommendation for healthier air in the vehicle is to use an A/C cleaning and purifying

# FR

## Fonction

Le filtre d'habitacle empêche les polluants nocifs de l'air extérieur d'entrer dans l'habitacle du véhicule par les conduits de ventilation et de climatisation.

Il existe 3 technologies de filtres d'habitacle :

- les filtres à particule contre les polluants de type solide (poussières, suies, pollens...)
- les filtres combinés qui cumulent la fonction antiparticule à une fonction antipollution en protégeant des gaz d'échappement nocifs et des odeurs ambiantes désagréables...
- les filtres polyphénol pour neutralisation des allergènes, polluants solides, gaz nocifs, mauvaises odeurs

## Remplacement

**Indispensable pour la sécurité et le confort ainsi que pour le bon fonctionnement de la climatisation, le filtre d'habitacle doit être remplacé tous les ans ou tous les 15.000 km minimum.**

Il est situé soit près de la grille d'auvent, soit près de l'évaporateur. Problèmes les plus fréquents liés au filtre d'habitacle :

- Manque d'air pulsé dans l'habitacle (moins de froid, mauvais déssembuage...)
- Réactions allergiques dans l'habitacle (éternuements, irritations...)
- Mauvaise qualité de l'air dans l'habitacle (odeurs, pollution...)

## Choisissez le filtre habitacle pour votre véhicule.

Le filtre polyphénol est recommandé pour une protection maximale des conducteurs et passagers.

Optimisez votre prestation en vous référant aux notices de montage livrées avec les filtres d'habitacle Valeo.

Pour une qualité de l'air optimale, pensez à utiliser un nettoyeur purifiant du circuit de climatisation à chaque remplacement du filtre d'habitacle (Climpur Valeo).

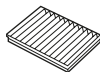

# DE

## Funktion

Innenraumluftfilter verhindert das Eindringen von Schadstoffen aus der Umgebungsluft in den Fahrzeuginnenraum durch die Lüftungs- und Klimatisierungsleitungen.

Drei verschiedene Innenraumluftfilter-Technologien stehen zur Verfügung:

- Partikelfilter für Schadstoffe in fester Form: Staub, Ruß, Pollen
- Kombifilter für feste und sonstige Schadstoffe (Abgase, unangenehme Gerüche usw.)
- Filter mit Polyphenol zur Neutralisierung von Allergenen, festen Schadstoffen, schädlichen Gasen, schlechten Gerüchen

## Austausch

**Innenraumluftfilter leisten einen unverzichtbaren Beitrag zur Sicherheit, zum Komfort und zur Leistungsfähigkeit des Klimasystems und müssen folglich regelmäßig ausgewechselt werden (einmal im Jahr oder alle 15.000 km).**

Der Innenraumfilter befindet sich in der Nähe des Lufteintritts oder des Verdampfers. Häufige Probleme mit Innenraumluftfiltern:

- Es wird zu wenig Luft in den Innenraum geblasen (unzureichende Leistung der Klimaanlage, die Scheiben bleiben beschlagen usw.)
- Allergiereaktionen der Fahrzeuginsassen (Niesen, Reizungen usw.)
- Schlechte Luftqualität im Innenraum (unangenehme Gerüche, Schadstoffe usw.)

## Reparaturempfehlungen

- Wählen Sie den passenden Innenraumluftfilter für Ihr Fahrzeug aus.
- Für den höchsten Schutz für Fahrer und Insassen wird der Polyphenolfilter empfohlen.
- Alle Innenraumluftfilter von Valeo werden mit präzisen Montageanweisungen geliefert, die den fachgerechten Einbau garantieren. Valeo empfiehlt bei jedem Wechsel des Innenraumluftfilters eine Desinfektion des Lüftungskreislaufs mit Climpur.

# ES

## Función

El filtro de habitáculo impide que los contaminantes nocivos del exterior entren en el habitáculo del vehículo por los conductos de ventilación y climatización.

Existen 3 tecnologías de filtros de habitáculo:

- los filtros de partículas para los contaminantes sólidos (polvo, alquitrán, polen, etc.)
- los filtros combinados para las partículas sólidas y otros contaminantes (gases de escape, olores desagradables, etc.)
- filtros de polifenol para la neutralización de alérgenos, contaminantes sólidos, gases nocivos, malos olores

## Sustitución

**Indispensable para la seguridad y el confort, así como para el buen funcionamiento de la climatización, el filtro de habitáculo debe sustituirse regularmente, cada año o cada 15.000 km.**

Este filtro puede colocarse junto a la entrada de aire o al evaporador. Problemas más frecuentes relativos al filtro de habitáculo:

- Falta de aire impulsado en el habitáculo (menos frío, antivaho más lento, etc.)
- Reacciones alérgicas (estornudos, irritaciones, etc.)
- Mala calidad del aire en el habitáculo (malos olores, contaminación, etc.)

## Recomendaciones para la reparación

- Elija el filtro de habitáculo adecuado para su vehículo
- El filtro de polifenol es aconsejable para una máxima protección de conductor y ocupantes
- Los filtros de habitáculo Valeo se entregan con instrucciones de instalación para facilitar una sustitución eficaz.
- Para una calidad óptima del aire, Valeo recomienda aplicar un tratamiento de limpieza y/o purificación del circuito de climatización cada vez que se reemplace el filtro de habitáculo (Climpur Valeo).



# PT

## Função

O filtro de habitáculo previne que os poluentes nocivos do ar entrem no habitáculo através do ar-condicionado e condutas de ventilação diferentes ações.

Há 3 tecnologias de filtros de habitáculo:

- filtros de partículas para poluentes sólidos: pó, polen, ...
- filtros combinados para poluentes sólidos + outra poluição: gases de escape, maus cheiros...
- filtros de polifenol para a neutralização de alergias, contaminantes sólidos, gases nocivos, maus odores

## Substituição

**Essencial pela segurança e conforto bem como para a eficiência do ar-condicionado, os filtros de habitáculo devem ser substituídos regularmente - todos os anos ou a cada 15.000 km.**

O filtro de habitáculo encontra-se perto da entrada do ar ou do evaporador. Problemas comuns com os filtros de habitáculo:

- Falta de fluxo de ar para o habitáculo (menos ar condicionado, desembaciamento mais lento...)
- Reações alérgicas (espirros, irritações...)
- Fraca qualidade do ar no habitáculo (maus cheiros, poluição...)

## Recomendações de reparação

- Escolha o filtro de habitáculo adequado para o seu veículo
- O filtro de polifenol é aconselhável para uma máxima protecção do condutor e ocupantes
- Instruções de montagem específicas estão incluídas em todos os filtros de habitáculo Valeo promovendo uma substituição eficiente.
- A recomendação da Valeo para um ar mais saudável dentro do habitáculo, é a utilização de produtos de purificação e limpeza Valeo quando substitui um filtro de habitáculo (Climpur da Valeo).

# IT

## Funzione

Il filtro abitacolo previene che gli inquinanti nocivi dell'aria esterna entrino nell'abitacolo del veicolo attraverso i condotti del sistema di aerazione e di climatizzazione. Esistono 3 diverse tecnologie di filtri abitacolo:

i filtri particellari, contro gli inquinanti di tipo solido: polveri, catrame, polline....

i filtri a carboni attivi, che uniscono la funzione antiparticellare ad una funzione antinquinante per trattenere i gas di scarico, gli odori sgradevoli...

i filtri ai polifenoli per la neutralizzazione degli allergeni (polline), inquinanti solidi, gas nocivi, cattivi odori

## Sostituzione

**Indispensabile per la sicurezza e il comfort, oltre che per il corretto funzionamento dell'impianto di aria condizionata, il filtro abitacolo deve essere sostituito una volta l'anno oppure almeno ogni 15.000 km.**

Il filtro abitacolo è situato vicino alla presa aria o all'evaporatore.

Problemi più frequenti relativi al filtro abitacolo:

- Aria insufficiente all'interno dell'abitacolo (scarso raffreddamento, disappannamento lento...)
- Reazioni allergiche, riniti, irritazioni...
- Cattiva qualità dell'aria nell'abitacolo (odori sgradevoli, inquinamento...)

## Raccomandazioni Valeo per la riparazione

- Scegli il corretto filtro abitacolo per la tua auto.
- Il filtro ai polifenoli è consigliato per la massima protezione dei passeggeri.
- Tutti i filtri abitacolo Valeo vengono forniti insieme alle relative istruzioni di montaggio per garantire una sostituzione ottimale.
- Per un'aria più sana all'interno del veicolo, Valeo raccomanda di procedere alla pulizia e alla purificazione del circuito di aria condizionata ad ogni sostituzione del filtro abitacolo con Climpur® Valeo.

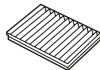

# NL

## Functie

De interieurfilter voorkomt dat schadelijke verontreinigende stoffen via de leidingen van de airconditioning en de ventilatie het interieur van het voertuig binnendringen.

Er zijn 3 verschillende technologieën interieurfilters:

- deeltjesfilters voor vaste verontreinigende stoffen: stof, teer, pollen.
- combinatiefilters voor vaste + niet-vaste verontreinigende stoffen: uitlaatgassen, onaangename geuren enz.
- polyfenolfilters voor allergieneutralisatie (pollen), vaste verontreinigende stoffen, schadelijke gassen, onaangename geuren.

## Vervanging

**Interieurfilters zijn belangrijk voor de veiligheid en het comfort, evenals voor de efficiënte werking van het airconditioningsysteem en moeten regelmatig worden vervangen - ieder jaar of na elke 15.000 km.**

De interieurfilter bevindt zich vlakbij de luchtinlaat van de verdamper.

Problemen die het meest voorkomen bij interieur luchtfilters :

- Er wordt te weinig lucht het interieur in geblazen (slechte werking van de airconditioning, wasem verdwijnt langzamer...)
- Allergische reacties (niezen, irritatie van de luchtwegen...)
- Slechte luchtkwaliteit in het interieur (onaangename geuren, verontreiniging enz.)

## Aanbevelingen bij de reparatie

- Kies het juiste interieurfilter, behorend bij het voertuig.
- Voor de hoogste bescherming van bestuurder en passagier wordt het polyfenolfilter geadviseerd.
- Bij alle Valeo interieurfilters zijn specifieke montage-instructies bijgesloten, zodat de filter zo efficiënt mogelijk vervangen kan worden.
- Voor optimale luchtkwaliteit in het voertuig adviseert Valeo om na iedere vervanging van de interieurfilter het airconditioning systeem een reinigings- en zuiveringsbehandeling te geven (Climpur Valeo).

# PL

## Funkcja

Filtr kabinowy zabezpiecza przed wnikaniem do wnętrza kabiny zewnętrznych szkodliwych zanieczyszczeń przez wloty systemu wentylacji i klimatyzacji.

Istnieją 3 różne technologie filtrów kabinowych.

- Filtry cząstek stałych chroni przed stałymi zanieczyszczeniami: kurzem i pyłkami.
- Filtr kombinowany chroni przed stałymi zanieczyszczeniami + zatrzymuje szkodliwe gazy i nieprzyjemne zapachy.
- Filtry z polifenolem neutralizujące alergeny (pyłki), wychytujące zanieczyszczenia stałe, szkodliwe gazy, nieprzyjemne zapachy.

## Wymiana filtra

**Dla zapewnienia bezpieczeństwa i komfortu jazdy jak również wydajności układu klimatyzacji niezwykle istotna jest regularna wymiana filtra kabinowego - co rok lub co 15.000 km (10.000 mil).**

Filtr kabinowy znajduje się przy nawiewie powietrza lub przy parowniku. Typowe problemy z filtrami kabinowymi.

- Niedostateczny nawiew powietrza do kabiny (osłabiona klimatyzacja, wolniejsze odparowywanie szyb)
- Reakcje alergiczne (kichanie, podrażnienia...)
- Niska jakość powietrza w kabinie (nieprzyjemne zapachy, zanieczyszczenia...)

## Zalecenia serwisowe

- Wybierz odpowiedni filtr kabinowy dopasowany do parametrów pojazdu.
- Dla najwyższej ochrony kierowcy i pasażerów zalecany jest filtr z polifenolem.
- Do zastosowań miejskich rekomendujemy kombinowany filtr węglowy dla zwiększenia komfortu kierowcy i pasażerów.
- Korzystaj z instrukcji montażu filtra Valeo dołączonej do każdego opakowania by efektywnie wymienić filtr kabinowy.
- Zgodnie z rekomendacją Valeo, by promować zdrowsze powietrze w kabinie pojazdu, stosuj środek czyszczący i odkażający system A/C (ClimPur™) przy każdej wymianie filtra a także środek czyszczący wnętrze kabiny (ClimSpray™).



# RU

## Функция

Салонные фильтры препятствуют проникновению в салон вредных веществ, пыли, грязи, запаха, а также способствуют очистке воздуха и кондиционированию вентиляционных патрубков.

Существует 3 технологии салонных фильтров:

- частичный фильтр, защищающий от твердых частиц: грязь, смолы, пыльца...
- угольный фильтр, защищающий от твердых частиц + других видов загрязнения: выхлопные газы, неприятные запахи...
- полифеноловые фильтры для нейтрализации действия аллергенов (полена), плотных загрязняющих частиц, вредных газов, неприятных запахов

## Замена

**Для безопасности и комфорта водителя, а также для эффективной работы системы кондиционирования, рекомендуется регулярно менять салонный фильтр (ежегодно, или каждые 15000 км)**

Салонный фильтр может находиться рядом с воздуховодом или испарителем

Типичные проблемы с салонными фильтрами

- Снижение потока воздуха в салон (ниже уровень кондиционирования, запотевание стекол)
- Аллергические реакции (чихание, слезоточивость...)
- Плохой воздух в салоне (неприятный запах, частицы пыли...)

## Рекомендации по замене

- подходящий фильтр в соответствии с параметрами Вашего автомобиля
- Для самой высокой степени защиты водителя и пассажиров рекомендуется использовать полифеноловый фильтр
- Специальные инструкции по установке прилагаются
- Valeo рекомендует использовать очиститель системы кондиционирования (ClimPur™) при каждой замене фильтра вместе с очистителем воздуха в салоне (ClimSpray™).

# CZ

## Funkce

Kabinový filtr zabraňuje pronikání škodlivin z ovzduší přes klimatizaci a ventilační otvory do kabiny vozu. Existují 3 různé technologie kabinových filtrů:

- filtry pevných částic - pro pevné znečišťující látky: prach, dehet, pyl.
- kombinované filtry (s aktivním uhlíkem) - pro pevné znečišťující látky + další znečištění: výfukové plyny, pachy...
- polyfenolové filtry pro neutralizaci alergenů (pyly), zachycení pevných částic, škodlivých plynů, zápachu

## Výměna

**Základním pravidlem pro bezpečnost a komfort, stejně tak jako pro správné fungování klimatizace, je nutnost pravidelné výměny kabinového filtru, a to každý rok nebo každých 15.000 km.**

Kabinový filtr může být umístěn blízko vstupu vzduchu do kabiny vozu nebo blízko výparníku. Typické příznaky starého kabinového filtru:

- nedostatečný tok ventilovaného vzduchu do kabiny (nižší účinnost klimatizace, pomalejší odmlžení skla...)
- alergická reakce (kýchání, podráždění očí...)
- špatná kvalita vzduchu v kabině (zápach, znečištění ...)

## Doporučení pro údržbu

- Zvolte si správný kabinový filtr podle vozidla.
- Pro nejlepší ochranu řidiče i cestujících se doporučuje používat polyfenolové filtry.
- montážní postupy pro snadnou výměnu kabinových filtrů jsou obsaženy v každém balení.
- Valeo doporučuje provést vyčištění systému klimatizace přípravkem ClimPur při každé výměně kabinového filtru.

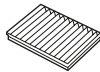

# HR

## Funkcija

Filter kabine sprečava ulazanje štetnih tvari iz zraka preko klima uređaja i ventilacijskih otvora u kabinu vozila.

Postoje 3 različite tehnologije filtera kabine:

- filteri krutih čestica - za krute onečišćujuće tvari: prašina, čađa, pelud
- kombinirani filteri (s aktivnim ugljikom) - za krute onečišćujuće tvari + drugo onečišćavanje: ispušni plinovi, loši mirisi...
- Filter s polifenolom za neutralizaciju alergeni tvari, krutih štetnih tvari, štetnih plinova, loših mirisa

## Zamjena

**Glavno pravilo za sigurnost i komfor, jednako kao i za ispravno funkcioniranje klima - uređaja je redovita izmjena filtera kabine, i to svake godine ili svakih 15.000 km.**

Filter kabine može biti postavljen u blizini ulaza zraka u kabinu vozila ili u blizini isparavanja.

Tipični simptomi starog filtera kabine

- nedovoljan protok ventilacijskog zraka u kabini (manji učinak klima - uređaja sporije čišćenje od zamagljenosti...)
- alergične reakcije (kihanje, nadraženost očiju...)
- loša kvaliteta zraka u kabini (loši mirisi, prljavština...)

## Preporuke za održavanje

- Odaberite odgovarajući filter kabine za svoje vozilo.
- Za najveću zaštitu vozača i putnika preporuča se polifenolni filter.
- Postupci montaže za lakšu izmjenu filtera kabine nalaze se u svakom pakiranju.
- Valeo preporuča čišćenje sustava klima - uređaja dodatkom "ClimPur" prilikom svake izmjene filtera kabine.

# HU

## Funkciója

A pollenszűrő megakadályozza, hogy a légszennyezés a jármű szellőző- és klímarendszerén keresztül az utastérbe jusson. 3 különböző típusú pollenszűrő létezik:

- szilárd részecské szűrő (por, korom, pollen,...)
- kombinált szűrők (aktív szén szűrő), amelyek kiszűrnek a szilárd részecskéket és egyben bizonyos gázokat is (kipufogógáz, kellemetlen szagok,...)
- polyphenol szűrők az allergének ( pollenek ) semlegesítéséért, szilárd szennyeződések, káros gázok és rossz szagok kiszűréséért

## Cseréje

**A pollenszűrő kulcsfontosságú biztonsági és kényelmi felszerelés, amely biztosítja a klímaberendezés hatékony működését. Ezért évente vagy 15.000 km-enként cserélni kell.**

A pollenszűrő általában a levegőbeszívó nyílás vagy a párologtató közelében található.

A pollenszűrővel kapcsolatos leggyakoribb problémák:

- A szellőző kevés levegőt juttat az utastérbe (kisebb hűtés, rossz páramentesítés...)
- Allergiás reakciók (tüszentes, légúti irritáció...)
- Az utastér levegője rossz minőségű (szagok, légszennyezés...)

## A Valeo tanácsa

- Válassza a megfelelő pollenszűrőt járműtípusához.
- A legmagasabb szintű vezető & utas védelemért a polyphenolos pollenszűrő használata javasolt.
- Hatékonyabbá teheti a munkafolyamatot, ha követi a szűrő csomagolásában található, a Valeo által mellékelte szerelési útmutatót.
- Az utastér levegője akkor lesz igazán tiszta és egészséges, ha a pollenszűrő cseréjével egyidejűleg speciális tisztítószerezrel kitisztítja a szellőző- és klímaberendezést.



# RO

## Funcțiune:

Filtrul de habitacul împiedică poluanții nocivi din aerul exterior să intre în habitacul vehiculului prin conductele de ventilație și de climatizare.

Există 3 tehnologii de filtre de habitacul:

- filtrele cu particulă împotriva poluanților de tip solid (prafuri, funingini, polenuri...)
- filtrele combinate care cumulează funcția anti-particulă cu funcția anti-poluare protejând de gazelenocive de eșapament și de mirosurile ambiante dezagreabile.
- Filtre cu polifenol pentru alergeni (polen), neutralizare, poluanți solizi, gaze nocive, mirosuri neplăcute

## Înlocuire:

**Indispensabil pentru siguranță și confort ca și pentru buna funcționare a climatizării, filtru de habitacul trebuie să fie înlocuit în fiecare an sau cel puțin la fiecare 15000 km.**

Este situat sau aproape de intrarea de aer sau aproape de ventilator Problemele cele mai frecvente legate de filtru de habitacul:

- Lipsa de aer pulsant în habitacul
- Reacții alergice în habitacul (strănuturi, iritații...)
- O calitate slabă a aerului în habitacul (mirosuri, poluare...)

## Recomandările Valeo pentru reparație:

- Alegeți filtrul potrivit pentru habitacul în funcție de autovehicul.
- Filtrul cu polifenol este recomandat pentru o protecție maximă a conducătorului și a pasagerilor.
- Optimizați prestația d'voastră referindu-vă la notițele de montare livrate cu filtrele de habitacul Valeo.
- Pentru o calitate deosebită a aerului, utilizați un produs care purifică circuitul de climatizare la fiecare înlocuitor de filtru de habitacul (Climpur Valeo)

# BG

## Функции

Филтърът купе предпазва от проникване на вредните замърсители от околната среда в купето на автомобила чрезклиматичната и вентилационна система.

Разработени са 2 технологии за филтър купе:

- Филтър за твърди частици (поленов) - за предпазване от навлизане на: прах, сажди, полени ...
- Комбиниран (карбонов) филтър за твърди частици + други замърсители: изгорели газове, лоши миризми ...

## Подмяна

**Не е необходимо е, както за сигурността и комфорта, така и за ефективната работа на климатичната система филтърта купе да се подменя редовно - всяка година или на 15 000 км.**

Филтърът купе се намира близо до входа на вентилационните отвори или изпарителя

Типични проблеми при филтрите купе:

- Загуба на количеството навлизаш въздух в купето (влошена работа на климатика, замъгленост ...)
- Алергични реакции (кихане, дразнения ...)
- Занижено качество на въздуха в купето (лоши миризми, замърсеност)

## Препоръки при подмяна

- Изберете точния филтър купе според спецификациите на автомобилпроизводителя
- За градски условия филтърът купе е препоръчително да бъде с активен въглен (карбонов), за да осигури комфорт на шофьора и неговите спътници
- За по - бърз и лесен монтаж във всяка опаковка ще намерите инструкции за подмяна.
- Препоръката на Valeo за по- здравословен въздух в автомобила е при всяка подмяна на филтърта купе да се третира климатичната система със спрейове за освежаване и пречистване



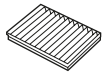

# TU

## İşlev

Kabin hava filtreleri dış ortamdan klima ve havalandırma kanalları yoluyla kabine girebilecek her türlü zararlı maddeyi engellemek üzere tasarlanmıştır.

- Parçacık filtreleri katı maddeleri engellerler (toz, katran, polen...)
- Kombine filtreler katı maddelerle birlikte diğer kirleticileri de engeller (egzost dumanı, kötü kokular...)
- Polifenol filtreler alerji yapan maddeleri (polen) nütürleştirir, parçacıkları, zararlı gazları ve kötü kokuları filtreler.

## Değişim

**Güvenli ve konforlu bir ortamın sağlanması yanında klima sisteminin etkinliği için kabin hava filtrelerinin düzenli olarak her yıl ya da her 15000 kilometrede bir değiştirilmesi gerekir.**

Kabin hava filtreleri hava kanalı girişi ya da evaporatör yanında konumlandırılmış olabilir.

Kabin hava filtreleriyle ilgili olası sorunlar:

- Kabine üflenen havada yetersizlik (daha az iklimlendirme, cam buğusunun geç açılması...)
- Sürücü ve yolcularda alerjik tepkiler (hapçırma, göz sulanması...)
- Kabin içindeki kötü hava kalitesi (kötü kokular, kirlilik...)

## Tavsiyeleri

- Aracınız için doğru kabin filtresini seçin!
- Sürücü ve yolcuların üst seviyede korunması için polifenol filtre önerilir
- Doğru uygulama yapılabilmesi için tümValeo kabin hava filtrelerinde montaj talimatnamesi mevcuttur.
- Araç içinde sürekli olarak sağlıklı ortam oluşturulabilmesi için her filtre değişimindeValeo bir klima sistemi temizleyicisi ve arındırıcısı kullanılmasını önerir (Valeo Climpur).

# GR

## Λειτουργία :

Το φίλτρο καμπίνας εμποδίζει τις επιβλαβείς ρυπογόνες ουσίες του εξωτερικού αέρα να εισέλθουν στο εσωτερικό του οχήματος, μέσω των αεραγωγών του συστήματος κλιματισμού και εξαερισμού. Υπάρχουν 3 διαφορετικές τεχνολογίες φίλτρων καμπίνας:

- φίλτρα σωματιδίων για στερεούς ρύπους: σκόνη, πίσσα, γύρη..
- συνδυασμένα φίλτρα για στερεούς ρύπους + αέριους ρύπους: αέρια εξάτμισης, δυσάρεστες οσμές...
- φίλτρα Ιολυκρενόλης για εξουδετέρωση αλλεργιογόνων (γύρη) & ρυπογόνων ουσιών, εμβλαβή αέρια και δυσοσμίες. **Ειλέξτε το σωστό φίλτρο καμπίνας ανάλογα με το όχημα**

## Αντικατάσταση :

**Είναι ουσιαστική για την άνεση και την ασφάλεια των επιβατών, όσο και για την καλή λειτουργία του συστήματος εξαερισμού. Το φίλτρο καμπίνας θα πρέπει να αντικαθιστάται μια φορά το χρόνο ή κάθε 15.000 χλμ.** Το φίλτρο καμπίνας βρίσκεται συνήθως τοποθετημένο στην εισαγωγή αέρα του συστήματος εξαερισμού ή κοντά στον εξατμιστή. Συνήθη προβλήματα από την κακή κατάσταση του φίλτρου:

- Ελλιπής εξαερισμός, ψύξη ή θέρμανση του εσωτερικού του οχήματος.
- Πρόκληση αλλεργικών αντιδράσεων (φερνίσματα, καταρροή ...).
- Δύσοσμος και ακάθαρτος αέρας από το σύστημα εξαερισμού.

## Προτάσεις απο την Valeo για την επισκευή :

Ειλέξτε το σωστό φίλτρο καμπίνας ανάλογα με το όχημα.



Για τη μεγαλύτερη ασφάλεια των οδηγών και των επιβατών, συνιστάται το φίλτρο Ιολυκρενόλης. Ειδικές οδηγίες συναρμολόγησης εσκωκίζονται σε όλα τα φίλτρα καμπίνας της Valeo για γρήγορη και αποτελεσματική αντικατάσταση.

Για την βελτίωση της ποιότητας της ατμόσφαιρας εντός του εσωτερικού του οχήματος, η Valeo προτείνει να πραγματοποιείται μια αντιβακτηριακή επεξεργασία του συστήματος κλιματισμού κάθε φορά που αλλάζετε το φίλτρο καμπίνας (Climpur Valeo).

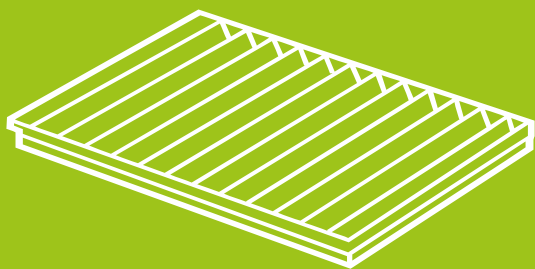





 		<b>Valeo</b>
ABARTH	500	715755
BMW	1 series, 2 series, 3 series, 4 series	715815
BMW	2 series, X1, i3	715811
BMW	2 series, X1, i3	715812
CHRYSLER	Ypsilon	715755
CITROËN	C1 (2014>)	715828
DACIA	Dokker	715803
FIAT	500	715809
FIAT	500, Panda	715755
FORD	Ranger	715745
FORD	Transit	715747
FORD	Transit (2006>)	715742
HYUNDAI	Azera, Santa Fé, Sonata	715804
HYUNDAI	Elantra, i20, i30	715816
HYUNDAI	i20	715748
HYUNDAI	Solaris / Accent	715807
JEEP	Renegade	715809
KIA	Carens, Ceed	715816
KIA	Optima	715804
LANCIA	Thema	715749
LANCIA	Ypsilon	715755
MAZDA	3 (2013>), 6 (2013>), CX-5	715813
MAZDA	Mazda BT50	715745
MERCEDES	A Class (W176)	715814
MERCEDES	B Class (W246)	715814
MERCEDES	CLA Class (117)	715814
MERCEDES	C Class, GL Class, ML Class	715751
MERCEDES	GLA Class (156)	715814
MINI	MINI	715811
MINI	MINI	715812
NISSAN	Almera (2000>)	701031
NISSAN	Almera Tino (2000>2005)	701031
NISSAN	Micra, Note	715756
NISSAN	Primera (P12)	701031
OPEL	Astra, Meriva	715752
PEUGEOT	108	715828
PEUGEOT	308	715805
PEUGEOT	308	715808
PORSCHE	911, Boxster	715754
PORSCHE	911, Boxster, Cayman	715753
RENAULT	Clio III	701030
RENAULT	Espace V, Kadjar, Mégane IV	701032
RENAULT	Espace V, Kadjar, Mégane IV	715820
RENAULT	Twingo III	701030
RENAULT	Wind (2010>2014)	701030
RENAULT	Zoé	715802
SEAT	Leon (2012>)	715806
TOYOTA	Aygo (2014>)	715828
VAUXHALL	Astra, Meriva	715752

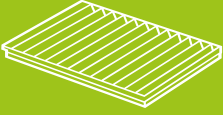





	AC				PA  	CA  	PCA 
---	----	---	---	---	---	---	--

## ABARTH

Nuova 500 (2008>2012)	A+		■	08/08▶06/12	46723321	<b>698866</b>	77365763	<b>715723</b>	
Nuova 500 (2012>)	M+		■	07/12▶	51854923	<b>715755</b> ●			
Grande Punto (2007>2010)	+		■	09/07▶06/10	55702456	<b>715552</b>	55702456	<b>715553</b>	<b>701003</b>
Punto Evo (2010>)	A+		■	05/10▶	55702456	<b>715552</b>	55702456	<b>715553</b>	<b>701003</b>



## ALFA ROMEO























145 (94>2001)	+/-		■	09/94▶06/01	46409630	<b>698174</b>			
146 (94>2001)	+		■	12/94▶06/01	46409630	<b>698174</b>			
147 (2000>2010)	+/-	2x 	■	10/00▶01/10			46799653	<b>698747</b>	<b>701017</b>
155 (91>97)	+/-		■	11/91▶08/97	46409630	<b>698174</b>			
156 (97>2003)	+/-		■	09/97▶03/03	60653642	<b>698689</b>			
156 (97>2003)	+/-		■	09/97▶03/03	60653641	<b>698197</b>	60653641	<b>698687</b>	
156 (2003>2007)	+/-	2x 	■	04/03▶06/07			46799653	<b>698747</b>	<b>701017</b>
159 (2005>)	+/-		■	07/05▶	71754158	<b>715532</b>	77363370	<b>715533</b>	
164 (87>98)	+		■	07/87▶09/98	60801430	<b>698199</b>			
166 (98>2007)	+		■	10/98▶12/07			46722335	<b>698688</b>	
Brera (2006>2010)	+/-		■	01/06▶10/10	71754158	<b>715532</b>	77363370	<b>715533</b>	
Giulietta (2010>)	+		■	06/10▶	77365352	<b>715705</b>			
GT (2003>2010)	+/-	2x 	■	09/03▶01/10			46799653	<b>698747</b>	<b>701017</b>
GTV (95>2006)	+/-		■	03/95▶02/06	46409630	<b>698174</b>			
Mi.To (2008>)	+/-		■	04/08▶	55702456	<b>715552</b>	55702456	<b>715553</b>	<b>701003</b>
Spider (95>2006)	+/-		■	02/95▶02/06	46409630	<b>698174</b>			
Spider (2003>2006)	+		■	03/03▶02/06	46409630	<b>698174</b>			
Spider (2006>2010)	+/-		■	03/06▶09/10	71754158	<b>715532</b>	77363370	<b>715533</b>	





















## ALPINA BMW

Roadster S (2004>2006)	+		■	03/04▶02/06	64319195193	<b>698861</b>			
------------------------	---	--	---	-------------	-------------	---------------	--	--	--

## AUDI

80 (91>95)  8CP240000▶ 8CP300000	+/-		■	09/91▶07/95	893091700	<b>698164</b>	380091800	<b>715578</b>	
100 (90>94)	-		■	12/90▶07/94			4A0819439A	<b>698684</b>	
A1	+/-		■	05/10▶	6R0820367	<b>715737</b>	6R0819653	<b>715727</b>	<b>701029</b>
A1	A+		■	05/10▶07/10			600819653	<b>698739</b>	<b>701009</b>
A2 (2000>2005)	+/-		■	05/00▶08/05	600820367	<b>698685</b>	600819653	<b>698739</b>	<b>701009</b>
A3 (96>2000)  8LV090451▶	+/-		■	09/96▶08/00			1J0819644	<b>698716</b>	<b>701016</b>
A3 (96>2000)  ▶8LV090450	+/-	With Plastic Frame	■	09/96▶	1H0819644	<b>698159</b>	1H0091800	<b>698686</b>	





	AC				PA  OE 	CA  OE 	PCA  		
<b>AUDI</b> 									
A3 (96>2000)  ▶8LV090450	+/-	W/O Plastic Frame	■	09/96▶	1H0819644B	<b>698885</b>			
A3 (2000>2003)	+/-		■	09/00▶06/03			1H0091800	<b>698686</b>	
A3 (2000>2003)	+/-		■	09/00▶06/03			1J0819644	<b>698716</b>	701016
A3 (2003>2008)	+/-		■	05/03▶06/08			1K2819653	<b>715665</b>	
A3 (2003>2008)	+/-		■	05/03▶06/08	1K0819644	<b>698800</b>	1K1819653	<b>698801</b>	701001
A3 (2008>2013)	+/-		■	07/08▶03/13			1K2819653	<b>715665</b>	
A3 (2008>2013)	+/-		■	07/08▶03/13	1K0819644	<b>698800</b>	1K1819653	<b>698801</b>	701001
A3 (2012>)	+/-		■	04/12▶05/14			5Q0818653	<b>715720</b>	701020
A3 (2012>)	+/-		■	05/14▶05/15			6Q0819653	<b>698739</b>	701009
A3 Cabriolet (2008>2013)	+/-		■	04/08▶05/13			1K2819653	<b>715665</b>	
A3 Cabriolet (2008>2013)	+/-		■	04/08▶05/13	1K0819644	<b>698800</b>	1K1819653	<b>698801</b>	701001
A3 Cabriolet (2013>)	+/-	ultrafine	■	10/13▶05/15			5Q0818653	<b>715720</b>	701020
A4 (94>98)	+/-		■	07/98▶12/98			3B0091800	<b>715578</b>	
A4 (99>2001)	+/-		■	01/99▶09/01	893091700	<b>698164</b>	3B0091800	<b>715578</b>	
A4 (2000>2004)	+/-		■	12/00▶12/04	8E0819439	<b>698606</b>	4B0819439C	<b>698683</b>	701023
A4 (2004>2008)	A+		■	11/04▶06/08			4B0819439C	<b>698683</b>	701023
A4 (2007>2012)	A+		■	11/07▶05/08	8K0819439	<b>715579</b>	8K0819439A	<b>715580</b>	
A4 (2011>2015)	+/-		■	11/11▶12/15	8K0819439	<b>715579</b>			
A4 Cabriolet (2002>2009)	+/-		■	04/02▶03/09	8E0819439	<b>698606</b>	4B0819439C	<b>698683</b>	701023
A4 Allroad Quattro (2009>)	+/-		■	04/09▶01/12	8K0819439	<b>715579</b>	8K0819439A	<b>715580</b>	
A5 (2007>2012)	+		■	06/07▶02/12	8K0819439	<b>715579</b>	8K0819439A	<b>715580</b>	
A5 Cabriolet (2009)	+/-		■	03/09▶03/12	8K0819439	<b>715579</b>	8K0819439A	<b>715580</b>	
A6 (94>97)	+/-		■	07/94▶09/97	4A0819439A	<b>715683</b>	4A0091800	<b>698684</b>	
A6 (97>2001)	-		■	04/97▶05/01	8E0819439	<b>698606</b>	4B0819439C	<b>698683</b>	701023
A6 (97>2001)	+/-		■	04/97▶11/98	4A0819439A	<b>715683</b>	4B0819439A	<b>698682</b>	
A6(2001>2005)	+/-		■	06/01▶04/05			4B0819439C	<b>698683</b>	701023
A6 (2004>2008)	+/-	2x 	■	04/04▶09/08	4F0819439	<b>715500</b>	4F0819439A	<b>715501</b>	
A6 (2008>2011)	A+	2x 	■	10/08▶08/11			4F0819439A	<b>715501</b>	
A6 (2010>)	+		■	11/10▶			4H0819439	<b>715733</b>	
A6 Allroad (2000>2005)	+		■	05/00▶08/05			4B0819439C	<b>698683</b>	701023
A6 Allroad (2006>2011)	+/-	2x 	■	05/06▶08/11	4F0819439	<b>715500</b>	4F0819439A	<b>715501</b>	
A6 Allroad (2012>)	+/-		■	01/12▶			4H0819439	<b>715733</b>	
A7 (2010>)	+/-		■	07/10▶			4H0819439	<b>715733</b>	
A8 (94>2002)	+/-	2x 	■	06/94▶09/02	4D0819439	<b>698790</b>	4D0819439A	<b>698791</b>	
A8 (2002>2010)	+/-		■	11/02▶07/10			4E0819439A	<b>698792</b>	
A8 (2009>)	+		■	11/09▶			4H0819439	<b>715733</b>	
Cabriolet	+/-		■	06/91▶08/00	893091700	<b>698164</b>	3B0091800	<b>715578</b>	

	AC				PA 	CA 	PCA 		
<b>AUDI</b> 									
Coupé	+/-		■	11/89▶01/96	893091700	<b>698164</b>	3B0091800	<b>715578</b>	
Q3	+/-		■	06/11▶			1K2819653	<b>715665</b>	
Q3	+/-		■	06/11▶	1K0819644	<b>698800</b>	1K1819653	<b>698801</b>	<b>701001</b>
Q5	+/-		■	11/08▶	8K0819439	<b>715579</b>	8K0819439A	<b>715580</b>	
Q7	A+		■	03/06▶	7H0819631	<b>715581</b>	7H0819631A	<b>698768</b>	
R8	A+	2x 	■	04/07▶			4F0819439A	<b>715501</b>	
RS Q3	A+		■	05/13▶04/15			1K2819653	<b>715665</b>	
RS Q3	A+		■	05/13▶04/15	1K0819644	<b>698800</b>	1K1819653	<b>698801</b>	<b>701001</b>
RS2	+		■	03/94▶06/95	893091700	<b>698164</b>	3B0091800	<b>715578</b>	
RS3 (2011>2012)	+		■	01/11▶12/12			1K1819653	<b>698801</b>	<b>701001</b>
RS3 (2011>2012)	+		■	01/11▶12/12			1K2819653	<b>715665</b>	
RS3 (2015>)	+		■	02/15▶			500818653	<b>715720</b>	<b>701020</b>
RS4 Quattro (2000>2001)	+		■	06/00▶09/01	893091700	<b>698164</b>	3B0091800	<b>715578</b>	
RS4 Quattro (2005>2008)	+/-		■	11/05▶06/08			4B0819439C	<b>698683</b>	<b>701023</b>
RS4 Quattro (2012>)	+		■	05/12▶	8K0819439	<b>715579</b>			
RS4 Quattro Cabriolet	+/-		■	05/06▶10/08	8E0819439	<b>698606</b>	4B0819439C	<b>698683</b>	<b>701023</b>
RS5 Quattro (2010>)	+		■	03/10▶	8K0819439	<b>715579</b>	8K0819439A	<b>715580</b>	
RS6 (2002>2004)	+/-		■	07/02▶09/04			4B0819439C	<b>698683</b>	<b>701023</b>
RS6 (2008>2010)	+/-	2x 	■	04/08▶08/10			4F0819439A	<b>715501</b>	
RS6 (2013>)	+		■	01/13▶			4H0819439	<b>715733</b>	
RS7 (2013>)	+		■	05/13▶			4H0819439	<b>715733</b>	
S1 (2014>)	+		■	01/14▶	6R0820367	<b>715737</b>	6R0819653	<b>715727</b>	<b>701029</b>
S3 (98>2003)	+/-		■	11/98▶06/03			1J0819644	<b>698716</b>	<b>701016</b>
S3 (2006>2013)	+/-		■	10/06▶03/13	1K0819644	<b>698800</b>	1K1819653	<b>698801</b>	<b>701001</b>
S3 (2006>2013)	+/-		■	06/07▶03/13			1K2819653	<b>715665</b>	
S3 (2012>)	A+		■	10/12▶05/14			500818653	<b>715720</b>	<b>701020</b>
S4 Cabriolet	+/-		■	02/04▶03/09	8E0819439	<b>698606</b>	4B0819439C	<b>698683</b>	<b>701023</b>
S4 (97>2001)	+/-		■	10/97▶09/01	893091700	<b>698164</b>	3B0091800	<b>715578</b>	
S4 (2003>2008)	+/-		■	03/03▶06/08	8E0819439	<b>698606</b>	4B0819439C	<b>698683</b>	<b>701023</b>
S4 (2008>)	A+		■	11/08▶	8K0819439	<b>715579</b>	8K0819439A	<b>715580</b>	
S5	A+		■	06/07▶02/12	8K0819439	<b>715579</b>	8K0819439A	<b>715580</b>	
S6 (94>97)	+/-		■	07/94▶10/97			4A0819439A	<b>698684</b>	
S6 (99>2001)	+		■	09/99▶10/99			4A0819430A	<b>698682</b>	
S6 (99>2005)	+/-		■	09/99▶01/05			4B0819439C	<b>698683</b>	<b>701023</b>
S6 (2006>2011)	A+	2x 	■	06/06▶08/11	4F0819439	<b>715500</b>	4F0819439A	<b>715501</b>	
S6 (2012>)	+		■	04/12▶			4H0819439	<b>715733</b>	
S7 (2012>2015)	+		■	04/12▶03/15			4H0819439	<b>715733</b>	
S8 (96>2002)	+/-	2x 	■	09/96▶09/02	4D0819439	<b>698790</b>	4D0819439A	<b>698791</b>	
S8 (2006>2010)	+/-		■	06/06▶07/10			4E0819439A	<b>698792</b>	



	AC				PA  	CA  	PCA 
--	----	---	---	---	---	---	--





## AUDI

S8 (2012>)	+		■	04/12▶			4H0819439	715733	
SQ5 (2012>)	+		■	12/12▶	8K0819439	715579			
TT (98>2006)  ▶8N1014000	+/-	With Plastic Frame	■	10/98▶09/00	1H0819644	698159	1J0819644	698716	701016
TT (98>2006)  ▶8N1014000	+/-	W/O Plastic Frame	■	10/98▶09/00	1H0819644B	698885			
TT (2006>2014)	A+		■	08/06▶			1K1819653	698801	701001
TT (2006>2014)	A+		■	08/06▶			1K2819653	715665	
TT (2014>)	+/-		■	07/14▶			500818653	715720	701020
TTRS (2009>2014)	+/-		■	07/09▶06/14			1K1819653	698801	701001
TTRS (2009>2014)	+/-		■	07/09▶06/14			1K2819653	715665	

## BENTLEY





















Continental (84>2011)	+/-	2x 	■	06/03▶			3D0819619A	698793	
-----------------------	-----	--	---	--------	--	--	------------	--------	--

## BMW

1 Series (E87)	A+		■	09/04▶02/07	64316142114	715502	64316946628	715503	
1 Series (E81/E82/E88)	+/-		■	01/07▶06/12	64316142114	715502	64316946628	715503	
1 Series (F20/F21)	A+		■	07/11▶02/15	64119237554	715815●			
1 Series (F20/F21)	A-		■	07/11▶02/15			64119237555	715719	701019
2 Series (F22-F23)	A-		■	09/13▶06/15	64119237554	715815●			
2 Series (F22-F23)	+/-		■	09/13▶06/15			64119237555	715719	701019
2 Series (F45)	+	2x 		09/14▶	64119321876	715812▲	64119321875	715811▲	
2 Series (F46)	A+	2x 		03/15▶	64119321876	715812▲	64119321875	715811▲	
3 Series (E36)	+		■	12/90▶02/00	64111393489	698171			
3 Series (E36)	+	2x 	■	02/94▶04/01	64118363274	698469			
3 Series (E46)	+		■	07/99▶02/03	64311000004	698489	64319071935	698750	
3 Series (E90/E91/E92/E93)	M+		■	03/05▶02/10	64316142114	715502	64316946628	715503	
3 Series (F30/F31)	A-		■	11/11▶	64119237554	715815●			
3 Series (F30/F31)	A+		■	11/11▶			64119237555	715719	701019
3 Series (F34) (2013>)	A-		■	03/13▶	64119237554	715815●			
3 Series (F34) (2013>)	A+		■	03/13▶			64119237555	715719	701019
3 Series LCI (E90/E91/E92/E93)	M+		■	07/07▶05/12	64316142114	715502	64316946628	715503	
4 Series (F32/F33)	+/-		■	07/13▶			64119237555	715719	701019
4 Series (F32/F33)	+/-		■	07/13▶	64119237554	715815●			
4 Series (F36)	+/-		■	03/14▶			64119237555	715719	701019
4 Series (F36)	+/-		■	03/14▶	64119237554	715815●			
5 Series (E34)	+		■	01/89▶09/96	64311390836	698170			
5 Series (E39)	+/-	2x 	■	09/95▶04/04	64118391198	715685	64110008138	698246	
5 Series (E60/E61)	+	2x 	■	05/03▶12/06	64316935822	698863	64316935823	698864	

	AC				PA 	CA 	PCA 
---	----	---	---	---	---	---	--

## BMW



5 Series (F10/F11/F18)	+	2x 	■	01/09►06/13	64119163328	<b>715715</b>	64119163329	<b>715690</b>	
5 Series (F07)	+		■	10/09►	64311000004	<b>698489</b>	64319071935	<b>698750</b>	
5 Series LCI (E60/61)	A+	2x 	■	01/07►08/07	64316935822	<b>698863</b>	64316935823	<b>698864</b>	
6 Series (E63) Coupé	A+	2x 	■	09/03►08/07	64316935822	<b>698863</b>	64316935823	<b>698864</b>	
6 Series (E64) Cabriolet	A+	2x 	■	03/04►08/07	64316935822	<b>698863</b>	64316935823	<b>698864</b>	
6 Series (F06)	+/-	2x 	■	03/10►	64119163328	<b>715715</b>	64119163329	<b>715690</b>	
6 series (E63/E64)	+/-	2x 	■	09/03►	64316935822	<b>698863</b>	64316935823	<b>698864</b>	
7 Series (E32)	+		■	09/86►05/94	64311390836	<b>698170</b>			
7 Series (E38)	+	2x 	■	06/94►08/01	64118390377	<b>698838</b>	64118390447	<b>698470</b>	
7 series (E65/E66/E67)	A+	2x 	■	09/01►10/08	64116921018	<b>698856</b>	64116921019	<b>698857</b>	
7 Series (E66)	A+	Rear AC	■	03/02►10/08			64106907746	<b>715582</b>	
7 series (F01, F02)	+/-	2x 	■	11/08►05/15			64119163329	<b>715690</b>	
i3	+	2x 		09/13►	64119321876	<b>715812▲</b>	64119321875	<b>715811▲</b>	
M3 (E36)	+		■	06/92►06/00	64111393489	<b>698171</b>			
M3 (E46)	+		■	07/00►09/06			64319071935	<b>698750</b>	
M3 (E90-92)	+	4x 	■	09/07►			64319159606	<b>715712</b>	
M3 (F80)	+/-		■	03/14►			64119237555	<b>715719</b>	<b>701019</b>
M5 (E34)	+		■	07/89►09/95	64311390836	<b>698170</b>			
M5 (E39)	+	2x 	■	07/99►06/03	64118391198	<b>715685</b>	64110008138	<b>698246</b>	
M5 (E60)	+	2x 	■	12/04►09/11	64316935822	<b>698863</b>	64316935823	<b>698864</b>	
M5 (F10)	+	2x 	■	09/11►	64119163328	<b>715715</b>	64119163329	<b>715690</b>	
M6 (E63/E64)	+	2x 	■	03/05►07/10	64316935822	<b>698863</b>	64316935823	<b>698864</b>	
M6 (F06/F12/F13)	+	2x 	■	03/12►	64119163328	<b>715715</b>	64119163329	<b>715690</b>	
X1 (E84)	+/-		■	10/09►06/12	64316142114	<b>715502</b>	64316946628	<b>715503</b>	
X1 (F48)	A-	2x 		09/15►	64119321876	<b>715812▲</b>	64119321875	<b>715811▲</b>	
X3 (E83)	A+		■	10/03►08/07	64311000004	<b>698489</b>	64319071935	<b>698750</b>	
X3 SAV (F25)	+/-		■	09/10►04/12	64319237158	<b>715714</b>	64319237157	<b>715713</b>	
X4 (F26) (2014>)	+/-		■	04/14►	64319237158	<b>715714</b>	64319237157	<b>715713</b>	
X5 (E53)	+		■	01/00►11/06	64318409043	<b>698775</b>	64318409044	<b>698776</b>	
X5 (E70)	+/-	2x 	■	12/06►	64116945593	<b>715583</b>	64116945594	<b>715584</b>	
X6 (E71/E72)	+/-	2x 	■	05/08►	64116945593	<b>715583</b>	64116945594	<b>715584</b>	
Z4 (E85/E86)	M+		■	09/02►08/08	64116915763	<b>698861</b>	64116915764	<b>698862</b>	
Z4 (E89)	A-		■	03/09►09/11	64116915763	<b>698861</b>			

## CADILLAC

BLS	-		■	03/05►09/10	93172129	<b>698711</b>	93172129	<b>698710</b>	<b>701010</b>
CTS	+			03/02►09/07			88957450	<b>715671</b>	
SRX	+			07/04►09/10			88957450	<b>715671</b>	
STS	+			05/05►10/07			88957450	<b>715671</b>	

	AC				PA  	CA  	PCA 
--	----	---	---	---	---	---	--

## CHEVROLET

Alero	+		■	01/05►06/07	96296618	<b>715587</b>		
Aveo	+		■	01/05►02/08	96435888	<b>715535</b>		
Aveo	+		■	06/11►	13271190	<b>715658</b>	13271191	<b>715659</b>
Captiva (2006>2011)	+		■	09/06►02/11	96440878	<b>715654</b>		
Captiva (2011>)	+		■	02/11►			22753219	<b>715731</b>
Cruze	A+		■	05/09►01/11	13271190	<b>715658</b>	13271191	<b>715659</b>
Epica	+/-		■	05/06►09/09	96296618	<b>715587</b>		
Evanda	+		■	01/05►06/07	96296618	<b>715587</b>		
Kalos	+		■	01/05►	96435888	<b>715535</b>		
Lacetti	+		■	01/05►12/12	96554378	<b>715526</b>		
Lanos	+/-		■	09/97►12/02	96190645	<b>698860</b>		
Malibu	+		■	07/12►	13271190	<b>715658</b>	13271191	<b>715659</b>
Matiz	+		■	01/05►02/11	96425700	<b>715588</b>		
Nubira	+		■	01/05►09/09	96554378	<b>715526</b>		
Orlando	+/-		■	01/11►	13271190	<b>715658</b>	13271191	<b>715659</b>
Rezzo	+/-	2x 		01/05►06/08	93740495	<b>715536</b>		
Spark (2005>2009)	+		■	05/05►12/09	96425700	<b>715588</b>		
Spark (2009>2013)	+		■	12/09►01/13	95947238	<b>715707</b>	95215156	<b>715710</b>
Spark (2012>)	+		■	09/12►	13271190	<b>715658</b>	13271191	<b>715659</b>
Tacuma	+	2x 		01/05►06/08	93740495	<b>715536</b>		
Trax	+		■	04/13►	13271190	<b>715658</b>	13271191	<b>715659</b>
Volt	+		■	11/11►	13271190	<b>715658</b>	13271191	<b>715659</b>

## CHRYSLER













































300C	+/-		■	06/04►09/07			4596501AB	<b>715648</b>
Crossfire	+		■	07/03►01/09	5101438AA	<b>698169</b>	2108301218	<b>698697</b>
Delta	+/-		■	09/11►12/14	71736776	<b>715686</b>		
Grand Voyager	+/-			03/01►01/08			5072176AA	<b>715611</b>
Grand Voyager	+/-		■	03/01►01/08			82205905	<b>698865</b>
Grand Voyager	+/-		■	02/08►01/12	68042866AA	<b>715711</b>		
PT Cruiser	+/-		■	06/00►	50580040AA	<b>715534</b>		
Sebring	+/-		■	03/07►03/11	5058693AA	<b>715735</b>		
Voyager	+/-		■	03/01►02/08			82205905	<b>698865</b>
Voyager	+/-			03/01►02/08			5072176AA	<b>715611</b>
Ypsilon	+/-		■	09/11►	51854923	<b>715755●</b>		

## CITROËN

C Crosser	+/-		■	07/07►01/13	6447ZY	<b>715631</b>	6447ZY	<b>715623</b>
C1 (2005>2014)	+		■	06/05►04/14	6447TV	<b>715515</b>		
C1 (2014>)	+			05/14►	B000975480	<b>715828●</b>		

	AC				PA  	CA  	PCA 
---	----	---	---	---	---	---	--

## CITROËN









C2 (2003>2010)  ►11528	A+			09/03►01/10		6447NV	698714	701014	
C2 (2003>2010)	M+			09/03►01/10	6447NT	698664			
C3 (2002>2011)	A+			04/02►01/11	6447NT	698664	6447NV	698714	701014
C3 (2009>)	+/-	2x 		10/09►	1609428080	715556	1609428180	715557	701007
C3 Picasso (2009>)	A+			02/09►09/15	6447NT	698664	6447NV	698714	701014
C3 Pluriel  ►11465	A+			05/03►01/11	6447NT	698664	6447NV	698714	701014
C4 (2004>)	A+			11/04►	6447NT	698664	6447NV	698714	701014
C4 Aircross	M+			03/12►	6447ZY	715631			
C4 Cactus (2014>)	+	2x 		05/14►	1609428080	715556	1609428180	715557	701007
C4 Picasso (2006>2013)	+/-	2x 		09/06►05/13	6447XF	715554	6447XG	715555	
C4 Picasso	+/-	2x 		05/13►	6447XF	715554	6447XG	715555	
C5 (2001>2004)	+/-			02/01►08/04	6447HT	698540	6447HV	698541	
C5 (2004>2008)	M+			09/04►06/08	647904	715570	6441EJ	698884	701002
C5 (2008>)	+			03/08►12/11			647945	715635	
C5 (2008>)	A+			05/12►			6447NV	698714	701014
C6 (2005>2012)	A+			10/06►01/11			647945	715635	
C6 (2005>2012)	M+			12/05►01/11			6441EJ	698884	701002
C8 (2002>)	M+			06/02►10/06	6447LZ	698738	6447SP	715558	701013
DS3	+/-	2x 		03/10►01/16	1609428080	715556	1609428180	715557	701007
DS4	A+			04/11►	6447NT	698664	6447NV	698714	701014
Evasion	+/-	Kit 3x 		07/94►05/02	6447HO	715530			
Saxo (96>2005)	+/-			03/96►05/05	6441G9	715589			
Space Tourer	+/-	2x 		03/16►	6447XF	715554	6447XG	715555	
Synergie (95>202)	+	Kit 3x 		10/95►05/02	6447HO	715530			
Xantia (93>202)	+/-			03/93►05/02	6447LV	698146			
Xsara (97>2000)	+			07/97►08/00	6447FG	698731			
Xsara (97>2005)	-			07/97►08/05	6447LV	698146	6447SR	715677	
Xsara (2000>2005)  8864►	+			09/00►08/05	6447LV	698146	6447SR	715677	
Xsara (2000>2005)	A+			09/00►08/05	6447HP	698657	6447SQ	715629	
Xsara (2000>2005)	M+			09/00►08/05	6447FG	698731			
Xsara Picasso (99>2010)	+/-			12/99►05/07	6447FF	698680	6447LN	715612	

## CITROËN

Berlingo (96>2002)  ►8805	+			07/96►12/00	6447LV	698146			
Berlingo (96>2002)  8806►	A+			12/00►12/02	6447HP	698657			
Berlingo (2002>2012)	+			12/02►	6447LV	698146	6447SR	715677	

	AC				PA  	CA  	PCA  
--	----	---	---	---	---	---	--

## CITROËN

Berlingo (2002>2012)	A+		■	12/02▶	6447HP	698657	6447SQ	715629	
Berlingo (B9) (2008>)	+/-	2x 	■	05/08▶	6447XF	715554	6447XG	715555	
Dispatch (2004>2006)	A+		■	01/04▶	6447HP	698657			
Dispatch (2007>)	+/-		■	01/07▶	6447YK	715614	6447YK	715613	
Jumper (94>2006)	+		■	02/94▶06/06	6447J0	698858			
Jumper (2006>)	+/-		■	07/06▶	6447YC	715636			
Jumpy (95>2003)	+	Kit 3x 	■	09/00▶12/03	6447H0	715530			
Jumpy (2007>)	+/-		■	01/07▶	6447YK	715614	6447YK	715613	
Jumpy IV (2016>)	+/-	2x 		05/16▶	6447XF	715554	6447XG	715555	
Nemo (2007>)	+/-		■	12/07▶	647960	715552			
Nemo (2007>)	+/-		■	12/07▶	647962	715616			
Relay (94>2006)	+		■	02/94▶06/06	6447J0	698858			
Relay (2006>)	+/-		■	07/06▶	6447YC	715636			

## DACIA

Duster	+/-		■	03/10▶06/10	272772835R	698753			
Lodgy (2012>)	+/-		■	04/12▶	272775340R	715803▲			
Logan (2004>2012)	+/-		■	09/04▶	272772835R	698753			
Logan (2013>)	+/-		■	01/13▶07/15	272773016R	715746	272770567R	715725	701026
Sandero (2008>2012)	+/-		■	06/08▶08/11	272772835R	698753			
Sandero (2012>)	+/-		■	10/12▶07/15	272773016R	715746	272770567R	715725	701026

## DACIA

Dokker	+/-		■	09/12▶	272775340R	715803▲			
--------	-----	--	---	--------	------------	---------	--	--	--

## DAEWOO

Evanda	+		■	08/02▶05/05	96327366	715587			
Kalos	+		■	09/02▶07/05	96435888	715535			
Korando	+	2x 		02/99▶07/05	6923005400	715566			
Lacetti	+		■	10/03▶12/04	96554378	715526			
Leganza	+		■	09/97▶01/03	960207422	698859			
Musso	+	2x 		01/99▶07/05	6923005400	715566			
Nubira	+		■	09/97▶09/04	96190645	698860			
Nubira	+		■	07/03▶07/05	96554378	715526			
Rezzo	+	2x 		04/00▶07/05	93740495	715536			
Tacuma	+	2x 		06/00▶07/05	93740495	715536			

## DAIHATSU

Charade	+		■	06/11▶	871390D010	715620	8713950060	715730	701021
---------	---	--	---	--------	------------	--------	------------	--------	--------

	AC				PA  	CA  	PCA 
---	----	---	---	---	---	---	--

















## DAIHATSU























Cuore (2003>2007)	+/-		■	05/03▶08/07	99906850M2-036	<b>715590</b>			
Cuore (2007>2013)	+		■	04/07▶11/13			8975K2000100	<b>715695</b>	
Sirion II	+		■	01/05▶	99906850M2-038	<b>715637</b>			
Terios	+		■	05/06▶11/06			8975K2000100	<b>715695</b>	

## DODGE

Avenger	+		■	07/07▶11/10	5058693AA	<b>715735</b>	5058381AA	<b>715537</b>	
Caliber	+/-		■	09/06▶05/11	5058693AA	<b>715735</b>	5058381AA	<b>715537</b>	
Journey	+		■	06/08▶05/11	5058693AA	<b>715735</b>	5058381AA	<b>715537</b>	
Nitro	+	2x 	■	06/07▶05/11	68033193AA	<b>715696</b>			













## FIAT

500	+/-		■	07/12▶	51854923	<b>715755</b> ●			
500L	+/-		■	10/12▶	77366480	<b>715809</b> ▲			
500X	+/-		■	11/14▶	77366480	<b>715809</b> ▲			
Nuova 500	+/-		■	07/07▶06/12	46723321	<b>698866</b>	77365763	<b>715723</b>	
Nuova 500	+/-		■	03/10▶06/12	6447YC	<b>715636</b>			
Nuova 500	+/-	W/O Plastic Frame 	■	07/07▶06/12	46723331	<b>698867</b>			
Aegea (2015>)	+			10/15▶	647962	<b>715616</b>			
Albea	+/-		■	04/02▶07/11	7082301	<b>715615</b>			
Barchetta (95>2005)	+		■	04/95▶05/05	46721374	<b>698198</b>			
Brava	+		■	06/95▶09/98	46412715	<b>698689</b>			
Brava  4935530▶	+/-		■	06/95▶	46442422	<b>698197</b>	46768502	<b>698687</b>	
Bravo I	+/-		■	06/95▶03/07	46412715	<b>698689</b>			
Bravo I	+/-		■	06/95▶03/07	46442422	<b>698197</b>	46768502	<b>698687</b>	
Bravo II	+/-		■	04/07▶	46723435	<b>715686</b>	46723435	<b>698692</b>	
Coupé	+/-		■	11/93▶	46409630	<b>698174</b>			
Coupé	+/-		■	11/93▶09/00	46412715	<b>698689</b>			
Croma (91>96)	+		■	10/85▶12/92	60811242	<b>698199</b>			
Croma (2005>)	+		■	06/05▶			46844822	<b>698710</b>	<b>701010</b>
Freemont	+		■	06/11▶	K05058693AA	<b>715735</b>	K05058693AA	<b>715537</b>	
Idea	+/-	W/O Plastic Frame 	■	10/03▶01/12	46723331	<b>698867</b>			
Linea	+		■	07/07▶	647962	<b>715616</b>			
Marea (96>99)	+/-		■	07/96▶01/99	46412715	<b>698689</b>			
Marea (96>99)	+/-		■	07/96▶01/99	46442422	<b>698197</b>			
Marea  0288430▶	+/-		■	02/99▶09/02	46442422	<b>698197</b>	46768502	<b>698687</b>	



























	AC				PA 	CA 	PCA 
<b>FIAT</b> 							
Marea	+/-		■	02/99►09/02	46412715	<b>698689</b>	
Marengo	+/-		■	11/89►01/95	46409630	<b>698174</b>	
Marengo	+/-		■	01/95►09/02	46442422	<b>698197</b>	
Multipla	+/-		■	11/98►05/10	46513960	<b>698454</b>	
Palio	+		■	09/99►	7082301	<b>715615</b>	
Palio  ►05968332	+		■	07/96►	7078711	<b>698691</b>	
Palio  05968332►	+		■	06/99►	7079682	<b>698690</b>	
Panda (2003>2013)	+/-		■	09/03►02/13	46723321	<b>698866</b>	77365763 <b>715723</b>
Panda (2003>2013)	+/-	W/O Plastic Frame 	■	09/03►02/13	46723331	<b>698867</b>	
Panda (2012>)	+/-		■	01/12►	51854923	<b>715755●</b>	
Grande Punto	+/-		■	10/05►12/11	55702456	<b>715552</b>	55702456 <b>715553</b> <b>701003</b>
Nuova Punto	+/-		■	10/11►	55702456	<b>715552</b>	55702456 <b>715553</b> <b>701003</b>
Punto (93>99)	+/-		■	07/93►09/99	46721374	<b>698198</b>	
Punto (99>2003)	+	W/O Plastic Frame 	■	07/99►06/03	46723331	<b>698867</b>	
Punto (99>2003)	+	With Plastic Frame	■	07/99►	46722862	<b>698535</b>	46723245 <b>698839</b>
Punto (2003>2010)	+	W/O Plastic Frame 	■	07/03►08/09	46723331	<b>698867</b>	46723245 <b>698839</b>
Punto Evo	+/-		■	10/09►12/11	55702456	<b>715552</b>	55702456 <b>715553</b> <b>701003</b>
Qubo	+		■	05/08►	55702456	<b>715552</b>	55702456 <b>715553</b> <b>701003</b>
Qubo	+		■	05/08►	647962	<b>715616</b>	
Sedici	+		■	04/06►01/12	71743821	<b>698886</b>	
Siena (97>2001)  ►0596832	+		■	11/97►	7078711	<b>698691</b>	
Siena (97>2001)  0596832►	+		■	11/97►12/01	7079682	<b>698690</b>	
Siena	+/-		■	01/02►12/11	7079682	<b>698690</b>	
Stilo	+/-		■	09/01►08/04	46723435	<b>715686</b>	46723435 <b>698692</b>
Strada Pick Up	+/-		■	03/99►03/03	7079682	<b>698690</b>	
Strada Pick Up	+		■	04/03►	7082301	<b>715615</b>	
Tempra	+/-		■	11/89►1996	46409630	<b>698174</b>	
Tipo	+		■	01/88►10/95	46409630	<b>698174</b>	
Tipo	+			11/15►	647962	<b>715616</b>	
Ulysse (94>2002)	+/-	Kit 3x 	■	06/94►08/02	1475478080	<b>715530</b>	
Ulysse (2002>2010)	+		■	09/02►07/06	1484383080	<b>698738</b>	9655190480 <b>715558</b> <b>701013</b>

	AC				PA  	CA  	PCA 
---	----	---	---	---	---	---	--

## FIAT

Doblo (2000>2005)	+	W/O Plastic Frame		02/01►12/05	46723331	<b>698867</b>			
Doblo (2000>2005)	+			10/00►12/05	46722862	<b>698535</b>	46723245	<b>698839</b>	
Doblo (2006>)	+	W/O Plastic Frame		01/06►	46723331	<b>698867</b>	46723245	<b>698839</b>	
Doblo (2010>)	+			01/10►	77364561	<b>715616</b>			
Ducato	+			02/94►12/11	1312764080	<b>698858</b>			
Ducato	+			07/06►11/11			77365763	<b>715723</b>	
Ducato	+			07/06►	6447YC	<b>715636</b>			
Fiorino	+			12/07►	55702456	<b>715552</b>	55702456	<b>715553</b>	<b>701003</b>
Fiorino	+			12/07►	647962	<b>715616</b>			
Scudo (95>2006)	+/-	Kit 3x 		07/95►12/06	1475478080	<b>715530</b>			
Scudo (2007>)	+/-			01/07►	1497497080	<b>715614</b>	1497497080	<b>715613</b>	

## FORD

B-Max	+/-			08/12►			1566997	<b>715661</b>	
C-Max	+/-			02/07►08/10	1315686	<b>698882</b>	1253220	<b>698883</b>	<b>701027</b>
C-Max	+/-			08/10►03/15			1709013	<b>715757</b>	
Cougar	A+			09/98►02/01	1097670	<b>698168</b>	1225788	<b>715674</b>	
Ecosport	+/-			08/13►07/15			1566997	<b>715661</b>	
Fiesta (95>2002)	+/-			08/95►03/02	1004051	<b>698201</b>	1089176	<b>715617</b>	
Fiesta (2002>2008)	+/-			03/02►11/08	1204459	<b>698694</b>	1204464	<b>698693</b>	<b>701004</b>
Fiesta VI (2008>2013)	+			10/08►05/13	1541456	<b>715660</b>	1566997	<b>715661</b>	
Fiesta (2012>)	+/-			11/12►	1541456	<b>715660</b>	1566997	<b>715661</b>	
Focus (98>2004)	+/-			10/98►08/04	1062253	<b>698487</b>	1121106	<b>698695</b>	<b>701005</b>
Focus (2004>)	+/-			09/04►	1354952	<b>715510</b>	1354953	<b>715511</b>	<b>701011</b>
Focus (2011>)	+/-			03/11►			1709013	<b>715757</b>	
Focus C-MAX	+			06/03►02/07	1315686	<b>698882</b>	1253220	<b>698883</b>	<b>701027</b>
Fusion (2002>2012)	+/-			06/02►06/12	1204459	<b>698694</b>	1204464	<b>698693</b>	<b>701004</b>
Galaxy (95>2006)	+			05/95►04/06	1054468	<b>698247</b>	1113627	<b>698696</b>	
Galaxy (2006>)	+			04/06►	1315686	<b>698882</b>	1253220	<b>698883</b>	<b>701027</b>
Ka (96>2008)	+/-			09/96►10/02	1004051	<b>698201</b>	1120475	<b>715617</b>	
Ka (2008>)	+/-			12/08►09/10	1557375	<b>698866</b>	1673744	<b>715723</b>	
Kuga (2008>2012)	+/-			04/08►11/12	1315686	<b>698882</b>	1253220	<b>698883</b>	<b>701027</b>
Kuga (2012>)	+/-			11/12►			1709013	<b>715757</b>	
Maverick (93>98)	+			02/93►03/98	5028225	<b>698707</b>			
Maverick	+			12/00►05/06	4134237	<b>698893</b>			
Mondeo (93>96)	+			01/93►08/96	1097670	<b>698168</b>	1225788	<b>715674</b>	
Mondeo (96>2000)	+/-			08/96►09/00	1097670	<b>698168</b>	1225788	<b>715674</b>	
Mondeo (2000>2003)	M+			10/00►05/03	1119613	<b>698779</b>	1119616	<b>698745</b>	



	AC				PA  	CA  	PCA 
--	----	---	---	---	---	---	--





## FORD























Mondeo (2003>2005)	+/-		■	06/03>04/05	1119613	<b>698779</b>	1119616	<b>698745</b>	
Mondeo (2005>2007)	A+		■	05/05>06/07			1119616	<b>698745</b>	
Mondeo (2005>2007)	M+		■	05/05>06/07	1119613	<b>698779</b>			
Mondeo (2007>2010)	+		■	06/07▶	1315686	<b>698882</b>	1253220	<b>698883</b>	<b>701027</b>
Mondeo (2010>)	M+		■	09/10▶			1253220	<b>698883</b>	<b>701027</b>
Puma	+/-		■	05/97▶12/01	1004051	<b>698201</b>	1120475	<b>715617</b>	
Ranger	+/-		■	09/11▶	1718237	<b>715745●</b>			
S-Max	+/-		■	04/06▶	1315686	<b>698882</b>	1253220	<b>698883</b>	<b>701027</b>
StreetKa	+		■	11/02▶	1004051	<b>698201</b>	1089176	<b>715617</b>	





































## FORD

Courrier	+		■	10/96▶09/02	1004051	<b>698201</b>	1089176	<b>715617</b>	
Tourneo Connect	+		■	05/02▶06/06	1062253	<b>698487</b>	1121106	<b>698695</b>	<b>701005</b>
Transit Connect	-		■	05/02▶	1062253	<b>698487</b>	1121106	<b>698695</b>	<b>701005</b>
Tourneo Courier	+/-		■	02/14▶			1566997	<b>715661</b>	
Transit (2000>)	+		■	01/00▶	1353267	<b>698762</b>			
Transit (2006>)	+		■	04/06▶			1745605	<b>715747●</b>	
Transit (2006>)	+/-		■	04/06▶	1745604	<b>715742●</b>			

## HONDA







Accord Coupé	+	2x 	■	10/97▶06/02	80291S84A01	<b>715593</b>			
Accord VI (CG/CH)	+		■	09/98▶01/03	79370S1A505	<b>715573</b>			
Accord VII (CL/CM)	+		■	02/03>05/08	80292SDAA01	<b>698868</b>	80292SFY003	<b>715678</b>	
Accord VIII (CU)	+		■	05/08▶04/11	80292SDAA01	<b>698868</b>	80292SFY003	<b>715678</b>	
City	+/-		■	10/81▶12/87	80291S4A505HE	<b>698886</b>			
Civic (EJ*) (96>2000)	-		■	03/96>03/00	79831S04003	<b>698196</b>			
Civic (EJ*) (96>2000)	+		■	03/96>03/00	79831S04003	<b>698869</b>			
Civic (EJ/EK) (95>2001)	-		■	10/95>03/01	79831S04003	<b>698196</b>			
Civic (EJ/EK) (95>2001)	+		■	10/95>03/01	79831S04003	<b>698869</b>			
Civic (EP) (2001>2006)	+	2x 	■	04/01▶06/06	80291S2H505	<b>715594</b>			
Civic (EP) (2001>2006)	+	2x 	■	04/01▶06/06	80291S5A003	<b>698735</b>			
Civic (MA/MB) (95>2001)	+		■	01/95>03/01	79831S04003	<b>698869</b>			
Civic (MA/MB) (95>2001)	M-		■	01/99>03/01	79831S04003	<b>698196</b>			
Civic Aerodeck (MB/MC)	-		■	09/97>03/01	79831S04003	<b>698196</b>			
Civic Aerodeck (MB/MC)	+/-		■	09/97>03/01	79831S04003	<b>698869</b>			
Civic VIII (FK/FD/FN)	+/-		■	01/06>06/09	80292SDAA01	<b>698868</b>	80292SFY003	<b>715678</b>	
CR-V (97>2002)	+		■	01/97▶02/02	79831S04003	<b>698869</b>			
CR-V (2002>2006)	+	2x 	■	03/02▶	80291S5A003	<b>698735</b>			
CR-V (2006>2012)	+		■	12/06>06/12	80292SDAA01	<b>698868</b>	80292SFY003	<b>715678</b>	
CR-Z (2010>)	+		■	06/10▶	80291TFOE01	<b>715692</b>			

	AC				PA  	CA  	PCA 
<b>HONDA</b> 							
FR-V (2004>2010)	+/-	2x 		10/04▶04/10	80291S5A003	<b>698735</b>	
HR-V (GH)	+	2x 		10/99▶09/05	80291S2H505	<b>715594</b>	
Insight	+			03/00▶	79831S04003	<b>698869</b>	
Insight Hybrid	-			02/09▶	80291TF0E01	<b>715692</b>	
Jazz (81>86)	+/-			10/81▶1986	80291SAA505HE	<b>698886</b>	
Jazz II (2002>2008)	+			01/02▶10/08	80291SAA505HE	<b>698886</b>	
Jazz III (2008>)	+			10/08▶	80291TF0E01	<b>715692</b>	
Legend	+/-			09/06▶10/10	80292SDAA01	<b>698868</b>	80292SFY003 <b>715678</b>
Logo	+/-	2x 		12/99▶04/01	80291S2H505	<b>715594</b>	

<b>HYUNDAI</b> 							
Accent (99>2003)	+	2x 		11/01▶01/03	976171C000	<b>715525</b>	
Accent (99>2003)	+			10/99▶01/03	9761037000	<b>715516</b>	
Accent (2003>2006)	+			02/03▶12/06	971331E000	<b>715592</b>	
Azera	+			02/11▶	971333SAA0	<b>715804▲</b>	
Coupé (2002>2008)	+			02/02▶09/08	971332D000	<b>715517</b>	
Elantra (2000>2007)	+			06/00▶01/07	971332D000	<b>715517</b>	
Elantra (2000>2007)	+			06/00▶01/07	971332D200	<b>715591</b>	
Elantra (2006>2011)	+			02/09▶05/11	971332H001	<b>715816●</b>	
Elantra (2006>2011)	+			11/06▶05/11	971331E000	<b>715592</b>	
Elantra (2012>)	+			02/12▶	971332H001	<b>715816●</b>	
Genesis Coupé (2008>)	+/-			09/08▶	971332E200	<b>715521</b>	
Getz	+	2x 		09/02▶03/04	976171C000	<b>715525</b>	
Getz	-			09/02▶	9999207019	<b>715656</b>	
Grandeur	+			04/05▶10/10	971332B010	<b>715541</b>	
i10	+			02/08▶	9713307010	<b>715524</b>	
i20	+	2x  		12/08▶	971331J000	<b>715662</b>	
i20	+/-			04/10▶04/12	971334P000	<b>715748●</b>	
i20	+			01/15▶	971331E000	<b>715592</b>	
i20				01/15▶	971332H001	<b>715816</b>	
i30 (2008>2012)	+/-			03/07▶07/12	971332L000	<b>715638</b>	
i30 (2012>)	+/-			01/12▶	971332H001	<b>715816●</b>	
i30 (2015>)	+			01/15▶	971331E000	<b>715592</b>	
i40 (2011>)	+/-			06/11▶	971332E200	<b>715521</b>	
ix20	+/-			10/10▶	971331P000	<b>715741</b>	
ix35	+/-			01/10▶	971332E250	<b>715740</b>	
ix55	+/-			09/08▶	971333J100	<b>715697</b>	
Matrix	+			05/01▶08/08	971332D000	<b>715517</b>	
Santa Fé (2000>2006)	+	2x 		04/03▶02/06	976193D000	<b>715529</b>	

	AC				PA  	CA  	PCA 
--	----	---	---	---	---	---	--

## HYUNDAI

Santa Fé (2000>2006)	+		■	04/03►02/06	9761938000	698888			
Santa Fé (2006>2009)	+/-		■	03/06►09/09	971332B010	715541			
Santa Fé (2009>2012)	+		■	09/09►06/12	971332B005	715716			
Santa Fé (2012>)	+		■	06/12►	971333SA40	715804▲			
Solaris (2011>)	+		■	03/11►	971334L000	715807▲			
Sonata (2001>2005)	+		■	07/01►03/03	9761938000	698888			
Sonata (2001>2005)	+/-	2x 	■	07/01►02/05	976193D000	715529			
Sonata (2005>2011)	+/-		■	03/05►01/11	971332B010	715541			
Sonata (2010>)	+/-		■	07/10►	971333SA40	715804▲			
Sonica (98>2001)	+		■	06/98►05/01	9761938000	698888			
Starex (98>2007)	+		■	11/01►04/04	974064A900	715738			
Terracan	+		■	03/02►07/07	97030H1726	715527			
Tiburon (2002>2006)	+		■	02/02►09/06	971332D000	715517			
Trajét (2000>2004)	+		■	01/00►02/04	9761938000	698888			
Trajét (2004>)	+	2x 	■	03/04►	976193D000	715529			
Tucson	+/-		■	07/04►	971332E200	715521			
Tucson	+	2x  	■	08/04►	971332E900	715639			
Tucson	+		■	07/04►	971332E250	715740			
Veloster (SB) (2011>)	+/-		■	04/11►	971332E200	715521			
XG (99>2002)	+/-		■	01/99►08/02	9761938000	698888			
XG (2002>2006)	+		■	09/02►03/03	9761938000	698888			
XG (2002>2006)	+	2x 	■	09/02►02/06	976193D000	715529			

## HYUNDAI

H1 (97>)	+		■	02/00►05/02	974064A900	715738			
H1 (2007>)	+/-		■	10/07►	974064A900	715738			
H1 (2007>)	+/-		■	10/07►	976174H000	715669			
Highway Van (2000>2004)	+/-		■	03/00►04/03	9761938000	698888			
Highway Van (2000>2004)	+	2x 	■	04/03►02/04	976193D000	715529			

## INFINITI



FX 35 /45	+/-		■	01/03►	B727A79925	715631	27277Z5000	715560	
G20	+	2x 	■	01/97►	272747J125	715561			
G35	+		■	05/02►	B727A79925	715631	27277Z5000	715560	
I30	+	2x 		03/00►09/04			B72003Y000	698873	
I35	+	2x 		03/00►09/04			B72003Y000	698873	
QX4	+	2x 	■	01/97►	272747J125	715561			

## ISUZU

D-Max	+		■	01/03►09/12	8973561270	715718			
-------	---	--	---	-------------	------------	--------	--	--	--

	AC				PA  	CA  	PCA 
---	----	---	---	---	---	---	--





## ISUZU

Rodeo	+			01/04▶12/04	8973561270	<b>715718</b>		
Trooper	+/-	2x 		01/98▶01/04	8971708040	<b>715569</b>		

## IVECO

Campagnola	+/-			12/08▶			2994769	<b>716063</b>
Daily (99>2006)	+/-			05/99▶03/06	500314688	<b>698197</b>	93162491	<b>698687</b>
Daily (2006>)	+			04/06▶	3802821	<b>715595</b>	2994769	<b>716063</b>
Massif	+/-			03/08▶	3802821	<b>715595</b>	2994769	<b>716063</b>
Rapido	+/-			02/07▶			2994769	<b>716063</b>

## JAGUAR

F type	+	2x 		10/12▶			6W83020B02AB	<b>715640</b>
S-Type  M45255▶	+			01/02▶10/07			XR830254	<b>715505</b>
Sovereign	+/-			10/02▶03/09			2W9319G244AA	<b>715504</b>
XF	+			08/07▶			C2Z6525	<b>715681</b>
XJ (2002>2009)	+			10/02▶12/09			2W9319G244AA	<b>715504</b>
XJ (2010>2015)	+			01/10▶07/15			C2Z6525	<b>715681</b>
XJR	+/-			10/02▶01/09			2W9319G244AA	<b>715504</b>
XK	+/-	2x 		09/05▶			6W83020B02AB	<b>715640</b>
XK8	+	2x 		08/02▶02/11			6W83020B02AB	<b>715640</b>
XKR	+	2x 		03/11▶10/12			6W83020B02AB	<b>715640</b>
X-Type	M+			02/01▶	1S7H16N619	<b>698779</b>	1S7H19G244	<b>698745</b>

## JEEP











Cherokee (2008>2014)	+	2x 		03/08▶09/10	68033193AA	<b>715696</b>		
Commander (2005>2010)	+/-			05/05▶06/10	5013595AA	<b>715670</b>		
Compass (2011>)	+/-			05/11▶	5058693AA	<b>715735</b>	5058381AA	<b>715537</b>
Grand Cherokee (93>2005)	+			01/93▶05/05	5013595AA	<b>715670</b>		
Grand Cherokee (2010>)	+			09/10▶	68079487AA	<b>715717</b>		
Liberty	+/-			03/08▶	68033193AA	<b>715696</b>		
Patriot	+/-			06/07▶	5058693AA	<b>715735</b>	5058381AA	<b>715537</b>
Renegade	+/-			07/14▶	77366480	<b>715809▲</b>		

## KIA

Carens (2002>2006)	+	2x 		07/02▶05/06	K2FA6152X	<b>715522</b>		
Carens (2006>2012)	+			06/06▶	971332E200	<b>715521</b>		
Carens (2013>)	+			03/13▶	971332H001	<b>715816●</b>		
Carnival (2006>2012)	+			03/06▶	971332F000	<b>698895</b>		
Cee'd (2006>2012)	+			08/06▶07/12	971331H000	<b>715638</b>		
Cee'd (2012>)	+			05/12▶	971332H001	<b>715816●</b>		

	AC				PA  OE 	CA  OE 	PCA  
--	----	---	---	---	---	---	---





## KIA

Cee'd (2015>)	+			07/15▶	971332H001	<b>715592</b>			
Cerato (2004>2008)	+		■	01/04▶09/06	971332F000	<b>698895</b>			
Clarus (95>2001)	+	2x 	■	05/95▶07/01	97619FD200	<b>715523</b>			
Elan (99>99)	+	2x 	■	01/99▶12/99	K2FA6152X	<b>715522</b>			
Magentis (2001>2005)	+		■	02/01▶12/05	9761938100	<b>698888</b>			
Magentis (2006>2008)	+		■	01/06▶	971332B010	<b>715541</b>			
Opirus (2003>2006)	+			04/03▶10/06	971143B100	<b>698889</b>			
Optima	+		■	11/10▶	971333SAA0	<b>715804▲</b>			
Picanto (2004>2007)	+		■	01/04▶08/06	9713307000	<b>715524</b>			
Picanto	+		■	12/07▶	9713307000	<b>715524</b>			
Rio (2002>2005)  20020708▶	+	2x 	■	07/02▶05/05	97619FD200	<b>715523</b>			
Rio (2005>2014)			■	06/05▶12/14	971332E200	<b>715521</b>			
Sedona	+		■	02/02▶11/05	971332F000	<b>698895</b>			
Shuma	+/-	2x 	■	10/97▶05/04	0K2N16152X	<b>715618</b>			
Sephia II	+	2x 	■	10/97▶05/01	0K2N16152X	<b>715618</b>			
Sorento (2002>2006)	+/-		■	04/02▶05/06	9761938100	<b>698888</b>			
Sorento (2006>2009)	+	2x 	■	04/06▶08/09	971332E900	<b>715639</b>			
Sorento (2009>)	+		■	05/09▶	971332F000	<b>698895</b>			
Soul	+		■	10/08▶07/11	971332K000	<b>715691</b>			
Spectra	+	2x 	■	05/01▶05/04	0K9A56152XA	<b>715618</b>			
Sportage 94>2004)	+	2x 	■	04/94▶09/04	0K9A56152XA	<b>715618</b>			
Sportage (2004>2006)	+		■	12/04▶	971332E200	<b>715521</b>			
Sportage (2004>2006)	+	2x 	■	12/04▶	971332E900	<b>715639</b>			
Sportage (2010>)	+		■	06/10▶	971332E250	<b>715740</b>			
Venga	+		■	12/09▶	971331P000	<b>715741</b>			

## LADA



110	+/-		■	01/95▶			211812202010	<b>715682</b>	
111	-		■	01/95▶			211812202010	<b>715682</b>	
112	-		■	01/95▶			211812202010	<b>715682</b>	
Kalina 1118	-		■	03/05▶	111808122010	<b>715739</b>			
Kalina 1119	+/-		■	03/05▶	111808122010	<b>715739</b>			

## LANCIA

Dedra (89>99)	+		■	03/89▶06/94	46409630	<b>698174</b>			
Dedra (94>99)	+		■	07/94▶09/99	46442422	<b>698197</b>	60653641	<b>698687</b>	
Delta (93>99)  ▶3301402	+		■	03/93▶09/98	46409630	<b>698174</b>			
Delta (93>99)  3301402▶	+		■	03/94▶08/99	46442422	<b>698197</b>	60653641	<b>698687</b>	

	AC				PA  	CA  	PCA 
---	----	---	---	---	---	---	--

## LANCIA

Delta	+		■	06/08▶12/14	46723435	<b>715686</b>			
Flavia	+/-		■	05/12▶	K05058693AA	<b>715735</b>	K05058693AA	<b>715537</b>	
Kappa (94>2001)	+/-		■	10/94▶10/01			46721047	<b>698688</b>	
Kappa (94>2001)	+/-	Kit 3x 	■	03/97▶04/98	1475478080	<b>715530</b>			
Lybra	+		■	09/99▶12/06	46442422	<b>698197</b>	60653641	<b>698687</b>	
Musa	+/-	W/O Plastic Frame 	■	01/06▶	46723331	<b>698867</b>			
Phedra	+/-		■	09/02▶2010	1484383080	<b>698738</b>	9655190480	<b>715558</b>	<b>701013</b>
Thema	+		■	09/92▶08/92	60811242	<b>698199</b>			
Thema	+		■	10/11▶	K68071668AA	<b>715749●</b>			
Thesis	+		■	09/02▶2006			46723024	<b>698751</b>	
Y Ipsilon (95>2003)	+		■	11/95▶09/03	46721374	<b>698198</b>			
Y Ipsilon (2000>2003)	+	W/O Plastic Frame 	■	09/00▶09/03	46723331	<b>698867</b>			
Ypsilon (2003>2012)	+	W/O Plastic Frame 	■	10/03▶04/11	46723331	<b>698867</b>			
Ypsilon 2011 (2011>)	+		■	05/11▶	51854923	<b>715755●</b>			
Zeta (94>2002)	+/-	Kit 3x 	■	10/94▶08/02	1475478080	<b>715530</b>			

## LAND ROVER

Discovery	+/-		■	11/04▶06/10	JKR500010	<b>715518</b>	JKR500020	<b>715519</b>	
Freelander (97>2003)  ▶YA999999	+		■	10/97▶	JKR100200	<b>698799</b>			
Freelander (97>2003)  1A000001▶	+		■	03/00▶09/03	JKR100280	<b>698817</b>			
Freelander (2006>)	+/-		■	02/06▶07/12	6G9N180543BA	<b>715597</b>	6G9N19N619BA	<b>715702</b>	
Range Rover (94>2002)	+/-	2x 	■	09/94▶02/02	BTR8037	<b>715598</b>			
Range Rover (2002>2012)	+/-		■	03/02▶12/10			JM0000010	<b>698776</b>	
Range Rover Evoque	+		■	03/11▶	6G9N180543BA	<b>715597</b>	6G9N19N619BA	<b>715702</b>	
Range Rover Sport	+		■	06/05▶06/13	JKR500010	<b>715518</b>	JKR500020	<b>715519</b>	

## LDV

Maxus	+		■	07/05▶	589150001	<b>715655</b>	573228900	<b>698688</b>	
-------	---	--	---	--------	-----------	---------------	-----------	---------------	--

## LEXUS

CT 200h	+		■	12/10▶12/13	8713930040	<b>715620</b>	8713950060	<b>715730</b>	<b>701021</b>
GS 300 (97>2004)	+		■	09/97▶09/00	8713930010	<b>715542</b>	8850530100	<b>715729</b>	
GS 300 (2005>2011)	+		■	01/05▶12/11	8713930040	<b>715620</b>	8713950060	<b>715730</b>	<b>701021</b>
GS 350	+		■	07/09▶12/11	8713930040	<b>715620</b>	8713950060	<b>715730</b>	<b>701021</b>
GS 430 (2000>2004)	+		■	07/00▶12/04			8713950030	<b>715641</b>	
GS 430 (2005>2008)	+		■	01/05▶09/08	8713930040	<b>715620</b>	8713950060	<b>715730</b>	<b>701021</b>
GS 450	+		■	02/06▶12/11	8713930040	<b>715620</b>	8713950060	<b>715730</b>	<b>701021</b>

	AC				PA  OE 	CA  OE 	PCA  OE 
--	----	---	---	---	--	--	---







## LEXUS

GS 460	+		■	09/07►08/13	8713930040	<b>715620</b>	8713950060	<b>715730</b>	<b>701021</b>
IS 200 (99>2005)	+		■	03/99►07/05	8713930010	<b>715542</b>	8850530100	<b>715729</b>	
IS 200D	+		■	08/10►	8713930040	<b>715620</b>	8713950060	<b>715730</b>	<b>701021</b>
IS 220D (2005>2012)	+		■	11/05►08/10	8713902020	<b>715620</b>	8713950060	<b>715730</b>	<b>701021</b>
IS 250	+		■	08/05►	8713930040	<b>715620</b>	8713950060	<b>715730</b>	<b>701021</b>
IS 300	+		■	09/01►07/05	8713930010	<b>715542</b>	8850530100	<b>715729</b>	
IS F	+		■	12/07►	8713930040	<b>715620</b>	8713950060	<b>715730</b>	<b>701021</b>
LFA	+		■	12/10►11/12	8713930040	<b>715620</b>	8713950060	<b>715730</b>	<b>701021</b>
LS400	+		■	10/94►08/00	8713930010	<b>715542</b>	8850530100	<b>715729</b>	
LS430	+		■	08/00►08/06			8713950030	<b>715641</b>	
LS 460	+		■	08/06►09/12	8713930040	<b>715620</b>	8713950060	<b>715730</b>	<b>701021</b>
LS 600	+		■	11/09►09/12	8713930040	<b>715620</b>	8713950060	<b>715730</b>	<b>701021</b>
LX 570	+/-		■	11/07►	8713930040	<b>715620</b>	8713950060	<b>715730</b>	<b>701021</b>
NX (2014>)			■	07/14►	8713930040	<b>715620</b>	8713950060	<b>715730</b>	<b>701021</b>
RX 300 (2000>2003)	+		■	07/00►02/03	8713930010	<b>715542</b>	8850530100	<b>715729</b>	
RX 300 (2003>2006)	+		■	02/03►01/06			8713933010	<b>715619</b>	
RX 350 (2006>2008)	+		■	01/06►			8713933010	<b>715619</b>	
RX 400	A+		■	03/05►			8713933010	<b>715619</b>	
RX 350 (2008>2012)	+		■	12/08►03/12	8713930040	<b>715620</b>	8713950060	<b>715730</b>	<b>701021</b>
SC430	+		■	08/05►07/10			8713950030	<b>715641</b>	

## MAYBACH







Maybach (2002>)	+	Active carbon 2x 	■	09/02►09/12	2108300018	<b>715531</b>	2108301118	<b>698772</b>	
Maybach (2002>)	+		■	09/02►	2108300018	<b>698169</b>			

## MAZDA

2 (2003>2008)	+/-		■	03/03►01/08	DD1061P11	<b>698870</b>	DD1061P11	<b>698693</b>	<b>701004</b>
2 (2007>)	+/-	2x 	■	06/07►	D65161J6X	<b>715642</b>			
3 (2003>2008)	+/-	2x 	■	06/03►11/08	BP4K61J6X	<b>698892</b>			
3 (2008>)	+/-	2x 	■	12/08►06/13	BBP261J6X	<b>715726</b>			
3 (2013>)	+/-		■	07/13►	KD4561J6X	<b>715813●</b>			
5 (2005>)	+/-	2x 	■	02/05►	BP4K61J6X	<b>698892</b>			
6 (2002>2012)  050401►	+/-		■	04/02►12/12	DD1061P11	<b>698870</b>	GJ6B61P11	<b>715679</b>	
6 (2013>)	+/-		■	02/13►	KD4561J6X	<b>715813●</b>			
121 (JA/JB)	+/-		■	03/96►09/01	1E0061J6X	<b>698201</b>	1120475	<b>715617</b>	
323 (BA) (94>98)	+/-	3x 	■	06/94►07/98	BC5D61J6X	<b>715664</b>			
323 (BJ) (98>2003)	-		■	08/98►10/03	GE7B61J6X	<b>715599</b>			
323 (BJ) (98>2003)	+	2x 	■	08/98►10/03	GE6T61J6X	<b>698891</b>			

	AC				PA  	CA  	PCA 
---	----	---	---	---	---	---	--









## MAZDA

626 (GF) (97>2002)	+	2x 	■	06/97▶05/02	GE6T61J6X	<b>698891</b>	CB1261J6X	<b>698890</b>	
626 (GF) (99>2002)	-		■	10/99▶05/02	GE7B61J6X	<b>715599</b>			
626 (GW) (97>99)	-	2x 	■	11/97▶09/99	GE6T61J6X	<b>698891</b>			
626 (GW) (99>2002)	-		■	10/99▶05/02	GE7B61J6X	<b>715599</b>			
CX-5	+		■	01/12▶	KD4561J6X	<b>715813●</b>			
CX-7	+/-		■	05/07▶			GJ6B61P11	<b>715679</b>	
Demio	+	2x 	■	05/99▶03/03	DC2161J6X	<b>715576</b>	DC4561J6X	<b>715750</b>	
MPV	+/-	2x 	■	06/99▶05/06	LDY461J6X	<b>715574</b>	LDY361J6X	<b>715728</b>	
Premacy (99>2001)	+	2x 	■	06/99▶06/01	GE6T61J6X	<b>698891</b>	C10261J6X	<b>698890</b>	
Premacy (2001>2005)	-		■	08/02▶08/05	GE7B61J6X	<b>715599</b>			
Premacy (2001>2005)	+	2x 	■	07/01▶08/05	GE6T61J6X	<b>698891</b>	C10261J6X	<b>698890</b>	
RX-8	+	2x 	■	02/03▶07/10	LDY461J6X	<b>715574</b>			
Tribute	+		■	01/00▶02/05	EC136114Y	<b>698893</b>			

































## MAZDA

BT50	-		■	10/11▶	UCY061P11	<b>715745●</b>			
------	---	--	---	--------	-----------	----------------	--	--	--

## MERCEDES









A Class (W168) (97>2004)	+/-		■	05/97▶06/04	1688300018	<b>698475</b>	1688300818	<b>698744</b>	
A Class (W169) (2004>2008)	+		■	07/04▶03/08	1698300118	<b>715506</b>	1698300218	<b>715507</b>	
A Class (W169) (2008>2012)	+		■	04/08▶09/12			1698300218	<b>715507</b>	
A Class (W176) (2012>)	+		■	09/12▶			2468300118	<b>715814●</b>	
AMG GT (2014>)	+		■	10/14▶			2048300018	<b>715600</b>	
B Class (W245) (2005>)	+/-		■	05/05▶			1698300218	<b>715507</b>	
B Class (W246) (2011>)	+		■	09/11▶09/14			2468300018	<b>715814●</b>	
C Class (202) (93>2001)	+/-		■	03/93▶02/01	2028300018	<b>698169</b>	2108300818	<b>698697</b>	
C Class (203) (2000>2003)	A+	Active carbon 2x 	■	04/00▶12/03			2038300318	<b>698742</b>	
C Class (203) (2000>2003)	A+		■	04/00▶12/03	2038300218	<b>698701</b>			
C Class (203) (2000>2008)	+/-		■	04/00▶02/08	2038300118	<b>698700</b>	2038300918	<b>698743</b>	
C Class (203) (2004>2008)	A+		■	01/04▶02/08	2038300218	<b>698701</b>			
C Class (203) (2004>2008)	A+	Active carbon 2x 	■	01/04▶02/08			2038300318	<b>698742</b>	
C Class (204) (2007>2011)	+		■	01/07▶02/11			2048300018	<b>715600</b>	
C Class (204) (2011>)	+/-	2x 	■	02/12▶			2218300018	<b>715643</b>	
C Class (205) (2014>)	+		■	03/14▶	1668300018	<b>715751●</b>			
CL (215) (99>2006)	+/-	Active carbon 2x 	■	08/99▶04/06	2108300018	<b>715531</b>	2108300218	<b>698772</b>	
CL (216) (2006>2014)	+/-	2x 	■	05/06▶09/10			2218300018	<b>715643</b>	
CLC (203) (2008>2011)	+/-		■	03/08▶03/11			2038300918	<b>698743</b>	



	AC				PA  OE 	CA  OE 	PCA  	
<b>MERCEDES</b> 								
CLC (203) (2008>2011)	A+	Active carbon 2x 	■	03/08>03/11		2038300318	698742	
CLA Class (117)	+		■	02/13>		2468300018	715814●	
CLK Class (208) (97>2003)	+/-		■	06/97>01/03	2028300018	698169	2108300818	698697
CLK Class (209) (2002>2009)	A-	2x  	■	04/06>06/09	2108300018	715531		
CLK Class (209) (2002>2009)	A-		■	04/06>06/09			2108300818	698697
CLK Class (209) (2002>2009)	A+	Active carbon 2x 	■	03/02>06/09			2038300318	698742
CLK Class (209) (2002>2009)	A+		■	03/02>06/09	2038300218	698701		
CLK Class (209) (2002>2009)	A+		■	03/02>06/09	2038300118	698700	2038300918	698743
CLS (219) (2004>2008)	+/-	2x 	■	07/04>01/08			2218300018	715643
CLS (219) (2004>2008)	A+		■	07/04>	2118300218	698702	2118300018	698741
CLS (219) (2004>2008)	A+	2x 	■	07/04>01/08			2118300818	698740
CLS (219) (2008>2011)	+/-		■	02/08>01/11			2118300018	698741
E Class (124) (93>98)	+/-	2x  	■	07/93>03/98	1248300118	715684		
E Class (210) (95>2003)	+/-		■	04/95>06/99	2028300018	698169	2108300818	698697
E Class (210) (95>2003)	A-	2x 	■	06/99>03/02			2118300818	698740
E Class (210) (95>2003)	A+	Active carbon 2x 	■	04/95>03/03	2108300018	715531	2108300218	698772
E Class (211) (2002>2006)	A+		■	03/02>03/06	2118300218	698702	2118300018	698741
E Class (211) (2002>2009)	A+	2x 	■	03/02>11/09			2118300818	698740
E Class (211) (2006>2009)	+/-		■	04/06>11/09	2118300218	698702	2118300018	698741
E Class (212) (2009>2013)	+/-		■	03/09>			2048300018	715600
G Class (M461/3) (89>)	+/-	2x  	■	01/92>09/06			2308300418	715621
G Class (M461/3) (89>)	+		■	07/97>09/06	4638300018	698685	4638300018	698739
GL Class (164) (2006>2013)	+/-	2x 	■	01/06>03/13			1648300218	715544
GL Class (166) (2012>)	+		■	11/12>	1668300018	715751●		
GLA Class (156)	+		■	11/13>			2468300118	715814●
GLK Class (204) (2008>2012)	+/-		■	07/08>06/09			2048300018	715600
ML Class (163) (97>2005)  ▶A145272	+/-		■	05/97>04/05	1638350047	698777	1638350047	698778
ML Class (164) (2005>2008)	+/-	2x 	■	05/05>04/08			1648300218	715544
ML Class (166) (2011>)	+		■	07/11>	1668300018	715751●		
ML Class (164) (2008>2013)	+/-	2x 	■	04/08>01/13			1648300218	715544
R Class (W251) (2005>)	+	2x 	■	10/05>04/08			1648300218	715544
S Class (140) (93>99)	+/-	Prefilter	■	07/93>07/99	1408350247	698797		
S Class (140) (93>99)	+/-		■	07/93>07/99	1408350047	698704		

	AC				PA  OE 	CA  OE 	PCA  
---	----	---	---	---	--	--	---

## MERCEDES

S Class (140) (93>99)	+/-			07/93▶07/99	1408350547	<b>698706</b>	1408350247	<b>698705</b>	
S Class (220) (98>2004)	+		■	09/98▶09/04	2028300018	<b>698169</b>			
S Class (220) (98>2004)	+	Active carbon 2x 		09/98▶09/04	2108300018	<b>715531</b>	2108300218	<b>698772</b>	
S Class (221) (2004>2013)	+/-	2x 	■	10/04▶06/13			2218300018	<b>715643</b>	
SL Class (230) (2001>2012)	+	2x 	■	08/01▶02/12			2308300418	<b>715621</b>	
SLK Class (170) (96>2003)	+/-		■	08/96▶12/03	2028300018	<b>698169</b>	2108300818	<b>698697</b>	
SLK Class (R171)	+/-		■	01/04▶			1718300418	<b>715508</b>	
SLR Class (199) (2004>2009)	+/-	2x 	■	04/04▶07/09			2308300418	<b>715621</b>	
SLS Class (197) (2010>)	+/-		■	01/10▶			2048300018	<b>715600</b>	
W124 (84>93)	+/-	2x  	■	12/84▶06/93	1248300118	<b>715684</b>			
W140 (91>93)	+/-		■	03/91▶06/93	1408350547	<b>698706</b>	1408350247	<b>698705</b>	
W140 (91>93)	M+		■	03/91▶06/93	1408350047	<b>698704</b>			
W140 (91>93)	M+	Prefilter	■	03/91▶06/93	1408350247	<b>698797</b>			

## MERCEDES

V Class (638) (96>2002)	+/-		■	10/96▶12/02	18353047	<b>715577</b>			
Sprinter I (95>2006)	+		■	02/95▶05/06	9018300018	<b>698840</b>	9018300418	<b>716023</b>	
Sprinter II (2006>)	A+		■	02/06▶12/10			9068300318	<b>715602</b>	
Sprinter II (2006>)	M+		■	02/06▶12/10	9068300218	<b>715601</b>			
Vaneo (414) (2001>2005)	+/-		■	10/01▶07/05	1688300018	<b>698475</b>	1688300818	<b>698744</b>	
Viano (639) (2003>)	+/-		■	01/03▶	6398350247	<b>698871</b>	6398350347	<b>698872</b>	
Vito (638) (96>2003)	+/-		■	01/96▶09/03	18353047	<b>715577</b>			
Vito (639) (2003>)	+/-		■	01/03▶	6398350247	<b>698871</b>	6398350347	<b>698872</b>	

## MG

MG XPower (2003>2005)	+/-		■	09/03▶04/05	JKR000030	<b>698879</b>	JKR000040	<b>698880</b>	
MG ZR (2001>2005)	+/-		■	06/01▶04/05	JKR100020	<b>698196</b>			
MG ZS (2001>2005)	-		■	07/01▶04/05	JKR100220	<b>698819</b>			
MG ZS (2001>2005)	+		■	07/01▶04/05	JKR100020	<b>698196</b>			
MG ZT (2001>2005)	+/-		■	06/01▶04/05	JKR000030	<b>698879</b>	JKR000040	<b>698880</b>	

## MINI







MINI (2001>2006)	+		■	09/01▶11/06	64311496710	<b>698724</b>	64311496711	<b>698725</b>	
MINI (R56/R57) (2006>)	A+		■	11/06▶	64319127515	<b>715585</b>	64319127515	<b>715586</b>	
MINI (F55-F56) (2014>)	A-	2x 		01/14▶	64119321876	<b>715812▲</b>	64119321875	<b>715811▲</b>	
MINI Clubman (F54)	A-	2x 		07/15▶	64119321876	<b>715812▲</b>	64119321875	<b>715811▲</b>	
MINI Clubman (R55)	+/-		■	08/07▶01/11	64319127515	<b>715585</b>	64319127515	<b>715586</b>	
MINI Countryman (R60)	+/-		■	08/10▶07/14	64319127515	<b>715585</b>	64319127515	<b>715586</b>	
MINI Coupé (R58)	+/-		■	09/11▶	64319127515	<b>715585</b>	64319127515	<b>715586</b>	

	AC				PA  	CA  	PCA 
--	----	---	---	---	---	---	--

## MINI

MINI Paceman (R61)	+/-		■	03/12►07/14	64319127515	<b>715585</b>	64319127515	<b>715586</b>	
MINI Roadster (R59)	+/-		■	03/12►	64319127515	<b>715585</b>	64319127515	<b>715586</b>	

## MITSUBISHI





ASX	+/-		■	04/10►	7803A004	<b>715631</b>			
Carisma	-	2x 	■	09/00►	MZ311917	<b>715548</b>			
Challenger (K9)	+/-	2x 	■	12/98►	MR460201	<b>715548</b>			
Colt (CJ) (95>2003)	+/-		■	11/95►06/03	MR227823	<b>715543</b>			
Colt (Z30) (2004>2008)	+/-		■	04/04►01/07	MR958016	<b>715603</b>	MR958017	<b>698802</b>	
Colt (Z30) (2008>2013)	+		■	10/08►03/13	MR958016	<b>715603</b>			
Galant (E5*) (92>96)	+		■	11/92►09/96			MR958017	<b>698802</b>	
Galant (EA) (96>2003)	+		■	10/96►05/03	MR315876	<b>715528</b>			
Grandis (2004>2010)	+/-		■	01/04►11/10			MR398288	<b>715546</b>	
Lancer (CS/CT) (2003>2011)	+/-		■	06/03►08/03			MR398288	<b>715546</b>	
Lancer IX (CY) (2007>)	+		■	03/07►12/10	7803A004	<b>715631</b>			
Lancer Sportback (CX)	+		■	07/08►11/10	7803A004	<b>715631</b>			
Montero (93>)	+			05/93►			7803A028	<b>715509</b>	
Montero Sport (K9) (98>2009)	+/-	2x 	■		MR460201	<b>715548</b>			
Outlander I	+/-		■	06/03►12/08			MR398288	<b>715546</b>	
Outlander II	+		■	11/06►07/12	7803A004	<b>715631</b>	7803A005	<b>715623</b>	
Outlander III	+/-		■	04/12►	7803A004	<b>715631</b>	7803A005	<b>715623</b>	
Pajero (99>2005)	+/-	2x 		08/99►02/05	MR315172	<b>715545</b>			
Pajero (2000>2006)	+			02/00►08/06			7803A028	<b>715509</b>	
Pajero (2006>)	+			09/06►			7803A027	<b>715622</b>	
Pajero (2006>)	+			09/06►			7803A028	<b>715509</b>	
Shogun 4 (2006>)	+			09/06►05/11			7803A027	<b>715622</b>	
Space Runner	+/-			06/91►2002	MR360889	<b>715547</b>			
Space Star	+/-		■	06/98►2004	MR262425	<b>715688</b>			
Space Star	+/-	2x 	■	12/98►1999	MR460201	<b>715548</b>			
Space Wagon	+/-			07/98►01/04	MR360889	<b>715547</b>			

## NISSAN

Altima	+		■	01/02►	27277CL025H	<b>715631</b>	27277Z5000	<b>715560</b>	
Almera (95>2000)	+	2x 	■	09/97►01/00	272751N626	<b>715575</b>			
Almera (2000>)	+		■	02/00►	27891BM400	<b>698734</b>	27891BM401	<b>715819</b>	<b>701031▲</b>
Almera Tino (2000>2005)	+		■	08/00►11/05	27891BM400	<b>698734</b>	27891BM401	<b>715819</b>	<b>701031▲</b>
Cube (2009>2012)	+		■	08/09►04/12	278911F00A	<b>715709</b>			
Juke	+		■	07/10►	272771KA0A	<b>715721</b>	272774936R	<b>715722</b>	<b>701025</b>
Leaf (2010>2013)	+/-		■	05/10►02/13	278911F00A	<b>715709</b>			

	AC				PA  	CA  	PCA 
---	----	---	---	---	---	---	--

## NISSAN

















Maxima (CA33)	+/-	W/O Plastic Frame 2x 		01/00▶08/02			272773Y525	698873	
Maxima VI	+		■	04/04▶05/06	27277CL025H	715631	27277Z5000	715560	
Micra (K11)	+		■	10/96▶02/03	278936F600	715549			
Micra (K12)	+/-		■	01/03▶03/10	27891AX010	698753			
Micra (2010>)	+/-		■	07/10▶06/13	272771HEOE	715706	272771HEOE	715756▲	701024
Murano	+/-		■	04/03▶05/08	27277CL025H	715631	27277Z5000	715560	
Murano	+		■	06/08▶	27277JN20A	715703			
Navara	+/-	2x 	■	05/05▶	27274EA000	715520			
Note	+/-		■	09/05▶12/07	27891AX010	698753			
Note	+/-		■	08/13▶	272771HEOE	715706	272771HEOE	715756▲	701024
Pathfinder	+	2x 	■	02/05▶	27274EA000	715520			
Patrol	+	2x 	■	10/97▶10/02	272747J125	715561			
Pixo	+		■	06/09▶04/12	278914A00C	715694			
Primera (P11)	+/-		■	06/96▶02/02	278912F000	698707			
Primera (P12)	+		■	02/01▶2006	27891BM400	698734	27891BM401	715819	701031▲
Pulsar (2014>)	+		■	08/14▶	272771KA0A	715721	272774936R	715722	701025
Qashqai (2007>2010)	+		■	03/07▶01/10	27277EN000	715559	27277JD10A	715732	701028
Qashqai (2010>)	+		■	01/10▶	27277EN000	715559			701028
Teana	+		■	02/08▶	27277JN20A	715703			
Terrano	+/-		■	03/93▶12/06	278912F000	698707			
Tiida (2007>)	+		■	03/07▶	27891EL00A	715708			
Tiida (2012>)	+		■	01/15▶	272771KA0A	715721	272774936R	715722	701025
X-Trail (2001>2007)	+		■	06/01▶09/03	272774M425	715651			
X-Trail (2001>2007)	+		■	06/01▶02/07	B727A79925	715631	27277Z5000	715560	
X-Trail (2007>)	+		■	03/07▶	27277EN025	715559			701028











## NISSAN















Kubistar	+		■	09/03▶11/09	B729800QAA	698255	7711228912	715538	
NV200	-		■	08/09▶	27891EL00A	715708			
Primastar	+/-		■	09/02▶09/06	2729800QAA	715513			

## OPEL

Adam	+/-		■	01/13▶			1808012	715553	701003
Agila	+/-		■	03/00▶12/07	4705463	698773			
Agila	+/-		■	01/09▶	4710210	715644			
Ampera	+/-		■	06/11▶	1808524	715658	1808246	715659	
Antara	+		■	10/06▶12/10	4803883	715654			
Astra F (91>2001)	+/-		■	03/91▶02/01	1808600	698165	1718044	715632	





	AC				PA  	CA  	PCA 		
<b>OPEL</b> 									
Astra G (98>2005)	+/-	Behr	■	02/98▶09/00	1808612	<b>698663</b>	1718042	<b>698708</b>	<b>701008</b>
Astra G (98>2005)	M+	Delphi	■	02/98▶01/03	1808610	<b>698662</b>	1718046	<b>698875</b>	
Astra H (2004>2011)	+/-		■	03/04▶11/11	6808606	<b>698874</b>	6808607	<b>698875</b>	
Astra J (2009>)	+/-		■	09/09▶12/14	1808524	<b>715658</b>	1808246	<b>715659</b>	
Astra K (2015>)	+/-		■	07/15▶			1808020	<b>715752●</b>	
Calibra	+/-		■	09/89▶07/97	1808600	<b>698165</b>	1718044	<b>715632</b>	
Cascada	+/-		■	03/13▶	1808524	<b>715658</b>	1808246	<b>715659</b>	
Corsa B (93>2000)	-		■	03/93▶08/00	1808604	<b>698166</b>			
Corsa B (93>2000)	+		■	03/93▶08/00	1808600	<b>698165</b>	1718044	<b>715632</b>	
Corsa B (93>2000)	+		■	03/93▶08/00	1808606	<b>715645</b>			
Corsa C (2000>2003)	+		■	09/00▶08/03	1808619	<b>698711</b>	1808617	<b>698710</b>	<b>701010</b>
Corsa C (2003>2006)	+/-		■	09/03▶07/06	1808619	<b>698711</b>	1808624	<b>698710</b>	<b>701010</b>
Corsa D (2006>)	+/-		■	07/06▶	6808622	<b>715552</b>	1808012	<b>715553</b>	<b>701003</b>
Corsa E (2014>)	+		■	09/14▶	6808622	<b>715552</b>	1808012	<b>715553</b>	<b>701003</b>
Insignia	+/-		■	01/09▶	1808524	<b>715658</b>	1808246	<b>715659</b>	
Meriva A (2003>2010)	+/-		■	05/03▶07/10	6808604	<b>698876</b>	13271407	<b>698877</b>	
Meriva B (2010>2013)  ▶C4999999	+/-		■	05/10▶	1808524	<b>715658</b>	1808246	<b>715659</b>	
Meriva B (2010>2013)  D4000001▶	+/-		■	10/13			1808020	<b>715752●</b>	
Meriva B (2013>)	+/-		■	11/13▶			1808020	<b>715752●</b>	
Mokka	+/-		■	12/12▶	1808524	<b>715658</b>	1808246	<b>715659</b>	
Monterey	+/-	2x 	■	07/98▶08/99	1808613	<b>715569</b>			
Omega B	+/-		■	02/94▶07/03	1808605	<b>698167</b>	1718022	<b>698746</b>	
Signum (2003>2008)	+/-		■	06/03▶11/08	1808619	<b>698711</b>	1808617	<b>698710</b>	<b>701010</b>
Sintra	+/-	2x 	■	03/96▶12/99	1718962	<b>698712</b>			
Tigra (94>2001)	-		■	10/94▶01/01	1808604	<b>698166</b>			
Tigra (94>2001)	+		■	10/94▶01/01	1808600	<b>698165</b>	1718044	<b>715632</b>	
Tigra (94>2001)	+		■	10/94▶01/01	1808606	<b>715645</b>			
Tigra Twintop (2004>)	+/-		■	07/04▶	1808619	<b>698711</b>	1808617	<b>698710</b>	<b>701010</b>
Vectra A (88>95)	+		■	09/88▶09/95	1808607	<b>698202</b>			
Vectra B (95>99)	+/-		■	10/95▶01/99	1808607	<b>698202</b>	1808608	<b>715675</b>	
Vectra B (99>2003)	+/-		■	02/99▶06/03			1808608	<b>715675</b>	
Vectra C (2002>2005)	+/-		■	04/02▶09/05	1808619	<b>698711</b>		<b>698710</b>	<b>701010</b>
Vectra C (2002>2005)	+/-		■	04/02▶09/05			1808617	<b>698710</b>	<b>701010</b>
Vectra C (2005>2009)	+/-		■	10/05▶02/09	1808619	<b>698711</b>	1808617	<b>698710</b>	<b>701010</b>
Zafira	+/-		■	01/99▶	1808612	<b>698663</b>	1718042	<b>698708</b>	<b>701008</b>
Zafira C (2011>)	+		■	10/11▶	1808524	<b>715658</b>	1808246	<b>715659</b>	

	AC				PA  	CA  	PCA 	
<b>OPEL</b> 								
Combo (93>2001)	-		■	03/93▶09/01	1808604	<b>698166</b>		
Combo (93>2001)	+		■	03/93▶09/01			1718044	<b>715632</b>
Combo (2001>)	+		■	10/01▶	1808619	<b>698711</b>		
Combo (2001>)	-		■	10/01▶			1808617	<b>698710</b>
Combo (2011>)	+		■	10/11▶	6808622	<b>715552</b>	6808623	<b>715553</b>
Vivaro	+/-		■	05/01▶	4408840	<b>715513</b>		

<b>PEUGEOT</b> 								
106	+/-		■	09/91▶07/03	644191	<b>715589</b>		
107	+		■	06/05▶	6447TT	<b>715515</b>		
108	+			05/14▶	8000975480	<b>715828●</b>		
206	A+		■	09/98▶2010	6447AZ	<b>698488</b>	2435	<b>698749</b>
206+	+/-		■	03/09▶10/10	6447AZ	<b>698488</b>		
207	M+	2x 	■	01/07▶	1609428080	<b>715556</b>	1609428180	<b>715557</b>
207+	+/-	2x 	■	11/12▶	1609428080	<b>715556</b>	1609428180	<b>715557</b>
208	+/-	2x 	■	03/12▶	1609428080	<b>715556</b>	1609428180	<b>715557</b>
306	+/-		■	05/93▶	002484	<b>715646</b>		
307  ▶10068	A+		■	03/01▶03/15	6447KK	<b>698664</b>	6447KL	<b>698714</b>
308	A+		■	09/07▶	6447KK	<b>698664</b>	6447KL	<b>698714</b>
308	+/-	2x 	■	07/13▶	9804163380	<b>715808▲</b>	9804163480	<b>715805▲</b>
405	+		■	07/92▶10/96	644793	<b>698235</b>		
406  9639▶	+		■	10/95▶10/04	6447S5	<b>698203</b>	6447PG	<b>698748</b>
407	+		■	04/04▶03/08	647904	<b>715570</b>	6441EJ	<b>698884</b>
407	+/-		■	04/08▶			647946	<b>715635</b>
508	+/-		■	01/11▶			6479K9	<b>715673</b>
605	+/-			07/94▶05/99	6447K6	<b>698815</b>		
607	+		■	05/00▶01/11			6447GW	<b>698713</b>
806	+/-	Kit 3x 	■	07/94▶05/02	6447P2	<b>715530</b>		
807	+/-		■	06/02▶10/06	6447LY	<b>698738</b>	6447TA	<b>715558</b>
1007	A+		■	04/05▶07/10	6447KK	<b>698664</b>	6447KL	<b>698714</b>
2008	A+	2x 	■	04/13▶	1609428080	<b>715556</b>	1609428180	<b>715557</b>
3008	+/-	2x 	■	03/09▶	6447XF	<b>715554</b>	6447XG	<b>715555</b>
4007	+		■	07/07▶	6447ZX	<b>715631</b>	6447ZX	<b>715623</b>
4008	+		■	03/12▶	6447ZX	<b>715631</b>	7803A005	<b>715623</b>
5008	+/-	2x 	■	09/09▶	6447XF	<b>715554</b>	6447XG	<b>715555</b>
RCZ	A+		■	05/10▶			6447KL	<b>698714</b>
Traveller (2016>)	+/-	2x 		03/16▶	6447XF	<b>715554</b>	6447XG	<b>715555</b>

	AC				PA  OE 	CA  OE 	PCA  OE 
--	----	---	---	---	--	--	---

## PEUGEOT

Bipper	+		■	12/07▶	647960	715552			
Bipper	+		■	12/07▶	647962	715616			
Boxer (94>2006)	+		■	02/94▶06/06	6447J0	698858			
Boxer (2006>)	+/-		■	07/06▶	6447YA	715636			
Expert	+/-		■	01/07▶	6447YJ	715614	6447YJ	715613	
Expert	+/-	2x 		05/16▶	6447XF	715554	6447XG	715555	
Partner	+/-		■	06/96▶	6447Z4	698146	6447PF	715677	
Partner  8806▶	+		■	05/98▶11/02	6447HP	698657	6447SZ	715629	
Partner	+	2x 	■	05/08▶	6447XF	715554	6447XG	715555	
Ranch (96>2002)  ▶8805	+/-		■	06/96▶12/00	6447Z4	698146			
Ranch (96>2002)  8806▶	+		■	12/00▶11/02	6447HP	698657			
Ranch (2002>)	+		■	11/02▶	6447HP	698657	6447SZ	715629	

## PORSCHE





























911 (996)	+		■	06/97▶09/01	99657121901	698203	99657121901	698748	
911 Carrera	+		■	12/11▶	99157237100	715754●	99157362300	715753●	
911 Carrera (997-1)	+		■	08/04▶			99657121901	698748	
911 GT3-1(996)	+		■	03/99▶06/05			99657121901	698748	
911 GT3-3(991)	+		■	08/13▶			99157362300	715753●	
911 Turbo (991T)	+		■	09/13▶			99157362300	715753●	
Boxster 981	+		■	01/12▶	99157237100	715754●	99157362300	715753●	
Boxster 986	+		■	08/96▶10/04	99657121901	698203	99657121901	698748	
Boxster 987	+		■	11/04▶			99657121901	698748	
Cayenne 92A	+		■	02/10▶09/11			95857221900	715704	
Cayenne 9PA	+		■	03/03▶02/10			95557221910	698768	
Cayman 981	+		■	03/13▶			99157362300	715753●	
Cayman 987	+		■	11/08▶03/13	99657121901	698203	99657121901	698748	
Panamera 970	+		■	02/09▶			97057362300	715693	

## PROTON

Wira	+/-		■	09/04▶	1K0819644	698800	1K1819653	698801	701001
------	-----	---	---	--------	-----------	--------	-----------	--------	--------

## RENAULT

Avantime	+	2x 	■	09/01▶03/03	6025370624	698290	6025372486	715568	
Captur	+		■	06/13▶	272773016R	715746	272770567R	715725	701026
Clio Campus Evolution	+/-		■	06/09▶12/12	7700424098	698255	7711228912	715538	701018
Clio II	+/-		■	03/98▶11/08	7700424098	698255	7711228912	715538	701018
Clio III	+/-		■	09/05▶04/09	272772835R	698753	7711426872	715818	701030▲

	AC				PA  	CA  	PCA 		
<b>RENAULT</b> 									
Clio IV	+/-		■	10/12▶	272773016R	<b>715746</b>	272770567R	<b>715725</b>	<b>701026</b>
Duster	+		■	03/10▶06/10	272772835R	<b>698753</b>			
Espace II	+/-	2x 	■	01/91▶08/96	6025370624	<b>698290</b>	6025372486	<b>715568</b>	
Espace III	+/-	2x 	■	09/96▶08/02	6025370624	<b>698290</b>	6025372486	<b>715568</b>	
Espace IV	+/-		■	09/02▶	7701056389	<b>715562</b>	7701056390	<b>698737</b>	
Espace V	+/-			03/15▶			272774812R	<b>715820▲</b>	<b>701032▲</b>
Fluence (2009>)	+		■	11/09▶	272772100R	<b>715721</b>	272774936R	<b>715722</b>	<b>701025</b>
Kadjar	+			06/15▶			272774812R	<b>715820▲</b>	<b>701032▲</b>
Koleos	A+		■	06/08▶	272774658R	<b>715724</b>	272770840R	<b>715667</b>	
Laguna I	+		■	01/94▶12/00	7700834816	<b>698173</b>			
Laguna II	+/-		■	01/01▶09/07	52485325	<b>698594</b>	7701048749	<b>698715</b>	<b>701015</b>
Laguna III	+/-	2x 	■	10/07▶			272770001R	<b>715607</b>	
Latitude	+/-	2x 	■	11/10▶			272774653R	<b>715734</b>	
Logan	+/-		■	09/04▶11/12	272772835R	<b>698753</b>			
Megane (95>99)  980403▶	-		■	11/95▶02/99	7700424098	<b>698255</b>	7711228912	<b>715538</b>	<b>701018</b>
Megane (95>99)  980403▶	+		■	11/95▶02/99	7700424093	<b>698276</b>			
Megane (95>99)  ▶980402	+/-		■	11/95▶04/98	7700845811	<b>698149</b>			
Megane (98>2002)	-		■	10/98▶08/02	7700424098	<b>698255</b>	7711228912	<b>715538</b>	<b>701018</b>
Megane (98>2002)	+		■	10/98▶08/02	7700424093	<b>698276</b>			
Megane II	+/-		■	09/02▶09/08	7701055109	<b>698730</b>	7701064235	<b>715539</b>	
Megane III	+/-		■	10/08▶			272778970R	<b>715647</b>	<b>701006</b>
Megane IV	+/-			11/15▶			272774812R	<b>715820▲</b>	<b>701032▲</b>
Megane Scenic (96>99)  980101	+/-		■	10/96▶01/98	7700845222	<b>698177</b>			
Megane Scenic (96>99)	+		■	01/98▶09/99	7700428820	<b>698279</b>			
Megane Scenic (96>99)	+		■	10/96▶09/99	7700845219	<b>698176</b>			
Megane Scenic (96>99)	-		■	10/96▶09/99	7700846236	<b>698175</b>			
Megane Scenic (99>2003)	+/-		■	09/99▶04/03	7701047513	<b>698512</b>			
Megane Scenic (99>2003)	+/-		■	09/99▶04/03	7700846236	<b>698175</b>			
Modus	+/-		■	09/04▶	272772835R	<b>698753</b>			
Scenic (99>2003)	-		■	09/99▶04/03	7700845219	<b>698176</b>			
Scenic (99>2003)	+		■	09/99▶04/03	7701047513	<b>698512</b>			
Scenic (99>2003)	+/-		■	09/99▶04/03	7700846236	<b>698175</b>			
Scenic (2003>2009)	+/-		■	05/03▶11/09	7701055110	<b>698736</b>	7701064237	<b>715610</b>	
Scenic (2009>)	+/-		■	04/09▶			272771128R	<b>715672</b>	<b>701012</b>
Thalia	+/-		■	12/99▶03/01	7700424098	<b>698255</b>	7711228912	<b>715538</b>	<b>701018</b>
Twingo I	+		■	08/94▶08/98	7701409324	<b>698878</b>			



	AC				PA  	CA  	PCA 
--	----	---	---	---	---	---	--

## RENAULT

Twingo II	+		■	09/96►06/07	272772835R	<b>698753</b>			
Twingo III	+/-		■	07/07►	272772835R	<b>698753</b>	7711426872	<b>715818</b>	<b>701030▲</b>
Vel Satis (2002>2005)	A+		■	01/02►01/05	52485325	<b>698594</b>	7701048749	<b>698715</b>	<b>701015</b>
Vel Satis (2005>2009)	+/-		■	02/05►12/09			7701048749	<b>698715</b>	<b>701015</b>
Wind (2010>2014)	+/-		■	07/10►	272772835R	<b>698753</b>	7711426872	<b>715818</b>	<b>701030▲</b>
Zoé (2013>)	+			01/13►			272775081R	<b>715802▲</b>	

## RENAULT

Kangoo (97>2003)	-		■	09/97►02/03	7701042499	<b>715633</b>			
Kangoo (97>2003)	+/-		■	09/97►02/03	7700424098	<b>698255</b>	7711228912	<b>715538</b>	<b>701018</b>
Kangoo (2003>2008)	-		■	03/03►10/08	7701042499	<b>715633</b>			
Kangoo (2003>2008)	-		■	06/05►10/08	7700846236	<b>698175</b>			
Kangoo (2003>2008)	+/-		■	03/03►10/08	7700424098	<b>698255</b>	7711228912	<b>715538</b>	<b>701018</b>
Kangoo (2008>)	+	2x 	■	11/08►	7701209837	<b>715649</b>			
Master	+	2x 	■	04/10►	7701209837	<b>715649</b>			
Trafic (2001>)	+/-		■	04/01►	7701050319	<b>715513</b>			

## ROVER



















25	+/-		■	12/99►	JKR100020	<b>698196</b>			
45	-		■	01/00►05/04	JKR100220	<b>698819</b>			
45	+		■	01/00►05/04	JKR100020	<b>698196</b>			
75	+/-		■	02/99►	JKR000030	<b>698879</b>	JKR000040	<b>698880</b>	
200	-		■	10/89►11/99	JKR100020	<b>698196</b>			
400	-		■	03/90►04/95	JKR100220	<b>698819</b>			
400	+		■	03/90►04/95	JKR100020	<b>698196</b>			
Streetwise	+		■	08/03►04/05	JKR100020	<b>698196</b>			

## SAAB

9-2x	+			2004►2006			G3210FE000	<b>715680</b>	
9-3 (98>2003)  ►Y2031117	+/-		■	04/98►2000	4632493	<b>715514</b>			
9-3 (2002>2012)	+/-		■	09/02►03/12	90535131	<b>698711</b>	9179904	<b>698710</b>	<b>701010</b>
9-5 (97>2001)	A+		■	09/97►08/01			12758727	<b>698723</b>	
9-5 (2001>2010)	+		■	09/01►06/10			12758727	<b>698723</b>	
9-5 (2010>2012)	+		■	05/10►03/12	13271190	<b>715658</b>	13271191	<b>715659</b>	
900 (93>98)	+/-		■	07/93►02/98	4632493	<b>715514</b>			
9000 (84>98)	+		■	06/84►07/91	9625674	<b>698199</b>			





## SCION

xA	+/-		■	05/03►10/07	8856852010	<b>698681</b>	8974000820	<b>715650</b>	
xB	+		■	05/03►10/07	8856852010	<b>698681</b>	8974000820	<b>715650</b>	

	AC				PA  	CA  	PCA 		
<b>SEAT</b> 									
Alhambra (96>2000)	+		■	03/96▶05/00	7H0819638A	<b>698247</b>	1491752	<b>698696</b>	
Alhambra (2000>2010)	+/-		■	06/00▶03/10	7H0819638A	<b>698247</b>	1491752	<b>698696</b>	
Alhambra (2010>)	+/-		■	06/10▶	1K0819644	<b>698800</b>	1K1819653	<b>698801</b>	<b>701001</b>
Alhambra (2010>)	+/-		■	06/10▶			1K2819653	<b>715665</b>	
Altea	+/-		■	05/05▶	1K0819644	<b>698800</b>	1K1819653	<b>698801</b>	<b>701001</b>
Altea	+/-		■	05/13▶12/13			1K2819653	<b>715665</b>	
Arosa  1025001▶	+/-		■	09/00▶			1J0819644	<b>698716</b>	<b>701016</b>
Arosa	+/-	With Plastic Frame	■		1H0819644	<b>698159</b>	1H0091800	<b>698686</b>	
Arosa	+/-	W/O Plastic Frame	■	02/97▶06/04	1H0819644B	<b>698885</b>			
Cordoba (93>96)	+/-	With Plastic Frame	■	02/93▶06/96	1H0819644	<b>698159</b>	1H0091800	<b>698686</b>	
Cordoba (93>96)	+/-	W/O Plastic Frame	■	02/93▶06/96	1H0819644B	<b>698885</b>			
Cordoba (96>99)	+/-		■	07/96▶05/99			1H0091800	<b>698686</b>	
Cordoba (96>99)	+/-	With Plastic Frame	■	07/96▶05/99	1H0819644	<b>698159</b>	1H0091800	<b>698686</b>	
Cordoba (96>99)	+/-	W/O Plastic Frame	■	07/96▶05/99	1H0819644B	<b>698885</b>			
Cordoba (99>2002)	+/-		■	05/99▶08/02			1H0091800	<b>698686</b>	
Cordoba (99>2002)	+/-	With Plastic Frame	■	03/99▶08/02	1H0819644	<b>698159</b>	1H0091800	<b>698686</b>	
Cordoba (99>2002)	+/-	W/O Plastic Frame	■	03/99▶08/02	1H0819644B	<b>698885</b>			
Cordoba (2002>2009)	+/-		■	09/02▶06/06	6Q0820367	<b>698685</b>	6Q0819653	<b>698739</b>	<b>701009</b>
Exeo (2008>)	+/-		■	12/08▶12/11	8E0819439	<b>698606</b>	4B0819439C	<b>698683</b>	<b>701023</b>
Ibiza (93>99)	+/-		■	02/93▶06/99	1H0819644B	<b>698159</b>	1H0091800	<b>698686</b>	
Ibiza (93>99)	+/-	W/O Plastic Frame	■	02/93▶06/99	1H0819644B	<b>698885</b>			
Ibiza (99>2001)	+/-		■	07/99▶08/01	1H0819644B	<b>698159</b>	1H0091800	<b>698686</b>	
Ibiza (99>2001)	+/-	W/O Plastic Frame	■	07/99▶08/01	1H0819644B	<b>698885</b>			
Ibiza (2001>2011)	+/-		■	09/01▶01/12	6Q0820367	<b>698685</b>	6Q0819653	<b>698739</b>	<b>701009</b>
Ibiza (2012>)	+/-		■	10/12▶	6R0820367	<b>715737</b>	6R0819653	<b>715727</b>	
Leon (99>2006)  2R000001▶	+/-	With Plastic Frame	■	03/01▶05/06	1H0819644B	<b>698159</b>	1J0819644	<b>698716</b>	<b>701016</b>
Leon (99>2006)	+/-	W/O Plastic Frame	■	08/99▶05/06	1H0819644B	<b>698885</b>			
Leon (2006>)	-		■	06/06▶05/07			1K2819653	<b>715665</b>	
Leon (2006>)	+/-		■	06/06▶05/07	1K0819644	<b>698800</b>	1K1819653	<b>698801</b>	<b>701001</b>
Leon (2006>)  ▶1M5092000	+/-	With Plastic Frame	■	07/05▶09/05	1H0819644	<b>698159</b>	1J0819644	<b>698716</b>	

	AC				PA  OE 	CA  OE 	PCA  OE 
--	----	---	---	---	--	--	---



## SEAT

Leon (2006>)  ►1M5092000	+/-	W/O Plastic Frame	■	07/05►09/05	1H0819644B	698885			
Leon (2010>2012)	+/-		■	05/10►12/12	1K0819644	698800	1K1819653	698801	701001
Leon (2010>2012)	+/-		■	05/10►12/12			1K2819653	715665	
Leon (2012>)	A+		■	09/12►05/14			5Q0819653	715720	701020
Leon (2012>)	+/-			09/12►02/13	5Q0819644	715806▲			
Mii	+/-		■	10/11►	1S0820367	715744			
Toledo (98>2004)	+/-	With Plastic Frame	■	10/98►07/04	1H0819644	698159	1H0091800	698686	
Toledo (98>2004)	+/-	W/O Plastic Frame	■	10/98►07/04	1H0819644B	698885			
Toledo (2004>2009)	+/-		■	09/04►05/09	1K0819644	698800	1K1819653	698801	701001
Toledo (2012>)	+/-		■	07/12►	6R0820367	715737	6R0819653	715727	701029

## SEAT







Inca (95>2003)	+/-		■	05/00►06/03			1J0819644	698716	701016
Inca (95>2003)	+/-	With Plastic Frame	■	11/95►06/03	1H0819644	698159	1H0091800	698686	
Inca (95>2003)	+/-	W/O Plastic Frame	■	11/95►06/03	1H0819644B	698885			

## SKODA

Citigo (2011>)	+/-		■	10/11►	1S0820367	715744			
Fabia (99>2010)	+/-		■	08/99►06/10	6Q0820367	698685	6Q0819653	698739	701009
Fabia (2010>)	+/-		■	06/10►	6R0820367	715737	6R0819653	715727	
Felicia	+/-		■	10/94►08/01	6Q0820367	698685	6Q0819653	698739	701009
Octavia	+/-	W/O Plastic Frame	■	10/96►05/04	1H0819644B	698885			
Octavia	+/-	With Plastic Frame	■	08/00►12/10	1H0819644B	698159	1J0819644A	698716	701016
Octavia (96>2004)	+/-		■	10/96►05/04	1H0819644B	698159	1H0091800	698686	
Octavia (2004>)	+/-		■	05/04►10/12	1K0819644A	698800	1K1819653A	698801	701001
Octavia (2004>)	+/-		■	06/04►10/12			1K2819653A	715665	
Octavia (2012>)	+	ultrafine	■	11/12►			5Q0818653	715720	701020
Rapid	+/-		■	07/12►	6Q0820367	698685	6Q0819653	698739	701009
Rapid	+/-		■	07/12►	6R0820367	715737	6R0819653	715727	
Roomster	+/-		■	03/06►07/10	6Q0820367	698685	6Q0819653	698739	701009
Roomster	+/-		■	07/10►	6R0820367	715737	6R0819653	715727	701029
Superb (2001>2008)	+/-	With Plastic Frame	■	12/01►03/08	1H0819644	698159			
Superb (2001>2008)	+/-	W/O Plastic Frame	■	12/01►03/08	1H0819644B	698885			
Superb (2008>2013)	+		■	03/08►05/13	1K0819644	698800	1K1819653	698801	701001

	AC				PA  	CA  	PCA 
---	----	---	---	---	---	---	--



## SKODA

Superb (2008>2013)	+/-		■	03/08▶05/13			1K2819653	<b>715665</b>	
Superb (2013>)	+		■	05/13▶	1K0819644	<b>698800</b>	1K1819653	<b>698801</b>	<b>701001</b>
Superb (2013>)	+/-		■	05/13▶			1K2819653	<b>715665</b>	
Superb (2015>)	+/-		■	03/15▶			5Q0819653	<b>715720</b>	<b>701020</b>
Yeti (2009>2013)	+/-		■	05/09▶11/13	1K0819644	<b>698800</b>	1K1819653	<b>698801</b>	<b>701001</b>
Yeti (2009>2013)	+/-		■	05/09▶11/13			1K2819653	<b>715665</b>	
Yéti (2013>)	+/-		■	11/13▶	1K0819644	<b>698800</b>	1K1819653	<b>698801</b>	<b>701001</b>
Yéti (2013>)	+/-		■	11/13▶			1K2819653	<b>715665</b>	

## SMART











Crossblade	+/-		■	06/02▶			0001110V004	<b>698774</b>	
Forfour	+/-		■	04/04▶			0013871V001	<b>698802</b>	
Fortwo	+/-		■	10/98▶12/06			0001110V004	<b>698774</b>	
Fortwo	+/-		■	03/07▶	4518350247	<b>715736</b>	4518300018	<b>715608</b>	
Roadster	+/-		■	05/03▶			'0013871V001	<b>698802</b>	

## SSANGYONG

Actyon	+/-	2x 	■	09/06▶	68111091A0	<b>715624</b>			
Korando	+	2x 		07/96▶03/99	6923005400	<b>715566</b>			
Korando	+	2x 		07/96▶03/99	6923005410	<b>715567</b>			
Kyron	+	2x 	■	11/05▶	68111091A0	<b>715624</b>			
Musso (93>2007)	M+	2x 		08/93▶2007	6923005400	<b>715566</b>			
Musso (93>2007)	A+	2x 		08/93▶2007	6923005410	<b>715567</b>			
Rexton	-	2x 		04/02▶	6812008030	<b>715699</b>			
Rodius	+	2x 		05/05▶06/12	6811021000	<b>715700</b>			

## SUBARU

Tribeca	+		■	09/06▶09/07	72880AG000	<b>698796</b>	72880XA000A	<b>715619</b>	
Forester I	+		■	08/97▶09/02	GE210FC000	<b>715626</b>			
Forester II	+		■	07/07▶	72880FG000	<b>715625</b>			
Forester III	+		■	09/02▶11/07	72880SA000	<b>715651</b>			
Impreza I	+		■	12/96▶09/00	GE210FC000	<b>715626</b>			
Impreza II	+			09/00▶08/05	72880FE000	<b>715551</b>	G3210FE000	<b>715680</b>	
Impreza III	+/-		■	10/11▶01/14	72880FG000	<b>715625</b>			
Justy (2003>2007)	+		■	10/03▶10/07	9586078F10	<b>698773</b>			
Justy	+/-		■	09/07▶	99906850M2-038	<b>715637</b>			
Legacy (98>2003)	+/-	2x 	■	10/98▶04/03	72880AE080	<b>715563</b>			
Legacy (2003>)	+		■	05/03▶	72880AG000	<b>698796</b>	72880AG000	<b>715619</b>	
Legacy (2009>)	+		■	05/09▶	72880AJ000	<b>715620</b>	8713950060	<b>715730</b>	<b>701021</b>

	AC				PA  	CA  	PCA 	
<b>SUZUKI</b> 								
Alto	+		■	01/09>12/10	95861M68K10	<b>715694</b>		
Grand Vitara I	+	2x 	■	05/98>03/03	9586165D000	<b>698894</b>		
Grand Vitara II	+		■	04/03>10/05	9586154J00	<b>715564</b>		
Grand Vitara III	+		■	10/05▶	9586164J00	<b>715609</b>		
Ignis	+		■	09/03>06/08	9207486	<b>698773</b>		
Jimny	+/-		■	04/05▶	9586081A10	<b>715668</b>		
Kizashi Sport	+		■	09/10▶	9586157L00	<b>715743</b>		
Liana	+/-		■	06/01▶01/06	9586154G00	<b>715698</b>		
Splash	+/-		■	03/08▶	9586051K00	<b>715644</b>		
Swift	+/-		■	04/05▶	9586062J00	<b>698886</b>		
SX4	+/-	SX4 JAP	■	05/06▶	9586080J00	<b>715652</b>		
SX4	+/-	SX4 HUN	■	05/06▶	9586062J000	<b>698886</b>		
Wagon R+	+/-		■	03/04▶2008	9207486	<b>698773</b>		

<b>TOYOTA</b> 									
Auris	+/-		■	03/06▶	871390D010	<b>715620</b>	8713950060	<b>715730</b>	<b>701021</b>
Avensis (T22)	+	2x  	■	10/97>06/00	8888020020	<b>715572</b>			
Avensis (T25)	+		■	01/03>11/08	87139YZ207	<b>698795</b>			
Avensis (T27)	+		■	11/08>11/11	871390D010	<b>715620</b>	8713950060	<b>715730</b>	<b>701021</b>
Avensis Verso	+		■	05/01>07/05	8713928010	<b>698796</b>	0897400850	<b>715701</b>	
Aygo (2005>2014)	+		■	02/05>04/14	885080H010	<b>715515</b>			
Aygo (2014>)	+			05/14▶	88508V010	<b>715828</b> ●			
Camry	+		■	08/01>01/06	871394701083	<b>698796</b>	87139YZ203	<b>715619</b>	
Camry	+		■	02/06▶	8713952020	<b>715620</b>	8713950060	<b>715730</b>	<b>701021</b>
Carina E (T19)	+	2x  	■	05/94>12/97	8888020020	<b>715572</b>			
Celica (ZT230) (99>2005)	+		■	08/99>09/05	8713928010	<b>698796</b>	8713933010	<b>715619</b>	
Corolla (110) (97>2001)	+/-		■	04/97>10/01	8850812010	<b>715565</b>			
Corolla (120) (2001>2007)	+/-		■	10/01>02/07	87139YZ207	<b>698795</b>			
Corolla (150) (2007>2013)	+/-		■	03/07>04/13	871390D010	<b>715620</b>	8713950060	<b>715730</b>	<b>701021</b>
Corolla Verso (2001>2009)	+/-		■	09/01>02/09	87139YZ207	<b>698795</b>	0897400850	<b>715701</b>	
Corolla Verso 2.0 D4D	+		■	01/02>05/04	87139YZ206	<b>715689</b>	0897400850	<b>715701</b>	
Echo	+		■	06/99>07/05	8856852010	<b>698681</b>	8974000820	<b>715650</b>	
Harrier (98>2003)	+		■	07/98>01/03	8713948020	<b>715542</b>	8850530100	<b>715729</b>	
Highlander	+		■	05/01>11/07	8713930010	<b>715542</b>	8850530100	<b>715729</b>	
Land Cruiser	+		■	08/09>08/02	871390D010	<b>715620</b>	8713950060	<b>715730</b>	<b>701021</b>
Land Cruiser	+/-		■	09/02>08/09	8713928010	<b>698796</b>	8713933010	<b>715619</b>	
Land Cruiser SW (2007>)	+		■	12/07>08/09	8713932010	<b>715550</b>			
Picnic (96>2001)	+	2x  	■	09/96>04/98	8888020020	<b>715572</b>			
Picnic (2001>2005)	+		■	05/01>07/05	8713928010	<b>698796</b>			

	AC				PA  	CA  	PCA 
---	----	---	---	---	---	---	--





















## TOYOTA

Previa	+		■	02/00▶01/06	8713928010	<b>698796</b>	8713933010	<b>715619</b>	
Prius	+		■	05/00▶03/09	8713928010	<b>698796</b>	8713933010	<b>715619</b>	
Prius	+		■	04/09▶	8713900010	<b>715620</b>	8713933010	<b>715619</b>	<b>701021</b>
RAV4 (2000>2005)	+		■	05/00▶11/05	8713952010	<b>698681</b>	8974000820	<b>715650</b>	
RAV4 (2005>2012)	+		■	11/05▶12/12	8713900010	<b>715620</b>	8713950060	<b>715730</b>	<b>701021</b>
Urban Cruiser	+/-		■	01/09▶	8713900010	<b>715620</b>	8713950060	<b>715730</b>	<b>701021</b>
Verso (2009>2012)	+		■	02/09▶11/12	8713900010	<b>715620</b>	8713950060	<b>715730</b>	<b>701021</b>
Verso S (2010>)	+/-		■	11/10▶	8713900010	<b>715620</b>	8713950060	<b>715730</b>	<b>701021</b>
Yaris	+/-	Yaris FR	■	01/01▶11/05	8713928010	<b>698796</b>	8713933010	<b>715619</b>	
Yaris (NCP/SCP)	+/-	Yaris JAP	■	01/99▶08/05	8713952010	<b>698681</b>	8974000820	<b>715650</b>	
Yaris II	+/-		■	01/06▶08/11	8713952020	<b>715620</b>	8713950060	<b>715730</b>	<b>701021</b>
Yaris III	+		■	09/11▶	8713952020	<b>715620</b>	8713950060	<b>715730</b>	<b>701021</b>
Yaris Verso	-		■	08/99▶11/01	8856852010	<b>698681</b>	8974000820	<b>715650</b>	
Yaris Verso	+/-		■	12/01▶	8713947010	<b>698796</b>	8713933010	<b>715619</b>	

## TOYOTA













Hilux	+/-		■	08/08▶	8713900010	<b>715620</b>	8713950060	<b>715730</b>	<b>701021</b>
-------	-----	--	---	--------	------------	---------------	------------	---------------	---------------

## VAUXHALL







Agila	+/-		■	06/00▶12/07	9196805	<b>698773</b>			
Agila	+/-		■	12/07▶04/14	93194847	<b>715644</b>			
Ampera	+/-		■	06/11▶	52425938	<b>715658</b>	13271191	<b>715659</b>	
Antara	+		■	10/06▶	96440878	<b>715654</b>			
Astra (86>2001)	+/-		■	01/86▶03/98	6808600	<b>698165</b>	9121625	<b>715632</b>	
Astra IV (98>2005)	+	Delphi 	■	02/98▶12/05	13175553	<b>698874</b>	13175554	<b>698875</b>	
Astra IV (98>2005)	-	Behr 	■	04/98▶12/05	90559549	<b>698663</b>	91132364	<b>698708</b>	<b>701008</b>
Astra V (2004>2012)	+/-		■	03/04▶12/11	13175553	<b>698874</b>	13175554	<b>698875</b>	
Astra VI (2009>)	+/-		■	09/09▶07/11	52425938	<b>715658</b>	13271191	<b>715659</b>	
Astra VII (2015>)	+/-		■	07/15▶			13356914	<b>715752</b> ●	
Calibra (90>97)	+/-		■	06/90▶07/97	6808600	<b>698165</b>	9121625	<b>715632</b>	
 R1000001▶									
Cascada	+/-		■	03/13▶	52425938	<b>715658</b>	13271191	<b>715659</b>	
Corsa I (93>2000)	-		■	04/93▶08/00	1808604	<b>698166</b>			
Corsa I (93>2000)	+		■	04/93▶08/00	90512706	<b>715645</b>			
Corsa II (2000>2003)	+/-		■	09/00▶08/03	6808601	<b>698711</b>	1808624	<b>698710</b>	<b>701010</b>
Corsa III (2006>)	+/-		■	07/06▶	55702456	<b>715552</b>	55702456	<b>715553</b>	<b>701003</b>
Insignia	+/-		■	01/09▶	52425938	<b>715658</b>	13271191	<b>715659</b>	
Meriva A	+		■	05/03▶07/10	93174800	<b>698876</b>	93174801	<b>698877</b>	
Meriva B	+/-		■	05/10▶	52425938	<b>715658</b>	13271191	<b>715659</b>	
 ▶C4999999									

	AC				PA  	CA  	PCA 
--	----	---	---	---	---	---	--



## VAUXHALL

























Meriva B  D4000001▶	+/-		■	05/10▶2013			13356914	715752●	
Mokka	+/-		■	12/12▶	52425938	715658	13271191	715659	
Monterey	+/-	2x 	■	07/99▶08/99	97170804	715569			
Omega	+/-		■	04/94▶09/00	90510338	698167	9121624	698746	
Signum	+/-		■	06/03▶11/08	6808601	698711	1808624	698710	701010
Sintra	+/-	2x 	■	03/96▶12/99	52470574	698712			
Tigra	-		■	11/94▶01/01	1808604	698166			
Tigra	+		■	11/94▶01/01	90512706	715645			
Tigra Twintop	+		■	07/04▶07/08	6808601	698711	1808624	698710	701010
Vectra (95>2002)	+/-		■	10/95▶03/02	90512779	698202	90541317	715675	
Vectra (2002>2009)	+/-		■	04/02▶02/09	6808601	698711	1808624	698710	701010
Zafira	+/-		■	05/99▶	90559549	698663	91132364	698708	701008
Zafira	+/-		■	10/11▶	52425938	715658	13271191	715659	

## VAUXHALL

Combo (93>2001)	-		■	10/93▶09/01	1808604	698166			
Combo (93>2001)	+		■	10/93▶09/01	6808600	698165	9121625	715632	
Combo (93>2001)	+		■	10/93▶09/01	90512706	715645			
Combo (2001>2011)	+/-		■	10/01▶10/11	6808601	698711	1808624	698710	701010
Combo (2011>)	+		■	12/11▶	55702456	715552	55702456	715553	701003
Vivaro A	+/-		■	08/01▶	7701050319	715513			
Vivaro B	+/-		■	07/14▶			95517359	715672	701012

## VOLKSWAGEN













Bora	+/-		■	09/98▶05/05	1H0819644B	698159	1J0819644	698716	701016
Eos	+/-		■	05/06▶			1K2819653	715665	
Eos	+/-		■	05/06▶	1K0819644	698800	1K1819653	698801	701001
Fox (2004>)	+/-		■	11/04▶	6Q0820367	698685	6Q0819653	698739	701009
Golf II (83>92)	+/-		■	08/83▶07/97	191091700	715653			
Golf II (83>92)	+/-	With Plastic Frame	■	08/83▶10/91	1H0819644	698159			
Golf II (83>92)	+/-	W/O Plastic Frame	■	08/83▶10/91	1H0819644B	698885			
Golf III (91>99)	+/-		■	07/93▶04/99	1H0819644	698159	1H0091800	698686	
Golf III (91>99)	+/-		■	11/91▶04/99			1J0819644	698716	701016
Golf III (91>99)  ▶1HP990000	+		■	09/91▶07/93	1H0819638	698160			
Golf III (91>99)	+/-	W/O Plastic Frame	■	11/91▶04/99	1H0819644B	698885			
Golf IV (97>2006)	+/-		■	10/97▶06/06			1J0819644	698716	701016

	AC				PA  	CA  	PCA 	
<b>VOLKSWAGEN</b> 								
Golf Sportsvan (2014>)	+/-		■	02/14▶		500818653	715720	701020
Golf V (2003>2009)	+/-		■	06/05▶11/08		1J0819644	698716	701016
Golf V (2003>2009)	A+		■	05/07▶11/08		1K2819653	715665	
Golf V (2003>2009)	+/-		■	05/07▶11/08	1K0819644	698800	1K1819653	698801 701001
Golf V Plus (2005>2009)	+/-		■	01/05▶05/09		1K2819653	715665	
Golf V Plus (2005>2009)	+/-		■	01/05▶05/09	1K0819644	698800	1K1819653	698801 701001
Golf VI (2008>)	+/-		■	10/08▶11/12	1K0819644	698800	1K1819653	698801 701001
Golf VI (2008>)	+/-		■	10/08▶			1K2819653	715665
Golf VI Plus (2009>)	+/-		■	01/09▶09/12			1K2819653	715665
Golf VI Plus (2009>)	+/-		■	01/09▶	1K0819644	698800	1K1819653	698801 701001
Golf VII (2012>)	+/-	ultrafine	■	08/12▶01/13			500818653	715720 701020
Golf I Cabriolet	-		■	04/84▶02/98	191091700	715653		
Golf II Cabriolet	-	With Plastic Frame	■	09/93▶02/98	1H0819644	698159		
Golf II Cabriolet (93>98)	-	W/O Plastic Frame	■	09/93▶02/98	1H0819644B	698885		
Golf III Cabriolet (98>2002)	+/-		■	03/98▶04/02	1H0819644	698159	1H0091800	698686
Golf III Cabriolet (98>2002)	+/-		■	03/98▶06/02			1J0819644	698716 701016
Golf III Cabriolet (98>2002)	+/-	W/O Plastic Frame	■	03/98▶04/02	1H0819644B	698885		
Golf VI Cabriolet (2011>)	+/-		■	03/11▶11/13			1K2819653	715665
Golf VI Cabriolet (2011>)	+/-		■	03/11▶11/13			1K1819653	698801 701001
Jetta (78>92)	+/-		■	08/83▶11/92	191091700	715653		
Jetta (2005>)	+/-		■	08/05▶10/10			1K2819653	715665
Jetta (2005>)	-		■	08/05▶	1K0819644	698800	1K1819653	698801 701001
Lupo (98>2005)	+/-		■	01/99▶07/05	1H0819644	698159	1J0819644	698716 701016
Lupo (98>2005)	+/-	W/O Plastic Frame	■	10/98▶07/05	1H0819644B	698885		
New Beetle (98>2010)	+/-	W/O Plastic Frame	■	01/98▶	1H0819644B	698159	1J0819644	698716 701016
New Beetle (2010>)	+/-		■	12/10▶			1K2819653	715665
New Beetle (2010>)	+/-		■	12/10▶	1K0819644	698800	1K1819653	698801 701001
Passat CC (2008>2012)	+/-		■	05/08▶01/12			1K2819653	715665
Passat CC (2008>2012)	+/-		■	05/08▶01/12	1K0819644	698800	1K1819653	698801 701001
Passat (93>97)	+/-		■	10/93▶05/97	357819638	698163		
Passat (96>2000)	+		■	10/96▶09/00	8A0819439A	698164	3B0091800	715578
Passat (2000>2005)	+/-	W/O Plastic Frame	■	10/00▶05/05	1H0819644A	698679	1H0091800	698686
Passat (2000>2005)	+/-	With Plastic Frame	■	10/00▶05/05	1H0819644	698159		
Passat (2000>2005)	+/-	W/O Plastic Frame	■	10/00▶05/05	1H0819644B	698885		



	AC				PA  OE 	CA  OE 	PCA  OE 
--	----	---	---	---	--	--	---

## VOLKSWAGEN



Passat (2005>)	+/-		■	03/05▶12/14	1K0819644	<b>698800</b>	1K1819653	<b>698801</b>	<b>701001</b>
Passat (2005>)	A+		■	03/05▶05/07			1K2819653	<b>715665</b>	
Passat (2010>2014)	+/-		■	08/10▶12/14			1K2819653	<b>715665</b>	
Passat (2014>)	A+		■	08/14▶			500818653	<b>715720</b>	<b>701020</b>
Phaeton	+/-	2x 	■	05/02▶			300898644	<b>698793</b>	
Polo (94>99)	+/-		■	10/94▶12/99			1J0819644	<b>698716</b>	<b>701016</b>
Polo (94>99)	+/-	With Plastic Frame	■	10/94▶12/99	1H0819644	<b>698159</b>	1H0091800	<b>698686</b>	
Polo (94>99)	+/-	W/O Plastic Frame	■	10/94▶12/99	1H0819644B	<b>698885</b>			
Polo (99>2001)	+/-	With Plastic Frame	■	10/99▶09/01	1H0819644	<b>698159</b>	1J0819644	<b>698716</b>	<b>701016</b>
Polo (99>2001)	+/-	W/O Plastic Frame	■	10/99▶09/01	1H0819644B	<b>698885</b>			
Polo (2001>2010)	+/-		■	10/01▶05/10	6Q0820367	<b>698685</b>	6Q0819653	<b>698739</b>	<b>701009</b>
Polo (2010>)	+/-		■	05/10▶	6R0820367	<b>715737</b>	6R0819653	<b>715727</b>	<b>701029</b>
Scirocco	+/-		■	08/08▶05/14			1K2819653	<b>715665</b>	
Scirocco	+/-		■	08/08▶05/14	1K0819644	<b>698800</b>	1K1819653	<b>698801</b>	<b>701001</b>
Sharan (95>2010)	+/-		■	09/95▶07/10	7M0819638A	<b>698247</b>	1491752	<b>698696</b>	
Sharan (2010>)	+/-		■	05/10▶01/13			1K2819653	<b>715665</b>	
Sharan (2010>)	+/-		■	05/10▶01/13	1K0819644	<b>698800</b>	1K1819653	<b>698801</b>	<b>701001</b>
Tiguan	+/-		■	11/07▶05/13	1K0819644	<b>698800</b>	1K1819653	<b>698801</b>	<b>701001</b>
Tiguan	+/-		■	11/07▶05/13			1K2819653	<b>715665</b>	
Touareg	+/-		■	11/02▶05/10			7H0819631A	<b>698768</b>	
Touareg II	+		■	01/10▶			7P0819631	<b>715704</b>	
Touran	+/-		■	02/03▶11/06	1K0819644	<b>698800</b>	1K1819653	<b>698801</b>	<b>701001</b>
Touran	+/-		■	02/03▶			1K2819653	<b>715665</b>	
UP	+/-		■	08/11▶	1S0820367	<b>715744</b>			
Vento	+/-		■	11/91▶12/97	1H0819644	<b>698159</b>	1H0091800	<b>698686</b>	
Vento	+/-	W/O Plastic Frame	■	11/91▶12/97	1H0819644B	<b>698885</b>			
Vento  ▶1HP990000	+/-		■	11/91▶07/93	1H0819644B	<b>698160</b>			

## VOLKSWAGEN











Amarok	+/-		■	11/09▶	7H0819631	<b>715581</b>			
Caddy II (95>2004)	+/-		■	11/95▶06/03	1H0819644	<b>698159</b>	1H0091800	<b>698686</b>	
Caddy II (95>2004)  9KY538001▶	+/-		■	04/00▶06/03			1J0819644	<b>698716</b>	<b>701016</b>
Caddy II (95>2004)  ▶9Y538000	+/-	W/O Plastic Frame	■	11/95▶06/03	1H0819644B	<b>698885</b>			
Caddy III (2004>2010)	-		■	02/04▶08/10	1K0819644	<b>698800</b>	1K1819653	<b>698801</b>	<b>701001</b>





















	AC				PA  	CA  	PCA 
---	----	---	---	---	---	---	--

## VOLKSWAGEN

Caddy III (2004>2010)	+/-		■	02/04▶08/10			1K2819653	715665	
Caddy III (2010>)	A-		■	08/10▶	1K0819644	698800	1K1819653	698801	701001
Caddy III (2010>)	A+		■	08/10▶			1K2819653	715665	
Caddy IV (2015>)	A+		■	05/15▶	1K0819644	698800	1K1819653	698801	701001
Caddy IV (2015>)	A+		■	05/15▶			1K2819653	715665	
Corrado (88>95)	+/-	W/O Plastic Frame	■	03/89▶02/95	1H0819644B	698885			
Crafter (2006>)	+/-		■	04/06▶07/11	2E0819638	715601	2E0819638A	715602	
LT (96>2006)	+/-		■	05/96▶07/06	2D0819638	698840			
Transporter (F70) (90>96)  70T000001▶	+/-		■	09/90▶05/96	703819989	698794			
Transporter (F7D) (96>2003)	+/-		■	01/96▶06/03	703819989	698794			
Transporter 7J/7H (2003>2009)	+/-		■	04/03▶11/09	7H0819631	715581	7H0819631A	698768	

## VOLVO

850	+/-		■	06/91▶12/96	9171296	698770			
C30	+/-		■	10/06▶12/12	8687389	715627	30676484	715628	
C70 (97>2005)	+/-		■	03/97▶09/02	9171296	698770			
C70 (2006>2014)  ▶16250	+		■	01/06▶04/14	8687389	715627	30676484	715628	
S40 (95>2004)	+		■	10/95▶03/04	30818694	715688			
S40 (95>2004)	+		■	10/95▶03/04	30612666	698769	30883952	715676	
S40 (2004>2012)  ▶281000	-		■	03/04▶06/12	8687389	715627	30676484	715628	
S60 (2000>2009)	+		■	08/00▶03/05	9204626	698771	9171756	715512	
S60 (2000>2009)  ▶361731	A+		■	08/00▶			9171757	715571	
S60 (2010>)  ▶131927	+		■	04/10▶	30733892	715597	30733893	715702	
S70 (96>2000)	+/-		■	12/96▶11/00	9171296	698770			
S80 (98>2006)	+		■	06/98▶05/05	9204626	698771	9171756	715512	
S80 (98>2006)  ▶356493	A+		■	06/98▶			9171757	715571	
S80 (2006>2013)	+		■	03/06▶04/11	30733892	715597	30733893	715702	
S90 (96>98)	+/-		■	06/96▶12/98	9171296	698770			
V40 (95>2004)	-		■	10/95▶12/98	30818694	715688			
V40 (95>2004)	+		■	10/95▶03/04	30612666	698769	30883952	715676	
V40 II (2012>)	+		■	06/12▶04/15			31369455	715757	
V50 (2004>2012)  ▶295173	+/-		■	03/04▶06/12	8687389	715627	30676484	715628	

	AC				PA   	CA   	PCA  		
<b>VOLVO</b> 									
V60 (2010>2013)  ▶75142	+/-		■	09/10▶09/13	30733892	<b>715597</b>	30733893	<b>715702</b>	
V70 (96>2000)	+/-		■	12/96▶03/00	9171296	<b>698770</b>			
V70 (2000>2007)	+		■	01/00▶03/05	9204626	<b>698771</b>	9171756	<b>715512</b>	
V70 (2000>2007)	+		■	01/00▶			9171757	<b>715571</b>	
V70 (2007>2013)	+		■	03/07▶03/11	30733892	<b>715597</b>	30733893	<b>715702</b>	
XC 60	+/-		■	07/08▶03/11	30733892	<b>715597</b>	30733893	<b>715702</b>	
XC 70 (97>99)	+/-		■	12/97▶12/99	9171296	<b>698770</b>			
XC 70 (97>2007)	+		■	12/97▶08/05	9204626	<b>698771</b>	30630754	<b>715512</b>	
XC 70 (97>2007)	+/-		■	12/97▶02/07			9171757	<b>715571</b>	
XC 70 (2007>)	+		■	03/07▶	30733892	<b>715597</b>	30733893	<b>715702</b>	
XC 90 (2002>2007)	+/-		■	05/02▶08/05	9204626	<b>698771</b>	9171756	<b>715512</b>	
XC 90 (2002>2007)	A+		■	05/02▶			9171757	<b>715571</b>	



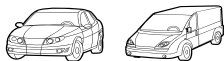



# CLIM PUR'

## Air conditioning cleaner

Nettoyant climatisation  
 Klimasystem-reiniger  
 Limpiador del climatizador  
 Limpador de ar condicionado  
 Detergente climatizzazione  
 Air conditioning reiniger  
 Środek czyszczący do klimatyzacji  
 Очиститель системы кондиционирования воздуха  
 Čistič prostředek pro klimatizace  
 Sredstvo za čišćenje klimatizacije  
 Klímaberendezés tisztító spray  
 Curățitor de aer condiționat  
 Klima temizleyici  
 ΚΑΘΑΡΙΣΤΙΚΟ ΚΛΙΜΑΤΙΣΤΙΚΟΥ



## Clim pur' display

Presentoir clim pur'  
 Clim pur' display  
 Expositor clim pur'  
 Display clim pur'  
 Confezione climatizzatore  
 Display clim pur'  
 Clim pur displej  
 Дисплей для clim pur  
 Clim pur na prodajnom nosaču  
 Klímaberendezés tisztító spray bemutató tartón  
 Afisare clim pur'  
 Clim pur дисплей  
 Clim pur' sergileme ünitesi  
 Εκθέτης CLIM PUR'



**Valeo**



**698984 CLIM PUR'**

1

**Valeo**



**698985 CLIM PUR' (698984) x15**

## Think about using Clim PUR' at each cabin filter change

Pensez à utiliser Clim PUR' à chaque changement du filtre habitacle  
 Verwenden Sie Climpur' bei jedem Wechsel des Innenraumluftfilters  
 Piense en utilizar Clim PUR' en cada cambio de Filtro de Habitáculo  
 Use o «ClimPur» a cada substituição do filtro de habitáculo  
 Ricordatevi di utilizzare il «Clim Pur» ad ogni sostituzione del filtro abitacolo  
 Denk ook aan het gebruik van de «Clim Pur» bij iedere vervanging van het interieurfilter  
 Sugerowane stosowanie «ClimPur» przy każdorazowej wymianie filtra kabionowego  
 Рекомендуется использовать ClimPur при каждой замене салонного фильтра  
 Používejte CLIM PUR' při každé výměně kabinového filtru  
 Upotrebľavajte «Clim Pur» priľikom svake izmjene filtera kabine  
 Minden pollenszűrőcsere során használjon Clim Pur-t.  
 Nu uitați să utilizați Clim Pur' la fiecare schimb de filtru  
 Помислете за ползите от подмяната на всеки филтър купе  
 Kabin filtresi değişimlerinde «ClimPur» kullanlmasi gerektigini dikkate aliniz  
 Σκεφτείτε τη χρήση του Clim Pur', με την αλλαγή κάθε φίλτρου καμπίνας



**Valeo**



**698991 CLIM PUR' Workshops/Ateliers**

20



# CLIM SPRAY

## Cabin cleaner

Purifiant habitacle  
Innenraum-luft-reiniger  
Purificador de aire del habitáculo  
Purificador do ar do habitáculo  
Detergente abitacolo  
Interieur verfrisser  
Odświeżacz kabinowy  
Очиститель воздуха  
Čistač kabine vozila  
Čistič interiéru vozu  
Utastér légtisztító spray  
Purificator habitaculu  
Почистващ въздуха на купето препарат  
Kabin hava temizleyicisi  
ΚΑΘΑΡΙΣΤΙΚΟ ΚΑΜΠΙΝΑΣ



## Clim spray display

Presentoir clim spray  
Display clim spray  
Clim spray display  
Expositor clim spray  
Confezione clim spray  
Display clim spray  
Clim spray displej  
Дисплей для clim spray  
Clim spray na prodajnom nosaču  
Utastér légtisztító spray bemutató tartón  
Afişare clim spray  
Clim spray дисплей  
Clim spray sergileme ünitesi  
Εκθέτης CLIM SPRAY

**Valeo**Qty  
**698899 CLIM SPRAY**

1

**Valeo**Qty  
**715899 CLIM SPRAY (698899) x15**

## Think about using clim spray every 6 months

Pensez a utiliser clim spray tous les 6 mois  
Denken sie daran, climspray alle 6 monate zu benutzen  
Recomendamos la utilización del clim spray cada 6 meses  
Recomendamos a utilização do clim spray a cada 6 meses  
Si consiglia l'utilizzo del clim spray ogni 6 mesi  
Denk er aan: gebruik clim spray om de 6 maanden !!!!!  
Pamiętaj aby używać climspray co 6 miesięcy  
Clim spray рекомендуется использовать каждые 6 месяцев  
Používejte clim spray každých 6 měsíců  
Preporučamo koristiti clim spray svakih 6 mjeseci  
Ajánlatos a clim spray-t rendszeresen, 6 havonta használni  
Nu uitati sa utilizati clim spray la fiecare 6 luni  
Помислете за ползете от използването на спрей за почистване на всеки 6 месеца  
6 Ayda bir clim spray kullanmayı unutmayınız  
Σκεφτείτε τη χρήση του Clim Spray κάθε 6 μήνες

**Valeo**Qty  
**715991 CLIM SPRAY  
Workshops/Ateliers**

20





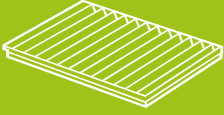
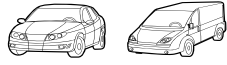

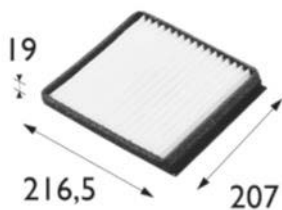
**698146**

**CITROËN** Berlingo, Xantia II (12/97 => 5/2002), Xsara (7/97 => 8/2000), Xsara FL (9/2000 => 8/2005)

**PEUGEOT** Partner (M49) (6/96 => 11/2002), Partner (M59) (11/2002), Ranch (M49) (6/96 => 11/2002)

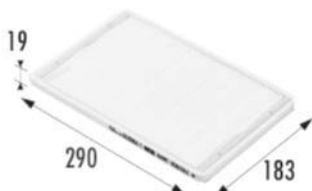
**698149**

**RENAULT** Mégane Classic

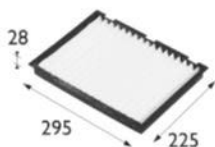
**698159**

**AUDI** A3 (9/96 => 8/2000), TT (10/98 => 6/2006)

**SEAT** Alhambra III, Arosa, Cordoba, Ibiza, Inca

**SKODA** Octavia I (10/96 => 7/2000), Octavia I FL (8/2000 => 12/2010), Superb (12/2001 => 3/2008)

**VOLKSWAGEN** Caddy II, Golf II, Golf III, Lupo (10/98 => 7/2005), Passat V FL (10/2000 => 5/2005), Polo V (10/94 => 12/1999)

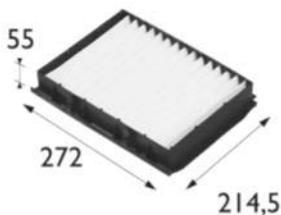
**698160**

**VOLKSWAGEN** Golf III (91>99)

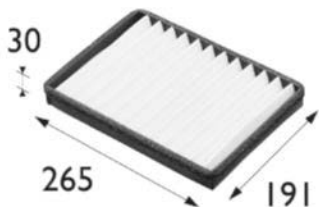
**698163**

**VOLKSWAGEN** Passat III (4/88 => 10/93), Passat IV (10/93 => 5/97)

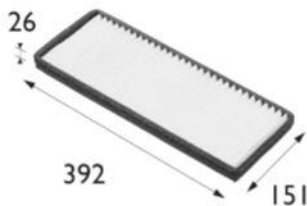
**698164**

**AUDI** 80, A4, A5 (8/2011), Cabriolet (6/91 => 8/2000), Coupé (11/88 => 1/96), Q5 (6/2012), RS2, RS4 Quattro

**VOLKSWAGEN** Passat V (10/96 => 8/2000), Passat V FL (10/2000 => 5/2005)

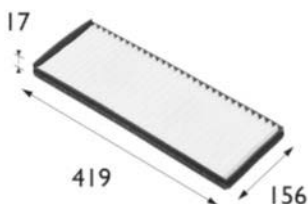
**698165**

**OPEL** Astra  
**VAUXHALL** Astra Belmont (1/86 => 9/91), Astra MK III (9/91 => 3/2001), Calibra (6/90 => 7/97), Combo

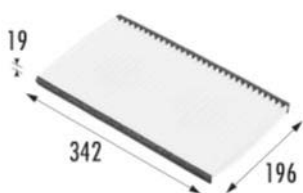
**698166**

**OPEL** Combo sur base Corsa B (3/93 => 9/2001), Corsa B (3/93 => 8/2000), Tigra (10/94 => 1/2001)  
**VAUXHALL** Combo, Corsa MKI (4/93 => 8/2000), Tigra (11/94 => 1/2001)

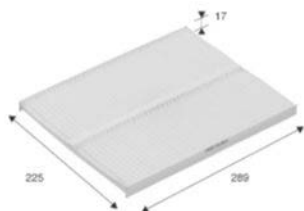
**698167**

**OPEL** Omega B (2/94 => 7/2003)  
**VAUXHALL** Omega (4/94 => 12/2003)

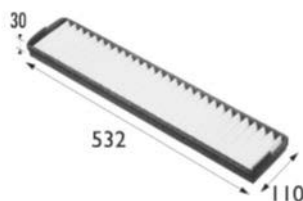
**698168**

**FORD** Cougar (9/98 => 2/2001), Mondeo I (FD) (1/93 => 8/96), Mondeo I FL (GD) (8/96 => 9/2000)

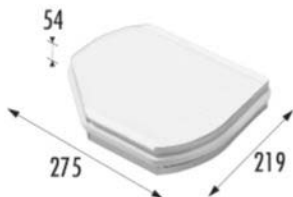
**698169**

**CHRYSLER** Crossfire (7/2003 => 1/2009)  
**MAYBACH** Maybach (9/2002)  
**MERCEDES** C Class (202), CLK Class (208), E Class (210), S Class (220), SLK Class (170)

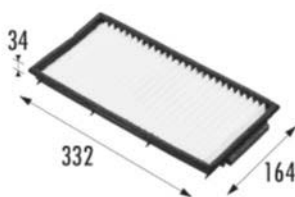
**698170**

**BMW** M5 (E34) (7/88 => 9/95), Série 5 (E34) (1/88 => 12/96), 7 Series (E32) (9/86 => 5/94)

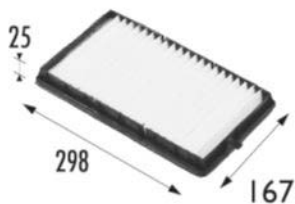
**698171****BMW**

M3 (E36) (6/92 =&gt; 6/2000), 3 Series (E36) (12/90 =&gt; 4/2001)

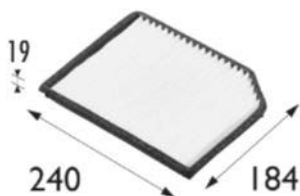
**698173****RENAULT**

Laguna

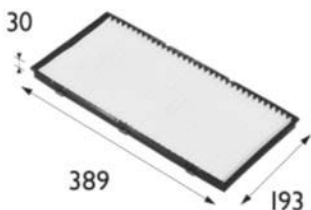
**698174****ALFA ROMEO**

145 (9/94 =&gt; 6/2001), 146 (12/94 =&gt; 6/2001), 155 (11/91 =&gt; 8/97), GTV, Spider

**FIAT**

Coupé, Marengo, Tempra, Tipo

**LANCIA**

Dedra, Delta

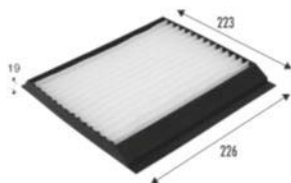
**698175****RENAULT**

Kangoo I FL (3/2003 =&gt; 6/2009), Mégane Scenic (JA/FA) (10/96 =&gt; 9/1999), Scenic Phase2 (9/1999 =&gt; 4/2003)

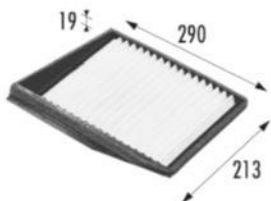
**698176****RENAULT**

Mégane Scenic (JA/FA) (10/96 =&gt; 9/1999), Scenic Phase2 (9/1999 =&gt; 4/2003)

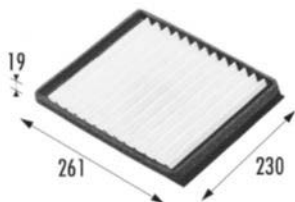
**698177****RENAULT**

Mégane Scenic (JA/FA) (10/96 =&gt; 9/1999)

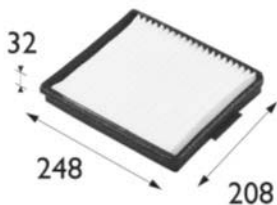
**698196**

**HONDA** Civic (EJ\*) (3/96 => 3/2000), Civic (EJ/EK) (10/95 => 3/2001), Civic (MA/MB) (1/95 => 3/2001)

**MG** MG ZR (6/2001 => 4/2005), MG ZS (7/2001 => 4/2005)

**ROVER** 200 Coupé/Cabriolet, 200, 25, 400, 45

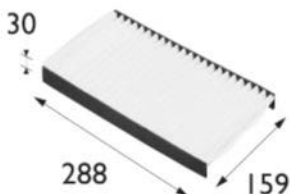
**698197**

**ALFA ROMEO** 156 (9/97 => 3/2003)

**FIAT** Brava (182) (6/95 => 9/98), Brava FL (182) (10/98 => 3/2002)

**IVECO** Daily

**LANCIA** Dedra, Delta, Lybra

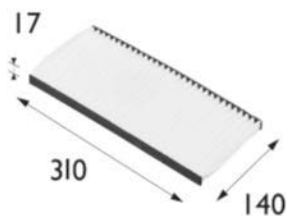
**698198**

**FIAT** Punto (176) (7/93 => 9/1999)

**LANCIA** Y Ipsilon (11/95 => 8/2000), Y Ipsilon FL2000 (9/2000 => 9/2003)

**698199**

**ALFA ROMEO** 164 (7/87 => 9/92), 164 FL92 (9/92 => 9/98), 164 Super (9/92 => 9/98)

**FIAT** Croma (154) (10/85 => 12/90), Croma FL90 (154) (1/91 => 12/96)

**LANCIA** Thema (834) FL92 (9/92 => 11/94), Thema (834) RL88 (10/88 => 8/92)

**SAAB** 9000 (6/84 => 7/98)

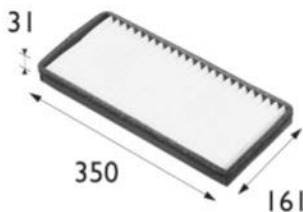
**698201**

**FORD** Courier/Courier (10/96 => 9/2002), Fiesta, Ka I (9/96 => 11/2008), Puma (5/97 => 12/2001), StreetKa (11/2002 => 12/2005)

**MAZDA** 121 (JA/JB) (3/96 => 1/2002)

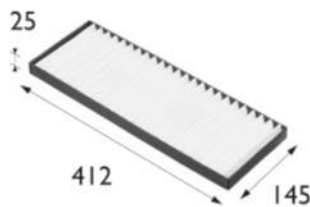
**698202**

**OPEL** Vectra A (9/88 => 9/95), Vectra B (10/95 => 1/1999), Vectra B (2/1999 => 6/2003)

**VAUXHALL** Vectra (10/95 => 3/2002)

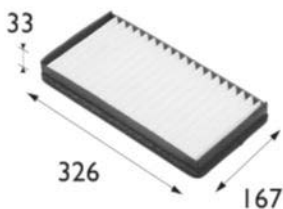
**698203**

**PEUGEOT** 406 (10/95 => 4/2003), 406 FL (4/1999 => 10/2004)

**PORSCHE** 911, Boxster 986, Cayman

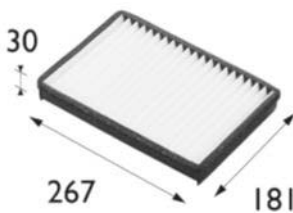
**698235**

**PEUGEOT** 405 - Restyling (7/92 => 10/96)

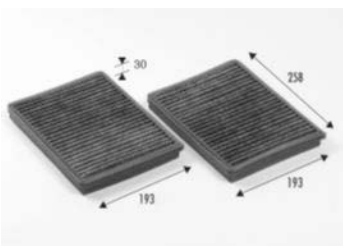
**698246**

**BMW** M5 (E39) (7/1999 => 6/2003), Série 5 (E39) (9/95 => 4/2004)

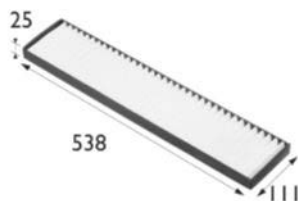
**698247**

**FORD** Galaxy I (VX) (5/95 => 3/2000)

**SEAT** Alhambra (3/96 => 5/2000), Alhambra II (6/2000 => 5/2003), Alhambra II FL (6/2003 => 3/2010)

**VOLKSWAGEN** Sharan I (9/95 => 2/2000), Sharan II (4/2000 => 5/2003), Sharan II FL (6/2003 => 3/2010)

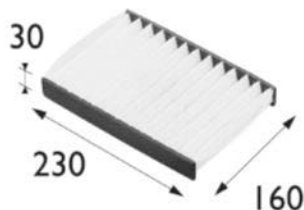
**698255**

**NISSAN** Kubistar (X76) (9/2003 => 11/2009)

**RENAULT** Clio Campus Evolution, Kangoo, Mégane Classic

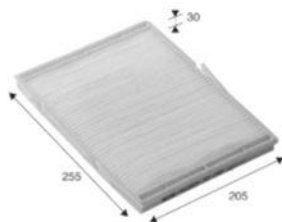
**698276**

**RENAULT** Mégane Classic

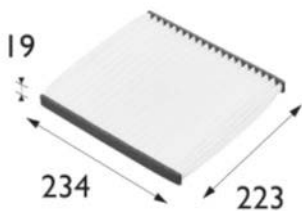
**698279****RENAULT**

Mégane Scenic (JA/FA) (10/96 =&gt; 9/1999)

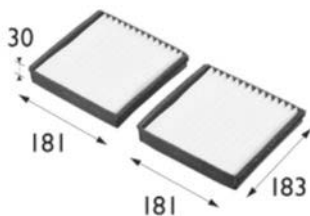
**698290****RENAULT**

Avantime (9/2001 =&gt; 3/2003), Espace II (1/91 =&gt; 8/96), Espace III (9/96 =&gt; 6/2000), Espace III FL (7/2000 =&gt; 10/2002)

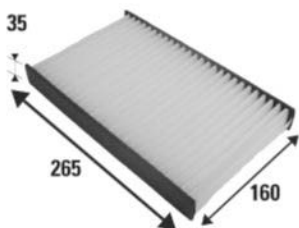
**698454****FIAT**

Multipla (186) (11/98 =&gt; 6/2004), Multipla FL (7/2004 =&gt; 5/2010)

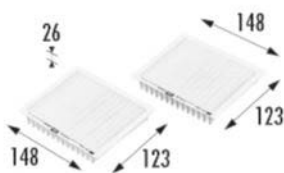
**698469****BMW**

3 Series (E36) (12/90 =&gt; 4/2001)

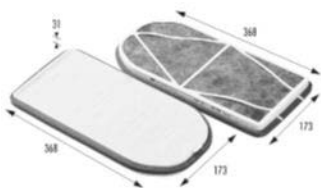
**698470****BMW**

7 Series (E38) (6/94 =&gt; 8/2001)

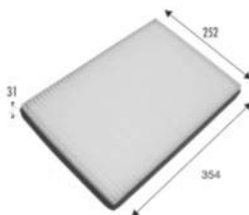
**698475****MERCEDES**

A Class (W168) (5/97 =&gt; 8/2004), Vaneo (414) (10/2001 =&gt; 7/2005)

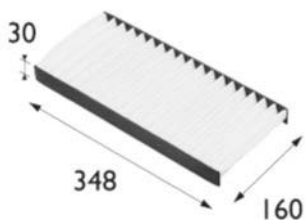
**698487****FORD**

Focus (10/98 => 10/2001), Focus FL  
(11/2001 => 8/2004), Tourneo Connect  
TC7 (5/2002 => 6/2006), Transit  
Connect TC7 (5/2002 => 6/2006)

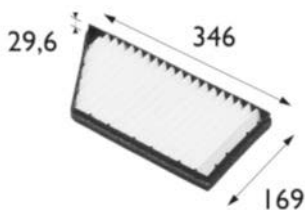
**698488****PEUGEOT**

206 (9/98 => 2010), 206+ (3/2009  
=> 1/2013)

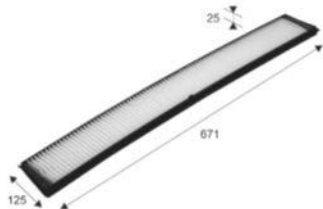
**698489****BMW**

3 Series (E46) (3/98 => 8/2006)

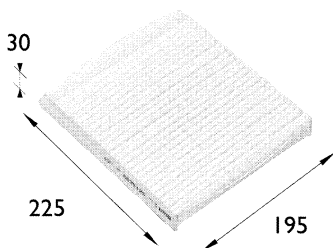
**698512****RENAULT**

Mégane Scenic (JA/FA) (10/96 =>  
9/1999), Scenic Phase2 (9/1999 =>  
4/2003)

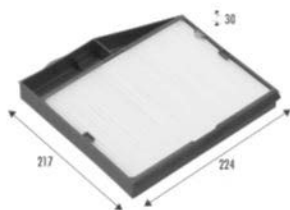
**698535****FIAT**

Doblo (223) (10/2000 => 12/2003),  
Doblo Cargo (223) (10/2000 =>  
12/2003), Punto (188) (7/1999 =>  
6/2003), Punto (188) FL (7/2003 =>  
11/2010)

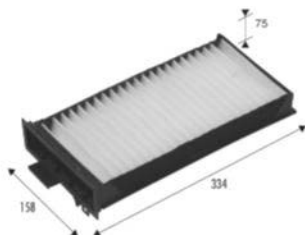
**698540****CITROËN**

C5 (2/2001 => 8/2004)

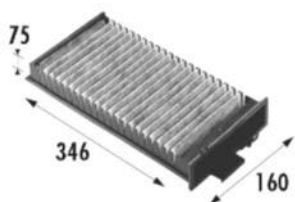
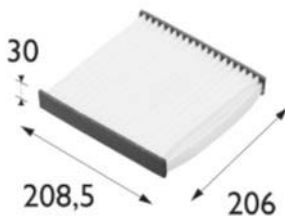
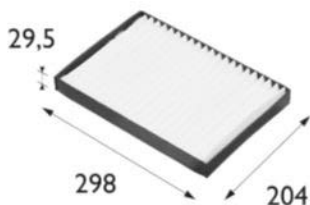
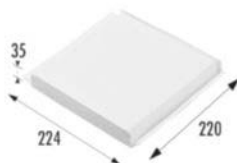
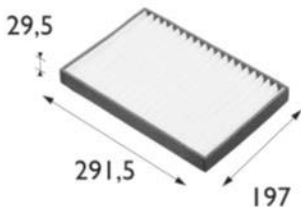
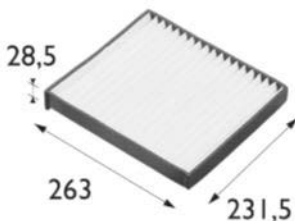

**698541**
**CITROËN** C5 (2/2001 => 8/2004)
**698594**
**RENAULT** Laguna II (BG0) (1/2001 => 2/2005), Vel Satis (1/2002 => 1/2005)
**698606**
**AUDI** A4 Cabriolet, A4, RS4 Quattro, RS4 Quattro Cabriolet, S4 Cabriolet  
**SEAT** Exeo (12/2008)
**698657**
**CITROËN** Berlingo (M49) (7/96 => 12/2002), Berlingo (M59) (12/2002 => 2/2012), Dispatch FL (1/2004 => 12/2006), Xsara FL (9/2000 => 8/2005)  
**PEUGEOT** Partner (M49) (6/96 => 11/2002), Partner (M59) (11/2002), Ranch (M49) (6/96 => 11/2002), Ranch (M59F/U) (11/2002 => 5/2008)
**698662**
**OPEL** Astra G (2/98 => 12/2005)
**698663**
**OPEL** Astra G, Zafira A, Zafira B  
**VAUXHALL** Astra MK IV (2/98 => 12/2005), Zafira

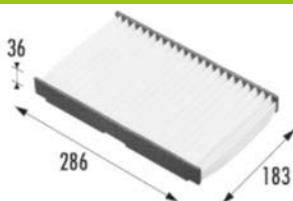
**698664****CITROËN**

C2 (9/2003 => 1/2010), C3, C3 Picasso (2/2009), C3 Pluriel (5/2003 => 1/2011), C4 (11/2004 => 1/2011), C4 (B7) (9/2010), DS4 (4/2011)

**PEUGEOT**

1007 (4/2005 => 7/2010), 307 (3/2001 => 6/2005), 307 Restyling (6/2005 => 3/2009), 308 (9/2007 => 3/2015)

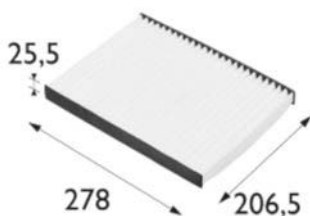
**698679****SKODA**

Superb (12/2001 => 3/2008)

**VOLKSWAGEN** Passat V FL (10/2000 => 5/2005)

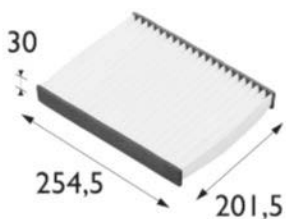
**698680****CITROËN**

Xsara Picasso (12/1999 => 12/2010)

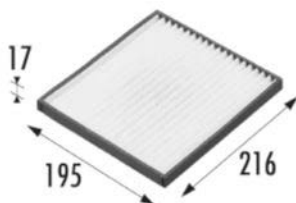
**698681****TOYOTA**

RAV4 (5/2000 => 11/2005), Yaris (NCP1/NLP10/SCP10) (JPN) (1/1999 => 8/2005), Yaris Verso (NCP) (8/1999 => 9/2005)

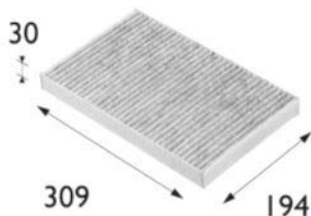
**698682****AUDI**

A6 (4/97 => 5/2001), S6 (9/1999 => 5/2001)

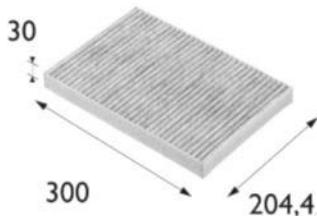
**698683****AUDI SEAT**

A4 Cabriolet, A4, A6, RS4 Quattro Exeo (12/2008)

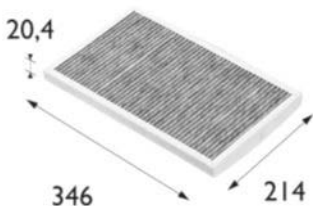
**698684**

**AUDI** 100, A6, S6 Plus Quattro, S6 (7/94 => 10/97)

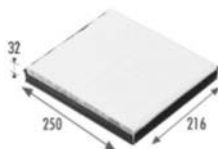
**698685**

**AUDI** A2 (5/2000 => 8/2005)  
**MERCEDES** G Class (M461/3) (9/89)  
**SEAT** Cordoba IV (9/2002 => 11/2009), Ibiza III (9/2001 => 11/2009), Ibiza IV (3/2008 => 3/2012)  
**SKODA** Fabia, Felicia, Rapid, Roomster  
**VOLKSWAGEN** Fox (11/2004), Polo IX (6/2009 => 5/2015), Polo VII (11/2001 => 6/2005), Polo VIII (4/2005 => 11/2009)

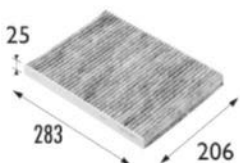
**698686**

**AUDI** A3 (9/96 => 8/2000), A3 (9/2000 => 6/2003)  
**SEAT** Arosa, Cordoba, Ibiza, Toledo  
**SKODA** Octavia I (10/96 => 7/2000), Octavia I FL (8/2000 => 12/2010)  
**VOLKSWAGEN** Caddy II, Golf III, Passat V, Polo V, Vento (11/91 => 12/97)

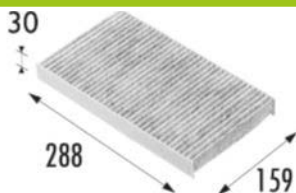
**698687**

**ALFA ROMEO** 156 (9/97 => 3/2003)  
**FIAT** Brava FL (182) (10/98 => 3/2002), Brava I FL (182) (10/98 => 3/2002), Marea FL (185) (2/1999 => 9/2002)  
**LANCIA** Dedra, Delta, Lybra

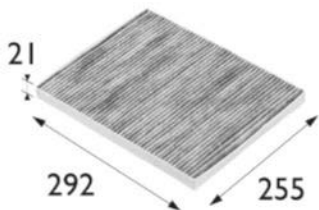
**698688**

**ALFA ROMEO** 166 (10/98 => 9/2003), 166 FL (10/2003 => 12/2007)  
**LANCIA** Kappa (838) (10/94 => 10/2001)

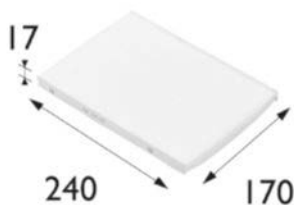
**698689**

**ALFA ROMEO** 156 (9/97 => 3/2003)  
**FIAT** Brava (182) (6/95 => 9/98), Brava FL (182) (10/98 => 3/2002), Bravo I (182) (6/95 => 9/98)

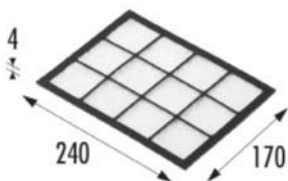
**698690****FIAT**

Palio (178) (7/97 => 2/2001), Palio FL (3/2001 => 9/2002), Palio Week End (178) (9/97 => 2/2001)

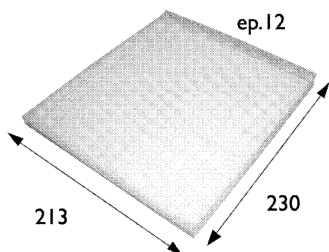
**698691****FIAT**

Palio (178) (7/97 => 2/2001), Palio Week End (178) (9/97 => 2/2001), Siena (178) (7/97 => 12/2001)

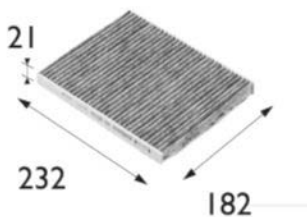
**698692****FIAT**

Bravo II (198) (2/2007 => 12/2009), Stilo (9/2001 => 12/2003), Stilo FL (1/2004 => 1/2008)

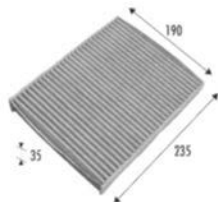
**698693****FORD**

Fiesta V 2002 (3/2002 => 9/2005), Fiesta V FL (10/2005 => 11/2008), Fusion (6/2002 => 9/2005), Fusion FL (10/2005 => 6/2012)

**MAZDA**

Mazda 2 (DY) (3/2003 => 8/2005), Mazda 2 FL (DY-N) (6/2005 => 1/2008)

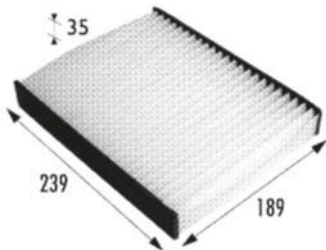
**698694****FORD**

Fiesta V 2002 (3/2002 => 9/2005), Fiesta V FL (10/2005 => 11/2008), Fusion (6/2002 => 9/2005), Fusion FL (10/2005 => 6/2012)

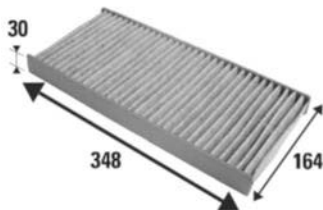
**698695****FORD**

Focus, Tourneo Connect

**698696**

**FORD** Galaxy I (VX) (5/95 => 3/2000), Galaxy I FL (VY) (4/2000 => 4/2006)

**SEAT** Alhambra (3/96 => 5/2000), Alhambra II (6/2000 => 5/2003), Alhambra II FL (6/2003 => 3/2010)

**VOLKSWAGEN** Sharan I (9/95 => 2/2000), Sharan II (4/2000 => 5/2003), Sharan II FL (6/2003 => 3/2010)

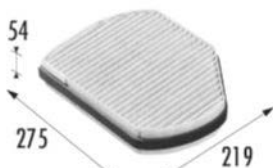
**698697**

**CHRYSLER** Crossfire (7/2003 => 1/2009)

**MERCEDES** C Class (202), CLK Class (208), CLK Class (209, E Class (210), SLK Class (170)

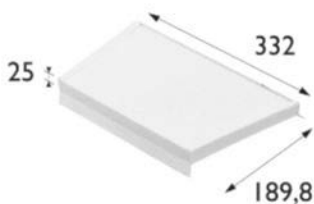
**698700**

**MERCEDES** C Class (203) (4/2000 => 12/2003), C Class (203) FL (1/2004 => 2/2008), CLK Class (209) (3/2002 => 6/2009)

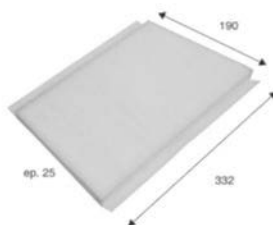
**698701**

**MERCEDES** C Class (203) (4/2000 => 12/2003), C Class (203) FL (1/2004 => 2/2008), CLK Class (209) (3/2002 => 6/2009)

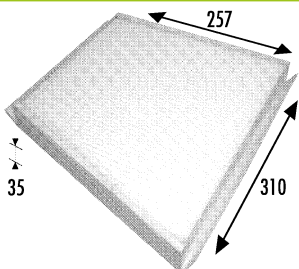
**698702**

**MERCEDES** C ClassLS (219) (7/2004 => 1/2008), E Class (211) (3/2002 => 3/2006), E Class FL (211) (4/2006 => 11/2009)

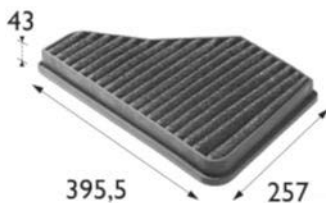
**698703**

**MERCEDES** S Class (140) (7/93 => 7/1999), W140 (3/91 => 6/93)

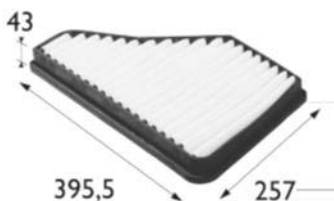
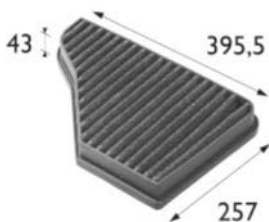
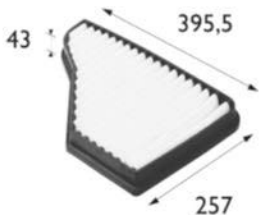
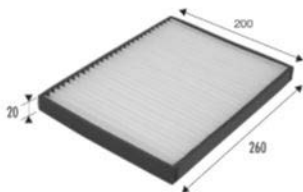
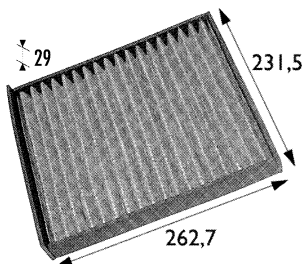
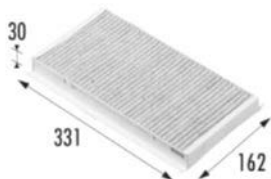
**698704****MERCEDES** S Class (140) (7/93 => 7/1999), W140  
(3/91 => 6/93)**698705****MERCEDES** S Class (140) (7/93 => 7/1999), W140  
(3/91 => 6/93)**698706****MERCEDES** S Class (140) (7/93 => 7/1999), W140  
(3/91 => 6/93)**698707****FORD** Maverick (2/93 => 3/98)  
**NISSAN** Primera (P11/W11) (6/96 => 2/2002),  
Terrano II (R20) (3/93 => 2/2004),  
Terrano II FL (R20) (2/2004 => 12/2006)**698708****OPEL** Astra G, Zafira A, Zafira B  
**VAUXHALL** Zafira**698710****CADILLAC** BLS (3/2005 => 9/2010)  
**FIAT** Croma II (194-294) (6/2005 => 10/2007)  
**OPEL** Combo  
**SAAB** 9-3 FL (9/2002 => 3/2012)  
**VAUXHALL** Combo, Corsa MKI, Signum, Tigra  
Twintop (7/2004 => 7/2008), Tigra

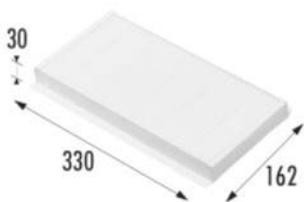
**698711**

**CADILLAC** BLS (3/2005 => 9/2010)  
**OPEL** Combo FL sur base Corsa C  
**SAAB** 9-3 FL (9/2002 => 3/2012)  
**VAUXHALL** Combo, Corsa, Signum, Tigra Twintop

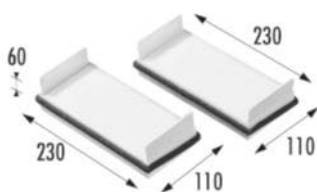
**698712**

**OPEL** Sintra (3/96 => 12/1999)  
**VAUXHALL** Sintra (3/96 => 12/1999)

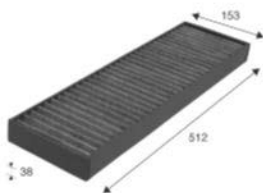
**698713**

**PEUGEOT** 607 (5/2000 => 9/2004), 607 FL (10/2004 => 1/2011)

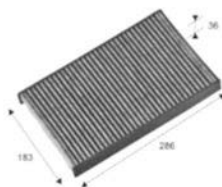
**698714**

**CITROËN** C2 (9/2003 => 1/2010), C3, C3 Picasso (2/2009), C3 Pluriel (5/2003 => 1/2011), C4, C5, DS4 (4/2011)  
**PEUGEOT** 1007 (4/2005 => 7/2010), 307 (3/2001 => 6/2005), 307 Restyling (6/2005 => 3/2009), 308 (9/2007 => 3/2015), 407 (4/2004 => 8/2011), RCZ (5/2010)

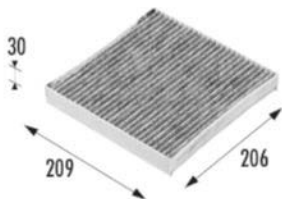
**698715**

**RENAULT** Laguna II (BG0) (1/2001 => 2/2005), Laguna II Phase 2 (3/2005 => 9/2007), Vel Satis

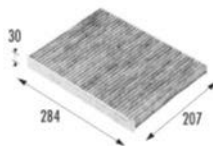
**698716**

**AUDI** A3 (9/96 => 8/2000), A3 (9/2000 => 6/2003), S3 (11/98 => 6/2003), TT (10/98 => 6/2006)  
**SEAT** Arosa (2/97 => 6/2004), Inca (11/95 => 6/2003), Leon I (8/1999 => 5/2006)  
**SKODA** Octavia I (10/96 => 7/2000), Octavia I FL (8/2000 => 12/2010)  
**VOLKSWAGEN** Bora, Caddy, Golf III, Golf IV, Golf V, Lupo (10/98 => 7/2005), New Beetle I

698723

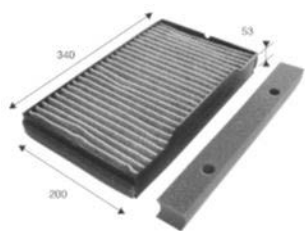

SAAB

9-5 (9/97 => 8/2001), 9-5 FL (9/2001  
=> 11/2005), 9-5 Restylé (11/2005  
=> 6/2010)

698724

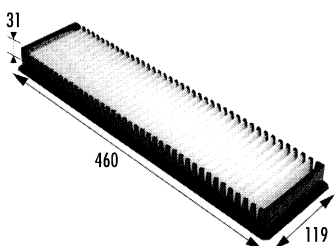

MINI

MINI (R50/52/53) (9/2001 => 11/2006)

698725

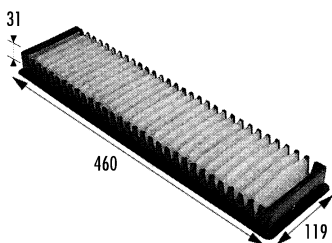

MINI

MINI (R50/52/53) (9/2001 => 11/2006)

698730

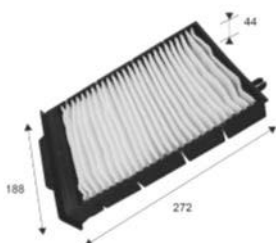

RENAULT

Mégane II (9/2002 => 7/2009)

698731

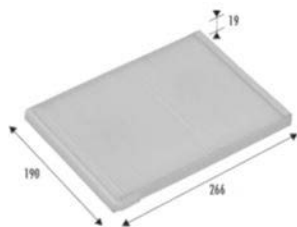

CITROËN

Xsara (7/97 => 8/2000), Xsara FL  
(9/2000 => 8/2005)

698734



NISSAN

Almera, Almera Tino, Primera

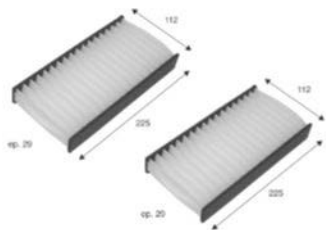

**698735****HONDA**

CR-V mk II (3/2002 => 12/2006),  
Civic (EP) (4/2001 => 6/2006), FR-V  
(10/2004 => 1/2007), FR-V FL (2/2007  
=> 4/2010)

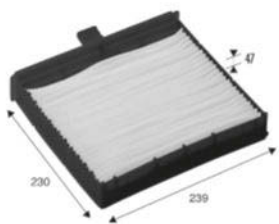
**698736****RENAULT**

Scenic II (5/2003 => 11/2009)

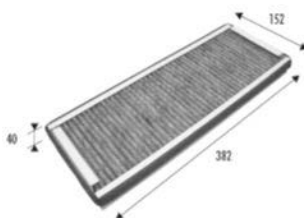
**698737****RENAULT**

Espace IV (9/2002 => 2/2006), Espace IV  
Phase 2 (3/2006 => 12/2010), Espace IV  
Phase 3 (9/2010 => 7/2012)

**698738****CITROËN**

C8 (6/2002)

**FIAT**

Ulysse II (9/2002 => 7/2010)

**LANCIA**

Phedra (9/2002 => 2010)

**PEUGEOT**

807 (6/2002)

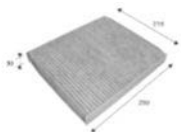
**698739****AUDI**

A1 (5/2010), A2 (5/2000 => 8/2005),  
A3 (4/2012)

**MERCEDES**

G Class (M461/3) (9/89)

**SEAT**

Cordoba IV (9/2002 => 11/2009), Ibiza  
III (9/2001 => 11/2009), Ibiza IV (3/2008  
=> 3/2012)

**SKODA**

Fabia, Felicia, Rapid, Roomster

**VOLKSWAGEN**

Fox (11/2004), Polo IX (6/2009 =>  
5/2015), Polo VII (11/2001 => 6/2005),  
Polo VIII (4/2005 => 11/2009)

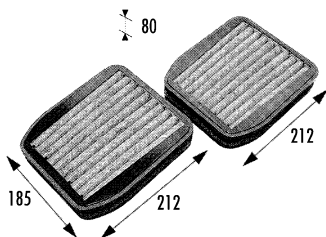
**698740****MERCEDES**

CLS Class (219) (7/2004 => 1/2008), E  
Class (210), E Class (211)

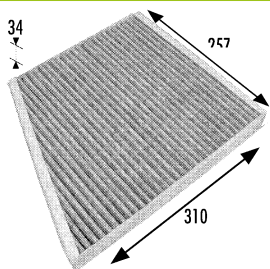
**698741**

**MERCEDES** CLS Class (219) (7/2004 => 1/2008), CLS Class FL (219) (2/2008 => 1/2011), E Class (211) (3/2002 => 3/2006), E Class FL (211) (4/2006 => 11/2009)

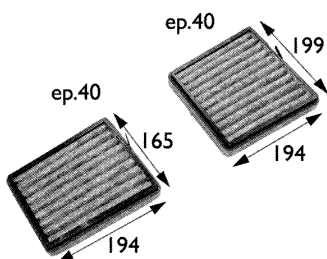
**698742**

**MERCEDES** C Class (203) (4/2000 => 12/2003), C Class (203) FL (1/2004 => 2/2008), C ClassLC (203) (3/2008 => 3/2011), CLK Class (209) (3/2002 => 6/2009)

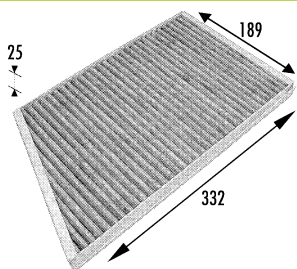
**698743**

**MERCEDES** C Class (203) (4/2000 => 12/2003), C Class (203) FL (1/2004 => 2/2008), CLC Class (203) (3/2008 => 3/2011), CLK Class (209) (3/2002 => 6/2009)

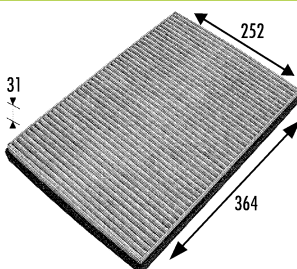
**698744**

**MERCEDES** A Class (W168) (5/97 => 8/2004), Vaneo (414) (10/2001 => 7/2005)

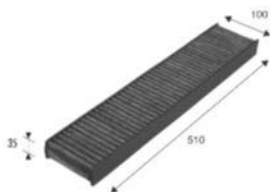
**698745**

**FORD** Mondeo II 2000 (GE) (10/2000 => 5/2003), Mondeo II 2000 FL (GE) (6/2003 => 4/2005), Mondeo II 2005 FL (GE) (5/2005 => 6/2007)

**JAGUAR** X-Type (2/2001 => 2/2008)

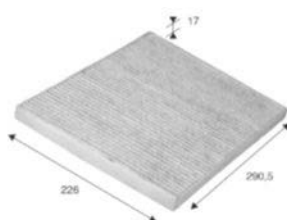
**698746**

**OPEL** Omega B (2/94 => 7/2003)

**VAUXHALL** Omega (4/94 => 12/2003)

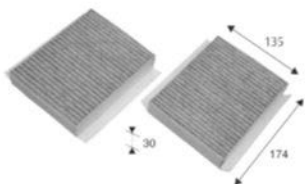
**698747**

**ALFA ROMEO** 147, 156, GT

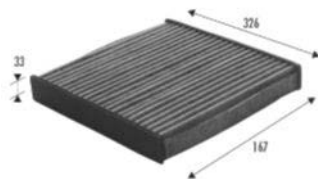
**698748**

**PEUGEOT** 406 (10/95 => 4/2003), 406 FL (4/1999 => 10/2004)

**PORSCHE** 911, 911 Carrera, Boxster 986, Cayman

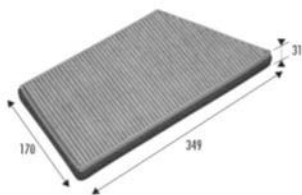
**698749**

**PEUGEOT** 206 (9/98 => 2010)

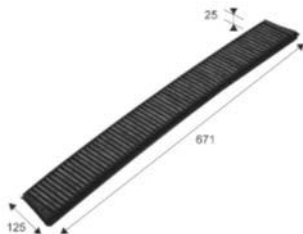
**698750**

**BMW** M3 (E46) (7/2000 => 9/2006), 3 Series (E46) (3/98 => 8/2006), X3 (E83) (10/2003 => 7/2006), X3 LCI (E83) (8/2006 => 9/2010)

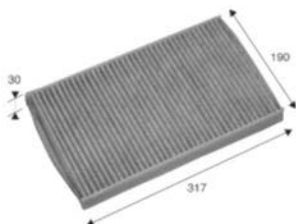
**698751**

**LANCIA** Thesis (9/2002 => 2009)

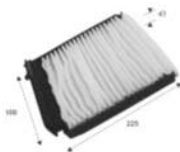
**698753**

**DACIA** Duster (3/2010), Logan (9/2004 => 11/2012), Sandero (6/2008 => 10/2012)

**NISSAN** Micra mk3 (K12E) (1/2003 => 5/2005), Micra mk3 FL (K12E) (6/2005 => 4/2011), Note (E11E) (9/2005 => 12/2007), Note FL (E11E) (1/2008)

**RENAULT** Clio III, Duster, Logan, Modus, Modus, Twingo, Wind

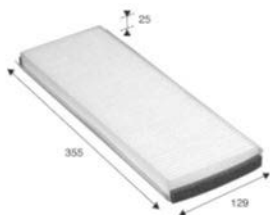
**698762**

**FORD** Transit 2000 (1/2000 => 12/2006)

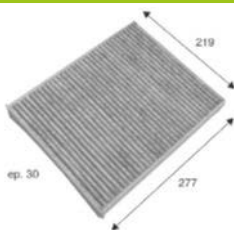
**698768**

**AUDI** Q7 (3/2006 => 6/2009), Q7 (6/2009)  
**PORSCHE** Cayenne 9PA (1/2003 => 12/2006), Cayenne 9PA1 (12/2006 => 2/2010)  
**VOLKSWAGEN** Touareg, Transporter (7E/7F), Transporter (7H/7J)

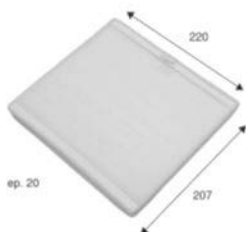
**698769**

**VOLVO** S40 (10/95 => 3/2004), V40 (10/95 => 3/2004)

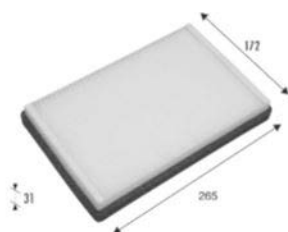
**698770**

**VOLVO** 850, C70, S70, V70, XC 70

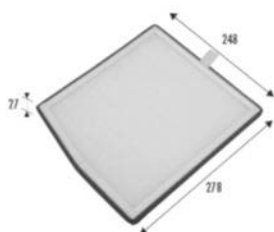
**698771**

**VOLVO** S60, S80, V70 II, XC 70, XC 90

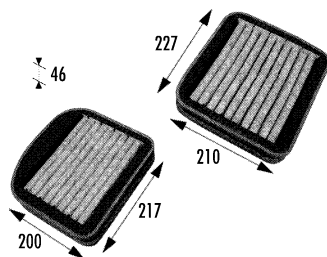
**698772**

**MAYBACH** Maybach (9/2002)  
**MERCEDES** E Class (210) (4/95 => 3/2003), S Class (220) (9/98 => 9/2004), Coupe CL(215) (8/1999 => 4/2006)

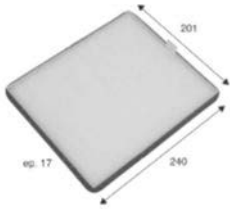
**698773**

**OPEL** Agila (3/2000 => 12/2007), Agila II (12/2007 => 3/2015)  
**SUBARU** G3X Justy (10/2003 => 10/2007)  
**SUZUKI** Ignis FL (RM) (9/2003 => 6/2008), Wagon R+ (RB) (3/2000 => 2008)  
**VAUXHALL** Agila (6/2000 => 12/2007)

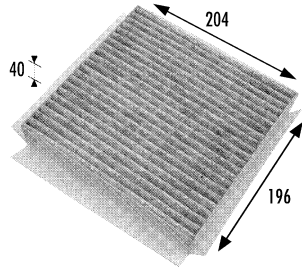
**698774**

**SMART** Crossblade (6/2002 => 12/2003), Fortwo MKI (10/98 => 12/2006)

**698775**

**BMW** X5 (E53) (1/2000 => 11/2006)

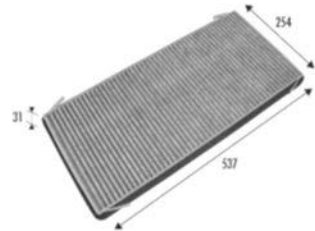
**698776**

**BMW** X5 (E53) (1/2000 => 11/2006)  
**LAND ROVER** Range Rover (3/2002 => 6/2009), Range Rover (6/2010 => 12/2012)

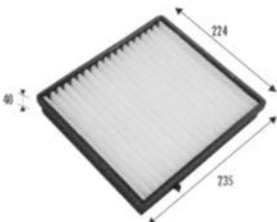
**698777**

**MERCEDES** ML Class (163) (5/97 => 4/2005)

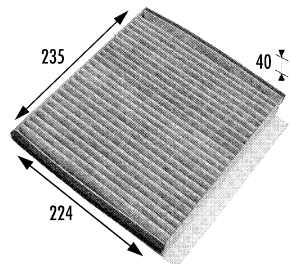
**698778**

**MERCEDES** ML Class (163) (5/97 => 4/2005)

**698779**

**FORD** Mondeo II 2000 (GE) (10/2000 => 5/2003), Mondeo II 2000 FL (GE) (6/2003 => 4/2005), Mondeo II 2005 FL (GE) (5/2005 => 6/2007)

**JAGUAR** X-Type (2/2001 => 2/2008)

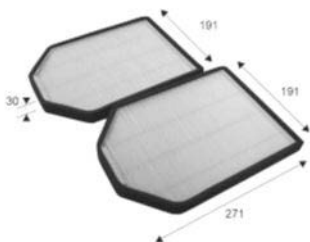
**698790**

**AUDI** A8 (6/94 => 12/98), A8 (10/98 => 9/2002), S8 (9/96 => 12/98), S8 (5/1999 => 9/2002)

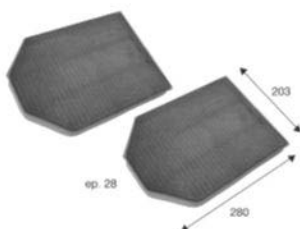
**698791**

**AUDI** A8 (6/94 => 12/98), A8 (10/98 => 9/2002), S8 (9/96 => 12/98), S8 (5/1999 => 9/2002)

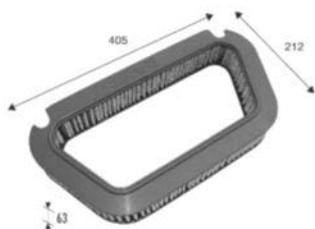
**698792**

**AUDI** A8 (11/2002 => 10/2007), A8 (9/2007 => 7/2010), S8 (6/2006 => 10/2007), S8 (9/2007 => 7/2010)

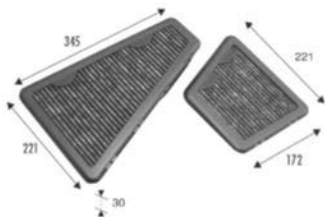
**698793**

**VOLKSWAGEN** Phaeton Phase I (5/2002 => 5/2007), Phaeton Phase II (3/2007 => 5/2010), Phaeton Phase III (5/2010)

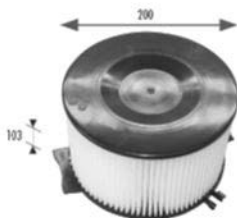
**698794**

**VOLKSWAGEN** Transporter (F70) (9/90 => 5/96), Transporter (F7D) (1/96 => 6/2003)

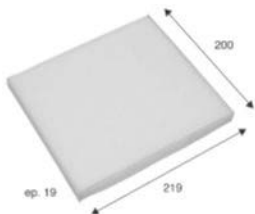
**698795****TOYOTA**

Avensis (T25) (1/2003 => 11/2008),  
Corolla (120) (10/2001 => 2/2007),  
Corolla Verso

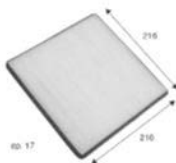
**698796****SUBARU**

B9 Tribeca (9/2006 => 9/2007), Legacy  
3 (10/98 => 4/2003), Legacy 4 (5/2003  
=> 5/2009)

**TOYOTA**

Avensis Verso (CM20) (5/2001 =>  
7/2005), Celica (ZT230) (8/1999 =>  
9/2005), Land Cruiser

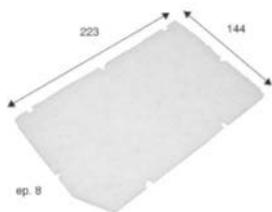
**698797****MERCEDES**

S Class (140) (7/93 => 7/1999), W140  
(3/91 => 6/93)

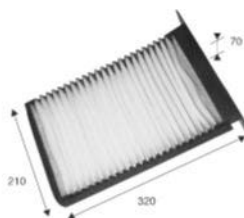
**698799****LAND ROVER**

Freelander (10/97 => 9/2003)

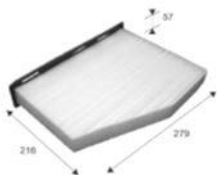
**698800****AUDI**

A3 Cabriolet, A3, Q3, S3

**SEAT**

Alhambra III, Altea, Leon, Toledo

**SKODA**

Octavia II, Superb II, Yeti

**VOLKSWAGEN**

CC (11/2011), Caddy III, Caddy IV, Eos,  
Golf V, Golf VI, Golf VI Cabriolet, Golf  
VI Plus

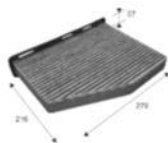
**698801****AUDI**

A3 Cabriolet, A3, Q3, RS Q3, RS3, S3

**SEAT**

Alhambra III (6/2010), Alhambra III FL  
(5/2015), Altea 2014 (5/2013), Leon II  
(7/2005 => 5/2010), Leon II FL (5/2010  
=> 12/2012)

**SKODA**

Octavia II, Superb II, Yeti

**VOLKSWAGEN**

CC (11/2011), Caddy III, Caddy IV,  
Eos, Golf V, Golf V Plus, Golf VI, Golf VI  
Cabriolet, Golf VI Plus

698802

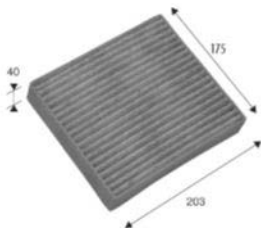

**MITSUBISHI** Colt (Z30) (4/2004 => 9/2008), Galant (E5\*) (11/92 => 9/96)

**SMART** Forfour (4/2004 => 6/2006), Roadster (5/2003 => 11/2005)

698815



**PEUGEOT** 605 - Restyling (7/94 => 5/1999)

698817

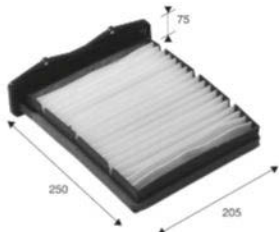

**LAND ROVER** Freelander (10/97 => 9/2003)

698819

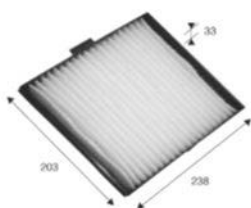

**MG** MG ZS (7/2001 => 4/2005)  
**ROVER** 25, 400, 45

698838

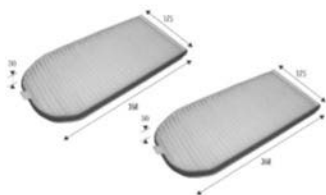

**BMW** 7 Series (E38) (6/94 => 8/2001)

698839

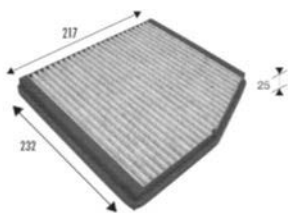

**FIAT** Doblo (223) (10/2000 => 12/2003), Doblo Cargo (223) (10/2000 => 12/2003)

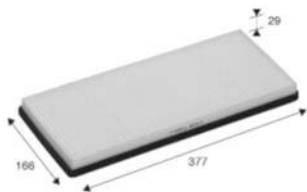

**698840**

**MERCEDES** Sprinter (901-905) (2/95 => 2/2006)  
**VOLKSWAGEN** LT II (5/96 => 5/2003), LT III (6/2003  
=> 7/2006)

**698856**

**BMW** 7 Series (E65) (9/2001 => 10/2008), 7  
Series (E66) (3/2002 => 10/2008), 7  
Series (E67) (10/2002 => 6/2008)

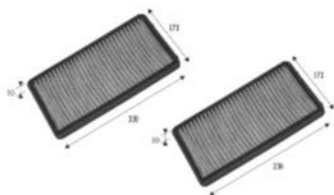
**698857**

**BMW** 7 Series (E65) (9/2001 => 10/2008), 7  
Series (E66) (3/2002 => 10/2008), 7  
Series (E67) (10/2002 => 6/2008)

**698858**

**CITROËN** Jumper I (2/94 => 12/2001), Jumper II  
(1/2002 => 6/2006), Relay I (2/94 =>  
12/2001), Relay II (1/2002 => 6/2006)  
**FIAT** Ducato (230-231-232-234) (2/94 =>  
12/2001), Ducato (243-244-245-247)  
(1/2002 => 6/2006), Ducato (RUS) (243-  
244-245) (1/2008 => 12/2011)  
**PEUGEOT** Boxer I (2/94 => 12/2001), Boxer II  
(1/2002 => 6/2006)

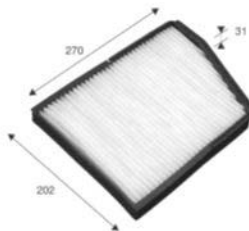
**698859**

**DAEWOO** Leganza (V100) (9/97 => 1/2003)

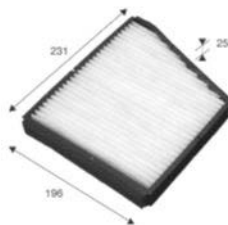
**698860**

**CHEVROLET** Lanos (T100) (9/97 => 12/2002)  
**DAEWOO** Nubira (J100) (9/97 => 5/1999), Nubira II  
(J150) (6/1999 => 9/2004)

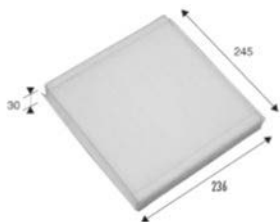
**698861**

**ALPINA BMW** Roadster S (2004 => 2006)  
**BMW** Z4 (E85/E86) (9/2002 => 3/2009), Z4 (E89) (3/2009)

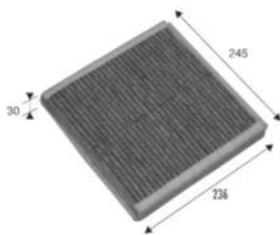
**698862**

**BMW** Z4 (E85/E86) (9/2002 => 3/2009)

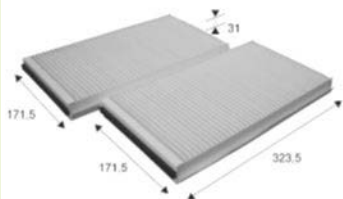
**698863**

**BMW** M5, M6 (E63/E64) (3/2005 => 7/2010),  
 Série 5 (E60/E61) (5/2003 => 12/2006)

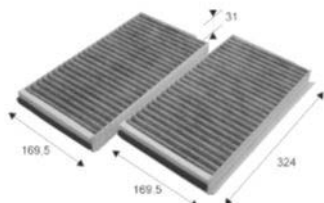
**698864**

**BMW** M5 (E60) (12/2004 => 3/2007), M5 LCI (E61) (1/2007 => 9/2011), M6 (E63/E64) (3/2005 => 7/2010),

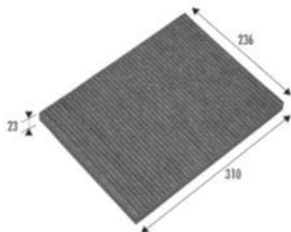
**698865**

**CHRYSLER** Grand Voyager, Voyager

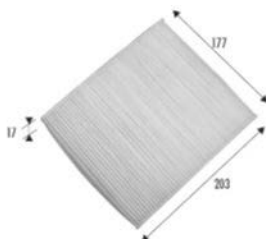
**698866**

**ABARTH** Nuova 500 (8/2008 => 6/2012)  
**FIAT** Nuova 500 (7/2007 => 6/2012), Panda 169 (9/2003 => 2/2013)  
**FORD** Ka II (12/2008)

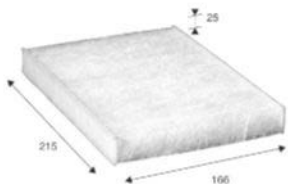
**698867**

**ABARTH** Nuova 500 (8/2008 => 6/2012)  
**FIAT** Doblo (223) (10/2000 => 12/2003),  
 Doblo Cargo (223) (10/2000 => 12/2003)  
**LANCIA** Musa, Y Ipsilon

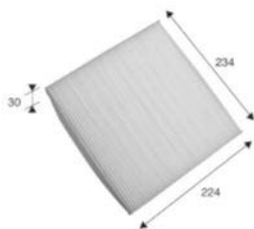
**698868**

**HONDA** Accord VII (CL/CM) (2/2003 => 5/2008),  
 Accord VIII (CU) (5/2008 => 4/2011)

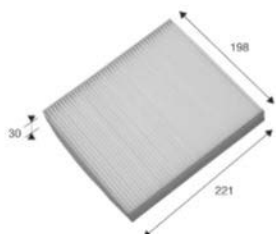
**698869**

**HONDA** CR-V mk I (1/97 => 2/2002), Civic (EJ\*)  
 (3/96 => 3/2000)  
**ROVER** 400 Série 2 (5/95 => 3/2000)

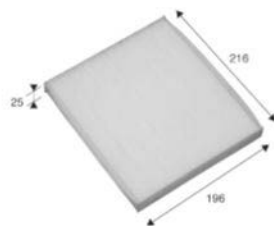
**698870**

**MAZDA** Mazda 2, Mazda 6

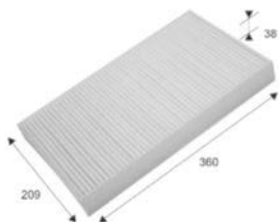
**698871**

**MERCEDES** Viano (639) (1/2003 => 9/2010), Viano  
 FL (639) (7/2010), Vito (639) (1/2003 =>  
 9/2010), Vito FL (639) (7/2010)

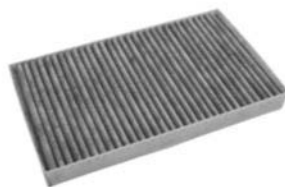
**698872**

**MERCEDES** Viano (639) (1/2003 => 9/2010), Viano  
 FL (639) (7/2010), Vito (639) (1/2003 =>  
 9/2010), Vito FL (639) (7/2010)

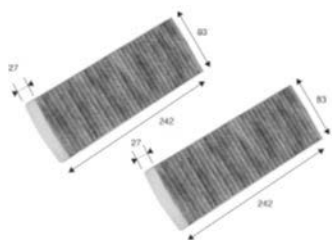
**698873**

**NISSAN** Maxima QX (CA33) (1/2000 => 1/2006)

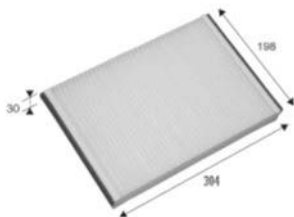
**698874**

**OPEL** Astra G (2/98 => 12/2005), Astra H (3/2004 => 11/2011)  
**VAUXHALL** Astra MK IV (2/98 => 12/2005), Astra MK V (3/2004 => 12/2012)

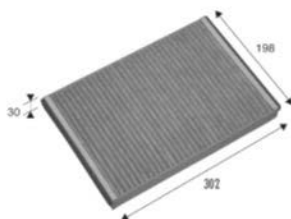
**698875**

**OPEL** Astra H (3/2004 => 11/2011)  
**VAUXHALL** Astra MK IV (2/98 => 12/2005), Astra MK V (3/2004 => 12/2012)

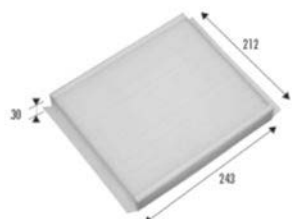
**698876**

**OPEL** Meriva A (5/2003 => 7/2010)  
**VAUXHALL** Meriva A (5/2003 => 7/2010)

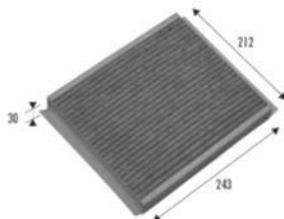
**698877**

**OPEL** Meriva A (5/2003 => 7/2010)  
**VAUXHALL** Meriva A (5/2003 => 7/2010)

**698878**

**RENAULT** Twingo I (X06) (3/93 => 8/98), Twingo I FL (X06) (9/98 => 6/2007)

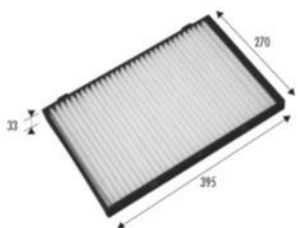
**698879**

**MG** MG XPower (9/2003 => 4/2005), MG ZT (6/2001 => 4/2005)  
**ROVER** 75 (2/1999 => 6/2004), 75 FL (3/2004 => 4/2005)

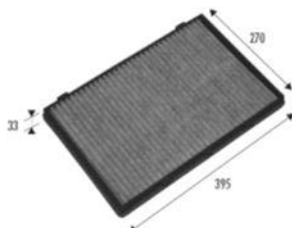
**698880**

**MG** MG XPower (9/2003 => 4/2005), MG ZT (6/2001 => 4/2005)  
**ROVER** 75 (2/1999 => 6/2004), 75 FL (3/2004 => 4/2005)

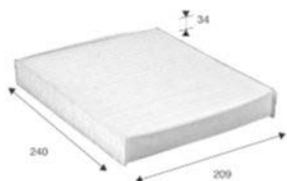
**698882**

**FORD** C-Max, Focus C-MAX, Galaxy II, Kuga, Mondeo, S-Max

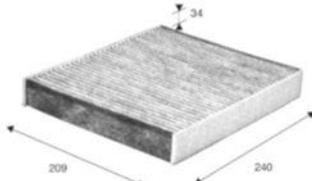
**698883**

**FORD** C-Max, Focus C-MAX, Galaxy II, Kuga, Mondeo, S-Max

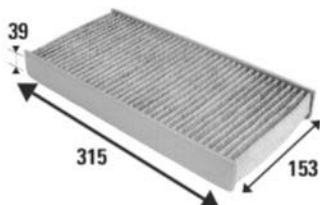
**698884**

**CITROËN** C5 FL (9/2004 => 6/2008), C6 (12/2005 => 12/2012)  
**PEUGEOT** 407 (4/2004 => 8/2011)

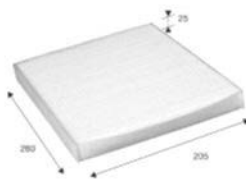
**698885**

**AUDI** A3 (9/96 => 8/2000), TT (10/98 => 6/2006)  
**SEAT** Alhambra III, Cordoba, Ibiza, Inca  
**SKODA** Octavia, Superb (12/2001 => 3/2008)  
**VOLKSWAGEN** Caddy II, Golf II, Golf II Cabriolet, Golf III, Golf III Cabriolet, Lupo, Passat V, Polo V

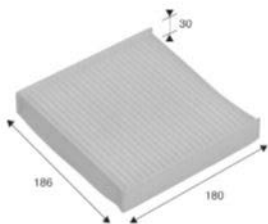
**698886**

**FIAT** Sedici  
**HONDA** City (10/81 => 12/87), Jazz I (10/81 => 86), Jazz II (CHN) (3/2005 => 10/2008), Jazz II (JPN) (1/2002 => 10/2008)  
**SUZUKI** SX4, Swift II RS, Swift III

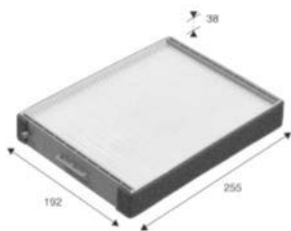
**698888**

**HYUNDAI** Highway Van (3/2000 => 2/2004), Santa Fé (8/2000 => 2/2006)  
**KIA** Magentis, Sorento

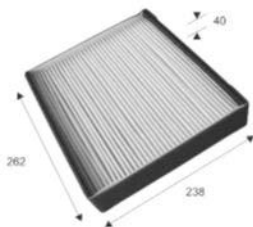
**698889**

**KIA** Opirus (4/2003 => 10/2006)

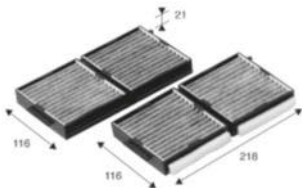
**698890**

**MAZDA** 323 (BJ), 626 (GF), Premacy

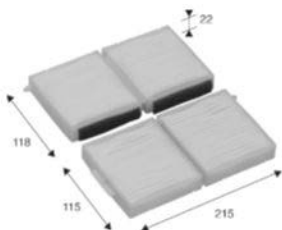
**698891**

**MAZDA** 323 (BJ), 626 (GF), 626 (GW), Premacy

**698892**

**MAZDA** Mazda 3, Mazda 5 (2/2005 => 12/2007), Mazda 5 FL (9/2007 => 10/2010), Mazda 5 II (6/2010)

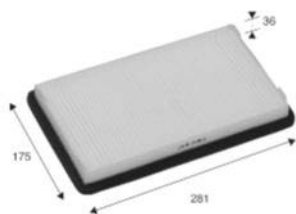
**698893**

**FORD** Maverick (12/2000 => 5/2006)  
**MAZDA** Tribute (1/2000 => 2/2005)

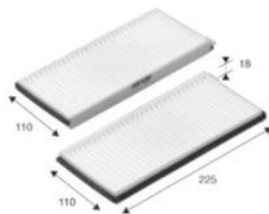
**698894**

**SUZUKI** Grand Vitara XL7 (3/2001 => 3/2006)

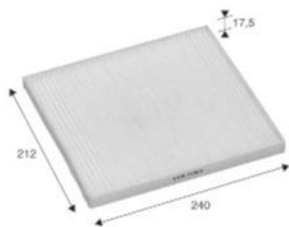
**698895**

**KIA** Carnival, Cerato, Sedona, Sorento

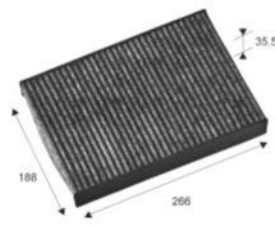
**701000**

**PEUGEOT** 508

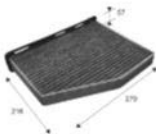
**701001**

**AUDI** A3 Cabriolet, A3, Q3, RS Q3, RS3  
**SEAT** Alhambra III (6/2010), Alhambra III FL (5/2015), Altea 2014 (5/2013), Leon II (7/2005 => 5/2010), Leon II FL (5/2010 => 12/2012)  
**SKODA** Octavia II, Superb II, Yeti  
**VOLKSWAGEN** CC (11/2011), Caddy III, Caddy IV, Eos, Golf V, Golf V Plus, Golf VI, Golf VI Cabriolet, Golf VI Plus

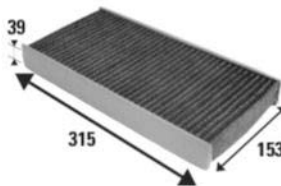
**701002**

**CITROËN** C5 FL (9/2004 => 6/2008), C6 (12/2005 => 12/2012)  
**PEUGEOT** 407 (4/2004 => 8/2011)

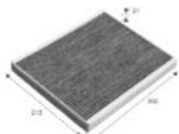
**701003**

- ABARTH** Grande Punto (9/2007 => 12/2010), Punto Evo (5/2010)
- ALFA ROMEO** Mi.To (4/2008 => 12/2010), Mi.To (5/2013), Mi.To (7/2010 => 9/2013)
- FIAT** Grande Punto (199) (1/2008 => 12/2009), Qubo (5/2008)
- OPEL** Corsa D (7/2006 => 11/2010), Corsa D FL (12/2010)
- VAUXHALL** Corsa MKIII (7/2006), Corsa MKIII FL (12/2010)

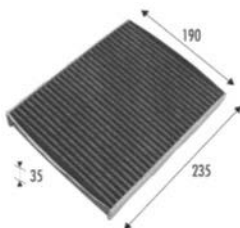
**701004**

- FORD** Fiesta V 2002 (3/2002 => 9/2005), Fiesta V FL (10/2005 => 11/2008), Fusion (6/2002 => 9/2005), Fusion FL (10/2005 => 6/2012)

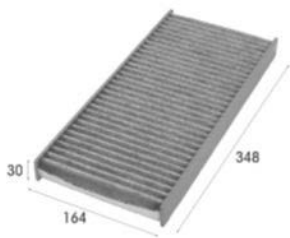
**701005**

- FORD** Focus, Tourneo Connect

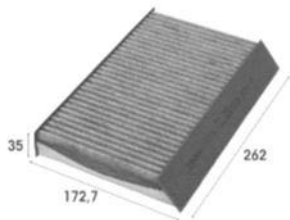
**701006**

- RENAULT** Mégane III Phase 1 (10/2008 => 3/2014), Mégane III Phase 2 (4/2012 => 1/2014), Mégane III Phase 3 (9/2013)

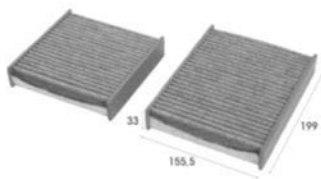
**701007**

- CITROËN** C3 (A51) (10/2009), C4 Cactus (5/2014), DS3 (A55) (3/2010 => 5/2014), DS3 (A55) FL (5/2014 => 1/2016)
- PEUGEOT** 207 (3/2006), 207+ (11/2012), 208 (3/2012)

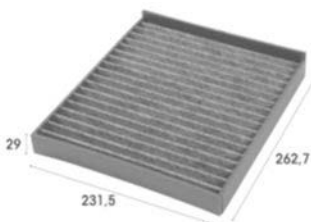
**701008**

- OPEL VAUXHALL** Astra G (2/98 => 12/2005), Zafira A Zafira

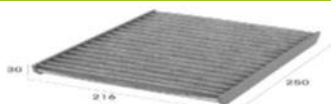

**701009**

**AUDI** A1 (5/2010), A2 (5/2000 => 8/2005), A3 (4/2012)

**MERCEDES** G Class (M461/3) (9/89)

**SEAT** Cordoba IV (9/2002 => 11/2009), Ibiza III (9/2001 => 11/2009), Ibiza IV (3/2008 => 3/2012)

**SKODA** Fabia, Felicia, Rapid (7/2012), Roomster (3/2006 => 3/2010), Roomster FL (3/2010)

**VOLKSWAGEN** Fox (11/2004), Polo IX (6/2009 => 5/2015), Polo VII (11/2001 => 6/2005), Polo VIII (4/2005 => 11/2009)

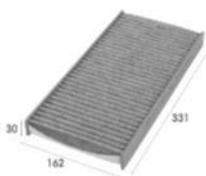
**701010**

**CADILLAC** BLS (3/2005 => 9/2010)

**FIAT** Croma II (194-294) (6/2005 => 10/2007)

**OPEL** Combo

**SAAB** 9-3 FL (9/2002 => 3/2012)

**VAUXHALL** Combo, Corsa MKI, Signum, Tigra Twintop (7/2004 => 7/2008), Tigra

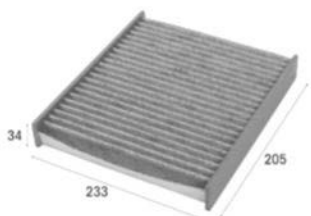
**701011**

**FORD** Focus

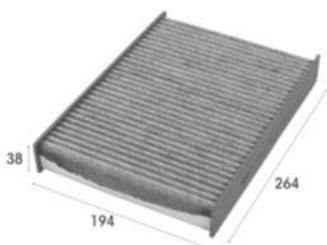
**701012**

**RENAULT** Scenic III (4/2009 => 1/2012), Scenic III Phase 2 (1/2012)

**VAUXHALL** Vivaro B (7/2014)

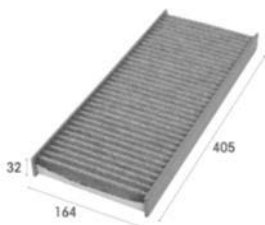
**701013**

**CITROËN** C8 (6/2002)

**FIAT** Ulysse II (9/2002 => 7/2010)

**LANCIA** Phedra (9/2002 => 2010)

**PEUGEOT** 807 (6/2002)

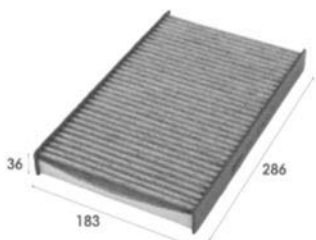
**701014**

**CITROËN** C2 (9/2003 => 1/2010), C3, C4, C5, C5A

**PEUGEOT** 1007 (4/2005 => 7/2010), 307 (3/2001 => 6/2005), 307 Restyling (6/2005 => 3/2009), 308 (9/2007 => 3/2015), 407 (4/2004 => 8/2011), RCZ (5/2010)

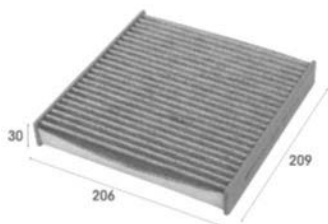
**701015**

**RENAULT** Laguna, Vel Satis

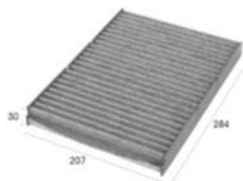
**701016**

**AUDI** A3, S3, TT  
**SEAT** Arosa (2/97 => 6/2004), Inca (11/95 => 6/2003), Leon I (8/1999 => 5/2006)  
**SKODA** Octavia I (10/96 => 7/2000), Octavia I FL (8/2000 => 12/2010)  
**VOLKSWAGEN** Bora, Caddy II, Golf III, Golf III Cabriolet, Golf IV, Golf V, Lupo, New Beetle I

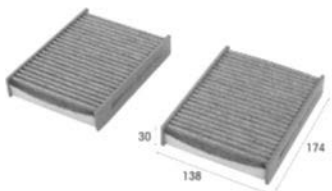
**701017**

**ALFA ROMEO** 147, 156, GT

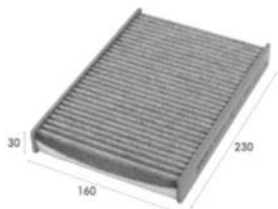
**701018**

**RENAULT** Clio Campus Evolution (6/2009 => 12/2012), Clio II

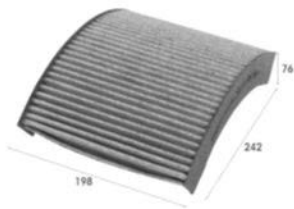
**701019**

**BMW** M3 (F80) (3/2014), M4 (F82 F83) (3/2014), 1 Series (F20/F21) (7/2011 => 2/2015)

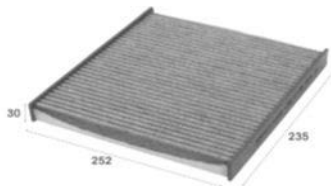
**701020**

**AUDI** A3 Cabriolet (8V) (10/2013), A3 (4/2012), RS3 (2/2015), S3 (10/2012), TT (7/2014)  
**SEAT** Leon III (9/2012)  
**SKODA** Octavia III (11/2012), Superb III (3/2015)  
**VOLKSWAGEN** Golf Sportsvan (2/2014), Golf VII (8/2012), Passat VIII (8/2014)

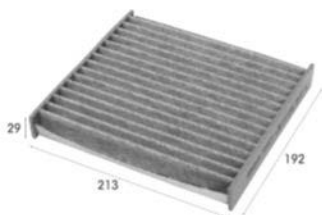
**701021**

**DAIHATSU** Charade (NPS90) (6/2011)  
**LEXUS** CT200h, GS 350, GS 300, GS 430, GS 450, GS 460  
**SUBARU** Legacy 5 (5/2009)  
**TOYOTA** Auris, Avensis, Camry

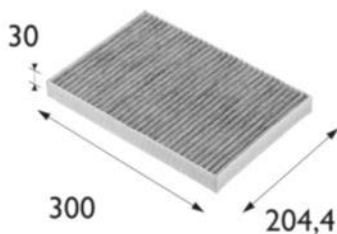
**701023**

**AUDI** A4 Cabriolet, A4, A6, RS4 Quattro  
**SEAT** Exeo (12/2008)

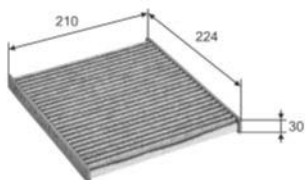
**701024**

**NISSAN** Micra mk4 (K13K) (IND) (7/2010 => 6/2013), Note II(E12E) (8/2013)

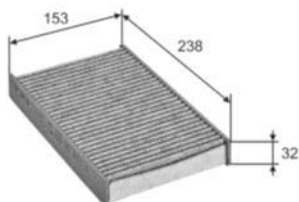
**701025**

**NISSAN** Juke

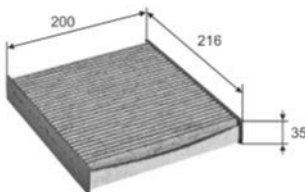
**701026**

**RENAULT** Clio IV (10/2012)

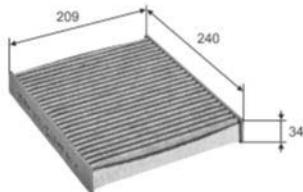
**701027**

**FORD** C-Max, Galaxy II, Kuga, Mondeo, S-Max

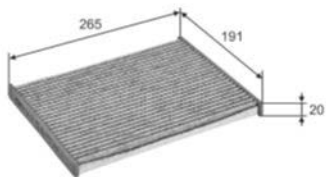
**701028**

**NISSAN** Qashqai (2007>2010)

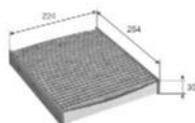
**701029**

**AUDI** A1 (5/2010), A1 (11/2014), S1 (1/2014)  
**SEAT** Ibiza IV FL (2/2012), Ibiza IV FL2 (5/2015), Toledo série 4 FL (5/2015), Tolédo série 4 (7/2012 => 6/2015)  
**SKODA** Fabia II FL (3/2010 => 12/2014), Rapid (7/2012), Roomster FL (3/2010)  
**VOLKSWAGEN** Polo IX (6/2009 => 5/2015), Polo IX FL (2/2014)

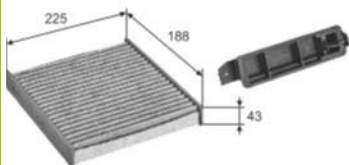
**701030**

**DACIA** Duster (3/2010), Duster Phase 2 (10/2013), Logan (9/2004 => 11/2012), Sandero (6/2008 => 10/2012)  
**LADA** Largus (3/2012)  
**RENAULT** Clio III (9/2005 => 4/2009), Clio III FL (4/2009 => 12/2012), Duster (3/2010 => 6/2015)

**701031**

**NISSAN** Almera, Almera Tino, Primera

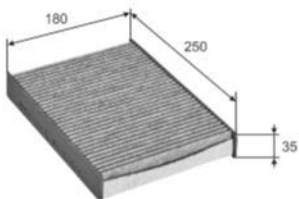
**701032**

**RENAULT** Espace V (3/2015), Kadjar (6/2015), Mégane IV (11/2015)

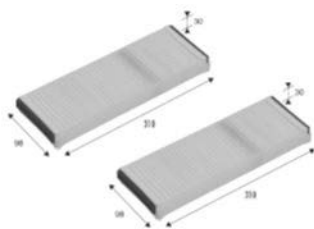
**715500**

**AUDI** A6 Allroad, A6 (4/2004 => 9/2008), S6 (6/2006 => 9/2008)

715501

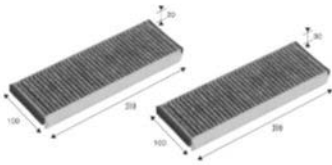

AUDI

A6, R8, S6

715502



BMW

1 Series (E81/E82/E88) (1/2007), 1 Series (E87) (9/2004 => 2/2007), 1 Series LCI (E87) (3/2007 => 6/2011)

715503



BMW

1 Series (E81/E82/E88) (1/2007), 1 Series (E87) (9/2004 => 2/2007), 1 Series LCI (E87) (3/2007 => 6/2011)

715504

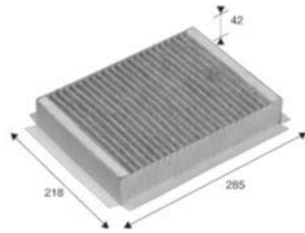

JAGUAR

Sovereign, XJ, XJR

715505

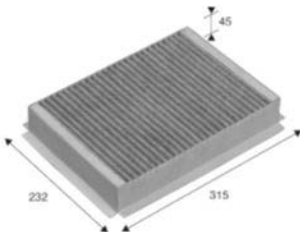

JAGUAR

S-Type

715506

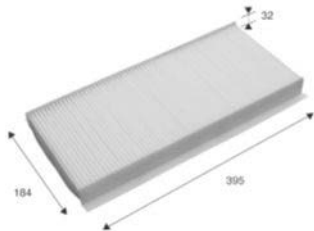

MERCEDES

A Class (W169) (7/2004 => 3/2008)

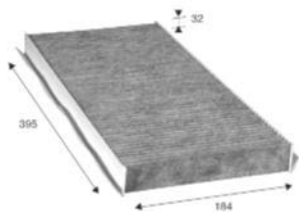
**715507**

**MERCEDES** A Class (W169) (7/2004 => 3/2008), A Class FL (W169) (4/2008 => 9/2012), B Class (W245) (5/2005 => 3/2008), B Class FL (W245) (4/2008 => 9/2011)

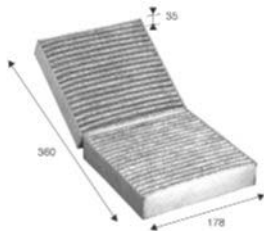
**715508**

**MERCEDES** SLK (R171)

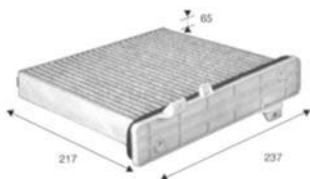
**715509**

**MITSUBISHI** Pajero 3 (VD/VF) (2/2000 => 8/2006), Pajero 4 (9/2006)

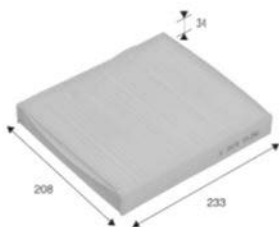
**715510**

**FORD** Focus II (9/2004 => 12/2007), Focus II Coupé Cabriolet (7/2006 => 4/2008), Focus II Coupé Cabriolet FL (4/2008 => 5/2012)

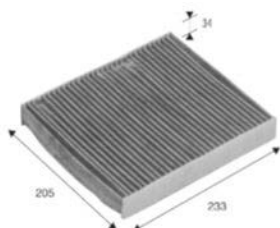
**715511**

**FORD** Focus II (9/2004 => 12/2007), Focus II Coupé Cabriolet (7/2006 => 4/2008)

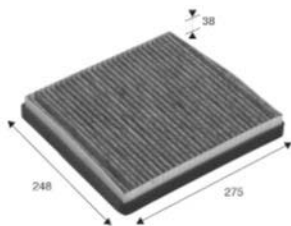
**715512**

**VOLVO** S60, S80, V70 II, XC 70, XC 90 I

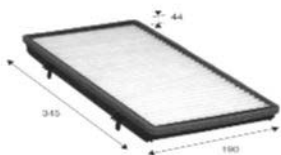
**715513**

**NISSAN** Primastar (X83) (9/2002 => 9/2006)  
**OPEL** Vivaro A (5/2001 => 7/2006), Vivaro A FL (7/2006), Vivaro B (7/2014)  
**RENAULT** Trafic II (4/2001 => 7/2006), Trafic II FL (7/2006)  
**VAUXHALL** Vivaro A (8/2001 => 6/2006), Vivaro A FL (7/2006)

**715514**

**SAAB** 9-3 (4/98 => 5/2003), 900 série 2 (7/93 => 2/98)

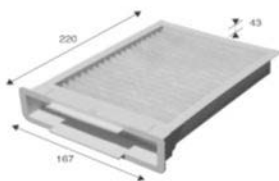
**715515**

**CITROËN** C1 (6/2005 => 2/2012), C1 FL (2/2012 => 4/2014)  
**PEUGEOT** 107 (6/2005 => 2/2012), 107 FL (2/2012 => 4/2014)  
**TOYOTA** Aygo (KGB/WNB) (2/2005 => 2/2012), Aygo FL (KGB/WNB) (2/2012 => 4/2014)

**715516**

**HYUNDAI** Accent FL (10/1999 => 1/2003)

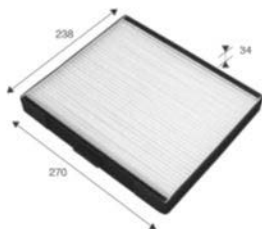
**715517**

**HYUNDAI** Elantra (6/2000 => 1/2007), Matrix (5/2001 => 8/2008)

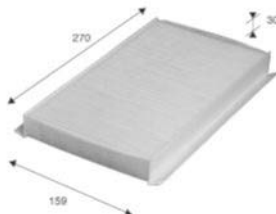
**715518**

**LAND ROVER** Discovery, Range Rover Sport

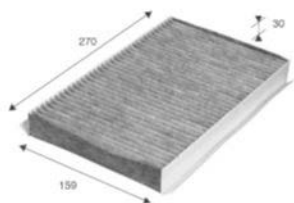
**715519**

**LAND ROVER** Discovery, Range Rover Sport

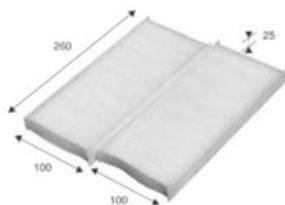
**715520**

**NISSAN** Navara (D40M) (5/2005 => 11/2010), Navara FL (D40M) (12/2009), Pathfinder (R51M) (2/2005 => 8/2010), Pathfinder FL (R51M) (1/2010)

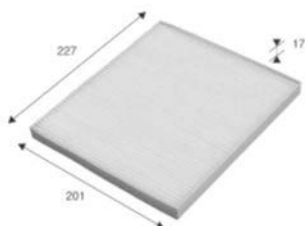
**715521**

**HYUNDAI** Tucson (7/2004 => 9/2006), Tucson FL (9/2006 => 10/2010)  
**KIA** Carens III (6/2006 => 10/2012), Sportage (12/2004 => 12/2006)

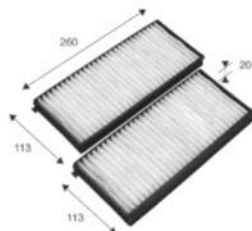
**715522**

**KIA** Carens II (7/2002 => 5/2006), Elan Roadster (1/1999 => 12/1999)

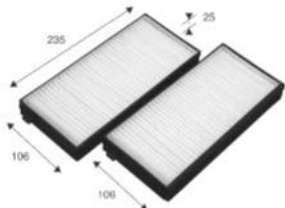
**715523**

**KIA** Clarus (5/95 => 7/2001), Rio I (FD) (7/2000 => 5/2005)

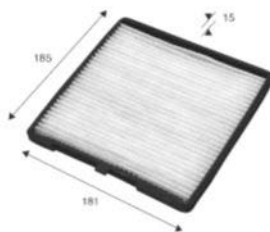
**715524**

**HYUNDAI** i10(TUR-EUR) (10/2013), i10 (IND) (12/2007 => 11/2010), i10 (IND) (9/2010 => 10/2013)  
**KIA** Picanto

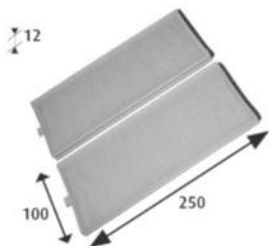

**715525**

**HYUNDAI** Accent FL (10/1999 => 1/2003), Getz (BJ) (9/2002 => 8/2005)

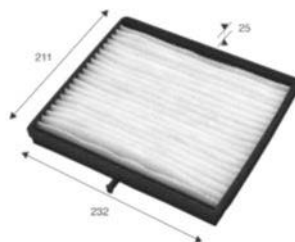
**715526**

**CHEVROLET** Lacetti (J200) (1/2005 => 12/2012), Nubira (J200) (1/2005 => 9/2009)  
**DAEWOO** Lacetti (10/2003 => 12/2004), Nubira III (J200) (7/2003 => 7/2005)

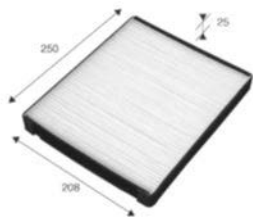
**715527**

**HYUNDAI** Terracan FL (3/2002 => 7/2007)

**715528**

**MITSUBISHI** Galant (EA) (10/96 => 5/2003)

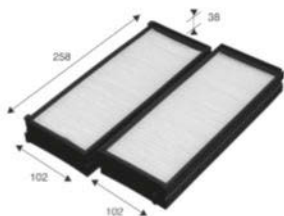
**715529**

**HYUNDAI** Highway Van (3/2000 => 2/2004), Santa Fé

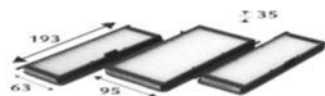
**715530**

**CITROËN** Evasion (7/94 => 9/98), Evasion FL (10/98 => 5/2002), Jumpy (9/95 => 12/2003), Synergie (10/95 => 9/98), Synergie FL (10/98 => 5/2002)  
**FIAT** Scudo (7/95 => 12/2003), Scudo FL (1/2004 => 12/2006), Ulysse (U6) (6/94 => 9/98), Ulysse (U6) FL (10/98 => 8/2002)  
**LANCIA** Kappa (838) (10/94 => 10/2001), Zeta (U60) (10/94 => 8/2002)  
**PEUGEOT** 806 (7/94 => 9/98), 806 FL (10/98 => 5/2002)

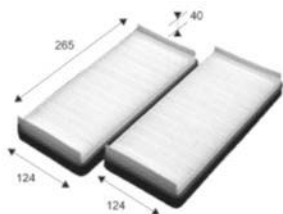
**715531**

**MAYBACH** Maybach (9/2002)  
**MERCEDES** CLK Class (209) (3/2002 => 6/2009), E Class (210) (4/95 => 3/2003), S Class (220) (9/98 => 9/2004), Coupe CL(215) (8/1999 => 4/2006)

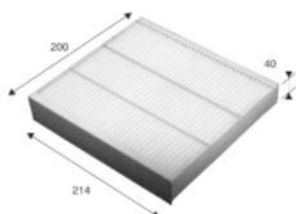
**715532**

**ALFA ROMEO** 159, Brera, Spider

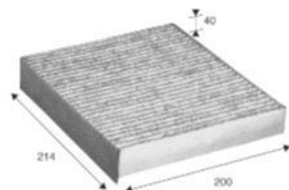
**715533**

**ALFA ROMEO** 159, Brera (1/2006 => 10/2010), Spider II (3/2006 => 9/2010)

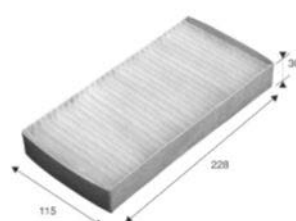
**715534**

**CHRYSLER** PT Cruiser (6/2000 => 11/2007), PT Cruiser Cabriolet (8/2003 => 11/2007)

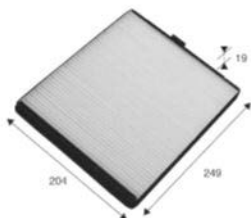
**715535**

**CHEVROLET** Aveo T250/1 (1/2005 => 5/2008), Kalos (T200) (1/2005 => 5/2008)  
**DAEWOO** Kalos (T200) (9/2002 => 7/2005)

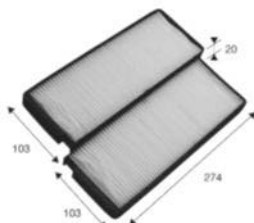
**715536**

**CHEVROLET** Rezzo (U100) (1/2005 => 6/2008), Tacuma (U100) (1/2005 => 6/2008)  
**DAEWOO** Rezzo (U100) (4/2000 => 7/2005), Tacuma (U100) (6/2000 => 7/2005)

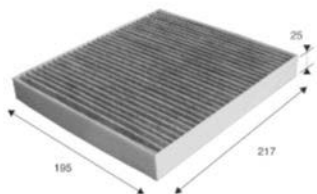
**715537**

**DODGE** Caliber (9/2006 => 5/2011)  
**FIAT** Freemont (6/2011)  
**JEEP** Patriot (6/2007 => 3/2011)  
**LANCIA** Flavia (5/2012)

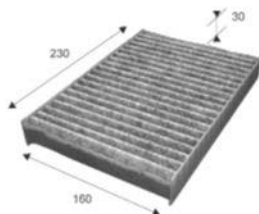
**715538**

**RENAULT** Clio Campus Evolution (6/2009 => 12/2012), Clio II (3/98 => 3/2001), Clio II FL (4/2001 => 5/2009), Kangoo

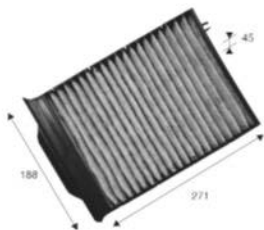
**715539**

**RENAULT** Mégane II (9/2002 => 7/2009)

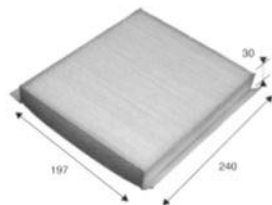
**715540**

**HONDA** Civic VIII (FK/FD/FN) (1/2006)

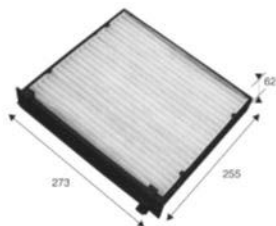
**715541**

**HYUNDAI** Grandeur (4/2005), Santa Fé 2 (3/2006 => 9/2009), Sonata  
**KIA** Magentis II (1/2006 => 5/2008)

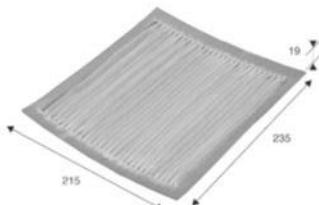
**715542**

**LEXUS** GS 300, IS 300, IS, LS400, RX 300  
**TOYOTA** Harrier (7/98 => 1/2003)

715543

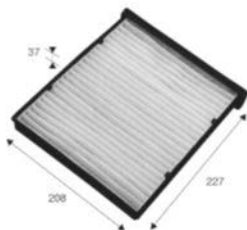

**mitsubishi** Colt (CJ) (11/95 => 6/2003)

715544

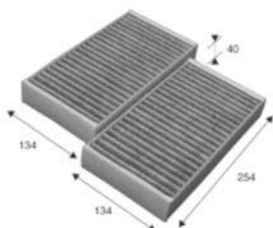

**MERCEDES** GL Class (164) (1/2006 => 3/2013), ML Class (164) (5/2005 => 4/2008), ML Class FL (164) (4/2008 => 1/2013), R Class (W251) (10/2005)

715545

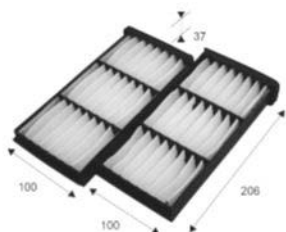

**mitsubishi** Pajero .Pinin (H7\*) (7/1999 => 2/2005)

715546

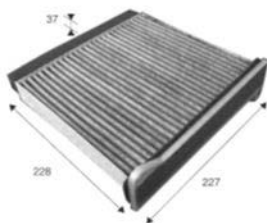

**mitsubishi** Grandis (1/2004 => 11/2010), Lancer (CS/CT) (6/2003 => 3/2011), Outlander (CU) (6/2003 => 12/2008)

715547

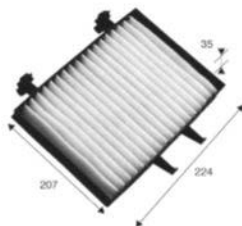

**mitsubishi** Space Runner (N1/2) (6/91 => 2002), Space Wagon (N8) (7/98 => 1/2004)

715548

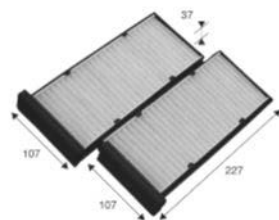

**mitsubishi** Carisma

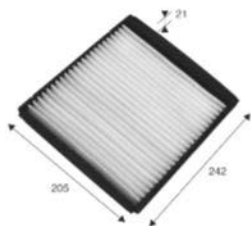
**715549**

**NISSAN** Micra mk2 (K11E) (8/92 => 6/2000),  
Micra mk2 FL (K11E) (7/2000 => 12/2002)

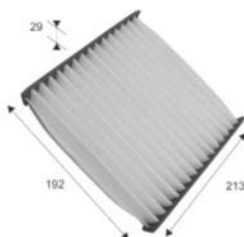
**715550**

**TOYOTA** Land Cruiser 120 (KD/GR) (9/2002 => 8/2009)

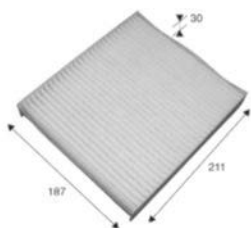
**715551**

**SUBARU** Impreza (G11) (9/2000 => 8/2005),  
Impreza FL (G11) (9/2005 => 6/2007)

**715552**

**ABARTH** Grande Punto (9/2007 => 12/2010),  
Nuova 500 (8/2008 => 6/2012), Punto  
Evo (5/2010)

**ALFA ROMEO** Mi.To

**CITROËN** Nemo (12/2007)

**FIAT** Grande Punto (199) (1/2008 => 12/2009), Grande Punto (199) (10/2005 => 1/2008), Qubo (5/2008)

**OPEL** Combo

**PEUGEOT** Bipper (12/2007)

**VAUXHALL** Combo, Corsa MKIII (7/2006), Corsa MKIII  
FL (12/2010), Corsa MKIV (9/2014)

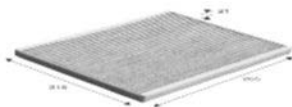
**715553**

**ABARTH** Grande Punto (9/2007 => 12/2010),  
Nuova 500 (8/2008 => 6/2012), Punto  
Evo (5/2010)

**ALFA ROMEO** Mi.To

**FIAT** Grande Punto (199) (1/2008 => 12/2009), Grande Punto (199) (10/2005 => 1/2008)

**OPEL** Adam (1/2013), Corsa D (7/2006 => 11/2010), Corsa D FL (12/2010), Corsa  
E (9/2014)

**VAUXHALL** Combo, Corsa MKIII (7/2006), Corsa MKIII  
FL (12/2010), Corsa MKIV (9/2014)

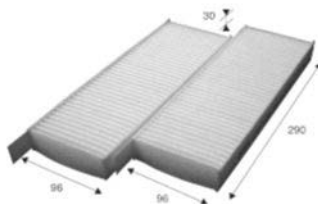
**715554**

**CITROËN** Berlingo (B9) (5/2008), Berlingo FL  
(B9) (4/2015), C4 Picasso (9/2006 => 5/2013), C4 Picasso II (5/2013)

**PEUGEOT** 3008, 5008, Partner

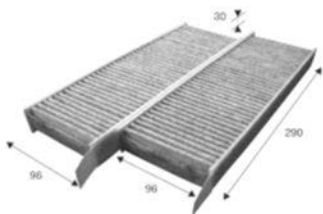
**715555**

**CITROËN** Berlingo (B9) (5/2008), Berlingo FL (B9) (4/2015), C4 Picasso (9/2006 => 5/2013)

**PEUGEOT** 3008, 5008, Partner

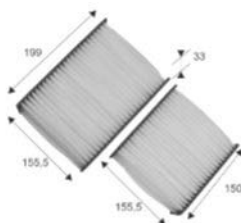
**715556**

**CITROËN** C3 (A51) (10/2009), C4 Cactus (5/2014), DS3 (A55) (3/2010 => 5/2014), DS3 (A55) FL (5/2014 => 1/2016)

**PEUGEOT** 2008 (4/2013), 207 (3/2006), 207+ (11/2012), 208 (3/2012)

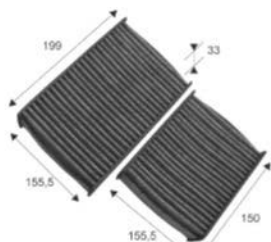
**715557**

**CITROËN** C3 (A51) (10/2009), C4 Cactus (5/2014), DS3 (A55) (3/2010 => 5/2014), DS3 (A55) FL (5/2014 => 1/2016)

**PEUGEOT** 2008 (4/2013), 207 (3/2006), 207+ (11/2012), 208 (3/2012)

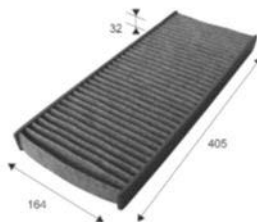
**715558**

**CITROËN** C8 (2002>)

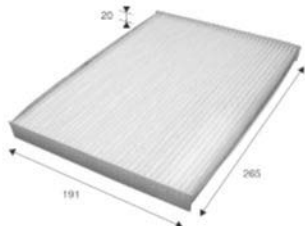
**715559**

**NISSAN** Qashqai (J10E/JJ10E) (3/2007 => 1/2010), Qashqai FL (J10E/JJ10E) (1/2010), X-Trail (T31) (JPN) (3/2007), X-Trail (T31R) (RUS) (10/2009)

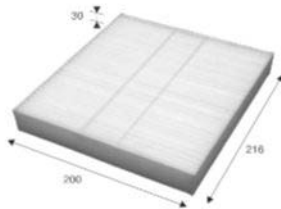
**715560**

**INFINITI** FX 35 /45

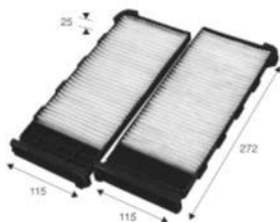
**715561****NISSAN**

Patrol GR (Y61) (10/97 =&gt; 7/2004)

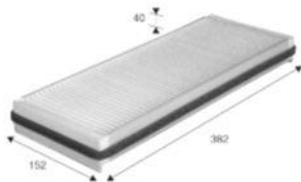
**715562****RENAULT**

Espace IV (9/2002 =&gt; 2/2006), Espace IV Phase 2 (3/2006 =&gt; 12/2010), Espace IV Phase 3 (9/2010 =&gt; 7/2012)

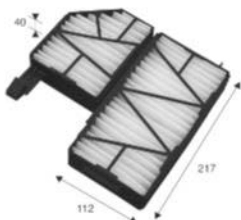
**715563****SUBARU**

Legacy 3 (10/98 =&gt; 4/2003)

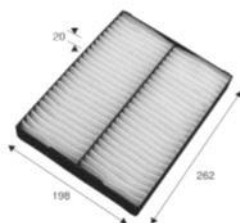
**715564****SUZUKI**

Grand Vitara (5/98 =&gt; 2/2005)

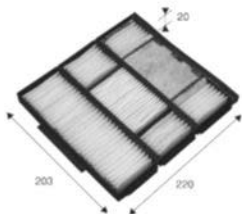
**715565****TOYOTA**

Corolla (110) (4/97 =&gt; 11/1999), Corolla FL (110) (10/1999 =&gt; 10/2001)

**715566****DAEWOO**

Korando KJ (2/1999 =&gt; 1/2005), Musso (1/1999 =&gt; 7/2005)

**SSANGYONG**

Korando série 2 (7/96 =&gt; 3/1999), Korando série 3 (3/1999 =&gt; 2006), Musso (8/93 =&gt; 2007)

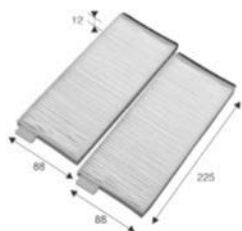
**715567**

**SSANGYONG** Korando série 2 (7/96 => 3/1999),  
Korando série 3 (3/1999 => 2006),  
Musso (8/93 => 2007)

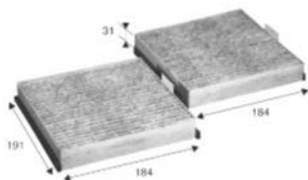
**715568**

**RENAULT** Avantime (9/2001 => 3/2003), Espace III  
(9/96 => 6/2000), Espace III FL (7/2000  
=> 10/2002)

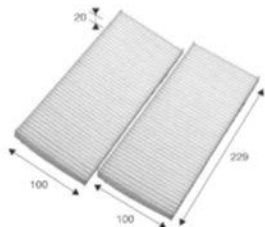
**715569**

**ISUZU** Trooper 98 (UBS) (1/98 => 1/2004)  
**OPEL** Monterey II (7/98 => 8/1999)  
**VAUXHALL** Monterey B (7/98 => 8/1999)

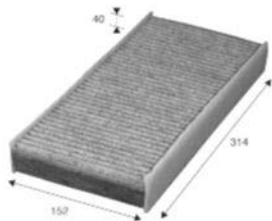
**715570**

**PEUGEOT** 407 (4/2004 => 8/2011)

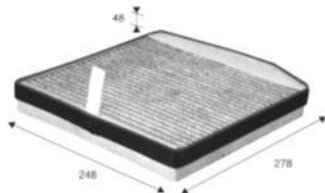
**715571**

**VOLVO** S60, S80, V70 II, XC, XC 90 I

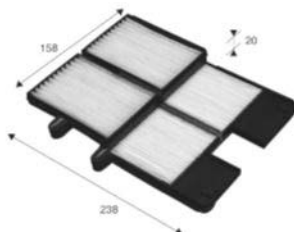
**715572**

**TOYOTA** Avensis (AT22\*) (10/97 => 6/2000),  
Carina E (AT/ST19\*) (2/92 => 12/97),  
Picnic (9/96 => 5/2001)

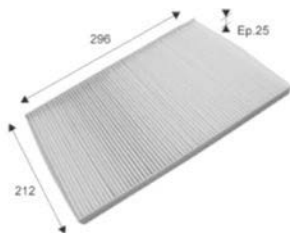

**715573****HONDA**

Accord VI (CG/CH) (9/98 =&gt; 1/2003)

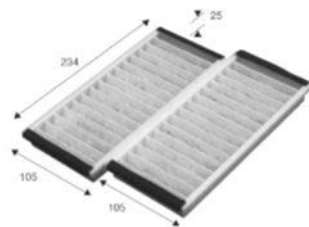
**715574****MAZDA**

MPV II FL (3/2002 =&gt; 5/2006), RX-8 (2/2003 =&gt; 1/2009), RX-8 (4/2008 =&gt; 7/2010)

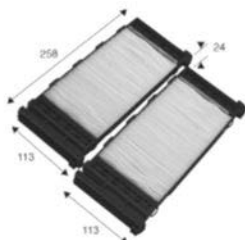
**715575****NISSAN**

Almera (N15) (7/95 =&gt; 1/2000)

**715576****MAZDA**

Demio (5/98 =&gt; 3/2003)

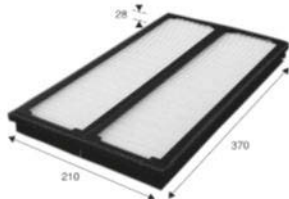
**715577****MERCEDES**

V Class (638) (10/96 =&gt; 12/2002), Vito (638) (1/96 =&gt; 9/2003)

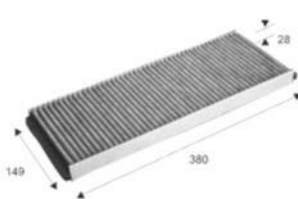
**715578****AUDI**

80, A4, A5 (8/2011), Cabriolet (8G), Coupé, Q5 (6/2012), RS2 (3/94 =&gt; 7/95), RS4 Quattro

**VOLKSWAGEN**

Passat V (10/96 =&gt; 8/2000), Passat V FL (10/2000 =&gt; 5/2005)

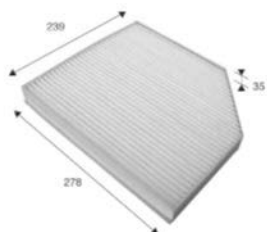
**715579**

**AUDI** A4, A5, Q5, RS4 Quattro

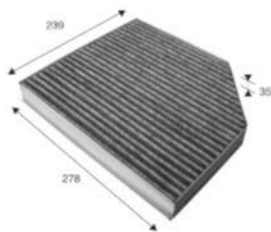
**715580**

**AUDI** A4, A5, Q5, RS5 Quattro, S4, S5

**715581**

**VOLKSWAGEN** Amarok, Transporter

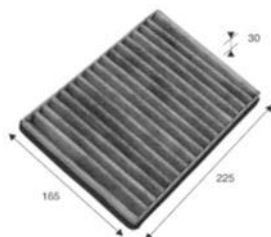
**715582**

**BMW** 7 Series (E66) (3/2002 => 10/2008)

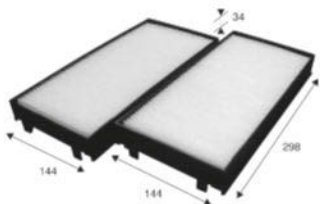
**715583**

**BMW** X5 (E70) (12/2006 => 3/2010), X5 LCI (E70) (3/2010), X5 M (E70M) (3/2010), X6 (E71/E72) (5/2008), X6 M (E71M) (3/2010)

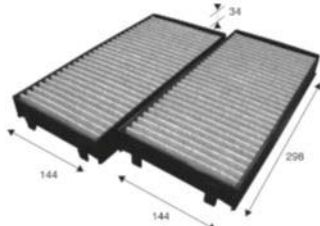
**715584**

**BMW** X5 (E70) (12/2006 => 3/2010), X5 LCI (E70) (3/2010), X5 M (E70M) (3/2010), X6 (E71/E72) (5/2008), X6 M (E71M) (3/2010)

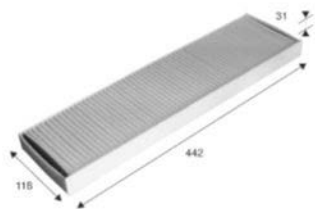
**715585****MINI**

MINI 2 (R56/R57)

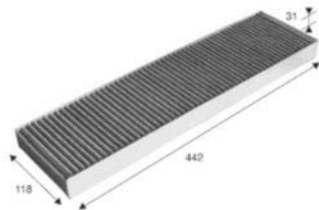
**715586****MINI**

MINI 2 (R56/R57)

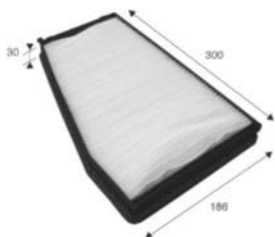
**715587****CHEVROLET**

Alero (3/1999 =&gt; 2004), Captiva (C100)

(9/2006 =&gt; 9/2009), Epica, Evanda

**DAEWOO**

Evanda (V200) (8/2002 =&gt; 5/2005)

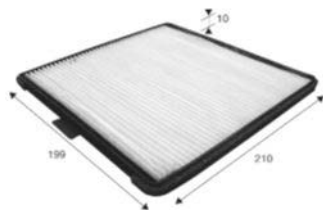
**715588****CHEVROLET**

Matiz (M200) (1/2005 =&gt; 2/2011), Spark

(M200) (5/2005 =&gt; 12/2009)

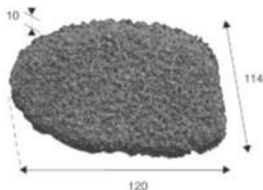
**715589****CITROËN**

Saxo (3/96 =&gt; 8/1999), Saxo FL (9/1999

=&gt; 5/2005)

**PEUGEOT**

106 (9/91 =&gt; 3/96), 106 - Restyling

(3/96 =&gt; 7/2003)

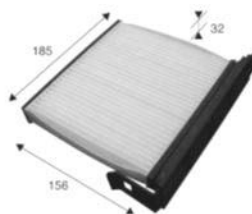
**715590****DAIHATSU**

Cuore (2003&gt;2007)

715591

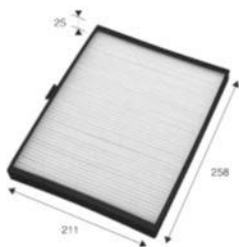

**HYUNDAI** Elantra (6/2000 => 1/2007)

715592

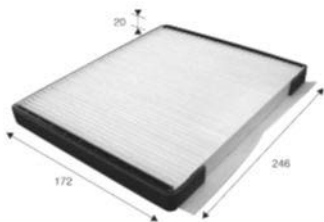

**HYUNDAI** Accent  
**KIA** Carens IV (3/2013), Ceed II (5/2012)

715593

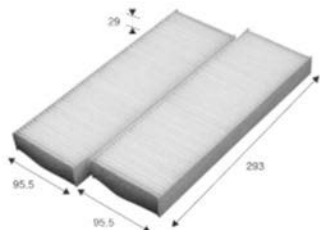

**HONDA** Accord Coupé (CG) (10/97 => 6/2002)

715594

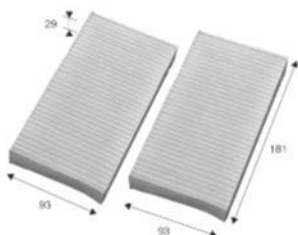

**HONDA** Civic (EP) (4/2001 => 6/2006), HR-V (GH) (10/98 => 9/2005), Logo (GA) (12/98 => 4/2001)

715595

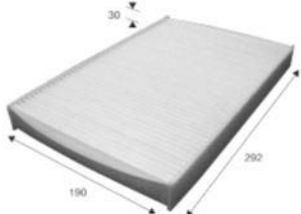

**IVECO** Daily, Massif

715597

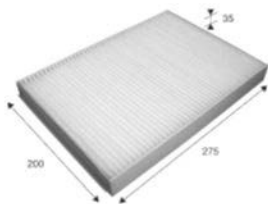

**LAND ROVER** Freelander 2 (2/2006), Range Rover Evoque (3/2011)  
**VOLVO** S60 II, S80 II, V60, V70 III, XC 60, XC 70

715598

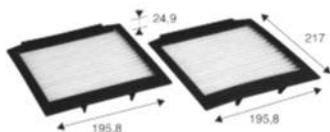

**LAND ROVER** Range Rover (9/94 => 2/2002)

715599

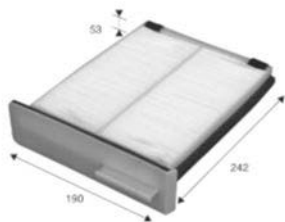

**MAZDA** 323 (BJ), 626 (GF)

715600

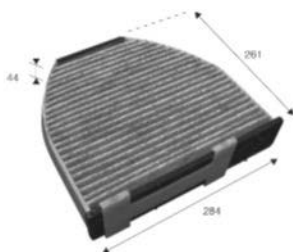

**MERCEDES** C Class (204) (1/2007 => 2/2011), E Class (207-212) (3/2009 => 4/2013), GLK Class (204) (7/2008 => 6/2012)

715601

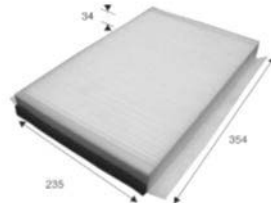

**MERCEDES** Sprinter II (906) (2/2006)  
**VOLKSWAGEN** Crafter (4/2006)

715602

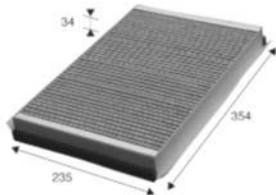

**MERCEDES** Sprinter II (906) (2/2006)  
**VOLKSWAGEN** Crafter (4/2006)

715603

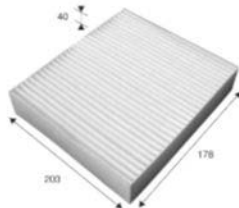

**MITSUBISHI** Colt (Z30) (4/2004 => 9/2008), Colt FL (Z30) (10/2008 => 3/2013)

715607

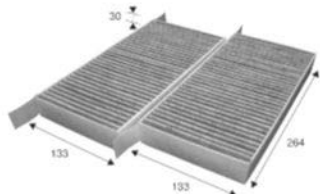

**RENAULT**

Captur (4/2013), Laguna III (10/2007 => 11/2010), Laguna III Phase 2 (11/2010)

715608

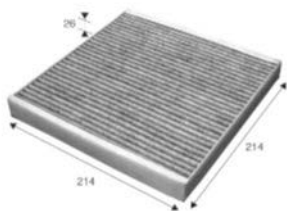

**SMART**

Fortwo MKI (10/98 => 12/2006)

715609

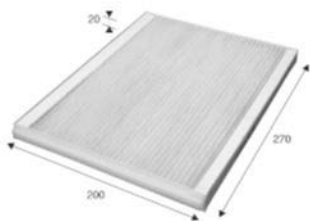

**SUZUKI**

Grand Vitara (5/98 => 2/2005), Grand Vitara (9/2005 => 10/2012), Grand Vitara FL (8/2012)

715610

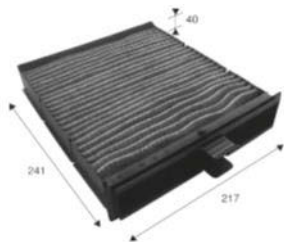

**RENAULT**

Scenic II (5/2003 => 11/2009)

715611

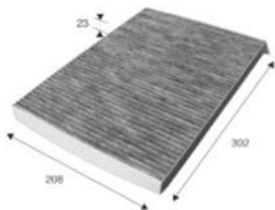

**CHRYSLER**

Grand Voyager, Voyager

715612

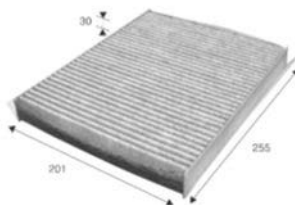

**CITROËN**

Xsara Picasso (12/1999 => 12/2010)

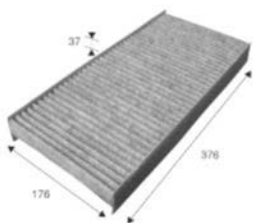
**715613**

**CITROËN** Dispatch II (1/2007), Jumpy II (1/2007)  
**FIAT** Scudo II (1/2007)  
**PEUGEOT** Expert II (1/2007)

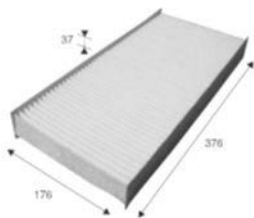
**715614**

**CITROËN** Dispatch II (1/2007), Jumpy II (1/2007)  
**FIAT** Scudo II (1/2007)  
**PEUGEOT** Expert II (1/2007)

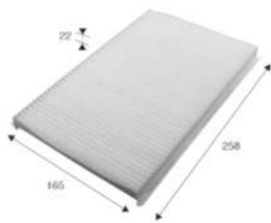
**715615**

**FIAT** Albea (4/2002 => 12/2006), Albea FL (7/2006 => 7/2011), Palio FL (3/2001 => 9/2002up (3/1999 => 3/2003)

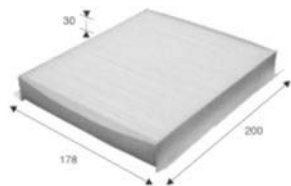
**715616**

**FIAT** Doblo Cargo III (263) (1/2010 => 2/2015), Doblo III (263) (1/2010 => 2/2015)  
**PEUGEOT** Bipper (12/2007)

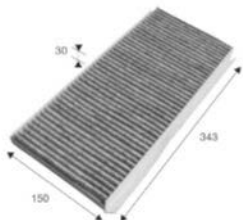
**715617**

**FORD** Courier/Courier (10/96 => 9/2002), Fiesta IV 95 (8/95 => 9/1999), Fiesta IV FL99 (8/1999 => 3/2002), StreetKa (11/2002 => 12/2005)

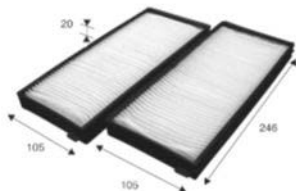
**715618**

**KIA** Shuma

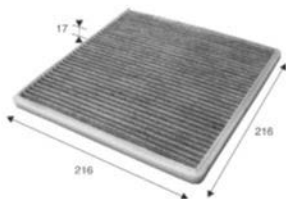
**715619**

**LEXUS** RX 300, RX 350, RX 400H  
**SUBARU** Legacy 3 (10/98 => 4/2003), Legacy 4 (5/2003 => 5/2009)  
**TOYOTA** Camry (ACV/MCV30) (8/2001 => 1/2006)

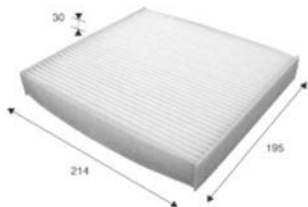
**715620**

**LEXUS** CT200h (12/2010 => 12/2013), GS 350, GS 300, GS 430, GS 450, GS 460  
**SUBARU** Legacy 5 (5/2009)  
**TOYOTA** Auris, Avensis, Camry

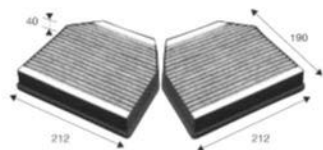
**715621**

**MERCEDES** G Class (M461/3) (9/89), SL Class (230) (8/2001 => 1/2008), SL Class FL (230) (2/2008 => 2/2012), SLR (199) (4/2004 => 7/2009)

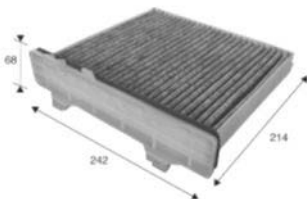
**715622**

**MITSUBISHI** Pajero 4 (9/2006), Shogun 4 (9/2006)

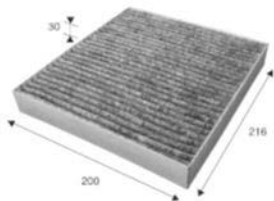
**715623**

**CITROËN** C Crosser (7/2007 => 1/2013)  
**PEUGEOT** 4007 (7/2007 => 12/2012)

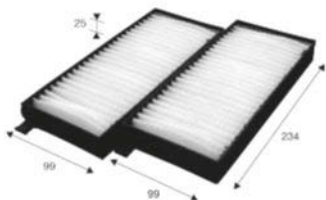
**715624**

**SSANGYONG** Actyon, Kyrón

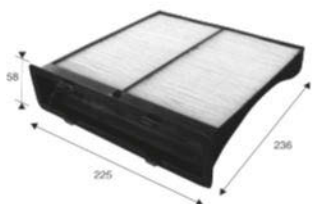

**715625**

**SUBARU** Forester 2 (9/2002 => 7/2005), Forester 3 (12/2007), Impreza (GJ/GP) (10/2011), Impreza FL (G11) (9/2005 => 6/2007)

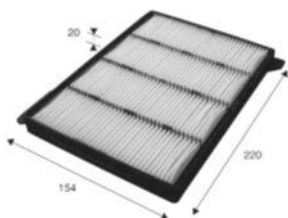
**715626**

**SUBARU** Forester I

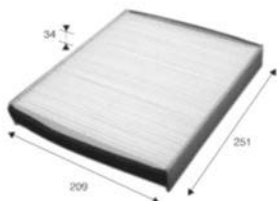
**715627**

**VOLVO** C30 (10/2006 => 12/2012), C70 CC (1/2006 => 4/2014), S40 (3/2004 => 6/2012), V50 (3/2004 => 6/2012)

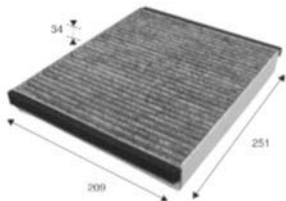
**715628**

**VOLVO** C30 (10/2006 => 12/2012), C70 CC (1/2006 => 4/2014), S40 (3/2004 => 6/2012), V50 (3/2004 => 6/2012)

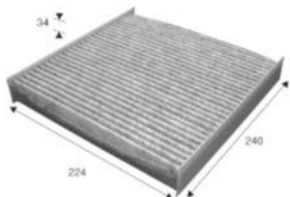
**715629**

**CITROËN** Berlingo (M59) (12/2002 => 2/2012), Xsara FL (9/2000 => 8/2005)  
**PEUGEOT** Partner (M49) (6/96 => 11/2002), Partner (M59) (11/2002), Ranch (M59F/U) (11/2002 => 5/2008)

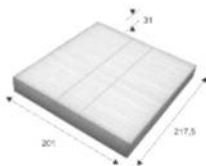
**715631**

**CITROËN** C Crosser (7/2007 => 1/2013), C4 Aircross (3/2012)  
**MITSUBISHI** ASX (EUR) (4/2010 => 6/2012)  
**NISSAN** X-Trail (T30) (6/2001 => 9/2003), X-Trail FL (T30) (9/2003 => 3/2007)  
**PEUGEOT** 4007 (7/2007 => 12/2012), 4008 (3/2012)

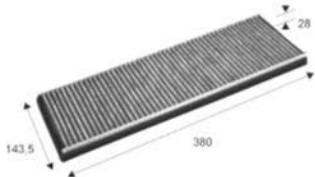
**715632****OPEL**

Astra F, Combo, Corsa B, Tigra (10/94 =&gt; 1/2001)

**715633****RENAULT**

Kangoo Extra (GB) (1/98 =&gt; 2/2003), Kangoo I (9/97 =&gt; 2/2003), Kangoo I FL (3/2003 =&gt; 6/2009)

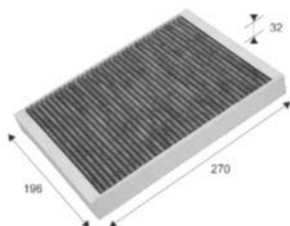
**715635****CITROËN**

C5 (X7) (3/2008), C6 (12/2005 =&gt; 12/2012)

**PEUGEOT**

407 (4/2004 =&gt; 8/2011)

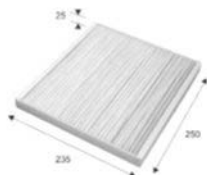
**715636****CITROËN**

Jumper III (7/2006), Jumper III FL (3/2014), Relay III (7/2006), Relay III FL (3/2014)

**FIAT**

Ducato II (250) (6/2014), Ducato II (250-251) (5/2011)

**PEUGEOT**

307 Restyling (6/2005 =&gt; 3/2009), Boxer III (7/2006), Boxer III FL (3/2014)

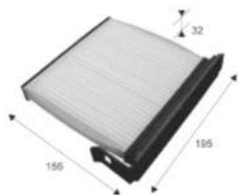
**715637****DAIHATSU**

Sirion II

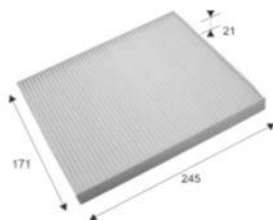
**715638****HYUNDAI**

i30

**KIA**

Ceed (8/2006 =&gt; 11/2009), Ceed FL (8/2009 =&gt; 7/2012)

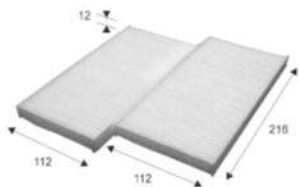
**715639**

**HYUNDAI** Tucson  
**KIA** Sorento, Sportage

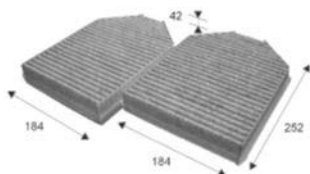
**715640**

**JAGUAR** F type, XK, XKR

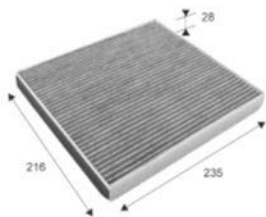
**715641**

**LEXUS** GS 430 (7/2000 => 12/2004), LS430  
 (8/2000 => 8/2006), SC430 (5/2001  
 => 7/2010)

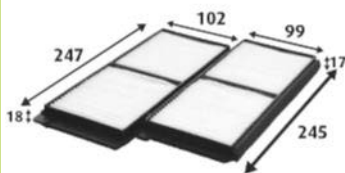
**715642**

**MAZDA** Mazda 2 II (DE) (6/2007 => 3/2011),  
 Mazda 2 II FL (DE-DH) (8/2010)

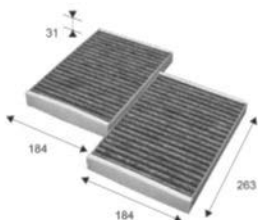
**715643**

**MERCEDES** C Class (204) FL (3/2011), CLS Class  
 (219) (7/2004 => 1/2008), S Class (221)  
 (10/2004 => 6/2009), S Class FL (221)  
 (6/2009 => 6/2013), Coupe CL(216)  
 (5/2006 => 2/2014)

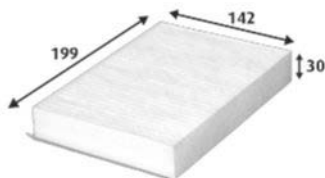
**715644**

**OPEL** Agila II (12/2007 => 3/2015)  
**SUZUKI** Splash (3/2008)  
**VAUXHALL** Agila II (12/2007 => 4/2015)

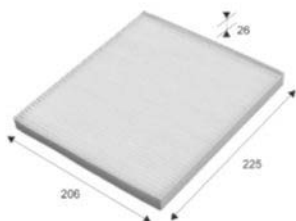
**715645**

**OPEL** Corsa B (3/93 => 8/2000), Tigra (10/94 => 1/2001)  
**VAUXHALL** Combo, Corsa MKI (4/93 => 8/2000), Tigra (11/94 => 1/2001)

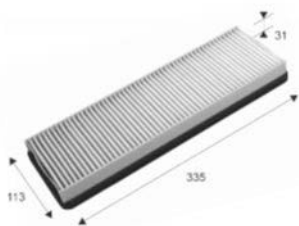
**715646**

**PEUGEOT** 306

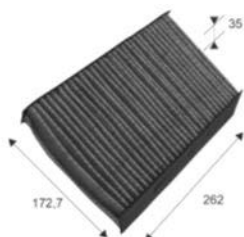
**715647**

**RENAULT** Mégane III

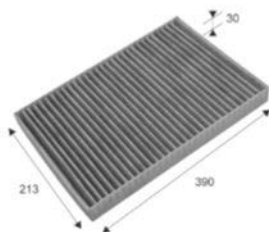
**715648**

**CHRYSLER** 300C (6/2004 => 9/2007)

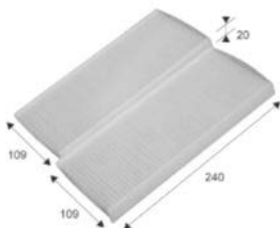
**715649**

**RENAULT** Kangoo II (11/2007 => 4/2013), Kangoo II FL (4/2013), Master III (4/2010), Master III FL (5/2014)

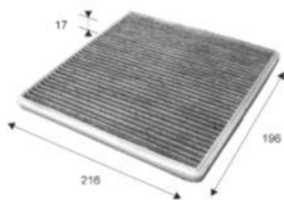
**715650**

**SCION** xA

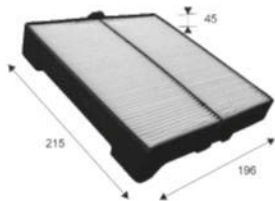
**715651**

**NISSAN** X-Trail (T30) (6/2001 => 9/2003), X-Trail FL (T30) (9/2003 => 3/2007)  
**SUBARU** Forester 2 (9/2002 => 7/2005), Forester 2 FL (8/2005 => 11/2007)

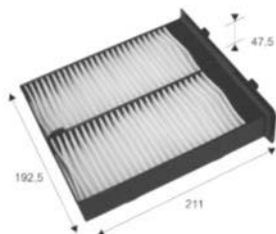
**715652**

**SUZUKI** SX4 (3/2006 => 6/2009), SX4 (HUN) (3/2006 => 6/2009), SX4 FL (7/2009)

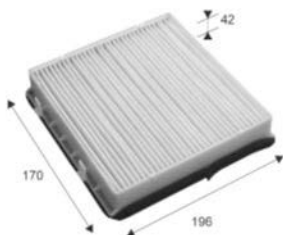
**715653**

**VOLKSWAGEN** Golf I Cabriolet, Golf II, Golf II Cabriolet, Jetta I, Jetta II

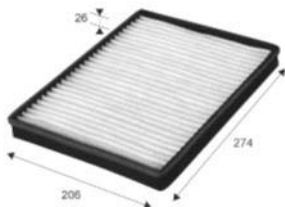
**715654**

**CHEVROLET** Captiva  
**OPEL** Antara (10/2006)  
**VAUXHALL** Antara (10/2006)

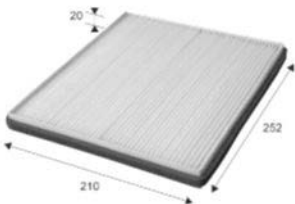
**715655**

**LDV** Maxus

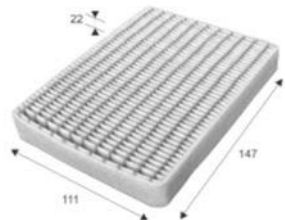
**715656**

**HYUNDAI** Getz

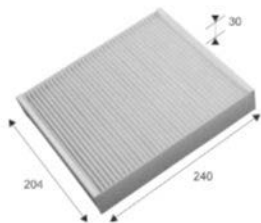
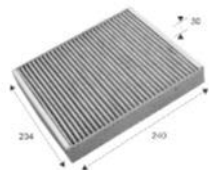
**715658****CHEVROLET** Aveo**715659**

**CHEVROLET** Aveo, Cruze, Malibu  
**OPEL** Ampera, Insignia  
**SAAB** 9-5 II (5/2010 => 3/2012)  
**VAUXHALL** Ampera (6/2011), Astra MK VI (9/2009), Cascada (3/2013), Insignia, Meriva B (5/2010 => 10/2013), Mokka (12/2012), Zafira

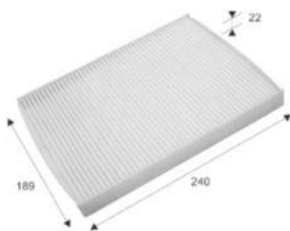
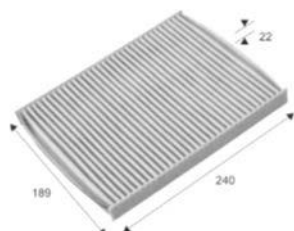
**715660****FORD** Fiesta VI (10/2008 => 5/2013)**715661**

**FORD** B-Max (8/2012), Ecosport (8/2013 => 7/2015), Fiesta VI (10/2008 => 5/2013), Fiesta VI FL (11/2012), Tourneo Courier (2/2014), Transit Courier (2/2014)

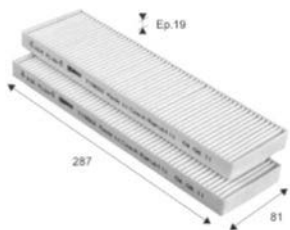
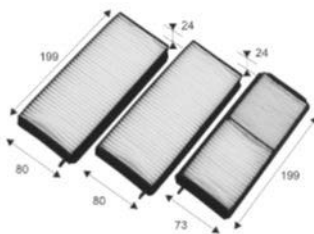
**715662****HYUNDAI** i20**715664**

**MAZDA** 323 (BA) (6/94 => 9/96), 323 (BA) FL (10/96 => 7/98)

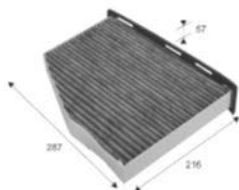
**715665**

**AUDI** A3 Cabriolet, A3, Q3, RS Q3, RS3  
**SEAT** Alhambra III, Altea, Leon II, Leon II  
**SKODA** Octavia II, Superb II, Yeti  
**VOLKSWAGEN** CC (11/2011), Caddy III, Caddy IV, Eos, Golf V, Golf V Plus, Golf VI, Golf VI Cabriolet, Golf VI Plus

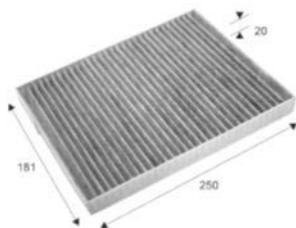
**715667**

**RENAULT** Koleos (X45) (6/2008 => 9/2011), Koleos FL (X45) (9/2011)

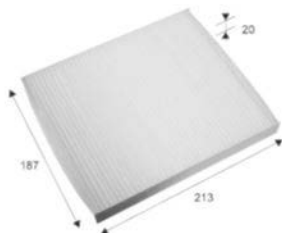
**715668**

**SUZUKI** Jimny (SN413V) (9/98)

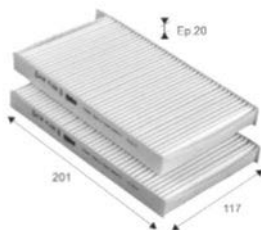
**715669**

**HYUNDAI** H1 (TQ) KEURPTQ07 (10/2007)

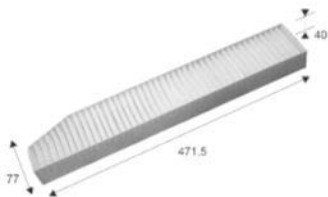
**715670**

**JEEP** Grand Cherokee

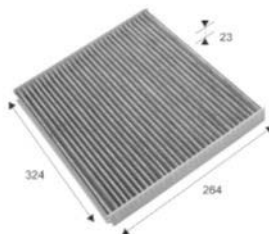
**715671**

**CADILLAC** CTS (3/2002 => 9/2007), CTS II (9/2007), SRX (7/2004 => 9/2010), STS (5/2005 => 9/2010)

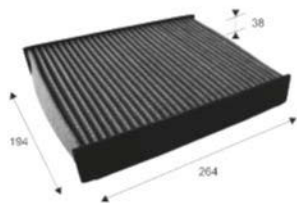
**715672**

**RENAULT** Scenic III (4/2009 => 1/2012), Scenic III Phase 2 (1/2012)  
**VAUXHALL** Vivaro B (7/2014)

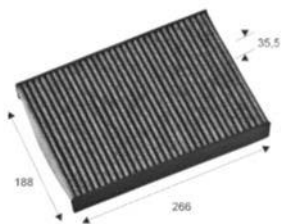
**715673**

**PEUGEOT** 508 (1/2011 => 9/2014), 508 FL (8/2014)

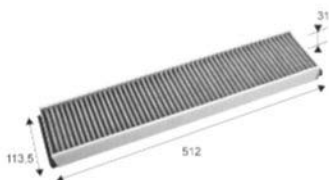
**715674**

**FORD** Cougar (9/98 => 2/2001), Mondeo I (FD) (1/93 => 8/96), Mondeo I FL (GD) (8/96 => 9/2000)

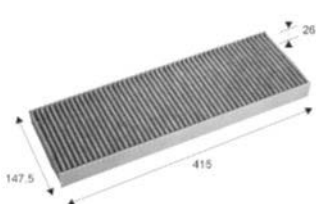
**715675**

**OPEL** Vectra B (10/95 => 1/1999), Vectra B (2/1999 => 6/2003)  
**VAUXHALL** Vectra (10/95 => 3/2002)

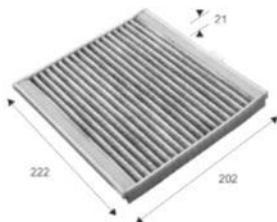
**715676**

**VOLVO** S40 (10/95 => 3/2004), V40 (10/95 => 3/2004)

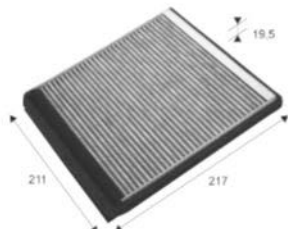
**715677**

**CITROEN** Berlingo (M59) (12/2002 => 2/2012), Xsara (7/97 => 8/2000), Xsara FL (9/2000 => 8/2005)  
**PEUGEOT** Partner (M49) (6/96 => 11/2002), Partner (M59) (11/2002)



715678

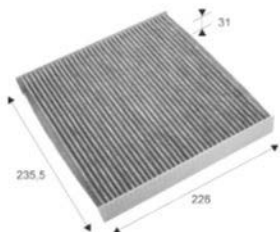

**HONDA**

Civic VIII (FK/FD/FN) (1/2006)

715679

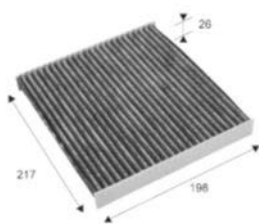

**MAZDA**

CX-7 (5/2007 => 9/2009), CX-7 FL (6/2009), Mazda 6 (2/2002 => 2/2005), Mazda 6 FL (3/2005 => 8/2007)

715680

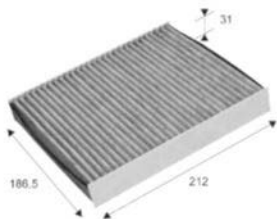

**SAAB**

9-2x

715681

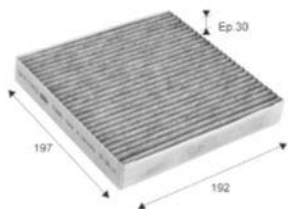

**JAGUAR**

XF, XJ

715682

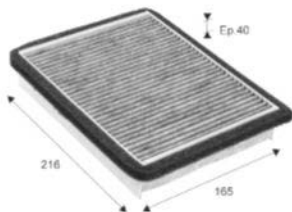

**LADA**

110

715683

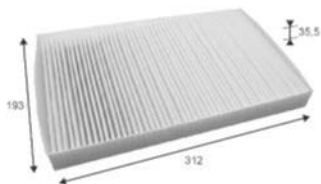

**AUDI**

A6 (94-97)

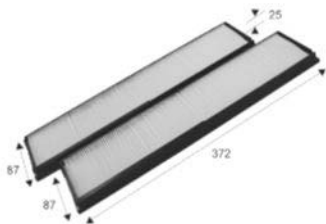
**715684**

**MERCEDES** E Class (124) (7/93 => 3/98), W124 (12/84 => 6/93)

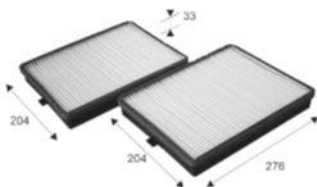
**715685**

**BMW** M5 (E39) (7/1999 => 6/2003), Série 5 (E39) (9/95 => 4/2004)

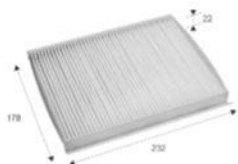
**715686**

**CHRYSLER** Delta (9/2011 => 12/2014)  
**FIAT** Bravo II (198) (2/2007 => 12/2009),  
 Bravo II FL (198) (1/2010), Stilo (9/2001  
 => 12/2003), Stilo FL (1/2004 =>  
 1/2008)  
**LANCIA** Delta (844) (6/2008 => 4/2011), Delta  
 Restyle (844) (11/2010 => 12/2014)

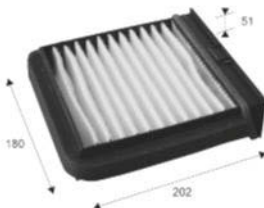
**715688**

**MITSUBISHI** Space Star (DG) (6/98 => 2004)  
**VOLVO** S40 (10/95 => 3/2004), V40 (10/95  
 => 3/2004)

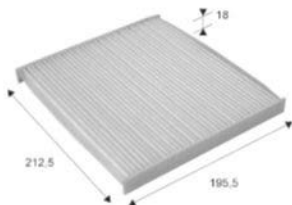
**715689**

**TOYOTA** Corolla Verso 2.0 D4D

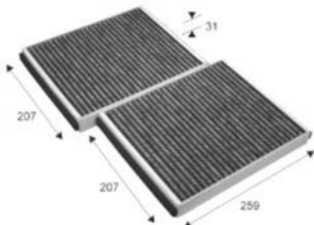
**715690**

**BMW** M5 (F10) (9/2011), M6 (F06/F12/F13)  
 (3/2012 => 4/2015), M6 LCI (F06/F12/  
 F13) (3/2015)

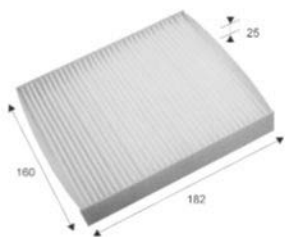
**715691****KIA**

Soul (10/2008 =&gt; 7/2011), Soul FL (8/2011 =&gt; 11/2013)

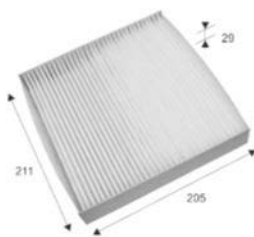
**715692****HONDA**

CR-Z (6/2010), Insight Hybrid (2/2009), Jazz III (10/2008)

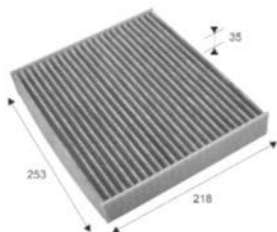
**715693****PORSCHE**

Panamera 970 (2/2009 =&gt; 6/2013), Panamera FL 970 (6/2013)

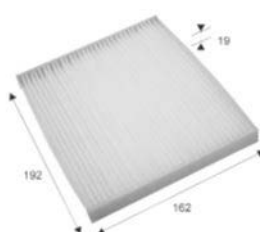
**715694****NISSAN**

Pixo (UA0) (6/2009)

**SUZUKI**

Alto (AMF310) (1/2009)

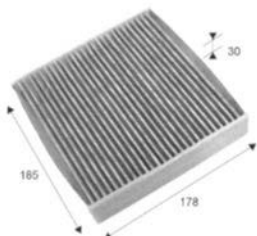
**715695****DAIHATSU**

Cuore L276 (4/2007 =&gt; 11/2013), Terios 2 (5/2006 =&gt; 1/2013)

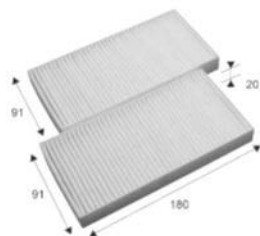
**715696****DODGE**

Nitro (6/2007 =&gt; 5/2011)

**JEEP**

Cherokee KK (3/2008 =&gt; 3/2014)

715697

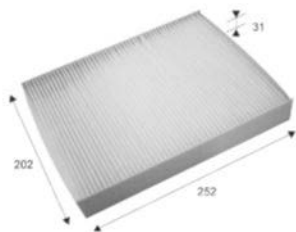

**HYUNDAI** ix55 (9/2008)

715698

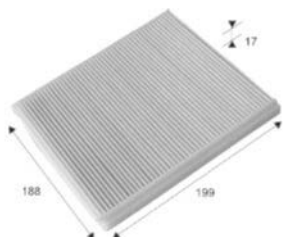

**SUZUKI** Liana (RH41\*) (6/2001 => 1/2006)

715699

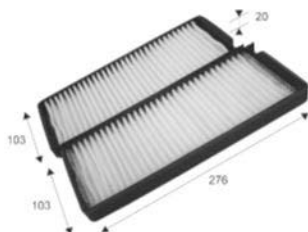

**SSANGYONG** Rexton

715700

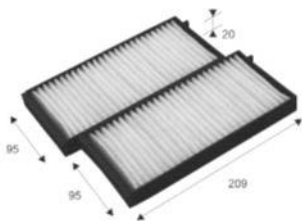

**SSANGYONG** Rodius (5/2005 => 6/2012)

715701

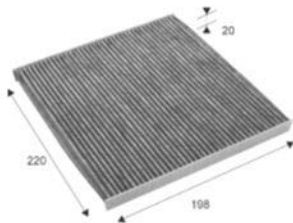

**TOYOTA** Avensis Verso

715702

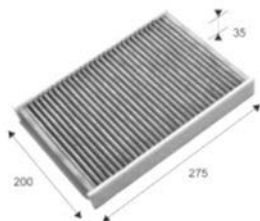

**LAND ROVER** Freelander 2 (2/2006), Range Rover Evoque (3/2011)

**VOLVO** S60 II, S80 II, V60, V70 II, XC 60, XC 70

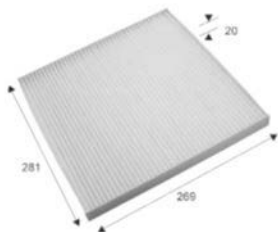
**715703**

**NISSAN** Murano II (Z51) (6/2008), Murano II (Z51R) (RUS) (12/2010), Teana II (2/2008), Teana RUS (6/2009)

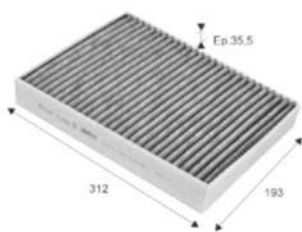
**715704**

**PORSCHE** Cayenne 92A (2/2010)  
**VOLKSWAGEN** Touareg II (1/2010 => 12/2014), Touareg II FL (7/2014)

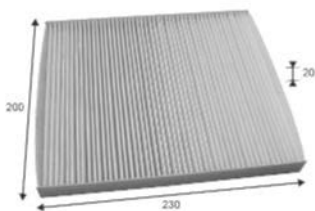
**715705**

**ALFA ROMEO** Giulietta (6/2010 => 9/2013)

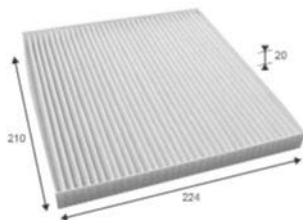
**715706**

**NISSAN** Micra mk4 (K13K) (IND) (7/2010 => 6/2013), Note II(E12E) (8/2013)

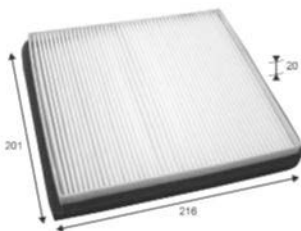
**715707**

**CHEVROLET** Spark (M300) (12/2009 => 1/2013)

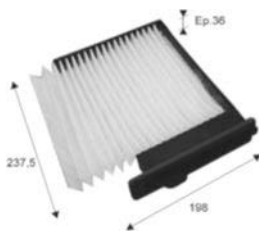
**715708**

**NISSAN** NV200 (ESP) (11/2009), NV200 (JPN) (8/2009), Tiida (8/2012), Tiida (C11X/SC11X) (3/2007)

715709

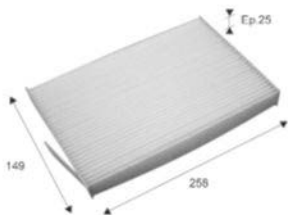

**NISSAN** Cube (Z12) (8/2009 => 4/2012)

715710

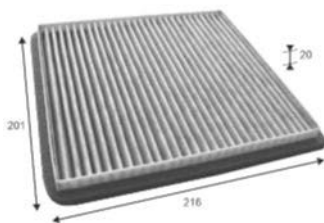

**CHEVROLET** Spark (M300) (12/2009 => 1/2013)

715711

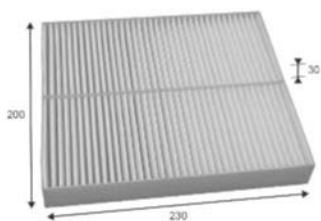

**CHRYSLER** Grand Voyager (1/2008)

715712

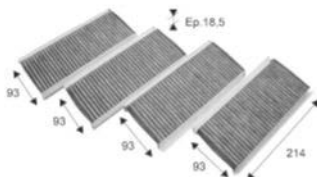

**BMW** M3 (E90-92-93) (9/2007 => 2/2010), M3 LCI (E90-92-93) (9/2008)

715713

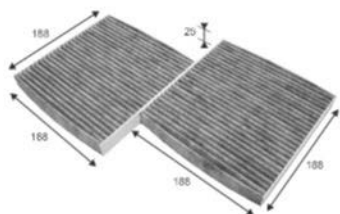

**BMW** X3 SAV (F25) (9/2010)

715714

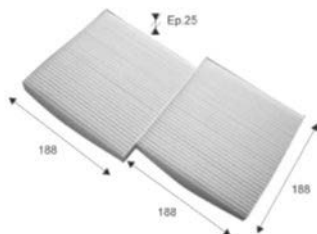

**BMW** X3 SAV (F25) (9/2010)

715715

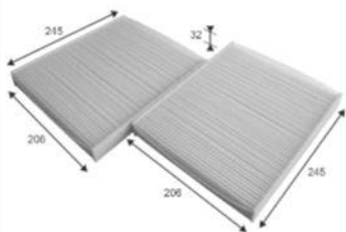

**BMW**

M5, M6, Série 5 (F10/F11/F18)

715716



**HYUNDAI**

Santa Fé 2 - Restyle (9/2009 => 6/2012)

715717

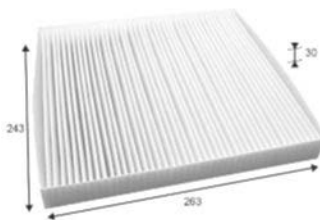

**JEEP**

Grand Cherokee

715718

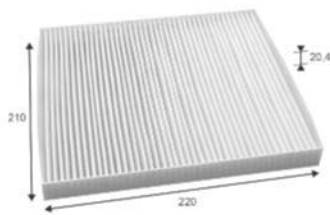

**ISUZU**

D-Max (1/2003 => 9/2012), Rodeo (1/89 => 12/2004)

715719

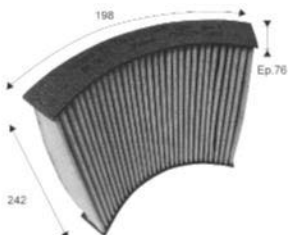

**BMW**

M3 (F80) (3/2014), M4 (F82 F83) (3/2014), 1 Series (F20/F21) (7/2011 => 2/2015)

715720

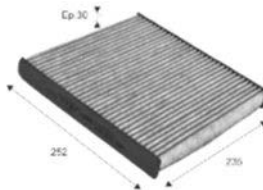

**AUDI**

A3 Cabriolet (8V) (10/2013), A3 (4/2012), RS3 (2/2015), S3 (10/2012), TT (7/2014)

**SEAT**

Leon III (9/2012)

**SKODA**

Octavia III (11/2012), Superb III (3/2015)

**VOLKSWAGEN**

Golf Sportsvan (2/2014), Golf VII (8/2012), Passat VIII (8/2014)

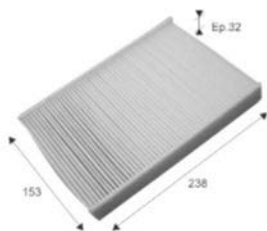
**715721**

**NISSAN** Juke, Pulsar, Tiida  
**RENAULT** Fluence FL (1/2013), Fluence/Megane Generation (11/2009)

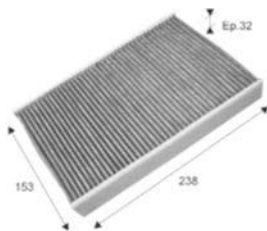
**715722**

**NISSAN** Juke

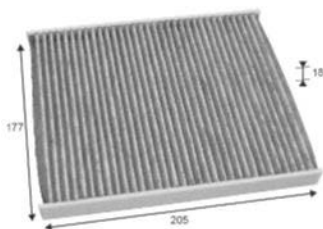
**715723**

**ABARTH** Nuova 500 (8/2008 => 6/2012)  
**FIAT** Ducato II (250-251) (7/2006 => 11/2011), Nuova 500 (7/2007 => 6/2012), Panda 169 (9/2003 => 2/2013)

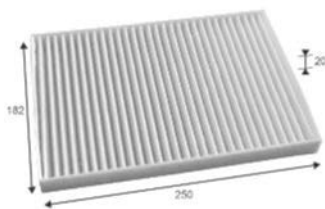
**715724**

**RENAULT** Koleos (X45) (6/2008 => 9/2011), Koleos FL (X45) (9/2011)

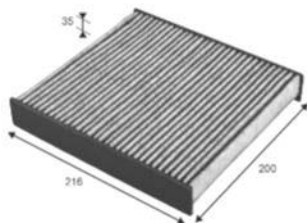
**715725**

**RENAULT** Clio IV (10/2012)

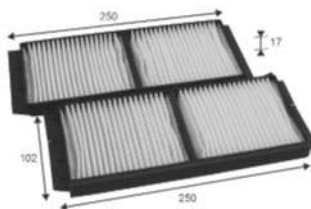
**715726**

**MAZDA** Mazda 3 II (12/2008 => 10/2011), Mazda 3 II FL (11/2011)

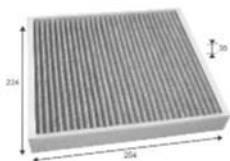

**715727**

**AUDI** A1 (5/2010), A1 (11/2014), S1 (1/2014)  
**SEAT** Ibiza IV FL (2/2012), Ibiza IV FL2 (5/2015), Toledo série 4 FL (5/2015), Toledo série 4 (7/2012 => 6/2015)  
**SKODA** Fabia II FL (3/2010 => 12/2014), Rapid (7/2012), Roomster FL (3/2010)  
**VOLKSWAGEN** Polo IX (6/2009 => 5/2015), Polo IX FL (2/2014)

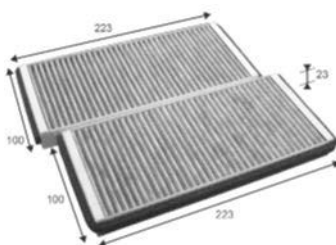
**715728**

**MAZDA** MPV II (6/1999 => 7/2002), MPV II FL (3/2002 => 5/2006)

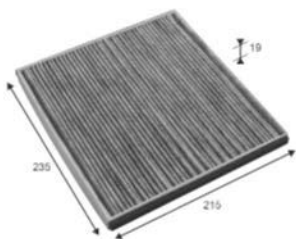
**715729**

**LEXUS** GS 300 (97>2004)

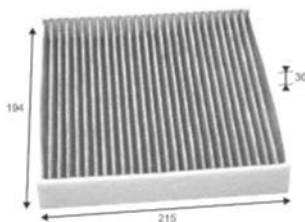
**715730**

**LEXUS** LS 460 (8/2006 => 9/2009), LS 460 (9/2009 => 9/2012), LS 600H/HL (11/2009 => 9/2012)

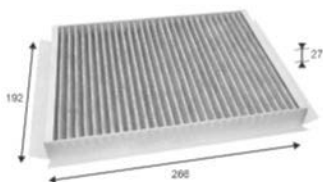
**715731**

**CHEVROLET** Captiva (C140) (2/2011)

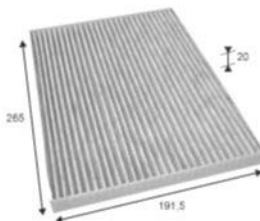
**715732**

**NISSAN** Qashqai (2007>2010)

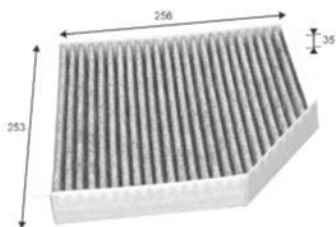
**715733**

**AUDI** A6, A7, A8, RS6, S6

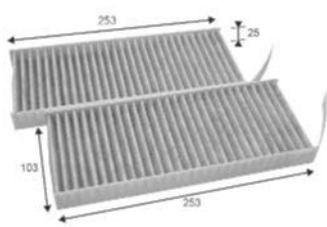
**715734**

**RENAULT** Latitude (11/2010)

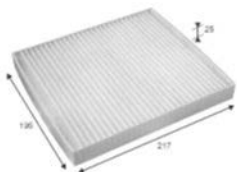
**715735**

**CHRYSLER** Sebring FL (3/2007 => 3/2011)  
**DODGE** Avenger (7/2007 => 11/2010), Caliber (9/2006 => 5/2011), Journey (6/2008 => 5/2011)  
**FIAT** Freemont (6/2011)  
**JEEP** Compass, Patriot  
**LANCIA** Flavia (5/2012)

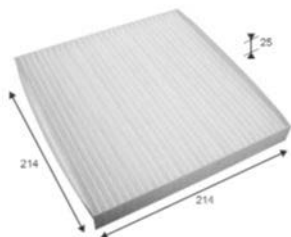
**715736**

**SMART** Fortwo

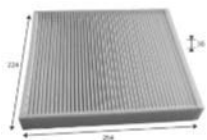
**715737**

**AUDI** A1 (5/2010), A1 (11/2014), S1 (1/2014)  
**SEAT** Ibiza IV FL (2/2012), Ibiza IV FL2 (5/2015), Toledo série 4 FL (5/2015), Toledo série 4 (7/2012 => 6/2015)  
**SKODA** Fabia II FL (3/2010 => 12/2014), Fabia III (8/2014), Rapid (7/2012), Roomster FL (3/2010)  
**VOLKSWAGEN** Polo IX (6/2009 => 5/2015), Polo IX FL (2/2014)

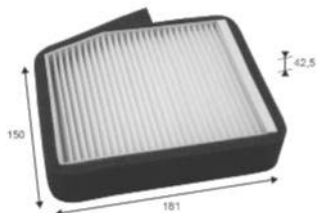
**715738**

**HYUNDAI** H1

715739

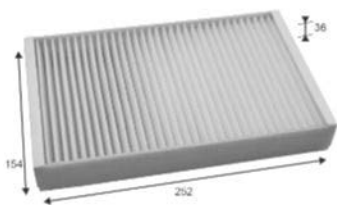

LADA

Kalina 1118

715740

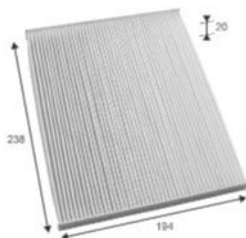

HYUNDAI  
KIA

Tucson  
Sportage (SVK) (6/2010), Sportage FL  
(SVK) (1/2014)

715741

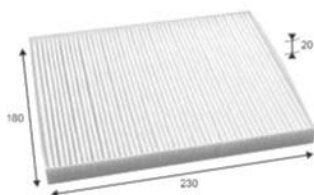

HYUNDAI  
KIA

ix20 (10/2010)  
Venga (12/2009 => 12/2014), Venga  
FL (1/2015)

715742

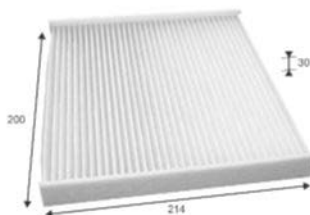

FORD

Transit/Tourneo 2006 (4/2006)

715743

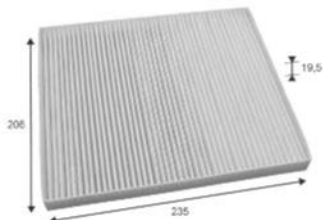

SUZUKI

Kizashi Sport (9/2010)

715744

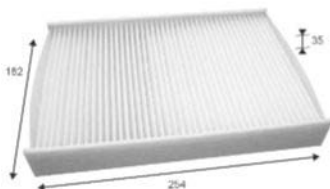

SEAT  
SKODA  
VOLKSWAGEN

Mii (10/2011)  
Citigo (10/2011)  
UP (8/2011)

715745

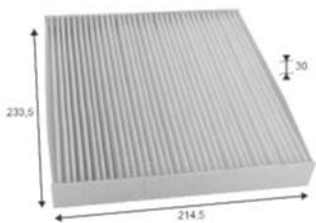

**FORD** Ranger (9/2011)  
**MAZDA** Mazda BT50 (10/2011)

715746

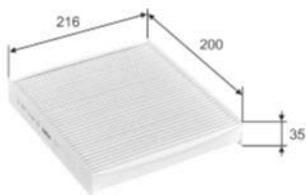

**DACIA** Logan 2 (1/2013), Sandero 2 (10/2012)  
**RENAULT** Clio IV (10/2012)

715747

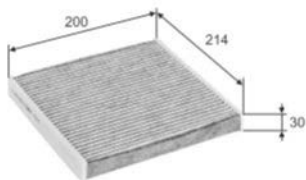

**FORD** Transit/Tourneo 2006 (4/2006)

715748

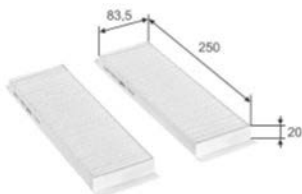

**HYUNDAI** i20

715749

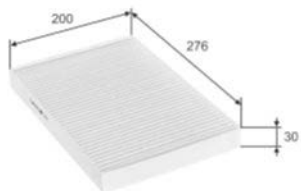

**LANCIA** Thema (10/2011)

715750

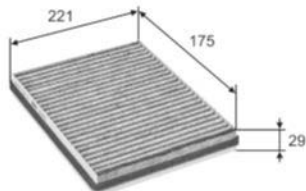

**MAZDA** Demio

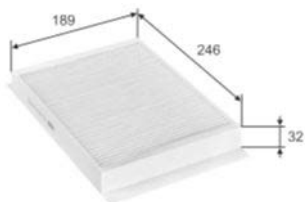
**715751**

**MERCEDES** C Class (205) (3/2014), GL Class (166) (11/2012), ML Class (166) (7/2011)

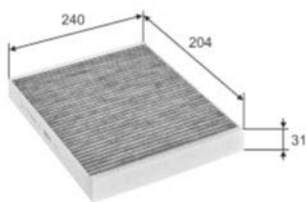
**715752**

**OPEL** Astra K (7/2015), Meriva B (5/2010 => 10/2013), Meriva B FL (11/2013)  
**VAUXHALL** Astra MK VII (7/2015), Meriva B (5/2010 => 10/2013), Meriva B FL (11/2013)

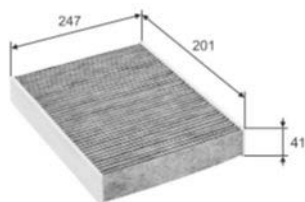
**715753**

**PORSCHE** 911 Carrera (991) (12/2011), 911 GT3-3(991) (8/2013), 911 Turbo (991T) (9/2013), Boxster 981 (1/2012), Cayman 981 (3/2013)

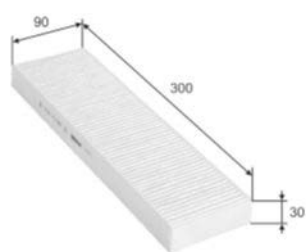
**715754**

**PORSCHE** 911 Carrera (991) (12/2011), Boxster 981 (1/2012)

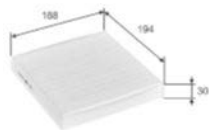
**715755**

**ABARTH** Nuova 500 (7/2012), Nuova 500 (8/2008 => 6/2012)  
**CHRYSLER** Ypsilon (9/2011)  
**FIAT** 500 (7/2012), 500 MCA (7/2015), Panda 312 (Nuova) (1/2012)  
**LANCIA** Ypsilon 2011 (5/2011)

**715756**

**NISSAN** Micra mk4 (K13K) (IND) (7/2010 => 6/2013), Note II(E12E) (8/2013)

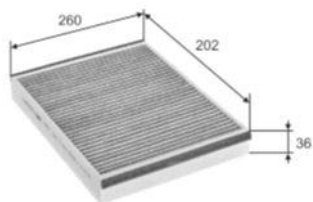
**715757**

**FORD** C-Max II (CB7) (8/2010 => 3/2015),  
C-Max II FL (CEU) (4/2015), Focus III  
(3/2011), Focus III FL (9/2014), Kuga  
(11/2012)

**VOLVO** V40 II (6/2012)

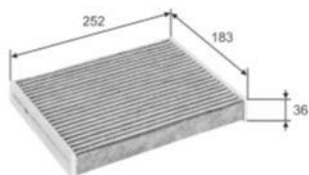
**715802**

**RENAULT** Zoé (1/2013)

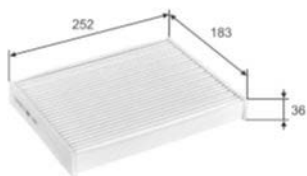
**715803**

**DACIA** Dokker (9/2012)

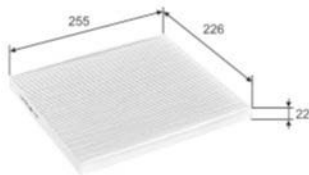
**715804**

**HYUNDAI** Azera, Sonata série 6 (YF) (7/2010)  
**KIA** Optima (11/2010), Optima II (8/2015)

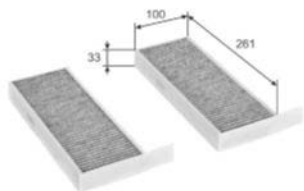
**715805**

**PEUGEOT** 308 II (7/2013)

**715806**

**SEAT** Leon III (9/2012)

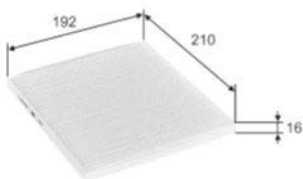
**715807**

**HYUNDAI** Solaris (TR) (3/2011), Solaris C40 (RUS) (11/2010)

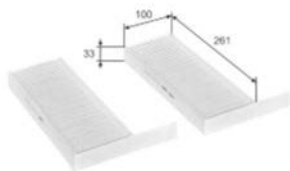
**715808**

**PEUGEOT** 308 II (7/2013)

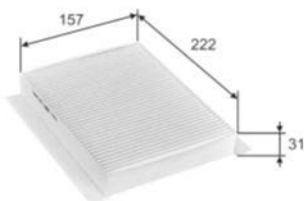
**715809**

**FIAT** 500L (10/2012), 500X (11/2014)  
**JEEP** Renegade (7/2014)

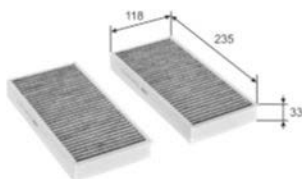
**715811**

**BMW** 2 Series Active Tourer (F45) (9/2014), 2 Series Gran Tourer (F46) (3/2015), X1 (F48) (9/2015), i3 (I01) (9/2013)  
**MINI** MINI 3 (F55-F56) (1/2014), MINI Clubman (F54) (7/2015)

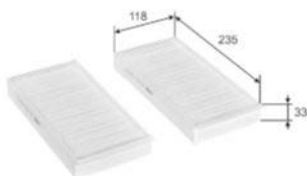
**715812**

**BMW** 2 Series Active Tourer (F45) (9/2014), 2 Series Gran Tourer (F46) (3/2015), X1 (F48) (9/2015), i3 (I01) (9/2013)  
**MINI** MINI 3 (F55-F56) (1/2014), MINI Clubman (F54) (7/2015)

**715813**

**MAZDA** CX-5 (1/2012 => 4/2015), CX-5 FL (5/2015), Mazda 3 III (7/2013), Mazda 6 III (12/2012), Mazda 6 III FL (5/2015)

715814



**MERCEDES** A Class (W176) B Class (W246) (9/2011 => 9/2014), B Class FL (W246) (9/2014), CLA Class(117) (2/2013), GLA Class(156) (11/2013)

715815

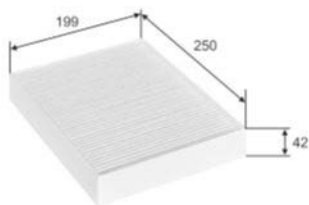

**BMW** 1 Series (F20/F21) (7/2011 => 2/2015), 1 Series (F20/F21) LCI (3/2015)

715816



**HYUNDAI** Elantra, i30  
**KIA** Carens IV (3/2013), Ceed II (5/2012)

715818



**RENAULT** Clio III (9/2005 => 4/2009), Clio III FL (4/2009 => 12/2012)

715820



**RENAULT** Espace V (3/2015), Kadjar (6/2015), Mégane IV (11/2015)

715828



**CITROËN** C1 (2014>)



716023

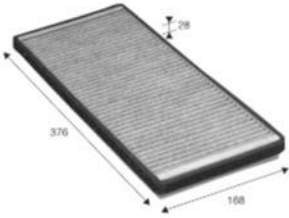

**MERCEDES** Sprinter (901-905) (2/95 => 2/2006)

716043



**VOLKSWAGEN** Amarok, Transporter

716063

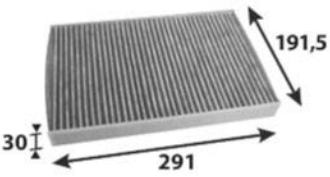

**IVECO** Campagnola



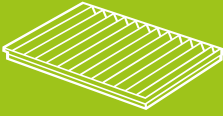
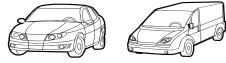

**Valeo**



**Valeo**



**Valeo**

<b>Valeo</b>			
<b>698146</b>	PA	6447LV	CITROËN Berlingo (M49)(96>2002), Berlingo (M59)(2002>2008), Xantia I(93>97), Xantia II(97>2002)
<b>698146</b>	PA	6447LV	PEUGEOT Partner (M49)(96>2002), Partner (M59)(2002>2008), Ranch (M49)(96>2002)
<b>698149</b>	PA	7700845811	RENAULT Megane Classic(96>99), Megane(95>99)
<b>698159</b>	PA	1H0819644	AUDI A3 Série 1 (AU34)(96>2000), TT série 1(98>2006)
<b>698159</b>	PA	1H0819644	SEAT Alhambra III(2010>2013), Arosa(97>2004), Cordoba I(93>96), Cordoba II(96>99), Cordoba II
<b>698159</b>	PA	1H0819644	SKODA Octavia I(96>2010), Superb(2001>2008)
<b>698159</b>	PA	1H0819644	VOLKSWAGEN Caddy II(95>2003), Golf II Cabriolet(93>98), Golf II(83>92), Golf III Cabriolet(98>2002)
<b>698160</b>	PA	1H0819638	SKODA Superb
<b>698163</b>	PA	357819638	VOLKSWAGEN Passat III(88>93), Passat IV(93>97)
<b>698164</b>	PA	893091700	AUDI 80 (8C)(91>95), A4 Série 1(94>2001), A5(2013), Cabriolet (8G)(91>2000), Coupé (8B)(88>96)
<b>698164</b>	PA	893091700	VOLKSWAGEN Passat V(96>2005)
<b>698165</b>	PA	1808600	OPEL Astra Classic(98>2002), Astra F(91>2001), Calibra(89>97), Corsa B(93>2000), Tigra
<b>698165</b>	PA	1808600	VAUXHALL Astra Belmont(86>91), Astra MK III(91>2001), Calibra(90>97), Combo (93>2001)
<b>698166</b>	PA	1808604	OPEL Combo sur base Corsa B(93>2001), Corsa B(93>2000), Tigra(94>2001)
<b>698166</b>	PA	1808604	VAUXHALL Combo (93>2001), Corsa MKI(93>2000), Tigra(94>2001)
<b>698167</b>	PA	1808605	OPEL Omega B(94>2003)
<b>698167</b>	PA	1808605	VAUXHALL Omega(94>2003)
<b>698168</b>	PA	1097670	FORD Cougar(98>2001), Mondeo I (FD)(93>96), Mondeo I (GD)(96>2000)
<b>698169</b>	PA	5101438AA	CHRYSLER Crossfire(2003>2009)
<b>698169</b>	PA	5101438AA	MAYBACH Maybach(2002>2012)
<b>698169</b>	PA	5101438AA	MERCEDES C Class (202)(93>2001), CLK Class (208)(97>2003), E Class (210)(95>2003), S Class(98>2005)
<b>698170</b>	PA	64311390836	BMW M5 (E34)(88>95), 5 Series (E34)(88>96), 7 Series (E32)(86>94)
<b>698171</b>	PA	64111393489	BMW M3 (E36)(92>2000), 3 Series (E36)(90>2000)
<b>698173</b>	PA	7700834816	RENAULT Laguna (B56)(94>2000)
<b>698174</b>	PA	46409630	ALFA ROMEO 145(94>2001), 146(94>2001), 155(91>97), GTV(95>2006), Spider (916)(95>2003), Spider(2003>2006)
<b>698174</b>	PA	46409630	FIAT Coupé (PC)(93>96), Coupé (PX)(96>2000), Marengo (159)(89>95), Tempra (160) MQ 93(93>96)
<b>698174</b>	PA	46409630	LANCIA Dedra (835)(89>99), Delta (836) MQ93(93>99)
<b>698175</b>	PA	7700846236	RENAULT Kangoo I(2005>2008), Megane Scenic (JA/FA)(96>99), Scenic(99>2003)
<b>698176</b>	PA	7700845219	RENAULT Megane Scenic (JA/FA)(96>99), Scenic(99>2003)
<b>698177</b>	PA	7700845222	RENAULT Megane Scenic (JA/FA)(96>99)
<b>698196</b>	PA	79831S04003	HONDA Civic (MA/MB)(95>2001), Civic Aerodeck (MB/MC)(97>2001)
<b>698196</b>	PA	79831S04003	MG MG ZR(2001>2005), MG ZS(2001>2005)
<b>698196</b>	PA	79831S04003	ROVER 200 Série 2(89>96), 200 Série 3(95>99), 25(99>2004)
<b>698197</b>	PA	60653641	ALFA ROMEO 156(97>2003)
<b>698197</b>	PA	60653641	FIAT Brava (182)(95>2002), Bravo I (182)(95>2002), Marea (185)(96>2002), Marengo (185)(95>2002)

<b>Valeo</b>			
698197	PA	60653641	IVECO Daily 99(99>2006)
698197	PA	60653641	LANCIA Dedra (835)(94>99), Delta (836) MQ93(93>99), Lybra (839)(99>2006)
698198	PA	46721374	FIAT Punto (176)(93>99)
698198	PA	46721374	LANCIA Y Ipsilon(95>2003)
698199	PA	60801430	ALFA ROMEO 164 Super(92>98), 164(87>92)
698199	PA	60801430	FIAT Croma (154)(85>96)
698199	PA	60801430	LANCIA Thema (834) RL88(88>92), Thema (834)(92>94)
698199	PA	60801430	SAAB 9000(84>98)
698201	PA	1004051	FORD Courier/Courier(96>2002), Fiesta IV 95(95>99), Fiesta IV(99>2002), Ka I(96>2008), Puma
698201	PA	1004051	MAZDA 121 (JAJB)(96>2002)
698202	PA	1808607	OPEL Vectra A(88>95), Vectra B(95>2003)
698202	PA	1808607	VAUXHALL Vectra(95>2002)
698203	PA	644755	PEUGEOT 406(95>2003), 406(99>2004)
698203	PA	644755	PORSCHE 911 (996)(97>2005), 911 GT3-1(996)(99>2001), Boxster 986(96>2004), Cayman 987C2
698235	PA	644793	PEUGEOT 405 - Restyling(92>96)
698246	CA	64110008138	BMW M5 (E39)(99>2003), 5 Series (E39)(95>2004)
698247	PA	1054468	FORD Galaxy I (VX)(95>2000)
698247	PA	1054468	SEAT Alhambra II(2000>2010), Alhambra(96>2000)
698247	PA	1054468	VOLKSWAGEN Sharan I(95>2000), Sharan II(2000>2010)
698255	PA	B729800QAA	NISSAN Kubistar (X76)(2003>2009)
698255	PA	B729800QAA	RENAULT Clio Campus Evolution(2009>2012), Clio II(98>2008), Kangoo I(97>2009), Megane Classic(98>2002)
698276	PA	7700424093	RENAULT Megane Classic(96>2002), Megane(95>2003)
698279	PA	7700428820	RENAULT Megane Scenic (JA/FA)(96>99)
698290	PA	6025370624	RENAULT Avantime(2001>2003), Espace II(91>96), Espace III(96>2002)
698454	PA	46513960	FIAT Multipla (186)(98>2004), Multipla(2004>2010)
698469	PA	64118363274	BMW 3 Series (E36)(94>2001)
698470	CA	64118390447	BMW 7 Series (E38)(94>2001)
698475	PA	1688300018	MERCEDES A Class (W168)(97>2004), Vaneo (414)(2001>2005)
698487	PA	1062253	FORD Focus(98>2004), Transit Connect TC7(2002>2006)
698488	PA	6447AZ	PEUGEOT 206(98>2010), 206+(2009>2013)
698489	PA	64311000004	BMW 3 Series (E46)(98>2006), 5 Series Gran Turismo (F07)(2009>2013), X3 (E83)(2003>2010)
698512	PA	7701047513	RENAULT Megane Scenic (JA/FA)(96>99), Scenic(99>2003)
698535	PA	46722862	FIAT Doblo Cargo (223)(2000>2003), Punto (188)(99>2009)
698540	PA	6447HT	CITROËN C5(2001>2004)
698541	CA	6447HV	CITROËN C5(2001>2004)
698594	PA	52485325	RENAULT Laguna II (BG0)(2001>2005), Vel Satis(2002>2005)
698606	PA	8E0819439	AUDI A4 Serie 2(2000>2009), RS4 Quattro Cabriolet(2006>2008), RS4 Quattro(2005>2008), S4 Cabriolet
698606	PA	8E0819439	SEAT Exeo(2008>2011)
698657	PA	6447HP	CITROËN Berlingo (M49)(96>2002), Berlingo (M59)(2002>2012), Dispatch(2004>2006), Xsara(2000>2005)

<b>Valeo</b>			
698657	PA	6447HP	PEUGEOT Partner (M49)(96>2002), Partner (M59)(2002>2008), Ranch (M49)(96>2002), Ranch (M59F/U)(2000>2002)
698662	PA	1808610	OPEL Astra G(98>2005)
698663	PA	1808612	OPEL Astra G(98>2005), Zafira A (F75)(99>2005), Zafira B Family(99>2011)
698663	PA	1808612	VAUXHALL Astra MK IV(98>2005), Zafira I (F75)(99>2005), Zafira II Classic(99>2011)
698664	PA	6447NT	CITROËN C2(2003>2010), C3 II(2005>2011), C3 Picasso(2009>2015), C3 Pluriel(2003>2011)
698664	PA	6447NT	PEUGEOT 1007(2005>2010), 307 Restyling(2005>2009), 307(2001>2005), 308(2007>2015)
698679	PA	1H0819644A	SKODA Superb(2001>2008)
698679	PA	1H0819644A	VOLKSWAGEN Passat V(2000>2005)
698680	PA	6447FF	CITROËN Xsara Picasso(99>2010)
698681	PA	8856852010	TOYOTA RAV4(2000>2005), Yaris (NCP1/NLP10/SCP10) (JPN)(99>2005), Yaris Verso (NCP)(99>2005)
698682	CA	4B0819439A	AUDI A6 Série 2(97>2001), S6 Série 2(99>2001)
698683	CA	4B0819439C	AUDI A4 Série 2(2000>2009), A6 Série 2(97>2003), A6 Série 2(2001>2005), RS4 Quattro Cabriolet
698683	CA	4B0819439C	SEAT Exeo(2008>2011)
698684	CA	4A0819439A	AUDI 100 (4A)(90>94), A6 Série 1 (AU55)(94>97), A6 Série 2(98>99), S6 Plus Quattro(96>97)
698685	PA	6Q0820367	AUDI A2 (AU24)(2000>2005)
698685	PA	6Q0820367	MERCEDES G Class (M461/3)(89>2006)
698685	PA	6Q0820367	SEAT Cordoba IV(2002>2009), Ibiza III(2001>2009), Ibiza IV(2008>2012)
698685	PA	6Q0820367	SKODA Fabia II(2006>2014), Fabia(99>2007), Felicia(94>2001), Rapid(2012), Roomster(2006>2010)
698685	PA	6Q0820367	VOLKSWAGEN Fox(2004), Polo IX(2009>2014), Polo VII(2001>2005), Polo VIII(2005>2009)
698686	CA	1H0091800	AUDI A3 Série 1 (AU34)(96>2003)
698686	CA	1H0091800	SEAT Arosa(97>98), Cordoba I(93>96), Cordoba II(96>99), Cordoba III(99>2002), Ibiza II(93>2001)
698686	CA	1H0091800	SKODA Octavia I(96>2004)
698686	CA	1H0091800	VOLKSWAGEN Caddy II(95>2003), Golf III Cabriolet(98>2002), Golf III(91>99), Passat V(2000>2005)
698687	CA	60653641	ALFA ROMEO 156(97>2003)
698687	CA	60653641	FIAT Brava (182)(98>2002), Bravo I (182)(98>2002), Mareo (185)(99>2002)
698687	CA	60653641	LANCIA Dedra (835)(94>99), Delta (836) MQ93(93>99), Lybra (839)(99>2006)
698688	CA	46722335	ALFA ROMEO 166(98>2007)
698688	CA	46722335	LANCIA Kappa (838)(94>2001)
698689	PA	60653642	ALFA ROMEO 156(97>2003)
698689	PA	60653642	FIAT Brava (182)(95>2002), Bravo I (182)(95>2002), Coupé (PC)(93>96), Coupé (PX)(96>2000)
698690	PA	7079682	FIAT Palio (178)(98>2001), Palio Week End (178)(97>2001), Palio Week End(2001>2002)
698691	PA	7078711	FIAT Palio (178)(98>2001), Palio Week End (178)(97>2001), Siena (178)(97>2001)

<b>Valeo</b>			
698692	CA	46723435	FIAT Bravo II (198)(2007>2009), Stilo(2001>2008)
698693	CA	1204464	FORD Fiesta V 2002(2002>2005), Fiesta V(2005>2008), Fusion(2002>2012)
698693	CA	1204464	MAZDA Mazda 2 (DY)(2003>2005), Mazda 2 (DY-N)(2005>2008)
698694	PA	1204459	FORD Fiesta V 2002(2002>2005), Fiesta V(2005>2008), Fusion(2002>2012)
698695	CA	1121106	FORD Focus(98>2004), Transit Connect TC7(2002>2011)
698696	CA	1113627	FORD Galaxy I (VX)(95>2000), Galaxy I (VY)(2000>2006)
698696	CA	1113627	SEAT Alhambra II(2000>2010), Alhambra(96>2000)
698696	CA	1113627	VOLKSWAGEN Sharan I(95>2000), Sharan II(2000>2010)
698697	CA	2108301218	CHRYSLER Crossfire(2003>2009)
698697	CA	2108301218	MERCEDES C Class (202)(93>2001), CLK Class (208)(97>2003), CLK Class (209)(2006>2009)
698700	PA	2038300118	MERCEDES C Class (203)(2000>2008), CLK Class (209)(2002>2009)
698701	PA	2038300218	MERCEDES C Class (203)(2000>2008), CLK Class (209)(2002>2009)
698702	PA	2118300218	MERCEDES CLS Class (219)(2004>2008), E Class (211)(2002>2009)
698704	PA	1408350047	MERCEDES S Class (140)(93>99), W140(91>93)
698705	CA	1408350247	MERCEDES S Class (140)(93>99), W140(91>93)
698706	PA	1408350547	MERCEDES S Class (140)(93>99), W140(91>93)
698707	PA	5028225	FORD Maverick(93>98)
698707	PA	5028225	NISSAN Primera (P11/W11)(96>2002), Terrano II (R20)(93>2006)
698708	CA	1718042	OPEL Astra G(98>2005), Zafira A (F75)(99>2005), Zafira B Family(1999>2005), Zafira B(2005>2011)
698708	CA	1718042	VAUXHALL Zafira I (F75)(99>2005), Zafira II Classic(2011>2011), Zafira II(2005>2011)
698710	CA	93172129	CADILLAC BLS(2005>2010)
698710	CA	93172129	FIAT Croma II (194-294)(2005>2007)
698710	CA	93172129	OPEL Combo Tour sur base Corsa C(2002>2011), Combo sur base Corsa C(2001>2004), Corsa C(2000>2006)
698710	CA	93172129	SAAB 9-3(2002>2012)
698710	CA	93172129	VAUXHALL Combo sur base Corsa C(2001>2011), Corsa MKII(2000>2006), Signum(2003>2008), Tigra Twint (2004>)
698711	PA	93172129	CADILLAC BLS(2005>2010)
698711	PA	93172129	OPEL Combo Tour sur base Corsa C(2002>2011), Combo sur base Corsa C(2001>2004)
698711	PA	93172129	SAAB 9-3(2002>2012)
698711	PA	93172129	VAUXHALL Combo sur base Corsa C(2001>2011), Corsa MKII(2000>2006), Signum(2003>2008)
698712	PA	1718962	OPEL Sintra(96>99)
698712	PA	1718962	VAUXHALL Sintra(96>99)
698713	CA	6447GW	PEUGEOT 607(2000>2011)
698714	CA	6447NV	CITROËN C2(2003>2010), C3 II(2005>2011), C3 Picasso(2009>2015), C3 Pluriel(2003>2011)
698714	CA	6447NV	PEUGEOT 1007(2005>2010), 307 Restyling(2005>2009), 307(2001>2005), 308(2007>2015), 407(2004>2011)
698715	CA	7701048749	RENAULT Laguna II (BG0)(2001>2005), Laguna II(2005>2007), Vel Satis(2002>2009)

<b>Valeo</b>			
698716	CA	1J0819644	AUDI A3 Série 1 (AU34)(96>2003), S3 Série 1(98>2003), TT série 1(98>2006)
698716	CA	1J0819644	SEAT Arosa(98>2004), Inca(95>2003), Leon I(99>2006)
698716	CA	1J0819644	SKODA Octavia I(96>2010)
698716	CA	1J0819644	VOLKSWAGEN Bora(98>2005), Caddy II(95>2003), Golf III Cabriolet(98>2002), Golf III(91>99)
698723	CA	12758727	SAAB 9-5 Restylé(2005>2010), 9-5(97>2005)
698724	PA	64311496710	MINI MINI (R50/52/53)(2001>2006)
698725	CA	64311496711	MINI MINI (R50/52/53)(2001>2006)
698730	PA	7701055109	RENAULT Megane II(2002>2009)
698731	PA	6447FG	CITROËN Xsara(97>2005)
698734	PA	27891BM400	NISSAN Almera (N16E)(2000>2006), Almera Tino (V10B)(2003>2005), Almera Tino (V10M)(2000>2003)
698735	PA	80291S5A003	HONDA CR-V mk II(2002>2006), Civic (EP)(2001>2006), FR-V(2004>2010)
698736	PA	7701055110	RENAULT Scenic II(2003>2009)
698737	CA	7701056390	RENAULT Espace IV(2002>2012)
698738	PA	6447LZ	CITROËN C8(2002>2006)
698738	PA	6447LZ	FIAT Ulysse II(2002>2010)
698738	PA	6447LZ	LANCIA Phedra(2002>2010)
698738	PA	6447LZ	PEUGEOT 807(2002>2006)
698739	CA	6Q0819653	AUDI A1(2010), A2 (AU24)(2000>2005), A3 Série 3(2012>2015)
698739	CA	6Q0819653	MERCEDES G Class (M461/3)(89>2006)
698739	CA	6Q0819653	SEAT Cordoba IV(2002>2009), Ibiza III(2001>2009), Ibiza IV(2008>2012)
698739	CA	6Q0819653	SKODA Fabia II(2006>2014), Fabia(99>2007), Felicia(94>2001), Rapid(2012), Roomster(2006>2010)
698739	CA	6Q0819653	VOLKSWAGEN Fox(2004), Polo IX(2009>2014), Polo VII(2001>2005), Polo VIII(2005>2009)
698740	CA	2118300818	MERCEDES CLS Class (219)(2004>2008), E Class (210)(99>2002), E Class (211)(2002>2009)
698741	CA	2118300018	MERCEDES CLS Class (219)(2004>2011), E Class (211)(2002>2009)
698742	CA	2038300318	MERCEDES C Class (203)(2000>2008), CLC Class (203)(2008>2011), CLK Class (209)(2002>2009)
698743	CA	2038300918	MERCEDES C Class (203)(2000>2008), CLC Class (203)(2008>2011), CLK Class (209)(2002>2009)
698744	CA	1688300818	MERCEDES A Class (W168)(97>2004), Vaneo (414)(2001>2005)
698745	CA	1119616	FORD Mondeo II 2000 (GE)(2000>2005), Mondeo II 2005 (GE)(2005>2007)
698745	CA	1119616	JAGUAR X-Type(2001>2008)
698746	CA	1718022	OPEL Omega B(94>2003)
698746	CA	1718022	VAUXHALL Omega(94>2003)
698747	CA	46799653	ALFA ROMEO 147(2000>2010), 156(2000>2007), GT(2003>2010)
698748	CA	6447PG	PEUGEOT 406(99>2004), 406(2002>2003)
698748	CA	6447PG	PORSCHE 911 (996)(97>2005), 911 Carrera (997-1)(2004>2008), 911 GT3-1(996)(99>2005), Boxster 986
698749	CA	2435	PEUGEOT 206(98>2010)
698750	CA	64319071935	BMW M3 (E46)(2000>2006), 3 Series (E46)(98>2006), X3 (E83)(2003>2010)
698751	CA	46723024	LANCIA Thesis(2002>2009)



<b>Valeo</b>			
698753	PA	272772835R	DACIA Duster(2010), Logan(2004>2012), Sandero(2008>2012)
698753	PA	272772835R	NISSAN Micra mk3 (K12E)(2003>2011), Note (E11E)(2005>2011)
698753	PA	272772835R	RENAULT Clio III(2005>2012), Duster(2010>2015), Logan(2004>2012), Modus(2004>2012), Twingo II
698762	PA	1353267	FORD Transit 2000(2000>2006)
698768	CA	7H0819631A	AUDI Q7(2006>2012)
698768	CA	7H0819631A	PORSCHE Cayenne 9PA(2003>2006), Cayenne 9PA1(2006>2010)
698768	CA	7H0819631A	VOLKSWAGEN Touareg II(2002>2010), Transporter (7E/7F)(2009>2013), Transporter (7H/7J)(2015),
698769	PA	30612666	VOLVO S40(95>2004), V40(95>2004)
698770	PA	9171296	VOLVO 850(91>96), C70(97>2005), S70(96>2000), V70(96>2000), XC 70(97>99)
698771	PA	9204626	VOLVO S60(2000>2009), S80(98>2006), V70 II(2000>2007), XC 70(97>2007), XC 90 II(2002>2007)
698772	CA	2108301118	MAYBACH Maybach(2002>2012)
698772	CA	2108301118	MERCEDES E Class (210)(95>2003), S Class (220)(98>2004), Coupé CL(215)(99>2006)
698773	PA	4705463	OPEL Agila II(2007>2011), Agila(2000>2007)
698773	PA	4705463	SUBARU G3X Justy(2003>2007)
698773	PA	4705463	SUZUKI Ignis (RM)(2003>2008), Wagon R+ (RB)(2004>2008)
698773	PA	4705463	VAUXHALL Agila(2000>2007)
698774	CA	0001110V004	SMART Crossblade(2002>2003), Fortwo MKI(98>2006)
698775	PA	64318409043	BMW X5 (E53)(2000>2006)
698776	CA	64318409044	BMW X5 (E53)(2000>2006)
698776	CA	64318409044	LAND ROVER Range Rover(2002>2012)
698777	PA	1638350047	MERCEDES ML Class (163)(97>2005)
698778	CA	1638350047	MERCEDES ML Class (163)(97>2005)
698779	PA	1119613	FORD Mondeo II 2000 (GE)(2000>2005), Mondeo II 2005 (GE)(2005>2007)
698779	PA	1119613	JAGUAR X-Type(2001>2008)
698790	PA	4D0819439	AUDI A8 Série 1(94>2002), S8 Série 1(96>2002)
698791	CA	4D0819439A	AUDI A8 Série 1(94>2002), S8 Série 1(96>2002)
698792	CA	4E0819439A	AUDI A8 Série 2(2002>2010), S8 Série 2(2006>2010)
698793	CA	3D0898644	VOLKSWAGEN Phaeton(2002>2010)
698794	PA	703819989	VOLKSWAGEN Transporter (F70)(90>96), Transporter (F7D)(96>2003)
698795	PA	87139YZ07	TOYOTA Avensis (T25)(2003>2008), Corolla (120)(2001>2007), Corolla Verso (CDE1*ZZE1*)(2001>)
698796	PA	72880AG000	SUBARU B9 Tribeca(2006>2007), Legacy 3(98>2003), Legacy 4(2003>2009)
698796	PA	72880AG000	TOYOTA Avensis Verso (CM20)(2001>2005), Celica (ZT230)(99>2005), Land Cruiser 120 (KD/GR)(2002>)
698797	PA	1408350247	MERCEDES S Class (140)(93>99), W140(91>93)
698799	PA	JKR100200	LAND ROVER Freelander(97>2003)
698800	PA	1K0819644	AUDI A3 Cabriolet (8P)(2011>2013), A3 Série 2(2003>2013), Q3(2011>2015), RS Q3(2013>2015)
698800	PA	1K0819644	SEAT Alhambra III(2010>2011), Alhambra III(2015), Altea(2004>2010)
698800	PA	1K0819644	SKODA Octavia II(2004>2013), Superb II(2008>2013), Yeti(2009>2013), Yeti(2013)

<b>Valeo</b>			
698800	PA	1K0819644	VOLKSWAGEN CC(2011>2012), Caddy III(2004>2010), Caddy IV(2015), Eos(2006>2010), Golf V Plus(2005>)
698801	CA	1K1819653	AUDIA3 Cabriolet (8P)(2011>2013), A3 Série 2(2003>2013), Q3(2011>2015), RS Q3(2013>2015)
698801	CA	1K1819653	SEAT Alhambra III(2010>2013), Alhambra III(2015), Altea 2014(2013>2013), Leon II(2005>2012)
698801	CA	1K1819653	SKODA Octavia II(2004>2013), Superb II(2008>2013), Yeti(2009>2013)
698801	CA	1K1819653	VOLKSWAGEN CC(2011>2012), Caddy III(2004>2010), Caddy IV(2015), Eos(2006>2010), Golf V Plus(2005>)
698802	CA	MR958017	MITSUBISHI Colt (Z30)(2004>2008), Galant (E5*)(92>96)
698802	CA	MR958017	SMART Forfour(2004>2006), Roadster(2003>2005)
698815	PA	6447K6	PEUGEOT 605 - Restyling(94>99)
698817	PA	JKR100280	LAND ROVER Freelander(97>2003)
698819	PA	JKR100220	MG MG ZS(2001>2005)
698819	PA	JKR100220	ROVER 25(99>2004), 400 Série 1(90>95), 400 Série 2(95>2000), 45(2000>2005)
698838	PA	64118390377	BMW 7 Series (E38)(94>2001)
698839	CA	46723245	FIAT Doblo Cargo (223)(2000>2003), Doblo II(2006>2011), Doblo(2004>2005), Punto (188)(99>2009)
698840	PA	9018300018	MERCEDES Sprinter (901-905)(95>2006)
698840	PA	9018300018	VOLKSWAGEN LT II(96>2003), LT III(2003>2006)
698856	PA	64116921018	BMW 7 Series (E65)(2001>2005), 7 Series (E66)(2002>2008)
698857	CA	64116921019	BMW 7 Series (E65)(2001>2005), 7 Series (E66)(2002>2008)
698858	PA	6447J0	CITROËN Jumper I(94>2001), Jumper II(2002>2006), Relay I(94>2001), Relay II(2002>2006)
698858	PA	6447J0	FIAT Ducato (230-231-232-234)(94>2001), Ducato (243-244-245-247)(2002>2006), Ducato (RUS)
698858	PA	6447J0	PEUGEOT Boxer I(94>2001), Boxer II(2002>2006)
698859	PA	960207422	DAEWOO Leganza (V100)(97>2003)
698860	PA	96190645	CHEVROLET Lanos (T100)(97>2002)
698860	PA	96190645	DAEWOO Nubira (J100)(97>99), Nubira II (J150)(99>2004)
698861	PA	64319195193	ALPINA BMW Roadster S(2004>2006)
698861	PA	64319195193	BMW Z4 (E85/E86)(2002>2009), Z4 (E89)(2009>2011)
698862	CA	64116915764	BMW Z4 (E85/E86)(2002>2009)
698863	PA	64316935822	BMW M5 (E60)(2004>2007), M5 (E61)(2007>2011), M6 (E63/E64)(2005>2010), 5 Series (E60/61)
698864	CA	64316935823	BMW M5 (E60)(2004>2007), M5 (E61)(2007>2011), M6 (E63/E64)(2005>2010), 5 Series (E60/61)
698865	CA	82205905	CHRYSLER Grand Voyager(2001>2008), Voyager IV(2001>2004), Voyager V(2004>2008)
698866	PA	46723321	ABARTH Nuova 500(2008>2012)
698866	PA	46723321	FIAT Nuova 500(2007>2012), Panda 169(2003>2013)
698866	PA	46723321	FORD Ka II(2008>2010)
698867	PA	46723331	ABARTH Nuova 500(2008>2012)
698867	PA	46723331	FIAT Doblo Cargo (223)(2000>2003), Doblo II(2006>2011), Doblo(2004>2005), Idea(2003>2012)
698867	PA	46723331	LANCIA Musa(2004>2011), Y Ipsilon(2000>2003), Ypsilon(2003>2012)

			
698868	PA	80292SDAA01	HONDA Accord VII (CL/CM)(2003>2008), Accord VIII (CU)(2008>2011), CR-V mk III(2006>2012)
698869	PA	79831S04003	HONDA CR-V mk I(97>2002), Civic (MA/MB)(95>2001), Civic Aerodeck (MB/MC)(97>2001)
698869	PA	79831S04003	ROVER 400 Série 2(95>2000)
698870	PA	DD1061P11	MAZDA Mazda 2 (DY)(2003>2005), Mazda 2 (DY-N)(2005>2008), Mazda 6 II(2007>2012)
698871	PA	6398350247	MERCEDES Viano (639)(2003>2010), Vito (639)(2003>2010)
698872	CA	6398350347	MERCEDES Viano (639)(2003>2010), Vito (639)(2003>2010)
698873	CA	B72003Y000	NISSAN Maxima QX (CA33)(2000>2006)
698874	PA	6808606	OPEL Astra G(98>2005), Astra H(2004>2011)
698874	PA	6808606	VAUXHALL Astra MK IV(98>2005), Astra MK V(2004>2012)
698875	CA	1718046	OPEL Astra H(2004>2011)
698875	CA	1718046	VAUXHALL Astra MK IV(98>2005), Astra MK V(2004>2012)
698876	PA	6808604	OPEL Meriva A(2003>2010)
698876	PA	6808604	VAUXHALL Meriva A(2003>2010)
698877	CA	13271407	OPEL Meriva A(2003>2010)
698877	CA	13271407	VAUXHALL Meriva A(2003>2010)
698878	PA	7701409324	RENAULT Twingo I (X06)(94>2007)
698879	PA	JKR000030	MG MG XPower(2003>2005), MG ZT(2001>2005)
698879	PA	JKR000030	ROVER 75(99>2005)
698880	CA	JKR000040	MG MG XPower(2003>2005), MG ZT(2001>2005)
698880	CA	JKR000040	ROVER 75(99>2005)
698882	PA	1315686	FORD C-Max (CB3)(2007>2010), Focus C-MAX(2003>2007), Galaxy II (CA1)(2006>2010)
698883	CA	1253220	FORD C-Max (CB3)(2007>2010), Focus C-MAX(2003>2007), Galaxy II (CA1)(2006>2015)
698884	CA	6441EJ	CITROËN C5(2004>2008), C6(2005>2012)
698884	CA	6441EJ	PEUGEOT 407(2004>2011)
698885	PA	1H0819644B	AUDI A3 Série 1 (AU34)(96>2000), TT série 1(98>2006)
698885	PA	1H0819644B	SEAT Alhambra III(2010>2013), Arosa(97>2004), Cordoba I(93>96), Cordoba II(96>99)
698885	PA	1H0819644B	SKODA Octavia I(96>2010), Superb(2001>2008)
698885	PA	1H0819644B	VOLKSWAGEN Caddy II(95>2003), Golf II Cabriolet(93>98), Golf III(83>92), Golf III Cabriolet(98>2002)
698886	PA	71743821	FIAT Sedici 2012(2012), Sedici(2006>2012)
698886	PA	71743821	HONDA City(81>87), Jazz I(81>86), Jazz II (CHN)(2005>2008), Jazz II (JPN)(2002>2008)
698886	PA	71743821	SUZUKI SX4 (HUN)(2006>2009), Swift II RS (HUN)(2008>2011), Swift II RS (JPN)(2005>2011)
698888	PA	9761938000	HYUNDAI Highway Van(2000>2004), Santa Fé(2000>2006), Sonata série 4(2001>2005), Trajet(2000>2004)
698888	PA	9761938000	KIA Magentis(2001>2005), Sorento(2002>2006)
698889	PA	971143B100	KIA Opirus(2003>2006)
698890	CA	CB1261J6X	MAZDA 323 (BJ)(2000>2003), 626 (GF)(99>2002), Premacy(99>2005)
698891	PA	GE6T61J6X	MAZDA 323 (BJ)(98>2003), 626 (GF)(99>2002), 626 (GW)(97>99), Premacy(99>2005)
698892	PA	BP4K61J6X	MAZDA Mazda 3(2003>2009), Mazda 5 II(2010), Mazda 5(2005>2010)

<b>Valeo</b>			
698893	PA	4134237	FORD Maverick(2000>2006)
698893	PA	4134237	MAZDA Tribute(2000>2005)
698894	PA	9586165D000	SUZUKI Grand Vitara XL7(2001>2006)
698895	PA	971332F000	KIA Carnival II(2006>2010), Cerato(2004>2008), Sedona II(2002>2005), Sorento II(2009>2010)
715500	PA	4F0819439	AUDI A6 Allroad 2(2008>2011), A6 Série 3(2004>2008), S6 Série 3(2006>2008)
715501	CA	4F0819439A	AUDI A6 Série 3(2004>2011), R8(2007>2012), RS6 (4F)(2008>2010), S6 Série 3(2006>2011)
715502	PA	64316142114	BMW 1 Series (E81/E82/E88)(2010>2012), 1 Series (E87)(2004>2011), 3 Series (E90/E91/E92)
715503	CA	64316946628	BMW 1 Series (E81/E82/E88)(2010>2012), 1 Series (E87)(2004>2011), 3 Series (E90/E91/E92)
715504	CA	2W9319G244AA	JAGUAR XJ (XJ350)(2002>2009), XJ(R)(2002>2009)
715505	CA	XR830254	JAGUAR S-Type(98>2007)
715506	PA	1698300118	MERCEDES A Class (W169)(2004>2008)
715507	CA	1698300218	MERCEDES A Class (W169)(2004>2012), B Class (W245)(2005>2011)
715508	CA	1718300418	MERCEDES SLK Class
715509	CA	7803A028	MITSUBISHI Pajero 3 (VD/VF)(2000>2006), Pajero 4(2006)
715510	PA	1354952	FORD Focus II Coupé Cabriolet(2006>2008), Focus II Coupé Cabriolet(2008>2012), Focus II(2004)
715511	CA	1354953	FORD Focus II Coupé Cabriolet(2006>2008), Focus II(2004>2012)
715512	CA	9171756	VOLVO S60(2000>2009), S80(98>2006), V70 II(2000>2007), XC 70(97>2007), XC 90 II(2002>2007)
715513	PA	2729800QAA	NISSAN Primastar (X83)(2002>2006)
715513	PA	2729800QAA	OPEL Vivaro A(2001>2011), Vivaro B(2014)
715513	PA	2729800QAA	RENAULT Trafic II(2001>2006)
715513	PA	2729800QAA	VAUXHALL Vivaro A(2001>2006)
715514	PA	4632493	SAAB 9-3(98>2003), 900 série 2(93>98)
715515	PA	6447TV	CITROËN C1(2005>2014)
715515	PA	6447TV	PEUGEOT 107(2005>2014)
715515	PA	6447TV	TOYOTA Aygo (KGB/WNB)(2005>2014)
715516	PA	9761037000	HYUNDAI Accent(99>2003)
715517	PA	971332D000	HYUNDAI Elantra(2000>2007), Matrix(2001>2008)
715518	PA	JKR500010	LAND ROVER Discovery III(2004>2009), Discovery IV(2009>2010), Range Rover Sport(2005>2013)
715519	CA	JKR500020	LAND ROVER Discovery III(2004>2009), Discovery IV(2009>2010), Range Rover Sport(2005>2013)
715520	PA	27274EA000	NISSAN Navara (D40M)(2005>2010), Pathfinder (R51M)(2005>2010)
715521	PA	971332E200	HYUNDAI Tucson(2004>2010)
715521	PA	971332E200	KIA Carens III(2006>2012), Sportage(2004>2006)
715522	PA	K2FAG152X	KIA Carens II(2002>2006), Elan Roadster(99>99)
715523	PA	97619FD200	KIA Clarus(95>2001), Rio I (FD)(2000>2005)
715524	PA	9713307010	HYUNDAI i10(TUR-EUR)(2013), i10 (IND)(2007>2013)
715524	PA	9713307010	KIA Picanto BC (SA)(2004>2007), Picanto SA(2007>2011), Picanto TA(2011)
715525	PA	976171C000	HYUNDAI Accent(99>2003), Getz (BJ)(2002>2005)
715526	PA	96554378	CHEVROLET Lacetti (J200)(2005>2012), Nubira (J200)(2005>2009)

<b>Valeo</b>			
715526	PA	96554378	DAEWOO Lacetti(2003>2004), Nubira III (J200)(2003>2005)
715527	PA	97030H1726	HYUNDAI Terracan(2002>2007)
715528	PA	MR315876	MITSUBISHI Galant (EA)(96>2003)
715529	PA	976193D000	HYUNDAI Highway Van(2000>2004), Santa Fé(2000>2006), Sonata série 4(2001>2005), Trajet(2000>2007)
715530	PA	6447H0	CITROËN Evasion(94>2002), Jumpy(95>2003), Synergie(95>2002)
715530	PA	6447H0	FIAT Scudo(95>2006), Ulysse (U6)(94>2002)
715530	PA	6447H0	LANCIA Kappa (838)(97>98), Zeta (U60)(94>2002)
715530	PA	6447H0	PEUGEOT 806(94>2002)
715531	PA	2108300018	MAYBACH Maybach(2002>2012)
715531	PA	2108300018	MERCEDES C ClassLK (209)(2006>2009), E Class (210)(95>2003), S Class (220)(98>2004)
715532	PA	71754158	ALFA ROMEO 159(2005>2013), Brera(2006>2010), Spider II(2006>2010)
715533	CA	77363370	ALFA ROMEO 159(2005>2013), Brera(2006>2010), Spider II(2006>2010)
715534	PA	50580040AA	CHRYSLER PT Cruiser Cabriolet(2003>2007), PT Cruiser(2000>2007), PT Cruiser(2005>2010)
715535	PA	96435888	CHEVROLET Aveo T250/1(2005>2008), Kalos (T200)(2005>2008)
715535	PA	96435888	DAEWOO Kalos (T200)(2002>2005)
715536	PA	93740495	CHEVROLET Rezzo (U100)(2005>2008), Tacuma (U100)(2005>2008)
715536	PA	93740495	DAEWOO Rezzo (U100)(2000>2005), Tacuma (U100)(2000>2005)
715537	CA	5058381AA	DODGE Caliber(2006>2011)
715537	CA	5058381AA	FIAT Freemont(2011)
715537	CA	5058381AA	JEEP Patriot(2007>2011)
715537	CA	5058381AA	LANCIA Flavia(2012)
715538	CA	7711228912	RENAULT Clio Campus Evolution(2009>2012), Clio II(98>2008), Kangoo I(97>2009)
715539	CA	7701064235	RENAULT Megane II(2002>2009)
715541	PA	971332B010	HYUNDAI Grandeur(2005>2010), Santa Fé 2(2006>2009), Sonata série 5 (NF)(2008>2011)
715541	PA	971332B010	KIA Magentis II(2006>2008)
715542	PA	8713930010	LEXUS GS 300(97>2000), IS 300(2001>2005), IS I(99>2005), LS400(94>2000), RX 300(2000>2006)
715542	PA	8713930010	TOYOTA Harrier(98>2003)
715543	PA	MR227823	MITSUBISHI Colt (CJ)(95>2003)
715544	CA	1648300218	MERCEDES GL Class (164)(2006>2013), ML Class (164)(2005>2013), R Class (W251)(2005>2010)
715545	PA	MR315172	MITSUBISHI Pajero .Pinin (H7*)(99>2005)
715546	CA	MR398288	MITSUBISHI Grandis(2004>2010), Lancer (CS/CT)(2003>2011), Outlander (CU)(2003>2008)
715547	PA	MR360889	MITSUBISHI Space Runner (N1/2)(91>2002), Space Wagon (N8)(98>2004)
715548	PA	MZ311917	MITSUBISHI Carisma
715549	PA	278936F600	NISSAN Micra mk2 (K11E)(92>2002)
715550	PA	8713932010	TOYOTA Land Cruiser 120 (KD/GR)(2004>2009)
715551	PA	72880FE000	SUBARU Impreza (G11)(2000>2007)
715552	PA	55702456	ABARTH Grande Punto(2007>2010), Nuova 500(2008>2009), Punto Evo(2010)

<b>Valeo</b>			
715552	PA	55702456	ALFA ROMEO Mi.To(2008>2013)
715552	PA	55702456	CITROËN Nemo(2007)
715552	PA	55702456	FIAT Grande Punto (199)(2005>2009), Nouveau Fiorino(2007), Nuova Punto (199)(2011)
715552	PA	55702456	OPEL Combo sur base Fiat Doblo(2011), Corsa D(2006>2010), Corsa E(2014)
715552	PA	55702456	PEUGEOT Bipper(2007)
715552	PA	55702456	VAUXHALL Combo sur base Fiat Doblo(2011), Corsa MKIII(2006), Corsa MKIII(2010), Corsa MKIV(2014)
715553	CA	55702456	ABARTH Grande Punto(2007>2010), Nuova 500(2008>2009), Punto Evo(2010)
715553	CA	55702456	ALFA ROMEO Mi.To(2008>2013)
715553	CA	55702456	FIAT Grande Punto (199)(2005>2009), Nouveau Fiorino(2007), Nuova Punto (199)(2011)
715553	CA	55702456	OPEL Adam(2013), Corsa D(2006>2010), Corsa E(2014)
715553	CA	55702456	VAUXHALL Combo sur base Fiat Doblo(2011), Corsa MKIII(2006), Corsa MKIII(2010), Corsa MKIV(2014)
715554	PA	6447XF	CITROËN Berlingo (B9), C4 Picasso (2006 >), Space Tourer, Jumpy IV (2016->)
715554	PA	6447XF	PEUGEOT 3008, 5008, Partner, Traveller, Expert IV (2016->)
715555	CA	6447XG	CITROËN Berlingo (B9), C4 Picasso (2006 >), Space Tourer, Jumpy IV (2016->)
715555	CA	6447XG	PEUGEOT 3008, 5008, Partner, Traveller, Expert IV (2016->)
715556	PA	1609428080	CITROËN C3 (A51)(2009), C4 Cactus(2014), DS3 (A55)(2010), DS3 (A55)(2014)
715556	PA	1609428080	PEUGEOT 2008(2013), 207(2006>2013), 207+(2012), 208(2012)
715557	CA	1609428180	CITROËN C3 (A51)(2009), C4 Cactus(2014), DS3 (A55)(2010), DS3 (A55)(2014)
715557	CA	1609428180	PEUGEOT 2008(2013), 207(2006>2013), 207+(2012), 208(2012)
715558	CA	6447SP	CITROËN C8
715559	PA	27277EN000	NISSAN Qashqai (J10E/JJ10E)(2007>2010), X-Trail (T31) (JPN)(2007>2010), X-Trail (T31R) (RUS)
715560	CA	27277Z5000	INFINITI QX70/FX
715561	PA	272747J125	NISSAN Patrol GR (Y61)(97>2004)
715562	PA	7701056389	RENAULT Espace IV(2002>2012)
715563	PA	72880AE080	SUBARU Legacy 3(98>2003)
715564	PA	9586154J00	SUZUKI Grand Vitara(98>2005)
715565	PA	8850812010	TOYOTA Corolla (110)(97>2001)
715566	PA	6923005400	DAEWOO Korando KJ(99>2005), Musso(99>2005)
715566	PA	6923005400	SSANGYONG Korando série 2(96>99), Korando série 3(99>2006), Musso(93>2007)
715567	PA	6923005410	SSANGYONG Korando série 2(96>99), Korando série 3(99>2006), Musso(93>2007)
715568	CA	6025372486	RENAULT Avantime(2001>2003), Espace III(96>2002)
715569	PA	8971708040	ISUZU Trooper 98 (UBS)(98>2004)
715569	PA	8971708040	OPEL Monterey II(98>99)
715569	PA	8971708040	VAUXHALL Monterey B(98>99)

<b>Valeo</b>			
715570	PA	647904	PEUGEOT 407(2004>2011)
715571	CA	9171757	VOLVO S60(2000>2009), S80(98>2006), V70 II(2000>2007), XC 70(97>2007), XC 90 II(2002>2007)
715572	PA	8888020020	TOYOTA Avensis (AT22*)(97>2000), Carina E (AT/ST19*)(92>97), Picnic(96>2001)
715573	PA	79370S1A505	HONDA Accord VI (CG/CH)(98>2003)
715574	PA	LDY461J6X	MAZDA MPV II(2002>2006), RX-8(2003>2010)
715575	PA	272751N626	NISSAN Almera (N15)(95>2000)
715576	PA	DC2161J6X	MAZDA Demio(98>2003)
715577	PA	18353047	MERCEDES V Class (638)(96>2002), Vito (638)(96>2003)
715578	CA	3B0091800	AUDI 80 (8C)(91>95), A4 Série 1(94>2001), A5(2013), Cabriolet (8G)(91>2000), Coupé (8B)(88>96)
715578	CA	3B0091800	VOLKSWAGEN Passat V(96>2005)
715579	PA	8K0819439	AUDI A4 Série 3(2007>2015), A5 Cabriolet(2009>2012), A5(2007>2014), Q5(2008>2012), RS4 Quattro
715580	PA	8K0819439A	AUDI A4 Série 3(2007>2012), A5 Cabriolet(2009>2012), A5(2007>2012), Q5(2008>2012), RS5 Quattro
715581	PA	7H0819631	VOLKSWAGEN Amarok 2H(2009>2012), Amarok S1(2012), Transporter (7E/7F)(2009>2013), Transporter (7J/H)
715582	CA	64106907746	BMW 7 Series (E66)(2002>2008)
715583	PA	64116945593	BMW X5 (E70)(2006>2010), X5 M (E70M)(2010), X6 (E71/E72)(2008), X6 M (E71M)(2010>2011)
715584	CA	64116945594	BMW X5 (E70)(2006>2010), X5 M (E70M)(2010), X6 (E71/E72)(2008), X6 M (E71M)(2010>2011)
715585	PA	64319127515	MINI MINI 2 (R56/R57)(2006>2010), MINI Clubman (R55)(2007>2011), MINI Clubman/Clubvan (R55)
715586	CA	64319127515	MINI MINI 2 (R56/R57)(2006>2010), MINI Clubman (R55)(2007>2011), MINI Clubman/Clubvan (R55)
715587	PA	96296618	CHEVROLET Alero(99>2004), Captiva (C100)(2006>2009), Epica (V250)(2006>2009), Evanda (V200)(2002>2005)
715587	PA	96296618	DAEWOO Evanda (V200)(2002>2005)
715588	PA	96425700	CHEVROLET Matiz (M200)(2005>2011), Spark (M200)(2005>2009)
715589	PA	6441G9	CITROËN Saxo(96>2005)
715589	PA	6441G9	PEUGEOT 106 - Restyling(96>2003), 106(91>96)
715590	PA	99906850M2-036	DAIHATSU Charade
715591	PA	971332D200	HYUNDAI Elantra(2000>2007)
715592	PA	971331E000	HYUNDAI Accent TR(2005>2012), Accent(2003>2006), Elantra(2006>2011), i20, i30
715592	PA	971331E000	KIA Carens IV(2013), Ceed II(2012)
715593	PA	80291S84A01	HONDA Accord Coupé (CG)(97>2002)
715594	PA	80291S2H505	HONDA Civic (EP)(2001>2006), HR-V (GH)(98>2005), Logo (GA)(98>2001)
715595	PA	3802821	IVECO Daily 2006(2006>2009), Daily 2009(2009>2011), Daily 2011(2011), Massif(2008>2011)
715597	PA	6G9N180543BA	LAND ROVER Freelander 2(2006>2012), Range Rover Evoque(2011)
715597	PA	6G9N180543BA	VOLVO S60 II(2010>2015), S80 II(2006>2013), V60(2010>2013), V70 III(2007>2013), XC 60(2008>)
715598	PA	BTR8037	LAND ROVER Range Rover(94>2002)
715599	PA	GE7B61J6X	MAZDA 323 (BJ)(98>2003), 626 (GW)(99>2002), Premacy(2001>2005)



<b>Valeo</b>			
<b>715600</b>	CA	2048300018	MERCEDES C Class (204)(2007>2011), E Class (207-212)(2009>2013), GLK Class (204)(2008>2012)
<b>715601</b>	PA	9068300218	MERCEDES Sprinter II (906)(2006>2010)
<b>715601</b>	PA	9068300218	VOLKSWAGEN Crafter(2006>2011)
<b>715602</b>	CA	9068300318	MERCEDES Sprinter II (906)(2006>2010)
<b>715602</b>	CA	9068300318	VOLKSWAGEN Crafter(2006>2011)
<b>715603</b>	PA	MR958016	MITSUBISHI Colt (Z30)(2004>2013)
<b>715607</b>	CA	272770001R	RENAULT Laguna III(2007>2010)
<b>715608</b>	CA	4518300018	SMART Fortwo MKI(2000>2006)
<b>715609</b>	PA	9586164J00	SUZUKI Grand Vitara(98>2012)
<b>715610</b>	CA	7701064237	RENAULT Scenic II(2003>2009)
<b>715611</b>	CA	5072176AA	CHRYSLER Grand Voyager(2001>2008), Voyager IV(2001>2004), Voyager V(2004>2008)
<b>715612</b>	CA	6447LN	CITROËN Xsara Picasso(99>2010)
<b>715613</b>	CA	6447YK	CITROËN Dispatch II(2007), Jumpy II(2007>2009)
<b>715613</b>	CA	6447YK	FIAT Scudo II(2007)
<b>715613</b>	CA	6447YK	PEUGEOT Expert II(2007>2010)
<b>715614</b>	PA	6447YK	CITROËN Dispatch II(2007), Jumpy II(2007>2009)
<b>715614</b>	PA	6447YK	FIAT Scudo II(2007)
<b>715614</b>	PA	6447YK	PEUGEOT Expert II(2007>2010)
<b>715615</b>	PA	7082301	FIAT Albea(2002>2011), Palio Week End(2001>2002), Siena(2002>2011), Strada II Pick-up
<b>715616</b>	PA	647962	CITROËN Nemo(2007)
<b>715616</b>	PA	647962	FIAT Doblo Cargo III (2010 > 2015), Doblo III (2010> 2015), Aegea (2015>)
<b>715616</b>	PA	647962	PEUGEOT Bipper(2007)
<b>715617</b>	CA	1089176	FORD Courier/Courier(99>2002), Fiesta IV 95(95>99), Fiesta IV(99>2002), StreetKa(2002>2005)
<b>715618</b>	PA	0K2N16152X	KIA Sephia
<b>715619</b>	CA	8713933010	LEXUS RX 300(2003>2006), RX 350(2006>2008), RX 400H(2005>2008)
<b>715619</b>	CA	8713933010	SUBARU Legacy 3(98>2003), Legacy 4(2003>2009)
<b>715619</b>	CA	8713933010	TOYOTA Camry (ACV/MCV30)(2001>2006)
<b>715620</b>	PA	871390D010	DAIHATSU Charade (NPS90)(2011)
<b>715620</b>	PA	871390D010	LEXUS CT200h, GS, GX 460(2009>2013), IS, (GSE2)(2009>2010), IS F(2007), LFA(2010>2012), LX 570
<b>715620</b>	PA	871390D010	SUBARU Legacy 5(2009)
<b>715620</b>	PA	871390D010	TOYOTA Auris, Avensis, Camry, Corolla, Hilux, Land Cruise, Prius Plug In 1(2009>2010), Prius+ M
<b>715621</b>	CA	2308300418	MERCEDES G Class (M461/3)(92>2006), S ClassL (230)(2001>2012), SLR (199)(2004>2009)
<b>715622</b>	CA	7803A027	MITSUBISHI Pajero 4(2006), Shogun 4(2006>2011)
<b>715623</b>	CA	6447ZY	CITROËN C Crosser(2007>2011)
<b>715623</b>	CA	6447ZY	PEUGEOT 4007(2007>2011)
<b>715624</b>	PA	68111091A0	SSANGYONG Actyon Sport II(2012), Actyon Sports(2007>2011), Actyon(2006>2011), Kyron(2005>2007)
<b>715625</b>	PA	72880FG000	SUBARU Forester 2(2002>2005), Forester 3(2007), Impreza (G11)(2005>2007), Impreza (GJ/GP)



<b>Valeo</b>			
<b>715626</b>	PA	GE210FC000	SUBARU Forester
<b>715627</b>	PA	8687389	VOLVO C30(2006>2012), C70 CC(2006>2014), S40(2004>2012), V50(2004>2012)
<b>715628</b>	CA	30676484	VOLVO C30(2006>2012), C70 CC(2006>2014), S40(2004>2012), V50(2004>2012)
<b>715629</b>	CA	6447SQ	CITROËN Berlingo (M59)(2002>2012), Xsara(2000>2005)
<b>715629</b>	CA	6447SQ	PEUGEOT Partner (M49)(96>2002), Partner (M59)(2002>2008), Ranch (M59F/U)(2002>2008)
<b>715631</b>	PA	6447ZY	CITROËN C Crossover(2007>2013), C4 Aircross(2012)
<b>715631</b>	PA	6447ZY	MITSUBISHI ASX (EUR)(2010>2012), ASX(2012), Lancer IX (CY)(2007>2010), Lancer Sportback (CX)
<b>715631</b>	PA	6447ZY	NISSAN X-Trail (T30)(2001>2007)
<b>715631</b>	PA	6447ZY	PEUGEOT 4007(2007>2012), 4008(2012)
<b>715632</b>	CA	1718044	OPEL Astra F(91>2001), Calibra(89>97), Combo sur base Corsa B(93>2001), Corsa B(93>2000)
<b>715633</b>	PA	7701042499	RENAULT Kangoo I(97>2009)
<b>715635</b>	CA	647945	CITROËN C5 (X7)(2008>2011), C6(2005>2012)
<b>715635</b>	CA	647945	PEUGEOT 407(2004>2011)
<b>715636</b>	PA	6447YC	CITROËN Jumper III(2006), Jumper III(2014), Relay III(2006), Relay III(2014)
<b>715636</b>	PA	6447YC	FIAT Ducato II (250-251)(2006>2011), Ducato II Maxi (250)(2014), Nuova 500(2010>2012), Panda
<b>715636</b>	PA	6447YC	PEUGEOT 307 Restyling(2005>2007), Boxer III(2006)
<b>715637</b>	PA	99906850M2-038	DAIHATSU Sirion
<b>715638</b>	PA	971332L000	HYUNDAI i30 (CZE)(2008>2012), i30(2007>2012)
<b>715638</b>	PA	971332L000	KIA Ceed(2006>2012)
<b>715639</b>	PA	971332E900	HYUNDAI Tucson(2004>2010)
<b>715639</b>	PA	971332E900	KIA Sorento(2006>2009), Sportage (KOR)(2006>2010), Sportage (SVK)(2007>2010), Sportage(2004>)
<b>715640</b>	CA	6W83020B02AB	JAGUAR F type(2012), XK(2005>2009), XKR(2002>2011)
<b>715641</b>	CA	8713950030	LEXUS GS 430(2000>2004), LS430(2000>2006), SC430(2005>2010)
<b>715642</b>	PA	D65161J6X	MAZDA Mazda 2 II (DE)(2007>2011), Mazda 2 II (DE-DH)(2010)
<b>715643</b>	CA	2218300018	MERCEDES C Class (204)(2012), CLS Class (219)(2004>2008), S Class (221)(2004>2013), Coupé CL
<b>715644</b>	PA	4710210	OPEL Agila II(2007>2015)
<b>715644</b>	PA	4710210	SUZUKI Splash(2008)
<b>715644</b>	PA	4710210	VAUXHALL Agila II(2007>2014)
<b>715645</b>	PA	1808606	OPEL Corsa B(93>2000), Tigra(94>2001)
<b>715645</b>	PA	1808606	VAUXHALL Combo sur base Corsa B(93>2001), Corsa MKI(93>2000), Tigra(94>2001)
<b>715646</b>	PA	002484	PEUGEOT 306
<b>715647</b>	CA	272778970R	RENAULT Megane III(2008>2014)
<b>715648</b>	CA	4596501AB	CHRYSLER 300C(2004>2007)
<b>715649</b>	PA	7701209837	RENAULT Kangoo II(2007>2013), Master III(2010), Master III(2014)
<b>715650</b>	CA	8974000820	TOYOTA RAV4
<b>715651</b>	PA	272774M425	NISSAN X-Trail (T30)(2001>2007)
<b>715651</b>	PA	272774M425	SUBARU Forester 2(2002>2007)
<b>715652</b>	PA	9586080J00	SUZUKI SX4 (HUN)(2006>2009), SX4(2009)

<b>Valeo</b>			
<b>715653</b>	PA	191091700	VOLKSWAGEN Golf I Cabriolet(86>93), Golf II Cabriolet(98>98), Golf III(83>92), Jetta I(81>84), Jetta
<b>715654</b>	PA	96440878	CHEVROLET Captiva (C100)(2006>2011), Captiva (C140)(2011)
<b>715654</b>	PA	96440878	OPEL Antara(2006>2010)
<b>715654</b>	PA	96440878	VAUXHALL Antara(2006)
<b>715655</b>	PA	589150001	LDV (EX LEYLAND DAF VI) Maxus
<b>715656</b>	PA	9999207019	HYUNDAI Getz
<b>715658</b>	PA	13271190	CHEVROLET Cruze
<b>715659</b>	CA	13271191	CHEVROLET Aveo T300(2011), Cruze(2009>2011), Malibu (V300)(2012), Orlando - J309(2011), Spark (M300)
<b>715659</b>	CA	13271191	OPEL Ampera(2011), Astra J(2009>2014), Cascada(2013), Insignia(2009>2013), Meriva B(2010>2013)
<b>715659</b>	CA	13271191	SAAB 9-5 II(2010>2012)
<b>715659</b>	CA	13271191	VAUXHALL Ampera(2011), Astra MK VI(2009>2011), Cascada(2013), Insignia(2009>2013), Meriva B(2010>)
<b>715660</b>	PA	1541456	FORD Fiesta VI(2008>2013)
<b>715661</b>	CA	1566997	FORD B-Max(2012), Ecosport(2013>2015), Fiesta VI(2008>2013), Transit Courier(2014)
<b>715662</b>	PA	971331J000	HYUNDAI i20 (TUR-EU)(2010>2012), i20(2008>2012)
<b>715664</b>	PA	BC5D61J6X	MAZDA 323 (BA)(94>98)
<b>715665</b>	CA	1K2819653	AUDIA3 Cabriolet (8P)(2011>2013), A3 Série 2(2003>2013), Q3(2011>2015), RS Q3(2013>2015), RS
<b>715665</b>	CA	1K2819653	SEAT Alhambra III(2010>2013), Alhambra III(2015), Altea 2014(2013>2013), Leon II(2005>2012)
<b>715665</b>	CA	1K2819653	SKODA Octavia II(2004>2013), Superb II(2008>2013), Yeti(2009>2013), Yeti(2013)
<b>715665</b>	CA	1K2819653	VOLKSWAGEN CC(2011>2012), Caddy III(2004>2010), Caddy IV(2015), Eos(2006>2010), Golf V Plus(2005>)
<b>715667</b>	CA	272770840R	RENAULT Koleos (X45)(2008>2011)
<b>715668</b>	PA	9586081A10	SUZUKI Jimmy (SN413V)(2005)
<b>715669</b>	PA	976174H000	HYUNDAI H1 (TQ) KEURPT007(2007)
<b>715670</b>	PA	5013595AA	JEEP Grand Cherokee WJ/G(2000>2003), Grand Cherokee(93>2005)
<b>715671</b>	CA	88957450	CADILLAC CTS II(2007>2010), CTS(2002>2007), SRX(2004>2010), STS(2005>2007)
<b>715672</b>	CA	272771128R	RENAULT Scenic III(2009>2012)
<b>715672</b>	CA	272771128R	VAUXHALL Vivaro B(2014)
<b>715673</b>	CA	6479K9	PEUGEOT 508(2011>2014)
<b>715674</b>	CA	1225788	FORD Cougar(98>2001), Mondeo I (FD)(93>96), Mondeo I (GD)(96>2000)
<b>715675</b>	CA	1808608	OPEL Vectra B(95>2003)
<b>715675</b>	CA	1808608	VAUXHALL Vectra(95>2002)
<b>715676</b>	CA	30883952	VOLVO S40(95>2004), V40(95>2004)
<b>715677</b>	CA	6447SR	CITROËN Berlingo (M59)(2002>2008), Xsara(97>2005)
<b>715677</b>	CA	6447SR	PEUGEOT Partner (M49)(96>2002), Partner (M59)(2002>2008)
<b>715678</b>	CA	80292SFY003	HONDA Civic VIII (FK/FD/FN)(2006>2009)
<b>715679</b>	CA	GJ6B61P11	MAZDA CX-7(2007>2009), Mazda 6(2002>2007)
<b>715680</b>	CA	G3210FE000	SUBARU Impreza
<b>715681</b>	CA	C226525	JAGUAR XF Facelift(2011), XF(2007>2012), XJ (XJ351)(2010>2015)
<b>715682</b>	CA	211812202010	LADA 110

<b>Valeo</b>			
<b>715683</b>	PA	4A0819439A	AUDI 100
<b>715684</b>	PA	1248300118	MERCEDES E Class (124)(93>98), W124(84-93)
<b>715685</b>	PA	64118391198	BMW M5 (E39)(99>2003), 5 Series (E39)(95>2004)
<b>715686</b>	PA	71736776	CHRYSLER Delta(2011>2014)
<b>715686</b>	PA	71736776	FIAT Bravo II (198)(2007>2009), Stilo(2001>2008)
<b>715686</b>	PA	71736776	LANCIA Delta (844)(2008>2011), Delta Restyle (844)(2010>2014)
<b>715688</b>	PA	MR262425	MITSUBISHI Space Star (DG)(98>2004)
<b>715688</b>	PA	MR262425	VOLVO S40(95>2004), V40(95>2004)
<b>715689</b>	PA	87139YZ06	TOYOTA Corolla Verso 2.0 D4D
<b>715690</b>	CA	64119163329	BMW M5, M6, 5 Series (F10/F11)(2012>2013), 5 Series, 6 Series (F12/13)(2011>2015), 7 Series
<b>715691</b>	PA	971332K000	KIA Soul(2008>2013)
<b>715692</b>	PA	80291TF0E01	HONDA CR-Z(2010), Insight Hybrid(2009), Jazz III(2008)
<b>715693</b>	CA	97057362300	PORSCHE Panamera 970(2009>2013)
<b>715694</b>	PA	278914A00C	NISSAN Pixo (UA0)(2009)
<b>715694</b>	PA	278914A00C	SUZUKI Alto (AMF310)(2009>2010)
<b>715695</b>	CA	8975K2000100	DAIHATSU Cuore L276(2007>2013), Terios 2(2006>2013)
<b>715696</b>	PA	68033193AA	DODGE Nitro(2007>2011)
<b>715696</b>	PA	68033193AA	JEEP Cherokee KK(2008>2010)
<b>715697</b>	PA	971333J100	HYUNDAI ix55(2008)
<b>715698</b>	PA	9586154G00	SUZUKI Liana (RH41*)(2001>2006)
<b>715699</b>	PA	6812008030	SSANGYONG Rexton
<b>715700</b>	PA	6811021000	SSANGYONG Rodius(2005>2012)
<b>715701</b>	CA	0897400850	TOYOTA Avensis
<b>715702</b>	CA	669N19N619BA	LAND ROVER Freelander 2(2006>2012), Range Rover Evoque(2011)
<b>715702</b>	CA	669N19N619BA	VOLVO S60 II(2010>2015), S80 II(2006>2013), V60(2010>2013), V70 III(2007>2013), XC 60(2008>)
<b>715703</b>	PA	27277JN20A	NISSAN Murano II (Z51)(2008), Murano II (Z51R) (RUS)(2010), Teana II(2008), Teana RUS(2009)
<b>715704</b>	CA	95857221900	PORSCHE Cayenne 92A(2010>2011)
<b>715704</b>	CA	95857221900	VOLKSWAGEN Touareg II(2010>2014)
<b>715705</b>	PA	77365352	ALFA ROMEO Giulietta(2010>2013)
<b>715706</b>	PA	272771HE0E	NISSAN Micra mk4 (K13K) (IND)(2010>2013), Note II(E12E)(2013)
<b>715707</b>	PA	95947238	CHEVROLET Spark (M300)(2009>2013)
<b>715708</b>	PA	27891EL00A	NISSAN NV200 (ESP)(2010), NV200 (JPN)(2009>2010), Tiida (C11X/SC11X)(2007), Tiida(2012)
<b>715709</b>	PA	278911FC0A	NISSAN Cube (Z12)(2009>2012)
<b>715710</b>	CA	95215156	CHEVROLET Spark (M300)(2009>2013)
<b>715711</b>	PA	68042866AA	CHRYSLER Grand Voyager(2008>2012)
<b>715712</b>	CA	64319159606	BMW M3 (E90-92-93)(2007>2010), M3 (E90-92-93)(2008>2010)
<b>715713</b>	CA	64319237157	BMW X3 SAV (F25)(2010>2012)
<b>715714</b>	PA	64319237158	BMW X3 SAV (F25)(2010>2012)
<b>715715</b>	PA	64119163328	BMW M5 (F10)(2011), M6 (F06/F12/F13)(2012>2015), M6 (F06N/F12N/F13N)(2015), 5 Series (F10/F11/F18)
<b>715716</b>	PA	971332B005	HYUNDAI Santa Fé 2 - Restyle(2009>2012)
<b>715717</b>	PA	68079487AA	JEEP Grand Cherokee IV(2010>2013)

<b>Valeo</b>			
<b>715718</b>	PA	8973561270	ISUZU D-Max(2003>2012), Rodeo(2004>2004)
<b>715719</b>	CA	64119237555	BMW M3 (F80)(2014), M4 (F82 F83)(2014), 1 Series (F20/F21)(2011>2015), 2 Series (F22-F23)
<b>715720</b>	CA	5Q0818653	AUDI A3 Série 3(2012>2015), RS3(2015), S3 Série 3(2012>2014), TT série 3(2014)
<b>715720</b>	CA	5Q0818653	SEAT Leon III(2012>2013)
<b>715720</b>	CA	5Q0818653	SKODA Octavia III(2012), Superb III(2015)
<b>715720</b>	CA	5Q0818653	VOLKSWAGEN Golf VII(2012>2013), Passat VIII(2014)
<b>715721</b>	PA	272771KA0A	NISSAN Juke UK (F15E)(2010>2014), Pulsar (C13M)(2014)
<b>715721</b>	PA	272771KA0A	RENAULT Fluence(2013), Fluence/Megane Generation(2009)
<b>715722</b>	CA	272774936R	NISSAN Juke
<b>715723</b>	CA	77365763	ABARTH Nuova 500(2008>2012)
<b>715723</b>	CA	77365763	FIAT Ducato II (250-251)(2006>2011), Nuova 500(2007>2012), Panda 169(2003>2013)
<b>715724</b>	PA	272774658R	RENAULT Koleos (X45)(2008>2011)
<b>715725</b>	CA	272770567R	RENAULT Clio
<b>715726</b>	PA	BBP261J6X	MAZDA Mazda 3 II(2008>2011)
<b>715727</b>	CA	6R0819653	AUDI A1(2010>2012), A1(2014), S1(2014)
<b>715727</b>	CA	6R0819653	SEAT Ibiza IV(2012>2012), Ibiza IV(2015), Toledo série 4(2015), Toledo série 4(2012>2015)
<b>715727</b>	CA	6R0819653	SKODA Fabia II(2010>2014), Rapid(2012), Roomster(2010)
<b>715727</b>	CA	6R0819653	VOLKSWAGEN Polo IX(2009>2014)
<b>715728</b>	CA	LDY361J6X	MAZDA MPV II(99>2005)
<b>715729</b>	CA	8850530100	LEXUS GS 300
<b>715730</b>	CA	8713950060	LEXUS LS 460(2006>2012), LS 600H/HL(2009>2012)
<b>715731</b>	CA	22753219	CHEVROLET Captiva (C140)(2011)
<b>715732</b>	CA	27277JD10A	NISSAN Qashqai
<b>715733</b>	CA	4H0819439	AUDI A6 Série 4(2010>2015), A6 série 4(2014>2015), A7(2010>2012), A7(2014), A8 Série 3(2009>)
<b>715734</b>	CA	272774653R	RENAULT Latitude(2010)
<b>715735</b>	PA	5058693AA	CHRYSLER Sebring(2007>2011)
<b>715735</b>	PA	5058693AA	DODGE Avenger(2007>2010), Caliber(2010>2011), Journey(2008>2011)
<b>715735</b>	PA	5058693AA	FIAT Freemont(2011)
<b>715735</b>	PA	5058693AA	JEEP Compass 2011(2011), Patriot(2007>2011)
<b>715735</b>	PA	5058693AA	LANCIA Flavia(2012)
<b>715736</b>	PA	4518350247	SMART Fortwo
<b>715737</b>	PA	6R0820367	AUDI A1(2010>2012), A1(2014), S1(2014)
<b>715737</b>	PA	6R0820367	SEAT Ibiza IV(2012>2012), Ibiza IV(2015), Toledo série 4(2015), Toledo série 4(2012>2015)
<b>715737</b>	PA	6R0820367	SKODA Fabia II(2010>2014), Fabia III(2014), Rapid(2012), Roomster(2010)
<b>715737</b>	PA	6R0820367	VOLKSWAGEN Polo IX(2009>2015)
<b>715738</b>	PA	974064A900	HYUNDAI H1 (G1) GEC4A09800(2000>2002), H1 (GA) EUR4A0PA02(2001>2006), H1 (GC) EUR4G0PA02(2006>)
<b>715739</b>	PA	111808122010	LADA Kalina
<b>715740</b>	PA	971332E250	HYUNDAI Tucson(2004>2010), ix35 (CZE)(2010)
<b>715740</b>	PA	971332E250	KIA Sportage (SVK)(2010), Sportage (SVK)(2014)

<b>Valeo</b>			
715741	PA	971331P000	HYUNDAI ix20(2010)
715741	PA	971331P000	KIA Venga(2009>2014)
715742	PA	1745604	FORD Transit 2006(2006>2007)
715743	PA	9586157L00	SUZUKI Kizashi Sport(2010)
715744	PA	1S0820367	SEAT Mii(2011)
715744	PA	1S0820367	SKODA Citigo(2011)
715744	PA	1S0820367	VOLKSWAGEN UP(2011)
715745	PA	1718237	FORD Ranger(2011)
715745	PA	1718237	MAZDA Mazda BT50(2011)
715746	PA	272773016R	DACIA Logan 2(2013), Sandero 2(2012)
715746	PA	272773016R	RENAULT Clio IV(2012)
715747	CA	1745605	FORD Transit 2006(2006>2007)
715748	PA	971334P000	HYUNDAI i20 (TUR-EU)(2010>2012), i20(2012)
715749	PA	K68071668AA	LANCIA Thema(2011)
715750	CA	DC4561J6X	MAZDA Demio
715751	PA	1668300018	MERCEDES C Class (205)(2014), G ClassL (166)(2012), ML Class (166)(2011)
715752	CA	1808020	OPEL Astra K(2015), Meriva B(2010>2013)
715752	CA	1808020	VAUXHALL Meriva B(2010>2013)
715753	CA	99157362300	PORSCHE 911 Carrera (991)(2011), 911 Turbo (991T)(2013), Boxster 981(2012), Cayman 981(2013)
715754	PA	99157237100	PORSCHE 911 Carrera (991)(2011), Boxster 981(2012)
715755	PA	51854923	ABARTH Nuova 500(2008>2012)
715755	PA	51854923	CHRYSLER Ypsilon(2011)
715755	PA	51854923	FIAT 500 MCA(2015), 500(2012), Panda 312 (Nuova)(2012)
715755	PA	51854923	LANCIA Ypsilon 2011(2011)
715756	CA	272771HEOE	NISSAN Micra mk4 (K13K) (IND)(2010>2013), Note II(E12E)(2013)
715757	CA	1709013	FORD C-Max II (CB7)(2010>2015), C-Max II (CEU)(2015), Focus III(2011), Focus III(2014), Kuga
715757	CA	1709013	VOLVO V40 II(2012>2015)
715802	CA	272775081R	RENAULT Zoé(2013)
715803	PA	272775340R	DACIA Dokker(2012)
715804	PA	971333SAA0	HYUNDAI Azera(2011), Santa Fé 3(2012), Sonata série 6 (YF)(2010)
715804	PA	971333SAA0	KIA Optima(2010)
715805	CA	9804163480	PEUGEOT 308 II(2013)
715806	PA	5Q0819644	SEAT Leon III(2012>2013)
715807	PA	971334L000	HYUNDAI Solaris C40 (RUS)(2010)
715808	PA	9804163380	PEUGEOT 308 II(2013)
715809	PA	77366480	FIAT 500L(2012), 500X(2014)
715809	PA	77366480	JEEP Renegade(2014)
715811	CA	64119321875	BMW 2 Series Active Tourer (F45)(2014), 2 Series Gran Tourer (F46)(2015), X1 (F48)(2015)
715811	CA	64119321875	MINI MINI 3 (F55-F56)(2014), MINI Clubman (F54)(2015)
715812	PA	64119321876	BMW 2 Series Active Tourer (F45)(2014), 2 Series Gran Tourer (F46)(2015), X1 (F48)(2015)
715812	PA	64119321876	MINI MINI 3 (F55-F56)(2014), MINI Clubman (F54)(2015)

<b>Valeo</b>	 PA CA	 TOE	
<b>715813</b>	PA	KD4561J6X	MAZDA CX-5(2012>2015), Mazda 3 III(2013>2015), Mazda 6 III(2012), Mazda 6 III(2015)
<b>715814</b>	CA	2468300118	MERCEDES A Class (W176)(2012>2015), B Class (W246)(2011>2014), CLA Class(117)(2013>2014)
<b>715815</b>	PA	64119237554	BMW 1 Series (F20/F21)(2011>2015), 2 Series (F22-F23)(2013), 3 Series (F30/F31)(2011>2015)
<b>715816</b>	PA	971332H001	HYUNDAI Elantra(2006>2011), i30 II (CZE)(2012>2015)
<b>715816</b>	PA	971332H001	KIA Carens IV (3/2013), Ceed II (5/2012), i20 II (2015>)
<b>715818</b>	CA	7711426872	RENAULT Clio III(2005>2012), Modus(2008>2012), Twingo II (X44)(2007>2011), Wind(2010>2014)
<b>715819</b>	CA	27891BM401	NISSAN Almera (N16E)(2000>2006), Almera Tino (V10B)(2003>2005), Primera 2 (P12/W12)(2001>2006)
<b>715820</b>	CA	272774812R	RENAULT Espace V(2015), Kadjar(2015)
<b>715828</b>	PA	B000975480	CITROËN C1

	<b>Valeo</b>
<b>ABARTH</b>	
46723321	698866
51854923	715755
55702456	715552
55702456	715553
77365763	715723
77365764	701003
77365764	715553
77366065	698867

<b>ALFA ROMEO</b>	
7797229	698199
46409630	698174
46721923	698174
46722335	698688
46799653	698747
46799653	701017
55702456	715552
55702456	715553
60653641	698197
60653641	698687
60653642	698689
60801430	698199
60809709	698174
60810570	698174
60813794	698174
60813795	698174
60814643	698688
71754158	715532
77363370	715533
77363481	715532
77365352	715705
77365764	701003
77365764	715553

<b>AUDI</b>	
893091700	698164
1H0091800	698686
1H0819644	698159
1H0819644A	698159
1H0819644A	698679
1H0819644B	698159
1H0819644B	698885
1J0819644	698716
1J0819644	701016
1J0819644A	698716
1J0819644A	701016
1K0819644	698800
1K0819644	715800
1K0819644A	698800

	<b>Valeo</b>
<b>AUDI</b>	
1K0819644B	698800
1K1819653	698801
1K1819653	701001
1K1819653	715801
1K1819653A	698801
1K1819653A	701001
1K1819653B	698801
1K1819653B	701001
1K2819653	715665
1K2819653A	715665
1K2819653B	715665
3B0091800	715578
4A0819430A	698682
4A0819439A	698684
4B0091800	698682
4B0819439A	698682
4B0819439C	698683
4B0819439C	701023
4D0819439	698790
4D0819439A	698791
4D0898438	698790
4D0898438A	698790
4E0819439A	698792
4F0819439	715500
4F0819439A	715501
4F0898438A	715501
4F0898438B	715501
4F0898438C	715501
4H0819439	715733
5Q0818653	701020
5Q0818653	715720
5Q0819653	701020
5Q0819653	715720
6Q0819653	698739
6Q0819653	701009
6Q0819653B	698739
6Q0819653B	701009
6Q0820367	698685
6Q0820367B	698685
6R0819653	701029
6R0819653	715727
6R0820367	715737
7H0819631	715581
7H0819631A	698768
8A0819439	698164
8A0819439A	698164
8A0819439B	715578
8D0091800	715578
8E0819439	698606

	<b>Valeo</b>
<b>AUDI</b>	
8E0819439C	698683
8E0819439C	701023
8K0819439	715579
8K0819439A	715580
8L0091800	698686

<b>BENTLEY</b>	
3D0819619A	698793
3D0819619B	698793
3D0898644	698793
3D2819619A	698793
3D2819620A	698793

<b>BMW</b>	
64106907746	715582
64110008138	698246
64111393489	698171
64116915763	698861
64116915764	698862
64116921018	698856
64116921019	698857
64116945593	715583
64116945594	715584
64118363274	698469
64118390377	698838
64118390447	698470
64118391198	698246
64118391198	715685
64119069895	698171
64119070073	698246
64119163328	715715
64119163329	715690
64119216588	698246
64119237554	715815
64119237555	701019
64119237555	715719
64119272641	715715
64119272642	715690
64119283497	701019
64119283497	715719
64119321875	715811
64119321876	715812
64311000004	698489
64311390836	698170
64316142114	715502
64316915763	698861
64316915764	698862
64316935822	698863
64316935823	698864

	<b>Valeo</b>
<b>BMW</b>	
64316945585	715583
64316945586	715584
64316946628	715503
64316946629	715502
64316962548	715502
64316962549	715503
64318361899	698489
64318409043	698775
64318409044	698776
64319069926	698470
64319069926	698838
64319069927	698246
64319069927	715685
64319070072	698470
64319071933	698469
64319071934	698489
64319071935	698750
64319142114	715502
64319142115	715503
64319159606	715712
64319171858	698864
64319174370	698863
64319174372	698863
64319195193	698861
64319195193	698861
64319216589	698246
64319216590	698750
64319216591	698489
64319218706	698776
64319224084	698775
64319224085	698776
64319237157	715713
64319237158	715714

<b>CADILLAC</b>	
88957450	715671
93172129	698710
93172129	698711
93172129	701010
93172299	698711

<b>CHEVROLET</b>	
13271191	715659
22753219	715731
52420930	715659
93740495	715536
95215156	715710
95947238	715707
96190645	698860

	<b>Valeo</b>
<b>CHEVROLET</b>	
96296618	715587
96299978	715587
96327366	715587
96331028	715536
96337653	715587
96425700	715588
96435888	715535
96440878	715654
96449577	715535
96539649	715535
96554378	715526
96554421	715526
96629614	715654
96800069	715654
96800837	715526
96830504	715535
96832648	715536
EC93740495	715536

<b>CHRYSLER</b>	
51854923	715755
71736776	715686
82205905	698865
2108301218	698697
4596501AB	715648
50580040AA	715534
5058040AA	715534
5058693AA	715735
5072176AA	715611
5101438AA	698169
5101438AA	698697
5101439AA	698169
5101439AA	698697
68042866AA	715711
B66809901	698697

<b>CITROËN</b>	
647904	715570
95667986	698146
1609428080	715556
1609428180	715557
9678792080	715817
9682603680	715635
6441-EJ	698884
6441-G9	715589
6447-FF	698680
6447-FG	698731
6447-H0	715530
6447-H1	715530

	<b>Valeo</b>
<b>CITROËN</b>	
6447-HP	698657
6447-HT	698540
6447-HV	698541
6447-J0	698858
6447-KR	698657
6447-LN	715612
6447-LV	698146
6447-LZ	698738
6447-NT	698664
6447-NV	698714
6447-NV	701014
6447-SQ	701013
6447-SR	715629
6447-SY	715677
6447-SZ	698858
6447-SZ	715629
6447-TC	698884
6447-TC	701002
6447-TV	715515
6447-TY	698858
6447-VX	701007
6447-VX	715556
6447-VX	715557
6447-VY	715556
6447-VY	715557
6447-XF	715554
6447-XG	715555
6447-YC	715636
6447-YK	715613
6447-YK	715614
6447-YN	715613
6447-YN	715614
6447-Z4	698146
6447-ZY	715623
6447-ZY	715631
6479-41	698714
6479-41	701014
6479-42	701013
6479-43	698884
6479-43	701002
6479-45	715635
6479-60	715552
6479-62	715616
6479-75	698714
6479-75	701014
6479-84	715552
6479-90	701007
6479-90	715557
6479-92	715554



	<b>Valeo</b>
<b>CITROËN</b>	
6479-A0	698858
6479-A1	698657
6479-A2	715629
6479-A5	715515
6479-C2	698664
6479-C9	715636
6479-E0	715616
6479-E5	698738
6479-E9	715631

<b>DAZIA</b>	
7701062227	698753
7711228912	715538
8201153808	701030
8201370532	701030
272772835R	698753
272773016R	715746
272775340R	715803
272775374R	698753

<b>DAEWOO</b>	
93740495	715536
96190645	698860
96207422	698859
96259613	698860
96327366	715587
96331028	715536
96337653	715587
96425700	715588
96435888	715535
96449577	715535
96539649	715535
96554378	715526
96554421	715526
96800837	715526
96830504	715535
96832648	715536
960207422	698859
6923005400	715566
EC96190645	698860
EC96207422	698859
EC96331028	715536

<b>DAIHATSU</b>	
08975-K2000-100	715695
87139-0D010	701021
87139-0D010	715620
87139-YZZ08	701021
87139-YZZ08	715620

	<b>Valeo</b>
<b>DODGE</b>	
04596501AB	715648
05103600AA	698840
5058381AA	715537
5058693AA	715735
68033193AA	715696

<b>FIAT</b>	
647962	715616
5908409	698198
7078711	698691
7079682	698690
7082301	715615
7797229	698199
46409630	698174
46412715	698689
46442422	698197
46513960	698454
46721374	698198
46721923	698174
46722862	698535
46723245	698839
46723321	698866
46723331	698867
46723435	698692
46723435	715686
46768502	698687
46770829	698535
46770829	698839
46770834	698535
46794399	698454
46844822	698710
46844822	701010
51854923	715755
55702456	715552
55702456	715553
60811242	698199
60812197	698174
60815647	698687
71712595	698174
71712596	698174
71736776	715686
71743821	698886
71754151	715552
77362394	698867
77364063	715636
77364561	715616
77365763	715723
77365764	701003
77365764	715553

	<b>Valeo</b>
<b>FIAT</b>	
77366065	698867
77366480	715809
82398550	698199
82472557	698199
1312764080	698858
1312766080	698858
1475478080	715530
1475479080	715530
1484383080	698738
1497497080	715613
1497497080	715614
1497498080	715613
1497498080	715614
9655190480	701013
6447H0	715530
6447H1	715530
6447SY	698858
6447YC	715636
6447YK	715613
6447YN	715614
K05058693AA	715537
K05058693AA	715735

<b>FORD</b>	
1004051	698201
1054468	698247
1062253	698487
1089176	715617
1097670	698168
1113627	698696
1119613	698779
1119616	698745
1120475	715617
1121106	698695
1121106	701005
1139654	698695
1139654	701005
1148366	698696
1204459	698694
1204464	698693
1204464	701004
1225788	715674
1253220	698883
1253223	698168
1315686	698882
1315687	698883
1315687	701027
1349791	698745
1353267	698762

	<b>Valeo</b>
<b>FORD</b>	
1353269	698693
1353269	701004
1353270	715617
1353271	698201
1354952	715510
1354953	701011
1354953	715511
1382861	698695
1452344	698883
1452344	701027
1459009	698762
1488903	715674
1491665	698168
1491752	698696
1494697	698883
1494697	701027
1541456	715660
1557375	698866
1566997	715661
1594615	715660
1673744	715723
1709013	715757
1713180	698883
1713180	701027
1718237	715745
1745604	715742
1745605	715747
1748479	715747
1748480	715742
1776360	715757
3401703	698168
4042703	698762
4134237	698893
4416570	698893
5028225	698707
5028226	698707
5029916	698707
6797072	698168
7180932	698168
7420372	698247
382400304	698688
1S7H16N619AC	698779
256H19G244AA	698693
3M5J19G244AA	698883
8V5118D543AA	715660
94BW19N619AB	698168
96FW16N619AB	698201
96FW19G2AA	715617
AV6N19G244AA	715757

	<b>Valeo</b>
<b>FORD</b>	
XS4H16N619AB	698487
XS4H19G244AA	698695
YC1H19N619AB	698762
YL8419N619AA	698893
YM2119N551AB	698696

<b>HONDA</b>	
08R79-S2H-600	715594
08R79-S50-600	715594
08R79ST3600	698196
79370-S1A-505	715573
79370-S1A-G01	715573
79831-S04-003	698196
79831-ST3-E01	698196
79831ST3EC1	698196
80290SDCA01	715573
80290-ST3-E01	698869
80291-S2H-505	715594
80291-S2H-E01	715594
80291S5A003	698735
80291-S84-A01	715593
80291-SAA-505HE	698886
80291-SAA-E01	698886
80291-ST3-505	698869
80291-ST3-515	698869
80291-ST3-E01	698869
80291-TF0-E01	715692
80292-S5A-003	698735
80292-S5D-A01	698735
80292-S6D-G01	698735
80292-SCA-E11	698735
80292-SDA-A01	698868
80292-SDC-505HE	698868
80292-SDC-A01	698868
80292SE4003	698868
80292-SFY-003	715678
80292-SHJ-A41	698868
80292-SMG-E01	715540
80292-SWW-G01	698868
80292-TF0-G01	715692
80292TV1E01	698868

<b>HYUNDAI</b>	
08790-2E200	715512
97030-H1726	715527
97133-07010	715524
97133-1E000	715592
97133-1E100	715592
97133-1J000	715662

	<b>Valeo</b>
<b>HYUNDAI</b>	
97133-1P000	715741
97133-2B005	715716
97133-2B010	715541
97133-2D000	715517
97133-2D200	715591
97133-2D205	715591
97133-2E-200	715521
97133-2E250	715740
97133-2E260	715740
97133-2E-900	715639
97133-2E910	715639
97133-2H000	715592
97133-2H001	715592
97133-2H001	715816
97133-2L000	715638
97133-3J100	715697
97133-3K000	715541
97133-3SAA0	715804
97133-4L000	715807
97133-4P000	715748
97406-4A900	715738
97610-37000	715516
97617-1C000	715525
97617-25000	715516
97617-4H000	715669
97617-4H900	715738
97619-38000	698888
97619-38100	698888
97619-3D000	715529
97619-3D100	715529
97619-3D200	715529
9999Z07010	698888
9999Z07015	715517
9999Z07016	715527
9999Z07017	715525
9999Z07018	715591
9999Z07024	715591
9999Z07025	715541

<b>INFINITI</b>	
272747J125	715561
27277CL025H	715631
278939F900	698707
999M1VP001	715631
999M1VP051	715631
B72000W010	715561
B72003Y000	698873
B727A79925	715631
B727C79925	715561

	<b>Valeo</b>
<b>ISUZU</b>	
8-97170-804-0	715569
8-97356-127-0	715718
8-98008-442-0	715718

<b>IVECO</b>	
3802821	715595
93162491	698687
500314688	698197

<b>JAGUAR</b>	
1S7H16N619	698779
1S7H19G244	698745
1X4H16N619	698779
1X4H19G244	698745
2W9319G244AA	715504
6W83020B02AB	715640
6W8318D483AA	715640
C2C6884	715504
C2P2410	715640
C2S8619	698745
C2S8619	698779
C2S8622	698745
C2S8622	698779
C2Z6525	715681
XR830254	715505
XR849205	715505

<b>JEEP</b>	
77366480	715809
82204691	715670
82208300	715670
5013595AA	715670
5013595AB	715670
5058381AA	715537
5058693AA	715735
68033193AA	715696
68079487AA	715717

<b>KIA</b>	
976193E000	698888
OK2FA-6152X	715522
OK2FA6152XA	715522
OK9A46152X	715523
OK9A4-6152XA	715523
OK9A46452XA	715521
971143B100	698889
97133-07000	715524
97133-07010	715524
97133-0X900	715524
97133-1H000	715638

	<b>Valeo</b>
<b>KIA</b>	
97133-1P000	715741
97133-2B010	715541
97133-2E-200	715521
97133-2E250	715740
97133-2E260	715740
97133-2E-900	715639
97133-2E910	715639
97133-2F000	698895
97133-2H001	715592
97133-2H001	715816
97133-2K000	715691
97133-2L000	715638
97133-3K000	715541
97133-3SAA0	715804
97619-38100	698888
97619-3C100	698888
97619FD200	715523
P87901F200	715521

<b>LADA</b>	
8201153808	701030
8201370532	701030

<b>LAMBORGHINI</b>	
4F0819439	715500
4F0819439A	715501

<b>LANCIA</b>	
7797229	698199
46409630	698174
46442422	698197
46721047	698688
46721374	698198
46721923	698174
46722335	698688
46723024	698751
46723331	698867
46723435	698692
46723435	715686
51854923	715755
60653641	698197
60653641	698687
60811242	698199
60812197	698174
60815647	698687
71712595	698174
71712596	698174
71736776	715686
77362394	698867
82398550	698199

	<b>Valeo</b>
<b>LANCIA</b>	
1475478080	715530
1475479080	715530
1484383080	698738
9655190480	701013
K05058693AA	715537
K05058693AA	715735
K68071668AA	715749

<b>LAND ROVER</b>	
6G9N180543BA	715597
6G9N-19N619-BA	715702
BTR8037	715598
JKR100200	698799
JKR100280	698817
JKR500010	715518
JKR500020	715519
JM0000010	698776
LR000899	715597
LR000901	715702
LR019192	715597
LR019589	715702

<b>LEXUS</b>	
8713949010	698796
8850530100	715542
871394701083	698796
87139-30010	715542
87139-30040	701021
87139-30040	715620
87139-33010	715619
87139-48020	715542
87139-50010	715542
87139-50030	715641
87139-50060	715730
87139-YZZ01	715641
87139-YZZ02	715542
87139-YZZ03	715619
87139-YZZ04	715542
87139-YZZ08	701021
87139-YZZ08	715620
88508-48020	715542

<b>MASERATI</b>	
382400304	698688
573228900	698688

<b>MAYBACH</b>	
2108300018	698169
2108300018	715531
2108301018	715531

	<b>Valeo</b>
<b>MAYBACH</b>	
2108301118	698772

<b>MAZDA</b>	
1353270	715617
410077732	715617
1E00-61-J6X	698201
BBP2-61-J6X	715726
BC5D-61-J6X	715664
BP4K-61-J6X	698892
C10261J6X	698890
CB12-61-J6X	698890
CB1261J6X9B	698890
CB1261J6XA9A	698890
CC29-61-J6X	698892
CC64-61-J6X	698892
D651-61-J6X	715642
DC21-61-J6X	715576
DD10-61-P11	698693
DD10-61-P11	698870
EC136114Y	698893
EC1361J6QA	698893
EC13-61-J6XA	698893
GE6T-61-J6X	698891
GE6T61J6XA9B	698891
GE7B-61-J6X	715599
GE7B-61-J6XA	715599
GJ6A-61-P11A	698870
GJ6A61P11A9B	698870
GJ6B-61-P11	715679
GS1D-61-P11	698870
KD45-61-J6X	715813
LDY3-61-J6X	715728
LDY4-61-J6X	715574
UCYO-61-P11	715745

<b>MERCEDES</b>	
18353047	715577
1248300118	715684
1248350047	715684
1408350047	698704
1408350147	698703
1408350247	698705
1408350247	698797
1408350447	698705
1408350547	698706
1638350047	698777
1638350047	698778
1638350247	698777
1648300218	715544

	<b>Valeo</b>
<b>MERCEDES</b>	
1668300018	715751
1668300218	715751
1688300018	698475
1688300818	698744
1698300118	715506
1698300218	715507
2028300018	698169
2028300318	698169
2038300118	698700
2038300218	698701
2038300318	698742
2038300418	698742
2038300518	698742
2038300918	698743
2038302118	698742
2048300018	715600
2048300518	715600
2108300018	698169
2108300018	715531
2108300218	698169
2108300218	698772
2108300618	698169
2108300718	698169
2108300818	698697
2108300918	698697
2108301018	715531
2108301118	698772
2108301218	698697
2118300018	698741
2118300218	698702
2118300318	698741
2118300818	698740
2128300018	715600
2128300218	715600
2208300118	698772
2208300218	698772
2218300018	715643
2218300318	715643
2308300418	715621
2468300018	715814
2468300118	715814
4638300018	698685
4638300018	698739
4638300018	701009
6388350047	715577
6398350247	698871
6398350347	698872
9018300018	698840
9018300418	716023

	<b>Valeo</b>
<b>MERCEDES</b>	
9018300518	698840
9068300218	715601
9068300318	715602
B66809901	698697
B66809903	698778

<b>MG</b>	
JKR000030	698879
JKR000040	698880
JKR100020	698196
JKR100180	698879
JKR100193	698880
JKR100220	698819
JXK100010	698819

<b>MINI</b>	
64119321875	715811
64119321876	715812
64311496710	698724
64311496711	698725
64319127515	715585
64319127516	715586

<b>MITSUBISHI</b>	
7803A004	715631
7803A005	715623
7803A027	715622
7803A028	715509
7803A043	715623
7803A109	715631
MR227823	715543
MR262425	715688
MR315172	715545
MR315876	715528
MR360889	715547
MR398288	715546
MR500058	715509
MR958016	715603
MR958016P	715603
MR958017	698802
MZ3600031	715547
MZ3600034	715545
MZ360034	715509
MZ600138	715547
MZ600163	715543
XR315172	715545
XR315172D	715545
XR315586	715528
XR315876	715528
XR315876D	715528

	<b>Valeo</b>
<b>MITSUBISHI</b>	
XR360889	715547
XR398288	715546
XR398288D	715546
XR500058D	715509
XZ311917	715545

<b>NISSAN</b>	
7711228912	715538
27274-7J125	715561
27274-EA000	715520
27275-1N626	715575
27275-1N6P6	715575
27277-1HE0E	701024
27277-1HE0E	715706
27277-1HE0E	715756
27277-1KA0A	715721
27277-1KA4A	715721
27277-3Y525	698873
27277-4M425	715651
27277CL025H	715631
27277-EN000	715559
27277-EN025	715559
27277-JN20A	715703
27298-00QAA	715513
27891-1FC0A	715709
27891-2F000	698707
27891-4A00C	715694
27891-AX010	698753
27891-BM400	698734
27891-BM401	698734
27891-BM401	701031
27891-BM401	715819
27891BM401KE	698734
27891-BM402	698734
27891-BM402	701031
27891-BM410	698734
27891-BM410	701031
27891-EL00A	715708
27893-2F900	698707
27893-6F600	715549
27893-9F500	698707
27893-9F500-KE	698707
278939F900	698707
999M1D4005	715520
999M1VP001	715631
999M1VP051	715631
B72000W010	715561
B72003Y000	698873
B72005M000	715631

	<b>Valeo</b>
<b>NISSAN</b>	
B72005M000	715651
B7277-JN20A	715703
B727A-79925	715631
B727AZ5003	715631
B727C79925	715561
B7298-00QAA	698255

<b>OPEL</b>	
1718022	698746
1718042	698708
1718042	701008
1718044	715632
1718962	698712
1808012	715553
1808020	715752
1808246	715659
1808600	698165
1808602	698165
1808604	698166
1808605	698167
1808606	715645
1808607	698202
1808608	715675
1808609	698712
1808610	698662
1808610	698874
1808612	698663
1808613	715569
1808614	698746
1808617	698710
1808617	701010
1808618	698746
1808619	698711
1808624	698710
1808624	701010
4408840	715513
4705463	698773
4708106	698773
4710210	715644
4803883	715654
6806612	698166
6808600	698165
6808601	698711
6808604	698876
6808605	698877
6808606	698874
6808607	698875
6808611	698663
6808613	698167

	<b>Valeo</b>
<b>OPEL</b>	
6808622	715552
6808623	701003
6808623	715553
13271407	698877
52420930	715659
93182437	698166
96629614	715654
96800069	715654

<b>PEUGEOT</b>	
002435	698749
647962	715616
647989	698713
85601415	698713
1609428080	715556
1609428180	715557
9671653780	715673
9678792080	715817
9682603680	715635
9804163380	715808
9804163480	715805
6441-91	715589
6441-EJ	698884
6441-G9	715589
6447-93	698235
6447-AZ	698488
6447-GW	698713
6447HP	698657
6447J0	698858
6447-K6	698815
6447-KK	698664
6447-KL	698714
6447-KL	701014
6447-KR	698657
6447-LY	698738
6447-P2	715530
6447-P3	715530
6447-PE	698749
6447-PF	715677
6447-PG	698748
6447-RG	698884
6447-RG	701002
6447-S5	698203
6447-SY	698858
6447-SZ	715629
6447-TA	701013
6447-TF	698488
6447-TT	715515
6447-TY	698858

	<b>Valeo</b>
<b>PEUGEOT</b>	
6447-VX	701007
6447-VX	715556
6447-VX	715557
6447-VY	715556
6447-VY	715557
6447-XF	715554
6447-XG	715555
6447-YA	715636
6447YC	715636
6447-YJ	715613
6447-YJ	715614
6447YK	715613
6447-YL	715613
6447-YL	715614
6447YN	715614
6447Z4	698146
6447-Z5	698146
6447-ZX	715623
6447-ZX	715631
6479-04	715570
6479-32	698714
6479-32	701014
6479-41	698714
6479-41	701014
6479-42	701013
6479-43	698884
6479-43	701002
6479-46	715635
6479-60	715552
6479-61	715552
6479-63	715616
6479-75	698714
6479-75	701014
6479-84	715552
6479-90	701007
6479-90	715557
6479-92	715554
6479-93	715555
6479-A0	698858
6479-A1	698657
6479-A2	715629
6479-A5	715515
6479-C2	698664
6479-C9	715636
6479-E0	715616
6479-E5	698738
6479-E9	715631
6479-K9	715673

	<b>Valeo</b>
<b>PORSCHE</b>	
95557221910	698768
95857221900	715704
97057362300	715693
99157237100	715754
99157362300	715753
99657121901	698203
99657121901	698748
99657121902	698748
99657121903	698748
99657221901	698203
99657221902	698203
99757121900	698748

<b>RENAULT</b>	
52419600	715607
52485325	698594
6025370624	698290
6025372486	715568
7700424093	698276
7700424098	698255
7700428820	698279
7700834816	698173
7700835266	698173
7700845219	698176
7700845222	698177
7700845811	698149
7700846236	698175
7701040543	698149
7701042499	698255
7701042499	715633
7701044813	698255
7701047513	698512
7701048748	698594
7701048749	698715
7701048749	701015
7701050319	715513
7701055109	698730
7701055110	698736
7701056389	715562
7701056390	698737
7701059997	698753
7701062227	698753
7701064235	715539
7701064237	715610
7701205278	698149
7701205279	698176
7701205280	698175
7701205281	698177
7701209837	715649

	<b>Valeo</b>
<b>RENAULT</b>	
7701409324	698878
7711228912	701018
7711228912	715538
7711426872	701030
7711426872	715818
8201153808	701030
8201370532	701030
64319195193	698861
272770001R	715607
272770840R	715667
272771128R	701012
272771128R	715672
272772100R	715721
272772835R	698753
272772951R	715607
272773016R	715746
272774653R	715734
272774658R	715724
272774812R	701032
272774812R	715820
272775081R	715802
272775374R	698753
272778970R	701006
272778970R	715647
27891JY10A	715667
27891JY15A	715724
B729800QAA	698255

<b>ROLLS-ROYCE</b>	
64116921019	698857

<b>ROVER</b>	
JKR000030	698879
JKR000040	698880
JKR100020	698196
JKR100080	698869
JKR100180	698879
JKR100183	698879
JKR100193	698880
JKR100220	698819
JKX100010	698819

<b>SAAB</b>	
4541546	698723
4632493	715514
5047113	715514
5335948	698723
5335955	698723
9179904	698710
9179904	698711

	<b>Valeo</b>
<b>SAAB</b>	
9179904	701010
9179905	698710
9179905	698711
9625674	698199
12758727	698723
13271191	715659
52420930	715659
90535131	698711
93172129	698710
93172129	698711
93172129	701010
93172299	698711

<b>SATURN</b>	
615974	715654
96629614	715654
96800069	715654

<b>SEAT</b>	
1491752	698696
191091700	715653
191819638	715653
1H0091800	698686
1H0819644	698159
1H0819644A	698159
1H0819644A	698679
1H0819644B	698159
1H0819644B	698885
1J0819644	698716
1J0819644	701016
1J0819644A	698716
1J0819644A	701016
1K0819644	698800
1K0819644	715800
1K0819644A	698800
1K0819644B	698800
1K1819653	698801
1K1819653	701001
1K1819653	715801
1K1819653A	698801
1K1819653A	701001
1K1819653B	698801
1K1819653B	701001
1K2819653	715665
1K2819653A	715665
1K2819653B	715665
1S0820367	715744
4B0819439C	698683
4B0819439C	701023

	<b>Valeo</b>
<b>SEAT</b>	
5Q0819644	715806
5Q0819653	701020
5Q0819653	715720
6Q0819653	698739
6Q0819653	701009
6Q0819653B	698739
6Q0819653B	701009
6Q0820367	698685
6Q0820367B	698685
6R0819653	701029
6R0819653	715727
6R0820367	715737
7H0819638A	698247
7M0091800	698696
7M0819644	698247
7M3819644	698696
7M3819644A	698696
8E0819439	698606
8L0091800	698686

<b>SKODA</b>	
1H0091800	698686
1H0819644	698159
1H0819644A	698159
1H0819644A	698679
1H0819644B	698159
1H0819644B	698885
1J0819644	698716
1J0819644	701016
1J0819644A	698716
1J0819644A	701016
1K0819644	698800
1K0819644	715800
1K0819644A	698800
1K0819644B	698800
1K1819653	698801
1K1819653	701001
1K1819653	715801
1K1819653A	698801
1K1819653A	701001
1K1819653B	698801
1K1819653B	701001
1K2819653	715665
1K2819653A	715665
1K2819653B	715665
1S0820367	715744
5Q0819653	701020
5Q0819653	715720
6Q0819653	698739

	<b>Valeo</b>
<b>SKODA</b>	
6Q0819653	701009
6Q0819653B	698739
6Q0819653B	701009
6Q0820367	698685
6Q0820367B	698685
6R0819653	701029
6R0819653	715727
6R0820367	715737
8L0091800	698686

<b>SMART</b>	
4518300018	715608
4548300018	698802
0001110V003	698774
0001110V004	698774
0013871V001	698802
0013871V00100000	698802

<b>SSANGYONG</b>	
6811021000	715700
6923005400	715566
6923005410	715567
68111-091A0	715624

<b>SUBARU</b>	
72880AE080	715563
72880AE090	715563
72880AG000	698796
72880AG000	715619
72880AJ000	701021
72880AJ000	715620
72880FE000	715551
72880FE001	715551
72880FG000	715625
72880SA000	715651
72880-SA0009P	715651
72880XA000	698796
72880XA000A	698796
72880XA000A	715619
72880XA00A	698796
95860-78F10	698773
G3010SA100	715651
G3210AE000	715563

<b>SUZUKI</b>	
9207486	698773
96337653	715587
586154G000	698681
95860-51K00	715644
9586051K00000	715644

	<b>Valeo</b>
<b>SUZUKI</b>	
95860-62J00	698886
9586062J000	698886
95860-63J10	698886
9586063J10000	698886
95860-78F10	698773
95860-80J00	715652
95860-81A10	715668
95861-54G00	715698
95861-54G00-000	715698
95861-54J00	715564
95861-57L00	715743
95861-64J00	715609
95861-65D00	698894
9586165D000	698894
95861-M68K10	715694
99000990NOF10	698894
99000990NOF30	698894
99000990NOF40	698894

<b>TOYOTA</b>	
8713947083	698796
8713949010	698796
8713952010	698681
8850812030	715565
8856802020	698796
8888020130	715572
871394701083	698796
885685201083	698681
87139-0D010	701021
87139-0D010	715620
87139-28010	698796
87139-30040	701021
87139-30040	715620
87139-32010	698796
87139-32010	715550
87139-33010	715619
87139-47010	698796
87139-48020	715542
87139-52020	701021
87139-52020	715620
87139-YZZ03	715619
87139YZZ04	715542
87139YZZ07	698795
87139-YZZ08	701021
87139-YZZ08	715620
88508-0H010	715515
88508-12010	715565
88508-12020	715565
88508-20120	698796

	<b>Valeo</b>
<b>TOYOTA</b>	
88568-02030	698795
88568-52010	698681
88880-20020	715572
88880-20060	715572
88880-20080	715572
88880-20090	698796
88880-20110	715572

<b>VAUXHALL</b>	
1718044	715632
1808604	698166
1808624	698710
6808600	698165
6808601	698711
9118699	698708
9118699	701008
9121624	698746
9121625	715632
9121653	698712
9192320	698746
9196805	698773
9200067	698165
9201440	698711
13175553	698874
13175554	698875
13271191	715659
13356914	715752
52470574	698712
55702456	715552
55702456	715553
55702468	701003
55702468	715553
90360171	698165
90386776	698166
90486282	698165
90509367	698166
90510338	698167
90512706	715645
90512779	698202
90520689	698662
90541317	715675
90559549	698663
91132364	698708
91132364	701008
91160128	715513
93172129	698710
93172129	698711
93172129	701010
93172299	698711

	<b>Valeo</b>
<b>VAUXHALL</b>	
93174800	698876
93174801	698877
93182435	698165
93182436	698663
93188572	698773
93194847	715644
95517359	701012
95517359	715672
96440878	715654
97170804	715569
7701050319	715513

<b>VOLKSWAGEN</b>	
1491752	698696
191091700	715653
191819638	715653
357819638	698163
703819989	698794
9068300218	715601
9068300318	715602
1H0091800	698686
1H0819644	698159
1H0819644A	698159
1H0819644A	698679
1H0819644B	698159
1H0819644B	698885
1J0819644	698716
1J0819644	701016
1J0819644A	698716
1J0819644A	701016
1K0819644	698800
1K0819644	715800
1K0819644A	698800
1K0819644B	698800
1K1819653	698801
1K1819653	701001
1K1819653	715801
1K1819653A	698801
1K1819653A	701001
1K1819653B	698801
1K1819653B	701001
1K2819653	715665
1K2819653A	715665
1K2819653B	715665
1S0820367	715744
2D0819638	698840
2D0819638A	698840
2E0819638	715601
2E0819638A	715602



	<b>Valeo</b>
<b>VOLKSWAGEN</b>	
3A0819638	698163
3A0819644	698163
3B0091800	715578
3D0898644	698793
5Q0818653	701020
5Q0818653	715720
5Q0819653	701020
5Q0819653	715720
6Q0819653	698739
6Q0819653	701009
6Q0819653B	698739
6Q0819653B	701009
6Q0820367	698685
6Q0820367B	698685
6R0819653	701029
6R0819653	715727
6R0820367	715737
7D0819989	698794
7H0819631	715581
7H0819631	716043
7H0819631A	698768
7M0091800	698696
7M0819638A	698247
7M0819644	698247
7M3819644	698696
7M3819644A	698696
7P0819631	715704
8A0819439A	698164
8D0091800	715578
8L0091800	698686

<b>VOLVO</b>	
8687389	715627
9171296	698770
9171756	715512
9171757	715571
9204626	698771
30612666	698769
30630754	715512
30676413	715512
30676484	715628
30733892	715597
30733893	715702
30733894	715597
30767022	715597
30767024	715702
30780377	715628
30818694	715688
30883952	715676



	<b>Valeo</b>
<b>VOLVO</b>	
31369455	715757
31404958	715757



	<b>Valeo</b>
---	--------------



	
<b>BEHR HELLA</b>	
8FL352105001	698290
8FL352107001	698712
8FL352108001	698146
8FL352110001	698691
8FL352112001	698279
8FL352113001	698173
8FL352116001	698770
8FL352121001	698663
8FL352122001	698171
8FL352123001	698235
8FL352124001	698159
8FL352125001	698169
8FL352128001	698255
8FL352129001	698164
8FL352130001	698197
8FL352130001	698687
8FL352131001	698689
8FL352132001	698149
8FL352134001	698662
8FL352135001	698167
8FL352137001	698199
8FL352138001	698198
8FL352139001	698606
8FL352140001	698170
8FL352141001	698203
8FL352143001	698166
8FL352145001	698201
8FL352147001	698487
8FL352150001	698174
8FL352152001	698202
8FL352153001	698165
8FL352155001	698858
8FL352157001	698168
8FL352157001	698779
8FL352158001	698247
8FL352159001	698731
8FL352159181	698290
8FL352159191	698840
8FL352159221	698663
8FL352159241	698684
8FL352159251	698177
8FL352159271	698878
8FL352159281	715685
8FL352159321	698739
8FL352159321	701009
8FL352159491	698771
8FL352200001	698772
8FL352203001	698716
8FL352203001	701016



	
<b>BEHR HELLA</b>	
8FL352204001	698679
8FL352205001	698697
8FL352207001	698197
8FL352209001	698164
8FL352209001	698682
8FL352215121	698684
8FL352215171	698290
8FL352215211	698708
8FL352215211	701008
8FL352215231	715685
8FL352215251	698742
8FL352215261	698740
8FL352215271	698739
8FL352215271	701009



<b>BOSCH</b>	
1987431001	698169
1987431002	698171
1987431003	698197
1987431005	698199
1987431006	698201
1987431007	698203
1987431008	698815
1987431009	698149
1987431009	698276
1987431010	698165
1987431012	698159
1987431013	698163
1987431014	698174
1987431015	698166
1987431016	698167
1987431017	698164
1987431018	698168
1987431019	698198
1987431021	698146
1987431022	698235
1987431027	698173
1987431028	698247
1987431030	698202
1987431032	698170
1987431034	698177
1987431035	698169
1987431036	698489
1987431037	698475
1987431038	698663
1987431038	698708
1987431039	698255
1987431040	698662
1987431042	698858



	
<b>BOSCH</b>	
1987431043	698840
1987431045	698487
1987431048	698488
1987431049	698290
1987431052	698712
1987431053	698869
1987431054	698680
1987431055	698196
1987431057	698685
1987431058	698707
1987431059	698454
1987431060	715530
1987431061	698279
1987431062	698770
1987431063	698769
1987431064	698771
1987431066	698773
1987431070	698700
1987431071	698606
1987431072	698535
1987431073	698779
1987431075	698734
1987431076	698711
1987431082	698724
1987431084	698681
1987431085	698796
1987431090	698276
1987431092	698870
1987431095	698878
1987431096	715514
1987431102	698863
1987431103	698856
1987431106	698866
1987431111	698876
1987431113	715510
1987431300	698716
1987431301	698697
1987431303	698687
1987431307	698748
1987431312	698686
1987431324	698606
1987431328	698696
1987431333	698684
1987431335	698697
1987431336	698750
1987431337	698744
1987431345	698695
1987431346	698778
1987431357	698739



	
<b>BOSCH</b>	
1987431360	698688
1987431361	698246
1987431362	698470
1987431364	698777
1987431365	698867
1987431366	698746
1987431370	698743
1987431371	698683
1987431373	698745
1987431376	698710
1987431377	698692
1987431378	698774
1987431379	698714
1987431380	698715
1987431382	698725
1987431386	698747
1987431387	698693
1987431398	698541
1987431399	698713
1987431402	698864
1987431409	698883
1987431410	715507
1987431411	698877
1987431412	698884
1987431413	715511
1987431554	715591
1987432001	698169
1987432006	715617
1987432009	698149
1987432012	698159
1987432027	698173
1987432037	698475
1987432043	698840
1987432044	715577
1987432049	698290
1987432051	715684
1987432058	698707
1987432061	698276
1987432061	715685
1987432066	698773
1987432069	698512
1987432070	698700
1987432081	698702
1987432089	698177
1987432090	698279
1987432093	698730
1987432094	698736
1987432095	698878
1987432097	698800

	
<b>BOSCH</b>	
1987432113	715627
1987432118	715575
1987432119	715549
1987432120	698753
1987432134	715543
1987432154	715589
1987432156	715668
1987432157	715688
1987432158	715517
1987432159	715572
1987432162	715664
1987432170	715521
1987432176	715523
1987432301	698697
1987432306	715617
1987432318	715674
1987432324	698682
1987432328	698696
1987432330	715675
1987432337	698744
1987432354	715612
1987432364	698777
1987432364	698778
1987432367	698791
1987432370	698743
1987432371	698683
1987432380	698715
1987432397	698801
1987432400	698737
1987432410	715507
1987432413	715628
1987432422	715501
1987432423	698792
1987432431	698768
0986AF4008	715522
0986AF4009	715521
0986AF4010	698895
0986AF4011	715624
0986AF4163	715592
0986AF5431	698800
0986AF5432	698801
0986AF5433	715501
A100	698168
A102	698247
A200	698199
A250	698202
A302	698164
A303	698165
A304	698201

	
<b>BOSCH</b>	
A310	698197
A400	698174
A422	698149
A500	698166
A501	698159
A503	698146
A505	698198
A507	698173
A520	698688
A600	698167
A601	698169
<b>CORTECO</b>	
21650107	698168
21651182	698165
21651183	698167
21651184	698166
21651185	698202
21651195	715531
21651196	698169
21651197	698170
21651198	698171
21651199	715684
21651292	698744
21651293	698488
21651294	698778
21651295	698774
21651296	698839
21651298	698173
21651881	698470
21651882	698246
21651887	698704
21651890	698164
21651891	698235
21651892	715655
21651893	698201
21651894	698198
21651895	698247
21651896	698199
21651897	715685
21651898	698163
21651899	698146
21651901	698197
21651911	698770
21651912	698885
21651915	698174
21651916	698173
21651917	698149
21651919	698815

 CORTECO	
21651920	698203
21651953	698687
21651954	698688
21651955	698686
21651956	715578
21651957	698682
21651958	698684
21651960	698696
21651961	698697
21651963	698746
21651964	715632
21651966	715675
21651967	698716
21651968	698163
21651969	698489
21651970	698689
21651972	698196
21651974	698706
21651975	698169
21651976	698840
21651979	698874
21651980	698663
21651981	715645
21651982	698712
21651983	698255
21651984	698279
21651986	698770
21651987	698794
21651991	698878
21651994	698858
21651995	698487
21652045	715577
21652308	698454
21652317	698771
21652335	698701
21652336	698750
21652338	698860
21652340	698859
21652341	698859
21652342	715530
21652345	698869
21652346	698734
21652347	698707
21652348	698276
21652349	698512
21652350	698773
21652351	698769
21652352	698747
21652353	698746

 CORTECO	
21652354	698695
21652355	715617
21652356	698685
21652357	698739
21652358	698700
21652359	715573
21652360	698762
21652361	698745
21652538	698692
21652539	698796
21652540	698714
21652541	698748
21652542	698715
21652543	698680
21652544	698867
21652546	698735
21652548	698664
21652550	698594
21652551	698681
21652552	698791
21652687	698290
21652688	698475
21652689	698606
21652694	698751
21652709	698779
21652713	698683
21652714	698711
21652715	698710
21652812	715621
21652848	698856
21652849	698861
21652850	698724
21652851	698857
21652852	698862
21652853	698725
21652854	698865
21652856	698738
21652857	698694
21652858	698693
21652859	715505
21652860	698891
21652861	698743
21652863	698702
21652865	698741
21652868	715528
21652870	715549
21652871	715562
21652872	698737
21652873	715565

 CORTECO	
21652874	698795
21652897	715572
21652898	698792
21652899	698691
21652900	698690
21652916	698776
21652959	715674
21652989	698886
21652990	715594
21652991	715504
21652993	698893
21652994	698876
21652995	698877
21652996	715512
21653002	698797
21653003	716011
21653006	716012
21653008	698801
21653009	698872
21653010	698703
21653011	698705
21653013	698802
21653014	698774
21653015	698768
21653017	698879
21653020	715581
21653022	716006
21653023	698790
21653024	698800
21653025	698871
21653026	698866
21653027	715686
21653028	698657
21653029	698777
21653030	698838
21653031	698793
21653032	698731
21653034	698882
21653035	698883
21653063	698863
21653064	698864
21653066	715501
21653067	715500
21653068	698749
21653069	715676
21653070	715568
21653071	698730
21653102	698884
21653114	715514

	<b>Valeo</b>
<b>CORTECO</b>	
21653115	698723
21653140	698177
21653141	698540
21653142	698541
21653143	715507
21653144	715506
21653145	698870
21653146	715629
21653148	698713
21653149	698713
21653151	698865
26152355	698201
49356177	698723
49356178	715589
49356179	715825
49356180	715825
49359582	715816
49365685	715752
80000021	698875
80000022	698469
80000029	698196
80000060	698817
80000061	715510
80000062	715511
80000063	715502
80000064	715503
80000065	698775
80000066	715598
80000067	698873
80000068	715509
80000069	715571
80000070	698880
80000072	715513
80000074	698753
80000077	715677
80000079	715670
80000080	698736
80000082	715534
80000083	715517
80000084	715525
80000113	698708
80000114	715538
80000155	715535
80000156	715593
80000157	715516
80000158	698888
80000159	715527
80000160	715569
80000162	715542

	<b>Valeo</b>
<b>CORTECO</b>	
80000163	715574
80000164	715551
80000165	715641
80000208	715728
80000330	698868
80000331	715603
80000338	698774
80000343	698792
80000345	715532
80000346	715533
80000356	716057
80000360	715518
80000361	715519
80000373	698176
80000375	698747
80000376	715655
80000403	698890
80000404	715678
80000405	698892
80000407	715648
80000408	715648
80000409	698723
80000415	715670
80000419	715650
80000431	715573
80000436	698279
80000438	715701
80000440	715517
80000536	698175
80000537	698887
80000538	715643
80000541	715552
80000546	715529
80000548	715522
80000594	698163
80000602	715665
80000603	698886
80000604	715620
80000605	701021
80000606	715640
80000614	715601
80000615	715555
80000616	715602
80000620	715540
80000621	698710
80000622	715540
80000628	715653
80000633	716045
80000634	715524

	<b>Valeo</b>
<b>CORTECO</b>	
80000634	698859
80000636	715653
80000637	715615
80000643	715545
80000644	715523
80000647	715544
80000648	715546
80000649	715520
80000652	715521
80000654	715523
80000655	698895
80000656	715618
80000657	715564
80000660	715556
80000662	715515
80000666	715556
80000667	715557
80000670	715539
80000676	715609
80000712	715597
80000713	715702
80000740	715585
80000741	715586
80000745	715619
80000746	715819
80000754	715723
80000760	698688
80000761	715645
80000764	715541
80000767	715541
80000771	715729
80000777	715553
80000783	715526
80000785	715564
80000788	698175
80000802	715509
80000804	715526
80000805	698751
80000807	715570
80000808	715504
80000809	715505
80000810	698873
80000813	715816
80000815	715636
80000817	698159
80000824	715547
80000825	715688
80000839	715554
80000844	715600

	<b>Valeo</b>
<b>CORTECO</b>	
80000847	715583
80000848	715584
80000852	715591
80000853	715631
80000854	715623
80000865	715614
80000869	715588
80000874	715559
80000875	715732
80000877	715654
80000878	715654
80000879	715579
80000880	715580
80000911	715639
80000915	715595
80001023	698894
80001024	715561
80001027	715616
80001029	715712
80001030	715607
80001031	715607
80001033	715536
80001034	715738
80001035	715608
80001039	698870
80001040	715679
80001041	715575
80001127	716029
80001128	715660
80001129	715661
80001130	715669
80001178	715681
80001179	715681
80001182	716062
80001183	715692
80001186	715659
80001187	715724
80001188	715667
80001210	715715
80001211	715690
80001214	715740
80001411	715651
80001439	715624
80001441	698895
80001443	715708
80001446	715668
80001450	715672
80001454	715741
80001456	715649

	<b>Valeo</b>
<b>CORTECO</b>	
80001458	715635
80001459	715635
80001460	715647
80001490	715544
80001491	715643
80001527	715600
80001579	716056
80001581	716054
80001582	716055
80001585	716000
80001586	716009
80001625	716033
80001626	716060
80001722	715707
80001723	715710
80001732	716052
80001738	715587
80001742	715704
<b>CTR</b>	
1215101	698199
1215102	698174
1215103	698198
1215104	698688
1215105	698197
1215106	698688
1215107	698454
1215108	698692
1215109	698858
1215111	698235
1215112	698203
1215114	698747
1215114	701017
1215120	698751
1215121	698738
1215122	698866
1215150	698173
1215152	698149
1215153	698279
1215154	698290
1215155	698512
1215156	698715
1215156	701015
1215202	698800
1215203	698159
1215206	698163
1215207	698716
1215207	701016
1215299	698488

	<b>Valeo</b>
<b>CTR</b>	
1215300	698664
1215301	698146
1215303	698731
1215304	698680
1215305	698657
1215401	698171
1215403	715685
1215404	698489
1215405	698857
1215415	698724
1215501	698196
1215502	698880
1215512	698840
1215513	698475
1215514	698700
1215520	698707
1215521	698734
1215602	698166
1215603	698167
1215604	698202
1215605	698662
1215606	698663
1215608	698711
1215609	698876
1215751	698769
1215801	698164
1215804	698682
1215805	698683
1215805	701023
1215806	698739
1215806	701009
1215901	698168
1215902	698201
1215903	698247
1215903	698696
1215904	698487
1215906	698694
1215907	698883
1215908	698762
<b>DELPHI</b>	
TSP0325001	698199
TSP0325002	698174
TSP0325003	698164
TSP0325004	698159
TSP0325004	698885
TSP0325004C	698686
TSP0325005	698171
TSP0325006	698170

	<b>Valeo</b>
<b>DELPHI</b>	
TSP0325007	698146
TSP0325009	698197
TSP0325009C	698687
TSP0325010	698198
TSP0325011	698168
TSP0325011	698779
TSP0325011C	698745
TSP0325012	698201
TSP0325012	715617
TSP0325014	698688
TSP0325015	698165
TSP0325016	698166
TSP0325017	698167
TSP0325017	698746
TSP0325018	698235
TSP0325019	698203
TSP0325019C	698748
TSP0325020	698173
TSP0325021	698149
TSP0325021	698176
TSP0325024	698163
TSP0325026	698202
TSP0325027	698159
TSP0325027C	698716
TSP0325028	698662
TSP0325029	698247
TSP0325029C	698696
TSP0325031	698279
TSP0325032	698819
TSP0325033	698196
TSP0325034	698255
TSP0325035	698177
TSP0325036	698290
TSP0325037	698276
TSP0325038C	698246
TSP0325039	698682
TSP0325040	698684
TSP0325042	698858
TSP0325043	698691
TSP0325044	698454
TSP0325047	698772
TSP0325048	698487
TSP0325048C	698695
TSP0325050	698753
TSP0325050	715549
TSP0325051	698663
TSP0325052	698860
TSP0325053	698859
TSP0325054	698865

	<b>Valeo</b>
<b>DELPHI</b>	
TSP0325055	715514
TSP0325056	698723
TSP0325058	698770
TSP0325059	698869
TSP0325060	715530
TSP0325061	698475
TSP0325061C	698744
TSP0325062	698488
TSP0325065	698790
TSP0325065	698791
TSP0325072	698707
TSP0325072C	698707
TSP0325077	698840
TSP0325079	698535
TSP0325080	698774
TSP0325081	698815
TSP0325082	698681
TSP0325083	698700
TSP0325083C	698743
TSP0325084	698512
TSP0325085	698680
TSP0325085C	715612
TSP0325086	698879
TSP0325088	715512
TSP0325098	698712
TSP0325101	698777
TSP0325102	698773
TSP0325105	698878
TSP0325106	698769
TSP0325107	698169
TSP0325107C	698697
TSP0325108	698734
TSP0325110C	698747
TSP0325111	698685
TSP0325111	698739
TSP0325111	701009
TSP0325111C	698739
TSP0325112	698606
TSP0325112C	698683
TSP0325113	698657
TSP0325113	715629
TSP0325114	698731
TSP0325115	698535
TSP0325116	698692
TSP0325119	698890
TSP0325119	698891
TSP0325122	698711
TSP0325122	698877
TSP0325123	698664

	<b>Valeo</b>
<b>DELPHI</b>	
TSP0325123C	698714
TSP0325124	698594
TSP0325128	698796
TSP0325129	698771
TSP0325133	698865
TSP0325139	698693
TSP0325139	698694
TSP0325139	701004
TSP0325139C	698693
TSP0325140	698762
TSP0325141	698735
TSP0325148	698795
TSP0325149	715619
TSP0325151	698794
TSP0325152	698867
TSP0325153	698868
TSP0325154	698689
TSP0325155	698489
TSP0325158	715577
TSP0325159	698724
TSP0325161	698775
TSP0325162	698738
TSP0325163	698866
TSP0325164	698882
TSP0325164	715510
TSP0325166	698751
TSP0325167	698799
TSP0325167	698817
TSP0325171	698876
TSP0325172	698737
TSP0325172	715562
TSP0325174	698800
TSP0325174C	698801
TSP0325175	715619
TSP0325176	698870
TSP0325176C	715679
TSP0325178	698753
TSP0325178C	698753
TSP0325179	715529
TSP0325180	715627
TSP0325180C	715628
TSP0325181	715575
TSP0325182	715524
TSP0325183	698884
TSP0325184	715502
TSP0325185	698802
TSP0325186	715506
TSP0325186C	715506
TSP0325187	715505

	<b>Valeo</b>
<b>DELPHI</b>	
TSP0325188	715500
TSP0325189	698874
TSP0325190	715534
TSP0325191	698871
TSP0325193	715513
TSP0325194	698730
TSP0325195	698736
TSP0325195C	698736
TSP0325196	698777
TSP0325196	698778
TSP0325200	715643
TSP0325201	715551
TSP0325208	698702
TSP0325211	715517
TSP0325222	715521
TSP0325224	715639
TSP0325227	715559
TSP0325227C	715559
TSP0325228	715631
TSP0325231	715609
TSP0325232	715619
TSP0325232	715620
TSP0325305C	715659

<b>DENSO</b>	
BFC101	698169
BFC104	698165
BFC105	698164
BFC107	698168
BFC108	698167
BFC109	698688
BFC110	698201
BFC111	698166
BFC112	698198
BFC113	698247
BFC114	698199
BFC118	698202
BFC119	698146
BFC121	698197
BFC122	698159
BFC124	698174
BFC125	698173
BFC126	698149
BFC142	698255

<b>ECO</b>	
328	698745
405	698697
406	698744

	<b>Valeo</b>
<b>ECO</b>	
419	698708
420	698684
440	698748
446	698723
451	715619
456	698470
457	698857
458	698750
459	698246
473	698746
479	698693
480	698688
487	698791
488	698747
490	698714
491	698541
494	715612
496	698865
502	698687
508	698715
510	698749
511	698716
512	715512
520	698682
521	698683
524	698695
531	715617
532	698696
542	698739
550	698743
553	698741
555	698776
567	715628
568	698883
572	715507
573	698692
582	715509
585	698864
586	698802
588	698884
590	698872
591	698890
600	715501
602	715503
603	715619
609	698877
610	698880
611	698801
614	698862

	<b>Valeo</b>
<b>ECO</b>	
615	715508
642	715619
1300	698199
1314	698171
1317	698163
1318	698165
1319	698166
1328	698168
1328	698779
1400	698172
1401	698198
1405	698169
1406	698475
1414	698235
1415	698888
1419	698663
1421	698146
1422	698196
1423	715516
1424	715517
1426	698795
1428	698290
1429	698177
1430	698279
1434	698707
1436	698202
1438	698173
1440	698203
1451	698796
1456	698838
1457	698856
1458	698489
1465	698815
1467	698840
1473	698167
1474	698878
1479	698694
1482	715525
1483	715530
1484	698794
1487	698790
1490	698664
1491	698540
1492	698657
1494	698680
1498	698690
1499	698691
1500	698454
1501	698535



	<b>Valeo</b>
<b>ECO</b>	
1501	698867
1502	698197
1504	698276
1506	698512
1508	698594
1510	698488
1512	698771
1521	698606
1522	698738
1524	698487
1529	698149
1531	698201
1532	698247
1540	698858
1542	698685
1543	698894
1544	698731
1547	715522
1550	698700
1552	715524
1553	698702
1555	698775
1558	698770
1564	715527
1566	698892
1567	715627
1568	698882
1568	715510
1572	715506
1579	715521
1585	698863
1590	698871
1591	698891
1592	698866
1593	715526
1598	698895
1599	698868
1600	715500
1609	698876
1610	698879
1611	698800
1614	698861
1625	698174
1632	698769
1642	698681
1644	715624
1652	698734
1652	698869
1323/1	698170

	<b>Valeo</b>
<b>ECO</b>	
1402/1	698164
1411/1	698159
1411/1	698679
1411/1	698885
1418/1	698662
1418/1	698874
1472/1	698711
1486/1	715514
1509/1	698255
1514/1	698469
411/1	698686
418/1	698709
418/1	698875
472/1	698710
<b>FIAAM</b>	
PC8002	698165
PC8003	698146
PC8004	698164
PC8005	698159
PC8006	698168
PC8007	698166
PC8008	698199
PC8010	698167
PC8011	698197
PC8012	698201
PC8012	715617
PC8013	698174
PC8014	698198
PC8015	698171
PC8016	698169
PC8017	698196
PC8018	698235
PC8019	698815
PC8020	698203
PC8022	698173
PC8022	698594
PC8023	698149
PC8024	698247
PC8025	698688
PC8028	698202
PC8030	698276
PC8031	698170
PC8032	698606
PC8035	698475
PC8038	698177
PC8038	698279
PC8041	698290
PC8043	698487

	<b>Valeo</b>
<b>FIAAM</b>	
PC8044	698454
PC8046	698663
PC8046	698708
PC8046	701008
PC8047	698662
PC8049	698731
PC8050	698770
PC8051	698858
PC8052	698712
PC8053	698489
PC8056	715530
PC8058	698840
PC8059	698255
PC8060	698488
PC8077	698685
PC8079	698773
PC8080	698869
PC8081	698707
PC8083	698734
PC8084	698715
PC8084	701015
PC8085	698771
PC8088	698664
PC8091	698680
PC8093	698839
PC8094	698163
PC8096	715619
PC8097	698711
PC8098	698762
PC8102	698149
PC8110	698540
PC8112	698878
PC8129	698879
PC8139	715627
PC8143-2	698735
PC8144	698796
PC8161	715510
PCK8036	698688
PCK8043	698695
PCK8043	701005
PCK8045	698686
PCK8045	698716
PCK8045	701016
PCK8053	698750
PCK8054	698246
PCK8054	715685
PCK8062	698682
PCK8065	698697
PCK8066	698696

	<b>Valeo</b>
<b>FIAAM</b>	
PCK8067	715675
PCK8068	698687
PCK8072	698686
PCK8073	698746
PCK8078	698470
PCK8090	698747
PCK8090	701017
PCK8092	698739
PCK8092	701009
PCK8095	698774
PCK8099	698745
PCK8100	698692
PCK8104	698746
PCK8109	698714
PCK8109	701014
PCK8122	715617
PCK8204-2	715555
PCK8240	715571

<b>FILTRON</b>	
K1000	698165
K1001	715645
K1002	698166
K1004	698164
K1006	698885
K1006A	698686
K1007	698146
K1008	698168
K1009	698202
K1009A	715675
K1010	698201
K1011	698860
K1014	698662
K1015	698171
K1016	698169
K1016A	698697
K1018	698235
K1019	698815
K1020	698203
K1022	698173
K1023	698149
K1024	698247
K1024A	698696
K1030	698276
K1031	698170
K1032A	698682
K1033	698174
K1034	698198
K1035	698197

	<b>Valeo</b>
<b>FILTRON</b>	
K1037	698794
K1039	698704
K1040-2x	698290
K1047A	698716
K1051	698279
K1052	698255
K1054	698487
K1055	698663
K1056	698858
K1058	698878
K1059	715653
K1060	698734
K1062-2x	715530
K1065	698475
K1065A	698744
K1066	698488
K1067	698177
K1068	698163
K1069A-2x	698791
K1072-2x	698469
K1075A-2x	698246
K1076A	698454
K1078	698606
K1078A	698683
K1079	698685
K1081	698711
K1083	698796
K1088	698840
K1089	698594
K1089A	698715
K1093	698664
K1095	698176
K1096	698707
K1097	698512
K1101	698867
K1102	698680
K1103A	698692
K1105A-2x	698747
K1106	698700
K1106A	698743
K1107	698731
K1108	715577
K1109-2x	715575
K1110	698694
K1111	698800
K1111A	698801
K1113	698762
K1115A	715676
K1118A	698792

	<b>Valeo</b>
<b>FILTRON</b>	
K1119	698724
K1121	715513
K1122	698866
K1123	698795
K1125	698540
K1127	698657
K1128	698738
K1130	698730
K1131	715562
K1131A	698737
K1134-2x	715572
K1136	698489
K1138	698876
K1140	698888
K1146	698702
K1146A	698741
K1148	698779
K1149	715517
K1151	698175
K1152	698753
K1154	698882
K1155	715581
K1155A	698768
K1162A-2x	715501
K1167	698736
K1174	715549
K1178	715535
K1181	715551
K1182-2x	715525
K1188	698871
K1201A-2x	715643
K1202A	715507
K1203-2x	715522
K1208-2x	715523
K1210	715550
K1220A-2x	698772
K1221A-2x	698740
K1222A-2x	698742
K1248	715649

<b>FRAM (SOGEFI)</b>	
CF10025	698866
CF10059	715510
CF10062	698868
CF10067	698736
CF10080	715515
CF10087	698817
CF10200	715532
CF10204-2	715556

	<b>Valeo</b>
<b>FRAM (SOGEFI)</b>	
CF10210	715521
CF10218-2	698892
CF10282	715552
CF10285	715550
CF10322	715550
CF10329	715517
CF10381	715541
CF10411	715540
CF10431	715631
CF5475	698165
CF5551	698146
CF5662	698164
CF5663	698159
CF5664	698168
CF5664	698779
CF5665	698166
CF5816	698167
CF5816	698746
CF5817	698201
CF5817	715617
CF5818	698198
CF5819	698197
CF5823	698174
CF5824	698684
CF5841	698199
CF5842	698169
CF5845	698815
CF5846	698203
CF5848	698173
CF5848	698594
CF5849	698149
CF5850	698247
CF5863	698202
CF5864	698235
CF5893	698276
CF5935	698170
CF5972	715531
CF8103	698171
CF8714	698770
CF8717	698777
CF8750	698731
CF8777	698475
CF8777	698744
CF8778	698723
CF8799	698177
CF8799	698279
CF8831	698487
CF8832	698290
CF8838	698255

	<b>Valeo</b>
<b>FRAM (SOGEFI)</b>	
CF8867	698663
CF8867	698708
CF8868	698662
CF8868	698874
CF8890	698858
CF8912	698246
CF8913	698489
CF8913	698750
CF8914	698712
CF8948	715530
CF8989	698691
CF9051	698840
CF9071	698488
CF9077	698454
CF9293	698512
CF9294	698657
CF9323	698685
CF9335	698773
CF9336	698769
CF9337	698707
CF9338	698196
CF9338	698819
CF9338	698869
CF9363	698734
CF9364	698594
CF9364	698715
CF9383	715577
CF9394	698859
CF9395	698860
CF9395	715526
CF9396	698771
CF9398	698664
CF9399	715573
CF9406	698680
CF9408	698839
CF9408	698867
CF9414	698163
CF9442	698730
CF9466	698681
CF9466	715619
CF9485	698762
CF9495	698710
CF9495	698711
CF9546	698176
CF9562	698540
CF9562	698541
CF9579	698794
CF9586	698738
CF9594	698724



	<b>Valeo</b>
<b>FRAM (SOGEFI)</b>	
CF9594	698725
CF9594	715585
CF9595	698878
CF9640	698879
CF9645	698606
CF9659	715565
CF9666	698694
CF9686	698795
CF9691	698753
CF9714	715645
CF9724	715514
CF9740	715572
CF9742	715633
CF9756	698888
CF9761	698799
CF9787	698882
CF9787	715627
CF9819-2	698735
CF9832-2	715536
CF9846	698796
CF9881	698768
CF9881	715581
CF9904	698876
CF9905	698700
CF9922	698800
CF9934	715513
CFA10055	715506
CFA10055	715507
CFA10103-2	698864
CFA10199	715533
CFA10205-2	715557
CFA10206	715503
CFA10209-2	715501
CFA10366	715613
CFA10366	715614
CFA10419-2	715554
CFA10436	715601
CFA10458	715580
CFA10474-2	715607
CFA10527	715511
CFA10584	698883
CFA6404	698747
CFA6405	698739
CFA8046	698745
CFA8788	698688
CFA8831	698695
CFA8869	698716
CFA8874	698746
CFA8876	698682



	<b>Valeo</b>
<b>FRAM (SOGEFI)</b>	
CFA8877	698697
CFA8878	698696
CFA8882	715578
CFA8893	698686
CFA8894	698687
CFA8912	698246
CFA8913	698750
CFA9322	698470
CFA9364	698715
CFA9404	698739
CFA9405	698747
CFA9408	698839
CFA9445	698774
CFA9495	698710
CFA9533	698692
CFA9534	698745
CFA9548	698683
CFA9562	698541
CFA9587	698714
CFA9623	715617
CFA9665	698870
CFA9666	698693
CFA9785	698741
CFA9788-2	698740
CFA9825-2	698742
CFA9827	698737
CFA9920	698884
CFA9921	698801
CFA9930	698751
CFA9931	698512



<b>FREUDENBERG</b>	
MC505	698697
MC511	715578
MC514	698875
MC515	698746
MC517	715617
MC5222	698697
MC5222	698772
MC525	698696
MC526	698697
MC530	698246
MC530	715685
MC5302	698246
MC5302	715685
MC533	715538
MC537	698744
MC538	698750
MC539	698197

	<b>Valeo</b>
<b>FREUDENBERG</b>	
MC539	698687
MC540	698687
MC541	698695
MC541	701005
MC544	698686
MC547	698708
MC547	701008
MC548	698684
MC549	698682
MC555	698748
MC557	698749
MC559	698743
MC560	698739
MC560	701009
MC561	698680
MC564	698715
MC564	701015
MC568-2	715568
MC571	698714
MC571	701014
MC574	698701
MC578	698535
MC578	698839
MC590	698774
MC591	698688
MC592	698716
MC592	701016
MC593-2	698470
MC593-2	698838
MC594	698778
MC595-2	698747
MC595-2	701017
MC596	698692
MC597	698745
MC597	698779
MC598	698751
MC599	698725
MC600-2	698791
MC606	698606
MC606	698683
MC606	701023
MC607	698710
MC607	701010
MC608-2	715621
MC609	698741
MC6112	698857
MC612	698862
MC613	698801
MC613	701001

	<b>Valeo</b>
<b>FREUDENBERG</b>	
MC614	698693
MC614	701004
MC615	698737
MC616	698738
MC618	715504
MC619	715505
MC622	698865
MC623	715611
MC624-2	698890
MC630	698725
MC639	698877
MC640	698884
MC640	701002
MC641	698768
MC642	698883
MC6442	698793
MC645	715511
MC645	715628
MC646	715512
MC648	698872
MC649	698776
MC659	698713
MC661	715507
MC6662	698864
MC667	715539
MC669	715571
MC670	698802
MC673	715629
MC676	715519
MC681	715628
MC685	715501
MC688	698541
MC689	698723
MC694	698710
MC694	701010
MC695	715503
MC700	715533
MC701-2	715555
MC721	698873
MC738-2	715544
MC739-2	715643
MC747	715509
MC748	715648
MP002	698170
MP003	698171
MP004	698704
MP005	698169
MP009	698165
MP011	698164

	
<b>FREUDENBERG</b>	
MP012	698235
MP013	698858
MP014	698662
MP014	698874
MP015	698167
MP016	698688
MP017	698201
MP017	715617
MP018	698166
MP019	698704
MP019	698706
MP020	698840
MP021	698198
MP022-2	698169
MP022-2	715531
MP023	715577
MP024	698794
MP025	698247
MP025	698794
MP026	698169
MP027	698199
MP028	715534
MP029	698196
MP030-2	698246
MP030-2	715685
MP031	698163
MP032	698202
MP033	698255
MP034	698146
MP036	715645
MP037	698475
MP038	698489
MP039	698197
MP040	698689
MP041	698487
MP042	698860
MP044	698159
MP044	698679
MP044	698885
MP045	698860
MP046	698859
MP047	698663
MP047	698708
MP047	701008
MP049	698164
MP050	698174
MP051	698173
MP052	698149
MP054	698815

	
<b>FREUDENBERG</b>	
MP055	698203
MP056	698770
MP057	698488
MP058	698712
MP059	698700
MP060	698685
MP061	698680
MP062	698878
MP063	698734
MP064	698594
MP065	698177
MP065	698276
MP065	698279
MP066	698735
MP0662	698735
MP068	698290
MP0682	698290
MP069	698770
MP071	698664
MP072	698723
MP074	698701
MP076	698168
MP077	698773
MP078	698535
MP078	698839
MP078	698867
MP079	698196
MP079	715573
MP080	698196
MP081	698454
MP082	698707
MP083-2	715593
MP084	698276
MP084	698279
MP085	715688
MP086	698771
MP0873	715530
MP088	698512
MP089	698512
MP091	698688
MP094	698777
MP097	698779
MP100-2	698790
MP101	698762
MP104	698681
MP105	698796
MP105	715563
MP106	698606
MP106	698683

	
<b>FREUDENBERG</b>	
MP106	701023
MP107	698711
MP109	698702
MP110	698704
MP1112	698856
MP112	698861
MP113	698800
MP114	698694
MP115	698737
MP115	715562
MP116	698738
MP117	698795
MP121	715542
MP124-2	698891
MP125	698753
MP125	715549
MP1262	715545
MP127	715528
MP128-2	715572
MP129	715565
MP130	698724
MP139	698876
MP140	715570
MP141	715581
MP142	698882
MP145	715510
MP145	715627
MP147	698870
MP148	698871
MP149	698775
MP157	698731
MP158	698886
MP160	715594
MP161	715506
MP162	698893
MP163	698866
MP164	698865
MP1662	698863
MP167	698730
MP170	715603
MP172	698870
MP173	698657
MP176	715518
MP179	698753
MP180	698868
MP181	715627
MP185	715500
MP187	715516
MP191	698691

	<b>Valeo</b>
<b>FREUDENBERG</b>	
MP192	698690
MP193	715532
MP193	715552
MP195	715502
MP196	715521
MP197	698895
MP198	698886
MP200	715532
MP201-2	715554
MP202	715540
MP2032	715525
MP204	698888
MP207	715515
MP210	715591
MP211	715527
MP213	715517
MP215-1	715523
MP218-1	715522
MP218-2	715522
MP219	715523
MP220	715524
MP223	715513
MP224	715651
MP225	715551
MP226-2	715576
MP227-2	698892
MP228-2	698894
MP228-2	715574
MP230	715564
MP232	698196
MP232	698819
MP233	698879
MP234	698799
MP236	715546
MP237-2	698869
MP237-2	715561
MP246	715569
MP263	715595
MP264	715556
MP270	715559
MP271	715579
MP272	715609
MP273	715550
MP277	715541
MP321	698690
MP321	715615
MP677	715602
MP693	715553
MP771	715580

	<b>Valeo</b>
<b>HENGST</b>	
E1901LI	698762
E1903LI	698694
E1906LI	698735
E1907LC	698883
E1907LJ	698882
E1909LC	698864
E1909LJ	698863
E190LI	698762
E1911LC	698174
E1912LC	698778
E1916LC	715512
E1918LC	715507
E1918LJ	715506
E1919LC	715621
E1925LJ	698737
E1990LJ	715510
E2915LC	715619
E2915LJ	715619
E2945LJ	715620
E900LC	698686
E900LC	698716
E900LC	701016
E900LJ	698159
E900LJ	698885
E901LJ	698165
E902LJ	698166
E903LC	698746
E903LJ	698167
E904LJ	698202
E905LJ	698164
E907LJ	698168
E908LC	715617
E908LJ	698201
E908LJ	715617
E909LJ	698712
E910LJ	698662
E911LC	698663
E911LC	698708
E911LC	701008
E912LJ	698840
E913LC	698744
E913LJ	698745
E914LC	698697
E914LJ	698169
E915LC	698684
E916LC	715512
E916LJ	698290
E917LJ	698878
E918LC	715507

	<b>Valeo</b>
<b>HENGST</b>	
E918LJ	715506
E919LC	698696
E919LJ	698247
E920LJ	698770
E921LJ	698163
E934LJ	698197
E936LC	698682
E936LJ	698606
E939LJ	698171
E940LJ	698146
E941LC	698695
E941LC	701005
E941LJ	698487
E943LJ	698197
E951LJ	698203
E952LJ	698173
E953LJ	698858
E955LC	698683
E955LC	701023
E955LJ	698683
E955LJ	701023
E957LJ	698704
E959LJ	698170
E960LC	698246
E960LC	715685
E961LC	698739
E961LC	701009
E961LJ	698685
E962LJ	698255
E964LC	698774
E965LJ	698149
E967LJ	698177
E970LC	698743
E970LJ	698700
E971LJ	698488
E972LC	698710
E972LC	701010
E972LJ	698711
E973LJ	698199
E977LC	698750
E977LJ	698489
E978LJ	715612
E979LJ	698279
E983LC	698740
E989LC	698741
E989LJ	698702
E990LC	698541
E990LJ	698540
E994LC	698725

	<b>Valeo</b>
<b>HENGST</b>	
E994LJ	698724
E997LC	698715
E997LC	701015

<b>KNECHT/MAHLE</b>	
LA09	698235
LA100	698819
LA100	698869
LA102	698489
LA107	698769
LA108	698276
LA108	698279
LA109	698681
LA11	698165
LA117	698711
LA118	698762
LA119	698734
LA120	698685
LA121	715577
LA122	698735
LA123	698858
LA126	698689
LA127	698540
LA129	698700
LA129/1	698701
LA130	698707
LA131	698796
LA134	698512
LA135	698731
LA136	698594
LA137	715645
LA138	698664
LA143	698773
LA144	698867
LA153	698680
LA155	698886
LA156	698702
LA157	698795
LA158	698870
LA167	698738
LA168/S	715594
LA169	698694
LA171	698724
LA175	698730
LA177	698170
LA180	715534
LA181	698800
LA182	715581
LA183	698893

	<b>Valeo</b>
<b>KNECHT/MAHLE</b>	
LA184	698657
LA189	698876
LA19	715653
LA191/S	715556
LA195/S	715525
LA196	715562
LA197	698863
LA197/S	698863
LA21	698166
LA216	698868
LA220	698882
LA221/S	715583
LA227	698736
LA229	698871
LA23	698173
LA230	698753
LA234	698861
LA235/S	698894
LA235/S	715574
LA237	698878
LA239	715500
LA241	698866
LA242	698779
LA243	698879
LA248	715502
LA25	698168
LA26	698815
LA265	715573
LA269	715565
LA27	698712
LA280	715518
LA287	698704
LA288	715598
LA289	715520
LA291	698859
LA298	698895
LA301	715521
LA304	715515
LA306	715532
LA306	715552
LA307	715601
LA31	698159
LA31	698679
LA31	698885
LA32/2	698203
LA32/3	698203
LA33	698149
LA34	698174
LA343	715541

	<b>Valeo</b>
<b>KNECHT/MAHLE</b>	
LA346/S	698892
LA35	698198
LA36	698167
LA360	698817
LA361	715535
LA362	715526
LA366/S	715545
LA37	698169
LA371	698869
LA377	715536
LA381	698799
LA384	715528
LA39	698176
LA394/S	715569
LA396	715559
LA40	698177
LA41	698175
LA42/1	715654
LA44	698163
LA45	698164
LA46	698606
LA47/S	715531
LA49	698202
LA51/S	698790
LA52	698247
LA54	698771
LA56	698197
LA57	698488
LA60	698279
LA65	698794
LA74	698663
LA75	698662
LA75	698874
LA76/S	698290
LA77	698201
LA77	715617
LA78	698487
LA79	698770
LA8	698146
LA8	698657
LA80	698171
LA81	698475
LA83	698840
LA84	698196
LA87	698255
LA9	698235
LA97	698454
LA98	698777
LAG113/S	698891



	<b>Valeo</b>
<b>KNECHT/MAHLE</b>	
LAK102	698750
LAK117	698710
LAK120	698739
LAK122	698864
LAK124	698839
LAK127	698541
LAK129	698743
LAK129/1	698743
LAK136	698715
LAK138	698714
LAK141	698747
LAK142	698692
LAK145	698751
LAK156	698741
LAK169	698693
LAK171	698725
LAK173	698857
LAK176	698792
LAK181	698801
LAK181/1	715665
LAK182	698768
LAK182	716043
LAK189	698877
LAK191/S	715557
LAK196	698737
LAK220	698883
LAK221/S	715584
LAK225/S	698793
LAK229	698872
LAK232	698884
LAK234	698862
LAK239	715501
LAK242	698745
LAK243	698880
LAK247	715648
LAK248	715503
LAK249	715504
LAK25	698745
LAK250	715505
LAK251	698802
LAK252	715507
LAK255	698723
LAK280	715519
LAK292/S	715643
LAK293	715511
LAK294	715641
LAK295/S	715544
LAK297	715533
LAK307	715602



	<b>Valeo</b>
<b>KNECHT/MAHLE</b>	
LAK31	698686
LAK32/1	698748
LAK36	698746
LAK364	715640
LAK37	698697
LAK385	715586
LAK45	715578
LAK46	698682
LAK46	698684
LAK52	698696
LAK54	715512
LAK54/1	715571
LAK56	698687
LAK57	698749
LAK59	698748
LAK62	698776
LAK63	698716
LAK64	698688
LAK70	698713
LAK73/S	698246
LAK74	698708
LAK75	698875
LAK78	698695
LAK81	698744
LAK93	698683
LAK96	698774
LAK98	698778
LAG113/S	698890
LKK116/S	698742
LKK165/S	698740
LKK72/S	698772



<b>MANN+HUMMEL</b>	
CJ 1006-2	698469
CJ 1009	715598
CJ 12 001	715589
CJ 15 001	715709
CJ 1546	715633
CJ 16 001	715590
CJ 1629	715721
CJ 1719	715526
CJ 1738	698794
CJ 1806-2	715576
CJ 1823	715594
CJ 1827	698886
CJ 1828	698681
CJ 1828	715550
CJ 1829	698753
CJ 1830	715603



	<b>Valeo</b>
<b>MANN+HUMMEL</b>	
CJ 19 000-3	715530
CJ 19 002	715738
CJ 19 004	715714
CJ 19 004-2	715714
CJ 1910	715524
CJ 1915	715688
CJ 1919	715620
CJ 1931-2	698290
CJ 1936	715559
CJ 20 006	715755
CJ 20 010	715707
CJ 2012	715588
CJ 2015	715565
CJ 2026	698866
CJ 2033-2	698891
CJ 2035	698795
CJ 2038	715653
CJ 2040	715616
CJ 2043	698870
CJ 21 000-2	715556
CJ 21 001-2	715572
CJ 21 002-2	715563
CJ 21 005-2	715669
CJ 21 008	715807
CJ 21 009	715830
CJ 2106-2	715545
CJ 2129	715668
CJ 2131	698796
CJ 2131	715619
CJ 2132	715736
CJ 2137	698769
CJ 2138	715564
CJ 2138	715609
CJ 2141	715631
CJ 2143	698876
CJ 2145	715551
CJ 2149	698594
CJ 22 001-2	698892
CJ 22 002-2	698894
CJ 22 003	715651
CJ 22 004	715625
CJ 22 007	715708
CJ 22 009-2	715624
CJ 22 010	715718
CJ 22 011	715746
CJ 22 013	715742
CJ 22 022	715809
CJ 2214-2	715639
CJ 2216-2	715569







	
MANN+HUMMEL	
CU 2224-2	698712
CU 2225	698146
CU 2227	715735
CU 2232	715532
CU 2240	698512
CU 2243	715552
CU 2245	698657
CU 2253	698196
CU 2253	698819
CU 23 000-2	715543
CU 23 003	715711
CU 23 005-2	715812
CU 23 009	715705
CU 23 010	715741
CU 23 011	715706
CU 2316	698730
CU 2317	715515
CU 2326	698773
CU 2327	698735
CU 2329	715534
CU 2330	715535
CU 2331	715592
CU 2335	698867
CU 2336	715521
CU 2337	698860
CU 2338	698777
CU 2339	698861
CU 2344	698691
CU 2345	698734
CU 2349	715645
CU 2351	698869
CU 2356	715517
CU 2358	698868
CU 2362	715541
CU 24 001	715743
CU 24 006	715745
CU 24 009	715813
CU 24 012-2	715817
CU 24 013	715816
CU 2418-2	715649
CU 2422	715686
CU 2423	698817
CU 2424	698276
CU 2424	698279
CU 2425	698175
CU 2430	698736
CU 2433	698693
CU 2433	698694
CU 2434	698895



	
MANN+HUMMEL	
CU 2435	698279
CU 2436	715660
CU 2440	715510
CU 2440	715627
CU 2441	715527
CU 2450	715579
CU 2454	715540
CU 25 001	715815
CU 25 002	715751
CU 25 004-2 KIT	715618
CU 25 008-2	715748
CU 25 012	715803
CU 2504	698690
CU 2506-2	715525
CU 2513	715564
CU 2516	715549
CU 2520	698196
CU 2520	698819
CU 2521-2	715523
CU 2525	698173
CU 2525/1	698173
CU 2530	698707
CU 2532	715638
CU 2533-2	715715
CU 2542-2	715529
CU 2544	715636
CU 2545	698685
CU 2559	698882
CU 26 000-2	715522
CU 26 006	715744
CU 26 008-2	715726
CU 26 009	715806
CU 26 010	715737
CU 26 014-2	715808
CU 26 017	715804
CU 2620	715724
CU 2622	715654
CU 2623	715520
CU 2628	715516
CU 2629	715615
CU 2630	698731
CU 2631	715638
CU 2634	715591
CU 2640	698887
CU 2642	698878
CU 2645	698859
CU 2647	698888
CU 2650	698770
CU 2672	698163



	
MANN+HUMMEL	
CU 2672	698679
CU 2680	698680
CU 27 007	715716
CU 27 008	715717
CU 2709	715528
CU 2733	715597
CU 2734	698177
CU 2734	698276
CU 2736-2	715685
CU 2745-2	715531
CU 2746	698893
CU 2747	715518
CU 2757	698663
CU 2757	698708
CU 28 003	715749
CU 2808-2	715561
CU 2835	698171
CU 2839	715573
CU 2841	698172
CU 2842	715581
CU 2842	716043
CU 2855	698771
CU 2861	698235
CU 2882	698159
CU 2882	698885
CU 2897	698169
CU 29 003-2	715554
CU 29 007	715829
CU 2930	698176
CU 2939	698800
CU 2940	698664
CU 2941-2	715583
CU 2945	698255
CU 2949	698790
CU 2951	698197
CU 2951/1	698689
CU 2952	715595
CU 30 004	715754
CU 3020	698454
CU 3023	715500
CU 3023-2	715500
CU 3032	698149
CU 3037	698606
CU 3039-2	715554
CU 3040	715587
CU 3042	698688
CU 3054	698662
CU 3054	698874
CU 3059	698167



 MANN+HUMMEL	
CU 3124-2	698856
CU 3136	698198
CU 3136	698199
CU 3138	698198
CU 3138	698199
CU 3139-2	698863
CU 3172	698702
CU 32 001	716066
CU 3240	715570
CU 3337	698711
CU 3338	698170
CU 3340	698203
CU 3360	698203
CU 3403	716017
CU 3448	698488
CU 3454	715513
CU 3455	698166
CU 3461	698700
CU 3461/1	698701
CU 3478	716016
CU 3518	698540
CU 3540	698871
CU 3553	698201
CU 3554	698201
CU 3554	715617
CU 3562	698684
CU 3567	698487
CU 3569	715601
CU 3642-2	698838
CU 3649	698762
CU 37 001	716052
CU 3759	715577
CU 3780	698475
CU 3822-2	715684
CU 3840	715562
CU 3847	715613
CU 3847	715614
CU 3858	698840
CU 3942	698174
CU 3943	698879
CU 3944	716055
CU 3955	698164
CU 3979	698164
CU 4007	698704
CU 4007/1	698706
CU 4054	715506
CU 4151	698202
CU 4179	698738
CU 42 001	716062

 MANN+HUMMEL	
CU 4251	698165
CU 4260	698815
CU 4416	715514
CU 4436	715585
CU 4442	698858
CU 45 120	716057
CU 4580	716054
CU 4624	698724
CU 4727	715670
CU 4926	716056
CU 50 102	716060
CU 5141	698779
CU 5257	698168
CU 5366	698775
CU 5480	698247
CU 6724	698489
CU 8430	715502
CU210001-2	715572
CU21001	715572
CU2127	715563
CUK 18 002	715832
CUK 18000-2	698740
CUK 1820-2	698747
CUK 1828	715650
CUK 1829	715818
CUK 1830	698802
CUK 19 004	715713
CUK 19004-2	715713
CUK 1919	715730
CUK 1931-2	715568
CUK 1936	715732
CUK 20000-2	698742
CUK 20010	715710
CUK 2026	715723
CUK 2030	715681
CUK 2032	698774
CUK 2033-2	698890
CUK 2043	715679
CUK 21 006	715682
CUK 21000-2	715557
CUK 2131	715619
CUK 2132	715608
CUK 2137	715676
CUK 2141	715623
CUK 2143	698877
CUK 2149	698715
CUK 2184	716053
CUK 22 011	715725
CUK 22 014	715582

 MANN+HUMMEL	
CUK 22 021	715826
CUK 22000-2	698772
CUK 22008-4	715712
CUK 22013	715747
CUK 2225	715677
CUK 2226	715619
CUK 2227	715537
CUK 2230	715509
CUK 2230/1	715622
CUK 2231	715546
CUK 2232	715533
CUK 2241-2	715621
CUK 2243	715553
CUK 2245	715629
CUK 2246	715641
CUK 2252	715560
CUK 23 004-2	715728
CUK 23 005-2	715811
CUK 2316	715539
CUK 2335	698839
CUK 2335 KIT	698839
CUK 2338	698777
CUK 2338	698778
CUK 2339	698862
CUK 2358	715678
CUK 24 003	715752
CUK 2422	698692
CUK 2430	715610
CUK 2433	698693
CUK 2433	698694
CUK 2440	715511
CUK 2440	715628
CUK 2442	715659
CUK 2450	715580
CUK 25 001	715719
CUK 25 006	715753
CUK 25 012	715802
CUK 25007	715757
CUK 2533-2	715690
CUK 2545	698739
CUK 2551	715600
CUK 2559	698883
CUK 26 003	715505
CUK 26 007	715814
CUK 26 009	715720
CUK 26 010	715727
CUK 26 011	715640
CUK 26 013-2	715734
CUK 26 014-2	715805

	
<b>MANN+HUMMEL</b>	
CUK 2622	715731
CUK 2641	715733
CUK 2646-2	715544
CUK 2672	698679
CUK 2680	715612
CUK 27 009	715672
CUK 2722-2	715643
CUK 2723-2	715607
CUK 2736-2	698246
CUK 2742	715635
CUK 2743	715673
CUK 2747	715519
CUK 2757	698708
CUK 28 001	715825
CUK 2842	698768
CUK 2855	715512
CUK 2855/1	715512
CUK 2855-1	715571
CUK 2862	698716
CUK 2882	698686
CUK 2897	698697
CUK 29 003-2	715555
CUK 29 005	715600
CUK 2939	698801
CUK 2939/1	715665
CUK 2940	698714
CUK 2941-2	715584
CUK 2945	715538
CUK 2949	698791
CUK 2950	715504
CUK 2951	698687
CUK 2956	698687
CUK 3023	715501
CUK 3023-2	715501
CUK 3037	698683
CUK 3039-2	715555
CUK 3042	698688
CUK 3054	698875
CUK 3059	698746
CUK 3124-2	698857
CUK 3137	715648
CUK 3139-2	698864
CUK 3142	698865
CUK 3142/1	715611
CUK 3172	698741
CUK 3192	698682
CUK 32 001	716065
CUK 3220	698723
CUK 3240	698884

	
<b>MANN+HUMMEL</b>	
CUK 3241	698751
CUK 3337	698710
CUK 3340	698748
CUK 3360	698748
CUK 3448	698749
CUK 3461	698743
CUK 35000-2	698793
CUK 3518	698541
CUK 3540	698872
CUK 3554	715617
CUK 3567	698695
CUK 3569	715602
CUK 3642-2	698470
CUK 3780	698744
CUK 3823	716012
CUK 3840	698737
CUK 3847	715614
CUK 3858	716023
CUK 3943	698880
CUK 3955	715578
CUK 4007	698703
CUK 4007-1	698705
CUK 4054	715507
CUK 4136	698792
CUK 4151	715675
CUK 4245	716013
CUK 4251	715632
CUK 4436	715586
CUK 4624	698725
CUK 5141	698745
CUK 5257	715674
CUK 5258	698713
CUK 5366	698776
CUK 5480	698696
CUK 6724	698750
CUK 8430	715503
FP 1829	701030
FP 1919	701021
FP 1936	701028
FP 21 000-2	701007
FP 22 011	701026
FP 2243	701003
FP 2433	701004
FP 2440	701011
FP 25 001	701019
FP 2559	701027
FP 26 009	701020
FP 27 009	701012
FP 2757	701008

	
<b>MANN+HUMMEL</b>	
FP 2862	701016
FP 2939	701001
FP 2940	701014
FP 3037	701023
FP 3337	701010
FP 3567	701005
<b>MECAFILTER</b>	
EKR7000	715632
EKR7002	698746
EKR7003	715675
EKR7004	698686
EKR7004	698716
EKR7005	715578
EKR7007	715617
EKR7017	715677
EKR7027	698203
EKR7027	698748
EKR7038	698682
EKR7040	698875
EKR7047	715538
EKR7049	698708
EKR7055	698695
EKR7068	698749
EKR7073	698744
EKR7074	698777
EKR7074	698778
EKR7075	715612
EKR7076	698739
EKR7078	698535
EKR7078	698839
EKR7081	698703
EKR7092	698683
EKR7095	698715
EKR7096	698745
EKR7097	698714
EKR7098	698750
EKR7104	698541
EKR7105	715629
EKR7106	698710
EKR7106	698711
EKR7107	698696
EKR7108	698776
EKR7117	715558
EKR7118	715512
EKR7123	698737
EKR7124	715539
EKR7127	698801
EKR7128	715511

 <b>Valeo</b>	
<b>MECAFILTER</b>	
EKR7128	715628
EKR7129	698768
EKR7130	698693
EKR7131	698877
EKR7132	698872
EKR7135	698865
EKR7136	698713
EKR7137	715506
EKR7137	715507
EKR7142	698725
EKR7145	698883
EKR7146	698741
EKR7148	715509
EKR7149	698792
EKR7151	715503
EKR7156	698723
EKR7159	715650
EKR7162	698884
EKR7162	715570
EKR7163	698862
EKR7165	698751
EKR7166	715533
EKR7172	715508
EKR7174	715519
EKR7193	698802
EKR7193	715603
EKR7197	715674
EKR7218	715613
EKR7218	715614
EKR7220	715580
EKR7269	715635
ELR7000	698165
ELR7001	698166
ELR7002	698167
ELR7003	698202
ELR7004	698159
ELR7004	698160
ELR7004	698679
ELR7005	698164
ELR7006	698168
ELR7007	698201
ELR7009	698247
ELR7010	698199
ELR7011	698174
ELR7013	698684
ELR7014	698171
ELR7016	698170
ELR7017	698146
ELR7018	698858



 <b>Valeo</b>	
<b>MECAFILTER</b>	
ELR7019	698197
ELR7019	698687
ELR7020	698198
ELR7022	698688
ELR7023	698697
ELR7026	698235
ELR7028	698815
ELR7029	698173
ELR7030	698149
ELR7036	698163
ELR7040	698662
ELR7040	698874
ELR7044	698794
ELR7045	698177
ELR7047	698255
ELR7048	698279
ELR7049	698663
ELR7050	698276
ELR7051	698196
ELR7051	698819
ELR7051	698869
ELR7052	698860
ELR7055	698487
ELR7056	698878
ELR7058	698770
ELR7060	698691
ELR7061	698454
ELR7068	698488
ELR7071	698176
ELR7072	698175
ELR7073	698475
ELR7075	698680
ELR7076	698685
ELR7077	698840
ELR7079	698689
ELR7081	698704
ELR7084	698700
ELR7085	698701
ELR7089	715577
ELR7092	698606
ELR7093	698773
ELR7094	698762
ELR7095	698594
ELR7096	698779
ELR7097	698664
ELR7098	698489
ELR7099	715645
ELR7100	698707
ELR7101	698512



 <b>Valeo</b>	
<b>MECAFILTER</b>	
ELR7103	715513
ELR7104	698540
ELR7105	698657
ELR7108	698775
ELR7109	698690
ELR7110	698879
ELR7111	715683
ELR7113	698734
ELR7117	698738
ELR7118	698771
ELR7119	698692
ELR7120	698867
ELR7122	698681
ELR7123	715562
ELR7124	698730
ELR7125	698817
ELR7126	698731
ELR7127	698800
ELR7128	715510
ELR7128	715627
ELR7129	715581
ELR7130	698694
ELR7131	698876
ELR7132	698871
ELR7134	698736
ELR7138	715514
ELR7140	715631
ELR7142	698724
ELR7143	698866
ELR7144	698886
ELR7145	698882
ELR7146	698702
ELR7151	715502
ELR7154	715542
ELR7157	698753
ELR7159	698796
ELR7159	715550
ELR7159	715619
ELR7163	698861
ELR7164	698795
ELR7166	715532
ELR7168	698870
ELR7173	698868
ELR7176	715565
ELR7180	715517
ELR7181	698888
ELR7185	715636
ELR7187	715552
ELR7187	715553



	<b>Valeo</b>
<b>MECAFILTER</b>	
ELR7191	715549
ELR7194	715547
ELR7195	715540
ELR7196	698769
ELR7198	715526
ELR7199	715535
ELR7206	715521
ELR7207	715541
ELR7212	715620
ELR7213	715515
ELR7214	715689
ELR7215	715615
ELR7216	715573
ELR7219	715559
ELR7220	715579
ELR7244	715667
ELR7245	715660
ELR7259	698895
ELR7261	715638
ELR7263	715658
ELR7267	715609
ELR7523	715595
JKR7046	715568
JKR7066	698470
JKR7086	698742
JKR7088	698772
JKR7090	698747
JKR7091	698791
JKR7121	698857
JKR7133	698740
JKR7158	715501
JKR7161	698864
JKR7201	715544
JKR7217	715556
JKR7217	715557
JKR7231	715607
JKR7234	715555
JLR7015	698246
JLR7039	698712
JLR7046	698290
JLR7054	715575
JLR7064	715530
JLR7065	698469
JLR7080	715684
JLR7087	698169
JLR7087	715531
JLR7091	698790
JLR7116	698891
JLR7121	698856



	<b>Valeo</b>
<b>MECAFILTER</b>	
JLR7150	715598
JLR7152	698735
JLR7158	715500
JLR7160	715561
JLR7161	698863
JLR7167	715664
JLR7190	715569
JLR7204	715520
JLR7205	698892
JLR7209	715668
JLR7210	715572
JLR7229	715525
JLR7230	715536
JLR7234	715554
JLR7243	715649
<b>MICRONAIR</b>	
MC505	698697
MC511	715578
MC514	698875
MC514	698709
MC515	698746
MC517	715617
MC5222	698697
MC5222	698772
MC525	698696
MC526	698697
MC530	698246
MC5302	698246
MC533	715538
MC537	698744
MC538	698750
MC539	698687
MC539	698197
MC540	698687
MC541	698695
MC544	698686
MC547	698708
MC548	698684
MC549	698682
MC555	698748
MC557	698749
MC559	698743
MC560	698739
MC561	698680
MC564	698715
MC5682	715568
MC571	698714
MC574	698701



	<b>Valeo</b>
<b>MICRONAIR</b>	
MC578	698839
MC578	698535
MC590	698774
MC591	698688
MC592	698716
MC5932	698470
MC5932	698838
MC594	698778
MC5952	698747
MC596	698692
MC597	698745
MC597	698779
MC598	698751
MC599	698725
MC6002	698791
MC606	698683
MC606	698606
MC607	698710
MC6082	715621
MC609	698741
MC6112	698857
MC612	698862
MC613	698801
MC614	698693
MC615	698737
MC616	698738
MC618	715504
MC619	715505
MC622	698865
MC623	715611
MC6242	698890
MC630	698725
MC639	698877
MC640	698884
MC641	698768
MC642	698883
MC643	715590
MC6442	698793
MC645	715511
MC646	715512
MC648	698872
MC649	698776
MC659	698713
MC661	715507
MC662	698864
MC667	715539
MC669	715571
MC670	698802
MC673	715629



 MICRONAIR	
MC675	715508
MC676	715519
MC681	715628
MC685	715501
MC688	698541
MC689	698723
MC694	698710
MC695	715503
MC700	715533
MC7012	715555
MC721	698873
MC7382	715544
MC7392	715643
MC747	715509
MC748	715648
MP002	698170
MP003	698171
MP004	698704
MP005	698169
MP009	698165
MP011	698164
MP012	698235
MP013	698858
MP014	698874
MP014	698662
MP015	698167
MP017	698201
MP017	715617
MP018	698166
MP019	698704
MP019	698706
MP020	698840
MP021	698198
MP0222	715531
MP023	715577
MP024	698794
MP025	698247
MP025	698794
MP026	698169
MP027	698199
MP028	715534
MP029	698196
MP0302	698246
MP031	698163
MP032	698202
MP033	698255
MP034	698146
MP036	715645
MP037	698475

 MICRONAIR	
MP038	698489
MP039	698197
MP040	698689
MP041	698487
MP042	698860
MP044	698159
MP044	698160
MP044	698679
MP044	698885
MP045	698860
MP046	698859
MP047	698663
MP047	698708
MP049	698164
MP050	698174
MP051	698173
MP052	698149
MP053	698172
MP054	698815
MP055	698203
MP056	698770
MP057	698488
MP058	698712
MP059	698700
MP060	698685
MP061	698680
MP062	698878
MP063	698734
MP064	698594
MP065	698279
MP065	698276
MP066	698735
MP0662	698735
MP068	698290
MP0682	698290
MP069	698770
MP071	698664
MP072	698723
MP074	698701
MP076	698168
MP077	698773
MP078	698535
MP078	698839
MP078	698867
MP079	715573
MP080	698196
MP081	698454
MP082	698707
MP0832	715593

 MICRONAIR	
MP084	698279
MP084	698276
MP085	698769
MP086	698771
MP0873	715530
MP088	698512
MP089	698512
MP094	698777
MP097	698779
MP1002	698790
MP101	698762
MP104	698681
MP105	715563
MP105	698796
MP106	698606
MP106	698683
MP107	698711
MP109	698702
MP110	698704
MP1112	698856
MP112	698861
MP113	698800
MP114	698694
MP115	698737
MP115	715562
MP116	698738
MP117	698795
MP121	715542
MP1242	698891
MP125	698753
MP125	715549
MP1262	715548
MP1262	715545
MP127	715528
MP1282	715572
MP129	715565
MP130	698724
MP139	698876
MP140	715570
MP141	715581
MP142	698882
MP145	715510
MP147	698870
MP148	698871
MP149	698775
MP157	698731
MP158	698886
MP160	715594
MP161	715506

	
<b>MICRONAIR</b>	
MP162	698893
MP163	698866
MP164	698865
MP1662	698863
MP167	698730
MP170	715603
MP172	698870
MP173	698657
MP176	715518
MP179	698753
MP180	698868
MP181	715627
MP185	715500
MP187	715516
MP191	698691
MP192	698690
MP193	715532
MP193	715552
MP195	715502
MP196	715521
MP197	698895
MP198	698886
MP200	715532
MP2012	715554
MP202	715540
MP2032	715525
MP204	698888
MP207	715515
MP210	715591
MP211	715527
MP213	715517
MP2151	715523
MP2181	715522
MP2182	715522
MP219	715523
MP220	715524
MP223	715513
MP224	715651
MP225	715551
MP2262	715576
MP2272	698892
MP228 2	698894
MP2282	715574
MP230	715564
MP232	698196
MP232	698819
MP233	698879
MP234	698799
MP236	715546

	
<b>MICRONAIR</b>	
MP2372	715561
MP2372	698869
MP246	715569
MP263	715595
MP264	715556
MP269	715596
MP270	715559
MP271	715579
MP272	715609
MP273	715550
MP277	715541
MP321	698690
MP321	715615
MP677	715602
MP693	715553
MP771	715580
<b>PURFLUX</b>	
AH101	698146
AH102	698203
AH103	698168
AH103	698779
AH104	698159
AH104	698679
AH104	698885
AH105	698166
AH106	698165
AH107	698197
AH108	698198
AH109	698199
AH111	698688
AH114	698235
AH115	698815
AH116	698149
AH117	698173
AH119	698164
AH120	698171
AH121	698174
AH122	698201
AH124	698202
AH125	698163
AH126	698475
AH127	698196
AH128	698167
AH129	698247
AH132	698176
AH133	698177
AH135	715653
AH137	715531



	
<b>PURFLUX</b>	
AH138	698169
AH138	698697
AH140	698488
AH141	715633
AH142	698878
AH143	698255
AH144	698279
AH149	698770
AH150	698276
AH151	715572
AH154	698535
AH157	698712
AH158	698840
AH159	715577
AH160	698681
AH160	715619
AH163	698290
AH165	698869
AH166	698680
AH167	698487
AH169	698512
AH170	698662
AH170	698874
AH171	698663
AH171	698708
AH173	698771
AH174	698691
AH175	698773
AH179	698664
AH180	698731
AH182	698794
AH184	698606
AH185	698594
AH186	715513
AH187	698489
AH189	698795
AH191	698685
AH193	698657
AH194	698700
AH194	698743
AH195	698694
AH198	698711
AH199	698730
AH201	698867
AH202	698800
AH203	715562
AH204	698734
AH205	698738
AH206	698876



 <b>Valeo</b>	
<b>PURFLUX</b>	
AH207	698753
AH209	715581
AH210	698796
AH212	698882
AH212	715627
AH214	715573
AH220	698735
AH221	698868
AH222	698817
AH223	715515
AH224	698762
AH225	698707
AH226	698860
AH227	698879
AH228	715514
AH229	698799
AH230	698888
AH231	698858
AH233	698866
AH234	698736
AH238	715510
AH244	715552
AH245	715556
AH248	715521
AH250	715532
AH251	698892
AH256	715550
AH257	715517
AH259	715620
AH260	715541
AH261	715554
AH265	715616
AH266	715540
AH267	715597
AH280	698871
AH282	715660
AH289	698769
AH297	698777
AH301	715524
AHC101	715677
AHC102	698748
AHC103	698745
AHC107	698687
AHC112	715530
AHC119	715578
AHC120	698171
AHC122	715617
AHC124	715675
AHC126	698744



 <b>Valeo</b>	
<b>PURFLUX</b>	
AHC128	698746
AHC129	698696
AHC130	698170
AHC134	698246
AHC136	698679
AHC139	698684
AHC140	698749
AHC142	698878
AHC143	715538
AHC145	698791
AHC147	698682
AHC149	698770
AHC153	698454
AHC154	698839
AHC156	698688
AHC166	715612
AHC167	698695
AHC169	698512
AHC177	698747
AHC178	698716
AHC179	698714
AHC181	698713
AHC183	698540
AHC183	698541
AHC184	698683
AHC185	698715
AHC187	698750
AHC188	698774
AHC190	698692
AHC191	698739
AHC192	698725
AHC195	698693
AHC198	698710
AHC199	715539
AHC200	698751
AHC202	698801
AHC203	698737
AHC208	698870
AHC211	698741
AHC212	698883
AHC213	698884
AHC215	698740
AHC219	698864
AHC237	715507
AHC238	715511
AHC239	698246
AHC245	715557
AHC246	715503
AHC247	715501

 <b>Valeo</b>	
<b>PURFLUX</b>	
AHC250	715533
AHC258	715613
AHC261	715555
AHC264	715607
AHC268	715602
AHC269	715580
AHC278	698802
<b>QUINTON HAZELL</b>	
QAP200	698165
QAP201	698166
QAP204	698198
QAP205	698171
QAP206	698199
QAP207	698168
QAP208	698174
QAP212	698146
QAP213	698159
QAP213	698679
QAP213	698885
QAP214	698164
QAP215	698770
QAP216	698170
QAP217	698197
QAP219	698202
QAP220	698201
QAP221	698707
QAP224	698149
QAP225	698167
QAP227	698173
QAP228	698203
QAP232	698247
QAP234	698196
QAP234	698819
QAP235	715514
QAP237	698858
QAP242	698235
QAP244	715530
QAP247	698869
QAP249	698174
QAP253	698840
QAP254	698172
QAP259	698177
QAP260	698691
QAP261	698663
QAP263	698279
QAP264	698276
QAP265	698196
QAP266	698662





	
QUINTON HAZELL	
QAP266	698874
QAP267	698487
QAP268	698860
QAP269	698859
QAP270	715633
QAP271	698475
QAP273	698488
QAP275	698790
QAP276	698535
QAP277	698489
QAP278	698690
QAP279	715512
QAP281	715531
QAP282	715575
QAP284	698290
QAP285	698255
QAP286	715561
QAP287	698838
QAP298	698469
QAP309	698454
QAP311	698700
QAP313	698734
QAP314	698773
QAP315	715646
QAP316	698878
QAP317	698512
QAP318	698681
QAP319	698879
QAP320	698680
QAP321	698771
QAP321	715512
QAP322	698711
QAP324	698685
QAP325	715670
QAP327	698712
QAP328	698606
QAP329	698594
QAP330	698779
QAP333	698769
QAP334	698775
QAP336	698815
QAP337	698867
QAP338	698657
QAP340	698891
QAP343	698196
QAP343	715573
QAP344	698664
QAP345	715517
QAP346	698888

	
QUINTON HAZELL	
QAP347	698796
QAP351	715548
QAP351	715549
QAP352	698794
QAP353	715594
QAP354	698735
QAP355	698795
QAP356	698856
QAP357	698702
QAP360	715516
QAP361	715527
QAP362	698738
QAP363	698762
QAP366	698694
QAP367	698800
QAP371	698876
QAP372	698870
QAP373	698753
QAP374	715562
QAP375	698736
QAP376	698730
QAP380	715626
QAP381	698886
QAP382	715551
QAP383	715522
QAP385	715523
QAP387	698866
QAP388	698724
QAP389	698540
QAP390	698882
QAP390	715510
QAP391	715534
QAP392	698871
QAP393	715500
QAP394	698868
QAP395	698893
QAP396	698863
QAP397	698892
QAP398	715535
QAP399	715587
QAP400	715524
QAP401	715526
QAP402	715521
QAP403	715506
QAP404	715627
QAP405	715563
QAP405	715619
QAP406	715570
QAP408	698895

	
QUINTON HAZELL	
QAP409	715502
QAP410	715520
QAP412	715529
QAP414	698861
QAP417	715518
QAP420	715552
QAP420	715553
QAP423	715620
QAP424	715588
QAP425	715595
QAP427	715592
QAP428	715601
QAP429	715540
QAP430	715636
QAP432	715585
QAP432	715586
QAP433	715554
QAP436	715583
QAP437	715642
QAP438	715616
QAP439	715644
QAP500	715632
QAP502	698682
QAP513	698686
QAP525	698746
QAP528	698748
QAP532	698696
QAP533	698697
QAP538	698246
QAP545	698716
QAP552	698688
QAP556	698684
QAP561	698708
QAP566	698709
QAP566	698875
QAP567	698695
QAP571	698744
QAP573	698749
QAP575	698791
QAP576	698839
QAP577	698750
QAP580	698774
QAP584	715568
QAP585	715538
QAP587	698470
QAP602	698703
QAP611	698742
QAP611	698743
QAP612	698778

 <b>Valeo</b>	
<b>QUINTON HAZELL</b>	
QAP619	698880
QAP622	698710
QAP624	698739
QAP626	698747
QAP628	698683
QAP629	698715
QAP630	698745
QAP632	698873
QAP634	698776
QAP638	715629
QAP639	698865
QAP640	698890
QAP642	698731
QAP644	698714
QAP649	698692
QAP650	715509
QAP656	698857
QAP657	698740
QAP657	698772
QAP659	698751
QAP662	715558
QAP666	698693
QAP667	698801
QAP668	715560
QAP670	698768
QAP671	698877
QAP674	698737
QAP675	715610
QAP677	715508
QAP682	715680
QAP686	698713
QAP688	698725
QAP689	698541
QAP690	698883
QAP690	715511
QAP692	698872
QAP693	715501
QAP696	698864
QAP703	715507
QAP706	698884
QAP707	698802
QAP709	715503
QAP714	698862
QAP731	715613
QAP731	715614
QAP733	715555
QAP741	715635
WP6802	715645
WP6809	715578

 <b>Valeo</b>	
<b>QUINTON HAZELL</b>	
WP6812	698160
WP6814	715677
WP6819	715675
WP6820	715617
WP6864	715683
WP6878	698704
WP6890	698163
WP6898	715653
WP6930	698176
WP6934	698169
WP6978	715577
WP9091	715676
WP9092	698689
WP9115	715612
WP9166	715581
WP9173	698792
WP9175	715539
WP9181	698723
WP9190	698799
WP9202	698175
WP9204	715572
WP9240	715528
WP9244	715525
WP9246	715513
WP9257	715556
WP9257	715557
WP9260	715532
WP9263	715544
WP9265	715643
WP9276	715515
WP9280	715615
WP9288	715688
WP9294	715631
WP9298	715541
WP9308	715597
WP9313	715546
WP9332	715684
WP9336	715649
WP9339	715584
WP9343	715519
WP9356	715658
<b>TECNOCAR</b>	
E302	698198
E304	698199
E305	698197
E306	698203
E307	698165
E308	698146



 <b>Valeo</b>	
<b>TECNOCAR</b>	
E309	698174
E310	698166
E311	698159
E311	698885
E312	698168
E313	698164
E315	715530
E317	698235
E318	698815
E319	698149
E320	698173
E321	698201
E323	698201
E323	715617
E327	698475
E329	698247
E330	698170
E337	698169
E341	698488
E343	698878
E344	698255
E345	698177
E346	698167
E348	698279
E354	698290
E359	715619
E363	698487
E366	698662
E366	698663
E369	698771
E372	698680
E373	698773
E382	698664
E383	698731
E394	698680
E397	698700
E400	698711
E403	698535
E407	698734
E410	698876
E416	715627
E442	715510
EC305	698687
EC323	715617
EC355	698688
EC380	698747
EC382	698714
EC388	698715
EC393	698692



	<b>Valeo</b>
<b>TECNOCAR</b>	
EC398	698693
EC400	698710



<b>ZAFFO</b>	
Z016	698840
Z049	715595
Z050	715601
Z050	715602
Z300	698199
Z314	698171
Z318	698165
Z318	715632
Z318	715675
Z319	698166
Z323	698170
Z328	698168
Z328	698779
Z328	715674
Z329	698159
Z329	698160
Z329	698679
Z329	698686
Z329	698885
Z330	698697
Z332	698163
Z333	698235
Z335	698172
Z338	698703
Z338	698704
Z340	715514
Z341	698146
Z341	715677
Z345	698688
Z346	715530
Z347	698167
Z348	698164
Z348	715578
Z350	698197
Z350	698687
Z350	698689
Z352	698682
Z353	698173
Z355 Couple	715531
Z356	698201
Z356	715617
Z357	698247
Z357	698696
Z359 Couple	698246
Z359 Couple	715685

	<b>Valeo</b>
<b>ZAFFO</b>	
Z360	698149
Z362	698174
Z368	698177
Z370	698198
Z371	698858
Z372	698691
Z374	698684
Z376	698663
Z376	698708
Z377	698723
Z378	698770
Z379 Couple	698290
Z379 Couple	715568
Z380	698279
Z381	715538
Z382	698276
Z383	698196
Z383	698819
Z383	698869
Z385	698662
Z385	698709
Z385	698874
Z385	698875
Z386	698487
Z386	698695
Z387	698454
Z388	698860
Z389	698859
Z390	698716
Z391 Couple	715561
Z392	698255
Z392	715633
Z394	698475
Z394	698744
Z396	698707
Z397	698488
Z397	698749
Z398	698683
Z399	698790
Z399	698791
Z400	698535
Z403	698489
Z403	698750
Z404 Couple	698470
Z404 Couple	698838
Z406	698690
Z407	698771
Z408	698774
Z409	698777

	<b>Valeo</b>
<b>ZAFFO</b>	
Z409	698778
Z410	715646
Z411	698734
Z412	698203
Z412	698748
Z413	698773
Z414	698681
Z414	715650
Z415	698878
Z416	698700
Z416	698742
Z416	698743
Z417	698512
Z418	698879
Z418	698880
Z419	698680
Z419	715612
Z420	715512
Z421	698710
Z422	698775
Z422	698776
Z423	698739
Z424	698685
Z425	715670
Z426 Couple	698747
Z427 Couple	698712
Z428	698606
Z429	698594
Z429	698715
Z430	698745
Z431	698746
Z432 Couple	698873
Z434	698769
Z434	715676
Z435	698815
Z436	698839
Z436	698867
Z437	698657
Z437	715629
Z438	698865
Z439 Couple	698890
Z439 Couple	698891
Z440	715549
Z441	698731
Z442	715542
Z444	715573
Z445	715626
Z446	698664
Z446	698714

 ZAFFO	
Z447	715517
Z447	715591
Z448	698888
Z450	715572
Z451	698692
Z451	715686
Z452	715509
Z453 Couple	715548
Z454	698794
Z455 Couple	715594
Z456 Couple	698735
Z457	698795
Z458 Couple	698856
Z458 Couple	698857
Z459	698702
Z459	698741
Z461	698751
Z462	715516
Z463	715527
Z464	698738
Z464	715558
Z465	698762
Z466	698711
Z467 Couple	715525
Z468	698693
Z468	698694
Z469 Couple	715536
Z470	698730
Z470	715539
Z472	698886
Z472	715695
Z473	698800
Z473	698801
Z473	715665
Z474	715560
Z474	715623
Z474	715630
Z474	715631
Z475	715701
Z476	698768
Z476	715581
Z477	698876
Z477	698877
Z478	698870
Z478	715679
Z479	715551
Z479	715680
Z480	698753
Z480	715708

 ZAFFO	
Z481	698737
Z481	715562
Z482	698736
Z482	715610
Z483 Couple	715522
Z485 Couple	715523
Z486	698713
Z487	698866
Z487	715723
Z488	698724
Z488	698725
Z489	698540
Z489	698541
Z490	715641
Z491	698882
Z491	698883
Z492	715505
Z493	715534
Z494	698871
Z494	698872
Z495 Couple	715508
Z496	715500
Z496	715501
Z497	698868
Z498	715590
Z499	698861
Z499	698862
Z500	698893
Z501 Couple	698863
Z501 Couple	698864
Z502	698892
Z503	715535
Z505	715524
Z505	715666
Z506	715526
Z507	715521
Z508	715506
Z508	715507
Z510	715510
Z510	715511
Z510	715627
Z510	715628
Z511	698796
Z511	715550
Z511	715619
Z512	698884
Z512	715570
Z513	698802
Z513	715603

 ZAFFO	
Z514	698895
Z515	715502
Z515	715503
Z516	715515
Z517	715532
Z517	715533
Z518 Couple	698793
Z519	715518
Z519	715519
Z520 Couple	715643
Z521 Couple	715544
Z522 Couple	715529
Z523	715541
Z524	715520
Z526	715552
Z526	715553
Z527	715504
Z528	715620
Z529	715564
Z529	715609
Z530	715698
Z531	715718
Z532	715588
Z533 Couple	715567
Z536 Couple	715624
Z537	715615
Z538	715648
Z539	715637
Z540	715556
Z540	715557
Z541	715540
Z542	715636
Z543	715546
Z544	715597
Z545	715569
Z546	715596
Z546	715638
Z547	698894
Z547	715668
Z548	715585
Z548	715586
Z549	715537
Z551	715608
Z552 Couple	715639
Z553	715702
Z554 Couple	715554
Z554 Couple	715555
Z555	715613
Z555	715614

	<b>Valeo</b>
<b>ZAFFO</b>	
Z557	715654
Z559 Couple	715574
Z561 Couple	715545
Z562	715592
Z563 Couple	715699
Z564	715579
Z564	715580
Z565	715640
Z566	715559
Z567	715600
Z568	715651
Z569	715625
Z570 Couple	715583
Z570 Couple	715584
Z571	715642
Z572	715616
Z573	715644
Z574 Couple	715607
Z575	715635
Z577	715658
Z577	715659
Z579	715663
Z580	715667
Z580	715724
Z581	715649
Z582	715647
Z583	715660
Z583	715661
Z584	715662
Z585	715712
Z586	715681
Z588	715694
Z589	715691
Z590 Couple	715690
Z590 Couple	715715
Z591	715672
Z593	715709
Z594	715721
Z594	715722
Z595	715704
Z596	715692
Z600	715706
Z601	715705
Z602	715693
Z607	715697
Z610	715716
Z612	715717
Z613	715673
Z616	715652

	<b>Valeo</b>
<b>ZAFFO</b>	
Z617	715513
ZF375	698202
ZF592 Couple	715696
ZF598 Couple	715669
ZF608 Couple	715713
ZF608 Couple	715714

	<b>Valeo</b>
---	--------------



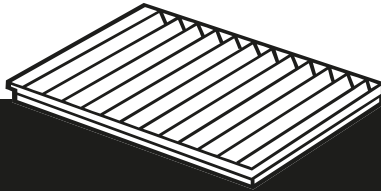

New Nouveau Neu Nuevo Novo Nuovo Nieuw  
Nowy Новый Nové Nou Nouă Нов Yeni

199



**Valeo**

201

ROLL MEDIA



207



**Valeo**

209



VT01

VT02

VT03

VT04

VT05

VT06

221

**Valeo**



229



**Valeo**



232



**Valeo**

234



		
	<b>4</b>	
<b>716065</b>	<b>MERCEDES TRUCKS</b>	Actros II
<b>716067</b>	<b>VOLVO TRUCKS</b>	FH II/FM/FMX II
<b>716068</b>	<b>VOLVO TRUCKS</b>	FH II, FM,FMX II
<b>716069</b>	<b>VOLVO TRUCKS</b>	FH II/FM/FMX II



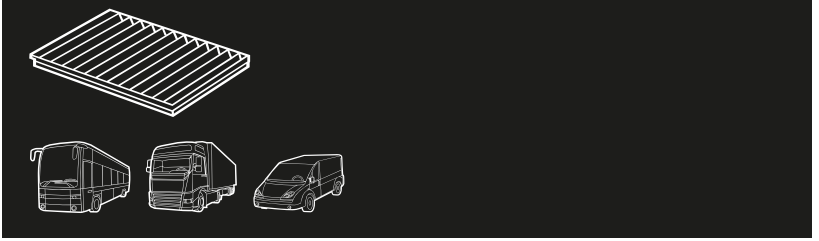

	AC			PA 	CA 
--	----	---	---	---	---

## DAF



65 CF	+/-		09/98►12/00	1347066	<b>716004</b>		
CF 65	+/-		01/01►	1347066	<b>716004</b>		
75 CF	+/-		03/98►12/00	1347066	<b>716004</b>		
CF 75	+/-		01/01►	1347066	<b>716004</b>		
85 CF	+/-		03/98►12/00	1347066	<b>716004</b>		
CF 85	+/-		01/01►	1362124	<b>716007</b>	1362168	<b>716008</b>
LF 45	+/-		02/01►	1600428	<b>716001</b>		
LF 55	+/-		02/01►	1600428	<b>716001</b>		
95 Serie	+/-		09/87►01/98	1347068	<b>716005</b>		
95 XF	+/-		02/98►09/02	1658991	<b>716006</b>		
XF 95	+/-		10/02►	1658991	<b>716006</b>		
XF 105	+/-		01/06►	1658991	<b>716006</b>		

## IRISBUS

Agora	+		02/96►03/06	5006175605	<b>716062</b>		
Agora	+	Webasto	01/02►	1100372A	<b>716049</b>		
Ares	+	Webasto	05/02►	1100372A	<b>716049</b>		
Arway	+	Webasto	12/05►	1101193	<b>716049</b>		
Axer	+	Webasto	03/05►01/07	1100372A	<b>716049</b>		
Citelis	+	Webasto	04/05►	1100372A	<b>716049</b>		
Citelis/ B	+		04/05►	5006175605	<b>716062</b>		
City Bus	+		09/03►	5006175605	<b>716062</b>		
City Class	+	Webasto	02/00►	1101193A	<b>716049</b>		
City Class	+		01/02►	5006175605	<b>716062</b>		
Daily Citis	+/-		09/06►			2994769	<b>716063</b>
Evadys	+	Webasto	09/04►	1100372A	<b>716049</b>		
Liliade H	+	Webasto	05/02►	1100372A	<b>716049</b>		
Midi GX	+	Webasto	09/04►	1100372A	<b>716049</b>		
Midys	+	Webasto	09/04►	1101193A	<b>716049</b>		
Moovy	+	Webasto	09/04►	1100372A	<b>716049</b>		
Recreo	+/-		09/06►			2994769	<b>716063</b>
Tourys	+/-		09/06►			2994769	<b>716063</b>
Way	+/-		09/06►			2994769	<b>716063</b>

## IVECO

Campagnola	+/-		12/08►			2994769	<b>716063</b>
Daily (2006>)	+		04/06►	3802821	<b>715595</b>	2994769	<b>716063</b>
Massif	+/-		03/08►	3802821	<b>715595</b>	2994769	<b>716063</b>
Rapido	+/-		02/07►			2994769	<b>716063</b>

	AC			PA  	CA  	<b>IVECO</b> 	
Civis	+	Webasto	05/01▶	93350A	<b>716049</b>		
Euroclass	+	Webasto	09/02▶	93350A	<b>716049</b>		
Euro Rider	+	Webasto	09/02▶	93350A	<b>716049</b>		
<b>IVECO</b> 							
Euromover	+		04/05▶	504024890	<b>716028</b>	2994583	<b>716029</b>
Eurostar	+/-		04/92▶	500387947	<b>716033</b>		
Eurotech	+/-		04/92▶	500387947	<b>716033</b>		
Eurotrakker	+/-		01/93▶	500387947	<b>716033</b>		
Stralis	+		02/02▶	504024890	<b>716028</b>	2994583	<b>716029</b>
Trakker	+		09/04▶	504024890	<b>716028</b>	2994583	<b>716029</b>
<b>MAN</b> 							
Lion's	+	Webasto	09/96▶	81779100016	<b>716049</b>		
Lion's City G/GL/GLX	+/-	Konvecta	02/01▶	83779720656	<b>716064</b>		
Lion's City LL (NL-Serie)	+/-	Konvecta	01/99▶	83779720656	<b>716064</b>		
Lion's City M (NM-Serie)	+/-	Konvecta	11/05▶	83779720656	<b>716064</b>		
Lion's City UELL	+/-	Konvecta	07/98▶	83779720656	<b>716064</b>		
Lions Coach	+/-	Konvecta	06/02▶	88779100002	<b>716048</b>		
Lions Coach	+	Webasto	07/06▶	18357047	<b>716046</b>		
Lions Coach	+/-		01/98▶12/01	81619100011	<b>716034</b>		
Lions Comfort	+/-		01/98▶12/01	81619100011	<b>716034</b>		
Lions Regio	+/-		2004▶	81619100018	<b>716036</b>		
Lions Regio	+/-		2004▶			81619100019	<b>716037</b>
Lions Series	+/-	Recir.air	04/00▶	88779100003	<b>716047</b>		
Lions Series	+		09/02▶	0018355547	<b>716056</b>		
NG	+/-		07/98▶	81779100012	<b>716057</b>		
NG	+/-	Konvecta	02/01▶	83779720656	<b>716064</b>		
NL	+/-		12/95▶	81779720155	<b>716057</b>		
NL	+/-	Konvecta	01/99▶	83779720656	<b>716064</b>		
NM	+/-	Konvecta	11/05▶	83779720656	<b>716064</b>		
NUE	+/-		02/98▶	81779100012	<b>716057</b>		
NUE	+/-	Konvecta	02/98▶	83779720656	<b>716064</b>		
UEL-313	+/-		09/96▶09/01	81619100011	<b>716034</b>		
UEL-353	+/-		06/97▶12/01	81619100011	<b>716034</b>		
<b>MAN</b> 							
F2000, F2000 Evolution	+/-		01/94▶	81619100011	<b>716034</b>		
FE Serie	+/-		08/95▶	81619100011	<b>716034</b>		
L2000, L2000 Evolution	+/-		05/94▶	85619500025	<b>716035</b>		
LE Serie (250-280)	+/-		08/88▶12/98	81619100011	<b>716034</b>		

	AC			PA  	CA  
--	----	--	--	------------	------------

## MAN

LE Serie (110-220)	+/-		08/00▶	85619500025	<b>716035</b>		
M2000, M2000 Evolution	+/-		05/94▶	85619500025	<b>716035</b>		
M2000, M2000 Evolution	+/-		08/95▶	81619100011	<b>716034</b>		
ME Serie	+/-		08/00▶	81619100011	<b>716034</b>		
TGA	+/-		03/00▶	81619100018	<b>716036</b>	81619100019	<b>716037</b>
TGL	+/-		06/05▶	81619100018	<b>716036</b>	81619100019	<b>716037</b>
TGM	+/-		11/05▶	81619100018	<b>716036</b>	81619100019	<b>716037</b>

## MERCEDES







Sprinter I (95>2006)	+		02/95▶05/06	9018300018	<b>698840</b>	9018300418	<b>716023</b>
----------------------	---	--	-------------	------------	---------------	------------	---------------

## MERCEDES (EVOBUS/SETRA)

CapaCity (O 530GL/628)	+	Konnecta	04/07▶	0018359247	<b>716064</b>		
Citaro K (628)	+	Webasto	09/06▶	6278350447	<b>716049</b>		
Citaro LE	+	Webasto	11/05▶	20401236	<b>716049</b>		
Comfort Class 400S	+	4x	10/03▶	0018357147	<b>716058</b>		
Citaro O530	-	Konnecta	03/98▶	0018359247	<b>716064</b>		
Integro (633)	-	Konnecta	03/06▶	0018359247	<b>716064</b>		
Intercity (634)	+	Konnecta	09/08▶	0018359247	<b>716064</b>		
Intouro II (633)	+	Konnecta	03/07▶	0018359247	<b>716064</b>		
O 345	+		03/98▶	0018355547	<b>716056</b>		
O 350	+		03/98▶	0018355547	<b>716056</b>		
O 345 - Conecto	+	Webasto	01/03▶	0018255447	<b>716049</b>		
O 530 - Citaro	+	Webasto	01/98▶	0018255447	<b>716049</b>		
O 530 - Citaro	+	Konnecta	03/98▶	H14002499	<b>716048</b>		
O 530 - Citaro	+	Konnecta	03/98▶	0018351547	<b>716050</b>		
O 530 - Citaro	+		03/98▶	0018359147	<b>716060</b>		
O 550 - Integro	+	Webasto	03/06▶	0018357047	<b>716046</b>		
O 550 - Integro M	+	Webasto	09/02▶03/06	0018357047	<b>716046</b>		
O 580 - Travego	+	Webasto	11/99▶01/06	0018255447	<b>716049</b>		
O 580 - Travego	+	4x	11/99▶	0018357147	<b>716058</b>		
S400 Serie	+	Webasto	09/01▶	0018357047	<b>716046</b>		
Setra S400	+	Konnecta	10/03▶	0018359247	<b>716064</b>		
Setra S400	+	Webasto	09/06▶	0018255447	<b>716049</b>		
Setra S400 Top Class	+	3x	06/02▶	0018356147	<b>716059</b>		
Setra S400 Top Class	+	2x	06/02▶	0018356247	<b>716061</b>		
Tourismo II/M	-	Konnecta	09/06▶	0018359247	<b>716064</b>		
Travego (O 580)	-	Konnecta	11/99▶12/06	0018359247	<b>716064</b>		

## MERCEDES

Actros II	+/-		09/11▶	9608300018	<b>716066</b>	9608300118	<b>716065</b>
-----------	-----	--	--------	------------	---------------	------------	---------------

	AC			PA 	CA 		
<b>MERCEDES</b> 							
Actros	+/-	Prefilter	09/96▶	0018350747	<b>716017</b>		
Actros	+/-	Road	09/96▶	0008301118	<b>716010</b>	0008301318	<b>716012</b>
Actros	+		09/96▶	0008301218	<b>716011</b>		
Actros	A+		09/96▶			0008301518	<b>716013</b>
Atego I	+/-		01/98▶09/04	9738350247	<b>716021</b>		
Atego I	+/-		01/98▶09/04	9738350147	<b>716014</b>	9738350347	<b>716015</b>
Atego II	+/-		09/04▶	9738350247	<b>716021</b>		
Atego II	+/-		09/04▶	9738350147	<b>716014</b>	9738350347	<b>716015</b>
Axor	+/-		10/01▶	9408350047	<b>716019</b>	9408350147	<b>716020</b>
Axor I	+/-		01/02▶09/04	9408350247	<b>716018</b>		
Axor II	+/-		09/04▶	9408350047	<b>716019</b>	9408350147	<b>716020</b>
Axor II	+/-		09/04▶	9408350247	<b>716018</b>		
Econic (957)	+/-		07/98▶	9408350047	<b>716019</b>	9408350147	<b>716020</b>
MK Serie	+/-		12/87▶09/96	0008356947	<b>716016</b>		
SK Serie	+/-		07/87▶09/96	0008356947	<b>716016</b>		

### NEOPLAN (NEOMAN)

Centroliner	+/-	Recir.air	03/02▶	88779100003	<b>716047</b>		
Centroliner	+	Webasto	10/98▶	0018255447	<b>716049</b>		
Centroliner	+/-		10/98▶	81779100012	<b>716057</b>		
Cityliner	+	Webasto	07/06▶	1101891A	<b>716046</b>		
Starliner I	+		09/96▶	180412710	<b>716055</b>		
Starliner II	+	Webasto	07/06▶	1101891B	<b>716046</b>		
Tourliner	+/-	Konvecta	01/03▶	88779100002	<b>716048</b>		
Tourliner	+/-	Recir.air	09/03▶	88779100003	<b>716047</b>		
Tourliner	+		09/03▶	0018355547	<b>716056</b>		
Transliner	+/-		11/90▶	180740200	<b>716054</b>		
Trendliner	+/-	Recir.air	09/04▶	81619100018	<b>716036</b>		
Trendliner	+/-		2004▶			81619100019	<b>716037</b>

### RENAULT

AE (Magnum)	+/-		09/90▶	5001829129	<b>716000</b>		
Kerax	+/-		09/97▶04/06	5001833354	<b>716001</b>		
Kerax	+/-		05/06▶	5001867491	<b>716009</b>		
Midlum	+/-		02/00▶04/06	5001833354	<b>716001</b>		
Midlum	+/-		05/06▶	5001867491	<b>716009</b>		
Premium	+/-		04/96▶04/06	5001833354	<b>716001</b>		
Premium	+/-		05/06▶	5001867491	<b>716009</b>		

### SCANIA

Omni	+		09/02▶	1100372B	<b>716049</b>		
------	---	--	--------	----------	---------------	--	--

	AC			PA 	CA 
--	----	--	--	--------	--------

## SCANIA

Serie 4	+/-	Prefilter	10/96►10/04	1326180	<b>716040</b>		
Serie 4	+/-		10/95►10/04	1420197	<b>716039</b>		
Serie P	+/-	Prefilter	09/04►	1326180	<b>716040</b>		
Serie P	+/-		09/04►	1420197	<b>716039</b>		
Serie R	+/-	Prefilter	06/04►	1326180	<b>716040</b>		
Serie R	+/-		06/04►	1420197	<b>716039</b>		
Serie T	+/-	Prefilter	09/04►12/05	1326180	<b>716040</b>		
Serie T	+/-		09/04►12/05	1420197	<b>716039</b>		
Serie P,G,R,T	+/-		10/07►	1770813	<b>716052</b>		

## VOLVO

FH II	+/-		05/12►	82348995	<b>716068</b>	82351184	<b>716069</b>
FM/FMX II	+/-		05/12►	82348995	<b>716068</b>	82351184	<b>716069</b>
F6	+/-		10/87►12/94	1584575	<b>716045</b>		
F7	+/-		08/79►05/88	1584575	<b>716045</b>		
F10	+/-		08/77►12/94	1584575	<b>716045</b>		
F12	+/-		08/77►09/91	1584575	<b>716045</b>		
F12	+/-		10/91►12/94	8143691-7	<b>716041</b>	20409908	<b>716053</b>
F16	+/-		10/87►12/94	1584575	<b>716045</b>		
FH	+/-		09/05►	8143691-7	<b>716041</b>	20409908	<b>716053</b>
FH12	+/-		08/93►12/05	8143691-7	<b>716041</b>	20409908	<b>716053</b>
FH16 Serie	+/-		08/93►	8143691-7	<b>716041</b>	20409908	<b>716053</b>
FL	+/-		04/06►	20559447	<b>716009</b>		
FL12	+/-		09/95►10/98	1584575	<b>716045</b>		
FM-Serie	+/-		09/05►	8143691-7	<b>716041</b>	20409908	<b>716053</b>
FM7-Serie	+/-		08/99►02/08	8143691-7	<b>716041</b>	20409908	<b>716053</b>
FM9-Serie	+/-		11/01►	8143691-7	<b>716041</b>	20409908	<b>716053</b>
FM10-Serie	+/-		08/98►	8143691-7	<b>716041</b>	20409908	<b>716053</b>
FM12-Serie	+/-		11/01►	8143691-7	<b>716041</b>	20409908	<b>716053</b>
FH II	+/-	Prefilter	05/12►	82354791	<b>716067</b>		
FM/FMX II	+/-	Prefilter	04/10►	82354791	<b>716067</b>		



## ROLL MEDIA

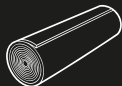

# ROLL MEDIA



**Valeo**



Qty

**716051** Height / Hauteur : 2 m  
Length / Longueur : 20 m  
Thickness / Largeur : 11 mm - 14 mm  
Diameter / Diamètre : 0.65 m  
Complete surface dimension /  
Dimension surface totale : 40 m<sup>2</sup>

1



## Bus universal filter roll media for interior and exterior air distribution

Rouleau de média filtrant universel pour bus, intérieur et extérieur

Bus universelles filter rollmittel für verteilung von innen- und außenluft

Rollo de material filtrante universal para autobus, distribución del aire interior y exterior

Rolo de material filtrante universal para autocarro, distribuição de ar interior e exterior

Rotolo filtro abitacolo a metro universale per bus per climatizzazione

Rol met universeel autobus filtermateriaal, interieur en exterior

Bus universalne zrolowane medium filtrujące

Автобус универсальный рулон со свернутым фильтром для фильтрации наружного и внутрисалонного воздуха

Univerzálny filtračný materiál pre autobusy, interné a externé rozvody vzduchu

Univerzální stočená filtrační tkanina pro autobusy, vnější i vnitřní přívody vzduchu

Univerzalni materijal za filtriranje, namijenjen za autobuse u unutrašnjoj i vanjskoj instalaciji zraka

Bus univerzális feltekerhető szűrő anyag külső és belső levegőszállításához

Rulou de material filtrant / filtru universal pentru distribuție de aer interior și exterior pentru bus

Otobüs üniversal filtre. Rulo malzeme. Diş hava ve dahili çevirim filtrelemesi

Διεθνές ρολό φίλτρου για λεωφορεία. Κατάλληλο για εσωτερική και εξωτερική χρήση, στο σύστημα εξαερισμού του οχήματος.

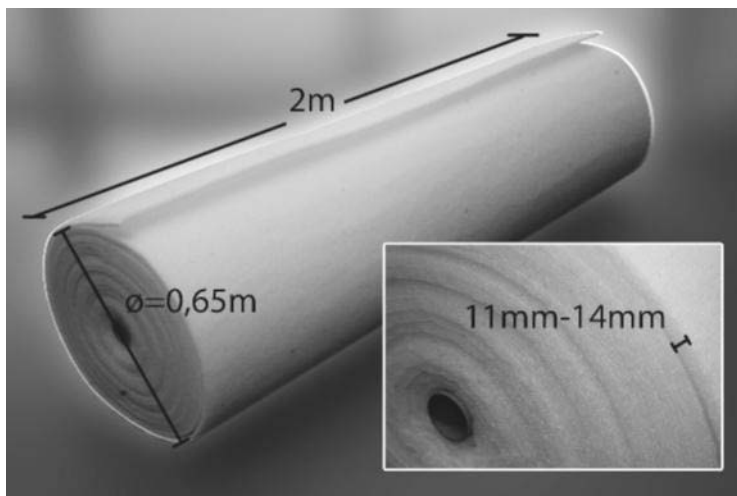



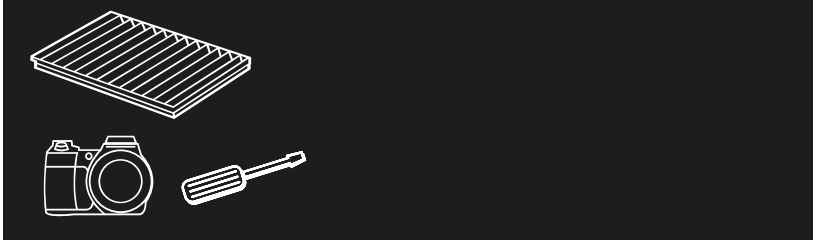

698840



VT 01

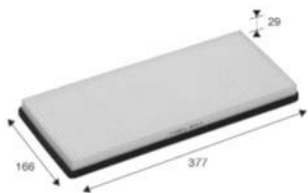

MERCEDES

Sprinter I

715595



VT 03

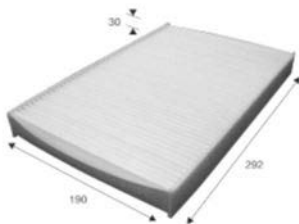

IVECO TRUCKS

Daily III

716000



VT 01

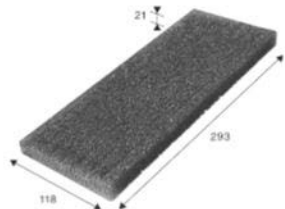

RENAULT TRUCKS

AE (Magnum)

716001



VT 01

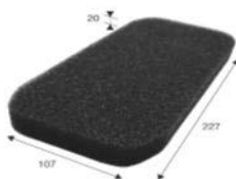

DAF

LF 45

LF 55

RENAULT TRUCKS

Kerax

Midlum

Premium

716004



VT 02

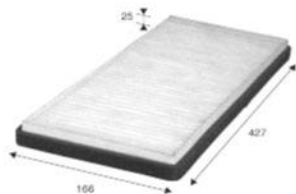

DAF

65 CF

75 CF

85 CF

CF 65

CF 75

716005

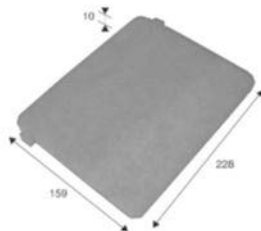

DAF

95 Serie

716006



VT 02

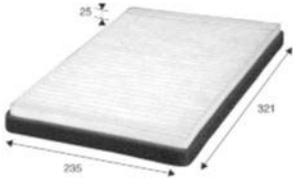

DAF

95 XF  
XF 105  
XF 95

716007



VT 02

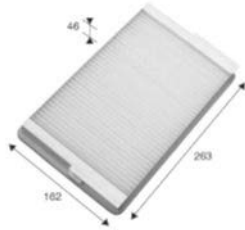

DAF

CF 85

716008



VT 02

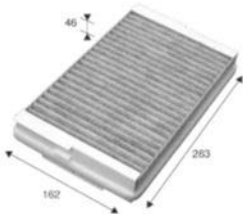

DAF

CF 85

716009



VT 01

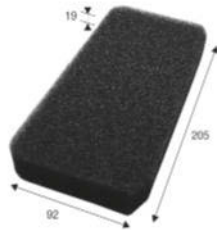

RENAULT TRUCKS

Midlum  
Premium

VOLVO TRUCKS

FL

716010



VT 02



MERCEDES TRUCKS

Actros

716011



VT 02

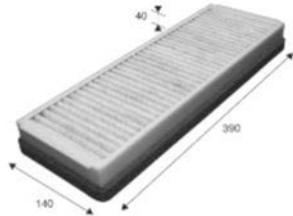

MERCEDES TRUCKS

Actros

716012



VT 05

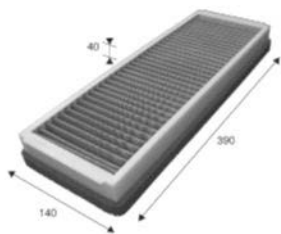

MERCEDES TRUCKS Actros

716013



VT 02

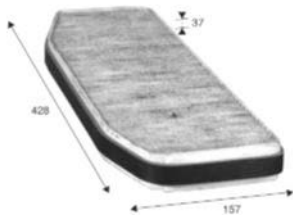

MERCEDES TRUCKS Actros

716014



VT 02

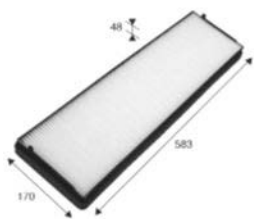

MERCEDES TRUCKS Atego I  
Atego II

716015



VT 02

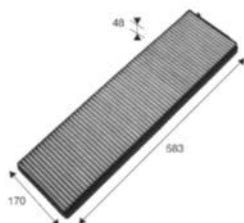

MERCEDES TRUCKS Atego I  
Atego II

716016

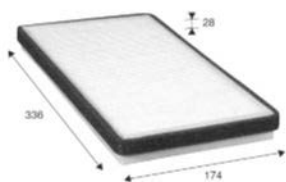

MERCEDES TRUCKS MK Serie  
SK Serie

716017



VT 02

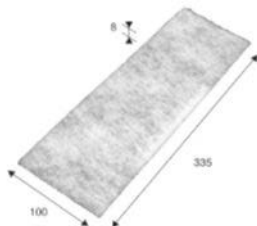

MERCEDES TRUCKS Actros

716018



VT 02

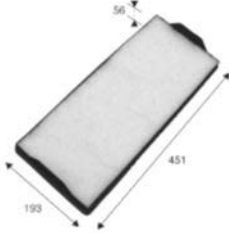

**MERCEDES TRUCKS** Axor I  
Axor II

716019



VT 02

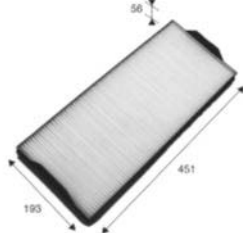

**MERCEDES TRUCKS** Axor  
Axor II  
Eonic (957)

716020



VT 02

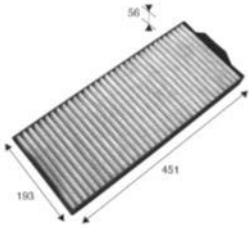

**MERCEDES TRUCKS** Axor  
Axor II  
Eonic (957)

716021



VT 02

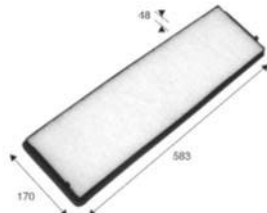

**MERCEDES TRUCKS** Atego I  
Atego II

716023



VT 01

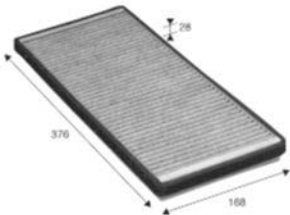

**MERCEDES** Sprinter I

716028



VT 02

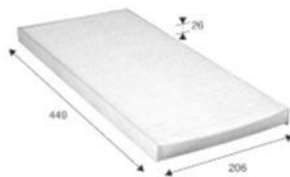

**IVECO TRUCKS** Euromover  
Stralis  
Trakker

716029

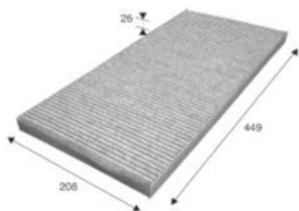

VT 02

**IVECO TRUCKS**Euromover  
Stralis  
Trakker

716033

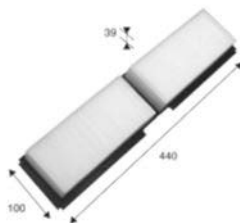

VT 01

**IVECO TRUCKS**Eurostar  
Eurotech  
Eurotrakker

716034

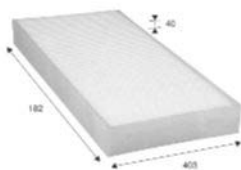

VT 02

**MAN (BUS)**Lions Coach, Comfort  
UEL313, UEL353**MAN TRUCKS**F2000, F2000 Evolution  
FE Serie, LE Serie (250-280)  
M2000, M2000 Evolution  
ME Serie

716035

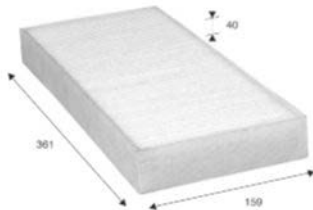

VT 01

**MAN TRUCKS**L2000, L2000 Evolution  
LE Serie (110-220)  
M2000, M2000 Evolution

716036



VT 02

**MAN (BUS)**

Lions Regio

**MAN TRUCKS**TGA  
TGL  
TGM**NEOPLAN**

Trendliner

716037

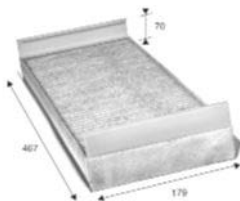

VT 02

**MAN (BUS)**

Lions Regio

**MAN TRUCKS**TGA  
TGL  
TGM**NEOPLAN**

Trendliner

716039



VT 06

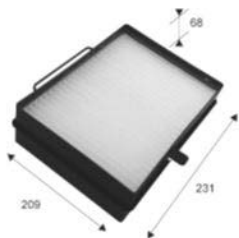

**SCANIA TRUCKS**

Serie 4  
Serie P  
Serie R  
Serie T

716040



VT 06

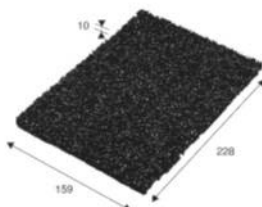

**SCANIA TRUCKS**

Serie 4  
Serie P  
Serie R  
Serie T

716041



VT 02

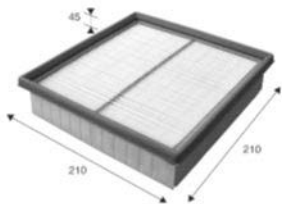

**VOLVO TRUCKS**

F12,FH,FH12,FH16 Serie  
FM12-Serie  
FM9-Serie,FM10-Serie  
FM-Serie,FM7-Serie

716045

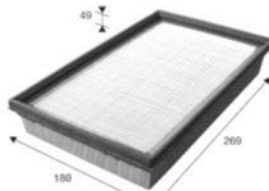

**VOLVO TRUCKS**

F16  
F6,F7,F10,F12  
FL12

716046

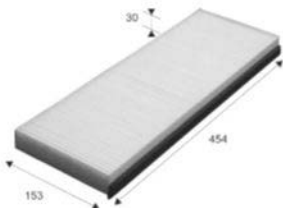

**MAN (BUS)**  
**MERCEDES (BUS)**  
**NEOPLAN**

Lions Coach  
O 550-Integro, S400  
Cityliner  
Starliner II

716047

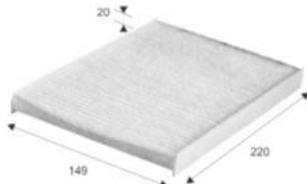

**MAN (BUS)**  
**NEOPLAN**

Lions Series  
Centroliner, Tourliner

716048

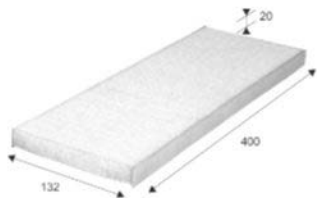

**MAN (BUS)** Lions Coach  
**MERCEDES (BUS)** O 530 - Citaro  
**NEOPLAN** Tourliner

716049

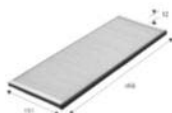

**IRISBUS** Agora, Ares, Arway, Axer  
 Citelis, CityClass, Evadys, Lillade H  
 Midi GX, Midys, Moovy  
**IVECO (BUS)** Cavis, Euroclass, Euro Rider  
**MAN (BUS)** Lion's  
**MERCEDES (BUS)** Citaro LE, Conecto  
 Citaro, Travego, Setra S400  
**NEOPLAN** Centroliner  
**SCANIA (BUS)** Omni

716050

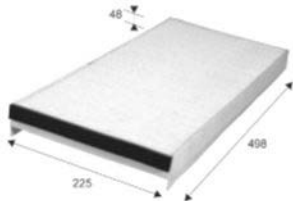

**MERCEDES (BUS)** O 530 - Citaro

716051



**ROLL MEDIA** 40m2

716052

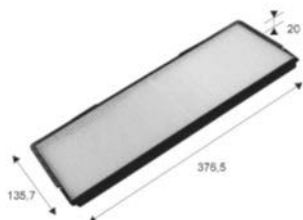

**SCANIA TRUCKS** G (G230-G480)  
 P (P230- P470)  
 R (R230-R620)

716053

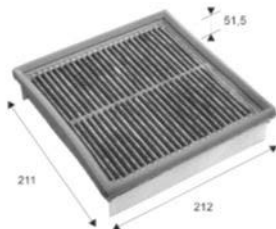

**VOLVO TRUCKS** F12, F16, FH, FH12, FH16-Serie  
 FM10-Serie, FM12-Serie, FM7-Serie  
 FM9-Serie, FM-Serie



716054

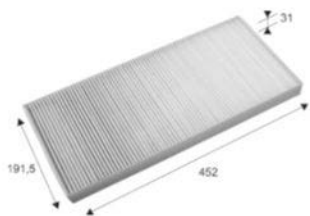

NEOPLAN (NEOMAN) Transliner

716055



NEOPLAN (NEOMAN) Starliner I

716056

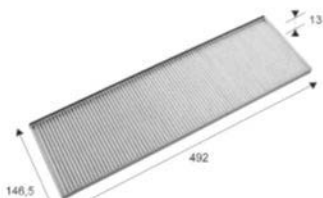

MAN (BUS) Lions Series  
MERCEDES 0340, 0350  
(EVOBUS/SETRA)  
NEOPLAN (NEOMAN) Tourliner

716057

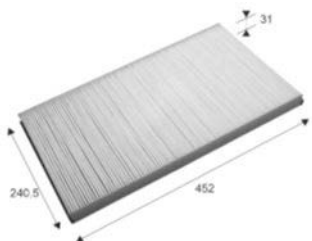

MAN (BUS) NG, NL, NUE  
NEOPLAN (NEOMAN) Centroliner

716058



MERCEDES Class 400S  
(EVOBUS/SETRA) Comfort  
0 580, Travego

716059



MERCEDES Setra S400  
(EVOBUS/SETRA)

716060

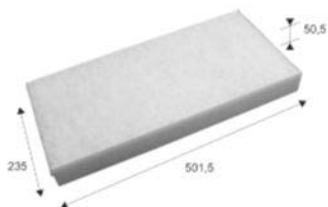

**MERCEDES  
(EVOBUS/SETRA)**

O 530 - Citaro

716061

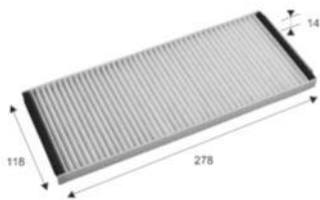

**MERCEDES  
(EVOBUS/SETRA)**

Setra S400

716062

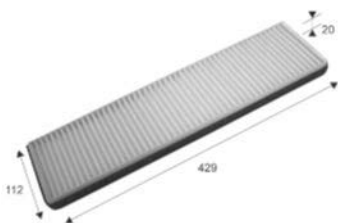

**IRISBUS**

Agora, Citelis/ B, City Bus, City Class

716063

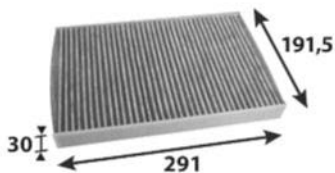

**IRISBUS**

Daily Citis, Recreo  
Tours, Way

**IVECO TRUCKS**

Daily (2006>), Massif

716064

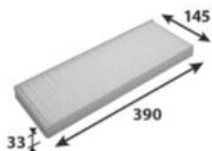

**MAN (BUS)**

Lion's City  
NG, NL, NM, NUE  
CapaCity (O 530GL/628)  
Citiro O530, Integro (633)  
Intercity (634), Intouro II (633)  
Setra S400, Turismo II/M  
Travego (O 580)

**MERCEDES  
(EVOBUS/SETRA)**

716065

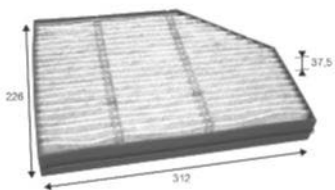

**MERCEDES TRUCKS** Actros II

716066

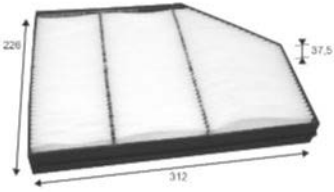

**MERCEDES TRUCKS** Actros II

716067



**VOLVO TRUCKS**

FH II, ,FM/FMX II (New FM /  
FMX 2013-)

716068



**VOLVO TRUCKS**

FH II, ,FM/FMX II (New FM /  
FMX 2013-), ,T (T308-T520), ,K  
(K308-K520), ,C (C380-C520,  
2013-)

716069



**VOLVO TRUCKS**

FH II, ,FM/FMX II (New FM /  
FMX 2013-), ,T (T308-T520), ,K  
(K308-K520), ,C (C380-C520,  
2013-)



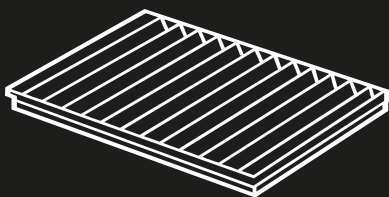
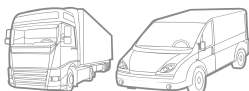

VT01

VT02

VT03

VT04

VT05

VT06



## Fitting instructions number

Référence notice de montage

Nummer der Einbauanleitung

Referencia de la instrucción de montaje

Referência das intrucções de montagem

Numero di istruzioni di montaggio

Inbouw instructie nummer

Instrukcja montazu nr

Номер на инструкция за монтаж

Císlo montážního postupu

Beszereelési útmutató sorszám

Broj instrukcije montaže

Montaj talimatname numarasi

Αριθμός οδηγιών τοποθέτησης



VT01

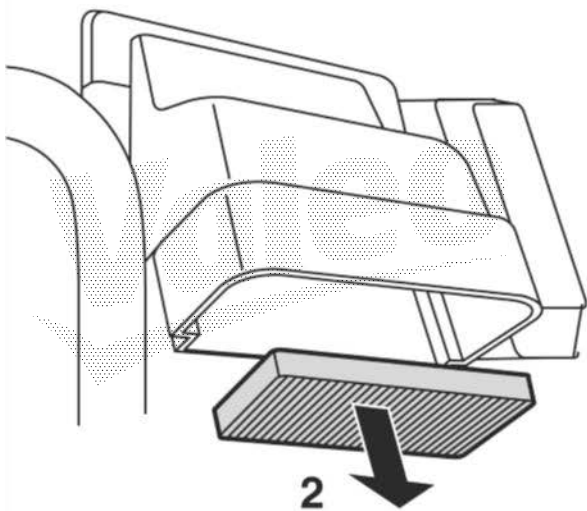
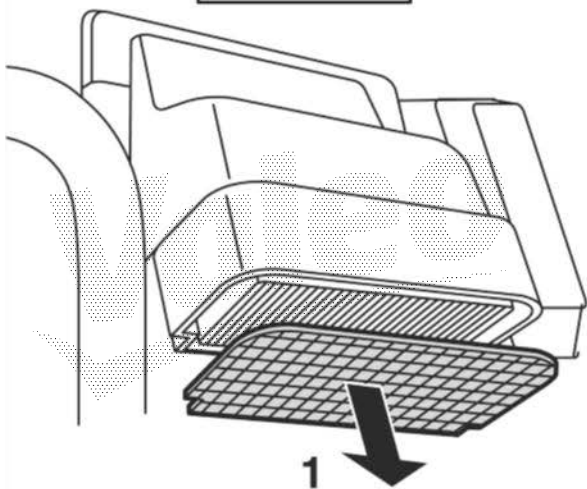

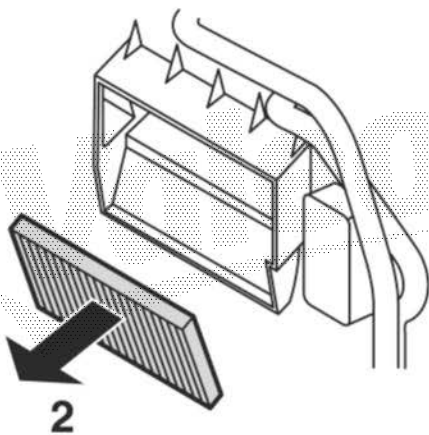
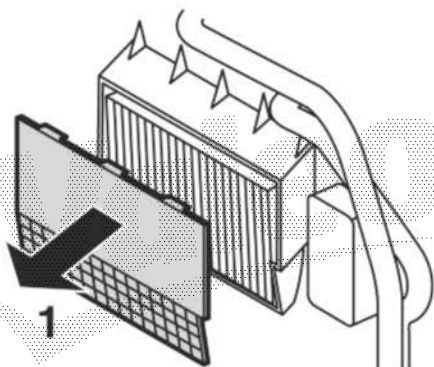



VT03

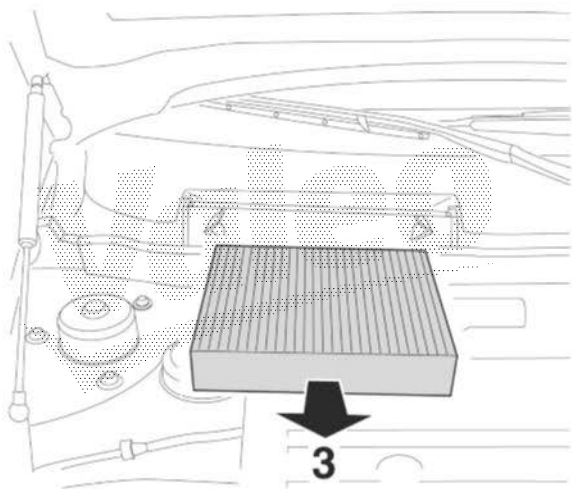
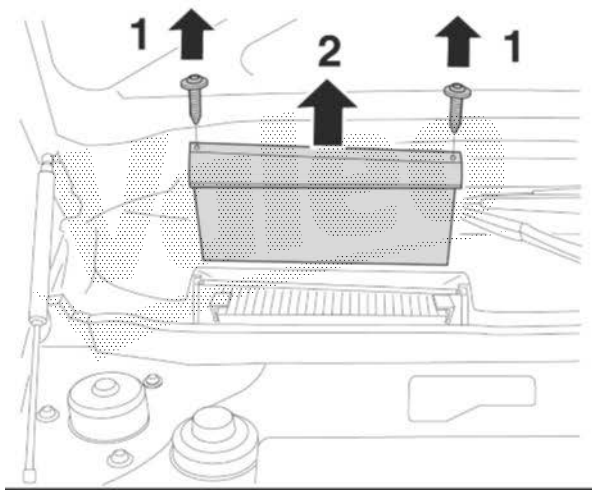



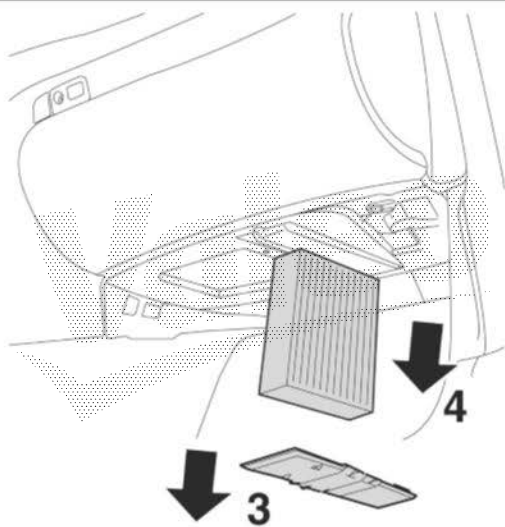
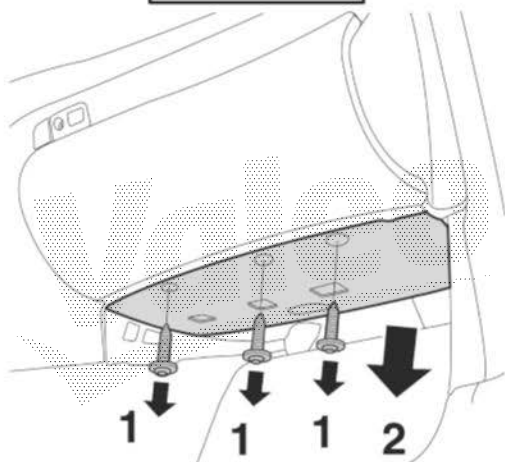



VT05

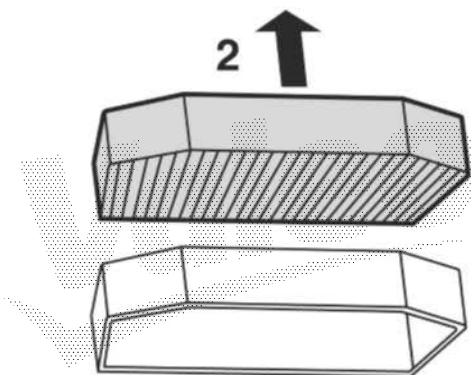
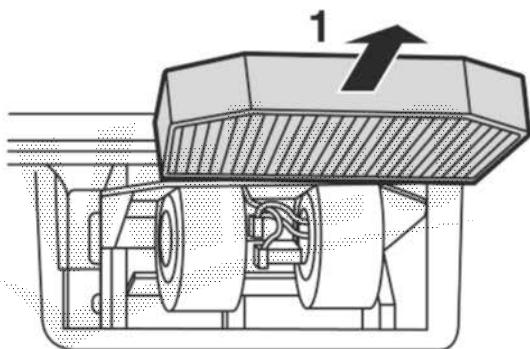
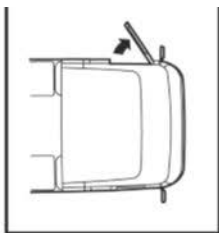

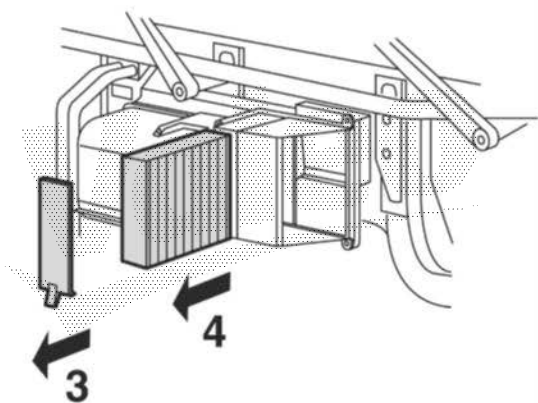
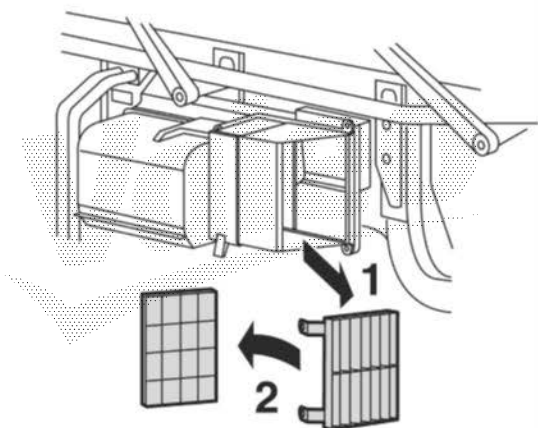



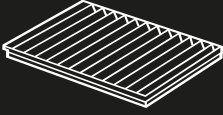

**Valeo**







**Valeo**



**Valeo**

 PA  
CA

<b>716000</b>	PA	5001829129	RENAULT TRUCKS	AE (Magnum)
<b>716001</b>	PA	1600428	DAF	LF 45
<b>716004</b>	PA	1347066	DAF	65 CF
<b>716005</b>	PA	1347068	DAF	95 Serie
<b>716006</b>	PA	1658991	DAF	95 XF
<b>716007</b>	PA	1362124	DAF	CF 85
<b>716008</b>	CA	1362168	DAF	CF 85
<b>716009</b>	PA	5001867491	RENAULT TRUCKS	Kerax
<b>716010</b>	PA	0008301118	MERCEDES TRUCKS	Actros
<b>716011</b>	PA	0008301218	MERCEDES TRUCKS	Actros
<b>716012</b>	CA	0008301318	MERCEDES TRUCKS	Actros
<b>716013</b>	CA	0008301518	MERCEDES TRUCKS	Actros
<b>716014</b>	PA	9738350147	MERCEDES TRUCKS	Atego I
<b>716015</b>	CA	9738350347	MERCEDES TRUCKS	Atego I
<b>716016</b>	PA	0008356947	MERCEDES TRUCKS	MK Serie
<b>716017</b>	PA	0018350747	MERCEDES TRUCKS	Actros
<b>716018</b>	PA	9408350247	MERCEDES TRUCKS	Axor I
<b>716019</b>	PA	9408350047	MERCEDES TRUCKS	Axor
<b>716020</b>	CA	9408350147	MERCEDES TRUCKS	Axor, Axor II, Econic (957)
<b>716021</b>	PA	9738350247	MERCEDES TRUCKS	Atego I
<b>716023</b>	CA	9018300418	MERCEDES	Sprinter (901-905)(99>2006)
<b>716028</b>	PA	504024890	IVECO	Euromover
<b>716029</b>	CA	2994583	IVECO	Euromover, Stralis, Trakker
<b>716033</b>	PA	500387947	IVECO	Eurostar
<b>716034</b>	PA	81619100011	MAN (BUS)	Lions Coach
<b>716035</b>	PA	85619500025	MAN TRUCKS	L2000, L2000 Evolution
<b>716036</b>	PA	81619100018	MAN (BUS)	Lions Regio
<b>716037</b>	CA	81619100019	MAN (BUS)	Lions Regio
<b>716039</b>	PA	1420197	SCANIA TRUCKS	Serie 4
<b>716040</b>	PA	1326180	SCANIA TRUCKS	Serie 4
<b>716041</b>	PA	8143691-7	VOLVO TRUCKS	F12
<b>716045</b>	PA	1584575	VOLVO TRUCKS	F6
<b>716046</b>	PA	18357047	MAN (BUS)	Lions Coach
<b>716047</b>	PA	88779100003	MAN (BUS)	Lions Series
<b>716048</b>	PA	88779100002	MAN (BUS)	Lions Coach
<b>716049</b>	PA	1100372A	IRISBUS	Agora
<b>716050</b>	PA	0018351547	MERCEDES (EVOBUS/SETRA)	O 530 - Citaro
<b>716052</b>	PA	1770813	SCANIA TRUCKS	Serie P,G,R,T
<b>716053</b>	CA	20409908	VOLVO TRUCKS	F12, FH12, FH16 Serie, FM-Serie, FM7-Serie
<b>716054</b>	PA	180740200	NEOPLAN (NEOMAN)	Transliner
<b>716055</b>	PA	180412710	NEOPLAN (NEOMAN)	Starliner I
<b>716056</b>	PA	0018355547	MAN (BUS)	Lions Series
<b>716057</b>	PA	81779100012	MAN (BUS)	NG
<b>716058</b>	PA	0018357147	MERCEDES (EVOBUS/SETRA)	Comfort Class 400S
<b>716059</b>	PA	0018356147	MERCEDES (EVOBUS/SETRA)	Setra S400 Top Class

<b>Valeo</b>	 PA CA		 
<b>716060</b>	PA	0018359147	MERCEDES (EVOBUS/SETRA) O 530 - Citaro
<b>716061</b>	PA	0018356247	MERCEDES (EVOBUS/SETRA) Setra S400 Top Class
<b>716062</b>	PA	5006175605	IRISBUS Agora
<b>716063</b>	CA	2994769	IRISBUS Daily Citis, Recreo, Tourys, Way
<b>716064</b>	PA	83779720656	MAN (BUS) Lion's City G/GL/GLX
<b>716065</b>	CA	2994769	MERCEDES TRUCKS Actros II
<b>716066</b>	PA	9608300018	MERCEDES TRUCKS Actros II
<b>716067</b>	PA	82354791	VOLVO TRUCKS FH II
<b>716068</b>	PA	82348995	VOLVO TRUCKS FH II
<b>716069</b>	CA	82351184	VOLVO TRUCKS FH II, FM/FMX II

	<b>Valeo</b>
<b>DAF</b>	
1322255	716006
1322259	716004
1347066	716004
1347068	716005
1362124	716007
1362168	716008
1600428	716001
1658991	716006
1659691	716004

<b>IRISBUS</b>	
93350A	716049
1100372A	716049
1101193	716049
1101193A	716049
2994769	716063
5006175605	716062

<b>IVECO</b>	
2994583	716029
2994769	716063
2995964	716028
3799020	716033
3802821	715595
93162385	716033
500387947	716033
504024890	716028
9000709A	716028

<b>IVECO Bus</b>	
1100372A	716049
1101193	716049
1101193A	716049
93350A	716049
50006175605	716049

<b>KING LONG BUSES</b>	
H14003495	716064

<b>MAN TRUCKS</b>	
81619100011	716034
81619100018	716036
81619100019	716037
85619500025	716035

<b>MAN (BUS)</b>	
001835547	716056
A0018357047	716046
1101891A	716046
1101891B	716046

	<b>Valeo</b>
<b>MAN (BUS)</b>	
18357047	716046
81619100011	716034
81619100018	716036
81619100019	716037
81779100012	716057
81779100016	716049
81779720148	716049
81779720155	716057
83779720656	716064
88779100002	716048
88779100003	716047

<b>MERCEDES</b>	
9018300418	716023
9018300018	698840
9018300518	698840
0008303318	698840

<b>MERCEDES TRUCKS</b>	
0008301118	716010
0008301218	716011
0008301518	716013
0008356947	716016
9408350047	716019
9408350147	716020
9408350247	716018
9608300018	716066
9608300118	716065
9738350147	716014
9738350247	716021
9738350347	716015
0008303418	716012
0008301318	716012
0018350747	716017
0008358947	716017
A9408350047	716019
A9408350147	716020
A9408350247	716018
A9738350247	716021
B67582415	716018

<b>MERCEDES (EVOBUS/SETRA)</b>	
0018255447	716049
0018351547	716050
0018352747	716048
0018355447	716049
0018355547	716056
0018356147	716059
0018356247	716061
0018357047	716046

	<b>Valeo</b>
<b>MERCEDES (EVOBUS/SETRA)</b>	
0018357147	716058
0018359147	716060
0018359247	716064
H14002499	716048
H14002484	716050
H14003495	716064
1101891A	716046
1101891B	716046
20401236	716049
6278350447	716049
88779100002	716048

<b>NEOPLAN (NEOMAN)</b>	
0018355547	716056
0018357047	716046
0018359247	716064
1101891A	716046
1101891B	716046
180412710	716055
180740200	716054
18255447	716049
18355447	716049
18357047	716046
20401236	716049
6278350447	716049
81619100018	716036
81619100019	716037
88779100002	716048
88779100003	716047
81779100012	716057

<b>RENAULT TRUCKS</b>	
5001829129	716000
5001833354	716001
5001844054	716000
5001867491	716009

<b>SCANIA TRUCKS</b>	
1326180	716040
1420197	716039
1770813	716052

<b>SCANIA (BUS)</b>	
1100372A	716049
1100372B	716049

<b>WISEON BUS</b>	
H14003495	716064



**Valeo****VOLVO TRUCKS**

8143691-7	716041
20409908	716053
20559447	716009
4771477	716041
8143691	716045
8144430	716045
11007388	716041
110073889	716041
1584575	716045

**VOLVO (Bus/Trucks)**

82354791	716067
82348995	716068
82351184	716069

	<b>Valeo</b>
<b>BALDWIN</b>	
PA3980	716034
PA4612	716006
PA4928	716004
PA4938	716039
PA4945	716019
PA4947	716033
PA4955	716036
PA5330	716001
PA5336	716028
PA5339	716035
PA5340	716014
PA5341	716007
PA9812	716010

<b>CORTECO</b>	
21651973	716034
21651976	698840
21651977	716010
21652002	716018
21652997	716007
21652998	716014
21652999	716015
21653000	716020
21653001	716021
21653003	716012
21653005	716036
21653006	716011
21653007	716019
21653016	716035
21653018	716047
21653019	716016
21653021	716004
80000633	716041
80000076	716048
80000333	716028
80000336	716049
80000337	716050
80000349	716017
80000350	716040
80000354	716005
80000362	716039
80000364	716037
80000623	716006
80000626	716008
80000631	716046
80000641	716046
80000645	716001
80000916	716063

	<b>Valeo</b>
<b>KNECHT/MAHLE</b>	
LA42/1	716010
LA43	716012
LA50	716006
LA55	716004
LA67	716034
LA71	716007
LA83	698840
LA85	716014
LA148	716041
LA154	716036
LA170	716028
LA198	716033
LA279	716035
LA355	716049
LA357	716050
LA358	716019
LAK43	716011
LAK85	716015
LAK154	716037

	<b>Valeo</b>
<b>MANN HUMMEL</b>	
CU1722	716039
CU2101	716009
CU2184	716041
CU2218	716047
CU2303	716001
CU2304	716040
CU2534	716007
CU2785	716045
CU3001	716000
CU3132	716006
CU32001	716066
CU3423	716016
CU37230	716035
CU3855	716012
CU3858	698840
CU3869	716010
CU3959	716064
CU4036	716048
CU40110	716034
CU4228	716004
CU4408	716018
CU4466	716033
CU4469	716019
CU4594	716028
CU4627	716049
CU4662	716046
CU4795	716036
CU5096	716050
CU5809	716021
CU5877	716014
CUK2534	716008
CUK2952	716063
CUK32001	716065
CUK3823	716011
CUK3858	716023
CUK4252	716013
CUK4469	716020
CUK4594	716029
CUK4795	716037
CUK5877	716015





Every effort has been made to ensure that the information contained in this catalogue is correct at the time of printing, but no warranty or representation is given or made as to the accuracy of such information and Valeo Service UK Ltd does not accept any liability whatsoever for any inaccuracies.

Valeo Service UK Ltd reserves the right to alter specifications and/or the final construction of products without notice.

Product references referred to in this catalogue may not be available in all countries.

All orders for products are only accepted subject to the terms and conditions of Valeo Service UK Ltd.

Photographs and drawings are not binding on Valeo Service UK Ltd. The copyright in this publication belongs to Valeo Service UK Ltd exclusively. No part of this publication may be reproduced by any means without the prior authorisation of Valeo Service UK Ltd.

L'affectation et la préconisation des produits figurant dans nos catalogues prennent en compte l'état du parc automobile au jour de leur parution.

La responsabilité de Valeo Service ne saurait être engagée en cas de modification, substitution ou suppression des affectations ou préconisations qui pourraient intervenir notamment à l'initiative des constructeurs de véhicules.

Les caractéristiques techniques de nos produits sont susceptibles d'évoluer à tout moment pour tenir compte des améliorations techniques

et technologiques.

Certaines références peuvent ne pas être disponibles dans tous les pays.

Les commandes sont régies par les conditions générales de vente de Valeo Service.

Photos et dessins non contractuels. La reproduction de tout ou partie de cette publication est interdite sans l'autorisation expresse et écrite de Valeo Service.

La aplicación de los productos sobre vehículos y las especificaciones de los productos que figuran en nuestros catálogos se refieren a la situación del parque de automóviles en la fecha de puesta en circulación de los productos.

Valeo Service España SA no asume ninguna responsabilidad en caso de modificación, sustitución o supresión de dichas aplicaciones y/o especificaciones que pudieran producirse por iniciativa de los fabricantes de automóviles.

Las características técnicas de nuestros productos son susceptibles de evolucionar en cualquier momento para incorporar las mejoras técnicas y tecnológicas que se desarrollen.

Las referencias de productos mencionadas en este catálogo puede que no estén disponibles en todos los países.

Los pedidos se regiran por las condiciones generales de venta de Valeo Service España SA.

Las fotografías y dibujos que aparecen en nuestros catálogos son meramente indicativas, por lo que no siempre coinciden exactamente con la apariencia externa de nuestros productos. Se prohíbe la reproducción de todo o parte de esta publicación sin la autorización expresa y escrita de Valeo Service España SA.

As prescrições e recomendações relativas ao uso ou utilidade dos produtos constantes de nossos catálogos levam em consideração o estado do parque automotivo à época do lançamento desses produtos.

A Valeo Sistemas Automotivos Ltda (Valeo Cibié Service) não será responsável por quaisquer modificações, substituições ou supressões incidentes sobre as prescrições e recomendações relativas ao uso ou utilidade de nossos produtos, que sejam decorrentes de ações dos construtores de veículos.

As características técnicas de nossos produtos são suscetíveis de alteração a qualquer momento para que sejam incorporadas melhorias técnicas e/ou tecnológicas.

Certas referências podem não estar disponíveis em todos os países.

Os pedidos feitos pelos clientes são regidos pelas condições gerais de venda da Valeo Sistemas Automotivos Ltda (Valeo Cibié Service).

Fotos e desenhos não contratuais. A reprodução do todo ou de parte desta publicação é proibida sem a autorização expressa e por escrito da Valeo Sistemas Automotivos Ltda (Valeo Cibié Service).

Le applicazioni e le specifiche dei prodotti che figurano nei nostri cataloghi si riferiscono alla situazione del parco circolante al momento della pubblicazione.

Valeo Service Italia S.p.A. declina qualsiasi responsabilità in caso di modifica, sostituzione o soppressione di applicazioni o specifiche eventualmente approntate, senza preavviso, da parte dei Costruttori.

Le caratteristiche tecniche dei nostri prodotti sono suscettibili di modifiche in qualsiasi momento, per apportare migliorie tecniche e tecnologiche.

Alcuni riferimenti presenti in questo catalogo non sono disponibili in tutti i paesi.

Gli ordini sono regolamentati dalle condizioni generali di vendita di Valeo Service Italia S.p.A..

Le Foto ed i disegni che appaiono nel catalogo sono puramente indicativi. E' vietata la riproduzione della totalità o di una parte della presente pubblicazione senza un'esplicita autorizzazione scritta da parte di Valeo Service Italia S.p.A..

De ter zake van de producten in onze catalogi aangegeven bestemmingen en gedane aanbevelingen zijn gebaseerd op het wagenpark ten tijde van publicatie.

Valeo Service Benelux B.V. sluit elke aansprakelijkheid uit met betrekking tot wijziging, vervanging of annulering van de bestemmingen of aanbevelingen, die met name op initiatief van de autofabrikanten kunnen worden doorgevoerd.

De technische eigenschappen van onze producten kunnen te allen tijde evolueren teneinde rekening te houden met technische en technologische verbeteringen.

Bepaalde artikelen kunnen in bepaalde landen niet beschikbaar zijn.

Orders zijn onderworpen aan de algemene verkoopvoorwaarden van Valeo Service Benelux B.V.

Foto's en tekeningen zijn niet bindend.

De gehele of gedeeltelijke vervoelvoudiging van deze uitgave zonder uitdrukkelijke voorafgaande schriftelijke toestemming van Valeo Service Benelux B.V. is verboden.

Die Verwendungsempfehlungen zu den in diesem Katalog aufgeführten Produkten beziehen sich auf den zum Zeitpunkt des Erscheinens des Katalogs existierenden Fahrzeugbestand.

Die Valeo Service Deutschland GmbH übernimmt keine Haftung für Änderungen, Ersetzungen oder Streichungen der Fahrzeuganwendung oder - Empfehlungen durch die Fahrzeughersteller.

Die technischen Eigenschaften unserer Produkte werden kontinuierlich weiterentwickelt, um einen hohen technologischen Standard zu gewährleisten.

Die Fotos oder Zeichnungen in diesem Katalog dienen ausschließlich zur Veranschaulichung unserer Produkte. Rechtliche Ansprüche können daraus nicht abgeleitet werden.

Einige Produktreferenzen sind nicht in allen Ländern verfügbar.

Lieferungen unterliegen den allgemeinen Geschäftsbedingungen der Valeo Service Deutschland GmbH.

Die Vervielfältigung dieses Katalogs oder Teilen daraus ist ohne schriftliches Einverständnis der Valeo Service Deutschland GmbH rechtlich nicht gestattet.

Przeznaczenie i zalecenia dotyczące produktów figurujących w naszych katalogach biorą pod uwagę stan parku samochodowego w dniu ich wprowadzenia na rynek.

Spółka "Valeo Service Eastern Europe Sp. z o.o." nie może być ponosić odpowiedzialności w przypadku zmiany, zastąpienia lub usunięcia wskazań dotyczących przeznaczenia i zaleceń, które mogą wystąpić z inicjatywy producentów samochodów.

Dane techniczne naszych produktów mogą być w każdej chwili zmienione w celu uwzględnienia ulepszeń technicznych i technologicznych.

Niektóre modele mogą być niedostępne w niektórych krajach.

Zamówienia podlegają ogólnym warunkom umów "Valeo Service Eastern Europe Sp. z o.o."

Wykorzystywanie w całości lub w części zdjęć i rysunków zamieszczonych w naszych katalogach wymaga pisemnej zgody "Valeo Service Eastern Europe Sp. z o.o."

Kataloglarımızda yer alan ürünlerin kullanım ve tanımları, otomobil parkının yaygın tarihindeki durumuna göredir.

Valeo Otomotiv Dağıtım AS, özellikle araç, üreticilerinin inisiyatifini sonucu yapılan değişiklik, ikame veya kaldırılmalardan sorumlu tutulamaz.

Ürünlerimizin teknik özellikleri, teknik ve teknolojik gelişmelere paralel olarak geliştirilebilir.

Bazı referanslar bazı ülkelerde bulunmayabilir.

Siparişler, Valeo Otomotiv Dağıtım AS'un genel satış koşullarına uygun olarak ödenir.

Fotoğraf ve resimler akdi değildir. İşbu yayının Valeo Otomotiv Dağıtım AS'un önceden verilmiş yazılı izni olmaksızın kısmen veya tamamen çoğaltılması yasaktır.

Učinili jsme všechny kroky nezbytné k tomu, aby informace v tomto dokumentu byly přesné ke dni jeho tisku. Valeo Service Export nezodpovídá za případné neúplné či chybné informace zde uvedené.

Valeo Service Export si vyhrazuje právo úpravy specifikace a / nebo konečné formy výrobku bez předchozího upozornění.

Katalogová čísla obsažená v tomto katalogu nemusí být dostupná k prodeji na všech trzích. Konečné objednávni výrobku se řídí obchodními podmínkami Valeo Service Export.

Fotografie a technické nákresy nezávisí na Valeo Service Export. Copyright je exkluzivně Valeo Service Export. Žádná část tohoto katalogu nesmí být kopírována bez autorizace Valeo Service Export.

A VALEO teljes tudásával arra törekszik, hogy a katalógusban szereplő adatok műszaki tartalma teljesen korrekt legyen, ezért a VALEO SERVICE EXPORT nem vállal garanciát azok helyességéért, pontatlanságáért és nem terheli felelősség az esetleges hibákból eredő károkért.

A VALEO SERVICE EXPORT fenntartja a jogot a termékváltoztatásokra mellékelt termékinformáció nélkül.

A katalógusban szereplő cikkszámok között előfordulhatnak olyanok is, melyek nem minden országban kerülnek forgalomba.

Minden termék rendelés a VALEO SERVICE EXPORT szerződéses kondíciói alapján érvényes.

A katalógusban szereplő fényképek és rajzok nem a VALEO SERVICE EXPORT készítményei. A szerzői jogok a VALEO SERVICE EXPORT kizárólagos tulajdonát képezik.

A kiadvány részét nem képező reprodukciókhoz nem szükséges a VALEO SERVICE EXPORT engedélye.

Назначение и рекомендации по эксплуатации продукции, содержащиеся в наших каталогах, указываются с учетом состояния автомобильного парка на день ее появления.

Компания «Valeo Service Eastern Europe Sp. z o.o.» не несет ответственности в случае внесения изменений в рекомендации по эксплуатации продукции или их устранения, произошедших, в частности, по инициативе производителей автомобилей.

Технические характеристики нашей продукции могут претерпевать изменения в любой момент, с учетом усовершенствования технических и технологических процессов.

Некоторые виды продукции могут не иметься в наличии в отдельных странах.

Заказы осуществляются согласно общим правилам торговли, применяемым в компании «Valeo Service Eastern Europe Sp. z o.o.».

Фотографии и изображения продукции могут не в полной мере соответствовать оригиналам. Воспроизведение всей или части настоящей публикации запрещено без специального письменного согласия компании «Valeo Service Eastern Europe Sp. z o.o.».

Η κατανομή και η σύσταση προϊόντων που εμφανίζονται στους καταλόγους γίνεται λαμβάνοντας υπ όψη την κατάσταση του στόλου αυτοκινήτων στην ημέρα της δημοσίευσής τους.

Η ευθύνη της Valeo Service δεν μπορεί να εμπλακεί σε περίπτωση τροποποίησης, αντικατάστασης ή κατάρτησης των προτάσεων ή των συστάσεων που θα μπορούσαν να προκύψουν κατόπιν πρωτοβουλίας των κατασκευαστών των οχημάτων.

Τα τεχνικά χαρακτηριστικά των προϊόντων μας ενδέχεται να εξελιχθούν ανά πάσα στιγμή λόγω τεχνικών και τεχνολογικών βελτιώσεων.

Μερικοί οδηγοί μπορούν να μην είναι διαθέσιμοι σε όλες τις χώρες.

Οι παραγγελίες διευθετούνται από τους γενικούς όρους πωλήσεων της Valeo Service.

Οι φωτογραφίες και τα σχέδια δεν είναι δεσμευτικά. Η αναπαραγωγή ολόκληρου ή τμήματος αυτού του καταλόγου απαγορεύεται να γίνει χωρίς τη ρητή και γραπτή άδεια της Valeo Service.

## EUROPE

### FRANCE

#### VALEO SERVICE FRANCE

70, RUE PLEYEL  
93285 SAINT-DENIS CEDEX - FRANCE  
Tel.: (+33) 1 49 45 32 32  
Fax: (+33) 1 49 45 37 36  
S.A.S. au capital de 12 900 000 €  
RCS Bobigny B 306 486 408

### SPAIN, PORTUGAL

#### VALEO SERVICE ESPAÑA, S.A.

CALLE RIO ALMANZORA, N°5  
AREA EMPRESARIAL ANDALUCIA C.L.A.  
28906 GETAFE (MADRID) - ESPAÑA  
Tel.: (+34) 91 495 85 00  
Fax: (+34) 91 495 86 99  
TEL. ATENCIÓN TÉCNICA: 902 011 799  
TEL. ATENCIÓN AL CLIENTE: 900 122 657  
Valeo Service España Sociedad Anónima  
inscrita en el Registro Mercantil de Madrid,  
Tomo 972 - Libro 941 de la sección 8a,  
Folio 25 - Hoja 65435 - Inscripción 1a NIF. A28772978

### ITALY

#### VALEO SERVICE ITALIA SPA (V.S. ADRIATIC)

VIA ASTI 89  
10026 SANTENA (TO) - ITALIA  
Tel.: (+39) 011 94 95 1  
Fax: (+39) 011 94 95 280  
TEL. LINEA TECNICA - 800 805 046  
N. iscrizione al Tribunale di Torino 2009/88 reg. soc.  
C.C.I.A.A. 715107 - Capitale sociale € 2.600.000

#### LIAISON OFFICE IN GREECE

KALAMAKOU AVENUE, 18  
ALIMOS - ATHENS - GREECE - PC 17455  
TEL.: +302104527447  
FAX: +302104527449

#### LIAISON OFFICE IN SERBIA

OGRAČAK BEOGRAD,  
19TH AVENUE GTC,  
VLADIMIR POPOVICA 38-40  
11070, NOVI BEOGRAD, SERBIA  
TEL: +302104527447/8

#### LIAISON OFFICE IN CROATIA

PODRUŽNICA ZAGREB HEKTOROVICEVA 2  
tel:+385 1 644 8288

### UNITED KINGDOM

#### VALEO SERVICE UK LTD

HEMING ROAD - WASHFORD  
REDDITCH - WORCS B98 0DZ - ENGLAND  
Tel.: (+44) 1527 838 300  
Fax: (+44) 1527 523 732  
Registration Number: 956685

### GERMANY

#### VALEO SERVICE DEUTSCHLAND GMBH

BRANDENBURGER STRASSE 46  
40880 RATINGEN - DEUTSCHLAND  
Tel.: (+49) 21 02 865 0  
Fax: (+49) 21 02 865 142  
Handelsregister Ratingen - HRB 3340

#### LIAISON OFFICE IN AUSTRIA

EURO PLAZA - AM EURO PLATZ 2  
GEBÄUDE G (YOUR OFFICE) BÜRO C1  
1120 WIEN  
Tel.: (+49) 21 02 865 0  
Fax: (+49) 21 02 865 142

### BENELUX

#### VALEO SERVICE BENELUX B.V.

HEIBLOENWEG 1  
5704 BS HELMOND - THE NETHERLANDS  
Tel. BELGIUM (NL): (+32) 2 366 99 17  
Tel. BELGIUM (FR): (+32) 2 355 14 46  
Tel. NETHERLANDS: (+31) 492 580 894  
Fax BELGIUM: (+32) 2 366 04 47  
FAX NETHERLANDS: (+31) 492 580 828  
K.v.K. Eindhoven 33113859

### POLAND, LITHUANIA, LATVIA, ESTONIA, MOLDAVIA, BELARUS, UKRAINE

#### VALEO SERVICE EASTERN EUROPE Sp. z o.o.

WOŁOSKA 9A  
02-583 WARSZAW POLSKA  
Tel.: (+48) 22 543 43 00  
Fax: (+48) 22 543 43 05  
Valeo Service Eastern Europe Sp. z o.o.; NIP 521-11-44-  
572 VAT UE PL5211144572 - REGON 011909673  
Wysokość kapitału zakładowego: 4 637 000 PLN -  
KRS 56793 SdD Rejonowy dla m. St. Warszawy w  
Warszawie,  
XIII Wydział Gospodarczy KRS

#### LIAISON OFFICE IN CZECH REPUBLIC

DEDINSKA 29  
16101 PRAGUE 6  
CZECH REPUBLIC  
Tel.: (+420) 220 102 277  
Fax: (+420) 220 102 278

### RUSSIA

#### VALEO SERVICE CO LTD

107140, MOSCOW, RUSAKOVSKAYA ST. 13,  
3RD FLOOR, OFFICE 6  
Tel.: (+7) 495 981-06-96  
Fax: (+7) 495 787-59-92

### USA

#### VALEO SERVICE USA

301 WEST PARK LANE, SUITE 301  
HAMPTON, VA 23666  
UNITED STATES OF AMERICA  
MI 48083-1116  
TEL 1-888-178-2536

### SOUTH AMERICA

### BRAZIL

#### VALEO SISTEMAS AUTOMOTIVOS LTDA

RUA SADAÉ TAKAGI, 2000  
BAIRRO COOPERATIVA  
09852-070 - SÃO BERNARDO DO CAMPO  
SÃO PAULO - BRASIL  
Tel.: (+55) 11 43 93 33 54  
Fax: (+55) 11 43 93 33 55  
C.N.P.J.: 57.010.66

### ARGENTINA

#### EMELAR S.A.

GRAL. MANUEL SAVIO 5740  
COMPLEJO LOGÍSTICO SUR  
CÓRDOBA | ARGENTINA  
Tel.: (+54) 9 351 6635067

### MEXICO

#### LIAISON OFFICE IN MEXICO

MONTECITO 38, PISO 14 OFICINA 38.  
TORRE WORLD TRADE CENTER  
COLONIA NÁPOLES | 03810 | MÉXICO, D.F.  
Tel.: +52 (55) 90001588

### ASIA

### CHINA

#### VALEO AUTO PART TRADING (SHANGHAI)

CO., LTD  
201, BUILDING B, IBC TOWER (NEW  
INTERNATIONAL BUSINESS CENTER)  
391 GUI PING ROAD, SHANGHAI 200233, CHINA  
TEL: (+86) 21 5171 3576  
MP: (+86) 139 1750 0406  
法雷奥汽车零部件贸易(上海)有限公司  
地址: 上海市徐汇区桂平路391号新漕河  
泾国际商务中心B座201  
电话: (+86) 21 5171 3576  
传真: (+86) 139 1750 0406

### INDIA

#### VALEO SERVICE INDIA AUTO PARTS PVT. LTD.

BLOCK-A, TECCI PARK, 173,  
RAJIV GANDHI SALAI (OMR),  
SHOLINGANALLUR CHENNAI  
600 119, INDIA  
Tel. (+91) 44 66235000

### TURKEY

#### VALEO OTOMOTIV DADITIM A.D.

AYDINEVLER SANAYI CADDESI  
CENTRUM IS MERKEZI N°3  
KAT: 3, DAIRE N°302-303 KÜÇÜKYALI - MALTEPE  
34854 ISTANBUL - TUR

### MIDDLE EAST

#### VALEO OTOMOTIV SANAYI VE TICARET A.Ş

VALEO SERVICE MIDDLE EAST  
BP-04 TO BP-06  
JEBEL ALI FREE ZONE (SOUTH-1)  
P.O. BOX  
17933, DUBAI

### AFRICA, AUSTRALIA, NEW-ZEALAND, DOM-TOM, ISRAEL

#### VALEO SERVICE AFRICA & OVERSEAS

70, RUE PLEYEL  
93285 SAINT-DENIS CEDEX - FRANCE  
Tel.: (+33) 01 49 45 32 32  
FAX: (+33) 01 49 45 36 59

#### LIAISON OFFICE IN TUNISIA

CENTRE D'AFFAIRES REGUS  
IMMEUBLE CARTHAGE  
RUE DU LAC DE CONSTANCE  
1053 TUNIS - TUNISIA  
TEL.: (216) 71 160 473

#### LIAISON OFFICE IN MOROCCO

CASA MASSIRA BUSINESS CENTER,  
12 RUE ALI ABDERRAZAK  
MASSIRA  
20100 CASABLANCA - MAROC  
TEL.: (212) 5 22 92 81 17

#### VALEO SERVICE AUSTRALIA PTY LTD

181 BAY STREET  
LEVEL 1  
BRIGHTON  
VIC 3186 - AUSTRALIA  
TEL: +27 (0) 11 258 8830

#### VALEO SERVICE IN SOUTH AFRICA

COUNTRY CLUB ESTATE BUILDING  
(REGUS BUILDING 2)  
15 WOODLANDS DRIVE;  
WOODMEAD; 2052; JOHANNESBURG.  
TEL: +27 11 255 8830 / +27 11 258 8801 /



# Air Quality Concept\*

## For Passenger Cars

Pour véhicules de tourisme



### Clim Filter™

Filter the air in the cabin

Filtere l'air dans l'habitacle



### Clim Pur™

Clean the air conditioning system

Nettoie le circuit de climatisation



### Clim Spray™

Purify and perfume the cabin

Purifie et parfume l'habitacle



\*Concept de Qualité

## For Trucks and Bus

Pour Camions et Bus



valeoservice.com

# Valeo

Valeo Service - Société par Actions Simplifiée - Capital 12 900 000 euros - 366 486 408 R.C.S. Boulogny - 70 rue  
93200 Saint-Denis - France - Picturas - ©Picturas - ©Lobbia / ©Aurelienne.fr / ©over / ©Christian Schryver - Compagnie - Packaging, Agence DP - Design - penjon-complete.com - Adverve - Enjoy - Made in France - Bel. 955688