



DOMUSCLASSICA®
| Collection |

Burlington®

KYLPYHUONE JA WC





OLEMME YLPEITÄ TUOTTEISTAMME!

ME TÄÄLLÄ DOMUKSELLA TUNNEMME VANHAT RAKENNUKSET. HALUAMME AUTTAA TEITÄ LÖYTÄMÄÄN KOTIINNE PARHAAT MAHDOLLISET RAKENNUSOSAT, JOILLA VANHAN TALONNE TUNNELMA SÄILYY JUURI SELLAISENA KUIN SE ON AIEMMINKIN OLLUT. TARJOAMAMME TUOTTEET VALMISTETAAN KYMMENIÄ VUOSIA TOIMINEISSA VERSTAISSA, JOISSA TYÖHÖN SUHTAUDUTAAN KUNNIAHIMOISESTI JA LAATUUN VAHVASTI PANOSTAEN. OLEMME ERITTÄIN YLPEITÄ VALIKOIMASTAMME!

HALUAMME OLLA APUNASI

SAAT MEIHIN YHTEYDEN SEURAAVASTI:

PUHELIN

0400-23 24 25

ASIAKASPALVELUMME ON AVOINNA
MA-TO KLO 9-15 JA SU KLO 12-15

SÄHKÖPOSTI

DOMUS@DOMUSCLASSICA.COM

VERKKOKAUPPA

WWW.DOMUSCLASSICA.FI

MYYMÄLÄMME

HELSINKI

EROTTAJANKATU 11, 00130 HELSINKI

PUHELIN 044-715 4200

AVOINNA MA-PE 10-18, LA 11-16

HATTULA

METSÄNKYLÄNTIE 2, 13900 PEKOLA

PUHELIN 0400-23 24 25

AVOINNA MA-TO 9-15, SU 12-15



DOMUSCLASSICA®
| Collection |

Contents

CERAMICS

There are four eras of history reflected in our designs; Classic, Edwardian, Victorian and Contemporary. Within each of these designs there are sizes to suit your bathroom, shower room or cloakroom. A selection of WCs and bidets are available to match your washbasin selection.

FURNITURE

A range of beautifully traditional furniture solutions to add classic style and sophisticated British elegance to your bathroom. Choose from free-standing, either a square or round design, wall-hung or fully-fitted options.

BATHS

Our range of baths includes grand free-standing baths, roll top baths and standard baths. Roll top baths have a range of matching feet and the Hampton roll top is even designed to fit into a corner, fitting a modest size bathroom.

TAPS & BRASSWARE

Burlington taps and mixers bring classic design packed with innovative technology. There are separate taps, one and three piece basin mixers, an Arch fitting and bath fittings with telephone handsets, each with a choice of handles for up to 324 combination.

SHOWERING

Shower mixers with modern safe thermostatic control are the way forward for controllable showering, and a period enclosure can complete your bathroom.

ACCESSORIES

The look is complete with stunning chrome plated solid brass accessories. From corner baskets for your shower, to soap dispensers, they provide the perfect finishing touch to your bathroom.

OVERVIEW	2
CLASSIC	8
EDWARDIAN & VICTORIAN	24
CONTEMPORARY & STONE	40
WCS	50
CLOAKROOMS	66

OVERVIEW	72
FREESTANDING	74
WALL HUNG	86
FITTED	90

OVERVIEW	102
DOUBLE ENDED	104
SINGLE ENDED	118
SHOWERING	126

OVERVIEW	132
BASIN & BATH	136
SUNDRY & WASTES	138

OVERVIEW	154
SHOWERS & VALVES	156
SHOWER ENCLOSURES	168

RADIATORS	176
MIRRORS & LIGHTS	180
ACCESSORIES	186

CERAMICS

FURNITURE

BATHS

TAPS & BRASSWARE

SHOWERING

ACCESSORIES

Introduction

From the late 1800's into the 1900's, Britain led the way in bathroom design and performance. Burlington bathrooms bring a complete collection of traditional bathroom products for you to create a classical, British bathroom from eras of great design. Our range is extensive and allows you to create a look and feel to suit your personal choice, safe in the knowledge that these are all designed to co-ordinate together perfectly.

CERAMICS



SEE PAGE 2

FURNITURE



SEE PAGE 72

BATHS



SEE PAGE 102

TAPS & BRASSWARE



SEE PAGE 132

SHOWERING



SEE PAGE 154

ACCESSORIES



SEE PAGE 176

Ceramics

There are a great variety of basin options within the Burlington family. Choose from the simply styled Classic basin in either a round or square design, the Edwardian basin with its subtle angular appearance, again in a round or square design, Victorian with a refined look or Contemporary for a minimal and pared back form. Basins can be available in one, two or three tap hole options and can be used on a variety of styled pedestals; either full, regal, semi-pedestal, washstand or even counter-top options.



... on all sanitaryware
See website for details

CERAMICS



The Ceramic Range

Yesterday's design with today's advanced technology

Burlington Bathroom design is governed largely by the washbasin style. Every design is crafted to reflect the specific era in which British sanitaryware rose in fame and was heralded as the best in aesthetic and performance. Burlington's key design themes are represented through Classic, Edwardian, Victorian and Contemporary eras. Every basin is crafted to the highest quality and is full of character and style with various choices in style, size and other options to suit your own individual tastes and requirements.

CERAMICS



CLASSIC

The Classic collection from Burlington is beautifully formed, either as a curvaceous round design or a grand square model. This collection also features the invisible overflow, and innovative waste technology *see p10 for details.*

Pages 08-23



CLOAKROOM

A selection of cloakroom options have been crafted so you can match your chosen style throughout the home. You'll find Edwardian, Victorian and more Classic styled cloakroom basins to achieve a consistent and beautiful look throughout every washroom.

Pages 66-71

Pages 24-33

EDWARDIAN

The Edwardian collection is the ultimate in traditional bathrooms with structured corners and angular designs, the feel is un-apologetic and proud.



VICTORIAN

A delicate and refined range, the simplicity of this ceramic basin is stunning. Available in a medium (56cm) or large (61cm) and a range of pedestal and tap hole options, the versatility of this style allows you to continue the style throughout your home and brings an air of luxury to every room.

Pages 34-39



CONTEMPORARY

As the name suggests, the Contemporary collection is styled on the elegance of past times but with a modern day twist. Simplistic, structured lines form the basis for this striking ceramic collection. Available as full pedestal, semi-pedestal or with a chrome washstand.

Pages 40-43

CERAMICS



...on all sanitaryware
See website for details

Regal Sanitaryware

Why We're Making Taller Sanitaryware

At Burlington we've reacted to market demands by creating our Regal range of sanitaryware.

In Europe the height of an average male has increased by approximately 15cm in the past 130 years (with the knee height increasing by an estimated 6cm).

EUROPEAN HEIGHT INCREASES

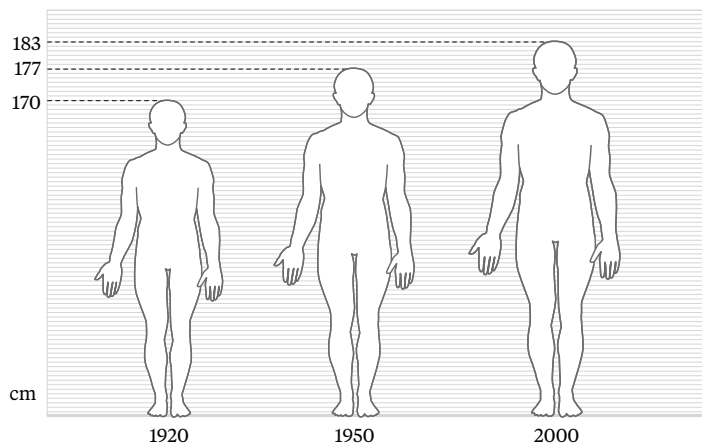

CERAMICS

Here at Burlington we've created a range that's 6cm higher than average sanitaryware.

When using a WC the correct seating position is to have a knee angle of approximately 90°. At 48cm high the Regal WCs enable this.

Higher sanitaryware not only helps taller people but it also helps if you're older: It's far easier getting on and off a loo that's 48cm high than one that's 42cm high. The basin height is higher too; reducing the need to arch your back too much.

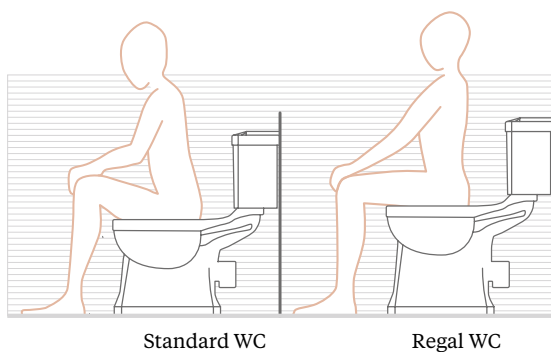

CLOSE COUPLED & LOW LEVEL WCS

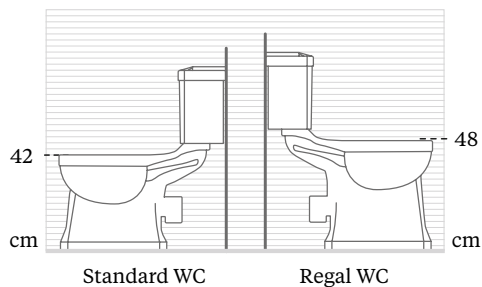

BACK TO WALL WCS

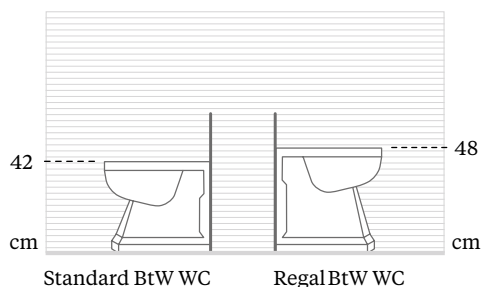

PEDESTAL OPTIONS ↓

Available with the Classic & Classic Round Basins

Burlington Regal pedestals are 6cm higher than the standard pedestals.

	Standard Height	Regal Height
Classic	86cm	92cm
Victorian classic	84cm	90cm
Edwardian classic	84cm	90cm
Contemporary classic	84cm	90cm



WASHSTAND OPTIONS ↓

Available with the Classic, Edwardian, Victorian and Cloakroom

Burlington Regal washstands are 6cm higher than the standard washstand to ensure a more ergonomic use for taller individuals.

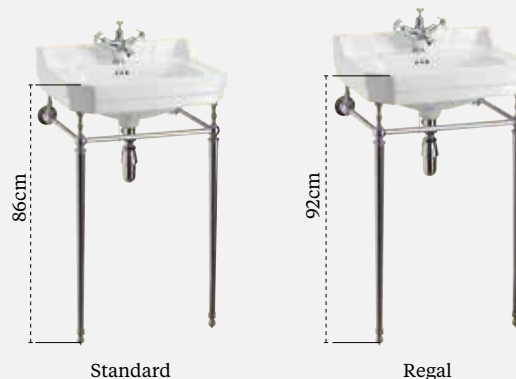

Classic

CERAMICS



Classic Basin with Invisible overflow. See page 20 for more details.

Classic Basin 1TH with Pedestal.



The Classic basin collection from Burlington is beautifully formed, either as a grand square design or a curvaceous round model. This collection also features an innovative waste technology. Choose a Classic basin with invisible overflow allowing you to have seamless ceramic without a plug. All Classic basins are available as 1, 2 or 3 tap holes on standard or regal pedestals or a range of washstands and furniture see page 74, 75 & 76 for more details.

CERAMICS

Classic Round 3TH with Regal Pedestal.



PEDESTAL OPTIONS ↓

Available with the Classic & Classic Round Basins

Burlington Regal pedestals are 6cm higher than the standard pedestal to ensure a more ergonomic use for taller individuals.







The Classic round basin has beautiful form with a curvaceous front adding an interesting feature to a simplistic overall appearance. The piece works seamlessly with other classically designed Burlington products such as close-coupled WCs or soft, rounded soaking tubs.

Classic round basin with standard pedestal, Claremont 5" basin pillar taps, plug & chain basin waste, close-coupled WC and cistern with ceramic lever with soft-close mahogany seat (or with chrome handles), and ceramic trap. Brindley bath and skirt.

See pages 22-23 for technical details on the Classic round basin.

WC FLUSH ←

Design a bathroom to suit your specific needs

View the full range of WCs from page 50 onwards

All Burlington WCs are fitted with box rims, which even though they are harder to manufacture, provide a more accurate flush spread. The cisterns are fitted with dual flush water saving technology.

CLASSIC ROUND BASINS

Pair your beautifully styled Classic round basin with the new round pedestal.

With its elegant form and tasteful detailing, the overall effect is one of refined class.

CERAMICS

This page and opposite: Classic round basin with Classic round pedestal, Claremont basin 5" pillar taps and plug and chain basin waste.

See pages 22-23 for technical details on the Classic round basin.



CERAMICS

A grand basin design, the Classic works beautifully in every surrounding to create a vintage inspired bathroom, effortlessly.

Bloomsbury radiator with angled radiator valves, Rectangular mirror, Classic basin with standard pedestal and Anglesey 3 tap hole basin mixer with pop-up waste.

See pages 22-23 for technical details on the Classic basin.

CLASSIC RECTANGULAR BASINS

Classic basin 1 tap hole with chrome basin stand, Claremont
1 tap hole basin mixer with pop-up waste and traditional
basin bottle trap.

See pages 22-23 for technical details on the Classic basin.

CERAMICS



English Garden

The English garden range sees the Classic style basins brought to life with delicate floral transfers. The new round pedestal is softened with finite moulded detail, exuding class and sophistication.

CERAMICS





CERAMICS



This page top: English garden close-coupled WC with cistern with soft-close seat white and ceramic trap (see page 63). English garden round basin and English garden round pedestal with Claremont 1 tap hole basin mixer with click-clack waste.

This page bottom: English garden basin and English garden pedestal with Claremont 1 tap hole basin mixer with central indice and click-clack waste.

See page 22 for technical details on the English Garden basins.

CLASSIC INVISIBLE OVERFLOW BASINS

CERAMICS



Rectangular mirror, Edwardian single elliptical lights, Classic basin invisible overflow with standard pedestal and invisible overflow waste and bottle trap, Claremont 5" basin pillar taps, medium-level WC with ceramic cistern lever with soft-close oak seat (or with chrome handles) and ceramic trap.

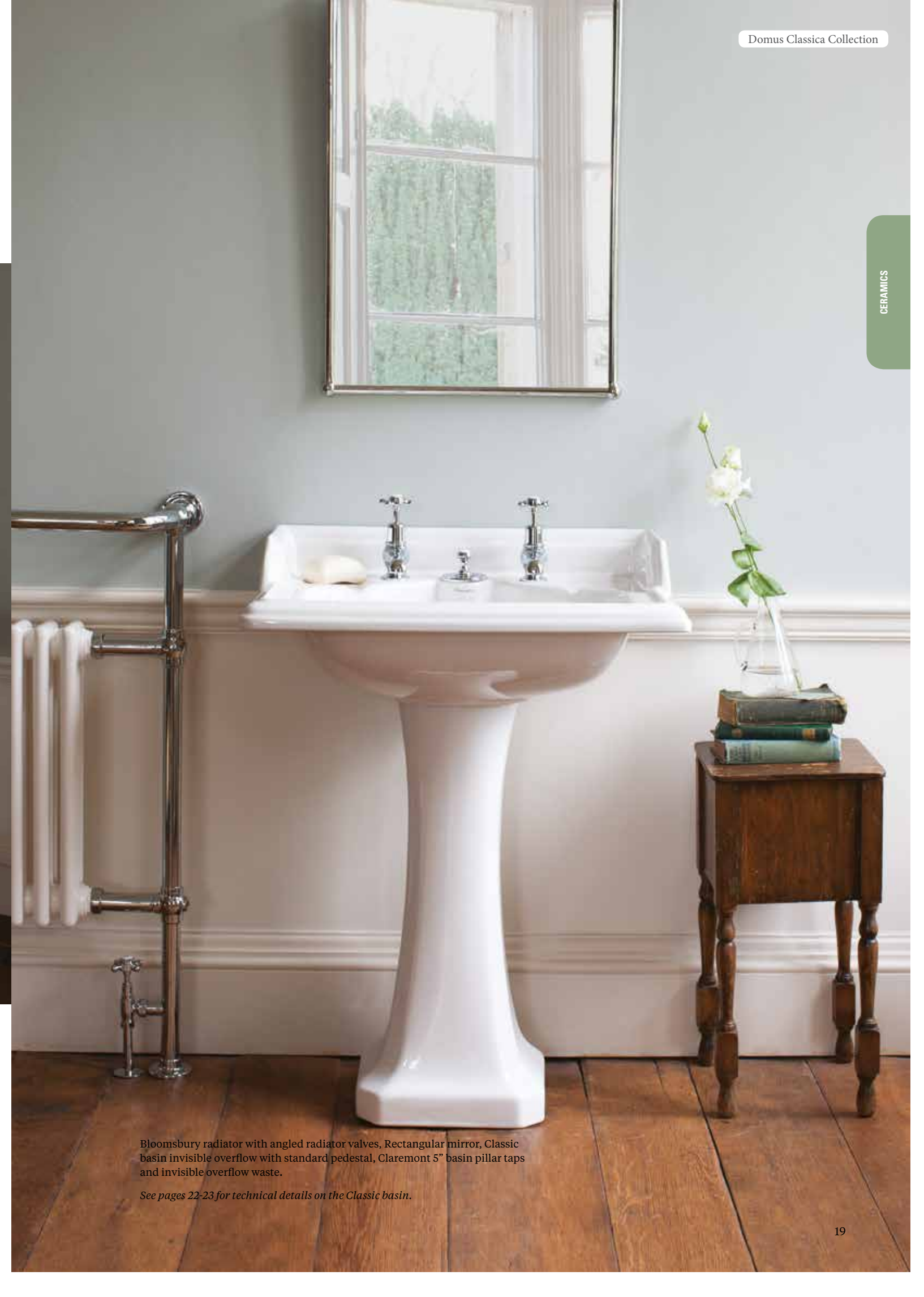

Bloomsbury radiator with angled radiator valves, Rectangular mirror, Classic basin invisible overflow with standard pedestal, Claremont 5" basin pillar taps and invisible overflow waste.

See pages 22-23 for technical details on the Classic basin.

Invisible Overflow

CERAMICS



Classic basin invisible
overflow & waste
W9



On all sanitaryware
See website for details

The benefit of invisible overflow is that the ceramic of the beautiful basins is un-interrupted with no requirement for a plug or external waste. Simply pull the lever up to drain water. Pair with the elegant and beautiful Arch basin mixer allowing you to mix hot and cold water.

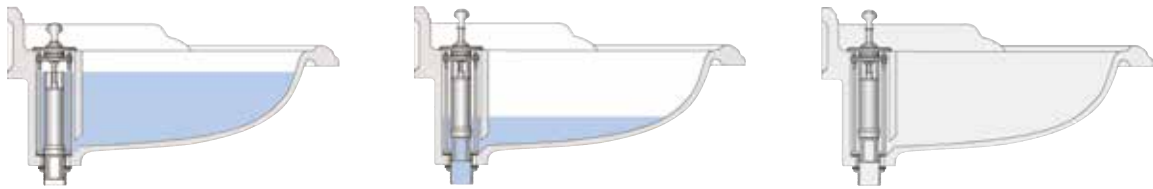

Classic Basins

CERAMICS

CLASSIC BASINS

Basin Shapes	Basins			Pedestals		Chrome Wash Stands		Aluminium Wash Stands (E)
				Standard (C)	Regal Round	Standard (D)	Regal	
	Width	Depth	Code	Code	Code	Code	Code	Code
Rectangular (A)	65cm	58cm	B15 z*	P6	P9R	T49ACHR	T49ACHR+T62	T38 ALU** T43 WHI** T48 BLA**
Round (B)	65cm	58cm	B17 z*	P6	P9R			

ENGLISH GARDEN CLASSIC BASINS

Basin Shapes	Basins			Pedestals*		Chrome Wash Stands		Aluminium Wash Stands
				Standard	Regal Round	Standard	Regal	
	Width	Depth	Code	Code	Code	Code	Code	
Rectangular	65cm	58cm	B15D*	-	P9RD	T49A CHR	T49ACHR+T62	T38 ALU** T43 WHI** T48 BLA**
Round	65cm	58cm	B17D*	-	-			
Corner Wall Mounted basin	59cm	45cm	B10D***	-				

* Classic basins are available with 1, 2 or 3 tap holes. To order the correct basin configuration Simply remove the 'z' and replace it with 1TH, 2TH or 3TH.

** To order the correct wash stand colour specify 'T38 ALU' for aluminium, 'T43 BLA' for Black, or 'T48 WHI' for white.

***B10D is compatible with T8 CHR towel rail



For Classic basins with furniture see pages 76, 77 and 86.

Classic Invisible Overflow Basins

CLASSIC INVISIBLE OVERFLOW BASINS

Basin Shapes	Basins			Pedestals		Chrome Wash Stands		Aluminium Wash Stands (E)
				Standard (C)	Regal Round	Standard (D)	Regal	
	Width	Depth	Code	Code	Code	Code	Code	Code
Rectangular (F)	65cm	58cm	B14*	P6	P9R	T49CHR	T49ACHR+T62	T38 ALU** T43 WHI** T48 BLA**
Round (G)	65cm	58cm	B16*	P6	P9R	-	-	-

Classic basins with invisible overflows are only available in two tap hole and must use basin waste W9

* Overall heights to the top of the front basin surface:

Classic Basin with Standard Pedestal: 86cm

Classic Basin with Regal Pedestal: 92cm

Classic Basin with wash stand: 88cm

Classic Basin with Regal basin stand: 92cm

Classic Basin with Aluminium wash stand: 89cm

** To order the correct wash stand colour specify 'T38 ALU' for aluminium, 'T48 BLA' for Black, or 'T43 WHI' for white.

Please note the B16 basin is available whilst stocks last



Classic basin invisible overflow & waste W9



For Classic Invisible Overflow basins with furniture see pages 76, 77 and 86.

CERAMICS

Edwardian

CERAMICS



Edwardian 61cm basin with standard pedestal and Claremont 3 tap hole basin mixer with pop-up waste.

See pages 30-33 for technical details on the Edwardian basins collection.

56cm Edwardian 1TH
Basin & Washstand.



The Edwardian collection is the ultimate in traditional bathrooms with structured upstands and angular designs, the feel is un-apologetic and proud. Edwardian basins come in a range of sizes from the Standard 56cm to the Large 61cm and now with the exciting addition of a Grand 80cm basin which will provide an eye catching centrepiece to your period styled bathroom. All are available in one, two or three taphole options and all can be used on the standard pedestal, the Regal pedestal, the semi-pedestal or on a washstand.

There is also a 56cm Edwardian round basin available with one or two tapholes, also suitable for all the pedestal and washstand options. With the strong personality of the upstand back, this basin is true traditional design at its very best.

61cm Edwardian 1TH Basin with
Semi-pedestal & Towel Rail.



56cm Edwardian Round 1TH
Basin & Regal Pedestal.



56cm Edwardian Round 1TH
Basin & Wash Stand



EDWARDIAN RECTANGULAR BASINS

CERAMICS



Edwardian 80cm basin with basin stand, Claremont 3 tap hole basin mixer with pop-up waste, flat bottomed basin bottle trap and curved mirror.

See pages 30-33 for technical details on the Edwardian basin.



Edwardian 80cm basin with standard pedestal and Claremont 3 tap hole basin mixer with pop-up waste.

EDWARDIAN RECTANGULAR BASINS



The Edwardian basin is available in a range of sizes and options. Pair with a semi-pedestal combined with a towel rail for the illusion of increased space in smaller bathrooms. The towel rails are available to add to any basin, adding extra functionality.



Edwardian Rectangular Basin

Edwardian 61cm basin with semi-pedestal and towel rail, Claremont 1 tap hole basin mixer with click-clack waste. Low-level WC slimline cistern with front flush button, soft-close oak seat (with chrome handles), ceramic trap and WC toilet roll holder.

See pages 30-33 for technical details on the Edwardian basin.



Edwardian Rectangular Basins

CERAMICS

EDWARDIAN RECTANGULAR BASINS

Basins			Pedestals			Chrome Basin Stands		Towel Rails (D)
Width	Depth	Code	Standard (B)	Regal	Semi	Standard (C)	Regal	Code
56cm	47cm	B4 z*	P1	P9	P8	T22A CHR	T22ACHR+T62	T1 CHR
61cm (A)	51 cm	B5 z*	P1	P9	P8	T23A CHR	T23ACHR+T62	T3 CHR
80cm	51cm	B18 z*	P6	P9		T50 CHR	T50CHR+T62	

* Edwardian Rectangular Basins are available with 1, 2 or 3 tap holes. To order the correct basin configuration simply remove the 'z' and replace it with 1TH, 2TH or 3TH.

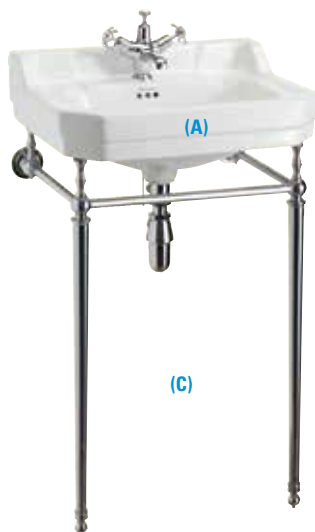

...on all sanitaryware
See website for details



Edwardian Round Basins

EDWARDIAN ROUND BASINS

Basins			Pedestals			Chrome Basin Stands		Towel Rails (D)
Width	Depth	Code	Standard (B)	Regal	Semi	Standard (C)	Regal	Code
56cm (A)	47cm	B6 z*	P1	P9	P8	T24A CHR	T24ACHR+T62	T4 CHR

* Edwardian Round Basins are available with 1 or 2 tap holes. To order the correct basin configuration Simply remove the 'z' and replace it with 1TH or 2TH.

Overall heights to the top of the front basin surface:

Edwardian Basin with Standard Pedestal: 84cm

Edwardian Basin with Regal Pedestal: 90cm

Edwardian Basin with Basin stand: 84cm

Edwardian Basin with Regal basin stand: 90cm



(A)



(A)

(B)

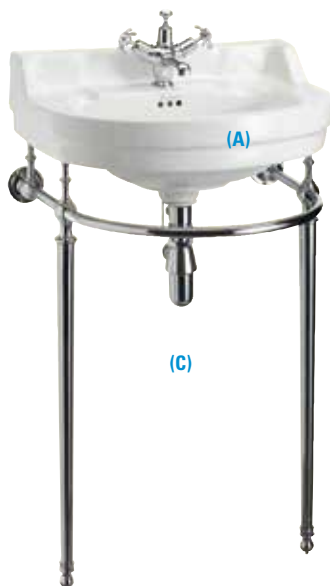

(A)

(C)



(A)

(D)



...on all sanitaryware
See website for details

Edwardian round 56cm basin with pedestal, Claremont 5" basin pillar taps and plug and chain waste. Low-level WC slimline cistern with front flush button with soft-close oak seat (with chrome handles) and ceramic trap. WC toilet roll holder. London round soaking tub with floor-standing Claremont bath shower mixer. Edwardian single elliptical light.

CERAMICS

Victorian

CERAMICS



Victorian 61cm 2 tap hole basin and pedestal with Claremont 5" pillar taps, plug and chain waste, rectangular mirror and soap dish.

See pages 39 for technical details on the Victorian basin.

Victorian 56cm 1TH, Semi-pedestal.



A delicate and refined range, the simplicity of this ceramic basin is stunning. Available in a large (61cm) and medium (56cm) with a range of pedestals, and in one, two or three tap hole options.

Victorian basin & wash stand.



Victorian 61cm 1TH, with Towel Rail.



PEDESTAL OPTIONS ↓

Available with the Victorian Basins

Burlington Regal pedestals are 6cm higher than the standard pedestal to ensure more ergonomic use for taller individuals.



This page: Victorian 56cm basin with regal pedestal Claremont 3 tap hole basin mixer with pop-up waste, rectangular mirror, round light with Chiffon silver shade, soap dish and towel ring.

Opposite: Victorian 56cm basin with chrome basin stand and Claremont 1 tap hole basin mixer with high central indice, click-clack waste and tumbler and holder.

See pages 39 for technical details on the Victorian basin.



VICTORIAN BASINS



Victorian 61cm basin with semi-pedestal & towel rail, Claremont 5" pillar taps, plug and chain waste, tumbler and holder.

See pages 39 for technical details on the Victorian basin.



CERAMICS

BASIN OPTIONS →

Design a bathroom to suit your specific needs

View our Victorian cloakroom basins on page 39 or visit us at burlingtonbathrooms.com

All Victorian basins are available on standard or regal pedestals, semi-pedestals or chrome washstands to suit your own needs and tastes. Also available as cloakroom basin sizes to continue the design linked appearance throughout your home.

Victorian cloakroom 2 tap hole basin with towel rail, Claremont 3" basin taps, plug and chain waste and bottle trap.



Match your exquisite Victorian basin with luxurious fittings and intricate detail with Burlington accessories and a high-level WC with ornate brackets, giving the extra “wow” factor to your period bathroom.

Victorian 61cm 2 tap hole basin and pedestal with Claremont 5” pillar taps, plug and chain waste, rectangular mirror and soap dish, Berkeley radiator (just seen) , Burlington round light with chrome base and chiffon silver shade. High-level WC white ceramic cistern with oak throne seat. Harewood slipper bath with white arc feet and Claremont deck-mounted angled bath shower mixer with ‘S’ adjuster and Fire Hydrant waste.

See pages 39 for technical details on the Victorian basin.

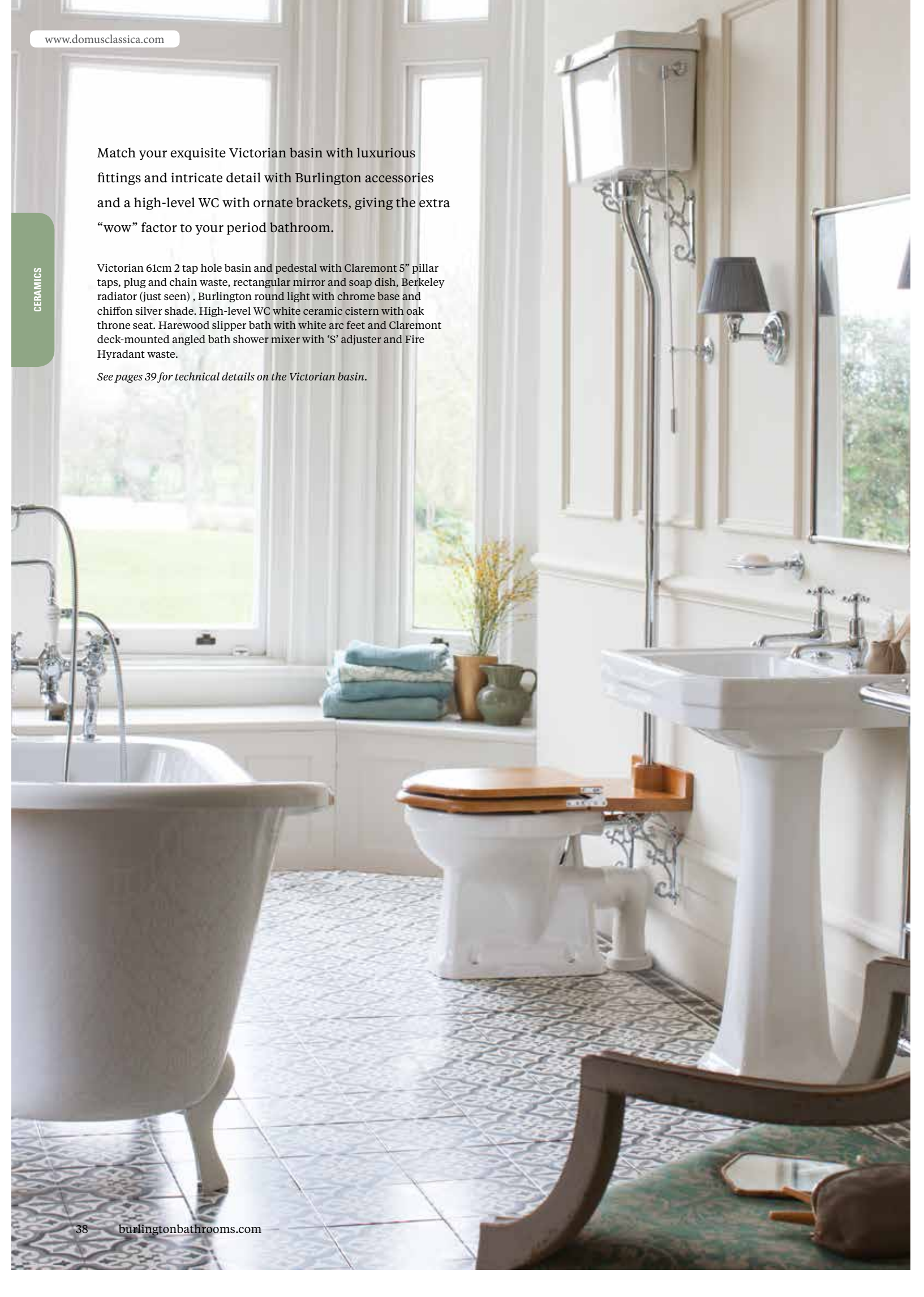

Victorian Basins

VICTORIAN BASINS

Basins			Pedestals			Chrome Basin Stands		Towel Rails (D)
Width	Depth	Code	Standard (B)	Regal	Semi	Standard (C)	Regal	Code
56cm	47cm	B2 z*	P1	P9	P8**	T22ACHR	T22ACHR	T1 CHR
61cm (A)	51cm	B3 z*	P1	P9	P8**	T23ACHR	T23ACHR	T3 CHR

* Victorian Basins are available with 1, 2 or 3 tap holes. To order the correct basin configuration Simply remove the 'z' and replace it with 1TH, 2TH or 3TH.

** 3TH basins cannot be used with semi pedestals

Overall heights to the top of the front basin surface:

Victorian Basin with Standard Pedestal: 84cm

Victorian Basin with Regal Pedestal: 90cm

Victorian Basin with Basin stand: 84cm

Victorian Basin with Regal basin stand: 90cm



(A)



(A)

(B)

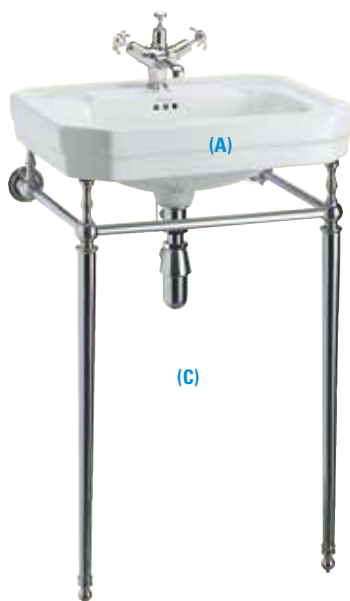

(A)

(C)



(A)

(D)



...on all sanitaryware
See website for details

Contemporary

CERAMICS



Rectangular mirror, Contemporary basin and semi-pedestal with Claremont 1 tap hole basin mixer with high central indice and pop-up waste.

See page 43 for technical details on the Contemporary basins.

As the name suggests, the Contemporary collection is styled on the elegance of past times but with a modern day twist. Simplistic, structured lines form the basis for this striking ceramic collection. Available as full pedestal, semi-pedestal or with a chrome washstand.

Contemporary 58cm 1TH, with Towel Rail.



Contemporary 58cm Washstand 1TH.



For a more intergrated look, sink either our semi-recessed or counter-top basins into your bathroom work surfaces.

SEMI-RECESSED BASIN 58CM

One tap hole B121TH
Two tap hole B122TH



COUNTERTOP BASIN 54CM

One tap hole B131TH
Two tap hole B132TH





This page & opposite: Contemporary basin with semi-pedestal, with Claremont 1 tap hole basin mixer with high central indice click-clack waste. Rectangular mirror.

See page 43 for technical details on the Contemporary basin.

Contemporary Basins

CONTEMPORARY BASINS

Basins			Pedestals			Chrome Basin Stands		Towel Rails (D)
Width	Depth	Code	Standard (B)	Regal	Semi	Standard (C)	Regal	Code
58cm (A)	47cm	B1 z*	P1	P9	P8	T22A CHR	T22A CHR+T62	T2 CHR

* Contemporary Basins are available with 1, 2 or 3 tap holes. To order the correct basin configuration Simply remove the 'z' and replace it with 1TH, 2TH or 3TH.

Overall heights to the top of the front basin surface:

Contemporary Basin with Standard Pedestal: 84cm

Contemporary Basin with Regal Pedestal: 90cm

Contemporary Basin with Basin stand: 84cm

Contemporary Basin with Regal basin stand: 90cm

CERAMICS



(A)



(A)

(B)

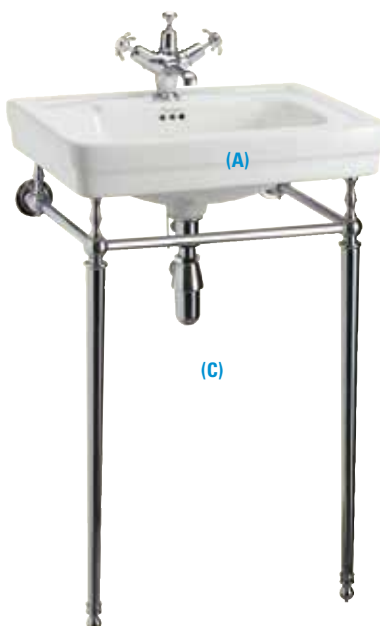

(A)

(C)



(A)

(D)



...on all sanitaryware
See website for details

STONE BASINS

Stone

Carrara marble top and basin with chrome washstand with Claremont 3 tap hole basin mixer with pop-up waste.

See page 47 for technical details on marble and granite washstands.

CERAMICS

Roll top natural stone basin
with stainless steel stand



Burlington stone covers both velvety soft natural stone basins and the divine marble and granite ranges. Pair exquisite pebble grey marble basin tops to either chrome or aluminium washstands. Marble and granite are natural materials, difference in colour, shading and veining are natural characteristics and this is part of their charm.

Carrera marble &
Chrome Washstand.



Carrera marble & Brushed
Aluminium Washstand.





MARBLE Provides an eye-catching and gorgeous focal point in your vintage setting. The beautiful pebble grey marble can be added to various washstands or even wooden vanity units.

Carrara marble top and basin with chrome washstand with Claremont 3 tap hole basin mixer with pop-up waste, and basin bottle trap.

GRANITE & MARBLE ↑

Design a bathroom to suit your specific needs

View all options online at burlingtonbathrooms.com, or look at page 47

All granite and marble basin worktops are provided with matching splashbacks and sides in the same box. Enabling you to tailor make your beautiful basin to your individual tastes.

Georgian Marble Washstands

GEORGIAN MARBLE WASH STANDS

Marble Basins			Chrome Basin Stands		Aluminium Wash Stands (C)	Aluminium Wash Stands with shelf (D)
Width	Depth	Code	Standard (B)	Regal	Code	Code
58cm (A)	58cm	G1 z*	T49ACHR	T49ACHR+T62	T38 ALU** T43 WHI** T48 BLA**	T38 ALU** + G11 T43 WHI** + G11 T48 BLA** + G11

* Marble Basins are available with 1, 2 or 3 tap holes. To order the correct basin configuration Simply remove the 'z' and replace it with 1TH, 2TH or 3TH.

** To order the correct wash stand colour specify 'T38 ALU' for aluminium, 'T48 BLA' for Black, or 'T43 WHI' for white.

Marble basins can be installed with rear & side upstands, rear upstand only or no upstand

Overall heights to the top of the front basin surface:

Basin with Basin stand: 81cm

Basin with Regal basin stand: 87cm

Basin with Aluminium wash stand: 81cm

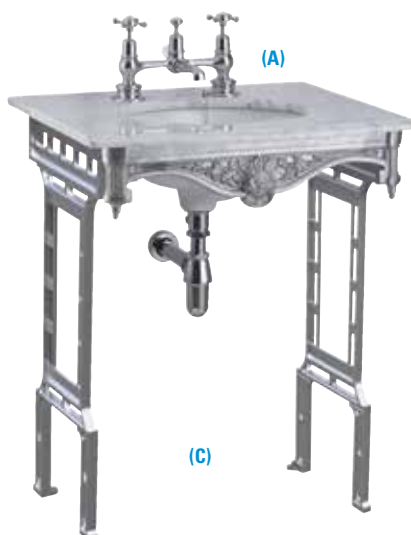

Traditional Natural Stone Basins

CERAMICS

NATURAL STONE BASINS & WASH STANDS

Natural Stone Roll Top Basins Basins				Stainless Steel Basin Stands
Model	Width	Depth	Code	Code
Small	55cm (A)	47cm	B7E	B7ES (D)
Medium	65cm (B)	47cm	B8E	B8ES (E)
Large	75cm (C)	47cm	B9E	B9ES (E)

* Natural Stone basins are available with no tap hole, 1 tap hole, 2 tap hole or 3 tap hole (drilled on site)
 Overall heights, when on a Basin stand, to the top of the front basin surface: 88cm

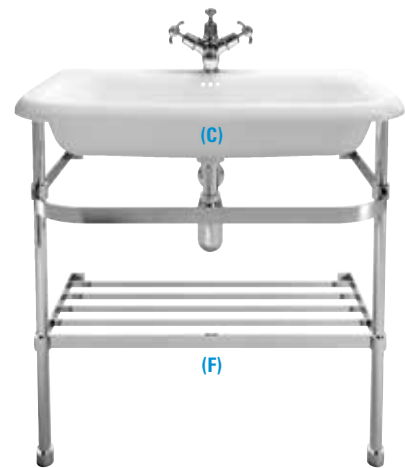
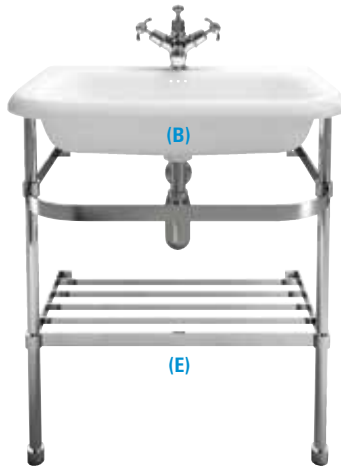
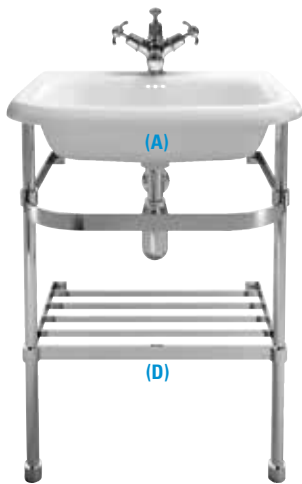

NATURAL STONE A velvety soft natural stone basin available in three sizes. Set these gorgeous basins into countertops or pair with our beautiful stainless steel washstands.

Medium natural stone basin with stainless steel basin stand
Claremont 1 tap hole basin mixer with click-clack waste,
and basin bottle trap.

See opposite page 48 for technical details on natural stone basins.



WCs



25 YEAR GUARANTEE
ON ALL OUR
SANITARYWARE

See website for details

Burlington WCs come in a range of options, from the more contemporary wall-hung or back-to-wall options, to traditional close-coupled or the impressive low, medium or high-level WCs. All options feature water saving technology, only flushing 6L for a full flush or 3L for a half. These factory settings can be adjusted to 4 ½ L for a full flush or 2 ½L for a half flush. Pair your WC with a real wood seat to accentuate the classic styling. Unlike many other traditional brands, Burlington offer soft-close options on white, oak and mahogany seats. Or for a premium look, select the throne seat with intricate and ornate brackets, which provide a focal point in your stunning vintage bathroom.

WC OPTIONS

Select a range of alternative cistern and seat options and colours to tailor your WC to your own tastes

For all options visit www.burlingtonbathrooms.com

Close-coupled, low-level and medium-level WCs are available with either a ceramic lever flush, or a more contemporary front flush button. All WCs with a cistern are also available in standard 51cm or slimline 44cm cisterns to add greater flexibility to the placement of your WC. Cisterns come in a range of colours and styles too, from deep mahogany for low-level, to simple white ceramic or for high-level, aluminium in white, black or brushed aluminium effect.



Wall-hung

Back-to-wall

Close-coupled

Low-level

Medium-level

High-level

nanoGLAZE
ceramic that stays cleaner

*A cleaner toilet, by design
and with NANO Glaze*

We believe that the toilet bowl should still remain as clean as possible even with reduced flushing water and therefore engineer our toilet bowls to maintain the correct water area as previous British Standards and by coating the toilet bowl with NANO Glaze to make them exceptionally easy to keep clean.

CERAMICS





All Burlington WC fittings are factory set at 3L and 6L flush. They can be adjusted on site to flush at 2 1/2L and 4 1/2L.



All Burlington Close-coupled WCs are supplied with dual flush WRAS fittings.



...on all sanitaryware
See website for details

REGAL WCs

Regal WC pans are 6cm higher than the standard option. The taller WC pan ensures the knee angle remains at approximately 90 degrees whilst in use. This provides a more comfortable use for taller people and the elderly but also transforms your bathroom into both a beautiful and functional space.



Regal WCs are available with all Burlington WCs except English Garden and Concealed Bottom Outlet

LEVER OR PUSH BUTTON CISTERN

Available with all Burlington Close-coupled, Low & Mid level WCs

Choose between the classic ceramic flush lever or the more contemporary flush front button.



Lever
51cm Cistern (C1)
44cm Cistern (C3)



Push Button
51cm Cistern (C2)
44cm Cistern (C4)

Close Coupled

The most traditional of the WC's, with a narrow width range for those smaller cloakrooms.

Edwardian cloakroom basin, Claremont 3" pillar taps, traditional basin bottle trap and Towel ring.

Close-coupled WC with slimline push button cistern, soft-close mahogany seat (with chrome handles).

Close Coupled WCs

CLOSE COUPLED WC'S

Model	Ceramic	Type*	As Shown	Width	Depth	Overall Height	Pan Height	Pan Code	Cistern Code
Standard CC WC with 520 ceramic lever cistern	White	P		52cm	73cm	78cm	42cm	P5	C1
Standard CC WC with 520 front push button cistern	White	P	P52 (B)	52cm	73cm	78cm	42cm	P5	C2
Standard CC WC with 440 ceramic lever cistern	White	P		52cm	73cm	78cm	42cm	P5	C3
Standard CC WC with 440 front push button cistern	White	P		44cm	73cm	78cm	42cm	P5	C4
Standard CC WC with 520 ceramic lever cistern (rear entry)	White	P		52cm	73cm	78cm	42cm	P5	C20/C30
Standard CC WC with 520 top push button cistern	White	P		52cm	73cm	78cm	42cm	P5	C25
English Garden CC WC with 520 English Garden ceramic lever cistern	English Garden	S		52cm	73cm	78cm	42cm	P5D	C10
S Trap CC WC with 520 ceramic lever cistern	White	S		52cm	73cm	78cm	42cm	P18	C1
S Trap CC WC with 520 front push button cistern	White	S		52cm	73cm	78cm	42cm	P18	C2
S Trap CC WC with 440 ceramic lever cistern	White	S		44cm	73cm	78cm	42cm	P18	C3
S Trap CC WC with 440 front push button cistern	White	S		44cm	73cm	78cm	42cm	P18	C4
S Trap CC WC with 520 ceramic lever cistern (rear entry)	White	S		52cm	73cm	78cm	42cm	P18	C24/C30
S Trap CC WC with 520 top push button cistern	White	S		52cm	73cm	78cm	42cm	P18	C25

* P means horizontal P trap pan; S means S trap pan

** Complete WC price is for a complete WC as described excluding the seat

*** C24 rough-in is 21cm. C30 rough-in is 24cm.

Note: Rear entry water supply cisterns (with rear entry cistern fittings) are available using Cistern Code: C24 for ceramic cistern lever & C25 for push button

REGAL CLOSE COUPLED WC'S

Model	Ceramic	Type*	As Shown	Width	Depth	Overall Height	Pan Height	Pan Code	Cistern Code
Regal CC WC with 520 ceramic lever cistern	white	P	P52 (A)	52cm	73cm	84cm	48cm	P12	C1
Regal CC WC with 520 front push button cistern	white	P		52cm	73cm	84cm	48cm	P12	C2
Regal CC WC with 440 ceramic lever cistern	white	P		44cm	73cm	84cm	48cm	P12	C3
Regal CC WC with 440 front push button cistern	white	P		44cm	73cm	84cm	48cm	P12	C4
Regal CC WC with 520 ceramic lever cistern (rear entry)	white	P		52cm	73cm	84cm	48cm	P12	C24/C30
Regal CC WC with 520 top push button cistern	white	P		52cm	73cm	84cm	48cm	P12	C25

Seats & Bidets

SEATS



Soft-Close Sand Seat
(excluding handles)
S43



Soft-Close Dark Olive Seat
(excluding handles)
S44



Soft-Close Matt White Seat
(excluding handles)
S45



Standard Oak Seat
(excluding handles)
S11



Standard Gloss Mahogany Seat
(excluding handles)
S12



White carbamide Standard
Not suitable for handles
S13

Soft-Close Oak Seat
(excluding handles)
S16

Soft-Close Gloss Mahogany Seat
(excluding handles)
S17

Soft Close
S18
Not suitable for handles

All seats are supplied less handles.

To add seat handles use code A51CHR.

BIDETS

Model	Ceramic	Width	As Shown	Depth	Overall Height	Code
Floor Standing	white	40cm	(C)	57cm	40cm	P4
Floor Standing	English Garden	40cm	(D)	57cm	40cm	P4D



Ceramic traps
For converting P-trap
pans to S-trap
C26

Straight ceramic trap
C29



Edwardian round 56cm basin with pedestal, Claremont 5" basin pillar taps and plug and chain waste. Low-level WC slimline cistern with front flush button with soft-close oak seat (with chrome handles) and ceramic trap. WC toilet roll holder. London round soaking tub with floor-standing Claremont bath shower mixer. Edwardian single elliptical light.

See page 32 for technical details on the round basin.



Seats and Bidets

SEATS

S43, S44, S45, S40 available as soft-close only.



Soft-Close Sand Seat
(excluding handles)
S43



Soft-Close Dark Olive Seat
(excluding handles)
S44



Soft-Close Matt White Seat
(excluding handles)
S45



Standard Oak Seat
(excluding handles)
S11



Standard Gloss Mahogany Seat
(excluding handles)
S12



White carbamide Standard
Not suitable for handles
S13

Soft-Close Oak Seat
(excluding handles)
S16

Soft-Close Gloss Mahogany Seat
(excluding handles)
S17

Soft Close
(excluding handles)
S18
Not suitable for handles

All seats are supplied less handles.

To add seat handles use code A51CHR.

BIDETS

Model	Ceramic	Width	As Shown	Depth	Overall Height	Code
Floor Standing	white	40cm	(E)	57cm	40cm	P4
Floor Standing	English Garden	40cm	(F)	57cm	40cm	P4D



Ceramic traps
For converting P-trap
pans to S-trap
C26

Straight ceramic trap
C29



LOW & MEDIUM LEVEL WCS



All Burlington WC fittings are factory set at 3L and 6L flush. They can be adjusted on site to flush at 2½L and 4½L.

[®] All Burlington Close-coupled WCs are supplied with dual flush WRAS fittings.
Water Regulations Advisory Scheme

Please note that the compatibility of cisterns is not limited to the combinations shown below.

Please speak to your local retailer for more information.

Low & Medium Level WCs, Seats & Bidets

LOW & MEDIUM LEVEL WC'S

Type	Model	Ceramic	Type*	As Shown	Width	Depth	Overall Height	Pan Height	Pan Code	Cistern Code	Flush Pipe Kit Code
Low Level	ceramic cistern lever	white	P	(A)	52cm	74cm	96-114cm	42cm	P2	C1	T31CHR
Low Level	push button	white	P		52cm	74cm	96-114cm	42cm	P2	C2	T31CHR
Low Level	ceramic cistern lever	English Garden	P	(B)	52cm	74cm	96-114cm	42cm	P2D	C1D	T31CHR
Low Level	ceramic cistern lever	white	S		52cm	74cm	96-114cm	42cm	P19	C24/C30***	T31CHR
Low Level	push button	white	S		45cm	74cm	96-114cm	42cm	P19	C25	T31CHR
Medium Level	ceramic cistern lever	white	P	(C)	52cm	71cm	134-143cm	42cm	P5	C1	T33CHR
Medium Level	push button	white	P		52cm	71cm	134-143cm	42cm	P5	C2	T33CHR
Medium Level	ceramic cistern lever	English Garden	P	(D)	52cm	71cm	134-143cm	42cm	P5D	C1D	T33CHR

* P means horizontal P trap pan; S means S trap pan

** complete WC price is for a complete WC as described excluding the seat

*** C24 rough-in is 26cm to 33cm. C30 rough-in is 29cm to 36cm.

Note: Rear entry water supply cisterns (with rear entry cistern fittings) are available using Cistern Code: C24 for ceramic cistern lever & C25 for push button

REGAL HEIGHT WC'S

Type	Model	Ceramic	For use in*	As Shown	Width	Depth	Overall Height	Pan Height	Pan Code	Cistern Code	Flush Pipe Kit Code
Low Level	ceramic cistern lever	white	UK		52cm	74cm	96-114cm	48cm	P16	C1	T31CHR
Low Level	push button	white	UK		52cm	74cm	96-114cm	48cm	P16	C2	T31CHR

LOW LEVEL

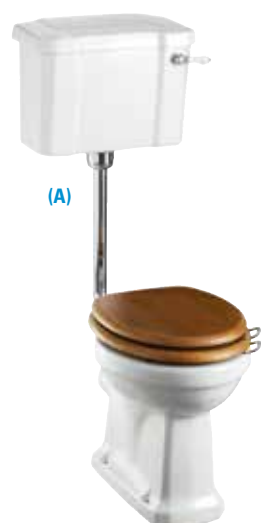

MEDIUM LEVEL



CERAMICS

HIGH-LEVEL WCS ↓

Design a bathroom to suit your specific needs

View the full range of WCs on pages 113

The angled high-level WC is a great option for those wanting to achieve the wow factor achieved with this type of WC, but needing to work around windows or within awkwardly shaped bathrooms. All high-level WCs are also supplied with a rigid pull rod to enable water saving; pull down for a full flush of 6 litres, or push up for a half flush of 3 litres. This can also be adjusted to 4.5 litres and 2.5 litres if required. Also available is a single flush chain and ceramic pull.

Toilet roll holder, High-level WC with white ceramic cistern and angled extension pipes with mahogany soft-close seat (with chrome handles).

See page 62 for technical details on high-level WCs.

Match your exquisite Victorian basin with luxurious fittings and intricate detail with Burlington accessories and a high-level WC with ornate brackets, giving the extra wow factor to your period bathroom.

Victorian 61cm 2 tap hole basin and pedestal with Claremont 5" pillar taps, plug and chain waste, rectangular mirror and soap dish, Berkeley radiator (just seen), Burlington round light with chrome base and chiffon silver shade. High-level WC white ceramic cistern with oak throne seat. Harewood slipper bath with white arc feet and Claremont deck-mounted angled bath shower mixer with 'S' adjuster and Fire Hydrant waste.

See page 39 for technical details on the Victorian basin.

High Level WCs, Seats & Bidets

Please note that the compatibility of cisterns is not limited to the combinations shown below.
Please speak to your local retailer for more information.

HIGH LEVEL WC'S

Type	Model	Ceramic	Type*	As Shown	Width	Depth	Overall Height	Pan Height	Pan Code	Cistern Code	Flush Pipe Kit Code
High Level	Ceramic cistern	white	P	(A)	52cm	67cm	230-238cm	42cm	P2	C5	T30CHR
High Level	Brushed aluminium cistern	white	P	(B)	43cm	67cm	232-240cm	42cm	P2	T58ALU	T30CHR
High Level	Black aluminium cistern	white	P	(C)	43cm	67cm	232-240cm	42cm	P2	T60BLA	T30CHR
High Level	White aluminium cistern	white	P	(D)	43cm	67cm	232-240cm	42cm	P2	T59WHI	T30CHR
High Level	Ceramic	English Garden	P	(E)	52cm	67cm	230-238cm	42cm	P2D	C5D	T30CHR
High Level	Ceramic single flush cistern	White	P		52cm	67cm	230-238cm	42cm	P2	C28S	T30 CHR
High Level	Ceramic cistern	white	S		51cm	67cm	230-238cm	42cm	P19	C5	T30CHR
High Level	Brushed aluminium cistern	white	S		51cm	67cm	230-238cm	42cm	P19	T58ALU	T30CHR

* P means horizontal P trap pan; S means S trap pan
All of the High Level combinations listed on this page are available as Angled High Level WC's (as shown on page 60). To order this simply replace T30CHR Flush Pipe Kit with T34CHR Flush Pipe Kit and add £150 to the overall cost

** Complete WC price is for a complete WC as described excluding the seat. All cisterns are dual flush except C28PK

Note: Rear entry water supply cisterns (with rear entry cistern fittings) are available using Cistern Code: C24 for ceramic cistern lever & C25 for push button





All Burlington WC fittings are factory set at 3L and 6L flush. They can be adjusted on site to flush at 2½L and 4½L.



All Burlington Close-coupled WCs are supplied with dual flush WRAS fittings.



Please note that the compatibility of cisterns is not limited to the combinations shown below. Please speak to your local retailer for more information.

...on all sanitaryware See website for details

REGAL HEIGHT WC'S

Type	Model	Ceramic	For use in*	Width	Depth	Overall Height	Pan Height	Pan Code	Cistern Code	Flush Pipe Kit Code
High Level	Ceramic cistern	white	P	52cm	74cm	236-244cm	48cm	P16	C5	T30CHR
High Level	Polished aluminium cistern	white	P	52cm	74cm	236-244cm	48cm	P16	T58ALU	T30CHR
High Level	Black aluminium cistern	white	P	52cm	74cm	236-244cm	48cm	P16	T60BLA	T30CHR
High Level	White aluminium cistern	white	P	52cm	74cm	236-244cm	48cm	P16	T59WHI	T30CHR
High Level	Ceramic single flush cistern	white	P	52cm	74cm	236-244cm	48cm	P16	C28S	T30 CHR
High Level	Ceramic cistern wit angled flush pipe kit*	white	P	52cm	74cm	236-244cm	48cm	P16	C5	T34CHR

* Angled flush pipe kit can be used with all high level cisterns

SEATS

S43, S44, S45, S40 available as soft-close only.



Soft-Close Sand Seat (excluding handles)
S43



Soft-Close Dark Olive Seat (excluding handles)
S44



Soft-Close Matt White Seat (excluding handles)
S45



Standard Oak Seat (excluding handles)
S11



Standard Gloss Mahogany Seat (excluding handles)
S12



White carbamide Standard
Not suitable for handles
S13



Oak Throne Seat
Not suitable for handles
S14

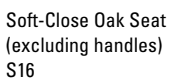

Soft-Close Oak Seat (excluding handles)
S16

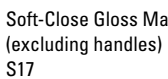

Soft-Close Gloss Mahogany Seat (excluding handles)
S17

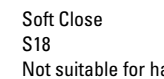

Soft Close
S18
Not suitable for handles

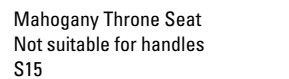

Mahogany Throne Seat
Not suitable for handles
S15

All seats are supplied less handles.

To add seat handles use code A51CHR.

BIDETS

Model	Ceramic	Width	Depth	Overall Height	Code
Floor Standing	white	40cm	57cm	40cm	P4
Floor Standing	English garden	40cm	57cm	40cm	P4D

Ceramic traps
For converting P-trap pans to S-trap
C26

Straight ceramic trap
C29



All prices include VAT at 20%. Prices exclude taps and wastes.

CERAMICS



Wall-hung WC with concealed lever cistern and soft-close white seat. Wall-hung bidet with Claremont bidet mixer with pop-up waste. Tissue holder.



Semi recessed 58cm basin, back to wall WC and Burlington soft close seat in Sand.

For furniture see page 90 & 91

Back to Wall and Wall Hung WCs & Bidets

BACK TO WALL & WALL HUNG WC'S

Type	Model	Ceramic	Type*	As Shown	Width	Depth	Height	Code
Back to wall	Standard height WC	white	P	(A)	37cm	48cm	42cm	P14
Back to wall	Regal height WC	white	P		37cm	48cm	48cm	P15
Wall Hung	WC	white	P	(B)	37cm	50cm	36cm	P10
Concealed cistern	With ceramic lever and front/top access	white	N/A		34cm	13cm	32cm	FTL



For seats see page 54

BIDETS

Model	Ceramic	Ceramic	Type*	As Shown	Width	Depth	Height	Code
Floor Standing	Standard height bidet	white	P	(C)	40cm	57cm	40cm	P4
Wall Hung	-	white	P	(D)	36cm	50cm	35cm	P11



* P means horizontal P trap pan; S means S trap pan

** complete WC price is for a complete WC as described excluding the seat



...on all sanitaryware
See website for details

CLOAKROOM OVERVIEW

CERAMICS





Cloakroom basins

Throughout the Burlington range of stunning ceramic styles, a selection of cloakroom options have been crafted so you can match your chosen style throughout the home. You'll find Edwardian, Victorian and more Classic styled cloakroom basins to achieve a consistent and beautiful look throughout every washroom.

See pages 71 for technical details on all our cloakroom basins.



Victorian cloakroom basin with chrome washstand with Claremont 3" basin taps basin plug and chain and traditional basin bottle trap.



VICTORIAN CLOAKROOM

Victorian cloakroom basin with Claremont 3" basin taps basin plug and chain and traditional basin bottle trap.

Please note the B9 basin is available whilst stocks last



EDWARDIAN CLOAKROOM

Edwardian cloakroom basin with towel rail with Claremont 3" basin taps, basin plug and chain and traditional basin bottle trap.



CORNER CLOAKROOM

Corner cloakroom basin with Chelsea straight basin tap without waste, basin plug and chain and traditional basin bottle trap.



CURVED CLOAKROOM

Curved cloakroom basin with Claremont 3" basin taps, basin plug and chain and traditional basin bottle trap.

Every cloakroom basin is available as wall-mounted, with or without a towel rail or alternatively a chrome washstand, except the Curved basin. View the full range of options on page 71.



On all sanitaryware
See website for details

Cloakroom WCs & Seats

Please note that the compatibility of cisterns is not limited to the combinations shown below.
Please speak to your local retailer for more information.

CERAMICS

STANDARD HEIGHT WC'S

Type	Model	Ceramic	Pan*	As Shown	Width	Depth	Overall Height	Pan Height	Pan Code	Cistern Code	Flush Pipe Kit Code
Close Coupled	ceramic cistern lever	white	P	(A)	44cm	71cm	78cm	42cm	P5	C3	-
Close Coupled	push button	white	P		44cm	71cm	78cm	42cm	P5	C4	-
Close Coupled	ceramic cistern lever	white	S		44cm	71cm	78cm	42cm	P18	C3	-
Close Coupled	push button	white	S		44cm	71cm	78cm	42cm	P18	C4	-
Low Level	ceramic cistern lever	white	P		44cm	71cm	114cm	42cm	P2	C3	T31CHR
Low Level	push button	white	P		44cm	71cm	114cm	42cm	P2	C4	T31CHR
Low Level	ceramic cistern lever	white	S		44cm	74cm max	114cm max	42cm	P19	C3	T31CHR
Low Level	push button	white	S		44cm	74cm max	114cm max	42cm	P19	C4	T31CHR

* P means horizontal P trap pan; S means S trap pan

** complete WC price is for a complete WC as described excluding the seat

Note: Rear entry water supply cisterns (with rear entry cistern fittings) are available using Cistern Code: C24 for ceramic cistern lever & C25 for push button

REGAL HEIGHT WC'S

Type	Model	Ceramic	Pan*	As Shown	Width	Depth	Overall Height	Pan Height	Pan Code	Cistern Code	Flush Pipe Kit Code
Close Coupled	ceramic cistern lever	white	P		44cm	73cm	78cm	48cm	P12	C3	-
Close Coupled	push button	white	P		44cm	73cm	78cm	48cm	P12	C4	-
Low Level	ceramic cistern lever	white	P		44cm	74cm	114cm	48cm	P16	C3	T31CHR
Low Level	push button	white	P		44cm	74cm	114cm	48cm	P16	C4	T31CHR



SEATS

Colour	Material	Standard Seat	Soft Close Seat
		Code	Code
White	Carbamide	S13	S18
Oak	Wood	S11	S16
Mahogany	Wood	S12	S17
Matt White***	Wood	-	S45
Dark Olive***	Wood	-	S44
Sand***	Wood	-	S43

*** See page 95

See page 62 for throne seats.
See page 63 for seat images.

Seat Handles are available in Chrome.
Add code A51 CHR when ordering.

Cloakroom Basins

CLOAKROOM BASINS

Basin	Basins			Chrome Basin Stands		Towel Rails (F)
				Standard (E)	Regal	
	Width	Depth	Code	Code	Code	Code
Edwardian Rectangular (A)	51cm	32cm	B8*	T21A CHR	T21A CHR+T62	T6 CHR
Victorian Rectangular (B)	51cm	32cm	B9	T21A CHR	T21CHR+T62	T6 CHR
Curved (C)	51cm	26cm	P13*			
Corner (D)	60cm	45cm	B10			T8 CHR

* Edwardian & Curved Cloakroom basins are available with one tap hole on the right. To order this simply add 'R' to the product code.
Please note the B9 basin is available whilst stocks last



(A)



(B)



(C)

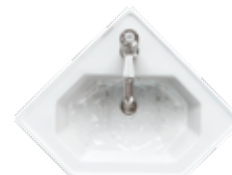

(D)



(F)



(F)

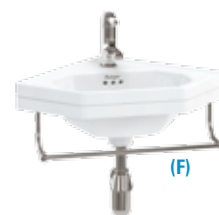

(F)



(E)

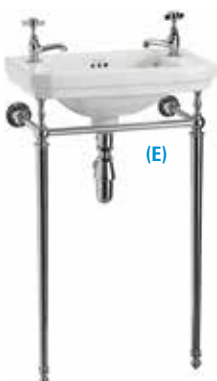

(E)



Surface mounted soap dispenser
Chrome (can be mounted through a ceramic basin tap hole or a work surface)
L: 11cm, W: 7cm, D: 7cm
A48 CHR



Tap hole stopper
Chrome
A49 CHR

CERAMICS

Furniture

Introducing the latest in furniture innovation from Burlington. A range of beautifully traditional furniture solutions to add classic style and sophisticated British elegance to your bathroom.

Choose from free-standing in either a square or curved design, wall-hung or fully-fitted options to tailor make the most functional use of space to suit your individual needs. A new range of baths each with panels or surrounds in corresponding colours, transform your entire bathroom into a space of peace and tranquillity with a subtle, traditionally British feel.

Each piece is packed full of innovative detailing such as soft close doors and drawers, internal lighting and wide opening spaces for maximum storage capacity.



FURNITURE



65 Freestanding

The 65 free-standing furniture with your choice of basin is the perfect solution for those needing to save space but still require storage solutions for their bathroom. With a width of just 65cm, this stylish piece combines beautiful ceramic or integrated basins atop units with either drawers or doors so you can tailor your bathroom to your preferred style.

Sand Freestanding 65 Vanity Unit with doors, 65cm Classic basin for integrated waste & overflow with two tapholes, Birkenhead Basin taps 5", Basin Plug and Chain, 60cm Mirror without LED in Sand.

See pages 76-77 for technical details.

FURNITURE



65 FREESTANDING FURNITURE



FURNITURE



Ergonomic comfort – Each of the Burlington free-standing furniture pieces are set to a height of 85cm to avoid over stretching or bending to wash your hands, making them exceptionally comfortable to use.

Above right; Sand Freestanding 65 Vanity Unit with doors, 65cm Classic basin for integrated waste & overflow with two tapholes, Claremont two taphole Arch mixer, Classic basin invisible overflow & waste, 60cm Mirror without LED in Sand.

Above left; Dark Olive Freestanding 65 Vanity Unit with doors, 67cm x 55cm Minerva Carrara White with integrated basin with one taphole, Claremont basin mixer with high central indice with click-clack waste, 60cm LED Mirror in Dark Olive.

Left; Matt White Freestanding 65 Vanity Unit with 2 drawers, 67cm x 55cm Minerva Black Granite with integrated basin with three tapholes, Claremont three taphole basin mixer with pop up waste, 50cm x 70cm Rectangular Mirror.

3 COLOURS

Sand, Matt White & Dark Olive



65 Vanity Units with Doors

65 VANITY UNITS WITH DOORS

Complete Unit	Type	Complete Vanity Unit Sizes				Vanity Unit Codes, Colours & Prices		
		Width	Depth	Height	+ Splash	Matt White Code	Sand Code	Olive Code
Free-standing 65 vanity unit with doors & Classic 65 basin for standard waste & overflow	2 Doors	67	58	93	-	FF8W +B15	FF8S +B15	FF80 +B15 (A)
Free-standing 65 vanity unit with doors & Classic 65 basin for integrated waste & overflow	2 Doors	67	58	93	-	FF8W +B14	FF8S +B14	FF80 +B14 (B)
Free-standing 65 vanity unit with doors & Minerva® Carrara White with vanity bowl	2 Doors	67	55	85	93	FF8W +BC66	FF8S +BC66 (C)	FF80 +BC66
Free-standing 65 vanity unit with doors & Minerva® White with vanity bowl	2 Doors	67	55	85	93	FF8W +BW66	FF8S +BW66	FF80 +BW66 (D)
Free-standing 65 vanity unit with doors & Minerva® Black Granite with vanity bowl	2 Doors	67	55	85	93	FF8W +BB66 (E)	FF8S +BB66	FF80 +BB66

FURNITURE



MINERVA CARE KIT

To restore your Minerva work top to its original best use the Care Kit to buff out all tiny scratches and scuffs. The kit contains all the sanding / buffing materials and liquids required.

BCARE £50



HDP

The plinths of the free-standing furniture are crafted from HDP Polymer - a waterproof base providing extra protection and giving peace of mind that wet floors will not lead to damage.

65 Vanity Units with Drawers

65 VANITY UNITS WITH DRAWERS

Complete Unit	Type	Complete Vanity Unit Sizes				Vanity Unit Codes, Colours & Prices		
		Width	Depth	Height	+ Splash	Matt White	Sand	Olive
						Code	Code	Code
Free-standing 65 vanity unit with drawers & Classic 65 basin for standard waste & overflow	2 Drawer	67	58	93	-	FF9W +B15	FF9S +B15	FF9O +B15 (A)
Free-standing 65 vanity unit with drawers & Classic 65 basin for integrated waste & overflow	2 Drawer	67	58	93	-	FF9W +B14	FF9S +B14	FF9O +B14 (B)
Free-standing 65 vanity unit with drawers & Minerva® Carrara White with vanity bowl	2 Drawer	67	55	85	93	FF9W +BC66	FF9S +BC66	FF9O +BC66 (C)
Free-standing 65 vanity unit with drawers & Minerva® White with vanity bowl	2 Drawer	67	55	85	93	FF9W +BW66 (D)	FF9S +BW66	FF9O +BW66
Free-standing 65 vanity unit with drawers & Minerva® Black Granite with vanity bowl	2 Drawer	67	55	85	93	FF9W +BB66	FF9S +BB66 (E)	FF9O +BB66

FURNITURE



(A)



(B)

3 COLOURS
Sand, Matt White
& Dark Olive



INFORMATION



Dimensions & Technical Drawings:
Dimensional drawings and technical details are shown at burlingtonbathrooms.com/furniture



(C)



(D)



(E)



Tap holes:
Minerva® worktops are supplied with an integrated bowl with overflow, and no tap holes. Tap holes are drilled by the installer in the required position and configuration. A template is provided with the Minerva® tops indicating tap hole positions and sizes.

130 FREESTANDING FURNITURE

Solid craftsmanship – All free-standing furniture pieces are supplied fully assembled for ease of installation. A combination of MDF and water-proof, PVC coated chipboard plinths ensure a rigid construction and means they'll continue to look their best for years to come.

Sand 130 Freestanding Vanity Unit with Drawers, 130cm x 55cm Minerva Black Granite with two integrated basins with one taphole, Chelsea Straight Basin Mixers with pop up (two required), 90cm Sand Mirror without LED.

FURNITURE





HDP

The plinths of the free-standing furniture are crafted from HDP Polymer - a waterproof base providing extra protection and giving peace of mind that wet floors will not lead to damage.



FURNITURE

130 Freestanding

Why not select the double basin option for a traditionally British feel. Choose from three exclusive Minerva® worktop colours available in either pristine White, opulent Black Granite, or luxurious Carrara White, each with a generous sized double basin bowl of 38x31cm. Each of the Burlington furniture pieces are equipped with soft-close door hinges and drawer runners for that extra feeling of indulgence in your bathroom. Select either the four drawer or double doors option to match your storage requirements.

Matt White 1300 Freestanding Vanity Unit with Doors, 130cm x 55cm Minerva Carrara White with two integrated basins with one taphole, Kensington Basin Mixer with click clack waste (two required), Matt White 90cm LED Mirror.

See pages 80-81 for technical details

3 COLOURS
Sand, Matt White & Dark Olive



130 Vanity Units with Doors

130 VANITY UNITS WITH DOORS

Complete Unit	Type	Complete Vanity Unit Sizes				Vanity Unit Codes, Colours & Prices		
		Width	Depth	Height	+ Splash	Matt White	Sand	Olive
						Code	Code	Code
Free-standing 130 vanity unit with doors & Minerva® Carrara White with double vanity bowl	4 Door	130	55	85	93	FC9W +BC12 <i>(A)</i>	FC9S +BC12	FC9O +BC12
Free-standing 130 vanity unit with doors & Minerva® White with double vanity bowl	4 Door	130	55	85	93	FC9W +BW12	FC9S +BW12 <i>(B)</i>	FC9O +BW12
Free-standing 130 vanity unit with doors & Minerva® Black Granite with double vanity bowl	4 Door	130	55	85	93	FC9W +BB12	FC9S +BB12	FC9O +BB12 <i>(C)</i>

INFORMATION



Dimensions & Technical Drawings: Dimensional drawings and technical details are shown at burlingtonbathrooms.com/furniture



Tap holes: Minerva® worktops are supplied with an integrated bowl with overflow, and no tap holes. Tap holes are drilled by the installer in the required position and configuration. A template is provided with the Minerva® tops indicating tap hole positions and sizes.



HDP

The plinths of the free-standing furniture are crafted from HDP Polymer - a waterproof base providing extra protection and giving peace of mind that wet floors will not lead to damage.

3 COLOURS
Sand, Matt White
& Dark Olive



130 Vanity Units with Drawers

130 VANITY UNITS WITH DRAWERS

Complete Vanity Unit Sizes						Vanity Unit Codes, Colours & Prices		
Complete Unit	Type	Width	Depth	Height	+ Splash	Matt White	Sand	Olive
						Code	Code	Code
Free-standing 130 vanity unit with drawers & Minerva® Carrara White with double vanity bowl	4 Drawer	130	55	85	93	FC10W +BC12 <i>(A)</i>	FC10S +BC12	FC100 +BC12
Free-standing 130 vanity unit with drawers & Minerva® White with double vanity bowl	4 Drawer	130	55	85	93	FC10W +BW12	FC10S +BW12 <i>(B)</i>	FC100 +BW12
Free-standing 130 vanity unit with drawers & Minerva® Black Granite with double vanity bowl	4 Drawer	130	55	85	93	FC10W +BB12	FC10S +BB12	FC100 +BB12 <i>(C)</i>



WHY MINERVA® ?

Design a bathroom to suit your specific needs

Minerva® worktops offer superior strength with a beautiful finish. You can even install a surface mounted soap dispenser. See page 188.



ROUTINE CLEANING

Minerva® does not require any specialist cleaning regimes, most dirt and light residue will easily wipe off with a damp cloth and soapy water. The work surface should then be rinsed with clean water and wiped dry. Persistent marks can be removed by using a mild abrasive cleaner, but harsh scouring powders should be avoided.





134 / 100 Curved

Our free-standing round design cabinets feature open wide doors for easy access to ample storage space.

Perfect for hiding away everyday bathroom necessities and keeping worktops free from clutter. This striking piece is available either as a centrepiece or as left and right handed options for perfect placement against a wall or into a corner.

Above left; Matt White 134 Curved Freestanding Vanity Unit with Doors and Drawers, 134cm x 55cm Minerva Carrara White with integrated basin with three tapholes, Claremont Regent three taphole basin mixer with pop up waste, Matt White 120cm Mirror without LED.

Above right; Matt White Freestanding 100 Curved Corner Vanity Unit with Right Hand Door, 134cm x 55cm Minerva Carrara White with right handed integrated basin with three tapholes, Anglesey three tap hole mixer with pop up waste.

Opposite; Dark Olive 134 Curved Freestanding Vanity Unit with Doors and Drawers, 134cm x 55cm Minerva Carrara White with integrated basin with three tapholes, Kensington Regent three taphole basin mixer with pop up waste, 50cm x 70cm Arched Mirror, Two Burlington Ornate lights with Vase clear glass shades.

See pages 84-85 for technical details

5 LAYERS OF PAINT ↓

Unique features and benefits:

Each of our furniture pieces are prepared with 5 layers of primer featuring UV stabilisation to minimise colour fading from exposure to sunlight. The painted top coat is then applied for glorious depth of colour.



3 COLOURS

Sand, Matt White & Dark Olive



134 Curved Vanity Units

134 CURVED VANITY UNITS

Complete Unit	Type	Complete Vanity Unit Sizes				Vanity Unit Codes, Colours & Prices		
		Width	Depth	Height	+ Splash	Matt White Code	Sand Code	Olive Code
Free-standing 134 curved vanity unit with doors & Minerva® White with vanity bowl	4 Door	134	55	85	93	FC1W +BW13	FC1S +BW13	FC10 +BW13 (A)
Free-standing 134 curved vanity unit with doors & Minerva® Black Granite with vanity bowl	4 Door	134	55	85	93	FC1W +BB13 (B)	FC1S +BB13	FC10 +BB13
Free-standing 134 curved vanity unit with doors & Minerva® Carrara White with vanity bowl	4 Door	134	55	85	93	FC1W +BC13	FC1S +BC13 (C)	FC10 +BC13
Free-standing 134 curved vanity unit with doors & drawers & Minerva® White with vanity bowl	2 Drawer 2 Door	134	55	85	93	FC4W +BW13	FC4S +BW13	FC40 +BW13 (D)
Free-standing 134 curved vanity unit with doors & drawers & Minerva® Black Granite with vanity bowl	2 Drawer 2 Door	134	55	85	93	FC4W +BB13 (E)	FC4S +BB13	FC40 +BB13
Free-standing 134 curved vanity unit with doors & drawers & Minerva® Carrara White with vanity bowl	2 Drawer 2 Door	134	55	85	93	FC4W +BC13	FC4S +BC13 (F)	FC40 +BC13



STAINING

Minerva®, unlike marble and granite, is not porous and will resist most household chemicals including alcohol and cosmetics, however, some chemicals and strong dyes can cause damage and discolouration. If spillage occurs, wipe off immediately and rinse the area thoroughly.



(A)



(B)



(C)



(D)



(E)



(F)

100 Curved Vanity Units

100 CURVED VANITY UNITS

Complete Unit	Type	Complete Vanity Unit Sizes				Vanity Unit Codes, Colours & Prices		
		Width	Depth	Height	+ Splash	Matt White	Sand	Olive
						Code	Code	Code
Free-standing 100 curved left handed vanity unit with doors & Minerva® White with left handed vanity bowl	LH 3 Door	98	55	85	93	FC2W +BW98L	FC2S +BW98L	FC20 +BW98L (A)
Free-standing 100 curved left handed vanity unit with doors & Minerva® Black Granite with left handed vanity bowl	LH 3 Door	98	55	85	93	FC2W +BB98L (B)	FC2S +BB98L	FC20 +BB98L
Free-standing 100 curved left handed vanity unit with doors & Minerva® Carrara White with left handed vanity bowl	LH 3 Door	98	55	85	93	FC2W +BC98L	FC2S +BC98L (C)	FC20 +BC98L
Free-standing 100 curved right handed vanity unit with doors & Minerva® White with right handed vanity bowl	RH 3 Door	98	55	85	93	FC3W +BW98R	FC3S +BW98R	FC30 +BW98R (D)
Free-standing 100 curved right handed vanity unit with doors & Minerva® Black Granite with right handed vanity bowl	RH 3 Door	98	55	85	93	FC3W +BB98R (E)	FC3S +BB98R	FC30 +BB98R
Free-standing 100 curved right handed vanity unit with doors & Minerva® Carrara White with right handed vanity bowl	RH 3 Door	98	55	85	93	FC3W +BC98R	FC3S +BC98R (F)	FC30 +BC98R



65 Wall Hung Units

65 WALL HUNG UNITS

Complete Unit	Type	Complete Vanity Unit Sizes				Vanity Unit Codes, Colours & Prices		
		Width	Depth	Height	+ Splash	Matt White Code	Sand Code	Olive Code
A: Wall-hung 60 vanity unit with single drawer & Classic basin for standard waste & overflow	1 Drawer	66	58	58	-	FW1W +B15	FW1S +B15	FW10 +B15 (A)
B: Wall-hung 60 vanity unit with single drawer & Classic basin for integrated waste & overflow	1 Drawer	66	58	58	-	FW1W +B14	FW1S +B14	FW10 +B14 (B)
C: Wall-hung 60 vanity unit with single drawer & Minerva® Carrara White with vanity bowl	1 Drawer	67	55	51	59	FW1W +BC66	FW1S +BC66 (C)	FW10 +BC66
D: Wall-hung 60 vanity unit with single drawer & Minerva® White with vanity bowl	1 Drawer	67	55	51	59	FW1W +BW66	FW1S +BW66	FW10 +BW66 (D)
E: Wall-hung 60 vanity unit with single drawer & Minerva® Black Granite with vanity bowl	1 Drawer	67	55	51	59	FW1W +BB66 (E)	FW1S +BB66	FW10 +BB66

FURNITURE



(A)



(B)



MINERVA CARE KIT

To restore your Minerva work top to its original best use the Care Kit to buff out all tiny scratches and scuffs. The kit contains all the sanding / buffing materials and liquids required.

BCARE

INFORMATION

Dimensions & Technical Drawings: Dimensional drawings and technical details are shown at burlingtonbathrooms.com/furniture



Tap holes: Minerva® worktops are supplied with an integrated bowl with overflow, and no tap holes. Tap holes are drilled by the installer in the required position and configuration. A template is provided with the Minerva® tops indicating tap hole positions and sizes.

INTEGRATED LIGHTING

Unique features and benefits:

Add an additional drawer light to illuminate your vanity unit when movement is detected.

LED1



(C)



(D)



(E)

65 Wall Hung Units

For those wishing to create the illusion of space, Burlington furniture offers a range of wall-hung basin units to keep floor space clear and make cleaning your bathroom easier. 65cm cabinets are available with integrated ceramic basins, or basins set into Minerva® work surfaces for the ultimate feeling of luxury.

Matt white Wall Hung 65 Vanity Unit with a single drawer, 66cm x 55cm Minerva White with integrated basin with one tap hole, Claremont basin mixer with high central indice with click-clack waste, Matt White 60cm LED Mirror.

See opposite page for technical details



WALL HUNG FURNITURE

FURNITURE



INFORMATION



Dimensions & Technical Drawings: Dimensional drawings and technical details are shown at burlingtonbathrooms.com/furniture



Tap holes: Minerva® worktops are supplied with an integrated bowl with overflow, and no tap holes. Tap holes are drilled by the installer in the required position and configuration. A template is provided with the Minerva® tops indicating tap hole positions and sizes.



3 COLOURS
Sand, Matt White & Dark Olive



*To order the correct furniture colour simply remove the 'z' from the product code and replace it with:
S for Sand (ie FF8S)
O for Dark Olive (ie FF8O)
W for Matt White (ie FF8W)

134 & 100 Curved Wall Units

Curved cabinets come in either a centre design or left or right handed options to place in corners for further flexibility. Pair yours with the 10cm splash-back provided to offer greater protection to your paint-work, wallpaper or grouting. Every furniture piece features exquisitely crafted brass handles for a delicate vintage feel of superior quality.

Above top; Sand Wall Hung 134 Curved Vanity unit, 134cm x 55cm Minerva White with one integrated basin with one tap hole, Chelsea Curved Basin Mixer with pop up waste, Matt White 90cm Mirror without LED.

Above bottom; Dark Olive Right Handed Wall Hung 100 Curved Corner Vanity Unit, 98cm x 55cm Minerva Carrara White with right handed integrated basin with three tap holes, Anglesey three tap hole basin mixer with pop up waste, Dark Olive 90cm Mirror without LED.

134 & 100 Curved Wall Units

134 & 100 CURVED WALL UNITS

Complete Unit	Type	Complete Vanity Unit Sizes				Vanity Unit Codes, Colours & Prices		
		Width	Depth	Height	+Splash	Matt White	Sand	Olive
						Code	Code	Code
134 Curved wall-hung vanity unit & Minerva® White with vanity bowl	3 Door	134	55	51	59	FW4W +BW13	FW4S +BW13	FW40 +BW13 (A)
134 Curved wall-hung vanity unit & Minerva® Black Granite with vanity bowl	3 Door	134	55	51	59	FW4W +BB13	FW4S +BB13	FW40 +BB13 (B)
134 Curved wall-hung vanity unit & Minerva® Carrara White with vanity bowl	3 Door	134	55	51	59	FW4W +BC13	FW4S +BC13	FW40 +BC13 (C)
100 Curved wall-hung left handed vanity unit with drawer & Minerva® White with left hand vanity bowl	LH 2 Door	98	55	51	59	FW5W +BW98L	FW5S +BW98L	FW50 +BW98L (D)
100 Curved wall-hung left handed vanity unit with drawer & Minerva® Black Granite with left hand vanity bowl	LH 2 Door	98	55	51	59	FW5W +BB98L	FW5S +BB98L	FW50 +BB98L
100 Curved wall-hung left handed vanity unit with drawer & Minerva® Carrara White with left hand vanity bowl	LH 2 Door	98	55	51	59	FW5W +BC98L (E)	FW5S +BC98L	FW50 +BC98L
100 Curved wall-hung right handed vanity unit with doors & Minerva® White with right handed vanity bowl	RH 2 Door	98	55	51	59	FW6W +BW98R	FW6S +BW98R	FW60 +BW98R
100 Curved wall-hung right handed vanity unit with doors & Minerva® Black Granite with right handed vanity bowl	RH 2 Door	98	55	51	59	FW6W +BB98R	FW6S +BB98R (F)	FW60 +BB98R
100 Curved wall-hung right handed vanity unit with doors & Minerva® Carrara White with right hand vanity bowl	RH 2 Door	98	55	51	59	FW6W +BC98R	FW6S +BC98R	FW60 +BC98R



(A)



(B)



(C)



(D)

Left hand



(E)

Left hand



(F)

Right hand

Fitted Furniture Example: 210cm Length Run

COLOUR: SAND

The Burlington fitted furniture collection is an ingenious system of individual units fitted together to give the illusion of space and maximise functionality in your bathroom. The uninterrupted straight lines accentuate the length of the interior and give a traditionally British feel.

FURNITURE



60cm Mirrored double door wall unit (F6MS)



60cm Double door wall unit (F6WS)



30cm Tall unit two door base unit (F3TS)



60cm Basin base unit for semi recessed basin with semi recessed 58cm basin Base Unit (F6BS) Basin (B12)



60cm Double door base unit Base Unit (F6OS)



60cm Back-to-wall WC unit with lever flush cistern WC unit (W60S) WC Pan (P14)



Burlington soft close seat, chrome hinge, Sand (S43)



Minerva® White 120cm worktop (BW305)



Minerva® Joint Kit White (MVWH)

Create a seamless feel with WC units and integrated basins semi-recessed into worktops and then fill your remaining space with low or tall storage units perfect for storing away the everyday bathroom clutter. Our bathroom configuration below is made up from the combination of base and wall units shown opposite.

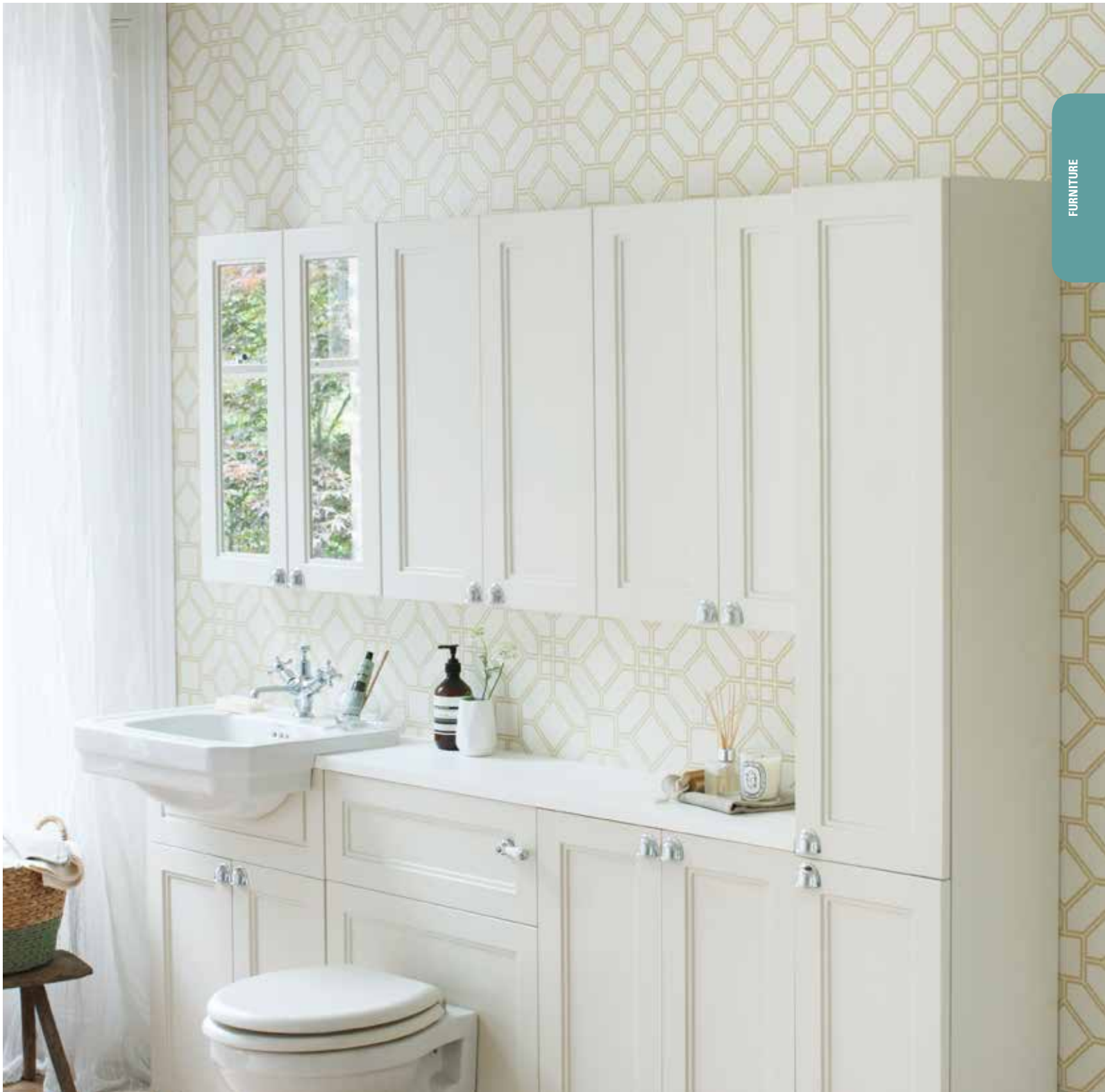

Fitted Furniture Example: 150cm Length

COLOUR: MATT WHITE

All Burlington furniture pieces are made using a dowel and KD screw joining system for exceptional strength. And you can guarantee we've thought of everything for simple installation and sublime style. Cut out drawers allow for under-counter basin pipework without compromising on space. While spacious work surfaces, glass shelves and soft-close features add luxurious finishes that elevate your bathroom to one of superior quality. Our bathroom configuration opposite is made up from the combination of base and wall units below.

FURNITURE



60cm Mirrored double door wall unit (F6MW)



30cm Single door wall unit (F3WW)



60cm Double door wall unit (F6WW)



Burlington soft close seat chrome hinge, Matt white (S45)



60cm Basin base unit for semi recessed basin with semi recessed 58cm basin Base unit (F6BW) Basin (B12)



30cm Single door base unit (F3OW)



60cm Wall-hung WC unit with lever flush cistern WC unit (W60W) Wall-hung WC Pan (P10) Steel frame (W33A)



Minerva® Carrara White 120cm Worktop (BC305)

Minerva® Joint Kit White (MVCA)

MINERVA® INFORMATION

Minerva® worktops are supplied with a template for mounting the Burlington semi recessed basin B12 - these are cut on site. The worktops can be extended with a seamless joint by using the Joint Kit (see p100) The lever flush cistern fittings have access from the front and the top for easy maintenance. The front panel of the WC unit is held on with magnets for easy access.

Minerva® worktops – Our stunning satin Minerva® Carrara White worktop placed on top of units provides an element of luxury with ultimate strength and superior finish. Cut and fit 120cm worktops together or extend your worktop using the joining kit, seamlessly polishing out joints for a flawless effect.



FITTED FURNITURE

Wall Furniture



60cm Double door wall unit
W: 60, D: 15, H: 75
F6Wz*



30cm Mirrored single door wall unit
W: 30, D: 15, H: 75
F3Mz*



60cm Mirrored double door wall unit
W: 60, D: 15, H: 75
F6Mz*



30cm Single door wall unit
W: 30, D: 15, H: 75
F3Wz*

FURNITURE

Floor Furniture



60cm Basin base unit for semi recessed basin with semi recessed 58cm basin

Unit: W: 60, D: 30, H: 85
Basin: W: 48, D: 58, H: 195
Base Unit F6Bz*
Basin B12



60cm Back-to-wall WC unit with lever flush cistern fittings and back-to-wall pan with white soft close seat - urea

Unit: W: 60, D: 30, H: 85
WC: W: 36.5, D: 48, H: 42
WC unit W60z*
WC Pan P14
Seat S18



60cm Back-to-wall WC unit with lever flush cistern fittings and regal back-to-wall pan with white soft close seat - urea

W: 60, D: 30, H: 85
WC: W: 36.5, D: 48, H: 48
WC unit W60z*
Regal WC Pan P15
Seat S18



60cm Double door base unit
W: 60, D: 30, H: 85
F60z*



30cm Single door base unit
W: 30, D: 30, H: 85
F30z*



Plumbing Cover - matt grey
W: 30, D: 15, H: 75
X02Gz*



30cm Tall two door base unit
W: 30, D: 30, H: 191
F3Tz*

Worktops



Minerva® White 120cm
W: 120, D: 30.5, H: 2.5
BW305



Minerva® Black Granite 120cm
W: 120, D: 30.5, H: 2.5
BB305



Minerva® Carrara White 120cm
W: 120, D: 30.5, H: 2.5
BC305

Minerva® Joint Kit
See page 100
White MVWH
Black Granite MVBG
Carrara White MVCA

Mirrors

Our stunning mirrors come with or without LED lighting, which can add to the ambiance of your bathroom. Perfect for applying make-up or grooming. The lights are activated with proximity switches. No need to touch a switch, a simple wave of the hand activates the lights surrounding your mirror.



Framed 60 mirror with LED illumination
W: 60, D: 4, H: 75
M6Mz*



Framed 90 mirror with LED illumination
W: 90, D: 4, H: 75
M9Mz*



Framed 90 mirror with LED illumination
W: 120, D: 4, H: 75
M12Mz*



Framed 60 mirror
W: 60, D: 4, H: 75
M60z*



Framed 90 mirror
W: 90, D: 4, H: 75
M90z*



Framed 120 mirror
W: 120, D: 4, H: 75
M120z*

INFORMATION



Dimensions & Technical Drawings:
Dimensional drawings and technical details are shown at burlingtonbathrooms.com/furniture



Tap holes:
Minerva® worktops are supplied with an integrated bowl with overflow, and no tap holes. Tap holes are drilled by the installer in the required position and configuration. A template is provided with the Minerva® tops indicating tap hole positions and sizes.

3 COLOURS
Sand, Matt White & Dark Olive



*To order the correct furniture colour simply remove the 'z' from the product code and replace it with:
S for Sand (ie FF8S)
O for Dark Olive (ie FF8O)
W for Matt White (ie FF8W)

WC Seats



Chrome Soft Close Sand Seat
S43
with chrome handles
S43 + A51CHR



Chrome Soft Close Dark Olive Seat
S44
with chrome handles
S44 + A51CHR



Chrome Soft Close Matt White Seat
S45
with chrome handles
S45 + A51CHR

To order seat handles please add A51 CHR to your order.

London Baths

Burlington Bathrooms now offer a new range of baths each with panels or surrounds in corresponding colours to your furniture, transforming your entire bathroom into a space of peace and tranquillity with a subtle, traditionally British feel.



HDP

The plinths of the free-standing furniture are crafted from HDP Polymer - a waterproof base providing extra protection and giving peace of mind that wet floors will not lead to damage.

London bath with curved surround including overflow & waste in matt white

L: 180, W: 85, H: 60
E22z*

London bath is supplied with overflow and fitted waste. No tap holes possible on bath rim.



London back-to-wall bath with curved surround including overflow & waste in matt white

L: 180, W: 95, H: 60
E23z*

London bath is supplied with overflow and fitted waste. Supplied with no tap holes, but these can be drilled into the furniture surround where appropriate.



3 COLOURS

Sand, Matt White & Dark Olive



*To order the correct furniture colour simply remove the 'z' from the product code and replace it with:

S for Sand (ie FF8S)
O for Dark Olive (ie FF8O)
W for Matt White (ie FF8W)

INFORMATION



Dimensions & Technical Drawings:

Dimensional drawings and technical details are shown at burlingtonbathrooms.com/baths



Tap holes:

The London bath is not suitable for deck-mounted taps. Floor mounted or wall mounted taps should be used.

Opposite above; London Bath with Sand Curved Surround including overflow & waste, deck mounted Birkenhead bath shower mixer, Stand pipes including horizontal support bar.

Opposite below; London Back To Wall Bath with Dark Olive Curved Surround including overflow & waste, deck mounted Claremont Regent bath shower mixer.



FURNITURE



Baths & Panels

For those with limited space, the Arundel bath can be fitted in a recess (front only), in a corner (front and end), peninsular (two fronts one end) or island (all panels) configuration, giving you complete flexibility over the placement of your bath.

FURNITURE



3 COLOURS

Sand, Matt White & Dark Olive



To order simply replace the 'z' at the end of the product code with S for Sand (ie E25ES), O for Dark Olive (ie E25EO) or W for Matt White (ie E25EW)

RECTANGULAR BATHS

Arundel Cleargreen bath 170 x 70
 L: 170, W: 70, H: 44
 (including adjustable legs)
 E28

See page 124 for more details



Arundel Cleargreen bath 170 x 75
 L: 170, W: 75, H: 44
 (including adjustable legs)
 E30

See page 124 for more details



Arundel 170 bath side panel
 L: 170, T: 1.8, H: 54
 E24Fz*



Arundel 70 bath end panel
 L: 68.2, T: 1.8, H: 54
 E25Ez*



Arundel 75 bath end panel
 L: 73.2, T: 1.8, H: 54
 E26Ez*



INFORMATION

Dimensions & Technical Drawings:
 Dimensional drawings and technical details are shown at burlingtonbathrooms.com/baths

Cleargreen Technology:
 The Arundel Bath has a full steel frame and legs, with Cleargreen thermal insulation and reinforcement, as well as acoustic damping.

Bath Grips



Luxury bath grips (pair)
 For use on all rectangular baths
 D: 3, W: 27, H: 7
 Weight: 1.9kg
 Finish: Chrome
 R30



Standard bath grips (pair)
 For use on all rectangular baths
 D: 2, W: 22, H: 4
 Weight: 0.4kg
 Finish: Chrome
 R37

Bathscreens

You can create a shower over Arundel baths, with or without an access panel within the screen.

If combining a bathscreen and bath grips ask your local specialist about the positioning of the grips.

For bathscreens that can be used with Arundel baths see page 128

FURNITURE

Minerva® Worktops

Minerva® worktops are available from stock in either pristine Minerva® White, elegant Minerva® Carrara White or opulent Minerva® Black Granite.

You can choose from our other 9 unique décor options, available to order with longer custom delivery times for the ultimate personalised look, ask your local specialist Burlington dealer.



White



Carrara White



Black Granite



Cocoa Brown



Desert Rock



Fossil



Silver Cloud



Peak Stone



Carrara Grey



Nimbus Grey



Amazonia Brown



Ice Crystal



Minor Scratching
Scratches to the work surface will be more evident on darker colours. Any minor scratches can be removed using a woven abrasive pad and other items in the care kit.



Staining
Minerva®, unlike marble and granite, is not porous and will resist most household chemicals including alcohol and cosmetics, however, some chemicals and strong dyes can cause damage and discolouration. If spillage occurs, wipe off immediately and rinse the area thoroughly.



Routine Cleaning
Minerva® does not require any specialist cleaning regimes, most dirt and light residue will easily wipe off with a damp cloth and soapy water. The work surface should then be rinsed with clean water and wiped dry. Persistent marks can be removed by using a mild abrasive cleaner, but harsh scouring powders should be avoided.



Minerva® Care Kit
To restore your Minerva® worktop to its original best use the Care Kit to buff out all tiny scratches and scuffs. The kit contains all the sanding / buffing materials and liquids required.



Minerva® Joint Kit

White	MVWH
Black Granite	MVBG
Carrara White	MVCA



Minerva® Care Kit

BCARE



120cm Minerva® Worktops

Minerva White 120cm	BW305
Minerva Black granite 120cm	BB305
Minerva Carrara white 120cm	BC305

Paint Your Own

Should you wish, our Matt White furniture is supplied ready for you to paint, so you can transform your entire bathroom to your individual colour scheme. We've chosen some Farrow & Ball colours as suggestions displayed below. We recommend using a water based primer before an egg shell emulsion for the best effect.

Before



After



FURNITURE



Pelt



Brassica



Vert De Terre



Cook's Blue

Bathing

The Burlington range of free-standing baths offers beautifully crafted exclusivity in a variety of styles to suit both modern and traditional spaces. Choose from soaking tubs, exclusive traditional baths with a range of feet in six styles and three colours to personalise your bath to your individual tastes and bathroom décor. All the baths are made using the highest quality techniques and processes to ensure the finished product will provide many years of blissful bathing. There are three exceptional Natural Stone baths for that extra piece of luxury in your bathroom. For the ultimate in vintage bathroom design, select the unique Fire Hydrant waste system. See page 148 for more information. Whichever bath from our extensive range you choose, you are assured of the finest quality.





BATHS

BATEAU The Bateau bath is a beautiful example of a classic roll top with a stylish presence. Provided in white, this bath was primed and painted a deep sea blue to match its surroundings. The Chrome feet provide an eye-catching focal point in the bathroom.

See page 130 for feet options.



Bateau bath with Chrome Arc feet. Burlington Claremont floor-standing bath shower mixer plug and chain waste, P-trap and P-trap connection pipe.

Bateau baths can be fitted with a fire hydrant, see page 148.

Note: The Bateau bath comes in a white finish. The exterior can be primed and painted. The photograph shows the bath in Fired Earth Carbon Blue. If you wish to paint yours then please note this is only possible on TSFR baths. You should seek advice from the paint manufacturer for suitable primers and processes.



Claremont floor-standing bath shower mixer with plug and chain waste.

DOUBLE ENDED BATHS - WINDSOR

WINDSOR The Windsor bath is a gorgeous example of a traditional roll top bath with perfectly formed curved and flowing lines. Being double-ended with gradually sloping sides it allows for luxurious bathing. Windsor baths are available in 150cm and 170cm.

For feet options see page 130.

Windsor 170cm bath with luxury chrome claw feet and Claremont deck-mounted angled bath shower mixer, decorative shrouds, exposed chrome waste and overflow, P-trap and P-trap connection pipe.

See page 116 for technical details on the Windsor bath.





BRINDLEY This graceful tub is an elegant addition to any bathroom and provides the perfect excuse for a leisurely soak. Its smooth curves, paired with traditional brassware for subtle style, will enhance any setting.

Brindley soaking tub and skirt with Claremont floor-standing bath shower mixer, plug and chain waste.

See page 117 for technical details on the Brindley bath.

DOUBLE ENDED BATHS - LONDON RECTANGULAR



BATHS

LONDON RECTANGULAR Make a statement with the London Rectangular, shown here primed and painted in silver to create the perfect centrepiece to a stunning bathroom. Its grand structure allows for generous internal capacity, allowing for comfort as well as style.

London rectangular soaking tub with Claremont floor-standing bath shower mixer. *See page 117 for technical details on the London rectangular bath.*



* The London Rectangular bath comes in a white finish, as show opposite. The exterior can be primed and painted. The photograph shows the bath painted in Craig & Rose paint in Sensual Silver. If you wish to paint yours then please note this is only possible on TSFR baths (not Natural Stone), you should seek advice from the paint manufacturer for suitable primers and process.

DOUBLE ENDED BATHS - LONDON ROUND



BATHS



BATHS

LONDON ROUND The double-ended London Round has a simple purity of form that will enhance any style of décor in your home. Shown here paired with traditional brassware for a timeless aesthetic.

London round soaking tub with Claremont floor-standing bath shower mixer.

See page 117 for technical details on the London round bath.





ADMIRAL 180 & 165 This stunning, dramatic bath will provide a gorgeous centrepiece in any bathroom. Its grand appearance and imposing structure deserves to be the centre of attention. The Admiral bath also comes in two sizes, a 180cm length and a 165cm for reduced space.

Admiral 180cm bath with Birkenhead floor-standing bath shower mixer and exposed chrome waste and overflow.

See page 117 for technical details on the Admiral bath.

Double-ended baths

WINDSOR 150 & 170



Windsor Double ended 150cm bath with chrome luxury claw feet

Length	Width	Height	Bath Code
150cm	75cm	63cm	E4
170cm	75cm	63cm	E3

Material	TSFR
Bath water capacity	185 / 200 litres (115 litres displaced water capacity)
Weight empty	45Kg / 47Kg
Compatible wastes	CW2, CW3, W4, W21, W8N
Tap Hole Options	0, 1, 2 (supplied with template, undrilled)
Overflow	Supplied with template, undrilled
Feet Options	See pages 130 & 131 (bath shown with L1C legs)

BATEAU



Bateau Double ended 170cm bath with chrome luxury feet

Length	Width	Height	Bath Code
164cm	70cm	72cm	T10F

Material	TSFR
Bath water capacity	99 litres (169 litres displaced water capacity)
Weight empty	42Kg
Compatible wastes	CW3, W4, CW6, W21
Tap Hole Options	Not suitable for rim mounted taps
Overflow	Pre-drilled
Feet Options	See pages 130 & 131 (bath shown with L2C legs)



BRINDLEY



Brindley soaking tub with surround

Length	Width	Height	Bath Code
170cm	75cm	67cm	E5.E12

Material	TSFR
Bath water capacity	250 litres (180 litres displaced water capacity)
Weight empty	34Kg
Compatible wastes	CW2, W3
Tap Hole Options	Not suitable for rim mounted taps
Overflow	Supplied with template, undrilled

LONDON RECTANGULAR



London rectangular soaking tub

Length	Width	Height	Bath Code
180cm	85cm	64cm	E19

Material	TSFR
Bath water capacity	290 litres (220 litres displaced water capacity)
Weight empty	45Kg
Compatible wastes	Pre fitted with a waste
Tap Hole Options	Not suitable for rim mounted taps
Overflow	Pre-drilled

ADMIRAL 165 & 180



Admiral soaking tub

Length	Width	Height	Bath Code
165cm	71cm	71cm	ET5C
180cm	89cm	75cm	ET6C

Material	TSFR
Bath water capacity	169 / 245 litres (99 / 175 litres displaced water capacity)
Weight empty	45Kg / 60Kg
Compatible wastes	CW3, W4, CW6
Tap Hole Options	Not suitable for rim mounted taps
Overflow	Pre-drilled

If using the W4 the bath needs the bottom waste drilled.
 If using CW11 this isn't applied as overflow drains to the floor.

LONDON ROUND



London round soaking tub

Length	Width	Height	Bath Code
180cm	85cm	64cm	E18

Material	TSFR
Bath water capacity	270 litres (200 litres displaced water capacity)
Weight empty	45Kg
Compatible wastes	Pre fitted with a waste
Tap Hole Options	Not suitable for rim mounted taps
Overflow	Pre-drilled

BATHS



SINGLE ENDED BATHS - BLENHEIM

BLENHEIM An elegant and simple shape providing timeless design and beautiful aesthetic. A classic addition to any traditionally styled bathroom. Keep simple with stylish feet in a chrome finish for a seamless and subtle look.

For feet options see page 130.

Blenheim single ended with standard classical legs, Birkenhead deck-mounted bath shower mixer, decorative shrouds, exposed chrome waste and overflow, P-trap and P-trap connection pipe.

See page 124 for technical details on the Blenheim bath.



BUCKINGHAM The Buckingham is a simple and stylish example of the slipper bath, with its raised end angled perfectly to support you for the ultimate comfortable bathe. Shown here with an optional Fire Hydrant waste.

For feet options see page 130.

Buckingham bath with luxury white arc feet, Claremont angled deck-mounted bath shower mixer with decorative shrouds and Fire Hydrant.

See page 125 for technical details on the Buckingham bath.



BATHS



FIRE HYDRANT ↑

Design a bathroom to suit your specific needs
View more information about Fire Hydrant on page 148

Burlington incorporates a distinctive free-standing waste system that operates from the plug hole. The Fire Hydrant is an elegant option for all baths with no pre-drilled overflow hole. Water fills the hydrant which incorporates a built in overflow and plug system, simply lift the handle to empty your bath. This innovative waste system with beautiful traditional handles adds a level of opulence to your bathroom.

SINGLE ENDED BATHS - EMPEROR

EMPEROR A tall and impressive bath; the emperor has a deep, regal stature which will act as a showpiece in your bathroom, yet its angled internal base also provides exceptional comfort and support for a tranquil bathe.



Emperor bath with Claremont floor-standing bath shower mixer, and click-clack waste.
See page 125 for technical details on the Emperor bath.

SINGLE ENDED BATHS - HAREWOOD

HAREWOOD The raised end of this stunning slipper bath is angled perfectly to support you and provide a luxurious bathe. Pair with beautifully traditional brassware and optional decorative shrouds for a unified classic look.

For feet options see page 130.

Harewood bath with standard chrome traditional legs with Anglesey deck-mounted bath shower mixer with decorative shrouds and Fire Hydrant.

See page 125 for technical details on the Harewood bath.

Single-ended baths

BLENHEIM



Blenheim single ended bath with chrome luxury classic feet

Length	Width	Height	Bath Code
170cm	75cm	64cm	E2

Material	TSFR
Bath water capacity	185 litres (115 litres displaced water capacity)
Weight empty	45Kg
Compatible wastes	CW2, CW3, W4, W21, W8N
Tap Hole Options	0, 1, 2 (supplied with template, undrilled)
Overflow	Supplied with template, undrilled
Feet Options	See pages 130-131 (bath shown with L3C legs)

ARUNDEL CLEARGREEN



Arundel Cleargreen Bath

Length	Width	Height	Bath Code
170cm	70cm	58m	E28

Material	Lucite / CG
Bath water capacity	178 litres (108 litres displaced water capacity)
Weight empty	24Kg
Compatible wastes	W4
Compatible bathscreens	C9, C10
Compatible bath grips	R30, R37
Tap Hole Options	Undrilled
Overflow	Overflow hole is predrilled
Bath panels	E24FW, E24FO, E24FS, E25EW, E25EO, E25ES See page 99

ARUNDEL CLEARGREEN



Arundel Cleargreen Bath

Length	Width	Height	Bath Code
170cm	75cm	58m	E30

Material	Lucite / CG
Bath water capacity	195 litres (125 litres displaced water capacity)
Weight empty	25Kg
Compatible wastes	W4
Compatible bathscreens	C9, C10
Compatible bath grips	R30, R37
Tap Hole Options	Undrilled
Overflow	Overflow hole is predrilled
Bath panels	E24FW, E24FO, E24FS, E26EW, E26EO, E26ES See page 99

Single & Double-ended baths

BUCKINGHAM / HAREWOOD



Buckingham 150cm, Harewood 170cm slipper bath with chrome luxury classic feet

Length	Width	Height	Bath Code
150cm	74cm	63cm	E6
170cm	74cm	63cm	E1

Material	TSFR
Bath water capacity	155 / 195 litres (85 / 125 litres displaced water capacity)
Weight empty	39Kg / 48Kg
Compatible wastes	CW2, CW3, W4, W21, W8N
Tap Hole Options	0, 1, 2 (supplied with template, undrilled)
Overflow	Supplied with template, undrilled
Legs	See pages 130-131 (bath shown with L3C legs)

EMPEROR



Emperor bath

Length	Width	Height	Bath Code
153cm	73cm	78cm	ET13B

Material	TSFR
Bath water capacity	312 litres (242 litres displaced water capacity)
Weight empty	38Kg
Compatible wastes	CW2, CW3, W4, CW6, W21
Tap Hole Options	Not suitable for rim mounted taps
Overflow	Supplied with template, undrilled

AVANTGARDE



Avantgarde Bath

Length	Width	Height	Bath Code
170cm	75cm	63cm	T12D

Material	TSFR
Bath water capacity	158 litres (228 litres displaced water capacity)
Weight empty	37Kg
Compatible wastes	CW2, CW3, W4, CW6, W21
Tap Hole Options	0, 1, 2 (supplied with template, undrilled)
Overflow	Supplied with template, undrilled
Legs	See pages 130-131 (bath shown with L1C legs)

HEART



Heart Bath

Material	TSFR
Bath water capacity	155 litres (225 litres displaced water capacity)
Weight empty	45Kg
Compatible wastes	CW3, W4, CW6, W21
Tap Hole Options	0, 1, 2 (supplied with template, undrilled)
Overflow	Overflow hole is predrilled
Legs	See pages 130-131 (bath shown with L1C legs)

Showering Over a Bath

The Hampton showering bath is available in either right or left hand options and gives great flexibility to those who may wish to have both bathing and showering options available to them. Simply place into a corner and pair with our innovative bath screen with access panel, allowing you to turn on the shower, before getting in, without getting wet.

BATHS



Water saving air-boosted shower head



BATHSCREEN WITH ACCESS PANEL

Easy access panel, allows you to turn on the shower without getting wet.

See page 128 for details.



Showering Baths



On all Burlington baths
See website for details

HAMPTON LEFT HANDED



Hampton Left Handed Bath
with chrome luxury classic feet

Length	Width	Height	Bath Code
150cm	75cm	65cm	E20
170cm	75cm	65cm	E13

Compatible wastes CW8N, W4, CW2, CW3,W21
 Compatible shower screens C9, C10
 Tap Hole Options 0, 1, 2 (supplied with template, undrilled)
 Overflow Supplied with template, undrilled
 Feet options See pages 130 & 131 (Shown with L3C legs)

HAMPTON RIGHT HANDED



Hampton Right Handed Bath
with chrome luxury classic feet

Length	Width	Height	Bath Code
150cm	75cm	65cm	E21
170cm	75cm	65cm	E14

Compatible wastes CW8N, W4, CW2, CW3,W21
 Compatible shower screens C9, C10
 Tap Hole Options 0, 1, 2 (supplied with template, undrilled)
 Overflow Supplied with template, undrilled
 Feet options See pages 130 & 131 (Shown with L3C legs)

BATHSCREEN WITH ACCESS PANEL



Width	Height	Screen Code
85cm	145cm	C10

Compatible baths E20, E21, E13, E14, E28, E30
 3 tm coating Glass resists stain so is easier to clean
 3M® Glass 8mm safety glass

SINGLE BATHSCREEN



Width	Height	Screen Code
85cm	145cm	C9

Compatible baths E20, E21, E13, E14, E28, E30
 3 tm coating Glass resists stain so is easier to clean
 3M® Glass 8mm safety glass



BATHS

Luxury Bath Feet

Chrome



White



Black



Claw Feet

	Chrome	White	Black
Code:	L1C	L1W	L1B

Arc Feet

	Chrome	White	Black
Code:	L2C	L2W	L2B

Classic Feet

	Chrome	White	Black
Code:	L3C	L3W	L3B



BATHS

Standard Bath Feet

Chrome



White



Black



Traditional Feet

	Chrome	White	Black
Code:	E11 CHR	E11 WHI	E11 BLA

Classical Feet

	Chrome	White	Black
Code:	E10 CHR	E10 WHI	E10 BLA

Period Feet

	Chrome	White	Black
Code:	E9 CHR	E9 WHI	E9 BLA



BATH FEET

Available with all Burlington roll top baths

Many Burlington baths have the flexibility for adjustable feet, meaning you can customise your beautiful bath with a range of styles and colours as shown to the left. Each of these come in Chrome, Black or White.



Brassware

The Brassware is packed full of innovative technology, not seen amongst other traditional competitors. Every Burlington tap is supplied with a flow straightener for areas with low water pressure and an aerator for areas with high water pressure. This, unlike most traditional taps, ensures your water is delivered at 13 litres per minute regardless of incoming water pressure. So you no longer have to cope with water splashing everywhere, the flow from a Burlington tap is perfect every time.



All bath fillers and bath shower mixers have rotating spouts so you can move the brassware out of the way to enjoy a relaxing bathe. Every bath shower mixer also comes with an 'S' Adjuster, allowing you to position the handset over the bath. You can install your bath shower mixer with or without this feature. All are also available as an angled option, so you see the indices when you walk into the room. Bridge basin mixer spouts also swivel to allow you to turn your tap into a drinking fountain.





Classic Basin with Invisible overflow. See page 20 for more details.

BRASSWARE OVERVIEW



TAPS & BRASSWARE

Burlington Taps

Water saving is becoming part of our lives.

Burlington is the first British Traditional Designed range available that enables water savings! The clever part in the taps is called an aerator. We believe that the finest manufacturer of aerators is the Swiss manufacturer called Neoperl. So we only use Neoperl.

In the UK some homes have low water pressure and some have high water pressure. We supply every tap with two Neoperl devices: A flow straightener which is for use with low water pressures and an aerator which is for use with high water pressures, so you can set up your tap correctly every time!

Our taps are designed to deliver the following maximum flows of water, regardless of the incoming water pressure:

- Basin taps 13 litres per minute
- Bath tap 14 litres per minute
- Bath shower mixer 22 litres per minute

So you can have fabulous performance whilst limiting the damage to our planet.

NORMAL SPOUT

The underside of a bath spout of a normal, traditional bath tap.



BURLINGTON SPOUT

The underside of a Burlington bath tap with a Neoperl aerator.



NORMAL TAP

Water flow in a normal traditional tap



LOW PRESSURE

Low pressure water flow with a Burlington tap using a flow straightener



HIGH PRESSURE

High pressure water flow with a Burlington tap using an aerator



SWIVELLING SPOUTS

All our Bath Fillers and Bath Shower Mixer spouts swivel - so you don't have the spout in your way when you shower (and if two of you bathe together the unlucky one doesn't have a spout sticking in their back!!)

ANGLED MIXERS

All our Bath Fillers and Bath Shower Mixers are available in an "angled" version . Now you can see your bath taps at the correct angle when you walk into your bathroom!

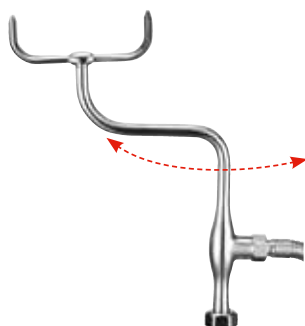
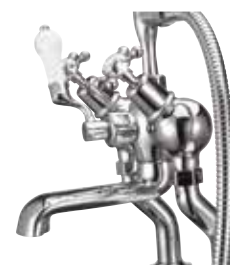

'S' ADJUSTERS

Every Bath Shower Mixer comes with our "S Adjuster". This means you can position the telephone handset over the bath - so when you are done it drips into the bath! You can swivel the "S Adjuster" parallel to the wall too! You can install your Bath Shower Mixer with or without the "S Adjuster".

BRIDGE MIXERS

Our Bridge Basin Mixer allows you to have mixed hot & cold water, whilst using a two taphole configuration. The spout swivels too...

Straight down
90° left or right
Straight up

Normal basin mixer
Off
Drinking fountain!

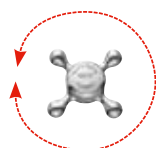
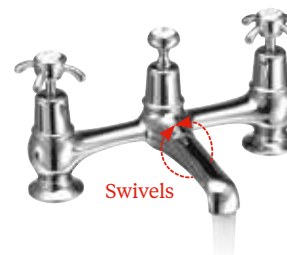

Traditional screw-down

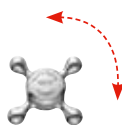

Quarter turn

VALVE OPTIONS

All Burlington taps are available with traditional screw-down valves or with quarter-turn valves. The taps work with both low and high pressure. See "technical PDF" for each tap on our website for specific flow rates.





On all brassware
See website for details

Claremont Deck Mounted Bath Shower Mixer with Handset "S" adjuster.



Burlington Taps

Eight Ranges

CLAREMONT TAPS

A classic favorite from Burlington. This simple range of tap heads suits all basin, bath and bidet taps in the Burlington range. Pair with a deck mounted bath shower mixer for classical styling.



CLAREMONT REGENT TAPS

If looking for a little extra when choosing your brassware, opt for the regent range. A shapely stylish base suitable for all one, two and three tap hole taps excluding Chelsea and Stafford.



ANGLESEY TAPS

Pair the Anglesey tap head range with our Burlington contemporary range of basins.



ANGLESEY REGENT TAPS

The Anglesey is also available with the regent tap base to offer extra height to your tap. Pair with any of the Burlington basins.

BIRKENHEAD TAPS

The Birkenhead taps work well with any of our basins or baths and look particularly beautiful on our range of classic baths.



BIRKENHEAD REGENT TAPS

Also available with the regent option in the Birkenhead tap head. For something striking in your bathroom, this is the perfect choice.



KENSINGTON TAPS

Burlington's Kensington range of tap heads offers opulence and sophistication. Taking inspiration from a bygone era the Kensington brings a traditional style with modern technology.



KENSINGTON REGENT TAPS

Add the regent base to this tap style for an extravagant appearance - particularly suited to the Edwardian basins.

ORDERING YOUR TAPS

When ordering your taps add the correct code to the start of the tap code

- Anglesey add AN
- Claremont add CL
- Birkenhead add BI
- Kensington add KE

QUARTER *turn*

All our taps (except Kensington) come with the traditional screw down valves as standard.

For 'Quarter Turn' simply add 'QT' to the product code.

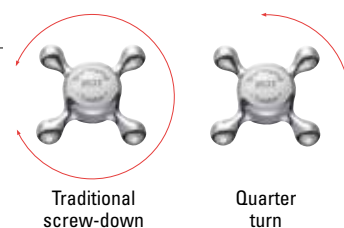

Traditional screw-down

Quarter turn



TAPS & BRASSWARE

Victorian 61cm 2 tap hole basin and pedestal with Claremont 5" pillar taps, plug and chain waste, rectangular mirror and soap dish.

Burlington Basin Taps

ONE TAP HOLE



Basin mixer with high central indice with click-clack waste
CL6

Regent
CLR6



Basin mixer with high central indice with pop-up waste
CL4

Regent
CLR4



Basin mixer with high central indice with plug and chain waste
CL5

Regent
CLR5



Bidet mixer with high central indice with pop-up waste
CL13

Regent
CLR13

TWO TAP HOLE



Basin tap 3"
CL1

Regent
CLR1



Basin tap 5"
CL2

Regent
CLR2



2 tap hole Bridge mixer with swiveling spout with plug and chain waste
CL10

Regent
CLR10



2 tap hole Arch mixer with curved spout (200mm centres)
CL27

Regent
CLR27

THREE TAP HOLE



3 tap hole mixer with pop-up waste
CL12

Regent
CLR12



3 tap hole thermostatic mixer with pop-up waste
CL29

Please note that Kensington levers are not suitable to be fitted to this product.



2 tap hole Arch mixer with curved spout (230mm centres)
CL28

Regent
CLR28

TAPS & BRASSWARE



On all brassware
See website for details

Claremont Deck Mounted Bath Shower Mixer with Handset "S" adjuster.



Burlington Bath Taps

DECK MOUNTED



Bath shower mixer deck mounted with "S" adjuster
CLR15

Regent
CLR15



Angled Bath shower mixer deck-mounted with "S" adjuster
CLR19

Regent
CLR19



NEW

Thermostatic bath shower mixer deck mounted with "S" adjuster
T2DB

Regent
T2DBR

Minimum pressure 3 bar

T11-QT Quarter Turn Angled Bath Filler (excluding tap heads, bases and unions) and the T11 Angled Bath Filler (excluding tap heads, bases and unions) is available whilst stocks last.



Bath filler deck-mounted
CLR23

Regent
CLR23



Angled bath filler deck-mounted
CLR25

Regent
CLR25



Bath tap deck-mounted
CLR3

Regent
CLR3

WALL MOUNTED



Bath shower mixer wall mounted with "S" adjuster
CLR17

Regent
CLR17



Angled bath shower mixer wall-mounted with "S" adjuster
CLR21

Regent
CLR21



Bath filler wall-mounted
CLR24

Regent
CLR24



Angled bath filler wall-mounted
CLR26

Regent
CLR26

TAPS & BRASSWARE

Thermostatic

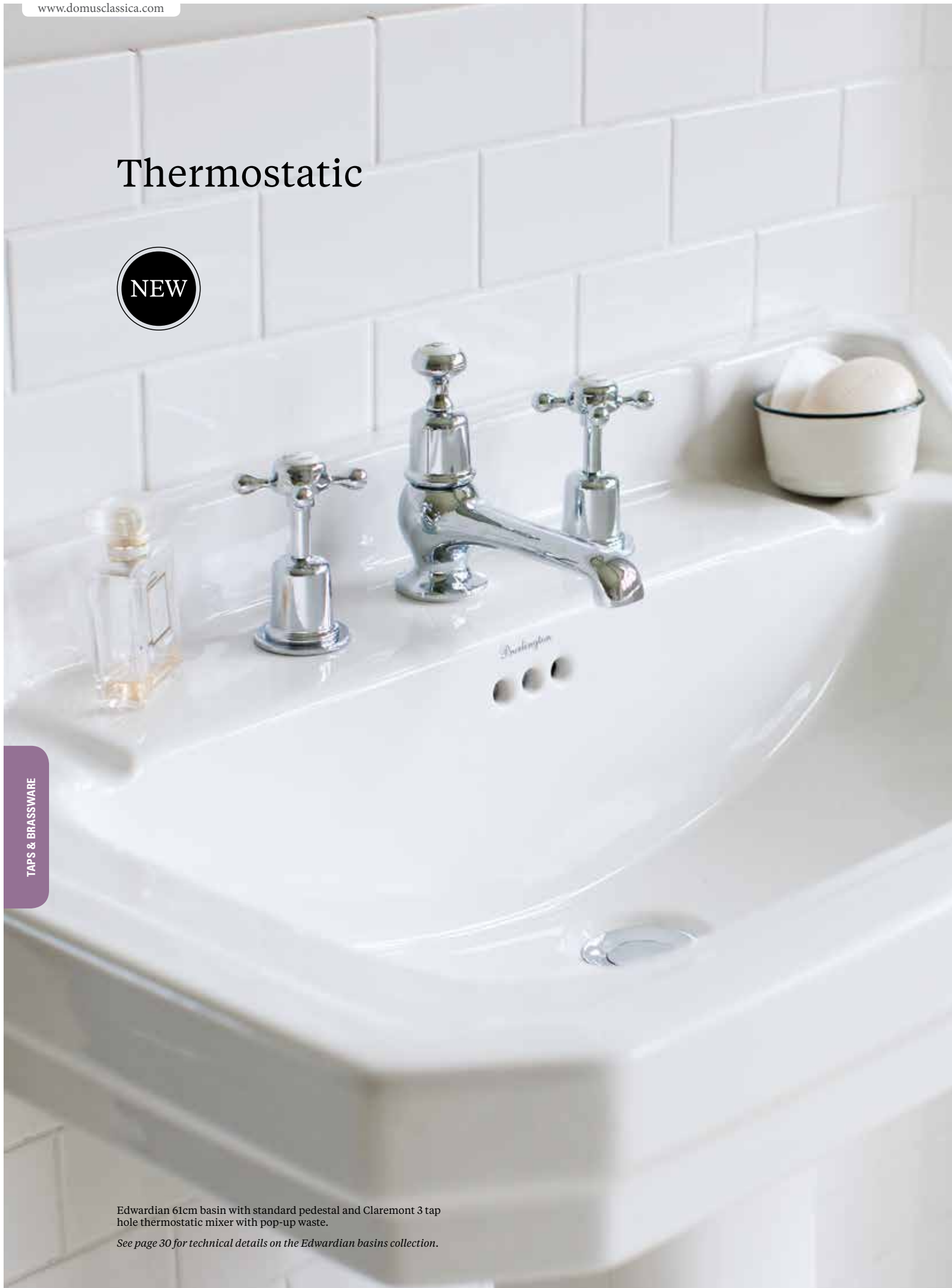

TAPS & BRASSWARE

Edwardian 61cm basin with standard pedestal and Claremont 3 tap hole thermostatic mixer with pop-up waste.

See page 30 for technical details on the Edwardian basins collection.

BURLINGTON THERMOSTATIC TAPS

Now, for the first time ever, you can have a traditional thermostatically controlled basin tap!

Now you can match your basin, bath and shower - all with the convenience and safety of thermostatic controls!



3 tap hole thermostatic mixer with pop-up waste
T26+T1



Bath shower mixer deck mounted with "S" adjuster
T2DB

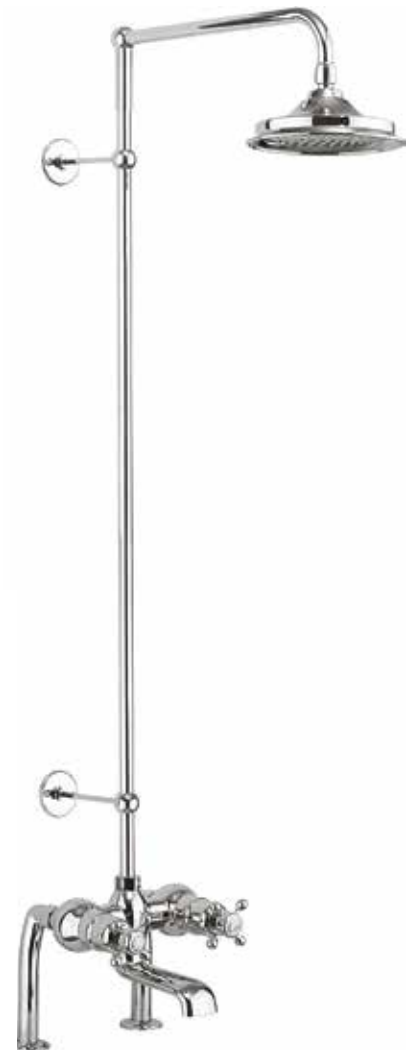

Thermostatic two outlet twin control bath shower mixer valve.
BT2DS + V16

Minimum pressure 3 bar for all 3 products

Stafford



STAFFORD

A unique tap design

The Stafford offers basin and bath taps or bath shower mixers for an alternative bathroom design. Stafford is not available in quarter-turn.



Stafford Bath Pillar Taps
Including the handles
STA13



Stafford Long Nose Basin Pillar Taps
Including the handles
STA12



Stafford Mono Basin Mixer with pop up waste
Including the handles
STA11



Stafford Bath Shower Mixer
Deck mounted
Including the handles
(The Stafford does not include an "S" adjuster)
STA14

Chelsea



Chelsea Curved Basin Mixer
with pop up waste
CH22



Chelsea Curved Basin Mixer
without waste
CH21



Chelsea Curved Bidet Mixer
with pop up waste
CH23



Chelsea Straight Basin
Mixer
without waste
CH19



Chelsea Straight Basin
Mixer
with pop up waste
CH20



Chelsea Straight Tall
Basin Mixer
without waste
CHE1



Chelsea Curved Tall
Basin Mixer
without waste
CHE2



On all brassware
See website for details

Fire Hydrant

for the ultimate traditional look

Traditional Fire Hydrant
Single ended baths. Supplied
with extension and P-trap waste
& extension
D: 80, W: 12, H: 70
W8N

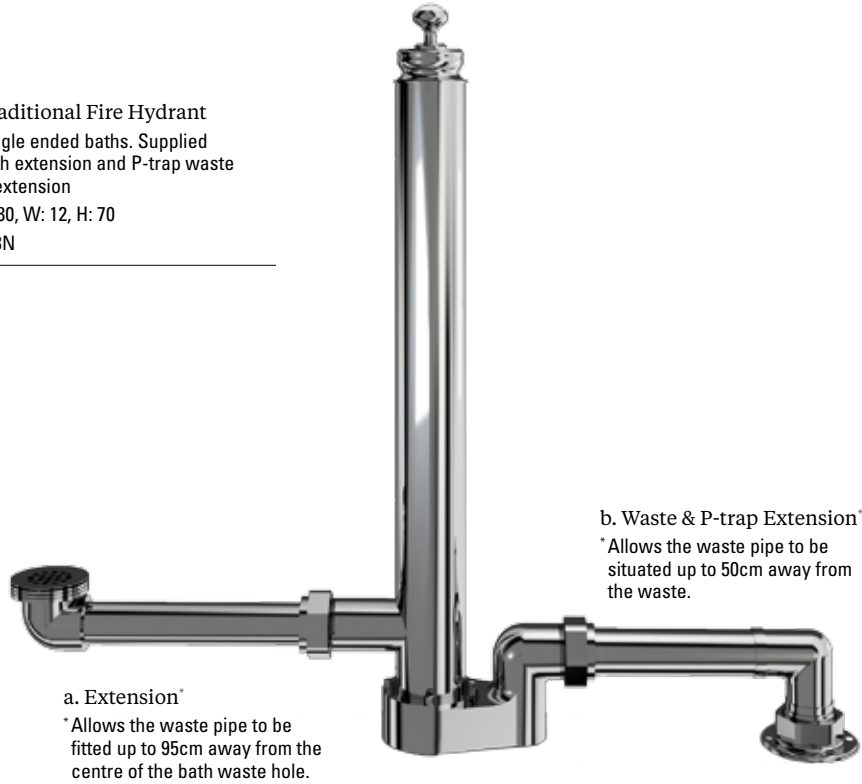

a. Extension*
*Allows the waste pipe to be fitted up to 95cm away from the centre of the bath waste hole.

b. Waste & P-trap Extension*
*Allows the waste pipe to be situated up to 50cm away from the waste.

Technology

Named Fire Hydrant due to its classic design, this is a very distinctive waste system that operates from the plug hole. Water fills the hydrant which incorporates a built in overflow and plug system, simply lift the handle to empty your bath. This waste system adds a level of opulence to your bathroom. Shown on page 80 on the Buckingham bath.

The waste pipe in our 'Fire Hydrant' is designed so that you can change the angles to fit into your waste in the floor.

Fire Hydrants can be used in a free-standing position.

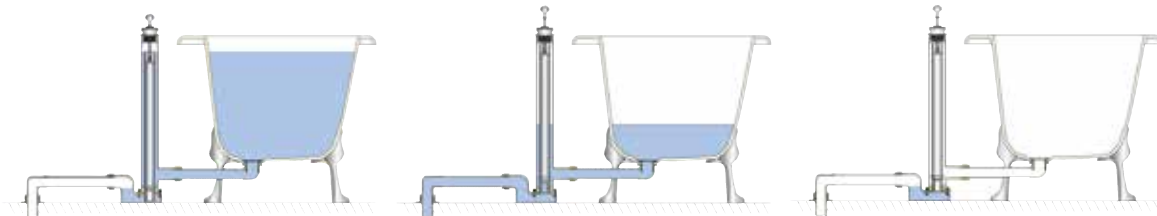

Full bath using overflow

Emptying bath

Empty bath



FIRE HYDRANT ↑

Design a bathroom to suit your specific needs

View more information about Fire Hydrant opposite or visit www.burlingtonbathrooms.com

Burlington incorporates a distinctive free-standing waste system that operates from the plug hole. The Fire Hydrant is an elegant option for all baths with no pre-drilled overflow hole. Water fills the hydrant which incorporates a built in overflow and plug system, simply lift the handle to empty your bath. This innovative waste system with beautiful traditional handles adds a level of opulence to your bathroom.

Stand Pipes



TAPS & BRASSWARE



Stand pipes including horizontal support bar

These are for use with baths where fittings are not rim or wall-mounted (Water runs through the pipes). Can be used with deck-mounted taps.

D: 10, W: 28, H: 60

W7

Shrouds



TAPS & BRASSWARE



Decorative shrouds

These are for use with baths with rim-mounted fittings and can be used with deck-mounted taps.

D: 7, W: 7, H: 71

W6

for Baths



Shallow
P trap
CW3

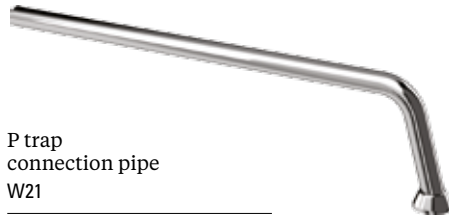

P trap
connection pipe
W21



Overflow filler
for single ended baths
W15



Overflow filler
for double ended baths
W2



Bath overflow,
plug & chain
W3



Exposed bath overflow, plug
& chain
W4

TAPS & BRASSWARE

for Bidets



Bidet
trap
W27

for Basins



Flat bottom
bottle trap
W13



Traditional
bottle trap
W14



Flip top basin waste, slotted
Chrome
W18



Tap hole stopper
Chrome
A49 CHR



'Click-clack' (push button)
basin waste
W11



Basin plug & chain
(slotted)
W1



Surface mounted soap
dispenser
Chrome (can be mounted
through a ceramic basin tap hole
or a work surface)
L: 11cm, W: 7cm, D: 7cm
A48 CHR



Burlington Basin tap shut
off valves (hot/cold)
D: 63.5 W: 348 H: 112
W28

For Classic invisible waste & overflow see page 20 & 21

for WCs



Cistern tank
on/off valve
W25



Angled connector for
telephone handset
Chrome
V62

for Showers

Showers

The Burlington range of showers provides extensive options so you can create a showering solution for your own bespoke setting. Whether you prefer showering over a bath or in an enclosure, Burlington has a solution for your own requirements. Thermostatic valves offer safe and controllable showering for the entire family. Shower valves and brassware features polished chrome, enhanced by timeless white ceramic, to both look fantastic and be ergonomic to use. Designed using the highest quality materials to achieve yesterday's designs with today's technology, you are ensured a great showering experience.

See pages 158-167 for the full showering range



SHOWERING

This page: Eden Thermostatic exposed shower barvalve single outlet with rigid riser and swivel shower arm with 9" rose. Shown with hinged door 80cm and in line panel 30cm and Chaplin Radiator.



This page: Stour Thermostatic Exposed shower valve two-outlet, rigid riser, fixed shower arm, handset and holder with hose and soap basket and 9" rose. Shown with hinged door 80cm and in line panel 30cm and Chaplin Radiator.

See pages 168-175 for the full shower enclosure range.



Anti-limescale

You can rub off limescale in an instant

With Burlington's EasyClean technology you can easily remove limescale.

Simply rub your fingers over the silicon nipples - and the limescale is removed.

The nipples also help direct the water in the correct direction, not sideways!

This results in a clean showerhead, delivering the experience it is designed to do... for years to come.



10 year guarantee

See www.burlingtonbathrooms.com/Home/Guarantee

Water label

The European Water Label (EWL) is a voluntary system by European Manufacturers supported by Burlington and 80 other major brands. The EWL's online database and product labels ensure transparency by clearly marking the water consumption of bathroom products.



One-way-water

All our shower valves have non-return valves built in. A non-return valve is a type of valve that allows the water to flow in one direction but closes automatically to prevent flow in the opposite direction (backflow). Preventing this backflow is important because: it can diminish process heating efficiency; prevents possible siphonage of contaminated water back into the potable water supply; can prevent water hammer (the noise of water in your pipes) and they protect your shower cartridge and thermostat.



AirBurst

More power, less water... Water saving without ruining your shower!

All our fixed shower heads have AirBurst built in

Air is forced into the water flow through a hole in the under-surface of the shower head. Water and air mix, this mixture spins around causing turbulence which increases the pressure inside the shower head. The water passes out of the shower head with the power of a traditional shower - so you do not feel any difference... except you can save up to 33% of water (and save up to 33% in energy costs to heat your shower water!)

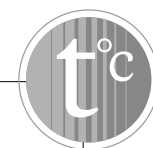

Thermostatic safety

Vernet is the world leader in thermostatic shower components, and provide the best possible temperature and safety measures available. The quality materials in the capsule minimise any potential limescale effects on working parts - enabling extended lifetimes of performance. Burlington uses Vernet wax capsules across its range - this means that the temperature of your shower will not vary by more than $\pm 1^{\circ}\text{C}$ - even if someone flushes a WC whilst you are showering!



Ceramic disc technology

Extremes of temperature, the stresses caused by hard water (water rich in lime) and the corrosion caused by chlorine means the ceramic disc and thermostatic cartridges are under daily attack. They are also the most hard working items in the bathroom.

Ceramic discs are harder than diamonds - The hardest material known to man!

Burlington is developing disc valves in Germany and is standardising this technology across its range.

Larger bore shower hoses

All our shower hoses are 11mm bore vs. the standard 8mm bore (the 'bore' is the hollow part inside the shower hose tube).

This allows for an increased water flow (a minimum of 33% more water) - especially important in low water pressure environments.



Trent Concealed Thermostatic Showers



10 year guarantee



Thermostatic safety

OPTIONS

Upgrade from a 6" head to 9" or 12"



9" AirBurst shower head

V17*



12" AirBurst shower head

V60*



Anglesey
Anglesey Valve
Handle (single)

V2



Birkenhead
Birkenhead Valve
Handle (single)

V3

* To upgrade the head, remove the V16 from the product code and add V17 (9" head) or V60 (12" head).

when ordering the optional bath Spout V32 you will also need the extended riser V22, if you wish to retain the handset function you will need to order V24 and V27 products

Thermostatic single function brass valve with independent temperature control

Traditional brass faceplate, Claremont handle, with ceramic lever

390mm adjustable fixed shower arm

6" AirBurst shower head

TF1S + V16

Thermostatic single function brass valve with independent temperature control

Traditional brass faceplate, Claremont handle, with ceramic lever

Slide rail including the elbow, hose and handset with ceramic handle

TF1H

Trent Concealed Thermostatic Showers



Air burst



Anti limescale



OPTIONS



Slide rail

V33



Cradle

V24



Soap basket

V23

Upgrade products for the vertical riser

Slide rail, cradle, soap basket and alternative valve handles can be ordered as extras.

Note TF1H includes slide rail.

Note that all thermostatic valves are 3 bar minimum pressure

Thermostatic dual function brass valve with independent flow diverter and temperature controls.

Traditional brass faceplate, Claremont handle, with ceramic lever

Wall outlet, and 1500mm shower hose

Adjustable wall bracket, and handset with ceramic handle

390mm adjustable fixed shower arm

6" AirBurst shower head

TF2S + V16

Thermostatic dual function brass valve with 2 independent on/off controls and central temperature control

Traditional brass faceplate, Claremont handle, with ceramic levers

Wall outlet, and 1500mm shower hose

Adjustable wall bracket, and handset with ceramic handle

390mm adjustable fixed shower arm

6" AirBurst shower head

TF3S + V16

Severn Concealed Thermostatic Showers



10 year guarantee



Thermostatic safety



OPTIONS

Upgrade from a 6" head to 9" or 12"



9" AirBurst shower head

V17*



12" AirBurst shower head

V60*



Anglesey
Anglesey Valve
Handle (single)

V2



Birkenhead
Birkenhead Valve
Handle (single)

V3

* To upgrade the head, remove the V16 from the product code and add V17 (9" head) or V60 (12" head).

Thermostatic single function brass valve with independent temperature control.

Traditional brass faceplate, Claremont handle, with ceramic lever

390mm adjustable fixed shower arm

6" AirBurst shower head

VF1S + V16

Thermostatic dual function brass valve with 2 independent on/off controls and central temperature control

Traditional brass faceplate, Claremont handle, with ceramic levers

Wall outlet, and 1500mm shower hose

Adjustable wall bracket, and handset with ceramic handle

390mm adjustable fixed shower arm

6" AirBurst shower head

VF3S + V16

Spey Exposed Thermostatic Showers



Air burst



Anti limescale

SHOWER HEAD HEIGHT

The standard riser pipe (V21) has a length of 856mm.

To increase the height of your shower head use the extended riser (V22) which has a length of 1814mm increasing the height by 958mm.

To order the extended riser simply add .EXT to the product code. For example BSF1S changes to BSF1S.EXT)

Please see the website for details.

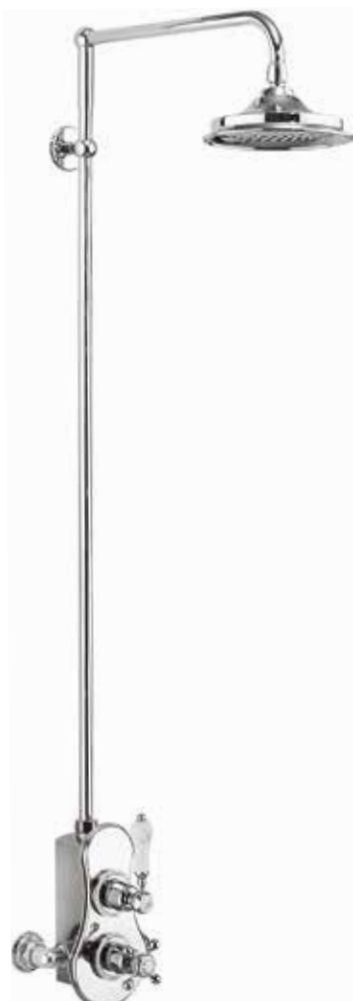

OPTIONS



Slide rail

V33

Slide rail, cradle, soap basket and alternative valve handles can be ordered as extras.

Upgrade products for the vertical riser



Cradle

V24



Soap basket

V23

Thermostatic single function brass valve with independent temperature control

Traditional brass faceplate, Claremont handle, with ceramic lever

18mm diameter vertical brass shower riser

355mm adjustable swivel shower arm

6" AirBurst shower head

BSF1S + V16

BSF1S.EXT + V16

Thermostatic dual function brass valve with 2 independent on/off controls and central temperature control

Traditional brass faceplate, Claremont handle, with ceramic levers

Adjustable wall bracket, 1500mm shower hose, and handset with ceramic handle

18mm diameter vertical brass shower riser

355mm adjustable swivel shower arm

6" AirBurst shower head

BSF3S + V16

BSF3S.EXT + V16

Avon Exposed Thermostatic Showers



10 year guarantee



Thermostatic safety



SHOWER HEAD HEIGHT

The standard riser pipe (V21) has a length of 856mm.

To increase the height of your shower head use the extended riser (V22) which has a length of 1814mm increasing the height by 958mm.

To order the extended riser simply add .EXT to the product code. For example BAF3S changes to BAF3S.EXT)

When ordering the optional bath Spout V32 you will also need the extended riser V22, if you wish to retain the handset function you will need to order V24 and V27 products.

Please see the website for details.

OPTIONS

Upgrade from a 6" head to 9" or 12"
V17*



9" AirBurst shower head

V60*



12" AirBurst shower head

V2



Anglesey
Anglesey Valve
Handle (single)

V3



Birkenhead
Birkenhead Valve
Handle (single)

V32



Spout Fitting

*To upgrade the head, remove the V16 from the product code and add V17 (9" head) or V60 (12" head).

Thermostatic single function brass valve with independent temperature control
Traditional brass body, Claremont handle, with ceramic lever
390mm adjustable fixed shower arm
6" AirBurst shower head

AF1S + V16

Thermostatic dual function brass valve with 2 independent on/off controls and central temperature control
Traditional brass body, Claremont handle, with ceramic levers
Adjustable wall bracket, 1500mm shower hose, and handset with ceramic handle
18mm diameter vertical brass shower riser
355mm adjustable swivel shower arm
6" AirBurst shower head

BAF3S + V16

BAF3S.EXT + V16



Air burst



Anti limescale

Tay Bath Shower Thermostatic Mixers



OPTIONS



V33

V27



Cradle

V24



Soap basket

V23

Slide rail, handset, hose, diverter, cradle, soap basket and alternative valve handles can be ordered as extras.

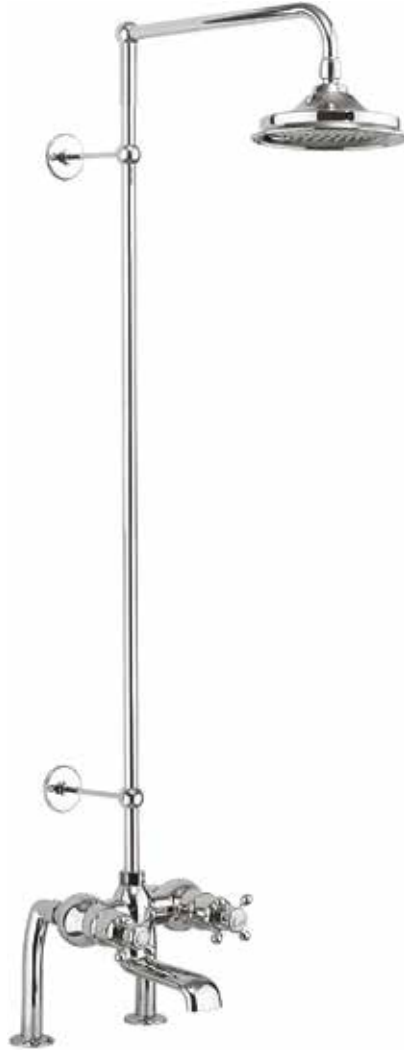

Thermostatic two outlet twin control bath shower mixer valve with independent flow diverter and temperature controls

Traditional brass body, and Claremont handles, with ceramic indices

Brass bath spout with swivel function

Available deck or wall mounted

18mm diameter vertical brass shower riser

355mm adjustable swivel shower arm

6" AirBurst shower head

Deck Mounted BT2DS + V16
BT2DS.EXT+V16



Wall mounted body

Wall mounted BT2WS + V16
BT2WS.EXT+V16



Thermostatic two outlet twin control bath shower mixer valve with independent flow diverter and temperature controls

Traditional brass body, and Claremont handles, with ceramic indices

Brass bath spout with swivel function

Available deck or wall mounted

S connector and bracket, 1500mm shower hose, and handset with ceramic handle

Deck Mounted T2DB



Wall mounted body

Wall mounted T2WB

Eden Exposed Thermostatic Showers



Thermostatic safety



Air burst



Anti limescale

SHOWER HEAD HEIGHT

The standard riser pipe (V21) has a length of 856mm.

To increase the height of your shower head use the extended riser (V22) which has a length of 1814mm increasing the height by 958mm.

To order the extended riser simply add .EXT to the product code. For example BEF1S changes to BEF1S.EXT

Please see the website for details.

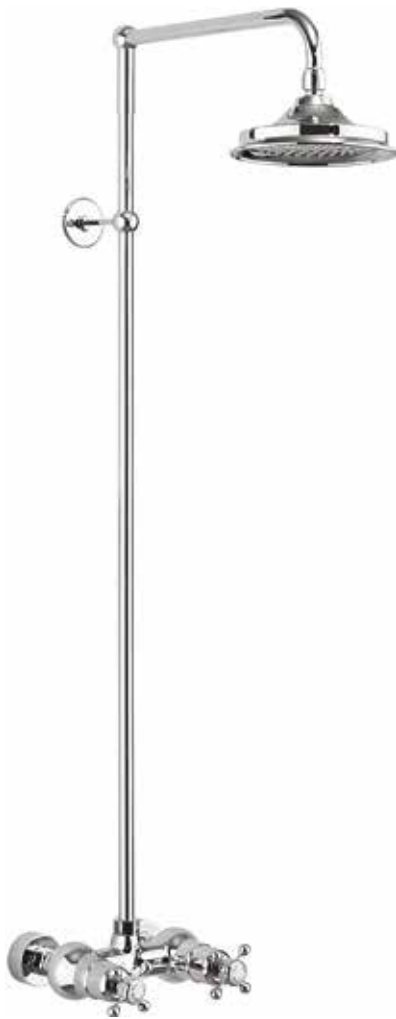

Thermostatic single outlet twin control valve with independent on/off flow and temperature controls

Traditional brass body, Claremont handles, with ceramic indices

18mm diameter vertical brass shower riser

355mm adjustable swivel shower arm

6" AirBurst shower head

BEF1S + V16

BEF1S.EXT + V16

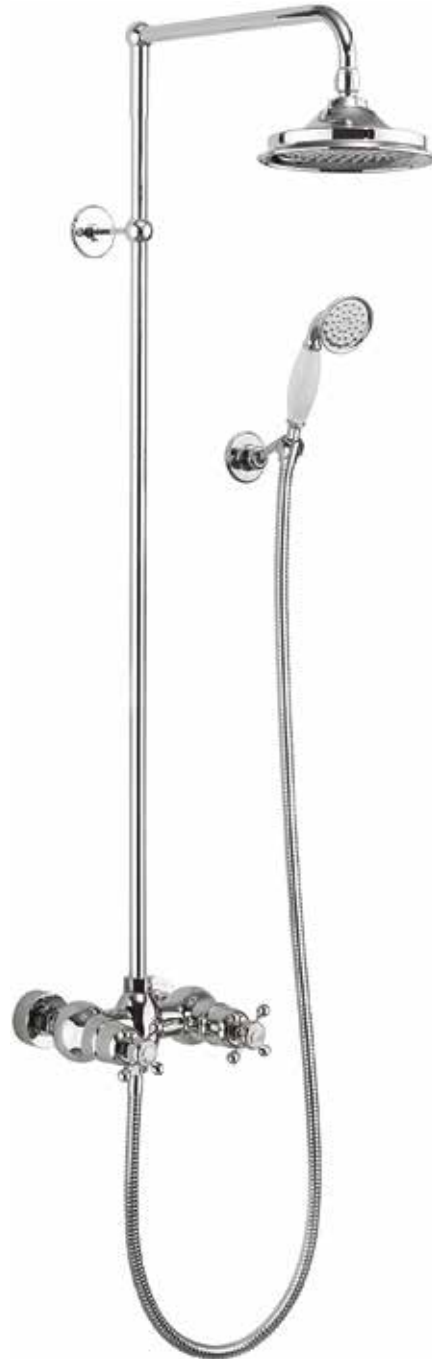

Thermostatic two outlet twin control valve with independent flow divertor and temperature controls

Traditional brass body, and Claremont handles, with ceramic indices

Adjustable wall bracket, 1500mm shower hose, and handset with ceramic handle

18mm diameter vertical brass shower riser 355mm adjustable swivel shower arm

6" AirBurst shower head

BEF2S + V16

BEF2S.EXT + V16



OPTIONS

Upgrade from a 6" head to 9" or 12"



9" AirBurst shower head

V17*



12" AirBurst shower head

V60*



Slide rail

V33

Upgrade products for the vertical riser



Cradle

V24



Soap basket

V23



Anglesey
Anglesey Valve
Handle (single)



Birkenhead
Birkenhead Valve
Handle (single)

* To upgrade the head, remove the V16 from the product code and add V17 (9" head) or V60 (12" head).

Slide rail, cradle, soap basket and alternative valve handles can be ordered as extras. Remember if your chosen shower has 2 valve handles and you are changing to Anglesey or Birkenhead, you will need 2 valve handles

Stour Exposed Thermostatic Showers



Thermostatic safety



Air burst



Anti limescale



Thermostatic single function brass valve with independent temperature control
Traditional brass body, ceramic handle, with ceramic levers
6" AirBurst shower head

BF1S + V16

Thermostatic single function brass valve with independent temperature control
Traditional brass body, ceramic handle, with ceramic levers
28mm diameter vertical brass shower riser
450mm adjustable fixed shower arm
Soap basket
6" AirBurst shower head

BF2S + V16

Thermostatic dual function brass valve with 2 independent on/off controls and central temperature control
Traditional brass body, ceramic handle, with ceramic levers
Fixed cradle, 1500mm shower hose, and handset with ceramic handle
28mm diameter vertical brass shower riser
450mm adjustable fixed shower arm
Soap basket
6" AirBurst shower head

BF3S + V16

10
year
guarantee

10 year
guarantee



SHOWERING

OPTIONS

Upgrade from a 6" head to 9" or 12"



9" AirBurst shower head

V17*



12" AirBurst shower head

V60*

Hinged Doors



A: Hinged Door

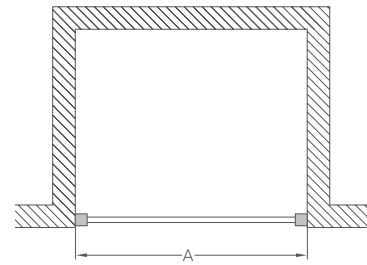

SHOWERING

Size*	Adjustment min-max	Enclosure Code	Tray Code
76 x 76	72-76	BU1 (C19)	Z1159
80 x 80	76-80	BU2 (C20)	Z1160
90 x 76	86-90	BU3 (C21)	Z1163
90 x 80	86-90	BU3 (C21)	Z1164
90 x 90	86-90	BU3 (C21)	Z1161
90 x 120	86-90	BU3 (C21)	Z1176

*This indicates depth of matching tray size available for use in a recessed installation. All enclosures are 1950 high and adjustable up to 20mm from each wall.

All shower posts are constructed from aluminium and can be installed with or without chrome ball header. Safety glass is 8mm thick and 3M™ easy clean coating.

Shower tray prices exclude waste

Z1205

Hinged Doors & Side Panels



On all showers
See website for details



A: Hinged Door
C: Side panel

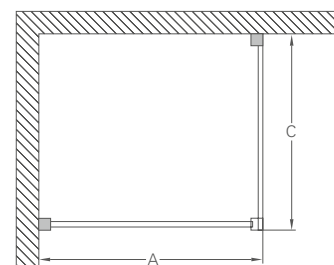

Size*	Adjustment min-max	Enclosure Code	Tray Code
76 x 76	73-75	BU11 (C19+C12)	Z1159
76 x 90	73-75, 87-89	BU12 (C19+C14)	Z1163
80 x 80	77-79	BU13 (C20+C13)	Z1160
80 x 90	77-79, 87-89	BU14 (C20+C14)	Z1164
90 x 76	87-89, 73-75	BU15 (C21+C12)	Z1163
90 x 80	87-89, 77-79	BU16 (C21+C13)	Z1164
90 x 90	87-89	BU17 (C21+C14)	Z1161

*All enclosures are 1950 high and adjustable up to 20mm from each wall.

All shower posts are constructed from aluminium and can be installed with or without chrome ball header. Safety glass is 8mm thick and 3M™ easy clean coating.

Shower tray prices exclude waste

Z1205

Hinged Doors with In-line Panels



1500mm Recessed hinged door

A: Hinged door
B: In-line panel

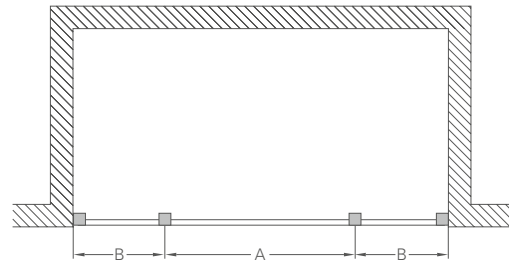

Size	Adjustment min-max	Enclosure Code	Tray Code
1000 x 700	960-1000	BU4 (C20+C15)	Z1165
1000 x 760	960-1000	BU4 (C20+C15)	Z1166
1000 x 800	960-1000	BU4 (C20+C15)	Z1167
1000 x 900	960-1000	BU4 (C20+C15)	Z1168
1000 x 1000	960-1000	BU4 (C20+C15)	Z1162
1100 x 700	1060-1100	BU5 (C20+C16)	Z1169
1100 x 760	1060-1100	BU5 (C20+C16)	Z1170
1100 x 800	1060-1100	BU5 (C20+C16)	Z1171
1100 x 900	1060-1100	BU5 (C20+C16)	Z1172
1200 x 700	1160-1200	BU6 (C20+C17)	Z1173
1200 x 760	1160-1200	BU6 (C20+C17)	Z1174
1200 x 800	1160-1200	BU6 (C20+C17)	Z1175
1200 x 900	1160-1200	BU6 (C20+C17)	Z1176
1400 x 800	1360-1400	BU7 (C20+C16+C16)	Z1177
1400 x 900	1360-1400	BU7 (C20+C16+C16)	Z1178
1500 x 700	1460-1500	BU8 (C21+C16+C16)	Z1179
1500 x 760	1460-1500	BU8 (C21+C16+C16)	Z1180
1500 x 800	1460-1500	BU8 (C21+C16+C16)	Z1181
1600 x 700	1560-1600	BU9 (C20+C17+C17)	Z1182
1700 x 700	1660-1700	BU10 (C21+C17+C17)	Z1183
1700 x 760	1660-1700	BU10 (C21+C17+C17)	Z1184
1700 x 800	1660-1700	BU10 (C21+C17+C17)	Z1185

*This indicates depth of matching tray size available for use in a recessed installation. All enclosures are 1950 high and adjustable up to 20mm from each wall.

All shower posts are constructed from aluminium and can be installed with or without chrome ball header. Safety glass is 8mm thick and 3M™ easy clean coating.

Shower tray prices exclude waste

Z1205

Hinged Doors with In-line & Side Panels



On all showers
See website for details



- A: Hinged door
- B: In-line panel
- C: Side panel

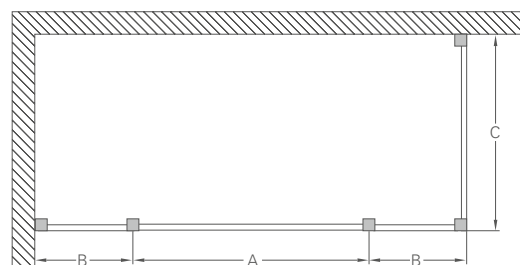

Size*	Adjustment min-max	Enclosure Code	Tray Code
1000 x 760	970-990, 730-750	BU19 (C20+C15+C12)	Z1166
1000 x 800	970-990, 770-790	BU20 (C20+C15+C13)	Z1167
1000 x 900	970-990, 870-890	BU21 (C20+C15+C14)	Z1168
1100 x 760	1070-1090, 730-750	BU23 (C20+C16+C12)	Z1170
1100 x 800	1070-1090, 770-790	BU24 (C20+C16+C13)	Z1171
1100 x 900	1070-1090, 870-890	BU25 (C20+C16+C14)	Z1172
1200 x 760	1170-1190, 730-750	BU27 (C20+C17+C12)	Z1174
1200 x 800	1170-1190, 770-790	BU28 (C20+C17+C13)	Z1175
1200 x 900	1170-1190, 870-890	BU29 (C20+C17+C14)	Z1176
1400 x 800	1370-1390, 770-790	BU30 (C20+C16+C16+C13)	Z1177
1400 x 900	1370-1390, 870-890	BU31 (C20+C16+C16+C14)	Z1178
1500 x 760	1470-1490, 730-750	BU33 (C21+C16+C16+C12)	Z1180
1500 x 800	1470-1490, 770-790	BU34 (C21+C16+C16+C13)	Z1181
1700 x 760	1670-1690, 730-750	BU37 (C21+C17+C17+C12)	Z1184
1700 x 800	1670-1690, 770-790	BU38 (C21+C17+C17+C13)	Z1185

*All enclosures are 1950 high and adjustable up to 20mm from each wall.

All shower posts are constructed from aluminium and can be installed with or without chrome ball header. Safety glass is 8mm thick and 3M™ easy clean coating.

Shower tray prices exclude waste

Z1205

Quadrants



D: Quadrant

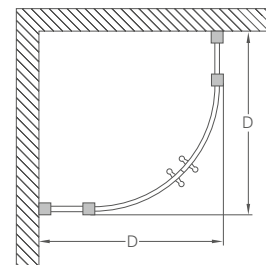

SHOWERING

Size	Adjustment min-max	Enclosure Code	Tray Code
80 x 80	77-79	BU39 (C22)	Z1192
90 x 90	87-89	BU40 (C23)	Z1193

*All enclosures are 1950 high and adjustable up to 20mm from each wall.

All shower posts are constructed from aluminium and can be installed with or without chrome ball header. Safety glass is 8mm thick and 3M™ easy clean coating.

Shower tray prices exclude waste
Z1205

Offset Quadrants



On all showers
See website for details



D: Quadrant
B: In-line panel

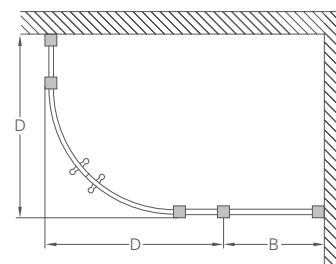

Left hand quadrant

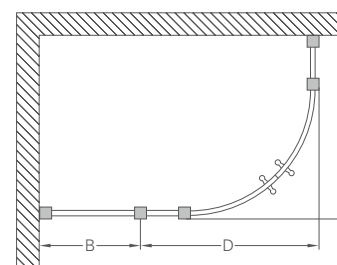

Right hand quadrant

Size	Enclosure	Adjustment min-max	Enclosure Code	Tray Code
80 x 100	Left hand	770-790, 970-990	BU41 (C22+C15)	Z1199
80 x 100	Right hand	770-790, 970-990	BU41 (C22+C15)	Z1200
80 x 120	Left hand	770-790, 1170-1190	BU91 (C22+C17)	Z1201
80 x 120	Right hand	770-790, 1170-1190	BU91 (C22+C17)	Z1202
90 x 120	Left hand	870-890, 1170-1190	BU42 (C23+C16)	Z1203
90 x 120	Right hand	870-890, 1170-1190	BU42 (C23+C16)	Z1204

*All enclosures are 1950 high and adjustable up to 20mm from each wall.

All shower posts are constructed from aluminium and can be installed with or without chrome ball header. Safety glass is 8mm thick and 3M™ easy clean coating.

Shower tray prices exclude waste

Z1205

SHOWERING

Sliding Doors



1200mm Sliding door

A: Slider
B: In-line panel

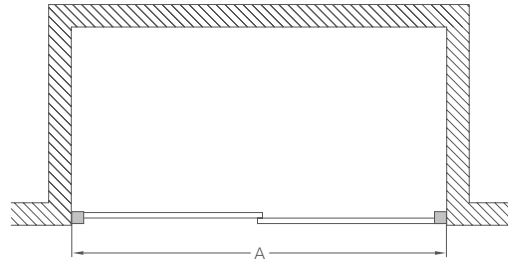

Sliding door

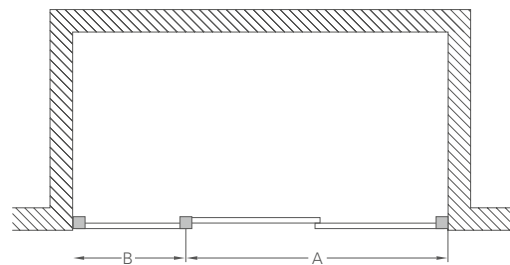

Sliding door with in-line panel

Soft-close sliding door

Size	Adjustment min-max	Enclosure Code	Tray Code
1100 x 700	1070-1090	BU68 (C6S)	Z1169
1100 x 760	1070-1090	BU68 (C6S)	Z1170
1100 x 800	1070-1090	BU68 (C6S)	Z1171
1100 x 900	1070-1090	BU68 (C6S)	Z1172
1200 x 700	1170-1190	BU69 (C7S)	Z1173
1200 x 760	1170-1190	BU69 (C7S)	Z1174
1200 x 800	1170-1190	BU69 (C7S)	Z1175
1200 x 900	1170-1190	BU69 (C7S)	Z1176
1400 x 800	1370-1390	BU70 (C8S)	Z1177
1400 x 900	1370-1390	BU70 (C8S)	Z1178

*This indicates depth of matching tray size available for use in a recessed installation. All enclosures are 1950 high and adjustable up to 20mm from each wall.

All shower posts are constructed from aluminium and can be installed with or without chrome ball header. Safety glass is 8mm thick and 3M™ easy clean coating.

Soft-close mechanisms are supplied with the door and can be fitted as an option.

Shower tray prices exclude waste

Z1205

Soft-close sliding door with in-line panel

Size	Adjustment min-max	Enclosure Code	Tray Code
1500 x 700	1470-1490	BU71 (C7S+C16)	Z1179
1500 x 760	1470-1490	BU71 (C7S+C16)	Z1180
1500 x 800	1470-1490	BU71 (C7S+C16)	Z1181
1600 x 700	1570-1590	BU72 (C8S+C15)	Z1182
1700 x 700	1670-1690	BU73 (C8S+C16)	Z1183
1700 x 760	1670-1690	BU73 (C8S+C16)	Z1184
1700 x 800	1670-1690	BU73 (C8S+C16)	Z1185



Sliding Doors with Side Panels



On all showers
See website for details



1700mm Sliding Door (with In line panels) & 800mm Side Panel

- A: Slider
- B: In-line panel
- C: Side panel

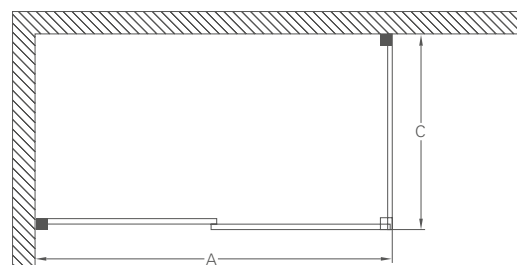

Sliding door with side panel

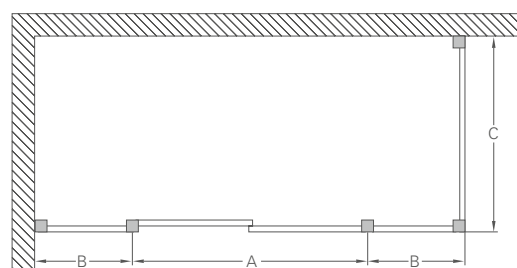

Sliding door with in-line and side panel

Soft-close sliding door with side panel

Size*	Adjustment min-max	Enclosure Code	Tray Code
1100 x 760	1070-1090, 730-750	BU75 (C6S+C12)	Z1170
1100 x 800	1070-1090, 770-790	BU76 (C6S+C13)	Z1171
1100 x 900	1070-1090, 870-890	BU77 (C6S+C14)	Z1172
1200 x 760	1170-1190, 730-750	BU79 (C7S+C12)	Z1174
1200 x 800	1170-1190, 770-790	BU80 (C7S+C13)	Z1175
1200 x 900	1170-1190, 870-890	BU81 (C7S+C14)	Z1176
1400 x 800	1370-1390, 770-790	BU82 (C8S+C13)	Z1177
1400 x 900	1370-1390, 870-890	BU83 (C8S+C14)	Z1178

Soft-close sliding door with in-line and side panel

Size*	Adjustment min-max	Enclosure Code	Tray Code
1500 x 760	1470-1490, 730-750	BU85 (C7S+C16+C12)	Z1180
1500 x 800	1470-1490, 770-790	BU86 (C7S+C16+C13)	Z1181
1700 x 760	1670-1690, 730-750	BU89 (C8S+C16+C12)	Z1184
1700 x 800	1670-1690, 770-790	BU90 (C8S+C16+C13)	Z1185

*All enclosures are 1950 high and adjustable up to 20mm from each wall.

All shower posts are constructed from aluminium and can be installed with or without chrome ball header. Safety glass is 8mm thick and 3M™ easy clean coating.

Soft-close mechanisms are supplied with the door and can be fitted as an option.

Shower tray prices exclude waste Z1205



Radiators

Burlington radiators offer a broad range of various styles. There are options here to complement your traditional bathroom beautifully. All Burlington radiators except the Strand, are designed to work with the extra fitting of an electric summer heating kit, allowing you to have warm towels all year round.

See pages 178-179 for the full range of radiators





Radiators



Chaplin radiator
(shown with angled valves)
D: 13, W: 54, H: 114
R12 CHR



Trafalgar radiator
(shown with angled valves)
D: 24, W: 64, H: 95
R1 CHR



Bloomsbury radiator
(shown with angled valves)
D: 24, W: 50, H: 95
R2 CHR



Vincent radiator
(shown with angled valves)
D: 24, W: 64, H: 95
R5 CHR



Berkeley radiator
(shown with angled valves)
D: 24, W: 64, H: 95
R4 CHR



Clever radiator
(shown with angled valves)
D: 24, W: 64, H: 72
R3 CHR



Strand radiator
(shown with angled valves)
D: 39, W: 64, H: 40
R11 CHR



400W Summer electric heating
Kit for Trafalgar
R10 CHR

250W Summer electric heating
kit for Bloomsbury and Vincent
R9 CHR

150W Summer electric heating
kit for Chaplin, Cleaver, Berkeley
R8 CHR

Electric Summer Heating Kits

All our radiators except R11CHR have been designed to allow for the fitting of an electric summer heating kit. This means that you can have warm towel rails all year round! Our radiators contain steel and are therefore only suitable for hot water (closed) central heating systems.

During electric heating use the valves must be left open so the radiator is full of water to ensure correct performance.

All Electric heating kits are rated IP44.



Straight radiator valves
D: 10, W: 9, H: 24
R7 CHR



Angled radiator valves
D: 7, W: 9, H: 24
R6 CHR

Radiator British Thermal Units (BTUs)

The heat outputs of our radiators connected to your central heating system:

	$\Delta T=50^{\circ}c$ Watts	$\Delta T=55^{\circ}c$ Watts	$\Delta T=60^{\circ}c$ Watts	BTU's
Trafalgar	558	623	688	2346
Bloomsbury	387	430	473	1613
Vincent	206	227	246	839
Berkeley	238	263	289	985
Cleaver	266	294	323	1101
Strand	153	174	196	669
Chaplin	320	372	408	1392

All radiator outputs are tested to EN442

Mirrors & Lights

The perfect addition to your bathroom, Burlington mirrors add intricate detail and increase the period feel of your bathroom. Choose between the simplistic and pared back rectangular or arched mirrors, or the detailed and beautiful Georgian style mirrors available in polished black or white aluminium. In addition to the classic Edwardian lights either in round or elliptical style, Burlington have increased their range of lighting options, giving you various possibilities. Choose your base style in beautiful chrome and compliment with a fabric shade or a glass cup. These pieces are sure to give that extra finishing touch to your vintage look.

See pages 182-185 for the full range of mirrors and lights





Mirrors





Brushed aluminium frame mirror
D: 4, W: 55, H: 75
T37 ALU



Black aluminium frame mirror
D: 4, W: 55, H: 75
T47 BLA



White aluminium frame mirror
D: 4, W: 55, H: 75
T42 WHI



Arched mirror
D: 3, W: 50, H: 70
A9



Rectangular mirror
D: 3, W: 50, H: 70
A11



Curved mirror
D: 3, W: 70, H: 70
A38

All mirrors are sealed with Gunther Seal-Kwik. This ensures that the mirrors aren't affected by 'black-edge' - the oxidation of the mirror's edge that occurs in moist environments.

For mirrors that match Burlington furniture see page 95

Lights



Burlington round light with chrome base and cup frosted glass shade
D: 19, W: 17, H: 22
BL11



Burlington round light with chrome base and vase clear glass shade
D: 17, W: 12, H: 30
BL14



Burlington round light with chrome base and tube frosted glass shade
D: 15, W: 12, H: 30
BL13



Burlington round light with chrome base and fine pleated shade in white
D: 18, W: 15, H: 23
BL12



Burlington round light with chrome base and chiffon silver shade
D: 17, W: 16, H: 33
BL15

Technical Information

Our Burlington ornate lights are supplied with G9 light bulbs.
They are 28 watts, but give 40 watts of light and have an IP rating of IP44.



Edwardian single round LED light
With pull cord
D: 17, W: 16, H: 25
T50



Edwardian single elliptical LED light
With pull cord
D: 15, W: 11, H: 24
T52

Our T50 and T52 Edwardian single elliptical lights will now include LED lighting as standard

The mouth blown glass shades are handmade and may feature unique characteristics such as air bubbles and individual variations.

Ornate Lights



Burlington ornate light with chrome base and cup frosted glass shade
D: 23, W: 17, H: 28
BL21



Burlington ornate light with chrome base and vase clear glass shade
D: 20, W: 12, H: 36
BL24



Burlington ornate light with chrome base and tube frosted glass shade
D: 18, W: 12, H: 36
BL23



Burlington ornate light with chrome base and fine pleated shade in white
D: 21, W: 15, H: 29
BL22



Burlington ornate light with chrome base and chiffon silver shade
D: 21, W: 16, H: 29
BL25

Technical Information

Our Burlington ornate lights are supplied with G9 light bulbs.

They are 28 watts, but give 40 watts of light and have an IP rating of IP44.

The mouth blown glass shades are handmade and may feature unique characteristics such as air bubbles and individual variations

All measurements shown are represented in cm

185

Accessories

Our range of accessories will provide the finishing touches to ensure your bathroom looks and functions perfectly. From classically styled chrome soap dishes, to ceramic toothbrush holders, every item is traditionally crafted in chrome plated solid brass, to guarantee the balance of functionality and style. *See page 174-175 for the full range of accessories*





Accessories



Soap Dish
D: 15, W: 16, H: 6
A1 CHR



Tumbler Holder
Chrome
D: 12, W: 8, H: 11
A2 CHR



Single Soap Dispenser
D: 14, W: 8, H: 21
A19 CHR



Double Soap Dispenser
D: 13, W: 19, H: 21
A20 CHR



Surface mounted soap dispenser
Chrome (can be mounted through a ceramic basin tap hole or a work surface)
L: 11cm, W: 7cm, D: 7cm
A48 CHR



Accessory Back Plate
D: 6, W: 3, H: 6
G13



Medium Ornate Bracket
D: 2, W: 23, H: 16
T32 CHR

Accessories Information

All accessories are plated with 12-15µm nickel and 0.3-0.4µm chrome. This compares to industry norms of 5-7µm nickel and 0.15-0.25µm chrome. This results in a deeper and more durable chrome finish.

All accessories are supplied with extra chrome plated domed head screws.

All accessories have 'screw-through' (patent pending) design to ensure no lateral movement.



See website for details



WC Roll Holder
D: 18, W: 8, H: 12
A5 CHR



WC Roll Holder
Without cover
D: 18, W: 10, H: 10
A16 CHR



Spire WC Roll Holder
D: 6, W: 17, H: 25
A45 CHR



Spare WC Roll Holder
D: 6, W: 12, H: 18
A6 CHR



WC Brush Holder
D: 15, W: 10, H: 43
A8 CHR



Robe Hook
D: 6, W: 6, H: 6
A14 CHR



Double Robe Hook
D: 11, W: 6, H: 12
A4 CHR



Triple Robe Hook
D: 7, W: 10, H: 9
A47 CHR



Towel Ring
D: 6, W: 17, H: 20
A3 CHR

Shelf & Racks



Glass Shelf With Railing
D: 16, W: 53, H: 6
A18 CHR



Brass Extendable Bath Rack
D: 21, W: 59-90, H: 9
A27 CHR



Towel Rack
D: 32, W: 66, H: 14
A46 CHR

Wire Baskets

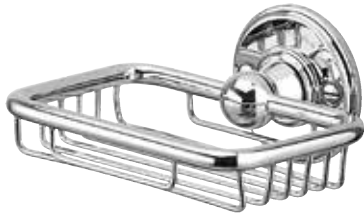

Soap Basket
D: 12, W: 14, H: 6
A13 CHR



Sponge Basket
D: 18, W: 22, H: 6
A15 CHR



Wire Basket
62mm deep
D: 16, W: 33, H: 9
A23 CHR



Corner Basket
36mm deep
D: 22, W: 22, H: 6
Code: A21 CHR



Corner Basket
62mm deep
D: 28, W: 28, H: 9
A22 CHR



Burlington bath basket
D: 24, W: 29, H: 11
A50 CHR



Burlington bath basket shown on a roll top bath

TOWEL RAILS

Towel Rails



Single Towel Rail
D: 6, W: 55, H: 6
A7 CHR



Double Towel Rail
D: 15, W: 66, H: 17
A17 CHR



For towel rails that fit under your basins see pages 30, 32, 35, 37, 39, 41 and 43.



Angled rail with soap basket
- left hand
D: 124 W: 435 H: 201
A52 CHR



Angled rail with soap basket
- right hand
D: 124 W: 435 H: 201
A53 CHR



Straight Rail
D: 90 W: 460 H: 60
A54 CHR



Angled Rail
D: 89 W: 396 H: 190
A55 CHR

Towel Ring

ACCESSORIES



Towel Ring
D: 6, W: 17, H: 20
A3 CHR



See website for details



burlingtonbathrooms.com
info@bathroombrands.com
Tel +44(0)1322 473222

Join us on social:
facebook.com/burlingtonbathrooms
twitter.com/burlingtonbaths
pinterest.com/burlingtonbaths

 **BATHROOMBRANDS®**

bathroombrands.com

The Bathroom Brands Group
Lake View House
Rennie Drive
Dartford
Kent
DA1 5FU

Due to continuous product improvements we reserve the right to change the product specification without prior notice. The text, images and layout of this catalogue are protected by copyright and other intellectual property rights. All images within this brochure are, where possible, a true representation of our products. Some colours may vary. Please visit the website for more information.

Our website should be used as reference for the most up to date product specification.





DOMUSCLASSICA®
| *Collection* |

puh. 0400 23 24 25 | domus@domusclassica.com | www.domusclassica.com
Metsänkyläntie 2 13900 Pekola (Hattula) | Asiakaspalvelu ma-to klo 9-15, su klo 12-15