

CATALOGO TECNICO

CERAMICA & ARREDO - RUBINETTERIA



INDICE GENERALE

Ceramica e arredo bagno:	pag.
Gemma 2	4
Mia	16
Quarzo	23
Piatti doccia:	pag.
Istruzione di installazione	33
Gemma 2	34
Onda	35
Quote cantiere	pag.
	40
Indice alfanumerico ceramica e arredo bagno	pag.
	49
Rubinetteria:	pag.
Base New	52
Gemma 2	57
Rubinetteria da cucina	pag.
	62
Indice alfanumerico rubinetteria	pag.
	65
Garanzia	pag.
	66

CERAMICA
E ARREDO BAGNO



J5211

Lavabo monoforo 65x52 cm, per installazione sospesa con colonna o semicolonna.

J521101	Lavabo 65x52 cm	kg 22,0
J521501	Colonna	kg 12,0
J521601	Semicolonna	kg 7,0

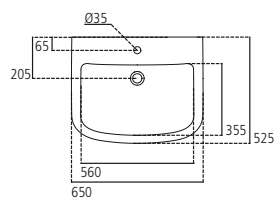
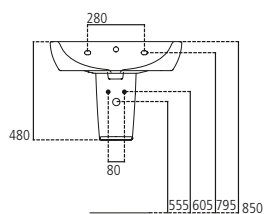
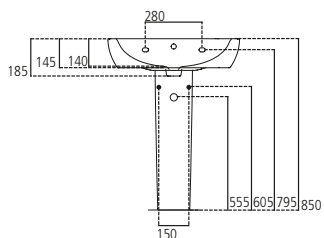

J5212

Lavabo monoforo 60x49 cm, per installazione sospesa con colonna o semicolonna.

J521201	Lavabo 60x49 cm	kg 20,5
J521501	Colonna	kg 12,0
J521601	Semicolonna	kg 7,0

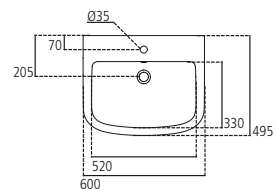
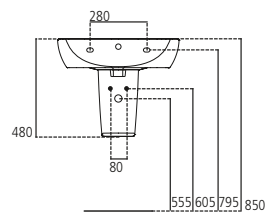
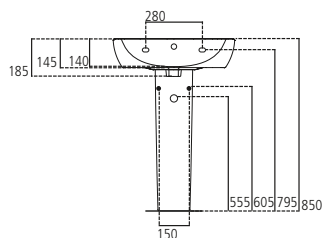

J5213

Lavabo monoforo 55x45 cm, per installazione sospesa con colonna o semicolonna.

J521301	Lavabo 55x45 cm	kg 16,0
J521501	Colonna	kg 12,0
J521601	Semicolonna	kg 7,0

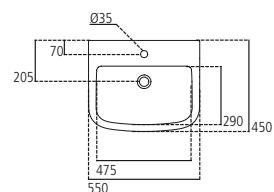
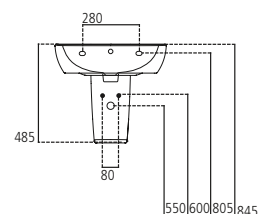
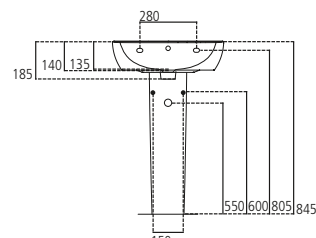

J5214

Lavabo monoforo 50x44 cm, per installazione sospesa con colonna o semicolonna.

J521401	Lavabo 50x44 cm	kg 16,0
J521501	Colonna	kg 12,0
J521601	Semicolonna	kg 7,0

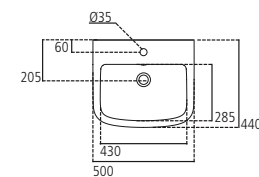
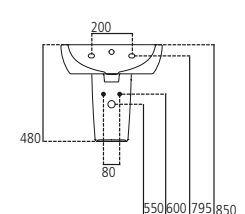
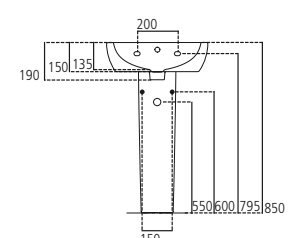



J5218

Lavabo monoforo incasso 50x43 cm.

J521801 Lavabo incasso 50x43 cm kg 8,0

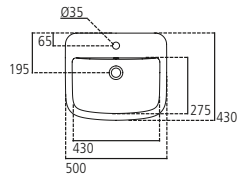
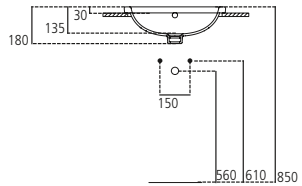

J5217

Lavabo monoforo semincasso 55x45 cm.

J521701 Lavabo semincasso 55x45 cm kg 13,0

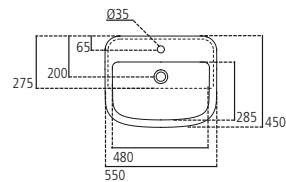
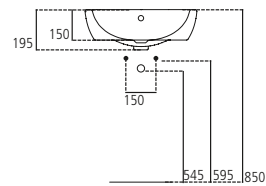
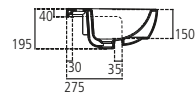

J5219

Lavamani monoforo 40x36 cm.

J521901 Lavamani 40x36 cm kg 8,0

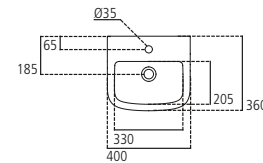
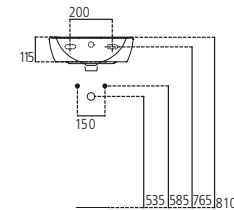
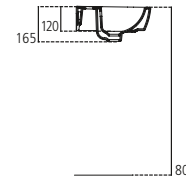

J5226

Bidet sospeso monoforo.

J522601 Bidet monoforo sospeso kg 18,0

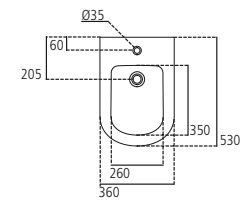
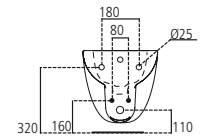
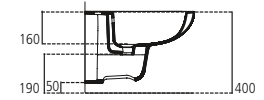



J5225

Vaso sospeso senza sedile. Scarico a 6/3 litri.

J522501	Vaso sospeso senza sedile	kg 17,0
J523201	Sedile con cerniere in metallo	kg 2,3
J523301	Sedile con cerniere a chiusura rallentata	kg 2,2
J117867	Staffe di fissaggio ad "L" complete di bulloni per vaso o bidet sospeso	kg 2,5
J117967	Set di protezione per vaso o bidet sospeso	kg 1,2

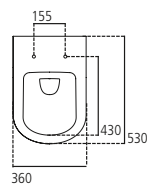
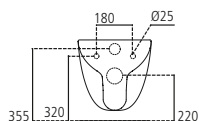
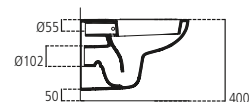

J5235

Bidet a terra filo parete.

J523501	Bidet monoforo a terra filo parete	kg 21,0
----------------	------------------------------------	---------

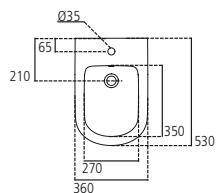
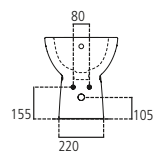
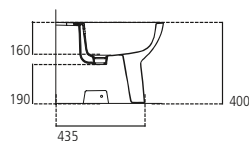

J5231

Vaso a terra filo parete senza sedile. Certificato per scarico ridotto a 4,5/3 litri. Scarico orizzontale, trasformabile in scarico verticale con curva tecnica J324867 non a corredo.

J523101	Vaso a terra filo parete, senza sedile	kg 22,0
J523201	Sedile con cerniere in metallo	kg 2,3
J523301	Sedile con cerniere a chiusura rallentata	kg 2,2

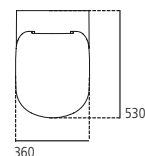
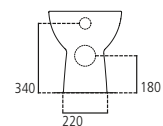
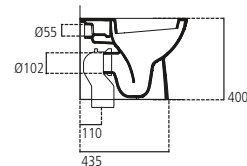

J5224

Bidet a terra monoforo.

J522401	Bidet a terra monoforo	kg 16,0
----------------	------------------------	---------

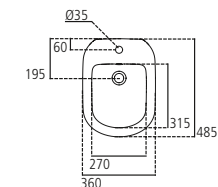
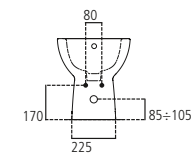
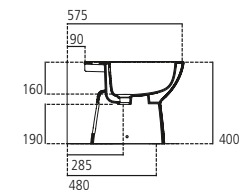



J5222

Vaso a terra senza sedile scarico a pavimento (S) non UNI senza sedile. Scarico a 4,5/3 litri.

J522201	Vaso a terra, scarico a pavimento, senza sedile	kg 19,0
J523201	Sedile con cerniere in metallo	kg 2,3
J523301	Sedile con cerniere a chiusura rallentata	kg 2,2

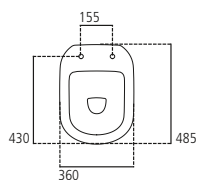
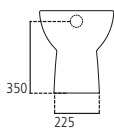
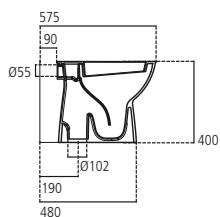

J5221

Vaso a terra senza sedile scarico a pavimento (S) UNI senza sedile. Scarico a 4,5/3 litri.

J522101	Vaso a terra UNI, scarico a pavimento, senza sedile	kg 20,0
J523201	Sedile con cerniere in metallo	kg 2,3

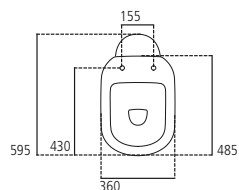
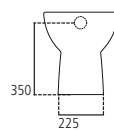
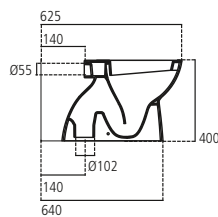

J5223

Vaso a terra senza sedile scarico a parete (P) senza sedile. Scarico a 4,5/3 litri.

J522301	Vaso a terra, scarico a parete, senza sedile	kg 19,0
J523201	Sedile con cerniere in metallo	kg 2,3
J523301	Sedile con cerniere a chiusura rallentata	kg 2,2

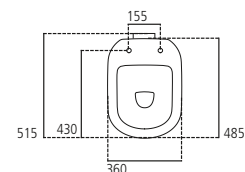
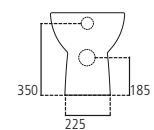
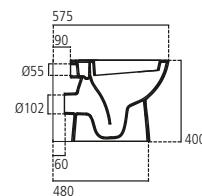

J5228

Vaso monoblocco senza sedile, scarico a pavimento (S).

J522801	Vaso monoblocco, scarico a pavimento, senza sedile	kg 24,0
J523201	Sedile con cerniere in metallo	kg 2,3
J523301	Sedile con cerniere a chiusura rallentata	kg 2,2
J522901	Cassetta entrata bassa, con coperchio	kg 11,3
E885067	Batteria per cassetta dual flush	kg 1,6

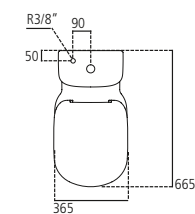
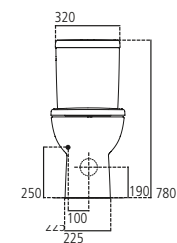
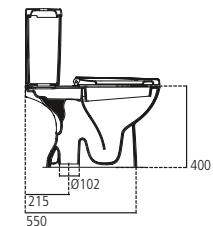



J5227

Vaso monoblocco senza sedile, scarico a parete (P).

J522701	Vaso monoblocco, scarico a parete, senza sedile	kg 24,0
J523201	Sedile con cerniere in metallo	kg 2,3
J523301	Sedile con cerniere a chiusura rallentata	kg 2,2
J522901	Cassetta entrata bassa, con coperchio	kg 11,3
E885067	Batteria per cassetta dual flush	kg 1,6

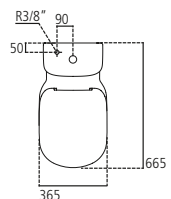
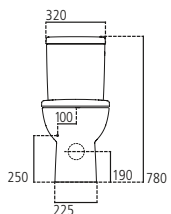
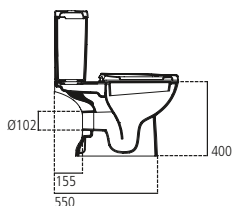

J5232 - J5233

Sedile per vaso.

J523201	Sedile con cerniere in metallo	kg 2,3
J523301	Sedile con cerniere a chiusura rallentata	kg 2,2



J5272

Lavabo Top con mobile sottolavabo sospeso. Due cassetti con rientro ammortizzato, maniglia cromata, disponibile in tre finiture.

J5272	Mobile da 60 cm sospeso con lavabo incluso	kg 31,0
WG	Bianco laccato lucido	
OS	Rovere chiaro	
SG	Rovere grigio	

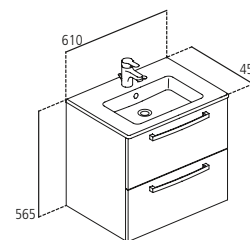

J5274

Lavabo Top con mobile sottolavabo sospeso. Due cassetti con rientro ammortizzato, maniglia cromata, disponibile in tre finiture.

J5274	Mobile da 80 cm sospeso con lavabo incluso	kg 36,3
WG	Bianco laccato lucido	
OS	Rovere chiaro	
SG	Rovere grigio	

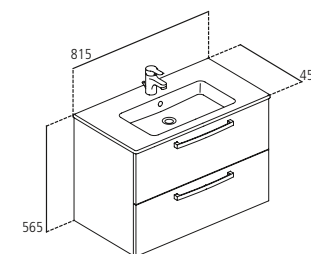



J5271

Lavabo Top con mobile sottolavabo a terra. Due ante con chiusura rallentata, maniglia cromata, piedini d'appoggio cromati, lucidi e regolabili. Disponibile in tre finiture.

J5271	Mobile da 60 cm con lavabo incluso (a terra con piedini a vista)	kg 29,8
WG	Bianco laccato lucido	
OS	Rovere chiaro	
SG	Rovere grigio	

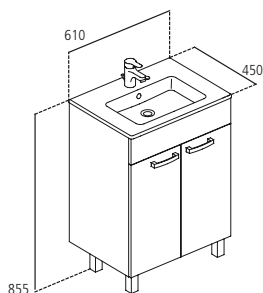

J5273

Lavabo Top con mobile sottolavabo a terra. Due ante con chiusura rallentata, maniglia cromata, piedini d'appoggio cromati, lucidi e regolabili. Disponibile in tre finiture.

J5273	Mobile da 80 cm con lavabo incluso (a terra con piedini a vista)	kg 40,7
WG	Bianco laccato lucido	
OS	Rovere chiaro	
SG	Rovere grigio	

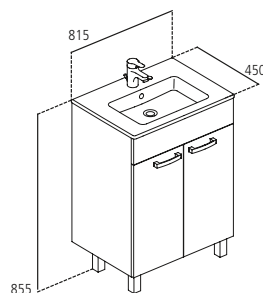

J5270

Lavabo Top con mobile sottolavabo a terra. Due ante con chiusura rallentata, maniglia cromata, disponibile in tre finiture.

J5270	Mobile da 60 cm con lavabo incluso (a terra con piedini nascosti)	kg 30,0
WG	Bianco laccato lucido	
OS	Rovere chiaro	
SG	Rovere grigio	

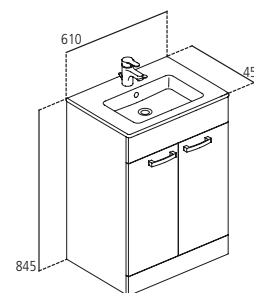

J5286

Mobile a colonna reversibile con due mensole regolabili. Disponibile in tre finiture.

J5286	Mobile a colonna	kg 17,3
WG	Bianco laccato lucido	
OS	Rovere chiaro	
SG	Rovere grigio	

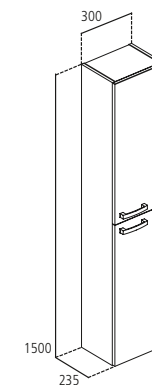



J4588

Lavabo con foro centrale per la rubinetteria aperto.

J458800	Lavabo sospeso 75x52 cm	kg 23,0
J053300	Colonna	kg 10,4
J437000	Semicolonna	kg 7,0

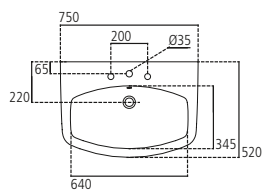
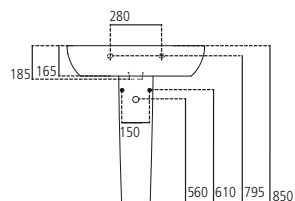
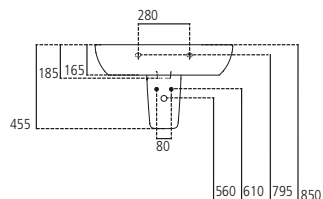

J4587

Lavabo con foro centrale per la rubinetteria aperto.

J458700	Lavabo sospeso 68x48 cm	kg 20,0
J053300	Colonna	kg 10,4
J437000	Semicolonna	kg 7,0

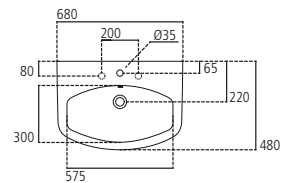
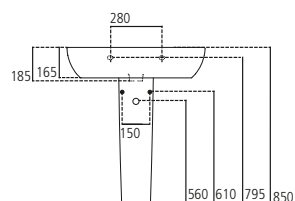
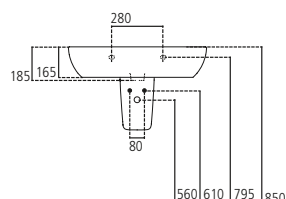

J4586

Lavabo con foro centrale per la rubinetteria aperto.

J458600	Lavabo sospeso 60x48 cm	kg 18,0
J053300	Colonna	kg 10,4
J437000	Semicolonna	kg 7,0

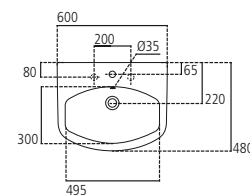
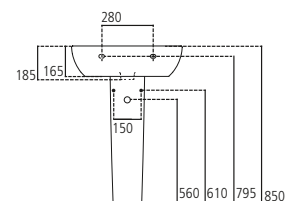
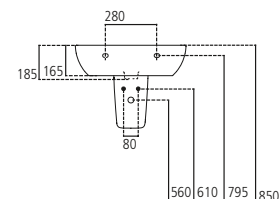

J4585

Lavabo con foro centrale per la rubinetteria aperto e laterali diaframmati.

J458500	Lavabo sospeso 55x48 cm	kg 16,0
J053300	Colonna	kg 10,4
J437000	Semicolonna	kg 7,0

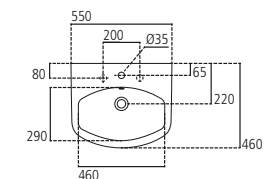
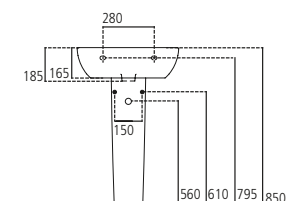
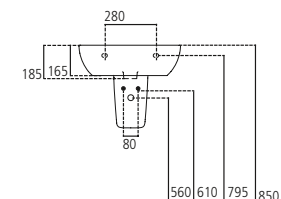



J4746

Lavamani sospeso con bacino rettangolare.
Installazione con bulloni.

J474600	Lavamani sospeso 45x35 cm	kg 11,8
J437000	Semicolonna	kg 7,0

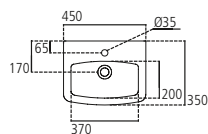
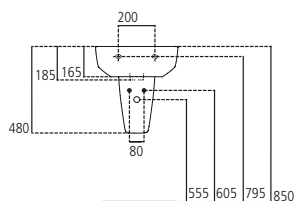
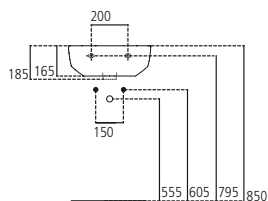

J4429

Lavabo semincasso con foro centrale per la rubinetteria aperto e laterali diaframmati.

J442900	Lavabo semincasso 67x49 cm	kg 18,7
----------------	----------------------------	---------

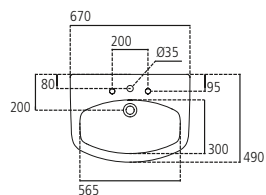
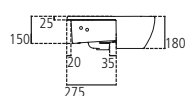
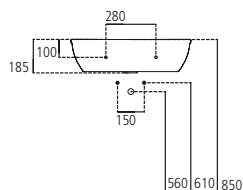

J4427

Lavabo d'appoggio su piano, senza foro troppopieno, con ampio bacino ovale. Fissaggio a corredo T654867.

J442700	Lavabo d'appoggio 60x44 cm	kg 14,0
J3291AA	Piletta a scarico libero	kg 0,4

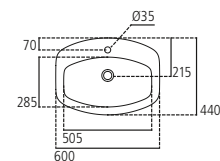
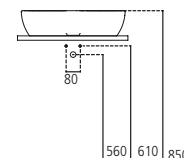

J4434

Lavabo Top d'appoggio o sospeso con foro centrale per la rubinetteria aperto e laterali diaframmati.

J443400	Lavabo Top d'appoggio o sospeso 100x50 cm	kg 38,8
J437000	Semicolonna	kg 7,0

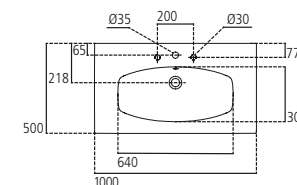
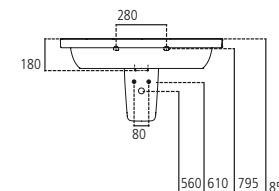



J4432

Lavabo Top d'appoggio o sospeso predisposto con foro centrale per la rubinetteria aperto e laterali diaframmati.

J443200	Lavabo Top d'appoggio o sospeso 80x50 cm	kg 28,0
J437000	Semicolonna	kg 7,0

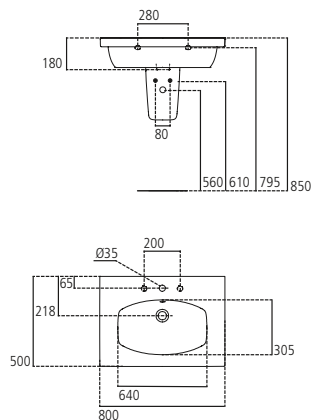

J4378

Bidet sospeso monoforo, con erogazione dell'acqua dal rubinetto. Completo di fissaggi nascosti.

J437800	Bidet sospeso	kg 19,8
----------------	---------------	---------

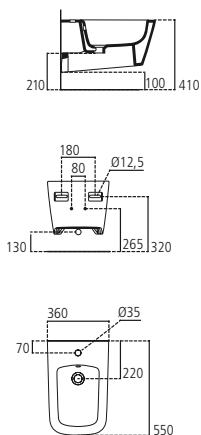

J5051 - J5052

Vaso sospeso con sedile completo di fissaggi nascosti, con sedile slim a chiusura rallentata.

J505100	Vaso sospeso con sedile slim a chiusura rallentata	kg 32,2
J505200	Vaso sospeso con sedile slim	kg 32,2

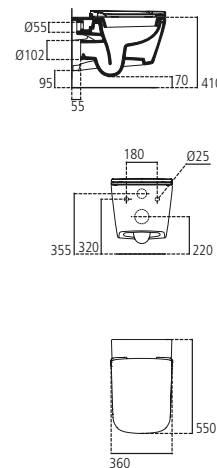

J4377

Bidet monoforo a terra filo parete, con erogazione dell'acqua dal rubinetto.

J437700	Bidet a terra filo parete	kg 26,2
----------------	---------------------------	---------

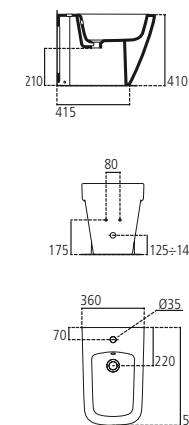



J5053 - J5054

Vaso BTW (filo parete) con sedile slim. Scarico a parete (P), si trasforma in scarico a pavimento (S) con l'apposita curva tecnica (J324867) fornita a corredo. Certificato per scarico a 6 litri.

J505300 Vaso filo parete con sedile slim a chiusura rallentata kg 32,2

J505400 Vaso filo parete con sedile slim kg 32,2

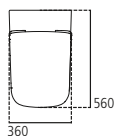
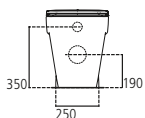
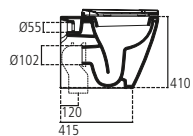

J5055 - J5056

Sedile per vaso.

J505500 Sedile slim per vaso Mia J5052/J5054 kg 2,7

J505600 Sedile slim a chiusura rallentata per vaso Mia J5051/J5053 kg 2,7

QUARZO



E8831

Lavabo monoforo 65x50 cm, per installazione sospesa con colonna o semicolonna.

E883101 Lavabo 65x50 cm kg 16,1

E885801 Colonna kg 10,2

E885901 Semicolonna kg 6,0

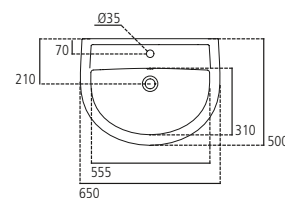
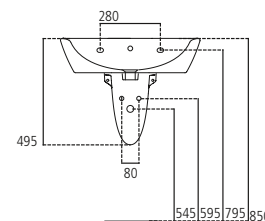
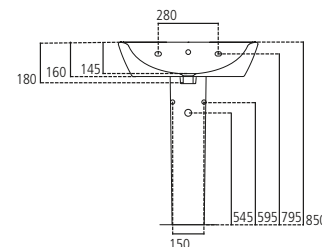

E8825

Lavabo monoforo 60x47 cm, per installazione sospesa con colonna o semicolonna.

E882501 Lavabo 60x47 cm kg 15,3

E885801 Colonna kg 10,2

E885901 Semicolonna kg 6,0

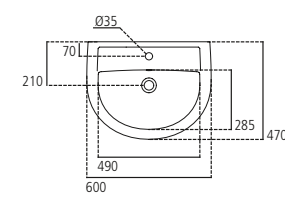
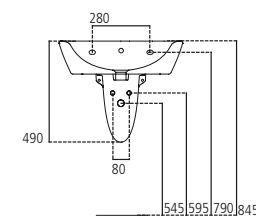
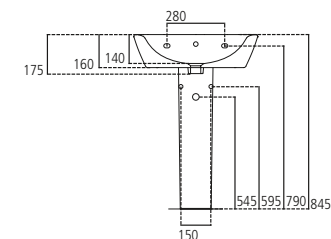



E8821

Lavabo monoforo 55x46 cm, per installazione sospesa con colonna o semicolonna.

E882101	Lavabo 55x46 cm	kg 15,5
E885801	Colonna	kg 10,2
E885901	Semicolonna	kg 6,0

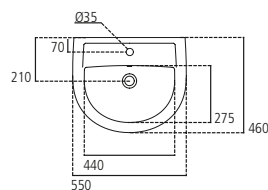
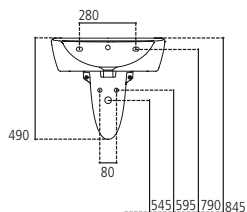
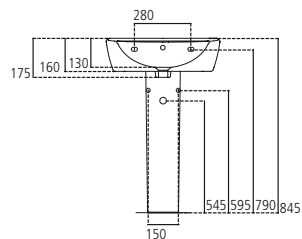

E8816

Lavabo monoforo 50x44 cm, per installazione sospesa con colonna o semicolonna.

E881601	Lavabo 50x44 cm	kg 14,0
E885801	Colonna	kg 10,2
E885901	Semicolonna	kg 6,0

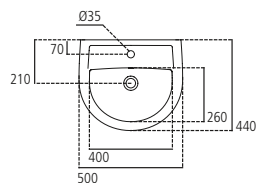
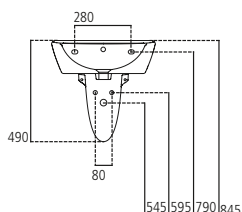
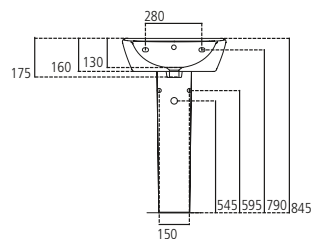

E8836

Lavabo monoforo incasso 56x46 cm, per installazione sopra piano.

E883601	Lavabo 56x46 cm	kg 10,5
----------------	-----------------	---------

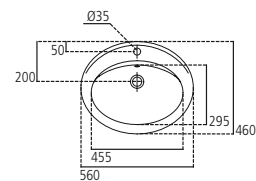
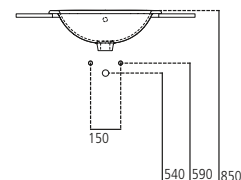

E8861

Bidet sospeso monoforo.

E886101	Bidet sospeso	kg 15,8
J117867	Staffe di fissaggio ad "L" completi di bulloni per vaso o bidet sospeso	kg 2,5
J117967	Set di protezione per vaso o bidet sospeso	kg 1,2

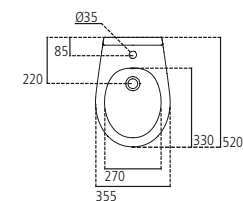
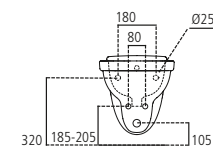
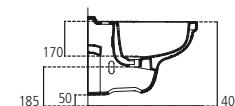



E8857

Vaso sospeso senza sedile.

E885701	Vaso sospeso	kg 14,0
E907901	Sedile con cerniere in metallo	kg 2,1
E908401	Sedile con cerniere in plastica	kg 2,1
J117867	Staffe di fissaggio ad "L" complete di bulloni per vaso o bidet sospeso	kg 2,5
J117967	Set di protezione per vaso o bidet sospeso	kg 1,2

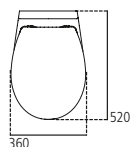
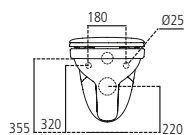
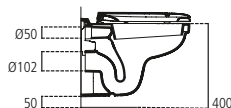

E8862

Bidet a terra monoforo.

E886201	Bidet a terra	kg 15,0
----------------	---------------	---------

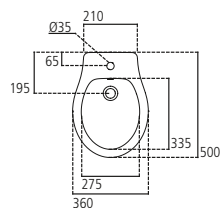
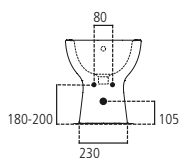
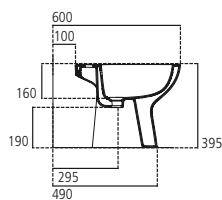

E8864 - E8865

Vaso a terra senza sedile scarico a pavimento senza sedile.

E886401	Vaso a terra (S) non UNI	kg 16,1
E886501	Vaso a terra (S) UNI	kg 15,5
E907901	Sedile con cerniere in metallo	kg 2,1
E908401	Sedile con cerniere in plastica	kg 2,1

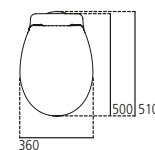
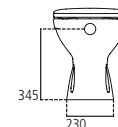
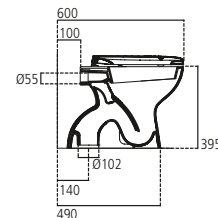

E8863

Vaso a terra senza sedile scarico a parete (P) senza sedile.

E886301	Vaso a terra	kg 13,5
E907901	Sedile con cerniere in metallo	kg 2,1
E908401	Sedile con cerniere in plastica	kg 2,1

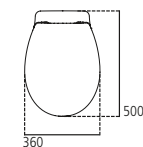
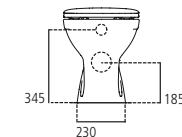
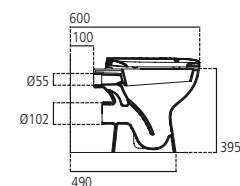



E8847

Vaso monoblocco senza sedile, scarico a pavimento (S).

E884701	Vaso monoblocco	kg 19,0
E907901	Sedile con cerniere in metallo	kg 2,1
E908401	Sedile con cerniere in plastica	kg 2,1
E885001	Cassetta entrata bassa con coperchio	kg 14,0
E885201	Cassetta entrata laterale con coperchio	kg 14,0

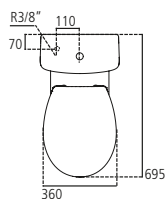
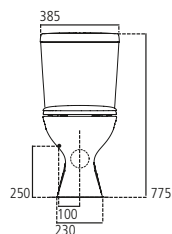
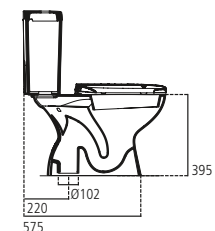

E8846

Vaso monoblocco senza sedile, scarico a parete (P).

E884601	Vaso monoblocco	kg 17,0
E907901	Sedile con cerniere in metallo	kg 2,1
E908401	Sedile con cerniere in plastica	kg 2,1
E885001	Cassetta entrata bassa con coperchio	kg 14,1
E885201	Cassetta entrata laterale con coperchio	kg 14,0

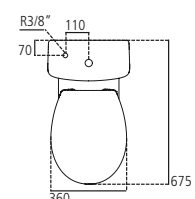
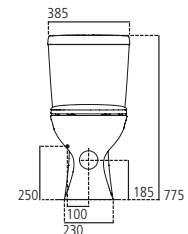
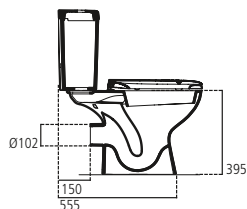

E9079 - E9084

Sedile per vaso.

E907901	Sedile con cerniere in metallo	kg 2,1
E908401	Sedile con cerniere in plastica	kg 2,1

PIATTI
DOCCIA

PIATTI DOCCIA CERAMICI DOLOMITE, UNA GARANZIA SENZA PARI

Ceramica Dolomite cura in prima persona tutte le fasi del processo produttivo dei piatti doccia ceramici, a partire dalla meticolosa cura nella scelta delle materie prime fino ai severi test di controllo dei prodotti finiti: minerali purissimi accuratamente selezionati, dosati, miscelati e cotti a 1250° formano un materiale totalmente impermeabile all'acqua, inattaccabile dagli acidi e dagli alcali. Il valore della filiera produttiva si riflette nella più alta qualità dei prodotti: non è un caso che i piatti doccia in ceramica godano della garanzia a vita.

Attenzione: perché la garanzia sia valida è necessario che il piatto, al momento dell'installazione, non abbia difetti visibili e che lo stesso venga installato nella modalità indicata da Ceramica Dolomite. Vi mostriamo qui accanto come procedere nel modo corretto.

COME INSTALLARLI

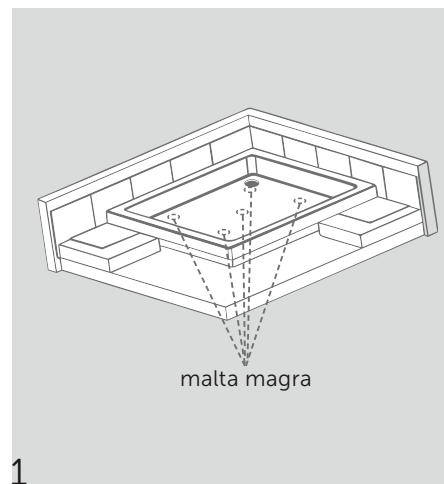

1

Predisporre lo scarico in relazione al foro della piletta e alla posizione voluta nel locale. Realizzare i punti di appoggio usando malta magra in corrispondenza degli angoli e al centro.

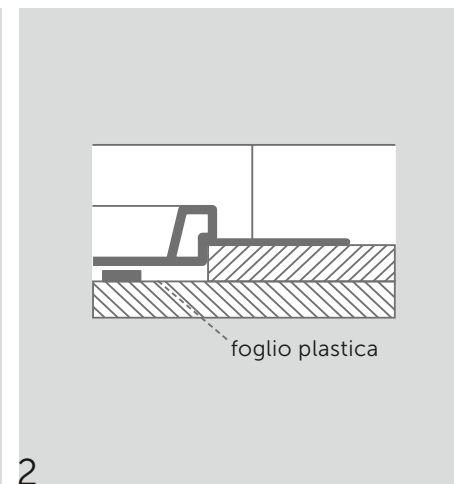

2

Tra il piatto doccia e la malta interporre un foglio di plastica comune o semplice carta, per evitare che le due parti si incollino.

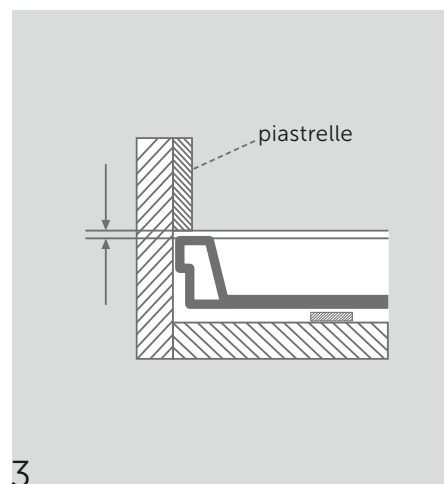

3

Alloggiare il piatto doccia tenendo conto dello spessore del rivestimento a parete. Controllare il perfetto posizionamento orizzontale con l'aiuto di una livella. Allacciare la piletta allo scarico e verificare l'assenza di perdite. Dopo la completa essiccazione della malta, procedere con il rivestimento delle pareti e del pavimento.

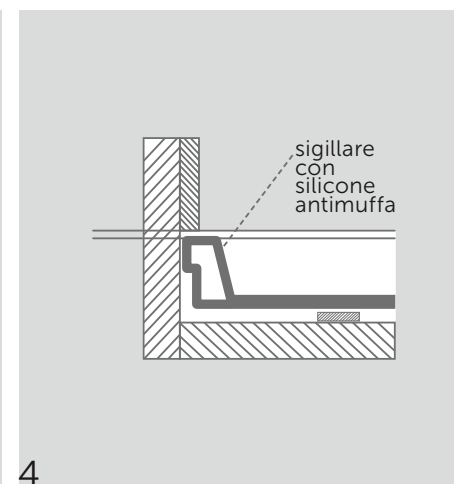

4

Il rivestimento delle pareti non deve gravare sul bordo del piatto doccia: in caso di assestamento del fabbricato potrebbe essere altrimenti soggetto a rottura. È dunque indispensabile lasciare uno spazio di 3 o 4 mm tra il bordo del piatto doccia e il rivestimento: le fughe dovranno essere sigillate con silicone antimuffa.



J5263 - J5262 - J5261 - J5260

Piatto doccia quadrato.

J526301	90x90x7 cm	kg 49,1
J526201	80x80x7 cm	kg 39,7
J526101	75x75x7 cm	kg 35,8
J526001	70x70x7 cm	kg 34,3
T8520AA	Piletta ispezionabile con foro 90 mm con coperchio piatto in ABS cromato 120 mm	kg 1,2

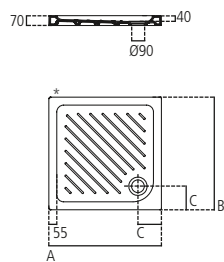

	A	B	C
J5263	900	900	165
J5262	800	800	165
J5261	750	750	165
J5260	700	700	165

* Lato non smaltato.



J5269 - J5268 - J5267 - J5266

Piatto doccia rettangolare.

J526901	120x87x7 cm	kg 49,5
J526801	100x80x7 cm	kg 41,0
J526701	100x70x7 cm	kg 39,1
J526601	90x70x7 cm	kg 32,7
T8520AA	Piletta ispezionabile con foro 90 mm con coperchio piatto in ABS cromato 120 mm	kg 1,2

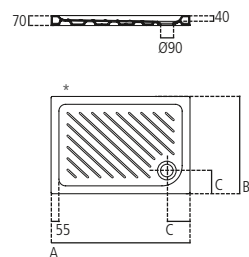

	A	B	C
J5269	1200	800	165
J5268	1000	800	165
J5267	1000	700	165
J5266	900	700	165

* Lato non smaltato.



J5265 - J5264

Piatto doccia quadrato con angolo curvo.

J526501	90x90x7 cm	kg 39,8
J526401	80x80x7 cm	kg 35,8
T8520AA	Piletta ispezionabile con foro 90 mm con coperchio piatto in ABS cromato 120 mm	kg 1,2

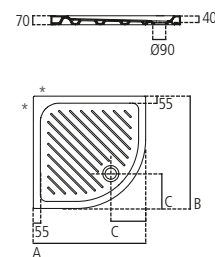

	A	B	C
J5265	900	900	280
J5264	800	800	275

* Lato non smaltato.

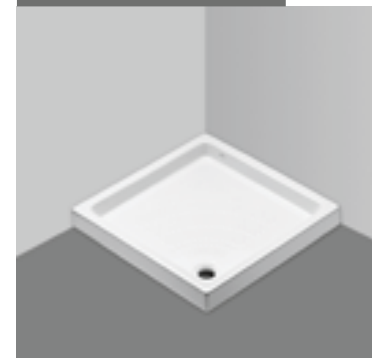

J4894 - J4906

Piatto doccia quadrato.

J489401	70x70 cm	kg 29,5
J490601	76x76 cm	kg 32,7

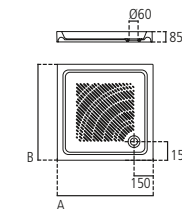

	A	B
J4906	760	760
J4894	700	700



J4892 - J4907

Piatto doccia quadrato.

J489201	80x80 cm	kg 35,8
J490701	90x90 cm	kg 32,2

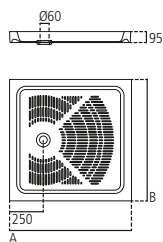

	A	B
J4907	900	900
J4892	800	800



J4908

Piatto doccia rettangolare.

J490801	85x70 cm	kg 33,4
----------------	----------	---------

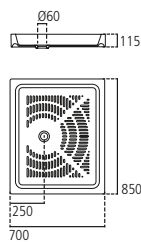

J4911 - J4909 - J4910

Piatto doccia rettangolare.

J491101	91x73 cm	kg 32,8
J490901	100x70 cm	kg 42,3
J491001	120x80 cm	kg 53,6

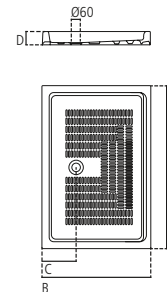

	A	B	C	D
J4910	1200	800	250	110
J4909	1000	700	155	110
J4911	910	730	250	95



J4990 - J4991

Piatto doccia quadrato.

J499001	80x80 cm	kg 37,1
J499101	90x90 cm	kg 44,3

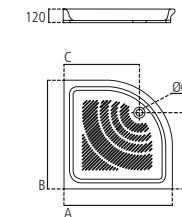

	A	B	C	D
J4991	900	900	630	630
J4990	800	800	535	535

QUOTE
CANTIERE

LAVABI

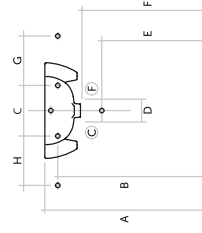

SERIE	CODICE	A	B	C	D	E	F	G	H	DIMENSIONI TOTALI	PESO (KG)
ATLANTIS	J0403	800				300	550			670x600x200	19
CLODIA	J0501	850	775	285	80	540	610			680x520x205	17
CLODIA	J0502	850	775	285	80	540	610			600x510x205	15
CRISTALLO	J4469	838	783	280	80	551	601			650x481x177	17,5
CRISTALLO	J4468	838	783	280	80	551	601			600x481x177	16,5
CRISTALLO	J4467	838	783	280	80	551	601			550x481x177	16
CRISTALLO	J4466	838	783	280	80	551	601			500x400x177	15
CRISTALLO	J4473	850	795	200	80	565	615			450x330x175	11,5
GEMMA 2	J5211	850	795	280	80	555	605			650x525x185	22
GEMMA 2	J5212	850	795	280	80	555	605			600x495x185	20,5
GEMMA 2	J5213	845	805	280	80	550	600			550x450x185	16
GEMMA 2	J5214	850	795	200	80	550	600			500x440x190	16
GEMMA 2	J5219	810	765	200	150	535	585			400x360x165	8
MAIA	J4983	800	735	280	80	300	550	80	80	770x590x165	24
MIA	J4434	850	795	280	150	560	610			1000x500x180	37
MIA	J4432	850	795	280	150	560	610			800x500x180	30
MIA	J4588	850	795	280	150	560	610			750x520x185	23
MIA	J4587	850	795	280	150	560	610			680x480x185	20
MIA	J4586	850	795	280	150	560	610			600x480x185	18

SERIE	CODICE	A	B	C	D	E	F	G	H	DIMENSIONI TOTALI	PESO (KG)
MIA	J4585	850	795	280	150	560	610			550x460x185	16
MIA	J4746	850	795	200	150	555	605			450x350x185	11,5
QUARZO	E8831	850	795	280	80	545	595			650x500x180	16
QUARZO	E8825	845	790	280	80	545	595			600x470x175	15
QUARZO	E8821	845	790	280	80	545	595			550x460x175	14
QUARZO	E8816	845	790	280	80	545	595			500x440x175	12

LAVABI CON COLONNA

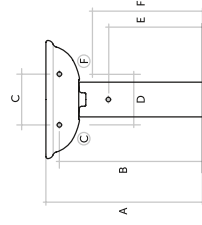

SERIE	CODICE	A	B	C	D	E	F	G	H	DIMENSIONI TOTALI	PESO (KG)
CLODIA	J0501	840	775	285	150	540	610			680x520x205	17
CLODIA	J0502	840	775	285	150	540	610			600x510x205	15
CRISTALLO	J4469	838	783	280	150	551	601			650x481x177	17,5
CRISTALLO	J4468	838	783	280	150	551	601			600x481x177	16,5
CRISTALLO	J4467	838	783	280	150	551	601			550x481x177	16
CRISTALLO	J4466	838	783	280	150	551	601			500x400x177	15
GEMMA 2	J5211	850	795	280	150	555	605			650x525x185	22
GEMMA 2	J5212	850	795	280	150	555	605			600x495x185	20,5
GEMMA 2	J5213	845	805	280	150	550	600			550x450x185	16
GEMMA 2	J5214	850	795	200	150	550	600			500x440x190	16
MIA	J4588	850	795	280	150	560	610			750x520x185	23
MIA	J4587	850	795	280	150	560	610			680x480x185	20
MIA	J4586	850	795	280	150	560	610			600x480x185	18
MIA	J4585	850	795	280	150	560	610			550x460x185	16
QUARZO	E8831	850	795	280	150	545	595			650x500x180	16
QUARZO	E8825	845	790	280	150	545	595			600x470x175	15
QUARZO	E8821	845	790	280	150	545	595			550x460x175	14
QUARZO	E8816	845	790	280	150	545	595			500x440x175	12

LAVABI CON SEMICOLONNA

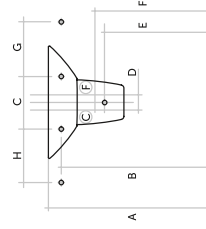

SERIE	CODICE	A	B	C	D	E	F	G	H	DIMENSIONI TOTALI	PESO (KG)
CLODIA	J0501	850	775	285	80	540	610			680x520x205	17
CLODIA	J0502	850	775	285	80	540	610			600x510x205	15
CRISTALLO	J4469	838	783	280	80	551	601			650x481x177	17,5
CRISTALLO	J4468	838	783	280	80	551	601			600x481x177	16,5
CRISTALLO	J4467	838	783	280	80	551	601			550x481x177	16
CRISTALLO	J4466	838	783	280	80	551	601			500x400x177	15
CRISTALLO	J4473	850	795	200	80	565	615			450x330x175	11,5
GEMMA 2	J5211	850	795	280	80	555	605			650x525x185	22
GEMMA 2	J5212	850	795	280	80	555	605			600x495x185	20,5
GEMMA 2	J5213	845	805	280	80	550	600			550x450x185	15
GEMMA 2	J5214	850	795	200	80	550	600			500x440x190	16
MIA	J4434	850	795	280	80	560	610			1000x500x180	37
MIA	J4432	850	795	280	80	560	610			800x500x180	30
MIA	J4588	850	795	280	80	560	610			750x520x185	23
MIA	J4587	850	795	280	80	560	610			680x480x185	20
MIA	J4586	850	795	280	80	560	610			600x480x185	18
MIA	J4585	850	795	280	80	560	610			550x460x185	16
MIA	J4746	850	795	200	80	555	605			450x350x185	11,5
QUARZO	E8831	850	795	280	80	545	595			650x500x180	16
QUARZO	E8825	845	790	280	80	545	595			600x470x175	15
QUARZO	E8821	845	790	280	80	545	595			550x460x175	14
QUARZO	E8816	845	790	280	80	545	595			500x440x175	12

LAVABI INCASSO

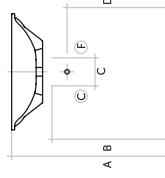

SERIE	CODICE	A	B	C	D	E	F	G	H	DIMENSIONI TOTALI	PESO (KG)
CRISTALLO	J4470	850	600	150	550					550x470x175	11
GEMMA 2	J5218	850	610	150	560					500x430x180	8
QUARZO	E8836	850	590	150	540					560x460x200	16

44

LAVABI SEMINCASSO

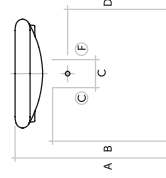

SERIE	CODICE	A	B	C	D	E	F	G	H	DIMENSIONI TOTALI	PESO (KG)
CLODIA	J0792	850	615	150	565					640x520x200	17
CRISTALLO	J4472	850	615	150	565					550x470x175	13,5
GEMMA 2	J5217	850	595	150	545					550x450x195	13
MIA	J4429	850	610	150	560					565x490x185	19

BIDET A TERRA

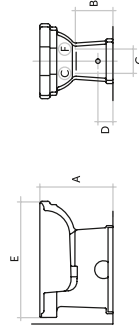

SERIE	CODICE	A	B	C	D	E	F	G	H	DIMENSIONI TOTALI	PESO (KG)
CLODIA	J0512	395	120	180	100	635				360x585x395	18
GEMMA 2	J5235	400	155	80	105	530				360x530x400	21
GEMMA 2	J5224	400	170	80	85-105	575				360x485x400	16
CRISTALLO	J4482	400	180-200	80	90-110	550				360x550x400	20,5
MIA	J4377	410	175	80	125-140	560				360x560x410	27
QUARZO	E8862	395	180-200	80	105	600				360x500x395	21,5

45

BIDET SOSPESO

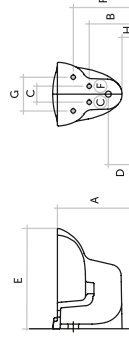

SERIE	CODICE	A	B	C	D	E	F	G	H	DIMENSIONI TOTALI	PESO (KG)
CLODIA	J0511	400	200	130	100	570	310	180		360x570x400	18
CRISTALLO	J4484	400	165	80	115	550	320	180	55	360x550x400	21
GEMMA 2	J5226	400	160	80	110	530	320	180	50	360x530x400	18
MIA	J4378	410	265	80	130	550	320	180	100	360x550x410	18
QUARZO	E8861	400	185-205	80	105	520	320	180	50	335x520x400	20

VASO A TERRA SC. PAVIMENTO E SC. PARETE

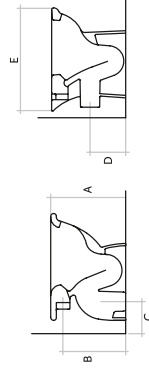

SERIE	CODICE	A	B	C	D	E	F	G	H	DIMENSIONI TOTALI	PESO (KG)
ATLANTIS	J0408	460	390	300	180	800				380x570x460	24
CLODIA	J2546	395	330	200	175	635				360x560x395	21
CRISTALLO	J4481	400	350	102	190	550				360x550x400	24,5
GEMMA 2	J5231 UNI	400	340	110	180	530				360x530x400	22
GEMMA 2	J5222 S	400	350	190		575				360x485x400	19
GEMMA 2	J5221 S UNI	400	350	140		625				360x595x400	20
GEMMA 2	J5223 P	400	350		185	575				360x515x400	19
MAIA	J4988	460	390	300	180	625				385x565x460	25
MIA	J5053 / J5054	410	350	120	190	560				360x560x410	25
QUARZO	E8863	395	345		185	600				360x500x395	23
QUARZO	E8864	395	345	190		600				360x510x395	15
QUARZO	E8865 UNI	395	345	140		600				360x530x400	16

VASO MONOBLOCCO A TERRA

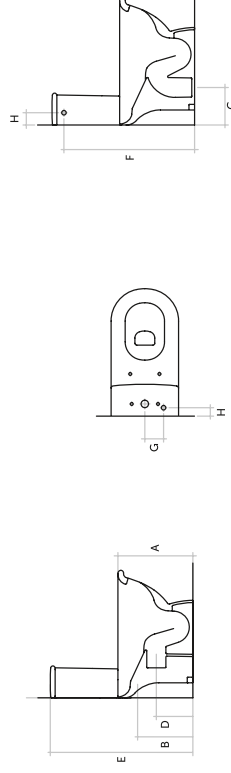

SERIE	CODICE	A	B	C	D	E	F	G	H	DIMENSIONI TOTALI	PESO (KG)
ATLANTIS	J2752	460		225	180	855	770		75	380x770x855	27
CLODIA	J2545	395	300	200	180	790		95	55	360x690x855	25
CRISTALLO	J4477	400	300	215		800		120	55	360x660x800	28
GEMMA 2	J5228 S	400	250	215		780		90	50	365x665x780	24
GEMMA 2	J5227 P	400	250		190	780		90	50	365x665x780	24
QUARZO	E8846 P	395	250		185	775		110	70	360x675x775	17
QUARZO	E8847 S	395	250	220		775		110	70	360x395x775	19

VASO SOSPESO

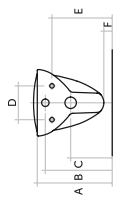

SERIE	CODICE	A	B	C	D	E	F	G	H	DIMENSIONI TOTALI	PESO (KG)
ATLANTIS	J3517	460	375	240	180	340				380x770x460	26
CLODIA	J2547	400	340	210	180	310				360x570x400	21
CRISTALLO	J4483	400	350	220	180	320	55			360x550x400	23
GEMMA 2	J5225	400	355	220	180	320	50			360x530x400	17
MAIA	V3405	450	405	270	180	370	95			750x390x450	22,5
MIA	J5051 / J5052	410	355	220	180	320	70			360x550x410	31
QUARZO	E8857P	400	355	220	180	320	50			360x520x400	14

INDICE ALFANUMERICO

E881601	pag. 24	J458800	pag. 16	J523101	pag. 9
E882101	pag. 24	J474600	pag. 18	J523201	pag. 8, 9, 10, 11, 12
E882501	pag. 23	J489201	pag. 36	J523301	pag. 8, 9, 10, 11, 12
E883101	pag. 23	J489401	pag. 35	J523501	pag. 8
E883601	pag. 25	J490601	pag. 35	J526001	pag. 34
E884601	pag. 28	J490701	pag. 36	J526101	pag. 34
E884701	pag. 28	J490801	pag. 36	J526201	pag. 34
E885001	pag. 28	J490901	pag. 37	J526201	pag. 34
E885067	pag. 11, 12	J491001	pag. 37	J526301	pag. 34
E885201	pag. 28	J491101	pag. 37	J526401	pag. 35
E885701	pag. 26	J499001	pag. 37	J526501	pag. 35
E885801	pag. 23, 24	J499101	pag. 37	J526601	pag. 34
E885901	pag. 23, 24	J505100	pag. 21	J526701	pag. 34
E886101	pag. 25	J505200	pag. 21	J526801	pag. 34
E886201	pag. 26	J505300	pag. 22	J526901	pag. 34
E886301	pag. 27	J505400	pag. 22	J5270OS	pag. 15
E886401	pag. 27	J505500	pag. 22	J5270SG	pag. 15
E886501	pag. 27	J505600	pag. 22	J5270WG	pag. 15
E907901	pag. 26, 27, 28, 29	J521101	pag. 4	J5271OS	pag. 14
E908401	pag. 26, 27, 28, 29	J521201	pag. 4	J5271SG	pag. 14
J053300	pag. 16, 17	J521301	pag. 5	J5271WG	pag. 14
J117867	pag. 8, 25, 26	J521401	pag. 5	J5272OS	pag. 13
J117967	pag. 8, 25, 26	J521501	pag. 4, 5	J5272SG	pag. 13
J3291AA	pag. 19	J521601	pag. 4, 5	J5272WG	pag. 13
J437000	pag. 16, 17, 18, 19, 20	J521701	pag. 6	J5273OS	pag. 14
J437700	pag. 21	J521801	pag. 6	J5273SG	pag. 14
J437800	pag. 20	J521901	pag. 7	J5273WG	pag. 14
J442700	pag. 19	J522101	pag. 10	J5274OS	pag. 13
J442900	pag. 18	J522201	pag. 10	J5274SG	pag. 13
J443200	pag. 20	J522301	pag. 11	J5274WG	pag. 13
J443400	pag. 19	J522401	pag. 9	J5286OS	pag. 15
J458500	pag. 17	J522501	pag. 8	J5286SG	pag. 15
J458600	pag. 17	J522601	pag. 7	J5286WG	pag. 15
J458700	pag. 16	J522701	pag. 12	T8520AA	pag. 34, 35
		J522801	pag. 11		
		J522901	pag. 11, 12		

RUBINETTERIA



B8601- B0346

Miscelatore monocomando per lavabo, con bocca d'erogazione fissa e rompigetto 24x1. Asta di comando scarico e piletta da 1-1/4". Completo di dispositivo per il risparmio energetico e di limitatore della temperatura dell'acqua (cartuccia EKO da 40 mm) e sistema di fissaggio Easy Fix. Tubi di collegamento flessibili.

B8601AA	Miscelatore per lavabo	kg 1,4
B0346AA	Miscelatore per lavabo con aeratore 5 l/m	kg 1,4

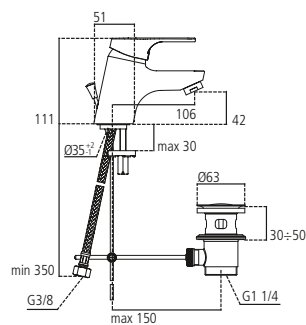

B8602

Miscelatore monocomando per bidet con bocca d'erogazione fissa a getto orientabile e rompigetto 18x1, asta di comando scarico e piletta da 1-1/4". Completo di dispositivo per il risparmio energetico e di limitatore della temperatura dell'acqua (cartuccia EKO da 40 mm) e sistema di fissaggio Easy Fix. Tubi di collegamento flessibili.

B8602AA	Miscelatore per bidet	kg 1,7
----------------	-----------------------	--------

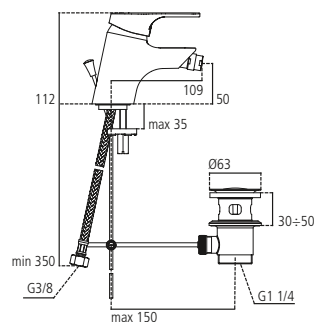

B8603

Miscelatore monocomando per doccia esterno, cartuccia EKO da 40 mm, con raccordi ad S da 1/2" regolabili per interasse da 137 a 163 mm. Accessori doccia non inclusi.

B8603AA	Miscelatore esterno doccia	kg 1,3
----------------	----------------------------	--------

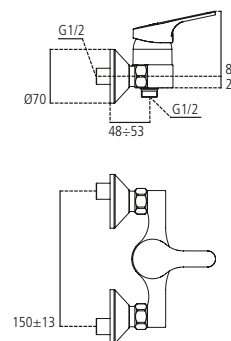

B8604

Miscelatore monocomando per vasca/doccia esterno, con deviatore automatico. Bocca d'erogazione e rompigetto 24x1, cartuccia EKO da 40 mm, raccordi a S da 1/2" regolabili per interasse da 137 a 163 mm. Dotato di doccetta monofunzione, supporto fisso e tubo flessibile doppio graffiato da 1.500 mm con raccordo conico da 1/2".

B8604AA	Miscelatore esterno vasca/doccia con accessori doccia	kg 2,1
----------------	---	--------

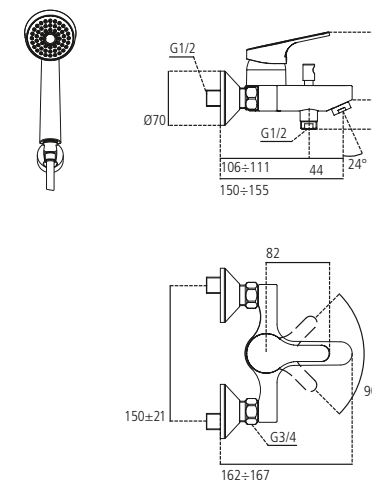



A4558

Miscelatore monocomando per doccia ad incasso, con attacchi di alimentazione e scarico alla doccia da 1/2". Cartuccia EKO da 47 mm. Non è corredato da accessori doccia.

A4558AA Miscelatore incasso doccia kg 1,1

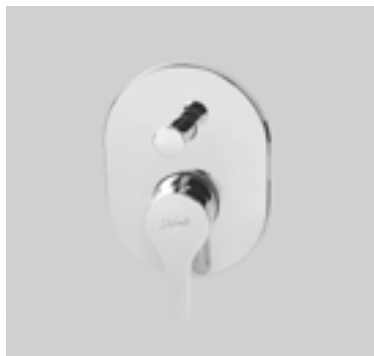
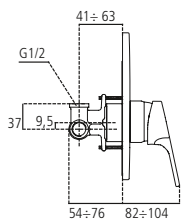
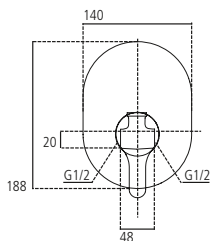

A4559

Miscelatore monocomando per vasca/doccia ad incasso, con deviatore automatico, attacchi di alimentazione e scarico alla doccia da 1/2", scarico alla vasca da 1/2". Cartuccia EKO da 47 mm. Non è corredato da accessori doccia.

A4559AA Miscelatore incasso vasca/doccia kg 1,5

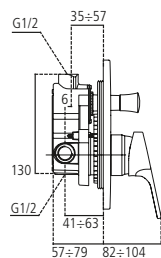
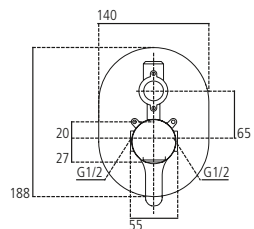

A5925

Miscelatore monocomando per doccia ad incasso con leva lunga, con attacchi di alimentazione e scarico alla doccia da 1/2". Cartuccia EKO da 47 mm. Non è corredato da componenti doccia.

A5925AA Miscelatore incasso doccia kg 1,2

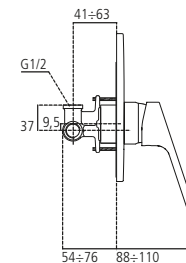
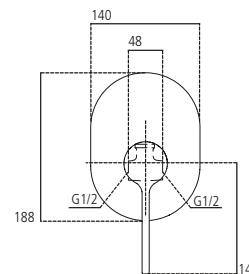

B9395 - B0347

Miscelatore monocomando lavabo con maniglia a leva lunga, bocca di erogazione fissa, rompigetto 24x1, asta comando scarico pileta da 1-1/4". Tubi flessibili, cartuccia EKO da 40 mm e sistema di fissaggio Easy Fix.

B9395AA Miscelatore per lavabo kg 2,0

B0347AA Miscelatore per lavabo con aeratore 5 l/m kg 2,0

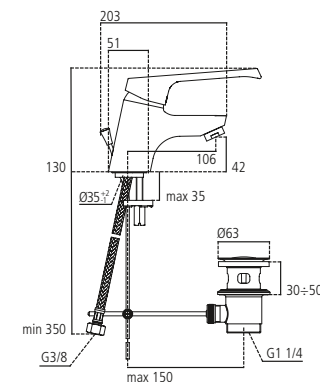



B9396

Miscelatore monocomando per vaso/bidet, attacchi da 1/2", raccordi ad S regolabili e cartuccia EKO da 40 mm. È corredato da doccetta on/off, flessibile a doppia graffatura da 1.500 mm e supporto fisso.

B9396AA Miscelatore esterno vaso/bidet kg 1,8

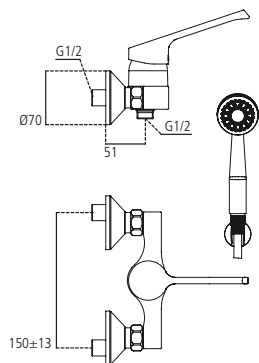

B0141

Doccetta on/off a una funzione, flessibile 1.500 mm a doppia aggraffatura e supporto fisso. Attacchi 1/2".

B0141AA Set doccia on/off kg 0,7

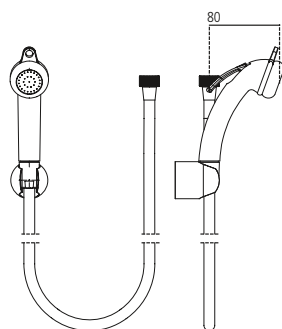

B9397

Miscelatore monocomando per vaso/bidet, attacchi da 1/2", raccordi ad S regolabili e cartuccia EKO da 40 mm. Non è corredato da componenti doccia.

B9397AA Miscelatore esterno vaso/bidet kg 1,4

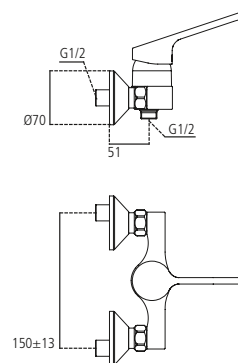

GEMMA 2



B0801 - B0819

Miscelatore monocomando da lavabo con piletta in metallo, tubi flessibili. Cartuccia EKO da 40 mm con limitatore della temperatura. Aeratore Cascade M24X1. Sistema di fissaggio Easy Fix.

B0801AA Miscelatore per lavabo kg 1,6

B0819AA Miscelatore per lavabo con apertura Bluestart e aeratore 5 l/m kg 1,2

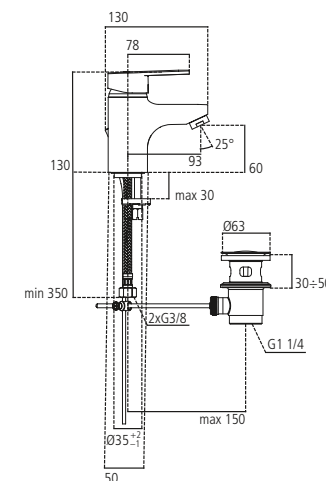



B0802

Miscelatore monocomando per bidet con piletta in metallo, tubi flessibili. Cartuccia EKO da 40 mm con limitatore della temperatura. Aeratore M24X1. Sistema di fissaggio Easy Fix.

B0802AA Miscelatore per bidet kg 1,5

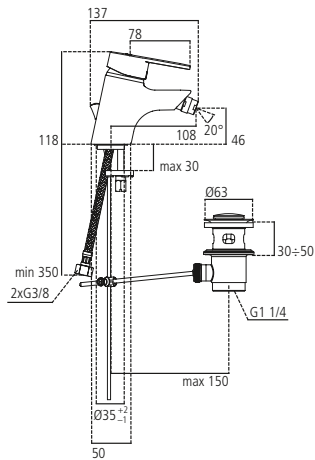

B0803 - B0804

Miscelatore monocomando esterno per vasca/doccia. Cartuccia EKO da 40 mm con limitatore della temperatura. Deviatore automatico. Raccordi a S regolabili.

B0803AA Miscelatore esterno vasca/doccia kg 2,3
corredato di accessori doccia

B0804AA Miscelatore esterno vasca/doccia kg 1,7
non corredato da accessori doccia

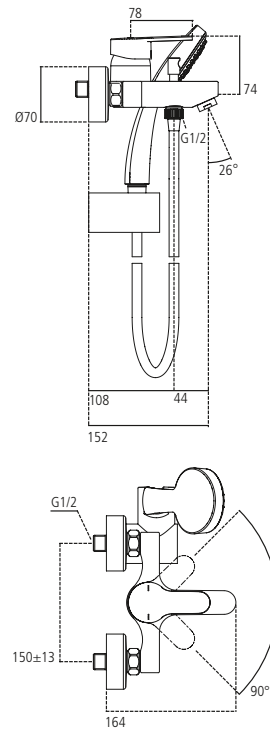

B0805

Miscelatore monocomando esterno per doccia. È dotato di cartuccia EKO da 40 mm con limitatore della temperatura. Raccordi a S regolabili. Non corredato da accessori doccia.

B0805AA Miscelatore esterno doccia, non kg 1,4
corredato da accessori doccia

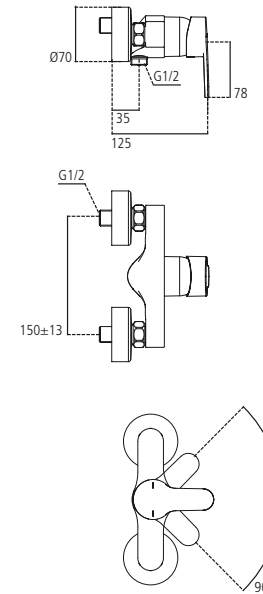

A6258

Gruppo monocomando ad incasso per doccia. Attacchi di alimentazione e scarico alla doccia da 1/2". Scarico della vasca da 1/2".

A6258AA Miscelatore incasso doccia kg 1,1

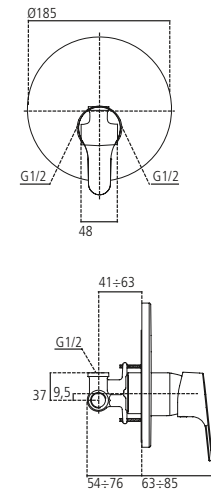



A6257

Gruppo monocomando ad incasso per vasca/
doccia con deviatore. Attacchi di alimentazione
e scarico alla doccia da 1/2". Scarico della vasca
da 1/2".

A6257AA Miscelatore incasso vasca/
doccia kg 1,7

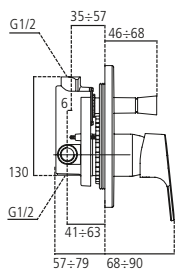
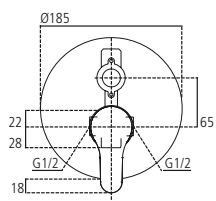

RUBINETTERIA DA CUCINA



B1036

Miscelatore monocomando d'appoggio su lavello con bocca d'erogazione orientabile e rompigetto Perlator 22x1. Completo di dispositivo per il risparmio energetico e di limitatore della temperatura dell'acqua (cartuccia EKO da 40 mm). Tubi di collegamento flessibili.

B1036AA Miscelatore per lavello da cucina kg 1,2

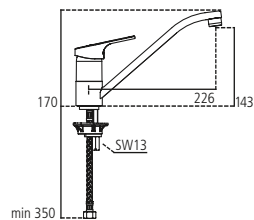

B8606

Miscelatore monocomando d'appoggio su lavello con bocca d'erogazione a manico d'ombrello orientabile e rompigetto 24x1. Completo di dispositivo per il risparmio energetico e di limitatore della temperatura dell'acqua (cartuccia EKO da 40 mm). Tubi di collegamento flessibili.

B8606AA Miscelatore per lavello da cucina kg 1,3

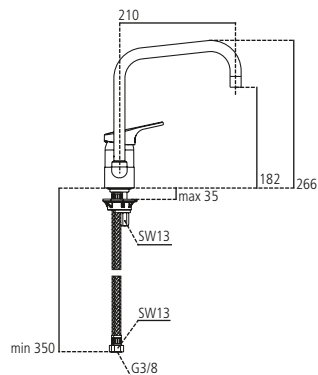

B8607

Miscelatore monocomando per lavello esterno a parete con bocca d'erogazione orientabile. Raccordi ad S da 1/2" regolabili per interasse da 137 a 163 mm (cartuccia EKO da 40 mm).

B8607AA Miscelatore per lavello da cucina kg 1,4

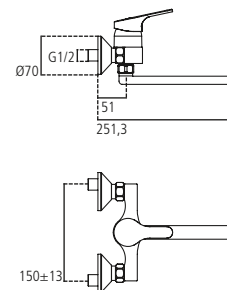

B0806

Miscelatore monocomando d'appoggio su lavello con bocca d'erogazione orientabile e rompigetto Perlator 22x1. Completo di dispositivo per il risparmio energetico e di limitatore della temperatura dell'acqua (cartuccia EKO da 40 mm). Tubi di collegamento flessibili.

B0806AA Miscelatore per lavello da cucina kg 1,3

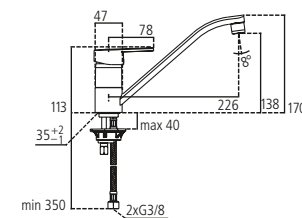



B0807

Miscelatore monocomando d'appoggio su lavello con bocca d'erogazione a manico d'ombrello orientabile e rompigitto. Completo di dispositivo per il risparmio energetico e di limitatore della temperatura dell'acqua (cartuccia EKO da 40 mm). Tubi di collegamento flessibili.

B0807AA Miscelatore per lavello da cucina kg 1,4

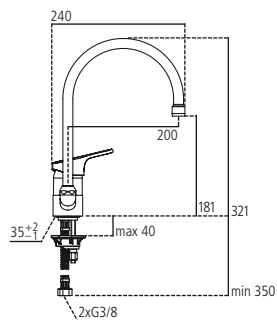

INDICE ALFANUMERICO

A4558AA	pag. 54
A4559AA	pag. 54
A5925AA	pag. 55
A6257AA	pag. 60
A6258AA	pag. 59
B0141AA	pag. 56
B0346AA	pag. 52
B0347AA	pag. 55
B0801AA	pag. 57
B0802AA	pag. 58
B0803AA	pag. 58
B0804AA	pag. 58
B0805AA	pag. 59
B0806AA	pag. 63
B0807AA	pag. 64
B0819AA	pag. 57
B1036AA	pag. 62
B8601AA	pag. 52
B8602AA	pag. 52
B8603AA	pag. 53
B8604AA	pag. 53
B8606AA	pag. 62
B8607AA	pag. 63
B9395AA	pag. 55
B9396AA	pag. 56
B9397AA	pag. 57

GARANZIE

	100	25	5	2
	Anni di Garanzia			
 Articoli in ceramica	•			
 Sedili per vasi				•
 Rubinetteria / Aste doccia Corpi rubinetteria classica, termostatica ed elettronica, aste doccia			•	
 Vasche normali, gusci e piatti doccia in acrilico		•		
 Telaio / pannelli			•	
 Mobili e specchi				•
 Ricambi Appartenenti a tutte le categorie di prodotto qui riportate, se non diversamente segnalati in tabella				•

Per la consultazione della tabella completa delle garanzie visita il sito www.ceramicadolomite.it

Condizioni di applicazione della garanzia

- La garanzia si applica solo ai prodotti acquistati e installati in Italia.
- In caso di reclamo, è richiesta la prova d'acquisto.
- La verifica di eventuali difetti estetici, dimensionali e funzionali deve essere effettuata dai nostri Centri di Assistenza Tecnica autorizzati di zona.
- I difetti estetici e dimensionali dovranno essere segnalati prima dell'installazione. Nel caso in cui la segnalazione pervenisse erroneamente dopo l'installazione ma comunque nei termini di legge, Ideal Standard riconoscerà la sola fornitura del prodotto senza le ulteriori spese di manodopera per la rimozione e la sostituzione dello stesso.
- Il prodotto deve essere installato, utilizzato e mantenuto con cura e secondo le istruzioni di installazione e manutenzione accluse ad esso. Inoltre, il prodotto deve essere installato secondo le generali regole di diligenza professionale.
- Nel caso sia riconosciuto un difetto di fabbricazione, Ideal Standard provvederà - a sua discrezione - alla riparazione o sostituzione del prodotto a titolo gratuito. In caso di sostituzione di un prodotto non più presente a catalogo, lo stesso verrà sostituito col prodotto equivalente più simile presente in gamma.
- Laddove la verifica del Centro Assistenza dovesse evidenziare che l'anomalia non è dovuta a difetto di fabbricazione, sarà addebitato il costo di uscita.
- La presente garanzia non è valida in caso di usura generale o nel caso il prodotto sia giudicato da Ideal Standard manomesso, erroneamente utilizzato, accidentalmente danneggiato o oggetto di cattiva manutenzione.
- La garanzia non copre danni o perdite derivanti da usi impropri, guasti o rottura del prodotto.
- La garanzia non copre i danni o le lesioni causati da pulizia inadeguata (consultare le nostre linee guida di cura e manutenzione).
- La garanzia non è trasferibile in caso il prodotto venga reinstallato in una diversa posizione.
- Le rotture di materiali in vetro (che per sua natura può frantumarsi) e i danni conseguenti non sono coperti da garanzia.