

ROCAST

OFERTĂ
SPECIALĂ



ROCAST MAX GIURGIU

Organe de asamblare

Sisteme de fixare

Unelte si scule

Blistere

2017 - 2018

ROCAST MAX GIURGIU

IMPORTANT:

- Transportul este inclus in pret.
- Comanda minima pentru programul **ROCAST MAX GIURGIU** este de 1000 de lei (fara TVA).
- Comenzile vor fi multiplu al unitatilor de ambalare specificate.
- Preturile sunt exprimate in Euro si **informativ in lei**, calculate la un curs de 4.5 Lei/Euro.
- Preturile in lei se actualizeaza zilnic in functie de cursul oficial BNR de la data livrării.

Pentru livrari de peste 2000 lei (fara TVA) se poate accesa lista de pret "**OFERTĂ SPECIALĂ MAX**" in care veti gasi probabil cele mai bune preturi din Romania.

Suplimentar se mai acorda urmatoarele discounturi:

- 3% pentru plata in avans.
- 5% pentru livrare direct din Giurgiu.

Preturile din catalog pot suferi modificari.

Aceste modificari sunt operate periodic si prezentate pe www.rocast.ro.



PRETURI LA VEDERE

Toate preturile sunt in Euro (fara TVA) si se factureaza la cursul BNR din ziua respectiva. Modificarile de preturi sunt operate pe site.



ACOPERIRE NATIONALĂ

Rețea de distribuție prin agenți de vânzări proprii, în toate județele țării.



PROMPTITUDINE SI EFICIENTĂ













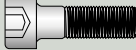









































Livrare în 24 de ore prin curierat rapid la sediul clientului, în orice localitate.

Zone de distributie











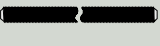

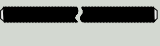

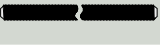











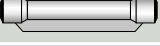











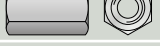















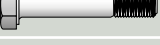

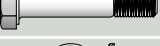

- | | |
|---|---|
| ■ Zona Nord - Est | ■ Zona Sud - Vest |
| ■ Zona Sud - Est | ■ Zona Bucuresti - Ilfov |
| ■ Zona Nord - Vest | |















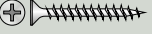













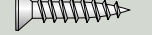

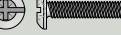
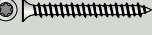

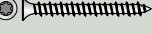

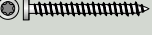





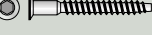

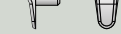
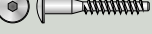





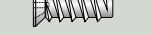

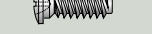

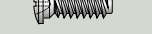
Organe de asamblare

DIN		Pag.	DIN		Pag.
7		1	912		8
84		1	912		8
85		1	912		9
93		1	913		9
94		1-2	914		10
125		2	917		10
125		2	929		10
127		2	931		10-11
315		2	931		11
316		3	931		12
433		3	933		12-13
434		3	-		13
435		3	933		13-14
436		3	933		14
439		3	934		14
440		3	934		14
463		3	934		14
471		3-4	935		14
472		4	963		14-15
571		4-5	964		15
580		5	965		15
582		5	966		15
601		5	975		16
603		6	975		16
660		6	975		16
660		7	975		16
741		7	975		16
912		7-8	975		16





















Organe de asamblare

DIN		Pag.	DIN		Pag.		
975		Tije filetate 2M, otel zincat, gr. 8.8	16	7504		Surub autoforant cu cap bombat, forma "N", otel zincat / vopsit	21
975		Tije filetate 3M, otel zincat, gr. 4.6	16	7504		Surub autoforant cu cap inecat, forma "P", otel zincat	21-22
975		Tija filetata 3M, otel, gr. 8.8	16	7504		Surub autoforant cu cap HEX si capacitate mare de gaurire, otel zincat	22
975		Tija filetata 3M, otel zincat, gr. 8.8	16	-		Piulita "Rampa Muffen", otel	22
976		Tije filetate, otel zincat, gr. 4.6	17	7979		Stift cilindric cu filet interior, forma "D", otel	22
985		Piulita HEX cu autoblocare, otel zincat, gr. 6	17	7981		Surub cu cap bombat pentru tabla, otel zincat	22
985		Piulita HEX de inalta rezistenta cu autoblocare, otel zincat, gr. 10	17	7982		Surub cu cap inecat pentru tabla, otel zincat	23
1052		Saiba pentru lemn, serie mare, otel zincat	17	7983		Surub cu cap semiinecat pentru tabla, otel zincat	23
1480		Piulita intinzatoare forjata, otel zincat	17	7985		Surub cu cap bombat si locas cruciform, otel zincat, gr. 4.8	23
1480		Intinzator ochi - ochi, otel zincat	17	7991		Surub cu cap inecat si locas Inbus, otel zincat, gr. 8.8	24
1480		Intinzator ochi - carlig, otel zincat	17	7991		Surub cu cap inecat si locas Inbus, otel, gr. 10.9	24
1480		Intinzator prezon - prezon, otel zincat	17	9021		Saiba plata - serie mare 3d, otel zincat	24
1481		Stift elastic - serie grea, otel	17-18	-		Piulita de sudare ambutisata, amprenta exterioara, otel	24
1587		Piulita infundata inalta, otel zincat, gr. 6	18	-		Piulita de sudare ambutisata, amprenta interioara, otel	24
6334		Piulita de cuplare, otel zincat	18	-		Surub ornamental, otel zincat galben	25
-		Piulita cilindrica de cuplare, otel zincat	19	-		Ochi filetat fara saibe si piulite, otel zincat	25
6340		Saiba plata - serie grea, otel	19	-		Carlig filetat fara saibe si piulite, otel zincat	25
6797		Saiba elastica cu dinti interiori, forma "I", otel zincat	19	-		Saiba pentru caroserii, otel zincat	25
6797		Saiba elastica cu dinti exteriori, forma "A", otel zincat	19	-		Surub "E-JET" pentru lemn, otel zincat galben	25
6798		Saiba elastica cu crestaturi interioare, forma "I", otel zincat	19	-		Rozeta din tabla stantata, otel nichelat	25
6798		Saiba elastica cu crestaturi exterioare, forma "A", otel zincat	19	-		Surub PAL total filetat, cu cap inecat, otel zincat galben	26
6799		Siguranta pentru arbori, otel	19	-		Surub PAL total filetat, cu cap inecat, otel zincat alb	26
6914		Surub cu cap hexagonal "IP" de inalta rezistenta, otel zincat, gr. 10.9	19	-		Surub PAL partial filetat, cu cap inecat, otel zincat galben	26
6914		Surub cu cap hexagonal "IP" de inalta rezistenta, otel, gr. 10.9	20	-		Surub PAL partial filetat, cu cap inecat, otel zincat alb	26
6916		Saiba plata "IP" de inalta rezistenta, otel zincat	20	-		Surub PAL cu cap semibombat, otel zincat galben	27
6921		Surub cu cap HEX si flansa, otel zincat, gr. 8.8	20	-		Surub PAL cu cap semibombat, otel nichelat	27
6923		Piulita hexagonala cu flansa, otel zincat, gr. 8	20	-		Surub cu cap plat, pentru lemn, otel zincat	27
7504		Surub autoforant cu cap HEX, forma "K", otel zincat / vopsit	20-21	-		Prezon pentru lemn, otel zincat	27

Organe de asamblare

DIN		Pag.	DIN		Pag.
-		27	-		30
-		27	-		30
-		28	-		30
-		28	-		30
-		28	-		30
-		28	-		30
-		28	-		31
-		28	-		31
-		28	-		31
-		28	-		31
-		28	-		31
-		28	-		31
-		28	-		31
-		29	-		31
-		29	-		31
-		29	-		31
-		29	-		31
-		29	-		32
-		29	-		32
-		29	-		32
-		29	-		32
-		29	-		32
-		29	-		32
-		29	-		32
-		29	-		32
-		30	-		32
-		30	-		32
-		30	-		32

Organe de asamblare

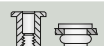
DIN		Pag.	DIN		Pag.		
-		Căpăcele din plastic Ø18 mm pentru șuruburi Torx T40, plastic colorat	32	-		Șaibă cauciucată pentru etanșare, oțel zincat + cauciuc EPDM	35
-		Holz-șurub "ochi sudat" Ø24, oțel zincat	33	125		Șaibă plată forma "A", inox A2	35
-		Holz-șurub "ochi sudat" Ø51, oțel zincat	33	933		Șurub total filetat cu cap hexagonal, inox A2	35
-		Șurub autoforant cu cap special "plat+șaibă", oțel zincat / vopsit	33	934		Piuliță hexagonală, inox A2	35
-		Șurub autoforant, cap HEX, șaibă cauciucată EPDM Ø14 mm, pentru prindere pe suport metalic, oțel zincat / vopsit + cauciuc EPDM	34	975		Tijă filetată 1M, inox A2	36
-		Șurub autoforant, cap HEX, șaibă cauciucată EPDM Ø16 mm, pentru prindere pe suport metalic, oțel zincat + cauciuc EPDM	34	-		Pop-nituri standard cap bombat, aluminiu / oțel	36
-		Șurub autoforant, cap HEX 8, șaibă cauciucată EPDM Ø14 mm, pentru prindere pe construcții din lemn, oțel zincat / vopsit + cauciuc EPDM	34-35	-		Pop-nituri cap teșit 120°, aluminiu / oțel	36
-		Șurub autoforant, cap HEX, șaibă cauciucată EPDM Ø16 mm, pentru prindere pe construcții din lemn, oțel zincat + cauciuc EPDM	35	-		Pop-nituri cap lat, aluminiu / oțel	36
-		Șurub autoforant pentru fibrociment cu șaibă "umbrelă" din cauciuc, pentru prindere pe suport metalic, oțel zincat + cauciuc EPDM	35	-		Pop-nituri cap bombat, aluminiu / aluminiu	36
-		Șurub cu capacitate mare de găurire pentru panouri sandwich, cu șaibă cauciucată EPDM Ø16 mm, oțel zincat + cauciuc EPDM	35	-		Pop-nituri cap bombat, oțel / oțel	36
-		Șurub cu capacitate mare de găurire pentru panouri sandwich, oțel zincat	35	-		Piulițe-nit standard, oțel zincat	36

Sisteme de fixare

	Pag.		Pag.		
	Dibluri standard, polietilenă	37		Diblu pentru izolație	38
	Dibluri standard, poliamidă 6.6	37		Rondelă suport din polietilenă	38
	Combinăție standard - diblu standard + Holzșurub	37		Set diblu-suport pentru calorifer din fontă	38
	Combinăție pentru construcții - diblu+holzșurub	37		Fixări cârlig cu clape și arc, pentru plăci	38
	Combinăție pentru fixări adânci - diblu+holzșurub	37		Diblu metalic autoforant ZAMAC-S	38
	Combinăție HEX lungă	37		Dibluri metalice de expansiune cu șurub	38
	Dibluri-cui cu fixare rapidă, cap cilindric, poliamidă 6.6	37		Dibluri metalice de expansiune fără șurub	38
	Dibluri-cui cu fixare rapidă, cap teșit, poliamidă 6.6	37		Conexpand bolț din oțel inoxidabil A2	38
	Diblu pentru gips - carton, nailon	37		Conexpand bolț standard, zincat, cu inel de strângere din oțel inoxidabil A2	38-39
	Bit pentru înfiletarea diblului pentru gips - carton	37		Conexpand bolț standard, cu inel de strângere din oțel zincat	39
	Dibluri pentru plăci	37		Conexpand clasic	39
	Set de fixare pentru WC	37		Conexpand de străpungere - tip 1	39
	Set de fixare pentru chiuvetă	38		Conexpand de străpungere - tip 8	40
	Set de fixare pentru oglindă	38		Conexpand "Ochi"	40





















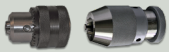

























Sisteme de fixare

	Pag.		Pag.
	40		45
	40		45
	40		45
	40		46
	40		46
	40		46
	40		46-47
	40		47
	41		47
	41		47
	41		48
	41		48
	42		48
	42		48
	42		48
	42		48-49
	43		49
	43		49
	43		49
	43		50
	43		50
	44		50
	44		50
	44		50
	45		50
	45		50

Blistere

DIN		Pag.	DIN		Pag.
125		51	-		56
127		51	-		56
315		51	-		56
316		51	-		57
571		51	-		57
603		51	-		57
912		51-52	-		58
933		52	-		58
933		52	-		58
934		52	-		59
965		52	-		59
985		53	-		59
986		53	-		59
6334		53	-		59
6798		53	-		60
6923		53	-		60
7504		53	-		60
7504		53	-		61
7504		54	-		61
7981		54	-		61
7982		54	-		61
-		54	-		61
7985		54	5229		61
-		54	5287		61
-		54	5229		61
-		55	-		61
-		55	-		61
-		55	-		61
-		55	-		61

Unelte si scule

	Pag.		Pag.		
	Burghie elicoidale	62-65		Nivela "Eurostar"	76
	Tarozii	65-67		Surubelnite si seturi de surubelnite	77
	Filiere	67		Bits	78
	Suportii pentru tarozii; DIN 1814	67		Clesti profesionali	79-81
	Cutite de strung	67-68		Chei si seturi de chei	80-81
	Mandrine	68		Truse combinate	81-83
	Spray-uri tehnice	68-69		Ciocane	83
	Siliconi	69		Dalti, punctatoare, extractoare de splinturi	83
	Adezivi	69		Foarfece	84
	Spume poliuretanic	70		Cutere	84
	Burghie pentru beton	70-71		Pensule	84
	Dalti pentru ciocane electrice	71		Lavete	85
	Discuri pentru debitare	71-72		Seturi de garnituri inelare Seturi de inele de siguranta	85
	Discuri abrazive pentru finisare	73		Manusi	86-87
	Perii disc, perii cupa, perii conice	73-74		Echipament de protectie	87-88
	Perii manuale	74		Electrozi	88
	Abrazive pe suport	74		Masini de gaurit Masini de gaurit cu acumulator	89
	Pile si seturi de pile	75		Masina de gaurit cu percutie	89
	Panze pentru fierastrai electrice	75		Ciocane rotopercutoare	89-90
	Panze pentru fierastrai manuale	75		Polizoare unghiulare	90-91
	Sublere	76		Sufianta cu aer cald	91
	Lere	76		Derulatoare	91
	Ruleta "two COMP"	76		Scule pentru aer comprimat	91-92

Stift cilindric m6, otel

DIN 7



Produs cu stoc limitat

mm	Ambalare (buc.)	Pret / 100 buc.		Cod
		LEI	EURO	
3 x 10	50	7.65	1.70	00070310SM*
5 x 10	50	16.88	3.75	00070510SM*

Surub cu cap cilindric crestat, otel zincat, gr. 4.8

DIN 84

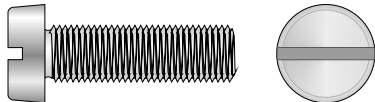

Produs cu stoc limitat

mm	Ambalare (buc.)	Pret / 100 buc.		Cod
		LEI	EURO	
M 2 x 3	1000	1.49	0.33	0084423SM*
M 2 x 5	1000	1.49	0.33	0084425SM*
M 2 x 8	1000	1.71	0.38	0084428SM*
M 2 x 10	1000	1.71	0.38	00844210SM*
M 2 x 12	1000	1.71	0.38	00844212SM*
M 2 x 20	1000	4.37	0.97	00844220SM*
M 2.5 x 16	1000	1.71	0.38	008442516SM*
M 2.5 x 20	1000	1.94	0.43	008442520SM*
M 2.5 x 25	1000	2.93	0.65	008442525SM*
M 2.5 x 30	1000	3.11	0.69	008442530SM*
M 3 x 5	1000	0.99	0.22	0084435SM*
M 3 x 6	1000	1.49	0.33	0084436SM*
M 3 x 8	1000	1.49	0.33	0084438SM*
M 3 x 10	1000	1.53	0.34	00844310SM*
M 3 x 12	1000	1.58	0.35	00844312SM*
M 3 x 14	1000	1.80	0.40	00844314SM*
M 3 x 16	1000	1.85	0.41	00844316SM*
M 3 x 20	1000	2.39	0.53	00844320SM*
M 3 x 25	1000	2.39	0.53	00844325SM*
M 3 x 30	1000	2.39	0.53	00844330SM*
M 3 x 35	1000	2.57	0.57	00844335SM*
M 3 x 40	1000	2.93	0.65	00844340SM*
M 3 x 45	1000	4.10	0.91	00844345SM*
M 3 x 50	1000	8.24	1.83	00844350SM*
M 4 x 8	1000	2.39	0.53	0084448SM*
M 4 x 10	1000	2.39	0.53	00844410SM*
M 4 x 12	1000	2.39	0.53	00844412SM*
M 4 x 14	1000	2.61	0.58	00844414SM*
M 4 x 16	1000	2.61	0.58	00844416SM*
M 4 x 20	1000	2.97	0.66	00844420SM*
M 4 x 25	1000	3.06	0.68	00844425SM*
M 4 x 30	1000	3.24	0.72	00844430SM*
M 4 x 35	1000	3.38	0.75	00844435SM*
M 4 x 40	1000	4.28	0.95	00844440SM*
M 4 x 45	1000	4.32	0.96	00844445SM*
M 4 x 50	1000	4.73	1.05	00844450SM*
M 4 x 55	1000	4.73	1.05	00844455SM*
M 4 x 60	1000	6.71	1.49	00844460SM*
M 4 x 65	1000	6.71	1.49	00844465SM*
M 4 x 70	1000	7.43	1.65	00844470SM*
M 4 x 80	1000	9.68	2.15	00844480SM*
M 4 x 90	1000	9.68	2.15	00844490SM*
M 4 x 100	1000	11.75	2.61	008444100SM*
M 5 x 6	500	2.66	0.59	0084456SM*
M 5 x 8	500	2.66	0.59	0084458SM*
M 5 x 10	500	3.38	0.75	00844510SM*
M 5 x 12	500	3.38	0.75	00844512SM*
M 5 x 14	500	3.38	0.75	00844514SM*
M 5 x 16	500	3.74	0.83	00844516SM*
M 5 x 20	500	4.64	1.03	00844520SM*
M 5 x 25	500	4.86	1.08	00844525SM*
M 5 x 30	500	5.00	1.11	00844530SM*
M 5 x 40	500	6.21	1.38	00844540SM*
M 5 x 45	500	7.47	1.66	00844545SM*
M 5 x 50	500	7.52	1.67	00844550SM*
M 5 x 60	500	9.18	2.04	00844560SM*
M 5 x 70	500	9.18	2.04	00844570SM*
M 5 x 80	500	9.45	2.10	00844580SM*
M 5 x 90	500	16.29	3.62	00844590SM*
M 6 x 10	250	4.37	0.97	00844610SM*
M 6 x 12	250	4.59	1.02	00844612SM*
M 6 x 14	250	5.54	1.23	00844614SM*
M 6 x 16	250	5.54	1.23	00844616SM*
M 6 x 20	250	5.99	1.33	00844620SM*
M 6 x 25	250	6.03	1.34	00844625SM*
M 6 x 30	250	7.11	1.58	00844630SM*
M 6 x 35	250	7.11	1.58	00844635SM*
M 6 x 40	250	8.06	1.79	00844640SM*
M 6 x 45	250	8.37	1.86	00844645SM*
M 6 x 50	250	8.42	1.87	00844650SM*
M 6 x 60	250	10.17	2.26	00844660SM*
M 6 x 65	250	12.87	2.86	00844665SM*
M 6 x 70	250	12.87	2.86	00844670SM*
M 6 x 80	250	16.70	3.71	00844680SM*
M 6 x 100	250	20.16	4.48	008446100SM*
M 8 x 12	100	7.61	1.69	00844812SM*
M 8 x 16	100	10.85	2.41	00844816SM*
M 8 x 20	100	12.69	2.82	00844820SM*
M 8 x 25	100	13.50	3.00	00844825SM*

Surub cu cap cilindric crestat, otel zincat, gr. 4.8 (continuare)

mm	Ambalare (buc.)	Pret / 100 buc.		Cod
		LEI	EURO	
M 8 x 30	100	15.57	3.46	00844830SM*
M 8 x 35	100	15.57	3.46	00844835SM*
M 8 x 40	100	15.62	3.47	00844840SM*
M 8 x 45	100	15.62	3.47	00844845SM*
M 8 x 50	100	24.03	5.34	00844850SM*
M 8 x 60	100	24.03	5.34	00844860SM*
M 8 x 70	100	24.08	5.35	00844870SM*
M 8 x 80	100	27.09	6.02	00844880SM*
M 8 x 90	100	50.99	11.33	00844890SM*
M 8 x 100	100	65.21	14.49	008448100SM*
M 10 x 16	50	17.10	3.80	008441016SM*
M 10 x 20	50	20.03	4.45	008441020SM*
M 10 x 70	50	53.55	11.90	008441070SM*

Surub cu cap bombat crestat, otel zincat, gr. 4.8

DIN 85



Produs cu stoc limitat

mm	Ambalare (buc.)	Pret / 100 buc.		Cod
		LEI	EURO	
M 3 x 8	1000	1.04	0.23	0085438SM*
M 3 x 12	1000	1.17	0.26	00854312SM*
M 3 x 16	1000	2.75	0.61	00854316SM*
M 4 x 6	1000	2.34	0.52	0085446SM*
M 4 x 10	1000	2.48	0.55	00854410SM*
M 5 x 16	500	8.01	1.78	00854516SM*
M 5 x 20	500	4.68	1.04	00854520SM*
M 5 x 25	500	5.09	1.13	00854525SM*
M 5 x 35	500	6.03	1.34	00854535SM*
M 5 x 50	500	7.74	1.72	00854550SM*
M 6 x 16	250	5.99	1.33	00854616SM*
M 6 x 40	250	9.05	2.01	00854640SM*
M 6 x 50	250	10.62	2.36	00854650SM*

Saiba de siguranta cu limba, otel

DIN 93

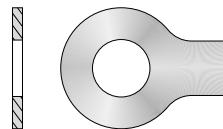

mm	Ambalare (buc.)	Pret / 100 buc.		Cod
		LEI	EURO	
6.4	1000	7.61	1.69	0093064SM
8.4	1000	9.09	2.02	0093084SM
10.5	500	11.03	2.45	00930105SM
13.0	500	17.37	3.86	0093013SM
15.0	200	25.70	5.71	0093015SM
17.0	200	25.74	5.72	0093017SM

Splint, otel zincat

DIN 94

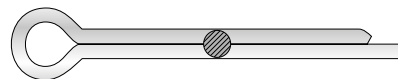

mm	Ambalare (buc.)	Pret / 100 buc.		Cod
		LEI	EURO	
1.0 x 18	100	0.81	0.18	00940118SM
1.2 x 8	100	1.04	0.23	00940128SM
1.2 x 10	100	1.04	0.23	009401210SM
1.2 x 12	100	1.26	0.28	009401212SM
1.2 x 16	100	1.35	0.30	009401216SM
1.6 x 10	100	0.81	0.18	009401610SM
1.6 x 12	100	1.22	0.27	009401612SM
1.6 x 14	100	1.22	0.27	009401614SM
1.6 x 16	100	1.22	0.27	009401616SM
1.6 x 20	100	1.22	0.27	009401620SM
1.6 x 22	100	1.53	0.34	009401622SM
1.6 x 25	100	1.53	0.34	009401625SM
1.6 x 32	100	1.53	0.34	009401632SM
1.6 x 40	100	2.39	0.53	009401640SM
1.6 x 50	100	2.84	0.63	009401650SM
2.0 x 10	100	0.86	0.19	00940210SM
2.0 x 14	100	0.86	0.19	00940214SM
2.0 x 16	100	1.08	0.24	00940216SM
2.0 x 18	100	1.67	0.37	00940218SM
2.0 x 20	100	1.67	0.37	00940220SM
2.0 x 25	100	1.67	0.37	00940225SM
2.0 x 40	100	2.34	0.52	00940240SM
2.5 x 20	100	1.80	0.40	009402520SM

Splint, otel zincat (continuare)

mm	Ambalare (buc.)	Pret / 100 buc.		Cod
		LEI	EURO	
2.5 x 25	100	1.94	0.43	009402525SM
2.5 x 32	100	2.34	0.52	009402532SM
2.5 x 40	100	3.11	0.69	009402540SM
2.5 x 50	100	3.33	0.74	009402550SM
3.2 x 16	50	3.02	0.67	009403216SM
3.2 x 18	50	3.15	0.70	009403218SM
3.2 x 20	50	3.15	0.70	009403220SM
3.2 x 22	50	3.15	0.70	009403222SM
3.2 x 25	50	3.38	0.75	009403225SM
3.2 x 28	50	3.56	0.79	009403228SM
3.2 x 32	50	3.74	0.83	009403232SM
3.2 x 36	50	3.74	0.83	009403236SM
3.2 x 40	50	4.23	0.94	009403240SM
3.2 x 50	50	4.73	1.05	009403250SM
3.2 x 56	50	5.18	1.15	009403256SM
3.2 x 63	50	5.22	1.16	009403263SM
4.0 x 20	50	4.01	0.89	00940420SM
4.0 x 25	50	4.41	0.98	00940425SM
4.0 x 28	50	4.64	1.03	00940428SM
4.0 x 32	50	5.54	1.23	00940432SM
4.0 x 36	50	6.03	1.34	00940436SM
4.0 x 40	50	6.30	1.40	00940440SM
4.0 x 45	50	7.20	1.60	00940445SM
4.0 x 50	50	7.38	1.64	00940450SM
4.0 x 56	50	7.92	1.76	00940456SM
4.0 x 63	50	8.82	1.96	00940463SM
4.0 x 71	50	8.87	1.97	00940471SM
4.0 x 80	50	10.89	2.42	00940480SM
5.0 x 22	25	9.90	2.20	00940522SM
5.0 x 25	25	9.90	2.20	00940525SM
5.0 x 28	25	10.17	2.26	00940528SM
5.0 x 32	25	10.17	2.26	00940532SM
5.0 x 36	25	10.35	2.30	00940536SM
5.0 x 40	25	10.62	2.36	00940540SM
5.0 x 45	25	11.12	2.47	00940545SM
5.0 x 50	25	17.55	3.90	00940550SM
5.0 x 56	25	18.09	4.02	00940556SM
5.0 x 63	25	18.86	4.19	00940563SM
5.0 x 71	25	19.26	4.28	00940571SM
5.0 x 80	25	19.62	4.36	00940580SM
5.0 x 90	25	19.67	4.37	00940590SM
5.0 x 100	25	20.12	4.47	009405100SM
6.3 x 36	25	14.90	3.31	009406336SM
6.3 x 40	25	16.11	3.58	009406340SM
6.3 x 45	25	17.37	3.86	009406345SM
6.3 x 50	25	18.09	4.02	009406350SM
6.3 x 56	25	20.43	4.54	009406356SM
6.3 x 63	25	22.46	4.99	009406363SM
6.3 x 71	25	25.47	5.66	009406371SM
6.3 x 80	25	29.39	6.53	009406380SM
6.3 x 90	25	40.32	8.96	009406390SM
6.3 x 100	25	42.17	9.37	0094063100SM
6.3 x 112	25	43.79	9.73	0094063112SM
6.3 x 125	25	47.30	10.51	0094063125SM
8.0 x 40	10	24.80	5.51	00940840SM
8.0 x 45	10	30.65	6.81	00940845SM
8.0 x 50	10	37.31	8.29	00940850SM
8.0 x 56	10	38.43	8.54	00940856SM
8.0 x 63	10	41.72	9.27	00940863SM
8.0 x 71	10	42.62	9.47	00940871SM
8.0 x 80	10	49.50	11.00	00940880SM
8.0 x 90	10	49.86	11.08	00940890SM
8.0 x 100	10	61.29	13.62	009408100SM
8.0 x 112	10	58.91	13.09	009408112SM
8.0 x 125	10	59.31	13.18	009408125SM
8.0 x 160	10	80.96	17.99	009408160SM
10.0 x 56	10	48.74	10.83	009401056SM
10.0 x 63	10	60.62	13.47	009401063SM
10.0 x 71	10	63.50	14.11	009401071SM
10.0 x 80	10	66.20	14.71	009401080SM
10.0 x 90	10	82.53	18.34	009401090SM
10.0 x 100	10	86.36	19.19	0094010100SM
10.0 x 112	10	96.48	21.44	0094010112SM
10.0 x 125	10	150.12	33.36	0094010125SM
10.0 x 140	10	150.17	33.37	0094010140SM
10.0 x 160	10	150.26	33.39	0094010160SM
13.0 x 80	5	168.48	37.44	009401380SM
13.0 x 90	5	188.64	41.92	009401390SM
13.0 x 100	5	188.64	41.92	0094013100SM
13.0 x 112	5	222.21	49.38	0094013112SM
13.0 x 125	5	226.98	50.44	0094013125SM
13.0 x 160	5	233.33	51.85	0094013160SM

Saiba plata, forma "A", otel zincat

DIN 125

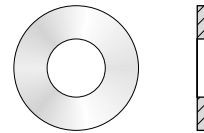

mm	Ambalare (buc.)	Pret / 100 buc.		Cod
		LEI	EURO	
3.2	1000	0.54	0.12	0125A32SM
4.3	1000	0.63	0.14	0125A43SM
5.3	1000	0.72	0.16	0125A53SM
6.4	1000	1.17	0.26	0125A64SM
8.4	1000	2.03	0.45	0125A84SM
10.5	500	4.05	0.90	0125A105SM
13.0	500	6.75	1.50	0125A13SM
15.0	200	10.40	2.31	0125A15SM
17.0	200	13.01	2.89	0125A17SM
19.0	200	17.24	3.83	0125A19SM
21.0	200	20.61	4.58	0125A21SM
23.0	100	23.85	5.30	0125A23SM
25.0	100	41.85	9.30	0125A25SM
28.0	50	57.96	12.88	0125A28SM
31.0	50	65.39	14.53	0125A31SM
34.0	50	71.78	15.95	0125A34SM
37.0	50	125.78	27.95	0125A37SM
40.0	25	180.95	40.21	0125A40SM
43.0	25	212.31	47.18	0125A43SM
46.0	25	288.27	64.06	0125A46SM
50.0	10	737.69	163.93	0125A50SM

Saiba plata, forma "A", otel zincat la cald

DIN 125

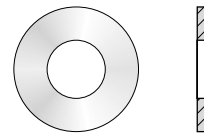

Produs cu stoc limitat

mm	Ambalare (buc.)	Pret / 100 buc.		Cod
		LEI	EURO	
25.0	100	79.16	17.59	0125025SM*

Saiba Grower, forma "B", otel zincat

DIN 127

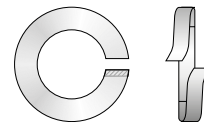

mm	Ambalare (buc.)	Pret / 100 buc.		Cod
		LEI	EURO	
2.5	1000	1.04	0.23	0127B25SM
3.0	1000	0.50	0.11	0127B3SM
4.0	1000	0.59	0.13	0127B4SM
5.0	1000	0.72	0.16	0127B5SM
6.0	1000	1.44	0.32	0127B6SM
8.0	1000	2.21	0.49	0127B8SM
10.0	1000	3.33	0.74	0127B10SM
12.0	500	5.22	1.16	0127B12SM
14.0	500	8.28	1.84	0127B14SM
16.0	250	11.66	2.59	0127B16SM
18.0	250	14.09	3.13	0127B18SM
20.0	100	20.03	4.45	0127B20SM
22.0	100	21.92	4.87	0127B22SM
24.0	100	34.65	7.70	0127B24SM
27.0	100	39.83	8.85	0127B27SM
30.0	100	70.34	15.63	0127B30SM
33.0	100	88.70	19.71	0127B33SM
36.0	100	127.49	28.33	0127B36SM

Piulita fluture, otel zincat

DIN 315

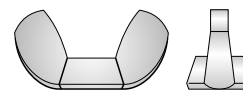

mm	Ambalare (buc.)	Pret / 100 buc.		Cod
		LEI	EURO	
M 4	250	8.15	1.81	031504SM
M 5	250	8.42	1.87	031505SM
M 6	250	9.90	2.20	031506SM
M 8	250	14.22	3.16	031508SM
M 10	200	23.27	5.17	0315010SM
M 12	100	46.08	10.24	0315012SM
M 14	50	133.02	29.56	0315014SM
M 16	50	163.89	36.42	0315016SM

Surub fluture, otel zincat

DIN 316

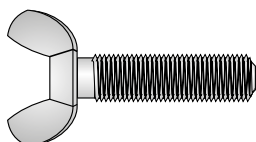

mm	Ambalare (buc.)	Pret / 100 buc.		Cod
		LEI	EURO	
M 4 x 15	100	30.42	6.76	03160415SM
M 5 x 10	50	29.16	6.48	03160510SM
M 5 x 20	50	38.30	8.51	03160520SM
M 5 x 30	50	38.70	8.60	03160530SM
M 5 x 35	50	49.01	10.89	03160535SM
M 5 x 40	50	49.77	11.06	03160540SM
M 6 x 20	50	38.70	8.60	03160620SM
M 8 x 12	50	65.88	14.64	03160812SM
M 8 x 45	50	84.47	18.77	03160845SM

Piulita hexagonala joasa, forma "B", otel zincat, gr. 4

DIN 439

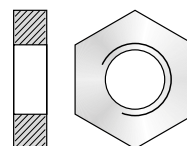

mm	Ambalare (buc.)	Pret / 100 buc.		Cod
		LEI	EURO	
M 5	250	1.35	0.30	043945SM
M 6	250	1.49	0.33	043946SM
M 8	250	4.59	1.02	043948SM
M 10	100	9.95	2.21	0439410SM
M 12	100	14.90	3.31	0439412SM
M 16	50	29.21	6.49	0439416SM

Saiba plata redusa, otel zincat

DIN 433

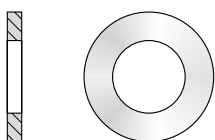

mm	Ambalare (buc.)	Pret / 100 buc.		Cod
		LEI	EURO	
3.2	100	0.81	0.18	0433032SM
4.3	100	1.04	0.23	0433043SM
5.3	100	3.06	0.68	0433053SM
6.4	100	3.06	0.68	0433064SM
8.4	100	3.11	0.69	0433084SM
10.5	50	3.11	0.69	04330105SM
13.0	50	4.10	0.91	0433013SM
17.0	50	9.45	2.10	0433017SM
19.0	50	11.25	2.50	0433019SM
21.0	50	17.96	3.99	0433021SM

Saiba plata, serie foarte mare, forma "R", otel zincat

DIN 440

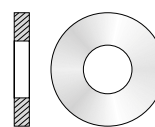

mm	Ambalare (buc.)	Pret / 100 buc.		Cod
		LEI	EURO	
5.5	50	3.38	0.75	0440055SM
6.6	50	5.67	1.26	0440066SM
9.0	50	13.37	2.97	0440099SM
11.0	50	17.46	3.88	0440011SM
13.5	25	36.68	8.15	04400135SM
17.5	10	79.97	17.77	04400175SM
22.0	10	152.28	33.84	0440022SM
24.0	10	231.75	51.50	0440024SM
26.0	10	245.52	54.56	0440026SM
30.0	10	579.60	128.80	0440030SM
33.0	10	647.64	143.92	0440033SM
36.0	10	648.86	144.19	0440036SM
42.0	10	2322.45	516.10	0440042SM

Saiba pentru profil "U", otel zincat la cald

DIN 434

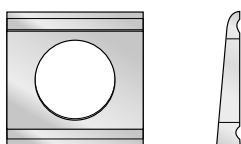

mm	Ambalare (buc.)	Pret / 100 buc.		Cod
		LEI	EURO	
9.0	50	31.95	7.10	043409SM
11.0	50	31.95	7.10	0434011SM
14.0	25	46.85	10.41	0434014SM
18.0	25	66.02	14.67	0434018SM
22.0	10	115.97	25.77	0434022SM
24.0	10	267.44	59.43	0434024SM
26.0	10	378.81	84.18	0434026SM

Saiba de siguranta cu doua limbi, otel

DIN 463

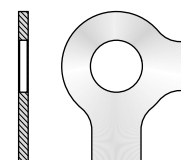

Produs cu stoc limitat

mm	Ambalare (buc.)	Pret / 100 buc.		Cod
		LEI	EURO	
4.3	1000	15.39	3.42	0463043SM*
5.3	1000	16.29	3.62	0463053SM*
6.4	1000	18.23	4.05	0463064SM*
8.4	1000	24.57	5.46	0463084SM*
10.5	500	28.94	6.43	04630105SM*
13.0	500	33.75	7.50	0463013SM*
15.0	200	33.75	7.50	0463015SM*
17.0	200	42.26	9.39	0463017SM*
21.0	200	42.26	9.39	0463021SM*
25.0	100	68.13	15.14	0463025SM*

Saiba pentru profil "I", otel zincat la cald

DIN 435

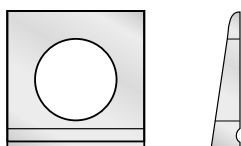

mm	Ambalare (buc.)	Pret / 100 buc.		Cod
		LEI	EURO	
9.0	50	35.37	7.86	043509SM
11.0	50	35.42	7.87	0435011SM
14.0	25	53.24	11.83	0435014SM
18.0	25	86.22	19.16	0435018SM
22.0	10	156.24	34.72	0435022SM
24.0	10	316.17	70.26	0435024SM

Inel de siguranta pentru arbori, otel fosfatat

DIN 471

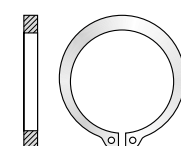

Produs cu stoc limitat.

mm	Ambalare (buc.)	Pret / 100 buc.		Cod
		LEI	EURO	
D 3	100	2.07	0.46	047103SM*
D 4	100	3.06	0.68	047104SM*
D 5	50	3.06	0.68	047105SM*
D 8	25	4.01	0.89	047108SM*
D 16	25	9.05	2.01	0471016SM*
D 21	25	13.77	3.06	0471021SM*

Inel de siguranta pentru arbori, otel fosfatat (continuare)

mm	Ambalare (buc.)	Pret / 100 buc.		Cod
		LEI	EURO	
D 26	25	13.77	3.06	0471026SM*
D 30	10	14.36	3.19	0471030SM*
D 39	10	43.88	9.75	0471039SM*
D 46	10	62.82	13.96	0471046SM*
D 48	10	74.70	16.60	0471048SM*
D 50	5	74.70	16.60	0471050SM*
D 54	5	115.34	25.63	0471054SM*
D 55	5	115.47	25.66	0471055SM*
D 60	5	115.70	25.71	0471060SM*
D 63	5	115.79	25.73	0471063SM*
D 65	5	115.83	25.74	0471065SM*
D 67	5	123.08	27.35	0471067SM*
D 85	2	126.95	28.21	0471085SM*
D 88	2	262.31	58.29	0471088SM*
D 90	2	262.71	58.38	0471090SM*
D 98	2	322.97	71.77	0471098SM*
D 100	2	324.14	72.03	04710100SM*
D 102	2	409.10	90.91	04710102SM*
D 110	2	494.10	109.80	04710110SM*
D 120	2	577.49	128.33	04710120SM*
D 130	2	596.52	132.56	04710130SM*
D 140	2	656.51	145.89	04710140SM*
D 150	2	1436.45	319.21	04710150SM*
D 160	2	1437.66	319.48	04710160SM*
D 165	2	1823.58	405.24	04710165SM*
D 175	2	2538.32	564.07	04710175SM*
D 180	2	2540.03	564.45	04710180SM*
D 185	2	2978.82	661.96	04710185SM*
D 190	2	3102.62	689.47	04710190SM*
D 210	2	3464.78	769.95	04710210SM*
D 230	2	3562.02	791.56	04710230SM*
D 250	2	3563.51	791.89	04710250SM*
D 280	2	3594.69	798.82	04710280SM*
D 300	2	4074.53	905.45	04710300SM*

Inel de siguranta pentru alezaje, otel fosfatat

DIN 472

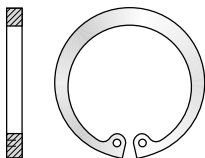

Prodot cu stoc limitat

mm	Ambalare (buc.)	Pret / 100 buc.		Cod
		LEI	EURO	
D 9	25	3.83	0.85	047209SM*
D 10	25	3.65	0.81	0472010SM*
D 11	25	4.82	1.07	0472011SM*
D 13	25	5.99	1.33	0472013SM*
D 14	25	5.99	1.33	0472014SM*
D 15	25	6.03	1.34	0472015SM*
D 17	25	6.12	1.36	0472017SM*
D 18	25	8.28	1.84	0472018SM*
D 21	25	9.09	2.02	0472021SM*
D 22	25	9.09	2.02	0472022SM*
D 23	25	13.50	3.00	0472023SM*
D 31	10	23.63	5.25	0472031SM*
D 32	10	23.63	5.25	0472032SM*
D 33	10	24.26	5.39	0472033SM*
D 37	10	31.32	6.96	0472037SM*
D 44	10	39.29	8.73	0472044SM*
D 53	5	73.31	16.29	0472053SM*
D 63	5	84.11	18.69	0472063SM*
D 68	5	87.26	19.39	0472068SM*
D 85	2	118.26	26.28	0472085SM*
D 100	2	149.54	33.23	04720100SM*
D 125	2	418.50	93.00	04720125SM*
D 140	2	419.13	93.14	04720140SM*
D 175	2	1396.26	310.28	04720175SM*
D 180	2	1396.53	310.34	04720180SM*
D 185	2	1723.05	382.90	04720185SM*
D 190	2	1753.83	389.74	04720190SM*
D 195	2	1883.16	418.48	04720195SM*
D 210	2	2111.27	469.17	04720210SM*
D 220	2	2406.96	534.88	04720220SM*
D 240	2	3929.63	873.25	04720240SM*
D 250	2	3932.28	873.84	04720250SM*
D 270	2	3933.54	874.12	04720270SM*
D 280	2	3933.77	874.17	04720280SM*
D 290	2	3933.99	874.22	04720290SM*
D 300	2	3934.22	874.27	04720300SM*

Holz-surub cu cap hexagonal, otel zincat

DIN 571

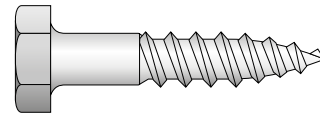

mm	Ambalare (buc.)	Pret / 100 buc.		Cod
		LEI	EURO	
5 x 20	200	3.83	0.85	05710520SM
5 x 25	200	4.50	1.00	05710525SM
5 x 30	200	5.09	1.13	05710530SM
5 x 35	200	5.63	1.25	05710535SM
5 x 40	200	6.26	1.39	05710540SM
5 x 50	200	7.56	1.68	05710550SM
5 x 60	200	8.87	1.97	05710560SM
6 x 20	500	4.46	0.99	05710620SM
6 x 25	200	4.14	0.92	05710625SM
6 x 30	200	4.73	1.05	05710630SM
6 x 35	200	5.81	1.29	05710635SM
6 x 40	200	6.75	1.50	05710640SM
6 x 45	200	6.80	1.51	05710645SM
6 x 50	200	6.80	1.51	05710650SM
6 x 55	200	7.97	1.77	05710655SM
6 x 60	200	8.01	1.78	05710660SM
6 x 70	200	9.14	2.03	05710670SM
6 x 75	200	9.68	2.15	05710675SM
6 x 80	200	9.81	2.18	05710680SM
6 x 90	100	11.39	2.53	05710690SM
6 x 100	100	13.46	2.99	057106100SM
6 x 120	100	15.62	3.47	057106120SM
7 x 30	200	8.78	1.95	05710730SM
7 x 35	200	9.59	2.13	05710735SM
7 x 40	200	10.40	2.31	05710740SM
7 x 45	200	11.21	2.49	05710745SM
7 x 50	200	11.25	2.50	05710750SM
7 x 60	100	12.87	2.86	05710760SM
7 x 70	100	18.09	4.02	05710770SM
7 x 80	100	18.14	4.03	05710780SM
7 x 90	100	18.68	4.15	05710790SM
7 x 100	100	20.16	4.48	057107100SM
7 x 110	100	23.27	5.17	057107110SM
7 x 120	100	24.21	5.38	057107120SM
8 x 25	200	8.24	1.83	05710825SM
8 x 30	200	9.23	2.05	05710830SM
8 x 35	200	10.13	2.25	05710835SM
8 x 40	200	11.39	2.53	05710840SM
8 x 45	200	12.06	2.68	05710845SM
8 x 50	200	13.01	2.89	05710850SM
8 x 60	200	16.25	3.61	05710860SM
8 x 65	200	19.22	4.27	05710865SM
8 x 70	200	19.26	4.28	05710870SM
8 x 80	200	19.67	4.37	05710880SM
8 x 90	100	21.02	4.67	05710890SM
8 x 100	100	22.82	5.07	057108100SM
8 x 110	100	25.61	5.69	057108110SM
8 x 120	100	27.72	6.16	057108120SM
8 x 130	50	29.84	6.63	057108130SM
8 x 140	50	31.91	7.09	057108140SM
8 x 150	50	33.98	7.55	057108150SM
8 x 160	50	36.45	8.10	057108160SM
8 x 180	50	46.35	10.30	057108180SM
8 x 200	50	51.21	11.38	057108200SM
10 x 30	100	18.45	4.10	057101030SM
10 x 35	100	18.00	4.00	057101035SM
10 x 40	100	20.07	4.46	057101040SM
10 x 45	100	21.74	4.83	057101045SM
10 x 50	100	22.68	5.04	057101050SM
10 x 60	100	26.10	5.80	057101060SM
10 x 70	100	31.73	7.05	057101070SM
10 x 80	100	31.41	6.98	057101080SM
10 x 90	100	35.96	7.99	057101090SM
10 x 100	100	37.94	8.43	0571010100SM
10 x 120	50	45.00	10.00	0571010120SM
10 x 130	50	48.20	10.71	0571010130SM
10 x 140	50	54.81	12.18	0571010140SM
10 x 150	50	54.95	12.21	0571010150SM
10 x 160	50	61.79	13.73	0571010160SM
10 x 180	50	70.70	15.71	0571010180SM
10 x 200	50	75.51	16.78	0571010200SM
10 x 220	25	87.57	19.46	0571010220SM
10 x 240	25	101.84	22.63	0571010240SM
10 x 260	25	114.93	25.54	0571010260SM
10 x 280	25	124.70	27.71	0571010280SM
10 x 300	25	134.42	29.87	0571010300SM
12 x 40	100	27.99	6.22	057101240SM
12 x 45	100	44.33	9.85	057101245SM
12 x 50	50	44.33	9.85	057101250SM
12 x 60	50	44.37	9.86	057101260SM
12 x 70	50	44.55	9.90	057101270SM
12 x 80	50	51.30	11.40	057101280SM
12 x 90	50	51.35	11.41	057101290SM
12 x 100	50	55.08	12.24	0571012100SM
12 x 110	50	62.01	13.78	0571012110SM
12 x 120	50	63.90	14.20	0571012120SM
12 x 130	50	74.66	16.59	0571012130SM
12 x 140	50	74.75	16.61	0571012140SM
12 x 150	50	77.40	17.20	0571012150SM

Holz-surub cu cap hexagonal, otel zincat (continuare)

mm	Ambalare (buc.)	Pret / 100 buc.		Cod
		LEI	EURO	
12 x 160	25	87.48	19.44	0571012160SM
12 x 180	25	99.68	22.15	0571012180SM
12 x 200	25	113.36	25.19	0571012200SM
12 x 220	25	126.77	28.17	0571012220SM
12 x 240	25	141.98	31.55	0571012240SM
12 x 260	25	152.82	33.96	0571012260SM
12 x 280	10	158.85	35.30	0571012280SM
12 x 300	10	198.45	44.10	0571012300SM
12 x 320	10	212.04	47.12	0571012320SM
12 x 340	10	234.14	52.03	0571012340SM
12 x 360	10	265.10	58.91	0571012360SM
12 x 380	10	281.16	62.48	0571012380SM
14 x 120	50	115.43	25.65	0571014120SM
16 x 60	10	177.66	39.48	057101660SM
16 x 70	10	201.51	44.78	057101670SM
16 x 80	10	229.19	50.93	057101680SM
16 x 90	10	240.71	53.49	057101690SM
16 x 100	10	240.84	53.52	0571016100SM
16 x 110	10	283.10	62.91	0571016110SM
16 x 120	10	283.14	62.92	0571016120SM
16 x 130	10	283.23	62.94	0571016130SM
16 x 180	10	283.32	62.96	0571016180SM
16 x 200	10	283.32	62.96	0571016200SM
16 x 220	5	283.68	63.04	0571016220SM
16 x 240	5	283.77	63.06	0571016240SM
16 x 260	5	314.28	69.84	0571016260SM
16 x 280	5	558.54	124.12	0571016280SM
16 x 300	5	558.63	124.14	0571016300SM
20 x 80	10	282.65	62.81	057102080SM
20 x 100	10	305.78	67.95	0571020100SM
20 x 120	10	332.82	73.96	0571020120SM
20 x 150	10	364.28	80.95	0571020150SM

Surub de ridicare, otel zincat

DIN 580

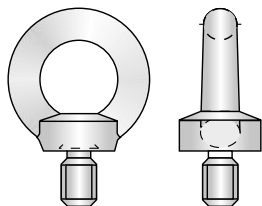

mm	Ambalare (buc.)	Pret / 100 buc.		Cod
		LEI	EURO	
M 6	10	133.88	29.75	058006SM
M 8	10	133.97	29.77	058008SM
M 10	10	196.07	43.57	0580010SM
M 12	10	274.68	61.04	0580012SM
M 14	10	350.28	77.84	0580014SM
M 16	10	408.78	90.84	0580016SM
M 18	2	434.16	96.48	0580018SM
M 20	2	682.97	151.77	0580020SM
M 22	2	935.06	207.79	0580022SM
M 24	2	1315.44	292.32	0580024SM
M 30	2	2697.53	599.45	0580030SM
M 36	2	4137.12	919.36	0580036SM

Piulița de ridicare, otel zincat

DIN 582

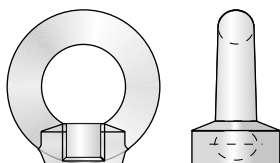

mm	Ambalare (buc.)	Pret / 100 buc.		Cod
		LEI	EURO	
M 6	10	134.60	29.91	058206SM
M 8	10	139.86	31.08	058208SM
M 10	10	210.42	46.76	0582010SM
M 12	10	287.28	63.84	0582012SM
M 14	10	367.47	81.66	0582014SM
M 16	10	481.50	107.00	0582016SM
M 18	2	498.42	110.76	0582018SM
M 20	2	543.11	120.69	0582020SM
M 22	2	672.53	149.45	0582022SM
M 24	2	1390.37	308.97	0582024SM
M 30	2	2751.12	611.36	0582030SM
M 36	2	3763.26	836.28	0582036SM

Surub cu cap HEX, partial filetat + piulita, otel zincat, gr. 4.6

DIN 601

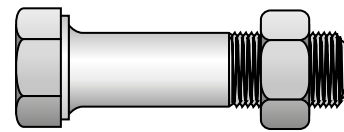

Produs cu stoc limitat.

mm	Ambalare (buc.)	Pret / 100 buc.		Cod
		LEI	EURO	
M 5 x 25	100	6.44	1.43	06014525SM*
M 5 x 30	100	8.55	1.90	06014530SM*
M 5 x 40	100	13.23	2.94	06014540SM*
M 5 x 50	100	13.28	2.95	06014550SM*
M 6 x 16	100	9.18	2.04	06014616SM*
M 6 x 25	100	9.23	2.05	06014625SM*
M 6 x 30	100	10.35	2.30	06014630SM*
M 6 x 40	100	10.40	2.31	06014640SM*
M 6 x 50	100	14.54	3.23	06014650SM*
M 6 x 60	100	14.63	3.25	06014660SM*
M 6 x 80	100	17.82	3.96	06014680SM*
M 6 x 100	50	21.02	4.67	060146100SM*
M 8 x 20	50	14.13	3.14	06014820SM*
M 8 x 25	50	20.70	4.60	06014825SM*
M 8 x 30	50	20.70	4.60	06014830SM*
M 8 x 80	50	34.70	7.71	06014880SM*
M 8 x 100	50	41.04	9.12	060148100SM*
M 10 x 16	20	32.31	7.18	060141016SM*
M 10 x 20	20	39.65	8.81	060141020SM*
M 10 x 25	20	39.69	8.82	060141025SM*
M 10 x 30	20	39.74	8.83	060141030SM*
M 10 x 60	20	46.22	10.27	060141060SM*
M 10 x 80	20	58.37	12.97	060141080SM*
M 10 x 100	20	70.38	15.64	0601410100SM*
M 10 x 120	20	80.55	17.90	0601410120SM*
M 10 x 150	10	80.60	17.91	0601410150SM*
M 10 x 200	10	185.18	41.15	0601410200SM*
M 10 x 240	10	195.71	43.49	0601410240SM*
M 10 x 280	10	198.81	44.18	0601410280SM*
M 12 x 40	20	53.60	11.91	060141240SM*
M 12 x 50	20	60.93	13.54	060141250SM*
M 12 x 60	20	68.00	15.11	060141260SM*
M 12 x 80	20	71.28	15.84	060141280SM*
M 12 x 120	20	99.54	22.12	0601412120SM*
M 16 x 30	10	131.49	29.22	060141630SM*
M 16 x 40	10	103.55	23.01	060141640SM*
M 16 x 60	10	186.71	41.49	060141660SM*
M 16 x 100	10	186.71	41.49	0601416100SM*
M 16 x 180	5	306.59	68.13	0601416180SM*
M 20 x 30	5	268.88	59.75	060142030SM*
M 20 x 35	5	254.03	56.45	060142035SM*
M 20 x 40	5	254.21	56.49	060142040SM*
M 20 x 50	5	254.30	56.51	060142050SM*
M 20 x 60	5	254.39	56.53	060142060SM*
M 20 x 80	5	335.52	74.56	060142080SM*
M 20 x 150	2	475.61	105.69	0601420150SM*
M 20 x 180	2	681.71	151.49	0601420180SM*
M 24 x 50	5	575.55	127.90	060142450SM*
M 24 x 60	5	460.62	102.36	060142460SM*
M 24 x 80	5	505.04	112.23	060142480SM*
M 24 x 100	5	579.33	128.74	0601424100SM*
M 27 x 60	5	827.19	183.82	060142760SM*
M 27 x 80	5	829.58	184.35	060142780SM*
M 27 x 100	5	829.71	184.38	0601427100SM*
M 27 x 120	5	1019.30	226.51	0601427120SM*
M 30 x 60	5	964.80	214.40	060143060SM*
M 30 x 80	5	1308.24	290.72	060143080SM*
M 30 x 100	5	1308.87	290.86	0601430100SM*
M 30 x 120	5	1309.19	290.93	0601430120SM*

Surub Torbant cu piulita, otel zincat

DIN 603

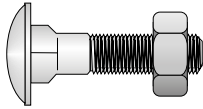

mm	Ambalare (buc.)	Pret / 100 buc.		Cod
		LEI	EURO	
M 5 x 16	100	7.79	1.73	06030516SM
M 5 x 20	100	8.33	1.85	06030520SM
M 5 x 25	100	8.91	1.98	06030525SM
M 5 x 30	100	9.81	2.18	06030530SM
M 5 x 35	100	10.26	2.28	06030535SM
M 5 x 40	100	11.25	2.50	06030540SM
M 5 x 45	100	12.29	2.73	06030545SM
M 5 x 50	100	12.83	2.85	06030550SM
M 5 x 55	100	13.77	3.06	06030555SM
M 5 x 60	100	14.76	3.28	06030560SM
M 5 x 65	100	15.75	3.50	06030565SM
M 5 x 70	100	16.29	3.62	06030570SM
M 6 x 16	100	8.78	1.95	06030616SM
M 6 x 20	100	8.33	1.85	06030620SM
M 6 x 25	100	10.53	2.34	06030625SM
M 6 x 30	100	10.98	2.44	06030630SM
M 6 x 35	100	10.98	2.44	06030635SM
M 6 x 40	100	11.43	2.54	06030640SM
M 6 x 45	100	12.60	2.80	06030645SM
M 6 x 50	100	13.05	2.90	06030650SM
M 6 x 55	100	14.54	3.23	06030655SM
M 6 x 60	100	16.38	3.64	06030660SM
M 6 x 65	50	16.38	3.64	06030665SM
M 6 x 70	50	16.47	3.66	06030670SM
M 6 x 75	50	16.88	3.75	06030675SM
M 6 x 80	50	17.64	3.92	06030680SM
M 6 x 90	50	19.04	4.23	06030690SM
M 6 x 100	50	20.61	4.58	060306100SM
M 6 x 110	50	21.83	4.85	060306110SM
M 6 x 120	50	23.90	5.31	060306120SM
M 8 x 20	50	17.19	3.82	06030820SM
M 8 x 25	50	18.09	4.02	06030825SM
M 8 x 30	50	19.22	4.27	06030830SM
M 8 x 35	50	20.66	4.59	06030835SM
M 8 x 40	50	21.65	4.81	06030840SM
M 8 x 45	50	22.95	5.10	06030845SM
M 8 x 50	50	25.07	5.57	06030850SM
M 8 x 55	50	25.07	5.57	06030855SM
M 8 x 60	50	27.09	6.02	06030860SM
M 8 x 65	50	28.49	6.33	06030865SM
M 8 x 70	50	29.25	6.50	06030870SM
M 8 x 75	50	31.77	7.06	06030875SM
M 8 x 80	50	33.08	7.35	06030880SM
M 8 x 90	50	39.33	8.74	06030890SM
M 8 x 100	50	39.42	8.76	060308100SM
M 8 x 110	50	41.76	9.28	060308110SM
M 8 x 120	50	44.42	9.87	060308120SM
M 8 x 130	50	47.25	10.50	060308130SM
M 8 x 140	50	49.59	11.02	060308140SM
M 8 x 150	25	52.79	11.73	060308150SM
M 8 x 160	25	59.72	13.27	060308160SM
M 8 x 170	25	62.60	13.91	060308170SM
M 8 x 180	25	65.61	14.58	060308180SM
M 10 x 25	50	30.78	6.84	060301025SM
M 10 x 30	50	33.08	7.35	060301030SM
M 10 x 35	50	35.37	7.86	060301035SM
M 10 x 40	50	37.53	8.34	060301040SM
M 10 x 50	50	43.52	9.67	060301050SM
M 10 x 60	50	46.31	10.29	060301060SM
M 10 x 70	50	49.64	11.03	060301070SM
M 10 x 75	50	53.96	11.99	060301075SM
M 10 x 80	50	55.94	12.43	060301080SM
M 10 x 90	50	59.36	13.19	060301090SM
M 10 x 100	50	63.41	14.09	060301100SM
M 10 x 110	50	68.36	15.19	060301110SM
M 10 x 120	50	71.73	15.94	060301120SM
M 10 x 130	50	77.76	17.28	060301130SM
M 10 x 140	50	82.80	18.40	060301140SM
M 10 x 150	25	87.35	19.41	060301150SM
M 10 x 160	25	91.71	20.38	060301160SM
M 10 x 180	25	107.46	23.88	060301180SM
M 10 x 200	25	116.19	25.82	060301200SM
M 10 x 220	10	135.41	30.09	060301220SM
M 12 x 30	50	72.81	16.18	060301230SM
M 12 x 40	50	62.42	13.87	060301240SM
M 12 x 50	50	67.41	14.98	060301250SM
M 12 x 60	50	76.14	16.92	060301260SM
M 12 x 70	50	80.51	17.89	060301270SM
M 12 x 80	50	86.27	19.17	060301280SM
M 12 x 100	50	98.46	21.88	0603012100SM
M 12 x 110	50	126.95	28.21	0603012110SM
M 12 x 120	50	126.99	28.22	0603012120SM
M 12 x 140	25	127.22	28.27	0603012140SM
M 12 x 150	25	133.52	29.67	0603012150SM
M 12 x 160	25	147.92	32.87	0603012160SM
M 12 x 170	25	160.02	35.56	0603012170SM
M 12 x 180	25	166.23	36.94	0603012180SM
M 12 x 200	25	179.73	39.94	0603012200SM
M 12 x 220	10	207.54	46.12	0603012220SM
M 12 x 260	10	254.79	56.62	0603012260SM
M 12 x 280	10	276.48	61.44	0603012280SM
M 12 x 320	10	301.01	66.89	0603012320SM

Surub Torbant cu piulita, otel zincat (continuare)

mm	Ambalare (buc.)	Pret / 100 buc.		Cod
		LEI	EURO	
M 12 x 340	10	317.79	70.62	0603012340SM
M 12 x 380	10	413.51	91.89	0603012380SM
M 16 x 40	50	139.68	31.04	060301640SM
M 16 x 50	50	149.67	33.26	060301650SM
M 16 x 80	10	189.81	42.18	060301680SM
M 16 x 90	10	203.13	45.14	060301690SM
M 16 x 100	10	232.65	51.70	0603016100SM
M 16 x 110	10	234.59	52.13	0603016110SM
M 16 x 120	10	243.27	54.06	0603016120SM
M 16 x 130	10	262.98	58.44	0603016130SM
M 16 x 140	10	263.07	58.46	0603016140SM
M 16 x 150	5	298.04	66.23	0603016150SM
M 16 x 200	5	367.52	81.67	0603016200SM
M 16 x 220	5	399.69	88.82	0603016220SM
M 16 x 240	5	471.83	104.85	0603016240SM
M 16 x 260	5	479.61	106.58	0603016260SM
M 16 x 300	5	484.65	107.70	0603016300SM
M 16 x 340	5	561.20	124.71	0603016340SM
M 16 x 360	5	651.47	144.77	0603016360SM
M 16 x 380	5	652.91	145.09	0603016380SM
M 16 x 400	5	653.45	145.21	0603016400SM

Nituri cu cap semirotund, otel

DIN 660



mm	Ambalare (buc.)	Pret / 100 buc.		Cod
		LEI	EURO	
3 x 6	250	2.93	0.65	0660136SM
3 x 8	250	3.24	0.72	0660138SM
3 x 10	250	3.74	0.83	06601310SM
3 x 12	250	4.37	0.97	06601312SM
3 x 16	250	5.09	1.13	06601316SM
3 x 20	250	5.99	1.33	06601320SM
3 x 25	250	6.08	1.35	06601325SM
3 x 30	250	7.11	1.58	06601330SM
4 x 6	250	3.47	0.77	0660146SM
4 x 8	250	4.86	1.08	0660148SM
4 x 10	250	5.58	1.24	06601410SM
4 x 12	250	6.12	1.36	06601412SM
4 x 16	250	6.71	1.49	06601416SM
4 x 20	250	8.06	1.79	06601420SM
4 x 25	250	9.68	2.15	06601425SM
4 x 30	250	11.25	2.50	06601430SM
4 x 35	250	12.15	2.70	06601435SM
4 x 40	250	13.28	2.95	06601440SM
5 x 8	250	8.46	1.88	0660158SM
5 x 10	250	8.46	1.88	06601510SM
5 x 12	250	9.50	2.11	06601512SM
5 x 16	250	11.88	2.64	06601516SM
5 x 20	100	13.68	3.04	06601520SM
5 x 25	100	15.93	3.54	06601525SM
5 x 30	100	18.86	4.19	06601530SM
5 x 35	50	20.88	4.64	06601535SM
5 x 40	50	23.76	5.28	06601540SM
5 x 45	50	24.66	5.48	06601545SM
5 x 50	50	27.45	6.10	06601550SM
5 x 60	50	28.94	6.43	06601560SM
6 x 10	100	11.88	2.64	06601610SM
6 x 12	100	13.32	2.96	06601612SM
6 x 16	100	15.39	3.42	06601616SM
6 x 20	100	17.73	3.94	06601620SM
6 x 25	50	21.47	4.77	06601625SM
6 x 30	50	24.80	5.51	06601630SM
6 x 35	50	28.67	6.37	06601635SM
6 x 40	50	32.40	7.20	06601640SM
6 x 45	50	36.23	8.05	06601645SM
6 x 50	50	39.69	8.82	06601650SM
6 x 60	50	41.18	9.15	06601660SM



Nituri cu cap semirotund, aluminiu

DIN 660



mm	Ambalare (buc.)	Pret / 100 buc.		Cod
		LEI	EURO	
3 x 6	250	2.93	0.65	0660236SM
3 x 8	250	3.29	0.73	0660238SM
3 x 10	250	3.83	0.85	06602310SM
3 x 12	250	4.41	0.98	06602312SM
3 x 16	250	5.18	1.15	06602316SM
3 x 20	250	6.17	1.37	06602320SM
3 x 25	250	7.07	1.57	06602325SM
3 x 30	250	7.83	1.74	06602330SM
4 x 6	250	5.22	1.16	0660246SM
4 x 8	250	5.63	1.25	0660248SM
4 x 10	250	6.03	1.34	06602410SM
4 x 12	250	6.89	1.53	06602412SM
4 x 16	250	7.97	1.77	06602416SM
4 x 20	250	9.36	2.08	06602420SM
4 x 25	250	10.58	2.35	06602425SM
4 x 30	250	11.61	2.58	06602430SM
4 x 35	250	14.67	3.26	06602435SM
4 x 40	250	16.92	3.76	06602440SM
5 x 8	250	9.14	2.03	0660258SM
5 x 10	250	9.54	2.12	06602510SM
5 x 12	250	10.13	2.25	06602512SM
5 x 16	250	12.69	2.82	06602516SM
5 x 20	100	15.03	3.34	06602520SM
5 x 25	100	17.10	3.80	06602525SM
5 x 30	100	21.74	4.83	06602530SM
5 x 35	100	24.35	5.41	06602535SM
5 x 40	100	31.73	7.05	06602540SM
5 x 45	100	36.95	8.21	06602545SM
5 x 50	100	42.21	9.38	06602550SM
5 x 60	100	47.52	10.56	06602560SM
6 x 10	100	15.17	3.37	06602610SM
6 x 12	100	16.92	3.76	06602612SM
6 x 16	100	18.50	4.11	06602616SM
6 x 20	100	23.63	5.25	06602620SM
6 x 25	50	28.58	6.35	06602625SM
6 x 30	50	32.72	7.27	06602630SM
6 x 35	50	36.95	8.21	06602635SM
6 x 40	50	44.28	9.84	06602640SM
6 x 45	50	48.56	10.79	06602645SM
6 x 50	50	53.87	11.97	06602650SM
6 x 60	50	63.32	14.07	06602660SM

Clips pentru cabluri metalice de tractiune, otel zincat

DIN 741

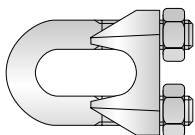

mm	Ambalare (buc.)	Pret / 100 buc.		Cod
		LEI	EURO	
M 4 x 3	100	22.82	5.07	0741043SM
M 5 x 5	100	25.38	5.64	0741055SM
M 5 x 6.5	100	31.86	7.08	07410565SM
M 6 x 8	100	44.46	9.88	0741068SM
M 8 x 10	50	72.99	16.22	07410810SM
M 8 x 11	50	74.21	16.49	07410811SM
M 10 x 13	50	131.72	29.27	074101013SM
M 12 x 16	25	227.39	50.53	074101216SM
M 12 x 19	25	285.08	63.35	074101219SM
M 14 x 22	25	359.96	79.99	074101422SM
M 14 x 25.4	25	421.65	93.70	0741014254SM

Surub cu cap Inbus, otel zincat, gr. 8.8

DIN 912

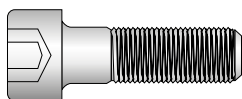

mm	Ambalare (buc.)	Pret / 100 buc.		Cod
		LEI	EURO	
M 3 x 6	100	5.13	1.14	0912836SM
M 3 x 8	100	4.46	0.99	0912838SM
M 3 x 10	100	4.59	1.02	09128310SM
M 3 x 12	100	4.59	1.02	09128312SM
M 3 x 16	100	6.12	1.36	09128316SM
M 3 x 18	100	6.17	1.37	09128318SM
M 3 x 20	100	6.17	1.37	09128320SM
M 3 x 25	100	7.79	1.73	09128325SM
M 3 x 30	100	7.97	1.77	09128330SM
M 3 x 35	100	10.31	2.29	09128335SM
M 3 x 40	100	12.60	2.80	09128340SM
M 4 x 8	100	4.77	1.06	0912848SM
M 4 x 10	100	4.50	1.00	09128410SM
M 4 x 12	100	4.64	1.03	09128412SM

Surub cu cap Inbus, otel zincat, gr. 8.8 (continuare)

mm	Ambalare (buc.)	Pret / 100 buc.		Cod
		LEI	EURO	
M 4 x 14	100	5.27	1.17	09128414SM
M 4 x 16	100	5.27	1.17	09128416SM
M 4 x 18	100	6.39	1.42	09128418SM
M 4 x 20	100	7.34	1.63	09128420SM
M 4 x 25	100	7.38	1.64	09128425SM
M 4 x 30	100	7.43	1.65	09128430SM
M 4 x 35	100	8.01	1.78	09128435SM
M 4 x 40	100	8.96	1.99	09128440SM
M 4 x 45	100	14.72	3.27	09128445SM
M 4 x 50	100	16.38	3.64	09128450SM
M 4 x 65	100	36.23	8.05	09128465SM
M 5 x 10	50	4.19	0.93	09128510SM
M 5 x 12	50	4.01	0.89	09128512SM
M 5 x 14	50	4.46	0.99	09128514SM
M 5 x 16	50	4.46	0.99	09128516SM
M 5 x 18	50	5.58	1.24	09128518SM
M 5 x 20	50	6.17	1.37	09128520SM
M 5 x 25	50	6.17	1.37	09128525SM
M 5 x 30	50	6.89	1.53	09128530SM
M 5 x 35	50	9.05	2.01	09128535SM
M 5 x 40	50	9.09	2.02	09128540SM
M 5 x 45	50	11.66	2.59	09128545SM
M 5 x 50	50	11.66	2.59	09128550SM
M 5 x 60	50	12.33	2.74	09128560SM
M 5 x 65	50	23.85	5.30	09128565SM
M 5 x 70	50	23.85	5.30	09128570SM
M 5 x 75	50	30.69	6.82	09128575SM
M 5 x 80	50	32.67	7.26	09128580SM
M 5 x 90	50	37.71	8.38	09128590SM
M 5 x 100	50	47.34	10.52	091285100SM
M 5 x 120	25	63.99	14.22	091285120SM
M 6 x 8	50	11.75	2.61	0912868SM
M 6 x 10	50	5.94	1.32	09128610SM
M 6 x 12	50	8.33	1.85	09128612SM
M 6 x 14	50	8.33	1.85	09128614SM
M 6 x 16	50	8.33	1.85	09128616SM
M 6 x 18	50	9.23	2.05	09128618SM
M 6 x 20	50	9.23	2.05	09128620SM
M 6 x 25	50	9.27	2.06	09128625SM
M 6 x 30	50	9.32	2.07	09128630SM
M 6 x 35	50	10.49	2.33	09128635SM
M 6 x 40	50	11.66	2.59	09128640SM
M 6 x 45	50	13.32	2.96	09128645SM
M 6 x 50	50	13.95	3.10	09128650SM
M 6 x 55	50	16.02	3.56	09128655SM
M 6 x 60	50	17.24	3.83	09128660SM
M 6 x 65	50	25.07	5.57	09128665SM
M 6 x 70	50	26.96	5.99	09128670SM
M 6 x 75	50	32.00	7.11	09128675SM
M 6 x 80	50	32.04	7.12	09128680SM
M 6 x 90	50	42.26	9.39	09128690SM
M 6 x 100	50	42.30	9.40	091286100SM
M 6 x 110	25	59.18	13.15	091286110SM
M 6 x 120	25	81.68	18.15	091286120SM
M 6 x 130	25	81.72	18.16	091286130SM
M 6 x 150	25	124.07	27.57	091286150SM
M 6 x 160	25	148.50	33.00	091286160SM
M 6 x 200	25	244.62	54.36	091286200SM
M 8 x 12	25	17.42	3.87	09128812SM
M 8 x 14	25	12.06	2.68	09128814SM
M 8 x 16	25	13.19	2.93	09128816SM
M 8 x 18	25	16.43	3.65	09128818SM
M 8 x 20	25	16.47	3.66	09128820SM
M 8 x 25	25	16.52	3.67	09128825SM
M 8 x 30	25	17.37	3.86	09128830SM
M 8 x 35	25	19.98	4.44	09128835SM
M 8 x 40	25	22.10	4.91	09128840SM
M 8 x 45	25	24.21	5.38	09128845SM
M 8 x 50	25	25.56	5.68	09128850SM
M 8 x 55	25	27.63	6.14	09128855SM
M 8 x 60	25	29.70	6.60	09128860SM
M 8 x 65	25	31.86	7.08	09128865SM
M 8 x 70	25	33.89	7.53	09128870SM
M 8 x 75	25	48.96	10.88	09128875SM
M 8 x 80	25	49.01	10.89	09128880SM
M 8 x 90	25	49.05	10.90	09128890SM
M 8 x 100	25	49.14	10.92	091288100SM
M 8 x 110	25	54.81	12.18	091288110SM
M 8 x 120	25	69.08	15.35	091288120SM
M 8 x 130	10	69.26	15.39	091288130SM
M 8 x 140	10	95.18	21.15	091288140SM
M 8 x 150	10	96.21	21.38	091288150SM
M 8 x 160	10	150.93	33.54	091288160SM
M 8 x 170	10	151.02	33.56	091288170SM
M 10 x 16	25	23.09	5.13	091281016SM
M 10 x 18	25	24.84	5.52	091281018SM
M 10 x 20	25	24.93	5.54	091281020SM
M 10 x 22	25	29.48	6.55	091281022SM
M 10 x 25	25	29.57	6.57	091281025SM
M 10 x 30	25	31.50	7.00	091281030SM
M 10 x 35	25	33.17	7.37	091281035SM
M 10 x 40	25	35.33	7.85	091281040SM
M 10 x 45	25	38.75	8.61	091281045SM
M 10 x 50	25	42.12	9.36	091281050SM
M 10 x 55	25	45.63	10.14	091281055SM
M 10 x 60	25	49.05	10.90	091281060SM
M 10 x 65	25	52.47	11.66	091281065SM
M 10 x 70	25	55.85	12.41	091281070SM
M 10 x 75	25	59.31	13.18	091281075SM
M 10 x 80	25	62.78	13.95	091281080SM
M 10 x 90	25	89.78	19.95	091281090SM

Surub cu cap Inbus, otel zincat, gr. 8.8 (continuare)

mm	Ambalare (buc.)	Pret / 100 buc.		Cod
		LEI	EURO	
M 10 x 100	25	97.61	21.69	0912810100SM
M 10 x 110	25	97.97	21.77	0912810110SM
M 10 x 120	25	99.41	22.09	0912810120SM
M 10 x 130	10	101.30	22.51	0912810130SM
M 10 x 140	10	141.17	31.37	0912810140SM
M 10 x 150	10	141.71	31.49	0912810150SM
M 10 x 160	10	158.99	35.33	0912810160SM
M 10 x 180	10	237.11	52.69	0912810180SM
M 10 x 200	10	270.86	60.19	0912810200SM
M 10 x 260	10	314.06	69.79	0912810260SM
M 12 x 20	20	52.02	11.56	091281220SM
M 12 x 25	20	40.91	9.09	091281225SM
M 12 x 30	20	40.91	9.09	091281230SM
M 12 x 35	20	44.73	9.94	091281235SM
M 12 x 40	20	48.42	10.76	091281240SM
M 12 x 45	20	53.78	11.95	091281245SM
M 12 x 50	20	58.50	13.00	091281250SM
M 12 x 55	20	63.23	14.05	091281255SM
M 12 x 60	20	68.04	15.12	091281260SM
M 12 x 65	20	72.72	16.16	091281265SM
M 12 x 70	20	96.44	21.43	091281270SM
M 12 x 75	20	96.62	21.47	091281275SM
M 12 x 80	20	96.66	21.48	091281280SM
M 12 x 90	20	96.80	21.51	091281290SM
M 12 x 100	20	105.12	23.36	0912812100SM
M 12 x 110	20	155.88	34.64	0912812110SM
M 12 x 120	20	155.93	34.65	0912812120SM
M 12 x 130	5	173.75	38.61	0912812130SM
M 12 x 140	5	173.84	38.63	0912812140SM
M 12 x 150	5	233.60	51.91	0912812150SM
M 12 x 160	5	233.64	51.92	0912812160SM
M 12 x 180	5	233.69	51.93	0912812180SM
M 12 x 200	5	331.92	73.76	0912812200SM
M 12 x 240	5	350.87	77.97	0912812240SM
M 14 x 30	10	55.76	12.39	091281430SM
M 14 x 35	10	60.98	13.55	091281435SM
M 14 x 40	10	66.29	14.73	091281440SM
M 14 x 45	10	103.19	22.93	091281445SM
M 14 x 50	10	103.19	22.93	091281450SM
M 14 x 55	10	103.28	22.95	091281455SM
M 14 x 60	10	104.81	23.29	091281460SM
M 14 x 65	10	137.61	30.58	091281465SM
M 14 x 70	10	157.64	35.03	091281470SM
M 14 x 80	10	157.64	35.03	091281480SM
M 14 x 90	10	158.67	35.26	091281490SM
M 14 x 100	10	195.66	43.48	0912814100SM
M 14 x 110	10	195.75	43.50	0912814110SM
M 14 x 120	10	204.53	45.45	0912814120SM
M 16 x 25	10	145.58	32.35	091281625SM
M 16 x 30	10	82.40	18.31	091281630SM
M 16 x 35	10	89.42	19.87	091281635SM
M 16 x 40	10	93.65	20.81	091281640SM
M 16 x 45	10	100.35	22.30	091281645SM
M 16 x 50	10	113.00	25.11	091281650SM
M 16 x 55	10	119.61	26.58	091281655SM
M 16 x 60	10	130.59	29.02	091281660SM
M 16 x 65	10	133.74	29.72	091281665SM
M 16 x 70	10	211.77	47.06	091281670SM
M 16 x 75	10	229.32	50.96	091281675SM
M 16 x 80	10	229.37	50.97	091281680SM
M 16 x 90	10	230.13	51.14	091281690SM
M 16 x 100	10	230.27	51.17	0912816100SM
M 16 x 110	10	230.94	51.32	0912816110SM
M 16 x 120	10	231.03	51.34	0912816120SM
M 16 x 130	10	240.71	53.49	0912816130SM
M 16 x 140	10	338.72	75.27	0912816140SM
M 16 x 150	5	339.44	75.43	0912816150SM
M 16 x 160	5	375.75	83.50	0912816160SM
M 16 x 180	5	376.56	83.68	0912816180SM
M 16 x 200	5	379.13	84.25	0912816200SM
M 16 x 240	5	1215.90	270.20	0912816240SM
M 16 x 300	5	1216.53	270.34	0912816300SM
M 18 x 30	5	129.60	28.80	091281830SM
M 18 x 35	5	129.65	28.81	091281835SM
M 18 x 45	5	149.27	33.17	091281845SM
M 18 x 55	5	247.19	54.93	091281855SM
M 18 x 60	5	247.23	54.94	091281860SM
M 18 x 70	5	301.37	66.97	091281870SM
M 18 x 80	5	301.46	66.99	091281880SM
M 18 x 100	5	301.50	67.00	0912818100SM
M 18 x 120	5	367.20	81.60	0912818120SM
M 18 x 150	2	367.25	81.61	0912818150SM
M 18 x 180	2	954.00	212.00	0912818180SM
M 20 x 30	5	146.93	32.65	091282030SM
M 20 x 40	5	254.52	56.56	091282040SM
M 20 x 45	5	254.57	56.57	091282045SM
M 20 x 50	5	254.70	56.60	091282050SM
M 20 x 60	5	254.75	56.61	091282060SM
M 20 x 65	5	313.47	69.66	091282065SM
M 20 x 70	5	333.36	74.08	091282070SM
M 20 x 75	5	333.81	74.18	091282075SM
M 20 x 80	5	333.86	74.19	091282080SM
M 20 x 90	5	405.72	90.16	091282090SM
M 20 x 100	5	405.81	90.18	0912820100SM
M 20 x 110	5	468.23	104.05	0912820110SM
M 20 x 120	5	468.27	104.06	0912820120SM
M 20 x 130	5	529.43	117.65	0912820130SM
M 20 x 140	5	529.47	117.66	0912820140SM
M 20 x 150	2	529.56	117.68	0912820150SM
M 20 x 160	2	529.61	117.69	0912820160SM
M 20 x 180	2	541.85	120.41	0912820180SM

Surub cu cap Inbus, otel zincat, gr. 8.8 (continuare)

mm	Ambalare (buc.)	Pret / 100 buc.		Cod
		LEI	EURO	
M 20 x 220	2	845.82	187.96	0912820220SM
M 20 x 240	2	845.96	187.99	0912820240SM
M 20 x 260	2	846.00	188.00	0912820260SM
M 20 x 280	2	1154.66	256.59	0912820280SM
M 24 x 40	2	451.62	100.36	091282440SM
M 24 x 50	2	390.47	86.77	091282450SM
M 24 x 60	2	512.46	113.88	091282460SM
M 24 x 65	2	512.55	113.90	091282465SM
M 24 x 70	2	627.71	139.49	091282470SM
M 24 x 80	2	627.75	139.50	091282480SM
M 24 x 90	2	627.84	139.52	091282490SM
M 24 x 100	2	627.89	139.53	0912824100SM
M 24 x 110	2	848.07	188.46	0912824110SM
M 24 x 120	2	848.12	188.47	0912824120SM
M 24 x 130	2	848.25	188.50	0912824130SM
M 24 x 140	2	848.30	188.51	0912824140SM
M 24 x 150	2	848.30	188.51	0912824150SM
M 24 x 160	2	908.82	201.96	0912824160SM
M 24 x 180	2	908.87	201.97	0912824180SM
M 24 x 200	2	910.67	202.37	0912824200SM
M 24 x 220	2	1179.86	262.19	0912824220SM
M 24 x 240	2	2489.63	553.25	0912824240SM
M 24 x 260	2	2489.67	553.26	0912824260SM
M 24 x 300	2	2489.67	553.26	0912824300SM
M 30 x 90	2	986.36	219.19	091283090SM
M 30 x 100	2	1192.01	264.89	0912830100SM
M 30 x 110	2	1216.89	270.42	0912830110SM
M 30 x 120	2	1228.64	273.03	0912830120SM
M 30 x 130	2	1247.85	277.30	0912830130SM
M 30 x 140	2	1535.99	341.33	0912830140SM
M 30 x 150	2	1536.03	341.34	0912830150SM
M 30 x 160	2	2412.09	536.02	0912830160SM
M 30 x 180	2	2412.14	536.03	0912830180SM
M 30 x 190	2	2412.23	536.05	0912830190SM
M 30 x 200	2	2412.32	536.07	0912830200SM

Surub cu cap Inbus, otel, gr. 10.9

DIN 912

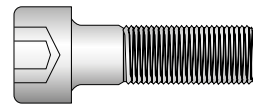

mm	Ambalare (buc.)	Pret / 100 buc.		Cod
		LEI	EURO	
M 6 x 20	10	6.12	1.36	09120620SM
M 6 x 30	10	7.79	1.73	09120630SM
M 6 x 40	10	10.35	2.30	09120640SM
M 6 x 50	10	12.42	2.76	09120650SM
M 6 x 60	10	15.35	3.41	09120660SM
M 8 x 20	10	13.95	3.10	09120820SM
M 8 x 30	10	15.39	3.42	09120830SM
M 8 x 40	10	19.62	4.36	09120840SM
M 8 x 50	10	22.68	5.04	09120850SM
M 8 x 60	10	26.33	5.85	09120860SM
M 10 x 30	10	25.83	5.74	091201030SM
M 10 x 40	10	31.37	6.97	091201040SM
M 10 x 50	10	37.49	8.33	091201050SM
M 10 x 60	10	43.61	9.69	091201060SM
M 12 x 30	10	36.36	8.08	091201230SM
M 12 x 40	10	43.02	9.56	091201240SM
M 12 x 50	10	51.98	11.55	091201250SM
M 12 x 60	10	60.44	13.43	091201260SM

Surub cu cap Inbus, otel zincat, gr. 10.9

DIN 912

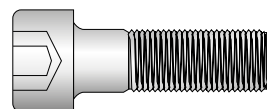

mm	Ambalare (buc.)	Pret / 100 buc.		Cod
		LEI	EURO	
M 6 x 20	10	7.07	1.57	09121620SM
M 6 x 30	10	8.96	1.99	09121630SM
M 6 x 40	10	11.88	2.64	09121640SM
M 6 x 50	10	14.27	3.17	09121650SM
M 6 x 60	10	17.64	3.92	09121660SM
M 8 x 20	10	16.02	3.56	09121820SM
M 8 x 30	10	17.69	3.93	09121830SM
M 8 x 40	10	22.55	5.01	09121840SM
M 8 x 50	10	26.06	5.79	09121850SM
M 8 x 60	10	30.29	6.73	09121860SM
M 10 x 30	10	29.70	6.60	091211030SM
M 10 x 40	10	36.09	8.02	091211040SM
M 10 x 50	10	43.11	9.58	091211050SM
M 10 x 60	10	50.13	11.14	091211060SM
M 12 x 30	10	41.81	9.29	091211230SM
M 12 x 40	10	49.46	10.99	091211240SM
M 12 x 50	10	59.76	13.28	091211250SM
M 12 x 60	10	69.53	15.45	091211260SM

Surub cu cap Inbus, otel, gr. 12.9

DIN 912

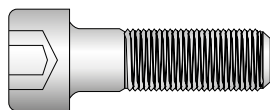

mm	Ambalare (buc.)	Pret / 100 buc.		Cod
		LEI	EURO	
M 3 x 6	50	7.20	1.60	0912936SM
M 3 x 10	50	4.32	0.96	09129310SM
M 3 x 12	50	4.41	0.98	09129312SM
M 3 x 16	50	6.21	1.38	09129316SM
M 3 x 20	50	6.44	1.43	09129320SM
M 3 x 25	50	7.25	1.61	09129325SM
M 3 x 30	50	9.00	2.00	09129330SM
M 3 x 40	50	11.84	2.63	09129340SM
M 4 x 12	50	5.94	1.32	09129412SM
M 4 x 16	50	6.30	1.40	09129416SM
M 4 x 20	50	6.89	1.53	09129420SM
M 4 x 25	50	8.24	1.83	09129425SM
M 4 x 30	50	10.35	2.30	09129430SM
M 4 x 35	50	11.43	2.54	09129435SM
M 4 x 40	50	12.42	2.76	09129440SM
M 5 x 12	25	6.80	1.51	09129512SM
M 5 x 16	25	6.44	1.43	09129516SM
M 5 x 20	25	7.88	1.75	09129520SM
M 5 x 25	25	8.55	1.90	09129525SM
M 5 x 30	25	9.90	2.20	09129530SM
M 5 x 35	25	11.30	2.51	09129535SM
M 5 x 40	25	12.69	2.82	09129540SM
M 5 x 50	25	15.44	3.43	09129550SM
M 5 x 55	25	16.16	3.59	09129555SM
M 5 x 60	25	20.48	4.55	09129560SM
M 5 x 70	25	20.61	4.58	09129570SM
M 5 x 80	25	23.99	5.33	09129580SM
M 5 x 90	25	34.61	7.69	09129590SM
M 5 x 100	25	68.13	15.14	091295100SM
M 5 x 120	25	92.21	20.49	091295120SM
M 5 x 150	25	158.31	35.18	091295150SM
M 5 x 180	25	236.52	52.56	091295180SM
M 6 x 10	10	7.97	1.77	09129610SM
M 6 x 12	10	8.42	1.87	09129612SM
M 6 x 16	10	9.14	2.03	09129616SM
M 6 x 18	10	9.90	2.20	09129618SM
M 6 x 20	10	9.90	2.20	09129620SM
M 6 x 25	10	11.48	2.55	09129625SM
M 6 x 30	10	12.65	2.81	09129630SM
M 6 x 35	10	15.12	3.36	09129635SM
M 6 x 40	10	16.79	3.73	09129640SM
M 6 x 45	10	18.45	4.10	09129645SM
M 6 x 50	10	20.07	4.46	09129650SM
M 6 x 55	10	23.09	5.13	09129655SM
M 6 x 60	10	24.84	5.52	09129660SM
M 6 x 65	10	26.10	5.80	09129665SM
M 6 x 70	10	27.54	6.12	09129670SM
M 6 x 80	10	32.09	7.13	09129680SM
M 6 x 90	10	38.66	8.59	09129690SM
M 6 x 100	10	40.86	9.08	091296100SM
M 6 x 110	10	68.18	15.15	091296110SM
M 6 x 120	10	68.22	15.16	091296120SM
M 6 x 140	10	121.37	26.97	091296140SM
M 6 x 150	10	178.70	39.71	091296150SM
M 6 x 160	10	197.73	43.94	091296160SM
M 6 x 170	10	200.25	44.50	091296170SM
M 6 x 180	10	219.69	48.82	091296180SM
M 6 x 190	10	537.75	119.50	091296190SM
M 6 x 200	10	537.75	119.50	091296200SM
M 8 x 16	10	18.99	4.22	09129816SM
M 8 x 20	10	19.85	4.41	09129820SM
M 8 x 25	10	22.14	4.92	09129825SM
M 8 x 30	10	25.02	5.56	09129830SM
M 8 x 35	10	28.76	6.39	09129835SM
M 8 x 40	10	31.82	7.07	09129840SM
M 8 x 45	10	34.88	7.75	09129845SM
M 8 x 50	10	36.81	8.18	09129850SM
M 8 x 55	10	39.78	8.84	09129855SM
M 8 x 60	10	42.75	9.50	09129860SM
M 8 x 65	10	45.90	10.20	09129865SM
M 8 x 70	10	48.78	10.84	09129870SM
M 8 x 75	10	51.80	11.51	09129875SM
M 8 x 80	10	54.72	12.16	09129880SM
M 8 x 90	10	60.62	13.47	09129890SM
M 8 x 100	10	66.56	14.79	091298100SM
M 8 x 110	10	78.93	17.54	091298110SM
M 10 x 16	10	33.26	7.39	091291016SM
M 10 x 20	10	34.43	7.65	091291020SM
M 10 x 25	10	38.16	8.48	091291025SM
M 10 x 30	10	41.85	9.30	091291030SM
M 10 x 35	10	46.94	10.43	091291035SM
M 10 x 40	10	50.85	11.30	091291040SM
M 10 x 45	10	55.80	12.40	091291045SM
M 10 x 50	10	60.66	13.48	091291050SM
M 10 x 55	10	65.70	14.60	091291055SM
M 10 x 60	10	70.65	15.70	091291060SM
M 10 x 65	10	75.56	16.79	091291065SM
M 10 x 70	10	80.42	17.87	091291070SM
M 10 x 80	10	90.41	20.09	091291080SM
M 10 x 90	10	100.26	22.28	091291090SM
M 10 x 100	10	109.98	24.44	091291100SM
M 12 x 25	10	53.60	11.91	091291225SM

Surub cu cap Inbus, otel, gr. 12.9 (continuare)

mm	Ambalare (buc.)	Pret / 100 buc.		Cod
		LEI	EURO	
M 12 x 30	10	58.91	13.09	091291230SM
M 12 x 35	10	64.40	14.31	091291235SM
M 12 x 40	10	69.75	15.50	091291240SM
M 12 x 45	10	77.40	17.20	091291245SM
M 12 x 50	10	84.24	18.72	091291250SM
M 12 x 55	10	91.04	20.23	091291255SM
M 12 x 60	10	97.92	21.76	091291260SM
M 12 x 70	10	110.12	24.47	091291270SM
M 12 x 80	10	123.93	27.54	091291280SM
M 12 x 90	10	137.66	30.59	091291290SM
M 12 x 100	10	151.38	33.64	0912912100SM
M 12 x 110	10	164.16	36.48	0912912110SM
M 12 x 120	10	177.98	39.55	0912912120SM
M 14 x 30	5	80.28	17.84	091291430SM
M 14 x 35	5	87.89	19.53	091291435SM
M 14 x 40	5	95.45	21.21	091291440SM
M 14 x 45	5	102.96	22.88	091291445SM
M 14 x 50	5	110.57	24.57	091291450SM
M 14 x 60	5	127.17	28.26	091291460SM
M 14 x 70	5	145.35	32.30	091291470SM
M 14 x 75	5	149.27	33.17	091291475SM
M 14 x 80	5	176.76	39.28	091291480SM
M 14 x 90	5	185.36	41.19	091291490SM
M 14 x 110	5	218.03	48.45	0912914110SM
M 14 x 120	5	236.30	52.51	0912914120SM
M 14 x 130	5	265.86	59.08	0912914130SM
M 14 x 160	5	266.72	59.27	0912914160SM
M 16 x 30	5	118.67	26.37	091291630SM
M 16 x 35	5	125.01	27.78	091291635SM
M 16 x 40	5	134.82	29.96	091291640SM
M 16 x 45	5	144.59	32.13	091291645SM
M 16 x 50	5	157.05	34.90	091291650SM
M 16 x 55	5	168.89	37.53	091291655SM
M 16 x 60	5	180.68	40.15	091291660SM
M 16 x 65	5	192.56	42.79	091291665SM
M 16 x 70	5	204.35	45.41	091291670SM
M 16 x 75	5	216.27	48.06	091291675SM
M 16 x 80	5	228.11	50.69	091291680SM
M 16 x 90	5	251.78	55.95	091291690SM
M 16 x 100	5	275.49	61.22	0912916100SM
M 16 x 110	5	299.21	66.49	0912916110SM
M 16 x 120	5	322.88	71.75	0912916120SM
M 16 x 130	5	346.55	77.01	0912916130SM
M 16 x 140	5	424.04	94.23	0912916140SM
M 16 x 150	5	424.22	94.27	0912916150SM
M 16 x 160	5	444.96	98.88	0912916160SM
M 16 x 180	5	495.54	110.12	0912916180SM
M 16 x 200	5	545.94	121.32	0912916200SM
M 16 x 220	2	550.40	122.31	0912916220SM
M 16 x 240	2	791.10	175.80	0912916240SM
M 16 x 260	2	791.24	175.83	0912916260SM
M 16 x 280	2	983.43	218.54	0912916280SM
M 20 x 40	2	278.69	61.93	091292040SM
M 20 x 45	2	249.08	55.35	091292045SM
M 20 x 50	2	265.01	58.89	091292050SM
M 20 x 55	2	273.33	60.74	091292055SM
M 20 x 60	2	296.82	65.96	091292060SM
M 20 x 65	2	312.75	69.50	091292065SM
M 20 x 70	2	328.73	73.05	091292070SM
M 20 x 80	2	367.07	81.57	091292080SM
M 20 x 90	2	403.25	89.61	091292090SM
M 20 x 100	2	457.56	101.68	0912920100SM
M 20 x 110	2	476.42	105.87	0912920110SM
M 20 x 120	2	508.28	112.95	0912920120SM
M 20 x 140	2	566.19	125.82	0912920140SM
M 20 x 160	2	656.96	145.99	0912920160SM
M 20 x 180	2	780.21	173.38	0912920180SM
M 20 x 220	2	939.15	208.70	0912920220SM
M 24 x 50	2	434.43	96.54	091292450SM
M 24 x 55	2	515.34	114.52	091292455SM
M 24 x 60	2	515.39	114.53	091292460SM
M 24 x 65	2	515.39	114.53	091292465SM
M 24 x 70	2	525.60	116.80	091292470SM
M 24 x 80	2	577.76	128.39	091292480SM
M 24 x 90	2	629.87	139.97	091292490SM
M 24 x 100	2	681.98	151.55	0912924100SM
M 24 x 110	2	802.67	178.37	0912924110SM
M 24 x 120	2	827.55	183.90	0912924120SM
M 24 x 140	2	890.55	197.90	0912924140SM
M 24 x 160	2	1197.90	266.20	0912924160SM
M 24 x 200	2	1653.17	367.37	0912924200SM
M 27 x 100	2	814.50	181.00	0912927100SM
M 27 x 120	2	942.21	209.38	0912927120SM
M 30 x 120	2	1769.22	393.16	0912930120SM

Stift filetata cu locas Inbus si cap plat, otel

DIN 913



mm	Ambalare (buc.)	Pret / 100 buc.		Cod
		LEI	EURO	
M 8 x 12	100	13.05	2.90	09130812SM
M 8 x 50	50	53.69	11.93	09130850SM
M 20 x 20	5	135.41	30.09	091302020SM

Stift filetat cu locas Inbus si varf, otel

DIN 914

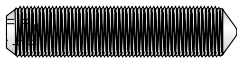

mm	Ambalare (buc.)	Pret / 100 buc.		Cod
		LEI	EURO	
M 6 x 6	50	6.44	1.43	0914066SM
M 6 x 16	50	9.99	2.22	09140616SM
M 8 x 10	50	10.40	2.31	09140810SM
M 8 x 16	50	17.96	3.99	09140816SM
M 10 x 10	25	16.11	3.58	091401010SM
M 16 x 100	10	657.72	146.16	0914016100SM

Piulita hexagonala infundata, otel zincat, gr. 6

DIN 917

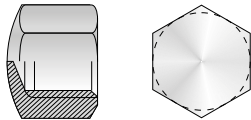

mm	Ambalare (buc.)	Pret / 100 buc.		Cod
		LEI	EURO	
M 5	100	8.91	1.98	091705SM
M 6	100	9.14	2.03	091706SM
M 8	100	13.68	3.04	091708SM
M 10	100	27.77	6.17	0917010SM
M 12	100	41.45	9.21	0917012SM
M 16	50	94.64	21.03	0917016SM

Piulita hexagonala pentru sudare, otel

DIN 929

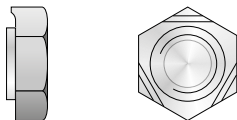

mm	Ambalare (buc.)	Pret / 100 buc.		Cod
		LEI	EURO	
M 4	100	3.78	0.84	092904SM
M 5	100	3.83	0.85	092905SM
M 6	100	3.92	0.87	092906SM
M 8	100	5.45	1.21	092908SM
M 10	50	11.48	2.55	0929010SM
M 12	20	16.47	3.66	0929012SM
M 16	20	43.02	9.56	0929016SM

Surub cu cap hexagonal partial filetat, otel zincat, gr. 8.8

DIN 931

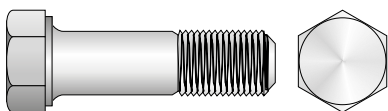

mm	Ambalare (buc.)	Pret / 100 buc.		Cod
		LEI	EURO	
M 5 x 30	200	6.39	1.42	09318530SM
M 5 x 40	200	8.15	1.81	09318540SM
M 5 x 50	200	10.08	2.24	09318550SM
M 5 x 60	200	11.34	2.52	09318560SM
M 5 x 65	200	17.46	3.88	09318565SM
M 5 x 70	200	17.51	3.89	09318570SM
M 5 x 80	200	49.91	11.09	09318580SM
M 6 x 30	200	7.70	1.71	09318630SM
M 6 x 35	200	8.73	1.94	09318635SM
M 6 x 40	200	9.86	2.19	09318640SM
M 6 x 45	200	10.80	2.40	09318645SM
M 6 x 50	200	11.75	2.61	09318650SM
M 6 x 60	200	14.54	3.23	09318660SM
M 6 x 65	200	15.66	3.48	09318665SM
M 6 x 70	200	16.74	3.72	09318670SM
M 6 x 75	200	17.73	3.94	09318675SM
M 6 x 80	200	18.86	4.19	09318680SM
M 6 x 90	100	23.18	5.15	09318690SM
M 6 x 100	100	24.30	5.40	093186100SM
M 6 x 110	100	28.53	6.34	093186110SM
M 6 x 120	100	29.88	6.64	093186120SM
M 6 x 130	100	37.67	8.37	093186130SM
M 6 x 150	100	52.16	11.59	093186150SM
M 8 x 35	100	17.37	3.86	09318835SM
M 8 x 40	100	20.48	4.55	09318840SM
M 8 x 45	100	21.20	4.71	09318845SM
M 8 x 50	100	23.13	5.14	09318850SM
M 8 x 55	100	24.30	5.40	09318855SM
M 8 x 60	100	25.74	5.72	09318860SM
M 8 x 65	100	30.69	6.82	09318865SM
M 8 x 70	100	32.54	7.23	09318870SM
M 8 x 80	100	33.62	7.47	09318880SM
M 8 x 90	100	36.68	8.15	09318890SM
M 8 x 100	100	40.41	8.98	093188100SM

Surub cu cap hexagonal partial filetat, otel zincat, gr. 8.8 (continuare)

mm	Ambalare (buc.)	Pret / 100 buc.		Cod
		LEI	EURO	
M 8 x 110	50	48.06	10.68	093188110SM
M 8 x 120	50	52.74	11.72	093188120SM
M 8 x 130	50	57.51	12.78	093188130SM
M 8 x 140	50	63.32	14.07	093188140SM
M 8 x 150	50	68.36	15.19	093188150SM
M 8 x 160	50	75.47	16.77	093188160SM
M 8 x 170	50	82.35	18.30	093188170SM
M 8 x 180	50	114.35	25.41	093188180SM
M 8 x 200	50	179.19	39.82	093188200SM
M 10 x 35	100	36.23	8.05	093181035SM
M 10 x 40	100	33.93	7.54	093181040SM
M 10 x 45	100	38.52	8.56	093181045SM
M 10 x 50	100	39.87	8.86	093181050SM
M 10 x 55	100	42.44	9.43	093181055SM
M 10 x 60	100	45.45	10.10	093181060SM
M 10 x 65	100	52.11	11.58	093181065SM
M 10 x 70	100	54.41	12.09	093181070SM
M 10 x 80	100	57.47	12.77	093181080SM
M 10 x 90	100	63.50	14.11	093181090SM
M 10 x 95	100	67.55	15.01	093181095SM
M 10 x 100	100	69.57	15.46	0931810100SM
M 10 x 120	50	85.19	18.93	0931810120SM
M 10 x 130	50	91.49	20.33	0931810130SM
M 10 x 140	50	97.74	21.72	0931810140SM
M 10 x 150	50	105.53	23.45	0931810150SM
M 10 x 160	50	116.46	25.88	0931810160SM
M 10 x 170	50	127.26	28.28	0931810170SM
M 10 x 180	50	133.25	29.61	0931810180SM
M 10 x 190	50	144.68	32.15	0931810190SM
M 10 x 200	50	214.70	47.71	0931810200SM
M 10 x 220	50	229.05	50.90	0931810220SM
M 10 x 240	50	242.01	53.78	0931810240SM
M 10 x 260	50	257.81	57.29	0931810260SM
M 12 x 40	100	49.05	10.90	093181240SM
M 12 x 45	100	51.98	11.55	093181245SM
M 12 x 50	100	56.30	12.51	093181250SM
M 12 x 55	100	60.71	13.49	093181255SM
M 12 x 60	100	64.98	14.44	093181260SM
M 12 x 65	50	68.13	15.14	093181265SM
M 12 x 70	50	72.45	16.10	093181270SM
M 12 x 75	50	79.74	17.72	093181275SM
M 12 x 80	50	81.05	18.01	093181280SM
M 12 x 90	50	89.60	19.91	093181290SM
M 12 x 100	50	97.92	21.76	0931812100SM
M 12 x 110	50	104.90	23.31	0931812110SM
M 12 x 120	50	113.63	25.25	0931812120SM
M 12 x 130	50	143.46	31.88	0931812130SM
M 12 x 140	50	143.46	31.88	0931812140SM
M 12 x 150	50	164.97	36.66	0931812150SM
M 12 x 160	25	165.06	36.68	0931812160SM
M 12 x 170	25	172.44	38.32	0931812170SM
M 12 x 180	25	180.27	40.06	0931812180SM
M 12 x 200	25	199.17	44.26	0931812200SM
M 12 x 220	25	229.68	51.04	0931812220SM
M 12 x 240	25	261.54	58.12	0931812240SM
M 12 x 260	25	357.03	79.34	0931812260SM
M 12 x 280	25	362.97	80.66	0931812280SM
M 12 x 300	25	506.48	112.55	0931812300SM
M 14 x 50	50	89.55	19.90	093181450SM
M 14 x 60	50	102.83	22.85	093181460SM
M 14 x 70	50	115.47	25.66	093181470SM
M 14 x 80	50	127.80	28.40	093181480SM
M 14 x 90	50	138.74	30.83	093181490SM
M 14 x 100	50	151.88	33.75	0931814100SM
M 14 x 110	25	178.34	39.63	0931814110SM
M 14 x 120	25	193.73	43.05	0931814120SM
M 14 x 130	25	205.56	45.68	0931814130SM
M 14 x 140	25	218.52	48.56	0931814140SM
M 14 x 150	25	235.08	52.24	0931814150SM
M 14 x 160	25	235.17	52.26	0931814160SM
M 14 x 180	25	238.10	52.91	0931814180SM
M 14 x 190	25	255.60	56.80	0931814190SM
M 14 x 200	25	275.13	61.14	0931814200SM
M 16 x 50	25	98.55	21.90	093181650SM
M 16 x 55	25	102.56	22.79	093181655SM
M 16 x 60	25	111.56	24.79	093181660SM
M 16 x 65	25	118.80	26.40	093181665SM
M 16 x 70	25	125.87	27.97	093181670SM
M 16 x 75	25	132.35	29.41	093181675SM
M 16 x 80	25	138.24	30.72	093181680SM
M 16 x 85	25	169.47	37.66	093181685SM
M 16 x 90	25	186.39	41.42	093181690SM
M 16 x 95	25	189.18	42.04	093181695SM
M 16 x 100	25	189.32	42.07	0931816100SM
M 16 x 110	25	217.85	48.41	0931816110SM
M 16 x 120	25	217.94	48.43	0931816120SM
M 16 x 130	25	227.03	50.45	0931816130SM
M 16 x 140	25	237.69	52.82	0931816140SM
M 16 x 150	25	265.55	59.01	0931816150SM
M 16 x 160	25	286.43	63.65	0931816160SM
M 16 x 170	25	302.94	67.32	0931816170SM
M 16 x 180	25	330.44	73.43	0931816180SM
M 16 x 200	25	364.55	81.01	0931816200SM
M 16 x 220	10	428.31	95.18	0931816220SM
M 16 x 240	10	457.38	101.64	0931816240SM
M 16 x 260	10	554.13	123.14	0931816260SM
M 16 x 280	10	612.81	136.18	0931816280SM
M 16 x 300	10	612.99	136.22	0931816300SM
M 18 x 70	25	202.59	45.02	093181870SM
M 18 x 75	25	221.63	49.25	093181875SM
M 18 x 80	25	223.88	49.75	093181880SM

Surub cu cap hexagonal partial filetat, otel zincat, gr. 8.8 (continuare)

mm	Ambalare (buc.)	Pret / 100 buc.		Cod
		LEI	EURO	
M 18 x 90	25	233.60	51.91	093181890SM
M 18 x 100	25	268.61	59.69	0931818100SM
M 18 x 110	25	302.54	67.23	0931818110SM
M 18 x 120	25	325.80	72.40	0931818120SM
M 18 x 130	25	344.43	76.54	0931818130SM
M 18 x 140	25	367.70	81.71	0931818140SM
M 18 x 150	25	390.96	86.88	0931818150SM
M 18 x 160	10	394.07	87.57	0931818160SM
M 18 x 180	10	399.51	88.78	0931818180SM
M 18 x 200	10	416.57	92.57	0931818200SM
M 18 x 220	2	659.12	146.47	0931818220SM
M 18 x 240	2	721.80	160.40	0931818240SM
M 20 x 65	25	202.32	44.96	093182065SM
M 20 x 70	25	213.39	47.42	093182070SM
M 20 x 75	25	238.14	52.92	093182075SM
M 20 x 80	25	238.19	52.93	093182080SM
M 20 x 85	25	285.08	63.35	093182085SM
M 20 x 90	25	285.12	63.36	093182090SM
M 20 x 100	25	285.21	63.38	0931820100SM
M 20 x 110	25	322.20	71.60	0931820110SM
M 20 x 120	25	359.15	79.81	0931820120SM
M 20 x 130	25	365.45	81.21	0931820130SM
M 20 x 140	25	394.92	87.76	0931820140SM
M 20 x 150	25	412.29	91.62	0931820150SM
M 20 x 160	10	479.34	106.52	0931820160SM
M 20 x 170	10	505.17	112.26	0931820170SM
M 20 x 180	10	530.96	117.99	0931820180SM
M 20 x 190	10	557.78	123.95	0931820190SM
M 20 x 200	10	584.69	129.93	0931820200SM
M 20 x 220	10	725.99	161.33	0931820220SM
M 20 x 240	10	832.55	185.01	0931820240SM
M 20 x 260	10	1085.94	241.32	0931820260SM
M 20 x 280	10	1086.93	241.54	0931820280SM
M 20 x 300	10	1087.43	241.65	0931820300SM
M 22 x 80	25	339.80	75.51	093182280SM
M 22 x 90	25	414.90	92.20	093182290SM
M 22 x 100	10	414.95	92.21	0931822100SM
M 22 x 120	10	515.30	114.51	0931822120SM
M 22 x 140	10	545.72	121.27	0931822140SM
M 22 x 160	10	546.03	121.34	0931822160SM
M 22 x 170	10	556.88	123.75	0931822170SM
M 22 x 180	10	760.19	168.93	0931822180SM
M 22 x 200	10	760.37	168.97	0931822200SM
M 22 x 210	10	760.41	168.98	0931822210SM
M 22 x 220	10	928.35	206.30	0931822220SM
M 22 x 230	10	930.02	206.67	0931822230SM
M 22 x 240	10	930.06	206.68	0931822240SM
M 22 x 250	10	930.15	206.70	0931822250SM
M 22 x 260	10	1096.70	243.71	0931822260SM
M 22 x 280	10	1096.79	243.73	0931822280SM
M 22 x 300	10	1354.41	300.98	0931822300SM
M 24 x 70	10	318.83	70.85	093182470SM
M 24 x 75	10	406.53	90.34	093182475SM
M 24 x 80	10	406.62	90.36	093182480SM
M 24 x 90	10	502.25	111.61	093182490SM
M 24 x 100	10	502.38	111.64	0931824100SM
M 24 x 110	10	560.48	124.55	0931824110SM
M 24 x 120	10	560.75	124.61	0931824120SM
M 24 x 130	10	586.94	130.43	0931824130SM
M 24 x 140	10	623.66	138.59	0931824140SM
M 24 x 150	10	660.29	146.73	0931824150SM
M 24 x 160	10	756.09	168.02	0931824160SM
M 24 x 180	10	756.72	168.16	0931824180SM
M 24 x 200	10	757.35	168.30	0931824200SM
M 24 x 220	10	1253.70	278.60	0931824220SM
M 24 x 230	10	1305.45	290.10	0931824230SM
M 24 x 240	10	1412.10	313.80	0931824240SM
M 24 x 300	10	1425.38	316.75	0931824300SM
M 27 x 90	5	660.56	146.79	093182790SM
M 27 x 100	5	730.53	162.34	0931827100SM
M 27 x 110	5	815.76	181.28	0931827110SM
M 27 x 120	5	819.86	182.19	0931827120SM
M 27 x 130	5	975.02	216.67	0931827130SM
M 27 x 150	5	996.12	221.36	0931827150SM
M 27 x 160	5	1116.36	248.08	0931827160SM
M 27 x 170	5	1117.62	248.36	0931827170SM
M 27 x 200	5	1181.88	262.64	0931827200SM
M 27 x 220	2	1519.70	337.71	0931827220SM
M 27 x 240	2	1620.36	360.08	0931827240SM
M 27 x 260	2	1708.38	379.64	0931827260SM
M 27 x 280	2	1819.35	404.30	0931827280SM
M 27 x 300	2	1974.51	438.78	0931827300SM
M 30 x 90	2	914.90	203.31	093183090SM
M 30 x 100	2	800.64	177.92	0931830100SM
M 30 x 110	2	1109.39	246.53	0931830110SM
M 30 x 120	2	1110.60	246.80	0931830120SM
M 30 x 130	2	1206.90	268.20	0931830130SM
M 30 x 140	2	1208.16	268.48	0931830140SM
M 30 x 150	2	1332.45	296.10	0931830150SM
M 30 x 160	2	1387.76	308.39	0931830160SM
M 30 x 180	2	1476.50	328.11	0931830180SM
M 30 x 200	2	1660.23	368.94	0931830200SM
M 30 x 220	2	1942.65	431.70	0931830220SM
M 30 x 240	2	1942.65	431.70	0931830240SM
M 30 x 260	2	1942.70	431.71	0931830260SM
M 30 x 280	2	2177.96	483.99	0931830280SM
M 30 x 300	2	2507.58	557.24	0931830300SM

Surub cu cap hexagonal partial filetat, otel, gr. 10.9

DIN 931

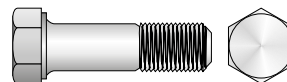

mm	Ambalare (buc.)	Pret / 100 buc.		Cod
		LEI	EURO	
M 6 x 60	100	13.73	3.05	09319660SM
M 8 x 40	50	18.18	4.04	09319840SM
M 8 x 50	50	21.69	4.82	09319850SM
M 8 x 60	50	24.12	5.36	09319860SM
M 8 x 70	50	27.59	6.13	09319870SM
M 8 x 80	50	31.19	6.93	09319880SM
M 8 x 100	25	42.26	9.39	093198100SM
M 10 x 40	25	31.86	7.08	093191040SM
M 10 x 50	25	37.44	8.32	093191050SM
M 10 x 60	25	42.71	9.49	093191060SM
M 10 x 70	25	48.29	10.73	093191070SM
M 10 x 80	25	54.00	12.00	093191080SM
M 10 x 90	25	59.63	13.25	093191090SM
M 10 x 100	25	65.25	14.50	0931910100SM
M 10 x 110	10	77.18	17.15	0931910110SM
M 10 x 120	10	80.24	17.83	0931910120SM
M 10 x 130	10	88.61	19.69	0931910130SM
M 12 x 40	20	46.13	10.25	093191240SM
M 12 x 50	20	52.88	11.75	093191250SM
M 12 x 55	20	57.02	12.67	093191255SM
M 12 x 60	20	60.98	13.55	093191260SM
M 12 x 70	20	68.04	15.12	093191270SM
M 12 x 80	20	76.10	16.91	093191280SM
M 12 x 90	20	84.11	18.69	093191290SM
M 12 x 100	20	91.98	20.44	0931912100SM
M 12 x 110	20	98.46	21.88	0931912110SM
M 12 x 120	20	106.56	23.68	0931912120SM
M 12 x 130	10	115.07	25.57	0931912130SM
M 12 x 140	10	135.59	30.13	0931912140SM
M 12 x 150	10	136.08	30.24	0931912150SM
M 14 x 50	10	75.29	16.73	093191450SM
M 14 x 55	10	80.82	17.96	093191455SM
M 14 x 60	10	86.36	19.19	093191460SM
M 14 x 70	10	96.35	21.41	093191470SM
M 14 x 80	10	107.42	23.87	093191480SM
M 14 x 90	10	116.51	25.89	093191490SM
M 14 x 100	10	127.58	28.35	0931914100SM
M 14 x 110	10	138.56	30.79	0931914110SM
M 14 x 120	10	150.48	33.44	0931914120SM
M 14 x 140	10	182.43	40.54	0931914140SM
M 14 x 150	10	183.47	40.77	0931914150SM
M 14 x 190	10	240.93	53.54	0931914190SM
M 16 x 50	10	95.13	21.14	093191650SM
M 16 x 55	10	101.52	22.56	093191655SM
M 16 x 60	10	107.51	23.89	093191660SM
M 16 x 65	10	119.79	26.62	093191665SM
M 16 x 70	10	119.88	26.64	093191670SM
M 16 x 80	10	133.25	29.61	093191680SM
M 16 x 90	10	147.02	32.67	093191690SM
M 16 x 100	10	159.84	35.52	0931916100SM
M 16 x 110	10	173.61	38.58	0931916110SM
M 16 x 120	10	198.00	44.00	0931916120SM
M 16 x 140	10	218.12	48.47	0931916140SM
M 16 x 150	5	233.55	51.90	0931916150SM
M 16 x 160	5	239.00	53.11	0931916160SM
M 16 x 170	5	264.51	58.78	0931916170SM
M 16 x 180	5	266.54	59.23	0931916180SM
M 16 x 190	5	554.09	123.13	0931916190SM
M 16 x 200	5	554.18	123.15	0931916200SM
M 16 x 220	2	554.31	123.18	0931916220SM
M 16 x 280	2	829.71	184.38	0931916280SM
M 18 x 60	10	148.91	33.09	093191860SM
M 18 x 70	10	168.98	37.55	093191870SM
M 18 x 80	10	179.19	39.82	093191880SM
M 18 x 90	10	210.24	46.72	093191890SM
M 18 x 100	10	214.97	47.77	0931918100SM
M 18 x 120	10	255.11	56.69	0931918120SM
M 20 x 70	2	196.88	43.75	093192070SM
M 20 x 80	2	217.40	48.31	093192080SM
M 20 x 90	2	239.36	53.19	093192090SM
M 20 x 100	2	258.26	57.39	0931920100SM
M 20 x 110	2	295.74	65.72	0931920110SM
M 20 x 120	2	299.21	66.49	0931920120SM
M 20 x 130	2	325.98	72.44	0931920130SM
M 20 x 140	2	377.42	83.87	0931920140SM
M 20 x 150	2	378.27	84.06	0931920150SM
M 20 x 160	2	388.76	86.39	0931920160SM
M 20 x 180	2	429.57	95.46	0931920180SM
M 20 x 200	2	479.48	106.55	0931920200SM
M 20 x 220	2	590.22	131.16	0931920220SM
M 20 x 240	2	591.98	131.55	0931920240SM
M 22 x 240	2	1206.68	268.15	0931922240SM
M 24 x 80	2	339.84	75.52	093192480SM
M 24 x 90	2	386.73	85.94	093192490SM
M 24 x 100	2	402.21	89.38	0931924100SM
M 24 x 110	2	451.08	100.24	0931924110SM
M 24 x 120	2	482.45	107.21	0931924120SM
M 24 x 130	2	902.03	200.45	0931924130SM
M 24 x 140	2	902.07	200.46	0931924140SM
M 24 x 150	2	902.12	200.47	0931924150SM
M 24 x 160	2	902.12	200.47	0931924160SM
M 24 x 180	2	902.21	200.49	0931924180SM
M 24 x 190	2	934.88	207.75	0931924190SM
M 24 x 200	2	934.88	207.75	0931924200SM
M 24 x 220	2	934.92	207.76	0931924220SM
M 24 x 240	2	935.01	2	

Surub cu cap hexagonal partial filetat, otel zincat, gr. 10.9

DIN 931

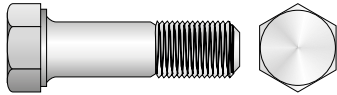

mm	Ambalare (buc.)	Pret / 100 buc.		Cod
		LEI	EURO	
M 10 x 60	25	49.10	10.91	0931Z1060SM
M 10 x 80	25	62.10	13.80	0931Z1080SM
M 10 x 100	25	75.06	16.68	0931Z10100SM
M 12 x 60	20	70.11	15.58	0931Z1260SM
M 12 x 70	20	78.26	17.39	0931Z1270SM
M 12 x 80	20	87.53	19.45	0931Z1280SM
M 12 x 100	20	105.80	23.51	0931Z12100SM
M 12 x 120	20	122.54	27.23	0931Z12120SM
M 14 x 80	10	123.53	27.45	0931Z1480SM
M 14 x 100	10	146.70	32.60	0931Z14100SM
M 14 x 120	10	173.07	38.46	0931Z14120SM
M 16 x 60	10	123.62	27.47	0931Z1660SM
M 16 x 80	10	153.23	34.05	0931Z1680SM
M 16 x 100	20	183.83	40.85	0931Z16100SM
M 16 x 120	10	227.70	50.60	0931Z16120SM
M 16 x 140	10	250.83	55.74	0931Z16140SM
M 16 x 160	5	274.86	61.08	0931Z16160SM
M 16 x 180	5	306.50	68.11	0931Z16180SM
M 18 x 100	10	247.23	54.94	0931Z18100SM
M 18 x 120	10	293.36	65.19	0931Z18120SM
M 20 x 80	3	250.02	55.56	0931Z2080SM
M 20 x 100	3	297.00	66.00	0931Z20100SM
M 20 x 120	3	344.07	76.46	0931Z20120SM
M 20 x 140	2	434.03	96.45	0931Z20140SM
M 20 x 160	2	447.08	99.35	0931Z20160SM
M 20 x 200	2	551.39	122.53	0931Z20200SM
M 24 x 80	2	390.83	86.85	0931Z2480SM
M 24 x 100	2	462.56	102.79	0931Z24100SM
M 24 x 120	2	554.81	123.29	0931Z24120SM
M 24 x 140	2	1037.39	230.53	0931Z24140SM
M 24 x 160	2	1037.43	230.54	0931Z24160SM
M 24 x 200	2	1075.10	238.91	0931Z24200SM

Surub cu cap hexagonal total filetat, otel zincat, gr. 8.8

DIN 933



mm	Ambalare (buc.)	Pret / 100 buc.		Cod
		LEI	EURO	
M 3 x 8	200	2.16	0.48	0933838SM
M 3 x 10	200	3.51	0.78	09338310SM
M 3 x 16	200	4.37	0.97	09338316SM
M 3 x 20	200	4.37	0.97	09338320SM
M 3 x 25	200	4.41	0.98	09338325SM
M 4 x 6	200	2.70	0.60	0933846SM
M 4 x 8	200	2.84	0.63	0933848SM
M 4 x 10	200	3.06	0.68	09338410SM
M 4 x 12	200	3.24	0.72	09338412SM
M 4 x 16	200	3.74	0.83	09338416SM
M 4 x 18	200	4.05	0.90	09338418SM
M 4 x 20	200	4.28	0.95	09338420SM
M 4 x 25	200	4.95	1.10	09338425SM
M 4 x 30	200	5.63	1.25	09338430SM
M 4 x 35	200	6.30	1.40	09338435SM
M 4 x 40	200	7.02	1.56	09338440SM
M 4 x 50	200	7.20	1.60	09338450SM
M 5 x 8	200	5.18	1.15	0933858SM
M 5 x 10	200	3.69	0.82	09338510SM
M 5 x 12	200	4.41	0.98	09338512SM
M 5 x 16	200	4.91	1.09	09338516SM
M 5 x 20	200	4.91	1.09	09338520SM
M 5 x 25	200	5.36	1.19	09338525SM
M 5 x 30	200	5.81	1.29	09338530SM
M 5 x 35	200	6.53	1.45	09338535SM
M 5 x 40	200	7.34	1.63	09338540SM
M 5 x 45	200	8.15	1.81	09338545SM
M 5 x 50	200	8.64	1.92	09338550SM
M 5 x 60	200	9.99	2.22	09338560SM
M 5 x 70	200	11.70	2.60	09338570SM
M 6 x 10	200	4.68	1.04	09338610SM
M 6 x 12	200	5.22	1.16	09338612SM
M 6 x 14	200	5.49	1.22	09338614SM
M 6 x 16	200	5.63	1.25	09338616SM
M 6 x 18	200	5.63	1.25	09338618SM
M 6 x 20	200	5.67	1.26	09338620SM
M 6 x 25	200	6.39	1.42	09338625SM
M 6 x 30	200	7.25	1.61	09338630SM
M 6 x 35	100	8.06	1.79	09338635SM
M 6 x 40	100	8.87	1.97	09338640SM
M 6 x 45	100	9.72	2.16	09338645SM
M 6 x 50	100	10.58	2.35	09338650SM
M 6 x 55	100	12.15	2.70	09338655SM
M 6 x 60	100	12.96	2.88	09338660SM
M 6 x 65	100	13.86	3.08	09338665SM
M 6 x 70	100	14.72	3.27	09338670SM
M 6 x 75	100	15.62	3.47	09338675SM
M 6 x 80	100	16.52	3.67	09338680SM

Surub cu cap hexagonal total filetat, otel zincat, gr. 8.8 (continuare)

mm	Ambalare (buc.)	Pret / 100 buc.		Cod
		LEI	EURO	
M 6 x 90	100	18.63	4.14	09338690SM
M 6 x 100	100	21.06	4.68	093386100SM
M 8 x 10	100	9.05	2.01	09338810SM
M 8 x 12	100	11.25	2.50	09338812SM
M 8 x 14	100	13.19	2.93	09338814SM
M 8 x 16	100	13.19	2.93	09338816SM
M 8 x 20	100	13.23	2.94	09338820SM
M 8 x 25	100	13.23	2.94	09338825SM
M 8 x 30	100	14.49	3.22	09338830SM
M 8 x 35	100	16.47	3.66	09338835SM
M 8 x 40	100	18.00	4.00	09338840SM
M 8 x 45	100	19.53	4.34	09338845SM
M 8 x 50	100	20.97	4.66	09338850SM
M 8 x 55	100	23.36	5.19	09338855SM
M 8 x 60	100	23.36	5.19	09338860SM
M 8 x 65	100	30.15	6.70	09338865SM
M 8 x 70	100	30.15	6.70	09338870SM
M 8 x 75	100	30.24	6.72	09338875SM
M 8 x 80	100	30.29	6.73	09338880SM
M 8 x 90	100	33.98	7.55	09338890SM
M 8 x 100	100	35.19	7.82	093388100SM
M 8 x 110	100	42.39	9.42	093388110SM
M 8 x 120	100	45.14	10.03	093388120SM
M 10 x 12	50	18.18	4.04	093381012SM
M 10 x 16	50	21.51	4.78	093381016SM
M 10 x 18	50	23.18	5.15	093381018SM
M 10 x 20	50	23.22	5.16	093381020SM
M 10 x 25	50	23.31	5.18	093381025SM
M 10 x 30	50	24.84	5.52	093381030SM
M 10 x 35	50	28.04	6.23	093381035SM
M 10 x 40	50	30.51	6.78	093381040SM
M 10 x 45	50	33.98	7.55	093381045SM
M 10 x 50	50	35.37	7.86	093381050SM
M 10 x 55	50	42.66	9.48	093381055SM
M 10 x 60	50	42.71	9.49	093381060SM
M 10 x 65	50	42.80	9.51	093381065SM
M 10 x 70	50	45.23	10.05	093381070SM
M 10 x 75	50	52.52	11.67	093381075SM
M 10 x 80	50	52.61	11.69	093381080SM
M 10 x 90	50	55.04	12.23	093381090SM
M 10 x 100	50	59.90	13.31	0933810100SM
M 10 x 110	25	67.77	15.06	0933810110SM
M 10 x 120	25	72.86	16.19	0933810120SM
M 10 x 130	25	77.94	17.32	0933810130SM
M 10 x 140	25	83.12	18.47	0933810140SM
M 10 x 150	25	89.46	19.88	0933810150SM
M 12 x 16	50	29.03	6.45	093381216SM
M 12 x 20	50	31.19	6.93	093381220SM
M 12 x 22	50	32.36	7.19	093381222SM
M 12 x 25	50	32.36	7.19	093381225SM
M 12 x 30	50	35.78	7.95	093381230SM
M 12 x 35	50	39.11	8.69	093381235SM
M 12 x 40	50	42.57	9.46	093381240SM
M 12 x 45	50	47.39	10.53	093381245SM
M 12 x 50	50	50.81	11.29	093381250SM
M 12 x 55	50	54.32	12.07	093381255SM
M 12 x 60	50	56.88	12.64	093381260SM
M 12 x 65	50	61.38	13.64	093381265SM
M 12 x 70	50	64.89	14.42	093381270SM
M 12 x 75	50	68.36	15.19	093381275SM
M 12 x 80	50	71.96	15.99	093381280SM
M 12 x 85	50	76.59	17.02	093381285SM
M 12 x 90	50	78.93	17.54	093381290SM
M 12 x 100	50	86.00	19.11	0933812100SM
M 12 x 110	25	92.34	20.52	0933812110SM
M 12 x 120	25	117.68	26.15	0933812120SM
M 12 x 130	25	117.72	26.16	0933812130SM
M 12 x 140	25	117.81	26.18	0933812140SM
M 12 x 150	25	119.30	26.51	0933812150SM
M 12 x 160	25	137.70	30.60	0933812160SM
M 14 x 20	20	65.21	14.49	093381420SM
M 14 x 25	20	55.94	12.43	093381425SM
M 14 x 30	20	66.38	14.75	093381430SM
M 14 x 35	20	68.72	15.27	093381435SM
M 14 x 40	20	74.21	16.49	093381440SM
M 14 x 45	20	79.65	17.70	093381445SM
M 14 x 50	20	87.53	19.45	093381450SM
M 14 x 55	20	90.50	20.11	093381455SM
M 14 x 60	20	95.90	21.31	093381460SM
M 14 x 70	20	106.97	23.77	093381470SM
M 14 x 80	20	116.96	25.99	093381480SM
M 14 x 90	20	127.80	28.40	093381490SM
M 14 x 100	20	139.73	31.05	0933814100SM
M 16 x 20	20	72.72	16.16	093381620SM
M 16 x 25	20	78.57	17.46	093381625SM
M 16 x 30	20	78.62	17.47	093381630SM
M 16 x 35	20	78.71	17.49	093381635SM
M 16 x 40	20	80.15	17.81	093381640SM
M 16 x 45	20	87.26	19.39	093381645SM
M 16 x 50	20	91.49	20.33	093381650SM
M 16 x 55	20	100.67	22.37	093381655SM
M 16 x 60	20	108.95	24.21	093381660SM
M 16 x 65	20	125.69	27.93	093381665SM
M 16 x 70	20	125.78	27.95	093381670SM
M 16 x 75	20	132.26	29.39	093381675SM
M 16 x 80	20	133.97	29.77	093381680SM
M 16 x 85	20	144.36	32.08	093381685SM
M 16 x 90	20	145.76	32.39	093381690SM
M 16 x 100	20	152.82	33.96	0933816100SM
M 16 x 110	10	173.34	38.52	0933816110SM
M 16 x 120	10	185.49	41.22	0933816120SM

Surub cu cap hexagonal total filetata, otel zincat, gr. 8.8 (continuare)

mm	Ambalare (buc.)	Pret / 100 buc.		Cod
		LEI	EURO	
M 16 x 130	10	197.73	43.94	0933816130SM
M 16 x 140	10	210.42	46.76	0933816140SM
M 16 x 150	10	223.11	49.58	0933816150SM
M 16 x 160	10	238.86	53.08	0933816160SM
M 16 x 180	10	306.14	68.03	0933816180SM
M 16 x 200	10	306.54	68.12	0933816200SM
M 18 x 35	10	108.00	24.00	093381835SM
M 18 x 40	10	152.01	33.78	093381840SM
M 18 x 45	10	152.15	33.81	093381845SM
M 18 x 50	10	152.24	33.83	093381850SM
M 18 x 55	10	162.27	36.06	093381855SM
M 18 x 60	10	171.23	38.05	093381860SM
M 18 x 70	10	189.09	42.02	093381870SM
M 18 x 80	10	208.17	46.26	093381880SM
M 18 x 90	10	226.04	50.23	093381890SM
M 18 x 100	10	243.99	54.22	0933818100SM
M 20 x 30	10	127.98	28.44	093382030SM
M 20 x 35	10	162.23	36.05	093382035SM
M 20 x 40	10	162.27	36.06	093382040SM
M 20 x 45	10	162.36	36.08	093382045SM
M 20 x 50	10	162.59	36.13	093382050SM
M 20 x 55	10	171.81	38.18	093382055SM
M 20 x 60	10	181.08	40.24	093382060SM
M 20 x 65	10	192.11	42.69	093382065SM
M 20 x 70	10	216.63	48.14	093382070SM
M 20 x 75	10	216.77	48.17	093382075SM
M 20 x 80	10	219.83	48.85	093382080SM
M 20 x 85	10	242.64	53.92	093382085SM
M 20 x 90	10	265.46	58.99	093382090SM
M 20 x 100	10	265.55	59.01	0933820100SM
M 20 x 110	10	298.40	66.31	0933820110SM
M 20 x 120	10	312.66	69.48	0933820120SM
M 20 x 130	10	332.19	73.82	0933820130SM
M 20 x 140	10	374.76	83.28	0933820140SM
M 20 x 150	10	375.03	83.34	0933820150SM
M 20 x 160	10	381.15	84.70	0933820160SM
M 22 x 50	10	239.31	53.18	093382250SM
M 22 x 60	10	274.28	60.95	093382260SM
M 22 x 70	10	293.90	65.31	093382270SM
M 22 x 80	10	322.29	71.62	093382280SM
M 22 x 90	10	346.91	77.09	093382290SM
M 22 x 100	10	346.95	77.10	0933822100SM
M 22 x 110	5	347.00	77.11	0933822110SM
M 22 x 120	5	371.25	82.50	0933822120SM
M 22 x 130	5	393.75	87.50	0933822130SM
M 22 x 180	5	785.34	174.52	0933822180SM
M 22 x 200	5	787.59	175.02	0933822200SM
M 24 x 50	10	287.19	63.82	093382450SM
M 24 x 55	10	291.60	64.80	093382455SM
M 24 x 60	10	291.65	64.81	093382460SM
M 24 x 65	10	306.00	68.00	093382465SM
M 24 x 70	10	320.40	71.20	093382470SM
M 24 x 75	10	388.62	86.36	093382475SM
M 24 x 80	10	388.62	86.36	093382480SM
M 24 x 90	10	388.67	86.37	093382490SM
M 24 x 100	10	405.81	90.18	0933824100SM
M 24 x 110	5	463.37	102.97	0933824110SM
M 24 x 120	5	463.46	102.99	0933824120SM
M 24 x 130	5	490.73	109.05	0933824130SM
M 24 x 140	5	513.09	114.02	0933824140SM
M 24 x 150	5	541.89	120.42	0933824150SM
M 24 x 160	5	572.63	127.25	0933824160SM
M 24 x 180	5	705.02	156.67	0933824180SM
M 24 x 200	5	707.67	157.26	0933824200SM
M 27 x 50	2	396.41	88.09	093382750SM
M 27 x 70	2	528.44	117.43	093382770SM
M 27 x 75	2	528.53	117.45	093382775SM
M 27 x 80	2	643.19	142.93	093382780SM
M 27 x 90	2	730.17	162.26	093382790SM
M 27 x 100	2	730.26	162.28	0933827100SM
M 30 x 50	2	713.61	158.58	093383050SM
M 30 x 60	2	713.84	158.63	093383060SM
M 30 x 80	2	818.73	181.94	093383080SM
M 30 x 90	2	931.05	206.90	093383090SM
M 30 x 100	2	931.19	206.93	0933830100SM
M 30 x 110	2	973.53	216.34	0933830110SM
M 30 x 120	2	1068.17	237.37	0933830120SM
M 30 x 130	2	1115.37	247.86	0933830130SM
M 30 x 140	2	1162.40	258.31	0933830140SM
M 30 x 160	2	1498.55	333.01	0933830160SM
M 30 x 180	2	1498.64	333.03	0933830180SM
M 30 x 200	2	1603.62	356.36	0933830200SM

Surub cu cap hexagonal crestat total filetata, otel zincat gr. 8.8

DIN 933



mm	Ambalare (buc.)	Pret / 100 buc.		Cod
		LEI	EURO	
M 6x 16	500	9.09	2.02	09336616SM
M 6x 20	500	9.81	2.18	09336620SM
M 6x 25	500	10.67	2.37	09336625SM
M 6x 30	500	12.29	2.73	09336630SM
M 8x 20	200	19.13	4.25	09336820SM
M 8x 25	200	20.88	4.64	09336825SM
M 8x 30	200	22.37	4.97	09336830SM

Surub cu cap hexagonal total filetata, otel, gr. 10.9

DIN 933

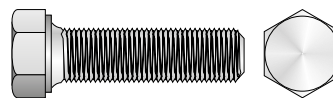

mm	Ambalare (buc.)	Pret / 100 buc.		Cod
		LEI	EURO	
M 6 x 10	100	4.14	0.92	09339610SM
M 6 x 12	100	4.37	0.97	09339612SM
M 6 x 16	100	7.61	1.69	09339616SM
M 6 x 20	100	7.61	1.69	09339620SM
M 6 x 25	100	10.85	2.41	09339625SM
M 6 x 30	100	10.85	2.41	09339630SM
M 6 x 40	100	10.89	2.42	09339640SM
M 6 x 50	100	10.94	2.43	09339650SM
M 6 x 60	100	12.20	2.71	09339660SM
M 6 x 80	100	15.57	3.46	09339680SM
M 8 x 16	50	15.44	3.43	09339816SM
M 8 x 20	50	11.21	2.49	09339820SM
M 8 x 25	50	12.33	2.74	09339825SM
M 8 x 30	50	13.73	3.05	09339830SM
M 8 x 35	50	15.71	3.49	09339835SM
M 8 x 40	50	17.15	3.81	09339840SM
M 8 x 50	50	19.71	4.38	09339850SM
M 8 x 60	50	21.87	4.86	09339860SM
M 8 x 65	50	35.28	7.84	09339865SM
M 8 x 70	50	35.28	7.84	09339870SM
M 8 x 80	50	35.33	7.85	09339880SM
M 10 x 20	25	18.86	4.19	093391020SM
M 10 x 25	25	22.23	4.94	093391025SM
M 10 x 30	25	23.54	5.23	093391030SM
M 10 x 35	25	26.33	5.85	093391035SM
M 10 x 40	25	28.62	6.36	093391040SM
M 10 x 45	25	30.92	6.87	093391045SM
M 10 x 50	25	33.17	7.37	093391050SM
M 10 x 60	25	37.89	8.42	093391060SM
M 10 x 70	25	45.77	10.17	093391070SM
M 10 x 80	25	49.28	10.95	093391080SM
M 10 x 100	25	56.21	12.49	0933910100SM
M 12 x 25	20	30.29	6.73	093391225SM
M 12 x 30	20	33.53	7.45	093391230SM
M 12 x 35	20	36.72	8.16	093391235SM
M 12 x 40	20	39.92	8.87	093391240SM
M 12 x 45	20	44.51	9.89	093391245SM
M 12 x 50	20	47.75	10.61	093391250SM
M 12 x 60	20	53.42	11.87	093391260SM
M 12 x 70	20	60.89	13.53	093391270SM
M 12 x 80	20	67.55	15.01	093391280SM
M 12 x 100	20	80.73	17.94	0933912100SM
M 14 x 35	10	58.19	12.93	093391435SM
M 14 x 40	10	62.82	13.96	093391440SM
M 14 x 50	10	72.05	16.01	093391450SM
M 14 x 60	10	82.76	18.39	093391460SM
M 14 x 70	10	97.43	21.65	093391470SM
M 14 x 80	10	98.96	21.99	093391480SM
M 14 x 90	10	108.95	24.21	093391490SM
M 14 x 100	10	125.37	27.86	0933914100SM
M 16 x 25	10	63.27	14.06	093391625SM
M 16 x 35	10	72.90	16.20	093391635SM
M 16 x 40	10	78.62	17.47	093391640SM
M 16 x 45	10	84.15	18.70	093391645SM
M 16 x 50	10	89.78	19.95	093391650SM
M 16 x 55	10	99.45	22.10	093391655SM
M 16 x 60	10	104.72	23.27	093391660SM
M 16 x 70	10	117.77	26.17	093391670SM
M 16 x 80	10	130.95	29.10	093391680SM
M 16 x 90	10	136.08	30.24	093391690SM
M 16 x 100	10	157.50	35.00	0933916100SM
M 16 x 120	10	177.53	39.45	0933916120SM
M 16 x 150	10	206.60	45.91	0933916150SM
M 18 x 30	10	96.98	21.55	093391830SM
M 18 x 40	10	108.36	24.08	093391840SM
M 18 x 45	10	166.64	37.03	093391845SM
M 18 x 55	10	166.64	37.03	093391855SM
M 18 x 70	10	166.77	37.06	093391870SM
M 20 x 40	5	133.25	29.61	093392040SM
M 20 x 50	5	152.64	33.92	093392050SM
M 20 x 55	5	167.67	37.26	093392055SM
M 20 x 60	5	167.72	37.27	093392060SM
M 20 x 65	5	177.98	39.55	093392065SM
M 20 x 70	5	180.27	40.06	093392070SM
M 20 x 80	5	204.57	45.46	093392080SM
M 20 x 90	5	253.04	56.23	093392090SM
M 20 x 100	5	253.08	56.24	0933920100SM
M 20 x 110	5	317.43	70.54	0933920110SM
M 20 x 120	5	317.43	70.54	0933920120SM
M 20 x 140	5	504.36	112.08	0933920140SM
M 20 x 150	5	504.41	112.09	0933920150SM
M 22 x 55	5	209.52	46.56	093392255SM
M 22 x 60	5	226.31	50.29	093392260SM
M 22 x 70	5	242.91	53.98	093392270SM
M 22 x 75	5	275.99	61.33	093392275SM
M 22 x 80	5	276.08	61.35	093392280SM
M 24 x 50	2	231.62	51.47	093392450SM
M 24 x 60	2	276.62	61.47	093392460SM
M 24 x 65	2	293.81	65.29	093392465SM
M 24 x 70	2	315.14	70.03	093392470SM
M 24 x 75	2	315.23	70.05	093392475SM
M 24 x 80	2	315.27	70.06	093392480SM
M 24 x 90	2	446.94	99.32	093392490SM

Surub cu cap hexagonal total filetat, otel, gr. 10.9 (continuare)

mm	Ambalare (buc.)	Pret / 100 buc.		Cod
		LEI	EURO	
M 24 x 100	2	568.44	126.32	0933924100SM
M 24 x 110	2	568.49	126.33	0933924110SM
M 24 x 120	2	568.62	126.36	0933924120SM
M 27 x 50	2	463.37	102.97	093392750SM
M 27 x 60	2	601.83	133.74	093392760SM
M 27 x 65	2	601.92	133.76	093392765SM
M 27 x 70	2	695.16	154.48	093392770SM
M 27 x 90	2	717.03	159.34	093392790SM
M 27 x 100	2	717.08	159.35	0933927100SM
M 27 x 140	2	1035.72	230.16	0933927140SM
M 27 x 160	2	1066.68	237.04	0933927160SM
M 27 x 200	2	1218.74	270.83	0933927200SM
M 30 x 60	2	699.80	155.51	093393060SM
M 30 x 80	2	813.06	180.68	093393080SM
M 30 x 110	2	1034.28	229.84	0933930110SM
M 30 x 120	2	1078.70	239.71	0933930120SM
M 30 x 150	2	1295.28	287.84	0933930150SM

Surub cu cap hexagonal total filetat, otel zincat, gr. 10.9

DIN 933



mm	Ambalare (buc.)	Pret / 100 buc.		Cod
		LEI	EURO	
M 10 x 40	25	32.90	7.31	0933Z1040SM
M 10 x 50	25	38.16	8.48	0933Z1050SM
M 10 x 60	25	43.56	9.68	0933Z1060SM
M 12 x 30	20	38.57	8.57	0933Z1230SM
M 12 x 40	20	45.90	10.20	0933Z1240SM
M 12 x 50	20	54.90	12.20	0933Z1250SM
M 12 x 60	20	61.43	13.65	0933Z1260SM
M 12 x 80	20	77.67	17.26	0933Z1280SM
M 14 x 40	10	72.23	16.05	0933Z1440SM
M 14 x 50	10	82.85	18.41	0933Z1450SM
M 14 x 60	10	95.18	21.15	0933Z1460SM
M 16 x 40	10	90.41	20.09	0933Z1640SM
M 16 x 50	10	103.23	22.94	0933Z1650SM
M 16 x 60	10	120.42	26.76	0933Z1660SM
M 16 x 80	10	150.62	33.47	0933Z1680SM
M 16 x 100	10	181.13	40.25	0933Z16100SM
M 20 x 50	5	175.55	39.01	0933Z2050SM
M 20 x 60	5	192.87	42.86	0933Z2060SM
M 20 x 70	5	207.32	46.07	0933Z2070SM
M 20 x 80	5	235.26	52.28	0933Z2080SM
M 20 x 100	5	291.06	64.68	0933Z20100SM
M 22 x 60	5	260.24	57.83	0933Z2260SM
M 22 x 80	5	317.48	70.55	0933Z2280SM
M 24 x 60	2	318.11	70.69	0933Z2460SM
M 24 x 70	2	362.39	80.53	0933Z2470SM
M 24 x 80	2	362.57	80.57	0933Z2480SM
M 24 x 90	2	513.99	114.22	0933Z2490SM
M 24 x 100	2	653.72	145.27	0933Z24100SM

Piulita hexagonala, otel zincat, gr. 8

DIN 934

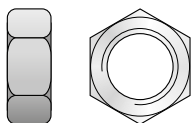

mm	Ambalare (buc.)	Pret / 100 buc.		Cod
		LEI	EURO	
M 2	1000	0.54	0.12	093482SM
M 3	1000	0.41	0.09	093483SM
M 4	1000	0.72	0.16	093484SM
M 5	1000	0.99	0.22	093485SM
M 6	1000	1.49	0.33	093486SM
M 8	500	3.06	0.68	093488SM
M 10	500	6.62	1.47	0934810SM
M 12	200	9.63	2.14	0934812SM
M 14	100	19.98	4.44	0934814SM
M 16	100	20.21	4.49	0934816SM
M 18	20	28.62	6.36	0934818SM
M 20	20	37.35	8.30	0934820SM
M 22	20	53.33	11.85	0934822SM
M 24	20	84.29	18.73	0934824SM
M 27	10	135.90	30.20	0934827SM
M 30	10	190.35	42.30	0934830SM
M 33	2	240.66	53.48	0934833SM
M 36	2	316.40	70.31	0934836SM
M 39	2	426.02	94.67	0934839SM
M 42	2	547.47	121.66	0934842SM
M 45	2	727.61	161.69	0934845SM
M 48	2	814.68	181.04	0934848SM
M 52	2	1026.50	228.11	0934852SM
M 56	2	1188.18	264.04	0934856SM
M 64	2	1796.49	399.22	0934864SM

Piulita hexagonala, otel, gr. 10

DIN 934

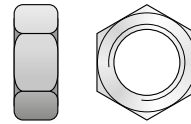

mm	Ambalare (buc.)	Pret / 100 buc.		Cod
		LEI	EURO	
M 6	100	2.16	0.48	093496SM
M 8	100	7.25	1.61	093498SM
M 10	50	9.32	2.07	0934910SM
M 12	50	13.68	3.04	0934912SM
M 14	25	19.26	4.28	0934914SM
M 16	25	26.33	5.85	0934916SM
M 18	10	37.71	8.38	0934918SM
M 20	10	53.33	11.85	0934920SM
M 22	10	62.64	13.92	0934922SM
M 24	5	91.13	20.25	0934924SM
M 27	5	139.77	31.06	0934927SM
M 30	5	207.23	46.05	0934930SM
M 36	5	377.37	83.86	0934936SM

Piulita hexagonala, otel zincat, gr. 10

DIN 934

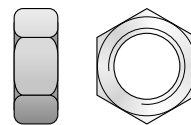

mm	Ambalare (buc.)	Pret / 100 buc.		Cod
		LEI	EURO	
M 6	100	2.48	0.55	0934Z6SM
M 10	50	10.71	2.38	0934Z10SM
M 12	50	15.75	3.50	0934Z12SM
M 14	25	22.14	4.92	0934Z14SM
M 16	25	30.29	6.73	0934Z16SM
M 18	25	43.38	9.64	0934Z18SM
M 20	10	61.34	13.63	0934Z20SM
M 22	10	72.05	16.01	0934Z22SM
M 24	5	104.81	23.29	0934Z24SM

Piulita crenelata, otel, gr. 6

DIN 935

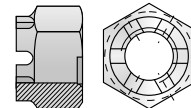

mm	Ambalare (buc.)	Pret / 100 buc.		Cod
		LEI	EURO	
M 6	10	30.69	6.82	093566SM
M 8	10	25.34	5.63	093568SM
M 10	10	30.42	6.76	0935610SM
M 12	10	46.31	10.29	0935612SM
M 14	10	92.61	20.58	0935614SM
M 16	10	128.57	28.57	0935616SM
M 18	2	277.83	61.74	0935618SM
M 20	2	299.07	66.46	0935620SM
M 24	2	497.30	110.51	0935624SM
M 27	2	911.43	202.54	0935627SM
M 30	2	911.43	202.54	0935630SM
M 39	2	1651.86	367.08	0935639SM

Surub cu cap inecat crestat, otel zincat, gr. 4.8

DIN 963



Produs cu stoc limitat.

mm	Ambalare (buc.)	Pret / 100 buc.		Cod
		LEI	EURO	
M 2 x 10	1000	5.13	1.14	09634210SM*
M 2 x 16	1000	2.93	0.65	09634216SM*
M 2.5 x 10	1000	2.16	0.48	096342510SM*
M 3 x 8	1000	3.20	0.71	0963438SM*
M 3 x 10	1000	2.16	0.48	09634310SM*
M 3 x 12	1000	2.16	0.48	09634312SM*
M 3 x 16	1000	2.16	0.48	09634316SM*
M 3 x 20	1000	2.21	0.49	09634320SM*
M 3 x 25	1000	2.66	0.59	09634325SM*
M 3 x 30	1000	2.66	0.59	09634330SM*
M 3 x 35	1000	2.66	0.59	09634335SM*
M 3 x 40	1000	4.01	0.89	09634340SM*
M 3 x 45	1000	4.05	0.90	09634345SM*
M 3 x 50	1000	4.05	0.90	09634350SM*
M 4 x 8	1000	1.76	0.39	0963448SM*
M 4 x 10	1000	1.17	0.26	09634410SM*
M 4 x 12	1000	1.98	0.44	09634412SM*

Surub cu cap inecat crestat, otel zincat, gr. 4.8 (continuare)

mm	Ambalare (buc.)	Pret / 100 buc.		Cod
		LEI	EURO	
M 4 x 16	1000	2.34	0.52	09634416SM*
M 4 x 20	1000	2.48	0.55	09634420SM*
M 4 x 25	1000	2.66	0.59	09634425SM*
M 4 x 30	1000	2.79	0.62	09634430SM*
M 4 x 35	1000	2.93	0.65	09634435SM*
M 4 x 40	1000	3.69	0.82	09634440SM*
M 4 x 50	1000	4.01	0.89	09634450SM*
M 4 x 60	1000	4.50	1.00	09634460SM*
M 4 x 70	1000	8.46	1.88	09634470SM*
M 5 x 10	500	2.93	0.65	09634510SM*
M 5 x 12	500	2.93	0.65	09634512SM*
M 5 x 16	500	3.47	0.77	09634516SM*
M 5 x 20	500	3.96	0.88	09634520SM*
M 5 x 25	500	3.96	0.88	09634525SM*
M 5 x 35	500	5.45	1.21	09634535SM*
M 5 x 40	500	5.90	1.31	09634540SM*
M 5 x 45	500	5.94	1.32	09634545SM*
M 5 x 50	500	8.33	1.85	09634550SM*
M 5 x 60	500	8.33	1.85	09634560SM*
M 5 x 70	500	10.76	2.39	09634570SM*
M 5 x 80	200	10.98	2.44	09634580SM*
M 6 x 12	250	4.14	0.92	09634612SM*
M 6 x 16	250	4.37	0.97	09634616SM*
M 6 x 20	250	5.04	1.12	09634620SM*
M 6 x 25	250	5.90	1.31	09634625SM*
M 6 x 30	250	6.35	1.41	09634630SM*
M 6 x 35	250	7.43	1.65	09634635SM*
M 6 x 40	250	8.42	1.87	09634640SM*
M 6 x 45	250	8.42	1.87	09634645SM*
M 6 x 50	250	9.81	2.18	09634650SM*
M 6 x 60	250	9.81	2.18	09634660SM*
M 6 x 70	100	11.79	2.62	09634670SM*
M 6 x 80	100	14.85	3.30	09634680SM*
M 6 x 100	100	14.90	3.31	096346100SM*
M 8 x 10	100	8.87	1.97	09634810SM*
M 8 x 16	100	10.49	2.33	09634816SM*
M 8 x 20	100	11.25	2.50	09634820SM*
M 8 x 25	100	13.41	2.98	09634825SM*
M 8 x 30	100	14.04	3.12	09634830SM*
M 8 x 35	100	14.04	3.12	09634835SM*
M 8 x 40	100	17.01	3.78	09634840SM*
M 8 x 50	100	17.10	3.80	09634850SM*
M 8 x 60	50	18.14	4.03	09634860SM*
M 8 x 80	50	18.23	4.05	09634880SM*
M 8 x 100	50	29.88	6.64	096348100SM*
M 10 x 16	50	17.28	3.84	096341016SM*
M 10 x 20	50	19.35	4.30	096341020SM*
M 10 x 25	50	21.38	4.75	096341025SM*
M 10 x 30	50	21.60	4.80	096341030SM*
M 10 x 35	50	21.65	4.81	096341035SM*
M 10 x 40	50	29.30	6.51	096341040SM*
M 10 x 50	50	29.48	6.55	096341050SM*
M 10 x 60	25	29.70	6.60	096341060SM*
M 10 x 80	25	51.89	11.53	096341080SM*
M 12 x 40	50	78.17	17.37	096341240SM*

Surub cu cap semiinecat crestat, otel zincat, gr. 4.8

DIN 964

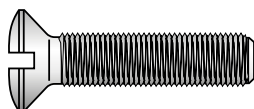

mm	Ambalare (buc.)	Pret / 100 buc.		Cod
		LEI	EURO	
M 3 x 8	500	2.21	0.49	0964438SM
M 3 x 10	500	2.21	0.49	09644310SM
M 4 x 12	500	2.39	0.53	09644412SM
M 4 x 16	500	2.48	0.55	09644416SM
M 4 x 20	500	2.84	0.63	09644420SM
M 5 x 12	250	2.61	0.58	09644512SM
M 5 x 16	250	2.66	0.59	09644516SM
M 6 x 8	100	4.77	1.06	0964468SM
M 6 x 10	100	4.91	1.09	09644610SM
M 6 x 16	100	6.12	1.36	09644616SM
M 6 x 25	100	6.75	1.50	09644625SM
M 6 x 30	100	7.92	1.76	09644630SM
M 6 x 40	100	7.92	1.76	09644640SM

Surub cu cap inecat si locas cruciform, otel zincat, gr. 4.8

DIN 965

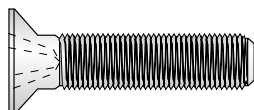

mm	Ambalare (buc.)	Pret / 100 buc.		Cod
		LEI	EURO	
M 2 x 5	1000	0.95	0.21	0965425SM
M 2.5 x 8	1000	1.22	0.27	09654258SM
M 2.5 x 10	1000	1.22	0.27	096542510SM

Surub cu cap semiinecat crestat, otel zincat, gr. 4.8 (continuare)

mm	Ambalare (buc.)	Pret / 100 buc.		Cod
		LEI	EURO	
M 2.5 x 16	1000	1.26	0.28	096542516SM
M 2.5 x 20	1000	1.26	0.28	096542520SM
M 3 x 5	1000	0.95	0.21	0965435SM
M 3 x 6	1000	1.31	0.29	0965436SM
M 3 x 8	1000	1.31	0.29	0965438SM
M 3 x 10	1000	1.31	0.29	09654310SM
M 3 x 16	1000	1.35	0.30	09654316SM
M 3 x 25	1000	1.44	0.32	09654325SM
M 4 x 10	1000	1.26	0.28	09654410SM
M 4 x 12	1000	1.44	0.32	09654412SM
M 4 x 16	1000	1.44	0.32	09654416SM
M 4 x 20	1000	1.80	0.40	09654420SM
M 4 x 25	1000	2.97	0.66	09654425SM
M 4 x 30	1000	2.97	0.66	09654430SM
M 4 x 40	1000	5.72	1.27	09654440SM
M 4 x 50	1000	5.72	1.27	09654450SM
M 4 x 60	1000	5.76	1.28	09654460SM
M 5 x 8	500	1.85	0.41	0965458SM
M 5 x 10	500	1.89	0.42	09654510SM
M 5 x 12	500	2.16	0.48	09654512SM
M 5 x 16	500	2.39	0.53	09654516SM
M 5 x 20	500	2.97	0.66	09654520SM
M 5 x 25	500	3.60	0.80	09654525SM
M 5 x 30	500	4.14	0.92	09654530SM
M 5 x 40	500	4.95	1.10	09654540SM
M 5 x 45	500	4.95	1.10	09654545SM
M 5 x 50	500	10.85	2.41	09654550SM
M 5 x 60	500	10.85	2.41	09654560SM
M 5 x 70	500	10.89	2.42	09654570SM
M 5 x 80	200	10.89	2.42	09654580SM
M 6 x 10	250	2.25	0.50	09654610SM
M 6 x 12	250	3.74	0.83	09654612SM
M 6 x 16	250	4.64	1.03	09654616SM
M 6 x 20	250	4.68	1.04	09654620SM
M 6 x 25	250	4.68	1.04	09654625SM
M 6 x 30	250	5.72	1.27	09654630SM
M 6 x 35	250	5.81	1.29	09654635SM
M 6 x 40	250	7.38	1.64	09654640SM
M 6 x 45	250	7.38	1.64	09654645SM
M 6 x 50	250	8.60	1.91	09654650SM
M 6 x 55	250	9.14	2.03	09654655SM
M 6 x 60	250	10.80	2.40	09654660SM
M 6 x 70	250	12.78	2.84	09654670SM
M 6 x 80	250	14.58	3.24	09654680SM
M 8 x 16	100	7.16	1.59	09654816SM
M 8 x 20	100	7.20	1.60	09654820SM
M 8 x 25	100	8.01	1.78	09654825SM
M 8 x 30	100	13.01	2.89	09654830SM
M 8 x 35	100	13.01	2.89	09654835SM
M 8 x 40	100	13.05	2.90	09654840SM
M 8 x 45	100	13.05	2.90	09654845SM
M 8 x 50	100	16.47	3.66	09654850SM
M 8 x 60	100	16.74	3.72	09654860SM

Surub cu cap semiinecat si locas cruciform, otel zincat, gr. 4.8

DIN 966

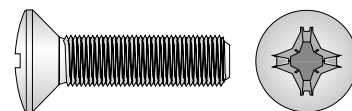

mm	Ambalare (buc.)	Pret / 100 buc.		Cod
		LEI	EURO	
M 3 x 8	1000	1.17	0.26	0966438SM
M 3 x 10	1000	1.22	0.27	09664310SM
M 3 x 12	1000	1.58	0.35	09664312SM
M 3 x 16	1000	1.71	0.38	09664316SM
M 3 x 25	1000	2.48	0.55	09664325SM
M 3 x 30	1000	2.52	0.56	09664330SM
M 4 x 10	1000	1.08	0.24	09664410SM
M 4 x 12	1000	2.07	0.46	09664412SM
M 4 x 16	1000	2.12	0.47	09664416SM
M 4 x 20	1000	2.16	0.48	09664420SM
M 5 x 16	500	3.02	0.67	09664516SM
M 5 x 20	500	3.02	0.67	09664520SM
M 5 x 25	500	3.92	0.87	09664525SM
M 5 x 30	500	4.32	0.96	09664530SM
M 6 x 16	250	4.01	0.89	09664616SM
M 6 x 20	250	4.37	0.97	09664620SM
M 6 x 25	250	5.45	1.21	09664625SM
M 6 x 40	250	6.71	1.49	09664640SM
M 6 x 45	250	8.24	1.83	09664645SM

Tije filetate 1m, otel zincat, gr. 4.6

DIN 975



mm	Ambalare (buc.)	Pret / 100 buc.		Cod
		LEI	EURO	
M 4	100	92.03	20.45	0975041SM
M 5	100	112.14	24.92	0975051SM
M 6	100	112.19	24.93	0975061SM
M 8	50	158.49	35.22	0975081SM
M 10	30	245.03	54.45	09750101SM
M 12	30	388.08	86.24	09750121SM
M 14	10	536.40	119.20	09750141SM
M 16	20	738.36	164.08	09750161SM
M 18	10	1191.42	264.76	09750181SM
M 20	10	1247.94	277.32	09750201SM
M 22	10	1250.19	277.82	09750221SM
M 24	10	1501.02	333.56	09750241SM
M 27	10	2370.69	526.82	09750271SM
M 30	2	2609.69	579.93	09750301SM
M 36	2	4284.00	952.00	09750361SM
M 39	2	4975.29	1105.62	09750391SM
M 42	2	6578.37	1461.86	09750421SM
M 45	2	6613.43	1469.65	09750451SM
M 48	2	7862.85	1747.30	09750481SM
M 52	2	10491.62	2331.47	09750521SM
M 56	2	10572.26	2349.39	09750561SM

Tije filetate 1m, otel, gr. 4.6

DIN 975



mm	Ambalare (buc.)	Pret / 100 buc.		Cod
		LEI	EURO	
M 4	100	88.79	19.73	0975141SM
M 5	100	89.87	19.97	0975151SM
M 6	100	98.19	21.82	0975161SM
M 8	50	153.86	34.19	0975181SM
M 10	25	259.65	57.70	09751101SM
M 12	20	385.56	85.68	09751121SM
M 14	10	539.37	119.86	09751141SM
M 16	10	657.90	146.20	09751161SM
M 18	10	1155.65	256.81	09751181SM
M 20	10	1156.37	256.97	09751201SM
M 24	10	1645.88	365.75	09751241SM
M 27	10	2116.67	470.37	09751271SM
M 30	2	2635.92	585.76	09751301SM
M 36	2	3848.00	855.11	09751361SM
M 48	2	9154.26	2034.28	09751481SM

Tije filetate 1m, otel zincat, gr. 8.8

DIN 975



mm	Ambalare (buc.)	Pret / 100 buc.		Cod
		LEI	EURO	
M 6	100	191.21	42.49	0975661SM
M 8	50	266.99	59.33	0975681SM
M 10	50	443.93	98.65	09756101SM
M 12	20	613.44	136.32	09756121SM
M 16	10	1151.01	255.78	09756161SM
M 20	10	1614.51	358.78	09756201SM
M 24	10	2517.48	559.44	09756241SM

Tije filetate 1m, otel, gr. 8.8

DIN 975



mm	Ambalare (buc.)	Pret / 100 buc.		Cod
		LEI	EURO	
M 6	100	148.68	33.04	0975861SM
M 8	50	242.69	53.93	0975881SM
M 10	50	425.21	94.49	09758101SM
M 12	20	539.91	119.98	09758121SM
M 14	10	717.21	159.38	09758141SM
M 16	10	1046.34	232.52	09758161SM
M 18	10	1251.50	278.11	09758181SM
M 20	10	1467.72	326.16	09758201SM
M 22	10	1813.86	403.08	09758221SM
M 24	10	2321.51	515.89	09758241SM
M 27	10	3339.27	742.06	09758271SM
M 30	2	3636.54	808.12	09758301SM
M 33	2	4468.19	992.93	09758331SM
M 36	2	5512.10	1224.91	09758361SM
M 42	2	8218.17	1826.26	09758421SM
M 48	2	10676.97	2372.66	09758481SM

Tije filetate 1m, otel, gr. 10.9

DIN 975



mm	Ambalare (buc.)	Pret / 100 buc.		Cod
		LEI	EURO	
M 8	50	250.97	55.77	0975981SM
M 10	50	401.72	89.27	09759101SM
M 12	20	630.32	140.07	09759121SM
M 16	10	1166.72	259.27	09759161SM
M 20	5	1825.70	405.71	09759201SM

Tije filetate 2m, otel zincat, gr. 4.6

DIN 975



mm	Ambalare (buc.)	Pret / 100 buc.		Cod
		LEI	EURO	
M 6	50	222.57	49.46	0975062SM
M 8	40	313.74	69.72	0975082SM
M 10	30	517.64	115.03	09750102SM
M 12	10	776.16	172.48	09750122SM
M 16	10	1417.68	315.04	09750162SM
M 20	10	2622.74	582.83	09750202SM
M 24	10	3302.15	733.81	09750242SM
M 27	10	4330.17	962.26	09750272SM

Tije filetate 2m, otel zincat, gr. 8.8

DIN 975



mm	Ambalare (buc.)	Pret / 100 buc.		Cod
		LEI	EURO	
M 8	50	600.84	133.52	0975882SM
M 10	50	903.60	200.80	09758102SM
M 12	20	1260.00	280.00	09758122SM
M 16	10	2532.20	562.71	09758162SM
M 20	10	3551.99	789.33	09758202SM
M 24	10	5538.51	1230.78	09758242SM
M 30	2	7368.03	1637.34	09758302SM
M 36	2	10149.98	2255.55	09758362SM

Tije filetate 3m, otel zincat, gr. 4.6

DIN 975



mm	Ambalare (buc.)	Pret / 100 buc.		Cod
		LEI	EURO	
M 6	50	333.90	74.20	0975063SM
M 8	25	505.26	112.28	0975083SM
M 10	25	776.43	172.54	09750103SM
M 12	10	1164.29	258.73	09750123SM
M 16	10	2238.39	497.42	09750163SM
M 20	10	3934.08	874.24	09750203SM
M 24	10	4953.29	1100.73	09750243SM

Tija filetata 3m, otel, gr. 8.8

DIN 975



mm	Ambalare (buc.)	Pret / 100 buc.		Cod
		LEI	EURO	
M 36	2	12337.83	2741.74	09758363SM

Tije filetate 3m, otel zincat, gr. 8.8

DIN 975



mm	Ambalare (buc.)	Pret / 100 buc.		Cod
		LEI	EURO	
M10	10	1154.43	256.54	09756103SM
M12	10	1588.68	353.04	09756123SM
M16	10	2919.24	648.72	09756163SM
M20	10	4651.29	1033.62	09756203SM
M24	10	6699.20	1488.71	09756243SM

Tije filetate, otel zincat, gr. 4.6

DIN 976



mm	Ambalare (buc.)	Pret / 100 buc.		Cod
		LEI	EURO	
M 6 x 30	50	15.80	3.51	09764630SM
M 6 x 35	50	16.65	3.70	09764635SM
M 6 x 40	50	17.24	3.83	09764640SM
M 6 x 50	50	18.59	4.13	09764650SM
M 6 x 60	50	20.30	4.51	09764660SM
M 6 x 70	50	21.92	4.87	09764670SM
M 6 x 80	50	22.91	5.09	09764680SM
M 6 x 90	50	24.08	5.35	09764690SM
M 6 x 100	50	25.61	5.69	097646100SM
M 8 x 40	50	20.57	4.57	09764840SM
M 8 x 50	50	22.82	5.07	09764850SM
M 8 x 60	50	25.34	5.63	09764860SM
M 8 x 70	50	27.77	6.17	09764870SM
M 8 x 80	50	29.39	6.53	09764880SM
M 8 x 90	50	31.14	6.92	09764890SM
M 8 x 100	50	33.35	7.41	097648100SM
M 8 x 120	50	39.92	8.87	097648120SM
M10 x 40	50	26.24	5.83	097641040SM
M10 x 50	50	29.88	6.64	097641050SM
M10 x 60	50	33.93	7.54	097641060SM
M10 x 70	50	37.80	8.40	097641070SM
M10 x 80	50	40.14	8.92	097641080SM
M10 x 90	50	43.07	9.57	097641090SM
M10 x 100	50	46.80	10.40	0976410100SM
M10 x 120	50	57.02	12.67	0976410120SM
M10 x 140	50	64.71	14.38	0976410140SM
M10 x 150	50	73.49	16.33	0976410150SM

Piulita hexagonala cu autoblocare, otel zincat, gr. 6

DIN 985

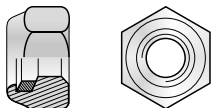

mm	Ambalare (buc.)	Pret / 100 buc.		Cod
		LEI	EURO	
M 3	250	2.12	0.47	098563SM
M 4	250	1.80	0.40	098564SM
M 5	250	1.89	0.42	098565SM
M 6	250	2.39	0.53	098566SM
M 8	250	5.04	1.12	098568SM
M 10	200	10.40	2.31	0985610SM
M 12	100	15.57	3.46	0985612SM
M 14	50	23.81	5.29	0985614SM
M 16	50	31.46	6.99	0985616SM
M 18	20	47.43	10.54	0985618SM
M 20	20	63.32	14.07	0985620SM
M 24	10	141.03	31.34	0985624SM
M 30	10	329.58	73.24	0985630SM

Piulita HEX de inalta rezistenta cu autoblocare, otel zincat, gr. 10

DIN 985

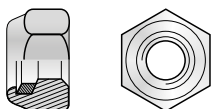

mm	Ambalare (buc.)	Pret / 100 buc.		Cod
		LEI	EURO	
M 6	25	4.32	0.96	098596SM
M 8	25	9.86	2.19	098598SM
M 10	25	16.07	3.57	0985910SM
M 12	10	20.75	4.61	0985912SM
M 14	10	47.25	10.50	0985914SM
M 16	5	47.30	10.51	0985916SM
M 20	5	130.05	28.90	0985920SM

Saiba pentru lemn, serie mare, otel zincat

DIN 1052

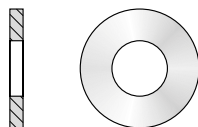

mm	Ambalare (buc.)	Pret / 100 buc.		Cod
		LEI	EURO	
14 x 58 x 6	50	133.20	29.60	1052014586SM
18 x 68 x 6	50	133.74	29.72	1052018686SM

Piulita intinzatoare forjata, otel zincat

DIN 1480

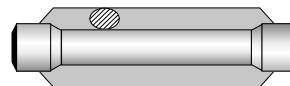

mm	Ambalare (buc.)	Pret / 100 buc.		Cod
		LEI	EURO	
M 6	2	128.25	28.50	148006SM
M 8	2	199.89	44.42	148008SM
M 10	2	313.20	69.60	148010SM
M 12	2	492.35	109.41	148012SM
M 16	2	771.84	171.52	148016SM
M 20	2	1423.76	316.39	148020SM
M 24	2	2288.61	508.58	148024SM
M 30	2	4393.94	976.43	148030SM
M 36	2	7486.70	1663.71	148036SM

Intinzator ochi - ochi, otel zincat

DIN 1480

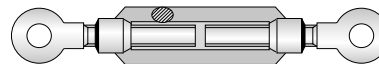

mm	Ambalare (buc.)	Pret / 100 buc.		Cod
		LEI	EURO	
M 6	2	225.59	50.13	148016SM
M 8	2	362.48	80.55	148018SM
M 10	2	506.57	112.57	148010SM
M 12	2	752.49	167.22	148012SM
M 14	2	1114.92	247.76	148014SM
M 16	2	1478.48	328.55	148016SM
M 20	2	2324.75	516.61	148012SM
M 24	2	3994.97	887.77	1480124SM

Intinzator ochi - carlig, otel zincat

DIN 1480

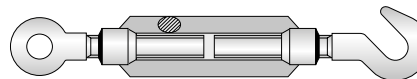

mm	Ambalare (buc.)	Pret / 100 buc.		Cod
		LEI	EURO	
M 6	2	300.65	66.81	148026SM
M 8	2	347.67	77.26	148028SM
M 10	2	534.51	118.78	1480210SM
M 12	2	635.81	141.29	1480212SM
M 14	2	1062.54	236.12	1480214SM
M 16	2	1487.21	330.49	1480216SM
M 20	2	2883.51	640.78	1480220SM
M 24	2	3739.91	831.09	1480224SM

Intinzator prezon - prezon, otel zincat

DIN 1480

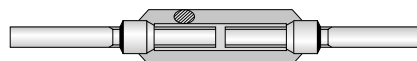

mm	Ambalare (buc.)	Pret / 100 buc.		Cod
		LEI	EURO	
M 6	2	217.89	48.42	148036SM
M 8	2	409.64	91.03	148038SM
M 10	2	565.56	125.68	1480310SM
M 12	2	715.50	159.00	1480312SM
M 16	2	1405.89	312.42	1480316SM
M 20	2	2583.45	574.10	1480320SM
M 24	2	4161.15	924.70	1480324SM
M 30	2	7628.90	1695.31	1480330SM
M 36	2	12607.20	2801.60	1480336SM

Stift elastic - serie grea, otel

DIN 1481



Produs cu stoc limitat

mm	Ambalare (buc.)	Pret / 100 buc.		Cod
		LEI	EURO	
1.5 x 6	50	5.13	1.14	14810156SM
1.5 x 10	50	6.84	1.52	148101510SM
1.5 x 12	50	6.84	1.52	148101512SM
1.5 x 14	50	10.22	2.27	148101514SM
1.5 x 16	50	10.22	2.27	148101516SM
1.5 x 18	50	11.88	2.64	148101518SM
1.5 x 20	50	13.41	2.98	148101520SM
2 x 6	50	6.48	1.44	1481026SM
2 x 8	50	5.18	1.15	1481028SM
2 x 10	50	5.18	1.15	14810210SM

Stift elastic - serie grea, otel (continuare)

mm	Ambalare (buc.)	Pret / 100 buc.		Cod
		LEI	EURO	
2 x 12	50	9.90	2.20	14810212SM
2 x 14	50	9.90	2.20	14810214SM
2 x 16	50	9.95	2.21	14810216SM
2 x 20	50	9.99	2.22	14810220SM
2 x 22	50	10.53	2.34	14810222SM
2 x 24	50	10.58	2.35	14810224SM
2 x 26	50	10.58	2.35	14810226SM
2 x 28	50	10.62	2.36	14810228SM
2.5 x 6	50	8.91	1.98	14810256SM
2.5 x 8	50	5.49	1.22	14810258SM
2.5 x 10	50	5.49	1.22	148102510SM
2.5 x 12	50	8.87	1.97	148102512SM
2.5 x 14	50	8.87	1.97	148102514SM
2.5 x 18	50	8.91	1.98	148102518SM
2.5 x 20	50	8.91	1.98	148102520SM
2.5 x 22	50	8.96	1.99	148102522SM
2.5 x 24	50	11.48	2.55	148102524SM
2.5 x 26	50	11.52	2.56	148102526SM
2.5 x 28	50	11.84	2.63	148102528SM
2.5 x 30	50	11.84	2.63	148102530SM
3 x 6	50	3.33	0.74	1481036SM
3 x 8	50	5.81	1.29	1481038SM
3 x 10	50	5.81	1.29	14810310SM
3 x 12	50	5.81	1.29	14810312SM
3 x 16	50	5.85	1.30	14810316SM
3 x 18	50	5.90	1.31	14810318SM
3 x 22	50	5.90	1.31	14810322SM
3 x 26	50	5.94	1.32	14810326SM
3 x 28	50	5.94	1.32	14810328SM
3 x 30	50	5.99	1.33	14810330SM
3 x 36	50	6.03	1.34	14810336SM
3 x 40	50	6.03	1.34	14810340SM
3.5 x 10	25	6.53	1.45	148103510SM
3.5 x 12	25	7.20	1.60	148103512SM
3.5 x 14	25	8.01	1.78	148103514SM
3.5 x 16	25	8.01	1.78	148103516SM
3.5 x 18	25	8.33	1.85	148103518SM
3.5 x 20	25	8.33	1.85	148103520SM
3.5 x 22	25	9.99	2.22	148103522SM
3.5 x 30	25	9.99	2.22	148103530SM
3.5 x 40	25	10.08	2.24	148103540SM
4 x 8	25	6.62	1.47	1481048SM
4 x 12	25	6.89	1.53	14810412SM
4 x 14	25	6.98	1.55	14810414SM
4 x 20	25	6.98	1.55	14810420SM
4 x 24	25	7.02	1.56	14810424SM
4 x 30	25	7.07	1.57	14810430SM
4 x 36	25	9.95	2.21	14810436SM
4.5 x 8	25	15.30	3.40	14810458SM
4.5 x 10	25	15.44	3.43	148104510SM
4.5 x 12	25	16.34	3.63	148104512SM
4.5 x 14	25	16.70	3.71	148104514SM
4.5 x 18	25	16.70	3.71	148104518SM
4.5 x 20	25	19.04	4.23	148104520SM
4.5 x 22	25	20.39	4.53	148104522SM
4.5 x 24	25	20.93	4.65	148104524SM
4.5 x 26	25	23.58	5.24	148104526SM
4.5 x 28	25	23.58	5.24	148104528SM
4.5 x 30	25	23.63	5.25	148104530SM
4.5 x 32	25	23.63	5.25	148104532SM
4.5 x 36	25	24.35	5.41	148104536SM
4.5 x 40	25	24.35	5.41	148104540SM
4.5 x 45	25	25.70	5.71	148104545SM
5 x 8	25	5.27	1.17	1481058SM
5 x 10	25	6.53	1.45	14810510SM
5 x 14	25	6.53	1.45	14810514SM
5 x 18	25	10.80	2.40	14810518SM
5 x 20	25	10.80	2.40	14810520SM
5 x 24	25	10.85	2.41	14810524SM
5 x 26	25	12.02	2.67	14810526SM
5 x 28	25	12.06	2.68	14810528SM
5 x 30	25	12.11	2.69	14810530SM
5 x 36	25	12.42	2.76	14810536SM
5 x 40	25	12.42	2.76	14810540SM
5 x 50	25	14.00	3.11	14810550SM
6 x 10	10	11.16	2.48	14810610SM
6 x 12	10	11.34	2.52	14810612SM
6 x 14	10	12.11	2.69	14810614SM
6 x 16	10	13.82	3.07	14810616SM
6 x 18	10	19.76	4.39	14810618SM
6 x 20	10	19.76	4.39	14810620SM
6 x 22	10	20.66	4.59	14810622SM
6 x 24	10	20.66	4.59	14810624SM
6 x 26	10	20.66	4.59	14810626SM
6 x 28	10	20.70	4.60	14810628SM
6 x 30	10	20.75	4.61	14810630SM
6 x 32	10	20.79	4.62	14810632SM
6 x 36	10	20.88	4.64	14810636SM
6 x 40	10	20.93	4.65	14810640SM
6 x 45	10	20.97	4.66	14810645SM
6 x 50	10	20.97	4.66	14810650SM
6 x 60	10	23.31	5.18	14810660SM
6 x 70	10	25.38	5.64	14810670SM
6 x 80	10	30.83	6.85	14810680SM
8 x 10	10	12.69	2.82	14810810SM
8 x 12	10	14.18	3.15	14810812SM
8 x 14	10	15.30	3.40	14810814SM
8 x 20	10	15.30	3.40	14810820SM
8 x 22	10	18.09	4.02	14810822SM
8 x 26	10	19.17	4.26	14810826SM
8 x 30	10	21.56	4.79	14810830SM

Stift elastic - serie grea, otel (continuare)

mm	Ambalare (buc.)	Pret / 100 buc.		Cod
		LEI	EURO	
8 x 32	10	30.96	6.88	14810832SM
8 x 36	10	30.96	6.88	14810836SM
8 x 40	10	31.01	6.89	14810840SM
8 x 50	10	32.90	7.31	14810850SM
8 x 60	10	47.03	10.45	14810860SM
8 x 70	10	48.96	10.88	14810870SM
8 x 80	10	49.01	10.89	14810880SM
8 x 90	10	49.05	10.90	14810890SM
8 x 100	10	81.81	18.18	148108100SM
10 x 20	5	28.49	6.33	148101020SM
10 x 30	5	28.53	6.34	148101030SM
10 x 32	5	41.94	9.32	148101032SM
10 x 36	5	41.99	9.33	148101036SM
10 x 40	5	55.49	12.33	148101040SM
10 x 50	5	55.49	12.33	148101050SM
10 x 60	5	55.58	12.35	148101060SM
10 x 70	5	75.87	16.86	148101070SM
10 x 80	5	87.57	19.46	148101080SM
10 x 100	5	99.05	22.01	1481010100SM
12 x 24	5	53.33	11.85	148101224SM
12 x 26	5	54.45	12.10	148101226SM
12 x 30	5	54.50	12.11	148101230SM
12 x 40	5	61.25	13.61	148101240SM
12 x 45	5	61.34	13.63	148101245SM
12 x 50	5	68.63	15.25	148101250SM
12 x 70	5	79.88	17.75	148101270SM
12 x 80	5	106.74	23.72	148101280SM
12 x 100	5	141.53	31.45	1481012100SM
12 x 120	5	144.59	32.13	1481012120SM
16 x 36	2	104.00	23.11	148101636SM
16 x 40	2	104.09	23.13	148101640SM
16 x 45	2	218.39	48.53	148101645SM
16 x 50	2	219.56	48.79	148101650SM
16 x 60	2	219.56	48.79	148101660SM

Piulita infundata inalta, otel zincat, gr. 6

DIN 1587

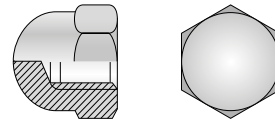

mm	Ambalare (buc.)	Pret / 100 buc.		Cod
		LEI	EURO	
M 4	50	4.32	0.96	158764SM
M 5	50	5.04	1.12	158765SM
M 6	50	5.36	1.19	158766SM
M 8	50	9.95	2.21	158768SM
M 10	50	20.61	4.58	1587610SM
M 12	50	30.83	6.85	1587612SM
M 14	25	46.76	10.39	1587614SM
M 16	25	65.97	14.66	1587616SM
M 20	25	131.45	29.21	1587620SM
M 24	10	206.55	45.90	1587624SM

Piulita de cuplare, otel zincat

DIN 6334

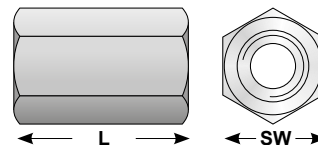

M x L x SW (mm)	Ambalare (buc.)	Pret / 100 buc.		Cod
		LEI	EURO	
M 5 x 20 x 8	200	12.47	2.77	633405208SM
M 6 x 20 x 10	200	17.28	3.84	6334062010SM
M 6 x 25 x 10	100	20.97	4.66	6334062510SM
M 6 x 30 x 10	100	26.96	5.99	6334063010SM
M 6 x 40 x 10	100	36.23	8.05	6334064010SM
M 6 x 50 x 10	100	55.67	12.37	6334065010SM
M 8 x 20 x 11	100	17.51	3.89	6334082011SM
M 8 x 25 x 11	100	18.63	4.14	6334082511SM
M 8 x 30 x 11	100	22.95	5.10	6334083011SM
M 8 x 40 x 11	100	26.19	5.82	6334084011SM
M 8 x 50 x 11	100	76.95	17.10	6334085011SM
M 10 x 20 x 13	100	22.95	5.10	63340102013SM
M 10 x 25 x 13	100	28.94	6.43	63340102513SM
M 10 x 30 x 13	100	28.94	6.43	63340103013SM
M 10 x 40 x 13	50	36.27	8.06	63340104013SM
M 10 x 50 x 13	50	53.69	11.93	63340105013SM
M 12 x 20 x 17	100	72.50	16.11	63340122017SM
M 12 x 25 x 17	100	76.14	16.92	63340122517SM
M 12 x 30 x 17	100	76.14	16.92	63340123017SM
M 12 x 35 x 17	100	76.19	16.93	63340123517SM
M 12 x 40 x 17	50	76.28	16.95	63340124017SM
M 12 x 50 x 17	50	76.32	16.96	63340125017SM
M 14 x 50 x 22	25	124.25	27.61	63340145022SM
M 16 x 40 x 24	50	116.01	25.78	63340164024SM
M 16 x 50 x 24	50	164.84	36.63	63340165024SM
M 20 x 50 x 30	25	405.86	90.19	63340205030SM
M 20 x 60 x 30	25	406.04	90.23	63340206030SM

Piulita cilindrica de cuplare, otel zincat



mm	Ambalare (buc.)	Pret / 100 buc.		Cod
		LEI	EURO	
M 4 x 20	200	13.05	2.90	X0320420SM
M 5 x 15	200	19.04	4.23	X0320515SM
M 5 x 20	200	19.04	4.23	X0320520SM
M 5 x 25	200	20.79	4.62	X0320525SM
M 6 x 15	200	19.89	4.42	X0320615SM
M 6 x 20	200	15.26	3.39	X0320620SM
M 6 x 25	200	17.69	3.93	X0320625SM
M 6 x 30	150	20.21	4.49	X0320630SM
M 6 x 40	100	31.55	7.01	X0320640SM
M 6 x 50	100	65.79	14.62	X0320650SM
M 8 x 15	100	24.35	5.41	X0320815SM
M 8 x 20	100	15.08	3.35	X0320820SM
M 8 x 25	100	17.87	3.97	X0320825SM
M 8 x 30	50	19.67	4.37	X0320830SM
M 8 x 35	50	43.88	9.75	X0320835SM
M 8 x 40	50	43.92	9.76	X0320840SM
M 8 x 50	50	57.51	12.78	X0320850SM
M 10 x 20	50	25.25	5.61	X03201020SM
M 10 x 25	50	20.97	4.66	X03201025SM
M 10 x 30	25	24.71	5.49	X03201030SM
M 10 x 40	25	40.91	9.09	X03201040SM
M 10 x 50	25	63.77	14.17	X03201050SM
M 12 x 20	50	38.84	8.63	X03201220SM
M 12 x 25	25	79.92	17.76	X03201225SM
M 12 x 30	25	37.62	8.36	X03201230SM
M 12 x 35	25	43.74	9.72	X03201235SM
M 12 x 40	25	43.74	9.72	X03201240SM
M 12 x 50	25	68.31	15.18	X03201250SM
M 16 x 50	25	140.63	31.25	X03201650SM
M 20 x 50	25	474.39	105.42	X03202050SM

Saiba plata - serie grea, otel

DIN 6340

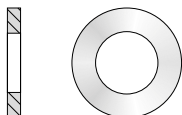

mm	Ambalare (buc.)	Pret / 100 buc.		Cod
		LEI	EURO	
6.4 x 17 x 3	50	5.31	1.18	6340064173SM
8.4 x 23 x 4	20	18.05	4.01	6340084234SM
10.5 x 28 x 4	20	19.80	4.40	63400105284SM
13 x 35 x 5	10	57.38	12.75	6340013355SM
17 x 45 x 6	5	75.87	16.86	6340017456SM
21 x 50 x 6	5	138.65	30.81	6340021506SM
25 x 60 x 8	2	170.87	37.97	6340025608SM
31 x 68 x 10	2	627.30	139.40	63400316810SM

Saiba elastica cu dinti interiori, forma "I", otel zincat

DIN 6797

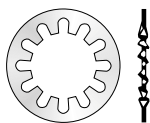

mm	Ambalare (buc.)	Pret / 100 buc.		Cod
		LEI	EURO	
5.3	1000	1.08	0.24	6797I53SM
6.4	1000	1.49	0.33	6797I64SM
8.4	1000	2.66	0.59	6797I84SM
10.5	1000	5.99	1.33	6797I105SM
13.0	500	6.03	1.34	6797I13SM
17.0	250	14.99	3.33	6797I17SM

Saiba elastica cu dinti exteriori, forma "A", otel zincat

DIN 6797

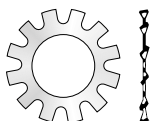

mm	Ambalare (buc.)	Pret / 100 buc.		Cod
		LEI	EURO	
3.2	1000	1.04	0.23	6797A32SM
5.3	1000	1.04	0.23	6797A53SM
6.4	1000	1.67	0.37	6797A64SM
10.5	1000	4.64	1.03	6797A105SM
17.0	250	10.26	2.28	6797A17SM
19.0	250	22.68	5.04	6797A19SM
25.0	100	37.89	8.42	6797A25SM

Saiba elastica cu crestaturi interioare, forma "I", otel zincat

DIN 6798



mm	Ambalare (buc.)	Pret / 100 buc.		Cod
		LEI	EURO	
3.2	1000	1.08	0.24	6798I32SM
5.3	1000	1.62	0.36	6798I53SM
6.4	1000	2.39	0.53	6798I64SM
10.5	1000	7.25	1.61	6798I105SM
13.0	500	8.37	1.86	6798I13SM
15.0	500	13.23	2.94	6798I15SM
17.0	250	16.38	3.64	6798I17SM
19.0	250	27.72	6.16	6798I19SM

Saiba elastica cu crestaturi exterioare, forma "A", otel zincat

DIN 6798

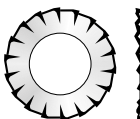

mm	Ambalare (buc.)	Pret / 100 buc.		Cod
		LEI	EURO	
3.2	1000	1.40	0.31	6798A32SM
4.3	1000	4.82	1.07	6798A43SM
5.3	1000	4.82	1.07	6798A53SM
6.4	1000	4.86	1.08	6798A64SM
8.4	1000	6.44	1.43	6798A84SM
10.5	1000	6.44	1.43	6798A105SM
13.0	500	7.07	1.57	6798A13SM
15.0	500	12.96	2.88	6798A15SM
17.0	250	16.29	3.62	6798A17SM
19.0	250	27.72	6.16	6798A19SM
21.0	200	27.77	6.17	6798A21SM
25.0	100	42.57	9.46	6798A25SM
28.0	100	66.92	14.87	6798A28SM

Siguranta pentru arbori, otel

DIN 6799

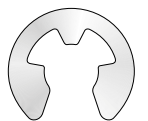

mm	Ambalare (buc.)	Pret / 100 buc.		Cod
		LEI	EURO	
D 1.2	100	5.54	1.23	67990012SM
D 1.5	100	2.57	0.57	67990015SM
D 1.9	100	3.06	0.68	67990019SM
D 2.3	100	3.11	0.69	67990023SM
D 4.0	100	3.20	0.71	679904SM
D 5.0	100	3.29	0.73	679905SM
D 6.0	100	3.69	0.82	679906SM
D 7.0	100	5.09	1.13	679907SM
D 10.0	100	9.54	2.12	6799010SM
D 12.0	100	13.28	2.95	6799012SM
D 19.0	50	24.98	5.55	6799019SM

Surub cu cap HEX "IP" de inalta rezistenta, otel zincat, gr. 10.9

DIN 6914



Produs cu stoc limitat.

mm	Ambalare (buc.)	Pret / 100 buc.		Cod
		LEI	EURO	
M 16 x 65	25	134.10	29.80	691411665SM
M 16 x 85	25	158.76	35.28	691411685SM
M 16 x 90	25	207.00	46.00	691411690SM
M 20 x 90	25	270.77	60.17	691412090SM
M 22 x 65	25	311.22	69.16	691412265SM
M 22 x 105	25	362.88	80.64	6914122105SM
M 24 x 90	15	438.89	97.53	691412490SM
M 24 x 95	15	456.30	101.40	691412495SM
M 24 x 105	15	453.20	100.71	6914124105SM
M 24 x 110	15	570.15	126.70	6914124110SM
M 24 x 120	15	550.85	122.41	6914124120SM
M 27 x 95	10	509.85	113.30	691412795SM
M 27 x 100	10	562.28	124.95	6914127100SM
M 27 x 115	10	638.69	141.93	6914127115SM
M 27 x 125	10	675.41	150.09	6914127125SM
M 27 x 140	10	735.53	163.45	6914127140SM
M 30 x 115	10	834.35	185.41	6914130115SM
M 30 x 130	10	1400.09	311.13	6914130130SM
M 30 x 140	5	1181.25	262.50	6914130140SM

Surub cu cap hexagonal "IP" de inalta rezistenta, otel, gr. 10.9

DIN 6914



Produs cu stoc limitat.

mm	Ambalare (buc.)	Pret / 100 buc.		Cod
		LEI	EURO	
M 12 x 65	50	91.89	20.42	691491265SM*
M 16 x 60	50	124.07	27.57	691491660SM*
M 16 x 65	25	145.71	32.38	691491665SM*
M 16 x 85	25	178.07	39.57	691491685SM*
M 16 x 90	25	168.84	37.52	691491690SM*
M 20 x 90	25	270.77	60.17	691492090SM*
M 22 x 70	25	289.13	64.25	691492270SM*
M 24 x 70	25	367.52	81.67	691492470SM*
M 24 x 95	15	481.59	107.02	691492495SM*
M 24 x 110	15	497.25	110.50	6914924110SM*
M 24 x 120	15	531.86	118.19	6914924120SM*
M 24 x 135	10	621.41	138.09	6914924135SM*
M 27 x 95	10	536.45	119.21	691492795SM*
M 27 x 100	10	559.62	124.36	6914927100SM*
M 27 x 115	10	607.64	135.03	6914927115SM*
M 27 x 125	10	715.68	159.04	6914927125SM*
M 27 x 140	10	809.10	179.80	6914927140SM*
M 30 x 100	10	793.04	176.23	6914930100SM*
M 30 x 115	10	841.64	187.03	6914930115SM*
M 30 x 135	5	935.33	207.85	6914930135SM*
M 30 x 140	5	1137.69	252.82	6914930140SM*

Surub cu cap hexagonal si flansa, otel zincat, gr. 8.8

DIN 6921

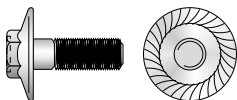

mm	Ambalare (buc.)	Pret / 100 buc.		Cod
		LEI	EURO	
M 6 x 12	500	10.13	2.25	69218612SM
M 6 x 16	500	10.85	2.41	69218616SM
M 6 x 20	500	10.89	2.42	69218620SM
M 6 x 30	500	13.86	3.08	69218630SM
M 6 x 35	500	14.81	3.29	69218635SM
M 6 x 40	500	18.05	4.01	69218640SM
M 8 x 16	200	19.71	4.38	69218816SM
M 8 x 20	200	20.16	4.48	69218820SM
M 8 x 25	200	20.30	4.51	69218825SM
M 8 x 35	200	32.27	7.17	69218835SM
M 8 x 40	200	32.36	7.19	69218840SM
M 10 x 20	200	39.65	8.81	692181020SM
M 10 x 25	200	33.66	7.48	692181025SM
M 10 x 30	200	34.61	7.69	692181030SM
M 10 x 35	100	37.62	8.36	692181035SM
M 10 x 50	100	49.64	11.03	692181050SM
M 12 x 25	100	60.75	13.50	692181225SM
M 12 x 30	100	60.80	13.51	692181230SM
M 12 x 35	100	76.23	16.94	692181235SM
M 12 x 40	100	81.77	18.17	692181240SM
M 12 x 60	100	85.86	19.08	692181260SM

Piulita hexagonala cu flansa, otel zincat, gr. 8

DIN 6923



mm	Ambalare (buc.)	Pret / 100 buc.		Cod
		LEI	EURO	
M 4	250	1.67	0.37	692384SM
M 5	250	2.52	0.56	692385SM
M 6	250	2.57	0.57	692386SM
M 8	100	5.76	1.28	692388SM
M 10	100	8.64	1.92	6923810SM
M 12	100	14.72	3.27	6923812SM
M 16	50	57.33	12.74	6923816SM

Surub autoforant cu cap HEX, forma "K", otel zincat / vopsit

DIN 7504

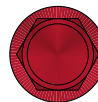
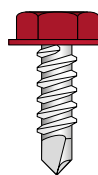

RAL	Culoarea
1021	Galben cadmiu
3002	Rosu carmin
3004	Rosu purpuriu
3005	Rosu visiniu
3009	Ruginiu
3011	Rosu maroniu
5010	Albastru gentiana
6003	Verde masliniu
6005	Verde muschi
6020	Verde crom
7043	Gri trafic B
8004	Maron cupru
8017	Maron ciocolatiu
9005	Negru intens
9010	Alb pur

mm	Ambalare (buc.)	Pret / 100 buc.		Cod
		LEI	EURO	
3.5 x 9.5 / 5.5 zincat	1000	1.71	0.38	7504K3595SM
3.5 x 13 / 5.5 zincat	500	1.71	0.38	7504K3513SM
3.5 x 16 / 5.5 zincat	500	1.71	0.38	7504K3516SM
3.5 x 19 / 5.5 zincat	500	2.79	0.62	7504K3519SM
3.5 x 25 / 5.5 zincat	250	2.84	0.63	7504K3525SM
3.5 x 32 / 5.5 zincat	250	2.84	0.63	7504K3532SM
3.9 x 13 / 5.5 zincat	200	3.47	0.77	7504K3913SM
3.9 x 16 / 5.5 zincat	200	2.61	0.58	7504K3916SM
3.9 x 19 / 5.5 zincat	200	2.61	0.58	7504K3919SM
3.9 x 25 / 5.5 zincat	200	2.61	0.58	7504K3925SM
4.2 x 13 / 7 zincat	500	2.39	0.53	7504K4213SM
4.2 x 16 / 7 zincat	500	2.70	0.60	7504K4216SM
4.2 x 16 / 7 RAL3011	500	5.45	1.21	7504K42161SM
4.2 x 16 / 7 RAL3002	500	5.45	1.21	7504K42162SM
4.2 x 16 / 7 RAL3004	500	5.45	1.21	7504K42163SM
4.2 x 16 / 7 RAL8017	500	5.45	1.21	7504K42164SM
4.2 x 16 / 7 RAL6003	500	5.45	1.21	7504K42165SM
4.2 x 16 / 7 RAL7043	500	5.45	1.21	7504K42166SM
4.2 x 16 / 7 RAL5010	500	5.45	1.21	7504K42167SM
4.2 x 16 / 7 RAL8004	500	5.45	1.21	7504K42168SM
4.2 x 16 / 7 RAL1021	500	5.45	1.21	7504K42169SM
4.2 x 16 / 7 RAL9010	500	5.45	1.21	7504K421610SM
4.2 x 16 / 7 RAL6020	500	5.45	1.21	7504K421611SM
4.2 x 16 / 7 RAL3009	500	5.45	1.21	7504K421612SM
4.2 x 16 / 7 RAL9005	500	5.45	1.21	7504K421613SM
4.2 x 16 / 7 RAL3005	500	5.45	1.21	7504K421614SM
4.2 x 16 / 7 RAL6005	500	5.45	1.21	7504K421615SM
4.2 x 19 / 7 zincat	500	2.88	0.64	7504K4219SM
4.2 x 19 / 7 RAL3011	500	5.72	1.27	7504K42191SM
4.2 x 19 / 7 RAL3002	500	5.72	1.27	7504K42192SM
4.2 x 19 / 7 RAL3004	500	5.72	1.27	7504K42193SM
4.2 x 19 / 7 RAL8017	500	5.72	1.27	7504K42194SM
4.2 x 19 / 7 RAL6003	500	5.72	1.27	7504K42195SM
4.2 x 19 / 7 RAL7043	500	5.72	1.27	7504K42196SM
4.2 x 19 / 7 RAL5010	500	5.72	1.27	7504K42197SM
4.2 x 19 / 7 RAL8004	500	5.72	1.27	7504K42198SM
4.2 x 19 / 7 RAL1021	500	5.72	1.27	7504K42199SM
4.2 x 19 / 7 RAL9010	500	5.72	1.27	7504K421910SM
4.2 x 19 / 7 RAL6020	500	5.72	1.27	7504K421911SM
4.2 x 19 / 7 RAL3009	500	5.72	1.27	7504K421912SM
4.2 x 19 / 7 RAL9005	500	5.72	1.27	7504K421913SM
4.2 x 19 / 7 RAL3005	500	5.72	1.27	7504K421914SM
4.2 x 19 / 7 RAL6005	500	5.72	1.27	7504K421915SM
4.2 x 22 / 7 zincat	250	3.15	0.70	7504K4222SM
4.2 x 25 / 7 zincat	250	3.24	0.72	7504K4225SM
4.2 x 32 / 7 zincat	250	3.42	0.76	7504K4232SM
4.2 x 38 / 7 zincat	250	5.81	1.29	7504K4238SM
4.8 x 13 / 8 zincat	500	3.42	0.76	7504K4813SM
4.8 x 16 / 8 zincat	250	3.42	0.76	7504K4816SM
4.8 x 16 / 8 RAL3011	250	6.21	1.38	7504K48161SM
4.8 x 16 / 8 RAL3002	250	6.21	1.38	7504K48162SM
4.8 x 16 / 8 RAL3004	250	6.21	1.38	7504K48163SM
4.8 x 16 / 8 RAL8017	250	6.21	1.38	7504K48164SM
4.8 x 16 / 8 RAL6003	250	6.21	1.38	7504K48165SM
4.8 x 16 / 8 RAL7043	250	6.21	1.38	7504K48166SM
4.8 x 16 / 8 RAL5010	250	6.21	1.38	7504K48167SM
4.8 x 16 / 8 RAL8004	250	6.21	1.38	7504K48168SM
4.8 x 16 / 8 RAL1021	250	6.21	1.38	7504K48169SM
4.8 x 16 / 8 RAL9010	250	6.21	1.38	7504K481610SM
4.8 x 16 / 8 RAL6020	250	6.21	1.38	7504K481611SM
4.8 x 16 / 8 RAL3009	250	6.21	1.38	7504K481612SM
4.8 x 16 / 8 RAL9005	250	6.21	1.38	7504K481613SM
4.8 x 16 / 8 RAL3005	250	6.21	1.38	7504K481614SM
4.8 x 16 / 8 RAL6005	250	6.21	1.38	7504K481615SM
4.8 x 19 / 8 zincat	250	3.60	0.80	7504K4819SM
4.8 x 19 / 8 RAL3011	250	6.44	1.43	7504K48191SM
4.8 x 19 / 8 RAL3002	250	6.44	1.43	7504K48192SM
4.8 x 19 / 8 RAL3004	250	6.44	1.43	7504K48193SM
4.8 x 19 / 8 RAL8017	250	6.44	1.43	7504K48194SM
4.8 x 19 / 8 RAL6003	250	6.44	1.43	7504K48195SM
4.8 x 19 / 8 RAL7043	250	6.44	1.43	7504K48196SM
4.8 x 19 / 8 RAL5010	250	6.44	1.43	7504K48197SM
4.8 x 19 / 8 RAL8004	250	6.44	1.43	7504K48198SM
4.8 x 19 / 8 RAL1021	250	6.44	1.43	7504K48199SM
4.8 x 19 / 8 RAL9010	250	6.44	1.43	7504K481910SM
4.8 x 19 / 8 RAL6020	250	6.44	1.43	7504K481911SM
4.8 x 19 / 8 RAL3009	250	6.44	1.43	7504K481912SM
4.8 x 19 / 8 RAL9005	250	6.44	1.43	7504K481913SM

Surub autoforant cu cap HEX, forma "K", otel zincat / vopsit

(continuare)

mm	Ambalare (buc.)	Pret / 100 buc.		Cod
		LEI	EURO	
4.8 x 19 / 8 RAL3005	250	6.44	1.43	7504K481914SM
4.8 x 19 / 8 RAL6005	250	6.44	1.43	7504K481915SM
4.8 x 22 / 8 zincat	250	4.01	0.89	7504K4822SM
4.8 x 25 / 8 zincat	250	4.32	0.96	7504K4825SM
4.8 x 25 / 8 RAL3011	250	7.07	1.57	7504K48251SM
4.8 x 25 / 8 RAL3002	250	7.07	1.57	7504K48252SM
4.8 x 25 / 8 RAL3004	250	7.07	1.57	7504K48253SM
4.8 x 25 / 8 RAL8017	250	7.07	1.57	7504K48254SM
4.8 x 25 / 8 RAL6003	250	7.07	1.57	7504K48255SM
4.8 x 25 / 8 RAL7043	250	7.07	1.57	7504K48256SM
4.8 x 25 / 8 RAL5010	250	7.07	1.57	7504K48257SM
4.8 x 25 / 8 RAL8004	250	7.07	1.57	7504K48258SM
4.8 x 25 / 8 RAL1021	250	7.07	1.57	7504K48259SM
4.8 x 25 / 8 RAL9010	250	7.07	1.57	7504K482510SM
4.8 x 25 / 8 RAL6020	250	7.07	1.57	7504K482511SM
4.8 x 25 / 8 RAL3009	250	7.07	1.57	7504K482512SM
4.8 x 25 / 8 RAL9005	250	7.07	1.57	7504K482513SM
4.8 x 25 / 8 RAL3005	250	7.07	1.57	7504K482514SM
4.8 x 25 / 8 RAL6005	250	7.07	1.57	7504K482515SM
4.8 x 32 / 8 zincat	250	5.04	1.12	7504K4832SM
4.8 x 38 / 8 zincat	250	5.85	1.30	7504K4838SM
4.8 x 45 / 8 zincat	250	6.12	1.36	7504K4845SM
4.8 x 50 / 8 zincat	250	6.89	1.53	7504K4850SM
5.5 x 19 / 8 zincat	250	4.95	1.10	7504K5519SM
5.5 x 22 / 8 zincat	250	5.22	1.16	7504K5522SM
5.5 x 25 / 8 zincat	250	5.67	1.26	7504K5525SM
5.5 x 32 / 8 zincat	250	6.89	1.53	7504K5532SM
5.5 x 38 / 8 zincat	250	7.65	1.70	7504K5538SM
5.5 x 45 / 8 zincat	250	7.74	1.72	7504K5545SM
5.5 x 50 / 8 zincat	250	10.94	2.43	7504K5550SM
5.5 x 60 / 8 zincat	100	10.98	2.44	7504K5560SM
5.5 x 75 / 8 zincat	100	12.78	2.84	7504K5575SM
6.3 x 19 / 10 zincat	250	6.89	1.53	7504K6319SM
6.3 x 25 / 10 zincat	250	7.97	1.77	7504K6325SM
6.3 x 32 / 10 zincat	250	9.32	2.07	7504K6332SM
6.3 x 38 / 10 zincat	250	10.49	2.33	7504K6338SM
6.3 x 45 / 10 zincat	250	11.03	2.45	7504K6345SM
6.3 x 50 / 10 zincat	250	11.16	2.48	7504K6350SM
6.3 x 60 / 10 zincat	100	13.41	2.98	7504K6360SM
6.3 x 70 / 10 zincat	100	16.07	3.57	7504K6370SM
6.3 x 80 / 10 zincat	100	19.53	4.34	7504K6380SM
6.3 x 90 / 10 zincat	100	25.20	5.60	7504K6390SM
6.3 x 100 / 10 zincat	100	25.25	5.61	7504K63100SM
6.3 x 110 / 10 zincat	100	25.29	5.62	7504K63110SM
6.3 x 120 / 10 zincat	100	42.44	9.43	7504K63120SM
6.3 x 130 / 10 zincat	100	51.62	11.47	7504K63130SM
6.3 x 140 / 10 zincat	100	51.66	11.48	7504K63140SM

Surub autoforant cu cap bombat, forma "N", otel zincat / vopsit

DIN 7504

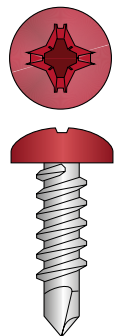

RAL	Culoarea
1021	Galben cadmiu
3002	Rosu carmin
3004	Rosu purpuriu
3005	Rosu visiniu
3009	Ruginiu
3011	Rosu maroniu
5010	Albastru gentiana
6003	Verde masliniu
6005	Verde muschi
6020	Verde crom
7043	Gri trafic B
8004	Maron cupru
8017	Maron ciocolatii
9005	Negru intens
9010	Alb pur

mm	Ambalare (buc.)	Pret / 100 buc.		Cod
		LEI	EURO	
2.9 x 9.5 / Ph2 zincat	500	1.17	0.26	7504N2995SM
2.9 x 13 / Ph2 zincat	500	2.07	0.46	7504N2913SM
2.9 x 16 / Ph2 zincat	500	2.07	0.46	7504N2916SM
3.5 x 9.5 / Ph2 zincat	1000	1.40	0.31	7504N3595SM
3.5 x 11 / Ph2 zincat	1000	1.62	0.36	7504N3511SM
3.5 x 13 / Ph2 zincat	500	1.62	0.36	7504N3513SM
3.5 x 16 / Ph2 zincat	500	1.76	0.39	7504N3516SM
3.5 x 19 / Ph2 zincat	500	1.85	0.41	7504N3519SM
3.5 x 22 / Ph2 zincat	500	1.89	0.42	7504N3522SM
3.5 x 25 / Ph2 zincat	250	2.21	0.49	7504N3525SM
3.5 x 32 / Ph2 zincat	250	2.88	0.64	7504N3532SM
3.9 x 9.5 / Ph2 zincat	500	1.71	0.38	7504N3995SM
3.9 x 13 / Ph2 zincat	500	1.76	0.39	7504N3913SM
3.9 x 16 / Ph2 zincat	500	2.21	0.49	7504N3916SM
3.9 x 19 / Ph2 zincat	500	2.21	0.49	7504N3919SM
3.9 x 22 / Ph2 zincat	250	2.25	0.50	7504N3922SM
3.9 x 25 / Ph2 zincat	250	2.34	0.52	7504N3925SM
3.9 x 32 / Ph2 zincat	250	3.65	0.81	7504N3932SM
3.9 x 38 / Ph2 zincat	250	3.92	0.87	7504N3938SM
4.2 x 13 / Ph2 zincat	500	2.25	0.50	7504N4213SM
4.2 x 13 / Ph2 RAL 3011	500	4.91	1.09	7504N42131SM
4.2 x 13 / Ph2 RAL 3002	500	4.91	1.09	7504N42132SM
4.2 x 13 / Ph2 RAL 3004	500	4.91	1.09	7504N42133SM
4.2 x 13 / Ph2 RAL 8017	500	4.91	1.09	7504N42134SM

Surub autoforant cap bombat, forma "N", otel zincat / vopsit

(continuare)

mm	Ambalare (buc.)	Pret / 100 buc.		Cod
		LEI	EURO	
4.2 x 13 / Ph2 RAL 6003	500	4.91	1.09	7504N42135SM
4.2 x 13 / Ph2 RAL 7043	500	4.91	1.09	7504N42136SM
4.2 x 13 / Ph2 RAL 5010	500	4.91	1.09	7504N42137SM
4.2 x 13 / Ph2 RAL 8004	500	4.91	1.09	7504N42138SM
4.2 x 13 / Ph2 RAL 1021	500	4.91	1.09	7504N42139SM
4.2 x 13 / Ph2 RAL 9010	500	4.91	1.09	7504N421310SM
4.2 x 13 / Ph2 RAL 6020	500	4.91	1.09	7504N421311SM
4.2 x 13 / Ph2 RAL 3009	500	4.91	1.09	7504N421312SM
4.2 x 13 / Ph2 RAL 9005	500	4.91	1.09	7504N421313SM
4.2 x 13 / Ph2 RAL 3005	500	4.91	1.09	7504N421314SM
4.2 x 13 / Ph2 RAL 6005	500	4.91	1.09	7504N421315SM
4.2 x 16 / Ph2 zincat	500	2.34	0.52	7504N4216SM
4.2 x 16 / Ph2 RAL 3011	500	5.18	1.15	7504N42161SM
4.2 x 16 / Ph2 RAL 3002	500	5.18	1.15	7504N42162SM
4.2 x 16 / Ph2 RAL 3004	500	5.18	1.15	7504N42163SM
4.2 x 16 / Ph2 RAL 8017	500	5.18	1.15	7504N42164SM
4.2 x 16 / Ph2 RAL 6003	500	5.18	1.15	7504N42166SM
4.2 x 16 / Ph2 RAL 7043	500	5.18	1.15	7504N42166SM
4.2 x 16 / Ph2 RAL 5010	500	5.18	1.15	7504N42167SM
4.2 x 16 / Ph2 RAL 8004	500	5.18	1.15	7504N42168SM
4.2 x 16 / Ph2 RAL 1021	500	5.18	1.15	7504N42169SM
4.2 x 16 / Ph2 RAL 9010	500	5.18	1.15	7504N421610SM
4.2 x 16 / Ph2 RAL 6020	500	5.18	1.15	7504N421611SM
4.2 x 16 / Ph2 RAL 3009	500	5.18	1.15	7504N421612SM
4.2 x 16 / Ph2 RAL 9005	500	5.18	1.15	7504N421613SM
4.2 x 16 / Ph2 RAL 3005	500	5.18	1.15	7504N421614SM
4.2 x 16 / Ph2 RAL 6005	500	5.18	1.15	7504N421615SM
4.2 x 19 / Ph2 zincat	500	5.27	1.17	7504N4219SM
4.2 x 19 / Ph2 RAL 3011	500	5.27	1.17	7504N42191SM
4.2 x 19 / Ph2 RAL 3002	500	5.27	1.17	7504N42192SM
4.2 x 19 / Ph2 RAL 3004	500	5.27	1.17	7504N42193SM
4.2 x 19 / Ph2 RAL 8017	500	5.27	1.17	7504N42194SM
4.2 x 19 / Ph2 RAL 6003	500	5.27	1.17	7504N42195SM
4.2 x 19 / Ph2 RAL 7043	500	5.27	1.17	7504N42196SM
4.2 x 19 / Ph2 RAL 5010	500	5.27	1.17	7504N42197SM
4.2 x 19 / Ph2 RAL 8004	500	5.27	1.17	7504N42198SM
4.2 x 19 / Ph2 RAL 1021	500	5.27	1.17	7504N42199SM
4.2 x 19 / Ph2 RAL 9010	500	5.27	1.17	7504N421910SM
4.2 x 19 / Ph2 RAL 6020	500	5.27	1.17	7504N421911SM
4.2 x 19 / Ph2 RAL 3009	500	5.27	1.17	7504N421912SM
4.2 x 19 / Ph2 RAL 9005	500	5.27	1.17	7504N421913SM
4.2 x 19 / Ph2 RAL 3005	500	5.27	1.17	7504N421914SM
4.2 x 19 / Ph2 RAL 6005	500	5.27	1.17	7504N421915SM
4.2 x 22 / Ph2 zincat	250	2.70	0.60	7504N4222SM
4.2 x 25 / Ph2 zincat	250	3.24	0.72	7504N4225SM
4.2 x 32 / Ph2 zincat	250	3.47	0.77	7504N4232SM
4.2 x 38 / Ph2 zincat	250	3.69	0.82	7504N4238SM
4.2 x 45 / Ph2 zincat	250	3.92	0.87	7504N4245SM
4.2 x 50 / Ph2 zincat	250	6.39	1.42	7504N4250SM
4.8 x 13 / Ph3 zincat	500	2.70	0.60	7504N4813SM
4.8 x 16 / Ph3 zincat	250	3.29	0.73	7504N4816SM
4.8 x 19 / Ph3 zincat	250	3.33	0.74	7504N4819SM
4.8 x 22 / Ph3 zincat	250	4.28	0.95	7504N4822SM
4.8 x 25 / Ph3 zincat	250	4.28	0.95	7504N4825SM
4.8 x 32 / Ph3 zincat	250	4.46	0.99	7504N4832SM
4.8 x 38 / Ph3 zincat	250	5.13	1.14	7504N4838SM
4.8 x 45 / Ph3 zincat	250	6.89	1.53	7504N4845SM
4.8 x 50 / Ph3 zincat	250	6.98	1.55	7504N4850SM
4.8 x 60 / Ph3 zincat	250	7.38	1.64	7504N4860SM
4.8 x 70 / Ph3 zincat	100	11.66	2.59	7504N4870SM
4.8 x 80 / Ph3 zincat	100	11.66	2.59	7504N4880SM
5.5 x 19 / Ph3 zincat	250	4.50	1.00	7504N5519SM
5.5 x 22 / Ph3 zincat	250	4.86	1.08	7504N5522SM
5.5 x 25 / Ph3 zincat	250	5.54	1.23	7504N5525SM
5.5 x 32 / Ph3 zincat	250	5.54	1.23	7504N5532SM
5.5 x 38 / Ph3 zincat	250	6.26	1.39	7504N5538SM
5.5 x 45 / Ph3 zincat	250	7.47	1.66	7504N5545SM
5.5 x 50 / Ph3 zincat	200	8.42	1.87	7504N5550SM
5.5 x 73 / Ph3 zincat	100	12.42	2.76	7504N5573SM
6.3 x 19 / Ph3 zincat	250	6.35	1.41	7504N6319SM

Surub autoforant cu cap inecat, forma "P", otel zincat

DIN 7504

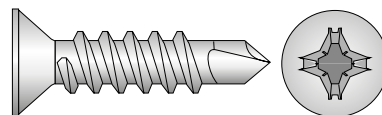

mm	Ambalare (buc.)	Pret / 100 buc.		Cod
		LEI	EURO	
2.9 x 13 / Ph2	1000	1.44	0.32	7504P2913SM
2.9 x 16 / Ph2	1000	1.44	0.32	7504P2916SM
3.5 x 9.5 / Ph2	1000	1.26	0.28	7504P3595SM
3.5 x 11 / Ph2	1000	0.63	0.14	7504P3511SM
3.5 x 13 / Ph2	500	1.40	0.31	7504P3513SM
3.5 x 16 / Ph2	500	1.53	0.34	7504P3516SM
3.5 x 19 / Ph2	500	1.67	0.37	7504P3519SM
3.5 x 22 / Ph2	500	2.57	0.57	7504P3522SM
3.5 x 25 / Ph2	250	2.57	0.57	7504P3525SM
3.5 x 32 / Ph2	250	2.61	0.58	7504P3532SM
3.9 x 13 / Ph2	500	1.44	0.32	7504P3913SM
3.9 x 16 / Ph2	500	1.76	0.39	7504P3916SM
3.9 x 19 / Ph2	500	1.94	0.43	7504P3919SM
3.9 x 22 / Ph2	250	2.12	0.47	7504P3922SM
3.9 x 25 / Ph2	250	2.34	0.52	7504P3925SM
3.9 x 32 / Ph2	250	3.56	0.79	7504P3932SM
3.9 x 38 / Ph2	250	3.56	0.79	7504P3938SM

Surub autoforant cu cap inecat, forma "P", otel zincat

(continuare)

mm	Ambalare (buc.)	Pret / 100 buc.		Cod
		LEI	EURO	
4.2 x 13 / Ph2	500	1.49	0.33	7504P4213SM
4.2 x 16 / Ph2	500	2.12	0.47	7504P4216SM
4.2 x 19 / Ph2	500	2.66	0.59	7504P4219SM
4.2 x 22 / Ph2	250	2.75	0.61	7504P4222SM
4.2 x 25 / Ph2	250	2.75	0.61	7504P4225SM
4.2 x 32 / Ph2	250	3.02	0.67	7504P4232SM
4.2 x 38 / Ph2	250	4.14	0.92	7504P4238SM
4.2 x 45 / Ph2	250	4.37	0.97	7504P4245SM
4.2 x 50 / Ph2	250	5.63	1.25	7504P4250SM
4.8 x 13 / Ph3	500	2.39	0.53	7504P4813SM
4.8 x 16 / Ph3	250	2.25	0.50	7504P4816SM
4.8 x 19 / Ph3	250	3.11	0.69	7504P4819SM
4.8 x 22 / Ph3	250	3.11	0.69	7504P4822SM
4.8 x 25 / Ph3	250	3.47	0.77	7504P4825SM
4.8 x 32 / Ph3	250	4.10	0.91	7504P4832SM
4.8 x 38 / Ph3	250	6.17	1.37	7504P4838SM
4.8 x 45 / Ph3	250	6.17	1.37	7504P4845SM
4.8 x 50 / Ph3	250	6.21	1.38	7504P4850SM
5.5 x 22 / Ph3	250	4.59	1.02	7504P5522SM
5.5 x 25 / Ph3	250	4.14	0.92	7504P5525SM
5.5 x 32 / Ph3	250	4.95	1.10	7504P5532SM
5.5 x 38 / Ph3	250	5.99	1.33	7504P5538SM
5.5 x 45 / Ph3	250	7.07	1.57	7504P5545SM
5.5 x 50 / Ph3	250	7.11	1.58	7504P5550SM
5.5 x 60 / Ph3	250	9.77	2.17	7504P5560SM

Surub autoforant cu cap HEX si capacitate mare de gaurire, otel zincat

DIN 7504

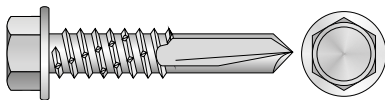

mm	Ambalare (buc.)	Pret / 100 buc.		Cod
		LEI	EURO	
5.5 x 32	250	10.17	2.26	7504T5532SM
5.5 x 38	250	11.30	2.51	7504T5538SM

Piulita "Rampa Muffen", otel

DIN 7965

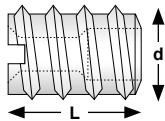

M x L x d (mm)	Ambalare (buc.)	Pret / 100 buc.		Cod
		LEI	EURO	
M 4 - 8 x 8	100	14.85	3.30	7965048SM
M 5 - 10 x 10	100	20.43	4.54	79650510SM
M 6 - 12 x 12	100	27.36	6.08	79650612SM
M 8 x 12 x 18	100	27.41	6.09	79650812SM

Stift cilindric cu filet interior, forma "D", otel

DIN 7979



mm	Ambalare (buc.)	Pret / 100 buc.		Cod
		LEI	EURO	
6 x 20	10	168.30	37.40	7979D620SM
6 x 24	10	208.17	46.26	7979D624SM
6 x 32	10	146.48	32.55	7979D632SM
6 x 36	10	178.56	39.68	7979D636SM
6 x 40	10	179.06	39.79	7979D640SM
6 x 45	10	194.36	43.19	7979D645SM
6 x 50	10	210.92	46.87	7979D650SM
8 x 24	10	169.79	37.73	7979D824SM
8 x 28	10	213.62	47.47	7979D828SM
8 x 32	10	213.66	47.48	7979D832SM
8 x 36	10	213.75	47.50	7979D836SM
8 x 40	10	222.57	49.46	7979D840SM
8 x 45	10	222.84	49.52	7979D845SM
8 x 50	10	229.19	50.93	7979D850SM
8 x 60	10	229.73	51.05	7979D860SM
8 x 70	10	254.25	56.50	7979D870SM
8 x 80	10	276.84	61.52	7979D880SM
8 x 100	10	463.68	103.04	7979D8100SM
10 x 24	10	183.56	40.79	7979D1024SM
10 x 32	10	206.64	45.92	7979D1032SM
10 x 36	10	235.53	52.34	7979D1036SM
10 x 40	10	246.15	54.70	7979D1040SM
10 x 50	10	304.52	67.67	7979D1050SM
10 x 60	10	392.22	87.16	7979D1060SM
12 x 28	5	356.36	79.19	7979D1228SM
12 x 32	5	250.25	55.61	7979D1232SM
12 x 36	5	367.20	81.60	7979D1236SM

Stift cilindric cu filet interior, forma "D", otel (continuare)

mm	Ambalare (buc.)	Pret / 100 buc.		Cod
		LEI	EURO	
12 x 40	5	369.68	82.15	7979D1240SM
12 x 45	5	400.55	89.01	7979D1245SM
12 x 50	5	400.82	89.07	7979D1250SM
12 x 60	5	484.79	107.73	7979D1260SM
12 x 70	5	484.88	107.75	7979D1270SM
12 x 80	5	485.46	107.88	7979D1280SM
12 x 100	5	665.55	147.90	7979D12100SM
16 x 40	5	417.47	92.77	7979D1640SM
16 x 50	5	746.87	165.97	7979D1650SM
16 x 70	5	972.18	216.04	7979D1670SM
16 x 80	5	972.36	216.08	7979D1680SM
20 x 60	5	1122.26	249.39	7979D2060SM

Surub cu cap bombat pentru tabla, otel zincat

DIN 7981

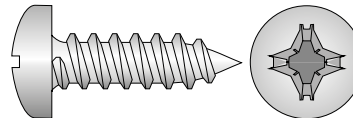

mm	Ambalare (buc.)	Pret / 100 buc.		Cod
		LEI	EURO	
2.2 x 6.5 / Ph1	2000	1.26	0.28	798102265SM
2.2 x 9.5 / Ph1	2000	2.52	0.56	798102295SM
2.2 x 13 / Ph1	2000	2.52	0.56	798102213SM
2.2 x 19 / Ph1	2000	2.52	0.56	798102219SM
2.9 x 6.5 / Ph1	1000	1.31	0.29	798102965SM
2.9 x 9.5 / Ph1	1000	1.08	0.24	798102995SM
2.9 x 13 / Ph1	1000	1.17	0.26	798102913SM
2.9 x 16 / Ph1	1000	1.26	0.28	798102916SM
2.9 x 19 / Ph1	1000	1.76	0.39	798102919SM
2.9 x 22 / Ph1	1000	1.76	0.39	798102922SM
2.9 x 25 / Ph1	500	1.80	0.40	798102925SM
3.5 x 6.5 / Ph2	1000	1.22	0.27	798103565SM
3.5 x 9.5 / Ph2	1000	1.26	0.28	798103595SM
3.5 x 13 / Ph2	500	1.53	0.34	798103513SM
3.5 x 16 / Ph2	500	1.53	0.34	798103516SM
3.5 x 19 / Ph2	500	1.80	0.40	798103519SM
3.5 x 22 / Ph2	500	1.80	0.40	798103522SM
3.5 x 25 / Ph2	250	1.80	0.40	798103525SM
3.5 x 32 / Ph2	250	2.70	0.60	798103532SM
3.9 x 9.5 / Ph2	500	1.58	0.35	798103995SM
3.9 x 13 / Ph2	500	1.94	0.43	798103913SM
3.9 x 16 / Ph2	500	1.94	0.43	798103916SM
3.9 x 19 / Ph2	500	2.25	0.50	798103919SM
3.9 x 22 / Ph2	250	3.33	0.74	798103922SM
3.9 x 25 / Ph2	250	3.33	0.74	798103925SM
3.9 x 32 / Ph2	250	4.01	0.89	798103932SM
3.9 x 38 / Ph2	250	4.01	0.89	798103938SM
3.9 x 45 / Ph2	250	5.04	1.12	798103945SM
4.2 x 9.5 / Ph2	500	1.76	0.39	798104295SM
4.2 x 13 / Ph2	500	2.03	0.45	798104213SM
4.2 x 16 / Ph2	500	2.34	0.52	798104216SM
4.2 x 19 / Ph2	500	2.34	0.52	798104219SM
4.2 x 22 / Ph2	250	2.75	0.61	798104222SM
4.2 x 25 / Ph2	250	3.06	0.68	798104225SM
4.2 x 32 / Ph2	250	3.42	0.76	798104232SM
4.2 x 38 / Ph2	250	3.78	0.84	798104238SM
4.2 x 50 / Ph2	250	3.92	0.87	798104250SM
4.2 x 70 / Ph2	250	4.95	1.10	798104270SM
4.8 x 9.5 / Ph3	500	2.61	0.58	798104895SM
4.8 x 13 / Ph3	500	2.66	0.59	798104813SM
4.8 x 16 / Ph3	250	2.97	0.66	798104816SM
4.8 x 19 / Ph3	250	3.33	0.74	798104819SM
4.8 x 22 / Ph3	250	3.92	0.87	798104822SM
4.8 x 25 / Ph3	250	3.92	0.87	798104825SM
4.8 x 32 / Ph3	250	4.23	0.94	798104832SM
4.8 x 38 / Ph3	250	6.66	1.48	798104838SM
4.8 x 45 / Ph3	250	6.66	1.48	798104845SM
4.8 x 50 / Ph3	250	6.71	1.49	798104850SM
4.8 x 60 / Ph3	250	10.08	2.24	798104860SM
4.8 x 70 / Ph3	100	10.08	2.24	798104870SM
4.8 x 90 / Ph2	100	10.26	2.28	798104890SM
5.5 x 16 / Ph3	250	4.05	0.90	798105516SM
5.5 x 19 / Ph3	250	4.05	0.90	798105519SM
5.5 x 22 / Ph3	250	4.05	0.90	798105522SM
5.5 x 25 / Ph3	250	4.91	1.09	798105525SM
5.5 x 32 / Ph3	250	4.91	1.09	798105532SM
5.5 x 38 / Ph3	250	7.02	1.56	798105538SM
5.5 x 45 / Ph3	250	8.15	1.81	798105545SM
5.5 x 50 / Ph3	250	8.87	1.97	798105550SM
5.5 x 60 / Ph3	100	10.44	2.32	798105560SM
5.5 x 70 / Ph3	100	10.85	2.41	798105570SM
5.5 x 80 / Ph3	100	13.28	2.95	798105580SM
6.3 x 16 / Ph3	250	5.13	1.14	798106316SM
6.3 x 19 / Ph3	250	6.17	1.37	798106319SM
6.3 x 25 / Ph3	250	6.48	1.44	798106325SM
6.3 x 32 / Ph3	250	8.87	1.97	798106332SM
6.3 x 38 / Ph3	250	8.87	1.97	798106338SM
6.3 x 50 / Ph3	250	10.08	2.24	798106350SM
6.3 x 60 / Ph3	100	17.51	3.89	798106360SM
6.3 x 70 / Ph3	100	17.55	3.90	798106370SM
6.3 x 80 / Ph3	100	17.73	3.94	798106380SM
6.3 x 90 / Ph3	50	18.00	4.00	798106390SM
6.3 x 100 / Ph3	50	20.34	4.52	7981063100SM
6.3 x 120 / Ph3	50	30.47	6.77	7981063120SM

Surub cu cap inecat pentru tabla, otel zincat

DIN 7982

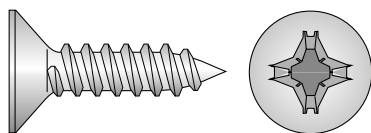

mm	Ambalare (buc.)	Pret / 100 buc.		Cod
		LEI	EURO	
2.2 x 9.5 / Ph1	2000	2.43	0.54	798202295SM
2.9 x 9.5 / Ph1	1000	0.81	0.18	798202995SM
2.9 x 13 / Ph1	1000	0.99	0.22	798202913SM
2.9 x 16 / Ph1	1000	1.58	0.35	798202916SM
2.9 x 19 / Ph1	1000	1.58	0.35	798202919SM
2.9 x 22 / Ph1	1000	1.62	0.36	798202922SM
2.9 x 25 / Ph1	500	1.67	0.37	798202925SM
3.5 x 9.5 / Ph2	1000	1.08	0.24	798203595SM
3.5 x 13 / Ph2	500	1.08	0.24	798203513SM
3.5 x 16 / Ph2	500	1.31	0.29	798203516SM
3.5 x 19 / Ph2	500	1.31	0.29	798203519SM
3.5 x 22 / Ph2	500	1.35	0.30	798203522SM
3.5 x 25 / Ph2	250	1.89	0.42	798203525SM
3.5 x 32 / Ph2	250	1.94	0.43	798203532SM
3.5 x 38 / Ph2	250	2.07	0.46	798203538SM
3.9 x 13 / Ph2	500	1.04	0.23	798203913SM
3.9 x 16 / Ph2	500	1.22	0.27	798203916SM
3.9 x 19 / Ph2	500	1.44	0.32	798203919SM
3.9 x 22 / Ph2	250	1.44	0.32	798203922SM
3.9 x 25 / Ph2	250	1.89	0.42	798203925SM
3.9 x 32 / Ph2	250	3.96	0.88	798203932SM
3.9 x 38 / Ph2	250	4.59	1.02	798203938SM
3.9 x 45 / Ph2	250	4.73	1.05	798203945SM
4.2 x 9.5 / Ph2	500	1.22	0.27	798204295SM
4.2 x 13 / Ph2	500	1.35	0.30	798204213SM
4.2 x 16 / Ph2	500	1.98	0.44	798204216SM
4.2 x 22 / Ph2	250	2.03	0.45	798204222SM
4.2 x 25 / Ph2	250	2.03	0.45	798204225SM
4.2 x 32 / Ph2	250	2.52	0.56	798204232SM
4.2 x 45 / Ph2	250	3.15	0.70	798204245SM
4.2 x 60 / Ph2	250	5.54	1.23	798204260SM
4.2 x 70 / Ph2	250	6.48	1.44	798204270SM
4.8 x 13 / Ph3	500	1.71	0.38	798204813SM
4.8 x 16 / Ph3	250	2.43	0.54	798204816SM
4.8 x 19 / Ph3	250	2.48	0.55	798204819SM
4.8 x 22 / Ph3	250	2.61	0.58	798204822SM
4.8 x 25 / Ph3	250	2.88	0.64	798204825SM
4.8 x 32 / Ph3	250	3.38	0.75	798204832SM
4.8 x 38 / Ph3	250	4.95	1.10	798204838SM
4.8 x 45 / Ph3	250	5.00	1.11	798204845SM
4.8 x 50 / Ph3	250	5.45	1.21	798204850SM
4.8 x 60 / Ph3	250	6.98	1.55	798204860SM
4.8 x 70 / Ph3	100	7.20	1.60	798204870SM
4.8 x 80 / Ph3	100	7.97	1.77	798204880SM
5.5 x 16 / Ph3	250	2.52	0.56	798205516SM
5.5 x 22 / Ph3	250	3.24	0.72	798205522SM
5.5 x 25 / Ph3	250	4.05	0.90	798205525SM
5.5 x 32 / Ph3	250	4.28	0.95	798205532SM
5.5 x 45 / Ph3	250	5.63	1.25	798205545SM
5.5 x 50 / Ph3	250	6.57	1.46	798205550SM
5.5 x 70 / Ph3	100	10.76	2.39	798205570SM
5.5 x 80 / Ph3	100	11.03	2.45	798205580SM
6.3 x 16 / Ph3	250	4.10	0.91	798206316SM
6.3 x 19 / Ph3	250	4.59	1.02	798206319SM
6.3 x 32 / Ph3	250	5.67	1.26	798206332SM
6.3 x 38 / Ph3	250	6.35	1.41	798206338SM
6.3 x 50 / Ph3	250	10.31	2.29	798206350SM
6.3 x 60 / Ph3	100	13.19	2.93	798206360SM
6.3 x 70 / Ph3	100	24.17	5.37	798206370SM

Surub cu cap semiinecat pentru tabla, otel zincat

DIN 7983

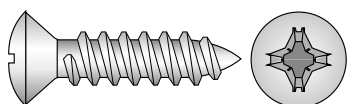

mm	Ambalare (buc.)	Pret / 100 buc.		Cod
		LEI	EURO	
2.9 x 9.5	1000	1.94	0.43	798302995SM
2.9 x 13	1000	1.13	0.25	798302913SM
2.9 x 25	500	1.85	0.41	798302925SM
3.5 x 9.5	1000	1.31	0.29	798303595SM
3.5 x 16	500	1.04	0.23	798303516SM
3.5 x 19	500	1.76	0.39	798303519SM
3.5 x 22	500	1.76	0.39	798303522SM
3.5 x 32	250	2.52	0.56	798303532SM
3.9 x 13	500	1.31	0.29	798303913SM
3.9 x 16	500	1.89	0.42	798303916SM
3.9 x 25	250	1.94	0.43	798303925SM
3.9 x 45	250	7.07	1.57	798303945SM
4.2 x 13	500	1.31	0.29	798304213SM
4.2 x 16	500	1.44	0.32	798304216SM
4.2 x 25	250	2.03	0.45	798304225SM
4.2 x 32	250	2.75	0.61	798304232SM
4.2 x 38	250	2.75	0.61	798304238SM
4.2 x 50	250	5.22	1.16	798304250SM
4.8 x 16	250	3.20	0.71	798304816SM
4.8 x 19	250	2.25	0.50	798304819SM

Surub cu cap semiinecat pentru tabla, otel zincat (continuare)

mm	Ambalare (buc.)	Pret / 100 buc.		Cod
		LEI	EURO	
4.8 x 45	250	6.48	1.44	798304845SM
5.5 x 13	250	8.91	1.98	798305513SM
5.5 x 16	250	9.36	2.08	798305516SM
5.5 x 32	250	9.45	2.10	798305532SM
5.5 x 38	250	9.77	2.17	798305538SM
5.5 x 45	250	10.49	2.33	798305545SM
6.3 x 19	250	11.48	2.55	798306319SM
6.3 x 50	250	13.50	3.00	798306350SM

Surub cu cap bombat si locas cruciform, otel zincat, gr. 4.8

DIN 7985

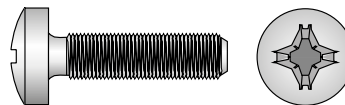

mm	Ambalare (buc.)	Pret / 100 buc.		Cod
		LEI	EURO	
M 2.5 x 10	500	1.13	0.25	798542510SM
M 2.5 x 12	500	1.04	0.23	798542512SM
M 3.0 x 6	500	1.04	0.23	7985436SM
M 3.0 x 10	500	1.17	0.26	79854310SM
M 3.0 x 20	500	1.67	0.37	79854320SM
M 3.0 x 25	500	1.67	0.37	79854325SM
M 3.0 x 30	500	2.25	0.50	79854330SM
M 3.0 x 35	500	2.61	0.58	79854335SM
M 3.0 x 45	500	2.93	0.65	79854345SM
M 4.0 x 8	500	1.85	0.41	7985448SM
M 4.0 x 10	500	1.76	0.39	79854410SM
M 4.0 x 12	500	1.80	0.40	79854412SM
M 4.0 x 14	500	1.80	0.40	79854414SM
M 4.0 x 16	500	2.70	0.60	79854416SM
M 4.0 x 20	500	2.70	0.60	79854420SM
M 4.0 x 25	500	2.88	0.64	79854425SM
M 4.0 x 30	500	3.56	0.79	79854430SM
M 4.0 x 40	500	3.65	0.81	79854440SM
M 4.0 x 45	500	5.63	1.25	79854445SM
M 4.0 x 50	500	5.63	1.25	79854450SM
M 4.0 x 80	500	7.52	1.67	79854480SM
M 5.0 x 6	100	2.57	0.57	7985456SM
M 5.0 x 8	100	2.84	0.63	7985458SM
M 5.0 x 10	100	3.11	0.69	79854510SM
M 5.0 x 12	100	3.11	0.69	79854512SM
M 5.0 x 16	100	3.60	0.80	79854516SM
M 5.0 x 20	100	5.72	1.27	79854520SM
M 5.0 x 25	100	5.72	1.27	79854525SM
M 5.0 x 30	100	5.72	1.27	79854530SM
M 5.0 x 40	100	5.76	1.28	79854540SM
M 5.0 x 45	100	7.47	1.66	79854545SM
M 5.0 x 50	100	7.79	1.73	79854550SM
M 5.0 x 60	100	8.42	1.87	79854560SM
M 6.0 x 12	100	5.36	1.19	79854612SM
M 6.0 x 16	100	5.36	1.19	79854616SM
M 6.0 x 20	100	7.43	1.65	79854620SM
M 6.0 x 25	100	7.43	1.65	79854625SM
M 6.0 x 30	100	7.47	1.66	79854630SM
M 6.0 x 35	100	7.47	1.66	79854635SM
M 6.0 x 40	100	8.73	1.94	79854640SM
M 6.0 x 45	100	8.73	1.94	79854645SM
M 6.0 x 50	100	10.80	2.40	79854650SM
M 6.0 x 60	100	11.61	2.58	79854660SM
M 8.0 x 16	50	14.54	3.23	79854816SM
M 8.0 x 20	50	12.42	2.76	79854820SM
M 8.0 x 25	50	15.39	3.42	79854825SM
M 8.0 x 35	50	15.39	3.42	79854835SM
M 8.0 x 45	50	18.45	4.10	79854845SM
M 8.0 x 50	50	21.78	4.84	79854850SM

Surub cu cap inecat si locas Inbus, otel zincat, gr. 8.8

DIN 7991

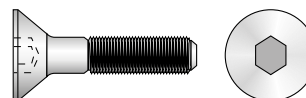

mm	Ambalare (buc.)	Pret / 100 buc.		Cod
		LEI	EURO	
M 3 x 10	100	2.34	0.52	79918310SM
M 3 x 12	100	2.07	0.46	79918312SM
M 3 x 20	100	5.94	1.32	79918320SM
M 4 x 10	100	2.12	0.47	79918410SM
M 4 x 12	100	3.56	0.79	79918412SM
M 4 x 16	100	3.56	0.79	79918416SM
M 4 x 20	100	3.56	0.79	79918420SM
M 4 x 25	100	4.64	1.03	79918425SM
M 4 x 30	100	17.10	3.80	79918430SM
M 5 x 10	50	4.82	1.07	79918510SM
M 5 x 12	50	3.78	0.84	79918512SM
M 5 x 16	50	5.22	1.16	79918516SM
M 5 x 20	50	6.03	1.34	79918520SM
M 5 x 25	50	6.30	1.40	79918525SM
M 5 x 30	50	6.30	1.40	79918530SM
M 5 x 35	50	11.03	2.45	79918535SM
M 5 x 40	50	11.03	2.45	79918540SM

Surub cu cap inecat si locas Inbus, otel zincat, gr. 8.8 (continuare)

mm	Ambalare (buc.)	Pret / 100 buc.		Cod
		LEI	EURO	
M 5 x 45	50	13.01	2.89	79918545SM
M 5 x 50	50	15.75	3.50	79918550SM
M 6 x 10	50	6.57	1.46	79918610SM
M 6 x 12	50	4.46	0.99	79918612SM
M 6 x 16	50	13.46	2.99	79918616SM
M 6 x 20	50	13.46	2.99	79918620SM
M 6 x 25	50	13.46	2.99	79918625SM
M 6 x 30	50	13.50	3.00	79918630SM
M 6 x 35	50	13.50	3.00	79918635SM
M 6 x 40	50	13.59	3.02	79918640SM
M 6 x 45	50	14.00	3.11	79918645SM
M 6 x 50	50	19.22	4.27	79918650SM
M 6 x 60	50	19.22	4.27	79918660SM
M 8 x 16	25	12.20	2.71	79918816SM
M 8 x 20	25	25.20	5.60	79918820SM
M 8 x 25	25	12.92	2.87	79918825SM
M 8 x 30	25	14.40	3.20	79918830SM
M 8 x 35	25	16.38	3.64	79918835SM
M 8 x 40	25	18.23	4.05	79918840SM
M 8 x 45	25	23.81	5.29	79918845SM
M 8 x 50	25	33.66	7.48	79918850SM
M 8 x 60	25	33.75	7.50	79918860SM
M 10 x 25	25	20.43	4.54	799181025SM
M 10 x 30	25	23.76	5.28	799181030SM
M 10 x 35	25	26.60	5.91	799181035SM
M 10 x 40	25	69.26	15.39	799181040SM
M 10 x 55	25	69.26	15.39	799181055SM
M 10 x 60	25	69.26	15.39	799181060SM
M 10 x 80	25	69.35	15.41	799181080SM
M 12 x 25	25	34.52	7.67	799181225SM
M 12 x 30	25	37.62	8.36	799181230SM
M 12 x 35	25	39.51	8.78	799181235SM
M 12 x 40	25	43.92	9.76	799181240SM
M 12 x 45	25	51.35	11.41	799181245SM
M 12 x 50	25	53.06	11.79	799181250SM
M 12 x 80	25	91.67	20.37	799181280SM
M 16 x 30	10	75.15	16.70	799181630SM
M 16 x 35	10	81.45	18.10	799181635SM
M 16 x 40	10	88.74	19.72	799181640SM
M 16 x 50	10	99.81	22.18	799181650SM
M 16 x 60	10	109.67	24.37	799181660SM
M 16 x 80	10	151.88	33.75	799181680SM
M 20 x 35	5	467.60	103.91	799182035SM
M 20 x 45	5	185.63	41.25	799182045SM
M 20 x 60	5	185.76	41.28	799182060SM
M 20 x 70	5	202.10	44.91	799182070SM
M 20 x 80	5	237.69	52.82	799182080SM
M 20 x 90	5	271.26	60.28	799182090SM
M 20 x 100	5	365.81	81.29	7991820100SM

Surub cu cap inecat si locas Inbus, otel, gr. 10.9 (continuare)

mm	Ambalare (buc.)	Pret / 100 buc.		Cod
		LEI	EURO	
M 8 x 40	50	19.71	4.38	79919840SM*
M 8 x 45	50	21.20	4.71	79919845SM*
M 8 x 50	50	24.71	5.49	79919850SM*
M 8 x 60	50	32.90	7.31	79919860SM*
M 8 x 70	50	35.96	7.99	79919870SM*
M 8 x 90	25	49.01	10.89	79919890SM*
M 8 x 100	25	62.82	13.96	799198100SM*
M 10 x 16	100	14.54	3.23	799191016SM*
M 10 x 20	100	19.53	4.34	799191020SM*
M 10 x 25	100	20.61	4.58	799191025SM*
M 10 x 30	100	23.67	5.26	799191030SM*
M 10 x 35	50	26.78	5.95	799191035SM*
M 10 x 40	50	32.85	7.30	799191040SM*
M 10 x 45	50	34.47	7.66	799191045SM*
M 10 x 50	50	36.05	8.01	799191050SM*
M 10 x 60	50	44.28	9.84	799191060SM*
M 10 x 70	25	51.12	11.36	799191070SM*
M 10 x 80	25	65.84	14.63	799191080SM*
M 12 x 25	50	30.78	6.84	799191225SM*
M 12 x 30	50	52.83	11.74	799191230SM*
M 12 x 35	50	52.83	11.74	799191235SM*
M 12 x 40	50	63.45	14.10	799191240SM*
M 12 x 45	50	63.45	14.10	799191245SM*
M 12 x 50	50	63.50	14.11	799191250SM*
M 12 x 60	50	63.59	14.13	799191260SM*
M 12 x 70	50	77.99	17.33	799191270SM*
M 12 x 80	50	104.99	23.33	799191280SM*
M 12 x 90	25	116.06	25.79	799191290SM*
M 14 x 40	25	90.41	20.09	799191440SM*
M 16 x 30	25	65.39	14.53	799191630SM*
M 16 x 40	25	80.24	17.83	799191640SM*
M 16 x 45	25	104.94	23.32	799191645SM*
M 16 x 50	25	104.99	23.33	799191650SM*
M 16 x 55	25	136.94	30.43	799191655SM*
M 16 x 60	25	136.94	30.43	799191660SM*
M 16 x 70	10	138.65	30.81	799191670SM*
M 16 x 80	10	156.51	34.78	799191680SM*
M 16 x 120	10	235.35	52.30	7991916120SM*
M 20 x 40	10	294.57	65.46	799192040SM*

Saiba plata - serie mare 3d, otel zincat

DIN 9021



mm	Ambalare (buc.)	Pret / 100 buc.		Cod
		LEI	EURO	
3.2	250	0.45	0.10	9021032SM
4.3	250	0.90	0.20	9021043SM
5.3	250	1.67	0.37	9021053SM
6.4	250	2.75	0.61	9021064SM
8.4	250	5.63	1.25	9021084SM
10.5	250	10.62	2.36	90210105SM
13.0	100	22.14	4.92	9021013SM
15.0	100	30.24	6.72	9021015SM
17.0	100	33.84	7.52	9021017SM
20.0	50	61.16	13.59	9021020SM
22.0	50	69.03	15.34	9021022SM
26.0	25	119.66	26.59	9021026SM
33.0	25	236.97	52.66	9021033SM

Piulita de sudare ambutisata, amprenta exterioara, otel

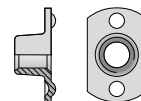

mm	Ambalare (buc.)	Pret / 100 buc.		Cod
		LEI	EURO	
M 4	100	11.39	2.53	VR0918.4SM
M 5	100	12.20	2.71	VR0918.5SM
M 6	50	13.01	2.89	VR0918.6SM
M 8	50	30.92	6.87	VR0918.8SM
M 10	25	32.54	7.23	VR0918.10SM

Piulita de sudare ambutisata, amprenta interioara, otel

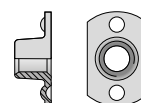

mm	Ambalare (buc.)	Pret / 100 buc.		Cod
		LEI	EURO	
M 3	100	11.39	2.53	VR0919.3SM
M 4	100	11.39	2.53	VR0919.4SM
M 5	100	12.20	2.71	VR0919.5SM
M 6	50	13.01	2.89	VR0919.6SM
M 8	50	30.92	6.87	VR0919.8SM
M 10	25	32.54	7.23	VR0919.10SM

Surub cu cap inecat si locas Inbus, otel, gr. 10.9

DIN 7991



Produs cu stoc limitat.

mm	Ambalare (buc.)	Pret / 100 buc.		Cod
		LEI	EURO	
M 3 x 6	250	2.12	0.47	7991936SM*
M 3 x 10	250	2.48	0.55	79919310SM*
M 3 x 12	250	2.48	0.55	79919312SM*
M 3 x 14	250	2.52	0.56	79919314SM*
M 3 x 16	250	2.88	0.64	79919316SM*
M 3 x 18	250	3.15	0.70	79919318SM*
M 3 x 20	250	3.42	0.76	79919320SM*
M 4 x 10	250	3.15	0.70	79919410SM*
M 4 x 12	250	3.56	0.79	79919412SM*
M 4 x 16	250	3.74	0.83	79919416SM*
M 4 x 20	250	4.55	1.01	79919420SM*
M 4 x 25	250	4.68	1.04	79919425SM*
M 5 x 10	250	4.86	1.08	79919510SM*
M 5 x 12	250	5.13	1.14	79919512SM*
M 5 x 16	250	5.18	1.15	79919516SM*
M 5 x 20	250	5.63	1.25	79919520SM*
M 5 x 25	250	7.83	1.74	79919525SM*
M 5 x 30	250	8.33	1.85	79919530SM*
M 5 x 35	100	10.80	2.40	79919535SM*
M 5 x 40	100	10.80	2.40	79919540SM*
M 5 x 45	100	13.19	2.93	79919545SM*
M 5 x 50	100	13.73	3.05	79919550SM*
M 6 x 10	250	6.62	1.47	79919610SM*
M 6 x 12	250	5.13	1.14	79919612SM*
M 6 x 16	250	5.13	1.14	79919616SM*
M 6 x 20	250	5.63	1.25	79919620SM*
M 6 x 25	250	6.62	1.47	79919625SM*
M 6 x 30	250	8.55	1.90	79919630SM*
M 6 x 35	100	8.82	1.96	79919635SM*
M 6 x 40	100	10.94	2.43	79919640SM*
M 6 x 45	100	13.19	2.93	79919645SM*
M 6 x 50	100	13.64	3.03	79919650SM*
M 6 x 60	100	16.07	3.57	79919660SM*
M 8 x 12	100	8.64	1.92	79919812SM*
M 8 x 16	100	10.13	2.25	79919816SM*
M 8 x 20	100	10.67	2.37	79919820SM*
M 8 x 25	100	12.65	2.81	79919825SM*
M 8 x 30	100	14.54	3.23	79919830SM*
M 8 x 35	50	16.52	3.67	79919835SM*

Surub ornamental, otel zincat galben

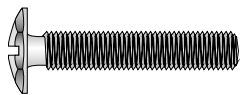

mm	Ambalare (buc.)	Pret / 100 buc.		Cod
		LEI	EURO	
M 6 x 30	100	55.80	12.40	VR2028.630SM
M 6 x 35	100	60.03	13.34	VR2028.635SM
M 6 x 40	100	61.74	13.72	VR2028.640SM
M 6 x 45	100	70.74	15.72	VR2028.645SM
M 6 x 50	100	77.99	17.33	VR2028.650SM
M 6 x 55	100	78.66	17.48	VR2028.655SM
M 6 x 60	100	93.56	20.79	VR2028.660SM
M 6 x 65	100	101.75	22.61	VR2028.665SM
M 6 x 70	100	112.68	25.04	VR2028.670SM
M 6 x 80	100	119.21	26.49	VR2028.680SM
M 6 x 85	100	124.25	27.61	VR2028.685SM

Ochi filetat fara saibe si piulite, otel zincat

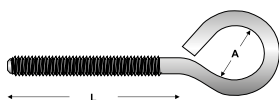

mm	Ambalare (buc.)	Pret / 100 buc.		Cod
		LEI	EURO	
M 6 x 20 x 16	25	37.35	8.30	X0312620SM
M 6 x 45 x 16	25	50.45	11.21	X0312645SM
M 6 x 60 x 16	25	54.41	12.09	X0312660SM
M 8 x 20 x 20	25	72.95	16.21	X0312820SM
M 8 x 50 x 20	25	99.50	22.11	X0312850SM
M 8 x 100 x 20	25	112.14	24.92	X03128100SM
M 10 x 30 x 25	25	147.92	32.87	X03121030SM
M 10 x 65 x 25	25	183.56	40.79	X03121065SM
M 10 x 100 x 25	25	196.65	43.70	X031210100SM
M 12 x 40 x 30	25	224.15	49.81	X03121240SM
M 12 x 75 x 30	25	275.85	61.30	X03121275SM
M 12 x 100 x 30	25	295.02	65.56	X031212100SM

Carlig filetat fara saibe si piulite, otel zincat

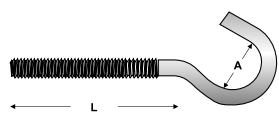

mm	Ambalare (buc.)	Pret / 100 buc.		Cod
		LEI	EURO	
M 6 x 20 x 16	25	33.80	7.51	X0314620SM
M 6 x 45 x 16	25	46.53	10.34	X0314645SM
M 6 x 60 x 16	25	50.36	11.19	X0314660SM
M 8 x 20 x 20	25	70.83	15.74	X0314820SM
M 8 x 50 x 20	25	90.09	20.02	X0314850SM
M 8 x 100 x 20	25	104.40	23.20	X03148100SM
M 10 x 30 x 25	25	124.88	27.75	X03141030SM
M 10 x 65 x 25	25	164.52	36.56	X03141065SM
M 10 x 100 x 25	25	172.94	38.43	X031410100SM
M 12 x 40 x 30	25	189.32	42.07	X03141240SM
M 12 x 75 x 30	25	246.20	54.71	X03141275SM
M 12 x 100 x 30	25	265.10	58.91	X031412100SM

Saiba pentru caroserii, otel zincat



mm	Ambalare (buc.)	Pret / 100 buc.		Cod
		LEI	EURO	
4.3 x 15 x 1.5	200	2.12	0.47	X0907431515SM
4.3 x 20 x 1.5	200	4.14	0.92	X0907432015SM
5.3 x 20 x 1.5	200	3.60	0.80	X0907532015SM
5.3 x 25 x 1.5	200	6.08	1.35	X0907532515SM
5.3 x 30 x 1.5	200	9.32	2.07	X0907533015SM
6.4 x 20 x 1.5	100	3.60	0.80	X0907642015SM
6.4 x 25 x 1.5	100	5.90	1.31	X0907642515SM
6.4 x 30 x 1.5	100	8.28	1.84	X0907643015SM
6.4 x 35 x 1.5	100	12.11	2.69	X0907643515SM
6.4 x 40 x 1.5	100	15.53	3.45	X0907644015SM
8.4 x 20 x 1.5	50	3.60	0.80	X0907842015SM
8.4 x 25 x 1.5	50	5.63	1.25	X0907842515SM
8.4 x 30 x 1.5	50	8.37	1.86	X0907843015SM
8.4 x 35 x 1.5	50	12.74	2.83	X0907843515SM
8.4 x 40 x 1.5	50	16.02	3.56	X0907844015SM
10.5 x 25 x 1.5	50	5.72	1.27	X09071052515SM
10.5 x 30 x 1.5	50	8.91	1.98	X09071053015SM
10.5 x 40 x 1.5	50	16.47	3.66	X09071054015SM

Surub "E-JET" pentru lemn, otel zincat galben



mm	Ambalare (buc.)	Pret / 100 buc.		Cod
		LEI	EURO	
3.0 x 20 T10	1000	1.94	0.43	EG3320SM
3.0 x 30 T10	1000	2.52	0.56	EG3330SM
3.0 x 35 T10	1000	2.52	0.56	EG3335SM
3.0 x 40 T10	1000	3.11	0.69	EG3340SM
3.0 x 45 T10	1000	3.29	0.73	EG3345SM
3.0 x 50 T10	500	3.74	0.83	EG3350SM
3.5 x 16 T15	1000	1.80	0.40	EG33516SM
3.5 x 18 T15	1000	2.12	0.47	EG33518SM
3.5 x 20 T15	1000	2.12	0.47	EG33520SM
3.5 x 25 T15	1000	2.52	0.56	EG33525SM
3.5 x 30 T15	1000	2.97	0.66	EG33530SM
3.5 x 35 T15	1000	3.20	0.71	EG33535SM
3.5 x 40 T15	500	3.74	0.83	EG33540SM
3.5 x 45 T15	500	3.74	0.83	EG33545SM
3.5 x 50 T15	500	4.01	0.89	EG33550SM
4.0 x 20 T20	1000	2.66	0.59	EG3420SM
4.0 x 30 T20	1000	3.47	0.77	EG3430SM
4.0 x 35 T20	1000	4.01	0.89	EG3435SM
4.0 x 40 T20	500	4.68	1.04	EG3440SM
4.0 x 45 T21	500	4.68	1.04	EG3445SM
4.0 x 50 T20	500	5.54	1.23	EG3450SM
4.0 x 60 T20	500	6.75	1.50	EG3460SM
4.0 x 70 T20	200	7.79	1.73	EG3470SM
4.5 x 20 T25	500	3.06	0.68	EG34520SM
4.5 x 25 T25	500	4.28	0.95	EG34525SM
4.5 x 30 T25	500	4.28	0.95	EG34530SM
4.5 x 35 T25	500	4.95	1.10	EG34535SM
4.5 x 40 T25	500	5.67	1.26	EG34540SM
4.5 x 45 T25	500	5.67	1.26	EG34545SM
4.5 x 50 T25	500	6.75	1.50	EG34550SM
4.5 x 60 T25	200	8.60	1.91	EG34560SM
4.5 x 80 T25	200	11.34	2.52	EG34580SM
5.0 x 35 T25	500	5.58	1.24	EG3535SM
5.0 x 40 T25	500	6.35	1.41	EG3540SM
5.0 x 45 T25	500	7.47	1.66	EG3545SM
5.0 x 50 T25	200	8.06	1.79	EG3550SM
5.0 x 60 T25	200	10.31	2.29	EG3560SM
5.0 x 70 T25	200	11.48	2.55	EG3570SM
5.0 x 80 T25	200	13.55	3.01	EG3580SM
5.0 x 90 T25	100	17.10	3.80	EG3590SM
5.0 x 100 T25	100	18.99	4.22	EG35100SM
5.0 x 110 T25	100	20.25	4.50	EG35110SM
5.0 x 120 T25	100	25.70	5.71	EG35120SM
6.0 x 40 T30	200	9.32	2.07	EG3640SM
6.0 x 50 T30	200	10.85	2.41	EG3650SM
6.0 x 60 T30	200	14.27	3.17	EG3660SM
6.0 x 70 T30	200	16.38	3.64	EG3670SM
6.0 x 80 T30	200	18.27	4.06	EG3680SM
6.0 x 90 T30	100	20.52	4.56	EG3690SM
6.0 x 100 T30	100	24.53	5.45	EG36100SM
6.0 x 110 T30	100	27.41	6.09	EG36110SM
6.0 x 120 T30	100	29.16	6.48	EG36120SM
6.0 x 140 T30	100	41.94	9.32	EG36140SM
6.0 x 150 T30	100	45.68	10.15	EG36150SM
6.0 x 160 T30	100	53.60	11.91	EG36160SM
6.0 x 180 T30	100	76.91	17.09	EG36180SM
6.0 x 200 T30	100	99.72	22.16	EG36200SM
6.0 x 220 T30	100	122.81	27.29	EG36220SM
6.0 x 240 T30	100	138.47	30.77	EG36240SM

Rozeta din tabla stantata, otel nichelat



mm	Ambalare (buc.)	Pret / 100 buc.		Cod
		LEI	EURO	
3 x 11	100	13.59	3.02	VR6570.311SM
5 x 11	100	11.84	2.63	VR6570.511SM
5 x 12.5	100	23.58	5.24	VR6570.5125SM
6 x 13	100	23.90	5.31	VR6570.613SM
7.2 x 15	100	31.28	6.95	VR6570.7215SM

Surub PAL total filetat, cu cap inecat, otel zincat galben

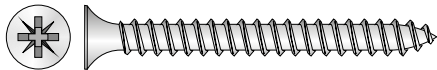

mm	Ambalare (buc.)	Pret / 100 buc.		Cod
		LEI	EURO	
2.5 x 12 / Pz1	2000	0.59	0.13	X0010T2512SM
2.5 x 14 / Pz1	2000	0.81	0.18	X0010T2514SM
2.5 x 16 / Pz1	2000	0.81	0.18	X0010T2516SM
2.5 x 18 / Pz1	2000	0.86	0.19	X0010T2518SM
2.5 x 20 / Pz1	2000	0.90	0.20	X0010T2520SM
2.5 x 25 / Pz1	2000	1.08	0.24	X0010T2525SM
3.0 x 10 / Pz1	1000	0.86	0.19	X0010T310SM
3.0 x 12 / Pz1	1000	0.63	0.14	X0010T312SM
3.0 x 13 / Pz1	1000	0.63	0.14	X0010T313SM
3.0 x 14 / Pz1	1000	0.90	0.20	X0010T314SM
3.0 x 16 / Pz1	1000	0.90	0.20	X0010T316SM
3.0 x 18 / Pz1	1000	0.95	0.21	X0010T318SM
3.0 x 20 / Pz1	1000	0.95	0.21	X0010T320SM
3.0 x 25 / Pz1	1000	1.13	0.25	X0010T325SM
3.0 x 30 / Pz1	1000	1.17	0.26	X0010T330SM
3.0 x 35 / Pz1	1000	1.44	0.32	X0010T335SM
3.0 x 40 / Pz1	1000	1.53	0.34	X0010T340SM
3.5 x 12 / Pz2	1000	0.86	0.19	X0010T3512SM
3.5 x 13 / Pz2	1000	0.99	0.22	X0010T3513SM
3.5 x 16 / Pz2	1000	1.04	0.23	X0010T3516SM
3.5 x 18 / Pz2	1000	1.08	0.24	X0010T3518SM
3.5 x 20 / Pz2	1000	1.13	0.25	X0010T3520SM
3.5 x 25 / Pz2	1000	1.31	0.29	X0010T3525SM
3.5 x 30 / Pz2	1000	1.49	0.33	X0010T3530SM
3.5 x 35 / Pz2	1000	1.62	0.36	X0010T3535SM
3.5 x 40 / Pz2	1000	1.89	0.42	X0010T3540SM
3.5 x 45 / Pz2	1000	2.07	0.46	X0010T3545SM
3.5 x 50 / Pz2	1000	2.34	0.52	X0010T3550SM
4.0 x 12 / Pz2	1000	1.17	0.26	X0010T412SM
4.0 x 14 / Pz2	1000	1.04	0.23	X0010T414SM
4.0 x 16 / Pz2	1000	1.22	0.27	X0010T416SM
4.0 x 18 / Pz2	1000	1.35	0.30	X0010T418SM
4.0 x 20 / Pz2	1000	1.49	0.33	X0010T420SM
4.0 x 25 / Pz2	1000	1.53	0.34	X0010T425SM
4.0 x 30 / Pz2	1000	1.85	0.41	X0010T430SM
4.0 x 35 / Pz2	1000	2.07	0.46	X0010T435SM
4.0 x 40 / Pz2	1000	2.34	0.52	X0010T440SM
4.0 x 45 / Pz2	1000	2.52	0.56	X0010T445SM
4.0 x 50 / Pz2	1000	2.79	0.62	X0010T450SM
4.0 x 60 / Pz2	500	3.38	0.75	X0010T460SM
4.0 x 70 / Pz2	500	3.83	0.85	X0010T470SM
4.5 x 16 / Pz2	1000	1.49	0.33	X0010T4516SM
4.5 x 18 / Pz2	1000	1.49	0.33	X0010T4518SM
4.5 x 20 / Pz2	1000	1.80	0.40	X0010T4520SM
4.5 x 25 / Pz2	1000	1.94	0.43	X0010T4525SM
4.5 x 30 / Pz2	1000	2.16	0.48	X0010T4530SM
4.5 x 35 / Pz2	1000	2.79	0.62	X0010T4535SM
4.5 x 40 / Pz2	1000	2.84	0.63	X0010T4540SM
4.5 x 45 / Pz2	500	3.15	0.70	X0010T4545SM
4.5 x 50 / Pz2	500	3.65	0.81	X0010T4550SM
4.5 x 60 / Pz2	500	4.23	0.94	X0010T4560SM
4.5 x 70 / Pz2	500	5.04	1.12	X0010T4570SM
4.5 x 80 / Pz2	500	6.08	1.35	X0010T4580SM
5.0 x 16 / Pz2	1000	1.71	0.38	X0010T516SM
5.0 x 20 / Pz2	1000	2.07	0.46	X0010T520SM
5.0 x 25 / Pz2	1000	2.48	0.55	X0010T525SM
5.0 x 30 / Pz2	1000	2.75	0.61	X0010T530SM
5.0 x 35 / Pz2	1000	3.20	0.71	X0010T535SM
5.0 x 40 / Pz2	1000	3.42	0.76	X0010T540SM
5.0 x 45 / Pz2	500	3.78	0.84	X0010T545SM
5.0 x 50 / Pz2	500	4.28	0.95	X0010T550SM
5.0 x 55 / Pz2	500	4.28	0.95	X0010T555SM
5.0 x 60 / Pz2	500	4.91	1.09	X0010T560SM
5.0 x 70 / Pz2	500	5.90	1.31	X0010T570SM
5.0 x 80 / Pz2	200	6.57	1.46	X0010T580SM
6.0 x 30 / Pz3	500	5.04	1.12	X0010T630SM
6.0 x 35 / Pz3	500	4.64	1.03	X0010T635SM
6.0 x 40 / Pz3	500	5.76	1.28	X0010T640SM
6.0 x 45 / Pz3	500	6.48	1.44	X0010T645SM
6.0 x 50 / Pz3	200	6.71	1.49	X0010T650SM
6.0 x 60 / Pz3	200	7.38	1.64	X0010T660SM
6.0 x 70 / Pz3	200	8.55	1.90	X0010T670SM
6.0 x 80 / Pz3	200	10.08	2.24	X0010T680SM

Surub PAL total filetat, cu cap inecat, otel zincat alb

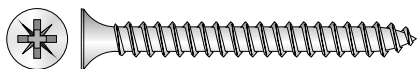

mm	Ambalare (buc.)	Pret / 100 buc.		Cod
		LEI	EURO	
3.0 x 16 / Pz1	1000	0.90	0.20	X001AT316SM
3.0 x 35 / Pz1	1000	1.08	0.24	X001AT335SM
4.0 x 30 / Pz2	1000	1.89	0.42	X001AT430SM
4.0 x 35 / Pz2	1000	2.12	0.47	X001AT435SM
4.0 x 40 / Pz2	1000	2.34	0.52	X001AT440SM
4.0 x 50 / Pz2	1000	2.84	0.63	X001AT450SM
4.0 x 60 / Pz2	500	3.47	0.77	X001AT460SM
4.0 x 70 / Pz2	500	3.96	0.88	X001AT470SM
4.5 x 60 / Pz2	500	4.23	0.94	X001AT4560SM
5.0 x 45 / Pz2	500	3.83	0.85	X001AT545SM
5.0 x 50 / Pz2	500	4.37	0.97	X001AT550SM
5.0 x 60 / Pz2	500	5.00	1.11	X001AT560SM
5.0 x 70 / Pz2	500	6.03	1.34	X001AT570SM
5.0 x 80 / Pz2	200	6.71	1.49	X001AT580SM
6.0 x 60 / Pz3	200	7.52	1.67	X001AT660SM
6.0 x 80 / Pz3	200	10.26	2.28	X001AT680SM

Surub PAL partial filetat, cu cap inecat, otel zincat galben

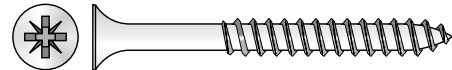

mm	Ambalare (buc.)	Pret / 100 buc.		Cod
		LEI	EURO	
3.0 x 25 / Pz1	1000	1.13	0.25	X0010P325SM
3.0 x 30 / Pz1	1000	1.17	0.26	X0010P330SM
3.0 x 35 / Pz1	1000	1.44	0.32	X0010P335SM
3.0 x 40 / Pz1	1000	1.53	0.34	X0010P340SM
3.5 x 25 / Pz2	1000	1.31	0.29	X0010P3525SM
3.5 x 30 / Pz2	1000	1.49	0.33	X0010P3530SM
3.5 x 35 / Pz2	1000	1.62	0.36	X0010P3535SM
3.5 x 40 / Pz2	1000	1.89	0.42	X0010P3540SM
3.5 x 45 / Pz2	1000	2.07	0.46	X0010P3545SM
3.5 x 50 / Pz2	1000	2.34	0.52	X0010P3550SM
4.0 x 25 / Pz2	1000	1.53	0.34	X0010P425SM
4.0 x 30 / Pz2	1000	1.85	0.41	X0010P430SM
4.0 x 35 / Pz2	1000	2.07	0.46	X0010P435SM
4.0 x 40 / Pz2	1000	2.34	0.52	X0010P440SM
4.0 x 45 / Pz2	1000	2.52	0.56	X0010P445SM
4.0 x 50 / Pz2	1000	2.79	0.62	X0010P450SM
4.0 x 60 / Pz2	500	3.38	0.75	X0010P460SM
4.0 x 70 / Pz2	500	3.83	0.85	X0010P470SM
4.5 x 35 / Pz2	1000	2.79	0.62	X0010P4535SM
4.5 x 40 / Pz2	1000	2.79	0.62	X0010P4540SM
4.5 x 45 / Pz2	500	3.15	0.70	X0010P4545SM
4.5 x 50 / Pz2	500	3.65	0.81	X0010P4550SM
4.5 x 60 / Pz2	500	4.14	0.92	X0010P4560SM
4.5 x 70 / Pz2	500	5.04	1.12	X0010P4570SM
4.5 x 80 / Pz2	500	6.08	1.35	X0010P4580SM
5.0 x 30 / Pz2	1000	2.75	0.61	X0010P530SM
5.0 x 35 / Pz2	1000	3.20	0.71	X0010P535SM
5.0 x 40 / Pz2	1000	3.42	0.76	X0010P540SM
5.0 x 45 / Pz2	500	3.78	0.84	X0010P545SM
5.0 x 50 / Pz2	500	4.28	0.95	X0010P550SM
5.0 x 55 / Pz2	500	4.28	0.95	X0010P555SM
5.0 x 60 / Pz2	500	4.91	1.09	X0010P560SM
5.0 x 70 / Pz2	500	5.90	1.31	X0010P570SM
5.0 x 80 / Pz2	200	6.57	1.46	X0010P580SM
5.0 x 90 / Pz2	200	8.15	1.81	X0010P590SM
5.0 x 100 / Pz2	200	9.59	2.13	X0010P5100SM
5.0 x 120 / Pz2	100	12.74	2.83	X0010P5120SM
5.0 x 140 / Pz2	100	18.14	4.03	X0010P5140SM
6.0 x 40 / Pz3	500	5.76	1.28	X0010P640SM
6.0 x 45 / Pz3	500	6.48	1.44	X0010P645SM
6.0 x 50 / Pz3	200	6.71	1.49	X0010P650SM
6.0 x 60 / Pz3	200	7.38	1.64	X0010P660SM
6.0 x 70 / Pz3	200	8.55	1.90	X0010P670SM
6.0 x 80 / Pz3	200	10.08	2.24	X0010P680SM
6.0 x 90 / Pz3	200	11.79	2.62	X0010P690SM
6.0 x 100 / Pz3	100	13.37	2.97	X0010P6100SM
6.0 x 110 / Pz3	100	15.84	3.52	X0010P6110SM
6.0 x 120 / Pz3	100	17.28	3.84	X0010P6120SM
6.0 x 130 / Pz3	100	19.80	4.40	X0010P6130SM
6.0 x 140 / Pz3	100	24.35	5.41	X0010P6140SM
6.0 x 150 / Pz3	100	27.45	6.10	X0010P6150SM
6.0 x 160 / Pz3	20	28.98	6.44	X0010P6160SM
6.0 x 180 / Pz3	20	40.86	9.08	X0010P6180SM
6.0 x 200 / Pz3	20	49.05	10.90	X0010P6200SM
6.0 x 220 / Pz3	20	58.23	12.94	X0010P6220SM

Surub PAL partial filetat, cu cap inecat, otel zincat alb

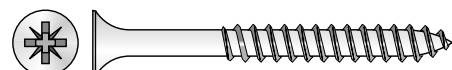

mm	Ambalare (buc.)	Pret / 100 buc.		Cod
		LEI	EURO	
4.0 x 30 / Pz2	1000	2.34	0.52	X001AP430SM
4.0 x 35 / Pz2	1000	2.48	0.55	X001AP435SM
4.0 x 40 / Pz2	1000	2.48	0.55	X001AP440SM
4.0 x 50 / Pz2	1000	3.83	0.85	X001AP450SM
4.0 x 60 / Pz2	500	3.83	0.85	X001AP460SM
4.0 x 70 / Pz2	500	4.82	1.07	X001AP470SM
4.5 x 60 / Pz2	500	4.23	0.94	X001AP4560SM
5.0 x 45 / Pz2	500	3.83	0.85	X001AP545SM
5.0 x 50 / Pz2	500	5.00	1.11	X001AP550SM
5.0 x 60 / Pz2	500	6.80	1.51	X001AP560SM
5.0 x 70 / Pz2	500	6.80	1.51	X001AP570SM
5.0 x 80 / Pz2	200	8.42	1.87	X001AP580SM
5.0 x 90 / Pz2	200	8.46	1.88	X001AP590SM
5.0 x 100 / Pz2	200	9.77	2.17	X001AP5100SM
5.0 x 120 / Pz2	100	13.01	2.89	X001AP5120SM
6.0 x 60 / Pz3	200	8.73	1.94	X001AP660SM
6.0 x 80 / Pz3	200	11.97	2.66	X001AP680SM
6.0 x 100 / Pz3	100	14.18	3.15	X001AP6100SM
6.0 x 120 / Pz3	100	17.60	3.91	X001AP6120SM
6.0 x 140 / Pz3	100	24.84	5.52	X001AP6140SM
6.0 x 150 / Pz3	100	27.99	6.22	X001AP6150SM
6.0 x 180 / Pz3	20	41.72	9.27	X001AP6180SM
6.0 x 200 / Pz3	20	50.00	11.11	X001AP6200SM

Surub PAL cu cap semibombat, otel zincat galben



Produs cu stoc limitat.

mm	Ambalare (buc.)	Pret / 100 buc.		Cod
		LEI	EURO	
3.0 x 12 / Pz1	1000	0.36	0.08	X0021312SM*
3.0 x 16 / Pz1	1000	0.45	0.10	X0021316SM*
3.0 x 20 / Pz1	1000	0.54	0.12	X0021320SM*
3.5 x 16 / Pz2	1000	0.68	0.15	X00213516SM*
3.5 x 20 / Pz2	1000	1.13	0.25	X00213520SM*
3.5 x 25 / Pz2	1000	1.13	0.25	X00213525SM*
3.5 x 30 / Pz2	1000	1.13	0.25	X00213530SM*
3.5 x 35 / Pz2	1000	1.58	0.35	X00213535SM*
3.5 x 40 / Pz2	1000	2.07	0.46	X00213540SM*
4.0 x 16 / Pz2	1000	1.31	0.29	X0021416SM*
4.0 x 20 / Pz2	1000	1.44	0.32	X0021420SM*
4.0 x 25 / Pz2	1000	1.89	0.42	X0021425SM*
4.0 x 30 / Pz2	1000	1.89	0.42	X0021430SM*
4.0 x 35 / Pz2	1000	1.94	0.43	X0021435SM*
4.0 x 40 / Pz2	1000	1.94	0.43	X0021440SM*
4.5 x 25 / Pz2	1000	1.85	0.41	X00214525SM*
4.5 x 45 / Pz2	500	3.38	0.75	X00214545SM*
4.5 x 50 / Pz2	500	3.83	0.85	X00214550SM*
5.0 x 16 / Pz2	1000	2.03	0.45	X0021516SM*
5.0 x 25 / Pz2	1000	4.05	0.90	X0021525SM*
5.0 x 30 / Pz2	1000	4.05	0.90	X0021530SM*
5.0 x 40 / Pz2	1000	4.10	0.91	X0021540SM*
5.0 x 50 / Pz2	500	4.64	1.03	X0021550SM*
6.0 x 50 / Pz3	200	5.85	1.30	X0021650SM*

Surub PAL cu cap semibombat, otel nichelat



mm	Ambalare (buc.)	Pret / 100 buc.		Cod
		LEI	EURO	
3 x 25	100	2.12	0.47	VR114N.325SM
3 x 30	100	2.75	0.61	VR114N.330SM
3.5 x 15	100	1.89	0.42	VR114N.3515SM
3.5 x 17	100	1.94	0.43	VR114N.3517SM
3.5 x 20	100	2.12	0.47	VR114N.3520SM
4 x 17	100	2.66	0.59	VR114N.417SM
4 x 25	100	3.24	0.72	VR114N.425SM

Surub cu cap plat pentru lemn, otel zincat

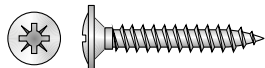

mm	Ambalare (buc.)	Pret / 100 buc.		Cod
		LEI	EURO	
3 x 16 / 14	500	1.49	0.33	VR1149.316SM
3 x 20 / 18	500	1.67	0.37	VR1149.320SM
3 x 25 / 23	500	1.94	0.43	VR1149.325SM
3 x 30 / 28	500	2.12	0.47	VR1149.330SM
3.5 x 17 / 14	500	1.94	0.43	VR1149.3517SM
3.5 x 25 / 22	500	7.52	1.67	VR1149.3525SM
3.5 x 30 / 27	500	7.52	1.67	VR1149.3530SM
4 x 13 / 11	500	2.07	0.46	VR1149.413SM
4 x 15 / 13	500	2.12	0.47	VR1149.415SM
4 x 17 / 15	500	2.34	0.52	VR1149.417SM
4 x 20 / 18	500	2.34	0.52	VR1149.420SM
4 x 25 / 23	500	2.75	0.61	VR1149.425SM
4 x 27 / 25	500	3.06	0.68	VR1149.427SM
4 x 30 / 28	500	3.11	0.69	VR1149.430SM
4 x 35 / 33	500	3.24	0.72	VR1149.435SM
4 x 40 / 38	500	4.19	0.93	VR1149.440SM

Prezon pentru lemn, otel zincat



mm	Ambalare (buc.)	Pret / 100 buc.		Cod
		LEI	EURO	
6.0 x 60	100	8.96	1.99	X0040660SM
6.0 x 70	100	8.96	1.99	X0040670SM
6.0 x 80	100	11.66	2.59	X0040680SM
6.0 x 100	100	12.96	2.88	X00406100SM
8.0 x 50	100	8.28	1.84	X0040850SM
8.0 x 60	100	11.34	2.52	X0040860SM
8.0 x 70	100	14.04	3.12	X0040870SM
8.0 x 80	100	17.33	3.85	X0040880SM
8.0 x 90	100	19.13	4.25	X0040890SM
8.0 x 100	100	21.60	4.80	X00408100SM
8.0 x 120	100	24.71	5.49	X00408120SM
8.0 x 140	50	25.70	5.71	X00408140SM
8.0 x 150	50	30.69	6.82	X00408150SM
8.0 x 160	50	36.72	8.16	X00408160SM
8.0 x 200	50	40.64	9.03	X00408200SM
10.0 x 60	100	19.58	4.35	X00401060SM
10.0 x 80	100	26.15	5.81	X00401080SM
10.0 x 90	100	26.15	5.81	X00401090SM
10.0 x 100	100	31.91	7.09	X004010100SM

Prezon pentru lemn, otel zincat (continuare)

mm	Ambalare (buc.)	Pret / 100 buc.		Cod
		LEI	EURO	
10.0 x 120	100	38.25	8.50	X004010120SM
10.0 x 140	50	51.08	11.35	X004010140SM
10.0 x 150	50	57.87	12.86	X004010150SM
10.0 x 160	50	64.35	14.30	X004010160SM
10.0 x 180	20	70.74	15.72	X004010180SM
10.0 x 200	20	70.79	15.73	X004010200SM
12.0 x 180	20	82.22	18.27	X004012180SM
12.0 x 200	20	128.34	28.52	X004012200SM

Prezon pentru lemn, filet redus, otel zincat

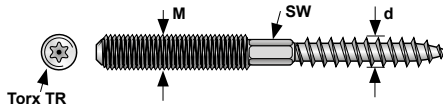

M	d (mm)	SW	TR
M 6	5.0	-	TR 15
M 8	7.0	6	TR 25
M 10	8.9	6	TR 25
M 12	11.7	10	TR 30

mm	Ambalare (buc.)	Pret / 100 buc.		Cod
		LEI	EURO	
M 6 x 40	100	5.90	1.31	VR2231.640SM
M 6 x 45	100	8.24	1.83	VR2231.645SM
M 6 x 50	100	8.24	1.83	VR2231.650SM
M 6 x 60	100	9.99	2.22	VR2231.660SM
M 6 x 70	100	10.89	2.42	VR2231.670SM
M 6 x 80	100	12.38	2.75	VR2231.680SM
M 6 x 90	100	13.77	3.06	VR2231.690SM
M 6 x 100	100	15.39	3.42	VR2231.6100SM
M 6 x 120	100	19.08	4.24	VR2231.6120SM
M 8 x 50	100	10.67	2.37	VR2231.850SM
M 8 x 60	100	13.50	3.00	VR2231.860SM
M 8 x 70	100	14.81	3.29	VR2231.870SM
M 8 x 80	100	17.15	3.81	VR2231.880SM
M 8 x 90	100	18.54	4.12	VR2231.890SM
M 8 x 100	100	23.99	5.33	VR2231.8100SM
M 8 x 110	100	25.61	5.69	VR2231.8110SM
M 8 x 120	100	27.63	6.14	VR2231.8120SM
M 8 x 130	100	29.57	6.57	VR2231.8130SM
M 8 x 140	100	31.50	7.00	VR2231.8140SM
M 8 x 150	100	35.06	7.79	VR2231.8150SM
M 8 x 160	100	42.12	9.36	VR2231.8160SM
M 8 x 180	100	42.35	9.41	VR2231.8180SM
M 8 x 200	100	52.97	11.77	VR2231.8200SM
M10 x 50	100	17.91	3.98	VR2231.1050SM
M10 x 60	100	21.29	4.73	VR2231.1060SM
M10 x 70	100	21.33	4.74	VR2231.1070SM
M10 x 80	100	28.35	6.30	VR2231.1080SM
M10 x 90	100	32.13	7.14	VR2231.1090SM
M10 x 100	100	36.18	8.04	VR2231.10100SM
M10 x 120	100	45.27	10.06	VR2231.10120SM
M10 x 140	100	50.27	11.17	VR2231.10140SM
M10 x 150	100	56.48	12.55	VR2231.10150SM
M10 x 160	100	60.93	13.54	VR2231.10160SM
M10 x 180	100	70.38	15.64	VR2231.10180SM
M10 x 200	100	74.66	16.59	VR2231.10200SM
M12 x 100	50	57.60	12.80	VR2231.12100SM
M12 x 120	50	70.25	15.61	VR2231.12120SM
M12 x 140	50	81.05	18.01	VR2231.12140SM
M12 x 180	25	124.88	27.75	VR2231.12180SM
M12 x 200	25	124.97	27.77	VR2231.12200SM

Surub pentru gips-carton, filet cu pas fin, tratat termic, otel fosfatat

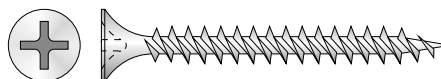

mm	Ambalare (buc.)	Pret / 100 buc.		Cod
		LEI	EURO	
3.5 x 19	1000	1.22	0.27	X01003519SM
3.5 x 25	1000	1.35	0.30	X01003525SM
3.5 x 32	1000	1.76	0.39	X01003532SM
3.5 x 35	1000	1.80	0.40	X01003535SM
3.5 x 41	1000	2.03	0.45	X01003541SM
3.5 x 45	1000	2.25	0.50	X01003545SM
3.5 x 51	1000	2.39	0.53	X01003551SM
3.5 x 55	1000	2.79	0.62	X01003555SM
3.8 x 64	1000	3.51	0.78	X01003864SM
3.9 x 25	1000	1.40	0.31	X01003925SM
3.9 x 35	1000	1.98	0.44	X01003935SM
3.9 x 45	1000	2.70	0.60	X01003945SM
3.9 x 55	1000	3.33	0.74	X01003955SM
4.2 x 65	250	4.10	0.91	X01004265SM
4.2 x 70	250	4.10	0.91	X01004270SM
4.2 x 75	250	4.64	1.03	X01004275SM
4.2 x 90	250	6.44	1.43	X01004290SM
4.8 x 90	250	8.96	1.99	X01004890SM
4.8 x 95	200	9.18	2.04	X01004895SM
4.8 x 102	100	10.94	2.43	X010048102SM
4.8 x 127	100	16.34	3.63	X010048127SM
4.8 x 152	100	20.88	4.64	X010048152SM

Surub pt. gips-carton, filet cu pas mare, tratat termic, otel fosfatat

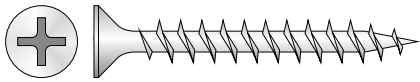

mm	Ambalare (buc.)	Pret / 100 buc.		Cod
		LEI	EURO	
3.5 x 19	1000	1.35	0.30	X01013519SM
3.5 x 25	1000	1.44	0.32	X01013525SM
3.5 x 32	1000	1.67	0.37	X01013532SM
3.5 x 35	1000	1.76	0.39	X01013535SM
3.5 x 45	1000	2.34	0.52	X01013545SM
3.5 x 51	1000	2.43	0.54	X01013551SM
3.5 x 55	1000	2.70	0.60	X01013555SM
3.8 x 64	1000	3.56	0.79	X01013864SM
3.9 x 25	1000	1.67	0.37	X01013925SM
3.9 x 35	1000	2.07	0.46	X01013935SM
4.2 x 75	250	4.50	1.00	X01014275SM
4.8 x 127	100	16.11	3.58	X010148127SM

Surub pt. gips-carton, filet dublu, tratat termic, otel fosfatat

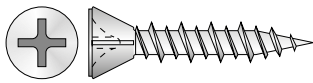

mm	Ambalare (buc.)	Pret / 100 buc.		Cod
		LEI	EURO	
3.9 x 25	1000	1.49	0.33	X01023925SM
3.9 x 35	1000	1.94	0.43	X01023935SM

Surub autoforant pentru gips-carton, otel fosfatat

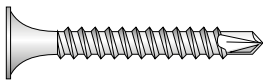

mm	Ambalare (buc.)	Pret / 100 buc.		Cod
		LEI	EURO	
3.5 x 25	1000	1.85	0.41	X01033525SM
3.5 x 35	1000	2.34	0.52	X01033535SM
3.5 x 45	1000	2.84	0.63	X01033545SM
3.5 x 55	1000	3.56	0.79	X01033555SM

Surub autofiletant cu cap special "plat+saiba", otel zincat

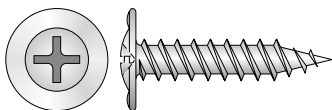

mm	Ambalare (buc.)	Pret / 100 buc.		Cod
		LEI	EURO	
4.2 x 13 / Ph2	500	1.89	0.42	X02114213SM
4.2 x 14 / Ph2	500	2.16	0.48	X02114214SM
4.2 x 16 / Ph2	500	2.34	0.52	X02114216SM
4.2 x 19 / Ph2	500	2.52	0.56	X02114219SM
4.2 x 25 / Ph2	500	2.97	0.66	X02114225SM
4.2 x 41 / Ph2	500	4.05	0.90	X02114241SM
4.2 x 51 / Ph2	500	4.23	0.94	X02114251SM

Surub autoforant pentru ferestre, otel zincat

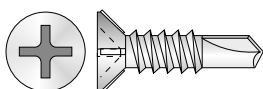

mm	Ambalare (buc.)	Pret / 100 buc.		Cod
		LEI	EURO	
3.9 x 16	1000	1.85	0.41	X02103916SM
3.9 x 19	1000	1.98	0.44	X02103919SM
3.9 x 22	1000	1.98	0.44	X02103922SM
3.9 x 25	1000	2.61	0.58	X02103925SM
3.9 x 32	1000	2.70	0.60	X02103932SM
3.9 x 35	500	3.38	0.75	X02103935SM

Surub pentru ferestre, filet Hi-Lo, PVC 10, otel zincat alb

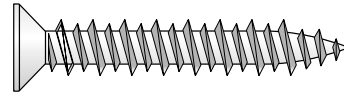

mm	Ambalare (buc.)	Pret / 100 buc.		Cod
		LEI	EURO	
3.9 x 16	500	1.71	0.38	X08113916SM
3.9 x 19	500	1.71	0.38	X08113919SM
3.9 x 22	500	1.71	0.38	X08113922SM
3.9 x 25	500	2.16	0.48	X08113925SM
3.9 x 30	500	2.43	0.54	X08113930SM
3.9 x 38	500	2.88	0.64	X08113938SM
3.9 x 45	500	3.24	0.72	X08113945SM

Surub pentru ferestre, filet Hi-Lo, PVC 10, otel zincat galben

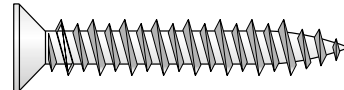

mm	Ambalare (buc.)	Pret / 100 buc.		Cod
		LEI	EURO	
3.9 x 16	500	1.71	0.38	X08013916SM
3.9 x 19	500	1.71	0.38	X08013919SM
3.9 x 22	500	1.71	0.38	X08013922SM
3.9 x 25	500	2.16	0.48	X08013925SM
3.9 x 30	500	2.43	0.54	X08013930SM
3.9 x 38	500	2.88	0.64	X08013938SM
3.9 x 45	500	3.24	0.72	X08013945SM

Surub pentru ferestre PVC 20, otel zincat galben

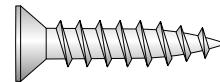

mm	Ambalare (buc.)	Pret / 100 buc.		Cod
		LEI	EURO	
4.3 x 25	500	2.21	0.49	X08024325SM
4.3 x 30	500	2.34	0.52	X08024330SM
4.3 x 38	500	2.70	0.60	X08024338SM
4.3 x 45	500	2.84	0.63	X08024345SM

Surub pentru ferestre PVC 20, otel zincat alb

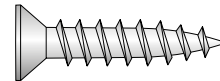

mm	Ambalare (buc.)	Pret / 100 buc.		Cod
		LEI	EURO	
4.3 x 25	500	2.21	0.49	X08124325SM

Surub pentru beton, cap tesit, otel zincat galben

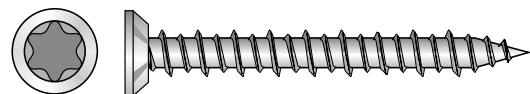

mm	Ambalare (buc.)	Pret / 100 buc.		Cod
		LEI	EURO	
7.5 x 42	100	10.71	2.38	X06007542SM
7.5 x 72	100	19.85	4.41	X06007572SM
7.5 x 92	100	24.71	5.49	X06007592SM
7.5 x 112	100	33.89	7.53	X060075112SM
7.5 x 132	100	46.17	10.26	X060075132SM
7.5 x 152	100	55.31	12.29	X060075152SM
7.5 x 182	100	84.78	18.84	X060075182SM

Surub pentru beton, cap tesit, otel zincat alb

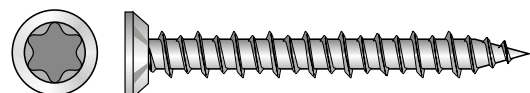

mm	Ambalare (buc.)	Pret / 100 buc.		Cod
		LEI	EURO	
7.5 x 72	100	20.25	4.50	X060A7572SM
7.5 x 92	100	26.33	5.85	X060A7592SM
7.5 x 112	100	35.06	7.79	X060A75112SM
7.5 x 132	100	45.81	10.18	X060A75132SM
7.5 x 152	100	60.35	13.41	X060A75152SM
7.5 x 182	100	88.02	19.56	X060A75182SM

Surub pentru beton, cap cilindric, otel zincat galben



mm	Ambalare (buc.)	Pret / 100 buc.		Cod
		LEI	EURO	
7.5 x 72	100	20.21	4.49	X06017572SM
7.5 x 112	100	33.12	7.36	X060175112SM
7.5 x 132	100	41.09	9.13	X060175132SM
7.5 x 152	100	52.79	11.73	X060175152SM
7.5 x 182	100	82.26	18.28	X060175182SM

Surub pentru beton, cap cilindric, otel zincat alb

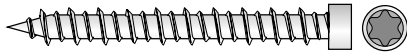

mm	Ambalare (buc.)	Pret / 100 buc.		Cod
		LEI	EURO	
7.5 x 72	100	23.81	5.29	VR6641.7572SM
7.5 x 92	100	32.40	7.20	VR6641.7592SM
7.5 x 112	100	40.10	8.91	VR6641.75112SM
7.5 x 132	100	42.89	9.53	VR6641.75132SM
7.5 x 152	100	55.49	12.33	VR6641.75152SM
7.5 x 182	100	75.11	16.69	VR6641.75182SM
7.5 x 212	100	124.25	27.61	VR6641.75212SM

Surub de imbinare UNITA, cap ingropat, locas Pozidriv cu orificiu pentru capac, otel zincat

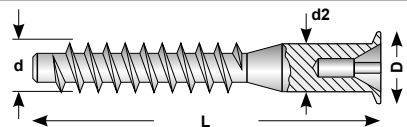

mm	Ambalare (buc.)	Pret / 100 buc.		Cod
		LEI	EURO	
5.0 x 40	100	6.21	1.38	VR.7501.01SM
5.0 x 50	100	6.75	1.50	VR.7501.02SM
6.3 x 40	100	10.35	2.30	VR.7501.05SM
6.3 x 50	100	10.35	2.30	VR.7501.06SM
6.3 x 60	100	11.61	2.58	VR.7501.07SM
7.0 x 40	100	9.05	2.01	VR.7501.08SM
7.0 x 50	100	9.95	2.21	VR.7501.09SM
7.0 x 60	100	14.45	3.21	VR.7501.10SM
7.0 x 70	100	16.07	3.57	VR.7501.11SM

Holz-surub de cuplare cu cap tesit, locas HEX, otel zincat

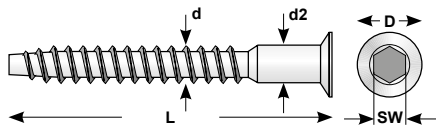

mm	Ambalare (buc.)	Pret / 100 buc.		Cod
		LEI	EURO	
5.0 x 50 SW3	100	6.53	1.45	X0050550SM
7.0 x 40 SW4	100	6.89	1.53	X0050740SM
7.0 x 50 SW4	100	7.11	1.58	X0050750SM
7.0 x 60 SW4	100	9.63	2.14	X0050760SM
7.0 x 70 SW4	100	11.12	2.47	X0050770SM

Surub de imbinare UNITA, cap bombat, locas Inbus SW4 cu orificiu pentru capac, otel zincat

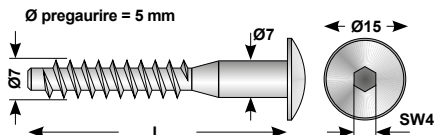

mm	Ambalare (buc.)	Pret / 100 buc.		Cod
		LEI	EURO	
6.3 x 40	100	9.59	2.13	VR.7541.01SM
6.3 x 50	100	9.59	2.13	VR.7541.02SM
7.0 x 40	100	9.59	2.13	VR.7541.05SM
7.0 x 50	100	9.59	2.13	VR.7541.06SM
7.0 x 60	100	12.33	2.74	VR.7541.07SM
7.0 x 70	100	15.03	3.34	VR.7541.08SM

Surub de imbinare UNITA, cap bombat, locas Inbus SW4, otel zincat

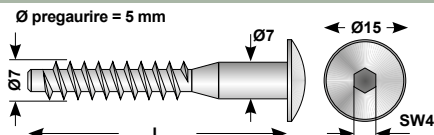

mm	Ambalare (buc.)	Pret / 100 buc.		Cod
		LEI	EURO	
50.0	100	15.57	3.46	VR.7560.02SM
70.0	100	18.72	4.16	VR.7560.04SM

Euro-surub cap ingropat Ø7 mm, locas Z, filet rar (pentru sine glisante), otel zincat

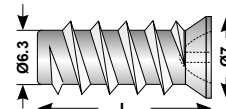

mm	Ambalare (buc.)	Pret / 100 buc.		Cod
		LEI	EURO	
9.0	100	2.07	0.46	VR.7472.01SM
11.0	100	2.48	0.55	VR.7472.02SM
13.0	100	2.61	0.58	VR.7472.03SM
14.0	100	3.02	0.67	VR.7472.04SM
16.0	100	3.20	0.71	VR.7472.05SM
19.0	100	3.38	0.75	VR.7472.06SM
30.0	100	5.18	1.15	VR.7472.09SM

Euro-surub cap ingropat Ø7.7 mm, locas Z, filet dublu, otel zincat

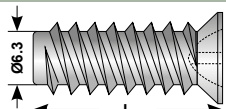

mm	Ambalare (buc.)	Pret / 100 buc.		Cod
		LEI	EURO	
11.0	100	4.64	1.03	VR.7471.01SM
12.0	100	2.97	0.66	VR.7471.02SM
13.0	100	2.97	0.66	VR.7471.03SM
15.0	100	3.56	0.79	VR.7471.04SM
16.0	100	3.56	0.79	VR.7471.05SM
19.0	100	3.69	0.82	VR.7471.06SM
25.0	100	6.30	1.40	VR.7471.07SM

Euro-surub cap ingropat Ø7.7 mm, locas Z, filet rar, otel zincat

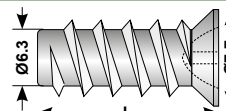

mm	Ambalare (buc.)	Pret / 100 buc.		Cod
		LEI	EURO	
11.0	100	2.57	0.57	VR.7470.01SM
13.0	100	2.84	0.63	VR.7470.02SM
15.0	100	3.02	0.67	VR.7470.03SM
16.0	100	3.15	0.70	VR.7470.04SM
19.0	100	3.51	0.78	VR.7470.05SM

Euro-surub cap bombat Ø9 mm, locas Z, filet dublu, otel zincat

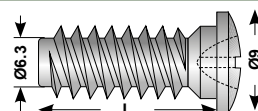

mm	Ambalare (buc.)	Pret / 100 buc.		Cod
		LEI	EURO	
9.0	100	3.02	0.67	VR.7461.01SM
10.0	100	4.28	0.95	VR.7461.02SM
11.0	100	4.28	0.95	VR.7461.03SM
12.0	100	4.32	0.96	VR.7461.04SM
13.0	100	4.32	0.96	VR.7461.05SM
15.0	100	4.50	1.00	VR.7461.06SM
16.0	100	4.50	1.00	VR.7461.07SM
19.0	100	4.68	1.04	VR.7461.08SM
25.0	100	5.36	1.19	VR.7461.09SM
30.0	100	10.17	2.26	VR.7461.10SM

Euro-surub cap bombat Ø9 mm, locas Z, filet dublu, otel nichelat

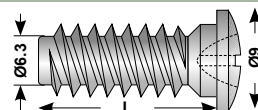

mm	Ambalare (buc.)	Pret / 100 buc.		Cod
		LEI	EURO	
15.0	100	4.95	1.10	VR.7461.13SM

Euro-surub cap bombat Ø9 mm, Pozidriv, filet rar, otel zincat

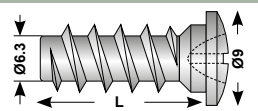

mm	Ambalare (buc.)	Pret / 100 buc.		Cod
		LEI	EURO	
11.0	100	3.51	0.78	VR.7460.01SM
13.0	100	3.51	0.78	VR.7460.02SM
16.0	100	3.92	0.87	VR.7460.03SM
25.0	100	5.18	1.15	VR.7460.04SM

Euro-surub cap bombat Ø9 mm, Pozidriv, filet rar, oțel nichelat

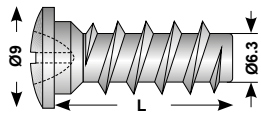

L (mm)	Ambalare (buc.)	Pret / 100 buc.		Cod
		LEI	EURO	
13.0	1000	4.32	0.96	VR.7460.06SM

Bolt filetata M6 cu cap slot semirotond, fara saibe si piulite, oțel zincat, gr. 4.6

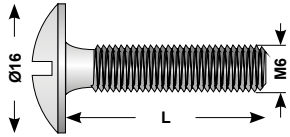

L (mm)	Ambalare (buc.)	Pret / 100 buc.		Cod
		LEI	EURO	
25.0	100	10.85	2.41	VR.0163.01SM
30.0	100	10.85	2.41	VR.0163.02SM
35.0	100	12.92	2.87	VR.0163.03SM
40.0	100	26.46	5.88	VR.0163.04SM

Surub cu filet M6, cap cilindric, locas Inbus SW 4, oțel zincat

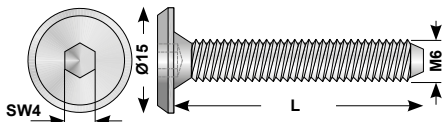

L (mm)	Ambalare (buc.)	Pret / 100 buc.		Cod
		LEI	EURO	
15.0	100	8.33	1.85	VR.7420.01SM
20.0	100	9.86	2.19	VR.7420.02SM
25.0	100	9.86	2.19	VR.7420.03SM
30.0	100	10.71	2.38	VR.7420.04SM
35.0	100	12.51	2.78	VR.7420.05SM
40.0	100	14.63	3.25	VR.7420.06SM
45.0	100	14.81	3.29	VR.7420.07SM
50.0	100	16.92	3.76	SCN.650SM
55.0	100	17.37	3.86	VR.7420.09SM
60.0	100	19.67	4.37	SCN.660SM
65.0	100	20.21	4.49	VR.7420.11SM
70.0	100	20.43	4.54	SCN.670SM
75.0	100	20.66	4.59	VR.7420.13SM
80.0	100	20.88	4.64	SCN.680SM
90.0	100	21.42	4.76	SCN.690SM
100.0	100	30.92	6.87	SCN.6100SM
120.0	100	30.92	6.87	SCN.6120SM

Surub cu filet M8, cap cilindric, locas Inbus, oțel zincat

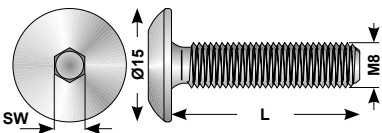

L x SW (mm)	Ambalare (buc.)	Pret / 100 buc.		Cod
		LEI	EURO	
55.0 x SW4	100	26.33	5.85	SCN.855SM
55.0 x SW5	100	26.33	5.85	SCN5.855SM

Surub cu filet M6, cap bombat, locas Inbus, oțel zincat

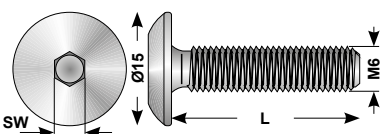

L x SW (mm)	Ambalare (buc.)	Pret / 100 buc.		Cod
		LEI	EURO	
16 x SW4	100	8.78	1.95	SCB.616SM
16 x SW5	100	8.78	1.95	SCB5.616SM
20 x SW4	100	8.19	1.82	SCB.620SM
20 x SW5	400	8.19	1.82	SCB5.620SM
25 x SW4	100	10.17	2.26	SCB.625SM
25 x SW5	200	10.17	2.26	SCB5.625SM
30 x SW4	100	10.35	2.30	SCB.630SM
30 x SW5	100	10.35	2.30	SCB5.630SM
35 x SW4	100	11.39	2.53	SCB.635SM
35 x SW5	200	11.39	2.53	SCB5.635SM
40 x SW4	100	13.19	2.93	SCB.640SM
40 x SW5	100	13.19	2.93	SCB5.640SM
45 x SW4	100	14.09	3.13	SCB.645SM
45 x SW5	100	14.09	3.13	SCB5.645SM
50 x SW4	100	14.13	3.14	SCB.650SM
50 x SW5	100	14.13	3.14	SCB5.650SM

Surub cu filet M6, cap bombat, locas Inbus, oțel zincat (continuare)

L x SW (mm)	Ambalare (buc.)	Pret / 100 buc.		Cod
		LEI	EURO	
55 x SW4	100	15.53	3.45	SCB.655SM
55 x SW5	100	15.53	3.45	SCB5.655SM
60 x SW4	100	15.84	3.52	VR.7410.11SM
70 x SW4	100	22.28	4.95	VR.7410.13SM
90 x SW4	100	23.22	5.16	VR.7410.15SM
100 x SW4	100	24.17	5.37	VR.7410.16SM

Surub cu filet M8, cap bombat, locas Inbus, oțel zincat

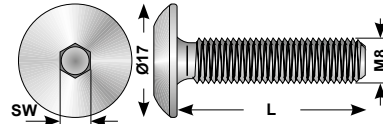

L (mm)	Ambalare (buc.)	Pret / 100 buc.		Cod
		LEI	EURO	
15 x SW4	100	11.16	2.48	SCB.815SM
15 x SW5	100	11.16	2.48	SCB5.815SM
35 x SW4	100	16.11	3.58	SCB.835SM
35 x SW5	100	16.11	3.58	SCB5.835SM
45 x SW4	100	19.04	4.23	SCB.845SM
45 x SW5	100	19.04	4.23	SCB5.845SM
55 x SW4	100	25.92	5.76	SCB.855SM
55 x SW5	200	25.92	5.76	SCB5.855SM
60 x SW4	100	25.97	5.77	SCB.860SM
60 x SW5	100	25.97	5.77	SCB5.860SM

Piulita butuc, orificiu cu filet M6, oțel zincat

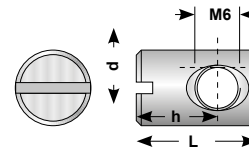

mm	Ambalare (buc.)	Pret / 100 buc.		Cod
		LEI	EURO	
10.0 x 12.5 x 7.5	100	13.10	2.91	VR.7330.09SM
10.0 x 14.0 x 8.0	100	15.26	3.39	VR.7330.10SM
10.0 x 14.0 x 9.0	100	16.02	3.56	VR.7330.11SM
10.0 x 16.0 x 11.0	100	16.07	3.57	VR.7330.12SM
10.0 x 20.0 x 10.0	100	18.00	4.00	VR.7330.15SM
10.0 x 20.0 x 14.0	100	18.77	4.17	VR.7330.17SM
15.8 x 11.0 x 5.5	100	54.36	12.08	VR.7330.20SM

Piulita manson forjata la rece, cap bombat, cu locas Inbus SW 5, oțel zincat

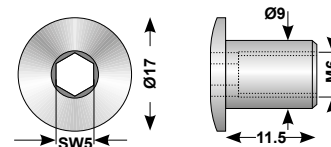

Filet	Ambalare (buc.)	Pret / 100 buc.		Cod
		LEI	EURO	
M6	100	15.03	3.34	VR.7250.02SM

Piulita manson forjata la rece, cap bombat cu locas Inbus SW 5, oțel nichelat

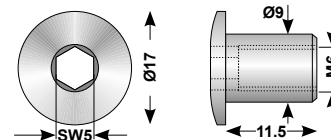

Filet	Ambalare (buc.)	Pret / 100 buc.		Cod
		LEI	EURO	
M6	100	16.70	3.71	VR.7250.06SM

Piulita conector "cap bombat cu saiba", oțel zincat

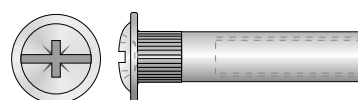

mm	Ambalare (buc.)	Pret / 100 buc.		Cod
		LEI	EURO	
M4 x 25	100	6.12	1.36	PCS.425SM
M4 x 30	100	10.94	2.43	PCS.430SM

Piulita conector cu cap bombat, otel zincat

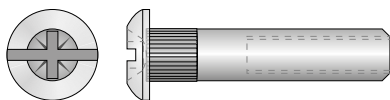

mm	Ambalare (buc.)	Pret / 100 buc.		Cod
		LEI	EURO	
M 6 x 30	100	12.11	2.69	PC.630SM

Piulita conector cu cap plat, zamac zincat

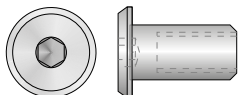

mm	Ambalare (buc.)	Pret / 100 buc.		Cod
		LEI	EURO	
M 6 x 12	100	12.11	2.69	PCN.612SM

Conector asamblat pentru bancuri de lucru, pentru Ø35 mm, cu piesa pentru montaj, otel zincat la cald

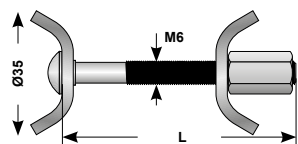

mm	Ambalare (buc.)	Pret / 100 buc.		Cod
		LEI	EURO	
65.0	10	82.58	18.35	VR.7787.01SM
150.0	10	102.60	22.80	VR.7787.04SM

Surub M4 cu cap bombat, locas cruciform, combi Z, otel zincat

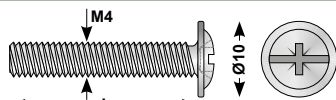

M x L (mm)	Ambalare (buc.)	Pret / 100 buc.		Cod
		LEI	EURO	
M 4 x 8.0	100	1.89	0.42	VR.7401.01SM
M 4 x 10.0	100	2.07	0.46	VR.7401.04SM
M 4 x 12.0	100	2.25	0.50	VR.7401.06SM
M 4 x 14.0	100	2.48	0.55	VR.7401.08SM
M 4 x 15.0	100	2.79	0.62	VR.7401.09SM
M 4 x 16.0	100	2.79	0.62	VR.7401.10SM
M 4 x 17.0	100	2.79	0.62	VR.7401.11SM
M 4 x 18.0	100	3.38	0.75	VR.7401.12SM
M 4 x 19.0	100	3.38	0.75	VR.7401.13SM
M 4 x 20.0	100	3.38	0.75	VR.7401.14SM
M 4 x 21.0	100	3.42	0.76	VR.7401.15SM
M 4 x 22.0	100	3.47	0.77	VR.7401.16SM
M 4 x 23.0	100	3.47	0.77	VR.7401.17SM
M 4 x 24.0	100	3.51	0.78	VR.7401.18SM
M 4 x 25.0	100	3.51	0.78	VR.7401.20SM
M 4 x 26.0	100	3.60	0.80	VR.7401.21SM
M 4 x 27.0	100	3.60	0.80	VR.7401.22SM
M 4 x 28.0	100	3.60	0.80	VR.7401.23SM
M 4 x 30.0	100	3.65	0.81	VR.7401.24SM
M 4 x 32.0	100	3.65	0.81	VR.7401.25SM
M 4 x 33.0	100	3.69	0.82	VR.7401.26SM
M 4 x 34.0	100	3.96	0.88	VR.7401.27SM
M 4 x 35.0	100	3.96	0.88	VR.7401.28SM
M 4 x 36.0	100	4.01	0.89	VR.7401.29SM
M 4 x 37.0	100	4.01	0.89	VR.7401.30SM
M 4 x 38.0	100	4.46	0.99	VR.7401.31SM
M 4 x 40.0	100	4.46	0.99	VR.7401.32SM
M 4 x 42.0	100	4.46	0.99	VR.7401.33SM
M 4 x 45.0	100	4.50	1.00	VR.7401.35SM
M 4 x 50.0	100	5.45	1.21	00850450SM
M 4 x 52.0	100	5.63	1.25	VR.7401.38SM
M 4 x 55.0	100	5.72	1.27	VR.7401.39SM
M 4 x 60.0	100	8.01	1.78	00850460SM
M 4 x 80.0	100	8.01	1.78	00850480SM
M 4 x 100.0	100	8.06	1.79	008504100SM

Surub M6 cap bombat, Pozidriv crestat, otel zincat

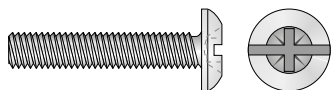

mm	Ambalare (buc.)	Pret / 100 buc.		Cod
		LEI	EURO	
M6 x 60	100	11.21	2.49	00851660SM
M6 x 80	100	14.18	3.15	00851680SM
M6 x 100	100	17.51	3.89	008516100SM
M6 x 120	100	20.75	4.61	008516120SM

Piulita cu gheara, otel

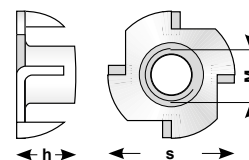

M x h x s (mm)	Ambalare (buc.)	Pret / 100 buc.		Cod
		LEI	EURO	
M 6 x 9 x 19	100	7.43	1.65	VR.2049.10SM
M 6 x 10 x 19	100	7.52	1.67	X0903610SM
M 6 x 12 x 19	100	10.44	2.32	X0903612SM
M 8 x 10 x 22	100	10.44	2.32	X0903810SM
M 8 x 11 x 22	100	11.16	2.48	VR.2049.15SM
M 8 x 15 x 22	100	19.26	4.28	VR.2049.16SM
M 10 x 13 x 22	100	19.26	4.28	VR.2049.18SM

Piulita de insertie cu soclu HEX, otel

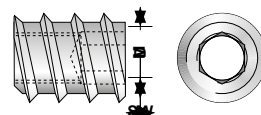

mm (M x D x L x SW)	Ambalare (buc.)	Pret / 100 buc.		Cod
		LEI	EURO	
M 6 x 12 x 12 x 6	100	26.46	5.88	VR.2288.01SM
M 8 x 14 x 15 x 8	100	50.49	11.22	VR.2288.04SM

Piulita de insertie tip "D", otel zincat



mm	Ambalare (buc.)	Pret / 100 buc.		Cod
		LEI	EURO	
M 6 x 13	100	13.01	2.89	X0913613SM
M 6 x 20	100	23.49	5.22	X0913620SM
M 8 x 13	100	23.54	5.23	X0913813SM
M 8 x 20	100	31.23	6.94	X0913820SM
M 8 x 25	100	37.94	8.43	X0913825SM

Cheie Inbus pentru mobila, otel zincat



mm	Ambalare (buc.)	Pret / 100 buc.		Cod
		LEI	EURO	
HEX 3 x 20 x 57	100	9.72	2.16	HCM.3SM
HEX 4 x 18 x 55	100	15.71	3.49	HCM.40SM
HEX 4 x 24 x 64	100	17.33	3.85	HCM.4SM
HEX 5 x 20 x 58	100	45.59	10.13	HCM.50SM
HEX 5 x 28 x 68	100	50.63	11.25	HCM.5SM
HEX 6 x 25 x 70	100	53.33	11.85	HCM.60SM
HEX 6 x 35 x 90	100	59.22	13.16	HCM.6SM

Cheie piulita HEX, otel zincat

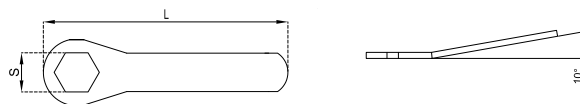

S x L mm	Ambalare (buc.)	Pret / 100 buc.		Cod
		LEI	EURO	
10 x 65	10	30.38	6.75	HCS.10SM
13 x 65	10	35.19	7.82	HCS.13SM

Suport de raft, Duplo 5/5 x 16, otel

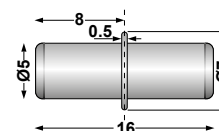

Acoperire	Ambalare (buc.)	Pret / 100 buc.		Cod
		LEI	EURO	
zincat	100	2.75	0.61	SP.516SM
nichelat	100	4.50	1.00	VR.7857.03SM

Mini-suport de raft cu un stift Ø5 mm, zamac nichelat

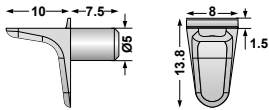

Material	Ambalare (buc.)	Pret / 100 buc.		Cod
		LEI	EURO	
zamac nichelat	50	36.27	8.06	VR.7810.01SM

Capacele din plastic Ø 12 mm, cu picior cilindric, plastic colorat

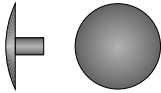

Culoare	Ambalare (buc.)	Pret / 100 buc.		Cod
		LEI	EURO	
RAL 9005 negru intens	100	3.69	0.82	VR.7800.06SM
RAL 9010 alb bur	100	3.69	0.82	VR.7800.08SM
stejar	100	3.69	0.82	VR.7800.14SM
maron deschis	100	3.69	0.82	VR.7800.15SM
maron inchis	100	3.69	0.82	VR.7800.17SM
stejar deschis	100	3.69	0.82	VR.7800.18SM

Capacele din plastic Ø 15 mm, cu picior cilindric, plastic colorat

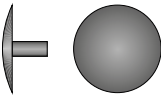

Culoare	Ambalare (buc.)	Pret / 100 buc.		Cod
		LEI	EURO	
RAL 9005 negru intens	100	3.69	0.82	VR.7801.03SM
RAL 9010 alb pur	100	3.69	0.82	VR.7801.04SM
stejar	100	3.69	0.82	VR.7801.06SM
maron deschis	100	3.69	0.82	VR.7801.07SM
maron inchis	100	3.69	0.82	VR.7801.08SM
stejar deschis	100	3.69	0.82	VR.7801.09SM

Capacele din plastic Ø8 mm pentru suruburi Pozidriv Pz1, plastic colorat

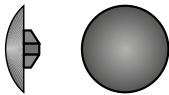

Culoare	Ambalare (buc.)	Pret / 100 buc.		Cod
		LEI	EURO	
RAL 9005 negru intens	100	3.69	0.82	VR.7699.01SM
RAL 9010 alb pur	100	3.69	0.82	VR.7699.02SM
maron deschis	100	3.69	0.82	VR.7699.05SM
maron inchis	100	3.69	0.82	VR.7699.07SM
stejar deschis	100	3.69	0.82	VR.7699.08SM

Capacele din plastic Ø12 mm pentru suruburi Pozidriv Pz2, plastic colorat

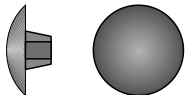

Culoare	Ambalare (buc.)	Pret / 100 buc.		Cod
		LEI	EURO	
negru intens	100	3.69	0.82	VR.7692.02SM
alb pur	100	3.69	0.82	VR.7692.03SM
stejar	100	3.69	0.82	VR.7692.07SM
maron deschis	100	3.69	0.82	VR.7692.08SM
maron inchis	100	3.69	0.82	VR.7692.10SM
stejar deschis	100	3.69	0.82	VR.7692.11SM

Capacele din plastic Ø13 mm pentru suruburi Pozidriv Pz3, plastic colorat

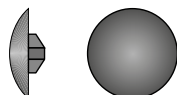

Culoare	Ambalare (buc.)	Pret / 100 buc.		Cod
		LEI	EURO	
negru intens	100	3.69	0.82	VR.7698.02SM
alb pur	100	3.69	0.82	VR.7698.03SM
stejar deschis	100	3.69	0.82	VR.7698.06SM

Capacele din plastic Ø12 mm pentru suruburi Torx T10, plastic colorat

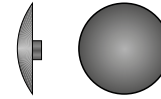

Culoare	Ambalare (buc.)	Pret / 100 buc.		Cod
		LEI	EURO	
negru intens	50	9.77	2.17	VR.7720.01SM
alb pur	50	5.31	1.18	VR.7720.02SM
stejar	50	5.31	1.18	VR.7720.03SM
maron deschis	50	21.60	4.80	VR.7720.04SM
maron inchis	50	21.60	4.80	VR.7720.05SM
stejar deschis	50	21.60	4.80	VR.7720.06SM

Capacele din plastic Ø12 mm pentru suruburi Torx T15, plastic colorat

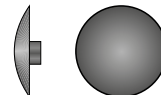

Culoare	Ambalare (buc.)	Pret / 100 buc.		Cod
		LEI	EURO	
negru intens	50	21.60	4.80	VR.7687.01SM
alb pur	50	21.60	4.80	VR.7687.02SM
stejar	50	21.60	4.80	VR.7687.03SM
maron deschis	50	21.60	4.80	VR.7687.04SM
maron inchis	50	21.60	4.80	VR.7687.05SM
stejar deschis	50	21.60	4.80	VR.7687.06SM

Capacele din plastic Ø12 mm pentru suruburi Torx T20, plastic colorat

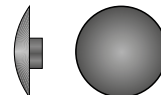

Culoare	Ambalare (buc.)	Pret / 100 buc.		Cod
		LEI	EURO	
negru intens	50	5.31	1.18	VR.7721.01SM
alb pur	50	5.31	1.18	VR.7721.02SM
stejar	50	21.60	4.80	VR.7721.03SM
maron deschis	50	5.31	1.18	VR.7721.04SM
maron inchis	50	5.31	1.18	VR.7721.05SM
stejar deschis	50	5.31	1.18	VR.7721.06SM

Capacele din plastic Ø13.5 mm pentru suruburi Torx T25, plastic colorat

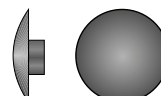

Culoare	Ambalare (buc.)	Pret / 100 buc.		Cod
		LEI	EURO	
negru intens	50	5.31	1.18	VR.7722.01SM
alb pur	50	5.31	1.18	VR.7722.02SM
stejar	50	21.60	4.80	VR.7722.03SM
maron deschis	50	5.31	1.18	VR.7722.04SM
maron inchis	50	21.60	4.80	VR.7722.05SM
stejar deschis	50	5.31	1.18	VR.7722.06SM

Capacele din plastic Ø16 mm pentru suruburi Torx T30, plastic colorat

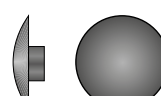

Culoare	Ambalare (buc.)	Pret / 100 buc.		Cod
		LEI	EURO	
negru intens	50	6.44	1.43	VR.7694.01SM
alb pur	50	5.31	1.18	VR.7694.02SM
stejar	50	23.99	5.33	VR.7694.03SM
maron deschis	50	21.60	4.80	VR.7694.04SM
maron inchis	50	5.99	1.33	VR.7694.05SM
stejar deschis	50	5.36	1.19	VR.7694.06SM

Capacele din plastic Ø18 mm pentru suruburi Torx T40, plastic colorat

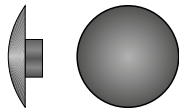

Culoare	Ambalare (buc.)	Pret / 100 buc.		Cod
		LEI	EURO	
negru intens	50	22.86	5.08	VR.7729.01SM
alb pur	50	21.60	4.80	VR.7729.02SM
stejar	50	21.60	4.80	VR.7729.03SM
maron deschis	50	21.60	4.80	VR.7729.04SM
maron inchis	50	21.60	4.80	VR.7729.05SM
stejar deschis	50	21.60	4.80	VR.7729.06SM

Holz-surub "ochi sudat" Ø24 mm, otel zincat



mm	Ambalare (buc.)	Pret / 100 buc.		Cod
		LEI	EURO	
12 x 120	10	362.84	80.63	X061012120SM
12 x 160	10	362.84	80.63	X061012160SM

Holz-surub "ochi sudat" Ø51 mm, otel zincat

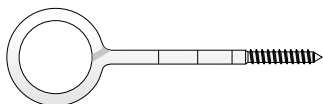

mm	Ambalare (buc.)	Pret / 100 buc.		Cod
		LEI	EURO	
12 x 140	5	232.74	51.72	X061112140SM
12 x 160	5	397.67	88.37	X061112160SM
12 x 200	5	397.67	88.37	X061112200SM
12 x 240	5	440.51	97.89	X061112240SM

Surub autoforant cu cap special "plat+saiba", otel zincat / vopsit

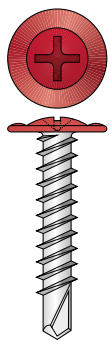

RAL	Culoarea
1021	Galben cadmiu
3002	Rosu carmin
3004	Rosu purpuriu
3005	Rosu visiniu
3009	Ruginiu
3011	Rosu maroniu
5010	Albastru gentiana
6003	Verde masliniu
6005	Verde muschi
6020	Verde crom
7043	Gri trafic B
8004	Maron cupru
8017	Maron ciocolatiu
9005	Negru intens
9010	Alb pur

mm	Ambalare (buc.)	Pret / 100 buc.		Cod
		LEI	EURO	
4.2x 13/Ph2 zincat	500	2.21	0.49	X02134213SM
4.2x 13/Ph2 RAL 3011	500	5.04	1.12	X021342131SM
4.2x 13/Ph2 RAL 3002	500	5.04	1.12	X021342132SM
4.2x 13/Ph2 RAL 3004	500	5.04	1.12	X021342133SM
4.2x 13/Ph2 RAL 8017	500	5.04	1.12	X021342134SM
4.2x 13/Ph2 RAL 6003	500	5.04	1.12	X021342135SM
4.2x 13/Ph2 RAL 7043	500	5.04	1.12	X021342136SM
4.2x 13/Ph2 RAL 5010	500	5.04	1.12	X021342137SM
4.2x 13/Ph2 RAL 8004	500	5.04	1.12	X021342138SM
4.2x 13/Ph2 RAL 1021	500	5.04	1.12	X021342139SM
4.2x 13/Ph2 RAL 9010	500	5.04	1.12	X0213421310SM
4.2x 13/Ph2 RAL 6020	500	5.04	1.12	X0213421311SM
4.2x 13/Ph2 RAL 3009	500	5.04	1.12	X0213421312SM
4.2x 13/Ph2 RAL 9005	500	5.04	1.12	X0213421313SM
4.2x 13/Ph2 RAL 3005	500	5.04	1.12	X0213421314SM
4.2x 13/Ph2 RAL 6005	500	5.04	1.12	X0213421315SM
4.2x 14/Ph2 zincat	500	2.34	0.52	X02134214SM
4.2x 16/Ph2 zincat	500	2.39	0.53	X02134216SM
4.2x 16/Ph2 RAL 3011	500	5.18	1.15	X021342161SM
4.2x 16/Ph2 RAL 3002	500	5.18	1.15	X021342162SM
4.2x 16/Ph2 RAL 3004	500	5.18	1.15	X021342163SM

Surub autoforant cu cap special "plat+saiba", otel zincat / vopsit (continuare)

mm	Ambalare (buc.)	Pret / 100 buc.		Cod
		LEI	EURO	
4.2x 16/Ph2 RAL 8017	500	5.18	1.15	X021342164SM
4.2x 16/Ph2 RAL 6003	500	5.18	1.15	X021342165SM
4.2x 16/Ph2 RAL 7043	500	5.18	1.15	X021342166SM
4.2x 16/Ph2 RAL 5010	500	5.18	1.15	X021342167SM
4.2x 16/Ph2 RAL 8004	500	5.18	1.15	X021342168SM
4.2x 16/Ph2 RAL 1021	500	5.18	1.15	X021342169SM
4.2x 16/Ph2 RAL 9010	500	5.18	1.15	X0213421610SM
4.2x 16/Ph2 RAL 6020	500	5.18	1.15	X0213421611SM
4.2x 16/Ph2 RAL 3009	500	5.18	1.15	X0213421612SM
4.2x 16/Ph2 RAL 9005	500	5.18	1.15	X0213421613SM
4.2x 16/Ph2 RAL 3005	500	5.18	1.15	X0213421614SM
4.2x 16/Ph2 RAL 6005	500	5.18	1.15	X0213421615SM
4.2x 19/Ph2 zincat	500	2.66	0.59	X02134219SM
4.2x 19/Ph2 RAL 3011	500	5.45	1.21	X021342191SM
4.2x 19/Ph2 RAL 3002	500	5.45	1.21	X021342192SM
4.2x 19/Ph2 RAL 3004	500	5.45	1.21	X021342193SM
4.2x 19/Ph2 RAL 8017	500	5.45	1.21	X021342194SM
4.2x 19/Ph2 RAL 6003	500	5.45	1.21	X021342195SM
4.2x 19/Ph2 RAL 7043	500	5.45	1.21	X021342196SM
4.2x 19/Ph2 RAL 5010	500	5.45	1.21	X021342197SM
4.2x 19/Ph2 RAL 8004	500	5.45	1.21	X021342198SM
4.2x 19/Ph2 RAL 1021	500	5.45	1.21	X021342199SM
4.2x 19/Ph2 RAL 9010	500	5.45	1.21	X0213421910SM
4.2x 19/Ph2 RAL 6020	500	5.45	1.21	X0213421911SM
4.2x 19/Ph2 RAL 3009	500	5.45	1.21	X0213421912SM
4.2x 19/Ph2 RAL 9005	500	5.45	1.21	X0213421913SM
4.2x 19/Ph2 RAL 3005	500	5.45	1.21	X0213421914SM
4.2x 19/Ph2 RAL 6005	500	5.45	1.21	X0213421915SM
4.2x 25/Ph2 zincat	500	3.11	0.69	X02134225SM
4.2x 25/Ph2 RAL 3011	500	5.94	1.32	X021342251SM
4.2x 25/Ph2 RAL 3002	500	5.94	1.32	X021342252SM
4.2x 25/Ph2 RAL 3004	500	5.94	1.32	X021342253SM
4.2x 25/Ph2 RAL 8017	500	5.94	1.32	X021342254SM
4.2x 25/Ph2 RAL 6003	500	5.94	1.32	X021342255SM
4.2x 25/Ph2 RAL 7043	500	5.94	1.32	X021342256SM
4.2x 25/Ph2 RAL 5010	500	5.94	1.32	X021342257SM
4.2x 25/Ph2 RAL 8004	500	5.94	1.32	X021342258SM
4.2x 25/Ph2 RAL 1021	500	5.94	1.32	X021342259SM
4.2x 25/Ph2 RAL 9010	500	5.94	1.32	X0213422510SM
4.2x 25/Ph2 RAL 6020	500	5.94	1.32	X0213422511SM
4.2x 25/Ph2 RAL 3009	500	5.94	1.32	X0213422512SM
4.2x 25/Ph2 RAL 9005	500	5.94	1.32	X0213422513SM
4.2x 25/Ph2 RAL 3005	500	5.94	1.32	X0213422514SM
4.2x 25/Ph2 RAL 6005	500	5.94	1.32	X0213422515SM
4.2x 32/Ph2 zincat	500	3.65	0.81	X02134232SM
4.2x 32/Ph2 RAL 3011	500	6.44	1.43	X021342321SM
4.2x 32/Ph2 RAL 3002	500	6.44	1.43	X021342322SM
4.2x 32/Ph2 RAL 3004	500	6.44	1.43	X021342323SM
4.2x 32/Ph2 RAL 8017	500	6.44	1.43	X021342324SM
4.2x 32/Ph2 RAL 6003	500	6.44	1.43	X021342325SM
4.2x 32/Ph2 RAL 7043	500	6.44	1.43	X021342326SM
4.2x 32/Ph2 RAL 5010	500	6.44	1.43	X021342327SM
4.2x 32/Ph2 RAL 8004	500	6.44	1.43	X021342328SM
4.2x 32/Ph2 RAL 1021	500	6.44	1.43	X021342329SM
4.2x 32/Ph2 RAL 9010	500	6.44	1.43	X0213423210SM
4.2x 32/Ph2 RAL 6020	500	6.44	1.43	X0213423211SM
4.2x 32/Ph2 RAL 3009	500	6.44	1.43	X0213423212SM
4.2x 32/Ph2 RAL 9005	500	6.44	1.43	X0213423213SM
4.2x 32/Ph2 RAL 3005	500	6.44	1.43	X0213423214SM
4.2x 32/Ph2 RAL 6005	500	6.44	1.43	X0213423215SM
4.2x 41/Ph2 zincat	500	4.55	1.01	X02134241SM
4.2x 41/Ph2 RAL 3011	500	7.38	1.64	X021342411SM
4.2x 41/Ph2 RAL 3002	500	7.38	1.64	X021342412SM
4.2x 41/Ph2 RAL 3004	500	7.38	1.64	X021342413SM
4.2x 41/Ph2 RAL 8017	500	7.38	1.64	X021342414SM
4.2x 41/Ph2 RAL 6003	500	7.38	1.64	X021342415SM
4.2x 41/Ph2 RAL 7043	500	7.38	1.64	X021342416SM
4.2x 41/Ph2 RAL 5010	500	7.38	1.64	X021342417SM
4.2x 41/Ph2 RAL 8004	500	7.38	1.64	X021342418SM
4.2x 41/Ph2 RAL 1021	500	7.38	1.64	X021342419SM
4.2x 41/Ph2 RAL 9010	500	7.38	1.64	X0213424110SM
4.2x 41/Ph2 RAL 6020	500	7.38	1.64	X0213424111SM
4.2x 41/Ph2 RAL 3009	500	7.38	1.64	X0213424112SM
4.2x 41/Ph2 RAL 9005	500	7.38	1.64	X0213424113SM
4.2x 41/Ph2 RAL 3005	500	7.38	1.64	X0213424114SM
4.2x 41/Ph2 RAL 6005	500	7.38	1.64	X0213424115SM
4.2x 51/Ph2 zincat	500	5.22	1.16	X02134251SM

Surub autoforant cu cap HEX si saiba cauciucata EPDM Ø14 mm, pentru prindere pe suport metalic, otel zincat / vopsit + cauciuc EPDM

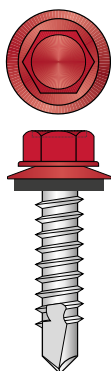

RAL	Culoarea	
	LEI	EURO
1021	Galben cadmiu	
3002	Rosu carmin	
3004	Rosu purpuriu	
3005	Rosu visiniu	
3009	Ruginiu	
3011	Rosu maroniu	
5010	Albastru gentiana	
6003	Verde masliniu	
6005	Verde muschi	
6020	Verde crom	
7043	Gri trafic B	
8004	Maron cupru	
8017	Maron ciocolatiu	
9005	Negru intens	
9010	Alb pur	

Surub autoforant pentru prindere pe suport metalic.

Saiba este cauciucata cu cauciuc EPDM rezistent la inghet si temperaturi pana la 200°C. Capul si saiba sunt vopsite in camp electrostatic.

Stratul de vopsea speciala rezistenta UV are o grosime de 60µm.

mm	Ambalare (buc.)	Pret / 100 buc.		Cod
		LEI	EURO	
4.8x 16 zincat	100	5.94	1.32	7504S4816SM
4.8x 16 RAL 3011	100	9.05	2.01	7504S48161SM
4.8x 16 RAL 3002	100	9.05	2.01	7504S48162SM
4.8x 16 RAL 3004	100	9.05	2.01	7504S48163SM
4.8x 16 RAL 8017	100	9.05	2.01	7504S48164SM
4.8x 16 RAL 6003	100	9.05	2.01	7504S48165SM
4.8x 16 RAL 7043	100	9.05	2.01	7504S48166SM
4.8x 16 RAL 5010	100	9.05	2.01	7504S48167SM
4.8x 16 RAL 8004	100	9.05	2.01	7504S48168SM
4.8x 16 RAL 1021	100	9.05	2.01	7504S48169SM
4.8x 16 RAL 9010	100	9.05	2.01	7504S481610SM
4.8x 16 RAL 6020	100	9.05	2.01	7504S481611SM
4.8x 16 RAL 3009	100	9.05	2.01	7504S481612SM
4.8x 16 RAL 9005	100	9.05	2.01	7504S481613SM
4.8x 16 RAL 3005	100	9.05	2.01	7504S481614SM
4.8x 16 RAL 6005	100	9.05	2.01	7504S481615SM
4.8x 19 zincat	100	6.12	1.36	7504S4819SM
4.8x 19 RAL 3011	100	9.18	2.04	7504S48191SM
4.8x 19 RAL 3002	100	9.18	2.04	7504S48192SM
4.8x 19 RAL 3004	100	9.18	2.04	7504S48193SM
4.8x 19 RAL 8017	100	9.18	2.04	7504S48194SM
4.8x 19 RAL 6003	100	9.18	2.04	7504S48195SM
4.8x 19 RAL 7043	100	9.18	2.04	7504S48196SM
4.8x 19 RAL 5010	100	9.18	2.04	7504S48197SM
4.8x 19 RAL 8004	100	9.18	2.04	7504S48198SM
4.8x 19 RAL 1021	100	9.18	2.04	7504S48199SM
4.8x 19 RAL 9010	100	9.18	2.04	7504S481910SM
4.8x 19 RAL 6020	100	9.18	2.04	7504S481911SM
4.8x 19 RAL 3009	100	9.18	2.04	7504S481912SM
4.8x 19 RAL 9005	100	9.18	2.04	7504S481913SM
4.8x 19 RAL 3005	100	9.18	2.04	7504S481914SM
4.8x 19 RAL 6005	100	9.18	2.04	7504S481915SM
4.8x 25 zincat	100	6.84	1.52	7504S4825SM
4.8x 25 RAL 3011	100	9.86	2.19	7504S48251SM
4.8x 25 RAL 3002	100	9.86	2.19	7504S48252SM
4.8x 25 RAL 3004	100	9.86	2.19	7504S48253SM
4.8x 25 RAL 8017	100	9.86	2.19	7504S48254SM
4.8x 25 RAL 6003	100	9.86	2.19	7504S48255SM
4.8x 25 RAL 7043	100	9.86	2.19	7504S48256SM
4.8x 25 RAL 5010	100	9.86	2.19	7504S48257SM
4.8x 25 RAL 8004	100	9.86	2.19	7504S48258SM
4.8x 25 RAL 1021	100	9.86	2.19	7504S48259SM
4.8x 25 RAL 9010	100	9.86	2.19	7504S482510SM
4.8x 25 RAL 6020	100	9.86	2.19	7504S482511SM
4.8x 25 RAL 3009	100	9.86	2.19	7504S482512SM
4.8x 25 RAL 9005	100	9.86	2.19	7504S482513SM
4.8x 25 RAL 3005	100	9.86	2.19	7504S482514SM
4.8x 25 RAL 6005	100	9.86	2.19	7504S482515SM

Surub autoforant cu cap HEX si saiba cauciucata EPDM Ø16 mm, pentru prindere pe suport metalic, otel zincat + cauciuc EPDM

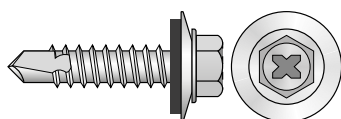

mm	Ambalare (buc.)	Pret / 100 buc.		Cod
		LEI	EURO	
4.8 x 16	100	6.26	1.39	X02014816SM
4.8 x 19	100	6.35	1.41	X02014819SM
4.8 x 25	100	6.75	1.50	X02014825SM
5.5 x 19	100	7.65	1.70	X02015519SM
5.5 x 22	100	7.83	1.74	X02015522SM

Surub autoforant cu cap HEX si saiba cauciucata EPDM Ø16 mm, pentru prindere pe suport metalic, otel zincat + cauciuc EPDM (continuare)

mm	Ambalare (buc.)	Pret / 100 buc.		Cod
		LEI	EURO	
5.5 x 25	100	8.24	1.83	X02015525SM
5.5 x 32	100	9.09	2.02	X02015532SM
5.5 x 38	100	9.77	2.17	X02015538SM
5.5 x 51	100	11.16	2.48	X02015551SM
5.5 x 76	100	15.39	3.42	X02015576SM
6.3 x 19	100	9.72	2.16	X02016319SM
6.3 x 25	100	10.76	2.39	X02016325SM
6.3 x 32	100	10.94	2.43	X02016332SM
6.3 x 38	100	12.92	2.87	X02016338SM
6.3 x 51	100	14.94	3.32	X02016351SM
6.3 x 60	100	18.36	4.08	X02016360SM
6.3 x 70	100	18.99	4.22	X02016370SM
6.3 x 90	50	24.30	5.40	X02016390SM
6.3 x 100	50	29.34	6.52	X020163100SM
6.3 x 130	50	35.69	7.93	X020163130SM

Surub autoforant cu cap HEX 8 mm si saiba cauciucata EPDM Ø14 mm, pentru prindere pe constructii din lemn, otel zincat / vopsit + cauciuc EPDM



RAL	Culoarea	
	LEI	EURO
1021	Galben cadmiu	
3002	Rosu carmin	
3004	Rosu purpuriu	
3005	Rosu visiniu	
3009	Ruginiu	
3011	Rosu maroniu	
5010	Albastru gentiana	
6003	Verde masliniu	
6005	Verde muschi	
6020	Verde crom	
7043	Gri trafic B	
8004	Maron cupru	
8017	Maron ciocolatiu	
9005	Negru intens	
9010	Alb pur	

Surub pentru prindere pe constructii din lemn.

Saiba este cauciucata cu cauciuc EPDM rezistent la inghet si temperaturi pana la 200°C. Capul si saiba sunt vopsite in camp electrostatic.

Stratul de vopsea speciala rezistenta UV are o grosime de 60µm.

mm	Ambalare (buc.)	Pret / 100 buc.		Cod
		LEI	EURO	
4.8x 29 zincat	100	7.92	1.76	X02004829SM
4.8x 29 RAL 3011	100	9.36	2.08	X020048291SM
4.8x 29 RAL 3002	100	9.36	2.08	X020048292SM
4.8x 29 RAL 3004	100	9.36	2.08	X020048293SM
4.8x 29 RAL 8017	100	9.36	2.08	X020048294SM
4.8x 29 RAL 6003	100	9.36	2.08	X020048295SM
4.8x 29 RAL 7043	100	9.36	2.08	X020048296SM
4.8x 29 RAL 5010	100	9.36	2.08	X020048297SM
4.8x 29 RAL 8004	100	9.36	2.08	X020048298SM
4.8x 29 RAL 1021	100	9.36	2.08	X020048299SM
4.8x 29 RAL 9010	100	9.36	2.08	X0200482910SM
4.8x 29 RAL 6020	100	9.36	2.08	X0200482911SM
4.8x 29 RAL 3009	100	9.36	2.08	X0200482912SM
4.8x 29 RAL 9005	100	9.36	2.08	X0200482913SM
4.8x 29 RAL 3005	100	9.36	2.08	X0200482914SM
4.8x 29 RAL 6005	100	9.36	2.08	X0200482915SM
4.8x 35 zincat	100	9.72	2.16	X02004835SM
4.8x 35 RAL 3011	100	10.44	2.32	X020048351SM
4.8x 35 RAL 3002	100	10.44	2.32	X020048352SM
4.8x 35 RAL 3004	100	10.44	2.32	X020048353SM
4.8x 35 RAL 8017	100	10.44	2.32	X020048354SM
4.8x 35 RAL 6003	100	10.44	2.32	X020048355SM
4.8x 35 RAL 7043	100	10.44	2.32	X020048356SM
4.8x 35 RAL 5010	100	10.44	2.32	X020048357SM
4.8x 35 RAL 8004	100	10.44	2.32	X020048358SM
4.8x 35 RAL 1021	100	10.44	2.32	X020048359SM
4.8x 35 RAL 9010	100	10.44	2.32	X0200483510SM
4.8x 35 RAL 6020	100	10.44	2.32	X0200483511SM
4.8x 35 RAL 3009	100	10.44	2.32	X0200483512SM
4.8x 35 RAL 9005	100	10.44	2.32	X0200483513SM
4.8x 35 RAL 3005	100	10.44	2.32	X0200483514SM
4.8x 35 RAL 6005	100	10.44	2.32	X0200483515SM
4.8x 50 zincat	100	10.76	2.39	X02004850SM
4.8x 50 RAL 3011	100	11.97	2.66	X020048501SM
4.8x 50 RAL 3002	100	11.97	2.66	X020048502SM
4.8x 50 RAL 3004	100	11.97	2.66	X020048503SM
4.8x 50 RAL 8017	100	11.97	2.66	X020048504SM
4.8x 50 RAL 6003	100	11.97	2.66	X020048505SM
4.8x 50 RAL 7043	100	11.97	2.66	X020048506SM
4.8x 50 RAL 5010	100	11.97	2.66	X020048507SM
4.8x 50 RAL 8004	100	11.97	2.66	X020048508SM
4.8x 50 RAL 1021	100	11.97	2.66	X020048509SM
4.8x 50 RAL 9010	100	11.97	2.66	X0200485010SM
4.8x 50 RAL 6020	100	11.97	2.66	X0200485011SM
4.8x 50 RAL 3009	100	11.97	2.66	X0200485012SM
4.8x 50 RAL 9005	100	11.97	2.66	X0200485013SM

Surub autoforant cu cap HEX 8 mm si saiba cauciucata EPDM Ø14, pentru prindere pe constructii din lemn, otel zincat / vopsit + cauciuc EPDM (continuare)

mm	Ambalare (buc.)	Pret / 100 buc.		Cod
		LEI	EURO	
4.8x 50 RAL 3005	100	11.97	2.66	X0200485014SM
4.8x 50 RAL 6005	100	11.97	2.66	X0200485015SM
4.8x 60 zincat	100	12.87	2.86	X02004860SM
4.8x 60 RAL 3011	100	14.09	3.13	X020048601SM
4.8x 60 RAL 3002	100	14.09	3.13	X020048602SM
4.8x 60 RAL 3004	100	14.09	3.13	X020048603SM
4.8x 60 RAL 8017	100	14.09	3.13	X020048604SM
4.8x 60 RAL 6003	100	14.09	3.13	X020048605SM
4.8x 60 RAL 7043	100	14.09	3.13	X020048606SM
4.8x 60 RAL 5010	100	14.09	3.13	X020048607SM
4.8x 60 RAL 8004	100	14.09	3.13	X020048608SM
4.8x 60 RAL 1021	100	14.09	3.13	X020048609SM
4.8x 60 RAL 9010	100	14.09	3.13	X0200486010SM
4.8x 60 RAL 6020	100	14.09	3.13	X0200486011SM
4.8x 60 RAL 3009	100	14.09	3.13	X0200486012SM
4.8x 60 RAL 9005	100	14.09	3.13	X0200486013SM
4.8x 60 RAL 3005	100	14.09	3.13	X0200486014SM
4.8x 60 RAL 6005	100	14.09	3.13	X0200486015SM

Surub autoforant cu cap hexagonal si saiba cauciucata EPDM Ø16 mm pentru prindere pe constructii din lemn, otel zincat + cauciuc EPDM

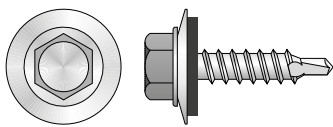

Surub pentru prindere pe constructii din lemn.

Saiba este cauciucata cu cauciuc EPDM rezistent la inghet si temperaturi pana la 200°C.

mm	Ambalare (buc.)	Pret / 100 buc.		Cod
		LEI	EURO	
4.8 x 16	700	12.47	2.77	X02034816SM
4.8 x 19	600	13.64	3.03	X02034819SM
5.5 x 22	500	14.22	3.16	X02035522SM
6.3 x 20	400	16.16	3.59	X02036320SM
6.3 x 25	400	28.71	6.38	X02036325SM
6.3 x 32	250	28.76	6.39	X02036332SM
6.3 x 38	250	28.80	6.40	X02036338SM
6.3 x 50	250	28.85	6.41	X02036350SM

Surub autoforant pentru fibrociment cu saiba "umbrela" din cauciuc, pentru prindere pe suport metalic, otel zincat + cauciuc EPDM

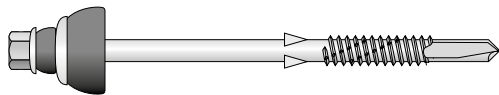

mm	Ambalare (buc.)	Pret / 100 buc.		Cod
		LEI	EURO	
6.3 x 110	100	60.30	13.40	X090063110SM
6.3 x 120	100	60.62	13.47	X090063120SM
6.3 x 125	100	88.47	19.66	X090063125SM
6.3 x 130	100	88.47	19.66	X090063130SM
6.3 x 150	100	88.56	19.68	X090063150SM
6.3 x 160	100	88.61	19.69	X090063160SM

Surub cu capacitate mare de gaurire pentru panouri sandwich cu saiba cauciucata EPDM Ø16 mm, otel zincat + cauciuc EPDM

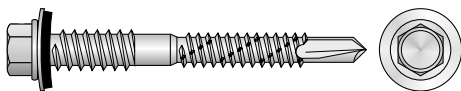

mm	Ambalare (buc.)	Pret / 100 buc.		Cod
		LEI	EURO	
5.5 / 6.3 x 85	100	23.45	5.21	X40066385SM
5.5 / 6.3 x 105	100	31.23	6.94	X400663105SM
5.5 / 6.3 x 130	100	40.19	8.93	X400663130SM
5.5 / 6.3 x 150	100	41.22	9.16	X400663150SM

Surub cu capacitate mare de gaurire pentru panouri sandwich, otel zincat



mm	Ambalare (buc.)	Pret / 100 buc.		Cod
		LEI	EURO	
5.5 / 6.3 x 105	100	25.02	5.56	X400563105SM
5.5 / 6.3 x 130	100	37.53	8.34	X400563130SM
5.5 / 6.3 x 150	100	42.71	9.49	X400563150SM

Saiba cauciucata pentru etansare, otel zincat + cauciuc EPDM

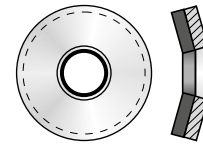

mm	Ambalare (buc.)	Pret / 100 buc.		Cod
		LEI	EURO	
5.0 x 14 / 4.2	500	2.21	0.49	X02204214SM
5.0 x 16 / 4.2	200	2.57	0.57	X02204216SM
5.3 x 14 / 4.8	500	1.89	0.42	X02204814SM
5.3 x 16 / 4.8	500	2.61	0.58	X02204816SM
5.3 x 19 / 4.8	200	3.96	0.88	X02204819SM
6.0 x 16 / 5.5	500	2.57	0.57	X02205516SM
6.0 x 19 / 5.5	500	4.10	0.91	X02205519SM
6.8 x 16 / 6.3	500	2.52	0.56	X02206316SM
6.8 x 19 / 6.3	500	4.05	0.90	X02206319SM
6.8 x 25 / 6.3	250	6.35	1.41	X02206325SM

Saiba plata forma "A", inox A2

DIN 125

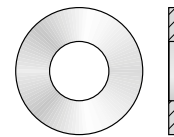

mm	Ambalare (buc.)	Pret / 100 buc.		Cod
		LEI	EURO	
6.4	100	2.48	0.55	0125264SM
8.4	100	3.87	0.86	0125284SM
10.5	100	7.43	1.65	01252105SM
13.0	50	14.58	3.24	0125213SM
17.0	25	24.12	5.36	0125217SM

Surub total filetata cu cap hexagonal, inox A2

DIN 933

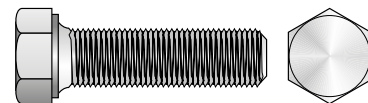

mm	Ambalare (buc.)	Pret / 100 buc.		Cod
		LEI	EURO	
M 6 x 20	20	15.03	3.34	09332620SM
M 6 x 25	20	17.10	3.80	09332625SM
M 6 x 30	20	19.40	4.31	09332630SM
M 6 x 35	20	21.65	4.81	09332635SM
M 6 x 40	20	23.76	5.28	09332640SM
M 6 x 50	10	28.44	6.32	09332650SM
M 6 x 60	10	32.81	7.29	09332660SM
M 8 x 20	10	27.72	6.16	09332820SM
M 8 x 25	10	31.28	6.95	09332825SM
M 8 x 30	10	34.88	7.75	09332830SM
M 8 x 35	10	38.57	8.57	09332835SM
M 8 x 40	10	42.17	9.37	09332840SM
M 8 x 50	10	49.14	10.92	09332850SM
M 8 x 60	10	56.34	12.52	09332860SM
M 10 x 25	10	55.71	12.38	093321025SM
M 10 x 30	10	61.65	13.70	093321030SM
M 10 x 40	10	73.35	16.30	093321040SM
M 10 x 50	10	85.14	18.92	093321050SM
M 12 x 30	5	88.34	19.63	093321230SM
M 12 x 40	5	105.75	23.50	093321240SM
M 12 x 50	5	122.13	27.14	093321250SM
M 12 x 60	5	136.85	30.41	093321260SM
M 16 x 50	2	242.82	53.96	093321650SM
M 16 x 60	2	275.81	61.29	093321660SM
M 16 x 70	2	306.27	68.06	093321670SM
M 16 x 80	2	339.21	75.38	093321680SM

Piulita hexagonala, inox A2

DIN 934

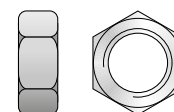

mm	Ambalare (buc.)	Pret / 100 buc.		Cod
		LEI	EURO	
M 6	100	6.30	1.40	093426SM
M 8	100	11.34	2.52	093428SM
M 10	100	25.29	5.62	0934210SM
M 12	50	37.76	8.39	0934212SM
M 16	25	72.86	16.19	0934216SM

Tija filetata 1m, inox A2

DIN 975



mm	Ambalare (buc.)	Pret / 100 buc.		Cod
		LEI	EURO	
M 6	2	376.02	83.56	0975261SM
M 8	2	676.22	150.27	0975281SM
M 10	2	1048.14	232.92	09752101SM
M 12	2	1519.88	337.75	09752121SM
M 16	2	2788.11	619.58	09752161SM

Pop-nituri standard cap bombat, aluminiu / otel

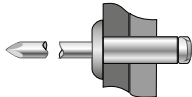

mm	Ambalare (buc.)	Pret / 100 buc.		Cod
		LEI	EURO	
2.4 x 10	8000	3.11	0.69	BR.1010002410SM
3.0 x 12	4000	3.87	0.86	BR.1010003012SM
3.0 x 14	4000	4.01	0.89	BR.1010003014SM
3.0 x 18	4000	4.37	0.97	BR.1010003018SM
3.2 x 12	4000	3.87	0.86	BR.1010003212SM
3.2 x 15	4000	4.10	0.91	BR.1010003215SM
4.0 x 6	4000	4.37	0.97	BR.1010004006SM
4.0 x 8	4000	4.50	1.00	BR.1010004008SM
4.0 x 10	4000	4.68	1.04	BR.1010004010SM
4.0 x 12	3000	4.86	1.08	BR.1010004012SM
4.0 x 16	3000	5.63	1.25	BR.1010004016SM
4.8 x 10	3000	6.21	1.38	BR.1010004810SM
4.8 x 12	3000	6.44	1.43	BR.1010004812SM
4.8 x 16	2000	7.52	1.67	BR.1010004816SM
4.8 x 18	1500	7.88	1.75	BR.1010004818SM
4.8 x 21	1500	8.51	1.89	BR.1010004821SM

Pop-nituri cap tesit 120°, aluminiu / otel

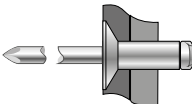

mm	Ambalare (buc.)	Pret / 100 buc.		Cod
		LEI	EURO	
3.0 x 12	4000	7.61	1.69	BR.1020003012SM
3.0 x 14	4000	7.92	1.76	BR.1020003014SM
3.0 x 16	4000	8.51	1.89	BR.1020003016SM
3.2 x 6	4000	6.98	1.55	BR.1020003206SM
3.2 x 8	4000	7.20	1.60	BR.1020003208SM
4.0 x 10	4000	8.60	1.91	BR.1020004010SM
4.0 x 12	3000	8.87	1.97	BR.1020004012SM
4.0 x 14	3000	9.27	2.06	BR.1020004014SM
4.0 x 18	3000	9.81	2.18	BR.1020004018SM
4.8 x 6	3000	10.26	2.28	BR.1020004806SM
4.8 x 10	3000	11.03	2.45	BR.1020004810SM
4.8 x 18	1500	13.10	2.91	BR.1020004818SM
4.8 x 27	1200	15.26	3.39	BR.1020004827SM
4.8 x 35	900	18.27	4.06	BR.1020004835SM
5.0 x 6	3000	10.89	2.42	BR.1020005006SM
5.0 x 8	3000	11.03	2.45	BR.1020005008SM
5.0 x 10	3000	11.34	2.52	BR.1020005010SM
5.0 x 12	3000	11.61	2.58	BR.1020005012SM
5.0 x 14	2000	12.51	2.78	BR.1020005014SM
5.0 x 16	2000	12.83	2.85	BR.1020005016SM
5.0 x 18	1500	13.50	3.00	BR.1020005018SM
5.0 x 25	1200	15.26	3.39	BR.1020005025SM

Pop-nituri cap lat, aluminiu / otel

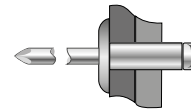

mm	Ambalare (buc.)	Pret / 100 buc.		Cod
		LEI	EURO	
3.2 x 10 x 9.5	4000	4.14	0.92	BR.1030003210SM
4.0 x 14 x 12.0	2000	6.08	1.35	BR.1040004014SM
4.8 x 12 x 14.0	1500	7.79	1.73	BR.1030004812SM
4.8 x 16 x 14.0	1500	8.55	1.90	BR.1030004816SM
4.8 x 18 x 14.0	1200	8.91	1.98	BR.1030004818SM
4.8 x 21 x 14.0	1200	9.41	2.09	BR.1030004821SM
4.8 x 35 x 14.0	600	12.02	2.67	BR.1030004835SM
4.8 x 16 x 16.0	1200	9.18	2.04	BR.1040004816SM
4.8 x 18 x 16.0	1200	9.59	2.13	BR.1040004818SM
4.8 x 21 x 16.0	900	9.99	2.22	BR.1040004821SM
5.0 x 30 x 14.0	900	11.39	2.53	BR.1030005030SM

Pop-nituri cap bombat, aluminiu / aluminiu

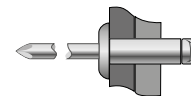

mm	Ambalare (buc.)	Pret / 100 buc.		Cod
		LEI	EURO	
4.8 x 10.0	3000	13.50	3.00	BR.1160004810SM

Pop-nituri cap bombat, otel / otel

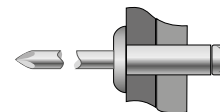

mm	Ambalare (buc.)	Pret / 100 buc.		Cod
		LEI	EURO	
4.8 x 12.0	2000	10.53	2.34	BR.1210004812SM

Piulite-nit standard, otel zincat

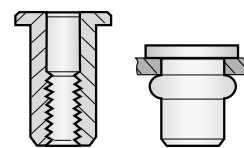

mm	Ambalare (buc.)	Pret / 100 buc.		Cod
		LEI	EURO	
M 8 x 16.5	1500	38.39	8.53	BR.301108011SM

Diblu standard, polietilena

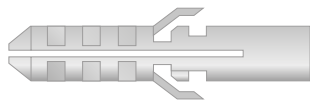

Ø x L mm	Ambalare (buc.)	Pret / 100 buc.		Cod
		LEI	EURO	
5 x 25	500	0.99	0.22	DS.525SM
6 x 30	500	1.22	0.27	DS.630SM
8 x 40	250	2.48	0.55	DS.840SM
10 x 50	250	4.37	0.97	DS.1050SM
12 x 60	100	7.29	1.62	DS.1260SM

Diblu standard, poliamida 6.6

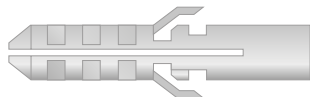

Ø x L mm	Ambalare (buc.)	Pret / 100 buc.		Cod
		LEI	EURO	
12 x 60	100	12.92	2.87	DSN.1260SM
14 x 70	25	23.63	5.25	DSN.1475SM
16 x 80	25	30.02	6.67	DSN.1680SM

Combinatie standard - diblu standard + holzsurub

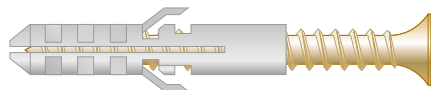

Ø diblu x Ø x L surub (mm)	Ambalare (buc.)	Pret / 100 buc.		Cod
		LEI	EURO	
5 - 3.5 x 30	500	2.61	0.58	DSH.525SM
6 - 4.0 x 35	500	3.47	0.77	DSH.630SM
8 - 5.0 x 45	250	6.57	1.46	DSH.840SM
10 - 6.0 x 60	250	12.33	2.74	DSH.1050SM

Combinatie pentru constructii - diblu+holzsurub



Ø x L mm	Ambalare (buc.)	Pret / 100 buc.		Cod
		LEI	EURO	
6 x 40	100	7.70	1.71	AA.0406040SM
6 x 60	100	10.62	2.36	AA.0406060SM
8 x 60	100	18.14	4.03	AA.0408060SM

Combinatie pentru fixari adanci - diblu+holzsurub



Ø x L mm	Ambalare (buc.)	Pret / 100 buc.		Cod
		LEI	EURO	
10 x 105	50	43.61	9.69	AA.04110105SM
10 x 120	50	48.42	10.76	AA.04110120SM
10 x 160	50	69.17	15.37	AA.04110160SM
10 x 200	25	112.46	24.99	I.TC6A10200SM

Combinatie HEX lunga

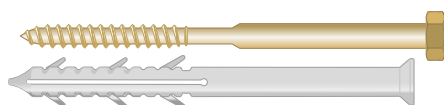

Ø x L) diblu / Smax. (mm)	Ambalare (buc.)	Pret / 100 buc.		Cod
		LEI	EURO	
8 x 80 / 15	100	28.67	6.37	I.TC6E08080SM
8 x 100 / 35	100	35.06	7.79	I.TC6E08100SM
8 x 120 / 55	100	44.51	9.89	I.TC6E08120SM
10 x 100 / 25	100	52.11	11.58	I.TC6E10100SM
10 x 160 / 85	100	78.89	17.53	I.TC6E10160SM
10 x 200 / 120	100	118.58	26.35	I.TC6E10200SM

Dibluri-cui cu fixare rapida, cap cilindric, poliamida 6.6



Ø x L) diblu / Smax. (mm)	Ambalare (buc.)	Pret / 100 buc.		Cod
		LEI	EURO	
6 x 35 / 10	100	6.21	1.38	I.TCCC06035SM
6 x 40 / 15	100	7.70	1.71	I.TCCC06040SM
6 x 50 / 25	100	9.72	2.16	I.TCCC06050SM
6 x 60 / 35	100	10.80	2.40	I.TCCC06060SM
6 x 70 / 45	100	11.16	2.48	I.TCCC06070SM
8 x 60 / 20	100	16.79	3.73	I.TCCC08060SM
8 x 80 / 40	100	18.99	4.22	I.TCCC08080SM

Dibluri-cui cu fixare rapida, cap tesit, poliamida 6.6



Ø x L) diblu / Smax. (mm)	Ambalare (buc.)	Pret / 100 buc.		Cod
		LEI	EURO	
6 x 35 / 10	100	5.00	1.11	I.TCCA06035SM
6 x 40 / 15	100	7.56	1.68	I.TCCA06040SM
6 x 50 / 25	100	9.00	2.00	I.TCCA06050SM
6 x 60 / 35	100	10.53	2.34	I.TCCA06060SM
6 x 70 / 45	100	11.93	2.65	I.TCCA06070SM
8 x 60 / 20	100	16.52	3.67	I.TCCA08060SM
8 x 80 / 40	100	20.61	4.58	I.TCCA08080SM
8 x 100 / 60	100	25.02	5.56	I.TCCA08100SM
8 x 120 / 80	100	30.74	6.83	I.TCCA08120SM

Diblu pentru gips - carton

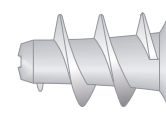

Ø x L (mm)	Ambalare (buc.)	Pret / 100 buc.		Cod
		LEI	EURO	
6 x 23	200	7.29	1.62	DGC.623SM

Bit pentru infiletarea diblului pentru gips - carton



mm	Ambalare (buc.)	Pret / 100 buc.		Cod
		LEI	EURO	
-	2	23.90	5.31	BDGCSM

Dibluri pentru placi

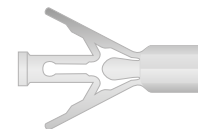

Ø x L / S max. (mm)	Ambalare (buc.)	Pret / 100 buc.		Cod
		LEI	EURO	
10 x 40 / 9 - 13	100	16.43	3.65	I.ANCLA40SM
10 x 47 / 13 - 20	100	20.39	4.53	I.ANCLA47SM

Set de fixare pentru WC

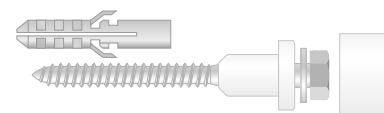

mm	Ambalare (buc.)	Pret / 100 buc.		Cod
		LEI	EURO	
WC1 HEX 6 x 80 / 10	40	52.83	11.74	AA.10006080SM
WC2 HEX 7 x 70 / 10	40	62.19	13.82	AA.10007070SM

Smax - grosimea maxima de fixare

Set de fixare pentru chiuveta

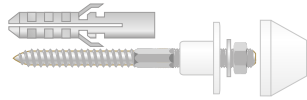

mm	Ambalare (buc.)	Pret / 100 buc.		Cod
		LEI	EURO	
Chiuveta1 M10x100/12	40	186.80	41.51	AA.10310100SM
Chiuveta2 M10x120/12	40	207.18	46.04	AA.10310120SM

Set de fixare pentru oglinda

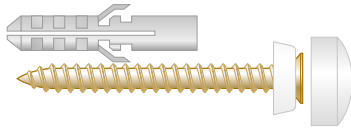

mm	Ambalare (buc.)	Pret / 100 buc.		Cod
		LEI	EURO	
4.5 x 50/6	40	36.95	8.21	AA.10445050SM

Diblu pentru izolatie

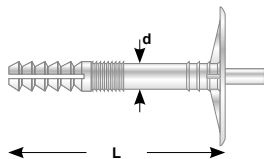

d x L (mm)	Ambalare (buc.)	Pret / 100 buc.		Cod
		LEI	EURO	
8 x 120	250	14.72	3.27	DI.8120SM
10 x 70	250	17.73	3.94	DI.1070SM
10 x 90	250	19.62	4.36	DI.1090SM
10 x 110	250	20.21	4.49	DI.10110SM
10 x 120	250	20.25	4.50	DI.10120SM
10 x 130	250	29.07	6.46	DI.10130SM
10 x 140	250	30.51	6.78	DI.10140SM
10 x 160	250	30.51	6.78	DI.10160SM
10 x 170	250	30.56	6.79	DI.10170SM
10 x 180	250	30.60	6.80	DI.10180SM
10 x 200	250	32.13	7.14	DI.10200SM
10 x 220	250	39.96	8.88	DI.10220SM

Rondela suport, polietilena



mm	Ambalare (buc.)	Pret / 100 buc.		Cod
		LEI	EURO	
70 x 5.5	50	55.62	12.36	AA.12270000SM
90 x 5.5	50	61.65	13.70	AA.12290000SM

Set diblu-suport pentru calorifer din fonta

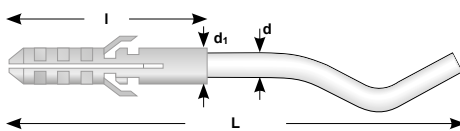

d x L / d ₁ x l (mm)	Ambalare (buc.)	Pret / 100 buc.		Cod
		LEI	EURO	
12 x 190 / 16 x 80	20	317.07	70.46	AA.11112190SM
12 x 220 / 16 x 80	20	360.18	80.04	AA.11112220SM
12 x 250 / 16 x 80	20	415.31	92.29	AA.11112250SM

Fixari carlig cu clape si arc, pentru placi

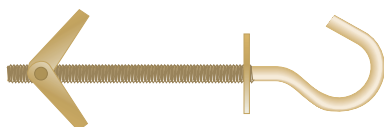

M x L (mm)	Ambalare (buc.)	Pret / 100 buc.		Cod
		LEI	EURO	
M4 x 75 hook	50	67.95	15.10	I.PAGAM04SM
M6 x 75 hook	50	68.13	15.14	I.PAGAM06SM

Diblu metalic autoforant ZAMAC-S



mm	Ambalare (buc.)	Pret / 100 buc.		Cod
		LEI	EURO	
ZAMAC-S/6x37/4.5x40	100	28.85	6.41	I.TAPLAZKSM

Dibluri metalice de expansiune cu surub

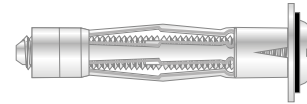

M x L (mm)	Ambalare (buc.)	Pret / 100 buc.		Cod
		LEI	EURO	
M 4 x 38	100	24.84	5.52	I.INCO438SM
M 4 x 45	100	24.89	5.53	I.INCO446SM
M 5 x 58	100	38.66	8.59	I.INCO558SM
M 5 x 71	100	46.67	10.37	I.INCO571SM
M 6 x 58	100	46.76	10.39	I.INCO658SM

Dibluri metalice de expansiune fara surub

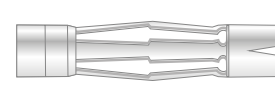

M x L (mm)	Ambalare (buc.)	Pret / 100 buc.		Cod
		LEI	EURO	
M 4 x 45	100	13.32	2.96	I.INSI446SM
M 5 x 45	100	17.73	3.94	I.INSI545SM
M 5 x 58	100	22.19	4.93	I.INSI558SM
M 6 x 58	100	25.74	5.72	I.INSI658SM
M 6 x 71	100	42.53	9.45	I.INSI671SM
M 6 x 88	100	42.53	9.45	I.INSI688SM

Conexpand bolt din otel inoxidabil A2

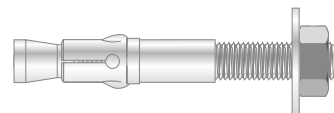

M x L (mm)	Ambalare (buc.)	Pret / 100 buc.		Cod
		LEI	EURO	
M 6 x 45	200	52.02	11.56	I.MI06045SM
M 8 x 50	100	191.70	42.60	I.MI08050SM
M 8 x 75	100	228.78	50.84	I.MI08075SM
M 8 x 90	100	248.04	55.12	I.MI08090SM
M 8 x 115	100	291.33	64.74	I.MI08115SM
M 10 x 70	100	342.63	76.14	I.MI10070SM
M 10 x 90	100	371.52	82.56	I.MI10090SM
M 10 x 120	50	450.14	100.03	I.MI10120SM
M 10 x 150	50	515.03	114.45	I.MI10150SM
M 12 x 110	50	595.89	132.42	I.MI12110SM
M 12 x 140	50	714.47	158.77	I.MI12140SM
M 16 x 170	25	1428.98	317.55	I.MI16170SM

Conexpand bolt standard, zincat, cu inel de strangere din otel inoxidabil A2

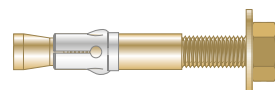

M x L (mm)	Ambalare (buc.)	Pret / 100 buc.		Cod
		LEI	EURO	
M 6 x 60	200	24.21	5.38	CBSX.660SM
M 6 x 70	200	33.12	7.36	CBSX.670SM
M 6 x 90	200	37.31	8.29	CBSX.690SM
M 8 x 60	100	47.25	10.50	CBSX.860SM
M 8 x 75	100	52.47	11.66	CBSX.875SM
M 8 x 90	100	60.30	13.40	CBSX.890SM
M 8 x 115	100	69.44	15.43	CBSX.8115SM
M 8 x 155	100	70.02	15.56	CBSX.8155SM
M 10 x 90	100	95.22	21.16	CBSX.1090SM
M 10 x 120	50	104.72	23.27	CBSX.10120SM
M 10 x 170	50	156.78	34.84	CBSX.10170SM
M 12 x 75	50	120.87	26.86	CBSX.1275SM

Conexpand bolt standard, zincat, cu inel de strangere din otel inoxidabil A2 (continuare)

M x L (mm)	Ambalare (buc.)	Pret / 100 buc.		Cod
		LEI	EURO	
M 12 x 90	50	120.87	26.86	CBSX.1290SM
M 12 x 110	50	142.20	31.60	CBSX.12110SM
M 12 x 140	50	156.51	34.78	CBSX.12140SM
M 12 x 160	50	157.37	34.97	CBSX.12160SM
M 12 x 220	50	255.78	56.84	CBSX.12220SM
M 12 x 250	25	295.02	65.56	CBSX.12250SM
M 14 x 145	25	290.57	64.57	CBSX.14145SM
M 14 x 170	25	306.36	68.08	CBSX.14170SM
M 14 x 220	25	398.93	88.65	CBSX.14220SM
M 16 x 125	25	280.89	62.42	CBSX.16125SM
M 16 x 145	25	306.90	68.20	CBSX.16145SM
M 16 x 170	25	385.74	85.72	CBSX.16170SM
M 16 x 220	25	461.12	102.47	CBSX.16220SM
M 20 x 120	20	687.56	152.79	CBSX.20120SM
M 20 x 170	20	554.40	123.20	CBSX.20170SM
M 20 x 220	20	573.93	127.54	CBSX.20220SM

Conexpand bolt standard, cu inel de strangere din otel zincat

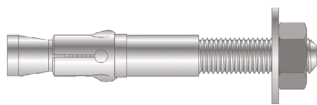

M x L (mm)	Ambalare (buc.)	Pret / 100 buc.		Cod
		LEI	EURO	
M 6 x 45	200	29.34	6.52	I.AM06045SM
M 6 x 60	200	29.39	6.53	I.AM06060SM
M 6 x 70	200	29.70	6.60	I.AM06070SM
M 6 x 80	200	32.54	7.23	I.AM06080SM
M 6 x 90	200	36.36	8.08	I.AM06090SM
M 6 x 120	100	49.91	11.09	I.AM06120SM
M 8 x 50	100	34.79	7.73	I.AM08050SM
M 8 x 60	100	36.54	8.12	I.AM08060SM
M 8 x 75	100	40.01	8.89	I.AM08075SM
M 8 x 90	100	47.43	10.54	I.AM08090SM
M 8 x 115	100	55.76	12.39	I.AM08115SM
M 8 x 130	100	77.27	17.17	I.AM08130SM
M 8 x 155	100	85.05	18.90	I.AM08155SM
M 10 x 70	100	61.52	13.67	I.AM10070SM
M 10 x 90	100	69.12	15.36	I.AM10090SM
M 10 x 120	50	82.62	18.36	I.AM10120SM
M 10 x 150	50	112.10	24.91	I.AM10150SM
M 10 x 170	50	131.09	29.13	I.AM10170SM
M 10 x 210	50	159.80	35.51	I.AM10210SM
M 10 x 230	50	201.87	44.86	I.AM10230SM
M 12 x 75	50	89.01	19.78	I.AM12075SM
M 12 x 90	50	100.26	22.28	I.AM12090SM
M 12 x 110	50	111.38	24.75	I.AM12110SM
M 12 x 140	50	137.07	30.46	I.AM12140SM
M 12 x 160	50	184.41	40.98	I.AM12160SM
M 12 x 180	50	188.46	41.88	I.AM12180SM
M 12 x 220	50	221.58	49.24	I.AM12220SM
M 12 x 250	25	257.40	57.20	I.AM12250SM
M 14 x 100	50	207.32	46.07	I.AM14100SM
M 14 x 120	25	233.06	51.79	I.AM14120SM
M 14 x 145	25	247.82	55.07	I.AM14145SM
M 14 x 170	25	303.12	67.36	I.AM14170SM
M 14 x 220	25	401.27	89.17	I.AM14220SM
M 16 x 90	25	223.11	49.58	I.AM16090SM
M 16 x 125	25	223.61	49.69	I.AM16125SM
M 16 x 145	25	256.91	57.09	I.AM16145SM
M 16 x 170	25	312.35	69.41	I.AM16170SM
M 16 x 220	25	367.11	81.58	I.AM16220SM
M 16 x 250	25	405.77	90.17	I.AM16250SM
M 16 x 280	25	533.84	118.63	I.AM16280SM
M 20 x 120	20	359.37	79.86	I.AM20120SM
M 20 x 170	20	469.62	104.36	I.AM20170SM
M 20 x 220	20	587.93	130.65	I.AM20220SM
M 20 x 270	20	717.71	159.49	I.AM20270SM
M 24 x 180	10	897.93	199.54	I.AM24180SM
M 24 x 260	10	1229.76	273.28	I.AM24260SM

Conexpand clasic



M x L x D (mm)	Ambalare (buc.)	Pret / 100 buc.		Cod
		LEI	EURO	
M 6 x 40 x 10	100	40.91	9.09	AA.14006040SM
M 6 x 50 x 10	100	44.46	9.88	AA.14006050SM
M 6 x 60 x 10	100	48.69	10.82	AA.14006060SM
M 6 x 80 x 10	100	61.83	13.74	AA.14006080SM
M 6 x 100 x 10	100	70.02	15.56	AA.14006100SM

Conexpand clasic (continuare)

M x L x D (mm)	Ambalare (buc.)	Pret / 100 buc.		Cod
		LEI	EURO	
M 6 x 120 - D10	25	83.84	18.63	AA.14006120SM
M 6 x 160 - D10	25	101.03	22.45	AA.14006160SM
M 8 x 50 - D12	100	74.16	16.48	AA.14008050SM
M 8 x 60 - D12	100	82.53	18.34	AA.14008060SM
M 8 x 70 - D12	100	89.01	19.78	AA.14008070SM
M 8 x 80 - D12	100	95.36	21.19	AA.14008080SM
M 8 x 90 - D12	100	102.15	22.70	AA.14008090SM
M 8 x 100 - D12	100	115.25	25.61	AA.14008100SM
M 8 x 120 - D12	100	127.58	28.35	AA.14008120SM
M 8 x 160 - D12	25	166.46	36.99	AA.14008160SM
M 8 x 180 - D12	25	178.79	39.73	AA.14008180SM
M 10 x 60 - D14	50	113.72	25.27	AA.14010060SM
M 10 x 70 - D14	50	126.41	28.09	AA.14010070SM
M 10 x 80 - D14	50	137.07	30.46	AA.14010080SM
M 10 x 90 - D14	50	147.56	32.79	AA.14010090SM
M 10 x 100 - D14	50	161.64	35.92	AA.14010100SM
M 10 x 120 - D14	50	180.59	40.13	AA.14010120SM
M 10 x 140 - D14	50	198.77	44.17	AA.14010140SM
M 10 x 180 - D14	25	245.88	54.64	AA.14010180SM
M 10 x 200 - D14	25	261.86	58.19	AA.14010200SM
M 12 x 80 - D16	50	184.41	40.98	AA.14012080SM
M 12 x 90 - D16	50	201.38	44.75	AA.14012090SM
M 12 x 100 - D16	50	210.51	46.78	AA.14012100SM
M 12 x 110 - D16	50	229.14	50.92	AA.14012110SM
M 12 x 120 - D16	50	239.00	53.11	AA.14012120SM
M 12 x 140 - D16	50	267.44	59.43	AA.14012140SM
M 12 x 160 - D16	50	307.22	68.27	AA.14012160SM
M 12 x 180 - D16	50	346.50	77.00	AA.14012180SM
M 12 x 200 - D16	50	369.54	82.12	AA.14012200SM
M 12 x 220 - D16	25	390.24	86.72	AA.14012220SM
M 12 x 250 - D16	25	407.88	90.64	AA.14012250SM
M 12 x 300 - D16	25	480.65	106.81	AA.14012300SM
M 16 x 80 - D22	10	332.55	73.90	AA.14016080SM
M 16 x 90 - D22	10	352.94	78.43	AA.14016090SM
M 16 x 100 - D22	10	393.71	87.49	AA.14016100SM
M 16 x 120 - D22	10	458.15	101.81	AA.14016120SM
M 16 x 150 - D22	10	524.34	116.52	AA.14016150SM
M 16 x 200 - D22	10	688.10	152.91	AA.14016200SM
M 16 x 250 - D22	10	828.14	184.03	AA.14016250SM
M 16 x 300 - D22	10	972.41	216.09	AA.14016300SM
M 18 x 200 - D25	10	831.47	184.77	AA.14018200SM
M 18 x 250 - D25	10	996.12	221.36	AA.14018250SM
M 20 x 200 - D28	10	1092.78	242.84	AA.14020200SM
M 20 x 250 - D28	10	1320.21	293.38	AA.14020250SM
M 20 x 300 - D28	10	1588.32	352.96	AA.14020300SM
M 24 x 250 - D32	10	2053.26	456.28	AA.14024250SM
M 24 x 300 - D32	10	2409.62	535.47	AA.14024300SM
M 24 x 350 - D32	10	2875.68	639.04	AA.14024350SM

Conexpand de strapungere - tip 1



M x L x D (mm)	Ambalare (buc.)	Pret / 100 buc.		Cod
		LEI	EURO	
M 6 x 60 x 10	25	69.66	15.48	AA.14106060SM
M 6 x 80 x 10	25	83.88	18.64	AA.14106080SM
M 6 x 100 x 10	25	104.18	23.15	AA.14106100SM
M 6 x 120 x 10	25	123.39	27.42	AA.14106120SM
M 6 x 160 x 10	25	164.84	36.63	AA.14106160SM
M 8 x 80 x 12	25	127.80	28.40	AA.14108080SM
M 8 x 100 x 12	25	143.78	31.95	AA.14108100SM
M 8 x 120 x 12	25	170.60	37.91	AA.14108120SM
M 8 x 160 x 12	25	219.60	48.80	AA.14108160SM
M 8 x 180 x 12	25	243.00	54.00	AA.14108180SM
M 10 x 100 x 14	25	208.76	46.39	AA.14110100SM
M 10 x 120 x 14	25	221.04	49.12	AA.14110120SM
M 10 x 140 x 14	25	263.21	58.49	AA.14110140SM
M 10 x 180 x 14	25	327.56	72.79	AA.14110180SM
M 10 x 200 x 14	25	360.32	80.07	AA.14110200SM
M 12 x 120 x 16	10	321.62	71.47	AA.14112120SM
M 12 x 140 x 16	10	373.59	83.02	AA.14112140SM
M 12 x 160 x 16	10	388.62	86.36	AA.14112160SM
M 12 x 180 x 16	10	417.74	92.83	AA.14112180SM
M 12 x 200 x 16	10	472.86	105.08	AA.14112200SM
M 12 x 220 x 16	10	505.08	112.24	AA.14112220SM
M 12 x 250 x 16	10	564.17	125.37	AA.14112250SM
M 12 x 300 x 16	10	682.47	151.66	AA.14112300SM
M 16 x 150 x 22	10	700.83	155.74	AA.14116150SM
M 16 x 200 x 22	10	892.94	198.43	AA.14116200SM
M 16 x 250 x 22	10	1103.58	245.24	AA.14116250SM
M 16 x 300 x 22	10	1313.87	291.97	AA.14116300SM

Conexpand de strapungere - tip 8



M x L x D (mm)	Ambalare (buc.)	Pret / 100 buc.		Cod
		LEI	EURO	
M 6 x 50 x 10	25	94.37	20.97	AA.14806050SM
M 6 x 60 x 10	25	91.22	20.27	AA.14806060SM
M 8 x 60 x 12	25	127.89	28.42	AA.14808060SM
M 8 x 80 x 12	25	156.69	34.82	AA.14808080SM
M 10 x 80 x 14	25	189.77	42.17	AA.14810080SM
M 10 x 100 x 14	25	235.62	52.36	AA.14810100SM
M 12 x 100 x 16	10	336.65	74.81	AA.14812100SM
M 12 x 120 x 16	10	402.30	89.40	AA.14812120SM

Conexpand "Ochi"

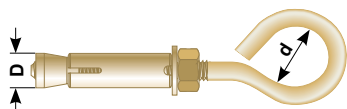

M x d x D (mm)	Ambalare (buc.)	Pret / 100 buc.		Cod
		LEI	EURO	
M 6 x 16 x 10	10	117.00	26.00	AA.14406000SM
M 8 x 20 x 12	10	180.77	40.17	AA.14408000SM
M 10 x 25 x 14	10	284.99	63.33	AA.14410000SM
M 12 x 30 x 16	10	445.55	99.01	AA.14412000SM

Conexpand "Carlig"

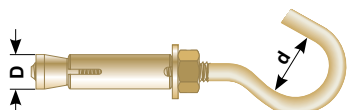

M x d x D (mm)	Ambalare (buc.)	Pret / 100 buc.		Cod
		LEI	EURO	
M 6 x 16 x 10	10	110.48	24.55	AA.14506000SM
M 8 x 20 x 12	10	168.17	37.37	AA.14508000SM
M 10 x 25 x 14	10	265.46	58.99	AA.14510000SM
M 12 x 30 x 16	10	414.72	92.16	AA.14512000SM

Piulita din otel expandabila - pentru beton, otel zincat



M - d x L (mm)	Ambalare (buc.)	Pret / 100 buc.		Cod
		LEI	EURO	
M 6 - 8 x 25	100	17.60	3.91	I.HENOM06SM
M 8 - 10 x 30	100	21.47	4.77	I.HENOM08SM
M 10 - 12 x 40	50	34.16	7.59	I.HENOM10SM
M 12 - 15 x 50	50	77.40	17.20	I.HENOM12SM
M 16 - 20 x 60	25	167.67	37.26	I.HENOM16SM
M 20 - 25 x 80	25	236.07	52.46	I.HENOM20SM

Piulita din alama expandabila - pentru marmura, gresie sau beton



M - d x L (mm)	Ambalare (buc.)	Pret / 100 buc.		Cod
		LEI	EURO	
M 6 - 8 x 23	200	62.06	13.79	I.TALAM06SM
M 8 - 10 x 28	100	88.34	19.63	I.TALAM08SM
M 10 - 12 x 33	150	147.92	32.87	I.TALAM10SM

Ancora pentru ferestre si usi - standard



(Ø x L) mm	Ambalare (buc.)	Pret / 100 buc.		Cod
		LEI	EURO	
10 x 72	100	30.24	6.72	I.EPS6072SM
10 x 92	100	35.42	7.87	I.EPS6092SM
10 x 112	100	41.76	9.28	I.EPS6112SM
10 x 132	100	46.58	10.35	I.EPS6132SM
10 x 152	100	50.90	11.31	I.EPS6152SM
10 x 182	100	63.86	14.19	I.EPS6182SM
10 x 202	50	64.89	14.42	AA.17010202SM

Ancora pentru ferestre si usi - pentru cavitati



(Ø x L) mm	Ambalare (buc.)	Pret / 100 buc.		Cod
		LEI	EURO	
10 x 112	100	48.33	10.74	AA.17110112SM
10 x 132	100	69.75	15.50	AA.17110132SM
10 x 152	100	69.75	15.50	AA.17110152SM
10 x 182	100	69.84	15.52	AA.17110182SM

Ancora tip "Cui"



(Ø x L) mm	Ambalare (buc.)	Pret / 100 buc.		Cod articol
		LEI	EURO	
6.40 x 50	50	22.91	5.09	AA.15000001SM

Suruburi pentru gard, model SG, zincate

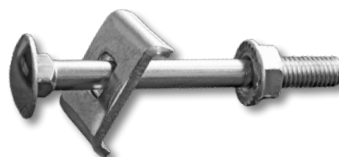

L.surub / a.stalp mm	Ambalare (buc.)	Pret / 100 buc.		Cod articol
		LEI	EURO	
M 6 x 60 / 40	50	61.02	13.56	SG660ZSM
M 6 x 80 / 60	50	65.07	14.46	SG680ZSM
M 8 x 60 / 40	50	73.26	16.28	SG860ZSM
M 8 x 80 / 60	50	80.15	17.81	SG880ZSM
M 8 x 100 / 80	50	86.67	19.26	SG8100ZSM
M 8 x 120 / 100	25	93.02	20.67	SG8120ZSM

Suruburi pentru gard, model SG, zincate, capul si clema vopsite verde

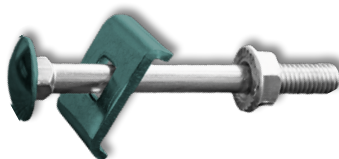

L.surub / a.stalp mm	Ambalare (buc.)	Pret / 100 buc.		Cod articol
		LEI	EURO	
M 6 x 60 / 40	50	67.10	14.91	SG660VSM
M 6 x 80 / 60	50	71.55	15.90	SG680VSM
M 8 x 60 / 40	50	79.92	17.76	SG860VSM
M 8 x 80 / 60	50	87.53	19.45	SG880VSM
M 8 x 100 / 80	50	94.73	21.05	SG8100VSM
M 8 x 120 / 100	25	101.03	22.45	SG8120VSM

Brida gard model BG, zincata, pentru stalpi rectangulari

Concepte special pentru fixarea panourilor de gard de stalpii rectangulari.
Avantaj - stalpii nu mai necesita gaurire.

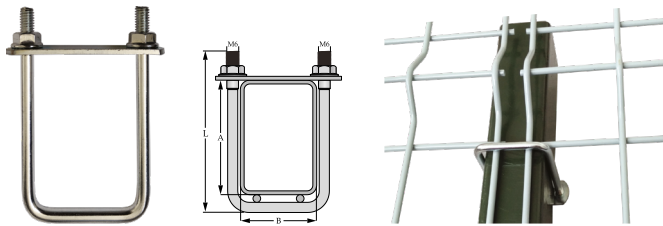

Brida M x L (mm)	Stalp A x B (mm)	Ambalare (buc.)	Preț / 100 buc.		Cod articol
			LEI	EURO	
M6 x 73	50 x 30	25	99.41	22.09	AF.BG5030SM
M6 x 63	40 x 40	25	71.87	15.97	AF.BG4040SM
M6 x 83	60 x 40	25	81.32	18.07	AF.BG6040SM
M6 x 53	30 x 50	25	76.82	17.07	AF.BG3050SM
M6 x 73	50 x 50	25	99.41	22.09	AF.BG5050SM
M6 x 123	100 x 50	25	122.90	27.31	AF.BG10050SM
M6 x 53	30 x 60	25	81.32	18.07	AF.BG3060SM
M6 x 103	80 x 60	25	103.05	22.90	AF.BG8060SM
M6 x 103	80 x 80	25	108.23	24.05	AF.BG8080SM
M6 x 123	100 x 100	25	140.09	31.13	AF.BG100100SM

Brida gard model BG, zincata, pentru stalpi rotunzi

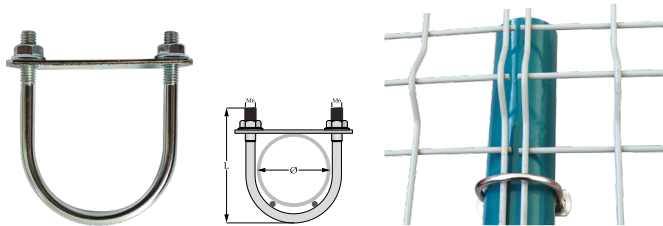

Concepte special pentru fixarea panourilor de gard de stalpii rotunzi.
Avantaj - stalpii nu mai necesita gaurire.

Brida M x L (mm)	Stalp (mm)	Ambalare (buc.)	Preț / 100 buc.		Cod articol
			LEI	EURO	
M 6 x 66	1 1/4" (ø42.4)	25	71.87	15.97	AF.BG1SM
M 6 x 72	1 1/2" (ø48.3)	25	78.62	17.47	AF.BG2SM

Cleme de gard

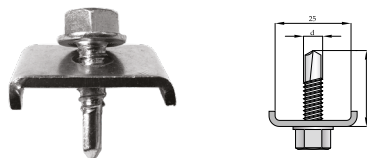

Clema d x L (mm)	Acoperire	Ambalare (buc)	Preț / 100 buc.		Cod articol
			LEI	EURO	
6.3 x 25	zincata	100	36.77	8.17	AF.CGZSM
6.3 x 25	vopsita alb electrostatic	100	40.41	8.98	AF.CGVSM

Prezoane cu varf tesit 2 x 45° si cap cu cep hexagonal, pentru fixari chimice, otel zincat gr. 4.6 (continuare)

M x L (mm)	Ambalare (buc.)	Preț / 100 buc.		Cod articol
		LEI	EURO	
M 12 x 250	25	377.69	83.93	AA.PO425SM
M 16 x 150	10	453.47	100.77	AA.PO615SM
M 16 x 165	10	486.00	108.00	AA.PO616SM
M 16 x 190	10	515.57	114.57	AA.PO619SM
M 16 x 250	10	646.97	143.77	AA.PO625SM
M 16 x 300	10	698.27	155.17	AA.PO630SM
M 20 x 220	10	833.31	185.18	AA.PO722SM
M 20 x 260	10	973.40	216.31	AA.PO726SM
M 20 x 300	10	1080.23	240.05	AA.PO730SM
M 20 x 350	10	1258.61	279.69	AA.PO735SM
M 24 x 260	10	1773.50	394.11	AA.PO826SM
M 30 x 380	5	3234.96	718.88	AA.PO938SM

Cartuse de injectie KAWO-PSF / KAWO-VSF



Capacitate (ml)	Ambalare (buc.)	Preț / 100 buc.		Cod articol
		LEI	EURO	
KAWO-PSF				
300	12	1958.04	435.12	KAWOPSF280SM
410	12	2167.83	481.74	KAWOPSF410SM
KAWO-VSF				
300	12	2517.48	559.44	KAWOVSF280SM
410	12	3006.99	668.22	KAWOVSF410SM

Prezoane cu varf tesit 2 x 45° si cap cu cep hexagonal, pentru fixari chimice, otel inoxidabil A2-50



M x L (mm)	Ambalare (buc.)	Preț / 100 buc.		Cod articol
		LEI	EURO	
M 10 x 130	10	431.87	95.97	AA.PX313SM
M 12 x 135	10	538.70	119.71	AA.PX413SM
M 12 x 160	10	608.72	135.27	AA.PX416SM
M 16 x 190	5	1196.55	265.90	AA.PX619SM

Prezoane cu varf tesit 2 x 45° si cap cu cep hexagonal, pentru fixari chimice, otel zincat gr. 4.6



M x L (mm)	Ambalare (buc.)	Preț / 100 buc.		Cod articol
		LEI	EURO	
M 8 x 110	50	158.13	35.14	AA.PO211SM
M 10 x 115	50	226.76	50.39	AA.PO311SM
M 10 x 130	50	237.56	52.79	AA.PO313SM
M 10 x 165	25	259.20	57.60	AA.PO316SM
M 10 x 190	25	269.33	59.85	AA.PO319SM
M 10 x 250	25	345.20	76.71	AA.PO325SM
M 10 x 300	25	415.89	92.42	AA.PO330SM
M 12 x 135	25	261.36	58.08	AA.PO413SM
M 12 x 160	25	276.53	61.45	AA.PO416SM
M 12 x 180	25	314.82	69.96	AA.PO418SM
M 12 x 210	25	345.20	76.71	AA.PO421SM

Colier standard cu, banda 20 x 2.0 mm

Piulita M8

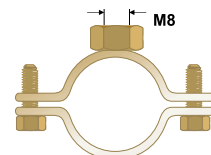

Ø teava (mm) Ø nominal (toli)	Ambalare (buc.)	Preț / 100 buc.		Cod articol
		LEI	EURO	
15 - 19 3/8"	50	121.50	27.00	CM01038SM
20 - 25 1/2"	50	135.23	30.05	CM02012SM
25 - 30 3/4"	50	152.91	33.98	CM03034SM
31 - 36 1"	50	165.02	36.67	CM04100SM
37 - 45 1 1/4"	50	181.49	40.33	CM05114SM
46 - 51 1 1/2"	25	207.68	46.15	CM06112SM
59 - 64 2"	25	208.85	46.41	CM07200SM
70 - 77 2 1/2"	25	233.46	51.88	CM07212SM
83 - 90 3"	25	256.28	56.95	CM08300SM
95 - 102 3 1/2"	25	283.41	62.98	CM08312SM
108 - 115 4"	25	325.80	72.40	CM08400SM

Colier standard cu piulita dubla, banda 20 x 2.0 mm

Piulita M10 + M12

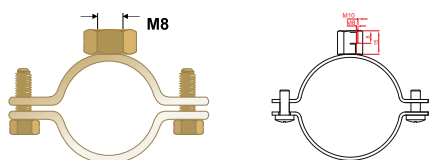

Ø teava (mm) Ø nominal (toli)	Ambalare (buc.)	Pret / 100 buc.		Cod articol
		LEI	EURO	
15 - 19 3/8"	50	133.65	29.70	CMA01038SM
20 - 25 1/2"	50	148.77	33.06	CMA02012SM
25 - 30 3/4"	50	168.21	37.38	CMA03034SM
31 - 36 1"	50	181.53	40.34	CMA04100SM
37 - 45 1 1/4"	50	199.62	44.36	CMA05114SM
46 - 51 1 1/2"	25	228.47	50.77	CMA06112SM
59 - 64 2"	25	229.68	51.04	CMA07200SM
70 - 77 2 1/2"	25	256.82	57.07	CMA07212SM
83 - 90 3"	25	281.88	62.64	CMA08300SM
95 - 102 3 1/2"	25	311.76	69.28	CMA08312SM
108 - 115 4"	25	358.38	79.64	CMA08400SM

Set colier standard + diblu Ø10 x 50 mm - banda 20 x 2.0 mm

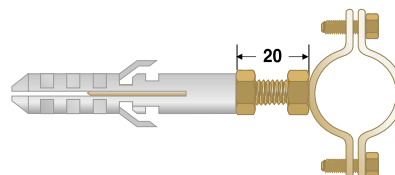

Ø teava (mm) Ø nominal (toli)	Ambalare (buc.)	Pret / 100 buc.		Cod articol
		LEI	EURO	
15 - 19 3/8"	50	184.95	41.10	CS01038SM
20 - 25 1/2"	50	198.72	44.16	CS02012SM
25 - 30 3/4"	50	209.61	46.58	CS03034SM
31 - 36 1"	50	228.96	50.88	CS04100SM
37 - 45 1 1/4"	50	240.93	53.54	CS05114SM
46 - 51 1 1/2"	25	256.05	56.90	CS06112SM
59 - 64 2"	25	269.37	59.86	CS07200SM
70 - 77 2 1/2"	25	274.64	61.03	CS07212SM
83 - 90 3"	25	315.86	70.19	CS08300SM
95 - 102 3 1/2"	25	340.11	75.58	CS08312SM
108 - 115 4"	25	363.06	80.68	CS08400SM

Colier standard cu protectie de cauciuc, banda 20 x 2.0 mm

Piulita M8

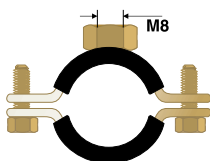

Ø teava (mm) Ø nominal (toli)	Ambalare (buc.)	Pret / 100 buc.		Cod articol
		LEI	EURO	
9 - 13	50	149.58	33.24	CC01038SM
14 - 19 3/8"	50	155.52	34.56	CC02012SM
19 - 24 1/2"	50	171.45	38.10	CC03034SM
25 - 30 3/4"	50	188.55	41.90	CC04100SM
31 - 39 1"	50	212.54	47.23	CC05114SM
40 - 45 1 1/4"	25	238.50	53.00	CC06112SM
46 - 51 1 1/2"	25	281.30	62.51	CC06113SM
53 - 58	25	297.77	66.17	CC07200SM
59 - 64 2"	25	339.57	75.46	CC07201SM
64 - 71	25	349.79	77.73	CC07212SM
72 - 77 2 1/2"	25	370.58	82.35	CC07213SM
77 - 84	25	385.92	85.76	CC08300SM
89 - 96 3"	25	426.65	94.81	CC08312SM
97 - 102 3 1/2"	25	460.58	102.35	CC08313SM
102 - 109	25	474.57	105.46	CC08400SM
110 - 115 4"	25	489.65	108.81	CC08401SM

Set colier standard cu protectie de cauciuc + diblu Ø10 x 50 mm, banda 20 x 2.0 mm

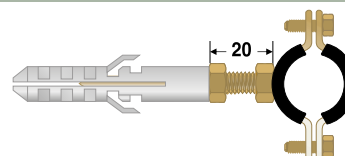

Ø teava (mm) Ø nominal (toli)	Ambalare (buc.)	Pret / 100 buc.		Cod articol
		LEI	EURO	
9 - 13	50	212.04	47.12	CS31038SM
14 - 19 3/8"	50	221.85	49.30	CS32012SM
19 - 24 1/2"	50	236.03	52.45	CS33034SM
25 - 30 3/4"	50	249.57	55.46	CS34100SM
31 - 39 1"	50	286.20	63.60	CS35114SM
40 - 45 1 1/4"	25	299.25	66.50	CS36112SM
46 - 51 1 1/2"	25	338.99	75.33	CS36113SM
53 - 58	25	348.75	77.50	CS37200SM
59 - 64 2"	25	399.65	88.81	CS37201SM
64 - 71	25	413.28	91.84	CS37212SM
72 - 77 2 1/2"	25	430.88	95.75	CS37213SM
77 - 84	25	445.82	99.07	CS38300SM
89 - 96 3"	25	480.74	106.83	CS38312SM
97 - 102 3 1/2"	25	499.59	111.02	CS38313SM
102 - 109	25	523.44	116.32	CS38400SM
110 - 115 4"	25	552.83	122.85	CS38401SM

Colier standard cu piulita dubla si protectie de cauciuc, banda 20 x 2.0 mm

Piulita M8 + M10

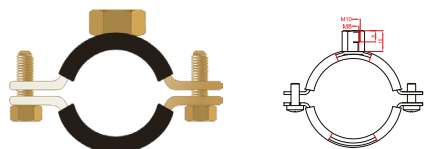

Ø teava (mm) Ø nominal (toli)	Ambalare (buc.)	Pret / 100 buc.		Cod articol
		LEI	EURO	
14 - 19 3/8"	50	171.05	38.01	CCA02012SM
19 - 24 1/2"	50	188.64	41.92	CCA03034SM
25 - 30 3/4"	50	207.41	46.09	CCA04100SM
31 - 39 1"	50	233.82	51.96	CCA05114SM
40 - 45 1 1/4"	25	262.40	58.31	CCA06112SM
46 - 51 1 1/2"	25	309.47	68.77	CCA06113SM
59 - 64 2"	25	373.55	83.01	CCA07201SM
72 - 77 2 1/2"	25	407.66	90.59	CCA07213SM
89 - 96 3"	25	469.31	104.29	CCA08312SM
97 - 102 3 1/2"	25	506.61	112.58	CCA08313SM
110 - 115 4"	25	538.61	119.69	CCA08401SM

Colier usor, banda 20 x 1.5; piulita M 8

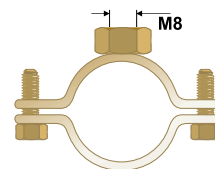

Ø teava (mm) Ø nominal (toli)	Ambalare (buc.)	Pret / 100 buc.		Cod articol
		LEI	EURO	
15 - 20 3/8"	50	109.40	24.31	CM31038SM
20 - 25 1/2"	50	121.73	27.05	CM32012SM
25 - 31 3/4"	50	137.57	30.57	CM33034SM
32 - 37 1"	50	148.46	32.99	CM34100SM
39 - 44 1 1/4"	50	163.26	36.28	CM35114SM
47 - 52 1 1/2"	25	186.93	41.54	CM36112SM

Colier greu, banda 25 x 2.5 mm

Piulita M10

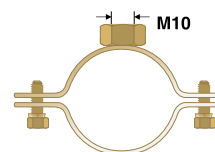

Ø teava (mm) Ø nominal (toli)	Ambalare (buc.)	Pret / 100 buc.		Cod articol
		LEI	EURO	
31 - 36 1"	25	266.22	59.16	CM21100SM
37 - 45 1 1/4"	25	283.77	63.06	CM22114SM
46 - 51 1 1/2"	25	320.18	71.15	CM23112SM
59 - 64 2"	25	333.23	74.05	CM24200SM
75 - 80 2 1/2"	25	390.20	86.71	CM25212SM
87 - 92 3"	25	429.89	95.53	CM26300SM
98 - 105 3 1/2"	25	469.08	104.24	CM27312SM
111 - 118 4"	25	509.54	113.23	CM28400SM

Set colier pentru gaze + diblu Ø10 x 50 mm, banda 20 x 1.5 mm

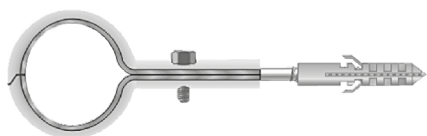

Ø nominal (toli) + Ø x L (mm)	Ambalare (buc.)	Pret / 100 buc.		Cod articol
		LEI	EURO	
3/8" + db10 x 50	50	137.07	30.46	CS21038SM
1/2" + db10 x 50	50	152.73	33.94	CS22012SM
3/4" + db10 x 50	50	163.98	36.44	CS23034SM
1" + db10 x 50	50	177.21	39.38	CS24100SM

Colier greu cu piulita dubla, banda 25 x 2.5 mm

Piulita M10 + M12

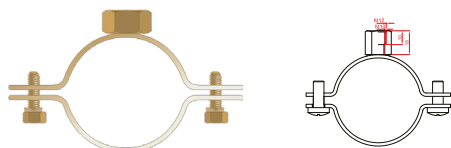

Ø teava (mm) Ø nominal (toli)	Ambalare (buc.)	Pret / 100 buc.		Cod articol
		LEI	EURO	
31 - 36 1"	25	292.86	65.08	CMA21100SM
37 - 45 1 1/4"	25	312.17	69.37	CMA22114SM
46 - 51 1 1/2"	25	352.22	78.27	CMA23112SM
59 - 64 2"	25	366.48	81.44	CMA24200SM
75 - 80 2 1/2"	25	429.26	95.39	CMA25212SM
87 - 92 3"	25	472.86	105.08	CMA26300SM
98 - 105 3 1/2"	25	515.97	114.66	CMA27312SM
111 - 118 4"	25	560.48	124.55	CMA28400SM

Colier greu cu protectie de cauciuc, banda 25 x 2.5 mm

Piulita M10

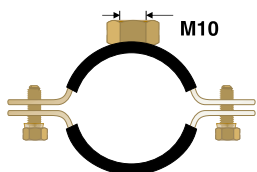

Ø teava (mm) Ø nominal (toli)	Ambalare (buc.)	Pret / 100 buc.		Cod articol
		LEI	EURO	
25 - 30 3/4"	25	344.21	76.49	CC21100SM
31 - 39 1"	25	368.42	81.87	CC22114SM
40 - 46 1 1/4"	25	409.41	90.98	CC23112SM
46 - 51 1 1/2"	25	463.46	102.99	CC23113SM
53 - 58	25	474.44	105.43	CC24200SM
59 - 64 2"	25	498.11	110.69	CC24201SM
69 - 74	25	523.76	116.39	CC25212SM
75 - 80 2 1/2"	25	567.50	126.11	CC25213SM
81 - 86	25	582.08	129.35	CC26300SM
87 - 92 3"	25	628.61	139.69	CC26301SM
92 - 99	25	649.44	144.32	CC27312SM
99 - 105 3 1/2"	25	678.96	150.88	CC27313SM
105 - 112	25	695.57	154.57	CC28400SM
111 - 118 4"	25	725.00	161.11	CC28401SM

Colier greu cu piulita dubla si protectie de cauciuc, banda 25 x 2.5 mm

Piulita M10 + M12

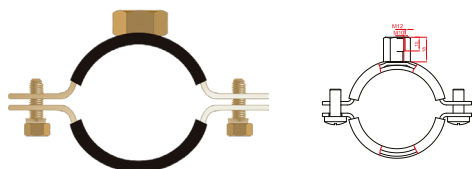

Ø teava (mm) Ø nominal (toli)	Ambalare (buc.)	Pret / 100 buc.		Cod articol
		LEI	EURO	
25 - 30 3/4"	25	378.68	84.15	CCA21100SM
31 - 39 1"	25	405.27	90.06	CCA22114SM
40 - 46 1 1/4"	25	450.36	100.08	CCA23112SM
46 - 51 1 1/2"	25	509.81	113.29	CCA23113SM
59 - 64 2"	25	547.88	121.75	CCA24201SM
75 - 80 2 1/2"	25	624.24	138.72	CCA25213SM
87 - 92 3"	25	691.47	153.66	CCA26301SM
99 - 105 3 1/2"	25	746.87	165.97	CCA27313SM
111 - 118 4"	25	797.54	177.23	CCA28401SM

Colier ranforsat fara protectie de cauciuc, banda 20 x 2.0 mm

Piulita M10



Ø nominal (mm - toli)	Ambalare (buc.)	Pret / 100 buc.		Cod articol
		LEI	EURO	
60 / 2"	10	270.23	60.05	CM9.060SM
75 / 2 1/2"	10	302.58	67.24	CM9.075SM
90 / 3"	10	342.68	76.15	CM9.090SM
110 / -	10	391.23	86.94	CM9.110SM
125 / 4 1/4"	10	436.50	97.00	CM9.125SM
140 / 5"	10	465.84	103.52	CM9.140SM
160 / 6"	10	513.59	114.13	CM9.160SM
200 / 6 1/2"	10	569.21	126.49	CM9.200SM

Colier ranforsat cu protectie de cauciuc, banda 20 x 2.0 mm; piulita M10



Ø nominal (mm - toli)	Ambalare (buc.)	Pret / 100 buc.		Cod articol
		LEI	EURO	
60 - 2"	10	368.28	81.84	CC9.060SM
75 - 2 1/2"	10	419.09	93.13	CC9.075SM
90 - 3"	10	482.36	107.19	CC9.090SM
110 -	10	556.29	123.62	CC9.110SM
125 - 4 1/4"	10	611.46	135.88	CC9.125SM
140 - 5"	10	678.78	150.84	CC9.140SM
160 - 6"	10	775.58	172.35	CC9.160SM
200 - 6 1/2"	10	956.57	212.57	CC9.200SM

Colier dublu orizontal

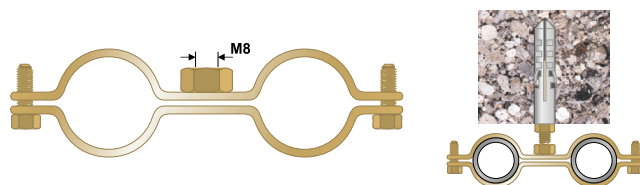

Ø teava (mm) Ø nominal (toli)	Ambalare (buc.)	Pret / 100 buc.		Cod articol
		LEI	EURO	
15 - 19 3/8"	10	196.65	43.70	CM51038SM
20 - 25 1/2"	10	231.08	51.35	CM52012SM

Colier dublu orizontal cu protectie de cauciuc

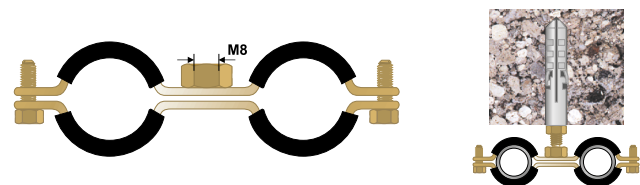

Ø teava (mm) Ø nominal (toli)	Ambalare (buc.)	Pret / 100 buc.		Cod articol
		LEI	EURO	
15 - 19 3/8"	10	356.49	79.22	CC51038SM
20 - 25 1/2"	10	376.61	83.69	CC52012SM

Colier "U" pentru tevi

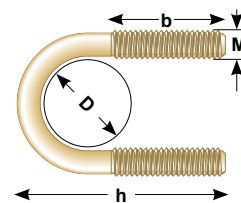

mm	Ambalare (buc.)	Pret / 100 buc.		Cod articol
		LEI	EURO	
M 6 / D18 h 60 b35	20	57.33	12.74	CU.06018SM
M 6 / D22 h 60 b35	20	57.92	12.87	CU.06022SM
M 6 / D25 h 65 b35	20	62.78	13.95	CU.06025SM
M 8 / D28 h 65 b35	20	80.55	17.90	CU.08028SM
M 8 / D32 h 70 b35	20	87.48	19.44	CU.08032SM
M 8 / D34 h 70 b35	20	87.98	19.55	CU.08034SM
M 8 / D40 h 75 b35	20	96.66	21.48	CU.08040SM
M 8 / D43 h 75 b35	20	99.00	22.00	CU.08043SM
M 10 / D30 h 70 b40	10	120.56	26.79	CU.10030SM
M 10 / D38 h 76 b40	10	132.75	29.50	CU.10038SM
M 10 / D46 h 86 b50	10	150.08	33.35	CU.10046SM
M 10 / D52 h 92 b50	10	165.29	36.73	CU.10052SM
M 12 / D56 h109 b50	10	238.64	53.03	CU.12056SM
M 12 / D64 h109 b50	10	245.75	54.61	CU.12064SM
M 12 / D70 h120 b50	10	270.36	60.08	CU.12070SM
M 12 / D78 h120 b50	10	274.59	61.02	CU.12078SM
M 12 / D82 h125 b50	10	288.63	64.14	CU.12082SM
M 12 / D94 h138 b50	10	321.08	71.35	CU.12094SM

Colier "U", zincat - TIP A, pentru tevi - SIMILAR DIN 3570

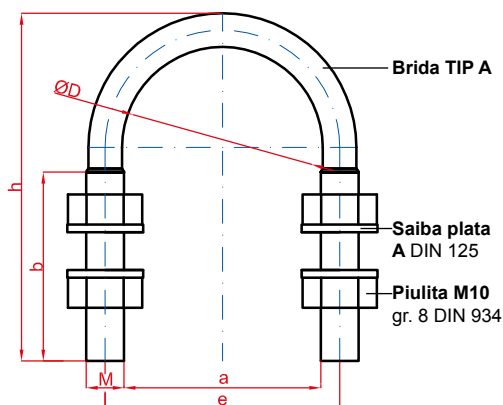

Brida TIP A
1 buc./colier

Saiba plata A DIN 125
2 buc./colier pentru marimile 30 - 46
4 buc./colier pentru marimile 52 - 332

Piulita M10 gr. 8 DIN 934
2 buc./colier pentru marimile 30 - 46
4 buc./colier pentru marimile 52 - 332

Marime a (mm)	Ø nom. teava		Dimensiuni (mm)					Amb. (buc.)	Pret / 100 buc.		Cod articol
	inch	mm	M	D	h	b	e		LEI	EURO	
30	¾	20	M10	25 - 27	70	40	40	20	131.54	29.23	CUA.102770SM
38	1	25	M10	30 - 34	76	40	48	20	147.47	32.77	CUA.103476SM
46	1 ¼	32	M10	38 - 43	86	50	56	20	168.30	37.40	CUA.104386SM
52	1 ½	40	M10	44 - 49	92	50	62	10	182.16	40.48	CUA.104992SM
64	2	50	M12	57 - 61	109	55	76	10	314.01	69.78	CUA.1261109SM
82	2 ½	65	M12	77	125	60	94	10	366.03	81.34	CUA.1277125SM
94	3	80	M12	89	138	60	106	10	407.70	90.60	CUA.1289138SM
120	4	100	M16	108 - 115	171	65	136	2	926.42	205.87	CUA.16115171SM
148	-	125	M16	133 - 140	191	65	164	2	1054.76	234.39	CUA.16140191SM
176	-	150	M16	159 - 169	217	65	192	2	1210.28	268.95	CUA.16169217SM
202	-	175	M16	191 - 194	249	65	218	2	1386.14	308.03	CUA.16194249SM
228	-	200	M20	216 - 220	283	70	248	2	2392.34	531.63	CUA.20220283SM
282	-	250	M20	267 - 273	334	70	302	2	2852.06	633.79	CUA.20273334SM
332	-	300	M20	318 - 324	385	70	352	2	3303.09	734.02	CUA.20324385SM

Colier "U", zincat - TIP B, pentru tevi - SIMILAR DIN 3570

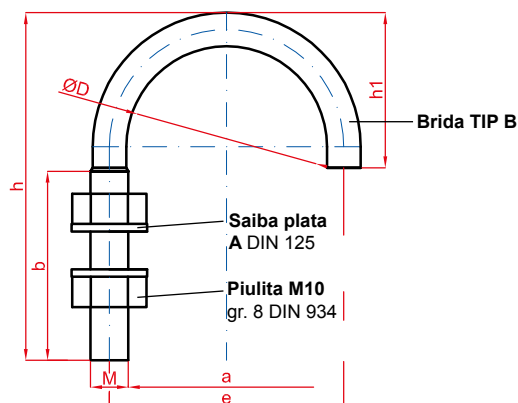

Brida TIP B
1 buc./colier

Saiba plata A DIN 125
1 buc./colier pentru marimile 30 - 46
2 buc./colier pentru marimile 52 - 94

Piulita M10 gr. 8 DIN 934
1 buc./colier pentru marimile 30 - 46
2 buc./colier pentru marimile 52 - 94

Marime a (mm)	Ø nom. teava		Dimensiuni (mm)					Amb. (buc.)	Pret / 100 buc.		Cod articol	
	inch	mm	M	D	h	h1	b		e	LEI		EURO
30	¾	20	M10	25 - 27	70	28	40	40	20	85.86	19.08	CUB.102770SM
38	1	25	M10	30 - 34	76	31	40	48	20	96.57	21.46	CUB.103476SM
46	1 ¼	32	M10	38 - 43	86	37	50	56	20	111.92	24.87	CUB.104386SM
52	1 ½	40	M10	44 - 49	92	40	50	62	10	122.67	27.26	CUB.104992SM
64	2	50	M12	57 - 61	109	49	55	76	10	211.59	47.02	CUB.1261109SM
82	2 ½	65	M12	77	125	57	60	94	10	248.36	55.19	CUB.1277125SM
94	3	80	M12	89	138	66	60	106	10	280.58	62.35	CUB.1289138SM

Colier pentru furtun, banda 10 x 0.8 mm, surub M6, oțel galvanizat



Colier pentru furtun, banda 10 x 0.8 mm, surub M6, oțel inoxidabil



Ø furtun (mm)	Ambalare (buc.)	Pret / 100 buc.		Cod articol
		LEI	EURO	
8 - 16	100	57.02	12.67	JS.00016SM
12 - 20	100	52.29	11.62	JS.00020SM
18 - 25	100	55.85	12.41	JS.00025SM
20 - 32	100	59.58	13.24	JS.00032SM
25 - 40	100	62.69	13.93	JS.00040SM
35 - 50	50	67.95	15.10	JS.00050SM
40 - 60	50	73.76	16.39	JS.00060SM
50 - 70	50	95.22	21.16	JS.00070SM
60 - 80	24	95.36	21.19	JS.00080SM
70 - 90	24	100.80	22.40	JS.00090SM
80 - 100	24	103.46	22.99	JS.00100SM
90 - 110	24	112.32	24.96	JS.00110SM
100 - 120	24	116.60	25.91	JS.00120SM
110 - 130	24	116.60	25.91	JS.00130SM
120 - 140	24	116.69	25.93	JS.00140SM
130 - 150	24	148.91	33.09	JS.00150SM

Ø furtun (mm)	Ambalare (buc.)	Pret / 100 buc.		Cod articol
		LEI	EURO	
8 - 16	100	119.16	26.48	JS.01016SM
12 - 20	100	122.76	27.28	JS.01020SM
18 - 25	100	129.74	28.83	JS.01025SM
20 - 32	100	141.75	31.50	JS.01032SM
25 - 40	100	145.58	32.35	JS.01040SM
35 - 50	50	154.67	34.37	JS.01050SM
40 - 60	50	162.90	36.20	JS.01060SM
50 - 70	50	167.45	37.21	JS.01070SM
60 - 80	24	168.66	37.48	JS.01080SM
70 - 90	24	184.77	41.06	JS.01090SM
80 - 100	24	185.04	41.12	JS.01100SM
90 - 110	24	185.09	41.13	JS.01110SM
100 - 120	24	185.22	41.16	JS.01120SM
110 - 130	24	209.61	46.58	JS.01130SM

Colier de presiune inalta, banda 24 x 1.5 mm, surub M8, otel galvanizat



Ø furtun (mm)	Ambalare (buc.)	Pret / 100 buc.		Cod articol
		LEI	EURO	
23 - 25	50	212.36	47.19	JS.02025SM
26 - 28	50	213.12	47.36	JS.02028SM
29 - 31	50	275.81	61.29	JS.02031SM
32 - 35	25	275.81	61.29	JS.02035SM
36 - 39	25	302.36	67.19	JS.02039SM
40 - 43	25	302.36	67.19	JS.02043SM
44 - 47	25	302.40	67.20	JS.02047SM
48 - 51	10	307.26	68.28	JS.02051SM
52 - 55	10	349.52	77.67	JS.02055SM
56 - 59	10	349.52	77.67	JS.02059SM
60 - 63	5	363.69	80.82	JS.02063SM
64 - 67	5	363.74	80.83	JS.02067SM
68 - 73	5	502.16	111.59	JS.02073SM
74 - 79	5	502.52	111.67	JS.02079SM
80 - 85	5	507.92	112.87	JS.02085SM
92 - 97	5	577.89	128.42	JS.02097SM
98 - 103	5	577.98	128.44	JS.02103SM
104 - 112	5	578.03	128.45	JS.02112SM
113 - 121	5	578.07	128.46	JS.02121SM
122 - 130	5	578.07	128.46	JS.02130SM
131 - 139	5	578.12	128.47	JS.02139SM
140 - 148	5	578.12	128.47	JS.02148SM
149 - 161	5	578.16	128.48	JS.02161SM
162 - 174	5	578.16	128.48	JS.02174SM
175 - 187	5	578.21	128.49	JS.02187SM
188 - 200	5	578.21	128.49	JS.02200SM
201 - 213	5	578.25	128.50	JS.02213SM
214 - 226	5	578.30	128.51	JS.02226SM
227 - 239	5	585.72	130.16	JS.02239SM

Brida usoara rapida

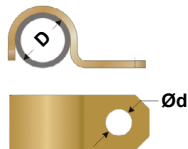

mm	Ambalare (buc.)	Pret / 100 buc.		Cod articol
		LEI	EURO	
D 5 / d 4.8	200	15.08	3.35	U005010SM
D 6 / d 4.8	200	16.34	3.63	U006010SM
D 7 / d 4.8	200	18.32	4.07	U007010SM
D 8 / d 4.8	200	17.33	3.85	U008010SM
D 9 / d 4.8	200	18.18	4.04	U009010SM
D 10 / d 4.8	200	19.22	4.27	U010010SM
D 11 / d 5.8	100	19.53	4.34	U011012SM
D 12 / d 5.8	100	20.79	4.62	U012012SM
D 13 / d 5.8	100	22.46	4.99	U013012SM
D 15 / d 5.8	100	24.75	5.50	U015012SM
D 16 / d 5.8	100	25.16	5.59	U016012SM

Brida standard rapida

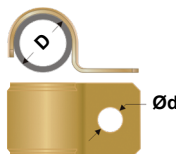

mm	Ambalare (buc.)	Pret / 100 buc.		Cod articol
		LEI	EURO	
D 16 / d 7	100	23.45	5.21	S016020SM
D 18 / d 7	100	26.64	5.92	S018020SM
D 20 / d 7	100	29.21	6.49	S020020SM
D 22 / d 7	100	31.77	7.06	S022020SM
D 26 / d 7	100	35.73	7.94	S026020SM

Brida standard

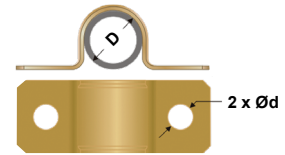

mm	Ambalare (buc.)	Pret / 100 buc.		Cod articol
		LEI	EURO	
D 16 / d 7	100	36.90	8.20	S116020SM
D 18 / d 7	100	36.86	8.19	S118020SM
D 20 / d 7	100	39.42	8.76	S120020SM
D 22 / d 7	100	41.31	9.18	S122020SM
D 26 / d 7	100	46.76	10.39	S126020SM
D 28 / d 7	100	48.56	10.79	S128020SM
D 32 / d 7	100	51.66	11.48	S132020SM
D 35 / d 7	50	54.86	12.19	S135020SM
D 42 / d 7	50	66.15	14.70	S142020SM
D 48 / d 7	50	71.96	15.99	S148020SM
D 60 / d 7	50	85.55	19.01	S160020SM
D 63 / d 7	50	90.05	20.01	S163020SM

Suporti de sustinere "V"

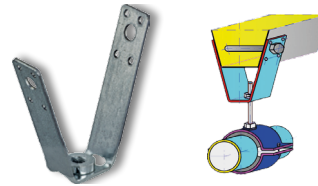

Fixare cu: suruburi autofiletante; suruburautoforante; pop-nituri 4 mm / surub M8

Perforatii: (2 x 4) Ø4.2 + (2 x 1) Ø9.5

Tip	Dimensiuni (mm)					Ambalare (buc.)	Pret / 100 buc.		Cod articol
							LEI	EURO	
M 8	92	88	25	2.5	M 8	10	279.54	62.12	AF.V9227SM
M 8	131	141	25	2.5	M 8	10	333.50	74.11	AF.V13127SM
M10	92	88	25	2.5	M10	10	284.45	63.21	AF.V9228SM
M10	131	141	25	2.5	M10	10	340.70	75.71	AF.V13128SM

Suporti cu gaura lisa (Ø) / filetata metric (M), pentru prindere pe grinda

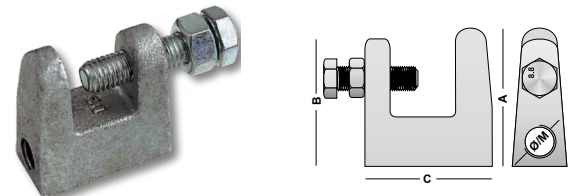

A x B x C	mm	Grosimea grinzii	Gaura lisa (Ø) / cu filet (M)	Ambalare (buc.)	Pret / 100 buc.		Cod articol
					LEI	EURO	
38 x 35 x 35	18	Ø 9	50	200.21	44.49	I.SUMOP09SM	
44 x 41 x 42	20	Ø 11	50	251.37	55.86	I.SUMOP11SM	
58 x 48 x 54	26	Ø 13	50	415.35	92.30	I.SUMOP13SM	
38 x 35 x 35	18	M 8	50	200.21	44.49	I.SUMOM08SM	
44 x 41 x 42	20	M 10	50	249.08	55.35	I.SUMOM10SM	
58 x 48 x 54	26	M 12	50	419.31	93.18	I.SUMOM12SM	

Clipsuri



mm	Ambalare (buc.)	Pret / 100 buc.		Cod articol
		LEI	EURO	
4	100	1.49	0.33	E022004SM
5	100	1.49	0.33	E022005SM
6	100	1.76	0.39	E022006SM
7	100	2.07	0.46	E022007SM
8	100	2.34	0.52	E022008SM
9	100	2.79	0.62	E022009SM
10	100	2.97	0.66	E022010SM
12	100	3.38	0.75	E022012SM
14	100	4.68	1.04	E022014SM
16	100	5.45	1.21	E022016SM
18	100	5.72	1.27	E022018SM
20	100	10.17	2.26	E022020SM
22	100	11.88	2.64	E022022SM

Supporti "Clip" fara diblu pentru tevi, polipropilena



Tip / Ø teava (mm)	Ambalare (buc.)	Pret / 100 buc.		Cod articol
		LEI	EURO	
PG 9 / 15 - 16	100	32.27	7.17	AB.012PG090SM
PG 13.5 / 20 - 21	100	35.28	7.84	AB.012PG135SM

Supporti "Clip" cu diblu pentru tevi, polipropilena



Tip / Ø teava (mm)	Ambalare (buc.)	Pret / 100 buc.		Cod articol
		LEI	EURO	
PG 9 / 15 - 16	100	46.67	10.37	AB.011PG090SM
PG 13.5 / 20 - 21	100	76.32	16.96	AB.011PG135SM

Banda de montaj din otel zincat; role de 10m (17 X 0.8 mm)



Tip	Ambalare (buc.)	Pret / 100 buc.		Cod articol
		LEI	EURO	
Dantelata - caseta din PVC	10	1752.71	389.49	E023401708SM
Lisa - caseta din PVC	10	1752.71	389.49	E023411708SM
Dantelata - fara caseta	10	1652.81	367.29	E023421708SM
Lisa - fara caseta	10	1652.81	367.29	E023431708SM

Placute

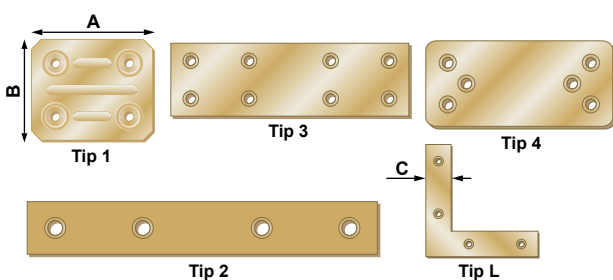

Tip	Dimensiuni (mm)				Perforatii	Ambalare (buc.)	Pret / 100 buc.		Cod articol
	A	B	C	s			LEI	EURO	
1	40	40	-	1.0	4 x Ø5.0	200	30.24	6.72	AF.TP104SM
	50	40	-	1.0	4 x Ø5.0	100	38.79	8.62	AF.TP105SM
	40	15	-	2.0	2 x Ø5.0	100	17.96	3.99	AF.TP204SM
	60	15	-	2.0	4 x Ø5.0	100	26.96	5.99	AF.TP206SM
	80	15	-	2.0	4 x Ø5.0	100	36.00	8.00	AF.TP208SM
2	100	15	-	2.0	4 x Ø5.0	100	44.46	9.88	AF.TP210SM
	120	15	-	2.0	4 x Ø5.0	100	56.39	12.53	AF.TP212SM
	140	15	-	2.0	4 x Ø5.0	100	65.39	14.53	AF.TP214SM
	160	15	-	2.0	4 x Ø5.0	100	75.15	16.70	AF.TP216SM
	180	15	-	2.0	4 x Ø5.0	100	82.80	18.40	AF.TP218SM
	200	15	-	2.0	4 x Ø5.0	100	92.97	20.66	AF.TP220SM
	3	40	30	-	2.0	4 x Ø5.0	50	37.44	8.32
60		30	-	2.0	8 x Ø5.0	50	54.81	12.18	AF.TP306SM
80		30	-	2.0	8 x Ø5.0	50	70.79	15.73	AF.TP308SM
100		30	-	2.0	8 x Ø5.0	50	90.99	20.22	AF.TP310SM
120		30	-	2.0	8 x Ø5.0	50	111.24	24.72	AF.TP312SM
4	160	30	-	2.0	8 x Ø5.0	50	153.09	34.02	AF.TP316SM
	200	30	-	2.0	8 x Ø5.0	50	185.13	41.14	AF.TP320SM
	90	40	-	2.5	6 x Ø5.0	100	117.00	26.00	AF.TP409SM
L	80	80	18	2.0	4 x Ø5.0	50	88.74	19.72	AF.TL108SM
	100	100	18	2.0	6 x Ø5.0	50	116.78	25.95	AF.TL110SM
	120	120	18	2.0	6 x Ø5.0	50	140.04	31.12	AF.TL112SM

Placute vopsite alb electrostatic

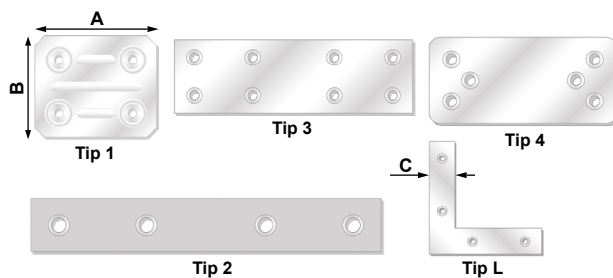

Tip	Dimensiuni (mm)				Perforatii	Ambalare (buc.)	Pret / 100 buc.		Cod articol
	A	B	C	s			LEI	EURO	
1	40	40	-	1.0	4 x Ø5.0	10	33.26	7.39	AF.TP104VSM
	50	40	-	1.0	4 x Ø5.0	10	42.71	9.49	AF.TP105VSM
	40	15	-	2.0	2 x Ø5.0	10	19.71	4.38	AF.TP204VSM
	60	15	-	2.0	4 x Ø5.0	10	29.66	6.59	AF.TP206VSM
	80	15	-	2.0	4 x Ø5.0	10	39.60	8.80	AF.TP208VSM
2	100	15	-	2.0	4 x Ø5.0	10	48.92	10.87	AF.TP210VSM
	120	15	-	2.0	4 x Ø5.0	10	62.06	13.79	AF.TP212VSM
	140	15	-	2.0	4 x Ø5.0	10	71.96	15.99	AF.TP214VSM
	160	15	-	2.0	4 x Ø5.0	10	82.62	18.36	AF.TP216VSM
	180	15	-	2.0	4 x Ø5.0	10	91.08	20.24	AF.TP218VSM
	200	15	-	2.0	4 x Ø5.0	10	102.29	22.73	AF.TP220VSM
	3	40	30	-	2.0	4 x Ø5.0	10	41.18	9.15
60		30	-	2.0	8 x Ø5.0	10	60.26	13.39	AF.TP306VSM
80		30	-	2.0	8 x Ø5.0	10	77.90	17.31	AF.TP308VSM
100		30	-	2.0	8 x Ø5.0	10	100.04	22.23	AF.TP310VSM
120		30	-	2.0	8 x Ø5.0	10	122.36	27.19	AF.TP312VSM
160		30	-	2.0	8 x Ø5.0	10	168.39	37.42	AF.TP316VSM
200		30	-	2.0	8 x Ø5.0	10	203.67	45.26	AF.TP320VSM
4	90	40	-	2.5	6 x Ø5.0	10	128.70	28.60	AF.TP409VSM
	80	80	18	2.0	4 x Ø5.0	10	97.61	21.69	AF.TL108VSM
L	100	100	18	2.0	6 x Ø5.0	10	128.43	28.54	AF.TL110VSM
	120	120	18	2.0	6 x Ø5.0	10	154.04	34.23	AF.TL112VSM

Coltare

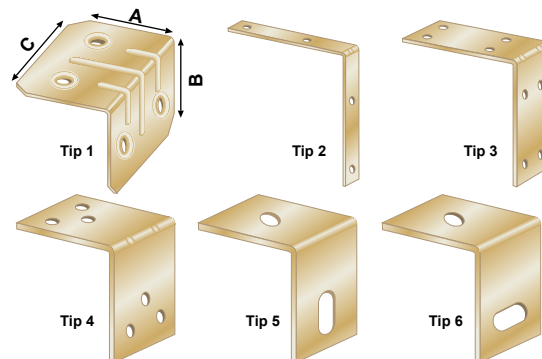

Tip	Dimensiuni (mm)				Perforatii	Ambalare (buc.)	Pret / 100 buc.		Cod articol
	A	B	C	s			LEI	EURO	
1	20	20	40	1.0	4 x Ø5.0	200	30.24	6.72	AF.TC103SM
	25	25	40	1.0	4 x Ø5.0	100	37.94	8.43	AF.TC104SM
	20	20	15	2.0	2 x Ø5.0	100	18.50	4.11	AF.TC202SM
	30	30	15	2.0	2 x Ø5.0	100	28.26	6.28	AF.TC203SM
	40	40	15	2.0	4 x Ø5.0	100	34.43	7.65	AF.TC204SM
2	50	50	15	2.0	4 x Ø5.0	100	43.16	9.59	AF.TC205SM
	60	60	15	2.0	4 x Ø5.0	100	51.89	11.53	AF.TC206SM
	70	70	15	2.0	4 x Ø5.0	100	59.49	13.22	AF.TC207SM
	80	80	15	2.0	4 x Ø5.0	100	70.02	15.56	AF.TC208SM
	90	90	15	2.0	4 x Ø5.0	100	72.27	16.06	AF.TC209SM
	100	100	15	2.0	4 x Ø5.0	100	89.51	19.89	AF.TC210SM
	3	20	20	30	2.0	4 x Ø5.0	50	34.79	7.73
30		30	30	2.0	8 x Ø5.0	50	51.48	11.44	AF.TC303SM
40		40	30	2.0	8 x Ø5.0	50	67.68	15.04	AF.TC304SM
50		50	30	2.0	8 x Ø5.0	50	82.58	18.35	AF.TC305SM
60		60	30	2.0	8 x Ø5.0	50	102.78	22.84	AF.TC306SM
4	80	80	30	2.0	8 x Ø5.0	50	138.65	30.81	AF.TC308SM
	100	100	30	2.0	8 x Ø5.0	50	179.96	39.99	AF.TC310SM
	45	45	40	2.5	6 x Ø5.0	100	116.46	25.88	AF.TC404SM
5	70	70	40	2.5	12 x Ø5.0	50	183.51	40.78	AF.TC407SM
	90	90	40	2.5	12 x Ø5.0	50	237.47	52.77	AF.TC409SM
6	17	21	25	1.5	1 x Ø5 1 x (13/5)	50	26.46	5.88	AF.TC501SM
	17	21	25	1.5	1 x Ø5 1 x (13/5)	50	26.46	5.88	AF.TC601SM

Coltare vopsite alb electrostatic

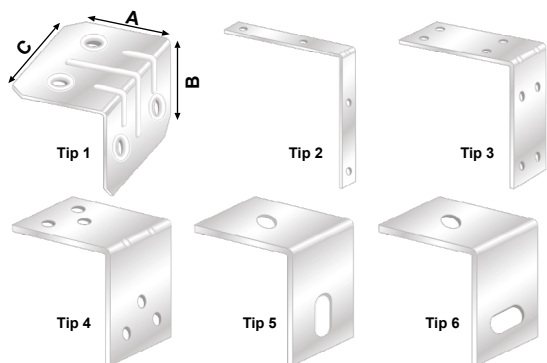

Tip	Dimensiuni (mm)				Perforatii	Ambalare (buc.)	Pret / 100 buc.		Cod articol
	A	B	C	s			LEI	EURO	
1	20	20	40	1.0	4 x Ø5.0	10	33.30	7.40	AF.TC103VSM
	25	25	40	1.0	4 x Ø5.0	10	41.72	9.27	AF.TC104VSM
	20	20	15	2.0	2 x Ø5.0	10	20.34	4.52	AF.TC202VSM
	30	30	15	2.0	2 x Ø5.0	10	31.14	6.92	AF.TC203VSM
	40	40	15	2.0	4 x Ø5.0	10	37.89	8.42	AF.TC204VSM
2	50	50	15	2.0	4 x Ø5.0	10	47.48	10.55	AF.TC205VSM
	60	60	15	2.0	4 x Ø5.0	10	57.11	12.69	AF.TC206VSM
	70	70	15	2.0	4 x Ø5.0	10	65.48	14.55	AF.TC207VSM
	80	80	15	2.0	4 x Ø5.0	10	77.00	17.11	AF.TC208VSM
	90	90	15	2.0	4 x Ø5.0	10	79.47	17.66	AF.TC209VSM
	100	100	15	2.0	4 x Ø5.0	10	98.46	21.88	AF.TC210VSM
	20	20	30	2.0	4 x Ø5.0	10	38.30	8.51	AF.TC302VSM
	30	30	30	2.0	8 x Ø5.0	10	56.61	12.58	AF.TC303VSM
	40	40	30	2.0	8 x Ø5.0	10	74.48	16.55	AF.TC304VSM
	50	50	30	2.0	8 x Ø5.0	10	90.86	20.19	AF.TC305VSM
3	60	60	30	2.0	8 x Ø5.0	10	113.09	25.13	AF.TC306VSM
	80	80	30	2.0	8 x Ø5.0	10	152.51	33.89	AF.TC308VSM
	100	100	30	2.0	8 x Ø5.0	10	197.91	43.98	AF.TC310VSM
	45	45	40	2.5	6 x Ø5.0	10	128.12	28.47	AF.TC404VSM
4	70	70	40	2.5	12 x Ø5.0	10	201.87	44.86	AF.TC407VSM
	90	90	40	2.5	12 x Ø5.0	10	261.23	58.05	AF.TC409VSM
5	17	21	25	1.5	1 x Ø5 1 x (13/5)	10	29.12	6.47	AF.TC501VSM
	17	21	25	1.5	1 x Ø5 1 x (13/5)	10	29.12	6.47	AF.TC601VSM

Bride gips-carton 3/6, zincate

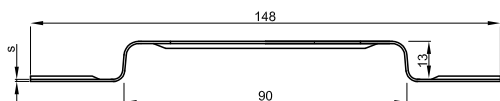

Tip brida	s (mm)	Ambalare (buc.)	Pret / 100 buc.		Cod articol
			LEI	EURO	
Executie standard	0.7	50	38.93	8.65	AF.GC36SM
Executie usoara	0.5	50	33.71	7.49	AF.GC36USM

Bride gips-carton 6/9, zincate

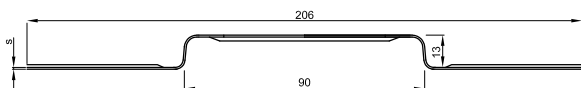

Tip brida	s (mm)	Ambalare (buc.)	Pret / 100 buc.		Cod articol
			LEI	EURO	
Executie standard	0.7	50	41.13	9.14	AF.GC69SM
Executie usoara	0.5	50	36.99	8.22	AF.GC69USM

Bride gips-carton 9/12, zincate

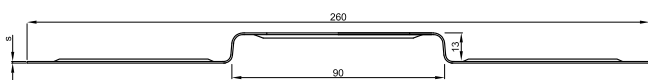

Tip brida	s (mm)	Ambalare (buc.)	Pret / 100 buc.		Cod articol
			LEI	EURO	
Executie standard	0.7	50	48.60	10.80	AF.GC912SM
Executie usoara	0.5	50	41.36	9.19	AF.GC912USM

Coltar metalic universal (Euro-coltar)

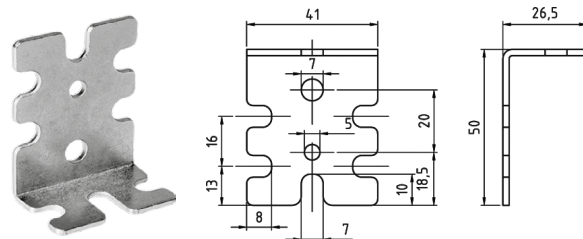

Acoperire	Ambalare (buc.)	Pret / 100 buc.		Cod articol
		LEI	EURO	
zincat	10	55.49	12.33	VR.7820.01SM

Coltar de legatura pentru picioare de masa

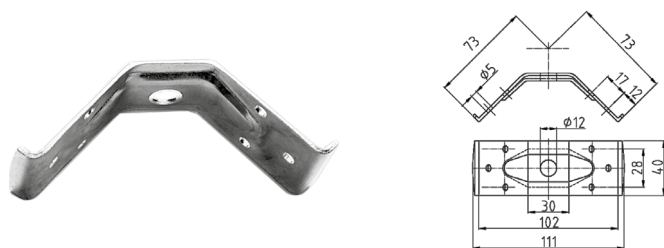

Acoperire	Ambalare (buc.)	Pret / 100 buc.		Cod articol
		LEI	EURO	
zincat	10	125.37	27.86	VR.7916.01SM

Placa "Demontabil" pentru pat

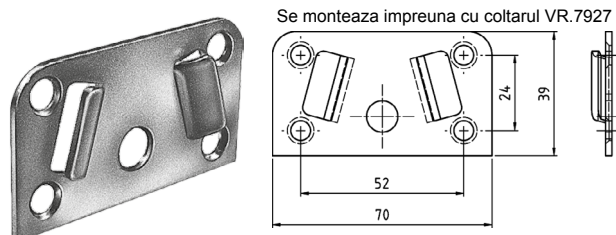

Acoperire	Ambalare (buc.)	Pret / 100 buc.		Cod articol
		LEI	EURO	
zincat	10	93.65	20.81	VR.7926.01SM

Coltar "Demontabil" pentru pat

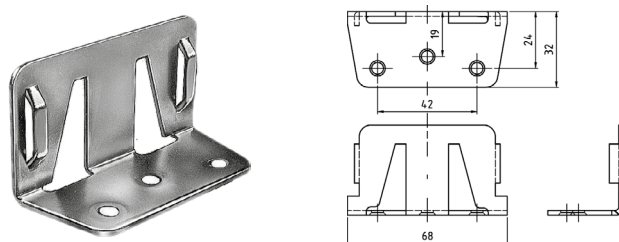

Acoperire	Ambalare (buc.)	Pret / 100 buc.		Cod articol
		LEI	EURO	
zincat	10	93.51	20.78	VR.7927.01SM

Coltare cu nervura, zincate

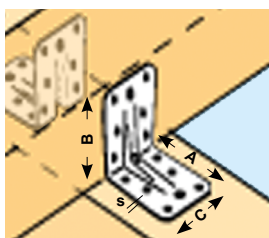
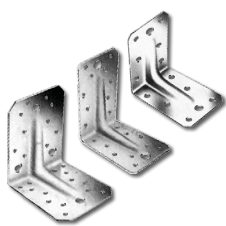

Tip	Dimensiuni				Perforatii (mm)	Ambalare (buc.)	Pret / 100 buc.		Cod articol
	A	B	C	s			LEI	EURO	
70N	70	70	50	1.5	(6+6) x Ø5.1 (1+1) x Ø9.0	10	90.41	20.09	AF.CN70SM
90N	90	90	60	2.0	(10+10) x Ø5.1 (1+1) x Ø11.0	10	158.45	35.21	AF.CN90SM
100N	100	100	90	2.0	(8+10) x Ø5.1 (3+1) x Ø11.0	10	243.90	54.20	AF.CN100SM

Coltare cu nervura, vopsite alb electrostatic

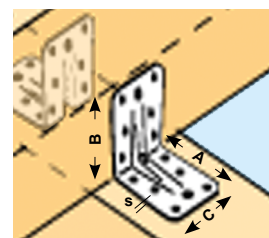
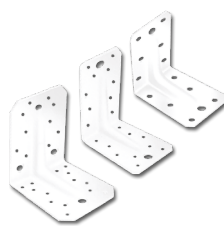

Tip	Dimensiuni				Perforatii (mm)	Ambalare (buc.)	Pret / 100 buc.		Cod articol
	A	B	C	s			LEI	EURO	
70NV	70	70	50	1.5	(6+6) Ø5.1 (1+1) Ø9.0	10	99.45	22.10	AF.CN70VSM
90NV	90	90	60	2.0	(10+10) Ø5.1 (1+1) Ø11.0	10	174.29	38.73	AF.CN90VSM
100NV	100	100	90	2.0	(8+10) Ø5.1 (3+1) x Ø11.0	10	268.25	59.61	AF.CN100VSM

Coltare drepte, zincate

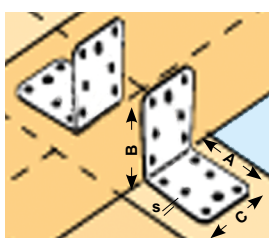

Tip	Dimensiuni				Perforatii (mm)	Ambalare (buc.)	Pret / 100 buc.		Cod articol
	A	B	C	s			LEI	EURO	
70	70	70	50	1.5	(6+6) x Ø5.1 (1+1) x Ø9.0	10	87.71	19.49	AF.CD70SM
90	90	90	60	2.0	(10+10) x Ø5.1 (1+1) x Ø11.0	10	153.68	34.15	AF.CD90SM
100	100	100	90	2.0	(8+10) x Ø5.1 (3+1) x Ø11.0	10	236.57	52.57	AF.CD100SM

Coltare drepte, vopsite alb electrostatic

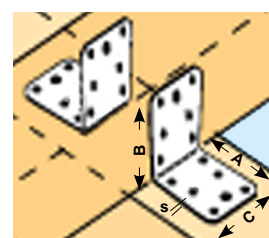

Tip	Dimensiuni				Perforatii (mm)	Ambalare (buc.)	Pret / 100 buc.		Cod articol
	A	B	C	s			LEI	EURO	
70V	70	70	50	1.5	(6+6) x Ø5.1 (1+1) x Ø9.0	10	96.48	21.44	AF.CD70VSM
90V	90	90	60	2.0	(10+10) x Ø5.1 (1+1) x Ø11.0	10	169.07	37.57	AF.CD90VSM
100V	100	100	90	2.0	(8+10) x Ø5.1 (3+1) x Ø11.0	10	260.28	57.84	AF.CD100VSM

Coltare perforate 1.5 mm, zincate

Fixare: cui ancora Ø4 mm / surub Ø5 mm
Perforatii: Ø5 mm

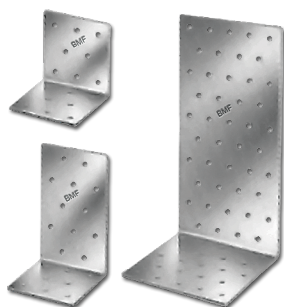

Tip	Dimensiuni (mm)				Ambalare (buc.)	Pret / 100 buc.		Cod articol
	A	B	C	s		LEI	EURO	
40 x 40 x 1.5 x 40	40	40	40	1.5	10	38.66	8.59	AF.CP40404015SM
40 x 40 x 1.5 x 60	40	40	60	1.5	10	70.83	15.74	AF.CP40406015SM
60 x 60 x 1.5 x 40	60	60	40	1.5	10	57.92	12.87	AF.CP60604015SM
60 x 60 x 1.5 x 60	60	60	60	1.5	10	106.20	23.60	AF.CP60606015SM
60 x 60 x 1.5 x 80	60	60	80	1.5	10	141.53	31.45	AF.CP60608015SM
80 x 80 x 1.5 x 60	80	80	60	1.5	10	141.62	31.47	AF.CP80806015SM
80 x 80 x 1.5 x 80	80	80	80	1.5	10	188.69	41.93	AF.CP80808015SM
80 x 80 x 1.5 x 100	80	80	100	1.5	10	235.89	52.42	AF.CP808010015SM
100 x 100 x 1.5 x 100	100	100	100	1.5	10	294.84	65.52	AF.CP10010010015SM
120 x 80 x 1.5 x 100	120	80	100	1.5	10	294.84	65.52	AF.CP1208010015SM

Coltare perforate 1.5 mm, vopsite alb electrostatic

Fixare: cui ancora Ø4 mm / surub Ø5 mm
Perforatii: Ø5 mm

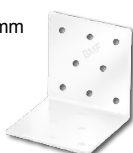

Tip	Dimensiuni (mm)				Ambalare (buc.)	Pret / 100 buc.		Cod articol
	A	B	C	s		LEI	EURO	
40 x 40 x 1.5 x 40	40	40	40	1.5	10	43.11	9.58	AF.CP40404015VSM
40 x 40 x 1.5 x 60	40	40	60	1.5	10	78.98	17.55	AF.CP40406015VSM
60 x 60 x 1.5 x 60	60	60	60	1.5	10	118.44	26.32	AF.CP60606015VSM

Placute, zincate

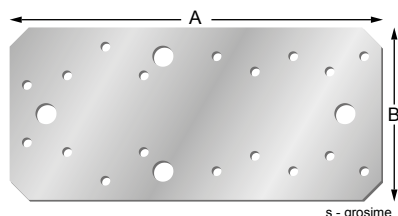

Tip	Dimensiuni (mm)			Perforatii Nr. x Ø (mm)	Ambalare (buc.)	Pret / 100 buc.		Cod articol
	A	B	s			LEI	EURO	
CP70	135	50	1.5	12 x 5.1 2 x 9.0	10	76.46	16.99	AF.CP70SM
CP90	174	60	2.0	20 x 5.1 2 x 11.0	10	134.01	29.78	AF.CP90SM
CP100	194	90	2.0	18 x 5.1 4 x 11.0	10	206.28	45.84	AF.CP100SM

Placate, vopsite alb electrostatic

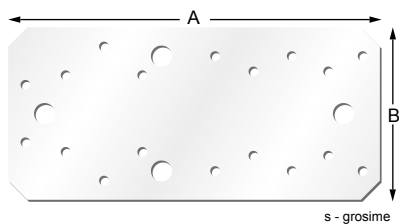

Tip	Dimensiuni (mm)			Perforatii Nr. x Ø (mm)	Ambalare (buc.)	Pret / 100 buc.		Cod articol
	A	B	s			LEI	EURO	
CP70V	135	50	1.5	12 x 5.1 2 x 9.0	10	89.24	19.83	AF.CP70VSM
CP90V	174	60	2.0	20 x 5.1 2 x 11.0	10	156.33	34.74	AF.CP90VSM
CP100V	194	90	2.0	18 x 5.1 4 x 11.0	10	240.66	53.48	AF.CP100VSM

Placi perforate 1.5 mm, zincate

Fixare: cui ancora Ø4 mm / surub Ø5 mm
Perforatii: Ø5 mm



Dimensiuni (mm)			Ambalare (buc.)	Pret / 100 buc.		Cod articol
40	80	1.5		LEI	EURO	
40	80	1.5	10	32.67	7.26	AF.PP401580SM
40	120	1.5	10	49.05	10.90	AF.PP4015120SM
40	160	1.5	10	65.34	14.52	AF.PP4015160SM
60	80	1.5	10	59.90	13.31	AF.PP601580SM
60	120	1.5	10	89.91	19.98	AF.PP6015120SM
60	160	1.5	10	119.84	26.63	AF.PP6015160SM
60	200	1.5	10	149.72	33.27	AF.PP6015200SM
80	120	1.5	10	119.79	26.62	AF.PP8015120SM
80	160	1.5	10	159.71	35.49	AF.PP8015160SM
80	200	1.5	10	199.53	44.34	AF.PP8015200SM
80	240	1.5	10	239.54	53.23	AF.PP8015240SM
80	280	1.5	10	279.45	62.10	AF.PP8015280SM
100	160	1.5	10	199.58	44.35	AF.PP10015160SM
100	200	1.5	10	249.53	55.45	AF.PP10015200SM
100	240	1.5	10	299.43	66.54	AF.PP10015240SM
100	280	1.5	10	349.34	77.63	AF.PP10015280SM
100	320	1.5	10	399.20	88.71	AF.PP10015320SM
100	400	1.5	10	499.01	110.89	AF.PP10015400SM

Placi perforate 1.5 mm, vopsite alb electrostatic

Fixare: cui ancora Ø4 mm / surub Ø5 mm
Perforatii: Ø5 mm



Dimensiuni (mm)			Ambalare (buc.)	Pret / 100 buc.		Cod articol
40	80	1.5		LEI	EURO	
40	80	1.5	10	37.17	8.26	AF.PP401580VSM
60	80	1.5	10	68.09	15.13	AF.PP601580VSM
60	120	1.5	10	102.15	22.70	AF.PP6015120VSM

Placi perforate 1200 x 1.5 mm, zincate

Fixare: cui ancora Ø4 mm / surub Ø5 mm
Perforatii: Ø5 mm



Dimensiuni (mm)			Ambalare (buc.)	Pret / 100 buc.		Cod articol
40	80	1.5		LEI	EURO	
40	1200	1.5	10	467.82	103.96	AF.PP40151200SM
60	1200	1.5	10	857.66	190.59	AF.PP60151200SM
80	1200	1.5	10	1143.09	254.02	AF.PP80151200SM
100	1200	1.5	10	1428.89	317.53	AF.PP100151200SM

Benzi contravantuire 1.5 mm, zincate

Fixare: cui ancora Ø4 mm / surub Ø5 mm
Perforatii: Ø5 mm



Dimensiuni (mm)			Ambalare (buc.)	Pret / 100 buc.		Cod articol
40	80	1.5		LEI	EURO	
40	25000	1.5	2	9281.88	2062.64	AF.CV4025SM
60	25000	1.5	2	17016.75	3781.50	AF.CV6025SM
80	25000	1.5	2	22679.42	5039.87	AF.CV8025SM
100	25000	1.5	2	28351.62	6300.36	AF.CV10025SM



Cuie pentru beton , tratate termic, metalizate



mm	Ambalare (buc.)	Pret / 100 buc.		Cod articol
		LEI	EURO	
2.7 x 20	250	3.65	0.81	0.18027020SM
2.7 x 25	250	4.23	0.94	0.18027025SM
2.7 x 30	250	4.82	1.07	0.18027030SM
2.7 x 35	250	5.13	1.14	0.18027035SM
2.7 x 40	250	5.81	1.29	0.18027040SM
2.7 x 50	250	6.44	1.43	0.18027050SM
2.7 x 60	250	7.43	1.65	0.18027060SM
2.7 x 70	250	8.10	1.80	0.18027070SM
2.7 x 80	250	10.13	2.25	0.18027080SM
3.5 x 35	250	8.78	1.95	0.18035035SM
3.5 x 40	250	9.41	2.09	0.18035040SM
3.5 x 45	250	9.90	2.20	0.18035045SM
3.5 x 50	250	10.35	2.30	0.18035050SM
3.5 x 55	250	11.34	2.52	0.18035055SM
3.5 x 60	250	12.24	2.72	0.18035060SM
3.5 x 65	250	12.78	2.84	0.18035065SM
3.5 x 70	250	13.86	3.08	0.18035070SM
3.5 x 75	250	14.99	3.33	0.18035075SM
3.5 x 80	250	17.64	3.92	0.18035080SM
4.5 x 40	250	13.68	3.04	0.18045040SM
4.5 x 50	250	15.48	3.44	0.18045050SM
4.5 x 60	250	16.88	3.75	0.18045060SM
4.5 x 70	250	20.21	4.49	0.18045070SM
4.5 x 80	250	22.55	5.01	0.18045080SM
4.5 x 90	250	26.60	5.91	0.18045090SM
4.5 x 100	250	28.98	6.44	0.18045100SM
6.0 x 55	250	33.57	7.46	0.18060055SM
6.0 x 65	250	39.56	8.79	0.18060065SM
6.0 x 75	250	44.24	9.83	0.18060075SM
6.0 x 85	250	48.47	10.77	0.18060085SM
6.0 x 100	250	52.25	11.61	0.18060100SM
6.0 x 120	100	68.67	15.26	0.18060120SM
6.0 x 150	100	82.94	18.43	0.18060150SM

Burghie pentru beton, cutit din carbura de tungsten, prindere normala; ISO 5468; DIN 8039



Prodotto con stock limitato.

mm	Ambalare (buc.)	Pret / buc.		Cod articol
		LEI	EURO	
5 x 85	2	0.99	0.22	BET.585M*
8 x 120	2	1.31	0.29	BET.8120M*
9 x 120	2	1.80	0.40	BET.9120M*
10 x 120	2	0.72	0.16	BET.10120M*
12 x 150	2	1.62	0.36	BET.12150M*
14 x 150	2	1.62	0.36	BET.14150M*
15 x 150	2	3.42	0.76	BET.15150M*
18 x 160	2	3.69	0.82	BET.18160M*
20 x 160	2	4.64	1.03	BET.20160M*

Bit Philips 1/4" - 25 mm



Prodotto con stock limitato.

mm	Ambalare (buc.)	Pret / buc.		Cod articol
		LEI	EURO	
Ph 3 x 25	2	0.18	0.04	BT.9253M*

Bit Philips 1/4" - 50 mm



Prodotto con stock limitato.

mm	Ambalare (buc.)	Pret / buc.		Cod articol
		LEI	EURO	
Ph 1 x 50	2	0.68	0.15	BT.9501M*

Bit Pozidriv 1/4" - 50 mm



Prodotto con stock limitato.

mm	Ambalare (buc.)	Pret / buc.		Cod articol
		LEI	EURO	
Pz 3 x 50	2	0.45	0.10	BT.8503M*

Bits tubulari magnetici



Prodotto con stock limitato.

mm	Ambalare (buc.)	Pret / buc.		Cod articol
		LEI	EURO	
45 mm - 7	2	2.21	0.49	BT.0745M*
65 mm - 5/16"	2	1.98	0.44	BT.1085M*
65 mm - 3/8"	2	2.52	0.56	BT.1065M*

Burghie pentru beton, prindere SDS



Prodotto con stock limitato.

mm	Ambalare (buc.)	Pret / buc.		Cod articol
		LEI	EURO	
5 x 110	2	1.80	0.40	SDS.5110M*
5 x 160	2	2.03	0.45	SDS.5160M*
6 x 110	2	1.85	0.41	SDS.6110M*
6 x 160	2	2.34	0.52	SDS.6160M*
6 x 210	2	2.84	0.63	SDS.6210M*
10 x 160	2	2.75	0.61	SDS.10160M*
10 x 210	2	3.06	0.68	SDS.10210M*
12 x 160	2	2.97	0.66	SDS.12160M*
12 x 210	2	3.47	0.77	SDS.12210M*
14 x 160	2	4.23	0.94	SDS.14160M*
18 x 260	2	8.82	1.96	SDS.18260M*
20 x 210	2	9.68	2.15	SDS.20210M*
22 x 210	2	10.80	2.40	SDS.22210M*
24 x 260	2	12.24	2.72	SDS.24260M*



Pentru un program complet solicitati catalogul ROCAST.

Programe complete
Cea mai bogata gama de produse oferita in Romania - peste 70 000 de articole diferite in stoc.

Ambalarea la blister



Saiba plata forma "A", otel zincat

DIN 125

BLISTER

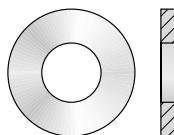

Dimensiuni (mm)	buc./ blister	Ambalare (nr. blistere)	Pret (€/blister)		Cod articol
			LEI	EURO	
3.2	100	10	1.13	0.25	0125A32BM
4.3	100	10	1.31	0.29	0125A43BM
5.3	100	10	1.40	0.31	0125A53BM
6.4	100	10	1.85	0.41	0125A64BM
8.4	50	10	1.62	0.36	0125A84BM
10.5	50	10	2.79	0.62	0125A105BM
13.0	25	10	2.39	0.53	0125A13BM
17.0	20	10	3.47	0.77	0125A17BM

Saiba Grower forma "B", otel zincat

DIN 127

BLISTER

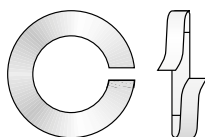

Dimensiuni (mm)	buc./ blister	Ambalare (nr. blistere)	Pret (€/blister)		Cod articol
			LEI	EURO	
3	100	10	1.08	0.24	0127B3BM
4	100	10	1.17	0.26	0127B4BM
5	100	10	1.31	0.29	0127B5BM
6	100	10	2.16	0.48	0127B6BM
8	50	10	1.80	0.40	0127B8BM
10	50	10	2.43	0.54	0127B10BM
12	25	10	2.03	0.45	0127B12BM
16	20	10	3.24	0.72	0127B16BM

Piulita fluture, otel zincat

DIN 315

BLISTER

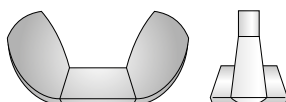

Dimensiuni (mm)	buc./ blister	Ambalare (nr. blistere)	Pret (€/blister)		Cod articol
			LEI	EURO	
M 5	25	10	3.38	0.75	031505BM
M 6	25	10	4.37	0.97	031506BM
M 8	25	10	5.85	1.30	031508BM
M10	15	10	5.45	1.21	0315010BM

Surub fluture, otel zincat

DIN 316

BLISTER

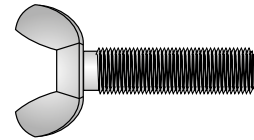

Dimensiuni (mm)	buc./ blister	Ambalare (nr. blistere)	Pret (€/blister)		Cod articol
			LEI	EURO	
M 6 x 10	8	10	6.80	1.51	03160610BM
M 6 x 12	8	10	6.84	1.52	03160612BM
M 6 x 15	8	10	7.20	1.60	03160615BM
M 6 x 25	8	10	7.79	1.73	03160625BM
M 6 x 35	8	10	8.46	1.88	03160635BM
M 6 x 40	4	10	4.68	1.04	03160640BM
M 8 x 25	4	10	6.66	1.48	03160825BM
M 8 x 30	4	10	6.84	1.52	03160830BM

Holzsurub cu cap hexagonal, otel zincat

DIN 571

BLISTER

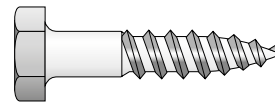

Dimensiuni (mm)	buc./ blister	Ambalare (nr. blistere)	Pret (€/blister)		Cod articol
			LEI	EURO	
6 x 50	8	10	1.17	0.26	05710650BM
6 x 60	8	10	1.31	0.29	05710660BM
6 x 70	8	10	1.44	0.32	05710670BM
6 x 80	8	10	1.53	0.34	05710680BM
6 x 100	4	10	1.08	0.24	057106100BM
7 x 70	8	10	2.12	0.47	05710770BM
8 x 60	8	10	2.12	0.47	05710860BM
8 x 70	8	10	2.25	0.50	05710870BM
8 x 80	8	10	2.57	0.57	05710880BM
8 x 100	4	10	1.71	0.38	057108100BM
8 x 120	4	10	1.89	0.42	057108120BM

Surub torbant cu piulita, otel zincat

DIN 603

BLISTER

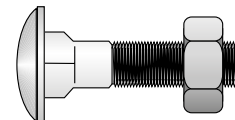

Dimensiuni (mm)	buc./ blister	Ambalare (nr. blistere)	Pret (€/blister)		Cod articol
			LEI	EURO	
M 6 x 16	10	10	1.53	0.34	06030616BM
M 6 x 20	10	10	1.44	0.32	06030620BM
M 6 x 30	8	10	1.49	0.33	06030630BM
M 6 x 40	8	10	1.58	0.35	06030640BM
M 6 x 50	8	10	1.76	0.39	06030650BM
M 6 x 60	8	10	1.98	0.44	06030660BM
M 6 x 80	4	10	1.35	0.30	06030680BM
M 8 x 40	4	10	1.53	0.34	06030840BM
M 8 x 50	4	10	1.67	0.37	06030850BM
M 8 x 60	4	10	1.80	0.40	06030860BM
M 8 x 80	4	10	2.12	0.47	06030880BM

Surub cu cap inbus, otel zincat gr. 8.8

DIN 912

BLISTER

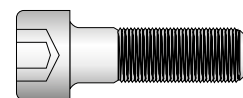

Dimensiuni (mm)	buc./ blister	Ambalare (nr. blistere)	Pret (€/blister)		Cod articol
			LEI	EURO	
M 6 x 10	10	10	1.17	0.26	09128610BM
M 6 x 12	10	10	1.44	0.32	09128612BM
M 6 x 16	8	10	1.26	0.28	09128616BM
M 6 x 18	8	10	1.31	0.29	09128618BM
M 6 x 20	8	10	1.31	0.29	09128620BM
M 6 x 25	8	10	1.31	0.29	09128625BM
M 6 x 30	8	10	1.31	0.29	09128630BM
M 6 x 40	8	10	1.58	0.35	09128640BM
M 6 x 50	8	10	1.80	0.40	09128650BM
M 8 x 12	8	10	2.12	0.47	09128812BM
M 8 x 16	8	10	1.71	0.38	09128816BM

Surub cu cap inbus, otel zincat gr. 8.8

Dimensiuni (mm)	buc./ blister	Ambalare (nr. blistere)	Pret (€/blister)		Cod articol
			LEI	EURO	
M 8 x 20	4	10	1.22	0.27	09128820BM
M 8 x 25	4	10	1.22	0.27	09128825BM
M 8 x 30	4	10	1.31	0.29	09128830BM
M 8 x 35	4	10	1.44	0.32	09128835B
M 8 x 40	4	10	1.53	0.34	09128840BM
M 8 x 45	4	10	1.62	0.36	09128845BM
M 8 x 50	4	10	1.71	0.38	09128850BM
M 8 x 60	4	10	1.89	0.42	09128860BM
M10 x 20	4	10	1.67	0.37	091281020BM
M10 x 25	4	10	1.85	0.41	091281025BM
M10 x 30	4	10	1.94	0.43	091281030BM
M10 x 40	4	10	2.12	0.47	091281040BM
M10 x 50	4	10	2.48	0.55	091281050BM

Surub total filetat cu cap hexagonal, cu piulita si saiba, otel zincat gr. 8.8

Dimensiuni (mm)	buc./ blister	Ambalare (nr. blistere)	Pret (€/blister)		Cod articol
			LEI	EURO	
M 6 x 30	6	10	1.17	0.26	SPS.630BM
M 6 x 40	6	10	1.31	0.29	SPS.640BM
M 8 x 16	6	10	1.80	0.40	SPS.816BM
M 8 x 20	6	10	1.80	0.40	SPS.820BM
M 8 x 25	6	10	1.80	0.40	SPS.825BM
M 8 x 30	6	10	1.89	0.42	SPS.830BM
M 8 x 40	6	10	2.16	0.48	SPS.840BM
M 8 x 50	4	10	1.71	0.38	SPS.850BM
M 8 x 60	4	10	1.85	0.41	SPS.860BM
M10 x 25	4	10	2.12	0.47	SPS.1025BM
M10 x 30	4	10	2.21	0.49	SPS.1030BM
M10 x 40	4	10	2.48	0.55	SPS.1040BM

Surub total filetat cu cap hexagonal, otel zincat gr. 8.8

DIN 933

BLISTER



Piulita hexagonala, otel zincat gr. 8

DIN 934

BLISTER

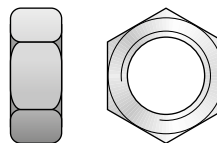

Dimensiuni (mm)	buc./ blister	Ambalare (nr. blistere)	Pret (€/blister)		Cod articol
			LEI	EURO	
M 6 x 10	15	10	1.31	0.29	09338610BM
M 6 x 12	15	10	1.40	0.31	09338612BM
M 6 x 16	15	10	1.49	0.33	09338616BM
M 6 x 20	15	10	1.49	0.33	09338620BM
M 6 x 25	15	10	1.62	0.36	09338625BM
M 6 x 30	10	10	1.31	0.29	09338630BM
M 6 x 35	10	10	1.44	0.32	09338635BM
M 6 x 40	10	10	1.53	0.34	09338640BM
M 6 x 50	10	10	1.71	0.38	09338650BM
M 6 x 60	10	10	1.98	0.44	09338660BM
M 6 x 80	10	10	2.43	0.54	09338680BM
M 8 x 16	10	10	1.98	0.44	09338816BM
M 8 x 20	10	10	1.98	0.44	09338820BM
M 8 x 25	10	10	1.98	0.44	09338825BM
M 8 x 30	10	10	2.21	0.49	09338830BM
M 8 x 35	10	10	2.43	0.54	09338835BM
M 8 x 40	10	10	2.61	0.58	09338840BM
M 8 x 45	8	10	2.34	0.52	09338845BM
M 8 x 50	8	10	2.48	0.55	09338850BM
M 8 x 60	8	10	2.66	0.59	09338860BM
M 8 x 80	4	10	1.85	0.41	09338880BM
M 8 x 100	4	10	2.12	0.47	093388100BM
M10 x 20	8	10	2.61	0.58	093381020BM
M10 x 25	8	10	2.61	0.58	093381025BM
M10 x 30	8	10	2.84	0.63	093381030BM
M10 x 40	6	10	2.66	0.59	093381040BM
M10 x 50	5	10	2.57	0.57	093381050BM
M10 x 60	5	10	2.93	0.65	093381060BM
M10 x 80	4	10	2.93	0.65	093381080BM
M12 x 30	5	10	3.06	0.68	093381230BM
M12 x 35	5	10	3.06	0.68	093381235BM
M12 x 40	5	10	3.06	0.68	093381240BM
M12 x 50	4	10	2.88	0.64	093381250BM
M12 x 60	4	10	3.20	0.71	093381260BM
M16 x 40	4	10	4.28	0.95	093381640BM
M16 x 50	4	10	4.82	1.07	093381650BM
M16 x 60	4	10	5.49	1.22	093381660BM
M16 x 80	4	10	6.62	1.47	093381680BM

Dimensiuni (mm)	buc./ blister	Ambalare (nr. blistere)	Pret (€/blister)		Cod articol
			LEI	EURO	
M 3	50	10	0.72	0.16	093483BM
M 4	50	10	1.08	0.24	093484BM
M 5	50	10	1.17	0.26	093485BM
M 6	50	10	1.44	0.32	093486BM
M 8	50	10	2.61	0.58	093488BM
M10	25	10	2.84	0.63	0934810BM
M12	12	10	2.16	0.48	0934812BM
M16	8	10	2.79	0.62	0934816BM

Surub cu cap inecat si locas cruciform, otel zincat gr. 4.8

DIN 965

BLISTER

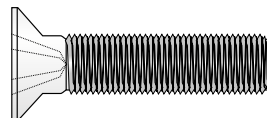

Dimensiuni (mm)	buc./ blister	Ambalare (nr. blistere)	Pret (€/blister)		Cod articol
			LEI	EURO	
M 3 x 5	50	10	1.17	0.26	0965435BM
M 3 x 6	50	10	1.22	0.27	0965436BM
M 3 x 10	50	10	1.22	0.27	09654310BM
M 3 x 16	50	10	1.26	0.28	09654316BM
M 3 x 25	50	10	2.12	0.47	09654325BM
M 4 x 10	50	10	1.35	0.30	09654410BM
M 4 x 16	50	10	1.53	0.34	09654416BM
M 4 x 20	50	10	1.71	0.38	09654420BM
M 4 x 25	50	10	2.16	0.48	09654425BM
M 4 x 30	50	10	2.25	0.50	09654430BM
M 4 x 40	50	10	3.74	0.83	09654440BM
M 4 x 50	50	10	3.74	0.83	09654450BM
M 4 x 60	50	10	3.74	0.83	09654460BM
M 5 x 8	50	10	1.85	0.41	0965458BM
M 5 x 10	50	10	1.85	0.41	09654510BM
M 5 x 12	50	10	1.85	0.41	09654512BM
M 5 x 16	25	10	1.31	0.29	09654516BM
M 5 x 20	25	10	1.35	0.30	09654520BM
M 5 x 25	25	10	1.58	0.35	09654525BM
M 5 x 30	25	10	1.71	0.38	09654530BM
M 5 x 40	25	10	2.16	0.48	09654540BM
M 5 x 50	10	10	1.71	0.38	09654550BM
M 5 x 60	10	10	1.71	0.38	09654560BM
M 5 x 70	10	10	1.71	0.38	09654570BM
M 6 x 12	10	10	0.90	0.20	09654612BM
M 6 x 16	10	10	1.04	0.23	09654616BM
M 6 x 20	10	10	1.04	0.23	09654620BM
M 6 x 25	10	10	1.04	0.23	09654625BM
M 6 x 30	10	10	1.17	0.26	09654630BM
M 6 x 40	10	10	1.31	0.29	09654640BM
M 6 x 50	10	10	1.49	0.33	09654650BM
M 6 x 60	8	10	1.49	0.33	09654660BM
M 6 x 70	8	10	1.67	0.37	09654670BM

Surub total filetat cu cap hexagonal, cu piulita si saiba, otel zincat gr. 8.8

DIN 933 + DIN 934 + DIN 125

BLISTER

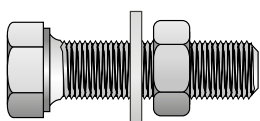

Dimensiuni (mm)	buc./ blister	Ambalare (nr. blistere)	Pret (€/blister)		Cod articol
			LEI	EURO	
M 6 x 10	8	10	1.17	0.26	SPS.610BM
M 6 x 16	8	10	1.31	0.29	SPS.616BM
M 6 x 20	8	10	1.31	0.29	SPS.620BM
M 6 x 25	8	10	1.35	0.30	SPS.625BM

Piulita hexagonala cu autoblocare, otel zincat gr. 6

DIN 985

BLISTER

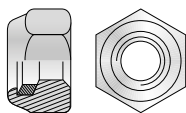

Dimensiuni (mm)	buc./ blister	Ambalare (nr. blistere)	Pret (€/blister)		Cod articol
			LEI	EURO	
M 5	25	10	1.13	0.25	098565BM
M 6	25	10	1.35	0.30	098566BM
M 8	25	10	2.30	0.51	098568BM
M10	15	10	2.97	0.66	0985610BM
M12	10	10	2.66	0.59	0985612BM
M16	8	10	4.41	0.98	0985616BM

Piulita infundata cu autoblocare, otel zincat gr. 6

DIN 986

BLISTER

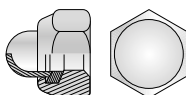

Dimensiuni (mm)	buc./ blister	Ambalare (nr. blistere)	Pret (€/blister)		Cod articol
			LEI	EURO	
M 5	10	10	2.25	0.50	098665BM
M 6	10	10	2.57	0.57	098666BM
M 8	10	10	3.06	0.68	098668BM
M10	10	10	6.21	1.38	0986610BM
M12	8	10	6.57	1.46	0986612BM
M16	8	10	18.68	4.15	0986616BM

Piulita de cuplare, otel zincat

DIN 6334

BLISTER

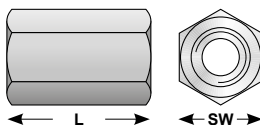

Dimensiuni (mm)	buc./ blister	Ambalare (nr. blistere)	Pret (€/blister)		Cod articol
			LEI	EURO	
M 6 x 20 x 10	4	10	1.31	0.29	6334062010BM
M 6 x 30 x 10	4	10	1.71	0.38	6334063010BM
M 8 x 25 x 11	4	10	1.58	0.35	6334082511BM
M10 x 30 x 13	4	10	2.03	0.45	63340103013BM
M12 x 35 x 17	2	10	2.25	0.50	63340123517BM
M16 x 50 x 24	2	10	4.41	0.98	63340165024BM

Saiba elastica cu crestaturi exterioare forma "A", otel zincat

DIN 6798

BLISTER

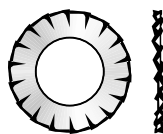

Dimensiuni (mm)	buc./ blister	Ambalare (nr. blistere)	Pret (€/blister)		Cod articol
			LEI	EURO	
3.2	25	10	1.04	0.23	6798A32BM
4.3	25	10	1.85	0.41	6798A43BM
5.3	25	10	1.85	0.41	6798A53BM
6.4	25	10	1.94	0.43	6798A64BM
8.4	25	10	3.06	0.68	6798A84BM
10.5	25	10	3.87	0.86	6798A105BM
13.0	25	10	3.87	0.86	6798A13BM

Piulita hexagonala cu flansa, otel zincat gr. 8

DIN 6923

BLISTER

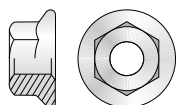

Dimensiuni (mm)	buc./ blister	Ambalare (nr. blistere)	Pret (€/blister)		Cod articol
			LEI	EURO	
M 6	25	10	1.67	0.37	692386BM
M 8	10	10	1.17	0.26	692388BM
M10	10	10	1.49	0.33	6923810BM
M12	10	10	2.52	0.56	6923812BM
M16	8	10	5.90	1.31	6923816BM

Surub autoforant cu cap hexagonal, forma "K", otel zincat + vopsit

DIN 7504

BLISTER

RAL

1021 ●
3011 ●

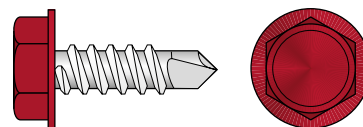

Dimensiuni (mm)	buc./ blister	Ambalare (nr. blistere)	Pret (€/blister)		Cod articol
			LEI	EURO	
3.5 x 13 Zincat	25	10	0.99	0.22	7504K3513BM
4.2 x 16 Zincat	25	10	1.31	0.29	7504K4216BM
4.2 x 19 Zincat	25	10	1.31	0.29	7504K4219BM
4.2 x 19 RAL 1021	25	10	1.67	0.37	7504K42199BM
4.2 x 25 Zincat	25	10	1.44	0.32	7504K4225BM
4.2 x 32 Zincat	25	10	1.49	0.33	7504K4232BM
4.8 x 16 Zincat	25	10	1.53	0.34	7504K4816BM
4.8 x 19 Zincat	25	10	1.53	0.34	7504K4819BM
4.8 x 19 RAL 3011	25	10	1.85	0.41	7504K48191BM
4.8 x 22 Zincat	25	10	1.67	0.37	7504K4822BM
4.8 x 25 Zincat	25	10	1.76	0.39	7504K4825BM
4.8 x 25 RAL 3011	25	10	1.98	0.44	7504K48251BM
4.8 x 32 Zincat	25	10	1.94	0.43	7504K4832BM
4.8 x 38 Zincat	25	10	2.16	0.48	7504K4838BM
4.8 x 45 Zincat	25	10	2.25	0.50	7504K4845BM
4.8 x 50 Zincat	25	10	2.52	0.56	7504K4850BM
5.5 x 19 Zincat	20	10	1.62	0.36	7504K5519BM
5.5 x 22 Zincat	20	10	1.71	0.38	7504K5522BM
5.5 x 25 Zincat	20	10	1.85	0.41	7504K5525BM
5.5 x 32 Zincat	20	10	2.12	0.47	7504K5532BM
5.5 x 38 Zincat	20	10	2.30	0.51	7504K5538BM
5.5 x 45 Zincat	20	10	2.30	0.51	7504K5545BM
5.5 x 50 Zincat	20	10	3.06	0.68	7504K5550BM
5.5 x 60 Zincat	20	10	3.06	0.68	7504K5560BM
6.3 x 19 Zincat	20	10	2.12	0.47	7504K6319BM
6.3 x 25 Zincat	20	10	2.39	0.53	7504K6325BM
6.3 x 32 Zincat	20	10	2.66	0.59	7504K6332BM
6.3 x 38 Zincat	20	10	3.60	0.80	7504K6338BM
6.3 x 50 Zincat	20	10	3.60	0.80	7504K6350BM
6.3 x 60 Zincat	20	10	4.01	0.89	7504K6360BM
6.3 x 70 Zincat	20	10	4.28	0.95	7504K6370BM
6.3 x 80 Zincat	20	10	5.09	1.13	7504K6380BM

Surub autoforant cu cap bombat, forma "N", otel zincat + vopsit

DIN 7504

BLISTER

RAL

9010 ○
3011 ●

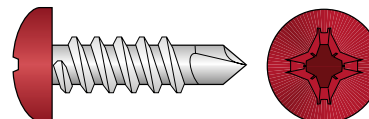

Dimensiuni (mm)	buc./ blister	Ambalare (nr. blistere)	Pret (€/blister)		Cod articol
			LEI	EURO	
3.5 x 9.5 Zincat	50	10	1.31	0.29	7504N3595BM
3.5 x 11 Zincat	50	10	1.58	0.35	7504N3511BM
3.5 x 13 Zincat	50	10	1.53	0.34	7504N3513BM
3.5 x 16 Zincat	50	10	1.53	0.34	7504N3516BM
3.5 x 19 Zincat	50	10	1.53	0.34	7504N3519BM
3.5 x 25 Zincat	50	10	1.80	0.40	7504N3525BM
3.9 x 9.5 Zincat	50	10	1.49	0.33	7504N3995BM
3.9 x 13 Zincat	50	10	1.49	0.33	7504N3913BM
3.9 x 16 Zincat	50	10	1.80	0.40	7504N3916BM
3.9 x 19 Zincat	50	10	1.80	0.40	7504N3919BM
4.2 x 13 Zincat	25	10	1.13	0.25	7504N4213BM
4.2 x 16 Zincat	25	10	1.17	0.26	7504N4216BM
4.2 x 16 RAL 9010	25	10	1.58	0.35	7504N421610BM
4.2 x 19 Zincat	25	10	1.22	0.27	7504N4219BM
4.2 x 19 RAL 3011	25	10	1.58	0.35	7504N42191BM
4.2 x 19 RAL 9010	25	10	1.58	0.35	7504N421910BM
4.2 x 25 Zincat	25	10	1.44	0.32	7504N4225BM
4.8 x 16 Zincat	25	10	1.44	0.32	7504N4816BM
4.8 x 19 Zincat	25	10	1.44	0.32	7504N4819BM
4.8 x 25 Zincat	25	10	1.71	0.38	7504N4825BM
4.8 x 50 Zincat	25	10	2.52	0.56	7504N4850BM
4.8 x 60 Zincat	25	10	2.66	0.59	7504N4860BM
4.8 x 90 Zincat	25	10	6.57	1.46	7504N4890BM
5.5 x 19 Zincat	25	10	2.21	0.49	7504N5519BM

Surub autoforant cu cap inecat, forma "P", otel zincat

DIN 7504

BLISTER

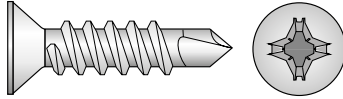

Dimensiuni (mm)	buc./ blister	Ambalare (nr. blistere)	Pret (€/blister)		Cod articol
			LEI	EURO	
3.5 x 16	50	10	1.40	0.31	7504P3516BM
3.5 x 19	50	10	1.44	0.32	7504P3519BM
3.9 x 16	50	10	1.53	0.34	7504P3916BM
3.9 x 19	50	10	1.62	0.36	7504P3919BM
3.9 x 25	50	10	1.85	0.41	7504P3925BM
3.9 x 32	25	10	1.49	0.33	7504P3932BM
3.9 x 38	25	10	1.49	0.33	7504P3938BM
4.2 x 19	25	10	1.26	0.28	7504P4219BM
4.2 x 25	25	10	1.31	0.29	7504P4225BM
4.2 x 32	25	10	1.35	0.30	7504P4232BM
4.2 x 50	25	10	2.12	0.47	7504P4250BM
4.8 x 50	25	10	2.25	0.50	7504P4850BM

Surub cu cap bombat pentru tabla, otel zincat

DIN 7981

BLISTER

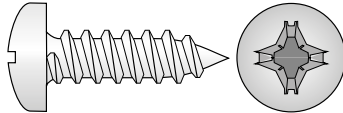

Dimensiuni (mm)	buc./ blister	Ambalare (nr. blistere)	Pret (€/blister)		Cod articol
			LEI	EURO	
2.2 x 9.5	100	10	3.33	0.74	798102295BM
2.9 x 9.5	100	10	1.71	0.38	798102995BM
2.9 x 13.0	100	10	1.85	0.41	798102913BM
3.5 x 9.5	100	10	1.98	0.44	798103595BM
4.2 x 13.0	100	10	2.88	0.64	798104213BM
4.2 x 16.0	100	10	3.20	0.71	798104216BM

Surub cu cap inecat pentru tabla, otel zincat

DIN 7982

BLISTER

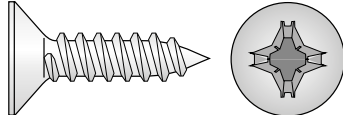

Dimensiuni (mm)	buc./ blister	Ambalare (nr. blistere)	Pret (€/blister)		Cod articol
			LEI	EURO	
2.2 x 9.5	100	10	3.24	0.72	798202295BM
2.9 x 9.5	100	10	1.40	0.31	798202995BM
3.5 x 16.0	100	10	1.98	0.44	798203516BM
4.8 x 16.0	100	10	3.33	0.74	798204816BM
4.8 x 38.0	100	10	6.30	1.40	798204838BM
5.5 x 70.0	50	10	6.84	1.52	798205570BM

Saiba plata serie mare 3d

BLISTER

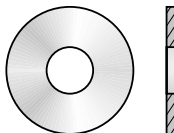

Dimensiuni (mm)	buc./ blister	Ambalare (nr. blistere)	Pret (€/blister)		Cod articol
			LEI	EURO	
3.2 x 9 x 0.8	25	10	0.68	0.15	9021032BM
4.3 x 12 x 1.0	25	10	0.77	0.17	9021043BM
5.3 x 15 x 1.2	25	10	0.99	0.22	9021053BM
6.4 x 18 x 1.6	25	10	1.31	0.29	9021064BM
8.4 x 24 x 2.0	25	10	2.12	0.47	9021084BM
10.5 x 30 x 2.5	25	10	3.60	0.80	90210105BM
13.0 x 37 x 3.0	15	10	4.41	0.98	90210113BM
17.0 x 50 x 3.0	10	10	4.46	0.99	90210117BM

Surub cu cap bombat si locas cruciform, otel zincat gr. 4.8

DIN 7985

BLISTER

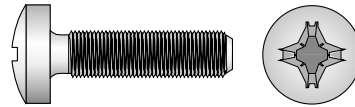

Dimensiuni (mm)	buc./ blister	Ambalare (nr. blistere)	Pret (€/blister)		Cod articol
			LEI	EURO	
M 4 x 6	50	10	1.98	0.44	7985446BM
M 4 x 8	50	10	1.62	0.36	7985448BM
M 4 x 10	50	10	1.62	0.36	79854410BM
M 4 x 12	50	10	1.76	0.39	79854412BM
M 4 x 16	50	10	1.98	0.44	79854416BM
M 4 x 20	50	10	2.66	0.59	79854420BM
M 4 x 25	50	10	2.79	0.62	79854425BM
M 4 x 30	50	10	2.79	0.62	79854430BM
M 4 x 40	50	10	3.33	0.74	79854440BM
M 4 x 50	50	10	4.10	0.91	79854450BM
M 5 x 8	50	10	2.25	0.50	7985458BM
M 5 x 10	50	10	2.48	0.55	79854510BM
M 5 x 12	50	10	2.52	0.56	79854512BM
M 5 x 16	50	10	2.66	0.59	79854516BM
M 5 x 20	25	10	2.12	0.47	79854520BM
M 5 x 25	25	10	2.12	0.47	79854525BM
M 5 x 45	25	10	2.75	0.61	79854545BM
M 6 x 12	10	10	1.08	0.24	79854612BM
M 6 x 16	10	10	1.13	0.25	79854616BM
M 6 x 20	10	10	1.31	0.29	79854620BM
M 6 x 25	10	10	1.31	0.29	79854625BM
M 6 x 30	10	10	1.44	0.32	79854630BM
M 6 x 50	10	10	1.76	0.39	79854650BM
M 6 x 60	10	10	1.98	0.44	79854660BM

Surub rapid autoforant HBS pentru lemn, otel zincat alb

BLISTER

rotho fixing



Dimensiuni (mm)	buc./ blister	Ambalare (nr. blistere)	Pret (€/blister)		Cod articol
			LEI	EURO	
8 x 80 T40	4	10	2.25	0.50	HBM880BM
8 x 100 T40	4	10	2.93	0.65	HBM8100BM
8 x 120 T40	4	10	3.11	0.69	HBM8120BM
8 x 140 T40	4	10	3.60	0.80	HBM8140BM
8 x 160 T40	4	10	3.92	0.87	HBM8160BM
10 x 120 T40	4	10	4.68	1.04	HBM10120BM

Surub E-JET pentru lemn, otel zincat galben

BLISTER

Schmid schrauben handfeld



ETA CE

Dimensiuni (mm)	buc./ blister	Ambalare (nr. blistere)	Pret (€/blister)		Cod articol
			LEI	EURO	
3 x 25 T10	100	10	2.61	0.58	EG3325BM
3.5 x 18 T15	100	10	2.61	0.58	EG33518BM
4 x 40 T20	40	10	2.39	0.53	EG3440BM
4 x 50 T20	40	10	2.70	0.60	EG3450BM
4 x 60 T20	30	10	2.52	0.56	EG3460BM
4.5 x 60 T25	15	10	1.76	0.39	EG34560BM
4.5 x 80 T25	15	10	2.16	0.48	EG34580BM
6 x 120 T30	10	10	3.38	0.75	EG36120BM



Surub total filetat PAL, cu cap inecat, otel zincat galben

BLISTER

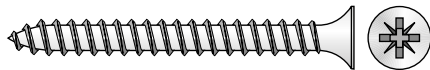

Dimensiuni (mm)	buc./ blister	Ambalare (nr. blistere)	Pret (€/blister)		Cod articol
			LEI	EURO	
2.5 x 12 / Pz1	200	10	1.89	0.42	X0010T2512BM
2.5 x 14 / Pz1	200	10	2.30	0.51	X0010T2514BM
2.5 x 16 / Pz1	200	10	2.39	0.53	X0010T2516BM
2.5 x 18 / Pz1	150	10	1.98	0.44	X0010T2518BM
2.5 x 20 / Pz1	150	10	2.12	0.47	X0010T2520BM
2.5 x 25 / Pz1	100	10	1.71	0.38	X0010T2525BM
3.0 x 14 / Pz1	200	10	2.66	0.59	X0010T314BM
3.0 x 16 / Pz1	200	10	3.11	0.69	X0010T316BM
3.0 x 18 / Pz1	150	10	2.52	0.56	X0010T318BM
3.0 x 20 / Pz1	150	10	2.52	0.56	X0010T320BM
3.0 x 25 / Pz1	100	10	1.85	0.41	X0010T325BM
3.0 x 30 / Pz1	100	10	1.85	0.41	X0010T330BM
3.0 x 35 / Pz1	75	10	1.71	0.38	X0010T335BM
3.0 x 40 / Pz1	75	10	1.85	0.41	X0010T340BM
3.5 x 16 / Pz2	100	10	1.71	0.38	X0010T3516BM
3.5 x 18 / Pz2	100	10	1.76	0.39	X0010T3518BM
3.5 x 20 / Pz2	100	10	1.85	0.41	X0010T3520BM
3.5 x 25 / Pz2	100	10	2.03	0.45	X0010T3525BM
3.5 x 30 / Pz2	75	10	1.85	0.41	X0010T3530BM
3.5 x 35 / Pz2	60	10	1.62	0.36	X0010T3535BM
3.5 x 40 / Pz2	50	10	1.58	0.35	X0010T3540BM
3.5 x 45 / Pz2	50	10	1.71	0.38	X0010T3545BM
3.5 x 50 / Pz2	50	10	1.98	0.44	X0010T3550BM
4.0 x 16 / Pz2	100	10	1.94	0.43	X0010T416BM
4.0 x 20 / Pz2	75	10	1.85	0.41	X0010T420BM
4.0 x 25 / Pz2	60	10	1.58	0.35	X0010T425BM
4.0 x 30 / Pz2	50	10	1.58	0.35	X0010T430BM
4.0 x 35 / Pz2	50	10	1.71	0.38	X0010T435BM
4.0 x 40 / Pz2	40	10	1.58	0.35	X0010T440BM
4.0 x 45 / Pz2	40	10	1.67	0.37	X0010T445BM
4.0 x 50 / Pz2	40	10	1.80	0.40	X0010T450BM
4.0 x 60 / Pz2	30	10	1.71	0.38	X0010T460BM
4.0 x 70 / Pz2	30	10	1.85	0.41	X0010T470BM
4.5 x 25 / Pz2	50	10	1.58	0.35	X0010T4525BM
4.5 x 30 / Pz2	50	10	1.76	0.39	X0010T4530BM
4.5 x 35 / Pz2	40	10	1.80	0.40	X0010T4535BM
4.5 x 40 / Pz2	40	10	1.80	0.40	X0010T4540BM
4.5 x 50 / Pz2	30	10	1.76	0.39	X0010T4550BM
4.5 x 60 / Pz2	15	10	1.26	0.28	X0010T4560BM
4.5 x 70 / Pz2	15	10	1.35	0.30	X0010T4570BM
5.0 x 20 / Pz2	75	10	2.66	0.59	X0010T520BM
5.0 x 25 / Pz2	50	10	1.94	0.43	X0010T525BM
5.0 x 30 / Pz2	40	10	1.80	0.40	X0010T530BM
5.0 x 35 / Pz2	30	10	1.62	0.36	X0010T535BM
5.0 x 40 / Pz2	30	10	1.71	0.38	X0010T540BM
5.0 x 45 / Pz2	30	10	1.85	0.41	X0010T545BM
5.0 x 50 / Pz2	30	10	1.98	0.44	X0010T550BM
5.0 x 60 / Pz2	25	10	1.94	0.43	X0010T560BM
5.0 x 70 / Pz2	15	10	1.53	0.34	X0010T570BM
5.0 x 80 / Pz2	15	10	1.62	0.36	X0010T580BM
6.0 x 30 / Pz3	30	10	2.25	0.50	X0010T630BM
6.0 x 40 / Pz3	20	10	1.85	0.41	X0010T640BM
6.0 x 50 / Pz3	20	10	2.07	0.46	X0010T650BM
6.0 x 60 / Pz3	20	10	2.25	0.50	X0010T660BM
6.0 x 70 / Pz3	10	10	1.49	0.33	X0010T670BM
6.0 x 80 / Pz3	10	10	1.67	0.37	X0010T680BM

Surub partial filetat PAL cu cap inecat, otel zincat galben

BLISTER

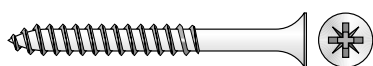

Dimensiuni (mm)	buc./ blister	Ambalare (nr. blistere)	Pret (€/blister)		Cod articol
			LEI	EURO	
5 x 90 / Pz2	15	10	1.94	0.43	X0010P590BM
5 x 100 / Pz2	15	10	2.16	0.48	X0010P5100BM
5 x 120 / Pz2	10	10	1.98	0.44	X0010P5120BM
6 x 90 / Pz3	10	10	1.85	0.41	X0010P690BM
6 x 100 / Pz3	10	10	2.07	0.46	X0010P6100BM
6 x 110 / Pz3	10	10	2.34	0.52	X0010P6110BM
6 x 120 / Pz3	10	10	2.52	0.56	X0010P6120BM
6 x 130 / Pz3	10	10	2.79	0.62	X0010P6130BM
6 x 140 / Pz3	10	10	3.33	0.74	X0010P6140BM
6 x 150 / Pz3	10	10	3.74	0.83	X0010P6150BM

Surub PAL cu cap bombat, otel zincat galben

BLISTER

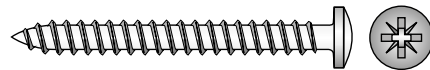

Dimensiuni (mm)	buc./ blister	Ambalare (nr. blistere)	Pret (€/blister)		Cod articol
			LEI	EURO	
3.0 x 12 / Pz1	200	10	4.05	0.90	X0020312BM
3.0 x 25 / Pz1	100	10	2.12	0.47	X0020325BM
3.5 x 16 / Pz2	100	10	2.07	0.46	X00203516BM
3.5 x 40 / Pz2	50	10	1.98	0.44	X00203540BM
4.0 x 16 / Pz2	100	10	2.57	0.57	X0020416BM
4.0 x 20 / Pz2	75	10	2.25	0.50	X0020420BM
4.0 x 25 / Pz2	60	10	1.98	0.44	X0020425BM
5.0 x 50 / Pz2	30	10	2.88	0.64	X0020550BM

Surub cu cap plat pentru lemn, otel zincat

BLISTER

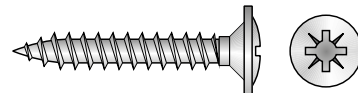

Dimensiuni (mm)	buc./ blister	Ambalare (nr. blistere)	Pret (€/blister)		Cod articol
			LEI	EURO	
4 x 13	50	10	1.67	0.37	VR1149.413BM
4 x 20	50	10	1.80	0.40	VR1149.420BM
4 x 25	50	10	2.03	0.45	VR1149.425BM
4 x 30	50	10	2.25	0.50	VR1149.430BM
4 x 35	50	10	2.34	0.52	VR1149.435BM
4 x 40	50	10	2.88	0.64	VR1149.440BM

Prezon pentru lemn, otel zincat

BLISTER



Dimensiuni (mm)	buc./ blister	Ambalare (nr. blistere)	Pret (€/blister)		Cod articol
			LEI	EURO	
8 x 70	4	10	1.13	0.25	X0040870BM
8 x 80	4	10	1.31	0.29	X0040880BM
8 x 100	4	10	1.44	0.32	X00408100BM
8 x 120	4	10	1.62	0.36	X00408120BM
8 x 150	4	10	1.94	0.43	X00408150BM
10 x 100	4	10	1.94	0.43	X004010100BM
10 x 120	4	10	2.25	0.50	X004010120BM

Surub pt. gips-carton, filet cu pas fin, tratat termic, otel fosfatat

BLISTER



Dimensiuni (mm)	buc./ blister	Ambalare (nr. blistere)	Pret (€/blister)		Cod articol
			LEI	EURO	
3.5 x 25	50	10	1.26	0.28	X01003525BM
3.5 x 35	50	10	1.53	0.34	X01003535BM
3.5 x 45	50	10	1.80	0.40	X01003545BM
3.5 x 55	50	10	2.12	0.47	X01003555BM
4.2 x 75	25	10	1.85	0.41	X01004275BM

Surub autoforant pentru gips-carton, otel fosfatat

BLISTER

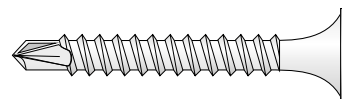

Dimensiuni (mm)	buc./ blister	Ambalare (nr. blistere)	Pret (€/blister)		Cod articol
			LEI	EURO	
3.5 x 25	50	10	1.58	0.35	X01033525BM
3.5 x 35	50	10	1.85	0.41	X01033535BM

Surub autofiletant cu cap special "plat + saiba", otel zincat

BLISTER

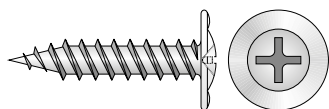

Dimensiuni (mm)	buc./ blister	Ambalare (nr. blistere)	Pret (€/blister)		Cod articol
			LEI	EURO	
4.2 x 13	25	10	1.04	0.23	X02114213BM
4.2 x 16	25	10	1.17	0.26	X02114216BM
4.2 x 19	25	10	1.22	0.27	X02114219BM
4.2 x 25	25	10	1.35	0.30	X02114225BM
4.2 x 41	25	10	1.67	0.37	X02114241BM

Surub pentru ferestre, filet Hi-Lo, PVC 10, otel zincat galben

BLISTER

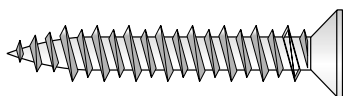

Dimensiuni (mm)	buc./ blister	Ambalare (nr. blistere)	Pret (€/blister)		Cod articol
			LEI	EURO	
3.9 x 25	50	10	1.76	0.39	X08013925BM
3.9 x 38	50	10	2.16	0.48	X08013938BM

Surub autoforant pentru ferestre, PVC 40, otel zincat galben

BLISTER

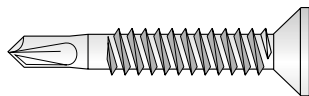

Dimensiuni (mm)	buc./ blister	Ambalare (nr. blistere)	Pret (€/blister)		Cod articol
			LEI	EURO	
3.9 x 32	50	10	2.57	0.57	X08043932BM
3.9 x 38	50	10	2.93	0.65	X08043938BM

Surub cu cap tesit pentru beton + capac alb, otel zincat galben + plastic

BLISTER

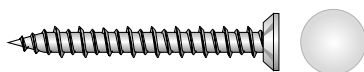

Dimensiuni (mm)	buc./ blister	Ambalare (nr. blistere)	Pret (€/blister)		Cod articol
			LEI	EURO	
7.5 x 72	4	10	1.62	0.36	X06CA7572BM
7.5 x 92	4	10	1.85	0.41	X06CA7592BM
7.5 x 132	4	10	2.79	0.62	X06CA75132BM
7.5 x 152	4	10	3.24	0.72	X06CA75152BM

Holzsurub de cuplare, cap tesit si locas hexagonal, otel zincat

BLISTER

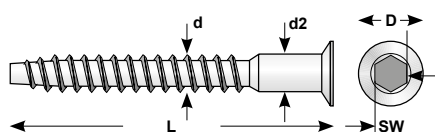

Dimensiuni (mm)	buc./ blister	Ambalare (nr. blistere)	Pret (€/blister)		Cod articol
			LEI	EURO	
5 x 50 SW3	20	10	1.98	0.44	X0050550BM
7 x 50 SW4	20	10	2.16	0.48	X0050750BM

Bolt filetat M6 cu cap Slot semirotund, fara saibe si piulite, otel zincat gr 4.6

BLISTER

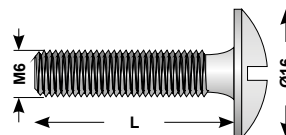

Dimensiuni (mm)	buc./ blister	Ambalare (nr. blistere)	Pret (€/blister)		Cod articol
			LEI	EURO	
M 6 x 25	25	10	3.60	0.80	VR.0163.01BM
M 6 x 30	25	10	3.60	0.80	VR.0163.02BM
M 6 x 40	25	10	8.06	1.79	VR.0163.04BM

Surub M4 cu cap bombat, locas cruciform combi Z, otel zincat

BLISTER

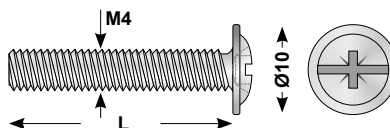

Dimensiuni (mm)	buc./ blister	Ambalare (nr. blistere)	Pret (€/blister)		Cod articol
			LEI	EURO	
M 4 x 10	25	10	1.08	0.24	VR.7401.04BM
M 4 x 15	25	10	1.31	0.29	VR.7401.09BM
M 4 x 20	25	10	1.44	0.32	VR.7401.14BM
M 4 x 25	25	10	1.49	0.33	VR.7401.20BM
M 4 x 30	25	10	1.53	0.34	VR.7401.24BM
M 4 x 35	25	10	1.58	0.35	VR.7401.28BM
M 4 x 40	25	10	1.76	0.39	VR.7401.32BM
M 4 x 45	25	10	1.76	0.39	VR.7401.35BM
M 4 x 50	25	10	2.03	0.45	00850450BM

Suport de raft, Duplo 5/5 x 16

BLISTER

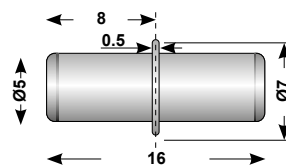

Acoperire	buc./ blister	Ambalare (nr. blistere)	Pret (€/blister)		Cod articol
			LEI	EURO	
zincat	16	10	0.99	0.22	SP.516BM

Surub autoforant cu cap special, "plat + saiba", otel zincat + vopsit

BLISTER

RAL	●
3011	●
8017	●

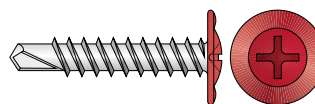

Dimensiuni (mm)	buc./ blister	Ambalare (nr. blistere)	Pret (€/blister)		Cod articol
			LEI	EURO	
4.2 x 13 Zincat	25	10	1.13	0.25	X02134213BM
4.2 x 13 RAL 3011	25	10	1.53	0.34	X021342131BM
4.2 x 13 RAL 8017	25	10	1.53	0.34	X021342134BM
4.2 x 16 Zincat	25	10	1.17	0.26	X02134216BM
4.2 x 16 RAL 3011	25	10	1.58	0.35	X021342161BM
4.2 x 16 RAL 8017	25	10	1.58	0.35	X021342164BM
4.2 x 19 Zincat	25	10	1.26	0.28	X02134219BM
4.2 x 19 RAL 3011	25	10	1.62	0.36	X021342191BM
4.2 x 19 RAL 8017	25	10	1.62	0.36	X021342194BM
4.2 x 25 Zincat	25	10	1.40	0.31	X02134225BM
4.2 x 25 RAL 3011	25	10	1.71	0.38	X021342251BM
4.2 x 25 RAL 8017	25	10	1.71	0.38	X021342254BM
4.2 x 32 Zincat	25	10	1.58	0.35	X02134232BM
4.2 x 32 RAL 3011	25	10	1.85	0.41	X021342321BM
4.2 x 32 RAL 8017	25	10	1.85	0.41	X021342324BM
4.2 x 41 Zincat	25	10	1.85	0.41	X02134241BM
4.2 x 41 RAL 3011	25	10	2.03	0.45	X021342411BM
4.2 x 41 RAL 8017	25	10	2.03	0.45	X021342414BM

Surub autoforant cu cap hexagonal si saiba cauciucata Ø14mm pt. prindere pe suport metalic, otel zincat sau vopsit

BLISTER

RAL	
3011	●
5010	●
8017	●

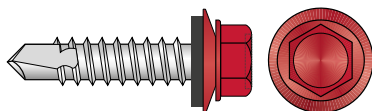

Dimensiuni (mm)	buc./ blister	Ambalare (nr. blistere)	Pret (€/blister)		Cod articol
			LEI	EURO	
4.8 x 16 Zincat	10	10	1.17	0.26	7504S4816BM
4.8 x 16 RAL 3011	10	10	1.22	0.27	7504S48161BM
4.8 x 16 RAL 8017	10	10	1.22	0.27	7504S48164BM
4.8 x 16 RAL 5010	10	10	1.22	0.27	7504S48167BM
4.8 x 19 Zincat	10	10	1.17	0.26	7504S4819BM
4.8 x 19 RAL 3011	10	10	1.26	0.28	7504S48191BM
4.8 x 19 RAL 8017	10	10	1.26	0.28	7504S48194BM
4.8 x 19 RAL 5010	10	10	1.26	0.28	7504S48197BM
4.8 x 25 Zincat	10	10	1.26	0.28	7504S4825BM
4.8 x 25 RAL 3011	10	10	1.31	0.29	7504S48251BM
4.8 x 25 RAL 8017	10	10	1.31	0.29	7504S48254BM
4.8 x 25 RAL 5010	10	10	1.31	0.29	7504S48257BM

Surub autoforant cu cap hexagonal si saiba cauciucata Ø14mm pentru Prindere pe constructii din lemn, otel zincat sau vopsit

BLISTER

RAL	
3011	●
5010	●
8017	●
9010	○

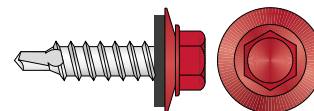

Dimensiuni (mm)	buc./ blister	Ambalare (nr. blistere)	Pret (€/blister)		Cod articol
			LEI	EURO	
4.8 x 29 Zincat	10	10	1.22	0.27	X02004829BM
4.8 x 29 RAL 3011	10	10	1.26	0.28	X020048291BM
4.8 x 29 RAL 8017	10	10	1.26	0.28	X020048294BM
4.8 x 29 RAL 5010	10	10	1.26	0.28	X020048297BM
4.8 x 29 RAL 9010	10	10	1.26	0.28	X0200482910BM
4.8 x 35 Zincat	10	10	1.31	0.29	X02004835BM
4.8 x 35 RAL 3011	10	10	1.35	0.30	X020048351BM
4.8 x 35 RAL 8017	10	10	1.35	0.30	X020048354BM
4.8 x 35 RAL 5010	10	10	1.35	0.30	X020048357BM
4.8 x 35 RAL 9010	10	10	1.35	0.30	X0200483510BM
4.8 x 50 Zincat	10	10	1.40	0.31	X02004850BM
4.8 x 50 RAL 3011	10	10	1.49	0.33	X020048501BM
4.8 x 50 RAL 8017	10	10	1.49	0.33	X020048504BM
4.8 x 50 RAL 5010	10	10	1.49	0.33	X020048507BM
4.8 x 50 RAL 9010	10	10	1.49	0.33	X0200485010BM
4.8 x 60 Zincat	10	10	1.58	0.35	X02004860BM
4.8 x 60 RAL 3011	10	10	1.67	0.37	X020048601BM
4.8 x 60 RAL 8017	10	10	1.67	0.37	X020048604BM
4.8 x 60 RAL 5010	10	10	1.67	0.37	X020048607BM
4.8 x 60 RAL 9010	10	10	1.67	0.37	X0200486010BM

Saiba cauciucata pentru etansare, otel zincat + cauciuc EPDM

BLISTER

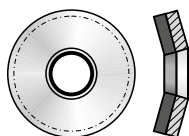

Dimensiuni (mm)	buc./ blister	Ambalare (nr. blistere)	Pret (€/blister)		Cod articol
			LEI	EURO	
4.2 x 14	50	10	1.80	0.40	X02204214BM
4.8 x 16	50	10	1.98	0.44	X02204816BM
4.8 x 19	50	10	2.75	0.61	X02204819BM
5.5 x 19	50	10	2.93	0.65	X02205519BM
6.3 x 19	50	10	2.88	0.64	X02206319BM

Pop-nituri standard, cap bombat, aluminiu / otel

BLISTER

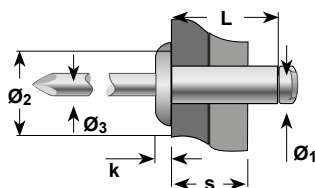

Ø ₁	Dimensiuni (mm)			buc./ blister	Ambalare (nr. blistere)	Pret (€/blister)		Cod articol		
	Ø ₂	Ø ₃	L			LEI	EURO			
2.4	5.00	1.45	6	0.60	2.0 - 4.0	25	10	1.22	0.27	BR.1010002406BM
3.0	6.00	1.80	10	1.00	5.0 - 7.0	25	10	1.44	0.32	BR.1010003010BM
			6	1.00	1.5 - 3.5	25	10	1.31	0.29	BR.1010003206BM
3.2	6.40	1.80	8	1.00	3.5 - 5.0	25	10	1.35	0.30	BR.1010003208BM
			10	1.00	5.0 - 7.0	25	10	1.40	0.31	BR.1010003210BM
			12	1.00	7.0 - 9.0	25	10	1.44	0.32	BR.1010003212BM
			6	1.40	1.0 - 3.5	25	10	1.58	0.35	BR.1010004006BM
4.0	8.00	2.20	8	1.40	3.0 - 5.0	25	10	1.58	0.35	BR.1010004008BM
			10	1.40	5.0 - 6.5	25	10	1.62	0.36	BR.1010004010BM
			12	1.40	6.5 - 8.5	25	10	1.71	0.38	BR.1010004012BM
			14	1.40	8.5 - 10.5	25	10	1.76	0.39	BR.1010004014BM
			16	1.40	10.5 - 12.5	25	10	1.89	0.42	BR.1010004016BM
			8	1.50	3.0 - 4.5	25	10	2.03	0.45	BR.1010004008BM
4.8	9.50	2.65	10	1.50	4.5 - 6.0	25	10	2.03	0.45	BR.1010004010BM
			12	1.50	6.0 - 8.0	25	10	2.07	0.46	BR.1010004012BM
			14	1.50	8.0 - 10.0	25	10	2.25	0.50	BR.1010004014BM
			16	1.50	10.0 - 12.0	25	10	2.34	0.52	BR.1010004016BM
			18	1.50	12.0 - 14.0	25	10	2.43	0.54	BR.1010004018BM
			21	1.50	14.0 - 17.0	25	10	2.61	0.58	BR.1010004021BM
5.0	9.50	2.65	10	1.60	4.5 - 6.0	25	10	2.12	0.47	BR.1010005010BM

Pop-nituri standard, cap bombat colorat, aluminiu / otel

BLISTER

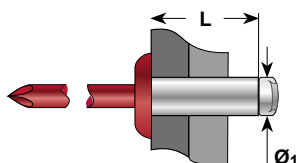

RAL	Ø ₁ (mm)	L (mm)	RAL	buc./ blister	Ambalare (nr. blistere)	Pret (€/blister)		Cod articol	
						LEI	EURO		
3009	4.0	8	3011	25	10	1.98	0.44	BR.101C0140081BM	
			8017	25	10	1.98	0.44	BR.101C0140084BM	
8004			25	10	1.98	0.44	BR.101C0140088BM		
9010			25	10	1.98	0.44	BR.101C01400810BM		
6020			25	10	1.98	0.44	BR.101C01400811BM		
3009			25	10	1.98	0.44	BR.101C01400812BM		
3011		10	8	9005	25	10	1.98	0.44	BR.101C01400813BM
				3011	25	10	2.03	0.45	BR.101C0140101BM
				8017	25	10	2.03	0.45	BR.101C0140104BM
				8004	25	10	2.03	0.45	BR.101C0140108BM
				9010	25	10	2.03	0.45	BR.101C01401010BM
				6020	25	10	2.03	0.45	BR.101C01401011BM
5010	8	10	3009	25	10	2.03	0.45	BR.101C01401012BM	
			9005	25	10	2.03	0.45	BR.101C01401013BM	

Set diblu din nailon si holz-surub cu cap tesit din otel zincat, cu certificare ETA-CE

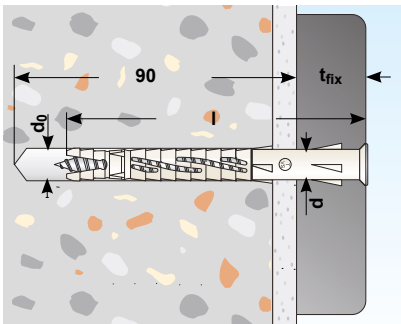

BLISTER



ACREDITARE TEHNICĂ EUROPEANĂ
Categoría: a, b, c
ETA-13/0135 - ETAG 020



diblu d x l	fixare		surub ds x ls	T	buc./ blister	Ambalare (nr. blistere)	Pret (€/blister)		Cod articol
	d0	tfix					LEI	EURO	
8 x 100	8	30	6 x 105	T30	4	10	3.60	0.80	T.VS1108100BM
8 x 140	8	70	6 x 145	T30	4	10	5.99	1.33	T.VS1108140BM
10 x 160	10	90	7 x 165	T40	4	10	7.74	1.72	T.VS1110160BM

Set diblu din nailon si holz-surub cu cap hex din otel zincat, cu certificare ETA-CE

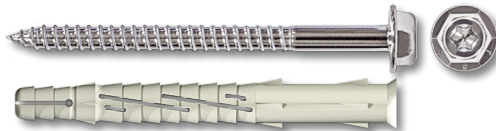
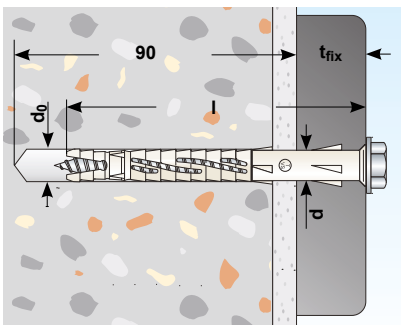

BLISTER



ACREDITARE TEHNICĂ EUROPEANĂ
Categoría: a, b, c
ETA-13/0135 - ETAG 020



diblu d x l	fixare		surub ds x ls	T	buc./ blister	Ambalare (nr. blistere)	Pret (€/blister)		Cod articol
	d0	tfix					LEI	EURO	
8 x 100	8	30	6 x 105	T30	4	10	4.19	0.93	T.VS3108100BM
8 x 140	8	70	6 x 145	T30	4	10	6.44	1.43	T.VS3108140BM
10 x 160	10	90	7 x 165	T40	4	10	9.14	2.03	T.VS3110160BM

Diblu standard (Eurodiblu)

BLISTER



Combinatie multiscop (diblu multiscop + holz-surub)

BLISTER

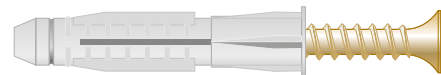

(Ø x L)diblu (mm)	buc./ blister	Ambalare (nr. blistere)	Pret (€/blister)		Cod articol
			LEI	EURO	
5 x 25	50	10	1.04	0.23	AA.01005025BM
6 x 30	25	10	0.77	0.17	AA.01006030BM
8 x 40	15	10	0.90	0.20	AA.01008040BM
10 x 50	15	10	1.17	0.26	AA.01010050BM
12 x 60	5	10	1.40	0.31	AA.01012060BM
14 x 75	2	10	0.95	0.21	AA.01014075BM
16 x 80	2	10	1.49	0.33	AA.01016080BM

Ø diblu (mm)	buc./ blister	Ambalare (nr. blistere)	Pret (€/blister)		Cod articol
			LEI	EURO	
6	15	10	1.22	0.27	AA.02206035BM
8	10	10	1.49	0.33	AA.02208050BM
10	6	10	1.53	0.34	AA.02210060BM

Combinatie standard (diblu standard + holz-surub)

BLISTER



Combinatii pentru fixari grele

(diblu pentru fixari grele + holz-surub DIN 571)

BLISTER

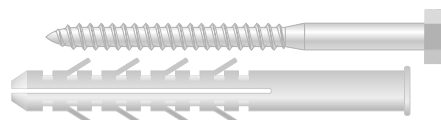

Ø diblu (mm)	buc./ blister	Ambalare (nr. blistere)	Pret (€/blister)		Cod articol
			LEI	EURO	
5	20	10	1.08	0.24	AA.01105035BM
6	15	10	1.04	0.23	AA.01106040BM
8	10	10	1.22	0.27	AA.01108050BM
10	5	10	1.17	0.26	AA.01110060BM

(Ø x L)diblu (mm)	buc./ blister	Ambalare (nr. blistere)	Pret (€/blister)		Cod articol
			LEI	EURO	
14 x 75	2	10	2.16	0.48	I.TCTB14080BM
14 x 100	2	10	2.48	0.55	I.TCTB14100BM
14 x 130	2	10	3.60	0.80	I.TCTB14130BM
14 x 160	2	10	4.37	0.97	I.TCTB14160BM
16 x 160	2	10	7.43	1.65	I.TCTB16160BM

Diblu multiscop cu guler

BLISTER



(Ø x L)diblu (mm)	buc./ blister	Ambalare (nr. blistere)	Pret (€/blister)		Cod articol
			LEI	EURO	
6 x 36	25	10	1.04	0.23	AA.02006036BM
8 x 50	10	10	0.86	0.19	AA.02008050BM
10 x 60	6	10	0.90	0.20	AA.02010060BM

Combinatii pentru constructii (diblu + holz-surub)

BLISTER



Smax - grosimea maxima de fixare

(Ø x L)diblu / Smax (mm)	buc./ blister	Ambalare (nr. blistere)	Pret (€/blister)		Cod articol
			LEI	EURO	
5 x 40 / 20	12	10	1.13	0.25	AA.0405040BM
6 x 40 / 10	8	10	0.99	0.22	AA.0406040BM
6 x 60 / 20	8	10	1.40	0.31	AA.0406060BM
8 x 60 / 15	8	10	1.89	0.42	AA.0408060BM
8 x 80 / 35	6	10	1.35	0.30	AA.0408080BM
8 x 100 / 55	4	10	1.26	0.28	AA.0408100BM
8 x 120 / 75	4	10	1.44	0.32	AA.0408120BM
8 x 140 / 95	4	10	1.80	0.40	AA.0408140BM
10 x 85 / 40	4	10	2.93	0.65	AA.0410085BM
10 x 105 / 60	4	10	3.24	0.72	AA.0410105BM
10 x 120 / 75	4	10	3.51	0.78	AA.0410120BM
10 x 140 / 95	4	10	4.14	0.92	AA.0410140BM
10 x 160 / 120	4	10	5.22	1.16	AA.0410160BM

Combinatii fixari adanci (diblu + holz-surub)

BLISTER



Smax - grosimea maxima de fixare

(Ø x L)diblu / Smax (mm)	buc./ blister	Ambalare (nr. blistere)	Pret (€/blister)		Cod articol
			LEI	EURO	
10 x 85 / 15	4	10	2.93	0.65	AA.04110085BM
10 x 105 / 35	4	10	3.24	0.72	AA.04110105BM
10 x 140 / 70	4	10	4.14	0.92	AA.04110140BM
10 x 160 / 90	4	10	5.22	1.16	AA.04110160BM

Combinatii hex lungi

BLISTER

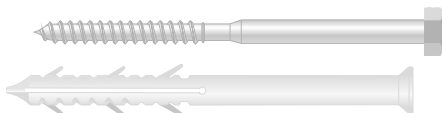

Smax - grosimea maxima de fixare

Ø x L diblu (mm)	Ø x L surub (mm)	Smax	buc./ blister	Ambalare (nr. blistere)	Pret (€/blister)		Cod articol
					LEI	EURO	
8 x 80	5 x 85	15	4	10	3.02	0.67	I.TC6E08080BM
8 x 100	5 x 100	35	4	10	3.69	0.82	I.TC6E08100BM
8 x 120	5 x 125	55	4	10	3.83	0.85	I.TC6E08120BM
8 x 140	5 x 145	75	4	10	4.05	0.90	I.TC6E08140BM
10 x 100	7 x 105	25	4	10	4.95	1.10	I.TC6E10100BM
10 x 120	7 x 120	40	4	10	5.36	1.19	I.TC6E10120BM
10 x 140	7 x 140	60	4	10	6.08	1.35	I.TC6E10140BM
10 x 160	7 x 165	85	4	10	6.57	1.46	I.TC6E10160BM

Combinatii pentru fixare rapida (diblu cu cap tesit+ cui)

BLISTER



Smax - grosimea maxima de fixare

(Ø x L)diblu / Smax (mm)	buc./ blister	Ambalare (nr. blistere)	Pret (€/blister)		Cod articol
			LEI	EURO	
5 x 30 / 10	12	10	1.58	0.35	AA.050005030BM
6 x 40 / 10	8	10	1.31	0.29	AA.050006040BM
6 x 60 / 20	8	10	1.71	0.38	AA.050006060BM
6 x 75 / 30	8	10	2.07	0.46	AA.050006080BM
8 x 60 / 15	8	10	2.30	0.51	AA.050008060BM
8 x 80 / 35	6	10	1.98	0.44	AA.050008080BM
8 x 100 / 55	4	10	1.67	0.37	AA.050008100BM
8 x 120 / 75	4	10	1.98	0.44	AA.050008120BM
8 x 140 / 95	4	10	2.57	0.57	AA.050008140BM

Diblu pentru gips-carton

BLISTER

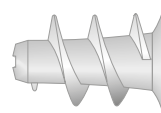

(Ø x L)diblu (mm)	buc./ blister	Ambalare (nr. blistere)	Pret (€/blister)		Cod articol
			LEI	EURO	
6 x 23	10	10	1.04	0.23	AA.03006023BM

Diblu pentru placi

BLISTER

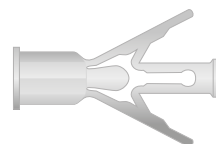

Smax - grosimea maxima de fixare

(Ø x L)diblu / Smax (mm)	buc./ blister	Ambalare (nr. blistere)	Pret (€/blister)		Cod articol
			LEI	EURO	
10 x 40 / 4 - 12	10	10	2.12	0.47	I.ANCLA40BM
10 x 47 / 15 - 19	10	10	2.30	0.51	I.ANCLA47BM

Seturi de fixare "INDEX"

BLISTER



Dimensiuni (mm)	Øorificiu (mm)	buc./ blister	Ambalare (nr. blistere)	Pret (€/blister)		Cod articol
				LEI	EURO	
Set fixare "L"						
M4 x 40	9	2	10	1.76	0.39	I.IPAGR09BM
M5 x 45	12	2	10	2.12	0.47	I.IPAGR12BM
Set fixare "Carlig"						
M4 x 40	9	2	10	1.94	0.43	I.IPAGN09BM
M5 x 45	12	2	10	2.34	0.52	I.IPAGN12BM
Set fixare "Ochi"						
M4 x 40	9	2	10	1.94	0.43	I.IPAAR09BM
M5 x 45	12	2	10	2.43	0.54	I.IPAAR12BM
Set fixare cu surub						
M4 x 40	9	2	10	1.58	0.35	I.IPATO09BM
M5 x 45	12	2	10	1.71	0.38	I.IPATO12BM

Seturi de fixare "Ochi" - diblu standard + holzsurub "ochi"

BLISTER

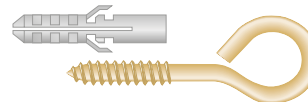

Ø (mm)		buc./ blister	Ambalare (nr. blistere)	Pret (€/blister)		Cod articol
surub	diblu			LEI	EURO	
4	6	4	10	1.17	0.26	AA.08004006BM
5	8	4	10	1.44	0.32	AA.08005008BM
9	12	2	10	3.33	0.74	AA.08009012BM

Seturi de fixare "carlig" - diblu standard + holzsurub "carlig"

BLISTER

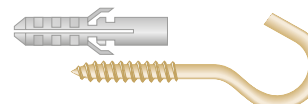

Ø (mm)		buc./ blister	Ambalare (nr. blistere)	Pret (€/blister)		Cod articol
surub	diblu			LEI	EURO	
4	6	4	10	1.13	0.25	AA.08104006BM
5	8	4	10	1.31	0.29	AA.08105008BM

Seturi de fixare "L" - diblu standard + holzsurub "L"

BLISTER

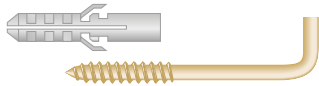

Ø (mm)		buc./ blister	Ambalare (nr. blistere)	Pret (€/blister)		Cod articol
surub	diblu			LEI	EURO	
4	6	4	10	1.13	0.25	AA.08204006BM
5	8	4	10	1.22	0.27	AA.08205008BM

Seturi de fixare "HEX" - diblu standard + holzsurub cu cap hexagonal si saiba

BLISTER

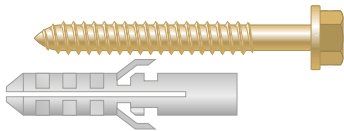

Dimensiuni (mm)		buc./ blister	Ambalare (nr. blistere)	Pret (€/blister)		Cod articol
holzsurub	diblu			LEI	EURO	
6 x 40	8 x 40	2	10	0.72	0.16	AA.06006040BM
6 x 60	8 x 40	2	10	0.77	0.17	AA.06006060BM
7 x 70	10 x 50	2	10	0.99	0.22	AA.06007070BM
8 x 70	12 x 60	2	10	1.35	0.30	AA.06008070BM
8 x 80	12 x 60	2	10	1.44	0.32	AA.06008080BM
8 x 100	12 x 60	2	10	1.44	0.32	AA.06008100BM
8 x 120	12 x 60	2	10	1.67	0.37	AA.06008120BM
10 x 70	14 x 75	2	10	1.85	0.41	AA.06010070BM

Seturi de fixare "PREZON" - diblu standard + prezon pentru lemn

BLISTER

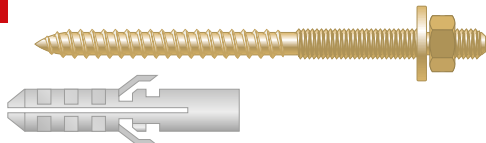

Dimensiuni (mm)		buc./ blister	Ambalare (nr. blistere)	Pret (€/blister)		Cod articol
prezon	diblu			LEI	EURO	
M 8 x 70	10 x 50	2	10	1.04	0.23	AA.07008070BM
M 8 x 100	10 x 50	2	10	1.17	0.26	AA.07008100BM
M 8 x 120	10 x 50	2	10	1.26	0.28	AA.07008120BM
M10 x 100	12 x 60	2	10	1.89	0.42	AA.07010100BM

Opritoare pentru usa

BLISTER

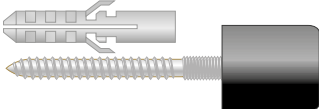

Material	Culoare	buc./ blister	Ambalare (nr. blistere)	Pret (€/blister)		Cod articol
				LEI	EURO	
Plastic	negru	2	10	2.52	0.56	AA.10500000BM
	alb	2	10	2.52	0.56	AA.10510000BM
	gri	2	10	2.52	0.56	AA.10520000BM

Conexpand bolt standard "INDEX", cu inel de strangere din otel zincat alb

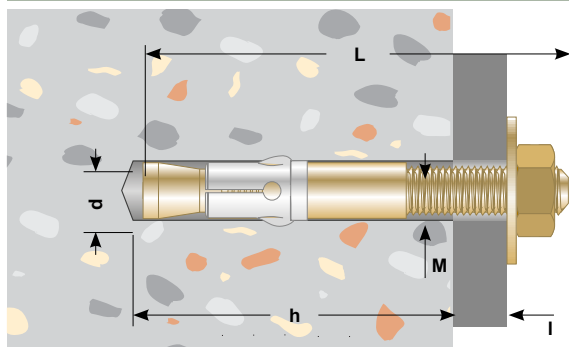

BLISTER

Dimensiuni (mm)				buc./ blister	Ambalare (nr. blistere)	Pret (€/blister)		Cod articol
M x L	d	l _{max}	h _{min}			LEI	EURO	
M 8 x 75	8	5	65	4	10	3.02	0.67	I.AM08075BM
M 8 x 90	8	20	65	4	10	3.20	0.71	I.AM08090BM
M 8 x 115	8	45	65	4	10	3.33	0.74	I.AM08115BM
M10 x 70	10	3	55	4	10	3.92	0.87	I.AM10070BM
M10 x 90	10	10	70	4	10	4.28	0.95	I.AM10090BM
M10 x 120	10	40	70	4	10	5.09	1.13	I.AM10120BM
M10 x 150	10	70	70	4	10	6.12	1.36	I.AM10150BM
M12 x 90	12	13	75	2	10	3.20	0.71	I.AM12090BM
M12 x 110	12	18	85	2	10	3.56	0.79	I.AM12110BM
M12 x 140	12	48	85	2	10	4.01	0.89	I.AM12140BM
M12 x 160	12	68	85	2	10	4.55	1.01	I.AM12160BM

Fixari pentru obiecte sanitare

BLISTER

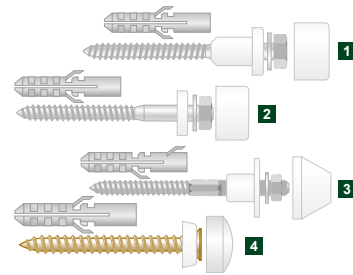

Dimensiuni (mm)	buc./ blister	Ambalare (nr. blistere)	Pret (€/blister)		Cod articol
			LEI	EURO	
1. Set fixare WC					
HEX 6 x 80 / 10	2	10	1.35	0.30	AA.10006080BM
HEX 7 x 70 / 10	2	10	1.53	0.34	AA.10007070BM
2. Set fixare etajera					
HEX 7 x 70 / 10	2	10	1.53	0.34	AA.10207070BM
3. Set fixare chiuveta					
M10 x 100 / 12	2	10	3.60	0.80	AA.10310100BM
M10 x 120 / 12	2	10	3.96	0.88	AA.10310120BM
4. Set fixare oglinda					
4.5 x 50 / 6 (capac alb)	4	10	1.71	0.38	AA.10445050BM
3.5 x 35 / 5 (capac negru)	4	10	1.58	0.35	AA.10435036BM

Dibluri metalice autoforante

BLISTER

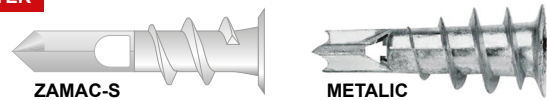

Smax - grosimea maxima de fixare

Grosime perete: 9 - 16 mm

Dimensiuni (mm)	Smax (mm)	buc./ blister	Ambalare (nr. blistere)	Pret (€/blister)		Cod articol
				LEI	EURO	
Zamac						
6 x 37	4.5 x 50	8	10	3.24	0.72	I.TAPLAZKBM
Metalic						
15 x 29	4.5 x 30	8	10	3.56	0.79	I.TAPLAMEBM

Dibluri metalice de expansiune cu surub

BLISTER

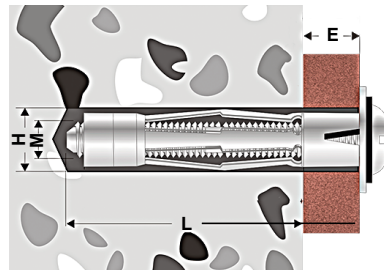

Filet	Dimensiuni (mm)			buc./ blister	Ambalare (nr. blistere)	Pret (€/blister)		Cod articol
	L	H	E			LEI	EURO	
M4	38	8	8 - 15	10	10	4.23	0.94	I.INCO438BM
	46	8	16 - 21	10	10	4.37	0.97	I.INCO446BM
M5	58	10	3 - 16	10	10	6.35	1.41	I.INCO558BM
	71	10	16 - 32	10	10	7.07	1.57	I.INCO571BM
M6	52	12	5 - 16	10	10	7.79	1.73	I.INCO652BM
	58	12	3 - 16	10	10	7.83	1.74	I.INCO658BM

Piulita expandabila din otel zincat, pentru beton

BLISTER



Dimensiuni (mm)		buc./ blister	Ambalare (nr. blistere)	Pret (€/blister)		Cod articol
M x L	Ø			LEI	EURO	
M 6 x 25	8	4	10	1.26	0.28	I.HENOM06BM
M 8 x 30	10	4	10	1.62	0.36	I.HENOM08BM
M10 x 40	12	4	10	2.30	0.51	I.HENOM10BM
M12 x 50	15	2	10	2.12	0.47	I.HENOM12BM

Piulita din alama expandabila, pt. marmura, gresie sau beton

BLISTER



Dimensiuni (mm)		buc./ blister	Ambalare (nr. blistere)	Pret (€/blister)		Cod articol
M x L	Ø			LEI	EURO	
M 6 x 23	8	4	10	1.85	0.41	I.TALAM06BM
M 8 x 28	10	4	10	2.84	0.63	I.TALAM08BM
M10 x 34	12	4	10	4.05	0.90	I.TALAM10BM

Ancore standard, pentru ferestre si usi

BLISTER



Dimensiuni (mm)		buc./ blister	Ambalare (nr. blistere)	Pret (€/blister)		Cod articol
M x L	Ø			LEI	EURO	
10 x 92		4	10	3.06	0.68	I.EPS6092BM
10 x 112		4	10	4.68	1.04	I.EPS6112BM
10 x 132		4	10	5.22	1.16	I.EPS6132BM
10 x 152		4	10	5.72	1.27	I.EPS6152BM

Colier pentru furtun, otel galvanizat

BLISTER



Banda 10 x 0.8 mm
Surub M6

Ø furtun (mm)	buc./ blister	Ambalare (nr. blistere)	Pret (€/blister)		Cod articol
			LEI	EURO	
8 - 16	4	10	3.11	0.69	JS.00016BM
12 - 20	4	10	3.24	0.72	JS.00020BM
18 - 25	4	10	3.47	0.77	JS.00025BM
20 - 32	4	10	3.65	0.81	JS.00032BM
25 - 40	2	10	2.16	0.48	JS.00040BM

Suporti "Clip" pentru cabluri

BLISTER



Ø furtun (mm)	buc./ blister	Ambalare (nr. blistere)	Pret (€/blister)		Cod articol
			LEI	EURO	
4	50	10	1.44	0.32	E022004BM
5	50	10	1.22	0.27	E022005BM
6	50	10	1.58	0.35	E022006BM
7	50	10	1.85	0.41	E022007BM
8	50	10	2.03	0.45	E022008BM
10	50	10	2.48	0.55	E022010BM

Cuie pentru beton, tratate termic, metalizate

BLISTER



Dimensiuni (mm)	buc./ blister	Ambalare (nr. blistere)	Pret (€/blister)		Cod articol
			LEI	EURO	
3.5 x 50	25	10	3.06	0.68	0.18035050BM
3.5 x 60	25	10	3.56	0.79	0.18035060BM
3.5 x 70	25	10	3.92	0.87	0.18035070BM
4.5 x 50	25	10	4.37	0.97	0.18045050BM
4.5 x 60	25	10	4.68	1.04	0.18045060BM
4.5 x 70	25	10	5.49	1.22	0.18045070BM

Agatatori pentru tablouri

BLISTER

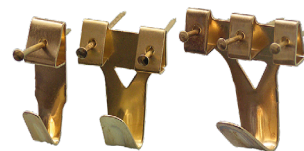

Numar de prinderi	buc./ blister	Ambalare (nr. blistere)	Pret (€/blister)		Cod articol
			LEI	EURO	
1	10	10	3.87	0.86	0.19001802BM
2	10	10	6.93	1.54	0.19002803BM

Ochi de blocare

BLISTER



DIN 5299

DIN 5287

DIN 5299

-

Dimensiuni (mm)	buc./ blister	Ambalare (nr. blistere)	Pret (€/blister)		Cod articol
			LEI	EURO	
1. Tip 1, zincat					
4 x 40	2	10	1.76	0.39	DL.24804EBM
6 x 60	2	10	2.16	0.48	DL.24806EBM
8 x 80	2	10	3.47	0.77	DL.24808EBM
2. Tip 2, nichelat					
25	4	10	1.40	0.31	DL.125025NBM
30	4	10	1.49	0.33	DL.125030NBM
40	4	10	1.85	0.41	DL.125040NBM
50	4	10	2.25	0.50	DL.125050NBM
3. Tip 3, zincat					
6 x 60	2	10	3.47	0.77	DL.24506SBM
8 x 80	2	10	4.86	1.08	DL.24508SBM
4. Tip 4, zincat					
5	2	10	2.25	0.50	DL.20005EBM
8	2	10	4.41	0.98	DL.20008EBM

Carabine, otel nichelat

BLISTER



1

2

3

Dimensiuni		buc./ blister	Ambalare (nr. blistere)	Pret (€/blister)		Cod articol
mm	inch			LEI	EURO	
1. Tip 1						
10 / 50	3/8	2	10	3.02	0.67	DL.5010KBM
16	5/8	2	10	6.03	1.34	DL.5016NBM
25	1	2	10	7.52	1.67	DL.5025NBM
2. Tip 2						
16	5/8	4	10	7.16	1.59	DL.202216NBM
3. Tip 3						
25	1	2	10	8.60	1.91	DL.6025NBM

Burghie elicoidale, DIN 338, tip VA, HSSE-Co 5 - gama profesionala



Profilul canalului: normal.
Miez: ingrosat.
Forma: C, cu punct de centrare.

Burghiu puternic cu taiș pe dreapta și rezistența stabila la caldura.

Ideal pentru gaurirea oțelurilor rezistente la rugina, acizi și caldura cu rezistența ridicata.



Otel		Otel	Aliaj cu titan
< 900	< 1100	inoxidabil	
<input checked="" type="radio"/>	<input checked="" type="radio"/>	<input checked="" type="radio"/>	<input type="radio"/>

Utilizare principala

Utilizare secundara

Ø (mm)	L (mm)	l (mm)	Ambalare (buc.)	Preț / buc.		Cod articol
				LEI	EURO	
1.0	34	12	10	1.76	0.39	RK.215010M
1.5	40	18	10	1.89	0.42	RK.215015M
2.0	49	24	10	2.03	0.45	RK.215020M
2.5	57	30	10	2.16	0.48	RK.215025M
3.0	61	33	10	2.39	0.53	RK.215030M
3.2	65	36	10	2.70	0.60	RK.215032M
3.5	70	39	10	2.84	0.63	RK.215035M
4.0	75	43	10	3.02	0.67	RK.215040M
4.2	75	43	10	3.33	0.74	RK.215042M
4.5	80	47	10	3.47	0.77	RK.215045M
5.0	86	52	10	3.96	0.88	RK.215050M
5.5	93	57	10	4.86	1.08	RK.215055M
6.0	93	57	10	5.18	1.15	RK.215060M
6.5	101	63	10	5.63	1.25	RK.215065M
7.0	109	69	10	7.43	1.65	RK.215070M
7.5	109	69	10	7.92	1.76	RK.215075M
8.0	117	75	10	8.78	1.95	RK.215080M
8.5	117	75	10	9.90	2.20	RK.215085M
9.0	125	81	10	10.76	2.39	RK.215090M
9.5	125	81	10	11.79	2.62	RK.215095M
10.0	133	87	10	13.41	2.98	RK.215100M
10.5	133	87	5	17.01	3.78	RK.215105M
11.0	142	94	5	18.63	4.14	RK.215110M
12.0	151	101	5	23.94	5.32	RK.215120M
12.5	151	101	5	36.18	8.04	RK.215125M
13.0	151	101	5	28.08	6.24	RK.215130M
14.0	160	108	5	43.02	9.56	RK.215140M
16.0	178	120	5	82.17	18.26	RK.215160M

Seturi de burghie spirale DIN 338 tip VA, HSSE-Co 5	Ambalare (seturi)	Preț / set		Cod articol
		LEI	EURO	
19 buc. Ø1.0 - Ø10.0 mm, increment 0.5 mm	3	154.67	34.37	RK.215214M
25 buc. Ø1.0 - Ø13.0 mm, increment 0.5 mm	3	309.96	68.88	RK.215215M

Burghie elicoidale, DIN 338, tip N, HSS-G - gama profesionala



Profilul canalului: normal.
Miez: normal.
Forma: N, rectificare tronconica, ascuțire normala

Burghiu elicoidal standard, rectificat și puternic, din oțel rapid cu performanțe ridicate.

Burghiul spiralat complet rectificat dispune de o precizie deosebita a rotirii concentrice.

Datorita ascuțirii in cruce, acest burghiu are o centrare buna și necesita o forță de avans reduca.



Otel		Otel	Aluminiu	Alama	Bronz	Materiale plastice	Fonta
< 900	< 1100	inoxidabil					
<input checked="" type="radio"/>	<input type="radio"/>	<input type="radio"/>	<input type="radio"/>	<input type="radio"/>	<input type="radio"/>	<input type="radio"/>	<input checked="" type="radio"/>

Utilizare principala Utilizare secundara

Ø (mm)	L (mm)	l (mm)	Ambalare (buc.)	Preț / buc.		Cod articol
				LEI	EURO	
1.0	34	12	10	1.22	0.27	RK.214010M
1.5	40	18	10	1.22	0.27	RK.214015M
2.0	49	24	10	1.22	0.27	RK.214020M
2.5	57	30	10	1.31	0.29	RK.214025M
3.0	61	33	10	1.31	0.29	RK.214030M
3.2	65	36	10	1.53	0.34	RK.214032M
3.3	65	36	10	1.53	0.34	RK.214033M
3.5	70	39	10	1.53	0.34	RK.214035M
4.0	75	43	10	1.76	0.39	RK.214040M
4.2	75	43	10	2.03	0.45	RK.214042M
4.5	80	47	10	2.03	0.45	RK.214045M
4.8	86	52	10	2.34	0.52	RK.214048M
5.0	86	52	10	2.34	0.52	RK.214050M
5.2	86	52	10	2.79	0.62	RK.214052M
5.5	93	57	10	2.79	0.62	RK.214055M
6.0	93	57	10	2.97	0.66	RK.214060M
6.5	101	63	10	3.74	0.83	RK.214065M
7.0	109	69	10	4.41	0.98	RK.214070M
7.5	109	66	10	4.59	1.02	RK.214075M
8.0	117	75	10	5.36	1.19	RK.214080M
8.5	117	75	10	5.85	1.30	RK.214085M
9.0	125	81	10	6.89	1.53	RK.214090M
10.0	133	87	10	10.22	2.27	RK.214100M
10.5	133	87	10	10.22	2.27	RK.214105M
11.0	142	94	5	12.02	2.67	RK.214110M
12.0	151	101	5	13.91	3.09	RK.214120M
12.5	151	98	5	15.12	3.36	RK.214125M
13.0	151	101	5	16.83	3.74	RK.214130M
14.0	160	108	5	28.85	6.41	RK.214140M

Seturi de burghie elicoidale, DIN 338, tip N, HSS-G	Ambalare (seturi)	Preț / set		Cod articol
		LEI	EURO	
19 buc. Ø1.0 - Ø10.0 mm, increment 0.5 mm	3	86.81	19.29	RK.214214M
25 buc. Ø1.0 - Ø13.0 mm, increment 0.5 mm	3	162.23	36.05	RK.214215M



Burghie elicoidale, DIN 338, tip N, HSS-R - gama profesionala



Profilul canalului: normal.
Miez: normal.
Forma: N, rectificarea tronconica, ascuțire normala

Burghiu elicoidal rulat, puternic și tratat cu abur, din oțel rapid cu performanțe ridicate.

Prin procedeul de fabricație (nicio rupere a structurii), materialul este întărit și, prin urmare, mai elastic.

Astfel ofera o siguranță la rupere mai ridicată și este adecvat pentru mașini de găurit robuste.



Oțel < 900	Alama	Bronz	Materiale plastice	Fonta
<input checked="" type="radio"/>	<input type="radio"/>	<input type="radio"/>	<input type="radio"/>	<input checked="" type="radio"/>

● Utilizare principala
○ Utilizare secundara

Ø (mm)	L (mm)	l (mm)	Ambalare (buc.)	Preț / buc.		Cod articol
				LEI	EURO	
1.0	34	12	10	0.63	0.14	RK.201010M
1.5	40	18	10	0.63	0.14	RK.201015M
2.0	49	24	10	0.63	0.14	RK.201020M
2.5	57	30	10	0.77	0.17	RK.201025M
3.0	61	33	10	0.77	0.17	RK.201030M
3.2	65	36	10	0.81	0.18	RK.201032M
3.5	70	39	10	0.81	0.18	RK.201035M
4.0	75	43	10	0.95	0.21	RK.201040M
4.2	75	43	10	0.99	0.22	RK.201042M
4.5	80	47	10	0.99	0.22	RK.201045M
5.0	86	52	10	1.13	0.25	RK.201050M
5.5	93	57	10	1.40	0.31	RK.201055M
6.0	93	57	10	1.40	0.31	RK.201060M
6.5	101	63	10	1.71	0.38	RK.201065M
7.0	109	69	10	2.07	0.46	RK.201070M
8.0	117	75	10	2.57	0.57	RK.201080M
8.5	117	75	10	2.79	0.62	RK.201085M
9.0	125	81	10	3.02	0.67	RK.201090M
9.5	125	81	10	3.65	0.81	RK.201095M
10.0	133	87	10	4.05	0.90	RK.201100M
10.5	133	87	5	4.77	1.06	RK.201105M
11.0	142	94	5	5.63	1.25	RK.201110M
12.0	151	101	5	6.35	1.41	RK.201120M
12.5	151	101	5	6.98	1.55	RK.201125M
13.0	151	101	5	7.20	1.60	RK.201130M
14.0	160	108	5	8.33	1.85	RK.201140M
15.0	169	114	5	9.50	2.11	RK.201150M
16.0	178	120	5	11.97	2.66	RK.201160M

Seturi de burghie elicoidale, DIN 338, tip N, HSS-R	Ambalare (seturi)	Preț / set		Cod articol
		LEI	EURO	
19 buc. Ø1.0 - Ø10.0 mm, increment 0.5 mm	3	66.78	14.84	RK.205212M
25 buc. Ø1.0 - Ø13.0 mm, increment 0.5 mm	3	131.54	29.23	RK.205213M

Burghie LUNGI elicoidale, DIN 340, HSS-G - gama profesionala



Profilul canalului: lat, cu muchii de spate rotunjite.
Miez: normal.
Forma: N, rectificarea tronconica, ascuțire normala

Burghiu elicoidal standard, rectificat cu structura solida, din oțel rapid cu performanțe ridicate.

Burghiul spiralat complet rectificat dispune de o precizie deosebita a rotirii concentrice.

<input checked="" type="radio"/>	Utilizare principala
<input type="radio"/>	Utilizare secundara

Oțel < 900	Oțel < 1100	Oțel inoxidabil	Aluminiu	Alama	Bronz	Materiale plastice	Fonta
<input checked="" type="radio"/>	<input type="radio"/>	<input type="radio"/>	<input type="radio"/>	<input type="radio"/>	<input type="radio"/>	<input type="radio"/>	<input type="radio"/>

Ø (mm)	L (mm)	l (mm)	Ambalare (buc.)	Preț / buc.		Cod articol
				LEI	EURO	
3.0	100	66	10	3.42	0.76	RK.203030M
3.5	112	73	10	3.42	0.76	RK.203035M
4.0	119	78	10	4.23	0.94	RK.203040M
4.5	126	82	10	5.04	1.12	RK.203045M
5.0	132	87	10	5.99	1.33	RK.203050M
5.5	139	91	10	6.57	1.46	RK.203055M
6.0	139	91	10	6.62	1.47	RK.203060M
6.5	148	97	10	8.46	1.88	RK.203065M
8.0	165	109	10	11.97	2.66	RK.203080M
7.0	156	102	10	9.81	2.18	RK.203070M
10.0	184	121	10	15.89	3.53	RK.203100M

Burghie elicoidale, DIN 338, tip N, HSS-Co5

TERRAX®



Profilul canalului: normal.
Miez: normal.
Forma: N, rectificare tronconica, ascutire normala

Burghiu elicoidal rulat, din otel rapid.

- Utilizare principala
- Utilizare secundara

Otel < 900	Alama	Bronz	Materiale plastice
<input checked="" type="radio"/>	<input type="radio"/>	<input type="radio"/>	<input type="radio"/>

Ø (mm)	L (mm)	l (mm)	Ambalare (buc.)	Preț / buc.		Cod articol
				LEI	EURO	
1.0	34	12	10	0.81	0.18	TX.215010M
1.5	40	18	10	0.95	0.21	TX.215015M
2.0	49	24	10	0.99	0.22	TX.215020M
2.5	57	30	10	1.22	0.27	TX.215025M
3.0	61	33	10	2.16	0.48	TX.215030M
3.3	65	36	10	2.66	0.59	TX.215033M
3.5	70	39	10	2.66	0.59	TX.215035M
4.0	75	43	10	2.84	0.63	TX.215040M
4.2	75	43	10	3.74	0.83	TX.215042M
4.5	80	47	10	3.74	0.83	TX.215045M
5.0	86	52	10	3.83	0.85	TX.215050M
5.5	93	57	10	4.23	0.94	TX.215055M
6.0	93	57	10	4.91	1.09	TX.215060M
6.5	101	63	10	5.40	1.20	TX.215065M
6.8	109	69	10	6.44	1.43	TX.215068M
7.0	109	69	10	6.44	1.43	TX.215070M
7.5	109	69	10	7.61	1.69	TX.215075M
8.0	117	75	10	9.90	2.20	TX.215080M
8.5	117	75	10	10.53	2.34	TX.215085M
9.0	125	81	10	11.66	2.59	TX.215090M
9.5	125	81	10	12.74	2.83	TX.215095M
10.0	133	87	10	14.85	3.30	TX.215100M
10.2	133	87	10	16.74	3.72	TX.215102M
10.5	133	87	5	16.74	3.72	TX.215105M
11.0	142	94	5	17.91	3.98	TX.215110M
11.5	142	94	5	19.40	4.31	TX.215115M
12.0	151	101	5	22.68	5.04	TX.215120M
12.5	151	101	5	23.81	5.29	TX.215125M
13.0	151	101	5	25.38	5.64	TX.215130M

Burghie elicoidale, DIN 338, tip N, HSS-G, TiN

TERRAX®



Profilul canalului: normal.
Miez: normal.
Forma: N, rectificare tronconica, ascutire normala

Burghiu elicoidal rulat, din otel rapid.

- Utilizare principala
- Utilizare secundara

Otel < 900	Alama	Bronz	Materiale plastice
<input checked="" type="radio"/>	<input type="radio"/>	<input type="radio"/>	<input type="radio"/>

Ø (mm)	L (mm)	l (mm)	Ambalare (buc.)	Preț / buc.		Cod articol
				LEI	EURO	
1.0	34	12	10	0.63	0.14	TX.250010M
1.5	40	18	10	0.68	0.15	TX.250015M
2.0	49	24	10	0.77	0.17	TX.250020M
2.5	57	30	10	0.95	0.21	TX.250025M
3.0	61	33	10	1.08	0.24	TX.250030M
3.3	65	36	10	1.13	0.25	TX.250033M
3.5	70	39	10	1.13	0.25	TX.250035M
4.0	75	43	10	1.53	0.34	TX.250040M
4.2	75	43	10	2.07	0.46	TX.250042M
4.5	80	47	10	2.07	0.46	TX.250045M
5.0	86	52	10	2.25	0.50	TX.250050M
5.5	93	57	10	2.66	0.59	TX.250055M
6.0	93	57	10	2.88	0.64	TX.250060M
6.5	101	63	10	3.15	0.70	TX.250065M
6.8	109	69	10	3.83	0.85	TX.250068M
7.0	109	69	10	3.83	0.85	TX.250070M
7.5	109	69	10	4.37	0.97	TX.250075M
8.0	117	75	10	5.22	1.16	TX.250080M
8.5	117	75	10	5.40	1.20	TX.250085M
9.0	125	81	10	6.12	1.36	TX.250090M
9.5	125	81	10	6.57	1.46	TX.250095M
10.0	133	87	10	7.29	1.62	TX.250100M
10.2	133	87	10	7.56	1.68	TX.250102M
10.5	133	87	5	7.56	1.68	TX.250105M
11.0	142	94	5	8.55	1.90	TX.250110M
11.5	142	94	5	9.14	2.03	TX.250115M
12.0	151	101	5	10.22	2.27	TX.250120M
12.5	151	101	5	10.85	2.41	TX.250125M
13.0	151	101	5	11.66	2.59	TX.250130M

Burghie elicoidale, DIN 338, tip N, HSS-R

TERRAX



Profilul canalului: normal.
Miez: normal.
Forma: N, rectificare tronconica, ascuțire normala

Burghiu elicoidal rulat, din oțel rapid.

Oțel < 900	Alama	Bronz	Materiale plastice
●	○	○	○



Ø (mm)	L (mm)	l (mm)	Ambalare (buc.)	Preț / buc.		Cod articol
				LEI	EURO	
1.0	34	12	10	0.32	0.07	TX.201010M
1.5	40	18	10	0.36	0.08	TX.201015M
2.0	49	24	10	0.45	0.10	TX.201020M
2.5	57	30	10	0.50	0.11	TX.201025M
3.0	61	33	10	0.50	0.11	TX.201030M
3.3	65	36	10	0.63	0.14	TX.201033M
3.5	70	39	10	0.63	0.14	TX.201035M
4.0	75	43	10	0.77	0.17	TX.201040M
4.2	75	43	10	0.77	0.17	TX.201042M
4.5	80	47	10	0.77	0.17	TX.201045M
5.0	86	52	10	0.95	0.21	TX.201050M
5.5	93	57	10	0.95	0.21	TX.201055M
6.0	93	57	10	0.99	0.22	TX.201060M
6.5	101	63	10	1.13	0.25	TX.201065M
6.8	109	69	10	1.31	0.29	TX.201068M
7.0	109	69	10	1.31	0.29	TX.201070M
7.5	109	69	10	1.58	0.35	TX.201075M
8.0	117	75	10	1.85	0.41	TX.201080M
8.5	117	75	10	2.16	0.48	TX.201085M
9.0	125	81	10	2.25	0.50	TX.201090M
9.5	125	81	10	2.79	0.62	TX.201095M
10.0	133	87	10	3.11	0.69	TX.201100M
10.2	133	87	10	3.11	0.69	TX.201102M
10.5	133	87	5	3.11	0.69	TX.201105M
11.0	142	94	5	3.65	0.81	TX.201110M
11.5	142	94	5	4.05	0.90	TX.201115M
12.0	151	101	5	4.37	0.97	TX.201120M
12.5	151	101	5	4.73	1.05	TX.201125M
13.0	151	101	5	4.86	1.08	TX.201130M

Seturi de burghie elicoidale, DIN 338, tip N, HSS-R	Ambalare (seturi)	Preț / set		Cod articol
		LEI	EURO	
19 buc. Ø1.0 - Ø10.0 mm, increment 0.5 mm	3	26.78	5.95	TX.A205210M
25 buc. Ø1.0 - Ø13.0 mm, increment 0.5 mm	3	53.55	11.90	TX.A205211M

Burghie elicoidale, DIN 338, tip N, HSS-G

TERRAX



Profilul canalului: normal.
Miez: normal.
Forma: N, rectificare tronconica, ascuțire normala

Burghiu elicoidal rulat, din oțel rapid.

Oțel < 900	Alama	Bronz	Materiale plastice
●	○	○	○



Ø (mm)	L (mm)	l (mm)	Ambalare (buc.)	Preț / buc.		Cod articol
				LEI	EURO	
1.0	34	12	10	0.59	0.13	TX.214010M
1.5	40	18	10	0.59	0.13	TX.214015M
2.0	49	24	10	0.63	0.14	TX.214020M
2.5	57	30	10	0.63	0.14	TX.214025M
3.0	61	33	10	0.68	0.15	TX.214030M
3.3	65	36	10	0.68	0.15	TX.214033M
3.5	70	39	10	0.68	0.15	TX.214035M
4.0	75	43	10	1.13	0.25	TX.214040M
4.2	75	43	10	1.44	0.32	TX.214042M
4.5	80	47	10	1.44	0.32	TX.214045M
5.0	86	52	10	1.71	0.38	TX.214050M
5.5	93	57	10	1.85	0.41	TX.214055M
6.0	93	57	10	2.16	0.48	TX.214060M
6.5	101	63	10	2.39	0.53	TX.214065M
6.8	109	69	10	2.88	0.64	TX.214068M
7.0	109	69	10	2.88	0.64	TX.214070M
7.5	109	69	10	3.33	0.74	TX.214075M
8.0	117	75	10	4.10	0.91	TX.214080M
8.5	117	75	10	4.41	0.98	TX.214085M
9.0	125	81	10	5.00	1.11	TX.214090M
9.5	125	81	10	5.36	1.19	TX.214095M
10.0	133	87	10	5.85	1.30	TX.214100M
10.2	133	87	10	6.35	1.41	TX.214102M
10.5	133	87	5	6.35	1.41	TX.214105M
11.0	142	94	5	7.29	1.62	TX.214110M
11.5	142	94	5	7.83	1.74	TX.214115M
12.0	151	101	5	8.78	1.95	TX.214120M
12.5	151	101	5	9.18	2.04	TX.214125M
13.0	151	101	5	10.40	2.31	TX.214130M

Seturi de burghie elicoidale, DIN 338, tip N, HSS-G	Ambalare (seturi)	Preț / set		Cod articol
		LEI	EURO	
19 buc. Ø1.0 - Ø10.0 mm, increment 0.5 mm	3	46.31	10.29	TX.A214214M
25 buc. Ø1.0 - Ø13.0 mm, increment 0.5 mm	3	93.56	20.79	TX.A214215M

Tarozii de mana, filet metric, seturi de 3 piese diferite, DIN 352 HSS-G

VÖLKEL



Aplicatii:

- materiale neabrazive pana la 900 N/mm²
- oțel nealiat si slab aliat
- pentru gauri strapunse si infundate
- pentru filetarea manuala



Filet	L (mm)	l (mm)	Ø (mm)	Ambalare (seturi)	Preț / set		Cod articol
					LEI	EURO	
M 3 x 0.50	40	11.0	3.5	10	18.27	4.06	VL.27326M
M 4 x 0.70	45	13.0	4.5	10	18.27	4.06	VL.27330M
M 5 x 0.80	50	16.0	6.0	10	19.85	4.41	VL.27334M
M 6 x 1.00	50	19.0	6.0	10	19.85	4.41	VL.27338M
M 8 x 1.25	56	22.0	6.0	10	23.40	5.20	VL.27342M
M10 x 1.50	70	24.0	7.0	10	32.13	7.14	VL.27346M
M12 x 1.75	75	29.0	9.0	5	42.08	9.35	VL.27350M
M16 x 2.00	80	32.0	12.0	5	59.54	13.23	VL.27358M
M20 x 2.50	95	40.0	16.0	5	87.30	19.40	VL.27366M
M24 x 3.00	110	50.0	18.0	5	126.99	28.22	VL.27374M

Tarozii de mana, filet metric, seturi de 3 piese diferite, DIN 352 HSS-E, Co5



3
piese

M

HSSE
Co 5

1200
N/mm²



DIN
352

ISO2
6H



filet
normal

Aplicatii:

- inalta capacitate de taiere
- materiale abrazive
- otel pana la 1200 N/mm²
- pentru gauri strapunse si infundate
- utilizare universala

Filet	L (mm)	l (mm)	Ø (mm)	Ambalare (seturi)	Preț / set		Cod articol
					LEI	EURO	
M 3 x 0.50	40	11	3.5	10	32.54	7.23	VL.57326M
M 4 x 0.70	45	13	4.5	10	33.35	7.41	VL.57330M
M 5 x 0.80	50	16	6.0	10	34.92	7.76	VL.57334M
M 6 x 1.00	50	19	6.0	10	34.92	7.76	VL.57338M
M 8 x 1.25	56	22	6.0	10	39.69	8.82	VL.57342M
M10 x 1.50	70	24	7.0	10	53.19	11.82	VL.57346M
M12 x 1.75	75	29	9.0	5	69.84	15.52	VL.57350M
M16 x 2.00	80	32	12.0	5	104.76	23.28	VL.57358M

Tarozii de masina (universali), scurți, HSS-E, filet metric, DIN 352, Co5



M

HSSE
Co 5

900
N/mm²



DIN
352

ISO2
6H



filet
normal

Aplicatii:

- materiale neabrazive pana la 900 N/mm²
- otel nealiat si slab aliat
- pentru filetarea manuala si pe masini
- pentru gauri strapunse

Filet	L (mm)	l (mm)	Ø (mm)	Ambalare (buc.)	Preț / buc.		Cod articol
					LEI	EURO	
M 3 x 0.50	40	11	3.5	10	9.54	2.12	VL.61526M
M 4 x 0.70	45	13	4.5	10	9.54	2.12	VL.61530M
M 5 x 0.80	48	16	6.0	10	9.81	2.18	VL.61534M
M 6 x 1.00	50	19	6.0	10	10.58	2.35	VL.61538M
M 8 x 1.25	56	22	6.0	10	12.42	2.76	VL.61542M
M10 x 1.50	70	24	7.0	10	15.08	3.35	VL.61546M
M12 x 1.75	75	29	9.0	5	21.69	4.82	VL.61550M
M16 x 2.00	80	32	12.0	5	35.73	7.94	VL.61558M

Tarozii de masina (universali), HSS-E, filet metric, DIN 352



M

HSSE
Co 5

900
N/mm²



ISO2
6H



filet
normal

Aplicatii:

- materiale neabrazive pana la 900 N/mm²
- otel nealiat si slab aliat
- pentru gauri strapunse
- pentru filetarea manuala si pe masini

Filet	L (mm)	l (mm)	Ø (mm)	Ambalare (buc.)	Preț / buc.		Cod articol
					LEI	EURO	
DIN 371							
M 3 x 0.50	56	11	3.5	10	14.81	3.29	VL.37526M
M 4 x 0.70	63	13	4.5	10	14.81	3.29	VL.37530M
M 5 x 0.80	70	16	6.0	10	15.89	3.53	VL.37534M
M 6 x 1.00	80	19	6.0	10	15.89	3.53	VL.37538M
M 8 x 1.25	90	22	8.0	10	19.31	4.29	VL.37542M
M10 x 1.50	100	24	10.0	10	23.81	5.29	VL.37546M
DIN 376							
M12 x 1.75	110	29	9.0	5	28.85	6.41	VL.38550M

Tarozii de masina (universali), HSS-E, filet metric, DIN 371/376



M

HSSE
Co 5

900
N/mm²



ISO2
6H



filet
normal

Aplicatii:

- materiale neabrazive pana la 900 N/mm²
- otel nealiat si slab aliat
- pentru gauri infundate
- pentru filetarea manuala si pe masini

Filet	L (mm)	l (mm)	Ø (mm)	Ambalare (buc.)	Preț / buc.		Cod articol
					LEI	EURO	
DIN 371							
M 4 x 0.70	63	7	4	10	17.73	3.94	VL.37730M
M 5 x 0.80	70	8	6	10	19.31	4.29	VL.37734M
M 6 x 1.00	80	10	6	10	19.31	4.29	VL.37738M
M 8 x 1.25	90	14	8	10	23.27	5.17	VL.37742M
M10 x 1.50	100	16	10	10	28.58	6.35	VL.37746M
DIN 376							
M12 x 1.75	110	18	9	5	34.38	7.64	VL.38750M
M16 x 2.00	110	22	12	5	50.00	11.11	VL.38758M

Tarozii de masina (universali), HSS-E, banda albastra, filet metric, DIN 371/376



M

HSSE
Co 5

1200
N/mm²



ISO2
6H



filet
normal

Aplicatii:

- otel rezistent la uzura pana la 1200 N/mm²
- otel inalt aliat aliat, otel inoxidabil cu aschie scurta
- pentru gauri strapunse
- otel aliat pentru scule
- pentru filetarea manuala si pe masini

Filet	L (mm)	l (mm)	Ø (mm)	Ambalare (buc.)	Preț / buc.		Cod articol
					LEI	EURO	
DIN 371							
M 3 x 0.50	56	11	3.5	10	23.04	5.12	VL.35426M
M 4 x 0.70	63	13	4.5	10	23.04	5.12	VL.35430M
M 5 x 0.80	70	16	6.0	10	25.16	5.59	VL.35434M
M 6 x 1.00	80	19	6.0	10	25.16	5.59	VL.35438M
M 8 x 1.25	90	22	8.0	10	29.12	6.47	VL.35442M
M10 x 1.50	100	24	10.0	10	40.23	8.94	VL.35446M
DIN 376							
M12 x 1.75	110	29	9.0	5	51.62	11.47	VL.35450M

Tarozii de masina (universali), HSS-E, banda albastra, filet metric, DIN 371/376

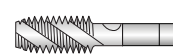
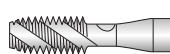

Aplicatii:

- otel rezistent la uzura pana la 1200 N/mm²
- otel inalt aliat, otel inoxidabil cu aschie scurta
- pentru gauri infundate
- otel aliat pentru scule
- pentru filetarea manuala si pe masini

Filet	L (mm)	l (mm)	Ø (mm)	Ambalare (buc.)	Preț / buc.		Cod articol
					LEI	EURO	
DIN 371							
M 4 x 0.70	63	7	4	10	27.54	6.12	VL.36430M
M 5 x 0.80	70	8	6	10	30.15	6.70	VL.36434M
M 6 x 1.00	80	10	6	10	30.15	6.70	VL.36438M
M 8 x 1.25	90	14	8	10	34.92	7.76	VL.36442M
M10 x 1.50	100	16	10	10	48.15	10.70	VL.36446M
DIN 376							
M12 x 1.75	110	18	9	5	61.92	13.76	VL.36450M

Suporți cu clichet pentru tarozii

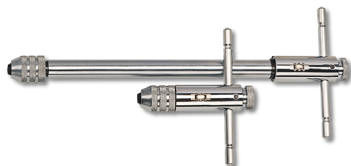

Nr.	Pentru tarozii	Ø (mm)	Ambalare (buc.)	Preț / buc.		Cod articol
				LEI	EURO	
1	M 3 - 10 BSW 1/8 - 3/8	2.4 - 5.5	10	21.15	4.70	VL.10001M
2	M 5 - 12 BSW 7/32 - 1/2	4.5 - 8.0	10	25.16	5.59	VL.10002M

Suporți pentru tarozii din Zamac, DIN 1814



Nr.	Pentru tarozii	Ø (mm)	Ambalare (buc.)	Preț / buc.		Cod articol
				LEI	EURO	
1	M1-10 BSW 1/16-3/8 G1/8	2.0 - 6.3	5	9.81	2.18	VL.13010M
1 1/2	M1-12 BSW 1/16-1/2 G1/8	2.1 - 8.0	5	9.81	2.18	VL.13015M
2	M4-12 BSW 5/32-1/2 G1/8	3.0 - 9.0	5	15.89	3.53	VL.13020M
3	M5-20 BSW 7/32-3/4 G1/8-1/2	4.9 - 12.0	5	29.88	6.64	VL.13030M

Suporți pentru tarozii din otel, DIN 1814



Nr.	Pentru tarozii	Ø (mm)	Ambalare (buc.)	Preț / buc.		Cod articol
				LEI	EURO	
1	M1-10 BSW 1/16-3/8 G1/8	2.0 - 6.3	5	15.08	3.35	VL.14010M
1 1/2	M1-12 BSW 1/16-1/2 G1/8	2.1 - 8.0	5	15.08	3.35	VL.14015M
2	M4-12 BSW 5/32-1/2 G1/8	3.0 - 9.0	5	26.73	5.94	VL.14020M
3	M5-20 BSW 7/32-3/4 G1/8-1/2	4.9 - 12.0	5	42.35	9.41	VL.14030M

Filieri forma B, filet metric ISO DIN 13, DIN 223 (DIN EN 22568)



Aplicatii

- materiale neabrazive pana la 800 N/mm²
- otel nealiat si slab aliat

Filet	D x E (mm)	Ambalare (buc.)	Preț / buc.		Cod articol
			LEI	EURO	
M 3 x 0.50	20 x 5	10	12.69	2.82	VL.27426M
M 4 x 0.70	20 x 5	10	12.69	2.82	VL.27430M
M 5 x 0.80	20 x 7	10	13.50	3.00	VL.27434M
M 6 x 1.00	20 x 7	10	13.50	3.00	VL.27438M
M 8 x 1.25	25 x 9	10	14.31	3.18	VL.27442M
M10 x 1.50	30 x 11	10	18.41	4.09	VL.27446M
M12 x 1.75	38 x 14	5	29.39	6.53	VL.27450M
M16 x 2.00	45 x 18	5	47.12	10.47	VL.27458M

Cutite de strung curbate DIN 4972 (ISO 2)



Placute din carburi metalice sudate
Recomandate pentru otel
Taiere pe dreapta

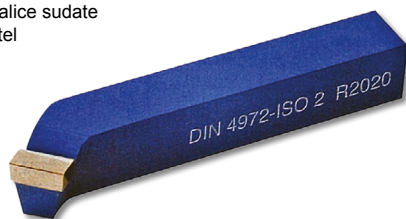

Tip carbura	Dimensiuni (mm)		Ambalare (buc.)	Preț / buc.		Cod articol
	a x b	L		LEI	EURO	
P25 / P30	16 x 16	120	5	10.37	2.30	NV.18605152M
	20 x 20	125	5	13.20	2.93	NV.18605202M
	25 x 25	140	5	20.85	4.63	NV.18605252M

Cutite de strung, dispunere laterala DIN 4980 (ISO 6)



Placute din carburi metalice sudate
Recomandate pentru otel
Taiere pe dreapta



Tip carbura	Dimensiuni (mm)		Ambalare (buc.)	Preț / buc.		Cod articol
	a x b	L		LEI	EURO	
P25 / P30	16 x 16	120	5	10.48	2.33	NV.18640152M
	20 x 20	125	5	13.08	2.91	NV.18640202M
	25 x 25	140	5	19.93	4.43	NV.18640252M

Cutite de strung DIN 4981 (ISO 7)



Placute din carburi metalice sudate
Recomandate pentru oțel
Taiere pe dreapta



Tip carbura	Dimensiuni (mm)		Ambalare (buc.)	Preț / buc.		Cod articol
	a x b	L		LEI	EURO	
P25 / P30	20 x 12	125	5	10.21	2.27	NV.18645152M
	25 x 16	140	5	14.57	3.24	NV.18645202M

Cutite de strung interioare DIN 4973 (ISO 8)



Placute din carburi metalice sudate
Recomandate pentru oțel
Taiere pe dreapta



Tipul carbunii	Dimensiuni (mm)			Ambalare (buc.)	Preț / buc.		Cod articol
	a x b	L	Ø min.		LEI	EURO	
P25 / P30	12 x 12	180	21	5	10.48	2.33	NV.18610152M
	16 x 16	210	27	5	12.81	2.85	NV.18610202M
	20 x 20	250	34	5	15.49	3.44	NV.18610252M

Mandrina cu cheie și adaptor SDS13 mm



Deschidere (mm)	Prindere	Cheie	Ambalare (buc.)	Preț / buc.		Cod articol
				LEI	EURO	
1.5-13	SDS-Plus	S2	5	18.09	4.02	BGS.9937M

Mandrina rapida



Recomandate pentru masini de gaurit cu acumulator și surubelnite electrice cu acumulator. Forța de strângere mare, fixare fara cheie.



Deschidere (mm)	Prindere	Ambalare (buc.)	Preț / buc.		Cod articol
			LEI	EURO	
2.0-13	1/2"	5	17.64	3.92	BGS.9936M

Spray vaselina



Spray transparent, fara acizi, pentru lubrifiere și protecție, pe baza de ulei vaselina. Protejeaza împotriva influențelor atmosferice și coroziei. Nu conține acizi. Rezistent la apa. Fara siliconi. Pentru aplicatii interioare și exterioare.

Exercita actiune lubrifianta pe metale și plastice și protejeaza împotriva influențelor atmosferice, acizilor slabi și bazelor și uzurii. Oferă protecție anticorozivă și împotriva apei.

Se poate utiliza la usi, ferestre, buloane, balamale, unelte de gradina, rulouri și obloane. **A nu se utiliza la frane și ambreiaje.**

Prezentare	Ambalare (buc.)	Preț / buc.		Cod articol
		LEI	EURO	
Spray 400 ml	6	17.28	3.84	SD.089242M

Multi spray 8 in 1



Spray universal de înalta calitate cu 8 acțiuni: respinge rugina, lubrifiant, curățător, elimina umiditatea, ulei degripant, previne corozia, spray de contact, spray antisoc.

Lubrifiant, curățător. Previne corozia și rugina. Elimina mizeria și grasimea. Are efect de întărire și contractare a suprafețelor (spray antisoc). Elimina umiditatea. Nu conține silicon.

Ideal pentru suruburi, piulițe, axe și osii, balamale, lanțuri; posedă calități de penetrare

Atunci când este folosit ca un curățător, după uscare rămâne pe suprafața un film protector.

Prezentare	Ambalare (buc.)	Preț / buc.		Cod articol
		LEI	EURO	
Spray 400 ml	6	14.18	3.15	SD.111929M

Spray vaselina alba



Lubrifiant de înalta calitate pe baza de săpun-lithiu alb cu teflon destinat aplicatiilor grele și pieselor în mișcare cu viteză redusă. Protejeaza contra uzurii. Rezistent la apa. Fara siliconi. Previne corozia. Pentru aplicatii interioare și exterioare.

Ideal pentru piese în mișcare, din metal sau cauciuc. Oferă un efect dublu: unul se pulverizează ca un ulei și are proprietăți de penetrare și altul se solidifică ca un gresant cu aderență (vaselina) și oferă o bună rezistență la compresiune.

Se poate utiliza la masini, rulmenți, axe, pinioane, benzi transportoare și garnituri de etansare la temp. de -20°C - +120°C.

Prezentare	Ambalare (buc.)	Preț / buc.		Cod articol
		LEI	EURO	
Spray 400 ml	6	16.11	3.58	SD.090668M

Spray curățător și degresant



Curățător și degresant cu uscare rapidă pentru toate lucrările de întreținere și montaj. Curăță grasimile. Uscare rapidă. Pentru aplicatii interioare și exterioare.

Ideal pentru curățarea și degresarea tuturor pieselor mecanice. Se poate utiliza pentru pregătirea suprafețelor înainte de aplicarea masticurilor etansante, curățarea izolațiilor pe baza MS, PU și silicon neuscați, resturilor de gudron și a grasimilor.

Folosit pe marea majoritate a suprafețelor poroase (metale, plastic, PVC etc)

Prezentare	Ambalare (buc.)	Preț / buc.		Cod articol
		LEI	EURO	
Spray 400 ml	6	12.47	2.77	SD.090682M

Spray curatator - MultiCleaner



Curatator universal care se pulverizeaza sub forma de spuma. Curata si degreseaza. Poate fi dizolvat. Nu lasa reziduri.

Elimina urmele de grasimi, nicotina, ceara, resturi de sapun si alte grasimi.

Deoarece produsul iese sub forma de spuma, nu curge, deci poate fi folosit pe suprafete verticale cum ar fi geamuri, placi ceramice, oglinzi, laminate, PVC, bucatarii, interioarele autovehiculelor, textile, tapetierii, echipamente de birou.

Prezentare	Ambalare (buc.)	Preț / buc.		Cod articol
		LEI	EURO	
Spray 400 ml	6	10.98	2.44	SD.090712M

Spray pentru curatarea franelor



Curatator cu uscare rapida pentru elementele constructive ale franelor si ambreiajelor. Curata si degreseaza. Nu raman resturi. Uscare rapida. Nu corodeaza metalele.

Elimina rapid lichidul de franainexces, resturile de ulei, grasimile etc.

Deblocheaza piesele componente ale franelor si elimina patinajul ambreiajelor

Prezentare	Ambalare (buc.)	Preț / buc.		Cod articol
		LEI	EURO	
Spray 400 ml	6	11.61	2.58	SD.135581M

Silicon universal



Silicon acetic universal de constructie pentru imbinarea si rostuirea materialelor ceramice, sticlei si a unor metale.

Caracteristici:

- Aderenta excelenta la substraturi tipic poroase: beton, caramida, lemn - si neporoase - sticla, ceramica si suprafete vitrate, multe metale.
- Nu se poate vopsi.
- Dupa intarire isi mentine culoarea si este rezistent la ultraviolete si la temperaturi cuprinse intre -60°C si +200°C.

Se poate utiliza la rosturile de legatura intre diferite materiale de constructii si finisaj in lucrari de constructii si de ateliere, etansarea incintelor frigorifice, instalatiilor de ventilare, la fabricarea containerelor etc.

Nu este recomandat pentru materiale sintetice sau metale sensibile la coroziune.

Prezentare	Culoare	Ambalare (buc.)	Preț / buc.		Cod articol
			LEI	EURO	
Tub 300 ml	incolor	15	9.95	2.21	SD.033498M
	alb	15	10.08	2.24	SD.033504M

Spray de contact



Spray de curatare si intretinere universala pentru contacte electrice. Dizolva rugina si previne coroziunea. Amelioreaza conductivitatea. Previne pierderile de tensiune. Respinge umiditatea, necoroziv.

Ideal pentru contacte electrice: intreruptoare, potentiometre, contacte culisante si glisante, reglatoare.

Dizolva murdaria si oxizii si permite un contact electric bun. Previne deranjamentele si pierderile de curent datorate umiditatii.

Ideal pentru instalatii electrice, aparate electrocasnice, papuci de cabluri, sigurante electrice, contacte electrice auto.

Prezentare	Ambalare (buc.)	Preț / buc.		Cod articol
		LEI	EURO	
Spray 400 ml	6	12.60	2.80	SD.090750M

Spray degripant



Ulei degripant cu calitati excelente antirugina. Inalta putere penetranta. Dizolva rugină. Inalt factor de protectie. Antirugina, anticorodant.

Degripant eficace pentru deblocarea pieselor ruginite si oxidate.

Datorita tensiunii superficiale scazute, uleiul penetreaza toate interstitiile, atacand rugină si permitand deblocarea pieselor gripate sau corodate.

Se poate utiliza la masini, buloane, suruburi, piulite, bride etc.

Prezentare	Ambalare (buc.)	Preț / buc.		Cod articol
		LEI	EURO	
Spray 400 ml	6	12.60	2.80	SD.111172M

Silicon sanitar



Silicon acetic sanitar de inalta calitate cu rezistenta sporita la umezeala, mucegai si ciuperci - pentru imbinarea si rostuirea materialelor ceramice, sticla si alte metale.

Caracteristici:

- Rezistenta sporita la umezeala, mucegai si ciuperci.
- Aderenta excelenta la suprafetele tipice sanitare - sticla, ceramica si suprafetele vitrate, beton, lemn si alte metale.
- Nu se poate vopsi.
- Dupa intarire isi mentine culoarea si este rezistent la UV si la temperaturi cuprinse intre -60°C si +200°C.

Se poate utiliza la rostuirea chiuvetelor, cazilor si caditelor de dus emaliate, chitirea rosturilor ale placilor ceramice la conexiunile intre perete si podea, etansarile elastice in incaperi cu umiditate ridicata.

Nu este recomandat pentru materiale sintetice sau metale sensibile la coroziune.

Prezentare	Culoare	Ambalare (buc.)	Preț / buc.		Cod articol
			LEI	EURO	
Tub 300 ml	incolor	15	10.40	2.31	SD.033443M
	alb	15	10.40	2.31	SD.033450M

Mastic acrilic



Acril universal pentru utilizari interioare.

Caracteristici:

- Durabil si rezistent la decolorare.
- Dupa intarire se poate vopsi
- Aderenta excelenta la toate suprafetele poroase utilizate in constructie: placa de ipsos si de ciment, beton, piatra, lemn, placa gips-carton etc.
- Nu contine solventi - inodor si rezista la temperaturi intre -20°C si +80°C.
- Non-coroziv pentru metale.

Se poate utiliza pentru mascarea crapaturilor si fisurilor in beton, zidarie, tencuieli, lemn etc., rostuirea placilor gips-carton in tehnologia constructiei uscate, rostuirea plintelor si tocurilor de fereastră, parapete, plafoane si cornise decorative etc.

Etansarea imbinarilor de constructie cu mobilitate redusa (de pana la 15%).

Prezentare	Culoare	Ambalare (buc.)	Preț / buc.		Cod articol
			LEI	EURO	
Tub 300 ml	alb	15	5.67	1.26	SD.033467M

Spuma poliuretanică



PU Spuma Universala de montaj cu o aderenta excelenta pentru majoritatea materialelor de constructie si cu un timp scurt de intarire. Ofera o izolare ridicata acustica si termica de etansare.

Caracteristici:

- Utilizare multipla - posibila intreruperea si innoirea lucrarii in orice moment fara risc de blocare a supapei.
- Dozare precisa - control complet asupra cantitatii spumei evacuate din tub (consum economic - la fel ca la spuma din pistol)
- Aderenta excelenta la lemn si materiale pe baza de lemn, PVC, aluminiu si alte metale (de asemenea acoperite cu strat de lac) beton, zid, tigla, suprafete vitrate etc.

Se poate utiliza pentru termoizolare, umplere si izolare fonica in constructii, etansarea si montarea ramelor de ferestre si usi de lemn, PVC si aluminiu, glafurilor, praguri, scari, conducte, instalatii.

Baza: Poliuretan

Consistenta: Spuma stabila

Sistem de uscare: Polimerizare datorita umiditatii atmosferice

Timp formare pelicula: Cca.10 minute (temp./umiditate 20°C/65% RH)

Timp de uscare: 90 min cordon 30 mm (20°C/65% RH)

Volum expandat: Cca 32 l/tub 750 ml (20°C/65% RH)

Greutate specifica: Cca 26 kg/m³

Rezistenta termica dupa uscare: Intre -40°C si +90°C, (max 1 ora + 120°C)

Clasa inflamabilitate: B3 (DIN 4102 partea 2)

Rezistenta la presiune: 3 N/cm²

Rezistenta la arcuire: 7 N/cm²

Rezistenta la forfecare: 17 N/cm²

Absorbtie apa: 1% din volum (DIN 53422)

Factor de izolare termica: 33 mW/mK (DIN 52612)

Prezentare	Ambalare (buc.)	Preț / buc.		Cod articol
		LEI	EURO	
Tub 500 ml	12	13.91	3.09	SD.033573M
Tub 750 ml	12	16.38	3.64	SD.033580M

Spuma poliuretanică (pentru pistol)



Spuma de montaj destinata tuturor lucrarilor de instalare si finisaje.

Caracteristici:

- Capacitate inalta si stabilitate dimensionala.
- Aderenta excelenta pentru lemn si materialele pe baza de lemn, PVC, aluminiu si alte metale (de asemenea straturi acoperite cu lac) beton, zid, tigla, suprafete vitrate, etc.

Se poate utiliza pentru etansarea in timpul montarii ramelor de ferestre si usi, profile colorate din PVC, montare si etansare glafuri, praguri, umplere si izolare fonica, termoizolare instalatii, izolatii termice si acustice a peretilor despartitori, a pardoseliilor, tavanelor, acoperisurilor, etc.

Baza: Poliuretan

Consistenta: Spuma stabila, tixotropica (nu curge de pe suprafetele verticale)

Sistem de uscare: Polimerizare datorita umiditatii atmosferice

Timp formare pelicula: Cca 8 minute (20°C/65% umiditate)

Timp de uscare: 20-25 min la 20°C

Timp de intarire: 1 ora la un cordon de 30 mm diametru

Volum expandat: 750 ml expandeaza 34 l de spuma intarita

Densitate: Cca 25 kg/m³ (extrudata, complet intarita)

Rezistenta termica dupa uscare: intre -40°C si +90°C

Clasa inflamabilitate: B3 (DIN 4102 partea 2)

Factor de izolare termica: 33 mW/mK (DIN 52612)

Rezistenta la forfecare: 17 N/cm² (DIN 53427)

Rezistenta la presiune: 3 N/cm² (DIN 53421)

Rezistenta la arcuire: 7 N/cm² (DIN 53423)

Absorbtie apa: 1% Vol. (DIN 53429)

Factor de izolare fonica: RST,W = 58 dB

Prezentare	Ambalare (buc.)	Preț / buc.		Cod articol
		LEI	EURO	
Tub 750 ml	12	18.14	4.03	SD.107250M

Burghie pentru beton, cuțit din carbura de tungsten, prindere SDS-Plus



Cuțit: placuta din carbura de wolfram sudata cu aliaj special

Unghi la varf: 130°

Prindere: SDS-plus

Taiere: pe dreapta



Burghie pentru rotopercutie.

Miezul durificat asigura transmiterea maxima a puterii.

Extrem de rezistente datorita calirii prin convecție fortata.

Canelurile elicoidale optimizeaza eliminarea prafului format in cursul gauririi.

Ø (mm)	L totala (mm)	L activa (mm)	Ambalare (buc.)	Preț / buc.		Cod articol
				LEI	EURO	
6.0	110	50	10	7.20	1.60	RK.211060M
6.0	160	100	10	8.24	1.83	RK.211061M
6.0	210	150	10	12.15	2.70	RK.211062M
6.0	260	200	10	15.93	3.54	RK.211063M
6.5	260	200	10	20.93	4.65	RK.211069M
8.0	110	50	10	8.46	1.88	RK.211080M
8.0	160	100	10	9.18	2.04	RK.211081M
8.0	210	150	10	11.07	2.46	RK.211082M
8.0	260	200	10	15.80	3.51	RK.211083M
10.0	160	100	10	10.67	2.37	RK.211100M
10.0	210	150	10	13.23	2.94	RK.211101M
10.0	260	200	10	16.38	3.64	RK.211102M
10.0	310	250	10	23.45	5.21	RK.211104M
12.0	210	150	10	16.52	3.67	RK.211122M
12.0	260	200	10	19.26	4.28	RK.211121M
12.0	310	250	10	28.80	6.40	RK.211124M
14.0	210	150	10	20.52	4.56	RK.211141M
14.0	260	200	10	25.02	5.56	RK.211142M
14.0	310	250	10	30.56	6.79	RK.211143M
16.0	210	150	10	29.03	6.45	RK.211160M
16.0	260	200	10	43.11	9.58	RK.211163M
16.0	310	250	10	45.54	10.12	RK.211164M

Disc pentru debitat inox/otel - XT70

RHODIUS

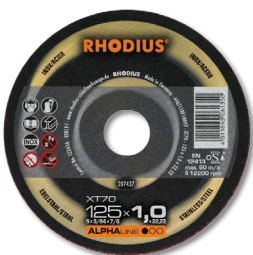

- Material:**
- Oteluri rezistente la acid si rugina
 - Oteluri calite
 - Oteluri inalt aliate
 - Oteluri de mare rezistenta
 - Piese galvanizate

- Aplicatii:**
- Tevi si profile cu pereti subtiri
 - Table din otel
 - Materiale pline
 - Platbanda

- Avantaje:**
- Putine scantei, puține bavuri
 - Viteza de taiere mare
 - Durata de viata mare
 - Degajare termica redusa

mm:
1.0 - 1.9

ALPHALINE ●○○

Durata de viata	●●●●○○
Taiere in materiale solide	●●●○○○
Taiere in materiale subtiri	●●●●●●

Ø (mm)	s (mm)	Ø (mm)	Ambalare (buc.)	Preț / buc.		Cod articol
				LEI	EURO	
115	1.0	22.23	100	3.33	0.74	RD.207436M
125	1.0	22.23	100	3.51	0.78	RD.207437M
125	1.5	22.23	100	3.60	0.80	RD.207439M
180	1.5	22.23	25	3.78	0.84	RD.208121M
230	1.9	22.23	25	5.63	1.25	RD.208122M

Disc pentru debitat otel - XT20

RHODIUS

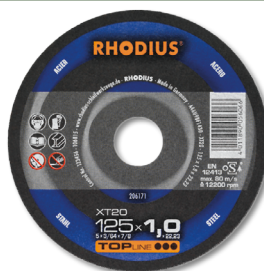

- Material:**
- Oteluri de inalta rezistenta
 - Oteluri pentru structuri
 - Oteluri de scule

- Aplicatii:**
- Tevi si profile cu pereti subtiri
 - Table din otel
 - Materiale pline
 - Platbanda

- Avantaje:**
- Putine scantei, putine bavuri
 - Viteza de taiere mare
 - Durata de viata mare
 - Degajare termica redusa
 - Degajare minima de noxe

mm:
1.0 - 1.9

TOPLINE ●●●

Durata de viata	●●●●●●
Taiere in materiale solide	●●●○○○
Taiere in materiale subtiri	●●●●●●

Ø (mm)	s (mm)	Ø (mm)	Ambalare (buc.)	Preț / buc.		Cod articol
				LEI	EURO	
115	1.0	22.23	50	6.26	1.39	RD.206170M
125	1.0	22.23	50	7.20	1.60	RD.206171M
125	1.5	22.23	50	7.25	1.61	RD.206173M
230	1.9	22.23	25	13.59	3.02	RD.206266M

Disc pentru debitat otel - XT 77

RHODIUS

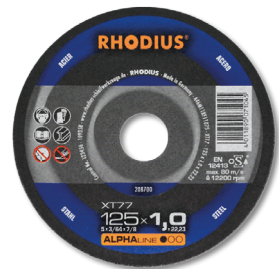

- Material:**
- Oteluri de inalta rezistenta
 - Oteluri pentru structuri
 - Oteluri de scule

- Aplicatii:**
- Profile cu pereti subtiri
 - Tevi cu pereti subtiri
 - Table din otel
 - Materiale pline
 - Platbanda

- Avantaje:**
- Putine bavuri
 - Putine scantei
 - Viteza de taiere mare
 - Durata de viata mare
 - Degajare minima de noxe

mm:
1.0 - 1.9

ALPHALINE ●○○

Durata de viata	●●●●○○
Taiere in materiale solide	●●●○○○
Taiere in materiale subtiri	●●●●●●

Ø (mm)	s (mm)	Ø (mm)	Ambalare (buc.)	Preț / buc.		Cod articol
				LEI	EURO	
115	1.5	22.23	100	2.48	0.55	RD.208699M
125	1.0	22.23	100	2.57	0.57	RD.208700M
125	1.5	22.23	100	2.61	0.58	RD.208701M
180	1.5	22.23	25	3.78	0.84	RD.208702M
230	1.9	22.23	25	5.40	1.20	RD.208703M

Disc pentru debitat otel - FT 33

RHODIUS

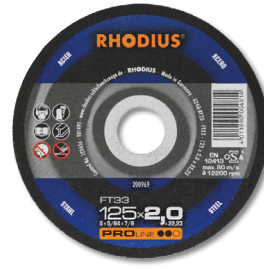

- Material:**
- Oteluri pentru structuri
 - Table de inalta rezistenta
 - Otel de scule
 - Fier beton

- Aplicatii:**
- Tevi si profile
 - Table din otel
 - Platbanda
 - Tabla din otel pentru constructii
 - Materiale pline

- Avantaje:**
- Viteza de taiere mare
 - Durata de viata mare
 - Taiere usoara
 - Comportament de taiere foarte bun
 - Eficienta

mm:
2.0 - 3.0

PROLINE ●●●

Durata de viata	●●●●○○
Taiere in materiale solide	●●●○○○
Taiere in materiale subtiri	●●●●●●

Ø (mm)	s (mm)	Ø (mm)	Ambalare (buc.)	Preț / buc.		Cod articol
				LEI	EURO	
125	2.0	22.23	25	3.65	0.81	RD.200969M
230	2.0	22.23	25	7.83	1.74	RD.200979M

Disc pentru polizat otel - RS67

RHODIUS

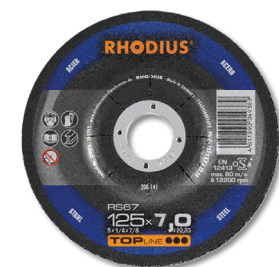

- Material:**
- Oteluri calite
 - Oteluri inalt aliate
 - Oteluri pentru structuri
 - Oteluri pentru scule

- Aplicatii:**
- Prelucrarea cordoanelor de sudura
 - Polizarea muchilor si suprafetelor
 - Indepartarea bavurilor
 - Nivelare

- Avantaje:**
- Durata de viata mare
 - Viteza mare de polizare
 - Eficienta
 - Polizare performanta

mm:
7.0

TOPLINE ●●●

Durata de viata	●●●●●●
Viteza de polizare	●●●●●●
Duritate	●●●●●●

Ø (mm)	s (mm)	Ø (mm)	Ambalare (buc.)	Preț / buc.		Cod articol
				LEI	EURO	
125	6.0	22.23	25	6.66	1.48	RD.200141M

Disc abraziv pt. finisare inox/otel/lemn - Jumbo Speed



- Material:**
- Oteluri rezistente la acid si rugina
 - Tabla de inalta rezistenta
 - Oteluri pentru structuri
 - Oteluri pentru scule
 - Piese galvanizate

- Aplicatii:**
- Polizarea suprafetelor si a muchiilor
 - Indepartarea bavurilor, ruginii
 - Polizarea pieselor forjate
 - Prelucrarea cordoanelor de sudura
 - Indepartarea asperitatilor

- Avantaje:**
- Segmente abrazive extralungi
 - Durata de viata mare
 - Viteza foarte mare de polizare
 - Nivel redus de vibratii si zgomot
 - Polizare performanta si agresiva

40/60/80

Abraziv: zircona.

TOPLINE

Durata de viata
Viteza de polizare

Ø (mm)	ø (mm)	[Diagram]	Ambalare (buc.)	Preț / buc.		Cod articol
				LEI	EURO	
125	22.23	40	10	10.62	2.36	RD.208746M
125	22.23	60	10	10.62	2.36	RD.208747M
125	22.23	80	10	10.62	2.36	RD.208748M

Disc abraziv pentru finisare inox/otel/lemn - LSZ F



- Material:**
- Oteluri rezistente la acid si rugina
 - Tabla de inalta rezistenta
 - Oteluri pentru structuri
 - Oteluri pentru scule
 - Metale neferoase
 - Lemn, lac, umplutura, fibra de sticla

- Aplicatii:**
- Polizarea suprafetelor si a muchiilor
 - Nivelare
 - Indepartarea bavurilor
 - Indepartarea ruginii, curatare
 - Prelucrarea cordoanelor de sudura

- Avantaje:**
- Viteza foarte mare de polizare
 - Degajare termica redusa
 - Nivel redus de vibratii si zgomot
 - Polizare performanta

40/60/80

Abraziv: zircona.

TOPLINE

Durata de viata
Viteza de polizare

Ø (mm)	ø (mm)	[Diagram]	Ambalare (buc.)	Preț / buc.		Cod articol
				LEI	EURO	
125	22.23	40	10	13.82	3.07	RD.205508M
125	22.23	60	10	13.82	3.07	RD.205509M
125	22.23	80	10	13.82	3.07	RD.205510M

Perii disc pentru otel - SRBZ



- Material:**
- Oteluri de scule
 - Otel pentru constructii
 - Tabla lacuita

- Aplicatii:**
- Debavurare
 - Inlaturarea ruginii, lacurilor, zgurii
 - Detartrare
 - Curatare

- Avantaje:**
- Pentru utilizare in conditii extreme
 - Utilizare la viteze periferice foarte mari
 - Operare extrem de agresiva

Perii disc din sarma rasucita

mm: 0.50

TOPLINE

Ø x E x s x ø	Grosime sarma (mm)	Turatie max. (rpm)	Ambalare (buc.)	Preț / buc.		Cod articol
				LEI	EURO	
125 x 13 x 28 x 22.23	0.50	12 500	10	26.96	5.99	RD.353078M

Perii disc cu tija pentru otel - SRBWBM



- Material:**
- Otel de scule
 - Otel pentru constructii
 - Tabla lacuita

- Aplicatii:**
- Debavurare
 - Degrosare
 - Inlaturarea lacurilor
 - Detartrare
 - Matuire
 - Curatare

- Avantaje:**
- Diametru mic pentru locuri greu accesibile si suprafete interioare
 - Sarma de perie flexibila
 - Densitate mare a sarmei

Perie disc cu tija, din sarma rasucita

mm: 0.30

TOPLINE

Ø (mm)	E (mm)	s (mm)	ø (mm)	Ambalare (buc.)	Preț / buc.		Cod articol
					LEI	EURO	
50	7	10	6.0	20	3.87	0.86	RD.353027M
75	10	16	6.0	10	6.48	1.44	RD.353028M
100	12	22	6.0	10	7.70	1.71	RD.353029M

Perii cupa pentru otel - STBW



- Material:**
- Otel de scule
 - Otel pentru constructii
 - Tabla lacuita

- Aplicatii:**
- Debavurare
 - Degrosare
 - Inlaturarea lacurilor
 - Detartrare
 - Matuire
 - Curatare

- Avantaje:**
- Sarma de perie flexibila

Perie conica din sarma rasucita

mm: 0.30

PROLINE

Ø (mm)	E (mm)	G (mm)	Ambalare (buc.)	Preț / buc.		Cod articol
				LEI	EURO	
65	21	M14 x 2.0	9	8.82	1.96	RD.353088M
100	30	M14 x 2.0	10	18.99	4.22	RD.353018M

Perii cupa pentru otel - STBZ



- Material:**
- Otel de scule
 - Otel pentru constructii
 - Tabla lacuita

- Aplicatii:**
- Debavurare
 - Inlaturarea ruginii si a lacurilor
 - Inlaturarea zgurii
 - Detartrare
 - Curatare

- Avantaje:**
- Rezulte foarte bune in lucrari dificile de curatare
 - Operare agresiva
 - Inel suport care evita deteriorarea si rarirea manunchiurilor de sarma

Perii cupa din sarma rasucita

mm: 0.35 - 0.50

PROLINE

Ø (mm)	E (mm)	(G) (mm)	Ambalare (buc.)	Preț / buc.		Cod articol
				LEI	EURO	
65	20	M14 x 2.0	10	12.42	2.76	RD.353085M
75	20	M14 x 2.0	15	27.23	6.05	RD.353010M
100	20	M14 x 2.0	10	33.08	7.35	RD.353012M

Perie conica pentru otel - SKBW

RHODIUS

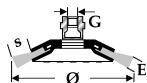

Material:

- Otel
- Otel de scule
- Otel pentru constructii
- Tabla lacuita

Aplicatii:

- Debavurare
- Degrosare
- Inlaturarea lacurilor
- Detartrare
- Matuire
- Curatare

Avantaje:

- Diametru mic pentru locuri greu accesibile si suprafete interioare
- Utilizari diverse

Perie conice din sarma ondulata



mm:
0.30

PROLINE ●●●

Ø (mm)	E (mm)	s (mm)	G (mm)	Ambalare (buc.)	Preț / buc.		Cod articol
					LEI	EURO	
100	10	20	M14 x 2.0	10	10.98	2.44	RD.353094M

Perii cupa cu tija pentru otel - STBZ

RHODIUS



Material:

- Otel de scule
- Otel pentru constructii
- Tabla lacuita

Aplicatii:

- Debavurare
- Inlaturarea ruginii, lacurilor si zgurii

Avantaje:

- Pentru lucru in locuri greu accesibile

Perii pensula din sarma ondulata



mm:
0.30

TOPLINE ●●●



Ø (mm)	E (mm)	Ø (mm)	Ø sarma (mm)	Turatie max. (rpm)	Ambalare (buc.)	Preț / buc.		Cod articol
						LEI	EURO	
17	25	6.0	0.30	4 500	12	3.92	0.87	RD.353032M
25	25	6.0	0.30	4 500	12	4.10	0.91	RD.353033M
30	25	6.0	0.30	4 500	12	4.50	1.00	RD.353034M

Perii manuale pentru otel / inox - UHBW

RHODIUS



Material:

- Oteluri ruginite sau corodate cu acizi
- Otel de scule
- Otel pentru constructii
- Tabla lacuita

Aplicatii:

- Inlaturarea ruginii
- Inlaturarea lacurilor
- Curatare

Avantaje:

- Se poate utiliza in spatii inchise
- Utilizare universala
- Maner confortabil

Perii manuale din sarma ondulata

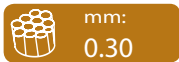

mm:
0.30

PROLINE ●●●

Pentru material	Grosimea sarmei (mm)	Ambalare (buc.)	Preț / buc.		Cod articol
			LEI	EURO	
inox	0.30	24	9.00	2.00	RD.353060M
otel	0.30	24	7.52	1.67	RD.353059M

Perii manuale pentru otel - SHGB

RHODIUS



Material:

- Otel de scule
- Otel pentru constructii
- Tabla lacuita

Aplicatii:

- Inlaturarea ruginii
- Inlaturarea lacurilor
- Curatare

Avantaje:

- Utilizare flexibila.
- Perie agresiva din sarma dreapta

Perii manuale cu sarma dreapta din otel



mm:
0.35

TOPLINE ●●●

Numar de randuri	Grosimea sarmei (mm)	Ambalare (buc.)	Preț / buc.		Cod articol
			LEI	EURO	
4	0.35	12	3.60	0.80	RD.353057M
5	0.35	12	4.10	0.91	RD.353058M

Abrazive pe suport pentru otel - KFS

RHODIUS

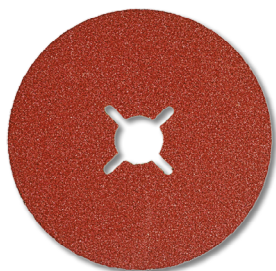

Material:

- Oteluri pentru constructii
- Oteluri pentru scule
- Fibra de sticla

Aplicatii:

- Netezire
- Degrosare
- Inlaturarea ruginii

Avantaje:

- Viteza mare de polizare
- Prelucrare rece
- Emisie reduca de mirosuri neplacute

Discuri abrazive pe suport de fibra vulcanizata
Abraziv: corindon (NK)

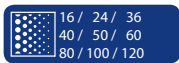

16 / 24 / 36
40 / 50 / 60
80 / 100 / 120

TOPLINE ●●●

Ø x Ø (mm)	Granulatie	Ambalare (buc.)	Preț / buc.		Cod articol
			LEI	EURO	
125 x 22.23	40	25	1.13	0.25	RD.300060M
	60	25	0.99	0.22	RD.300062M
	80	25	0.90	0.20	RD.300063M
	100	25	0.90	0.20	RD.300064M
	120	25	0.90	0.20	RD.300065M

Abrazive pe suport pentru metal / lemn - KERR Velcro

RHODIUS



Discuri abrazive pe suport din panza cu arici

Abraziv: corindon (NK)



40 / 60 / 80
100 / 120

Ø (mm)	Granulatie	Ambalare (buc.)	Preț / buc.		Cod articol
			LEI	EURO	
125	40	50	1.49	0.33	RD.304138M
	60	50	1.35	0.30	RD.304139M
	80	50	1.35	0.30	RD.304140M
	120	50	1.31	0.29	RD.304142M
150	40	50	1.89	0.42	RD.304143M
	60	50	1.76	0.39	RD.304144M
	80	50	1.62	0.36	RD.304145M

Pile cu maner din plastic



L (mm)	Sectiune (mm)	Finete (mm)	Ambalare (buc.)	Preț / buc.		Cod articol
				LEI	EURO	
Pila lata						
200	20.0 x 5.0	2	10	12.78	2.84	CR.SB11002002M
Pila semirotonda						
200	20.7 x 5.9	2	10	17.64	3.92	CR.SB12012002M

Seturi de pile



Finete 2

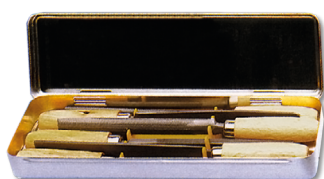

Prezentare	Profil	L (mm)	Ambalare (seturi)	Preț / set.		Cod articol
				LEI	EURO	
Set de 6 pile cu maner de lemn, in cutie din carton		100	5	32.94	7.32	CR.1001M
Set de 6 pile cu maner de lemn, in cutie din metal		100	5	33.30	7.40	CR.1002M

Panze pentru fierastrai manuala



Dimensiuni (mm)	Dinti / inch	Ambalare (buc.)	Preț / buc.		Cod articol
			LEI	EURO	
300 x 13 x 0.65	24	10	3.65	0.81	RK.2130024M



Dimensiuni (mm)	Dinti / inch	Ambalare (buc.)	Preț / buc.		Cod articol
			LEI	EURO	
300 x 13 x 0.65	24	10	3.29	0.73	RK.8130024M

Panza cu dantura dubla pt. fierastrau de mana



Dimensiuni (mm)	Dinti / inch	Ambalare (buc.)	Preț / buc.		Cod articol
			LEI	EURO	
300 x 25 x 0.80	24	50	2.75	0.61	NW.814081M

Panze pentru fierastrai electrice - SET DE 5 BUCĂȚI



Material	DENUMIRE material, dantura	L (mm)	Ambalare (seturi)	APLICATII	Preț / set		Cod articol	
					LEI	EURO		
Otel, Fier	PFL							
Tabla de otel	Cofraj							
Inox	Profile							
Aluminiu	Taiere pe contur							
Plastic	Taiere curata							
Stratificate	Taiere dreapta							
Lemn	Taiere rapida							
	RUKO 8001	100	5	otel de scule, dantura rectificata	7.9	1.45	2.5 10 TPI	3218001 10 18.77 4.17 RK.3218001M
	RUKO 8002	100	5	otel de scule, dantura rectificata	7.9	1.70	4.0 6 TPI	3218002 10 18.77 4.17 RK.3218002M
	RUKO 8006	100	5	otel de scule, dantura alternanta	7.5	1.3	4.0 6 TPI	3218006 10 13.05 2.90 RK.3218006M
	RUKO 8007	100	5	otel de scule, dantura rectificata	7.9	1.45	4.0 6 TPI	3218007 10 16.02 3.56 RK.3218007M
	RUKO 8009	77	5	otel HSS, dantura ondulata	7.1	1.00	1.2 21 TPI	3218009 10 18.77 4.17 RK.3218009M
	RUKO 8024	132	5	otel de scule, danturarectificata	9.5	1.45	4.0 6 TPI	3218024 10 21.15 4.70 RK.3218024M

Subler standard - otel cementat si calit

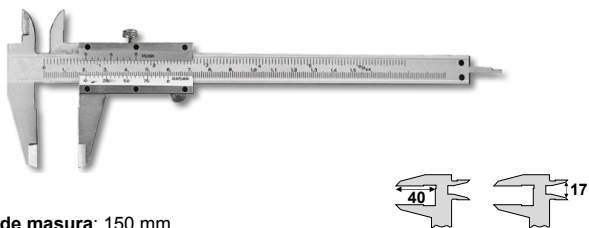

Domeniu de masura: 150 mm

Vernier		Fixare	Ambalare (buc.)	Preț / buc.		Cod articol
inferior (mm)	superior (inch)			LEI	EURO	
1/20 - 39	1/128	declic	5	45.36	10.08	MB.01002006M
1/20 - 39	1/128	surub	5	45.36	10.08	MB.01002007M

Creion de trasat cu varf din carbura metalica



Varf din carbura metalica; corp nichelat cu agațatoare; lungime 160 mm.

Lungime (mm)	Varf (mm)	Ambalare (buc.)	Preț / buc.		Cod articol
			LEI	EURO	
160	20	20	7.65	1.70	MB.04055015M

Subler standard - DIN 862 - otel inoxidabil cementat si calit

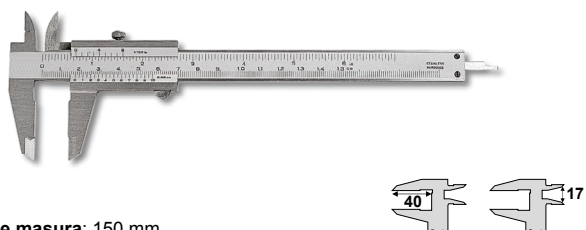

Domeniu de masura: 150 mm

Vernier		Fixare	Ambalare (buc.)	Preț / buc.		Cod articol
inferior (mm)	superior (inch)			LEI	EURO	
1/20 - 39	1/128	declic	5	66.65	14.81	MB.01001001M



Lere pentru filete cu 52 de lame - G84



Pentru masurari interioare si exterioare.

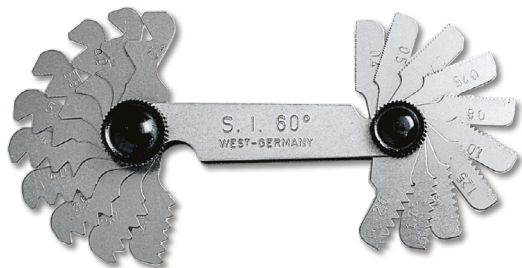

Tip Filet	Componenta			Ambalare (buc.)	Preț / buc.		Cod articol
	Nr. de lame	Interval (mm)	Pas (mm)		LEI	EURO	
Whitworth 55° (28 lame)	3	4.00 - 5.00	0.50	5	17.01	3.78	MB.08081005M
	8	6.00 - 13.00	1.00				
	3	14.00 - 18.00	2.00				
	1	19.00	-				
	3	20.00 - 24.00	2.00				
	1	25.00	-				
	3	26.00 - 30.00	2.00				
	3	32.00 - 40.00	4.00				
	3	48.00 - 62.00	2.00				
	Metric 60° (24 lame)	5	0.25 - 0.45				
3		0.50 - 0.70	0.10				
1		0.75	-				
3		0.80 - 1.00	0.10				
4		1.25 - 2.00	0.25				
8		2.50 - 6.00	0.50				

Ruleta „two COMP”



Ruleta cu mecanism robust, rezistenta la impact.



Lungime (mm)	Latime banda (mm)	Ambalare (buc.)	Preț / buc.		Cod articol
			LEI	EURO	
3.0	16	12	16.92	3.76	BM.472341M
5.0	19	12	24.80	5.51	BM.472541M
8.0	25	12	36.95	8.21	BM.472841M

Nivele „Eurostar”



Modele de calitate superioara cu doua bule de nivel - verticala si orizontala, cu efect de lentila.

Marcajul cu laser pe bulele de nivel asigura o precizie de 0.5 mm/m.

Panta de 2% marcata pe bula orizontala.

Marcaje aditionale, pentru precizie, pe toate bulele de nivel.



Lungime L (mm)	Ambalare (buc.)	Preț / buc.		Cod articol
		LEI	EURO	
60	5	50.90	11.31	BM.690060EM
80	5	57.87	12.86	BM.690080EM
100	5	63.90	14.20	BM.690100EM

Seturi de surubelnite profesionale - lama cu profil circular - seria 400



Profi



Profi VDE

Nr. de piese	Componenta	Ambalare (buc.)	Preț / buc.		Cod articol
			LEI	EURO	
Profi					
7	200	3	78.71	17.49	FE.20097398M
	201				
	202				
Profi VDE					
6	613	3	60.21	13.38	FE.61396298M
	614				
	Tester VDE 0680 / 6, 220 - 250 V				

Surubelnita cu locas HEX 1/4" pentru bits

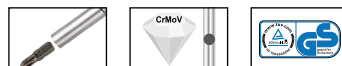

Model		Ambalare (buc.)	Preț / buc.		Cod articol
			LEI	EURO	
Frico	1/4"	6	27.41	6.09	FE.53812540M

Surubelnite Profesional - lama cu profil circular



Tip x dimensiuni (mm)	L lama (mm)	Dim. lama (mm)	Ambalare (buc.)	Preț / buc.		Cod articol
				LEI	EURO	
Slot 3.0 x 0.5	80	3.00	12	6.98	1.55	FE.20003290M
Slot 4.0 x 0.8	100	4.00	12	8.37	1.86	FE.20004390M
Slot 5.0 x 0.8	125	5.00	12	9.32	2.07	FE.20005490M
Ph 1	80	3.50	12	9.09	2.02	FE.20210290M
Ph 2	100	6.00	12	13.41	2.98	FE.20220390M
Pz 1	80	4.50	12	9.09	2.02	FE.20110290M
Pz 2	100	6.00	12	13.41	2.98	FE.20120390M

Set de surubelnite vinclu Inbus, cu cap sferic - 9 piese



Componenta	Ambalare (seturi)	Preț / set		Cod articol
		LEI	EURO	
SW 1.5 / SW 2 / SW 2.5 SW 3 / SW 4 / SW 5 SW 6 / SW 8 / SW 10	6	40.91	9.09	FE.35500901M

Surubelnite tester 220 - 250 V



Tip x dimensiuni (mm)	Lungime lama (mm)	Ambalare (buc.)	Preț / buc.		Cod articol
			LEI	EURO	
Slot 3.0 x 0.8	65	12	5.09	1.13	FE.36130000M

Set de 9 surubelnite vinclu inbus, extralungi, cromate

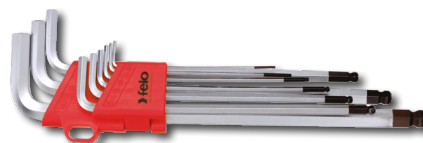

Set	Componenta	Ambalare (seturi)	Preț / set		Cod articol
			LEI	EURO	
BLX9 (metric)	SW 1.5 / SW 2 / SW 2.5 SW 3 / SW 4 / SW 5 SW 6 / SW 8 / SW 10	6	66.20	14.71	FE.36500901M

Set de 8 surubelnite vinclu Torx



Set	Componenta	Ambalare (seturi)	Preț / set		Cod articol
			LEI	EURO	
LTX 8 (cap sferic)	T 9 / T 10 / T 15 / T 20 T 25 / T 27 / T 30 / T 40	6	116.19	25.82	FE.34808001M

Set de surubelnite vinclu Inbus, scurte - 6 piese



Componenta	Ambalare (seturi)	Preț / set		Cod articol
		LEI	EURO	
SW 1.5 / SW 2 / SW 2.5 SW 3 / SW 4 / SW 5	12	15.62	3.47	FE.34500601M

Bits de Impact - forma C, lungime 25 mm **felo**

	Tip	Ambalare (buc.)	Preț / buc.		Cod articol
			LEI	EURO	
Pozidriv 	Pz 1	5	6.89	1.53	FE.02101040M
	Pz 2	5	6.89	1.53	FE.02102040M
	Pz 3	5	7.11	1.58	FE.02103040M
Phillips 	Ph 1	5	6.89	1.53	FE.02201040M
	Ph 2	5	6.89	1.53	FE.02202040M
	Ph 3	5	7.11	1.58	FE.02203040M
Torx 	T 20	5	8.19	1.82	FE.02622040M
	T 25	5	8.19	1.82	FE.02625040M
	T 30	5	8.64	1.92	FE.02630040M



Bits de Torsiune - forma C, lungime 25 mm **felo**

	Tip	Ambalare (buc.)	Preț / buc.		Cod articol
			LEI	EURO	
Pozidriv 	Pz 1	5	2.34	0.52	FE.02101000M
	Pz 2	5	2.34	0.52	FE.02102000M
	Pz 3	5	2.57	0.57	FE.02103000M
Phillips 	Ph 1	5	2.34	0.52	FE.02201000M
	Ph 2	5	2.34	0.52	FE.02202000M
	Ph 3	5	2.57	0.57	FE.02203000M
Torx 	T 20	5	4.28	0.95	FE.02620000M
	T 25	5	4.28	0.95	FE.02625000M
	T 30	5	4.55	1.01	FE.02630000M

Bits TiN forma C, lungime 25 mm **felo**

	Tip	Ambalare (buc.)	Preț / buc.		Cod articol
			LEI	EURO	
Pozidriv 	Pz 1	10	2.03	0.45	FE.02101070M
	Pz 2	10	2.03	0.45	FE.02102070M
	Pz 3	10	2.03	0.45	FE.02103070M
Phillips 	Ph 1	10	2.03	0.45	FE.02201070M
	Ph 2	10	2.03	0.45	FE.02202070M
	Ph 3	10	2.03	0.45	FE.02203070M
Torx 	T 20	10	4.19	0.93	FE.02620070M
	T 25	10	4.19	0.93	FE.02625070M
	T 30	10	4.19	0.93	FE.02630070M

Bits Industrial forma C, lungime 25 mm **felo**

	Tip	Ambalare (buc.)	Preț / buc.		Cod articol
			LEI	EURO	
Pozidriv 	Pz 1	100	0.80	0.18	FE.02101010M
	Pz 2	100	0.80	0.18	FE.02102010M
	Pz 3	100	0.80	0.18	FE.02103010M
Phillips 	Ph 1	100	0.80	0.18	FE.02201010M
	Ph 2	100	0.81	0.18	FE.02202010M
	Ph 3	100	0.80	0.18	FE.02203010M
Torx 	T 10	100	2.61	0.58	FE.02610010M
	T 20	100	1.98	0.44	FE.02620010M
	T 25	100	1.98	0.44	FE.02625010M
	T 30	10	1.94	0.43	FE.02630010M
	T 40	10	1.94	0.43	FE.02640010M
Inbus 	SW 3	10	2.03	0.45	FE.02430010M
	SW 4	10	2.03	0.45	FE.02440010M
	SW 5	10	2.34	0.52	FE.02450010M

Comanda bits si accesorii in valoare de minim **200€** (fara TVA) si iti oferim gratuit display-ul pentru bits.



Display pentru bits -exemplu de utilizare-

Bits TiN forma E, lungime 50 mm **felo**



Tip	Ambalare (buc.)	Preț / buc.		Cod articol
		LEI	EURO	
Pz2	10	7.07	1.57	FE.03102570M
Ph1	10	6.80	1.51	FE.03201570M
Ph2	10	6.80	1.51	FE.03202570M

Bits Industrial forma E, lungime 50 mm **felo**



Tip	Ambalare (buc.)	Preț / buc.		Cod articol
		LEI	EURO	
Pz 1	10	4.05	0.90	FE.03101510M
Pz 2	10	3.83	0.85	FE.03102510M
Ph 1	10	3.42	0.76	FE.03201510M
Ph 2	10	3.42	0.76	FE.03202510M
T 20	10	5.36	1.19	FE.03620510M
T 25	10	5.36	1.19	FE.03625510M
T 30	10	5.36	1.19	FE.03630510M

Bits tubulari magnetici, lungime 66 mm **felo**

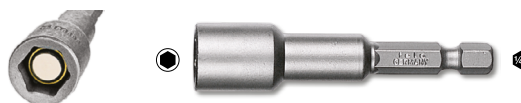

Dimensiune (mm)	Ambalare (buc.)	Preț / buc.		Cod articol
		LEI	EURO	
8.0	5	5.99	1.33	FE.03908010M
10.0	5	7.29	1.62	FE.03910010M
13.0	5	10.62	2.36	FE.03913010M

Cap magnetic standard **felo**



Lungime (mm)	Ambalare (buc.)	Preț / buc.		Cod articol
		LEI	EURO	
58	6	5.18	1.15	FE.03810390M

Cap magnetic cu magnet extraputernic **felo**



Lungime (mm)	Ambalare (buc.)	Preț / buc.		Cod articol
		LEI	EURO	
47	6	11.66	2.59	FE.03810990M

Cap magnetic standard cu inel de retinere **felo**



Lungime (mm)	Ambalare (buc.)	Preț / buc.		Cod articol
		LEI	EURO	
74	6	14.00	3.11	FE.03810290M
150	6	36.86	8.19	FE.03810790M

Clești combinați



- Cu zone de prindere pentru materiale plate și rotunjite pentru uz versatil.
- Cu margini de tăiere pentru sarma cu duritate variabila.

- Cu muchii lungi de tăiere pentru cabluri groase.
- Muchiile taietoare tratate suplimentar prin inducție ajung la o duritate de tăiere de 60HRC.
- Oțel special, forjat, tratat în ulei.
- DIN ISO 5746.



Descriere	mm	Taiere				Ambalare (buc.)	Preț / buc.		Cod articol
		Ø mm	Ø mm	Ø mm	mm²		LEI	EURO	
Clește cu strat protector negru lustruit și manere cu manson din plastic	180	3.4	2.2	12	16	6	43.02	9.56	KN.0301180M
Clește cu strat protector negru lustruit și manere cu manson bicomponent	180	3.4	2.2	12	16	6	53.60	11.91	KN.0302180M

Set de clești pentru inele de siguranță



Nr. de piese	Tipul	Dimensiune Ø (mm)		Ø (mm)	Ambalare (seturi)	Preț / set		Cod articol	
						LEI	EURO		
4		interior	19 - 60	-	1.8	2	223.52	49.67	KN.001956M
		exterior	-	19 - 60					
	$\angle 90^\circ$	interior	19 - 60	-					
	$\angle 90^\circ$	exterior	-	19 - 60					

Clește Alligator



- Mai multa putere și confort în comparație cu cleștii convenționali de aceeași dimensiune: 9 trepte de reglare pentru 30% mai multa capacitate de prindere.
- Acces bun la piesa de lucru datorită design-ului subțire al capului și al zonei de articulatie.

- Autoblocare pe țevi sau piulițe: fara alunecare pe piesa și forța de strângere necesara mica.
- Falcile sunt prevazute cu zimți ce au o duritate de 61HRC (uzura scazuta și o buna stabilitate în prindere).
- Oțel crom-vanadium, forjat, tratat în ulei.
- DIN ISO 8976.



Descriere	mm	(Ø inch)	(Ø mm)	(mm)	Nr. de pozitii	Ambalare (buc.)	Preț / buc.		Cod articol
							LEI	EURO	
Clește cu strat protector negru lustruit și manere cu manșon din plastic anti-alunecare	250	2	50	46	9	6	63.45	14.10	KN.8801250M

Clești Cobra



- Buton pentru ajustarea deschiderii falcilor (direct pe piesa de lucru).
- Reglaj fin pentru adaptarea optima la diferite dimensiuni.

- Autoblocare pe piesa de lucru ce nu permite alunecarea. Nu este necesara o forța minima de strângere.
- Falcile sunt prevazute cu zimți ce au o duritate de 61HRC (uzura scazuta și o buna stabilitate în prindere).
- Oțel vanadium, forjat și tratat în ulei.



Descriere	mm	(Ø inch)	(Ø mm)	(mm)	Nr. de pozitii	Ambalare (buc.)	Preț / buc.		Cod articol
							LEI	EURO	
Clește cu strat protector gri lustruit și manere din plastic anti-alunecare	250	2	50	46	25	6	83.52	18.56	KN.8701250M

Clești menghina



- Utilizati pentru strângerea și fixarea materiale rotunde și plate.
- Prevazut cu surub de reglare și parghie pentru eliberare rapida.

- Pot fi utilizati cu o singura mana.
- Oțel special pentru scule, forjat și tratat în ulei, cu falci din crom-vanadium.



Descriere	mm	(Ø mm)	(Ø mm)	(Ø mm)	Ambalare (buc.)	Preț / buc.		Cod articol
						LEI	EURO	
Clește menghina, cu doua falci semi-rotunde	250	40	20	30	3	62.78	13.95	KN.4104250M

Cleste manual pentru pop-nituri, BM-45



- Pentru lucru in interior si in exterior.
- Design special pentru acces in locuri inguste.
- Corp din aluminiu turnat.
- Parghie de actionare din otel calit.
- Inel de inchidere a bratelor.
- Magazie pentru bucsa de actionare.

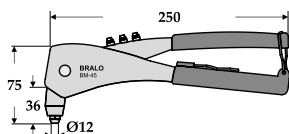

Material pop-nit	Domeniu de utilizare (mm)
Aluminiu	2.4 / 3.0 / 3.2 / 4.0 / 4.8 / 5.0
Otel	3.0 / 3.2 / 4.0
Inox	2.4 / 3.0 / 3.2 / 4.0
Cupru	3.0 / 3.2 / 4.0

Cursa (mm)	Greutate (g)	Ambalare (buc.)	Preț / buc.		Cod articol
			LEI	EURO	
5	530	5	46.13	10.25	BR.BM-45M

Cleste manual pentru pop-nituri, BM-85



- Pentru lucru in interior si in exterior.
- Design special pentru acces in locuri inguste.
- Corp din aluminiu turnat.
- Parghie de actionare din otel calit.
- Sistem cu parghie intermediara pentru reducerea fortei de actionare si atenuarea socurilor.
- Magazie pentru bucsa de actionare.

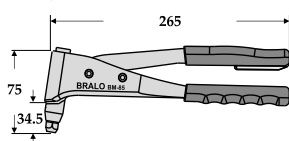

Material pop-nit	Domeniu de utilizare (mm)
Aluminiu	2.4 / 3.0 / 3.2 / 4.0 / 4.8 / 5.0
Otel	3.0 / 3.2 / 4.0
Inox	2.4 / 3.0 / 3.2 / 4.0
Cupru	3.0 / 3.2 / 4.0

Cursa (mm)	Greutate (g)	Ambalare (buc.)	Preț / buc.		Cod articol
			LEI	EURO	
6	670	3	92.21	20.49	BR.BM-85M

Chei fixe duble, DIN 3110



Executie: otel crom-vanadiu
Acoperire: cromate



Ø (mm)	Ambalare (buc.)	Preț / buc.		Cod articol
		LEI	EURO	
10 x 11	10	3.92	0.87	BGS.118410X11M
12 x 13	10	4.41	0.98	BGS.118412X13M
16 x 17	5	5.63	1.25	BGS.118416X17M
18 x 19	5	6.35	1.41	BGS.118418X19M
20 x 22	5	7.34	1.63	BGS.118420X22M
24 x 27	5	16.16	3.59	BGS.118424X27M
30 x 32	5	17.64	3.92	BGS.118430X32M

Chei combinate, DIN 3113 A



Executie: otel Crom Vanadiu
Acoperire: cromate



Marime (mm)	Ambalare (buc.)	Preț / buc.		Cod articol
		LEI	EURO	
8	10	2.70	0.60	BGS.1058M
10	10	3.20	0.71	BGS.1060M
13	10	3.92	0.87	BGS.1063M
15	5	4.64	1.03	BGS.1065M
17	5	4.64	1.03	BGS.1067M
19	5	5.90	1.31	BGS.1069M
22	5	8.55	1.90	BGS.1072M

Seturi de chei fixe duble, DIN 3110



Executie: otel Crom Vanadiu
Acoperire: cromate

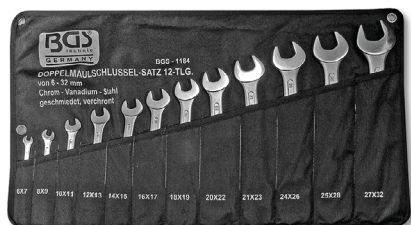

Nr. de piese	Dimensiuni (mm)	Ambalare (seturi)	Preț / set		Cod articol
			LEI	EURO	
12	6 x 7 / 8 x 9 / 10 x 11 / 12 x 13 / 14 x 15 / 16 x 17 / 18 x 19 / 20 x 22 / 21 x 23 / 24 x 27 / 25 x 28 / 30 x 32	5	92.03	20.45	BGS.1184M

Seturi de chei combinate



Executie: otel Crom Vanadiu
Acoperire: cromate



Nr. de piese	Lungime (mm)	Ambalare (seturi)	Preț / set		Cod articol
			LEI	EURO	
12	6, 7, 8, 9, 10, 11, 12, 13, 14, 17, 19, 22	5	38.93	8.65	BGS.1197M
25	6, 7, 8, 9, 10, 11, 12, 13, 14, 15, 16, 17, 18, 19, 20, 21, 22, 23, 24, 25, 26, 27, 28, 29, 30, 32	4	151.47	33.66	BGS.1196M

Seturi de chei inelare duble cotite



Executie: oțel Crom Vanadiu
Acoperire: cromate



Nr. de piese	Dimensiuni (mm)	Ambalare (seturi)	Preț / set		Cod articol
			LEI	EURO	
12	6 x 7 / 8 x 9 / 10 x 11 12 x 13 / 14 x 15 / 16 x 17 18 x 19 / 20 x 22 / 21 x 23 24 x 26 / 25 x 28 / 27 x 32	4	90.05	20.01	BGS.1214M

Capete tubulare scurte, 1/2", 6 laturi - "Super Lock"



Executie: oțel Crom Vanadiu
Acoperire: cromate



6 laturi

Antrenor: 1/2"

Ø (mm)	Ambalare (buc.)	Preț / buc.		Cod articol
		LEI	EURO	
10	10	4.64	1.03	BGS.2910M
13	10	4.64	1.03	BGS.2913M
14	10	4.64	1.03	BGS.2914M
15	10	4.64	1.03	BGS.2915M
16	10	4.64	1.03	BGS.2916M
17	10	5.40	1.20	BGS.2917M
19	10	5.40	1.20	BGS.2919M

Trusa 2294 - oțel Crom Vanadiu



	1/4"	1/2"	
Adaptor 1/4" - 1/2"	1 piesa: 30 mm		
Cap tubular pentru bits		1 piesa, pentru bits 8 mm	
Antrenor cu maner de PVC	1 piesa: 150 mm		
Prelungitoare	2 piese: 50 mm; 100 mm	2 piese: 125 mm, 250 mm + adaptor	
Intermediare cardanice	1 piesa - BGS.250	1 piesa - BGS.251	
Antrenor "T"	1 piesa - BGS.276		
Prelungitor flexibil	1 piesa: 150 mm - BGS.2320		
Capete tubulare	13 piese: 4.0 - 4.5 - 5.0 - 5.5 mm 6.0 - 7.0 - 8.0 - 9.0 mm 10.0 - 11.0 - 12.0 - 13.0 - 14.0 mm	18 piese: 10 - 11 - 12 - 13 - 14 - 15 - 16 - 17 - 18 mm 19 - 20 - 21 - 22 - 23 - 24 - 27 - 30 - 32 mm	
Capete tubulare lungi	8 piese: 6 - 7 - 8 - 9 - 10 - 11 - 12 - 13 mm	4 piese: 14 - 15 - 17 - 19 mm	
Antrenor cu clichet reversibil	1 piesa: 155 mm	1 piesa - 260 mm	
Bits cu soclu tubular	3 piese: 4.0 - 4.5 - 7.0 mm	5/16"	
	2 piese: Ph 1 - Ph 2		
	2 piese: Pz 1 - Pz 2		
	4 Piese: HEX 3 - 4 - 5 - 6 mm		
	6 piese: T8 - T10 - T15 - T20 - T25 - T30	Bits 5/16"	
		Slot	3 piese: 8 - 10 - 12 mm
		Phillips	2 piese: Ph3 - Ph4
		Pozidriv	2 piese: Pz 3 - Pz 4
		Inbus	3 piese: HEX 10-12-14 mm
		Torx supertratat	4 piese: T40 - T45 - T50 - T55
Capete tubulare pentru buji	2 piese - 1.2": SW16 - SW21		
Chei vinclu - HEX interior	3 piese: 1.5 - 2.0 - 3.0 mm		



Nr. de piese	Ambalare (truse)	Preț / trusa		Cod articol
		LEI	EURO	
94	2	389.07	86.46	BGS.2294M

Trusa 2224



Componenta	1/2"			
Antrenor "T" cu adaptor	2 piese			
Prelungitoare	2 piese: 125, 250 mm			
Antrenor cu clichet reversibil, 72 dinti	1 piesa			
Capete tubulare "Pro-Torque" metric	20 piese: 8, 9, 10, 11, 12, 13, 14, 15, 16, 17, 18, 19, 20, 21, 22, 23, 24, 27, 30, 32 mm			
Capete tubulare pentru bujii - 2 piese: 16, 21 mm				
Nr. de piese	Ambalare (truse)	Preț / trusa		Cod articol
27	3	LEI	EURO	BGS.2224M
		234.41	52.09	



Organe de asamblare Sisteme de fixare
Unelte și scule Mașini-unelte
2017 - 2018

Pentru un program complet solicitati catalogul ROCAST.

Programe complete
Cea mai bogata gama de produse oferita in Romania - peste 70 000 de articole diferite in stoc.

Trusa "Lacatus" - ROCAST 1

Componenta	
Cutie metalica de scule PROMAT	530 x 195 x 200 mm
Chei fixe BGS - 12 piese	6 x 7; 8 x 9; 10 x 11; 12 x 13; 14 x 15; 16 x 17; 18 x 19; 20 x 22; 21 x 23;
Chei inelare BGS - 12 piese	24 x 27; 25 x 28; 30 x 32 mm
Ciocan "Profi" BGS, 2 piese	500 g, 1000 g
Ciocan din cauciuc - STAHLWILLE	Ø65 mm
Cleste combinat "Patent" Standard - KNIPEX	180 mm
Cleste de cuie negru - KNIPEX	180 mm
Cleste diagonal Standard - KNIPEX	160 mm
Cleste reglabil, 5 pozitii, Standard - KNIPEX	240 mm
Creion de trasat - MIB	150 mm
Cutter metalic	lama 18 x 0.4 mm
Delta in cruce - RENNSTEIG	200 mm
Delta plata - RENNSTEIG	200 mm
Fierastrau profesional + panza - RUKO	300 mm
Foarfeca standard, dreapta - PROMAT	L 250 mm
Surubelnite vinclu Inbus cu un cap sferic, 9 piese - FELO	1.5; 2.0; 2.5; 3.0; 4.0; 5.0; 6.0; 8.0; 10.0 mm
Perie de sarma, 5 rand. maner din lemn RHODIUS	sarma Ø0.35 mm
Pila lata cu maner - CORONA	L 200 mm
Pila rotunda cu maner - CORONA	L 200 mm
Priboi - RENNSTEIG	Ø3 x L120 mm
Punctator - RENNSTEIG	Ø5 x L120 mm
Ruleta TwoComp - BMI	3 m
Sabar triunghiular - RENNSTEIG	L 200 mm
Spray Multifunctional 8 in 1 - SOUDAL	400 ml
2 surubelnite Phillips "Profesional" - FELO	Ph 1; Ph 2
3 surubelnite slot "Profesional"- FELO	0.8 x 4.0; 1.0 x 5.5; 1.2 x 6.5



Ambalare (truse)	Preț / trusa		Cod articol
	LEI	EURO	
2	840.38	186.75	RCS.001AM

Trusa "Electrician" - ROCAST 3

Componenta	
Cutie metalica de scule - PROMAT	530 x 195 x 200 mm
Chei fixe 8 piese - BGS	6 x 7; 8 x 9; 10 x 11; 12 x 13; 14 x 15; 16 x 17; 18 x 19; 20 x 22 mm
Ciocan "Profi" - BGS	500 g
Cleste combinat "Patent" 1000V VDE - KNIPEX	180 mm
Cleste dezizolator 1000V VDE - KNIPEX	160 mm
Cleste diagonal 1000V VDE - KNIPEX	160 mm
Cleste pentru cabluri - KNIPEX	165 mm
Cleste pentru sertizare standard - KNIPEX	180 mm
Creion de trasat - MIB	150 mm
Cutter metalic	lama 18 x 0.4 mm
Dezizolator universal cu lama pivotanta - FELO	dezizolare Ø4 ÷ 28 mm
Fierastrau profesional + panza - RUKO	300 mm
Surubelnite vinclu Inbus cu un cap sferic, 9 piese - FELO	1.5; 2.0; 2.5; 3.0; 4.0; 5.0; 6.0; 8.0; 10.0 mm
Multimetru digital MM1 - BENNING	
Cleste radio, falci semirotonde lungi, cutite, 1000V VDE - KNIPEX	160 mm
Cleste radio, falci semirotonde lungi, 45°, cutite, 1000V VDE - KNIPEX	160 mm
Patent, falci rotunde lungi, 1000V VDE - KNIPEX	160 mm
Punctator - RENNSTEIG	Ø5 x L120 mm
Spray de contact - SOUDAL	400 ml
2 surubelnite Phillips "Profesional" VDE - FELO	Ph 1; Ph 2
3 surubelnite slot "Profesional" VDE - FELO	0.4 x 2.5; 0.8 x 4.0; 1.0 x 5.5
Surubelnita tester VDE - FELO	220 ÷ 250V



Ambalare (truse)	Preț / trusa		Cod articol
	LEI	EURO	
2	1346.63	299.25	RCS.003AM

Trusa "Mecanic Auto" - ROCAST 4

Componenta	
Cutie metalica de scule - PROMAT	530 x 195 x 200 mm
Adaptor pentru antrenor "T" - BGS	1/2"
Antrenor cu crichet reversibil - BGS	1/2", 72 dinti
Capete tubulare "Pro-Torque", 20 piese - BGS	8; 9; 10; 11; 12; 13; 14 15; 16; 17; 18; 19; 20; 21; 22; 23; 24; 27; 30; 32 mm
Chei fixe, 12 piese - BGS	6 x 7; 8 x 9; 10 x 11; 12 x 13; 14 x 15; 16 x 17; 18 x 19; 20 x 22; 21 x 23; 24 x 27; 25 x 28; 30 x 32 mm
Chei inelare 12 piese - BGS	
Ciocan "Profi" - BGS	500 g
Ciocan din cauciuc - STAHLWILLE	Ø65 mm
Cleste combinat "Patent" Standard - KNIPEX	180 mm
Clesti cu falci drepte pentru inele de siguranta exterioare si interioare - KNIPEX	180 mm
Cleste diagonal Standard - KNIPEX	160 mm
Delta in cruce - RENNSTEIG	200 mm
Delta plata - RENNSTEIG	200 mm
Intermediar cardanic - BGS	1/2"
Cleste radio, falci semirotunde lungi, cutite standard - KNIPEX	160 mm
Pila lata cu maner - CORONA	L 200 mm
Pila rotunda cu maner - CORONA	L 200 mm
2 prelungitoare 1/2" - BGS	L 125 mm; L 250 mm
2 surubelnite Phillips "Profesional" - FELO	Ph 1; Ph 2
2 surubelnite slot "Profesional" - FELO	1.0 x 5.5; 1.2 x 6.5
Capete tubulare pentru bujii, 2 piese	16 mm; 21 mm



Ambalare (truse)	Preț / trusa		Cod articol
	LEI	EURO	
2	874.13	194.25	RCS.004AM

Ciocan "Profi"



Greutate (g)	Ambalare (buc.)	Preț / buc.		Cod articol
		LEI	EURO	
300	6	12.74	2.83	BGS.852M
500	6	16.65	3.70	BGS.854M
1000	6	25.47	5.66	BGS.856M
2000	2	38.16	8.48	BGS.858M

Set de 6 extractoare de splinturi standard



Componenta	Ambalare (buc.)	Preț / buc.		Cod articol
		LEI	EURO	
Ø3, Ø4, Ø5, Ø6, Ø8, Ø10 mm	3	58.10	12.91	RN.4251700M

Dalti plate pentru metal - DIN 6453



Dimensiuni (mm)				Ambalare (buc.)	Preț / buc.		Cod articol
L	Ø	g	g		LEI	EURO	
200	23 x 13	24	370	10	16.56	3.68	RN.3102001M
250	23 x 13	25	500	10	20.21	4.49	RN.3102501M

Punctatoare standard - DIN 7250



Corp din otel crom-vanadiu, suprafata cromata.



Dimensiuni (mm)				Ambalare (buc.)	Preț / buc.		Cod articol
L	Ø	g	g		LEI	EURO	
100	8	3	30	10	4.91	1.09	RN.4301000M
120	10	4	70	10	5.22	1.16	RN.4301200M
120	10	5	75	10	5.31	1.18	RN.4311200M

Set compus din 3 dalti și 3 priboae



delta plata: 125 / 150 mm
delta in cruce: 125 mm
punctator standard: 120 mm
priboae: Ø3 / 120 mm, Ø4 / 120 mm

Componenta	Ambalare (buc.)	Preț / buc.		Cod articol
		LEI	EURO	
2 dalti plate, 1 delta in cruce, 1 punctator standard, 2 priboae	3	71.69	15.93	RN.4210010M

Cutter cu corp din aluminiu



Lama (mm)	Ghidaj	Fixare	Ambalare (buc.)	Preț / buc.		Cod articol
				LEI	EURO	
18	metalic	automata	24	7.52	1.67	CE.95652010M

Cutter cu corp din plastic+cauciuc



Lama (mm)	Ghidaj	Fixare	Ambalare (buc.)	Preț / buc.		Cod articol
				LEI	EURO	
18	metalic	automata	24	4.68	1.04	CE.95651010M

Cutter cu corp din plastic



Lama (mm)	Ghidaj	Fixare	Ambalare (buc.)	Preț / buc.		Cod articol
				LEI	EURO	
18	plastic	-	24	2.30	0.51	CE.95690010M

Cutter cu corp din plastic



Lama (mm)	Ghidaj	Fixare	Ambalare (buc.)	Preț / buc.		Cod articol
				LEI	EURO	
18	-	-	48	1.13	0.25	CE.95620010M

Set de 10 lame de rezerva pentru cuttere



Ambalare	Latime (mm)	Grosime (mm)	Ambalare (seturi)	Preț / set		Cod articol
				LEI	EURO	
cutie de plastic	18.0	0.4	50	1.94	0.43	CE.30683500M
distribuitor din plastic	18.0	0.5	20	9.18	2.04	CE.30680100M

Foarfece pentru electricieni



- Lama de taiere cu zimți fini pentru o taiere curată, fără alunecare și lacas pentru cabluri.
- Conține husă pentru protecție.
- Manere cu manson bicomponent ramforsat cu fibra de sticlă.
- Muchiile taietoare din oțel inoxidabil cu duritate de 56HRC.



Lungime (mm)	Ambalare (buc.)	Preț / buc.		Cod articol
		LEI	EURO	
160	3	57.65	12.81	KN.9505155SBM

Creioane pentru dulgher - set 6 buc.



L (mm)	Greutate (g)	Ambalare (seturi)	Preț / set		Cod articol
			LEI	EURO	
250	190	10	9.05	2.01	BGS.2071M

Creta pentru trasare



Din piatra naturala.
Fara protectie din hartie.
Rezistent la caldura pana la 2000°C.
Se utilizeaza pentru trasare pe fierul cald, tabla, oțel.
Prezentare: cutii de 10 buctai

Dimensiuni (mm)	Ambalare (cutii)	Preț / cutie		Cod articol
		LEI	EURO	
100 x 10 x 10	5	14.36	3.19	NW.871858M

Pensule plate de grosime medie (grad 6)



Par sintetic, fractionare 70%
Manseta: tabla alamata
Maner: plastic



Dimensiuni (mm)			Ambalare (buc.)	Preț / buc.		Cod articol
■	■	■		LEI	EURO	
30	12	50	12	2.70	0.60	CE.81442510M
40	13	50	12	3.11	0.69	CE.81443510M
50	14	50	12	3.69	0.82	CE.81445010M
70	16	50	12	5.27	1.17	CE.81447010M

Pistol de injectie pentru cartuse de 310ml

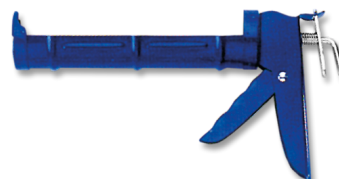

Descriere	Ambalare (buc.)	Preț / buc.		Cod articol
		LEI	EURO	
Pistol lacuit, teava dreapta	12	6.39	1.42	CE.94101010M

Pistol de ungere



Corp cromat.
Se livreaza cu tub de evacuare rigid.



Capacitate (cm ³)	L (mm)	g	Ambalare (buc.)	Preț / buc.		Cod articol
				LEI	EURO	
400	300	1300	5	63.14	14.03	BGS.3065M

Seturi de garnituri inelare "O Ring"



**419 buc. asortate, in mm
28 dimensiuni, Øint. 3 ÷ 50 mm**

3.0	14.0	23.5	34.5
4.4	16.0	25.0	36.0
5.0	18.0	26.5	38.0
7.0	19.0	28.0	41.0
10.0	20.0	30.0	44.0
11.0	21.0	31.0	47.0
13.0	22.0	33.0	50.0

Ambalare (seturi)	Preț / set		Cod articol
	LEI	EURO	
3	43.07	9.57	BGS.8045M



**225 buc. / 20 dim.,
Øint. 3 ÷ 22 mm**

3.0	9.0	16.0
4.0	10.0	17.0
4.5	11.0	18.0
5.0	12.0	19.0
6.0	13.0	20.0
7.0	14.0	22.0
8.0	15.0	

Ambalare (seturi)	Preț / set		Cod articol
	LEI	EURO	
5	15.66	3.48	BGS.8044M

Set de inele de siguranta pentru arbori



300 buc., 3 ÷ 32 mm

3.0	11.0	20.0
4.0	12.0	22.0
5.0	13.0	25.0
6.0	14.0	26.0
8.0	15.0	28.0
9.0	19.0	32.0

Ambalare (seturi)	Preț / set		Cod articol
	LEI	EURO	
5	20.57	4.57	BGS.8046M

Set de inele de siguranta pentru alezaje



300 buc., 3 ÷ 32 mm

3.0	11.0	20.0
4.0	12.0	22.0
5.0	13.0	25.0
6.0	14.0	26.0
8.0	15.0	28.0
9.0	19.0	32.0

Ambalare (seturi)	Preț / set		Cod articol
	LEI	EURO	
5	20.57	4.57	BGS.8049M

Laveta din bumbac, 400 x 400 mm

Lavetele sunt confectionate din tesatura de bumbac 100%, tricot tip jersey cu o densitate cuprinsa intre 160-180g/mp.

Utilizare: Curatenie / protectie. Aceste produse au o arie larga de utilizare, atat casnic pentru curatenie cat si industrial pentru indepartarea grasimilor, uleiurilor, cernelurilor sau a diverselor lichide petroliere.



Laveta din microfibra, 400 x 400 mm

Concepute special pentru o absorbtie marita a hidrocarburilor.

Densitate 130-160 g/mp.

Lavetele au o putere de absorbtie de 297% si o rezistenta ridicata in contact cu substantele chimice periculoase.



Denumire	Ambalare (buc.)	Preț / buc.		Cod articol
		LEI	EURO	
Laveta din bumbac	100	0.45	0.10	RCS.LV14040M

Denumire	Ambalare (buc.)	Preț / buc.		Cod articol
		LEI	EURO	
Laveta din microfibra	150	0.32	0.07	RCS.LM14040M

Benzi autoadezive

Banda pentru impachetare din polipropilena transparenta.

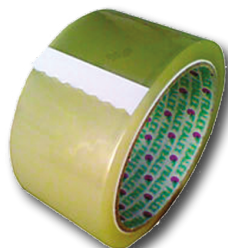

Dimensiuni (mm x m)	Ambalare (buc.)	Preț / buc.		Cod articol
		LEI	EURO	
50 x 66	36	3.42	0.76	3M.372M

Chinga de fixare cu clichet



Material: nailon.
Incarcare maxima: 120 kg.
Fixare cu clema cu clichet.
Certificare TÜV / GS



Dimensiuni (mm)	Ambalare (buc.)	Preț / buc.		Cod articol
		LEI	EURO	
24 mm x 5	12	11.75	2.61	BGS.3550M

Manuși din tricot nailon

Caracteristici:

- Culoare: alba
- Manșeta: elastica
- Aplicații punctiforme PVC roșii



Model	Marime	Ambalare (buc.)	Preț / buc.		Cod articol
			LEI	EURO	
FLEXIGREY	M	12	2.70	0.60	RE.1603MM
	L	12	2.70	0.60	RE.1603LM
	XL	12	2.70	0.60	RE.1603XLM

Manuși de protecție din piele MASTER 1554

- Modele rezistente
- Utilizare universala

Caracteristici:

- Partea anterioara: piele șpalt de bovina
- Partea posterioara: bumbac
- Captușeala: bumbac
- Dublura pentru palma: piele box de bovina
- Grosimea pielii: 1.2 mm
- Marime: universala, 10.5"
- Manșeta: canvas cauciucat



Model	Ambalare (buc.)	Preț / buc.		Cod articol
		LEI	EURO	
MASTER 1554	12	9.63	2.14	RE.1554M

Manuși din tricot gros 1010

Caracteristici:

- Material: bumbac
- Lungime: 25 cm
- Culoare: bumbac natur
- Fabricare: croșetate circular
- Marime: 9"



Model	Ambalare (buc.)	Preț / buc.		Cod articol
		LEI	EURO	
TRICOT GROS 1010	12	1.40	0.31	RE.10109M

Manuși de protecție din piele, CE EN 388

- Modele rezistente
- Utilizare universala

Caracteristici:

- Partea anterioara: piele multicolora de bovina
- Partea posterioara: bumbac
- Captușeala: bumbac
- Dublura pentru palma: piele de bovina
- Grosimea pielii: 1.0-1.1 mm
- Marime: universala, 10.5"



Model	Ambalare (buc.)	Preț / buc.		Cod articol
		LEI	EURO	
Standard 1578	12	5.99	1.33	RE.1578M

Manuși cu fețe antialunecare

- Priza buna la suprafețele alunecoase
- Mulare foarte buna pe mana
- Rezistenta buna la abraziune
- Pot fi purtate pe ambele fețe

Caracteristici:

- Material: tricot din fibre mixte
- Manșeta: tricotata
- Aplicații punctiforme, din PVC pe ambele fețe
- Lungime: 25 cm
- Marime: 10"



Model	Ambalare (buc.)	Preț / buc.		Cod articol
		LEI	EURO	
Picot dublu 1040-2	12	2.21	0.49	RE.1040-2M

Manuși de protecție din piele FORTE 1552

- Modele rezistente
- Utilizare universala

Caracteristici:

- Partea anterioara: piele șpalt de bovina
- Partea posterioara: bumbac
- Captușeala: bumbac
- Dublura pentru palma: piele șpalt de bovina
- Grosimea pielii: 1.2 mm
- Marime: universala, 10.5"
- Manșeta: canvas cauciucat



Model	Ambalare (buc.)	Preț / buc.		Cod articol
		LEI	EURO	
FORTE 1552	12	8.78	1.95	RE.1552M

Manuși din bumbac fin

Caracteristici:

- Manușa: bumbac subțire
- Culoare alba



Model	Marime	Ambalare (buc.)	Preț / buc.		Cod articol
			LEI	EURO	
Bumbac fin 1020	9	12	1.53	0.34	RE.10209M

Manuși de protecție din piele STANDARD PLUS 1551

- Modele rezistente
- Utilizare universala

Caracteristici:

- Partea anterioara: piele șpalt
- Partea posterioara: bumbac
- Captușeala: bumbac
- Dublura pentru palma: -
- Grosimea pielii: 1.0-1.1 mm
- Marime: universala, 10.5"



Model	Ambalare (buc.)	Preț / buc.		Cod articol
		LEI	EURO	
Standard Plus 1551	12	6.30	1.40	RE.1551M

Manuși pentru sudura, EN 388/EN 407 - Sudor 1800

Caracteristici:

- Material: piele șpalt
- Captușeala: -
- Grosimea pielii: 1.2 mm
- Lungime: 35 cm
- Marime: universala, 10.5"



Model	Ambalare (buc.)	Preț / buc.		Cod articol
		LEI	EURO	
SUDOR 1800	10	13.41	2.98	RE.1800M

Manuși pentru sudura, EN 388/EN 407 - Welder 1801

Caracteristici:

- Material: piele șpalt
- Captușeala: bumbac ignifug
- Grosimea pielii: 1.2 mm
- Lungime: 35 cm
- Marime: universala, 10.5"



Model	Ambalare (buc.)	Preț / buc.		Cod articol
		LEI	EURO	
WELDER	10	18.86	4.19	RE.1801RM

Ochelari de protectie - Ferro

Rama: plastic
Lentila: policarbonat



Model	Ambalare (buc.)	Preț / buc.		Cod articol
		LEI	EURO	
FERRO Incolori	10	6.03	1.34	RE.8160M

Semimasca antipraf simpla (Set de 10 buc.)



Construcție cu supapa
Protectie la pulberi netoxice, fum.
Norma: CE EN 149-2001



Model	Ambalare (seturi)	Preț / set		Cod articol
		LEI	EURO	
FFP2	3	41.72	9.27	CE.50500200M

Manuși cu protecție antichimica

Grad de protecție antichimica Cat.II
Rezistența la: detergenți, dezinfectanți, acizi și baze, uleiuri, carburanți, alte chimicale de uz industrial
Buna rezistența mecanică

Caracteristici:

- Material: PVC pe suport textil
- Manșeta: tricot textil
- Lungime: 27 cm
- Grosime: 1.2 mm
- Marime: 10.5"



Model	Ambalare (buc.)	Preț / buc.		Cod articol
		LEI	EURO	
REDPOINT 1440	12	5.22	1.16	RE.1440M

Ochelari de protectie - Panoramic 8150

Rama: monobloc
Lentila: policarbonat



Model	Ambalare (buc.)	Preț / buc.		Cod articol
		LEI	EURO	
Panoramic 8150	10	4.59	1.02	RE.8150M

Caști antifon



Model	Ambalare (buc.)	Preț / buc.		Cod articol
		LEI	EURO	
Casca antifon Pro	5	15.17	3.37	BGS.3623M

Masti de sudura cu reglare automata



Caracteristici tehnice:

- Dimensiunea casetei: 110 x 90 x 9 mm
- Alimentare cu energie: celule solare
- Functie pornit/oprit: complet automatizat
- Protectie UV/IR: permanent DIN 16
- Nivele de protectie: DIN 9 pana la DIN 13
- Protectie la stralucire: 4
- Clasa: 1/2/3
- Timp de reactie standard la lumina: 1/30000s
- Timp de reactie de la luminos la intunecat setare in 3 trepte (scurt-mediu-lung): 0.25-0.8 sec
- Sensibilitate: Reglabila fara trepte
- Material: Rezistent la uzura
- Greutate totala: 460 g



Recomandata pentru sudura cu electrozi și MIG-MAG

VarioProtect L

- Reglare automata, nivel de protectie DIN9-13
- Timp de reactie 1/30000s
- 2 senzori

Model	Ambalare (buc.)	Preț / buc.		Cod articol
		LEI	EURO	
VarioProtect L	3	172.13	38.25	SW.1654000M



Recomandata pentru sudura cu electrozi și MIG-MAG

VarioProtect XL

- Reglare automata, nivel de protectie DIN 9-13
- Timp de reactie 1/30000s
- Finisare „Carbon”
- 4 senzori

Model	Ambalare (buc.)	Preț / buc.		Cod articol
		LEI	EURO	
VarioProtect XL	3	203.85	45.30	SW.1654001M



Recomandata pentru sudura cu electrozi, MIG-MAG și WIG

VarioProtect XXL W

- Special pentru sudarea ideala TIG
- Nivel de protectie DIN 9-13
- Timp de reactie 1/30000 s
- 4 senzori

Model	Ambalare (buc.)	Preț / buc.		Cod articol
		LEI	EURO	
VarioProtect XLW	3	271.89	60.42	SW.1654010M

Electrozi AWS E 6013 pentru sudarea oțelurilor nealiate

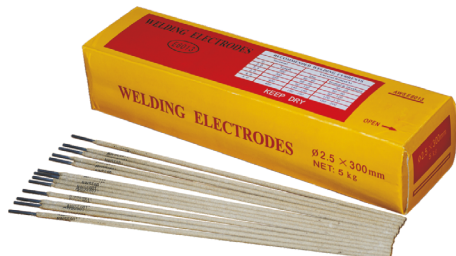

Electrozi cu invelis rutilic

Denumire tehnica conform standard: DIN AWS A5.1-E6013

Tip de curent: = + / ~

Compoziție chimica (%): C ≤ 0.12, Mn 0.3-0.6, Si ≤ 0.35, S ≤ 0.035, P ≤ 0.040

Caracteristici mecanice

- Limita de curgere (N / mm²): ≥ 420
- Alungirea (%): ≥ 17
- Rezistența la rupere (N / mm²): ≥ 330
- Valoarea de impact (J): 50-80

Caracteristici

Electrozi cu invelis rutilic, recomandati in principal pentru sudarea constructiilor metalice usoare si a tablelor subtiri din otel carbon. Sunt indicati pentru sudarea otelurilor nealiate cu un continut de carbon de maxim 0,25 %, pentru structuri usoare, utilizate pentru temperaturi de pana la 0°C, ca de exemplu: OL 37.3; OL 44.2.

Arcul de sudura este foarte stabil, stropirea este foarte redusa atat in curent alternativ cat si in curent continuu. Amorsare si reamorsare usoara. Cordonul rezultat este estetic, zgura se detaseaza usor.

Pozitii de sudare: vertical, orizontal, deasupra capului

Ø x 1 (mm)	Pachet (kg)	Ambalare (kg)	Preț / kg.		Cod articol
			LEI	EURO	
2.5 x 300	5.0	20	5.36	1.19	WE.0025/PM
3.2 x 350	5.0	20	5.04	1.12	WE.0032/PM

Electrozi AWS E 7018 pentru sudarea oțelurilor nealiate



Electrozi cu invelis bazic

Denumire tehnica conform standard: DIN AWS A5.1 -E7018

Tip de curent: = + / ~

Compoziție chimica (%): C ≤ 0.12, Mn ≤ 0.16, Si ≤ 0.75, S ≤ 0.035, P ≤ 0.040

Caracteristici mecanice

- Limita de curgere (N / mm²): ≥ 490
- Valoarea de impact (J): ≥ 27 (la -30°C)
- Rezistența la rupere (N / mm²): ≥ 400
- Alungirea (%): ≥ 22

Caracteristici

Electrozi bazici cu pulbere de fier in invelis, destinati structurilor puternic solicitate static si dinamic si profilelor groase din oteluri slab aliate, La temperaturi de pana la - 40 °c. Sunt recomandate pentru sudarea urmatoarelor oteluri: OL 44.4; OL 52.2; OL 52.4; OL 50

Aspect bun al cordonului de sudura, stropire redusa. Arc de sudura stabil. Zgura acopera bine cordonul de sudura. Continutul de hidrogen difuzabil: max 5 cm³ / 100 g. Randamentul nominal efectiv: 116%

Pozitii de sudare: vertical, orizontal, deasupra capului

Ø x 1 (mm)	Pachet (kg)	Ambalare (kg)	Preț / kg.		Cod articol
			LEI	EURO	
2.5 x 300	5.0	20	7.83	1.74	WE.1025/PM
3.2 x 350	5.0	20	7.20	1.60	WE.1032/PM

Masina de gaurit cu acumulator - DD 2G 18.0 Set

FLEX

POWER SYSTEM 18V



- Mașina de gaurit cu doua trepte de turatii: 0 - 380 / 0 - 1650 rpm.
- Cuplu maxim: 68 Nm. 24 de pozitii reglare cuplu de inșurubare.
- Selector cu 2 pozitii a modului de lucru: gaurire / inșurubare.
- Sistem electronic de management (EMS) ce protejeaza unealta, maresta eficienta si creste durata de utilizare a acumulatorului.
- Buton de accelerare a turatiei cu functie de blocare.
- Mandrina rapida cu autoblocare: 1.5 - 13 mm. Carcasa robusta din aluminiu.
- Posibilitatea schimbarii sensului de rotatie.
- Iluminare cu LED si indicator cu LED pentru rezerva de putere a acumulatorului.
- Compatibil cu toti acumulatorii de 18V FLEX.

Volumul livrării:
2 acumulatori 18V/2.5 Ah Li-ion, incarcator rapid (40 min.), maner, cutie de transport.

Model	Acumulator		Turatii (rpm)	Mandrina (mm)	Capacitate de gaurire (mm)		Ambalare (buc.)	Preț / buc.		Cod articol
	(V)	(Ah)			otel	lemn		LEI	EURO	
DD 2G 18.0 Set	18	2.5	0 - 380 / 0 - 1650	1.5 - 13	13	30	2	985.50	219.00	FL.436577M

Masina de gaurit - BE 750 RE

AEG

750 W

Tr. 1: 0-3000 rpm



- Cu sistem de reglare si blocare a turatiei pe buton.
- Sistem IMB integrat (Integrated-Metal-Block) pentru o stabilitate si durabilitate mare.
- O treapta de turatie: 0 - 3000.
- Cuplu maxim: 27 Nm.
- Mandrina cu cheie: 13 mm.
- Posibilitatea schimbarii sensului de rotatie.
- Maner ergonomic, anti-alunecare.
- Greutate: 1.9 kg.



Volumul livrării: geanta de transport.



Model	Putere (W)	Turatii (rpm)	Mandrina (mm)	Capacitate de gaurire (mm)		Ambalare (buc.)	Preț / buc.		Cod articol
				otel	lemn		LEI	EURO	
BE 750 RE	750	0 - 3000	1.5 - 13	13	30	2	265.95	59.10	AG.4935449160M

Ciocan rotopercurtor - FHE 2-22 SDS Plus

FLEX

710 W

Percutie 4300 bpm

1400 rpm



- Ciocan rotopercurtor cu functie de gaurire si rotopercuție.
- Posibilitatea schimbarii sensului de rotatie.
- Buton cu functie de blocare.
- Limitator de adancime reglabil
- Greutate: 2.3 kg.



Volumul livrării: maner suplimentar, limitator de adancime, cutie de plastic.

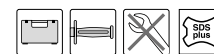

Model	Turatie (rpm)	Percutie (bpm)	Energie de impact (J)	Putere (W)	Capacitate de gaurire diametru max. (mm)			Ambalare (buc.)	Preț / buc.		Cod articol
					beton	otel	lemn		LEI	EURO	
FHE 2-22 SDS Plus	1400	4300	2.1	710	22	13	26	2	394.88	87.75	FL.413674M

Masina de gaurit universala cu percucie - CHE 2-82 SDS Plus

FLEX

800 W

Percutie 0-4000 bpm

0-1300 rpm



- Mașina de gaurit universala cu rotopercuție, rotație stanga - dreapta, daltuire fara rotatie.
- Viteza variabila, buton cu functie de blocare.
- Limitator de adancime reglabil
- Greutate: 2.65 kg.



Volumul livrării: maner suplimentar, limitator de adancime, cutie de plastic.

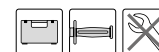

Model	Putere (W)	Turatie (rpm)	Percutie (bpm)	Energie de impact (J)	Capacitate de gaurire diametru max. (mm)			Ambalare (buc.)	Preț / buc.		Cod articol
					beton	otel	lemn		LEI	EURO	
CHE 2-28 SDS-plus	800	0 - 1300	0 - 4000	2.7	26	13	30	2	655.92	145.76	FL.413666M

Ciocan rotopercurtor - KH 28 Super XE

AEG
POWER TOOLS

1010 W

Percutie

Tr. 1: 0-1500 rpm



- Modul „Soft” reduce energia de impact pentru daluirea si gaurirea in materiale sensibile.
- Mandrina rapida FixTec. Prindere SDS Plus.
- Posibilitatea schimbarii sensului de rotatie.
- Posibilitate de lucru in mod „dalta”.
- Viteza variabila, buton cu functie de blocare.
- Limitator de adancime reglabil.
- Maner ergonomic, anti-alunecare.
- Greutate: 2.8 kg.



Volumul livrării: maner suplimentar, limitator de adancime, cutie de transport.



Model	Putere (W)	Turatie (rpm)	Percutie (bpm)	Energie de impact (J)	Capacitate de gaurire diametru max. (mm)			Ambalare (buc.)	Preț / buc.		Cod articol
					beton	otel	lemn		LEI	EURO	
KH 28 Super XE	1010	0 - 1500	0 - 5000	2.8	28	13	30	2	923.45	205.21	AG.4935428190M

Polizor unghiular - L801 / 125

FLEX

125

800 W

Tr. 1: 12000 rpm



- Protectie anti-praf extinsa pentru motor si transmisie .
- Design usor, ergonomic, și ușor de manipulat.
- Sistem de blocare a axului.
- Maner suplimentar.
- Aparatoare reglabila fara cheie.

Volumul livrării: aparatoare, maner, flanșa de prindere, piulița M 14, cheie.



Model	Disc (Ø mm)	Turatie (rpm)	Putere (W)		Prindere	Greutate (kg)	Ambalare (buc.)	Preț / buc.		Cod articol
			nominala	utila				LEI	EURO	
L801 / 125	125	12000	800	480	M14	1.9	2	202.50	45.00	FL.438324M

Polizoare unghiulare - LE 9-11 / 125

FLEX

125

900 W

6000-11500 rpm



- Viteza constanta: microprocesor FR de control constant al vitezei cu ajutorul unui modul electronic de control al turatiei, start lin, protecție la repornire dupa caderi de tensiune, suprasarcina și monitorizarea temperaturii.
- Protectie anti-recul. Motorul se opreste automat daca discul de blocheaza.
- Protectie anti-praf extinsa pentru motor si transmisie.
- Strat dublu de protecție cu lac al bobinajului: reduce uzura motorului și prelungeste durata de viața.
- Maner suplimentar.

- Aparatoare reglabila fara cheie.
- Sistem de blocare a axului.

Volumul livrării: aparatoare, maner, flanșa de prindere, piulița M 14, cheie.



Model	Disc (Ø mm)	Turatie (rpm)	Putere (W)		Prindere	Greutate (kg)	Ambalare (buc.)	Preț / buc.		Cod articol
			nominala	utila				LEI	EURO	
LE 9-11 125	125	6000 - 11500	900	600	M14	2.0	2	352.35	78.30	FL.436291M

Polizor unghiular L 1001 / 125

FLEX

125

1010 W

10000 rpm



- Bobinaj acoperit in rasina epoxidica.
- Design ergonomic și ușor de manipulat.
- Sistem de blocare a axului.

Volumul livrării: aparatoare, maner, flanșa de prindere, piulița M 14, cheie.



Model	Disc (Ø mm)	Turatie (rpm)	Putere (W)		Prindere	Greutate (kg)	Ambalare (buc.)	Preț / buc.		Cod articol
			nominala	utila				LEI	EURO	
L 1001 / 125	125	10000	1010	600	M14	2.2	2	267.30	59.40	FL.438340M

Polizoare unghiulare L 21-6 230 / L 24-6 230

FLEX



- Motor si reductor robust și solid in carcasa din oțel. Rulmenții maresc fiabilitatea și durabilitatea.
- Prindere facila, carcasa motorului foarte ingusta pentru manevrare ușoara.
- Dotat suplimentar cu un inel amortizor intre carcasa motorului si manerul posterior ce reduce vibratiile.
- Maner SoftVib, pentru reducerea vibrațiilor, cu posibilitate de montare in 3 poziții. Manerul SoftVib are si rolul de deblocare a discului.
- Carcasa captușita cu cauciuc moale pentru o prindere sigura.

- Buton de siguranța pornit-oprit.
- Protecție la caderile de tensiune.
- Start lin, fara șocuri.
- Aparatoare reglabila fara cheie.
- Sistem de blocare a axului.
- Diametru guler (pentru prinderea pe stand de debitare) 64 mm.

Volumul livrării: aparatoare, maner SoftVib, flanșa de prindere, piulița, cheie.



Model	Disc (Ø mm)	Turatie (rpm)	Putere (W)		Prindere	Greutate (kg)	Ambalare (buc.)	Preț / buc.		Cod articol
			nominala	utila				LEI	EURO	
L 21-6 230	230	6500	2100	1250	M14	5.2	2	431.33	95.85	FL.391514M
L 24-6 230			2400	1450				516.38	114.75	FL.391522M

Suflanta cu aer cald - HG 560 D

AEG

440 W



- Suflanta cu aer cald extrem de usoara - 0.85 kg.
- 2 trepte de temperatura: 300° / 560°.
- Debit de aer: 253 - 420 litri/min.
- Ventilator rezistent, pentru o utilizare indelungata.
- Cu mansoa de cauciuc in partea din spate pentru utilizare stationara.



Model	Putere (W)	Debit de aer (litri / min.)	Trepțe de temperatura (°C)	Ambalare (buc.)	Preț / buc.		Cod articol
					LEI	EURO	
HG 560 D	1500	253 - 420	300 / 560	2	243.54	54.12	AG.4935441015M

Derulator - 230V, pentru interior, Garant® Export

brennenstuhl®



- Cablu tip H05VV-F.
- Carcasa din plastic special si cadru din otel galvanizat.
- Maner ergonomic, util pentru rularea si derularea cablului.
- 4 prize cu impamantare.
- Protecție de siguranța
- Prize: 230V P + N + E

Derulator Garant® S, IP44

brennenstuhl®



- Cablu tip H05VV-F.
- Pentru scurt timp poate fi folosit si in exterior.
- Carcasa si cadru din otel galvanizat, rezistente la rugina. Maner ergonomic, util pentru rularea si derularea cablului.
- Cu intrerupator termic de siguranța si indicator pentru supraincalzire si supraincarcare.
- Cablu cauciucat.
- Prize: 230V P + N + E



Lungime (m)	Tip cablu	Ambalare (buc.)	Preț / buc.		Cod articol
			LEI	EURO	
25	3 x 1.5 mm ²	2	125.19	27.82	BN.1215056M

Lungime (m)	Tip cablu	Ambalare (buc.)	Preț / buc.		Cod articol
			LEI	EURO	
40	3 x 2.5 mm ²	2	391.86	87.08	BN.1198260M

Lampa pentru inspectie, rezistenta

brennenstuhl®

- Model standard.
- Grilaj rezistent la impact, flexibil.
- Tip cablu: H05RN-F 2 x 0,75 mm² - lungime 5 m.
- Cu paravan de protecție
- Putere maxima: 60W.
- Tip dulie: E27.
- Cu stecker tip European.
- Se livreaza fara bec.



Descriere	Ambalare (buc.)	Preț / buc.		Cod articol
		LEI	EURO	
Lampa pentru inspectie	10	23.04	5.12	BN.1176420M

Pistol pentru suflat aer BP Pro

Aircat

Utilizare universala in manufacturi, ateliere, service auto sau in gospodarie.

Pentru operatii de curatare rapida pe suprafete mari sau in locuri greu accesibile.

Greutate: 0.14 kg



Model	Ambalare (buc.)	Preț / buc.		Cod articol
		LEI	EURO	
Pistol BP Pro	10	22.37	4.97	AC.2112120M

Pistol BPK - scurt



Pistol pentru suflat aer, execuție robusta din aluminiu, duza scurta

Presiune de lucru (bar): 2.0-6.0
Consum de aer (litri): 100-200
Greutatea (kg): 0.18



Model	Ambalare (buc.)	Preț / buc.		Cod articol
		LEI	EURO	
Pistol BPK - scurt	10	13.19	2.93	AC.2112100M

Pistol pentru suflat aer BPL, lung



Pistol pentru suflat aer, execuție robusta din aluminiu, duza lunga

Presiune de lucru: 2.0-6.0 bar
Consum de aer: 100-200 litri/min.
Lungime tija: 160 mm
Greutate: 0.22 kg



Model	Ambalare (buc.)	Preț / buc.		Cod articol
		LEI	EURO	
Pistol BPL - lung	10	15.35	3.41	AC.2112110M

Pistol pentru umflarea pneurilor SD



Cu conector rapid
Presiune maxima de lucru: 8 bar
Domeniul de masura: 0 - 8 bar
Greutate: 0.39 kg



Model	Ambalare (buc.)	Preț / buc.		Cod articol
		LEI	EURO	
Pistol SD	5	36.45	8.10	AC.2102300M

Trusa de scule pneumatice de 6 piese



Pistol de suflat aer BK
 Pistol pentru umflarea pneurilor SD
 Furtun spiralat de inalta calitate din poliuretan
 Set de 3 adaptoare

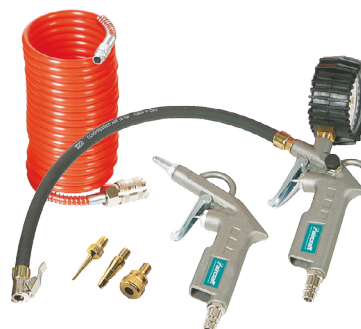

Model	Ambalare (truse)	Preț / trusa		Cod articol
		LEI	EURO	
Trusa de 6 piese	2	72.63	16.14	AC.2102006M

Furtun FLEXAIR



Echiptat cu racord rapid si niplu

- Furtun pentru aer comprimat, pentru uz profesional.
- Extrem de flexibil inclusiv la temperaturi reduse.
- Rezistent la aer comprimat contaminat cu ulei.
- Insetie din tesatura.



Ø (mm)		L (m)	Presiune max. lucru (bar)	Ambalare (buc.)	Preț / buc.		Cod articol
int.	ext.				LEI	EURO	
6	10.7	10	20	5	35.19	7.82	AC.2105410M
9	14.5	10		5	41.49	9.22	AC.2105510M

Furtun spiralat



Se livreaza standard cu racord rapid si niplu.

Material: poliuretan.



Ø (mm)		L (m)	Presiune max. lucru (bar)	Ambalare (buc.)	Preț / buc.		Cod articol
int.	ext.				LEI	EURO	
6	10	5.0	10	5	22.64	5.03	AC.2115605M
6	10	7.5	10	5	32.45	7.21	AC.2115608M
8	12	10.0	15	5	47.52	10.56	AC.2115610M

Banda izolatoare din PVC



Material: PVC

Lungime: 18.28 m.



Grosime x latime (mm)	Culoare	Ambalare (buc.)	Preț / buc.		Cod articol
			LEI	EURO	
0.15 x 19	negru	10	2.66	0.59	EL.51001M
	alb	10	2.66	0.59	EL.51005M

Reglete - 12 poli



Material: polietilena



Conductor S max. (mm²)	I max. (A)	Ambalare (buc.)	Preț / buc.		Cod articol
			LEI	EURO	
1.5	3	10	1.40	0.31	EL.31003M
4.0	6	10	1.67	0.37	EL.31006M

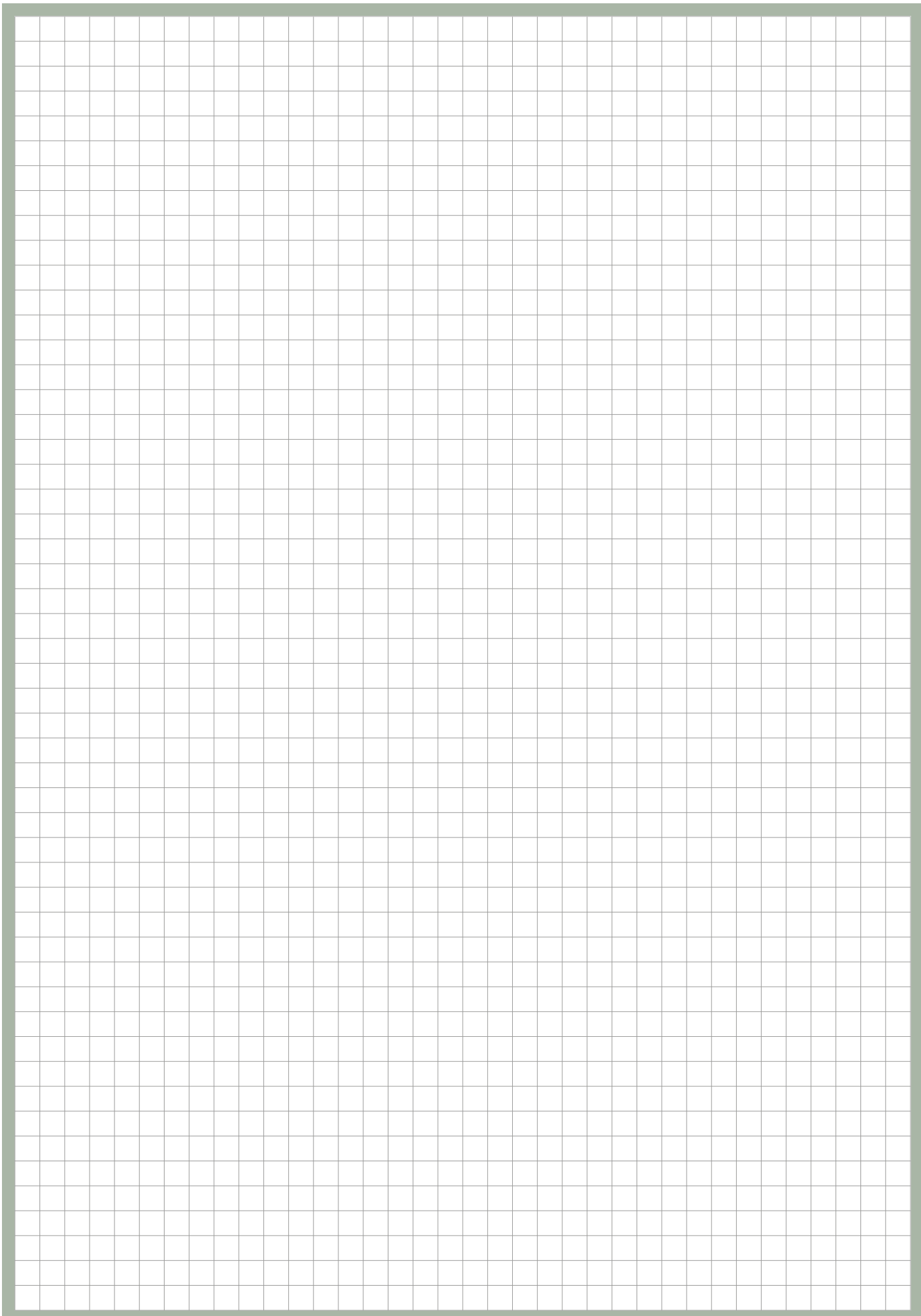

Pentru un program complet solicitati catalogul ROCAST.



PROGRAME COMPLETE

Cea mai bogata gama de produse oferita in Romania - peste 70.000 de articole diferite in stoc.



CALITATE GERMANĂ

Certificat ISO 9001 pentru asigurarea calitatii.

made in Germany O gama larga de scule profesionale produse in Germania.

Peste 40 de furnizori din Germania.

Cea mai bogata gama de masini-unelte proiectate in Germania de ingineri cu multa experienta in domeniu.

Produsele ROCAST sunt distribuite de 72 de agenti comerciali

54 in tara

ALBA 0729 997 216	ARAD 0729 997 234 0733 692 611	ARGES 0729 997 228 0733 692 554	BACĂU 0729 997 237 0728 083 236	BIHOR 0729 997 223	BISTRITA-NĂȘĂUD 0728 083 235
BOTOSANI 0733 450 571	BRĂILA 0729 997 210	BRASOV 0729 997 240 0729 997 229	BUZĂU 0730 654 992	CARAS-SEVERIN 0729 997 224	CĂLĂRASI 0730 585 638
CLUJ 0728 083 231 0733 692 609	CONSTANTA 0729 997 241 0733 450 652	COVASNA 0733 692 568	DÂMBOVITA 0729 997 227	DOLJ 0729 997 219	GALATI 0728 083 239 0799 402 342
GIURGIU 0724 202 784	GORJ 0729 997 213	HARGHITA 0733 692 568	HUNEDOARA 0728 083 234	IALOMITA 0729 997 226	IASI 0731 220 434 0733 692 576
MARAMURES 0729 997 221 0733 692 596	MEHEDINTI 0733 692 580	MURES 0724 383 595 0729 997 232	NEAMT 0730 585 637 0729 997 239	OLT 0733 692 598	PRAHOVA 0729 997 214 0733 692 592
SATU MARE 0730 240 457 0733 692 572	SĂLAJ 0733 692 606	SIBIU 0730 641 775 0733 692 582	SUCEAVA 0721 250 543	TELEORMAN 0729 997 238	TIMIS 0724 202 790 0730 707 883
TULCEA 0733 692 601	VÂLCEA 0729 997 236	VASLUI 0728 083 232	VRANCEA 0729 997 217		

18 in Bucuresti si Ilfov

Sector 1 0727 777 658 0731 220 432 0799 402 341	Sector 2 0728 808 755 0724 383 596 0733 692 556	Sector 3 0730 654 991 0728 808 754 0733 450 570	Sector 4 0728 808 753 0728 808 756 0709 402 340	Sector 5 0728 083 233 0723 200 554 0730 654 990	Sector 6 0727 777 659 0733 692 602 0733 692 570
---	---	---	---	---	---

Directori zonal

Director national 0730 641 776	Zona Buc. + Ilfov 0731 066 032	Zona Sud-Est 0733 450 666	Zona Nord-Est 0733 692 566	Zona Nord-Vest 0733 692 564	Zona Sud-Vest 0733 692 555
--	--	-------------------------------------	--------------------------------------	---------------------------------------	--------------------------------------

ROCAST

Sos. Odaii, Nr. 62 - 68, Otopeni, Jud. Ilfov

Tel.: (021) 252 53 90 - 95

Fax: (021) 252 53 89

Mobil: 0372 135 900

0723 293 471

Vanzari: 0731 066 024 (National)

0724 383 593 (Bucuresti)

0724 383 597 (Provincia)

www.rocast.ro
office@rocast.ro

Preturile din catalog sunt exprimate in Euro
si nu includ TVA.

ROCAST nu raspunde pentru eventuale erori de tipar sau de
prezentare. Fotografiiile au caracter informativ si pot contine anumite
accesorii care nu sunt incluse in pachetul standard de livrare sau se
pot modifica fara notificare prealabila.

Livrarea si plata produselor se face in conformitate cu conditiile
ROCAST.

ROCAST poate modifica conditiile de livrare si preturile din catalog
fara notificare prealabila. Aceste modificari vor fi operate periodic si
prezentate pe www.rocast.ro