

2015



# Get the essential of Brake Pads

www.valeoservice.com

- EN Brake pads
- FR Plaquettes de frein
- IT Pastiglie freni
- PL Klocki hamulcowe
- RU Тормозные колодки
- DE Bremsbeläge
- NL Remblokken
- AR منصات الفرامل
- HU Fékbetét
- HR Kočione obloge
- ES Pastillas de freno
- PT Pastilhas de travão
- SR Kočine pločice
- TR Fren balataları
- ZH 刹车片



**FIRST**  
Make the clever choice

WANT TO  
KNOW MORE?\*











\*En savoir plus

valeo added



Automotive technology, naturally



## GENERAL SYMBOLS & ABBREVIATIONS

 	<p>Model Modèle Modelo Modelo Modello Model Modell Model Модель Model Μοντέλο Modell</p>	<p>Engine number N° moteur Número de motor Número do motor N° motore Kód motoru Nr. Silnika № Двигателя Motor numarası Αρ. Κινητήρα Motorszám</p>
	<p>Limousine Berline Berlina Berlina Berlina Sedan Седан Sedan Μπερλίνα lépcsőshátú</p>	<p>Technical information Información técnica Informações técnicas Informazioni tecniche Technické informace Informacje techniczne Техническая информация Teknik bilgi Τεχνικά χαρακτηριστικά Tecnikai</p>
	<p>Station wagon Break Break Break Station wagon Kombi Kombi Универсал Station wagon Station wagon Kombi</p>	<p>Handbrake Frein de parking Freno de mano Travão de mão Freno a mano Ruční brzda Hamulec ręczny Ручной стояночный тормоз El freni Χειρόφρενο Kézfék</p>
	<p>Coupé Coupé Coupé Coupé Coupé Coupé Coupé Coupé Coupé Coupé Coupé Coupé Coupé Coupé</p>	<p>Braking system Système de frein Sistema de freno Sistema de travão Impianto frenante Remsysteem Typ der Bremse Typ brzd System hamulcowy Тип тормозной системы Fren tipi Τύπος φρένου Fék típus</p>
	<p>Van Fourgonnette Camioneta Van VAN Menší dodávka Van Фургон Van Фортягы kisáruszállító</p>	<p>Number of connections Nombre de connexions Cantidad de conexiones Quantidade de conexões Numero di connessioni Počet připojek Nr. Powiązań Количество соединений Bağlantı sayısı Αριθμός συνδέσεων Szám</p>
	<p>Convertible Décapotable Descapotable Conversível Cabriolet Kabriolet Kabriolet Кабриолет Üstü açılır Όχημα με πτυσσόμενη οροφή Kabrió</p>	<p>Without / Except Sans / Hormis Sin / Excepto Sem / Excerpto Senza / Eccetto Zonder / Behalve Ohne / Ausser Bez Bez Bez Olmadan / Haricinde Χωρίς nélkül/kivéve</p>
	<p>Van Fourgon Camioneta Van Furgone Dodávka Van Фургон Van Фортягы Kisáruszállító</p>	<p>With / For Avec / Pour Con / A Com / Para Con / Per Met / Voor Mit / Für S / pro Z C Birlikte / İçin Me / Για Vele/ehhez</p>
	<p>Pick-up Pick-up Pick-up Pick-up Pick-up Pick-up Pick-up Пикап Pikap Ημιφορτηγό Pick-up</p>	<p>With or without Avec ou sans Con or sin Com ou sem Con o senza Met of zonder Mit oder ohne S nebo bez Z lub Bez С или без Birlikte ya da olmadan Me ή χωρίς vele vagy nélkülü</p>
	<p>Seats Sièges Asientos Assentos Sedili Zitplaats Sitze Sedadla Siedzenia Сиденья Koltuklar Καθίσματα Ülések</p>	<p>Chassis number N° châssis Número de chasis Número do chassi N° telaio Číslo podvozku Nr. Zawieszenia № Шасси Şasi numarası Αρ. Πλαισίου Alvázzám</p>

<p><b>DV</b></p> <p>Ventilated disc Disque ventilé Disco freno ventilado Disco ventilado Disco ventilato Geventleerbe schijf Belüftete Bremsscheibe Větráný kotouč Tarczta wentylowana диски вентилируемые Fren Diski - i Sogutmal Αεριζόμενων ή διακόπτακα Hűtött féktárcsa</p>	<p><b>CERA+</b></p> <p>With ceramic disc Avec disque céramique Con disco de cerámi ca Com disco cerâmico Con disco in ceramica With ceramic disc Mit keramischer Bremsscheibe S keramickými disky Z ceramicznymi tarczami hamulcowymi С керамическим тормозом Seramik disk ile Με κεραμικούς δίσκους Kerámia féktárcsához</p>	<p><b>ETCV+</b></p> <p>With traction control+ Avec contrôle de traction Con control de la tracción Com controle de tracção Con controllo di trazione Met tractieregeling Mit Antriebs-fähigkeitskontrolle S řízením trakce Z kontrolą trakcji С противобуксовочной системой Çekiş kontrol ile Με σύστημα ελέγχου έλξης Traction control+</p>
<p><b>DP</b></p> <p>Solid disc Disque plein Disco freno macizo Disco freno maciço Disco freno pieno Massieve schijf Volle Bremsscheibe Plný kotouč Tarczta pełna диски сплошные Fren Diski - Sogutmasiv Συμπληρωτική διακόπτακα Szilárd féktárcsa</p>	<p><b>CU</b></p> <p>Extra load Charge utile élevée Carga útil elevada Carga util elevada Sovraccarico Extra laadvermogen Erhöhte Nutzlast Zvýšená nosnost Wzmożnienie Усиленная нагрузка İlave yük Παράπλεον φορτίο Extra terhelés</p>	<p><b>ETS+</b></p> <p>With drive ability control+ Avec contrôle de motricité Con control de la tracción Com controle de Tracção Con controllo di trazione Met tractieregeling Mit Antriebs-fähigkeitskontrolle S řízením schopnost pohonu Z kontrolą trakcji С регулировкой приводного блока Sürüş kontrol ile Με σύστημα ελέγχου οδήγησης Drive ability control+</p>
<p><b>ABS</b></p> <p>Anti-lock system Système antiblocage ABS ABS ABS ABS ABS ABS ABS ABS blokkolásgátló rendszer</p>	<p><b>DA</b></p> <p>Power steering Direction assistée Dirección asistida Direcção assistida Servosterzo Stuurbekrachtiging Servolenkung Posilovač řízení Wspomaganie kierownicy Усилитель рулевого управления Servo direksiyon Υδραυλικό τιμόνι Szervókormány</p>	<p><b>ETX</b></p> <p>Bendix/Bosch caliper Étrier Bendix/Bosch Estribo Bendix / Bosch Estribo Bendix/Bosch Pinza Bendix/Bosch Remklauw Bendix/Bosch Bremssattel (Bendix/Bosch ) Tímen Bendix/Bosch Zacisk typu Bendix/Bosch Суппорт Bendix/Bosch Bendix/Bosch kaliper Δαγκάνα Bendix/Bosch Bendix/Bosch féknyereg</p>
<p><b>ABSX</b></p> <p>With ABS Bendix Avec antiblocage Bendix Con ABS Bendix Com ABS Bendix ABS Bendix ABS Bendix Bendix ABS ABS Bendix Z systemem ABS Bendix ABS Bendix Bendix ABS ile Με ABS Bendix Bendix ABS-szel szerelt változat</p>	<p><b>DCI</b></p> <p>Double circuit Double circuit Doble circuito Dupla circuito Doppio circuito Dubbel circuit Zweikreis Dvouokruhové brzdy Dwuobwodowy system hamulcowy Двойной контур Çift devreli Διπλό κύκλωμα Kettős fékkör</p>	<p><b>FA</b></p> <p>Power brake Freinage assisté Freno asistido Travão assistido Servofreno Rembekrachtiging Bremskraftverstärker Posilovač brzdy Systemu wspomagania hamulca (bez servo) Усилитель тормозов Güç destekli fren sistemi Υποβοήθηση φρένου Szervofék</p>
<p><b>AC</b></p> <p>Air conditioning Air climatisé Aire acondicionado Ar condicionado Aria condizionata Airco Klimaanlage Klimatizace Klimatyzacja кондиционер Klima Air condition Légkondicionáló</p>	<p><b>ESP</b></p> <p>ESP ESP ESP ESP ESP ESP elektronikus menetstabilizáló ESP</p>	<p><b>FAD</b></p> <p>Brake disc Frein à disque Freno de disco Travão de disco Freno a disco Schijfremmen Scheibenbremsanlage Kotoučová brzda Hamulce tarczowe Тормозной диск Fren disk Δισκόφρενο Féktárcsa</p>
<p><b>APB+</b></p> <p>With automatic parking brake Avec frein de parking automatique Con freno de mano automático Com controle de mão automático Con freno di stazionamento automatico Met automatische handrem Mit automatische Handbremse S automatickou parkovací brzdou Z automatycznym hamulcem parkin-gowym С автоматическим стояночным тормозом Otomatik park freni ile Με ηλεκτρικό χειρόφρενο Automata kézifékes járműhöz</p>	<p><b>ETA</b></p> <p>Teves caliper Étrier Teves Estribo Teves Estribo Teves Pinza Teves Remklauw Teves Bremssattel Teves Tímen Teves Zacisk Teves Суппорт Teves Teves kaliper Δαγκάνα Teves Teves féknyereg</p>	<p><b>FREL+</b></p> <p>With electric parking brake Avec frein à main électrique Con freno de mano eléctrico Com controle de mão elétrico Con freno di stazionamento automatico Met elektrische handrem Mit automatische Handbremse S automatickou parkovací brzdou Z automatycznym hamulcem parkin-gowym С автоматическим стояночным тормозом Otomatik park freni ile Με αυτόματο φρένο στάθμευσης Automata kézifékes járműhöz</p>
<p><b>ASR</b></p> <p>ASR Système antipatinage ASR ASR ASR ASR ASR ASR (patinaj önleme sistemi) ASR kipörgésgátló rendszer</p>	<p><b>ETL</b></p> <p>Lucas caliper Étrier Lucas Estribo Lucas Estribo Lucas Pinza Lucas Remklauw Lucas Bremssattel Lucas Tímen Lucas Zacisk Lucas Суппорт Lucas Lucas kaliper Δαγκάνα Lucas Lucas féknyereg</p>	<p><b>FREM</b></p> <p>With mechanic parking brake Avec frein à main mécanique Con freno de mano mecánico Com controle de mão mecânico Con freno di stazionamento meccanico Met mechanische handrem Mit mechanisch Handbremse S mechanickou parkovací brzdou Z mechanicznym hamulcem parkin-gowym С механическим стояночным тормозом Mekanik park freni ile Με συμβατικό χειρόφρενο Mechanikus kézifékes járműhöz</p>

HD	<p>Heavy duty          Equipement renforcé          Equipamiento reforzado          Equipamento reforzado          Equipaggiamenti per carichi pesanti          Versterkte uitvoering          Verstärkter Bremsanlage          Pro těžký provoz          Wzmocniony          Повышенная надежность          Ağır hizmet          Ενισχυμένο εξοπλισμό          Erősített kivitel</p>
MV	<p>Booster          Servo-frein          Servofreno          Intensificador          Servofreno          Rembekrachtiger          Bremskraftverstärker          Posilovač          Wzmacniacz          Тормозной усилитель          Servo fren          Συσκευή ενίσχυσης          Erősítő</p>
SR3-	<p>Except third seat row          Sans troisième rangée de sièges          Excepto la tercera fila de asientos          Exclua a terceira linha de assento          Eccetto la terza fila di sedili          Behalve de derde regel van de zitplaatsen          Außer der dritten linie von plätzen          Kromě vozidel s třetí řadou sedadel          Z wyłączeniem trzech rzędów siedzeń          За исключением третьего ряда кресел          Üçüncü sıra koltuklu araçlar hariç          Χωρίς τρίτη σειρά καθισμάτων          Harmadik ülésor nélküli</p>
SCI	<p>Single circuit          Simple circuit          Circuito simple          Circuito simples          Circuito singolo          Enkel circuit          Einkreisbremsanlage          Jednookruhový brzdový systém          Jednoobwodowy system hamulcowy          Одинарный контур          Tek devreli          Μονό κύκλωμα          Egykörös fékrendszer</p>
TU	<p>WeaWear indicator          Temoïn d'usure          Indicator de degaste          Indicator de degaste          Indicatore d'usura          Slijtage indicator          Verschleissanzeige          Indikátor opotřebení          Wskaźnik zużycia          индикатор износа          Fren İkaz Kablosu          Δείκτης φθοράς          Korásjelző</p>
VEB+	<p>For armored vehicle          Pour véhicules blindés          Per veicolo blindato          Voor armored auto          Für gepanzerten wagen          Pro obrněné vozidlo          Do pojazdów opancerzonych          Для бронированных транспортных средств          Zırhlı araçlar için          Για θωρακισμένο όχημα          Páncélozott járművekhez</p>



1   **Valeo**

3 



2 **Valeo**  

132 



3 **WVA**  

161 

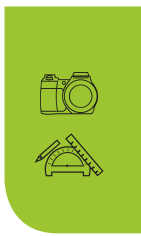

4   **Valeo**

351 



5   **Valeo**

387 























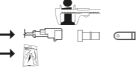



































































































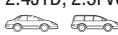

































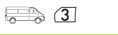



**Valeo**

























































































ALFA ROMEO	4	LAND ROVER	54
AUDI	6	LDV	55
AUTOBIANCHI	13	LEXUS	55
BEDFORD	13	MAZDA	55
BMW	13	MERCEDES	57
CADILLAC	17	MG	61
CHEVROLET	18	MINI	62
CHRYSLER	19	MITSUBISHI	62
CITROËN	19	NISSAN	66
DACIA	24	OPEL	70
DAEWOO	24	PEUGEOT	77
DAF	25	PORSCHE	82
DAIHATSU	25	PROTON	82
DODGE	25	RENAULT	82
FIAT	25	ROVER	92
FORD	32	SAAB	93
FSO POLSKI	39	SEAT	93
GALLOPER	39	SKODA	99
HONDA	39	SMART MCC	102
HYUNDAI	42	SSANGYONG	102
INFINITI	49	SUBARU	102
ISUZU	49	SUZUKI	103
IVECO	49	TALBOT	104
JAGUAR	49	TOYOTA	104
JEEP	50	VAUXHALL	108
KIA	50	VOLKSWAGEN	114
LADA	52	VOLVO	128
LANCIA	52		

											
<b>ALFA ROMEO</b>											
<b>33 (89&gt;94)</b> 											
1.7i, 1.7ie  ABS+	08/89 ▶ 09/94		LUC	<b>301142</b>	21103		87,3	44,4	14,4		
<b>145 (94&gt;2001)</b> 											
1.8i Twin Spark, 1.8i Twin Spark AGV, 2.0i, 2.0i AGV	11/95 ▶ 06/01		ATE	<b>301023</b>	21636		156,3	58,9	19		↳ 2x  216 mm
1.4i Twin Spark, 1.6i Twin Spark, 1.9TD	07/96 ▶ 06/01		ATE	<b>301040</b>	21930		151,5	52,5	17,4		↳ 1x  200 mm
1.8i Twin Spark	12/96 ▶ 06/01		ATE	<b>301065</b>	21636		155,3	61,7	19		↳ 2x  200 mm
1.3i, 1.6i, 1.7i, 1.9TD	09/94 ▶ 12/96		TRW	<b>301219</b>	20838		104,5	66,6	17,2		↳ 2x  
2.0i, 2.0i AGV	01/00 ▶ 06/01		ATE	<b>301990</b>	21637		155,3	61,6	19,1		↳ 2x  211 mm
							156,45	55,9			
1.3i, 1.4i Twin Spark, 1.6i, 1.6i Twin Spark, 1.7i, 1.8i Twin Spark, 1.8i Twin Spark AGV, 1.9JTD, 1.9TD, 2.0i, 2.0i AGV ABS+	09/94 ▶ 06/01		LUC	<b>301142</b>	21103		87,3	44,4	14,4		
<b>146 (94&gt;2001)</b> 											
1.8i Twin Spark, 1.8i Twin Spark AGV, 2.0i, 2.0i Twin Spark AGV	10/95 ▶ 06/01		ATE	<b>301023</b>	21636		156,3	58,9	19		↳ 2x  216 mm
1.4i Twin Spark, 1.6i Twin Spark, 1.9TDs	07/96 ▶ 06/01		ATE	<b>301040</b>	21930		151,5	52,5	17,4		↳ 1x  200 mm
1.8i Twin Spark	12/96 ▶ 06/01		ATE	<b>301065</b>	21636		155,3	61,7	19		↳ 2x  200 mm
1.3i, 1.6i, 1.7i, 1.9TDs	12/94 ▶ 12/96		TRW	<b>301219</b>	20838		104,5	66,6	17,2		↳ 2x  
1.8i Twin Spark AGV, 2.0i Twin Spark AGV	01/00 ▶ 06/01		ATE	<b>301990</b>	21637		155,3	61,6	19,1		↳ 2x  211 mm
							156,45	55,9			
1.3i, 1.4i Twin Spark, 1.6i, 1.6i Twin Spark, 1.7i, 1.8i Twin Spark, 1.8i Twin Spark AGV, 1.9JTD, 1.9TDs, 2.0i, 2.0i Twin Spark AGV ABS+	12/94 ▶ 06/01		LUC	<b>301142</b>	21103		87,3	44,4	14,4		
<b>147 (2000&gt;2004)</b> 											
1.6i Twin Spark, 1.9JTD, 2.0i Twin Spark    3021490 ▶ _	▶ 09/04		ATE	<b>301990</b>	21637		155,3	61,6	19,1		↳ 2x  211 mm
							156,45	55,9			
1.6i Twin Spark, 1.9JTD, 2.0i Twin Spark, 3.2i V6  	10/00 ▶ 09/04		LUC	<b>301407</b>	23661		95,8	43,7	16,5		
<b>147 (2004&gt;2010)</b> 											
1.6i Twin Spark, 1.9JTD, 1.9JTDM, 2.0i Twin Spark  	10/04 ▶ 01/10		ATE	<b>301990</b>	21637		155,3	61,6	19,1		↳ 2x  211 mm
							156,45	55,9			
1.6i Twin Spark, 1.9JTD, 1.9JTDM, 2.0i Twin Spark, 3.2i V6  	10/04 ▶ 01/10		LUC	<b>301407</b>	23661		95,8	43,7	16,5		
<b>155 (91&gt;97)</b> 											
2.0i Twin Spark	03/95 ▶ 08/97		ATE	<b>301065</b>	21636		155,3	61,7	19		↳ 2x  200 mm
1.6i Twin Spark, 1.7i Twin Spark, 1.8i Twin Spark, 1.9TD, 2.0i Twin Spark			TRW	<b>301219</b>	20838		104,5	66,6	17,2		↳ 2x  



































































										
<b>ALFA ROMEO (.../...)</b>										
<b>155 (91&gt;97)  (.../...)</b>										
1.6i Twin Spark, 1.7i Twin Spark, 1.8i Twin Spark, 1.9TD, 2.0i Turbo, 2.0i Twin Spark, 2.5TD, 2.5i V6	11/91 ▶ 08/97		LUC	<b>301142</b>	21103		87,3	44,4	14,4	
<b>156 (97&gt;2003) </b>										
2.0i Twin Spark, 2.4JTD, 2.5i V6   (4), (5)  125458 ▶ _  _ ▶ 169498			ATE	<b>301023</b>	21636	 	156,3	58,9	19	↳ 2x  216 mm
2.0i Twin Spark, 2.4JTD   (4), (5)  _ ▶ 125457	09/97 ▶		ATE	<b>301065</b>	21636	 	155,3	61,7	19	↳ 2x  200 mm
1.6i Twin Spark, 1.8i Twin Spark, 1.9JTD, 2.0JTS, 2.0i Twin Spark, 2.4JTD, 2.5i V6   (4), (5)  383457 ▶ _	▶ 03/03		ATE	<b>301990</b>	21637	 	155,3	61,6	19,1	↳ 2x  211 mm
1.6i Twin Spark, 1.8i Twin Spark, 1.9JTD, 2.0JTS, 2.0i Twin Spark, 2.4JTD, 2.5i V6, 3.2i V6   (4), (5)	09/00 ▶ 03/03		LUC	<b>301407</b>	23661		95,8	43,7	16,5	
1.6i Twin Spark, 1.8i Twin Spark, 1.9JTD, 2.0i Twin Spark, 2.4JTD, 2.5i V6   (4), (5)	09/97 ▶ 03/03		LUC	<b>301581</b>	21606		89,8	50	16,4	
<b>156 (2003&gt;2007) </b>										
1.6i Twin spark, 1.8i Twin Spark, 1.9JTD, 2.0JTS, 2.0JTS TwinSpark, 2.4JTD, 2.5i V6   (4), (5)	04/03 ▶ 11/06		ATE	<b>301990</b>	21637	 	155,3	61,6	19,1	↳ 2x  211 mm
1.6i Twin Spark, 1.8i Twin spark, 1.9JTD, 2.0JTS, 2.0JTS TwinSpark, 2.4JTD, 2.5i V6, 3.2i V6   (4), (5)	04/03 ▶ 06/07		LUC	<b>301407</b>	23661		95,8	43,7	16,5	
<b>164 (87&gt;92) </b>										
2.0 Turbo, 2.0 V6 Turbo, 2.0i Twin Spark, 2.5TD, 3.0i V6	07/87 ▶ 09/92		LUC	<b>301125</b>	20668		87	66,9	16,6	
<b>164 (92&gt;98) </b>										
2.0 V6 Turbo, 2.0i Twin Spark, 2.5TD, 3.0i V6	09/92 ▶ 09/98		LUC	<b>301125</b>	20668		87	66,9	16,6	
3.0i, 3.0i V6	09/92 ▶ 09/98		LUC	<b>301581</b>	21606		89,8	50	16,4	
<b>166 (98&gt;2007) </b>										
2.0i Twin Spark, 2.4JTD	10/98 ▶ 04/06		ATE	<b>301023</b>	21636	 	156,3	58,9	19	↳ 2x  216 mm
2.0i Twin Spark, 2.0i V6 Turbo, 2.4JTD, 2.5i V6, 3.0i V6, 3.2i V6	10/98 ▶ 12/07		LUC	<b>301581</b>	21606		89,8	50	16,4	
<b>Alfetta (72&gt;85) </b>										
1.6, 1.8, 2, 2.0TD, 2i   (2), (4)	05/72 ▶ 1985		ATE	<b>301099</b>	20228		61,8	56,6	15	
<b>AR8 (80&gt;86) </b>										
2.4D  (3)	03/80 ▶ 06/81		AP	<b>301129</b>	20359	 	105	74,7	18	↳ 4x  195 mm / 145 mm
<b>Giulia (64&gt;79) </b>										
1.3, 1.6, 1.7D    (2), (4)	07/64 ▶ 1979		ATE	<b>301099</b>	20228		61,8	56,6	15	
<b>Giulietta (76&gt;86) </b>										
1.3, 1.6, 1.8, 2.0TD, 2.0i  (4)	10/77 ▶ 1982		ATE	<b>301099</b>	20228		61,8	56,6	15	





												
<b>ALFA ROMEO (.../...)</b>												
<b>GT (2003&gt;2010)</b> 												
1.8i Twinspark, 1.9JTD, 2.0JTS			ATE	<b>301990</b>	21637		155,3	61,6	19,1	↳ 2x + 211 mm		
							156,45	55,9				
1.8i Twinspark, 1.9JTD, 2.0JTS, 3.2 V6	09/03 ▶ 01/10		LUC	<b>301407</b>	23661		95,8	43,7	16,5			
<b>GTV (80&gt;87)</b> 												
2.0, 2.0i	12/80 ▶ 1986		ATE	<b>301099</b>	20228		61,8	56,6	15			
<b>GTV (95&gt;2003)</b> 												
1.8i Twin Spark, 2.0 Twin Spark AGV, 2.0 V6 Turbo, 2.0i Twin Spark	03/95 ▶		ATE	<b>301023</b>	21636		156,3	58,9	19	↳ 2x + 216 mm		
 _ ▶ 6063379												
1.8i Twin Spark, 2.0 Twin Spark AGV, 2.0 V6 Turbo, 2.0i Twin Spark	▶ 02/03		ATE	<b>301065</b>	21636		155,3	61,7	19	↳ 2x + 200 mm		
 6063380 ▶ _												
1.8i Twin Spark, 2.0 Twin Spark AGV, 2.0 V6 Turbo, 2.0i Twin Spark, 3.0i V6	03/95 ▶ 02/03		LUC	<b>301142</b>	21103		87,3	44,4	14,4			
<b>GTV (2003&gt;2006)</b> 												
2.0JTS, 2.0i Twin Spark	03/03 ▶ 02/06		ATE	<b>301065</b>	21636		155,3	61,7	19	↳ 2x + 200 mm		
2.0JTS, 2.0i Twin Spark, 3.2i V6	03/03 ▶ 02/06		LUC	<b>301142</b>	21103		87,3	44,4	14,4			
<b>Spider (105-115-915) (71&gt;93)</b> 												
1.6	06/80 ▶ 12/89		ATE	<b>301099</b>	20228		61,8	56,6	15			
<b>Spider (916) (95&gt;2003)</b> 												
1.8i Twin Spark, 2.0i Twin Spark, 2.0i V6 Turbo, 3.0i V6	07/95 ▶		ATE	<b>301023</b>	21636		156,3	58,9	19	↳ 2x + 216 mm		
 6009486 ▶ _												
 _ ▶ 6063379												
1.8i Twin Spark, 2.0i Twin Spark, 2.0i V6 Turbo, 3.0i V6	▶ 02/03		ATE	<b>301065</b>	21636		155,3	61,7	19	↳ 2x + 200 mm		
 6063380 ▶ _												
2.0i Twin Spark	02/95 ▶ 07/95		TRW	<b>301219</b>	20838		104,5	66,6	17,2	↳ 2x 		
 _ ▶ 6009485												
1.8i Twin Spark, 2.0i Twin Spark, 2.0i V6 Turbo, 3.0i V6	02/95 ▶ 02/03		LUC	<b>301142</b>	21103		87,3	44,4	14,4			
<b>Spider (916) (2003&gt;2006)</b> 												
2.0JTS, 2.0i Twin Spark	03/03 ▶ 02/06		ATE	<b>301065</b>	21636		155,3	61,7	19	↳ 2x + 200 mm		
2.0JTS, 2.0i Twin Spark, 3.2i V6	03/03 ▶ 02/06		LUC	<b>301142</b>	21103		87,3	44,4	14,4			
<b>AUDI</b>												
<b>50 (74&gt;78)</b> 												
1.1, 1.3	08/74 ▶ 07/78		ATE	<b>301099</b>	20228		61,8	56,6	15			
<b>80 (72&gt;81)</b> 												
1.3, 1.5, 1.6, 1.6i	03/73 ▶ 07/81		ATE	<b>301099</b>	20228		61,8	56,6	15			
<b>80 (81-85) (81&gt;87)</b> 												
1.8, 1.8i, 2.0i, 2.2, 2.2i	08/82 ▶ 08/86		LUC	<b>301125</b>	20668		87	66,9	16,6			
 (2),(4)												

























































































												
<b>AUDI (.../...)</b>												
<b>80 (89-8A) (86&gt;91)</b> 												
1.4, 1.6, 1.6D, 1.6TD, 1.6i, 1.8, 1.8i, 1.9D, 1.9i, 2.0i	08/86 ▶ 09/91		LUC	<b>301003</b>	20901		119	69,5	19,1			
1.8, 1.8i, 1.9i, 2.0i	08/86 ▶ 09/91		LUC	<b>301125</b>	20668		87	66,9	16,6			
<b>80 (8C) (91&gt;95)</b> 												
1.6i, 1.9TD, 1.9TDi, 2.0E, 2.0S, 2.0i, 2.3E, 2.6E V6   (4), (5)  P-000 001 ▶ _  _ ▶ N-300 000	09/91 ▶ 07/95		LUC	<b>301003</b>	20901		119	69,5	19,1			
1.6i, 1.9TD, 1.9TDi, 2.0E, 2.0S, 2.0i, 2.2i Turbo, 2.3E, 2.6E V6, 2.8i V6   (4), (5)  P-050 000 ▶ _	09/91 ▶ 07/95		LUC	<b>301125</b>	20668		87	66,9	16,6			
<b>Cabriolet (8G) (91&gt;2000)</b> 												
2.3E  _ ▶ N-025 000	06/91 ▶ 08/92		LUC	<b>301003</b>	20901		119	69,5	19,1			
1.8E, 1.9TDi, 2.0E, 2.3E, 2.6E V6, 2.8i V6  _ ▶ P-005 333	06/91 ▶ 08/00		LUC	<b>301125</b>	20668		87	66,9	16,6			
<b>90 (81-85) (84&gt;87)</b> 												
2.2i	06/84 ▶ 03/87		LUC	<b>301016</b>	20901		119	69,5	15,7		 2 x  225 mm	
2.2i	06/84 ▶ 03/87		LUC	<b>301125</b>	20668		87	66,9	16,6			
<b>90 (89-8A) (87&gt;91)</b> 												
1.6TD, 1.8i, 2.0i, 2.2i, 2.3i	04/87 ▶ 12/91		LUC	<b>301003</b>	20901		119	69,5	19,1			
1.8i, 2.0i, 2.2i, 2.3i	04/87 ▶ 12/91		LUC	<b>301125</b>	20668		87	66,9	16,6			
<b>100 (C1) (68&gt;72)</b> 												
1.8, 1.9   (2), (4)	07/68 ▶ 09/71		ATE	<b>301099</b>	20228		61,8	56,6	15			
<b>100 (43) (71&gt;82)</b> 												
1.9, 2.0D, 2.0TD, 2.2, 2.2i   (2), (4), (5)	08/76 ▶ 07/82		LUC	<b>301003</b>	20901		119	69,5	19,1			
<b>100 (44) (82&gt;90)</b> 												
1.8, 1.8i, 1.9, 2.0D, 2.0TD, 2.0i, 2.2, 2.2i, 2.2i Turbo, 2.3i, 2.4D   (4), (5) I+ TU+ : Wear warning+  _ ▶ G-073 363	08/82 ▶ 12/90		LUC	<b>301003</b>	20901		119	69,5	19,1			
1.8, 2.2, 2.2 Turbo, 2.2i, 2.2i Turbo, 2.3i, 2.5TDi   (4), (5)  14"  15"	08/82 ▶ 12/90		LUC	<b>301125</b>	20668		87	66,9	16,6			
<b>100 (4A) (90&gt;94)</b> 												
1.6, 1.6i, 2.0, 2.0i, 2.2i Turbo, 2.3i, 2.4D, 2.5TDi, 2.6 V6, 2.6i V6, 2.8i V6, 4.2i V8   (4), (5)	12/90 ▶ 07/94		ATE	<b>301049</b>	20676		156,5	74,2	19,5		 2 x  210 mm	
1.6, 1.6i, 2.0, 2.0i, 2.2i Turbo, 2.3i, 2.4D, 2.5TDi, 2.6 V6, 2.6i V6, 2.8i V6, 4.2i V8   (4), (5)	12/90 ▶ 07/94		LUC	<b>301125</b>	20668		87	66,9	16,6			
<b>200 (43-44) (79&gt;90)</b> 												
2.1, 2.1 Turbo, 2.2, 2.2 Turbo   (4), (5)  _ ▶ G-073 362	10/79 ▶ 12/85		LUC	<b>301003</b>	20901		119	69,5	19,1			
2.1, 2.1 Turbo, 2.2, 2.2 Turbo, 2.3 Turbo   (4), (5)	10/79 ▶ 12/90		LUC	<b>301125</b>	20668		87	66,9	16,6			

								
<b>AUDI (.../...)</b>								
<b>A1 (2010&gt;) </b>								
1.2TFSI, 1.2TFSI 86, 1.6TDI, 1.6TDI 105, 1.6TDI 90  (3), (5)	05/10 ▶		ATE	<b>301332</b>	21974		146 54,7 19,8	
1.4TFSI, 1.4TFSI 122, 1.4TFSI 185, 2.0TDI, 2.0TDI 136, 2.0TDI 143, 2.0TFSI 256  (3), (5)	05/10 ▶		ATE	<b>301635</b>	23587		156,4 71,4 20,3 155,2 66	↳ 1 x  155 mm
1.2TFSI, 1.2TFSI 86, 1.4TFSI, 1.4TFSI 122, 1.4TFSI 185, 1.6TDI, 1.6TDI 105, 1.6TDI 90, 2.0TDI, 2.0TDI 136, 2.0TDI 143  (3), (5)	05/10 ▶		LUC	<b>301463</b>	20960		87 52,9 17	
<b>A2 (2000&gt;2005) </b>								
1.4TDi, 1.4i, 1.6FSI	06/00 ▶ 08/05		ATE	<b>301408</b>	21974		146 54,7 18,5	↳ 1 x  155 mm
1.2TDi TU+ : Wear warning+	03/01 ▶ 08/05		KELS	<b>301734</b>	23395		141,8 49,8 14,3 48,1	↳ 1 x  235 mm
1.4TDi, 1.4i, 1.6FSI	06/00 ▶ 08/05		LUC	<b>301674</b>	20960		87 53 17	↳ 1 x  260 mm
<b>A3 (96&gt;2000) </b>								
1.6i, 1.8i, 1.9TDi	09/96 ▶ 08/00		ATE	<b>301332</b>	21974		146 54,7 19,8	
1.8i Turbo, 1.9TDi	12/96 ▶ 08/00		ATE	<b>301486</b>	21911		156,35 74,1 19,5	↳ 1 x  155 mm
1.6i, 1.8i, 1.8i Turbo, 1.9TDi	09/96 ▶ 08/00		LUC	<b>301180</b>	20960		87 53 15,2	
1.6i, 1.8i, 1.8i Turbo, 1.9TDi	09/96 ▶ 08/00		LUC	<b>301463</b>	20960		87 52,9 17	
<b>A3 (2000&gt;2003) </b>								
1.6i, 1.8i, 1.9TDi TU+ : Wear warning+	09/00 ▶ 06/03		ATE	<b>301408</b>	21974		146 54,7 18,5	↳ 1 x  155 mm
1.8i Turbo, 1.9TDi	09/00 ▶ 06/03		ATE	<b>301486</b>	21911		156,35 74,1 19,5	↳ 1 x  155 mm
1.6i, 1.8i, 1.8i Turbo, 1.9TDi	09/00 ▶ 06/03		LUC	<b>301180</b>	20960		87 53 15,2	
1.6i, 1.8i, 1.8i Turbo, 1.9TDi	09/00 ▶ 06/03		LUC	<b>301463</b>	20960		87 52,9 17	
<b>A3 (2003&gt;2008) </b>								
1.4TFSi, 1.6FSi, 1.6i, 1.9TDi, 1.9TDie	05/03 ▶ 06/08		ATE	<b>301408</b>	21974		146 54,7 18,5	↳ 1 x  155 mm
1.8TFSi, 2.0FSi, 2.0TDi, 2.0TFSi	05/03 ▶ 06/08		ATE	<b>301635</b>	23587		156,4 71,4 20,3 155,2 66	↳ 1 x  155 mm
1.4TFSi, 1.6FSi, 1.6i, 1.9TDi, 1.9TDie	05/03 ▶ 06/08		LUC	<b>301463</b>	20960		87 52,9 17	
1.8TFSi, 2.0FSi, 2.0TDi, 2.0TFSi, 3.2i V6	05/03 ▶ 06/08		TRW	<b>301752</b>	23914		105,1 56 17	
<b>A3 (2008&gt;2013) </b>								
1.2TFSi 105, 1.2TFSi 105, 1.4TFSi 125, 1.6TDi 105, 1.6TDi 90, 1.6TDie 105, 1.6i 102, 1.9TDi 105, 1.9TDie 105	07/08 ▶		ATE	<b>301408</b>	21974		146 54,7 18,5	↳ 1 x  155 mm
1.8TFSi 160, 2.0TDi 136, 2.0TDi 140, 2.0TDi 170, 2.0TFSi 200	07/08 ▶ 03/13		ATE	<b>301635</b>	23587		156,4 71,4 20,3 155,2 66	↳ 1 x  155 mm









											
<b>AUDI (.../...)</b>											
<b>A3 (2008&gt;2013)  (.../...)</b>											
1.2TFSi 105, 1.2TSi 105, 1.4TFSi 125, 1.6TDi 105, 1.6TDi 90, 1.6TDie 105, 1.6i 102, 1.8TFSi 160, 1.9TDi 105, 1.9TDie 105, 2.0TDi 136, 2.0TDi 140	07/08 ▶		LUC	<b>301463</b>	20960		87	52,9	17		
1.8TFSi 160, 2.0TDi 140, 2.0TDi 170, 2.0TFSi 200, 3.2i V6	07/08 ▶ 03/13		TRW	<b>301752</b>	23914		105,1	56	17		
<b>A3 (2012&gt;) </b>											
1.4TFSi, 1.6TDi	04/12 ▶		ATE	<b>301408</b>	21974		146	54,7	18,5	↳ 1 x ↗ 155 mm	
1.4TFSi, 1.8TFSi, 2.0TDi	04/12 ▶		ATE	<b>301635</b>	23587		156,4 155,2	71,4 66	20,3	↳ 1 x ↗ 155 mm	
1.4TFSi, 1.6TDi, 2.0TDi	04/12 ▶		LUC	<b>301463</b>	20960		87	52,9	17		
1.8TFSi, 2.0TDi	04/12 ▶		TRW	<b>301752</b>	23914		105,1	56	17		
<b>A3 Cabriolet (2008&gt;) </b>											
1.2TSi 105, 1.4TSi 125, 1.6TDi CR 105, 1.6i 102, 1.9TDi 105	04/08 ▶		ATE	<b>301408</b>	21974		146	54,7	18,5	↳ 1 x ↗ 155 mm	
1.8TFSi 160, 2.0TDi 136, 2.0TDi 140, 2.0TDi CR 136, 2.0TDi CR 140, 2.0TFSi 200	04/08 ▶		ATE	<b>301635</b>	23587		156,4 155,2	71,4 66	20,3	↳ 1 x ↗ 155 mm	
1.2TSi 105, 1.4TSi 125, 1.6TDi CR 105, 1.6i 102, 1.9TDi 105	04/08 ▶		LUC	<b>301463</b>	20960		87	52,9	17		
2.0TFSi 200	04/08 ▶		TRW	<b>301752</b>	23914		105,1	56	17		
<b>A4 (94&gt;98) </b>											
1.6i, 1.8i, 1.9TDi  V-054 062 ▶ _  V-160 001 ▶ _  _ ▶ V-160 000	11/94 ▶ 12/98		LUC	<b>301003</b>	20901		119	69,5	19,1		
1.8i, 1.8i Turbo, 1.9TDi, 2.4i V6, 2.5TDi V6, 2.6i V6, 2.8i V6  _ ▶ V-054 061	11/94 ▶ 12/98		ATE	<b>301355</b>	21911		156,3	74	19,8		
1.6i, 1.8i, 1.8i Turbo, 1.9TDi, 2.4i V6, 2.5TDi V6, 2.6i V6, 2.8i V6  _ ▶ V-160 000	11/94 ▶ 12/98		LUC	<b>301125</b>	20668		87	66,9	16,6		
1.6i, 1.8i, 1.8i Turbo, 1.9TDi, 2.4i V6, 2.5TDi V6, 2.6i V6, 2.8i V6  V-160 001 ▶ _	07/95 ▶ 12/98		LUC	<b>301463</b>	20960		87	52,9	17		
<b>A4 (99&gt;2001) </b>											
1.8i, 1.8i Turbo, 1.9TDi, 2.4i V6, 2.5TDi V6, 2.8i V6 TAXI+ : Taxi+	01/99 ▶ 09/01		ATE	<b>301483</b>	20676		156,4	74,2	20,3	↳ 2 x ↗ 210 mm	
1.6i, 1.8i, 1.8i Turbo, 1.9TDi	01/99 ▶ 09/01		LUC	<b>301484</b>	23393		119	69,5	19,4	↳ 2 x ↗ 210 mm	
1.8i, 1.8i Turbo, 1.9TDi, 2.4i V6, 2.5TDi V6, 2.8i V6	02/99 ▶ 11/00		LUC	<b>301125</b>	20668		87	66,9	16,6		
1.6i, 1.8i, 1.8i Turbo, 1.9TDi, 2.4i V6, 2.5TDi V6, 2.7i V6, 2.8i V6	01/99 ▶ 09/01		LUC	<b>301463</b>	20960		87	52,9	17		
<b>A4 (2000&gt;2004) </b>											
2.4i V6, 2.5TDi, 2.5TDi V6, 3.0i, 3.0i V6	12/00 ▶ 12/04		ATE	<b>301483</b>	20676		156,4	74,2	20,3	↳ 2 x ↗ 210 mm	
1.6i, 1.8i Turbo, 1.9TDi, 2.0FSi, 2.0i	12/00 ▶ 12/04		LUC	<b>301484</b>	23393		119	69,5	19,4	↳ 2 x ↗ 210 mm	































































										
<b>AUDI (.../...)</b>										
<b>A4 (2000&gt;2004)  (.../...)</b>										
1.6i, 1.9TDi, 2.0FSi, 2.0i	12/00 ▶ 12/03		LUC	<b>301463</b>	20960		87	52,9	17	
1.6i, 1.8i Turbo, 1.9TDi, 2.0FSi, 2.0i, 2.4i V6, 2.5TDi, 2.5TDi V6, 3.0i, 3.0i V6	12/00 ▶ 12/04		LUC	<b>301474</b>	20960		87	53	16	
<b>A4 (2004&gt;2008) </b>										
1.8i Turbo, 2.0TDi, 2.0TFSi, 2.0i, 2.5TDi V6, 2.7TDi V6, 3.0TDi V6, 3.0i, 3.2FSi V6	11/04 ▶ 06/08		ATE	<b>301483</b>	20676		156,4	74,2	20,3	↳ 2x ↗ 210 mm
1.6i, 1.9TDi	11/04 ▶ 06/08		LUC	<b>301484</b>	23393		119	69,5	19,4	↳ 2x ↗ 210 mm
1.8i Turbo, 2.0TDi, 2.0TFSi, 2.0i, 2.5TDi V6, 2.7TDi V6, 3.0TDi V6, 3.0i, 3.2FSi V6	11/04 ▶ 06/08		ATE	<b>301751</b>	20676		156,4	74,2	19,2	↳ 2x ↗ 210 mm
1.6i, 1.8i Turbo, 1.9TDi, 2.0TDi, 2.0TFSi, 2.0i	11/04 ▶ 06/08		LUC	<b>301474</b>	20960		87	53	16	
2.5TDi V6, 2.7TDi V6, 3.0TDi V6, 3.0i, 3.2FSi V6	11/04 ▶ 06/08		TRW	<b>301752</b>	23914		105,1	56	17	
<b>A4 Cabriolet (2002&gt;2005) </b>										
1.8i Turbo, 2.0i, 2.4i V6, 2.5TDi V6, 3.0i V6	04/02 ▶ 12/05		ATE	<b>301483</b>	20676		156,4	74,2	20,3	↳ 2x ↗ 210 mm
1.8i Turbo, 2.0i, 2.4i V6, 2.5TDi V6, 3.0i V6	04/02 ▶ 12/05		ATE	<b>301751</b>	20676		156,4	74,2	19,2	↳ 2x ↗ 210 mm
1.8i Turbo, 2.0i, 2.4i V6, 2.5TDi V6, 3.0i V6	04/02 ▶ 12/05		LUC	<b>301463</b>	20960		87	52,9	17	
<b>A4 Cabriolet II (2006&gt;2009) </b>										
1.8i Turbo, 2.0TDi, 2.7TDi V6	01/06 ▶ 03/09		ATE	<b>301483</b>	20676		156,4	74,2	20,3	↳ 2x ↗ 210 mm
1.8i Turbo, 2.0TDi, 2.7TDi V6	01/06 ▶ 03/09		ATE	<b>301751</b>	20676		156,4	74,2	19,2	↳ 2x ↗ 210 mm
1.8i Turbo, 2.0TDi, 2.0TFSi, 2.7TDi V6	01/06 ▶ 03/09		LUC	<b>301474</b>	20960		87	53	16	
2.7TDi V6, 3.0TDi V6, 3.2FSi V6	01/06 ▶ 03/09		TRW	<b>301752</b>	23914		105,1	56	17	
<b>A6 (94&gt;97) </b>										
1.8E, 1.8i, 1.9TDi, 2.0E, 2.0i, 2.3E, 2.3i, 2.4i V6, 2.5TDi, 2.6E V6, 2.8E V6, 2.8i V6	07/94 ▶ 09/97		ATE	<b>301049</b>	20676		156,5	74,2	19,5	↳ 2x ↗ 210 mm
1.8E, 1.8i, 1.9TDi, 2.0E, 2.0i, 2.3E, 2.3i, 2.4i V6, 2.5TDi, 2.6E V6, 2.8E V6, 2.8i V6	07/94 ▶ 09/97		LUC	<b>301125</b>	20668		87	66,9	16,6	
<b>A6 (97&gt;2001) </b>										
1.8i, 1.8i Turbo, 1.9TDi, 2.4i V6, 2.5TDi V6, 2.7i V6 Bi Turbo, 2.8i V6  X 070 001 ▶ _  ▶ X 060 000  ▶ X 070 000			ATE	<b>301483</b>	20676		156,4	74,2	20,3	↳ 2x ↗ 210 mm
1.8i, 1.8i Turbo, 1.9TDi, 2.4i V6, 2.5TDi V6, 2.7i V6 Bi Turbo, 2.8i V6, 4.2i V8	04/97 ▶ 05/01		LUC	<b>301463</b>	20960		87	52,9	17	
<b>A6 (2001&gt;2005) </b>										
1.8i Turbo, 1.9TDi, 2.0i, 2.4i V6, 2.5TDi V6, 2.7i V6 Bi Turbo, 3.0i V6	06/01 ▶ 04/05		ATE	<b>301483</b>	20676		156,4	74,2	20,3	↳ 2x ↗ 210 mm
2.5TDi V6, 2.7i V6 Bi Turbo, 3.0i V6	06/01 ▶ 04/05		ATE	<b>301751</b>	20676		156,4	74,2	19,2	↳ 2x ↗ 210 mm
1.8i Turbo, 1.9TDi, 2.0i, 2.4i V6, 2.5TDi V6, 2.7i V6 Bi Turbo, 3.0i V6, 4.2i V8	06/01 ▶ 04/05		LUC	<b>301463</b>	20960		87	52,9	17	
<b>A6 (2004&gt;2008) </b>										
2.0TDi, 2.0TFSi	07/04 ▶ 09/08		ATE	<b>301483</b>	20676		156,4	74,2	20,3	↳ 2x ↗ 210 mm







												
<b>AUDI (.../...)</b>												
<b>A6 (2004&gt;2008)  (.../...)</b>												
2.0TDi, 2.0TFSi	07/04 ▶ 09/08		ATE	<b>301751</b>	20676		156,4	74,2	19,2	↳ 2x ↔ 210 mm		
4.2FSi V8	04/04 ▶ 09/08		LUC	<b>301004</b>	23326		115,95	58,92	17,4			
2.0TDi, 2.0TFSi, 2.4i V6, 2.7TDi V6, 2.8FSi V6, 3.0 V6, 3.0TDi V6, 3.2FSi V6	04/04 ▶ 09/08		TRW	<b>301752</b>	23914		105,1	56	17			
<b>A6 (2008&gt;2011) </b>												
2.0TDi, 2.0TDi e, 2.0TFSi, 2.7TDi V6	10/08 ▶ 08/11		ATE	<b>301483</b>	20676		156,4	74,2	20,3	↳ 2x ↔ 210 mm		
4.2FSi V8	10/08 ▶ 03/11		LUC	<b>301004</b>	23326		115,95	58,92	17,4			
2.0TDi, 2.0TDi e, 2.0TFSi, 2.7TDi V6, 2.8FSi V6, 3.0TDi V6, 3.0TFSi V6, 3.2FSi V6	10/08 ▶ 08/11		TRW	<b>301752</b>	23914		105,1	56	17			
<b>A6 Allroad (2000&gt;2005) </b>												
2.5TDi V6, 2.7i V6 Turbo, 4.2FSi V8	05/00 ▶ 08/05		LUC	<b>301463</b>	20960		87	52,9	17			
<b>A6 Allroad (2006&gt;2011) </b>												
4.2FSi V8	05/06 ▶ 12/10		LUC	<b>301004</b>	23326		115,95	58,92	17,4			
2.7TDi V6, 3.0TDi V6, 3.0TFSi V6, 3.2FSi V6	05/06 ▶ 08/11		TRW	<b>301752</b>	23914		105,1	56	17			
<b>A8 (94&gt;2002) </b>												
2.5TDi V6, 2.8E V6, 2.8i V6, 3.7i V8, 4.2i V8	06/94 ▶ 12/98		LUC	<b>301125</b>	20668		87	66,9	16,6			
2.5TDi V6, 2.8E V6, 3.3TDi V8, 3.7i V8, 4.2i V8, 6.0i W12	10/98 ▶ 09/02		LUC	<b>301463</b>	20960		87	52,9	17			
<b>A8 (2002&gt;2010) </b>												
6.0i W12 CERA+ : Ceramics Disc+	02/04 ▶ 10/07		LUC	<b>301004</b>	23326		115,95	58,92	17,4			
<b>Coupé (85) (80&gt;88) </b>												
1.8i, 2.2, 2.2i, 2.3E, 2.3i	08/81 ▶ 07/88		LUC	<b>301125</b>	20668		87	66,9	16,6			
<b>Coupé (8B) (88&gt;96) </b>												
1.8E, 2.0E, 2.0i, 2.2i, 2.3E, 2.6E V6 TU+ : Wear warning+	11/88 ▶ 01/96		LUC	<b>301003</b>	20901		119	69,5	19,1			
1.8E, 2.0E, 2.0i, 2.2i, 2.2i Turbo, 2.3 Turbo, 2.3E, 2.3i, 2.6E V6, 2.8i V6	11/88 ▶ 01/96		LUC	<b>301125</b>	20668		87	66,9	16,6			
<b>Quattro (85) (80&gt;91) </b>												
2.2i Turbo  D-900 001 ▶ _  _ ▶ C-902 000  _ ▶ G-902 400	07/80 ▶ 07/87		LUC	<b>301003</b>	20901		119	69,5	19,1			
2.2i Turbo, 2.3i Turbo	07/80 ▶ 07/91		LUC	<b>301125</b>	20668		87	66,9	16,6			
<b>Q7 (2006&gt;2009) </b>												
3.0TDi V6, 3.0TDi V6 DPF, 3.6FSi V6, 4.2FSi V8, 4.2TDi V8, 6.0TDi V12 ⊙17" ⊙18"	03/06 ▶		BRE	<b>301770</b>	23694		117,3	73,1	16,7			
<b>Q7 (2009&gt;) </b>												
3.0TDi V6, 3.0TFSi V6, 3.6FSi V6, 4.2FSi V8, 4.2TDi V8 ⊙17"	06/09 ▶		BRE	<b>301770</b>	23694		117,3	73,1	16,7			







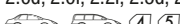











										
<b>AUDI (.../...)</b>										
<b>RS3 (2011&gt;)</b> 										
2.5TSFi    (5)	01/11 ▶		TRW	<b>301752</b>	23914		105,1	56	17	
<b>S3 (98&gt;2003)</b> 										
1.8i Turbo  (3)	11/98 ▶ 06/03		ATE	<b>301635</b>	23587		156,4	71,4	20,3	↳ 1 x ↖ 155 mm
1.8i Turbo  (3)	11/98 ▶ 06/03		TRW	<b>301752</b>	23914		105,1	56	17	
<b>S3 (2006&gt;2013)</b> 										
2.0TFSi   (3), (5)	10/06 ▶ 03/13		TRW	<b>301752</b>	23914		105,1	56	17	
<b>S3 (2012&gt;)</b> 										
2.0TFSi  (3)	10/12 ▶		TRW	<b>301752</b>	23914		105,1	56	17	
<b>S4 (97&gt;99)</b> 										
2.7i V6 Bi Turbo   (4), (5)	10/97 ▶ 01/99		LUC	<b>301125</b>	20668		87	66,9	16,6	
<b>S4 (99&gt;2001)</b> 										
2.7i V6   (4), (5)	02/99 ▶ 09/01		LUC	<b>301463</b>	20960		87	52,9	17	
<b>S4 (2003&gt;2004)</b> 										
4.2i V8   (4), (5)	03/03 ▶ 12/04		LUC	<b>301004</b>	23326		115,95	58,92	17,4	
<b>S4 (2004&gt;2008)</b> 										
4.2i V8   (4), (5)	11/04 ▶ 06/08		LUC	<b>301463</b>	20960		87	52,9	17	
<b>S4 Cabriolet (2004&gt;2005)</b> 										
4.2i V8	02/04 ▶ 12/05		LUC	<b>301004</b>	23326		115,95	58,92	17,4	
<b>S6 (94&gt;97)</b> 										
2.2i Turbo, 4.2i V8   (4), (5)	07/94 ▶ 10/97		LUC	<b>301125</b>	20668		87	66,9	16,6	
<b>S6 Plus Quattro (96&gt;97)</b> 										
4.2i V8   (4), (5)	06/96 ▶ 10/97		LUC	<b>301125</b>	20668		87	66,9	16,6	
<b>S6 (99&gt;2001)</b> 										
4.2i V8   (4), (5)	09/99 ▶ 05/01		LUC	<b>301463</b>	20960		87	52,9	17	
<b>S6 (2001&gt;2005)</b> 										
4.2i V8   (4), (5)	06/01 ▶ 01/05		LUC	<b>301463</b>	20960		87	52,9	17	
<b>S6 (2006&gt;2008)</b> 										
5.2FSi V10   (4), (5)	06/06 ▶ 09/08		LUC	<b>301004</b>	23326		115,95	58,92	17,4	
<b>S6 (2008&gt;2011)</b> 										
5.2FSi V10   (4), (5)	10/08 ▶ 08/11		LUC	<b>301004</b>	23326		115,95	58,92	17,4	
<b>S8 (96&gt;98)</b> 										
4.2i V8	09/96 ▶ 12/98		LUC	<b>301125</b>	20668		87	66,9	16,6	



				<b>Valeo</b>	<b>WVA</b>					
<b>AUDI (.../...)</b>										
<b>S8 (99&gt;2002)</b> 										
4.2i V8	05/99 ▶ 09/02		LUC	<b>301463</b>	20960		87	52,9	17	
<b>TT (98&gt;2006)</b> 										
1.8i Turbo	10/98 ▶ 06/06		ATE	<b>301486</b>	21911		156,35	74,1	19,5	↳ 1 x ↗ 155 mm
1.8i Turbo  1 ▶ _	10/98 ▶ 06/06		LUC	<b>301180</b>	20960		87	53	15,2	
1.8i Turbo, 3.2i V6	10/98 ▶ 06/06		LUC	<b>301463</b>	20960		87	52,9	17	
<b>TT (2006&gt;)</b> 										
1.8TFSi, 2.0TDI, 2.0TDI 170, 2.0TFSi, 2.0TFSi 211	08/06 ▶		ATE	<b>301635</b>	23587		156,4	71,4	20,3	↳ 1 x ↗ 155 mm
							155,2	66		
1.8TFSi, 2.0TDI, 2.0TDI 170, 2.0TFSi, 2.0TFSi 211, 2.0TFSi 265, 3.2i V6	08/06 ▶		TRW	<b>301752</b>	23914		105,1	56	17	
<b>TT RS (2009&gt;)</b> 										
2.5TFSi	07/09 ▶		TRW	<b>301752</b>	23914		105,1	56	17	
<b>V8 (88&gt;93)</b> 										
3.6i V8, 4.2i V8	10/88 ▶ 07/93		LUC	<b>301125</b>	20668		87	66,9	16,6	
<b>AUTOBIANCHI</b>										
<b>Y10 (85&gt;95)</b> 										
1, 1.05, 1.0ie, 1.1ie	07/85 ▶ 10/95		BDX	<b>301091</b>	20775		108,8	47,4	18	↳ 2 x ⇐
1.05 Turbo, 1.1ie, 1.3	07/85 ▶ 10/95		TRW	<b>301219</b>	20838		104,5	66,6	17,2	↳ 2 x ⇐
<b>BEDFORD</b>										
<b>Brava (88&gt;90)</b> 										
2.2D, 2.3, 2.5D	10/88 ▶ 06/90		AKE	<b>301020</b>	21543		127	51	16,5	↳ 4 x ⇐
<b>Novavan (82&gt;88)</b> 										
1.2	07/82 ▶ 07/88		GME	<b>301182</b>	20867		100	59	15,4	
<b>BMW</b>										
<b>1600 (64&gt;73)</b> 										
1.6    (2), (3)	03/66 ▶ 12/73		ATE	<b>301099</b>	20228		61,8	56,6	15	
<b>1800 (63&gt;73)</b> 										
1.8   (2), (3)	1964 ▶ 02/73		ATE	<b>301099</b>	20228		61,8	56,6	15	
<b>1502 (74&gt;77)</b> 										
1.5  (2)	1974 ▶ 07/77		ATE	<b>301099</b>	20228		61,8	56,6	15	
<b>1602 (71&gt;75)</b> 										
1.6  (2)	03/71 ▶ 05/75		ATE	<b>301099</b>	20228		61,8	56,6	15	
<b>1802 (71&gt;75)</b> 										
1.8   (2), (3)	03/71 ▶ 05/75		ATE	<b>301099</b>	20228		61,8	56,6	15	



















































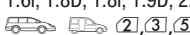













												
<b>BMW (.../...)</b>												
<b>2002 (71&gt;75)</b> 												
2, 2 Turbo   (2), (3)	03/71 ▶ 05/75		ATE	<b>301099</b>	20228		61,8	56,6	15			
<b>1 Series (E87) (2004&gt;2007)</b> 												
2.0d, 3.0i  (5)	09/04 ▶ 02/07		ATE	<b>301703</b>	23926	 	123	43,5	17,3			
								44,5				
<b>1 Series (E87) (2007&gt;)</b> 												
2.0d, 3.0i 258, 3.0i 265  (5)	03/07 ▶		ATE	<b>301703</b>	23926	 	123	43,5	17,3			
								44,5				
<b>1 Series (E81/82/88) (2007&gt;)</b> 												
3.0i  (2)	02/11 ▶		ATE	<b>301410</b>	23312		155,3	68,5	19,8			
2.0d, 2.0i, 3.0i, 3.0i 258, 3.0i 265  (2), (3)	01/07 ▶		ATE	<b>301703</b>	23926	 	123	43,5	17,3			
								44,5				
<b>3 Series (E30) (82&gt;93)</b> 												
1.6i, 1.8, 1.8i, 2.0i, 2.3i, 2.4TD, 2.4d, 2.5i, 2.7i  (2), (4), (5) ABS+	09/82 ▶ 09/93		ATE	<b>301103</b>	20675		125,2	37,6	17,3			
<b>3 Series (E36) (90&gt;2001)</b> 												
1.6i, 1.7TD, 1.8i, 1.9i, 2.0i, 2.5TD, 2.5i, 2.8i  (2), (3), (4), (5) CU+ : Extra load+	12/90 ▶ 04/01		ATE	<b>301018</b>	21292		151,3	57	17,3			
1.6i, 1.7TD, 1.8i, 1.9i, 2.0i, 2.5TD, 2.5i, 2.8i  (2), (3), (4)	12/90 ▶ 04/01		ATE	<b>301386</b>	20180	 	123	45	16,8			
1.6i, 1.7TD, 1.8i, 1.9i, 2.0i, 2.5TD, 2.5i, 2.8i  (2), (3), (4), (5) ABS+	12/90 ▶ 02/00		ATE	<b>301753</b>	21934	 	123	45	17			
<b>3 Series (E46) (98&gt;2006)</b> 												
1.6Ti, 1.6i, 1.8i, 1.9i, 2.0TD, 2.0d, 2.0i, 2.2i, 2.5i, 2.5ti, 2.8i  (2), (3), (4), (5) CU+ : Extra load+	03/98 ▶ 07/06		ATE	<b>301018</b>	21292		151,3	57	17,3			
1.6Ti, 1.6i, 1.8i, 1.9i  (2), (3), (4)	03/98 ▶ 05/06		ATE	<b>301753</b>	21934	 	123	45	17			
<b>3 Series (E90/91/92/93) (2005&gt;)</b> 												
2.0d, 2.0d 150, 2.0d 163, 2.0i, 2.5i, 3.0d, 3.0i  (2), (4), (5) CU+ : Extra load+	03/05 ▶		ATE	<b>301640</b>	23794	 	154,8	63,6	20			
								155,4				
2.0d, 2.0d 136, 2.0d 150, 2.0d 163, 2.0i, 2.5i, 3.0i  (2), (4), (5) CU+ : Extra load+	03/05 ▶		ATE	<b>301703</b>	23926	 	123	43,5	17,3			
								44,5				
<b>3 Series (E90/91/92/93) (2007&gt;)</b> 												
2.5i, 3.0d, 3.0i  (2), (4), (5)	07/07 ▶		ATE	<b>301640</b>	23794	 	154,8	63,6	20			
								155,4				



































































				<b>Valeo</b>	<b>WVA</b>				<b>BMW (.../...)</b>													
<b>3 Series (E90/91/92/93) (2007&gt;)  (.../...)</b>																						
1.6i, 2.0d, 2.0d 136, 2.0d 163, 2.0i, 2.5i, 3.0i  (2), (4), (5)	07/07 ▶		ATE	<b>301703</b>	23926		123 43,5 44,5															
<b>5 Series (E28) (81&gt;88) </b>																						
1.8, 1.8i, 2.0i, 2.4D, 2.4TD, 2.5i, 2.7i, 2.8i, 3.4i ABS+	04/81 ▶ 08/88		ATE	<b>301103</b>	20675		125,2 37,6 17,3															
<b>5 Series (E34) (88&gt;96) </b>																						
1.8i, 2.0i, 2.4TD, 2.5TD, 2.5i, 3.0i, 3.0i V8, 3.4i, 4.0i V8  (4), (5) CU+ : Extra load+	01/88 ▶ 09/96		ATE	<b>301231</b>	21064		156,3 64 20															
4.0i V8  (4)	09/92 ▶ 09/95		ATE	<b>301103</b>	20675		125,2 37,6 17,3															
1.8i, 2.0i, 2.4TD, 2.5TD, 2.5i, 3.0i, 3.0i V8, 3.4i, 4.0i V8  (4), (5) ABS+	01/88 ▶ 09/96		ATE	<b>301259</b>	20996		123 45 17,3															
<b>5 Series (E39) (95&gt;2004) </b>																						
2.0i, 2.5Td, 2.5Tds, 2.8i  (4)	09/95 ▶ 04/03		ATE	<b>301310</b>	21677		156,4 64 20,3 155,3															
2.0d, 2.0i, 2.2i, 2.5Td, 2.5d, 2.5i, 2.5tds, 2.8i, 3.0d  (4), (5)	11/96 ▶ 04/04		ATE	<b>301409</b>	21064		155,4 63,6 20 154,8															
2.0d, 2.2i, 2.5d, 2.5i, 3.0d, 3.0i, 3.5i, 4.4i  (4), (5)	07/96 ▶ 04/04		ATE	<b>301412</b>	23449		156,4 73,6 19															
2.0d, 2.0i, 2.2i, 2.5Td, 2.5Tds, 2.5d, 2.5i, 2.8i, 3.0d, 3.0i, 3.5i, 4.4i  (4), (5)	09/95 ▶ 04/04		ATE	<b>301311</b>	21691		122 45 17,3															
<b>5 Series (E60/61) (2003&gt;2010) </b>																						
3.0d, 3.0i, 4.0i V8, 4.4i V8, 4.8i V8  (4), (5) HD+ : Heavy duty+	05/03 ▶ 09/10		ATE	<b>301410</b>	23312		155,3 68,5 19,8															
2.0d, 2.0i, 2.2i, 2.5d, 2.5i  (4), (5)	05/03 ▶ 09/10		ATE	<b>301640</b>	23794		154,8 63,6 20 155,4															
2.0d, 2.0i, 2.2i, 2.5d, 2.5i, 3.0d, 3.0i  (4), (5)	05/03 ▶ 09/10		ATE	<b>301754</b>	23732		121,8 58 17,3 59,2															
<b>6 Series (E24) (76&gt;89) </b>																						
2.8i, 3.4i, 3.5i	05/82 ▶ 04/89		ATE	<b>301103</b>	20675		125,2 37,6 17,3															
<b>6 Series (E63/64) (2003&gt;2011) </b>																						
3.0i, 4.4i, 4.8i V8	09/03 ▶ 03/11		ATE	<b>301410</b>	23312		155,3 68,5 19,8															
3.0i	09/04 ▶ 08/07		ATE	<b>301754</b>	23732		121,8 58 17,3 59,2															
<b>7 Series (E23) (77&gt;86) </b>																						
2.5i, 2.8i, 3.2i, 3.4i, 3.4i Turbo, 3.5i	07/81 ▶ 05/86		ATE	<b>301103</b>	20675		125,2 37,6 17,3															

											
<b>BMW (.../...)</b>											
<b>7 Series (E32) (86&gt;94)</b> 											
3.0i, 3.0i V8, 3.4i, 4.0i V8, 5.0i	09/86 ▶ 05/94		ATE	<b>301231</b>	21064		156,3	64	20		
4.0i V8, 5.0i	01/90 ▶ 05/94		ATE	<b>301103</b>	20675		125,2	37,6	17,3		
3.0i, 3.0i V8, 3.4i, 4.0i V8, 5.0i	09/86 ▶ 05/94		ATE	<b>301259</b>	20996		123	45	17,3		
<b>7 Series (E38) (94&gt;2001)</b> 											
4.0i V8, 4.4i V8	06/94 ▶ 08/01		ATE	<b>301412</b>	23449		156,4	73,6	19		
2.5TD, 2.8i, 2.9TD, 3.0i V8, 3.5i V8	06/94 ▶ 08/01		ATE	<b>301580</b>	21487		123,1	59,2	17		
<b>7 Series (E65) (2001&gt;2008)</b> 											
3.0d, 3.0i, 3.6i V8, 3.9d, 4.0i V8, 4.4i V8, 4.8i V8, 6.0i V12	09/01 ▶ 10/08		ATE	<b>301410</b>	23312		155,3	68,5	19,8		
<b>7 Series (E66) (2002&gt;2008)</b> 											
3.0d, 3.0i, 3.6i V8, 4.0i V8, 4.4i V8, 4.8i V8, 6.0i V12	03/02 ▶ 10/08		ATE	<b>301410</b>	23312		155,3	68,5	19,8		
<b>8 Series (E31) (89&gt;2000)</b> 											
4.0, 4.4, 5.0, 5.0i, 5.4	09/89 ▶ 2000		ATE	<b>301103</b>	20675		125,2	37,6	17,3		
<b>M3 (E30) (86&gt;91)</b> 											
2.3i, 2.5i 	09/86 ▶ 06/91		ATE	<b>301259</b>	20996		123	45	17,3		
<b>M3 (E36) (92&gt;2000)</b> 											
3.0i, 3.2i 	06/92 ▶ 06/00		ATE	<b>301231</b>	21064		156,3	64	20		
3.0i, 3.2i 	06/92 ▶ 06/00		ATE	<b>301259</b>	20996		123	45	17,3		
<b>M3 (E46) (2000&gt;2006)</b> 											
3.2i 	07/00 ▶ 09/06		ATE	<b>301580</b>	21487		123,1	59,2	17		
<b>M3 (E90/92/93) (2007&gt;)</b> 											
4.0i V8 	09/07 ▶		ATE	<b>301410</b>	23312		155,3	68,5	19,8		
<b>M5 (E28) (84&gt;88)</b> 											
3.4i, 3.5i 	10/84 ▶ 08/88		ATE	<b>301103</b>	20675		125,2	37,6	17,3		
<b>M5 (E34) (88&gt;95)</b> 											
3.6i, 3.8i 	07/88 ▶ 05/94		ATE	<b>301231</b>	21064		156,3	64	20		
3.6i 	07/88 ▶ 12/91		ATE	<b>301259</b>	20996		123	45	17,3		
<b>M5 (E39) (99&gt;2003)</b> 											
5.0i 	07/99 ▶ 06/03		ATE	<b>301412</b>	23449		156,4	73,6	19		
5.0i 	07/99 ▶ 06/03		ATE	<b>301580</b>	21487		123,1	59,2	17		
<b>X1 (E84) (2009&gt;)</b> 											
2.0d 204, 2.0i 245, 3.0i 218	10/09 ▶		ATE	<b>301640</b>	23794		154,8	63,6	20		
							155,4				



















											
<b>BMW (.../...)</b>											
<b>X1 (E84) (2009&gt;)  (.../...)</b>											
2.0d 116, 2.0d 136, 2.0d 143, 2.0d 163, 2.0d 177, 2.0d 184, 2.0d 204, 2.0d ed 163, 2.0i 150, 2.0i 184, 2.0i 245, 3.0i 218	10/09 ▶		ATE	<b>301703</b>	23926	 	123	43,5	17,3		
								44,5			
<b>X3 (E83) (2003&gt;2006) </b>											
2.0d, 2.0i, 2.5i, 3.0d, 3.0i	10/03 ▶ 07/06		ATE	<b>301580</b>	21487		123,1	59,2	17		
<b>X3 (E83) (2006&gt;2010) </b>											
3.0sd	08/06 ▶ 09/10		ATE	<b>301412</b>	23449	 	156,4	73,6	19		
1.8d, 2.0d, 2.0i, 2.5si, 3.0d, 3.0sd, 3.0si	08/06 ▶ 09/10		ATE	<b>301580</b>	21487		123,1	59,2	17		
<b>X5 (E53) (2000&gt;2006) </b>											
3.0d, 3.0d 211, 3.0i, 4.4i	01/00 ▶ 11/06		ATE	<b>301412</b>	23449	 	156,4	73,6	19		
3.0d, 3.0d 211, 3.0i, 4.4i, 4.6is, 4.8is	01/00 ▶ 11/06		ATE	<b>301580</b>	21487		123,1	59,2	17		
<b>Z1 (E30) (89&gt;92) </b>											
2.5i	03/89 ▶ 09/90		ATE	<b>301103</b>	20675		125,2	37,6	17,3		
2.5i	09/90 ▶ 1992		ATE	<b>301386</b>	20180	 	123	45	16,8		
2.5i	09/90 ▶ 1992		ATE	<b>301753</b>	21934	 	123	45	17		
<b>Z3 (E36) (96&gt;2002) </b>											
1.8i, 1.9i, 2.0i, 2.2i, 2.8i, 3.0i	01/96 ▶ 06/02		ATE	<b>301018</b>	21292		151,3	57	17,3		
3.2i	06/96 ▶ 05/02		ATE	<b>301231</b>	21064		156,3	64	20		
3.2i	06/96 ▶ 05/02		ATE	<b>301259</b>	20996		123	45	17,3		
1.8i, 1.9i, 2.0i, 2.2i, 2.8i, 3.0i	01/96 ▶ 06/02		ATE	<b>301386</b>	20180	 	123	45	16,8		
<b>Z4 (E85/86) (2002&gt;2009) </b>											
2.0i, 2.2i, 2.5i, 2.5si, 3.0i 	09/02 ▶ 08/08		ATE	<b>301018</b>	21292		151,3	57	17,3		
3.2i  	02/06 ▶ 08/08		ATE	<b>301580</b>	21487		123,1	59,2	17		
2.0i, 2.2i, 2.5i 	09/02 ▶ 08/08		ATE	<b>301753</b>	21934	 	123	45	17		
<b>Z4 (E89) (2009&gt;) </b>											
2.0i 184, 2.0i 245, 2.5i, 3.0i 	03/09 ▶		ATE	<b>301640</b>	23794	 	154,8	63,6	20		
							155,4				
<b>Z8 (E52) (2000&gt;2003) </b>											
5.0i V8	03/00 ▶ 07/03		ATE	<b>301580</b>	21487		123,1	59,2	17		
<b>CADILLAC</b>											
<b>BLS (2005&gt;2010) </b>											
1.9Tid, 2.0T DV1+ : 288x25 brake disc+, DV7+ : 305x28 brake disc+	03/05 ▶ 09/10		ATE	<b>301678</b>	23402	 	156,5	71	20,3		

											
<b>CADILLAC (.../...)</b>											
<b>BLS (2005&gt;2010)  (.../...)</b>											
1.9Tid, 2.0T, 2.8 V6			ATE	<b>301783</b>	24137		122,9	51,7	16,4		
<b>CHEVROLET</b>											
<b>Alero (99&gt;2004) </b>											
2.4i	01/05 ▶ 06/07		AKE	<b>301361</b>	23235		143	51,4	18		↳ 2x ⇐
<b>Aveo (2005&gt;2008) </b>											
1.4i  4	01/05 ▶ 02/08		AKE	<b>301644</b>	23974		133	49	17,8		
<b>Aveo (2008&gt;2011) </b>											
1.2i, 1.4i  3,  4,  5  _ ▶ B000161	03/08 ▶ 2009		AKE	<b>301644</b>	23974		133	49	17,8		
<b>Captiva (C100) (2006&gt;2011) </b>											
2.0VCDi, 3.2V6	09/06 ▶ 09/09		MAND	<b>301942</b>	24510		149	62,2	17,6		↳ 2x ⇐
2.0VCDi, 2.0VCDi 127, 2.0VCDi 150, 2.4i 136, 3.2V6, 3.2V6 230	09/06 ▶ 02/11		MAND	<b>301941</b>	24498		110,7	45,9	15,8		↳ 2x ⇐
<b>Cruze (2009&gt;) </b>											
1.6i 109, 1.6i 113, 1.6i 124, 1.8i, 2.0VCDi, 2.0VCDi 150, 2.0VCDi 163  4,  5 16"	05/09 ▶		BSC	<b>301070</b>	25080		148,1	61,2	18,8		↳ 2x ⇐
1.6i 109, 1.6i 113, 1.6i 124, 1.8i, 2.0VCDi, 2.0VCDi 150, 2.0VCDi 163  4,  5 15" 16"	05/09 ▶		BSC	<b>301055</b>	25096		116,6	42,7	16,3		↳ 2x ⇐
<b>Epica (2006&gt;2009) </b>											
2.0VCDi, 2.0i V6	05/06 ▶ 09/09		AKE	<b>301361</b>	23235		143	51,4	18		↳ 2x ⇐
<b>Evanda (2005&gt;2007) </b>											
2.0i, 2.0i GPL	01/05 ▶ 06/07		AKE	<b>301361</b>	23235		143	51,4	18		↳ 2x ⇐
<b>Kalos (2005&gt;2008) </b>											
1.2i, 1.4i  3,  4,  5	01/05 ▶ 05/08		AKE	<b>301644</b>	23974		133	49	17,8		
<b>Lacetti (2005&gt;) </b>											
1.4i, 1.6i, 1.8i  4,  5	01/05 ▶ 12/06		SUM	<b>301874</b>	24071		104,2	38,8	14,6		
<b>Lanos (97&gt;2002) </b>											
1.3i 75, 1.5i 86  3,  4,  5  447434 ▶ _	▶ 12/02		AKE	<b>301316</b>	23241		127	48,5	16,7		
<b>Matiz (2005&gt;2011) </b>											
0.8i, 1.0i	01/05 ▶ 02/11		AKE	<b>301316</b>	23241		127	48,5	16,7		
<b>Nubira (2005&gt;2009) </b>											
1.6i, 1.6i GPL, 1.8i, 1.8i GPL  4,  5	01/05 ▶ 12/06		SUM	<b>301874</b>	24071		104,2	38,8	14,6		
<b>Orlando (2011&gt;) </b>											
1.8i 141, 2.0VCDi 131, 2.0VCDi 163	01/11 ▶		BSC	<b>301070</b>	25080		148,1	61,2	18,8		↳ 2x ⇐
1.8i 141, 2.0VCDi 131, 2.0VCDi 163	01/11 ▶		BSC	<b>301055</b>	25096		116,6	42,7	16,3		↳ 2x ⇐







































































				<b>Valeo</b>	<b>WVA</b>					
<b>CHEVROLET (.../...)</b>										
<b>Rezzo (2005&gt;2008)</b> 										
1.6i, 1.6i GPL, 2.0i, 2.0i GPL	01/05 ▶ 06/08		AKE	<b>301361</b>	23235		143	51,4	18	↳ 2x ◁
<b>Spark (2005&gt;2009)</b> 										
0.8i, 1.0i	05/05 ▶ 12/09		AKE	<b>301316</b>	23241		127	48,5	16,7	
<b>Tacuma (2005&gt;2008)</b> 										
1.6i, 2.0i	01/05 ▶ 06/08		AKE	<b>301361</b>	23235		143	51,4	18	↳ 2x ◁
<b>CHRYSLER</b>										
<b>Crossfire (2003&gt;2009)</b> 										
3.2i V6 	07/03 ▶ 01/09		ATE	<b>301636</b>	21670		156,3	63,6	20,3	
							156,3	69,5		
3.2i V6 	07/03 ▶ 01/09		ATE	<b>301444</b>	21919		63,7	73	15,3	
<b>CITROËN</b>										
<b>AX (86&gt;91)</b> 										
1.0, 1.1, 1.1i, 1.3, 1.4, 1.4D, 1.4i 	09/86 ▶ 10/90		ATE	<b>301156</b>	21145		71,9	60,6	17,1	↳ 4x ◁ 170 mm
<b>AX (91&gt;98)</b> 										
1.1, 1.4, 1.4D, 1.4i, 1.5D 	05/91 ▶ 07/96		BDX	<b>301155</b>	21061		111,4	53,4	18	
Electrique 	07/94 ▶ 07/98		ATE	<b>301360</b>	21145		71,9	60,6	17,3	
<b>Berlingo (96&gt;2002)</b> 										
1.1i, 1.1i GPL, 1.4, 1.4i, 1.4i GPL, 1.6i, 1.8D, 1.8i, 1.9D, 2.0HDi, Electrique 	07/96 ▶ 11/01		LUC	<b>301326</b>	23124		130	56,2	18,5	↳ 4x ◁ 275 mm / 310 mm
1.6i, 1.8D, 1.8i, 1.9D, 2.0HDi, Electrique 	11/01 ▶ 12/02		BSC	<b>301464</b>	23599		137	50	19	
<b>Berlingo (2002&gt;2012)</b> 										
1.1i, 1.4i, 1.4i GNV, 1.4i GPL, 1.6HDi, 1.6i, 1.9D, 2.0HDi 	12/02 ▶ 02/12		BSC	<b>301464</b>	23599		137	50	19	
ABS-, ESP-										
1.6HDi, 1.6i, 2.0HDi 	12/02 ▶ 05/08		BSC	<b>301465</b>	23600		137	57,3	19	
ESP+										
1.6HDi, 1.6i, 2.0HDi 	12/02 ▶ 05/08		LUC	<b>301463</b>	20960		87	52,9	17	
ESP+										
<b>C1 (2005&gt;2012)</b> 										
1.0i, 1.4HDi	06/05 ▶ 02/12		BSC	<b>301718</b>	23959		122,7	46,7	17,6	
<b>C1 (2012&gt;)</b> 										
1.0i	02/12 ▶		BSC	<b>301718</b>	23959		122,7	46,7	17,6	
<b>C2 (2003&gt;2010)</b> 										
1.4HDi, 1.6HDi, 1.6i I 16°	07/04 ▶ 01/10		BSC	<b>301464</b>	23599		137	50	19	
1.1i, 1.4HDi, 1.4i I	09/03 ▶ 01/10		LUC	<b>301500</b>	23407		122,8	53	19,3	







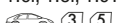

















































				<b>Valeo</b>	<b>WVA</b>						
<b>CITROËN (.../...)</b>											
<b>C2 (2003&gt;2010)  (.../...)</b>											
1.4HDi, 1.4i, 1.6HDi, 1.6i	09/03 ▶ 01/10		LUC	<b>301463</b>	20960		87	52,9	17		
<b>C3 (2002&gt;2005) </b>											
1.1i, 1.4HDi, 1.4i, 1.4i GNV	04/02 ▶ 10/05		LUC	<b>301500</b>	23407		122,8	53	19,3		
1.4HDi, 1.6i ESP+	04/02 ▶ 10/05		LUC	<b>301463</b>	20960		87	52,9	17		
<b>C3 (2005&gt;2011) </b>											
1.4i, 1.6HDi, 1.6i	11/05 ▶ 10/09		BSC	<b>301464</b>	23599		137	50	19		
1.6HDi, 1.6i	11/05 ▶ 10/09		BSC	<b>301465</b>	23600		137	57,3	19		
1.1i, 1.1i GPL, 1.4HDi, 1.4i, 1.4i GNV	11/05 ▶ 01/11		LUC	<b>301500</b>	23407		122,8	53	19,3		
1.6HDi, 1.6i	11/05 ▶ 10/09		LUC	<b>301463</b>	20960		87	52,9	17		
<b>C3 (2009&gt;) </b>											
1.0VTi 68, 1.1i, 1.2VTi 82, 1.4HDi 68, 1.4HDi 70, 1.4VTi 95, 1.4i, 1.4i GPL, 1.6HDi 90, 1.6HDi 92	10/09 ▶ 04/13		BSC	<b>301464</b>	23599		137	50	19		
1.6HDi 110, 1.6VTi 120	10/09 ▶ 10/11		LUC	<b>301474</b>	20960		87	53	16		
<b>C3 Pluriel (2003&gt;2011) </b>											
1.6i	05/03 ▶ 01/11		LUC	<b>301463</b>	20960		87	52,9	17		
<b>C3 Picasso (2009&gt;) </b>											
1.4VTi 95, 1.6HDi 90, 1.6e-HDi 90	02/09 ▶ 04/13		BSC	<b>301464</b>	23599		137	50	19		
1.4VTi 95, 1.6HDi 110, 1.6HDi 112, 1.6HDi 90, 1.6VTi 115, 1.6VTi 120	02/09 ▶ 10/11		LUC	<b>301474</b>	20960		87	53	16		
<b>C4 (2004&gt;2011) </b>											
1.4i, 1.6HDi, 1.6VTi, 1.6i, 1.6i Bioflex  ③,⑤	11/04 ▶ 01/11		BSC	<b>301464</b>	23599		137	50	19		
1.4i, 1.6HDi, 1.6THP, 1.6VTi, 1.6i, 2.0HDi, 2.0i  ③,④,⑤ ESP+	11/04 ▶ 12/10		BSC	<b>301465</b>	23600		137	57,3	19		
1.4i, 1.6HDi, 1.6i, 1.6i Bioflex, 2.0HDi, 2.0i  ③,④,⑤	11/04 ▶ 06/08		LUC	<b>301463</b>	20960		87	52,9	17		
<b>C4 Aircross (2012&gt;) </b>											
1.6HDi 115, 1.6i 115, 1.8HDi 150, 2.0i 150	03/12 ▶ 10/12		AKE	<b>301852</b>	24014		85,5	40	15,5		
<b>C5 (2008&gt;) </b>											
1.6THP-155, 2.0HDi, 2.0HDi-150, 2.0HDi-160, 2.0i, 2.2HDi, 2.2HDi 200, 2.7HDi V6, 3.0HDi V6, 3.0i V6  ④,⑤	03/08 ▶		ATE	<b>301783</b>	24137		122,9	51,7	16,4		
<b>C8 (2002&gt;) </b>											
2.0HDi, 2.0HDi 135, 2.0HDi 160, 2.0i, 2.2HDi, 2.2i, 3.0i V6	06/02 ▶		LUC	<b>301463</b>	20960		87	52,9	17		
<b>C15 (84&gt;2005) </b>											
1.0, 1.1, 1.1i, 1.3, 1.4, 1.4i, 1.7D  ③	10/84 ▶ 02/01		LUC	<b>301119</b>	20989		90	62,9	17,5	↳ 4 x ↗ 225 mm	
1.9D  ③	09/01 ▶ 12/05		BDX	<b>301155</b>	21061		111,4	53,4	18		



















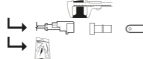

















































				<b>Valeo</b>	<b>WVA</b>						
<b>CITROËN (.../...)</b>											
<b>CX (74&gt;91)</b> 											
2.0, 2.2, 2.2 GPL, 2.2D, 2.3, 2.3i, 2.3i Injection, 2.5D, 2.5D Turbo, 2.5D Turbo 2, 2.5i, 2.5i Turbo, 2.5i Turbo 2  (4)	07/74 ▶ 1989		CIT	<b>301292</b>	20575		54	65	15,4		
<b>C Crosser (2007&gt;)</b> 											
2.0i 147, 2.2HDi, 2.4i	07/07 ▶		AKE	<b>301852</b>	24014	 	85,5	40	15,5		
							106	35,5			
<b>C-Elysée (2012&gt;)</b> 											
1.2VTi, 1.6HDi, 1.6VTi	11/12 ▶ 04/13		BSC	<b>301464</b>	23599		137	50	19		
<b>Dispatch (95&gt;2003)</b> 											
1.9TD, 2.0HDi  (3,4)	07/98 ▶ 12/03		LUC	<b>301064</b>	21801		130	57,4	18,8		↳ 4 x ↗ 240 mm / 195 mm
<b>DS3 (2010&gt;)</b> 											
1.2VTi 82, 1.4HDi 68, 1.4VTi 95, 1.4VTi GPL-95, 1.4e-HDi 70, 1.6HDi 90, 1.6e-HDi 90  (2,3)	03/10 ▶ 04/13		BSC	<b>301464</b>	23599		137	50	19		
1.6HDi 115, 1.6THP 150, 1.6THP 156, 1.6THP 202, 1.6THP 206, 1.6VTi 120, 1.6e-HDi 110  (3)	03/10 ▶		LUC	<b>301474</b>	20960		87	53	16		
<b>Evasion (94&gt;98)</b> 											
1.9TD, 2.0i, 2.0i Turbo CT, 2.1TD	07/94 ▶ 09/98		LUC	<b>301064</b>	21801		130	57,4	18,8		↳ 4 x ↗ 240 mm / 195 mm
<b>Evasion (98&gt;2002)</b> 											
1.9TD, 2.0HDi, 2.0i, 2.0i Turbo CT, 2.1TD	10/98 ▶ 05/02		LUC	<b>301064</b>	21801		130	57,4	18,8		↳ 4 x ↗ 240 mm / 195 mm
<b>Fukang (93&gt;98)</b> 											
1.4, 1.6i  (3) ABS-	07/93 ▶ 1998		BDX	<b>301155</b>	21061		111,4	53,4	18		
<b>Jumper (94&gt;2001)</b> 											
1.9D, 1.9TD, 2.0, 2.0HDi, 2.0i, 2.5D, 2.5TD, 2.5TDi, 2.8D, 2.8HDi, 2.8TD  (2,3,4,5)	02/94 ▶ 12/01		LUC	<b>301010</b>	21797		145	60,8	19,2		↳ 2 x ↗ 200 mm
1.9D, 1.9TD, 2.0, 2.0HDi, 2.0i, 2.5D, 2.5TD, 2.5TDi, 2.8D, 2.8HDi, 2.8TD  (2,3,4,5)	02/94 ▶ 12/01		LUC	<b>301429</b>	21797		145	60,9	19,5		↳ 1 x ↗ 300 mm
<b>Jumper (2002&gt;2006)</b> 											
2.0HDi, 2.0i, 2.0i GNV, 2.2HDi, 2.8HDi  (2,3,4)	01/02 ▶ 06/06		BRE	<b>301568</b>	23918		140,5	65,8	19		↳ 1 x ↗ 175 mm
2.0i, 2.0i GNV, 2.0i GPL, 2.2HDi, 2.8HDi  (2,4)	01/02 ▶ 06/06		BRE	<b>301569</b>	23919		164,6	69,3	18,3		↳ 1 x ↗ 175 mm
2.0i, 2.0i GNV, 2.0i GPL, 2.2HDi, 2.8HDi  (2,4)	01/02 ▶ 06/06		BRE	<b>301570</b>	23921		109,5	49,8	20		
<b>Jumper (2006&gt;)</b> 											
2.2HDi, 2.2HDi 110, 2.2HDi 130, 2.2HDi 150, 3.0HDi, 3.0HDi 180  (2,3,4,5)	07/06 ▶		BSC	<b>301892</b>	24465		137	48,8	18,8		
<b>Jumpy (95&gt;2003)</b> 											
1.6i, 1.9D, 1.9TD, 2.0HDi, 2.0i  (2,3,4)	09/95 ▶ 12/03		LUC	<b>301064</b>	21801		130	57,4	18,8		↳ 4 x ↗ 240 mm / 195 mm



































						
<b>CITROËN (.../...)</b>						
<b>Nemo (2007&gt;)</b> 						
1.4Hdi, 1.4i 	12/07 ▶		BSC	<b>301426</b>	23705	 123 53,3 17,8 ↪ 1 x ↪ 215 mm
<b>Relay (94&gt;2001)</b> 						
1.9D, 1.9TD, 2.0Hdi, 2.0i, 2.5D, 2.5TD, 2.5TDi, 2.8Hdi   (2),(4)	02/94 ▶ 12/01		LUC	<b>301010</b>	21797	 145 60,8 19,2 ↪ 2 x ↪ 200 mm
1.9D, 1.9TD, 2.0Hdi, 2.0i, 2.5D, 2.5TD, 2.5TDi, 2.8Hdi   (2),(4)	02/94 ▶ 12/01		LUC	<b>301429</b>	21797	 145 60,9 19,5 ↪ 1 x ↪ 300 mm
<b>Relay (2002&gt;2006)</b> 						
2.0Hdi, 2.0i, 2.2Hdi, 2.8Hdi  (2),(4)	01/02 ▶ 06/06		BRE	<b>301568</b>	23918	 140,5 65,8 19 ↪ 1 x ↪ 175 mm
2.2Hdi, 2.8Hdi  (2),(4)	01/02 ▶ 06/06		BRE	<b>301569</b>	23919	 164,6 69,3 18,3 ↪ 1 x ↪ 175 mm
2.2Hdi, 2.8Hdi  (2),(4)	01/02 ▶ 06/06		BRE	<b>301570</b>	23921	 109,5 49,8 20
<b>Relay (2006&gt;)</b> 						
2.2Hdi, 2.2Hdi 110, 2.2Hdi 130, 2.2Hdi 150, 3.0Hdi, 3.0Hdi 180   (2),(4),(5)	07/06 ▶		BSC	<b>301892</b>	24465	 137 48,8 18,8
<b>Saxo (96&gt;99)</b> 						
1.6i  (3),(5)	03/96 ▶ 08/99		ATE	<b>301074</b>	21430	 140,3 47,5 17
1.0i, 1.1i, 1.1i GPL, 1.4i, 1.5D, Electrique  (3),(5) 4	03/96 ▶ 08/99		BDX	<b>301075</b>	21061	 105 53,7 18
1.0i, 1.1i, 1.1i GPL  (3),(5) 3	03/96 ▶ 08/99		ATE	<b>301360</b>	21145	 71,9 60,6 17,3
1.6i  (3)	03/96 ▶ 08/99		BDX	<b>301396</b>	20635	 105 54,7 11
<b>Saxo (99&gt;2005)</b> 						
1.4i, 1.6i  (3),(5)	09/99 ▶ 12/03		ATE	<b>301074</b>	21430	 140,3 47,5 17
1.1i, 1.1i GPL, 1.4i, 1.4i GPL, 1.5D, 1.6i, Electrique  (3),(5)	09/99 ▶ 05/05		BDX	<b>301075</b>	21061	 105 53,7 18
1.0i  (3),(5) 3	09/99 ▶ 12/03		ATE	<b>301360</b>	21145	 71,9 60,6 17,3
1.6i  (3)	09/99 ▶ 12/03		BDX	<b>301396</b>	20635	 105 54,7 11
<b>Synergie (95&gt;98)</b> 						
1.9TD, 2.0i	10/95 ▶ 09/98		LUC	<b>301064</b>	21801	 130 57,4 18,8 ↪ 4 x ↪ 240 mm / 195 mm
<b>Synergie (98&gt;2002)</b> 						
1.9TD, 2.0Hdi, 2.0i	10/98 ▶ 05/02		LUC	<b>301064</b>	21801	 130 57,4 18,8 ↪ 4 x ↪ 240 mm / 195 mm
<b>Visa (78&gt;88)</b> 						
1.6i, 1.8D  (3),(5)	03/84 ▶ 1988		LUC	<b>301119</b>	20989	 90 62,9 17,5 ↪ 4 x ↪ 225 mm
<b>Xantia (93&gt;97)</b> 						
1.6i, 1.8i, 1.8i GPL, 1.9D, 1.9SD, 1.9TD, 2.0i  (5)	03/93 ▶ 12/97		BDX	<b>301031</b>	21631	 131 60,5 16
1.6i, 1.8i, 1.8i GPL, 1.9D, 1.9SD, 1.9TD, 2.0i, 2.0i Turbo CT, 2.1TD, 3.0i V6  (5)	03/93 ▶ 12/97		CIT	<b>301292</b>	20575	 54 65 15,4

						
<b>CITROËN (.../...)</b>						
<b>Xantia (97&gt;2002)</b> 						
1.6i, 1.8i, 1.8i GPL, 1.9SD, 1.9TD, 2.0HDi  (3), (5)	12/97 ▶ 05/02		BDX	<b>301031</b>	21631	 131 60,5 16
1.6i, 1.8i, 1.8i GPL, 1.9SD, 1.9TD, 2.0HDi, 2.0i, 2.0i Turbo CT, 2.1TD, 3.0i V6  (5)	12/97 ▶ 05/02		CIT	<b>301292</b>	20575	 54 65 15,4
<b>XM (89&gt;94)</b> 						
2.0, 2.0i, 2.0i Turbo CT, 2.1D D12, 2.1TD Turbo D12, 3.0i V6  (5)	05/89 ▶ 06/94		CIT	<b>301292</b>	20575	 54 65 15,4
<b>XM (94&gt;2001)</b> 						
2.0i, 2.0i Turbo CT, 2.1D D12, 2.1TD Turbo D12, 2.5TD Turbo D, 3.0i V6  (5)	07/94 ▶ 07/01		CIT	<b>301292</b>	20575	 54 65 15,4
<b>Xsara (97&gt;2000)</b> 						
2.0i  (3), (5)	01/98 ▶ 08/00		LUC	<b>301069</b>	21674	 130 56,5 19 ↪ 4x ↪ 310 mm
1.4i, 1.4i GPL, 1.5D, 1.6i, 1.8D, 1.8i, 1.9D, 1.9TD  (3), (5)	07/97 ▶ 08/00		ATE	<b>301074</b>	21430	 140,3 47,5 17
1.4i, 1.4i GPL, 1.5D, 1.6i, 1.8D, 1.8i, 1.8i GPL, 1.9D, 1.9SD, 1.9TD, 2.0HDi, 2.0i  (3), (5) ABS+	07/97 ▶ 08/00		LUC	<b>301326</b>	23124	 130 56,2 18,5 ↪ 4x ↪ 275 mm / 310 mm
1.8i, 1.8i GPL, 2.0HDi, 2.0i  (3), (5)	07/97 ▶ 08/00		BSC	<b>301462</b>	23396	 131 52,2 17,8
1.4i, 1.4i GPL, 1.5D  (3), (5) ABS-	07/97 ▶ 08/00		BSC	<b>301726</b>	21980	 131 47,3 18
1.8i, 1.8i GPL, 2.0HDi, 2.0i  (5)	03/98 ▶ 08/00		BDX	<b>301396</b>	20635	 105 54,7 11
<b>Xsara (2000&gt;2005)</b> 						
2.0HDi, 2.0i  (3), (5)	09/00 ▶ 09/01		LUC	<b>301069</b>	21674	 130 56,5 19 ↪ 4x ↪ 310 mm
1.4HDi, 1.4i, 1.6i, 1.9D, 2.0HDi  (3), (5)	09/00 ▶ 08/05		BSC	<b>301464</b>	23599	 137 50 19
2.0HDi, 2.0i  (3), (5)	09/01 ▶ 08/05		BSC	<b>301465</b>	23600	 137 57,3 19
1.6i, 2.0HDi, 2.0i  (3), (5)	09/00 ▶ 08/05		BDX	<b>301396</b>	20635	 105 54,7 11
<b>Xsara Picasso (99&gt;2010)</b> 						
1.6HDi, 1.6i, 1.8i, 2.0HDi ESP-	12/99 ▶ 05/07		BSC	<b>301464</b>	23599	 137 50 19
1.6HDi, 1.6i, 1.8i, 2.0HDi, 2.0i ESP+, ETS+ : Drive ability control+	11/02 ▶ 05/07		BSC	<b>301465</b>	23600	 137 57,3 19
1.6HDi, 1.6i, 1.8i, 2.0HDi, 2.0i ESP+	11/02 ▶ 05/07		LUC	<b>301463</b>	20960	 87 52,9 17
<b>ZX (91&gt;98)</b> 						
2.0i  (3)	07/95 ▶ 07/98		LUC	<b>301069</b>	21674	 130 56,5 19 ↪ 4x ↪ 310 mm
1.1, 1.1i, 1.4, 1.4D, 1.4i, 1.5D, 1.8D, 1.9D  (3), (5)	03/91 ▶ 07/98		BDX	<b>301155</b>	21061	 111,4 53,4 18
1.6i, 1.8i, 1.9TD, 1.9i, 2.0i  (3), (5) ABS+	03/91 ▶ 07/98		BDX	<b>301396</b>	20635	 105 54,7 11

				<b>Valeo</b>	<b>WVA</b>					
<b>DACIA</b>										
<b>Dokker (2012&gt;)</b> 										
1.5dCi 75, 1.5dCi 90, 1.6MPI 85	09/12 ▶		LUC	<b>301641</b>	23973		116,4	52,5	17,3	
<b>Duster (2010&gt;)</b> 										
1.5dCi 110, 1.5dCi 85, 1.5dCi 90, 1.6i 105, 1.6i 110 ABS-	03/10 ▶		LUC	<b>301641</b>	23973		116,4	52,5	17,3	
<b>Lodgy (2012&gt;)</b> 										
1.5dCi, 1.6MPI 85 ESP-	04/12 ▶		LUC	<b>301641</b>	23973		116,4	52,5	17,3	
<b>Logan (2004&gt;)</b> 										
1.2, 1.2 GPL, 1.4MPI, 1.4MPI GPL, 1.5dCi, 1.5dCi 65, 1.5dCi 75, 1.5dCi 90, 1.5dCi eco2, 1.6MPI, 1.6MPI 85, 1.6MPI GPL, 1.6i, 1.6i 105  (4),(5) ABS -, DV10+ : 259x20.7 brake disc+	09/04 ▶		LUC	<b>301002</b>	20772		100	64,9	18	
1.4MPI, 1.5dCi, 1.5dCi 65, 1.5dCi 70, 1.5dCi 85, 1.5dCi eco2, 1.6MPI, 1.6MPI GPL, 1.6i, 1.6i 90  (2),(5) DV11+ : 260x22 brake disc+	10/06 ▶ 11/08		ATE	<b>301017</b>	24673		150,2	52,5	17,8	
1.4MPI, 1.5dCi, 1.5dCi 65, 1.5dCi 70, 1.5dCi 75, 1.5dCi 85, 1.5dCi 90, 1.5dCi eco2, 1.6MPI, 1.6MPI 85, 1.6MPI GPL, 1.6i, 1.6i 105, 1.6i 90  (2),(4),(5) DV11+ : 260x22 brake disc+	11/08 ▶		LUC	<b>301641</b>	23973		116,4	52,5	17,3	
<b>Sandero (2008&gt;)</b> 										
1.0i HI-FLEX, 1.2i, 1.2i GPL, 1.4MPI, 1.4MPI 75-GPL, 1.4MPI GPL, 1.5dCi, 1.5dCi 65, 1.5dCi 70, 1.5dCi 75, 1.5dCi 90, 1.6MPI 105-E85, 1.6MPI 85, 1.6MPI 90, 1.6MPI 90-E85, 1.6MPI 90-GPL DP1+ : 238x12 brake disc+, DP2+ : 259x12 brake disc+, DV10+ : 259x20.7 brake disc+	06/08 ▶		LUC	<b>301002</b>	20772		100	64,9	18	
<b>DAEWOO</b>										
<b>Aranos (95&gt;2005)</b> 										
1.5i, 1.8i, 2.0i	02/95 ▶ 07/05		ATE	<b>301184</b>	21201		156,3	52,6	17	
<b>Espero (93&gt;99)</b> 										
1.5i, 1.8i, 2.0i	09/93 ▶ 05/99		ATE	<b>301184</b>	21201		156,3	52,6	17	
<b>Evanda (2002&gt;2005)</b> 										
2.0i, 2.0i GPL  _ ▶ 075442	08/02 ▶		AKE	<b>301361</b>	23235		143	51,4	18	↳ 2x ⇐
2.0i, 2.0i GPL	08/02 ▶		LUC	<b>301902</b>	23237		114	54,9	14,5	
<b>Lacetti (2003&gt;2004)</b> 										
1.4i, 1.6i, 1.6i GPL, 1.8i, 1.8i GPL	10/03 ▶ 12/04		SUM	<b>301874</b>	24071		104,2	38,8	14,6	
<b>Lanos (97&gt;2005)</b> 										
1.6i  (3),(4),(5)	09/97 ▶ 07/05		ATE	<b>301184</b>	21201		156,3	52,6	17	
1.3i, 1.5i  (3),(4),(5)	09/97 ▶ 07/05		ATE	<b>301356</b>	21353		140,1 141,4	58,3 48,4	16,8	
<b>Leganza (97&gt;2003)</b> 										
2.0i, 2.2i	09/97 ▶ 01/03		AKE	<b>301361</b>	23235		143	51,4	18	↳ 2x ⇐

 				<b>Valeo</b>	<b>WVA</b>					
<b>DAEWOO (.../...)</b>										
<b>Leganza (97&gt;2003)  (.../...)</b>										
2.0i, 2.2i	09/97 ▶ 01/03		LUC	<b>301902</b>	23237		114	54,9	14,5	
<b>Lublin (97&gt;2005) </b>										
2.4D, 2.4TD   (3)	04/97 ▶		LUC	<b>301061</b>	20916		129,85	55,5	18,3	↳ 2x ↗ 260 mm
<b>Matiz (98&gt;2005) </b>										
0.8i, 1.0i	03/98 ▶ 01/05		AKE	<b>301316</b>	23241		127	48,5	16,7	
<b>Nexia (95&gt;2005) </b>										
1.5   (3,4,5)	03/95 ▶ 07/05		ATE	<b>301184</b>	21201		156,3	52,6	17	
1.5   (3,4,5)	03/95 ▶ 07/05		ATE	<b>301356</b>	21353		140,1	58,3	16,8	
							141,4	48,4		
<b>Nubira (97&gt;2005) </b>										
1.6i, 1.6i GPL, 1.8i, 1.8i GPL, 2.0i   (4,5)	09/97 ▶ 07/05		LUC	<b>301902</b>	23237		114	54,9	14,5	
<b>Rezzo (2000&gt;2005) </b>										
1.6i, 1.6i GPL, 1.8i, 2.0i, 2.0i GPL	04/00 ▶		AKE	<b>301361</b>	23235		143	51,4	18	↳ 2x ⇐
<b>Tacuma (2000&gt;2005) </b>										
1.6i, 1.8i, 2.0i	06/00 ▶ 07/05		AKE	<b>301361</b>	23235		143	51,4	18	↳ 2x ⇐
<b>DAF</b>										
<b>400 (86&gt;96) </b>										
3.5  _ ▶ 816133	10/88 ▶		AP	<b>301129</b>	20359		105	74,7	18	↳ 4x ↗ 195 mm / 145 mm
<b>DAIHATSU</b>										
<b>Applause (89&gt;2000) </b>										
1.6, 1.6i	06/89 ▶ 09/97		SUM	<b>301624</b>	20031		102	38,98	12,5	
<b>Charade (2011&gt;) </b>										
1.3VVTi 99	06/11 ▶		ATE	<b>301028</b>	24574		123,1	43,7	14,5	↳ 2x ⇐
<b>DODGE</b>										
<b>Caliber (2006&gt;2011) </b>										
1.8VVT, 2.0CRD, 2.0VVT	09/06 ▶ 05/11		AKE	<b>301852</b>	24014		85,5	40	15,5	
							106	35,5		
<b>FIAT</b>										
<b>500 (2007&gt;2012) </b>										
1.2MPi, 1.3MJTD, 1.4MPi   (2,3)	07/07 ▶ 06/12		BSC	<b>301015</b>	24764		122,8	51,68	17,7	↳ 1x ↗ 216 mm
1.4MPi  (3)	07/07 ▶ 01/08		BSC	<b>301426</b>	23705		123	53,3	17,8	↳ 1x ↗ 215 mm
<b>500 (2012&gt;) </b>										
1.2MPi  (2)	07/12 ▶		BSC	<b>301015</b>	24764		122,8	51,68	17,7	↳ 1x ↗ 216 mm

				<b>Valeo</b>	<b>WVA</b>							
<b>FIAT (.../...)</b>												
<b>900 (76&gt;87)</b> 												
0.9  	10/76 ▶ 1987		BDX	<b>301091</b>	20775		108,8	47,4	18	↳ 2x 		
<b>Albea (2002&gt;)</b> 												
1.2i, 1.3JTD, 1.6i 	04/02 ▶		BSC	<b>301426</b>	23705		123	53,3	17,8	↳ 1x  215 mm		
<b>Argenta (81&gt;86)</b> 												
1.6, 1.8, 2, 2.5D, 2.5TD, 2i	04/81 ▶ 1986		TRW	<b>301219</b>	20838		104,5	66,6	17,2	↳ 2x 		
<b>Barchetta (95&gt;2003)</b> 												
1.8i	04/97 ▶ 06/03		ATE	<b>301006</b>	21927		156,5	52,5	17,6	↳ 2x  200 mm		
1.8i	05/95 ▶ 06/03		LUC	<b>301142</b>	21103		87,3	44,4	14,4			
<b>Barchetta (2003&gt;2006)</b> 												
1.8i	07/03 ▶ 06/06		ATE	<b>301006</b>	21927		156,5	52,5	17,6	↳ 2x  200 mm		
1.8i	07/03 ▶ 06/06		LUC	<b>301142</b>	21103		87,3	44,4	14,4			
<b>Brava (182) (95&gt;2002)</b> 												
1.6i, 1.8i, 1.9JTD, 1.9TD  	▶ 03/02		ATE	<b>301006</b>	21927		156,5	52,5	17,6	↳ 2x  200 mm		
 4937345 ▶ _												
1.2i, 1.4i, 1.6i, 1.9D, 1.9TD  	06/95 ▶ 03/02		ATE	<b>301040</b>	21930		151,5	52,5	17,4	↳ 1x  200 mm		
<b>Bravo (182) (95&gt;2002)</b> 												
1.6i, 1.8i, 1.9JTD, 1.9TD	06/95 ▶		ATE	<b>301006</b>	21927		156,5	52,5	17,6	↳ 2x  200 mm		
2.0i	06/95 ▶ 05/99		ATE	<b>301023</b>	21636		156,3	58,9	19	↳ 2x  216 mm		
1.2i, 1.4i, 1.6i, 1.9D, 1.9TD	06/95 ▶ 03/02		ATE	<b>301040</b>	21930		151,5	52,5	17,4	↳ 1x  200 mm		
2.0i  4833801 ▶ 4993952			ATE	<b>301065</b>	21636		155,3	61,7	19	↳ 2x  200 mm		
2.0i  4993953 ▶ _	▶ 03/02		ATE	<b>301990</b>	21637		155,3	61,6	19,1	↳ 2x  211 mm		
							156,45	55,9				
2.0i	06/95 ▶ 03/02		LUC	<b>301142</b>	21103		87,3	44,4	14,4			
<b>Bravo II (198) (2007&gt;2009)</b> 												
1.4MPI	02/07 ▶ 12/09		BSC	<b>301426</b>	23705		123	53,3	17,8	↳ 1x  215 mm		
<b>Bravo II (198) (2010&gt;)</b> 												
1.4MPI, 1.4MPI GPL	01/10 ▶		BSC	<b>301426</b>	23705		123	53,3	17,8	↳ 1x  215 mm		
<b>Cinquecento (170) (92&gt;98)</b> 												
0.7, 0.7i, 0.9, 0.9i, 1.1i  	▶ 02/98		BDX	<b>301012</b>	21365		115	55,3	17			
 1066591 ▶ _												
<b>Coupe (PC) (93&gt;96)</b> 												
1.8i, 2.0i, 2.0i Turbo	11/93 ▶ 09/96		ATE	<b>301065</b>	21636		155,3	61,7	19	↳ 2x  200 mm		
1.8i, 2.0i, 2.0i Turbo	11/93 ▶ 09/96		LUC	<b>301142</b>	21103		87,3	44,4	14,4			









































				<b>Valeo</b>	<b>WVA</b>					
<b>FIAT (.../...)</b>										
<b>Coupe (PX) (96&gt;2000)</b> 										
1.8i, 2.0i	07/96 ▶ 03/99		ATE	<b>301023</b>	21636		156,3	58,9	19	↳ 2 x  216 mm
1.8i, 2.0i	04/99 ▶ 09/00		ATE	<b>301065</b>	21636		155,3	61,7	19	↳ 2 x  200 mm
1.8i, 2.0i, 2.0i Turbo	07/96 ▶ 09/00		LUC	<b>301142</b>	21103		87,3	44,4	14,4	
<b>Croma (154) (85&gt;90)</b> 										
1.6, 2.0CHT, 2.0TDiD, 2.0ie Turbo, 2.5D, 2.5TD, 2ie	10/85 ▶ 12/90		LUC	<b>301125</b>	20668		87	66,9	16,6	
<b>Croma (154) (91&gt;96)</b> 										
2.0TDiD, 2.0ie, 2.0ie Turbo, 2.5 V6, 2.5TD ABS+	01/91 ▶ 12/96		LUC	<b>301125</b>	20668		87	66,9	16,6	
<b>Croma II (194-294) (2005&gt;2007)</b> 										
1.8i, 1.9JTD, 1.9JTD Multijet, 2.2i  2060169 ▶ _	▶ 10/07		ATE	<b>301678</b>	23402		156,5	71	20,3	
<b>Croma II (194-294) (2007&gt;2011)</b> 										
1.8MPi, 1.9JTD, 2.2MPi	10/07 ▶ 01/11		ATE	<b>301678</b>	23402		156,5	71	20,3	
<b>Doblo II (223) (2006&gt;)</b> 										
1.3MJTD, 1.4i, 1.6i GNV, 1.9MJTD  (5) D257+ : 257x22+	01/06 ▶		BSC	<b>301426</b>	23705		123	53,3	17,8	↳ 1 x  215 mm

				<b>Valeo</b>	<b>WVA</b>					
<b>FIAT (.../...)</b>										
<b>Doblo Cargo II (223) (2006&gt;)</b> 										
1.3MJTD, 1.4i, 1.6i GNV, 1.9MJTD   (3), (4) D257+ : 257x22+	01/06 ▶		BSC	<b>301426</b>	23705		123	53,3	17,8	↳ 1 x + 215 mm
<b>Ducato (230) (94&gt;2001)</b> 										
1.9D, 1.9TD, 2.0, 2.0JTD-EGR, 2.0i, 2.5D, 2.5TD, 2.8D, 2.8JTD, 2.8TDi   (2), (3), (4), (5)  ▶ 5782691	02/94 ▶		LUC	<b>301010</b>	21797		145	60,8	19,2	↳ 2 x + 200 mm
1.9D, 1.9TD, 2.0, 2.0i, 2.5D, 2.5TD, 2.8D, 2.8JTD, 2.8TDi   (2), (3), (4)  5782691 ▶ _  5782692 ▶ _  5788442 ▶ _	02/94 ▶ 12/01		LUC	<b>301429</b>	21797		145	60,9	19,5	↳ 1 x + 300 mm
1.9D, 1.9TD, 2.0, 2.0JTD-EGR, 2.0i, 2.5D, 2.5TD, 2.8D, 2.8JTD, 2.8TDi   (2), (3), (4), (5)	02/94 ▶ 12/01		BRE	<b>301568</b>	23918		140,5	65,8	19	↳ 1 x + 175 mm
2.0i, 2.5D, 2.5TD, 2.8D, 2.8JTD, 2.8TDi   (2), (3), (4)	02/94 ▶ 12/01		BRE	<b>301569</b>	23919		164,6	69,3	18,3	↳ 1 x + 175 mm
<b>Ducato (244) (2002&gt;2006)</b> 										
2.0JTD, 2.0i, 2.0i GPL, 2.3JTD, 2.8JTD, 2.8TD   (2), (4), (5)	01/02 ▶ 06/06		BRE	<b>301568</b>	23918		140,5	65,8	19	↳ 1 x + 175 mm
2.0i, 2.0i GPL, 2.3JTD, 2.8JTD, 2.8TD   (2), (4), (5)	01/02 ▶ 06/06		BRE	<b>301569</b>	23919		164,6	69,3	18,3	↳ 1 x + 175 mm
<b>Ducato (244-245) Made in Russia (2008&gt;2011)</b> 										
2.3JTD  (5)	01/08 ▶ 12/11		BRE	<b>301568</b>	23918		140,5	65,8	19	↳ 1 x + 175 mm
2.3JTD  (5)	01/08 ▶ 12/11		BRE	<b>301569</b>	23919		164,6	69,3	18,3	↳ 1 x + 175 mm
2.3JTD  (5)	01/08 ▶ 12/11		BRE	<b>301570</b>	23921		109,5	49,8	20	
<b>Ducato (250-251) (2006&gt;)</b> 										
2.2MJTD, 2.3MJTD, 3.0GNV 140, 3.0MJTD   (2), (4), (5)	07/06 ▶		BSC	<b>301892</b>	24465		137	48,8	18,8	
<b>Ducato (250-251) (2011&gt;)</b> 										
2.0M-Jet2 115, 2.3M-Jet2 130, 2.3M-Jet2 150, 3.0M-Jet2 180   (5)	05/11 ▶		BSC	<b>301892</b>	24465		137	48,8	18,8	
<b>Fiorino (225-255) (2007&gt;)</b> 										
1.3MJTD 75, 1.4i 70-GNV, 1.4i 75  (5)  ▶ 6446	12/07 ▶		BSC	<b>301426</b>	23705		123	53,3	17,8	↳ 1 x + 215 mm
<b>Linea (2007&gt;)</b> 										
1.4TJET, 1.6MJTD	07/07 ▶		LUC	<b>301407</b>	23661		95,8	43,7	16,5	
<b>Marea (185) (96&gt;2002)</b> 										
1.2i, 1.6i, 1.6i Bipower, 1.8i, 1.9JTD, 1.9TD   (4), (5)	07/96 ▶ 09/02		ATE	<b>301006</b>	21927		156,5	52,5	17,6	↳ 2 x + 200 mm
2.0i, 2.4JTD, 2.4TD   (4), (5)  ▶ 0249007	07/96 ▶		ATE	<b>301023</b>	21636		156,3	58,9	19	↳ 2 x + 216 mm
1.2i, 1.4i, 1.6i, 1.9TD   (4), (5)	07/96 ▶ 09/02		ATE	<b>301040</b>	21930		151,5	52,5	17,4	↳ 1 x + 200 mm
2.0i, 2.4JTD   (4), (5)  0249008 ▶ 2048540  0249008 ▶ _			ATE	<b>301065</b>	21636		155,3	61,7	19	↳ 2 x + 200 mm



















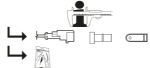



















































































































































											
<b>FIAT (.../...)</b>											
<b>Marea (185) (96&gt;2002)  (.../...)</b>											
2.0i   (4), (5)  2048541 ▶ _	▶ 09/02		ATE	<b>301990</b>	21637		155,3 156,45	61,6 55,9	19,1	↳ 2x  211 mm	
2.0i, 2.4JTD, 2.4TD   (4), (5)	07/96 ▶ 09/02		LUC	<b>301142</b>	21103		87,3	44,4	14,4		
<b>Marengo (159) (89&gt;93) </b>											
1.9D, 1.9Tds	11/89 ▶ 02/93		TRW	<b>301219</b>	20838		104,5	66,6	17,2	↳ 2x 	
1.9D, 1.9Tds ABS+	11/89 ▶ 02/93		LUC	<b>301142</b>	21103		87,3	44,4	14,4		
<b>Marengo (159) (93&gt;95) </b>											
1.9D	03/93 ▶ 12/94		TRW	<b>301219</b>	20838		104,5	66,6	17,2	↳ 2x 	
1.9D, 1.9TD	03/93 ▶ 01/95		LUC	<b>301142</b>	21103		87,3	44,4	14,4		
<b>Marengo (185) (95&gt;2002) </b>											
1.9JTD, 1.9TD	05/98 ▶ 09/02		ATE	<b>301006</b>	21927		156,5	52,5	17,6	↳ 2x  200 mm	
1.9TD	01/95 ▶ 09/02		ATE	<b>301040</b>	21930		151,5	52,5	17,4	↳ 1x  200 mm	
<b>Multipla (186) (98&gt;2004) </b>											
1.6i, 1.6i Bipower, 1.6i Blupower, 1.9JTD	11/98 ▶ 06/04		ATE	<b>301065</b>	21636		155,3	61,7	19	↳ 2x  200 mm	
<b>Multipla (186) (2004&gt;2010) </b>											
1.6i, 1.6i Bipower, 1.6i Bipower GPL, 1.9JTD	07/04 ▶ 05/10		ATE	<b>301065</b>	21636		155,3	61,7	19	↳ 2x  200 mm	
<b>Panda (141) (80&gt;86) </b>											
0.6, 0.8, 0.9, 1.0  (3)  06166305 ▶ _	▶ 02/86		BDX	<b>301091</b>	20775		108,8	47,4	18	↳ 2x 	
<b>Panda (11A/141/151) (86&gt;2003) </b>											
0.7, 0.9, 0.9ie, 1, 1.1ie, 1.3D, 1ie   (3)	03/86 ▶ 08/03		BDX	<b>301091</b>	20775		108,8	47,4	18	↳ 2x 	
<b>Panda (169) (2003&gt;) </b>											
1.1i, 1.2i, 1.2i GNV, 1.2i LPG	09/03 ▶		BDX	<b>301012</b>	21365		115	55,3	17		
1.2i, 1.2i GNV, 1.3MJTD, 1.4i GNV	09/03 ▶		BSC	<b>301015</b>	24764		122,8	51,68	17,7	↳ 1x  216 mm	
1.3MJTD, 1.4i  _ ▶ 971810	09/04 ▶		BSC	<b>301426</b>	23705		123	53,3	17,8	↳ 1x  215 mm	
<b>Panda (169) (2003&gt;2009) </b>											
1.2i	09/09 ▶ 09/09		BSC	<b>301015</b>	24764		122,8	51,68	17,7	↳ 1x  216 mm	
1.3JTD Multijet  _ ▶ 971810	01/06 ▶		BSC	<b>301426</b>	23705		123	53,3	17,8	↳ 1x  215 mm	
<b>Panda (169) (2009&gt;2010) </b>											
1.2i 69, 1.2i GNV 60, 1.3MJTD 70, 1.3MJTD 75	08/09 ▶ 06/10		BSC	<b>301015</b>	24764		122,8	51,68	17,7	↳ 1x  216 mm	
<b>Panda (169) (2010&gt;2011) </b>											
1.4i GNV 77	07/10 ▶ 12/11		BSC	<b>301015</b>	24764		122,8	51,68	17,7	↳ 1x  216 mm	

										
<b>FIAT (.../...)</b>										
<b>Panda (169) (2012&gt;)</b> 										
1.2i 69, 1.3MJTD 75	01/12 ▶		BSC	<b>301015</b>	24764		122,8	51,68	17,7	↳ 1 x ↗ 216 mm
<b>Punto (176) (93&gt;99)</b> 										
1.4i Turbo  (3)	06/96 ▶ 09/99		ATE	<b>301006</b>	21927		156,5	52,5	17,6	↳ 2 x ↗ 200 mm
1.1i, 1.2i, 1.7D, 1.7TD   (2,3,5) ABS+	10/94 ▶ 09/99		BDX	<b>301012</b>	21365		115	55,3	17	
1.1i, 1.2i, 1.4i Turbo, 1.6i, 1.7TD   (2,3,5) ABS+	07/93 ▶ 09/99		TRW	<b>301219</b>	20838		104,5	66,6	17,2	↳ 2 x ↗
1.4i Turbo  (3)	07/93 ▶ 09/99		LUC	<b>301142</b>	21103		87,3	44,4	14,4	
<b>Punto II (188) (99&gt;2003)</b> 										
1.2i  (3,5)	07/99 ▶ 06/03		BDX	<b>301012</b>	21365		115	55,3	17	
<b>Punto II (188) (2003&gt;2009)</b> 										
1.2i, 1.2i Bipower, 1.2i GPL  (3,5)	07/03 ▶ 08/09		BDX	<b>301012</b>	21365		115	55,3	17	
1.8i, 1.9JTD  (3,5)	07/03 ▶ 08/09		ATE	<b>301990</b>	21637		155,3	61,6	19,1	↳ 2 x ↗ 211 mm
							156,45	55,9		
<b>Grande Punto (199) (2005&gt;2011)</b> 										
1.2i, 1.2i 65  (3,5)			BSC	<b>301426</b>	23705		123	53,3	17,8	↳ 1 x ↗ 215 mm
1.3MJTD, 1.3MJTD 90, 1.3MJTD 95, 1.4MPi, 1.4T-Jet 120, 1.4i 95, 1.6MJTD 120, 1.9JTD, 1.9MJTD 120, 1.9MJTD 130  (3,5)			BSC	<b>301721</b>	23708		137	57,4	19	↳ 1 x ↗ 215 mm
<b>Qubo (2008&gt;)</b> 										
1.3MJTD 75, 1.4i 75  (3,5) _ ▶ 6446	05/08 ▶		BSC	<b>301426</b>	23705		123	53,3	17,8	↳ 1 x ↗ 215 mm
<b>Regata (138) (83&gt;90)</b> 										
1.1, 1.3, 1.3 GPL, 1.5, 1.5ie, 1.6, 1.6 GPL, 1.7D  (4,5)	09/83 ▶ 1990		BDX	<b>301091</b>	20775		108,8	47,4	18	↳ 2 x ↗
1.3, 1.5, 1.6, 1.7D, 1.9D, 1.9TD  (4,5)	09/83 ▶ 1990		TRW	<b>301219</b>	20838		104,5	66,6	17,2	↳ 2 x ↗
<b>Ritmo (138) (82&gt;88)</b> 										
1.0, 1.1, 1.3, 1.5, 1.6, 1.7D  (2,3,5)	11/82 ▶ 1988		BDX	<b>301091</b>	20775		108,8	47,4	18	↳ 2 x ↗
1.6, 1.9TD Turbo  (3,5)	11/82 ▶ 1988		TRW	<b>301219</b>	20838		104,5	66,6	17,2	↳ 2 x ↗
<b>Scudo (220) (95&gt;2003)</b> 										
1.6i, 1.9D, 1.9TD, 2.0JTD, 2.0i  (2,4)	07/95 ▶ 12/03		LUC	<b>301064</b>	21801		130	57,4	18,8	↳ 4 x ↗ 240 mm / 195 mm
<b>Scudo (220) (2004&gt;2006)</b> 										
2.0, 2.0JTD  (4)	01/04 ▶		LUC	<b>301064</b>	21801		130	57,4	18,8	↳ 4 x ↗ 240 mm / 195 mm
<b>Seicento (187) (98&gt;2010)</b> 										
0.9i, 1.1i			BDX	<b>301012</b>	21365		115	55,3	17	
CVT Elettra	09/98 ▶ 08/05		TRW	<b>301219</b>	20838		104,5	66,6	17,2	↳ 2 x ↗





















				<b>Valeo</b>	<b>WVA</b>					
<b>FIAT (.../...)</b>										
<b>Siena (178) (2002&gt;2011)</b> 										
1.2i	01/02 ▶ 12/11		BSC	<b>301426</b>	23705		123	53,3	17,8	↳ 1 x  215 mm
<b>Stilo (2001&gt;2003)</b> 										
1.2i, 1.6i   	09/01 ▶ 12/03		BSC	<b>301426</b>	23705		123	53,3	17,8	↳ 1 x  215 mm
<b>Stilo (2004&gt;2008)</b> 										
1.4i, 1.6i  	01/04 ▶ 04/07		BSC	<b>301426</b>	23705		123	53,3	17,8	↳ 1 x  215 mm
<b>Strada (85&gt;88)</b> 										
1.1, 1.3, 1.5 	04/85 ▶ 1988		BDX	<b>301091</b>	20775		108,8	47,4	18	↳ 2 x 
<b>Tempra (160) (89&gt;93)</b> 										
1.4, 1.4ie, 1.6, 1.6ie   	11/89 ▶ 02/93		LUC	<b>301095</b>	21105		90	63	17	↳ 1 x  255 mm
1.4, 1.4ie, 1.6, 1.6ie, 1.8ie, 1.9D, 1.9TDs, 2.0ie   	11/89 ▶ 02/93		TRW	<b>301219</b>	20838		104,5	66,6	17,2	↳ 2 x 
1.4, 1.4ie, 1.6, 1.6ie, 1.8ie, 1.9D, 1.9TDs, 2.0ie   	11/89 ▶ 02/93		LUC	<b>301142</b>	21103		87,3	44,4	14,4	
<b>Tempra (160) (93&gt;96)</b> 										
1.4ie, 1.6, 1.6ie, 1.8ie, 1.9D, 1.9TD, 2.0ie   			TRW	<b>301219</b>	20838		104,5	66,6	17,2	↳ 2 x 
1.4ie, 1.6, 1.6ie, 1.8ie, 1.9D, 1.9TD, 2.0ie   	▶ 1996		LUC	<b>301142</b>	21103		87,3	44,4	14,4	
ABS+  6073159 ▶ _  7490102 ▶ _										
<b>Tipo (160) (88&gt;93)</b> 										
1.1, 1.4, 1.4ie, 1.6, 1.6ie, 1.7D, 1.9D	01/88 ▶ 02/93		LUC	<b>301095</b>	21105		90	63	17	↳ 1 x  255 mm
1.1, 1.4, 1.4ie, 1.6, 1.6 2ACT, 1.6ie, 1.7D, 1.8ie, 1.9D, 1.9TDs, 2.0ie ABS+	01/88 ▶ 02/93		TRW	<b>301219</b>	20838		104,5	66,6	17,2	↳ 2 x 
1.1, 1.4, 1.4ie, 1.6, 1.6 2ACT, 1.6ie, 1.7D, 1.8ie, 1.9D, 1.9TDs, 2.0ie ABS+	01/88 ▶ 02/93		LUC	<b>301142</b>	21103		87,3	44,4	14,4	
<b>Tipo (160) (93&gt;95)</b> 										
1.4, 1.4ie, 1.6, 1.6ie, 1.8ie, 1.9TD ABS+	03/93 ▶ 10/95		TRW	<b>301219</b>	20838		104,5	66,6	17,2	↳ 2 x 
1.4, 1.4ie, 1.6, 1.6ie, 1.7D, 1.8ie, 1.9D, 1.9TD, 2.0ie ABS+	03/93 ▶ 10/95		LUC	<b>301142</b>	21103		87,3	44,4	14,4	
<b>Ulysse (220) (94&gt;98)</b> 										
1.9TD, 2.0ie, 2.0ie Turbo, 2.1TD	06/94 ▶ 09/98		LUC	<b>301064</b>	21801		130	57,4	18,8	↳ 4 x  240 mm / 195 mm
<b>Ulysse (220) (98&gt;2002)</b> 										
1.9TD, 2.0JTD, 2.0ie, 2.0ie Turbo, 2.1TD	10/98 ▶ 08/02		LUC	<b>301064</b>	21801		130	57,4	18,8	↳ 4 x  240 mm / 195 mm
<b>Ulysse (179) (2002&gt;2010)</b> 										
2.0JTD, 2.0i, 2.2JTD, 3.0i V6	09/02 ▶ 07/10		LUC	<b>301463</b>	20960		87	52,9	17	

											
<b>FIAT (.../...)</b>											
<b>Uno (146) (83&gt;89)</b> 											
0.9, 1.0, 1.1, 1.1 GPL, 1.3, 1.3D, 1.5   (3), (5)	01/83 ▶ 10/89		BDX	<b>301091</b>	20775		108,8	47,4	18	↳ 2x 	
1.1, 1.3 Turbo ie, 1.4TD, 1.7D  (3), (5)	03/85 ▶ 1989		LUC	<b>301095</b>	21105		90	63	17	↳ 1x  255 mm	
1.3 Turbo ie  (3), (5)	03/85 ▶ 1989		LUC	<b>301142</b>	21103		87,3	44,4	14,4		
<b>Uno (146) (89&gt;95)</b> 											
0.9ie, 1.0, 1.0ie, 1.1, 1.1ie, 1.3D, 1.4, 1.4i, 1.4ie, 1.5ie  (3), (5)	10/89 ▶ 12/93		BDX	<b>301091</b>	20775		108,8	47,4	18	↳ 2x 	
1.1, 1.4TD, 1.4ie, 1.5ie, 1.7D, 1.9D  (3), (5)	10/89 ▶ 08/95		LUC	<b>301095</b>	21105		90	63	17	↳ 1x  255 mm	
1.3ie Turbo, 1.4TD, 1.4ie Turbo  (3), (5) ABS+	10/89 ▶ 09/93		TRW	<b>301219</b>	20838		104,5	66,6	17,2	↳ 2x 	
1.3ie Turbo, 1.4ie Turbo  (3)	10/89 ▶ 09/93		LUC	<b>301142</b>	21103		87,3	44,4	14,4		
<b>Uno Mondo (146) (98&gt;2010)</b> 											
1.0i, 1.1, 1.4  (5)	01/98 ▶ 12/10		BDX	<b>301091</b>	20775		108,8	47,4	18	↳ 2x 	
<b>FORD</b>											
<b>C-Max (2007&gt;2010)</b> 											
1.6TDCi, 1.6i, 1.8TDCi, 1.8i, 1.8i 125-E85, 2.0TDCi, 2.0i, 2.0i CNG, 2.0i GPL	02/07 ▶ 08/10		ATE	<b>301649</b>	23723		156,3	67	17,5		
1.6TDCi, 1.6i, 1.8TDCi, 1.8i, 1.8i 125-E85, 2.0TDCi, 2.0i, 2.0i CNG, 2.0i GPL	02/07 ▶ 08/10		ATE	<b>301472</b>	23482		155,1	62,5			
1.6TDCi, 1.6i, 1.8TDCi, 1.8i, 1.8i 125-E85, 2.0TDCi, 2.0i, 2.0i CNG, 2.0i GPL	02/07 ▶ 08/10		ATE	<b>301472</b>	23482		123,1	52	16,6		
<b>Cougar (98&gt;2001)</b> 											
2.5i V6	09/98 ▶ 02/01		ATE	<b>301033</b>	21394		155,2	58,4	18	↳ 2x  220 mm	
							156,3	58,6			
2.0i	09/98 ▶ 02/01		ATE	<b>301034</b>	21394		155,2	58,4	18		
							156,3	58,6			
2.0i, 2.5i V6	09/98 ▶ 02/01		BDX	<b>301005</b>	21586		116	54	15		
<b>Courier/Courier (91&gt;96)</b> 											
1.3, 1.3i, 1.8D   (3)	08/91 ▶ 09/96		ATE	<b>301212</b>	20783		151,3	46,4	18		
<b>Courier/Courier (96&gt;2002)</b> 											
1.3i, 1.6i, 1.8D    (2), (3)	10/96 ▶ 02/00		ATE	<b>301212</b>	20783		151,3	46,4	18		
1.3i, 1.6i, 1.8D    (2), (3)	02/00 ▶ 09/02		ATE	<b>301563</b>	23200		150,2	54,1	18,6		
<b>Escort (80&gt;86)</b> 											
1.1, 1.3, 1.6, 1.6 Turbo, 1.6D, 1.6i     (2), (3), (5) TU- : Wear warning-	08/80 ▶ 02/86		ATE	<b>301212</b>	20783		151,3	46,4	18		
<b>Escort (86&gt;90)</b> 											
1.1, 1.3, 1.4, 1.4i, 1.6, 1.6D, 1.6i, 1.8D     (2), (3), (5)	01/86 ▶ 09/90		ATE	<b>301212</b>	20783		151,3	46,4	18		















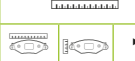
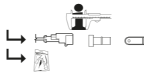



































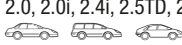



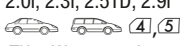

				<b>Valeo</b>	<b>WVA</b>						
<b>FORD (.../...)</b>											
<b>Escort (86&gt;90)  (.../...)</b>											
1.6 Turbo  (3)	01/86 ▶ 09/90		ATE	<b>301335</b>	20908			151,3	52,5	18	
<b>Escort (90&gt;94) </b>											
1.1, 1.3, 1.3i, 1.4, 1.4i, 1.6, 1.6i, 1.8D, 1.8TD, 1.8i     (2),(3),(5)	09/90 ▶ 12/94		BDX	<b>301172</b>	21171			131	57,4	18,3	
1.8i, 2.0i   (2),(3)	02/91 ▶ 12/94		ATE	<b>301335</b>	20908			151,3	52,5	18	
1.3, 1.3i, 1.4, 1.4i, 1.6, 1.6i, 1.8D, 1.8TD, 1.8i     (2),(3),(5)	09/90 ▶ 12/94		BDX	<b>301399</b>	23300			131,1	57,3	19	
2.0i  (3)	02/91 ▶ 12/94		LUC	<b>301240</b>	20981			90	54	13,7	
<b>Escort (95&gt;2001) </b>											
1.3i, 1.4i, 1.6i, 1.8D, 1.8TD, 1.8i     (2),(3),(4),(5)	01/95 ▶ 09/01		BDX	<b>301172</b>	21171			131	57,4	18,3	
1.6i  (3)	03/95 ▶ 08/96		ATE	<b>301335</b>	20908			151,3	52,5	18	
1.3i, 1.4i, 1.6i, 1.8D, 1.8TD, 1.8i     (2),(3),(4),(5)	01/95 ▶ 09/01		BDX	<b>301399</b>	23300			131,1	57,3	19	
2.0i  (3)	08/95 ▶ 12/95		LUC	<b>301240</b>	20981			90	54	13,7	
<b>Explorer (90&gt;2000) </b>											
4.0i  (3),(5)	01/90 ▶ 12/94		WAGNER	<b>301906</b>	23472			154	56,1	17,3	↳ 2x ⇐
<b>Fiesta (76&gt;83) </b>											
1.6  (3)	10/81 ▶ 08/83		ATE	<b>301212</b>	20783			151,3	46,4	18	
<b>Fiesta (83&gt;89) </b>											
1.6  (3)	02/84 ▶ 1989		ATE	<b>301212</b>	20783			151,3	46,4	18	
<b>Fiesta (89&gt;95) </b>											
1.0, 1.1, 1.1i, 1.3, 1.3i, 1.4, 1.4i, 1.8D, 1.8TD  (3),(5)	02/89 ▶ 07/95		ATE	<b>301043</b>	21203			141,5	45,6	17,4	
1.0, 1.1, 1.1i, 1.3, 1.3i, 1.4, 1.4i, 1.8D, 1.8TD  (3),(5)	02/89 ▶ 07/95		ATE	<b>301171</b>	21203			141,5	45,6	17	
1.1, 1.1i, 1.3, 1.3i, 1.4, 1.4i, 1.6, 1.6i, 1.6i Turbo, 1.8D, 1.8TD, 1.8i  (3),(5) ABS+	02/89 ▶ 07/95		ATE	<b>301212</b>	20783			151,3	46,4	18	
<b>Fiesta (95&gt;99) </b>											
1.0i, 1.1i, 1.2i, 1.3i, 1.4i, 1.8D  (3),(5)	08/95 ▶ 09/99		ATE	<b>301043</b>	21203			141,5	45,6	17,4	
1.0i, 1.1i  (3),(5)	08/95 ▶ 08/99		ATE	<b>301171</b>	21203			141,5	45,6	17	
1.0i, 1.2i, 1.4i, 1.8D  (3),(5)   ABS+	08/95 ▶ 08/99		ATE	<b>301212</b>	20783			151,3	46,4	18	
<b>Fiesta (99&gt;2002) </b>											
1.2i, 1.3i, 1.4i, 1.6i, 1.8D  (3),(5)	08/99 ▶ 02/00		ATE	<b>301212</b>	20783			151,3	46,4	18	
1.2i, 1.3i, 1.4i, 1.6i, 1.8D, 1.8TDdi  (3),(5) ABS-	02/00 ▶ 03/02		ATE	<b>301563</b>	23200			150,2	54,1	18,6	

































				<b>Valeo</b>	<b>WVA</b>					
<b>FORD (.../...)</b>										
<b>Fiesta (99&gt;2002)  (.../...)</b>										
1.2i, 1.3i, 1.4i, 1.6i, 1.8D, 1.8TDdi  (3), (5) ABS+	02/00 ▶ 03/02		ATE	<b>301564</b>	23202		150,4	58	18,5	
							151,4	61,5		
<b>Fiesta (2002&gt;2005) </b>										
1.2i, 1.3i, 1.4TDCi, 1.4i, 1.6TDCi, 1.6i (3), (5)	03/02 ▶ 09/05		ATE	<b>301564</b>	23202		150,4	58	18,5	
							151,4	61,5		
2.0i (3)	01/05 ▶ 09/05		ATE	<b>301639</b>	23440		156,3	67,2	18,1	
2.0i (3)	01/05 ▶ 09/05		LUC	<b>301431</b>	23353		87,2	42,5	14,5	
<b>Fiesta (2005&gt;2008) </b>										
1.2i, 1.3i, 1.4TDCi, 1.4i, 1.6TDCi, 1.6i (3), (5)	10/05 ▶ 11/08		ATE	<b>301564</b>	23202		150,4	58	18,5	
							151,4	61,5		
2.0i (3)	10/05 ▶ 11/08		ATE	<b>301639</b>	23440		156,3	67,2	18,1	
2.0i (3)	10/05 ▶ 11/08		LUC	<b>301431</b>	23353		87,2	42,5	14,5	
<b>Focus (98&gt;2001) </b>										
1.4i, 1.6i, 1.8GPLi, 1.8TDCi, 1.8TDi, 1.8i, 2.0i  (3), (4), (5)	10/98 ▶ 10/01		ATE	<b>301317</b>	23154		177,6	58	18,8	
								60		
1.4i, 1.6i, 1.8GPLi, 1.8TDCi, 1.8TDi, 1.8i, 2.0i  (3), (4), (5) ABS+	10/98 ▶ 10/01		LUC	<b>301431</b>	23353		87,2	42,5	14,5	
<b>Focus (2001&gt;2004) </b>										
2.0i  (3), (5)	11/01 ▶ 08/04		ATE	<b>301639</b>	23440		156,3	67,2	18,1	
1.4i, 1.6i, 1.8TDCi, 1.8TDi, 1.8i, 2.0i, 2.0i Turbo  (3), (4), (5) ABS+	11/01 ▶ 08/04		LUC	<b>301431</b>	23353		87,2	42,5	14,5	
<b>Focus (2004&gt;2007) </b>										
1.4i, 1.6TDCi, 1.6Ti-VCT, 1.6i, 1.8TDCi, 1.8i CNG, 1.8i Flexifuel, 2.0TDCi, 2.0i, 2.5i  (3), (4), (5)	09/04 ▶		ATE	<b>301649</b>	23723		156,3	67	17,5	
							155,1	62,5		
1.4i, 1.6TDCi, 1.6Ti-VCT, 1.6i, 1.8TDCi, 1.8i CNG, 1.8i Flexifuel, 2.0TDCi, 2.0i, 2.5i  (3), (4), (5) ESP+	09/04 ▶ 12/07		ATE	<b>301472</b>	23482		123,1	52	16,6	
<b>Focus II (2007&gt;2011) </b>										
1.4, 1.6, 1.6TDCi, 1.6TDCi 110, 1.6TDCi 90, 1.6Ti-VCT, 1.6Ti-VCT 115 GPL, 1.8, 1.8 Flexifuel, 1.8TDCi, 2.0, 2.0TDCi, 2.0i CNG 145, 2.0i LPG 145  (3), (4), (5)	12/07 ▶		ATE	<b>301649</b>	23723		156,3	67	17,5	
							155,1	62,5		
1.4, 1.6, 1.6TDCi, 1.6TDCi 110, 1.6TDCi 90, 1.6Ti-VCT, 1.6Ti-VCT 115 GPL, 1.8, 1.8 Flexifuel, 1.8TDCi, 2.0, 2.0TDCi, 2.0i CNG 145, 2.0i LPG 145, 2.5T  (3), (4), (5)	12/07 ▶		ATE	<b>301472</b>	23482		123,1	52	16,6	

				<b>Valeo</b>	<b>VVA</b>								
<b>FORD (.../...)</b>													
<b>Focus C-Max (2003&gt;2007)</b> 													
1.6TDCi, 1.6Ti-VCT, 1.6i, 1.8TDCi, 1.8i, 1.8i CNG, 1.8i Flexifuel, 2.0TDCi, 2.0i	06/03 ▶		ATE	<b>301649</b>	23723		156,3	67	17,5				
							155,1	62,5					
1.6TDCi, 1.6Ti-VCT, 1.6i, 1.8TDCi, 1.8i, 1.8i CNG, 1.8i Flexifuel, 2.0TDCi, 2.0i	06/03 ▶ 02/07		ATE	<b>301472</b>	23482		123,1	52	16,6				
<b>Focus Coupé Cabriolet (2006&gt;2008)</b> 													
1.6i, 2.0TDCi, 2.0i	07/06 ▶ 04/08		ATE	<b>301649</b>	23723		156,3	67	17,5				
							155,1	62,5					
1.6i, 2.0TDCi, 2.0i	07/06 ▶ 04/08		ATE	<b>301472</b>	23482		123,1	52	16,6				
<b>Focus Coupé Cabriolet (2008&gt;)</b> 													
1.6i, 2.0TDCi, 2.0i	04/08 ▶		ATE	<b>301649</b>	23723		156,3	67	17,5				
							155,1	62,5					
1.6i, 2.0TDCi, 2.0i	04/08 ▶		ATE	<b>301472</b>	23482		123,1	52	16,6				
<b>Fusion (2002&gt;2005)</b> 													
1.25i, 1.4TDCi, 1.4i, 1.6TDCi, 1.6i	06/02 ▶ 09/05		ATE	<b>301564</b>	23202		150,4	58	18,5				
							151,4	61,5					
<b>Fusion (2005&gt;2012)</b> 													
1.2i, 1.4TDCi, 1.4i, 1.6TDCi, 1.6i	10/05 ▶ 06/12		ATE	<b>301564</b>	23202		150,4	58	18,5				
							151,4	61,5					
<b>Galaxy (VX) (95&gt;2000)</b> 													
1.9TDi, 2.0i, 2.3i, 2.8i VR6	05/95 ▶ 03/00		ATE	<b>301008</b>	20676		156,3	74	19,8				
													
1.9TDi, 2.0i, 2.3i, 2.8i VR6	05/95 ▶ 03/00		LUC	<b>301463</b>	20960		87	52,9	17				
<b>Galaxy (VY) (2000&gt;2006)</b> 													
2.0i, 2.3i ⊙15"	04/00 ▶ 04/01		ATE	<b>301008</b>	20676		156,3	74	19,8				
													
2.8i V6	04/00 ▶ 04/06		ATE	<b>301565</b>	23269		161,4	72,8	19,6			↳ 2 x ↖ 270 mm	
							74,5						
1.9TDCi, 1.9TDi ⊙16"	04/00 ▶ 04/06		ATE	<b>301801</b>	23418		156,2	78,4	19,6			↳ 1 x ↖	
													
2.0i, 2.3i	04/00 ▶ 04/06		LUC	<b>301463</b>	20960		87	52,9	17				
													
1.9TDCi, 1.9TDi ⊙15"	04/00 ▶ 04/06		LUC	<b>301681</b>	20960		87	53	17,2			↳ 1 x ↖ 205 mm	
													
<b>Granada (92&gt;95)</b> 													
2.0i, 2.5TD, 2.5TDi, 2.9i 	10/94 ▶ 01/95		ATE	<b>301034</b>	21394		155,2	58,4	18				
							156,3	58,6					
2.0i, 2.5TD, 2.9i 	01/92 ▶ 08/92		ATE	<b>301335</b>	20908		151,3	52,5	18				
													

												
<b>FORD (.../...)</b>												
<b>Ka (96&gt;2008)</b> 												
1.3i	09/96 ▶ 02/00		ATE	<b>301043</b>	21203		141,5	45,6	17,4			
1.3i	09/96 ▶ 02/00		ATE	<b>301171</b>	21203		141,5	45,6	17			
1.3i, 1.6i	02/00 ▶ 11/08		ATE	<b>301563</b>	23200	 	150,2	54,1	18,6			
1.6i	04/03 ▶ 11/08		ATE	<b>301564</b>	23202	 	150,4	58	18,5			
							151,4	61,5				
<b>Ka (2008&gt;)</b> 												
1.3TDCi, 1.3TDCi 75	12/08 ▶		BSC	<b>301015</b>	24764	 	122,8	51,68	17,7			↳ 1 x ↗ 216 mm
<b>Kuga (2008&gt;)</b> 												
2.0TDCi 136, 2.0TDCi 140, 2.0TDCi 163, 2.5T	04/08 ▶		ATE	<b>301649</b>	23723	 	156,3	67	17,5			
							155,1	62,5				
<b>Mondeo (93&gt;96)</b> 												
1.6i, 1.8TD, 1.8i, 2.0i  (4),(5) TU+ : Wear warning+	01/93 ▶ 08/96		ATE	<b>301033</b>	21394		155,2	58,4	18			↳ 2 x ↗ 220 mm
							156,3	58,6				
1.6i, 1.8TD, 1.8i, 2.0i, 2.5i V6  (4),(5) TU- : Wear warning-	01/93 ▶ 08/96		ATE	<b>301034</b>	21394		155,2	58,4	18			
							156,3	58,6				
1.6i, 1.8TD, 1.8i, 2.0i, 2.5i V6  (4),(5)	01/93 ▶ 08/96		BDX	<b>301005</b>	21586		116	54	15			
<b>Mondeo (96&gt;2000)</b> 												
1.6i, 1.8TD, 1.8i, 2.0i, 2.5i V6  (4),(5)	08/96 ▶ 09/00		ATE	<b>301033</b>	21394		155,2	58,4	18			↳ 2 x ↗ 220 mm
							156,3	58,6				
1.6i, 1.8TD, 1.8i, 2.0i, 2.5i V6  (4),(5)	08/96 ▶ 09/00		ATE	<b>301034</b>	21394		155,2	58,4	18			
							156,3	58,6				
1.6i, 1.8TD, 1.8i, 2.0i, 2.5i V6  (4),(5)	08/96 ▶ 09/00		BDX	<b>301005</b>	21586		116	54	15			
<b>Mondeo (2000&gt;2003)</b> 												
1.8i, 2.0Di, 2.0TDCi, 2.0TDDi, 2.0i, 2.5i V6, 3.0i V6  (4),(5)	10/00 ▶ 05/03		BSC	<b>301433</b>	23279		149	60,5	18			
1.8i, 2.0Di, 2.0TDCi, 2.0TDDi, 2.0i, 2.5i V6, 3.0i V6  (4),(5)	10/00 ▶ 05/03		BSC	<b>301434</b>	23557		115,9	51,9	16,8			
3.0i V6  (4),(5)	03/02 ▶ 05/03		LUC	<b>301681</b>	20960		87	53	17,2			↳ 1 x ↗ 205 mm
<b>Mondeo (2003&gt;2005)</b> 												
1.8SCi, 1.8i, 2.0TDCi, 2.0TDDi, 2.0i, 2.2TDCi, 2.5i V6, 3.0i V6  (4),(5)	06/03 ▶ 04/05		BSC	<b>301433</b>	23279		149	60,5	18			
1.8SCi, 1.8i, 2.0TDCi, 2.0TDDi, 2.0i, 2.5i V6  (4),(5)	06/03 ▶ 09/04		BSC	<b>301434</b>	23557		115,9	51,9	16,8			
1.8SCi, 1.8i, 2.0TDCi, 2.0TDDi, 2.0i, 2.2TDCi, 2.5i V6, 3.0i V6  (4),(5)	09/04 ▶ 04/05		BSC	<b>301740</b>	24260	 	101,8	50,6	17			

































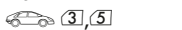

















				<b>Valeo</b>	<b>WVA</b>			
<b>FORD (.../...)</b>								
<b>Mondeo (2005&gt;2007)</b> 								
1.8SCi, 1.8i, 2.0TDCi, 2.0i, 2.2TDCi, 3.0i V6  (4),(5)	05/05 ▶ 06/07		BSC	<b>301433</b>	23279		149 60,5 18	
1.8SCi, 1.8i, 2.0TDCi, 2.0i, 2.2TDCi, 3.0i V6  (4),(5)	05/05 ▶ 06/07		BSC	<b>301740</b>	24260		101,8 50,6 17	
<b>Orion (83&gt;90)</b> 								
1.3, 1.4, 1.4i, 1.6, 1.6D, 1.6i, 1.8D	09/83 ▶ 08/90		ATE	<b>301212</b>	20783		151,3 46,4 18	
<b>Orion (90&gt;93)</b> 								
1.3, 1.3i, 1.4, 1.4i, 1.6, 1.6i, 1.8D, 1.8TD, 1.8i	09/90 ▶ 09/93		BDX	<b>301172</b>	21171		131 57,4 18,3	
1.8i	01/92 ▶ 09/93		ATE	<b>301335</b>	20908		151,3 52,5 18	
1.3, 1.3i, 1.4, 1.4i, 1.6, 1.6i, 1.8D, 1.8TD, 1.8i ABS+	09/90 ▶ 09/93		BDX	<b>301399</b>	23300		131,1 57,3 19	
<b>P100 Pick-up (88&gt;93)</b> 								
1.8TD, 2.0  (2)	01/88 ▶ 05/93		ATE	<b>301212</b>	20783		151,3 46,4 18	
<b>Probe (92&gt;97)</b> 								
2.0i, 2.5i V6	10/93 ▶ 12/97		SUM	<b>301629</b>	21754		131,95 51,5 15	↳ 2x ⇄
<b>Puma (97&gt;2001)</b> 								
1.4i, 1.7i	05/97 ▶ 02/00		ATE	<b>301212</b>	20783		151,3 46,4 18	
1.4i, 1.6i, 1.7i	02/00 ▶ 12/01		ATE	<b>301564</b>	23202		150,4 58 18,5 151,4 61,5	
<b>Scorpio (85&gt;92)</b> 								
1.8, 2, 2.4i, 2.5D, 2.5TD, 2.8i, 2.9i, 2i  (4),(5)	03/85 ▶ 01/92		ATE	<b>301335</b>	20908		151,3 52,5 18	
<b>Scorpio (92&gt;94)</b> 								
2.0, 2.0i, 2.4i, 2.5TD, 2.9i  (4),(5) TU- : Wear warning-	08/92 ▶ 10/94		ATE	<b>301034</b>	21394		155,2 58,4 18 156,3 58,6	
2.9i  (4),(5) TU- : Wear warning-	02/92 ▶ 10/94		AP	<b>301129</b>	20359		105 74,7 18	↳ 4x ⇄ 195 mm / 145 mm
2.0, 2.0i, 2.4i, 2.5TD, 2.9i  (4),(5) TU- : Wear warning-	02/92 ▶ 10/94		ATE	<b>301335</b>	20908		151,3 52,5 18	
<b>Scorpio (94&gt;98)</b> 								
2.0i, 2.3i, 2.5TD, 2.9i  (4),(5) TU- : Wear warning-	10/94 ▶ 07/98		ATE	<b>301034</b>	21394		155,2 58,4 18 156,3 58,6	
<b>Sierra (82&gt;86)</b> 								
1.6, 1.8, 2.0, 2.0i, 2.3, 2.3D, 2i  (3),(5)	08/82 ▶ 1987		ATE	<b>301212</b>	20783		151,3 46,4 18	
1.8, 2, 2.8, 2.8i  (3),(5) ABS+	08/82 ▶ 1987		ATE	<b>301335</b>	20908		151,3 52,5 18	
2.0  (3)	01/86 ▶ 1987		LUC	<b>301240</b>	20981		90 54 13,7	

				<b>Valeo</b>	<b>WVA</b>							
<b>FORD (.../...)</b>												
<b>Sierra (87&gt;93)</b> 												
1.6, 1.6i, 1.8, 1.8TD, 1.8i, 2.0, 2.0i, 2.3D  (3),(4),(5) ABS+	01/87 ▶ 01/93		ATE	<b>301212</b>	20783		151,3	46,4	18			
1.6, 1.6i, 1.8, 1.8TD, 1.8i, 2.0, 2.0i, 2.3D, 2.8i, 2.9i  (3),(4),(5)	01/87 ▶ 01/93		ATE	<b>301335</b>	20908		151,3	52,5	18			
2.0i, 2.8i  (4),(5) ABS+	01/87 ▶ 01/93		LUC	<b>301240</b>	20981		90	54	13,7			
<b>StreetKa (2002&gt;2005)</b> 												
1.6i	11/02 ▶ 12/05		ATE	<b>301564</b>	23202		150,4	58	18,5			
							151,4	61,5				
<b>Tourneo Connect (2002&gt;2006)</b> 												
1.8TDCi, 1.8TDdi, 1.8i (4)	05/02 ▶ 06/06		ATE	<b>301639</b>	23440		156,3	67,2	18,1			
1.8TDCi, 1.8TDdi, 1.8i (4) ABS+	05/02 ▶ 06/06		ATE	<b>301472</b>	23482		123,1	52	16,6			
1.8TDCi, 1.8TDdi, 1.8i (4) ABS+	05/02 ▶ 06/06		ATE	<b>301783</b>	24137		122,9	51,7	16,4			
<b>Tourneo Connect (2006&gt;)</b> 												
1.8TDCi (5)	06/06 ▶		ATE	<b>301639</b>	23440		156,3	67,2	18,1			
1.8TDCi (5) ABS+	06/06 ▶		ATE	<b>301472</b>	23482		123,1	52	16,6			
1.8TDCi (5) ABS+	06/06 ▶		ATE	<b>301783</b>	24137		122,9	51,7	16,4			
<b>Transit (78&gt;85)</b> 												
2.0, 2.4D	01/78 ▶ 12/85		AP	<b>301129</b>	20359		105	74,7	18			↳ 4 x  195 mm / 145 mm
<b>Transit (85&gt;91)</b> 												
2.0, 2.0i, 2.5D, 2.9i V6	10/85 ▶ 12/91		AP	<b>301129</b>	20359		105	74,7	18			↳ 4 x  195 mm / 145 mm
<b>Transit (91&gt;94)</b> 												
2.0, 2.0i, 2.5D, 2.5TD ⊙14"	06/91 ▶ 08/94		BDX	<b>301036</b>	21470		138,9	64,1	18,3			
2.0, 2.5D, 2.5TD, 2.9i V6 ⊙15"	08/91 ▶ 08/94		BDX	<b>301037</b>	21469		138,9	72	18,3			
<b>Transit (94&gt;99)</b> 												
2.0i, 2.0i GPL, 2.5D, 2.5TD ⊙14"	09/94 ▶ 12/99		BDX	<b>301036</b>	21470		138,9	64,1	18,3			
2.0i, 2.0i GPL, 2.5D, 2.5TD ⊙15"	09/94 ▶ 12/99		BDX	<b>301037</b>	21469		138,9	72	18,3			
<b>Transit (2006&gt;)</b> 												
2.2TDCi, 2.2TDCi 100, 2.2TDCi 110, 2.2TDCi 125, 2.2TDCi 130, 2.2TDCi 140, 2.2TDCi 155, 2.3i, 2.4TDCi 100, 2.4TDCi 115, 2.4TDCi 120, 2.4TDCi 140, 3.2TDCi	04/06 ▶		BSC	<b>301816</b>	24484		164,8	66,7	18			
<b>Transit Connect (2002&gt;2006)</b> 												
1.8TDCi, 1.8TDdi, 1.8i	05/02 ▶ 06/06		ATE	<b>301639</b>	23440		156,3	67,2	18,1			

				<b>Valeo</b>	<b>WVA</b>			
<b>FORD (.../...)</b>								
<b>Transit Connect (2002&gt;2006)  (.../...)</b>								
1.8TDCi, 1.8TDdi, 1.8i ABS+	05/02 ▶ 06/06		ATE	<b>301472</b>	23482		123,1 52 16,6	
1.8TDCi, 1.8TDdi, 1.8i ABS+	05/02 ▶ 06/06		ATE	<b>301783</b>	24137		122,9 51,7 16,4	
<b>Transit Connect (2006&gt;) </b>								
1.8TDCi, 1.8TDCi 110, 1.8TDCi 75, 1.8TDCi 90	06/06 ▶		ATE	<b>301639</b>	23440		156,3 67,2 18,1	
1.8TDCi, 1.8TDCi 110, 1.8TDCi 75, 1.8TDCi 90 ABS+	06/06 ▶		ATE	<b>301472</b>	23482		123,1 52 16,6	
1.8TDCi, 1.8TDCi 110, 1.8TDCi 75, 1.8TDCi 90 ABS+	06/06 ▶		ATE	<b>301783</b>	24137		122,9 51,7 16,4	
<b>FSO POLSKI</b>								
<b>Atou (95&gt;97) </b>								
1.4i, 1.6i	10/95 ▶ 12/97		LUC	<b>301095</b>	21105		90 63 17	↳ 1 x ↗ 255 mm
<b>Caro (91&gt;99) </b>								
1.4i, 1.5, 1.5i, 1.6, 1.6i, 1.9D	07/91 ▶ 12/99		LUC	<b>301095</b>	21105		90 63 17	↳ 1 x ↗ 255 mm
<b>Celina (95&gt;98) </b>								
1.6i	10/95 ▶ 06/98		LUC	<b>301095</b>	21105		90 63 17	↳ 1 x ↗ 255 mm
<b>GALLOPER</b>								
<b>Santamo (98&gt;2002) </b>								
2.0i	11/98 ▶ 12/02		SUM	<b>301625</b>	21647		127,7 51,7 16	↳ 2 x ⇔
<b>HONDA</b>								
<b>Accord II (AC/AD) (83&gt;85) </b>								
1.6, 1.8  3, 4	09/83 ▶ 09/85		AKE	<b>301052</b>	21012		127,4 49 14,8	↳ 2 x ⇔
<b>Accord IV (CB) (89&gt;93) </b>								
2.0, 2.0i, 2.2i ABS+	09/89 ▶ 1993		AKE	<b>301682</b>	21719		88,9 47,5 15,4	↳ 2 x ⇔
<b>Accord V (CC) (93&gt;95) </b>								
1.8i, 2.0i, 2.3i	03/93 ▶ 06/95		AKE	<b>301682</b>	21719		88,9 47,5 15,4	↳ 2 x ⇔
<b>Accord VI (CE/CF) (95&gt;98) </b>								
1.8i, 2.0TDi, 2.0i, 2.2i	07/95 ▶ 08/98		AKE	<b>301682</b>	21719		88,9 47,5 15,4	↳ 2 x ⇔
<b>Accord VI (CG/CH/CL) (98&gt;2003) </b>								
1.8i, 2.0TD, 2.0i, 2.3i  4, 5	09/98 ▶ 01/03		LUC	<b>301436</b>	23095		131,7 58,5 17,2	↳ 2 x ⇔
2.2i  4	09/98 ▶ 01/03		AKE	<b>301627</b>	21651		148,6 57,7 17,5	↳ 2 x ⇔
<b>Accord VIII (CL/CM/CN) (2003&gt;2008) </b>								
2.0i, 2.2i-CDTi, 2.4i  4	02/03 ▶ 05/08		AKE	<b>301682</b>	21719		88,9 47,5 15,4	↳ 2 x ⇔
<b>Accord Aerodeck (CB/CC) (90&gt;93) </b>								
2.2i	07/90 ▶ 06/91		AKE	<b>301682</b>	21719		88,9 47,5 15,4	↳ 2 x ⇔

				<b>Valeo</b>	<b>WVA</b>						
<b>HONDA (.../...)</b>											
<b>Accord Aerodeck (CE) (93&gt;97)</b> 											
2.0i, 2.2i	09/93 ▶ 12/97		AKE	<b>301627</b>	21651		148,6	57,7	17,5		↳ 2x ⇐
2.0i, 2.2i	09/93 ▶ 12/97		AKE	<b>301682</b>	21719		88,9	47,5	15,4		↳ 2x ⇐
<b>Accord coupe (CC) (91&gt;93)</b> 											
2.0i	07/91 ▶ 08/93		AKE	<b>301682</b>	21719		88,9	47,5	15,4		↳ 2x ⇐
<b>Accord coupe (CD) (93&gt;97)</b> 											
2.0i, 2.2i	09/93 ▶ 09/97		AKE	<b>301627</b>	21651		148,6	57,7	17,5		↳ 2x ⇐
2.0i, 2.2i	09/93 ▶ 09/97		AKE	<b>301682</b>	21719		88,9	47,5	15,4		↳ 2x ⇐
<b>Civic II (AJ/AH/AK) (83&gt;87)</b> 											
1.2, 1.3 	09/83 ▶ 08/87		AKE	<b>301047</b>	20959		116	45	15		↳ 2x ⇐
<b>Civic III (EC/ED/EE) (87&gt;91)</b> 											
1.2, 1.3, 1.4, 1.6i 	09/87 ▶ 1991		AKE	<b>301047</b>	20959		116	45	15		↳ 2x ⇐
1.5i, 1.6i 	09/87 ▶ 08/91		AKE	<b>301053</b>	21312		89	35	13		↳ 2x ⇐
<b>Civic IV (EG/EH/EJ) (91&gt;95)</b> 											
1.3 	09/91 ▶ 09/95		AKE	<b>301047</b>	20959		116	45	15		↳ 2x ⇐
1.3, 1.5i, 1.6i 	09/91 ▶ 09/95		SUM	<b>301760</b>	21697		131,5	54,5	15		↳ 2x ⇐
<b>Civic V (MA/MB) (95&gt;2001)</b> 											
1.4i, 1.5i, 1.6i, 2.0TDi 	01/95 ▶ 03/01		LUC	<b>301022</b>	21515		129	69	18		↳ 2x ⇐
1.4i, 1.5i, 1.6i, 2.0TDi 	01/95 ▶ 03/01		AKE	<b>301053</b>	21312		89	35	13		↳ 2x ⇐
1.8i 	07/96 ▶ 03/01		AKE	<b>301682</b>	21719		88,9	47,5	15,4		↳ 2x ⇐
<b>Civic V (EJ9/EK/EM1) (95&gt;2001)</b> 											
1.4i 	10/95 ▶ 03/01		SUM	<b>301760</b>	21697		131,5	54,5	15		↳ 2x ⇐
<b>Civic (EM2/EP/ES/EU/EV) (2001&gt;2006)</b> 											
1.4i, 1.4i Sport, 1.6i VTEC 	04/01 ▶ 06/06		LUC	<b>301022</b>	21515		129	69	18		↳ 2x ⇐
2.0i VTEC 	09/03 ▶ 06/06		SUM	<b>301887</b>	23722		148,72	59,02	16,9		↳ 2x ⇐
1.3i, 1.4i, 1.4i Sport, 1.6i VTEC, 1.7CTDi, 1.7i, 1.7i VTEC, 2.0i VTEC 	04/01 ▶ 06/06		AKE	<b>301682</b>	21719		88,9	47,5	15,4		↳ 2x ⇐
<b>Civic (FK/FD/FN) (2006&gt;)</b> 											
1.3i-VTEC IMA, 1.6i-VTEC, 1.8i-VTEC, 1.8i-VTEC 132 	01/06 ▶ 06/09		AKE	<b>301682</b>	21719		88,9	47,5	15,4		↳ 2x ⇐
<b>Civic Aerodeck (MB/MC) (97&gt;2001)</b> 											
1.4i, 1.5i VTEC, 1.6i	09/97 ▶ 03/01		LUC	<b>301022</b>	21515		129	69	18		↳ 2x ⇐
1.4i, 1.5i VTEC, 1.6i ABS+	09/97 ▶ 03/01		AKE	<b>301053</b>	21312		89	35	13		↳ 2x ⇐
1.8i	09/97 ▶ 03/01		AKE	<b>301682</b>	21719		88,9	47,5	15,4		↳ 2x ⇐

















































































												
<b>HONDA (.../...)</b>												
<b>Concerto (HW) (89&gt;96)</b> 												
1.4, 1.5i, 1.6, 1.6i  (4), (5)	10/89 ▶ 09/95		LUC	<b>301022</b>	21515		129	69	18	↳ 2x ⇐		
1.6, 1.6i  (4), (5)	10/89 ▶ 09/94		AKE	<b>301053</b>	21312		89	35	13	↳ 2x ⇐		
<b>CR-V (97&gt;2002)</b> 												
2.0i	01/97 ▶ 02/02		AKE	<b>301627</b>	21651		148,6	57,7	17,5	↳ 2x ⇐		
<b>CR-V (2002&gt;2006)</b> 												
2.0i VTEC	03/02 ▶ 12/06		AKE	<b>301682</b>	21719		88,9	47,5	15,4	↳ 2x ⇐		
<b>CRX (ED/EE/EF) (87&gt;92)</b> 												
1.6i	08/89 ▶ 02/92		AKE	<b>301047</b>	20959		116	45	15	↳ 2x ⇐		
1.4, 1.6i	09/87 ▶ 02/92		AKE	<b>301053</b>	21312		89	35	13	↳ 2x ⇐		
<b>FR-V (2004&gt;2007)</b> 												
1.7i VTEC, 2.0i VTEC, 2.2i-CDTi	10/04 ▶ 01/07		SUM	<b>301887</b>	23722		148,72	59,02	16,9	↳ 2x ⇐		
<b>FR-V (2007&gt;2010)</b> 												
1.8i-VTEC, 2.2i-CDTi	02/07 ▶ 04/10		SUM	<b>301887</b>	23722		148,72	59,02	16,9	↳ 2x ⇐		
<b>HR-V (GH) (98&gt;2005)</b> 												
1.6i, 1.6i VTEC (3), (5)	10/98 ▶ 09/05		AKE	<b>301627</b>	21651		148,6	57,7	17,5	↳ 2x ⇐		
<b>Integra (DA) (85&gt;89)</b> 												
1.6i  (3), (5)	03/85 ▶ 07/87		AKE	<b>301053</b>	21312		89	35	13	↳ 2x ⇐		
<b>Integra R (DC) (97&gt;2001)</b> 												
1.8i  (3)	11/97 ▶ 08/01		AKE	<b>301627</b>	21651		148,6	57,7	17,5	↳ 2x ⇐		
<b>Jazz II (GD) Made in Japan (2002&gt;2008)</b> 												
1.2i, 1.4i (5)	01/02 ▶ 10/08		SUM	<b>301760</b>	21697		131,5	54,5	15	↳ 2x ⇐		
<b>Legend (KA3-4/HS) (85&gt;90)</b> 												
2.7  (2)	07/89 ▶ 09/90		AKE	<b>301682</b>	21719		88,9	47,5	15,4	↳ 2x ⇐		
<b>Legend (KA7-8) (90&gt;96)</b> 												
3.2i  (2), (4)	10/90 ▶ 02/96		AKE	<b>301682</b>	21719		88,9	47,5	15,4	↳ 2x ⇐		
<b>Legend (KA9) (96&gt;2006)</b> 												
3.5i V6  (4)	09/98 ▶ 08/06		SUM	<b>301887</b>	23722		148,72	59,02	16,9	↳ 2x ⇐		
3.5i V6  (4)	03/96 ▶ 08/06		AKE	<b>301682</b>	21719		88,9	47,5	15,4	↳ 2x ⇐		
<b>Logo (GA) (98&gt;2001)</b> 												
1.3i	12/98 ▶ 04/01		SUM	<b>301760</b>	21697		131,5	54,5	15	↳ 2x ⇐		
<b>Odyssey (RA) (97&gt;2000)</b> 												
2.2i	07/97 ▶ 12/00		AKE	<b>301627</b>	21651		148,6	57,7	17,5	↳ 2x ⇐		
2.2i	07/97 ▶ 12/00		AKE	<b>301682</b>	21719		88,9	47,5	15,4	↳ 2x ⇐		

											
<b>HONDA (.../...)</b>											
<b>Prelude (AB/BA) (82&gt;87)</b> 											
1.8, 2.0i	09/85 ▶ 09/87		AKE	<b>301053</b>	21312		89	35	13	↳ 2x ⇐	
<b>Prelude (BB1-2-3) (91&gt;96)</b> 											
2.2i, 2.3i	10/91 ▶ 09/96		AKE	<b>301627</b>	21651		148,6	57,7	17,5	↳ 2x ⇐	
<b>Prelude (BB5-6-8-9) (96&gt;2001)</b> 											
2.2i VTEC	10/96 ▶ 03/01		AKE	<b>301627</b>	21651		148,6	57,7	17,5	↳ 2x ⇐	
2.0i, 2.2i, 2.2i VTEC	10/96 ▶ 09/01		AKE	<b>301682</b>	21719		88,9	47,5	15,4	↳ 2x ⇐	
<b>S2000 (AP) (99&gt;2004)</b> 											
2.0i VTEC	04/99 ▶ 02/04		AKE	<b>301682</b>	21719		88,9	47,5	15,4	↳ 2x ⇐	
<b>S2000 (AP) (2004&gt;2009)</b> 											
2.0i VTEC	03/04 ▶ 06/09		AKE	<b>301682</b>	21719		88,9	47,5	15,4	↳ 2x ⇐	
<b>Shuttle (RA) (94&gt;2000)</b> 											
2.2i, 2.3i	12/94 ▶ 10/00		AKE	<b>301627</b>	21651		148,6	57,7	17,5	↳ 2x ⇐	
2.2i, 2.3i	12/94 ▶ 10/00		AKE	<b>301682</b>	21719		88,9	47,5	15,4	↳ 2x ⇐	
<b>Stream (RN) (2001&gt;2005)</b> 											
1.7i VTEC, 2.0i VTEC	03/01 ▶ 09/05		SUM	<b>301887</b>	23722		148,72	59,02	16,9	↳ 2x ⇐	
1.7i VTEC, 2.0i VTEC	03/01 ▶ 09/05		AKE	<b>301682</b>	21719		88,9	47,5	15,4	↳ 2x ⇐	
<b>HYUNDAI</b>											
<b>Accent (94&gt;99)</b> 											
1.3i, 1.5i   (3),(4),(5)	11/96 ▶ 09/99		AKE	<b>301052</b>	21012		127,4	49	14,8	↳ 2x ⇐	
1.3i, 1.5i   (3),(4),(5)	07/94 ▶ 09/99		AKE	<b>301574</b>	21727		137,3	54,4	17,5	↳ 2x ⇐	
<b>Accent (99&gt;2003)</b> 											
1.3i, 1.5CRDi, 1.5i   (3),(4),(5)	10/99 ▶ 01/03		AKE	<b>301052</b>	21012		127,4	49	14,8	↳ 2x ⇐	
<b>Accent (2003&gt;2006)</b> 											
1.3i, 1.5CRDi, 1.6i   (4),(5)	02/03 ▶ 12/06		AKE	<b>301052</b>	21012		127,4	49	14,8	↳ 2x ⇐	
<b>Accent Made in Turkey (2005&gt;2012)</b> 											
1.4i, 1.5CRDi, 1.6i   (3),(4),(5)	12/05 ▶ 02/12		MAND	<b>301868</b>	24317		129,6	56	18	↳ 2x ⇐	
1.4i, 1.5CRDi, 1.6i   (3),(4),(5) ABS+	12/05 ▶ 02/12		MAND	<b>301867</b>	24320		92,9	41	15,9	↳ 2x ⇐	
<b>Amica (2000&gt;2001)</b> 											
1.0i	02/00 ▶ 06/01		AKE	<b>301575</b>	23238		104,7	41,3	16	↳ 2x ⇐	
1.0i	02/00 ▶ 07/01		MAND	<b>301708</b>	24277		104,7	47,2	16,3	↳ 2x ⇐	
<b>Amica (2001&gt;2003)</b> 											
1.0i	07/01 ▶ 12/03		MAND	<b>301708</b>	24277		104,7	47,2	16,3	↳ 2x ⇐	

				<b>Valeo</b>	<b>WVA</b>							
<b>HYUNDAI (.../...)</b>												
<b>Atos/Atoz (98&gt;2001)</b> 												
1.0i	01/98 ▶ 06/01		AKE	<b>301575</b>	23238		104,7	41,3	16	↳ 2x ⇐		
1.0i	01/98 ▶ 06/01		MAND	<b>301708</b>	24277		104,7	47,2	16,3	↳ 2x ⇐		
<b>Atos (2001&gt;2004)</b> 												
1.0i	07/01 ▶ 06/04		MAND	<b>301708</b>	24277		104,7	47,2	16,3	↳ 2x ⇐		
<b>Atos (2004&gt;2008)</b> 												
1.1i	07/04 ▶ 03/06		AKE	<b>301575</b>	23238		104,7	41,3	16	↳ 2x ⇐		
<b>Atos Prime (99&gt;2001)</b> 												
1.0i	12/99 ▶ 06/01		AKE	<b>301575</b>	23238		104,7	41,3	16	↳ 2x ⇐		
1.0i	12/99 ▶ 06/01		MAND	<b>301708</b>	24277		104,7	47,2	16,3	↳ 2x ⇐		
<b>Atos Prime (2001&gt;2004)</b> 												
1.0i	07/01 ▶ 06/04		MAND	<b>301708</b>	24277		104,7	47,2	16,3	↳ 2x ⇐		
<b>Atos Prime (2004&gt;2008)</b> 												
1.1i	07/04 ▶ 03/08		AKE	<b>301575</b>	23238		104,7	41,3	16	↳ 2x ⇐		
<b>Coupe (95&gt;2001)</b> 												
1.6i, 2.0i	05/96 ▶ 12/01		AKE	<b>301574</b>	21727		137,3	54,4	17,5	↳ 2x ⇐		
1.6i, 2.0i ABS+	05/96 ▶ 12/01		SUM	<b>301817</b>	21553		85	46,5	14	↳ 2x ⇐		
<b>Coupe (2002&gt;2006)</b> 												
1.6i, 2.0i, 2.7i V6	01/02 ▶ 12/06		MAND	<b>301744</b>	23891		131,5	60,1	17,5	↳ 2x ⇐		
1.6i, 2.0i, 2.7i V6	01/02 ▶ 12/06		SUM	<b>301817</b>	21553		85	46,5	14	↳ 2x ⇐		
<b>Coupe (2006&gt;2008)</b> 												
1.6i, 2.0i, 2.7i V6	09/06 ▶ 09/08		MAND	<b>301744</b>	23891		131,5	60,1	17,5	↳ 2x ⇐		
1.6i, 2.0i, 2.7i V6	09/06 ▶ 09/08		SUM	<b>301817</b>	21553		85	46,5	14	↳ 2x ⇐		
<b>Elantra (90&gt;95)</b> 												
1.6, 1.8  4	12/90 ▶ 05/95		AKE	<b>301574</b>	21727		137,3	54,4	17,5	↳ 2x ⇐		
1.5  4	12/90 ▶ 05/95		AKE	<b>301574</b>	21727		137,3	54,4	17,5	↳ 2x ⇐		
<b>Elantra (95&gt;2000)</b> 												
1.6i  4, 5	08/95 ▶ 03/97		AKE	<b>301574</b>	21727		137,3	54,4	17,5	↳ 2x ⇐		
1.6i, 1.8i, 2.0i  4, 5	05/95 ▶ 05/00		AKE	<b>301574</b>	21727		137,3	54,4	17,5	↳ 2x ⇐		
1.6i, 1.8i, 2.0i  4, 5 ABS+	05/95 ▶ 05/00		SUM	<b>301817</b>	21553		85	46,5	14	↳ 2x ⇐		
<b>Elantra (2000&gt;2007)</b> 												
1.6i, 1.8i, 2.0CRDi, 2.0i  4, 5	06/00 ▶ 09/01		AKE	<b>301574</b>	21727		137,3	54,4	17,5	↳ 2x ⇐		

				<b>Valeo</b>	<b>WVA</b>					
<b>HYUNDAI (.../...)</b>										
<b>Elantra (2000&gt;2007)  (.../...)</b>										
1.6i, 1.8i, 2.0CRDi, 2.0i   (4),(5) ABS+	05/05 ▶ 08/06		MAND	<b>301744</b>	23891		131,5	60,1	17,5	↳ 2x ⇐
1.6i, 1.8i, 2.0CRDi, 2.0i   (4),(5) ABS-	06/00 ▶ 01/07		MAND	<b>301781</b>	24031		136,7	63,5	17,6	↳ 2x ⇐
1.6i, 1.8i, 2.0CRDi, 2.0i   (4),(5) ABS+	06/00 ▶ 01/07		SUM	<b>301817</b>	21553		85	46,5	14	↳ 2x ⇐
<b>Excel (86&gt;89) </b>										
1.3, 1.5  (4)	1986 ▶ 10/89		AKE	<b>301052</b>	21012		127,4	49	14,8	↳ 2x ⇐
<b>Excel (89&gt;94) </b>										
1.3, 1.3i, 1.5, 1.5i   (3),(4),(5)	08/89 ▶ 05/90		AKE	<b>301052</b>	21012		127,4	49	14,8	↳ 2x ⇐
1.3, 1.3i, 1.5, 1.5i   (3),(4),(5)	06/90 ▶ 10/94		AKE	<b>301574</b>	21727		137,3	54,4	17,5	↳ 2x ⇐
<b>Excel (94&gt;99) </b>										
1.3, 1.5   (3),(4),(5)	11/96 ▶ 09/99		AKE	<b>301052</b>	21012		127,4	49	14,8	↳ 2x ⇐
1.3, 1.5   (3),(4),(5)	07/94 ▶ 11/96		AKE	<b>301574</b>	21727		137,3	54,4	17,5	↳ 2x ⇐
<b>Getz (2002&gt;2005) </b>										
1.1i, 1.3i, 1.5CRDi, 1.6i   (3),(5)	09/02 ▶ 08/05		AKE	<b>301052</b>	21012		127,4	49	14,8	↳ 2x ⇐
1.5CRDi, 1.6i   (3),(5) ABS+ FAD+	09/02 ▶ 08/05		MAND	<b>301748</b>	23543		98,7	40,8	15,7	↳ 2x ⇐
<b>Getz (2005&gt;2006) </b>										
1.1i, 1.4i, 1.5CRDi, 1.6i  (3),(5)	09/05 ▶ 12/06		AKE	<b>301052</b>	21012		127,4	49	14,8	↳ 2x ⇐
1.4i, 1.5CRDi, 1.6i  (3),(5) ABS+	09/05 ▶ 12/06		MAND	<b>301748</b>	23543		98,7	40,8	15,7	↳ 2x ⇐
<b>Getz Made in Korea (2006&gt;2011) </b>										
1.1i, 1.4i, 1.5CRDi, 1.6i  (3),(5)	11/06 ▶ 07/10		AKE	<b>301052</b>	21012		127,4	49	14,8	↳ 2x ⇐
1.1i, 1.4i, 1.5CRDi, 1.6i  (3),(5) FAD+	11/06 ▶ 07/10		MAND	<b>301748</b>	23543		98,7	40,8	15,7	↳ 2x ⇐
<b>Getz Made in India (2007&gt;) </b>										
1.1i, 1.4i, 1.6i  (5)	01/07 ▶		AKE	<b>301052</b>	21012		127,4	49	14,8	↳ 2x ⇐
1.1i, 1.4i, 1.6i  (5) FAD+	01/07 ▶		MAND	<b>301748</b>	23543		98,7	40,8	15,7	↳ 2x ⇐
<b>Grandeur Azera (2005&gt;) </b>										
2.2CRDi, 2.7MPI V6, 3.3MPI V6	06/10 ▶		AKE	<b>301301</b>	25337		99,80	41,00	14,90	↳ 2x ⇐
2.2CRDi, 2.7MPI V6, 3.3MPI V6	04/05 ▶		MAND	<b>301748</b>	23543		98,7	40,8	15,7	↳ 2x ⇐
<b>H1 (97&gt;2002) </b>										
2.4i, 2.5TD  (4)	10/97 ▶ 05/02		MAND	<b>301908</b>	23536		146,95	54,45	17	↳ 2x ⇐





































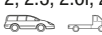







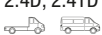









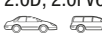

















































































											
<b>HYUNDAI (.../...)</b>											
<b>H1 (2007&gt;)</b> 											
2.4i 175, 2.5CRDi 140, 2.5CRDi 170	10/07 ▶		MAND	<b>301308</b>	24599		110,4	47,8	15,6	↳ 2x ⇐	
<b>H1 Mini Bus (2001&gt;2006)</b> 											
2.5CRDi, 2.5TD    (3), (5)	10/01 ▶ 09/06		AKE	<b>301505</b>	23569		149	58	17,4	↳ 2x ⇐	
2.5CRDi, 2.5TD    (3), (5)	10/01 ▶ 10/02		MAND	<b>301908</b>	23536		146,95	54,45	17	↳ 2x ⇐	
<b>H1 Mini Bus (2006&gt;)</b> 											
2.4i 100, 2.5CRDi 110, 2.5CRDi 140, 2.5CRDi 170  (4)	09/06 ▶		AKE	<b>301505</b>	23569		149	58	17,4	↳ 2x ⇐	
<b>H1 Made in Turkey (2007&gt;)</b> 											
2.5CRDi 110, 2.5CRDi 140, 2.5CRDi 170, 2.5TD 110  (4)	01/07 ▶		AKE	<b>301505</b>	23569		149	58	17,4	↳ 2x ⇐	
<b>H100 (93&gt;2000)</b> 											
2.4, 2.5D  (4)	07/93 ▶		LUC	<b>301634</b>	23081		130	73	18,1	↳ 2x ⇐	
<b>Highway Van (2000&gt;2004)</b> 											
2.0i, 2.7i V6	03/00 ▶ 02/04		AKE	<b>301759</b>	23569		149	58	17	↳ 2x ⇐	
2.0i, 2.7i V6	03/00 ▶ 02/04		MAND	<b>301748</b>	23543		98,7	40,8	15,7	↳ 2x ⇐	
<b>i20 (2008&gt;2012)</b> 											
1.4CRDi 75, 1.4CRDi 90, 1.4CRDi VGT 75, 1.4CVT, 1.6CRDi 128, 1.6CVT (3), (5)	10/08 ▶ 03/12		MAND	<b>301868</b>	24317		129,6	56	18	↳ 2x ⇐	
1.2i, 1.4CRDi 75, 1.4CRDi 90, 1.4CRDi VGT 75, 1.4CVT, 1.6CRDi 128, 1.6CVT (3), (5)	10/08 ▶ 03/12		MAND	<b>301867</b>	24320		92,9	41	15,9	↳ 2x ⇐	
<b>i20 (2012&gt;)</b> 											
1.1CRDi, 1.4CRDi, 1.4i (3), (5)	03/12 ▶		MAND	<b>301868</b>	24317		129,6	56	18	↳ 2x ⇐	
1.1CRDi, 1.2i, 1.4CRDi, 1.4i (3), (5)	03/12 ▶		MAND	<b>301867</b>	24320		92,9	41	15,9	↳ 2x ⇐	
<b>i20 Made in Turkey (2010&gt;2012)</b> 											
1.4CRDi 75, 1.4CRDi 90, 1.4CVT 100, 1.6CRDi 126, 1.6CVT 126 (5)	05/10 ▶ 04/12		MAND	<b>301868</b>	24317		129,6	56	18	↳ 2x ⇐	
1.2i 78, 1.4CRDi 75, 1.4CRDi 90, 1.4CVT 100, 1.6CRDi 126, 1.6CVT 126 (5)	04/10 ▶ 04/12		MAND	<b>301867</b>	24320		92,9	41	15,9	↳ 2x ⇐	
<b>i30 Made in Korea (2007&gt;2012)</b> 											
1.4i, 1.6CRDi, 1.6CVT, 2.0CRDi, 2.0CVT   (5) 15" 16"	03/07 ▶		MAND	<b>301842</b>	23966		130	58,1	16,7	↳ 2x ⇐	
1.4i, 1.6CRDi, 1.6CVT, 2.0CRDi, 2.0CVT   (5)	03/07 ▶ 07/12		MAND	<b>301867</b>	24320		92,9	41	15,9	↳ 2x ⇐	
<b>i30 Made in Czech Republic (2008&gt;2012)</b> 											
1.4i, 1.6CRDi, 1.6CVT, 2.0CRDi, 2.0CVT   (5) 15" 16"	11/08 ▶ 07/12		MAND	<b>301842</b>	23966		130	58,1	16,7	↳ 2x ⇐	
1.4i, 1.6CRDi, 1.6CVT, 2.0CRDi, 2.0CVT   (5)	11/08 ▶ 07/12		MAND	<b>301867</b>	24320		92,9	41	15,9	↳ 2x ⇐	
<b>i30 Made in Czech Republic (2012&gt;)</b> 											
1.4CRDi, 1.4i, 1.6CRDi, 1.6i   (3), (5) 15" 16"	01/12 ▶		MAND	<b>301842</b>	23966		130	58,1	16,7	↳ 2x ⇐	

				<b>Valeo</b>	<b>WVA</b>					
<b>HYUNDAI (.../...)</b>										
<b>i30 Made in Czech Republic (2012&gt;)  (.../...)</b>										
1.4CRDi, 1.4i, 1.6CRDi, 1.6i  (3),(5)	01/12 ▶		MAND	<b>301867</b>	24320		92,9	41	15,9	↳ 2x ⇐
<b>i40 (2011&gt;) </b>										
1.6GDI 135, 1.7CRDi 115, 1.7CRDi 136, 2.0GDI 177  (4),(5) Ⓞ16" Ⓞ17"	06/11 ▶		AKE	<b>301301</b>	25337		99,80	41,00	14,90	↳ 2x ⇐
<b>ix20 (2010&gt;) </b>										
1.4CRDi 75, 1.4CRDi 90, 1.4i 90, 1.6CRDi 115, 1.6i 125	10/10 ▶		MAND	<b>301867</b>	24320		92,9	41	15,9	↳ 2x ⇐
<b>ix35 Made in Korea (2010&gt;) </b>										
2.0CRDi 136, 2.0CRDi 184, 2.0MPI 166, 2.4MPI 177	01/10 ▶		MAND	<b>301867</b>	24320		92,9	41	15,9	↳ 2x ⇐
<b>ix35 Made in Czech Republic (2010&gt;) </b>										
1.6GDI 135, 1.7CRDi 115, 2.0CRDi 136, 2.0CRDi 184, 2.0MPI 166	01/10 ▶		MAND	<b>301867</b>	24320		92,9	41	15,9	↳ 2x ⇐
<b>ix55 (2008&gt;) </b>										
3.0CRDi, 3.8i	09/08 ▶		MAND	<b>301308</b>	24599		110,4	47,8	15,6	↳ 2x ⇐
<b>Jobs (98&gt;) </b>										
2.5TD  (2)	10/98 ▶		LUC	<b>301634</b>	23081		130	73	18,1	↳ 2x ⇐
<b>Lantra (90&gt;95) </b>										
1.6, 1.8  (4)	12/90 ▶ 05/95		AKE	<b>301574</b>	21727		137,3	54,4	17,5	↳ 2x ⇐
1.5  (4)	12/90 ▶ 05/95		AKE	<b>301574</b>	21727		137,3	54,4	17,5	↳ 2x ⇐
<b>Lantra (95&gt;2000) </b>										
1.5i, 1.6i, 1.8i  (4),(5)	05/95 ▶ 07/00		AKE	<b>301574</b>	21727		137,3	54,4	17,5	↳ 2x ⇐
1.5i, 1.6i, 1.8i, 1.9D, 2.0i  (4),(5) ABS+	05/95 ▶ 07/00		AKE	<b>301574</b>	21727		137,3	54,4	17,5	↳ 2x ⇐
1.5i, 1.6i, 1.8i, 1.9D, 2.0i  (4),(5) ABS+	05/95 ▶ 07/00		SUM	<b>301817</b>	21553		85	46,5	14	↳ 2x ⇐
<b>Matrix (2001&gt;2008) </b>										
1.5CRDi, 1.6i, 1.8i	05/01 ▶ 03/02		AKE	<b>301574</b>	21727		137,3	54,4	17,5	↳ 2x ⇐
1.5CRDi, 1.6i, 1.8i	05/01 ▶ 08/08		MAND	<b>301781</b>	24031		136,7	63,5	17,6	↳ 2x ⇐
<b>Matrix (2008&gt;) </b>										
1.5CRDi, 1.6i, 1.8i	08/08 ▶		MAND	<b>301781</b>	24031		136,7	63,5	17,6	↳ 2x ⇐
<b>Plaza (98&gt;2004) </b>										
2.5TD	01/98 ▶ 09/04		MAND	<b>301908</b>	23536		146,95	54,45	17	↳ 2x ⇐
<b>Pony (82&gt;94) </b>										
1.2, 1.3, 1.3i, 1.4, 1.5, 1.5i  (2),(3),(4),(5)	1982 ▶ 05/90		AKE	<b>301052</b>	21012		127,4	49	14,8	↳ 2x ⇐
1.3, 1.3i, 1.5, 1.5i  (2),(3),(4),(5)	06/90 ▶ 10/94		AKE	<b>301574</b>	21727		137,3	54,4	17,5	↳ 2x ⇐
<b>Pony (94&gt;99) </b>										
1.3i, 1.5i  (3),(4),(5)	09/94 ▶ 12/99		AKE	<b>301052</b>	21012		127,4	49	14,8	↳ 2x ⇐

				<b>Valeo</b>	<b>WVA</b>							
<b>HYUNDAI (.../...)</b>												
<b>Pony (94&gt;99)  (.../...)</b>												
1.3i, 1.5i   (3),(4),(5)	07/94 ▶ 11/96		AKE	<b>301574</b>	21727		137,3	54,4	17,5	↳ 2x ⇐		
<b>Santa Fé (2000&gt;2006) </b>												
2.0CRDi, 2.0CRDi 145, 2.0i, 2.4i, 2.7i V6   (5) FAD+	08/00 ▶ 02/06		AKE	<b>301505</b>	23569		149	58	17,4	↳ 2x ⇐		
2.7i V6  (5)	10/05 ▶ 02/06		MAND	<b>301937</b>	24351		157,1	60,8	17,1	↳ 2x ⇐		
2.0CRDi, 2.0CRDi 145, 2.0i, 2.4i, 2.7i V6   (5) ABS+	08/00 ▶ 02/06		MAND	<b>301748</b>	23543		98,7	40,8	15,7	↳ 2x ⇐		
2.7i V6  (5)	10/05 ▶ 02/06		MAND	<b>301932</b>	24488		118,7	46,8	15,53	↳ 2x ⇐		
<b>Santa Fé (2006&gt;2009) </b>												
2.2CRDi, 2.7i V6  (5)	03/06 ▶ 09/09		MAND	<b>301937</b>	24351		157,1	60,8	17,1	↳ 2x ⇐		
2.2CRDi, 2.7i V6  (5)	03/06 ▶ 09/09		MAND	<b>301932</b>	24488		118,7	46,8	15,53	↳ 2x ⇐		
<b>Santamo (98&gt;2001) </b>												
2.0i	07/98 ▶ 12/01		SUM	<b>301625</b>	21647		127,7	51,7	16	↳ 2x ⇐		
<b>Satellite (98&gt;2007) </b>												
2.5CRDi	02/02 ▶ 12/03		AKE	<b>301505</b>	23569		149	58	17,4	↳ 2x ⇐		
2.4i, 2.5TD	01/98 ▶ 12/07		MAND	<b>301908</b>	23536		146,95	54,45	17	↳ 2x ⇐		
<b>Scoupe (90&gt;96) </b>												
1.5, 1.5i, 1.5i Turbo	03/90 ▶ 05/96		AKE	<b>301052</b>	21012		127,4	49	14,8	↳ 2x ⇐		
<b>Solaris Made in Russia (2010&gt;) </b>												
1.4i, 1.6i   (4),(5)	11/10 ▶		MAND	<b>301021</b>	25348		132,80	58,10	17,20	↳ 2x ⇐		
1.4i, 1.6i   (4),(5)	11/10 ▶		AKE	<b>301301</b>	25337		99,80	41,00	14,90	↳ 2x ⇐		
<b>Solaris Made in Turkey (2011&gt;) </b>												
1.4i, 1.6i   (4),(5)	03/11 ▶		MAND	<b>301021</b>	25348		132,80	58,10	17,20	↳ 2x ⇐		
1.4i, 1.6i   (4),(5)	03/11 ▶		AKE	<b>301301</b>	25337		99,80	41,00	14,90	↳ 2x ⇐		
<b>Sonata (88&gt;93) </b>												
1.8, 2.0, 2.4i, 3.0i V6	10/88 ▶ 03/91		AKE	<b>301574</b>	21727		137,3	54,4	17,5	↳ 2x ⇐		
1.8, 2.0, 2.0i, 3.0i V6	03/91 ▶ 06/93		AKE	<b>301574</b>	21727		137,3	54,4	17,5	↳ 2x ⇐		
<b>Sonata (93&gt;98) </b>												
1.8, 2.0, 3.0	07/93 ▶ 07/98		AKE	<b>301574</b>	21727		137,3	54,4	17,5	↳ 2x ⇐		
<b>Sonata (98&gt;2001) </b>												
2.0i, 2.4i, 2.5i V6	08/98 ▶ 06/01		AKE	<b>301574</b>	21727		137,3	54,4	17,5	↳ 2x ⇐		
2.0i, 2.4i, 2.5i V6 ABS+	08/98 ▶ 06/01		MAND	<b>301748</b>	23543		98,7	40,8	15,7	↳ 2x ⇐		

											
<b>HYUNDAI (.../...)</b>											
<b>Sonata (2001&gt;2005)</b> 											
2.0i, 2.7i V6	07/01 ▶ 02/05		MAND	<b>301744</b>	23891		131,5	60,1	17,5	↳ 2x ⇐	
<b>Sonata (2005&gt;2008)</b> 											
2.4i	03/05 ▶		MAND	<b>301744</b>	23891		131,5	60,1	17,5	↳ 2x ⇐	
2.0CRDi, 2.4i, 3.3i V6	03/05 ▶ 04/08		MAND	<b>301748</b>	23543		98,7	40,8	15,7	↳ 2x ⇐	
<b>Sonata (2008&gt;2011)</b> 											
2.0CRDi, 2.0i, 2.4i, 3.3i V6	06/10 ▶ 01/11		AKE	<b>301301</b>	25337		98,80	41,00	14,90	↳ 2x ⇐	
<b>Sonica (98&gt;2001)</b> 											
2.0i, 2.5i	09/98 ▶ 06/01		AKE	<b>301574</b>	21727		137,3	54,4	17,5	↳ 2x ⇐	
2.0i, 2.5i ABS+	09/98 ▶ 06/01		MAND	<b>301748</b>	23543		98,7	40,8	15,7	↳ 2x ⇐	
<b>Starex (98&gt;2007)</b> 											
2.5CRDi	02/02 ▶ 12/03		AKE	<b>301505</b>	23569		149	58	17,4	↳ 2x ⇐	
2.4i, 2.5D, 2.5TD	01/98 ▶ 12/07		MAND	<b>301908</b>	23536		146,95	54,45	17	↳ 2x ⇐	
<b>Stellar (83&gt;92)</b> 											
1.6, 2	01/87 ▶ 01/92		AKE	<b>301052</b>	21012		127,4	49	14,8	↳ 2x ⇐	
<b>Terracan (2001&gt;2002)</b> 											
2.5TD, 2.9CRDi, 3.5i V6  	05/01 ▶ 02/02		LUC	<b>301506</b>	20789		149	58	16,6	↳ 2x ⇐	
2.5TD, 2.9CRDi, 3.5i V6  	08/01 ▶ 02/02		MAND	<b>301024</b>	23813		110,6	46,3	15,6	↳ 2x ⇐	
<b>Terracan (2002&gt;2007)</b> 											
2.9CRDi, 3.5i V6  	03/02 ▶ 07/07		LUC	<b>301506</b>	20789		149	58	16,6	↳ 2x ⇐	
2.9CRDi, 3.5i V6  	03/02 ▶		MAND	<b>301024</b>	23813		110,6	46,3	15,6	↳ 2x ⇐	
<b>Tiburon (2002&gt;2006)</b> 											
1.6i, 2.0i, 2.7i V6	01/02 ▶ 12/06		MAND	<b>301744</b>	23891		131,5	60,1	17,5	↳ 2x ⇐	
1.6i, 2.0i, 2.7i V6	01/02 ▶ 12/06		SUM	<b>301817</b>	21553		85	46,5	14	↳ 2x ⇐	
<b>Trajat (2000&gt;2004)</b> 											
2.0CRDi, 2.0i, 2.7i V6 	01/00 ▶ 02/04		AKE	<b>301759</b>	23569		149	58	17	↳ 2x ⇐	
2.0CRDi, 2.0i, 2.7i V6 	01/00 ▶ 02/04		MAND	<b>301748</b>	23543		98,7	40,8	15,7	↳ 2x ⇐	
<b>Trajat (2004&gt;2007)</b> 											
2.0CRDi, 2.0i, 2.7i V6  	03/04 ▶		AKE	<b>301759</b>	23569		149	58	17	↳ 2x ⇐	
2.0CRDi, 2.0i, 2.7i V6  	03/04 ▶		MAND	<b>301748</b>	23543		98,7	40,8	15,7	↳ 2x ⇐	
<b>Tucson (2004&gt;2006)</b> 											
2.0CRDi, 2.0i, 2.7i V6  	07/04 ▶ 09/06		MAND	<b>301744</b>	23891		131,5	60,1	17,5	↳ 2x ⇐	
2.0CRDi, 2.0i, 2.7i V6  	07/04 ▶ 09/06		MAND	<b>301748</b>	23543		98,7	40,8	15,7	↳ 2x ⇐	





				<b>Valeo</b>	<b>WVA</b>					
<b>HYUNDAI (.../...)</b>										
<b>Tucson (2006&gt;2010)</b> 										
2.0CRDi, 2.0i, 2.7i V6 	09/06 ▶ 10/10		MAND	<b>301744</b>	23891		131,5	60,1	17,5	↳ 2x ⇐
2.0CRDi, 2.0i, 2.7i V6 	09/06 ▶ 10/10		MAND	<b>301748</b>	23543		98,7	40,8	15,7	↳ 2x ⇐
<b>Veloster (2011&gt;)</b> 										
1.6GDI, 1.6T-GDI	04/11 ▶		AKE	<b>301301</b>	25337		99,80	41,00	14,90	↳ 2x ⇐
<b>XG (99&gt;2002)</b> 										
2.5i V6, 3.0i V6	01/99 ▶ 08/02		MAND	<b>301748</b>	23543		98,7	40,8	15,7	↳ 2x ⇐
<b>XG (2002&gt;2006)</b> 										
2.5i V6, 3.0i V6, 3.5i V6	09/02 ▶ 02/06		AKE	<b>301505</b>	23569		149	58	17,4	↳ 2x ⇐
2.5i V6, 3.0i V6, 3.5i V6	09/02 ▶ 02/06		MAND	<b>301748</b>	23543		98,7	40,8	15,7	↳ 2x ⇐
<b>INFINITI</b>										
<b>EX QX50 (2008&gt;)</b> 										
3.5i V6	04/08 ▶		AKE	<b>301009</b>	23871		105,8	38	14	↳ 1x ⇐
<b>FX QX70 (2008&gt;)</b> 										
3.5i V6	07/08 ▶ 08/09		AKE	<b>301009</b>	23871		105,8	38	14	↳ 1x ⇐
<b>G35 (2006&gt;2008)</b> 										
3.5i V6	12/06 ▶ 12/08		AKE	<b>301009</b>	23871		105,8	38	14	↳ 1x ⇐
<b>ISUZU</b>										
<b>Trooper (81&gt;97)</b> 										
2, 2.3, 2.6i, 2.8D, 2.8TD, 2.8TDId Intercooler, 2.8i  (2),(3)	06/87 ▶ 1992		AKE	<b>301020</b>	21543		127	51	16,5	↳ 4x ⇐
3.1TD, 3.2i V6  (3),(5)	01/92 ▶ 12/97		SUM	<b>301507</b>	21875		109,6	42,5	15,8	↳ 2x ⇐
<b>Trooper (98&gt;2004)</b> 										
3.0DTI, 3.1TD, 3.2i V6, 3.5i V6  (3),(5) HD+ : Heavy duty+	01/98 ▶ 01/04		SUM	<b>301507</b>	21875		109,6	42,5	15,8	↳ 2x ⇐
<b>IVECO</b>										
<b>Daily (78&gt;89)</b> 										
2.4D, 2.4TD  (2),(3),(4)	1978 ▶		AP	<b>301129</b>	20359		105	74,7	18	↳ 4x ⇐ 195 mm / 145 mm
<b>JAGUAR</b>										
<b>XF (2007&gt;2012)</b> 										
2.7D V6, 3.0 V6, 3.0D V6, 3.0DS V6, 4.2 V8, 5.0 V8  (4)	08/07 ▶ 05/12		ATE	<b>301783</b>	24137		122,9	51,7	16,4	
<b>X-Type (2001&gt;2008)</b> 										
2.0D, 2.0i V6, 2.5i V6, 3.0i V6  (4),(5)	02/01 ▶ 02/08		BSC	<b>301433</b>	23279		149	60,5	18	
2.0D, 2.0i V6, 2.5i V6, 3.0i V6  (4),(5)			BSC	<b>301434</b>	23557		115,9	51,9	16,8	

												
<b>JEEP</b>												
<b>Cherokee (77&gt;2001)</b> 												
2.1TD 88, 2.5i, 4.0i   (3), (5)	01/88 ▶ 10/99		KELS	<b>301491</b>	21822	 	177	55	17,1			
<b>Grand Cherokee (93&gt;2000)</b> 												
4.0i, 5.2i 	01/93 ▶ 07/00		KELS	<b>301491</b>	21822	 	177	55	17,1			
<b>Wrangler (96&gt;2006)</b> 												
2.5i, 4.0i	08/96 ▶ 12/01		KELS	<b>301491</b>	21822	 	177	55	17,1			
<b>KIA</b>												
<b>Carens (2002&gt;2006)</b> 												
1.6i, 1.8i, 2.0CRDi, 2.0CVT	07/02 ▶		MAND	<b>301842</b>	23966	 	130	58,1	16,7			↳ 2x ⇐
<b>Carens (2006&gt;)</b> 												
1.6CRDi 128, 1.6CVT, 2.0CRDi, 2.0CRDi 136, 2.0CVT	06/06 ▶		SUM	<b>301934</b>	24501	 	137,8	61	16,6			↳ 2x ⇐
<b>Carnival (99&gt;2002)</b> 												
2.5i V6, 2.9CRDi ABS+	01/99 ▶ 05/00		KELS	<b>301491</b>	21822	 	177	55	17,1			
2.5i V6, 2.9CRDi	12/99 ▶ 01/02		SUM	<b>301821</b>	23649		154	56,2	16,5			↳ 2x ⇐
<b>Carnival (2002&gt;2006)</b> 												
2.5i V6, 2.9CRDi	02/02 ▶ 02/06		SUM	<b>301821</b>	23649		154	56,2	16,5			↳ 2x ⇐
<b>Carnival / Sedona (2006&gt;)</b> 												
2.2CRDi, 2.7CVT V6, 2.9CRDi	03/06 ▶		MAND	<b>301308</b>	24599		110,4	47,8	15,6			↳ 2x ⇐
<b>Ceed (2006&gt;2009)</b> 												
1.4CVT, 1.6CRDi VGT, 1.6CVT, 1.6i CVT 126, 2.0CRDi VGT, 2.0CVT   (3), (5)	08/06 ▶ 11/09		MAND	<b>301842</b>	23966	 	130	58,1	16,7			↳ 2x ⇐
1.4CVT, 1.6CRDi VGT, 1.6CVT, 1.6i CVT 126, 2.0CRDi VGT, 2.0CVT   (3), (5)	08/06 ▶ 11/09		MAND	<b>301867</b>	24320		92,9	41	15,9			↳ 2x ⇐
<b>Ceed (2009&gt;2012)</b> 												
1.4i CVT 90, 1.6CRDi 115 VGT, 1.6CRDi 128 VGT, 1.6CRDi 90 VGT, 1.6i CVT 115, 1.6i CVT 125, 1.6i CVT 126, 2.0CRDi 140 VGT, 2.0i CVT 143   (3), (5)	08/09 ▶ 07/12		MAND	<b>301842</b>	23966	 	130	58,1	16,7			↳ 2x ⇐
1.4i CVT 90, 1.6CRDi 115 VGT, 1.6CRDi 128 VGT, 1.6CRDi 90 VGT, 1.6i CVT 115, 1.6i CVT 125, 1.6i CVT 126, 2.0CRDi 140 VGT, 2.0i CVT 143   (3), (5)	08/09 ▶ 07/12		MAND	<b>301867</b>	24320		92,9	41	15,9			↳ 2x ⇐
<b>Ceed (2012&gt;)</b> 												
1.4CRDi, 1.4CVT, 1.4i, 1.6CRDi, 1.6GDI, 1.6i   (3), (5) APB+ : Frein parking automatique APB/EPB+	05/12 ▶		AKE	<b>301301</b>	25337		99,80	41,00	14,90			↳ 2x ⇐
<b>Cerato (2004&gt;2008)</b> 												
1.5CRDi, 1.6CRDi, 1.6i, 1.6i CVT, 2.0CRDi, 2.0CVT   (4), (5)	01/04 ▶ 12/08		MAND	<b>301705</b>	24218		164,8	58,9	16,9			↳ 2x ⇐
1.5CRDi, 1.6CRDi, 1.6i, 1.6i CVT, 2.0CRDi, 2.0CVT   (4), (5)	01/04 ▶ 12/08		SUM	<b>301817</b>	21553		85	46,5	14			↳ 2x ⇐
<b>Cerato (2008&gt;)</b> 												
1.6CVT 126, 2.0CVT 156   (2), (4)	08/10 ▶		MAND	<b>301842</b>	23966	 	130	58,1	16,7			↳ 2x ⇐

				<b>Valeo</b>	<b>WVA</b>							
<b>KIA (.../...)</b>												
<b>Joice (99&gt;2003)</b> 												
2.0i   5	09/99 ▶ 03/03		AKE	<b>301574</b>	21727		137,3	54,4	17,5	↳ 2x ◁		
<b>K2700 (97&gt;2004)</b> 												
2.7D  2	07/97 ▶ 01/99		MAND	<b>301269</b>	20002		133,3	52	15	↳ 2x ◁		
<b>Magentis (2001&gt;2005)</b> 												
2.0i, 2.5i V6	02/01 ▶ 12/05		AKE	<b>301574</b>	21727		137,3	54,4	17,5	↳ 2x ◁		
2.0i, 2.5i V6 ABS+	02/01 ▶ 12/05		MAND	<b>301748</b>	23543		98,7	40,8	15,7	↳ 2x ◁		
<b>Magentis (2006&gt;2008)</b> 												
2.0CRDi, 2.0i, 2.7i V6	01/06 ▶ 05/08		MAND	<b>301744</b>	23891		131,5	60,1	17,5	↳ 2x ◁		
2.0CRDi, 2.0i, 2.7i V6	01/06 ▶ 05/08		MAND	<b>301748</b>	23543		98,7	40,8	15,7	↳ 2x ◁		
<b>Magentis (2008&gt;2010)</b> 												
2.0CRDi, 2.0i, 2.7i V6	05/08 ▶ 08/10		MAND	<b>301744</b>	23891		131,5	60,1	17,5	↳ 2x ◁		
2.0CRDi, 2.0i, 2.7i V6	05/08 ▶ 08/10		MAND	<b>301748</b>	23543		98,7	40,8	15,7	↳ 2x ◁		
<b>Optima (2010&gt;)</b> 												
1.7CRDi, 2.0MPI, 2.4MPI	11/10 ▶		MAND	<b>301294</b>	25644		133,10	58,2	17,3	↳ 2x ◁		
<b>Pregio (95&gt;2005)</b> 												
2.5TCi, 2.7D  3,6	11/95 ▶ 10/05		SUM	<b>301821</b>	23649		154	56,2	16,5	↳ 2x ◁		
<b>Pride (87&gt;2000)</b> 												
1.1, 1.3, 1.3i   3,5	10/87 ▶ 07/00		SUM	<b>301268</b>	21355		78,7	63,3	14,4	↳ 4x ◁		
<b>Pride Wagon (98&gt;2000)</b> 												
1.3i	08/98 ▶ 07/00		SUM	<b>301268</b>	21355		78,7	63,3	14,4	↳ 4x ◁		
<b>Rio (2000&gt;2005)</b> 												
1.3i, 1.5i   4,5	07/00 ▶ 07/02		SUM	<b>301274</b>	21654		91,5	64	15	↳ 2x ◁		
<b>Rio (2005&gt;2006)</b> 												
1.4i, 1.5CRDi, 1.6i   4,5	06/05 ▶ 12/06		MAND	<b>301868</b>	24317		129,6	56	18	↳ 2x ◁		
1.4i, 1.5CRDi, 1.6i   4,5 ABS-	06/05 ▶ 12/06		MAND	<b>301867</b>	24320		92,9	41	15,9	↳ 2x ◁		
<b>Rio (2006&gt;)</b> 												
1.4i, 1.4i CVVT, 1.5CRDi, 1.6i, 1.6i CVVT 112   4,5	09/06 ▶		MAND	<b>301868</b>	24317		129,6	56	18	↳ 2x ◁		
1.4i, 1.4i CVVT, 1.5CRDi, 1.6i, 1.6i CVVT 112   4,5 ABS+	09/06 ▶		MAND	<b>301867</b>	24320		92,9	41	15,9	↳ 2x ◁		
<b>Rio (2011&gt;)</b> 												
1.1CRDi 75, 1.2i-CVVT 85, 1.4CRDi 90, 1.4i-CVVT 109  3,5	06/11 ▶		MAND	<b>301021</b>	25348		132,80	58,10	17,20	↳ 2x ◁		
1.1CRDi 75, 1.2i-CVVT 85, 1.4CRDi 90, 1.4i-CVVT 109  3,5	06/11 ▶		AKE	<b>301301</b>	25337		98,80	41,00	14,90	↳ 2x ◁		



















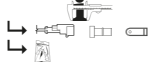



































































				<b>Valeo</b>	<b>WVA</b>						
<b>KIA (.../...)</b>											
<b>Sedona (99&gt;2002)</b> 											
2.5i V6, 2.9CrDi	09/99 ▶ 01/02		SUM	<b>301821</b>	23649		154	56,2	16,5	↳ 2x ⇐	
<b>Sedona (2002&gt;2005)</b> 											
2.5i V6, 2.9CrDi	02/02 ▶ 11/05		SUM	<b>301821</b>	23649		154	56,2	16,5	↳ 2x ⇐	
<b>Sportage (2004&gt;2006)</b> 											
2.0CRDi, 2.0i, 2.7i V6	12/04 ▶ 04/05		MAND	<b>301744</b>	23891		131,5	60,1	17,5	↳ 2x ⇐	
2.0CRDi, 2.0i, 2.7i V6	12/04 ▶ 12/06		MAND	<b>301748</b>	23543		98,7	40,8	15,7	↳ 2x ⇐	
<b>Sportage Made in Korea (2006&gt;)</b> 											
2.0CRDi 112, 2.0CRDi 140, 2.0CRDi 150, 2.0i, 2.7i V6	09/06 ▶		MAND	<b>301748</b>	23543		98,7	40,8	15,7	↳ 2x ⇐	
<b>Sportage Made in Korea (2010&gt;)</b> 											
2.0CRDi VGT 136, 2.0GDi CVT 163, 2.4GDi CVT 163	05/10 ▶		MAND	<b>301867</b>	24320		92,9	41	15,9	↳ 2x ⇐	
<b>Sportage Made in Slovakia (2010&gt;)</b> 											
1.6GDi CVT 135, 1.7CRDi VGT 115, 2.0CRDi VGT 136, 2.0GDi CVT 163	06/10 ▶		MAND	<b>301867</b>	24320		92,9	41	15,9	↳ 2x ⇐	
<b>Venga (2009&gt;)</b> 											
1.4CRDi 75, 1.4CRDi 77, 1.4CRDi 90, 1.4CVT 90, 1.6CRDi 116, 1.6CRDi 128, 1.6CVT 125	12/09 ▶		LUC	<b>301584</b>	23417		95,5	42,7	15,2	↳ 2x ⇐	
<b>LADA</b>											
<b>1200/1300/1500/1600/ Classica</b> 											
1.2, 1.3, 1.5, 1.6  4, 5	1973 ▶ 12/86		BDX	<b>301405</b>	20166		83,9	60	16		
<b>Kalinka (95&gt;98)</b> 											
1.7i  5	10/96 ▶ 1998		BDX	<b>301405</b>	20166		83,9	60	16		
<b>Natacha (93&gt;97)</b> 											
1.1, 1.5  2	05/93 ▶ 1997		LUC	<b>301406</b>	21170		104,3	62	17,3		
<b>Niva (76&gt;99)</b> 											
1.6	03/76 ▶ 1995		BDX	<b>301389</b>	20660		126	45	16		
<b>Niva (93&gt;2006)</b> 											
1.7i, 1.9D	07/93 ▶ 2006		BDX	<b>301389</b>	20660		126	45	16		
<b>Sagona (91&gt;99)</b> 											
1.5, 1.5D	09/91 ▶ 1999		LUC	<b>301406</b>	21170		104,3	62	17,3		
<b>Samara (86&gt;99)</b> 											
1.1, 1.3, 1.5, 1.5D  3, 5	07/86 ▶ 1999		LUC	<b>301406</b>	21170		104,3	62	17,3		
<b>LANCIA</b>											
<b>Dedra (835) (89&gt;94)</b> 											
1.6ie  4	03/89 ▶ 06/94		LUC	<b>301095</b>	21105		90	63	17	↳ 1x ⇐ 255 mm	
1.6ie, 1.8ie, 1.9TDs, 2.0ie  4 ABS+	03/89 ▶ 06/94		TRW	<b>301219</b>	20838		104,5	66,6	17,2	↳ 2x ⇐	







































































































				<b>Valeo</b>	<b>WVA</b>			
<b>LANCIA (.../...)</b>								
<b>Dedra (835) (89&gt;94)  (.../...)</b>								
1.6ie, 1.8ie, 1.9TDs, 2.0ie, 2.0ie Turbo  <b>(4)</b> ABS+	03/89 ▶ 06/94		LUC	<b>301142</b>	21103		87,3 44,4 14,4	
<b>Dedra (835) (94&gt;99) </b>								
1.6ie, 1.8ie   <b>(4,5)</b>	03/96 ▶ 09/99		ATE	<b>301006</b>	21927		156,5 52,5 17,6	↳ 2x  200 mm
2.0ie  <b>(5)</b>	06/95 ▶ 1996		ATE	<b>301065</b>	21636		155,3 61,7 19	↳ 2x  200 mm
1.6ie, 1.8ie, 1.9TDs, 2.0ie   <b>(4,5)</b>	07/94 ▶ 11/94		TRW	<b>301219</b>	20838		104,5 66,6 17,2	↳ 2x  
1.6ie, 1.8ie, 1.9TDs, 2.0ie   <b>(4,5)</b>	07/94 ▶ 09/99		LUC	<b>301142</b>	21103		87,3 44,4 14,4	
<b>Delta (831) (86&gt;94) </b>								
1.6 Turbo, 1.6ie, 2.0i Turbo <b>(5)</b>	04/86 ▶ 04/90		TRW	<b>301219</b>	20838		104,5 66,6 17,2	↳ 2x  
2.0i Turbo <b>(5)</b>	07/90 ▶ 1994		LUC	<b>301180</b>	20960		87 53 15,2	
<b>Delta (836) (93&gt;99) </b>								
1.8ie <b>(5)</b>	07/95 ▶ 08/99		ATE	<b>301006</b>	21927		156,5 52,5 17,6	↳ 2x  200 mm
1.6ie <b>(3,5)</b>	07/95 ▶ 08/99		ATE	<b>301040</b>	21930		151,5 52,5 17,4	↳ 1x  200 mm
1.8ie, 2.0i, 2.0i Turbo <b>(3,5)</b>	06/95 ▶ 08/99		ATE	<b>301065</b>	21636		155,3 61,7 19	↳ 2x  200 mm
1.4ie, 1.6ie, 1.8ie, 1.9TD <b>(5)</b>	03/93 ▶ 12/94		TRW	<b>301219</b>	20838		104,5 66,6 17,2	↳ 2x  
1.6ie, 1.8ie, 1.9TD, 2.0i, 2.0i Turbo <b>(3,5)</b>	03/93 ▶ 08/99		LUC	<b>301142</b>	21103		87,3 44,4 14,4	
<b>Kappa (838) (94&gt;2001) </b>								
2.0ie, 2.4JTD, 2.4TDs, 2.4ie   <b>(2,4,5)</b>  2090630 ▶ _  2091155 ▶ _	▶ 10/01		ATE	<b>301023</b>	21636		156,3 58,9 19	↳ 2x  216 mm
2.0ie, 2.0ie Turbo, 2.4JTD, 2.4TDs, 2.4ie, 3.0ie V6   <b>(2,4,5)</b>	05/97 ▶ 10/01		LUC	<b>301581</b>	21606		89,8 50 16,4	
<b>Lybra (839) (99&gt;2006) </b>								
1.8i, 1.9JTD, 2.0i, 2.4JTD   <b>(4,5)</b>	09/99 ▶ 04/00		ATE	<b>301023</b>	21636		156,3 58,9 19	↳ 2x  216 mm
1.8i, 1.9JTD, 2.0i, 2.4JTD   <b>(4,5)</b>	09/99 ▶ 12/06		ATE	<b>301990</b>	21637		155,3 61,6 19,1 156,45 55,9	↳ 2x  211 mm
1.6i, 1.8i, 1.9JTD, 2.0i, 2.4JTD   <b>(4,5)</b>	09/99 ▶ 12/06		LUC	<b>301407</b>	23661		95,8 43,7 16,5	
<b>Phedra (179) (2002&gt;2010) </b>								
2.0JTD, 2.0i, 2.2JTD, 2.2JTD 170, 3.0i V6	09/02 ▶ 2010		LUC	<b>301463</b>	20960		87 52,9 17	
<b>Prisma (831) (83&gt;86) </b>								
1.6  3067650 ▶ _	▶ 05/86		TRW	<b>301219</b>	20838		104,5 66,6 17,2	↳ 2x  
<b>Thema (834) (84&gt;88) </b>								
2.4TD, 2.8, 2ie, 2ie Turbo, 3.0i V8   <b>(4,5)</b>	10/84 ▶ 09/88		LUC	<b>301125</b>	20668		87 66,9 16,6	

				<b>Valeo</b>	<b>WVA</b>							
<b>LANCIA (.../...)</b>												
<b>Thema (834) (88&gt;92)</b> 												
2.5TD, 2.8, 2ie, 2ie Turbo, 3.0   (4),(5)	10/88 ▶ 08/92		LUC	<b>301125</b>	20668		87	66,9	16,6			
<b>Thema (834) (92&gt;94)</b> 												
2.0i, 2.0i Turbo, 2.5TDs, 3.0 V6   (4),(5)	09/92 ▶ 11/94		LUC	<b>301125</b>	20668		87	66,9	16,6			
<b>Y10 (156) (89&gt;95)</b> 												
1.0, 1.0ie, 1.1ie	01/89 ▶ 10/95		BDX	<b>301091</b>	20775		108,8	47,4	18			↳ 2x 
<b>Y Ipsilon (840) (95&gt;2000)</b> 												
1.1i, 1.2i ABS-	11/95 ▶ 08/00		BDX	<b>301012</b>	21365		115	55,3	17			
1.1i, 1.2i, 1.4i ABS+	11/95 ▶ 07/97		TRW	<b>301219</b>	20838		104,5	66,6	17,2			↳ 2x 
<b>Y Ipsilon (840) (2000&gt;2003)</b> 												
1.2i ABS-	09/00 ▶ 09/03		BDX	<b>301012</b>	21365		115	55,3	17			
<b>Zeta (220) (94&gt;2002)</b> 												
2.0JTD, 2.0ie, 2.0ie Turbo, 2.1TD	10/94 ▶ 08/02		LUC	<b>301064</b>	21801		130	57,4	18,8			↳ 4x  240 mm / 195 mm
<b>LAND ROVER</b>												
<b>Defender (90&gt;2007)</b> 												
2.5, 2.5D, 2.5TDi, 3.5 V8   (2),(3)  _ ▶ HA701009	10/90 ▶		AP	<b>301129</b>	20359		105	74,7	18			↳ 4x  195 mm / 145 mm
2.5, 2.5D, 2.5TDi  (2),(3)	10/90 ▶ 1993		AP	<b>301129</b>	20359		105	74,7	18			↳ 4x  195 mm / 145 mm
2.5, 2.5D, 2.5TDi, 2.5Td5, 3.5 V8, 4.0i V8   (2),(3),(5)  KA930455 ▶ _	▶ 04/07		AP	<b>301497</b>	21237		88,6	72	15,5			↳ 1x  250 mm
<b>Defender II (2007&gt;)</b> 												
2.4TDCI    (3)	03/07 ▶		AP	<b>301497</b>	21237		88,6	72	15,5			↳ 1x  250 mm
<b>Discovery (89&gt;94)</b> 												
2.0i, 2.5TDi, 3.5 V8, 3.5i V8, 3.9i V8  (3),(5)	09/89 ▶ 03/94		AP	<b>301497</b>	21237		88,6	72	15,5			↳ 1x  250 mm
<b>Discovery (94&gt;98)</b> 												
2.0i, 2.5TDi, 3.9i V8  (3),(5)	03/94 ▶ 11/98		AP	<b>301497</b>	21237		88,6	72	15,5			↳ 1x  250 mm
<b>Freelander 2 (2006&gt;)</b> 												
2.2SD4 190, 2.2TD4, 2.2TD4 150, 2.2eD4 150, 3.2i V6, 3.2i V6-233  (5)	02/06 ▶		ATE	<b>301879</b>	24123		155,1	66,6	19,2			
							156,3	72				
<b>Range Rover (81&gt;86)</b> 												
3.5 V8 (3),(5)	07/81 ▶ 09/86		AP	<b>301129</b>	20359		105	74,7	18			↳ 4x  195 mm / 145 mm
3.5 V8 (3),(5)	07/81 ▶ 09/86		AP	<b>301497</b>	21237		88,6	72	15,5			↳ 1x  250 mm
<b>Range Rover (86&gt;94)</b> 												
2.4TD, 2.5TD, 2.5TDi, 3.5 V8, 3.5i V8, 3.9i V8, 4.2i V8  (3),(5)	08/86 ▶ 09/94		AP	<b>301497</b>	21237		88,6	72	15,5			↳ 1x  250 mm
												

















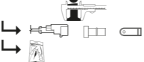





















										
<b>LAND ROVER (.../...)</b>										
<b>Range Rover (2002&gt;2009)</b> 										
2.9Td6, 3.6TDV8, 4.2i V8, 4.4i V8  (3)	03/02 ▶ 06/09		ATE	<b>301580</b>	21487		123,1	59,2	17	
<b>LEXUS</b>										
<b>IS 200D (2010&gt;)</b> 										
2.2D4-D 150, 2.2D4-D 177	08/10 ▶		SUM	<b>301035</b>	23983		154,6	59,5	17,7	
<b>IS 220D (2005&gt;2008)</b> 										
2.2D4-D	11/05 ▶ 08/08		SUM	<b>301035</b>	23983		154,6	59,5	17,7	
<b>IS 220D (2008&gt;2012)</b> 										
2.2D4-D	08/08 ▶ 08/10		SUM	<b>301035</b>	23983		154,6	59,5	17,7	
<b>IS 250 (2005&gt;2008)</b> 										
2.5i V6	08/05 ▶ 08/08		SUM	<b>301035</b>	23983		154,6	59,5	17,7	
<b>IS 250 (2008&gt;2013)</b> 										
2.5i V6	08/08 ▶ 04/13		SUM	<b>301035</b>	23983		154,6	59,5	17,7	
<b>IS 250C - Cabriolet (2009&gt;)</b> 										
2.5i V6	04/09 ▶		SUM	<b>301035</b>	23983		154,6	59,5	17,7	
<b>IS 300 (2013&gt;)</b> 										
0i 223 Hybride	04/13 ▶		SUM	<b>301035</b>	23983		154,6	59,5	17,7	
<b>LX 470 (2002&gt;2007)</b> 										
4.7i V8	08/02 ▶ 08/07		SUM	<b>301535</b>	23524		119,6	78	15,5	↳ 2x □
4.7i V8	08/02 ▶ 08/07		AKE	<b>301865</b>	23539		123,1	45,1	17,5	
<b>LDV</b>										
<b>Sherpa II (82&gt;89)</b> 										
3.5  _ ▶ 816133	1984 ▶		AP	<b>301129</b>	20359		105	74,7	18	↳ 4x  195 mm / 145 mm
<b>MAZDA</b>										
<b>2 (2003&gt;2008)</b> 										
1.25i, 1.4MZ-CD, 1.4i, 1.6i (3), (5)	03/03 ▶ 01/08		ATE	<b>301564</b>	23202	 	150,4	58	18,5	
<b>3 (2006&gt;2009)</b> 										
1.6MZ-CD, 2.3i Turbo  (4), (5)	03/06 ▶ 07/09		ATE	<b>301649</b>	23723	 	156,3	67	17,5	
<b>3 (2008&gt;2011)</b> 										
2.3DISI Turbo  (5)	05/09 ▶ 10/11		ATE	<b>301649</b>	23723	 	156,3	67	17,5	

				<b>Valeo</b>	<b>WVA</b>					
<b>MAZDA (.../...)</b>										
<b>3 (2011&gt;)</b> 										
2.3MZR DISI Turbo   (5)	11/11 ▶		ATE	<b>301649</b>	23723		156,3	67	17,5	
							155,1	62,5		
<b>6 (2002&gt;2007)</b> 										
1.8i, 2.0DiTD, 2.0i, 2.3DISI Turbo, 2.3i   (4),(5)	03/05 ▶ 08/07		AKE	<b>301780</b>	24045		107,6	39,2	13,1	
<b>121 (88&gt;90)</b> 										
1.1, 1.3, 1.3i  (3)	01/88 ▶ 10/90		SUM	<b>301268</b>	21355		78,7	63,3	14,4	↳ 4x ⇐
<b>121 (90&gt;96)</b> 										
1.1, 1.3, 1.3i  (4)	11/90 ▶ 02/96		SUM	<b>301274</b>	21654		91,5	64	15	↳ 2x ⇐
<b>121 (96&gt;2002)</b> 										
1.2  (3),(5)	03/96 ▶ 01/00		ATE	<b>301212</b>	20783		151,3	46,4	18	
1.2  (3),(5)	01/00 ▶ 01/02		ATE	<b>301563</b>	23200		150,2	54,1	18,6	
1.2, 1.3, 1.8D, 1.8TD  (3),(5)	01/00 ▶ 01/02		ATE	<b>301564</b>	23202		150,4	58	18,5	
							151,4	61,5		
<b>323 (BG) (89&gt;94)</b> 										
1.3, 1.6i, 1.8, 1.8i, 1.8i Turbo   (3),(4),(5)	06/89 ▶ 05/94		SUM	<b>301624</b>	20031		102	38,98	12,5	
<b>323 (BA) (94&gt;98)</b> 										
1.3i, 1.5i   (3),(4),(5)			SUM	<b>301274</b>	21654		91,5	64	15	↳ 2x ⇐
<b>323 (BJ) (98&gt;2000)</b> 										
1.8i, 2.0Di, 2.0DiTD  (5)	08/98 ▶ 09/00		SUM	<b>301629</b>	21754		131,95	51,5	15	↳ 2x ⇐
										
<b>323 (BJ) (2000&gt;2003)</b> 										
1.6i, 2.0DiTD, 2.0i   (4),(5)	10/00 ▶ 10/03		SUM	<b>301629</b>	21754		131,95	51,5	15	↳ 2x ⇐
										
<b>626 (GD) (87&gt;92)</b> 										
2.2i    (2),(4),(5)	08/89 ▶ 01/92		AKE	<b>301780</b>	24045		107,6	39,2	13,1	
<b>626 (GE) (91&gt;97)</b> 										
1.8i, 2.0D, 2.0i, 2.5i   (4),(5)	08/91 ▶ 05/97		SUM	<b>301629</b>	21754		131,95	51,5	15	↳ 2x ⇐
										
2.0i  (5)	09/91 ▶ 05/97		SUM	<b>301624</b>	20031		102	38,98	12,5	
2.0i  (5)	09/91 ▶ 05/94		AKE	<b>301780</b>	24045		107,6	39,2	13,1	
<b>626 (GF) (97&gt;2002)</b> 										
1.8i, 2.0DiTD, 2.0i   (4),(5)			SUM	<b>301629</b>	21754		131,95	51,5	15	↳ 2x ⇐
										
<b>626 Wagon (GV) (88&gt;92)</b> 										
2.2i	09/90 ▶ 02/92		AKE	<b>301780</b>	24045		107,6	39,2	13,1	
<b>626 Wagon (GW) (97&gt;99)</b> 										
1.8i, 2.0i	11/97 ▶ 09/99		SUM	<b>301629</b>	21754		131,95	51,5	15	↳ 2x ⇐
										

				<b>Valeo</b>	<b>WVA</b>								
<b>MAZDA (.../...)</b>													
<b>626 Wagon (GW) (99&gt;2002)</b> 													
1.8i, 2.0i	10/99 ▶ 05/02		SUM	<b>301629</b>	21754			131,95	51,5	15			↳ 2x ⇐
<b>MX6 (91&gt;97)</b> 													
2.0i, 2.5i V6	07/91 ▶ 08/97		SUM	<b>301629</b>	21754			131,95	51,5	15			↳ 2x ⇐
<b>Premacy (99&gt;2001)</b> 													
1.8i, 2.0iTD	06/99 ▶ 06/01		SUM	<b>301629</b>	21754			131,95	51,5	15			↳ 2x ⇐
<b>Premacy (2001&gt;2005)</b> 													
2.0iTD SR3- : Third seat row-	07/01 ▶ 08/05		SUM	<b>301629</b>	21754			131,95	51,5	15			↳ 2x ⇐
<b>RX7 (FC) (85&gt;91)</b> 													
2.6i	11/85 ▶ 04/89		AKE	<b>301780</b>	24045			107,6	39,2	13,1			
<b>Xedos 6 (91&gt;99)</b> 													
2.0i V6	10/91 ▶ 11/99		SUM	<b>301629</b>	21754			131,95	51,5	15			↳ 2x ⇐
<b>MERCEDES</b>													
<b>190 (201) (82&gt;93)</b> 													
1.8i, 2.0, 2.0D, 2.0i, 2.3i, 2.5D, 2.5D Turbo, 2.6i, 3.0i TAXI+ : Taxi+	12/82 ▶ 08/93		LUC	<b>301241</b>	21010			95	52,7	17,9			
2.3i, 2.5i	08/84 ▶ 1993		LUC	<b>301315</b>	21028			110	59,7	18,8			
1.8i, 2.0, 2.0D, 2.0i, 2.3i, 2.5D, 2.5D Turbo, 2.6i, 3.0i	12/82 ▶ 08/93		ATE	<b>301105</b>	20687			61,8	54,3	13			
2.5i	07/89 ▶ 1993		ATE	<b>301272</b>	21197			61,6	58,6	15			
2.3i, 2.5i	08/84 ▶ 1993		ATE	<b>301345</b>	20687			61,7	54,3	15,5			
<b>200/300 (W124) (84&gt;93)</b> 													
2.0, 2.0D, 2.0i, 2.2i, 2.3i, 2.5D, 2.5TD Turbo, 2.6i, 3.0D, 3.0TD Turbo, 3.0i 	12/84 ▶ 06/93		LUC	<b>301315</b>	21028			110	59,7	18,8			
2.0, 2.0D, 2.0i, 2.3i, 2.5D, 2.5TD Turbo, 2.6i, 2.8i, 3.0D, 3.0TD Turbo, 3.0i, 3.2i, 4.2i, 5.0i 	03/86 ▶		ATE	<b>301272</b>	21197			61,6	58,6	15			
ASR+  _ ▶ B927760													
2.0, 2.0D, 2.0i, 2.2i, 2.3i, 2.5D, 2.5TD Turbo, 2.6i, 3.0D, 3.0TD Turbo, 3.0i 	12/84 ▶ 06/93		ATE	<b>301345</b>	20687			61,7	54,3	15,5			
ASR- 													
5.0i  4  B927761 ▶ _	▶ 06/93		ATE	<b>301617</b>	21305			61,7	69,6	15,5			
<b>A Class (W168) (97&gt;2004)</b> 													
1.4i, 1.6i, 1.7CDI, 1.9i, 2.1i 	05/97 ▶ 06/04		LUC	<b>301549</b>	23070			116,5	57,3	17			
1.6i, 1.7CDI, 1.9i, 2.1i 	04/99 ▶ 06/04		LUC	<b>301583</b>	23138			95,8	41,5	14,3			
<b>A Class (W169) (2008&gt;2012)</b> 													
	12/10 ▶ 09/12		LUC	<b>301583</b>	23138			95,8	41,5	14,3			

				<b>Valeo</b>	<b>WVA</b>							
<b>MERCEDES (.../...)</b>												
<b>C Class (W202) (93&gt;2001)</b> 												
1.8i, 2.0D, 2.0i, 2.2CDI, 2.2D, 2.2i, 2.3i, 2.5D, 2.8i  (4), (5) HD+ : Heavy duty+  _ ▶ A344660  _ ▶ F331440	03/93 ▶		LUC	<b>301013</b>	21439		110	75	20,3			
1.8i, 2.0D, 2.0i, 2.2D, 2.3i, 2.4i, 2.5TD, 2.8i  (4), (5)  A344661 ▶ _  F331441 ▶ _  _ ▶ F576240			ATE	<b>301272</b>	21197		61,6	58,6	15			
2.0D, 2.0i, 2.2D, 2.2i, 2.5D, 2.8i  (4)  _ ▶ A344660  _ ▶ A419828  _ ▶ F331440  _ ▶ F443892	03/93 ▶		ATE	<b>301345</b>	20687		61,7	54,3	15,5			
1.8i, 2.0D, 2.0i, 2.2CDI, 2.2D, 2.3i, 2.4i V6, 2.5TD, 2.6i V6, 2.8i  (5)  F576241 ▶ _	▶ 02/01		ATE	<b>301444</b>	21919		63,7	73	15,3			
3.6i, 4.3i, 4.3i V8  (4), (5)	09/94 ▶ 02/01		ATE	<b>301617</b>	21305		61,7	69,6	15,5			
1.8i, 2.0D, 2.0i, 2.2CDI, 2.2D, 2.2i, 2.3i, 2.5D  (4) ETCV+ : Traction control+  A394903 ▶ _  A419829 ▶ _  F399003 ▶ _  F443893 ▶ _	▶ 03/00		ATE	<b>301763</b>	21900		63,7	63,4	15,5			
<b>C Class (W203) (2000&gt;2003)</b> 												
1.8CGI, 1.8i, 2.0i, 2.1CDI, 2.3i  (3), (4), (5)	04/00 ▶ 12/03		LUC	<b>301448</b>	23144		131,1	69,8	19,5			
1.8CGI, 1.8i, 2.0i, 2.1CDI  (3), (4)	04/00 ▶ 12/03		ATE	<b>301444</b>	21919		63,7	73	15,3			
3.0CDI, 3.2i V6  (3), (4), (5)	09/00 ▶ 12/03		ATE	<b>301617</b>	21305		61,7	69,6	15,5			
<b>C Class (W203) (2004&gt;2008)</b> 												
1.8CGI, 1.8i, 2.1CDI  (3), (4), (5)	01/04 ▶		LUC	<b>301448</b>	23144		131,1	69,8	19,5			
1.8CGI, 1.8i, 2.1CDI  (3), (4)	01/04 ▶		ATE	<b>301444</b>	21919		63,7	73	15,3			
3.0CDI, 3.5i V6, 5.5i V8  (3), (4), (5)	01/04 ▶ 02/08		ATE	<b>301617</b>	21305		61,7	69,6	15,5			
<b>CL Class (W215) (99&gt;2006)</b> 												
5.0i, 5.4i, 5.8i	08/99 ▶ 04/06		BRE	<b>301445</b>	23271		119,6	71,5	17,7			
<b>CLC Class (W203) (2008&gt;)</b> 												
1.6i, 1.8i, 2.1CDI	03/08 ▶		LUC	<b>301448</b>	23144		131,1	69,8	19,5			
1.6i, 1.8i, 2.1CDI	03/08 ▶		ATE	<b>301444</b>	21919		63,7	73	15,3			
<b>CLK Class (W208) (97&gt;2003)</b> 												
2.0i, 2.3i 	06/97 ▶ 01/03		ATE	<b>301357</b>	21195		151,4	60	19,3			
								66,1				

				<b>Valeo</b>	<b>VVA</b>					
<b>MERCEDES (.../...)</b>										
<b>CLK Class (W208) (97&gt;2003)  (.../...)</b>										
2.0i, 2.3i, 3.2i, 4.3i 	06/97 ▶ 01/03		ATE	<b>301636</b>	21670		156,3	63,6	20,3	
							156,3	69,5		
2.0i, 2.3i 	06/97 ▶ 01/03		ATE	<b>301444</b>	21919		63,7	73	15,3	
2.0i, 2.3i, 3.2i, 4.3i, 5.4i 			ATE	<b>301617</b>	21305		61,7	69,6	15,5	
<b>CLK Class (W209) (2002&gt;2009) </b>										
1.8, 1.8i, 2.2CDI 	03/02 ▶ 06/09		LUC	<b>301448</b>	23144		131,1	69,8	19,5	
1.8, 1.8i, 2.2CDI 	03/02 ▶ 06/09		ATE	<b>301444</b>	21919		63,7	73	15,3	
5.0i V8, 5.4i V8, 5.5i V8 	03/02 ▶ 06/09		ATE	<b>301617</b>	21305		61,7	69,6	15,5	
<b>E Class (W124) (93&gt;98) </b>										
2.0D, 2.0i, 2.2i, 2.5D, 2.5TD, 2.5TD Turbo, 3.0D, 3.0TD, 3.0TD Turbo, 3.0i 	07/93 ▶ 03/98		LUC	<b>301315</b>	21028		110	59,7	18,8	
2.0i, 2.2i, 2.5D, 2.5TD Turbo, 2.8i, 3.0D, 3.0TD Turbo, 3.0i, 3.2i, 3.6i, 4.2i, 5.0i V8 			ATE	<b>301272</b>	21197		61,6	58,6	15	
 B927761 ▶ _  _ ▶ F323055										
2.0D, 2.0i, 2.2i, 2.5D, 2.5TD, 3.0TD, 3.0i 	07/93 ▶ 06/97		ATE	<b>301345</b>	20687		61,7	54,3	15,5	
3.2i, 5.0i V8 			ATE	<b>301617</b>	21305		61,7	69,6	15,5	
 F323056 ▶ _  _ ▶ B927760										
<b>E Class (W210) (95&gt;2003) </b>										
2.0D, 2.0i, 2.1CDI, 2.2D, 2.3i, 2.4i, 2.5D, 2.5TD, 2.6i, 2.9TD, 3.0D 	04/95 ▶ 03/03		ATE	<b>301357</b>	21195		151,4	60	19,3	
ESP- 								66,1		
2.0i, 2.1CDI, 2.4i, 2.5D, 2.7CDI, 2.8i, 2.9TD, 3.0TD, 3.2CDI, 3.2i, 4.3i 	04/95 ▶ 03/03		ATE	<b>301636</b>	21670		156,3	63,6	20,3	
ESP+ 							156,3	69,5		
2.0D, 2.0i, 2.2D, 2.3i, 2.4i, 2.5D, 2.9TD, 3.0D 	04/95 ▶		ATE	<b>301272</b>	21197		61,6	58,6	15	
ESP-  _ ▶ A379346										
2.0D, 2.0i, 2.1CDI, 2.2D, 2.3i, 2.4i, 2.5D, 2.5TD, 2.6i, 2.9TD, 3.0D 	▶ 03/02		ATE	<b>301444</b>	21919		63,7	73	15,3	
ESP-  A379347 ▶ _										
2.0i, 2.1CDI, 2.3i, 2.4i, 2.5D, 2.5TD, 2.6i, 2.7CDI, 2.8i, 2.9TD, 3.0TD, 3.2CDI, 3.2i, 4.2i, 4.3i, 5.0i V8, 5.4i 	04/95 ▶		ATE	<b>301617</b>	21305		61,7	69,6	15,5	
ESP +, VEB+ : V√©hicule blind√©+  _ ▶ A379346										













































































									
<b>MERCEDES (.../...)</b>									
<b>E Class (W211) (2002&gt;2006) </b>									
2.6i V6, 3.0CDI, 3.2i V6  (4), (5)	03/03 ▶ 03/06		ATE	<b>301636</b>	21670		156,3 156,3	63,6 69,5	20,3
1.8i, 2.1 CDI, 2.6i V6, 2.7CDI, 3.0CDI, 3.0CDI V6, 3.0i V6, 3.2CDI  (4), (5)	03/02 ▶ 03/06		BSC	<b>301638</b>	23743		137	67,8	20
<b>E Class (W211) (2006&gt;2009) </b>									
3.0CDI V6, 3.0i V6, 3.5i V6  (4), (5)	04/06 ▶ 11/09		ATE	<b>301636</b>	21670		156,3 156,3	63,6 69,5	20,3
1.8i, 2.1 CDI, 2.5i V6, 3.0CDI V6, 3.0i V6  (4), (5)	04/06 ▶ 11/09		BSC	<b>301638</b>	23743		137	67,8	20
<b>G Class (M461/3) (89&gt;) </b>									
3.0CDI V6, 3.2i V6, 4.0CDI V8, 5.0i V8, 5.4i V8  (2), (3), (5)	07/97 ▶		BSC	<b>301300</b>	23021		125,7	61,8	18,4
<b>ML Class (163) (97&gt;2005) </b>									
2.7CDi, 3.2i, 3.7i, 4.0CDi V8, 4.3i, 5.0i V8, 5.4i  A145273 ▶ _  A289560 ▶ _  X707756 ▶ _  X754620 ▶ _	▶ 04/05		BRE	<b>301445</b>	23271		119,6	71,5	17,7
<b>S Class (W140) (91&gt;93) </b>									
2.8, 3.2, 3.5TD, 4.2, 5.0i V8, 6.0 V12, 6.0i V12  (2), (4)	03/91 ▶ 06/93		ATE	<b>301617</b>	21305		61,7	69,6	15,5
<b>S Class (W140) (93&gt;99) </b>									
2.8i, 3.0TD, 3.2i, 3.5TD, 4.2i, 5.0i, 5.0i V8, 6.0i V12  (2), (4)	07/93 ▶ 07/99		ATE	<b>301617</b>	21305		61,7	69,6	15,5
<b>S Class (W220) (98&gt;2004) </b>									
2.8i, 3.2CDI, 3.2i, 4.0CDI, 4.3i, 5.0i, 5.4i, 5.8i	09/98 ▶ 09/04		BRE	<b>301445</b>	23271		119,6	71,5	17,7
3.7i	09/02 ▶ 09/04		ATE	<b>301636</b>	21670		156,3 156,3	63,6 69,5	20,3
5.0i, 5.8i	09/98 ▶ 09/04		ATE	<b>301617</b>	21305		61,7	69,6	15,5
<b>SL Class (129) (89&gt;2001) </b>									
2.8i, 3.2i, 5.0i, 6.0i V12 ESP+	08/93 ▶ 07/01		BRE	<b>301445</b>	23271		119,6	71,5	17,7
2.8i, 3.0i, 3.2i, 5.0i  _ ▶ F125157	03/89 ▶		ATE	<b>301272</b>	21197		61,6	58,6	15
2.8i, 5.0i, 6.0i V12  F125158 ▶ _	▶ 07/01		ATE	<b>301617</b>	21305		61,7	69,6	15,5
<b>SLK Class (170) (96&gt;2003) </b>									
2.0i, 2.3i	08/96 ▶ 12/03		ATE	<b>301357</b>	21195		151,4 66,1	60	19,3
3.2i	01/00 ▶ 12/03		ATE	<b>301636</b>	21670		156,3 156,3	63,6 69,5	20,3































				<b>Valeo</b>	<b>WVA</b>				
<b>MERCEDES (.../...)</b>									
<b>SLK Class (170) (96&gt;2003)  (.../...)</b>									
2.0i, 2.3i  _ ▶ F017687	08/96 ▶		ATE	<b>301272</b>	21197		61,6	58,6	15
2.0i, 2.3i, 3.2i  F017688 ▶ _	▶ 12/03		ATE	<b>301444</b>	21919		63,7	73	15,3
3.2i	10/01 ▶ 12/03		ATE	<b>301617</b>	21305		61,7	69,6	15,5
<b>SLK Class (171) (2004&gt;2007) </b>									
1.8i	01/04 ▶ 12/07		LUC	<b>301448</b>	23144		131,1	69,8	19,5
1.8i, 3.0i V6	01/04 ▶ 12/07		ATE	<b>301444</b>	21919		63,7	73	15,3
<b>SLK Class (171) (2008&gt;) </b>									
1.8i	01/08 ▶		LUC	<b>301448</b>	23144		131,1	69,8	19,5
1.8i, 3.0i V6	01/08 ▶		ATE	<b>301444</b>	21919		63,7	73	15,3
5.4i V8	01/08 ▶		ATE	<b>301617</b>	21305		61,7	69,6	15,5
<b>Sprinter (901-2-3-4-5) (95&gt;2006) </b>									
2.2D, 2.3D, 2.3i, 2.7D, 2.9D   (2),(3),(4)	02/95 ▶ 02/06		ATE	<b>301044</b>	21576		156,25	64,8	20,5
2.2D, 2.3D, 2.3i, 2.7D, 2.9D   (2),(3),(4)	02/95 ▶ 02/06		ATE	<b>301046</b>	21661		156,4	54,6	18,5
2.2D, 2.3D, 2.3i, 2.7D, 2.9D   (2),(3),(4)	02/95 ▶ 02/06		BSC	<b>301300</b>	23021		125,7	61,8	18,4
<b>Sprinter II (906) (2006&gt;) </b>									
2.2D, 3.0D V6   (2),(4),(5)	02/06 ▶		BRE	<b>301881</b>	29200		169,1	73,5	20,8
<b>V Class (638) (96&gt;2002) </b>									
2.0, 2.2CDI, 2.3, 2.3TD, 2.8	10/96 ▶ 12/02		ATE	<b>301044</b>	21576		156,25	64,8	20,5
2.0, 2.2CDI, 2.3, 2.3TD, 2.8	10/96 ▶ 12/02		ATE	<b>301062</b>	21279		63,5	57	16,9  2 x  130 mm
<b>Vaneo (414) (2001&gt;2005) </b>									
1.6i, 1.7CDI, 1.9i	10/01 ▶ 07/05		LUC	<b>301583</b>	23138		95,8	41,5	14,3
<b>Vito (638) (96&gt;2003) </b>									
2.0i, 2.2CDI, 2.3D, 2.3TD, 2.3i  (3),(4)	01/96 ▶ 09/03		ATE	<b>301044</b>	21576		156,25	64,8	20,5
2.0i, 2.2CDI, 2.3D, 2.3TD, 2.3i  (3),(4)	01/96 ▶ 09/03		ATE	<b>301062</b>	21279		63,5	57	16,9  2 x  130 mm
<b>MG</b>									
<b>MG ZR (2001&gt;2005) </b>									
1.4i, 1.8i, 2.0TD  (3),(5)	06/01 ▶ 04/05		LUC	<b>301022</b>	21515		129	69	18  2 x 
1.8i WC  (3),(5)	06/01 ▶ 04/05		LUC	<b>301436</b>	23095		131,7	58,5	17,2  2 x 
1.4i, 1.8i, 2.0TD  (3),(5)	06/01 ▶ 04/05		AKE	<b>301053</b>	21312		89	35	13  2 x 
1.8i WC, 2.0TD  (3),(5)	06/01 ▶ 04/05		AKE	<b>301682</b>	21719		88,9	47,5	15,4  2 x 

											
<b>MG (.../...)</b>											
<b>MG ZS (2001&gt;2005)</b> 											
1.6i, 1.8i, 2.0TD, 2.5i V6   (4),(5)	07/01 ▶ 04/05		LUC	<b>301436</b>	23095		131,7	58,5	17,2	↳ 2x ⇐	
1.6i, 1.8i, 2.0TD, 2.5i V6   (4),(5)	07/01 ▶ 04/05		AKE	<b>301682</b>	21719		88,9	47,5	15,4	↳ 2x ⇐	
<b>MG ZT (2001&gt;2005)</b> 											
1.8i, 1.8i Turbo, 2.0CDT, 2.0CDTi, 2.5i V6, 4.6i V8   (4),(5)	06/01 ▶ 04/05		ATE	<b>301753</b>	21934		123	45	17		
<b>MINI</b>											
<b>MINI (R56/57) (2006&gt;2010)</b> 											
1.4i, 1.6D, 1.6i, 1.6i Turbo   (2),(3)	11/06 ▶		LUC	<b>301041</b>	24289		95,5	49,2	17		
1.4i, 1.4i 75, 1.6D 110, 1.6D 90, 1.6i, 1.6i 122, 1.6i 98, 1.6i Turbo 184, 1.6i Turbo 211, 2.0D 112, 2.0D 143   (2),(3)	03/09 ▶		LUC	<b>301041</b>	24289		95,5	49,2	17		
<b>MINI Clubman (R55) (2007&gt;2011)</b> 											
1.4i, 1.6D, 1.6i, 1.6i Turbo  (3)	08/07 ▶ 01/11		LUC	<b>301041</b>	24289		95,5	49,2	17		
<b>MINI Clubman/Clubvan (R55) (2009&gt;)</b> 											
1.4i, 1.6D 110, 1.6D 90, 1.6i, 1.6i 122, 1.6i 98, 1.6i Turbo 184, 1.6i Turbo 211, 2.0D 112, 2.0D 143   (3)	03/09 ▶		LUC	<b>301041</b>	24289		95,5	49,2	17		
<b>MINI Coupé (R58) (2011&gt;)</b> 											
1.6i 122, 1.6i Turbo 184, 1.6i Turbo 211, 2.0D 143  (2)	09/11 ▶		LUC	<b>301041</b>	24289		95,5	49,2	17		
<b>MINI Roadster (R59) (2012&gt;)</b> 											
1.6i 122, 1.6i Turbo 184, 1.6i Turbo 211, 2.0D 143  (2)	03/12 ▶		LUC	<b>301041</b>	24289		95,5	49,2	17		
<b>MITSUBISHI</b>											
<b>3000 GT (90&gt;2000)</b> 											
3.0i Turbo  (2)	04/90 ▶ 05/93		AKE	<b>301517</b>	21363		150	59	15,7	↳ 2x ⇐	
<b>ASX (2010&gt;2012)</b> 											
1.6i MIVEC, 1.8DI-D HP, 1.8DI-D LP (5)	04/10 ▶ 06/12		AKE	<b>301886</b>	23584		144,8	55	16		
<b>ASX (2012&gt;)</b> 											
1.8DI-D HP, 1.8DI-D LP (5)	07/12 ▶		AKE	<b>301886</b>	23584		144,8	55	16		
<b>Carisma (95&gt;99)</b> 											
1.8GDI, 1.8i   (4),(5)	05/95 ▶ 02/99		LUC	<b>301318</b>	21920		130	72,57	15,1		











































































										
<b>MITSUBISHI (.../...)</b>										
<b>Carisma (99&gt;2003)</b> 										
1.6i, 1.8i, 1.9TD  (4),(5)	03/99 ▶		LUC	<b>301318</b>	21920		130	72,57	15,1	
1.6i, 1.8GDI, 1.8i, 1.9DI-D  (4),(5)	03/99 ▶		LUC	<b>301493</b>	21983		130	77	17	
1.6i, 1.8GDI, 1.8i, 1.9DI-D  (4),(5)	03/99 ▶		LUC	<b>301319</b>	21861		87,3	47	15,3	
<b>Challenger (98&gt;2009)</b> 										
2.5TD  (5)	10/98 ▶ 02/09		AKE	<b>301517</b>	21363		150	59	15,7	↳ 2x ⇐
<b>Colt (C5) (88&gt;92)</b> 										
1.8  (3)	11/89 ▶ 05/92		SUM	<b>301625</b>	21647		127,7	51,7	16	↳ 2x ⇐
<b>Colt (CA/CC) (91&gt;96)</b> 										
1.8  (3)	12/91 ▶ 12/96		SUM	<b>301625</b>	21647		127,7	51,7	16	↳ 2x ⇐
<b>Colt (Z3) (2004&gt;2008)</b> 										
1.1i, 1.3i Mivec, 1.5DI-D, 1.5i Mivec  (2),(3),(5)	04/04 ▶		LUC	<b>301318</b>	21920		130	72,57	15,1	
1.5i Turbo  (2),(3)	06/05 ▶ 09/08		LUC	<b>301493</b>	21983		130	77	17	
1.1i, 1.3i Mivec, 1.5DI-D, 1.5i Mivec, 1.5i Turbo  (2),(3),(5)	04/04 ▶		LUC	<b>301319</b>	21861		87,3	47	15,3	
<b>Colt (Z3) (2008&gt;2013)</b> 										
1.5i Turbo  (3)	10/08 ▶ 02/11		LUC	<b>301493</b>	21983		130	77	17	
1.1i, 1.3MIVEC, 1.3i, 1.3i Mivec, 1.5i Mivec, 1.5i Turbo  (3),(5)	10/08 ▶ 03/13		LUC	<b>301319</b>	21861		87,3	47	15,3	
<b>Galant (E3) (87&gt;92)</b> 										
2.0  (4),(5)	11/89 ▶ 10/92		AKE	<b>301517</b>	21363		150	59	15,7	↳ 2x ⇐
1.8, 1.8TD, 2.0  (4),(5)	10/89 ▶ 10/92		SUM	<b>301625</b>	21647		127,7	51,7	16	↳ 2x ⇐
<b>Galant (E5/6/7/8) (92&gt;96)</b> 										
1.8, 2.0, 2.0 V6, 2.0TD  (4),(5)	11/92 ▶ 09/96		SUM	<b>301625</b>	21647		127,7	51,7	16	↳ 2x ⇐
<b>Galant (EA) (96&gt;2003)</b> 										
2.0i, 2.4i, 2.5i V6  (4),(5) HD+ : Heavy duty+	08/98 ▶ 02/00		AKE	<b>301517</b>	21363		150	59	15,7	↳ 2x ⇐
2.0TD, 2.0i, 2.5i V6  (4),(5)	10/96 ▶ 02/00		SUM	<b>301625</b>	21647		127,7	51,7	16	↳ 2x ⇐
2.0i, 2.4GDI, 2.5i V6  (4),(5)	03/00 ▶ 05/03		AKE	<b>301886</b>	23584		144,8	55	16	
<b>Galant (DJ/DM) (2006&gt;2010)</b> 										
2.4i  (4)	07/06 ▶ 07/10		AKE	<b>301886</b>	23584		144,8	55	16	
<b>Grandis (2004&gt;)</b> 										
2.0DI-D, 2.4i	01/04 ▶		SUM	<b>301518</b>	21016		139	58,5	16	
2.0DI-D, 2.4i	01/04 ▶		AKE	<b>301520</b>	23582		111,5 91	45	15,5	

				<b>Valeo</b>	<b>WVA</b>					
<b>MITSUBISHI (.../...)</b>										
<b>L200 (K1/2/3) (86&gt;2001)</b> 										
2.5D   (4)	06/94 ▶ 12/96		AKE	<b>301517</b>	21363		150	59	15,7	↳ 2x ⇐
<b>L200 (K6/7) (96&gt;2007)</b> 										
2.4i, 2.5D, 2.5TD  (2), (4) ABS+	01/96 ▶ 12/07		AKE	<b>301517</b>	21363		150	59	15,7	↳ 2x ⇐
2.0i, 2.4i, 2.5D, 2.5TD   (2), (4) ABS+	01/96 ▶ 12/07		AKE	<b>301522</b>	23290		137,8	55	15,7	
<b>L300 (Truck) (94&gt;2000)</b> 										
2.0, 2.5D  (3), (4)	06/94 ▶ 04/00		AKE	<b>301522</b>	23290		137,8	55	15,7	
<b>L400 (PA/PB/PD) (94&gt;2001)</b> 										
2.4i, 2.5TD  (5)	12/94 ▶ 03/96		AKE	<b>301517</b>	21363		150	59	15,7	↳ 2x ⇐
2.0i, 2.5TD  (5)	12/94 ▶ 2001		AKE	<b>301522</b>	23290		137,8	55	15,7	
<b>Lancer (CB/CD4) (92&gt;2000)</b> 										
1.6i  (5)	06/92 ▶ 2000		SUM	<b>301625</b>	21647		127,7	51,7	16	↳ 2x ⇐
<b>Lancer F (C6/7) (88&gt;95)</b> 										
1.6, 1.8   (4), (5) ABS+ FAD+	11/89 ▶ 07/95		SUM	<b>301625</b>	21647		127,7	51,7	16	↳ 2x ⇐
<b>Lancer F (CB/CD) (91&gt;96)</b> 										
1.8  (4)	05/92 ▶ 12/96		SUM	<b>301625</b>	21647		127,7	51,7	16	↳ 2x ⇐
<b>Lancer (CS/CT) (2003&gt;)</b> 										
1.3, 1.6i, 2.0i   (4), (5)	06/03 ▶		AKE	<b>301886</b>	23584		144,8	55	16	
1.3, 1.6i, 2.0i   (4), (5)	06/03 ▶		AKE	<b>301852</b>	24014		85,5	40	15,5	
<b>Lancer (CY) (2007&gt;)</b> 										
1.5MIVEC, 1.6MIVEC 115, 1.8DI-D 117, 1.8DI-D 150, 1.8MIVEC, 1.8MIVEC GPL, 2.0DI-D, 2.0MIVEC  (4)	03/07 ▶		AKE	<b>301886</b>	23584		144,8	55	16	
1.5MIVEC, 1.6MIVEC 115, 1.8DI-D 117, 1.8DI-D 150, 1.8MIVEC, 1.8MIVEC GPL, 2.0DI-D, 2.0MIVEC  (4)	03/07 ▶		AKE	<b>301852</b>	24014		85,5	40	15,5	
<b>Lancer Sportback (CX) (2008&gt;)</b> 										
1.5MIVEC, 1.6MIVEC 115, 1.8DI-D 117, 1.8DI-D 150, 1.8MIVEC, 1.8MIVEC 140, 2.0DI-D  (5)	07/08 ▶		AKE	<b>301886</b>	23584		144,8	55	16	
1.5MIVEC, 1.6MIVEC 115, 1.8DI-D 117, 1.8DI-D 150, 1.8MIVEC, 1.8MIVEC 140, 2.0DI-D  (5)	07/08 ▶		AKE	<b>301852</b>	24014		85,5	40	15,5	
<b>Montero (V2/4) (93&gt;2006)</b> 										
2.5TD, 2.8TD  (3), (5)	11/93 ▶ 08/06		AKE	<b>301517</b>	21363		150	59	15,7	↳ 2x ⇐
2.5TD, 2.8TD  (3), (5)	11/93 ▶ 08/06		AKE	<b>301519</b>	21840		108	43,5	14	↳ 2x ⇐

				<b>Valeo</b>	<b>WVA</b>						
<b>MITSUBISHI (.../...)</b>											
<b>Montero Sport (K9) (98&gt;2009)</b> 											
2.5TD <u>5</u>	08/98 ▶ 02/09		AKE	<b>301517</b>	21363		150	59	15,7	↳ 2x ⇐	
<b>Outlander (CU) (2003&gt;2008)</b> 											
2.0i, 2.0i Turbo, 2.4i <u>5</u>	06/03 ▶ 12/08		AKE	<b>301852</b>	24014	 	85,5 106	40 35,5	15,5		
<b>Outlander (CW) (2006&gt;)</b> 											
2.0DI-D, 2.2DI-D, 2.4MIVEC, 2.4i, 3.0 V6 <u>5</u>	11/06 ▶		AKE	<b>301520</b>	23582	 	111,5 91	45	15,5		
<b>Pajero (V2/4) (90&gt;2004)</b> 											
2.4i, 2.5TD, 2.8D, 2.8TD, 3.0i V6, 3.5i V6 <u>3</u> , <u>5</u>	12/90 ▶		AKE	<b>301517</b>	21363		150	59	15,7	↳ 2x ⇐	
2.5D <u>3</u>	06/95 ▶ 05/99		AKE	<b>301522</b>	23290	 	137,8	55	15,7		
2.4i, 2.5TD, 2.8TD, 3.0i V6, 3.5i V6 <u>3</u> , <u>5</u>	12/90 ▶		AKE	<b>301519</b>	21840	 	108	43,5	14	↳ 2x ⇐	
<b>Pajero (V6/V7) (2000&gt;2006)</b> 											
2.5TD, 3.2DI-D, 3.5GDI V6 <u>3</u> , <u>5</u>	02/00 ▶ 08/06		SUM	<b>301518</b>	21016		139	58,5	16		
2.5TD, 3.2DI-D, 3.5GDI V6 <u>3</u> , <u>5</u>	02/00 ▶ 08/06		AKE	<b>301520</b>	23582	 	111,5 91	45	15,5		
<b>Pajero (V8/9) (2006&gt;)</b> 											
3.2DI-D, 3.8i V6 <u>3</u>	09/06 ▶		SUM	<b>301518</b>	21016		139	58,5	16		
3.2DI-D, 3.8i V6 <u>3</u>	09/06 ▶		AKE	<b>301520</b>	23582	 	111,5 91	45	15,5		
<b>Pajero Sport (K9) (98&gt;2009)</b> 											
2.5TD <u>5</u>	08/98 ▶ 02/09		AKE	<b>301517</b>	21363		150	59	15,7	↳ 2x ⇐	
<b>Pajero Pinin (H7) (99&gt;2005)</b> 											
1.8GDI, 1.8i, 2.0GDI <u>3</u> , <u>5</u>	08/99 ▶ 02/05		AKE	<b>301521</b>	23487		123,2	48	15,5		
<b>Shogun (V2/4) (90&gt;2001)</b> 											
2.5TD, 2.8D, 2.8TD, 3.0i V6, 3.5i V6 <u>3</u> , <u>5</u>	12/90 ▶ 05/01		AKE	<b>301517</b>	21363		150	59	15,7	↳ 2x ⇐	
2.5D <u>3</u>	06/95 ▶ 05/99		AKE	<b>301522</b>	23290	 	137,8	55	15,7		
2.5TD, 2.8TD, 3.0i V6, 3.5i V6 <u>3</u> , <u>5</u>	12/90 ▶ 05/01		AKE	<b>301519</b>	21840	 	108	43,5	14	↳ 2x ⇐	
<b>Shogun (V6/7) (2000&gt;2006)</b> 											
2.5TD, 3.2DI-D, 3.5GDI V6 <u>3</u> , <u>5</u>	02/00 ▶ 08/06		SUM	<b>301518</b>	21016		139	58,5	16		
2.5TD, 3.2DI-D, 3.5GDI V6 <u>3</u> , <u>5</u>	02/00 ▶ 08/06		AKE	<b>301520</b>	23582	 	111,5 91	45	15,5		

				<b>Valeo</b>	<b>WVA</b>							
<b>MITSUBISHI (.../...)</b>												
<b>Shogun (V8/9) (2006&gt;)</b> 												
3.2DI-D, 3.8i V6  (3)	09/06 ▶		SUM	<b>301518</b>	21016		139	58,5	16			
3.2DI-D, 3.8i V6  (3)	09/06 ▶		AKE	<b>301520</b>	23582	 	111,5	45	15,5			
<b>Shogun Pinin (99&gt;2005)</b> 												
1.8GDI, 1.8i, 2.0GDI  (3), (5)	08/99 ▶ 2005		AKE	<b>301521</b>	23487		123,2	48	15,5			
<b>Sigma (F0/1) (90&gt;96)</b> 												
3.0i V6   (4), (5)	12/90 ▶ 10/94		AKE	<b>301517</b>	21363		150	59	15,7			↳ 2x ⇐
3.0i V6  (4)	12/90 ▶ 05/94		AKE	<b>301519</b>	21840	 	108	43,5	14			↳ 2x ⇐
<b>Space Gear (PA/PC/PD) (94&gt;98)</b> 												
2.4i, 2.5TD	12/94 ▶ 03/96		AKE	<b>301517</b>	21363		150	59	15,7			↳ 2x ⇐
2.0i, 2.4i, 2.5TD	12/94 ▶ 11/98		AKE	<b>301522</b>	23290	 	137,8	55	15,7			
2.4i, 2.5TD	12/94 ▶ 11/98		AKE	<b>301519</b>	21840	 	108	43,5	14			↳ 2x ⇐
<b>Space Runner (N1/2/6) (91&gt;2002)</b> 												
1.8i, 2.0TD	06/91 ▶ 2002		SUM	<b>301625</b>	21647	 	127,7	51,7	16			↳ 2x ⇐
2.0i, 2.4GDi	05/00 ▶ 2002		AKE	<b>301886</b>	23584		144,8	55	16			
<b>Space Star (DG) (98&gt;2004)</b> 												
1.3i, 1.6i, 1.8GDi, 1.9Di-D	06/98 ▶ 2004		LUC	<b>301318</b>	21920		130	72,57	15,1			
1.3i, 1.6i, 1.8GDi, 1.9Di-D ABS+	06/98 ▶ 2004		LUC	<b>301319</b>	21861	 	87,3	47	15,3			
<b>Space Wagon (N3) (91&gt;2000)</b> 												
1.8, 1.8TD, 2.0, 2.0TD, 2.4	05/91 ▶ 11/00		SUM	<b>301625</b>	21647	 	127,7	51,7	16			↳ 2x ⇐
<b>Space Wagon (N8) (98&gt;2004)</b> 												
2.4GDi	09/99 ▶ 09/00		AKE	<b>301517</b>	21363		150	59	15,7			↳ 2x ⇐
<b>NISSAN</b>												
<b>100 NX (B13) (90&gt;94)</b> 												
2.0i	10/90 ▶ 10/94		SUM	<b>301668</b>	21715		105,2	46,8	16			
<b>300 ZX (Z31) (84&gt;89)</b> 												
3.0 Turbo, 3.0i	02/84 ▶ 01/89		AKE	<b>301123</b>	21099	 	130	49	16,4			↳ 2x ⇐
<b>720 Pick-up (79&gt;85)</b> 												
1.6, 1.8, 2.2, 2.3D, 2.5D  (2), (4)	01/83 ▶ 08/85		AKE	<b>301123</b>	21099	 	130	49	16,4			↳ 2x ⇐
<b>Almera (N15) (95&gt;2000)</b> 												
1.4i, 1.6i, 2.0D   (3), (4), (5) ABS+	07/95 ▶ 01/98		AKE	<b>301449</b>	23023		99,5	40	15			↳ 2x ⇐

				<b>Valeo</b>	<b>WVA</b>								
<b>NISSAN (.../...)</b>													
<b>Almera (N15) (95&gt;2000)  (.../...)</b>													
1.4i, 1.6i, 2.0D, 2.0i   (3),(4),(5) ABS+	04/96 ▶ 01/00		SUM	<b>301668</b>	21715		105,2	46,8	16				
<b>Almera (N16E) (2000&gt;2003) </b>													
1.5dCi, 1.5i   (3),(4),(5)	02/00 ▶ 01/03		LUC	<b>301054</b>	21546		129	57,3	17				
1.5dCi, 1.5i, 1.8i, 2.2TDi, 2.2VDi   (3),(4),(5) ABS+	02/00 ▶ 01/03		LUC	<b>301450</b>	23093		124,2	57,3	16,6				
1.5dCi, 1.5i, 1.8i, 2.2TDi, 2.2VDi   (3),(4),(5) ABS+	02/00 ▶ 01/03		LUC	<b>301057</b>	21545		84	56,3	15,8	↳ 2x ⇐			
<b>Almera (N16E) (2003&gt;2006) </b>													
1.5dCi, 1.5i   (3),(4),(5)	02/03 ▶ 11/06		LUC	<b>301054</b>	21546		129	57,3	17				
1.5dCi, 1.5i, 1.8i, 2.2DCi   (3),(4),(5) ABS+	02/03 ▶ 11/06		LUC	<b>301450</b>	23093		124,2	57,3	16,6				
1.5dCi, 1.5i, 1.8i, 2.2DCi   (3),(4),(5)	02/03 ▶ 11/06		LUC	<b>301057</b>	21545		84	56,3	15,8	↳ 2x ⇐			
<b>Almera (B10RS) (2006&gt;) </b>													
1.6i  (4)	03/06 ▶		AKE	<b>301747</b>	24647		135	48,5	16,1	↳ 1x ⇐			
<b>Almera Tino (V10M) (2000&gt;2003) </b>													
1.8i, 2.0i, 2.2VDi	08/00 ▶ 01/03		LUC	<b>301057</b>	21545		84	56,3	15,8	↳ 2x ⇐			
<b>Almera Tino (V10B) (2003&gt;2005) </b>													
1.8i, 2.2DCi	02/03 ▶ 11/05		LUC	<b>301057</b>	21545		84	56,3	15,8	↳ 2x ⇐			
<b>Bluebird (T12) (85&gt;90) </b>													
1.6, 1.8 Turbo, 1.8i, 1.8i Turbo, 2.0, 2.0D, 2.0i   (3),(4),(5)	12/85 ▶ 12/90		AKE	<b>301123</b>	21099		130	49	16,4	↳ 2x ⇐			
1.8 Turbo   (4),(5)	12/85 ▶ 01/88		SUM	<b>301817</b>	21553		85	46,5	14	↳ 2x ⇐			
<b>Bluebird (T72) (85&gt;90) </b>													
1.6, 1.8 Turbo, 1.8i, 1.8i Turbo, 2.0, 2.0D, 2.0i   (3),(4),(5)	12/85 ▶ 12/90		AKE	<b>301123</b>	21099		130	49	16,4	↳ 2x ⇐			
<b>Bluebird (U11) (83&gt;90) </b>													
1.8, 1.8 Turbo, 1.8T Turbo, 2.0, 2.0D, 2.0D Turbo   (4),(5)	10/83 ▶ 1987		AKE	<b>301123</b>	21099		130	49	16,4	↳ 2x ⇐			
<b>Cedric (Y30) (83&gt;88) </b>													
2.0, 2.3D, 2.8D, 3.0    (2),(4),(5)	10/83 ▶ 06/88		AKE	<b>301123</b>	21099		130	49	16,4	↳ 2x ⇐			
2.0, 2.3D, 3.0    (2),(4),(5)	01/86 ▶ 06/88		AKE	<b>301618</b>	21347		161	49,8	17	↳ 2x ⇐			
<b>D21 Pick-up (85&gt;98) </b>													
2.0, 2.4, 2.5D (2)	10/87 ▶ 02/98		AKE	<b>301123</b>	21099		130	49	16,4	↳ 2x ⇐			
2.4i (2)	04/92 ▶ 02/98		AKE	<b>301618</b>	21347		161	49,8	17	↳ 2x ⇐			
<b>D22 King Cab (98&gt;) </b>													
2.4i, 2.5TD, 2.5TDi (2),(4)	02/98 ▶		AKE	<b>301618</b>	21347		161	49,8	17	↳ 2x ⇐			

											
<b>NISSAN (.../...)</b>											
<b>D22 King Cab (98&gt;)  (.../...)</b>											
2.4i, 2.5TDi  (2), (4)	11/01 ▶		AKE	<b>301889</b>	23970		164,2	57	17	↳ 2x ◁	
<b>Kubistar (2003&gt;) </b>											
1.2E, 1.4E, 1.5dCi, 1.5dCi 60, 1.5dCi 70, 1.5dCi 85, 1.6E  (3), (4)	09/03 ▶		BSC	<b>301726</b>	21980		131	47,3	18		
<b>Laurel (C32) (85&gt;90) </b>											
2.0, 2.4i, 2.8D, 3.0i	01/85 ▶ 06/90		AKE	<b>301123</b>	21099		130	49	16,4	↳ 2x ◁	
<b>Maxima (J30) (88&gt;94) </b>											
3.0	12/88 ▶ 09/94		SUM	<b>301817</b>	21553		85	46,5	14	↳ 2x ◁	
<b>Maxima QX (A32) (94&gt;99) </b>											
2.0i V6, 3.0i V6	10/94 ▶ 12/99		SUM	<b>301668</b>	21715		105,2	46,8	16		
<b>Maxima QX (CA33) (2000&gt;2006) </b>											
2.0i V6, 3.0i V6	01/00 ▶ 04/04		SUM	<b>301668</b>	21715		105,2	46,8	16		
<b>Micra (K11E) (92&gt;2000) </b>											
1.0i, 1.3i, 1.5D  (3), (5)	08/92 ▶ 06/00		AKE	<b>301014</b>	21626		120,9	45	15,5		
1.0i, 1.3i, 1.5D  (3), (5)	08/92 ▶ 06/00		AKE	<b>301642</b>	23454		88,9	45	15		
<b>Micra (K11E) (2000&gt;2002) </b>											
1.0i, 1.4i, 1.5D  (3), (5)	07/00 ▶ 12/02		AKE	<b>301014</b>	21626		120,9	45	15,5		
1.0i, 1.4i, 1.5D  (3), (5)	07/00 ▶ 12/02		AKE	<b>301642</b>	23454		88,9	45	15		
<b>Micra (K12E) (2003&gt;2005) </b>											
1.0i, 1.2i, 1.4i, 1.5dCi  (3), (5)	01/03 ▶ 05/05		LUC	<b>301641</b>	23973		116,4	52,5	17,3		
<b>Micra (K12E) (2005&gt;2011) </b>											
1.2i, 1.4i, 1.5dCi, 1.6i  (2), (3), (5)	06/05 ▶ 04/11		LUC	<b>301641</b>	23973		116,4	52,5	17,3		
<b>Murano (Z50) (2005&gt;2008) </b>											
3.5i V6	02/05 ▶ 06/08		SUM	<b>301337</b>	23698		157,00	58,50	17,00	↳ 2x ◁	
3.5i V6	02/05 ▶ 06/08		AKE	<b>301672</b>	23871		105,5	38	14	↳ 2x ◁	
<b>Murano (Z51) (2008&gt;) </b>											
3.5i V6	06/08 ▶ 01/09		SUM	<b>301337</b>	23698		157,00	58,50	17,00	↳ 2x ◁	
<b>Navara (D40M) (2005&gt;2010) </b>											
2.5TDi  (2), (4) 	05/05 ▶ 11/10		SUM	<b>301337</b>	23698		157,00	58,50	17,00	↳ 2x ◁	
<b>Navara (D40M) (2009&gt;) </b>											
2.5dCi  (2), (4)	12/09 ▶		SUM	<b>301337</b>	23698		157,00	58,50	17,00	↳ 2x ◁	
<b>Note (E11E) (2005&gt;2007) </b>											
1.4i, 1.5dCi, 1.6i	09/05 ▶ 12/07		LUC	<b>301641</b>	23973		116,4	52,5	17,3		





































































											<b>NISSAN (.../...)</b>
<b>Note (E11E) (2008&gt;)</b> 											
1.4i, 1.5dCi 106, 1.5dCi 68, 1.5dCi 86, 1.5dCi 90, 1.6i	01/08 ▶		LUC	<b>301641</b>	23973		116,4	52,5	17,3		
<b>NP300 (D22SS) (2010&gt;)</b> 											
2.5dCi 133   (2),(4)	08/10 ▶		AKE	<b>301618</b>	21347		161	49,8	17	↳ 2x 	
2.5dCi 133  (2),(4)	08/10 ▶		AKE	<b>301889</b>	23970		164,2	57	17	↳ 2x 	
<b>Pathfinder (D21) (86&gt;98)</b> 											
2.4  (2)	08/86 ▶ 02/98		AKE	<b>301123</b>	21099		130	49	16,4	↳ 2x 	
<b>Pathfinder (R51M) (2005&gt;2010)</b> 											
2.5dCi, 4.0C-VTC  (5)  17"	02/05 ▶ 08/10		SUM	<b>301337</b>	23698		157,00	58,50	17,00	↳ 2x 	
<b>Prairie (M10) (82&gt;88)</b> 											
1.5, 1.8, 2.0, 2.0i	09/82 ▶ 09/88		AKE	<b>301123</b>	21099		130	49	16,4	↳ 2x 	
<b>Primastar (2002&gt;2006)</b> 											
1.9dCi, 2.0i, 2.5dCi  (4)	09/02 ▶ 09/06		LUC	<b>301545</b>	23099		145	62,5	18		
<b>Primastar (2006&gt;)</b> 											
2.0dCi, 2.5dCi  (2),(5)	09/06 ▶		LUC	<b>301545</b>	23099		145	62,5	18		
<b>Primera (P10/W10) (90&gt;98)</b> 											
2.0, 2.0D, 2.0e, 2.0i   (4),(5)	02/90 ▶ 05/96		LUC	<b>301054</b>	21546		129	57,3	17		
2.0, 2.0D, 2.0e, 2.0i   (4),(5)	02/90 ▶ 05/96		LUC	<b>301057</b>	21545		84	56,3	15,8	↳ 2x 	
<b>Primera (P11/W11) (96&gt;2002)</b> 											
1.6i, 1.8i, 2.0TD, 2.0i   (4),(5) ABS-	06/96 ▶ 02/02		LUC	<b>301054</b>	21546		129	57,3	17		
1.6i, 1.8i, 2.0TD, 2.0i   (4),(5) ABS+	06/96 ▶ 02/02		LUC	<b>301450</b>	23093		124,2	57,3	16,6		
1.6i, 1.8i, 2.0TD, 2.0i   (4),(5)	06/96 ▶ 02/02		LUC	<b>301057</b>	21545		84	56,3	15,8	↳ 2x 	
<b>Primera (P12/W12) (2001&gt;2006)</b> 											
1.6i, 1.8i, 1.9dCi, 2.0i, 2.2VDi, 2.2dCi, 2.5i   (4),(5)	02/01 ▶		ATE	<b>301472</b>	23482		123,1	52	16,6		
<b>Qashqai (J10E/JJ10E) (2007&gt;2010)</b> 											
1.5dCi, 1.6i, 2.0dCi, 2.0i	03/07 ▶ 01/10		AKE	<b>301067</b>	24632		141,9	58,7	16,8		
1.5dCi, 1.6i, 2.0dCi, 2.0i	03/07 ▶ 01/10		AKE	<b>301009</b>	23871		105,8	38	14	↳ 1x 	
<b>Qashqai (J10E/JJ10E) (2010&gt;)</b> 											
1.5dCi 103, 1.5dCi 106, 1.5dCi 110, 1.6dCi 130, 1.6i 115, 1.6i 117, 2.0dCi 150, 2.0i 140	01/10 ▶		AKE	<b>301067</b>	24632		141,9	58,7	16,8		
<b>Silvia (S12) (83&gt;88)</b> 											
1.8 Turbo, 2.0	10/83 ▶ 08/88		AKE	<b>301123</b>	21099		130	49	16,4	↳ 2x 	
<b>Stanza (T11) (81&gt;85)</b> 											
1.6	08/81 ▶ 08/82		AKE	<b>301123</b>	21099		130	49	16,4	↳ 2x 	



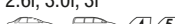















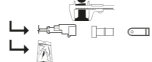













































				<b>Valeo</b>	<b>WVA</b>				
<b>NISSAN (.../...)</b>									
<b>Sunny (N14) (90&gt;95)</b> 									
2.0  (3), (5)	10/90 ▶ 05/95		SUM	<b>301668</b>	21715		105,2	46,8	16
<b>Terrano (WD21) (87&gt;95)</b> 									
2.4i, 2.7TD, 3.0 V6	08/87 ▶ 02/93		AKE	<b>301123</b>	21099		130	49	16,4
2.4i, 2.7TD, 3.0 V6	08/87 ▶ 06/92		AKE	<b>301618</b>	21347		161	49,8	17
<b>Tiida (C11X) (2007&gt;)</b> 									
1.5dCi, 1.6i, 1.8i  (4), (5)	03/07 ▶		AKE	<b>301009</b>	23871		105,8	38	14
<b>Urvan (E24) (87&gt;97)</b> 									
2.0, 2.3D, 2.4i, 2.5D  (4), (5)	02/87 ▶ 05/97		AKE	<b>301618</b>	21347		161	49,8	17
<b>Vanette (C220) Made in Spain (86&gt;94)</b> 									
1.5, 2.0D  (4), (5)	04/87 ▶ 11/94		AKE	<b>301123</b>	21099		130	49	16,4
<b>Vanette (C23M) (92&gt;2001)</b> 									
1.6i, 2.0D, 2.3D  (5)	07/92 ▶ 11/01		AKE	<b>301123</b>	21099		130	49	16,4
<b>Vanette (GC22) (86&gt;93)</b> 									
2.0D  (4), (5)	09/86 ▶ 03/93		AKE	<b>301123</b>	21099		130	49	16,4
1.5, 2.0, 2.0D, 2.4i  (4), (5)	09/86 ▶ 03/93		AKE	<b>301618</b>	21347		161	49,8	17
<b>X-Trail (T30) (2001&gt;2003)</b> 									
2.0i, 2.2Di	06/01 ▶ 09/03		AKE	<b>301672</b>	23871		105,5	38	14
<b>X-Trail (T30) (2003&gt;2007)</b> 									
2.0, 2.2dCi, 2.5i	09/03 ▶ 03/07		AKE	<b>301672</b>	23871		105,5	38	14
<b>X-Trail (T31) Made in Japan (2007&gt;)</b> 									
2.0, 2.0dCi, 2.5	03/07 ▶ 07/10		AKE	<b>301067</b>	24632		141,9	58,7	16,8
<b>OPEL</b>									
<b>Agila (2007&gt;)</b> 									
1.0i, 1.2i, 1.3CDTi	12/07 ▶		LUC	<b>301847</b>	23973		116,2	52,1	17,3
<b>Antara (2006&gt;)</b> 									
2.0CDTi 127, 2.0CDTi 150, 2.4i 140, 3.2i V6-227  _ ▶ 9B999999	10/06 ▶		MAND	<b>301942</b>	24510		149	62,2	17,6
2.0CDTi 127, 2.0CDTi 150, 2.2CDTi 163, 2.2CDTi 184, 2.4i 140, 2.4i 167, 3.0i 258-V6, 3.2i V6-227	10/06 ▶		MAND	<b>301941</b>	24498		110,7	45,9	15,8
<b>Ascona A (70&gt;75)</b> 									
1.2, 1.6, 1.6S, 1.9  (2), (4), (5)	08/70 ▶ 07/75		ATE	<b>301099</b>	20228		61,8	56,6	15
<b>Ascona B (75&gt;81)</b> 									
1.2, 1.3, 1.3S, 1.6, 1.6S, 1.9, 2.0, 2.0D, 2.0E  (2), (4)	08/75 ▶ 07/81		GME	<b>301182</b>	20867		100	59	15,4
<b>Ascona C (81&gt;88)</b> 									
1.3, 1.3S, 1.6, 1.6D, 1.6S, 1.6i, 1.8E, 1.8i, 2i  (2), (4), (5)	08/81 ▶ 08/88		GME	<b>301182</b>	20867		100	59	15,4



























































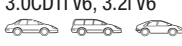

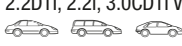











				<b>Valeo</b>	<b>WVA</b>								
<b>OPEL (.../...)</b>													
<b>Astra F (91&gt;2001)</b> 													
1.4i, 1.6i, 1.7D, 1.7TD, 1.7TD Ecoturbo, 1.7TD Turbo, 1.8i, 2.0i  (2),(3),(4),(5) HD+ : Heavy duty+	09/91 ▶ 02/01		ATE	<b>301184</b>	21201		156,3	52,6	17				
1.4, 1.4i, 1.6i, 1.7D, 1.7TD, 1.7TD Ecoturbo, 1.7TD Turbo, 1.8i  (2),(3),(4),(5)	09/91 ▶ 02/01		ATE	<b>301356</b>	21353		140,1	58,3	16,8				
1.8i, 2.0i  (2),(3),(4),(5)	07/93 ▶ 02/01		ATE	<b>301253</b>	21140		61,8	57,2	15,3				
<b>Astra G (98&gt;2005)</b> 													
1.2i, 1.4i, 1.6i, 1.6i Twinport, 1.7CDTI, 1.7DTi, 1.7TD Ecoturbo, 1.8i, 2.0DTi, 2.0Di, 2.2DTi  (2),(3),(4),(5)	02/98 ▶ 12/05		ATE	<b>301322</b>	23063		160	63	18	↳ 4x ⇐			
1.6i GNV, 2.0i, 2.2i  (2),(3),(4),(5)	02/98 ▶ 12/05		ATE	<b>301454</b>	23062		156,4	78,5	20	↳ 2x ⇐			
1.2i, 1.4i, 1.6i, 1.6i GNV, 1.6i Twinport, 1.7CDTI, 1.7DTi, 1.7TD Ecoturbo, 1.8i, 2.0DTi, 2.0i Turbo, 2.2DTi, 2.2i  (2),(3),(4),(5)	02/98 ▶ 12/05		LUC	<b>301584</b>	23417		95,5	42,7	15,2	↳ 2x ⇐			
1.2i, 1.4i, 1.6i, 1.6i GNV, 1.6i Twinport, 1.7CDTI, 1.7DTi, 1.7TD Ecoturbo, 1.8i, 2.0DTi, 2.0Di, 2.0i, 2.2DTi, 2.2i  (2),(3),(4),(5)	02/98 ▶ 12/05		BSC	<b>301926</b>	23258		104,8	42,7	17	↳ 2x ⇐			
<b>Astra Classic (98&gt;2002)</b> 													
1.6i  (4),(5)	09/98 ▶ 12/02		ATE	<b>301184</b>	21201		156,3	52,6	17				
1.4i, 1.6i  (4),(5)	09/98 ▶ 12/02		ATE	<b>301356</b>	21353		140,1	58,3	16,8				
<b>Astra H (2004&gt;2011)</b> 													
2.0i Turbo  (3)	03/05 ▶ 06/10		ATE	<b>301678</b>	23402		156,5	71	20,3				
1.2i Twinport, 1.3CDTI, 1.4i GPL, 1.4i Twinport, 1.6i, 1.6i Turbo, 1.6i Twinport, 1.7CDTI, 1.8i, 1.9CDTI, 2.0i Turbo, 2.2i  (2),(3),(4),(5)	03/04 ▶ 12/10		ATE	<b>301860</b>	23832		156,1	76	20,4	↳ 2x ⇐			
1.2i Twinport, 1.3CDTI, 1.4i GPL, 1.4i Twinport, 1.6i, 1.6i ECOTEC, 1.6i Turbo, 1.6i Twinport, 1.7CDTI, 1.8i, 1.9CDTI, 2.0i Turbo, 2.2i  (2),(3),(4),(5)	03/04 ▶ 11/11		LUC	<b>301584</b>	23417		95,5	42,7	15,2	↳ 2x ⇐			
<b>Astra J (2009&gt;)</b> 													
1.3CDTI, 1.4GPL Turbo, 1.4i, 1.4i Turbo, 1.4i Twinport, 1.6i, 1.6i 115, 1.6i Turbo, 1.7CDTI, 1.7CDTI 110, 1.7CDTI 125, 2.0CDTI  (4),(5) Ⓢ16"	09/09 ▶		BSC	<b>301070</b>	25080		148,1	61,2	18,8	↳ 2x ⇐			
1.3CDTI, 1.4GPL Turbo, 1.4i, 1.4i Turbo, 1.4i Twinport, 1.6i, 1.6i 115, 1.6i Turbo, 1.7CDTI, 1.7CDTI 110, 1.7CDTI 125, 2.0CDTI, 2.0CDTI BiTurbo 195  (3),(4),(5) Ⓢ15" Ⓢ16"	09/09 ▶		BSC	<b>301055</b>	25096		116,6	42,7	16,3	↳ 2x ⇐			
<b>Calibra (89&gt;97)</b> 													
2.0i	09/89 ▶ 07/97		ATE	<b>301184</b>	21201		156,3	52,6	17				
2.0i Turbo, 2.5i V6	07/96 ▶ 07/97		ATE	<b>301305</b>	21829		156,3	74,2	20,3				

								
<b>OPEL (.../...)</b>								
<b>Calibra (89&gt;97)  (.../...)</b>								
2.5i V6	07/96 ▶ 07/97		ATE	<b>301183</b>	21051		61,7 61,2 15,7	
2.0i, 2.0i Turbo, 2.5i V6	09/89 ▶ 07/97		ATE	<b>301253</b>	21140		61,8 57,2 15,3	
<b>Campo (88&gt;96) </b>								
2.2D, 2.3, 2.5D, 2.5TD, 3.1TD  2	10/88 ▶ 06/96		AKE	<b>301020</b>	21543		127 51 16,5	↳ 4x ⇐
<b>Campo (96&gt;2002) </b>								
2.5DTI, 2.5TD, 3.1TDS  2, 4	07/96 ▶		AKE	<b>301020</b>	21543		127 51 16,5	↳ 4x ⇐
<b>Combo (85&gt;93) </b>								
1.3, 1.3i, 1.4, 1.4i	07/85 ▶ 03/93		GME	<b>301182</b>	20867		100 59 15,4	
1.6, 1.6D, 1.6i, 1.7D	07/85 ▶ 03/93		ATE	<b>301356</b>	21353		140,1 58,3 16,8 141,4 48,4	
<b>Combo (93&gt;2001) </b>								
1.2, 1.2i, 1.4i, 1.7D	03/93 ▶ 09/01		ATE	<b>301356</b>	21353		140,1 58,3 16,8 141,4 48,4	
<b>Combo/Combo Tour (2001&gt;2004) </b>								
1.6i, 1.7DI, 1.7DTi  3, 5  _ ▶ 43999999	10/01 ▶		LUC	<b>301456</b>	23225		131,6 52,8 16,8 55,5	
1.6i, 1.7DI, 1.7DTi  3, 5  53000001 ▶ _	▶ 06/04		ATE	<b>301860</b>	23832		156,1 76 20,4 154,9 69,7	↳ 2x ⇐
1.6i, 1.7DI, 1.7DTi  3	10/01 ▶ 06/04		LUC	<b>301584</b>	23417		95,5 42,7 15,2	↳ 2x ⇐
<b>Combo/Combo Tour (2004&gt;) </b>								
1.3CDTI, 1.4i Twinport, 1.7CDTI  3, 5  _ ▶ 43999999	07/04 ▶		LUC	<b>301456</b>	23225		131,6 52,8 16,8 55,5	
1.3CDTI, 1.4i Twinport, 1.7CDTI  3, 5  53000001 ▶ _			ATE	<b>301860</b>	23832		156,1 76 20,4 154,9 69,7	↳ 2x ⇐
1.3CDTI, 1.4i Twinport, 1.7CDTI  3	07/04 ▶		LUC	<b>301584</b>	23417		95,5 42,7 15,2	↳ 2x ⇐
<b>Corsa A (82&gt;93) </b>								
1.0, 1.2, 1.3, 1.3i, 1.4, 1.5D, 1.5TD  2, 3, 4, 5  _ ▶ M4999999	10/82 ▶		GME	<b>301182</b>	20867		100 59 15,4	
1.0, 1.2, 1.2i, 1.4, 1.4i, 1.5D, 1.5TD, 1.6i  2, 3, 4, 5  N4000001 ▶ _	▶ 03/93		ATE	<b>301356</b>	21353		140,1 58,3 16,8 141,4 48,4	

										
<b>OPEL (.../...)</b>										
<b>Corso B (93&gt;2000)</b> 										
1.0i, 1.2, 1.2i, 1.4i, 1.5D, 1.5TD, 1.6i, 1.7D  (3), (5)	03/93 ▶ 08/00		ATE	<b>301356</b>	21353		140,1 141,4	58,3 48,4	16,8	
<b>Corso C (2000&gt;2003)</b> 										
1.0i, 1.2i, 1.4i, 1.7Di, 1.7DTi, 1.8i  (2), (3), (5)	09/00 ▶ 08/03		LUC	<b>301456</b>	23225		131,6	52,8 55,5	16,8	
1.4i, 1.8i  (3), (5) ESP+	09/00 ▶ 08/03		LUC	<b>301457</b>	23284		95,5	43,9	13,8	↳ 2x □
<b>Corso C (2003&gt;2006)</b> 										
1.0i Twinport, 1.2i, 1.2i Twinport, 1.3CDTI, 1.4i Twinport, 1.8i  (3), (5)	09/03 ▶ 07/06		LUC	<b>301456</b>	23225		131,6	52,8 55,5	16,8	
1.7CDTI  (3), (5)	09/03 ▶ 07/06		ATE	<b>301860</b>	23832		156,1 154,9	76	20,4	↳ 2x □
1.4i Twinport, 1.8i  (3), (5) ESP+	09/03 ▶ 07/06		LUC	<b>301457</b>	23284		95,5	43,9	13,8	↳ 2x □
<b>Corso D (2006&gt;)</b> 										
1.0i Twinport, 1.0i Twinport 65, 1.2GPL Twinport 83, 1.2GPL Twinport 85, 1.2i Twinport, 1.2i Twinport 85, 1.2i Twinport GPL, 1.3CDTI 75, 1.4i Twinport, 1.4i Twinport 87  (3), (5)	07/06 ▶		BSC	<b>301825</b>	24288		122,8	53,2	17,8	↳ 1x □
1.6i Turbo, 1.6i Turbo 192, 1.6i Turbo 210  (3)	02/07 ▶		ATE	<b>301860</b>	23832		156,1 154,9	76	20,4	↳ 2x □
<b>Frontera A (91&gt;98)</b> 										
2.0i, 2.3TD, 2.4i  (3), (5)			AKE	<b>301020</b>	21543		127	51	16,5	↳ 4x □
2.0i, 2.2i, 2.5TDS, 2.8TDi  (3), (5)	04/95 ▶ 09/98		SUM	<b>301507</b>	21875		109,6	42,5	15,8	↳ 2x □
<b>Frontera B (98&gt;2005)</b> 										
2.2DTi, 2.2i, 3.2i V6  (3), (5)	10/98 ▶ 07/05		AKE	<b>301661</b>	23250		137,8	57,8	18,5	↳ 2x □
2.2DTi, 2.2i, 3.2i V6  (3), (5)	10/98 ▶ 07/05		SUM	<b>301507</b>	21875		109,6	42,5	15,8	↳ 2x □
<b>Kadett C (73&gt;79)</b> 										
1, 1.2N, 1.2S, 1S  (2), (3), (4), (5)	08/73 ▶ 07/79		ATE	<b>301099</b>	20228		61,8	56,6	15	
<b>Kadett D (79&gt;84)</b> 										
1.0, 1.2, 1.3, 1.6, 1.6D, 1.8i  (2), (3), (4), (5)	08/79 ▶ 08/84		GME	<b>301182</b>	20867		100	59	15,4	

				<b>Valeo</b>	<b>WVA</b>							
<b>OPEL (.../...)</b>												
<b>Kadett E (84&gt;91)</b> 												
1.2S, 1.3, 1.3N, 1.3S, 1.4S, 1.4i, 1.5TD, 1.6, 1.6D, 1.6S, 1.6i, 1.7D, 1.8, 1.8E, 1.8i, 2.0i  (2),(3),(4),(5)  -> J2789612  -> J5273427  -> L250000	08/84 ▶		GME	<b>301182</b>	20867		100	59	15,4			
1.8i  (5)	08/89 ▶ 1991		ATE	<b>301184</b>	21201		156,3	52,6	17			
2.0i  (2),(3),(4),(5)	09/86 ▶ 1991		ATE	<b>301253</b>	21140		61,8	57,2	15,3			
<b>Manta A (70&gt;75)</b> 												
1.2, 1.6, 1.9	08/70 ▶ 07/75		ATE	<b>301099</b>	20228		61,8	56,6	15			
<b>Manta B (75&gt;88)</b> 												
1.2N, 1.2S, 1.3N, 1.3S, 1.6N, 1.6S, 1.8S, 1.9N, 1.9S, 2.0S, 2E	08/75 ▶ 08/88		GME	<b>301182</b>	20867		100	59	15,4			
<b>Meriva A (2003&gt;2010)</b> 												
1.4i Twinport, 1.6i  4	05/03 ▶ 05/10		LUC	<b>301456</b>	23225		131,6	52,8	16,8			
1.3CDTi, 1.4i Twinport, 1.6i, 1.6i Turbo, 1.7CDTi, 1.7DTi, 1.8i  5	05/03 ▶ 07/10		ATE	<b>301860</b>	23832		156,1	76	20,4			↳ 2x ⇔
1.3CDTi, 1.4i Twinport, 1.6i, 1.6i Turbo, 1.7CDTi, 1.7DTi, 1.8i  4  5	05/03 ▶ 07/10		LUC	<b>301584</b>	23417		95,5	42,7	15,2			↳ 2x ⇔
<b>Meriva B (2010&gt;)</b> 												
1.3CDTi, 1.4GPL Turbo, 1.4Turbo, 1.4i, 1.7CDTi	05/10 ▶		ATE	<b>301860</b>	23832		156,1	76	20,4			↳ 2x ⇔
1.3CDTi, 1.4GPL Turbo, 1.4Turbo, 1.4i, 1.7CDTi	05/10 ▶		LUC	<b>301584</b>	23417		95,5	42,7	15,2			↳ 2x ⇔
<b>Monterey (91&gt;99)</b> 												
3.0DTi, 3.1TD, 3.2i V6, 3.5i V6  (3),(5)	09/91 ▶ 08/99		SUM	<b>301507</b>	21875		109,6	42,5	15,8			↳ 2x ⇔
<b>Monza (78&gt;86)</b> 												
2.0i, 2.2i, 2.5i, 2.8, 3.0, 3.0i			ATE	<b>301099</b>	20228		61,8	56,6	15			
<b>Omega A (86&gt;94)</b> 												
1.8, 1.8i, 2.0i, 2.3D, 2.3TD  (4),(5)  -> K1000098  -> L1019854	10/86 ▶		GME	<b>301182</b>	20867		100	59	15,4			
1.8, 1.8i, 2.0i, 2.3D, 2.3TD, 2.4i  (4),(5)  K1000099 ▶ _  L1019855 ▶ _	▶ 02/94		ATE	<b>301184</b>	21201		156,3	52,6	17			
2.6i, 3.0i, 3i  (4),(5)  M1000001 ▶ _	▶ 02/94		LUC	<b>301256</b>	21368		129,8	63,9	18,6			
1.8, 1.8i, 2.0i, 2.3D, 2.3TD, 2.4i, 2.6i, 3.0i, 3i  (4),(5)  K1000099 ▶ _	▶ 02/94		ATE	<b>301183</b>	21051		61,7	61,2	15,7			

























































										<b>OPEL (.../...)</b>
<b>Omega B (94&gt;2003)</b> 										
2.0DTi, 2.0i, 2.2DTi, 2.2i, 2.5TD, 2.5TDi, 2.5i V6, 2.6i V6, 3.0i V6, 3.2i V6   (4), (5)  W1000001 ▶ _	▶ 07/03		LUC	<b>301256</b>	21368		129,8	63,9	18,6	
2.0DTi, 2.0i, 2.2DTi, 2.2i, 2.5TD, 2.5TDi, 2.5i V6, 2.6i V6, 3.0i V6, 3.2i V6  (4), (5)	02/94 ▶ 07/03		ATE	<b>301183</b>	21051		61,7	61,2	15,7	
<b>Rekord D (72&gt;77)</b> 										
1.7, 1.9, 2.1D  (2), (4), (5)	01/72 ▶ 09/73		ATE	<b>301099</b>	20228		61,8	56,6	15	
<b>Rekord E (77&gt;86)</b> 										
1.7, 1.8, 1.9, 2, 2.1D, 2.2i, 2.3D, 2.3TD, 2D, 2E  (4), (5)	08/77 ▶ 09/86		GME	<b>301182</b>	20867		100	59	15,4	
<b>Senator A (78&gt;87)</b> 										
2.0i, 2.2i, 2.3TD, 2.5i, 2.8, 3.0, 3.0i			ATE	<b>301099</b>	20228		61,8	56,6	15	
<b>Senator B (87&gt;93)</b> 										
2.5i, 2.6i, 3.0i	10/89 ▶ 06/93		LUC	<b>301256</b>	21368		129,8	63,9	18,6	
2.5i, 2.6i, 3.0i	02/87 ▶ 06/93		ATE	<b>301183</b>	21051		61,7	61,2	15,7	
<b>Signum (2003&gt;2005)</b> 										
1.8i, 1.9CDTi, 2.0DTi, 2.0i Turbo, 2.2DIG, 2.2DTi, 3.0CDTi V6, 3.2i V6 CSS+ : Chassis suspension of sport+  ▶ 31068238	06/03 ▶		ATE	<b>301678</b>	23402		156,5	71	20,3	
1.8i, 1.9CDTi, 2.0DTi, 2.0i Turbo, 2.2DIG, 2.2DTi, 3.0CDTi V6, 3.2i V6	06/03 ▶		ATE	<b>301472</b>	23482		123,1	52	16,6	
1.8i, 1.9CDTi, 2.0DTi, 2.0i Turbo, 2.2DIG, 2.2DTi, 3.0CDTi V6, 3.2i V6	06/03 ▶ 09/05		ATE	<b>301783</b>	24137		122,9	51,7	16,4	
<b>Signum (2005&gt;2008)</b> 										
1.8i, 1.9CDTi, 2.0i Turbo, 2.2DIG	10/05 ▶ 11/08		ATE	<b>301678</b>	23402		156,5	71	20,3	
1.8i, 1.9CDTi, 2.0i Turbo, 2.2DIG, 2.8i V6 Turbo, 3.0CDTi V6	10/05 ▶ 12/07		ATE	<b>301783</b>	24137		122,9	51,7	16,4	
<b>Sintra (96&gt;99)</b> 										
2.2DTi, 2.2i, 3.0i V6	03/96 ▶ 12/99		GME	<b>301458</b>	23358		148	61,5	18	↳ 2x □
<b>Tigra (94&gt;2001)</b> 										
1.4i, 1.6i	10/94 ▶ 01/01		ATE	<b>301356</b>	21353		140,1	58,3	16,8	
							141,4	48,4		
<b>Tigra Twintop (2004&gt;2008)</b> 										
1.3CDTi, 1.4i Twinport, 1.8i	07/04 ▶ 07/08		LUC	<b>301456</b>	23225		131,6	52,8	16,8	
							55,5			
1.8i	07/04 ▶ 07/08		LUC	<b>301457</b>	23284		95,5	43,9	13,8	↳ 2x □
<b>Vectra A (88&gt;95)</b> 										
1.4, 1.6S, 1.6i, 1.7D, 1.7TD, 1.8i  (4), (5)  ▶ N1038529	09/88 ▶		GME	<b>301182</b>	20867		100	59	15,4	

				<b>Valeo</b>	<b>WVA</b>						
<b>OPEL (.../...)</b>											
<b>Vectra A (88&gt;95)  (.../...)</b>											
1.6S, 1.6i, 1.7D, 1.7TD, 1.8, 1.8i, 2.0i, 2i  (4,5)  S1000001 ▶ _	▶ 09/95		ATE	<b>301184</b>	21201		156,3	52,6	17		
1.4, 1.6S, 1.6i, 1.7D, 1.7TD, 1.8i  (4,5)  N1038530 ▶ R1999999  N1038530 ▶ _  _ ▶ R1999999			ATE	<b>301356</b>	21353		140,1	58,3	16,8		
2 Turbo, 2.0i, 2.5i V6, 2i  (4,5)	09/88 ▶ 09/95		ATE	<b>301253</b>	21140		61,8	57,2	15,3		
<b>Vectra B (95&gt;99) </b>											
1.6i, 1.7TD, 1.8i, 2.0Di, 2.0TDi, 2.0i  (4,5)  _ ▶ W1999999	10/95 ▶		ATE	<b>301184</b>	21201		156,3	52,6	17		
1.6i, 1.7TD, 1.8i, 2.0Di, 2.0TDi, 2.0i, 2.5i V6  (4,5)  X1000001 ▶ _	▶ 01/99		ATE	<b>301305</b>	21829		156,3	74,2	20,3		
1.6i, 1.7TD, 1.8i, 2.0Di, 2.0TDi, 2.0i, 2.5i V6  (4,5)	10/95 ▶ 01/99		ATE	<b>301183</b>	21051		61,7	61,2	15,7		
<b>Vectra B (99&gt;2003) </b>											
1.6i, 1.8i, 1.8i 115, 2.0DTi, 2.2DTi, 2.2i, 2.6i V6  (4,5)	02/99 ▶ 06/03		ATE	<b>301305</b>	21829		156,3	74,2	20,3		
1.6i, 1.8i, 1.8i 115, 2.0DTi, 2.2DTi, 2.2i, 2.6i V6  (4,5)	02/99 ▶ 06/03		ATE	<b>301183</b>	21051		61,7	61,2	15,7		
<b>Vectra C (2002&gt;2005) </b>											
1.6i, 1.8i, 1.8i GPL, 1.9CDTi, 2.0DTi, 2.0i Turbo, 2.2DIG, 2.2DTi, 2.2i, 3.0CDTi V6, 3.2i V6  (4,5)  _ ▶ 31070293  _ ▶ 38047797	04/02 ▶		ATE	<b>301678</b>	23402		156,5	71	20,3		
1.6i, 1.8i, 1.9CDTi, 2.0DTi, 2.0i Turbo, 2.2DIG, 2.2DTi, 2.2i, 3.0CDTi V6, 3.2i V6  (4,5)	04/02 ▶		ATE	<b>301472</b>	23482		123,1	52	16,6		
1.6i, 1.8i, 1.8i GPL, 1.9CDTi, 2.0DTi, 2.0i Turbo, 2.2DIG, 2.2DTi, 2.2i, 3.0CDTi V6, 3.2i V6  (4,5)	04/02 ▶ 09/05		ATE	<b>301783</b>	24137		122,9	51,7	16,4		
<b>Vectra C (2005&gt;2009) </b>											
1.6i, 1.8i, 1.9CDTi, 2.0i Turbo, 2.2DIG  (4,5)  _ ▶ 58999999  61000001 ▶ _			ATE	<b>301678</b>	23402		156,5	71	20,3		
1.6i, 1.8i, 1.9CDTi, 2.0i Turbo, 2.2DIG, 2.8i V6 Turbo, 3.0CDTi V6  (4,5)  _ ▶ 71041573	10/05 ▶		ATE	<b>301783</b>	24137		122,9	51,7	16,4		
<b>Vivaro (2001&gt;2006) </b>											
1.9Di, 1.9DTi, 2.0i, 2.5DTi (3,5)	05/01 ▶ 07/06		LUC	<b>301545</b>	23099		145	62,5	18		
<b>Vivaro (2006&gt;) </b>											
2.0CDTi, 2.0i, 2.5CDTi (5)	07/06 ▶		LUC	<b>301545</b>	23099		145	62,5	18		
<b>Zafira A (98&gt;2003) </b>											
1.6i, 1.8i, 2.0Di, 2.0DTi, 2.2DTi, 2.2i	01/99 ▶ 06/03		ATE	<b>301454</b>	23062		156,4	78,5	20	↳ 2x	
							155,4	71,5			



















































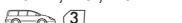



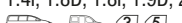



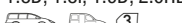







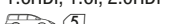

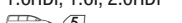









				<b>Valeo</b>	<b>WVA</b>							
<b>OPEL (.../...)</b>												
<b>Zafira A (98&gt;2003)  (.../...)</b>												
1.8i, 2.0DTi, 2.0i Turbo, 2.2DTI, 2.2i	01/99 ▶ 06/03		LUC	<b>301584</b>	23417		95,5	42,7	15,2		↳ 2x ⇐	
1.6i, 1.8i, 2.0Di, 2.0DTI, 2.0i Turbo, 2.2DTI, 2.2i	01/99 ▶ 06/03		BSC	<b>301926</b>	23258		104,8	42,7	17		↳ 2x ⇐	
<b>Zafira A (2003&gt;2005) </b>												
1.6i, 1.6i GNV, 1.8i, 2.0DTI, 2.2DTI, 2.2i	07/03 ▶ 06/05		ATE	<b>301454</b>	23062		156,4	78,5	20		↳ 2x ⇐	
							155,4	71,5				
1.6i GNV, 1.8i, 2.0DTI, 2.0i Turbo, 2.2DTI, 2.2i	07/03 ▶ 06/05		LUC	<b>301584</b>	23417		95,5	42,7	15,2		↳ 2x ⇐	
1.6i, 1.6i GNV, 1.8i, 2.0DTI, 2.0i Turbo, 2.2DTI, 2.2i	07/03 ▶ 06/05		BSC	<b>301926</b>	23258		104,8	42,7	17		↳ 2x ⇐	
<b>Zafira B (2005&gt;2008) </b>												
2.0i Turbo	07/05 ▶ 07/08		ATE	<b>301678</b>	23402		156,5	71	20,3			
												
1.6i, 1.6i GNV, 1.6i VVT, 1.7CDTI, 1.8i, 1.9CDTI, 2.0i Turbo, 2.2i	07/05 ▶ 07/08		ATE	<b>301860</b>	23832		156,1	76	20,4		↳ 2x ⇐	
							154,9	69,7				
1.6i, 1.6i GNV, 1.6i VVT, 1.7CDTI, 1.8i, 1.9CDTI, 2.0i Turbo, 2.2i	07/05 ▶ 07/08		LUC	<b>301584</b>	23417		95,5	42,7	15,2		↳ 2x ⇐	
<b>Zafira B (2008&gt;) </b>												
2.0i Turbo	07/08 ▶ 04/09		ATE	<b>301678</b>	23402		156,5	71	20,3			
												
1.6T GNV, 1.6i, 1.6i GNV, 1.7CDTI, 1.8i, 1.9CDTI, 2.0i Turbo, 2.2i	07/08 ▶		ATE	<b>301860</b>	23832		156,1	76	20,4		↳ 2x ⇐	
							154,9	69,7				
1.6T GNV, 1.6i, 1.6i GNV, 1.7CDTI, 1.8i, 1.9CDTI, 2.0i Turbo, 2.2i	07/08 ▶		LUC	<b>301584</b>	23417		95,5	42,7	15,2		↳ 2x ⇐	
<b>Zafira C (2011&gt;) </b>												
1.4Ti 120, 1.4Ti 140, 1.6Ti 150-CNG, 1.8i 115, 1.8i 140, 2.0CDTI 110, 2.0CDTI 130, 2.0CDTI 165	10/11 ▶		BSC	<b>301070</b>	25080		148,1	61,2	18,8		↳ 2x ⇐	
												
1.4Ti 120, 1.4Ti 140, 1.6Ti 150-CNG, 1.8i 115, 1.8i 140, 2.0CDTI 110, 2.0CDTI 130, 2.0CDTI 165	10/11 ▶		BSC	<b>301055</b>	25096		116,6	42,7	16,3		↳ 2x ⇐	
												
<b>PEUGEOT</b>												
<b>106 (91&gt;96) </b>												
1.3i, 1.4D, 1.5D, 1.6i  ABS+  51132347 ▶ _	▶ 03/96		ATE	<b>301074</b>	21430		140,3	47,5	17			
 DA+ : Power steering+	07/94 ▶ 03/96		BDX	<b>301075</b>	21061		105	53,7	18			
1.0, 1.0i, 1.1, 1.1i  DA- : Power steering-  _ ▶ 50994342	09/91 ▶		ATE	<b>301156</b>	21145		71,9	60,6	17,1		↳ 4x ⇐ 170 mm	
1.0, 1.0i, 1.1, 1.1i, 1.3i, 1.4, 1.4D, 1.4i, 1.5D, 1.6i  ABS+			BDX	<b>301181</b>	21061		105	51,9	18			
1.0, 1.0i, 1.1, 1.1i  50994343 ▶ _	▶ 03/96		ATE	<b>301360</b>	21145		71,9	60,6	17,3			

										
<b>PEUGEOT (.../...)</b>										
<b>106 (96&gt;2003)</b> 										
1.6i  	03/96 ▶ 07/03		ATE	<b>301074</b>	21430		140,3	47,5	17	
	03/96 ▶ 07/03		BDX	<b>301075</b>	21061		105	53,7	18	
1.0i, 1.1, 1.1i, 1.1i GPL, 1.4, 1.4i, 1.5D, 1.6i   	03/96 ▶ 07/03		BDX	<b>301081</b>	21061		105	53,4	18	
ABS+										
1.0i, 1.1, 1.1i, 1.1i GPL, 1.4, 1.4i, 1.6i   	03/96 ▶ 07/03		BDX	<b>301181</b>	21061		105	51,9	18	
ABS-										
1.0i, 1.1, 1.1i, 1.1i GPL   	03/96 ▶ 07/03		ATE	<b>301360</b>	21145		71,9	60,6	17,3	
1.6i 	03/96 ▶ 07/03		BDX	<b>301396</b>	20635		105	54,7	11	
<b>107 (2005&gt;2012)</b> 										
1.0i, 1.4HDi  	06/05 ▶ 02/12		BSC	<b>301718</b>	23959		122,7	46,7	17,6	
<b>107 (2012&gt;)</b> 										
1.0i  	02/12 ▶		BSC	<b>301718</b>	23959		122,7	46,7	17,6	
<b>1007 (2005&gt;2010)</b> 										
1.4HDi, 1.4i, 1.6i	04/05 ▶ 07/10		BSC	<b>301464</b>	23599		137	50	19	
1.6HDi	02/07 ▶ 07/10		BSC	<b>301465</b>	23600		137	57,3	19	
1.6HDi, 1.6i	04/05 ▶ 07/10		LUC	<b>301463</b>	20960		87	52,9	17	
<b>205 (74) (83&gt;87)</b> 										
1.0, 1.1, 1.3, 1.4, 1.6, 1.6i, 1.7D, 1.9i   	02/83 ▶ 07/87		BDX	<b>301081</b>	21061		105	53,4	18	
1.1, 1.3, 1.4, 1.6, 1.6i, 1.7D   	02/83 ▶ 07/87		LUC	<b>301176</b>	20989		90	63	17,5	↳ 2 x  200 mm
1.8, 1.9i  	08/83 ▶ 07/87		BDX	<b>301396</b>	20635		105	54,7	11	
<b>205 (20) (87&gt;98)</b> 										
1.7D  	03/94 ▶ 10/96		ATE	<b>301038</b>	21430		140,3	47,5	17	↳ 2 x  275 mm
1.0, 1.0i, 1.1, 1.1i, 1.3, 1.4, 1.4i, 1.6, 1.6i, 1.7D, 1.7TD, 1.9D, 1.9i   	08/87 ▶ 09/98		BDX	<b>301081</b>	21061		105	53,4	18	
1.0, 1.0i, 1.1, 1.1i, 1.3, 1.4, 1.4i, 1.6, 1.6i, 1.7D, 1.7TD, 1.9D   	08/87 ▶ 09/98		LUC	<b>301176</b>	20989		90	63	17,5	↳ 2 x  200 mm
1.6i, 1.9i  	08/87 ▶ 09/98		BDX	<b>301396</b>	20635		105	54,7	11	
<b>206 (98&gt;2010)</b> 										
1.1i, 1.4HDi, 1.4i, 1.6i, 1.9D   	09/98 ▶ 2010		BSC	<b>301461</b>	23597		131	47,5	18	
1.6i, 2.0HDi, 2.0i   	04/99 ▶ 09/01		BSC	<b>301462</b>	23396		131	52,2	17,8	
1.4i, 1.6HDi, 1.6i, 2.0HDi, 2.0i    	09/01 ▶ 2010		BSC	<b>301464</b>	23599		137	50	19	
2.0i  	05/03 ▶ 02/09		BSC	<b>301465</b>	23600		137	57,3	19	

				<b>Valeo</b>	<b>WVA</b>								
<b>PEUGEOT (.../...)</b>													
<b>206 (98&gt;2010)  (.../...)</b>													
1.4i, 1.6HDi, 1.6i, 2.0i  (2),(3),(4),(5)	04/99 ▶ 2010		BDX	<b>301396</b>	20635		105	54,7	11				
<b>206+ (2009&gt;) </b>													
1.1i, 1.4HDi, 1.4i  (3),(5)	03/09 ▶		BSC	<b>301461</b>	23597		131	47,5	18				
<b>207 (2006&gt;) </b>													
1.4HDi, 1.4HDi 68, 1.4e, 1.6HDi  (3),(5)	03/06 ▶		BSC	<b>301464</b>	23599		137	50	19				
1.4VTi, 1.6HDi, 1.6THP, 1.6THP 156, 1.6VTi, 1.6e  (2),(3),(5)	03/06 ▶		BSC	<b>301465</b>	23600		137	57,3	19				
1.6HDi, 1.6THP, 1.6THP 156, 1.6VTi, 1.6e ESP+  (2),(3),(5)	09/08 ▶		LUC	<b>301474</b>	20960		87	53	16				
<b>207+ (2012&gt;) </b>													
1.4 HDi, 1.4 i  (3),(5)	11/12 ▶ 04/13		BSC	<b>301464</b>	23599		137	50	19				
<b>208 (2012&gt;) </b>													
1.0VTi 68, 1.2VTi 82, 1.4HDi 68, 1.4VTi 95, 1.4e-HDi 68, 1.6VTi 120, 1.6e-HDi 115, 1.6e-HDi 92  (3),(5)	03/12 ▶		BSC	<b>301464</b>	23599		137	50	19				
<b>301 (2012&gt;) </b>													
1.2VTi, 1.6HDi, 1.6VTi	11/12 ▶ 04/13		BSC	<b>301464</b>	23599		137	50	19				
<b>305 (82&gt;90) </b>													
1.1, 1.3, 1.5, 1.6, 1.7D, 1.9, 1.9D, 1.9i  (3),(4),(5)	08/82 ▶ 06/90		BDX	<b>301081</b>	21061		105	53,4	18				
<b>306 (93&gt;97) </b>													
1.1i, 1.4, 1.4i, 1.6i, 1.8D, 1.8i, 1.9D, 1.9TD  (2),(3),(4),(5) ABS+	02/93 ▶ 02/97		ATE	<b>301038</b>	21430		140,3	47,5	17			↳ 2 x ↖ 275 mm	
2.0i  (3)	03/96 ▶ 02/97		LUC	<b>301069</b>	21674		130	56,5	19			↳ 4 x ↖ 310 mm	
1.1i, 1.4, 1.4i  (3),(4),(5) ABS-	02/93 ▶ 02/97		BDX	<b>301181</b>	21061		105	51,9	18				
2.0i  (2),(3),(4),(5)	06/93 ▶ 02/97		BDX	<b>301396</b>	20635		105	54,7	11				
<b>306 (97&gt;2002) </b>													
2.0i  (3)	03/97 ▶ 02/02		LUC	<b>301069</b>	21674		130	56,5	19			↳ 4 x ↖ 310 mm	
1.4, 1.4i, 1.4i GPL, 1.6i, 1.8D, 1.8i, 1.9D, 1.9SD, 1.9TD  (2),(3),(4),(5)	03/97 ▶ 09/02		ATE	<b>301074</b>	21430		140,3	47,5	17				
1.4, 1.4i, 1.4i GPL, 1.6i, 1.8i, 1.8i GPL, 1.9D, 1.9SD, 1.9TD, 2.0HDi, 2.0i  (2),(3),(4),(5) ABS+	03/97 ▶ 09/02		LUC	<b>301326</b>	23124		130	56,2	18,5			↳ 4 x ↖ 275 mm / 310 mm	
1.4, 1.4i, 1.4i GPL, 1.6i, 1.8i, 1.8i GPL, 1.9D, 1.9SD, 1.9TD, 2.0HDi, 2.0i  (2),(3),(4),(5) ABS+	03/97 ▶ 09/02		BSC	<b>301462</b>	23396		131	52,2	17,8				
1.4, 1.4i, 1.4i GPL  (3),(4),(5) ABS-	03/97 ▶ 02/02		BSC	<b>301726</b>	21980		131	47,3	18				
1.8i, 1.8i GPL, 2.0HDi, 2.0i  (2),(3),(4),(5)	03/97 ▶ 09/02		BDX	<b>301396</b>	20635		105	54,7	11				

				<b>Valeo</b>	<b>WVA</b>						
<b>PEUGEOT (.../...)</b>											
<b>307 (2001&gt;2005)</b> 											
1.4HDi, 1.4i, 1.6HDi, 1.6i, 2.0HDi  (3), (5) ESP-	03/01 ▶ 06/05		BSC	<b>301464</b>	23599		137	50	19		
1.4i, 1.6HDi, 1.6i, 2.0HDi, 2.0i  (2), (3), (5) ESP+	03/01 ▶ 06/05		BSC	<b>301465</b>	23600		137	57,3	19		
1.4HDi, 1.4i, 1.6HDi, 1.6i, 2.0HDi, 2.0i  (2), (3), (5)	03/01 ▶ 06/05		LUC	<b>301463</b>	20960		87	52,9	17		
<b>307 (2005&gt;2009)</b> 											
1.4i, 1.6HDi, 1.6i  (3), (5)	06/05 ▶ 01/08		BSC	<b>301464</b>	23599		137	50	19		
1.4i, 1.6HDi, 1.6i, 2.0HDi, 2.0i  (2), (3), (5) ESP+	06/05 ▶		BSC	<b>301465</b>	23600		137	57,3	19		
1.4i, 1.6HDi, 1.6i, 2.0HDi, 2.0i  (2), (3), (5)	06/05 ▶		LUC	<b>301463</b>	20960		87	52,9	17		
<b>308 (2007&gt;)</b> 											
1.4VTi, 1.4VTi 98, 1.6HDi, 1.6HDi 110, 1.6HDi 90, 1.6HDi 92, 1.6THP, 1.6THP 156, 1.6VTi, 1.6VTi 120, 1.6i, 2.0HDi, 2.0HDi 150, 2.0HDi 163  (2), (3), (5)	09/07 ▶		LUC	<b>301463</b>	20960		87	52,9	17		
<b>309 (85&gt;89)</b> 											
1.1, 1.3, 1.4, 1.4i, 1.5, 1.6, 1.6i, 1.7D, 1.9, 1.9D, 1.9i  (3), (5)	09/85 ▶ 07/89		BDX	<b>301081</b>	21061		105	53,4	18		
1.1, 1.3, 1.4, 1.4i, 1.5, 1.6, 1.6i, 1.7D, 1.9, 1.9D, 1.9i  (3), (5)	09/85 ▶ 07/89		LUC	<b>301176</b>	20989		90	63	17,5	↳ 2x ↗ 200 mm	
1.6i, 1.9i  (3), (5)	09/85 ▶ 07/89		BDX	<b>301396</b>	20635		105	54,7	11		
<b>309 (89&gt;94)</b> 											
1.1, 1.1i, 1.3, 1.4, 1.4i, 1.5, 1.6, 1.6i, 1.7D, 1.7TD, 1.9, 1.9D, 1.9i  (3), (5)	08/89 ▶ 08/94		BDX	<b>301081</b>	21061		105	53,4	18		
1.1, 1.1i, 1.3, 1.4, 1.4i, 1.5, 1.6, 1.6i, 1.7D, 1.7TD, 1.9, 1.9D, 1.9i  (3), (5)	08/89 ▶ 08/94		LUC	<b>301176</b>	20989		90	63	17,5	↳ 2x ↗ 200 mm	
1.9i  (3), (5)	08/89 ▶ 08/93		BDX	<b>301396</b>	20635		105	54,7	11		
<b>405 (87&gt;92)</b> 											
1.4, 1.4i GPL, 1.6, 1.7D, 1.7TD, 1.9, 1.9D  (3), (4), (5)	06/87 ▶ 06/92		BDX	<b>301081</b>	21061		105	53,4	18		
1.6i, 1.7TD, 1.9, 1.9D, 1.9i  (3), (4), (5)	06/87 ▶ 06/92		LUC	<b>301179</b>	21209		95	49	18,6	↳ 2x ↗ 190 mm / 310 mm	
1.6i, 1.9, 1.9i  (4), (5)	06/87 ▶ 06/92		LUC	<b>301180</b>	20960		87	53	15,2		
<b>405 (92&gt;96)</b> 											
1.4, 1.6, 1.9  (3), (4), (5)	07/92 ▶ 10/96		BDX	<b>301081</b>	21061		105	53,4	18		
1.4, 1.4i, 1.6, 1.6i, 1.7TD, 1.8i, 1.9, 1.9D, 1.9TD, 1.9i, 2.0i, 2.0i Turbo  (3), (4), (5) HD+ : Heavy duty+	07/92 ▶ 10/96		LUC	<b>301179</b>	21209		95	49	18,6	↳ 2x ↗ 190 mm / 310 mm	
1.9i, 2.0i, 2.0i Turbo  (4), (5)	07/92 ▶ 10/96		LUC	<b>301180</b>	20960		87	53	15,2		



















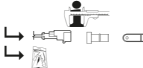

























































								
<b>PEUGEOT (.../...)</b>								
<b>406 (95&gt;2004)</b> 								
1.6i, 1.8i, 1.8i GPL, 1.9TD  (2),(4),(5)	10/95 ▶ 04/04		LUC	<b>301068</b>	21724		130 53 19	↳ 4 x ↗ 310 mm / 280 mm
1.9TD, 2.0, 2.0HDi, 2.0HPi, 2.0i, 2.0i Turbo, 2.1TD, 2.2HDI, 2.2i, 3.0, 3.0i V6  (2),(4),(5)	10/95 ▶ 10/04		LUC	<b>301069</b>	21674		130 56,5 19	↳ 4 x ↗ 310 mm
2.2HDI, 3.0i V6  (2)	05/97 ▶ 04/03		BRE	<b>301466</b>	21381		109,7 69,3 17,8	↳ 4 x ↗ 370 mm / 290 mm
1.8i, 1.8i GPL, 2.0, 2.0HDi, 2.0HPi, 2.0i, 2.0i Turbo, 2.1TD, 2.2HDI, 2.2i, 3.0, 3.0i V6  (2),(4),(5)	10/95 ▶ 10/04		ATE	<b>301063</b>	21279		63,5 57 16,4	
<b>407 (2004&gt;2011)</b> 								
1.6HDI, 1.8i, 2.0HDi, 2.0i  (4),(5)	04/04 ▶ 05/11		LUC	<b>301662</b>	24134		131,4 66,8 19,5	↳ 2 x ↗ 325 mm / 365 mm
<b>4007 (2007&gt;)</b> 								
2.0i 147, 2.2HDI, 2.4i	07/07 ▶		AKE	<b>301852</b>	24014		85,5 40 15,5 106 35,5	
<b>4008 (2012&gt;)</b> 								
1.6HDI 115, 1.6i 115, 1.8HDI 150, 2.0i 150	03/12 ▶ 10/12		AKE	<b>301852</b>	24014		85,5 40 15,5 106 35,5	
<b>607 (2000&gt;2004)</b> 								
2.0HDi, 2.0i, 2.2HDI, 2.2i, 3.0i V6	05/00 ▶ 09/04		ATE	<b>301063</b>	21279		63,5 57 16,4	
<b>806 (94&gt;98)</b> 								
1.9TD, 2.0i, 2.0i Turbo, 2.1TD	07/94 ▶ 09/98		LUC	<b>301064</b>	21801		130 57,4 18,8	↳ 4 x ↗ 240 mm / 195 mm
<b>806 (98&gt;2002)</b> 								
1.9TD, 2.0HDi, 2.0i, 2.0i Turbo CT, 2.1TD	10/98 ▶ 05/02		LUC	<b>301064</b>	21801		130 57,4 18,8	↳ 4 x ↗ 240 mm / 195 mm
<b>807 (2002&gt;)</b> 								
2.0HDi, 2.0HDi 136, 2.0HDi 163, 2.0i, 2.2HDI, 2.2i, 3.0i V6	06/02 ▶		LUC	<b>301463</b>	20960		87 52,9 17	
<b>Bipper (2007&gt;)</b> 								
1.4HDI, 1.4i  (5)	12/07 ▶		BSC	<b>301426</b>	23705		123 53,3 17,8	↳ 1 x ↗ 215 mm
<b>Boxer I (94&gt;2001)</b> 								
1.9D, 1.9TD, 2.0, 2.0HDi, 2.0i, 2.5D, 2.5TD, 2.5TDi, 2.8D, 2.8HDI, 2.8TD  (2),(3),(4)	02/94 ▶ 12/01		LUC	<b>301010</b>	21797		145 60,8 19,2	↳ 2 x ↗ 200 mm
1.9D, 1.9TD, 2.0, 2.0HDi, 2.0i, 2.5D, 2.5TD, 2.5TDi, 2.8D, 2.8HDI, 2.8TD  (2),(3),(4)	02/94 ▶ 12/01		LUC	<b>301429</b>	21797		145 60,9 19,5	↳ 1 x ↗ 300 mm
<b>Boxer II (2002&gt;2006)</b> 								
2.0HDi, 2.0i, 2.2HDI, 2.8HDI  (2),(4)	01/02 ▶ 06/06		BRE	<b>301568</b>	23918		140,5 65,8 19	↳ 1 x ↗ 175 mm
2.0i, 2.2HDI, 2.8HDI  (2),(4)	01/02 ▶ 06/06		BRE	<b>301569</b>	23919		164,6 69,3 18,3	↳ 1 x ↗ 175 mm
2.0i, 2.2HDI, 2.8HDI  (2),(4)	01/02 ▶ 06/06		BRE	<b>301570</b>	23921		109,5 49,8 20	

				<b>Valeo</b>	<b>WVA</b>							
<b>PEUGEOT (.../...)</b>												
<b>Boxer III (2006&gt;)</b> 												
2.2HDI, 2.2HDI 110, 2.2HDI 120, 2.2HDI 130, 2.2HDI 150, 3.0HDI, 3.0HDI 160, 3.0HDI 180   (2),(4),(5)	07/06 ▶		BSC	<b>301892</b>	24465		137	48,8	18,8			
<b>Expert I (95&gt;2003)</b> 												
1.6i, 1.9D, 1.9TD, 2.0HDI, 2.0i   (2),(3),(4),(5)	09/95 ▶ 12/03		LUC	<b>301064</b>	21801		130	57,4	18,8	↳ 4x  240 mm / 195 mm		
<b>Partner (M49) (96&gt;2002)</b> 												
1.1i, 1.1i GPL, 1.4, 1.4i, 1.4i GPL, 1.6i, 1.8D, 1.8i, 1.9D, 2.0HDI   (3),(5)	06/96 ▶ 11/02		LUC	<b>301326</b>	23124		130	56,2	18,5	↳ 4x  275 mm / 310 mm		
1.6i, 1.8D, 1.8i, 1.9D, 2.0HDI   (3),(5)	05/00 ▶ 11/02		BSC	<b>301464</b>	23599		137	50	19			
<b>Partner (M59) (2002&gt;)</b> 												
1.1i, 1.4i, 1.4i GNV, 1.4i GPL, 1.6HDI, 1.6i, 1.9D, 2.0HDI   (2),(3) ESP-	11/02 ▶		BSC	<b>301464</b>	23599		137	50	19			
1.6HDI, 1.6i, 2.0HDI  (3) ESP+	11/02 ▶ 05/08		BSC	<b>301465</b>	23600		137	57,3	19			
1.6HDI, 1.6i, 2.0HDI  (3) ESP+	11/02 ▶ 05/08		LUC	<b>301463</b>	20960		87	52,9	17			
<b>Ranch (M49) (96&gt;2002)</b> 												
1.4i, 1.8D, 1.8i, 1.9D, 2.0HDI   (3),(5)	06/96 ▶ 11/02		LUC	<b>301326</b>	23124		130	56,2	18,5	↳ 4x  275 mm / 310 mm		
1.8D, 1.8i, 1.9D, 2.0HDI   (3)	11/01 ▶ 11/02		BSC	<b>301464</b>	23599		137	50	19			
<b>Ranch (M59) (2002&gt;2008)</b> 												
1.4i, 1.6HDI, 1.6i, 1.9D, 2.0HDI   (3),(5) ESP-	11/02 ▶ 05/08		BSC	<b>301464</b>	23599		137	50	19			
1.6HDI, 1.6i, 2.0HDI  (5) ESP+	11/02 ▶ 05/08		BSC	<b>301465</b>	23600		137	57,3	19			
1.6HDI, 1.6i, 2.0HDI  (5) ESP+	11/02 ▶ 05/08		LUC	<b>301463</b>	20960		87	52,9	17			
<b>PORSCHE</b>												
<b>Cayenne (9PA) (2003&gt;2006)</b> 												
4.5i V8, 4.5i V8 Turbo	03/03 ▶ 12/06		BRE	<b>301770</b>	23694		117,3	73,1	16,7			
<b>PROTON</b>												
<b>300 (96&gt;)</b> 												
1.6i  (3)	08/96 ▶		SUM	<b>301625</b>	21647		127,7	51,7	16	↳ 2x ⇔		
<b>400 (93&gt;2006)</b> 												
1.6i, 1.8i   (4),(5)	11/93 ▶ 2006		SUM	<b>301625</b>	21647		127,7	51,7	16	↳ 2x ⇔		
<b>RENAULT</b>												
<b>Super 5 (84&gt;96)</b> 												
1.2, 1.4, 1.4 Turbo, 1.4i, 1.6D, 1.7 (3),(5)	07/84 ▶ 12/96		LUC	<b>301002</b>	20772		100	64,9	18			
0.9, 1.1 (3),(5)	07/84 ▶ 1996		BDX	<b>301080</b>	20635		105	54,7	15	↳ 2x  205 mm		

											
<b>RENAULT (.../...)</b>											
<b>Super 5 (84&gt;96)  (.../...)</b>											
1.2, 1.4, 1.4 Turbo, 1.4i, 1.6D, 1.7   (3), (5)	07/84 ▶ 12/96		BDX	<b>301081</b>	21061		105	53,4	18		
1.4 Turbo, 1.7  (3)	07/84 ▶ 08/90		BDX	<b>301396</b>	20635		105	54,7	11		
<b>R9 (81&gt;88) </b>											
1.1, 1.2, 1.4, 1.4 Turbo, 1.6D, 1.7	10/81 ▶ 12/88		LUC	<b>301002</b>	20772		100	64,9	18		
1.1, 1.2, 1.4, 1.6D, 1.7	10/81 ▶ 12/88		BDX	<b>301081</b>	21061		105	53,4	18		
1.4 Turbo	07/86 ▶ 09/88		BDX	<b>301396</b>	20635		105	54,7	11		
<b>R11 (82&gt;89) </b>											
1.1, 1.2, 1.4, 1.4 GPL, 1.4 Turbo, 1.4i, 1.6D, 1.7, 1.7 GPL, 1.7i   (3), (5)	07/82 ▶ 07/89		LUC	<b>301002</b>	20772		100	64,9	18		
1.1, 1.2, 1.4, 1.4 GPL, 1.4i, 1.6D, 1.7, 1.7 GPL, 1.7i   (3), (5)	07/82 ▶ 07/89		BDX	<b>301081</b>	21061		105	53,4	18		
1.4 Turbo   (3), (5)	10/86 ▶ 07/89		BDX	<b>301396</b>	20635		105	54,7	11		
<b>R18 (77&gt;86) </b>											
1.4, 1.6, 1.6 Turbo, 1.6i Turbo, 2.0, 2.1D, 2.1TD Turbo, 2.2 Turbo   (3), (4), (5)	07/80 ▶ 10/86		LUC	<b>301002</b>	20772		100	64,9	18		
1.4, 1.6, 1.6 Turbo, 1.6i, 2.0, 2.1D, 2.1TD Turbo   (3), (4), (5)	07/79 ▶ 10/86		BDX	<b>301081</b>	21061		105	53,4	18		
<b>R19 (88&gt;92) </b>											
1.2, 1.4, 1.4 GPL, 1.4i, 1.7, 1.7i, 1.8, 1.8i, 1.9D, 1.9TD    (2), (3), (4), (5)	07/88 ▶ 04/92		LUC	<b>301002</b>	20772		100	64,9	18		
1.2, 1.4, 1.4 GPL, 1.4i, 1.7, 1.7i, 1.9D, 1.9TD   (3), (4), (5)	07/88 ▶ 04/92		BDX	<b>301081</b>	21061		105	53,4	18		
1.4i, 1.7, 1.7i, 1.8, 1.8i, 1.9D, 1.9TD    (2), (3), (4), (5)	06/91 ▶ 04/92		BDX	<b>301158</b>	20635		105	54,7	11		
1.4i, 1.7, 1.7i, 1.8, 1.8i, 1.9D, 1.9TD    (2), (3), (4), (5)	07/88 ▶ 06/91		BDX	<b>301396</b>	20635		105	54,7	11		
<b>R19 (92&gt;95) </b>											
1.2, 1.2e, 1.4, 1.4e, 1.4i, 1.7, 1.7i, 1.8i, 1.9D, 1.9TD    (2), (3), (4), (5)	05/92 ▶ 11/95		LUC	<b>301002</b>	20772		100	64,9	18		
1.2, 1.2e, 1.4, 1.4e, 1.4i, 1.7, 1.9D   (3), (4), (5) ABS-	05/92 ▶ 11/95		BDX	<b>301081</b>	21061		105	53,4	18		
1.4e, 1.4i, 1.7, 1.7i, 1.8i, 1.9D, 1.9TD    (2), (3), (4), (5) ABS+	05/92 ▶ 12/94		BDX	<b>301158</b>	20635		105	54,7	11		
1.4e, 1.4i, 1.7, 1.7i, 1.8i, 1.9D, 1.9TD    (2), (3), (4), (5) ABS+	12/94 ▶ 11/95		BDX	<b>301396</b>	20635		105	54,7	11		
<b>R20 (75&gt;84) </b>											
2.0, 2.1, 2.1TD Turbo D	10/79 ▶ 1984		LUC	<b>301002</b>	20772		100	64,9	18		
1.6, 2.0, 2.1	10/79 ▶ 1984		BDX	<b>301081</b>	21061		105	53,4	18		
<b>R21 (86&gt;94) </b>											
1.4, 1.7, 1.7i, 1.9D, 2.0   (4), (5)	03/86 ▶ 1994		LUC	<b>301002</b>	20772		100	64,9	18		

				<b>Valeo</b>	<b>WVA</b>					
<b>RENAULT (.../...)</b>										
<b>R21 (86&gt;94)  (.../...)</b>										
1.4, 1.7, 1.7i   (4),(5)	03/86 ▶ 1994		BDX	<b>301081</b>	21061		105	53,4	18	
2.0, 2.0i, 2.0i Turbo, 2.1D, 2.1TD, 2.2, 2.2i   (4),(5) ABS+	03/86 ▶ 1994		BRE	<b>301007</b>	20358		126	58,3	15	
<b>R21 Nevada Savanna (86&gt;95) </b>										
1.4, 1.7, 1.7i, 1.9D, 2.0  (3),(5)	06/86 ▶ 08/95		LUC	<b>301002</b>	20772		100	64,9	18	
1.7, 1.9D  (3),(5)	06/86 ▶ 01/93		BDX	<b>301081</b>	21061		105	53,4	18	
2.0, 2.1TD, 2.2  (5) ABS+	06/86 ▶ 08/95		BRE	<b>301007</b>	20358		126	58,3	15	
<b>R25 (83&gt;93) </b>										
2.0, 2.1D, 2.1TD, 2.2 ABS+	09/83 ▶ 1992		LUC	<b>301002</b>	20772		100	64,9	18	
2.5 V6 Turbo, 2.6 V6 Injection, 2.8 V6, 2.8 V6 Injection	09/83 ▶ 1992		LUC	<b>301061</b>	20916		129,85	55,5	18,3	↳ 2 x  260 mm
<b>R30 (75&gt;84) </b>										
2.1TD Turbo D	10/81 ▶ 1984		LUC	<b>301002</b>	20772		100	64,9	18	
<b>Alpine GT D500 (84&gt;91) </b>										
2.5 V6 Turbo, 2.8 V6	09/84 ▶ 1991		LUC	<b>301002</b>	20772		100	64,9	18	
<b>Avantime (2001&gt;2003) </b>										
2.0i Turbo, 2.2dCi, 3.0i V6	09/01 ▶ 03/03		LUC	<b>301180</b>	20960		87	53	15,2	
<b>Captur (2013&gt;) </b>										
0.9TCe	04/13 ▶		LUC	<b>301641</b>	23973		116,4	52,5	17,3	
<b>Cherokee (84&gt;93) </b>										
2.1TD, 4.0 (3),(5)	01/90 ▶ 01/93		KELS	<b>301491</b>	21822		177	55	17,1	
<b>Clio I (90&gt;96) </b>										
1.1, 1.2, 1.2i, 1.4, 1.4i, 1.7, 1.8i, 1.9D, 2.0i, Electrique (3),(5)	06/90 ▶ 02/96		LUC	<b>301002</b>	20772		100	64,9	18	
1.1 (3),(5)	06/90 ▶ 05/92		BDX	<b>301080</b>	20635		105	54,7	15	↳ 2 x  205 mm
1.1, 1.2, 1.2i, 1.4, 1.4i, 1.7, 1.8i, 1.9D, Electrique (3),(5)	06/90 ▶ 02/96		BDX	<b>301081</b>	21061		105	53,4	18	
1.2i, 1.4i, 1.7, 1.8i, 1.9D, 2.0i (3),(5) ABS+	06/90 ▶ 05/95		BDX	<b>301158</b>	20635		105	54,7	11	
1.2i, 1.4i, 1.7, 1.8i, 1.9D, 2.0i (3),(5) ABS+	06/90 ▶ 02/96		BDX	<b>301396</b>	20635		105	54,7	11	
<b>Clio I (96&gt;98) </b>										
1.2, 1.2i, 1.4, 1.4i, 1.8i, 1.9D, Electrique (3),(5)	03/96 ▶ 02/98		LUC	<b>301002</b>	20772		100	64,9	18	
1.2, 1.2i, 1.4, 1.4i, 1.8i, 1.9D, Electrique (3),(5)	03/96 ▶ 02/98		BDX	<b>301081</b>	21061		105	53,4	18	
1.2i, 1.4i, 1.8i, 1.9D (3),(5) ABS+	03/96 ▶ 02/98		BDX	<b>301396</b>	20635		105	54,7	11	















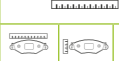
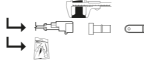















































				<b>Valeo</b>	<b>WVA</b>						<b>RENAULT (.../...)</b>
<b>Clio II (98&gt;2001)</b> 											
1.2i, 1.2i GPL, 1.4i, 1.6i, 1.9D, 1.9dTi   (3),(4),(5)	03/98 ▶ 03/01		LUC	<b>301002</b>	20772		100	64,9	18		
2.0i  (3)	01/00 ▶ 03/01		LUC	<b>301473</b>	20916		129	55,6	18		
2.0i  (3)	01/00 ▶ 03/01		BDX	<b>301396</b>	20635		105	54,7	11		
<b>Clio II (2001&gt;2008)</b> 											
1.0i, 1.2i, 1.2i GPL, 1.4i, 1.5dCi, 1.6i, 1.6i GNV, 1.9D, 1.9dTi   (3),(4),(5)	04/01 ▶ 11/08		LUC	<b>301002</b>	20772		100	64,9	18		
2.0i  (3)	04/01 ▶ 12/04		LUC	<b>301473</b>	20916		129	55,6	18		
1.6i, 1.6i GNV, 2.0i  (3),(5) ESP+	04/01 ▶ 12/04		BDX	<b>301396</b>	20635		105	54,7	11		
<b>Clio III (2005&gt;2009)</b> 											
1.2i, 1.2i TCE, 1.4i, 1.5dCi, 1.6i   (3),(5)	09/05 ▶ 04/09		LUC	<b>301641</b>	23973		116,4	52,5	17,3		
1.2i, 1.2i TCE, 1.4i, 1.5dCi, 1.6i, 2.0i   (3),(5) ESP+	09/05 ▶ 04/09		LUC	<b>301180</b>	20960		87	53	15,2		
2.0i  (3)	06/06 ▶ 04/09		LUC	<b>301474</b>	20960		87	53	16		
<b>Clio III (2009&gt;)</b> 											
1.2TCe 100, 1.2i 65, 1.2i 75, 1.4i, 1.5dCi 105, 1.5dCi 106, 1.5dCi 70, 1.5dCi 75, 1.5dCi 85, 1.5dCi 90, 1.6i 110, 1.6i 128, 2.0i 140   (3),(5)	04/09 ▶		LUC	<b>301641</b>	23973		116,4	52,5	17,3		
1.2TCe 100, 1.2i 65, 1.2i 75, 1.4i, 1.5dCi 105, 1.5dCi 106, 1.5dCi 70, 1.5dCi 75, 1.5dCi 85, 1.5dCi 90, 1.6i 110, 1.6i 128, 2.0i 140   (3),(5)	04/09 ▶		LUC	<b>301180</b>	20960		87	53	15,2		
2.0i 201  (3)	04/09 ▶		LUC	<b>301474</b>	20960		87	53	16		
<b>Clio Campus Evolution (2009&gt;)</b> 											
1.2i, 1.5dCi 65, 1.5dCi 70, 1.5dCi 85  (3),(5)	06/09 ▶		LUC	<b>301002</b>	20772		100	64,9	18		
<b>Clio IV (2012&gt;)</b> 											
0.9TCe, 1.2, 1.2TCe, 1.5dCi  (5)	01/13 ▶		LUC	<b>301641</b>	23973		116,4	52,5	17,3		
<b>Duster (2010&gt;)</b> 											
1.5dCi, 1.6i, 1.6i Gaz (5) ABS-	03/10 ▶		LUC	<b>301641</b>	23973		116,4	52,5	17,3		
<b>Espace II (91&gt;96)</b> 											
2.8 V6	04/91 ▶ 08/96		LUC	<b>301061</b>	20916		129,85	55,5	18,3	↳ 2x → 260 mm	
<b>Espace III (96&gt;2000)</b> 											
2.0i, 3.0i V6	09/96 ▶ 06/00		BRE	<b>301007</b>	20358		126	58,3	15		
<b>Espace III (2000&gt;2002)</b> 											
2.0i, 2.2dCi, 3.0i V6	07/00 ▶ 10/02		LUC	<b>301545</b>	23099		145	62,5	18		
2.0i, 2.2dCi, 3.0i V6	07/00 ▶ 10/02		LUC	<b>301180</b>	20960		87	53	15,2		

										
<b>RENAULT (.../...)</b>										
<b>Espace IV (2002&gt;2006)</b> 										
1.9dCi, 2.0i, 2.0i Turbo, 2.2dCi, 3.0dCi, 3.5i V6	09/02 ▶ 02/06		ATE	<b>301471</b>	23659		155,2	70	18	
							156,4	66,5		
1.9dCi, 2.0i, 2.0i Turbo, 2.2dCi, 3.0dCi, 3.5i V6	09/02 ▶ 02/06		ATE	<b>301472</b>	23482		123,1	52	16,6	
<b>Espace IV (2006&gt;2010)</b> 										
2.0dCi, 2.0i, 2.0i Turbo, 2.2dCi, 3.0dCi V6, 3.5i V6	03/06 ▶ 12/10		ATE	<b>301471</b>	23659		155,2	70	18	
							156,4	66,5		
2.0dCi, 2.0i, 2.0i Turbo, 2.2dCi, 3.0dCi V6, 3.5i V6	03/06 ▶ 12/10		ATE	<b>301472</b>	23482		123,1	52	16,6	
<b>Espace IV (2010&gt;2012)</b> 										
2.0dCi 130, 2.0dCi 150, 2.0dCi 175	09/10 ▶ 07/12		ATE	<b>301471</b>	23659		155,2	70	18	
							156,4	66,5		
2.0dCi 130, 2.0dCi 150, 2.0dCi 175	09/10 ▶ 07/12		ATE	<b>301472</b>	23482		123,1	52	16,6	
<b>Express (85&gt;91)</b> 										
1.0, 1.1, 1.4, 1.4i, 1.6D 	09/85 ▶ 08/91		LUC	<b>301002</b>	20772		100	64,9	18	
1.0, 1.1, 1.6D 	09/85 ▶ 05/88		BDX	<b>301080</b>	20635		105	54,7	15	↳ 2 x → 205 mm
1.0, 1.1, 1.4, 1.4i, 1.6D 	09/85 ▶ 08/91		BDX	<b>301081</b>	21061		105	53,4	18	
<b>Express (91&gt;2003)</b> 										
1.1, 1.2, 1.2i, 1.4, 1.4i, 1.6D, 1.9D 	09/91 ▶ 08/97		LUC	<b>301002</b>	20772		100	64,9	18	
1.1, 1.2, 1.2i, 1.4, 1.4i, 1.6D, 1.9D 	09/91 ▶ 02/03		BDX	<b>301081</b>	21061		105	53,4	18	
<b>Extra (85&gt;91)</b> 										
1.0, 1.1 	09/85 ▶ 06/88		BDX	<b>301080</b>	20635		105	54,7	15	↳ 2 x → 205 mm
1.0, 1.1, 1.4, 1.6D 	09/85 ▶ 08/91		BDX	<b>301081</b>	21061		105	53,4	18	
<b>Extra (91&gt;97)</b> 										
1.2, 1.2i, 1.4, 1.4i, 1.6D, 1.9D 	09/91 ▶ 08/97		LUC	<b>301002</b>	20772		100	64,9	18	
1.2, 1.2i, 1.4, 1.4i, 1.6D, 1.9D 	09/91 ▶ 08/97		BDX	<b>301081</b>	21061		105	53,4	18	
<b>Fluence (2009&gt;)</b> 										
1.5dCi, 1.5dCi 110, 1.5dCi 85, 1.5dCi 90, 1.6dCi 130, 1.6i 110, 1.6i 115, 2.0TCe 180, 2.0i 140  ABS+ FREM+ : Mecanic parking brake+	11/09 ▶		LUC	<b>301474</b>	20960		87	53	16	
<b>Fuego (79&gt;85)</b> 										
1.4, 1.6, 1.6 Turbo, 1.6i Turbo, 2.0, 2.1TD, 2.2	09/79 ▶ 06/85		LUC	<b>301002</b>	20772		100	64,9	18	
1.4, 1.6, 2.0, 2.2, 2.2 Turbo	09/79 ▶ 1985		BDX	<b>301081</b>	21061		105	53,4	18	

											
<b>RENAULT (.../...)</b>											
<b>Jeep (82&gt;93)</b> 											
2.5	03/89 ▶ 01/93		KELS	<b>301491</b>	21822			177	55	17,1	
<b>Kangoo (97&gt;2003)</b> 											
1.6i, 1.9dCi, 1.9dTi  (4),(5)	01/02 ▶ 02/03		BSC	<b>301558</b>	23930			136,8	59,5	18,3	
1.2i, 1.4i, 1.6i, 1.9D, 1.9DTi  (4),(5)	09/97 ▶ 02/03		BSC	<b>301726</b>	21980			131	47,3	18	
ABS-											
1.2i, 1.2i GPL, 1.4i, 1.5dCi, 1.6i, 1.9D, 1.9DTi, Road  (4),(5)	09/97 ▶ 02/03		BSC	<b>301726</b>	21980			131	47,3	18	
<b>Kangoo (2003&gt;2009)</b> 											
1.6i, 1.9dCi  (4),(5)	03/03 ▶ 12/07		BSC	<b>301558</b>	23930			136,8	59,5	18,3	
1.2i, 1.2i GPL, 1.4i, 1.5dCi, 1.6i, 1.6i GNV, 1.9D, 1.9dCi, 1.9dTi  (4),(5)	03/03 ▶ 06/09		BSC	<b>301726</b>	21980			131	47,3	18	
<b>Kangoo (2007&gt;)</b> 											
1.5dCi, 1.5dCi 105, 1.5dCi 75, 1.5dCi 90, 1.6i, 1.6i 105  (3),(4),(5)	11/07 ▶		LUC	<b>301641</b>	23973			116,4	52,5	17,3	
<b>Kangoo (2013&gt;)</b> 											
1.5dCi, 1.6i  (5) 14"	04/13 ▶		LUC	<b>301641</b>	23973			116,4	52,5	17,3	
<b>Koleos (2008&gt;2011)</b> 											
2.0dCi, 2.5i	06/08 ▶		AKE	<b>301009</b>	23871			105,8	38	14	↳ 1x ⇐
<b>Laguna I (B56) (94&gt;98)</b> 											
1.8i, 2.0i, 2.2D, 2.2Dt, 3.0i V6	01/94 ▶ 04/98		LUC	<b>301061</b>	20916			129,85	55,5	18,3	↳ 2x ⇐ 260 mm
1.8i, 2.0i, 2.2D, 2.2Dt, 3.0i V6 ABS+	01/94 ▶ 04/98		BRE	<b>301007</b>	20358			126	58,3	15	
<b>Laguna I (B56) (98&gt;2000)</b> 											
1.6i, 1.8i, 1.8i GPL, 1.9dTi, 2.0i, 2.2dT, 3.0i V6	05/98 ▶ 12/00		LUC	<b>301061</b>	20916			129,85	55,5	18,3	↳ 2x ⇐ 260 mm
1.6i, 1.8i, 1.9dCi, 2.2dT, 3.0i V6	05/98 ▶ 12/00		LUC	<b>301473</b>	20916			129	55,6	18	
<b>Laguna I Nevada (K56) (95&gt;98)</b> 											
1.8i, 2.0i, 2.2D, 2.2dT, 3.0i V6 (3),(5)	07/95 ▶ 04/98		LUC	<b>301061</b>	20916			129,85	55,5	18,3	↳ 2x ⇐ 260 mm
1.8i, 2.0i, 2.2D, 2.2dT, 3.0i V6 (3),(5)	07/95 ▶ 04/98		BRE	<b>301007</b>	20358			126	58,3	15	
ABS+											
<b>Laguna I Nevada (K56) (98&gt;2000)</b> 											
1.6i, 1.8i, 1.8i GPL, 1.9dTi, 2.0i, 2.2dT, 3.0i V6 (3),(5)	05/98 ▶ 12/00		LUC	<b>301061</b>	20916			129,85	55,5	18,3	↳ 2x ⇐ 260 mm
1.6i, 1.8i, 1.9dCi, 2.0i (5)	05/98 ▶ 12/00		LUC	<b>301473</b>	20916			129	55,6	18	
<b>Laguna II (2001&gt;2005)</b> 											
1.6i, 1.6i GPL, 1.8i, 1.9dCi, 2.0i, 2.0i Turbo, 2.0ide, 2.2dCi, 3.0i V6  (5) 16"	01/01 ▶ 02/05		ATE	<b>301471</b>	23659			155,2	70	18	
1.6i, 1.6i GPL, 1.8i, 1.9dCi, 2.0i, 2.0i Turbo, 2.0ide, 2.2dCi, 3.0i V6  (5)	01/01 ▶ 02/05		ATE	<b>301783</b>	24137			122,9	51,7	16,4	

											
<b>RENAULT (.../...)</b>											
<b>Laguna II (2005&gt;2007)</b> 											
1.8i, 1.9dCi, 2.0dCi, 2.0i, 2.0i Turbo, 2.0ide, 2.2dCi, 3.0i V6  (5)	03/05 ▶ 09/07		ATE	<b>301471</b>	23659		155,2	70	18		
							156,4	66,5			
1.6i, 1.6i GPL, 1.8i, 1.9dCi, 2.0dCi, 2.0i, 2.0i Turbo, 2.0ide, 2.2dCi, 3.0i V6  (5)	03/05 ▶ 09/07		ATE	<b>301783</b>	24137		122,9	51,7	16,4		
<b>Laguna III (2007&gt;2010)</b> 											
1.5dCi, 1.6i, 2.0dCi, 2.0i, 2.0i Ethanol, 2.0i Turbo, 3.0dCi V6, 3.5i V6  (3),(5)	10/07 ▶ 11/10		ATE	<b>301783</b>	24137		122,9	51,7	16,4		
<b>Laguna III (2010&gt;)</b> 											
1.5dCi 110, 2.0dCi 130, 2.0dCi 150, 2.0dCi 175, 2.0dCi 180, 2.0i 140, 2.0i Turbo 204, 3.0dCi V6-235, 3.5i V6-240  (3),(5)	11/10 ▶		ATE	<b>301783</b>	24137		122,9	51,7	16,4		
<b>Logan (2004&gt;)</b> 											
1.2i, 1.4i, 1.4i Gaz, 1.5dCi, 1.6i, 1.6i GPL, 1.6i Gaz  (4),(5) DV10+ : 259x20.7 brake disc+	09/04 ▶		LUC	<b>301002</b>	20772		100	64,9	18		
1.4i, 1.5dCi, 1.6i, 1.6i GPL, 1.6i Gaz  (2),(5) DV11+ : 260x22 brake disc+	11/08 ▶		LUC	<b>301641</b>	23973		116,4	52,5	17,3		
<b>Lutecia (Japan) (94&gt;98)</b> 											
1.4i, 1.8i	10/94 ▶ 02/98		LUC	<b>301002</b>	20772		100	64,9	18		
1.4i, 1.8i	10/94 ▶ 02/98		BDX	<b>301081</b>	21061		105	53,4	18		
1.8i	10/94 ▶ 04/95		BDX	<b>301158</b>	20635		105	54,7	11		
1.4i, 1.8i ABS+	04/95 ▶ 02/98		BDX	<b>301396</b>	20635		105	54,7	11		
<b>Mégane (95&gt;99)</b> 											
1.4i, 1.6i, 1.9D, 1.9dT, 1.9dTi, 2.0i  (2),(3),(5)	11/95 ▶ 02/99		LUC	<b>301002</b>	20772		100	64,9	18		
1.6i, 2.0i, 2.0ide  (2),(5)	11/95 ▶ 02/99		LUC	<b>301061</b>	20916		129,85	55,5	18,3	↳ 2x → 260 mm	
2.0i, 2.0ide  (2),(5)	11/95 ▶ 02/99		BDX	<b>301396</b>	20635		105	54,7	11		
<b>Mégane (98&gt;2003)</b> 											
1.4i, 1.6i, 1.9D, 1.9dTi, 2.0i  (2),(3),(5) HD+ : Heavy duty+	10/98 ▶ 02/03		LUC	<b>301002</b>	20772		100	64,9	18		
1.6i, 1.9dTi, 2.0i, 2.0ide  (2),(3),(5) HD- : Heavy duty-	10/98 ▶ 08/01		LUC	<b>301061</b>	20916		129,85	55,5	18,3	↳ 2x → 260 mm	
1.4i, 1.6i, 1.8i, 1.9dCi, 1.9dTi, 2.0i, 2.0ide  (2),(3),(5)	10/98 ▶ 02/03		LUC	<b>301473</b>	20916		129	55,6	18		
1.4i, 1.6i, 1.8i, 1.9dCi, 1.9dTi  (5) ABS+	10/98 ▶ 02/03		LUC	<b>301180</b>	20960		87	53	15,2		
1.4i, 1.6i, 1.8i, 1.9dCi, 1.9dTi, 2.0i, 2.0ide  (2),(3),(5) ESP+	02/99 ▶ 02/03		BDX	<b>301396</b>	20635		105	54,7	11		

				<b>Valeo</b>	<b>WVA</b>				<b>RENAULT (.../...)</b>		
<b>Mégane Classic (96&gt;99)</b> 											
1.4i, 1.6e, 1.6i, 1.9D, 1.9dT, 1.9dTi, 2.0i  HD+ : Heavy duty+	09/96 ▶ 02/99		LUC	<b>301002</b>	20772		100 64,9 18				
1.6i  HD- : Heavy duty-	06/98 ▶ 02/99		LUC	<b>301061</b>	20916		129,85 55,5 18,3	↳ 2 x ↖ 260 mm			
<b>Mégane Classic (99&gt;2002)</b> 											
1.4i, 1.6i, 1.9dCi, 1.9dTi, 2.0i  HD+ : Heavy duty+	03/99 ▶ 08/02		LUC	<b>301002</b>	20772		100 64,9 18				
1.9dTi, 2.0i 	03/99 ▶ 10/01		LUC	<b>301061</b>	20916		129,85 55,5 18,3	↳ 2 x ↖ 260 mm			
1.6i, 1.8i, 1.9D, 1.9dCi, 1.9dTi, 2.0i  HD- : Heavy duty-	03/99 ▶ 08/02		LUC	<b>301473</b>	20916		129 55,6 18				
1.4i, 1.6i, 1.8i, 1.9dCi, 1.9dTi, 2.0i  ESP+	01/00 ▶ 08/02		BDX	<b>301396</b>	20635		105 54,7 11				
<b>Mégane II (2002&gt;2009)</b> 											
1.4i 	09/02 ▶ 10/08		BSC	<b>301557</b>	23934		122,8 54,3 18,3				
1.4i, 1.5dCi, 1.6i, 1.6i GPL, 1.9dCi, 2.0i, 2.0i Turbo 	09/02 ▶ 10/05		BSC	<b>301558</b>	23930		136,8 59,5 18,3				
1.4i, 1.5dCi, 1.6i, 1.6i GPL, 1.9dCi, 2.0dCi, 2.0i, 2.0i Turbo 	09/02 ▶		LUC	<b>301180</b>	20960		87 53 15,2				
2.0i Turbo 	03/04 ▶ 10/08		ATE	<b>301472</b>	23482		123,1 52 16,6				
1.4i, 1.5dCi, 1.6i, 1.6i Ethanol 85, 1.6i GPL, 1.9dCi, 2.0dCi, 2.0i, 2.0i Turbo 	09/02 ▶ 07/09		LUC	<b>301474</b>	20960		87 53 16				
<b>Mégane III (2008&gt;2012)</b> 											
1.4TCe 130, 1.4i 130, 1.5dCi 105, 1.5dCi 106, 1.5dCi 110, 1.5dCi 85, 1.5dCi 90, 1.6i 100, 1.6i 110, 1.9dCi 130, 2.0TCe 180, 2.0TCe 250, 2.0dCi 150, 2.0dCi 160, 2.0i 140  FREM+ : Mecanic parking brake+	10/08 ▶		LUC	<b>301474</b>	20960		87 53 16				
<b>Mégane III (2012&gt;)</b> 											
1.2TCe 115, 1.4TCe 130, 1.5dCi 110, 1.5dCi 90, 1.6dCi 130, 1.6i 110, 2.0T 265, 2.0TCe 180, 2.0dCi 160  FREM+ : Mecanic parking brake+	04/12 ▶		LUC	<b>301474</b>	20960		87 53 16				
<b>Mégane Scenic (96&gt;99)</b> 											
1.4i, 1.6i	10/96 ▶ 09/98		LUC	<b>301002</b>	20772		100 64,9 18				
1.4i, 1.6i, 1.9D, 1.9dT, 1.9dTi, 2.0i	10/96 ▶ 09/99		LUC	<b>301061</b>	20916		129,85 55,5 18,3	↳ 2 x ↖ 260 mm			
1.4i, 1.6i, 1.9D, 1.9dTi	10/96 ▶ 09/99		LUC	<b>301473</b>	20916		129 55,6 18				
<b>Mégane Scenic (99&gt;2003)</b> 											
1.8i, 1.9dCi, 2.0i	09/99 ▶ 04/03		ATE	<b>301471</b>	23659		155,2 70 18 156,4 66,5				
1.4i, 1.6i, 1.6i GPL, 1.8i, 1.9dCi, 1.9dTi, 2.0i	09/99 ▶ 04/03		LUC	<b>301473</b>	20916		129 55,6 18				



























































										
<b>RENAULT (.../...)</b>										
<b>Mégane Scenic (99&gt;2003)  (.../...)</b>										
1.4i, 1.6i, 1.6i GPL, 1.8i, 1.9dCi, 1.9dTi, 2.0i ABS+	09/99 ▶ 04/03		LUC	<b>301180</b>	20960		87	53	15,2	
<b>Modus (2004&gt;2007) </b>										
1.2i, 1.2i TCE, 1.4i, 1.5dCi, 1.5dCi 105 FAP, 1.6i	09/04 ▶ 12/07		LUC	<b>301641</b>	23973		116,4	52,5	17,3	
1.2i, 1.2i TCE, 1.4i, 1.5dCi, 1.5dCi 105 FAP, 1.6i	09/04 ▶ 12/07		LUC	<b>301180</b>	20960		87	53	15,2	
<b>Modus (2008&gt;) </b>										
1.2TCE 100, 1.2i 75, 1.2i 80, 1.2i TCE, 1.4i 100, 1.5dCi 105, 1.5dCi 65, 1.5dCi 70, 1.5dCi 75, 1.5dCi 85, 1.5dCi 90, 1.6i 110	01/08 ▶		LUC	<b>301641</b>	23973		116,4	52,5	17,3	
1.2TCE 100, 1.2i 75, 1.2i 80, 1.2i TCE, 1.4i 100, 1.5dCi 105, 1.5dCi 65, 1.5dCi 70, 1.5dCi 75, 1.5dCi 85, 1.5dCi 90, 1.6i 110 ESP+	01/08 ▶		LUC	<b>301180</b>	20960		87	53	15,2	
<b>Rapid (85&gt;91) </b>										
1.0, 1.1 	09/85 ▶ 06/88		BDX	<b>301080</b>	20635		105	54,7	15	↳ 2 x  205 mm
1.0, 1.1, 1.4, 1.4i, 1.6D 	09/85 ▶ 08/91		BDX	<b>301081</b>	21061		105	53,4	18	
<b>Rapid (91&gt;98) </b>										
1.4i, 1.9D 	09/91 ▶ 03/98		LUC	<b>301002</b>	20772		100	64,9	18	
1.4i, 1.9D 	09/91 ▶ 03/98		BDX	<b>301081</b>	21061		105	53,4	18	
<b>Safrane (92&gt;96) </b>										
2.0Si, 2.0i, 2.1Dt, 2.2Si, 2.2i, 2.5Dt, 3.0i V6, 3.0i V6i, 3.0i V6i Biturbo	05/92 ▶ 09/96		LUC	<b>301061</b>	20916		129,85	55,5	18,3	↳ 2 x  260 mm
2.0Si, 2.0i, 2.1Dt, 2.2Si, 2.2i, 2.5Dt, 3.0i V6 ABS+	05/92 ▶ 09/96		BRE	<b>301007</b>	20358		126	58,3	15	
3.0i V6i, 3.0i V6i Biturbo	05/92 ▶ 09/96		BDX	<b>301396</b>	20635		105	54,7	11	
<b>Safrane (96&gt;2000) </b>										
2.0i, 2.2TD, 2.5i, 3.0i	09/96 ▶ 03/99		LUC	<b>301061</b>	20916		129,85	55,5	18,3	↳ 2 x  260 mm
2.0i, 2.2TD, 2.5i, 3.0i	03/99 ▶ 11/00		LUC	<b>301473</b>	20916		129	55,6	18	
2.0i, 2.2TD, 2.5i, 3.0i	09/96 ▶ 11/00		BRE	<b>301007</b>	20358		126	58,3	15	
<b>Sandero (2008&gt;) </b>										
1.4i, 1.4i Gaz, 1.6i	06/08 ▶		LUC	<b>301002</b>	20772		100	64,9	18	
<b>Scenic II (2003&gt;2009) </b>										
1.4i, 1.5dCi, 1.6i, 1.6i GPL, 1.9dCi, 2.0i, 2.0i Turbo	05/03 ▶ 10/05		BSC	<b>301558</b>	23930		136,8	59,5	18,3	
1.4i, 1.5dCi, 1.6i, 1.6i GPL, 1.9dCi, 2.0dCi, 2.0i, 2.0i Turbo	05/03 ▶ 04/07		LUC	<b>301180</b>	20960		87	53	15,2	
1.4i, 1.5dCi, 1.6i, 1.6i GPL, 1.9dCi, 2.0dCi, 2.0i, 2.0i Turbo	05/03 ▶ 11/09		LUC	<b>301474</b>	20960		87	53	16	
<b>Scenic III (2009&gt;2012) </b>										
1.4TCE 130, 1.5dCi 105, 1.5dCi 110, 1.5dCi 85, 1.5dCi 95, 1.6i 110, 1.9dCi 130, 2.0dCi 150, 2.0dCi 160, 2.0i 140 FREM+ : Mecanic parking brake+	04/09 ▶		LUC	<b>301474</b>	20960		87	53	16	

										
<b>RENAULT (.../...)</b>										
<b>Scenic III (2012&gt;)</b> 										
1.2Tce 115, 1.4TCE 130, 1.5dCi 110, 1.5dCi 95, 1.6i 110, 2.0dCi 150, 2.0dCi 160 FREM+ : Mecanic parking brake+	01/12 ▶		LUC	<b>301474</b>	20960		87	53	16	
<b>Spider (96&gt;99)</b> 										
2.0i	01/96 ▶ 10/99		LUC	<b>301061</b>	20916		129,85	55,5	18,3	↳ 2 x ↖ ↗ 260 mm
<b>Thalia (2001&gt;2008)</b> 										
1.4i, 1.5dCi, 1.6i  4	01/01 ▶ 09/08		LUC	<b>301002</b>	20772		100	64,9	18	
<b>Thalia - Symbole (2008&gt;)</b> 										
1.2i, 1.4i, 1.5dCi, 1.6i  4	10/08 ▶		LUC	<b>301002</b>	20772		100	64,9	18	
<b>Trafic II (2001&gt;2006)</b> 										
1.9dCi, 2.0i, 2.5dCi  2, 3, 5	04/01 ▶ 07/06		LUC	<b>301545</b>	23099		145	62,5	18	
<b>Trafic II (2006&gt;)</b> 										
2.0dCi, 2.0dCi eco2, 2.0i, 2.5dCi  2, 3, 5	07/06 ▶		LUC	<b>301545</b>	23099		145	62,5	18	
<b>Twingo I (93&gt;98)</b> 										
1.2i	07/96 ▶ 08/98		LUC	<b>301002</b>	20772		100	64,9	18	
1.2, 1.2i	03/93 ▶ 08/98		BDX	<b>301080</b>	20635		105	54,7	15	↳ 2 x ↖ ↗ 205 mm
<b>Twingo I (98&gt;2007)</b> 										
1.2i, 1.2i GPL	09/98 ▶ 06/07		LUC	<b>301002</b>	20772		100	64,9	18	
<b>Twingo II (2007&gt;2011)</b> 										
1.2i, 1.2i LEV, 1.2i TCE, 1.5dCi, 1.5dCi 75, 1.5dCi 85	07/07 ▶ 12/11		LUC	<b>301002</b>	20772		100	64,9	18	
1.6i	06/08 ▶ 12/11		LUC	<b>301474</b>	20960		87	53	16	
<b>Twingo II (2012&gt;)</b> 										
1.2TCE 100, 1.2i 75, 1.5dCi 75, 1.5dCi 85	01/12 ▶		LUC	<b>301002</b>	20772		100	64,9	18	
1.6 133	01/12 ▶ 11/12		LUC	<b>301474</b>	20960		87	53	16	
<b>Vel Satis (2002&gt;2005)</b> 										
2.0i Turbo, 2.2dCi, 3.0dCi V6, 3.5i V6	01/02 ▶ 01/05		ATE	<b>301471</b>	23659		155,2	70	18	
							156,4	66,5		
2.0i Turbo, 2.2dCi, 3.0dCi V6, 3.5i V6	01/02 ▶ 01/05		ATE	<b>301472</b>	23482		123,1	52	16,6	
<b>Vel Satis (2005&gt;2009)</b> 										
2.0dCi, 2.0i Turbo, 2.2dCi, 3.0dCi V6, 3.5i V6	02/05 ▶ 12/09		ATE	<b>301471</b>	23659		155,2	70	18	
							156,4	66,5		
2.0dCi, 2.0i Turbo, 2.2dCi, 3.0dCi V6, 3.5i V6	02/05 ▶ 12/09		ATE	<b>301472</b>	23482		123,1	52	16,6	
<b>Wind (2010&gt;)</b> 										
1.2TCE 100, 1.6i 133	07/10 ▶		LUC	<b>301474</b>	20960		87	53	16	

				<b>Valeo</b>	<b>WVA</b>							
<b>ROVER</b>												
<b>25 (99&gt;2005)</b> 												
1.1i, 1.4i, 1.6i, 1.8i, 2.0D, 2.0Di  (3), (5)	12/99 ▶ 04/05		LUC	<b>301022</b>	21515		129	69	18			↳ 2x ◁
1.8i, 2.0Di  (3), (5)	12/99 ▶ 04/05		AKE	<b>301053</b>	21312		89	35	13			↳ 2x ◁
<b>45 (2000&gt;2005)</b> 												
1.4i, 1.6i, 1.8i, 2.0D, 2.0Di, 2.0i V6, 2.0iDT  (4), (5)	01/00 ▶ 04/05		LUC	<b>301022</b>	21515		129	69	18			↳ 2x ◁
1.6i, 1.8i, 2.0Di, 2.0i V6  (4), (5)	01/00 ▶ 04/05		AKE	<b>301053</b>	21312		89	35	13			↳ 2x ◁
<b>75 (99&gt;2005)</b> 												
1.8T, 1.8i, 2.0CDT, 2.0CDTi, 2.0i V6, 2.5i V6  (4), (5)	02/99 ▶ 04/05		ATE	<b>301753</b>	21934		123	45	17			
<b>200 (89&gt;96)</b> 												
1.4, 1.4i, 1.6i, 1.8D, 1.8TD Turbo, 1.9D, 2.0i, 2.0i Turbo  (2), (3), (5) ABS+	10/89 ▶ 03/96		LUC	<b>301022</b>	21515		129	69	18			↳ 2x ◁
1.4, 1.4i, 1.6i, 1.8D, 1.8TD Turbo, 1.9D, 2.0i, 2.0i Turbo  (2), (3), (5) ABS+	10/89 ▶ 03/96		AKE	<b>301053</b>	21312		89	35	13			↳ 2x ◁
<b>200 (95&gt;99)</b> 												
1.1i, 1.4i, 1.6i, 1.8i, 2.0TD  (3), (5)	11/95 ▶ 11/99		LUC	<b>301022</b>	21515		129	69	18			↳ 2x ◁
1.4i, 1.6i, 1.8i, 2.0TD  (3), (5)	11/95 ▶ 11/99		AKE	<b>301053</b>	21312		89	35	13			↳ 2x ◁
<b>200 Coupé/Cabriolet (96&gt;99)</b> 												
1.6i, 1.8i VVC  (2)	03/96 ▶ 1999		LUC	<b>301022</b>	21515		129	69	18			↳ 2x ◁
1.6i, 1.8i VVC  (2) ABS+	03/96 ▶ 1999		AKE	<b>301053</b>	21312		89	35	13			↳ 2x ◁
<b>400 (90&gt;95)</b> 												
1.4i, 1.6i, 1.7TD, 1.9D, 2.0i, 2.0i Turbo  (4), (5) ABS+	03/90 ▶ 04/95		LUC	<b>301022</b>	21515		129	69	18			↳ 2x ◁
1.4i, 1.6i, 1.7TD, 1.9D, 2.0i, 2.0i Turbo  (4), (5) ABS+  _ ▶ 263665	03/90 ▶		AKE	<b>301053</b>	21312		89	35	13			↳ 2x ◁
<b>400 (95&gt;2000)</b> 												
1.4i, 1.6i, 1.8i, 2.0TD, 2.0i  (4), (5)	05/95 ▶ 03/00		LUC	<b>301022</b>	21515		129	69	18			↳ 2x ◁
1.4i, 1.6i, 1.8i, 2.0TD, 2.0i  (4), (5) ABS+	05/95 ▶ 03/00		AKE	<b>301053</b>	21312		89	35	13			↳ 2x ◁
<b>600 (93&gt;2000)</b> 												
1.8i, 2.0i, 2.0i Turbo, 2.3i	04/93 ▶ 06/00		AKE	<b>301627</b>	21651		148,6	57,7	17,5			↳ 2x ◁
1.8i, 2.0Di, 2.0SDi, 2.0i, 2.0i Turbo, 2.3i			AKE	<b>301682</b>	21719		88,9	47,5	15,4			↳ 2x ◁
<b>800 (91&gt;99)</b> 												
2.0i, 2.0i Turbo, 2.5TD, 2.5i V6, 2.7i V6  (2), (4), (5)			LUC	<b>301022</b>	21515		129	69	18			↳ 2x ◁















































































				<b>Valeo</b>	<b>WVA</b>						
<b>ROVER (.../...)</b>											
<b>Streetwise (2003&gt;2005)</b> 											
1.4i, 1.6i, 1.8i, 2.0D   (3),(5)	08/03 ▶ 04/05		LUC	<b>301022</b>	21515		129	69	18	↳ 2x 	
<b>SAAB</b>											
<b>9-3 (98&gt;2003)</b> 											
2.0SE Turbo, 2.0i, 2.0i Turbo, 2.2TiD, 2.3i   (2),(3),(5)	04/98 ▶ 12/98		ATE	<b>301305</b>	21829		156,3	74,2	20,3		
2.0SE Turbo, 2.0i, 2.0i Turbo, 2.2TiD, 2.3i, 2.3i Turbo   (2),(3),(5)	04/98 ▶ 05/03		ATE	<b>301183</b>	21051		61,7	61,2	15,7		
<b>9-3 (2002&gt;)</b> 											
1.8i, 1.8t Turbo, 1.9TiD, 2.0t Turbo, 2.2TiD   (2),(4),(5)	09/02 ▶		ATE	<b>301678</b>	23402		156,5	71	20,3		
1.8i, 1.8t Turbo, 2.0t Turbo, 2.2TiD   (2),(4)	09/02 ▶ 12/03		ATE	<b>301472</b>	23482		123,1	52	16,6		
1.8i, 1.8t Turbo, 1.9TTiD, 1.9TiD, 2.0t Turbo, 2.2TiD, 2.8t V6   (2),(4),(5)	09/02 ▶		ATE	<b>301783</b>	24137		122,9	51,7	16,4		
<b>9-5 (97&gt;2001)</b> 											
2.0i Turbo, 2.3i Turbo, 3.0i V6 Turbo   (4),(5)	09/97 ▶ 12/98		ATE	<b>301305</b>	21829		156,3	74,2	20,3		
2.0i Turbo, 2.3i Turbo, 3.0i V6 Turbo   (4),(5)  _ ▶ X3025751	09/97 ▶		ATE	<b>301183</b>	21051		61,7	61,2	15,7		
2.0i Turbo, 2.3i Turbo, 3.0i V6 Turbo   (4),(5)  X3025752 ▶ _	▶ 08/01		ATE	<b>301753</b>	21934		123	45	17		
<b>9-5 (2001&gt;2005)</b> 											
2.0i Turbo, 2.2TiD, 2.3T Turbo, 2.3i Turbo, 3.0TiD V6, 3.0i V6 Turbo   (4),(5)	09/01 ▶ 11/05		ATE	<b>301753</b>	21934		123	45	17		
<b>9-5 (2005&gt;2010)</b> 											
1.9TiD Turbo, 2.0i Turbo, 2.3i Turbo   (4),(5)  15"  16"	11/05 ▶ 06/10		ATE	<b>301753</b>	21934		123	45	17		
<b>99 (67&gt;85)</b> 											
1.9, 2.0  (2)	11/67 ▶ 07/74		ATE	<b>301099</b>	20228		61,8	56,6	15		
<b>900 (93&gt;98)</b> 											
2.0, 2.0 Turbo, 2.3, 2.5 V6   (3),(5)	07/96 ▶ 02/98		ATE	<b>301305</b>	21829		156,3	74,2	20,3		
2.0, 2.0 Turbo, 2.3, 2.5 V6   (3),(5)	07/93 ▶ 02/98		ATE	<b>301253</b>	21140		61,8	57,2	15,3		
<b>SEAT</b>											
<b>Alhambra (96&gt;2000)</b> 											
1.8i, 1.9TDi, 2.0i	03/96 ▶ 05/00		ATE	<b>301008</b>	20676		156,3	74	19,8		
1.8i, 1.9TDi, 2.0i	03/96 ▶ 05/00		LUC	<b>301463</b>	20960		87	52,9	17		
<b>Alhambra (2000&gt;2003)</b> 											
1.8i Turbo, 1.9TDi, 2.8i VR6 TU+ : Wear warning+	06/00 ▶ 05/03		ATE	<b>301565</b>	23269		161,4	72,8	19,6	↳ 2x  270 mm	
							74,5				
1.9TDi, 2.0i TU+ : Wear warning+	06/00 ▶ 05/03		ATE	<b>301801</b>	23418		156,2	78,4	19,6	↳ 1x 	

				<b>Valeo</b>	<b>WVA</b>							
<b>SEAT (.../...)</b>												
<b>Alhambra (2000&gt;2003)  (.../...)</b>												
1.8i Turbo, 1.9TDi, 2.8i VR6 TU+ : Wear warning+	06/00 ▶ 05/03		LUC	<b>301650</b>	23446		95	51	16,2	↳ 2 x +  205 mm		
1.8i Turbo, 1.9TDi, 2.0i TU+ : Wear warning+  _ ▶ 1-530 756	06/00 ▶ 05/03		LUC	<b>301681</b>	20960		87	53	17,2	↳ 1 x +  205 mm		
<b>Alhambra (2003&gt;2010) </b>												
1.8i Turbo, 1.9TDi, 2.0TDi, 2.0i, 2.8i VR6	06/03 ▶ 03/10		ATE	<b>301565</b>	23269		161,4	72,8	19,6	↳ 2 x +  270 mm		
1.9TDi	06/03 ▶ 03/10		ATE	<b>301801</b>	23418		156,2	78,4	19,6	↳ 1 x + 		
1.8i Turbo, 1.9TDi, 2.0TDi, 2.0i, 2.8i VR6	06/03 ▶ 03/10		LUC	<b>301650</b>	23446		95	51	16,2	↳ 2 x +  205 mm		
1.9TDi	06/03 ▶ 03/10		LUC	<b>301681</b>	20960		87	53	17,2	↳ 1 x +  205 mm		
<b>Alhambra (2010&gt;) </b>												
1.4TSi 150, 2.0TDi CR 116, 2.0TDi CR 136, 2.0TDi CR 140, 2.0TDi CR 170, 2.0TFSi 200	06/10 ▶		TRW	<b>301752</b>	23914		105,1	56	17			
<b>Altea (2004&gt;2009) </b>												
1.4i 86, 1.6i 102, 1.9TDi 105	03/04 ▶ 03/09		ATE	<b>301408</b>	21974		146	54,7	18,5	↳ 1 x +  155 mm		
1.4TSi 125, 1.8FSi 160, 1.8TFSi 160, 2.0FSi 150, 2.0TDi 136, 2.0TDi 140, 2.0TDi 170, 2.0TDi PD 170, 2.0TFSi 200	03/04 ▶ 03/09		ATE	<b>301635</b>	23587		156,4	71,4	20,3	↳ 1 x +  155 mm		
1.4i 86, 1.6i 102, 1.9TDi 105	03/04 ▶ 03/09		LUC	<b>301463</b>	20960		87	52,9	17			
1.4TSi 125, 1.8FSi 160, 1.8TFSi 160, 2.0FSi 150, 2.0TDi 136, 2.0TDi 140, 2.0TDi 170, 2.0TDi PD 170, 2.0TFSi 200	03/04 ▶ 03/09		TRW	<b>301752</b>	23914		105,1	56	17			
<b>Altea (2009&gt;) </b>												
1.2TSi 105, 1.4i 86, 1.6TDi CR 105, 1.6TDi CR 90, 1.6i 102, 1.6i LPG 102, 1.9TDi 105, 1.9TDi 90	03/09 ▶		ATE	<b>301408</b>	21974		146	54,7	18,5	↳ 1 x +  155 mm		
1.4TSi 125, 1.8TFSi 160, 2.0TDi 140, 2.0TDi CR 140, 2.0TDi CR 170, 2.0TDi PD 170, 2.0TFSi 211	03/09 ▶		ATE	<b>301635</b>	23587		156,4	71,4	20,3	↳ 1 x +  155 mm		
1.2TSi 105, 1.4i 86, 1.6TDi CR 105, 1.6TDi CR 90, 1.6i 102, 1.6i LPG 102, 1.9TDi 105, 1.9TDi 90	03/09 ▶		LUC	<b>301463</b>	20960		87	52,9	17			
1.4TSi 125, 1.8TFSi 160, 2.0TDi 140, 2.0TDi CR 140, 2.0TDi CR 170, 2.0TDi PD 170, 2.0TFSi 211	03/09 ▶		TRW	<b>301752</b>	23914		105,1	56	17			
<b>Arosa (97&gt;2004) </b>												
1.4i	10/99 ▶ 06/04		LUC	<b>301330</b>	21945		119	69,5	16,3			
1.0i, 1.4TDi, 1.4i, 1.7SDi	02/97 ▶ 06/04		ATE	<b>301488</b>	21865		141,8	51,2	17,3			
1.4i	10/99 ▶ 06/02		LUC	<b>301463</b>	20960		87	52,9	17			
1.4i	07/02 ▶ 06/04		LUC	<b>301674</b>	20960		87	53	17	↳ 1 x +  260 mm		

				<b>Valeo</b>	<b>WVA</b>				<b>SEAT (.../...)</b>
<b>Cordoba (93&gt;96)</b> 									
1.8i, 2.0i  (4)  _ ▶ TR-184 566	09/93 ▶ 04/96		LUC	<b>301016</b>	20901		119 69,5 15,7	↳ 2 x ↗ 225 mm	
1.4i, 1.6i, 1.8i, 1.9D, 1.9SDi, 1.9TD  (4) ABS+  TR-046 559 ▶ _	09/95 ▶ 06/96		ATE	<b>301066</b>	21866		141,8 50,5 19,7		
1.4i  (4) ABS-  TR-099 021 ▶ _	11/95 ▶ 06/96		VW	<b>301258</b>	20887		137,8 49 17,2 51,1		
1.8i, 2.0i  (4)	09/93 ▶ 06/96		LUC	<b>301330</b>	21945		119 69,5 16,3		
1.8i, 2.0i  (4)	09/93 ▶ 06/96		LUC	<b>301180</b>	20960		87 53 15,2		
<b>Cordoba (96&gt;99)</b> 									
1.0i, 1.4i, 1.6i, 1.9D, 1.9SDi   (2,4,5)  _ ▶ V-241 400	07/96 ▶ 04/99		ATE	<b>301066</b>	21866		141,8 50,5 19,7		
1.8i, 2.0i   (2,4,5)	07/96 ▶ 05/99		LUC	<b>301252</b>	20901		119 69,5 19,6		
1.0i, 1.4i, 1.6i, 1.9D, 1.9SDi   (2,4,5) ABS-  _ ▶ V-241 400	07/96 ▶ 09/97		VW	<b>301258</b>	20887		137,8 49 17,2 51,1		
1.4i, 1.6i, 1.9TD, 1.9TDi   (2,4,5)	07/96 ▶ 05/99		LUC	<b>301330</b>	21945		119 69,5 16,3		
1.0i, 1.4i, 1.6i, 1.9SDi   (2,4,5)  W-000 001 ▶ _	05/97 ▶ 05/99		ATE	<b>301403</b>	21866		141,8 50,5 15 51,2		
1.9TDi, 2.0i   (2,4,5)	07/96 ▶ 05/99		LUC	<b>301180</b>	20960		87 53 15,2		
<b>Cordoba (99&gt;2002)</b> 									
1.8i Turbo, 1.9TDi   (2,4,5)	03/99 ▶ 08/02		LUC	<b>301252</b>	20901		119 69,5 19,6		
1.0i, 1.4i, 1.6i, 1.9SDi, 1.9TDi   (2,4,5)	05/99 ▶ 08/02		LUC	<b>301330</b>	21945		119 69,5 16,3		
1.0i, 1.4i, 1.6i, 1.9SDi, 1.9TDi   (2,4,5)	05/99 ▶ 08/02		ATE	<b>301403</b>	21866		141,8 50,5 15 51,2		
1.8i Turbo, 1.9TDi   (2,4,5)	03/99 ▶ 08/02		LUC	<b>301463</b>	20960		87 52,9 17		
<b>Cordoba (2002&gt;2009)</b> 									
1.2i, 1.4TDi, 1.4i, 1.6i, 1.9SDi, 1.9TDi, 2.0i  (4)	09/02 ▶ 11/09		ATE	<b>301332</b>	21974		146 54,7 19,8		
1.9TDi  (4)	10/02 ▶ 11/09		LUC	<b>301667</b>	23581		131,4 62,3 18,7		
1.9TDi  (4)	10/02 ▶ 11/09		LUC	<b>301463</b>	20960		87 52,9 17		
1.4i, 1.6i, 1.9TDi, 2.0i  (4)	09/02 ▶ 11/09		LUC	<b>301674</b>	20960		87 53 17	↳ 1 x ↗ 260 mm	
<b>Exeo (2008&gt;)</b> 									
1.8TFSi, 1.8i Turbo, 2.0TDI, 2.0TDI 143   (4,5)	12/08 ▶		ATE	<b>301483</b>	20676		156,4 74,2 20,3	↳ 2 x ↗ 210 mm	

											
<b>SEAT (.../...)</b>											
<b>Exeo (2008&gt;)  (.../...)</b>											
 1.6i, 1.8TFSi, 2.0TDI, 2.0TDI 120   (4),(5)	12/08 ▶		LUC	<b>301484</b>	23393		119	69,5	19,4	↳ 2 x  210 mm	
 1.6i, 1.8TFSi, 1.8i Turbo, 2.0TDI, 2.0TDI 120, 2.0TDI 143   (4),(5)	12/08 ▶		LUC	<b>301474</b>	20960		87	53	16		
 2.0TFSi   (4),(5)	03/09 ▶		TRW	<b>301752</b>	23914		105,1	56	17		
<b>Ibiza (84&gt;93) </b>											
0.9, 1.2, 1.2i, 1.5, 1.5i, 1.7D, 1.7i (3),(5)	08/84 ▶ 02/93		BDX	<b>301091</b>	20775		108,8	47,4	18	↳ 2 x 	
<b>Ibiza (93&gt;96) </b>											
1.8i, 2.0i (3),(5)	02/93 ▶ 06/96		LUC	<b>301016</b>	20901		119	69,5	15,7	↳ 2 x  225 mm	
1.8i (3)	▶ 06/96		ATE	<b>301066</b>	21866		141,8	50,5	19,7		
 TR-046 559 ▶ _											
1.05i, 1.4i, 1.9SDI (3),(5)	▶ 06/96		VW	<b>301258</b>	20887		137,8	49	17,2		
 TR-099 021 ▶ _							51,1				
1.8i, 2.0i (3),(5)	02/93 ▶ 06/96		LUC	<b>301330</b>	21945		119	69,5	16,3		
1.8i, 2.0i (3),(5)	02/93 ▶ 06/96		LUC	<b>301180</b>	20960		87	53	15,2		
<b>Ibiza (96&gt;99) </b>											
1.0i, 1.4i, 1.6i, 1.9D, 1.9SDi (3),(5)	07/96 ▶ 09/97		ATE	<b>301066</b>	21866		141,8	50,5	19,7		
 _ ▶ V-241 400											
1.8i, 1.9TDi, 2.0i (3),(5)	07/96 ▶ 06/99		LUC	<b>301252</b>	20901		119	69,5	19,6		
1.0i, 1.4i, 1.6i, 1.9D, 1.9SDi (3),(5)	07/96 ▶ 09/97		VW	<b>301258</b>	20887		137,8	49	17,2		
 _ ▶ V-241 400							51,1				
1.4i, 1.6i, 1.9TD, 1.9TDi (3),(5)	07/96 ▶ 06/99		LUC	<b>301330</b>	21945		119	69,5	16,3		
1.0i, 1.4i, 1.6i, 1.9D, 1.9SDi (3),(5)	09/97 ▶ 06/99		ATE	<b>301403</b>	21866		141,8	50,5	15		
 W-000 001 ▶ _							51,2				
<b>Ibiza (99&gt;2001) </b>											
1.8i Turbo, 1.9TDi (3),(5)	03/99 ▶ 11/01		LUC	<b>301252</b>	20901		119	69,5	19,6		
1.4i, 1.6i (3),(5)	06/99 ▶ 11/01		LUC	<b>301330</b>	21945		119	69,5	16,3		
1.0i, 1.4i, 1.6i, 1.9SDi, 1.9TDi (3),(5)	04/99 ▶ 11/01		ATE	<b>301403</b>	21866		141,8	50,5	15		
1.8i Turbo, 1.9TDi (3),(5)	03/99 ▶ 11/01		LUC	<b>301463</b>	20960		87	52,9	17		
<b>Ibiza (2001&gt;2009) </b>											
1.2i, 1.4TDi, 1.4i, 1.9SDi (3),(5)	11/01 ▶ 11/09		ATE	<b>301332</b>	21974		146	54,7	19,8		
1.8i Turbo, 1.9TDi (3)	12/03 ▶ 02/08		ATE	<b>301486</b>	21911		156,35	74,1	19,5	↳ 1 x  155 mm	

























				<b>Valeo</b>	<b>VVA</b>				
<b>SEAT (.../...)</b>									
<b>Ibiza (2001&gt;2009)  (.../...)</b>									
1.4i, 1.6i, 1.8i Turbo, 1.9TDi, 2.0i   (3), (5)	09/01 ▶ 11/09		LUC	<b>301667</b>	23581		131,4	62,3	18,7
1.4i, 1.6i, 1.8i Turbo, 1.9TDi, 2.0i   (3), (5) TU+ : Wear warning+	09/01 ▶ 11/09		LUC	<b>301720</b>	23581		131,4	62,3	18,7
1.4i, 1.8i Turbo, 1.9TDi, 2.0i   (3), (5)	09/01 ▶ 11/09		LUC	<b>301463</b>	20960		87	52,9	17
1.4i, 1.6i, 1.8i Turbo, 1.9TDi, 2.0i   (3), (5)	09/01 ▶ 11/09		LUC	<b>301674</b>	20960		87	53	17
<b>Ibiza (2008&gt;2012) </b>									
1.2TDi, 1.2TSi, 1.2i, 1.2i 60, 1.4TDi, 1.4i, 1.6TDi, 1.6i, 1.9TDi   (3), (5)	03/08 ▶ 03/12		ATE	<b>301332</b>	21974		146	54,7	19,8
1.2TDi, 1.2TSi, 1.2i, 1.2i 60, 1.4TDi, 1.4i, 1.6TDi, 1.6i, 1.9TDi   (3), (5)	03/08 ▶ 03/12		ATE	<b>301408</b>	21974		146	54,7	18,5
1.4TSi, 2.0TDi, 2.0i   (3), (5)	09/08 ▶ 03/12		ATE	<b>301635</b>	23587		156,4	71,4	20,3
1.4TFSi, 1.4TSi, 2.0TDi, 2.0i   (3), (5)	09/08 ▶ 03/12		LUC	<b>301463</b>	20960		87	52,9	17
<b>Ibiza (2012&gt;) </b>									
1.4TSi, 2.0TDi, 2.0i   (3), (5)	02/12 ▶		ATE	<b>301635</b>	23587		156,4	71,4	20,3
1.2TSi, 1.4TSi, 1.6TDi, 1.6i, 2.0TDi, 2.0i   (3), (5)	02/12 ▶		LUC	<b>301463</b>	20960		87	52,9	17
<b>Inca (95&gt;2003) </b>									
1.4i, 1.6i, 1.9D, 1.9SDi	11/95 ▶ 03/96		LUC	<b>301252</b>	20901		119	69,5	19,6
1.4i, 1.6i, 1.7SDi, 1.9D, 1.9SDi	03/96 ▶ 06/03		LUC	<b>301330</b>	21945		119	69,5	16,3
<b>Leon (99&gt;2006) </b>									
1.4i, 1.6i, 1.8i, 1.9SDi, 1.9TDi TU- : Wear warning-	08/99 ▶ 05/06		ATE	<b>301332</b>	21974		146	54,7	19,8
1.4i, 1.6i, 1.8i, 1.9SDi, 1.9TDi TU+ : Wear warning+	08/99 ▶ 05/06		ATE	<b>301408</b>	21974		146	54,7	18,5
1.8i Turbo, 1.9TDi, 2.8i V6	08/99 ▶ 05/06		ATE	<b>301486</b>	21911		156,35	74,1	19,5
1.4i, 1.6i, 1.8i, 1.8i Turbo, 1.9SDi, 1.9TDi, 2.8i V6	08/99 ▶ 05/06		LUC	<b>301463</b>	20960		87	52,9	17
<b>Leon (2005&gt;2010) </b>									
1.2TSi 105, 1.4i 86, 1.6TDi CR 105, 1.6i 102, 1.6i LPG 102, 1.9TDi 105, 1.9TDi 90	07/05 ▶ 05/10		ATE	<b>301408</b>	21974		146	54,7	18,5
1.4TFSi 125, 1.8TFSi 160, 2.0FSi 150, 2.0TDi 136, 2.0TDi 140, 2.0TDi 170, 2.0TFSi 185, 2.0TFSi 200, 2.0TFSi 211	07/05 ▶ 05/10		ATE	<b>301635</b>	23587		156,4	71,4	20,3
1.2TSi 105, 1.4TFSi 125, 1.4i 86, 1.6TDi CR 105, 1.6i 102, 1.6i LPG 102, 1.8TFSi 160, 1.9TDi 105, 1.9TDi 90, 2.0FSi 150, 2.0TDi 136, 2.0TDi 140	07/05 ▶ 05/10		LUC	<b>301463</b>	20960		87	52,9	17
1.8TFSi 160, 2.0TDi 170, 2.0TFSi, 2.0TFSi 185, 2.0TFSi 200, 2.0TFSi 241, 2.0TFSi 265	11/05 ▶		TRW	<b>301752</b>	23914		105,1	56	17

											
<b>SEAT (.../...)</b>											
<b>Leon (2010&gt;)</b> 											
1.2TSi 105, 1.4i 86, 1.6TDi CR 105, 1.6TDi CR 90, 1.6i 102, 1.6i LPG 102, 1.9TDi 105, 1.9TDi 90	05/10 ▶		ATE	<b>301408</b>	21974		146	54,7	18,5	↳ 1 x  155 mm	
1.4TFSi 125, 1.8TFSi 160, 2.0TDi 140, 2.0TDi 170, 2.0TDi CR 140, 2.0TDi CR 170, 2.0TFSi 211	05/10 ▶		ATE	<b>301635</b>	23587		156,4	71,4	20,3	↳ 1 x  155 mm	
							155,2	66			
1.2TSi 105, 1.4TFSi 125, 1.4i 86, 1.6TDi CR 105, 1.6TDi CR 90, 1.6i 102, 1.6i LPG 102, 1.8TFSi 160, 1.9TDi 105, 1.9TDi 90, 2.0TDi 140, 2.0TDi CR 140	05/10 ▶		LUC	<b>301463</b>	20960		87	52,9	17		
2.0TFSi 241, 2.0TFSi 265	05/10 ▶		TRW	<b>301752</b>	23914		105,1	56	17		
<b>Malaga (85&gt;93)</b> 											
1.2, 1.5, 1.7D	05/85 ▶ 12/93		BDX	<b>301091</b>	20775		108,8	47,4	18	↳ 2 x 	
<b>Marbella (86&gt;98)</b> 											
0.8, 0.9	11/86 ▶ 05/98		BDX	<b>301091</b>	20775		108,8	47,4	18	↳ 2 x 	
<b>Panda (80&gt;86)</b> 											
0.9	1980 ▶ 1986		BDX	<b>301091</b>	20775		108,8	47,4	18	↳ 2 x 	
<b>Ronda (82&gt;87)</b> 											
1.2, 1.5, 1.6, 1.7D	06/82 ▶ 06/87		BDX	<b>301091</b>	20775		108,8	47,4	18	↳ 2 x 	
<b>Terra (87&gt;96)</b> 											
0.9, 1.3D, 1.4D	02/87 ▶ 12/96		BDX	<b>301091</b>	20775		108,8	47,4	18	↳ 2 x 	
<b>Toledo (91&gt;98)</b> 											
1.8i, 1.9TDi, 2.0i  TR-016 700 ▶ TR-031 348	02/91 ▶ 09/98		LUC	<b>301016</b>	20901		119	69,5	15,7	↳ 2 x  225 mm	
1.6i, 1.8i, 1.9D, 1.9TD, 1.9TDi	09/95 ▶ 09/98		ATE	<b>301066</b>	21866		141,8	50,5	19,7		
1.9TDi, 2.0i	03/94 ▶ 09/98		LUC	<b>301252</b>	20901		119	69,5	19,6		
1.8i, 1.9TDi, 2.0i	02/91 ▶ 09/98		LUC	<b>301330</b>	21945		119	69,5	16,3		
1.9TDi	05/97 ▶ 09/98		ATE	<b>301403</b>	21866		141,8	50,5	15		
								51,2			
1.9TDi, 2.0i  ZD-328 001 ▶ _	03/94 ▶ 09/98		LUC	<b>301180</b>	20960		87	53	15,2		
<b>Toledo (98&gt;2004)</b> 											
1.6i ⊙14" ⊙15"	10/98 ▶ 12/99		ATE	<b>301332</b>	21974		146	54,7	19,8		
1.4i, 1.6i ⊙15"	01/00 ▶ 07/04		ATE	<b>301408</b>	21974		146	54,7	18,5	↳ 1 x  155 mm	
1.8i, 1.9TDi, 2.3i VR5	10/98 ▶ 07/04		ATE	<b>301486</b>	21911		156,35	74,1	19,5	↳ 1 x  155 mm	
1.4i, 1.6i, 1.8i, 1.9TDi, 2.3i VR5	10/98 ▶ 07/04		LUC	<b>301463</b>	20960		87	52,9	17		
<b>Toledo (2004&gt;2009)</b> 											
1.4FSi, 1.4SRE, 1.6i, 1.9TDi TU+ : Wear warning+	09/04 ▶ 05/09		ATE	<b>301408</b>	21974		146	54,7	18,5	↳ 1 x  155 mm	











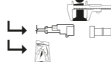























										
<b>SEAT (.../...)</b>										
<b>Toledo (2004&gt;2009)  (.../...)</b>										
1.8FSi, 2.0FSi, 2.0TDi, 2.0TDi PD, 2.0TFSi	09/04 ▶ 05/09		ATE	<b>301635</b>	23587		156,4 155,2	71,4 66	20,3	↳ 1 x  155 mm
1.4FSi, 1.4SRE, 1.6i, 1.8FSi, 1.9TDi, 2.0FSi, 2.0TDi, 2.0TDi PD, 2.0TFSi	09/04 ▶ 05/09		LUC	<b>301463</b>	20960		87	52,9	17	
<b>Toledo (2012&gt;) </b>										
1.2TSI, 1.4TSI, 1.6SRE, 1.6TDI	07/12 ▶		ATE	<b>301635</b>	23587		156,4 155,2	71,4 66	20,3	↳ 1 x  155 mm
1.2TSI, 1.4TSI, 1.6SRE, 1.6TDI	07/12 ▶		LUC	<b>301463</b>	20960		87	52,9	17	
<b>SKODA</b>										
<b>Citigo (2011&gt;) </b>										
1.0Sre 60, 1.0Sre 75, 1.0Sre CNG	10/11 ▶		ATE	<b>301332</b>	21974		146	54,7	19,8	
<b>Fabia (99&gt;2004) </b>										
1.0i, 1.2i, 1.4TDi, 1.4i, 1.9SDi  DA+ : Power steering+	08/99 ▶ 07/04		ATE	<b>301332</b>	21974		146	54,7	19,8	
1.0i, 1.2i, 1.4TDi, 1.4i, 1.9SDi  DA+ : Power steering+ TU+ : Wear warning+	08/99 ▶ 07/04		ATE	<b>301408</b>	21974		146	54,7	18,5	↳ 1 x  155 mm
1.0i  DA- : Power steering-	10/00 ▶ 08/02		ATE	<b>301488</b>	21865		141,8	51,2 50,6	17,3	
1.4i, 1.9TDi, 2.0i  4,5	11/99 ▶ 07/04		LUC	<b>301667</b>	23581		131,4	62,3	18,7	
1.4i, 1.9TDi, 2.0i  TU+ : Wear warning+	11/99 ▶ 07/04		LUC	<b>301720</b>	23581		131,4	62,3	18,7	↳ 1 x  180 mm
1.0i  DA- : Power steering- TU+ : Wear warning+	10/00 ▶ 08/02		ATE	<b>301805</b>	21865		141,8	50,6	17	↳ 1 x  180 mm
1.4i, 1.9TDi, 2.0i  4,5  4-115 001 ▶ _	05/02 ▶ 07/04		LUC	<b>301180</b>	20960		87	53	15,2	
1.4i, 1.9TDi, 2.0i  4,5	11/99 ▶ 07/04		LUC	<b>301463</b>	20960		87	52,9	17	
1.4i, 1.9TDi, 2.0i  TU+ : Wear warning+	11/99 ▶ 07/04		LUC	<b>301674</b>	20960		87	53	17	↳ 1 x  260 mm
<b>Fabia (2004&gt;2007) </b>										
1.2i, 1.4TDi, 1.4i, 1.9SDi  4,5	08/04 ▶ 12/07		ATE	<b>301332</b>	21974		146	54,7	19,8	
1.2i, 1.4TDi, 1.4i, 1.9SDi  TU+ : Wear warning+	08/04 ▶ 12/07		ATE	<b>301408</b>	21974		146	54,7	18,5	↳ 1 x  155 mm
1.4i, 1.9TDi, 2.0i  4,5	08/04 ▶ 12/07		LUC	<b>301667</b>	23581		131,4	62,3	18,7	
1.4i, 1.9TDi, 2.0i  TU+ : Wear warning+	08/04 ▶ 12/07		LUC	<b>301720</b>	23581		131,4	62,3	18,7	↳ 1 x  180 mm

										
<b>SKODA (.../...)</b>										
<b>Fabia (2004&gt;2007)  (.../...)</b>										
1.4i, 1.9TDI, 2.0i  (4,5)	08/04 ▶ 12/07		LUC	<b>301180</b>	20960		87	53	15,2	
1.4i, 1.9TDI, 2.0i  (4,5)	08/04 ▶ 12/07		LUC	<b>301463</b>	20960		87	52,9	17	
<b>Fabia (2006&gt;2010) </b>										
1.2i, 1.4TDI, 1.4i  ⑤ ⑮"	12/06 ▶ 03/10		ATE	<b>301332</b>	21974		146	54,7	19,8	
1.2i, 1.4TDI, 1.4i  ⑤ ⑮" TU+ : Wear warning+	12/06 ▶ 03/10		ATE	<b>301408</b>	21974		146	54,7	18,5	↳ 1 x ↖ 155 mm
1.2i, 1.4TDI  ⑤ ⑬"	12/06 ▶ 03/10		ATE	<b>301488</b>	21865		141,8	51,2	17,3	
1.4TDI, 1.4i, 1.6i, 1.9TDI  ⑤ ⑮"	01/07 ▶ 03/10		LUC	<b>301667</b>	23581		131,4	62,3	18,7	
1.4TDI, 1.4i, 1.6i, 1.9TDI  ⑤ ⑮" TU+ : Wear warning+	01/07 ▶ 03/10		LUC	<b>301720</b>	23581		131,4	62,3	18,7	↳ 1 x ↖ 180 mm
1.2i, 1.4TDI  ⑤ ⑬"	12/06 ▶ 03/10		ATE	<b>301805</b>	21865		141,8	50,6	17	↳ 1 x ↖ 180 mm
1.6i, 1.9TDI  ⑤	04/07 ▶		LUC	<b>301463</b>	20960		87	52,9	17	
<b>Fabia (2010&gt;) </b>										
1.2HTP 60, 1.2HTP 70, 1.2TDI, 1.2TDi Green Line, 1.2TSi 85, 1.4i 86, 1.6TDI 75, 1.6TDI 90  ⑤	03/10 ▶		ATE	<b>301332</b>	21974		146	54,7	19,8	
1.2TSi 105, 1.4TFSi 180, 1.6TDi 105, 1.6i 105  ⑤	03/10 ▶		ATE	<b>301635</b>	23587		156,4	71,4	20,3	↳ 1 x ↖ 155 mm
1.2TSi 105, 1.4TFSi 180, 1.6TDi 105, 1.6i 105  ⑤	03/10 ▶		LUC	<b>301463</b>	20960		87	52,9	17	
<b>Octavia (96&gt;2000) </b>										
1.4i, 1.6i, 1.8i, 1.9SDi, 1.9TDi  ⑤ X-415 000	10/96 ▶ 05/99		ATE	<b>301332</b>	21974		146	54,7	19,8	
1.4i, 1.6i, 1.9SDi, 1.9TDi, 2.0i  ⑤ Y-000 001 ▶ _	10/96 ▶ 07/00		ATE	<b>301408</b>	21974		146	54,7	18,5	↳ 1 x ↖ 155 mm
1.8i, 1.8i Turbo  ⑤	05/98 ▶ 07/00		ATE	<b>301486</b>	21911		156,35	74,1	19,5	↳ 1 x ↖ 155 mm
1.8i, 1.8i Turbo, 1.9TDi, 2.0i  ⑤	10/96 ▶ 07/00		LUC	<b>301463</b>	20960		87	52,9	17	
<b>Octavia (2000&gt;2010) </b>										
1.4i, 1.6i, 1.9D, 1.9TDi, 2.0i  ⑤	08/00 ▶ 12/10		ATE	<b>301332</b>	21974		146	54,7	19,8	
1.4i, 1.6i, 1.9D, 1.9TDi, 2.0i  ⑤ TU+ : Wear warning+	08/00 ▶ 12/10		ATE	<b>301408</b>	21974		146	54,7	18,5	↳ 1 x ↖ 155 mm
1.8, 1.8i Turbo  ⑤	08/00 ▶ 12/10		ATE	<b>301486</b>	21911		156,35	74,1	19,5	↳ 1 x ↖ 155 mm
1.8, 1.8i Turbo, 1.9D, 1.9TDi, 2.0i  ⑤	08/00 ▶ 12/10		LUC	<b>301463</b>	20960		87	52,9	17	



				<b>Valeo</b>	<b>WVA</b>					
<b>SKODA (.../...)</b>										
<b>Octavia (2004&gt;2008)</b> 										
1.4i, 1.6FSi, 1.6i, 1.9TDi 	05/04 ▶ 10/08		ATE	<b>301408</b>	21974		146	54,7	18,5	↳ 1 x + 155 mm
1.8TFSi, 2.0FSi, 2.0TDi, 2.0TFSi 	05/04 ▶ 10/08		ATE	<b>301635</b>	23587		156,4	71,4	20,3	↳ 1 x + 155 mm
1.4i, 1.6FSi, 1.6i, 1.9TDi 	05/04 ▶ 10/08		LUC	<b>301463</b>	20960		87	52,9	17	
1.8TFSi, 2.0FSi, 2.0TDi, 2.0TFSi 	05/04 ▶ 10/08		TRW	<b>301752</b>	23914		105,1	56	17	
<b>Octavia (2008&gt;2013)</b> 										
1.2TSi, 1.4i, 1.6TDi CR, 1.6i, 1.9TDi PD, 2.0TDi CR 110 	11/08 ▶ 06/13		ATE	<b>301408</b>	21974		146	54,7	18,5	↳ 1 x + 155 mm
1.4TFSi, 1.8TFSi, 2.0TDi, 2.0TDi 136, 2.0TDi CR, 2.0TDi CR 140, 2.0TDi PD, 2.0TDi PD 140, 2.0TFSi 	11/08 ▶ 06/13		ATE	<b>301635</b>	23587		156,4	71,4	20,3	↳ 1 x + 155 mm
1.2TSi, 1.4i, 1.6TDi CR, 1.6i, 1.9TDi PD, 2.0TDi CR 110 	11/08 ▶ 06/13		LUC	<b>301463</b>	20960		87	52,9	17	
1.4TFSi, 1.8TFSi, 2.0TDi, 2.0TDi 136, 2.0TDi PD, 2.0TDi PD 140, 2.0TFSi 	11/08 ▶ 11/09		TRW	<b>301752</b>	23914		105,1	56	17	
<b>Rapid (2012&gt;)</b> 										
1.2MPI, 1.2TSi, 1.6TDi, 1.6i 	07/12 ▶		ATE	<b>301332</b>	21974		146	54,7	19,8	
1.4TSi 	07/12 ▶		ATE	<b>301635</b>	23587		156,4	71,4	20,3	↳ 1 x + 155 mm
1.2TSi, 1.4TSi, 1.6TDi, 1.6i 	07/12 ▶		LUC	<b>301463</b>	20960		87	52,9	17	
<b>Roomster (2006&gt;2010)</b> 										
1.2i, 1.4TDi, 1.4i	05/06 ▶ 03/10		ATE	<b>301332</b>	21974		146	54,7	19,8	
1.2i, 1.4TDi, 1.4i	05/06 ▶ 03/10		ATE	<b>301408</b>	21974		146	54,7	18,5	↳ 1 x + 155 mm
1.6i, 1.9TDi	03/06 ▶ 03/10		LUC	<b>301667</b>	23581		131,4	62,3	18,7	
1.6i, 1.9TDi	03/06 ▶ 03/10		LUC	<b>301720</b>	23581		131,4	62,3	18,7	↳ 1 x + 180 mm
1.6i, 1.9TDi	03/06 ▶ 02/07		LUC	<b>301180</b>	20960		87	53	15,2	
1.6i, 1.9TDi	03/06 ▶		LUC	<b>301463</b>	20960		87	52,9	17	
<b>Roomster (2010&gt;)</b> 										
1.2HTP 70, 1.2TDi CR 75, 1.2TSi 85, 1.4i 86, 1.6TDi CR 90	03/10 ▶		ATE	<b>301332</b>	21974		146	54,7	19,8	
1.2TSi 105, 1.6TDi CR 105, 1.6i 105	03/10 ▶		ATE	<b>301635</b>	23587		156,4	71,4	20,3	↳ 1 x + 155 mm
1.2TSi 105, 1.6TDi CR 105, 1.6i 105	03/10 ▶		LUC	<b>301463</b>	20960		87	52,9	17	

 				<b>Valeo</b>	<b>VVA</b>						
<b>SKODA (.../...)</b>											
<b>Superb (2001&gt;2008)</b> 											
1.8i Turbo, 1.9TDi, 2.0TDi, 2.0i, 2.5TDi V6, 2.8i V6   (4)	12/01 ▶ 03/08		ATE	<b>301483</b>	20676		156,4	74,2	20,3	↳ 2x +  210 mm	
1.9TDi, 2.0TDi, 2.0i  (4)	12/01 ▶ 03/08		ATE	<b>301751</b>	20676		156,4	74,2	19,2	↳ 2x +  210 mm	
1.8i Turbo, 1.9TDi, 2.0TDi, 2.0i, 2.5TDi V6, 2.8i V6  (4)			LUC	<b>301463</b>	20960		87	52,9	17		
<b>Superb (2008&gt;)</b> 											
1.4TFSi, 1.6TDi, 1.6TDi Greenline, 1.8TFSi, 1.9TDi, 2.0TDi, 2.0TFSi   (5)	03/08 ▶		ATE	<b>301635</b>	23587		156,4	71,4	20,3	↳ 1x +  155 mm	
1.4TFSi, 1.6TDi, 1.6TDi Greenline, 1.8TFSi, 1.9TDi, 2.0TDi, 2.0TFSi, 3.6FSi   (5)	03/08 ▶		TRW	<b>301752</b>	23914		155,2	66			
<b>Yeti (2009&gt;)</b> 											
1.2TSI, 1.6TDI, 2.0TDI CR, 2.0TDI CR 110	09/09 ▶		ATE	<b>301408</b>	21974		146	54,7	18,5	↳ 1x +  155 mm	
1.4TFSi 122, 1.8TSi 152, 1.8TSi 160, 2.0TDI CR 140, 2.0TDI CR 170	05/09 ▶		ATE	<b>301635</b>	23587		156,4	71,4	20,3	↳ 1x +  155 mm	
1.2TSI, 1.4TFSi 122, 1.6TDI, 2.0TDI CR, 2.0TDI CR 110, 2.0TDI CR 140	09/09 ▶		LUC	<b>301463</b>	20960		87	52,9	17		
2.0TDI CR 170	11/09 ▶		TRW	<b>301752</b>	23914		105,1	56	17		
<b>SMART MCC</b>											
<b>Forfour (2004&gt;2006)</b> 											
1.1i, 1.3i, 1.5Cdi, 1.5i	04/04 ▶ 06/06		LUC	<b>301318</b>	21920		130	72,57	15,1		
1.5i Turbo	09/04 ▶ 06/06		LUC	<b>301493</b>	21983		130	77	17		
1.1i, 1.3i, 1.5Cdi, 1.5i, 1.5i Turbo	04/04 ▶ 06/06		LUC	<b>301319</b>	21861		87,3	47	15,3		
<b>SSANGYONG</b>											
<b>Actyon (2006&gt;2011)</b> 											
2.0Xdi, 2.3i	09/06 ▶ 01/11		AKE	<b>301505</b>	23569		149	58	17,4	↳ 2x ⇄	
<b>Actyon Sports (2007&gt;2011)</b> 											
2.0XDi	04/07 ▶ 12/11		AKE	<b>301505</b>	23569		149	58	17,4	↳ 2x ⇄	
<b>Kyron (2005&gt;2007)</b> 											
2.0XDi	11/05 ▶ 09/07		AKE	<b>301505</b>	23569		149	58	17,4	↳ 2x ⇄	
<b>Kyron (2007&gt;)</b> 											
2.0Xdi	09/07 ▶		AKE	<b>301505</b>	23569		149	58	17,4	↳ 2x ⇄	
<b>Rodius (2005&gt;)</b> 											
2.7Xdi	05/05 ▶		MAND	<b>301748</b>	23543		98,7	40,8	15,7	↳ 2x ⇄	
<b>SUBARU</b>											
<b>Forester (97&gt;2002)</b> 											
2.0i ⊙15"	06/02 ▶ 09/02		TOKI	<b>301853</b>	23865		136,8	56,5	17,5	↳ 2x ⇄	











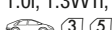

				<b>Valeo</b>	<b>WVA</b>					<b>SUBARU (.../...)</b>
<b>Forester (97&gt;2002)  (.../...)</b>										
2.0i Turbo	07/98 ▶ 09/02		AKE	<b>301895</b>	23572		108,4	41,5	14,5	
<b>Forester (2002&gt;2005) </b>										
2.0X, 2.0XT Turbo, 2.5XT Turbo	09/02 ▶ 07/05		TOKI	<b>301853</b>	23865		136,8	56,5	17,5	↳ 2x ⇐
<b>Forester (2005&gt;2007) </b>										
2.0X, 2.5XT	08/05 ▶ 11/07		TOKI	<b>301853</b>	23865		136,8	56,5	17,5	↳ 2x ⇐
<b>Forester (2007&gt;) </b>										
2.0D, 2.0X, 2.0XS, 2.5X, 2.5XS, 2.5XT	12/07 ▶		TOKI	<b>301853</b>	23865		136,8	56,5	17,5	↳ 2x ⇐
<b>Impreza (G11) (2000&gt;2005) </b>										
2.0i   (4), (5)	09/00 ▶ 08/05		TOKI	<b>301853</b>	23865		136,8	56,5	17,5	↳ 2x ⇐
2.0i  (4)	09/00 ▶ 08/05		AKE	<b>301895</b>	23572		108,4	41,5	14,5	
<b>Impreza (G11) (2005&gt;2007) </b>										
2.0R   (4), (5)	09/05 ▶ 06/06		TOKI	<b>301853</b>	23865		136,8	56,5	17,5	↳ 2x ⇐
<b>Impreza (GR/GV) (2007&gt;) </b>										
2.0D, 2.0i, 2.5STi, 2.5Ti  (5)	06/07 ▶		TOKI	<b>301853</b>	23865		136,8	56,5	17,5	↳ 2x ⇐
<b>Justy (95&gt;2003) </b>										
1.3i  (3), (5)	10/95 ▶ 12/97		AKE	<b>301666</b>	21333		107,3	44,6	14,5	↳ 2x ⇐
<b>Legacy (98&gt;2003) </b>										
2.0i, 2.5i   (4), (5) ABS+	10/98 ▶ 02/00		AKE	<b>301895</b>	23572		108,4	41,5	14,5	
<b>Legacy (2003&gt;2009) </b>										
2.0i, 2.5i, 3.0i   (4), (5)	05/03 ▶ 05/09		TOKI	<b>301853</b>	23865		136,8	56,5	17,5	↳ 2x ⇐
3.0i   (4), (5)	09/03 ▶ 05/09		AKE	<b>301895</b>	23572		108,4	41,5	14,5	
<b>Legacy (2009&gt;) </b>										
2.0D, 2.0i   (4), (5)	05/09 ▶		TOKI	<b>301853</b>	23865		136,8	56,5	17,5	↳ 2x ⇐
<b>SUZUKI</b>										
<b>Alto (SH410) (94&gt;2002) </b>										
1.0  (3), (5)	03/94 ▶ 05/02		AKE	<b>301666</b>	21333		107,3	44,6	14,5	↳ 2x ⇐
<b>Baleno (95&gt;2002) </b>										
1.8i    (3), (4), (5)	06/96 ▶		SUM	<b>301624</b>	20031		102	38,98	12,5	
<b>Cappuccino (SX306) (91&gt;98) </b>										
0.7	10/91 ▶ 03/98		AKE	<b>301666</b>	21333		107,3	44,6	14,5	↳ 2x ⇐
<b>Splash (2008&gt;) </b>										
1.0i, 1.2i, 1.3DDiS	03/08 ▶		LUC	<b>301847</b>	23973		116,2	52,1	17,3	↳ 1x ⇐

											
<b>SUZUKI (.../...)</b>											
<b>Swift (SA) Made in Japan (83&gt;89)</b> 											
1.3  (3), (5)	08/84 ▶ 01/88		AKE	<b>301666</b>	21333		107,3	44,6	14,5	↳ 2x ◁	
<b>Swift (SF) Made in Japan (89&gt;96)</b> 											
1.0, 1.0i, 1.3, 1.3i  (2), (3), (4), (5)	03/89 ▶ 08/96		AKE	<b>301666</b>	21333		107,3	44,6	14,5	↳ 2x ◁	
<b>Swift (SF) Made in Hungary (95&gt;96)</b> 											
1.0i, 1.3i  (3), (4), (5)	01/95 ▶ 08/96		AKE	<b>301666</b>	21333		107,3	44,6	14,5	↳ 2x ◁	
<b>Swift (SF) Made in Hungary (96&gt;2005)</b> 											
1.0i, 1.3i  (3), (4), (5)	09/96 ▶ 12/97		AKE	<b>301666</b>	21333		107,3	44,6	14,5	↳ 2x ◁	
<b>Swift (RS) Made in Hungary (2005&gt;2011)</b> 											
1.3DDiS, 1.3i, 1.5i, 1.6i  (3), (5)	04/05 ▶		LUC	<b>301847</b>	23973		116,2	52,1	17,3	↳ 1x ◁	
<b>Swift (RS) Made in Japan (2005&gt;2011)</b> 											
1.3i, 1.5i, 1.6i  (5)	04/05 ▶ 09/11		LUC	<b>301847</b>	23973		116,2	52,1	17,3	↳ 1x ◁	
<b>TALBOT</b>											
<b>1000 (66&gt;78)</b> 											
0.8, 0.9, 1.0, 1.1, 1.3  (2), (4)	07/66 ▶ 06/78		ATE	<b>301099</b>	20228		61,8	56,6	15		
<b>1100 (67&gt;81)</b> 											
1.0, 1.1, 1.2, 1.3  (3), (5)	09/67 ▶ 07/81		ATE	<b>301099</b>	20228		61,8	56,6	15		
<b>1200S (69&gt;71)</b> 											
1.2  (2)	07/69 ▶ 06/71		ATE	<b>301099</b>	20228		61,8	56,6	15		
<b>1307/8/9 (75&gt;79)</b> 											
1.3, 1.4, 1.6  (5)	07/75 ▶ 07/79		BDX	<b>301081</b>	21061		105	53,4	18		
<b>Murena (81&gt;83)</b> 											
1.6, 2.2  (2)	1981 ▶ 1983		BDX	<b>301081</b>	21061		105	53,4	18		
<b>Solara (80&gt;85)</b> 											
1.3, 1.4, 1.6  (4)	04/80 ▶ 07/80		BDX	<b>301081</b>	21061		105	53,4	18		
<b>TOYOTA</b>											
<b>Auris (AH) Made in Japan (2006&gt;2012)</b> 											
1.3VVT-i 100, 1.4VVT-i 97, 1.6VVT-i 124, 1.6VVT-i 132, 1.8VVT-i 147, 2.0D-4D	10/06 ▶		AKE	<b>301943</b>	24336		139	56,1	17,4		
<b>Aygo (B10) (2005&gt;2012)</b> 											
1.0VVTi, 1.4D	02/05 ▶ 02/12		BSC	<b>301718</b>	23959		122,7	46,7	17,6		
<b>Aygo (B10) (2012&gt;)</b> 											
1.0VVTi	02/12 ▶		BSC	<b>301718</b>	23959		122,7	46,7	17,6		
<b>Camry (SV/CV10) (82&gt;86)</b> 											
1.8, 1.8TD, 2.0TD, 2.0i  (4), (5)	10/82 ▶ 10/86		AKE	<b>301266</b>	20870		119,7	47,5	15		





































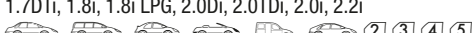















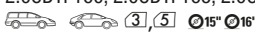









				<b>Valeo</b>	<b>WVA</b>			
<b>TOYOTA (.../...)</b>								
<b>Camry (SV/CV20) (86&gt;91)</b> 								
1.8, 2.0TD, 2.0i  (4), (5) ABS+	10/86 ▶ 08/89		AKE	<b>301266</b>	20870		119,7 47,5 15	
2.0TD, 2.0i, 2.5i V6  (4), (5)	08/88 ▶ 06/91		AKE	<b>301402</b>	21158		140 55,5 15	
2.0i, 2.5i V6  (5)	01/90 ▶ 06/91		AKE	<b>301540</b>	21833		107,6 42,5 15	↳ 2x ⇐
<b>Camry (SX/VC10) (91&gt;96)</b> 								
2.2i  (4), (5)	06/91 ▶ 09/93		AKE	<b>301551</b>	21601		133,2 53 17,5	↳ 2x ⇐
<b>Camry (MCV/SXV20) (96&gt;2001)</b> 								
2.2i, 3.0i V6  (4)	12/97 ▶ 08/99		AKE	<b>301025</b>	24522		116,8 59,2 16,9	
2.2i, 3.0i V6  (4)	08/99 ▶ 07/01		AKE	<b>301540</b>	21833		107,6 42,5 15	↳ 2x ⇐
<b>Camry (ACV/MCV30) (2001&gt;2006)</b> 								
2.0i, 2.4i, 3.0i V6  (4)	08/01 ▶ 01/06		AKE	<b>301862</b>	23806		131,4 58,5 17,3	
<b>Camry (ACV/GSV40) (2006&gt;2009)</b> 								
2.4i, 3.5i V6  (4)	01/06 ▶ 03/09		AKE	<b>301890</b>	24350		157,5 56,92 17,6	
2.4i, 3.5i V6  (4)	01/06 ▶ 03/09		AKE	<b>301819</b>	24338		96,6 49,2 15,4	
<b>Camry (ACV/GSV40) (2009&gt;2011)</b> 								
2.4i, 3.5i V6  (4)	01/09 ▶ 08/11		AKE	<b>301819</b>	24338		96,6 49,2 15,4	
<b>Carina II (T15) (83&gt;87)</b> 								
1.6, 1.8i, 2.0D, 2.0i  (4), (5)	09/83 ▶ 12/87		AKE	<b>301266</b>	20870		119,7 47,5 15	
<b>Carina II (T17) (87&gt;92)</b> 								
1.6, 1.6i, 2.0D, 2.0i  (4), (5)	12/87 ▶ 11/92		AKE	<b>301266</b>	20870		119,7 47,5 15	
2.0i  (4), (5)	12/87 ▶ 03/92		AKE	<b>301540</b>	21833		107,6 42,5 15	↳ 2x ⇐
<b>Carina E (T19) (92&gt;97)</b> 								
1.6i, 1.8i, 2.0D, 2.0TD, 2.0i  (4), (5)	02/92 ▶ 12/97		AKE	<b>301551</b>	21601		133,2 53 17,5	↳ 2x ⇐
2.0i  (4)	02/92 ▶ 01/96		AKE	<b>301540</b>	21833		107,6 42,5 15	↳ 2x ⇐
<b>Celica (T16) (85&gt;89)</b> 								
1.6, 1.6i, 2.0i, 2.0i Turbo  (2), (3)	08/85 ▶ 08/89		AKE	<b>301266</b>	20870		119,7 47,5 15	
<b>Celica (T18) (89&gt;93)</b> 								
1.6, 2.0, 2.0 Turbo  (2), (3)	10/89 ▶ 10/93		AKE	<b>301266</b>	20870		119,7 47,5 15	
<b>Celica (T20) (93&gt;99)</b> 								
1.8i, 2.0i  (2), (3)	08/95 ▶ 07/99		AKE	<b>301540</b>	21833		107,6 42,5 15	↳ 2x ⇐
<b>Celica (T23) (99&gt;2005)</b> 								
1.8VVT-i  (2)	08/99 ▶ 12/01		AKE	<b>301737</b>	23510		116,3 51,5 16,5	↳ 2x ⇐
1.8i  (2)	08/00 ▶ 09/05		AKE	<b>301827</b>	23526		117,5 58,6 17,4	



















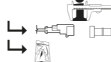

































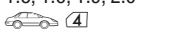































				<b>Valeo</b>	<b>WVA</b>							
<b>TOYOTA (.../...)</b>												
<b>Celica (T23) (99&gt;2005)  (.../...)</b>												
1.8VVT-i, 1.8i   <b>(2)</b>	08/99 ▶ 09/05		SUM	<b>301577</b>	23521		78,5	55	14	↳ 2x ⇐		
<b>Corolla (80) (83&gt;87) </b>												
1.3, 1.6, 1.6i, 1.8D   <b>(3,4,5)</b>	05/83 ▶ 09/87		AKE	<b>301266</b>	20870		119,7	47,5	15			
<b>Corolla (90) (87&gt;92) </b>												
1.3, 1.3i, 1.6, 1.8D    <b>(3,4,5)</b>	05/87 ▶ 05/92		AKE	<b>301266</b>	20870		119,7	47,5	15			
<b>Corolla (100) (92&gt;97) </b>												
1.3    <b>(4,5)</b>	05/92 ▶ 04/97		AKE	<b>301266</b>	20870		119,7	47,5	15			
1.3, 1.6, 1.8, 2.0D    <b>(3,4,5)</b>	05/92 ▶ 04/97		AKE	<b>301551</b>	21601		133,2	53	17,5	↳ 2x ⇐		
<b>Corolla (120) (2001&gt;2007) </b>												
2.0D4-D  <b>(5)</b>	07/02 ▶ 05/04		AKE	<b>301827</b>	23526		117,5	58,6	17,4			
1.4i, 1.6VVT-i, 2.0D4-D   <b>(4,5)</b>	10/01 ▶ 10/06		SUM	<b>301577</b>	23521		78,5	55	14	↳ 2x ⇐		
1.4D4-D, 1.4i, 1.6VVT-i, 1.8i, 2.0D4-D    <b>(3,4,5)</b>	11/01 ▶ 02/07		LUC	<b>301680</b>	23816		95,7	38	15,8	↳ 2x ⇐		
<b>Corolla (150) (2006&gt;) </b>												
1.3VVT-i, 1.4VVT-i, 1.6VVT-i  <b>(4)</b>	11/06 ▶		AKE	<b>301943</b>	24336		139	56,1	17,4			
<b>Corolla Verso (E12) (2001&gt;2003) </b>												
1.6VVTi, 1.8VVTi, 2.0D4-D  <b>(5)</b>	09/01 ▶ 12/03		SUM	<b>301577</b>	23521		78,5	55	14	↳ 2x ⇐		
<b>Dyna 100 (85&gt;2001) </b>												
1.8, 2.4D   <b>(2,4)</b>	08/85 ▶ 08/88		AKE	<b>301402</b>	21158		140	55,5	15			
<b>Hiace (H5-6) (82&gt;89) </b>												
1.8, 2.0, 2.2D, 2.2i, 2.4D   <b>(4,5)</b>	12/82 ▶ 08/88		AKE	<b>301402</b>	21158		140	55,5	15			
<b>Hilux (LN/RN/YN 5-6) (83&gt;98) </b>												
1.6, 1.8, 2.0, 2.2, 2.2D, 2.4, 2.4D  <b>(2)</b>	08/83 ▶ 07/98		AKE	<b>301402</b>	21158		140	55,5	15			
<b>Hilux (KUN 15-25-26) (2008&gt;) </b>												
2.5D-4D, 3.0D-4D   <b>(2,4)</b> ESP+	08/08 ▶		SUM	<b>301857</b>	24024		134,2	76,9	17,8	↳ 2x ⇐		
<b>Hilux (KUN 25-26-35) (2011&gt;) </b>												
2.5D-4D 144, 3.0D-4D 171   <b>(2,4)</b> ESP+	07/11 ▶		SUM	<b>301857</b>	24024		134,2	76,9	17,8	↳ 2x ⇐		
<b>Land Cruiser (HD/UZ10) (98&gt;2007) </b>												
4.2TD, 4.7i	01/98 ▶ 08/07		SUM	<b>301535</b>	23524		119,6	78	15,5	↳ 2x ⇐		
4.2TD, 4.7i	01/98 ▶ 08/07		AKE	<b>301865</b>	23539		123,1	45,1	17,5			
<b>Land Cruiser (KD/GR) (2002&gt;2009) </b>												
3.0D-4D, 4.0i VVT-i	09/02 ▶ 08/09		SUM	<b>301857</b>	24024		134,2	76,9	17,8	↳ 2x ⇐		

										
<b>TOYOTA (.../...)</b>										
<b>MR 2 (W11) (84&gt;89)</b> 										
1.6i   (2)	11/84 ▶ 10/89		AKE	<b>301266</b>	20870		119,7	47,5	15	
<b>MR 2 (W30) (99&gt;2005)</b> 										
1.8VVT-i  (2)	12/99 ▶ 09/05		AKE	<b>301737</b>	23510		116,3	51,5	16,5	↳ 2x ⇐
<b>Paseo (EL54) (95&gt;99)</b> 										
1.5i   (2)	08/95 ▶ 07/99		AKE	<b>301266</b>	20870		119,7	47,5	15	
<b>Picnic (M10) (96&gt;2001)</b> 										
2.0i, 2.2TD	09/96 ▶ 05/01		AKE	<b>301551</b>	21601		133,2	53	17,5	↳ 2x ⇐
<b>Prius (W11) (2000&gt;2003)</b> 										
1.5i	05/00 ▶ 12/01		AKE	<b>301737</b>	23510		116,3	51,5	16,5	↳ 2x ⇐
1.5i	05/00 ▶ 07/03		SUM	<b>301577</b>	23521		78,5	55	14	↳ 2x ⇐
<b>RAV4 (SXA) (94&gt;2000)</b> 										
2.0i (3),(5)	04/94 ▶ 07/00		AKE	<b>301551</b>	21601		133,2	53	17,5	↳ 2x ⇐
<b>RAV4 (ACA/CLA/ZSA) (2005&gt;2010)</b> 										
2.0VVTi, 2.0VVTi 158, 2.2D-4D, 2.2D-4D 150, 2.4VVTi (5)	11/05 ▶		AKE	<b>301819</b>	24338		96,6	49,2	15,4	
<b>RAV4 (ALA/ZSA) (2010&gt;2012)</b> 										
2.0VVTi 158, 2.2D-4D 150 (5)	02/10 ▶ 12/12		AKE	<b>301819</b>	24338		96,6	49,2	15,4	
<b>RAV4 (2012&gt;)</b> 										
2.0D-4D 124, 2.0VVTi 151, 2.2D-4D 150, 2.2D-CAT 150 (5)	12/12 ▶		AKE	<b>301819</b>	24338		96,6	49,2	15,4	
<b>Starlet (P8) (89&gt;95)</b> 										
1.0, 1.3, 1.3i, 1.5D (3),(5) ABS+	12/89 ▶ 12/95		AKE	<b>301266</b>	20870		119,7	47,5	15	
<b>Starlet (P9) (96&gt;99)</b> 										
1.3i (3),(5) ABS+	01/96 ▶ 07/99		AKE	<b>301266</b>	20870		119,7	47,5	15	
<b>Tercel (AL2) (82&gt;88)</b> 										
1.3, 1.5   (3),(5)	05/82 ▶ 01/88		AKE	<b>301266</b>	20870		119,7	47,5	15	
<b>Urban Cruiser (2009&gt;)</b> 										
1.3VVT-i 100, 1.4D-4D 90	01/09 ▶		AKE	<b>301943</b>	24336		139	56,1	17,4	
<b>Verso S (2010&gt;)</b> 										
1.33VVT-i 100, 1.4D-4D 90	11/10 ▶		AKE	<b>301943</b>	24336		139	56,1	17,4	
<b>Yaris (P10LA/RA - P13LA) Made in Japan (99&gt;2005)</b> 										
1.0i, 1.3i, 1.4D-4D  (3),(5)	01/99 ▶ 08/05		AKE	<b>301606</b>	23348		112,5	46,8	16,5	↳ 2x ⇐
1.0i, 1.3i, 1.4D-4D, 1.5VVTi  (3),(5) FAD+	01/99 ▶ 08/05		AKE	<b>301737</b>	23510		116,3	51,5	16,5	↳ 2x ⇐
1.0i, 1.3i, 1.4D-4D, 1.5VVTi  (3),(5)	01/99 ▶ 08/05		SUM	<b>301577</b>	23521		78,5	55	14	↳ 2x ⇐



















































											
<b>TOYOTA (.../...)</b>											
<b>Yaris (P10LC/RC - P12LC/RC) Made in France (2001&gt;2005)</b> 											
1.0i, 1.3VVTi, 1.4D-4D  (3),(5)	01/01 ▶ 11/05		BSC	<b>301736</b>	23340		130,6	44,9	16,8		↳ 2x ⇐
1.0i, 1.3VVTi, 1.4D-4D  (3),(5) FAD+	01/01 ▶ 11/05		AKE	<b>301737</b>	23510		116,3	51,5	16,5		↳ 2x ⇐
1.0i, 1.3VVTi, 1.4D-4D  (3),(5)	01/01 ▶ 11/05		SUM	<b>301577</b>	23521		78,5	55	14		↳ 2x ⇐
<b>Yaris (P90LC/RC) Made in France (2005&gt;2011)</b> 											
1.0VVTi, 1.3VVTi, 1.3VVTi 100, 1.4D4-D  (3),(5) ASR+, ESP+	11/05 ▶ 07/11		ATE	<b>301028</b>	24574		123,1	43,7	14,5		↳ 2x ⇐
<b>Yaris (P130LC/RC) Made in France (2011&gt;)</b> 											
1.33VVTi 99, 1.4D4-D  (3),(5)	07/11 ▶		ATE	<b>301028</b>	24574		123,1	43,7	14,5		↳ 2x ⇐
<b>Yaris Verso (P20-21-22) (99&gt;2005)</b> 											
1.3i, 1.4D-4D, 1.5VVT-i  (5)	08/99 ▶ 09/05		AKE	<b>301737</b>	23510		116,3	51,5	16,5		↳ 2x ⇐
1.3i, 1.4D-4D, 1.5VVT-i  (5)	08/99 ▶ 09/05		SUM	<b>301577</b>	23521		78,5	55	14		↳ 2x ⇐
<b>VAUXHALL</b>											
<b>Antara (2006&gt;)</b> 											
2.0CDTi, 2.0CDTi 127, 2.4i, 3.2i V6  → 9B999999	10/06 ▶		MAND	<b>301942</b>	24510		149	62,2	17,6		↳ 2x ⇐
2.0CDTi, 2.0CDTi 127, 2.2CDTi 163, 2.2CDTi 184, 2.4i, 2.4i 167, 3.0i 258-V6, 3.2i V6	10/06 ▶		MAND	<b>301941</b>	24498		110,7	45,9	15,8		↳ 2x ⇐
<b>Agila (2007&gt;)</b> 											
1.0i, 1.2i, 1.3CDTi 	12/07 ▶		LUC	<b>301847</b>	23973		116,2	52,1	17,3		↳ 1x ⇐
<b>Astra MK I (80&gt;84)</b> 											
1.2, 1.3, 1.6, 1.6D, 1.8i  (3),(5)	02/80 ▶ 10/84		GME	<b>301182</b>	20867		100	59	15,4		
<b>Astra MK II (84&gt;91)</b> 											
1.2, 1.3, 1.4i, 1.6, 1.6D, 1.6i, 1.7D, 1.8i, 2.0i  (2),(3),(5)	10/84 ▶ 10/91		GME	<b>301182</b>	20867		100	59	15,4		
1.8i, 2.0i  (2),(3),(5)	10/84 ▶ 09/91		ATE	<b>301184</b>	21201		156,3	52,6	17		
2.0i  (2),(3),(5)	03/87 ▶ 09/91		ATE	<b>301253</b>	21140		61,8	57,2	15,3		
<b>Astra Belmont (86&gt;91)</b> 											
1.3, 1.4i, 1.5DT, 1.6, 1.6D, 1.7D  (4)	01/86 ▶ 09/91		GME	<b>301182</b>	20867		100	59	15,4		
1.8i  (4)	01/86 ▶ 09/91		ATE	<b>301184</b>	21201		156,3	52,6	17		
<b>Astra MK III (91&gt;2001)</b> 											
1.4i, 1.6i, 1.7D, 1.7TD Turbo, 1.8i, 2.0i  (2),(3),(4),(5) HD+ : Heavy duty+	09/91 ▶ 03/01		ATE	<b>301184</b>	21201		156,3	52,6	17		
1.4, 1.4i, 1.6i, 1.7D, 1.7TD Turbo, 1.8i  (2),(3),(4),(5)	09/91 ▶ 03/01		ATE	<b>301356</b>	21353		140,1 141,4	58,3 48,4	16,8		





















































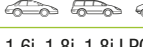













												
<b>VAUXHALL (.../...)</b>												
<b>Astra MK III (91&gt;2001)  (.../...)</b>												
1.8i, 2.0i  (2),(3),(4),(5)	10/91 ▶ 03/01		ATE	<b>301253</b>	21140		61,8	57,2	15,3			
<b>Astra MK IV (98&gt;2005) </b>												
1.2i, 1.4i, 1.6i, 1.6i Twinport, 1.7CDTi, 1.7D Turbo, 1.7DTi, 1.8i, 1.8i LPG, 2.0Di, 2.0TDi  (2),(3),(4),(5)	02/98 ▶ 12/05		ATE	<b>301322</b>	23063		160	63	18		↳ 4x □	
1.6i GNV, 2.0i, 2.2i  (2),(3),(4),(5)	04/98 ▶ 12/05		ATE	<b>301454</b>	23062		156,4	78,5	20		↳ 2x □	
1.2i, 1.4i, 1.6i, 1.6i GNV, 1.6i Twinport, 1.7CDTi, 1.7D Turbo, 1.7DTi, 1.8i, 1.8i LPG, 2.0SRi Turbo, 2.0TDi, 2.2i  (2),(3),(4),(5)	02/98 ▶ 12/05		LUC	<b>301584</b>	23417		95,5	42,7	15,2		↳ 2x □	
1.2i, 1.4i, 1.6i, 1.6i GNV, 1.6i Twinport, 1.7CDTi, 1.7D Turbo, 1.7DTi, 1.8i, 1.8i LPG, 2.0Di, 2.0TDi, 2.0i, 2.2i  (2),(3),(4),(5)	02/98 ▶ 12/05		BSC	<b>301926</b>	23258		104,8	42,7	17		↳ 2x □	
<b>Astra MK V (2004&gt;2011) </b>												
2.0i Turbo  (3)	03/05 ▶ 12/11		ATE	<b>301678</b>	23402		156,5	71	20,3			
1.3CDTi, 1.4 Twinport, 1.4i GPL, 1.4i Twinport, 1.6i, 1.6i Turbo, 1.6i Twinport, 1.7CDTi, 1.8i, 1.9CDTi, 2.0T, 2.0i Turbo  (2),(3),(5)	03/04 ▶ 12/11		ATE	<b>301860</b>	23832		156,1	76	20,4		↳ 2x □	
1.3CDTi, 1.4 Twinport, 1.4i GPL, 1.4i Twinport, 1.6i, 1.6i Turbo, 1.6i Twinport, 1.7CDTi, 1.8i, 1.9CDTi, 2.0T, 2.0i Turbo  (2),(3),(5)	03/04 ▶ 12/11		LUC	<b>301584</b>	23417		95,5	42,7	15,2		↳ 2x □	
<b>Astra MK VI (2009&gt;) </b>												
1.3CDTi, 1.4GPL Turbo, 1.4i 100, 1.4i 87, 1.4i Turbo, 1.4i Turbo 140, 1.6i, 1.6i Turbo, 1.6i Turbo 180, 1.7CDTi 110, 1.7CDTi 125, 1.7CDTi 130, 2.0CDTi 160, 2.0CDTi 165  (5) 16"	09/09 ▶		BSC	<b>301070</b>	25080		148,1	61,2	18,8		↳ 2x □	
1.3CDTi, 1.4GPL Turbo, 1.4i 100, 1.4i 87, 1.4i Turbo, 1.4i Turbo 120, 1.4i Turbo 140, 1.6i, 1.6i Turbo, 1.6i Turbo 180, 1.7CDTi 110, 1.7CDTi 125, 1.7CDTi 130, 2.0CDTi 160, 2.0CDTi 165, 2.0CDTi BiTurbo 195  (3),(5) 15" 16"	09/09 ▶		BSC	<b>301055</b>	25096		116,6	42,7	16,3		↳ 2x □	
<b>Astramax (91&gt;98) </b>												
1.4, 1.4i, 1.6i, 1.7D, 1.7D Turbo, 1.8i  (3)	10/91 ▶ 03/98		LUC	<b>301456</b>	23225		131,6	52,8	16,8			
2.2D, 2.3, 2.5D, 2.5TD  (2)	10/88 ▶ 06/96		AKE	<b>301020</b>	21543		127	51	16,5		↳ 4x □	
<b>Brava (96&gt;2002) </b>												
2.5TD  (2)	07/96 ▶ 09/02		AKE	<b>301020</b>	21543		127	51	16,5		↳ 4x □	
<b>Calibra (90&gt;97) </b>												
2.0i	06/90 ▶ 06/97		ATE	<b>301184</b>	21201		156,3	52,6	17			
2.0i Turbo, 2.5i V6	07/96 ▶ 07/97		ATE	<b>301305</b>	21829		156,3	74,2	20,3			
2.5i V6	07/96 ▶ 07/97		ATE	<b>301183</b>	21051		61,7	61,2	15,7			



















									
<b>VAUXHALL (.../...)</b>									
<b>Calibra (90&gt;97)  (.../...)</b>									
2.0i, 2.0i Turbo, 2.5i V6 	06/90 ▶ 07/97		ATE	<b>301253</b>	21140		61,8	57,2	15,3
<b>Carlton (78&gt;86) </b>									
1.8, 2.0, 2.0i, 2.2i, 2.3D   (4), (5)	01/78 ▶ 10/86		GME	<b>301182</b>	20867		100	59	15,4
<b>Carlton (86&gt;94) </b>									
1.8, 1.8i, 2.0i, 2.3D, 2.3TD Turbo   (4), (5)  _ ▶ K1000098  _ ▶ L1019854	11/86 ▶		GME	<b>301182</b>	20867		100	59	15,4
1.8, 1.8i, 2.0i, 2.3D, 2.3TD Turbo, 2.4i   (4), (5)  K1000099 ▶ _  L1019855 ▶ _	▶ 05/94		ATE	<b>301184</b>	21201		156,3	52,6	17
2.6i, 3.0i   (4), (5)  M1000001 ▶ _	▶ 05/94		LUC	<b>301256</b>	21368		129,8	63,9	18,6
1.8, 1.8i, 2.0i, 2.3D, 2.3TD Turbo, 2.4i, 2.6i, 3.0i   (4), (5)  K1000099 ▶ _	▶ 05/94		ATE	<b>301183</b>	21051		61,7	61,2	15,7
<b>Cavalier (75&gt;81) </b>									
1.3, 1.6, 1.9, 2.0  (4)	10/75 ▶ 07/81		GME	<b>301182</b>	20867		100	59	15,4
<b>Cavalier (81&gt;88) </b>									
1.3, 1.6, 1.6D, 1.8i, 2.0i    (2), (4), (5)	08/81 ▶ 08/88		GME	<b>301182</b>	20867		100	59	15,4
<b>Cavalier (88&gt;95) </b>									
1.4, 1.6, 1.6i, 1.7D, 1.7D Turbo, 1.8, 1.8i   (4), (5)  _ ▶ N1038529	10/88 ▶		GME	<b>301182</b>	20867		100	59	15,4
1.7D, 1.7D Turbo, 1.8, 1.8i, 2.0i   (4), (5)  S1000001 ▶ _	▶ 10/95		ATE	<b>301184</b>	21201		156,3	52,6	17
1.4, 1.6, 1.6i, 1.7D, 1.7D Turbo, 1.8, 1.8i   (4), (5)  N1038530 ▶ R1999999  N1038530 ▶ _			ATE	<b>301356</b>	21353		140,1	58,3	16,8
2.0i, 2.0i Turbo, 2.5i V6   (4), (5)	10/88 ▶ 10/95		ATE	<b>301253</b>	21140		61,8	57,2	15,3
<b>Combo (93&gt;2001) </b>									
1.4i, 1.7D AC-	10/93 ▶ 09/01		ATE	<b>301356</b>	21353		140,1	58,3	16,8
							141,4	48,4	
<b>Combo (2001&gt;2004) </b>									
1.6i, 1.6i GPL, 1.7DTi, 1.7Di  _ ▶ 43999999	10/01 ▶		LUC	<b>301456</b>	23225		131,6	52,8	16,8
							55,5		
1.6i, 1.6i GPL, 1.7DTi, 1.7Di  53000001 ▶ _	▶ 06/04		ATE	<b>301860</b>	23832		156,1	76	20,4
							154,9	69,7	↳ 2x ⇐
1.6i, 1.6i GPL, 1.7DTi, 1.7Di	10/01 ▶ 06/04		LUC	<b>301584</b>	23417		95,5	42,7	15,2
									↳ 2x ⇐

















											
<b>VAUXHALL (.../...)</b>											
<b>Combo (2004&gt;)</b> 											
1.3CDTi, 1.4i GPL Twinport, 1.4i Twinport, 1.7CDTi  _ ▶ 43999999	07/04 ▶		LUC	<b>301456</b>	23225		131,6	52,8	16,8		
								55,5			
1.3CDTi, 1.4i GPL Twinport, 1.4i Twinport, 1.7CDTi  53000001 ▶ _			ATE	<b>301860</b>	23832		156,1	76	20,4	↳ 2x ⇐	
							154,9	69,7			
1.3CDTi, 1.4i GPL Twinport, 1.4i Twinport, 1.7CDTi	07/04 ▶		LUC	<b>301584</b>	23417		95,5	42,7	15,2	↳ 2x ⇐	
<b>Corsa MK I (93&gt;2000)</b> 											
1.0i, 1.2i, 1.4i, 1.5D, 1.5D Turbo, 1.6i, 1.7D   (3), (5)	04/93 ▶ 08/00		ATE	<b>301356</b>	21353		140,1	58,3	16,8		
							141,4	48,4			
<b>Corsa MK II (2000&gt;2003)</b> 											
1.0i, 1.2i, 1.4i, 1.7DTi, 1.7Di, 1.8i   (2), (3), (5)	09/00 ▶ 08/03		LUC	<b>301456</b>	23225		131,6	52,8	16,8		
								55,5			
1.4i, 1.8i  (3), (5) ESP+	09/00 ▶ 08/03		LUC	<b>301457</b>	23284		95,5	43,9	13,8	↳ 2x ⇐	
<b>Corsa MK II (2003&gt;2006)</b> 											
1.0i, 1.0i Twinport, 1.2i, 1.2i Dualfuel, 1.3CDTi, 1.4i Twinport, 1.8i   (3), (5)	09/03 ▶ 10/06		LUC	<b>301456</b>	23225		131,6	52,8	16,8		
								55,5			
1.7CDTi  (3), (5)	09/03 ▶ 10/06		ATE	<b>301860</b>	23832		156,1	76	20,4	↳ 2x ⇐	
							154,9	69,7			
1.4i Twinport, 1.8i  (3), (5) ESP+	09/03 ▶ 10/06		LUC	<b>301457</b>	23284		95,5	43,9	13,8	↳ 2x ⇐	
<b>Corsa MK III (2006&gt;)</b> 											
1.0i 60, 1.0i 65, 1.2i, 1.2i Twinport 85, 1.2i Twinport GPL, 1.3CDTi 75, 1.4i  (3), (5)	07/06 ▶		BSC	<b>301825</b>	24288		122,8	53,2	17,8	↳ 1x ⇐	
1.6i  (3)	02/07 ▶		ATE	<b>301860</b>	23832		156,1	76	20,4	↳ 2x ⇐	
							154,9	69,7			
<b>Frontera A (91&gt;98)</b> 											
2.0i, 2.3TD, 2.4i  (3), (5)			AKE	<b>301020</b>	21543		127	51	16,5	↳ 4x ⇐	
2.0i, 2.2i, 2.5TDS, 2.8TDi  (3), (5)	04/95 ▶ 09/98		SUM	<b>301507</b>	21875		109,6	42,5	15,8	↳ 2x ⇐	
<b>Frontera B (98&gt;2005)</b> 											
2.2DTi, 2.2i, 3.2i V6  (3), (5)	10/98 ▶ 07/05		AKE	<b>301661</b>	23250		137,8	57,8	18,5	↳ 2x ⇐	
2.2DTi, 2.2i, 3.2i V6  (3), (5)	10/98 ▶ 07/05		SUM	<b>301507</b>	21875		109,6	42,5	15,8	↳ 2x ⇐	

											
<b>VAUXHALL (.../...)</b>											
<b>Meriva (2003&gt;2010)</b> 											
1.4i Twinport, 1.6i  4	05/03 ▶ 07/10		LUC	<b>301456</b>	23225		131,6	52,8	16,8		
								55,5			
1.3CDTi, 1.4i Twinport, 1.6i, 1.6i Turbo, 1.7CDTi, 1.7DTi, 1.8i  5	05/03 ▶ 07/10		ATE	<b>301860</b>	23832		156,1	76	20,4	↳ 2x ⇐	
							154,9	69,7			
1.3CDTi, 1.4i Twinport, 1.6i, 1.6i Turbo, 1.7CDTi, 1.7DTi, 1.8i  4  5	05/03 ▶ 07/10		LUC	<b>301584</b>	23417		95,5	42,7	15,2	↳ 2x ⇐	
<b>Meriva (2010&gt;)</b> 											
1.3CDTi, 1.4GPL Turbo, 1.4Turbo, 1.4i, 1.7CDTi	05/10 ▶		ATE	<b>301860</b>	23832		156,1	76	20,4	↳ 2x ⇐	
							154,9	69,7			
1.3CDTi, 1.4GPL Turbo, 1.4Turbo, 1.4i, 1.7CDTi	05/10 ▶		LUC	<b>301584</b>	23417		95,5	42,7	15,2	↳ 2x ⇐	
<b>Monterey A (94&gt;98)</b> 											
3.1TD, 3.2i  3, 5	05/94 ▶ 06/98		SUM	<b>301507</b>	21875		109,6	42,5	15,8	↳ 2x ⇐	
<b>Monterey B (98&gt;99)</b> 											
3.0DTi, 3.5i V6  3, 5	07/98 ▶ 08/99		SUM	<b>301507</b>	21875		109,6	42,5	15,8	↳ 2x ⇐	
<b>Nova (83&gt;93)</b> 											
1.0, 1.2, 1.2i, 1.3, 1.4, 1.4i, 1.5D, 1.5TD, 1.6i  2, 3, 4, 5  1 → M4999999	04/83 ▶		GME	<b>301182</b>	20867		100	59	15,4		
1.0, 1.2, 1.2i, 1.3, 1.4, 1.4i, 1.5D, 1.5TD, 1.6i  2, 3, 4, 5  1 N4000001 ▶ _	▶ 03/93		ATE	<b>301356</b>	21353		140,1	58,3	16,8		
							141,4	48,4			
<b>Omega (94&gt;2003)</b> 											
2.0Di, 2.0i, 2.2DTi, 2.2i, 2.5TD, 2.5TDi, 2.5i V6, 2.6i V6, 3.0i, 3.0i V6, 3.2i V6  4, 5  1 W1000001 ▶ _	▶ 12/03		LUC	<b>301256</b>	21368		129,8	63,9	18,6		
2.0Di, 2.0i, 2.2DTi, 2.2i, 2.5TD, 2.5TDi, 2.5i V6, 2.6i V6, 3.0i, 3.0i V6, 3.2i V6  4, 5 1+	04/94 ▶ 12/03		ATE	<b>301183</b>	21051		61,7	61,2	15,7		
<b>Senator B (87&gt;93)</b> 											
2.5i, 2.6i, 3.0i	10/89 ▶ 08/93		LUC	<b>301256</b>	21368		129,8	63,9	18,6		
2.5i, 2.6i, 3.0i	09/87 ▶ 08/93		ATE	<b>301183</b>	21051		61,7	61,2	15,7		
<b>Signum (2003&gt;2005)</b> 											
1.8i, 1.9CDTi, 2.0DTi, 2.0i Turbo, 2.2DIG, 2.2DTi, 3.0CDTi V6, 3.2i V6 CSS+ : Chassis suspension of sport+  1 → 31068238	06/03 ▶		ATE	<b>301678</b>	23402		156,5	71	20,3		
2.0DTi, 2.0i Turbo, 2.2DIG, 2.2DTi, 3.0CDTi V6, 3.2i V6	06/03 ▶		ATE	<b>301472</b>	23482		123,1	52	16,6		
1.8i, 1.9CDTi, 2.0DTi, 2.0i Turbo, 2.2DIG, 2.2DTi, 3.0CDTi V6, 3.2i V6	06/03 ▶ 09/05		ATE	<b>301783</b>	24137		122,9	51,7	16,4		















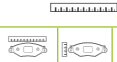































































				<b>Valeo</b>	<b>WVA</b>					
<b>VAUXHALL (.../...)</b>										
<b>Signum (2005&gt;2008)</b> 										
1.8i, 1.9CDTi, 2.0i Turbo, 2.2DGI	10/05 ▶ 11/08		ATE	<b>301678</b>	23402		156,5	71	20,3	
1.8i, 1.9CDTi, 2.0i Turbo, 2.2DGI, 2.8i V6 Turbo, 3.0CDTi V6	10/05 ▶ 11/08		ATE	<b>301783</b>	24137		122,9	51,7	16,4	
<b>Sintra (96&gt;99)</b> 										
2.2TDi, 2.2i, 3.0i V6	03/96 ▶ 12/99		GME	<b>301458</b>	23358		148	61,5	18	↳ 2x ⇐
<b>Tigra (94&gt;2001)</b> 										
1.4i, 1.6i	11/94 ▶ 01/01		ATE	<b>301356</b>	21353		140,1	58,3	16,8	
							141,4	48,4		
<b>Tigra Twintop (2004&gt;2008)</b> 										
1.3CDTi Twinport, 1.4i Twinport, 1.8i	07/04 ▶ 07/08		LUC	<b>301456</b>	23225		131,6	52,8	16,8	
								55,5		
1.8i	07/04 ▶ 07/08		LUC	<b>301457</b>	23284		95,5	43,9	13,8	↳ 2x ⇐
<b>Vectra (95&gt;2002)</b> 										
1.6i, 1.7TD, 1.8i, 2.0DTi, 2.0Di  (4),(5)  _ ▶ W1999999	10/95 ▶		ATE	<b>301184</b>	21201		156,3	52,6	17	
1.6i, 1.7TD, 1.8i, 2.0DTi, 2.0Di, 2.0i, 2.2DTi, 2.2i, 2.5i V6, 2.6i V6  (4),(5)  X1000001 ▶ _	▶ 03/02		ATE	<b>301305</b>	21829		156,3	74,2	20,3	
1.6i, 1.7TD, 1.8i, 2.0DTi, 2.0Di, 2.0i, 2.2DTi, 2.2i, 2.5i V6, 2.6i V6  (4),(5)	10/95 ▶ 03/02		ATE	<b>301183</b>	21051		61,7	61,2	15,7	
<b>Vectra (2002&gt;2005)</b> 										
1.6i, 1.8i, 1.8i LPG, 1.9CDTi, 2.0DTi, 2.0i Turbo, 2.2DGI, 2.2DTi, 2.2i, 3.0CDTi V6, 3.2i V6  (4),(5)  _ ▶ 31070293  _ ▶ 38047797	04/02 ▶		ATE	<b>301678</b>	23402		156,5	71	20,3	
1.8i, 1.9CDTi, 2.0DTi, 2.0i Turbo, 2.2DTi, 2.2i, 3.0CDTi V6, 3.2i V6  (4),(5)	04/02 ▶		ATE	<b>301472</b>	23482		123,1	52	16,6	
1.6i, 1.8i, 1.8i LPG, 1.9CDTi, 2.0DTi, 2.0i Turbo, 2.2DGI, 2.2DTi, 2.2i, 3.0CDTi V6, 3.2i V6  (4),(5)	04/02 ▶ 09/05		ATE	<b>301783</b>	24137		122,9	51,7	16,4	
<b>Vectra (2005&gt;2009)</b> 										
1.6i, 1.8i, 1.9CDTi, 2.0i Turbo, 2.2DGI  (4),(5)  _ ▶ 58999999  61000001 ▶ _			ATE	<b>301678</b>	23402		156,5	71	20,3	
1.6i, 1.8i, 1.9CDTi, 2.0i Turbo, 2.2DGI, 2.8i V6 Turbo, 3.0CDTi V6  (4),(5)			ATE	<b>301783</b>	24137		122,9	51,7	16,4	
<b>Vivaro (2001&gt;2006)</b> 										
1.9Di, 1.9DTi, 2.0i, 2.5DTi  (2),(4),(5)	08/01 ▶ 06/06		LUC	<b>301545</b>	23099		145	62,5	18	
<b>Vivaro (2006&gt;)</b> 										
2.0CDTi, 2.5CDTi  (5)	07/06 ▶		LUC	<b>301545</b>	23099		145	62,5	18	

				<b>Valeo</b>	<b>WVA</b>					
<b>VAUXHALL (.../...)</b>										
<b>Zafira I (99&gt;2003)</b> 										
1.6i, 1.6i GNV, 1.8i, 2.0Di, 2.2DTI, 2.2i	05/99 ▶ 06/03		ATE	<b>301454</b>	23062		156,4	78,5	20	↳ 2x ⇐
							155,4	71,5		
1.8i, 2.0Di, 2.0i Turbo, 2.2DTI, 2.2i	05/99 ▶ 06/03		LUC	<b>301584</b>	23417		95,5	42,7	15,2	↳ 2x ⇐
1.6i, 1.6i GNV, 1.8i, 2.0Di, 2.0i Turbo, 2.2DTI, 2.2i	05/99 ▶ 06/03		BSC	<b>301926</b>	23258		104,8	42,7	17	↳ 2x ⇐
<b>Zafira I (2003&gt;2005)</b> 										
1.6i, 1.6i GNV, 1.8i, 2.0DTI, 2.0i, 2.0i Turbo, 2.2i	07/03 ▶ 06/05		ATE	<b>301454</b>	23062		156,4	78,5	20	↳ 2x ⇐
							155,4	71,5		
1.6i, 1.6i GNV, 1.8i, 2.0DTI, 2.0i, 2.0i Turbo, 2.2i	07/03 ▶ 06/05		LUC	<b>301584</b>	23417		95,5	42,7	15,2	↳ 2x ⇐
<b>Zafira II (2005&gt;2009)</b> 										
2.0i Turbo	07/05 ▶ 02/09		ATE	<b>301678</b>	23402		156,5	71	20,3	
										
1.6i GNV, 1.6i Twinport, 1.7CDTI, 1.8i, 1.9CDTI, 2.0i Turbo, 2.2i	07/05 ▶ 02/09		ATE	<b>301860</b>	23832		156,1	76	20,4	↳ 2x ⇐
							154,9	69,7		
1.6i GNV, 1.6i Twinport, 1.7CDTI, 1.8i, 1.9CDTI, 2.0i Turbo, 2.2i	07/05 ▶ 02/09		LUC	<b>301584</b>	23417		95,5	42,7	15,2	↳ 2x ⇐
<b>Zafira II (2009&gt;)</b> 										
2.0i	02/09 ▶		ATE	<b>301678</b>	23402		156,5	71	20,3	
										
1.6T CNG, 1.6i, 1.6i CNG, 1.7CDTI, 1.7CDTI 110, 1.7CDTI 125, 1.8i VWT, 1.9CDTI, 2.0i, 2.2i	02/09 ▶		ATE	<b>301860</b>	23832		156,1	76	20,4	↳ 2x ⇐
							154,9	69,7		
1.6T CNG, 1.6i, 1.6i CNG, 1.7CDTI, 1.7CDTI 110, 1.7CDTI 125, 1.8i VWT, 1.9CDTI, 2.0i, 2.2i	02/09 ▶		LUC	<b>301584</b>	23417		95,5	42,7	15,2	↳ 2x ⇐
<b>Zafira III (2011&gt;)</b> 										
1.4Ti 120, 1.4Ti 140, 1.6Ti 150-CNG, 1.8i 115, 1.8i 140, 2.0CDTI 110, 2.0CDTI 130, 2.0CDTI 165	10/11 ▶		BSC	<b>301070</b>	25080		148,1	61,2	18,8	↳ 2x ⇐
										
1.4Ti 120, 1.4Ti 140, 1.6Ti 150-CNG, 1.8i 115, 1.8i 140, 2.0CDTI 110, 2.0CDTI 130, 2.0CDTI 165	10/11 ▶		BSC	<b>301055</b>	25096		116,6	42,7	16,3	↳ 2x ⇐
										
<b>VOLKSWAGEN</b>										
<b>412 (68&gt;74)</b> 										
1.7, 1.8   (2), (4), (5)	08/68 ▶ 07/74		ATE	<b>301099</b>	20228		61,8	56,6	15	
<b>Bora (98&gt;2005)</b> 										
1.4i, 1.6i, 1.9SDi, 1.9TDi, 2.0i  (4)	09/98 ▶ 05/99		ATE	<b>301332</b>	21974		146	54,7	19,8	
										
1.4i, 1.6FSI, 1.6i, 1.9SDi, 1.9TDi, 2.0i   (4), (5) TU+ : Wear warning+	09/98 ▶ 05/05		ATE	<b>301408</b>	21974		146	54,7	18,5	↳ 1x ⇐ 155 mm
										
1.8i, 1.8i Turbo, 1.9TDi, 2.3i V5, 2.8i VR6   (4), (5)	09/98 ▶ 05/05		ATE	<b>301486</b>	21911		156,35	74,1	19,5	↳ 1x ⇐ 155 mm
										
1.4i, 1.6FSI, 1.6i, 1.8i, 1.8i Turbo, 1.9SDi, 1.9TDi, 2.0i, 2.3i V5, 2.8i VR6   (4), (5)	09/98 ▶ 05/05		LUC	<b>301463</b>	20960		87	52,9	17	
										

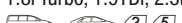















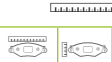















































				<b>Valeo</b>	<b>WVA</b>			
<b>VOLKSWAGEN (.../...)</b>								
<b>Caddy II (95&gt;2004)</b> 								
1.4i, 1.6i, 1.9D, 1.9SDi  _ ▶ T-514 500	11/95 ▶ 03/96		LUC	<b>301252</b>	20901		119 69,5 19,6	
1.4i, 1.6i, 1.7SDi, 1.9D, 1.9SDi, 1.9TDi  T-514 501 ▶ _	03/96 ▶ 06/03		LUC	<b>301330</b>	21945		119 69,5 16,3	
<b>Caddy III (2004&gt;2010)</b> 								
1.4i, 1.9TDi, 2.0SDi	02/04 ▶ 08/10		ATE	<b>301408</b>	21974		146 54,7 18,5	↳ 1 x ↗ 155 mm
1.6i, 1.9TDi, 2.0TDi, 2.0i CNG	02/04 ▶ 08/10		ATE	<b>301635</b>	23587		156,4 71,4 20,3 155,2 66	↳ 1 x ↗ 155 mm
1.4i, 1.9TDi, 2.0SDi	02/04 ▶ 08/10		LUC	<b>301463</b>	20960		87 52,9 17	
1.4i, 1.6i, 1.9TDi, 2.0SDi, 2.0TDi, 2.0i CNG TU+ : Wear warning+	02/04 ▶		TRW	<b>301752</b>	23914		105,1 56 17	
<b>Caddy IV (2010&gt;)</b> 								
1.2TSI 86, 1.6TDI 75, 2.0TDI 85	08/10 ▶		ATE	<b>301408</b>	21974		146 54,7 18,5	↳ 1 x ↗ 155 mm
1.2TSI 105, 1.6SRE 102, 1.6TDI 102, 2.0TDI 110, 2.0TDI 140, 2.0i CNG 109	08/10 ▶		ATE	<b>301635</b>	23587		156,4 71,4 20,3 155,2 66	↳ 1 x ↗ 155 mm
1.2TSI 105, 1.2TSI 86, 1.6SRE 102, 1.6TDI 102, 1.6TDI 75, 2.0TDI 110, 2.0TDI 85, 2.0i CNG 109	08/10 ▶		LUC	<b>301463</b>	20960		87 52,9 17	
<b>Crafter (2006&gt;)</b> 								
2.5TDi   (2),(4),(5) CU+ : Extra load+	04/06 ▶ 05/09		BRE	<b>301881</b>	29200		169,1 73,5 20,8	
<b>Corrado (88&gt;95)</b> 								
1.8i, 2.0i	04/89 ▶ 07/95		LUC	<b>301016</b>	20901		119 69,5 15,7	↳ 2 x ↗ 225 mm
1.8i G60, 2.9E VR6	09/88 ▶ 07/95		LUC	<b>301252</b>	20901		119 69,5 19,6	
1.8i, 2.0i	04/89 ▶ 07/95		LUC	<b>301330</b>	21945		119 69,5 16,3	
1.8i, 1.8i G60, 2.0i, 2.9E VR6  _ ▶ P-009 000	09/88 ▶ 07/95		LUC	<b>301180</b>	20960		87 53 15,2	
1.8i G60, 2.9E VR6  P-009 001 ▶ _	03/93 ▶ 07/95		LUC	<b>301463</b>	20960		87 52,9 17	
<b>Derby (77&gt;81)</b> 								
0.9, 1.1, 1.3  (3)	01/77 ▶ 09/81		ATE	<b>301099</b>	20228		61,8 56,6 15	
<b>Derby (81&gt;84)</b> 								
1.05, 1.1, 1.3  (2)	10/81 ▶ 10/84		ATE	<b>301099</b>	20228		61,8 56,6 15	
<b>Eos (2006&gt;2010)</b> 								
1.4FSi, 1.6FSi, 2.0FSi, 2.0TDi, 2.0TFSi	05/06 ▶ 11/10		ATE	<b>301635</b>	23587		156,4 71,4 20,3 155,2 66	↳ 1 x ↗ 155 mm
1.4FSi, 1.6FSi	05/06 ▶ 11/10		LUC	<b>301463</b>	20960		87 52,9 17	
1.4FSi, 2.0FSi, 2.0TDi, 2.0TFSi, 3.2i V6, 3.6i V6	05/06 ▶ 11/10		TRW	<b>301752</b>	23914		105,1 56 17	

				<b>Valeo</b>	<b>WVA</b>						
<b>VOLKSWAGEN (.../...)</b>											
<b>Eos (2010&gt;)</b> 											
 	1.4TSI 122, 1.4TSI 160, 2.0TDI 136, 2.0TDI 140, 2.0TSI 200, 2.0TSI 211	11/10 ▶		ATE	<b>301635</b>	23587		156,4 155,2	71,4 66	20,3	↳ 1 x  155 mm
	1.4TSI 122, 2.0TDI 136	11/10 ▶		LUC	<b>301463</b>	20960		87	52,9	17	
<b>Fox (2004&gt;)</b> 											
	1.2i, 1.2i 55, 1.2i 60, 1.4TDi, 1.4i DA+ : Power steering+	11/04 ▶		ATE	<b>301332</b>	21974		146	54,7	19,8	
	1.2i, 1.2i 55, 1.2i 60, 1.4TDi, 1.4i DA- : Power steering-	11/04 ▶		ATE	<b>301488</b>	21865		141,8 50,6	51,2	17,3	
<b>Golf I (74&gt;83)</b> 											
	1.1, 1.3, 1.5D, 1.6D  	04/74 ▶ 12/83		ATE	<b>301099</b>	20228		61,8	56,6	15	
	1.6, 1.7i, 1.8  	06/76 ▶ 12/83		VW	<b>301124</b>	20887		137,8 51,1	49	15,3	
<b>Golf I Cabriolet (79&gt;93)</b> 											
	1.3i, 1.8, 1.8i	08/82 ▶ 07/93		VW	<b>301124</b>	20887		137,8 51,1	49	15,3	
<b>Golf II (83&gt;92)</b> 											
	1.8i 	08/88 ▶ 10/91		LUC	<b>301016</b>	20901		119	69,5	15,7	↳ 2 x  225 mm
	1.8i  	02/86 ▶ 07/88		ATE	<b>301066</b>	21866		141,8	50,5	19,7	
	1.8, 1.8i  	01/84 ▶ 10/91		VW	<b>301124</b>	20887		137,8 51,1	49	15,3	
	1.8, 1.8 G60  	08/88 ▶ 07/91		LUC	<b>301252</b>	20901		119	69,5	19,6	
	1.8i 	08/88 ▶ 10/91		LUC	<b>301330</b>	21945		119	69,5	16,3	
	1.8, 1.8 G60, 1.8i  	01/84 ▶ 10/91		LUC	<b>301180</b>	20960		87	53	15,2	
<b>Golf II Cabriolet (93&gt;98)</b> 											
	1.6i, 1.8i, 1.9TDi, 2.0i  _ ▶ T-030 000	09/93 ▶ 05/96		LUC	<b>301016</b>	20901		119	69,5	15,7	↳ 2 x  225 mm
	1.8i ABS+	01/98 ▶ 02/98		VW	<b>301124</b>	20887		137,8 51,1	49	15,3	
	1.6i, 1.8i, 1.9TDi, 2.0i  V-000 001 ▶ _	09/93 ▶ 02/98		LUC	<b>301252</b>	20901		119	69,5	19,6	
	1.6i, 1.8i, 1.9TDi, 2.0i  _ ▶ T-030 000	09/93 ▶ 05/96		LUC	<b>301330</b>	21945		119	69,5	16,3	
	1.8i, 1.9TDi, 2.0i ABS+	08/95 ▶ 02/98		LUC	<b>301180</b>	20960		87	53	15,2	



















































				<b>Valeo</b>	<b>WVA</b>			
<b>VOLKSWAGEN (.../...)</b>								
<b>Golf III (91&gt;99)</b> 								
1.6i, 1.8, 1.8i, 1.9D, 1.9D Ecomatic, 1.9TD, 1.9TDi, 2.0E, 2.0i    (3),(5)   ABS-  _ ▶ T-500 000	11/91 ▶ 04/99		LUC	<b>301016</b>	20901		119 69,5 15,7	↳ 2 x  225 mm
1.4, 1.4i, 1.6, 1.8, 1.9D, 1.9D Ecomatic, 1.9SDi, 1.9SDi Ecomatic, 1.9TD   (3),(5)	11/91 ▶ 05/98		ATE	<b>301066</b>	21866		141,8 50,5 19,7	
2.0E  (3),(5)	10/94 ▶ 12/97		VW	<b>301124</b>	20887		137,8 49 15,3 51,1	
1.6, 1.6i, 1.8, 1.8i, 1.9D, 1.9SDi, 1.9TD, 1.9TDi, 2.0, 2.0E   (3),(5)   ABS- ETR+ : Red caliper+  _ ▶ T-500 000	11/91 ▶ 04/99		LUC	<b>301252</b>	20901		119 69,5 19,6	
1.4, 1.6, 1.6i, 1.8, 1.8i, 1.9SDi, 1.9SDi Ecomatic, 1.9TD, 1.9TDi, 2.0E, 2.0i   (3),(5)	11/91 ▶ 04/99		LUC	<b>301330</b>	21945		119 69,5 16,3	
1.4, 1.6, 1.9D, 1.9D Ecomatic, 1.9SDi, 1.9SDi Ecomatic   (3),(5)	11/91 ▶ 02/99		ATE	<b>301403</b>	21866		141,8 50,5 15 51,2	
1.9TDi, 2.0E, 2.8 VR6, 2.9i VR6   (3),(5)	01/94 ▶ 04/99		ATE	<b>301486</b>	21911		156,35 74,1 19,5	↳ 1 x  155 mm
2.0, 2.0E, 2.8 VR6  (3),(5)	11/91 ▶ 02/95		LUC	<b>301982</b>	21366		118,9 69,5 16,3	↳ 2 x  220 mm
1.6i, 1.8, 1.8i, 1.9TDi, 2.0, 2.0E, 2.8 VR6, 2.9i VR6  (3),(5)	11/91 ▶ 12/97		LUC	<b>301180</b>	20960		87 53 15,2	
1.6, 1.6i, 1.8i, 1.9TDi, 2.0, 2.0E, 2.8 VR6, 2.9i VR6   (3),(5) ABS+  V-000 001 ▶ _	10/92 ▶ 04/99		LUC	<b>301463</b>	20960		87 52,9 17	
<b>Golf III Cabriolet (98&gt;2002)</b> 								
1.6i, 1.8i, 1.9TDi, 2.0i ABS-	03/98 ▶ 06/02		LUC	<b>301252</b>	20901		119 69,5 19,6	
1.6i, 1.8i, 1.9TDi, 2.0i ABS+	03/98 ▶ 06/02		LUC	<b>301330</b>	21945		119 69,5 16,3	
1.6i, 1.8i, 1.9TDi, 2.0i ABS-	03/98 ▶ 06/02		LUC	<b>301180</b>	20960		87 53 15,2	
<b>Golf IV (97&gt;2006)</b> 								
1.4i, 1.6i, 1.8i, 1.9SDi, 1.9TDi, 2.0i  (3),(5)  X-000 001 ▶ X-800 000  X-000 001 ▶ _  _ ▶ W-200 000  _ ▶ X-800 000	10/97 ▶ 05/99		ATE	<b>301332</b>	21974		146 54,7 19,8	
1.4i, 1.6FSI, 1.6i, 1.8i, 1.9SDi, 1.9TDi, 2.0i   (3),(5) TU+ : Wear warning+  Y-000 001 ▶ _	07/98 ▶ 06/06		ATE	<b>301408</b>	21974		146 54,7 18,5	↳ 1 x  155 mm
1.8i Turbo, 1.9TDi, 2.3i VR5, 2.8i V6, 2.8i VR6   (3),(5) TU+ : Wear warning+  Y-000 001 ▶ _  _ ▶ X-800 000	10/97 ▶ 05/06		ATE	<b>301486</b>	21911		156,35 74,1 19,5	↳ 1 x  155 mm

											
<b>VOLKSWAGEN (.../...)</b>											
<b>Golf IV (97&gt;2006)  (.../...)</b>											
1.4i, 1.6FSi, 1.6i, 1.8i, 1.8i Turbo, 1.9SDi, 1.9TDi, 2.0i, 2.3i VR5, 2.8i V6, 2.8i VR6, 3.2i V6   (3),(5)	10/97 ▶ 06/06		LUC	<b>301463</b>	20960		87	52,9	17		
<b>Golf V (2003&gt;2009) </b>											
1.4FSi, 1.4TFSi, 1.4TSi, 1.4i, 1.6FSi, 1.6i, 1.9TDi, 2.0SDi   (3),(5)	10/03 ▶ 06/09		ATE	<b>301408</b>	21974		146	54,7	18,5	↳ 1 x +  155 mm	
1.6FSi, 2.0FSi, 2.0TDi, 2.0TFSi   (3),(5)	10/03 ▶ 06/09		ATE	<b>301635</b>	23587		156,4	71,4	20,3	↳ 1 x +  155 mm	
							155,2	66			
1.4FSi, 1.4TFSi, 1.4TSi, 1.4i, 1.6FSi, 1.6i, 1.9TDi, 2.0SDi   (3),(5)	10/03 ▶ 11/08		LUC	<b>301463</b>	20960		87	52,9	17		
1.9TDi, 2.0FSi, 2.0TDi, 2.0TFSi, 3.2i VR6   (3),(5)	10/03 ▶ 06/09		TRW	<b>301752</b>	23914		105,1	56	17		
<b>Golf VI (2008&gt;) </b>											
1.2TSi 86, 1.2TSi, 1.4i, 1.6TDi, 1.6i, 2.0TDi, 2.0TDi 110   (3),(5)	10/08 ▶		ATE	<b>301408</b>	21974		146	54,7	18,5	↳ 1 x +  155 mm	
1.4TFSi, 1.4TSi, 1.8TFSi, 2.0GTi, 2.0TDi, 2.0TFSi, 2.0TSi   (3),(5)	10/08 ▶		ATE	<b>301635</b>	23587		156,4	71,4	20,3	↳ 1 x +  155 mm	
							155,2	66			
1.2TSi, 1.4i, 1.6TDi, 1.6i, 2.0TDi  (3),(5)	10/08 ▶		LUC	<b>301463</b>	20960		87	52,9	17		
1.2TSi, 1.4TFSi, 1.4TSi, 1.4i, 1.6TDi, 1.6i, 1.8TFSi, 2.0GTi, 2.0TDi, 2.0TFSi, 2.0TSi   (3),(5)	10/08 ▶		TRW	<b>301752</b>	23914		105,1	56	17		
<b>Golf VI Cabriolet (2011&gt;) </b>											
1.2TSi, 1.4TSi, 1.6TDi, 2.0TDi	03/11 ▶		ATE	<b>301635</b>	23587		156,4	71,4	20,3	↳ 1 x +  155 mm	
							155,2	66			
1.2TSi, 1.4TSi, 1.6TDi, 2.0TDi	03/11 ▶		LUC	<b>301463</b>	20960		87	52,9	17		
<b>Golf V Plus (2005&gt;2009) </b>											
1.4FSi, 1.4TFSi, 1.4TSi, 1.4i, 1.6i, 1.9TDi	01/05 ▶		ATE	<b>301408</b>	21974		146	54,7	18,5	↳ 1 x +  155 mm	
1.6FSi, 2.0FSi, 2.0TDi	01/05 ▶ 01/09		ATE	<b>301635</b>	23587		156,4	71,4	20,3	↳ 1 x +  155 mm	
							155,2	66			
1.4FSi, 1.4TFSi, 1.4TSi, 1.4i, 1.6FSi, 1.6i, 1.9TDi, 2.0FSi, 2.0TDi	01/05 ▶		LUC	<b>301463</b>	20960		87	52,9	17		
<b>Golf VI Plus (2009&gt;) </b>											
1.2TSi, 1.2TSi 86, 1.4TSi, 1.4i, 1.6TDi, 1.6i, 2.0TDi	01/09 ▶		ATE	<b>301408</b>	21974		146	54,7	18,5	↳ 1 x +  155 mm	
1.4TSi, 2.0TDi	01/09 ▶		ATE	<b>301635</b>	23587		156,4	71,4	20,3	↳ 1 x +  155 mm	
							155,2	66			
1.2TSi, 1.2TSi 86, 1.4TSi, 1.4i, 1.6TDi, 1.6i, 2.0TDi	01/09 ▶		LUC	<b>301463</b>	20960		87	52,9	17		
1.4TSi, 2.0TDi	01/09 ▶		TRW	<b>301752</b>	23914		105,1	56	17		

										
<b>VOLKSWAGEN (.../...)</b>										
<b>Jetta I (78&gt;84)</b> 										
1.1, 1.3, 1.6D	08/79 ▶ 02/84		ATE	<b>301099</b>	20228		61,8	56,6	15	
1.7, 1.8	08/81 ▶ 02/84		VW	<b>301124</b>	20887		137,8	49	15,3	
								51,1		
1.8	08/82 ▶ 02/84		LUC	<b>301180</b>	20960		87	53	15,2	
<b>Jetta II (83&gt;92)</b> 										
1.8i  K-240 001 ▶ _  KB-075 001 ▶ _	08/86 ▶ 10/91		LUC	<b>301016</b>	20901		119	69,5	15,7	↳ 2 x  225 mm
1.05, 1.3, 1.3i, 1.6D	08/83 ▶ 07/92		ATE	<b>301099</b>	20228		61,8	56,6	15	
1.8, 1.8i ABS+  H-560 001 ▶ _  _ ▶ K240000  _ ▶ KB075000	01/84 ▶ 10/91		VW	<b>301124</b>	20887		137,8	49	15,3	
								51,1		
1.8i  K-240 001 ▶ _  KB-075 001 ▶ _	08/86 ▶ 10/91		LUC	<b>301330</b>	21945		119	69,5	16,3	
1.8, 1.8i ABS+  H-560 001 ▶ _	01/84 ▶ 10/91		LUC	<b>301180</b>	20960		87	53	15,2	
<b>Jetta III (2005&gt;2010)</b> 										
1.4TSi, 1.6TDI 105, 1.6TDI 90, 1.6i, 1.9TDI	08/05 ▶		ATE	<b>301408</b>	21974		146	54,7	18,5	↳ 1 x  155 mm
1.4TSi, 1.6FSi, 2.0FSi, 2.0TDi, 2.0TDi 136, 2.0TFSi, 2.0TSi, 2.0TSi 200, 2.5i, 2.5i 170	08/05 ▶		ATE	<b>301635</b>	23587		156,4	71,4	20,3	↳ 1 x  155 mm
							155,2	66		
1.6FSi, 1.6i, 1.9TDI	08/05 ▶		LUC	<b>301463</b>	20960		87	52,9	17	
1.4TSi, 1.6FSi, 1.6TDI 105, 1.6TDI 90, 1.6i, 1.9TDI, 2.0FSi, 2.0TDi, 2.0TFSi, 2.0TSi, 2.0TSi 200, 2.5i	08/05 ▶		TRW	<b>301752</b>	23914		105,1	56	17	
<b>Jetta IV (2010&gt;)</b> 										
1.2TSi 105, 1.4TSi 122, 1.6TDI 105, 1.6i 105, 2.0TDI 110, 2.0i 115	04/10 ▶		ATE	<b>301408</b>	21974		146	54,7	18,5	↳ 1 x  155 mm
1.4TSi 150, 1.4TSi 160, 1.4TSi 170, 1.8TFSi 170, 2.0GLi 200, 2.0TDI 140, 2.5i 170	04/10 ▶		ATE	<b>301635</b>	23587		156,4	71,4	20,3	↳ 1 x  155 mm
							155,2	66		
<b>Lupo (98&gt;2005)</b> 										
1.0i, 1.4FSi, 1.4TDi, 1.4i, 1.7SDi	10/98 ▶ 07/05		ATE	<b>301488</b>	21865		141,8	51,2	17,3	
								50,6		
1.2TDi	05/99 ▶ 07/05		ATE	<b>301735</b>	23395		141,8	48,3	14,4	
								48,8		
1.6i	06/00 ▶ 07/05		ATE	<b>301805</b>	21865		141,8	50,6	17	↳ 1 x  180 mm
1.4FSi, 1.4i, 1.6i	05/99 ▶ 07/05		LUC	<b>301463</b>	20960		87	52,9	17	

				<b>Valeo</b>	<b>WVA</b>			
<b>VOLKSWAGEN (.../...)</b>								
<b>Lupo (98&gt;2005)  (.../...)</b>								
1.4FSI, 1.4i, 1.6i	05/99 ▶ 07/05		LUC	<b>301674</b>	20960		87 53 17	↳ 1 x +  260 mm
<b>LT II (96&gt;2003) </b>								
2.3i, 2.5SDi, 2.5TDI, 2.8TD, 2.8TDI	05/96 ▶ 05/03		ATE	<b>301044</b>	21576		156,25 64,8 20,5	
2.3i, 2.5SDi, 2.5TDI, 2.8TD, 2.8TDI  2-008 001 ▶ _  _ ▶ X-002 119			ATE	<b>301046</b>	21661		156,4 54,6 18,5	
2.3i, 2.5SDi, 2.5TDI, 2.8TD  X-002 120 ▶ 2-008 000  X-002 120 ▶ _  _ ▶ 2-008 000			BSC	<b>301300</b>	23021		125,7 61,8 18,4	
<b>LT III (2003&gt;2006) </b>								
2.5TDI, 2.8TDi	06/03 ▶ 07/06		ATE	<b>301044</b>	21576		156,25 64,8 20,5	
2.5TDI, 2.8TDi	06/03 ▶ 07/06		ATE	<b>301046</b>	21661		156,4 54,6 18,5	
2.5TDI, 2.8TDi	06/03 ▶ 07/06		BSC	<b>301300</b>	23021		125,7 61,8 18,4	
<b>New Beetle (98&gt;2001) </b>								
1.9TDi, 2.0i  X-400 001 ▶ _  _ ▶ X-999 000	01/98 ▶ 05/01		ATE	<b>301332</b>	21974		146 54,7 19,8	
1.6i, 1.9TDi, 2.0i  Y-600 001 ▶ _	11/98 ▶ 05/01		ATE	<b>301408</b>	21974		146 54,7 18,5	↳ 1 x +  155 mm
1.8i Turbo, 2.3i V5, 3.2i V6 TU+ : Wear warning+  Y-600 001 ▶ _  _ ▶ X-699 000	01/99 ▶ 05/01		ATE	<b>301486</b>	21911		156,35 74,1 19,5	↳ 1 x +  155 mm
1.6i, 1.8i Turbo, 1.9TDi, 2.0i, 2.3i V5, 3.2i V6	01/98 ▶ 05/01		LUC	<b>301463</b>	20960		87 52,9 17	
<b>New Beetle (2001&gt;2005) </b>								
1.4i, 1.6i, 1.9TDi, 2.0i TU+ : Wear warning+	06/01 ▶ 06/05		ATE	<b>301408</b>	21974		146 54,7 18,5	↳ 1 x +  155 mm
1.8i Turbo, 2.3i V5	06/01 ▶ 06/05		ATE	<b>301486</b>	21911		156,35 74,1 19,5	↳ 1 x +  155 mm
1.4i, 1.6i, 1.8i Turbo, 1.9TDi, 2.0i, 2.3i V5	06/01 ▶ 06/05		LUC	<b>301463</b>	20960		87 52,9 17	
<b>New Beetle (2005&gt;2010) </b>								
1.4i, 1.6i, 1.8i Turbo, 1.9TDi, 2.0i	07/05 ▶ 09/10		ATE	<b>301408</b>	21974		146 54,7 18,5	↳ 1 x +  155 mm
2.5i	07/05 ▶ 09/10		ATE	<b>301486</b>	21911		156,35 74,1 19,5	↳ 1 x +  155 mm
1.4i, 1.6i, 1.8i Turbo, 1.9TDi, 2.0i, 2.5i	07/05 ▶		LUC	<b>301463</b>	20960		87 52,9 17	
<b>New Beetle II (2010&gt;) </b>								
1.2TSI, 1.6TDi	07/11 ▶		ATE	<b>301408</b>	21974		146 54,7 18,5	↳ 1 x +  155 mm
1.4TSi, 1.4TSi 170, 2.0TDI, 2.0TSI	12/10 ▶		ATE	<b>301635</b>	23587		156,4 71,4 20,3 155,2 66	↳ 1 x +  155 mm

										
<b>VOLKSWAGEN (.../...)</b>										
<b>Passat I (73&gt;81)</b> 										
1.3, 1.5, 1.5D, 1.6  (3), (5)  _ ▶ 328 2300 000  _ ▶ 32A 0099 142	05/73 ▶ 02/80		ATE	<b>301099</b>	20228		61,8	56,6	15	
1.9, 2.2  (3), (5)	01/81 ▶ 07/81		VW	<b>301124</b>	20887		137,8	49	15,3	
								51,1		
<b>Passat II (81&gt;88)</b> 										
1.8, 2.0i, 2.3, 2.3i  (4), (5)	08/84 ▶ 07/88		LUC	<b>301016</b>	20901		119	69,5	15,7	↳ 2 x  225 mm
1.3, 1.6D  (2), (4), (5)  _ ▶ C-055 251	08/81 ▶ 07/83		ATE	<b>301099</b>	20228		61,8	56,6	15	
1.9, 2.0i, 2.2, 2.2i, 2.3i  (2), (4), (5)	08/81 ▶ 04/88		VW	<b>301124</b>	20887		137,8	49	15,3	
								51,1		
1.8, 2.0i, 2.3, 2.3i  (4), (5)	08/84 ▶ 07/88		LUC	<b>301330</b>	21945		119	69,5	16,3	
1.8, 2.0i, 2.3, 2.3i  (4), (5)	08/84 ▶ 07/88		LUC	<b>301180</b>	20960		87	53	15,2	
<b>Passat III (88&gt;93)</b> 										
1.8, 1.8i, 2.0, 2.0i  (4), (5)	04/88 ▶ 10/93		LUC	<b>301016</b>	20901		119	69,5	15,7	↳ 2 x  225 mm
1.8  (4), (5)	09/89 ▶ 10/93		VW	<b>301124</b>	20887		137,8	49	15,3	
								51,1		
1.6, 1.6TD, 1.6i, 1.8, 1.8i, 1.9D, 1.9TD, 2.0, 2.0i, 2.8i, 2.8i V6, 2.8i VR6  (4), (5)  L-085 001 ▶ _	04/88 ▶ 10/93		LUC	<b>301252</b>	20901		119	69,5	19,6	
1.8, 1.8i, 2.0, 2.0i  (4), (5)	04/88 ▶ 10/93		LUC	<b>301330</b>	21945		119	69,5	16,3	
1.8, 1.8i, 2.0, 2.0i, 2.8i, 2.8i V6, 2.8i VR6  (4), (5)  _ ▶ P-080 000	04/88 ▶ 10/93		LUC	<b>301180</b>	20960		87	53	15,2	
1.8, 2.0, 2.0i, 2.8i, 2.8i V6, 2.8i VR6  (4), (5)	10/92 ▶ 10/93		LUC	<b>301463</b>	20960		87	52,9	17	
<b>Passat IV (93&gt;97)</b> 										
2.0i  (5)	01/94 ▶ 05/97		LUC	<b>301016</b>	20901		119	69,5	15,7	↳ 2 x  225 mm
1.6i, 1.8i, 1.9TD, 1.9TDi  (4), (5)	10/93 ▶ 12/96		LUC	<b>301252</b>	20901		119	69,5	19,6	
1.9TDi, 2.0i  (4), (5)	10/93 ▶ 05/97		LUC	<b>301330</b>	21945		119	69,5	16,3	
2.0i, 2.8i VR6, 2.9i VR6  (4), (5)	10/93 ▶ 05/97		ATE	<b>301486</b>	21911		156,35	74,1	19,5	↳ 1 x  155 mm
2.0i, 2.9i VR6  (5)	01/94 ▶ 05/97		LUC	<b>301180</b>	20960		87	53	15,2	
1.9TDi, 2.0i, 2.8i VR6  (4), (5)	10/93 ▶ 12/96		LUC	<b>301463</b>	20960		87	52,9	17	

				<b>Valeo</b>	<b>WVA</b>			
<b>VOLKSWAGEN (.../...)</b>								
<b>Passat V (96&gt;2000)</b> 								
1.6i, 1.8i, 1.9TDi  (4), (5)  X-600 000	10/96 ▶ 04/99		ATE	<b>301355</b>	21911		156,3 74 19,8	
1.6i, 1.8i, 1.8i Turbo, 1.9TDi, 2.3i VR5, 2.5TDi V6, 2.8i V6  (4), (5)  Y-000 001 ▶ _	10/96 ▶ 08/00		ATE	<b>301483</b>	20676		156,4 74,2 20,3	↳ 2 x ↗ 210 mm
1.9TDi  (4), (5)  Y-000 001 ▶ _	05/99 ▶ 08/00		LUC	<b>301484</b>	23393		119 69,5 19,4	↳ 2 x ↗ 210 mm
1.6i, 1.8i, 1.8i Turbo, 1.9TDi, 2.3i VR5, 2.5TDi V6, 2.8i V6  (4), (5)  Y-000 001 ▶ _	10/96 ▶ 08/00		ATE	<b>301751</b>	20676		156,4 74,2 19,2	↳ 2 x ↗ 210 mm
1.6i, 1.8i, 1.8i Turbo, 1.9TDi, 2.3i VR5, 2.5TDi V6, 2.8i V6  (4), (5)	10/96 ▶ 08/00		LUC	<b>301463</b>	20960		87 52,9 17	
<b>Passat VI (2000&gt;2005)</b> 								
1.6i, 1.8i Turbo, 1.9TDi, 2.0TDi, 2.0i, 2.3i V5, 2.5TDi V6, 2.8i V6  (4), (5) Ⓞ15" TU+ : Wear warning+	10/00 ▶ 05/05		ATE	<b>301483</b>	20676		156,4 74,2 20,3	↳ 2 x ↗ 210 mm
1.6i, 1.9TDi, 2.0TDi, 2.0i  (4), (5) Ⓞ15"	10/00 ▶ 05/05		ATE	<b>301751</b>	20676		156,4 74,2 19,2	↳ 2 x ↗ 210 mm
1.6i, 1.8i Turbo, 1.9TDi, 2.0TDi, 2.0i, 2.3i V5, 2.5TDi, 2.5TDi V6, 2.8i V6, 4.0i W8  (4), (5) Ⓞ15" HD+ : Heavy duty+	10/00 ▶ 05/05		LUC	<b>301463</b>	20960		87 52,9 17	
<b>Passat VII (2005&gt;2010)</b> 								
1.4FSi, 1.4TFSi, 1.4TSI CNG 150, 1.6FSi, 1.6TDi, 1.6i, 1.8FSi, 1.8FSi 160, 1.9TDi, 2.0FSi, 2.0TDi, 2.0TFSi, 2.0TFSi 200  (4), (5)	03/05 ▶		ATE	<b>301635</b>	23587		156,4 71,4 20,3 155,2 66	↳ 1 x ↗ 155 mm
1.4FSi, 1.4TFSi, 1.4TSI CNG 150, 1.6FSi, 1.6TDi, 1.6i, 1.8FSi, 1.8FSi 160, 1.9TDi, 2.0FSi, 2.0TDi, 2.0TFSi, 2.0TFSi 200, 3.2FSi V6, 3.6FSi V6  (4), (5)	03/05 ▶		TRW	<b>301752</b>	23914		105,1 56 17	
<b>Passat (2010&gt;)</b> 								
1.4TSI 122, 1.4TSI 160, 1.4TSI CNG 150, 1.6TDi 105, 1.8TFSi 160, 2.0TDi 136, 2.0TDi 140, 2.0TDi 170, 2.0TFSi 211, 3.6FSi V6-300  (4), (5)	08/10 ▶		TRW	<b>301752</b>	23914		105,1 56 17	
<b>Passat CC (2008&gt;2012)</b> 								
1.4TSI, 1.8TFSi, 2.0TDi, 2.0TFSi	05/08 ▶		ATE	<b>301635</b>	23587		156,4 71,4 20,3 155,2 66	↳ 1 x ↗ 155 mm
1.4TSI, 1.8TFSi, 2.0TDi, 2.0TFSi, 3.6FSi V6	05/08 ▶		TRW	<b>301752</b>	23914		105,1 56 17	
<b>Polo I (74&gt;81)</b> 								
0.8, 0.9, 1.1, 1.3	04/75 ▶ 09/81		ATE	<b>301099</b>	20228		61,8 56,6 15	
<b>Polo II (81&gt;86)</b> 								
1.05, 1.1, 1.3  (2), (3)  F-127 903	10/81 ▶ 02/85		ATE	<b>301099</b>	20228		61,8 56,6 15	
1.05, 1.3  (2), (3), (4)  F-127 904 ▶ _	02/85 ▶ 07/86		VW	<b>301258</b>	20887		137,8 49 17,2 51,1	

										
<b>VOLKSWAGEN (.../...)</b>										
<b>Polo III (86&gt;90)</b> 										
1.3  (3)  _ ▶ F127903	08/87 ▶		ATE	<b>301099</b>	20228		61,8	56,6	15	
1.3  (2)	01/87 ▶ 10/90		VW	<b>301124</b>	20887		137,8	49	15,3	
								51,1		
<b>Polo IV (90&gt;94)</b> 										
1.3  (3)	10/90 ▶ 10/94		VW	<b>301124</b>	20887		137,8	49	15,3	
								51,1		
1.05, 1.3, 1.3i, 1.4D    (2),(3),(4)	10/90 ▶ 10/94		VW	<b>301258</b>	20887		137,8	49	17,2	
								51,1		
<b>Polo V (94&gt;99)</b> 										
1.9SDi   (4),(5)  _ ▶ W-518 000  _ ▶ W-518 500	05/96 ▶ 08/97		ATE	<b>301066</b>	21866		141,8	50,5	19,7	
1.0i, 1.3i, 1.4i, 1.6i, 1.9D, 1.9SDi, 1.9TDi    (3),(4),(5)  _ ▶ W-518 000  _ ▶ W-518 500	10/94 ▶ 08/97		VW	<b>301258</b>	20887		137,8	49	17,2	
								51,1		
1.4i, 1.6i   (3),(4),(5)  _ ▶ V-022 628	03/96 ▶ 12/99		LUC	<b>301330</b>	21945		119	69,5	16,3	
1.4i, 1.9SDi  (5)  W-518 001 ▶ _	08/97 ▶ 08/99		ATE	<b>301332</b>	21974		146	54,7	19,8	
1.4i, 1.6i, 1.7SDi, 1.8i, 1.9SDi, 1.9TDi, 2.0i   (4),(5)  V-022 629 ▶ _  W-518 001 ▶ _  W-518 500 ▶ _  W-518 501 ▶ _	10/96 ▶ 09/99		ATE	<b>301403</b>	21866		141,8	50,5	15	
								51,2		
1.0i, 1.3i, 1.4i, 1.6i, 1.7SDi, 1.9D, 1.9SDi  (3),(5) ABS-	10/94 ▶ 12/99		ATE	<b>301488</b>	21865		141,8	51,2	17,3	
								50,6		
1.6i, 1.9TDi, 2.0i   (4),(5) ABS-	05/96 ▶ 09/99		LUC	<b>301180</b>	20960		87	53	15,2	
1.4i, 1.6i, 1.9TDi, 2.0i    (3),(4),(5) ABS+	04/96 ▶ 12/99		LUC	<b>301463</b>	20960		87	52,9	17	
<b>Polo VI (99&gt;2001)</b> 										
1.4TDi, 1.4i, 1.6i, 1.9TDi, 2.0i    (3),(4),(5) ABS+	10/99 ▶ 09/01		LUC	<b>301330</b>	21945		119	69,5	16,3	
1.4i, 1.6i, 1.8i, 1.9SDi   (4),(5)	10/99 ▶ 09/01		ATE	<b>301403</b>	21866		141,8	50,5	15	
								51,2		

											
<b>VOLKSWAGEN (.../...)</b>											
<b>Polo VI (99&gt;2001)  (.../...)</b>											
1.0i, 1.4i, 1.7SDi, 1.9D, 1.9SDi   (3),(5) ABS-	10/99 ▶ 09/01		ATE	<b>301488</b>	21865		141,8	51,2	17,3		
								50,6			
1.4TDi, 1.4i, 1.6i, 1.9TDi, 2.0i    (3),(4),(5)	10/99 ▶ 09/01		LUC	<b>301463</b>	20960		87	52,9	17		
<b>Polo VII (2001&gt;) </b>											
1.0i, 1.2i, 1.4, 1.4FSi, 1.4TDi, 1.4i, 1.6i, 1.9SDi, 1.9TDi, 2.0i   (3),(4),(5) DA+ : Power steering+	11/01 ▶		ATE	<b>301332</b>	21974		146	54,7	19,8		
1.0i, 1.2i, 1.4, 1.4FSi, 1.4TDi, 1.4i, 1.6i, 1.9SDi, 1.9TDi   (3),(4),(5) DA+ : Power steering+ TU+ : Wear warning+	11/01 ▶		ATE	<b>301408</b>	21974		146	54,7	18,5	↳ 1 x  155 mm	
1.2i, 1.9SDi  (3),(5) DA- : Power steering-	11/01 ▶ 05/05		ATE	<b>301488</b>	21865		141,8	51,2	17,3		
								50,6			
1.9TDi  (3),(5)	11/03 ▶ 05/05		LUC	<b>301667</b>	23581		131,4	62,3	18,7		
1.9TDi  (3),(5) TU+ : Wear warning+	11/03 ▶ 05/05		LUC	<b>301720</b>	23581		131,4	62,3	18,7	↳ 1 x  180 mm	
1.2i, 1.9SDi  (3),(5) DA- : Power steering- TU+ : Wear warning+	11/01 ▶ 05/05		ATE	<b>301805</b>	21865		141,8	50,6	17	↳ 1 x  180 mm	
1.4, 1.4TDi, 1.4i, 1.6i, 1.9SDi, 1.9TDi, 2.0i   (3),(4),(5)  4-000 001 ▶ _	09/02 ▶		LUC	<b>301463</b>	20960		87	52,9	17		
1.4, 1.4TDi, 1.4i, 1.6i, 1.9SDi, 1.9TDi   (3),(4),(5)  _ ▶ 3-300 000	11/01 ▶		LUC	<b>301674</b>	20960		87	53	17	↳ 1 x  260 mm	
<b>Polo VIII (2005&gt;) </b>											
1.2i, 1.4FSi, 1.4TDi, 1.4i, 1.6i, 1.9SDi, 1.9TDi  (3),(5) DA+ : Power steering+	04/05 ▶		ATE	<b>301332</b>	21974		146	54,7	19,8		
1.2i, 1.4FSi, 1.4TDi, 1.4i, 1.6i, 1.9SDi, 1.9TDi  (3),(5) DA+ : Power steering+	04/05 ▶		ATE	<b>301408</b>	21974		146	54,7	18,5	↳ 1 x  155 mm	
1.8GTI Turbo  (3),(5)	05/06 ▶		ATE	<b>301486</b>	21911		156,35	74,1	19,5	↳ 1 x  155 mm	
1.2i  (3),(5) DA- : Power steering-	04/05 ▶ 07/07		ATE	<b>301488</b>	21865		141,8	51,2	17,3		
								50,6			
1.8GTI Turbo, 1.9TDi  (3),(5)	04/05 ▶		LUC	<b>301667</b>	23581		131,4	62,3	18,7		
1.8GTI Turbo, 1.9TDi  (3),(5)	04/05 ▶		LUC	<b>301720</b>	23581		131,4	62,3	18,7	↳ 1 x  180 mm	
1.2i  (3),(5) DA- : Power steering- TU+ : Wear warning+	04/05 ▶ 07/07		ATE	<b>301805</b>	21865		141,8	50,6	17	↳ 1 x  180 mm	
1.4i, 1.6i, 1.8GTI Turbo, 1.9TDi  (3),(5)	04/05 ▶		LUC	<b>301463</b>	20960		87	52,9	17		
1.4i, 1.6i, 1.8GTI Turbo, 1.9TDi  (3),(5)	04/05 ▶		LUC	<b>301674</b>	20960		87	53	17	↳ 1 x  260 mm	

















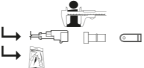















































































































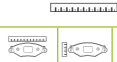

































											
<b>VOLKSWAGEN (.../...)</b>											
<b>Sharan (2000&gt;2003)  (.../...)</b>											
1.8i Turbo, 1.9TDi, 2.0i  → 1-070 000	04/00 ▶ 05/01		LUC	<b>301681</b>	20960		87	53	17,2	↳ 1 x +  205 mm	
<b>Sharan (2003&gt;2010) </b>											
1.8i Turbo, 1.9TDi, 2.8i VR6	06/03 ▶ 03/10		ATE	<b>301565</b>	23269		161,4	72,8	19,6	↳ 2 x +  270 mm	
								74,5			
1.9TDi, 2.0TDi, 2.0i	06/03 ▶ 03/10		ATE	<b>301801</b>	23418		156,2	78,4	19,6	↳ 1 x + 	
1.8i Turbo, 1.9TDi, 2.8i VR6	06/03 ▶ 03/10		LUC	<b>301650</b>	23446		95	51	16,2	↳ 2 x +  205 mm	
1.9TDi, 2.0TDi, 2.0i	06/03 ▶ 03/10		LUC	<b>301681</b>	20960		87	53	17,2	↳ 1 x +  205 mm	
<b>Sharan (2010&gt;) </b>											
1.4TSi 150, 2.0TDi CR 116, 2.0TDi CR 136, 2.0TDi CR 140, 2.0TDi CR 170, 2.0TFSi 200	05/10 ▶		TRW	<b>301752</b>	23914		105,1	56	17		
<b>Tiguan (2007&gt;2011) </b>											
1.4TSi, 1.4TSi 122, 2.0FSi, 2.0TDi, 2.0TDi 110, 2.0TFSi, 2.0TSi	11/07 ▶ 05/11		TRW	<b>301752</b>	23914		105,1	56	17		
<b>Tiguan (2011&gt;) </b>											
1.4TSi 122, 1.4TSi 150, 1.4TSi 160, 2.0TDi 110, 2.0TDi 136, 2.0TDi 140, 2.0TDi 170, 2.0TFSi 180, 2.0TFSi 200, 2.0TFSi 211	05/11 ▶		TRW	<b>301752</b>	23914		105,1	56	17		
<b>Touareg (2002&gt;2006) </b>											
3.0TDi V6, 3.2i V6, 4.2i V8, 5.0TDi V10, 6.0i W12	11/02 ▶ 11/06		BRE	<b>301770</b>	23694		117,3	73,1	16,7		
<b>Touareg (2006&gt;2010) </b>											
4.2FSi V8, 5.0TDi V10, 6.0i W12	12/06 ▶ 05/10		BRE	<b>301770</b>	23694		117,3	73,1	16,7		
<b>Touran (2003&gt;2006) </b>											
1.4TSi, 1.6FSi, 1.6i, 1.9TDi, 2.0FSi, 2.0TDi, 2.0i	02/03 ▶ 11/06		ATE	<b>301635</b>	23587		156,4	71,4	20,3	↳ 1 x +  155 mm	
							155,2	66			
1.4TSi, 1.6FSi, 1.6i, 1.9TDi, 2.0FSi, 2.0TDi, 2.0i	02/03 ▶ 11/06		TRW	<b>301752</b>	23914		105,1	56	17		
<b>Touran (2006&gt;2010) </b>											
1.4TSi CNG 150, 1.4TSi, 1.6FSi, 1.6TDi, 1.6i, 1.9TDi, 2.0FSi, 2.0TDi, 2.0i	11/06 ▶ 05/10		ATE	<b>301635</b>	23587		156,4	71,4	20,3	↳ 1 x +  155 mm	
							155,2	66			
1.4TSi CNG 150, 1.4TSi, 1.6FSi, 1.6i, 1.9TDi, 2.0FSi, 2.0TDi, 2.0i	11/06 ▶		TRW	<b>301752</b>	23914		105,1	56	17		
<b>Touran (2010&gt;) </b>											
1.2TSi, 1.4TSi CNG 150, 1.4TSi, 1.6TDi, 2.0TDi	05/10 ▶		ATE	<b>301635</b>	23587		156,4	71,4	20,3	↳ 1 x +  155 mm	
							155,2	66			
<b>Transporter (F70) (90&gt;96) </b>											
1.8, 1.9D, 1.9TD, 2.0, 2.4D, 2.5, 2.5TDi, 2.5i  (2),(3),(4)    15"	09/90 ▶ 05/96		LUC	<b>301048</b>	20652		91,5	80	18,3		
1.8, 1.9D, 1.9TD, 2.0, 2.4D, 2.5, 2.5TDi, 2.5i  (2),(3),(4)    15"	09/90 ▶ 05/96		LUC	<b>301622</b>	21479		128	65	19,2		

											
<b>VOLKSWAGEN (.../...)</b>											
<b>Transporter (F70) (90&gt;96)  (.../...)</b>											
2.4D, 2.5i   (2),(3)  T-200 000 ▶ _	11/92 ▶ 05/96		LUC	<b>301482</b>	21748		94,9	57,4	17		
<b>Transporter (F7D) (96&gt;2003) </b>											
1.9TD, 2.0i, 2.4D, 2.5DTi, 2.5TDi, 2.5i, 2.8i VR6   (2),(3),(4)   15"  _ ▶ X-250 000	01/96 ▶ 05/99		LUC	<b>301048</b>	20652		91,5	80	18,3		
2.4D, 2.5DTi, 2.5TDi, 2.5i, 2.8i V6, 2.8i VR6   (2),(3),(4) 16" ETA+ : Teves caliper+, TU+ : Wear warning+  1-000 955 ▶ _	05/96 ▶ 06/03		ATE	<b>301565</b>	23269		161,4	72,8	19,6	↳ 2 x ↗ 270 mm	
1.9TD, 2.0i, 2.4D, 2.5DTi, 2.5TDi, 2.5i   (2),(3),(4)   15" ETL+ : Lucas caliper+  _ ▶ X-250 000	01/96 ▶ 05/99		LUC	<b>301622</b>	21479		128	65	19,2		
2.4D, 2.5DTi, 2.5TDi, 2.5i, 2.8i VR6   (2),(3),(4) 15" 16" ETA+ : Teves caliper+  _ ▶ X-250 000	01/96 ▶ 05/99		ATE	<b>301675</b>	21883		156,4	68,5	19,5		
1.9TD, 2.0i, 2.4D, 2.5DTi, 2.5TDi, 2.5i   (2),(3),(4)   15" ETL+ : Lucas caliper+, TU+ : Wear warning+  Y-000 001 ▶ _	05/97 ▶ 06/03		LUC	<b>301814</b>	21479		129,5	65,2	19,2	↳ 1 x ↗ 210 mm	
1.9TD, 2.0i, 2.4D, 2.5DTi, 2.5TDi, 2.5i, 2.8i V6, 2.8i VR6   (2),(3),(4) 15"	01/96 ▶ 06/03		LUC	<b>301482</b>	21748		94,9	57,4	17		
2.4D, 2.5DTi, 2.5TDi, 2.5i, 2.8i V6, 2.8i VR6   (2),(3),(4) 16" TU+ : Wear warning+  W-000 001 ▶ _	01/96 ▶ 06/03		LUC	<b>301650</b>	23446		95	51	16,2	↳ 2 x ↗ 205 mm	
<b>Transporter (7J/7H) (2003&gt;2009) </b>											
1.9TDi, 2.0i, 2.5TDi, 3.2i V6   (2),(3),(4)	04/03 ▶ 11/09		LUC	<b>301004</b>	23326		115,95	58,92	17,4		
<b>Transporter (7E/7F) (2009&gt;) </b>											
2.0BITDI 180, 2.0TDI 102, 2.0TDI 114, 2.0TDI 116, 2.0TDI 136, 2.0TDI 140, 2.0TDI 84, 2.0TSI, 2.0TSI 204, 2.0i   (2),(4),(5)	09/09 ▶		LUC	<b>301004</b>	23326		115,95	58,92	17,4		
<b>UP (2011&gt;) </b>											
1.0Sre 60, 1.0Sre 75, 1.0Sre CNG (3),(5)	08/11 ▶		ATE	<b>301332</b>	21974		146	54,7	19,8		
<b>Vento (91&gt;97) </b>											
1.6i, 1.8i, 1.9TDi, 2.0E	11/91 ▶ 05/96		LUC	<b>301016</b>	20901		119	69,5	15,7	↳ 2 x ↗ 225 mm	
1.6i, 1.8i, 1.9D, 1.9SDi  TW-028 356 ▶ _	▶ 12/97		ATE	<b>301066</b>	21866		141,8	50,5	19,7		
1.6i, 1.8i, 1.9TD, 1.9TDi, 2.0E  TW-028 356 ▶ _	▶ 12/97		LUC	<b>301252</b>	20901		119	69,5	19,6		
1.6i, 1.8i, 1.9D, 1.9SDi, 1.9TD, 1.9TDi, 2.0E ABS+  _ ▶ VW-300 000	11/91 ▶		LUC	<b>301330</b>	21945		119	69,5	16,3		
1.9D, 1.9SDi ABS+  VW-300 001 ▶ _	▶ 12/97		ATE	<b>301403</b>	21866		141,8	50,5	15		
2.0E, 2.8i VR6	07/95 ▶ 12/97		ATE	<b>301486</b>	21911		156,35	74,1	19,5	↳ 1 x ↗ 155 mm	

				<b>Valeo</b>	<b>WVA</b>			
<b>VOLKSWAGEN (.../...)</b>								
<b>Vento (91&gt;97)  (.../...)</b>								
2.0E, 2.8i, 2.8i VR6	11/91 ▶ 07/95		LUC	<b>301982</b>	21366		118,9 69,5 16,3	↳ 2 x  220 mm
1.8i, 1.9TDi, 2.0E, 2.8i, 2.8i VR6  PB-030 000 ▶ _  PB-030 001 ▶ _  PW-240 001 ▶ _  _ ▶ PB-030 000  _ ▶ PW-240 000			LUC	<b>301180</b>	20960		87 53 15,2	
1.8i, 1.9TDi, 2.0E, 2.8i VR6	01/92 ▶ 12/97		LUC	<b>301463</b>	20960		87 52,9 17	
<b>VOLVO</b>								
<b>240 (82&gt;93) </b>								
2.0, 2.1 Turbo, 2.3, 2.4D   (4), (5)	09/82 ▶ 06/84		ATE	<b>301270</b>	20467		61,5 56,5 15	
<b>242 (74&gt;84) </b>								
2.1i, 2.3i  (2)	08/74 ▶ 07/79		ATE	<b>301270</b>	20467		61,5 56,5 15	
<b>244 (79&gt;82) </b>								
2.0, 2.3, 2.4D  (4)	03/79 ▶ 08/82		ATE	<b>301270</b>	20467		61,5 56,5 15	
<b>245 (79&gt;82) </b>								
2.0, 2.1 Turbo, 2.4D, 2.4D D6  (5)	07/79 ▶ 08/82		ATE	<b>301270</b>	20467		61,5 56,5 15	
<b>262 (78&gt;80) </b>								
2.7   (2)	08/78 ▶ 07/80		ATE	<b>301270</b>	20467		61,5 56,5 15	
<b>264 (78&gt;82) </b>								
2.3, 2.4D, 2.7, 2.8  (4)	08/78 ▶ 07/82		ATE	<b>301270</b>	20467		61,5 56,5 15	
<b>265 (78&gt;85) </b>								
2.7, 2.8  (5)	08/78 ▶ 07/85		ATE	<b>301270</b>	20467		61,5 56,5 15	
<b>740 (84&gt;92) </b>								
2.0, 2.0 Turbo, 2.0 Turbo Intercooler, 2.3, 2.3 Turbo, 2.3 Turbo Intercooler, 2.4D, 2.4TD   (4), (5)	07/84 ▶ 08/92		ATE	<b>301270</b>	20467		61,5 56,5 15	
<b>760 (82&gt;90) </b>								
2.4TD Intercooler, 2.8  (5)	07/86 ▶ 1990		ATE	<b>301270</b>	20467		61,5 56,5 15	
<b>780 (85&gt;91) </b>								
2.0 Turbo, 2.4TD Intercooler, 2.8 V6   (2), (4)	03/85 ▶ 07/90		ATE	<b>301270</b>	20467		61,5 56,5 15	
<b>850 (91&gt;96) </b>								
2.0, 2.0 Turbo, 2.3 Turbo, 2.5, 2.5TDi, 2.5i Turbo   (4), (5)	06/91 ▶ 12/96		ATE	<b>301616</b>	21273		156,3 58,3 19,5	
2.0, 2.0 Turbo, 2.3 Turbo, 2.5, 2.5TDi, 2.5i Turbo   (4), (5)	06/91 ▶ 12/96		ATE	<b>301270</b>	20467		61,5 56,5 15	
<b>940 (90&gt;98) </b>								
2.0, 2.0 Turbo, 2.3, 2.3 Turbo, 2.4TD   (4), (5)	09/90 ▶ 06/98		ATE	<b>301270</b>	20467		61,5 56,5 15	
<b>960 (90&gt;97) </b>								
2.0 Turbo, 2.3 Turbo, 2.4TD, 2.5, 2.8i, 3.0   (4), (5)	09/90 ▶ 01/97		ATE	<b>301270</b>	20467		61,5 56,5 15	

						
<b>VOLVO (.../...)</b>						
<b>C30 (2006&gt;2012)</b> 						
1.6D Turbo, 1.6TD 110, 1.6TD 115, 1.6i, 1.8i, 1.8i Flexifuel, 2.0D Turbo, 2.0TD, 2.0TD 150, 2.0i, 2.0i Flexifuel, 2.4TDi, 2.4i ⊙15" ⊙16"	10/06 ▶		ATE	<b>301649</b>	23723	 156,3 67 17,5 155,1 62,5
1.6D Turbo, 1.6TD 110, 1.6TD 115, 1.6i, 1.8i, 1.8i Flexifuel, 2.0D Turbo, 2.0TD, 2.0TD 150, 2.0i, 2.0i Flexifuel, 2.4TDi, 2.4i	10/06 ▶		ATE	<b>301783</b>	24137	 122,9 51,7 16,4
<b>S40 (95&gt;2004)</b> 						
1.6i, 1.8i, 1.9TD, 1.9i Turbo, 2.0i, 2.0i Turbo	10/95 ▶ 12/97		LUC	<b>301318</b>	21920	 130 72,57 15,1
1.6i, 1.8i, 1.9TD, 1.9TDCi, 1.9TDi, 1.9i Turbo, 2.0i, 2.0i Turbo	01/98 ▶ 03/04		LUC	<b>301493</b>	21983	 130 77 17
1.6i, 1.8i, 1.9TD, 1.9TDCi, 1.9TDi, 1.9i Turbo, 2.0i, 2.0i Turbo	10/95 ▶ 03/04		LUC	<b>301319</b>	21861	 87,3 47 15,3
<b>S40 (2004&gt;)</b> 						
1.6D, 1.6D 115, 1.6i, 1.8i, 2.0D, 2.0D 150, 2.0D 177, 2.0i, 2.4D5, 2.4i, 2.5i ⊙15" ⊙16"	03/04 ▶		ATE	<b>301649</b>	23723	 156,3 67 17,5 155,1 62,5
1.6D, 1.6D 115, 1.6i, 1.8i, 2.0D, 2.0D 150, 2.0D 177, 2.0i, 2.4D5, 2.4i, 2.5i	03/04 ▶		ATE	<b>301783</b>	24137	 122,9 51,7 16,4
<b>V40 (95&gt;2004)</b> 						
1.6i, 1.8i, 1.9T, 1.9TD, 2.0T Turbo, 2.0i	10/95 ▶ 12/97		LUC	<b>301318</b>	21920	 130 72,57 15,1
1.6i, 1.8i, 1.9T, 1.9TD, 1.9TDi, 2.0T Turbo, 2.0i, 2.0i Turbo	01/98 ▶ 03/04		LUC	<b>301493</b>	21983	 130 77 17
1.6i, 1.8i, 1.9T, 1.9TD, 1.9TDi, 2.0T Turbo, 2.0i, 2.0i Turbo	10/95 ▶ 03/04		LUC	<b>301319</b>	21861	 87,3 47 15,3
<b>V50 (2004&gt;)</b> 						
1.6D, 1.6i, 1.8i, 1.8i Flexifuel, 2.0D, 2.0D 150, 2.0D 177, 2.0F Flexifuel, 2.0i, 2.4D5, 2.4i, 2.5i ⊙15" ⊙16"	03/04 ▶		ATE	<b>301649</b>	23723	 156,3 67 17,5 155,1 62,5
1.6D, 1.6i, 1.8i, 1.8i Flexifuel, 2.0D, 2.0D 150, 2.0D 177, 2.0F Flexifuel, 2.0i, 2.4D5, 2.4i, 2.5i	03/04 ▶		ATE	<b>301783</b>	24137	 122,9 51,7 16,4
<b>S60 (2000&gt;2009)</b> 						
2.0i Turbo, 2.3i Turbo, 2.4TDi, 2.4i, 2.4i CNG, 2.4i GPL, 2.4i Turbo, 2.5i Turbo ⊙15" ⊙16" ⊙17"	08/00 ▶ 03/09		ATE	<b>301479</b>	23072	 155,4 72,5 18,5 156,4 69
2.0i Turbo, 2.3i Turbo, 2.4TDi, 2.4i, 2.4i CNG, 2.4i GPL, 2.4i Turbo, 2.5i Turbo	08/00 ▶ 03/09		ATE	<b>301480</b>	23075	 122,6 53,8 17
<b>S60 (2010&gt;)</b> 						
1.6Ti 150, 1.6Ti 180, 1.6d 115, 2.0TDi 136, 2.0TDi 163, 2.0Ti 180, 2.0Ti 203, 2.4TDi 205, 2.4TDi 215, 2.5Ti 250, 3.0Ti 304 ⊙16"	04/10 ▶		ATE	<b>301879</b>	24123	 155,1 66,6 19,2 156,3 72
1.6Ti 150, 1.6Ti 180, 1.6d 115, 2.0TDi 136, 2.0TDi 163, 2.0Ti 180, 2.0Ti 203, 2.4TDi 205, 2.4TDi 215, 2.5Ti 250, 3.0Ti 304 I+	04/10 ▶		LUC	<b>301928</b>	24496	 106,2 48,6 16,8
<b>C70 (97&gt;2005)</b> 						
2.0i Turbo, 2.3i Turbo, 2.4i, 2.4i Turbo, 2.5i, 2.5i Turbo  ⊙16"	03/97 ▶ 12/05		ATE	<b>301616</b>	21273	 156,3 58,3 19,5

											
<b>VOLVO (.../...)</b>											
<b>C70 (97&gt;2005)  (.../...)</b>											
2.0i Turbo, 2.3i Turbo, 2.4i, 2.4i Turbo, 2.5i, 2.5i Turbo 	03/97 ▶ 12/05		ATE	<b>301270</b>	20467		61,5	56,5	15		
<b>C70 CC (2006&gt;) </b>											
2.0D, 2.0D 150, 2.0D 177, 2.4, 2.4TDi, 2.4i, 2.5i Turbo   15"  16"	01/06 ▶		ATE	<b>301649</b>	23723		156,3	67	17,5		
							155,1	62,5			
2.0D, 2.0D 150, 2.0D 177, 2.4, 2.4TDi, 2.4i, 2.5i Turbo 	01/06 ▶		ATE	<b>301783</b>	24137		122,9	51,7	16,4		
<b>S70 (96&gt;2000) </b>											
2.0i, 2.0i Turbo, 2.3i, 2.3i Turbo, 2.4TDi, 2.4i, 2.4i GPL, 2.4i Turbo, 2.5i, 2.5i GPL, 2.5i Turbo  15"  16"	12/96 ▶ 11/00		ATE	<b>301616</b>	21273		156,3	58,3	19,5		
2.0i, 2.0i Turbo, 2.3i, 2.3i Turbo, 2.4TDi, 2.4i, 2.4i GPL, 2.4i Turbo, 2.5i, 2.5i GPL, 2.5i Turbo HD+ : Heavy duty+	12/96 ▶ 11/00		ATE	<b>301270</b>	20467		61,5	56,5	15		
2.4i, 2.4i Turbo  596636 ▶ _  598923 ▶ _	▶ 11/00		ATE	<b>301480</b>	23075		122,6	53,8	17		
<b>V60 (2010&gt;) </b>											
1.6TDi 115, 1.6Ti 150, 1.6Ti 180, 2.0TDi 136, 2.0TDi 163, 2.0Ti 180, 2.0Ti 204, 2.4TDi 205, 2.4TDi 215, 3.0Ti 304  16"	09/10 ▶		ATE	<b>301879</b>	24123		155,1	66,6	19,2		
							156,3	72			
1.6TDi 115, 1.6Ti 150, 1.6Ti 180, 2.0TDi 136, 2.0TDi 163, 2.0Ti 180, 2.0Ti 204, 2.4TDi 205, 2.4TDi 215, 3.0Ti 304 I+	09/10 ▶		LUC	<b>301928</b>	24496		106,2	48,6	16,8		
<b>V70 (96&gt;2000) </b>											
2.0i, 2.0i Turbo, 2.3i, 2.3i Turbo, 2.4TDi, 2.4i, 2.4i GPL, 2.4i Turbo, 2.5i, 2.5i Turbo  15"  16"	12/96 ▶ 03/00		ATE	<b>301616</b>	21273		156,3	58,3	19,5		
2.0i, 2.0i Turbo, 2.3i, 2.3i Turbo, 2.4TDi, 2.4i, 2.4i GPL, 2.4i Turbo, 2.5i, 2.5i Turbo	12/96 ▶ 03/00		ATE	<b>301270</b>	20467		61,5	56,5	15		
2.0i Turbo, 2.3i Turbo, 2.4i, 2.4i Turbo, 2.5i Turbo  587597 ▶ _  588640 ▶ _	▶ 03/00		ATE	<b>301480</b>	23075		122,6	53,8	17		
<b>V70 (2000&gt;2007) </b>											
2.0i Turbo, 2.3i, 2.4TDi, 2.4i, 2.5T, 2.5TDi  15"  16"  17"	01/00 ▶ 04/07		ATE	<b>301479</b>	23072		155,4	72,5	18,5		
							156,4	69			
2.0i Turbo, 2.3i, 2.4TDi, 2.4i, 2.5T, 2.5TDi	01/00 ▶ 04/07		ATE	<b>301480</b>	23075		122,6	53,8	17		
<b>V70 (2007&gt;) </b>											
1.6Ti 180, 1.6Ti, 1.6d 110, 1.6d 115, 2.0 240, 2.0T 203, 2.0TD, 2.0d 163, 2.0i, 2.4D 163, 2.4TDi, 2.4TDi 175, 2.4TDi 205, 2.4d 215, 2.5i, 2.5i 231, 3.0Ti, 3.0Ti 304, 3.2i, 3.2i 243  16"	03/07 ▶		ATE	<b>301879</b>	24123		155,1	66,6	19,2		
							156,3	72			
1.6Ti 180, 1.6Ti, 1.6d 110, 1.6d 115, 2.0 240, 2.0T 203, 2.0TD, 2.0d 163, 2.0i, 2.4D 163, 2.4TDi, 2.4TDi 175, 2.4TDi 205, 2.4d 215, 2.5i, 2.5i 231, 3.0Ti, 3.0Ti 304, 3.2i, 3.2i 243 FREL+ : Electric parking brake+	03/07 ▶		LUC	<b>301928</b>	24496		106,2	48,6	16,8		

				<b>Valeo</b>	<b>WVA</b>							<b>VOLVO (.../...)</b>
<b>S80 (98&gt;2006)</b> 												
2.0i, 2.0i Turbo, 2.4TDi, 2.4i, 2.4i CNG, 2.4i GPL, 2.4i Turbo, 2.5i Turbo, 2.8i, 2.9i, 3.0i	06/98 ▶ 02/06		ATE	<b>301479</b>	23072		155,4 156,4	72,5 69	18,5			
2.0i, 2.0i Turbo, 2.4TDi, 2.4i, 2.4i CNG, 2.4i GPL, 2.4i Turbo, 2.5i Turbo, 2.8i, 2.9i, 3.0i	06/98 ▶ 02/06		ATE	<b>301480</b>	23075		122,6	53,8	17			
<b>S80 (2006&gt;)</b> 												
1.6T 180, 1.6Ti 180, 1.6d, 1.6d 115, 2.0, 2.0T 203, 2.0T 240, 2.0d 163, 2.0i, 2.0i Flexifuel, 2.4TDi, 2.4TDi 215, 2.4d 175, 2.5T, 2.5T 231, 2.5i Flexifuel, 3.0i 285, 3.0i 304, 3.2i, 4.4i V8 ⊙16"	03/06 ▶		ATE	<b>301879</b>	24123		155,1 156,3	66,6 72	19,2			
1.6T 180, 1.6Ti 180, 1.6d, 1.6d 115, 2.0, 2.0T 203, 2.0T 240, 2.0d 163, 2.0i, 2.0i Flexifuel, 2.4TDi, 2.4TDi 215, 2.4d 175, 2.5T, 2.5T 231, 2.5i Flexifuel, 3.0i 285, 3.0i 304, 3.2i, 4.4i V8 FREL+ : Electric parking brake+	03/06 ▶		LUC	<b>301928</b>	24496		106,2	48,6	16,8			
<b>XC 60 (2008&gt;)</b> 												
2.0T, 2.0TDi 163, 2.0Ti 240, 2.4D, 2.4TDi, 2.4TDi 215, 3.0Ti, 3.0Ti 204, 3.2Ti, 3.2Ti 243	07/08 ▶		LUC	<b>301928</b>	24496		106,2	48,6	16,8			
<b>XC 70 (97&gt;99)</b> 												
2.0i, 2.4i, 2.5i ⊙15" ⊙16"	12/97 ▶ 12/99		ATE	<b>301616</b>	21273		156,3	58,3	19,5			
2.0i, 2.4i, 2.5i  587442 ▶ _	▶ 12/99		ATE	<b>301480</b>	23075		122,6	53,8	17			
<b>XC 70 (2000&gt;2007)</b> 												
2.3i Turbo, 2.4TDi, 2.4i Turbo, 2.5T ⊙15" ⊙16" ⊙17"	01/00 ▶ 03/07		ATE	<b>301479</b>	23072		155,4 156,4	72,5 69	18,5			
2.3i Turbo, 2.4TDi, 2.4i Turbo, 2.5T	01/00 ▶ 03/07		ATE	<b>301480</b>	23075		122,6	53,8	17			
<b>XC 70 (2007&gt;2010)</b> 												
2.4D, 2.4D5, 2.4TDi, 3.0T6, 3.2i ⊙16"	03/07 ▶ 05/10		ATE	<b>301879</b>	24123		155,1 156,3	66,6 72	19,2			
2.4D, 2.4D5, 2.4TDi, 3.0T6, 3.2i FREL+ : Electric parking brake+	03/07 ▶ 05/10		LUC	<b>301928</b>	24496		106,2	48,6	16,8			
<b>XC 70 (2010&gt;)</b> 												
2.0D 163, 2.4D 163, 2.4D 175, 2.4D 205, 2.4D 215, 3.0T 285, 3.0T 304, 3.2i 238, 3.2i 243 ⊙16"	05/10 ▶		ATE	<b>301879</b>	24123		155,1 156,3	66,6 72	19,2			
2.0D 163, 2.4D 163, 2.4D 175, 2.4D 205, 2.4D 215, 3.0T 285, 3.0T 304, 3.2i 238, 3.2i 243 FREL+ : Electric parking brake+	05/10 ▶		LUC	<b>301928</b>	24496		106,2	48,6	16,8			
<b>XC 90 (2002&gt;2007)</b> 												
2.4TDi, 2.5T, 2.9i, 3.2i V6, 4.4i V8 ⊙16"	05/02 ▶ 09/07		ATE	<b>301030</b>	23590		156,4 155,2	71 72	18,2			
2.4TDi, 2.5T, 2.9i, 3.2i V6, 4.4i V8 ⊙17"	05/02 ▶ 09/07		ATE	<b>301657</b>	24141		155,2	75 74	19			











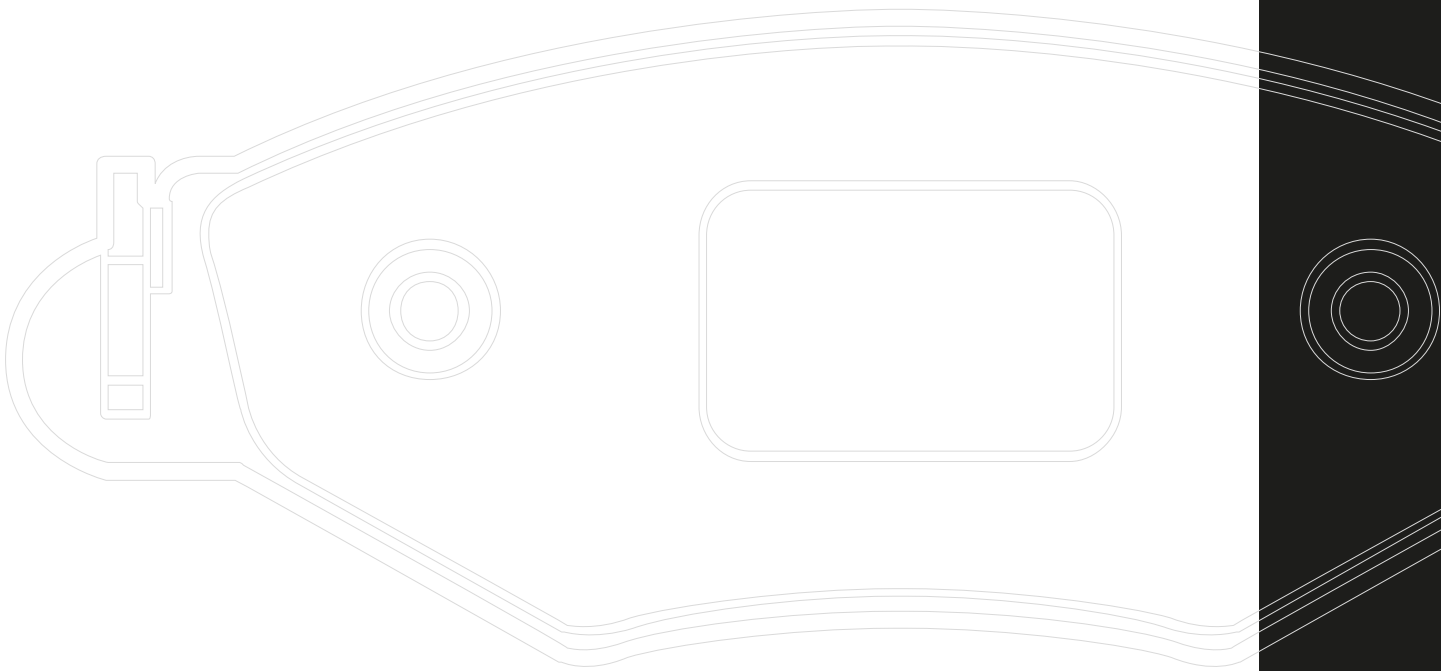





**Valeo**









**Valeo**













					
301002	LUC	20772	173	<b>DACIA</b> ↳ Logan (2004>) ..... 24 ↳ Sandero (2008>) ..... 24 ↳ Logan (2004>) ..... 24 ↳ Sandero (2008>) ..... 24  <b>RENAULT</b> ↳ Super 5 (84>96) ..... 82 ↳ R9 (81>88) ..... 82 ↳ R11 (82>89) ..... 82 ↳ R18 (77>86) ..... 82 ↳ R19 (88>92) ..... 82 ↳ R19 (92>95) ..... 82 ↳ R20 (75>84) ..... 83 ↳ R21 (86>94) ..... 83 ↳ R21 Nevada Savanna (86>95) ..... 83 ↳ R25 (83>93) ..... 83 ↳ R30 (75>84) ..... 83 ↳ Alpine GT D500 (84>91) ..... 83 ↳ Clio I (90>96) ..... 83 ↳ Clio I (96>98) ..... 84 ↳ Clio II (98>2001) ..... 84 ↳ Clio II (2001>2008) ..... 84 ↳ Clio Campus Evolution (2009>) ..... 84 ↳ Express (85>91) ..... 85 ↳ Express (91>2003) ..... 85 ↳ Extra (91>97) ..... 85 ↳ Fuego (79>85) ..... 86 ↳ Logan (2004>) ..... 87 ↳ Lutecia (Japan) (94>98) ..... 87 ↳ Mégane (95>99) ..... 87 ↳ Mégane (98>2003) ..... 87 ↳ Mégane Classic (96>99) ..... 88 ↳ Mégane Classic (99>2002) ..... 88 ↳ Mégane Scenic (96>99) ..... 88 ↳ Rapid (91>98) ..... 89 ↳ Sandero (2008>) ..... 89 ↳ Thalia (2001>2008) ..... 90 ↳ Thalia - Symbole (2008>) ..... 90 ↳ Twingo I (93>98) ..... 90 ↳ Twingo I (98>2007) ..... 90 ↳ Twingo II (2007>2011) ..... 90 ↳ Twingo II (2012>) ..... 90	
301003	LUC	20901	178	<b>AUDI</b> ↳ 80 (89-8A) (86>91) ..... 7 ↳ 80 (8C) (91>95) ..... 7 ↳ Cabriolet (8G) (91>2000) .. 7 ↳ 90 (89-8A) (87>91) ..... 7 ↳ 100 (43) (71>82) ..... 7 ↳ 100 (44) (82>90) ..... 7 ↳ 200 (43-44) (79>90) ..... 7 ↳ A4 (94>98) ..... 9 ↳ Coupé (8B) (88>96) ..... 11 ↳ Quattro (85) (80>91) ..... 11	





					
301004	LUC	23326	270	<b>AUDI</b> ↳ A6 (2004>2008) ..... 11 ↳ A6 (2008>2011) ..... 11 ↳ A6 Allroad (2006>2011) .. 11 ↳ A8 (2002>2010) ..... 11 ↳ S4 (2003>2004) ..... 12 ↳ S4 Cabriolet (2004>2005) 12 ↳ S6 (2006>2008) ..... 12 ↳ S6 (2008>2011) ..... 12  <b>VOLKSWAGEN</b> ↳ Transporter (7J/7H) (2003>2009) ..... 126 ↳ Transporter (7E/7F) (2009>) ..... 126	
301005	BDX	21586	214	<b>FORD</b> ↳ Cougar (98>2001) ..... 32 ↳ Mondeo (93>96) ..... 35 ↳ Mondeo (96>2000) ..... 36	
301006	ATE	21927	243	<b>FIAT</b> ↳ Barchetta (95>2003) ..... 26 ↳ Barchetta (2003>2006) .. 26 ↳ Brava (182) (95>2002) ... 26 ↳ Bravo (182) (95>2002) ... 26 ↳ Marea (185) (96>2002) .. 28 ↳ Marengo (185) (95>2002) ..... 28 ↳ Punto (176) (93>99) ..... 29  <b>LANCIA</b> ↳ Dedra (835) (94>99) ..... 52 ↳ Delta (836) (93>99) ..... 52	
301007	BRE	20358	166	<b>RENAULT</b> ↳ R21 (86>94) ..... 83 ↳ R21 Nevada Savanna (86>95) ..... 83 ↳ Espace III (96>2000) ..... 85 ↳ Laguna I (B56) (94>98) ... 86 ↳ Laguna I Nevada (K56) (95>98) ..... 86 ↳ Safrane (92>96) ..... 89 ↳ Safrane (96>2000) ..... 89	
301008	ATE	20676	172	<b>FORD</b> ↳ Galaxy (VX) (95>2000) ... 34 ↳ Galaxy (VY) (2000>2006) 35 ↳ Galaxy (VX) (95>2000) ... 34 ↳ Galaxy (VY) (2000>2006) 35  <b>SEAT</b> ↳ Alhambra (96>2000) ..... 93  <b>VOLKSWAGEN</b> ↳ Sharan (95>2000) ..... 124	
301009	AKE	23871	309	<b>INFINITI</b> ↳ EX QX50 (2008>) ..... 48 ↳ FX QX70 (2008>) ..... 48 ↳ G35 (2006>2008) ..... 48  <b>NISSAN</b> ↳ Qashqai (J10E/JJ10E) (2007>2010) ..... 69 ↳ Tiida (C11X) (2007>) ..... 69 ↳ Qashqai (J10E/JJ10E) (2007>2010) ..... 69 ↳ Tiida (C11X) (2007>) ..... 69  <b>RENAULT</b> ↳ Koleos (2008>2011) ..... 86	



					
301010	LUC	21797	230	<b>CITROËN</b> ➤ Jumper (94>2001)..... 21 ➤ Relay (94>2001) ..... 22 ➤ Jumper (94>2001)..... 21 ➤ Relay (94>2001) ..... 22 <b>FIAT</b> ➤ Ducato (230) (94>2001) . 27 <b>PEUGEOT</b> ➤ Boxer I (94>2001)..... 81	
301012	BDX	21365	202	<b>FIAT</b> ➤ Cinquecento (170) (92>98) ..... 26 ➤ Panda (169) (2003>) ..... 29 ➤ Punto (176) (93>99)..... 29 ➤ Punto II (188) (99>2003) 29 ➤ Punto II (188) (2003>2009) ..... 29 ➤ Seicento (187) (98>2010) ..... 30 <b>LANCIA</b> ➤ Y Ipsilon (840) (95>2000)53 ➤ Y Ipsilon (840) (2000>2003).. 53 ➤ Y Ipsilon (840) (95>2000)53 ➤ Y Ipsilon (840) (2000>2003) 53	
301013	LUC	21439	207	<b>MERCEDES</b> ➤ C Class (W202) (93>2001)...57	
301014	AKE	21626	216	<b>NISSAN</b> ➤ Micra (K11E) (92>2000) . 67 ➤ Micra (K11E) (2000>2002) ..67	
301015	BSC	24764	347	<b>FIAT</b> ➤ 500 (2007>2012)..... 25 ➤ 500 (2012>)..... 25 ➤ Panda (169) (2003>) ..... 29 ➤ Panda (169) (2003>2009) ... 29 ➤ Panda (169) (2009>2010) ... 29 ➤ Panda (169) (2010>2011)... 29 ➤ Panda (169) (2012>) ..... 29 <b>FORD</b> ➤ Ka (2008>)..... 35	
301016	LUC	20901	178	<b>AUDI</b> ➤ 90 (81-85) (84>87) ..... 7 <b>SEAT</b> ➤ Cordoba (93>96)..... 94 ➤ Ibiza (93>96)..... 95 ➤ Toledo (91>98)..... 97 ➤ Cordoba (93>96)..... 94 ➤ Ibiza (93>96)..... 95 ➤ Toledo (91>98)..... 97 <b>VOLKSWAGEN</b> ➤ Corrado (88>95) ..... 114 ➤ Golf II (83>92)..... 115 ➤ Golf II Cabriolet (93>98) 115 ➤ Golf III (91>99) ..... 116 ➤ Jetta II (83>92) ..... 118 ➤ Passat II (81>88)..... 120 ➤ Passat III (88>93)..... 120 ➤ Passat IV (93>97)..... 120 ➤ Scirocco (74>90) ..... 124 ➤ Vento (91>97) ..... 126	
301017	ATE	24673	346	<b>DACIA</b> ➤ Logan (2004>) ..... 24	





					
301018	ATE	21292	197	<b>BMW</b> ➤ 3 Series (E36) (90>2001) 14 ➤ 3 Series (E46) (98>2006) 14 ➤ Z3 (E36) (96>2002)..... 17 ➤ Z4 (E85/86) (2002>2009) ..17	
301020	AKE	21543	212	<b>BEDFORD</b> ➤ Brava (88>90)..... 13 <b>ISUZU</b> ➤ Trooper (81>97) ..... 49 <b>OPEL</b> ➤ Campo (88>96)..... 71 ➤ Campo (96>2002)..... 71 ➤ Frontera A (91>98) ..... 73 <b>VAUXHALL</b> ➤ Brava (88>96)..... 108 ➤ Brava (96>2002)..... 108 ➤ Frontera A (91>98)..... 110	
301021	MAND	25348	350	<b>HYUNDAI</b> ➤ Solaris Made in Russia (2010>) ..... 47 ➤ Solaris Made in Turkey (2011>) ..... 47 <b>KIA</b> ➤ Rio (2011>)..... 51	
301022	LUC	21515	211	<b>HONDA</b> ➤ Civic V (MA/MB) (95>2001) ..... 39 ➤ Civic (EM2/EP/ES/EU/EV) (2001>2006) ..... 40 ➤ Civic Aerodeck (MB/MC) (97>2001) ..... 40 ➤ Concerto (HW) (89>96)... 40 <b>MG</b> ➤ MG ZR (2001>2005) ..... 61 <b>ROVER</b> ➤ 25 (99>2005)..... 91 ➤ 45 (2000>2005)..... 91 ➤ 200 (89>96)..... 91 ➤ 200 (95>99)..... 91 ➤ 200 Coupé/Cabriolet (96>99) ..... 91 ➤ 400 (90>95)..... 91 ➤ 400 (95>2000)..... 92 ➤ 800 (91>99)..... 92 ➤ Streetwise (2003>2005) 92	
301023	ATE	21636	217	<b>ALFA ROMEO</b> ➤ 145 (94>2001)..... 4 ➤ 146 (94>2001)..... 4 ➤ 156 (97>2003)..... 5 ➤ 166 (98>2007)..... 5 ➤ GTV (95>2003)..... 6 ➤ Spider (916) (95>2003)... 6 <b>FIAT</b> ➤ Bravo (182) (95>2002)... 26 ➤ Coupe (PX) (96>2000) .... 27 ➤ Marea (185) (96>2002) .. 28	
301024	MAND	23813	306	<b>LANCIA</b> ➤ Kappa (838) (94>2001) .. 53 ➤ Lybra (839) (99>2006) ... 53 <b>HYUNDAI</b> ➤ Terracan (2001>2002)..... 47 ➤ Terracan (2002>2007)..... 48	





		WVA			
301025	AKE	24522	342	<b>TOYOTA</b> ⇒ Camry (MCV/SXV20) (96>2001).....	104
301028	ATE	24574	343	<b>DAIHATSU</b> ⇒ Charade (2011>).....	25
				<b>TOYOTA</b> ⇒ Yaris (P90LC/RC) Made in France (2005>2011).....	107
				⇒ Yaris (P130LC/RC) Made in France (2011>).....	107
301030	ATE	23590	294	<b>VOLVO</b> ⇒ XC 90 (2002>2007) .....	131
				⇒ XC 90 (2007>) .....	131
301031	BDX	21631	216	<b>CITROËN</b> ⇒ Xantia (93>97).....	22
				⇒ Xantia (97>2002).....	23
301033	ATE	21394	206	<b>FORD</b> ⇒ Cougar (98>2001).....	32
				⇒ Mondeo (93>96) .....	35
				⇒ Mondeo (96>2000) .....	36
301034	ATE	21394	206	<b>FORD</b> ⇒ Cougar (98>2001).....	32
				⇒ Granada (92>95).....	35
				⇒ Mondeo (93>96) .....	35
				⇒ Mondeo (96>2000) .....	36
				⇒ Scorpio (92>94).....	37
				⇒ Scorpio (94>98).....	37
301035	SUM	23983	319	<b>LEXUS</b> ⇒ IS 200D (2010>) .....	54
				⇒ IS 220D (2005>2008) ...	54
				⇒ IS 220D (2008>2012) ...	54
				⇒ IS 250 (2005>2008).....	54
				⇒ IS 250 (2008>2013).....	54
				⇒ IS 250C-Cabriolet (2009>).....	54
				⇒ IS 300 (2013>).....	54
301036	BDX	21470	208	<b>FORD</b> ⇒ Transit (91>94).....	38
				⇒ Transit (94>99).....	38
301037	BDX	21469	207	<b>FORD</b> ⇒ Transit (91>94).....	38
				⇒ Transit (94>99).....	38
301038	ATE	21430	206	<b>PEUGEOT</b> ⇒ 205 (20) (87>98).....	77
				⇒ 306 (93>97).....	78
301040	ATE	21930	244	<b>ALFA ROMEO</b> ⇒ 145 (94>2001).....	4
				⇒ 146 (94>2001).....	4
				<b>FIAT</b> ⇒ Brava (182) (95>2002)...	26
				⇒ Bravo (182) (95>2002)...	26
				⇒ Marea (185) (96>2002)..	28
				⇒ Marengo (185) (95>2002)	28
				.....	28
				<b>LANCIA</b> ⇒ Delta (836) (93>99).....	52

		WVA			
301041	LUC	24289	331	<b>MINI</b> ⇒ MINI (R56/57) (2006>2010)	61
				⇒ MINI (R56/57) (2009>).....	61
				⇒ MINI Clubman (R55) (2007>2011) .....	61
				⇒ MINI Clubman/Clubvan (R55) (2009>).....	61
				⇒ MINI Coupé (R58) (2011>)	62
				⇒ MINI Roadster (R59) (2012>)	62
				.....	62
301043	ATE	21203	194	<b>FORD</b> ⇒ Fiesta (89>95).....	33
				⇒ Fiesta (95>99).....	33
				⇒ Ka (96>2008).....	35
301044	ATE	21576	214	<b>MERCEDES</b> ⇒ Sprinter (901-2-3-4-5) (95>2006) .....	60
				⇒ V Class (638) (96>2002).	61
				⇒ Vito (638) (96>2003) .....	61
				<b>VOLKSWAGEN</b> ⇒ LT II (96>2003).....	119
				⇒ LT III (2003>2006).....	119
301046	ATE	21661	221	<b>MERCEDES</b> ⇒ Sprinter (901-2-3-4-5) (95>2006) .....	60
				<b>VOLKSWAGEN</b> ⇒ LT II (96>2003).....	119
				⇒ LT III (2003>2006).....	119
301047	AKE	20959	180	<b>HONDA</b> ⇒ Civic II (AJ/AH/AK) (83>87) .....	39
				⇒ Civic III (EC/ED/EE) (87>91) .....	39
				⇒ Civic IV (EG/EH/EJ) (91>95) .....	39
				⇒ Civic IV (EG/EH/EJ) (91>95) .....	39
				⇒ CRX (ED/EE/EF) (87>92) .	40
				⇒ Civic II (AJ/AH/AK) (83>87) .....	39
				⇒ Civic III (EC/ED/EE) (87>91) .....	39
				⇒ Civic IV (EG/EH/EJ) (91>95) .....	39
				⇒ Civic IV (EG/EH/EJ) (91>95) .....	39
				⇒ CRX (ED/EE/EF) (87>92) .	40
301048	LUC	20652	170	<b>VOLKSWAGEN</b> ⇒ Transporter (F70) (90>96) .....	126
				⇒ Transporter (F7D) (96>2003) .....	126
301049	ATE	20676	172	<b>AUDI</b> ⇒ 100 (4A) (90>94).....	7
				⇒ A6 (94>97).....	10





301052	AKE	21012	185	<b>HONDA</b> ⇒ Accord II (AC/AD) (83>85) <b>39</b>  <b>HYUNDAI</b> ⇒ Accent (94>99) ..... <b>42</b> ⇒ Accent (99>2003) ..... <b>42</b> ⇒ Accent (2003>2006) ..... <b>42</b> ⇒ Excel (86>89)..... <b>43</b> ⇒ Excel (89>94)..... <b>43</b> ⇒ Excel (94>99)..... <b>43</b> ⇒ Getz (2002>2005)..... <b>43</b> ⇒ Getz (2005>2006)..... <b>44</b> ⇒ Getz Made in Korea (2006>2011) ..... <b>44</b> ⇒ Getz Made in India (2007>) ..... <b>44</b> ⇒ Pony (82>94) ..... <b>46</b> ⇒ Pony (94>99) ..... <b>46</b> ⇒ Scoupe (90>96) ..... <b>46</b> ⇒ Stellar (83>92)..... <b>47</b>	
301053	AKE	21312	198	<b>HONDA</b> ⇒ Civic III (EC/ED/EE) (87>91) <b>39</b> ⇒ Civic V (MA/MB) (95>2001) <b>39</b> ⇒ Civic Aerodeck (MB/MC) (97>2001)..... <b>40</b> ⇒ Concerto (HW) (89>96).... <b>40</b> ⇒ CRX (ED/EE/EF) (87>92) .. <b>40</b> ⇒ Integra (DA) (85>89)..... <b>40</b> ⇒ Prelude (AB/BA) (82>87).. <b>41</b>  <b>MG</b> ⇒ MG ZR (2001>2005)..... <b>61</b>  <b>ROVER</b> ⇒ 25 (99>2005)..... <b>91</b> ⇒ 45 (2000>2005)..... <b>91</b> ⇒ 200 (89>96)..... <b>91</b> ⇒ 200 (95>99)..... <b>91</b> ⇒ 200 Coupé/Cabriolet (96>99) ..... <b>91</b> ⇒ 400 (90>95)..... <b>91</b> ⇒ 400 (95>2000)..... <b>92</b>	
301054	LUC	21546	213	<b>NISSAN</b> ⇒ Almera (N16E) (2000>2003) ..... <b>66</b> ⇒ Almera (N16E) (2003>2006) ..... <b>66</b> ⇒ Primera (P10/W10) (90>98) ..... <b>68</b> ⇒ Primera (P11/W11) (96>2002) ..... <b>68</b>	
301055	BSC	25096	349	<b>CHEVROLET</b> ⇒ Cruze (2009>) ..... <b>18</b> ⇒ Orlando (2011>) ..... <b>18</b>  <b>OPEL</b> ⇒ Astra J (2009>) ..... <b>71</b> ⇒ Zafira C (2011>) ..... <b>76</b>  <b>VAUXHALL</b> ⇒ Astra MK VI (2009>) ..... <b>108</b> ⇒ Zafira III (2011>)..... <b>113</b>	





301057	LUC	21545	212	<b>NISSAN</b> ⇒ Almera (N16E) (2000>2003) ..... <b>66</b> ⇒ Almera (N16E) (2003>2006) ..... <b>66</b> ⇒ Almera Tino (V10M) (2000>2003) ..... <b>66</b> ⇒ Almera Tino (V10B) (2003>2005) ..... <b>66</b> ⇒ Primera (P10/W10) (90>98) ..... <b>68</b> ⇒ Primera (P11/W11) (96>2002) ..... <b>69</b>	
301061	LUC	20916	180	<b>DAEWOO</b> ⇒ Lublin (97>2005) ..... <b>25</b>  <b>RENAULT</b> ⇒ R25 (83>93) ..... <b>83</b> ⇒ Espace II (91>96) ..... <b>85</b> ⇒ Laguna I (B56) (94>98) .. <b>86</b> ⇒ Laguna I (B56) (98>2000) ..... <b>86</b> ⇒ Laguna I Nevada (K56) (95>98) ..... <b>86</b> ⇒ Laguna I Nevada (K56) (98>2000) ..... <b>86</b> ⇒ Mégane (95>99) ..... <b>87</b> ⇒ Mégane (98>2003) ..... <b>88</b> ⇒ Mégane Classic (96>99) <b>88</b> ⇒ Mégane Classic (99>2002) ..... <b>88</b> ⇒ Mégane Scenic (96>99) . <b>89</b> ⇒ Safrane (92>96)..... <b>89</b> ⇒ Safrane (96>2000)..... <b>89</b> ⇒ Spider (96>99)..... <b>90</b>	
301062	ATE	21279	197	<b>MERCEDES</b> ⇒ V Class (638) (96>2002) .. <b>61</b> ⇒ Vito (638) (96>2003) ..... <b>61</b>	
301063	ATE	21279	197	<b>PEUGEOT</b> ⇒ 406 (95>2004) ..... <b>80</b> ⇒ 607 (2000>2004)..... <b>80</b>	
301064	LUC	21801	231	<b>CITROËN</b> ⇒ Dispatch (95>2003) ..... <b>21</b> ⇒ Evasion (94>98)..... <b>21</b> ⇒ Evasion (98>2002)..... <b>21</b> ⇒ Jumpy (95>2003) ..... <b>21</b> ⇒ Synergie (95>98) ..... <b>22</b> ⇒ Synergie (98>2002) ..... <b>22</b>  <b>FIAT</b> ⇒ Scudo (220) (95>2003) .. <b>30</b> ⇒ Scudo (220) (2004>2006) ..... <b>30</b> ⇒ Ulysse (220) (94>98)..... <b>31</b> ⇒ Ulysse (220) (98>2002).. <b>31</b>  <b>LANCIA</b> ⇒ Zeta (220) (94>2002) ..... <b>53</b>  <b>PEUGEOT</b> ⇒ 806 (94>98)..... <b>80</b> ⇒ 806 (98>2002)..... <b>80</b> ⇒ Expert I (95>2003) ..... <b>81</b>	

		WVA			
301065	ATE	21636	217	<b>ALFA ROMEO</b> ⇒ 145 (94>2001)..... 4 ⇒ 146 (94>2001)..... 4 ⇒ 155 (91>97)..... 4 ⇒ 156 (97>2003)..... 5 ⇒ GTV (95>2003)..... 6 ⇒ GTV (2003>2006)..... 6 ⇒ Spider (916) (95>2003).... 6 ⇒ Spider (916) (2003>2006) 6  <b>FIAT</b> ⇒ Bravo (182) (95>2002)... 26 ⇒ Coupe (PC) (93>96)..... 26 ⇒ Coupe (PX) (96>2000).... 27 ⇒ Marea (185) (96>2002).. 28 ⇒ Multipla (186) (98>2004) 28 ⇒ Multipla (186) (2004>2010) ..... 28  <b>LANCIA</b> ⇒ Dedra (835) (94>99) ..... 52 ⇒ Delta (836) (93>99)..... 52	
301066	ATE	21866	238	<b>SEAT</b> ⇒ Cordoba (93>96)..... 94 ⇒ Cordoba (96>99)..... 94 ⇒ Ibiza (93>96)..... 95 ⇒ Ibiza (96>99)..... 95 ⇒ Toledo (91>98)..... 97  <b>VOLKSWAGEN</b> ⇒ Golf II (83>92)..... 115 ⇒ Golf III (91>99)..... 116 ⇒ Polo V (94>99) ..... 122 ⇒ Vento (91>97) ..... 126	
301067	AKE	24632	344	<b>NISSAN</b> ⇒ Qashqai (J10E/JJ10E) (2007>2010)..... 69 ⇒ Qashqai (J10E/JJ10E) (2010>)..... 69 ⇒ X-Trail (T31) Made in Japan (2007>) ..... 70 ⇒ Qashqai (J10E/JJ10E) (2007>2010)..... 69 ⇒ Qashqai (J10E/JJ10E) (2010>)..... 69 ⇒ X-Trail (T31) Made in Japan (2007>) ..... 70	
301068	LUC	21724	227	<b>PEUGEOT</b> ⇒ 406 (95>2004)..... 80	
301069	LUC	21674	223	<b>CITROËN</b> ⇒ Xsara (97>2000)..... 23 ⇒ Xsara (2000>2005)..... 23 ⇒ ZX (91>98)..... 23  <b>PEUGEOT</b> ⇒ 306 (93>97)..... 78 ⇒ 306 (97>2002)..... 79 ⇒ 406 (95>2004)..... 80	
301070	BSC	25080	348	<b>CHEVROLET</b> ⇒ Cruze (2009>)..... 18 ⇒ Orlando (2011>)..... 18  <b>OPEL</b> ⇒ Astra J (2009>)..... 71 ⇒ Zafira C (2011>)..... 76  <b>VAUXHALL</b> ⇒ Astra MK VI (2009>) ..... 108 ⇒ Zafira III (2011>) ..... 113	











		WVA			
301074	ATE	21430	206	<b>CITROËN</b> ⇒ Saxo (96>99) ..... 22 ⇒ Saxo (99>2005) ..... 22 ⇒ Xsara (97>2000)..... 23  <b>PEUGEOT</b> ⇒ 106 (91>96)..... 77 ⇒ 106 (96>2003)..... 77 ⇒ 306 (97>2002)..... 79	
301075	BDX	21061	187	<b>CITROËN</b> ⇒ Saxo (96>99) ..... 22 ⇒ Saxo (99>2005) ..... 22  <b>PEUGEOT</b> ⇒ 106 (91>96)..... 77 ⇒ 106 (96>2003)..... 77	
301080	BDX	20635	169	<b>RENAULT</b> ⇒ Super 5 (84>96)..... 82 ⇒ Clio I (90>96) ..... 83 ⇒ Express (85>91)..... 85 ⇒ Extra (85>91)..... 85 ⇒ Rapid (85>91)..... 89 ⇒ Twingo I (93>98) ..... 90	
301081	BDX	21061	187	<b>PEUGEOT</b> ⇒ 106 (96>2003)..... 77 ⇒ 205 (74) (83>87)..... 77 ⇒ 205 (20) (87>98)..... 78 ⇒ 305 (82>90)..... 78 ⇒ 309 (85>89)..... 79 ⇒ 309 (89>94)..... 79 ⇒ 405 (87>92)..... 80 ⇒ 405 (92>96)..... 80  <b>RENAULT</b> ⇒ Super 5 (84>96)..... 82 ⇒ R9 (81>88) ..... 82 ⇒ R11 (82>89) ..... 82 ⇒ R18 (77>86) ..... 82 ⇒ R19 (88>92) ..... 82 ⇒ R19 (92>95) ..... 82 ⇒ R20 (75>84) ..... 83 ⇒ R21 (86>94) ..... 83 ⇒ R21 Nevada Savanna (86>95)..... 83 ⇒ Clio I (90>96) ..... 83 ⇒ Clio I (96>98) ..... 84 ⇒ Express (85>91)..... 85 ⇒ Express (91>2003)..... 85 ⇒ Extra (85>91)..... 85 ⇒ Extra (91>97)..... 85 ⇒ Fuego (79>85) ..... 86 ⇒ Lutecia (Japan) (94>98) . 87 ⇒ Rapid (85>91)..... 89 ⇒ Rapid (91>98)..... 89  <b>TALBOT</b> ⇒ 1307/8/9 (75>79) ..... 103 ⇒ Murena (81>83)..... 103 ⇒ Solara (80>85)..... 103	















		<b>WVA</b>			
<b>301124</b>	<b>VW</b>	20887	<b>177</b>	<b>VOLKSWAGEN</b> <ul style="list-style-type: none"> <li>⇒ Golf I (74&gt;83)..... <b>115</b></li> <li>⇒ Golf I Cabriolet (79&gt;93) <b>115</b></li> <li>⇒ Golf II (83&gt;92)..... <b>115</b></li> <li>⇒ Golf II Cabriolet (93&gt;98) <b>116</b></li> <li>⇒ Golf III (91&gt;99)..... <b>116</b></li> <li>⇒ Jetta I (78&gt;84)..... <b>118</b></li> <li>⇒ Jetta II (83&gt;92)..... <b>118</b></li> <li>⇒ Passat I (73&gt;81)..... <b>120</b></li> <li>⇒ Passat II (81&gt;88)..... <b>120</b></li> <li>⇒ Passat III (88&gt;93)..... <b>120</b></li> <li>⇒ Polo III (86&gt;90)..... <b>122</b></li> <li>⇒ Polo IV (90&gt;94)..... <b>122</b></li> <li>⇒ Santana (81&gt;84)..... <b>124</b></li> <li>⇒ Scirocco (74&gt;90)..... <b>124</b></li> </ul>	
<b>301125</b>	<b>LUC</b>	20668	<b>171</b>	<b>ALFA ROMEO</b> <ul style="list-style-type: none"> <li>⇒ 164 (87&gt;92)..... <b>5</b></li> <li>⇒ 164 (92&gt;98)..... <b>5</b></li> </ul> <b>AUDI</b> <ul style="list-style-type: none"> <li>⇒ 80 (81-85) (81&gt;87)..... <b>6</b></li> <li>⇒ 80 (89-8A) (86&gt;91)..... <b>7</b></li> <li>⇒ 80 (8C) (91&gt;95)..... <b>7</b></li> <li>⇒ Cabriolet (8G) (91&gt;2000) ... <b>7</b></li> <li>⇒ 90 (81-85) (84&gt;87)..... <b>7</b></li> <li>⇒ 90 (89-8A) (87&gt;91)..... <b>7</b></li> <li>⇒ 100 (44) (82&gt;90)..... <b>7</b></li> <li>⇒ 100 (4A) (90&gt;94)..... <b>7</b></li> <li>⇒ 200 (43-44) (79&gt;9 0)..... <b>7</b></li> <li>⇒ A4 (94&gt;98)..... <b>9</b></li> <li>⇒ A4 (99&gt;2001)..... <b>9</b></li> <li>⇒ A6 (94&gt;97)..... <b>10</b></li> <li>⇒ A8 (94&gt;2002)..... <b>11</b></li> <li>⇒ Coupé (85) (80&gt;88)..... <b>11</b></li> <li>⇒ Coupé (8B) (88&gt;96)..... <b>11</b></li> <li>⇒ Quattro (85) (80&gt;91)..... <b>11</b></li> <li>⇒ S4 (97&gt;99)..... <b>12</b></li> <li>⇒ S6 (94&gt;97)..... <b>12</b></li> <li>⇒ S6 Plus Quattro (96&gt;97) .. <b>12</b></li> <li>⇒ S8 (96&gt;98)..... <b>12</b></li> <li>⇒ V8 (88&gt;93)..... <b>13</b></li> </ul> <b>FIAT</b> <ul style="list-style-type: none"> <li>⇒ Croma (154) (85&gt;90)..... <b>27</b></li> <li>⇒ Croma (154) (91&gt;96)..... <b>27</b></li> </ul> <b>LANCIA</b> <ul style="list-style-type: none"> <li>⇒ Thema (834) (84&gt;88)..... <b>53</b></li> <li>⇒ Thema (834) (88&gt;92)..... <b>53</b></li> <li>⇒ Thema (834) (92&gt;94)..... <b>53</b></li> </ul>	
<b>301129</b>	<b>AP</b>	20359	<b>167</b>	<b>ALFA ROMEO</b> <ul style="list-style-type: none"> <li>⇒ AR8 (80&gt;86)..... <b>5</b></li> </ul> <b>DAF</b> <ul style="list-style-type: none"> <li>⇒ 400 (86&gt;96)..... <b>25</b></li> </ul> <b>FORD</b> <ul style="list-style-type: none"> <li>⇒ Scorpio (92&gt;94)..... <b>37</b></li> <li>⇒ Transit (78&gt;85)..... <b>38</b></li> <li>⇒ Transit (85&gt;91)..... <b>38</b></li> </ul> <b>IVECO</b> <ul style="list-style-type: none"> <li>⇒ Daily (78&gt;89)..... <b>49</b></li> </ul> <b>LAND ROVER</b> <ul style="list-style-type: none"> <li>⇒ Defender (90&gt;2007)..... <b>53</b></li> <li>⇒ Defender (90&gt;2007)..... <b>53</b></li> <li>⇒ Range Rover (81&gt;86)..... <b>54</b></li> </ul> <b>LDV</b> <ul style="list-style-type: none"> <li>⇒ Sherpa II (82&gt;89)..... <b>55</b></li> </ul>	





		<b>WVA</b>			
<b>301142</b>	<b>LUC</b>	21103	<b>189</b>	<b>ALFA ROMEO</b> <ul style="list-style-type: none"> <li>⇒ 33 (89&gt;94)..... <b>4</b></li> <li>⇒ 145 (94&gt;2001)..... <b>4</b></li> <li>⇒ 146 (94&gt;2001)..... <b>4</b></li> <li>⇒ 155 (91&gt;97)..... <b>5</b></li> <li>⇒ GTV (95&gt;2003)..... <b>6</b></li> <li>⇒ GTV (2003&gt;2006)..... <b>6</b></li> <li>⇒ Spider (916) (95&gt;2003)..... <b>6</b></li> <li>⇒ Spider (916) (2003&gt;2006) .. <b>6</b></li> </ul> <b>FIAT</b> <ul style="list-style-type: none"> <li>⇒ Barchetta (95&gt;2003)..... <b>26</b></li> <li>⇒ Barchetta (2003&gt;2006) ... <b>26</b></li> <li>⇒ Bravo (182) (95&gt;2002)..... <b>26</b></li> <li>⇒ Coupe (PC) (93&gt;96)..... <b>26</b></li> <li>⇒ Coupe (PX) (96&gt;2000)..... <b>27</b></li> <li>⇒ Marea (185) (96&gt;2002) ... <b>29</b></li> <li>⇒ Marengo (159) (89&gt;93) ... <b>29</b></li> <li>⇒ Marengo (159) (93&gt;95) ... <b>29</b></li> <li>⇒ Punto (176) (93&gt;99)..... <b>30</b></li> <li>⇒ Tempra (160) (89&gt;93)..... <b>31</b></li> <li>⇒ Tempra (160) (93&gt;96)..... <b>31</b></li> <li>⇒ Tipo (160) (88&gt;93)..... <b>31</b></li> <li>⇒ Tipo (160) (93&gt;95)..... <b>31</b></li> <li>⇒ Uno (146) (83&gt;89)..... <b>32</b></li> <li>⇒ Uno (146) (89&gt;95)..... <b>32</b></li> </ul> <b>LANCIA</b> <ul style="list-style-type: none"> <li>⇒ Dedra (835) (89&gt;94)..... <b>53</b></li> <li>⇒ Dedra (835) (94&gt;99)..... <b>53</b></li> <li>⇒ Delta (836) (93&gt;99)..... <b>53</b></li> <li>⇒ Dedra (835) (89&gt;94)..... <b>53</b></li> <li>⇒ Dedra (835) (94&gt;99)..... <b>53</b></li> <li>⇒ Delta (836) (93&gt;99)..... <b>53</b></li> </ul>	
<b>301155</b>	<b>BDX</b>	21061	<b>187</b>	<b>CITROËN</b> <ul style="list-style-type: none"> <li>⇒ AX (91&gt;98)..... <b>19</b></li> <li>⇒ C15 (84&gt;2005)..... <b>20</b></li> <li>⇒ Fukang (93&gt;98)..... <b>21</b></li> <li>⇒ ZX (91&gt;98)..... <b>23</b></li> </ul>	
<b>301156</b>	<b>ATE</b>	21145	<b>190</b>	<b>CITROËN</b> <ul style="list-style-type: none"> <li>⇒ AX (86&gt;91)..... <b>19</b></li> </ul> <b>PEUGEOT</b> <ul style="list-style-type: none"> <li>⇒ 106 (91&gt;96)..... <b>77</b></li> </ul>	
<b>301158</b>	<b>BDX</b>	20635	<b>169</b>	<b>RENAULT</b> <ul style="list-style-type: none"> <li>⇒ R19 (88&gt;92)..... <b>82</b></li> <li>⇒ R19 (92&gt;95)..... <b>82</b></li> <li>⇒ Clío I (90&gt;96)..... <b>83</b></li> <li>⇒ Lutecia (Japan) (94&gt;98) .. <b>87</b></li> </ul>	
<b>301171</b>	<b>ATE</b>	21203	<b>194</b>	<b>FORD</b> <ul style="list-style-type: none"> <li>⇒ Fiesta (89&gt;95)..... <b>33</b></li> <li>⇒ Fiesta (95&gt;99)..... <b>33</b></li> <li>⇒ Ka (96&gt;2008)..... <b>35</b></li> </ul>	
<b>301172</b>	<b>BDX</b>	21171	<b>192</b>	<b>FORD</b> <ul style="list-style-type: none"> <li>⇒ Escort (90&gt;94)..... <b>32</b></li> <li>⇒ Escort (95&gt;2001)..... <b>32</b></li> <li>⇒ Orion (90&gt;93)..... <b>36</b></li> </ul>	
<b>301176</b>	<b>LUC</b>	20989	<b>183</b>	<b>PEUGEOT</b> <ul style="list-style-type: none"> <li>⇒ 205 (74) (83&gt;87)..... <b>77</b></li> <li>⇒ 205 (20) (87&gt;98)..... <b>78</b></li> <li>⇒ 309 (85&gt;89)..... <b>79</b></li> <li>⇒ 309 (89&gt;94)..... <b>79</b></li> </ul>	
<b>301179</b>	<b>LUC</b>	21209	<b>194</b>	<b>PEUGEOT</b> <ul style="list-style-type: none"> <li>⇒ 405 (87&gt;92)..... <b>80</b></li> <li>⇒ 405 (92&gt;96)..... <b>80</b></li> </ul>	













		<b>WVA</b>						<b>WVA</b>					
<b>301180</b>	<b>LUC</b>	20960	<b>181</b>	<b>AUDI</b> ☞ A3 (96>2000) ..... 8 ☞ A3 (2000>2003) ..... 8 ☞ TT (98>2006) ..... 13  <b>LANCIA</b> ☞ Delta (831) (86>94) ..... 52  <b>PEUGEOT</b> ☞ 405 (87>92) ..... 80 ☞ 405 (92>96) ..... 80 ☞ 405 (87>92) ..... 80 ☞ 405 (92>96) ..... 80  <b>RENAULT</b> ☞ Avantime (2001>2003) ... 83 ☞ Clio III (2005>2009) ..... 84 ☞ Clio III (2009>) ..... 84 ☞ Espace III (2000>2002) ... 85 ☞ Mégane (98>2003) ..... 88 ☞ Mégane II (2002>2009) ... 88 ☞ Mégane Scenic (99>2003) 89 ☞ Modus (2004>2007) ..... 89 ☞ Modus (2008>) ..... 89 ☞ Scenic II (2003>2009) .... 90  <b>SEAT</b> ☞ Cordoba (93>96) ..... 94 ☞ Cordoba (96>99) ..... 94 ☞ Ibiza (93>96) ..... 95 ☞ Toledo (91>98) ..... 97  <b>SKODA</b> ☞ Fabia (99>2004) ..... 98 ☞ Fabia (2004>2007) ..... 99 ☞ Roomster (2006>2010) . 100  <b>VOLKSWAGEN</b> ☞ Corrado (88>95) ..... 114 ☞ Golf II (83>92) ..... 115 ☞ Golf II Cabriolet (93>98) 116 ☞ Golf III (91>99) ..... 116 ☞ Golf III Cabriolet (98>2002) .. 116 ☞ Jetta I (78>84) ..... 118 ☞ Jetta II (83>92) ..... 118 ☞ Passat II (81>88) ..... 120 ☞ Passat III (88>93) ..... 120 ☞ Passat IV (93>97) ..... 121 ☞ Polo V (94>99) ..... 122 ☞ Scirocco (74>90) ..... 124 ☞ Vento (91>97) ..... 127									
<b>301181</b>	<b>BDX</b>	21061	<b>187</b>	<b>PEUGEOT</b> ☞ 106 (91>96) ..... 77 ☞ 106 (96>2003) ..... 77 ☞ 306 (93>97) ..... 78									
<b>301182</b>	<b>GME</b>	20867	<b>176</b>							<b>BEDFORD</b> ☞ Novavan (82>88) ..... 13  <b>OPEL</b> ☞ Ascona B (75>81) ..... 70 ☞ Ascona C (81>88) ..... 70 ☞ Combo (85>93) ..... 71 ☞ Corsa A (82>93) ..... 72 ☞ Kadett D (79>84) ..... 73 ☞ Kadett E (84>91) ..... 73 ☞ Manta B (75>88) ..... 73 ☞ Omega A (86>94) ..... 74 ☞ Rekord E (77>86) ..... 74 ☞ Vectra A (88>95) ..... 75  <b>VAUXHALL</b> ☞ Astra MK I (80>84) ..... 107 ☞ Astra MK II (84>91) ..... 107 ☞ Astra Belmont (86>91) . 107 ☞ Carlton (78>86) ..... 109 ☞ Carlton (86>94) ..... 109 ☞ Cavalier (75>81) ..... 109 ☞ Cavalier (81>88) ..... 109 ☞ Cavalier (88>95) ..... 109 ☞ Nova (83>93) ..... 111			
<b>301183</b>	<b>ATE</b>	21051	<b>186</b>							<b>OPEL</b> ☞ Calibra (89>97) ..... 71 ☞ Omega A (86>94) ..... 74 ☞ Omega B (94>2003) ..... 74 ☞ Senator B (87>93) ..... 74 ☞ Vectra B (95>99) ..... 75 ☞ Vectra B (99>2003) ..... 75  <b>SAAB</b> ☞ 9-3 (98>2003) ..... 92 ☞ 9-5 (97>2001) ..... 92 ☞ 9-3 (98>2003) ..... 92 ☞ 9-5 (97>2001) ..... 92  <b>VAUXHALL</b> ☞ Calibra (90>97) ..... 109 ☞ Carlton (86>94) ..... 109 ☞ Omega (94>2003) ..... 111 ☞ Senator B (87>93) ..... 111 ☞ Vectra (95>2002) ..... 112			
<b>301184</b>	<b>ATE</b>	21201	<b>193</b>							<b>DAEWOO</b> ☞ Aranos (95>2005) ..... 24 ☞ Espero (93>99) ..... 24 ☞ Lanos (97>2005) ..... 24 ☞ Nexia (95>2005) ..... 25  <b>OPEL</b> ☞ Astra F (91>2001) ..... 70 ☞ Astra Classic (98>2002) . 70 ☞ Calibra (89>97) ..... 71 ☞ Kadett E (84>91) ..... 73 ☞ Omega A (86>94) ..... 74 ☞ Vectra A (88>95) ..... 75 ☞ Vectra B (95>99) ..... 75  <b>VAUXHALL</b> ☞ Astra MK II (84>91) ..... 107 ☞ Astra Belmont (86>91) . 107 ☞ Astra MK III (91>2001) . 108 ☞ Calibra (90>97) ..... 109 ☞ Carlton (86>94) ..... 109 ☞ Cavalier (88>95) ..... 109 ☞ Vectra (95>2002) ..... 112			







					
301212	ATE	20783	174	<b>FORD</b> ⇒ Courier/Courier (91>96) <b>32</b> ⇒ Courier/Courier (96>2002) .. <b>32</b> ⇒ Escort (80>86) ..... <b>32</b> ⇒ Escort (86>90) ..... <b>32</b> ⇒ Fiesta (76>83)..... <b>32</b> ⇒ Fiesta (83>89)..... <b>32</b> ⇒ Fiesta (89>95)..... <b>33</b> ⇒ Fiesta (95>99)..... <b>33</b> ⇒ Fiesta (99>2002)..... <b>33</b> ⇒ Orion (83>90) ..... <b>36</b> ⇒ P100 Pick-up (88>93).... <b>36</b> ⇒ Puma (97>2001)..... <b>36</b> ⇒ Sierra (82>86)..... <b>37</b> ⇒ Sierra (87>93)..... <b>37</b> <b>MAZDA</b> ⇒ 121 (96>2002)..... <b>55</b>	
301219	TRW	20838	175	<b>ALFA ROMEO</b> ⇒ 145 (94>2001)..... <b>4</b> ⇒ 146 (94>2001)..... <b>4</b> ⇒ 155 (91>97)..... <b>4</b> ⇒ Spider (916) (95>2003).... <b>6</b> <b>AUTOBIANCHI</b> ⇒ Y10 (85>95)..... <b>13</b> <b>FIAT</b> ⇒ Argenta (81>86)..... <b>26</b> ⇒ Marengo (159) (89>93) .. <b>28</b> ⇒ Marengo (159) (93>95) .. <b>28</b> ⇒ Punto (176) (93>99)..... <b>29</b> ⇒ Regata (138) (83>90).... <b>30</b> ⇒ Ritmo (138) (82>88)..... <b>30</b> ⇒ Seicento (187) (98>2010) <b>30</b> ⇒ Tempra (160) (89>93) .... <b>30</b> ⇒ Tempra (160) (93>96) .... <b>30</b> ⇒ Tipo (160) (88>93) ..... <b>31</b> ⇒ Tipo (160) (93>95) ..... <b>31</b> ⇒ Uno (146) (89>95)..... <b>31</b> <b>LANCIA</b> ⇒ Dedra (835) (89>94) ..... <b>52</b> ⇒ Dedra (835) (94>99) ..... <b>52</b> ⇒ Delta (831) (86>94)..... <b>52</b> ⇒ Delta (836) (93>99)..... <b>52</b> ⇒ Prisma (831) (83>86).... <b>53</b> ⇒ Y Ipsilon (840) (95>2000) <b>53</b>	
301231	ATE	21064	188	<b>BMW</b> ⇒ 5 Series (E34) (88>96) ... <b>15</b> ⇒ 7 Series (E32) (86>94) ... <b>16</b> ⇒ M3 (E36) (92>2000)..... <b>16</b> ⇒ M5 (E34) (88>95)..... <b>16</b> ⇒ Z3 (E36) (96>2002)..... <b>17</b>	
301240	LUC	20981	182	<b>FORD</b> ⇒ Escort (90>94) ..... <b>32</b> ⇒ Escort (95>2001) ..... <b>32</b> ⇒ Sierra (82>86)..... <b>37</b> ⇒ Sierra (87>93)..... <b>37</b>	
301241	LUC	21010	184	<b>MERCEDES</b> ⇒ 190 (201) (82>93)..... <b>56</b>	
301252	LUC	20901	178	<b>SEAT</b> ⇒ Cordoba (96>99)..... <b>94</b> ⇒ Cordoba (99>2002)..... <b>94</b> ⇒ Ibiza (96>99)..... <b>95</b> ⇒ Ibiza (99>2001)..... <b>95</b> ⇒ Inca (95>2003) ..... <b>96</b> ⇒ Toledo (91>98)..... <b>97</b>	





					
301252	LUC	20901	178	<b>VOLKSWAGEN</b> ⇒ Caddy II (95>2004) ..... <b>114</b> ⇒ Corrado (88>95) ..... <b>114</b> ⇒ Golf II (83>92)..... <b>115</b> ⇒ Golf II Cabriolet (93>98) <b>116</b> ⇒ Golf III (91>99) ..... <b>116</b> ⇒ Golf III Cabriolet (98>2002) <b>116</b> ⇒ Passat III (88>93) ..... <b>120</b> ⇒ Passat IV (93>97)..... <b>120</b> ⇒ Vento (91>97) ..... <b>126</b>	
301253	ATE	21140	190	<b>OPEL</b> ⇒ Astra F (91>2001) ..... <b>70</b> ⇒ Calibra (89>97) ..... <b>71</b> ⇒ Kadett E (84>91) ..... <b>73</b> ⇒ Vectra A (88>95)..... <b>75</b> <b>SAAB</b> ⇒ 900 (93>98)..... <b>92</b> <b>VAUXHALL</b> ⇒ Astra MK II (84>91) ..... <b>107</b> ⇒ Astra MK III (91>2001)... <b>108</b> ⇒ Calibra (90>97) ..... <b>109</b> ⇒ Cavalier (88>95)..... <b>109</b>	
301256	LUC	21368	204	<b>OPEL</b> ⇒ Omega A (86>94)..... <b>74</b> ⇒ Omega B (94>2003) ..... <b>74</b> ⇒ Senator B (87>93)..... <b>74</b> <b>VAUXHALL</b> ⇒ Carlton (86>94)..... <b>109</b> ⇒ Omega (94>2003)..... <b>111</b> ⇒ Senator B (87>93)..... <b>111</b>	
301258	VW	20887	177	<b>SEAT</b> ⇒ Cordoba (93>96)..... <b>94</b> ⇒ Cordoba (96>99)..... <b>94</b> ⇒ Ibiza (93>96)..... <b>95</b> ⇒ Ibiza (96>99)..... <b>95</b> <b>VOLKSWAGEN</b> ⇒ Polo II (81>86) ..... <b>122</b> ⇒ Polo IV (90>94) ..... <b>122</b> ⇒ Polo V (94>99) ..... <b>122</b>	
301259	ATE	20996	184	<b>BMW</b> ⇒ 5 Series (E34) (88>96) .... <b>15</b> ⇒ 7 Series (E32) (86>94) .... <b>16</b> ⇒ M3 (E30) (86>91) ..... <b>16</b> ⇒ M3 (E36) (92>2000) ..... <b>16</b> ⇒ M5 (E34) (88>95)..... <b>16</b> ⇒ Z3 (E36) (96>2002) ..... <b>17</b>	
301266	AKE	20870	176	<b>TOYOTA</b> ⇒ Camry (SV/CV10) (82>86) .. <b>104</b> ⇒ Camry (SV/CV20) (86>91) ... <b>104</b> ⇒ Carina II (T15) (83>87) . <b>104</b> ⇒ Carina II (T17) (87>92) . <b>104</b> ⇒ Celica (T16) (85>89) .... <b>104</b> ⇒ Celica (T18) (89>93) .... <b>105</b> ⇒ Corolla (80) (83>87) .... <b>105</b> ⇒ Corolla (90) (87>92) .... <b>105</b> ⇒ Corolla (100) (92>97) ... <b>105</b> ⇒ MR 2 (W11) (84>89) .... <b>106</b> ⇒ Paseo (EL54) (95>99) ... <b>106</b> ⇒ Starlet (P8) (89>95)..... <b>106</b> ⇒ Starlet (P9) (96>99)..... <b>106</b> ⇒ Tercel (AL2) (82>88)..... <b>106</b>	





				
301268	SUM	21355	201	<b>KIA</b> ↳ Pride (87>2000)..... 51 ↳ Pride Wagon (98>2000) . 51 <b>MAZDA</b> ↳ 121 (88>90)..... 55
301269	MAND	20002	163	<b>KIA</b> ↳ K2700 (97>2004)..... 50
301270	ATE	20467	168	<b>VOLVO</b> ↳ 240 (82>93)..... 127 ↳ 242 (74>84)..... 127 ↳ 244 (79>82)..... 127 ↳ 245 (79>82)..... 127 ↳ 262 (78>80)..... 127 ↳ 264 (78>82)..... 127 ↳ 265 (78>85)..... 127 ↳ 740 (84>92)..... 127 ↳ 760 (82>90)..... 127 ↳ 780 (85>91)..... 127 ↳ 850 (91>96)..... 128 ↳ 940 (90>98)..... 128 ↳ 960 (90>97)..... 128 ↳ C70 (97>2005)..... 129 ↳ S70 (96>2000)..... 129 ↳ V70 (96>2000)..... 129
301272	ATE	21197	193	<b>MERCEDES</b> ↳ 190 (201) (82>93)..... 56 ↳ 200/300 (W124) (84>93) . 57 ↳ C Class (W202) (93>2001)..... 57 ↳ E Class (W124) (93>98)... 58 ↳ E Class (W210) (95>2003)59 ↳ SL Class (129) (89>2001) 60 ↳ SLK Class (170) (96>2003).... 60
301274	SUM	21654	221	<b>KIA</b> ↳ Rio (2000>2005)..... 51 <b>MAZDA</b> ↳ 121 (90>96)..... 55 ↳ 323 (BA) (94>98) ..... 55
301292	CIT	20575	168	<b>CITROËN</b> ↳ CX (74>91)..... 21 ↳ Xantia (93>97) ..... 22 ↳ Xantia (97>2002) ..... 23 ↳ XM (89>94) ..... 23 ↳ XM (94>2001)..... 23
301294	MAND	25644	350	<b>KIA</b> ↳ Optima (2010>)..... 50
301300	BSC	23021	249	<b>MERCEDES</b> ↳ G Class (M461/3) (89>) ... 59 ↳ Sprinter (901-2-3-4-5) (95>2006)..... 60 <b>VOLKSWAGEN</b> ↳ LT II (96>2003)..... 119 ↳ LT III (2003>2006)..... 119
301301	AKE	25337	349	<b>HYUNDAI</b> ↳ Grandeur Azera (2005>).. 44 ↳ i40 (2011>)..... 45 ↳ Solaris Made in Russia (2010>)..... 47 ↳ Solaris Made in Turkey (2011>) ..... 47 ↳ Sonata (2008>2011)..... 47 ↳ Veloster (2011>)..... 48 <b>KIA</b> ↳ Ceed (2012>)..... 50 ↳ Rio (2011>)..... 51







				
301305	ATE	21829	233	<b>OPEL</b> ↳ Calibra (89>97)..... 71 ↳ Vectra B (95>99)..... 75 ↳ Vectra B (99>2003)..... 75 <b>SAAB</b> ↳ 9-3 (98>2003) ..... 92 ↳ 9-5 (97>2001) ..... 92 ↳ 900 (93>98)..... 92 <b>VAUXHALL</b> ↳ Calibra (90>97)..... 109 ↳ Vectra (95>2002) ..... 112
301308	MAND	24599	344	<b>HYUNDAI</b> ↳ H1 (2007>)..... 44 ↳ ix55 (2008>) ..... 45 <b>KIA</b> ↳ Carnival / Sedona (2006>)49
301310	ATE	21677	223	<b>BMW</b> ↳ 5 Series (E39) (95>2004)15
301311	ATE	21691	224	<b>BMW</b> ↳ 5 Series (E39) (95>2004) 15
301315	LUC	21028	186	<b>MERCEDES</b> ↳ 190 (201) (82>93)..... 56 ↳ 200/300 (W124) (84>93) 57 ↳ E Class (W124) (93>98) . 58
301316	AKE	23241	263	<b>CHEVROLET</b> ↳ Lanos (97>2002) ..... 18 ↳ Matiz (2005>2011) ..... 18 ↳ Spark (2005>2009)..... 19 <b>DAEWOO</b> ↳ Matiz (98>2005) ..... 25
301317	ATE	23154	258	<b>FORD</b> ↳ Focus (98>2001)..... 33
301318	LUC	21920	242	<b>MITSUBISHI</b> ↳ Carisma (95>99)..... 62 ↳ Carisma (99>2003) ..... 62 ↳ Colt (Z3) (2004>2008).... 62 ↳ Space Star (DG) (98>2004) 65 <b>SMART MCC</b> ↳ Forfour (2004>2006).... 101 <b>VOLVO</b> ↳ S40 (95>2004)..... 128 ↳ V40 (95>2004)..... 128 ↳ S40 (95>2004)..... 128 ↳ V40 (95>2004)..... 128
301319	LUC	21861	236	<b>MITSUBISHI</b> ↳ Carisma (99>2003) ..... 62 ↳ Colt (Z3) (2004>2008) ..... 62 ↳ Colt (Z3) (2008>2013) ..... 62 ↳ Space Star (DG) (98>2004)66 <b>SMART MCC</b> ↳ Forfour (2004>2006)..... 101 <b>VOLVO</b> ↳ S40 (95>2004)..... 128 ↳ V40 (95>2004) ..... 128
301322	ATE	23063	251	<b>OPEL</b> ↳ Astra G (98>2005)..... 70 <b>VAUXHALL</b> ↳ Astra MK IV (98>2005) . 108







					
301326	LUC	23124	256	<b>CITROËN</b> ⇒ Berlingo (96>2002) ..... 19 ⇒ Xsara (97>2000) ..... 23 ⇒ Berlingo (96>2002) ..... 19 ⇒ Xsara (97>2000) ..... 23 <b>PEUGEOT</b> ⇒ 306 (97>2002) ..... 79 ⇒ Partner (M49) (96>2002) 81 ⇒ Ranch (M49) (96>2002) . 81	
301330	LUC	21945	246	<b>SEAT</b> ⇒ Arosa (97>2004) ..... 94 ⇒ Cordoba (93>96) ..... 94 ⇒ Cordoba (96>99) ..... 94 ⇒ Cordoba (99>2002) ..... 94 ⇒ Ibiza (93>96) ..... 95 ⇒ Ibiza (96>99) ..... 95 ⇒ Ibiza (99>2001) ..... 95 ⇒ Inca (95>2003) ..... 96 ⇒ Toledo (91>98) ..... 97 <b>VOLKSWAGEN</b> ⇒ Caddy II (95>2004) ..... 114 ⇒ Corrado (88>95) ..... 114 ⇒ Golf II (83>92) ..... 115 ⇒ Golf II Cabriolet (93>98) 116 ⇒ Golf III (91>99) ..... 116 ⇒ Golf III Cabriolet (98>2002) ..... 116 ⇒ Jetta II (83>92) ..... 118 ⇒ Passat II (81>88) ..... 120 ⇒ Passat III (88>93) ..... 120 ⇒ Passat IV (93>97) ..... 121 ⇒ Polo V (94>99) ..... 122 ⇒ Polo VI (99>2001) ..... 123 ⇒ Scirocco (74>90) ..... 124 ⇒ Vento (91>97) ..... 127	
301332	ATE	21974	247	<b>AUDI</b> ⇒ A1 (2010>) ..... 8 ⇒ A3 (96>2000) ..... 8 <b>SEAT</b> ⇒ Cordoba (2002>2009) .... 95 ⇒ Ibiza (2001>2009) ..... 96 ⇒ Ibiza (2008>2012) ..... 96 ⇒ Leon (99>2006) ..... 96 ⇒ Toledo (98>2004) ..... 98 <b>SKODA</b> ⇒ Citigo (2011>) ..... 98 ⇒ Fabia (99>2004) ..... 98 ⇒ Fabia (2004>2007) ..... 99 ⇒ Fabia (2006>2010) ..... 99 ⇒ Fabia (2010>) ..... 99 ⇒ Octavia (96>2000) ..... 99 ⇒ Octavia (2000>2010) ... 100 ⇒ Rapid (2012>) ..... 100 ⇒ Roomster (2006>2010) 100 ⇒ Roomster (2010>) ..... 101 <b>VOLKSWAGEN</b> ⇒ Bora (98>2005) ..... 113 ⇒ Fox (2004>) ..... 115 ⇒ Golf IV (97>2006) ..... 117 ⇒ New Beetle (98>2001) . 119 ⇒ Polo V (94>99) ..... 122 ⇒ Polo VII (2001>) ..... 123 ⇒ Polo VIII (2005>) ..... 123 ⇒ Polo IX (2009>) ..... 124 ⇒ UP (2011>) ..... 126	













					
301335	ATE	20908	179	<b>FORD</b> ⇒ Escort (86>90) ..... 32 ⇒ Escort (90>94) ..... 32 ⇒ Escort (95>2001) ..... 32 ⇒ Granada (92>95) ..... 35 ⇒ Orion (90>93) ..... 36 ⇒ Scorpio (85>92) ..... 37 ⇒ Scorpio (92>94) ..... 37 ⇒ Sierra (82>86) ..... 37 ⇒ Sierra (87>93) ..... 37	
301337	SUM	23698	299	<b>NISSAN</b> ⇒ Murano (Z50) (2005>2008) . 68 ⇒ Murano (Z51) (2008>) .... 68 ⇒ Navara (D40M) (2005>2010) 68 ⇒ Navara (D40M) (2009>).. 68 ⇒ Pathfinder (R51M) (2005>2010) ..... 68	
301345	ATE	20687	173	<b>MERCEDES</b> ⇒ 190 (201) (82>93) ..... 57 ⇒ 200/300 (W124) (84>93) . 57 ⇒ C Class (W202) (93>2001) ..... 57 ⇒ E Class (W124) (93>98) ... 58	
301355	ATE	21911	241	<b>AUDI</b> ⇒ A4 (94>98) ..... 9 <b>VOLKSWAGEN</b> ⇒ Passat V (96>2000) ..... 121	
301356	ATE	21353	201	<b>DAEWOO</b> ⇒ Lanos (97>2005) ..... 24 ⇒ Nexia (95>2005) ..... 25 <b>OPEL</b> ⇒ Astra F (91>2001) ..... 70 ⇒ Astra Classic (98>2002) . 70 ⇒ Combo (85>93) ..... 71 ⇒ Combo (93>2001) ..... 71 ⇒ Corsa A (82>93) ..... 72 ⇒ Corsa B (93>2000) ..... 72 ⇒ Tigra (94>2001) ..... 75 ⇒ Vectra A (88>95) ..... 75 <b>VAUXHALL</b> ⇒ Astra MK III (91>2001) . 108 ⇒ Cavalier (88>95) ..... 109 ⇒ Combo (93>2001) ..... 109 ⇒ Corsa MK I (93>2000) .. 110 ⇒ Nova (83>93) ..... 111 ⇒ Tigra (94>2001) ..... 112	
301357	ATE	21195	192	<b>MERCEDES</b> ⇒ CLK Class (W208) (97>2003) ..... 58 ⇒ E Class (W210) (95>2003) ..... 59 ⇒ SLK Class (170) (96>2003) ..... 60	
301360	ATE	21145	190	<b>CITROËN</b> ⇒ AX (91>98) ..... 19 ⇒ Saxo (96>99) ..... 22 ⇒ Saxo (99>2005) ..... 22 <b>PEUGEOT</b> ⇒ 106 (91>96) ..... 77 ⇒ 106 (96>2003) ..... 77	













		WVA			
301361	AKE	23235	261	<b>CHEVROLET</b> ⇒ Alero (99>2004)..... 18 ⇒ Epica (2006>2009) ..... 18 ⇒ Evanda (2005>2007) ..... 18 ⇒ Rezzo (2005>2008)..... 19 ⇒ Tacuma (2005>2008)..... 19 <b>DAEWOO</b> ⇒ Evanda (2002>2005) ..... 24 ⇒ Leganza (97>2003)..... 24 ⇒ Rezzo (2000>2005)..... 25 ⇒ Tacuma (2000>2005)..... 25	
301386	ATE	20180	165	<b>BMW</b> ⇒ 3 Series (E36) (90>2001) 14 ⇒ Z1 (E30) (89>92)..... 17 ⇒ Z3 (E36) (96>2002)..... 17	
301389	BDX	20660	170	<b>LADA</b> ⇒ Niva (76>99)..... 52 ⇒ Niva (93>2006)..... 52	
301396	BDX	20635	169	<b>CITROËN</b> ⇒ Saxo (96>99) ..... 22 ⇒ Saxo (99>2005) ..... 22 ⇒ Xsara (97>2000) ..... 23 ⇒ Xsara (2000>2005) ..... 23 ⇒ ZX (91>98)..... 23 <b>PEUGEOT</b> ⇒ 106 (96>2003)..... 77 ⇒ 205 (74) (83>87)..... 77 ⇒ 205 (20) (87>98)..... 78 ⇒ 206 (98>2010)..... 78 ⇒ 306 (93>97)..... 78 ⇒ 306 (97>2002)..... 79 ⇒ 309 (85>89)..... 79 ⇒ 309 (89>94)..... 79 <b>RENAULT</b> ⇒ Super 5 (84>96)..... 82 ⇒ R9 (81>88)..... 82 ⇒ R11 (82>89)..... 82 ⇒ R19 (88>92)..... 82 ⇒ R19 (92>95)..... 83 ⇒ Clio I (90>96) ..... 84 ⇒ Clio I (96>98)..... 84 ⇒ Clio II (98>2001)..... 84 ⇒ Clio II (2001>2008)..... 84 ⇒ Lutecia (Japan) (94>98) .. 87 ⇒ Mégane (95>99)..... 87 ⇒ Mégane (98>2003)..... 88 ⇒ Mégane Classic (99>2002)88 ⇒ Safrane (92>96)..... 89	
301399	BDX	23300	269	<b>FORD</b> ⇒ Escort (90>94)..... 32 ⇒ Escort (95>2001)..... 32 ⇒ Orion (90>93) ..... 36	
301402	AKE	21158	191	<b>TOYOTA</b> ⇒ Camry (SV/CV20) (86>91) 104 ⇒ Dyna 100 (85>2001).... 105 ⇒ Hiace (H5-6) (82>89) ... 105 ⇒ Hilux (LN/RN/YN 5-6) (83>98) ..... 105	
301403	ATE	21866	238	<b>SEAT</b> ⇒ Cordoba (96>99)..... 94 ⇒ Cordoba (99>2002)..... 94 ⇒ Ibiza (96>99)..... 95 ⇒ Ibiza (99>2001)..... 96 ⇒ Toledo (91>98)..... 97	

		WVA			
301403	ATE	21866	238	<b>VOLKSWAGEN</b> ⇒ Golf III (91>99)..... 116 ⇒ Polo V (94>99) ..... 122 ⇒ Polo VI (99>2001)..... 123 ⇒ Vento (91>97) ..... 127	
301405	BDX	20166	164	<b>LADA</b> ⇒ 1200/1300/1500/1600/Classica..... 51 ⇒ Kalinka (95>98) ..... 52	
301406	LUC	21170	191	<b>LADA</b> ⇒ Natacha (93>97)..... 52 ⇒ Sagona (91>99)..... 52 ⇒ Samara (86>99)..... 52	
301407	LUC	23661	298	<b>ALFA ROMEO</b> ⇒ 147 (2000>2004)..... 4 ⇒ 147 (2004>2010)..... 4 ⇒ 156 (97>2003)..... 5 ⇒ 156 (2003>2007)..... 5 ⇒ GT (2003>2010)..... 6 <b>FIAT</b> ⇒ Linea (2007>)..... 28 <b>LANCIA</b> ⇒ Lybra (839) (99>2006)..... 53	
301408	ATE	21974	247	<b>AUDI</b> ⇒ A2 (2000>2005)..... 8 ⇒ A3 (2000>2003)..... 8 ⇒ A3 (2003>2008)..... 8 ⇒ A3 (2008>2013)..... 8 ⇒ A3 (2012>)..... 9 ⇒ A3 Cabriolet (2008>)..... 9 <b>SEAT</b> ⇒ Altea (2004>2009)..... 93 ⇒ Altea (2009>) ..... 93 ⇒ Ibiza (2008>2012)..... 96 ⇒ Leon (99>2006)..... 96 ⇒ Leon (2005>2010)..... 97 ⇒ Leon (2010>)..... 97 ⇒ Toledo (98>2004)..... 98 ⇒ Toledo (2004>2009)..... 98 <b>SKODA</b> ⇒ Fabia (99>2004) ..... 98 ⇒ Fabia (2004>2007) ..... 99 ⇒ Fabia (2006>2010) ..... 99 ⇒ Octavia (96>2000) ..... 99 ⇒ Octavia (2000>2010) ... 100 ⇒ Octavia (2004>2008) ... 100 ⇒ Octavia (2008>2013) ... 100 ⇒ Roomster (2006>2010) 100 ⇒ Yeti (2009>) ..... 101 <b>VOLKSWAGEN</b> ⇒ Bora (98>2005)..... 113 ⇒ Caddy III (2004>2010) . 114 ⇒ Caddy IV (2010>) ..... 114 ⇒ Golf IV (97>2006)..... 117 ⇒ Golf V (2003>2009)..... 117 ⇒ Golf VI (2008>)..... 117 ⇒ Golf V Plus (2005>2009) 117 ⇒ Golf VI Plus (2009>) ..... 118 ⇒ Jetta III (2005>2010) ... 118 ⇒ Jetta IV (2010>) ..... 118 ⇒ New Beetle (98>2001) . 119 ⇒ New Beetle (2001>2005)119 ⇒ New Beetle (2005>2010)119 ⇒ New Beetle II (2010>) .. 120 ⇒ Polo VII (2001>)..... 123 ⇒ Polo VIII (2005>)..... 123	

					
301409	ATE	21064	188	<b>BMW</b> ⇒ 5 Series (E39) (95>2004) <b>15</b>	
301410	ATE	23312	269	<b>BMW</b> ⇒ 1 Series (E81/82/88) (2007>) ..... <b>14</b> ⇒ 5 Series (E60/61) (2003>2010) ..... <b>15</b> ⇒ 6 Series (E63/64) (2003>2011) ..... <b>15</b> ⇒ 7 Series (E65) (2001>2008) <b>16</b> ⇒ 7 Series (E66) (2002>2008) <b>16</b> ⇒ M3 (E90/92/93) (2007>) <b>16</b>	
301412	ATE	23449	281	<b>BMW</b> ⇒ 5 Series (E39) (95>2004) <b>15</b> ⇒ 7 Series (E38) (94>2001) <b>16</b> ⇒ M5 (E39) (99>2003) ..... <b>16</b> ⇒ X3 (E83) (2006>2010) ..... <b>17</b> ⇒ X5 (E53) (2000>2006) ..... <b>17</b>	
301426	BSC	23705	299	<b>CITROËN</b> ⇒ Nemo (2007>) ..... <b>22</b> <b>FIAT</b> ⇒ 500 (2007>2012) ..... <b>25</b> ⇒ Albea (2002>) ..... <b>26</b> ⇒ Bravo II (198) (2007>2009) .. <b>26</b> ⇒ Bravo II (198) (2010>) ..... <b>26</b> ⇒ Doblo II (223) (2006>) ..... <b>27</b> ⇒ Doblo Cargo II (223) (2006>) ..... <b>27</b> ⇒ Fiorino (225-255) (2007>) .. <b>28</b> ⇒ Panda (169) (2003>) ..... <b>29</b> ⇒ Panda (169) (2003>2009) .. <b>29</b> ⇒ Grande Punto (199) (2005>2011) ..... <b>29</b> ⇒ Qubo (2008>) ..... <b>30</b> ⇒ Siena (178) (2002>2011) ... <b>30</b> ⇒ Stilo (2001>2003) ..... <b>30</b> ⇒ Stilo (2004>2008) ..... <b>30</b> <b>PEUGEOT</b> ⇒ Bipper (2007>) ..... <b>80</b>	
301429	LUC	21797	230	<b>CITROËN</b> ⇒ Jumper (94>2001) ..... <b>21</b> ⇒ Relay (94>2001) ..... <b>22</b> <b>FIAT</b> ⇒ Ducato (230) (94>2001) . <b>27</b> <b>PEUGEOT</b> ⇒ Boxer I (94>2001) ..... <b>81</b>	
301431	LUC	23353	272	<b>FORD</b> ⇒ Fiesta (2002>2005) ..... <b>33</b> ⇒ Fiesta (2005>2008) ..... <b>33</b> ⇒ Focus (98>2001) ..... <b>33</b> ⇒ Focus (2001>2004) ..... <b>34</b>	
301433	BSC	23279	266	<b>FORD</b> ⇒ Mondeo (2000>2003) .... <b>36</b> ⇒ Mondeo (2003>2005) .... <b>36</b> ⇒ Mondeo (2005>2007) .... <b>36</b> <b>JAGUAR</b> ⇒ X-Type (2001>2008) ..... <b>49</b>	
301434	BSC	23557	289	<b>FORD</b> ⇒ Mondeo (2000>2003) ..... <b>36</b> ⇒ Mondeo (2003>2005) ..... <b>36</b> <b>JAGUAR</b> ⇒ X-Type (2001>2008) ..... <b>49</b>	













					
301436	LUC	23095	254	<b>HONDA</b> ⇒ Accord VI (CG/CH/CL) (98>2003) ..... <b>39</b> <b>MG</b> ⇒ MG ZR (2001>2005) ..... <b>61</b> ⇒ MG ZS (2001>2005) ..... <b>61</b>	
301444	ATE	21919	242	<b>CHRYSLER</b> ⇒ Crossfire (2003>2009) .... <b>19</b> <b>MERCEDES</b> ⇒ C Class (W202) (93>2001) ..... <b>57</b> ⇒ C Class (W203) (2000>2003) ..... <b>58</b> ⇒ C Class (W203) (2004>2008) ..... <b>58</b> ⇒ CLC Class (W203) (2008>) ..... <b>58</b> ⇒ CLK Class (W208) (97>2003) ..... <b>58</b> ⇒ CLK Class (W209) (2002>2009) ..... <b>58</b> ⇒ E Class (W210) (95>2003) <b>59</b> ⇒ SLK Class (170) (96>2003) ..... <b>60</b> ⇒ SLK Class (171) (2004>2007) ..... <b>60</b> ⇒ SLK Class (171) (2008>) .. <b>60</b>	
301445	BRE	23271	266	<b>MERCEDES</b> ⇒ CL Class (W215) (99>2006) ..... <b>58</b> ⇒ ML Class (163) (97>2005) ..... <b>59</b> ⇒ S Class (W220) (98>2004) ..... <b>60</b> ⇒ SL Class (129) (89>2001) ..... <b>60</b>	
301448	LUC	23144	257	<b>MERCEDES</b> ⇒ C Class (W203) (2000>2003) ..... <b>58</b> ⇒ C Class (W203) (2004>2008) ..... <b>58</b> ⇒ CLC Class (W203) (2008>) ..... <b>58</b> ⇒ CLK Class (W209) (2002>2009) ..... <b>58</b> ⇒ SLK Class (171) (2004>2007) ..... <b>60</b> ⇒ SLK Class (171) (2008>) <b>60</b>	
301449	AKE	23023	249	<b>NISSAN</b> ⇒ Almera (N15) (95>2000) .. <b>66</b>	
301450	LUC	23093	254	<b>NISSAN</b> ⇒ Almera (N16E) (2000>2003) ..... <b>66</b> ⇒ Almera (N16E) (2003>2006) ..... <b>66</b> ⇒ Primera (P11/W11) (96>2002) ..... <b>69</b>	
301454	ATE	23062	250	<b>OPEL</b> ⇒ Astra G (98>2005) ..... <b>70</b> ⇒ Zafira A (98>2003) ..... <b>76</b> ⇒ Zafira A (2003>2005) ..... <b>76</b> <b>VAUXHALL</b> ⇒ Astra MK IV (98>2005) . <b>108</b> ⇒ Zafira I (99>2003) ..... <b>113</b> ⇒ Zafira I (2003>2005) .... <b>113</b>	





											
301456	LUC	23225	261	<b>OPEL</b> ➤ Combo/Combo Tour (2001>2004)..... 71 ➤ Combo/Combo Tour (2004>) ..... 72 ➤ Corsa C (2000>2003)..... 72 ➤ Corsa C (2003>2006)..... 72 ➤ Meriva A (2003>2010) ... 73 ➤ Tigra Twintop (2004>2008) ..... 75 <b>VAUXHALL</b> ➤ Astramax (91>98) ..... 108 ➤ Combo (2001>2004).... 109 ➤ Combo (2004>)..... 110 ➤ Corsa MK II (2000>2003) ..... 110 ➤ Corsa MK II (2003>2006) ..... 110 ➤ Meriva (2003>2010) .... 111 ➤ Tigra Twintop (2004>2008) ..... 112		301463	LUC	20960	181	<b>AUDI</b> ➤ A1 (2010>)..... 8 ➤ A3 (96>2000) ..... 8 ➤ A3 (2000>2003) ..... 8 ➤ A3 (2003>2008) ..... 8 ➤ A3 (2008>2013) ..... 9 ➤ A3 (2012>) ..... 9 ➤ A3 Cabriolet (2008>) ..... 9 ➤ A4 (94>98) ..... 9 ➤ A4 (99>2001) ..... 9 ➤ A4 (2000>2004) ..... 10 ➤ A4 Cabriolet (2002>2005) 10 ➤ A6 (97>2001) ..... 10 ➤ A6 (2001>2005) ..... 10 ➤ A6 Allroad (2000>2005) .. 11 ➤ A8 (94>2002) ..... 11 ➤ S4 (99>2001) ..... 12 ➤ S4 (2004>2008) ..... 12 ➤ S6 (99>2001) ..... 12 ➤ S6 (2001>2005) ..... 12 ➤ S8 (99>2002) ..... 13 ➤ TT (98>2006) ..... 13 <b>CITROËN</b> ➤ Berlingo (2002>2012) .... 19 ➤ C2 (2003>2010) ..... 20 ➤ C3 (2002>2005) ..... 20 ➤ C3 (2005>2011) ..... 20 ➤ C3 Pluriel (2003>2011) ... 20 ➤ C4 (2004>2011) ..... 20 ➤ C8 (2002>) ..... 20 ➤ Xsara Picasso (99>2010). 23 <b>FIAT</b> ➤ Ulysse (179) (2002>2010) 31 <b>FORD</b> ➤ Galaxy (VX) (95>2000) .... 35 ➤ Galaxy (VY) (2000>2006) . 35 ➤ Galaxy (VX) (95>2000) .... 35 ➤ Galaxy (VY) (2000>2006) . 35 <b>LANCIA</b> ➤ Phedra (179) (2002>2010) 53 <b>PEUGEOT</b> ➤ 1007 (2005>2010) ..... 77 ➤ 307 (2001>2005) ..... 79 ➤ 307 (2005>2009) ..... 79 ➤ 308 (2007>) ..... 79 ➤ 807 (2002>) ..... 80 ➤ Partner (M59) (2002>) .... 81 ➤ Ranch (M59) (2002>2008) 81	
301457	LUC	23284	267	<b>OPEL</b> ➤ Corsa C (2000>2003) ..... 72 ➤ Corsa C (2003>2006) ..... 72 ➤ Tigra Twintop (2004>2008) ..... 75 <b>VAUXHALL</b> ➤ Corsa MK II (2000>2003) ..... 110 ➤ Corsa MK II (2003>2006) ..... 110 ➤ Tigra Twintop (2004>2008) ..... 112 ➤ Corsa MK II (2000>2003) ..... 110 ➤ Corsa MK II (2003>2006) ..... 110 ➤ Tigra Twintop (2004>2008) ..... 112							
301458	GME	23358	273	<b>OPEL</b> ➤ Sintra (96>99)..... 75 <b>VAUXHALL</b> ➤ Sintra (96>99)..... 112							
301461	BSC	23597	295	<b>PEUGEOT</b> ➤ 206 (98>2010)..... 78 ➤ 206+ (2009>) ..... 78							
301462	BSC	23396	275	<b>CITROËN</b> ➤ Xsara (97>2000) ..... 23 <b>PEUGEOT</b> ➤ 206 (98>2010)..... 78 ➤ 306 (97>2002)..... 79							





											
301463	LUC	20960	181	<b>SEAT</b> ☞ Alhambra (96>2000) ..... 93 ☞ Altea (2004>2009) ..... 93 ☞ Altea (2009>) ..... 93 ☞ Arosa (97>2004) ..... 94 ☞ Cordoba (99>2002) ..... 94 ☞ Cordoba (2002>2009) ..... 95 ☞ Ibiza (99>2001) ..... 96 ☞ Ibiza (2001>2009) ..... 96 ☞ Ibiza (2008>2012) ..... 96 ☞ Ibiza (2012>) ..... 96 ☞ Leon (99>2006) ..... 96 ☞ Leon (2005>2010) ..... 97 ☞ Leon (2010>) ..... 97 ☞ Toledo (98>2004) ..... 98 ☞ Toledo (2004>2009) ..... 98 ☞ Toledo (2012>) ..... 98  <b>SKODA</b> ☞ Fabia (99>2004) ..... 98 ☞ Fabia (2004>2007) ..... 99 ☞ Fabia (2006>2010) ..... 99 ☞ Fabia (2010>) ..... 99 ☞ Octavia (96>2000) ..... 99 ☞ Octavia (2000>2010) .... 100 ☞ Octavia (2004>2008) .... 100 ☞ Octavia (2008>2013) .... 100 ☞ Rapid (2012>) ..... 100 ☞ Roomster (2006>2010) . 100 ☞ Roomster (2010>) ..... 101 ☞ Superb (2001>2008) ..... 101 ☞ Yeti (2009>) ..... 101  <b>VOLKSWAGEN</b> ☞ Bora (98>2005) ..... 114 ☞ Caddy III (2004>2010) ... 114 ☞ Caddy IV (2010>) ..... 114 ☞ Corrado (88>95) ..... 114 ☞ Eos (2006>2010) ..... 115 ☞ Eos (2010>) ..... 115 ☞ Golf III (91>99) ..... 116 ☞ Golf IV (97>2006) ..... 117 ☞ Golf V (2003>2009) ..... 117 ☞ Golf VI (2008>) ..... 117 ☞ Golf VI Cabriolet (2011>) 117 ☞ Golf V Plus (2005>2009) 117 ☞ Golf VI Plus (2009>) ..... 118 ☞ Jetta III (2005>2010) ..... 118 ☞ Lupo (98>2005) ..... 119 ☞ New Beetle (98>2001) .. 119 ☞ New Beetle (2001>2005) ..... 119 ☞ New Beetle (2005>2010) ..... 120 ☞ Passat III (88>93) ..... 120 ☞ Passat IV (93>97) ..... 121 ☞ Passat V (96>2000) ..... 121 ☞ Passat VI (2000>2005) .. 121 ☞ Polo V (94>99) ..... 123 ☞ Polo VI (99>2001) ..... 123 ☞ Polo VII (2001>) ..... 123 ☞ Polo VIII (2005>) ..... 124 ☞ Polo IX (2009>) ..... 124 ☞ Scirocco (2008>) ..... 124 ☞ Sharan (95>2000) ..... 124 ☞ Vento (91>97) ..... 127	301464	BSC	23599	295	<b>CITROËN</b> ☞ Berlingo (96>2002) ..... 19 ☞ Berlingo (2002>2012) .... 19 ☞ C2 (2003>2010) ..... 19 ☞ C3 (2005>2011) ..... 20 ☞ C3 (2009>) ..... 20 ☞ C3 Picasso (2009>) ..... 20 ☞ C4 (2004>2011) ..... 20 ☞ C-Elysée (2012>) ..... 21 ☞ DS3 (2010>) ..... 21 ☞ Xsara (2000>2005) ..... 23 ☞ Xsara Picasso (99>2010) 23  <b>PEUGEOT</b> ☞ 1007 (2005>2010) ..... 77 ☞ 206 (98>2010) ..... 78 ☞ 207 (2006>) ..... 78 ☞ 207+ (2012>) ..... 78 ☞ 208 (2012>) ..... 78 ☞ 301 (2012>) ..... 78 ☞ 307 (2001>2005) ..... 79 ☞ 307 (2005>2009) ..... 79 ☞ Partner (M49) (96>2002) 81 ☞ Partner (M59) (2002>) .... 81 ☞ Ranch (M49) (96>2002) . 81 ☞ Ranch (M59) (2002>2008) ..... 81		
301465	BSC	23600	296	<b>CITROËN</b> ☞ Berlingo (2002>2012) .... 19 ☞ C3 (2005>2011) ..... 20 ☞ C4 (2004>2011) ..... 20 ☞ Xsara (2000>2005) ..... 23 ☞ Xsara Picasso (99>2010) 23  <b>PEUGEOT</b> ☞ 1007 (2005>2010) ..... 77 ☞ 206 (98>2010) ..... 78 ☞ 207 (2006>) ..... 78 ☞ 307 (2001>2005) ..... 79 ☞ 307 (2005>2009) ..... 79 ☞ Partner (M59) (2002>) .... 81 ☞ Ranch (M59) (2002>2008) ..... 81	301466	BRE	21381	205	<b>PEUGEOT</b> ☞ 406 (95>2004) ..... 80		
301471	ATE	23659	297	<b>RENAULT</b> ☞ Espace IV (2002>2006) .. 85 ☞ Espace IV (2006>2010) .. 85 ☞ Espace IV (2010>2012) .. 85 ☞ Laguna II (2001>2005) ... 87 ☞ Laguna II (2005>2007) ... 87 ☞ Mégane Scenic (99>2003) 89 ☞ Vel Satis (2002>2005) .... 90 ☞ Vel Satis (2005>2009) .... 91							











											
301472	ATE	23482	284	<b>FORD</b> ☞ C-Max (2007>2010)..... 31 ☞ Focus (2004>2007)..... 34 ☞ Focus II (2007>2011) ..... 34 ☞ Focus C-Max (2003>2007)..... 34 ☞ Focus Coupé Cabriolet (2006>2008) ..... 34 ☞ Focus Coupé Cabriolet (2008>)..... 34 ☞ Tourneo Connect (2002>2006) ..... 37 ☞ Tourneo Connect (2006>) 37 ☞ Transit Connect (2002>2006) ..... 38 ☞ Transit Connect (2006>) .. 38 <b>NISSAN</b> ☞ Primera (P12/W12) (2001>2006) ..... 69 <b>OPEL</b> ☞ Signum (2003>2005) ..... 74 ☞ Vectra C (2002>2005) ..... 75 <b>RENAULT</b> ☞ Espace IV (2002>2006) ... 85 ☞ Espace IV (2006>2010) ... 85 ☞ Espace IV (2010>2012) ... 85 ☞ Mégane II (2002>2009) ... 88 ☞ Vel Satis (2002>2005) ..... 91 ☞ Vel Satis (2005>2009) ..... 91 ☞ Espace IV (2002>2006) ... 85 ☞ Espace IV (2006>2010) ... 85 ☞ Espace IV (2010>2012) ... 85 ☞ Mégane II (2002>2009) ... 88 ☞ Vel Satis (2002>2005) ..... 91 ☞ Vel Satis (2005>2009) ..... 91 <b>SAAB</b> ☞ 9-3 (2002>) ..... 92 <b>VAUXHALL</b> ☞ Signum (2003>2005) ..... 112 ☞ Vectra (2002>2005) ..... 112	301474	LUC	20960	181	<b>RENAULT</b> ☞ Clio III (2005>2009)..... 84 ☞ Clio III (2009>)..... 84 ☞ Fluence (2009>)..... 86 ☞ Mégane II (2002>2009) ... 88 ☞ Mégane III (2008>2012) .. 88 ☞ Mégane III (2012>)..... 88 ☞ Scenic II (2003>2009) .... 90 ☞ Scenic III (2009>2012) .... 90 ☞ Scenic III (2012>)..... 90 ☞ Twingo II (2007>2011) .... 90 ☞ Twingo II (2012>) ..... 90 ☞ Wind (2010>) ..... 91 <b>SEAT</b> ☞ Exeo (2008>)..... 95 <b>VOLVO</b> ☞ S60 (2000>2009)..... 128 ☞ V70 (2000>2007) ..... 129 ☞ S80 (98>2006)..... 130 ☞ XC 70 (2000>2007) ..... 130 <b>VOLVO</b> ☞ S60 (2000>2009)..... 128 ☞ S70 (96>2000) ..... 129 ☞ V70 (96>2000) ..... 129 ☞ V70 (2000>2007) ..... 129 ☞ S80 (98>2006)..... 130 ☞ XC 70 (97>99)..... 130 ☞ XC 70 (2000>2007)..... 130 <b>VOLKSWAGEN</b> ☞ Transporter (F70) (90>96) ..... 126 ☞ Transporter (F7D) (96>2003) ..... 126 ☞ Transporter (F70) (90>96) ..... 126 ☞ Transporter (F7D) (96>2003) ..... 126 <b>AUDI</b> ☞ A4 (99>2001)..... 9 ☞ A4 (2000>2004)..... 9 ☞ A4 (2004>2008)..... 10 ☞ A4 Cabriolet (2002>2005) ..... 10 ☞ A4 Cabriolet II (2006>2009) ..... 10 ☞ A6 (97>2001)..... 10 ☞ A6 (2001>2005)..... 10 ☞ A6 (2004>2008)..... 10 ☞ A6 (2008>2011)..... 11 <b>SEAT</b> ☞ Exeo (2008>) ..... 95 <b>SKODA</b> ☞ Superb (2001>2008).... 101 <b>VOLKSWAGEN</b> ☞ Passat V (96>2000)..... 121 ☞ Passat VI (2000>2005) . 121		
301473	LUC	20916	180	<b>RENAULT</b> ☞ Clio II (98>2001) ..... 84 ☞ Clio II (2001>2008) ..... 84 ☞ Laguna I (B56) (98>2000) ..... 86 ☞ Laguna I Nevada (K56) (98>2000) ..... 87 ☞ Mégane (98>2003) ..... 88 ☞ Mégane Classic (99>2002) ..... 88 ☞ Mégane Scenic (96>99) . 89 ☞ Mégane Scenic (99>2003) ..... 89 ☞ Safrane (96>2000)..... 89	301479	ATE	23072	252	<b>VOLVO</b> ☞ S60 (2000>2009)..... 128 ☞ V70 (2000>2007) ..... 129 ☞ S80 (98>2006)..... 130 ☞ XC 70 (2000>2007) ..... 130		
301474	LUC	20960	181	<b>AUDI</b> ☞ A4 (2000>2004) ..... 10 ☞ A4 (2004>2008) ..... 10 ☞ A4 Cabriolet II (2006>2009) ..... 10 <b>CITROËN</b> ☞ C3 (2009>)..... 20 ☞ C3 Picasso (2009>)..... 20 ☞ DS3 (2010>)..... 21 <b>PEUGEOT</b> ☞ 207 (2006>)..... 78	301480	ATE	23075	253	<b>VOLVO</b> ☞ S60 (2000>2009)..... 128 ☞ S70 (96>2000) ..... 129 ☞ V70 (96>2000) ..... 129 ☞ V70 (2000>2007) ..... 129 ☞ S80 (98>2006)..... 130 ☞ XC 70 (97>99)..... 130 ☞ XC 70 (2000>2007)..... 130		
301474	LUC	20960	181	<b>AUDI</b> ☞ A4 (99>2001)..... 9 ☞ A4 (2000>2004)..... 9 ☞ A4 (2004>2008)..... 10 <b>SEAT</b> ☞ Exeo (2008>) ..... 95 <b>VOLKSWAGEN</b> ☞ Passat V (96>2000)..... 121	301482	LUC	21748	228	<b>VOLKSWAGEN</b> ☞ Transporter (F70) (90>96) ..... 126 ☞ Transporter (F7D) (96>2003) ..... 126 ☞ Transporter (F70) (90>96) ..... 126 ☞ Transporter (F7D) (96>2003) ..... 126		
301474	LUC	20960	181	<b>AUDI</b> ☞ A4 (99>2001)..... 9 ☞ A4 (2000>2004)..... 9 ☞ A4 (2004>2008)..... 10 <b>SEAT</b> ☞ Exeo (2008>) ..... 95 <b>VOLKSWAGEN</b> ☞ Passat V (96>2000)..... 121	301483	ATE	20676	172	<b>AUDI</b> ☞ A4 (99>2001)..... 9 ☞ A4 (2000>2004)..... 9 ☞ A4 (2004>2008)..... 10 <b>SEAT</b> ☞ Exeo (2008>) ..... 95 <b>SKODA</b> ☞ Superb (2001>2008).... 101 <b>VOLKSWAGEN</b> ☞ Passat V (96>2000)..... 121 ☞ Passat VI (2000>2005) . 121		
301474	LUC	20960	181	<b>AUDI</b> ☞ A4 (99>2001)..... 9 ☞ A4 (2000>2004)..... 9 ☞ A4 (2004>2008)..... 10 <b>SEAT</b> ☞ Exeo (2008>) ..... 95 <b>VOLKSWAGEN</b> ☞ Passat V (96>2000)..... 121	301484	LUC	23393	273	<b>AUDI</b> ☞ A4 (99>2001)..... 9 ☞ A4 (2000>2004)..... 9 ☞ A4 (2004>2008)..... 10 <b>SEAT</b> ☞ Exeo (2008>) ..... 95 <b>VOLKSWAGEN</b> ☞ Passat V (96>2000)..... 121		







		<b>VVA</b>			
<b>301486</b>	<b>ATE</b>	21911	<b>241</b>	<b>AUDI</b> ⇒ A3 (96>2000)..... <b>8</b> ⇒ A3 (2000>2003)..... <b>8</b> ⇒ TT (98>2006)..... <b>13</b>  <b>SEAT</b> ⇒ Ibiza (2001>2009)..... <b>96</b> ⇒ Leon (99>2006)..... <b>96</b> ⇒ Toledo (98>2004)..... <b>98</b>  <b>SKODA</b> ⇒ Octavia (96>2000)..... <b>99</b> ⇒ Octavia (2000>2010) ... <b>100</b>  <b>VOLKSWAGEN</b> ⇒ Bora (98>2005)..... <b>114</b> ⇒ Golf III (91>99)..... <b>116</b> ⇒ Golf IV (97>2006)..... <b>117</b> ⇒ New Beetle (98>2001) . <b>119</b> ⇒ New Beetle (2001>2005) ..... <b>119</b> ⇒ New Beetle (2005>2010) ..... <b>119</b> ⇒ Passat IV (93>97)..... <b>121</b> ⇒ Polo VIII (2005>)..... <b>123</b> ⇒ Vento (91>97) ..... <b>127</b>	
<b>301488</b>	<b>ATE</b>	21865	<b>237</b>	<b>SEAT</b> ⇒ Arosa (97>2004)..... <b>94</b>  <b>SKODA</b> ⇒ Fabia (99>2004) ..... <b>98</b> ⇒ Fabia (2006>2010) ..... <b>99</b>  <b>VOLKSWAGEN</b> ⇒ Fox (2004>) ..... <b>115</b> ⇒ Lupo (98>2005)..... <b>119</b> ⇒ Polo V (94>99) ..... <b>122</b> ⇒ Polo VI (99>2001)..... <b>123</b> ⇒ Polo VII (2001>)..... <b>123</b> ⇒ Polo VIII (2005>)..... <b>123</b>	
<b>301491</b>	<b>KELS</b>	21822	<b>232</b>	<b>JEEP</b> ⇒ Cherokee (77>2001) ..... <b>49</b> ⇒ Grand Cherokee (93>2000) ..... <b>49</b> ⇒ Wrangler (96>2006)..... <b>49</b>  <b>KIA</b> ⇒ Carnival (99>2002) ..... <b>49</b>  <b>RENAULT</b> ⇒ Cherokee (84>93)..... <b>83</b> ⇒ Jeep (82>93) ..... <b>86</b>	
<b>301493</b>	<b>LUC</b>	21983	<b>248</b>	<b>MINI</b> ⇒ Cooper (99>2003)..... <b>62</b> ⇒ Cooper S (99>2003)..... <b>62</b> ⇒ Cooper S (2004>2008).... <b>62</b> ⇒ Cooper S (2008>2013).... <b>62</b>  <b>SMART MCC</b> ⇒ Forfour (2004>2006).... <b>101</b>  <b>VOLVO</b> ⇒ S40 (95>2004)..... <b>128</b> ⇒ V40 (95>2004)..... <b>128</b>	
<b>301497</b>	<b>AP</b>	21237	<b>195</b>	<b>LAND ROVER</b> ⇒ Defender (90>2007)..... <b>54</b> ⇒ Defender II (2007>) ..... <b>54</b> ⇒ Discovery (89>94) ..... <b>54</b> ⇒ Discovery (94>98)..... <b>54</b> ⇒ Range Rover (81>86) ..... <b>54</b> ⇒ Range Rover (86>94) ..... <b>54</b>	





		<b>VVA</b>			
<b>301500</b>	<b>LUC</b>	23407	<b>277</b>	<b>CITROËN</b> ⇒ C2 (2003>2010) ..... <b>19</b> ⇒ C3 (2002>2005) ..... <b>20</b> ⇒ C3 (2005>2011) ..... <b>20</b>	
<b>301505</b>	<b>AKE</b>	23569	<b>290</b>	<b>HYUNDAI</b> ⇒ H1 Mini Bus (2001>2006) ..... <b>44</b> ⇒ H1 Mini Bus (2006>)..... <b>44</b> ⇒ H1 Made in Turkey (2007>) ..... <b>44</b> ⇒ Santa Fé (2000>2006) ... <b>46</b> ⇒ Satellite (98>2007) ..... <b>46</b> ⇒ Starex (98>2007)..... <b>47</b> ⇒ XG (2002>2006) ..... <b>48</b>  <b>SSANGYONG</b> ⇒ Actyon (2006>2011) .... <b>101</b> ⇒ Actyon Sports (2007>2011) ..... <b>101</b> ⇒ Kyron (2005>2007)..... <b>101</b> ⇒ Kyron (2007>)..... <b>102</b>	
<b>301506</b>	<b>LUC</b>	20789	<b>175</b>	<b>HYUNDAI</b> ⇒ Terracan (2001>2002) ... <b>47</b> ⇒ Terracan (2002>2007) ... <b>48</b>	
<b>301507</b>	<b>SUM</b>	21875	<b>239</b>	<b>ISUZU</b> ⇒ Trooper (81>97)..... <b>49</b> ⇒ Trooper (98>2004)..... <b>49</b>  <b>OPEL</b> ⇒ Frontera A (91>98) ..... <b>73</b> ⇒ Frontera B (98>2005) ..... <b>73</b> ⇒ Monterey (91>99) ..... <b>73</b>  <b>VAUXHALL</b> ⇒ Frontera A (91>98) ..... <b>110</b> ⇒ Frontera B (98>2005).... <b>111</b> ⇒ Monterey A (94>98)..... <b>111</b> ⇒ Monterey B (98>99) ..... <b>111</b>	
<b>301517</b>	<b>AKE</b>	21363	<b>202</b>	<b>MINI</b> ⇒ Cooper (99>2003)..... <b>62</b> ⇒ Cooper S (99>2003)..... <b>62</b> ⇒ Cooper S (2004>2008).... <b>62</b> ⇒ Cooper S (2008>2013).... <b>62</b>  <b>SMART MCC</b> ⇒ Forfour (2004>2006).... <b>101</b>  <b>VOLVO</b> ⇒ S40 (95>2004)..... <b>128</b> ⇒ V40 (95>2004)..... <b>128</b>	
<b>301518</b>	<b>SUM</b>	21016	<b>185</b>	<b>MINI</b> ⇒ Cooper (99>2003)..... <b>62</b> ⇒ Cooper S (99>2003)..... <b>62</b> ⇒ Cooper S (2004>2008).... <b>62</b> ⇒ Cooper S (2008>2013).... <b>62</b>  <b>SMART MCC</b> ⇒ Forfour (2004>2006).... <b>101</b>  <b>VOLVO</b> ⇒ S40 (95>2004)..... <b>128</b> ⇒ V40 (95>2004)..... <b>128</b>	





		WVA			
301519	AKE	21840	235	<b>MITSUBISHI</b> <ul style="list-style-type: none"> <li>☞ Montero (V2/4) (93&gt;2006) <b>64</b></li> <li>☞ Pajero (V2/4) (90&gt;2004) .. <b>64</b></li> <li>☞ Shogun (V2/4) (90&gt;2001) <b>65</b></li> <li>☞ Sigma (FO/1) (90&gt;96) ..... <b>65</b></li> <li>☞ Space Gear (PA/PC/PD) (94&gt;98) ..... <b>65</b></li> </ul>	
301520	AKE	23582	292	<b>MITSUBISHI</b> <ul style="list-style-type: none"> <li>☞ Grandis (2004&gt;) ..... <b>63</b></li> <li>☞ Outlander (CW) (2006&gt;)... <b>64</b></li> <li>☞ Pajero (V6/V7) (2000&gt;2006) ..... <b>64</b></li> <li>☞ Pajero (V8/9) (2006&gt;) ..... <b>65</b></li> <li>☞ Shogun (V6/7) (2000&gt;2006) ..... <b>65</b></li> <li>☞ Shogun (V8/9) (2006&gt;) .... <b>65</b></li> </ul>	
301521	AKE	23487	285	<b>MITSUBISHI</b> <ul style="list-style-type: none"> <li>☞ Pajero Pinin (H7) (99&gt;2005) ..... <b>65</b></li> <li>☞ Shogun Pinin (99&gt;2005) <b>65</b></li> <li>☞ Pajero Pinin (H7) (99&gt;2005) ..... <b>65</b></li> <li>☞ Shogun Pinin (99&gt;2005) <b>65</b></li> </ul>	
301522	AKE	23290	268	<b>MITSUBISHI</b> <ul style="list-style-type: none"> <li>☞ L200 (K6/7) (96&gt;2007)... <b>63</b></li> <li>☞ L300 (Truck) (94&gt;2000) . <b>63</b></li> <li>☞ L400 (PA/PB/PD) (94&gt;2001) ..... <b>63</b></li> <li>☞ Pajero (V2/4) (90&gt;2004) . <b>64</b></li> <li>☞ Shogun (V2/4) (90&gt;2001) <b>65</b></li> <li>☞ Space Gear (PA/PC/PD) (94&gt;98) ..... <b>65</b></li> </ul>	
301535	SUM	23524	287	<b>LEXUS</b> <ul style="list-style-type: none"> <li>☞ LX 470 (2002&gt;2007) ..... <b>55</b></li> </ul> <b>TOYOTA</b> <ul style="list-style-type: none"> <li>☞ Land Cruiser (HD/UZ10) (98&gt;2007) ..... <b>106</b></li> </ul>	
301540	AKE	21833	234	<b>TOYOTA</b> <ul style="list-style-type: none"> <li>☞ Camry (SV/CV20) (86&gt;91) ..... <b>104</b></li> <li>☞ Camry (MCV/SXV20) (96&gt;2001) ..... <b>104</b></li> <li>☞ Carina II (T17) (87&gt;92) .. <b>104</b></li> <li>☞ Carina E (T19) (92&gt;97) .. <b>104</b></li> <li>☞ Celica (T20) (93&gt;99)..... <b>105</b></li> </ul>	
301545	LUC	23099	255	<b>NISSAN</b> <ul style="list-style-type: none"> <li>☞ Primastar (2002&gt;2006) .. <b>68</b></li> <li>☞ Primastar (2006&gt;) ..... <b>68</b></li> </ul> <b>OPEL</b> <ul style="list-style-type: none"> <li>☞ Vivaro (2001&gt;2006) ..... <b>76</b></li> <li>☞ Vivaro (2006&gt;) ..... <b>76</b></li> </ul> <b>RENAULT</b> <ul style="list-style-type: none"> <li>☞ Espace III (2000&gt;2002) .. <b>85</b></li> <li>☞ Trafic II (2001&gt;2006)..... <b>90</b></li> <li>☞ Trafic II (2006&gt;)..... <b>90</b></li> </ul> <b>VAUXHALL</b> <ul style="list-style-type: none"> <li>☞ Vivaro (2001&gt;2006) ..... <b>113</b></li> <li>☞ Vivaro (2006&gt;) ..... <b>113</b></li> </ul>	
301549	LUC	23070	252	<b>MERCEDES</b> <ul style="list-style-type: none"> <li>☞ A Class (W168) (97&gt;2004) ..... <b>57</b></li> </ul>	







		WVA			
301551	AKE	21601	215	<b>TOYOTA</b> <ul style="list-style-type: none"> <li>☞ Camry (SX/VC10) (91&gt;96) <b>104</b></li> <li>☞ Carina E (T19) (92&gt;97) . <b>104</b></li> <li>☞ Corolla (100) (92&gt;97) ... <b>105</b></li> <li>☞ Picnic (M10) (96&gt;2001) <b>106</b></li> <li>☞ RAV4 (SXA) (94&gt;2000) . <b>106</b></li> </ul>	
301557	BSC	23934	314	<b>RENAULT</b> <ul style="list-style-type: none"> <li>☞ Mégane II (2002&gt;2009).. <b>88</b></li> </ul>	
301558	BSC	23930	314	<b>RENAULT</b> <ul style="list-style-type: none"> <li>☞ Kangoo (97&gt;2003) ..... <b>86</b></li> <li>☞ Kangoo (2003&gt;2009) .... <b>86</b></li> <li>☞ Mégane II (2002&gt;2009).. <b>88</b></li> <li>☞ Scenic II (2003&gt;2009).... <b>90</b></li> </ul>	
301563	ATE	23200	259	<b>FORD</b> <ul style="list-style-type: none"> <li>☞ Courier/Courier (96&gt;2002) <b>32</b></li> <li>☞ Fiesta (99&gt;2002)..... <b>33</b></li> <li>☞ Ka (96&gt;2008)..... <b>35</b></li> </ul> <b>MAZDA</b> <ul style="list-style-type: none"> <li>☞ 121 (96&gt;2002)..... <b>55</b></li> </ul>	
301564	ATE	23202	260	<b>FORD</b> <ul style="list-style-type: none"> <li>☞ Fiesta (99&gt;2002)..... <b>33</b></li> <li>☞ Fiesta (2002&gt;2005)..... <b>33</b></li> <li>☞ Fiesta (2005&gt;2008)..... <b>33</b></li> <li>☞ Fusion (2002&gt;2005)..... <b>34</b></li> <li>☞ Fusion (2005&gt;2012)..... <b>34</b></li> <li>☞ Ka (96&gt;2008)..... <b>35</b></li> <li>☞ Puma (97&gt;2001)..... <b>36</b></li> <li>☞ StreetKa (2002&gt;2005) ... <b>37</b></li> </ul> <b>MAZDA</b> <ul style="list-style-type: none"> <li>☞ 2 (2003&gt;2008)..... <b>55</b></li> <li>☞ 121 (96&gt;2002)..... <b>55</b></li> <li>☞ 2 (2003&gt;2008)..... <b>55</b></li> <li>☞ 121 (96&gt;2002)..... <b>55</b></li> </ul>	
301565	ATE	23269	265	<b>FORD</b> <ul style="list-style-type: none"> <li>☞ Galaxy (VY) (2000&gt;2006) <b>35</b></li> </ul> <b>SEAT</b> <ul style="list-style-type: none"> <li>☞ Alhambra (2000&gt;2003) .. <b>93</b></li> <li>☞ Alhambra (2003&gt;2010) .. <b>93</b></li> </ul> <b>VOLKSWAGEN</b> <ul style="list-style-type: none"> <li>☞ Sharan (2000&gt;2003).... <b>125</b></li> <li>☞ Sharan (2003&gt;2010).... <b>125</b></li> <li>☞ Transporter (F7D) (96&gt;2003) ..... <b>126</b></li> </ul>	
301568	BRE	23918	311	<b>CITROËN</b> <ul style="list-style-type: none"> <li>☞ Jumper (2002&gt;2006) ..... <b>21</b></li> <li>☞ Relay (2002&gt;2006) ..... <b>22</b></li> </ul> <b>FIAT</b> <ul style="list-style-type: none"> <li>☞ Ducato (230) (94&gt;2001) . <b>27</b></li> <li>☞ Ducato (244) (2002&gt;2006) <b>27</b></li> <li>☞ Ducato (244-245) Made in Russia (2008&gt;2011) ..... <b>27</b></li> </ul> <b>PEUGEOT</b> <ul style="list-style-type: none"> <li>☞ Boxer II (2002&gt;2006) ..... <b>81</b></li> </ul>	
301569	BRE	23919	312	<b>CITROËN</b> <ul style="list-style-type: none"> <li>☞ Jumper (2002&gt;2006) ..... <b>21</b></li> <li>☞ Relay (2002&gt;2006) ..... <b>22</b></li> </ul> <b>FIAT</b> <ul style="list-style-type: none"> <li>☞ Ducato (230) (94&gt;2001) . <b>27</b></li> <li>☞ Ducato (244) (2002&gt;2006) ..... <b>27</b></li> <li>☞ Ducato (244-245) Made in Russia (2008&gt;2011) ..... <b>27</b></li> </ul>	







					
301569	BRE	23919	312	<b>PEUGEOT</b> ⇒ Boxer II (2002>2006) ..... <b>81</b>	
301570	BRE	23921	312	<b>CITROËN</b> ⇒ Jumper (2002>2006) ..... <b>21</b> ⇒ Relay (2002>2006)..... <b>22</b> <b>FIAT</b> ⇒ Ducato (244-245) Made in Russia (2008>2011)..... <b>27</b> <b>PEUGEOT</b> ⇒ Boxer II (2002>2006) ..... <b>81</b>	
301574	AKE	21727	227	<b>HYUNDAI</b> ⇒ Accent (94>99) ..... <b>42</b> ⇒ Coupe (95>2001)..... <b>42</b> ⇒ Elantra (90>95)..... <b>43</b> ⇒ Elantra (95>2000)..... <b>43</b> ⇒ Elantra (2000>2007)..... <b>43</b> ⇒ Excel (89>94)..... <b>43</b> ⇒ Excel (94>99)..... <b>43</b> ⇒ Lantra (90>95)..... <b>45</b> ⇒ Lantra (95>2000)..... <b>45</b> ⇒ Matrix (2001>2008)..... <b>46</b> ⇒ Pony (82>94) ..... <b>46</b> ⇒ Pony (94>99) ..... <b>46</b> ⇒ Sonata (88>93) ..... <b>47</b> ⇒ Sonata (93>98)..... <b>47</b> ⇒ Sonata (98>2001)..... <b>47</b> ⇒ Sonica (98>2001) ..... <b>47</b> <b>KIA</b> ⇒ Joice (99>2003)..... <b>50</b> ⇒ Magentis (2001>2005) .. <b>50</b>	
301575	AKE	23238	262	<b>HYUNDAI</b> ⇒ Amica (2000>2001) ..... <b>42</b> ⇒ Atos/Atoz (98>2001) ..... <b>42</b> ⇒ Atos (2004>2008)..... <b>42</b> ⇒ Atos Prime (99>2001).... <b>42</b> ⇒ Atos Prime (2004>2008) <b>42</b>	
301577	SUM	23521	286	<b>TOYOTA</b> ⇒ Celica (T23) (99>2005).. <b>105</b> ⇒ Corolla (120) (2001>2007) <b>105</b> ⇒ Corolla Verso (E12) (2001>2003)..... <b>105</b> ⇒ Prius (W11) (2000>2003). <b>106</b> ⇒ Yaris (P10LA/RA - P13LA) Made in Japan (99>2005) .. <b>107</b> ⇒ Yaris (P10LC/RC - P12LC/RC) Made in France (2001>2005) <b>107</b> ⇒ Yaris Verso (P20-21-22) (99>2005) ..... <b>107</b>	
301580	ATE	21487	210	<b>BMW</b> ⇒ 7 Series (E38) (94>2001) <b>16</b> ⇒ M3 (E46) (2000>2006) .... <b>16</b> ⇒ M5 (E39) (99>2003) ..... <b>16</b> ⇒ X3 (E83) (2003>2006) ..... <b>17</b> ⇒ X3 (E83) (2006>2010)..... <b>17</b> ⇒ X5 (E53) (2000>2006) ..... <b>17</b> ⇒ Z4 (E85/86) (2002>2009) <b>17</b> ⇒ Z8 (E52) (2000>2003) ..... <b>17</b> <b>LAND ROVER</b> ⇒ Range Rover (2002>2009).... <b>54</b>	
301581	LUC	21606	215	<b>ALFA ROMEO</b> ⇒ 156 (97>2003)..... <b>5</b> ⇒ 164 (92>98) ..... <b>5</b> ⇒ 166 (98>2007)..... <b>5</b> <b>LANCIA</b> ⇒ Kappa (838) (94>2001) ... <b>53</b>	





					
301583	LUC	23138	256	<b>MERCEDES</b> ⇒ A Class (W168) (97>2004) <b>57</b> ⇒ A Class (W169) (2008>2012) ..... <b>57</b> ⇒ Vaneo (414) (2001>2005) <b>61</b>	
301584	LUC	23417	277	<b>KIA</b> ⇒ Venga (2009>)..... <b>51</b> <b>OPEL</b> ⇒ Astra G (98>2005)..... <b>70</b> ⇒ Astra H (2004>2011)..... <b>71</b> ⇒ Combo/Combo Tour (2001>2004) ..... <b>72</b> ⇒ Combo/Combo Tour (2004>) ..... <b>72</b> ⇒ Meriva A (2003>2010)..... <b>73</b> ⇒ Meriva B (2010>) ..... <b>73</b> ⇒ Zafira A (98>2003) ..... <b>76</b> ⇒ Zafira A (2003>2005) ..... <b>76</b> ⇒ Zafira B (2005>2008)..... <b>76</b> ⇒ Zafira B (2008>) ..... <b>76</b> <b>VAUXHALL</b> ⇒ Astra MK IV (98>2005) .. <b>108</b> ⇒ Astra MK V (2004>2011) <b>108</b> ⇒ Combo (2001>2004) ..... <b>110</b> ⇒ Combo (2004>) ..... <b>110</b> ⇒ Meriva (2003>2010)..... <b>111</b> ⇒ Meriva (2010>)..... <b>111</b> ⇒ Zafira I (99>2003) ..... <b>113</b> ⇒ Zafira I (2003>2005) .... <b>113</b> ⇒ Zafira II (2005>2009) .... <b>113</b> ⇒ Zafira II (2009>) ..... <b>113</b>	
301606	AKE	23348	272	<b>TOYOTA</b> ⇒ Yaris (P10LA/RA - P13LA) Made in Japan (99>2005) .. <b>107</b>	
301616	ATE	21273	196	<b>VOLVO</b> ⇒ 850 (91>96)..... <b>127</b> ⇒ C70 (97>2005) ..... <b>129</b> ⇒ S70 (96>2000)..... <b>129</b> ⇒ V70 (96>2000)..... <b>129</b> ⇒ XC 70 (97>99) ..... <b>130</b>	
301617	ATE	21305	198	<b>MERCEDES</b> ⇒ 200/300 (W124) (84>93). <b>57</b> ⇒ C Class (W202) (93>2001) ..... <b>57</b> ⇒ C Class (W203) (2000>2003) ..... <b>58</b> ⇒ C Class (W203) (2004>2008) ..... <b>58</b> ⇒ CLK Class (W208) (97>2003) ..... <b>58</b> ⇒ CLK Class (W209) (2002>2009) ..... <b>58</b> ⇒ E Class (W124) (93>98)... <b>59</b> ⇒ E Class (W210) (95>2003) <b>59</b> ⇒ S Class (W140) (91>93)... <b>59</b> ⇒ S Class (W140) (93>99)... <b>59</b> ⇒ S Class (W220) (98>2004) ..... <b>60</b> ⇒ SL Class (129) (89>2001) <b>60</b> ⇒ SLK Class (170) (96>2003) ..... <b>60</b> ⇒ SLK Class (171) (2008>).. <b>60</b>	





		WVA			
301618	AKE	21347	200	<b>NISSAN</b> ⇒ Cedric (Y30) (83>88)..... 67 ⇒ D21 Pick-up (85>98) ..... 67 ⇒ D22 King Cab (98>)..... 67 ⇒ NP300 (D22SS) (2010>). 68 ⇒ Terrano (WD21) (87>95). 69 ⇒ Urvan (E24) (87>97)..... 69 ⇒ Vanette (GC22) (86>93).. 69	
301622	LUC	21479	209	<b>VOLKSWAGEN</b> ⇒ Transporter (F70) (90>96) 126 ⇒ Transporter (F7D) (96>2003) ..... 126	
301624	SUM	20031	163	<b>DAIHATSU</b> ⇒ Applause (89>2000)..... 25 <b>MAZDA</b> ⇒ 323 (BG) (89>94)..... 55 ⇒ 626 (GE) (91>97)..... 56 <b>SUZUKI</b> ⇒ Baleno (95>2002) ..... 103	
301625	SUM	21647	219	<b>GALLOPER</b> ⇒ Santamo (98>2002)..... 38 <b>HYUNDAI</b> ⇒ Santamo (98>2001)..... 46 <b>MITSUBISHI</b> ⇒ Colt (C5) (88>92) ..... 62 ⇒ Colt (CA/CC) (91>96)..... 62 ⇒ Galant (E3) (87>92)..... 63 ⇒ Galant (E5/6/7/8) (92>96) ..... 63 ⇒ Galant (EA) (96>2003).... 63 ⇒ Lancer (CB/CD4) (92>2000) ..... 63 ⇒ Lancer F (C6/7) (88>95). 63 ⇒ Lancer F (CB/CD) (91>96) ..... 63 ⇒ Space Runner (N1/2/6) (91>2002) ..... 65 ⇒ Space Wagon (N3) (91>2000) ..... 66 <b>PROTON</b> ⇒ 300 (96>)..... 82 ⇒ 400 (93>2006)..... 82 ⇒ 300 (96>)..... 82 ⇒ 400 (93>2006)..... 82	
301627	AKE	21651	220	<b>HONDA</b> ⇒ Accord VI (CG/CH/CL) (98>2003) ..... 39 ⇒ Accord Aerodeck (CE) (93>97) ..... 39 ⇒ Accord coupe (CD) (93>97) ..... 39 ⇒ CR-V (97>2002)..... 40 ⇒ HR-V (GH) (98>2005) .... 40 ⇒ Integra R (DC) (97>2001) 41 ⇒ Odyssey (RA) (97>2000) 41 ⇒ Prelude (BB1-2-3) (91>96) ..... 41 ⇒ Prelude (BB5-6-8-9) (96>2001) ..... 41 ⇒ Shuttle (RA) (94>2000)... 41 <b>ROVER</b> ⇒ 600 (93>2000)..... 92	
301629	SUM	21754	229	<b>FORD</b> ⇒ Probe (92>97)..... 36	







		WVA			
301629	SUM	21754	229	<b>MAZDA</b> ⇒ 323 (BJ) (98>2000)..... 56 ⇒ 323 (BJ) (2000>2003).... 56 ⇒ 626 (GE) (91>97) ..... 56 ⇒ 626 (GF) (97>2002)..... 56 ⇒ 626 Wagon (GW) (97>99)56 ⇒ 626 Wagon (GW) (99>2002) ..... 56 ⇒ MX6 (91>97)..... 56 ⇒ Premacy (99>2001) ..... 56 ⇒ Premacy (2001>2005) ... 56 ⇒ Xedos 6 (91>99) ..... 56	
301634	LUC	23081	253	<b>HYUNDAI</b> ⇒ H100 (93>2000) ..... 44 ⇒ Jobs (98>) ..... 45	
301635	ATE	23587	293	<b>AUDI</b> ⇒ A1 (2010>)..... 8 ⇒ A3 (2003>2008)..... 8 ⇒ A3 (2008>2013)..... 8 ⇒ A3 (2012>)..... 9 ⇒ A3 Cabriolet (2008>)..... 9 ⇒ S3 (98>2003)..... 12 ⇒ TT (2006>)..... 13 <b>SEAT</b> ⇒ Altea (2004>2009) ..... 93 ⇒ Altea (2009>) ..... 93 ⇒ Ibiza (2008>2012)..... 96 ⇒ Ibiza (2012>)..... 96 ⇒ Leon (2005>2010) ..... 97 ⇒ Leon (2010>) ..... 97 ⇒ Toledo (2004>2009)..... 98 ⇒ Toledo (2012>)..... 98 <b>SKODA</b> ⇒ Fabia (2010>) ..... 99 ⇒ Octavia (2004>2008) ... 100 ⇒ Octavia (2008>2013) ... 100 ⇒ Rapid (2012>)..... 100 ⇒ Roomster (2010>)..... 101 ⇒ Superb (2008>)..... 101 ⇒ Yeti (2009>) ..... 101 <b>VOLKSWAGEN</b> ⇒ Caddy III (2004>2010) . 114 ⇒ Caddy IV (2010>) ..... 114 ⇒ Eos (2006>2010) ..... 115 ⇒ Eos (2010>) ..... 115 ⇒ Golf V (2003>2009)..... 117 ⇒ Golf VI (2008>)..... 117 ⇒ Golf VI Cabriolet (2011>) ..... 117 ⇒ Golf V Plus (2005>2009) ..... 117 ⇒ Golf VI Plus (2009>) .... 118 ⇒ Jetta III (2005>2010) ... 118 ⇒ Jetta IV (2010>) ..... 118 ⇒ New Beetle II (2010>) .. 120 ⇒ Passat VII (2005>2010) 121 ⇒ Passat CC (2008>2012) 121 ⇒ Polo IX (2009>) ..... 124 ⇒ Scirocco (2008>) ..... 124 ⇒ Touran (2003>2006) .... 125 ⇒ Touran (2006>2010) .... 125 ⇒ Touran (2010>) ..... 126	







					
301636	ATE	21670	222	<b>CHRYSLER</b> ➤ Crossfire (2003>2009) ... 19  <b>MERCEDES</b> ➤ CLK Class (W208) (97>2003) ..... 58 ➤ E Class (W210) (95>2003) ..... 59 ➤ E Class (W211) (2002>2006) ..... 59 ➤ E Class (W211) (2006>2009) ..... 59 ➤ S Class (W220) (98>2004) ..... 60 ➤ SLK Class (170) (96>2003) ..... 60	
301638	BSC	23743	304	<b>MERCEDES</b> ➤ E Class (W211) (2002>2006) ..... 59 ➤ E Class (W211) (2006>2009) ..... 59	
301639	ATE	23440	279	<b>FORD</b> ➤ Fiesta (2002>2005) ..... 33 ➤ Fiesta (2005>2008) ..... 33 ➤ Focus (2001>2004) ..... 33 ➤ Tourneo Connect (2002>2006) ..... 37 ➤ Tourneo Connect (2006>) ..... 37 ➤ Transit Connect (2002>2006) ..... 38 ➤ Transit Connect (2006>) ..... 38	
301640	ATE	23794	305	<b>BMW</b> ➤ 3 Series (E90/91/92/93) (2005>) ..... 14 ➤ 3 Series (E90/91/92/93) (2007>) ..... 14 ➤ 5 Series (E60/61) (2003>2010) ..... 15 ➤ X1 (E84) (2009>) ..... 16 ➤ Z4 (E89) (2009>) ..... 17	
301641	LUC	23973	318	<b>DACIA</b> ➤ Dokker (2012>) ..... 24 ➤ Duster (2010>) ..... 24 ➤ Lodgy (2012>) ..... 24 ➤ Logan (2004>) ..... 24  <b>NISSAN</b> ➤ Micra (K12E) (2003>2005) ..... 67 ➤ Micra (K12E) (2005>2011) ..... 68 ➤ Note (E11E) (2005>2007) ..... 68 ➤ Note (E11E) (2008>) ..... 68  <b>RENAULT</b> ➤ Captur (2013>) ..... 83 ➤ Clio III (2005>2009) ..... 84 ➤ Clio III (2009>) ..... 84 ➤ Clio IV (2012>) ..... 84 ➤ Duster (2010>) ..... 84 ➤ Kangoo (2007>) ..... 86 ➤ Kangoo (2013>) ..... 86 ➤ Logan (2004>) ..... 87 ➤ Modus (2004>2007) ..... 89 ➤ Modus (2008>) ..... 89	
301642	AKE	23454	282	<b>NISSAN</b> ➤ Micra (K11E) (92>2000) .. 67 ➤ Micra (K11E) (2000>2002) ..... 67	

					
301644	AKE	23974	318	<b>CHEVROLET</b> ➤ Aveo (2005>2008) ..... 18 ➤ Aveo (2008>2011) ..... 18 ➤ Kalos (2005>2008) ..... 18	
301649	ATE	23723	302	<b>FORD</b> ➤ C-Max (2007>2010) ..... 31 ➤ Focus (2004>2007) ..... 34 ➤ Focus II (2007>2011) ..... 34 ➤ Focus C-Max (2003>2007) ..... 34 ➤ Focus Coupé Cabriolet (2006>2008) ..... 34 ➤ Focus Coupé Cabriolet (2008>) ..... 34 ➤ Kuga (2008>) ..... 35  <b>MAZDA</b> ➤ 3 (2006>2009) ..... 55 ➤ 3 (2008>2011) ..... 55 ➤ 3 (2011>) ..... 55  <b>VOLVO</b> ➤ C30 (2006>2012) ..... 128 ➤ S40 (2004>) ..... 128 ➤ V50 (2004>) ..... 128 ➤ C70 CC (2006>) ..... 129	
301650	LUC	23446	280	<b>SEAT</b> ➤ Alhambra (2000>2003) ... 93 ➤ Alhambra (2003>2010) ... 93  <b>VOLKSWAGEN</b> ➤ Sharan (2000>2003) ..... 125 ➤ Sharan (2003>2010) ..... 125 ➤ Transporter (F7D) (96>2003) ..... 126	
301657	ATE	24141	327	<b>VOLVO</b> ➤ XC 90 (2002>2007) ..... 131 ➤ XC 90 (2007>) ..... 131	
301661	AKE	23250	263	<b>OPEL</b> ➤ Frontera B (98>2005) ..... 73  <b>VAUXHALL</b> ➤ Frontera B (98>2005) ... 111	
301662	LUC	24134	325	<b>PEUGEOT</b> ➤ 407 (2004>2011) ..... 80	
301666	AKE	21333	199	<b>SUBARU</b> ➤ Justy (95>2003) ..... 102  <b>SUZUKI</b> ➤ Alto (SH410) (94>2002) 102 ➤ Cappuccino (SX306) (91>98) ..... 103 ➤ Swift (SA) Made in Japan (83>89) ..... 103 ➤ Swift (SF) Made in Japan (89>96) ..... 103 ➤ Swift (SF) Made in Hungary (95>96) ..... 103 ➤ Swift (SF) Made in Hungary (96>2005) ..... 103	





Valeo		WVA			
301667	LUC	23581	291	<b>SEAT</b> ⇒ Cordoba (2002>2009).... <b>95</b> ⇒ Ibiza (2001>2009)..... <b>96</b> ⇒ Cordoba (2002>2009).... <b>95</b> ⇒ Ibiza (2001>2009)..... <b>96</b> <b>SKODA</b> ⇒ Fabia (99>2004) ..... <b>98</b> ⇒ Fabia (2004>2007) ..... <b>99</b> ⇒ Fabia (2006>2010) ..... <b>99</b> ⇒ Roomster (2006>2010) <b>100</b> <b>VOLKSWAGEN</b> ⇒ Polo VII (2001>)..... <b>123</b> ⇒ Polo VIII (2005>)..... <b>123</b>	
301668	SUM	21715	226	<b>NISSAN</b> ⇒ 100 NX (B13) (90>94) .... <b>66</b> ⇒ Almera (N15) (95>2000).. <b>66</b> ⇒ Maxima QX (A32) (94>99) <b>67</b> ⇒ Maxima QX (CA33) (2000>2006) ..... <b>67</b> ⇒ Sunny (N14) (90>95)..... <b>69</b>	
301672	AKE	23871	309	<b>NISSAN</b> ⇒ Murano (Z50) (2005>2008).. <b>68</b> ⇒ X-Trail (T30) (2001>2003) <b>69</b> ⇒ X-Trail (T30) (2003>2007) <b>69</b>	
301674	LUC	20960	181	<b>AUDI</b> ⇒ A2 (2000>2005)..... <b>8</b> <b>SEAT</b> ⇒ Arosa (97>2004) ..... <b>94</b> ⇒ Cordoba (2002>2009).... <b>95</b> ⇒ Ibiza (2001>2009)..... <b>96</b> <b>SKODA</b> ⇒ Fabia (99>2004)..... <b>98</b> <b>VOLKSWAGEN</b> ⇒ Lupo (98>2005) ..... <b>119</b> ⇒ Polo VII (2001>)..... <b>123</b> ⇒ Polo VIII (2005>)..... <b>124</b>	
301675	ATE	21883	239	<b>VOLKSWAGEN</b> ⇒ Transporter (F7D) (96>2003)..... <b>126</b>	
301678	ATE	23402	276	<b>CADILLAC</b> ⇒ BLS (2005>2010)..... <b>17</b> <b>FIAT</b> ⇒ Croma II (194-294) (2005>2007) ..... <b>27</b> ⇒ Croma II (194-294) (2007>2011) ..... <b>27</b> <b>OPEL</b> ⇒ Astra H (2004>2011)..... <b>71</b> ⇒ Signum (2003>2005)..... <b>74</b> ⇒ Signum (2005>2008)..... <b>74</b> ⇒ Vectra C (2002>2005).... <b>75</b> ⇒ Vectra C (2005>2009).... <b>76</b> ⇒ Zafira B (2005>2008)..... <b>76</b> ⇒ Zafira B (2008>)..... <b>76</b> <b>SAAB</b> ⇒ 9-3 (2002>)..... <b>92</b> <b>VAUXHALL</b> ⇒ Astra MK V (2004>2011).... <b>108</b> ⇒ Signum (2003>2005).... <b>111</b> ⇒ Signum (2005>2008).... <b>112</b> ⇒ Vectra (2002>2005) ..... <b>112</b> ⇒ Vectra (2005>2009) ..... <b>112</b> ⇒ Zafira II (2005>2009).... <b>113</b> ⇒ Zafira II (2009>)..... <b>113</b>	





Valeo		WVA			
301680	LUC	23816	307	<b>TOYOTA</b> ⇒ Corolla (120) (2001>2007) ..... <b>105</b>	
301681	LUC	20960	181	<b>FORD</b> ⇒ Galaxy (VY) (2000>2006) . <b>35</b> ⇒ Mondeo (2000>2003)..... <b>36</b> <b>SEAT</b> ⇒ Alhambra (2000>2003) ... <b>93</b> ⇒ Alhambra (2003>2010) ... <b>93</b> <b>VOLKSWAGEN</b> ⇒ Sharan (95>2000) ..... <b>124</b> ⇒ Sharan (2000>2003)..... <b>125</b> ⇒ Sharan (2003>2010)..... <b>125</b>	
301682	AKE	21719	226	<b>HONDA</b> ⇒ Accord IV (CB) (89>93) .... <b>39</b> ⇒ Accord V (CC) (93>95) .... <b>39</b> ⇒ Accord VI (CE/CF) (95>98) <b>39</b> ⇒ Accord VIII (CL/CM/CN) (2003>2008) ..... <b>39</b> ⇒ Accord Aerodeck (CB/CC) (90>93) ..... <b>39</b> ⇒ Accord Aerodeck (CE) (93>97) ..... <b>39</b> ⇒ Accord coupe (CC) (91>93) ..... <b>39</b> ⇒ Accord coupe (CD) (93>97) ..... <b>39</b> ⇒ Civic V (MA/MB) (95>2001) ..... <b>40</b> ⇒ Civic (EM2/EP/ES/EU/EV) (2001>2006) ..... <b>40</b> ⇒ Civic (FK/FD/FN) (2006>) . <b>40</b> ⇒ Civic Aerodeck (MB/MC) (97>2001) ..... <b>40</b> ⇒ CR-V (2002>2006) ..... <b>40</b> ⇒ Legend (KA3-4/HS) (85>90) ..... <b>41</b> ⇒ Legend (KA7-8) (90>96) .. <b>41</b> ⇒ Legend (KA9) (96>2006) . <b>41</b> ⇒ Odyssey (RA) (97>2000).. <b>41</b> ⇒ Prelude (BB5-6-8-9) (96>2001) ..... <b>41</b> ⇒ S2000 (AP) (99>2004)..... <b>41</b> ⇒ S2000 (AP) (2004>2009) . <b>41</b> ⇒ Shuttle (RA) (94>2000).... <b>41</b> ⇒ Stream (RN) (2001>2005) <b>41</b> <b>MG</b> ⇒ MG ZR (2001>2005)..... <b>61</b> ⇒ MG ZS (2001>2005)..... <b>61</b> <b>ROVER</b> ⇒ 600 (93>2000)..... <b>92</b>	
301703	ATE	23926	313	<b>BMW</b> ⇒ 1 Series (E87) (2004>2007) ..... <b>14</b> ⇒ 1 Series (E87) (2007>) .... <b>14</b> ⇒ 1 Series (E81/82/88) (2007>) ..... <b>14</b> ⇒ 3 Series (E90/91/92/93) (2005>)..... <b>14</b> ⇒ 3 Series (E90/91/92/93) (2007>) ..... <b>15</b> ⇒ X1 (E84) (2009>)..... <b>17</b>	
301705	MAND	24218	328	<b>KIA</b> ⇒ Cerato (2004>2008)..... <b>50</b>	







					
301708	MAND	24277	330	<b>HYUNDAI</b> ⇒ Amica (2000>2001) ..... 42 ⇒ Amica (2001>2003) ..... 42 ⇒ Atos/Atoz (98>2001) ..... 42 ⇒ Atos (2001>2004) ..... 42 ⇒ Atos Prime (99>2001) .... 42 ⇒ Atos Prime (2001>2004) 42	
301718	BSC	23959	315	<b>CITROËN</b> ⇒ C1 (2005>2012) ..... 19 ⇒ C1 (2012>) ..... 19 ⇒ C1 (2005>2012) ..... 19 ⇒ C1 (2012>) ..... 19 <b>PEUGEOT</b> ⇒ 107 (2005>2012)..... 77 ⇒ 107 (2012>)..... 77 <b>TOYOTA</b> ⇒ Aygo (B10) (2005>2012) ..... 104 ⇒ Aygo (B10) (2012>) ..... 104	
301720	LUC	23581	291	<b>SEAT</b> ⇒ Ibiza (2001>2009)..... 96 <b>SKODA</b> ⇒ Fabia (99>2004) ..... 98 ⇒ Fabia (2004>2007) ..... 99 ⇒ Fabia (2006>2010) ..... 99 ⇒ Roomster (2006>2010) 100 <b>VOLKSWAGEN</b> ⇒ Polo VII (2001>)..... 123 ⇒ Polo VIII (2005>)..... 124	
301721	BSC	23708	300	<b>FIAT</b> ⇒ Grande Punto (199) (2005>2011) ..... 29	
301726	BSC	21980	248	<b>CITROËN</b> ⇒ Xsara (97>2000) ..... 23 <b>NISSAN</b> ⇒ Kubistar (2003>) ..... 67 <b>PEUGEOT</b> ⇒ 306 (97>2002)..... 79 <b>RENAULT</b> ⇒ Kangoo (97>2003) ..... 86 ⇒ Kangoo (2003>2009) ..... 86	
301734	KELS	23395	274	<b>AUDI</b> ⇒ A2 (2000>2005)..... 8	
301735	ATE	23395	274	<b>VOLKSWAGEN</b> ⇒ Lupo (98>2005) ..... 119	
301736	BSC	23340	271	<b>TOYOTA</b> ⇒ Yaris (P10LC/RC - P12LC/RC) Made in France (2001>2005) ..... 107	
301737	AKE	23510	285	<b>TOYOTA</b> ⇒ Celica (T23) (99>2005) 105 ⇒ MR 2 (W30) (99>2005) 106 ⇒ Prius (W11) (2000>2003) ..... 106 ⇒ Yaris (P10LA/RA - P13LA) Made in Japan (99>2005) .. 107 ⇒ Yaris (P10LC/RC - P12LC/RC) Made in France (2001>2005) ..... 107 ⇒ Yaris Verso (P20-21-22) (99>2005) ..... 107	







					
301740	BSC	24260	329	<b>FORD</b> ⇒ Mondeo (2003>2005)..... 36 ⇒ Mondeo (2005>2007)..... 36	
301744	MAND	23891	310	<b>HYUNDAI</b> ⇒ Coupe (2002>2006)..... 43 ⇒ Coupe (2006>2008)..... 43 ⇒ Elantra (2000>2007)..... 43 ⇒ Sonata (2001>2005) ..... 47 ⇒ Sonata (2005>2008) ..... 47 ⇒ Tiburon (2002>2006) ..... 48 ⇒ Tucson (2004>2006) ..... 48 ⇒ Tucson (2006>2010) ..... 48 <b>KIA</b> ⇒ Magentis (2006>2008) .. 50 ⇒ Magentis (2008>2010) .. 50 ⇒ Sportage (2004>2006) ... 51	
301747	AKE	24647	345	<b>NISSAN</b> ⇒ Almera (B10RS) (2006>) 66	
301748	MAND	23543	289	<b>HYUNDAI</b> ⇒ Getz (2002>2005) ..... 43 ⇒ Getz (2005>2006) ..... 44 ⇒ Getz Made in Korea (2006>2011) ..... 44 ⇒ Getz Made in India (2007>) ..... 44 ⇒ Grandeur Azera (2005>) .. 44 ⇒ Highway Van (2000>2004) ..... 44 ⇒ Santa Fé (2000>2006)..... 46 ⇒ Sonata (98>2001) ..... 47 ⇒ Sonata (2005>2008) ..... 47 ⇒ Sonica (98>2001)..... 47 ⇒ Trajet (2000>2004)..... 48 ⇒ Trajet (2004>2007)..... 48 ⇒ Tucson (2004>2006) ..... 48 ⇒ Tucson (2006>2010) ..... 48 ⇒ XG (99>2002)..... 48 ⇒ XG (2002>2006)..... 48 <b>KIA</b> ⇒ Magentis (2001>2005).... 50 ⇒ Magentis (2006>2008).... 50 ⇒ Magentis (2008>2010).... 50 ⇒ Sportage (2004>2006) .... 51 ⇒ Sportage Made in Korea (2006>) ..... 51 <b>SSANGYONG</b> ⇒ Rodius (2005>) ..... 102	
301751	ATE	20676	172	<b>AUDI</b> ⇒ A4 (2004>2008)..... 10 ⇒ A4 Cabriolet (2002>2005) ..... 10 ⇒ A4 Cabriolet II (2006>2009) ..... 10 ⇒ A6 (2001>2005)..... 10 ⇒ A6 (2004>2008)..... 11 <b>SKODA</b> ⇒ Superb (2001>2008).... 101 <b>VOLKSWAGEN</b> ⇒ Passat V (96>2000)..... 121 ⇒ Passat VI (2000>2005) . 121	





























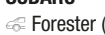

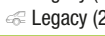
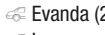

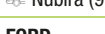
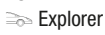
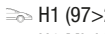
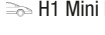

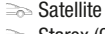

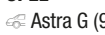

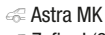

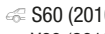
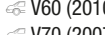
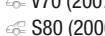
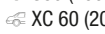
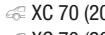
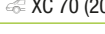

Valeo		WVA			
301752	TRW	23914	310	<b>AUDI</b> ☞ A3 (2003>2008) ..... 8 ☞ A3 (2008>2013) ..... 9 ☞ A3 (2012>) ..... 9 ☞ A3 Cabriolet (2008>) ..... 9 ☞ A4 (2004>2008) ..... 10 ☞ A4 Cabriolet II (2006>2009) ..... 10 ☞ A6 (2004>2008) ..... 11 ☞ A6 (2008>2011) ..... 11 ☞ A6 Allroad (2006>2011) .. 11 ☞ RS3 (2011>) ..... 12 ☞ S3 (98>2003) ..... 12 ☞ S3 (2006>2013) ..... 12 ☞ S3 (2012>) ..... 12 ☞ TT (2006>) ..... 13 ☞ TT RS (2009>) ..... 13  <b>SEAT</b> ☞ Alhambra (2010>) ..... 93 ☞ Altea (2004>2009) ..... 93 ☞ Altea (2009>) ..... 93 ☞ Exeo (2008>) ..... 95 ☞ Leon (2005>2010) ..... 97 ☞ Leon (2010>) ..... 97  <b>SKODA</b> ☞ Octavia (2004>2008) .... 100 ☞ Octavia (2008>2013) .... 100 ☞ Superb (2008>) ..... 101 ☞ Yeti (2009>) ..... 101  <b>VOLKSWAGEN</b> ☞ Caddy III (2004>2010) ... 114 ☞ Eos (2006>2010) ..... 115 ☞ Golf V (2003>2009) ..... 117 ☞ Golf VI (2008>) ..... 117 ☞ Golf VI Plus (2009>) ..... 118 ☞ Jetta III (2005>2010) ..... 118 ☞ Passat VII (2005>2010) . 121 ☞ Passat (2010>) ..... 121 ☞ Passat CC (2008>2012) 121 ☞ Scirocco (2008>) ..... 124 ☞ Sharan (2010>) ..... 125 ☞ Tiguan (2007>2011) ..... 125 ☞ Tiguan (2011>) ..... 125 ☞ Touran (2003>2006) ..... 125 ☞ Touran (2006>2010) ..... 125	
301753	ATE	21934	245	<b>BMW</b> ☞ 3 Series (E36) (90>2001) 14 ☞ 3 Series (E46) (98>2006) 14 ☞ Z1 (E30) (89>92) ..... 17 ☞ Z4 (E85/86) (2002>2009) 17  <b>MG</b> ☞ MG ZT (2001>2005) ..... 61  <b>ROVER</b> ☞ 75 (99>2005) ..... 91  <b>SAAB</b> ☞ 9-5 (97>2001) ..... 92 ☞ 9-5 (2001>2005) ..... 92 ☞ 9-5 (2005>2010) ..... 92	
301754	ATE	23732	303	<b>BMW</b> ☞ 5 Series (E60/61) (2003>2010) ..... 15 ☞ 6 Series (E63/64) (2003>2011) ..... 15	

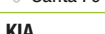

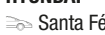

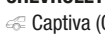

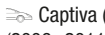





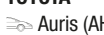
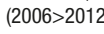
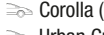

Valeo		WVA			
301759	AKE	23569	290	<b>HYUNDAI</b> ☞ Highway Van (2000>2004) ..... 44 ☞ Trajet (2000>2004) ..... 48 ☞ Trajet (2004>2007) ..... 48	
301760	SUM	21697	225	<b>HONDA</b> ☞ Civic IV (EG/EH/EJ) (91>95) ..... 39 ☞ Civic V (EJ9/EK/EM1) (95>2001) ..... 40 ☞ Jazz II (GD) Made in Japan (2002>2008) ..... 41 ☞ Logo (GA) (98>2001) ..... 41	
301763	ATE	21900	240	<b>MERCEDES</b> ☞ C Class (W202) (93>2001) ..... 57	
301770	BRE	23694	298	<b>AUDI</b> ☞ Q7 (2006>2009) ..... 11 ☞ Q7 (2009>) ..... 11  <b>VOLKSWAGEN</b> ☞ Touareg (2002>2006) .... 125 ☞ Touareg (2006>2010) .... 125	
301780	AKE	24045	323	<b>MAZDA</b> ☞ 6 (2002>2007) ..... 55 ☞ 626 (GD) (87>92) ..... 56 ☞ 626 (GE) (91>97) ..... 56 ☞ 626 Wagon (GV) (88>92) . 56 ☞ RX7 (FC) (85>91) ..... 56	
301781	MAND	24031	322	<b>HYUNDAI</b> ☞ Elantra (2000>2007) ..... 43 ☞ Matrix (2001>2008) ..... 46 ☞ Matrix (2008>) ..... 46	
301783	ATE	24137	326	<b>CADILLAC</b> ☞ BLS (2005>2010) ..... 18 <b>CITROËN</b> ☞ C5 (2008>) ..... 20 <b>FORD</b> ☞ Tourneo Connect (2002>2006) ..... 37 ☞ Tourneo Connect (2006>) 38 ☞ Transit Connect (2002>2006) ..... 38 ☞ Transit Connect (2006>) .. 38 <b>JAGUAR</b> ☞ XF (2007>2012) ..... 49 <b>OPEL</b> ☞ Signum (2003>2005) ..... 74 ☞ Signum (2005>2008) ..... 74 ☞ Vectra C (2002>2005) ..... 75 ☞ Vectra C (2005>2009) ..... 76 <b>RENAULT</b> ☞ Laguna II (2001>2005) .... 87 ☞ Laguna II (2005>2007) .... 87 ☞ Laguna III (2007>2010) ... 87 ☞ Laguna III (2010>) ..... 87 <b>SAAB</b> ☞ 9-3 (2002>) ..... 92 <b>VAUXHALL</b> ☞ Signum (2003>2005) .... 112 ☞ Signum (2005>2008) .... 112 ☞ Vectra (2002>2005) ..... 112 ☞ Vectra (2005>2009) ..... 112 <b>VOLVO</b> ☞ C30 (2006>2012) ..... 128 ☞ S40 (2004>) ..... 128 ☞ V50 (2004>) ..... 128 ☞ C70 CC (2006>) ..... 129	

					
301801	ATE	23418	278	<b>FORD</b> ⇒ Galaxy (VY) (2000>2006) <b>35</b> <b>SEAT</b> ⇒ Alhambra (2000>2003).. <b>93</b> ⇒ Alhambra (2003>2010).. <b>93</b> <b>VOLKSWAGEN</b> ⇒ Sharan (2000>2003).... <b>125</b> ⇒ Sharan (2003>2010).... <b>125</b>	
301805	ATE	21865	237	<b>SKODA</b> ⇒ Fabia (99>2004) ..... <b>98</b> ⇒ Fabia (2006>2010) ..... <b>99</b> <b>VOLKSWAGEN</b> ⇒ Lupo (98>2005) ..... <b>119</b> ⇒ Polo VII (2001>)..... <b>123</b> ⇒ Polo VIII (2005>)..... <b>124</b>	
301814	LUC	21479	209	<b>VOLKSWAGEN</b> ⇒ Transporter (F7D) (96>2003) ..... <b>126</b>	
301816	BSC	24484	336	<b>FORD</b> ⇒ Transit (2006>)..... <b>38</b>	
301817	SUM	21553	213	<b>HYUNDAI</b> ⇒ Coupe (95>2001) ..... <b>42</b> ⇒ Coupe (2002>2006) ..... <b>43</b> ⇒ Coupe (2006>2008) ..... <b>43</b> ⇒ Elantra (95>2000) ..... <b>43</b> ⇒ Elantra (2000>2007) ..... <b>43</b> ⇒ Lantira (95>2000) ..... <b>46</b> ⇒ Tiburon (2002>2006) ..... <b>48</b> <b>KIA</b> ⇒ Cerato (2004>2008) ..... <b>50</b> <b>NISSAN</b> ⇒ Bluebird (T12) (85>90) .... <b>67</b> ⇒ Maxima (J30) (88>94) ..... <b>67</b>	
301819	AKE	24338	333	<b>TOYOTA</b> ⇒ Camry (ACV/GSV40) (2006>2009) ..... <b>104</b> ⇒ Camry (ACV/GSV40) (2009>2011) ..... <b>104</b> ⇒ RAV4 (ACA/CLA/ZSA) (2005>2010) ..... <b>106</b> ⇒ RAV4 (ALA/ZSA) (2010>2012) ..... <b>106</b> ⇒ RAV4 (2012>)..... <b>106</b>	
301821	SUM	23649	296	<b>KIA</b> ⇒ Carnival (99>2002) ..... <b>49</b> ⇒ Carnival (2002>2006) .... <b>49</b> ⇒ Pregio (95>2005)..... <b>50</b> ⇒ Sedona (99>2002) ..... <b>51</b> ⇒ Sedona (2002>2005) ..... <b>51</b>	
301825	BSC	24288	330	<b>OPEL</b> ⇒ Corsa D (2006>) ..... <b>72</b> <b>VAUXHALL</b> ⇒ Corsa MK III (2006>) .... <b>110</b>	
301827	AKE	23526	287	<b>TOYOTA</b> ⇒ Celica (T23) (99>2005) <b>105</b> ⇒ Corolla (120) (2001>2007) ..... <b>105</b>	
301829	ATE	24011	320	<b>VOLVO</b> ⇒ XC 90 (2002>2007)..... <b>131</b> ⇒ XC 90 (2007>)..... <b>131</b>	

					
301842	MAND	23966	316	<b>HYUNDAI</b> ⇒ i30 Made in Korea (2007>2012) ..... <b>45</b> ⇒ i30 Made in Czech Republic (2008>2012) ..... <b>45</b> ⇒ i30 Made in Czech Republic (2012>) ..... <b>45</b> <b>KIA</b> ⇒ Carens (2002>2006) ..... <b>49</b> ⇒ Ceed (2006>2009) ..... <b>50</b> ⇒ Ceed (2009>2012) ..... <b>50</b> ⇒ Cerato (2008>)..... <b>50</b>	
301847	LUC	23973	318	<b>OPEL</b> ⇒ Agila (2007>) ..... <b>70</b> <b>SUZUKI</b> ⇒ Splash (2008>) ..... <b>103</b> ⇒ Swift (RS) Made in Hungary (2005>2011) ..... <b>103</b> ⇒ Swift (RS) Made in Japan (2005>2011) ..... <b>103</b> <b>VAUXHALL</b> ⇒ Agila (2007>) ..... <b>107</b>	
301852	AKE	24014	321	<b>CITROËN</b> ⇒ C4 Aircross (2012>) ..... <b>20</b> ⇒ C Crosser (2007>) ..... <b>21</b> <b>DODGE</b> ⇒ Caliber (2006>2011) ..... <b>25</b> <b>MITSUBISHI</b> ⇒ Lancer (CS/CT) (2003>)... <b>64</b> ⇒ Lancer (CY) (2007>) ..... <b>64</b> ⇒ Lancer Sportback (CX) (2008>)..... <b>64</b> ⇒ Outlander (CU) (2003>2008) ..... <b>64</b> <b>PEUGEOT</b> ⇒ 4007 (2007>) ..... <b>80</b> ⇒ 4008 (2012>) ..... <b>80</b>	
301853	TOKI	23865	309	<b>SUBARU</b> ⇒ Forester (97>2002) ..... <b>102</b> ⇒ Forester (2002>2005) .. <b>102</b> ⇒ Forester (2005>2007) .. <b>102</b> ⇒ Forester (2007>)..... <b>102</b> ⇒ Impreza (G11) (2000>2005) ..... <b>102</b> ⇒ Impreza (G11) (2005>2007) ..... <b>102</b> ⇒ Impreza (GR/GV) (2007>) ..... <b>102</b> ⇒ Legacy (2003>2009).... <b>102</b> ⇒ Legacy (2009>)..... <b>102</b>	
301857	SUM	24024	322	<b>TOYOTA</b> ⇒ Hilux (KUN 15-25-26) (2008>)..... <b>105</b> ⇒ Hilux (KUN 25-26-35) (2011>)..... <b>105</b> ⇒ Land Cruiser (KD/GR) (2002>2009) ..... <b>106</b>	

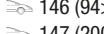
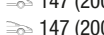
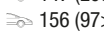
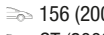
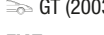
									
301860	ATE	23832	308	<b>OPEL</b> ➤ Astra H (2004>2011)..... 71 ➤ Combo/Combo Tour (2001>2004)..... 71 ➤ Combo/Combo Tour (2004>)..... 72 ➤ Corsa C (2003>2006)..... 72 ➤ Corsa D (2006>)..... 72 ➤ Meriva A (2003>2010) ... 73 ➤ Meriva B (2010>)..... 73 ➤ Zafira B (2005>2008)..... 76 ➤ Zafira B (2008>)..... 76  <b>VAUXHALL</b> ➤ Astra MK V (2004>2011)..... 108 ➤ Combo (2001>2004)..... 110 ➤ Combo (2004>)..... 110 ➤ Corsa MK II (2003>2006)..... 110 ➤ Corsa MK III (2006>) .... 110 ➤ Meriva (2003>2010) .... 111 ➤ Meriva (2010>) ..... 111 ➤ Zafira II (2005>2009) ... 113 ➤ Zafira II (2009>) ..... 113	<b>301868</b> <b>MAND</b> 24317 <b>332</b> <b>HYUNDAI</b> ➤ Accent Made in Turkey (2005>2012)..... 42 ➤ i20 (2008>2012)..... 44 ➤ i20 (2012>)..... 45 ➤ i20 Made in Turkey (2010>2012)..... 45  <b>KIA</b> ➤ Rio (2005>2006)..... 51 ➤ Rio (2006>)..... 51				
301862	AKE	23806	306	<b>TOYOTA</b> ➤ Camry (ACV/MCV30) (2001>2006)..... 104	<b>301874</b> <b>SUM</b> 24071 <b>323</b> <b>CHEVROLET</b> ➤ Lacetti (2005>)..... 18 ➤ Nubira (2005>2009)..... 18  <b>DAEWOO</b> ➤ Lacetti (2003>2004)..... 24				
301865	AKE	23539	288	<b>LEXUS</b> ➤ LX 470 (2002>2007) ..... 55  <b>TOYOTA</b> ➤ Land Cruiser (HD/UZ10) (98>2007) ..... 106	<b>301879</b> <b>ATE</b> 24123 <b>324</b> <b>LAND ROVER</b> ➤ Freelander 2 (2006>) ..... 54  <b>VOLVO</b> ➤ S60 (2010>)..... 129 ➤ V60 (2010>)..... 129 ➤ V70 (2007>)..... 130 ➤ S80 (2006>)..... 130 ➤ XC 70 (2007>2010) .... 130 ➤ XC 70 (2010>) ..... 130				
301867	MAND	24320	332	<b>HYUNDAI</b> ➤ Accent Made in Turkey (2005>2012)..... 42 ➤ i20 (2008>2012)..... 44 ➤ i20 (2012>)..... 45 ➤ i20 Made in Turkey (2010>2012)..... 45 ➤ i30 Made in Korea (2007>2012)..... 45 ➤ i30 Made in Czech Republic (2008>2012)..... 45 ➤ i30 Made in Czech Republic (2012>)..... 45 ➤ ix20 (2010>) ..... 45 ➤ ix35 Made in Korea (2010>)..... 45 ➤ ix35 Made in Czech Republic (2010>)..... 45  <b>KIA</b> ➤ Ceed (2006>2009)..... 50 ➤ Ceed (2009>2012)..... 50 ➤ Rio (2005>2006)..... 51 ➤ Rio (2006>)..... 51 ➤ Sportage Made in Korea (2010>)..... 51 ➤ Sportage Made in Slovakia (2010>)..... 51	<b>301881</b> <b>BRE</b> 29200 <b>351</b> <b>MERCEDES</b> ➤ Sprinter II (906) (2006>). 60  <b>VOLKSWAGEN</b> ➤ Crafter (2006>) ..... 114				
					<b>301886</b> <b>AKE</b> 23584 <b>292</b> <b>MITSUBISHI</b> ➤ ASX (2010>2012)..... 62 ➤ ASX (2012>)..... 62 ➤ Galant (EA) (96>2003).... 63 ➤ Galant (DJ/DM) (2006>2010)..... 63 ➤ Lancer (CS/CT) (2003>). 63 ➤ Lancer (CY) (2007>)..... 64 ➤ Lancer Sportback (CX) (2008>)..... 64 ➤ Space Runner (N1/2/6) (91>2002)..... 65				
					<b>301887</b> <b>SUM</b> 23722 <b>301</b> <b>HONDA</b> ➤ Civic (EM2/EP/ES/EU/EV) (2001>2006)..... 40 ➤ FR-V (2004>2007) ..... 40 ➤ FR-V (2007>2010) ..... 40 ➤ Legend (KA9) (96>2006) 41 ➤ Stream (RN) (2001>2005)..... 41				
					<b>301889</b> <b>AKE</b> 23970 <b>317</b> <b>NISSAN</b> ➤ D22 King Cab (98>)..... 67 ➤ NP300 (D22SS) (2010>). 68				
					<b>301890</b> <b>AKE</b> 24350 <b>334</b> <b>TOYOTA</b> ➤ Camry (ACV/GSV40) (2006>2009)..... 104				
					<b>301892</b> <b>BSC</b> 24465 <b>336</b> <b>CITROËN</b> ➤ Jumper (2006>)..... 21 ➤ Relay (2006>)..... 22  <b>FIAT</b> ➤ Ducato (250-251) (2006>) 28 ➤ Ducato (250-251) (2011>) 28  <b>PEUGEOT</b> ➤ Boxer III (2006>)..... 81				

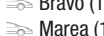
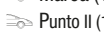
					
301895	AKE	23572	290	<b>SUBARU</b>  Forester (97>2002) ..... 102  Impreza (G11) (2000>2005) ..... 102  Legacy (98>2003) ..... 102  Legacy (2003>2009) ..... 102	
301902	LUC	23237	262	<b>DAEWOO</b>  Evanda (2002>2005) ..... 24  Leganza (97>2003) ..... 25  Nubira (97>2005) ..... 25	
301906	WAGNER	23472	283	<b>FORD</b>  Explorer (90>2000) ..... 32	
301908	MAND	23536	288	<b>HYUNDAI</b>  H1 (97>2002) ..... 44  H1 Mini Bus (2001>2006) ..... 44  Plaza (98>2004) ..... 46  Satellite (98>2007) ..... 46  Starex (98>2007) ..... 47	
301926	BSC	23258	264	<b>OPEL</b>  Astra G (98>2005) ..... 70  Zafira A (98>2003) ..... 76  Zafira A (2003>2005) ..... 76 <b>VAUXHALL</b>  Astra MK IV (98>2005) .. 108  Zafira I (99>2003) ..... 113  Astra MK IV (98>2005) .. 108  Zafira I (99>2003) ..... 113	
301928	LUC	24496	338	<b>VOLVO</b>  S60 (2010>) ..... 129  V60 (2010>) ..... 129  V70 (2007>) ..... 130  S80 (2006>) ..... 130  XC 60 (2008>) ..... 130  XC 70 (2007>2010) ..... 130  XC 70 (2010>) ..... 131	
301932	MAND	24488	337	<b>HYUNDAI</b>  Santa Fé (2000>2006) ..... 46  Santa Fé (2006>2009) ..... 46	
301934	SUM	24501	340	<b>KIA</b>  Carens (2006>) ..... 49	
301937	MAND	24351	335	<b>HYUNDAI</b>  Santa Fé (2000>2006) ... 46  Santa Fé (2006>2009) ... 46	
301941	MAND	24498	339	<b>CHEVROLET</b>  Captiva (C100) (2006>2011) ..... 18 <b>OPEL</b>  Antara (2006>) ..... 70 <b>VAUXHALL</b>  Antara (2006>) ..... 107	
301942	MAND	24510	341	<b>CHEVROLET</b>  Captiva (C100) (2006>2011) ..... 18 <b>OPEL</b>  Antara (2006>) ..... 70 <b>VAUXHALL</b>  Antara (2006>) ..... 107	

					
301943	AKE	24336	333	<b>TOYOTA</b>  Auris (AH) Made in Japan (2006>2012) ..... 103  Corolla (150) (2006>)... 105  Urban Cruiser (2009>).. 106  Verso S (2010>) ..... 106	
301982	LUC	21366	203	<b>VOLKSWAGEN</b>  Golf III (91>99) ..... 116  Vento (91>97) ..... 127	
301990	ATE	21637	218	<b>ALFA ROMEO</b>  145 (94>2001) ..... 4  146 (94>2001) ..... 4  147 (2000>2004) ..... 4  147 (2004>2010) ..... 4  156 (97>2003) ..... 5  156 (2003>2007) ..... 5  GT (2003>2010) ..... 6 <b>FIAT</b>  Bravo (182) (95>2002)... 26  Marea (185) (96>2002).. 28  Punto II (188) (2003>2009).. 29 <b>LANCIA</b>  Lybra (839) (99>2006) ... 53	



## 20002 (WVA)

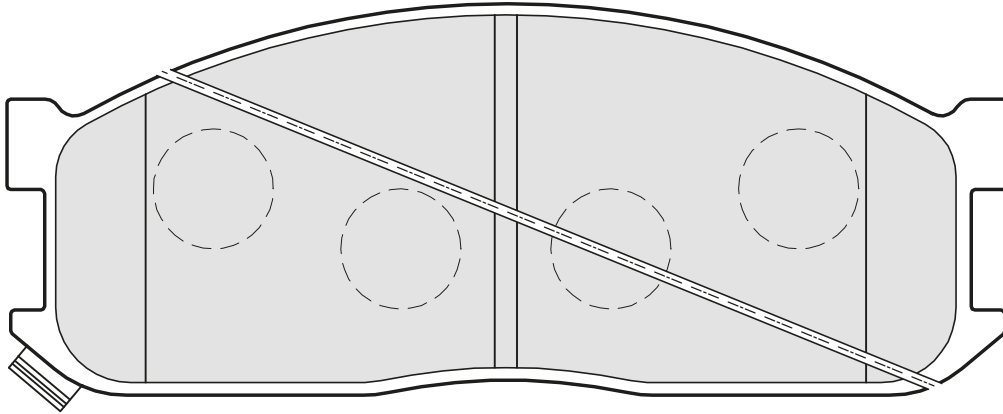

301269	↳ 2x	133,3	52	15		MAND			KIA

## 20031 (WVA)

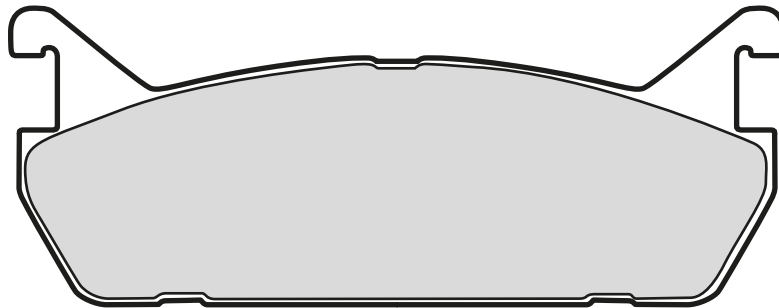







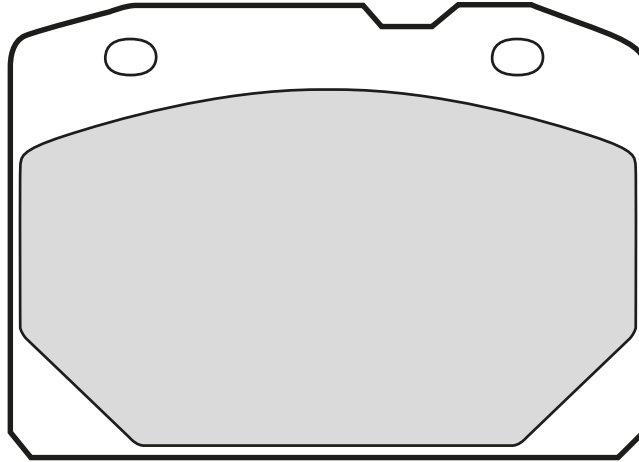





301624		102	38,98	12,5		SUM			DAIHATSU, MAZDA, SUZUKI



## 20166 (WVA)



								 
								
<b>301405</b>		83,9	60	16	BDX			<b>LADA</b>





## 20228 (WVA)

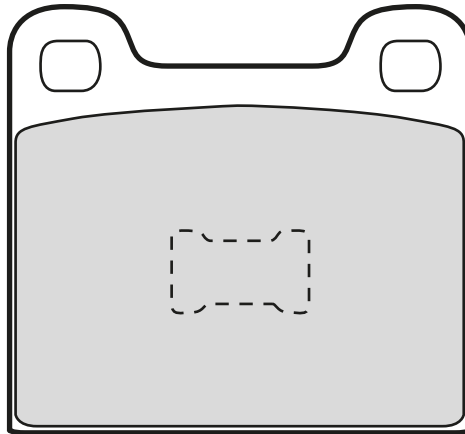

301099		61,8	56,6	15		ATE	  	<b>ALFA ROMEO, AUDI, BMW, OPEL</b> <b>OPEL</b> <b>SAAB, TALBOT, VOLKSWAGEN</b>	

## 20358 (WVA)

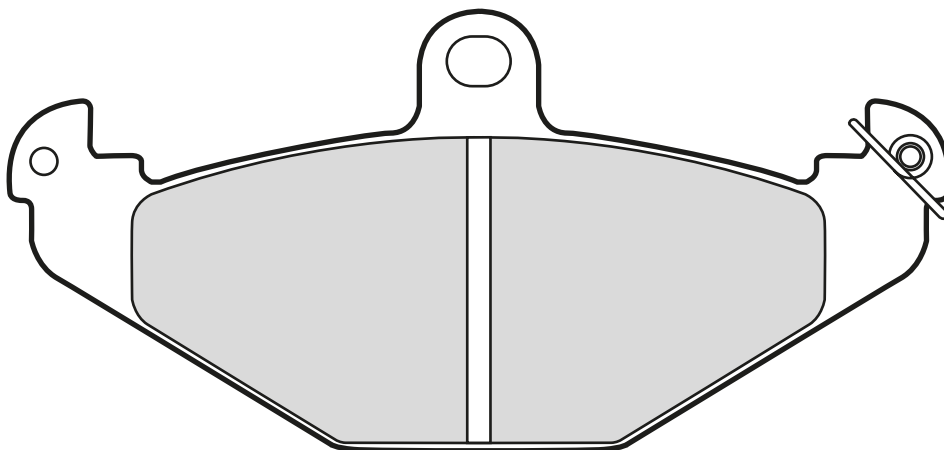

301007		126	58,3	15		BRE		<b>RENAULT</b>	

## 20359 (WVA)

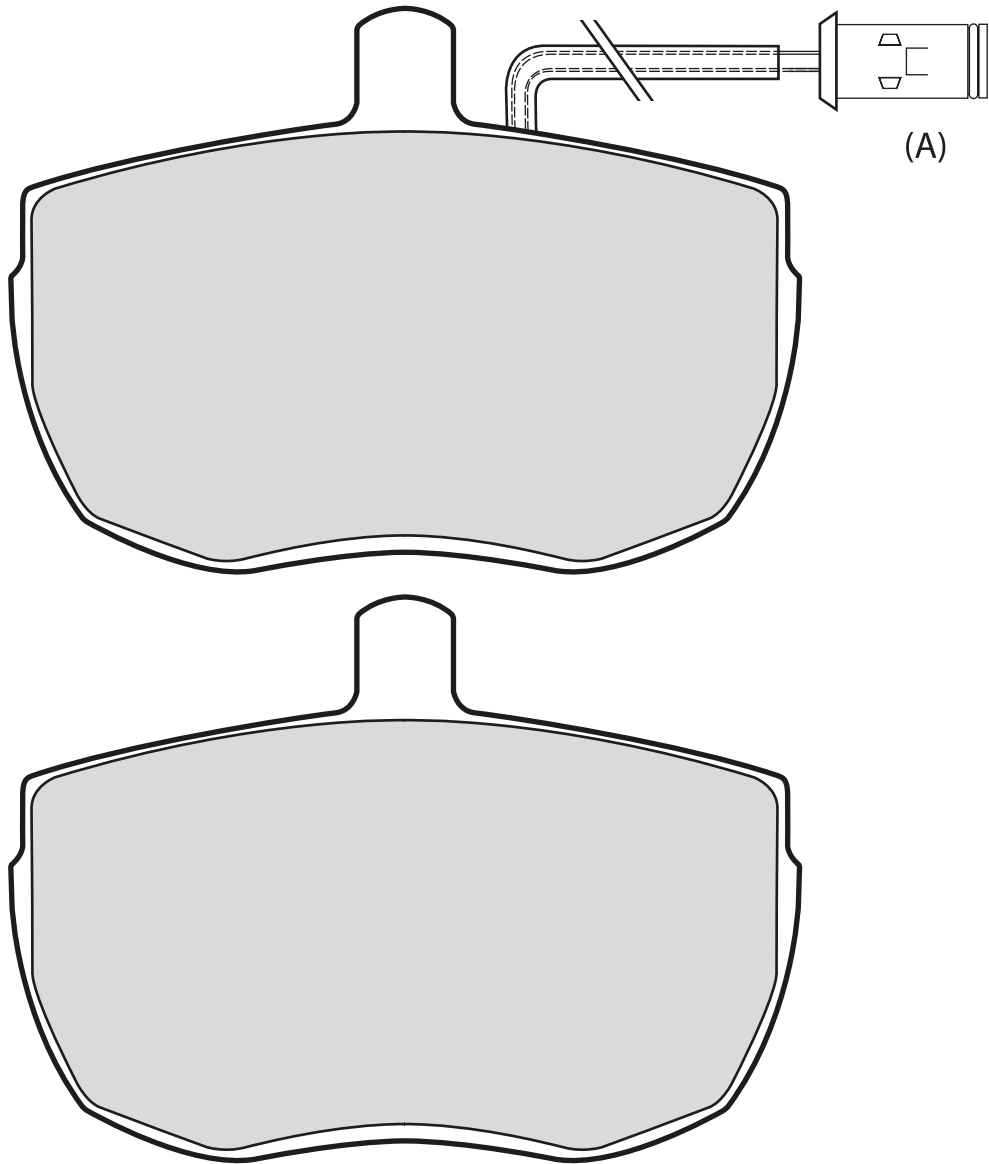

<b>Valeo</b>									
<b>301129</b> (A)	4 x 195 mm/145 mm	105	74,7	18	AP				<b>FORD, LAND ROVER</b> <b>LAND ROVER</b> <b>ALFA ROMEO, DAF, FORD, IVECO, LDV</b>

## 20467 (WVA)

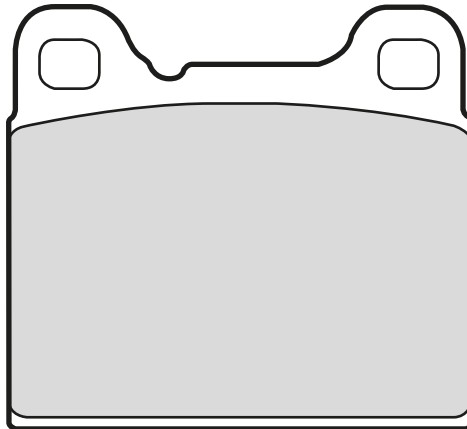

Valeo									
301270		61,5	56,5	15		ATE			VOLVO



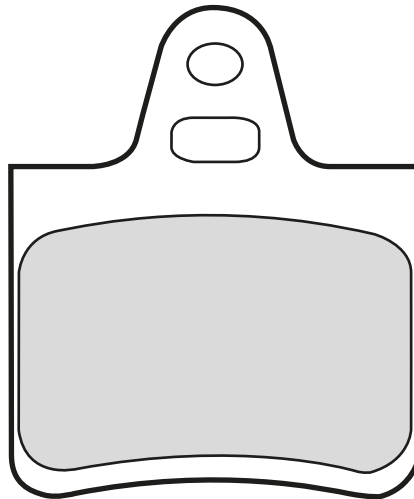





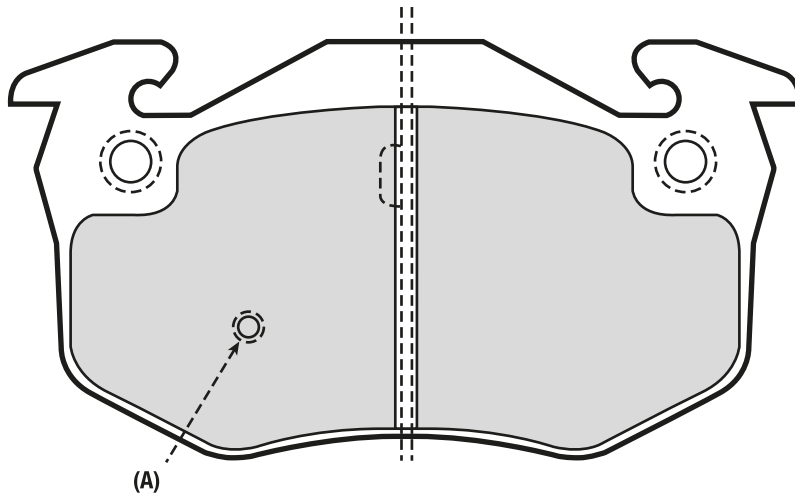











## 20575 (WVA)



Valeo									
301292		54	65	15,4		CIT			CITROËN

## 20635 (WVA)



Valeo	 							 
								
301080	↳ 2 x  205 mm	105	54,7	15		BDX	 	  <b>RENAULT</b> <b>RENAULT</b>
301158 (A)		105	54,7	11		BDX		 <b>RENAULT</b>
301396		105	54,7	11		BDX		 <b>CITROËN, PEUGEOT, RENAULT</b>



## 20652 (WVA)

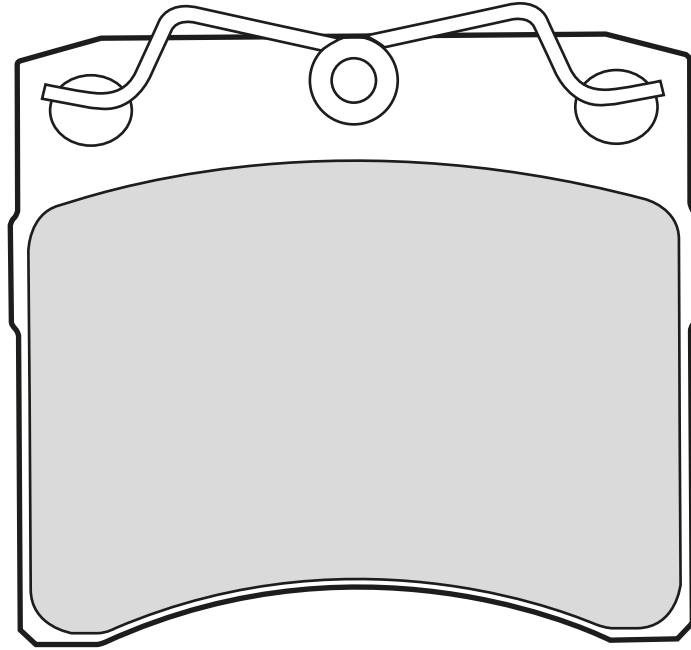

301048		91,5	80	18,3		LUC			
								VOLKSWAGEN	

## 20660 (WVA)

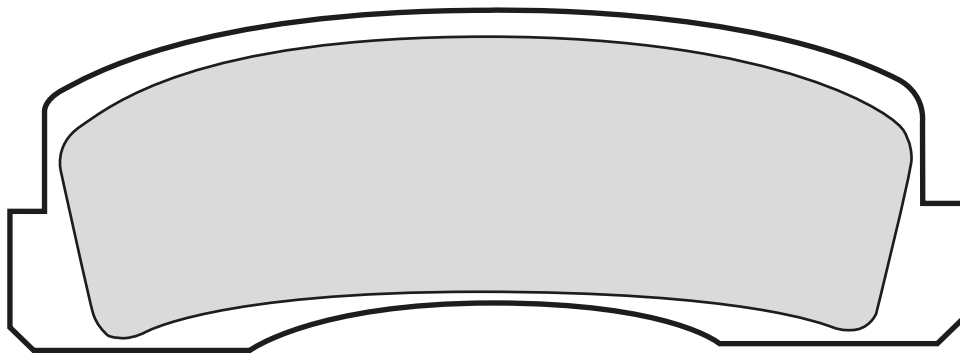

301389		126	45	16		BDX			LADA

## 20668 (WVA)

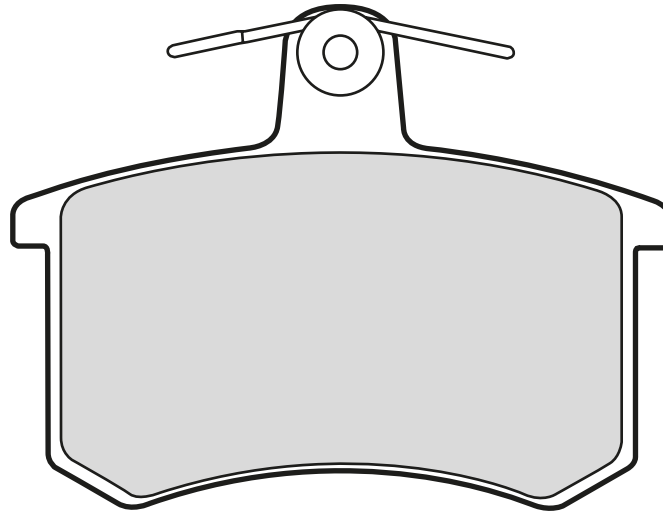

301125		87	66,9	16,6	LUC				ALFA ROMEO, AUDI, FIAT, LANCIA





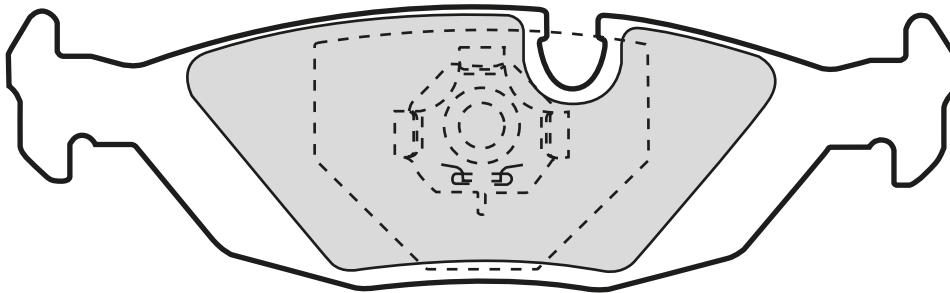





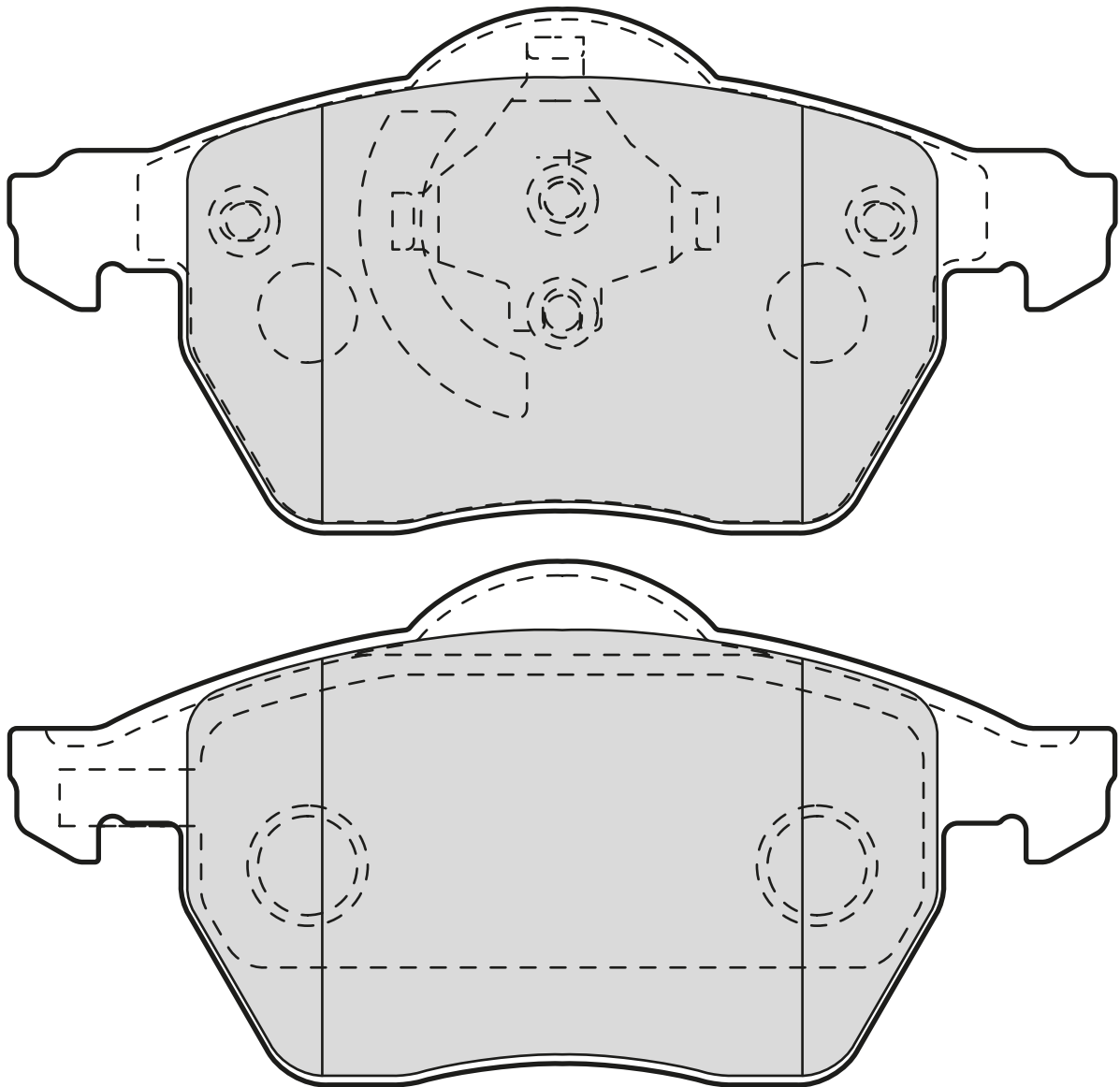











## 20675 (WVA)



301103		125,2	37,6	17,3	ATE				BMW

## 20676 (WVA)



Valeo	   							 
								
301008		156,3	74	19,8		ATE		FORD, SEAT, VOLKSWAGEN
301049	↳ 2 x  210 mm	156,5	74,2	19,5		ATE		AUDI
301483	↳ 2 x  210 mm	156,4	74,2	20,3		ATE		AUDI, SEAT, SKODA, VOLKSWAGEN
301751	↳ 2 x  210 mm	156,4	74,2	19,2		ATE		AUDI, SKODA, VOLKSWAGEN

## 20687 (WVA)

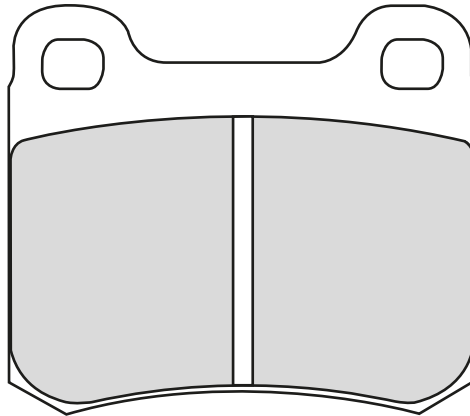

Valeo									
301105		61,8	54,3	13		ATE			MERCEDES
301345		61,7	54,3	15,5		ATE			MERCEDES

## 20772 (WVA)

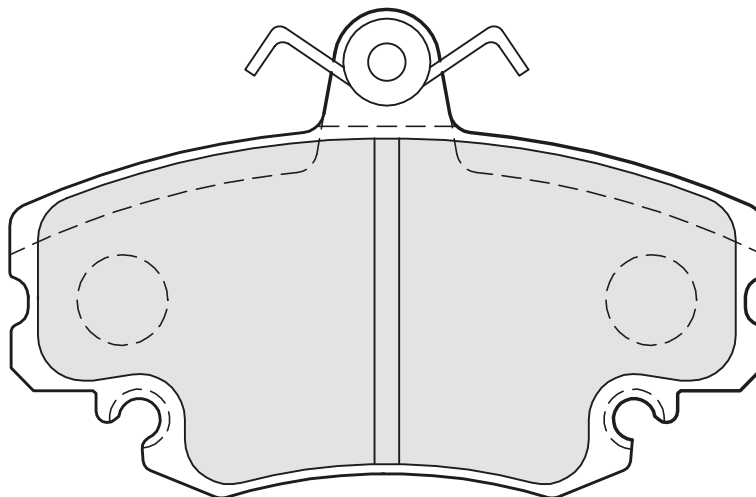

Valeo									
301002		100	64,9	18		LUC			DACIA, RENAULT RENAULT



## 20775 (WVA)

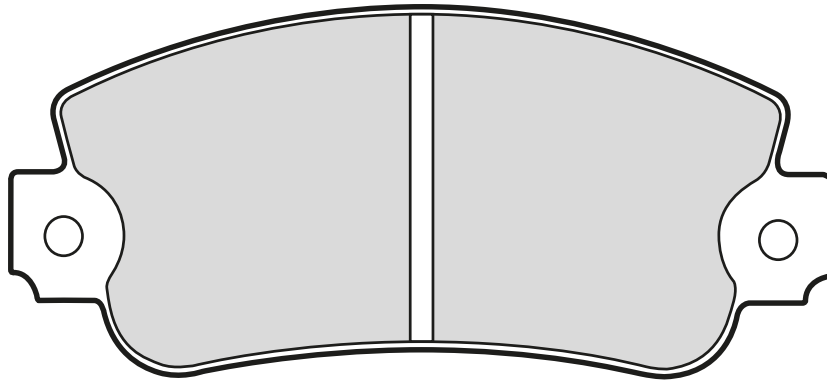

301091	↳ 2x	108,8	47,4	18		BDX			AUTOBIANCHI, FIAT, LANCIA, SEAT SEAT

## 20783 (WVA)

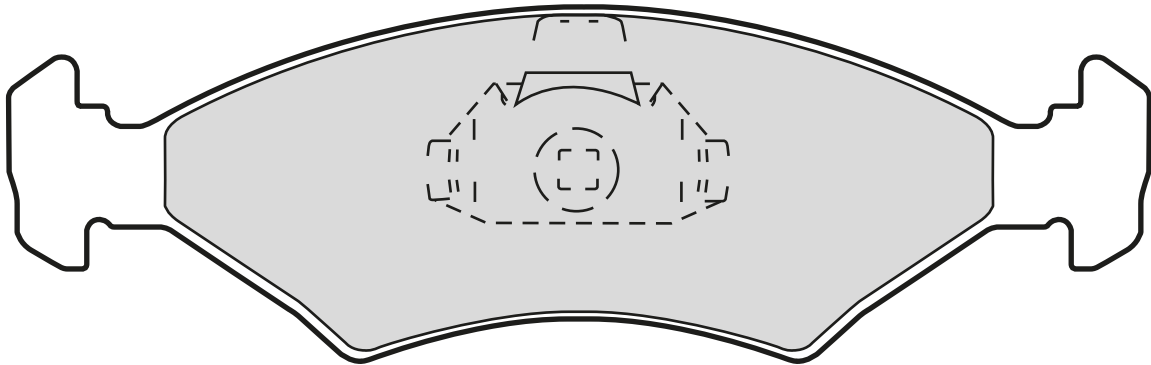

301212		151,3	46,4	18		ATE			FORD, MAZDA FORD

## 20789 (WVA)

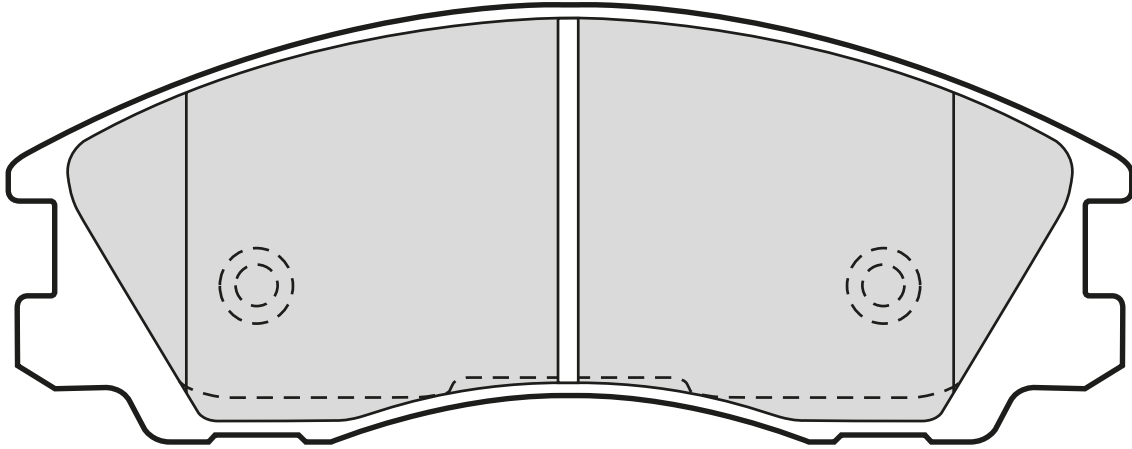

301506	↳ 2x	149	58	16,6		LUC		HYUNDAI

## 20838 (WVA)

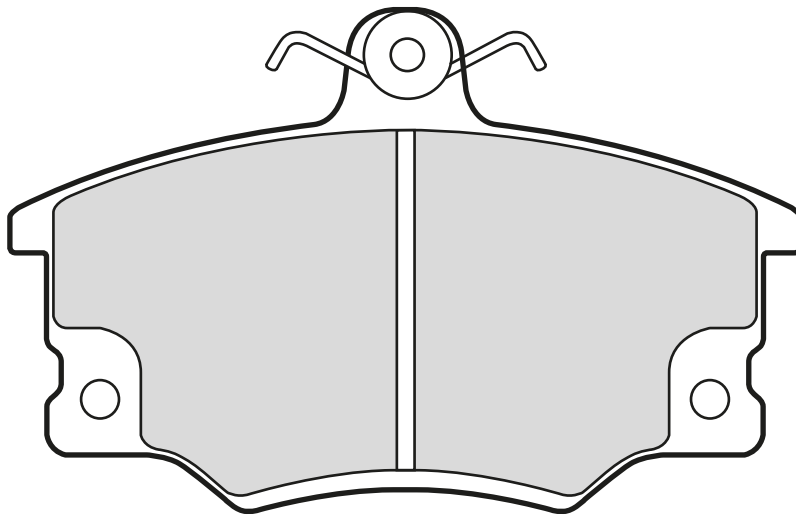

301219	↳ 2x	104,5	66,6	17,2		TRW		ALFA ROMEO, AUTOBIANCHI, FIAT, LANCIA

## 20867 (WVA)

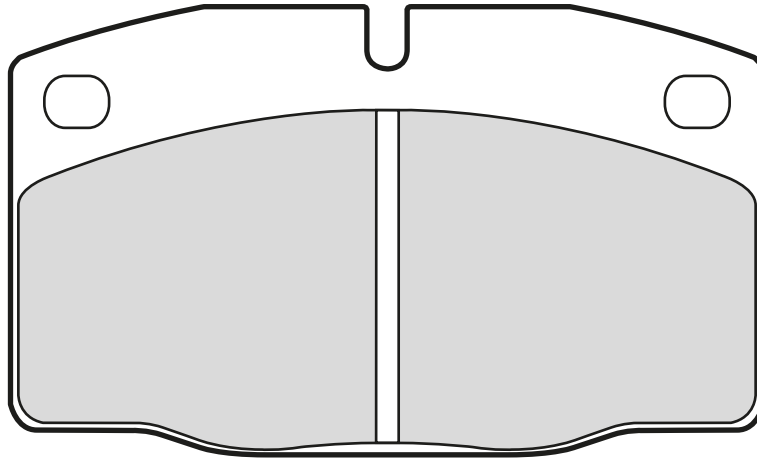

301182		100	59	15,4		GME		
								<b>OPEL, VAUXHALL</b> <b>BEDFORD, OPEL</b>



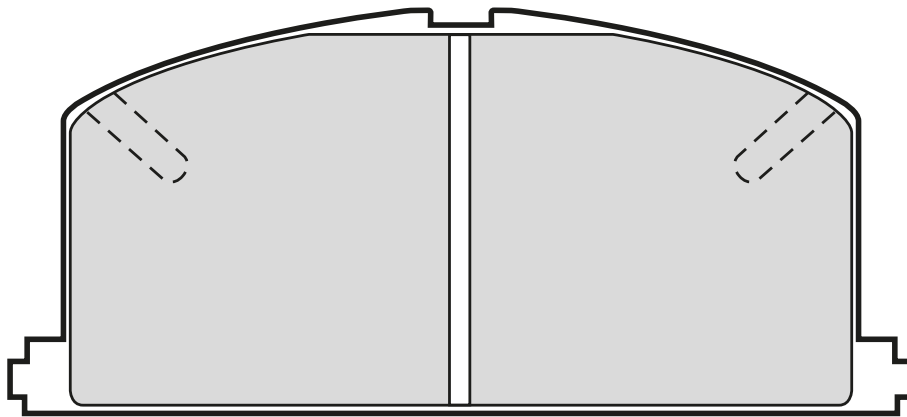





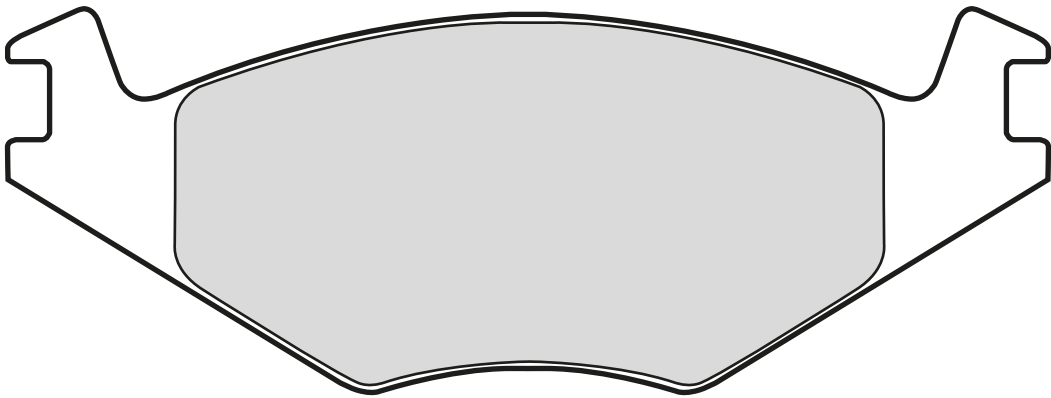
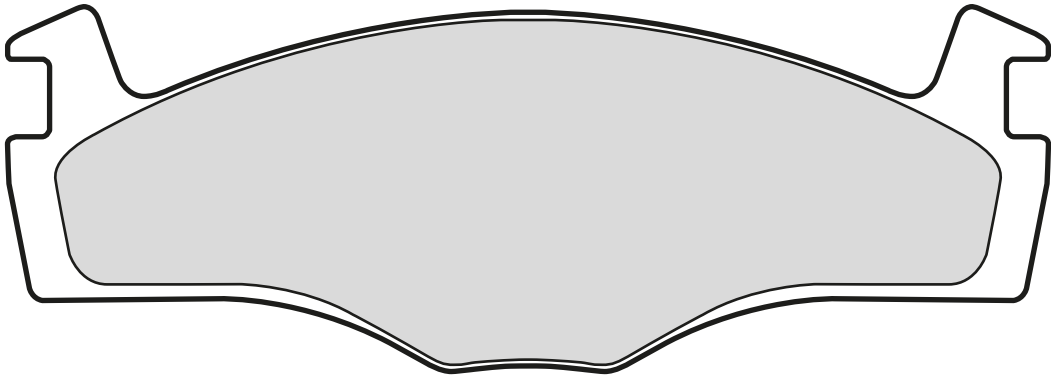





## 20870 (WVA)



301266		119,7	47,5	15		AKE		
								<b>TOYOTA</b>









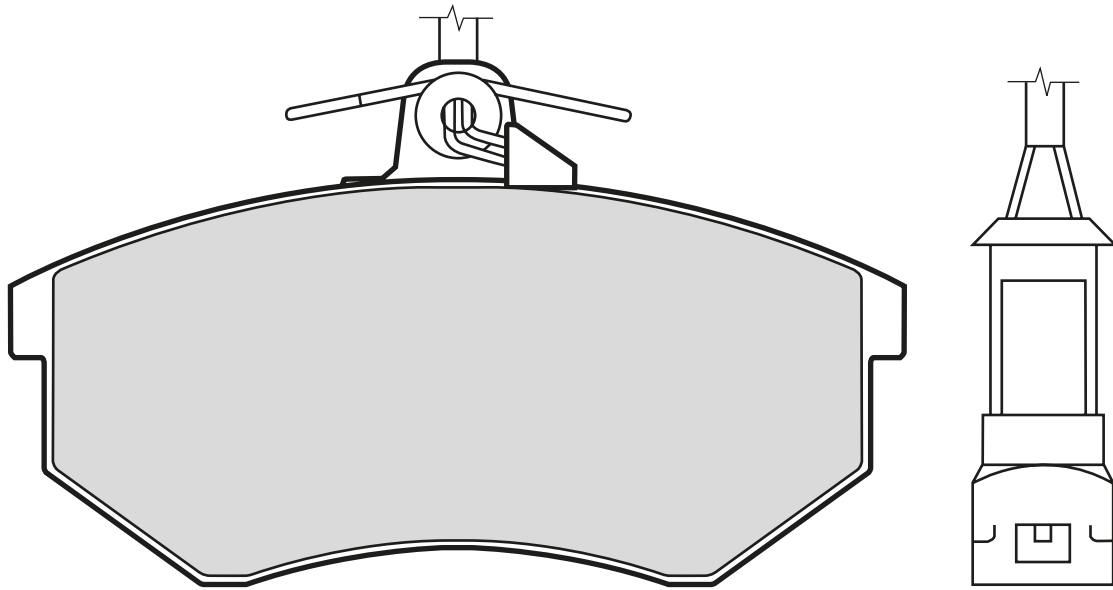













## 20887 (WVA)



Valeo	   							 
								
301124		137,8	49 51,1	15,3		VW		VOLKSWAGEN
301258		137,8	49 51,1	17,2		VW		SEAT, VOLKSWAGEN

## 20901 (WVA)



Valeo	 							 	
									
301003		119	69,5	19,1		LUC			AUDI
301016	↳ 2 x  225 mm	119	69,5	15,7		LUC			AUDI, SEAT, VOLKSWAGEN
301252		119	69,5	19,6		LUC	 	 	SEAT, VOLKSWAGEN SEAT, VOLKSWAGEN



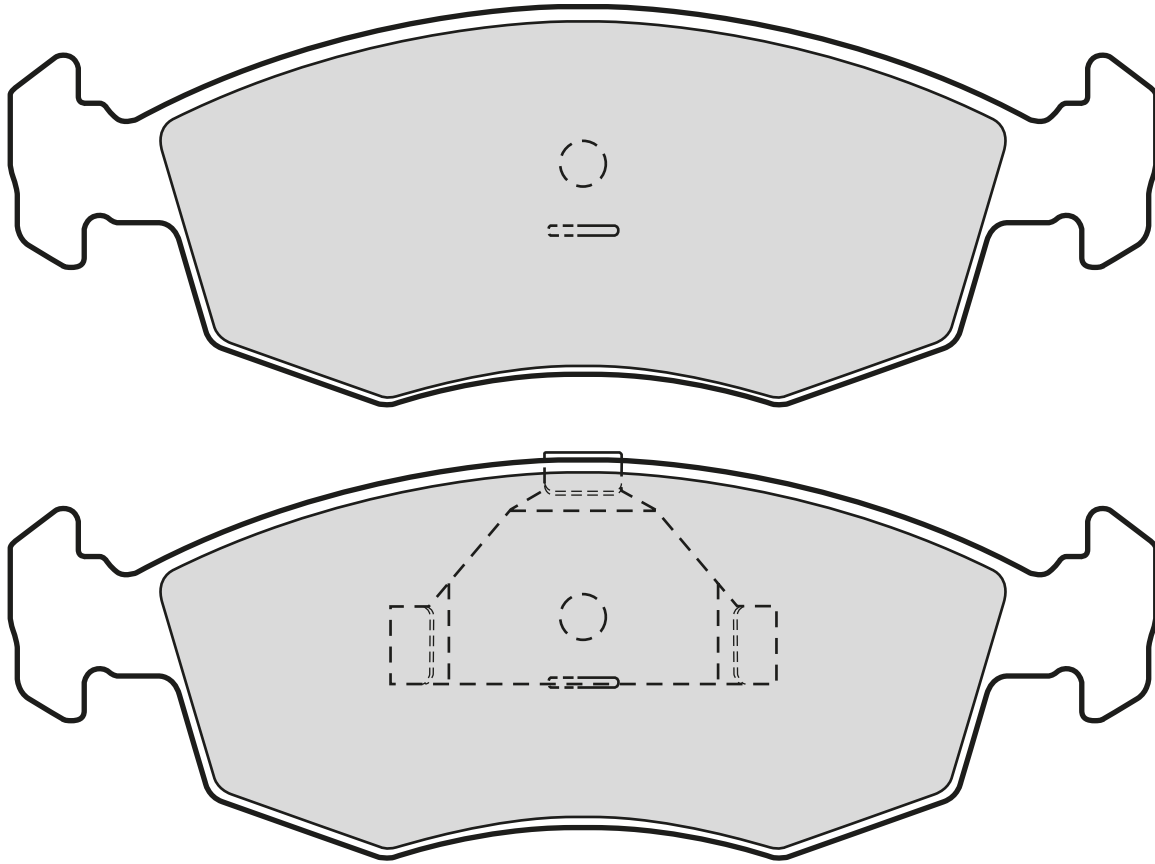





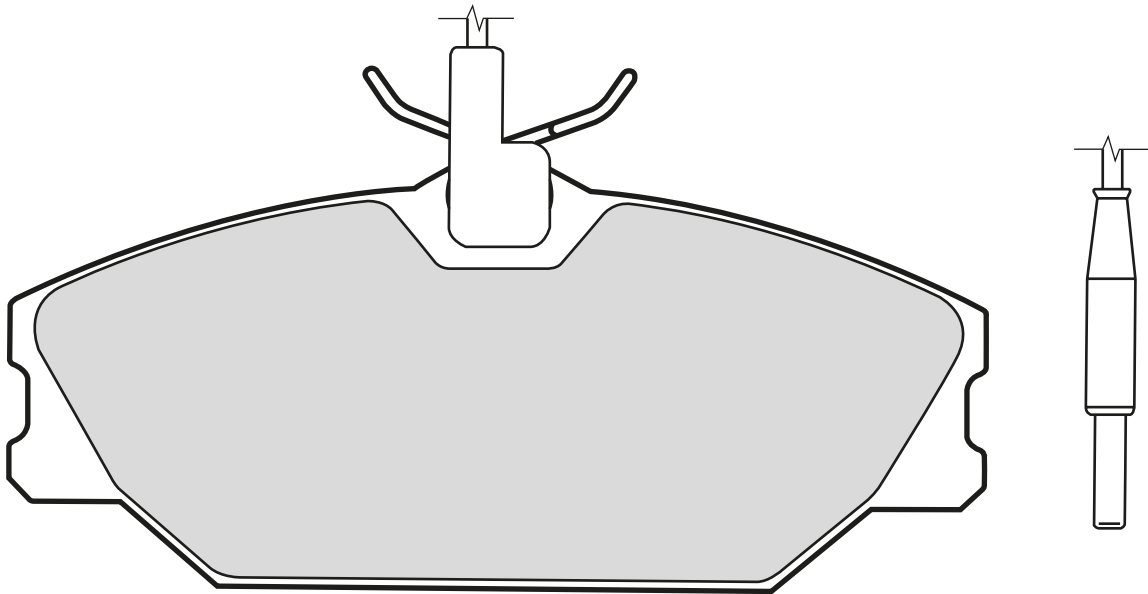

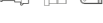







## 20908 (WVA)



301335		151,3	52,5	18	ATE			FORD

## 20916 (WVA)



Valeo	 							 	
									
<b>301061</b>	↳ 2 x  260 mm	129,85	55,5	18,3		LUC	 	 	<b>RENAULT</b> <b>DAEWOO</b>
<b>301473</b>		129	55,6	18		LUC			<b>RENAULT</b>

## 20959 (WVA)

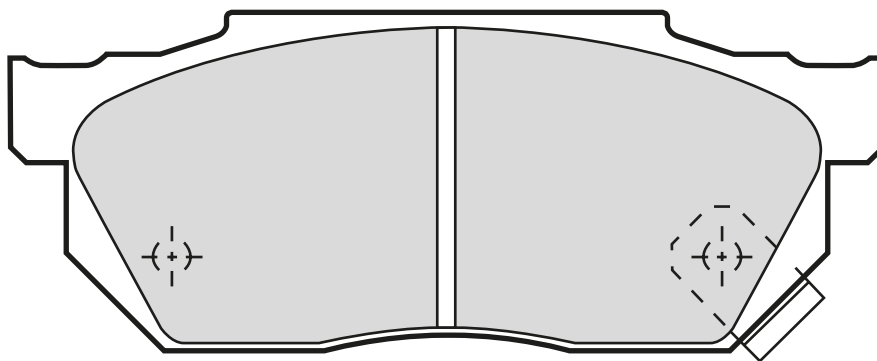

Valeo	 							 	
									
<b>301047</b>	↳ 2 x 	116	45	15		AKE		 	<b>HONDA</b>

## 20960 (WVA)

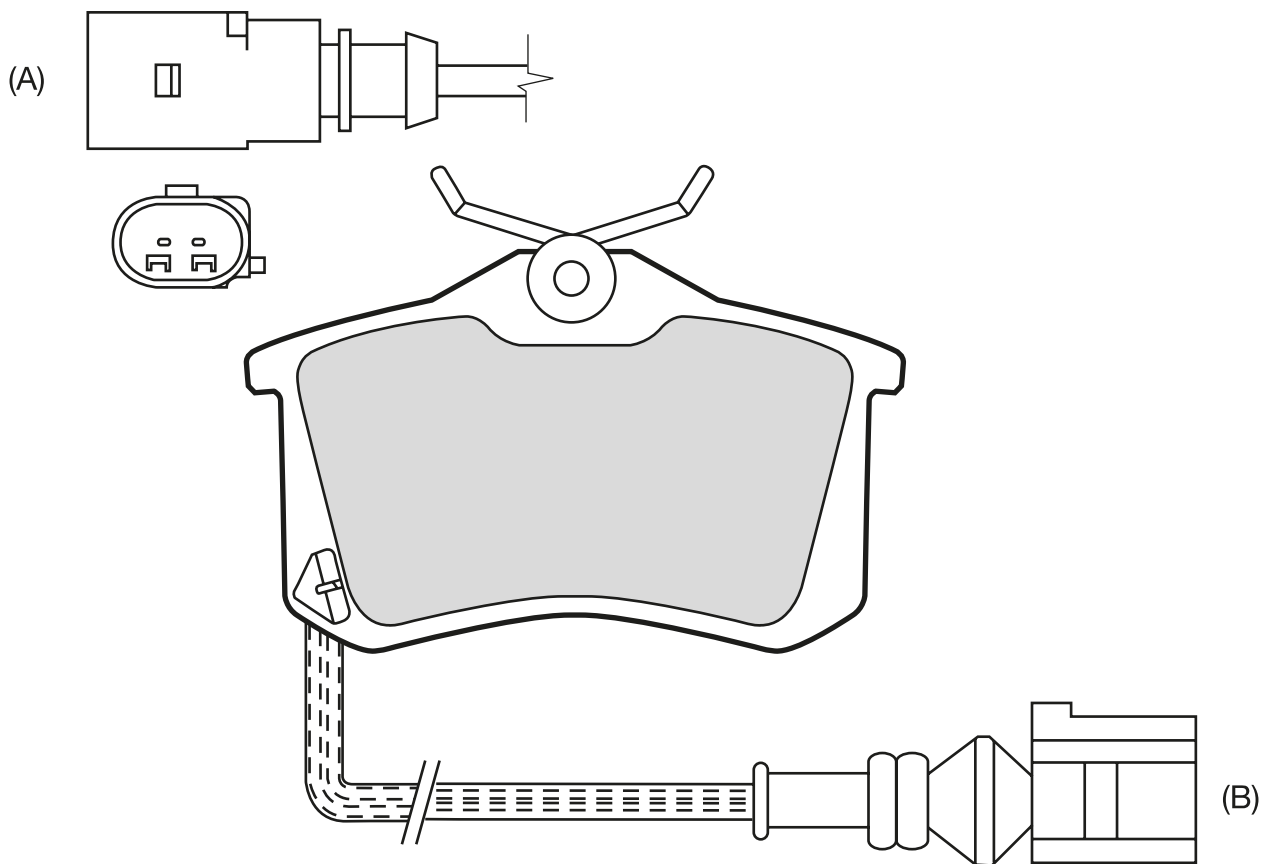

Valeo										
301180		87	53	15,2		LUC				AUDI, LANCIA, PEUGEOT, RENAULT, SEAT, SKODA, VOLKSWAGEN
301463		87	52,9	17		LUC				AUDI, CITROËN, FIAT, FORD, LANCIA, PEUGEOT, SEAT, SKODA, VOLKSWAGEN CITROËN, PEUGEOT, VOLKSWAGEN
301474		87	53	16		LUC				AUDI, CITROËN, PEUGEOT, RENAULT, SEAT
301674	(B)  1 x 260 mm	87	53	17		LUC				AUDI, SEAT, SKODA, VOLKSWAGEN
301681	(A)  1 x 205 mm	87	53	17,2		LUC				FORD, SEAT, VOLKSWAGEN





## 20981 (WVA)

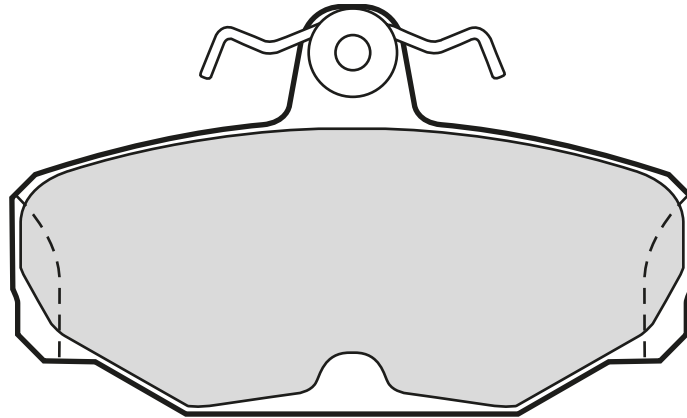







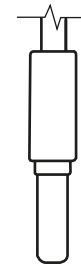
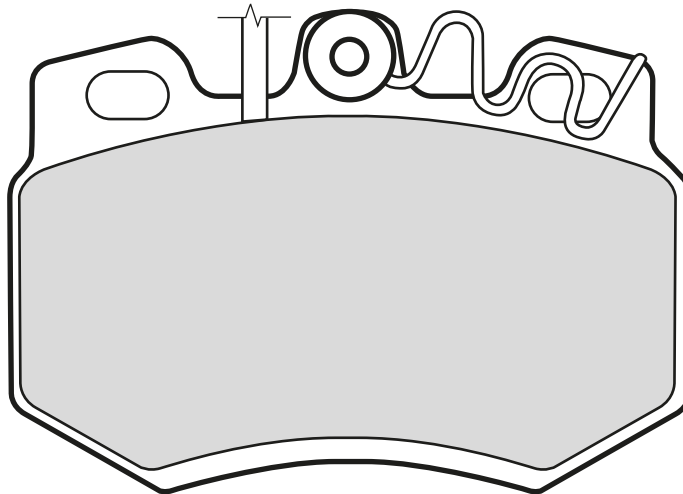
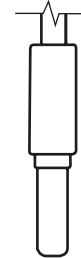
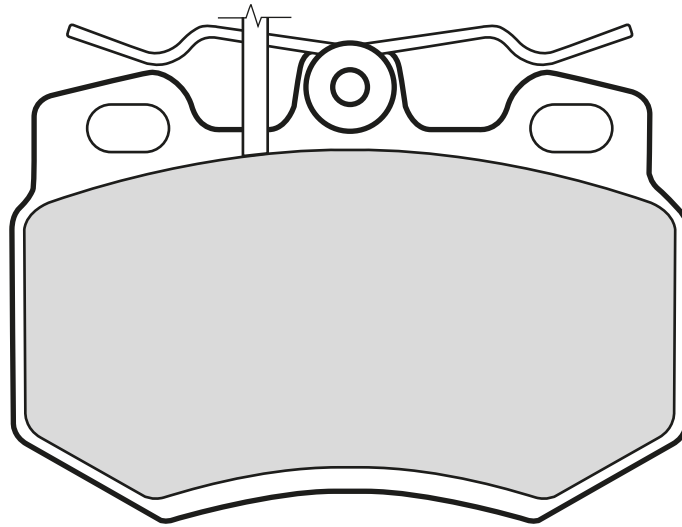









301240		90	54	13,7		LUC		<b>FORD</b>



## 20989 (WVA)



Valeo	 							 
								
301119	↳ 4 x  225 mm	90	62,9	17,5		LUC	 	<b>CITROËN</b> <b>CITROËN</b>
301176	↳ 2 x  200 mm	90	63	17,5		LUC		<b>PEUGEOT</b>

## 20996 (WVA)

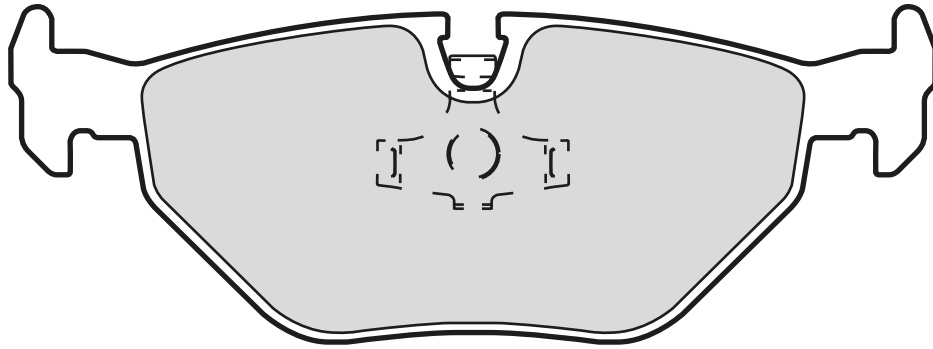

301259		123	45	17,3		ATE			BMW

## 21010 (WVA)

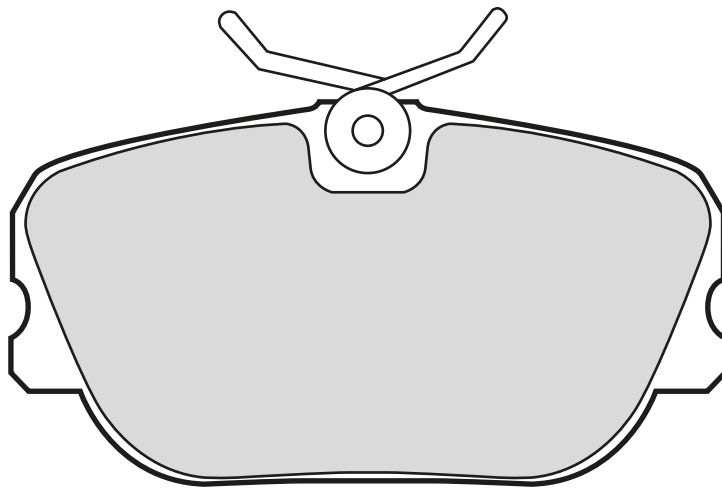

301241		95	52,7	17,9		LUC			MERCEDES

## 21012 (WVA)

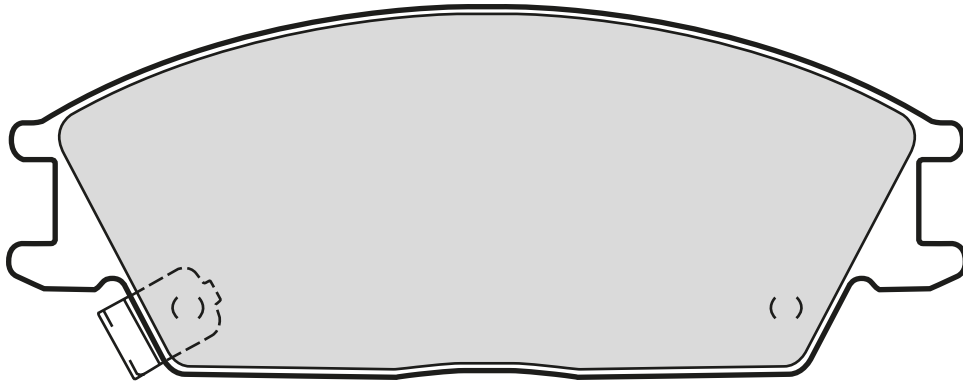

<b>Valeo</b>									
<b>301052</b>	2x	127,4	49	14,8	AKE			<b>HONDA, HYUNDAI</b>	

## 21016 (WVA)

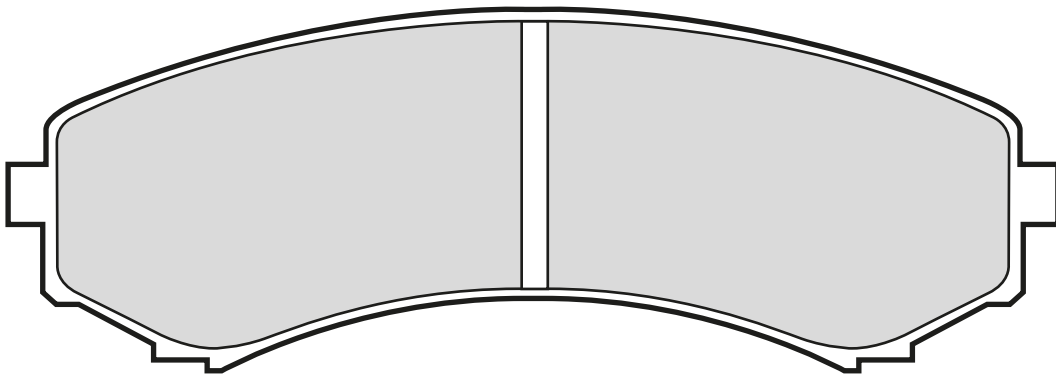

<b>Valeo</b>									
<b>301518</b>		139	58,5	16	SUM			<b>MITSUBISHI</b>	



## 21028 (WVA)

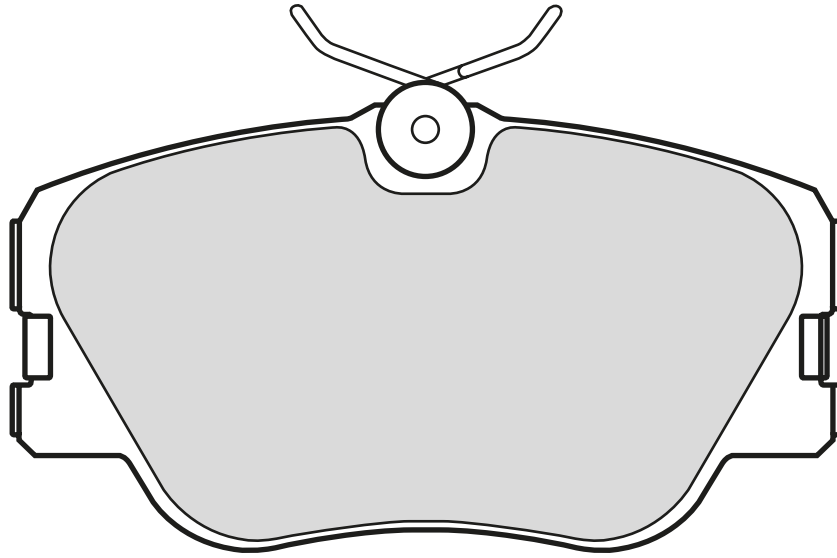

301315		110	59,7	18,8		LUC			MERCEDES

## 21051 (WVA)

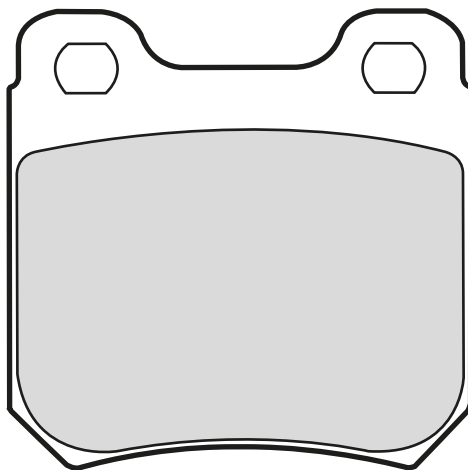

301183		61,7	61,2	15,7		ATE			OPEL, SAAB, VAUXHALL

## 21061 (WVA)

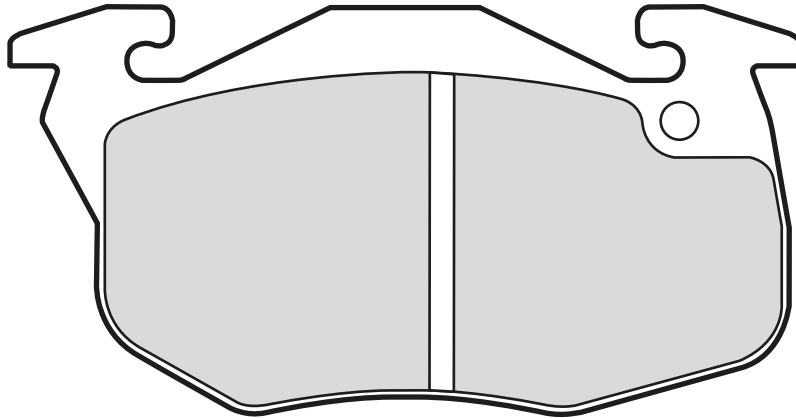

Valeo								
301075		105	53,7	18		BDX		<b>CITROËN, PEUGEOT</b>
301081		105	53,4	18		BDX		<b>PEUGEOT, RENAULT, TALBOT RENAULT</b>
301155		111,4	53,4	18		BDX		<b>CITROËN CITROËN</b>
301181		105	51,9	18		BDX		<b>PEUGEOT</b>



## 21064 (WVA)

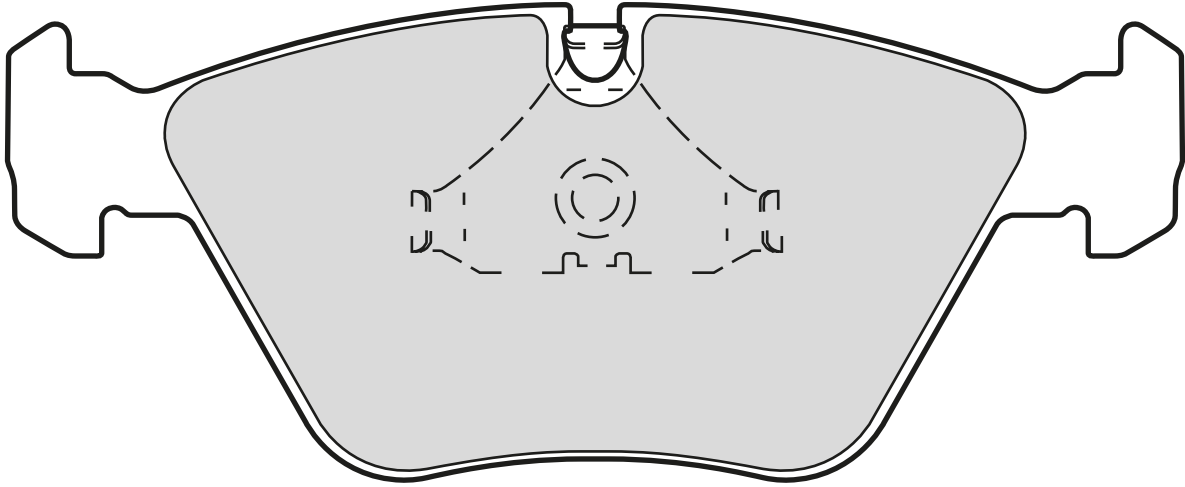

Valeo	   								
301231		156,3	64	20		ATE			BMW
301409		155,4 154,8	63,6	20		ATE			BMW

## 21099 (WVA)

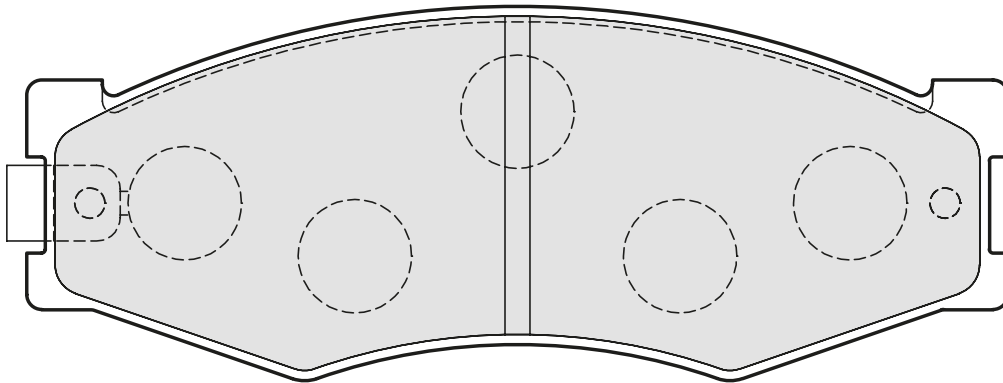

Valeo	   								
301123	↳ 2x	130	49	16,4		AKE			NISSAN NISSAN

## 21103 (WVA)

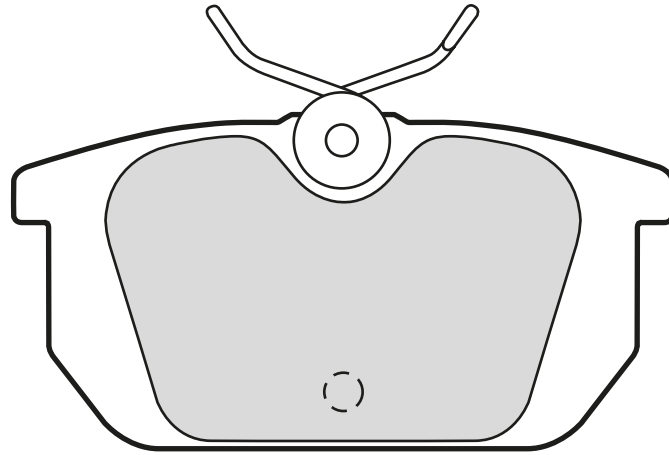

301142		87,3	44,4	14,4		LUC			ALFA ROMEO, FIAT, LANCIA

## 21105 (WVA)

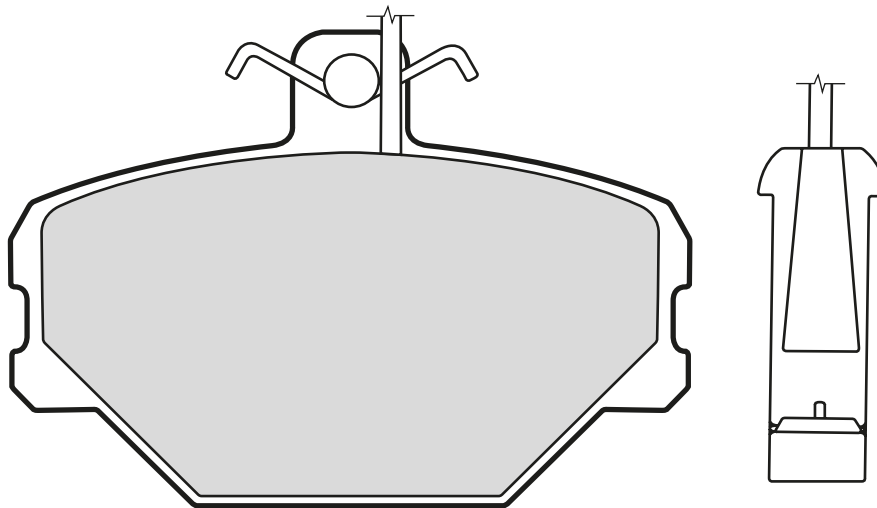

301095	↳ 1 x  255 mm	90	63	17		LUC			FIAT, FSO POLSKI, LANCIA



## 21140 (WVA)

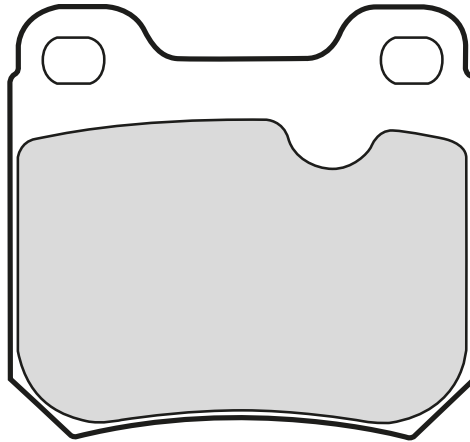

301253		61,8	57,2	15,3		ATE			OPEL, SAAB, VAUXHALL

## 21145 (WVA)

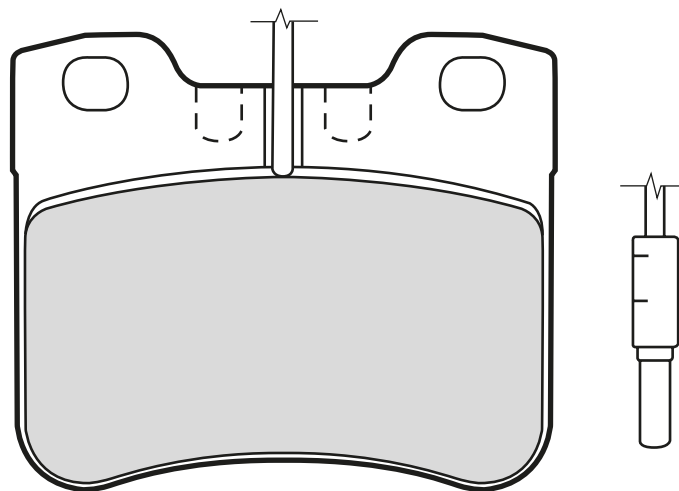

301156	↳ 4 x  170 mm	71,9	60,6	17,1		ATE			CITROËN, PEUGEOT
301360		71,9	60,6	17,3		ATE			CITROËN, PEUGEOT

## 21158 (WVA)

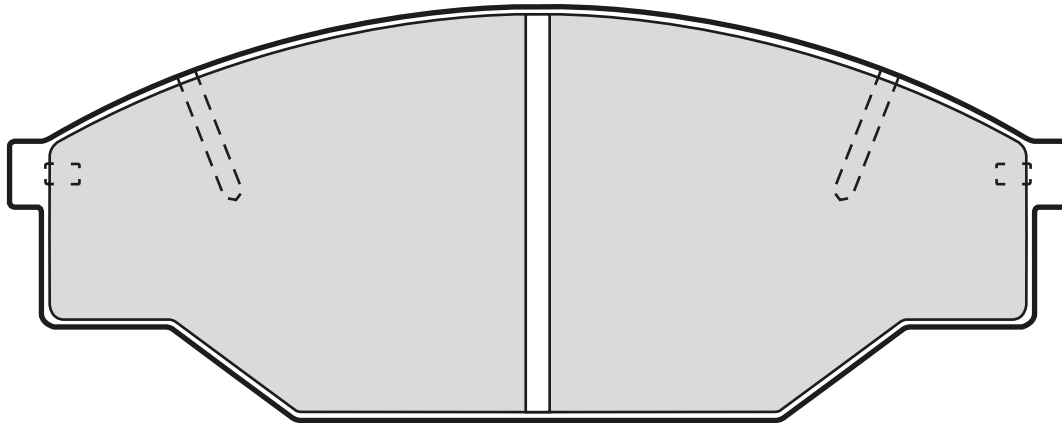

301402		140	55,5	15		AKE			<b>TOYOTA</b>  <b>TOYOTA</b>

## 21170 (WVA)

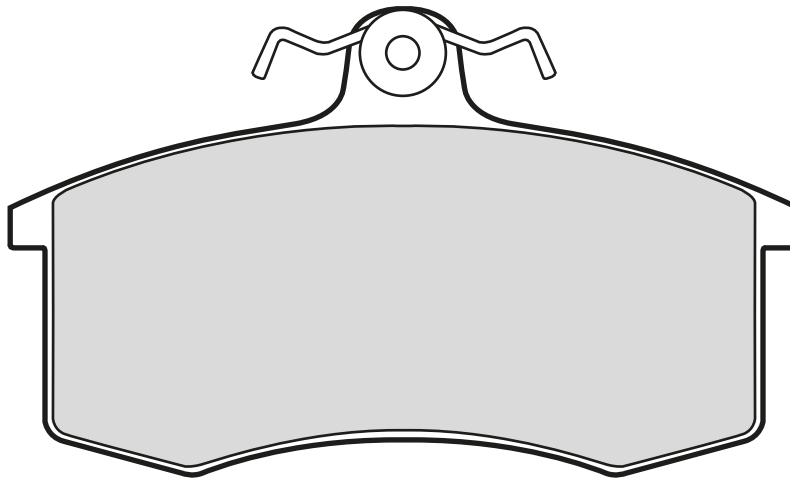

301406		104,3	62	17,3		LUC			<b>LADA</b>

## 21171 (WVA)

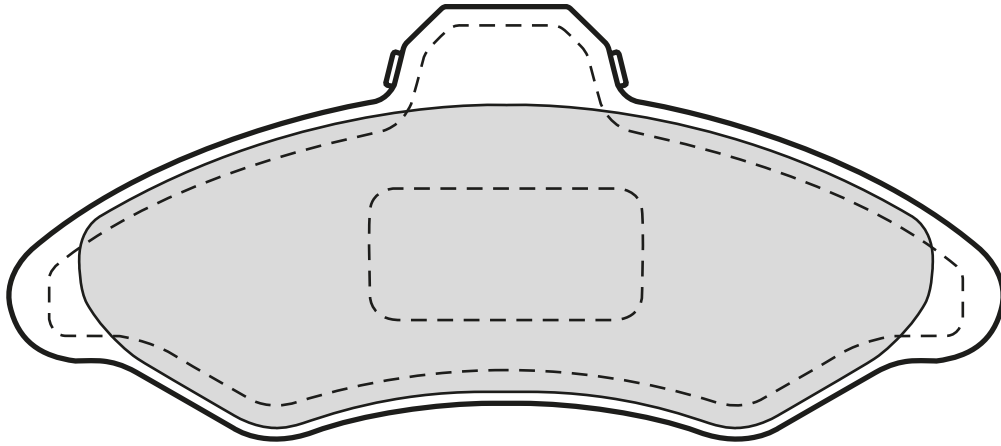

301172		131	57,4	18,3	BDX				FORD

## 21195 (WVA)

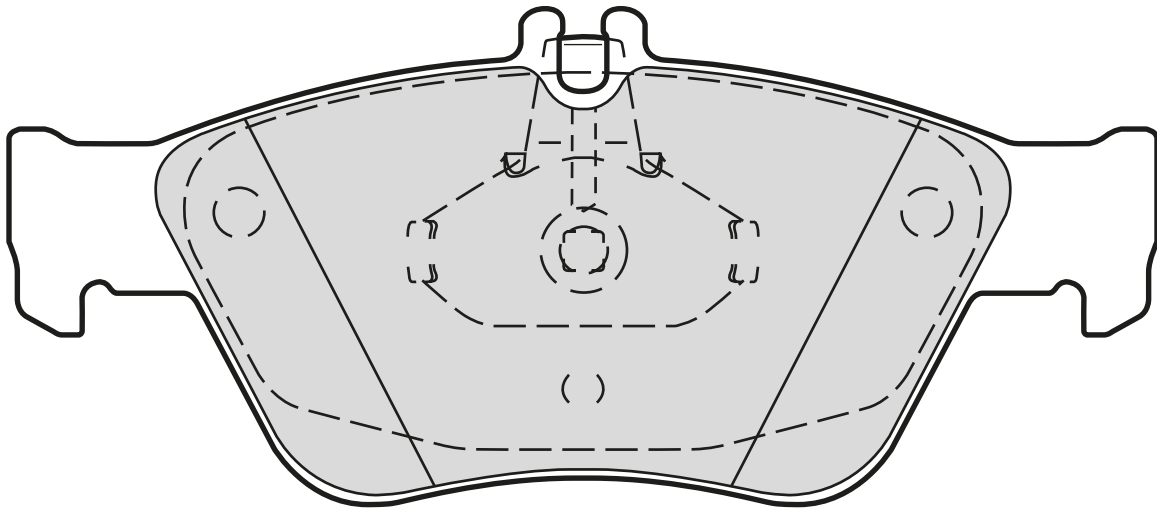

301357		151,4	60 66,1	19,3	ATE				MERCEDES

## 21197 (WVA)

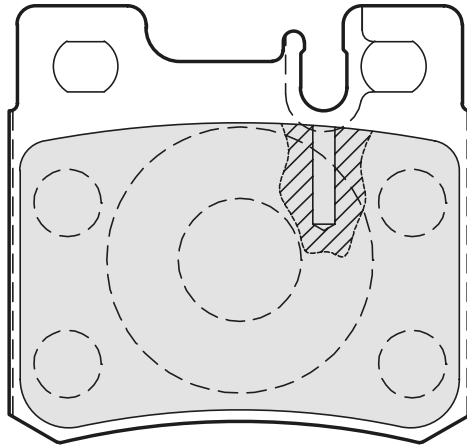

<b>Valeo</b> 								
301272		61,6	58,6	15	ATE			MERCEDES

## 21201 (WVA)

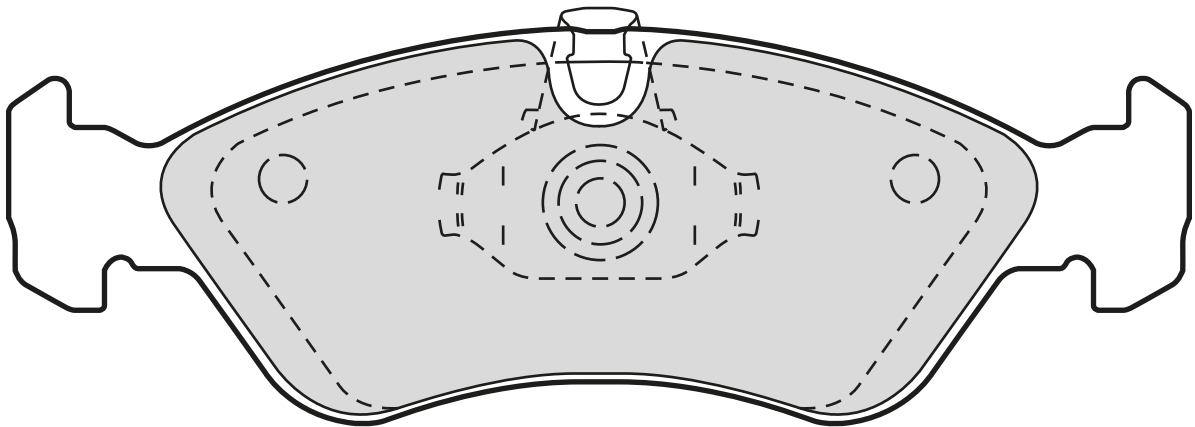

<b>Valeo</b> 								
301184		156,3	52,6	17	ATE			DAEWOO, OPEL, VAUXHALL

## 21203 (WVA)

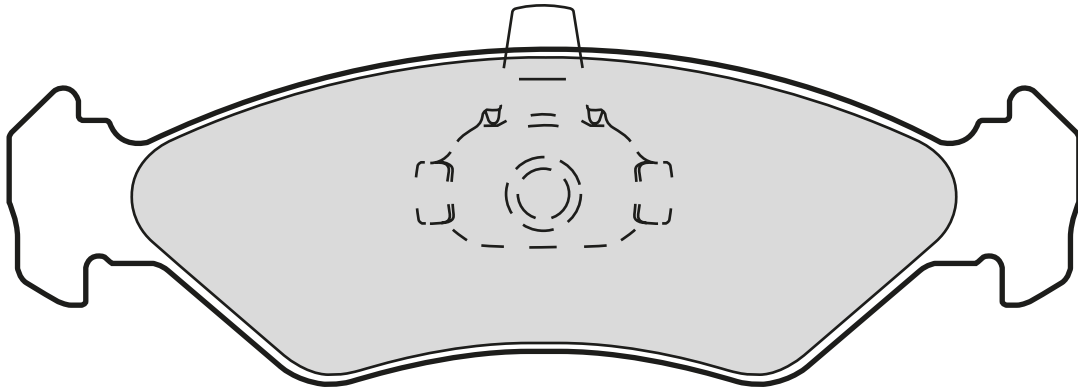

Valeo								
301043		141,5	45,6	17,4		ATE		FORD
301171		141,5	45,6	17		ATE		FORD

## 21209 (WVA)

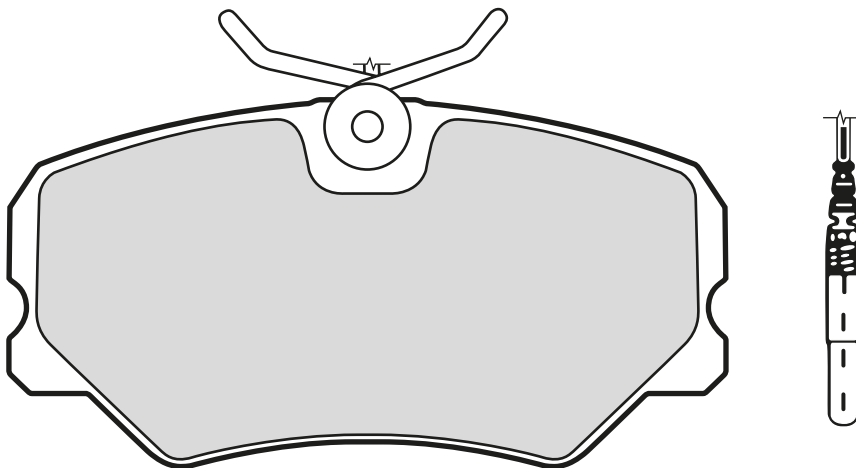

Valeo								
301179	2 x 190 mm/310 mm	95	49	18,6		LUC		PEUGEOT

## 21237 (WVA)

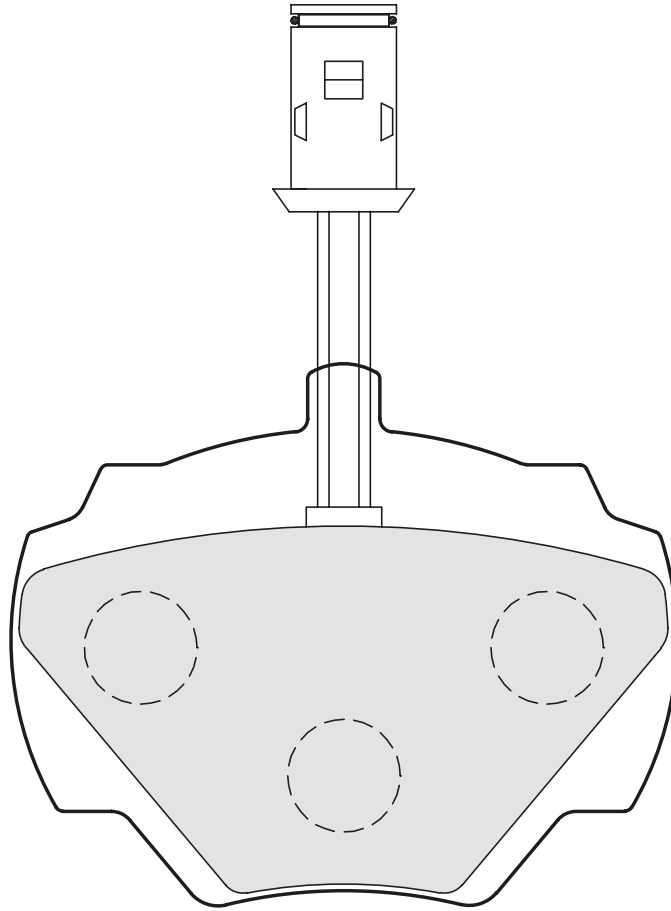

<b>301497</b>	1 x  250 mm	88,6	72	15,5		AP			<b>LAND ROVER</b>



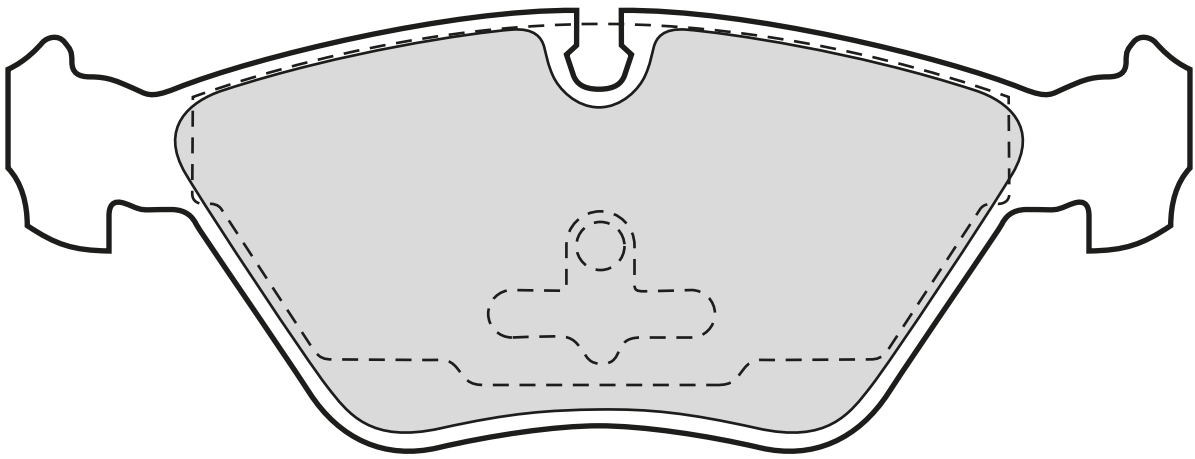
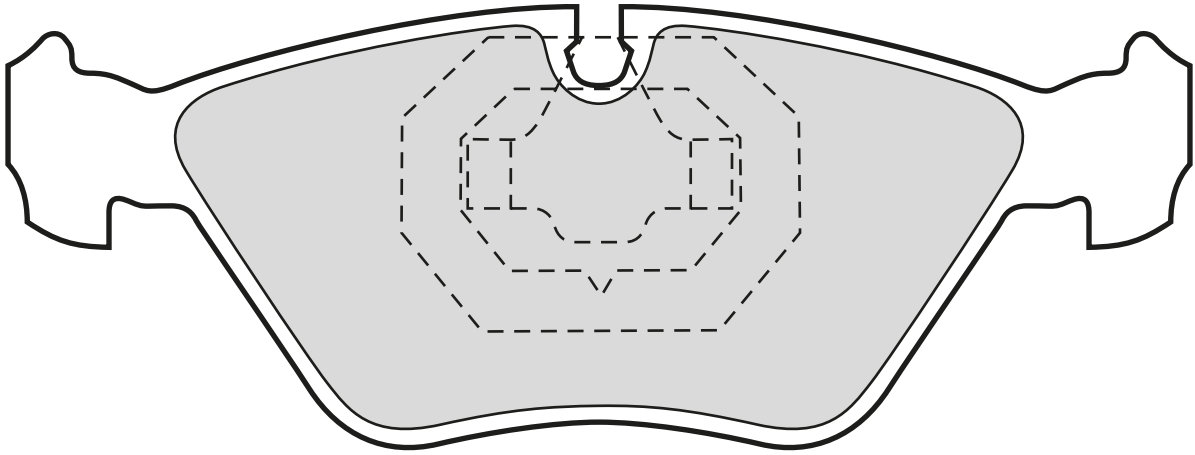





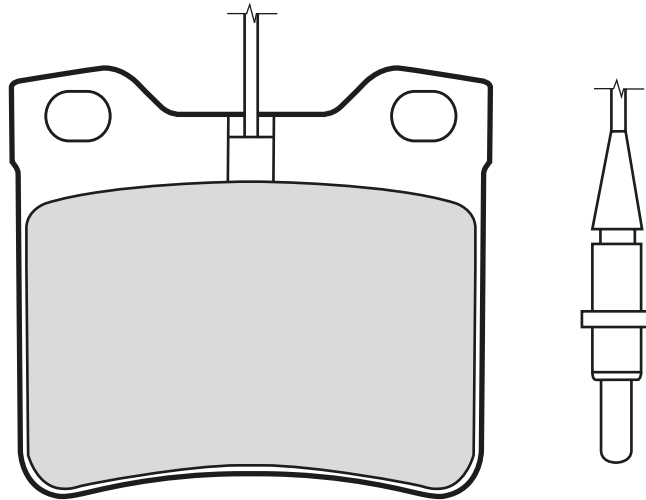











## 21273 (WVA)



301616		156,3	58,3	19,5		ATE		<b>VOLVO</b>

## 21279 (WVA)



Valeo	 							 	
									
301062	↳ 2 x  130 mm	63,5	57	16,9		ATE	 	 	<b>MERCEDES</b> <b>MERCEDES</b>
301063		63,5	57	16,4		ATE			<b>PEUGEOT</b>

## 21292 (WVA)

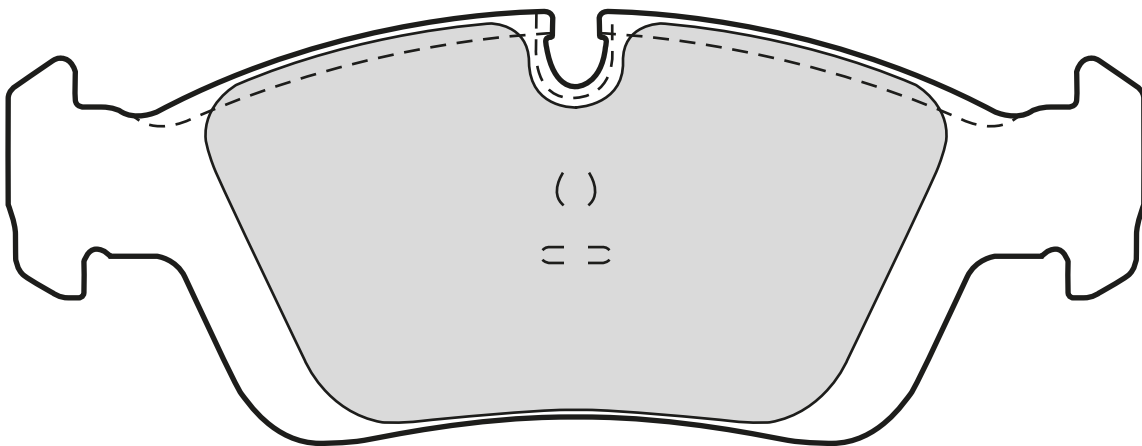

Valeo	 							 	
									
301018		151,3	57	17,3		ATE			<b>BMW</b>



## 21305 (WVA)

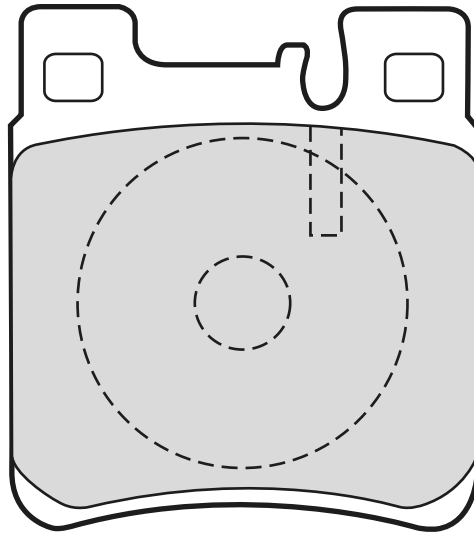

301617		61,7	69,6	15,5		ATE			MERCEDES

## 21312 (WVA)

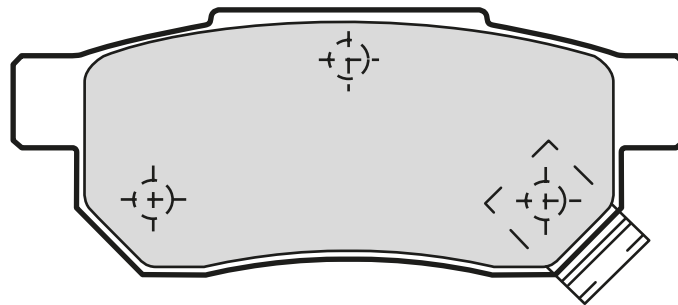

301053	↳ 2 x	89	35	13		AKE			HONDA, MG, ROVER

## 21333 (WVA)

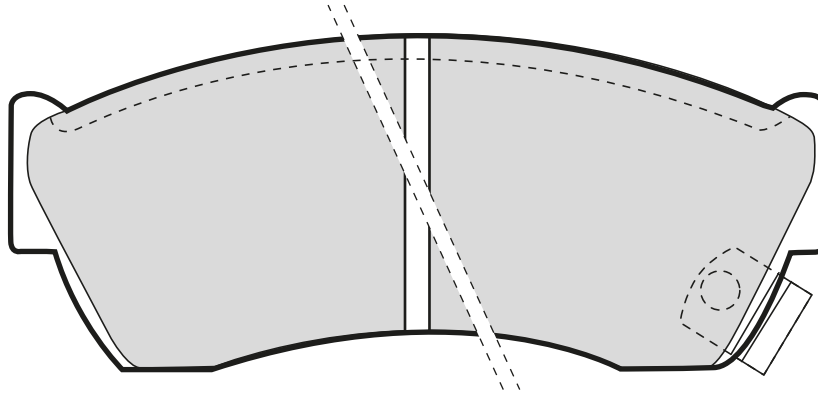

301666	↳ 2 x	107,3	44,6	14,5		AKE		SUBARU, SUZUKI



## 21347 (WVA)

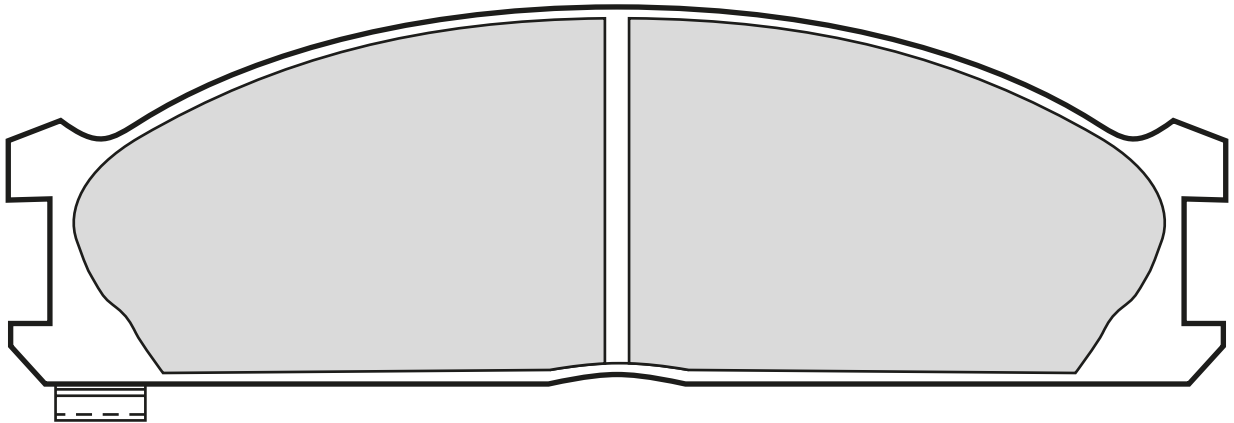
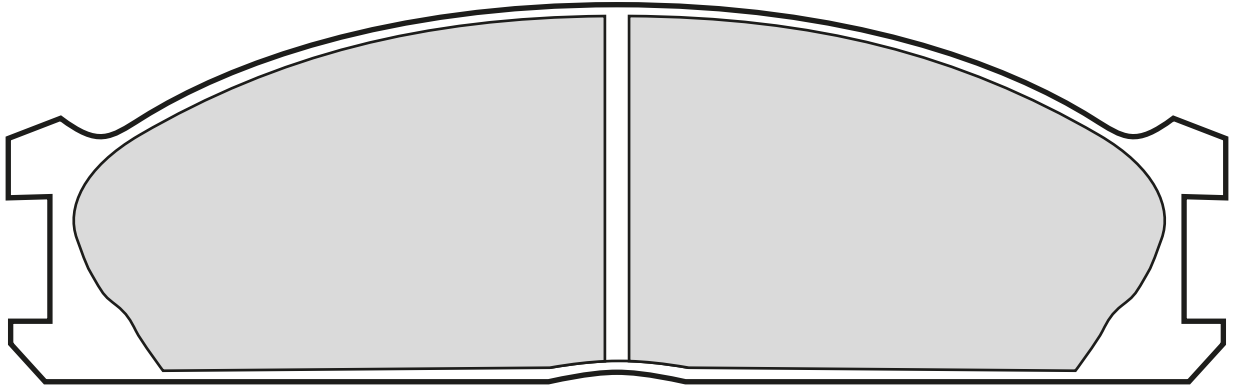

<b>301618</b>	↳ 2x	161	49,8	17	AKE			<b>NISSAN</b> <b>NISSAN</b>	

## 21353 (WVA)

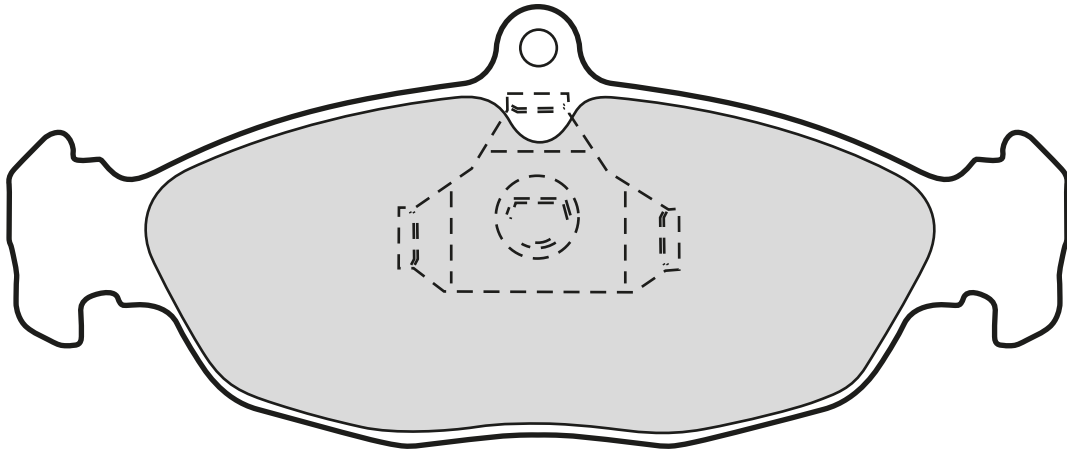

301356		140,1 141,4	58,3 48,4	16,8		ATE			<b>DAEWOO, OPEL, VAUXHALL</b> <b>OPEL, VAUXHALL</b>

## 21355 (WVA)

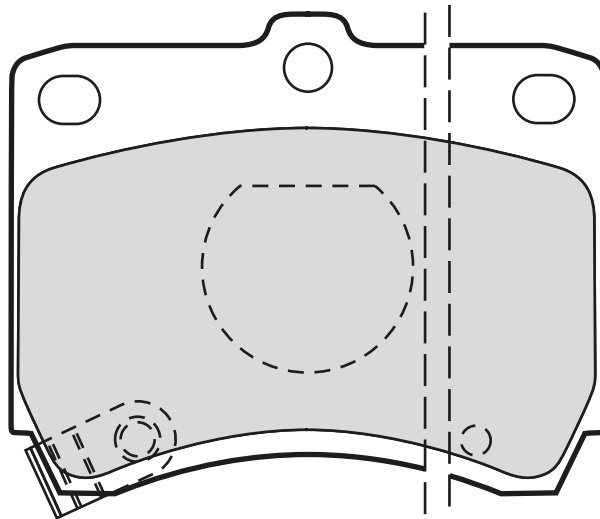

301268	↳ 4 x	78,7	63,3	14,4		SUM			<b>KIA, MAZDA</b>

## 21363 (WVA)

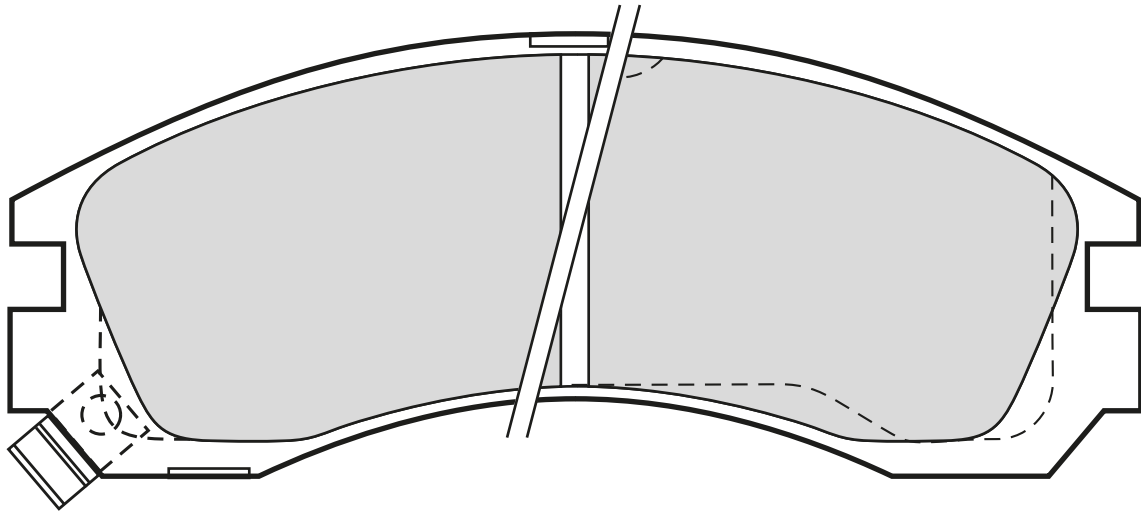

301517	↳ 2x	150	59	15,7	AKE	 	<b>MITSUBISHI</b> <b>MITSUBISHI</b>

## 21365 (WVA)

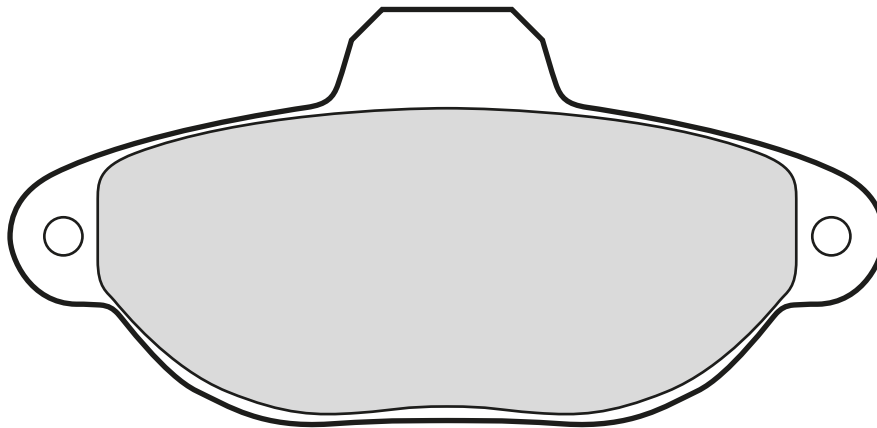

301012		115	55,3	17	BDX		<b>FIAT, LANCIA</b>

## 21366 (WVA)

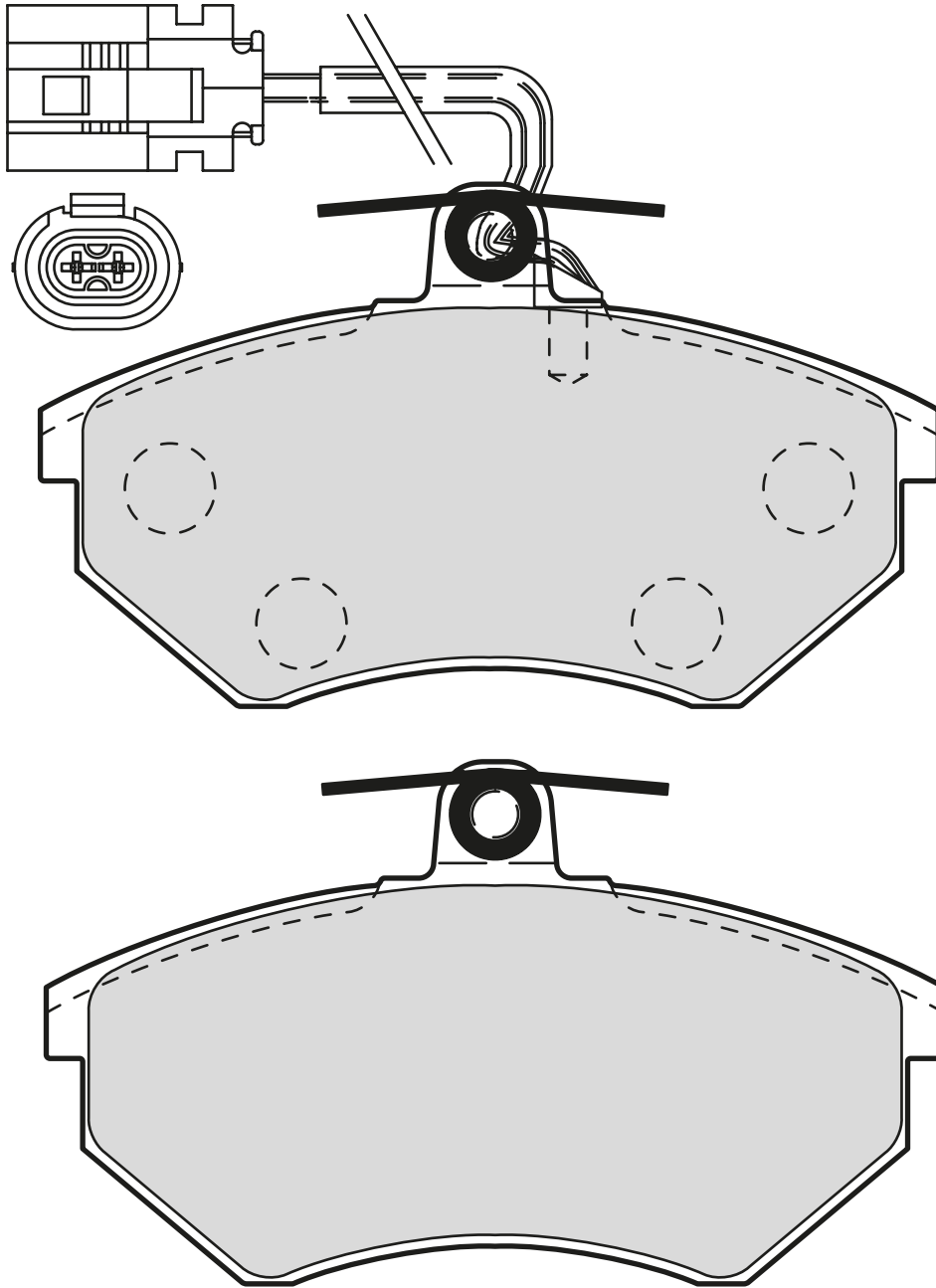

<b>Valeo</b> 								
<b>301982</b> (B)	↳ 2 x  220 mm	118,9	69,5	16,3	LUC		<b>VOLKSWAGEN</b>	

## 21368 (WVA)

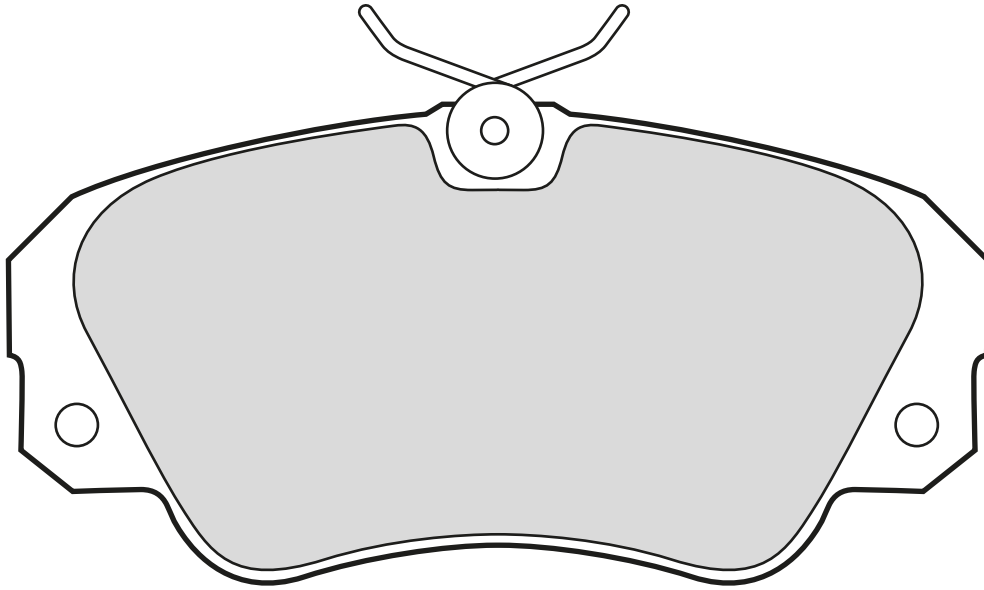

301256		129,8	63,9	18,6		LUC			OPEL, VAUXHALL

## 21381 (WVA)

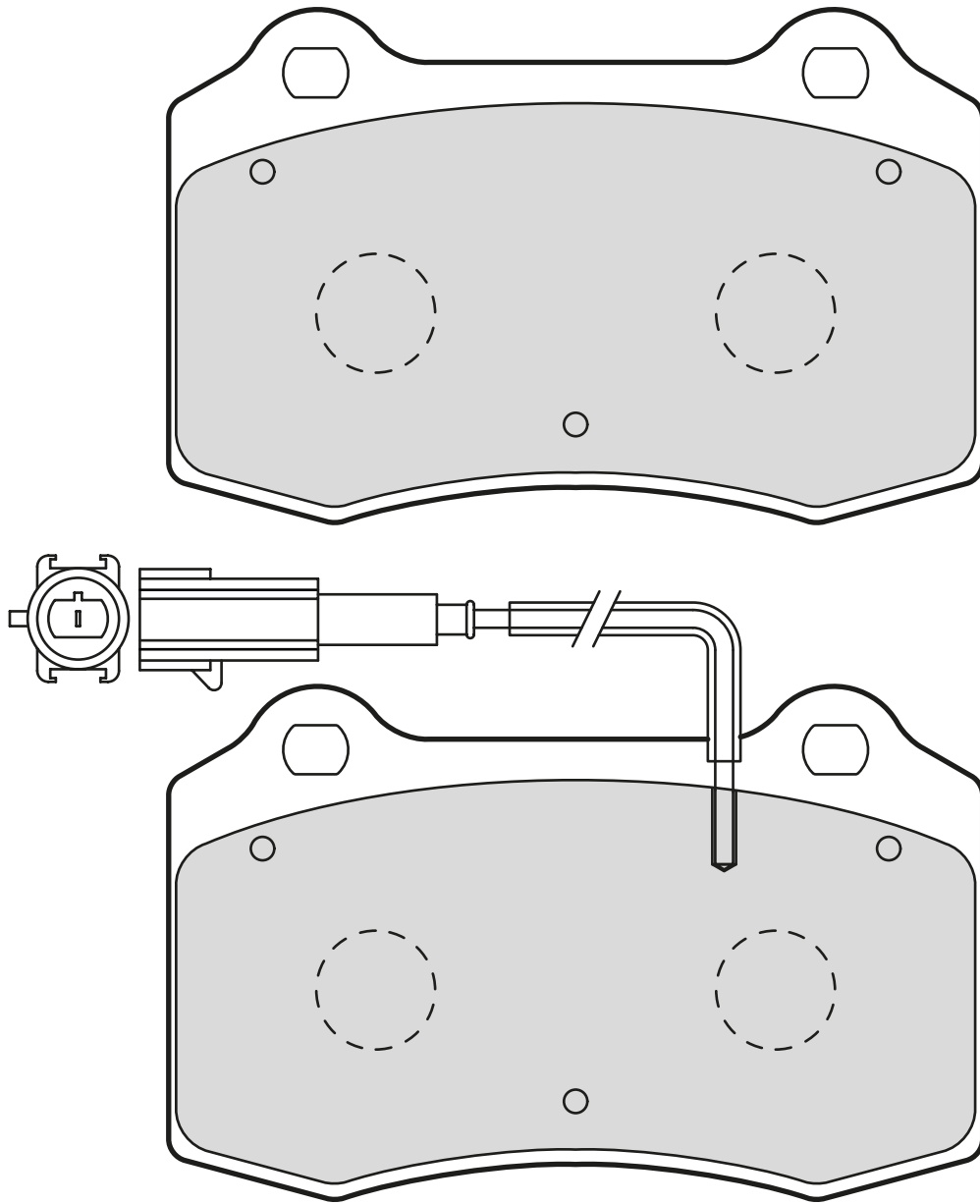

<b>301466</b>	↳ 4 x  370 mm/290 mm	109,7	69,3	17,8	BRE			<b>PEUGEOT</b>



## 21394 (WVA)

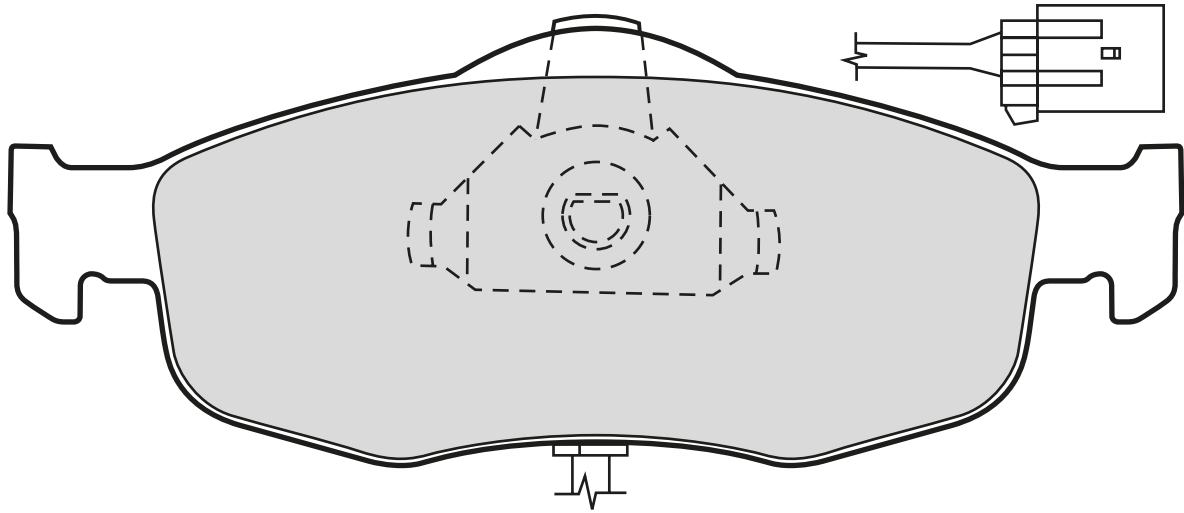

Valeo	 							
301033	↳ 2 x  220 mm	155,2 156,3	58,4 58,6	18		ATE		FORD
301034		155,2 156,3	58,4 58,6	18		ATE		FORD

## 21430 (WVA)

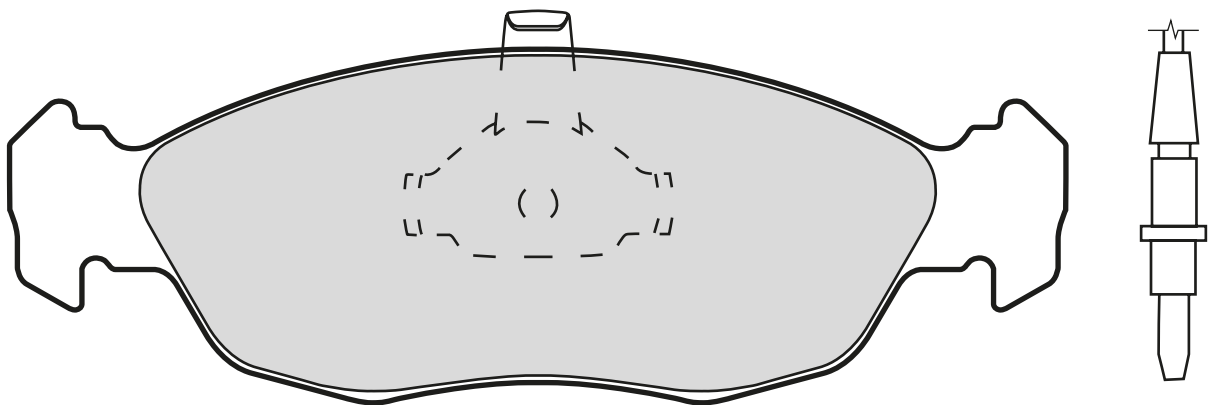

Valeo	 							
301038	↳ 2 x  275 mm	140,3	47,5	17		ATE		PEUGEOT
301074		140,3	47,5	17		ATE		CITROËN, PEUGEOT

## 21439 (WVA)

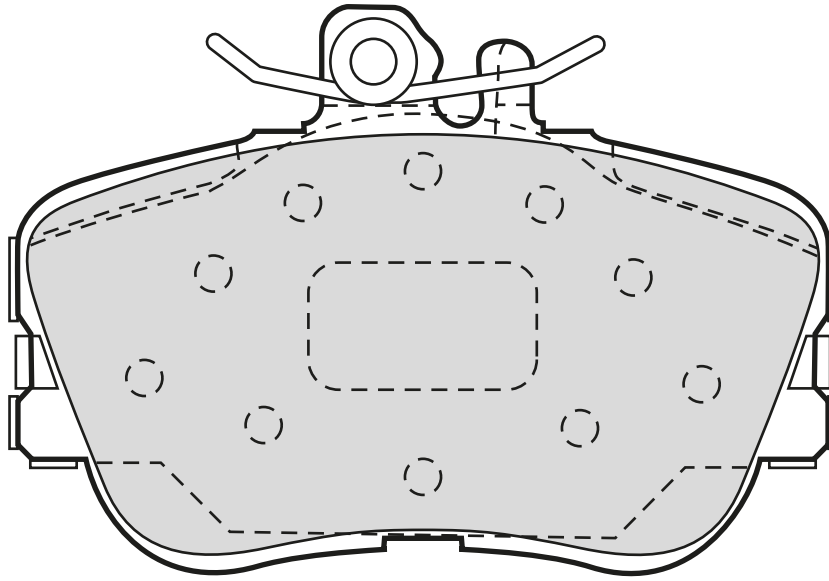

301013		110	75	20,3		LUC			MERCEDES



## 21469 (WVA)

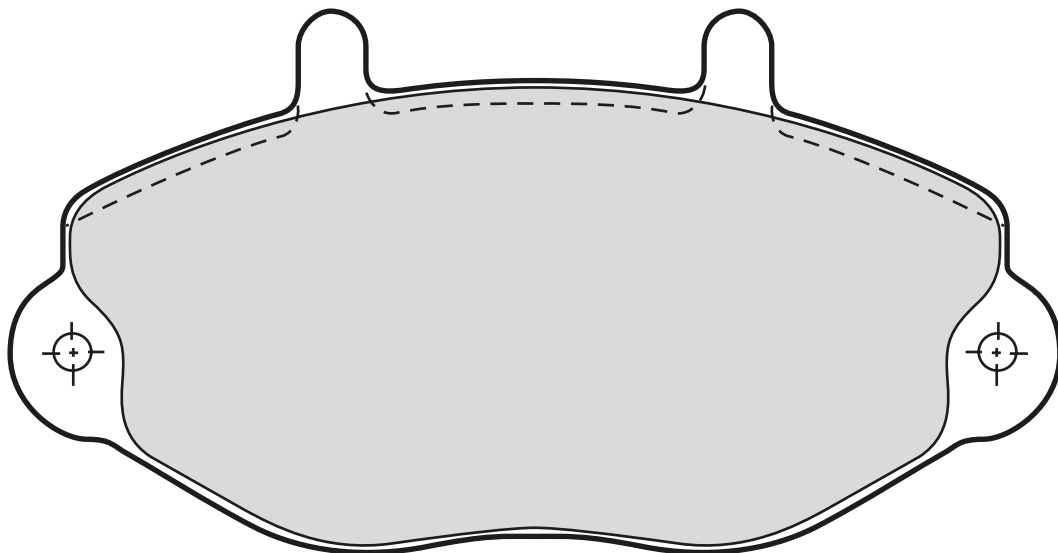

301037		138,9	72	18,3		BDX			FORD



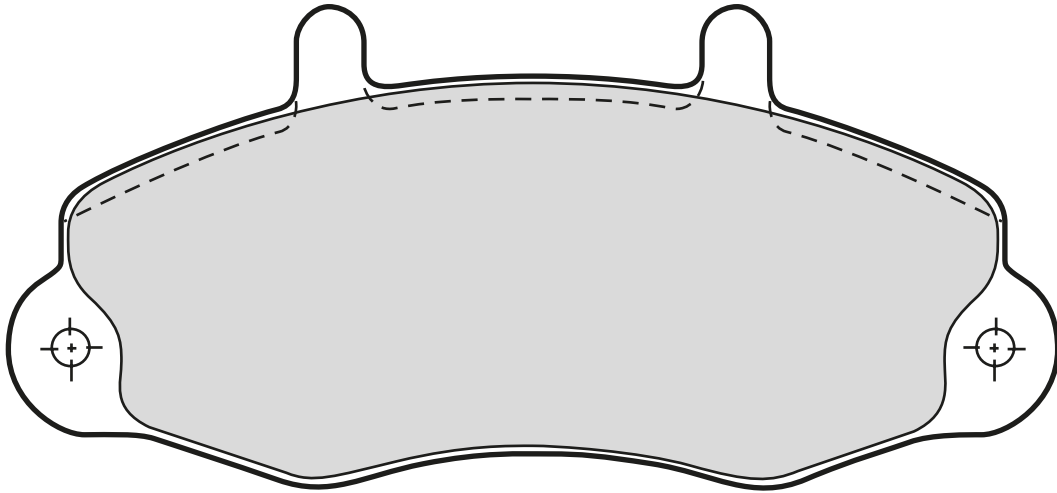





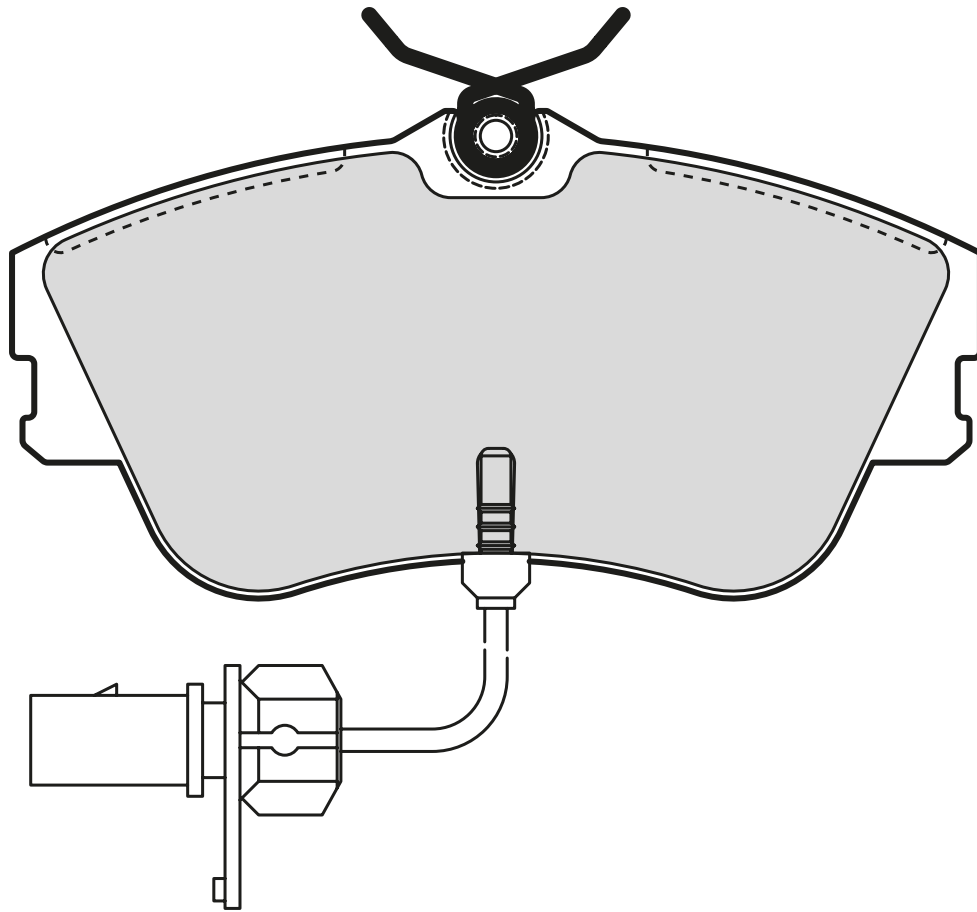







## 21470 (WVA)



301036		138,9	64,1	18,3		BDX		  <b>FORD</b>

## 21479 (WVA)



Valeo	 								
									
301622		128	65	19,2		LUC			<b>VOLKSWAGEN</b>
301814	↳ 1x  210 mm	129,5	65,2	19,2		LUC			<b>VOLKSWAGEN</b>

## 21487 (WVA)

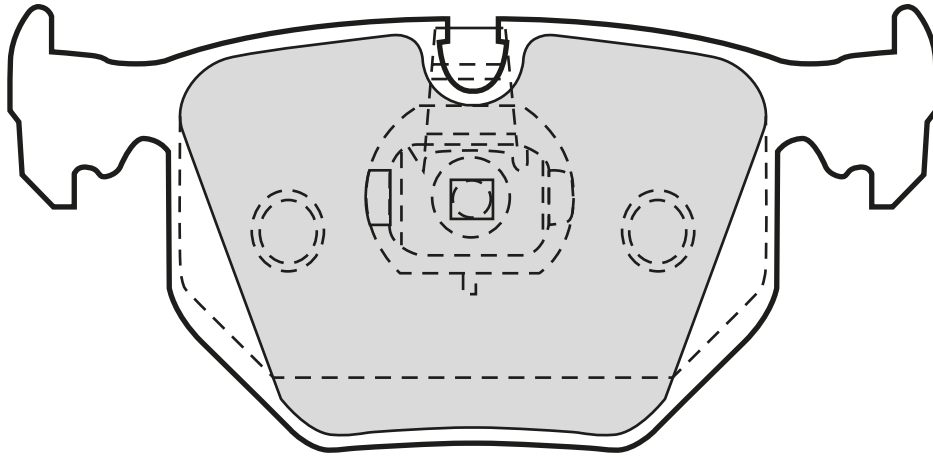

301580		123,1	59,2	17		ATE				BMW, LAND ROVER

## 21515 (WVA)

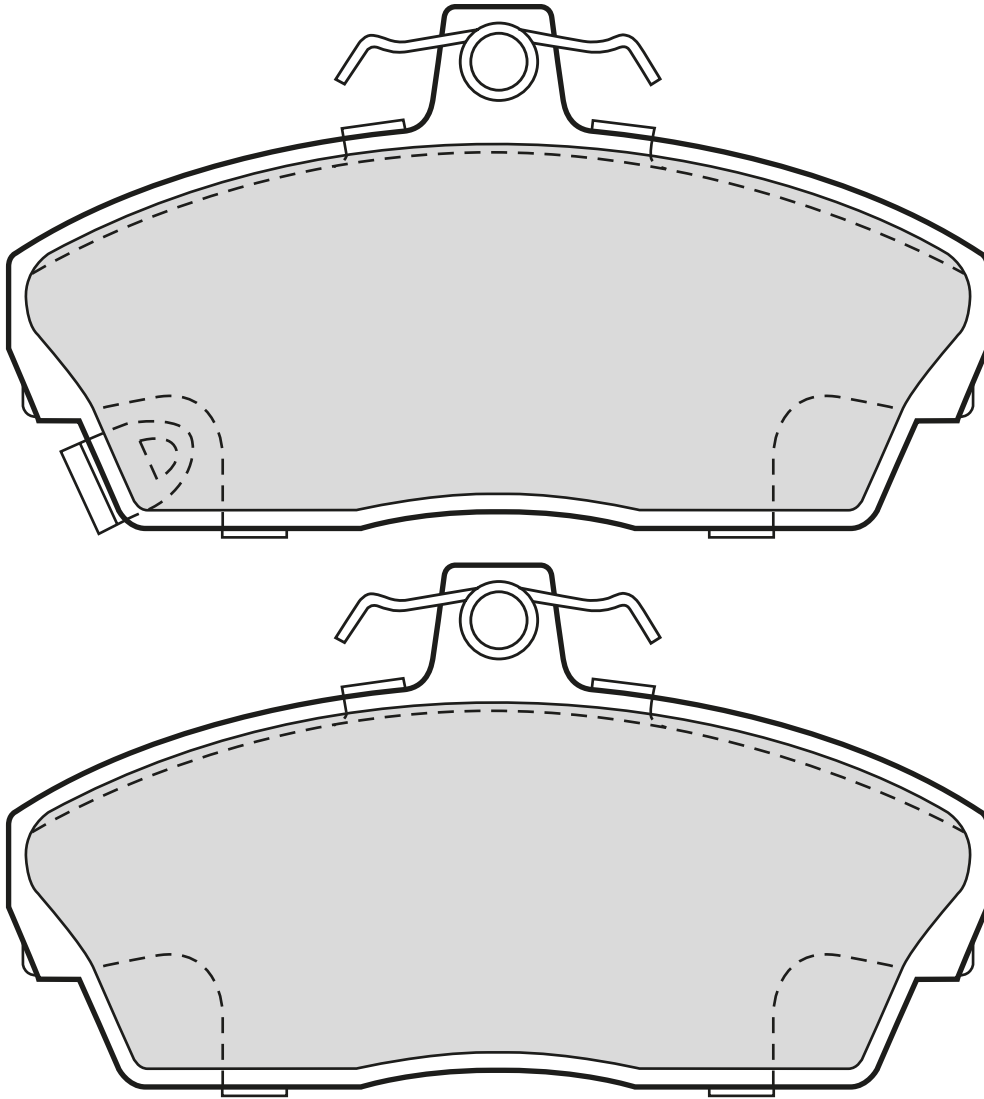

301022	↳ 2 x □	129	69	18	LUC		HONDA, MG, ROVER	

## 21543 (WVA)

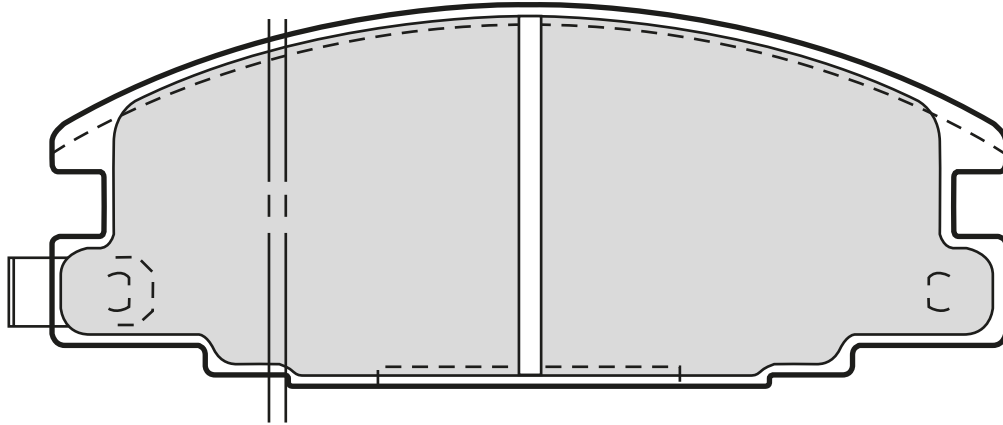

301020	↳ 4 x	127	51	16,5		AKE		
								<b>ISUZU, OPEL, VAUXHALL</b> <b>BEDFORD, OPEL, VAUXHALL</b>

## 21545 (WVA)

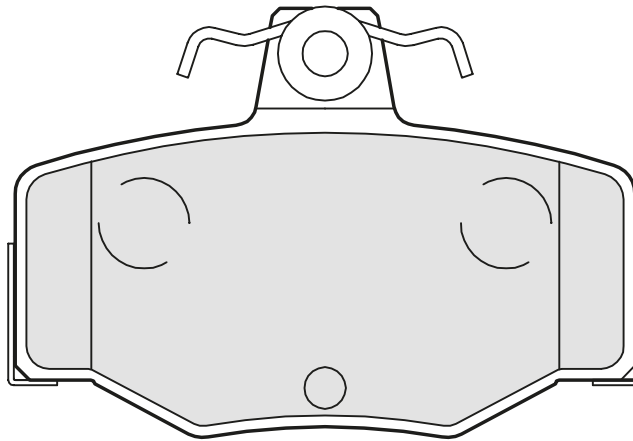

301057	↳ 2 x	84	56,3	15,8		LUC		
								<b>NISSAN</b>

## 21546 (WVA)

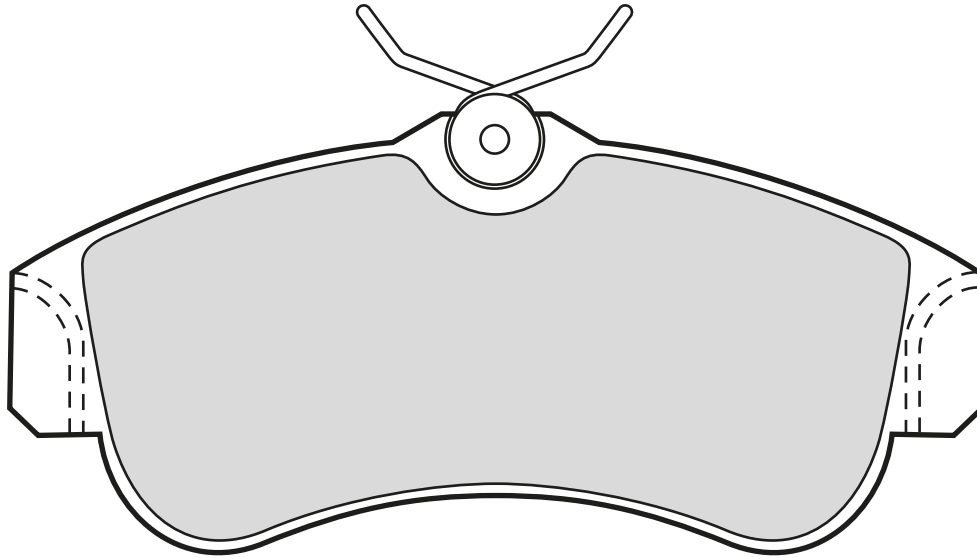

301054		129	57,3	17		LUC			NISSAN

## 21553 (WVA)

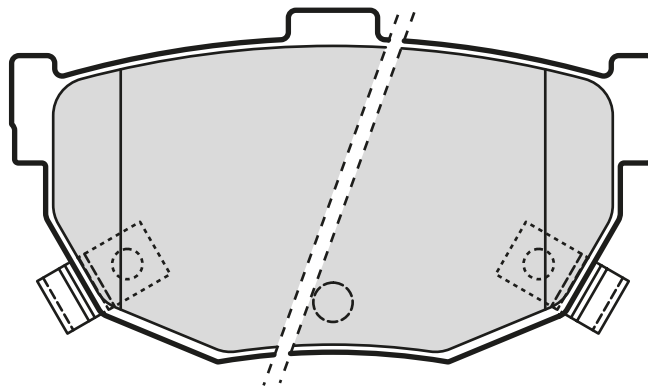

301817	↳ 2x	85	46,5	14		SUM			HYUNDAI, KIA, NISSAN



## 21576 (WVA)

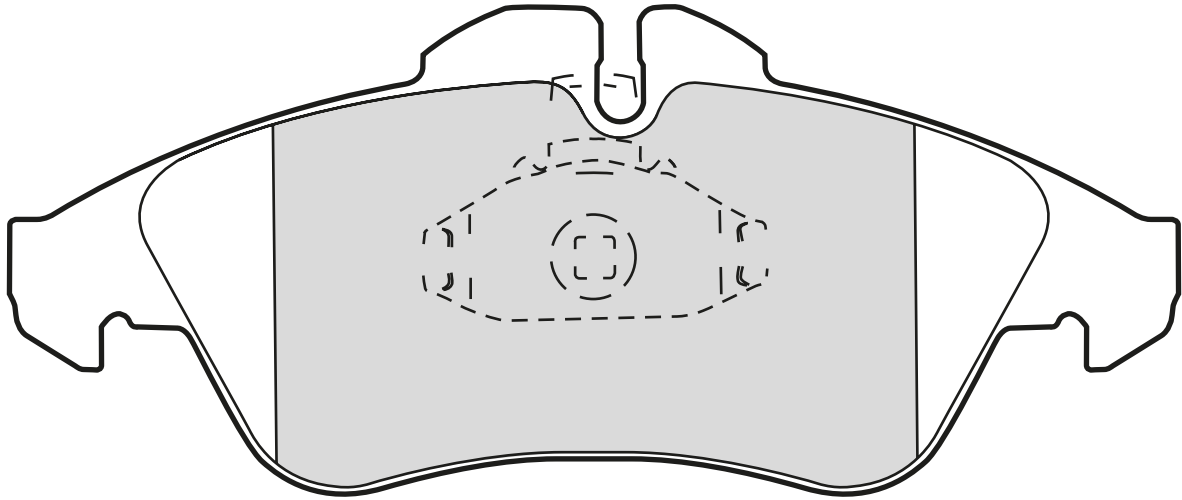

301044		156,25	64,8	20,5	ATE				<b>MERCEDES</b> <b>MERCEDES, VOLKSWAGEN</b>

## 21586 (WVA)

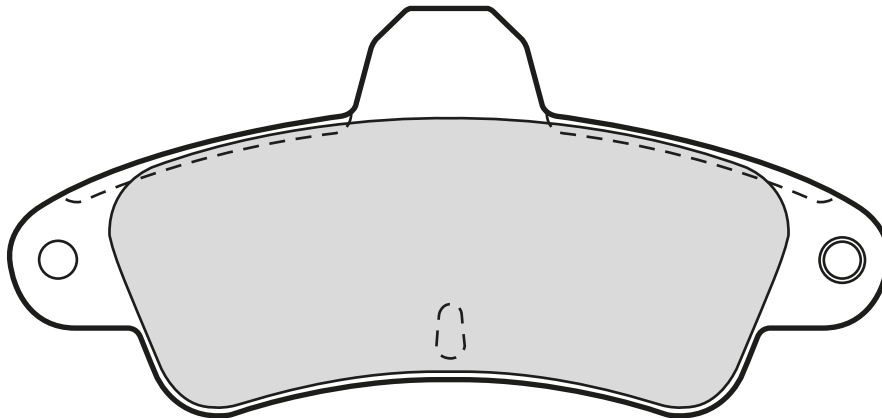

301005		116	54	15	BDX				<b>FORD</b>

## 21601 (WVA)

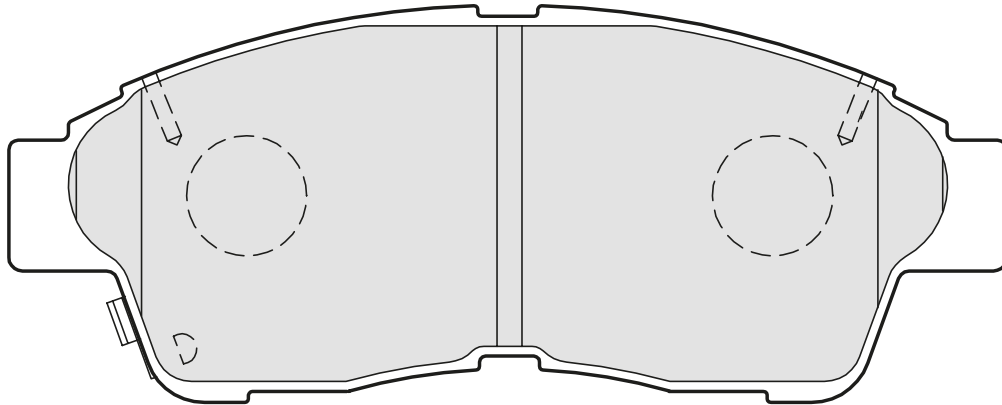

<b>Valeo</b> 								
<b>301551</b>	2x	133,2	53	17,5	AKE		<b>TOYOTA</b>	

## 21606 (WVA)

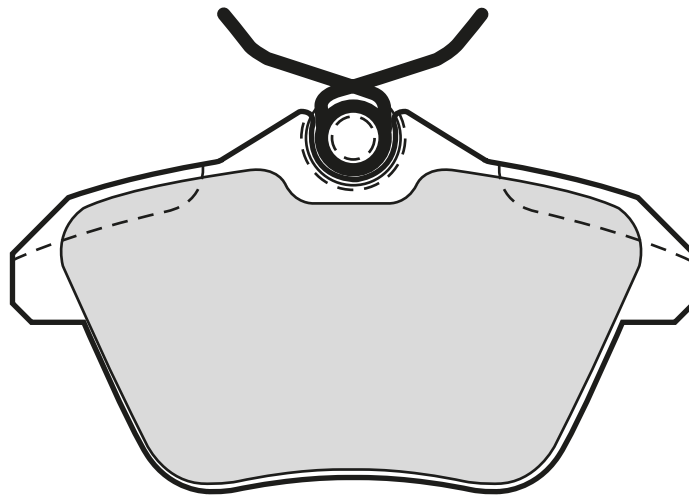

<b>Valeo</b> 								
<b>301581</b>		89,8	50	16,4	LUC		<b>ALFA ROMEO, LANCIA</b>	



## 21626 (WVA)

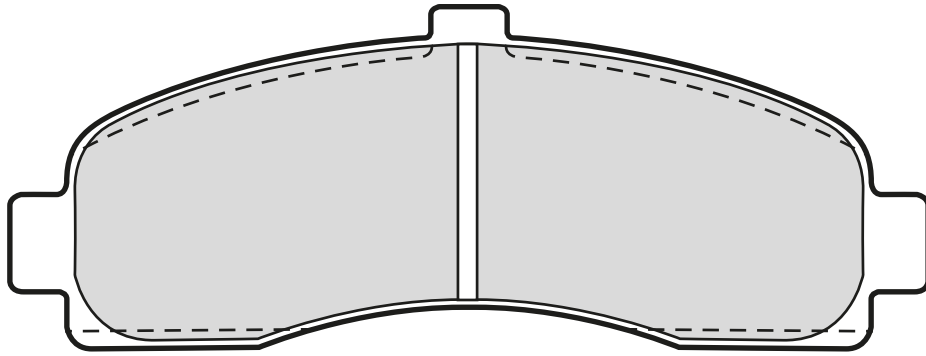

301014		120,9	45	15,5		AKE			NISSAN



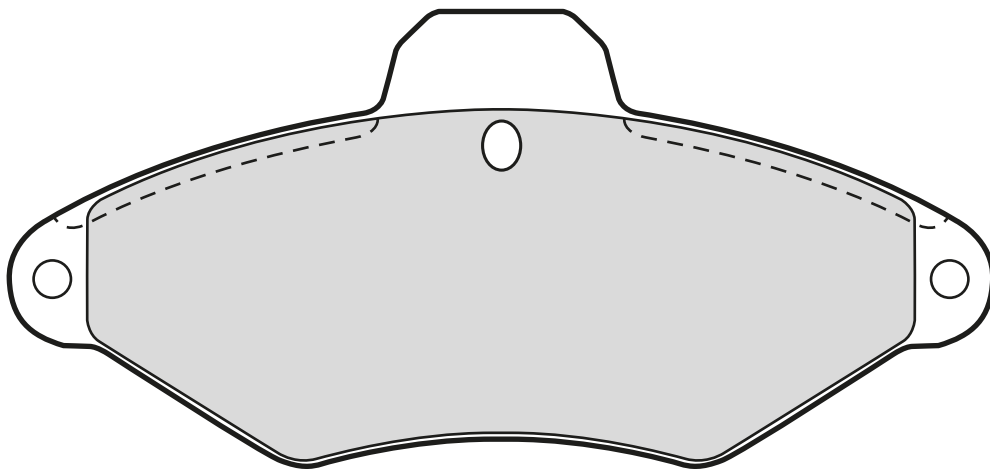





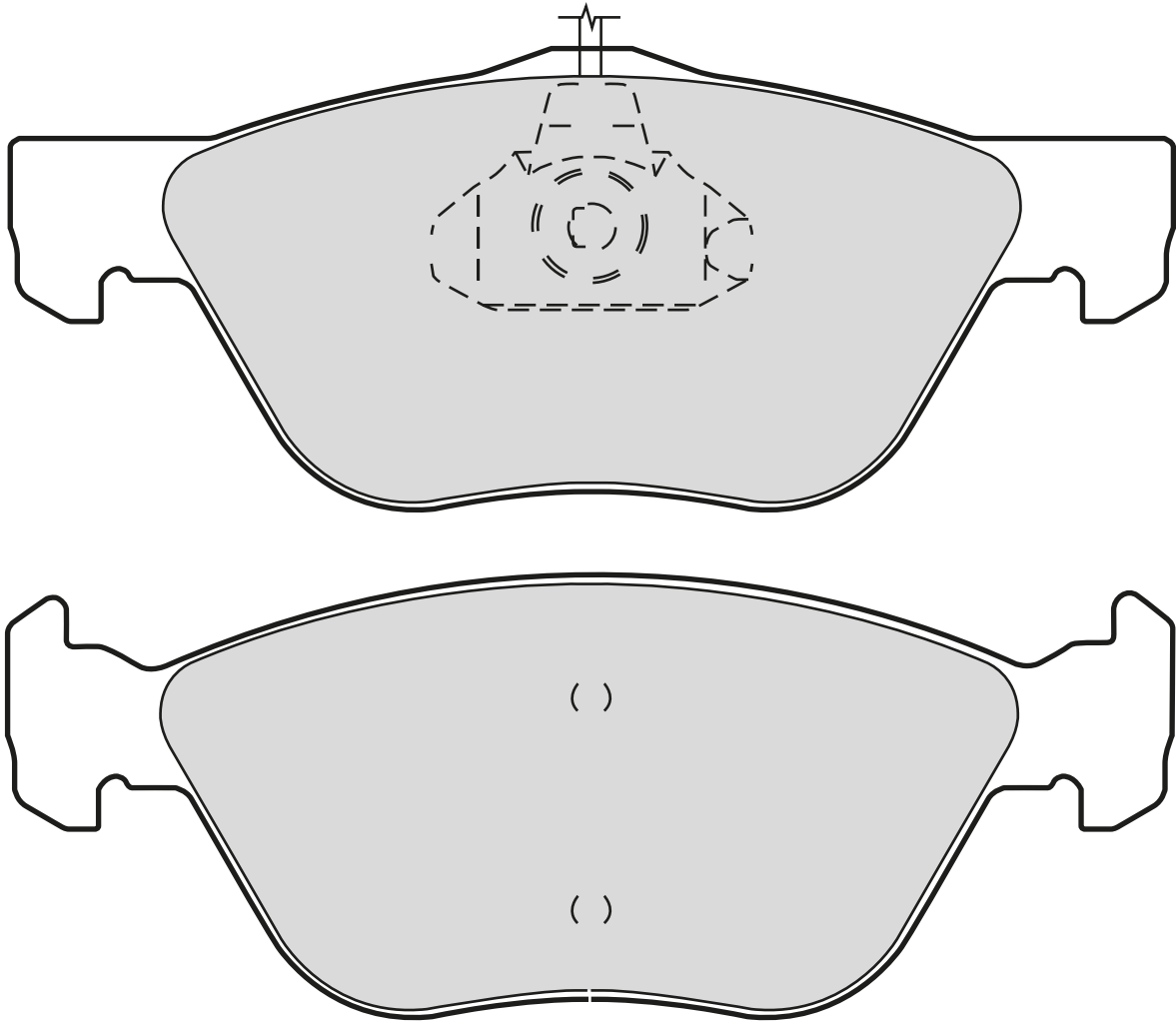







## 21631 (WVA)



301031		131	60,5	16		BDX			CITROËN

## 21636 (WVA)



Valeo	 								
									
301023	↳ 2 x  216 mm	156,3	58,9	19		ATE			<b>ALFA ROMEO, FIAT, LANCIA</b>
301065	↳ 2 x  200 mm	155,3	61,7	19		ATE			<b>ALFA ROMEO, FIAT, LANCIA</b>

## 21637 (WVA)

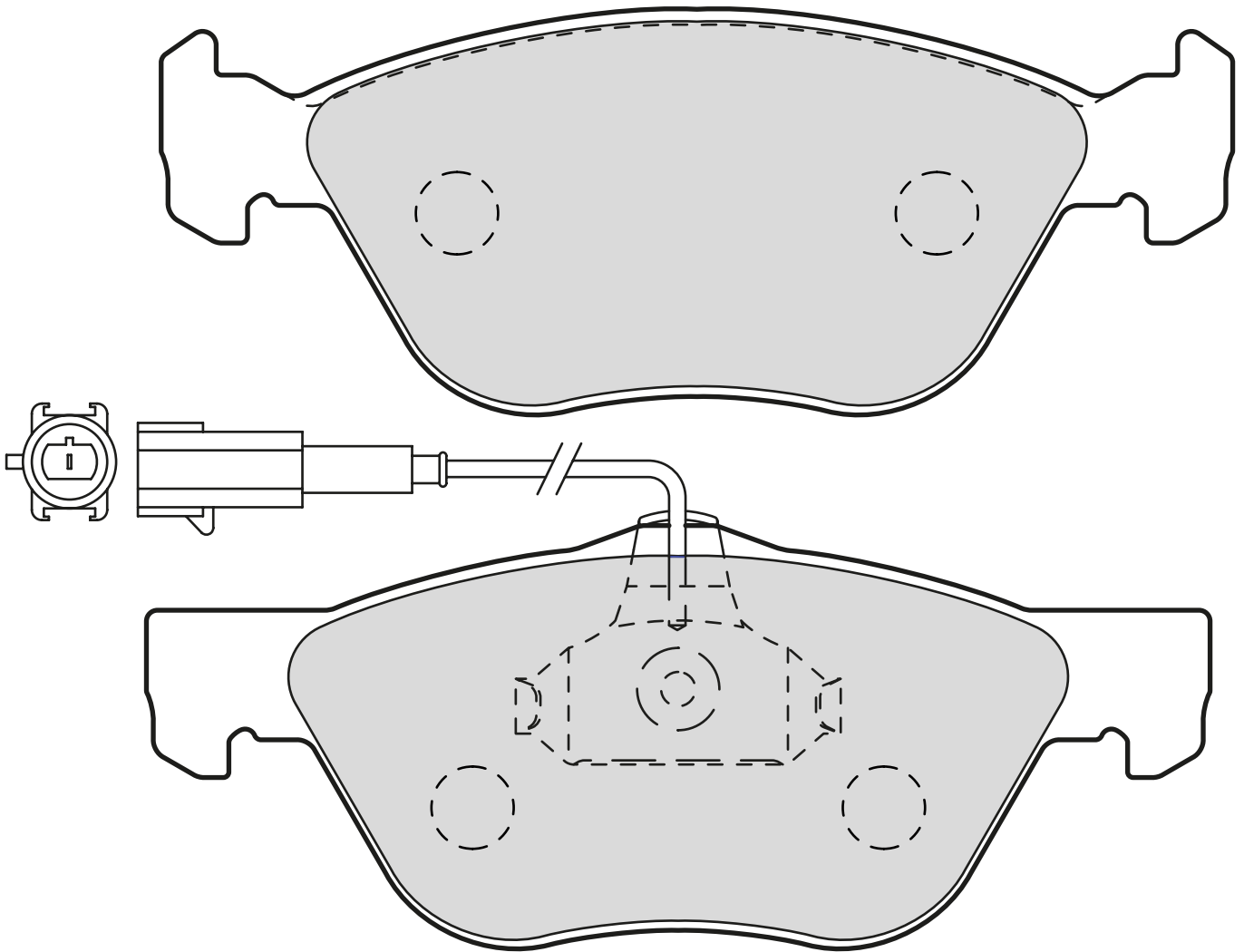

<b>301990</b>	2 x  211 mm	155,3 156,45	61,6 55,9	19,1	PERROT		<b>ALFA ROMEO, FIAT, LANCIA</b>	

## 21647 (WVA)

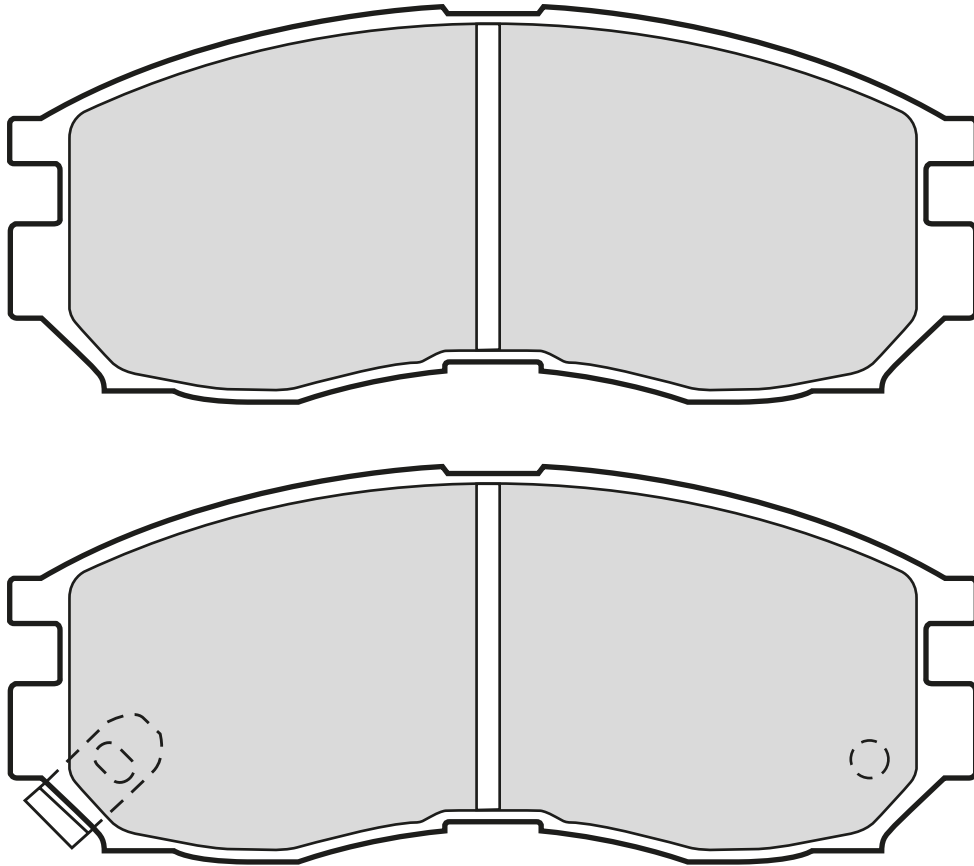

301625	↳ 2x	127,7	51,7	16	SUM		GALLOPER, HYUNDAI, MITSUBISHI, PROTON	

## 21651 (WVA)

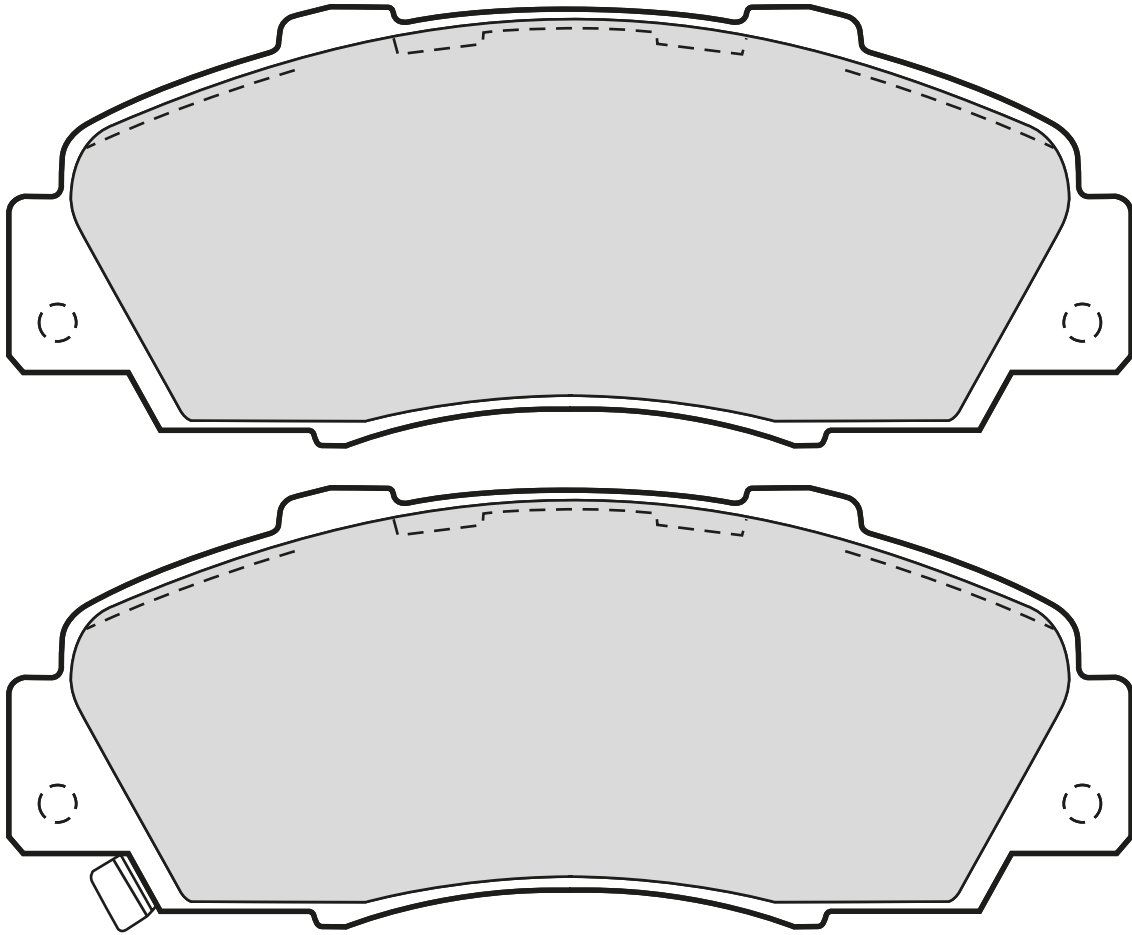

301627	↳ 2x	148,6	57,7	17,5		AKE		HONDA, ROVER

## 21654 (WVA)

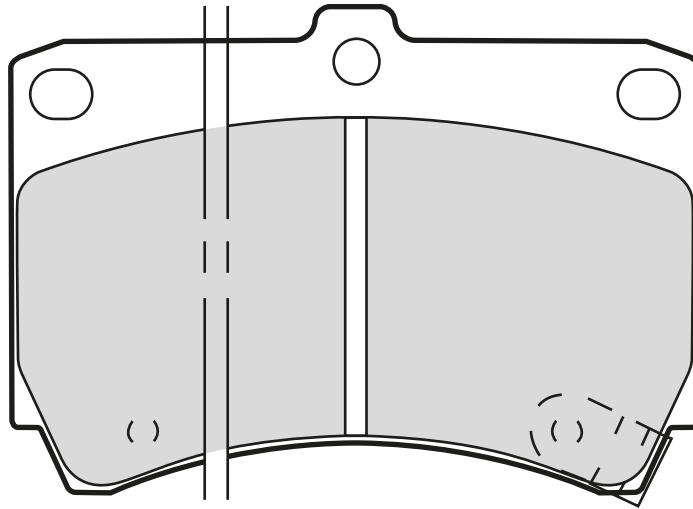

<b>Valeo</b> 									
301274	↳ 2x	91,5	64	15		SUM			KIA, MAZDA



## 21661 (WVA)

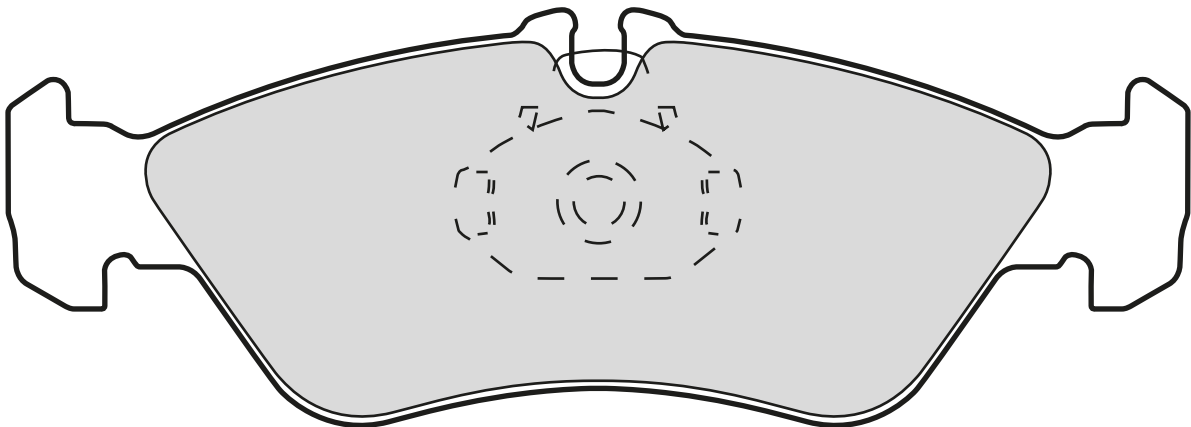

<b>Valeo</b> 									
301046		156,4	54,6	18,5		ATE			MERCEDES, VOLKSWAGEN



## 21670 (WVA)

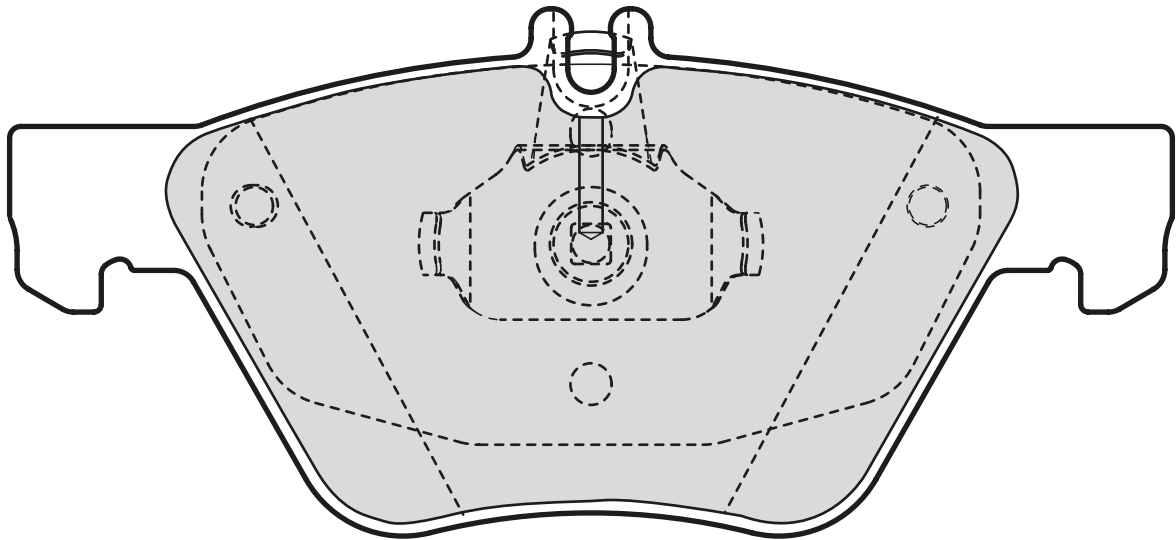
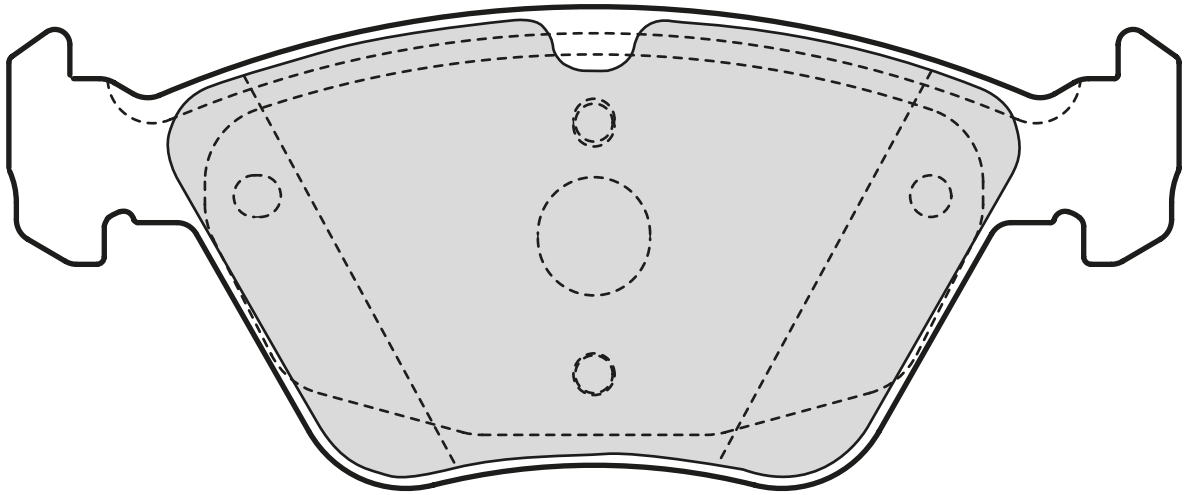

301636		156,3 156,3	63,6 69,5	20,3		ATE		<b>CHRYSLER, MERCEDES</b>

## 21674 (WVA)

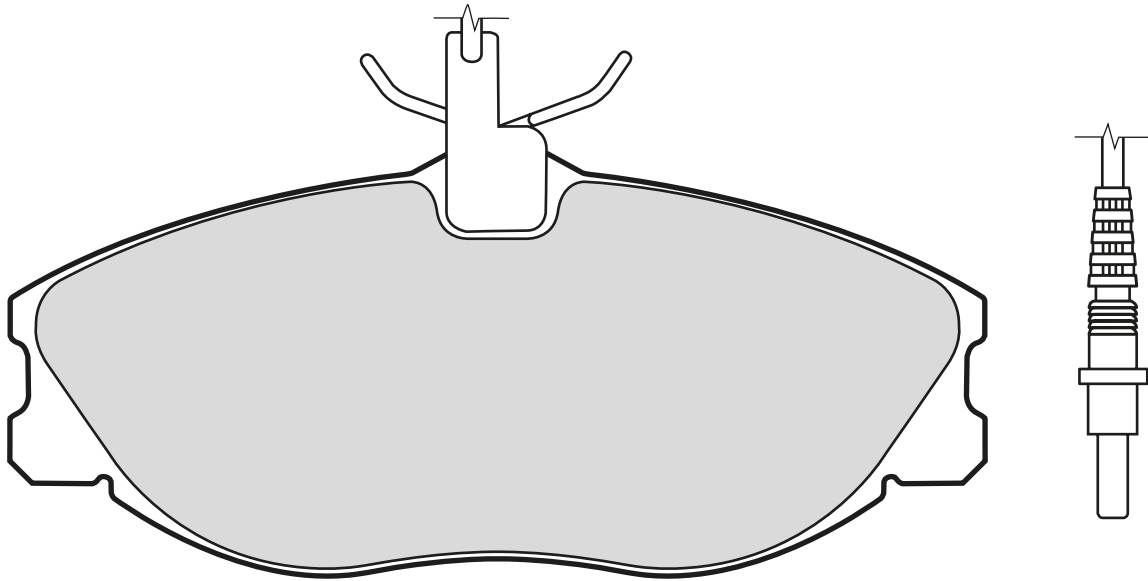

301069	↳ 4 x  310 mm	130	56,5	19		LUC			CITROËN, PEUGEOT

## 21677 (WVA)

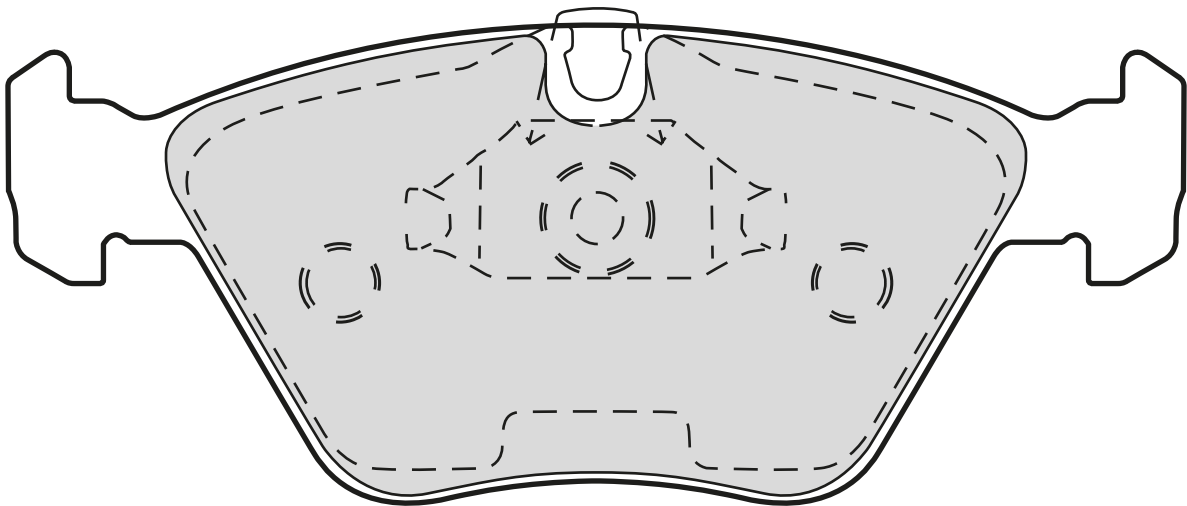

301310		156,4 155,3	64	20,3		ATE			BMW

## 21691 (WVA)

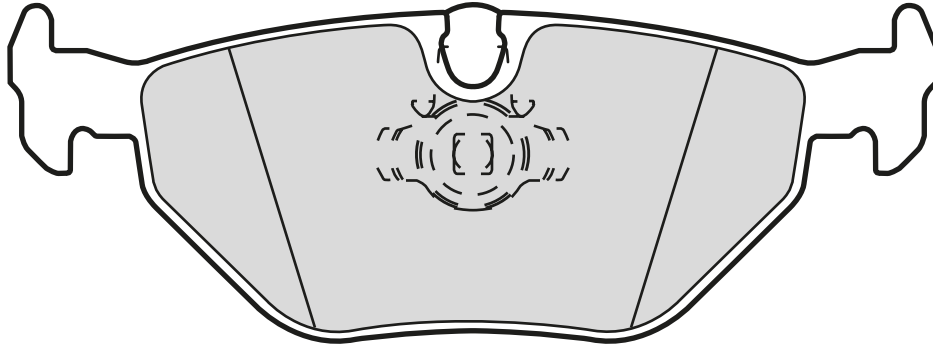

301311		122	45	17,3		ATE			BMW



## 21697 (WVA)

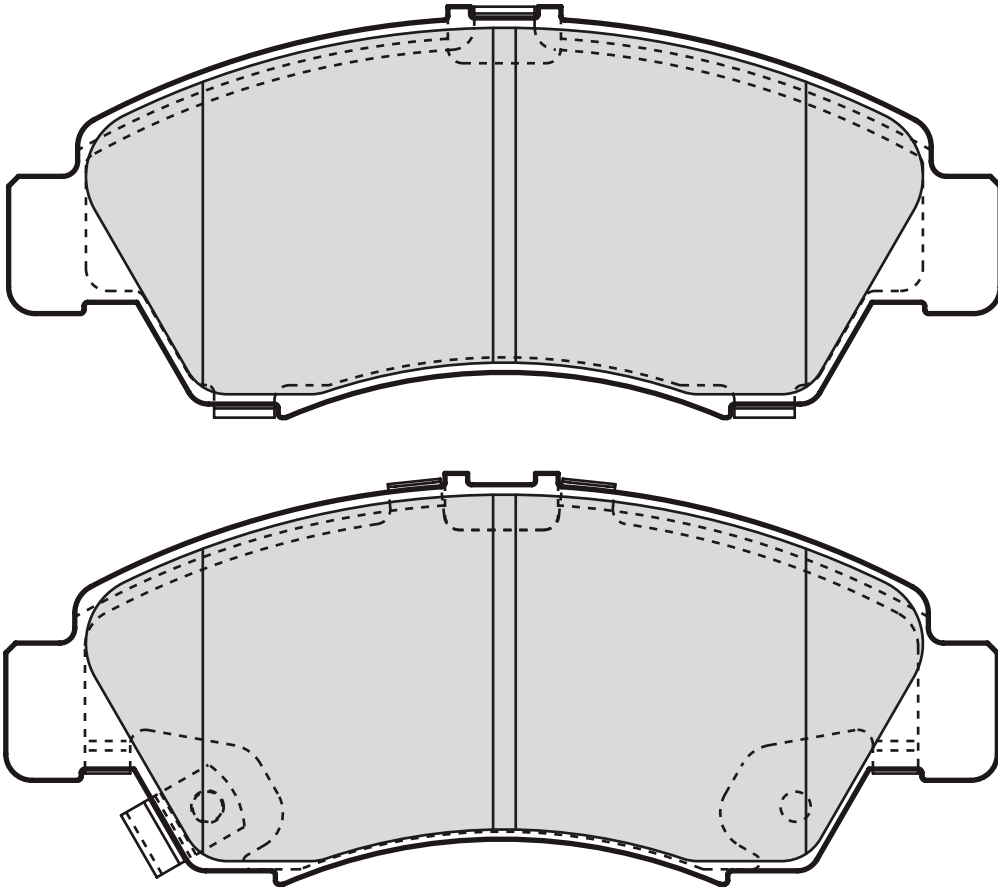

<b>301760</b>	2x	131,5	54,5	15	SUM		<b>HONDA</b>	

## 21715 (WVA)

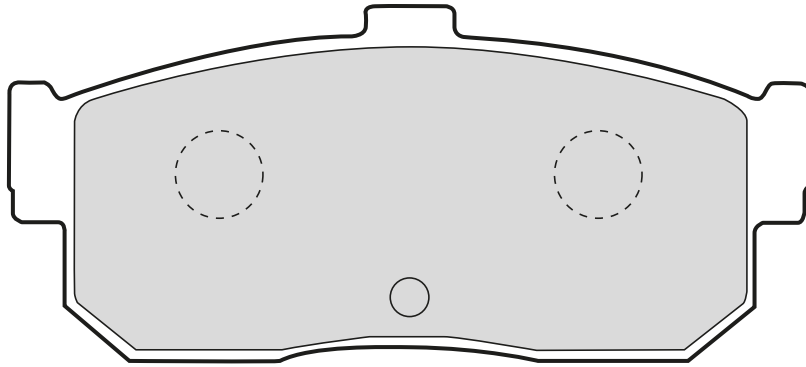

<b>Valeo</b> 									
301668		105,2	46,8	16		SUM			NISSAN

## 21719 (WVA)

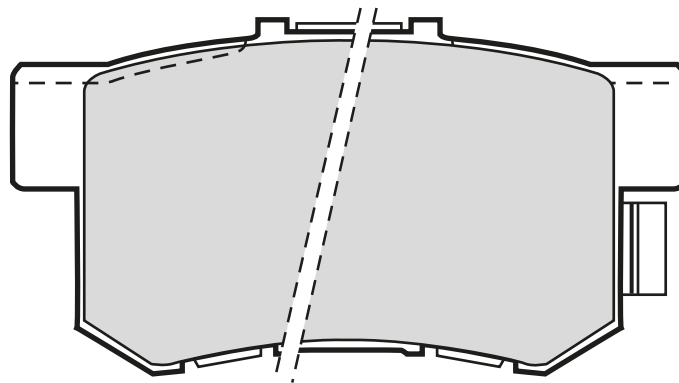

<b>Valeo</b> 									
301682	↳ 2 x	88,9	47,5	15,4		AKE			HONDA, MG, ROVER

## 21724 (WVA)

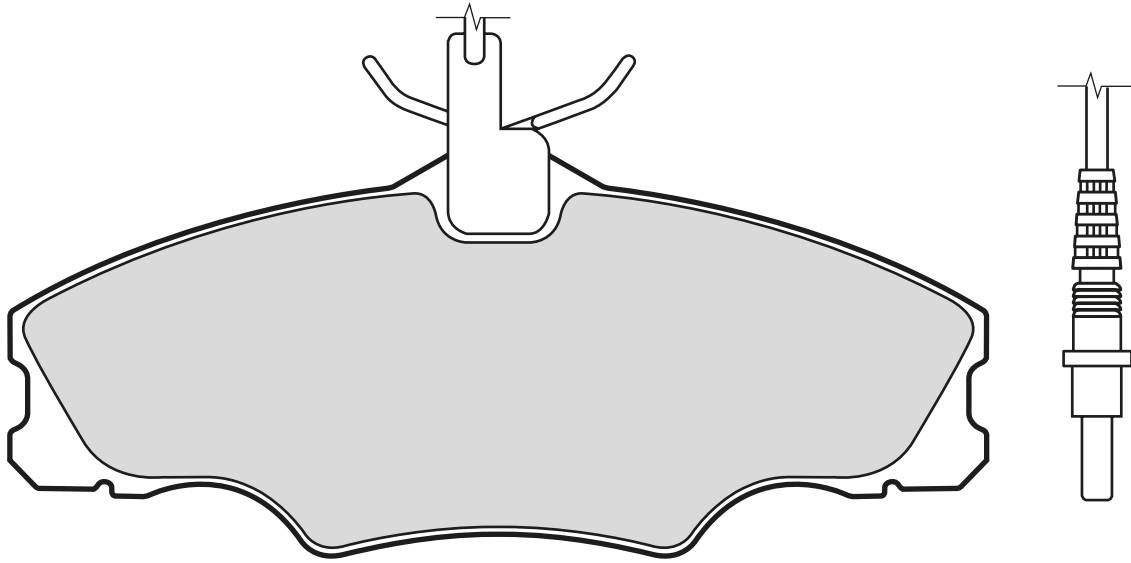

<b>Valeo</b>									
<b>301068</b>	4 x  310 mm/280 mm	130	53	19	LUC			<b>PEUGEOT</b>	

## 21727 (WVA)

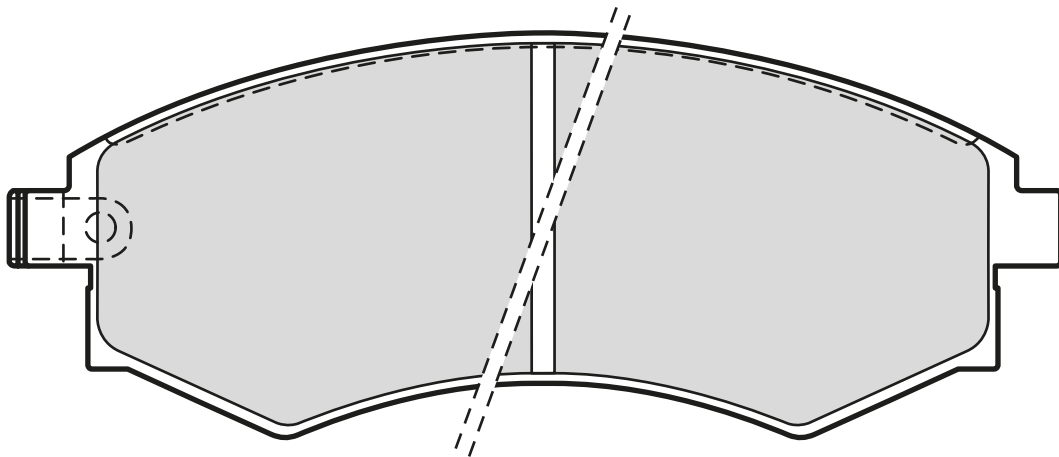

<b>Valeo</b>									
<b>301574</b>	2 x	137,3	54,4	17,5	AKE			<b>HYUNDAI, KIA</b>	

## 21748 (WVA)

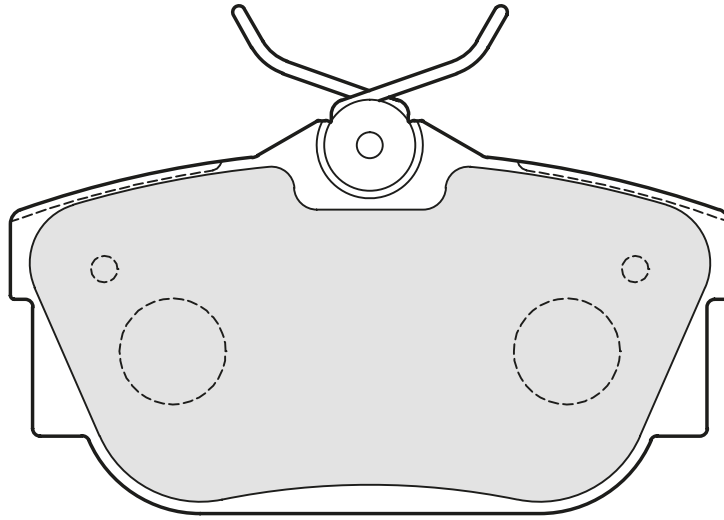

301482			94,9	57,4	17		LUC		<b>VOLKSWAGEN</b>

## 21754 (WVA)

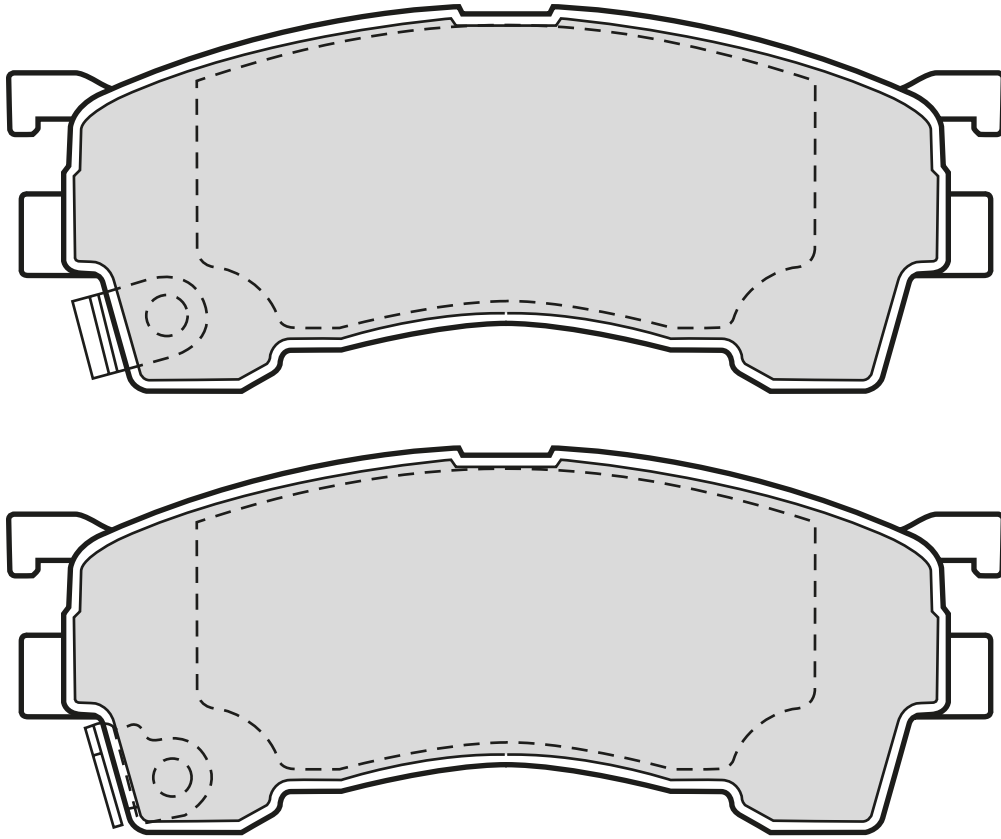







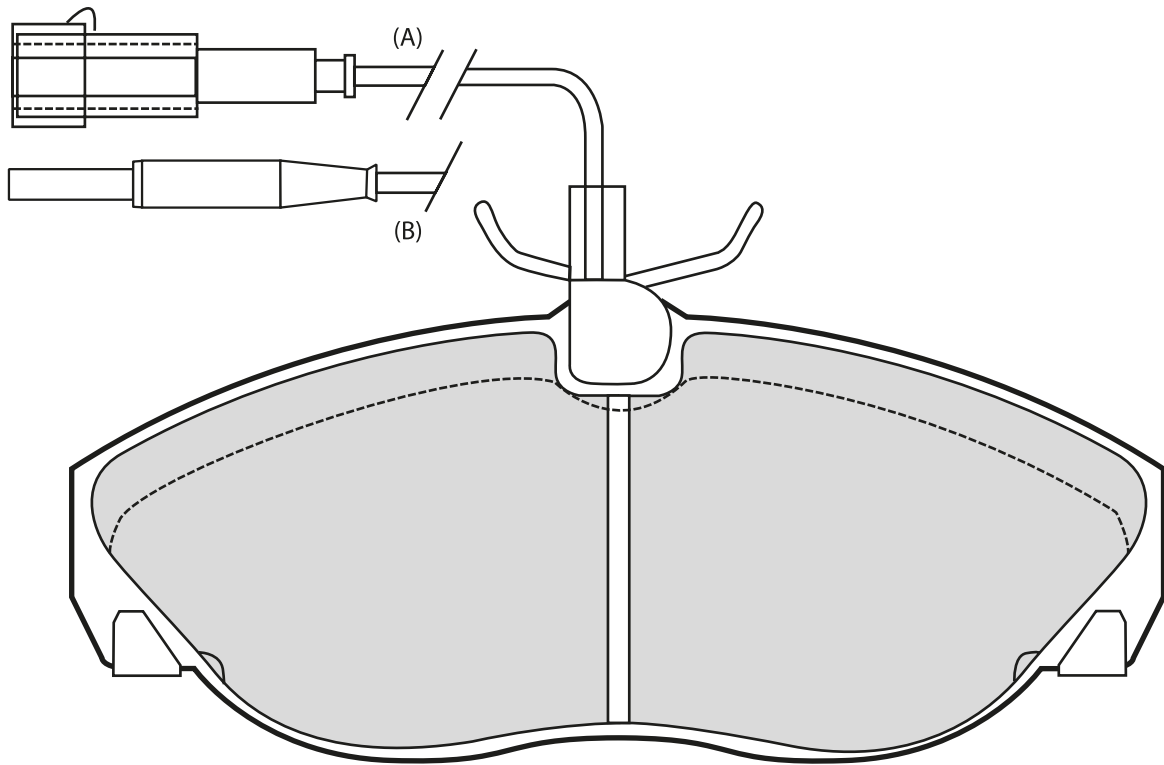









301629	↳ 2 x	131,95	51,5	15		SUM		FORD, MAZDA



## 21797 (WVA)



Valeo	 								
									
<b>301010</b>	(B)  2 x 200 mm	145	60,8	19,2		LUC			<b>CITROËN, FIAT, PEUGEOT</b>
<b>301429</b>	(A)  1 x 300 mm	145	60,9	19,5		LUC			<b>CITROËN, FIAT, PEUGEOT</b>

## 21801 (WVA)

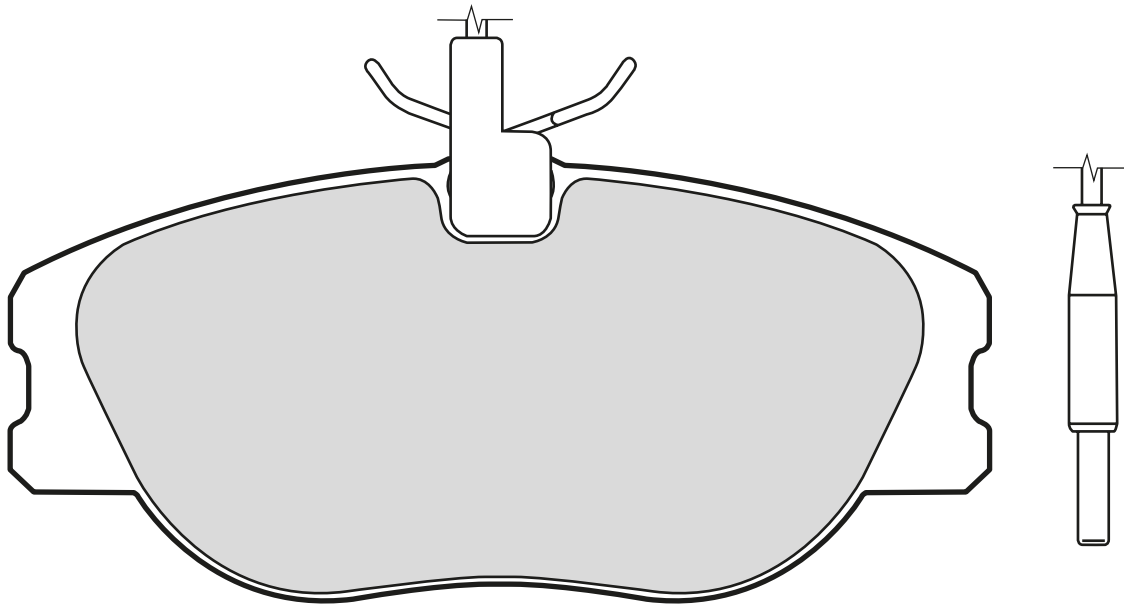

<b>301064</b>	↳ 4 x  240 mm/195 mm	130	57,4	18,8	LUC			<b>CITROËN, FIAT, LANCIA, PEUGEOT</b>	<b>CITROËN, FIAT, PEUGEOT</b>



## 21822 (WVA)

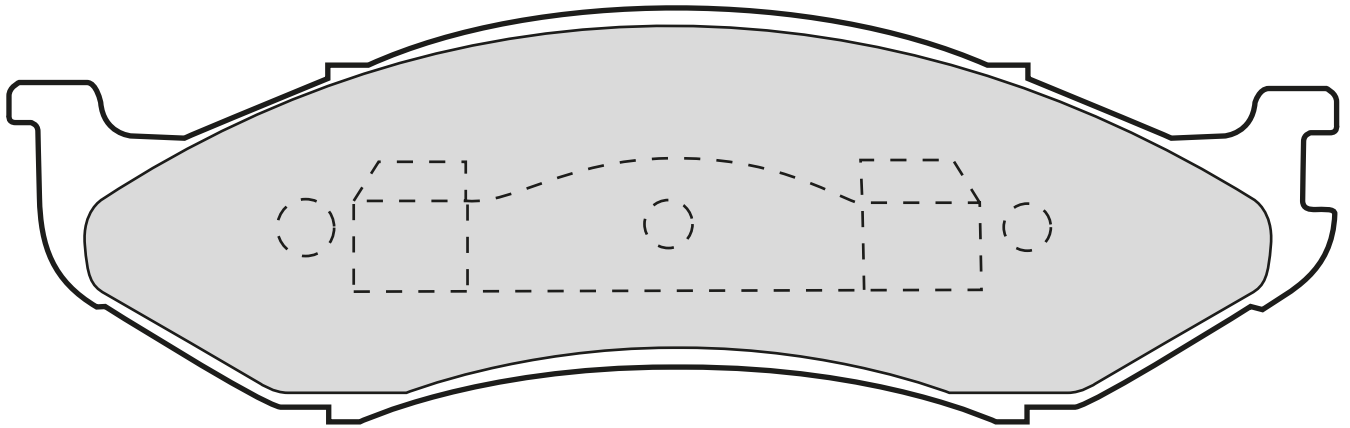
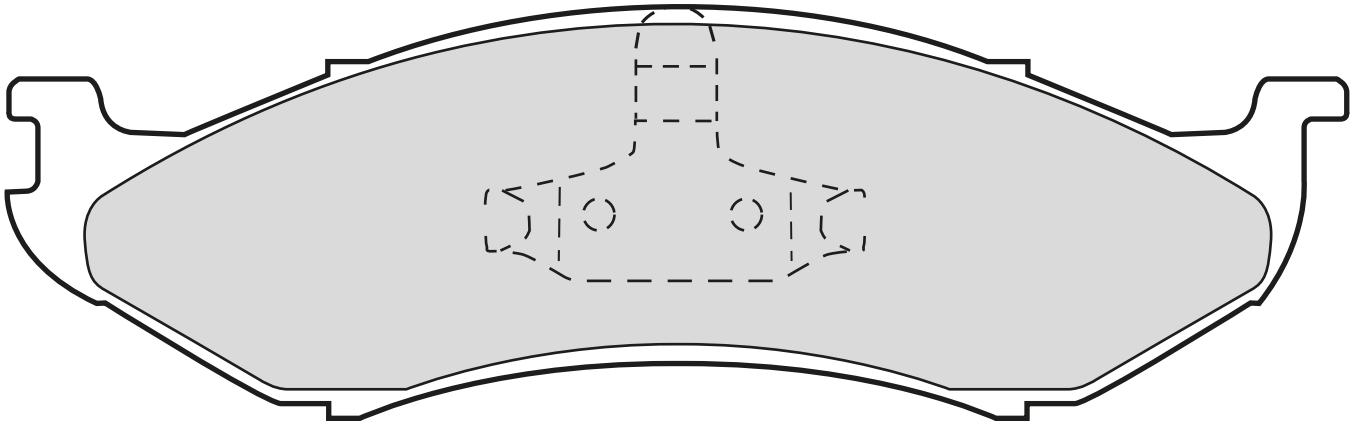

301491		177	55	17,1		KELS			JEEP, KIA, RENAULT

## 21829 (WVA)

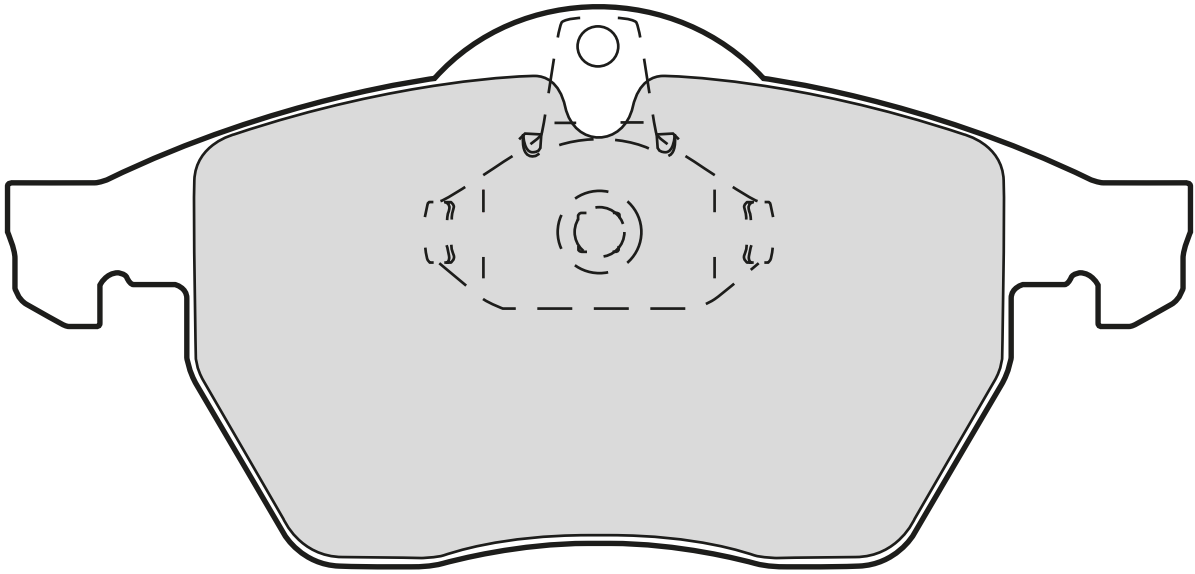

301305		156,3	74,2	20,3		ATE		OPEL, SAAB, VAUXHALL	



## 21833 (WVA)

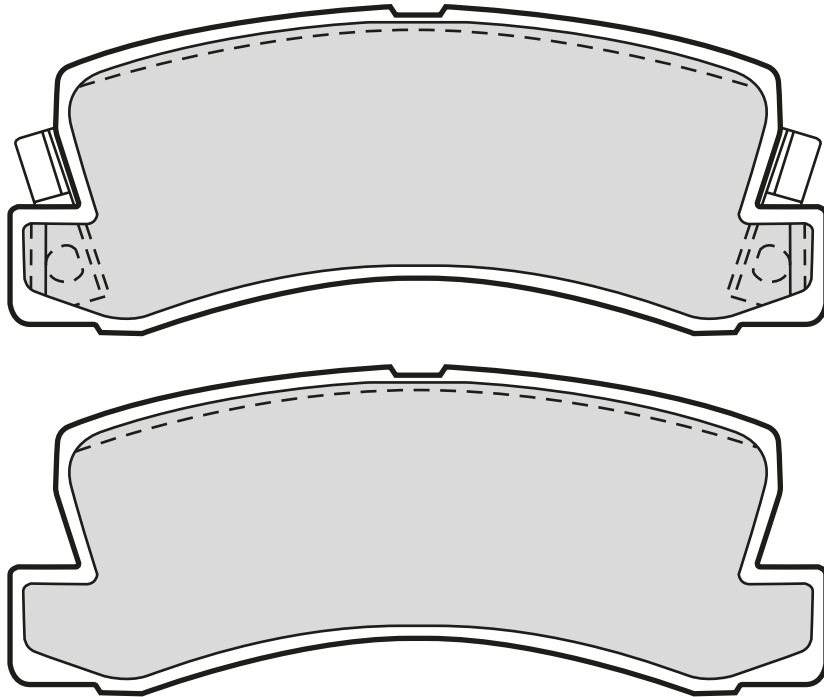

<b>301540</b>		107,6	42,5	15	AKE			<b>TOYOTA</b>



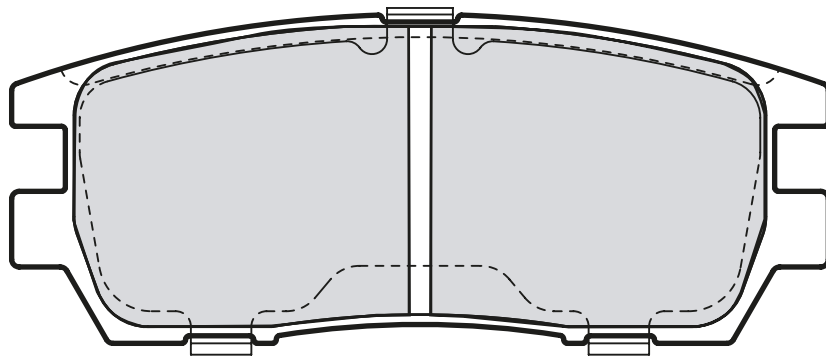
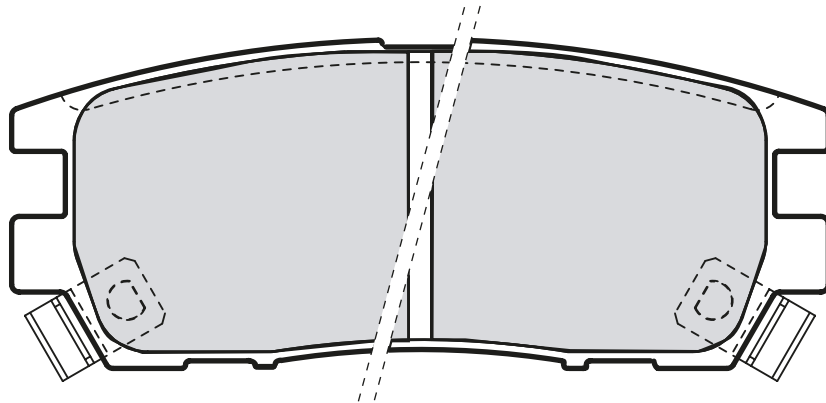





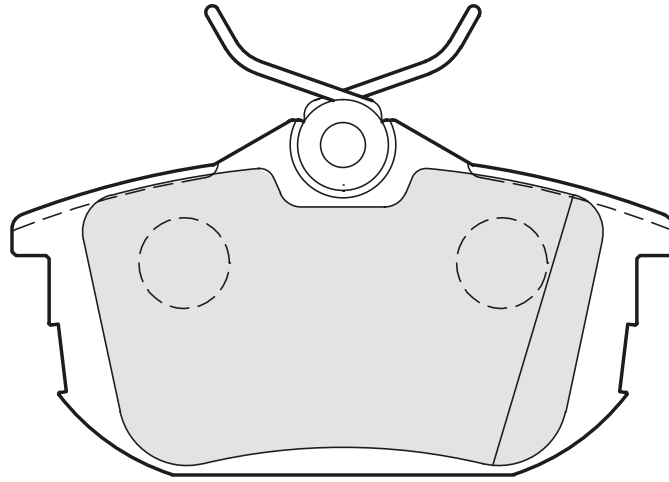



## 21840 (WVA)



<b>301519</b>	2x	108	43,5	14	AKE				<b>mitsubishi</b>

## 21861 (WVA)



									
									
301319		87,3	47	15,3		LUC			<b>mitsubishi, smart MCC, volvo</b>

## 21865 (WVA)

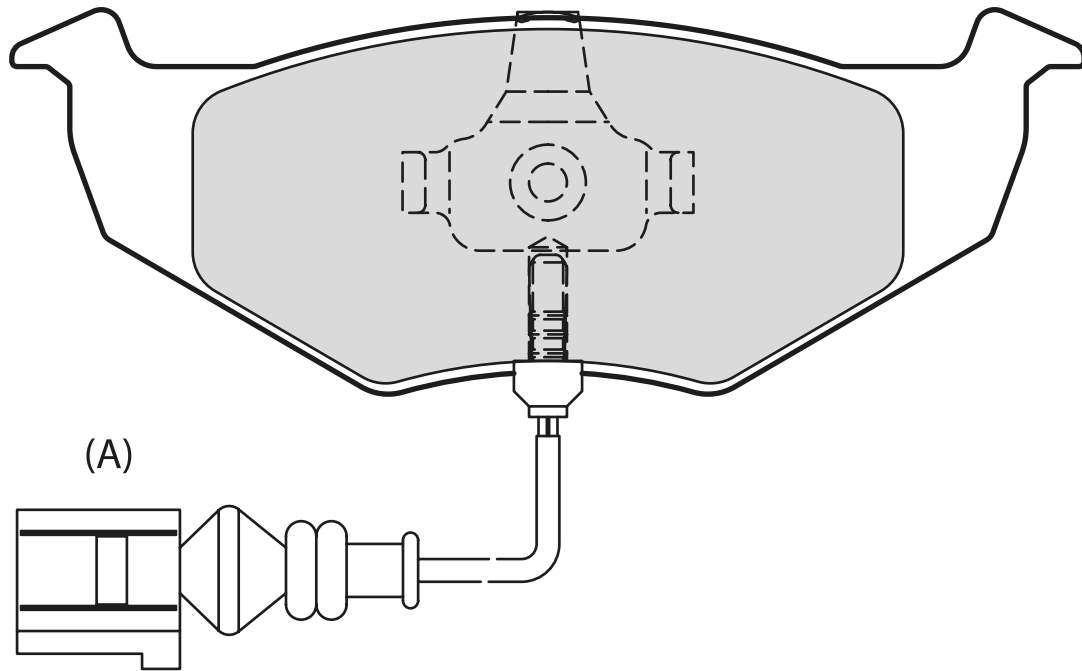

Valeo								
301488		141,8	51,2 50,6	17,3	ATE			SEAT, SKODA, VOLKSWAGEN
301805	(A)  180 mm	141,8	50,6	17	ATE			SKODA, VOLKSWAGEN





## 21866 (WVA)

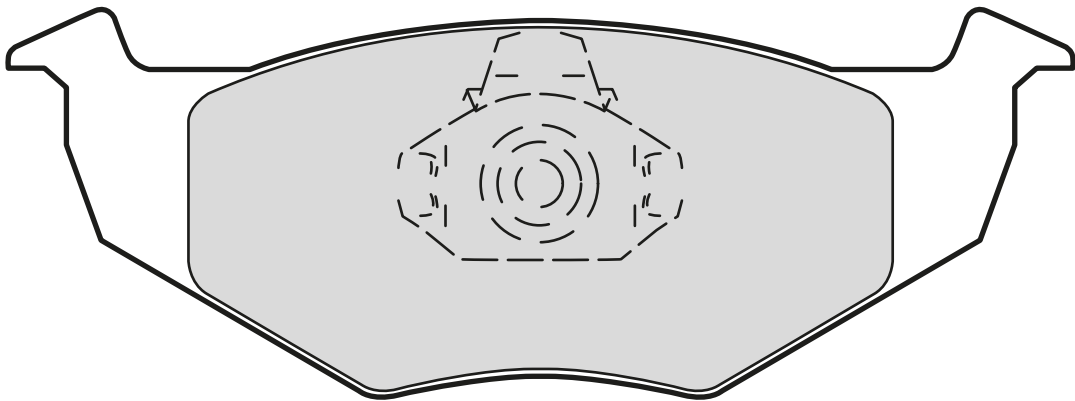
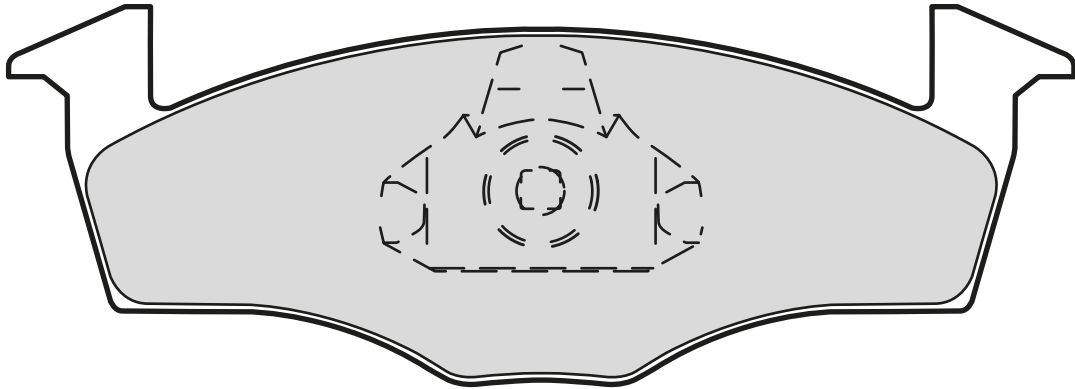

Valeo								
301066		141,8	50,5	19,7		ATE		SEAT, VOLKSWAGEN
301403		141,8	50,5 51,2	15		ATE		SEAT, VOLKSWAGEN

## 21875 (WVA)

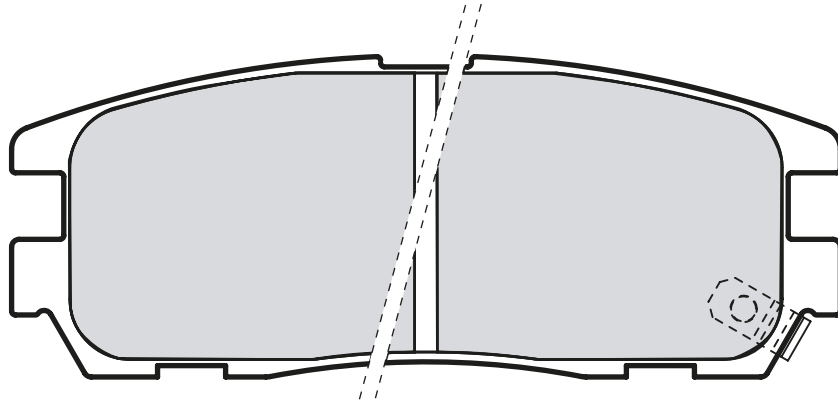

<b>Valeo</b> 									
<b>301507</b>	2x	109,6	42,5	15,8	SUM				<b>ISUZU, OPEL, VAUXHALL</b>

## 21883 (WVA)

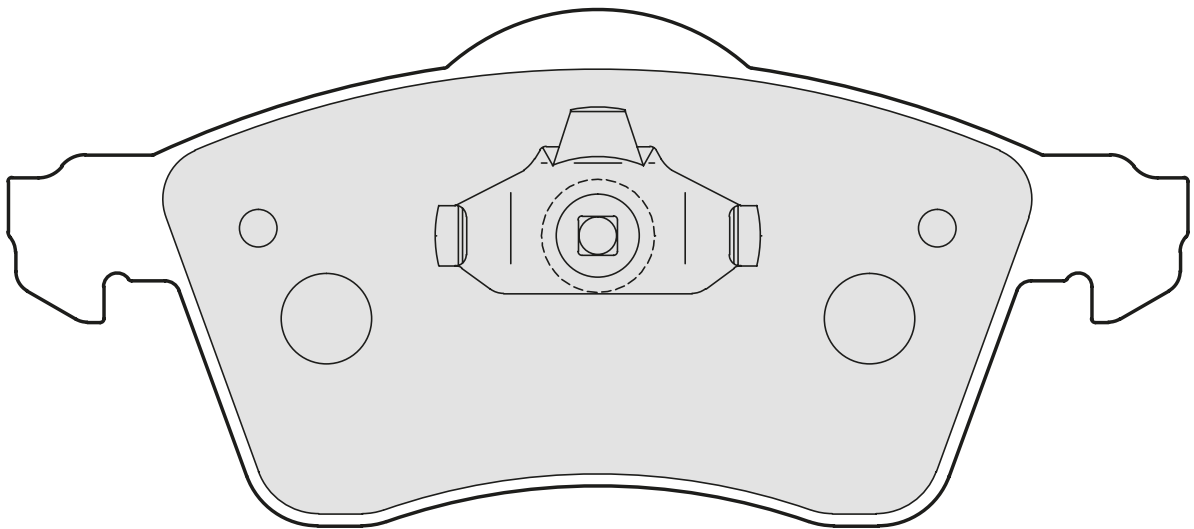







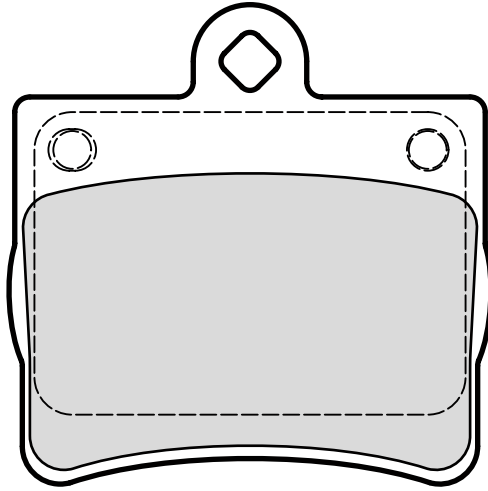

<b>Valeo</b> 									
<b>301675</b>		156,4	68,5	19,5	ATE				<b>VOLKSWAGEN</b>











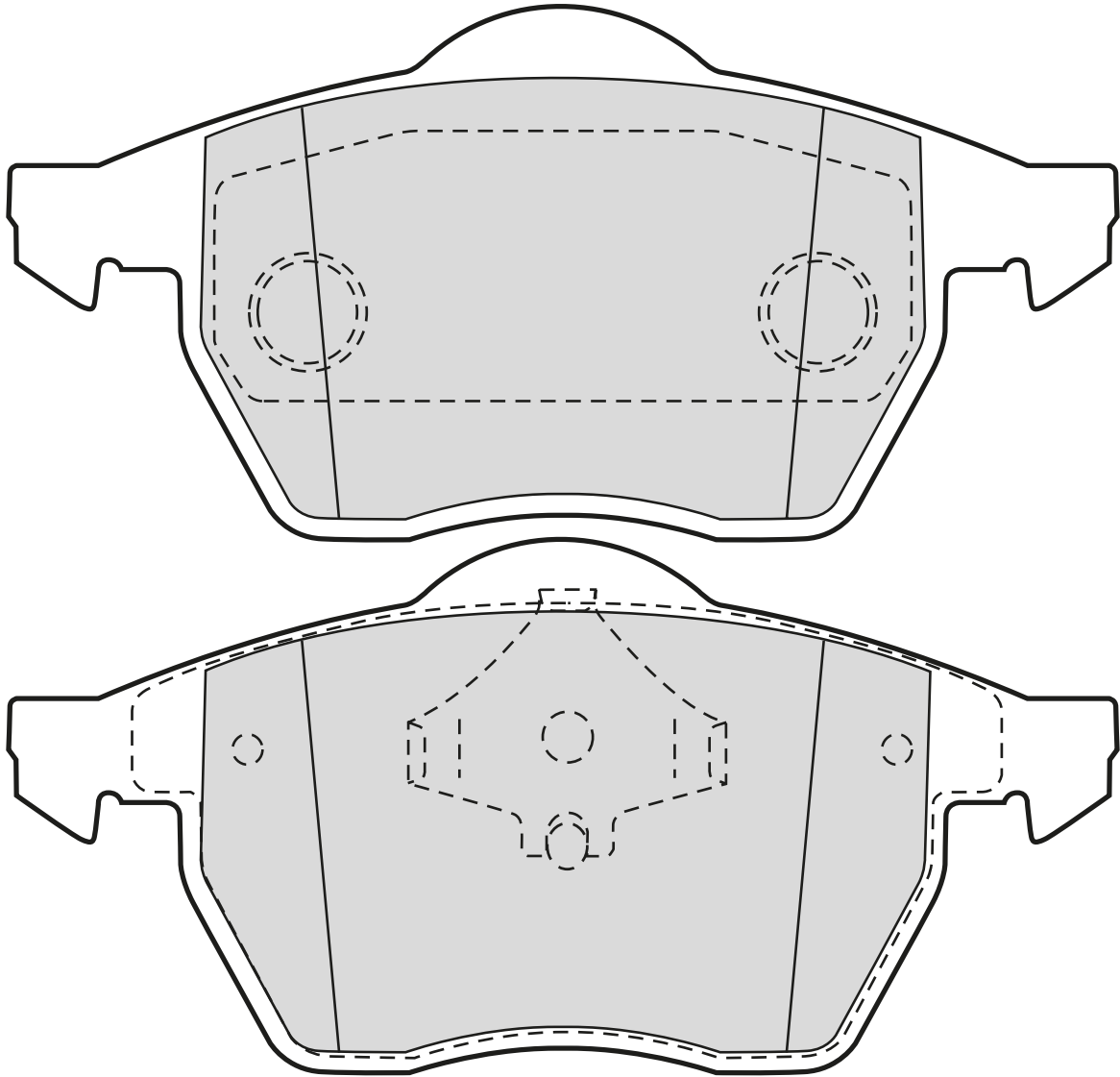







## 21900 (WVA)



  								
								
<b>301763</b>	63,7	63,4	15,5		ATE			

## 21911 (WVA)



Valeo	 							 
								
301355		156,3	74	19,8		ATE		AUDI, VOLKSWAGEN
301486	 1 x  155 mm	156,35	74,1	19,5		ATE		AUDI, SEAT, SKODA, VOLKSWAGEN

## 21919 (WVA)

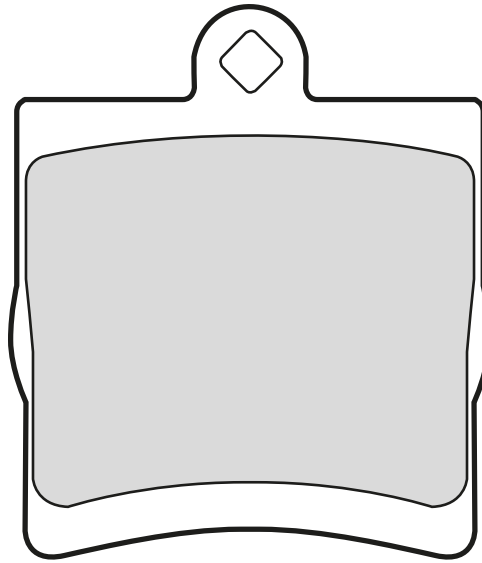

301444		63,7	73	15,3		ATE		CHRYSLER, MERCEDES

## 21920 (WVA)

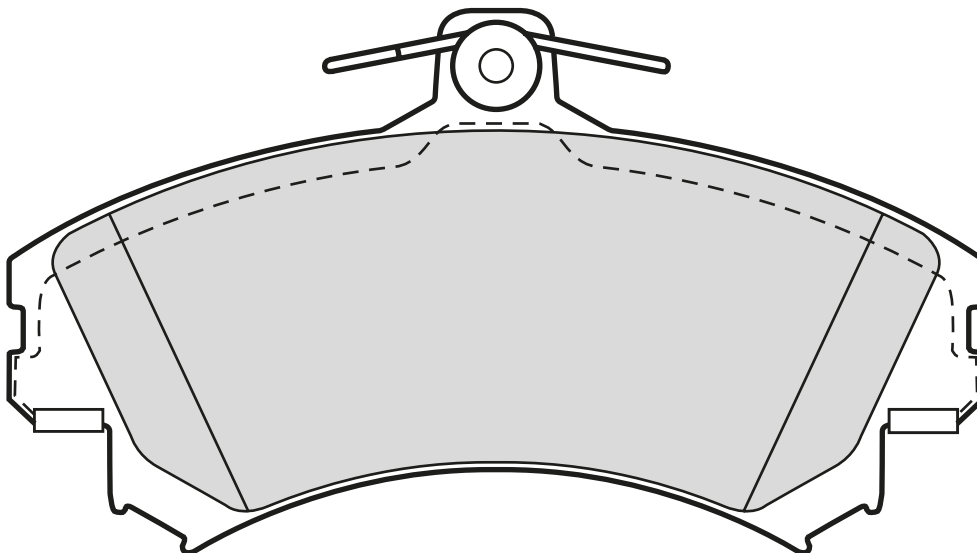

301318		130	72,57	15,1		LUC		<b>MITSUBISHI, SMART MCC, VOLVO</b>

## 21927 (WVA)

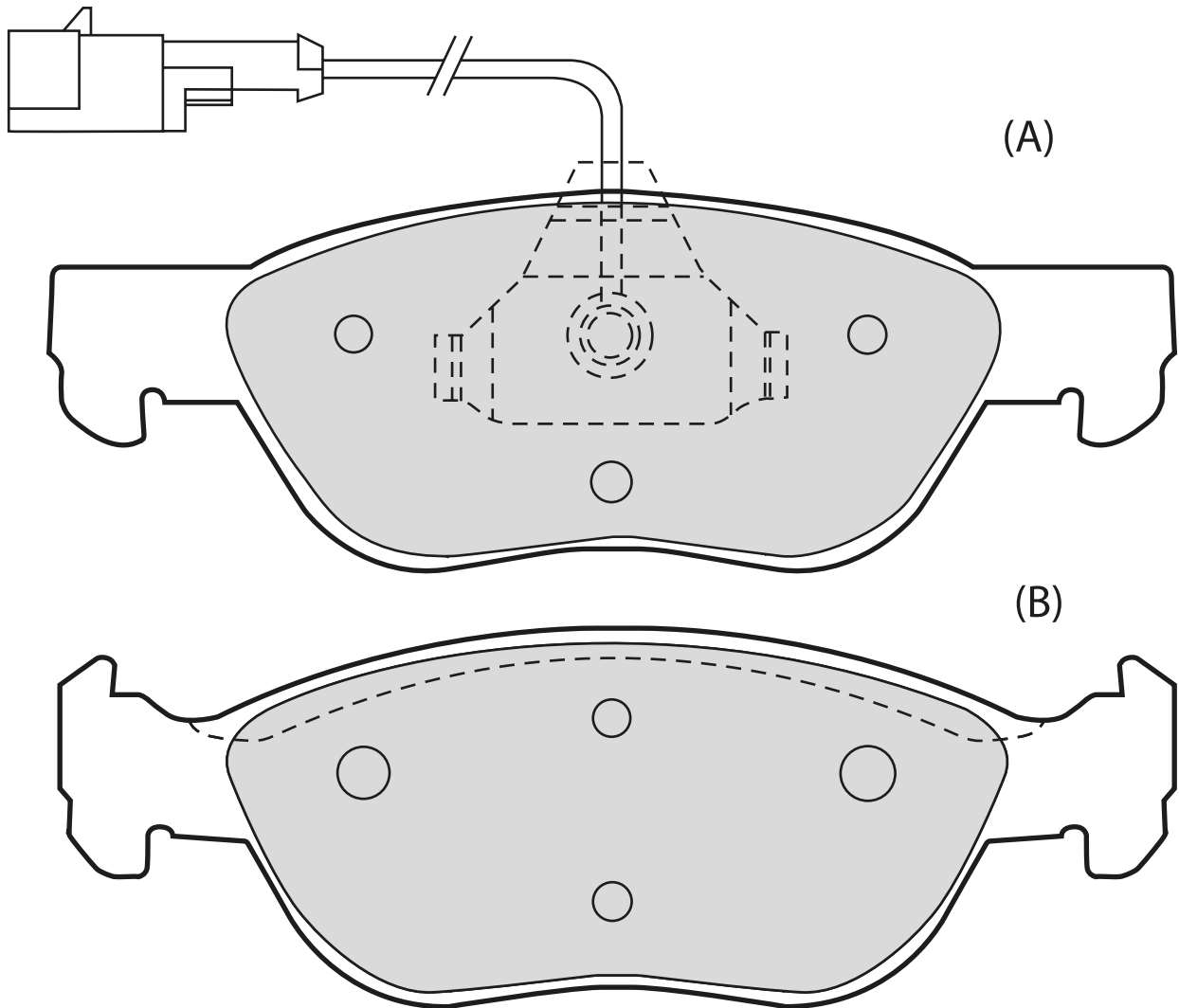

<b>301006</b>	<b>(A+B)</b>	2 x  200 mm	156,5	52,5	17,6	ATE		<b>FIAT, LANCIA</b>

## 21930 (WVA)

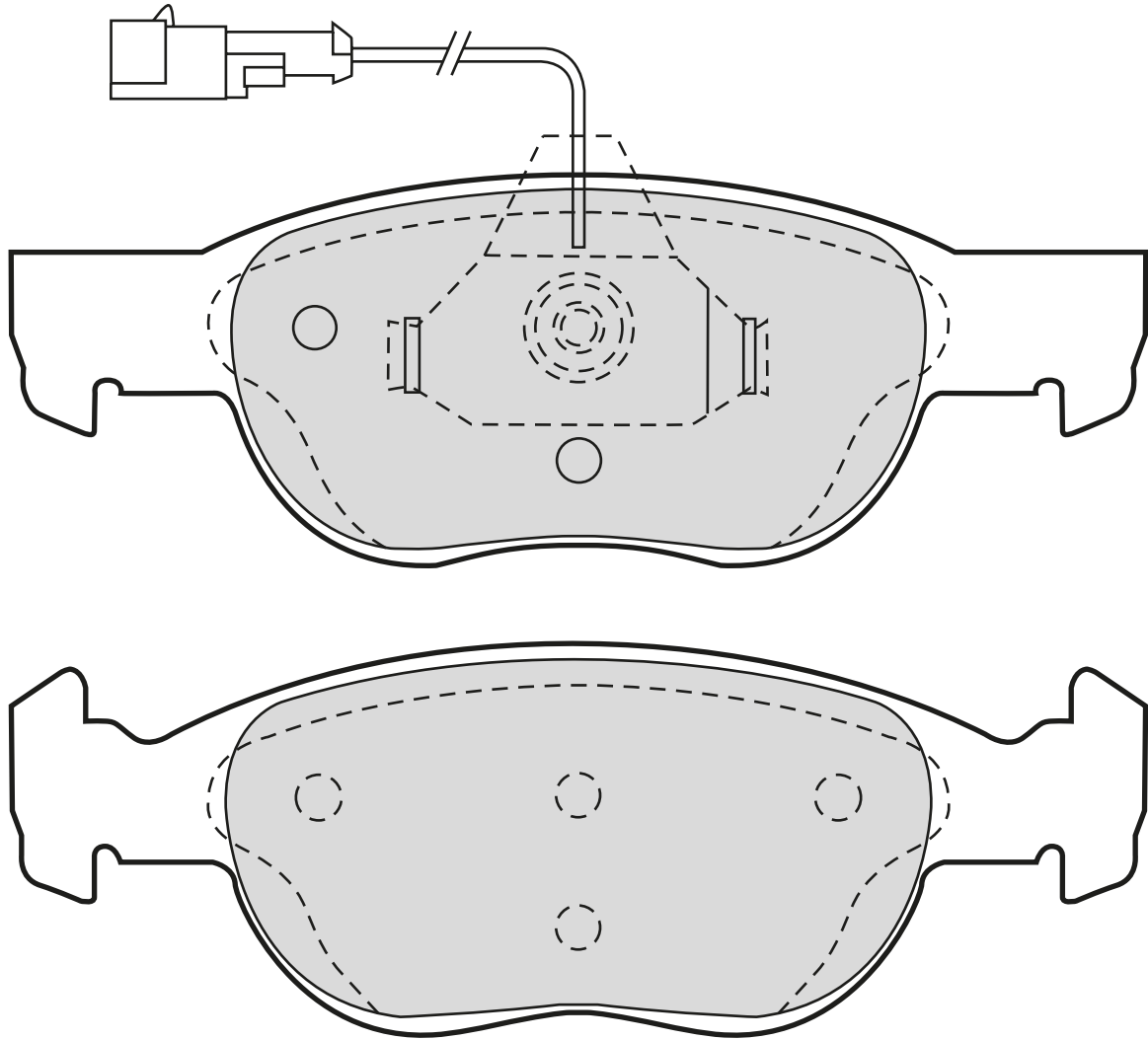

<b>301040</b>	1 x  200 mm	151,5	52,5	17,4	ATE		<b>ALFA ROMEO, FIAT, LANCIA</b>	

## 21934 (WVA)

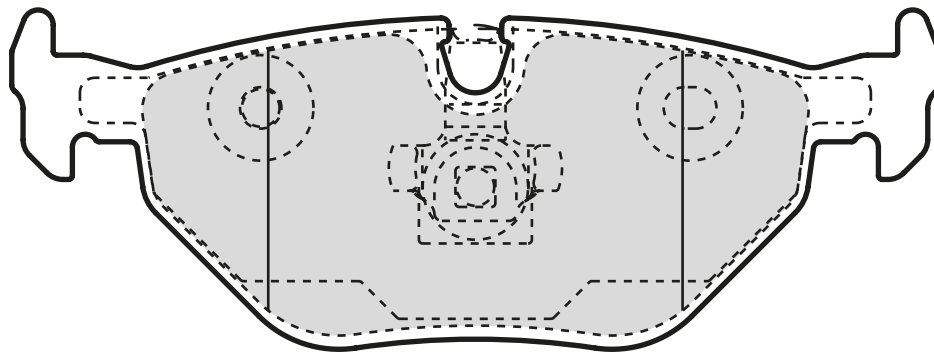
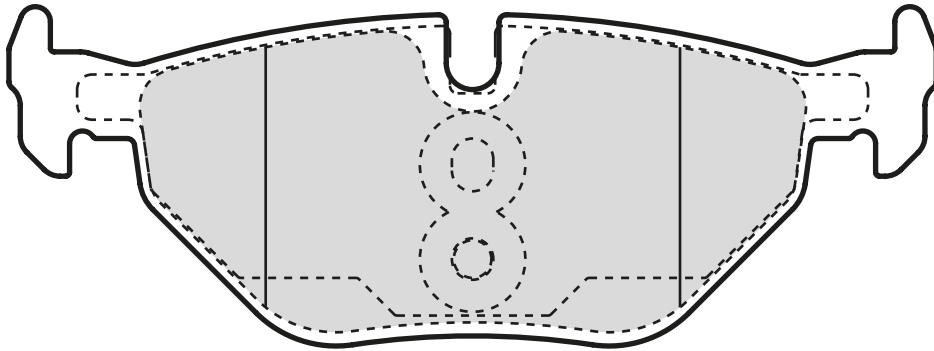

<b>301753</b>		123	45	17		ATE			<b>BMW, MG, ROVER, SAAB</b>





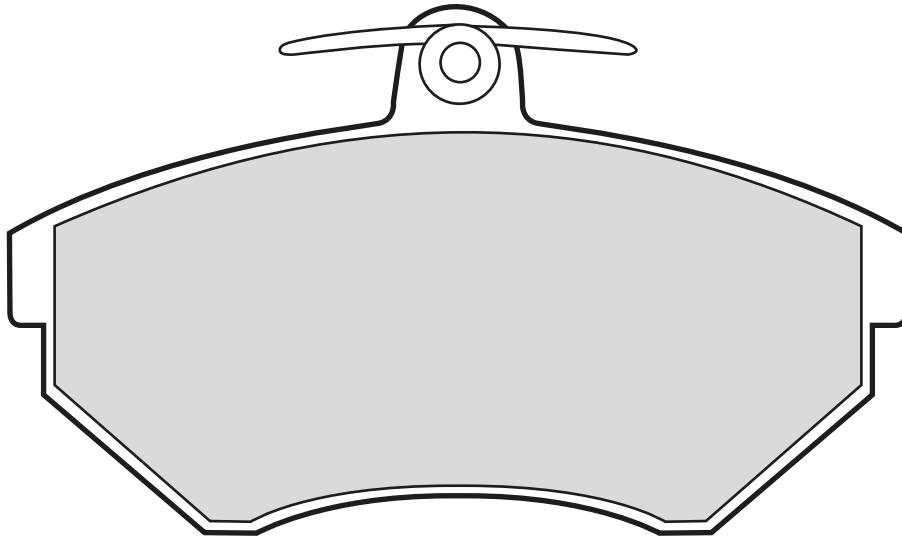





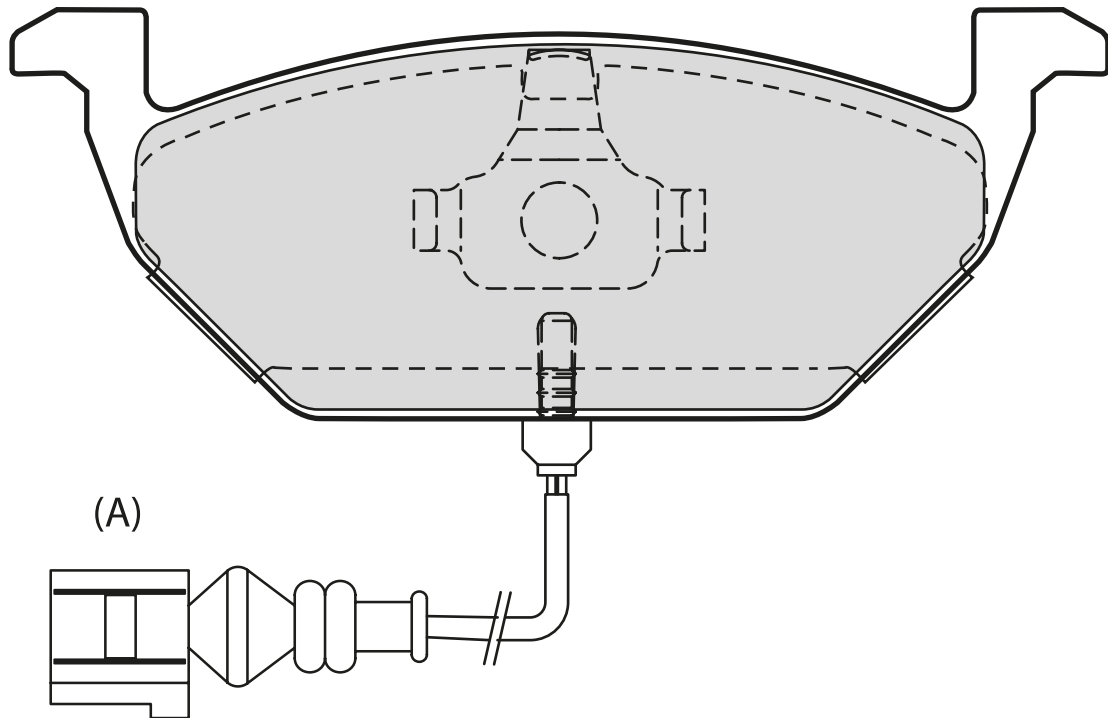











## 21945 (WVA)



301330			119	69,5	16,3		LUC		
								SEAT, VOLKSWAGEN	SEAT, VOLKSWAGEN
								SEAT, VOLKSWAGEN	SEAT, VOLKSWAGEN

## 21974 (WVA)









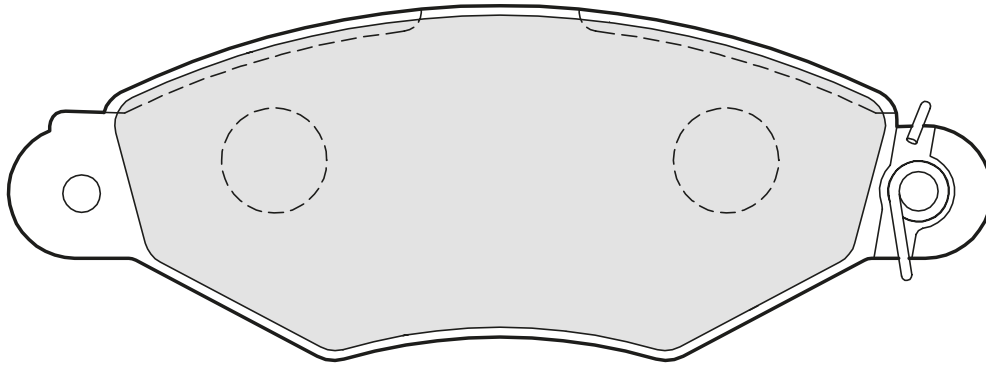

Valeo	 								
									
301332		146	54,7	19,8		ATE			AUDI, SEAT, SKODA, VOLKSWAGEN
301408	(A)  1 x  155 mm	146	54,7	18,5		ATE	 	 	AUDI, SEAT, SKODA, VOLKSWAGEN VOLKSWAGEN











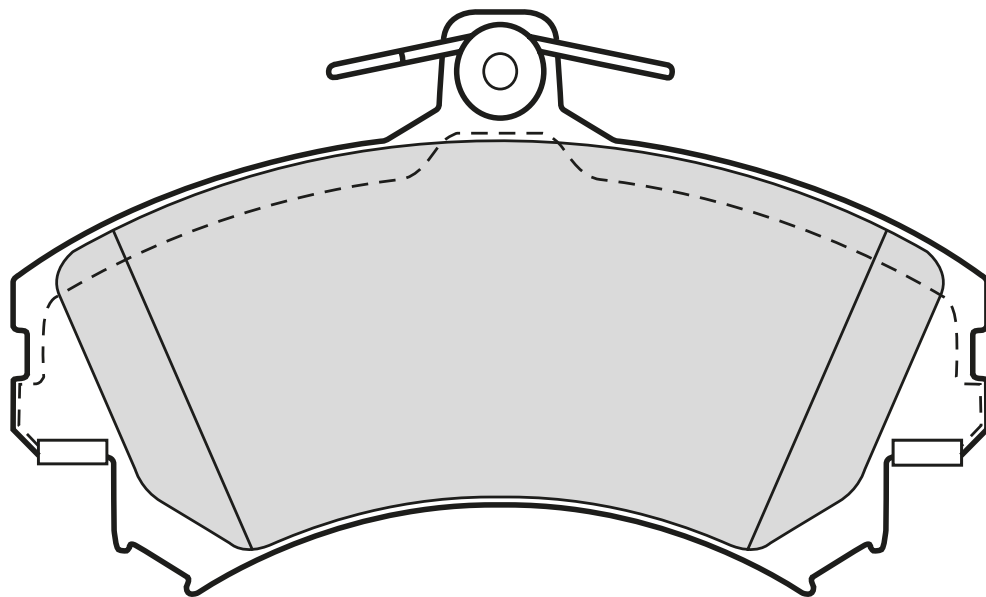



## 21980 (WVA)



<b>Valeo</b>  							 
							
301726	131	47,3	18		BSC		

## 21983 (WVA)



<b>Valeo</b>  							 
							
301493	130	77	17		LUC		

## 23021 (WVA)

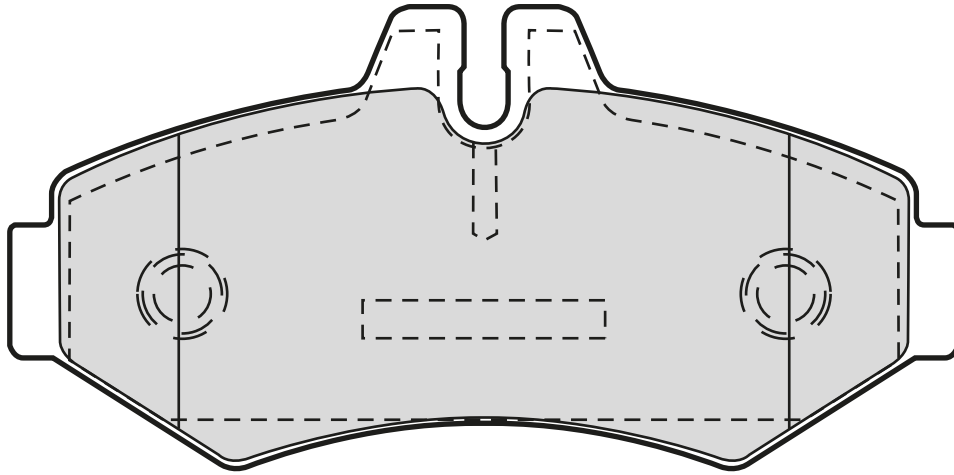

301300		125,7	61,8	18,4	BSC				<b>MERCEDES</b> <b>MERCEDES, VOLKSWAGEN</b>

## 23023 (WVA)

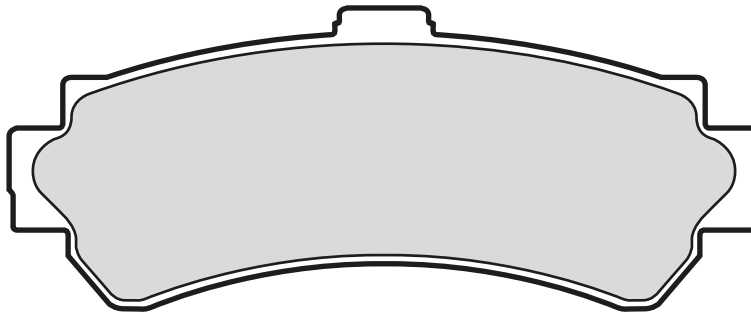

301449	↳ 2 x	99,5	40	15	AKE				<b>NISSAN</b>

## 23062 (WVA)

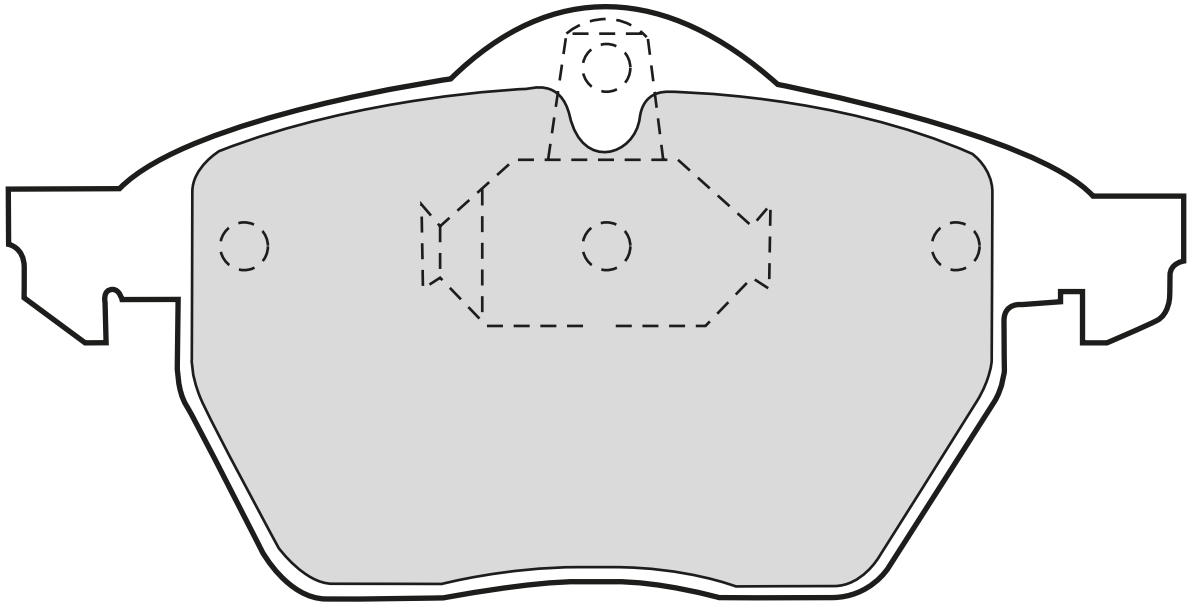

<b>301454</b>	2 x	156,4 155,4	78,5 71,5	20	ATE			<b>OPEL, VAUXHALL</b>	

## 23063 (WVA)

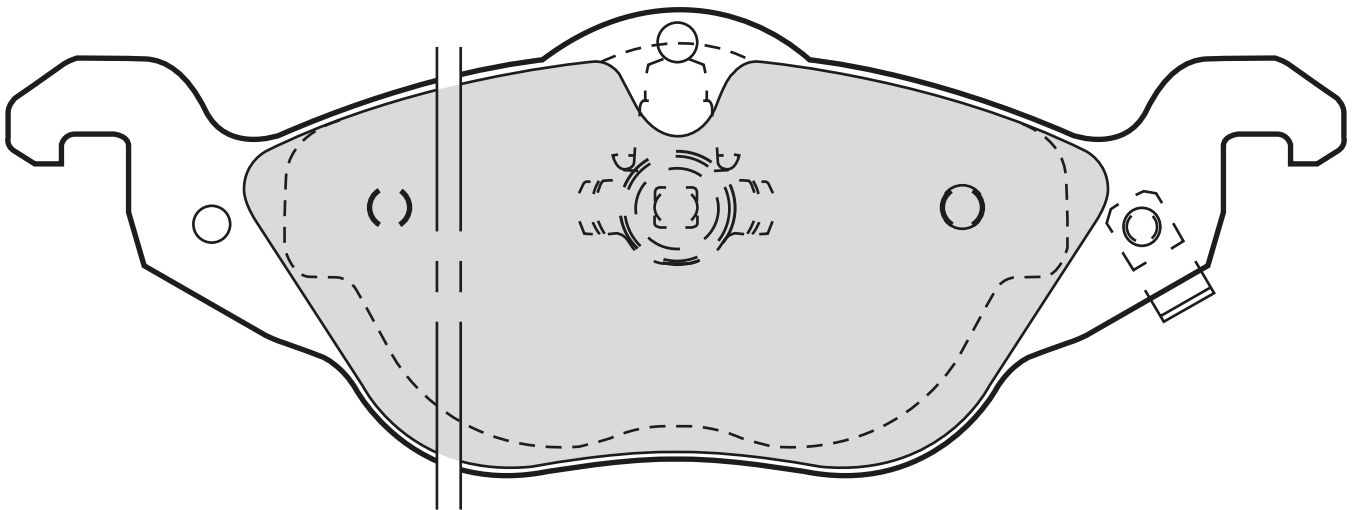
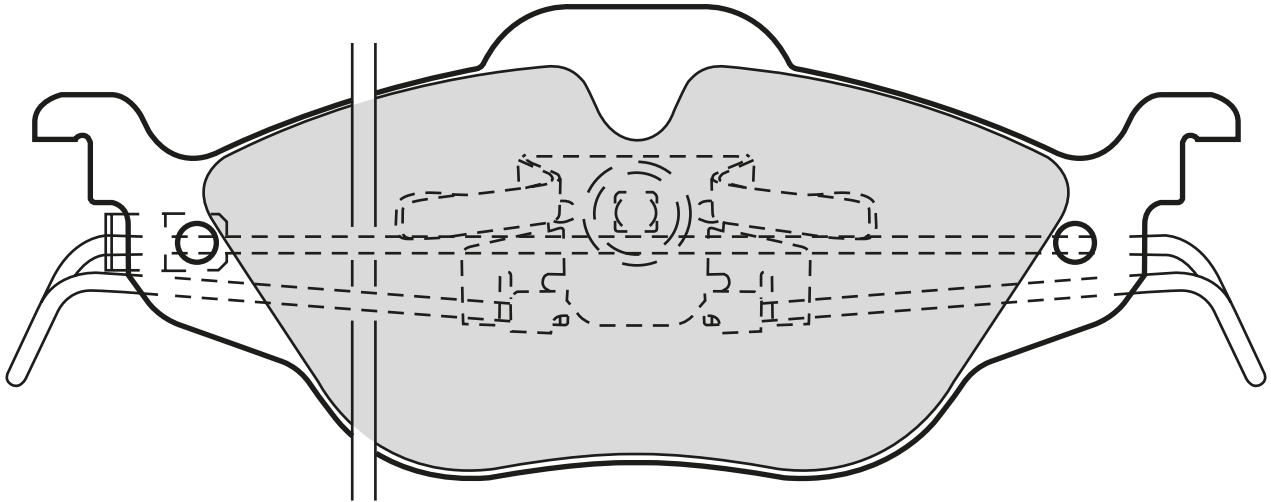

<b>301322</b>	4x	160 177,6	63 62,1	18	ATE			<b>OPEL, VAUXHALL</b>

## 23070 (WVA)

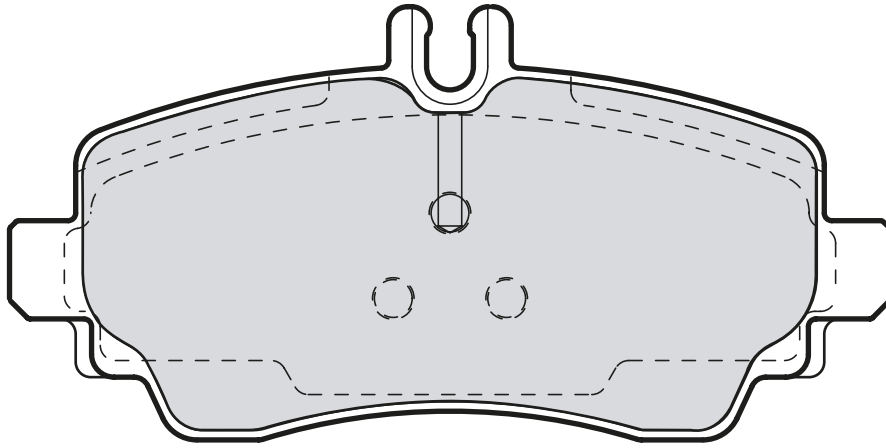

301549		116,5	57,3	17		LUC			MERCEDES

## 23072 (WVA)

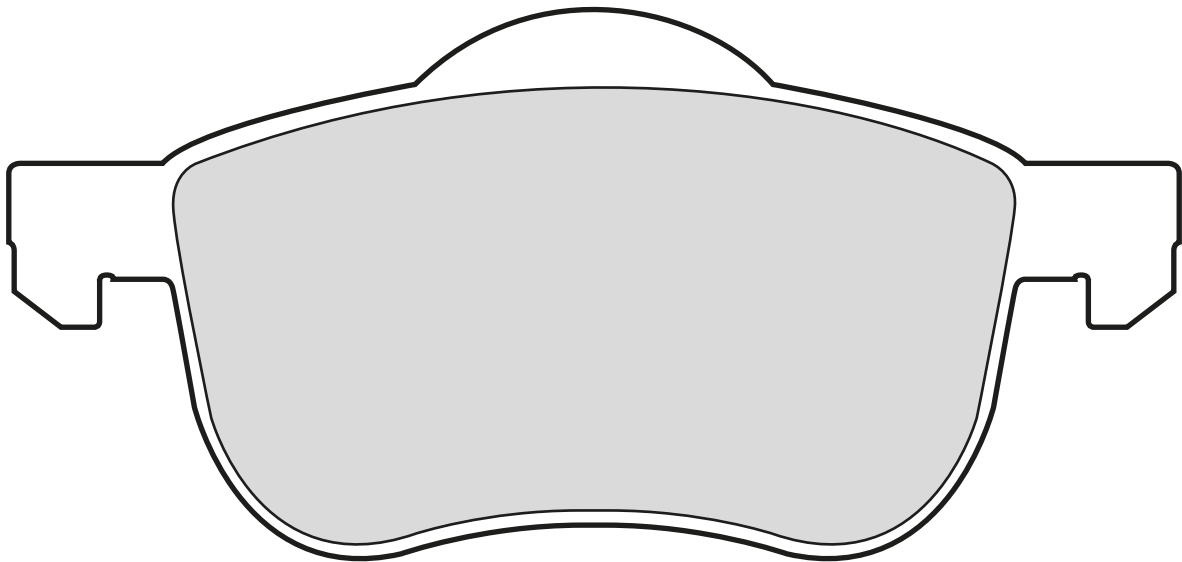

301479		155,4 156,4	72,5 69	18,5		ATE			VOLVO

## 23075 (WVA)

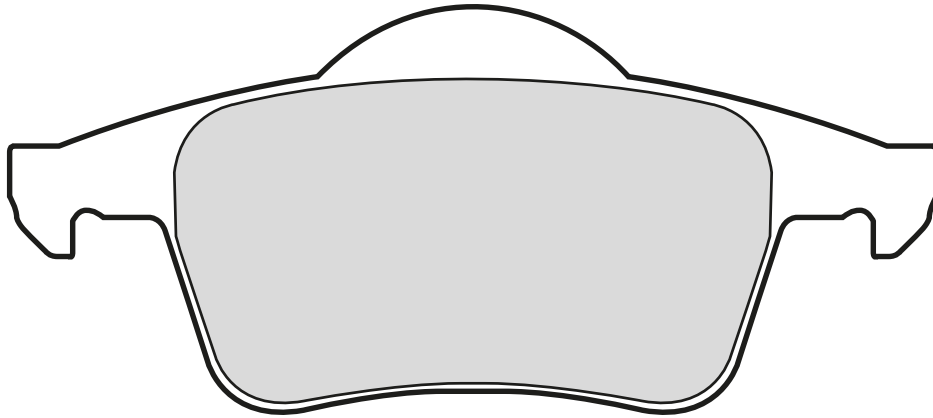

301480		122,6	53,8	17		ATE		VOLVO

## 23081 (WVA)

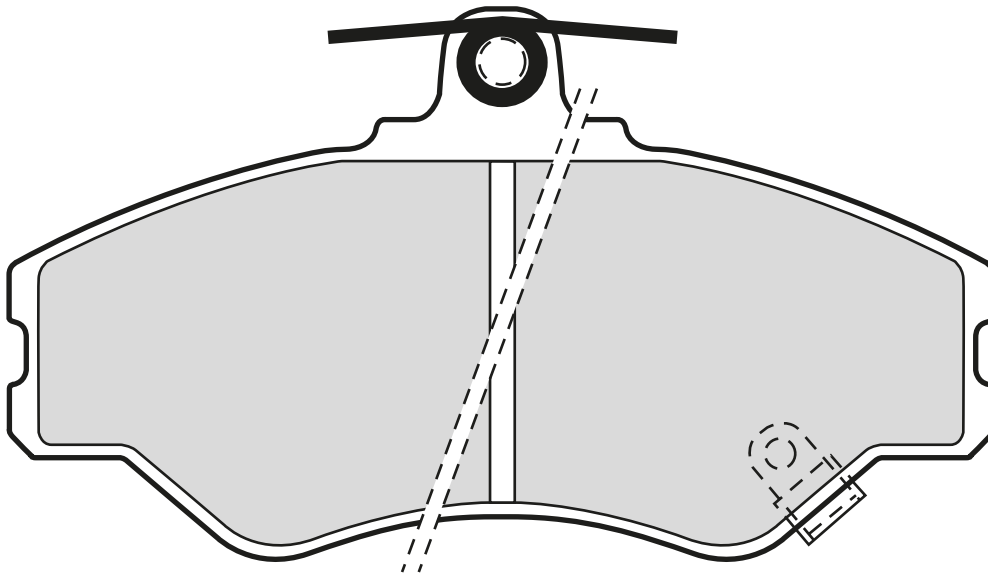

301634	↳ 2x	130	73	18,1		LUC		HYUNDAI





## 23093 (WVA)

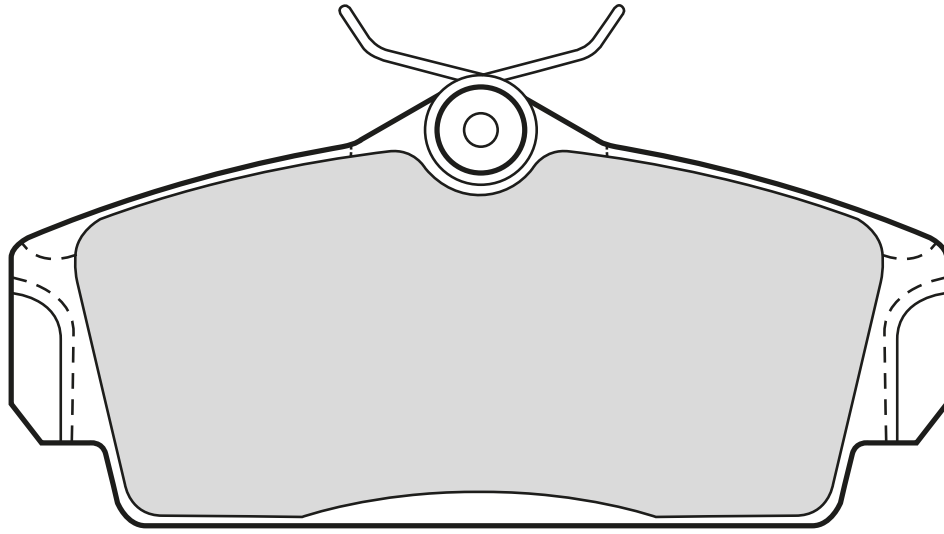

301450		124,2	57,3	16,6		LUC		<b>NISSAN</b>

## 23095 (WVA)

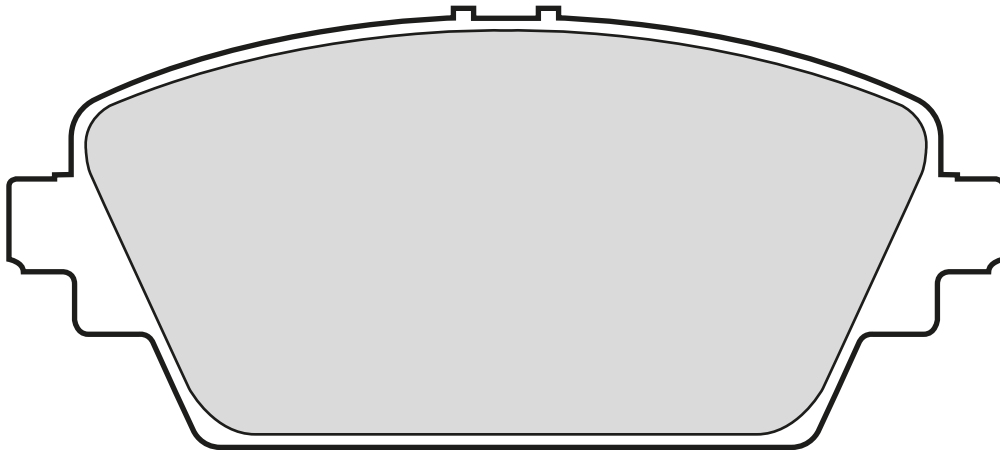

301436	↳ 2x	131,7	58,5	17,2		LUC		<b>HONDA, MG</b>

## 23099 (WVA)

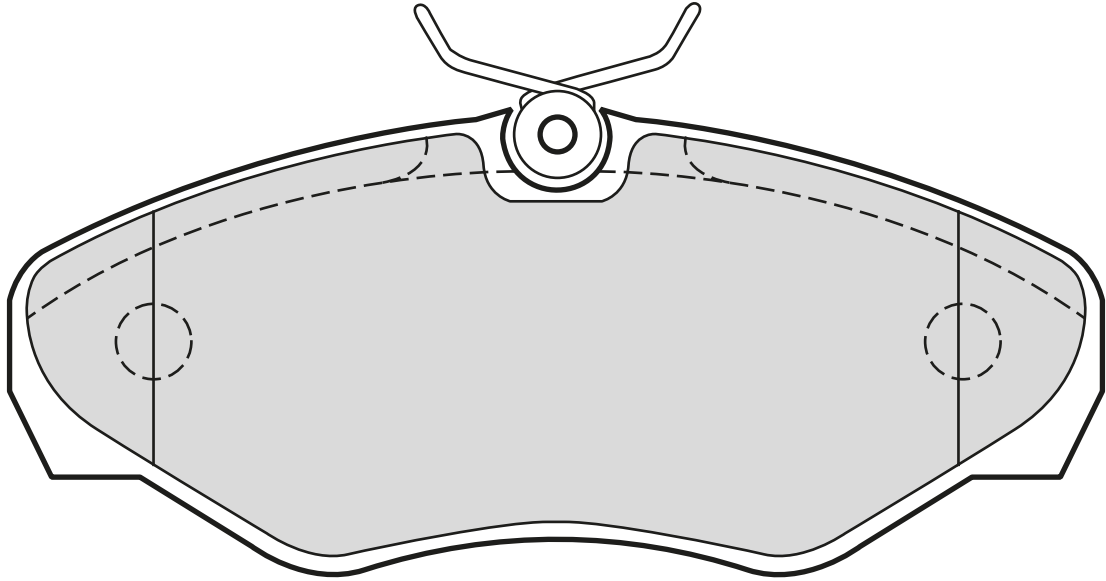

301545		145	62,5	18		LUC			<b>RENAULT</b> <b>NISSAN, OPEL, RENAULT, VAUXHALL</b>



## 23124 (WVA)

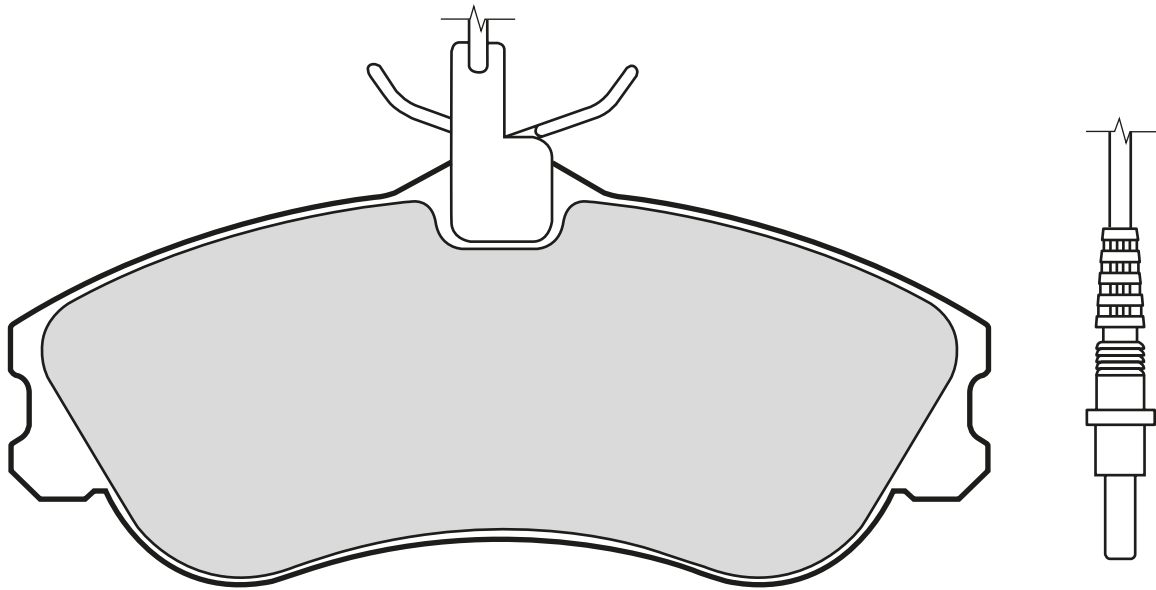

301326	↳ 4 x  275 mm/310 mm	130	56,2	18,5		LUC			<b>CITROËN, PEUGEOT</b> <b>CITROËN, PEUGEOT</b>

## 23138 (WVA)

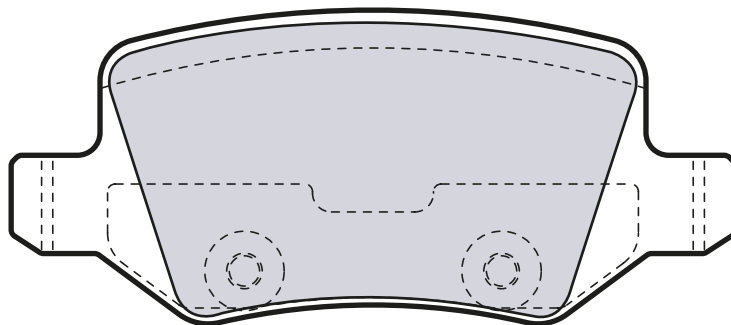

301583		95,8	41,5	14,3		LUC			<b>MERCEDES</b>

## 23144 (WVA)

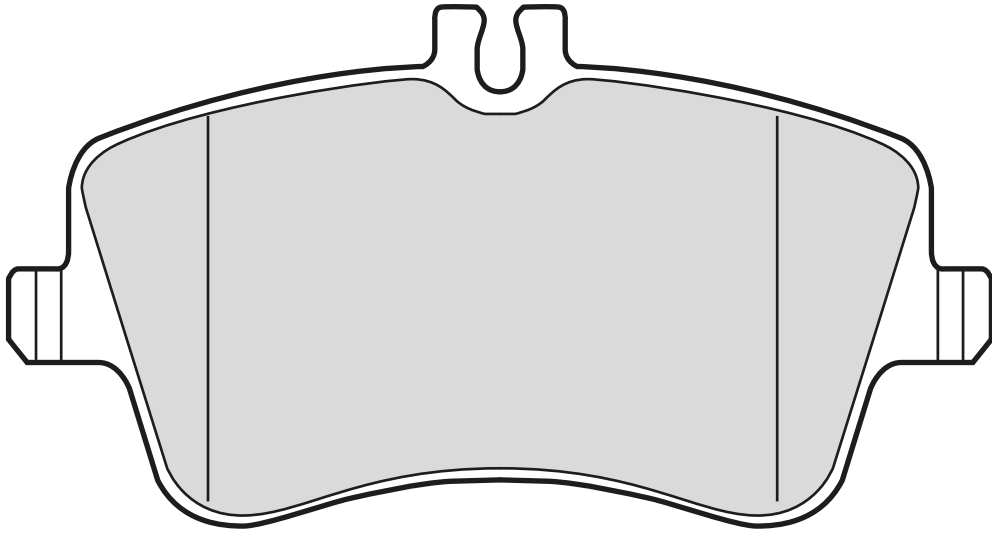

301448		131,1	69,8	19,5	LUC			<b>MERCEDES</b>	



## 23154 (WVA)

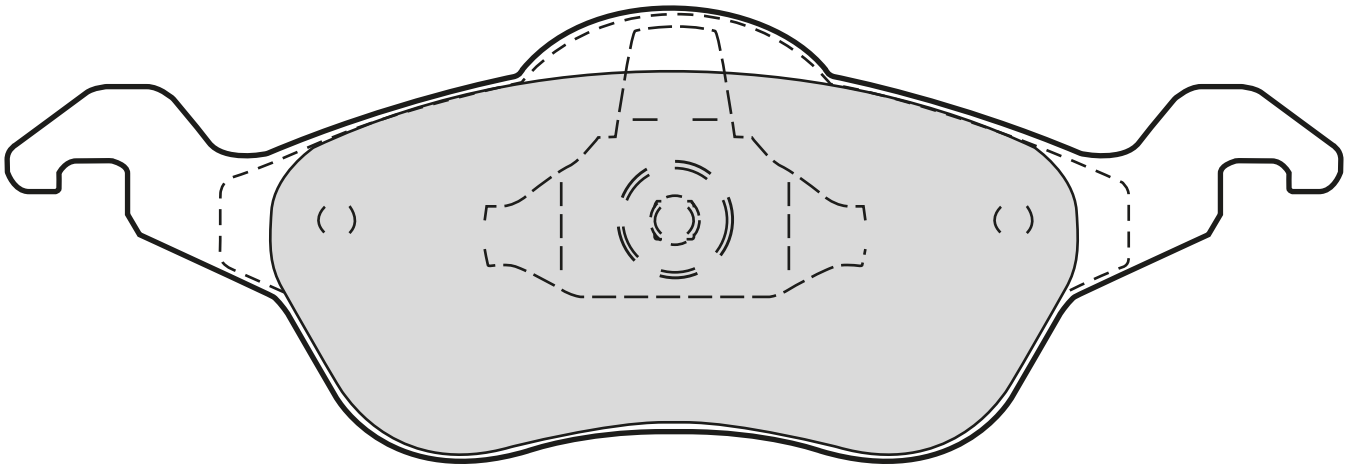
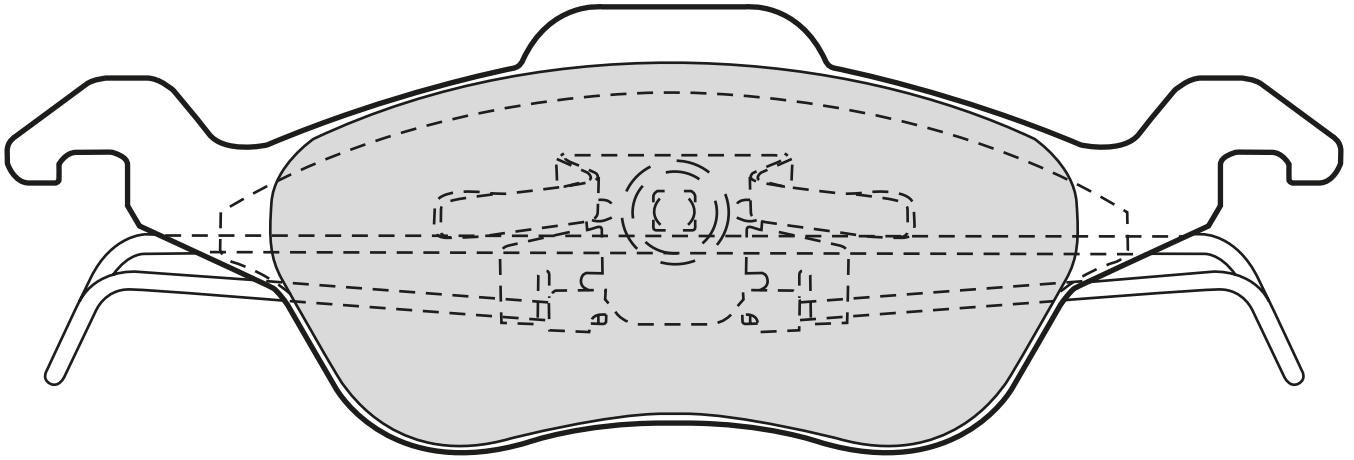

301317		177,6	58 60	18,8		ATE		FORD

## 23200 (WVA)

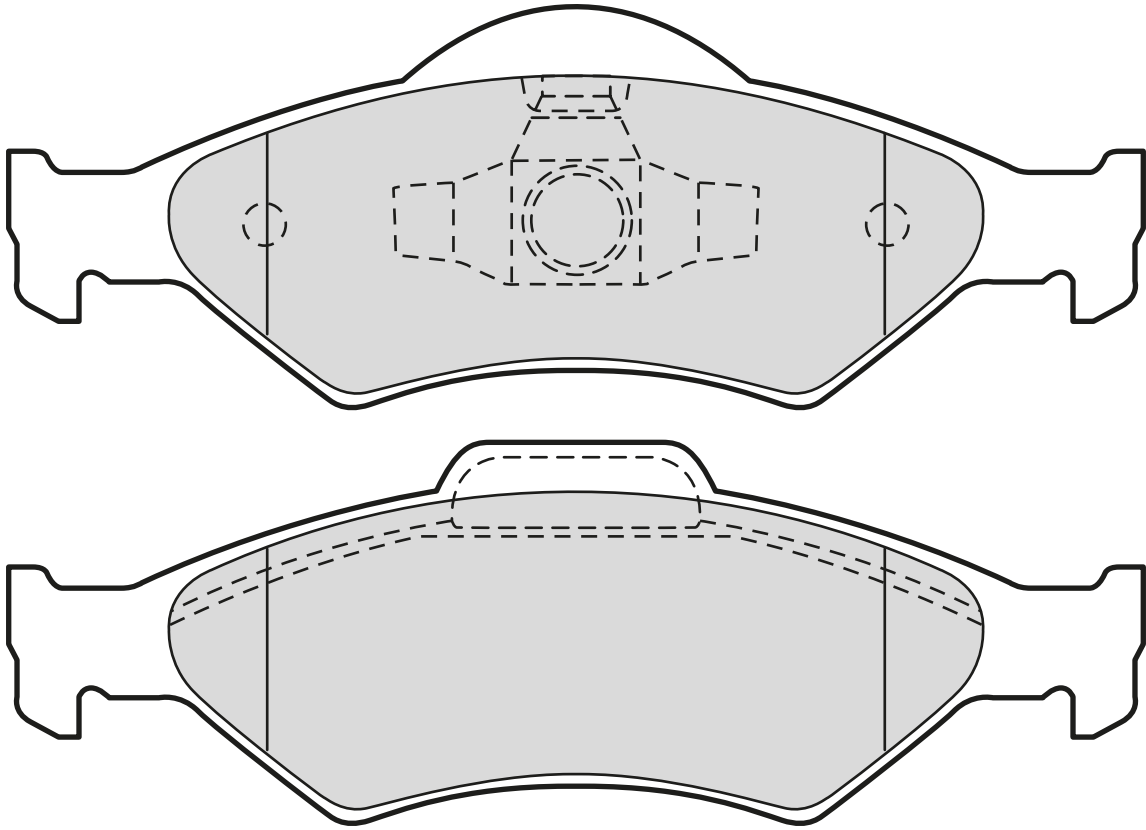

301563		150,2	54,1	18,6	ATE			FORD, MAZDA	FORD

## 23202 (WVA)

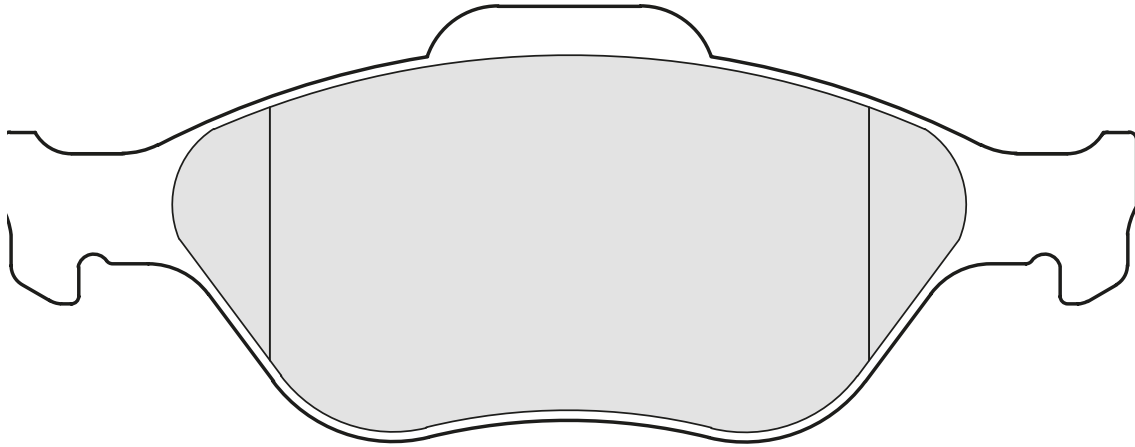
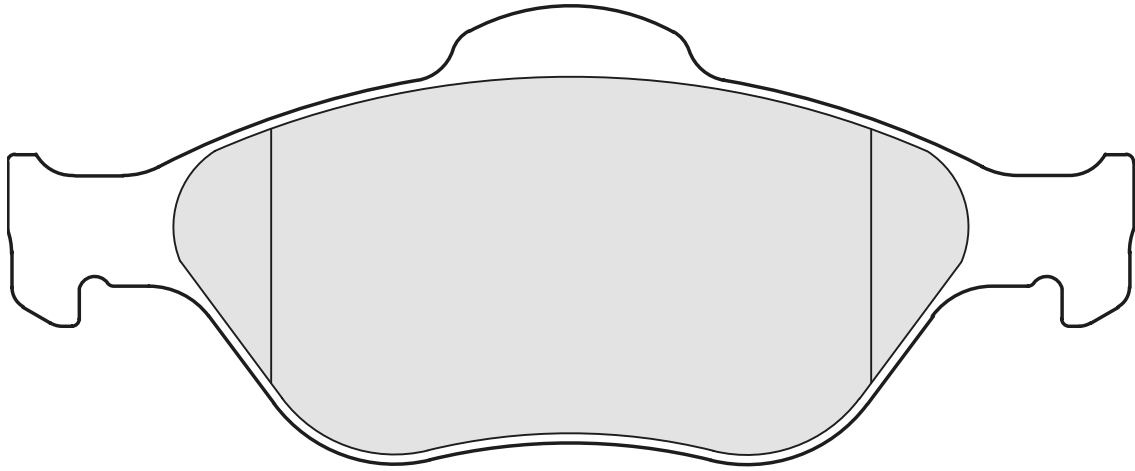

301564		150,4 151,4	58 61,5	18,5		ATE		FORD, MAZDA

## 23225 (WVA)

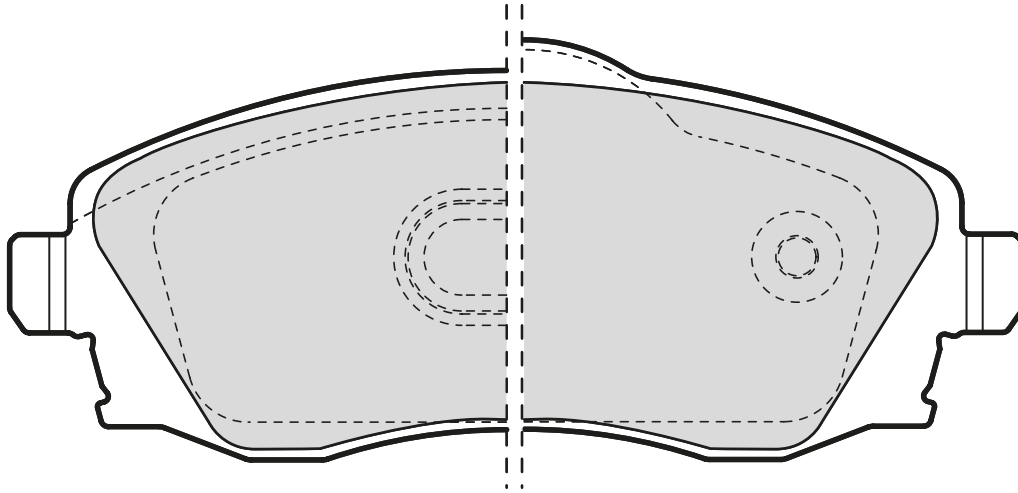

<b>Valeo</b> 									
301456		131,6	52,8 55,5	16,8	LUC				<b>OPEL, VAUXHALL</b>  <b>OPEL, VAUXHALL</b>

## 23235 (WVA)

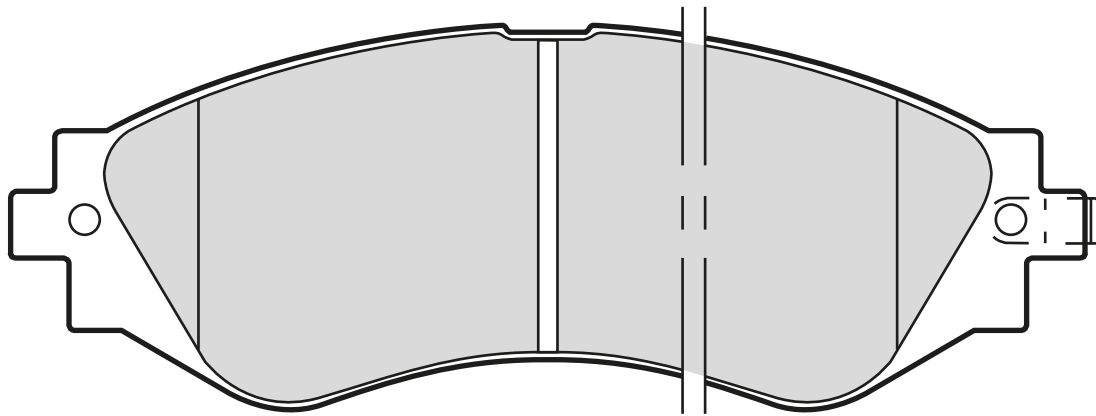

<b>Valeo</b> 									
301361	↳ 2 x	143	51,4	18	AKE				<b>CHEVROLET, DAEWOO</b>



## 23237 (WVA)

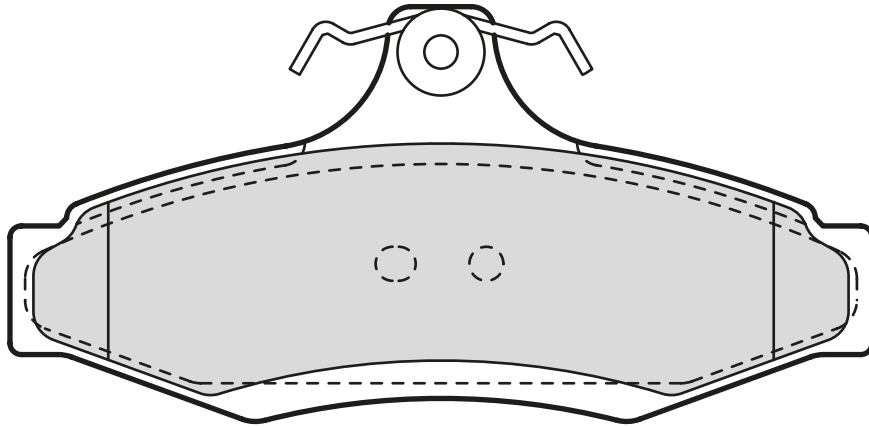

301902		114	54,9	14,5		LUC		 <b>DAEWOO</b>

## 23238 (WVA)

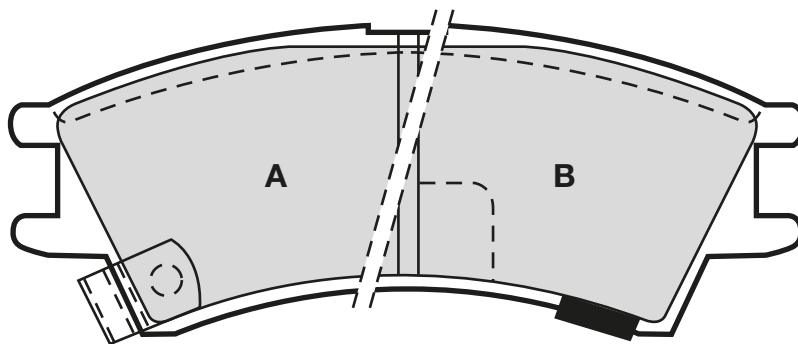

301575	↳ 2x	104,7	41,3	16		AKE		 <b>HYUNDAI</b>

## 23241 (WVA)

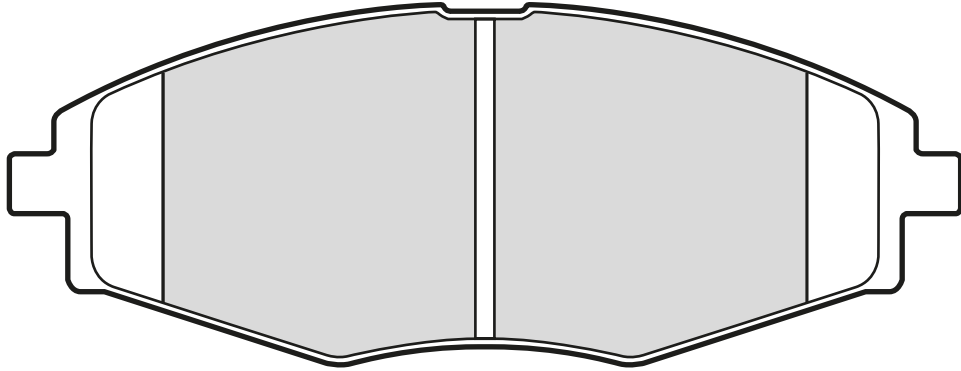

<b>Valeo</b> 									
301316		127	48,5	16,7		AKE			CHEVROLET, DAEWOO

## 23250 (WVA)

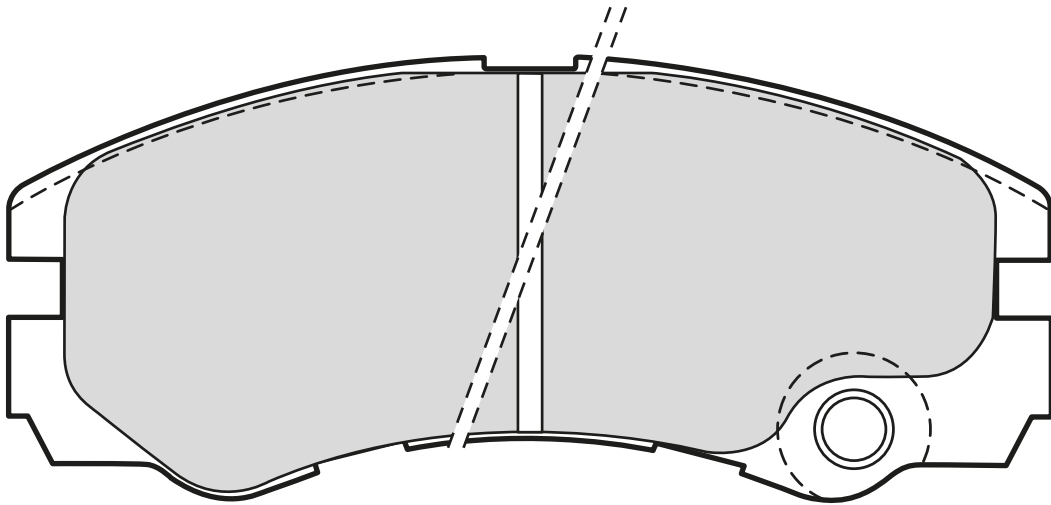

<b>Valeo</b> 									
301661	↳ 2 x	137,8	57,8	18,5		AKE			OPEL, VAUXHALL



## 23258 (WVA)

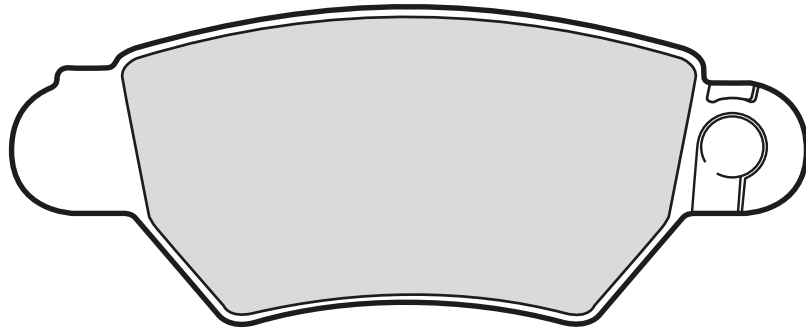

301926	↳ 2 x	104,8	42,7	17	BSC		<b>OPEL, VAUXHALL</b>



**23269** (WVA)

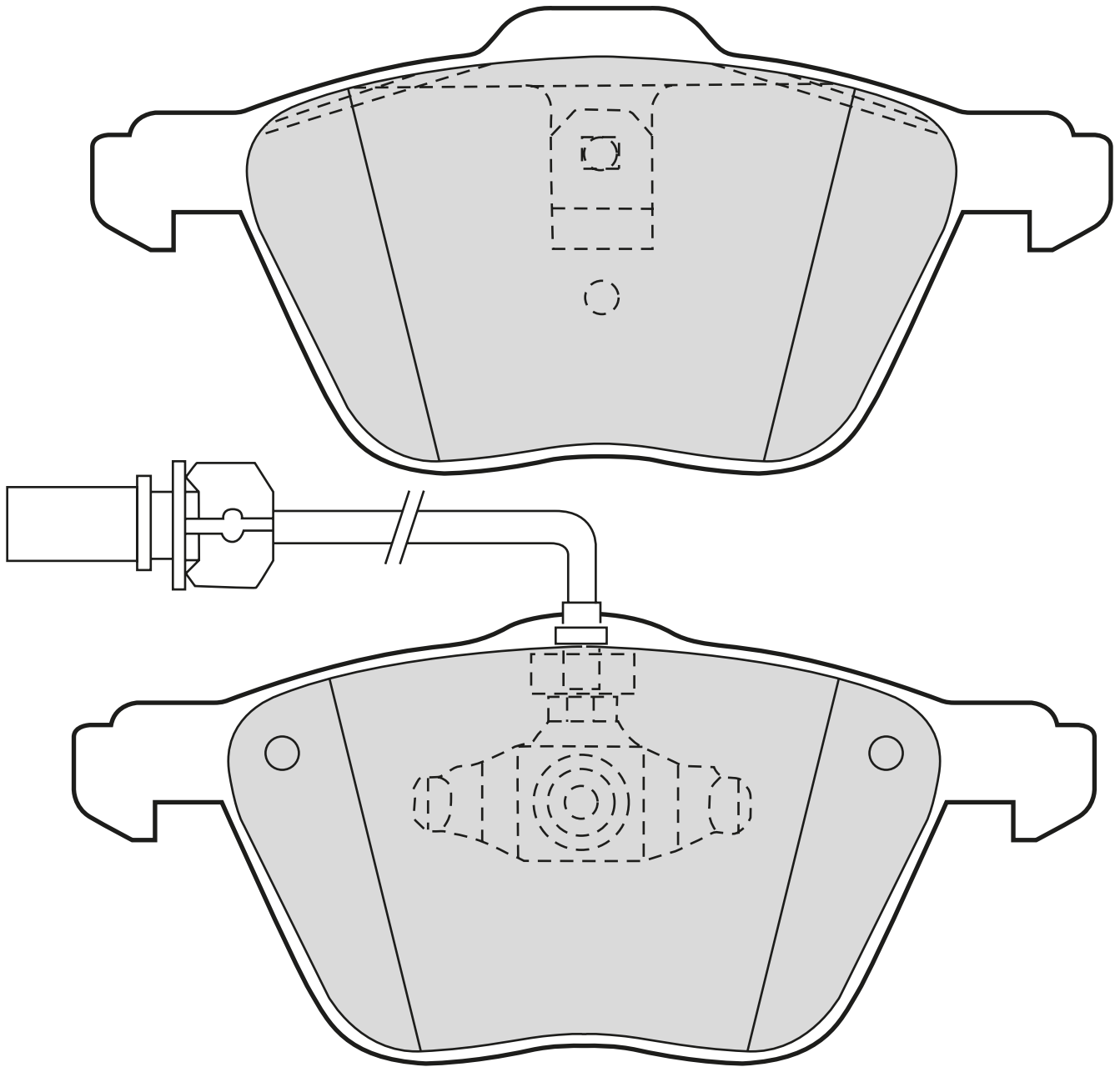

<b>Valeo</b>									
<b>301565</b>	↳ 2 x  270 mm	161,4	72,8 74,5	19,6	ATE			<b>FORD, SEAT, VOLKSWAGEN</b> <b>VOLKSWAGEN</b>	

## 23271 (WVA)

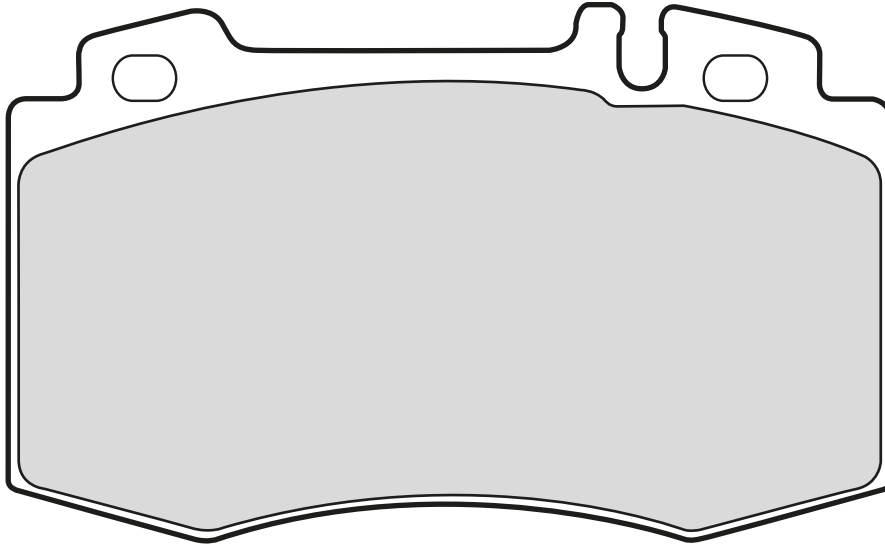

301445		119,6	71,5	17,7		BRE			MERCEDES

## 23279 (WVA)

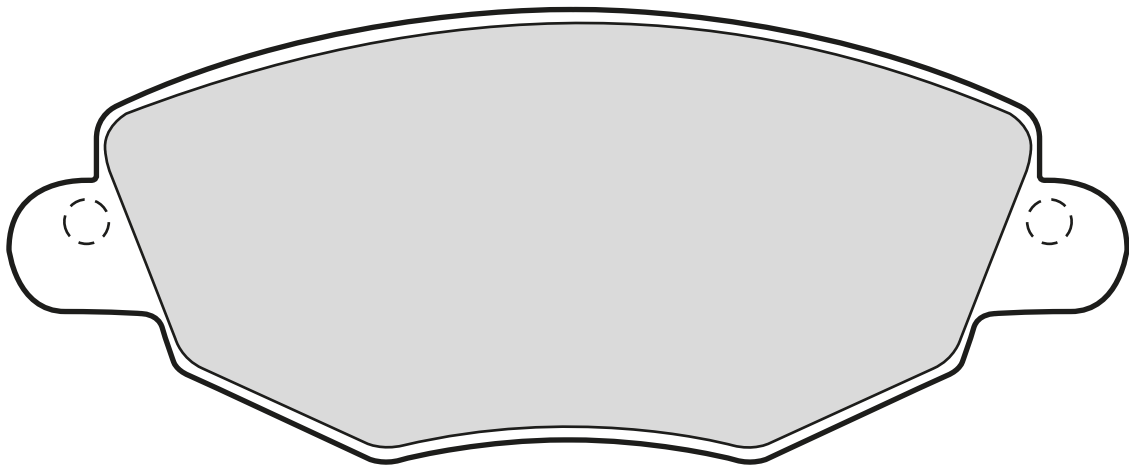

301433		149	60,5	18		BSC			FORD, JAGUAR

## 23284 (WVA)

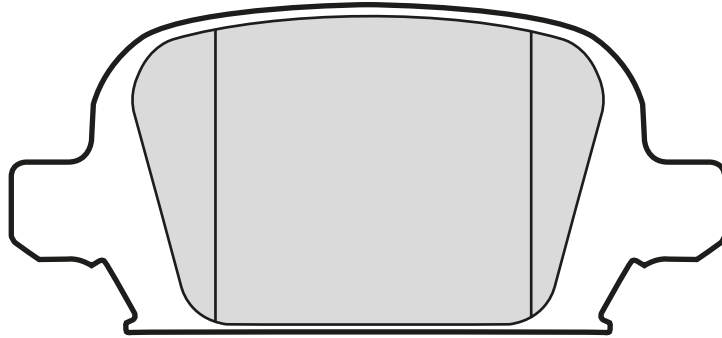

<b>301457</b>	2 x	95,5	43,9	13,8	LUC		<b>OPEL, VAUXHALL</b>		



## 23290 (WVA)

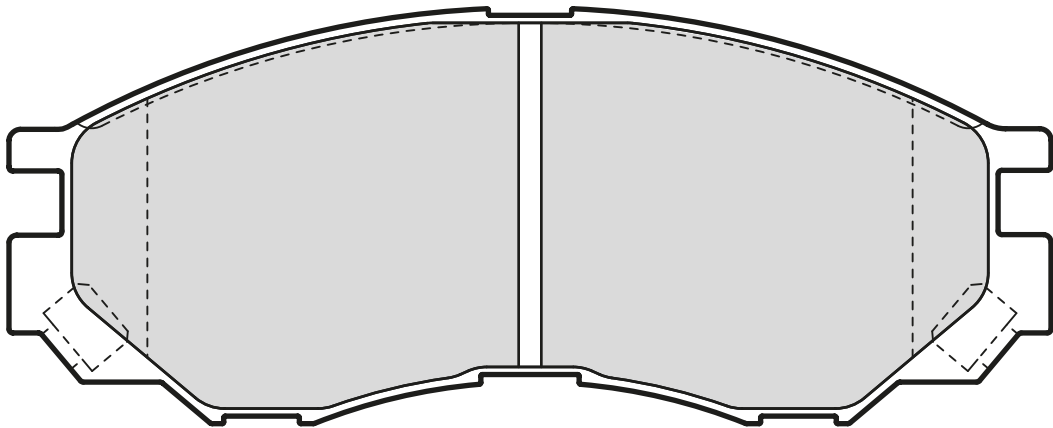
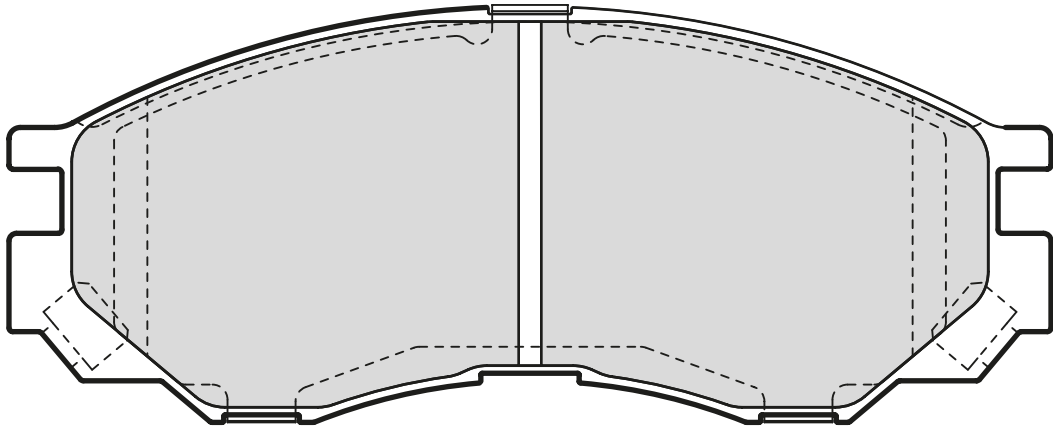

301522		137,8	55	15,7		AKE			<b>MITSUBISHI</b> <b>MITSUBISHI</b>

## 23300 (WVA)

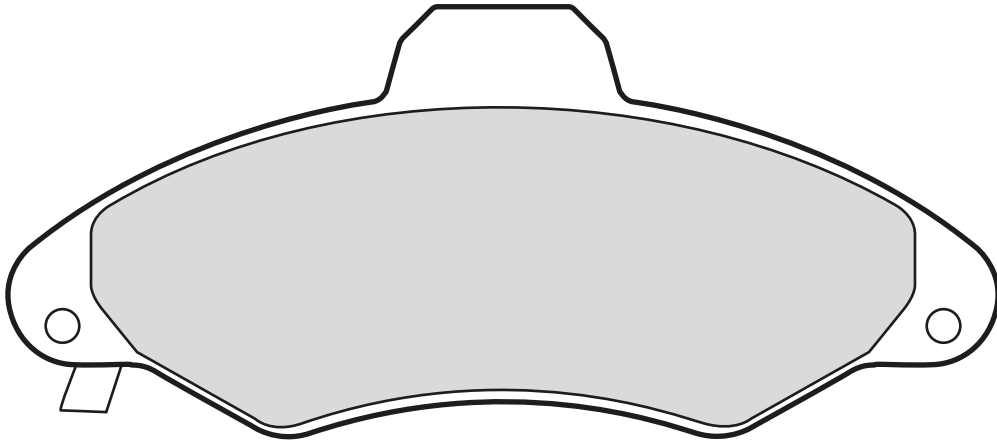

301399		131,1	57,3	19	BDX			FORD	

## 23312 (WVA)

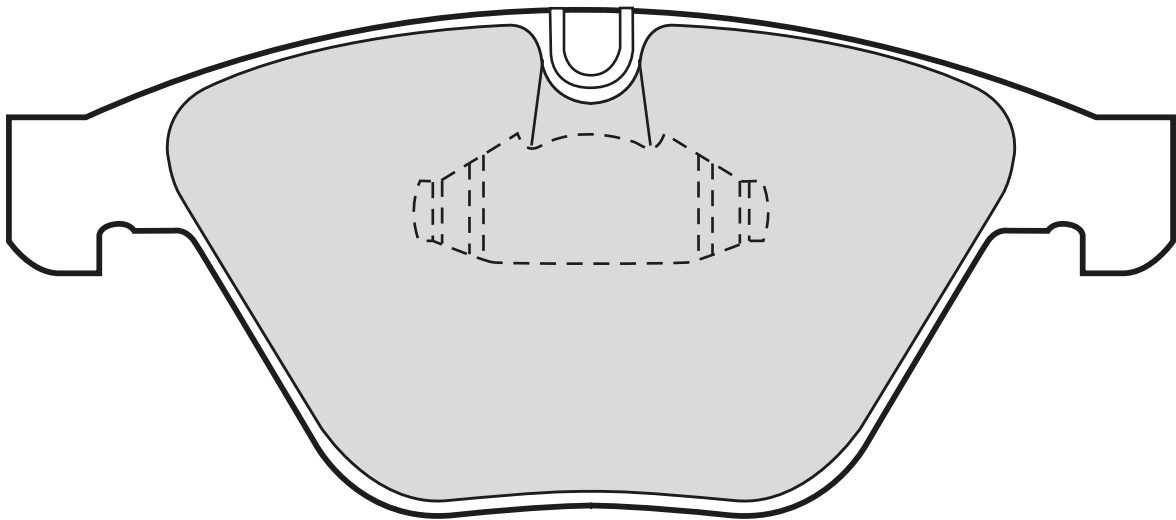

301410		155,3	68,5	19,8	ATE			BMW	



## 23326 (WVA)

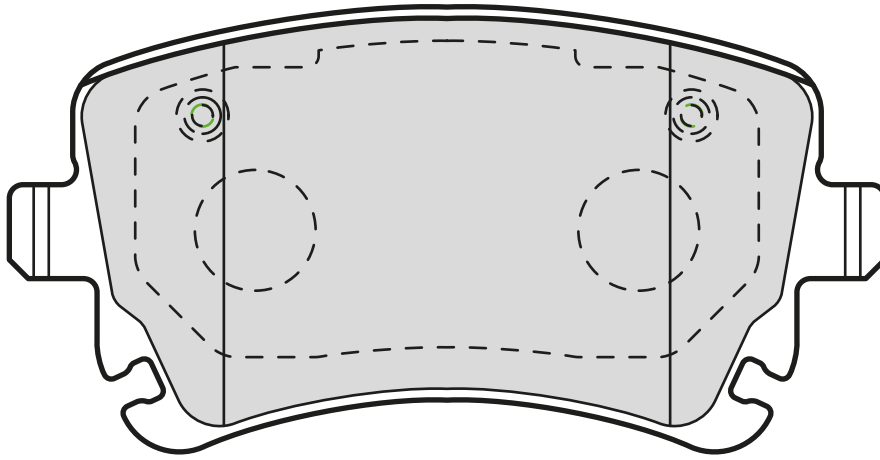

301004		115,95	58,92	17,4		LUC	 	 	<b>AUDI</b> <b>VOLKSWAGEN</b>

## 23340 (WVA)

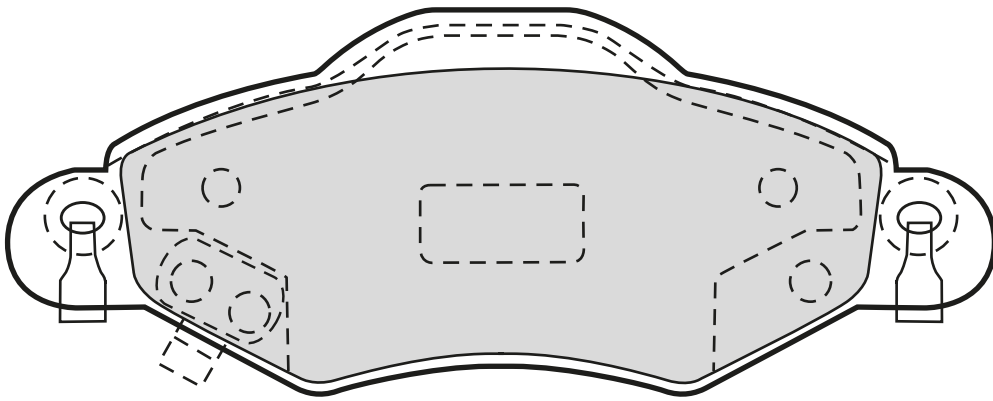
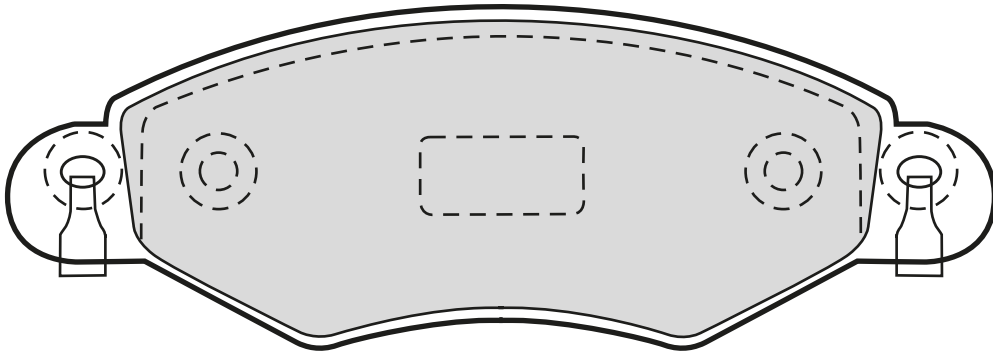

301736	↳ 2x	130,6	44,9 51	16,8		BSC		<b>TOYOTA</b>

## 23348 (WVA)

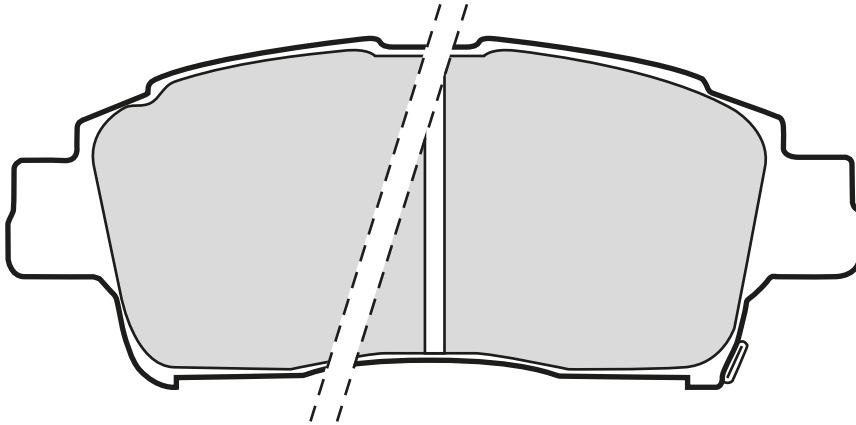

301606	↳ 2 x ◻	112,5	46,8	16,5		AKE		TOYOTA

## 23353 (WVA)

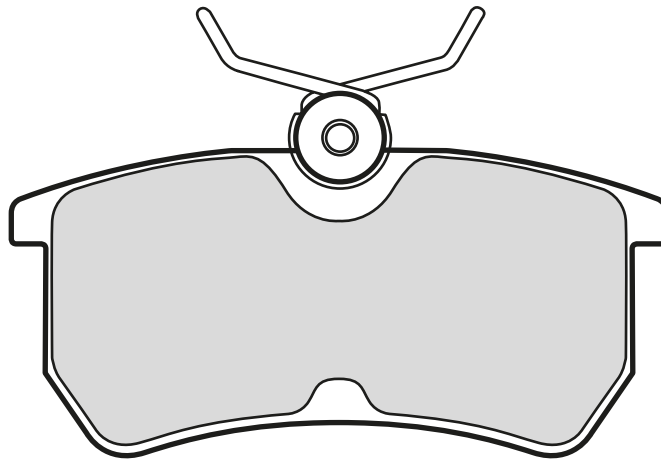

301431		87,2	42,5	14,5		LUC		FORD

## 23358 (WVA)

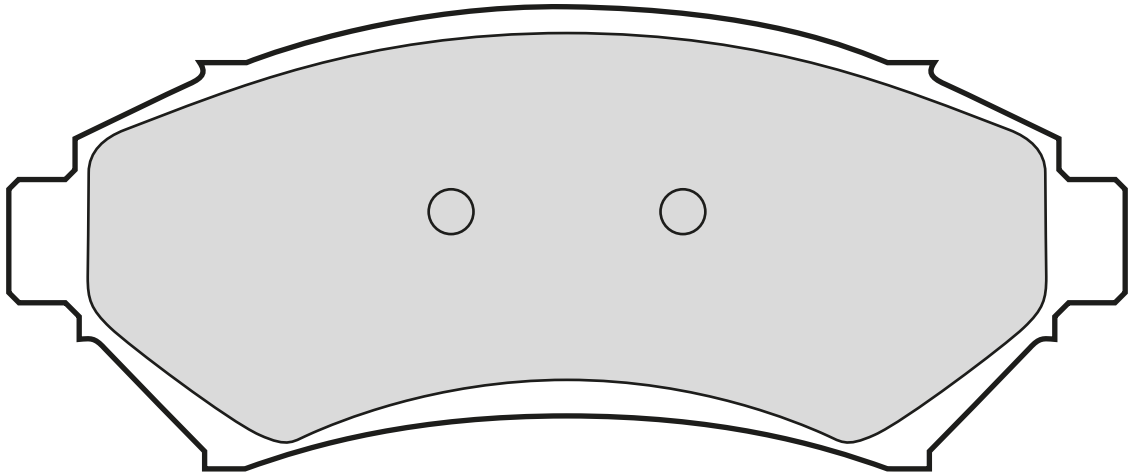

<b>Valeo</b> 									
<b>301458</b>	2 x	148	61,5	18	GME				<b>OPEL, VAUXHALL</b>



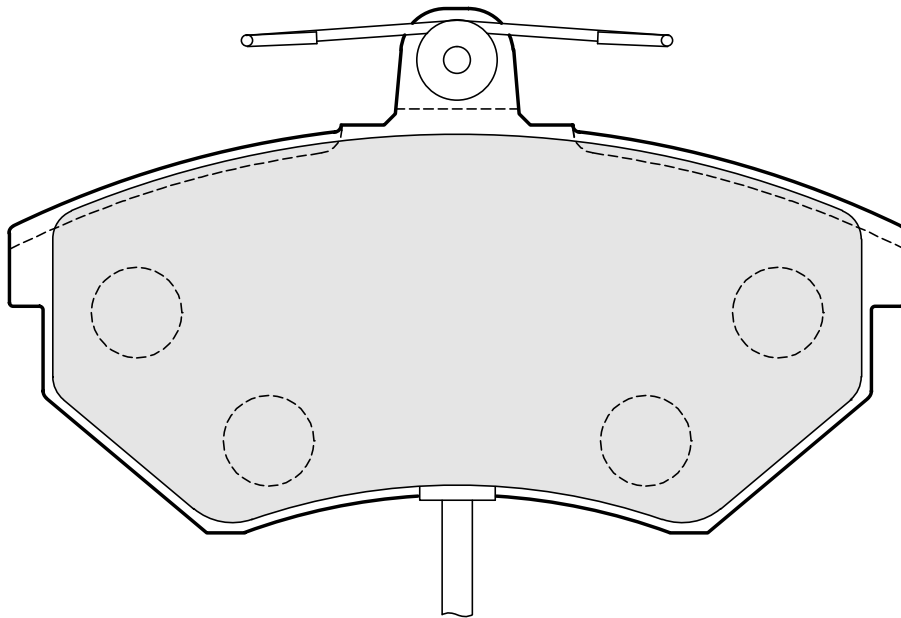





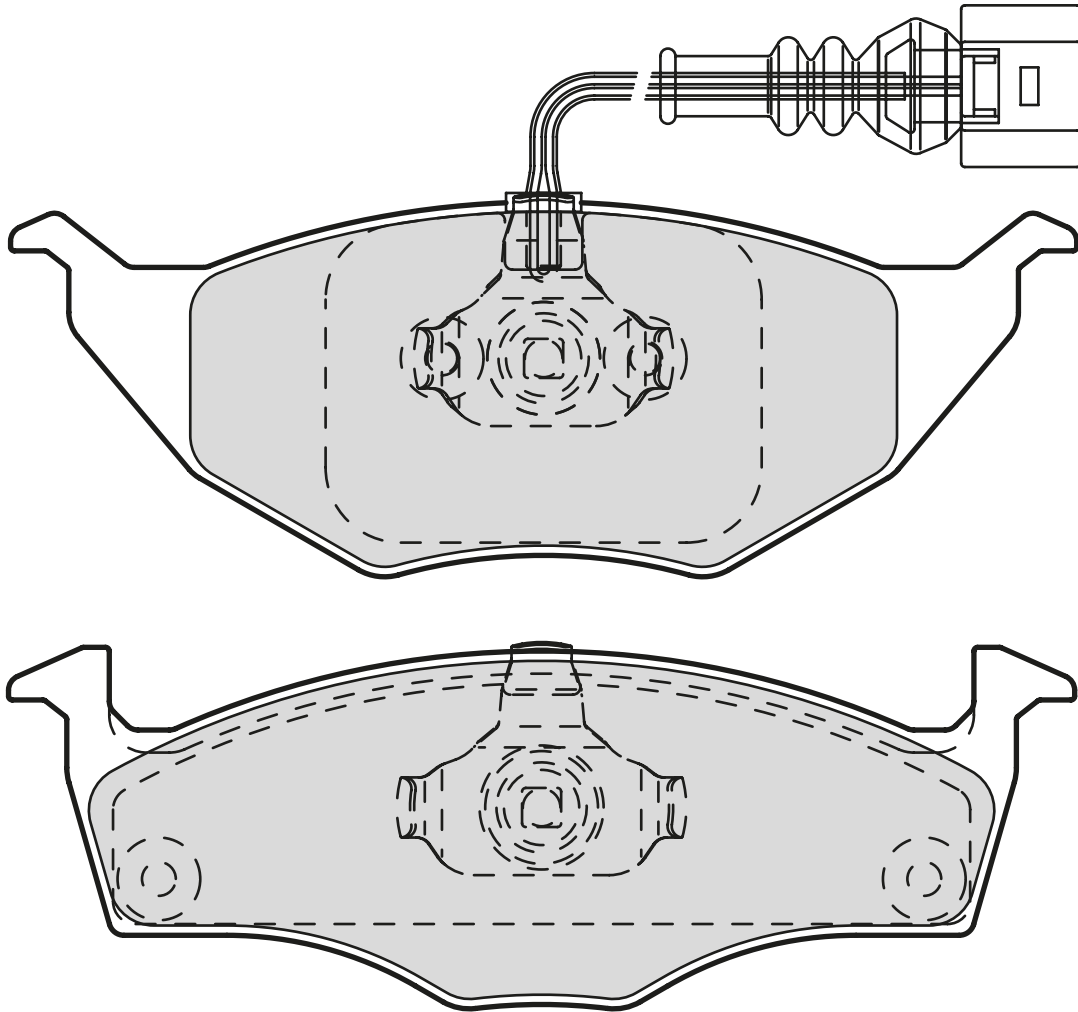









## 23393 (WVA)



<b>Valeo</b> 									
<b>301484</b> (A)	2 x  210 mm	119	69,5	19,4	LUC				<b>AUDI, SEAT, VOLKSWAGEN</b>

## 23395 (WVA)



Valeo	 							 	
									
301734	↳ 1 x  235 mm	141,8	49,8 48,1	14,3		KELS			AUDI
301735		141,8	48,3 49,8	14,4		ATE			VOLKSWAGEN

## 23396 (WVA)

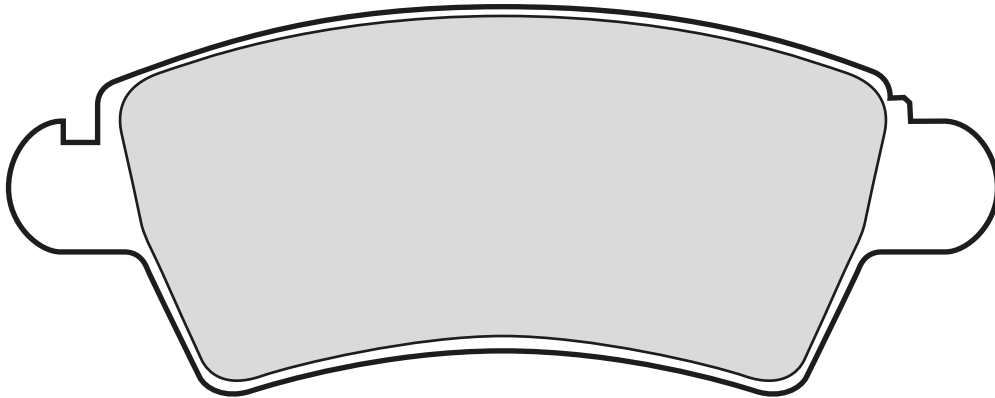

301462		131	52,2	17,8	BSC			CITROËN, PEUGEOT



## 23402 (WVA)

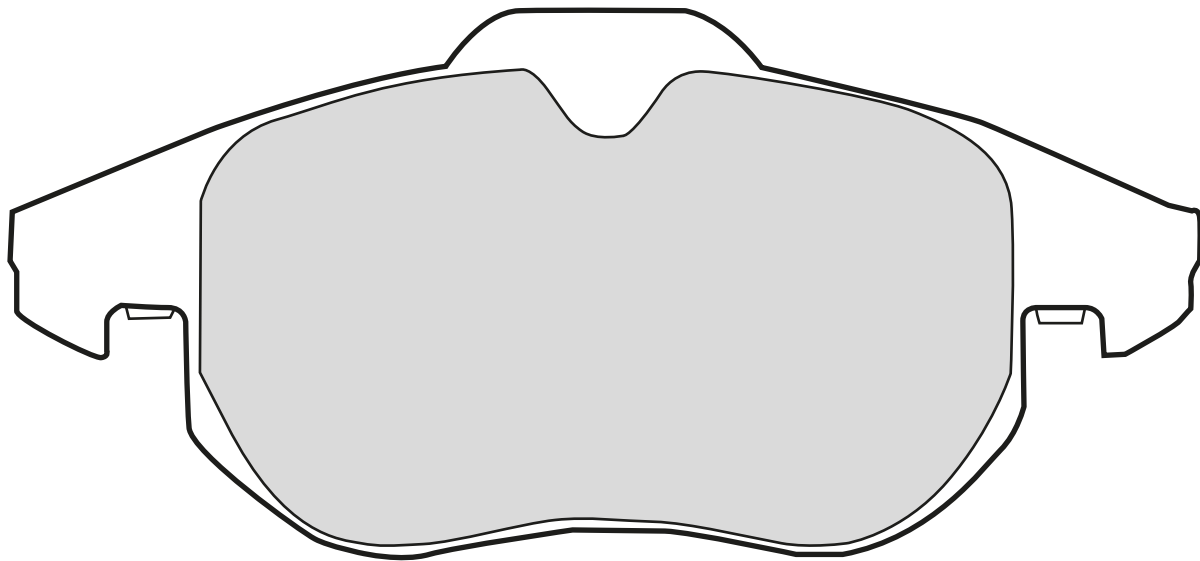
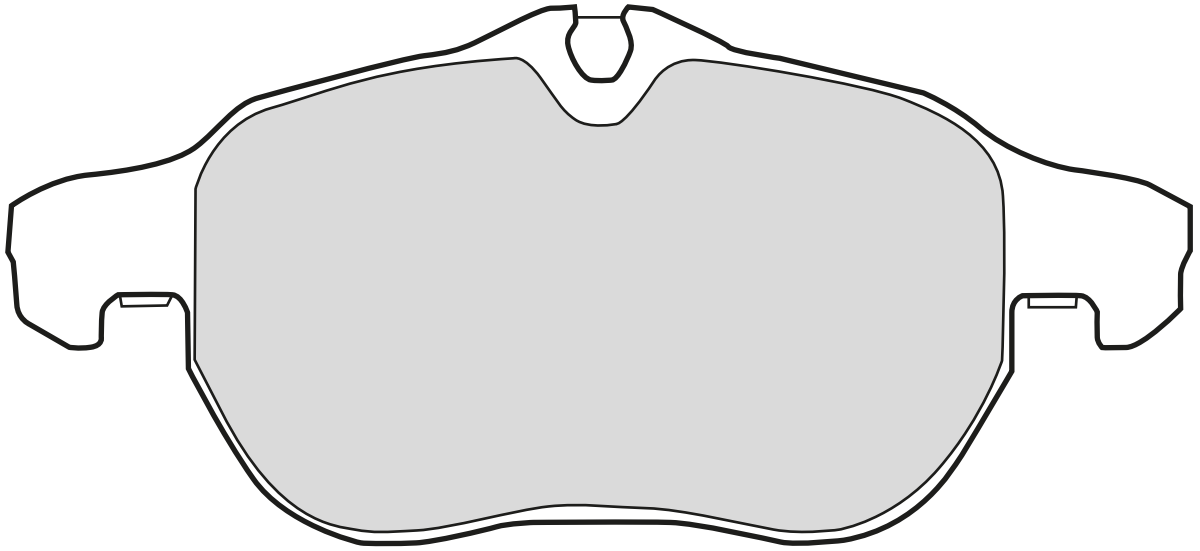

<b>Valeo</b>								
<b>301678</b>		156,5	71	20,3		ATE		<b>CADILLAC, FIAT, OPEL, SAAB, VAUXHALL</b>

## 23407 (WVA)

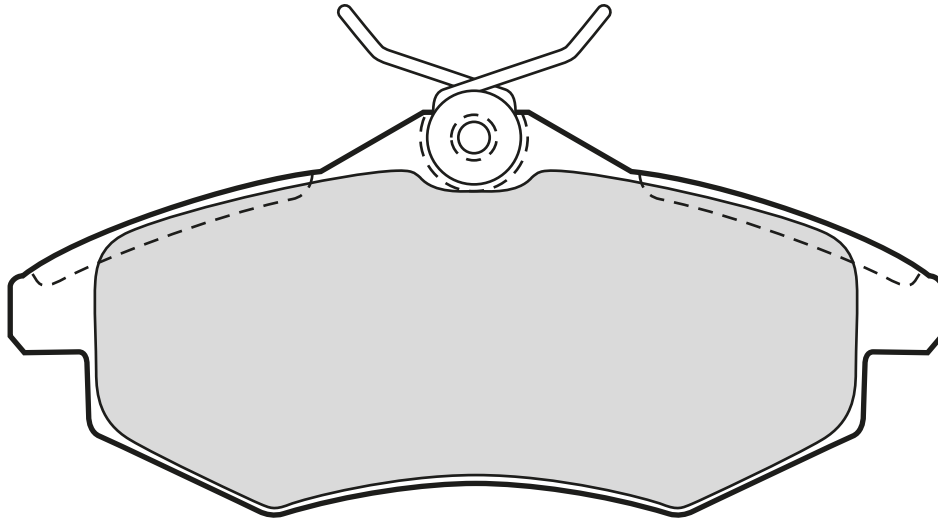

301500		122,8	53	19,3		LUC			CITROËN



## 23417 (WVA)

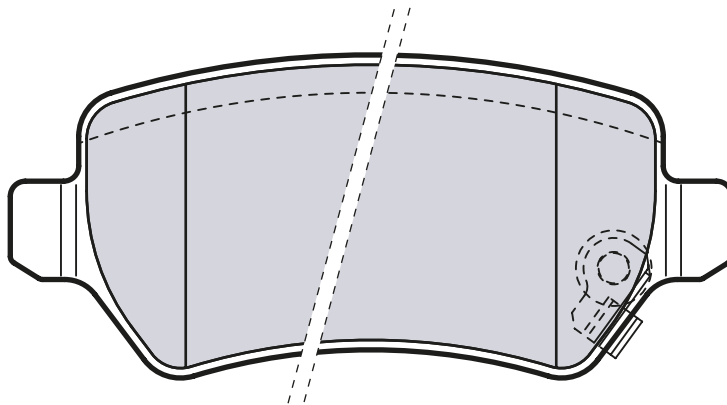

301584	↳ 2x	95,5	42,7	15,2		LUC			KIA, OPEL, VAUXHALL OPEL, VAUXHALL



## 23418 (WVA)

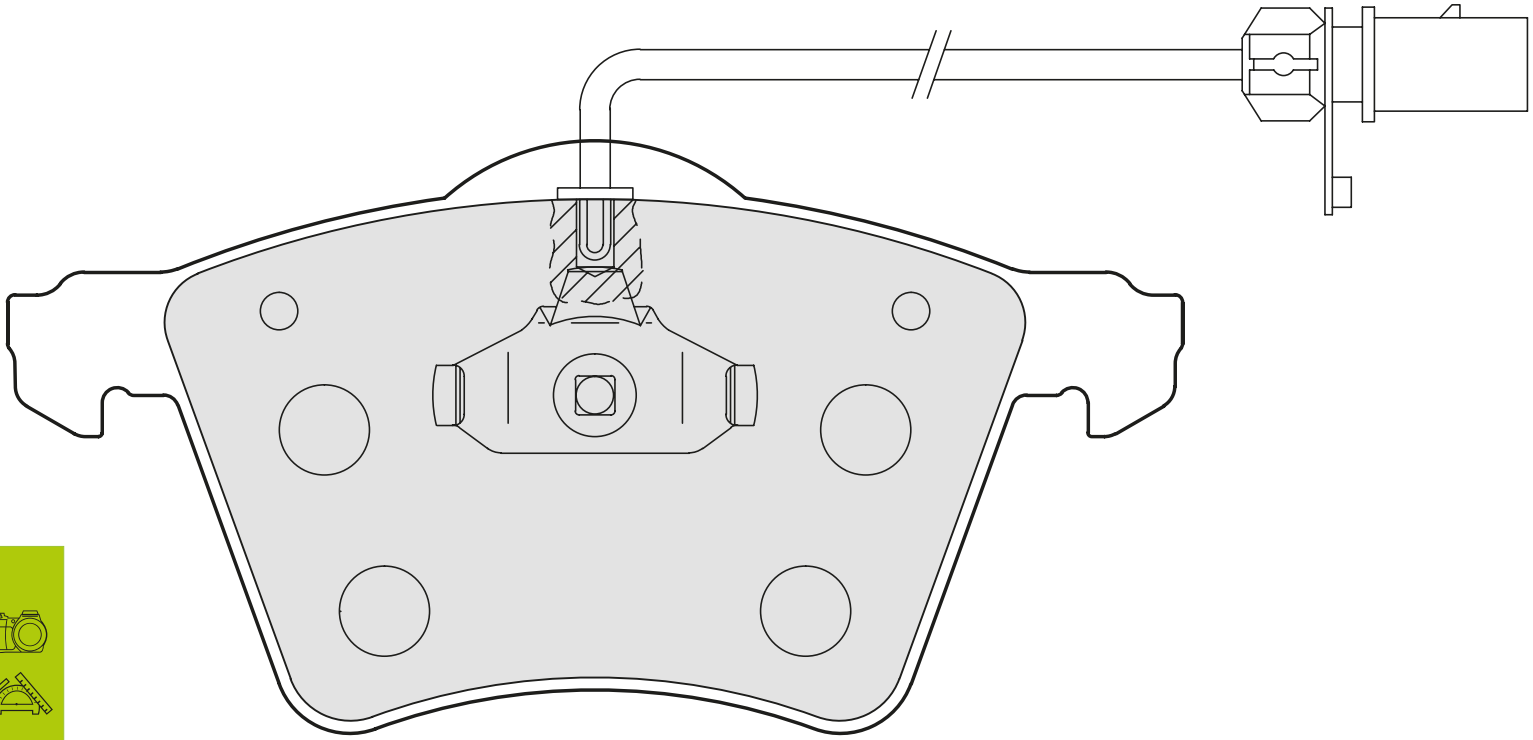

<b>301801</b>	1x	156,2	78,4	19,6	ATE		<b>FORD, SEAT, VOLKSWAGEN</b>

## 23440 (WVA)

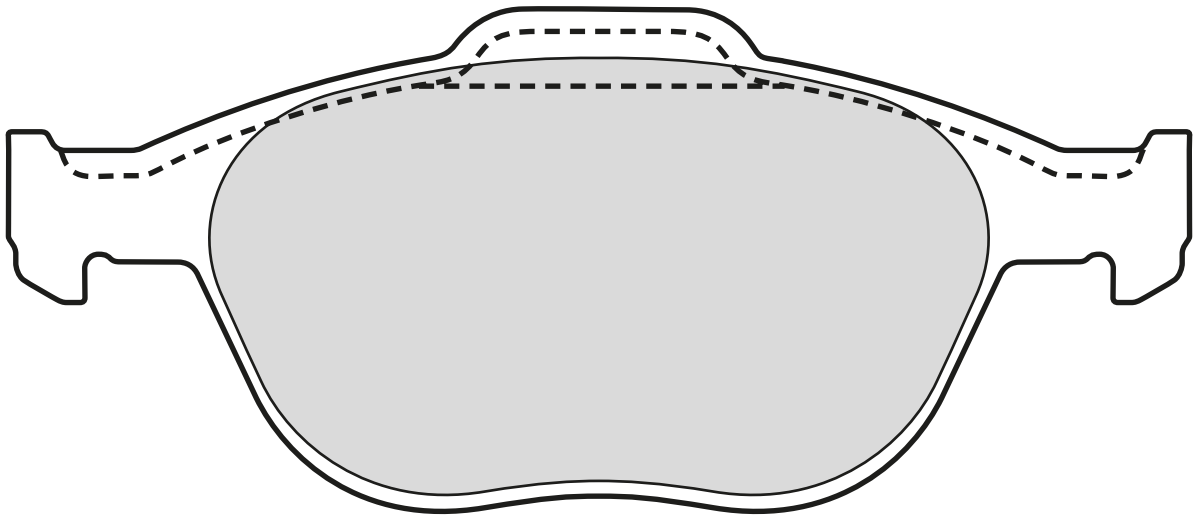
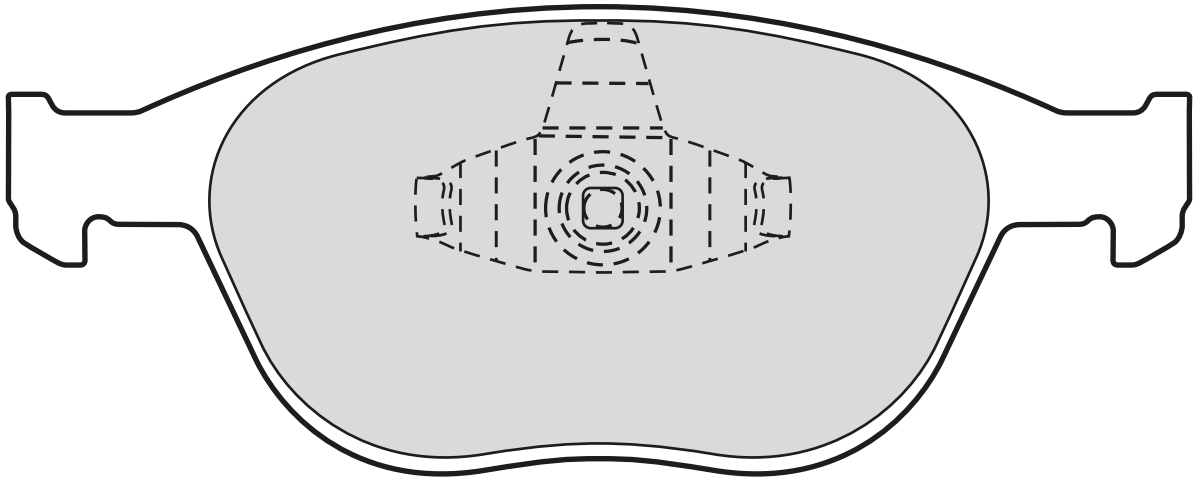

301639		156,3	67,2	18,1	ATE			<b>FORD</b> <b>FORD</b>	

## 23446 (WVA)

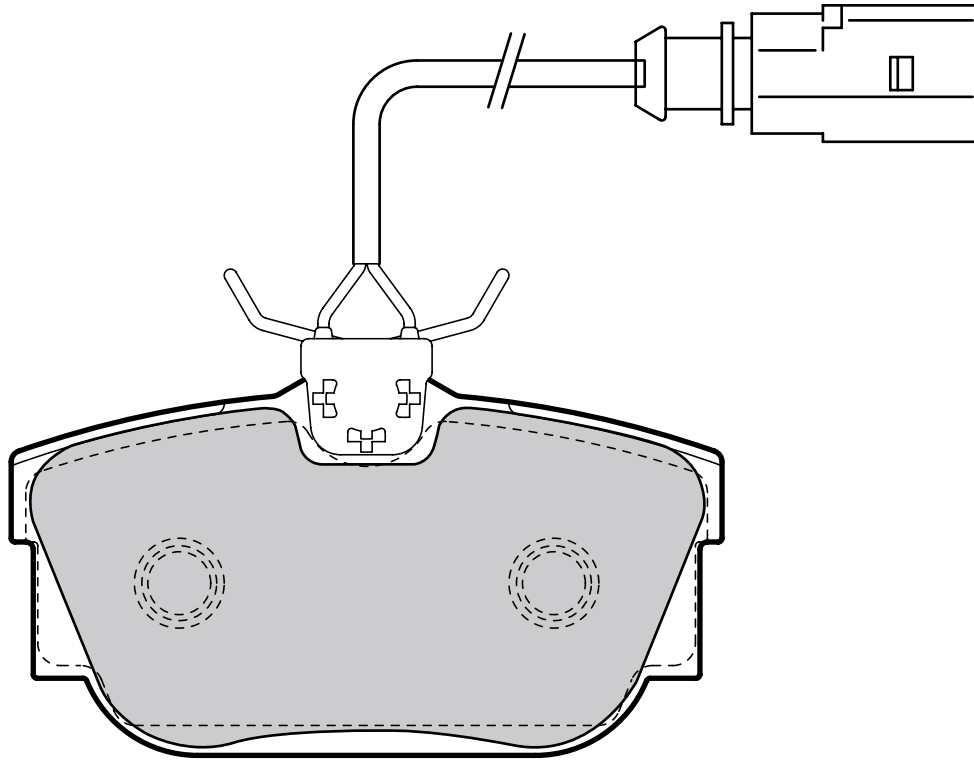

<b>301650</b>	2 x  205 mm	95	51	16,2		LUC		<b>SEAT, VOLKSWAGEN</b> <b>VOLKSWAGEN</b>

## 23449 (WVA)

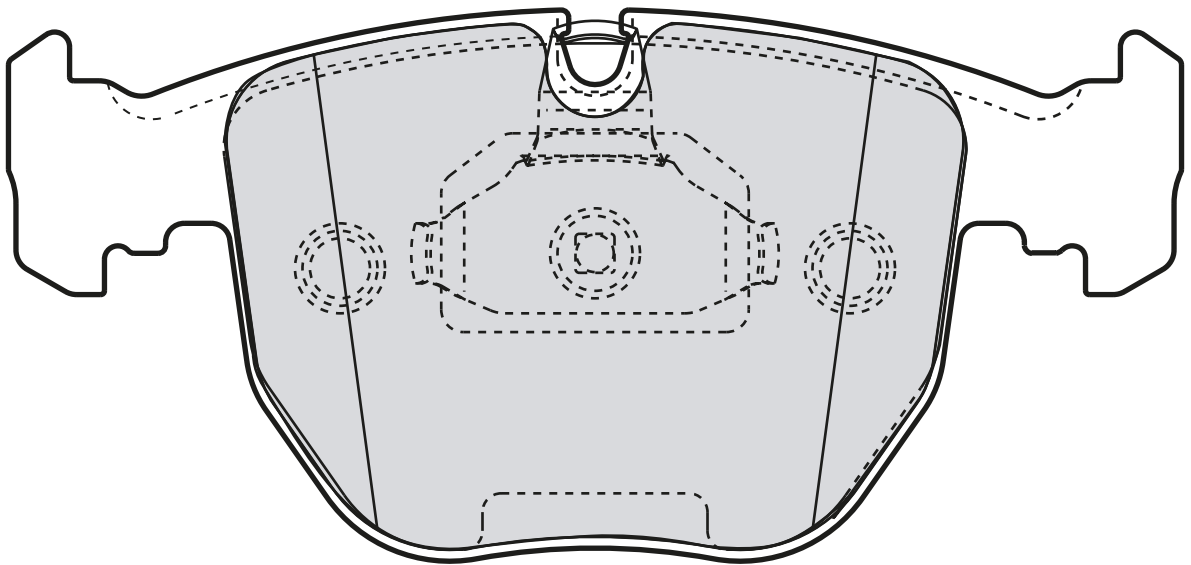
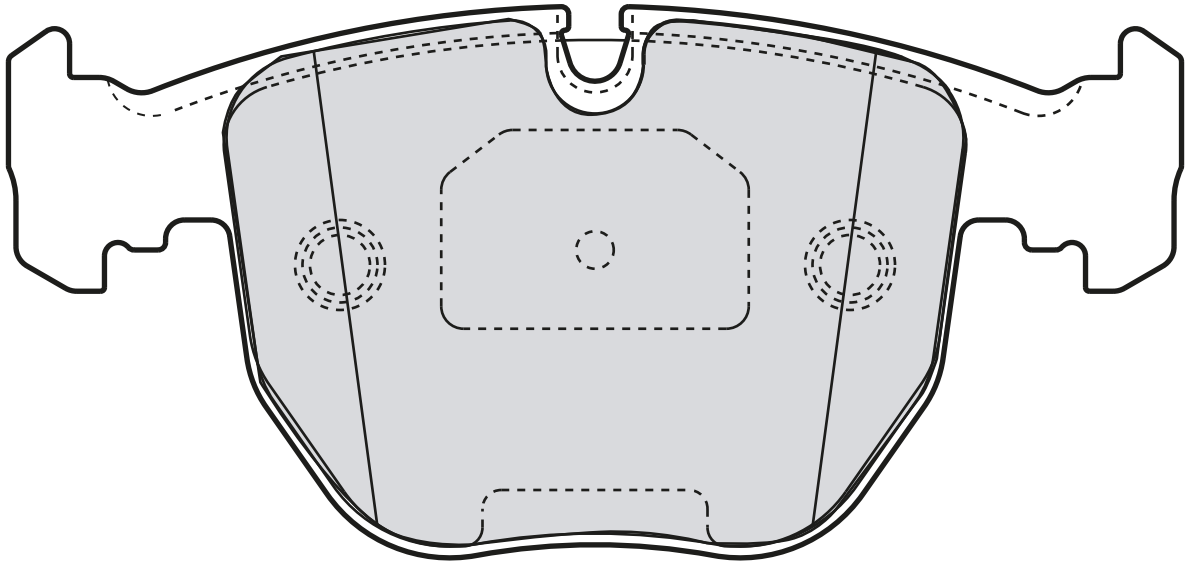

301412		156,4	73,6	19		ATE			BMW

## 23454 (WVA)

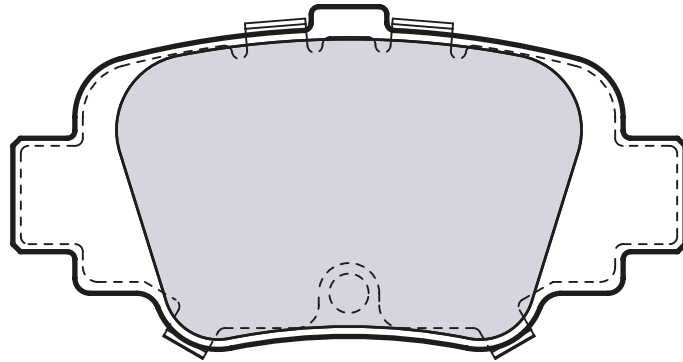

301642		88,9	45	15		AKE		NISSAN



## 23472 (WVA)

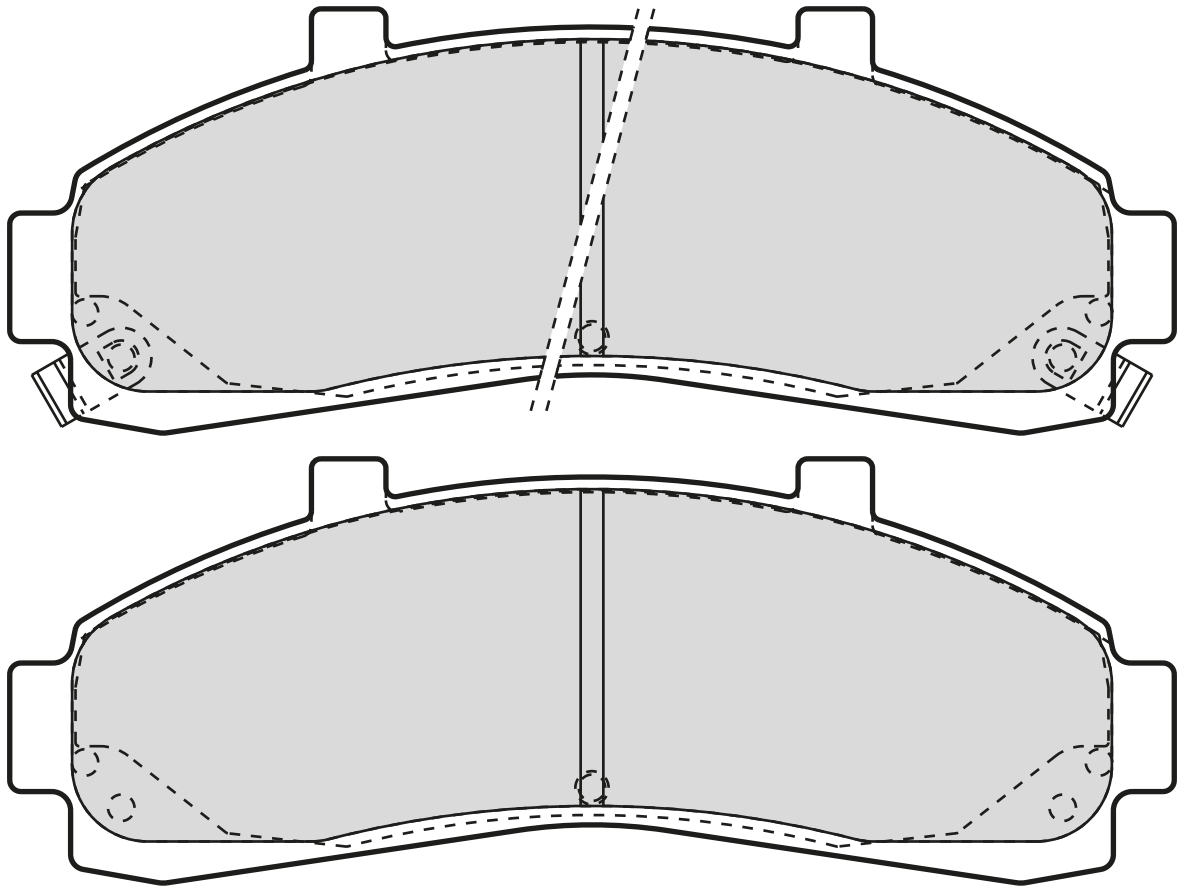

301906	↳ 2 x	154	56,1	17,3	WAGNER		FORD	

## 23482 (WVA)

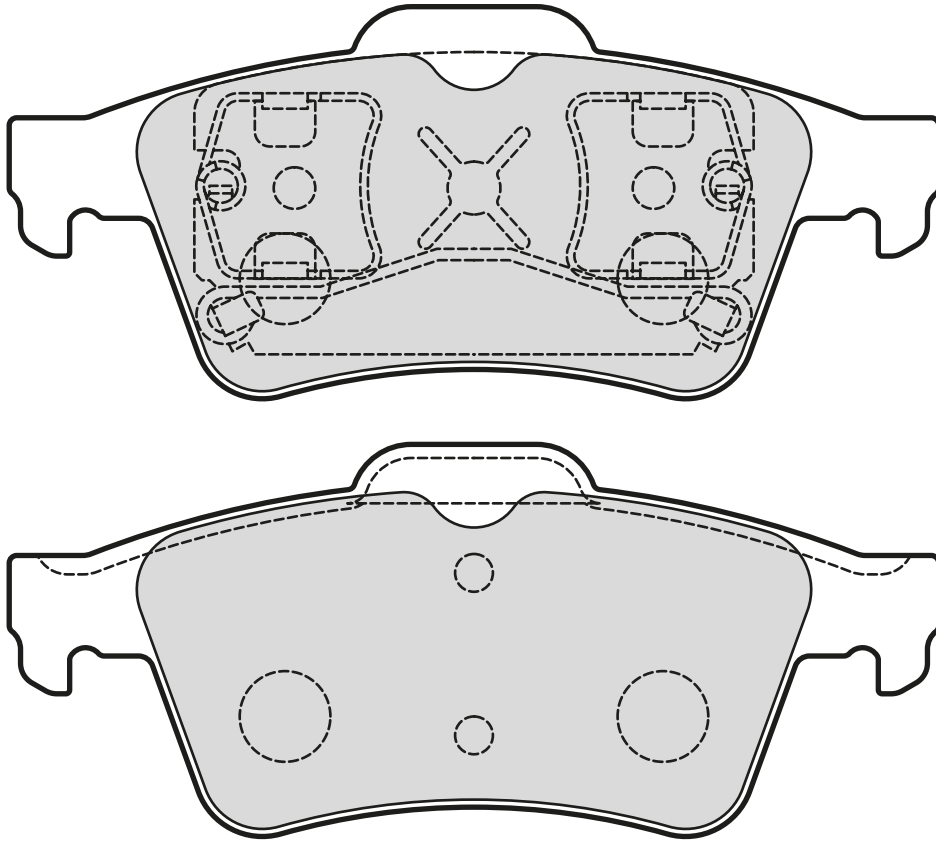

301472		123,1	52	16,6		ATE			<b>FORD, NISSAN, OPEL, RENAULT, SAAB, VAUXHALL</b>
									<b>FORD</b>

## 23487 (WVA)

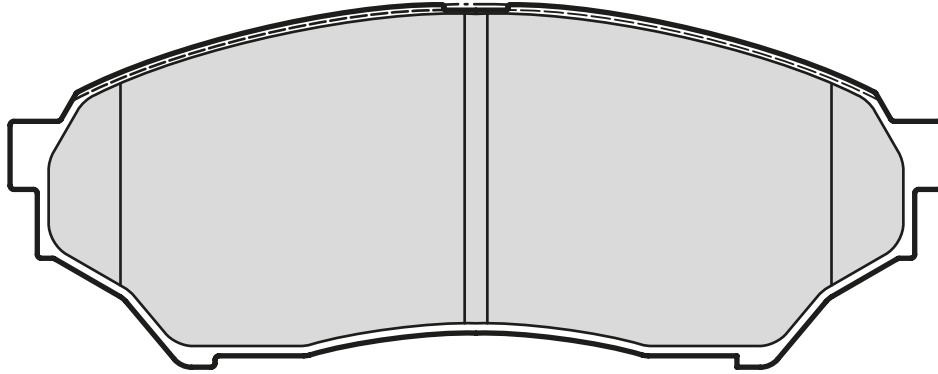

<b>Valeo</b> 								
301521		123,2	48	15,5		AKE		<b>MITSUBISHI</b>

## 23510 (WVA)

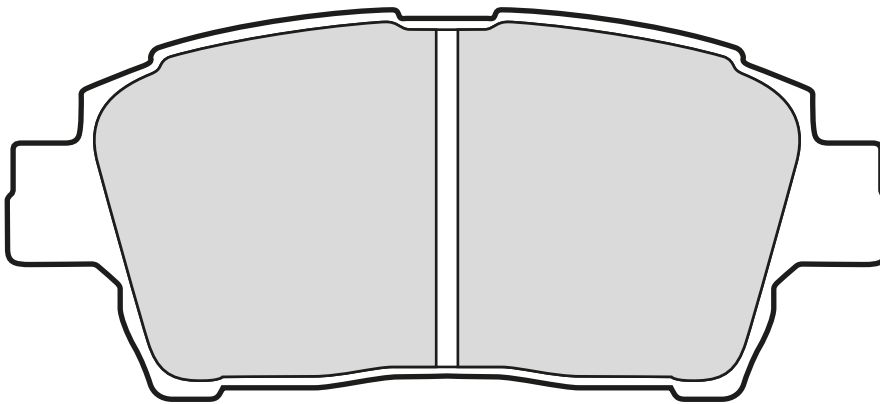

<b>Valeo</b> 								
301737	↳ 2 x	116,3	51,5	16,5		AKE		<b>TOYOTA</b>





## 23521 (WVA)

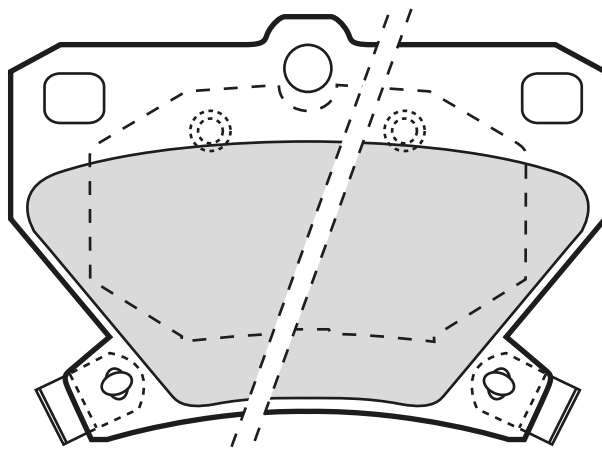
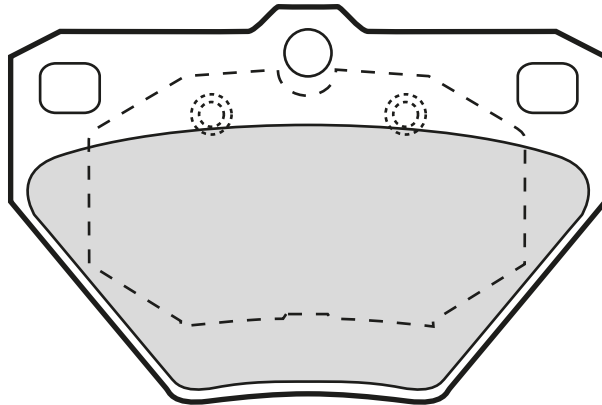

<b>301577</b>	2x	78,5	55	14	SUM			<b>TOYOTA</b>	

## 23524 (WVA)

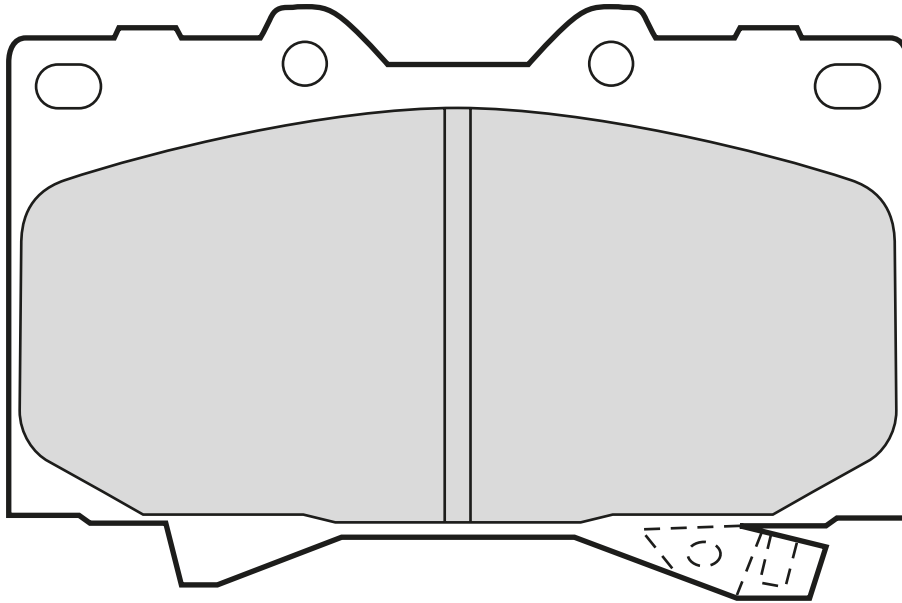

301535	↳ 2x	119,6	78	15,5	SUM		LEXUS, TOYOTA	

## 23526 (WVA)

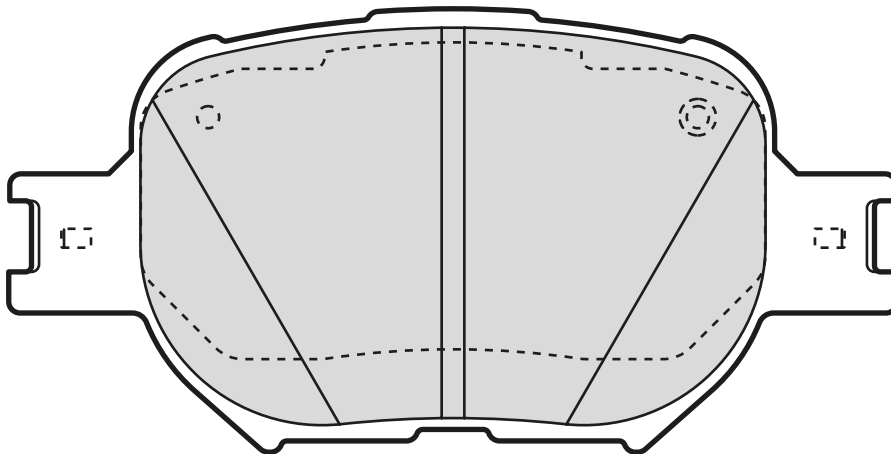

301827		117,5	58,6	17,4	AKE		TOYOTA	

## 23536 (WVA)

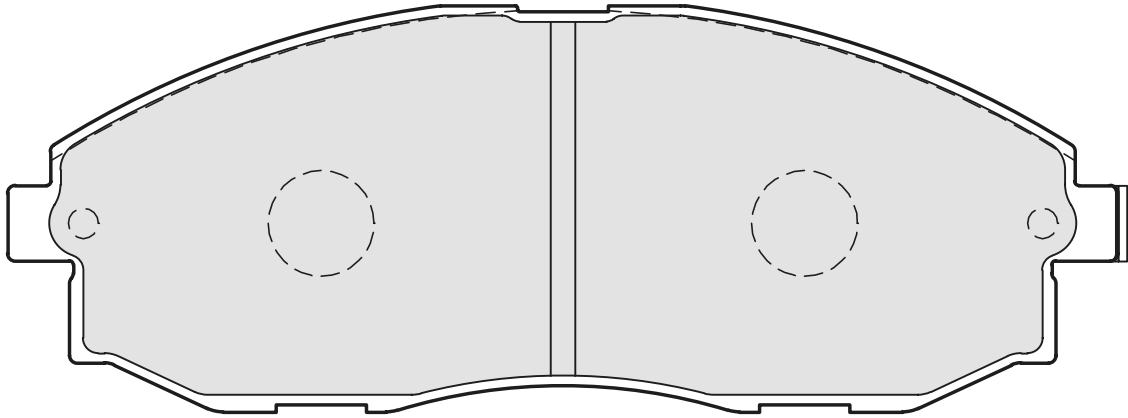

301908	↳ 2x	146,95	54,45	17	MAND			<b>HYUNDAI</b> <b>HYUNDAI</b>

## 23539 (WVA)

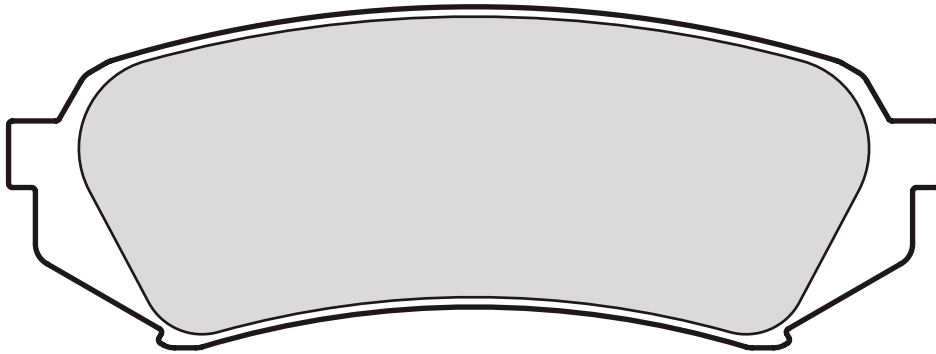

301865		123,1	45,1	17,5	AKE			<b>LEXUS, TOYOTA</b>

## 23543 (WVA)

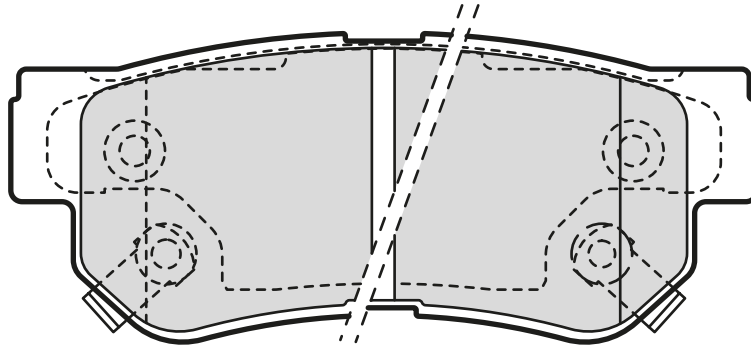

<b>Valeo</b> 								
<b>301748</b>	2x	98,7	40,8	15,7	MAND			<b>HYUNDAI, KIA, SSANGYONG</b> <b>HYUNDAI</b>

## 23557 (WVA)

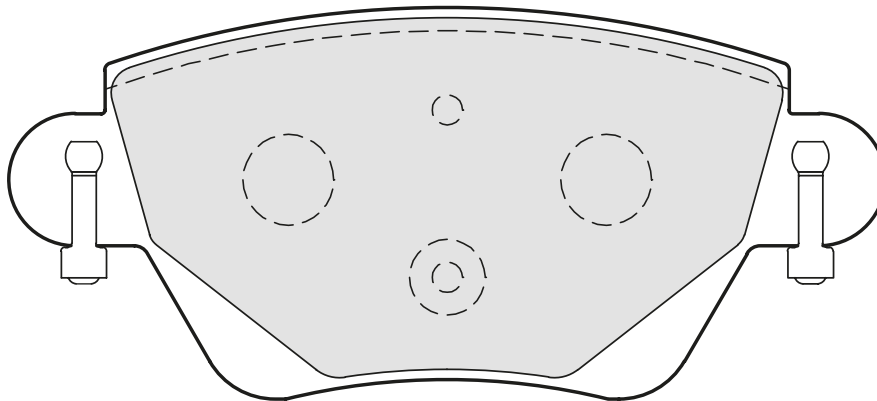







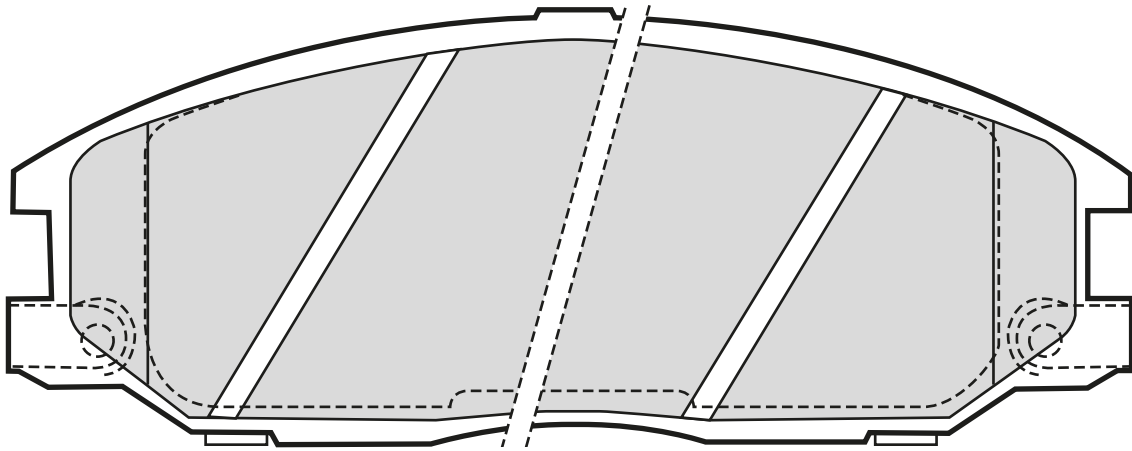











<b>Valeo</b> 								
<b>301434</b>		115,9	51,9	16,8	BSC			<b>FORD, JAGUAR</b>











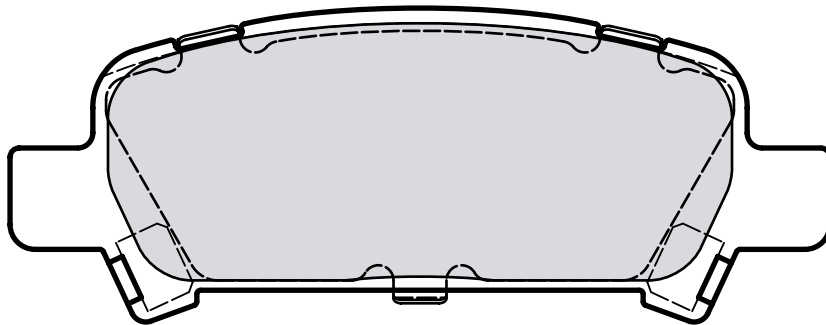

## 23569 (WVA)



Valeo	 								
									
301505	↳ 2x 	149	58	17,4		AKE	 		<b>HYUNDAI, SSANGYONG</b> <b>HYUNDAI</b>
301759	↳ 2x 	149	58	17		AKE	 		<b>HYUNDAI</b> <b>HYUNDAI</b>

## 23572 (WVA)



Valeo	 								
									
301895		108,4	41,5	14,5		AKE			<b>SUBARU</b>

## 23581 (WVA)

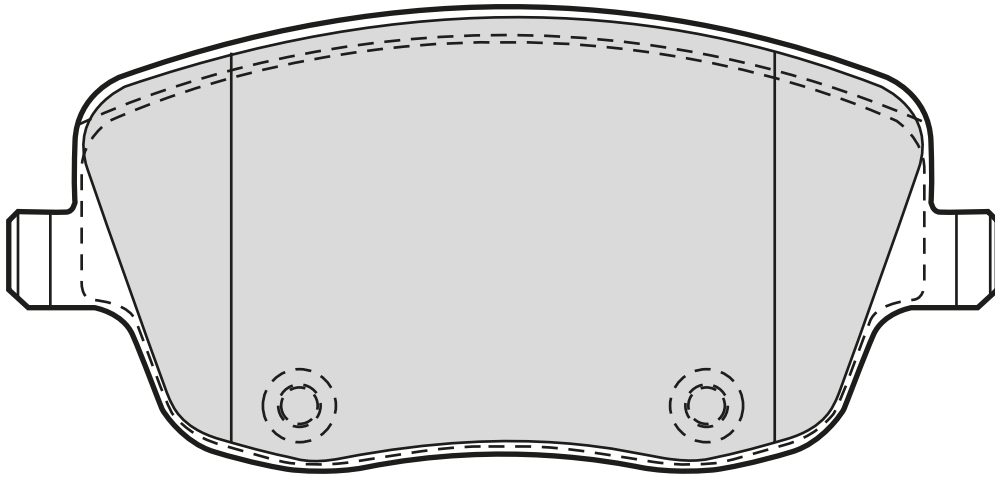

Valeo										
301667		131,4	62,3	18,7		LUC				SEAT, SKODA, VOLKSWAGEN
301720	↳ 1 x  180 mm	131,4	62,3	18,7		LUC				SEAT, SKODA, VOLKSWAGEN



## 23582 (WVA)

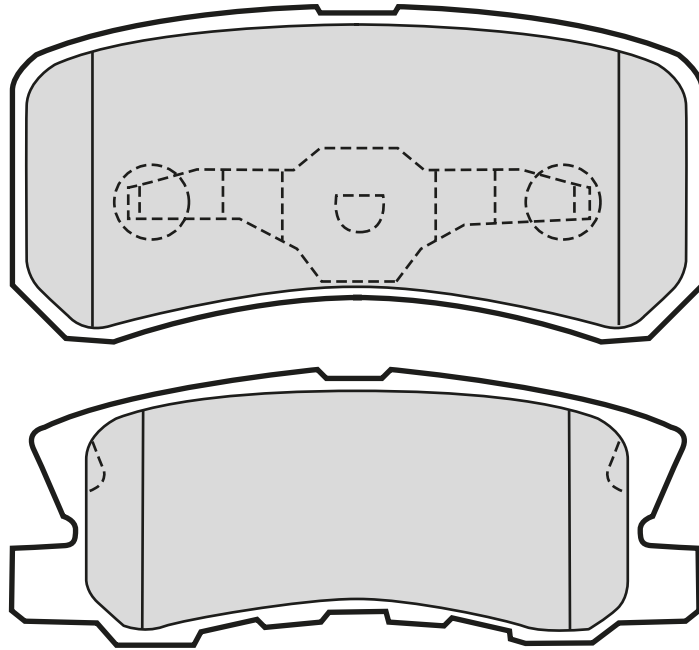

301520		111,5 91	45	15,5		AKE			 <b>MITSUBISHI</b>

## 23584 (WVA)

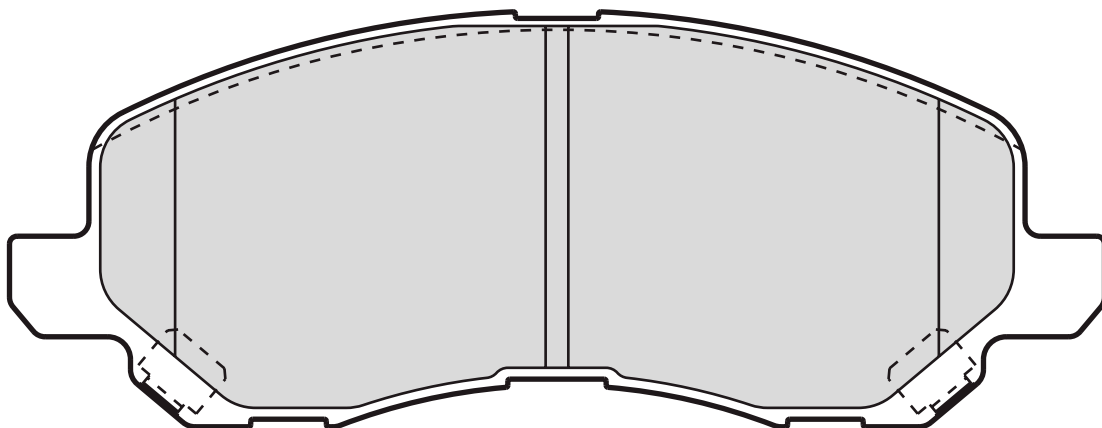

301886		144,8	55	16		AKE			 <b>MITSUBISHI</b>

## 23587 (WVA)

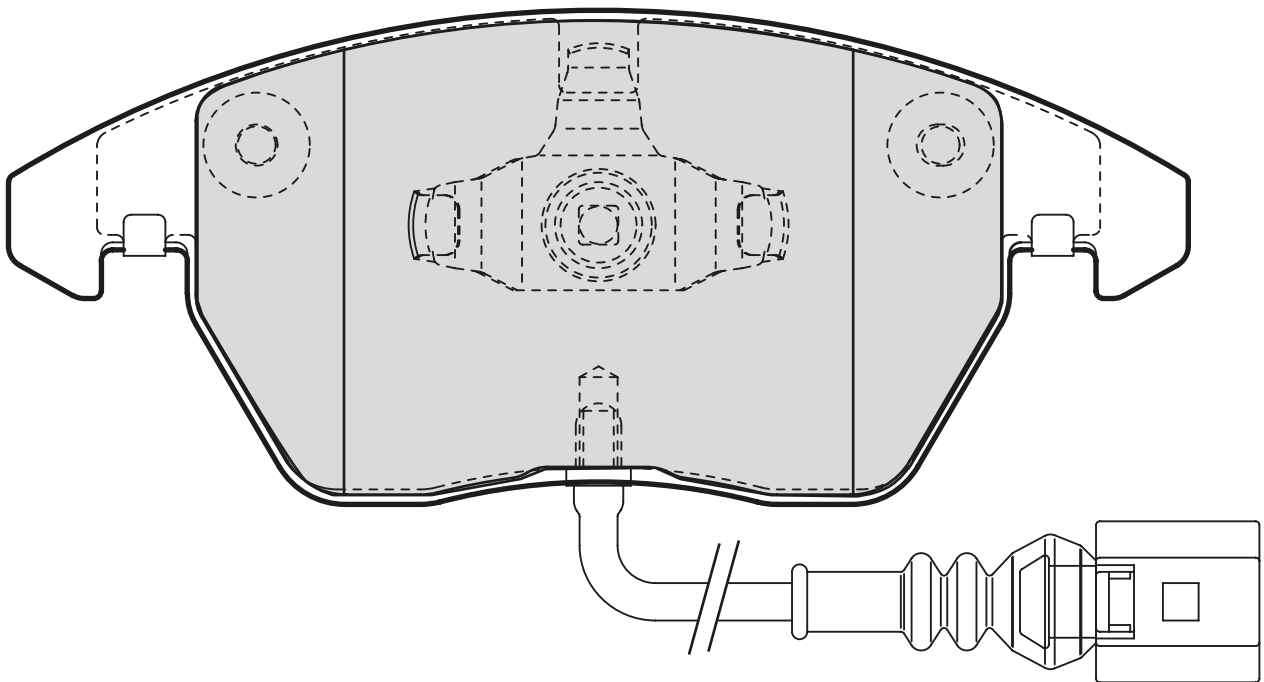
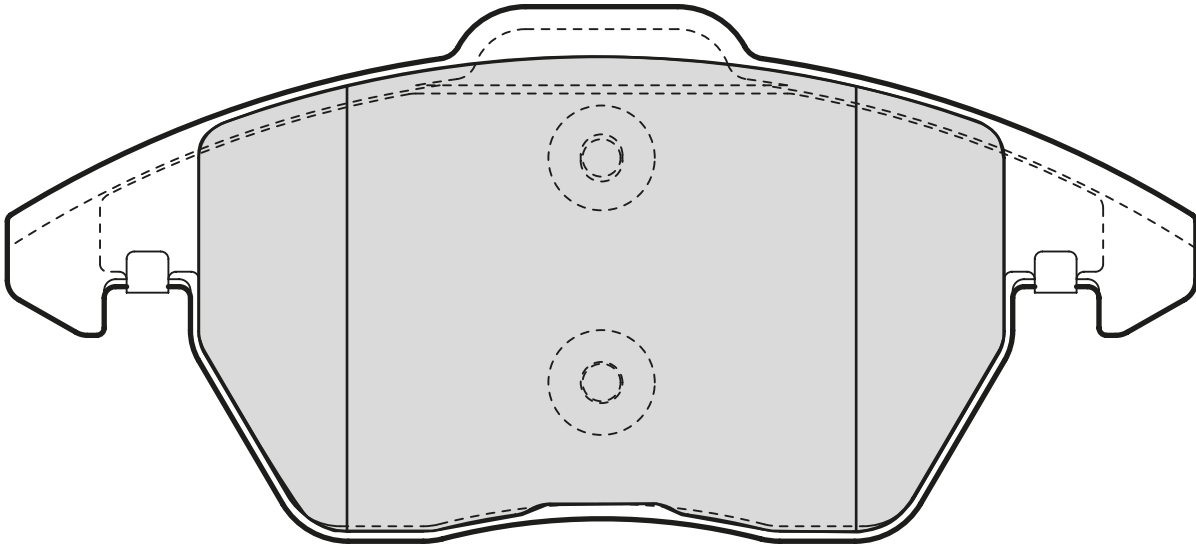

<b>Valeo</b>								
<b>301635</b>	1 x  155 mm	156,4 155,2	71,4 66	20,3	ATE			<b>AUDI, SEAT, SKODA, VOLKSWAGEN</b> <b>VOLKSWAGEN</b>



## 23590 (WVA)

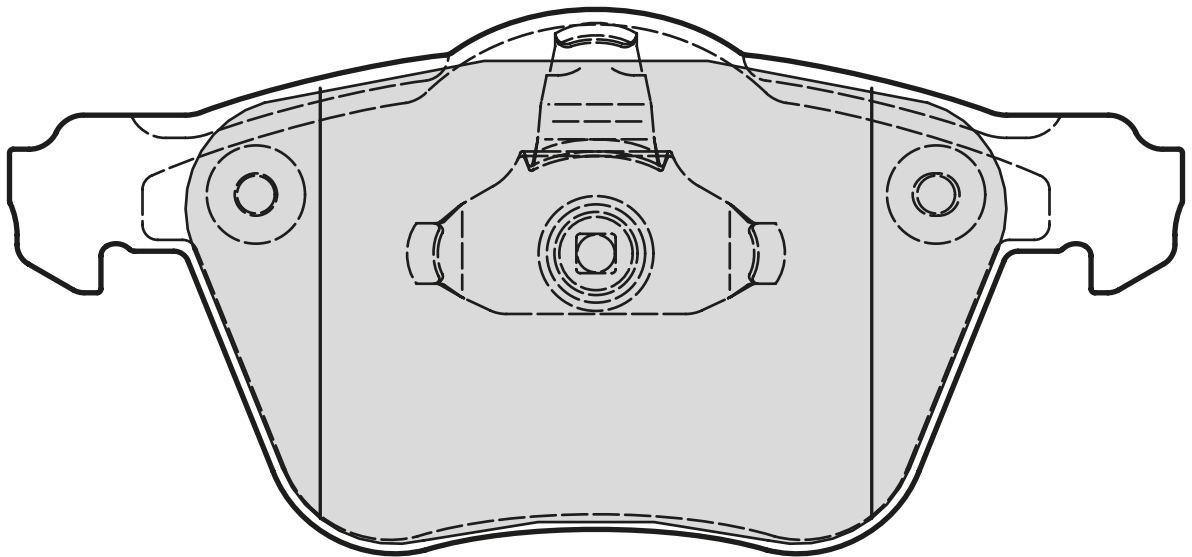
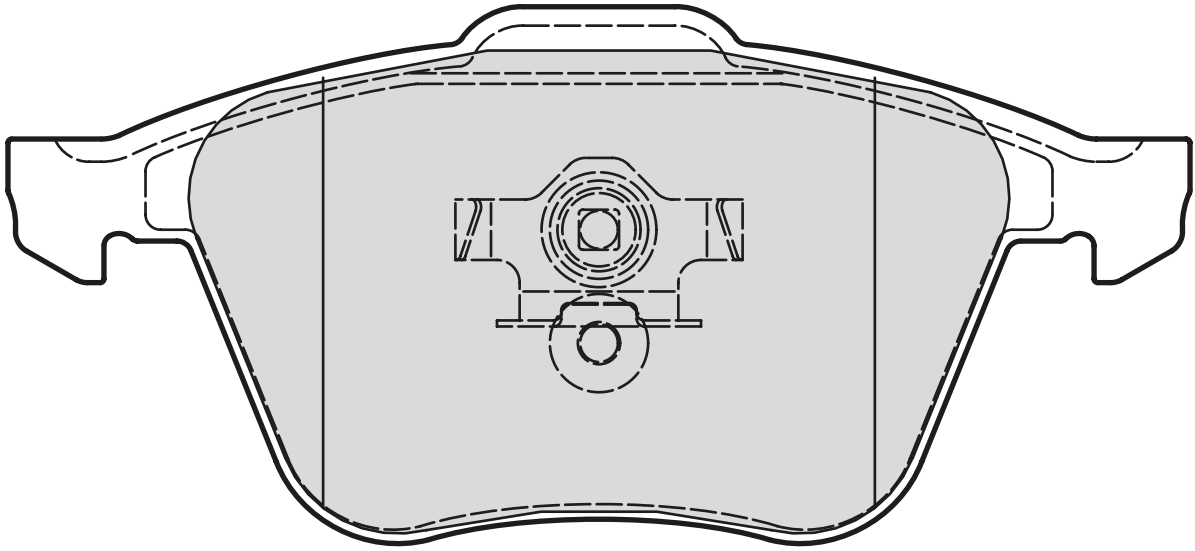

<b>301030</b>		156,4 155,2	71 72	18,2					

## 23597 (WVA)

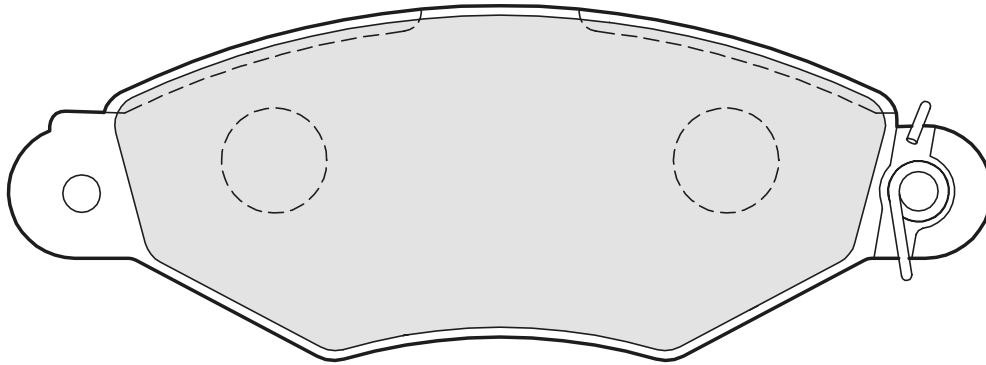

<b>Valeo</b> 								
301461		131	47,5	18		BSC		PEUGEOT

## 23599 (WVA)

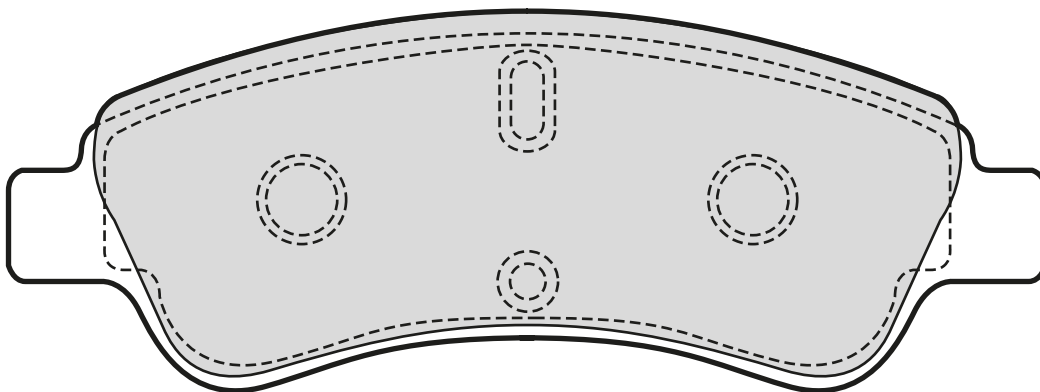

<b>Valeo</b> 								
301464		137	50	19		BSC		CITROËN, PEUGEOT CITROËN, PEUGEOT



## 23600 (WVA)

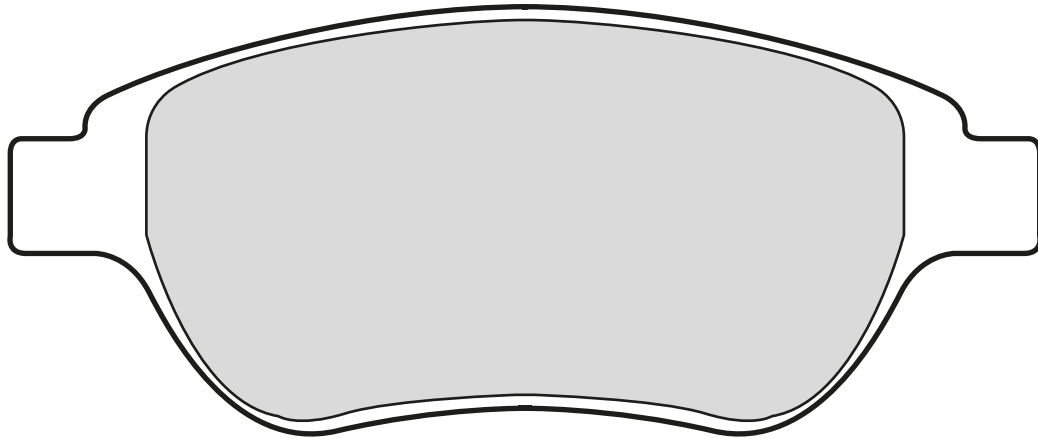

<b>Valeo</b> 								
301465		137	57,3	19		BSC		<b>CITROËN, PEUGEOT</b> <b>CITROËN, PEUGEOT</b>

## 23649 (WVA)

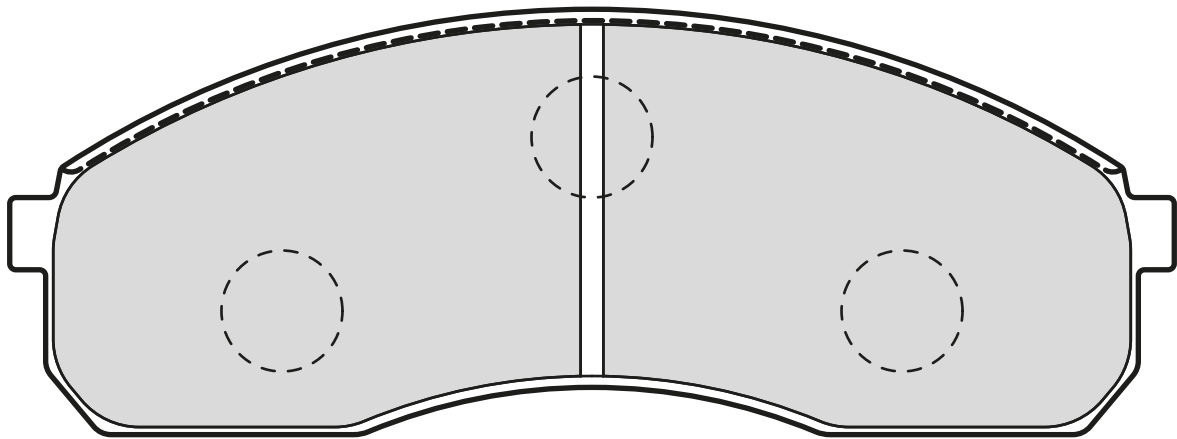

<b>Valeo</b> 								
301821	↳ 2x	154	56,2	16,5		SUM		<b>KIA</b> <b>KIA</b>

## 23659 (WVA)

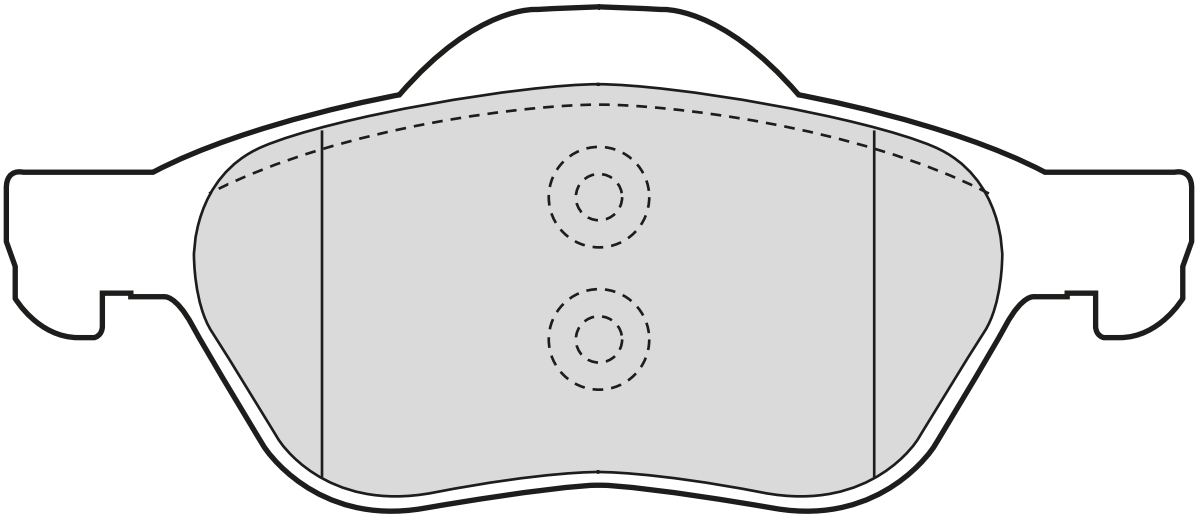
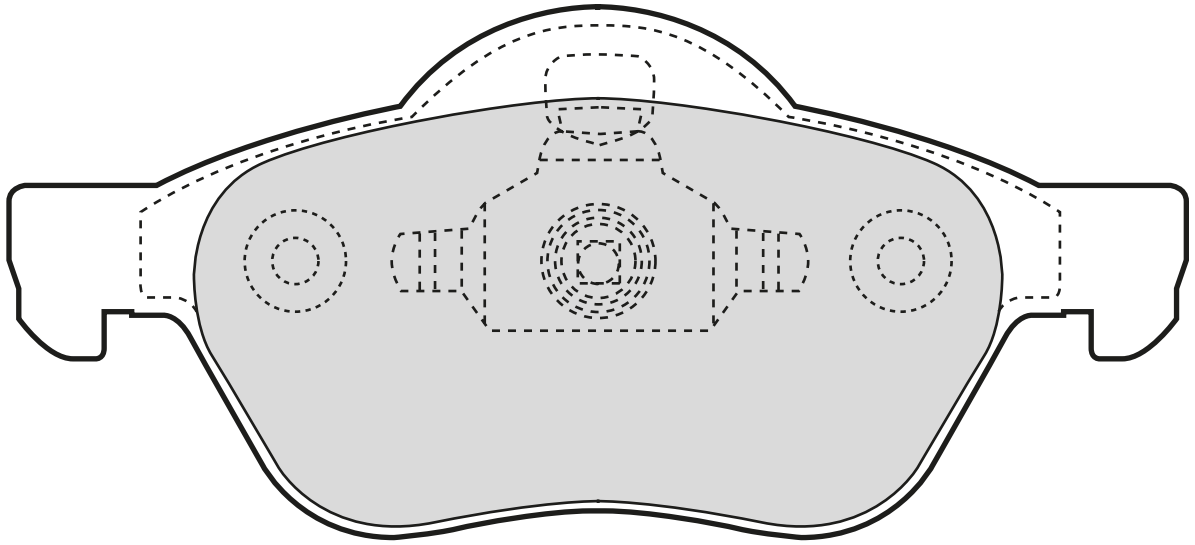

301471		155,2 156,4	70 66,5	18		ATE			RENAULT

## 23661 (WVA)

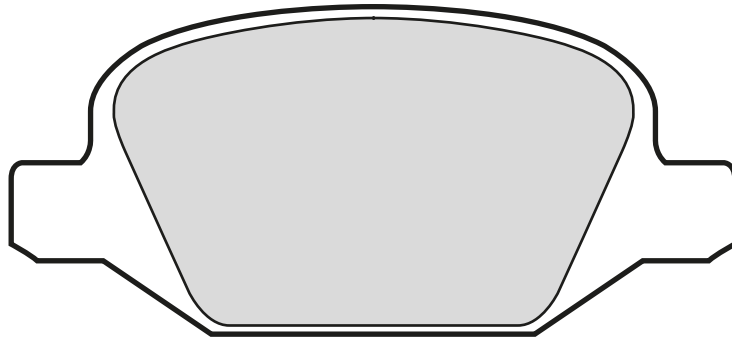

<b>Valeo</b> 									
301407		95,8	43,7	16,5		LUC			ALFA ROMEO, FIAT, LANCIA

## 23694 (WVA)

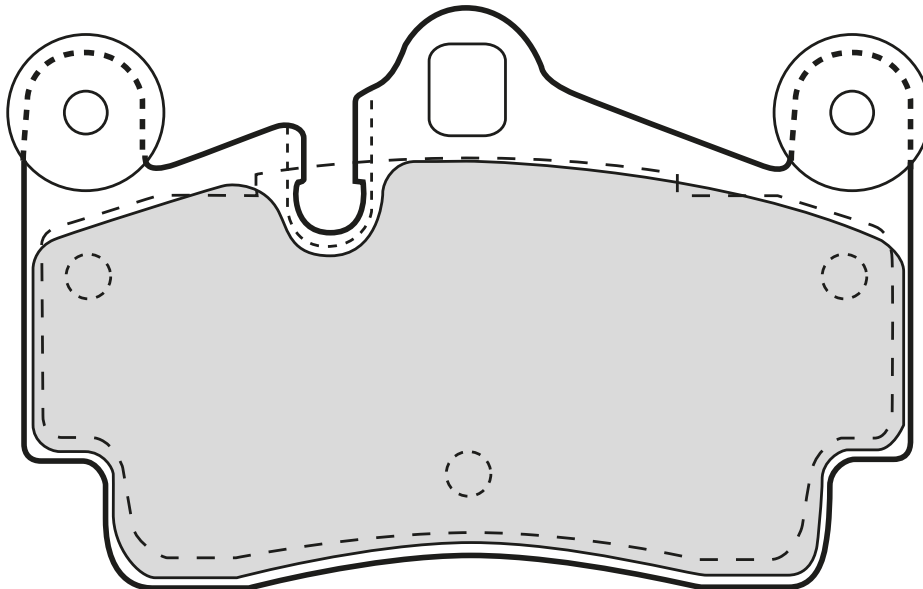

<b>Valeo</b> 									
301770		117,3	73,1	16,7		BRE			AUDI, PORSCHE, VOLKSWAGEN

## 23698 (WVA)

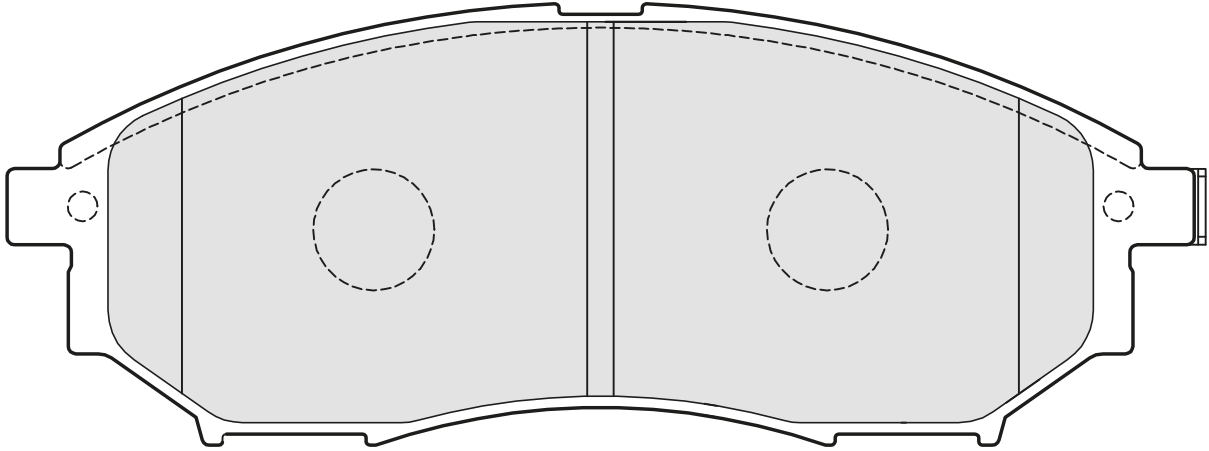

<b>Valeo</b> 	 								
301337	↳ 2 x	157,00	58,50	17,00		SUM			NISSAN

## 23705 (WVA)

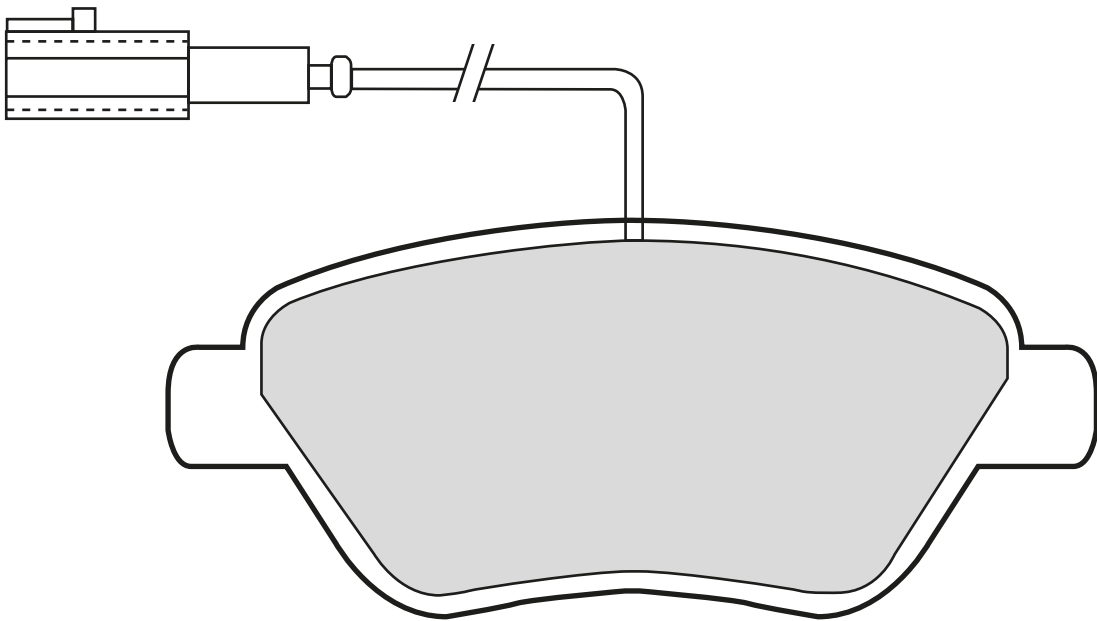

<b>Valeo</b> 	 								
301426	↳ 1 x  215 mm	123	53,3	17,8		BSC			FIAT CITROËN, FIAT, PEUGEOT

## 23708 (WVA)

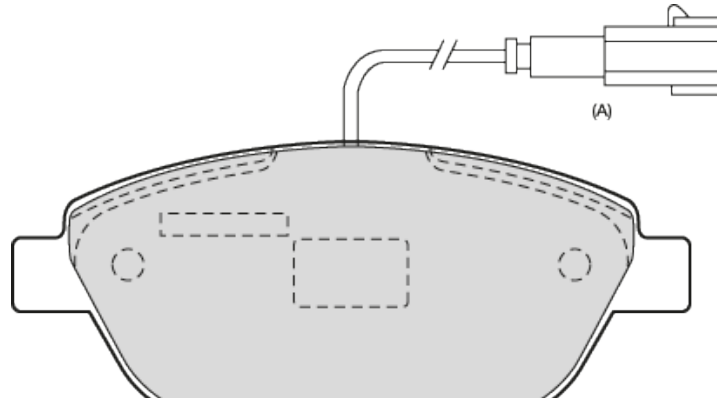

<b>301721</b>	1 x $\varnothing$ 215 mm	137	57,4	19		BSC		<b>FIAT</b>



## 23722 (WVA)

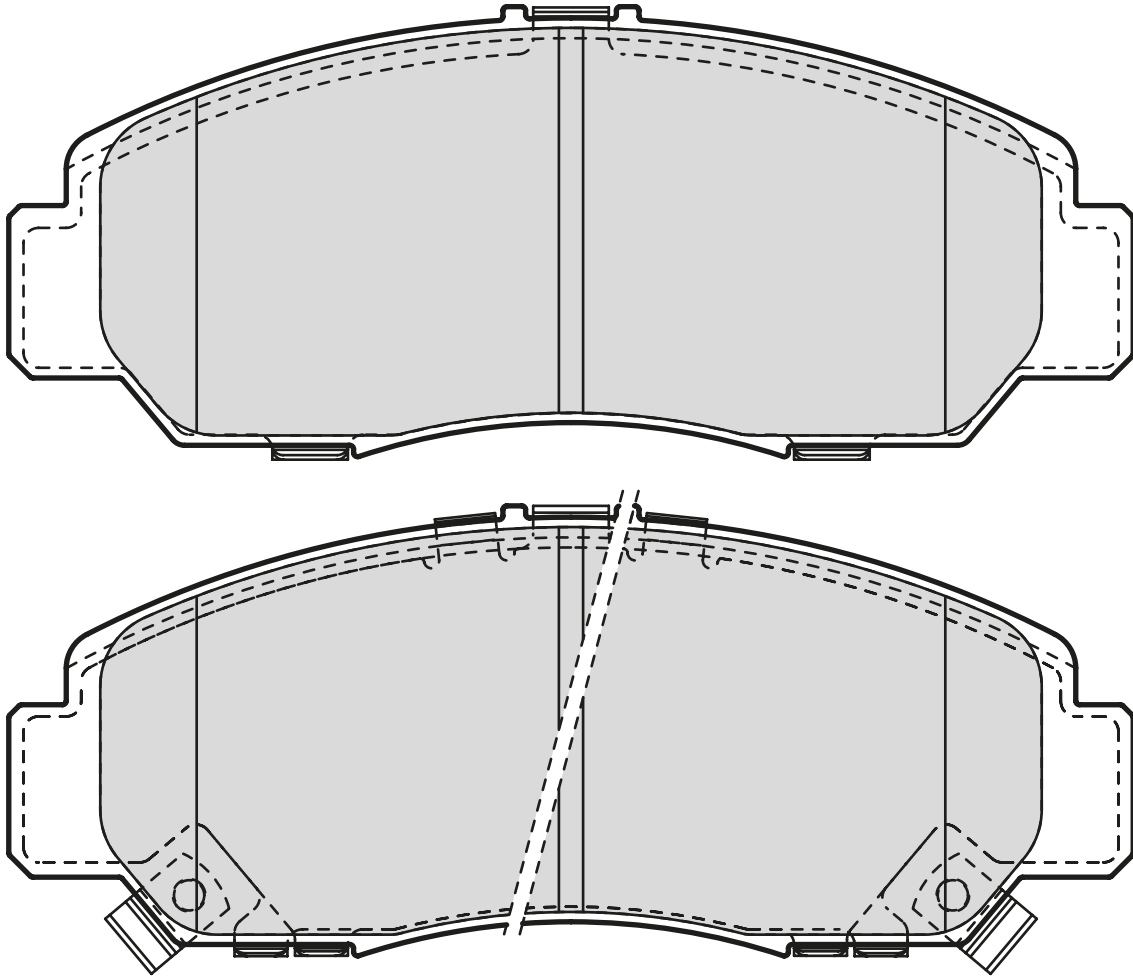

<b>Valeo</b>								
<b>301887</b>	↳ 2x	148,72	59,02	16,9	SUM		<b>HONDA</b>	



## 23723 (WVA)

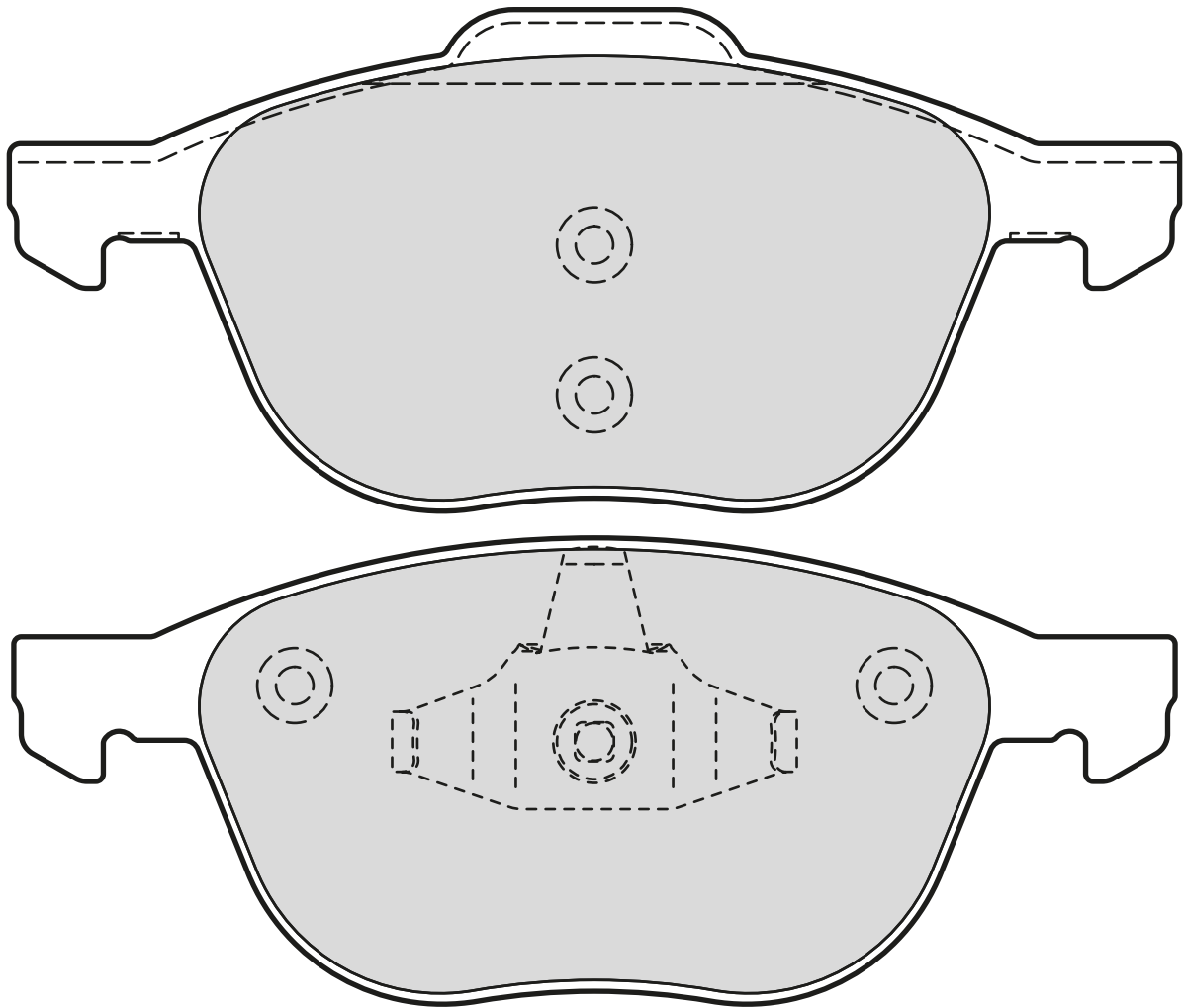

<b>301649</b>		156,3 155,1	67 62,5	17,5		ATE		<b>FORD, MAZDA, VOLVO</b>	

## 23732 (WVA)

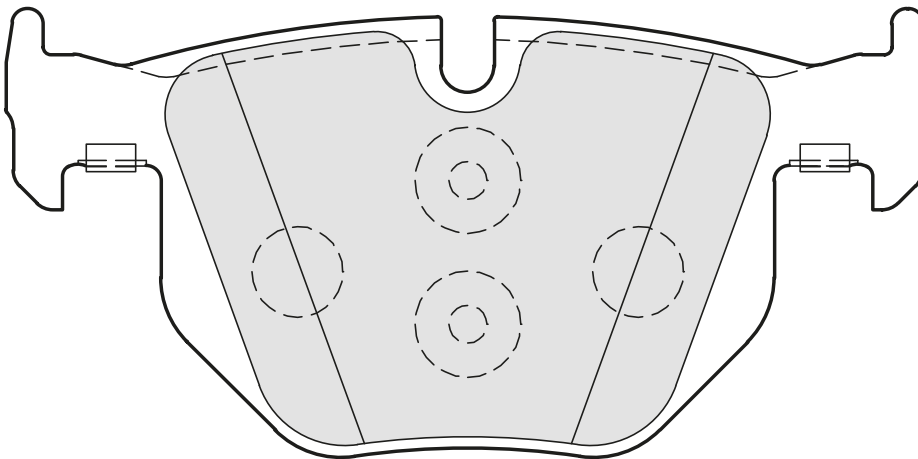
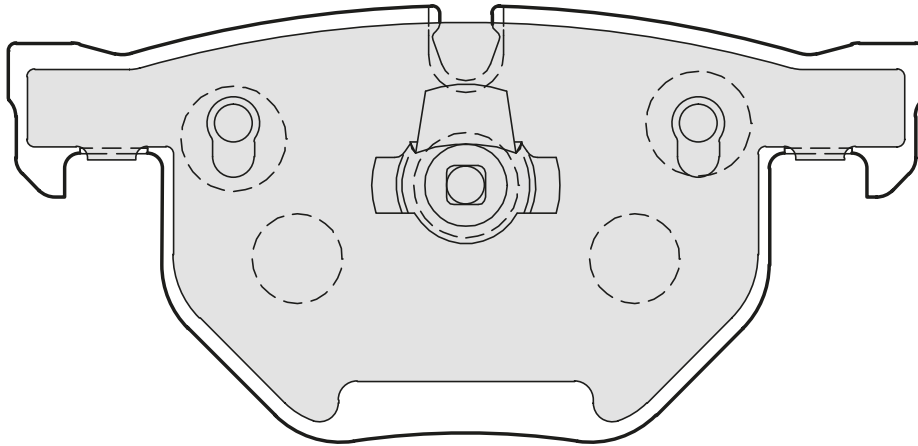

301754		121,8	58 59,2	17,3	ATE		  <b>BMW</b>

## 23743 (WVA)

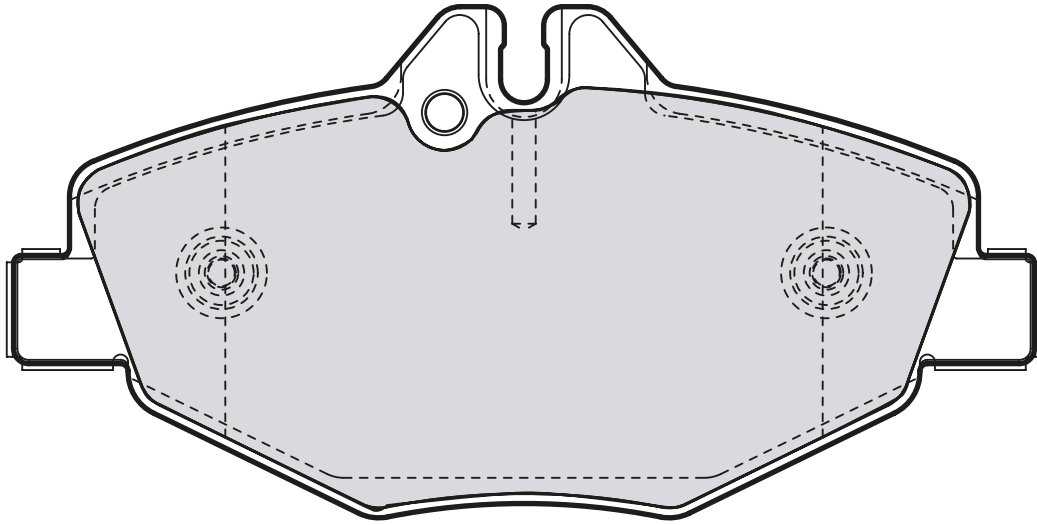

301638		137	67,8	20		BSC			MERCEDES

## 23794 (WVA)

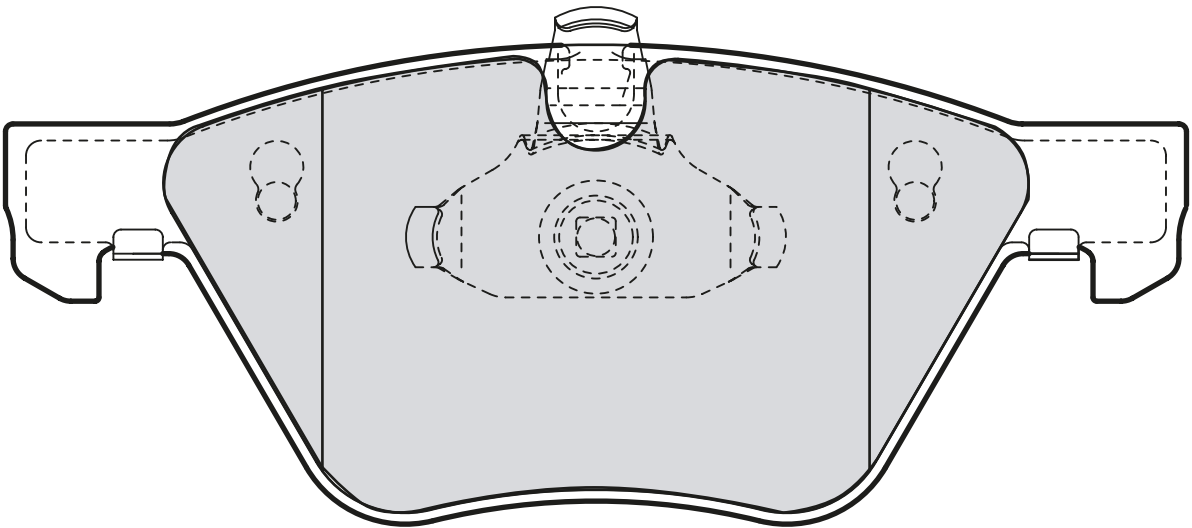
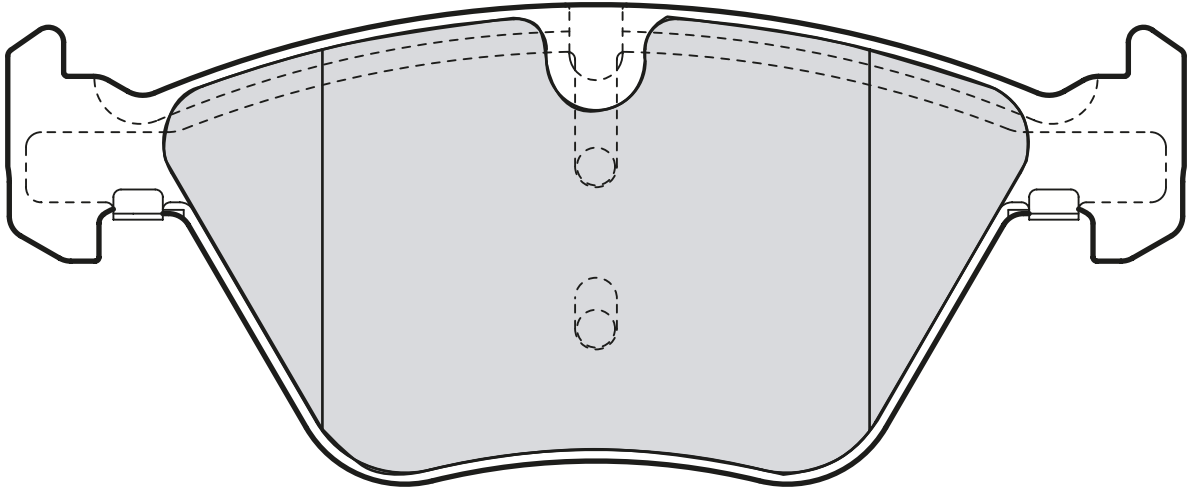

301640		154,8 155,4	63,6	20		ATE			<b>BMW</b>

## 23806 (WVA)

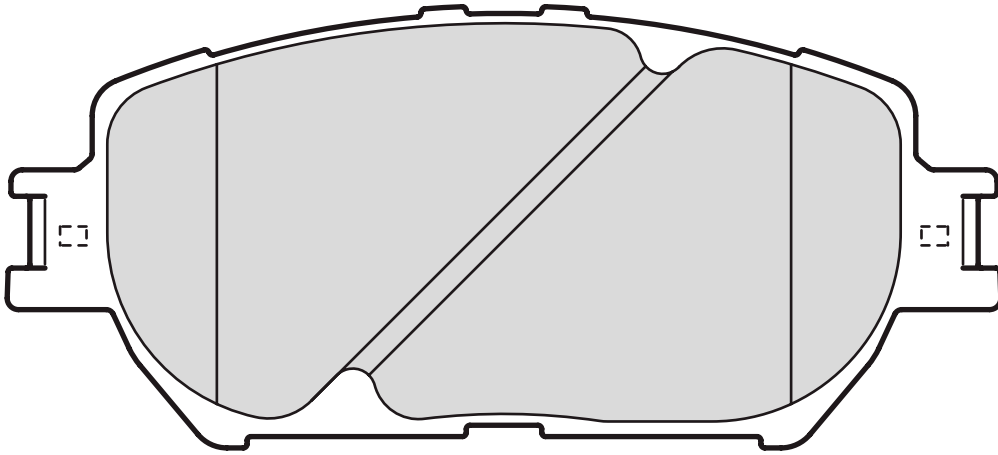

301862		131,4	58,5	17,3		AKE			TOYOTA

## 23813 (WVA)

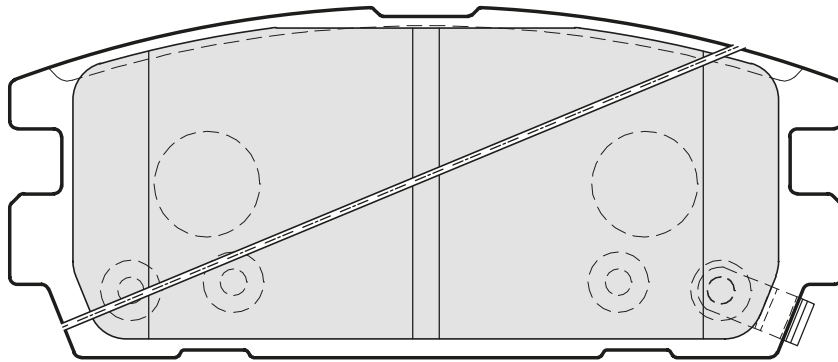

301024	↳ 2x	110,6	46,3	15,6		MAND			HYUNDAI

## 23816 (WVA)

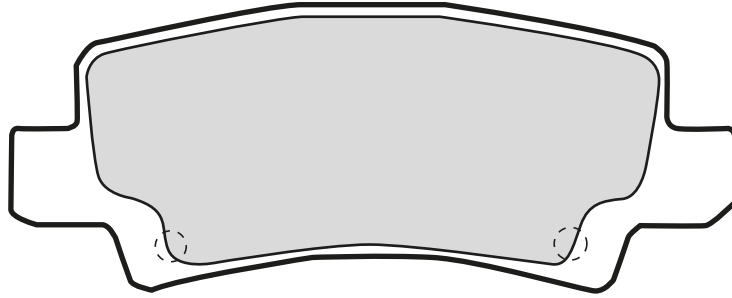

301680	↳ 2 x	95,7	38	15,8		LUC			TOYOTA



## 23832 (WVA)

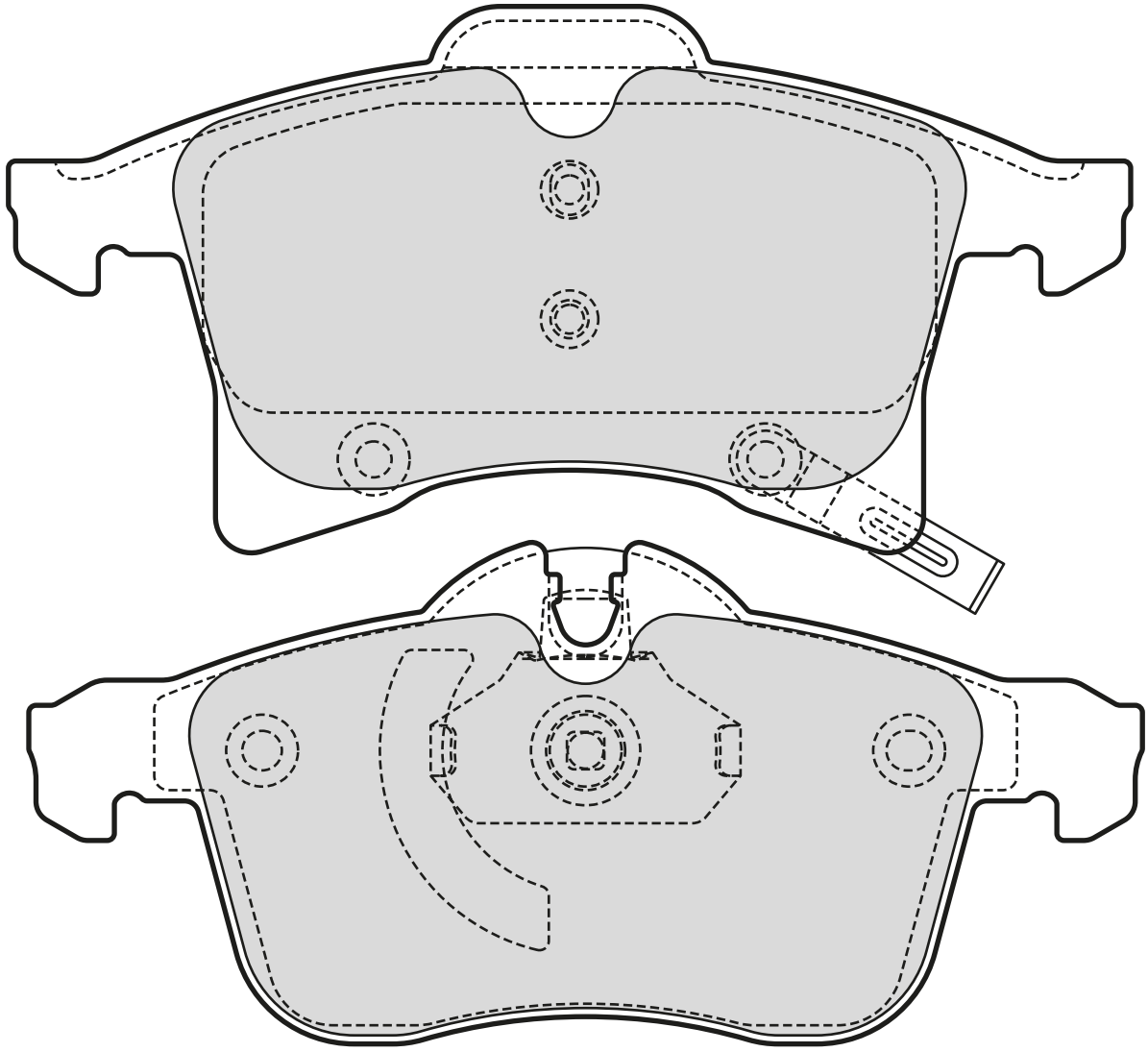

<b>301860</b>	2x	156,1 154,9	76 69,7	20,4	ATE			<b>OPEL, VAUXHALL</b> <b>OPEL, VAUXHALL</b>



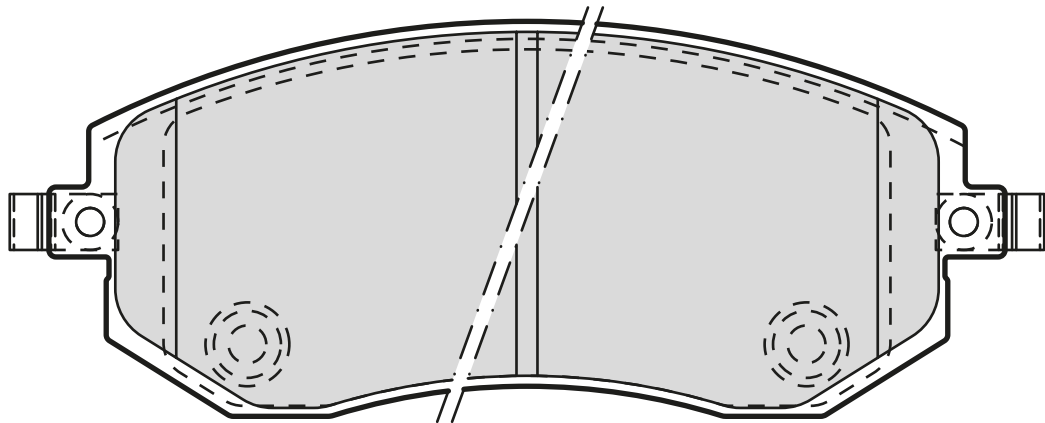





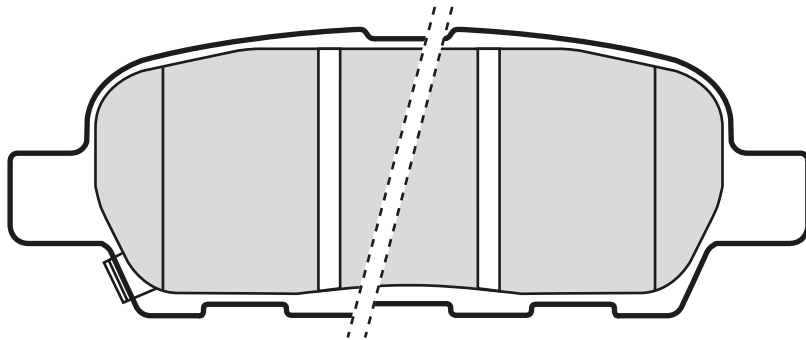











## 23865 (WVA)



Valeo	   						 	 
								
301853	↳ 2x 	136,8	56,5	17,5		TOKI		 <b>SUBARU</b>

## 23871 (WVA)



Valeo	   						 	 
								
301009	↳ 1x 	105,8	38	14		AKE		 <b>INFINITI, NISSAN, RENAULT</b>
301672	↳ 2x 	105,5	38	14		AKE		 <b>NISSAN</b>





## 23891 (WVA)

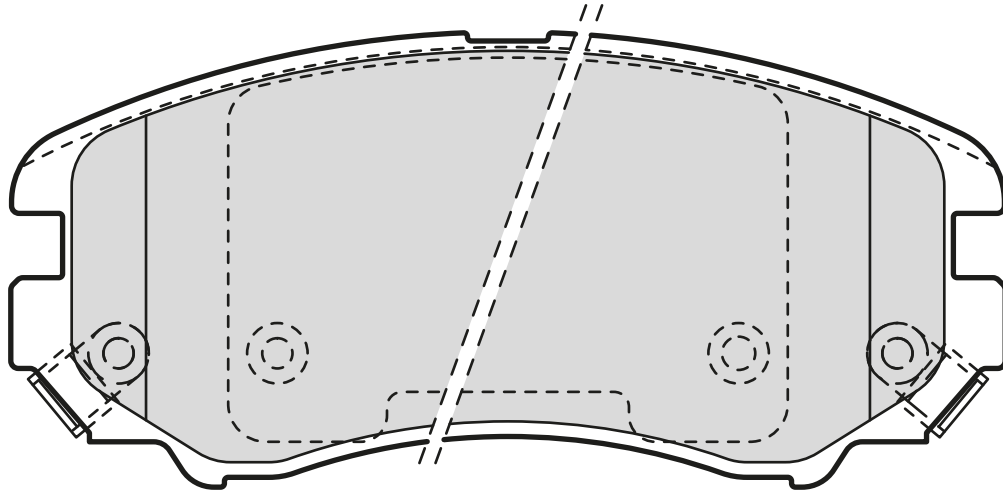

301744	↳ 2x	131,5	60,1	17,5		MAND			HYUNDAI, KIA

## 23914 (WVA)

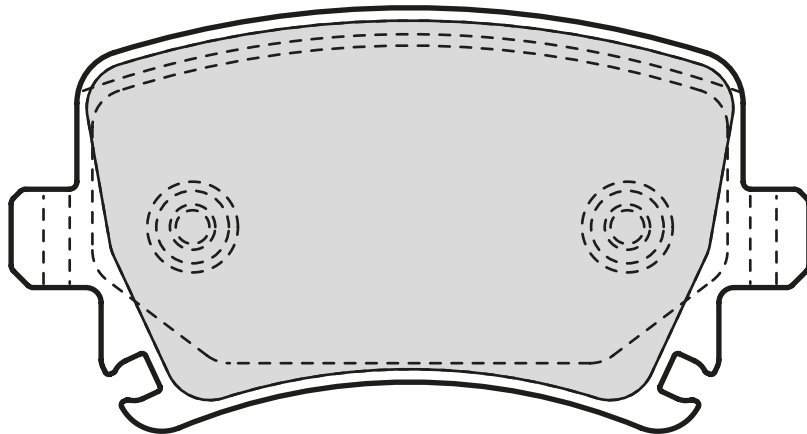

301752		105,1	56	17		TRW			AUDI, SEAT, SKODA, VOLKSWAGEN VOLKSWAGEN

## 23918 (WVA)

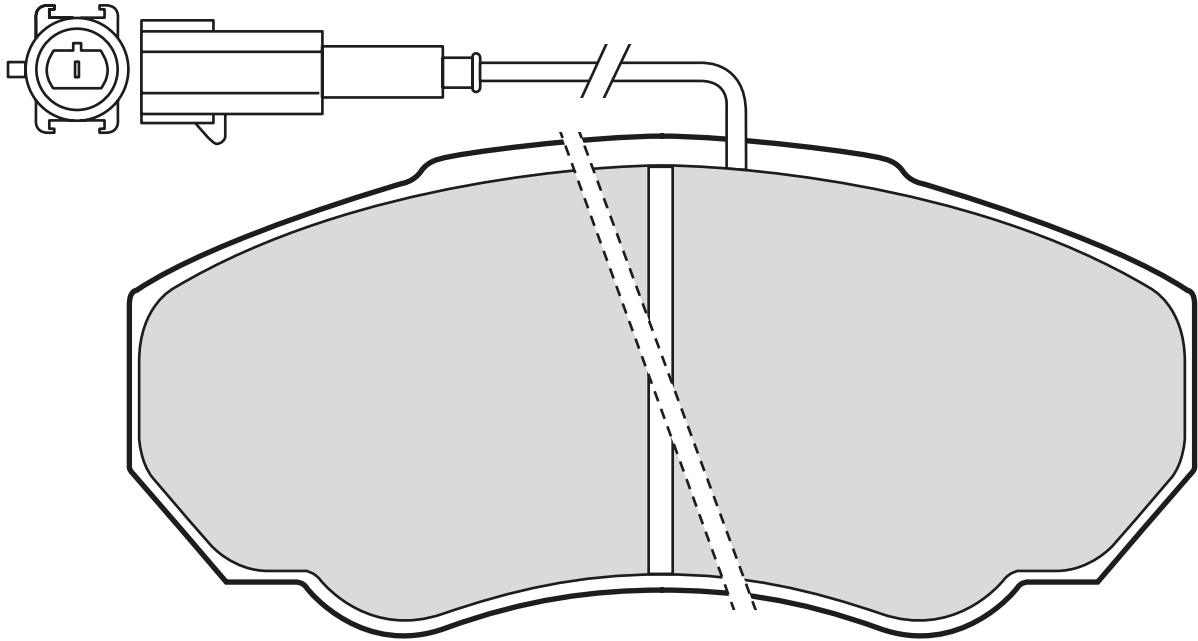

<b>301568</b>	1x  175 mm	140,5	65,8	19	BRE		<b>CITROËN, FIAT, PEUGEOT</b>	



## 23919 (WVA)

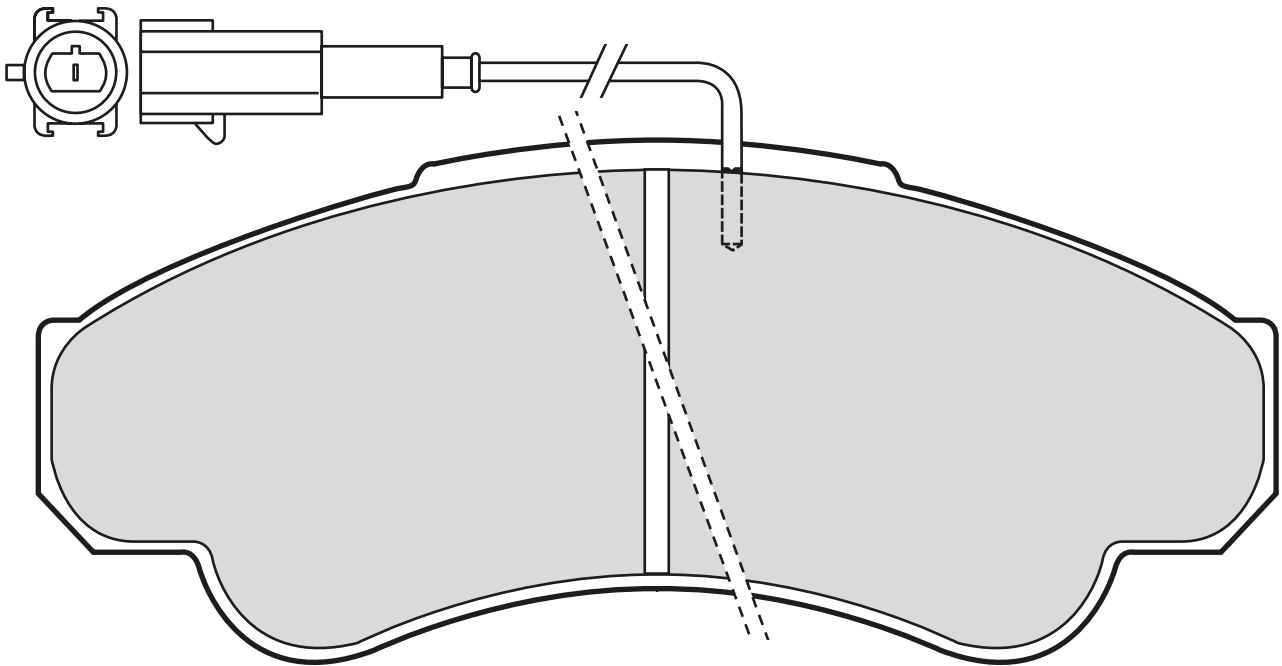

<b>Valeo</b>								
<b>301569</b>	1 x  175 mm	164,6	69,3	18,3	BRE		<b>CITROËN, FIAT, PEUGEOT</b>	

## 23921 (WVA)

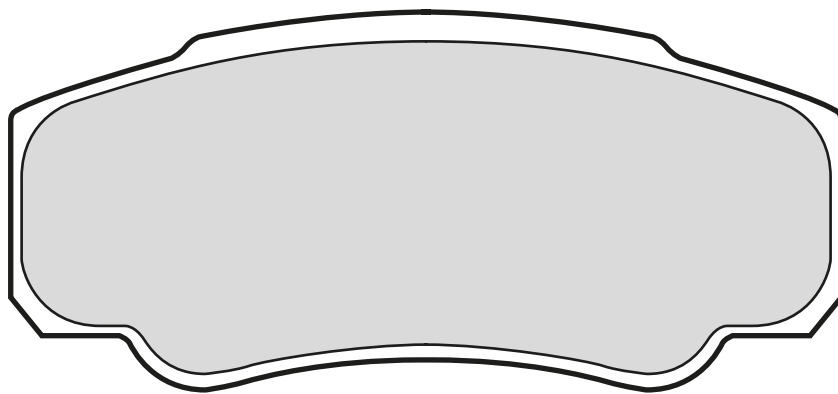

<b>Valeo</b>								
<b>301570</b>		109,5	49,8	20	BRE		<b>CITROËN, FIAT, PEUGEOT</b>	

## 23926 (WVA)

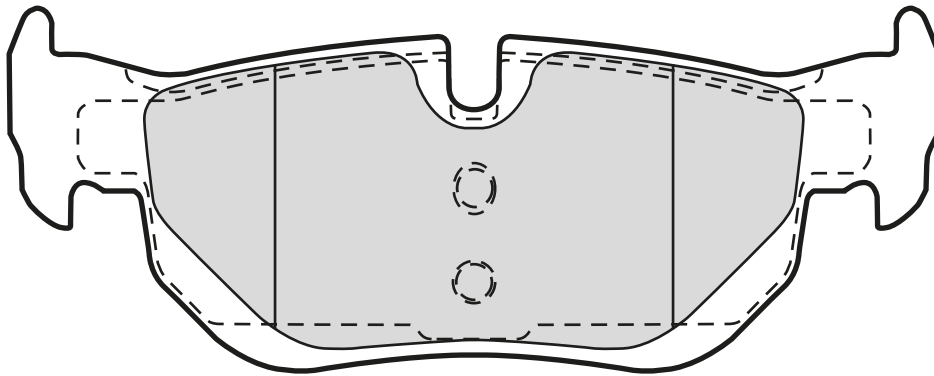
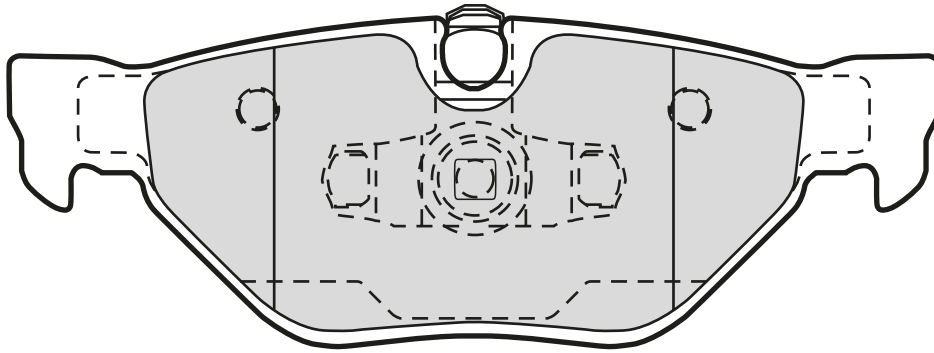

301703		123	43,5 44,5	17,3		ATE			 <b>BMW</b>

## 23930 (WVA)

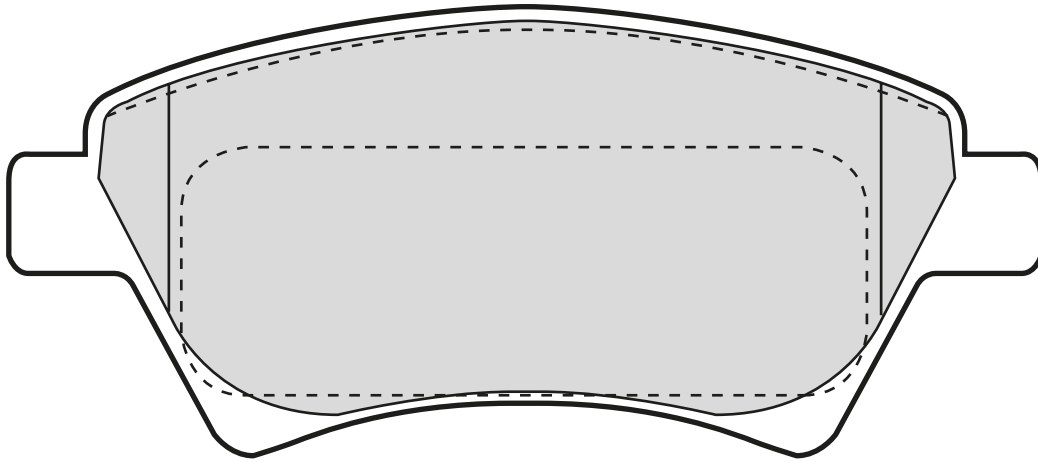

301558		136,8	59,5	18,3		BSC		<b>RENAULT</b> <b>RENAULT</b>

## 23934 (WVA)

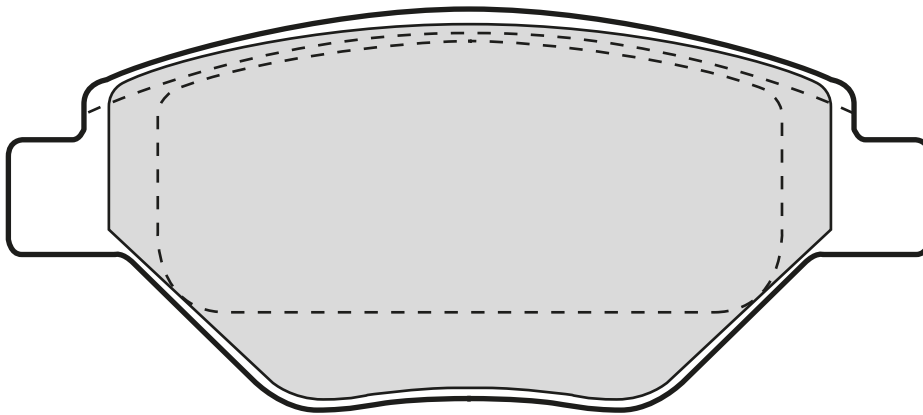

301557		122,8	54,3	18,3		BSC		<b>RENAULT</b>

## 23959 (WVA)

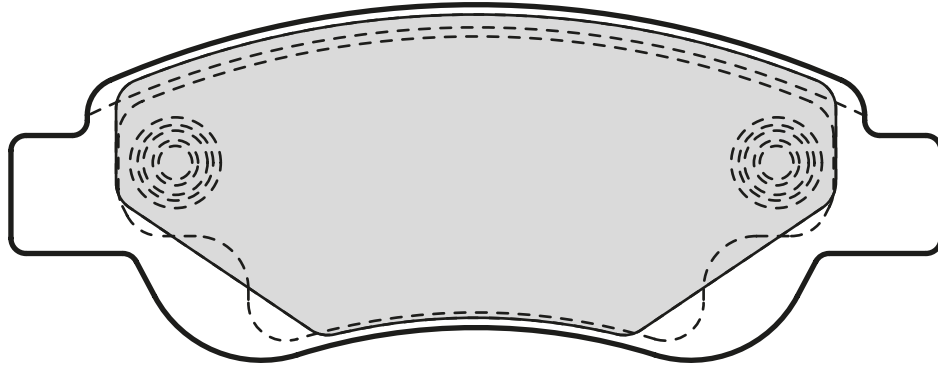

301718		122,7	46,7	17,6		BSC			CITROËN, PEUGEOT, TOYOTA



## 23966 (WVA)

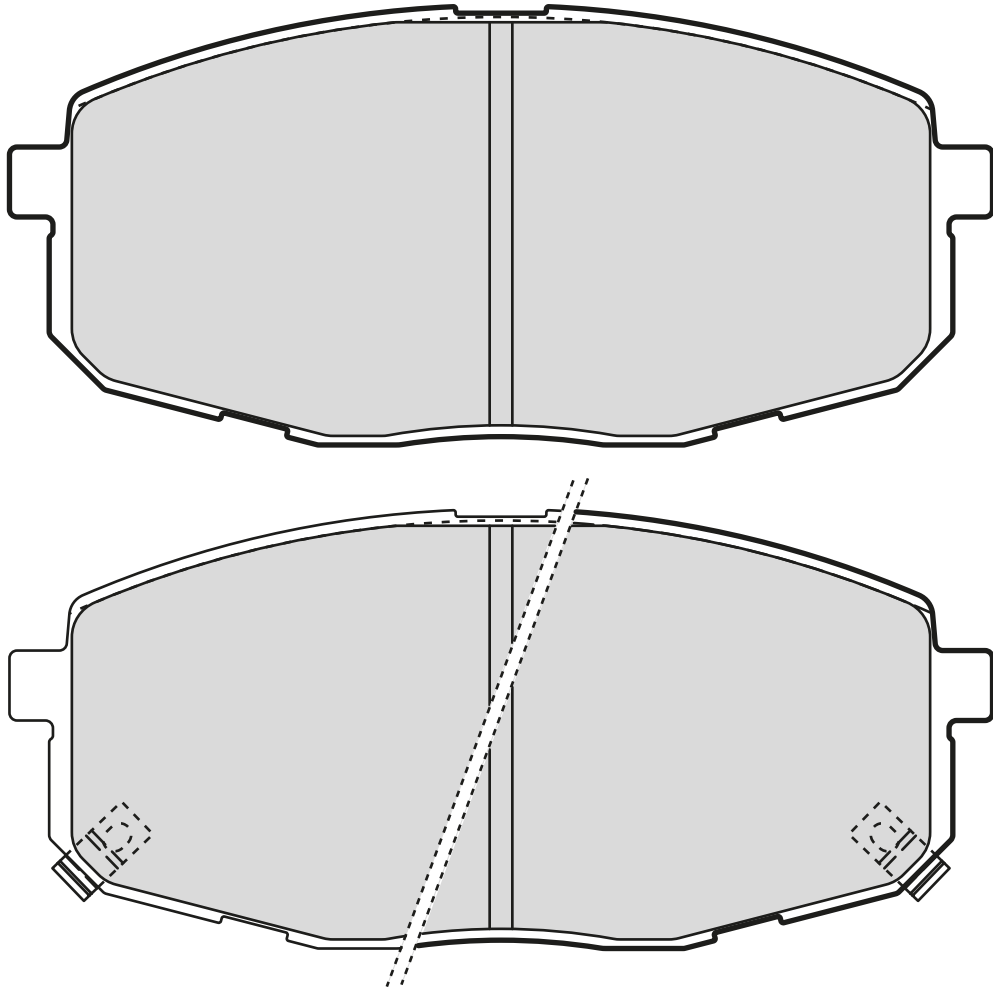

301842	↳ 2x	130	58,1	16,7	MAND			HYUNDAI, KIA	

## 23970 (WVA)

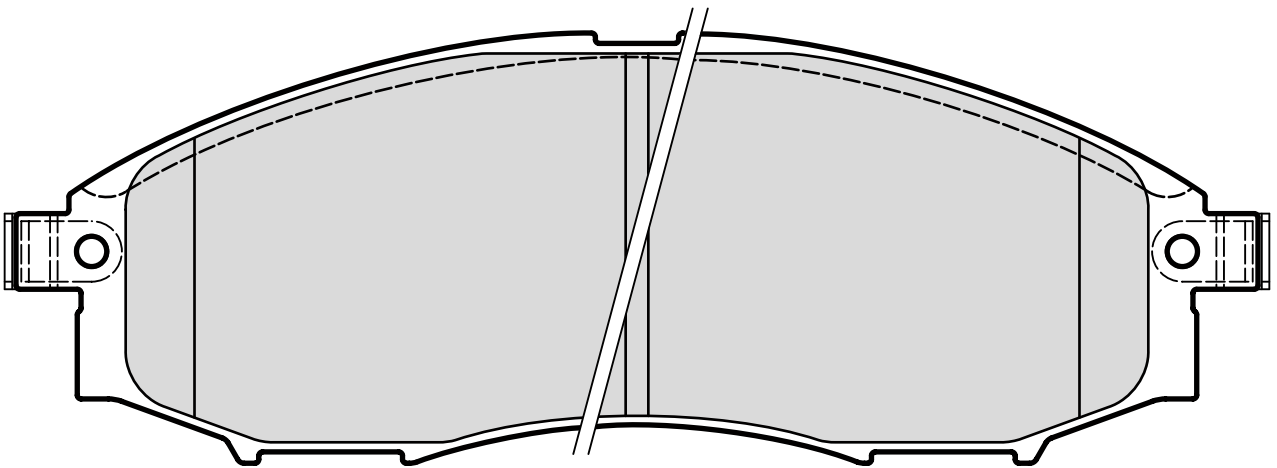
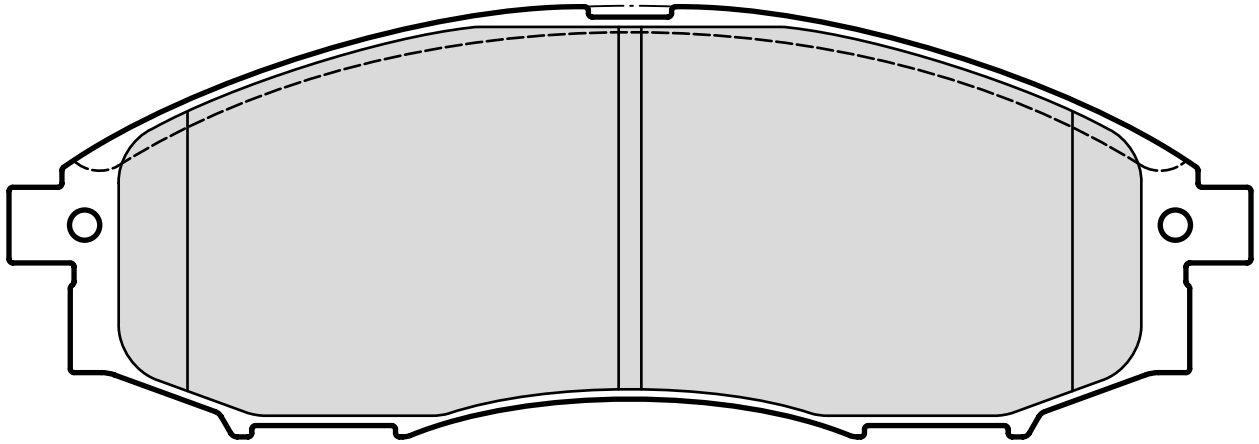







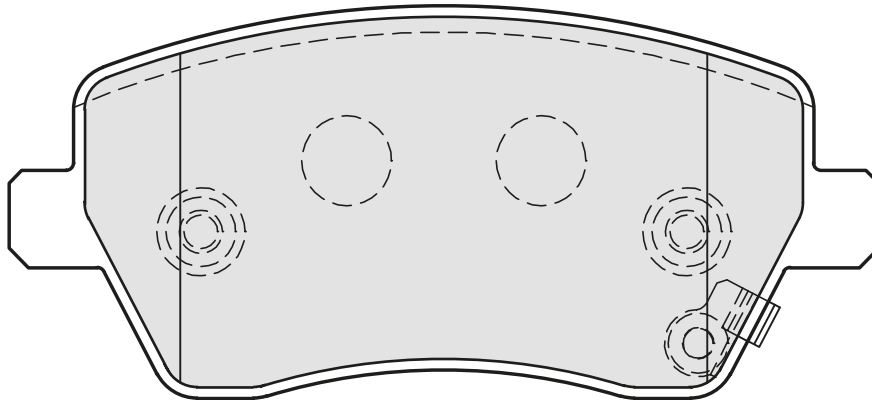











301889	↳ 2x	164,2	57	17		AKE		NISSAN
								NISSAN











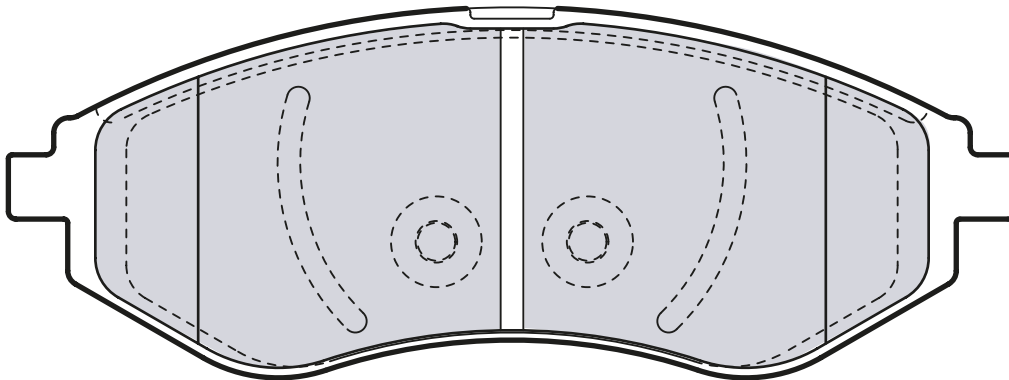

## 23973 (WVA)



Valeo	 								
									
301641		116,4	52,5	17,3		LUC	 	 	DACIA, NISSAN, RENAULT RENAULT
301847	↳ 1x 	116,2	52,1	17,3		LUC			OPEL, SUZUKI, VAUXHALL

## 23974 (WVA)



Valeo	 								
									
301644		133	49	17,8		AKE			CHEVROLET

## 23983 (WVA)

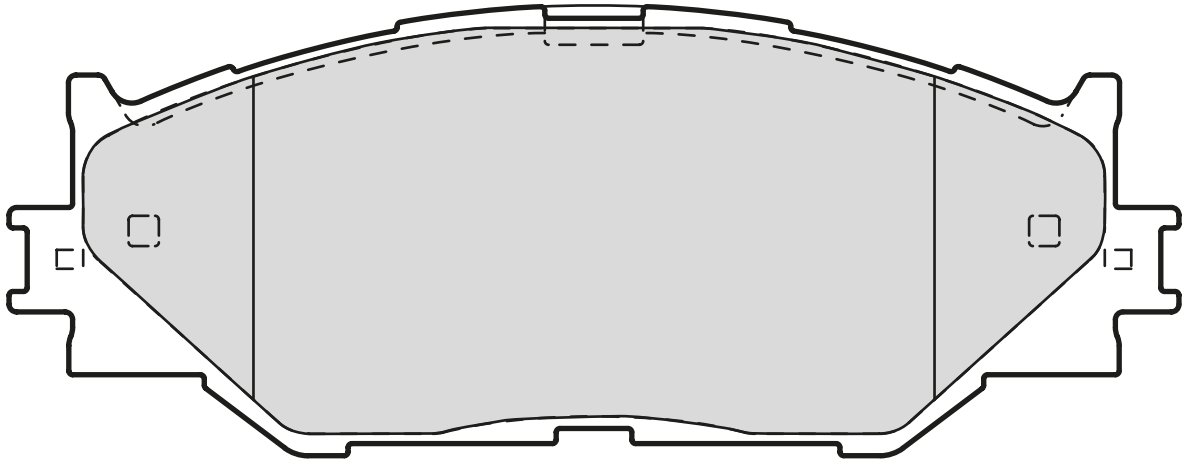

301035		154,6	59,5	17,7		SUM			LEXUS



## 24011 (WVA)

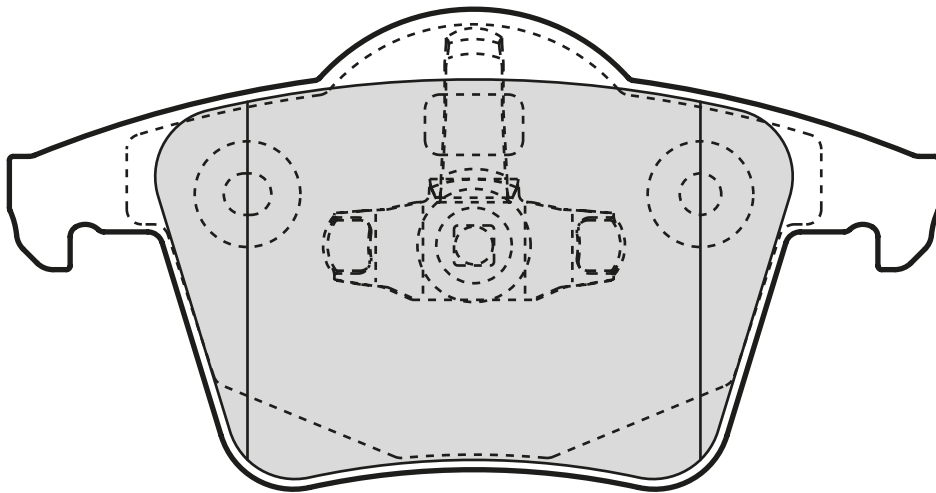
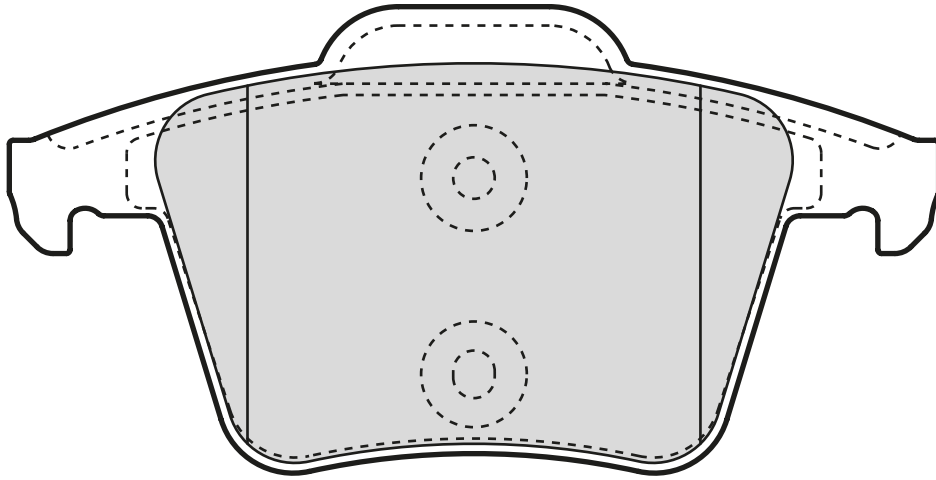

301829		122,9	63,6 61,6	18,7		ATE		VOLVO

## 24014 (WVA)

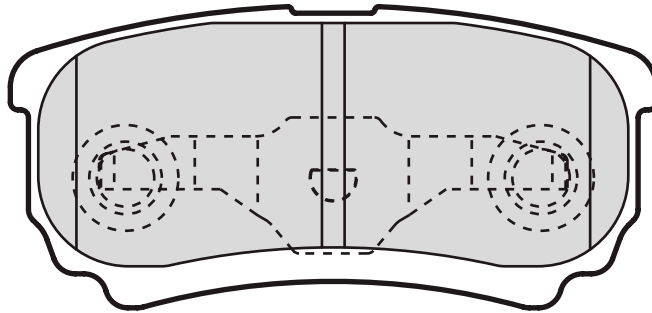
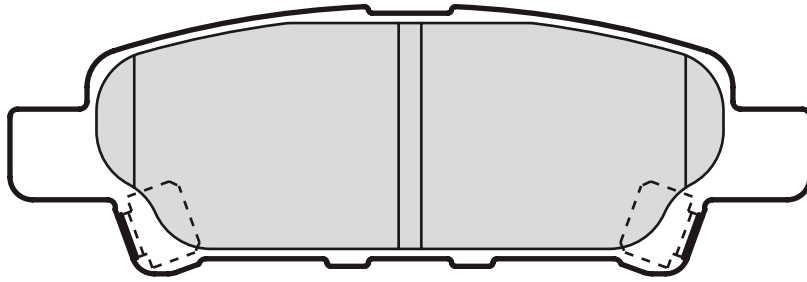

301852		85,5 106	40 35,5	15,5		AKE			CITROËN, DODGE, MITSUBISHI, PEUGEOT



## 24024 (WVA)

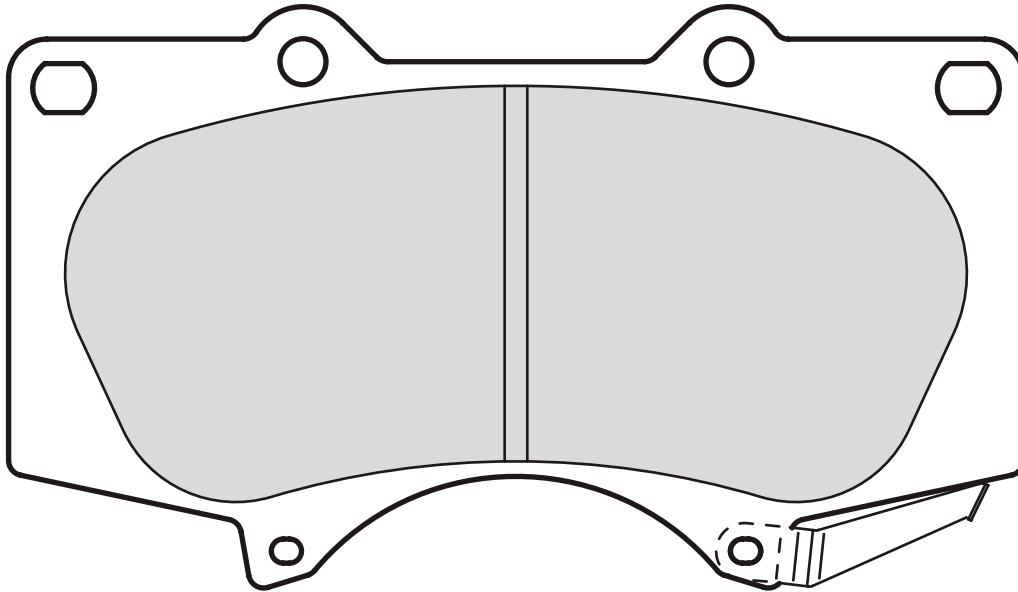

301857	↳ 2x	134,2	76,9	17,8	SUM				TOYOTA

## 24031 (WVA)

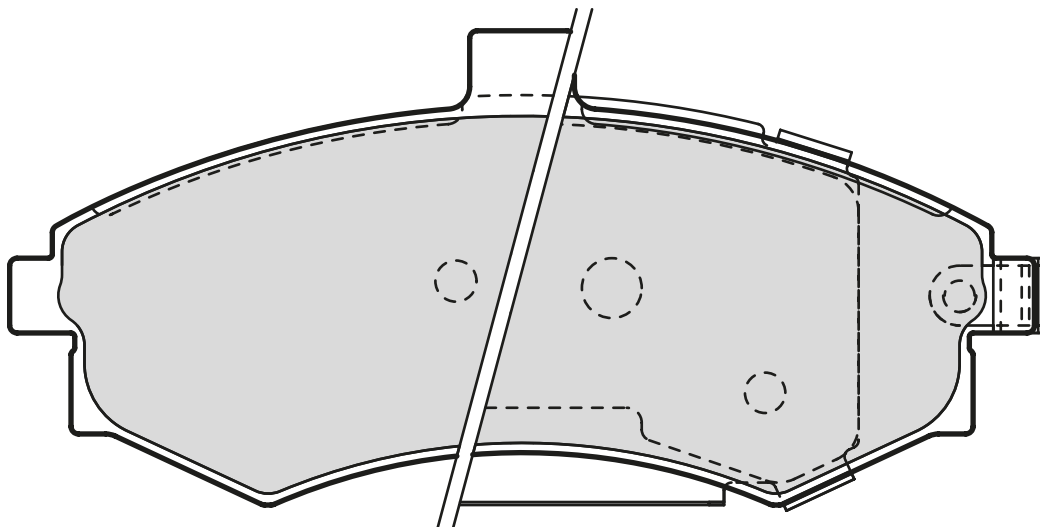

301781	↳ 2x	136,7	63,5	17,6	MAND				HYUNDAI

## 24045 (WVA)

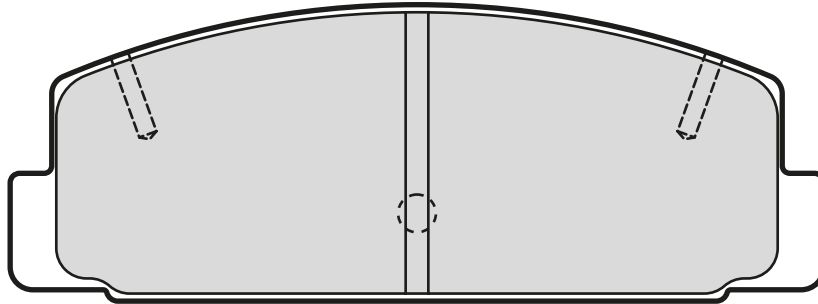

<b>Valeo</b> 									
301780		107,6	39,2	13,1		AKE			MAZDA

## 24071 (WVA)

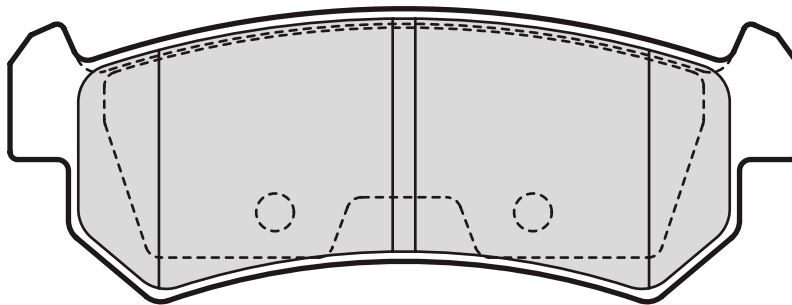

<b>Valeo</b> 									
301874		104,2	38,8	14,6		SUM			CHEVROLET, DAEWOO



## 24123 (WVA)

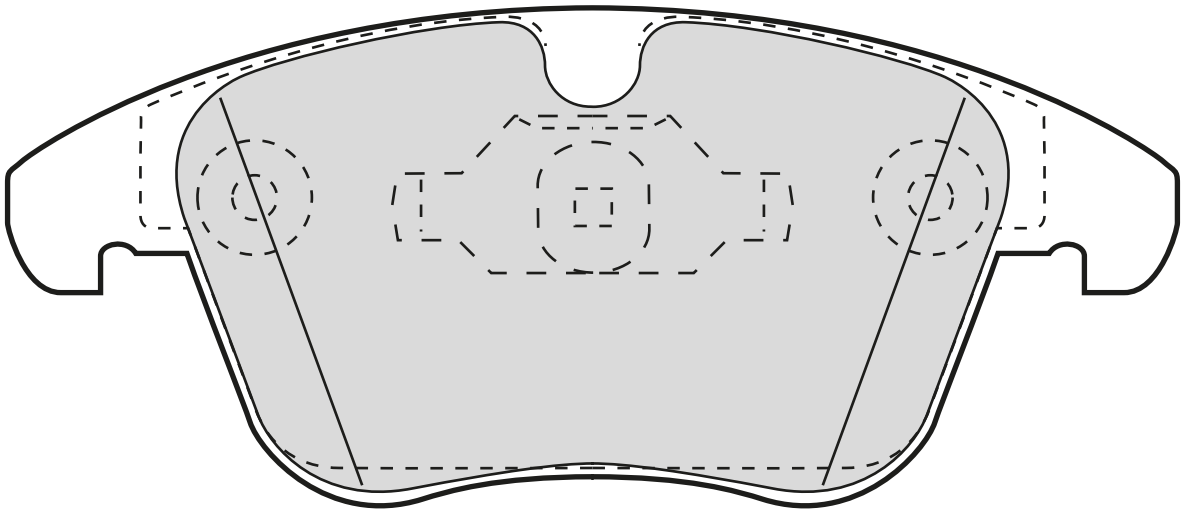
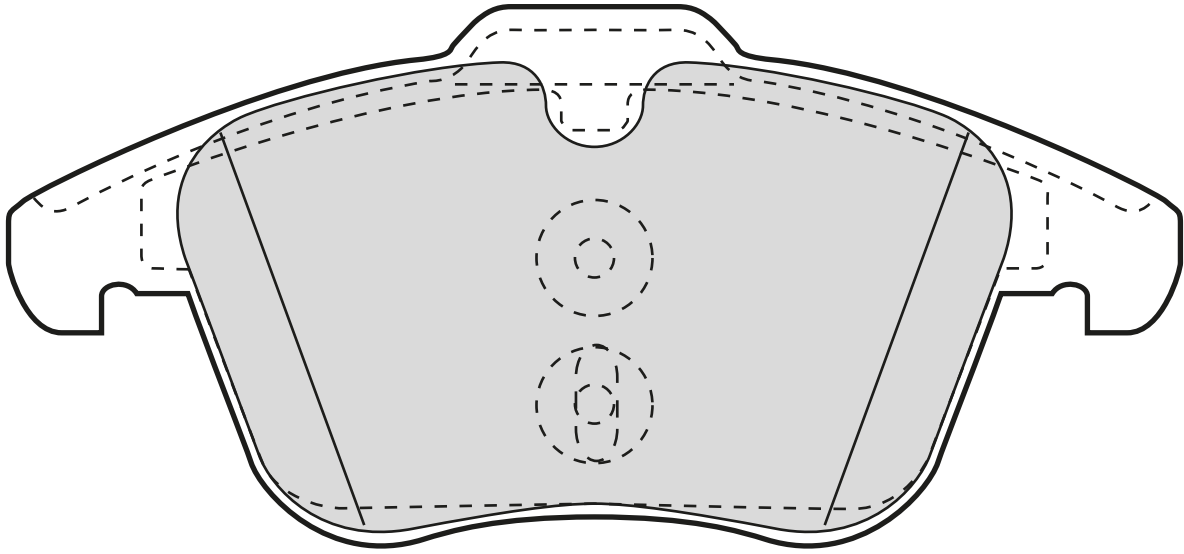

301879		155,1 156,3	66,6 72	19,2		ATE			LAND ROVER, VOLVO

## 24134 (WVA)

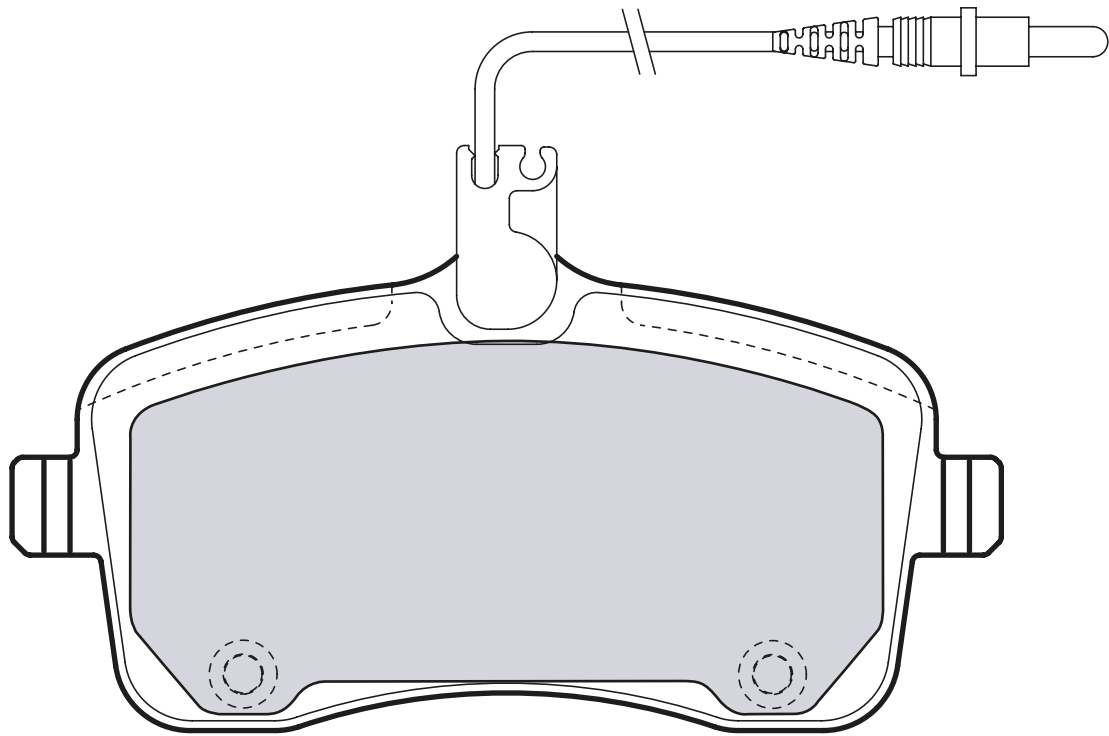

<b>301662</b>	2 x  325 mm/365 mm	131,4	66,8	19,5		LUC			<b>PEUGEOT</b>	



## 24137 (WVA)

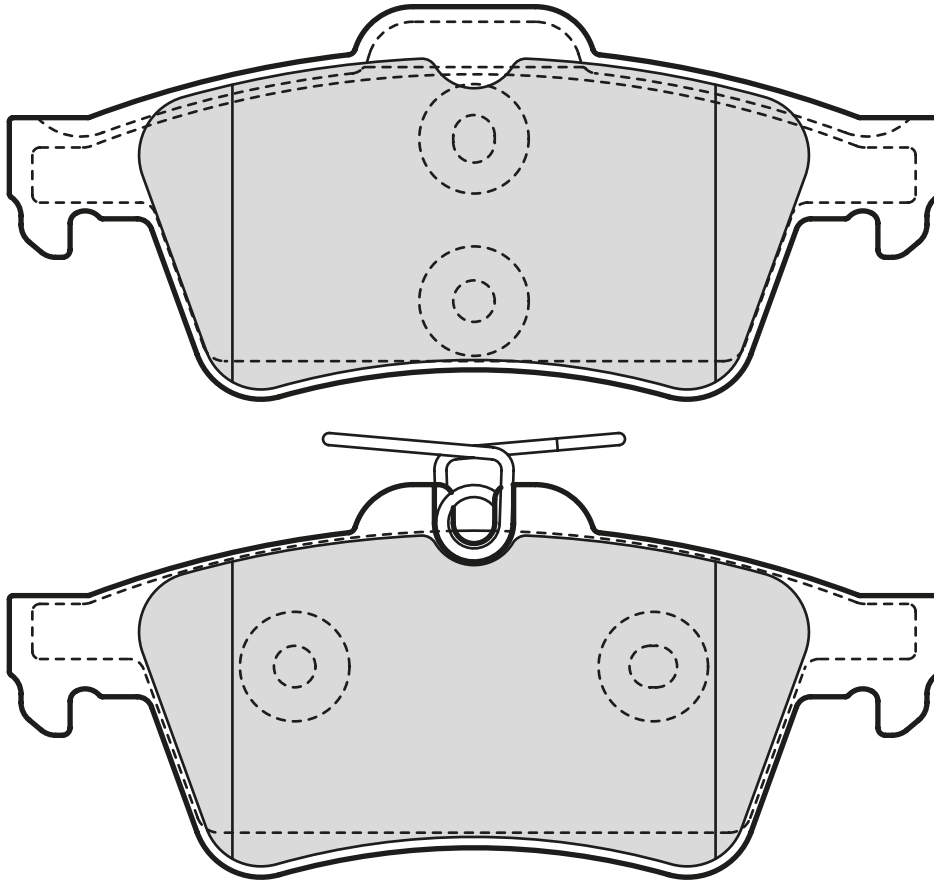

301783		122,9	51,7	16,4		ATE			<b>CADILLAC, CITROËN, JAGUAR, OPEL, RENAULT, SAAB, VAUXHALL, VOLVO FORD</b>

## 24141 (WVA)

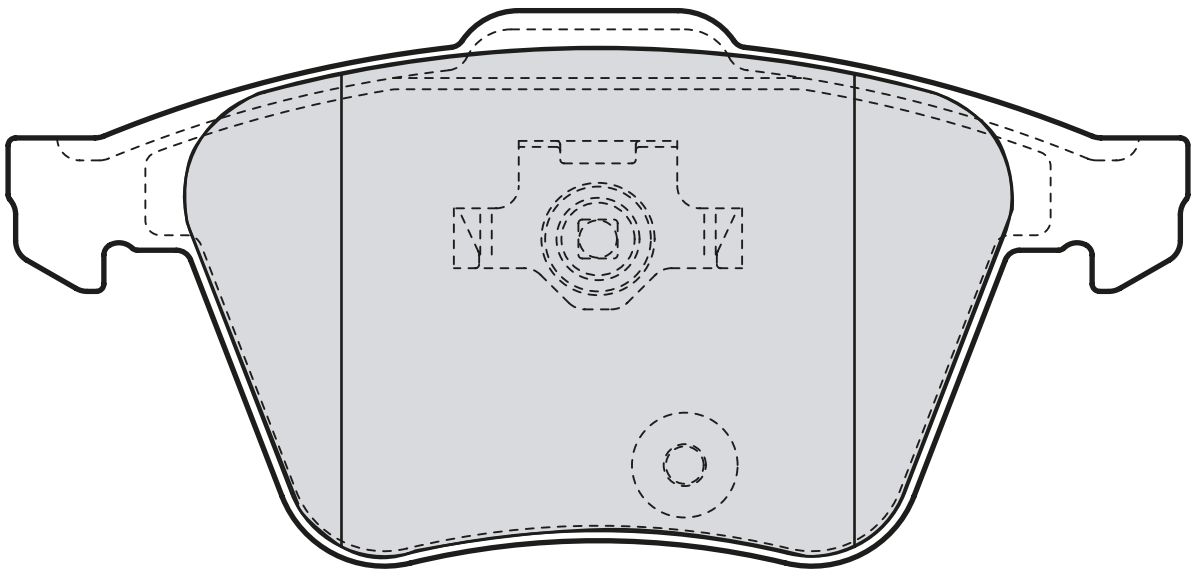
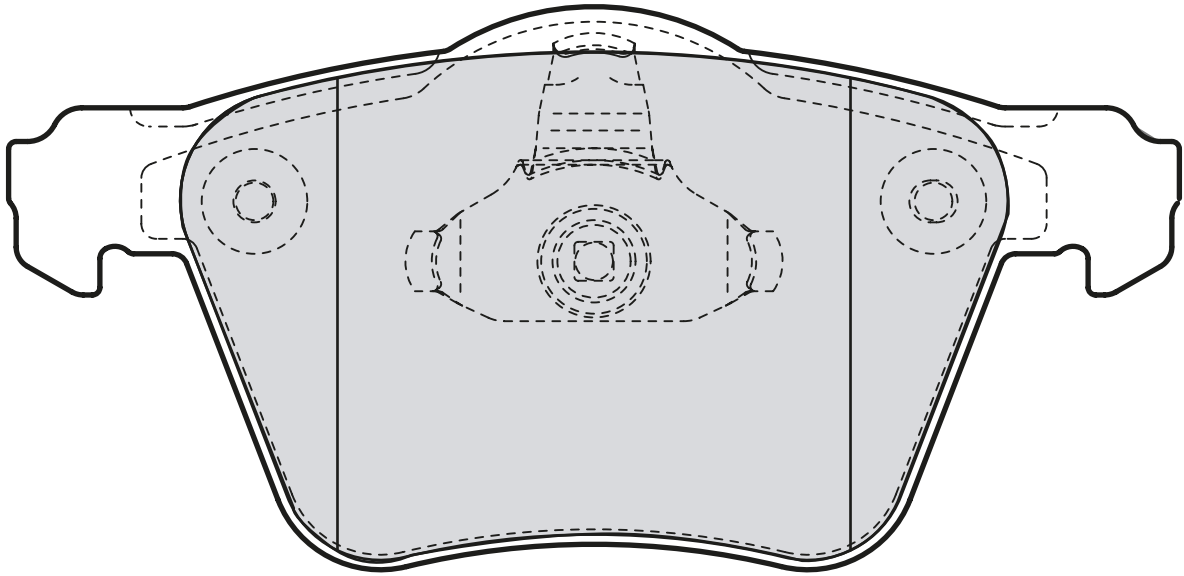

301657		155,2	75 74	19		ATE				VOLVO

## 24218 (WVA)

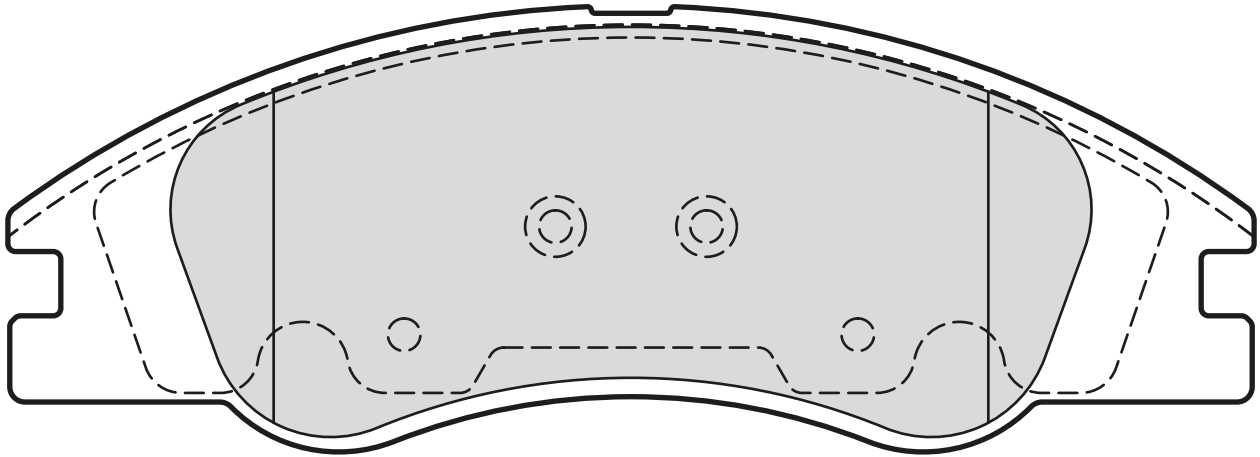

<b>301705</b>	2x	164,8	58,9	16,9		MAND		<b>KIA</b>

## 24260 (WVA)

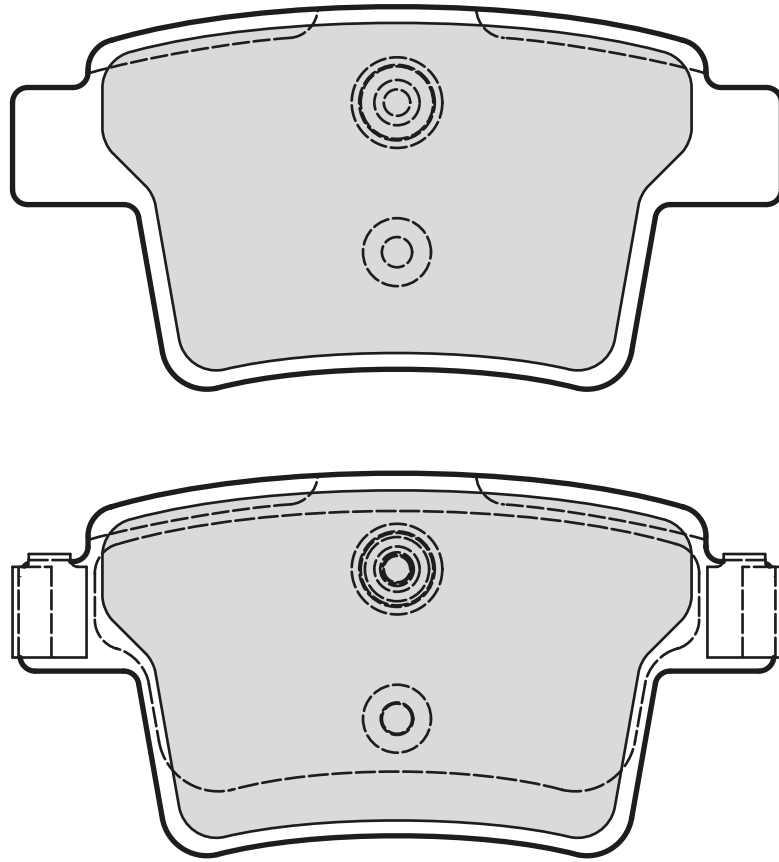

301740		101,8	50,6	17	BSC		<b>FORD</b>

## 24277 (WVA)

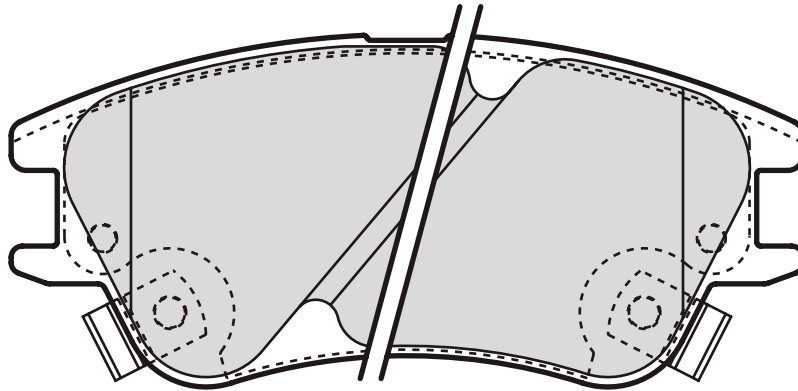

301708	↳ 2x	104,7	47,2	16,3		MAND		HYUNDAI

## 24288 (WVA)

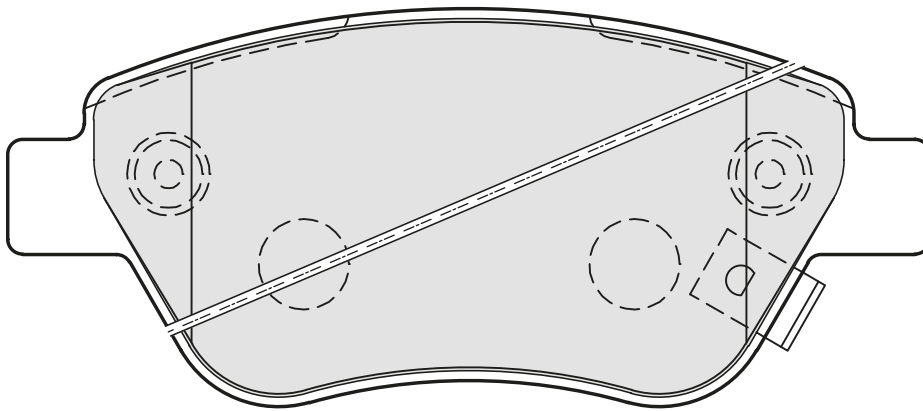

301825	↳ 1x	122,8	53,2	17,8		BSC		OPEL, VAUXHALL

## 24289 (WVA)

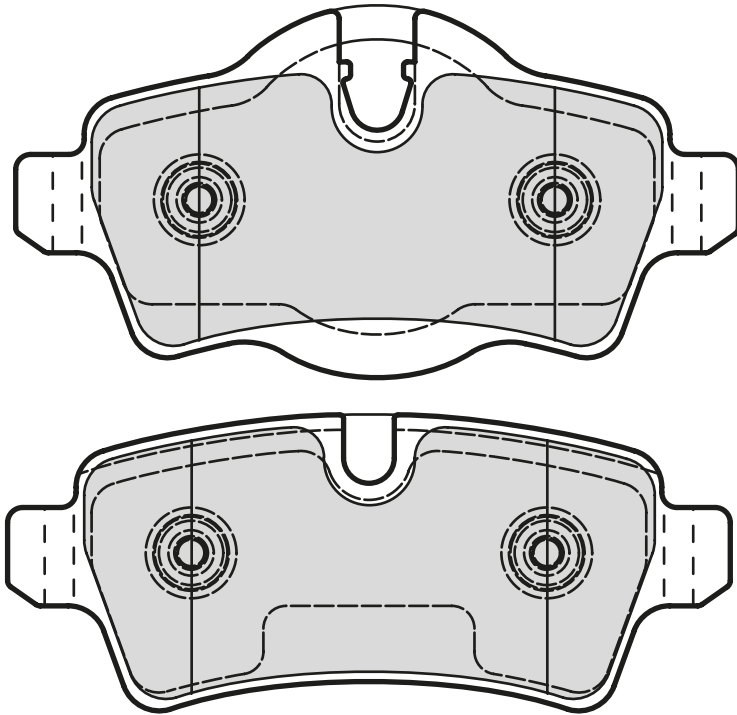

301041		95,5 95,5	49,2 39,2	17		LUC			MINI



## 24317 (WVA)

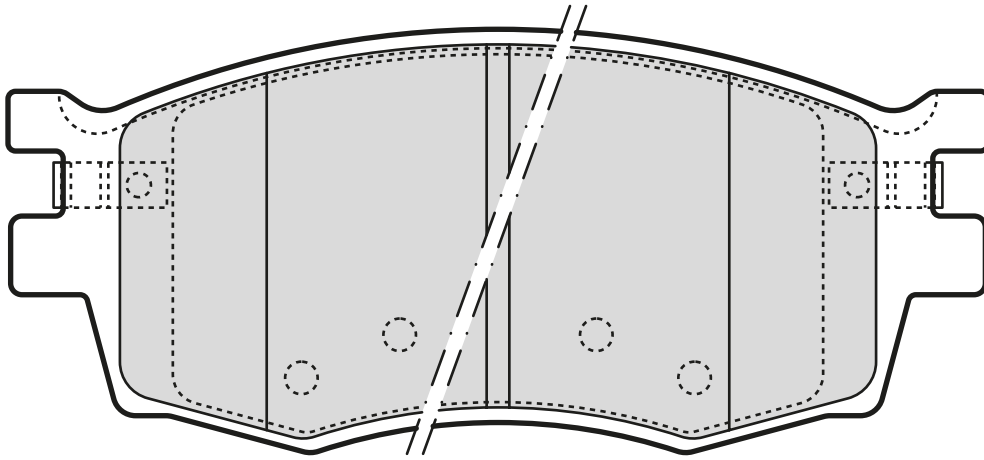

301868	↳ 2x	129,6	56	18		MAND			HYUNDAI, KIA

## 24320 (WVA)

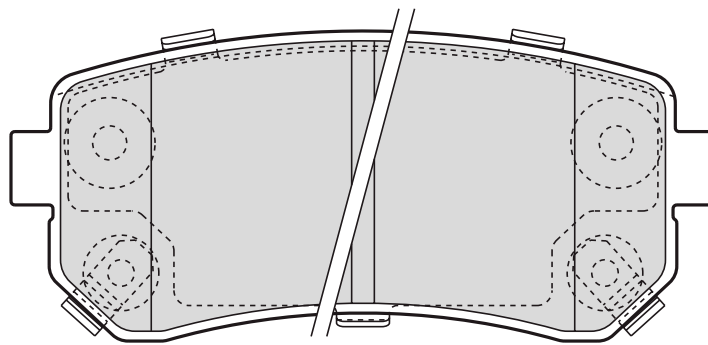

301867	↳ 2x	92,9	41	15,9		MAND			HYUNDAI, KIA

## 24336 (WVA)

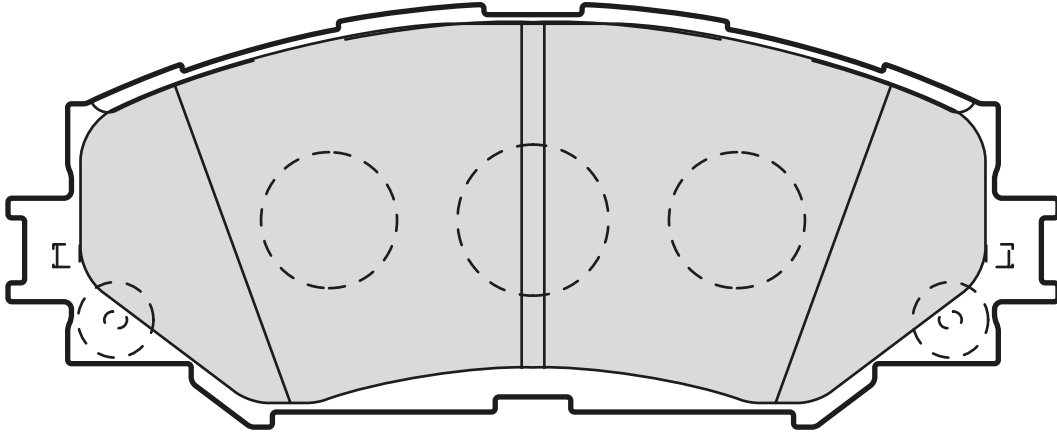

<b>Valeo</b> 								
<b>301943</b>		139	56,1	17,4	AKE		<b>TOYOTA</b>	

## 24338 (WVA)

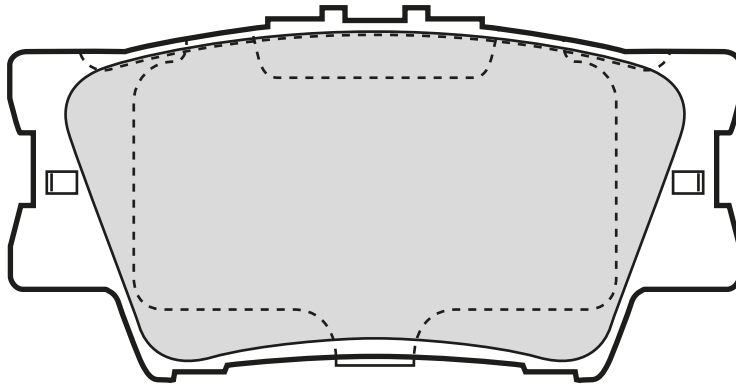

<b>Valeo</b> 								
<b>301819</b>		96,6	49,2	15,4	AKE		<b>TOYOTA</b>	





## 24350 (WVA)

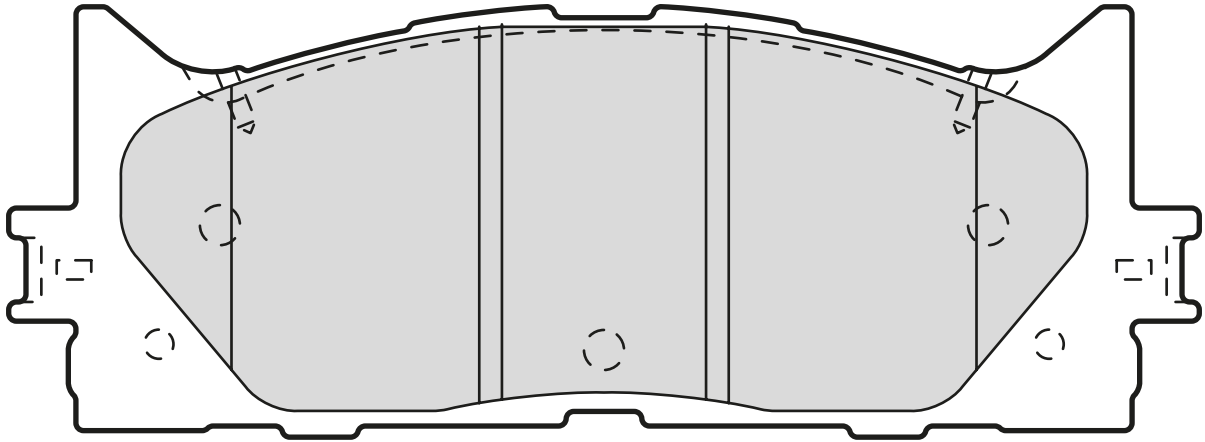

301890		157,5	56,92	17,6	AKE		TOYOTA	

## 24351 (WVA)

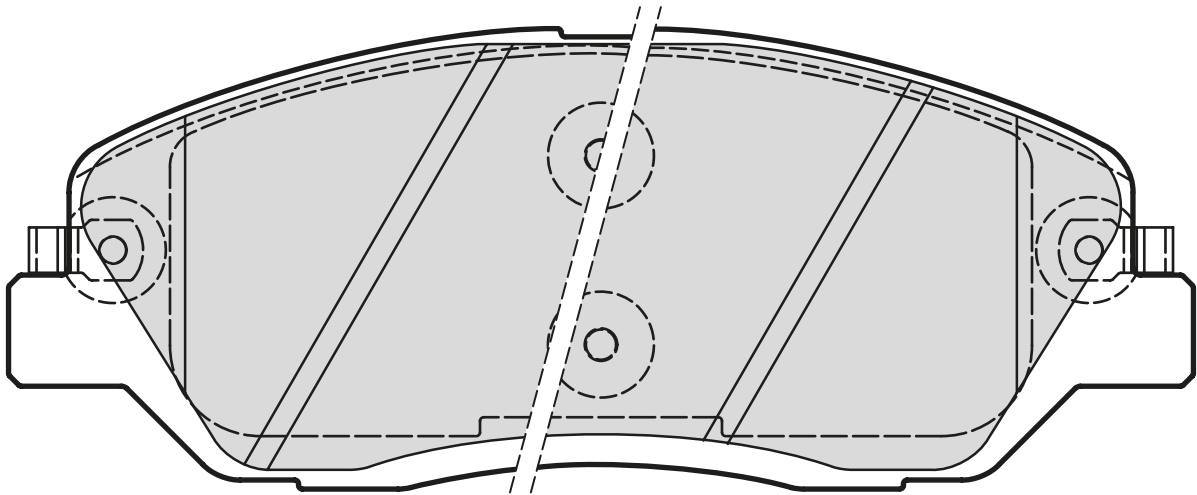
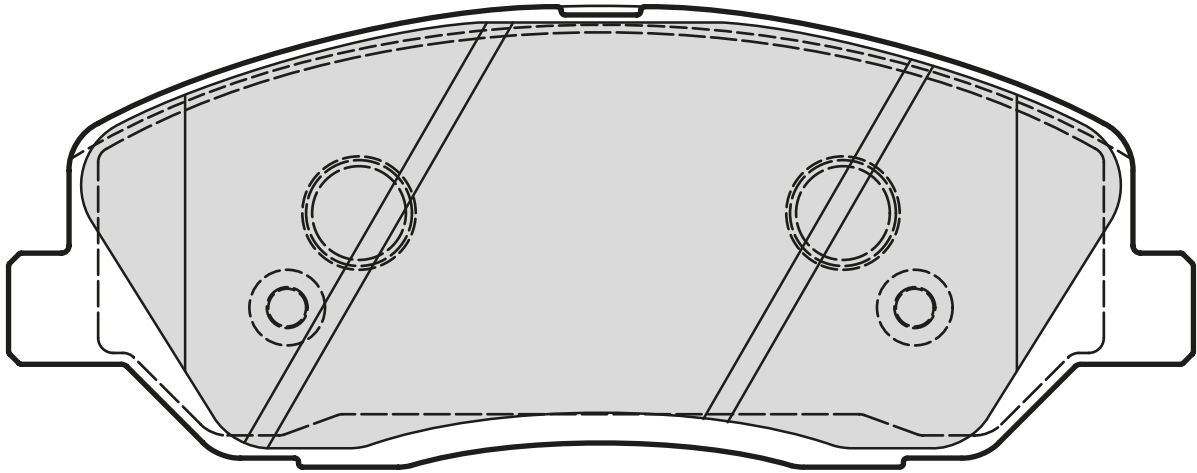

<b>Valeo</b>							
<b>301937</b>	↳ 2x	157,1	60,8	17,1	MAND		<b>HYUNDAI</b>

## 24465 (WVA)

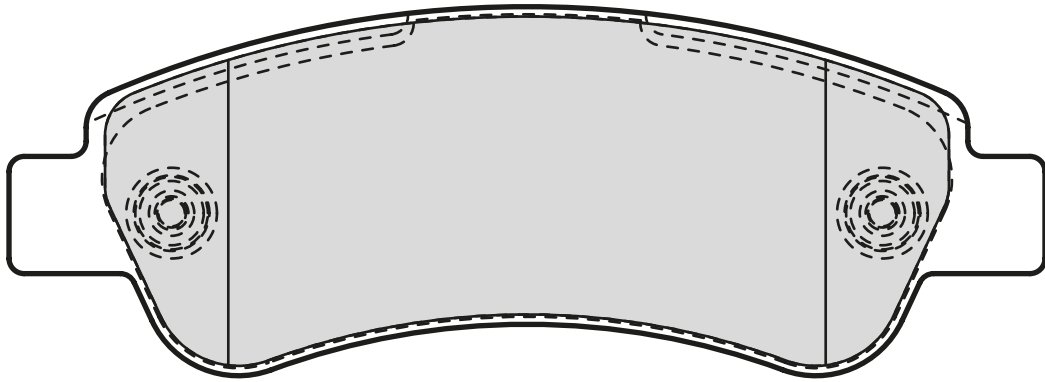

<b>Valeo</b> 							
301892		137	48,8	18,8	BSC		CITROËN, FIAT, PEUGEOT

## 24484 (WVA)

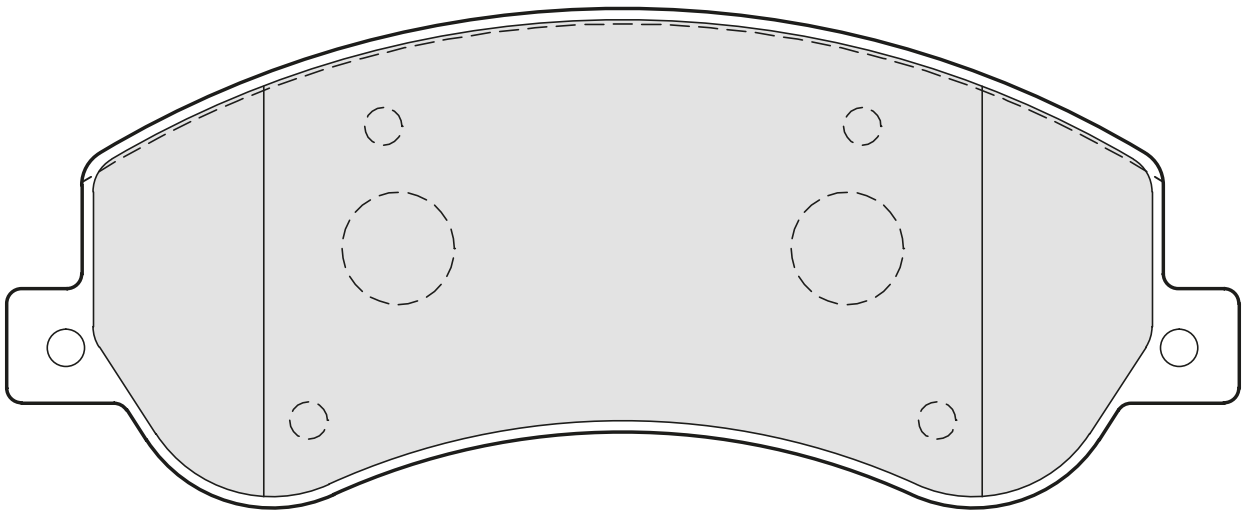

<b>Valeo</b> 							
301816		164,8	66,7	18	BSC		FORD



## 24496 (WVA)

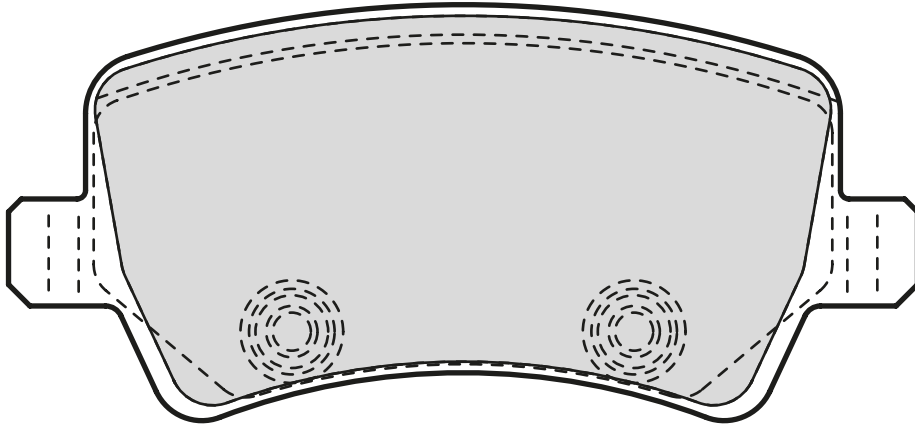

301928		106,2	48,6	16,8		LUC			 VOLVO

## 24498 (WVA)

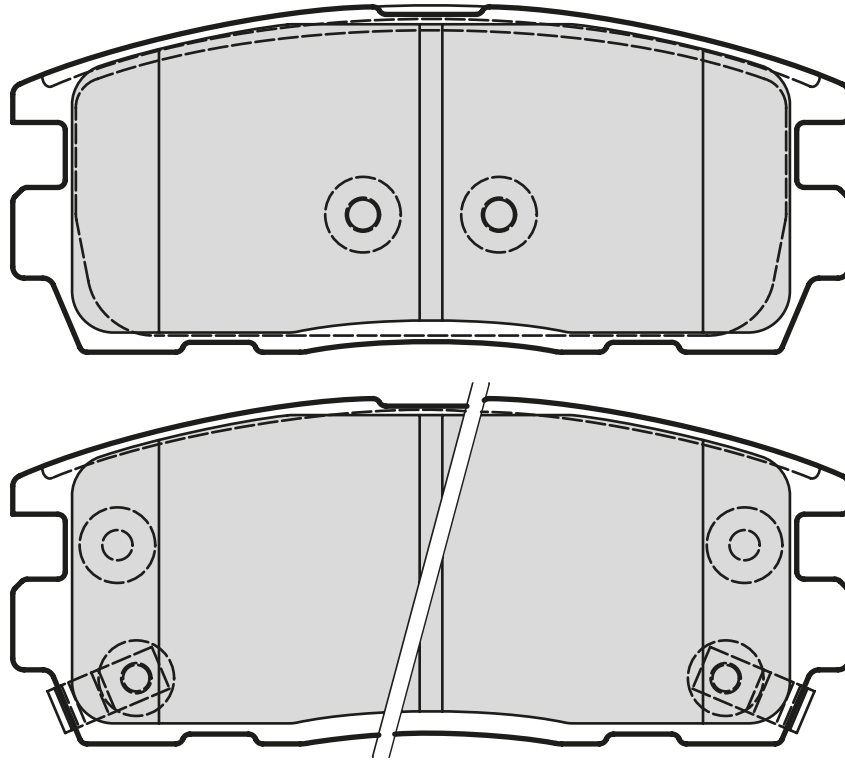

301941	↳ 2x	110,7	45,9	15,8	MAND			CHEVROLET, OPEL, VAUXHALL	

## 24501 (WVA)

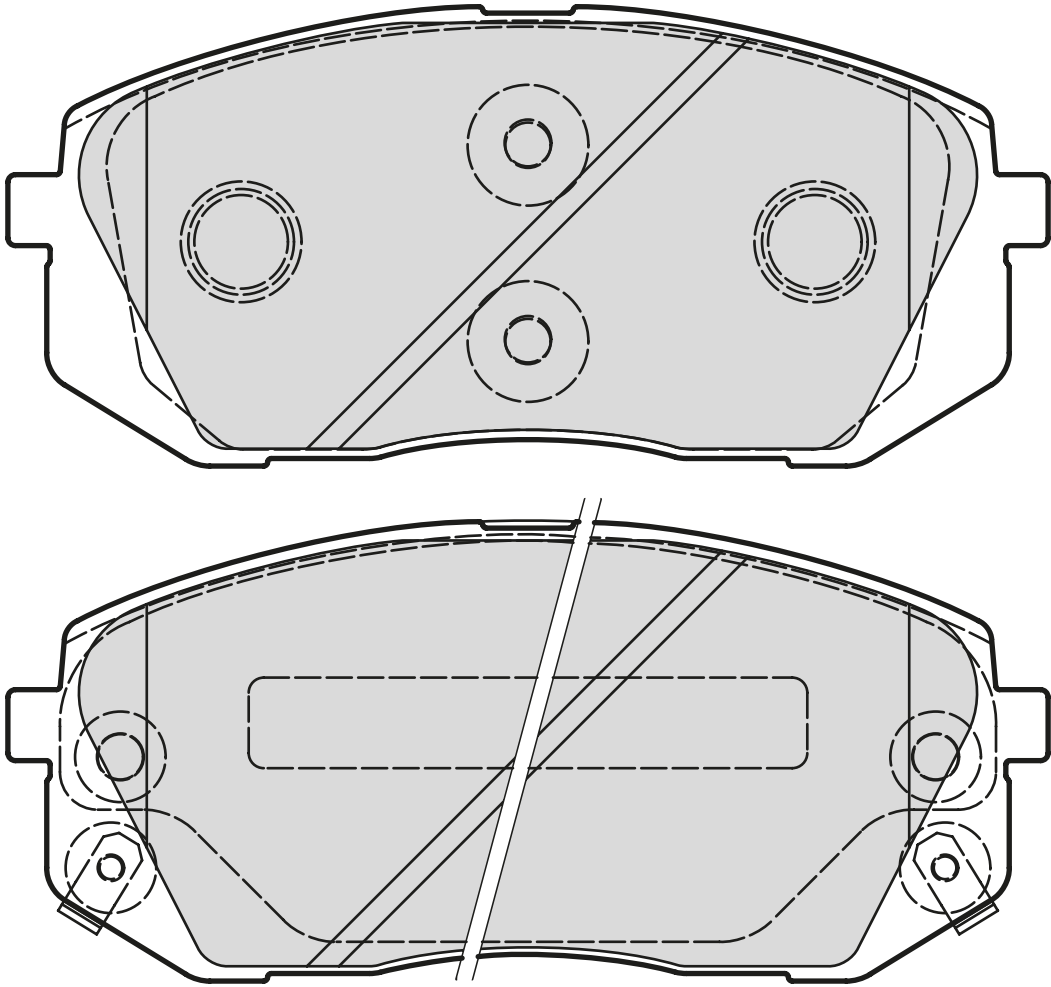

301934	↳ 2 x	137,8	61	16,6	SUM		KIA

## 24510 (WVA)

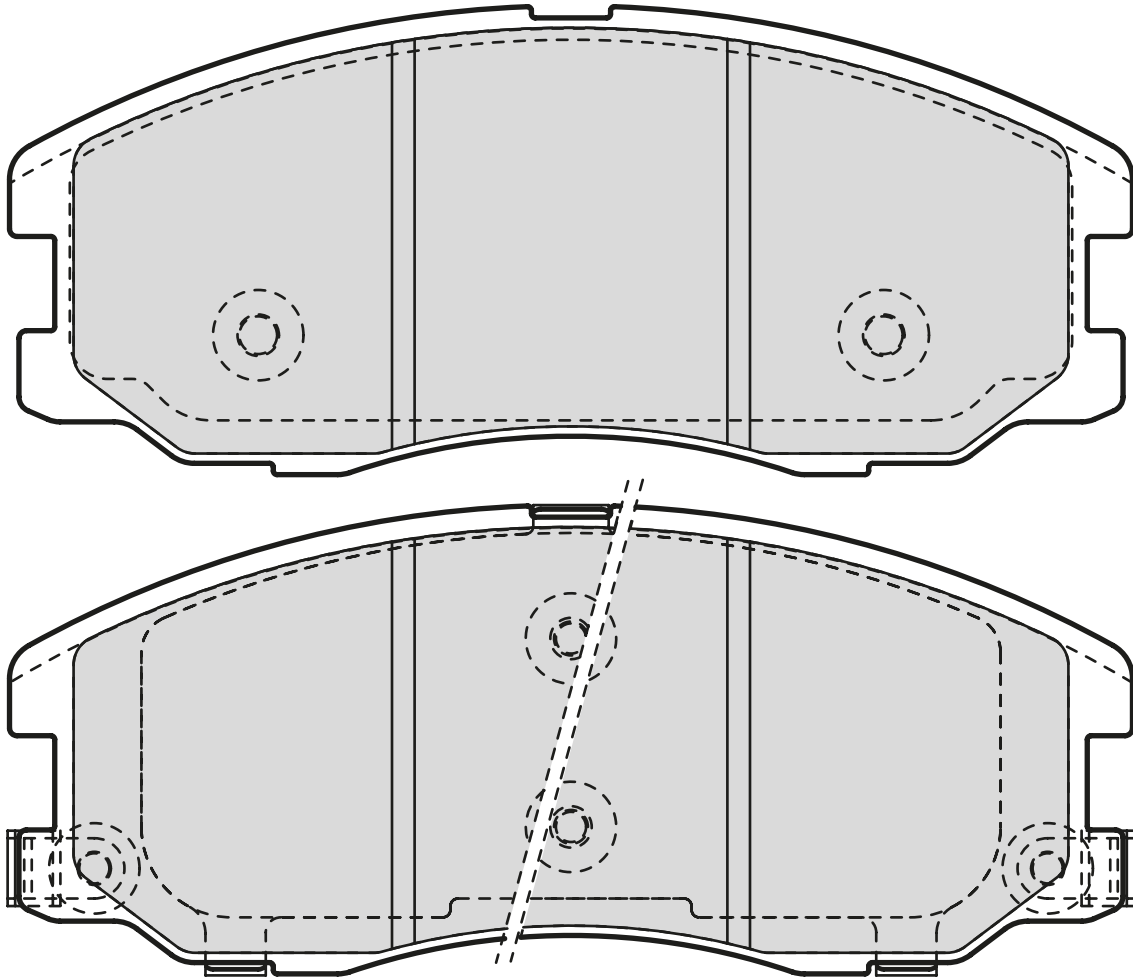







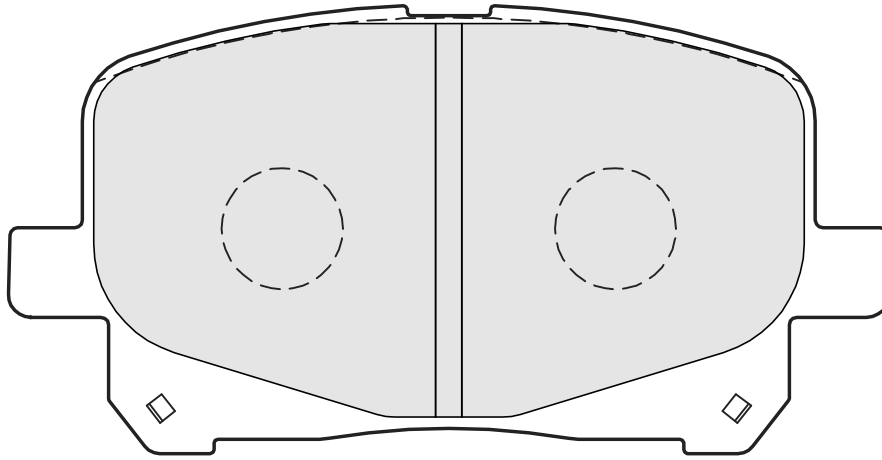

<b>Valeo</b>								
<b>301942</b>	2x	149	62,2	17,6	MAND			<b>CHEVROLET, OPEL, VAUXHALL</b>



## 24522 (WVA)



									
									
301025		116,8	59,2	16,9		AKE			TOYOTA

## 24574 (WVA)

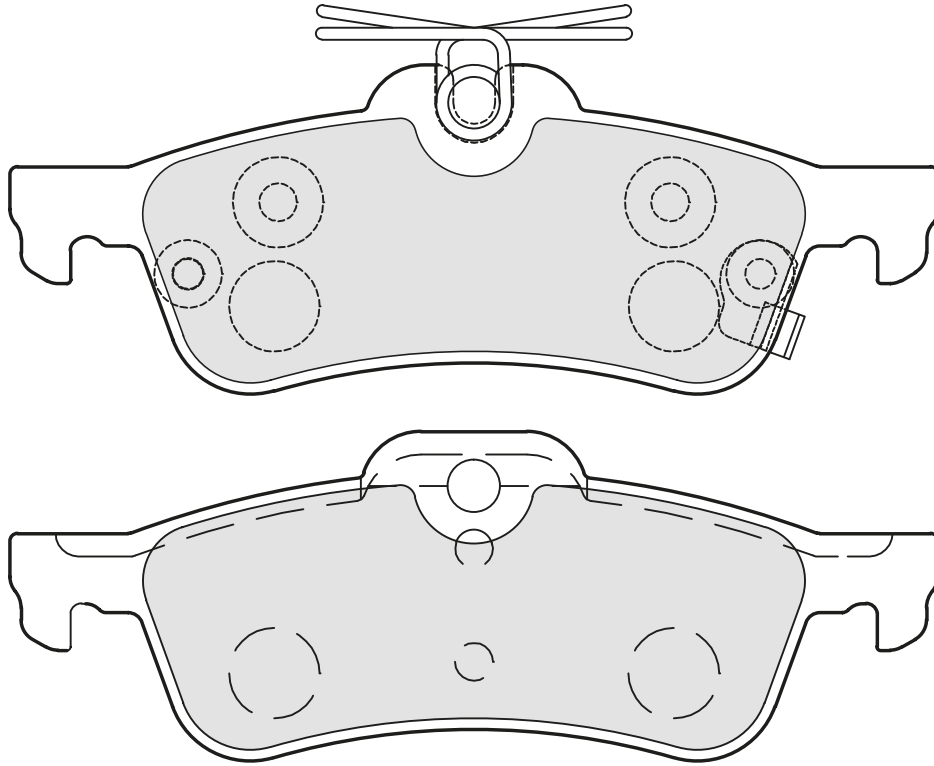

<b>301028</b>	2x	123,1	43,7	14,5	ATE			<b>DAIHATSU, TOYOTA</b>	

## 24599 (WVA)

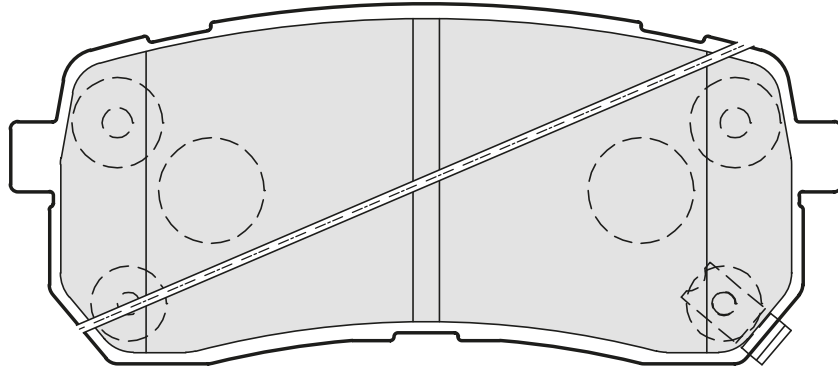

Valeo									
301308	2x	110,4	47,8	15,6		MAND			
									<b>HYUNDAI</b> <b>HYUNDAI</b> <b>KIA</b>

## 24632 (WVA)

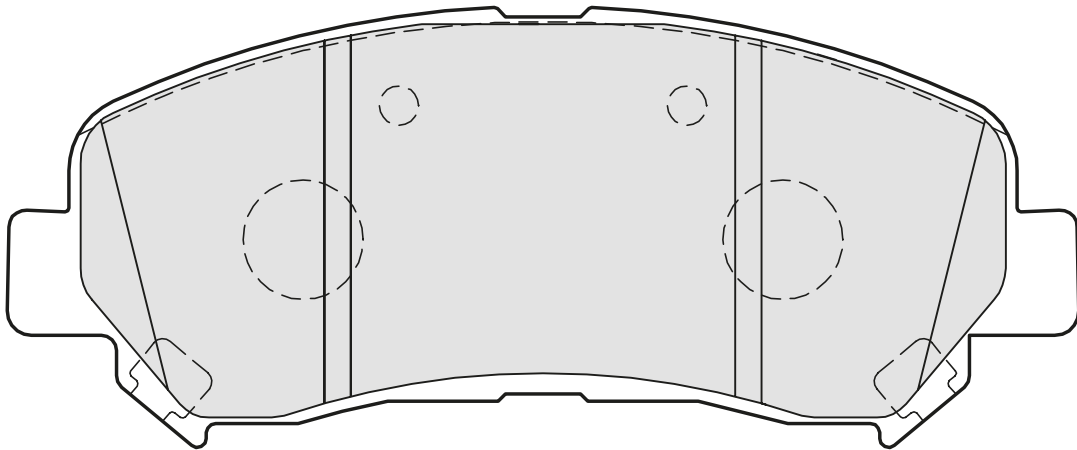

Valeo									
301067		141,9	58,7	16,8		AKE			<b>NISSAN</b>

## 24647 (WVA)

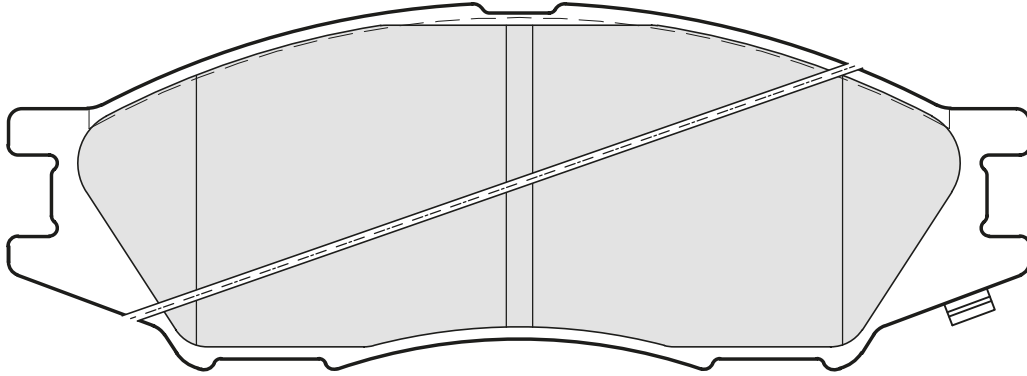

<b>301747</b>	↳ 1x	135	48,5	16,1		AKE		<b>NISSAN</b>	



## 24673 (WVA)

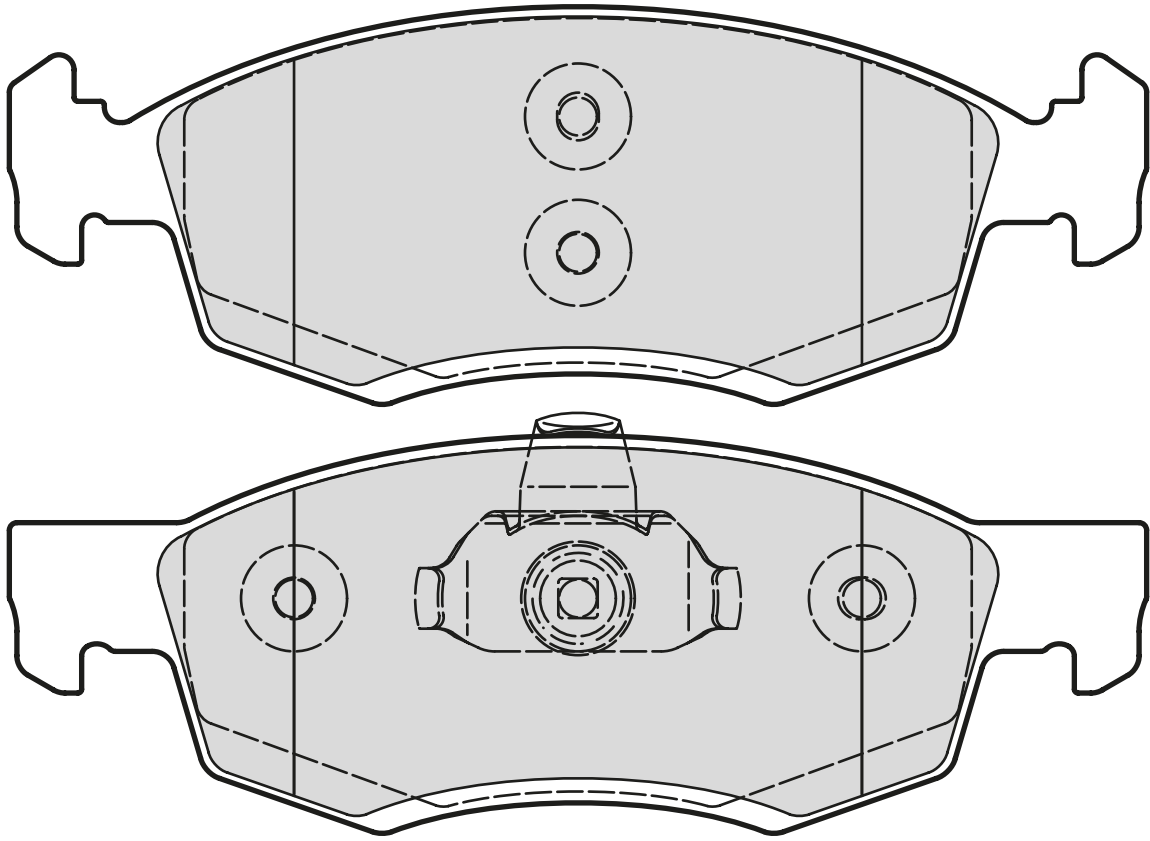

301017		150,2	52,5	17,8		ATE			DACIA

## 24764 (WVA)

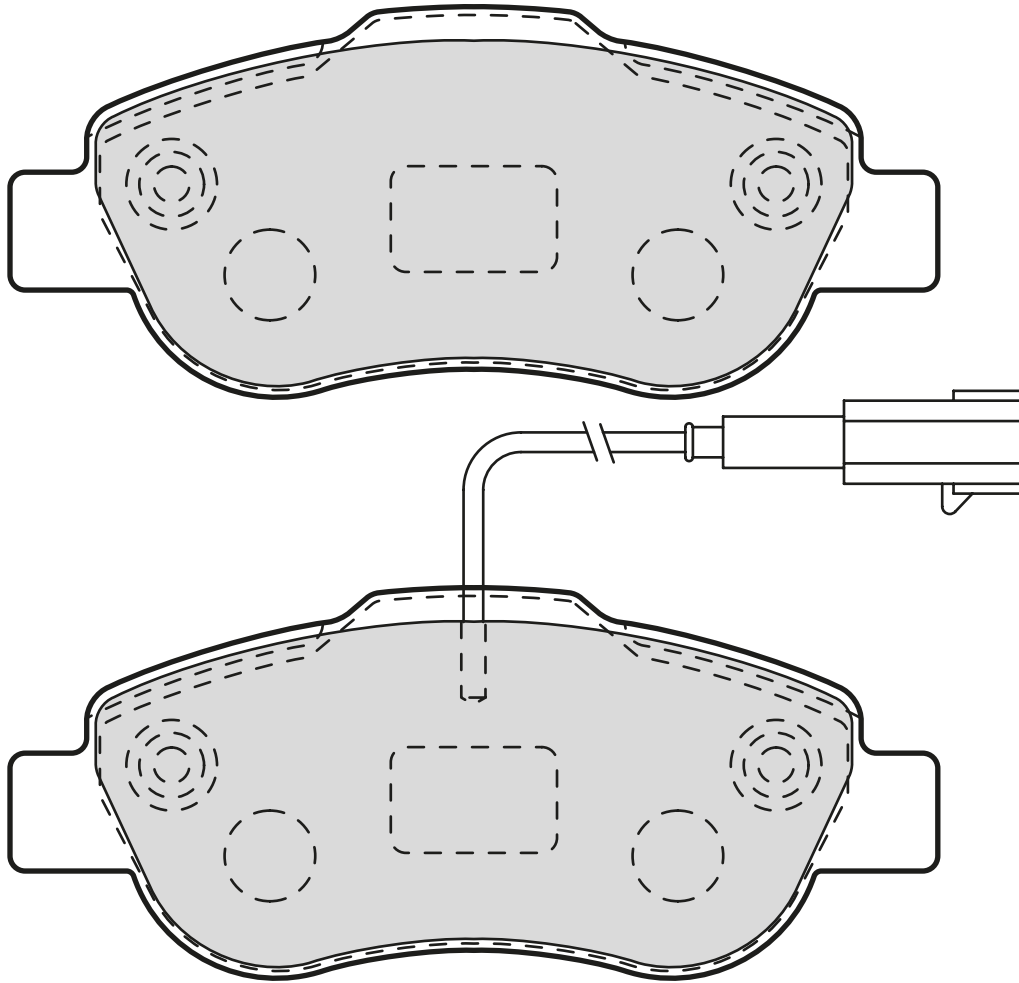

<b>301015</b>	1x 216 mm	122,8	51,68	17,7		BSC		<b>FIAT, FORD</b>

## 25080 (WVA)

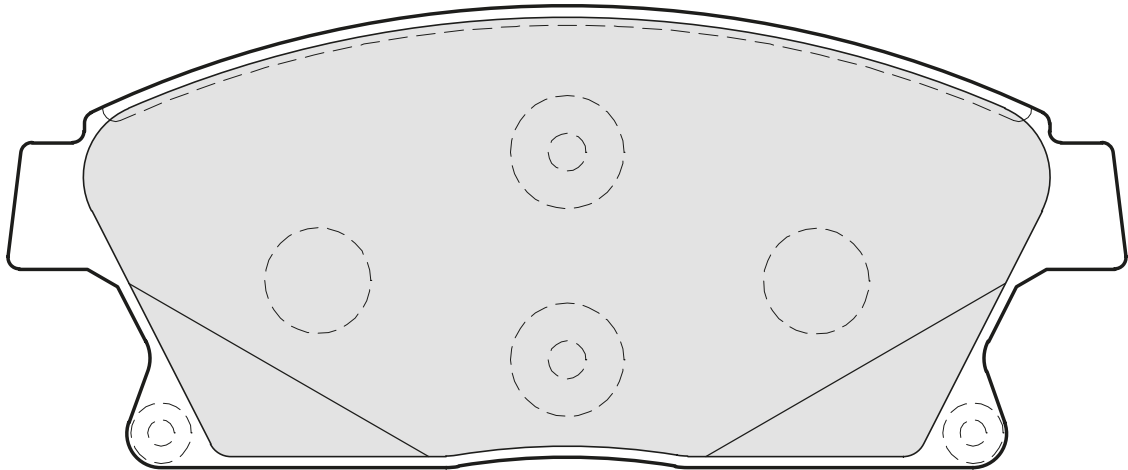
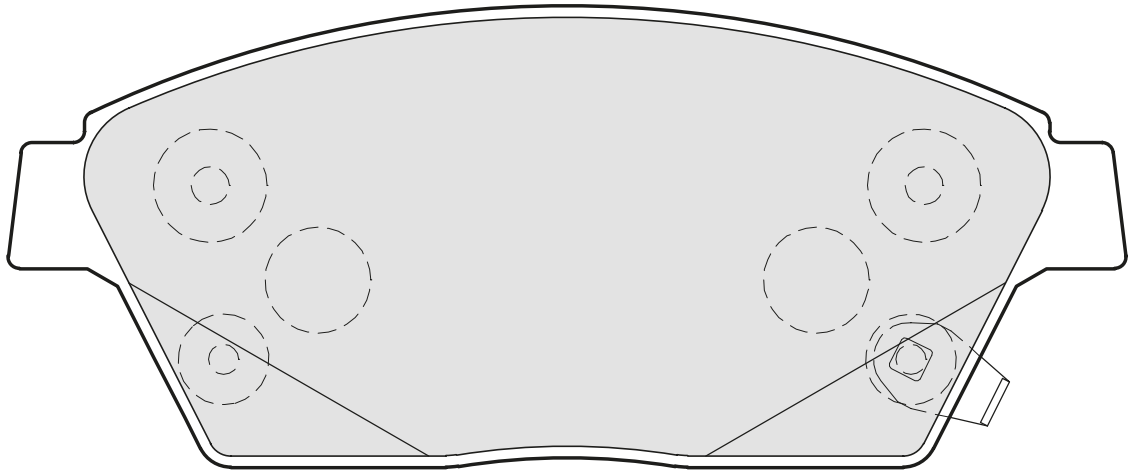

<b>301070</b>	2 x	148,1	61,2	18,8	BSC			<b>CHEVROLET, OPEL, VAUXHALL</b>	

## 25096 (WVA)

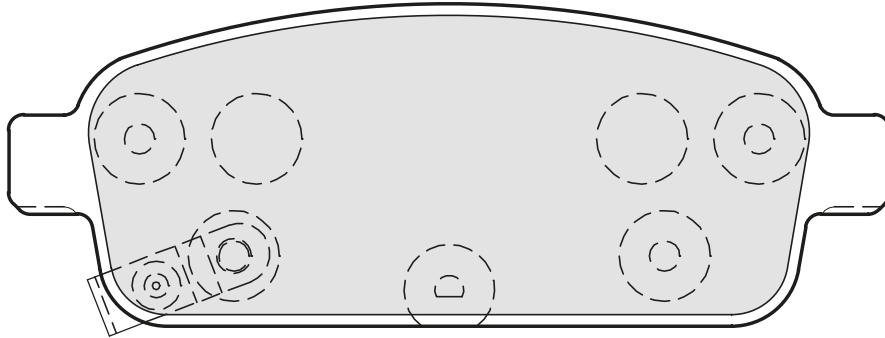

301055	↳ 2x	116,6	42,7	16,3		BSC			CHEVROLET, OPEL, VAUXHALL

## 25337 (WVA)

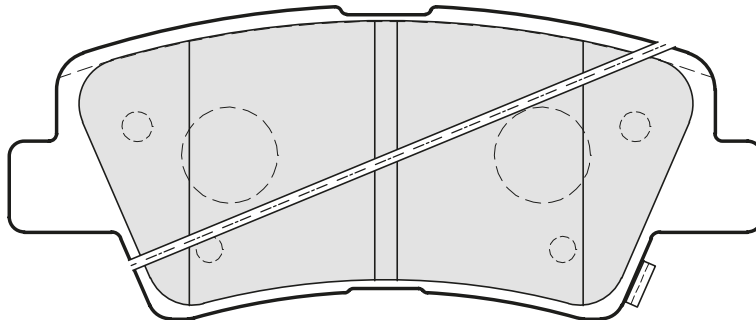

301301	↳ 2x	99,80	41,00	14,90		AKE			HYUNDAI, KIA





## 25348 (WVA)

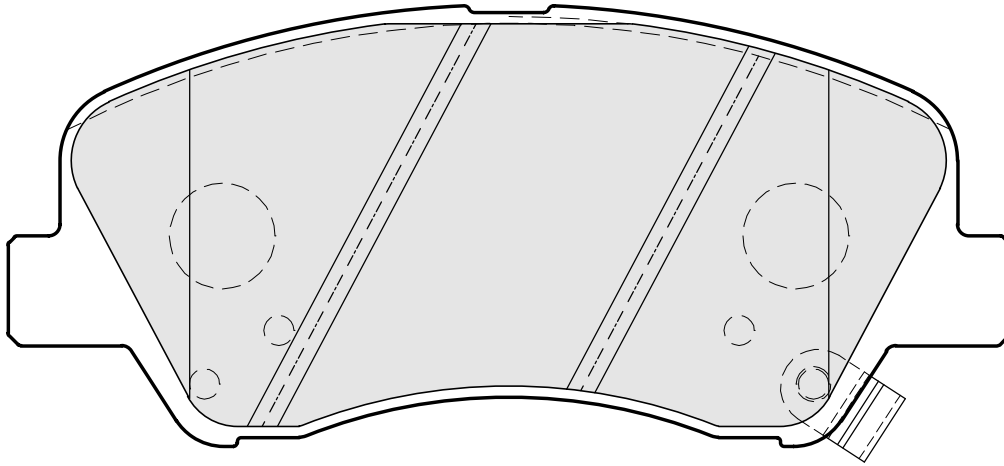

<b>301021</b>	2x	132,80	58,10	17,20	MAND		<b>HYUNDAI, KIA</b>	

## 25644 (WVA)

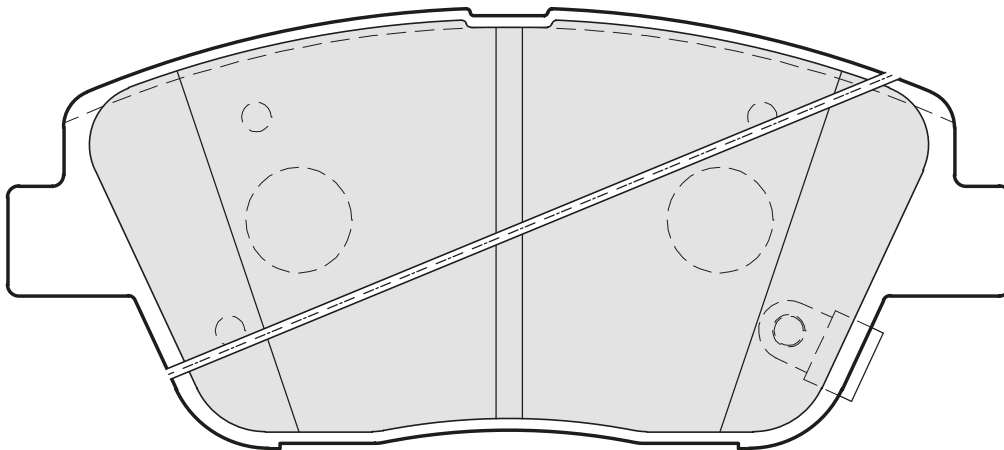

<b>301294</b>	2x	133,10	58,2	17,3	MAND		<b>KIA</b>	

## 29200 (WVA)

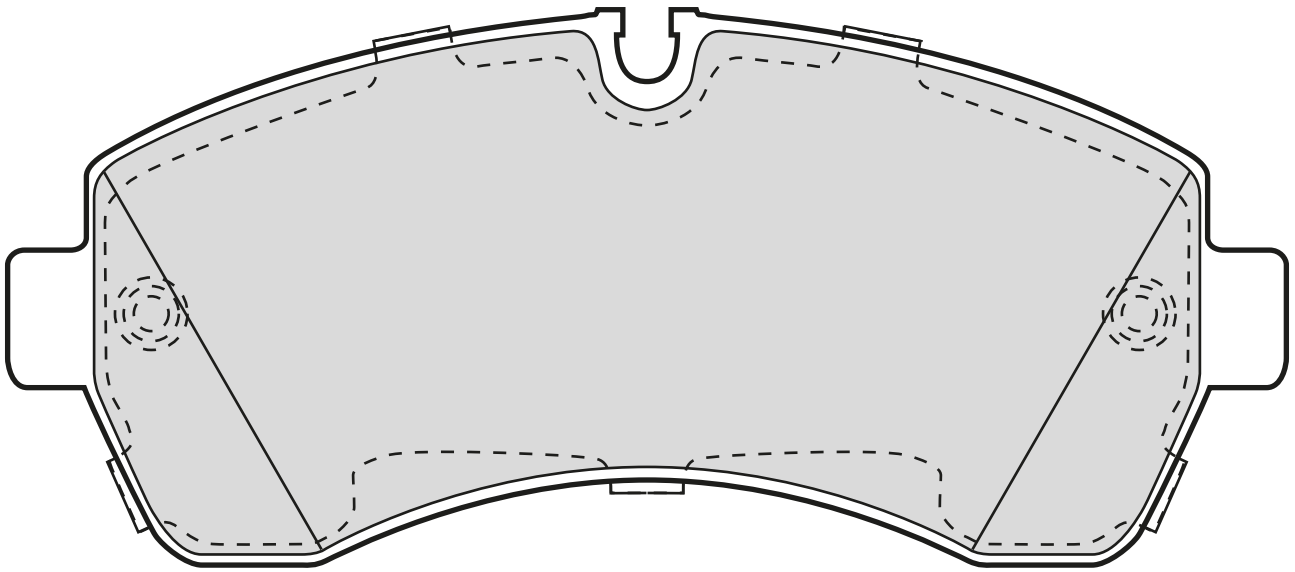

301881		169,1	73,5	20,8		BRE		<b>MERCEDES, VOLKSWAGEN</b>







4







**Valeo**







 	
<b>APEC</b>	
PAD1002	301458
PAD1006	301074
PAD1017	301575
PAD1020	301474
PAD1021	301399
PAD1022	301322
PAD1023	301454
	301860
PAD1024	301926
PAD1034	301317
PAD1039	301431
PAD1043	301436
PAD1045	301753
PAD1052	301581
PAD1053	301065
PAD1059	301522
PAD1060	301463
PAD1062	301332
PAD1063	301444
PAD1075	301479
PAD1076	301535
PAD1084	301493
PAD1087	301003
PAD1089	301482
PAD1090	301780
PAD1104	301300
PAD1107	301462
PAD1109	301408
PAD1110	301486
PAD1113	301577
PAD1116	301737
PAD1117	301564
	301639
PAD1125	301563
PAD1135	301661
PAD1141	301473
PAD1143	301895
PAD1153	301445
PAD1155	301814
PAD1157	301681
PAD1158	301650
PAD1166	301448
PAD1174	301433
PAD1175	301434
PAD1178	301667
PAD1184	301565
PAD1186	301471
PAD1189	301457
PAD1194	301465
PAD1195	301472
	301783
PAD1198	301464
PAD1201	301521
PAD1202	301545
PAD1205	301429
PAD1209	301407
PAD121	301099
	301270
PAD1214	301583
PAD1220	301674



 	
<b>APEC</b>	
PAD1221	301456
PAD1239	301568
PAD1242	301852
PAD1243	301680
PAD1248	301678
PAD1251	301569
	301570
PAD1252	301720
PAD1263	301410
PAD1265	301734
PAD1268	301518
PAD1271	301480
PAD1274	301426
PAD1286	301584
PAD1289	301500
PAD1293	301721
PAD1294	301549
PAD1298	301004
PAD1305	301557
PAD1308	301558
PAD1312	301641
PAD1313	301635
PAD1315	301736
PAD1316	301638
PAD1317	301030
PAD1318	301657
	301770
PAD1321	301574
PAD1324	301752
PAD1329	301874
PAD1339	301829
PAD1341	301640
PAD1344	301754
PAD135	301081
PAD1360	301024
PAD1379	301735
PAD1389	301662
PAD1406	301805
PAD1415	301649
PAD1447	301703
PAD1460	301718
PAD1466	301847
PAD1467	301740
PAD1475	301816
PAD1502	301337
PAD1503	301879
PAD1514	301881
PAD1521	301825
PAD1552	301028
PAD1566	301928
PAD1581	301308
PAD1586	301035
PAD1589	301892
PAD1612	301015
PAD1648	301041
PAD251	301519
PAD274	301389
	301405
	301405
PAD286	301125
	301219
PAD331	301123



 	
<b>APEC</b>	
PAD356	301171
PAD388	301052
PAD404	301103
	301259
PAD405	301105
	301345
PAD421	301266
PAD428	301182
PAD435	301124
PAD466	301044
	301315
PAD470	301080
PAD472	301047
PAD473	301119
PAD476	301402
PAD516	301156
PAD524	301142
PAD530	301406
PAD532	301335
PAD533	301180
PAD534	301269
PAD537	301240
PAD538	301075
PAD548	301095
PAD559	301091
PAD561	301043
PAD580	301540
PAD587	301053
PAD590	301386
PAD596	301231
PAD597	301253
PAD605	301618
PAD615	301020
PAD619	301183
PAD625	301002
	301176
PAD636	301179
PAD652	301241
PAD662	301666
PAD680	301682
PAD682	301272
PAD683	301624
PAD684	301274
PAD685	301172
PAD692	301054
	301450
PAD693	301057
PAD706	301497
PAD707	301016
	301252
PAD724	301048
PAD725	301018
PAD728	301036
PAD729	301037
PAD730	301356
PAD737	301627
PAD749	301007
PAD757	301256
PAD759	301617
PAD770	301292



 	
<b>APEC</b>	
PAD771	301158
	301396
PAD781	301517
PAD789	301049
	301483
PAD79	301129
PAD792	301551
PAD800	301014
PAD801	301034
PAD802	301033
PAD803	301031
PAD805	301013
PAD807	301005
PAD812	301012
PAD813	301616
PAD814	301038
PAD816	301760
PAD829	301982
PAD834	301022
PAD848	301622
PAD852	301491
PAD855	301258
PAD867	301010
PAD871	301642
PAD875	301008
	301355
PAD886	301357
PAD888	301449
PAD891	301061
PAD892	301184
PAD898	301064
PAD901	301068
PAD902	301069
PAD906	301063
PAD911	301066
PAD912	301318
PAD914	301625
PAD917	301360
PAD920	301155
	301181
PAD923	301636
PAD929	301046
PAD933	301488
PAD934	301319
PAD936	301062
PAD938	301006
PAD941	301305
PAD942	301311
PAD943	301023
PAD948	301412
PAD949	301040
PAD953	301310
	301409
PAD954	301675
PAD956	301580
PAD961	301330
PAD962	301025
PAD964	301751
PAD967	301763
PAD970	301326
PAD973	301484



 	
<b>APEC</b>	
PAD974	301403
PAD976	301461
	301726
PAD987	301990
PAD988	301906
PAD994	301466
PAD995	301212
<b>ATE</b>	
13.0460-2701.2	301483
13.0460-2709.2	301641
13.0460-2712.2	301583
13.0460-2714.2	301041
13.0460-2722.2	301928
13.0460-2726.2	301448
13.0460-2727.2	301448
13.0460-2740.2	301180
	301463
	301474
13.0460-2749.2	301752
13.0460-2803.2	301022
13.0460-2806.2	301982
13.0460-2813.2	301219
13.0460-2815.2	301256
13.0460-2816.2	301068
13.0460-2817.2	301069
13.0460-2818.2	301482
13.0460-2819.2	301463
13.0460-2820.2	301180
	301463
13.0460-2821.2	301330
13.0460-2822.2	301003
13.0460-2823.2	301463
13.0460-2825.2	301119
13.0460-2826.2	301142
13.0460-2827.2	301581
13.0460-2829.2	301326
13.0460-2830.2	301318
13.0460-2831.2	301319
13.0460-2833.2	301549
13.0460-2834.2	301002
13.0460-2835.2	301431
13.0460-2837.2	301484
13.0460-2838.2	301814
13.0460-2842.2	301180
13.0460-2845.2	301180
13.0460-2850.2	301429
13.0460-2853.2	301493
13.0460-2854.2	301448
13.0460-2855.2	301583
13.0460-2857.2	301456
13.0460-2858.2	301457
13.0460-2859.2	301681
13.0460-2860.2	301180
13.0460-2861.2	301473
13.0460-2864.2	301463
13.0460-2867.2	301407
13.0460-2868.2	301584
13.0460-2870.2	301545
13.0460-2871.2	301500
13.0460-2872.2	301650
	301681





 	
<b>ATE</b>	
13.0460-2873.2	301482
13.0460-2874.2	301482
13.0460-2877.2	301674
13.0460-2880.2	301752
13.0460-2883.2	301667
13.0460-2884.2	301720
13.0460-2886.2	301463
13.0460-2887.2	301752
13.0460-2888.2	301004
13.0460-2889.2	301004
13.0460-2891.2	301662
13.0460-2894.2	301180
	301463
13.0460-2895.2	301473
13.0460-2896.2	301318
13.0460-2897.2	301319
13.0460-2915.2	301129
13.0460-2916.2	301129
13.0460-2923.2	301241
13.0460-2925.2	301003
13.0460-2927.2	301315
13.0460-2928.2	301240
13.0460-2932.2	301241
13.0460-2934.2	301003
13.0460-2937.2	301180
13.0460-2941.2	301219
13.0460-2942.2	301219
13.0460-2944.2	301219
13.0460-2948.2	301095
13.0460-2949.2	301219
13.0460-2951.2	301142
13.0460-2956.2	301119
	301176
	301179
13.0460-2957.2	301016
13.0460-2958.2	301003
	301252
13.0460-2962.2	301125
	301142
13.0460-2965.2	301406
13.0460-2966.2	301405
13.0460-2971.2	301179
13.0460-2972.2	301048
13.0460-2973.2	301048
13.0460-2975.2	301013
13.0460-2976.2	301010
13.0460-2978.2	301064
13.0460-2982.2	301622
13.0460-2983.2	301061
13.0460-2984.2	301180
	301463
13.0460-3401.2	301270
13.0460-3403.2	301270
13.0460-3602.2	301125
13.0460-3605.2	301386
	301753
13.0460-3802.2	301259
13.0460-3803.2	301103
	301259
13.0460-3805.2	301272
13.0460-3807.2	301012





 	
<b>ATE (.../...)</b>	
13.0460-3808.2	301270
13.0460-3811.2	301465
13.0460-3814.2	301557
13.0460-3815.2	301558
13.0460-3818.2	301426
13.0460-3822.2	301158
13.0460-3823.2	301396
13.0460-3826.2	301426
13.0460-3827.2	301721
13.0460-3829.2	301718
13.0460-3831.2	301740
13.0460-3834.2	301816
13.0460-3839.2	301825
13.0460-3845.2	301099
13.0460-3846.2	301015
13.0460-3850.2	301426
13.0460-3911.2	301081
13.0460-3926.2	301396
13.0460-3934.2	301080
	301081
13.0460-3935.2	301172
13.0460-3939.2	301091
13.0460-3940.2	301091
13.0460-3941.2	301081
13.0460-3943.2	301155
	301181
13.0460-3950.2	301012
13.0460-3952.2	301155
13.0460-3953.2	301080
13.0460-3954.2	301158
	301396
13.0460-3955.2	301080
13.0460-3956.2	301031
13.0460-3959.2	301037
13.0460-3960.2	301036
13.0460-3962.2	301075
	301081
	301181
13.0460-3964.2	301005
13.0460-3965.2	301172
	301399
13.0460-3966.2	301465
13.0460-3974.2	301726
13.0460-3975.2	301461
13.0460-3976.2	301926
13.0460-3977.2	301726
13.0460-3978.2	301462
13.0460-3982.2	301426
13.0460-3987.2	301433
13.0460-3988.2	301434
13.0460-3990.2	301300
13.0460-3994.2	301464
13.0460-3999.2	301638
13.0460-4014.2	301179
13.0460-4028.2	301099
13.0460-4029.2	301099
13.0460-4030.2	301105
13.0460-4033.2	301099
13.0460-4034.2	301345
13.0460-4035.2	301099
	301182





 	
<b>ATE (.../...)</b>	
13.0460-4040.2	301183
13.0460-4041.2	301156
13.0460-4042.2	301156
13.0460-4043.2	301253
13.0460-4047.2	301617
13.0460-4059.2	301063
13.0460-4060.2	301763
13.0460-4064.2	301444
13.0460-4066.2	301156
	301360
13.0460-4412.2	301099
13.0460-4812.2	301892
13.0460-4901.2	301292
13.0460-4905.2	301292
13.0460-4956.2	301292
13.0460-4957.2	301007
13.0460-4969.2	301466
13.0460-4976.2	301770
13.0460-4978.2	301568
13.0460-4979.2	301569
	301570
13.0460-4980.2	301569
	301570
13.0460-4984.2	301445
13.0460-5029.2	301125
13.0460-5405.2	301018
13.0460-5603.2	301943
13.0460-5700.2	301847
13.0460-5711.2	301682
13.0460-5725.2	301821
13.0460-5742.2	301842
13.0460-5743.2	301862
13.0460-5746.2	301535
13.0460-5747.2	301857
13.0460-5752.2	301067
13.0460-5765.2	301819
13.0460-5777.2	301937
13.0460-5778.2	301337
13.0460-5780.2	301867
13.0460-5782.2	301932
13.0460-5785.2	301942
13.0460-5788.2	301941
13.0460-5800.2	301736
13.0460-5801.2	301641
13.0460-5803.2	301575
13.0460-5804.2	301780
13.0460-5807.2	301450
13.0460-5810.2	301737
13.0460-5811.2	301606
13.0460-5812.2	301577
13.0460-5817.2	301827
13.0460-5819.2	301680
13.0460-5825.2	301436
13.0460-5827.2	301682
13.0460-5829.2	301708
13.0460-5832.2	301505
	301759
13.0460-5833.2	301574
	301748
13.0460-5841.2	301449





 	
<b>ATE (.../...)</b>	
13.0460-5843.2	301009
	301672
13.0460-5853.2	301518
13.0460-5854.2	301521
13.0460-5855.2	301520
	301852
13.0460-5859.2	301361
13.0460-5872.2	301052
	301505
	301574
13.0460-5873.2	301574
	301744
13.0460-5874.2	301817
13.0460-5875.2	301781
13.0460-5878.2	301887
13.0460-5881.2	301123
13.0460-5886.2	301506
13.0460-5890.2	301522
13.0460-5897.2	301491
13.0460-5899.2	301644
13.0460-5919.2	301047
13.0460-5920.2	301022
13.0460-5922.2	301047
13.0460-5925.2	301184
	301356
13.0460-5927.2	301507
13.0460-5929.2	301682
13.0460-5933.2	301574
13.0460-5936.2	301052
13.0460-5937.2	301123
13.0460-5938.2	301402
13.0460-5939.2	301266
13.0460-5942.2	301020
13.0460-5943.2	301760
13.0460-5944.2	301274
13.0460-5950.2	301054
13.0460-5951.2	301551
13.0460-5952.2	301625
13.0460-5954.2	301629
13.0460-5955.2	301627
13.0460-5956.2	301014
13.0460-5957.2	301618
13.0460-5958.2	301517
13.0460-5964.2	301123
13.0460-5970.2	301268
13.0460-5972.2	301624
13.0460-5976.2	301266
13.0460-5980.2	301519
13.0460-5981.2	301519
13.0460-5982.2	301627
13.0460-5983.2	301668
13.0460-5985.2	301666
13.0460-5986.2	301057
13.0460-5989.2	301642
13.0460-5993.2	301902
13.0460-5994.2	301361
13.0460-5996.2	301316
13.0460-5998.2	301053
13.0460-6033.2	301231
13.0460-6906.2	301129
13.0460-6910.2	301129





 	
<b>ATE (.../...)</b>	
13.0460-6911.2	301129
13.0460-6917.2	301497
13.0460-7026.2	301212
13.0460-7030.2	301258
13.0460-7033.2	301124
13.0460-7036.2	301103
13.0460-7038.2	301182
13.0460-7040.2	301335
13.0460-7047.2	301103
13.0460-7048.2	301099
	301182
13.0460-7051.2	301356
13.0460-7052.2	301184
13.0460-7053.2	301616
13.0460-7056.2	301033
13.0460-7057.2	301034
13.0460-7058.2	301038
13.0460-7059.2	301258
13.0460-7060.2	301033
13.0460-7064.2	301040
13.0460-7065.2	301006
13.0460-7067.2	301040
13.0460-7069.2	301023
	301065
13.0460-7071.2	301212
13.0460-7072.2	301066
13.0460-7073.2	301043
	301171
13.0460-7076.2	301008
13.0460-7077.2	301355
13.0460-7078.2	301412
13.0460-7079.2	301580
13.0460-7082.2	301044
13.0460-7084.2	301046
13.0460-7085.2	301062
13.0460-7086.2	301357
13.0460-7087.2	301636
13.0460-7088.2	301074
13.0460-7089.2	301310
	301409
13.0460-7090.2	301311
13.0460-7091.2	301305
13.0460-7100.2	301488
13.0460-7101.2	301403
13.0460-7102.2	301675
13.0460-7109.2	301018
13.0460-7110.2	301483
	301751
13.0460-7111.2	301332
13.0460-7112.2	301023
13.0460-7115.2	301322
13.0460-7116.2	301454
13.0460-7117.2	301408
13.0460-7121.2	301317
13.0460-7122.2	301486
13.0460-7134.2	301063
13.0460-7135.2	301480
13.0460-7137.2	301472
	301783
13.0460-7140.2	301065
	301990



 	 
<b>ATE (.../...)</b>	
13.0460-7142.2	301564
13.0460-7145.2	301479
13.0460-7148.2	301563
13.0460-7153.2	301565
13.0460-7154.2	301801
13.0460-7158.2	301471
13.0460-7159.2	301471
13.0460-7160.2	301472
13.0460-7164.2	301805
13.0460-7167.2	301410
13.0460-7172.2	301678
13.0460-7173.2	301305
13.0460-7174.2	301754
13.0460-7176.2	301640
13.0460-7177.2	301735
13.0460-7178.2	301734
13.0460-7179.2	301860
13.0460-7181.2	301990
13.0460-7184.2	301635
13.0460-7186.2	301639
13.0460-7187.2	301030
13.0460-7188.2	301657
13.0460-7189.2	301829
13.0460-7192.2	301860
13.0460-7193.2	301649
13.0460-7194.2	301472
	301783
13.0460-7195.2	301472
	301783
13.0460-7196.2	301044
13.0460-7203.2	301636
13.0460-7209.2	301783
13.0460-7214.2	301028
13.0460-7216.2	301640
13.0460-7217.2	301703
13.0460-7226.2	301635
13.0460-7228.2	301879
13.0460-7251.2	301783
13.0460-7253.2	301783
13.0460-7263.2	301070
13.0460-7264.2	301055
13.0460-8002.2	301458
13.0460-8006.2	301389
13.0463-2821.2	301330
13.0463-2822.2	301003
13.0463-2834.2	301002
13.0463-2854.2	301448
13.0463-2957.2	301016
13.0463-2958.2	301003
	301252
13.0463-2975.2	301013
13.0463-5405.2	301018
13.0463-6033.2	301231
13.0463-7051.2	301356
13.0463-7052.2	301184
13.0463-7071.2	301212
13.0463-7086.2	301357
13.0463-7087.2	301636
13.0463-7089.2	301310
	301409
13.0463-7091.2	301305



 	 
<b>ATE (.../...)</b>	
13.0463-7110.2	301483
	301751
13.0463-7115.2	301322
13.0463-7116.2	301454
13.0463-7117.2	301332
	301408
13.0463-7121.2	301317
13.0463-7122.2	301486
13.0463-7142.2	301564
13.0470-2749.2	301752
13.0470-2837.2	301484
13.0470-2891.2	301662
13.0470-4047.2	301617
13.0470-4064.2	301444
13.0470-4984.2	301445
13.0470-7110.2	301483
13.0470-7195.2	301472
	301783
13.0470-7216.2	301640
27.0460-0700.2	301256
27.0460-1208.2	301081
27.0460-1501.2	301389
27.0460-2014.2	301268
27.0460-2205.2	301123
<b>BENDIX</b>	
571202B	301405
571205B	301099
	301584
	301941
571213B	301099
	301270
571221B	301099
571221X	301099
571232B	301099
571243B	301142
571250B	301129
571250X	301129
571264B	301292
571264X	301292
571265B	301389
571276B	301182
571276X	301182
571279B	301099
571279X	301099
571285B	301081
571291B	301212
571291X	301171
	301212
571297B	301091
571297X	301091
	301219
571300B	301103
571301B	301125
	301142
	301219
571309B	301012
	301091
	301095
	301219



 	 
<b>BENDIX (.../...)</b>	
571309X	301012
	301091
	301095
	301219
571313B	301061
571315B	301258
571315X	301258
571316B	301124
571316X	301124
571318B	301091
571319B	301119
	301176
571319X	301119
571320B	301176
571320X	301176
571327B	301002
571330B	301095
	301219
571330X	301095
	301219
571331B	301080
571331X	301080
571332B	301081
	301179
571332X	301075
	301081
	301179
571333B	301081
571333X	301081
571334B	301158
	301396
571334X	301396
571335B	301396
571344B	301105
571346B	301406
571350B	301125
	301142
571351B	301033
	301034
	301335
571351X	301033
	301034
	301335
571353B	301241
571353X	301241
571355B	301231
	301310
571355X	301231
	301310
571356B	301003
571356X	301003
571357B	301003
	301252
571357X	301003
	301252
571359B	301179
571359X	301179
571361B	301180
	301463
571361X	301180
	301463
571363B	301292



 	 
<b>BENDIX (.../...)</b>	
571367B	301156
	301181
	301360
571367X	301156
	301360
571376B	301016
	301252
	301330
571376X	301016
571379B	301129
571382B	301315
571382X	301315
571384B	301099
571387B	301103
	301259
	301386
571387X	301103
	301259
	301386
571388B	301272
571389B	301183
571390B	301183
571391B	301184
	301356
571391X	301184
571395B	301753
571400B	301123
571407B	301253
571407X	301253
571408B	301240
571409B	301142
	301219
571411B	301018
571412B	301043
	301171
571417B	301270
571421B	301057
571425B	301007
571425X	301007
571429B	301103
571435B	301272
571437B	301022
571438B	301022
	301436
571439B	301129
571439X	301129
571440B	301497
571457B	301616
571457X	301616
571458B	301048
571460B	301048
571462B	301016
	301125
	301142
571464B	301091
571473B	301156
571473X	301156
571474B	301125
571476B	301061
571476X	301061



 	 
<b>BENDIX (.../...)</b>	
571491B	301099
571492B	301184
	301356
571492X	301356
571493B	301256
571509B	301038
	301074
571509X	301038
	301074
571512B	301483
571513B	301180
571519B	301491
571522B	301033
	301034
	301036
571522X	301033
	301034
571523B	301012
571524B	301075
	301081
	301181
571524X	301075
	301181
571525B	301155
571525X	301155
571526B	301002
571526X	301002
571527B	301103
	301386
571528B	301012
571528X	301012
571536B	301212
571536X	301212
571539B	301182
571545B	301103
571546B	301103
	301259
571555B	301345
571557B	301103
571559B	301241
571560B	301315
571722B	301617
571725B	301172
571726B	301172
571726X	301172
571743B	301155
571743X	301155
571744B	301396
571745B	301036
571745X	301036
571746B	301037
571746X	301037
571747B	301158
571747X	301158
571748B	301080
	301396
571749B	301012
571749X	301012
571753B	301345
571754B	301005
571755B	301005



 	
<b>BENDIX (.../...)</b>	
571755X	301005
571757B	301031
571803B	301497
571828B	301013
571828X	301013
571832B	301033
	301034
571832X	301034
571833B	301182
571833X	301182
571835B	301018
571838B	301064
571839B	301010
571839X	301010
571844B	301044
571845B	301062
571847B	301622
571847X	301622
571848B	301258
571848X	301258
571849B	301033
	301034
571850B	301240
571855B	301240
571856B	301982
571862B	301095
571867B	301081
571868B	301241
571873B	301412
571875B	301482
571876B	301636
571877B	301357
571880B	301231
	301310
571882B	301040
	301483
571883B	301006
571884B	301023
	301065
571887B	301040
571888B	301065
571893B	301012
571897B	301068
571897X	301068
571898B	301069
571898X	301069
571899B	301063
571899X	301063
571900B	301008
	301048
571902B	301038
	301074
571905B	301219
571906B	301180
	301463
571906X	301180
	301463
571908B	301581
571910B	301044
	301046
571911B	301075
	301081

 	
<b>BENDIX (.../...)</b>	
571911X	301075
	301081
571912B	301156
	301360
571913B	301043
	301171
571914B	301212
571915B	301066
571915X	301066
571918B	301580
571919B	301326
571919X	301326
571920B	301305
571923B	301488
571924B	301356
571925B	301444
571929B	301332
571930B	301726
571931B	301726
571934B	301675
571936B	301311
571939B	301403
571939X	301403
571940B	301318
571941B	301319
571944B	301549
571945B	301549
571948B	301048
571950B	301300
571951B	301023
571954B	301461
571954X	301461
571955B	301003
571959B	301018
571959X	301018
571960B	301753
571961B	301445
571964B	301399
571964X	301399
571965B	301462
571967B	301317
571967X	301317
571968B	301322
571969B	301330
571971B	301408
571971X	301408
571975B	301454
	301860
571976B	301022
571976X	301022
571977B	301053
571977X	301053
571979X	301142
571982B	301483
	301751
571982X	301483
	301751
571984B	301463
	301486
571985B	301332
571986B	301448



 	
<b>BENDIX (.../...)</b>	
571987B	301448
571990B	301410
571996B	301563
571996X	301563
571997B	301305
571998B	301431
571998X	301431
571999B	301466
572100B	301268
572127B	301817
572129B	301817
572135B	301053
572136B	301053
572137B	301053
572138B	301627
	301682
572145B	301274
572146B	301274
572162B	301624
572163B	301624
572169B	301780
572179B	301666
572182B	301540
572186B	301519
572188B	301540
572193B	301780
572200B	301519
572221B	301507
572227B	301020
572230B	301123
572233B	301123
572237B	301047
572238B	301047
572255B	301266
	301402
	301551
572256B	301266
	301551
572257B	301014
572266B	301266
572268B	301052
572269B	301052
	301817
572271B	301020
572272B	301020
572284B	301047
572309B	301047
572310B	301054
572312B	301123
572313B	301123
572322B	301507
572324B	301760
572325B	301629
572330B	301047
572333B	301551
572347B	301574
572350B	301627
572354B	301627
572355B	301402
572361B	301123
572370B	301517



 	
<b>BENDIX (.../...)</b>	
572373B	301123
	301618
572376B	301668
572381B	301625
572391B	301266
572393B	301627
572398B	301449
572401B	301575
572402B	301316
572404B	301606
572405B	301737
572406B	301902
572407B	301361
	301902
572411B	301634
572419B	301522
572422B	301450
572424B	301895
572429B	301436
572430B	301022
572434B	301629
572442B	301908
572449B	301887
572450B	301577
572453B	301505
	301759
572490B	301780
572496B	301574
572497B	301518
572498B	301520
572499B	301521
572501B	301672
572510B	301736
572513B	301781
572514B	301744
572515B	301857
572517B	301827
572525B	301943
572528B	301535
572532B	301821
572539B	301644
572540B	301506
572547B	301852
572548B	301865
572550B	301853
572551B	301889
572553B	301862
572557B	301748
572568B	301642
572570B	301942
572575B	301337
572577B	301842
572604B	301867
573002B	301409
573003B	301479
573005B	301180
573006B	301484
573007B	301180
	301463
573008B	301473
573009B	301457



 	
<b>BENDIX (.../...)</b>	
573010B	301926
573011B	301456
573012B	301434
573013B	301433
573014B	301407
573015B	301563
573017B	301471
573018B	301472
	301783
573020B	301433
573021B	301480
573025B	301471
573030B	301464
573031B	301465
573032B	301180
	301463
573036B	301462
573037B	301483
	301751
573038B	301650
	301681
573039B	301493
573040B	301735
573041B	301564
573042B	301023
	301065
	301990
573045B	301801
573047B	301565
573048B	301650
573049B	301048
	301482
	301650
	301681
573050B	301814
573051B	301461
573053B	301763
573058B	301545
573060B	301429
573063B	301458
573064B	301483
573065B	301681
573066B	301661
573074B	301426
573074X	301426
573082B	301583
573083B	301500
573085B	301639
573089B	301678
	301860
573089X	301678
	301860
573091B	301638
573092B	301445
573093B	301444
573098B	301463
573101B	301667
573111B	301805
573112B	301674
573113B	301568
573114B	301569

 	
<b>BENDIX (.../...)</b>	
573115B	301570
573115X	301570
573120B	301434
573122B	301584
573123B	301557
573124B	301558
573125B	301641
573126B	301734
573127B	301720
573128B	301635
573132B	301662
573135B	301718
573139B	301703
573142B	301030
573143B	301657
573146B	301305
573151B	301640
573153B	301860
573158B	301752
573164B	301426
573165B	301721
573169B	301012
573183B	301464
573184B	301465
573186B	301472
	301783
573188B	301640
573189B	301410
573190B	301044
573201B	301879
573204B	301825
573206B	301801
573209B	301649
573214B	301005
573216B	301874
573218B	301740
573219B	301004
573224B	301754
573227B	301770
573236B	301829
573250B	301928
573266B	301015
573275B	301816
<b>BOSCH</b>	
0 986 424 030	301010
0 986 424 033	301064
0 986 424 044	301129
0 986 424 081	301091
0 986 424 098	301091
0 986 424 135	301052
	301817
0 986 424 147	301396
0 986 424 214	301022
0 986 424 215	301574
0 986 424 218	301044
0 986 424 219	301046
0 986 424 223	301069
0 986 424 227	301068
0 986 424 229	301062
0 986 424 230	301266
0 986 424 233	301636



 	
<b>BOSCH (.../...)</b>	
0 986 424 234	301357
0 986 424 236	301008
0 986 424 246	301040
0 986 424 248	301023
	301065
	301990
0 986 424 267	301497
0 986 424 277	301005
0 986 424 284	301491
0 986 424 287	301129
	301497
0 986 424 295	301780
0 986 424 347	301066
0 986 424 359	301033
0 986 424 360	301305
0 986 424 361	301488
0 986 424 362	301006
0 986 424 364	301332
0 986 424 365	301580
0 986 424 367	301507
0 986 424 368	301634
0 986 424 371	301318
0 986 424 375	301482
0 986 424 379	301012
0 986 424 382	301402
	301540
0 986 424 383	301540
0 986 424 400	301310
	301409
	301640
0 986 424 402	301675
0 986 424 410	301038
	301074
0 986 424 411	301156
	301360
0 986 424 414	301326
0 986 424 416	301043
	301171
0 986 424 418	301817
0 986 424 427	301319
0 986 424 449	301403
0 986 424 450	301317
0 986 424 452	301074
0 986 424 453	301461
	301726
0 986 424 455	301726
0 986 424 456	301322
0 986 424 457	301454
	301860
0 986 424 459	301311
0 986 424 462	301212
0 986 424 466	301458
0 986 424 468	301330
0 986 424 469	301549
0 986 424 470	301549
0 986 424 472	301431
0 986 424 474	301361
	301902
0 986 424 475	301445
0 986 424 478	301926
0 986 424 481	301355



 	
<b>BOSCH (.../...)</b>	
0 986 424 482	301483
	301751
0 986 424 483	301018
0 986 424 484	301753
0 986 424 485	301310
0 986 424 487	301726
0 986 424 488	301305
0 986 424 490	301057
	301450
0 986 424 492	301037
0 986 424 496	301444
0 986 424 497	301763
0 986 424 501	301486
0 986 424 502	301735
0 986 424 503	301408
0 986 424 506	301581
0 986 424 508	301003
0 986 424 510	301065
0 986 424 512	301316
0 986 424 516	301300
0 986 424 517	301448
0 986 424 518	301448
0 986 424 519	301444
0 986 424 522	301583
0 986 424 523	301517
0 986 424 527	301456
0 986 424 528	301457
0 986 424 529	301462
0 986 424 533	301473
0 986 424 534	301737
0 986 424 535	301606
	301737
0 986 424 539	301480
0 986 424 540	301479
0 986 424 541	301493
0 986 424 542	301650
	301681
0 986 424 545	301142
0 986 424 546	301433
0 986 424 547	301617
0 986 424 553	301407
0 986 424 556	301429
0 986 424 558	301564
	301639
0 986 424 559	301681
0 986 424 563	301497
0 986 424 567	301129
0 986 424 571	301464
0 986 424 572	301522
0 986 424 575	301575
0 986 424 576	301023
0 986 424 578	301023
	301065
	301990
0 986 424 584	301412
0 986 424 593	301006
0 986 424 596	301721
0 986 424 597	301426
0 986 424 616	301471
0 986 424 617	301472
	301783



 	
<b>BOSCH (.../...)</b>	
0 986 424 618	301471
0 986 424 630	301577
0 986 424 632	301734
0 986 424 634	301500
0 986 424 636	301545
0 986 424 640	301535
0 986 424 641	301865
0 986 424 644	301172
	301399
0 986 424 645	301563
0 986 424 646	301584
0 986 424 650	301895
0 986 424 651	301410
0 986 424 656	301906
0 986 424 658	301466
0 986 424 659	301465
0 986 424 660	301461
	301726
0 986 424 661	301682
0 986 424 663	301436
0 986 424 667	301753
0 986 424 670	301908
0 986 424 672	301814
0 986 424 674	301484
0 986 424 676	301305
0 986 424 677	301678
0 986 424 680	301407
0 986 424 683	301434
0 986 424 694	301629
0 986 424 701	301639
0 986 424 703	301568
0 986 424 704	301570
0 986 424 706	301483
	301751
0 986 424 707	301454
	301860
0 986 424 709	301518
0 986 424 713	301521
0 986 424 714	301821
0 986 424 716	301886
0 986 424 717	301520
0 986 424 722	301887
0 986 424 723	301805
0 986 424 726	301821
0 986 424 727	301574
0 986 424 728	301748
0 986 424 729	301505
	301759
0 986 424 734	301449
0 986 424 741	301770
0 986 424 745	301005
0 986 424 747	301482
0 986 424 748	301482
0 986 424 751	301463
	301474
0 986 424 757	301902
0 986 424 760	301661
0 986 424 764	301410
0 986 424 766	301754
0 986 424 767	301231
	301412



 	
<b>BOSCH (.../...)</b>	
0 986 424 769	301569
0 986 424 771	301682
0 986 424 774	301557
0 986 424 777	301565
0 986 424 780	301801
0 986 424 781	301450
0 986 424 785	301558
0 986 424 787	301638
0 986 424 788	301736
0 986 424 790	301680
0 986 424 794	301649
0 986 424 795	301641
	301847
0 986 424 796	301004
	301752
0 986 424 797	301635
0 986 424 800	301642
0 986 424 801	301462
0 986 424 803	301737
0 986 424 808	301827
0 986 424 810	301574
	301781
0 986 424 811	301842
0 986 424 813	301674
0 986 424 814	301852
0 986 424 815	301744
0 986 424 817	301780
0 986 424 818	301644
0 986 424 821	301703
0 986 424 822	301640
0 986 424 824	301752
0 986 424 829	301667
0 986 460 101	301099
0 986 460 113	301183
	301256
0 986 460 346	301099
0 986 460 736	301091
0 986 460 938	301356
0 986 460 939	301256
0 986 460 941	301048
0 986 460 943	301016
0 986 460 944	301003
	301252
0 986 460 948	301982
0 986 460 949	301172
0 986 460 952	301018
0 986 460 954	301048
0 986 460 955	301253
0 986 460 958	301292
0 986 460 960	301020
0 986 460 962	301037
0 986 460 963	301036
0 986 460 964	301386
	301753
0 986 460 965	301617
0 986 460 967	301063
0 986 460 969	301034
0 986 460 970	301158
	301396
0 986 460 971	301033
0 986 460 972	301047







 	
<b>BOSCH (.../...)</b>	
0 986 460 975	301629
0 986 460 977	301013
0 986 460 979	301625
0 986 460 983	301155
0 986 460 991	301005
0 986 460 993	301057
0 986 460 998	301179
0 986 461 006	301682
0 986 461 106	301258
0 986 461 111	301103
0 986 461 119	301012
0 986 461 121	301574
0 986 461 122	301014
0 986 461 123	301551
0 986 461 126	301760
0 986 461 127	301052
	301574
0 986 461 130	301156
0 986 461 131	301053
0 986 461 133	301618
0 986 461 136	301540
0 986 461 141	301274
0 986 461 142	301627
	301682
0 986 461 144	301668
0 986 461 145	301519
0 986 461 146	301624
0 986 461 147	301054
0 986 461 148	301007
	301080
0 986 461 149	301158
	301396
0 986 461 661	301405
0 986 461 731	301099
0 986 461 752	301616
0 986 461 753	301622
0 986 461 757	301031
0 986 461 763	301075
	301081
	301181
0 986 461 764	301038
0 986 461 765	301061
0 986 461 768	301519
0 986 461 769	301180
	301463
	301474
0 986 461 770	301125
0 986 462 282	301099
0 986 462 283	301099
0 986 463 641	301129
0 986 465 141	301182
0 986 465 751	301292
0 986 466 346	301080
0 986 466 402	301212
0 986 466 601	301389
0 986 466 683	301180
	301463
	301474
0 986 466 693	301003
0 986 466 700	301003
0 986 466 751	301103



 	
<b>BOSCH (.../...)</b>	
0 986 466 871	301345
0 986 466 874	301105
0 986 467 590	301129
0 986 467 720	301002
	301474
0 986 467 760	301091
0 986 468 380	301095
	301219
0 986 468 701	301266
	301402
0 986 468 871	301124
0 986 469 070	301335
0 986 469 191	301061
0 986 469 390	301182
0 986 469 410	301315
0 986 469 810	301240
0 986 469 860	301075
	301081
	301181
0 986 469 960	301103
	301259
0 986 490 260	301272
0 986 490 440	301047
0 986 490 500	301183
0 986 490 550	301241
0 986 490 640	301231
0 986 490 800	301119
	301176
0 986 490 990	301123
0 986 491 030	301125
	301142
	301219
0 986 491 050	301095
0 986 491 441	301125
	301142
0 986 491 900	301182
	301184
0 986 492 020	301043
	301171
0 986 492 090	301179
0 986 493 340	301666
0 986 493 480	301123
	301618
0 986 493 550	301268
0 986 493 720	301266
	301402
0 986 494 000	301062
0 986 494 001	301636
0 986 494 002	301357
0 986 494 003	301008
0 986 494 004	301023
	301065
	301990
0 986 494 005	301488
0 986 494 006	301580
0 986 494 007	301310
	301409
	301640
0 986 494 008	301675
0 986 494 009	301311
	301753
0 986 494 010	301330



 	
<b>BOSCH (.../...)</b>	
0 986 494 011	301431
0 986 494 012	301445
0 986 494 014	301926
0 986 494 015	301018
0 986 494 016	301444
0 986 494 017	301763
0 986 494 018	301486
0 986 494 019	301408
0 986 494 020	301581
0 986 494 021	301003
	301484
0 986 494 023	301583
0 986 494 024	301473
0 986 494 025	301650
	301681
0 986 494 026	301433
0 986 494 027	301464
0 986 494 028	301412
0 986 494 032	301472
	301783
0 986 494 033	301471
0 986 494 036	301410
0 986 494 038	301465
0 986 494 039	301461
0 986 494 042	301484
0 986 494 044	301678
0 986 494 046	301434
0 986 494 048	301568
0 986 494 049	301570
0 986 494 050	301483
	301751
0 986 494 051	301482
0 986 494 052	301638
0 986 494 053	301752
0 986 494 055	301063
0 986 494 057	301258
0 986 494 058	301241
0 986 494 059	301016
	301125
	301142
0 986 494 061	301703
0 986 494 062	301463
	301752
0 986 494 065	301718
0 986 494 070	301426
0 986 494 073	301678
0 986 494 076	301740
0 986 494 090	301009
	301672
0 986 494 092	301825
0 986 494 097	301662
0 986 494 102	301829
0 986 494 105	301720
0 986 494 110	301892
0 986 494 113	301426
0 986 494 114	301015
0 986 494 115	301012
0 986 494 118	301640
0 986 494 119	301004
0 986 494 127	301472
	301783



 	
<b>BOSCH (.../...)</b>	
0 986 494 130	301028
0 986 494 132	301426
0 986 494 133	301874
0 986 494 138	301506
0 986 494 139	301868
0 986 494 140	301867
0 986 494 146	301705
0 986 494 152	301889
0 986 494 153	301857
0 986 494 154	301819
0 986 494 155	301575
	301708
0 986 494 157	301825
0 986 494 158	301030
0 986 494 159	301657
0 986 494 160	301847
0 986 494 169	301879
0 986 494 170	301816
0 986 494 175	301928
0 986 494 194	301881
0 986 494 197	301017
0 986 494 285	301638
0 986 494 295	301337
0 986 494 344	301752
0 986 505 402	301862
0 986 AB1 201	301634
0 986 AB1 202	301574
0 986 AB1 203	301908
0 986 AB1 222	301506
0 986 AB1 224	301361
0 986 AB1 233	301708
0 986 AB1 241	301316
0 986 AB1 255	301874
0 986 AB1 266	301937
0 986 AB1 270	301361
0 986 AB2 004	301266
0 986 AB2 041	301540
0 986 AB2 085	301827
0 986 AB2 090	301577
0 986 AB2 093	301737
0 986 AB2 096	301857
0 986 AB2 104	301520
0 986 AB2 106	301886
0 986 AB2 109	301853
0 986 AB2 119	301402
0 986 AB2 125	301535
0 986 AB2 126	301865
0 986 AB2 137	301890
0 986 AB2 138	301819
0 986 AB2 141	301449
0 986 AB2 169	301053
0 986 AB2 176	301760
0 986 AB2 207	301123
0 986 AB2 213	301123
	301618
0 986 AB2 222	301668
0 986 AB2 238	301618
0 986 AB2 309	301517
0 986 AB2 311	301625
0 986 AB2 313	301519
0 986 AB2 322	301522



 	
<b>BOSCH (.../...)</b>	
0 986 AB2 328	301517
0 986 AB2 330	301521
0 986 AB2 458	301780
0 986 AB2 461	301274
0 986 AB2 463	301629
0 986 AB2 610	301895
0 986 AB2 651	301047
0 986 AB2 662	301627
0 986 AB2 663	301682
0 986 AB2 664	301047
0 986 AB2 666	301760
0 986 AB2 675	301682
0 986 AB3 802	301408
0 986 AB3 803	301463
0 986 AB3 805	301252
0 986 AB3 806	301155
0 986 AB3 808	301464
0 986 AB3 811	301682
0 986 AB3 838	301668
0 986 AB3 841	301535
0 986 AB3 842	301865
0 986 AB4 166	301184
	301356
0 986 AB4 189	301356
0 986 AB4 278	301449
0 986 AB4 279	301625
0 986 AB4 297	301305
0 986 BB0 161	301142
F 026 000 000	301040
F 026 000 001	301023
	301065
	301990
F 026 000 002	301488
F 026 000 003	301675
F 026 000 004	301038
	301074
F 026 000 005	301403
F 026 000 006	301074
F 026 000 007	301212
F 026 000 008	301018
F 026 000 009	301753
F 026 000 010	301172
	301399
F 026 000 011	301563
F 026 000 012	301356
F 026 000 013	301048
F 026 000 014	301018
F 026 000 015	301258
F 026 000 016	301212
F 026 000 017	301124
F 026 000 020	301315
F 026 000 022	301012
F 026 000 023	301156
	301360
F 026 000 024	301319
F 026 000 025	301461
	301726
F 026 000 026	301549
F 026 000 027	301926
F 026 000 028	301457



 		
<b>BOSCH (.../...)</b>		
F 026 000 029	301650	
	301681	
F 026 000 030	301584	
F 026 000 035	301005	
F 026 000 036	301012	
F 026 000 037	301158	301396
F 026 000 039	301292	
F 026 000 041	301002	
F 026 000 042	301091	
F 026 000 043	301182	
F 026 000 044	301075	301081
		301181
F 026 000 046	301241	
F 026 000 047	301142	
F 026 000 048	301008	
F 026 000 049	301317	
F 026 000 050	301355	
F 026 000 051	301010	
F 026 000 052	301064	
F 026 000 055	301091	
F 026 000 056	301052	301817
F 026 000 057	301022	
F 026 000 058	301069	
F 026 000 061	301066	
F 026 000 063	301332	
F 026 000 064	301318	
F 026 000 066	301326	
F 026 000 068	301043	301171
F 026 000 070	301322	
F 026 000 071	301454	
F 026 000 073	301330	
F 026 000 074	301763	
F 026 000 075	301003	
F 026 000 076	301456	
F 026 000 078	301473	
F 026 000 082	301480	
F 026 000 083	301030	301479
F 026 000 084	301493	
F 026 000 086	301564	
F 026 000 087	301577	
F 026 000 088	301305	
F 026 000 092	301256	
F 026 000 093	301016	
F 026 000 094	301003	301252
F 026 000 095	301982	
F 026 000 096	301172	
F 026 000 098	301048	
F 026 000 099	301253	
F 026 000 100	301292	
F 026 000 102	301037	
F 026 000 103	301036	
F 026 000 104	301034	
F 026 000 105	301396	
F 026 000 106	301033	
F 026 000 107	301013	



 		
<b>BOSCH (.../...)</b>		
F 026 000 111	301057	
F 026 000 114	301682	
F 026 000 117	301014	
F 026 000 118	301551	
F 026 000 119	301156	
F 026 000 120	301053	
F 026 000 122	301274	
F 026 000 123	301627	301682
F 026 000 124	301668	
F 026 000 125	301007	301080
F 026 000 127	301616	
F 026 000 128	301622	
F 026 000 129	301031	
F 026 000 130	301075	301081
		301181
F 026 000 131	301038	
F 026 000 132	301061	
F 026 000 133	301180	301463
F 026 000 135	301099	
F 026 000 136	301182	
F 026 000 139	301080	
F 026 000 142	301180	
F 026 000 143	301003	
F 026 000 144	301003	
F 026 000 145	301345	
F 026 000 146	301105	
F 026 000 148	301095	301219
F 026 000 150	301266	301402
F 026 000 152	301335	
F 026 000 154	301240	
F 026 000 155	301183	
F 026 000 156	301119	301176
F 026 000 157	301123	
F 026 000 158	301095	
F 026 000 159	301125	301142
F 026 000 161	301182	301184
F 026 000 162	301043	301171
F 026 000 163	301179	
F 026 000 164	301666	
<b>BREMBO</b>		
P 06 001	301099	
P 06 009	301103	
P 06 011	301103	301259
P 06 012	301231	
P 06 013	301386	
P 06 014	301018	
P 06 016	301103	
P 06 017	301013	
P 06 020	301580	
P 06 021	301412	



 		
<b>BREMBO (.../...)</b>		
P 06 022	301310	301409
P 06 023	301311	
P 06 024	301018	
P 06 025	301753	
P 06 031	301410	
P 06 033	301754	
P 06 036	301640	
P 06 038	301703	
P 06 044	301580	
P 06 046	301410	
P 06 048	301412	
P 06 052	301041	
P 10 001	301874	
P 10 003	301942	
P 10 004	301941	
P 10 006	301361	
P 10 007	301361	
P 10 011	301678	
P 10 013	301584	
P 15 002	301361	
P 15 005	301902	
P 15 006	301316	
P 23 001	301183	301256
P 23 013	301091	
P 23 017	301095	301219
P 23 021	301091	
P 23 024	301091	
P 23 026	301142	
P 23 044	301095	
P 23 057	301040	
P 23 058	301023	301065
P 23 061	301064	
P 23 065	301407	
P 23 067	301581	
P 23 068	301010	
P 23 070	301006	
P 23 071	301040	301065
P 23 077	301023	301065
		301990
P 23 083	301429	
P 23 084	301429	
P 23 085	301426	
P 23 087	301721	
P 23 091	301568	
P 23 092	301569	
P 23 093	301570	
P 23 096	301012	
P 23 107	301015	
P 23 108	301426	
P 23 112	301990	
P 23 116	301023	
P 24 004	301129	
P 24 006	301212	
P 24 018	301240	
P 24 019	301335	



 		
<b>BREMBO (.../...)</b>		
P 24 026	301123	301618
P 24 028	301043	301171
P 24 029	301172	
P 24 032	301036	
P 24 033	301037	
P 24 034	301033	
P 24 037	301034	
P 24 043	301212	
P 24 044	301043	301171
P 24 045	301399	
P 24 046	301317	
P 24 047	301431	
P 24 048	301644	
P 24 049	301036	
P 24 050	301037	
P 24 054	301563	
P 24 055	301564	
P 24 058	301639	
P 24 059	301434	
P 24 060	301433	
P 24 061	301649	
P 24 063	301740	
P 24 064	301816	
P 24 071	301639	
P 24 076	301879	
P 24 078	301928	
P 28 006	301047	
P 28 008	301047	
P 28 011	301053	
P 28 017	301053	
P 28 020	301022	
P 28 022	301682	
P 28 024	301760	
P 28 026	301627	
P 28 028	301627	
P 28 029	301436	
P 28 030	301682	
P 28 034	301887	
P 28 039	301682	
P 30 001	301052	
P 30 002	301574	
P 30 003	301817	
P 30 005	301634	
P 30 010	301908	
P 30 011	301575	
P 30 012	301821	
P 30 013	301505	301759
P 30 014	301748	
P 30 017	301506	
P 30 018	301744	
P 30 020	301781	
P 30 022	301574	
P 30 024	301052	
P 30 025	301867	
P 30 026	301868	
P 30 027	301708	
P 30 034	301842	



 		
<b>BREMBO (.../...)</b>		
P 30 036	301937	
P 30 037	301932	
P 30 039	301934	
P 30 042	301705	
P 30 043	301744	
P 30 046	301867	
P 37 004	301491	
P 41 001	301405	
P 41 002	301389	
P 41 003	301406	
P 41 004	301406	
P 44 001	301497	
P 44 003	301497	
P 49 013	301268	
P 49 015	301624	
P 49 016	301274	
P 49 018	301629	
P 49 023	301629	
P 49 036	301780	
P 49 037	301780	
P 50 007	301105	
P 50 008	301315	
P 50 009	301272	
P 50 011	301241	
P 50 013	301345	
P 50 017	301617	
P 50 019	301046	
P 50 020	301300	
P 50 023	301357	
P 50 024	301763	
P 50 025	301444	
P 50 026	301636	
P 50 029	301044	
P 50 030	301062	
P 50 035	301549	
P 50 036	301549	
P 50 041	301445	
P 50 045	301448	
P 50 046	301448	
P 50 049	301638	
P 50 055	301318	
P 50 058	301583	
P 50 059	301881	
P 50 072	301444	
P 50 075	301636	
P 50 080	301044	
P 50 082	301046	
P 54 012	301519	
P 54 014	301625	
P 54 017	301517	
P 54 018	301519	
P 54 020	301522	
P 54 022	301318	
P 54 023	301319	
P 54 028	301521	
P 54 029	301518	
P 54 030	301886	
P 54 031	301520	301852
P 54 034	301852	
P 54 036	301493	



 	
<b>BREMBO (.../...)</b>	
P 56 004	301123
P 56 005	301817
P 56 014	301123
P 56 022	301054
P 56 024	301057
P 56 029	301668
P 56 031	301014
P 56 032	301642
P 56 035	301449
P 56 036	301450
P 56 038	301726
P 56 046	301009
	301672
P 56 049	301889
P 56 056	301123
P 56 058	301337
P 56 061	301545
P 56 062	301067
P 59 001	301099
	301270
P 59 002	301003
P 59 005	301182
P 59 011	301356
P 59 013	301184
	301356
P 59 014	301183
P 59 015	301020
P 59 016	301256
P 59 017	301184
P 59 018	301183
	301253
P 59 021	301507
P 59 022	301305
P 59 023	301183
P 59 024	301183
P 59 028	301458
P 59 029	301305
P 59 030	301322
P 59 031	301926
P 59 032	301454
P 59 033	301661
P 59 036	301456
P 59 037	301457
P 59 038	301584
P 59 042	301472
	301678
	301783
P 59 043	301678
P 59 044	301472
	301783
P 59 045	301860
P 59 050	301847
P 59 051	301825
P 61 020	301081
P 61 028	301081
P 61 030	301119
	301176
	301181
P 61 031	301119
	301176
P 61 032	301396



 	
<b>BREMBO (.../...)</b>	
P 61 034	301156
P 61 035	301179
P 61 037	301292
P 61 042	301155
	301181
P 61 044	301075
	301081
	301155
	301181
P 61 045	301075
P 61 047	301156
P 61 051	301038
	301074
P 61 052	301031
P 61 054	301038
P 61 056	301068
P 61 057	301069
P 61 058	301063
P 61 059	301156
	301360
P 61 060	301326
P 61 062	301292
P 61 063	301461
	301726
P 61 064	301466
P 61 065	301462
P 61 066	301464
P 61 067	301462
P 61 068	301465
P 61 074	301500
P 61 077	301662
P 61 081	301718
P 61 082	301464
P 61 088	301463
P 61 091	301892
P 61 097	301075
P 61 098	301461
	301726
P 61 099	301155
P 68 008	301002
P 68 010	301002
	301075
	301081
	301181
P 68 014	301061
P 68 015	301080
P 68 017	301007
	301080
	301396
P 68 018	301158
P 68 020	301080
P 68 024	301180
	301474
P 68 027	301473
P 68 030	301471
P 68 031	301557
P 68 032	301471
P 68 033	301641
P 68 034	301558
P 68 035	301180
P 68 037	301002



 	
<b>BREMBO (.../...)</b>	
P 68 038	301002
P 68 039	301017
P 71 006	301753
P 71 008	301183
P 78 011	301895
P 78 013	301853
P 79 005	301666
P 83 011	301266
	301402
P 83 013	301402
P 83 015	301540
P 83 016	301266
P 83 034	301551
P 83 048	301535
P 83 049	301865
P 83 050	301606
P 83 051	301737
P 83 052	301577
	301737
P 83 053	301736
P 83 054	301827
P 83 062	301862
P 83 065	301680
P 83 066	301857
P 83 074	301035
P 83 079	301943
P 83 082	301943
P 83 087	301028
P 83 089	301819
P 85 003	301099
P 85 004	301099
P 85 005	301124
P 85 010	301124
P 85 011	301003
	301252
P 85 013	301125
	301142
P 85 015	301016
P 85 016	301003
P 85 017	301180
	301463
	301474
P 85 020	301180
	301463
P 85 024	301258
P 85 025	301488
P 85 027	301048
P 85 028	301048
P 85 029	301622
P 85 030	301066
P 85 031	301403
P 85 032	301330
P 85 034	301982
P 85 036	301355
P 85 037	301483
	301751
P 85 039	301008
P 85 041	301332
P 85 042	301003
P 85 043	301408
P 85 044	301484



 	
<b>BREMBO (.../...)</b>	
P 85 045	301486
P 85 046	301482
P 85 047	301675
P 85 050	301814
P 85 051	301483
	301751
P 85 055	301735
P 85 057	301667
P 85 058	301674
	301681
P 85 059	301650
	301681
P 85 061	301565
P 85 062	301801
P 85 063	301734
P 85 066	301674
P 85 070	301770
P 85 071	301805
P 85 072	301408
P 85 073	301752
P 85 074	301463
P 85 075	301635
P 85 076	301004
P 85 077	301720
P 85 085	301483
	301751
P 85 086	301484
	301751
P 85 088	301770
P 85 089	301180
	301463
P 85 092	301003
P 85 095	301752
P 85 096	301483
P 85 103	301770
P 85 108	301752
P 85 109	301752
P 86 001	301270
P 86 002	301270
P 86 013	301616
P 86 014	301480
P 86 016	301479
P 86 017	301493
P 86 018	301657
P 86 019	301829
P 86 020	301479
P 86 022	301030
P A6 001	301129
P A6 004	301129
<b>DELPHI</b>	
LP0018	301099
	301270
LP0021	301099
LP0041	301129
LP0076	301099
LP0092	301405
LP0171	301081
LP0189	301389
LP0248	301002
LP0255	301212
LP0275	301219



 	
<b>DELPHI (.../...)</b>	
LP0353	301091
LP0358	301123
LP0444	301003
LP0451	301125
LP0459	301095
	301219
LP0460	301266
LP0475	301497
LP0479	301129
LP0490	301081
LP0491	301080
LP0522	301142
LP0542	301061
LP0557	301240
LP0564	301179
LP0565	301180
LP0566	301095
LP0581	301182
LP0585	301356
LP0586	301253
LP0590	301183
LP0602	301231
LP0606	301574
LP0613	301266
LP0616	301054
LP0617	301057
LP0620	301268
LP0625	301053
LP0629	301020
LP0655	301292
LP0699	301396
LP0702	301184
	301356
LP0703	301156
LP0707	301123
LP0743	301274
LP0766	301036
LP0767	301037
LP0769	301982
LP0781	301033
	301034
LP0784	301008
LP0787	301031
LP0788	301061
LP0789	301551
LP0793	301074
LP0801	301629
LP0836	301158
	301396
LP0839	301616
LP0841	301617
LP0851	301012
LP0868	301240
LP0877	301010
LP0881	301013
LP0946	301272
LP0948	301682
LP0975	301668
LP0980	301044
LP0985	301068
LP0986	301069



 	
<b>DELPHI (.../...)</b>	
LP0991	301063
LP0993	301318
LP1003	301412
LP1006	301006
LP1007	301065
LP1008	301357
LP1009	301636
LP1010	301625
LP1012	301449
LP1016	301066
LP1018	301581
LP1019	301482
LP1023	301319
LP1027	301095
LP1043	301062
LP1045	301046
LP1051	301360
LP1053	301075
	301081
LP1069	301305
LP1072	301817
LP1073	301817
LP1076	301629
LP1077	301488
LP1081	301043
	301171
LP1082	301212
LP1083	301184
LP1085	301326
LP1092	301675
LP1100	301666
LP1104	301332
	301408
LP1107	301311
LP1115	301069
LP1116	301466
LP1118	301396
LP1124	301449
LP1126	301817
LP1128	301007
LP1133	301726
LP1139	301172
	301399
LP1143	301580
LP1206	301048
LP1249	301403
LP1304	301361
LP1307	301926
LP1308	301535
LP1309	301322
	301454
	301860
LP1315	301317
LP1316	301431
LP1390	301316
LP1397	301040
LP1398	301493
LP1401	301549
LP1402	301763
LP1403	301444
LP1404	301065



 	
<b>DELPHI (.../...)</b>	
LP1407	301008
	301355
LP1408	301023
LP1409	301330
LP1410	301003
LP1412	301330
	301982
LP1413	301065
LP1414	301606
LP1417	301036
LP1418	301037
LP1421	301018
LP1423	301018
	301753
LP1424	301902
LP1434	301908
LP1435	301450
LP1436	301332
LP1437	301300
LP1438	301865
LP1441	301183
LP1444	301219
LP1448	301521
LP1453	301061
LP1455	301482
LP1457	301466
LP1458	301030
	301479
LP1462	301518
	301520
LP1469	301564
LP1470	301563
LP1472	301142
LP1502	301575
LP1503	301436
LP1504	301480
	301829
LP1507	301682
LP1509	301895
LP1511	301482
LP1513	301577
LP1514	301408
LP1517	301462
LP1518	301629
LP1519	301726
LP1524	301473
LP1525	301486
LP1527	301629
LP1533	301433
LP1534	301627
LP1539	301748
LP1541	301482
	301650
LP1542	301814
LP1552	301661
LP1553	301926
LP1556	301650
	301681
LP1585	301040
	301065
LP1586	301006



 	
<b>DELPHI (.../...)</b>	
LP1587	301023
	301065
LP1588	301357
LP1589	301636
LP1591	301066
LP1593	301319
LP1596	301046
LP1597	301074
LP1599	301634
LP1600	301305
LP1601	301488
LP1603	301043
	301171
LP1604	301212
LP1605	301184
LP1606	301069
	301179
LP1607	301326
LP1608	301310
	301409
LP1609	301458
LP1610	301726
LP1615	301491
LP1617	301461
	301726
LP1631	301484
LP1653	301465
LP1671	301821
LP1672	301483
LP1673	301322
	301454
	301860
LP1675	301734
	301735
LP1676	301456
LP1677	301457
LP1679	301464
	301465
LP1681	301584
LP1682	301434
LP1683	301005
	301434
LP1684	301886
LP1685	301407
LP1686	301065
	301990
LP1687	301483
	301751
LP1688	301445
LP1691	301520
LP1695	301545
LP1696	301448
LP1699	301461
LP1701	301472
	301783
LP1704	301887
LP1708	301471
LP1709	301805
LP1713	301180
	301500
	301674



 	
<b>DELPHI (.../...)</b>	
LP1716	301500
LP1717	301584
LP1718	301853
LP1721	301721
LP1722	301426
LP1723	301678
LP1724	301639
LP1725	301434
LP1726	301472
LP1727	301464
LP1728	301667
LP1730	301558
LP1731	301860
LP1733	301650
	301681
LP1736	301734
LP1738	301862
LP1741	301583
LP1742	301737
LP1743	301505
	301759
LP1744	301473
LP1748	301429
LP1750	301568
LP1751	301569
LP1754	301720
LP1760	301483
LP1766	301780
LP1772	301889
LP1778	301396
LP1782	301857
LP1783	301678
LP1787	301030
	301657
LP1790	301570
LP1791	301638
LP1794	301410
LP18	301099
	301270
LP1800	301406
LP1801	301565
LP1803	301580
LP1804	301827
LP1807	301009
	301672
LP1815	301463
	301674
LP1816	301361
LP1819	301842
LP1821	301657
LP1824	301752
LP1835	301657
LP1837	301635
LP1840	301736
LP1846	301462
LP1851	301636
LP1852	301852
LP1853	301506
LP1860	301004
LP1861	301860
LP1864	301680



 	
<b>DELPHI (.../...)</b>	
LP1865	301641
LP1866	301557
LP1869	301649
LP189	301389
LP1890	301662
LP1895	301644
LP1902	301744
LP1904	301635
LP1910	301874
LP1915	301703
LP1920	301004
LP1927	301754
LP1932	301705
LP1949	301718
LP1951	301868
LP1952	301867
LP1958	301472
	301783
LP1977	301035
LP1987	301942
LP1988	301941
LP1994	301892
LP2008	301928
LP2013	301012
LP2030	301337
LP204	301212
LP211	301497
LP213	301129
LP2137	301017
LP2167	301055
LP2170	301070
LP219	301123
LP224	301124
LP229	301292
LP255	301171
	301212
LP275	301219
LP305	301091
LP353	301091
	301219
LP358	301123
LP382	301081
LP401	301780
LP403	301052
LP41	301129
LP415	301182
	301356
LP420	301124
LP429	301003
LP440	301105
LP441	301080
LP442	301103
LP444	301003
LP445	301047
LP45	301129
LP451	301125
	301142
LP454	301817
LP455	301241
LP457	301335



 	
<b>DELPHI (.../...)</b>	
LP459	301091
	301095
	301219
LP460	301266
LP475	301497
LP481	301129
LP490	301002
	301075
	301081
	301181
LP491	301080
LP493	301119
	301176
LP496	301219
LP499	301044
	301315
LP507	301240
LP509	301091
LP518	301002
	301080
LP522	301125
	301142
LP523	301125
LP536	301176
	301181
LP538	301402
LP542	301002
	301061
LP543	301123
	301618
LP551	301406
LP553	301091
LP555	301103
	301259
LP556	301095
LP557	301240
LP562	301053
LP563	301156
LP564	301179
LP565	301125
	301180
	301463
LP566	301095
LP571	301180
	301463
LP581	301182
LP585	301184
LP586	301253
LP587	301335
LP590	301183
LP591	301043
	301171
LP593	301052
LP597	301241
LP602	301231
LP606	301574
LP608	301315
LP611	301540
LP613	301266
	301402
LP616	301054
	301450



 	
<b>DELPHI (.../...)</b>	
LP617	301057
LP618	301022
LP619	301022
LP620	301268
	301274
LP625	301053
LP629	301020
LP647	301018
LP652	301156
LP655	301292
LP667	301062
LP673	301172
LP676	301666
LP687	301123
LP696	301075
	301081
	301155
	301181
LP699	301396
LP702	301356
LP703	301156
	301360
LP704	301052
LP707	301123
LP710	301018
LP713	301345
LP720	301047
LP726	301618
LP732	301091
LP743	301274
LP76	301099
LP766	301036
LP767	301037
LP769	301982
LP770	301016
	301330
LP778	301003
	301016
	301252
LP779	301014
LP780	301642
LP781	301033
LP782	301034
LP784	301008
	301355
LP785	301048
LP787	301031
LP788	301061
LP789	301551
LP793	301038
	301074
LP794	301034
LP801	301629
LP803	301625
LP810	301760
LP821	301007
LP825	301080
	301080
	301396
LP834	301540
LP838	301002
LP839	301616



 	
<b>DELPHI (.../...)</b>	
LP841	301617
LP846	301103
LP848	301256
LP850	301180
LP851	301012
LP853	301005
LP86	301099
LP871	301517
LP872	301627
LP877	301010
LP881	301013
LP884	301003
LP885	301002
LP901	301003
LP907	301386
LP909	301064
LP911	301022
LP915	301345
LP918	301048
	301622
	301814
LP92	301389
LP931	301624
LP946	301272
LP948	301682
LP954	301519
LP961	301266
LP965	301507
	301661
LP975	301668
LP978	301355
LP979	301258
LP980	301044
LP986	301069
LP991	301063
LP993	301318
<b>FERODO</b>	
FDB1000	301064
FDB1017	301507
FDB1038	301044
FDB1040	301040
FDB1040B	301040
FDB1044	301062
FDB1049	301357
FDB105	301099
FDB1050	301636
FDB1052	301023
	301065
	301990
FDB1052B	301023
	301065
	301990
FDB1054	301066
FDB1055	301008
	301463
FDB1056	301006
	301040
FDB1056B	301006
	301040
FDB1062	301068
FDB1063	301069



 	
<b>FERODO (.../...)</b>	
FDB1067	301184
FDB1068	301305
FDB1072	301258
FDB1072G	301258
FDB1073	301310
	301409
FDB1075	301311
FDB1081	301212
FDB1082	301171
FDB1083	301180
	301463
FDB1085	301061
FDB1094	301332
FDB1096	301450
FDB11	301003
FDB1101	301488
FDB1104	301668
FDB1109	301360
FDB1112	301326
FDB1113	301125
	301142
	301219
FDB1116	301361
FDB1117	301183
FDB1117B	301183
FDB1129	301906
FDB1135	301726
FDB1167	301355
FDB1168	301074
FDB1265	301458
FDB1276	301399
FDB128	301099
FDB1285	301616
FDB1288	301403
FDB1289	301003
FDB1293	301322
FDB1294	301926
FDB1295	301454
FDB1300	301018
FDB1301	301753
FDB1303	301549
FDB1310	301763
FDB1311	301444
FDB1312	301330
FDB1318	301317
FDB1319	301431
FDB1319B	301431
FDB1323	301483
FDB1325	301406
FDB1326	301575
FDB1333	301895
FDB1336	301902
FDB1337	301316
FDB1349	301407
FDB1357	301549
FDB1368	301606
FDB1370	301462
FDB1378	301461
	301726
FDB1379	301466
FDB1382	301030



 	
<b>FERODO (.../...)</b>	
FDB1383	301480
FDB1392	301737
FDB1393	301563
FDB1394	301564
FDB1395	301577
FDB1398	301408
FDB1399	301464
FDB1409	301557
FDB1414	301638
FDB1415	301063
FDB1416	301434
FDB1419	301667
FDB1420	301473
FDB1422	301522
FDB1424	301456
FDB1425	301433
FDB1426	301445
FDB1428	301448
FDB1429	301448
FDB1439	301436
FDB1441	301471
FDB1451	301484
FDB1454	301449
FDB1456	301535
FDB1457	301865
FDB1463	301180
	301486
FDB1466	301426
FDB1467	301721
FDB1472	301457
FDB1476	301465
FDB1481	301681
FDB1482	301482
	301650
	301681
FDB1483	301580
FDB1491	301180
FDB1497	301565
FDB1505	301627
FDB1511	301661
FDB1513	301736
FDB1515	301545
FDB1517	301735
FDB1520	301678
FDB1521	301584
FDB1528	301827
FDB1540	301472
FDB1541	301471
FDB1542	301500
FDB1544	301558
FDB1574	301680
FDB1594	301649
FDB1595	301821
FDB1596	301521
FDB1599	301462
FDB1603	301518
FDB1604	301520
FDB1605	301505
	301759
FDB1606	301748
FDB1617	301641



 	FERODO (.../...)	
FDB1620		301862
FDB1621		301886
FDB1627		301770
FDB1628		301410
FDB1630		301012
FDB1631		301657
FDB1632		301829
FDB1633		301734
FDB1634		301805
FDB1635		301408
FDB1636		301752
FDB1637		301463
FDB1639		301853
FDB1640		301860
FDB1641		301635
FDB1645		301674
FDB1654		301801
FDB1655		301004
FDB1662		301720
FDB1666		301426
FDB1668		301483
		301751
FDB1669		301887
FDB1670		301506
FDB1679		301682
FDB1693		301672
FDB1698		301857
FDB1699		301644
FDB1717		301751
FDB1721		301780
FDB1725		301662
FDB173		301182
		301356
FDB1733		301744
FDB1737		301574
FDB1738		301318
FDB1745		301889
FDB175		301124
FDB1753		301005
FDB1766		301783
FDB1770		301180
FDB1773		301640
FDB1781		301002
FDB1782		301583
FDB1788		301180
		301463
FDB1790		301718
FDB1807		301703
FDB1827		301484
		301751
FDB1835		301770
FDB1839		301852
FDB1840		301781
FDB1867		301753
FDB1869		301842
FDB1885		301740
FDB1889		301874
FDB1892		301819
FDB1897		301879
FDB1910		301932
FDB1918		301928



 	FERODO (.../...)	
FDB1920		301825
FDB1931		301472
		301783
FDB1934		301942
FDB1935		301941
FDB1936		301035
FDB1944		301012
FDB1945		301015
FDB1946		301426
FDB195		301389
FDB1950		301708
FDB1955		301868
FDB1956		301867
FDB1969		301361
FDB1990		301821
FDB1992		301852
FDB206		301212
FDB212		301212
FDB222		301125
FDB225		301123
FDB235		301081
FDB256		301080
FDB276		301335
FDB284		301817
FDB296		301103
FDB2H		301099
		301270
FDB300		301047
FDB308		301266
FDB318		301402
FDB328		301105
FDB340		301123
FDB346		301091
		301219
FDB363		301091
FDB370		301091
		301219
FDB372		301780
FDB375		301182
		301356
FDB392		301124
FDB393		301002
		301075
		301081
		301181
FDB393D		301081
FDB398		301240
FDB3M		301099
FDB4004		301180
FDB4014		301705
FDB4035		301017
FDB4041		301028
FDB4051		301067
FDB406		301061
FDB4066		301464
FDB4076		301052
FDB415		301315
FDB4178		301463
FDB4183		301474
FDB4188		301678
FDB419		301181



 	FERODO (.../...)	
FDB4192		301752
FDB4235		301867
FDB4263		301055
FDB4264		301070
FDB4265		301055
FDB434		301119
FDB435		301052
FDB440		301080
		301396
FDB455		301119
		301176
		301181
FDB456		301125
FDB471		301497
FDB472		301053
FDB478		301540
FDB520		301129
		301497
FDB524		301095
FDB525		301183
FDB527		301406
FDB535		301156
FDB540		301179
FDB541		301180
FDB558		301158
		301396
		301570
FDB577		301231
FDB578		301259
FDB579		301335
FDB584		301184
FDB585		301047
FDB586		301183
		301253
FDB588		301666
FDB589		301043
FDB590		301355
FDB597		301268
FDB600		301574
FDB602		301266
FDB604		301054
FDB609		301183
FDB613		301022
FDB615		301292
FDB617		301172
		301399
FDB619		301063
FDB621		301053
FDB638		301817
FDB641		301123
		301618
FDB644		301272
FDB654		301624
FDB660		301241
FDB667		301054
		301450
FDB669		301241
FDB678		301020
FDB686		301256
FDB691		301574
FDB707		301057



 	FERODO (.../...)	
FDB708		301052
FDB715		301274
FDB717		301123
FDB719		301155
		301181
FDB725		301018
FDB729		301075
		301081
		301155
		301181
FDB730		301075
		301155
		301181
FDB732		301356
FDB745		301156
FDB764		301625
FDB765		301517
FDB766		301033
		301034
FDB767		301033
FDB774		301016
		301330
FDB775		301003
		301252
FDB777		301760
FDB779		301231
FDB799		301617
FDB804		301519
FDB844		301497
FDB845		301002
FDB850		301386
FDB854		301013
FDB859		301014
FDB867		301551
FDB874		301031
FDB876		301038
		301074
FDB877		301158
		301396
FDB878		301007
FDB881		301080
FDB884		301034
FDB905		301627
FDB925		301012
FDB950		301629
FDB951		301982
FDB954		301003
FDB956		301682
FDB96		301389
FDB973		301183
FDB979		301345
FDB992		301642
FDB994		301023
FDB995		301581
FDB997		301412
FDB998		301412
FDS1040		301040
FDS1049		301357
FDS1050		301636
FDS1052		301023
		301065



 	FERODO (.../...)	
FDS1056		301006
		301040
FDS1063		301069
FDS1067		301184
FDS1068		301305
FDS1072		301258
FDS1073		301310
		301409
FDS1081		301212
FDS1082		301171
FDS1083		301180
		301463
FDS1101		301488
FDS1109		301360
FDS1112		301326
FDS1113		301125
		301142
		301219
FDS1285		301616
FDS1288		301403
FDS1289		301003
FDS1293		301322
FDS1294		301926
FDS1295		301454
FDS1300		301018
FDS1301		301753
FDS1312		301330
FDS1318		301317
FDS1323		301483
FDS1333		301895
FDS1349		301407
FDS1370		301462
FDS1378		301461
FDS1379		301466
FDS1398		301408
FDS1399		301464
FDS1419		301667
FDS1463		301180
		301486
FDS173		301182
		301356
FDS1773		301640
FDS212		301212
FDS256		301080
FDS276		301335
FDS308		301266
FDS370		301091
		301219
FDS392		301124
FDS393		301002
		301075
		301081
		301181
FDS406		301061
FDS434		301119
FDS541		301180
FDS558		301158
		301396
		301570
FDS578		301259
FDS584		301184



 	
<b>FERODO (.../...)</b>	
FDS586	301183
	301253
FDS600	301574
FDS604	301054
FDS613	301022
FDS617	301172
	301399
FDS654	301624
FDS725	301018
FDS729	301081
	301155
	301181
FDS732	301356
FDS745	301156
FDS765	301517
FDS766	301033
	301034
FDS767	301033
FDS774	301016
	301330
FDS775	301003
	301252
FDS777	301760
FDS779	301231
FDS845	301002
FDS850	301386
FDS867	301551
FDS876	301038
	301074
FDS905	301627
FDS925	301012
FDS96	301389
FDS995	301581
FDS998	301412
FQT1000	301064
FQT1040	301040
FQT1049	301357
FQT1050	301636
FQT1052	301023
	301065
	301990
FQT1056	301006
	301040
FQT1063	301069
FQT1067	301184
FQT1068	301305
FQT1073	301310
	301409
FQT1075	301311
FQT1082	301171
FQT1083	301180
	301463
FQT1094	301332
FQT1101	301488
FQT1112	301326
FQT1113	301125
	301142
	301219
FQT1117	301183
FQT1135	301726
FQT1168	301074



 	
<b>FERODO (.../...)</b>	
FQT1276	301399
FQT1285	301616
FQT1288	301403
FQT1293	301322
FQT1294	301926
FQT1295	301454
FQT1300	301018
FQT1301	301753
FQT1303	301549
FQT1311	301444
FQT1312	301330
FQT1318	301317
FQT1319	301431
FQT1323	301483
FQT1349	301407
FQT1370	301462
FQT1378	301461
	301726
FQT1382	301030
FQT1394	301564
FQT1398	301408
FQT1399	301464
FQT1414	301638
FQT1415	301063
FQT1416	301434
FQT1420	301473
FQT1424	301456
FQT1425	301433
FQT1426	301445
FQT1428	301448
FQT1429	301448
FQT1439	301436
FQT1441	301471
FQT1451	301484
FQT1463	301180
	301486
FQT1467	301721
FQT1476	301465
FQT1481	301681
FQT1482	301482
	301650
	301681
FQT1483	301580
FQT1491	301180
FQT1497	301565
FQT1520	301678
FQT1521	301584
FQT1540	301472
FQT1541	301471
FQT1544	301558
FQT1594	301649
FQT1605	301505
	301759
FQT1606	301748
FQT1627	301770
FQT1628	301410
FQT1631	301657
FQT1632	301829
FQT1635	301408
FQT1640	301860
FQT1641	301635



 	
<b>FERODO (.../...)</b>	
FQT1654	301801
FQT1717	301751
FQT1766	301783
FQT1788	301180
	301463
FQT1931	301472
	301783
FQT393	301002
	301075
	301081
	301181
FQT406	301061
FQT558	301158
	301396
	301570
FQT613	301022
FQT619	301063
FQT719	301155
	301181
FQT725	301018
FQT729	301075
	301081
	301155
	301181
FQT732	301356
FQT774	301016
	301330
FQT775	301003
	301252
FQT845	301002
FQT850	301386
FQT854	301013
FQT867	301551
FQT874	301031
FQT876	301038
	301074
FQT884	301034
FQT925	301012
FQT995	301581
FQT997	301412
FQT998	301412
FSL1000	301064
FSL1017	301507
FSL1038	301044
FSL1040	301040
FSL1044	301062
FSL1045	301046
FSL1049	301357
FSL105	301099
FSL1050	301636
FSL1052	301023
	301065
FSL1054	301066
FSL1055	301008
	301463
FSL1056	301006
	301040
FSL1062	301068
FSL1063	301069
FSL1067	301184
FSL1068	301305
FSL1072	301258



 	
<b>FERODO (.../...)</b>	
FSL1073	301310
	301409
FSL1075	301311
FSL1081	301212
FSL1082	301171
FSL1083	301180
	301463
FSL1094	301332
FSL1096	301450
FSL1101	301488
FSL1109	301360
FSL1112	301326
FSL1113	301125
	301142
	301219
FSL1116	301361
FSL1117	301183
FSL1131	301048
FSL1132	301482
FSL1135	301726
FSL1163	301675
FSL1167	301355
FSL1168	301074
FSL1276	301399
FSL1285	301616
FSL1288	301403
FSL1289	301003
FSL1293	301322
FSL1294	301926
FSL1295	301454
FSL1300	301018
FSL1301	301753
FSL1303	301549
FSL1310	301763
FSL1311	301444
FSL1312	301330
FSL1318	301317
FSL1319	301431
FSL1323	301483
FSL1326	301575
FSL1333	301895
FSL1336	301902
FSL1337	301316
FSL1338	301036
FSL1339	301037
FSL1349	301407
FSL1368	301606
FSL1370	301462
FSL1378	301461
	301726
FSL1382	301030
FSL1383	301480
FSL1392	301737
FSL1393	301563
FSL1394	301564
FSL1395	301577
FSL1396	301429
FSL1398	301408
FSL1399	301464
FSL1409	301557
FSL1414	301638



 	
<b>FERODO (.../...)</b>	
FSL1415	301063
FSL1416	301434
FSL1419	301667
FSL1420	301473
FSL1422	301522
FSL1424	301456
FSL1425	301433
FSL1426	301445
FSL1428	301448
FSL1439	301436
FSL1441	301471
FSL1451	301484
FSL1463	301486
FSL1466	301426
FSL1467	301721
FSL1472	301457
FSL1476	301465
FSL1478	301568
FSL1479	301569
	301570
FSL1480	301569
	301570
FSL1481	301681
FSL1482	301482
	301650
	301681
FSL1483	301580
FSL1505	301627
FSL1511	301661
FSL1513	301736
FSL1515	301545
FSL1519	301814
FSL1520	301678
FSL1521	301584
FSL1528	301827
FSL1540	301472
FSL1541	301471
FSL1542	301500
FSL1544	301558
FSL1568	301639
FSL1574	301680
FSL1594	301649
FSL1595	301821
FSL1599	301462
FSL1603	301518
FSL1604	301520
FSL1606	301748
FSL1617	301641
FSL1621	301886
FSL1631	301657
FSL1634	301805
FSL1635	301408
FSL1636	301752
FSL1637	301463
FSL1639	301853
FSL1640	301860
FSL1641	301635
FSL1644	301004
FSL1645	301674
FSL1654	301801
FSL1662	301720

 	FERODO (.../...)	
FSL1666,	301426	
FSL1669	301887	
FSL1679	301682	
FSL1693	301672	
FSL1699	301644	
FSL1717	301751	
FSL1721	301780	
FSL1725	301662	
FSL173	301182	
	301356	
FSL1733	301744	
FSL1738	301318	
FSL175	301124	
FSL1753	301005	
FSL1766	301783	
FSL1773	301640	
FSL1777	301881	
FSL1781	301002	
FSL1782	301583	
FSL1790	301718	
FSL1807	301703	
FSL1839	301852	
FSL1840	301781	
FSL1876	301046	
FSL1885	301740	
FSL1889	301874	
FSL1892	301819	
FSL1897	301879	
FSL1920	301825	
FSL1928	301816	
FSL1931	301472	
	301783	
FSL1944	301012	
FSL1946	301426	
FSL195	301389	
FSL206	301212	
FSL212	301212	
FSL222	301125	
FSL276	301335	
FSL296	301103	
FSL300	301047	
FSL308	301266	
FSL318	301402	
FSL328	301105	
FSL340	301123	
FSL346	301091	
	301219	
FSL370	301091	
	301219	
FSL392	301124	
FSL393	301002	
	301075	
	301081	
	301181	
FSL398	301240	
FSL406	301061	
FSL415	301315	
FSL434	301119	
FSL435	301052	
FSL440	301080	
	301396	



 	FERODO (.../...)	
FSL455	301119	
	301176	
	301181	
FSL471	301497	
FSL472	301053	
FSL478	301540	
FSL520	301129	
	301497	
FSL524	301095	
FSL525	301183	
FSL527	301406	
FSL535	301156	
FSL540	301179	
FSL541	301180	
FSL558	301158	
	301396	
	301570	
FSL577	301231	
FSL578	301259	
FSL579	301335	
FSL584	301184	
FSL585	301047	
FSL586	301183	
	301253	
FSL589	301043	
FSL590	301355	
FSL597	301268	
FSL600	301574	
FSL602	301266	
FSL604	301054	
FSL609	301183	
FSL613	301022	
FSL615	301292	
FSL617	301172	
	301399	
FSL619	301063	
FSL621	301053	
FSL638	301817	
FSL641	301123	
	301618	
FSL644	301272	
FSL654	301624	
FSL660	301241	
FSL667	301054	
	301450	
FSL669	301241	
FSL678	301020	
FSL686	301256	
FSL700	301036	
FSL701	301037	
FSL707	301057	
FSL715	301274	
FSL719	301155	
	301181	
FSL722	301048	
FSL725	301018	
FSL729	301075	
	301081	
	301155	
	301181	



 	FERODO (.../...)	
FSL730	301075	
	301155	
	301181	
FSL732	301356	
FSL745	301156	
FSL764	301625	
FSL765	301517	
FSL766	301033	
	301034	
FSL767	301033	
FSL774	301016	
	301330	
FSL775	301003	
	301252	
FSL777	301760	
FSL779	301231	
FSL799	301617	
FSL804	301519	
FSL829	301129	
FSL844	301497	
FSL845	301002	
FSL850	301386	
FSL854	301013	
FSL859	301014	
FSL867	301551	
FSL874	301031	
FSL876	301038	
	301074	
FSL877	301158	
	301396	
FSL878	301007	
FSL881	301080	
FSL884	301034	
FSL886	301129	
FSL905	301627	
FSL925	301012	
FSL950	301629	
FSL954	301003	
FSL956	301682	
FSL96	301389	
FSL967	301010	
FSL970	301622	
FSL973	301183	
FSL979	301345	
FSL989	301129	
FSL995	301581	
FSL997	301412	
FVR1000	301064	
FVR1038	301044	
FVR1044	301062	
FVR1045	301046	
FVR1131	301048	
FVR1132	301482	
FVR1163	301675	
FVR1306	301300	
FVR1338	301036	
FVR1339	301037	
FVR1396	301429	
FVR1478	301568	
FVR1479	301569	
	301570	



 	FERODO (.../...)	
FVR1480	301569	
	301570	
FVR1497	301565	
FVR1498	301908	
FVR1515	301545	
FVR1519	301814	
FVR1568	301639	
FVR1644	301004	
FVR1777	301881	
FVR1876	301046	
FVR1927	301892	
FVR1928	301816	
FVR641	301123	
	301618	
FVR700	301036	
FVR701	301037	
FVR722	301048	
FVR829	301129	
FVR886	301129	
FVR967	301010	
FVR970	301622	
FVR989	301129	
TAR1000	301064	
TAR1017	301507	
TAR1038	301044	
TAR1040	301040	
TAR1044	301062	
TAR1045	301046	
TAR105	301099	
TAR1052	301023	
	301065	
TAR1054	301066	
TAR1055	301008	
	301463	
TAR1056	301006	
	301040	
TAR1062	301068	
TAR1063	301069	
TAR1067	301184	
TAR1068	301305	
TAR1072	301258	
TAR1081	301212	
TAR1082	301171	
TAR1083	301180	
	301463	
TAR1094	301332	
TAR1096	301450	
TAR11	301003	
TAR1101	301488	
TAR1112	301326	
TAR1113	301125	
	301142	
TAR1116	301361	
TAR1117	301183	
TAR1131	301048	
TAR1132	301482	
TAR1135	301726	
TAR1163	301675	
TAR1167	301355	
TAR1168	301074	
TAR1276	301399	



 	FERODO (.../...)	
TAR1288	301403	
TAR1289	301003	
TAR1293	301322	
TAR1294	301926	
TAR1295	301454	
TAR1300	301018	
TAR1301	301753	
TAR1303	301549	
TAR1312	301330	
TAR1318	301317	
TAR1319	301431	
TAR1323	301483	
TAR1326	301575	
TAR1336	301902	
TAR1337	301316	
TAR1338	301036	
TAR1339	301037	
TAR1368	301606	
TAR1370	301462	
TAR1378	301461	
TAR1393	301563	
TAR1394	301564	
TAR1396	301429	
TAR1398	301408	
TAR1399	301464	
TAR1415	301063	
TAR1416	301434	
TAR1420	301473	
TAR1422	301522	
TAR1424	301456	
TAR1425	301433	
TAR1439	301436	
TAR1451	301484	
TAR1463	301180	
	301486	
TAR1513	301736	
TAR1520	301678	
TAR173	301182	
	301356	
TAR175	301124	
TAR206	301212	
TAR212	301212	
TAR222	301125	
TAR225	301123	
TAR256	301080	
TAR276	301335	
TAR296	301103	
TAR300	301047	
TAR308	301266	
TAR318	301402	
TAR340	301123	
TAR346	301091	
	301219	
TAR370	301091	
	301219	
TAR375	301182	
	301356	
TAR392	301124	
TAR398	301240	
TAR406	301061	
TAR434	301119	







 	
<b>FERODO (.../...)</b>	
TAR435	301052
TAR440	301080
	301396
TAR455	301119
	301176
	301181
TAR471	301497
TAR472	301053
TAR478	301540
TAR520	301129
	301497
TAR524	301095
TAR525	301183
TAR527	301406
TAR535	301156
TAR540	301179
TAR541	301180
TAR558	301158
	301396
	301570
TAR578	301259
TAR579	301335
TAR584	301184
TAR585	301047
TAR586	301253
TAR589	301043
TAR590	301355
TAR597	301268
TAR600	301574
TAR602	301266
TAR604	301054
TAR609	301183
TAR613	301022
TAR615	301292
TAR617	301172
	301399
TAR619	301063
TAR621	301053
TAR641	301123
	301618
TAR654	301624
TAR678	301020
TAR686	301256
TAR700	301036
TAR701	301037
TAR708	301052
TAR715	301274
TAR719	301155
	301181
TAR722	301048
TAR725	301018
TAR729	301081
	301155
	301181
TAR730	301075
	301155
	301181
TAR732	301356
TAR745	301156
TAR764	301625
TAR765	301517



 	
<b>FERODO (.../...)</b>	
TAR766	301033
	301034
TAR767	301033
TAR774	301016
	301330
TAR775	301003
	301252
TAR777	301760
TAR779	301231
TAR799	301617
TAR829	301129
TAR844	301497
TAR845	301002
TAR850	301386
TAR859	301014
TAR867	301551
TAR874	301031
TAR876	301038
	301074
TAR877	301158
	301396
TAR878	301007
TAR881	301080
TAR884	301034
TAR886	301129
TAR905	301627
TAR925	301012
TAR950	301629
TAR951	301982
TAR954	301003
TAR956	301682
TAR96	301389
TAR967	301010
TAR970	301622
TAR973	301183
TAR989	301129
TAR995	301581
<b>FTE</b>	
BL1002A1	301274
BL1003A1	301099
BL1007A1	301099
BL1011A2	301129
BL1020A1	301618
BL1022A1	301270
BL1024A3	301048
BL1024B3	301048
BL1027A1	301497
BL1030A2	301497
BL1031A1	301292
BL1034A3	301016
BL1035A3	301003
	301252
BL1035B3	301003
	301252
BL1037A2	301386
BL1041A1	301099
BL1042A1	301099
BL1064A1	301129
BL1073A1	301007
BL1098A1	301292
BL1112A1	301396



 	
<b>FTE (.../...)</b>	
BL1114A1	301212
BL1114B1	301212
BL1118A1	301048
BL1123A3	301003
BL1123B3	301003
BL1125A2	301103
BL1125B2	301103
BL1131A2	301091
BL1140A1	301105
BL1140B1	301105
BL1141A1	301345
BL1142A2	301129
BL1151A4	301095
	301219
BL1155A1	301172
BL1163A3	301266
	301402
BL1167A3	301124
BL1167B3	301124
BL1168A3	301258
BL1174B2	301182
BL1175A4	301003
BL1175B4	301003
BL1176A1	301335
BL1183A2	301061
BL1185A2	301182
BL1187A2	301091
BL1187B2	301091
BL1193A3	301180
	301463
	301474
BL1194A3	301180
	301463
BL1194A4	301681
BL1198A1	301240
BL1200A2	301075
	301081
	301181
BL1200B2	301075
	301081
	301181
BL1201A2	301155
BL1202A2	301155
	301181
BL1202B2	301075
	301155
	301181
BL1203A2	301119
	301176
BL1204A2	301103
	301259
BL1204B2	301103
	301259
BL1209A1	301052
BL1209A2	301052
	301574
BL1212A4	301315
BL1212B4	301315
BL1217A1	301183
BL1219A4	301241
BL1219B4	301241
BL1220A2	301231



 	
<b>FTE (.../...)</b>	
BL1223A2	301240
BL1224A2	301176
BL1224B2	301176
BL1229A2	301080
BL1229B2	301080
BL1230A1	301142
BL1231A2	301095
BL1231B2	301095
BL1236A2	301123
BL1243A1	301253
BL1243B1	301253
BL1246A3	301125
	301142
	301180
BL1246B3	301125
	301142
	301180
BL1251A2	301402
BL1254A1	301406
BL1255A1	301172
BL1255A2	301172
	301399
BL1255B1	301172
BL1257A2	301156
BL1260A2	301184
BL1260B2	301184
BL1263A2	301272
BL1263B2	301272
BL1264A1	301043
	301171
BL1264B1	301043
	301171
BL1266A2	301179
BL1277A2	301616
BL1278A2	301063
BL1279A3	301063
BL1281A2	301103
BL1282A2	301018
BL1287A2	301617
BL1288A2	301053
	301682
BL1293A2	301666
BL1297A2	301123
	301618
BL1298A2	301047
BL1299A1	301356
BL1299B1	301356
BL1300A2	301268
BL1303A2	301982
BL1303B2	301982
BL1305A3	301256
BL1306A2	301266
	301402
BL1313A2	301061
BL1315A1	301034
BL1318A2	301038
BL1319A1	301012
BL1320A4	301013
BL1320B4	301013
BL1323A2	301002
BL1323B2	301002



 	
<b>FTE (.../...)</b>	
BL1324A1	301037
BL1324A2	301037
BL1325A1	301036
BL1325A2	301036
BL1327A3	301622
BL1327A4	301814
BL1327B3	301622
BL1329A2	301580
BL1335A4	301022
	301436
BL1336A2	301574
BL1338A2	301020
BL1339A1	301057
BL1340A1	301054
BL1342A2	301817
BL1344A1	301624
BL1352A3	301158
BL1353A2	301551
BL1355A2	301355
BL1357A1	301014
BL1358A2	301031
BL1360A2	301023
	301065
	301990
BL1361A2	301034
BL1361A4	301033
BL1362A2	301625
BL1364A2	301627
BL1365A2	301274
BL1368A2	301357
BL1369A2	301636
BL1369B2	301636
BL1374A2	301760
BL1376A2	301519
BL1378A2	301668
BL1380A2	301682
BL1381A4	301068
BL1382A2	301574
BL1383A2	301240
BL1385A2	301629
BL1388A2	301517
BL1389A2	301010
BL1391A2	301064
BL1392A1	301305
BL1393A2	301540
BL1396A2	301519
BL1399A1	301488
BL1399A2	301805
BL1399B1	301488
BL1400A1	301066
BL1400B1	301066
BL1401A2	301507
BL1403A1	301482
BL1404A3	301318
BL1405A2	301006
BL1406A2	301040
BL1428U1	301491
BL1438A2	301044
BL1441A2	301046
BL1467A2	301062



 	
FTE (.../...)	
BL1470A2	301310
	301409
BL1471A2	301311
BL1474A3	301330
BL1475A3	301003
BL1475A4	301484
BL1475B3	301003
BL1475B4	301484
BL1476A1	301675
BL1477A1	301008
BL1480A1	301043
	301171
BL1481A1	301212
BL1481B1	301212
BL1483A4	301326
BL1484A1	301038
	301074
BL1485A1	301156
	301360
BL1487A4	301069
BL1489A2	301080
	301396
BL1490A4	301319
BL1493A1	301780
BL1514U2	301906
BL1519U2	301458
BL1524A2	301486
BL1525A1	301403
BL1525B1	301403
BL1526A2	301322
BL1527A2	301454
BL1538A3	301581
BL1591A1	301183
BL1593A3	301270
BL1612A2	301018
BL1613A2	301386
	301753
BL1614A1	301332
BL1614A2	301408
BL1614B1	301332
BL1617A4	301483
	301751
BL1633A2	301634
BL1640A2	301522
BL1641A2	301040
BL1644A2	301412
BL1649A2	301449
BL1651A1	301763
BL1652A4	301726
BL1657A3	301142
BL1658A2	301023
BL1665A1	301317
BL1665B1	301317
BL1666A3	301431
BL1668A4	301436
BL1669A2	301682
BL1678A1	301444
BL1683A1	301450
BL1684A2	301926
BL1685A4	301493
BL1690A2	301305



 	
FTE (.../...)	
BL1693A1	301735
BL1693A2	301734
BL1695A4	301549
BL1696A4	301549
BL1700A2	301466
BL1704A2	301361
BL1705A3	301902
BL1706A1	301316
BL1711A2	301575
BL1715A2	301606
BL1716A1	301479
BL1717A1	301480
BL1727A2	301184
BL1728A3	301473
BL1731A4	301448
BL1732A4	301448
BL1739A2	301456
BL1740A1	301444
BL1741A2	301300
BL1744A2	301445
BL1750A3	301583
BL1751A2	301753
BL1752A1	301433
BL1753A4	301457
BL1771A4	301482
BL1773A4	301650
	301681
BL1774A2	301565
BL1776A1	301563
BL1777A1	301564
BL1780A1	301545
BL1780A2	301545
BL1782A3	301471
BL1783A3	301471
BL1784A1	301472
	301783
BL1785A3	301183
BL1790A3	301434
BL1794A3	301465
BL1795A4	301429
BL1796A4	301426
BL1797A2	301410
BL1800A3	301500
BL1806A2	301887
BL1807A2	301682
BL1809A2	301518
BL1810A2	301520
BL1812A4	301429
BL1815A1	301639
BL1816A2	301483
BL1817A2	301678
BL1818A2	301678
BL1824A2	301770
BL1828A3	301584
BL1828A4	301584
BL1829A2	301638
BL1829A4	301638
BL1833A2	301454
	301860
BL1834A2	301661
BL1843A1	301407



 	
FTE (.../...)	
BL1845A2	301737
BL1846A4	301674
BL1850A3	301780
BL1855A2	301895
BL1857A4	301721
BL1859A4	301568
BL1860A4	301569
BL1861A3	301570
BL1864A2	301801
BL1866A2	301736
BL1872A3	301004
BL1873A4	301667
	301720
BL1874A2	301640
BL1875A2	301754
BL1876A3	301641
BL1876A4	301847
BL1879A1	301827
BL1880A2	301577
BL1881A2	301680
BL1885A2	301744
BL1889A4	301005
BL1891A3	301461
BL1892A3	301462
BL1893A2	301065
	301990
BL1895A2	301635
BL1896A4	301752
BL1899A3	301557
BL1900A3	301558
BL1901A2	301853
BL1902A2	301781
BL1905A3	301780
BL1909A1	301829
BL1910A1	301649
BL1911A3	301463
BL1912A1	301644
BL1913A1	301874
BL1916A2	301886
BL1917A2	301852
BL1918A1	301521
BL1921A1	301862
BL1923A2	301857
BL1924A2	301889
BL1925A2	301009
	301672
BL1927A3	301464
BL1929A2	301505
	301759
BL1930A2	301748
BL1933A2	301821
BL1935A2	301842
BL1961A2	301708
BL1965A4	301705
BL1966A1	301472
	301783
BL1968A3	301740
BL1970A3	301464
BL1973A4	301662
BL1981A2	301868
BL1982A2	301867



 	
FTE (.../...)	
BL1983A1	301518
BL1997A2	301770
BL2002A2	301703
BL2005A1	301030
BL2006A1	301657
BL2010A4	301825
BL2017A4	301426
BL2022A3	301892
BL2043A4	301816
BL2053A2	301942
BL2054A2	301941
BL2062A2	301067
BLF1418B1	301212
JURID	
571202J	301405
571205J	301099
	301584
	301941
571213J	301099
	301270
571221D	301099
571221J	301099
	301270
571222J	301099
571232J	301099
571243J	301142
571250D	301129
571250J	301129
571264D	301292
571264J	301292
571264J-AS	301292
571265J	301389
571276D	301182
571276J	301182
571276J-AS	301182
571279D	301099
571279J	301099
571285J	301081
571291D	301171
	301212
571291J	301212
571297D	301091
	301219
571297J	301091
571300J	301103
571300J-AS	301103
571301J	301125
	301142
	301219
571309D	301012
	301091
	301095
	301219
571309J	301012
	301091
	301095
	301219
571313J	301061
571315D	301258
571315J	301258
571315J-AS	301258



 	
JURID (.../...)	
571316D	301124
571316J	301124
571316J-AS	301124
571318J	301091
571319D	301119
571319J	301119
	301176
571320D	301176
571320J	301176
571327J-AS	301002
571330D	301095
	301219
571330J	301095
	301219
571331D	301080
571331J	301080
571332D	301075
	301081
	301179
571332J	301081
	301179
571333D	301081
571333J	301081
571334D	301396
571334J	301158
	301396
571335J	301396
571335J-AS	301396
571344J	301105
571346J	301406
571350J	301125
	301142
571351D	301033
	301034
	301335
571351J	301033
	301034
	301335
571353D	301241
571353J	301241
571353J-AS	301241
571355D	301231
	301310
571355J	301231
	301310
571355J-AS	301231
	301310
571356D	301003
571356J	301003
571356J-AS	301003
571357D	301003
	301252
571357J	301003
	301252
571357J-AS	301003
	301252
571359D	301179
571359J	301179
571359J-AS	301179
571361D	301180
	301463



 	
JURID (.../...)	
571361J	301180
	301463
571361J-AS	301180
	301463
571363J	301292
571367D	301156
	301360
571367J	301156
	301181
	301360
571367J-AS	301156
	301360
571376D	301016
571376J	301016
	301252
	301330
571376J-AS	301016
	301330
571379J	301129
571382D	301315
571382J	301315
571382J-AS	301315
571384J	301099
571387D	301103
	301259
	301386
571387J	301103
	301259
	301386
571387J-AS	301103
	301259
	301386
571388J	301272
571389J	301183
571390J	301183
571391D	301184
571391J	301184
	301356
571391J-AS	301184
571395J	301753
571400J	301123
571407D	301253
571407J	301253
571408J	301240
571409J	301142
	301219
571411J	301018
571412J	301043
	301171
571417J	301270
571421J	301057
571425D	301007
571425J	301007
571425J-AS	301007
571429J	301103
571435J	301272
571437J	301022
571438J	301022
	301436
571439D	301129
571439J	301129
571440J	301497



 	
JURID (.../...)	
571457D	301616
571457J	301616
571458J	301048
571460J	301048
571462J	301016
	301125
	301142
571464J	301091
571473D	301156
571473J	301156
571473J-AS	301156
571474J	301125
571476D	301061
571476J	301061
571492D	301356
571492J	301184
	301356
571492J-AS	301356
571493J	301256
571509D	301038
	301074
571509J	301038
	301074
571509J-AS	301038
571512J	301483
571513J	301180
571513J-AS	301180
571519J	301491
571522D	301033
	301034
571522J	301033
	301034
	301036
571524D	301075
	301181
571524J	301075
	301081
	301181
571525D	301155
571525J	301155
571525J-AS	301155
571526D	301002
571526J	301002
571527J	301103
	301386
571528D	301012
571528J	301012
571536D	301212
571536J	301212
571539J	301182
571539J-AS	301182
571545J	301103
571546J	301103
	301259
	301311
571546J-AS	301103
	301259
571555J-AS	301345
571559J-AS	301241
571560J-AS	301315
571722J	301617



 	
JURID (.../...)	
571722J-AS	301617
571725J	301172
571725J-AS	301172
571726D	301172
571726J	301172
571726J-AS	301172
571743D	301155
571743J	301155
571744J	301396
571744J-AS	301396
571745D	301036
571745J	301036
571746D	301037
571746J	301037
571747D	301158
571747J	301158
571747J-AS	301158
571748J	301080
	301396
571748J-AS	301080
	301396
571749D	301012
571749J	301012
571753J	301345
571754J	301005
571755D	301005
571755J	301005
571757J	301031
571803J	301497
571828D	301013
571828J	301013
571828J-AS	301013
571832D	301033
	301034
571832J	301033
	301034
571833D	301182
571833J	301182
571833J-AS	301182
571835J	301018
571838J	301064
571838J-AS	301064
571839D	301010
571839J	301010
571844J	301044
571844J-AS	301044
571845J	301062
571845J-AS	301062
571847D	301622
571847J	301622
571847J-AS	301622
571848D	301258
571848J	301258
571849J	301033
	301034
571850J	301240
571855J	301240
571856J	301982
571862J	301095
571864J	301399
571867J	301081



 	
JURID (.../...)	
571868J	301241
571873J	301412
571873J-AS	301412
571875J	301482
571875J-AS	301482
571876J	301636
571876J-AS	301636
571877J	301357
571877J-AS	301357
571880J	301231
	301310
	301409
571880J-AS	301310
571882J	301040
	301483
571883J	301006
571884J	301023
	301065
571887J	301040
571888J	301065
571893J	301012
571897D	301068
571897J	301068
571898D	301069
571898J	301069
571899D	301063
571899J	301063
571900J	301008
	301048
571902J	301038
	301074
571902J-AS	301038
	301074
571905J	301219
571906D	301180
	301463
571906J	301180
	301463
571908J	301581
571910J	301044
	301046
571910J-AS	301044
	301046
571911D	301075
	301081
571911J	301075
	301081
571912J	301156
	301360
571913J	301043
	301171
571914J	301212
571915D	301066
571915J	301066
571918J	301580
571918J-AS	301259
	301580
571919D	301326
571919J	301326
571919J-AS	301326
571920J	301305
571923J	301488



 	
JURID (.../...)	
571924J	301356
571925J	301444
571925J-AS	301444
571929J	301332
571930J	301726
571930J-AS	301726
571931J	301726
571931J-AS	301726
571934J	301675
571936J	301311
571939D	301403
571939J	301403
571940J	301318
571941J	301319
571944J	301549
571944J-AS	301549
571945J	301549
571945J-AS	301549
571948J	301048
571950J	301300
571950J-AS	301300
571951J	301023
571954D	301461
571954J	301461
571954J-AS	301461
571955J	301003
571959D	301018
571959J	301018
571959J-AS	301018
571960J	301753
571960J-AS	301753
571961J-AS	301445
571964D	301399
571964J	301399
571965J	301462
571967D	301317
571967J	301317
571968J	301322
571969J	301330
571971D	301408
571971J	301408
571975J	301454
	301860
571976D	301022
571976J	301022
571977D	301053
571977J	301053
571979D	301142
571982D	301483
571982J	301751
	301483
	301751
571984J	301463
	301486
571985J	301332
571986J	301448
571986J-AS	301448
571987J	301448
571987J-AS	301448
571990J	301410
571990J-AS	301410



 	
<b>JURID (.../...)</b>	
571996D	301563
571996J	301563
571997J	301305
571998D	301431
571998J	301431
571999J	301466
572100J	301268
572127J	301817
572129J	301817
572135J	301053
572136J	301053
572137J	301053
572138J	301627
	301682
572145J	301274
572146J	301274
572162J	301624
572163J	301624
572169J	301780
572179J	301666
572182J	301540
572186J	301519
572188J	301540
572193J	301266
	301780
572200J	301519
572221J	301507
572227J	301020
572230J	301123
572233J	301123
572237J	301047
572238J	301047
572255J	301266
	301402
	301551
572256J	301266
	301551
572257J	301014
572266J	301266
572268J	301052
572269J	301052
	301817
572271J	301020
572272J	301020
572284J	301047
572293J	301627
572309J	301047
572310J	301054
572312J	301123
572313J	301123
572322J	301507
572324J	301760
572325J	301629
572330J	301022
	301047
572333J	301551
572347J	301574
572350J	301627
572354J	301627
572355J	301402
572361J	301123



 	
<b>JURID (.../...)</b>	
572370J	301517
572373J	301123
	301618
572376J	301668
572381J	301625
572393J	301627
572398J	301449
572401J	301575
572402J	301316
572404J	301606
572405J	301737
572406J	301902
572407J	301361
	301902
572411J	301634
572419J	301522
572422J	301450
572424J	301895
572429J	301436
572429J-AS	301436
572430J	301022
572434J	301629
572442J	301908
572449J	301887
572450J	301577
572453J	301505
	301759
572490J	301780
572496J	301574
572497J	301518
572498J	301520
572499J	301521
572501J	301672
572510J	301736
572513J	301781
572514J	301744
572515J	301857
572517J	301827
572525J-AS	301943
572528J	301535
572532J	301821
572539J	301644
572540J	301506
572547J	301852
572548J	301865
572550J	301853
572551J	301889
572553J	301862
572557J	301748
572568J	301642
572570J	301942
572575J	301337
572577J	301842
572604J	301867
573002J	301409
573002J-AS	301409
573003J	301479
573003J-AS	301479
573005J	301180
573006J	301484



 	
<b>JURID (.../...)</b>	
573007J	301180
	301463
573008J	301473
573009J	301457
573010J	301926
573011J	301456
573012J	301434
573013J	301433
573014J	301407
573017J	301471
573018J	301472
	301783
573020J	301433
573021J	301480
573025J	301471
573030J	301464
573030J-AS	301464
573031J	301465
573032J	301180
	301463
573036J	301462
573036J-AS	301462
573037J	301483
	301751
573038J	301650
	301681
573039J	301493
573040J	301735
573041J	301564
573042J	301023
	301065
	301990
573045J	301801
573047J	301565
573047J-AS	301565
573048J	301650
573049J	301048
	301482
	301650
	301681
573050J	301814
573051J	301461
573053J	301763
573058J	301545
573058J-AS	301545
573060J	301429
573063J	301458
573064J	301483
573065J	301681
573066J	301661
573074D	301426
573074J	301426
573082J	301583
573083J	301500
573085J	301639
573089D	301678
	301860
573089J	301678
	301860
573091J	301638
573092J-AS	301445



 	
<b>JURID (.../...)</b>	
573093J	301444
573093J-AS	301444
573098J	301463
573101J	301667
573111J	301805
573112J	301674
573113J	301568
573114J	301569
573115D	301570
573115J	301570
573120J	301434
573122J	301584
573123J	301557
573124J	301558
573125J	301641
573126J	301734
573127J	301720
573128J-AS	301635
573132J-AS	301662
573135J-AS	301718
573139J	301703
573139J-AS	301703
573142J-AS	301030
573143J-AS	301657
573146J	301305
573151J	301640
573151J-AS	301640
573153J	301860
573158J	301752
573164J	301426
573165J	301721
573169J	301012
573183J-AS	301464
573184J-AS	301465
573186J	301472
	301783
573188J-AS	301640
573189J-AS	301410
573190J-AS	301044
573201J-AS	301879
573204J	301825
573206J	301801
573209J	301649
573214J	301005
573216J	301874
573218J	301740
573219J	301004
573224J	301754
573227J	301770
573236J	301829
573250J	301928
573266J	301015
573275J	301816
<b>LPR</b>	
05P006	301091
05P007	301091
05P013	301129
05P024	301099
	301270
05P025	301099
05P035	301268



 	
<b>LPR (.../...)</b>	
05P060	301266
05P061	301540
05P068	301266
05P072	301053
05P083	301052
05P089	301817
05P092	301123
05P094	301091
	301095
	301142
	301219
05P095	301125
05P096	301219
05P099	301091
05P1001	301736
05P1003	301737
05P1009	301634
05P101	301142
	301219
05P1012	301625
05P1014	301682
05P1015	301908
05P1017	301629
05P102	301095
05P1036	301436
05P1045	301629
05P1050	301535
05P1054	301458
05P1059	301036
05P106	301125
05P1062	301737
05P1068	301680
05P1071	301887
05P1072	301821
05P1079	301018
05P1080	301644
05P1097	301574
05P1098	301990
05P1105	301462
05P1106	301726
05P1107	301002
05P1119	301751
05P1120	301805
05P1124	301638
05P1134	301062
05P1141	301466
05P1188	301464
05P1190	301649
05P1191	301012
05P1193	301410
05P1194	301754
05P1196	301662
05P1197	301860
05P1199	301874
05P1212	301575
	301708
05P1216	301678
05P1219	301752
05P1221	301318
05P1222	301052
05P1225	301426





 	Valeo
<b>LPR (.../...)</b>	
05P1227	301926
05P1229	301847
05P1231	301580
05P1234	301829
05P1235	301718
05P1236	301472
	301783
05P1237	301657
05P1247	301825
05P1252	301703
05P1255	301879
05P1258	301943
05P1260	301816
05P1263	301015
05P1264	301426
05P1266	301426
05P127	301389
05P1271	301640
05P1277	301649
05P1281	301819
05P1286	301030
05P1289	301892
05P1291	301506
05P1292A	301005
05P1295	301881
05P1314	301067
05P1321	301361
05P1322	301942
05P1323	301941
05P1326	301740
05P1327	301464
05P133	301292
05P1343	301889
05P1344	301867
05P1345	301868
05P1347	301886
05P1349	301705
05P135	301099
05P1353	301661
05P1361	301862
05P1362	301770
05P1363	301853
05P1369	301744
05P1373	301852
05P1374	301781
05P1375	301842
05P1379	301857
05P1381	301103
05P1382	301937
05P1390	301752
05P1398	301004
05P140	301129
05P1406	301337
05P1412	301035
05P1415	301934
05P1417	301932
05P1423	301682
05P1426	301480
05P1444	301821
05P1448	301506
05P145	301081





 	Valeo
<b>LPR (.../...)</b>	
05P1458	301028
05P1469	301044
05P1474	301928
05P1481	301041
05P1482	301770
05P1512	301640
05P1523	301636
05P1524	301678
05P1562	301070
05P1563	301070
05P1575	301055
05P158	301105
05P179	301389
05P181	301345
05P186	301052
05P190	301182
	301356
05P206	301183
05P215	301125
	301180
05P216	301003
	301252
05P220	301002
05P221	301003
05P224	301124
05P225	301124
05P226	301124
05P230	301081
05P231	301080
05P232	301212
05P233	301212
05P238	301103
05P242	301212
05P252	301123
05P258	301002
	301061
05P264	301123
05P266	301402
05P268	301266
05P269	301335
05P271	301075
	301081
	301181
05P272	301176
	301181
05P273	301241
05P274	301119
05P275	301158
05P279	301240
05P280	301044
	301315
05P282	301176
05P283	301156
05P285	301002
05P286	301219
05P288	301406
05P293	301176
	301179
05P294	301180
	301463





 	Valeo
<b>LPR (.../...)</b>	
05P295	301043
	301171
05P296	301231
05P297	301103
	301259
	301386
05P298	301581
05P299	301016
05P302	301241
05P304	301184
05P307	301158
	301396
05P317	301183
05P322	301047
05P327	301171
	301172
	301212
05P331	301018
05P333	301183
	301253
05P334	301183
05P336	301780
05P343	301666
05P344	301219
05P348	301574
05P349	301002
	301474
05P355	301054
	301450
05P362	301270
05P364	301052
05P366	301274
05P378	301123
	301618
05P379	301618
05P383	301172
05P384	301155
	301181
05P387	301057
05P392	301497
05P406	301636
05P407	301183
05P409	301357
05P410	301125
05P420	301318
05P424	301040
05P427	301007
05P428	301272
05P430	301022
05P431	301497
05P435	301080
05P436	301616
05P437	301048
05P439	301048
05P440	301125
	301180
05P444	301156
05P445	301061
05P449	301256
05P450	301038
05P453	301483





 	Valeo
<b>LPR (.../...)</b>	
05P459	301491
05P461	301033
	301034
	301036
	301037
05P462	301012
05P463	301386
	301753
05P464	301012
05P471	301034
05P472	301627
05P477	301617
05P481	301036
05P482	301037
05P483	301012
05P484	301080
05P487	301031
05P492	301013
05P493	301010
05P495	301982
05P496	301040
05P498	301064
05P503	301817
05P506	301053
05P507	301053
05P508	301682
05P513	301624
05P514	301540
05P518	301519
05P524	301507
05P527	301123
05P539	301014
05P542	301052
05P544	301020
05P556	301219
05P558	301760
05P559	301629
05P561	301551
05P569	301518
05P578	301517
05P582	301158
	301396
05P584	301183
05P591	301258
05P599	301356
05P600	301003
	301252
05P602	301668
05P605	301622
05P608	301044
05P610	301046
05P612	301008
05P613	301016
	301330
05P614	301023
	301065
05P615	301318
05P616	301482
05P619	301068
05P620	301069
05P621	301319





 	Valeo
<b>LPR (.../...)</b>	
05P622	301063
05P623	301062
05P624	301449
05P625	301043
	301171
05P627	301066
05P628	301212
05P631	301048
05P634	301180
	301463
	301474
	301681
05P635	301305
05P636	301179
05P638	301488
05P640	301574
05P642	301075
05P643	301360
05P644	301074
05P645	301675
05P646	301006
05P649	301231
	301310
	301409
05P650	301311
05P652	301040
05P655	301171
05P656	301184
05P659	301099
05P661	301726
05P662	301726
05P664	301065
	301407
05P667	301403
05P668	301332
05P669	301355
05P670	301549
05P671	301549
05P675	301753
05P676	301219
05P677	301240
05P678	301335
05P682	301867
05P683	301326
05P685	301020
05P690	301454
05P692	301408
	301734
05P693	301316
05P694	301902
05P695	301575
	301708
05P696	301317
05P697	301431
05P698	301322
05P699	301926
05P700	301606
05P704	301479
05P705	301480
05P706	301450



 		
<b>LPR (.../...)</b>		
05P708		301461
05P711		301493
05P716		301005
05P717		301399
05P718		301330
05P719		301003
05P720		301023
05P725		301763
05P726		301444
05P729		301361
05P730		301332
05P738		301080
		301396
05P742		301129
05P756		301017
05P757		301018
05P758		301456
05P763		301426
05P764		301721
05P766		301462
05P767		301448
05P771		301412
05P772		301616
05P773		301429
05P776		301735
05P786		301650
05P790		301483
		301751
05P795		301563
05P802		301464
05P805		301500
05P807		301407
		301465
05P811		301584
05P812		301860
05P814		301678
05P815		301472
		301783
05P816		301473
05P817		301667
05P819		301521
05P835		301865
05P836		301577
05P837		301827
05P838		301895
05P848		301748
05P850		301583
05P853		301674
05P857		301672
05P858		301505
		301759
05P864		301471
05P865		301433
05P866		301635
05P867		301641
05P868		301463
05P869		301545
05P871		301407
05P874		301642
05P876		301780
05P885		301570



 		
<b>LPR (.../...)</b>		
05P897		301434
05P899		301445
05P903		301461
		301726
05P906		301639
05P908		301545
05P910		301557
05P911		301558
05P913		301639
05P914		301080
		301396
05P919		301047
05P920		301634
05P928		301053
05P940		301436
05P946		301482
05P949		301564
05P954		301520
		301852
05P956		301300
05P964		301429
05P966		301568
05P967		301569
05P969		301486
05P971		301565
05P972		301734
05P973		301720
05P974		301482
		301650
05P977		301814
05P979		301484
05P980		301681
05P982		301801
05P986		301315
05P987		301240
05P988		301406
05P989		301906
05P998		301457
<b>LUCAS GIRLING</b>		
6101012		301099
		301270
6101022		301099
6101483		301081
6101979		301123
6101999		301182
6102382		301171
		301212
6102552		301212
6102653		301389
6102849		301052
6102942		301105
6102973		301091
		301219
6102992		301103
6103069		301817
6103083		301081
6103189		301123
6103239		301266
6103259		301047



 		
<b>LUCAS GIRLING(.../...)</b>		
6103273		301002
		301075
		301081
6103283		301080
6103416		301129
6103426		301129
6103519		301402
6103589		301047
6103603		301125
6103679		301123
6103712		301335
6103739		301052
6103946		301129
6104001		301002
6104041		301003
6104221		301091
6104251		301002
		301061
6104461		301119
		301176
6104471		301179
6104571		301219
6104581		301091
		301219
6104595		301124
6104661		301125
		301142
		301219
6104691		301406
6104721		301240
6104961		301022
6104971		301022
6104999		301053
6106482		301099
6106562		301099
6106632		301099
6106981		301219
6107649		301052
6107669		301123
		301618
6107739		301268
		301274
6107749		301682
6107759		301053
6107911		301048
6107931		301179
6107942		301156
6107989		301266
6108071		301002
6108081		301176
6108141		301125
6108171		301241
6108181		301044
		301315
6108231		301180
		301474
6108261		301003
6108331		301095
		301219
6108481		301054
		301450



 		
<b>LUCAS GIRLING(.../...)</b>		
6108521		301095
6108689		301266
6108709		301020
6108839		301666
6108879		301624
6108939		301052
6108959		301574
6108973		301172
6109053		301158
6109062		301156
6109112		301345
6109142		301183
6109152		301183
6109162		301231
6109172		301103
		301259
		301386
6109512		301184
6109522		301183
		301253
6109532		301043
		301171
6109571		301256
6109681		301002
6109746		301497
6109766		301497
6109869		301292
6109872		301272
6109959		301627
6110109		301817
6110179		301618
6110209		301123
6110249		301274
6110301		301061
6110312		301156
		301360
6110333		301155
		301181
6110391		301179
6110402		301356
6110419		301007
6110441		301003
		301252
6110481		301016
6110492		301483
6110571		301982
6110599		301014
6110609		301642
6110619		301627
6110731		301180
6110793		301080
6110804		301037
6110831		301022
6110844		301036
6110921		301622
6110941		301013
6111002		301018
6111013		301031
6111042		301038
		301074
6111051		301010



 		
<b>LUCAS GIRLING(.../...)</b>		
6111072		301034
6111082		301033
6111123		301005
6111153		301012
6111192		301103
6111203		301080
		301396
6111232		301617
6111269		301517
6111279		301519
6111289		301625
6111399		301629
6111439		301551
6111471		301581
6111481		301064
6111535		301491
6111592		301616
6111602		301270
6111631		301125
6111649		301760
6111689		301540
6111691		301022
6111879		301507
6111892		301386
6111931		301068
6111941		301069
6111961		301463
6111981		301318
6112002		301355
6112042		301008
6112052		301357
6112122		301023
		301065
6112152		301636
6112182		301066
6112195		301258
6112202		301044
6112212		301043
		301171
6112222		301212
6112231		301219
6112479		301292
6112591		301069
6112601		301326
6112612		301412
6112632		301046
6112642		301310
6112652		301311
6112661		301003
6112712		301305
6112742		301488
6112762		301063
6112792		301360
6112822		301675
6112832		301763
6112869		301522
6112892		301062
6112902		301006
6112912		301040
6112921		301549
6112931		301549



 	LUCAS GIRLING (.../...)	
6113002	301184	
6113022	301183	
6113053	301061	
	301396	
6113062	301403	
6113072	301483	
	301751	
6113089	301458	
6113131	301493	
6113141	301319	
6113151	301581	
6113171	301318	
6113213	301726	
6113222	301074	
6113251	301482	
6113261	301650	
6113281	301180	
6113301	301180	
	301463	
	301474	
	301752	
6113321	301002	
6113331	301142	
6113352	301444	
6113372	301065	
6113422	301305	
6113432	301386	
6113442	301753	
6113462	301183	
6113482	301018	
6113493	301399	
6113502	301454	
	301860	
6113512	301322	
6113524	301926	
6113541	301431	
6113575	301332	
6113582	301317	
6113599	301466	
6113614	301461	
6113622	301023	
6113642	301065	
6113661	301484	
6113671	301814	
6113691	301482	
6113752	301735	
6113762	301355	
6113854	301462	
6113865	301408	
6113882	301479	
6113892	301480	
6113961	301407	
6113994	301300	
6114024	301726	
6114032	301486	
6114042	301409	
6114051	301473	
6114062	301616	
6114121	301457	
6114131	301448	
6114141	301667	



 	LUCAS GIRLING (.../...)	
6114151	301681	
6114161	301463	
6114182	301563	
6114192	301564	
	301639	
6114251	301429	
6114272	301023	
6114292	301616	
6114302	301753	
6114322	301063	
6114344	301433	
6114354	301434	
6114369	301661	
6114371	301330	
6114391	301180	
6114452	301990	
6114461	301406	
6114511	301483	
6114549	301445	
6114602	301565	
6114634	301464	
6114644	301465	
6114651	301002	
6114661	301545	
6114671	301180	
6114682	301471	
6114692	301472	
	301783	
6114714	301926	
6114721	301720	
6114745	301734	
6114751	301674	
6114781	301545	
6114811	301583	
6114824	301426	
6114882	301751	
6114922	301678	
6114951	301500	
6114982	301410	
6115004	301461	
6115014	301462	
6115041	301463	
6115139	301480	
6115141	301448	
6115151	301584	
6115161	301004	
6115179	301568	
6115189	301569	
6115201	301407	
6115219	301570	
6115254	301434	
6115272	301580	
6115302	301580	
6115322	301639	
6115382	301801	
6115424	301638	
6115432	301445	
6115452	301444	
6115502	301635	
6115524	301558	
6115592	301640	



 	LUCAS GIRLING (.../...)	
6115622	301860	
6115634	301464	
6115652	301657	
6115662	301829	
6115701	301456	
6115714	301557	
6115724	301036	
6115734	301037	
6115762	301030	
6115781	301463	
6115813	301005	
6115832	301649	
6115841	301318	
6115862	301805	
6115871	301463	
6115941	301662	
6115974	301558	
6116022	301990	
6116132	301678	
6116154	301075	
6116212	301472	
	301783	
6116221	301752	
6116234	301464	
6116244	301465	
6116262	301703	
6116334	301718	
6116341	301002	
6116351	301002	
6116461	301407	
6116529	301770	
6116539	301770	
6116544	301426	
6116554	301721	
6116572	301678	
6116582	301408	
6116611	301004	
6116654	301740	
6116682	301860	
6116694	301465	
6116764	301465	
6116773	301464	
6116824	301892	
6116832	301879	
6116851	301928	
6116862	301678	
6116969	301881	
6117004	301426	
	301825	
6117159	301942	
6117169	301941	
6117244	301816	
6117272	301754	
6117453	301012	
6117464	301015	
	301426	
6117492	301017	
6117631	301752	
6117661	301041	
6118311	301584	
6118449	301055	



 	LUCAS GIRLING (.../...)	
6118479	301070	
6130889	301780	
6130891	301634	
6130921	301057	
6131159	301449	
6131339	301625	
6131479	301551	
6131549	301682	
6131619	301020	
6131649	301540	
6131659	301575	
6131681	301450	
6131699	301574	
6131709	301817	
6131719	301361	
6131721	301902	
6131759	301682	
6131769	301760	
6131779	301627	
6131782	301212	
6131819	301668	
6131849	301266	
6131861	301436	
6131889	301627	
6131901	301682	
6131919	301682	
6131929	301629	
6131959	301316	
6131969	301627	
6131979	301535	
6131989	301865	
6132019	301908	
6132069	301274	
6132079	301551	
6132099	301629	
6132119	301574	
6132129	301760	
6132169	301361	
6132189	301606	
6132239	301895	
6132409	301887	
6132429	301737	
6132439	301577	
6132449	301759	
6132469	301518	
6132479	301520	
	301852	
6132569	301574	
6132579	301505	
6132589	301748	
6132599	301574	
6132619	301821	
6132629	301274	
6132671	301022	
6132689	301887	
6132699	301682	
6132709	301521	
6132711	301054	
6132749	301668	
6132829	301748	
6132839	301574	



 	LUCAS GIRLING (.../...)	
6132849	301748	
6132879	301886	
6132891	301680	
6132922	301472	
6132949	301009	
	301672	
6132979	301505	
6132989	301748	
6132999	301506	
6133019	301821	
6133119	301780	
6133149	301862	
6133169	301827	
6133244	301736	
6133289	301853	
6133309	301644	
6133319	301052	
6133321	301641	
6133409	301889	
6133419	301852	
6133429	301842	
6133459	301361	
6133489	301874	
6133529	301744	
6133649	301857	
6133679	301705	
6133689	301817	
6133719	301853	
6133779	301575	
	301708	
6133789	301781	
6133869	301744	
6133879	301748	
6133891	301493	
6133929	301337	
6133939	301672	
6133961	301847	
6134109	301035	
6134139	301748	
6134189	301937	
6134199	301932	
6134209	301868	
6134219	301867	
6134259	301943	
6134269	301819	
6134329	301748	
6134339	301821	
6134479	301682	
6134509	301842	
6134519	301867	
6134582	301028	
6134619	301934	
6134659	301506	
6134679	301067	
6134749	301867	
6134814	301943	
6140109	301906	
6141045	301491	
6141439	301852	
GDB1271	301305	
GDB1274	301488	

 	
<b>LUCAS GIRLING (.../...)</b>	
GDB1276	301063
GDB1279	301360
GDB1282	301675
GDB1283	301763
GDB1286	301522
GDB1289	301062
GDB1290	301006
GDB1291	301040
GDB1292	301549
GDB1293	301549
GDB1302	301183
GDB1304	301580
GDB1305	301396
GDB1306	301403
GDB1307	301483
	301751
GDB1308	301458
GDB1312	301330
GDB1313	301493
GDB1315	301581
GDB1317	301318
GDB1322	301074
GDB1326	301650
GDB1328	301180
GDB1332	301002
GDB1337	301065
GDB1343	301386
GDB1346	301183
GDB1348	301018
GDB1351	301322
GDB1352	301926
GDB1354	301431
GDB1357	301332
GDB1358	301317
GDB1359	301466
GDB1360	301180
GDB1361	301461
GDB1362	301023
GDB1364	301065
GDB1367	301814
GDB1372	301463
GDB1375	301735
GDB1376	301355
GDB1385	301462
GDB1386	301408
GDB1388	301479
GDB1389	301480
GDB1396	301407
GDB1397	301332
GDB1399	301300
GDB140	301405
GDB1402	301726
GDB1403	301486
GDB1404	301409
GDB1405	301473
GDB1406	301616
GDB1411	301456
GDB1412	301457
GDB1414	301667
GDB1416	301463
GDB1419	301564



 	
<b>LUCAS GIRLING (.../...)</b>	
GDB1422	301408
GDB1425	301429
GDB1427	301023
GDB1430	301753
GDB1432	301063
GDB1433	301583
GDB1434	301433
GDB1435	301434
GDB1436	301661
GDB1437	301330
GDB1445	301990
GDB1451	301483
GDB1460	301565
GDB1462	301464
GDB1463	301464
GDB1464	301465
GDB1465	301002
GDB1466	301545
GDB1467	301180
GDB1471	301926
GDB1472	301720
GDB1474	301734
GDB1478	301545
GDB1481	301583
GDB1482	301426
GDB1491	301436
GDB1492	301678
GDB1495	301500
GDB1498	301410
GDB1500	301461
GDB1501	301462
GDB1509	301434
GDB1514	301448
GDB1515	301584
GDB1516	301004
	301463
GDB1517	301568
GDB1518	301569
GDB1520	301407
GDB1521	301570
GDB1522	301396
GDB1532	301639
GDB1542	301638
GDB1545	301444
GDB1549	301770
GDB1551	301752
GDB1562	301860
GDB1563	301464
GDB1565	301657
GDB1566	301829
GDB1570	301456
GDB1578	301463
GDB1582	301464
GDB1584	301318
GDB1587	301463
GDB1594	301662
GDB1613	301678
GDB1614	301641
GDB1626	301703
GDB238	301212
GDB255	301212



 	
<b>LUCAS GIRLING (.../...)</b>	
GDB265	301389
GDB294	301105
GDB297	301091
GDB299	301103
GDB301	301335
GDB306	301817
GDB308	301081
GDB3088	301780
GDB3089	301634
GDB3092	301057
GDB3108	301666
GDB3111	301668
GDB3115	301449
GDB3116	301184
GDB3133	301625
GDB3154	301682
GDB3161	301020
GDB3165	301575
GDB3168	301450
GDB3169	301574
GDB3170	301817
GDB3172	301902
GDB3175	301682
GDB3176	301760
GDB3177	301627
GDB3178	301212
GDB318	301123
GDB3181	301668
GDB3188	301627
GDB3191	301682
GDB3192	301629
GDB3194	301780
GDB3196	301627
GDB3201	301908
GDB3209	301629
GDB3211	301574
GDB3212	301760
GDB3216	301361
GDB3223	301895
GDB3244	301759
GDB325	301047
GDB3256	301574
GDB3259	301574
GDB3262	301274
GDB3267	301022
GDB3269	301682
GDB3271	301054
GDB328	301080
GDB3283	301574
GDB3284	301748
GDB3287	301886
GDB3292	301472
GDB3295	301887
GDB3301	301821
GDB3328	301853
GDB3330	301644
GDB3331	301052
GDB3332	301641
GDB3378	301781
GDB367	301123
GDB371	301335



 	
<b>LUCAS GIRLING (.../...)</b>	
GDB373	301052
GDB391	301270
GDB394	301129
GDB4010	301906
GDB404	301003
GDB4104	301491
GDB425	301061
GDB433	301176
GDB446	301119
GDB458	301219
GDB459	301124
GDB466	301142
GDB469	301406
GDB472	301240
GDB484	301179
GDB496	301022
GDB499	301053
GDB648	301099
GDB656	301099
GDB663	301099
GDB698	301219
GDB733	301047
GDB764	301052
GDB765	301574
GDB766	301618
GDB773	301268
GDB775	301053
GDB791	301048
GDB793	301179
GDB794	301156
GDB808	301176
GDB817	301241
GDB818	301315
GDB826	301003
GDB829	301125
GDB833	301095
GDB848	301054
GDB852	301095
GDB854	301003
GDB862	301048
GDB870	301020
GDB883	301666
GDB887	301624
GDB893	301052
GDB895	301574
GDB897	301172
GDB905	301158
	301396
	301345
GDB911	301345
GDB914	301183
GDB915	301183
GDB916	301231
GDB917	301103
	301259
GDB951	301184
GDB952	301253
GDB953	301043
	301171
GDB957	301256
GDB968	301002
GDB974	301497



 	
<b>LUCAS GIRLING (.../...)</b>	
GDB976	301497
GDB986	301292
GDB995	301627
<b>METELLI</b>	
22-0002-1	301099
22-0003-0	301099
22-0005-4	301081
22-0010-0	301099
22-0010-1	301099
22-0016-0	301129
22-0016-4	301129
22-0029-0	301212
22-0030-0	301219
22-0030-1	301095
	301219
22-0030-2	301219
22-0033-0	301091
22-0033-1	301091
22-0036-2	301080
22-0036-5	301080
22-0037-0	301081
22-0037-1	301155
22-0037-4	301181
22-0037-5	301075
	301081
	301181
22-0038-0	301396
22-0038-1	301158
22-0038-2	301396
22-0041-0	301241
22-0044-0	301182
22-0045-0K	301124
22-0045-2K	301258
22-0046-0	301389
22-0048-0	301125
22-0049-0	301119
	301176
22-0049-1	301176
22-0050-0	301016
22-0050-1	301982
22-0050-2	301003
	301252
22-0059-0	301095
22-0060-0	301156
22-0060-1	301156
22-0060-2	301156
	301360
22-0061-0	301315
22-0062-0	301406
22-0062-1	301406
22-0064-0	301142
22-0066-0	301123
22-0067-0	301266
22-0070-1	301103
22-0071-0	301172
22-0071-1	301172
	301399
22-0072-3	301064
22-0073-0	301043
	301171
22-0077-0	301356







 	
<b>METELLI (.../...)</b>	
22-0079-0	301040
22-0081-0	301052
22-0081-1	301052
22-0082-0	301006
22-0083-0	301023
	301065
	301990
22-0083-1	301023
22-0083-2	301065
	301990
22-0088-0	301043
	301171
22-0092-0	301105
22-0092-1	301345
22-0093-0	301212
22-0094-2	301335
22-0095-2	301240
22-0099-0	301179
22-0100-0	301180
22-0100-1	301180
	301463
	301474
22-0100-2	301180
	301463
	301474
22-0100-3	301681
22-0100-4	301674
22-0100-5	301463
22-0107-0	301618
22-0107-1	301618
22-0108-0	301266
22-0113-0	301581
22-0117-0	301184
22-0118-0	301305
22-0118-1	301305
22-0120-0	301002
22-0120-OK	301002
22-0122-0	301231
22-0123-0	301054
22-0124-0	301018
22-0125-0	301103
	301259
22-0134-0	301517
22-0138-0	301760
22-0141-0	301253
22-0142-0	301061
22-0142-1	301061
22-0142-2	301473
22-0143-OK	301005
22-0143-2	301005
22-0144-0	301031
22-0145-0	301014
22-0146-0	301034
22-0146-1	301033
22-0148-0	301003
22-0148-1	301003
22-0149-0	301551
22-0151-0	301519
22-0154-0	301010
22-0154-1	301429
22-0156-0	301038



 	
<b>METELLI (.../...)</b>	
22-0156-1	301074
22-0158-0	301013
22-0159-1	301012
22-0161-0	301540
22-0161-1	301540
22-0163-0	301048
22-0163-1	301048
22-0164-0	301622
22-0164-1	301814
22-0165-0	301007
22-0168-0	301666
22-0170-0	301053
22-0170-1	301053
22-0172-0	301627
22-0173-0	301682
22-0174-0	301022
22-0180-0	301386
22-0181-1	301355
22-0181-3	301483
22-0181-4	301486
22-0182-0	301616
22-0188-0	301574
22-0188-1	301574
22-0192-0	301062
22-0192-1	301063
22-0193-1	301668
22-0194-0	301036
22-0194-1	301036
22-0195-0	301037
22-0195-1	301037
22-0196-0	301274
22-0199-0	301057
22-0200-0	301270
22-0203-0	301272
22-0205-1	301033
22-0206-0	301488
22-0206-1	301066
22-0206-2	301403
22-0206-3	301805
22-0207-0	301310
	301409
22-0208-0	301184
22-0210-0	301311
22-0211-0	301332
22-0211-1	301332
22-0211-2	301408
22-0213-0	301068
22-0214-0	301069
22-0215-0	301003
22-0215-1	301330
22-0215-2	301484
22-0216-0	301318
22-0216-1	301318
22-0217-0	301326
22-0217-1	301326
22-0218-1	301491
22-0219-0	301357
22-0223-0	301629
22-0223-1	301629
22-0224-0	301625
22-0227-0	301402



 	
<b>METELLI (.../...)</b>	
22-0244-0	301020
22-0247-0	301047
22-0247-1	301047
22-0251-1	301466
22-0251-2	301480
22-0252-0	301636
22-0253-0	301726
22-0253-1	301726
22-0254-0	301461
22-0254-1	301461
	301726
22-0255-0	301763
22-0256-0	301044
22-0256-1	301044
22-0257-0	301322
22-0258-0	301454
22-0259-0	301926
22-0260-0	301018
22-0261-0	301753
22-0263-0	301675
22-0275-0	301183
22-0275-1	301183
22-0279-0	301008
22-0284-0	301292
22-0285-0	301292
22-0286-0	301493
22-0291-0	301317
22-0292-0	301606
22-0293-0	301316
22-0294-0	301361
22-0297-0	301908
22-0298-0	301627
22-0299-0	301142
22-0302-1	301780
22-0305-0	301450
22-0309-0	301479
22-0310-0	301549
22-0311-0	301046
22-0312-0	301018
22-0313-0	301462
22-0313-1	301462
22-0314-0	301483
	301751
22-0315-0	301563
22-0316-0	301564
22-0317-0	301431
22-0318-0	301433
22-0319-0	301434
22-0321-0	301426
22-0321-1	301426
22-0321-2	301825
22-0322-0	301721
22-0322-1	301465
22-0324-1	301407
22-0325-0	301568
22-0326-0	301569
22-0327-0	301464
22-0328-0	301500
22-0336-0	301471
22-0336-1	301471



 	
<b>METELLI (.../...)</b>	
22-0337-0	301472
	301783
22-0337-1	301472
	301783
22-0338-2	301545
22-0340-0	301456
22-0342-0	301448
22-0343-0	301444
22-0345-0	301735
22-0345-1	301734
22-0346-0	301482
22-0346-1	301482
22-0346-2	301650
	301681
22-0347-0	301319
22-0348-0	301480
22-0357-1	301661
22-0358-0	301507
22-0361-0	301575
22-0362-0	301817
22-0364-0	301505
	301759
22-0365-0	301748
22-0366-0	301634
22-0369-0	301902
22-0370-0	301268
22-0374-0	301821
22-0390-0	301624
22-0397-0	301521
22-0398-0	301519
22-0399-0	301518
22-0400-0	301520
	301852
22-0401-0	301522
22-0403-0	301449
22-0409-0	301618
22-0414-0	301895
22-0421-0	301736
22-0423-0	301737
22-0424-0	301577
22-0447-0	301680
22-0452-0	301535
22-0453-0	301865
22-0454-0	301857
22-0462-0	301887
22-0464-1	301436
22-0481-0	301886
22-0485-0	301641
22-0485-1	301847
22-0500-0	301853
22-0502-0	301708
22-0503-0	301744
22-0504-0	301781
22-0506-0	301506
22-0508-0	301644
22-0509-0	301361
22-0511-0	301874
22-0513-0	301842
22-0532-0	301570
22-0533-0	301639
22-0534-0	301649



 	
<b>METELLI (.../...)</b>	
22-0538-0	301256
22-0539-0	301860
22-0540-0	301678
22-0541-0	301457
22-0542-0	301584
22-0542-1	301584
22-0543-0	301557
22-0544-0	301558
22-0547-0	301667
22-0547-1	301720
22-0548-0	301635
22-0550-0	301801
22-0551-0	301565
22-0553-0	301752
22-0554-2	301004
22-0556-1	301028
22-0557-0	301640
22-0557-3	301640
22-0558-0	301410
22-0559-0	301412
22-0560-0	301580
22-0562-0	301638
22-0563-0	301445
22-0565-0	301583
22-0567-0	301617
22-0572-0	301300
22-0599-0	301657
22-0600-0	301662
22-0611-0	301889
22-0612-0	301672
22-0614-0	301827
22-0630-0	301705
22-0631-0	301821
22-0632-0	301505
22-0633-0	301506
22-0637-0	301718
22-0638-1	301015
22-0642-0	301703
22-0644-0	301754
22-0655-0	301770
22-0673-0	301881
22-0675-0	301879
22-0676-0	301928
22-0677-0	301740
22-0678-0	301129
22-0680-0	301816
22-0688-0	301829
22-0696-0	301458
22-0710-0	301892
22-0724-0	301868
22-0725-0	301867
22-0737-0	301852
22-0742-0	301642
22-0747-0	301943
22-0749-0	301819
22-0751-0	301862
22-0774-0	301751
22-0778-0	301942
22-0779-0	301941
22-0783-0	301934
22-0787-0	301937



 	
<b>METELLI (.../...)</b>	
22-0788-0	301932
22-0792-0	301067
22-0802-0	301017
22-0806-0	301752
22-0810-0	301747
22-0819-0	301337
<b>MINTEX</b>	
MDB1002	301099 301270
MDB1003	301183 301256
MDB1005	301180
MDB1012	301099 301584
MDB1068	301099
MDB1074	301405
MDB1081	301099
MDB1083	301099
MDB1087	301219
MDB1088	301125
MDB1112	301081
MDB1120	301292
MDB1141	301182 301184
MDB1156	301389
MDB1169	301124
MDB1175	301212
MDB1183	301123
MDB1189	301091
MDB1190	301003
MDB1191	301125 301142
MDB1214	301002
MDB1215	301081
MDB1218	301091 301219
MDB1220	301817
MDB1221	301105
MDB1222	301105 301272
MDB1236	301172 301335
MDB1239	301103
MDB1240	301095 301219
MDB1241	301047 301052
MDB1243	301047 301760
MDB1250	301266
MDB1251	301266 301402 301551
MDB1257	301219
MDB1258	301125
MDB1259	301047 301052
MDB1266	301124
MDB1273	301258
MDB1276	301219
MDB1278	301219



 	
<b>MINTEX (.../...)</b>	
MDB1279	301123
MDB1280	301123
MDB1286	301240
MDB1287	301240
MDB1290	301335
MDB1291	301002 301075 301081 301181
MDB1293	301003
MDB1298	301052
MDB1300	301176
MDB1309	301142 301219
MDB1312	301315
MDB1316	301002 301061
MDB1327	301119 301176
MDB1331	301080
MDB1333	301158
MDB1334	301402
MDB1339	301158 301396
MDB1350	301780
MDB1353	301406
MDB1360	301053
MDB1369	301103 301259 301311
MDB1371	301003
MDB1372	301618
MDB1376	301179
MDB1377	301180 301463 301681
MDB1380	301123
MDB1382	301180 301463
MDB1384	301095
MDB1385	301253
MDB1386	301184 301356
MDB1393	301231
MDB1395	301268 301274
MDB1400	301266
MDB1402	301241
MDB1404	301043 301171
MDB1406	301266
MDB1409	301022
MDB1411	301053
MDB1414	301624
MDB1417	301574
MDB1421	301020
MDB1423	301054
MDB1425	301292
MDB1431	301052
MDB1436	301315
MDB1437	301315



 	
<b>MINTEX (.../...)</b>	
MDB1441	301063
MDB1442	301063
MDB1445	301007 301080
MDB1450	301817
MDB1455	301256
MDB1472	301002
MDB1474	301666
MDB1481	301519
MDB1482	301123 301618
MDB1483	301156
MDB1488	301574
MDB1489	301057
MDB1493	301172
MDB1501	301668
MDB1507	301052 301817
MDB1509	301625
MDB1510	301627
MDB1511	301142
MDB1519	301075 301081 301155 301181
MDB1528	301091
MDB1530	301274
MDB1531	301751
MDB1537	301048
MDB1538	301018
MDB1539	301517
MDB1540	301256
MDB1543	301627
MDB1552	301103 301580
MDB1556	301184 301356
MDB1557	301156 301360
MDB1558	301036 301345
MDB1559	301037
MDB1560	301345
MDB1563	301048
MDB1564	301642 301682
MDB1565	301272
MDB1569	301642
MDB1570	301016
MDB1571	301003 301252 301982
MDB1572	301259 301386
MDB1578	301551
MDB1588	301005
MDB1589	301627
MDB1606	301219
MDB1613	301061
MDB1614	301616



 	
<b>MINTEX (.../...)</b>	
MDB1615	301047 301760
MDB1616	301053
MDB1620	301034
MDB1622	301033
MDB1623	301014
MDB1627	301617
MDB1628	301002
MDB1629	301031
MDB1632	301982
MDB1635	301627
MDB1640	301013
MDB1642	301013 301357
MDB1646	301519
MDB1651	301183
MDB1654	301022
MDB1658	301551
MDB1659	301022
MDB1662	301038 301074
MDB1666	301012
MDB1668	301080 301396
MDB1676	301080
MDB1677	301158 301396
MDB1678	301629
MDB1682	301622
MDB1698	301507
MDB1699	301129
MDB1700	301982
MDB1702	301064
MDB1703	301010
MDB1707	301668
MDB1727	301318
MDB1731	301068
MDB1732	301069
MDB1733	301040
MDB1734	301006
MDB1735	301023 301065 301990
MDB1736	301357
MDB1738	301046
MDB1739	301044
MDB1741	301008
MDB1742	301142 301581
MDB1745	301412
MDB1762	301634
MDB1769	301491
MDB1786	301906
MDB1793	301258
MDB1804	301066
MDB1805	301488
MDB1806	301360
MDB1807	301075 301081 301181



 	
<b>MINTEX (.../...)</b>	
MDB1808	301038 301074
MDB1811	301332
MDB1812	301326
MDB1813	301305
MDB1814	301675
MDB1817	301310 301409
MDB1818	301450
MDB1822	301048
MDB1823	301522
MDB1824	301458
MDB1826	301125 301483 301751
MDB1828	301040
MDB1829	301006 301040 301065
MDB1831	301319
MDB1832	301449
MDB1834	301063
MDB1837	301461 301726
MDB1841	301519
MDB1842	301172 301399
MDB1845	301518
MDB1855	301062
MDB1858	301763
MDB1866	301682
MDB1868	301330
MDB1869	301179
MDB1871	301636
MDB1872	301403
MDB1876	301142
MDB1879	301311 301753
MDB1882	301466
MDB1883	301212
MDB1884	301043 301171
MDB1888	301311 301386 301753
MDB1889	301184
MDB1899	301902
MDB1900	301361
MDB1901	301018
MDB1903	301908
MDB1905	301865
MDB1906	301535
MDB1907	301454
MDB1908	301322
MDB1909	301018
MDB1918	301183
MDB1919	301003
MDB1924	301549
MDB1926	301444
MDB1932	301406
MDB1934	301065



 	
MINTEX (.../...)	
MDB1938	301575
MDB1940	301305
MDB1941	301316
MDB1943	301480
MDB1944	301479
MDB1951	301023
MDB1958	301317
MDB1959	301431
MDB1960	301461
MDB1962	301125
MDB1984	301616
MDB1985	301661
MDB1989	301436
MDB1990	301682
MDB1994	301540
MDB1995	301493
MDB1996	301521
MDB1997	301300
MDB1999	301895
MDB2000	301036
MDB2001	301037
MDB2004	301580
MDB2006	301606
MDB2012	301462
MDB2013	301827
MDB2014	301577
MDB2029	301737
MDB2034	301332
MDB2036	301748
MDB2040	301408
MDB2041	301408 301486
MDB2043	301887
MDB2051	301407
MDB2054	301629
MDB2055	301726
MDB2057	301735
MDB2059	301563
MDB2060	301564
MDB2062	301433
MDB2063	301505 301759
MDB2064	301445
MDB2068	301023 301065 301990
MDB2070	301448
MDB2073	301456
MDB2074	301473
MDB2075	301484
MDB2080	301520
MDB2081	301434
MDB2096	301650 301681
MDB2105	301482
MDB2107	301409
MDB2111	301583
MDB2113	301482
MDB2118	301674 301681
MDB2119	301821



 	
MINTEX (.../...)	
MDB2126	301565
MDB2129	301270
MDB2130	301926
MDB2131	301461
MDB2133	301990
MDB2134	301886
MDB2145	301483
MDB2146	301734
MDB2157	301429
MDB2158	301429
MDB2159	301545
MDB2168	301457
MDB2177	301814
MDB2180	301889
MDB2183	301464
MDB2186	301465
MDB2223	301584
MDB2225	301471
MDB2231	301483 301751
MDB2239	301426
MDB2240	301721
MDB2247	301337
MDB2253	301500
MDB2256	301180 301463 301681
MDB2261	301672
MDB2262	301678
MDB2263	301862
MDB2267	301744
MDB2272	301639
MDB2274	301853
MDB2277	301518
MDB2278	301720 301805
MDB2279	301434
MDB2281	301472 301783
MDB2283	301464
MDB2291	301827
MDB2294	301667
MDB2309	301780
MDB2314	301564
MDB2327	301558
MDB2328	301568
MDB2329	301569
MDB2351	301574
MDB2352	301817
MDB2357	301584
MDB2418	301410 301580
MDB2484	301012
MDB2494	301156 301360
MDB2514	301155
MDB2526	301091
MDB2534	301580
MDB2538	301720
MDB2539	301638
MDB2540	301570



 	
MINTEX (.../...)	
MDB2542	301781
MDB2543	301030
MDB2553	301857
MDB2555	301158 301396
MDB2561	301473
MDB2563	301361
MDB2566	301674
MDB2576	301657
MDB2580	301752
MDB2584	301462
MDB2591	301557
MDB2595	301641
MDB2596	301680
MDB2600	301471
MDB2604	301635
MDB2605	301506
MDB2608	301842
MDB2609	301736
MDB2611	301874
MDB2612	301852
MDB2613	301829
MDB2625	301801
MDB2628	301464
MDB2633	301860
MDB2634	301649
MDB2637	301644
MDB2644	301426
MDB2673	301004
MDB2683	301703
MDB2686	301472 301783
MDB2688	301044
MDB2691	301740
MDB2692	301640
MDB2701	301662
MDB2703	301705
MDB2719	301754
MDB2733	301868
MDB2734	301867
MDB2742	301770
MDB2743	301718
MDB2747	301035
MDB2752	301770
MDB2755	301747
MDB2757	301629
MDB2762	301708
MDB2763	301753
MDB2766	301318
MDB2767	301493
MDB2777	301937
MDB2782	301180
MDB2784	301479
MDB2785	301943
MDB2787	301819
MDB2788	301890
MDB2793	301639
MDB2796	301847
MDB2820	301180
MDB2841	301726
MDB2850	301892



 	
MINTEX (.../...)	
MDB2851	301816
MDB2854	301825
MDB2855	301932
MDB2863	301928
MDB2864	301941
MDB2865	301934
MDB2868	301396
MDB2872	301942
MDB2888	301752
MDB2923	301943
MDB2962	301017
MDB3056	301867
MDB3087	301055
MDB3089	301070
MDB3099	301070
MDB3182	301055
MGB533	301270
MLB105	301497
MLB115	301129
MLB116	301129 301497
MLB40	301129
MLB41	301129
MLB43	301497
MLB76	301129
<b>OPTIMAL</b>	
10038	301906
10043	301064
10050	301044
10052	301046
10055	301581
10057	301522
10063	301357
10064	301355
10065	301008
10068	301184
10072	301040
10073	301065
10074	301318
10081	301412
10088	301636
10090	301068
10093	301319
10096	301062
10098	301449
10099	301043
10101	301580
10106	301066
10124	301305
10128	301488
10134	301075
10135	301360
10137	301675
10139	301006
10141	301310
10142	301311
10148	301171
10169	301763
10170	301330
10173	301326
10175	301057



 	
OPTIMAL (.../...)	
10180	301012
10186	301003
10188	301403
10190	301458
10197	301902
10198	301074
10204	301466
10205	301549
10207	301399
10217	301183
10237	301574
10261	301575
10264	301020
10271	301444
10279	301409
10283	301018
10288	301454
10289	301322
10302	301317
10303	301332
10304	301142
10309	301069
10310	301431
10311	301436
10313	301316
10318	301023
10321	301629
10327	301908
10328	301450
10330	301517
10333	301865
10335	301493
10347	301606
10348	301479
10349	301480
10376	301661
10403	301300
10415	301577
10421	301486
10445	301484
10462	301564
10467	301448
10486	301650
10490	301429
10492	301667
10494	301434
10535	301990
10537	301520
12007	301048
12014	301545
12020	301491
12023	301814
12029	301570
12043	301091
12059	301253
12064	301551
12066	301726
12072	301361
12075	301406
12076	301483
12078	301563



 	
OPTIMAL (.../...)	
12079	301408
12081	301926
12084	301759
12085	301735
12086	301518
12091	301433
12094	301457
12095	301737
12096	301681
12097	301445
12115	301407
12119	301583
12121	301680
12126	301456
12127	301638
12131	301641
12132	301558
12133	301639
12135	301842
12142	301030
12148	301708
12154	301644
12155	301635
12159	301557
12170	301736
12172	301805
12174	301860
12175	301674
12183	301801
12186	301770
12187	301829
12188	301482
12190	301024
12192	301649
12208	301474
12211	301465
12213	301025
12219	301781
12223	301662
12234	301703
12242	301004
12251	301754
12258	301827
12260	301705
12264	301584
12266	301747
12267	301744
12268	301748
12273	301657
12280	301868
12284	301886
12293	301934
12296	301881
12305	301857
12311	301819
12314	301890
12324	301825
12330	301642
12331	301015
12334	301752
12336	301783



 	
OPTIMAL (.../...)	
12345	301337
12350	301740
12353	301682
12354	301867
12362	301942
12363	301941
12372	301067
12373	301672
12375	301017
12379	301028
12383	301640
12398	301055
12401	301928
12402	301889
12407	301070
12410	301505
12420	301874
12428	301892
12433	301041
12438	301718
12446	301816
12451	301932
12483	301943
12487	301847
12505	301879
12560	301301
2145	301182
64320	301461
71811	301734
72610	301462
74712	301887
77132	301506
77501	301720
83602	301565
84010	301464
84200	301472
84300	301471
84501	301521
85700	301410
85901	301721
87601	301009
88100	301500
88800	301678
9151	301405
9205	301389
9272	301125
9320	301103
9322	301105
9338	301016
9356	301124
9363	301258
9386	301123
9392	301315
9401	301047
9406	301402
9415	301081
9423	301345
9425	301129
9449	301497
9469	301618
9478	301176



 	
OPTIMAL (.../...)	
9495	301666
9509	301270
9512	301240
9518	301269
9536	301335
9539	301179
9540	301463
9542	301095
9544	301753
9548	301180
9549	301266
9551	301231
9552	301268
9560	301780
9572	301053
9580	301241
95901	301569
9594	301519
96001	301568
9603	301817
9612	301156
9649	301063
9657	301272
9658	301624
9661	301274
9664	301172
9675	301022
9680	301052
9684	301625
9689	301054
9697	301007
9728	301668
9750	301155
9756	301256
9762	301181
9766	301119
9768	301049
9769	301036
9770	301037
9771	301356
9772	301252
9793	301627
9795	301617
9807	301540
9816	301760
9828	301507
9838	301014
9839	301033
9840	301005
9856	301031
9858	301158
9870	301002
9871	301061
9875	301013
9877	301616
9900	301038
9912	301982
9929	301622
9939	301034
9943	301010



 	
OPTIMAL (.../...)	
9945	301386
9955	301634
PAGID	
C6026	301881
T0004	301123
T0008	301047
	301760
T0009	301123
	301618
T0032	301666
T0034	301053
T0035	301268
	301274
T0042	301266
T0047	301497
T0048	301129
T0053	301063
T0063	301129
	301497
T0085	301129
T0150	301292
T0221	301095
	301219
T0230	301270
T0249	301219
T0303	301256
T0307	301103
T0318	301266
	301402
	301551
	301052
T0324	301052
T0325	301123
T0331	301402
T0340	301817
T0352	301241
T0352-ECO	301241
T0353	301095
T0353-ECO	301095
T0366	301052
	301817
T0375	301182
T0375-ECO	301182
T0381	301129
T0388	301258
T0388-ECO	301258
T0389	301036
T0390	301037
T0391	301817
T0392	301574
T0393	301540
T0398	301625
T0405	301099
T0412	301103
T0412-ECO	301103
T0449	301099
T0449-ECO	301099
T0451	301099
T0455	301099
	301584
T0475	301183
	301256



 	
PAGID (.../...)	
T0481	301099
	301270
T0481-ECO	301099
T0559	301129
T0571	301129
T0624	301091
	301219
T0624-ECO	301091
T0649	301081
T0659	301125
T0810	301405
T0825	301389
T0838	301123
T0841	301182
T0841-ECO	301182
T1004	301105
T1004-ECO	301105
T1005	301335
T1006	301335
T1010	301345
T1010-ECO	301345
T1014	301272
T1014-ECO	301272
T1016	301183
T1016-ECO	301183
T1021	301184
T1022	301043
	301171
T1022-ECO	301043
	301171
T1026	301231
T1026-ECO	301231
T1027	301103
	301259
	301311
T1027-ECO	301103
	301259
T1034	301183
	301253
T1034-ECO	301253
T1035	301751
T1037	301018
T1037-ECO	301018
T1038	301063
T1039	301259
	301386
T1045	301356
T1045-ECO	301356
T1050	301617
T1050-ECO	301617
T1061	301033
T1062	301034
T1065	301080
T1075	301038
	301074
T1078	301616
T1081	301033
T1082	301184
T1082-ECO	301182
	301184
T1085	301305



 	
<b>PAGID (.../...)</b>	
T1087	301013
T1090	301156
	301360
T1091	301357
T1091-ECO	301357
T1092	301636
T1092-ECO	301636
T1094	301488
T1095	301006
T1097	301066
T1097-ECO	301066
T1098	301040
T1099	301023
	301065
	301990
T1101	301332
T1103	301310
	301409
T1104	301311
	301753
T1106	301008
T1106-ECO	301008
T1107	301675
T1107-ECO	301675
T1111	301044
T1111P8027	301044
T1112	301305
T1113	301043
	301171
T1113-ECO	301043
	301171
T1114	301040
T1117	301580
T1120	301103
	301580
T1122	301305
T1124	301046
T1124P8027	301046
T1125	301062
T1132	301491
T1136	301412
T1137	301038
	301074
T1138	301156
	301360
T1139	301763
T1140	301006
	301040
	301065
T1141	301212
T1141-ECO	301212
T1143	301403
T1143-ECO	301403
T1145	301454
T1149	301125
	301483
	301751
T1150	301065
T1153	301444
T1154	301408
	301486



 	
<b>PAGID (.../...)</b>	
T1156	301735
T1159	301906
T1163	301408
T1163-ECO	301408
T1164	301322
T1165	301332
T1165-ECO	301332
T1166	301023
T1167	301317
T1167-ECO	301317
T1170	301300
T1174	301445
T1177	301018
T1177-ECO	301018
T1178	301311
	301386
	301753
T1184	301270
T1189	301479
T1190	301480
T1191	301183
T1192	301563
T1193	301564
T1195	301565
T1198	301444
T1204	301734
T1206	301183
T1207	301753
T1208	301023
T1210	301433
T1211	301434
T1213	301471
T1214	301471
T1215	301472
	301783
T1225	301454
	301860
T1230	301410
	301580
T1234	301678
T1240	301407
T1241	301535
T1242	301908
T1243	301865
T1244	301895
T1245	301461
	301726
T1250	301518
T1252	301018
T1253	301902
T1255	301682
T1256	301827
T1257	301521
T1261	301639
T1263	301682
T1265	301821
T1268	301629
T1274	301886
T1276	301520
	301852
T1284	301887



 	
<b>PAGID (.../...)</b>	
T1285	301315
T1287	301720
	301805
T1295	301462
T1305	301748
T1307	301505
	301759
T1324	301500
T1325	301445
T1328	301483
T1330	301827
T1331	301853
T1334	301009
	301672
T1349	301406
T1351	301463
T1354	301568
T1355	301569
T1356	301570
T1359	301862
T1366	301754
T1367	301781
T1368	301857
T1373	301558
T1374	301557
T1376	301635
T1377	301752
T1378	301842
T1380	301801
T1384	301889
T1387	301409
T1388	301483
	301751
T1392	301674
T1393	301736
T1394	301829
T1395	301852
T1396	301506
T1398	301680
T1399	301641
T1409	301361
T1410	301004
T1412	301744
T1422	301464
T1424	301545
T1428	301780
T1436	301649
T1438	301518
T1439	301990
T1443	301644
T1447	301703
T1448	301640
T1451	301584
T1458	301874
T1460	301770
T1461	301662
T1463	301429
T1468	301464
T1471	301642
T1473	301030
T1485	301044



 	
<b>PAGID (.../...)</b>	
T1488	301657
T1489	301472
	301678
	301783
T1492	301752
T1501	301426
T1519	301705
T1528	301639
T1530	301583
T1531	301718
T1534	301740
T1537	301005
T1541	301035
T1557	301629
T1562	301708
T1563	301580
T1564	301318
T1565	301493
T1577	301180
	301474
T1579	301479
T1580	301943
T1582	301819
T1591	301868
T1592	301867
T1594	301847
T1602	301937
T1605	301890
T1629	301002
T1631	301678
T1634	301726
T1640	301816
T1643	301180
T1644	301180
	301463
	301681
T1647	301825
T1648	301426
T1653	301879
T1655	301892
T1658	301928
T1659	301941
T1660	301934
T1672	301932
T1676	301942
T1679	301337
T1699	301752
T1716	301028
T1722	301744
T1726	301943
T1738	301041
T1751	301067
T1772	301017
T1813	301636
T1824	301046
T1832	301015
T1835	301044
T1874	301747
T1908	301867
T1911	301361
T1926	301640



 	
<b>PAGID (.../...)</b>	
T1956	301055
T1957	301055
T1959	301070
T1975	301070
T2006	301119
	301176
T2006-ECO	301119
	301176
T2017	301176
T2017-ECO	301176
T3002	301629
T3003	301020
T3013	301551
T3014	301274
T3016	301627
T3017	301642
	301682
T3019	301519
T3022	301014
T3024	301760
T3025	301517
T3028	301668
T3031	301519
T3032	301624
T3034	301507
T3035	301627
T3036	301634
T3040	301318
T3041	301574
T3052	301780
T3053	301551
T3070	301627
T3074	301266
T3086	301458
T3093	301316
T3095	301493
T3096	301575
T3098	301606
T3099	301737
T3105	301661
T3106	301361
T3111	301436
T3113	301668
T3114	301449
T3117	301577
	301737
T3118	301760
T3123	301522
T4017	301212
T4017-ECO	301212
T4114	301099
T4150	301258
T4151	301124
T4151-ECO	301124
T5005	301315
T5005-ECO	301315
T5006	301240
T5006-ECO	301240
T5007	301240
T5009	301003
T5009-ECO	301003



 	
<b>PAGID (.../...)</b>	
T5014	301002
T5016	301091
T5021	301003
T5021-ECO	301003
T5022	301180
	301463
	301474
T5022-ECO	301180
	301463
T5025	301142
	301219
T5026	301406
T5027	301179
T5027-ECO	301179
T5030	301256
T5037	301219
T5048	301048
T5048-ECO	301048
T5050	301016
T5050-ECO	301016
T5051	301003
	301252
	301982
T5051-ECO	301003
	301252
T5056	301125
	301142
T5056-ECO	301125
	301142
T5059	301982
T5059-ECO	301982
T5063	301054
T5064	301057
T5065	301022
T5067	301013
T5067-ECO	301013
T5072	301622
T5072-ECO	301622
	301814
T5075	301180
	301463
	301681
T5075-ECO	301180
	301463
	301681
T5077	301002
T5077-ECO	301002
T5078	301010
T5080	301022
T5084	301064
T5090	301068
T5092	301069
T5095	301330
T5095-ECO	301330
T5098	301003
T5098-ECO	301003
T5099	301326
T5100	301319
T5101	301549
T5102	301581
T5110	301549



 	
<b>PAGID (.../...)</b>	
T5111	301448
T5112	301448
T5114	301142
T5115	301048
T5115-ECO	301048
T5117	301179
T5118	301431
T5121	301450
T5122	301484
T5122-ECO	301484
T5128	301456
T5130	301583
T5134	301482
T5135	301650
	301681
T5136	301482
T5136-ECO	301482
T5137	301482
	301650
T5138	301674
	301681
T5140	301814
T5142	301466
T5143	301457
T5150	301770
T5154	301638
T5158	301584
T5159	301429
T5160	301667
T5161	301720
T5162	301426
T5163	301721
T5166	301464
T5167	301465
T5170	301429
T6064	301080
T6064-ECO	301080
T6065	301158
	301396
T6088	301002
	301075
	301081
	301181
T6088-ECO	301002
	301075
	301081
	301181
T6112	301002
	301061
T9000	301158
T9003	301091
T9008	301292
T9009	301125
T9012	301172
T9012-ECO	301172
T9017	301125
T9026	301005
T9028	301155
	301181



 	
<b>PAGID (.../...)</b>	
T9029	301075
	301081
	301181
T9029-ECO	301075
	301081
	301181
T9031	301012
T9033	301061
T9037	301007
	301080
T9038	301031
T9049	301158
	301396
T9052	301497
T9053	301080
	301396
T9066	301926
T9069	301172
	301399
T9069-ECO	301172
	301399
T9070	301726
T9073	301461
	301726
T9096	301462
T9099	301036
T9100	301037
T9101	301473



 	
<b>PAGID (.../...)</b>	



 	
<b>PAGID (.../...)</b>	



 	
<b>REMSA</b>	
0006.00	301099 301270
0006.30	301099
0006.60	301099 301270
0007.00	301099
0017.00	301099
0017.10	301099
0017.20	301099
0021.06	301081
0022.40	301266 301402
0025.30	301125 301219
0034.00	301519
0039.00	301075 301081
0052.10	301497
0056.00	301129
0056.04	301129
0056.12	301129
0065.00	301540
0080.00	301389 301405
0101.00	301182
0101.10	301182
0102.10	301292
0103.00	301389
0117.00	301123
0117.02	301123
0119.00	301212
0119.10	301212
0119.15	301212
0119.20	301212
0119.32	301171 301212
0121.00	301124
0128.32	301091
0134.00	301003
0134.02	301003
0134.20	301003
0134.40	301003 301252
0134.42	301982
0134.50	301016
0134.62	301982
0135.00	301125
0135.10	301125
0135.20	301125
0135.40	301125
0141.02	301002 301176
0141.10	301002
0141.20	301002
0141.30	301002
0141.32	301002
0144.06	301396
0144.12	301081
0144.32	301080
0144.50	301061 301396



 	
<b>REMSA (.../...)</b>	
0144.60	301061 301396
0144.70	301158 301396
0144.80	301080
0144.92	301080 301396
0145.00	301241
0146.14	301091 301219
0146.22	301219
0146.44	301219
0146.80	301219
0147.00	301052
0147.22	301666
0151.00	301817
0155.00	301103 301259
0157.00	301105
0157.10	301345
0167.04	301266
0167.10	301266
0170.04	301119
0170.12	301176
0170.14	301119 301176
0171.00	301124
0171.60	301258
0172.00	301335
0172.02	301335
0172.32	301017
0179.20	301780
0179.30	301780
0179.40	301780
0182.02	301052
0184.00	301123
0184.02	301123
0189.00	301044 301315
0189.02	301044 301315
0189.10	301044 301315
0192.10	301075
0192.12	301075 301081 301155 301181
0192.22	301080
0192.34	301155 301181
0192.44	301155 301181
0192.96	301075 301155
0193.00	301047
0193.02	301047
0197.10	301402
0205.00	301240
0208.00	301473
0208.02	301002 301061



 	
<b>REMSA (.../...)</b>	
0208.12	301061
0212.12	301274
0212.42	301274
0214.04	301540
0214.14	301540
0214.22	301540
0221.00	301406
0221.02	301406
0222.01	301497
0224.00	301052
0224.02	301052
0224.22	301052
0231.00	301125 301142
0233.00	301053
0233.02	301053
0236.00	301123 301618
0236.02	301123 301618
0237.02	301047
0238.04	301020
0238.14	301020
0238.24	301020
0239.00	301183
0239.10	301183
0239.40	301183
0239.50	301183
0241.02	301002
0247.04	301156
0247.10	301360
0247.14	301156
0247.24	301156
0251.12	301022
0257.10	301270
0257.20	301270
0261.02	301179
0262.02	301179
0262.12	301179
0263.00	301180 301463
0263.01	301180 301463
0263.03	301180 301463
0263.05	301180 301463 301474
0263.10	301180
0263.14	301474
0263.15	301180
0263.16	301180
0263.20	301180
0263.41	301674
0263.50	301463
0263.51	301681
0263.74	301180 301463
0264.02	301095 301219
0264.42	301095



 	
<b>REMSA (.../...)</b>	
0265.00	301103 301259 301386
0265.15	301311
0265.30	301386 301753
0265.40	301753
0265.41	301753
0265.50	301386
0267.00	301129
0267.11	301497
0268.04	301266
0270.00	301231
0270.15	301310 301409 301409
0270.25	301409
0270.50	301310
0271.02	301268 301274
0273.02	301629
0282.00	301183 301253
0282.10	301183 301253
0282.20	301272
0284.00	301241
0285.10	301043 301171
0285.20	301043 301171
0286.10	301184
0286.20	301184
0286.30	301184
0286.50	301184
0287.00	301574
0294.12	301817
0294.22	301817
0294.32	301817
0305.44	301064
0311.00	301292
0316.04	301266
0318.05	301574
0318.12	301574
0318.42	301574
0318.52	301574
0318.82	301574
0318.92	301574
0320.00	301054 301450
0320.20	301054
0321.10	301063
0321.22	301062
0325.02	301682
0325.12	301682
0325.22	301682
0325.32	301682
0325.42	301682
0325.52	301682
0329.00	301624
0330.02	301022
0331.00	301172



 	
<b>REMSA (.../...)</b>	
0331.04	301399
0337.02	301022
0343.00	301057
0344.00	301054 301123 301450
0345.00	301007
0345.10	301007
0351.02	301627 301682
0351.32	301627
0351.42	301627
0354.02	301517
0366.12	301668
0366.22	301668
0372.02	301091 301219
0381.00	301103
0381.20	301580
0381.30	301580
0381.60	301754
0382.00	301256
0383.00	301048
0384.00	301018
0384.40	301018
0385.10	301048
0390.00	301008
0390.01	301355
0390.02	301483
0390.10	301305
0390.22	301483 301751
0390.32	301305
0390.40	301355
0390.41	301486
0390.50	301616
0390.52	301751
0391.00	301036
0391.02	301036
0392.00	301037
0392.02	301037
0393.00	301356
0393.20	301356
0396.10	301518
0402.02	301551
0402.22	301551
0402.42	301551
0405.02	301519
0406.02	301627
0407.00	301617
0414.01	301012
0414.02	301012
0414.20	301012
0414.21	301012
0415.04	301629
0415.12	301629
0419.02	301760
0419.22	301760
0425.32	301661
0426.02	301507
0431.10	301014

 	
REMSA (.../...)	
0432.00	301034
0432.02	301033
	301036
	301037
0433.02	301005
0433.12	301005
0434.14	301466
0434.30	301480
0437.02	301033
0438.04	301031
0445.02	301013
0446.00	301616
0459.00	301666
0460.02	301625
0460.12	301625
0461.00	301038
	301074
0461.02	301038
0461.10	301074
0467.00	301491
0480.00	301622
0480.21	301814
0486.02	301010
0486.11	301429
0490.02	301022
0494.02	301634
0499.00	301642
0508.22	301483
0571.02	301906
0574.00	301581
0578.00	301044
0578.10	301044
0580.00	301046
0580.10	301046
0581.10	301023
	301581
0581.80	301581
0583.00	301522
0586.00	301357
0587.01	301006
0587.11	301006
0587.12	301065
0588.01	301040
0588.11	301040
0589.02	301023
	301065
0589.21	301990
0589.22	301023
0589.32	301023
0589.42	301990
0590.02	301318
0590.12	301318
0590.21	301318
0591.00	301482
0591.10	301482
0596.00	301412
0596.10	301412
0601.00	301636
0603.04	301068
0604.02	301069
0604.04	301069



 	
REMSA (.../...)	
0605.12	301319
0607.02	301449
0609.00	301066
0609.10	301488
0609.11	301805
0609.20	301403
0618.00	301675
0630.00	301763
0631.00	301330
0631.10	301003
	301484
0631.12	301003
	301484
0633.00	301332
0633.20	301332
0633.21	301408
0633.31	301332
	301408
0633.41	301408
0633.50	301332
0634.04	301326
0641.02	301458
0643.00	301461
	301726
0643.01	301726
0643.10	301461
0643.20	301461
	301726
0645.02	301361
0645.12	301361
0645.32	301361
0646.10	301902
0650.00	301549
0660.02	301065
0675.02	301575
0678.00	301444
0683.02	301454
	301860
0684.02	301322
0685.02	301926
0685.22	301926
0691.00	301317
0692.00	301142
0693.00	301431
0694.02	301436
0695.02	301682
0696.00	301316
0703.02	301908
0704.00	301450
0706.00	301865
0707.04	301535
0708.02	301493
0712.02	301606
0713.00	301479
0714.00	301480
0718.00	301735
0718.11	301734
0722.00	301616
0726.00	301462
0726.10	301462
0727.10	301407



 	
REMSA (.../...)	
0727.20	301407
0729.02	301895
0733.00	301300
0740.02	301737
0741.02	301577
0742.00	301827
0746.02	301748
0746.12	301748
0746.22	301748
0746.32	301748
0746.72	301748
0746.75	301748
0747.12	301887
0748.02	301889
0765.00	301563
0766.00	301564
	301639
0767.00	301482
0767.01	301482
	301650
0767.10	301482
0767.12	301650
0768.00	301448
0769.00	301445
0769.02	301445
0771.02	301759
0771.12	301505
0771.22	301505
0771.32	301506
0774.02	301456
0775.00	301667
0775.01	301720
0776.00	301433
0777.00	301434
0777.10	301434
0803.02	301520
	301852
0804.12	301886
0804.31	301886
0818.00	301583
0821.02	301821
0821.12	301821
0834.00	301545
0834.10	301545
0835.02	301457
0836.02	301565
0840.10	301464
0840.20	301464
0840.30	301464
0841.00	301465
0842.00	301472
	301783
0842.20	301472
	301783
0842.30	301472
0842.50	301783
0843.00	301471
0843.10	301471
0845.01	301521
0852.14	301337
0857.00	301410



 	
REMSA (.../...)	
0858.01	301426
0858.11	301426
0858.31	301825
0858.32	301426
0859.01	301721
0859.10	301465
0859.11	301721
0862.02	301028
0874.02	301680
0876.01	301672
0876.21	301009
0881.00	301500
0884.00	301842
	301862
0888.00	301678
0888.40	301678
0893.02	301781
0897.00	301004
0951.02	301853
0951.11	301853
0953.02	301744
0953.12	301744
0953.22	301744
0957.02	301584
0959.01	301569
	301570
0960.01	301568
0961.00	301570
0973.02	301662
0976.00	301558
0976.10	301558
0976.20	301558
0977.00	301557
0978.02	301736
0984.00	301639
0986.00	301644
0987.00	301641
0987.11	301847
0988.00	301857
0990.02	301638
0995.00	301030
0996.00	301657
	301770
0996.10	301770
1030.01	301635
1030.11	301635
1031.00	301752
1036.02	301860
1038.12	301842
1038.02	301842
1043.00	301657
1044.00	301829
1048.00	301874
1051.02	301852
1052.00	301640
1070.00	301030
1082.00	301649
1100.11	301015
	301426
1102.04	301662
1134.02	301705



 	
REMSA (.../...)	
1139.02	301575
	301708
1145.00	301703
1149.10	301740
1177.00	301718
1201.00	301035
1204.02	301744
1208.02	301868
1209.02	301867
1209.12	301867
1219.00	301879
1226.02	301937
1231.00	301819
1232.00	301943
1236.00	301928
1236.10	301928
1238.00	301892
1239.02	301932
1243.00	301881
1244.02	301821
1250.02	301816
1260.12	301941
1261.12	301942
1302.02	301934
1318.00	301067
1322.12	301308
1342.00	301752
1344.00	301041
1362.42	301301
1391.00	301474
1391.10	301474
1431.02	301070
1432.02	301055
1432.12	301055
8208.00	301061
8208.01	301061
8208.02	301473
8208.03	301061
8208.04	301473
8208.05	301061
8224.00	301052
8231.00	301142
8247.00	301156
8247.01	301360
8262.00	301179
8263.00	301180
	301463
8263.01	301180
	301463
8263.02	301180
8263.03	301180
	301463
8263.04	301180
8264.00	301095
8270.00	301409
8284.00	301241
8285.00	301043
	301171
8285.01	301043
	301171
8286.00	301184







 	
<b>REMSA (.../...)</b>	
8286.01	301184
8305.00	301064
8318.00	301574
8318.01	301574
8331.00	301172
8331.01	301399
8337.00	301022
8337.01	301022
8372.00	301091
8384.00	301018
8384.01	301018
8384.02	301018
8390.00	301483
8390.02	301305
8390.03	301355
8390.04	301008
8390.06	301486
8391.00	301036
8391.01	301036
8392.00	301037
8392.01	301037
8414.00	301012
8432.00	301033
	301036
	301037
8438.00	301031
8445.00	301013
8445.01	301013
8445.02	301013
8461.01	301038
8461.02	301074
8486.00	301010
8486.01	301010
8578.00	301044
8578.01	301044
8587.01	301065
8588.00	301040
8603.00	301068
8604.00	301069
8609.00	301066
8609.01	301488
8609.02	301403
8609.03	301403
8609.04	301403
8631.00	301330
8631.01	301003
8631.02	301003
8631.03	301330
8633.00	301332
8633.01	301408
8633.02	301332
8633.03	301332
8633.04	301332
8634.00	301326
8643.00	301726
8643.02	301461
8643.03	301461
8643.04	301461
8643.06	301461
8643.07	301461
8683.00	301454



 	
<b>REMSA (.../...)</b>	
8684.00	301322
8691.00	301317
8726.00	301462
8733.00	301300
8733.01	301300
8774.00	301456
8774.01	301456
8774.02	301456
<b>ROADHOUSE</b>	
2006.00	301099
	301270
2006.30	301099
2006.60	301099
	301270
2007.00	301099
2017.00	301099
2017.10	301099
2017.20	301099
2021.06	301081
2021.16	301081
2022.40	301266
	301402
2025.30	301125
	301219
2034.00	301519
2039.00	301075
	301081
2052.10	301497
2056.00	301129
2056.04	301129
2056.12	301129
2065.00	301540
2080.00	301389
	301405
2101.00	301182
2101.10	301182
2102.10	301292
2103.00	301389
21030.01	301635
21031.00	301752
21036.02	301860
21038.02	301842
21038.12	301842
21043.00	301657
21044.00	301829
21048.00	301874
21051.02	301852
21052.00	301640
21070.00	301030
21082.00	301649
21085.02	301506
21100.11	301015
	301426
21102.04	301662
21134.02	301705
21139.02	301575
	301708
21145.00	301703
21149.10	301740
2117.00	301123
2117.02	301123



 	
<b>ROADHOUSE (.../...)</b>	
21177.00	301718
2119.00	301212
2119.10	301212
2119.15	301212
2119.20	301212
2119.32	301171
	301212
21201.00	301035
21204.02	301744
21208.02	301868
21209.02	301867
2121.00	301124
21219.00	301879
21223.02	301361
21226.02	301937
21231.00	301819
21232.00	301943
21236.00	301928
21238.00	301892
21239.02	301932
21243.00	301881
21244.02	301821
21250.02	301816
21260.12	301941
21261.12	301942
2128.32	301091
21302.02	301934
21318.00	301067
2134.00	301003
2134.02	301003
2134.20	301003
2134.40	301003
	301252
2134.42	301982
2134.50	301016
2134.62	301982
21344.00	301041
2135.00	301125
2135.10	301125
2135.20	301125
2135.40	301125
2141.02	301002
	301176
2141.10	301002
2141.20	301002
2141.30	301002
	301780
2141.32	301002
21431.02	301070
21432.02	301055
21432.12	301055
2144.06	301396
2144.12	301081
2144.32	301080
2144.50	301061
	301396
2144.60	301061
	301396
2144.70	301158
	301396
2144.80	301080



 	
<b>ROADHOUSE (.../...)</b>	
2144.92	301080
	301396
2145.00	301241
2146.14	301091
	301219
2146.22	301219
2146.44	301219
2146.80	301219
2147.00	301052
2147.22	301666
2151.00	301817
2151.12	301629
2155.00	301103
	301259
2157.00	301105
2157.10	301345
2167.04	301266
2167.10	301266
2170.04	301119
2170.12	301176
2170.14	301119
	301176
2171.00	301124
2171.10	301181
2171.60	301258
2172.00	301335
2172.02	301335
2172.32	301017
2179.30	301780
2179.40	301780
2182.02	301052
2184.00	301123
2184.02	301123
2189.00	301044
	301315
2189.02	301044
	301315
2189.10	301044
	301315
2192.10	301075
2192.12	301075
	301081
	301155
	301181
2192.22	301080
2192.34	301155
	301181
2192.44	301155
	301181
2192.96	301075
2193.00	301047
2193.02	301047
2197.10	301402
2205.00	301240
2208.00	301473
2208.02	301002
	301061
2208.12	301061
2212.12	301274
2212.42	301274
2214.04	301540



 	
<b>ROADHOUSE (.../...)</b>	
2214.14	301540
2214.22	301540
2221.00	301406
2221.02	301406
2222.01	301497
2224.00	301052
2224.02	301052
2224.22	301052
2231.00	301125
	301142
	301219
2233.00	301053
2233.02	301053
2236.00	301123
	301618
2236.02	301123
	301618
2237.02	301047
2238.04	301020
2238.14	301020
2238.24	301020
2239.00	301183
2239.10	301183
2239.40	301183
2239.50	301183
2241.02	301002
2247.04	301156
2247.10	301360
2247.14	301156
2247.24	301156
2251.12	301022
2257.10	301270
2257.20	301270
2261.02	301179
2262.02	301179
2262.12	301179
2263.00	301180
	301463
2263.01	301180
	301463
2263.03	301180
	301463
2263.05	301180
	301463
	301474
	301752
2263.10	301180
	301474
2263.14	301474
2263.15	301180
2263.16	301180
2263.20	301180
2263.41	301463
	301674
2263.50	301463
2263.51	301681
2263.74	301180
	301463
2264.02	301095
	301219
2264.42	301095



 	
ROADHOUSE (.../...)	
2265.00	301103
	301259
	301386
2265.15	301311
2265.30	301386
	301753
2265.40	301753
2265.41	301753
2265.50	301386
2267.00	301129
2267.11	301497
2268.04	301266
2270.00	301231
2270.15	301310
	301409
2270.25	301409
2271.02	301268
	301274
2273.02	301629
2282.00	301183
	301253
2282.10	301183
	301253
2282.20	301272
2284.00	301241
2285.10	301043
	301171
2285.20	301043
	301171
2286.10	301184
2286.20	301184
2286.30	301184
2286.50	301184
2287.00	301574
2294.12	301817
2294.22	301817
2294.32	301817
2305.44	301064
2311.00	301292
2316.04	301266
2318.05	301574
2318.12	301574
2318.42	301574
2318.52	301574
2318.82	301574
2318.92	301574
2320.00	301054
	301450
2320.20	301054
2321.10	301063
2321.22	301062
2325.02	301682
2325.12	301682
2325.22	301682
2325.32	301682
2325.42	301682
2325.52	301682
2329.00	301624
2330.02	301022
2331.00	301172
2331.04	301399



 	
ROADHOUSE (.../...)	
2337.02	301022
2343.00	301057
2344.00	301054
	301123
	301450
2345.00	301007
2345.10	301007
2351.02	301627
2351.32	301627
2351.42	301627
2354.02	301517
2366.12	301668
2366.22	301668
2372.02	301091
	301219
2381.00	301103
2381.20	301580
2381.30	301580
2381.60	301754
2382.00	301256
2383.00	301048
2384.00	301018
2384.40	301018
2385.10	301048
2390.00	301008
2390.01	301355
2390.02	301483
2390.10	301305
2390.22	301483
	301751
2390.32	301305
2390.40	301355
2390.41	301486
2390.50	301616
2390.52	301751
2391.00	301036
2391.02	301036
2392.00	301037
2392.02	301037
2393.20	301356
2396.10	301518
2402.02	301551
2402.22	301551
2402.42	301551
2405.02	301519
2406.02	301627
2407.00	301617
2414.01	301012
2414.02	301012
2414.20	301012
2415.04	301629
2415.12	301629
2419.02	301760
2419.22	301760
2425.32	301661
2426.02	301507
2431.10	301014
2432.00	301034
2432.02	301033
	301036
	301037



 	
ROADHOUSE (.../...)	
2433.02	301005
2433.12	301005
2434.14	301466
2434.30	301480
2437.02	301033
2438.04	301031
2445.02	301013
2446.00	301616
2459.00	301666
2460.02	301625
2460.12	301625
2461.00	301038
	301074
2461.02	301038
	301074
2461.10	301074
2467.00	301491
2480.00	301622
2480.21	301814
2486.02	301010
2486.11	301429
2490.02	301022
2494.02	301634
2499.00	301642
2508.22	301483
2571.02	301906
2574.00	301581
2578.00	301044
2580.00	301046
2580.10	301046
2581.10	301023
	301581
2581.80	301581
2583.00	301522
2586.00	301357
2587.01	301006
2587.11	301006
2587.12	301065
2588.01	301040
2588.11	301040
2589.02	301023
	301065
2589.21	301990
2589.22	301023
2589.32	301023
2589.42	301990
2590.02	301318
2590.12	301318
2590.21	301318
2591.00	301482
2591.10	301482
2596.00	301412
2596.10	301412
2601.00	301636
2603.04	301068
2604.02	301069
2604.04	301069
2605.12	301319
2607.02	301449
2609.00	301066
2609.10	301488



 	
ROADHOUSE (.../...)	
2609.11	301805
2609.20	301403
2618.00	301675
2630.00	301763
2631.00	301330
2631.10	301003
2631.12	301484
2633.00	301332
2633.20	301332
2633.21	301408
2633.31	301408
2633.41	301408
2634.04	301326
2641.02	301458
2643.00	301461
	301726
2643.01	301726
2643.10	301461
2643.20	301461
	301726
2645.02	301361
2645.12	301361
2645.32	301361
2646.10	301902
2650.00	301549
2660.02	301065
2675.02	301575
2678.00	301444
2683.02	301454
	301860
2684.02	301322
2685.02	301926
2685.22	301926
2691.00	301317
2692.00	301142
2693.00	301431
2694.02	301436
2695.02	301682
2696.00	301316
2703.02	301908
2704.00	301450
2706.00	301865
2707.04	301535
2708.02	301493
2712.02	301606
2713.00	301479
2714.00	301480
2718.00	301735
2718.11	301734
2722.00	301616
2726.00	301462
2726.10	301462
2727.10	301407
2727.20	301407
2729.02	301895
2733.00	301300
2740.02	301737
2741.02	301577
2742.00	301827
2746.02	301748
2746.12	301748



 	
ROADHOUSE (.../...)	
2746.22	301748
2746.32	301748
2747.12	301887
2748.02	301889
2765.00	301563
2766.00	301564
	301639
2767.00	301482
2767.01	301482
	301650
2767.10	301482
2767.12	301650
2768.00	301448
2769.00	301445
2769.02	301445
2771.02	301759
2771.12	301505
2771.22	301505
2771.32	301506
2774.02	301456
2775.00	301667
2775.01	301720
2776.00	301433
2777.00	301434
2777.10	301434
2803.02	301520
	301852
2804.12	301886
2804.31	301886
2818.00	301583
2821.02	301821
2821.12	301821
2834.00	301545
2834.10	301545
2835.02	301457
2836.02	301565
2840.10	301464
2840.20	301464
2840.30	301464
2841.00	301465
2842.00	301472
	301783
2842.20	301472
	301783
2843.00	301471
2843.10	301471
2845.01	301521
2852.14	301337
2857.00	301410
2858.01	301426
2858.31	301825
2858.32	301426
2859.10	301465
2859.11	301721
2862.02	301028
2874.02	301680
2876.01	301009
	301672
2881.00	301500
2884.00	301862
2888.00	301678



 	
ROADHOUSE (.../...)	
2888.40	301678
2893.02	301781
2897.00	301004
2951.02	301853
2951.11	301853
2953.02	301744
2953.12	301744
2953.22	301744
2957.02	301584
2959.01	301569
	301570
2960.01	301568
2961.00	301570
2976.00	301558
2976.10	301558
2976.20	301558
2977.00	301557
2978.02	301736
2984.00	301639
2986.00	301644
2987.00	301641
2987.11	301847
2988.00	301857
2990.02	301638
2996.00	301770
2996.10	301770
8208.00	301061
8208.01	301061
8208.02	301473
8208.03	301061
8208.04	301473
8208.05	301061
8224.00	301052
8231.00	301142
8247.00	301156
8247.01	301360
8262.00	301179
8263.00	301180
	301463
8263.01	301180
	301463
8263.02	301180
8263.03	301180
	301463
8263.04	301180
8264.00	301095
8270.00	301409
8284.00	301241
8285.00	301043
	301171
8285.01	301043
	301171
8286.00	301184
8286.01	301184
8305.00	301064
8318.00	301574
8318.01	301574
8331.00	301172
8331.01	301399
8337.00	301022



 	
ROADHOUSE (.../...)	
8337.01	301022
8372.00	301091
8384.00	301018
8384.01	301018
8384.02	301018
8390.00	301483
8390.02	301305
8390.03	301355
8390.04	301008
8390.06	301486
8391.00	301036
8391.01	301036
8392.00	301037
8392.01	301037
8414.00	301012
8432.00	301033
	301036
	301037
8438.00	301031
8445.00	301013
8445.01	301013
8445.02	301013
8461.01	301038
8461.02	301074
8486.00	301010
8486.01	301010
8578.00	301044
8578.01	301044
8587.01	301065
8588.00	301040
8603.00	301068
8604.00	301069
8609.00	301066
8609.01	301488
8609.02	301403
8609.03	301403
8609.04	301403
8631.00	301330
8631.01	301003
8631.02	301003
8631.03	301330
8633.00	301332
8633.01	301408
8633.02	301332
8633.03	301332
8633.04	301332
8634.00	301326
8643.00	301726
8643.02	301461
8643.03	301461
8643.04	301461
8643.06	301461
8643.07	301461
8683.00	301454
8684.00	301322
8691.00	301317
8726.00	301462
8733.00	301300
8733.01	301300
8774.00	301456
8774.01	301456



 	
ROADHOUSE (.../...)	
8774.02	301456
TEXTAR	
2000906	301099
	301584
2001102	301183
	301256
2001107	301256
2003101	301780
2003402	301099
	301270
2008802	301270
2012401	301048
2014701	301013
2016203	301292
2016603	301405
2016801	301016
2016804	301003
	301252
	301982
2016805	301982
2017301	301099
2022802	301099
2022803	301099
2029301	301125
2034402	301497
2035905	301129
2035907	301129
2035908	301129
2036404	301129
2041001	301007
	301080
	301396
2042103	301081
2054701	301356
2057504	301292
2057511	301292
2063402	301080
2065302	301129
2066001	301389
2066921	301003
2066922	301003
2067502	301103
2067602	301751
2068701	301345
2068703	301105
2070804	301219
2071802	301123
2071901	301219
2075303	301212
2075506	301270
2077801	301003
2083302	301095
	301219
2084102	301125
2087001	301266
	301402
	301551
2088707	301124
2088708	301258
2088902	301258



 	
TEXTAR (.../...)	
2090506	301002
	301075
	301081
	301181
2090602	301075
	301081
	301181
2090603	301075
	301081
	301155
	301181
2090604	301155
	301181
2090702	301335
2090802	301335
2092602	301158
2093903	301182
2093904	301182
2094102	301315
2094103	301315
2094601	301091
2094602	301091
2095005	301091
2095006	301091
	301219
2095901	301047
2095902	301047
	301760
2096101	301180
2096102	301180
2096104	301180
	301463
	301681
2096105	301674
	301681
2096108	301180
	301463
	301681
2096110	301463
2096801	301231
2097401	301158
	301396
2098101	301240
2098901	301119
	301176
2099501	301103
	301259
	301311
2101202	301052
	301817
2101204	301052
2103501	301099
2105001	301183
2105002	301183
2105503	301241
2105505	301241
2109601	301080
2109901	301123
2109902	301123
2110005	301095
2110701	301125
2112201	301817



 	
TEXTAR (.../...)	
2114001	301183
	301253
2114401	301125
	301142
2115801	301402
2117002	301406
2117105	301172
	301399
2117902	301156
2119701	301272
2120203	301043
	301171
2120909	301179
2123701	301497
2126702	301156
	301360
2127304	301616
2127801	301063
2127803	301063
2128201	301103
	301580
2130501	301617
2130503	301617
2130504	301617
2130591	301617
2131201	301053
2133301	301666
2134702	301123
	301618
2135501	301268
	301274
2136301	301517
2136801	301256
2137201	301266
2137801	301063
2138802	301061
2141401	301155
2141404	301155
2143001	301038
	301074
2143602	301012
2143905	301013
2143906	301013
2145401	301483
2145901	301129
2145902	301129
	301497
2146303	301002
2146304	301002
2146306	301002
2146901	301037
2146902	301037
2147001	301036
	301345
2147002	301036
2147902	301622
2147903	301814
2148602	301412
2148604	301412
2148691	301412
2148701	301580





 	Valeo	
TEXTAR (.../...)		
2148702	301580	
2148703	301580	
2148791	301580	
2149201	301616	
2151503	301022	
2152001	301022	
2152601	301574	
2154302	301020	
2154501	301057	
2154601	301054	
2155301	301817	
2155901	301624	
2157601	301044	
2157670	301044	
2158602	301005	
2158901	301180	
2159201	301046	
2159270	301046	
2159701	301158	
	301396	
2160101	301551	
2160601	301581	
2160702	301259	
	301386	
2160901	301155	
2162601	301014	
2163102	301031	
2163501	301048	
2163602	301023	
	301065	
	301990	
2163702	301023	
2164302	301018	
2164701	301625	
2165101	301627	
2165404	301274	
2166404	301357	
2166491	301357	
2167001	301636	
2167091	301636	
2167403	301069	
2167703	301310	
	301409	
2167791	301310	
	301409	
2169103	301311	
	301753	
2169191	301311	
2169701	301760	
2170001	301627	
2170602	301519	
2171201	301315	
2171301	301668	
2171901	301642	
	301682	
2172402	301068	
2172501	301574	
2172901	301240	
2175401	301629	
2175501	301629	
2176301	301266	





 	Valeo	
TEXTAR (.../...)		
2178601	301519	
2179101	301551	
2179701	301010	
2180101	301064	
2182202	301491	
2182702	301038	
	301074	
2182901	301305	
2183001	301906	
2183301	301540	
2184002	301519	
2184802	301008	
	301355	
2185701	301156	
	301360	
2186102	301319	
2186201	301184	
2186601	301403	
2186602	301488	
2186603	301066	
2186801	301720	
	301805	
2187501	301507	
2187901	301627	
2188302	301675	
2190003	301763	
2190403	301062	
2191901	301444	
2191903	301444	
2191991	301444	
2192001	301318	
2192003	301318	
2192701	301006	
2192901	301040	
	301065	
2193002	301040	
2193201	301040	
2193402	301311	
	301386	
	301753	
2193404	301753	
2193491	301753	
2193801	301125	
	301483	
	301715	
2193891	301483	
	301751	
2194502	301330	
2194503	301003	
2194504	301484	
2198003	301726	
2198004	301461	
	301726	
2198009	301726	
2198302	301493	
2198304	301493	
2199003	301409	
2199091	301409	
2301802	301483	
	301751	





 	Valeo	
TEXTAR (.../...)		
2301891	301483	
	301751	
2302101	301300	
2302170	301300	
2302301	301449	
2303201	301018	
2305701	301454	
2306302	301322	
2307003	301549	
2307004	301549	
2307104	301033	
2307303	301479	
2307391	301479	
2307401	301479	
2307602	301480	
2307691	301480	
2308101	301634	
2309102	301183	
2309401	301436	
2309902	301545	
2310101	301043	
	301171	
2310301	301212	
2311502	301305	
2311602	301305	
2312401	301326	
2313001	301332	
2313091	301332	
2313101	301408	
2313191	301408	
2313803	301583	
2313805	301583	
2314002	301065	
2314401	301448	
2314402	301448	
2314491	301448	
2314492	301448	
2315402	301317	
2316901	301179	
2317203	301473	
2317703	301142	
2320001	301563	
2320201	301564	
2322201	301990	
2322411	301482	
2322415	301482	
2322416	301482	
	301650	
2322501	301456	
2323401	301361	
2323701	301902	
2323802	301575	
2324102	301316	
2324502	301471	
2324802	301471	
2325001	301661	
2325803	301926	
2326903	301565	
2327102	301445	
2327191	301445	
2327904	301433	





 	Valeo	
TEXTAR (.../...)		
2328402	301457	
2328404	301457	
2328702	301018	
2328791	301018	
2328902	301023	
	301065	
	301990	
2329002	301522	
2330002	301172	
	301399	
2331204	301410	
	301580	
2331207	301410	
2331291	301410	
2332601	301004	
2332691	301004	
2333201	301462	
2334001	301736	
2334803	301606	
2335301	301431	
2335801	301458	
2339201	301408	
	301486	
2339402	301735	
2339502	301734	
2339602	301462	
2340203	301678	
2340702	301500	
2341702	301584	
2341703	301584	
2341801	301801	
2344004	301639	
2344007	301639	
2344605	301650	
	301681	
2345401	301642	
2346302	301450	
2348202	301472	
	301783	
2348701	301521	
2348801	301518	
2351002	301737	
2351703	301407	
2352101	301577	
	301737	
2352402	301535	
2352601	301827	
2352701	301682	
2353601	301908	
2353902	301865	
2354301	301748	
2354901	301319	
2355401	301180	
	301463	
	301474	
2355402	301180	
	301463	
	301681	
2355403	301674	
	301681	





 	Valeo	
TEXTAR (.../...)		
2355406	301180	
	301474	
2355491	301180	
	301463	
2355701	301434	
2356901	301505	
	301759	
2357202	301895	
2358101	301667	
2358102	301720	
2358202	301520	
	301852	
2358401	301886	
2358701	301635	
2358791	301635	
2359001	301030	
2359703	301461	
	301726	
2359901	301464	
2360001	301465	
2360201	301429	
2360301	301429	
2360406	301564	
2364901	301821	
2365201	301682	
2367101	301406	
2369402	301770	
2369801	301337	
2370502	301426	
2370503	301426	
2370802	301721	
2372301	301649	
2372901	301887	
2373201	301754	
2373291	301754	
2373807	301678	
2374303	301638	
2374391	301638	
2375301	301466	
2379301	301640	
2379391	301640	
2379401	301640	
2379491	301640	
2381601	301680	
2382301	301674	
2382901	301483	
2383201	301860	
2384504	301629	
2386401	301827	
2386501	301853	
2387101	301009	
	301672	
2389101	301744	
2390101	301046	
2391401	301752	
2391402	301752	
2391491	301752	
2391492	301752	
2391701	301568	
2391901	301569	
2392101	301570	



 	 
<b>TEXTAR (.../...)</b>	
2392601	301703
2392701	301703
2392791	301703
2392801	301862
2393001	301558
2393401	301557
2395401	301464
2395901	301718
2396601	301842
2397001	301889
2397301	301641
2397302	301847
2397401	301644
2397901	301426
2398202	301825
2398301	301035
2399001	301044
2399002	301044
2399070	301044
2401001	301770
2401101	301829
2401401	301852
2402401	301857
2403101	301781
2404501	301780
2405901	301506
2406201	301361
2406601	301518
2407101	301874
2407202	301015
2410101	301464
2412201	301943
2412301	301879
2413401	301662
2413701	301472
	301678
	301783
2414101	301657
2415501	301678
2421801	301705
2426001	301740
2427701	301708
2428901	301041
2431701	301868
2432001	301867
2433601	301943
2433801	301819
2435001	301890
2435101	301937
2446501	301892
2448301	301752
2448302	301752
2448392	301752
2448401	301816
2448801	301932
2449602	301928
2449801	301941
2450101	301934
2451001	301942
2457401	301028
2458601	301744



 	 
<b>TEXTAR (.../...)</b>	
2463201	301067
2464701	301747
2467301	301017
2472201	301636
2486401	301361
2503401	301070
2507901	301070
2509601	301055
2509602	301055
2920001	301881
2920002	301881
2920070	301881
<b>TRW</b>	
GDB101	301099
	301270
GDB1010	301817
GDB1017	301618
GDB102	301099
GDB1020	301123
GDB1024	301274
GDB1030	301061
GDB1031	301156
GDB1033	301155
	301181
GDB1039	301179
GDB1040	301356
GDB1041	301007
GDB1044	301003
	301252
GDB1048	301016
GDB1049	301483
GDB1050	301125
GDB1055	301463
GDB1057	301982
GDB1059	301014
GDB1060	301642
GDB1061	301627
GDB1063	301682
GDB1073	301180
GDB1078	301081
GDB1079	301080
GDB1080	301037
GDB1083	301022
GDB1084	301036
GDB1092	301622
GDB1094	301013
GDB1100	301018
GDB1101	301031
GDB1104	301038
	301074
GDB1105	301010
GDB1107	301034
GDB1108	301033
GDB1112	301005
GDB1115	301012
GDB1119	301103
GDB1120	301080
	301396
GDB1121	301180
GDB1123	301617
GDB1126	301517



 	 
<b>TRW (.../...)</b>	
GDB1127	301519
GDB1128	301625
GDB1139	301629
GDB1143	301551
GDB1147	301581
GDB1148	301064
GDB1153	301491
GDB1159	301616
GDB1160	301270
GDB1163	301125
GDB1164	301760
GDB1168	301540
GDB1169	301022
GDB1187	301507
GDB1189	301386
	301753
GDB1193	301068
GDB1194	301069
GDB1196	301463
GDB1198	301318
GDB1200	301355
GDB1204	301008
GDB1205	301357
GDB1210	301040
GDB1212	301023
	301065
GDB1215	301636
GDB1217	301396
GDB1218	301066
GDB1219	301258
GDB1220	301044
GDB1221	301043
	301171
GDB1222	301212
GDB1223	301219
GDB1247	301292
GDB1259	301069
GDB1260	301326
GDB1261	301412
GDB1263	301046
GDB1264	301310
	301409
GDB1265	301311
GDB1266	301003
GDB1267	301463
GDB1271	301305
GDB1274	301488
GDB1276	301063
GDB1277	301075
GDB1278	301074
GDB1279	301360
GDB1282	301675
GDB1283	301763
GDB1286	301522
GDB1289	301062
GDB1290	301006
GDB1291	301040
GDB1292	301549
GDB1293	301549
GDB1297	301091
GDB1299	301012



 	 
<b>TRW (.../...)</b>	
GDB1300	301184
GDB1302	301183
GDB1304	301580
GDB1305	301396
GDB1306	301403
GDB1307	301483
	301751
GDB1308	301458
GDB1310	301125
GDB1311	301463
GDB1312	301330
GDB1313	301493
GDB1314	301319
GDB1315	301581
GDB1317	301318
GDB1321	301726
GDB1322	301074
GDB1324	301482
GDB1325	301482
GDB1326	301650
GDB1328	301180
GDB1330	301180
	301463
GDB1332	301002
GDB1333	301142
GDB1335	301444
GDB1337	301065
GDB1343	301386
GDB1344	301753
GDB1346	301183
GDB1348	301018
GDB1349	301399
GDB1350	301454
	301860
GDB1351	301322
GDB1352	301926
GDB1354	301431
GDB1357	301332
GDB1358	301317
GDB1359	301466
GDB1360	301180
GDB1361	301461
GDB1362	301023
GDB1364	301065
GDB1366	301484
GDB1367	301814
GDB1369	301482
GDB1372	301463
GDB1375	301735
GDB1376	301355
GDB1385	301462
GDB1386	301408
GDB1388	301479
GDB1389	301480
GDB1396	301407
GDB1397	301408
GDB1399	301300
GDB1402	301726
GDB1403	301486
GDB1404	301409
GDB1405	301473



 	 
<b>TRW (.../...)</b>	
GDB1406	301616
GDB1411	301456
GDB1412	301457
GDB1413	301448
GDB1414	301667
GDB1415	301681
GDB1416	301463
GDB1418	301563
GDB1419	301564
	301639
GDB1422	301408
GDB1425	301429
GDB1427	301023
GDB1430	301753
GDB1432	301063
GDB1433	301583
GDB1434	301433
GDB1435	301434
GDB1436	301661
GDB1437	301330
GDB1439	301180
GDB1445	301990
GDB1446	301406
GDB1451	301483
GDB1454	301445
GDB1460	301565
GDB1462	301464
GDB1463	301464
GDB1464	301465
GDB1465	301002
GDB1466	301545
GDB1467	301180
	301463
GDB1468	301471
GDB1469	301472
	301783
GDB1471	301926
GDB1472	301720
GDB1474	301734
GDB1475	301674
GDB1478	301545
GDB148	301081
GDB1481	301583
GDB1482	301426
GDB1488	301751
GDB1491	301436
GDB1492	301678
GDB1495	301500
GDB1498	301410
GDB1500	301461
GDB1501	301462
GDB1504	301463
GDB1509	301434
GDB1513	301480
GDB1514	301448
GDB1515	301584
GDB1516	301004
GDB1517	301568
GDB1518	301569
GDB1520	301407
GDB1521	301570

 	
TRW (.../...)	
GDB1522	301396
GDB1527	301580
GDB1530	301580
GDB1532	301639
GDB1538	301801
GDB1542	301638
GDB1543	301445
GDB1545	301444
GDB1549	301770
GDB1550	301635
GDB1551	301752
GDB1552	301558
GDB1559	301640
GDB1562	301860
GDB1563	301464
GDB1565	301657
GDB1566	301829
GDB1570	301456
GDB1571	301557
GDB1572	301036
GDB1573	301037
GDB1576	301030
GDB1578	301463
GDB1581	301005
GDB1582	301464
GDB1583	301649
GDB1584	301318
GDB1586	301805
GDB1587	301463
GDB1594	301662
GDB1597	301558
GDB1602	301990
GDB1604	301407
GDB1613	301678
GDB1614	301641
GDB1615	301075
GDB1621	301472
	301783
GDB1622	301752
GDB1623	301464
GDB1624	301465
GDB1626	301703
GDB1633	301718
GDB1634	301002
GDB1635	301002
GDB1646	301407
GDB1652	301770
GDB1653	301770
GDB1654	301426
GDB1655	301721
GDB1657	301678
GDB1658	301408
GDB1661	301004
GDB1665	301740
GDB1668	301860
GDB1669	301465
GDB1676	301465
GDB1677	301464
GDB1682	301892
GDB1683	301879
GDB1685	301928



 	
TRW (.../...)	
GDB1686	301678
GDB1696	301881
GDB1700	301426
	301825
GDB1715	301942
GDB1716	301941
GDB1724	301816
GDB1727	301754
GDB1745	301012
GDB1746	301015
	301426
GDB1749	301017
GDB1831	301584
GDB1844	301055
GDB1847	301070
GDB197	301123
GDB199	301182
GDB238	301171
	301212
GDB255	301212
GDB265	301389
GDB284	301052
GDB294	301105
GDB297	301091
	301219
GDB299	301103
GDB306	301817
GDB308	301081
GDB3088	301780
GDB3089	301634
GDB3092	301057
GDB3111	301668
GDB3115	301449
GDB3116	301184
GDB3133	301625
GDB3147	301551
GDB3154	301682
GDB3159	301450
GDB3161	301020
GDB3164	301540
GDB3165	301575
GDB3168	301450
GDB3169	301574
GDB3170	301817
GDB3171	301361
GDB3172	301902
GDB3175	301682
GDB3176	301760
GDB3177	301627
GDB3178	301212
GDB318	301123
GDB3181	301668
GDB3184	301266
GDB3186	301436
GDB3188	301627
GDB3190	301682
GDB3191	301682
GDB3192	301629
GDB3194	301780
GDB3195	301316
GDB3196	301627



 	
TRW (.../...)	
GDB3197	301535
GDB3198	301865
GDB3201	301908
GDB3207	301551
GDB3209	301629
GDB3211	301574
GDB3212	301760
GDB3216	301361
GDB3218	301606
GDB3223	301895
GDB323	301266
GDB3231	301780
GDB3240	301887
GDB3242	301737
GDB3243	301577
GDB3244	301759
GDB3246	301518
GDB3247	301520
GDB325	301047
GDB3256	301574
GDB3257	301505
GDB3258	301748
GDB3259	301574
GDB3261	301821
GDB3262	301274
GDB3267	301022
GDB3268	301887
GDB3269	301682
GDB327	301002
	301075
	301081
GDB3270	301521
GDB3271	301054
GDB3274	301668
GDB328	301080
GDB3282	301748
GDB3283	301574
GDB3284	301748
GDB3287	301886
GDB3289	301680
GDB3292	301472
GDB3294	301672
GDB3297	301505
GDB3298	301748
GDB3299	301506
GDB3301	301821
GDB3311	301780
GDB3314	301862
GDB3316	301827
GDB3324	301736
GDB3328	301853
GDB3330	301644
GDB3331	301052
GDB3332	301641
GDB3340	301889
GDB3341	301852
GDB3342	301842
GDB3345	301361
GDB3348	301874
GDB3352	301744
GDB3364	301857



 	
TRW (.../...)	
GDB3367	301705
GDB3368	301817
GDB3371	301853
GDB3377	301708
GDB3378	301781
GDB3386	301744
GDB3387	301748
GDB3389	301493
GDB3392	301337
GDB3393	301009
	301672
GDB3396	301847
GDB341	301129
GDB3410	301035
GDB3418	301937
GDB3419	301932
GDB342	301129
GDB3420	301868
GDB3421	301867
GDB3422	301744
GDB3425	301943
GDB3426	301819
GDB3429	301890
GDB3432	301748
GDB3433	301821
GDB3481	301943
GDB351	301402
GDB358	301047
GDB360	301125
GDB367	301123
GDB371	301335
GDB373	301052
GDB391	301270
GDB394	301129
GDB400	301002
GDB4010	301906
GDB404	301003
GDB4104	301491
GDB422	301091
GDB425	301002
	301061
GDB446	301119
	301176
GDB447	301179
GDB457	301219
GDB458	301091
	301219
GDB459	301124
GDB466	301125
	301142
GDB469	301406
GDB472	301240
GDB496	301022
GDB497	301022
GDB499	301053
GDB648	301099
GDB656	301099
GDB663	301099
GDB698	301219
GDB764	301052



 	
TRW (.../...)	
GDB766	301123
	301618
GDB773	301268
	301274
GDB774	301682
GDB775	301053
GDB791	301048
GDB793	301179
GDB794	301156
GDB798	301266
GDB807	301002
GDB808	301176
GDB809	301002
GDB814	301125
GDB817	301241
GDB818	301044
	301315
GDB823	301180
GDB826	301003
GDB833	301095
	301219
GDB848	301054
	301450
GDB852	301095
GDB854	301003
GDB868	301266
GDB870	301020
GDB883	301666
GDB887	301624
GDB893	301052
GDB895	301574
GDB897	301172
GDB905	301158
GDB906	301156
GDB908	301081
GDB911	301345
GDB914	301183
GDB915	301183
GDB916	301231
GDB917	301259
GDB951	301184
GDB952	301253
GDB953	301043
	301171
GDB957	301256
GDB968	301002
GDB974	301497
GDB976	301497
GDB979	301272
GDB986	301292
GDB987	301272
GDB995	301627





 	
<b>ALFA ROMEO</b>	
0000794962	301219
00071712910	301581
00077362276	301407
00077362675	301407
0009945750	301125
0009945775	301581
0009947776	301040
0009947935	301065
0009947955	301023
0009948092	301023
0009948334	301023
0009948577	301581
0009948845	301990
0009949134	301065
0009949332	301407
0009949334	301407
0009949334	301407
0009949412	301023
0009950479	301142
0009950637	301065
0009950713	301142
0009950714	301142
0009950778	301065
0009959479	301142
0060711959	301099
0060724069	301099
0060727286	301099
0060743578	301125
0060760120	301125
0060765020	301142
0060777600	301219
0060777601	301142
0060778263	301099
0060810239	301219
0071712910	301581
009950479	301142
5892735	301219
60724069	301099
60765020	301142
60777600	301219
60777601	301142
60778263	301099
71712910	301581
71752984	301142
71752987	301581
71752994	301219
71753039	301990
71753044	301065
77362187	301125
77362222	301023
77362228	301023
77362229	301990
77362231	301990
77362242	301142
77362254	301023
77362257	301581
77362275	301407
77362276	301407
77362300	301040
77362675	301407
77362683	301990
77363341	301407

 	
<b>ALFA ROMEO (.../...)</b>	
77364920	301407
77365786	301407
794962	301219
93806190	301129
93806593	301129
9945750	301125
9945775	301581
9947935	301065
9948334	301023
9948577	301581
9948845	301990
9949134	301065
9949332	301407
9949334	301407
9950479	301142
9950637	301065
9950778	301065
<b>AUDI</b>	
171698151B	301099
171698151C	301099
171698151H	301099
1J0698151	301332
1J0698151A	301332
1J0698151B	301332
1J0698151D	301408
1J0698151E	301408
1J0698151F	301408
1J0698151G	301408
1J0698151J	301332
1J0698151M	301486
1J0698451	301463
1J0698451B	301463
1J0698451D	301463
1J0698451F	301180
1J0698451H	301463
1J0698451J	301463
1J0698451L	301463
1J0698451N	301180
1J0698451P	301463
1K0698151	301635
1K0698151A	301408
1K0698151F	301408
1K0698451	301752
1K0698451A	301463
1K0698451B	301752
1K0698451C	301463
1K0698451D	301752
1K0698451E	301752
1K0698451F	301752
1K0698451G	301752
1K0698451H	301752
1K0698451J	301463
1K0698451K	301752
3C0698151B	301635
3C0698151C	301635
431698151D	301003
431698151F	301003
431698151G	301003
437698151	301003
443698151D	301003
443698151F	301003



 	
<b>AUDI (.../...)</b>	
443698151J	301003
443698151K	301003
443698451	301125
443698451A	301125
443698451B	301125
447698451	301125
447698451A	301125
4A0698451	301125
4B0698151	301483
4B0698151A	301483
4B0698151AB	301483
4B0698151B	301483
4B0698151C	301483
4B0698151E	301483
4B0698151H	301483
4B0698151J	301483
4B0698151K	301751
4B0698151M	301483
4B0698151N	301751
4B0698451	301463
4B0698451B	301463
4B0698451E	301463
4B3698451	301004
4D0698451	301125
4D0698451A	301125
4D0698451B	301125
4D0698451C	301463
4D0698451D	301463
4D0698451E	301463
4E0698451	301004
4F0698151	301751
4F0698451	301004
4F0698451A	301752
4F0698451D	301752
4F0698451E	301752
4F0698451F	301004
5K0698151	301635
6Q0698451B	301674
6R0698151A	301332
6X0698451A	301463
7L0698451B	301770
7L0698451G	301770
7L5698451	301770
803698151C	301099
811698151	301099
857698451	301125
859698151	301016
859698151A	301016
861698151A	301099
8A0698151A	301003
8A0698151B	301003
8A0698151C	301003
8D0698151	301003
8D0698151A	301355
8D0698151C	301355
8E0698151	301003
8E0698151A	301003
8E0698151B	301484
8E0698151F	301751
8E0698151K	301483
8E0698151M	301484



 	
<b>AUDI (.../...)</b>	
8E0698451	301463
8E0698451A	301463
8E0698451B	301180
8E0698451C	301004
8E0698451D	301463
8E0698451E	301463
8E0698451F	301752
8E0698451J	301752
8E0698451K	301463
8E0698451L	301474
8E0698451M	301752
8E0698451N	301004
8J0698151	301635
8J0698151C	301635
8N0698151A	301486
8Z0698151	301734
<b>AUTOBIANCHI</b>	
5892310	301091
71748384	301091
792489	301219
792561	301091
793470	301219
<b>BEDFORD</b>	
90167765	301182
90398758	301182
94483220	301020
<b>BMW</b>	
34 11 1 157 039	301231
34 11 1 157 569	301231
34 11 1 157 813	301231
34 11 1 158 265	301231
34 11 1 159 259	301231
34 11 1 159 279	301231
34 11 1 160 356	301018
34 11 1 160 450	301231
34 11 1 160 459	301231
34 11 1 161 437	301018
34 11 1 161 438	301018
34 11 1 161 445	301018
34 11 1 161 446	301018
34 11 1 162 535	301231
34 11 1 163 307	301412
34 11 1 163 387	301310
34 11 1 163 850	301018
34 11 1 163 953	301310
34 11 1 164 330	301310
34 11 1 164 331	301310
34 11 1 164 498	301018
34 11 1 164 500	301018
34 11 1 164 627	301409
34 11 1 164 629	301409
34 11 1 164 737	301018
34 11 1 165 227	301412
34 11 1 165 555	301018
34 11 1 165 556	301018
34 11 1 165 557	301018
34 11 2 228 248	301231
34 11 2 282 166	301412
34 11 2 282 554	301231
34 11 2 282 556	301412
34 11 2 283 865	301410



 	
<b>BMW (.../...)</b>	
34 11 3 427 503	301412
34 11 6 752 482	301018
34 11 6 752 731	301018
34 11 6 753 668	301410
34 11 6 756 128	301018
34 11 6 761 237	301018
34 11 6 761 242	301018
34 11 6 761 244	301018
34 11 6 761 252	301412
34 11 6 761 278	301409
34 11 6 761 279	301310
34 11 6 761 280	301409
34 11 6 761 283	301410
34 11 6 763 089	301410
34 11 6 763 591	301410
34 11 6 763 617	301640
34 11 6 763 618	301640
34 11 6 764 540	301410
34 11 6 767 191	301410
34 11 6 767 580	301410
34 11 6 771 868	301640
34 11 6 781 873	301410
34 11 6 799 166	301640
34 21 1 157 334	301259
34 21 1 157 563	301259
34 21 1 157 757	301103
34 21 1 157 758	301103
34 21 1 157 814	301259
34 21 1 157 925	301103
34 21 1 157 926	301103
34 21 1 158 266	301259
34 21 1 158 270	301259
34 21 1 158 562	301259
34 21 1 158 642	301103
34 21 1 158 912	301103
34 21 1 158 919	301103
34 21 1 159 003	301103
34 21 1 159 273	301103
34 21 1 159 276	301103
34 21 1 159 912	301103
34 21 1 160 198	301103
34 21 1 160 199	301259
34 21 1 160 340	301386
34 21 1 160 341	301386
34 21 1 161 455	301386
34 21 1 161 456	301386
34 21 1 162 446	301386
34 21 1 162 866	301103
34 21 1 163 324	301580
34 21 1 163 326	301580
34 21 1 163 395	301311
34 21 1 164 499	301753
34 21 1 164 501	301753
34 21 1 164 581	301580
34 21 1 164 582	301580
34 21 1 165 233	301386
34 21 1 165 235	301386
34 21 2 226 013	301103
34 21 3 403 241	301580
34 21 4 398 213	301753
34 21 6 750 160	301580













 	
<b>BMW (.../...)</b>	
34 21 6 750 190	301753
34 21 6 761 238	301386
34 21 6 761 239	301753
34 21 6 761 240	301580
34 21 6 761 241	301753
34 21 6 761 248	301580
34 21 6 761 253	301259
34 21 6 761 281	301311
34 21 6 763 043	301754
34 21 6 763 044	301754
34 21 6 767 150	301703
34 21 6 773 161	301703
34 21 6 774 692	301703
<b>CADILLAC</b>	
13322091	301783
93183140	301783
93188111	301678
93188112	301678
93190338	301783
<b>CHEVROLET</b>	
13300867	301055
13301234	301070
13319294	301055
96273708	301316
96281945	301316
96288629	301316
96316582	301316
96391892	301902
96405131	301874
96446176	301316
96446742	301361
96475027	301361
96495227	301361
96534653	301644
96626070	301942
96626076	301941
<b>CHRYSLER</b>	
5114 555AA	301636
5126 300AA	301444
<b>CITROËN</b>	
4251-10	301064
4251-17	301010
4251-28	301360
4251-37	301075
4251-38	301074
4251-39	301074
4251-40	301075
4251-44	301069
4251-46	301396
4251-47	301075
4251-55	301326
4251-56	301031
4251-69	301726
4251-70	301074
4251-72	301292
4251-83	301292
4251-89	301360
4251-92	301726
4251-97	301396
4252-03	301462
4252-05	301726



 	
<b>CITROËN (.../...)</b>	
4252-18	301464
4252-26	301429
4252-33	301463
4252-35	301465
4252-36	301500
4252-40	301464
4252-41	301463
4252-43	301568
4252-45	301569
4252-47	301570
4252-53	301465
4252-57	301396
4252-58	301500
4252-72	301075
4252-73	301075
4252-74	301396
4252-85	301360
4252-91	301031
4253-05	301726
4253-06	301074
4253-21	301156
4253-28	301718
4253-30	301464
4253-31	301465
4253-42	301464
4253-45	301500
4253-60	301892
4253-69	301500
4253-70	301465
4253-84	301500
4253-91	301852
4254-02	301396
4254-05	301783
4254-07	301426
4254-20	301474
4254-23	301464
4254-28	301463
4254-41	301463
4254-48	301852
4254-50	301074
4254-51	301010
4254-53	301064
4254-55	301429
4254-58	301568
4254-59	301569
4254-67	301463
4254-68	301570
4254-69	301892
4254-71	301465
4254-74	301718
4254-75	301464
4254-82	301074
4254-83	301075
4254-84	301462
4254-85	301326
4254-87	301726
4254-89	301465
4254-90	301396
4254-92	301465
4254-93	301360
4254-96	301426



 	
<b>CITROËN (.../...)</b>	
4254-98	301075
4254-99	301075
4254-C5	301463
95611498	301119
95616818	301119
95619601	301156
95647733	301119
95650872	301292
95650936	301156
95650938	301156
95651047	301292
95654085	301292
95659340	301155
95659341	301396
95659616	301155
95659642	301292
95666970	301155
95666971	301396
95666973	301292
95667786	301031
95667788	301292
<b>DACIA</b>	
410602192R	301002
410608481R	301641
6001547619	301002
6001547911	301002
6001549803	301017
7701207066	301002
7701208265	301002
7701208422	301641
7701209639	301002
7701210142	301002
7711130071	301002
<b>DAEWOO</b>	
11046948322	301356
11046948372	301356
11046952012	301184
96245178	301361
96245179	301902
96253367	301361
96253368	301902
96253382	301361
96288629	301316
96316582	301316
96391892	301902
96405131	301874
96446742	301361
96495227	301361
96534653	301644
S4521001	301902
S4521006	301902
<b>DAF</b>	
RTC4812	301129
<b>DAIHATSU</b>	
04466-0D010	301028
04492-87101-000	301624
04492-87102-000	301624
<b>DODGE</b>	
5191271AA	301852
<b>F.S.O. / POLSKI</b>	
063576	301095



 	
<b>FIAT</b>	
4434879	301219
5888147	301219
5888153	301219
5888781	301095
5892309	301091
5892310	301091
5892330	301095
5892549	301219
5892650	301125
5892727	301219
5892728	301219
5892732	301219
5892733	301219
5892734	301219
5892735	301219
5892737	301012
5892738	301219
5951660	301091
5951671	301091
5983918	301219
71748384	301091
71752978	301569
71752979	301568
71752980	301010
71752984	301142
71752994	301219
71753039	301990
77362091	301426
77362185	301012
77362186	301006
77362193	301065
77362194	301426
77362216	301569
77362219	301568
77362231	301990
77362242	301142
77362245	301012
77362267	301012
77362274	301570
77362479	301012
77363604	301678
77363958	301721
77363992	301426
77364016	301892
77364224	301678
77364394	301426
77364517	301426
77364567	301407
77364588	301426
77364636	301015
77364637	301426
77364832	301426
77364839	301407
77364919	301426
77365113	301721
77365337	301012
792487	301219
792489	301219
792588	301219
792589	301091
792725	301091

 	
<b>FIAT (.../...)</b>	
793184	301219
793220	301219
793221	301219
793323	301091
793325	301091
793356	301219
793357	301219
793382	301095
793385	301219
793470	301219
794079	301095
794091	301219
794963	301219
795121	301219
9404252328	301463
9939503	301125
9939966	301142
9940969	301125
9941605	301142
9941669	301142
9941873	301125
9942904	301142
9942953	301142
9943830	301095
9945496	301142
9945629	301125
9945788	301010
9945821	301142
9945822	301142
9945823	301142
9946016	301064
9947007	301142
9947118	301040
9947156	301065
9947629	301040
9947630	301006
9948045	301012
9948054	301012
9948095	301023
9948222	301006
9948476	301065
9948626	301429
9949048	301006
9949173	301142
9949183	301012
9949273	301426
9949362	301569
9949407	301570
9949482	301568
9949516	301568
9949517	301569
9951217	301990
<b>FORD</b>	
1001095	301008
1001096	301463
1010502	301171
1010503	301212
1013843	301043
1015598	301172
1022079	301033
1027640	301463

 	
<b>FORD (.../...)</b>	
1027703	301008
1030601	301171
1031843	301008
1039106	301212
1042688	301212
1048308	301399
1048309	301172
1048310	301399
1064762	301043
1064763	301212
1073731	301034
1073732	301033
1074971	301036
1074972	301037
1075558	301317
1075565	301431
1079347	301034
1079348	301033
1079919	301171
1079920	301212
1095201	301034
1095202	301033
1096940	301033
1096942	301034
1101464	301564
1107698	301431
1111857	301563
1111858	301563
1121894	301433
1121895	301434
1126718	301433
1126719	301434
1128463	301564
1129986	301005
1130120	301434
1130715	301563
1130751	301172
1130753	301399
1130758	301033
1130759	301034
1133446	301565
1133447	301681
1133448	301681
1133748	301172
1133750	301399
1136519	301317
1151377	301801
1152316	301434
1204845	301434
1205557	301463
1206062	301563
1206064	301564
1207104	301434
1207518	301681
1207519	301681
1219892	301434
1219894	301434
1227108	301434
1236880	301564
1250688	301433
1301589	301036



 	
<b>FORD (.../...)</b>	
1301592	301037
1321517	301649
1343513	301681
1343514	301463
1345337	301681
1345340	301463
1355950	301639
1356392	301740
1359884	301639
1360254	301472
1360303	301639
1360304	301783
1360305	301649
1371402	301816
1379971	301879
1425407	301431
1426143	301928
1426144	301928
1433952	301816
1436498	301879
1437761	301879
1439866	301928
1458247	301879
1459450	301928
1465126	301171
1488962	301816
1503969	301928
1504143	301005
1508074	301649
1519528	301649
1521325	301033
1521326	301034
1521328	301564
1521414	301005
1553797	301816
1559697	301015
1560014	301816
1571570	301129
1571571	301129
1571572	301129
1637872	301240
1638880	301240
1642643	301129
1647730	301335
1652206	301240
1672938	301005
1721087	301816
4346371	301639
4387361	301639
4387371	301472
4427737	301639
5010553	301129
5015935	301129
5018194	301212
5018899	301212
5018908	301129
5020817	301335
5022398	301129
5023994	301212
5025919	301043
5025929	301171



 	
<b>FORD (.../...)</b>	
5028763	301036
5028764	301037
5029147	301034
5029148	301033
6130483	301212
6132807	301212
6165965	301129
6178479	301212
6180371	301172
6188427	301043
6197738	301036
6197739	301037
6203650	301171
6500951	301335
6500952	301172
6500954	301172
6511773	301212
6567002	301129
6669780	301005
6704268	301212
6704269	301335
6704271	301172
6785599	301240
6877836	301034
6877837	301033
6882582	301033
6882584	301034
6962492	301172
6965579	301036
6965580	301037
7017948	301399
7018202	301036
7018203	301037
7075049	301172
7075050	301172
7153477	301005
7261715	301033
91AB2K021BB	301172
91AB2K021JA	301172
91AB2K021JB	301172
92VB2K021AB	301036
92VB2K021AC	301036
92VB2K021BB	301037
92VB2K021BC	301037
<b>FORD USA</b>	
3886184	301906
3894048	301629
3898530	301629
3922123	301629
<b>GALLOPER</b>	
58101-M2A01	301625
<b>HONDA</b>	
06022-SP8-000	301053
06430-S5A-E50	301627
06430-S7S-000	301682
43022-S2A-000	301682
43022-S2A-E50	301682
43022-S3N-000	301682
43022-S3N-E50	301682
43022-S5A-E50	301682
43022-S5A-J00	301682



 	
<b>HONDA (.../...)</b>	
43022-S6D-000	301682
43022-S6D-E50	301682
43022-S7S-010	301682
43022-S9A-E51	301682
43022-S9A-E52	301682
43022-SE0-N50	301053
43022-SEA-E01	301682
43022-SF1-000	301053
43022-SF1-010	301053
43022-SF1-305	301053
43022-SF1-315	301053
43022-SG0-020	301682
43022-SH3-930	301053
43022-SH3-931	301053
43022-SH3-932	301053
43022-SH3-G00	301053
43022-SH3-G01	301053
43022-SM4-950	301682
43022-SM4-G00	301682
43022-SN7-000	301682
43022-SP0-E00	301682
43022-SP0-E01	301682
43022-SP0-E02	301682
43022-SP0-E03	301682
43022-ST3-E00	301053
43022-ST3-E50	301053
43022-SV4-A00	301682
43022-SV4-A20	301682
43022-SV4-G00	301682
43022-SV4-G20	301682
43022-SV4-G22	301682
43022-SX0-A51	301682
43022-SY8-A01	301682
43022-SZ3-A01	301682
43022-SZ3-E50	301682
45022-S04-G00	301760
45022-S04-J02	301760
45022-S10-A00	301627
45022-S10-E50	301627
45022-S1A-E02	301436
45022-S1A-E20	301627
45022-S1A-E50	301436
45022-S1A-E70	301627
45022-S30-A00	301627
45022-S30-A02	301627
45022-S6D-E01	301022
45022-S6D-E50	301022
45022-S6D-E51	301022
45022-S74-E10	301022
45022-S74-E50	301022
45022-S7A-E00	301887
45022-SA5-000	301047
45022-SA5-010	301047
45022-SA5-020	301047
45022-SAG-600	301052
45022-SAG-N50	301052
45022-SAA-G00	301760
45022-SB0-505	301047
45022-SB0-670	301047
45022-SB0-671	301047



 	
<b>HONDA (.../...)</b>	
45022-SB0-672	301047
45022-SB2-670	301047
45022-SB2-671	301047
45022-SB2-672	301047
45022-SB2-673	301047
45022-SB2-674	301047
45022-SB2-675	301047
45022-SH3-G00	301047
45022-SH3-G03	301047
45022-SH3-G50	301047
45022-SH3-N30	301047
45022-SJF-E00	301887
45022-SK3-E00	301022
45022-SL0-G00	301627
45022-SL0-G01	301627
45022-SL0-G02	301627
45022-SM5-A00	301627
45022-SN7-G50	301627
45022-SP0-E00	301627
45022-SR3-910	301047
45022-SR3-920	301047
45022-SR3-G00	301760
45022-SR3-G01	301760
45022-SS0-G00	301627
45022-SS0-G01	301627
45022-SS0-G02	301627
45022-ST3-E00	301022
45022-ST3-E01	301022
45022-ST3-E30	301022
45022-ST7-R00	301627
45022-ST7-R01	301627
45022-ST7-R02	301627
45022-SZ3-G00	301887
<b>HYUNDAI</b>	
58101-02A00	301575
58101-02A10	301708
58101-05A10	301575
58101-1CA00	301052
58101-1CA10	301052
58101-1G-E00	301868
58101-1HA10	301842
58101-1HA20	301842
58101-1JA10	301868
58101-1RA05	301021
58101-22A00	301052
58101-22A10	301052
58101-24A00	301052
58101-24B00	301052
58101-24C00	301052
58101-25A10	301052
58101-26A10	301505
58101-26A30	301505
58101-28A00	301574
58101-28A10	301052
58101-28A20	301574
58101-29A00	301574
58101-29A10	301574
58101-29A20	301574
58101-29A30	301574
58101-29A40	301574
58101-29A50	301574







 	
<b>HYUNDAI (.../...)</b>	
58101-29A90	301574
58101-29B00	301574
58101-2BA10	301937
58101-2CA20	301744
58101-2DA20	301574
58101-2DA40	301781
58101-2DA60	301781
58101-2EA11	301744
58101-32300	301052
58101-32310	301052
58101-32B00	301052
58101-33A00	301574
58101-33C00	301574
58101-34A10	301574
58101-34A20	301574
58101-34A21	301574
58101-35A10	301574
58101-38A40	301574
58101-38A80	301744
58101-38A81	301744
58101-39A40	301505
58101-3AA20	301759
58101-3K-A40	301744
58101-43A00	301634
58101-44A00	301634
58101-4AA00	301908
58101-4AA26	301505
58101-4AA30	301908
58101-4AA31	301908
58101-4AA32	301908
58101-4AA60	301908
58101-4AA61	301908
58101-4BA00	301634
58101-4LA00	301021
58101-H1A00	301506
58101-H1A10	301506
58101-H1A80	301506
58101-M2A01	301625
58302-17A00	301748
58302-1CA00	301748
58302-1CA10	301748
58302-1GA00	301867
58302-1HA10	301867
58302-1JA30	301867
58302-1KA30	301867
58302-1RA30	301301
58302-26A00	301748
58302-26A30	301748
58302-29A00	301817
58302-29A10	301817
58302-2BA20	301932
58302-2DA10	301817
58302-2EA30	301748
58302-2SA30	301867
58302-2SA70	301867
58302-2VA50	301301
58302-2YA30	301867
58302-38A10	301748
58302-38A20	301748
58302-38A30	301748
58302-39A40	301748



 	
<b>HYUNDAI (.../...)</b>	
58302-3AA20	301748
58302-3JA50	301308
58302-3KA30	301748
58302-3KA35	301301
58302-3KA40	301748
58302-3ZA10	301301
58302-3ZA70	301301
58302-4HA50	301308
<b>INFINITI</b>	
41060-EG090	301337
D4060-EG50C	301009
<b>ISUZU</b>	
8-94483-220-1	301020
8-97035-266-0	301507
8-97039-269-0	301507
97039269	301507
<b>IVECO</b>	
1902294	301129
1906154	301129
<b>JAGUAR</b>	
C2C27271	301783
C2S17129	301433
C2S17362	301434
C2S20893	301434
<b>JEEP</b>	
4713 175	301491
4778 058	301491
4778 058AB	301491
4883 344	301491
<b>KIA</b>	
0K2JA-33-28Z	301842
0K2JA-33-28ZA	301842
0K553-33-23Z	301491
0K553-33-23ZA	301491
0K553-33-23ZB	301491
0K56A-33-23Z	301821
0K56B-33-23ZA	301821
0K58A-3323Z	301821
0K72G-33-28Z	301821
0K75A-33-28Z	301821
0K75B-33-28Z	301821
58101-1DE00	301934
58101-1FE00	301744
58101-1G-E00	301868
58101-1HA00	301842
58101-1MA20	301842
58101-1WA05	301021
58101-1WA35	301021
58101-2F-A20	301705
58101-2FA21	301705
58101-2TA50	301294
58101-3CA20	301574
58101-3K-A40	301744
58101-3QA50	301294
58101-M2A02	301574
58101-M2A04	301574
58302-1FE00	301748
58302-1G-A00	301867
58302-1HA00	301867
58302-1PA30	301584
58302-1WA35	301301



 	
<b>KIA (.../...)</b>	
58302-2F-A10	301817
58302-2G-A00	301748
58302-2SA30	301867
58302-2SA70	301867
58302-2YA30	301867
58302-38A10	301748
58302-38A20	301748
58302-39A40	301748
58302-3CA10	301748
58302-4DE00	301308
58302-A6A20	301301
K0BA2-33-28Z	301274
KK150-33-28Z	301268
MDA19-33-28Z	301268
<b>LADA</b>	
2101-350109001	301405
2108-3501080	301406
2108-3501089	301406
21213-3501090	301389
2121-3501090	301389
<b>LANCIA</b>	
5892310	301091
5892330	301095
5892650	301125
5892728	301219
5892732	301219
5892733	301219
5892734	301219
5892735	301219
5983919	301219
5983950	301219
71737179	301012
71748384	301091
71752984	301142
71752987	301581
71752994	301219
71753039	301990
77362185	301012
77362202	301023
77362231	301990
77362242	301142
77362248	301012
77362254	301023
77362276	301407
77362309	301219
77365786	301407
792561	301091
792698AV	301219
792699AV	301219
793132AV	301219
793271	301219
793322	301091
793355	301219
793470	301219
794079	301095
794091	301219
9404252328	301463
9939503	301125
9940969	301125
9941211	301142
9941873	301125



 	
<b>LANCIA (.../...)</b>	
9942904	301142
9942953	301142
9944395	301180
9945496	301142
9945629	301125
9945821	301142
9945822	301142
9945823	301142
9946016	301064
9946568	301581
9947156	301065
9947468	301012
9947482	301219
9947629	301040
9947630	301006
9947916	301581
9948054	301012
9948095	301023
9948338	301407
9949048	301006
9949173	301142
9949183	301012
9949334	301407
9951101	301023
9951217	301990
<b>LAND ROVER</b>	
LRO04936	301879
RTC3163	301129
RTC3164	301497
RTC4519	301497
RTC5756	301129
RTC6591	301497
SFP000120	301580
SFP000150	301497
SFP000270	301497
STC1276	301497
STC8569	301497
STC8570	301497
STC9147	301497
STC9148	301497
STC9188	301497
STC9189	301497
<b>LEXUS</b>	
04465-53020	301035
04465-53040	301035
04465-60230	301535
04466-60070	301865
<b>LEYLAND</b>	
RTC4812	301129
<b>MAZDA</b>	
1E06-33-23Z	301212
1E06-33-23ZA	301212
1E06-33-23ZB	301212
1E07-33-23Z	301564
1E07-33-23ZA	301564
1E10-33-23Z	301564
1E12-33-23Z	301563
B3YF-33-23Z	301649
B4Y6-33-23Z	301274
B4Y6-33-23ZA	301274
B5Y6-33-23Z	301274



 	
<b>MAZDA (.../...)</b>	
B5Y6-33-23ZA	301274
B5Y6-33-28Z	301274
B5Y6-33-28ZA	301274
B5Y8-33-23Z	301274
B5Y8-33-23ZA	301274
B5Y8-33-28ZB	301274
BCYC-33-23Z	301274
BCYW-33-23Z	301274
BCYW-33-23ZC	301274
BPYK-33-23Z	301649
BPYK-33-23ZA	301649
BRY7-33-23ZA	301274
BWYH-26-43Z	301624
CBY0-33-23Z	301629
CBY1-33-23ZA	301629
CBY1-33-23ZD	301629
CBY1-33-23ZE	301629
CBY1-33-23ZF	301629
CBY1-33-23ZG	301629
CBY9-33-23Z	301629
DA19-33-28ZA	301268
DDY2-33-28Z	301564
E0Y8-26-43Z	301624
E0Y8-26-43ZA	301624
E0Y8-26-43ZB	301624
FB71-26-28ZA	301780
GAYR-33-23ZA	301629
GBYH-33-23Z	301629
GCYD-33-23Z	301629
GCYD-33-23ZA	301629
GCYD-33-23ZB	301629
GCYD-33-23ZC	301629
GCYD-33-23ZD	301629
GEYC-26-48Z	301780
GEYC-26-48ZA	301780
GEYT-33-28Z	301629
GEYT-33-28ZA	301629
GGYB-26-43Z	301780
GGYM-26-43Z	301780
GJYB-26-43Z	301780
GJYB-26-48Z	301780
GPYB-26-48Z	301780
NAV0-26-43Z	301624
NAV0-26-43ZA	301624
<b>MCC</b>	
4544200920	301318
4544201020	301319
4544210010	301493
<b>MERCEDES</b>	
0004208820	301105
0004209120	301241
0004209720	301300
0004209820	301345
0004209920	301315
0004209920WC	301315
0014200120	301105
0014201020	301241
0014208120	301241
0014209520	301272
0014209620	301241
0024200220	301241

 	
<b>MERCEDES (.../...)</b>	
0024200520	301617
0024201620	301617
0024202120	301013
0024202220	301013
0024203920	301044
0024204020	301046
0024204420	301357
0024204520	301636
0024204620	301617
0024204820	301062
0024205020	301636
0024205120	301763
0024206020	301046
0024207120	301444
0024207420	301444
0024208020	301617
0024209620	301357
0024209920	301044
0034200020	301062
0034200520	301445
0034201820	301445
0034202420	301300
0034202520	301448
0034202620	301448
0034202720	301444
0034203020	301617
0034204220	301445
0034204520	301448
0034204820	301617
0034204920	301617
0034205920	301448
0034206020	301448
0034206520	301638
0034208320	301636
0034209520	301448
0034209920	301638
0044200320	301636
0044200420	301445
0044200720	301636
0044201620	301617
0044202520	301300
0044205520	301044
0044208220	301881
0044208720	301638
0044209120	301444
0054200320	301013
0054201720	301272
0054204620	301013
0054206220	301448
1634200620	301445
1634200820	301445
1634201020	301445
1684200020	301549
1684200120	301549
1684200420	301583
1684200720	301549
1684200820	301549
1694200420	301583
1694201120	301583
4144200120	301583



 	
<b>MG</b>	
EJP1437	301053
SFP000070	301436
SFP000080	301682
SFP000370	301436
SFP000380	301753
SFP000390	301022
SFP000410	301022
SFP100260	301022
SFP100520	301753
<b>MINI</b>	
34 21 6 778 327	301041
<b>MITSUBISHI</b>	
4605A041	301518
4605A261	301886
4605A447	301520
4605A479	301852
4605A487	301520
4605A491	301886
4605A493	301852
4605A557	301886
4605A558	301852
4605A658	301493
4605A879	301886
M620770	301319
M850976	301493
M850978	301319
MB699266	301625
MB699453	301517
MB858375	301625
MB858380	301519
MB858463	301519
MB895072	301625
MB928049	301517
MN102628	301520
MN116445	301518
MN125772	301319
MR205269	301519
MR235557	301318
MR249241	301318
MR389532	301625
MR389533	301625
MR389537	301625
MR389541	301625
MR389542	301517
MR389543	301517
MR389544	301517
MR389546	301517
MR389547	301522
MR389548	301517
MR389550	301522
MR389571	301519
MR389572	301519
MR407946	301318
MR475453	301521
MR510544	301520
MR527656	301493
MR527675	301886
MR527868	301518
MR569403	301886
MR955068	301852
MR955351	301493



 	
<b>MITSUBISHI (.../...)</b>	
MR977117	301318
MW30620770	301319
<b>NISSAN</b>	
41060-00QAE	301545
41060-00QAF	301726
41060-00QAG	301726
41060-03R85	301123
41060-03R86	301123
41060-04C85	301123
41060-08N90	301618
41060-08N91	301618
41060-08N92	301618
41060-09W26	301123
41060-09W92	301123
41060-09W93	301123
41060-11P86	301123
41060-11P92	301123
41060-11P93	301123
41060-11P94	301123
41060-13E85	301123
41060-13E90	301123
41060-16C90	301123
41060-1F025	301014
41060-21P92	301123
41060-23C90	301618
41060-23C91	301618
41060-23C92	301618
41060-23C93	301618
41060-23C94	301618
41060-25N25	301123
41060-27N91	301618
41060-2F025	301054
41060-2F026	301054
41060-2F027	301054
41060-2F257	301450
41060-2F525	301450
41060-2F526	301450
41060-2F527	301450
41060-2S790	301618
41060-2S791	301618
41060-31E85	301123
41060-31E88	301123
41060-31E90	301123
41060-31E91	301123
41060-31E92	301123
41060-32E91	301123
41060-37G93	301123
41060-3S590	301618
41060-4M525	301054
41060-4M526	301054
41060-51E86	301123
41060-56L25	301123
41060-5M325	301450
41060-5M326	301450
41060-5T091	301123
41060-6F625	301014
41060-6F626	301014
41060-71J25	301054
41060-71J26	301054
41060-95FOA	301747
41060-99B25	301014



 	
<b>NISSAN (.../...)</b>	
41060-99B26	301014
41060-9C025	301123
41060-9C026	301123
41060-AX625	301641
41060-BM425	301054
41060-BM525	301450
41060-D1488	301123
41060-D4690	301123
41060-D6090	301123
41060-EB325	301337
41060-V5094	301123
41060-V6791	301123
41060-V6794	301123
41060-V7085	301618
41060-V7090	301123
41060-V7091	301618
41060-V7093	301618
41060-VJ490	301618
41060-VK190	301889
41060-Y9601	301123
41083-AX626	301641
44060 BA00F	301472
44060-0M890	301449
44060-0N690	301668
44060-31U90	301668
44060-31U92	301668
44060-3F025	301057
44060-3F085	301057
44060-4U090	301668
44060-61E91	301817
44060-70J26	301057
44060-73C91	301668
44060-75C90	301668
44060-7E690	301668
44060-8H385	301672
44060-90E90	301817
44060-99B25	301642
44060-99B85	301642
44060-AL585	301672
44060-AV625	301472
44060-AV725	301472
44060-BM425	301057
44060-BM426	301057
44060-D3591	301817
D1060-11P27	301123
D1060-11P86	301123
D1060-11P87	301123
D1060-11P88	301123
D1060-11P91	301123
D1060-11P92	301123
D1060-11P93	301123
D1060-2S790	301618
D1060-32E25	301123
D1060-AX60A	301641
D1060-AX61A	301641
D1060-AX61F	301641
D1060-JD00A	301067
D1060-V6794	301123
D1060-V7090	301618
D1060-V7091	301618
D1060-VK190	301889



 	
<b>NISSAN (.../...)</b>	
D4060-4U090	301668
D4060-8H385	301672
D4060-BM40A	301057
D4060-EM11A	301009
D4060-JA00A	301009
DA060-EB325	301337
<b>OPEL</b>	
1605000	301322
1605002	301661
1605004	301256
1605006	301183
1605009	301454
1605025	301926
1605026	301183
1605031	301183
1605033	301256
1605034	301322
1605035	301454
1605036	301305
1605039	301926
1605040	301926
1605047	301183
1605067	301458
1605070	301322
1605080	301860
1605081	301456
1605084	301661
1605086	301584
1605087	301356
1605088	301678
1605089	301184
1605091	301322
1605092	301456
1605093	301926
1605094	301678
1605095	301678
1605098	301678
1605099	301860
1605105	301926
1605113	301678
1605117	301783
1605122	301584
1605123	301941
1605128	301584
1605136	301678
1605137	301678
1605139	301678
1605196	301783
1605252	301860
1605258	301825
1605282	301678
1605283	301678
1605353	301825
1605357	301825
1605359	301825
16053590	301825
1605455	301356
1605456	301860
1605466	301099
1605543	301099
1605586	301182







 	
<b>OPEL (.../...)</b>	
1605625	301584
1605670	301182
1605687	301183
1605703	301182
1605704	301182
1605710	301099
1605712	301099
1605728	301253
1605746	301184
1605782	301256
1605783	301182
1605787	301182
1605788	301182
1605789	301184
1605791	301182
1605795	301182
1605799	301183
1605808	301184
1605810	301356
1605820	301182
1605824	301356
1605825	301020
1605851	301507
1605870	301182
1605877	301253
1605879	301183
1605881	301356
1605883	301183
1605907	301356
1605911	301184
1605912	301305
1605916	301020
1605924	301183
1605931	301020
1605932	301256
1605947	301458
1605957	301454
1605959	301322
1605961	301926
1605964	301456
1605965	301457
1605966	301305
1605967	301584
1605972	301678
1605973	301472
1605974	301456
1605992	301860
1605993	301783
1605994	301457
1605995	301584
1605996	301860
1605997	301860
1605998	301860
1777990	301305
4414021	301545
4414519	301545
4708239	301847
4808861	301942
542039	301055
542040	301055
542115	301070



 	
<b>PEUGEOT</b>	
4248-87	301081
4248-91	301099
4250-32	301081
4250-33	301081
4250-35	301081
4250-37	301176
4250-39	301176
4250-42	301396
4250-49	301081
4250-50	301081
4250-51	301081
4250-55	301179
4250-56	301180
4250-57	301081
4250-71	301396
4250-72	301081
4250-75	301081
4250-76	301081
4250-77	301176
4250-78	301179
4250-82	301176
4250-87	301179
4250-88	301081
4250-90	301156
4250-91	301181
4250-92	301181
4250-93	301179
4250-95	301179
4250-97	301081
4251-02	301155
4251-04	301396
4251-08	301180
4251-09	301064
4251-16	301010
4251-20	301181
4251-21	301038
4251-22	301038
4251-27	301075
4251-30	301063
4251-31	301068
4251-32	301069
4251-34	301074
4251-35	301179
4251-41	301081
4251-42	301074
4251-43	301069
4251-48	301396
4251-52	301462
4251-54	301326
4251-60	301069
4251-64	301156
4251-65	301181
4251-67	301074
4251-79	301099
4251-82	301466
4251-95	301466
4251-96	301396
4252-04	301461
4252-08	301063
4252-12	301461
4252-19	301466



 	
<b>PEUGEOT (.../...)</b>	
4252-21	301464
4252-22	301465
4252-23	301463
4252-24	301429
4252-28	301461
4252-29	301462
4252-32	301463
4252-38	301464
4252-39	301464
4252-42	301568
4252-44	301569
4252-46	301570
4252-50	301465
4252-51	301466
4252-52	301465
4252-56	301396
4252-59	301464
4252-61	301081
4252-62	301081
4252-63	301181
4252-64	301181
4252-65	301181
4252-66	301063
4252-67	301074
4252-68	301068
4252-70	301179
4252-71	301396
4252-75	301075
4252-76	301464
4252-77	301662
4252-82	301176
4252-84	301156
4252-86	301360
4253-02	301461
4253-03	301461
4253-04	301074
4253-11	301396
4253-14	301181
4253-15	301038
4253-16	301038
4253-19	301726
4253-20	301461
4253-27	301718
4253-35	301662
4253-38	301464
4253-39	301465
4253-41	301464
4253-47	301662
4253-59	301892
4253-85	301465
4253-90	301852
4253-96	301180
4254-06	301426
4254-18	301465
4254-20	301474
4254-22	301662
4254-23	301464
4254-28	301463
4254-41	301463
4254-42	301396
4254-48	301852



 	
<b>PEUGEOT (.../...)</b>	
4254-50	301074
4254-51	301010
4254-53	301064
4254-55	301429
4254-58	301568
4254-59	301569
4254-67	301463
4254-68	301570
4254-69	301892
4254-71	301465
4254-74	301718
4254-75	301464
4254-83	301081
4254-84	301462
4254-85	301326
4254-86	301464
4254-87	301726
4254-89	301465
4254-90	301396
4254-92	301465
4254-93	301360
4254-94	301461
4254-96	301426
4254-98	301181
4254-99	301075
4254-C5	301463
<b>PORSCHE</b>	
955 352 939 00	301770
955 352 939 01	301770
955 352 939 02	301770
955 352 939 50	301770
<b>PROTON</b>	
MB858375	301625
MR389533	301625
<b>RENAULT</b>	
410602192R	301002
410607125R	301473
410607613R	301471
410607716R	301471
410608481R	301641
410608713R	301558
410609192R	301557
440600002R	301783
440600295R	301474
440600364R	301180
440601689R	301783
440603511R	301180
440603530R	301474
440605713R	301474
440607960R	301474
6000008018	301002
6000008126	301002
6000008895	301061
6025070807	301002
6025308186	301007
6025371279	301545
6025371650	301180
7701050914	301545
7701054771	301545
7701201669	301002
7701201773	301002



 	
<b>RENAULT (.../...)</b>	
7701201774	301002
7701201775	301002
7701202050	301061
7701202057	301081
7701202210	301396
7701202213	301080
7701202216	301081
7701202217	301081
7701202227	301080
7701202283	301081
7701202284	301002
7701202289	301002
7701202302	301081
7701202308	301396
7701202475	301081
7701202517	301080
7701202518	301081
7701202662	301396
7701202710	301080
7701202711	301081
7701202847	301081
7701202848	301002
7701202891	301080
7701202892	301081
7701202896	301061
7701202973	301061
7701203070	301061
7701203124	301007
7701203633	301007
7701203635	301080
7701203668	301158
7701203726	301007
7701203775	301002
7701203795	301002
7701203796	301002
7701203797	301002
7701203842	301080
7701203919	301158
7701203968	301061
7701203969	301396
7701204036	301158
7701204066	301002
7701204220	301061
7701204357	301002
7701204358	301002
7701204417	301061
7701204530	301081
7701204626	301396
7701204664	301396
7701204708	301081
7701204833	301002
7701204845	301396
7701204903	301081
7701205015	301007
7701205277	301080
7701205355	301002
7701205513	301726
7701205995	301726
7701205996	301726
7701206288	301061
7701206343	301180

 	
<b>RENAULT (...)</b>	
7701206379	301473
7701206599	301471
7701206609	301472
7701206747	301471
7701206784	301180
7701206811	301726
7701207034	301396
7701207066	301002
7701207484	301180
7701207615	301471
7701207672	301558
7701207673	301557
7701207695	301180
7701207968	301472
7701207977	301471
7701207996	301783
7701208122	301558
7701208142	301726
7701208182	301471
7701208213	301180
7701208265	301002
7701208416	301180
7701208421	301180
7701208422	301641
7701209077	301061
7701209380	301473
7701209444	301558
7701209639	301002
7701209735	301474
7701209809	301471
7701209810	301471
7701209841	301474
7701210142	301002
7701349751	301002
7701349969	301081
7711130008	301081
7711130034	301081
7711130036	301002
7711130071	301002
8305252531	301491
D4060-JA00A	301009
<b>ROVER</b>	
EJ1P1437	301053
GBP90315AF	301022
GBP90316AF	301053
GBP90321AF	301022
GBP90324AF	301022
GBP90325AF	301022
GBP90329AF	301627
GBP90331AF	301682
GBP90336AF	301022
GBP90339AF	301682
GBP90340AF	301022
GBP90341AF	301753
RTC3163	301129
RTC3164	301497
RTC4519	301497
RTC5756	301129
RTC6591	301497
SFP000070	301436
SFP000080	301682



 	
<b>ROVER (...)</b>	
SFP000370	301436
SFP000380	301753
SFP000390	301022
SFP000410	301022
SFP100180EVA	301022
SFP100190EVA	301022
SFP100260	301022
SFP100520	301753
<b>SAAB</b>	
12799240	301472
12800120	301678
12803551	301678
13322091	301783
4467072	301253
4778254	301305
4836987	301183
4837241	301183
5057336	301183
5058110	301753
5062203	301305
7872906	301099
93183140	301783
93185751	301678
93188111	301678
93188112	301678
93190338	301783
<b>SEAT</b>	
191698151G	301124
191698451C	301180
191698451D	301180
1H0698151A	301066
1H0698151B	301403
1H0698451A	301180
1H0698451C	301180
1H0698451D	301463
1H0698451E	301180
1H0698451F	301180
1HM698151	301330
1HM698151A	301330
1J0698151	301332
1J0698151A	301332
1J0698151B	301332
1J0698151D	301408
1J0698151E	301408
1J0698151G	301408
1J0698151H	301332
1J0698151J	301332
1J0698151M	301486
1J0698451	301463
1J0698451C	301463
1J0698451F	301180
1J0698451G	301463
1J0698451J	301463
1J0698451K	301463
1J0698451L	301463
1J0698451M	301180
1J0698451P	301463
1K0698151	301635
1K0698151A	301408



 	
<b>SEAT (...)</b>	
1K0698151F	301408
1K0698451A	301463
1K0698451C	301463
1K0698451D	301752
1K0698451F	301752
1K0698451G	301752
1K0698451H	301752
1K0698451J	301463
357698151	301003
357698151A	301016
357698151B	301252
357698151E	301330
3C0698151B	301635
3C0698151C	301635
3C0698451E	301752
3C0698451F	301752
4D0698451C	301463
5K0698151	301635
6N0698151	301488
6N0698151C	301488
6Q0698151	301332
6Q0698151A	301667
6Q0698151B	301805
6Q0698151C	301720
6Q0698451	301674
6Q0698451B	301674
6X0698451	301463
6X0698451A	301463
7D0698451F	301650
7M0698151	301008
7M0698451	301463
7M3698151A	301565
7M3698151B	301801
7M3698451	301681
7M3698451B	301681
7M3698451C	301681
7M3698451D	301650
7M3698451F	301650
867698151	301258
8E0698151K	301483
8E0698151M	301484
8E0698451J	301752
8E0698451L	301474
8N0698151A	301486
SE021165081A	301091
SE021165081B	301091
SE022165081A	301091
SE131165081A	301091
SE141165081A	301091
<b>SKODA</b>	
1J0698151	301332
1J0698151A	301332
1J0698151B	301332
1J0698151D	301408
1J0698151E	301408
1J0698151G	301408
1J0698151H	301332
1J0698151J	301332
1J0698151M	301486
1J0698451	301463
1J0698451C	301463



 	
<b>SKODA (...)</b>	
1J0698451F	301180
1J0698451G	301463
1J0698451J	301463
1J0698451K	301463
1J0698451M	301180
1J0698451P	301463
1J0698451S	301463
1K0698151	301635
1K0698151A	301408
1K0698151D	301408
1K0698151F	301408
1K0698451	301752
1K0698451C	301463
1K0698451D	301752
1K0698451G	301752
1K0698451H	301752
1K0698451J	301463
1K0698451K	301752
3B0698451A	301463
3C0698151B	301635
3C0698151C	301635
4B0698151AB	301483
4B0698151J	301483
4B0698151N	301751
5K0698151	301635
6N0698151B	301330
6N0698151C	301488
6Q0698151	301332
6Q0698151A	301667
6Q0698151B	301805
6Q0698151C	301720
6Q0698451	301674
6Q0698451B	301674
6R0698151A	301332
8E0698151J	301483
8E0698451A	301463
8E0698451K	301463
8N0698151A	301486
<b>SSANGYONG</b>	
48130-091A0	301505
48413-21B10	301748
<b>SUBARU</b>	
26296 AG040	301853
26296 FC001	301895
26296 FC002	301895
26296 FE081	301853
26296 FG010	301853
26296 SA011	301853
26296 SA020	301853
26296 SA030	301853
26296SA010	301853
26696 AG020	301895
26696 FC001	301895
26696 FC002	301895
55200-61880	301666
<b>SUZUKI</b>	
55200-61880	301666
55200-62840	301666
55800-62G00	301624
55800-62G01	301624
55810-62J00	301847

 	
<b>SUZUKI (...)</b>	
55810-62J20	301847
55810-62J50	301847
<b>TALBOT</b>	
4248-87	301081
4248-91	301099
4250-75	301081
4251-79	301099
<b>TOYOTA</b>	
04465-02170	301943
04465-05010	301551
04465-0D010	301736
04465-0D040	301736
04465-0H020	301718
04465-10040	301266
04465-12020	301266
04465-12040	301266
04465-12090	301266
04465-12220	301266
04465-12490	301266
04465-12610	301943
04465-13030	301827
04465-16010	301266
04465-16040	301266
04465-16070	301266
04465-16120	301266
04465-17070	301266
04465-17100	301737
04465-17101	301737
04465-17140	301737
04465-20120	301551
04465-20160	301266
04465-20170	301266
04465-20200	301266
04465-20270	301266
04465-20300	301266
04465-20500	301827
04465-26210	301402
04465-26230	301402
04465-26330	301402
04465-2B040	301827
04465-33020	301551
04465-33040	301551
04465-33050	301551
04465-33260	301862
04465-33440	301890
04465-33450	301890
04465-35290	301857
04465-42010	301551
04465-42011	301551
04465-44020	301551
04465-52010	301737
04465-52011	301737
04465-52070	301606
04465-52130	301606
04465-52140	301606
04465-59020	301606
04465-60120	301535
04465-60140	301535
04465-60150	301535
04465-60151	301535
04465-60160	301535









 	
<b>TOYOTA (.../...)</b>	
04465-60230	301535
04465-60240	301535
04465-60270	301857
04466-02070	301680
04466-02160	301680
04466-0D010	301028
04466-20020	301540
04466-20060	301540
04466-20090	301577
04466-32010	301540
04466-33160	301819
04466-33180	301819
04466-42060	301819
04466-52010	301577
04466-52020	301577
04466-52030	301577
04466-52040	301577
04466-52050	301577
04466-60030	301865
04466-60070	301865
04491-05010	301551
04491-10161	301266
04491-12170	301266
04491-12230	301266
04491-12231	301266
04491-12250	301266
04491-12251	301266
04491-12280	301266
04491-12281	301266
04491-12320	301266
04491-12321	301266
04491-12322	301266
04491-12323	301266
04491-12330	301266
04491-12331	301266
04491-12421	301266
04491-12422	301266
04491-12432	301266
04491-12440	301266
04491-12490	301266
04491-12491	301266
04491-12540	301266
04491-12541	301266
04491-12650	301551
04491-12651	301551
04491-16040	301266
04491-16041	301266
04491-17030	301266
04491-20191	301266
04491-20192	301266
04491-20220	301266
04491-20310	301266
04491-20311	301266
04491-20380	301266
04491-20470	301266
04491-20471	301266
04491-20500	301266
04491-20501	301266
04491-20581	301402
04491-20590	301266
04491-20591	301266



 	
<b>TOYOTA (.../...)</b>	
04491-20620	301266
04491-20670	301266
04491-20680	301266
04491-20710	301266
04491-20740	301266
04491-20820	301266
04491-20890	301551
04491-26030	301402
04491-26040	301402
04491-26070	301402
04491-26071	301402
04491-26150	301402
04491-26151	301402
04491-2B010	301551
04491-32030	301266
04491-32031	301266
04491-32081	301266
04491-32151	301266
04491-32341	301402
04491-33011	301551
04491-33030	301551
04491-33080	301551
04491-35051	301402
04491-35063	301402
04491-42010	301551
04491-42011	301551
04491-42012	301551
04491-50060	301266
04492-20010	301540
04492-20011	301540
04492-20022	301540
04492-20090	301540
04492-20100	301540
04492-32070	301540
04492-32080	301540
04492-33010	301540
04492-33030	301540
04492-33031	301540
<b>VAUXHALL</b>	
13300867	301055
13301234	301070
13319294	301055
13322091	301783
18024962	301458
18045382	301458
90010584	301182
90167765	301182
90273260	301183
90297357	301182
90297358	301182
90297537	301253
90398116	301256
90398235	301182
90398758	301182
90398759	301182
90398760	301184
90398800	301182
90399437	301182
90399495	301184
90421528	301183



 	
<b>VAUXHALL (.../...)</b>	
90421736	301356
90442385	301182
90442995	301356
90443902	301182
90485136	301253
90485138	301183
90485140	301356
90487271	301183
90510331	301356
90511162	301184
90512037	301305
90540177	301183
90541257	301020
90541293	301256
90544001	301454
90544025	301322
90544439	301305
9117717	301926
91376429	301454
9192124	301256
9192125	301183
9192126	301183
9192157	301454
9192180	301507
9192181	301507
9193251	301926
9193476	301183
9195058	301183
9195077	301256
9195144	301322
9195145	301454
9195146	301305
9195147	301926
9195607	301322
9195641	301926
9195642	301926
9195685	301926
9198598	301926
9198688	301305
9199257	301545
9200108	301456
9200132	301457
9201354	301183
93166798	301678
93169143	301584
93169254	301825
93170602	301584
93171035	301322
93172174	301678
93172190	301472
93172261	301456
93173641	301545
93175378	301678
93176114	301456
93176115	301860
93176116	301783
93176118	301584
93176120	301356
93176121	301678
93176122	301184
93176429	301860



 	
<b>VAUXHALL (.../...)</b>	
93178789	301457
93179164	301584
93179707	301860
93181189	301860
93183140	301783
93183728	301678
93183729	301678
93184269	301456
93184519	301322
93185751	301678
93185752	301678
93186003	301678
93186713	301860
93188111	301678
93188112	301678
93188727	301584
93189698	301860
93189815	301825
93190338	301783
93190577	301584
93191697	301825
93191698	301825
93192578	301860
93192639	301356
93192962	301847
94483220	301020
95507655	301584
96626070	301942
96626076	301941
97039269	301507
97114300	301020
97201441	301661
97227235	301661
<b>VOLKSWAGEN</b>	
171698151B	301099
171698151C	301099
171698151D	301099
171698151E	301099
171698151H	301099
191698151B	301124
191698151G	301124
191698451	301180
191698451A	301180
191698451B	301180
191698451C	301180
191698451D	301180
1E0698451	301180
1E0698451A	301180
1H0698151A	301066
1H0698151B	301403
1H0698451	301180
1H0698451A	301180
1H0698451C	301180
1H0698451D	301463
1H0698451E	301180
1H0698451F	301180
1HM698151	301330
1HM698151A	301330
1J0698151	301332
1J0698151A	301332
1J0698151B	301332



 	
<b>VOLKSWAGEN (.../...)</b>	
1J0698151D	301408
1J0698151E	301408
1J0698151F	301408
1J0698151G	301408
1J0698151J	301332
1J0698151K	301486
1J0698151M	301486
1J0698451	301463
1J0698451B	301463
1J0698451C	301463
1J0698451D	301463
1J0698451E	301463
1J0698451F	301180
1J0698451G	301463
1J0698451J	301463
1J0698451K	301463
1J0698451L	301463
1J0698451P	301463
1K0698151	301635
1K0698151A	301408
1K0698151D	301408
1K0698151F	301408
1K0698451	301752
1K0698451A	301463
1K0698451C	301463
1K0698451D	301752
1K0698451E	301752
1K0698451F	301752
1K0698451G	301752
1K0698451H	301752
1K0698451J	301463
1K0698451K	301752
1K0698451M	301463
2D0698151	301044
2D0698151C	301044
2D0698451	301046
2D0698451B	301300
2E0698151A	301881
311698151C	301099
321698151B	301124
321698151D	301124
321698151E	301124
321698151H	301124
357698151	301003
357698151A	301016
357698151B	301252
357698151C	301982
357698151E	301330
3B0698451A	301463
3C0698151	301635
3C0698151A	301635
3C0698151B	301635
3C0698151C	301635
3C0698451	301752
3C0698451A	301752
3C0698451B	301752
3C0698451C	301752
3C0698451D	301752
3C0698451E	301752
3C0698451F	301752
411698151E	301099

 	
<b>VOLKSWAGEN (.../...)</b>	
431698151D	301003
431698151F	301003
431698151G	301003
437698151	301003
437698451	301125
443698151A	301003
443698151C	301003
443698151D	301003
443698151F	301003
443698151G	301003
443698151H	301003
443698151J	301003
443698151K	301003
443698451	301125
443698451A	301125
443698451B	301125
447698451	301125
447698451A	301125
447698451C	301125
440698451	301125
480698151E	301483
480698151J	301483
480698151N	301751
480698451	301463
480698451B	301463
480698451E	301463
4D0698451A	301125
4D0698451C	301463
5K0698151	301635
6E0698151	301735
6N0698151	301488
6N0698151A	301330
6N0698151B	301330
6N0698151C	301488
6Q0698151	301332
6Q0698151A	301667
6Q0698151B	301805
6Q0698151C	301720
6Q0698451	301674
6Q0698451B	301674
6R0698151A	301332
6X0698451	301463
6X0698451A	301463
701698151	301048
701698151A	301048
701698151B	301048
701698151E	301622
701698151F	301048
701698151G	301048
701698151H	301048
701698151J	301622
701698451	301482
7D0698151	301675
7D0698151B	301814
7D0698151E	301675
7D0698151G	301814
7D0698451A	301482
7D0698451B	301650
7D0698451E	301482
7D0698451F	301650
7D0698451G	301482

 	
<b>VOLKSWAGEN (.../...)</b>	
7D0698451J	301482
7H0698451A	301004
7L0698451A	301770
7L0698451B	301770
7L0698451G	301770
7L6698451A	301770
7M0698151	301008
7M0698451	301463
7M3698151A	301565
7M3698151B	301801
7M3698451	301681
7M3698451C	301681
7M3698451D	301650
7M3698451E	301681
7M3698451F	301650
803698151C	301099
811698151	301099
857698451	301125
861698151	301099
861698151A	301099
867698151	301258
8A0698151B	301003
8D0698151A	301355
8D0698151C	301355
8D0698151F	301355
8E0698151	301003
8E0698151A	301003
8E0698151B	301484
8E0698151M	301484
8E0698451	301463
8E0698451A	301463
8E0698451K	301463
8N0698151A	301486
<b>VOLVO</b>	
270166.2	301270
271477	301270
271586.0	301270
271587.8	301616
271702.3	301270
271758.5	301270
271824.5	301270
271962.3	301270
272343.5	301616
272399.7	301480
272401.1	301479
272407.8	301270
272463.1	301270
272911.9	301270
274285	301030
274330	301829
274331	301657
274528	301829
30620770	301319
30623253	301493
30623259	301493
30623264	301319
30648381	301616
30648382	301480
30648383	301270
30648385	301479
30648387	301479

 	
<b>VOLVO (.../...)</b>	
30665552	301480
30683554	301649
30715023	301649
30736610	301783
30742030	301649
30742031	301783
30793093	301829
30793265	301030
30793941	301879
30794554	301928
30794555	301928
30850976.9	301493
30850978.5	301319
3345670.8	301318
3345678.1	301319
8623861	301479
8623862	301480
8634921	301479
8634925	301480
9485267	301616
9485593	301616

 	
<b>VOLVO (.../...)</b>	

 	
<b>VOLVO (.../...)</b>	





# W skrócie o Коротко о Valeo First



Ponad  
Более

**300**  
referencji  
артикулов

**80%**

pokrycia parku  
samochodowego  
покрытия парка

**100%**

jakości "Valeo"  
Качество "Valeo"

## 1 **FIRST** rozwiniesz swój biznes

### Profesjonalna linia produktowa

- Certyfikat ECE R90
- Dołączone niezbędne akcesoria
- Zabezpieczenie antykorozyjne

### Atrakcyjna oferta

- Dedykowane na rynek IAM
- W ofercie aplikacje do najpopularniejszych modeli samochodów
- Szeroka gama aplikacji

### Nowoczesne opakowanie

- Łatwe do rozpoznania
- Łatwe w przechowywaniu
- Łatwe w sprzedaży



## Увеличьте продажи с **FIRST**

### Умный продукт

- Сертифицирован ECE R90
- Разумный подбор ассортимента аксессуаров
- Полная антикоррозийная обработка

### Умный ассортимент

- Товар специально для постгарантийных автомобилей
- Акцент на ходовые позиции
- Применяемость на иностранные модели

### Умная упаковка

- Легко найти
- Легко хранить
- Легко продавать

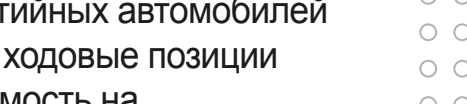
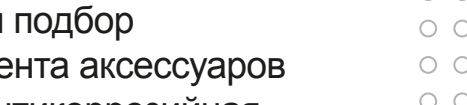

*Make the clever choice*

# Valeo First subito en un vistazo

**300**  
riferimenti  
referencias

Copertura dell'  
**80%**  
del parco circolante  
de cobertura del parque

**100%**  
qualità della gamma  
"Valeo"  
Calidad "Valeo"



## **FIRST** farà crescere le vostre vendite

### Prodotto intelligente

- Certificato ai sensi del Regolamento ECE R90
- Livello adeguato di accessori
- Trattamento anti-ruggine completo

### Gamma intelligente

- Prodotti dedicati al mercato IAM
- Focus sulle pastiglie con il maggior livello di vendite
- Applicazioni per veicoli internazionali

### Packaging intelligente

- Facile da identificare
- Facile da tenere in magazzino
- Facile da vendere



## **FIRST** disparará sus ventas

### Producto Inteligente

- Certificado ECE R90
- Con los accesorios adecuados
- Completo tratamiento antioxidante

### Gama Inteligente

- Producto específico para postventa
- Centrada en las pastillas de máxima rotación
- Con aplicaciones de coches a nivel internacional

### Envase Inteligente

- Fácil de identificar
- Fácil de almacenar
- Fácil de vender

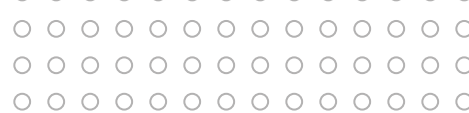
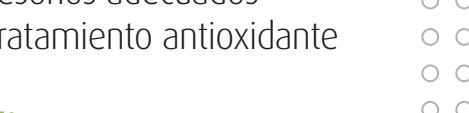

*Make the clever choice*

# Bir bakışta Един поглед към Valeo First



**300**

den fazla referans  
Повече от 300  
референции

**80%**

araç parkı  
kapsama oranı  
покрытие на  
автопарка

**100%**

"Valeo" kalitesi  
Качество "Valeo"

## FIRST

ile satışlarınızı **arttıracaksınız**

### Akıllı ürün

- ECE R90 sertifikalı
- Yeterli seviyede donanım
- Paslanmaya karşı tam işlemden geçirilmiş

### Akıllı seri

- Yenileme pazarına özel ürün
- Hızlı referans içeriği
- Uluslararası araç uygulamaları

### Akıllı ambalaj

- Kolay anlaşılabilir
- Kolay stoklama
- Kolay satış



**Увеличете продажбите с**

## FIRST

### Интелигентен продукт

- Сертифицирани по ECE R90
- Правилен подбор на аксесоари
- Анти-корозионна защита

### Интелигентен асортимент

- Продукт предназначен за вторично вграждане
- Фокус върху най-продаваните накладки
- Подходящи за широка гама автомобили

### Интелигентна опаковка

- Лесни за идентифициране
- Лесни за складиране
- Лесни за продажба

*Make the clever choice*

# Valeo First με μία ματιά na prvi pogled

**300+**

κωδικοί  
reference

**80%**

κάλυψη του  
πάρκου  
αυτοκινήτων  
pokrivenost auto  
delova

**100%**

όσον αφορά την ποιότητα  
της γκάμας "Valeo"  
opseg kvaliteta "Valeo"



Η σειρά **FIRST**  
θα ενδυναμώσει τις  
πωλήσεις σας

## Έξυπνο προϊόν

- Πιστοποιημένο με ECE R90
- Με το σωστό επίπεδο αξεσουάρ
- Πλήρης Διαχείριση κατά της σκουριάς

## Έξυπνη σειρά

- Προϊόν σχεδιασμένο για το IAM
- Εστιάζοντας σε τακάκια με υψηλές πωλήσεις
- Διεθνείς Εφαρμογές αυτοκινήτων

## Έξυπνη συσκευασία

- Εύκολη αναγνώριση
- Εύκολη αποθήκευση
- Εύκολη πώληση



**FIRST**  
će pojačati vaše prodaje

## Pametni proizvodi

- ECE R90 sertifikovan
- Pravi stepen opreme
- Detaljan tretman protiv korozije

## Pametna opseg

- Namenski IAM proizvod
- Fokus na najprodavanije pločice
- Međunarodne prijave vozila

## Pametni paket

- Lako se indetifikuje
- Lako se skladišti
- Lako se prodaje

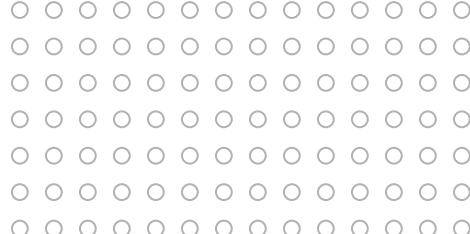
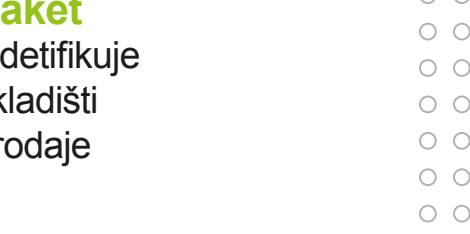
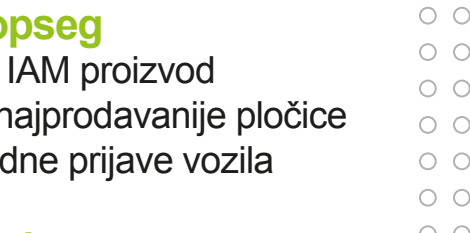
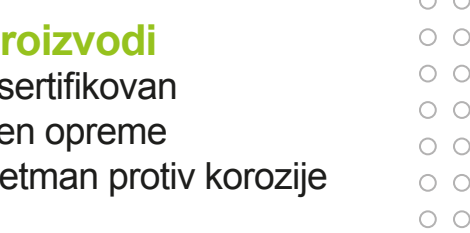

*Make the clever choice*

# Valeo First pe scurt kínálat áttekintése

**300+**

repere  
Több mint 300  
cikkszám

**80%**

acoperire parc  
auto  
járműpark lefedettség

**100%**

calitate gamă "Valeo"  
minősítés "Valeo"



## **FIRST** impulsionează creșterea vânzărilor

### Produs inteligent

- Certificat ECE R90
- Număr optim de accesorii
- Tratament anti-rugină complet

### Gamă inteligentă

- Produs aftermarket dedicat
- Accent pus pe cele mai vândute repere
- Pentru parc auto internațional

### Pachetaj inteligent

- Ușor de identificat
- Ușor de stocat
- Ușor de vandut



## Fejlessze fel üzletét a

## **FIRST** fékbetétekkel

### Okos termék

- ECE R90 homologáció
- Optimális kiegészítők a csomagolásban
- Teljeskörű korrózió védelem

### Okos választék

- Kifejezetten a pótalkatrész piacra tervezve
- A legnépszerűbb autó modellekhez
- Magas nemzetközi lefedettség

### Okos csomagolás

- Egyszerű beazonosítani
- Egyszerű raktározni
- Egyszerű eladni

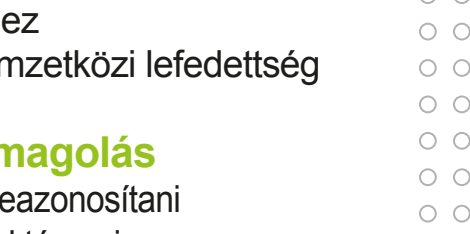
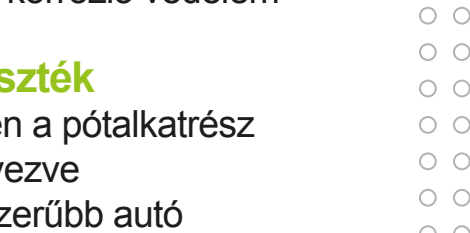
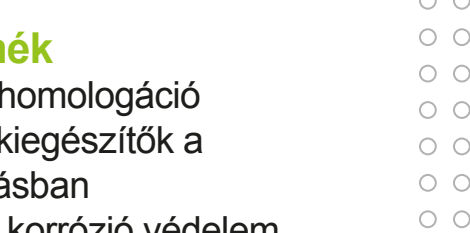

*Make the clever choice*

# Valeo First at a glance en un coup d'œil

**300+**  
références  
références

**80%**  
car parc coverage  
de couverture de parc

**100%**  
"Valeo" quality range  
qualité Valeo



## **FIRST** will **boost** your sales

### **Clever product**

- ECE R90 certified
- Right level of accessories
- Full anti-rust treatment

### **Clever range**

- Dedicated IAM product
- Focus on top selling pads
- International car applications

### **Clever pack**

- Easy to identify
- Easy to stock
- Easy to sell

## **FIRST** fait **décoller** vos ventes

### **Un produit astucieux**

- Homologué ECE R90
- Niveau d'accessoires adapté
- Traitement anti-corrosion complet

### **Une gamme astucieuse**

- Spécialement conçue pour la Rechange
- L'essentiel des ventes dans une gamme courte
- Couverture de parc internationale

### **Un pack astucieux**

- Facile à identifier
- Facile à stocker
- Facile à vendre

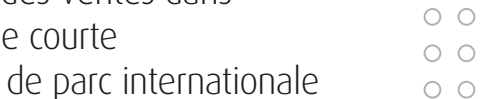

*Make the clever choice*

# Valeo, your braking systems multi-specialist\*

\*Valeo votre multispécialiste des systèmes de freinage

valeo added 



Automotive technology, naturally

**Valeo**