

Workshop Solutions

One call for complete peace of mind



Garage Equipment, Tools,
Training & Technology

Valid until 30th September 2017



Diagnostic Health Checks

NO HASSLE
WARRANTY

BEST PRICE
PROMISE

DIAGNOSTIC HEALTH CHECKS

Have you ever thought of offering your customers a diagnostic health check when they bring their vehicle to you for service or repair?

Your diagnostics equipment device is a specialist tool for extracting encrypted vehicle information that requires decoding in order for it to be understood. For a small fee, you can interrogate a vehicle's general state of health before commencing working on it. Even if you don't need diagnostics for the work you plan to do, it's quite a shrewd move when you consider the benefits.

Doing a health check before you start a job protects your customer and your workshop. First, it minimises the potential for unnecessary and unwelcome comebacks – a log of the vehicle's overall condition prior to starting work is a great safeguard against customers returning with a new, unrelated problem but claiming "It must be something you did". It can help generate additional work; pointing out issues before they become problems can lead to additional work being included while you have a car on the ramp. And, it's a straightforward revenue generator; you can add £5 or more to a customer's bill for use of this specialist equipment.



DIAGNOSTIC HEALTH CHECKS – REVENUE CALCULATOR

FROM

Daily income (Based on a £5 charge x 2 cars per day)

£10

Weekly Gross Income (5 days x £10)

£50

Annual Gross Income (Weekly gross income x 50 weeks)

£2,500

Potential gross income (from diagnostic health checks alone) over 2 years

£5,000

Whether or not you undertake any further chargeable work, a couple of diagnostic health checks every day is enough to cover the cost of most diagnostic devices within their warranty period. Isn't this reason

enough to equip each tech with their own diagnostic service tool and make sure the first thing they do each time is to "run a report"?

*Finance example typically based on a 5 year lease purchase agreement. Finance subject to status, full terms and conditions available on request. Other finance options available. All prices exclude VAT at 20%. Price, availability and specification may change without prior notice. Warranty subject to manufacturers terms and conditions of use. Errors and omissions excluded. Offers valid until 30th September 2017. Prices correct at time of going to press: June 2017.

2 0845 603 3636
OVER 200 BRANCHES NATIONWIDE

LAUNCH X431 PRO AND PRO3S

Based on the Android 5 operating system, the X431 Pro3S is the latest diagnostic tool from Launch.

With remote diagnostic features and a built-in social network, this tool encompasses the best in Launch technology and tablet computer usability.

Incorporating the best in already existing Launch diagnostic tools, the Pro3S can read and clear DTCs, read a car's data stream, perform actuation tests and much more, at lightning fast speeds.

Pro3S can perform diagnostics effectively on cars manufactured in Europe, America and Asia, and is compatible with all of their individual software; making the Pro3S one of the most reliable and all-encompassing diagnostic tools available on the market today.

Operates both wireless and bluetooth connectivity.

A built-in social network service enables users to connect to a community for help with diagnosis. Users also have access to a car database and repair tips, allowing for faster and more efficient performance.

- Full system diagnosis
- Data stream storage and re-display
- Service light resets
- Coding, reset and programming functions
- Diesel particulate filters regen/replacement
- Online technical support and advice
- Electronic parking brake reset
- Key/immobiliser coding
- VIN recognition, auto search
- Live data recording & multiple graphing
- Special functions for specific manufacturers
- Capable of 24v Heavy goods vehicle diagnosis – optional HD Truck module required Pro3S only

LAUNCH X431 PRO3S V2

355 77 5150

- Durable handheld tablet in protective silicone case.
- Easy to read & operate multi-touch capacitive LCD 10" screen.



LAUNCH X431 PRO V2

355 77 4860

- Durable handheld tablets in protective silicone case.
- Easy to read & operate multi-touch capacitive LCD 8" screen.

WEEKLY FROM ONLY **£8.54⁺**
ONLY **£1,695.00**



WEEKLY FROM ONLY **£6.02⁺**
ONLY **£1,195.00**

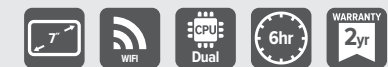

SMOKEPRO

355 77 0450

The Smoke Pro® Total Tech® is the essential tool for finding EVAP system leaks and many others including:

- EGR Valves
- Gaskets, fittings and hoses
- MAP/MAF sensors
- Worn throttle shafts
- Brake boosters
- Catalytic converters
- Central locking systems
- Diaphragms and seats
- Door and window seals
- Turbos and intercoolers
- Oil leaks
- Cracked or broken plastic components
- Head and tail lamp housings
- Cracked manifolds
- And many more!



FROM ONLY **£525.00**

*Finance example typically based on a 5 year lease purchase agreement. Finance subject to status, full terms and conditions available on request. Other finance options available. All prices exclude VAT at 20%. Price, availability and specification may change without prior notice. Warranty subject to manufacturers terms and conditions of use. Errors and omissions excluded. Offers valid until 30th September 2017. Prices correct at time of going to press: June 2017.

VDO AUTODIAGNOS CHECK II

355 77 9840

Plug & Play service tool with embedded vehicle manufacturer OE data & vehicle auto ID.

With auto vehicle identification across all major manufacturers and access to OE data, this tool offers complete coverage and enables maximum efficiency and accuracy

LARGE 5" SCREEN

OE DATA



WEEKLY FROM ONLY **£6.02⁺**
FROM ONLY **£1,195.00**

G-SCAN TAB

355 78 0050

- Runs on a Windows based tablet, or any standard Windows device, including laptop and desktop PCs
- G-scan Tab shares the same database with G-scan and G-scan2, and provides full coverage of the same functionality and reliability.
- Works on cars and commercial vehicles
- Wireless and reliable connection between the GVCI and the PC is made simple and easy via Bluetooth.
- 24V Commercial Vehicle Support – supports communication with buses and trucks, and accepts power and signals of 24V commercial vehicles.

*Requires laptop, laptop is not included.

FROM ONLY **£895.00**



BRAIN BEE CONNEX

Diagnostic Software platform supplied complete with 10.1" Tablet Device and VCI dongle, or supplied with dongle only and software licence for operating with separate Windows or Android device.

Connex is a networked platform, connecting the user to the Brain Bee cloud with live updating, automatic VIN search, vehicle technical information, guided troubleshooting (optional), and real-time assistance (optional). The Connex tablet is a semi-rugged 10.1" touchscreen.



BRAIN BEE CONNEX CABLE

355 99 0250

WEEKLY FROM ONLY **£7.55⁺**
FROM ONLY **£1,499.00**



BRAIN BEE CONNEX BLUETOOTH

355 99 0260

WEEKLY FROM ONLY **£8.56⁺**
FROM ONLY **£1,699.00**



BRAIN BEE CONNEX SMART

355 99 0410

FROM ONLY **£849.00**

*Requires laptop, laptop is not included.

*price shown does not include a subscription – a subscription is necessary to operate the device

Part Number	Description	Price
356 77 7160	BRAIN BEE CONNEX 12 MONTHS SOFTWARE SUBSCRIPTION	£620.00
356 77 7170	BRAIN BEE CONNEX 36 MONTHS SOFTWARE SUBSCRIPTION	£1,465.00

*Finance example typically based on a 5 year lease purchase agreement. Finance subject to status, full terms and conditions available on request. Other finance options available. All prices exclude VAT at 20%. Price, availability and specification may change without prior notice. Warranty subject to manufacturers terms and conditions of use. Errors and omissions excluded. Offers valid until 30th September 2017. Prices correct at time of going to press: June 2017.

G-SCAN 2

- All the outstanding capability and performance of the G-Scan, plus...
- Built in Oscilloscope excluding base model
- Digital Multimeter
- Super fast triple processor for high speed performance
- Communication line inspection function

G-SCAN 2 BASE
355 77 7650

WEEKLY FROM ONLY **£9.05⁺**
FROM ONLY **£1,795.00**

G-SCAN 2 LITE
with Oscilloscope
355 77 4020

WEEKLY FROM ONLY **£12.07⁺**
FROM ONLY **£2,395.00**

G-SCAN 2 ASIAN
Full Asian Package
355 77 4330

WEEKLY FROM ONLY **£13.58⁺**
FROM ONLY **£2,695.00**



2 YEARS FREE SOFTWARE UPDATES

2 YEARS WARRANTY

AUTEL MS908 PRO

355990270

The MS908 has been the UK's best selling premier Autel diagnostic tool. Its capabilities are optimised even further with the release of the MS908Pro with our advanced J2534 pass through device included in the package. The J2534 opens up further programming capabilities for the MS908 via the manufacturer cloud. The MS908Pro also has further programming options directly within the tool software itself without the need to use manufacturer OEM software in some cases.

WEEKLY FROM ONLY **£12.57⁺**
FROM ONLY **£2,495.00**



LAUNCH X431 EUROPAD 2S

- Durable handheld tablet in protective silicone case.
- Easy to read & operate multi-touch capacitive 10" LCD screen
- Has IP65 protection against solid objects; totally protected against dust & liquids
- Operates 4 Channel Oscilloscope, Multi meter & Endoscope camera as accessories (accessories must be purchased separately)
- Capable of 24v Heavy goods vehicle diagnosis – optional HD Truck module required

2 YEARS UPDATES

	Europad II Full
10" Diagnostic Tablet	•
Operating System	Android 5
Charging Cable	•
EOBD wireless Dongle (covers vehicles 1998 on)	•
Connector Adaptors Set (covers pre 1998 vehicles)	•
Docking Station	•
Plastic Carry Case	•
Tote Carry Bag	-
Software Updates incl.	2 years



LAUNCH X431 EUROPAD 2S
355 77 5160

WEEKLY FROM ONLY **£12.57⁺**
ONLY **£2,495.00**



*Finance example typically based on a 5 year lease purchase agreement. Finance subject to status, full terms and conditions available on request. Other finance options available. All prices exclude VAT at 20%. Price, availability and specification may change without prior notice. Warranty subject to manufacturers terms and conditions of use. Errors and omissions excluded. Offers valid until 30th September 2017. Prices correct at time of going to press: June 2017.

J-BOX 2 PASS THRU DEVICE

355 77 1450

J-Box 2, a thoroughly capable Pass Thru device that can be used for repairs and general maintenance on the majority of vehicle marques.

Easy to install on your PC, this device will help reprogramme control modules in-house, ensuring you can keep custom in your garage without needing to send customers elsewhere.

- support for over 36 OEM's
- how to videos included



WEEKLY FROM ONLY **£6.53⁺**
ONLY **£1,295.00**



EDIS TRUCK MULTIPLEXER + EDIS TRUCK SOFTWARE

355 78 0040

- Read and delete of error codes saved in the vehicle ECU
- Display and graph live vehicle data
- Adjust vehicle settings
- Activate devices and components
- Recode Electronic Keys
- Programme ECU's on many systems
- Log Data through EDIS internal memory card

Price includes EDIS Truck 12 months software subscription and 12 months Technical Support

*Requires laptop, laptop is not included.



WEEKLY FROM ONLY **£12.57⁺**
FROM ONLY **£2,495.00**



DURABOOK R11 RUGGED TABLET

355 77 9860

Ultra-thin and lightweight fully rugged tablet with 11.6" touchscreen. Equipped with a full array of communication options: WLAN, LAN, Bluetooth 4.0 (standard), 4G LTE and GPS (Optional modules), 5 Megapixel autofocus camera with LED flashlight. With 7 hours battery life. Robust features and superior performance the R11 is ideal for the workshop.

- 4G RAM
- Supplied with Windows 10
- Toughened touchscreen display
- Ultra light weight, only 1.2kg
- Processor speed 2.2 GHz
- Palm strap and stylus available (optional extra)



WEEKLY FROM ONLY **£7.03⁺**
ONLY **£1,395.00**



DURABOOK SA14S SEMI-RUGGED NOTEBOOK

355 77 3260

Full-function, tough and durable notebook with 14" HD LED display, Windows 10, and complete connectivity pack. Offers flexibility moving between the workshop and the desk.

- Rugged Features – IP53 and MIL-STD 810G certified.
- Built with high-quality magnesium alloy to withstand rough treatment.
- Advanced Touchscreen Display
- 8G RAM
- Supplied with Windows 10
- Processor speed 2.3 GHz
- 500GB HDD



WEEKLY FROM ONLY **£8.04⁺**
ONLY **£1,595.00**



*Finance example typically based on a 5 year lease purchase agreement. Finance subject to status, full terms and conditions available on request. Other finance options available. All prices exclude VAT at 20%. Price, availability and specification may change without prior notice. Warranty subject to manufacturers terms and conditions of use. Errors and omissions excluded. Offers valid until 30th September 2017. Prices correct at time of going to press: June 2017.

KTS560, KTS590

- Works with any Windows-based PC that has a licensed version of the Bosch diagnostics software ES[tronic]2.0 installed. Performs Pass Thru by working with OEM software*
- Operates OEM software with many approvals already in place
- Supports all of today's relevant diagnostic protocols including Diagnostics over Internet Protocol (DoIP) – and that means it's capable of all the latest OEM procedures
- USB2.0 and Bluetooth® connections means you can either stay tethered or not – your choice.
- Rugged design with high resistance to dust and water

ASK FOR A DEMO



*minimum spec. Windows7 and above

KTS560
355 77 9240

WEEKLY FROM ONLY **£9.05+**
ONLY **£1,795.00**



KTS590
WITH BUILT-IN OSCILLOSCOPE
355 77 9220

WEEKLY FROM ONLY **£11.06+**
ONLY **£2,195.00**



DCU100 TABLET
355 77 9830

ALL NEW HARDWARE – GREAT FOR THE MOBILE TECH!

- Ergonomic rubberised handgrips enables easier handling
- Robust Design: Suitable to work in any workshop conditions
- Integrated Bluetooth (Class 1) enables mobility and minimises cable clutter in the workshop
- Wifi enabled: Allowing web access
- SD card slot : Provides flexibility for data transfer
- Lithium-ion battery and easy to engage standby button: Prolongs the battery life



WEEKLY FROM ONLY **£10.05+**
ONLY **£1,995.00**

*ESI subscription required



SUPERFAST BOOT-UP AND PROCESSING

DCU 220
355 99 0190

Carefully thought out details make operation easier

- Easily switched from tablet to notebook mode – continue to work as you change
- Sturdy housing with 11.6" touchscreen monitor – view more data in one go
- Integrated camera: Document and use to show customers or order parts photographed

Mobile work over extended periods

- Inclusion of two identical lithium-ion batteries
- If required, batteries can be replaced without interruption (hot swap function)



WEEKLY FROM ONLY **£12.07+**
ONLY **£2,395.00**

*ESI subscription required



*Finance example typically based on a 5 year lease purchase agreement. Finance subject to status, full terms and conditions available on request. Other finance options available. All prices exclude VAT at 20%. Price, availability and specification may change without prior notice. Warranty subject to manufacturers terms and conditions of use. Errors and omissions excluded. Offers valid until 30th September 2017. Prices correct at time of going to press: June 2017.

KTS350
355 77 9850

NEW

The new KTS 350 is a compact all-in-one tester consisting of a 10-inch tablet PC and an integrated communication module.

Thanks to this versatile solution, the KTS 350 is ideally suited as a tester for independent workshops, fast fitter or as a second device for mobile use. With the preinstalled Bosch diagnostic application ESI[tronic] 2.0, the KTS 350 provides an efficient overall package for control unit diagnosis, maintenance, troubleshooting and repair.

- Supports the new, Ethernet-based data protocols and is therefore perfectly prepared for the future demands of the automotive environment.
- Supports the PassThru Technology. This allows you to reprogram vehicle ECUs via OEM portals (separate subscriptions from each OEM required).
- Improved processor and modern SSD technology means a quick system start and fast working.
- Equipped with Windows 10 which means you can install additional applications. This means it can be easily integrated in your existing workflows.



*ESI subscription required

WEEKLY FROM ONLY **£17.61[†]**
ONLY **£3,495.00**

BUY A KTS350 AND STD. 12 MONTHS ESI SUBSCRIPTION AND GET ESI MASTER 12 MONTH SUBSCRIPTION

ESI[TRONIC] 2.0

ESI[tronic] 2.0 software is used in conjunction with the KTS range of diagnostic tools for vehicle fault diagnosis and service function procedures. The range of features available through the software is truly vast.

THE MAIN ESI PACKAGE ARE:

SD Diagnostics

Enables users to:

- Read Fault codes
- Erase Fault codes
- Collect Actual Data Values
- Actuate Components
- Carry out Function Tests
- Carry out service functions such as service lights, dpf, handbrakes, batteries and windscreens
- Carry out some coding

SIS Trouble shooting

Identifying a fault code is just the tip of the iceberg in a vehicle repair process. Trouble shooting is the solution to guide you to the root cause of the problem. It can guide the user from the fault code, real time data or symptoms through a number of tests to the root cause of the problem. It integrates the multimeter and scope (fitted to the KTS) to the guided diagnostics. SIS gives the user all of this in addition to the base SD package.

MP Master Pack

Trouble shooting takes users to the root cause, but users will need:

- Wiring diagrams for body electrics
- Technical bulletins
- Installation information
- Mechanical and service information
- Torque settings
- Locations and pin information on components

ESI STANDARD SUBSCRIPTION

SD Diagnostics / SIS Trouble shooting

ONE YEAR

356 77 1580+356 77 1660

WEEKLY FROM ONLY **£4.52[†]**
ONLY **£896.00**

THREE YEARS

356 77 1590+356 77 1670

WEEKLY FROM ONLY **£11.31[†]**
ONLY **£2,245.00**

SAVE £443

ESI MASTER SUBSCRIPTION

SD Diagnostics / SIS Trouble shooting / MP Master Pack

ONE YEAR

356 77 1580+356 77 1600

WEEKLY FROM ONLY **£5.65[†]**
ONLY **£1,121.00**

THREE YEARS

356 77 1590+356 77 1610

WEEKLY FROM ONLY **£14.16[†]**
ONLY **£2,810.00**

SAVE £553

*Finance example typically based on a 5 year lease purchase agreement. Finance subject to status, full terms and conditions available on request. Other finance options available. All prices exclude VAT at 20%. Price, availability and specification may change without prior notice. Warranty subject to manufacturers terms and conditions of use. Errors and omissions excluded. Offers valid until 30th September 2017. Prices correct at time of going to press: June 2017.

EXPERIENCE-BASED REPAIR (EBR) – KNOWN FIXES

**THE NEW INFORMATION TYPE FOR ESI[TRONIC] 2.0
USERS FIND THE RIGHT SOLUTION WITHIN SECONDS –
EVEN FOR CHALLENGING TROUBLESHOOTING**



BENEFITS OF EXPERIENCE-BASED REPAIR (EBR) AT A GLANCE

- Repair instructions generated by the experienced Bosch authoring team and validated through the expertise of the worldwide Bosch diagnostic community
- The database already has 500,000 real-life cases/vehicle combinations – this is growing day by day!
- Time saving at its best: The free text search allows you to search for error codes, symptoms, faults without trouble codes, and even components
- Common structure of each repair instruction to make the repair process easy
- EBR always provides you with the latest content due to the required online connection

UNIQUE IN THE MARKET

EBR-Finder

Bosch developed an innovative algorithm which enables the so called EBR-Finder to identify trending vehicle problems from a multitude of sources – using this as input, the experienced Bosch SIS-authors create a repair solution.

EBR MAKES TROUBLESHOOTING SIMPLE

- Add this unique information type to your normal ESI[tronic] 2.0 subscription and make your daily troubleshooting even easier than before
- If you are not yet registered for the EBR information type, the complete database listing of known fixes will be locked until the EBR license has been activated
- To benefit from the new ESI[tronic] 2.0 EBR information type, please contact your local sales agent.

**BOSCH ESI EBR
INFOTYPE 12M**
356 77 6990

FROM ONLY **£170.00**

**BOSCH ESI EBR
INFOTYPE 36M**
356 77 7010

FROM ONLY **£433.00**

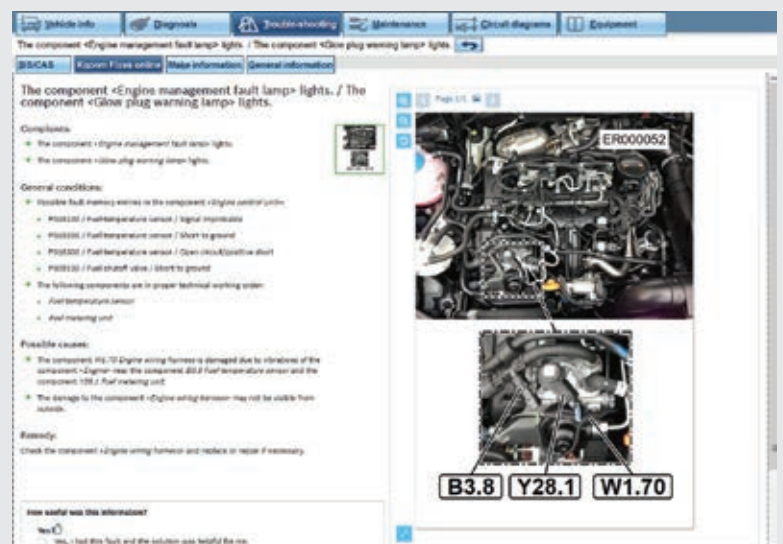

CONTINUOUS IMPROVEMENT

Feedback function

The feedback function at the bottom of each repair instruction allows you and other ESI[tronic] diagnostic experts to rank and view the ratings of the selected solution. This indicates how popular the solution is and makes the search even simpler with the most common solutions listed at the top.



*Finance example typically based on a 5 year lease purchase agreement. Finance subject to status, full terms and conditions available on request. Other finance options available. All prices exclude VAT at 20%. Price, availability and specification may change without prior notice. Warranty subject to manufacturers terms and conditions of use. Errors and omissions excluded. Offers valid until 30th September 2017. Prices correct at time of going to press: June 2017.

PICO MASTER KIT EVERYTHING FOR THE AUTOMOTIVE DIAGNOSTIC EXPERT

- Eliminate guesswork and test individual components before they are replaced. Stop playing "parts darts" where more and more parts are replaced until the fault goes away.
- Find intermittent wiring and connector faults.
- Solve issues when a vehicle has a problem but no code has been set or when multiple / misleading codes have been set.
- Solve problems with actuators such as motors and injectors that are not monitored by the ECU.
- Identify mechanical problems such as compression and slipped / incorrectly fitted timing belts

- Only with Pico do you get 150 guided tests and access to their library of over 3000 reference waveforms, to help you analyse your captured signals

**SAVE
£300**



**EURO ACADEMY PICO TRAINING COURSE
NOW AVAILABLE
CALL BRANCH FOR DETAILS**

PICO MASTER KIT
in plastic Carrycase PQ039
355 77 9590

WEEKLY FROM ONLY **£20.13⁺**
ONLY **£3,995.00**

PICO MASTER KIT
In Foam Trays PQ040 (Pictured)
355 77 9580

WEEKLY FROM ONLY **£20.13⁺**
ONLY **£3,995.00**

AVL DITEST SCOPE 1400

NEW

Digital, high-resolution 4-channel scope module for signal capture in motor vehicles. The retrieval of measurement results via connection to PC or tablet.



STANDARD SET
355 99 0470

- AVL DiTEST Scope 1400 Modul
- Power supply with cable
- USB cable
- 4 x cable URD
- 4 x test probes black
- 4 x test probes red
- 4 x crocodile clips red
- 4 x crocodile clips black
- Stimuli wire set
- Current clamp I100 Standard
- Current clamp I1800
- CD manual
- Transport case
- Packing

WEEKLY FROM ONLY **£13.08⁺**
FROM ONLY **£2,595.00**



HIGH END SET
355 99 0480

- AVL DiTEST Scope 1400 Modul
- Power supply with cable
- USB cable
- Cigarette lighter and vehicle battery supply
- Cable URD
- 4 x test probes red
- 4 x test probes black
- 4 x crocodile clips red
- 4 x crocodile clips black
- Stimuli wire set
- Current clamp I1500 High End
- Current clamp I1800
- Temperature sensor -20° to 200°C
- Pressure sensor -1bar to 100bar
- Trigger clamp
- KV clip
- CD manual
- Transport case
- Packing

WEEKLY FROM ONLY **£20.15⁺**
FROM ONLY **£3,999.00**

*Finance example typically based on a 5 year lease purchase agreement. Finance subject to status, full terms and conditions available on request. Other finance options available. All prices exclude VAT at 20%. Price, availability and specification may change without prior notice. Warranty subject to manufacturers terms and conditions of use. Errors and omissions excluded. Offers valid until 30th September 2017. Prices correct at time of going to press: June 2017.

AUTOLOGIC ASSIST PLUS

- Autologic Assist is the industry's first fully integrated diagnosis support system combining dealer-trained technician expertise with state-of-the-art technology and access to online databases of third party vehicle information.
- Assistplus Is The Cloud-Connected Diagnostics Device
- Assist support is the real-time access to Autologic's 50+ European dealer-trained master technicians, plus the simultaneous integration of data resources that joins expert knowledge and service.

REAL-TIME ASSISTANCE



Bronze360 Contract

ASSIST PLUS + SUPPORT SERVICE
(36 month instalment)
355 77 4730 + 356 77 6760

WEEKLY FROM ONLY **£58.46⁺**
ONLY **£11,600.00**

Silver450 Contract

ASSIST PLUS + SUPPORT SERVICE
(36 month instalment)
355 77 4730 + 356 77 6770

WEEKLY FROM ONLY **£60.73⁺**
ONLY **£12,050.00**

Gold600 Contract

ASSIST PLUS + SUPPORT SERVICE
(36 month instalment)
355 77 4730 + 356 77 6780

WEEKLY FROM ONLY **£66.02⁺**
ONLY **£13,100.00**

CALL YOUR LOCAL BRANCH FOR AN UNBEATABLE OFFER

SUPPORTING YOUR BUSINESS

Assist Support is integral to your 3 year contract and consists of 3 key elements to get you from fault to fix, fast:

VEHICLE DIAGNOSTIC SUPPORT	SOFTWARE SUPPORT	PASS-THRU SUPPORT
Autologic's award winning Fault 2 Fix Team provides you with real-time vehicle diagnostic support. You have access to 100+ European dealer-trained master technicians, with the experience to address the ever-increasing complexity involved in diagnosing and repairing European cars, to get you from fault to fix, fast.	We want you to enjoy an efficient fault to fix experience, so in the unlikely event that your AssistPlus device is not working to its full potential, we provide comprehensive software support.	Pass-Thru is the only secure, accurate, safe and compliant process to programme ECUs. OEM registration and initial set-up can be a daunting process, so we provide the option of Pass-Thru Support within your contract as a single cost of 30 AssistCredits. Your Assist advisor will brief you on what is required to get you up and running.

*Finance example typically based on a 5 year lease purchase agreement. Finance subject to status, full terms and conditions available on request. Other finance options available. All prices exclude VAT at 20%. Price, availability and specification may change without prior notice. Warranty subject to manufacturers terms and conditions of use. Errors and omissions excluded. Offers valid until 30th September 2017. Prices correct at time of going to press: June 2017.

HELLA GUTMANN MEGA MACS PC

355 77 5520 + 356 77 6750

- Suitable for your Windows netbook, PC or Tablet
- Comprehensive in-depth vehicle coverage
- Equipped with PassThru® technology
- DOIP Capable



WEEKLY FROM ONLY **£8.45⁺**
ONLY **£1,676.00**



MEGA MACS 42SE

355 77 4350

- Compact and lightweight diagnostic tool
- Comprehensive in-depth vehicle coverage
- Equipped with PassThru® technology
- Comes complete with Bluetooth adapter for remote printing and a docking/charging cradle
- Comprehensive onboard technical data
- DOIP capable



WEEKLY FROM ONLY **£12.35⁺**
ONLY **£2,450.00**



MEGA MACS 56

355 77 4720

REAL-TIME REPAIR ASSISTANCE

- Wi-Fi and Bluetooth connectivity enable wireless printing. Downloads technical data quickly and easily even whilst in use.
- PassThru® ready
- HGS Technical Data technical data included
- Comprehensive onboard technical data
- DOIP capable



WEEKLY FROM ONLY **£17.61⁺**
ONLY **£3,495.00**



MEGA MACS 66

355 77 0000

REAL-TIME REPAIR ASSISTANCE

- Diagnostics of all components, with instructions
- Interactive coloured circuit diagrams with depiction of actual values and parameters in real-time.
- Sets new standards in speed and accuracy of diagnosis
- Comprehensive onboard technical data
- DOIP capable



WEEKLY FROM ONLY **£23.94⁺**
ONLY **£4,750.00**



*Finance example typically based on a 5 year lease purchase agreement. Finance subject to status, full terms and conditions available on request. Other finance options available. All prices exclude VAT at 20%. Price, availability and specification may change without prior notice. Warranty subject to manufacturers terms and conditions of use. Errors and omissions excluded. Offers valid until 30th September 2017. Prices correct at time of going to press: June 2017.

**ANY
CUSTOMER**

**ANY
DIAGNOSTIC DEVICE**

**ANY
VEHICLE MANUFACTURER**

Ever had a problem you can't fix? The increasing complexity of new systems and engine options now including petrol, diesel, electric or hybrid, computers controlling almost every aspect of their operation- from suspension, braking, fuel and air flow, to emissions, traction and parking assistance.

How are the independent workshops going to be able to compete? With no information available to help the only option is to call in a specialist or turn the job away to a main dealer.

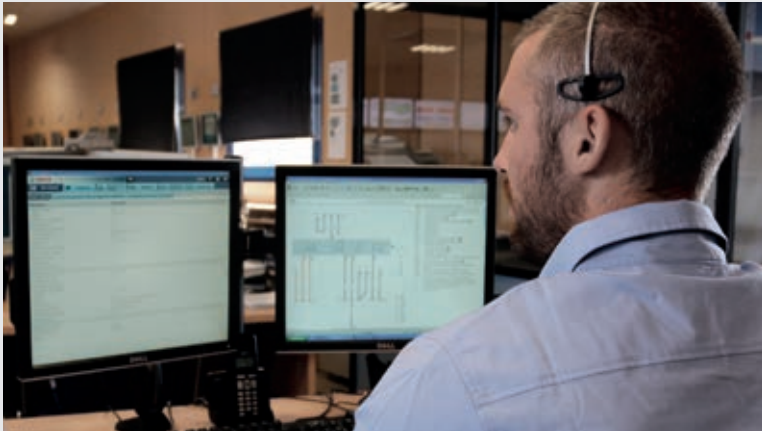

EURO ACADEMY MEMBERSHIP NOW OFFERS YOU ACCESS TO SUPERB TECHNICAL INFORMATION AND ASSISTANCE IN 3 DIFFERENT WAYS:



TECHNICAL HELPLINE



ONLINE FAULT LIBRARY



TRAINING FACILITY

Euro Academy Technical helpline is like having a master technician standing next to you. Unlike some of our competitors

- **NO LIMIT** to the amount of time you can spend on a call
- **NO LIMIT** to the number of times you can call us
- **EXPERIENCED** based fault diagnostics from 1000's of customers Our team of master technicians have years of practical experience along with access to the latest technical information on any vehicle, regardless of the manufacturer.

So whether you're looking for repair manuals, circuit diagrams, parts catalogues or component locations for any vehicle in your workshop, simply pick up the phone and let us help. One simple call to our technical helpline could save you hours of searching for an elusive component failure.

YOUR MEMBERSHIP

Becoming a Euro Academy member is an investment in your business, and one which will increase revenue and profits while saving time and money. Memberships are available by annual subscription paid monthly, and start from as little as £79.00 for level 1 subscribers.

FROM ONLY **£79.99**

CONTACT YOUR LOCAL BRANCH FOR MORE DETAILS

*Finance example typically based on a 5 year lease purchase agreement. Finance subject to status, full terms and conditions available on request. Other finance options available. All prices exclude VAT at 20%. Price, availability and specification may change without prior notice. Warranty subject to manufacturers terms and conditions of use. Errors and omissions excluded. Offers valid until 30th September 2017. Prices correct at time of going to press: June 2017.

EURO ACADEMY TRAINING COURSES – MEMBERS ONLY

Euro Academy training courses cover all areas of mechanical, electrical, electronic and diagnostics fault-finding and repair over the entire vehicle for members.

We offer a structured solution that spans all ability levels from Basic to Master Technician; in fact, it's all the training your business will ever need. Technicians achieve career development from Euro Academy training, gaining qualifications that prove they are competent to repair customers' vehicles.

Each subject is covered by eight hours of e-learning, accessed wherever and whenever it suits the technician, and eight hours of on-site practical training.

- On-site training takes place at a venue determined by the location of the trainees, and is restricted to no more than 10 technicians at a time.
- Course content is continually re-assessed and is aligned to the Euro Vehicle Troubleshooting online Helpline – as the database grows, these known faults and repairs are incorporated into the syllabus, to keep the training up to date and give technicians the information they need.
- Practical training can be held in Euro Academy's new IMI Approved Centre, where all training sessions are IMI Quality Assured.

COURSE DURATION: 2 DAYS BLENDED TRAINING

- **On-site:** 8 hours of practical training
- **E-learning:** 8 hours accessed wherever and whenever it suits the technician

ELECTRICITY AND ELECTRONICS

IMI ACCREDITED

Understanding the basic principles of electricity is a pre-cursor to any mechanic looking to up his game and move towards a diagnostic / fault finding career path. Without the basics, it is impossible to safely and effectively diagnose today's increasingly complex range of vehicles.

MULTIMETER AND OSCILLOSCOPE (HIGH LEVEL)

IMI ACCREDITED

Having grasped the basics of electricity, most mechanics will want to keep feeding their knowledge. This section takes a more detailed look at the procedures involved to be able to test and verify the many sensors and actuators found in modern vehicles. Also, as a result of more complex digital electronics, new high-speed networks (CAN, LIN, MOST) have had to be implemented.

Euro Academy Members – call 0845 603 3636 or email training@eurocarparts.com to sign in to the course you need.

DIAGNOSIS

IMI ACCREDITED

A prudent and wise mechanic will retain their customers with a proper diagnostic process, by using the skills that they have learnt, to not only replace parts, but to ensure the part that they are replacing is the cause of the problem. In this section the student will be introduced to a methodology that they will use on a daily basis.

PETROL INJECTION

IMI ACCREDITED

Gain a thorough understanding of fuel systems and how emission control standards are met. Fuel, ignition and air intake systems work hand in hand with post-ignition treatment of exhaust gases to achieve or surpass these stringent regulations. The mechanic will gain an insight as to how these systems operate and begin to successfully test and diagnose petrol injection system faults.

DIESEL INJECTION

IMI ACCREDITED

With almost 50% of all UK car sales diesel engine vehicles, this training offers an invaluable insight and introduction to basic mechanical systems, and up-to-the minute common-rail high pressure systems including the necessary safety and cleanliness requirements.

**Need more courses than your membership entitlement?
Additional courses only £299.00 per day**

AIR CONDITIONING

IMI ACCREDITED

Understand the basic operating principles and the components involved in the air conditioning, in order to be able to safely diagnose operating defects. F-gas certificate is a prerequisite.

BRAKES – LEVEL 1 & BRAKES – LEVEL 2

IMI ACCREDITED

An introduction to hydraulic circuits and components to mechanical and electrically operated handbrake systems. Safety and awareness regarding the cleanliness and contamination of brake fluid and brake warning lamps is also paramount. An overview of ABS/ESP systems and the diagnosis of errors, using diagnostic tools is then introduced.

SUSPENSION

IMI ACCREDITED

Often the importance of a correctly operating and well maintained suspension system is disregarded. This can lead to premature tyre wear and dangerously increase stopping distances. The student will be introduced to the various elements that make up traditional and active suspension systems, and how they work in conjunction with each other, including how to spot common failure areas.

STEERING

IMI ACCREDITED

Power assisted steering is now commonplace on almost all vehicles. However, before repair, a thorough understanding as to the safety and operating principles of standard non-power assisted steering must be applied. Also included - hydraulic, electric and rear steer systems.

BOSCH TRAINING COURSES*

As the world's largest supplier of advanced electronic automotive systems, vehicle manufacturers from around the world rely on Bosch for innovation and technical expertise. You can also benefit from this expertise through the range of training courses offered by Bosch at our Euro Academy Training Centre, at Bosch's own Service Training Centre (STC) in Uxbridge, or on a regional basis across the UK and Ireland.

BOSCH COURSE VENUES

- Euro Academy**
Fifth Way, Avonmouth BS11 8DT
- Training 2000 Limited**
Furthergate Business Park, Harwood St, Blackburn BB1 3BD
- DTM Diesel & Petrol Injection Specialists Ltd**
Short Street, St Phillips, Avon, Bristol BS2 0SW
- Suzuki Training Facility**
Rands Lane Industrial Estate, Armthorpe, Doncaster DN3 3DY
- LAGTA Limited,**
Eurocentral Scotland, Condor Glen, Holytown, Motherwell ML1 4UY
- South Devon College**
Vantage Point, Long Rd, Paignton TQ4 7EJ
- Bosch Service and Training Centre**
Riverside Way, Uxbridge UB8 2YF
- GTG West Midlands**
Bearing Dr, Wolverhampton WV11 3SZ

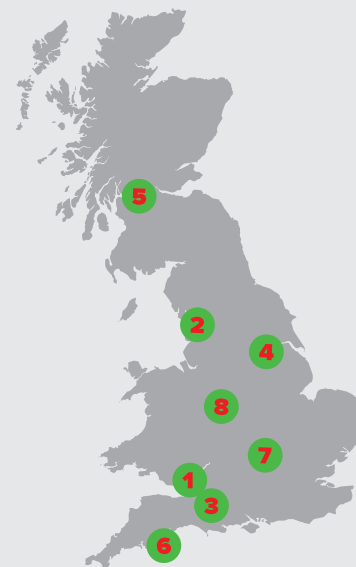

ONLY £159.00 PER DAY

AVONMOUTH BOSCH COURSES* PROGRAMME

COURSE CODE	COURSE TITLE	DESCRIPTION	START DATE	DURATION
VSH24.1	Hybrid & Electric Vehicle – Routine Maintenance (L2 QCF)	Learn how to identify high- voltage components and how to safely carry out maintenance work in that environment	01-Aug-17	2 days
VSC6	Braking & Chassis Systems, ABS & ESP	Gain essential knowledge about the operation, maintenance and testing of electronically controlled braking systems, covering both Bosch and non-Bosch variants	08-Aug-17	2 days
VSG5	Steering Geometry & Four Wheel Alignment	Correctly diagnose alignment faults and propose the appropriate corrective action	23-Aug-17	1 day
VS8	Airbag & Supplementary Safety Systems	Gain knowledge of Airbag and SRS control systems and learn how to carry out accurate diagnosis on these safety critical systems	30-Aug-17	2 days
VSTD9	Oscilloscope Operation & Signal Test Methods	Competently operate an oscilloscope and use all its functions	26-Sep-17	2 days
VSH24.1	Hybrid & Electric Vehicle – Routine Maintenance (L2 QCF)	Learn how to identify high- voltage components and how to safely carry out maintenance work in that environment*	03-Oct-17	2 days
VSE1	Essential Test Procedures	Gain a working knowledge of standard electrical test procedures and how they are applied correctly.	10-Oct-17	2 days
VSG5	Steering Geometry & Four Wheel Alignment	Correctly diagnose alignment faults and propose the appropriate corrective action	18-Oct-17	1 day
VSC6	Braking & Chassis Systems, ABS & ESP	Gain essential knowledge about the operation, maintenance and testing of electronically controlled braking systems, covering both Bosch and non-Bosch variants	25-Oct-17	2 days

FULL COURSE DESCRIPTIONS AND NATIONWIDE SCHEDULES AVAILABLE AT THE BRANCH

PICOSCOPE OSCILLOSCOPE TRAINING COURSE*

A 5-step training programme developed with Picoscope covering the full range of capabilities of the little blue box in your drawer. From the basics of “why do I need an Oscilloscope” and simply connecting and setting up, through using the maths channels, to expanding the ‘scope to measure pressure, noise and vibration.

The steps covered are:

- Oscilloscope Diagnostics a Picoscope Guide:** Introduction to oscilloscopes
- Starting Scope Diagnostics:** Getting a new user comfortable using the Picoscope
- Advance Scope Diagnostics:** Looking at the more advanced features
- Pressure Testing:** using the WPS500X for all pressure applications
- Noise & Vibration Testing:** Analyzing Noise, Vibration and Harshness measurements.

CALL THE BRANCH FOR THE LATEST NEWS ON COURSE DATES

*External courses are not included within the Euro Academy Membership entitlement and are charged separately.

*Finance example typically based on a 5 year lease purchase agreement. Finance subject to status, full terms and conditions available on request. Other finance options available. All prices exclude VAT at 20%. Price, availability and specification may change without prior notice. Warranty subject to manufacturers terms and conditions of use. Errors and omissions excluded. Offers valid until 30th September 2017. Prices correct at time of going to press: June 2017.

AUTODATA

Autodata is the comprehensive and trusted online tool, designed to provide quick and easy access to technical information to efficiently carry out complex diagnostics and repair procedures, as well as day-to-day servicing and maintenance operations. Genuine manufacturer data, delivered in an easy-to-use and consistent format, covering 136 vehicle manufacturers and 32,000 models worldwide.

- Full service and maintenance procedures
- Data embedded directly into service schedules
- Interactive coloured wiring diagrams
- Fast and easy diagnostics and troubleshooting
- Interactive component location
- Comprehensive technical data and specifications



FREE 14 DAY TRIAL

DESCRIPTION	PART NUMBER	PRICE PER MONTH*
AUTODATA, SERVICE & MAINTENANCE SUBSCRIPTION PACKAGE		
1 USER	256 77 1450	£43.75
2 USERS	256 77 1490	£50.33
5 USERS	256 77 1510	£61.25
AUTODATA, DIAGNOSTIC & REPAIR SUBSCRIPTION PACKAGE		
1 USER	256 77 1370	£73.00
2 USERS	256 77 1520	£84.00
5 USERS	256 77 1530	£102.00

*Minimum 12 month contract

HELLA GUTMANN HGS DATA

356 77 6470

The complete vehicle technical database, accessible through any internet-enabled PC, with information and repair solutions for over 38,000 vehicles. With HGS Data you can access all the technical data you require for virtually any service or repair job, all at the touch of a button.

Technical specifications for over 38,000 vehicle models, as well as maintenance plans, engine control, ABS, airbag and thermal management data, updated repair aids and wiring diagrams are all covered

- 2 logins per subscription from any online device
- Technical data for over 38,000 vehicles
- Circuit diagrams
- Air bag, thermal management and engine control data

ONLY £499.00



*Finance example typically based on a 5 year lease purchase agreement. Finance subject to status, full terms and conditions available on request. Other finance options available. All prices exclude VAT at 20%. Price, availability and specification may change without prior notice. Warranty subject to manufacturers terms and conditions of use. Errors and omissions excluded. Offers valid until 30th September 2017. Prices correct at time of going to press: June 2017.

ALLDATA REPAIR

NEW

You pride yourself on doing the job, so start with the right information. ALLDATA doesn't alter the OEM data, so you get exactly what you need from each manufacturer – all in one easy-to-use portal.

Automotive repair shops using ALLDATA improve repair quality and accuracy, save time and money and meet manufacturer standards, improving customer satisfaction and business profitability.

- Manufacturer Electrical Wiring Diagrams
- Factory Technical Service Bulletins
- Factory mechanical repair procedures
- Trouble codes and diagnostic test charts
- OEM filling quantities
- Factory chassis repair instructions
- Factory maintenance interval and service schedules
- Factory tightening torques

WHY YOU NEED ORIGINAL MANUFACTURER INFORMATION

Technical data for the aftermarket needed to diagnose and repair today's complex vehicles is difficult to obtain or unavailable. To stay competitive and to maintain quality standards, you need access to a single source of original manufacturer repair information.

With ALLDATA Repair®, designed by automotive experts, technicians can easily search and find in-depth technical repair information to repair vehicles correctly, save time and improve customer satisfaction.



FEATURES AND BENEFITS

- OEM repair information direct from the manufacturer including 22 brands and 28 million articles of unedited and original repair articles in a comprehensive online portal. Available in five languages, you have access to an easy-to-use navigation structure and search to save you time, increase efficiency, and improve overall profitability.
- Access to the industry's largest source of OEM information online 24/7.
- With original manufacturer maintenance, diagnostic and repair information, you save time and money, and can repair vehicles to quality standards, and drive repeat business.
- Access to the most current manufacturer information so you can repair the newest vehicles on the road and ensure every repair is profitable.
- Common navigation across all brands and advanced search capability make it easy to find the information you need quickly and efficiently.

ENTER "ECP WS" CODE FOR YOUR FREE 2 WEEK TRIAL

1 USER
12 MONTH SUBSCRIPTION
256 77 1770

MONTHLY FROM ONLY **£69.00**

3 USER
12 MONTH SUBSCRIPTION
256 77 1760

MONTHLY FROM ONLY **£83.00**

ADDITIONAL USER
OVER 3 LICENSES PER MONTH
256 77 1780

MONTHLY FROM ONLY **£15.00**

*Finance example typically based on a 5 year lease purchase agreement. Finance subject to status, full terms and conditions available on request. Other finance options available. All prices exclude VAT at 20%. Price, availability and specification may change without prior notice. Warranty subject to manufacturers terms and conditions of use. Errors and omissions excluded. Offers valid until 30th September 2017. Prices correct at time of going to press: June 2017.

OUR SPECIALIST EQUIPMENT SERVICE AND MAINTENANCE TEAM PROVIDES ALL INSTALLATION, SERVICING AND MOT CALIBRATION REQUIREMENTS INCLUDING PLANNED MAINTENANCE AND SCHEDULING

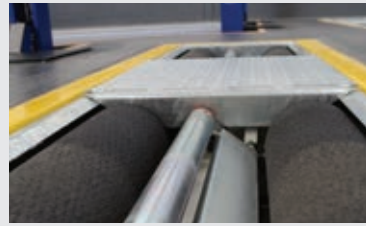
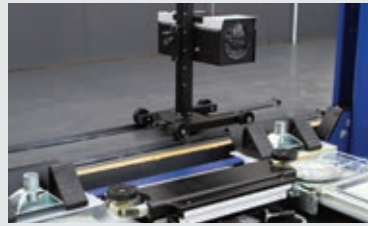

SPECIAL OFFER – GET YOUR AIRCON MACHINE SERVICED AT THE SAME TIME AS YOUR BOSCH OR CRYPTON EMISSIONS CALIBRATION FOR ONLY £ 150 PLUS PARTS!*

*offer applies only to Bosch or Crypton emissions analysers

PLANNED MAINTENANCE

A preventative maintenance contract can provide a significant reduction in repair costs, ensuring total peace of mind for both the equipment owner and operator. Alternatively, services can be secured on 'as required' basis.

PLANNED MAINTENANCE		FROM
Vehicle Lift Maintenance & Repairs	Single Post, 2 Post, 4 Post, Scissor Lift Servicing and Repair	£55.00*
JACKING BEAM REPAIR		CALL
Air & Oil Pipework	Supply and installation including galvanised steel tube, Transair and John Guest aluminium	CALL
Spraybooth Servicing	Complete spraybooth service including certification and testing	£287.50
Compressor Servicing	Service support for compressed air systems excluding parts	£117.00*
Air Conditioning Machine Servicing	Service support and maintenance facility including repairs, training and F-gas assessments	£205.00
WELDING EQUIPMENT SERVICING		£30.00
Spray Gun Repairs	For a variety of spray guns regardless of manufacturer carried out in fast response time	CALL
Waste Collection	Variety of waste collections for various quantities	CALL

The above prices do not include any parts that may be needed.

BREAKDOWN RESPONSE

Regardless of whether or not we have been maintaining your equipment on a service contract, you can take advantage of our prompt breakdown repair service. We understand the urgency of the situation and will dispatch most efficiently.

BREAKDOWN RESPONSE		FROM
Vehicle Lifts call out and repair	2 Post, 4 Post, Scissor Lift	£100.00
Air Conditioning Machine call out and repair	All Makes call out and repair	£75.00
Welding Equipment repair	Spot and Mig Welders, Plasma Cutters, Induction Heaters, TKR Riveters, Oxy/Acet Equipment, Dent Pullers	£30.00
Compressors call out and repair	All Makes call out and repair	£115.00

The above prices do not include any parts that may be needed.

CALIBRATION SERVICES

Once you give us your calibration contract, our database tracks when your MOT equipment is due – so your calibration will always be timely. Using only suitably accredited engineers, we aim to minimise equipment down-time.

CALIBRATION SERVICES		FROM
MOT Equipment Calibration	For both Car and Motorcycle equipment	£150.00
Tyre Changer & Balancer	Alignment Systems calibrations	£140.00
Emission Analyser Calibration	Scheduled calibrations	£330.00
Tools Calibration	For a wide variety of tools including tyre gauge, torque wrench, pressure gauge, paint thickness & tracking sticks	CALL
Paint Scales Calibration	All Makes Paint Scales calibration	£75.00

The above prices do not include any parts that may be needed. Minimum charge for tool calibrations, prices above don't include admin or travel fee. Yearly calibration (2 gas, 1 smoke).

CERTIFICATION & TESTING

We will carry out your required inspections and issue the necessary certificates.

CERTIFICATION & TESTING		FROM
LEV Exhaust Ventilation System Test & Certification		£90.00
Spraybooths Smoke Clearance Test & Certification		£56.25
Spraybooths Breathing Air Quality Test		£95.00

*Minimum quantity applies

The above prices do not include any parts that may be needed.

*Finance example typically based on a 5 year lease purchase agreement. Finance subject to status, full terms and conditions available on request. Other finance options available. All prices exclude VAT at 20%. Price, availability and specification may change without prior notice. Warranty subject to manufacturers terms and conditions of use. Errors and omissions excluded. Offers valid until 30th September 2017. Prices correct at time of going to press: June 2017.

REFRIGERATED DRYERS

Due to our high humidity climate, untreated compressed air carries a lot of water vapour with it and through into your air tools and equipment. This reduces the performance capability of the equipment, as well as shortening its working life.

Refrigerated dryers are available in all sizes depending on the system airflow rate (cfm), and can be retrofitted to an existing setup.

- Better working – get the full capability from your equipment
- Less wear – get longer lifecycles from your equipment
- Fewer breakdowns – enjoy better productivity and lower maintenance costs

ASK THE BRANCH FOR DETAILS



FROM ONLY **£499.00**

ANTI-VIBRATION MOUNTS

592 77 2860

A set of 4 Anti-vibration mounts made of a large area damper material, designed to bolt between the compressor feet and the floor.

- Ensures quieter running
- Reduces the effect of motor vibration
- Extends compressor life



ONLY **£95.23**

ECOBOX OIL WATER SEPARATOR

595 77 7650

The ECOBOX is an affordable condensate cleaning solution for piston or screw compressors with an output up to 60 cfm. It is designed to remove the oil traces from compressor condensate in line with Water Resources Act (1991) Chapter II, para 85, referring to an offence of knowingly polluting waters, by the disposal of poisonous, noxious or polluting matter.

- Economic
- Compact
- Environmentally friendly
- Quick and easy installation



ONLY **£75.97**

Do you have unwanted water and particulates within your compressed air system?

- Is water effecting your application at point of use?
- Are you tools failing and rusting due to water ingress?
- Are you tired of replacing filter elements?

The Original Dropout® is a unique, scientifically engineered, patent protected multi-stage Compressed Air Filter that removes 99.9999% of Water and 99% solid particulates down to 1 Micron. This unique multi-stage compressed air filter performance is constant regardless of the flow rate.

- Dropout provides a low maintenance, robust solution for unwanted water and particulates within your compressed air system
- Dropout requires no mains power to operate and can accommodate for pulsed flows or stop/start with instantaneous recovery
- Install Dropout at point of use to guarantee water free, clean air
- ISO 12500 accredited so you can be confident Dropout is as good as advertised

Match your Dropout to your compressed air output – start enjoying the benefits

ITEM DESCRIPTION	INLET/OUTLET CONNECTION	CFM MIN/MAX	BAR MIN/MAX	PART NUMBER	PRICE
DO300S	1/2" (f)	0.04 - 15	1 to 15	595 77 0250	£344.50
DO600S	3/4" (f)	0.04 - 30	1 to 15	595 77 0260	£409.50
DO900S	3/4" (f)	0.04 - 45	1 to 15	595 77 0270	£474.50
DO1500S	1" (f)	0.04 - 90	1 to 15	595 77 0280	£604.50



JUST DRAIN PERIODICALLY AND CONTINUE USING AT THE SAME HIGH EFFICIENCY

*Finance example typically based on a 5 year lease purchase agreement. Finance subject to status, full terms and conditions available on request. Other finance options available. All prices exclude VAT at 20%. Price, availability and specification may change without prior notice. Warranty subject to manufacturers terms and conditions of use. Errors and omissions excluded. Offers valid until 30th September 2017. Prices correct at time of going to press: June 2017.

SELECTING THE RIGHT COMPRESSOR

When selecting the right air compressor, the tank size is important. A small tank will overwork the motor. It is equally if not more important to select an air compressor that provides enough cubic feet per minute (cfm) of airflow. CFM is going to determine how many tools you can run, and whether each tool will function at its best.

TOOL/EQUIPMENT	CFM	BAR
3/8" Impact Wrench	2 – 3	6
1/2" Impact Wrench	4 – 6	6
3/4" Impact Wrench	9	6
1" Impact Wrench	14	6
3/8" Ratchet	2 – 5	6
1/2" Ratchet	5	6
3/8" Drill	12	6
DA Sander (Top Quality)	10	6
DA Sander (econ. model)	20	6
7" Sander/Polisher	25	6
Zip/Impact Cutter	4 – 5	6
Cutters Shears	4 – 8	6
4" Angle Grinder	18 – 25	6
7" Angle Grinder	25 – 35	6
Tyre Inflator	2 – 4	10 – 16
Tyre Changer (Manual)	4	10
Tyre Changer (Auto)	6	10
Sand Blast Cabinet	10 – 50	3.5 – 7
Sand Blast Hand Gun	8 – 12	7

TOOL/EQUIPMENT	CFM	BAR
Spray Gun – Airbrush	0.25	2
Spray Gun – Miniature	4 – 7	1.5 – 3.5
Spray Gun – Low Pressure	1.5 – 4	1.5 – 3
Spray Gun – Standard	7.14	3.5 – 4
Spray Gun – HVLP	14 – 20	5 – 6
HA/GEO/9000 series LVLP	7 – 9.5	2 – 2.5
Air Fed Mask	5 – 6	1.5 – 3
Oil Pump	1.5	7 – 10.5
Grease Pump	4.5	7 – 10.5
Air Water Wash	10	10.5
Car Wash	1.5 – 5	5 – 7
Blow Gun (safety nozzle)	3	7
Spark Plug Cleaner	3	7
Underseal Gun	4	7
Rivet Gun	1.5 – 3	50 – 6
2 Ton Air/Hydraulic Lift	5 – 8	9 – 10.5
Brake Tester	3 – 7	5 – 7
Plasma Cutter	6 – 8	4 – 7

COMPRESSORS AND AIR TREATMENT

Compressed air is all about the compressor, right?

Wrong. Of course, a quality compressor is important if you're doing anything with air tools but there are other factors you need to consider if you want an efficient system that won't let you down, particularly in challenging environments like spray booths, where the quality of air you're using is critical to the quality of the job you produce.

Air Pipework

Next, we come to the pipework, that essential conduit between compressor and tool. Any amount of 'hissing' means you've got at least one leak and that's the sound of your hard-earned cash escaping from your pocket in the form of wasted energy. Your compressor has to work harder to produce the air you need, leading to a shorter compressor lifespan and poorer performing equipment.

If your pipework design is not optimised, you're losing efficiency (and money) over the length of the system. It's not just leaks in old galvanised pipework you should worry about, the internal bore may well be severely compromised through a lifetime build-up of deposits and corrosion, which will only compound the loss of efficiency of your compressor and air tools.

Our Workshop Equipment Specialists can help maximise your profits by calculating the savings you'll make by installing a new

plastic/aluminium air ring main, designed to support your current and future needs. It won't corrode and it will provide greater flexibility and performance than your current galvanised option, delivering a consistent airflow with no efficiency loss and, a minimum maintenance requirement.

Drying and Filtration

We live in a climate with an average 90% humidity. Compressors don't introduce water into your compressed air system, it's always there; so, it's important to remove it to maximise performance and provide a truly efficient system.

Even the toughest compressed air tools work best on dry air that is free of foreign particles but it's absolutely essential for certain environments like spray booths where surface finish and personal protection (breathing air) is critical.

Your compressed air system will provide maximum performance and extended tool life when drying and filtration are incorporated because water vapour and foreign particles in the air feed will always reduce the efficiency of the system and lifespan of your tools.

Talk to our WESs for a full consultation on your compressed air system and on how you can save on energy and equipment replacement costs whilst getting the best efficiency and all the power from your air tools.

*Finance example typically based on a 5 year lease purchase agreement. Finance subject to status, full terms and conditions available on request. Other finance options available. All prices exclude VAT at 20%. Price, availability and specification may change without prior notice. Warranty subject to manufacturers terms and conditions of use. Errors and omissions excluded. Offers valid until 30th September 2017. Prices correct at time of going to press: June 2017.

ABAC PRO PISTON COMPRESSORS

Ideal for a small workshop where only single phase is available.

Belt driven, resulting in a quieter and more efficient compressor

Typically used with Tyre Inflator, Blow Gun, Spray Gun, Impact/ Ratchet wrenches



PRO A39B 150 FM3

572 77 0580



ONLY **£508.25**

PRO A39B 200 FM3

572 77 0560



ONLY **£561.75**

PRO B4900 200 FT4

572 77 0670

Perfect for a small workshop with three phase

Typically Used with Tyre Inflator, Blow Gun, Spray Gun, Impact/ Ratchet wrenches, low consumption shot blast cabinet



ONLY **£690.15**

PRO B5900B 200 FT5.5

572 77 0680

Perfect for a medium workshop with three phase



ONLY **£810.00**

PRO A39 270 FM3 TANDEM

572 77 0690

Ideal for a small workshop where only single phase is available. Largest single phase piston compressor available.

Belt driven, resulting in a quieter and more efficient compressor.



WEEKLY FROM ONLY **£8.31⁺**
ONLY **£1,649.00**

WILKINSON STAR WORKHORSE COMPRESSORS

Typically used with: Impact wrench, Ratchet wrench, Air chisel, underseal gun, tyre inflator

Ideal for a small workshop where only single phase is available



WORKHORSE WR3HP - 150SEC

572 77 1630



ONLY **£434.60**

WORKHORSE WR3HP - 200SEC

572 77 1670



ONLY **£487.60**

WORKHORSE WR4HP - 200SEC

572 77 1680



ONLY **£793.94**

Typically used with: Impact wrench, Tyre changer, Small DA Sander, brake tester

For the busier 2/3 man mechanical workshop where three phase is available



WORKHORSE 5.5HP - 200SEC

572 77 1690



ONLY **£858.60**

WORKHORSE WR5.5HP - 270SEC

572 77 1710



ONLY **£879.80**

WORKHORSE WR7.5HP - 270SEC

572 77 1740



WEEKLY FROM ONLY **£5.32⁺**
ONLY **£1,054.00**

WORKHORSE WR10HP - 200SEC

572 77 1750

Typically used with: Spray gun, DA Sander, Lift, 1" Impact wrench
For a commercial workshop / small bodyshop
Accident / Car panel Repair.



WEEKLY FROM ONLY **£7.72⁺**
ONLY **£1,531.70**

*Finance example typically based on a 5 year lease purchase agreement. Finance subject to status, full terms and conditions available on request. Other finance options available. All prices exclude VAT at 20%. Price, availability and specification may change without prior notice. Warranty subject to manufacturers terms and conditions of use. Errors and omissions excluded. Offers valid until 30th September 2017. Prices correct at time of going to press: June 2017.

Compressors

NO HASSLE WARRANTY
BEST PRICE PROMISE

WILKINSON STAR SILVER SCREW COMPRESSORS

- For applications where there is a constantly high demand for air power
- Powerful, efficient heavy duty belt drive motors
- Low noise levels



SILVER 10 300L

572 77 1870



WEEKLY FROM ONLY **£18.40⁺**
ONLY £3,651.70

SILVER 15 300L

572 77 1890



WEEKLY FROM ONLY **£24.01⁺**
ONLY £4,764.70

WILKINSON STAR SILVER D SCREW COMPRESSORS

- Refrigerated dryer option for clean, dry air production.
- Simple-to-use control units
- Enabling manage, monitor and optimise the machine's operation



SILVER D 10 300L

572 77 2080



WEEKLY FROM ONLY **£23.66⁺**
ONLY £4,695.00

SILVER D 15 300L

572 77 1910



WEEKLY FROM ONLY **£28.29⁺**
ONLY £5,613.00

SILVER D 20 300L

572 77 1930



WEEKLY FROM ONLY **£30.69⁺**
ONLY £6,089.70

2 YEAR CONDITIONAL WARRANTY
SUPPORTED BY FACTORY-TRAINED ENGINEERS

ABAC SPINN COMPRESSORS

SPINN 2.2KW

572 77 0270

Typical use: Spray gun, impact wrenches, tyre machines.
Single phase, low noise.



WEEKLY FROM ONLY **£13.46⁺**
ONLY £2,669.65



SPINN 4KW

572 77 0230

Typical use: Spray gun, impact wrenches, tyre machines.
Low noise, good quality air



WEEKLY FROM ONLY **£14.26⁺**
ONLY £2,830.15

Typical use: Spray guns, impact wrenches, tyre machines, sanders, air fed masks. Low noise, good quality air

SPINN 5.5KW

572 77 0710



WEEKLY FROM ONLY **£15.61⁺**
ONLY £3,097.65

SPINN E 5.5KW With Dryer

572 77 0490



WEEKLY FROM ONLY **£18.87⁺**
ONLY £3,745.00

ABAC GENESIS COMPRESSORS

With Dryer And Filtration Build In

2 YEAR STANDARD WARRANTY
(SUBJECT TO MANUFACTURERS TERMS OF USE)*

GENESIS 7.5KW

572 77 0440

Typical use: Spray guns, impact wrenches, tyre machines, sanders, air fed masks.
Low noise, high output, good quality dry air, small footprint.



WEEKLY FROM ONLY **£24.78⁺**
ONLY £4,916.65



Typical use: Tyre Inflator, Blow Gun, Spray Gun, Impact/ Ratchet wrenches. Low noise, higher output for larger spray shops.

GENESIS 11KW

572 77 0180



WEEKLY FROM ONLY **£25.86⁺**
ONLY £5,130.65

GENESIS 15KW

572 77 0380



WEEKLY FROM ONLY **£26.94⁺**
ONLY £5,344.65

*Must be commissioned and serviced by an authorised distributor

*Finance example typically based on a 5 year lease purchase agreement. Finance subject to status, full terms and conditions available on request. Other finance options available. All prices exclude VAT at 20%. Price, availability and specification may change without prior notice. Warranty subject to manufacturers terms and conditions of use. Errors and omissions excluded. Offers valid until 30th September 2017. Prices correct at time of going to press: June 2017.

Transform your equipment output, save energy and money

HISSING AIR PIPEWORK? UNEVEN PRESSURE IN DIFFERENT PARTS OF THE WORKSHOP? TOOLS AND EQUIPMENT UNDERPERFORMING?

PREVOST ALUMINIUM PIPEWORK



GIVE US A CALL



Speed and efficiency are the watchwords automotive repair workshops. That's why it is absolutely necessary to have tools and equipment working at capability so that technicians can make best use of the time they spend working on vehicles.

Workshop Solutions offers a free re-design of your workshop compressed air distribution system that will ensure the air arrives at the technician's workstations with a minimal loss of pressure, and in the best condition to power the tools and equipment.



Our Workshop Equipment Specialists, working with Prevost, can carry out a survey of an existing workshop air pipework system, and using real-life data, can work out exactly how much energy (and therefore cash) is being hissed away.

We can design and install a Prevost Aluminium and Plastic pipework system which will lower workshop energy bills, provide equalised pressure throughout, and which will not corrode and develop leaks over time.



Using Prevost aluminium and plastic pipework, we can install a compressed air system that is matched to your current and future requirements and which keep you working at maximum efficiency whilst also saving you money from wasted energy.

- Energy Efficient – aluminium provides perfectly smooth internal pipe surface – that means an optimised flow rate, and Clean and good-quality air supply.
- Guaranteed for 10 years – aluminium pipework is compact, lightweight and resistant to corrosion – that means easy to install and maintain
- No leaks – Prevost pipe fittings are engineered to ensure perfectly leak-tightness even under the harshest conditions

- A general diagram of your compressed air ring main complete with downpipes is drawn so that you can see the location and layout of your system in your building.
- A detailed drawing identifying the connections and purposes of each downpipe is then generated.
- A complete quote listing each item, the corresponding quantities, and the price of the proposed ringmain is provided for your consideration.



*Finance example typically based on a 5 year lease purchase agreement. Finance subject to status, full terms and conditions available on request. Other finance options available. All prices exclude VAT at 20%. Price, availability and specification may change without prior notice. Warranty subject to manufacturers terms and conditions of use. Errors and omissions excluded. Offers valid until 30th September 2017. Prices correct at time of going to press: June 2017.

ECOCOOLER EVAPORATIVE COOLING – COOLING WITH ENVIRONMENTAL RESPONSIBILITY

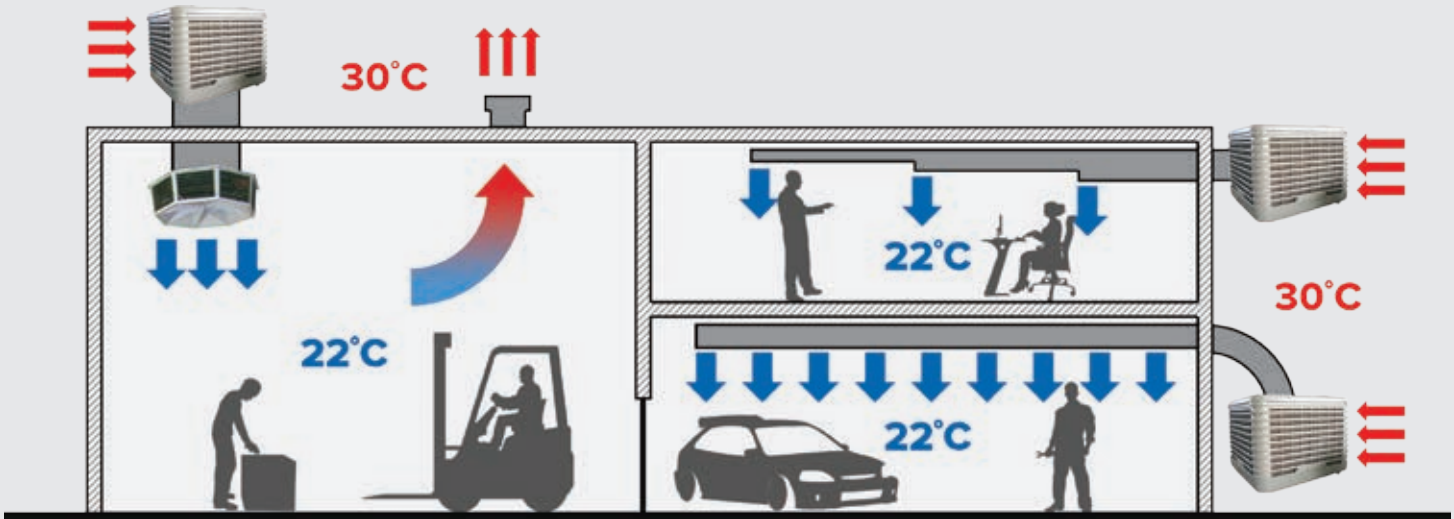

SIMPLE

With only a fraction of the moving parts of an air conditioning system and requiring only basic water and electrical services, evaporative cooling is the simplest method of cooling your building.

A variety of installation options allows us to provide our customers with the optimum solution.

SAFE

Potentially dangerous organisms do not present a risk as the water in an evaporative cooler circulates at a naturally cool temperature. Unique design and process controls prevent water stagnation. The plastic and stainless construction avoids corrosion. A constant supply of naturally cooled air is supplied by the coolers without the use of environmentally damaging refrigerants.

LOW COST

Typically an Ecocooling evaporative cooler is 25% of the capital cost and 15% of the running cost of a refrigerant based industrial air conditioning system.

As an example an Ecocooler can produce 35kW of cooling for 1.5kW of power. This equates to one cooler providing enough cool air for 300m² for a cost of less than 15 pence an hour.

ENERGY EFFICIENT

Ecocoolers consume 85% less electricity than conventional air conditioning systems which equates to savings of 10 tonnes of carbon per annum per cooler.

CALL FOR A QUOTE!



*Finance example typically based on a 5 year lease purchase agreement. Finance subject to status, full terms and conditions available on request. Other finance options available. All prices exclude VAT at 20%. Price, availability and specification may change without prior notice. Warranty subject to manufacturers terms and conditions of use. Errors and omissions excluded. Offers valid until 30th September 2017. Prices correct at time of going to press: June 2017.

HEAVY DUTY WORKBENCHES

- Can take up to 1000kg (uniformly distributed load)
- Choice of worktops including galvanised steel, stainless steel, wood and solid slip black vinyl.
- All heavy duty workbenches include as standard a single cupboard, bottom shelf, vice plate and a rear Upstand.
- Choice of four standard lengths, each of which is available in three depths.
- Fully welded and ready to use.
- Worktops: Galvanised Steel, Stainless Steel, Wood Worktop & Black Vinyl



CALL FOR A QUOTE
STATE THE SIZE AND THE WORKTOP REQUIRED

FROM ONLY **£305.00**

MOBILE WORKBENCHES

- Mobile workbenches take up to 1000kg on legs and 360kg on castors.
- Stands on four legs when in use and wheels when on the move.
- Simple lever action pushed the under-carriage and take the weight off the legs onto the castors.
- Two versions available – one with a standard cupboard and one with a five drawer unit and matching cupboard.
- All mobile workbenches include as standard a single cupboard, bottom shelf, lowering undercarriage and vice plate.
- Worktops: Galvanised Steel, Stainless Steel, Wood Worktop & Black Vinyl



CALL FOR A QUOTE
STATE THE SIZE AND THE WORKTOP REQUIRED

FROM ONLY **£305.00**

MEDIUM DUTY WORKBENCHES

Medium duty workbenches or assembly workbenches (as they are also known) come fully welded (not flat pack) and ready to use. They are made from 1.5 thick box section and come with all-metal levelling feet.

These workbenches provide an ideal platform for working on small components. There are a number of sizes available and choice of worktops, which include – Grey Laminate, ESD (Antistatic), MDF, Steel, Solid Slip Vinyl. The uniformly distributed load (UDL) is up to 500kg. The standard height is 840mm, but this can be changed at no extra cost.



CALL FOR A QUOTE
STATE THE SIZE AND THE WORKTOP REQUIRED

FROM ONLY **£200.00**

SUPER HEAVY DUTY WORKBENCHES

These workbenches are the heaviest load capacity commonly available. Super heavy duty workbenches come fully welded (not flat pack) and ready to use. They are constructed from steel angle with braced 2mm galvanised steel top over 45mm solid wood. The uniformly distributed load (UDL) is up to 1500kg for each workbench. The standard height is 840mm, but this can be changed at no extra cost.

- Fully welded and ready to use.
- As standard this range includes a single cupboard (600mm x 600mm x depth of workbench), galvanised bottom shelf, rear lip and vice plate (welded under front right hand corner) included in the price.



CALL FOR A QUOTE
STATE THE SIZE AND THE WORKTOP REQUIRED

FROM ONLY **£370.00**

*Finance example typically based on a 5 year lease purchase agreement. Finance subject to status, full terms and conditions available on request. Other finance options available. All prices exclude VAT at 20%. Price, availability and specification may change without prior notice. Warranty subject to manufacturers terms and conditions of use. Errors and omissions excluded. Offers valid until 30th September 2017. Prices correct at time of going to press: June 2017.

CARBON ZAPP ES3 DIESEL AND PETROL ENGINE TREATMENT UNIT

590 01 1220

An engine deep-clean is an obvious 'first option' to resolving high emissions or poor performance issues. Engine cleaning can also be offered within a standard menu of additional services available during routine service visits.

- One machine treats both petrol and diesel engines
- Adaptability to all makes and models
- Comes complete with a supply of detergent
- De-carbonisation of combustion chamber
- Maximum restoration of engine performance
- Exhaust emissions reduction by up to 70%
- High pressure pump conditioning
- Decarbonised valves and piston ring release
- Improved idle speed stability
- Fading of engine knocking
- Adaptors available for de-carbonisation of Intake Manifold and DPF (sold separately)

PAYS FOR ITSELF IN JUST 35 TREATMENTS!

WEEKLY FROM ONLY **£12.90⁺**
ONLY **£2,559.00**

INTAKE MANIFOLD ADAPTOR
590 01 1230

ONLY **£375.00**

DPF ADAPTOR ONLY
590 01 1240

ONLY **£420.00**



BOSCH EPS118 DIESEL INJECTION TESTER

596 77 0010

The EPS118 is so easy to use, it represents an entry-level opportunity for common rail injector testing. With the proportion of diesel vehicles continuing to grow every year, this is a route to earning more profit!

- Keep the business in the workshop – don't outsource this lucrative revenue earner
- Easy to operate even without previous experience
- Fast identification of defective injectors
- Report printout makes it easier to convince customers
- Unbeatable price
- Requires Calibration Oil (522 77 3515)



PAYS FOR ITSELF FROM JUST 2 TESTS PER WEEK!

WEEKLY FROM ONLY **£30.72⁺**
ONLY **£6,095.00**

CARBON ZAPP DS1R

590 01 0210

Test Bench for one Common Rail Diesel Injector at a time. Delivers a quick Pass / Fail test – no more than what a workshop really needs to know.

- Gives a 'workshop level' diagnosis
- 8" touch screen
- Manual or Automatic modes



WEEKLY FROM ONLY **£22.65⁺**
ONLY **£4,495.00**

*Finance example typically based on a 5 year lease purchase agreement. Finance subject to status, full terms and conditions available on request. Other finance options available. All prices exclude VAT at 20%. Price, availability and specification may change without prior notice. Warranty subject to manufacturers terms and conditions of use. Errors and omissions excluded. Offers valid until 30th September 2017. Prices correct at time of going to press: June 2017.

Auto Transmission Fluid Exchange

NO HASSLE WARRANTY

BEST PRICE PROMISE

With the high proportion of automatic transmission vehicles on the road, it makes sense to keep this capability in-house. Making simple work of scheduled service interval fluid changes, an automatic transmission fluid exchanger also offers a clean 'first option' for fixing problems including 'sealed for life' boxes. A simple flush and refill can often cure the problem and is an easy option to sell before going to the expense of a full strip-out at a specialist.

LAUNCH CAT501S

590 00 1060

DEMO AVAILABLE

The CAT-501S offers a range of automatic functions to exchange transmission fluid with minimal fuss and involvement. May also be used in a manual operation. The CAT-501S is supplied with a full set of connectors.

- 5" LCD display
- Oil exchange and level adjustment
- Print out the procedure and more vehicle data
- Monitoring of oil temperature
- Monitoring of oil pressure
- Empty fluid tank without disassembly
- Choose between 68 pieces universal adapters kit and bespoke UK adapters kit
- Online database access included
- 2 year warranty



The majority of manufacturers recommend changing the ATF fluid on automatic gearboxes every 30,000 to 40,000 miles.

Any of these symptoms below can be made better by a 100% ATF fluid flush and refill

- Rough gear change during acceleration
- Slow or delayed gearshifts
- Difficult to move from Park to Drive/Reverse
- Noisy gear changes or loud transmission running noise
- An increase in transmission vibrations felt inside the cabin

An ATF flush and refill produces the following benefits

- Smoother gear change
- Reduced transmission noise
- Easier gear selection
- Reduced transmission vibrations
- Faster up-shift during acceleration



WEEKLY FROM ONLY **£14.09⁺**
ONLY **£2,795.00**

*Return on investment example is not a guarantee of earnings. Based on 1 service per week charged out at £ 250 +vat

	COSTS/REVENUE
SERVICE TO GARAGE CUSTOMER	£250.00
COST OF FLUSH	-£8.50
COST OF FLUID	-£90.00
LABOUR AND OVERHEADS	-£25.00
PROFIT PER SERVICE	£126.00

PAYS FOR ITSELF IN JUST 6 MONTHS
FROM JUST ONE SERVICE PER WEEK*

*Finance example typically based on a 5 year lease purchase agreement. Finance subject to status, full terms and conditions available on request. Other finance options available. All prices exclude VAT at 20%. Price, availability and specification may change without prior notice. Warranty subject to manufacturers terms and conditions of use. Errors and omissions excluded. Offers valid until 30th September 2017. Prices correct at time of going to press: June 2017.





The chances of a vehicle pulling up outside your garage with the new HFO-1234yf refrigerant in its air conditioning (AC) unit are fast increasing so you need to make sure you're ready to service it. However, this doesn't mean you can forget about its predecessor, R134a, just yet.

Experts predict that vehicles requiring the R134a refrigerant will be in the marketplace for at least another decade. So, what does this mean for you? Put simply, if you haven't done so already, you should invest in a new air conditioning machine fitted with the latest technology capable of servicing HFO-1234yf to the highest of standards.

It may also be the right time to replace your existing R134a machine. Or if you're currently outsourcing AC servicing because you don't have the right machine at your garage, consider purchasing one for the first time. This will ensure you avoid turning away loyal customers and will enable you to maximise revenue streams.

While some older cars might not be equipped with AC units, it's more or less a given in new cars. Identifying the right AC machines to enable your garage to service them effectively is an area that needs your full attention. A popular choice for smaller outfits is the ECK Twin. With two machines in one unit to service both refrigerant types, this option offers excellent value for money.



AC is not part of a routine vehicle service. Consequently, it often becomes an after-thought despite manufacturers recommending that the system should be serviced every 12 months.

While many of your customers will see AC as invaluable, skimped maintenance could be at the detriment of the car's health, resulting in costly repairs. Taking the opportunity to remind your customers of this and encouraging them to have their AC serviced with you every 12 months will result in increased repeat business and customers who feel valued.

To keep your AC machines in top working order, you should consider purchasing the following accessories: Refrigerant, PAG oils, UV dye and vacuum pump oil for routine maintenance. A thermometer, sniffer and UV torch for performance checks and finding leaks



Nitrogen kits and the Marksman II for more advanced leak finding. They are easy to use and will pinpoint any leak of anti-bacterial treatments. Finally, anybody using an R134a machine must hold an F-Gas certificate. It's the law. Speak to a member of the Euro Car Part team who all have an in-depth knowledge of the various machines on offer and the accessories needed for their respective up-keep

No-one knows AC machines better than we do. At Workshop Solutions, we provide not only the AC equipment and tools you need for your garage, but expert consultancy to help you choose the right machines. But it doesn't stop there. We have a network of engineers covering the UK servicing, installing and repairing machines as required. We offer an end-to-end solution so you can focus on running the rest of your business.

*Finance example typically based on a 5 year lease purchase agreement. Finance subject to status, full terms and conditions available on request. Other finance options available. All prices exclude VAT at 20%. Price, availability and specification may change without prior notice. Warranty subject to manufacturers terms and conditions of use. Errors and omissions excluded. Offers valid until 30th September 2017. Prices correct at time of going to press: June 2017.

HFO-1234YF THE NEW REFRIGERANT

The introduction of HFO-1234yf is a very significant development in automotive air conditioning. In the initial introduction of HFO-1234yf, production was limited and this led to only a number of models being produced. It is estimated today that more than 50 vehicle model types have HFO-1234yf within their air conditioning system with many more due for release in 2016. From 1st January 2017 every vehicle manufactured with air

conditioning must use a refrigerant with a Global Warming Potential of less than 150. The vehicle manufacturers choice is HFO-1234yf.

Given the company's unique standing in the UK AC servicing market Autoclimate is maintaining close contact with the VMs and equipment suppliers in order to exchange information about the latest developments which we can share with our customers.

PRODUCTION

Vehicles (categories M1 and N1) receiving type approval from January 1st 2011 must use a refrigerant with a GWP (Global Warming Potential) of less than 150. The current refrigerant HFC R-134a does not meet this requirement. However, due to manufacturing issues the MAC Directive this was suspended until the end of 2012.

All new vehicles (all categories) produced from January 1st 2017 must use a refrigerant with a GWP of less than 150.

The initial global production of HFO-1234yf will only be sufficient to supply VMs production requirements.

Further production is scheduled to come on stream during 2015.

ABOUT HFO-1234YF

- Developed and manufactured jointly by DuPont and Honeywell
- Has a Global Warming Potential (GWP) of just 4, the maximum is 150
- The performance characteristics are very similar to HFC R-134a
- Classed as a flammable refrigerant, albeit mildly. HFC R-134a is not flammable
- Lifespan if released to atmosphere is 11 days. HFC R-134a is 13 years
- The price will be higher than that of HFC R-134a, at least initially

FAQ'S

Q. "We are a franchise dealer. If a vehicle with HFO-1234yf experiences an AC fault, what should we do if we have yet to purchase a suitable AC machine?"

A. Please ask the vehicle manufacturer for their advice and also contact us for the latest technical information. With more vehicle manufacturer relationships and approvals than any other UK-based RMS supplier, Autoclimate is actively supporting the introduction of HFO-1234yf.

Q. "I am an accident repairer. What if I have to repair a vehicle with HFO-1234yf?"

A. As things stand, we believe that the chances of you seeing such a vehicle during 2012 and 2013 are low, given the number of known model introductions. Our advice is, that given that both the gas and a compatible AC machine will be required; such repairs should be managed in co-operation with the appropriate franchise dealer, although if required we can supply a suitable AC machine.

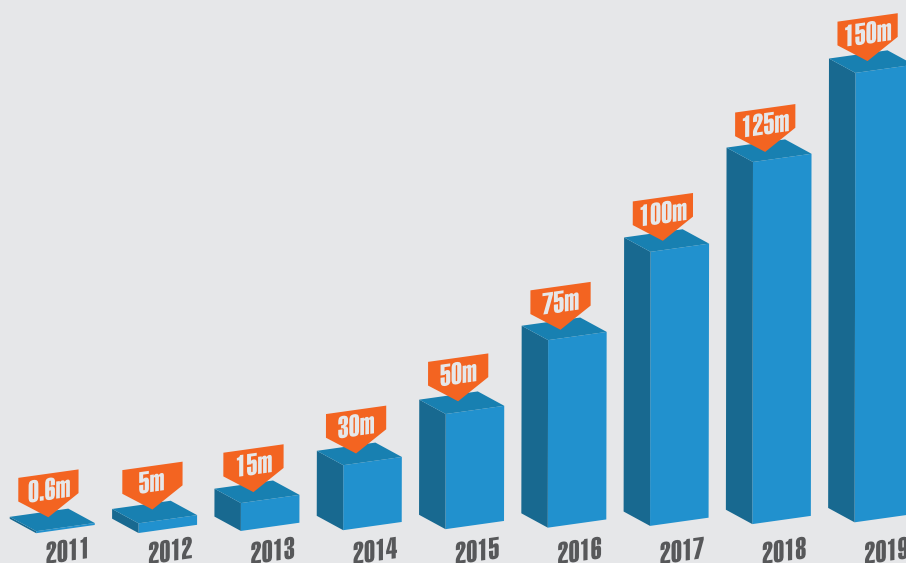

European consolidated number of new vehicles introduction with 1234yf air conditioning systems (in millions)

*Finance example typically based on a 5 year lease purchase agreement. Finance subject to status, full terms and conditions available on request. Other finance options available. All prices exclude VAT at 20%. Price, availability and specification may change without prior notice. Warranty subject to manufacturers terms and conditions of use. Errors and omissions excluded. Offers valid until 30th September 2017. Prices correct at time of going to press: June 2017.

ECOTECHNICS TWIN-PRO DUAL-GAS AIRCON MACHINE FOR R134A & HFO1234YF

251 77 0820

The ECK Twin is a reliable, effective and easy-to-use refrigerant management station for servicing both R134a and HFO-1234yf refrigerant systems. It automatically controls the recovery, recycling, vacuum and recharging processes of a/c servicing. With a number

of patented designs including hermetic dye/oil cartridges and automatic discharge of non-condensable gases via solenoid valves. This machine delivers both high performance and excellent operational reliability.

WHY BUY ME?

- **EASY TO USE:** 7" color touch screen display with high resolution and icon messaging for an easy user interface.
- **SPACE:** Its wheels have been specifically designed to let the station spin around its main axis and make it very easy to move around where space is limited
- **BIG TANK:** 2 tanks 12L, with 2 electronic scales + 2 automatic heater blankets
- **HIGH PRECISION TECHNOLOGY:** with 95% of the recovered refrigerant from an A/C system.
- **AUTOMATIC NITROGEN LEAK TEST:** this test, made with an inert gas under pressure, is an excellent alternative in case dye is not permissible (for example, in automobile manufacturing) or anti-economic for example in case of leak detection on A/C systems with the new gas HFO1234yf.
- **HERMETIC OIL & DYE CONTAINERS:** eliminate contact between the humidity naturally present in ambient air and the oil or dye, grant high quality of the product charged, protect the internal components of the station from possible damage from oils and/or dyes of uncertain provenance.
- **AUTOMATIC AIR PURGE:** made with pressure and temperature sensors, grants at any time to have the ideal tank pressure without air, avoiding unpleasant machine's stop for high pressure alarm



WEEKLY FROM ONLY **£18.52⁺**
FROM ONLY **£3,675.00**



ROBINAIR AC690PROyF AUTOMATIC AIRCON MACHINE FOR HFO1234YF

251 77 2050

Robinair AC690PROyF Automatic Aircon Machine for HFO1234YF. The AC690PRO is a fully automatic refrigerant management station with complete 'programme and walk-away' capability. It automatically controls the recovery, recycling, vacuum and re-charging process for

oil, dye and refrigerant. The AC690PRO has an extensive, integrated vehicle database, user database, built-in vehicle-specific diagnostics facility and integral printer.

WHY BUY ME?

- **EASY TO USE:** 20 languages – fully automatic station with including dye injection. The software can be programmed in only a few button presses
- **SPACE:** Its wheels have been specifically designed to let the station spin around its main axis and make it very easy to move around where space is limited
- **FAST:** Up to the minute data base – Manufactured by Autoclimate
- **BIG TANK:** 20kg tank for garages carrying out over 10 services per day, plus large 170l vacuum pump to speed that service up
- **USE:** Low running costs as gas recovery and recycle is 95%
- **VACUUM LEAK:** Vacuum leak detection and Built in diagnostic functionality
- **DIAGNOSTIC PROGRAMME:** Saves time identifying "vehicle" faults, suggest out of 36 common faults depending on test results
- **MEMORY:** 4 MB memory facility to store and edit service data for up to an extra 250 vehicles
- **COMPRESSOR:** Hermetic 1/3 Hp compressor means fast and complete refrigerant recovery from the system at 500 gms pm
- **VACUUM PUMP:** Powerful two-stage 180 litres per minute vacuum pump to remove air and moisture
- **PRINTER:** Generates data to help the sales process as well as creating job records for you and your customers. Complete flexibility to print at any stage, includes customer and contact details



WEEKLY FROM ONLY **£12.60⁺**
FROM ONLY **£2,499.99**



*Finance example typically based on a 5 year lease purchase agreement. Finance subject to status, full terms and conditions available on request. Other finance options available. All prices exclude VAT at 20%. Price, availability and specification may change without prior notice. Warranty subject to manufacturers terms and conditions of use. Errors and omissions excluded. Offers valid until 30th September 2017. Prices correct at time of going to press: June 2017.

ECOTECHNICS 3500-UP AUTOMATIC AIRCON MACHINE FOR R134A

251 77 0840

The ECK 3500-UP is a fully automatic machine, equipped with the most advanced features such as HYBRID function to be compatible with cars with electric compressor, with a special connection to make

an automatic leak test detection with Nitrogen (under pressure) and with a large 5" color display with an easy user interface.

WHY BUY ME?

- **EASY TO USE:** Color 5" display with high resolution and icon messaging for an easy user interface.
- **SPACE:** Its wheels have been specifically designed to let the station spin around its main axis and make it very easy to move around where space is limited
- **BIG TANK:** Big refrigerant tank with 22 liters it is the ideal machine for intensive use
- **HIGH PRECISION TECHNOLOGY:** with 95% of the recovered refrigerant from an A/C system.
- **AUTOMATIC NITROGEN LEAK TEST:** this test, made with an inert gas under pressure, is an excellent alternative in case dye is not permissible (for example, in automobile manufacturing) or anti-economic for example in case of leak detection on A/C systems with the new gas HFO1234yf.
- **HERMETIC OIL & DYE CONTAINERS:** eliminate contact between the humidity naturally present in ambient air and the oil or dye, grant high quality of the product charged, protect the internal components of the station from possible damage from oils and/or dyes of uncertain provenance.
- **AUTOMATIC AIR PURGE:** made with pressure and temperature sensors, grants at any time to have the ideal tank pressure without air, avoiding unpleasant machine's stop for high pressure alarm



WEEKLY FROM ONLY **£12.60⁺**
FROM ONLY **£2,499.99**



ROBINAIR AC595PRO-UK AUTOMATIC AIRCON MACHINE R134A

251 77 0710

The AC595PRO is one of the most sold air conditioning service units for cars and trucks. Like all completely automatic Robinair units, it is designed to carry out the maintenance of R-134a-based air conditioning systems with a minimum of manual intervention. The unit automatically controls every phase of maintenance, including oil and refrigerant recovery, recycling and refilling without needing direct

intervention from a technician. However, the manual mode allows the user to control all aspects individually if so desired. It comes equipped with a data base to provide the necessary oil and refrigerant quantities for the vehicle's air conditioner. The AC595PRO also has an integrated printer to create detailed reports.

WHY BUY ME?

- **EASY TO USE:** 20 languages – fully automatic station with including dye injection. The software can be programmed in only a few button presses
- **SPACE:** Its wheels have been specifically designed to let the station spin around its main axis and make it very easy to move around where space is limited
- **FAST:** Up to the minute data base – Manufactured by Autoclimate
- **BIG TANK:** The AC 690 Pro 8kg tank for garages carrying out less than 10 services per day
- **VACUUM LEAK:** Vacuum leak detection and Built in diagnostic functionality
- **LOW RUNNING COST:** as gas recovery and recycle is at 95%
- **EFFICIENT:** Offering excellent performance for carrying out A/C servicing on cars and light commercial vehicles, the AC595PRO is particularly well suited for repairers carrying out low volumes of A/C servicing or those who require a second 'support' unit in the workshop.
- **AUTOMATIC:** Automatic oil discharge with electronic scale, automatic oil injection with electronic scale, automatic UV dye injection and automatic air-purge system
- **DATABASE:** Data transfer and database update through electronic key



WEEKLY FROM ONLY **£9.68⁺**
FROM ONLY **£1,919.95**



*Finance example typically based on a 5 year lease purchase agreement. Finance subject to status, full terms and conditions available on request. Other finance options available. All prices exclude VAT at 20%. Price, availability and specification may change without prior notice. Warranty subject to manufacturers terms and conditions of use. Errors and omissions excluded. Offers valid until 30th September 2017. Prices correct at time of going to press: June 2017.

MASTERCool COMMANDER 2000 251 77 0170

The Commander 2000 is equipped with the latest technology, this model come standard with an 8" colour touch screen command centre. The graphic interface will enable navigation through all of the functions and features with the greatest of ease. There is no longer a need to read any external instructions or paper manuals, simply sit back and watch as the information is played on the colour command centre.

The Arctic Commander series of machines incorporate a powerful windows based tablet, making database and software upgrades a breeze. Wi-Fi capability allows for real time, interactive communication. The pre-installed team viewer program lets our technicians access any machine throughout the world to aid with any troubleshooting issues.

WHY BUY ME?

- **EASY TO USE:** Large, easy to use manifold valves, large access door for easy maintenance
- **DISPLAY:** 8" colour Multi-coloured command centre with touch screen. LED status bar
- **SPACE:** Its wheels have been specifically designed to let the station spin around its main axis and make it very easy to move around where space is limited
- **BIG TANK:** Tank heater Provides quick charging at high or low temperatures
- **SUSPENSION SCALE:** Advanced, four point suspension scale platform design to extend load cell life.
- **USB PORT:** Easy to access USB port
- **SYSTEM:** Wi-Fi capability allows for real time, interactive communication. The pre-installed team viewer program lets our technicians access any machine throughout the world to aid with any troubleshooting issues.
- **COOLING FAN:** Dedicated PC board cooling fan keeps the PC board consistently cool



WEEKLY FROM ONLY **£15.12⁺**
FROM ONLY **£2,999.99**



ECOTECHNICS 1800 AUTOMATIC AIRCON MACHINE FOR R134A 251 77 0850

ECK1800 is our biggest mover and this machine offers excellent value for money for garages considering entering the air conditioning market for the first time or those looking for a second unit on site. For the really forward thinking workshops, or those that are working on newer cars. Fully automatic machine, equipped with the most

important features for an AC service. Being a fully compliant R134a station it's suitable for all workshop environments. Automatically controls recovery, recycling, vacuum and recharging process for oil, UV dye and gas. Equipped with a built in USB port for software updates. The refrigerant management also gives a usage report.

WHY BUY ME?

- **EASY TO USE:** complete information on cars and truck's A/C system refrigerant quantity
- **SPACE:** Its wheels have been specifically designed to let the station spin around its main axis and make it very easy to move around where space is limited
- **BIG TANK:** Refrigerant tank with 12 liters, the ideal entry level machine
- **AUTOMATIC LEAK TEST:** thanks to a specific sensor, the machine checks for a leakage during the vacuum phase monitoring the vacuum degree on the A/C system.
- **FULLY AUTOMATIC CYCLE:** with automatic oil and dye injection using an electronic scale providing high precision on charging and quick & easy service
- **REFRIGERANT MANAGEMENT:** the machine stores all services done and the user can save it on a USB memory key to transfer on a PC and create his own data records.
- **USB:** Build in USB port for software updates
- **DATABASE:** complete information on cars and truck's A/C system refrigerant quantity
- **BOTTLE HEATER:** allowing quick refrigerant charging with cold or hot ambient temperatures
- **FLUSHING SW:** machine comes with built-in SW to handle the Ecotechnics Flushing Kit (optional)
- **STATIC DIAGNOSIS:** an important help for the user: he can get a quick advice on possible failures on the A/C system using A/C pressure and ambient/vent temperature.



WEEKLY FROM ONLY **£7.53⁺**
FROM ONLY **£1,495.00**



*Finance example typically based on a 5 year lease purchase agreement. Finance subject to status, full terms and conditions available on request. Other finance options available. All prices exclude VAT at 20%. Price, availability and specification may change without prior notice. Warranty subject to manufacturers terms and conditions of use. Errors and omissions excluded. Offers valid until 30th September 2017. Prices correct at time of going to press: June 2017.

HEADLAMP TESTERS

Also available in a 'service' version for pre-MOT preparation. The DVSA approved headlight beam tester come in two options: mirror visor (analogue), or laser (digital). They are supplied with a standard length of rails, (additional rail lengths are available as a further option). Engineer installation is included to a prepared sites.

ANALOGUE HEADLAMP TESTER

(including installation)
586 77 0130

ONLY **£849.00**

LASER HEADLAMP TESTER

(including installation)
586 77 0150

WEEKLY ONLY **£5.29⁺**
ONLY **£1,049.00**

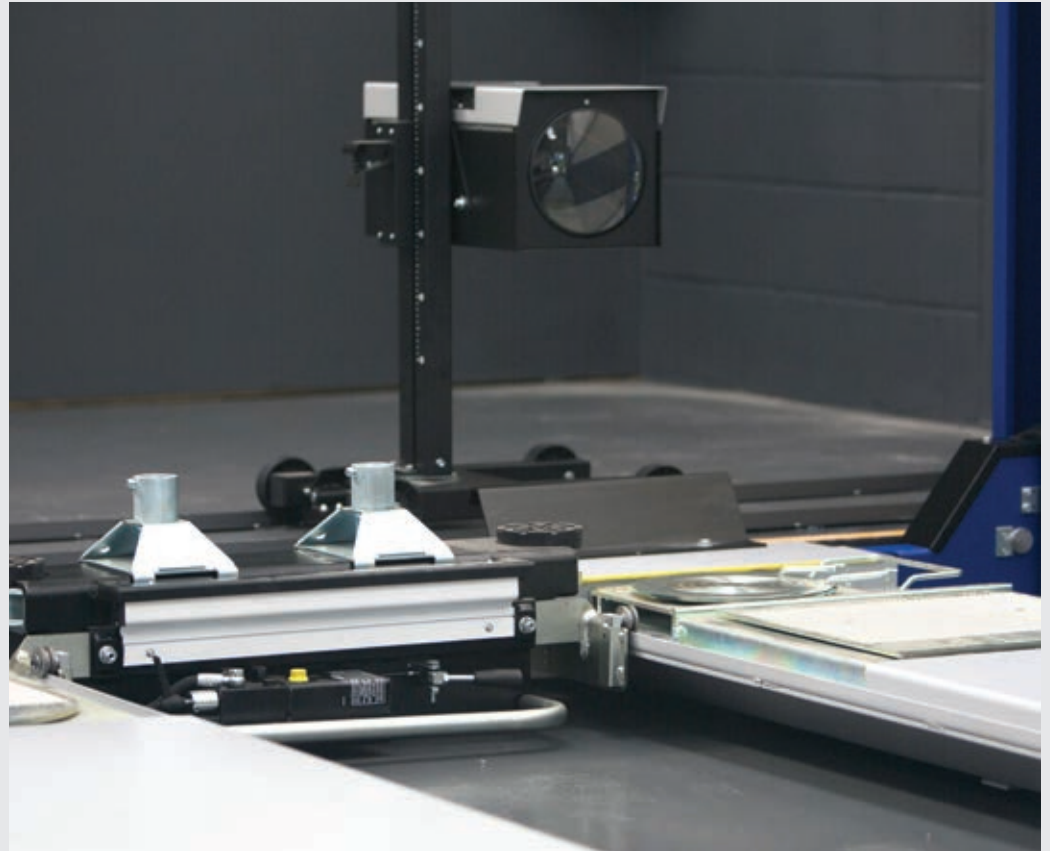

MAJORLIFT JACKING BEAMS

The Complete Package supplied as standard (includes arms*, delivery, and 95mm raiser blocks.)

**EXCLUSIVE WORKSHOP SOLUTIONS
SUPPLIED WITH 95MM RAISER BLOCKS
within the package**

- Supplied with a 1700mm double-extending top beam as standard – **NEW FEATURE**
- Provides 260mm of lift as standard – **NEW FEATURE**
- Low height to suit vehicles with low clearance
- Support arms available to suit all makes of lift
- Support arms included to suit all makes of lift*
- Ultra-low jacking position
- 5-year warranty



MANUAL 2.0T

579 77 0460

FROM ONLY **£835.00**

MANUAL 2.8T

579 77 0490

WEEKLY FROM ONLY **£6.02⁺**
ONLY **£1,195.00**

AIR OPERATED 2.0T

579 77 0510

WEEKLY FROM ONLY **£5.54⁺**
ONLY **£1,099.00**

AIR OPERATED 2.8T

579 77 0520

WEEKLY FROM ONLY **£7.05⁺**
ONLY **£1,399.00**

*Finance example typically based on a 5 year lease purchase agreement. Finance subject to status, full terms and conditions available on request. Other finance options available. All prices exclude VAT at 20%. Price, availability and specification may change without prior notice. Warranty subject to manufacturers terms and conditions of use. Errors and omissions excluded. Offers valid until 30th September 2017. Prices correct at time of going to press: June 2017.

OPTL PACKAGES

A One person Test Lane requires a lift equipped with play detectors. Originally, the OPTL option was only designed as an upgrade to the traditional 2-man test lane when equipment was ready for changing, or to improve the profitability on labour costs. However, nowadays, OPTL lift and brake tester packages are sometimes the first choice for a new site as they offer, in exchange for some reduced functionality in the brake tester, some cost savings against a full ATL lift and brake tester package. An OPTL brake tester is not equipped with the axle weighing capability of a full ATL brake tester.



Configure your OPTL Package

CALL FOR A QUOTE!

1. CHOOSE YOUR LIFT

4 POST LIFTS

- **Class IV** available with platform lengths 4300mm, 4600mm, 5200mm
- **Class VII** available with platform lengths from 5200mm, 5700mm, 6500mm



SCISSOR LIFTS

- **Class IV** available with platform lengths 4300mm, 4600mm, 5200mm
- **Class VII** available with platform lengths 5200mm, 5700mm, 6500mm



2. CHOOSE YOUR BRAKE TESTER

STANDARD

- **Standard Brake Tester** – dials and no weighing



COMPUTERISED

- **Computerised Brake Tester** – electronic monitor and no weighing



CLASS IV 4 POST OPTL PACKAGE

WEEKLY FROM ONLY **£90.71⁺**
ONLY £17,999.00

CLASS IV SCISSOR OPTL PACKAGE

WEEKLY FROM ONLY **£95.75⁺**
ONLY £18,999.00

CLASS VII 4 POST OPTL PACKAGE

WEEKLY FROM ONLY **£98.27⁺**
ONLY £19,499.00

CLASS VII SCISSOR OPTL PACKAGE

WEEKLY FROM ONLY **£113.39⁺**
ONLY £22,499.00

*Finance example typically based on a 5 year lease purchase agreement. Finance subject to status, full terms and conditions available on request. Other finance options available. All prices exclude VAT at 20%. Price, availability and specification may change without prior notice. Warranty subject to manufacturers terms and conditions of use. Errors and omissions excluded. Offers valid until 30th September 2017. Prices correct at time of going to press: June 2017.

Tecalemit is among the UK's longest established suppliers of MOT Testing equipment, offering the most comprehensive range of technically advanced VOSA approved equipment. Each principal item of equipment has been developed to provide time saving features to ensure that the test lane operates at optimum output.



Take a look at what you get!

STANDARD CLASS IV 4 POST PACKAGE COMES WITH 4 Ton 4.3m Elec/Hyd Lift, with flush fitting play detector and radius plates, 2T manual jacking beam, Single bed electronic car brake tester – wall mounted display, Headlamp beam tester, Pair of convex mirrors inclusive of installation, Brake pedal applicator

CLASS IV

WEEKLY FROM ONLY **£108.35⁺**
ONLY **£21,499.00**

STANDARD CLASS VII 4 POST PACKAGE COMES WITH 4 Ton 5.2m Elec/Hyd Lift, with flush fitting play detector and radius plates, 3T manual jacking beam, LGV brake tester – wall mounted display, Headlamp beam tester, Pair of convex mirrors inclusive of installation, Brake pedal applicator, rail extensions 5.7 & 6.5m options available

CLASS VII

WEEKLY FROM ONLY **£126.76⁺**
ONLY **£25,150.00**

TECALEMIT TGD/MDS COMBINED EMISSION TESTER

- Only one calibration per year on both petrol and diesel
- DVSA approved for all classes of MOT testing
- Mobile cabinet
- PC operating platform
- Integral DiSpeed 492 engine RPM measurement
- 1 year manufacturer's warranty

SUPPLIED WITH ATL PACKAGE

588 01 0170
WEEKLY FROM ONLY **£24.39⁺**
ONLY **£4,245.00**

STANDALONE PRICE

588 01 0160
WEEKLY FROM ONLY **£27.71⁺**
ONLY **£5,499.00**



*Finance example typically based on a 5 year lease purchase agreement. Finance subject to status, full terms and conditions available on request. Other finance options available. All prices exclude VAT at 20%. Price, availability and specification may change without prior notice. Warranty subject to manufacturers terms and conditions of use. Errors and omissions excluded. Offers valid until 30th September 2017. Prices correct at time of going to press: June 2017.

DVSA APPROVED 4-POST LIFT, SCISSOR LIFT & PIT LANE ATL PACKAGES FOR CLASSES IV & VII

The Crypton Automated Test lane is DVSA approved for 'One Man' testing of Class IV and VII vehicles, offering improved garage efficiency for a greater return on investment.

All Crypton ATL Packages include:

- Choice of lift or pit lane
- Combined emissions analyser
- Automated brake tester (optional adapter kits for 4x4 and motorcycles)
- Headlight aligner
- Jacking beam
- Wheel play detectors (wireless with scissor lifts)
- Turntables
- 2x inspection mirrors (wall or post mounted)
- Brake pedal depressor
- Site survey and CAD drawings

3 YEARS WARRANTY



FREE MOT BANNER WITH ANY CRYPTON ATL PACKAGE



All lifts are finished in an attractive high quality checker plate surface for maximum protection against corrosion

4-POST PACKAGE

WEEKLY FROM ONLY **£118.43⁺**
FROM ONLY **£23,499.00**

SCISSOR PACKAGE

WEEKLY FROM ONLY **£124.99⁺**
FROM ONLY **£24,799.00**

PIT PACKAGE

WEEKLY FROM ONLY **£93.23⁺**
FROM ONLY **£18,499.00**

*Finance example typically based on a 5 year lease purchase agreement. Finance subject to status, full terms and conditions available on request. Other finance options available. All prices exclude VAT at 20%. Price, availability and specification may change without prior notice. Warranty subject to manufacturers terms and conditions of use. Errors and omissions excluded. Offers valid until 30th September 2017. Prices correct at time of going to press: June 2017.



ASK ABOUT LIFTMASTER EXTENDED WARRANTY AND CARE PLANS

LIFTMASTER OFFERS THE LARGEST RANGE OF ATL OPTIONS – MAKE NO COMPROMISE ON YOUR LAYOUT PLANS!

- Dual Revenue ATL/Alignment options on most lifts
- Delivered and installed by the same team on same day
- Exceptional Warranty back-up with the Lifetime Rolling Warranty option
- FREE Brake Tester Cassette included to assist with groundworks

UPGRADE OPTIONS:

- Wireless Tablet
- Dual Revenue (ATL + Alignment) 4 Post or Scissor Lifts
- Motorcycle Testing
- 4 Post Lift
- Scissor Lift
- Secondary Platform Lift

PIT PACKAGE: Hydraulic Play Detectors; Turning Plates; Manual Jacking Beam; computer-controlled Roller Brake Tester with integrated weighing; rail-mounted Headlamp Aligner

4 Post or Scissor Lift Package: Vehicle Lift with integrated Turning Plates; Hydraulic Plate Detectors; Manual Jacking Beam; computer-controlled Roller Brake Tester with integrated weighing rail-mounted Headlamp Aligner

As specialists on vehicle lifts and MOT testing equipment, Liftmaster’s equipment sourcing policy is based on quality above all else. A Liftmaster ATL package is brought together from products made by the leading UK and European manufacturers in their field. This focus on quality equipment, coupled with the training, experience and skill of Liftmaster’s own engineers is what gives Liftmaster the confidence to back the equipment with the unique Rolling Warranty offer for the service lifetime of the equipment.

WEEKLY FROM ONLY £83.13*
PIT PACKAGE FROM ONLY £16,495.00

*Finance example typically based on a 5 year lease purchase agreement. Finance subject to status, full terms and conditions available on request. Other finance options available. All prices exclude VAT at 20%. Price, availability and specification may change without prior notice. Warranty subject to manufacturers terms and conditions of use. Errors and omissions excluded. Offers valid until 30th September 2017. Prices correct at time of going to press: June 2017.

Emission Analysers

NO HASSLE WARRANTY

BEST PRICE PROMISE

THE MARKET LEADER

Crypton's Combined Gas and Smoke Emissions Analyser is one of the very best around. With a robust design, it is perfect for handling the harshest garage environment.

- Complies to the latest DVSA regulations
- Links directly to the DVSA online system
- Test vehicle classes IV, V & VII (petrol & diesel)
- Operates the brake tester (when purchased)
- Housed in a quality, mobile cabinet
- Available in cabled or wireless
- Manufactured and supported in the UK

3 YEARS WARRANTY

Includes:



23" Colour Screen



Digital smoke meter with automatic calibration



Oil Temperature Probe



Printer, mouse & keyboard with dust/grease protection



Battery RPM Measurement



Gas Analyser accurate to OIML class 0



WHY NOT UPGRADE TO 5YEAR EXTENDED CARE?

- Parts
- Routine consumables
- MOT updates
- Labour
- Calibrations

CCP800 E CABLED
588 01 0060

WEEKLY FROM ONLY **£21.42⁺**
ONLY **£4,250.00**

CCP800 E WIRELESS
588 01 0070

WEEKLY FROM ONLY **£24.44⁺**
ONLY **£4,850.00**

WEEKLY FROM ONLY **£16.12⁺**
FROM ONLY **£3,199.00**

DESCRIPTION	WHAT'S INCLUDED				PART NUMBER	WEEKLY	PRICE
	WARRANTY*	SERVICE	CALIBRATIONS**	VOSA UPDATES			
Crypton CCP800 Combi Analyser – Cable	36m	NO	NO	NO	588 01 0060	£21.41⁺	£4,249
Crypton CCP800 Combi Analyser – Wireless	36m	NO	NO	NO	588 01 0070	£24.44⁺	£4,850
Crypton Emissions – Single Smoke Calibration ONLY 1 Visit	NO	NO	1	NO	588 77 0270	-	£165
Crypton Emissions – Single Gas Calibration ONLY 1 Visit	NO	NO	1	NO	588 77 0280	-	£185
Crypton Combi Calibration Annual Contract**	NO	NO	2 + 1	YES	588 77 0200	-	£360
Crypton Combi 3 YEAR Care Plan <i>available only at point of sale</i>	36m	Callout, labour and parts (including consumables but not peripherals)	6 + 3	YES	263 77 0910	£9.07⁺	£1,800
Crypton Combi 5 YEAR Care Plan <i>available only at point of sale</i>	60m	Callout, labour and parts (including consumables but not peripherals)	10 + 5	YES	263 77 0920	£16.12⁺	£3,199

* Subject to Manufacturer's Terms & Conditions of use

** VOSA mandates that a gas (petrol) bench is calibrated every 6 months, and a smoke (diesel) every 12 months. There for a combined analyser annual calibration contract is 2 gas and 1 smoke calibration.

*Finance example typically based on a 5 year lease purchase agreement. Finance subject to status, full terms and conditions available on request. Other finance options available. All prices exclude VAT at 20%. Price, availability and specification may change without prior notice. Warranty subject to manufacturers terms and conditions of use. Errors and omissions excluded. Offers valid until 30th September 2017. Prices correct at time of going to press: June 2017.

0845 603 3636
OVER 200 BRANCHES NATIONWIDE

Emission Analysers

NO HASSLE WARRANTY

BEST PRICE PROMISE

5 YEARS EMISSIONS TOTAL SOLUTION FOR LESS THAN THE PRICE OF ONE MOT TEST

588 77 0090

Premier Diagnostics combi emissions tester and the operational training, plus 5 years total care (excluding consumables) in one easy package. With the equipment, and the maintenance, care and warranty all taken care of, all you have to do is just test! The 5 Years total package includes DVSA software updates (consumables e.g. oxygen sensor, filters, printer paper not included)

Full 5 years warranty includes – parts and labour, covering all major parts including PC, Gas Bench, Smokehead, Printer, Monitor, Keyboard and Mouse, plus 5 years calibrations.

British built combined petrol and diesel emission analyser with integrated oil temperature and unique RPM measurement technology

- 5 Years Emissions Solution consists of a Premier Combi analyser and 5 Years Care Package
- Premier Combi analyser is equipped with Wi-Fi enabled PC with flexibility to run own programmes, CD Rom, 17" colour monitor, keyboard, mouse and printer
- Every MOT test is stored to memory for instant retrieval and automatic printout of results
- Cable-less smokehead is Euro 6 compliant for a future-proofed investment
- Fast nationwide on-site support by dedicated UKAS accredited engineers
- EOBD, RPM, and Oil Temperature Kit are fully compliant to latest DVSA guidelines
- British designed and manufactured

ASK FOR A DEMO



PREMIER DIAGNOSTICS 5 YEARS EMISSIONS COMPLETE SOLUTION ONLY £42.³⁴* PER WEEK

BOSCH EMISSIONS

COMING SOON!

New generation premium combi emissions solutions designed for efficiency and high demand usage.

Offered in three configuration options, the new Bosch emissions line-up offers everything in the set-up that best suits you to quickly and cost-effectively test petrol and diesel vehicles. The perfect solution to current and future demands of workshops.

BEA 950 S1: COMBI EMISSIONS ANALYSER WITH TROLLEY AND PC

588 01 0530

All measurement modules, control unit testers plus a PC, 19" monitor, keyboard and A4 printer in one compact package on a trolley.



WEEKLY FROM ONLY **£31.73⁺**
FROM ONLY **£6,295.00**

BEA 950 S3: COMBI EMISSIONS ANALYSER WITH TROLLEY – USE YOUR OWN PC/LAPTOP

588 01 0540

Measurement modules and control unit testers supplied on a trolley ready for Bluetooth connection to an existing tablet or laptop.



WEEKLY FROM ONLY **£29.21⁺**
FROM ONLY **£5,795.00**

BEA 550: COMBI EMISSIONS FOR MOBILE OPERATION

588 01 0550

Quick and easy to set up in both mobile and workshop environments for precise testing of petrol and diesel vehicles. This makes the BEA 550 with its compact shape and low weight a perfect companion for flexible emissions testing.



WEEKLY FROM ONLY **£29.69⁺**
FROM ONLY **£5,890.00**

*Laptop/Tablet (e.g. Bosch DCU100) required to operate

*Finance example typically based on a 5 year lease purchase agreement. Finance subject to status, full terms and conditions available on request. Other finance options available. All prices exclude VAT at 20%. Price, availability and specification may change without prior notice. Warranty subject to manufacturers terms and conditions of use. Errors and omissions excluded. Offers valid until 30th September 2017. Prices correct at time of going to press: June 2017.



JOHN BEAN TABLET-DRIVEN AUTOMATED TEST LANE

John Bean's modernised ATL, with its completely wirelessly operated system and tablet operation, truly is industry-leading. By using the unique and easy to use tablet, MOT test results can be submitted in the vehicle, saving you time.

John Bean has options for MOT and ATL bays, Class VII or Class IV testing, four-tonne and five-tonne lifts, along with pit ATL bays, all backed up by a full service to support you through the whole process of choosing your bay, getting DVSA approval, installation and activation.

Features:

- Dual revenue 5.2m or 5.7m lift with rear slip plates as standard, to allow wheel alignment on the same lift, creating better return for your investment
- Wireless torch and shaker plate control
- Unique cable and pulley alignment
- Hose and wiring tidier

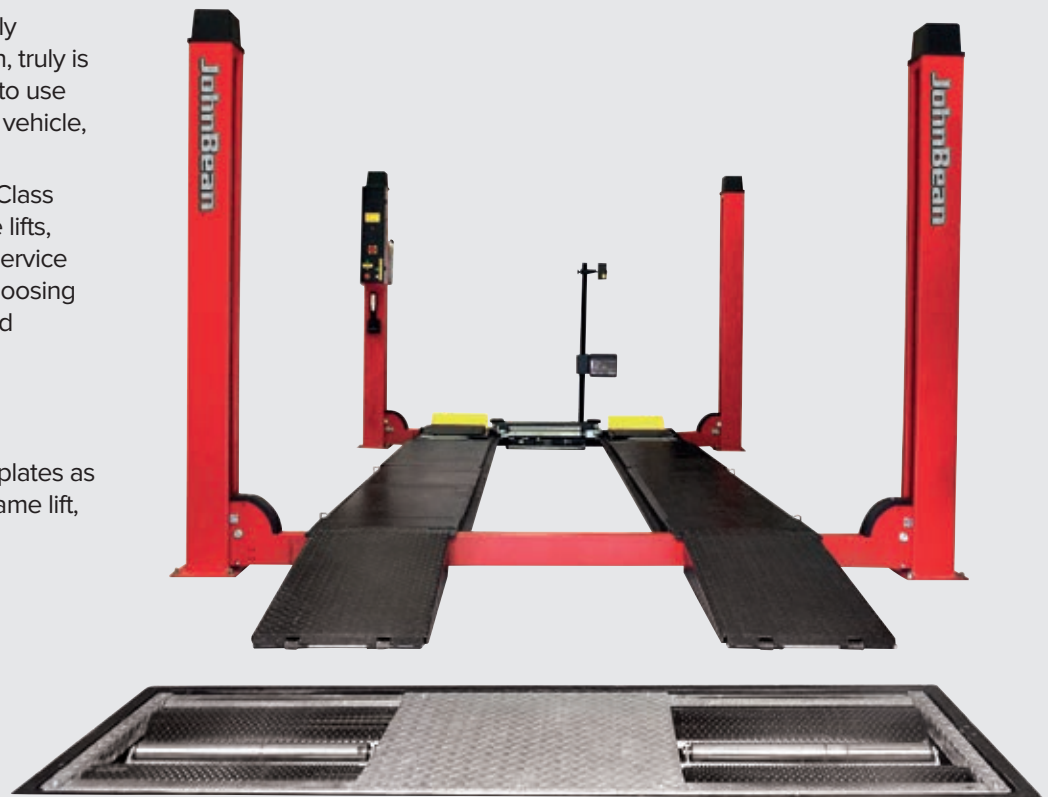

CLASS IV

WEEKLY FROM ONLY **£110.87⁺**
FROM ONLY **£21,999.00**

CLASS VII

WEEKLY FROM ONLY **£146.15⁺**
FROM ONLY **£28,999.00**

JOHN BEAN GEOGAS 5000

The John Bean geogas 5000 diagnostic gas analyser and emissions platform has been developed with the modern workshop in mind. This multi-functional product means you can also integrate your John Bean brake tester or add the Prism alignment system, saving you money, space and providing you with an additional revenue stream.

- Fast warm-up – Fast warm-up and initialisation means the geogas 5000 is ready for action in a matter of seconds.
- User-friendly interface – The unit is operated through a simple, icon-based navigation system that can be operated without any special training.
- Remote control functionality – A remote control device is provided so that you can even operate the programme while sitting in the car or walking around the bay.

WEEKLY FROM ONLY **£28.20⁺**
FROM ONLY **£5,595.00**

The geogas 5000 includes a wireless smoke meter, wireless RPM and oil temperature measurement device with ripple/battery measurement function, and a wireless EOBD RPM and oil temperature trigger device which is approved for low emission diesel testing.

- Accessibility – Access the filters easily at an appropriate working height for ergonomic benefit.
- DVSA website link – Route straight through to the DVSA website through the geogas 5000 platform.
- Service and support – Receive faster support remote access functionality.



*Finance example typically based on a 5 year lease purchase agreement. Finance subject to status, full terms and conditions available on request. Other finance options available. All prices exclude VAT at 20%. Price, availability and specification may change without prior notice. Warranty subject to manufacturers terms and conditions of use. Errors and omissions excluded. Offers valid until 30th September 2017. Prices correct at time of going to press: June 2017.

BENDPAK 4 POST ALIGNMENT LIFTS – ROBUST AND RELIABLE

- Electric / hydraulic power system with single hydraulic cylinder mounted underneath platform – less to go wrong
- Available with single phase or 3 phase electric motor at no additional cost with two power unit locations.
- Platforms accommodate narrow and standard vehicles.
- Push-button pneumatic safety release from multi-position safety locks in each column.
- Longer approach ramps for low-ground clearance vehicles (HDS14, 14X, 14LSX & 14LSXE)
- Wheel alignment lifts available (HDS14LSX & HDS14LSXE)

ADD A BENDPAK JACKING BEAM FROM ONLY £500 EXTRA

3 YEARS WARRANTY



HDS14LSX 6.3T

4 Post alignment Lift with 5054 mm platforms
578 77 0090

WEEKLY FROM ONLY **£28.72⁺**
ONLY **£5,699.00**

HDS14 / 14X 6.35T

4 Post alignment Lift with 5054 / 5816mm platforms
578 77 0000

WEEKLY FROM ONLY **£34.65⁺**
ONLY **£6,875.00**

ALIGNMENT SCISSOR LIFTS

- Large platforms and a sturdy structure, assuring maximum rigidity and stability.
- Mechanical locking device with automatic engagement and pneumatic release, ensuring maximum safety.
- Hydraulic levelling system by means of a patented synchronisation device assures level lifting of platforms regardless of weight distribution.
- Platforms for total wheel alignment, with front radius plate locations and rear slip plates.
- Please note that the radius plates are not included, but available as an optional extra



WEEKLY FROM ONLY **£50.37⁺**
FROM ONLY **£9,995.00**

*optional secondary scissor lift shown

WERTHER 450 AT

578 77 0220

Electro-hydraulic 4 post lift with front recesses and rear slipping plates for wheel alignment.

- Overload safety valve
- Descent control valve
- 'Buzzer' on last portion of descent
- Pipe burst safety valve • 24 V, low tension dead man controls
- Automatic release of safety locking devices



WEEKLY FROM ONLY **£32.73⁺**
FROM ONLY **£6,495.00**

*Finance example typically based on a 5 year lease purchase agreement. Finance subject to status, full terms and conditions available on request. Other finance options available. All prices exclude VAT at 20%. Price, availability and specification may change without prior notice. Warranty subject to manufacturers terms and conditions of use. Errors and omissions excluded. Offers valid until 30th September 2017. Prices correct at time of going to press: June 2017.

Case Study: **Ballards of Finchley Installation of ATL bay**

EQUIPMENT REQUIRED:

- Class VII Scissor ATL Package with Emissions
- 2 CCTV viewing cameras

ADDITIONAL WORK REQUESTED:

- Cut an opening in an external wall to create a new workshop doorway
- Move existing pipework to accommodate the new doorway
- Reclad the building exterior
- Build a drive-on ramp access to the new doorway
- Remove an interior wall to open out the bay area
- Finish the floor with a resin coating and line painting



Can you turn this dead space into money-making space?

This was a unique project in which a new workshop doorway required to be cut into an external wall in order to accommodate a one-way drive-thru Class VII ATL layout.

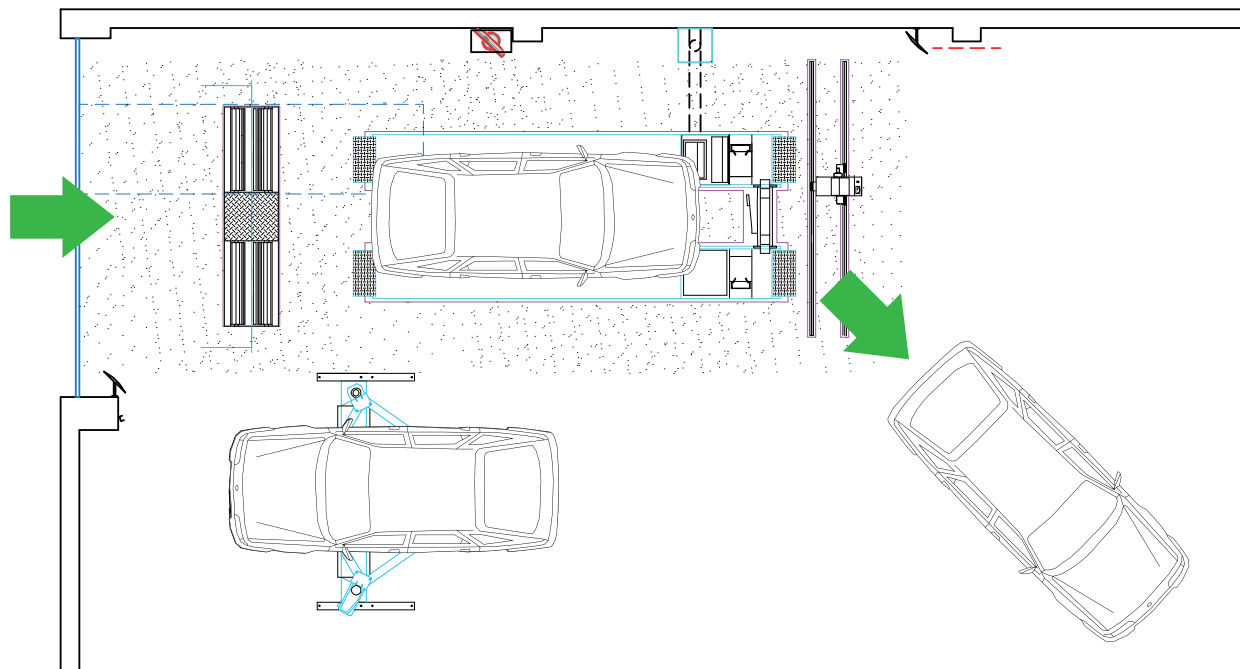

“Our solution will allow this premises to maximise its revenue potential, turning what used to be dead space into a full Class VII bay”

Paul Darbyshire Workshop Solutions Projects Manager

*Finance example typically based on a 5 year lease purchase agreement. Finance subject to status, full terms and conditions available on request. Other finance options available. All prices exclude VAT at 20%. Price, availability and specification may change without prior notice. Warranty subject to manufacturers terms and conditions of use. Errors and omissions excluded. Offers valid until 30th September 2017. Prices correct at time of going to press: June 2017.

Additionally, the setup had to allow for vehicles to drive off the lift diagonally well as straight ahead. This meant that there needed to be an in-fill between the lift platforms; that also accommodated the jacking beam as the lift platforms descended.



New Doorway



Sunken Jacking Beam

Our proposed solution also had to satisfy the building landlord (structural integrity of the building with the new doorway) and the DVSA inspector (jacking beam mounting on the ATL scissor lift).



Raised In-fill



Jacking Beam Recess

The equipment was delivered and installed. Load testing and certification, DVSA inspector to view the premises and agree everything was to the required standards.



Drive-on Ramp Access



Let's get testing!

*Finance example typically based on a 5 year lease purchase agreement. Finance subject to status, full terms and conditions available on request. Other finance options available. All prices exclude VAT at 20%. Price, availability and specification may change without prior notice. Warranty subject to manufacturers terms and conditions of use. Errors and omissions excluded. Offers valid until 30th September 2017. Prices correct at time of going to press: June 2017.

BENDPAK 4 POST SERVICE LIFTS – ROBUST AND RELIABLE

- Electric / hydraulic power system with single hydraulic cylinder mounted underneath platform – less to go wrong
- Available with single phase or 3 phase electric motor at no additional cost with two power unit locations.
- Platforms accommodate narrow and standard vehicles.
- Push-button pneumatic safety release from multi-position safety locks in each column.
- Longer approach ramps for low-ground clearance vehicles (HDS14, 14X, 14LSX & 14LSXE)
- Wheel alignment lifts available (HDS14LSX & HDS14LSXE)

ADD A BENDPAK JACKING BEAM FROM ONLY £600 EXTRA

3 YEARS WARRANTY



HD-9 4T 4 Post Service Lift
with 4166mm platforms
578 77 0050

WEEKLY FROM ONLY **£16.10⁺**
ONLY **£3,195.00**

HD9XW 4T 4 Post Service Lift
with 4775 mm platforms
578 77 0080

WEEKLY FROM ONLY **£17.13⁺**
ONLY **£3,399.00**

HDS-14 4 Post Service Lift
6.35Ton, 3 Phase
578 77 0010

WEEKLY FROM ONLY **£24.19⁺**
ONLY **£4,7399.00**

FULL PLATFORM SCISSOR LIFTS

- Very compact and low platform height
- With short access ramps, for low clearance vehicle
- Two independent hydraulic circuits guarantees perfect synchronisation and safe lifting and lowering
- Powerful, quiet and long lasting oil-submerged motor
- Fast lifting and lowering times
- Above ground or in-ground installation
- No mechanical connection between platforms

Standard configuration:

- Control unit is one metre from front right hand platform other configuration are available at additional cost
- Standard colour grey, blue colour available on special offer



WEEKLY FROM ONLY **£43.32⁺**
FROM ONLY **£8,595v.00**

*Finance example typically based on a 5 year lease purchase agreement. Finance subject to status, full terms and conditions available on request. Other finance options available. All prices exclude VAT at 20%. Price, availability and specification may change without prior notice. Warranty subject to manufacturers terms and conditions of use. Errors and omissions excluded. Offers valid until 30th September 2017. Prices correct at time of going to press: June 2017.

Full Rise Scissor Lifts



L3200S SHORT PLATFORM SURFACE MOUNTED SCISSOR LIFT

Ideal for service bays, tyre shops, general repair, brake repairs, suspension and transmission replacement, and body shops. Can handle almost all heavy-weight passenger cars derived vans. The ultra-low profile construction will accommodate most sports cars and other low skirted vehicles.

- Minimum pick-up height as low as 110mm, no problem for low-profile vehicles
- Design offers full access to front, rear, and sides of vehicle
- Supplied complete with sill-protecting rubber blocks
- Automatic activated safety lock through all lifting travel, easy pneumatic release
- Extendible platform length by utilising lockable approach ramps



L3200S 3 Phase
581 01 0150

WEEKLY FROM ONLY **£18.12⁺**
ONLY **£3,595.00**

L3200S 1 Phase
581 01 0090

WEEKLY FROM ONLY **£18.12⁺**
ONLY **£3,595.00**

BRADBURY H8 SERIES SHORT PLATFORM SCISSOR LIFTS

2 YEARS WARRANTY

Ideal for service bays, tyre shops, general repair, brake repairs, suspension and transmission replacement and body shops. Featuring a low profile platform ideal for lifting a large range of vehicles including low skirted sport cars.

Bradbury H8903/H8901E 3.2t extra low profile

Bradbury H8603/H8601E 3.6t Short Platform Recessed Scissor Lift

- Hydraulically synchronised platforms.
- Improves utilisation of workshop space.
- Full access to sides, front and rear of vehicle.
- Ideal for service bays, tyre shops and general repair.
- Complete with lifting blocks.
- Safety valves detects hydraulic failure.
- Overload mechanical safety device – Ratchet safety mechanism engages each time the lift stops throughout the lifting height of 1850mm.
- Control panel allows precise lifting.
- Reflector/light beam sensor ensures platform remains level during lift.



Bradbury H8903E/H8901E

H8903E
Surface mounted, 3 Phase
581 77 0090

WEEKLY FROM ONLY **£18.37⁺**
ONLY **£3,645.00**

H8901E
Surface mounted, 1 Phase
581 77 0100

WEEKLY FROM ONLY **£18.37⁺**
ONLY **£3,645.00**



Bradbury H8603E/H8601E

H8603E
Recessed, 3 Phase
581 77 0070

WEEKLY FROM ONLY **£18.37⁺**
ONLY **£3,645.00**

H8601E
Recessed, 1 Phase
581 77 0080

WEEKLY FROM ONLY **£18.37⁺**
ONLY **£3,645.00**

*Finance example typically based on a 5 year lease purchase agreement. Finance subject to status, full terms and conditions available on request. Other finance options available. All prices exclude VAT at 20%. Price, availability and specification may change without prior notice. Warranty subject to manufacturers terms and conditions of use. Errors and omissions excluded. Offers valid until 30th September 2017. Prices correct at time of going to press: June 2017.



If you're thinking of introducing additional lift capacity into your workshop but have limited space, then a 2-post option may well be the way to go. There are a number of options for you to consider and you'll find some of the key points throughout the pages of this feature.

The featured lifts are only a selection of the available options so, when you've had a look through this feature, why not let your local Workshop Solutions Specialist help you decide on exactly the right option for you. Just call your local branch and we'll do the rest.



Baseplate or Baseless?

BASEPLATE

A lift with a baseplate has the electrics and cables or chains running across the floor, between the posts. This is commonly known as a Floorplate or H Frame setup.

Pros: Accommodates low workshop ceiling height and may help in overcoming poor floor conditions. No Vehicle height restriction (other than your ceiling height!).

Cons: Intrusive when using a transmission jack and when manoeuvring vehicles over the cross member.

BASELESS

A baseless lift requires the cables and hydraulics to pass over the top of the posts.

Pros: No Floor connections so no problems with transmission jacks or manoeuvring vehicles. Easy to keep floor clean.

Cons: High ceilings are required! Not suitable for large/tall vehicle work (Touch top Bar).

Mechanical Screw or Hydraulic Operation?

MECHANICAL SCREW LIFTS

Standard for a lot of older designs – electrically powered.

Pros: A vehicle on the lift does not have to go up before lowering.

Cons: Slower Operation, old fashioned and costly to run.

HYDRAULIC LIFTS

Pros: Generally Faster operation, no Regular nut replacement, simple design, cheaper electrical costs

Cons: Generally, these use 'safety locks' – a vehicle has to raise out of locks before lowering, which can be inconvenient for gearbox or engine work where precise placement is required – there are some exceptions.

Lift Arm Configuration Symmetrical or Asymmetrical?

ASYMMETRIC

Asymmetric lifts have one arm longer than the other on each post

Pros: Allow ease of access - opening the vehicle front doors (60/40 split)

Cons: The lift can only be installed facing one way. The control box can only be mounted to one post. Vehicles can only be driven on in one direction.

SYMMETRIC

Symmetric lifts have arms of the same length

Pros: Vehicles can be driven, or reversed on. Electrics to be fitted to either post.

Cons: May struggle to accommodate some shorter chassis vehicles

Other considerations

LIFT ARM LENGTHS:

Determine the range of chassis lengths the lift can accommodate.

DRIVE-THRU WIDTHS:

Most lifts have a set width between the posts. Some are available in two different width options, offering greater flexibility in lift positioning.

POWER SUPPLY:

Most lifts require three-phase supply as standard, there's usually a premium to pay for single-phase.

COUNTRY OF DESIGN AND COUNTRY OF MANUFACTURE:

Some European or American designed lifts are manufactured in the Far East, others are manufactured in Europe or America.

WARRANTY:

How important is peace of mind? Standard warranties vary between 1, 2, 3 and 5 years.

2 Post Baseplate Lifts

NO HASSLE WARRANTY

BEST PRICE PROMISE

BENDPAK XPR SERIES BASELESS LIFTS

The XPR-Series offers an abundant roster of options and accessories that allows you to fully tailor your lift to your unique circumstance

Wide or Narrow configurable options

Specific models in the range feature an adjustable top beam to accommodate wide or narrow installation setups. This unique configurable design allows you to choose the best setting for your specific space or vehicle lifting requirements.

Optional column height extension

Specific models in the range feature optional post extensions for extra height. This gives you the flexibility of increasing the overhead clearance to maximize the vehicles you can service.



NOW SUPPLIED WITH ADJUSTABLE HEIGHT SCREWPADS AS STANDARD

5 YEARS WARRANTY

XPR10TS
577 77 0240



WEEKLY FROM ONLY **£15.11[†]**
ONLY £2,999.00

XPR10TS-168
577 77 0080



WEEKLY FROM ONLY **£19.13[†]**
ONLY £3,795.00

XPR12C
577 77 0170



WEEKLY FROM ONLY **£28.70[†]**
ONLY £5,695.00

XPR12CL192-LWB
577 77 7450



WEEKLY FROM ONLY **£30.21[†]**
ONLY £5,995.00

BENDPAK XPR SERIES BASEFRAME LIFTS

Low-profile, dropped-end frame c/w **NEW** screw contact pads

Squeeze under even the lowest compact and sport vehicles. The new adjustable screw pads ensure that the vehicle is lifted safely at all times

Triple-telescoping front arms and two-stage rear arms

Increases overall arm positioning for lifting a variety of different wheel base vehicles. Overall arm sweep and minimum arm reach are also extended to precisely lift vehicles that have unibody construction, OEM recommended pick-up points and wide and / or narrow wheelbase configurations.

5 YEARS WARRANTY

- 51mm Double screw adapter pads as standard on XPR9 & 10 Series.
- 4-Piece, 63mm stackable pad height adapter set included as standard on XPR9 & 10 Series. (Other lifting adapters are available)
- 8-Piece 63mm & 125mm stackable pad height adapter set included as standard on XPR12 series.
- 1308mm Lifting Arms on XPR9 & 10 Series.
- 1500mm Lifting Arms on XPR12 series.
- 1800mm Lifting Arms on LWB versions.
- 3-phase standard available with single phase motor at no additional cost.

NEW UPDATED MODELS



NOW SUPPLIED WITH ADJUSTABLE HEIGHT SCREWPADS AS STANDARD

XPR9TS 577 77 0870



WEEKLY FROM ONLY **£15.11[†]**
ONLY £2,999.00

XPR12FDL 577 77 0030



WEEKLY FROM ONLY **£22.65[†]**
ONLY £4,495.00

XPR12FDL-LWB 577 77 0070



WEEKLY FROM ONLY **£23.68[†]**
ONLY £4,699.00

*Finance example typically based on a 5 year lease purchase agreement. Finance subject to status, full terms and conditions available on request. Other finance options available. All prices exclude VAT at 20%. Price, availability and specification may change without prior notice. Warranty subject to manufacturers terms and conditions of use. Errors and omissions excluded. Offers valid until 30th September 2017. Prices correct at time of going to press: June 2017.



2 Post H-Frame Lifts



BRADBURY HYDRAULIC 2 POST LIFTS

- Baseless option – ideal for transmission jacks
- 3 stage arms and large, adjustable dual screw lifting pads
- Electro-mechanical locking device
- Easy access for cable adjustment



BRADBURY H2401/3

4t standard length posts



WEEKLY FROM ONLY **£16.86⁺**
ONLY **£3,345.00**

BRADBURY H2601/3

6t standard length posts



WEEKLY FROM ONLY **£24.67⁺**
ONLY **£4,885.00**

BRADBURY H2401/3

4t extra height posts



WEEKLY FROM ONLY **£17.87⁺**
ONLY **£3,545.00**

BRADBURY H2601/3

6t extra height posts



WEEKLY FROM ONLY **£26.18⁺**
ONLY **£5,195.00**

TECALEMIT SF/9207 – SENTINEL 4 TON HYDRAULIC 2 POST LIFT WITH BASE FRAME AND 3 STAGE ARMS

The SF 9207 is mounted on a heavy duty steel base frame which ensures a stable lifting platform and the minimum lifting pad height of only 100mm ensures that even vehicles with low ground clearance can be accommodated on the lift.

The lift has 3 stage arms enabling the lift to be used on a wider range of vehicles.

- Electro-hydraulic operation
- Asymmetric lifting arms 3 stages for lifting a wide range of vehicles
- Rapid lifting time
- Structural base frame
- Electronically controlled safety latches



INCLUDES FREE HIGH LIFT PADS



577 77 0370



WEEKLY FROM ONLY **£16.61⁺**
ONLY **£3,295.00**

577 77 0360



WEEKLY FROM ONLY **£15.09⁺**
ONLY **£2,995.00**

TECALEMIT SF/8909/H – AZUR 3 TON 2 POST LIFT WITH BASE FRAME 576 77 0230

- Suitable for lifting most passenger cars and car derived vans
- Automatic arm locking
- 5 Year warranty on self-lubricating Nylatron operating and safety nuts
- Low minimum lifting pad height of just 90mm
- Foot/toe protection device using an audible buzzer
- Heavy duty base-frame



WEEKLY FROM ONLY **£13.58⁺**
ONLY **£2,695.00**

*Finance example typically based on a 5 year lease purchase agreement. Finance subject to status, full terms and conditions available on request. Other finance options available. All prices exclude VAT at 20%. Price, availability and specification may change without prior notice. Warranty subject to manufacturers terms and conditions of use. Errors and omissions excluded. Offers valid until 30th September 2017. Prices correct at time of going to press: June 2017.

2 Post Lifts

NO HASSLE WARRANTY

BEST PRICE PROMISE

L4000 M/E 2 POST 4 TON HYDRAULIC LIFT

This value Lift has a lot to offer. Symmetric arms offer wide flexibility to lift most cars and car derived vans in either direction. Electro-magnetic safety locks conveniently release at the push of a button. (A manual lock release version of this lift is also available)

- Hydraulic hoses and balance cables are all fully concealed, providing a clean appearance.
- The double hydraulic cylinders and high strength chain drive provide smooth lifting and lowering.
- Screw height adaptors supplied as standard - 4x4 adaptors available at extra cost.
- An emergency lowering valve can be manually operated to lower the lift safely in the event of a power failure.
- Meanwhile, a flow-control valve prevents the possibility of a rapid uncontrolled descent
- Door rubbers on the posts protect the car doors from direct contact, and sill protector rubbers on the upper arms perform the same function protecting the undersides of longer chassis vehicles



- Minimum pad height 110mm
- Drive-thru width 2486mm
- Maximum Lifting Height 1850mm
- Lifting time 40-50sec
- Lowering time 20-40sec



MANUAL LOCKS 1 Phase
577 01 0060

WEEKLY FROM ONLY **£10.31⁺**
ONLY **£2,045.00**

ELECTRONIC LOCKS 1 Phase
577 01 0070

WEEKLY FROM ONLY **£11.82⁺**
ONLY **£2,345.00**

ELECTRONIC LOCKS 3 Phase
577 01 0080

WEEKLY FROM ONLY **£11.82⁺**
ONLY **£2,345.00**

LIFTMASTER LMS SERIES

5 YEARS COMPREHENSIVE WARRANTY

- Built in Germany and approved by multiple vehicle manufacturers for their workshops.
- This series of lift is available with 3.0T or 3.5T capacity.
- Electro-Mechanical Operation with low wear nyatron-nut means quiet operation.
- 5 years warranty on spindle and spindle-nuts.
- Driven by twin motors integrated into columns.
- The baseless lift gives an unobstructed floor space between the posts which allows Technicians to easily move tool boxes, transmission jacks, oil drainers and other service equipment underneath the elevated vehicle.
- Triple reach telescopic asymmetric front lifting arms means lifting points are easily reached.
- Low lifting point (from 75mm using Minimax Arms) allows vehicles with lower clearance to be lifted.
- This asymmetric Lift allows the vehicles' doors to be opened wider.
- Height adjustable gantry at the top connection at time of installation.



LMS3000MM
Standard configuration 576 77 0480



WEEKLY FROM ONLY **£20.61⁺**
ONLY **£4,090.00**

LMS3000TRA
with 3-stage arms 577 77 0120



WEEKLY FROM ONLY **£15.85⁺**
ONLY **£3,145.00**

LMS3500TRA
3.5t version 576 77 0490



WEEKLY FROM ONLY **£18.39⁺**
ONLY **£3,649.00**

LMS3500MM
3.5t version 576 77 0510



WEEKLY FROM ONLY **£23.41⁺**
ONLY **£4,645.00**

*Finance example typically based on a 5 year lease purchase agreement. Finance subject to status, full terms and conditions available on request. Other finance options available. All prices exclude VAT at 20%. Price, availability and specification may change without prior notice. Warranty subject to manufacturers terms and conditions of use. Errors and omissions excluded. Offers valid until 30th September 2017. Prices correct at time of going to press: June 2017.



Mid-Rise Scissor Lifts



JOHN BEAN SSL 33 ELECTRO-HYDRAULIC MID-RISE LIFT 581 05 0010

Portable lift designed to lift cars and light commercial vehicles.

- Small size and portability make this a great investment for any busy garage
- Single phase operation
- 1m lifting height
- Pneumatic safety lock
- Includes mobile kit
- Run on ramps double as lift extensions



WEEKLY FROM ONLY **£14.81⁺**
ONLY **£2,939.00**

CRYPTON CML3000 3T MIDRISE SCISSOR LIFT 581 77 0320

Safely lifts most vehicles including SUV's up to 3tonnes.

- Portable lift to move around your workshop quickly and easily
- 1m lifting height for wheel and tyre refits, brakes and suspension inspection and under body, paint and bodywork
- Arrives pre-assembled for fast and easy set-up. Simply unpack, fill with hydraulic oil and plug in
- Two cylinders and independent hydraulic systems protects the lift from sagging and ensures mechanical synchronisation
- No compressed air required
- Galvanised anti-skid platforms with adjustable length
- Suitable for indoor and outdoor use (additional working space)
- Fast lifting and lowering times
- 3 year warranty as standard



WEEKLY FROM ONLY **£13.10⁺**
ONLY **£2,599.00**

3 YEARS WARRANTY

LIFTMASTER SPRINTER 3T MID-RISE SCISSOR LIFT 581 77 0031

With almost one meter lifting height, the Sprinter covers 90% of all activities in the workshop. Thanks to the mobile kit (supplied as standard), the lift is easily moveable around the workshop.

By picking up the vehicle at the sillboards, the Sprinter safely picks up most vehicles (including SUV vehicles), up to 3 Tons. Super ductile polymer pads (supplied as standard) protect the car's underbody.

Ideal for Wheel and Tyre work, Chassis and Underbody work; Bodypanel and Smart repair; Valeting and Detailing

Capacity (kg)	3000
Lifting time approx. (sec.)	11
Lifting height (mm)	980
Drive over height (mm)	102
Runway length (mm)	1400-2010
Runway width (mm)	450
Motor (kW)	1,5

WEEKLY FROM ONLY **£14.09⁺**
ONLY **£2,795.00**

PRICE INCLUDES INSTALLATION



ADD 2 YEARS WARRANTY

- Almost 1 metre lifting height
- Electro-Hydraulic operation
- Single Phase 16amp supply required
- Lifting platforms adjust from 1400-2010mm
- Includes mobile kit
- Made in Germany

*Finance example typically based on a 5 year lease purchase agreement. Finance subject to status, full terms and conditions available on request. Other finance options available. All prices exclude VAT at 20%. Price, availability and specification may change without prior notice. Warranty subject to manufacturers terms and conditions of use. Errors and omissions excluded. Offers valid until 30th September 2017. Prices correct at time of going to press: June 2017.

Wheel Service – Low Volume

NO HASSLE WARRANTY **BEST PRICE PROMISE**

WERTHER TITANIUM COMPLETE TYRE PACKAGE 583 01 0030

- Fully automatic tyre changer plus wheel balancer
- Single phase supply
- Including assistant arm
- From 11" to 24" wheels



WEEKLY FROM ONLY **£12.57⁺**
ONLY £2,495.00

HOFMANN MEGAPLAN ECOMOUNT 22 PLUS TYRE CHANGER AND JUNIOR LITE BALANCER PACKAGE 583 01 0130

- 10" to 24" Clamping (22" external)
- 13" rim width capability
- Fully-Automatic Operation
- Includes 'megafit 2' assist arm

UPGRADE TO 'JUNIOR' BALANCER FOR £345



WEEKLY FROM ONLY **£13.68⁺**
FROM ONLY £2,715.00

BRADBURY WC5301AA TYRE CHANGER AND WC5521i WHEEL BALANCER 583 77 0100

- Fully automatic tyre changer and wheel balancer
- Single phase supply
- From 12"-23" wheels
- 14"-26" clamping

COMES WITH FREE STARTER PACK WORTH £80



WEEKLY FROM ONLY **£16.38⁺**
FROM ONLY £3,250.00

PROWAY ELITE 220 TYRE CHANGER AND ELITE 110 WHEEL BALANCER FROM HOFMANN MEGAPLAN 583 77 0930

- Reliable and efficient design.
- Extensively tested prior to delivery.
- Operator training included.
- The ideal entry-level option.



WEEKLY FROM ONLY **£12.07⁺**
ONLY £2,395.00

*Finance example typically based on a 5 year lease purchase agreement. Finance subject to status, full terms and conditions available on request. Other finance options available. All prices exclude VAT at 20%. Price, availability and specification may change without prior notice. Warranty subject to manufacturers terms and conditions of use. Errors and omissions excluded. Offers valid until 30th September 2017. Prices correct at time of going to press: June 2017.

SAVE £200 WHEN YOU BUY THE TCE4430 AND WBE4200 OR WBE4120

BOSCH TCE 4430-24 TYRE CHANGER

4 YEARS WARRANTY

The tilt back tyre changer TCE 4430-24 is equipped with a 24" (external clamping) turntable.

The tyre changer offers pneumatic positioning of the mounting head, and an adjustable bead breaker. The extreme rigidity of the structure and the use of the G-frame concept make this machine the market benchmark for robust and solid performance. The helper system and the wheel lift makes the work even easier.

- Comes with a 4 year warranty (2 years parts and labour 2 years parts only)

3 PHASE
583 77 0490

1 PHASE
583 77 0970



WEEKLY FROM ONLY **£19.13⁺**
ONLY **£3,795.00**



BOSCH WBE 4200 WHEEL BALANCER

584 04 0370

Semi-automatic wheel balancer offers garages and workshops a simple, high precision and easy-to-use value machine. Clear digital read-outs for passenger cars, light commercial vehicles and motorcycles, with a new ergonomic design allowing for better access to the inside of the wheel and an improved working position, creating more comfort for the user.

- Comes with 2 years warranty as standard with the option of additional service/calibration plans



WEEKLY FROM ONLY **£10.05⁺**
ONLY **£1,995.00**



WBE4120D/DT COMPACT AND RELIABLE WHEEL BALANCER

The WBE 4120 series is an electronic wheel balancer designed for low to medium volume workshops. It is extremely versatile thanks to the compact design making it suitable for the narrowest environments, while still capable of working with all types of car, motorcycle and light commercial vehicle wheels. Supplied with a TFT monitor, Easyfit internal electronic measuring arm and a complete software package including all static and dynamic balancing programmes.

Thanks to the new wheel cover shape and the new weight holders, WBE4120D is the perfect equipment in the workshop environment.

- Small footprint – suitable for the narrowest environment
- Max. wheel weight 65kg
- Optional, external electronic measuring arm for rim width
- Comes with a manufacturer's 2 year warranty

WBE4120D
584 77 0620



WEEKLY FROM ONLY **£9.05⁺**
ONLY **£1,795.00**

WBE4120DT
584 77 0630



WEEKLY FROM ONLY **£11.06⁺**
ONLY **£2,195.00**



*Finance example typically based on a 5 year lease purchase agreement. Finance subject to status, full terms and conditions available on request. Other finance options available. All prices exclude VAT at 20%. Price, availability and specification may change without prior notice. Warranty subject to manufacturers terms and conditions of use. Errors and omissions excluded. Offers valid until 30th September 2017. Prices correct at time of going to press: June 2017.

Wheel Service – High Volume

NO HASSLE
WARRANTY

BEST PRICE
PROMISE

HOFMANN MEGAPLAN MEGAMOUNT 503XL

583 77 0410

Fully Automatic and boasting a 'top end' specification, the Megamount 503XL is capable in any environment. The patented, adjustable turntable enables alloy rims up to 26" in diameter to be clamped from the outside, and the tall column and wide bead breaker opening ensures suitability for extra-wide rims up to 15". A bead breaker 'stroke limiter' for shallow-welled BMW rims and quick-release, interchangeable demount head system, with standard/run-flat, plastic and 'raised spoke' heads, completes the luxury specification.

- 10" to 28" Clamping (26" external)
- 15" Rim Width Capability
- Quick-Release Demount Head System for Standard/RFT, Plastic and 'Raised Spoke'
- Includes 'Megafit 2XL' assist arm
- BMW/Run-Flat 'Stroke Limiter' as standard
- Double-acting bead breaker
- Fully-Automatic Operation



WEEKLY FROM ONLY **£20.13⁺**
ONLY **£3,995.00**

**UPGRADE TO MEGAMOUNT 503 EVO
WITH LEVERLESS OPERATION
FOR ONLY £ 1,299 +VAT**



HOFMANN MEGAPLAN MEGASPIN 200V

583 05 0510

The Megaspin 200V has to offer one of the best price/performance ratios of any wheel balancer on today's market. Fully-automatic (3D) data input is achieved using the inner measuring/weight placement arm and Hofmann Megaplan's revolutionary IWA (Intelligent Width Assessment) software.

Values are displayed live on the full colour TFT display. The displayed graphics will guide the operator to the designated weight placement position, as well as delivering what is probably the simplest, fastest method of 'split weight' (hiding the weights behind the spokes) ever.

- 3D Fully-Automatic Data Input via IWA
- Colour TFT Display
- Can handle rims up to 30" diameter
- Simple, speedy operation
- 4 years PCB Warranty



WEEKLY FROM ONLY **£12.57⁺**
ONLY **£2,495.00**



*Finance example typically based on a 5 year lease purchase agreement. Finance subject to status, full terms and conditions available on request. Other finance options available. All prices exclude VAT at 20%. Price, availability and specification may change without prior notice. Warranty subject to manufacturers terms and conditions of use. Errors and omissions excluded. Offers valid until 30th September 2017. Prices correct at time of going to press: June 2017.



Wheel Service – Medium to High Volume

NO HASSLE
WARRANTY

BEST PRICE
PROMISE

JOHN BEAN B100 AND T5305

Tyre and wheel package including tilt back tyre changer for all conventional tyres on the market, including helper arm and 10"-20" clamping range, and digital wheel balancer with 2D SAPE (semi-automatic parameter entry) for measurement of wheel offset and wheel diameter in one process.

B100 FEATURES

- Built using the VPI measuring system for high accuracy and repeatability
- Automatic start of measurement when hood is closed and brake applied at end of spin cycle
- Intuitive control panel and display
- Split weight mode – hide weights behind wheel spokes for more appealing cosmetic finish
- Tyre matching mode – optimise tyre to rim so using less weights

T5305 FEATURES

- Pneumatic tilting column
- Table has two cylinders for improved gripping of the rim
- Side bead breaking with adjustable inclination
- Assist arm:
 - Drop centre pressing tool
 - Rim centre pushing tool
- Steel head with plastic inserts



*Some run-flat tyres may require additional adaptors

B100

584 05 0150



WEEKLY FROM ONLY **£10.56⁺**
ONLY £2,095.00

T5305

583 01 0140



WEEKLY FROM ONLY **£15.11⁺**
ONLY £2,999.00

B100 + T5305 PACKAGE

583 01 0170

WEEKLY FROM ONLY **£20.13⁺**
ONLY £3,995.00

JOHN BEAN B340L AND T5545

Tyre and wheel package including twin-speed tyre changer for all conventional tyres on the market, including helper arm and 10"-24" clamping range, and touchscreen wheel balancer with 2D SAPE (semi-automatic parameter entry) and Smart Sonar input for automatic measurement of wheel offset, wheel diameter and wheel width, plus a pinpoint laser indicator for weight placement.

B340L FEATURES

- 10in touchscreen LCD display
- EasyWeight pinpoint laser indicator for adhesive weight placement
- EasyALU to automatically recognise the weight mode – ALU-P or steel
- QuickBal – reduced measurement 4.5 seconds (15" rim)

T5545 FEATURES

- Double-acting bead breaker cylinder
- Four self-centring turntable jaws
- Quick-inflating valve
- Outer clamping range up to 24 inches
- Pneumatic tilt back post, pneumatically locked in working position
- e-designed assist arm suited for handling run-flat tyre systems (additional optional adaptors required for PAX and CSR)



B340L

584 77 0640



WEEKLY FROM ONLY **£19.56⁺**
ONLY £3,880.00

T5545

583 01 0160



WEEKLY FROM ONLY **£22.73⁺**
ONLY £4,510.00

B340L + T5545 PACKAGE

583 77 1010

WEEKLY FROM ONLY **£42.31⁺**
ONLY £8,395.00

*Finance example typically based on a 5 year lease purchase agreement. Finance subject to status, full terms and conditions available on request. Other finance options available. All prices exclude VAT at 20%. Price, availability and specification may change without prior notice. Warranty subject to manufacturers terms and conditions of use. Errors and omissions excluded. Offers valid until 30th September 2017. Prices correct at time of going to press: June 2017.

0845 603 3636
OVER 200 BRANCHES NATIONWIDE

Wheel Service – High Volume

NO HASSLE
WARRANTY

BEST PRICE
PROMISE

HOFMANN MEGAPLAN MEGAMOUNT EASY

583 77 0420

The Megamount Easy represents an alternative style of tyre changer, where manual effort is reduced to a minimum, and the emphasis is on larger rims fitted with low profile tyres.

An integral wheel lifter makes light work of the heaviest assemblies, and the centre post clamping with the simple and speedy 'Smart Lock' ensures there is no contact with the outer edge of the rim. The famous Hofmann Megaplan 'Evolution' leverless system is enhanced with the new 'Lever No Lever' design, which enables the operator to switch between leverless operation and traditional lever & demount head at the flick of a switch.

Unlike many other 'Next Generation' tyre changers on the market, the EASY was designed with one major focus; simplicity. In every element of the tyre fitting and removal process, the directive has been to ensure that operation remains simple, minimising the number of controls and functions – Easy by name, and Easy by nature.

- 10" to 30" Clamping Capability via Centre Post method with 'Smart Lock'
- Lever No Lever system enables dual leverless or traditional levered fitting as preferred
- Integral wheel lifter
- Dynamic bead breaking system via roller
- 'Next generation' tyre changer design



WEEKLY FROM ONLY **£29.21***
ONLY £5,795.00

HOFMANN MEGAPLAN MEGASPIN 420

584 77 0370

The most advanced technology the industry has seen in a wheel balancer. The combination of revolutionary new technology, incredible simplicity, and typical Hofmann Megaplan reliability makes this, in our opinion, the best value wheel balancer on the market today.

Boasting 'No Checkspin' technology and 6 o'clock weight positioning, the Megaspin 420 only requires the operator to select the weight position(s) and lower the hood – it's that simple! Two laser points guide the operator to the chosen weight position, and the rim locks into position at each inner and outer 6 o'clock placement position.

There is no possibility for error, no chance of the machine throwing up an extra 5 or 10gms, and absolutely No Checkspin Required!

- Worlds' first balancer with 'No Checkspin' technology
- Easier 6 o'clock weight position
- Super Automatic Data Input via sonar (touch-free)
- Laser Guided weight placement
- Handles rims up to 30" diameter
- The simplest, fastest wheel balancer ever produced



WEEKLY FROM ONLY **£17.11***
ONLY £3,395.00

*Finance example typically based on a 5 year lease purchase agreement. Finance subject to status, full terms and conditions available on request. Other finance options available. All prices exclude VAT at 20%. Price, availability and specification may change without prior notice. Warranty subject to manufacturers terms and conditions of use. Errors and omissions excluded. Offers valid until 30th September 2017. Prices correct at time of going to press: June 2017.



Wheel Service – High Volume

NO HASSLE WARRANTY

BEST PRICE PROMISE

BOSCH TCE4470 S122

Bosch TCE 4470 tilting back tyre changer provides a range of innovative features designed for maximum speed, performance and durability – even for the toughest UHP or RFT passenger car and light commercial tyres. With the addition of a special accessory kit, this machines can also handle motorcycle tyres.

The new design helper arm is especially designed for tyre specialists and high-volume workshops. A wheel lift, which allows you to work always in an ergonomic position, is available as an optional extra.

- Big space for wheel seating – outside clamping
- Suitable for fast-fits and high volume workshops
- Big space for wheel seating – outside clamping 28 inch and wheel width up to 15 inch without any special pre-adjustment
- Pneumatic positioning mounting head
- Revolutionary Ergo Control bead breaker makes the operation safe, quick, precise and comfortable
- Fitted with TCE 330, helper arm with two independent pressure points
- TSL 230 lift as accessory with integrated roller board – optional extra
- Manufactured in Europe
- Available in 1ph and 3ph
- Comes with a 4 year warranty (2 years parts and labour 2 years parts only)

1PH

583 77 0980



WEEKLY FROM ONLY **£30.21⁺**
ONLY £5,995.00

3PH

583 77 0990



WEEKLY FROM ONLY **£30.21⁺**
ONLY £5,995.00



4 YEARS WARRANTY

BOSCH WBE4400

584 04 0380

Wheel balancer developed for precise measurement and easy handling. The WBE4400 has a new ergonomic design developed for easy and precise wheel balancing for cars, motorcycles and vans. The unit offers a new feature to detect the positioning of weights and various static and dynamic balancing options. The wheel balancing machine will accommodate wheels with a diameter up to 1,200 mm and are equipped with an easy-to-read 19" TFT monitor.

- Space-saving wheel guard design
- Weight positioning system with automatic diameter and clearance measurement
- Optional external arm for automatic rim width measurement
- Large, deep weight compartments



WEEKLY FROM ONLY **£14.09⁺**
ONLY £2,795.00

SAVE £275
WHEN YOU BUY THE TCE4470 +
WBE4400 TOGETHER!



*Finance example typically based on a 5 year lease purchase agreement. Finance subject to status, full terms and conditions available on request. Other finance options available. All prices exclude VAT at 20%. Price, availability and specification may change without prior notice. Warranty subject to manufacturers terms and conditions of use. Errors and omissions excluded. Offers valid until 30th September 2017. Prices correct at time of going to press: June 2017.

0845 603 3636
OVER 200 BRANCHES NATIONWIDE

BOSCH FWA4630+

587 77 2090

“Real 3D”, short setup times, simple operation, precise and fast results.

Once the vehicle has been driven onto the turn plates and sliding plates, the setup and measuring process will only take seven minutes. Unlike conventional run-out measurements, the vehicle can be driven rather than pushed, this is because of the high frequency cameras. Alignment can be carried out by a single technician even with SUVs or LCVs. The wheel alignment process itself is then simultaneously performed on all four wheels.

- Market leader in Accuracy & Repeatability
- 12 cameras takes 29 pictures per second – fastest in the industry
- Measures TOE/CAMBER/CASTER/SET BACK (front) and TOE/CAMBER/THRUST ANGLE/SET BACK (rear)
- Measuring time through to print out of results in 90 seconds
- Single person operation – no need to manually push the vehicle
- New software and user interface: perfectly geared to quick wheel alignment
- The FWA 4630+ has an OEM database which uses over 130 vehicle manufacturer data values
- Minimal space requirements with no need to set up in front of the lift
- Mobile due to being trolley based
- Manufactured in Germany

Included in the package:

- FWA 4630+ 3D reference system with 12 CCD stereo cameras
- Bosch trolley with 27” monitor, PC and printer
- 4 measuring boards
- Steering wheel & brake pedal lock
- 15m cable set
- 4 Multi-fit wheel clamps with special claws for UHP/RFT tyres
- 2 mechanical turntables



**ALSO AVAILABLE
IS THE BOSCH DAS 1000 CAMERA SENSOR
CALIBRATION SYSTEM FOR ADAS
ASK BRANCH FOR DETAILS**

WEEKLY
FROM ONLY **£74.26⁺**
ONLY **£14,735.00**

*Finance example typically based on a 5 year lease purchase agreement. Finance subject to status, full terms and conditions available on request. Other finance options available. All prices exclude VAT at 20%. Price, availability and specification may change without prior notice. Warranty subject to manufacturers terms and conditions of use. Errors and omissions excluded. Offers valid until 30th September 2017. Prices correct at time of going to press: June 2017.

JOHN BEAN V2200

587 77 0050

Patented 3D imaging technology provides accurate and real-time measurements which improves productivity. User-friendly features such as EZ Toe, VODI and an extensive vehicle specification database delivers customer satisfaction, ease of use and accuracy.

- **Motorised camera boom**
The camera height adjustment is motorised providing ergonomic and time saving advantages.
- **VODI (Vehicle Orientation Directional Indicators)**
Monitor out of sight when making adjustments? VODI can provide a secondary visual allowing you to complete a job without stopping.
- **Fast readings**
The V2200's software, manufacturers' specifications and customisable options allow for full four-wheel alignment readings to be recorded in just minutes.
- **Elevated adjustment**
This function allows for live adjustment of suspension components when in an elevated position, saving you time and making your job easier.
- **Alignment report**
Print colour reports for your customers. The before and after illustration can help you communicate the benefits of wheel alignment simply and clearly.
- **EZ Toe**
Turn the front wheels and access difficult adjustment points while still displaying centred toe readings.
- **Adjustment modes**
Have access to a wide range of adjustment modes, including A-arm and cradle adjustment.
- **Measurement options**
Choose from various measurement options including, toe, camber, caster, maximum steering angle, and toe curve measurements.
- **Extensive database**
Our comprehensive coverage of vehicle specifications and adjustment procedures provide comfort that you'll be able to meet your customer's request.
- **Wheel clamps**
The V2200 has universal wheel clamping up to 26" (with additional adaptors).

2 YEARS WARRANTY

WEEKLY FROM ONLY **£45.35⁺**
ONLY **£8,999.00**

JOHN BEAN V2400

587 77 2110

The John Bean V2400 offers advanced features that grow business for high-volume garages and dealerships, and is an ideal investment for bodyshops.

All the features of the V2200 plus:

- **Measurement of toe, camber, caster, maximum steering angle, rolling radius and cross diagonal**
- **ProAckermann, graphical caster trail, scrub radius and steering axis inclination**
- **A-arm and cradle adjust**
- **EZ Toe for easy and convenient adjustment at maximum steering angle**
- **EZ Access for measurement with demounted wheels**
- **Target Imaging Pointer for ride height measurement**

2 YEARS WARRANTY

WEEKLY FROM ONLY **£79.35⁺**
ONLY **£15,745.00**



*Finance example typically based on a 5 year lease purchase agreement. Finance subject to status, full terms and conditions available on request. Other finance options available. All prices exclude VAT at 20%. Price, availability and specification may change without prior notice. Warranty subject to manufacturers terms and conditions of use. Errors and omissions excluded. Offers valid until 30th September 2017. Prices correct at time of going to press: June 2017.

NO HASSLE
WARRANTY

BEST PRICE
PROMISE

HD MEGALINE SSENCE 600 3D WHEEL ALIGNER

587 77 2130

NEW

The Megaline Ssence 600 3D - HD represents the very latest High Definition 3D wheel alignment technology. It utilises smaller 'reflective targets' and high definition head and camera system to give precise results in a wide variety of conditions. It's fast, simple, and ideal for those customers looking to invest in the most advanced wheel alignment capability available on today's market. The software has been upgraded, to allow for simpler manufacturer and model searches. The interface explains the alignment process step by step to even the least experienced of alignment technician, minimising unnecessary procedures commonly found on other, similar systems.

The super-advanced 600 HD, comes with 32" display and automatic camera bar. You can be guaranteed a product that will earn you thousands of pounds in valuable extra revenue and keep your workshop at the cutting edge of wheel alignment geometry.

- NEW: More accurate HD cameras
- Less light pollution due to sharper imagery
- Works in a range of lighting situations including low light and 'glaring' sun
- Most precise results
- NEW: Smaller, lighter targets
- Works with a greater number of lifts
- Easier to position, easy to use
- NEW: Updated interface with intuitive search function
- Even less light pollution due to sharper HD images
- Large 32" monitor
- Fully-Automatic camera boom
- Includes Autodata database
- Includes mechanical turnplates
- Latest alignment technology

SPECIAL PACKAGE PRICE:

- Ssence 600HD Aligner
 - Alignment Lift
 - Jacking Beam
- ONLY £16,995**

WEEKLY
FROM ONLY **£55.43⁺**
FROM ONLY **£10,999.00**

ASK FOR A DEMO



**ADD A MEGATAB
(WORTH £995 FOR ONLY £495)**



*Finance example typically based on a 5 year lease purchase agreement. Finance subject to status, full terms and conditions available on request. Other finance options available. All prices exclude VAT at 20%. Price, availability and specification may change without prior notice. Warranty subject to manufacturers terms and conditions of use. Errors and omissions excluded. Offers valid until 30th September 2017. Prices correct at time of going to press: June 2017.



NO HASSLE WARRANTY

BEST PRICE PROMISE

HOFMANN MEGAPLAN ECOLINE 58/88 – FULLY COMPUTERISED WHEEL ALIGNMENT WITH A4 PRINTER

Bridging the gap between laser alignment and fully computerised systems with printout, which traditionally made the jump too big for many workshops.

Ecoline 58 and 88 are supplied with a comprehensive vehicle database from the recognised industry name, Autodata, and offers a before and after printout. The Ecoline series – is the logical choice for anybody wanting to move into advanced vehicle geometry without the cost traditionally associated with computerised systems.

Only one alignment a week turns this investment into profit!

ECOLINE 58/88 FEATURES

- Simple to use – faster readings, saves time increasing your profit
- Supplied with PC, 19" monitor – clear impressive graphics with onscreen instructions
- Onsite training – your machine, your premises Hofmann Megaplan's specialists
- Comprehensive Vehicle Database by Autodata – over 17,000 models from 80 manufacturers
- A4 Printer – Provides before and after readings for customers
- Traditional 4-Point Clamps (58 only) – handles up to 23" rims as standard
- Front Cameras and Rear Sensors – increases accuracy and repeatability
- Zigbee® wireless communication – offers stronger and more reliable signal over Bluetooth®

ECOLINE 88 ONLY FEATURES

- 3 Point 'Grab Clamps' – even faster mounting, saves more time
- Front & Rear Cameras – ideal for advanced geometry when speed is needed



ECOLINE 58
587 77 1340

WEEKLY FROM ONLY **£20.64⁺**
ONLY **£4,095.00**

ECOLINE 88
587 77 1270

WEEKLY FROM ONLY **£27.69⁺**
ONLY **£5,495.00**

JOHN BEAN PRISM ELITE

The Visualiner Prism Elite allows you to add alignment to your garage services without needing to hire an experienced alignment technician.

Plus, not only will you be able to pinpoint alignment problems, it generates reports that can be shared with customers, which is why your alignment business will start growing from day one.

If you already own a John Bean Geogas 3000 or 5000 Emissions Analyser, you can add a Prism kit to this unit – saving you space in your workshop and allowing your MOT bay to carry out alignments.

Computerised wheel alignment with Pro 42 software.

- Accurate, flexible and easy to service
- Perform alignments quickly from virtually anywhere in the workshop
- Integrated help system
- Extensive manufacturers' specification database

SHARING THE GEOGAS PC
587 77 1130

WEEKLY FROM ONLY **£31.73⁺**
ONLY **£6,295.00**

STANDALONE PRICE
587 77 0570

WEEKLY FROM ONLY **£34.37⁺**
ONLY **£6,820.00**



*Finance example typically based on a 5 year lease purchase agreement. Finance subject to status, full terms and conditions available on request. Other finance options available. All prices exclude VAT at 20%. Price, availability and specification may change without prior notice. Warranty subject to manufacturers terms and conditions of use. Errors and omissions excluded. Offers valid until 30th September 2017. Prices correct at time of going to press: June 2017.

HOFMANN MEGALINE 4 – WALL MOUNTED OR TROLLEY LASER ALIGNMENT SYSTEM

Proven in hundreds of tyre shops and garages throughout the UK as a highly profitable and technically valuable system. Individual front and rear toe, rear thrust line, set back and steering wheel position can all be achieved in just a matter of minutes.

Supplied with all necessary accessories including pedal depressor, steering wheel holder and extensions for lowered vehicles, light commercials and 4x4s, the megaline system 4 is a must for anybody involved in vehicle servicing or tyres.

The megaline system 4 represents a great profit opportunity, as it can be installed for as little as £15 + VAT per week - that's just one alignment per week to pay for the system! The very latest design ensures maximum vehicle coverage including rims from 12" to 23", and the clever 'prism' design of the lasers minimises costly and vulnerable components within the measurement heads.

- Simple, speedy 'hang-on' heads
- Laser accuracy
- Handles rims up to 23"
- Supplied with necessary accessories
- Low cost means fast return on investment



SYSTEM 4WE – WALL MOUNTED WITHOUT LIGHTBOX
587 77 1330

WEEKLY FROM ONLY **£9.80⁺**
ONLY **£1,945.00**

SYSTEM 4T – PORTABLE TROLLEY
587 77 0040

WEEKLY FROM ONLY **£12.57⁺**
ONLY **£2,495.00**

SYSTEM 4W – WALL MOUNTED
587 77 1320

WEEKLY FROM ONLY **£10.05⁺**
ONLY **£1,995.00**

JOHN BEAN A300/A350

The John Bean wall or trolley-mounted four-wheel laser alignment system is a highly profitable and technically valuable tool.

- Wheel rims – 12 inches to 23 inches
- Alloy friendly clamp contact
- Turn plates included
- Continual operation up to 8 hours
- 2 Year warranty

Individual front and rear toe, rear thrust line, set back and steering wheel position can all be achieved in just a matter of minutes.

The unit is designed to ensure that it is able to cover the vast majority of vehicles in the market, including rims from 12 inches to 23 inches.



A300 LASER WHEEL ALIGNER – WALL MOUNT
587 77 0300

WEEKLY FROM ONLY **£10.52⁺**
ONLY **£2,087.00**

A350 LASER WHEEL ALIGNER – TROLLEY MOUNT
587 77 0310

WEEKLY FROM ONLY **£12.07⁺**
ONLY **£2,395.00**

*Finance example typically based on a 5 year lease purchase agreement. Finance subject to status, full terms and conditions available on request. Other finance options available. All prices exclude VAT at 20%. Price, availability and specification may change without prior notice. Warranty subject to manufacturers terms and conditions of use. Errors and omissions excluded. Offers valid until 30th September 2017. Prices correct at time of going to press: June 2017.

LITE ALIGN 450 WALL MOUNTED

587 77 0020

Wall mounted car and light commercial four wheel laser aligner kit. Includes two front laser heads, two rear flag units, brake pedal depressor, steering clamp, turn discs, wall mount rack and 100mm rim buttons

MEASURES:

- Front and rear individual and total toe, to ensure correct tracking and stability on the road
- Thrust Line, to make sure the rear wheels are pointing in the straight ahead position in relation to the centre line of the vehicle
- Set back, to check front and rear wheels to ensure correct alignment across the vehicle
- Corrects steering wheel alignment. Rear flags enable the end user to adjust the alignment to achieve perfect steering wheel alignment first time.

KEY FEATURES:

- Unique tyre/wheel mounting system, resulting in more accurate measurement, reduced risk of heads becoming detached during adjustments
- Rechargeable battery operation, no cables
- Fits 12 to 22 inch wheels, cars and light commercials, XL kit available for larger wheels
- Optional digital Camber/Caster/SAI gauge available



WEEKLY FROM ONLY **£8.06⁺**
ONLY **£1,599.00**

LITE ALIGN 450 WALL MOUNTED WITH MAGNETIC CASTER CAMBER GAUGE

587 77 0640

Wall mounted car and light commercial four wheel laser aligner with magnetic caster camber gauge. Includes two front laser heads, two rear flag units, brake pedal depressor, steering clamp, turn discs, wall mount rack and 100mm rim buttons.

WEEKLY FROM ONLY **£9.55⁺**
ONLY **£1,895.00**

LITE ALIGN LA650

587 77 1390

ASK FOR A DEMO

Computer 4 Wheel Laser Aligner*

- Fits on practically car and light commercials, 12" to 22" wheels as standard (depending on tyre size – optional larger head and rim buttons also available)
- Ultra-low measuring position on front heads (enables use on vehicles with low body clearance)
- Measures: Individual Toe, Set Back, Caster, Camber, Thrust Line and Steering Wheel Position
- Zigbee wireless technology sends information to customer-supplied laptop/PC
- Live readings on computer screen, live readings displayed on gauges can also be used without a computer.
- Provides 'Before' and 'After' printout of results
- Provides Autodata database with red/green readability
- Provides tutorials on adjustments required to correct alignment errors - with pictures
- Customers own user data can be entered into database
- On site installation/training provided on delivery
- On-rack charging battery operation (no cables)



Included in the package:

- Lite Align LA650 aligner (*computer not supplied)
- 1 pair turnplates,
- Software/ dongle to install on customers own PC/laptop.
- Autodata database
- Steering wheel clamp
- Brake pedal depressor
- On-site installation and training
- Twin built in camber/ caster/sai gauges



WEEKLY FROM ONLY **£18.12⁺**
ONLY **£3,595.00**

ASK FOR A DEMO

*Computer not included

*Finance example typically based on a 5 year lease purchase agreement. Finance subject to status, full terms and conditions available on request. Other finance options available. All prices exclude VAT at 20%. Price, availability and specification may change without prior notice. Warranty subject to manufacturers terms and conditions of use. Errors and omissions excluded. Offers valid until 30th September 2017. Prices correct at time of going to press: June 2017.

One call for complete peace of mind – Workshop Solutions

Your business is your livelihood. We understand that and we care. At Workshop Solutions we provide you with all the equipment, service, repair and maintenance programmes, assistance with health & safety procedures and project planning skills you need all in one place. We are the equipment and service provider of choice to many motor manufacturer groups, independent garages and bodyshops nationwide. From a new compressor to an MOT bay, comprehensive building works to aftersales servicing and maintenance, Workshop Solutions manages the whole process, ensuring a smooth, hassle-free, one-stop service that is delivered on time and on budget.



Our panel of finance houses can spread the cost tax-efficiently



From preventative maintenance plans to emergency call-outs



Waste Management – Keeping you fully compliant and stress free

THE LATEST TECHNOLOGY FROM THE BEST BRANDS

We aim to provide you with the tools, equipment and service that match both your personal expectations and your business requirements.



Health & Safety – Safeguarding your people and your business



Please contact our Equipment Service & Maintenance team on 01527 882 778 to arrange an initial free, no obligation consultation.

DO YOU PAY YOUR STAFF 5 YEARS IN ADVANCE? NO, SO WHY PAY FOR YOUR EQUIPMENT THAT WAY! PAY FOR IT AS IT WORKS FOR YOU!

NO HASSLE WARRANTY

BEST PRICE PROMISE

- Fixed payments (excluding VAT)
- Tax efficient – see table
- Preserves working capital
- 1–5 year terms available
- No deposit
- Why wait? Buy the equipment your business needs now!

EQUIPMENT VALUE (EXCLUDING VAT) – £5,000

2 YEARS LEASE

Weekly Payment	£55.47
First Payment	£240.35
23 Payments	£240.35
Total Cost	£5,768.40
Tax Relief @ 20%	£5,768.40
Net Cost of Finance	£4,614.72

3 YEARS LEASE

Weekly Payment	£38.61
First Payment	£167.30
35 Payments	£167.30
Total Cost	£6,022.80
Tax Relief @ 20%	£1,204.56
Net Cost of Finance	£4,818.24

4 YEARS LEASE

Weekly Payment	£30.21
First Payment	£130.90
23 Payments	£130.90
Total Cost	£6,283.20
Tax Relief @ 20%	£1,256.64
Net Cost of Finance	£5,026.56

5 YEARS LEASE

Weekly Payment	£25.20
First Payment	£109.20
23 Payments	£109.20
Total Cost	£6,552.00
Tax Relief @ 20%	£1,310.40
Net Cost of Finance	£5,241.60

Payments shown above are subject to businesses trading more than 3 years, credit approval and VAT. New start businesses may require a higher rate. The tax relief shown is an illustration only. Euro Car Parts Ltd is regulated by the Financial Conduct Authority (FCA) reference number 559185.

*Finance example typically based on a 5 year lease purchase agreement. Finance subject to status, full terms and conditions available on request. Other finance options available. All prices exclude VAT at 20%. Price, availability and specification may change without prior notice. Warranty subject to manufacturers terms and conditions of use. Errors and omissions excluded. Offers valid until 30th September 2017. Prices correct at time of going to press: June 2017.





Introducing a national network of independant garages

Autofirst Network is a unique combination of independant local garages with full pratical & promotional support of the UK's leading parts distribution company.

- Keep your own independence
- Be an integral part of something bigger
- Get access to a range of member benefits
- Enhance your corporate image
- Telephone and online support
- National advertising appearance
- National coverage
- Professional service
- Quality parts

**Begin your journey as an
Autofirst Network partner today!**
www.autofirstnetwork.com