

2013

2013



CHINA

刹车片和刹车盘

PADS AND DISCS

PLAQUETTES ET DISQUES

PASTILLAS Y DISCOS

PASTILAS E DISCOS

PASTIGLIE E DISCHI

REMBLOKKEN EN REMSCHIJVEN

BREMSBELÄGE UND

BREMSSCHEIBEN

KLOCKI I TARCZE

BRZDOVÉ DESTIČKY

A KOTOUČE

FÉKBETÉTEK ÉS

FÉKTÁRCSÁK

BALATALARI VE DISKLERI

Колодки и диски

Δισκόφρενα &

Δισκόπλακες



WANT TO KNOW MORE?\*



\*en savoir plus

valeo added

www.valeoservice.com



Valeo

驶于科技，融于自然  
Automotive technology, naturally

Valeo  
法雷奥

	<b>CN</b>	<b>RU</b>	<b>EN</b>	<b>TU</b>	اللغة العربية	<b>SP</b>
	车型	Автомобиль	Vehicle	Arac	آلية ثقيلة أو شاحنة	Vehículo
	出厂年份	Выпуск	Date of vehicle	Uretim Tarihi	تاريخ الصنع	Periodo de fabricación
	页数	Номер страницы	Page number	Sayfa Numarası	رقم الصفحة	Número de pagina
	取消	Аннулирован	Cancel	İptal	إلغاء	Cancelación
	技术信息	Техническая информация	Technical information	Teknik Bilgiler	معلومات تقنية	Información técnica
	供应商编号	Поставщик - производитель запасной части	Manufacturer reference	Uretici Numarası	رقم المصنّع	Referencia constructor
	刹车卡钳	Скоба	Caliper	Kaliper	سيلندر فرامل	Pinza
	刹车盘厚度	Толщина диска	Thickness	Kalınlik	السماكة	Espesor
	磨损指示器	Датчик расхода	Wear indicator	Fren İkaz Kablosu	شريط كولييه	Indicador de desgaste
	四门轿车	Седан	Sedan	Sedan	سيارة بأربعة أبواب	Berlina
	旅行车	Универсал	Station wagon	Station Wagon	سيارة ستايشن	Break
	敞篷车	Кабриолет	Convertible	Kabrio	سيارة رياضية	Descapotable
	运动型双门轿跑车	Купе	2 doors	2 Kapı	سيارة ببابين	Coupé
	越野车	4 X 4	4 X 4	4 x 4	سيارة رباعية الدفع	4 X 4
	普通刹车盘	Диски сплошные	Solid disc	Fren Diski - Sogutmasız	ديسك فرامل دون تهوية	Disco macizo
	通风刹车盘	Диски вентилируемые	Ventilated disc	Fren Diski - 1 Sogutmal	ديسك فرامل مع تهوية	Disco freno ventilado
	螺栓孔数目	Количество болтов крепления колеса	Fixing holes number	Bijon Sayısı	عدد فتحات التثبيت	Número de taladros
	轮径	Диаметр колеса	Wheel diameter	Lastik Capı	قطر العجلة	Diametro de rueda
	新产品编号	Новая референция	New part number	Yeni Parca Numarası	أرقام جديدة	Nueva referencia
	即将面世产品编号	Доступен в ближайшее время	Product soon available	Yakında Ticari Olacak Referans	منتج سيتوفّر قريباً	Referencia proximately disponible
	直到库存枯竭	Доступен до окончания на складе	Available until exhaustion of stocks	Referans Stok Bitimine Kadar Ticaridir	متوفّر حتى نفاذ الكمية	Producto disponible hasta agotar existencias
	和	С	With	Beraber	مع	Con
	除了	Без	Except	Harıç	ماعدا	Excepto
	四轮驱动	4 X 4	4 wheels drive	4 Ceker	سيارة رباعية الدفع	4 ruedas motrices
	前刹车片	Передние тормозные колодки	Front brake pads	Ön Fren Balatası	فرامل أمامية	Freno delantero
	后刹车片	Задние тормозные колодки	Rear brake pads	Arka Fren Balatası	فرامل خلفية	Freno trasero
	手刹	Стояночный тормоз	Handbrake	El Freni	فرامل يد	Freno de mano
	所有发动机	Все двигатели	All engines	Tüm Motorlar	كّل المحركات	Todos los motores



# 舒适与安全 ——法雷奥制动产品

## Comfort and safety: the valeo braking range

通过对产品材质的严苛要求以实现最大程度缩短制动距离及延长使用寿命。

高水平的机械加工工艺保证了精确的平面度，优化制动片与制动盘的贴合度，从而避免制动片抖动和缩短制动距离。

No compromise for product material quality for a long lasting usage. High level of machining precision for perfect mounting and vibration free brakes, providing shorter braking distances.

### 制动片/ Brake Pads

- 采用陶瓷基低金属配方满足不同车型需求。
- 预压工艺提高摩擦材料孔隙率及摩擦磨损性能，有效降低热衰退。
- 高温烧蚀工艺确保了制动片装车后快速达到最佳制动效能。
- 高档消音片及进口润滑脂能够最大程度降低噪音。
- Ceramic and low metal friction compounds adapted for various car applications.
- Pre-bedding process increases the porosity and performance of friction material, lessening fading effect.
- Scorching method ensures immediate excellent braking efficiency from start.
- Premium anti-noise shim and imported lubricant grease to maximize noise reduction and facilitate mounting.

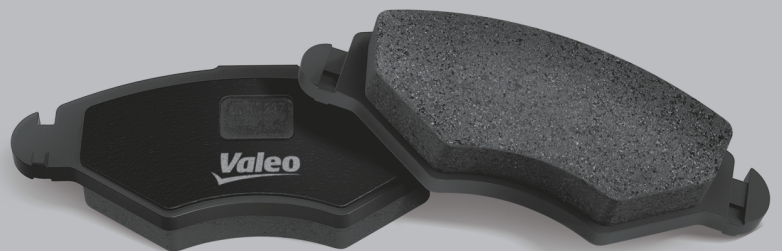

### 制动盘/ Brake Discs

- 平面跳动值小于15微米以确保稳定的制动感受。
- 高品质的铸件会有更好的表现。
- 不低于200布氏硬度。
- 应力释放工艺有效避免应力点断裂。
- A machining tolerance of 15 microns which provides vibration free braking.
- High quality casting for better performance.
- Hardness of >200 Brinell.
- Stress release process effectively prevents the breaks at stress points.



valeo added ■■■■■■

Automotive technology, naturally



# 法雷奥制动片全球首发创新包装

## Valeo brake pads new packaging

A REAL INNOVATION FIRST USED FOR CHINA, EASY TO STORE, EASY TO SELL

- ✓ 信息清晰 MODERN
  - ✓ 外形时尚 USEFULL
  - ✓ 包装坚固 ATTRACTIVE
- And VERY PROTECTIVE

- 包装优化  
自锁设计提高强度  
Improved box Safety lock  
Improved pack resistance
- 产品外观  
内部产品一目了然  
Product visual  
See what's inside the box  
Show drivers how premium Valeo pads are
- 包装标贴人性化  
可三面读取产品编码/信息  
Part numbers on 3 faces  
Simpler storage, faster pick-up from shelves
- 剖面图示  
形象解析制造工艺  
Product key benefits  
for better understanding by the mechanics



valeo added ■■■■■■

Automotive technology, naturally



车型索引  
Car Model List



3

国产车型  
Domestic Car Models

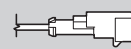

9

进口车型  
Import Car Models

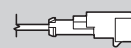

35

国产刹车片图片  
Local Range Image

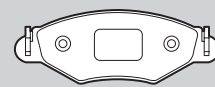

79

进口刹车片图片  
Imported Range Image

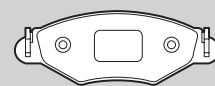

125

国产/进口刹车盘图片  
Local/Imported Range  
Brake Disc Image

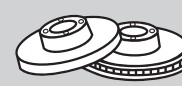

243

件号对照表  
Part Number Cross List



257





## 车型索引 Car Model List

### Pads and Discs

Plaquettes et Disques

### Pastillas y Discos

Pastilas e Discos

### Pastiglie e Dischi

Blokjes en Schijven

### Bremsbeläge und Bremsscheiben

Klocki i Tarcze

### Balatalari ve Diskleri

Колодки и диски

Δισκόφρενα & Δισκόπλακες

刹车片和刹车盘

بطانات و قرص

## 国产车型目录 / Domestic Car Models

<b>一汽大众 / FAW-Volkswagen</b>		
奥迪100 / Audi 100 (1988.8>1995.6)		10
奥迪A4(B6) / Audi A4(B6) (2003.2>2005.7)		10
奥迪A4(B7) / Audi A4(B7) (2005.7>2008.9)		10
奥迪A4L(B8) / Audi A4L(B8) (2007.12>)		10
奥迪A6(C5) / Audi A6(C5) (1999.9>2005.12)		10
奥迪A6L(C6) / Audi A6L(C6) (2005.3>)		11
宝来 / BORA (2001.12>)		11
宝来三厢 / BORA GP (2006.7>2008.12)		12
宝来两厢 / BORA HS (2006.10>2008.12)		12
开迪 / Caddy (2005.3>2007.12)		12
捷达 / Jetta (1991.5>)		12
捷达王 / Jetta King (1998.1>2002.1)		12
迈腾(B6) / Magotan(B6) (2007.6>2011.7)		12
迈腾(B7L) / Magotan(B7L) (2011.7>)		13
速腾 / Sagitar (2006.2>)		13
都市高尔夫 / City Golf (1996.5>2002.9)		13
高尔夫 / Golf (2003.7>2009.7)		13
<b>上海大众 / SVW</b>		
波罗 / Polo (2002.1>2006.3)		13
劲取 / Polo-Jinqu (2006.6>)		14
劲情 / Polo-Jinqing (2006.6>)		14
帕萨特(B5) / Passat (B5) (2000.4>2009.4)		14
帕萨特领驭(B5) / Passat Lingyu(B5) (2005.11>)		14
晶锐 / Fabia (2008.12>)		14
明锐 / Octavia (2007.6>2010.4)		15
桑塔纳 / Santana (1985.3>)		15
桑塔纳2000 / Santana 2000 (1995.4>2004.3)		15
桑塔纳3000 / Santana 3000 (2004.3>2007.10)		15
桑塔纳Vista志俊 / Santana Vista (2008.1>)		15
桑塔纳旅行车 / Santana Estate (1996.8>)		15
朗逸 / Lavidia (2008.4>)		16
途安 / Touran (2004.11>2008.1)		16
<b>上海通用别克 / SGM-Buick</b>		
GL8 / GL8 I (2000.5>2005.7)		16
GL8陆尊 / GL8 II (2005.7>)		16
凯越 / Excelle (2003.8>2008.5)		16
凯越HRV / Excelle HRV (2004.10>)		16
新凯越 / New Excelle (2008.5>)		17
凯越旅行车 / Excelle Estate (2005.11>)		17
英朗GT / Excelle GT (2010.06>)		17
英朗XT / Excelle XT (2010.01>)		17
别克世纪 / Century (1999.7>2002.12)		17
君威 / Regal I (2002.10>2008.12)		17
新君威 / Regal II (2008.12>)		18
君越 / Lacrosse (2006.3>2009.7)		18
新君越 II / Lacrosse II (2009.7>)		18

<b>上海通用别克 / SGM-Buick</b>		
赛欧 / Sail (2001.6>2005.2)		18
<b>上海通用雪佛兰 / SGM-Chevrolet</b>		
乐风 / Lova (2006.3>2011.3)		18
乐骋 / Aveo (2005.7>2010.5)		19
景程 / Epica (2006.4>)		19
科鲁兹 / Cruze (2009.4>)		19
赛欧 / Sail (2005.2>2007.12)		19
<b>上汽通用五菱 / SAIC-GM-Wuling</b>		
乐驰 / Spark (2003.12>)		19
<b>一汽丰田 / FAW-Toyota</b>		
RAV4 / RAV4 (2009.4>)		19
威驰 / Vios (2005.10>2008.2)		19
新威驰 / Vios (2008.10>)		20
普拉多 / Prado (2003.10>2010.6)		20
普锐斯 / Prius (2006.1>2009.12)		20
皇冠 / Crown Royal (2005.2>)		20
花冠 / Corolla (2004.2>2007.5)		20
花冠EX / Corolla EX (2007.5>)		20
卡罗拉 / Corolla (2007.5>)		20
锐志 / Reiz (2005.10>)		20
陆地巡洋舰 / Land Cruiser (2003.10>2007.7)		21
兰德酷路泽 / Land Cruiser (2007.12>)		21
<b>广汽丰田 / Guangzhou-Toyota</b>		
凯美瑞 / Camry (2006.6>)		21
汉兰达 / Highlander (2009.5>)		21
雅力士 / Yaris (2008.6>2010.9)		21
<b>东风本田 / Dongfeng-Honda</b>		
CR-V 思威 / CR-V (2004.6>2010.12)		21
思域 / Civic (2006.4>)		22
思铂睿 / Spiorior (2009.7>)		22
<b>广汽本田 / Guangzhou-Honda</b>		
奥德赛 / Odyssey (2002.4>)		22
思迪 / City (2006.4>2008.12)		22
锋范 / City (2008.12>)		22
雅阁 / ACCORD VI (1999.1>2007.12)		22
雅阁 / ACCORD VII (2003.1>2007.12)		22
雅阁 / ACCORD VIII (2008.1>)		23
飞度三厢 / Fit (2003.9>2006.4)		23
飞度两厢 / Fit Hatchback (2004.9>)		23
<b>东风日产 / DongFeng-Nissan</b>		
天籁 (J31) / Teana (J31) (2004.9>2008.6)		23
天籁 (J32) / Teana (J32) (2008.6>)		23
奇骏 / X-Trail (2008.11>)		24
蓝鸟 / Bluebird (2000.4>2006.12)		24
轩逸 / Bluebird Sylphy (2006.8>)		24



## 国产车型目录 / Domestic Car Models

   	
<b>东风日产 / DongFeng-Nissan</b>	
逍客 / Qashqai (2008.3>2010.12)	24
阳光 / Sunny (2003.6>2007.12)	24
颐达 / Tiida Saloon (2005.4>)	24
骐达 / Tiida Hatchback (2005.7>)	24
骊威 / Livina (2007.4>2010.3)	25
骏逸 / Livina Geniss (2006.11>2010.1)	25
<b>郑州日产 / Zhengzhou-Nissan</b>	
帕拉丁 / Paladin (2003.2>)	25
<b>东风雪铁龙 / Dong Feng-Citroen</b>	
C2 / C2 (2006.10>)	25
C5 / C5 (2009.1>)	25
凯旋 / C-Triomphe (2006.5>)	25
富康三厢 / Fukang Saloon (1992.2>2008.12)	25
富康两厢 / Fukang Hatchback (1992.2>2008.12)	26
毕加索 / Xsara Picasso (2001.9>2007.3)	26
爱丽舍三厢 / Elysee Saloon (2002.6>)	26
爱丽舍两厢 / Elysee Hatchback (2009.2>)	26
赛纳 / Xsara Saloon (2003.5>2005.12)	26
世嘉三厢 / C-quatre Saloon (2009.6>)	26
<b>东风标致 / Dong Feng-Peugeot</b>	
206 / 206 (2006.1>2009.2)	26
307 / 307 (2004.8>)	27
408 / 408 (2010.1>)	27
<b>东风悦达起亚 / Dongfeng Yueda Kia</b>	
RIO锐欧 / Rio (2007.1>)	27
狮跑 / Sportage (2007.11>)	27
远舰 / Optima (2004.9>)	27
福瑞迪 / Forte (2009.6>)	27
<b>北京现代 / Beijing Hyundai</b>	
伊兰特·悦动 / Elantra Yue Dong (2008.4>)	28
伊兰特 / Elantra (2003.12>)	28
索纳塔 / Sonata (EF) (2002.12>2007.7)	28
索纳塔 御翔 / Sonata (NF) (2005.9>)	28
途胜 / Tucson (2005.5>)	28
雅绅特 / Accent (2006.2>)	28
i30 / i30 (2009.7>)	29
ix35 / ix35 (2010.4>)	29
<b>华泰现代 / Huatai Automobile</b>	
圣达菲 / Santa Fe (2006.10>)	29
特拉卡 / Terracan (2003.3>2008.12)	29
<b>北京吉普 / Beijing-Jeep</b>	
吉普2500 / Jeep 2500 (2003.6>2006.2)	29
<b>北京汽车 / Beijing Automobile</b>	
陆霸 / Luba (2003.6>)	29

   	
<b>一汽海马 / FAW-Haima</b>	
普力马 / Freema (2007.3>2009.10)	30
海马3 / Haima 3 (2007.6>2010.12)	30
福美来2代 / Family II (2006.9>2010.11)	30
福美来3代 / Family III (2010.11>)	30
<b>海南马自达 / Hainan Automobile</b>	
普力马 / Freema (2001.1>2007.2)	30
福美来 / Familia (2002.10>2006.12)	30
<b>长安福特 / Changan Ford</b>	
嘉年华 / Fiesta (2003.3>)	30
福克斯 / Focus (2005.9>)	31
蒙迪欧 / Mondeo (2003.5>)	31
蒙迪欧-致胜 / Mondeo (2007.9>)	31
<b>长安马自达 / Changan Mazda</b>	
马自达2两厢 / 2 Hatchback (2007.10>)	31
马自达3 / 3 Saloon (2006.2>)	31
<b>一汽夏利 / FAW Tianjin Xiali</b>	
威乐 / Vela (2002.7>)	31
威姿 / Vizi (2003.1>)	31
威志两厢 / Weizhi Hatchback (2007.1>)	32
<b>一汽轿车 / FAW Car Co., Ltd</b>	
奔腾B70 / Besturn B70 (2006.9>)	32
红旗世纪星 / Century Star (CA7202) (2000.9>)	32
红旗旗舰 / Flagship (CA7460) (1999.2>)	32
红旗明仕 / Mingshi (CA7180) (2001.1>)	32
<b>一汽马自达/FAW Mazda</b>	
马自达6 (2003.4>)	32
<b>华晨汽车 / Shenyang Brilliance</b>	
尊驰 / Zunchi (M1) (2004.12>2008.12)	33
骏捷 / Junjie (M2) (2006.2>)	33
<b>吉利汽车 / Geely</b>	
远景 / Vision (2005.12>)	33
金刚 / KingKong (2005.6>)	33
<b>奇瑞汽车 / Chery</b>	
A5 / A5 (2006.1>)	33
东方之子 / Eastar (2003.6>)	33
旗云 / Qiyun (2003.8>2010.5)	33
QQ3 / QQ3 (2003.6>2010.3)	34
QQ6 / QQ6 (2006.12>)	34
瑞虎 / Tiggo (2005.3>2008.12)	34
<b>比亚迪 / BYD</b>	
F3 / F3 (2005.9>2010.12)	34
<b>江淮汽车 / JAC</b>	
宾悦 / Bin Yue (2007.11>)	34

## 进口车型目录 / Import Car Models

<b>奥迪 / Audi</b>	
奥迪 A3 / A3 (2010.6>)	36
奥迪 A4 / A4 (2003.2>2008.12)	36
奥迪 A5 / A5 (2007.6>)	36
奥迪 A6 / A6 (1999.9>2005.12)	37
奥迪 A8 / A8 (2004.5>2011.5)	37
奥迪 S8 / A8 (2007.12>2011.5)	38
奥迪 Q5 / Q5 (2009.10>)	38
奥迪 Q7 / Q7 (2006.3>)	38
奥迪 TT / TT (2002.4>)	38
奥迪 TTS / TTS (2011.1>)	39
奥迪 Allroad / ALLROAD (2004.5>2005.8)	39
<b>宾利 / Bentley</b>	
欧陆GT / Continental Coupe (2003.6>)	39
欧陆飞刺 / Continental Flying Spur (2008.9>)	39
<b>奔驰 / Mercedes-Benz</b>	
A级 (1999.2>)	39
B级 (2009.10>)	40
C级 (2002.5>2007.1)	40
CLK级 (1997.6>2002.10)	41
CLS级 (2004.10>)	41
E级 (1996.2>)	42
G级 (1998.4>)	43
GL级 (2006.9>)	43
GLK级 (2008.6>)	43
ML级 (2000.2>)	43
R级 (2006.1>)	44
S级 (2002.9>)	45
SL级 (1998.5>)	46
SLK级 (2004.4>)	46
唯雅诺(W639) / VIANO (2007.9>)	47
<b>宝马 / BMW</b>	
宝马1系 (2004.9>)	47
宝马3系 (1999.10>)	48
宝马5系 (1995.11>)	48
宝马6系 (2004.1>)	49
宝马7系 (1995.8>)	50
宝马M系 (2005.1>)	51
宝马X1 (2010.1>)	51
宝马X3 (2004.1>2010.7)	51
宝马X5 (2002.2>)	51
宝马X6 (2010.10>)	52
宝马Z3 (2000.8>2003.1)	52
宝马Z4 (2003.2>)	52
<b>雪佛兰 / Chevrolet</b>	
科帕奇 / CAPTIVA (2006.6>2011.11)	52

<b>克莱斯勒 / Chrysler</b>	
PT漫步者 / PT CRUISER (2000.6>2010.7)	53
交叉火力 / CROSSFIRE (2004.1>2008.8)	53
克莱斯勒 300C / 300 C (2004.9>)	53
大捷龙 / VOYAGER IV (2000.2>2007.12)	53
赛百灵 / SEBRING (2001.4>2006.8)	54
<b>雪铁龙 / Citroen</b>	
C4毕加索 / C4 Grand Picasso (2006.10>)	54
塞纳 / XSARA (2003.3>2007.2)	54
塞纳毕加索 / XSARA PICASSO (2000.2>2005.3)	54
雪铁龙 C3 / C3 (2002.2>)	54
雪铁龙 C4 / C4 (2008.7>)	55
雪铁龙 C5 / C5 (2004.8>)	55
雪铁龙 C6 / C6 (2005.9>)	55
<b>大宇 / Daewoo</b>	
旅行家 / Nubira (1997.5>2005.1)	55
蓝龙 / Lanos (1997.5>2003.9)	55
<b>道奇 / Dodge</b>	
酷博 / Caliber (2006.6>)	55
<b>菲亚特 / Fiat</b>	
博悦(198) / Bravo II (198) (2008.1>)	55
朋多 / Punto (1994.3>)	55
大朋多 / Grande Punto (2005.10>)	56
<b>现代 / Hyundai</b>	
君爵 / XG (1998.12>2006.1)	56
圣达菲 / Santa Fe (2008.7>)	56
特杰 / Trajet (FO) (2000.9>2007.6)	57
索纳塔 / Sonata IV (EF) (2002.1>)	57
美佳 / Matrix (FC) (2001.6>)	57
途胜 / Tucson (JM) (2005.8>)	57
雅尊 / GrandeUR (TG) (2006.1>)	57
<b>捷豹 / Jaguar</b>	
捷豹 / S-Type (CCX) (1999.1>2008.3)	57
捷豹 XF / XF (2008.3>)	57
捷豹 XJ / XJ (2003.5>)	57
捷豹 / X-Type (CF1) (2001.6>2009.5)	58
<b>吉普 / Jeep</b>	
切诺基 / Cherokee (2005.6>)	58
大切诺基 / Grand Cherokee (2005.6>)	58
指挥官 / Commander (2005.9>)	58
牧马人 / Wrangler (1996.8>)	58
<b>起亚 / Kia</b>	
佳乐 / Carens (2006.9>)	58
狮跑 / Sportage (2004.9>)	59



## 进口车型目录 / Import Car Models

<b>路虎 / Land Rover</b>		
卫士 / Defender (2007.1>)	59	
发现 / Discovery (2004.7>)	59	
极光 / Evoque (2011.6>)	59	
神行者 / Freelander (2001.9>2007.3)	59	
神行者2 / Freelander2 (2007.3>)	59	
路虎揽胜 / Range Rover (2005.5>)	59	
路虎运动版 / Range Rover Sport (2007.3>)	60	
<b>雷克萨斯 / Lexus</b>		
GS300 (2005.4>)	60	
GS450h (2006.2>)	60	
IS200 (1999.4>2005.7)	60	
IS250 (2008.12>)	60	
LX470 (1998.5>2007.8)	60	
RX300 (2003.2>)	60	
SC430 (2005.8>2010.7)	60	
<b>马自达 / Mazda</b>		
3 (BL) (2009.6>)	60	
5 (CR19) (2005.3>)	61	
RX-8(SE17) (2003.10>2008.4)	61	
<b>迷你 / Mini</b>		
迷你 / MINI (R56) (2006.10>)	61	
<b>三菱 / Mitsubishi</b>		
太空旅行车 / Space Wagon (1998.10>2004.12)	61	
帕杰罗 / Pajero (2000.4>)	61	
格兰迪斯 / Grandis (2004.4>2009.3)	61	
欧蓝德 / Outlander (2007.10>2009.9)	61	
<b>日产 / Nissan</b>		
霹雳马 / Primera (2002.3>2010.8)	62	
<b>欧宝 / Opel</b>		
威达 / Vectra (2003.3>2008.10)	62	
欧米茄 / Omega B (1999.9>2003.7)	62	
赛飞利 / Zafira (2005.7>)	62	
雅特 / Astra (2004.3>)	63	
<b>标致 / Peugeot</b>		
标致 206CC / 206 CC (2000.9>2007.3)	63	
标致 207 / 207 (2007.2>)	63	
标致 307CC / 307CC (2003.10>2005.5)	63	
标致 307SW / 307SW (2005.3>)	64	
标致 308CC / 308CC (2009.6>)	64	
标致 308SW / 308SW (2009.9>)	64	
3008 / 3008 (2011.2>)	64	
标致 406 / 406 (2000.3>2009.12)	64	
标致 407 / 407 (2004.5>2006.12)	64	
标致 607 / 607 (2000.2>)	65	

<b>保时捷 / Porsche</b>		
卡雷拉 911(996) / 911 (996) (2010.1>)	65	
博克斯特(987) / Boxster (987) (2004.11>)	65	
卡宴(955) / Cayenne(955) (2004.1>)	65	
卡宴 / Cayenne (2010.6>)	65	
卡宴S (955) / Cayenne S (955) (2004.1>)	66	
卡曼 (987) / Cayman(987) (2006.7>)	66	
<b>雷诺 / Renault</b>		
拉古娜 III / Laguna III (2007.10>)	66	
拉古娜 II / Laguna II (2001.4>2007.9)	66	
梅甘娜 I / Megane I (1999.3>2003.8)	66	
梅甘娜 II / MeganeII (2002.11>)	67	
梅甘娜 III / MeganeIII (2008.11>)	67	
科雷傲 / Koleos (2008.9>)	67	
风景 II / Scenic II (2003.6>)	68	
风景III / Scenic III (2009.2>)	68	
<b>萨博 / Saab</b>		
萨博 9-3 / 9-3 (2002.1>)	68	
萨博 9-5 / 9-5 (2003.7>)	68	
<b>斯柯达 / Skoda</b>		
昊锐 / Superb (2002.2>)	68	
明锐 / Octavia (2004.2>)	69	
晶锐 / Fabia (2000.8>2007.8)	69	
<b>Smart / Smart</b>		
Forfour / FORFOUR (2004.1>2006.6)	69	
<b>双龙 / SsangYong</b>		
雷斯特 / Rexton (2002.4>)	69	
<b>斯巴鲁 / Subaru</b>		
力狮 / Legacy (1996.6>2009.5)	70	
森林人 / Forester (2005.9>)	70	
<b>铃木 / Suzuki</b>		
吉姆尼 / Jimny (1998.9>)	70	
<b>丰田 / Toyota</b>		
RAV 4 / RAV 4 (2005.11>)	70	
兰德酷路泽100 / Land Cruiser 100 (1998.1>2007.9)	70	
<b>大众 / Volkswagen</b>		
Eos / EOS (2006.3>)	71	
尚酷 / Scirocco (2008.5>)	71	
帕萨特 / Passat (2000.11>)	71	
帕萨特CC / Passat CC (2008.6>)	71	
甲壳虫 / New Beetle (2000.10>)	71	
辉腾 / Phaeton (2003.5>)	72	
途观 / Tiguan (2008.5>)	72	
途锐 / Touareg (2003.4>)	72	
高尔夫 / Golf (2002.1>)	73	

## 进口车型目录 / Import Car Models

 	
<b>沃尔沃 / Volvo</b>	
沃尔沃C30 / C30 (2006.10>)	73
沃尔沃C70 / C70 (2006.3>2010.2)	73
沃尔沃S40 / S40 (2004.1>2007.7)	74
沃尔沃S60 / S60 (2000.11>)	75
沃尔沃S80 / S80 (TS, XY) (1999.1>)	75
沃尔沃XC60 / XC60 (2008.5>)	76
沃尔沃XC90 / XC90 (2002.10>)	76



## 国产车型 Domestic Car Models

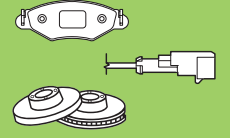

### Pads and Discs

Plaquettes et Disques

### Pastillas y Discos

Pastilas e Discos

### Pastiglie e Dischi

Blokjes en Schijven

### Bremsbeläge und Bremsscheiben

Klocki i Tarcze



























### Balatalari ve Diskleri

Колодки и диски

Δισκόφρενα & Δισκόπλακες

刹车片和刹车盘

بطانات و قرص

											
<b>一汽大众 / FAW-Volkswagen</b>											
<b>奥迪 100 / Audi 100</b>											
1.8L	1988.8-1990.12	F	601157	2							
2.0L	1993.11-1994.7	F	601157	2							
2.2L	1989.8-1990.12	F	601157	2							
2.6L	1993.1-1995.6	F	601157	2							
<b>奥迪 A4(B6) / Audi A4(B6)</b>											
1.8 T	2003.2-2005.7	F	601195	1		312 × 25(23)	9	<b>197404</b>			
		R	601255	0		255 × 11,9(10)	10	<b>197438</b>			
2.4L	2004.1-2005.7	F	601195	1		312 × 25(23)	9	<b>197404</b>			
		R	601247	0		255 × 11,9(10)	10	<b>197438</b>			
3.0 quattro	2003.2-2005.7	F	601195	1							
		R	601255	0		255 × 11,9(10)	10	<b>197438</b>			
<b>奥迪 A4(B7) / Audi A4(B7)</b>											
1.8 T	2005.7-2008.9	F	601195	1		312 × 25(23)	9	<b>197404</b>			
		R	601255	0		255 × 11,9(10)	10	<b>197438</b>			
	287,7 × 12(10)				5+1	<b>197038</b>					
2.0 T	2005.7-2008.9	F	601195	1		312 × 25(23)	9	<b>197404</b>			
		R	601255	0		255 × 11,9(10)	10	<b>197438</b>			
	287,7 × 12(10)				5+1	<b>197038</b>					
3.0 quattro	2005.7-2008.9	F	601195	1		312 × 25(23)	9	<b>197404</b>			
		R	601255	0		255 × 11,9(10)	10	<b>197438</b>			
		R	601263	0		287,7 × 12(10)	5+1	<b>197038</b>			
<b>奥迪 A4L(B8) / Audi A4L(B8)</b>											
2.0 TFSI	2007.12-	F	601163	1							
<b>奥迪 A6(C5) / Audi A6(C5)</b>											
1.8L	2000.1-2005.12	F	601195	1		288 × 24,9(23)	5	<b>186271</b>			
		R	601255	0		245 × 9,9(8)	5	<b>186294</b>			
1.8 T	2000.1-2005.12	F	601195	1		288 × 24,9(23)	5	<b>186271</b>			
		R	601255	0		245 × 9,9(8)	5	<b>186294</b>			
2.4L	1999.9-2005.12	F	601195	1		288 × 24,9(23)	5	<b>186271</b>			
		R	601255	0		245 × 9,9(8)	5	<b>186294</b>			
2.5 柴油 /Diesel	2004.8-2005.12	F	601195	1		288 × 24,9(23)	5	<b>186271</b>			
		R	601255	0		245 × 9,9(8)	5	<b>186294</b>			











							
							
<b>一汽大众 / FAW-Volkswagen</b>							
<b>奥迪 A6(C5) / Audi A6(C5)</b>							
2.8L	2000.9-2005.7	F	601195	1	 288 × 24,9(23)	5	186271
		R	601255	0	 245 × 9,9(8)	5	186294
<b>奥迪 A6L(C6) / Audi A6L(C6)</b>							
2.0 TFSI	2005.9-2011.12	F			 320,8 × 30(28)	5	197388
		R	601263	0	 301,7 × 12(10)	9	197426
2.4L	2005.3-	F	601195	1	 347 × 30(28)	5	197389
		R	601263	0	 301,7 × 12(10)	9	197426
2.8L	2008.4-	R	601263	0	 301,7 × 12(10)	9	197426
3.0 quattro	2005.3-	F			 320,8 × 30(28)	5	197388
		R	601263	0	 301,7 × 12(10)	9	197426
3.2 FSI quattro	2006.11-2008.10	F			 320,8 × 30(28)	5	197388
		R	601263	0	 301,7 × 12(10)	9	197426
4.2 FSI quattro	2006.11-2008.10	R			 301,7 × 12(10)	9	197426
<b>宝来 / BORA</b>							
1.6L	2004.10-2006.9	F	601186	1	 280 × 22(19)	5+1	186604
		R	601255	0	 256 × 22(20)	5	197427
					 231,7 × 9(7)	5	197442
1.6L	2008.11-	F	601186	1	 280 × 22(19)	5+1	186604
		R	601255	0	 231,7 × 9(7)	5	197442
1.8L	2001.12-2006.12	F	601186	1	 280 × 22(19)	5+1	186604
		R	601255	0	 256 × 22(20)	5	197427
					 231,7 × 9(7)	5	197442
1.8 T	2001.12-2006.12	F	601209	1	 288 × 24,9(22)	5	197230
		R	601255	0	 256 × 22(20)	5	197427
					 231,7 × 9(7)	5	197442
1.9 TDi	2004.3-2006.12	F	601186	1	 280 × 22(19)	5+1	186604
		R	601255	0	 231,7 × 9(7)	5	197442
2.0L	2008.11-2010.12	F	601186	1			
		R	601255	0			

											
<b>一汽大众 / FAW-Volkswagen</b>											
<b>宝来三厢 / BORA GP</b>											
1.6L	2006.7-2008.12	F	601186	1	 288 × 24,9(22)	5	197230				
		R	601255	0	 231,7 × 9(7)	5	197442				
1.8L	2006.7-2008.12	F	601186	1	 288 × 24,9(22)	5	197230				
		R	601255	0	 231,7 × 9(7)	5	197442				
<b>宝来两厢 / BORA HS</b>											
1.6L	2006.10-2008.12	F	601186	1	 288 × 24,9(22)	5	197230				
		R	601255	0	 231,7 × 9(7)	5	197442				
1.8L	2006.10-2008.12	F	601186	1	 288 × 24,9(22)	5	197230				
		R	601255	0	 231,7 × 9(7)	5	197442				
<b>开迪 / Caddy</b>											
1.6L	2005.3-2007.12	F			 279,9 × 22(19)	9	197394				
					 287,8 × 24,9(22)	9	197397				
		R	601263	0	 259,8 × 11,9(10)	9	197429				
2.0 柴油 /Diesel	2005.3-2007.12	F			 279,9 × 22(19)	9	197394				
					 287,8 × 24,9(22)	9	197397				
		R	601263	0	 259,8 × 11,9(10)	9	197429				
<b>捷达 / Jetta</b>											
1.6L	2000.4-	F	601188	0							
		R	564110( 刹车蹄 /Shoes)								
1.6L	1991.5-1999.12	F			 239 × 11,9(10)	4+1	186245				
		R	564110( 刹车蹄 /Shoes)								
1.9 TDi	1998.8-	R	564110( 刹车蹄 /Shoes)								
<b>捷达王 / Jetta King</b>											
1.6L	1998.1-2002.1	F	601188	0							
		R	564110( 刹车蹄 /Shoes)								
<b>迈腾 (B6) / Magotan(B6)</b>											
1.8 TSi	2007.6-2011.7	F			 312 × 25(22)	9	197384				
		R	601263	0	 286 × 12(10)	9+1	197031				
2.0L	2007.6-2008.4	F			 312 × 25(22)	9	197384				
		R	601263	0	 286 × 12(10)	9+1	197031				
2.0 TSi	2008.4-2011.7	F			 312 × 25(22)	9	197384				
		R	601263	0							





































											
<b>一汽大众 / FAW-Volkswagen</b>											
<b>迈腾 (B7L) / Magotan(B7L)</b>											
1.8T	2011.7-	R	601263	0							
<b>速腾 / Sagitar</b>											
1.4 TSI	2009.9-	R	601263	0		259,8 × 11,9(10)	9	197429			
1.6L	2006.2-	F	601186	1		279,9 × 22(19)	9	197394			
		R	601263	0		259,8 × 11,9(10)	9	197429			
1.8 T	2006.4-2008.4	F				287,8 × 24,9(22)	9	197397			
		R	601263	0		259,8 × 11,9(10)	9	197429			
1.8 TSI	2008.7-	F				287,8 × 24,9(22)	9	197397			
		R	601263	0		259,8 × 11,9(10)	9	197429			
2.0L	2006.4-2009.6	F	601186	1		279,9 × 22(19)	9	197394			
		R	601263	0		259,8 × 11,9(10)	9	197429			
<b>都市高尔夫 / City Golf</b>											
1.6L	1996.5-2002.9	F	601186	1		256 × 21,9(19)	5+1	186603			
<b>高尔夫 / Golf</b>											
1.6L	2003.8-2005.1	F	601186(小卡钳 /Small caliper)	1		256 × 21,9(19)	5+1	186603			
						280 × 22(19)	5+1	186604			
		R	601255	0		231,7 × 9(7)	5	197442			
1.8L	2003.7-2009.7	F	601186(小卡钳 /Small caliper)	1		256 × 21,9(19)	5+1	186603			
						280 × 22(19)	5+1	186604			
		R	601255	0		231,7 × 9(7)	5	197442			
2.0L	2003.8-2005.12	F	601186(小卡钳 /Small caliper)	1		256 × 21,9(19)	5+1	186603			
						280 × 22(19)	5+1	186604			
		R	601255	0		231,7 × 9(7)	5	197442			
<b>上海大众 / SVW</b>											
<b>波罗三厢 / Polo Saloon</b>											
1.4L	2003.6-2006.3	F	601186	1		256 × 21,9(19)	5+1	186603			
		R	601255	0		231,7 × 9(7)	5	197442			
1.6L	2002.1-2006.1	F	601186	1		256 × 21,9(19)	5+1	186603			
		R	601255	0		231,7 × 9(7)	5	197442			
<b>波罗两厢 / Polo Hatchback</b>											
1.4L	2002.1-2006.3	F	601186	1		256 × 21,9(19)	5+1	186603			
		R	601255	0		231,7 × 9(7)	5	197442			

							
<b>上海大众 / SVW</b>							
<b>波罗两厢 / Polo Hatchback</b>							
1.6L	2002.1-2006.1	F	601186	1	256 × 21,9(19)	5+1	186603
		R	601255	0	231,7 × 9(7)	5	197442
<b>劲取 / Polo-Jinqu</b>							
1.4L	2006.6-	F	601186	1	256 × 21,9(19)	5+1	186603
		R	564110( 刹车蹄 /Shoes)				
1.6L	2007.12-	F	601186	1	256 × 21,9(19)	5+1	186603
		R	564110( 刹车蹄 /Shoes)				
<b>劲情 / Polo-Jinqing</b>							
1.4L	2006.6-	F	601186	1	256 × 21,9(19)	5+1	186603
		R	564110( 刹车蹄 /Shoes)				
1.6L	2006.6-2007.12	F	601186	1	256 × 21,9(19)	5+1	186603
		R	564110( 刹车蹄 /Shoes)				
<b>帕萨特 (B5) / Passat (B5)</b>							
1.8L	2000.4-2003.2	F	601195	1	288 × 24,9(23)	5	186271
		R	601255	0	245 × 9,9(8)	5	186294
1.8 T	2001.1-2009.4	F	601195	1	288 × 24,9(23)	5	186271
		R	601255	0	245 × 9,9(8)	5	186294
2.0L	2003.2-2009.4	F	601195	1	288 × 24,9(23)	5	186271
		R	601255	0	245 × 9,9(8)	5	186294
2.8L	2001.12-2006.12	F	601195	1	288 × 24,9(23)	5	186271
		R	601255	0	245 × 9,9(8)	5	186294
<b>帕萨特领驭 (B5) / Passat Lingyu(B5)</b>							
1.8 T	2005.11-	F	601195	1	288 × 24,9(23)	5	186271
		R	601255	0	245 × 9,9(8)	5	186294
2.0L	2006.4-	F	601195	1	288 × 24,9(23)	5	186271
		R	601255	0	245 × 9,9(8)	5	186294
2.8L	2005.11-	F	601195	1	288 × 24,9(23)	5	186271
		R	601255	0	245 × 9,9(8)	5	186294
<b>晶锐 / Fabia</b>							
1.4L	2008.12-	F	601186	1			
		R	564110( 刹车蹄 /Shoes)				
1.6L	2008.12-	F	601186	1			
		R	564110( 刹车蹄 /Shoes)				



							
							
<b>上海大众 / SVW</b>							
<b>明锐 / Octavia</b>							
1.6L	2007.6-2010.4	F	601186	1	 279,9 × 22(19)	9	197394
		R	601263	0			
1.8 TSI	2007.6-2010.4	F	601186	1	 279,9 × 22(19)	9	197394
		R	601263	0			
2.0L	2007.6-2010.4	F	601186	1	 279,9 × 22(19)	9	197394
		R	601263	0			
<b>桑塔纳 / Santana</b>							
1.6L	1996.8-	F			 239 × 11,9(10)	4+1	186245
		R	564109( 刹车蹄 /Shoes)				
1.8L	1985.3-1996.8	F			 239 × 11,9(10)	4+1	186245
		R	564109( 刹车蹄 /Shoes)				
1.8L	1996.8-	F			 239 × 11,9(10)	4+1	186245
		R	564109( 刹车蹄 /Shoes)				
<b>桑塔纳 2000 / Santana 2000</b>							
1.8L	1995.4-2004.3	F	601156	0	 256 × 19,9(18)	4+1	186247
		R	564110( 刹车蹄 /Shoes)				
<b>桑塔纳 3000 / Santana 3000</b>							
1.8L	2004.3-2007.10	F	601156	0	 256 × 19,9(18)	4+1	186247
		R	564110( 刹车蹄 /Shoes)				
2.0L	2006.5-2007.10	F	601156	0	 256 × 19,9(18)	4+1	186247
		R	564110( 刹车蹄 /Shoes)				
<b>桑塔纳 Vista 志俊 / Santana Vista</b>							
1.6L	2010.7-	F	601156	0	 256 × 19,9(18)	4+1	186247
		R	564110( 刹车蹄 /Shoes)				
1.8L	2008.1-	F	601156	0	 256 × 19,9(18)	4+1	186247
		R	564110( 刹车蹄 /Shoes)				
2.0L	2008.1-	F	601156	0	 256 × 19,9(18)	4+1	186247
		R	564110( 刹车蹄 /Shoes)				
<b>桑塔纳旅行车 / Santana Estate</b>							
1.8L	1996.8-	F			 239 × 11,9(10)	4+1	186245
		R	564109( 刹车蹄 /Shoes)				

											
<b>上海大众 / SVW</b>											
<b>朗逸 / Lavida</b>											
1.4 TSi	2010.3-	F	601186	1							
		R	601255	0							
1.6L	2008.4-	F	601186	1							
		R	601255	0							
2.0L	2008.4-	F	601186	1							
		R	601255	0							
<b>途安 / Touran</b>											
1.8 T	2005.5-	F				287,8 × 24,9(22)	9	<b>197397</b>			
		R	601263	0		259,8 × 11,9(10)	9	<b>197429</b>			
2.0L	2004.11-2008.1	R	601263	0							
<b>上海通用别克 / SGM-Buick</b>											
<b>GL8 / GL8 I</b>											
2.5L	2000.5-2005.7	F	601196	0		277,9 × 32,2(30,7)	5	<b>197392</b>			
		R	601249	0		278 × 11(9)	5	<b>197433</b>			
3.0L	2000.5-2005.7	F	601196	0		277,9 × 32,2(30,7)	5	<b>197392</b>			
		R	601249	0		278 × 11(9)	5	<b>197433</b>			
<b>GL8 陆尊 / GL8 II</b>											
3.0L	2006.5-	F				297 × 32,2(30,7)	5	<b>197387</b>			
		R	601274(2008- )	2							
3.0L	2005.7-2006.5	F	601196	0		297 × 32,2(30,7)	5	<b>197387</b>			
		R				278 × 11(9)	5	<b>197433</b>			
<b>凯越 / Excelle</b>											
1.6L	2003.8-2008.5	F				255,8 × 24(22)	4	<b>197406</b>			
		R	601250(2003-2005)	0							
		R	601231(2006- )	0		257,8 × 10,5(8)	4	<b>197440</b>			
1.8L	2003.8-2008.5	F				255,8 × 24(22)	4	<b>197406</b>			
		R	601250(2003-2005)	0							
		R	601231(2006- )	0		257,8 × 10,5(8)	4	<b>197440</b>			
<b>凯越 HRV / Excelle HRV</b>											
1.6L	2004.10-	F				255,8 × 24(22)	4	<b>197406</b>			
		R	601231	0		257,8 × 10,5(8)	4	<b>197440</b>			

  		 		 			
<b>上海通用别克 / SGM-Buick</b>							
<b>新凯越 / New Excelle</b>							
1.6L	2008.5-	F			 255,8 × 24(22)	4	<b>197406</b>
		R	<b>601250</b>	0	 257,8 × 10,5(8)	4	<b>197440</b>
1.8L	2008.5-	F			 255,8 × 24(22)	4	<b>197406</b>
		R	<b>601250</b>	0	 257,8 × 10,5(8)	4	<b>197440</b>
<b>凯越旅行车 / Excelle Estate</b>							
1.8L	2005.11-	F			 255,8 × 24(22)	4	<b>197406</b>
		R	<b>601231</b>	0	 257,8 × 10,5(8)	4	<b>197440</b>
<b>英朗 GT / Excelle GT</b>							
1.6L	2010.06-	F	<b>601162</b>	2			
		R	<b>601229</b>	2			
1.6 T	2010.06-	F	<b>601162</b>	2			
		R	<b>601229</b>	2			
1.8L	2010.06-	F	<b>601162</b>	2			
		R	<b>601229</b>	2			
<b>英朗 XT / Excelle XT</b>							
1.6L	2010.01-	F	<b>601162</b>	2			
		R	<b>601229</b>	2			
1.6 T	2010.01-	F	<b>601162</b>	2			
		R	<b>601229</b>	2			
1.8L	2010.01-	F	<b>601162</b>	2			
		R	<b>601229</b>	2			
<b>别克世纪 / Century</b>							
2.5L	1999.7-2002.12	F	<b>601196</b>	0	 277,9 × 32,2(30,7)	5	<b>197392</b>
		R			 278 × 11(9)	5	<b>197433</b>
3.0L	1999.7-2002.12	F	<b>601196</b>	0	 277,9 × 32,2(30,7)	5	<b>197392</b>
		R			 278 × 11(9)	5	<b>197433</b>
<b>君威 / Regal I</b>							
2.0L	2003.2-2008.12	F	<b>601196</b>	0	 277,9 × 32,2(30,7)	5	<b>197392</b>
		R	<b>601249</b>	0	 278 × 11(9)	5	<b>197433</b>
2.5L	2002.12-2008.12	F	<b>601196</b>	0	 277,9 × 32,2(30,7)	5	<b>197392</b>
		R	<b>601249</b>	0	 278 × 11(9)	5	<b>197433</b>
3.0L	2002.10-2006.5	F	<b>601196</b>	0	 277,9 × 32,2(30,7)	5	<b>197392</b>
		R	<b>601249</b>	0	 278 × 11(9)	5	<b>197433</b>







											
<b>上海通用别克 / SGM-Buick</b>											
<b>新君威 / Regal II</b>											
2.0L	2008.12-	F	601185	0							
		R	601241	0							
2.4L	2008.12-	F	601185	0							
		R	601241	0							
2.4L	2011.1-	R	601241	0							
GS 2.0	2009.6-	F	601185	0							
		R	601241	0							
<b>君越 / Lacrosse</b>											
2.4L	2006.3-2009.7	F				 297 × 32,2(30,7)	5	<b>197387</b>			
		R	601267	2		 270 × 14(12,5)	5	<b>197432</b>			
3.0L	2006.3-2009.7	F				 297 × 32,2(30,7)	5	<b>197387</b>			
		R	601267	2		 270 × 14(12,5)	5	<b>197432</b>			
<b>新君越 II / Lacrosse II</b>											
2.0T	2010.4-	F	601177	0							
		R	601267	2							
2.4L	2009.7-	F	601177	0							
		R	601267	2							
3.0L	2009.7-	F	601177	0							
		R	601267	2							
<b>赛欧 SRV / Sail SRV</b>											
1.6L	2001.6-2005.2	F	601194	0		 236 × 19,9(17)	6+1	<b>186188</b>			
		R	564116( 刹车蹄 /Shoes)								
<b>赛欧三厢 / Sail Saloon</b>											
1.6L	2001.6-2005.2	F	601194	0		 236 × 19,9(17)	6+1	<b>186188</b>			
		R	564116( 刹车蹄 /Shoes)								
<b>上海通用雪佛兰 / SGM-Chevrolet</b>											
<b>乐风 / Lova</b>											
1.2L	2008.12-2010.12	R	564124( 刹车蹄 /Shoes)								
1.4L	2006.3-2011.7	F	601205	0							
		R	564124( 刹车蹄 /Shoes)								
1.6L	2006.3-2011.3	F	601205	0							
		R	564124( 刹车蹄 /Shoes)								

								
<b>上海通用雪佛兰 / SGM-Chevrolet</b>								
<b>乐骋 / Aveo</b>								
1.4L	2005.7-2010.5	F	601205	0				
<b>景程 / Epica</b>								
1.8L	2009.10-	F	601220	2				
2.0L	2006.4-2009.9	F	601220(2008-)	2				
		R	601268(2008-)	0				
		R	601240(2005-2008)	0				
<b>科鲁兹 / Cruze</b>								
1.6L	2009.4-	F	601162	2				
		R	601229	2				
1.8L	2009.4-	F	601162	2				
		R	601229	2				
<b>赛欧 SRV / Sail SRV</b>								
1.6L	2005.2-2007.12	F			 236 × 19,9(17)	6+1	<b>186188</b>	
<b>赛欧三厢 / Sail Saloon</b>								
1.6L	2005.2-2007.12	F			 236 × 19,9(17)	6+1	<b>186188</b>	
<b>上汽通用五菱 / SAIC-GM-Wuling</b>								
<b>乐驰 / Spark</b>								
0.8L	2003.12-2009.3	F	601191	0				
		R	564117( 刹车蹄 /Shoes)					
1.0L	2004.12-2010.4	F	601191	0				
		R	564117( 刹车蹄 /Shoes)					
1.0L	2010.4-	R	564117( 刹车蹄 /Shoes)					
1.2L	2008.12-	R	564117( 刹车蹄 /Shoes)					
<b>一汽丰田 / FAW-Toyota</b>								
<b>RAV4 / RAV4</b>								
2.0L	2009.4-	F	601224	0				
		R	601264	0				
2.4L 4WD	2009.4-	F	601224	0				
		R	601264	0				
<b>威驰 / Vios</b>								
1.3L	2005.10-2008.2	F	601198	0	 254,9 × 20(18)	4	<b>197418</b>	
		R	564118( 刹车蹄 /Shoes)					







									
<b>一汽丰田 / FAW-Toyota</b>									
<b>威驰 / Vios</b>									
1.5L	2005.10-2008.2	F	601198	0	 254,9 × 20(18)	4	197418		
		R	564118( 刹车蹄 /Shoes)						
<b>新威驰 / Vios</b>									
1.3L	2008.10-	F	601221	0					
		R	564118( 刹车蹄 /Shoes)						
1.6L	2008.10-	F	601221	0					
		R	564118( 刹车蹄 /Shoes)						
<b>普拉多 / Prado</b>									
4.0L 4WD	2003.10-2010.6	F	601165	0					
		R	601232	0					
<b>普锐斯 / Prius</b>									
1.5L	2006.1-2009.12	F	601172	0					
<b>皇冠 / Crown Royal</b>									
2.5L	2005.2-	F	601222	0					
		R	601269	2					
3.0L	2005.2-	F	601222	0					
		R	601269	2					
<b>花冠 / Corolla</b>									
1.8L	2004.2-2007.5	F	601198(2004.02-2005.02)	0	 275 × 25(23)	4	197400		
		F	601172(2005.02- )	0					
		R	601251(2004.02-2005.02)	0	 268,9 × 9,3(7,4)	4	197423		
		R	601242(2005.02- )	2					
<b>花冠 EX / Corolla EX</b>									
1.6L	2007.5-	F	601172	0	 275 × 25(23)	4	197400		
		R	601242	2	 268,9 × 9,3(7,4)	4	197423		
<b>卡罗拉 / Corolla</b>									
1.8L	2007.5-	F			 275 × 25(23)	4	197400		
<b>锐志 / Reiz</b>									
2.5L	2005.10-	F	601222	0					
		R	601269	2					
3.0L	2005.10-	F	601222	0					
		R	601269	2					

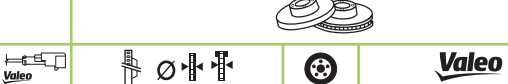

							
<b>一汽丰田 / FAW-Toyota</b>							
<b>陆地巡洋舰 / Land Cruiser</b>							
4.5L	2003.10-2007.4	F	601166	0			
		R	601253	0			
4.7 4WD	2003.10-2007.7	F	601166	0			
<b>兰德酷路泽 / Land Cruiser</b>							
4.0 4WD	2007.12-	F	601165	0			
		R	601232	0			
<b>广汽丰田 / Guangzhou-Toyota</b>							
<b>凯美瑞 / Camry</b>							
2.0L	2006.6-	F	601214	0			
		R	601264	0			
2.4L	2006.6-	F	601214	0			
		R	601264	0			
<b>汉兰达 / Highlander</b>							
2.7 FWD	2009.5-	F	601161	0			
		R	601228	0			
3.5L	2009.5-	F	601161	0			
		R	601228	0			
<b>雅力士 / Yaris</b>							
1.3L	2008.6-2010.9	F	601221	0			
		R	564126( 刹车蹄 /Shoes)				
1.6L	2008.6-2010.9	F	601221	0			
		R	564126( 刹车蹄 /Shoes)				
<b>东风本田 / Dongfeng-Honda</b>							
<b>CR-V 思威 / CR-V</b>							
2.0L 4WD	2004.6-2007.2	F	601208	0	281,7 × 23(21)	5	197267
		R	601248(2005-)	2			
2.0L 4WD	2007.3-2010.2	F	601179	2			
		R	601270	0			
2.4L 4WD	2004.6-2007.2	F	601208	0			
2.4L 4WD	2007.3-2010.12	F	601179	2			
		R	601270	0			

									
<b>东风本田 / Dongfeng-Honda</b>									
<b>思域 / Civic</b>									
1.8L	2006.4-	F	601217	2	 281,7 × 23(21)	5	<b>197267</b>		
		R	601244	2					
<b>思铂睿 / Spior</b>									
2.4L	2009.7-	F	601217	2					
		R	601245	2					
<b>广汽本田 / Guangzhou-Honda</b>									
<b>奥德赛 / Odyssey</b>									
2.3L	2002.4-2004.12	F	601217	2					
		R	601248	2					
2.4L	2005.3-2009.8	F	601217	2	 300 × 28(26)	5	<b>197393</b>		
2.4L	2009.8-	F	601217	2					
		R	601259	0					
<b>思迪 / City</b>									
1.3L	2006.4-2008.12	F	601207	2	 239,5 × 21(19)	4	<b>197420</b>		
		R	564119( 刹车蹄 /Shoes)						
1.5L	2006.4-2008.12	F	601207	2	 239,5 × 21(19)	4	<b>197420</b>		
		R	564119( 刹车蹄 /Shoes)						
<b>锋范 / City</b>									
1.5L	2008.12-	F	601181	2					
1.8L	2008.12-	F	601181	2					
		R	601244	2					
<b>雅阁 / ACCORD VI</b>									
2.0L	1999.1-2007.12	F			 281,8 × 23(21)	5	<b>197412</b>		
		R	601248	2					
2.3 Vtec	2000.6-2002.12	R	601244	2					
3.0 Vtec	2000.6-2002.12	F			 281,8 × 23(21)	5	<b>197412</b>		
		R	601244	2					
<b>雅阁 / ACCORD VII</b>									
2.0L	2003.1-2007.12	F	601217	2	 281,8 × 23(21)	5	<b>197412</b>		
		R	601244	2					
2.4L	2003.1-2007.12	F	601217	2	 281,8 × 23(21)	5	<b>197412</b>		
		R	601244	2					







									
<b>广汽本田 / Guangzhou-Honda</b>									
<b>雅阁 / ACCORD VII</b>									
3.0L	2003.1-2007.12	F	601217	2	300 × 28(26)	5	197393		
		R	601244	2					
<b>雅阁 / ACCORD VIII</b>									
2.0L	2008.3-	F	601217	2					
		R	601245	2					
2.4L	2008.1-	F	601217	2					
		R	601245	2					
3.5L	2008.3-	F	601217	2					
		R	601245	2					
<b>飞度三厢 / Fit</b>									
1.3L	2003.9-2006.4	F	601207	2	239,5 × 21(19)	4	197420		
		R	564119( 刹车蹄 /Shoes)						
1.5L	2004.6-2006.4	F	601207	2	239,5 × 21(19)	4	197420		
		R	564119( 刹车蹄 /Shoes)						
<b>飞度两厢 / Fit Hatchback</b>									
1.3L	2004.9-2008.7	F	601207	2	239,5 × 21(19)	4	197420		
		R	564119( 刹车蹄 /Shoes)						
1.3L	2008.7-	F	601181	2					
1.5L	2004.9-2008.7	F	601207	2	239,5 × 21(19)	4	197420		
		R	564119( 刹车蹄 /Shoes)						
1.5L	2008.7-	F	601181	2					
<b>东风日产 / DongFeng-Nissan</b>									
<b>天籁 (J31) / Teana (J31)</b>									
2.0L	2006.4-2008.6	F	601176	2					
		R	601246	2					
2.3L	2004.9-2008.6	F	601176	2					
		R	601246	2					
3.5L	2004.9-2008.6	F	601176	2					
		R	601246	2					
<b>天籁 (J32) / Teana (J32)</b>									
2.0L	2008.6-	F	601176	2					
		R	601246	2					
2.5L	2008.6-	F	601176	2					
		R	601246	2					

						
<b>东风日产 / DongFeng-Nissan</b>						
<b>天籁 (J32) / Teana (J32)</b>						
3.5L	2008.6-2010.11	F	601176	2		
		R	601246	2		
<b>奇骏 / X-Trail</b>						
2.0L	2008.11-	F	601183	1		
		R	601246	2		
2.5L	2008.11-	F	601183	1		
		R	601246	2		
<b>蓝鸟 / Bluebird</b>						
2.0L	2000.4-2006.12	F	601187	0	 257 × 22(20)	4+2 <b>186485</b> (2002-2004)
		R	601261	2		
<b>轩逸 / Bluebird Sylphy</b>						
1.6L	2007.1-	F	601211	0		
		R	601246	2		
2.0L	2006.8-	F	601176	2		
		R	601246	2		
<b>逍客 / Qashqai</b>						
1.6L	2008.11-2010.12	F	601182	0		
		R	601246	2		
2.0L	2008.3-2010.12	F	601182	0		
		R	601246	2		
<b>阳光 / Sunny</b>						
2.0L	2003.6-2007.12	F	601201	2	 257 × 22(20)	4+2 <b>186485</b> (2005- )
		R	564120( 刹车蹄 /Shoes)			
<b>颐达 / Tiida Saloon</b>						
1.6L	2005.4-	F	601211	0	 259,9 × 22(20)	4 <b>197399</b>
		R	564125( 刹车蹄 /Shoes)			
		R	601246	2		
<b>骐达 / Tiida Hatchback</b>						
1.6L	2005.7-	F	601211	0	 259,9 × 22(20)	4 <b>197399</b>
		R	564125( 刹车蹄 /Shoes)			
		R	601246	2		
1.6L	2011.05-	F	601176	2		
		R	601246	2		

									
<b>东风日产 / DongFeng-Nissan</b>									
<b>骊威 / Livina</b>									
1.6L	2007.4-2010.3	F	601211	0	 259,9 × 22(20)	4	<b>197399</b>		
<b>骏逸 / Livina Geniss</b>									
1.8L	2006.11-2010.1	F	601211	0					
<b>郑州日产 / Zhengzhou-Nissan</b>									
<b>帕拉丁 / Paladin</b>									
2.4L	2003.2-	F	601204	0					
		R	564123( 刹车蹄 /Shoes)						
3.3 4WD	2003.2-	F	601204	0					
<b>东风雪铁龙 / Dong Feng-Citroen</b>									
<b>C2 / C2</b>									
1.4L	2006.10-	F	601184	0	 247 × 20,5(18,5)	4+2	<b>186194</b>		
		R	564113( 刹车蹄 /Shoes)						
1.6L	2006.10-	F			 266 × 22(20,4)	4+2	<b>186695</b>		
		R	564113( 刹车蹄 /Shoes)						
<b>C5 / C5</b>									
2.0L	2009.1-	F	601178	0					
		R	601256	0					
2.3L	2010.1-	F	601178	0					
		R	601256	0					
3.0L	2010.1-	F	601178	0					
		R	601256	0					
<b>凯旋 / C-Triomphe</b>									
2.0 L	2006.5-	F	601213	0	 283 × 26(24)	4+2	<b>186693</b>		
		R	601255	0					
<b>富康三厢 / Fukang Saloon</b>									
1.4L	1992.2-2001.8	F	601158(-ABS)	4	 247 × 20,5(18,5)	4+2	<b>186194(2000- )</b>		
		R	564112( 刹车蹄 /Shoes, -ABS)						
1.4L	2007.12-2008.12	F			 266 × 22(20,4)	4+2	<b>186695</b>		
1.6L	1998.9-2008.12	F			 247 × 20,5(18,5)	4+2	<b>186194</b>		

<b>东风雪铁龙 / Dong Feng-Citroen</b>							
<b>富康两厢 / Fukang Hatchback</b>							
1.4L	1992.2-2005.12	F	601158(-ABS)	4	247 × 20,5(18,5)	4+2	186194(1998-)
		R	564112( 刹车蹄 /Shoes, -ABS)				
1.6L	1997.2-2005.12	F			247 × 20,5(18,5)	4+2	186194(1998-)
1.6L	2005.5-2008.12	F			266 × 22(20,4)	4+2	186695
<b>毕加索 / Xsara Picasso</b>							
1.6L	2001.9-2007.3	R	564114( 刹车蹄 /Shoes)				
2.0L	2002.4-2007.3	F	601213	0			
		R	601255	0			
<b>爱丽舍三厢 / Elysee Saloon</b>							
1.6L	2002.6-2008.4	F			266 × 22(20,4)	4+2	186695
		R	564113( 刹车蹄 /Shoes)				
		R	564115( 刹车蹄 /Shoes, -ABS)				
1.6L	2008.4-	R	564113( 刹车蹄 /Shoes)				
		R	564115( 刹车蹄 /Shoes, -ABS)				
<b>爱丽舍两厢 / Elysee Hatchback</b>							
1.6L	2009.2-	R	564113( 刹车蹄 /Shoes)				
		R	564115( 刹车蹄 /Shoes, -ABS)				
<b>赛纳 / Xsara Saloon</b>							
2.0L	2003.5-2005.12	F	601213	0	283 × 26(24)	4+2	186693
<b>世嘉三厢 / C-quatre Saloon</b>							
1.6L	2009.6-	F	601213	0			
		R	601255	0			
2.0L	2009.6-	F	601213	0			
		R	601255	0			
<b>东风标致 / Dong Feng-Peugeot</b>							
<b>206 / 206</b>							
1.4L	2006.7-2009.2	F	601184	0	266 × 22(20,4)	4+2	186695
		R	564113( 刹车蹄 /Shoes)				
1.6L	2006.1-2009.2	F			266 × 22(20,4)	4+2	186695
		R	564113( 刹车蹄 /Shoes)				

							
<b>东风标致 / Dong Feng-Peugeot</b>							
<b>307 三厢 / 307 Saloon</b>							
1.6L	2004.8-	F	601213	0	283 × 26(24)	4+2	186693
		R	601255	0			
2.0L	2004.8-	F	601213	0	283 × 26(24)	4+2	186693
		R	601255	0			
<b>307 两厢 / 307 Hatchback</b>							
1.6L	2008.2-	F	601213	0			
		R	601273	0			
2.0L	2008.2-	F	601213	0			
		R	601273	0			
<b>408 / 408</b>							
1.6L	2010.1-	F	601213	0			
		R	601273	0			
2.0L	2010.1-	F	601213	0			
		R	601273	0			
<b>东风悦达起亚 / Dongfeng Yueda Kia</b>							
<b>RIO 锐欧 / Rio</b>							
1.4L	2007.1-	F	601210	2			
		R			262 × 10(8,4)	4+3	197029
1.6L	2007.1-	F	601210	2			
		R			262 × 10(8,4)	4+3	197029
<b>狮跑 / Sportage</b>							
2.0L	2007.11-	F	601173	2			
		R	601236	2			
2.7L 4WD	2007.11-	F	601173	2			
		R	601236	2			
<b>远舰 / Optima</b>							
2.0L	2004.9-	F	601173	2			
		R	601236	2			
<b>福瑞迪 / Forte</b>							
1.6L	2009.6-	F	601175	0			
		R	601239	2			
2.0L	2009.6-	F	601175	0			
		R	601239	2			

								
<b>北京现代 / Beijing Hyundai</b>								
<b>伊兰特·悦动 / Elantra Yue Dong</b>								
1.6L	2008.4-	F	601175	0				
		R	601239	2				
1.8L	2008.4-	F	601175	0				
		R	601239	2				
<b>伊兰特三厢 / Elantra Saloon</b>								
1.6L	2003.12-	F	601169	0	 257 × 24(22,4)	4+2	<b>186825</b>	
		R	601235	2	 258 × 10(8)	4	<b>197441</b>	
1.8L	2003.12-	F	601169	0	 257 × 24(22,4)	4+2	<b>186825</b>	
		R	601235	2	 258 × 10(8)	4	<b>197441</b>	
<b>伊兰特两厢 / Elantra Hatchback</b>								
1.6L	2007.3-	F	601169	0	 257 × 24(22,4)	4+2	<b>186825</b>	
		R	601235	2	 258 × 10(8)	4	<b>197441</b>	
<b>索纳塔 / Sonata (EF)</b>								
2.0L	2002.12-2007.7	F	601173	2				
		R	601236	2				
2.5L	2002.12-2007.7	F	601173	2				
		R	601236	2				
<b>索纳塔 御翔 / Sonata (NF)</b>								
2.0L	2005.9-	F	601173	2				
		R	601236	2				
2.4L	2005.9-	F	601173	2				
		R	601236	2				
<b>途胜 / Tucson</b>								
2.0L	2005.5-	F	601173	2				
		R	601236	2				
2.7 4WD	2005.5-	F	601173	2				
		R	601236	2				
<b>雅绅特 / Accent</b>								
1.4L	2006.2-	F	601210	2				
		R	601239	2	 262 × 10(8,4)	4+3	<b>197029</b>	
1.6L	2006.2-	F	601210	2				
		R	601239	2	 262 × 10(8,4)	4+3	<b>197029</b>	



											
<b>北京现代 / Beijing Hyundai</b>											
<b>i30 / i30</b>											
1.6L	2009.7-	F	601175	0							
		R	601239	2							
2.0L	2009.7-	F	601175	0							
		R	601239	2							
<b>ix35 / ix35</b>											
2.0L	2010.4-	R	601239	2							
2.4L	2010.4-	R	601239	2							
<b>华泰现代 / Huatai Hyundai</b>											
<b>圣达菲 / Santa Fe</b>											
2.0 TDI 4WD	2006.10-	F	601164	2							
		R	601230	2							
2.7 4WD	2006.10-	F	601164	2							
		R	601230	2							
<b>特拉卡 / Terracan</b>											
2.5T 柴油 /Diesel	2003.3-2008.12	F	601167	2							
		R	601233	0							
2.9T 柴油 /Diesel	2005.4-2008.12	F	601168	0							
		R	601233	0							
<b>北京吉普 / Beijing-Jeep</b>											
<b>吉普 2500 / Jeep 2500</b>											
2.4L	2003.6-2006.2	R	601255	0							
2.4 4WD	2003.6-2006.2	R	601255	0							
<b>北京汽车 / BEIJING Automobile</b>											
<b>陆霸 / Luba</b>											
2.4 4WD	2004.6-	F	601166	0							
		R	601232	0							
2.4L	2004.6-	F	601166	0							
		R	601232	0							
3.0 4WD	2003.6-	F	601166	0							
		R	601232	0							

											
<b>北京汽车 / BEIJING Automobile</b>											
<b>陆霸 / Luba</b>											
3.4 4WD	2005.1-	F	601166	0							
		R	601232	0							
<b>一汽海马 / FAW-Haima</b>											
<b>普力马 / Freema</b>											
1.8L	2007.3-2009.10	R	601243	0							
<b>海马 3 / Haima 3</b>											
1.8L	2007.6-2010.12	R	601243	0							
<b>福美来 2 代 / Family II</b>											
1.6L	2006.9-2010.11	R	601243	0							
<b>福美来 3 代 / Family III</b>											
1.6L	2010.11-	R	601243	0							
<b>海南马自达 / Hainan Automobile</b>											
<b>普力马 / Freema</b>											
1.8L	2001.1-2007.2	R	601243	0							
<b>福美来 / Familia</b>											
1.6L	2003.3-2006.12	R	601243	0							
1.8L	2002.10-2006.12	R	601243	0							
<b>长安福特 / Changan Ford</b>											
<b>嘉年华三厢 / Fiesta Saloon</b>											
1.3L	2003.3-2006.6	R	564121( 刹车蹄 /Shoes)								
1.3L	2010.3-	F	601225	2							
		R	564127( 刹车蹄 /Shoes)								
1.5L	2009.2-	F	601225	2							
		R	564127( 刹车蹄 /Shoes)								
1.6L	2003.3-2006.6	R	564121( 刹车蹄 /Shoes)								
<b>嘉年华两厢 / Fiesta Hatchback</b>											
1.3L	2009.2-	F	601225	2							
		R	564127( 刹车蹄 /Shoes)								
1.5L	2009.2-	F	601225	2							
		R	564127( 刹车蹄 /Shoes)								

								
<b>长安福特 / Changan Ford</b>								
<b>福克斯三厢 / Focus Saloon</b>								
1.8L	2005.9-	R	601256	0	264,8 × 11(9)	5	197430	
2.0L	2005.9-	R	601256	0	264,8 × 11(9)	5	197430	
<b>福克斯两厢 / Focus Hatchback</b>								
1.8L	2006.8-	R	601256	0	264,8 × 11(9)	5	197430	
2.0L	2006.8-	R	601256	0	264,8 × 11(9)	5	197430	
<b>蒙迪欧 / Mondeo</b>								
2.0L	2003.5-	F	601206	0	300 × 24(22)	5	197390	
		R	601257(-2004)	0	280 × 12(10)	5	197431	
		R	601258	0				
2.5L	2003.5-	F	601206	0	300 × 24(22)	5	197390	
		R	601257(-2004)	0	280 × 12(10)	5	197431	
		R	601258	0				
<b>蒙迪欧 – 致胜 / Mondeo</b>								
2.0L	2007.9-	R	601266	0				
2.3L	2007.9-	R	601266	0				
<b>长安马自达 / Changan Mazda</b>								
<b>马自达 2 两厢 / 2 Hatchback</b>								
1.3L	2007.10-	F	601225	2				
		R	564127( 刹车蹄 /Shoes)					
1.5L	2007.10-	F	601225	2				
		R	564127( 刹车蹄 /Shoes)					
<b>马自达 3 / 3 Saloon</b>								
1.6L	2006.2-	R	601256	0				
2.0L	2006.2-	F			258 × 24(22)	5+1	186457	
		R	601256	0	264,8 × 11(9)	5	197430	
<b>一汽夏利 / FAW Tianjin Xiali</b>								
<b>威乐 / Vela</b>								
1.5L	2002.7-	F	601198	0	254,9 × 20(18)	4	197418(2007- )	
1.6L	2004.3-	R	564118( 刹车蹄 /Shoes)					
<b>威姿 / Vizi</b>								
1.3L	2003.1-	F	601198	0	254,9 × 20(18)	4	197418	
		R	564118( 刹车蹄 /Shoes)					

		R	F						
		Valeo		Valeo				Valeo	
<b>一汽夏利 / FAW Tianjin Xiali</b>									
<b>威志两厢 / Weizhi Hatchback</b>									
1.3L	2007.1-	F				254,9 × 20(18)	4	<b>197418</b>	
<b>一汽轿车 / FAW Car Co., Ltd</b>									
<b>奔腾 B70 / Besturn B70</b>									
2.0L	2006.9-	F	<b>601180</b>		2				
<b>红旗世纪星 / Century Star (CA7202)</b>									
2.0L	2000.2-	F	<b>601195</b>		1	288 × 24,9(23)	5	<b>186271</b>	
		R	<b>601255</b>		0	245 × 9,9(8)	5	<b>186294</b>	
2.4L	2000.9-	F	<b>601195</b>		1				
		R	<b>601255</b>		0				
<b>红旗旗舰 / Flagship (CA7460)</b>									
4.6L	1999.2-	R	<b>564111( 刹车蹄 /Shoes)</b>						
<b>红旗明仕 / Mingshi (CA7180)</b>									
1.8L	2001.1-	F	<b>601195</b>		1				
		R	<b>601255</b>		0				
		R	<b>564111( 刹车蹄 /Shoes)</b>						
<b>一汽马自达 /FAW Mazda</b>									
<b>马自达 6 旅行车 / 6 Estate</b>									
2.0L	2003.4-	F				273,6 × 24(22)	5	<b>197264</b>	
2.3L	2003.4-	F				273,6 × 24(22)	5	<b>197264</b>	
		R				279,7 × 10(8)	5	<b>197294</b>	
<b>马自达 6 三厢 / 6 Saloon</b>									
2.0L	2003.4-	F	<b>601180</b>		2	273,6 × 24(22)	5	<b>197264</b>	
		R	<b>601243</b>		0	279,7 × 10(8)	5	<b>197294</b>	
2.3L	2003.4-	F	<b>601180</b>		2	273,6 × 24(22)	5	<b>197264</b>	
		R	<b>601243</b>		0	279,7 × 10(8)	5	<b>197294</b>	
<b>马自达 6 睿翼 / 6 Rui Yi</b>									
2.0L	2009.10-	F	<b>601223</b>		2				
		R	<b>601271</b>		0				
2.5L	2009.1-	F	<b>601223</b>		2				
		R	<b>601271</b>		0				

									
									
<b>华晨汽车 / Shenyang Brilliance</b>									
<b>尊驰 / Zunchi (M1)</b>									
2.0L	2004.12-	F	601157	2					
2.4L	2004.12-2008.12	F	601157	2					
<b>骏捷 / Junjie (M2)</b>									
2.0L	2006.2-2008.12	F	601157	2					
<b>骏捷 Wagon / Junjie Wagon</b>									
2.0L	2008.12-	F	601157	2					
<b>吉利汽车 / Geely</b>									
<b>远景 / Vision</b>									
1.8L	2005.12-	R	601242	2					
<b>金刚 / KingKong</b>									
1.5L	2006.5-	F	601198	0					
		R	564118( 刹车蹄 /Shoes)						
1.6L	2006.5-	F	601198	0					
		R	564118( 刹车蹄 /Shoes)						
1.8L	2005.6-	F	601198	0					
		R	564118( 刹车蹄 /Shoes)						
<b>奇瑞汽车 / Chery</b>									
<b>A5 / A5</b>									
1.5L	2009.6-	F	601157	2					
1.6L	2006.1-2009.1	F	601157	2					
1.8L	2007.9-	F	601157	2					
2.0L	2006.1-	F	601157	2					
<b>东方之子 / Eastar</b>									
1.8L	2006.12-	F	601157	2					
2.0L	2004.3-2008.12	F	601157	2					
2.4L	2003.6-2007.12	F	601157	2					
<b>旗云 / Qiyun</b>									
1.3L	2006.9-2008.7	F	601188	0					
		R	564110( 刹车蹄 /Shoes)						
1.5L	2008.7-2010.5	F	601188	0					
		R	564110( 刹车蹄 /Shoes)						
1.6L	2003.8-2008.7	F	601188	0					
		R	564110( 刹车蹄 /Shoes)						

<b>奇瑞汽车 / Chery</b>							
<b>QQ3 / QQ3</b>							
0.8L	2004.3-	F	601191	0			
		R	564117( 刹车蹄 /Shoes)				
1.1L	2003.6-2010.3	F	601191	0			
		R	564117( 刹车蹄 /Shoes)				
<b>QQ6 / QQ6</b>							
1.1L	2006.12-	R	564117( 刹车蹄 /Shoes)				
<b>瑞虎 / Tiggo</b>							
1.6L	2006.7-2007.12	F	601157	2			
2.0L	2005.3-2008.12	F	601157	2			
2.4L	2005.3-2008.12	F	601157	2			
<b>比亚迪 / BYD</b>							
<b>F3 / F3</b>							
1.5L	2007.9-2010.12	R	601242	2			
1.6L	2005.9-2010.12	R	601242	2			
<b>江淮汽车 / JAC</b>							
<b>宾悦 / Bin Yue</b>							
2.0L	2007.11-	F	601157	2			
2.4L	2007.11-	F	601157	2			

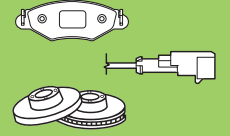

## 进口车型 Import Car Models

### Pads and Discs

Plaquettes et Disques

### Pastillas y Discos

Pastilas e Discos

### Pastiglie e Dischi

Blokjes en Schijven

### Bremsbeläge und Bremsscheiben

Klocki i Tarcze



























### Balatalari ve Diskleri

Колодки и диски

Δισκόφρενα & Δισκόπλακες

































刹车片和刹车盘







بطانات و قرص









































								
<b>奥迪 / Audi</b>								
<b>奥迪 A3 / A3</b>								
1.4 TFSI	2010.6-	F	ATE 21974 	<b>598408</b>	1	 280 × 22 (19)	5+5	<b>186754</b>
		R	LUC 20960 	<b>598463</b>	0 (D)			
1.8 TFSI	2010.6-	F	ATE 23587 	<b>598635</b>	1	 255 × 10 (8)	9+1	<b>186857</b>
		R	LUC 20960 	<b>598463</b>	0 (D)			
		R	LUC 23914 	<b>598752</b>	0			
<b>奥迪 A4 / A4</b>								
1.8 T	2003.2-2005.7	F				 280 × 22 (20)	5	<b>186582</b>
		F				 312 × 25 (23)	5+5	<b>186758</b>
		R	LUC 20960 	<b>598463</b>	0 (D)			
1.8 T	2005.7-2008.12	R	LUC 20960 	<b>598463</b>	0 (D)			
		R	LUC 20960 	<b>598474</b>	0 (D+C)			
2.0L	2003.2-2005.7	F				 280 × 22 (20)	5	<b>186582</b>
		F				 312 × 25 (23)	5+5	<b>186758</b>
		R	LUC 20960 	<b>598463</b>	0 (D)			
		R	LUC 20960 	<b>598474</b>	0 (D+C)			
3.0L quattro	2005.7-2008.12	F				 312 × 25 (23)	5+5	<b>186758</b>
		R	LUC 20960 	<b>598463</b>	0 (D)			
		R	LUC 20960 	<b>598474</b>	0 (D+C)			
<b>奥迪 A5 / A5</b>								
2.0 TFSI	2008.6-	R				 300 × 12 (10)	5+1	<b>197126</b>
2.0 TFSI quattro	2008.6-	F				 314 × 25 (23)	5+1	<b>197213</b>
		R				 300 × 12 (10)	5+1	<b>197126</b>
2.7 TDI	2007.6-	F	ATE 24705 	<b>598996</b>	1			
3.2 FSI	2008.4-	R				 300 × 12 (10)	5+1	<b>197126</b>
3.2 FSI quattro	2008.4-	R				 300 × 12 (10)	5+1	<b>197126</b>















































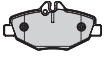

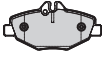
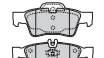

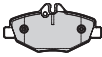

		 R F		 WVA		 Valeo		 Valeo		   Valeo	
<b>奥迪 / Audi</b>											
<b>奥迪 A6 / A6</b>											
1.8T	1999.9-2005.12	F							312 × 25 (23)	5+5	<b>186758</b>
		R	LUC 20960		<b>598463</b>	0 (D)					
1.8T quattro	1999.9-2005.12	F							312 × 25 (23)	5+5	<b>186758</b>
		R	LUC 20960		<b>598463</b>	0 (D)					
2.4L	1999.9-2005.12	F							312 × 25 (23)	5+5	<b>186758</b>
		R	LUC 20960		<b>598463</b>	0 (D)					
2.4 quattro	1999.9-2005.12	F							312 × 25 (23)	5+5	<b>186758</b>
		R	LUC 20960		<b>598463</b>	0 (D)					
2.8L	1999.9-2005.12	F	LUC 23118		<b>598992</b>	2					
		R	LUC 20960		<b>598463</b>	0 (D)					
3.0L	2004.5-2005.12	F							312 × 25 (23)	5+5	<b>186758</b>
		R	LUC 20960		<b>598463</b>	0 (D)					
3.0L quattro	2004.5-2005.12	F							312 × 25 (23)	5+5	<b>186758</b>
		R	LUC 20960		<b>598463</b>	0 (D)					
<b>奥迪 A8 / A8</b>											
2.8 FSI	2007.8-2011.5	F	ATE 23762		<b>598779</b>	2			321 × 30 (28)	5+1	<b>197199</b>
		R							280 × 22 (20)	5	<b>186582</b>
3.0L	2004.5-2011.5	F	ATE 23762		<b>598779</b>	2			321 × 30 (28)	5+1	<b>197199</b>
		R	LUC 23326		<b>601004</b>	0			280 × 22 (20)	5	<b>186582</b>
3.2 FSI	2005.6-2011.5	F	ATE 23762		<b>598779</b>	2			321 × 30 (28)	5+1	<b>197199</b>
		R	LUC 23326		<b>601004</b>	0			280 × 22 (20)	5	<b>186582</b>
3.2 FSI quattro	2005.6-2011.5	F	ATE 23762		<b>598779</b>	2			321 × 30 (28)	5+1	<b>197199</b>
		R	LUC 23326		<b>601004</b>	0			280 × 22 (20)	5	<b>186582</b>
3.7L quattro	2004.5-2011.5	F	ATE 23885		<b>598845</b>	2					
		R	LUC 23326		<b>601004</b>	0					



















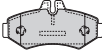
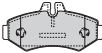

									
		R	F						
<b>奥迪 / Audi</b>									
<b>奥迪 A8 / A8</b>									
4.2 FSI quattro	2006.6-2010.7	F	ATE 23885		<b>598845</b>	2			
		R	LUC 23326		<b>601004</b>	0			
6.0L W12 quattro	2005.5-2011.5	F	ATE 23885		<b>598845</b>	2			
		R	LUC 23326		<b>601004</b>	0			
<b>奥迪 S8 / S8</b>									
5.2L quattro	2007.12-2011.5	F	ATE 23885		<b>598845</b>	2			
		R	LUC 23326		<b>601004</b>	0			
<b>奥迪 Q5 / Q5</b>									
2.0 TFSI quattro	2009.10-	R					 300 × 12 (10)	5+1	<b>197126</b>
<b>奥迪 Q7 / Q7</b>									
3.0 TDI	2007.11-	F	BBO 23693		<b>598656</b>	0			
		R	BBO 23694		<b>598770</b>	0	 358 × 28 (26)	5+2	<b>197051</b>
							 330 × 28 (26)	5+2	<b>197090</b>
3.0 TFSI	2010.5-	F	BBO 23693		<b>598656</b>	0			
		R	BBO 23694		<b>598770</b>	0	 330 × 28 (26)	5+2	<b>197090</b>
3.6 FSI	2006.8-2010.5	F	BBO 23693		<b>598656</b>	0			
		R	BBO 23694		<b>598770</b>	0	 358 × 28 (26)	5+2	<b>197051</b>
							 330 × 28 (26)	5+2	<b>197090</b>
4.2 FSI	2006.3-2010.5	F	BBO 23693		<b>598656</b>	0			
		R	BBO 23694		<b>598770</b>	0	 358 × 28 (26)	5+2	<b>197051</b>
							 330 × 28 (26)	5+2	<b>197090</b>
6.0 TDI	2008.9-	R	BBO 23694		<b>598770</b>	0			
<b>奥迪 TT / TT</b>									
1.8 T quattro	2002.4-2006.6	F	ATE 21911		<b>598303</b>	0	 312 × 25 (23)	9+1	<b>197246</b>
		F	ATE 21911		<b>598486</b>	1			

























		 R F		 WVA Valeo		 Valeo			
<b>奥迪 / Audi</b>									
<b>奥迪 TT / TT</b>									
1.8 T quattro	2002.4-2006.6	R	LUC 20960		598180	0 (D)	232 × 9 (7)	5	186597
		R	LUC 20960		598463	0 (D)	239 × 8,9 (7)	5+1	197011
2.0 TFSI	2006.8-	F	ATE 23587		598635	1	312 × 25 (22)	5+5	197242
		R	LUC 23914		598752	0			
2.0 TFSI quattro	2008.6-	F	ATE 23587		598635	1	312 × 25 (22)	5+5	197242
		R	LUC 23914		598752	0			
3.2L V6 quattro	2006.8-	R	LUC 23914		598752	0			
<b>奥迪 TTS / TTS</b>									
2.0 TFSI quattro	2011.1-	F	ATE 23587		598635	1			
		R	LUC 23914		598752	0			
<b>奥迪 Allroad / ALLROAD</b>									
2.7 T quattro	2004.5-2005.8	R	LUC 20960		598463	0 (D)			
<b>宾利 / Bentley</b>									
<b>欧陆 GT / Continental Coupe</b>									
6.0L	2003.6-	R	ATE 23730		598820	0			
<b>欧陆飞刺 / Continental Flying Spur</b>									
6.0L	2008.9-	R	ATE 23730		598820	0			
<b>奔驰 / Mercedes-Benz</b>									
<b>A160 (W168)</b>									
1.6L	1999.2-2005.8	R	LUC 23138		598583	0			
<b>A160 (W169)</b>									
1.5L	2010.11-	F	LUC 24077		598704	0	276 × 12 (10)	5+1	186798
		R	LUC 23138		598583	0	258 × 8 (7)	5+1	197036
<b>A180 (W169)</b>									
1.7L	2010.11-	F	LUC 24077		598704	0	276 × 22 (19,4)	5+1	186799
		R	LUC 23138		598583	0	258 × 8 (7)	5+1	197036

											
		R	F								
<b>奔驰 / Mercedes-Benz</b>											
<b>A190 (W168)</b>											
1.9L	2004.6-	R	LUC 23138 	<b>598583</b>	0						
<b>B200 (W245)</b>											
2.0L	2009.10-	F	LUC 23881 	<b>598795</b>	2		288 × 25 (22,4)	5+1	<b>197091</b>		
		R	LUC 23138 	<b>598583</b>	0		258 × 8 (7)	5+1	<b>197036</b>		
<b>C180 (W204)</b>											
1.6L	2008.1-	F					295 × 28 (26)	5+1	<b>197201</b>		
		F							<b>197316</b>		
		R	ATE 24253 	<b>601051</b>	0		300 × 10 (8,3)	5+1	<b>197127</b>		
							278 × 9 (7,3)	5+1	<b>197128</b>		
<b>C200 CGI Kompressor (W203)</b>											
1.8L	2003.7-	F	LUC 23144 	<b>598448</b>	0		288 × 25 (22,4)	5+2	<b>186864</b>		
		R	ATE 21919 	<b>598444</b>	0		290 × 10 (8,3)	5	<b>186469</b>		
								278 × 9 (7,3)	5+1	<b>186470</b>	
<b>C200 Kompressor (W203)</b>											
1.8L	2002.5-2007.1	F	LUC 23144 	<b>598448</b>	0		288 × 25 (22,4)	5+2	<b>186864</b>		
		R	ATE 21919 	<b>598444</b>	0		278 × 9 (7,3)	5+1	<b>186470</b>		
<b>C200 Kompressor (W204)</b>											
1.8L	2007.1-	F					295 × 28 (26)	5+1	<b>197201</b>		
		F					295 × 28 (25,4)	5+1	<b>197202</b>		
		R	ATE 24253 	<b>601051</b>	0		300 × 10 (8,3)	5+1	<b>197127</b>		
<b>C230</b>											
2.5L	2005.1-	F	LUC 23144 	<b>598448</b>	0						
		R	ATE 21899 	<b>598447</b>	0		290 × 10 (8,3)	5	<b>186469</b>		
2.5L	2007.1-	F					295 × 28 (26)	5+1	<b>197201</b>		
		F					295 × 28 (25,4)	5+1	<b>197202</b>		
		R	ATE 24253 	<b>601051</b>	0		300 × 10 (8,3)	5+1	<b>197127</b>		





























													
<b>奔驰 / Mercedes-Benz</b>													
<b>C230 Kompressor(W202)</b>													
2.3L	2000.3-2004.4	F							288 × 25 (22,4)	5+1		<b>186467</b>	
		R	ATE 21197		<b>598272</b>	0			278 × 9 (7,3)	5+1		<b>186470</b>	
<b>C240 4-matic(W203)</b>													
2.6L	2002.7-	F	LUC 23144		<b>598448</b>	0							
		R	ATE 21899		<b>598447</b>	0			290 × 10 (8,3)	5		<b>186469</b>	
<b>C280(W203)</b>													
3.0L	2005.1-	F	LUC 23144		<b>598448</b>	0							
		R	ATE 21899		<b>598447</b>	0			290 × 10 (8,3)	5		<b>186469</b>	
<b>CLK200K(C209)</b>													
1.8L	2006.10-	F	LUC 23144		<b>598448</b>	0							
		R	ATE 21899		<b>598447</b>	0			290 × 10 (8,3)	5		<b>186469</b>	
<b>CLK230(C208)</b>													
2.3L	1997.6-2002.10	F	ATE 21195		<b>598357</b>	0			288 × 25 (22,4)	5+1		<b>186467</b>	
		R	ATE 21919		<b>598444</b>	0			290 × 10 (8,3)	5		<b>186469</b>	
										278 × 9 (7,3)	5+1		<b>186470</b>
<b>CLK240(C209)</b>													
2.6L	2004.1-	F	LUC 23144		<b>598448</b>	0							
		R	ATE 21899		<b>598447</b>	0			290 × 10 (8,3)	5		<b>186469</b>	
<b>CLK280(A209)</b>													
3.0L	2005.1-	F	LUC 23144		<b>598448</b>	0							
		R	ATE 21899		<b>598447</b>	0			290 × 10 (8,3)	5		<b>186469</b>	
<b>CLK350(A209)</b>													
3.5L	2005.1-	F	LUC 23144		<b>598448</b>	0							
		R	ATE 21899		<b>598447</b>	0			290 × 10 (8,3)	5		<b>186469</b>	
<b>CLS350(C219)</b>													
3.5L	2008.7-	F	BBO 23745		<b>598659</b>	0							
		F	BBO 23960		<b>598995</b>	0							
		R	ATE 23334		<b>598637</b>	0						<b>197324</b>	



























															
		R	F												
<b>奔驰 / Mercedes-Benz</b>															
<b>CLS500(C219)</b>															
5.0L	2004.10-	F	BBO 23745		<b>598659</b>	0									
		R	ATE 23334		<b>598637</b>	0									<b>197324</b>
<b>E50AMG(W210)</b>															
5.0L	1996.2-1997.8	R								 300 × 22 (19,4)	5+2			<b>197094</b>	
<b>E200</b>															
1.8L	2002.11-	F	BOS 23743		<b>598638</b>	2								<b>197326</b>	
		R	ATE 23334		<b>598637</b>	0		 300 × 10 (8,3)	5+1					<b>197035</b>	
<b>E240(W211)</b>															
2.6L	2002.3-	F	BOS 23743		<b>598638</b>	2								<b>197326</b>	
		R	ATE 23334		<b>598637</b>	0		 300 × 10 (8,3)	5+1					<b>197035</b>	
<b>E320 4-matic(W211)</b>															
3.2L	2003.3-	F	ATE 21670		<b>598636</b>	0									
		R	ATE 23334		<b>598637</b>	0		 300 × 10 (8,3)	5+1					<b>197035</b>	
3.5L	2005.3-	F	ATE 21670		<b>598636</b>	0								<b>197326</b>	
		F	BBO 23745		<b>598659</b>	0									
		R	ATE 23334		<b>598637</b>	0								<b>197324</b>	
<b>E350 4-matic(W212)</b>															
3.5L	2009.1-	R	ATE 23334		<b>598637</b>	0								<b>197324</b>	
<b>E500(W211)</b>															
5.0L	2004.9-	F	BBO 23745		<b>598659</b>	0									
		R	ATE 23334		<b>598637</b>	0								<b>197324</b>	
<b>E500 4-matic(W211)</b>															
5.0L	2004.9-	F	ATE 21484		<b>598712</b>	1		 330 × 32 (29,4)	5+1				<b>197093</b>		
		R	ATE 23334		<b>598637</b>	0							<b>197324</b>		

































															
<b>奔驰 / Mercedes-Benz</b>															
<b>E55AMG(W211)</b>															
5.5L	2002.10-	R													<b>197324</b>
<b>G500(W463)</b>															
5.0L	1998.4-	R	BOS 23021		<b>598300</b>	0		272 × 16 (14)	5						<b>187045</b>
<b>G55AMG(W463)</b>															
5.5L	2006.8-	R	BOS 23021		<b>598300</b>	0		272 × 16 (14)	5						<b>187045</b>
<b>GL450(X164)</b>															
4.7L	2006.9-	F	ATE 23922		<b>598728</b>	0									
		R	ATE 23923		<b>598802</b>	0									
<b>GL550 (X164)</b>															
5.5L	2006.9-	F	ATE 23922		<b>598728</b>	0									
		R	ATE 23923		<b>598802</b>	0									
<b>GLK300 4-matic (X204)</b>															
3.0L	2009.7-	R	ATE 24253		<b>601051</b>	0									<b>197324</b>
<b>GLK350 4-matic (X204)</b>															
3.5L	2008.6-	R	ATE 24253		<b>601051</b>	0									<b>197324</b>
<b>ML320(W163)</b>															
3.2L	2002.6-	F	KH 23193		<b>598442</b>	1		345 × 31,9 (30)	5+3						<b>186811</b>
								303 × 26 (23)	5				<b>197237</b>		
		R	KH 23189		<b>598443</b>	1									
		R	BOS 23189		<b>598813</b>	1			285 × 15 (13)	5+1					<b>186753</b>
<b>ML350(W163)</b>															
3.7L	2003.2-	F	BBO 23271		<b>598445</b>	0		345 × 31,9 (30)	5+3						<b>186811</b>
		R	BBO 23157		<b>598719</b>	0		285 × 15 (13)	5+1						<b>186753</b>

															
<b>奔驰 / Mercedes-Benz</b>															
<b>ML350 4-matic(W164)</b>															
3.5L	2005.7-2008.1	F	ATE 23922		<b>598728</b>	0	330 × 32 (29,4)	5+3	<b>197092</b>						
		R	ATE 23923		<b>598802</b>	0									
<b>ML500 4-matic(W164)</b>															
5.5L	2007.12-	R	ATE 23923		<b>598802</b>	0									
5.0L	2005.7-2008.1	F	ATE 23922		<b>598728</b>	0									
		R	ATE 23923		<b>598802</b>	0									
<b>ML55AMG(W163)</b>															
5.5L	2000.2-	F	BBO 23271		<b>598445</b>	0	345 × 31,9 (30)	5+3	<b>186811</b>						
		R	BBO 23157		<b>598719</b>	0									
<b>ML63AMG 4-matic(W164)</b>															
6.2L	2006.1-	F	ATE 23922		<b>598728</b>	0									
		R	ATE 23923		<b>598802</b>	0									
<b>R300(W251,V251)</b>															
3.0L	2009.7-	F	ATE 23922		<b>598728</b>	0	330 × 32 (29,4)	5+3	<b>197092</b>						
		R	ATE 23923		<b>598802</b>	0									
<b>R350(W251,V251)</b>															
3.5L	2007.1-	F	ATE 23922		<b>598728</b>	0	330 × 32 (29,4)	5+3	<b>197092</b>						
		R	ATE 23923		<b>598802</b>	0									
<b>R500(W251,V251)</b>															
5.0L	2006.1-	F	ATE 23922		<b>598728</b>	0									
		R	ATE 23923		<b>598802</b>	0									
<b>R550(W251,V251)</b>															
5.5L	2007.1-	R	ATE 23923		<b>598802</b>	0									





















									
		R	F						
<b>奔驰 / Mercedes-Benz</b>									
<b>S280(W220)</b>									
2.8L	2005.1-	F	BBO 23271		<b>598445</b>	0			
		F	BBO 23745		<b>598659</b>	0			
		R	ATE 23078		<b>598446</b>	0			
		R	ATE 23334		<b>598637</b>	0			
<b>S320(W220)</b>									
3.2 柴油 /Diesel	2005.12-	F	BBO 23745		<b>598659</b>	0			
		R	ATE 23334		<b>598637</b>	0			
<b>S350(W220)</b>									
3.7L	2005.12-	F	BBO 23745		<b>598659</b>	0			
		R	ATE 23334		<b>598637</b>	0			
<b>S350(W221)</b>									
3.5L	2005.10-	F	BBO 23960		<b>598995</b>	0			
		R	ATE 23334		<b>598637</b>	0			
<b>S350 4-matic(W220)</b>									
3.7L	2005.12-	F	ATE 21670		<b>598636</b>	0			
		R	ATE 23334		<b>598637</b>	0			
<b>S400(W221)</b>									
3.5L	2009.1-	F	BBO 23960		<b>598995</b>	0			
<b>S430 4-matic(W220)</b>									
4.3L	2005.12-	F	ATE 21484		<b>598712</b>	1			
		R	ATE 23334		<b>598637</b>	0			
<b>S500(W221)</b>									
5.5L	2005.10-	F	BBO 23960		<b>598995</b>	0			
		R	ATE 23334		<b>598637</b>	0			

																
<b>奔驰 / Mercedes-Benz</b>																
<b>S500 4-matic(W220)</b>																
5.0L	2002.9-2005.8	F	ATE 21484		<b>598712</b>	1										
		R	ATE 21305		<b>598617</b>	0										
		R	ATE 23334		<b>598637</b>	0										
<b>S500 4-matic(W221)</b>																
5.5L	2005.10-	F	BBO 23960		<b>598995</b>	0										
		R	ATE 23334		<b>598637</b>	0										
<b>S600 (W220)</b>																
5.5L	2005.8-	R	ATE 21305		<b>598617</b>	0										
<b>SL350(R230)</b>																
3.5L	2006.3-	F	BBO 23745		<b>598659</b>	0										
		R	ATE 23334		<b>598637</b>	0										
<b>SL500 (R230)</b>																
5.5L	2011.4-	F	BBO 23960		<b>598995</b>	0										
		R	ATE 23334		<b>598637</b>	0										
<b>SL500(R129)</b>																
5.0L	1998.5-2002.12	F	ATE 21153		<b>598601</b>	0										
		R	ATE 21197		<b>598272</b>	0										
		R	ATE 21305		<b>598617</b>	0										
<b>SLK200K(R171)</b>																
1.8L	2008.1-	F	LUC 23144		<b>598448</b>	0										
		R	ATE 21919		<b>598444</b>	0		278 × 9 (7,3)	5+1						<b>186470</b>	
<b>SLK230(R170)</b>																
2.3L	2004.4-	F	ATE 21195		<b>598357</b>	0		288 × 25 (22,4)	5+1						<b>186467</b>	
		R	ATE 21197		<b>598272</b>	0		278 × 9 (7,3)	5+1						<b>186470</b>	
		R	ATE 21197		<b>598444</b>	0										

										
		R	F		WVA					
<b>奔驰 / Mercedes-Benz</b>										
<b>SLK280(R171)</b>										
3.0L	2006.6-	F	LUC 23144		598448	0				
		R	ATE 21919		598444	0		278 × 9 (7,3)	5+1	186470
<b>SLK350(R171)</b>										
3.5L	2004.6-2008.1	F	BBO 23745		598659	0		330 × 28 (26)	5+2	197200
		R	ATE 21899		598447	0		290 × 10 (8,3)	5	186469
3.5L	2008.1-	F	ATE 23945		601034	0				
		R	ATE 21899		598447	0		290 × 10 (8,3)	5	186469
<b>SLK55AMG (R171)</b>										
5.5L	2011.4-	F	BBO 23745		598659	0				
		R	ATE 21305		598617	0				
<b>唯雅诺 (W639) / VIANO</b>										
3.5L	2007.9-	F	BBO 29192		598882	0		300 × 28 (25)	5+1	186890
		R	BOS 24008		598765	2				
<b>宝马 / BMW</b>										
<b>宝马 116i(E81, E87)</b>										
1.6L	2007.9-	F						284 × 22 (20,4)	5+1	186816
<b>宝马 118d(E81, E87)</b>										
2.0 柴油 /Diesel	2007.4-	F						292 × 22 (20,4)	5+1	186817
<b>宝马 118i(E81, E87)</b>										
2.0L	2004.9-	R	LUC 23623		598701	0				
<b>宝马 120d(E81, E87)</b>										
2.0 柴油 /Diesel	2004.9-	F	ATE 23935		598700	0				
<b>宝马 120d(E82)</b>										
2.0 柴油 /Diesel	2007.10-	R						300 × 20 (18,4)	5+1	197181
<b>宝马 130i(E81, E87)</b>										
3.0L	2005.3-2009.8	F						330 × 24 (22,4)	5+1	197073
		R	ATE 23926		598703	0		300 × 20 (18,4)	5+1	197158

									
		R	F						
<b>宝马 / BMW</b>									
<b>宝马 318i(E46)</b>									
2.0L	2001.9-	F	ATE 21292 	598018	0	286 × 21,9 (20,4)	5	186275	
			300 × 22 (20,4)			5+1	186815		
		R	ATE 21934 	598753	0	276 × 18,9 (17,4)	5+1	186559	
			294 × 18,9 (17,4)			5+1	186861		
<b>宝马 325i(E90)</b>									
2.5L	2005.1-	F	ATE 23794 	598640	0	300 × 24 (22,4)	5+1	197234	
		F	ATE 23313 	601027	0	330 × 24 (22,4)	5+1	197073	
		R	ATE 23926 	598703	0	300 × 20 (18,4)	5+1	197049	
		R	ATE 23550 	598885	0				
<b>宝马 330d(E46)</b>									
3.0 柴油 /Diesel	1999.10-2005.2	R						197323	
<b>宝马 330i(E90)</b>									
3.0L	2005.1-	F	ATE 23794 	598640	0	300 × 24 (22,4)	5+1	197234	
			330 × 24 (22,4)			5+1	197073		
		R	ATE 23550 	598885	0	336 × 22 (20,4)	5+1	197175	
<b>宝马 335i(E90)</b>									
3.0L	2008.11-	F	ATE 23347 	598898	0	348 × 30 (28,4)	5+1	197176	
		R	ATE 23550 	598885	0	336 × 22 (20,4)	5+1	197175	
<b>宝马 520i(E60)</b>									
2.2L	2003.7-2005.7	F	ATE 23312 	598410	0	310 × 24 (22,4)	5	186732	
		F	ATE 23794 	598640	0	324 × 30 (28,4)	5+1	197193	
		R	ATE 21732 	598754	0				

													
		R	F										
<b>宝马 / BMW</b>													
<b>宝马 523i(E60)</b>													
2.5L	2007.1-	F	ATE 23312		<b>598410</b>	0	324 × 30 (28,4)	5+1	197193				
		F	ATE 23794		<b>598640</b>	0							
		R	ATE 21732		<b>598754</b>	0							
<b>宝马 525TDS (E39)</b>													
2.5 柴油 /Diesel	1996.1-2003.6	F	ATE 21064		<b>598409</b>	0	298 × 9,9 (8,4)	5+1	186568				
		F	ATE 21677		<b>598310</b>	0							
		R											
<b>宝马 528i (E39)</b>													
2.8L	1995.11-2000.9	R					298 × 20 (18,4)	5+1	186860				
<b>宝马 530d(E60)</b>													
3.0 柴油 /Diesel	2003.7-	R							197319				
<b>宝马 530i(E60)</b>													
3.0L	2003.7-	F	ATE 23312		<b>598410</b>	0	324 × 30 (28,4)	5+1	197193				
		R	ATE 21732		<b>598754</b>	0							
		R	ATE 23730		<b>598820</b>	0							
<b>宝马 540i (E39)</b>													
4.4L	1996.4-2003.6	R	ATE 21691		<b>598311</b>	0							
<b>宝马 545i(E60)</b>													
4.4L	2003.9-2005.7	F	ATE 23312		<b>598410</b>	0							
		R	ATE 23730		<b>598820</b>	0							
<b>宝马 630i(E63)</b>													
3.0L	2004.9-2010.7	F	ATE 23312		<b>598410</b>	0	324 × 30 (28,4)	5+1	197193				
		R	ATE 21732		<b>598754</b>	0							
		R	ATE 23730		<b>598820</b>	0							









													
		R	F										
<b>宝马 / BMW</b>													
<b>宝马 645i(E63)</b>													
4.4L	2004.1-2005.6	F	ATE 23312		<b>598410</b>	0							
		R	ATE 23730		<b>598820</b>	0							
<b>宝马 650i(E63)</b>													
4.8L	2006.11-	F	ATE 23312		<b>598410</b>	0							
		R	ATE 23730		<b>598820</b>	0							
<b>宝马 728Li(E38)</b>													
2.8L	1995.8-2001.11	F								316 × 28 (26,4)	5+1	<b>197227</b>	
		R	ATE 21487		<b>598580</b>	0							
<b>宝马 730Li(E65, E66)</b>													
3.0L	2005.3-2008.10	F	ATE 23312		<b>598410</b>	0							
		R	ATE 21282		<b>598411</b>	0							
<b>宝马 735i/Li(E65, E66)</b>													
3.6L	2001.11-2008.10	F	ATE 23312		<b>598410</b>	0							
		R	ATE 21282		<b>598411</b>	0							
<b>宝马 740i/Li (E65, E66)</b>													
4.0L	2005.7-2009.4	F	ATE 23312		<b>598410</b>	0							
		R	ATE 23730		<b>598820</b>	0							
<b>宝马 745Li(E65, E66)</b>													
4.4L	2001.11-2006.5	F	ATE 23312		<b>598410</b>	0							
		R	ATE 23730		<b>598820</b>	0							
<b>宝马 750i/Li(E65, E66)</b>													
4.8L	2005.7-	F	ATE 23312		<b>598410</b>	0							
		R	ATE 23730		<b>598820</b>	0							

										
		R	F	 WVA						
<b>宝马 / BMW</b>										
<b>宝马 760Li (E65, E66)</b>										
6.0L	2003.1-2008.12	F	ATE 23312		<b>598410</b>	0				
		R	ATE 23730		<b>598820</b>	0				
<b>宝马 M3 (E90)</b>										
4.0L	2007.3-	F	ATE 23312		<b>598410</b>	0				
		R	ATE 23730		<b>598820</b>	0				
<b>宝马 M5 (E60)</b>										
5.0L	2005.1-	R	ATE 23730		<b>598820</b>	0				
<b>宝马 M6 (E63)</b>										
5.0L	2005.9-	R	ATE 23730		<b>598820</b>	0				
<b>宝马 X1 sDrive18i (E84)</b>										
2.0L	2010.1-	F	ATE 23313		<b>601027</b>	0	 312 × 23,9 (22,4)	5+1	<b>197159</b>	
		R	ATE 23926		<b>598703</b>	0	 300 × 20 (18,4)	5+1	<b>197158</b>	
<b>宝马 X1 (E84)</b>										
3.0L	2010.1-	F	ATE 23347		<b>598898</b>	0	 348 × 30 (28,4)	5+1	<b>197176</b>	
		R	ATE 23550		<b>598885</b>	0	 336 × 22 (20,4)	5+1	<b>197175</b>	
<b>宝马 X3(E83)</b>										
2.5L	2006.9-2010.7	F	ATE 23183		<b>598811</b>	0	 325 × 25 (23,4)	5+1	<b>197083</b>	
		R	ATE 21487		<b>598580</b>	0	 320 × 22 (20,4)	5+1	<b>197251</b>	
3.0L	2004.1-2006.8	F	ATE 23183		<b>598811</b>	0	 325 × 25 (23,4)	5+1	<b>197083</b>	
		R	ATE 21487		<b>598580</b>	0	 320 × 22 (20,4)	5+1	<b>197251</b>	
<b>宝马 X5(E53)</b>										
4.4L	2003.12-	F	ATE 23449		<b>598412</b>	0	 332 × 30 (28,4)	5+3	<b>186808</b>	
		R	ATE 21487		<b>598580</b>	0	 324 × 12 (10,4)	5+1	<b>186809</b>	
4.6L	2002.2-2006.10	R	ATE 21487		<b>598580</b>	0				
4.8L	2004.4-2006.10	R	ATE 21487		<b>598580</b>	0				

										
		R	F		WVA					
<b>宝马 / BMW</b>										
<b>宝马 X5(E70)</b>										
3.0 柴油 /Diesel	2007.9-2008.9	R						345 × 24 (22,4)	5+1	<b>197180</b>
<b>宝马 X5 xDrive(E70)</b>										
3.0L	2008.9-2010.3	F						332 × 29,9 (28,4)	5+1	<b>197177</b>
<b>宝马 X5 xDrive35i (E70)</b>										
3.0L	2010.9-	F						348 × 29,9 (28,4)	5+1	<b>197178</b>
		R						320 × 19,9 (18,4)	5+1	<b>197179</b>
<b>宝马 X6(E71, E72)</b>										
4.4L Hybrid	2010.10-	R	ATE 23730		<b>598820</b>	0				
<b>宝马 Z3(E36)</b>										
2.2L	2000.8-2003.1	F	ATE 21292		<b>598018</b>	0		286 × 21,9 (20,4)	5	<b>186275</b>
<b>宝马 Z4(E85)</b>										
2.5L	2003.2-	F	ATE 21292		<b>598018</b>	0		286 × 21,9 (20,4)	5	<b>186275</b>
		R	ATE 21934		<b>598753</b>	0		280 × 9,9 (8,4)	5+1	<b>186295</b>
2.5Si	2006.1-	F	ATE 21292		<b>598018</b>	0		300 × 22 (20,4)	5+1	<b>186815</b>
		R	ATE 21934		<b>598753</b>	0				
3.0L	2003.2-	F	ATE 21292		<b>598018</b>	0		300 × 22 (20,4)	5+1	<b>186815</b>
		R	ATE 21934		<b>598753</b>	0				
3.0Si	2006.1-	F	ATE 23183		<b>598811</b>	0		325 × 25 (23)	5+1	<b>186731</b>
		R	ATE 21934		<b>598753</b>	0				
<b>雪佛兰 / Chevrolet</b>										
<b>科帕奇 / CAPTIVA (C100, C140)</b>										
3.2L 4WD	2006.6-2011.11	F	MDO 24510		<b>598942</b>	2		296 × 29 (27,5)	5+1	<b>197190</b>
		R	AKE 24498		<b>598941</b>	2		303 × 20 (18,4)	5+2	<b>197191</b>





											
		R	F		WVA					Valeo	
<b>克莱斯勒 / Chrysler</b>											
<b>PT 漫步者 / PT Cruiser</b>											
2.0L	2000.6-2004.12	F	LUC 23532		<b>598543</b>	0		280 × 23 (21,4)	5	<b>186734</b>	
		R	KH 23561		<b>598544</b>	0					
2.4L	2000.6-2010.7	F	LUC 23532		<b>598543</b>	0		280 × 23 (21,4)	5	<b>186734</b>	
		R	KH 23561		<b>598544</b>	0					
<b>交叉火力 / Crossfire</b>											
3.2L	2004.1-2008.8	F	ATE 21670		<b>598636</b>	0					
		R	ATE 21919		<b>598444</b>	0					278 × 9 (7,3)
<b>克莱斯勒 300C / 300 C</b>											
2.7L	2004.9-	F	BOS 23590		<b>601032</b>	8					
		R			<b>601033</b>	8					
3.5L	2004.9-	F	BOS 23590		<b>601032</b>	8					
		R			<b>601033</b>	8					
5.7 SRT8	2004.9-	F	BOS 23590		<b>601032</b>	8					
		R			<b>601033</b>	8					
<b>大捷龙 / Voyager IV</b>											
2.4L	2000.2-2007.12	F	ATE 23640		<b>598415</b>	2		281 × 28 (25,3)	5	<b>197069</b>	
		F	ATE 23807		<b>598756</b>						
		R	KH 24036		<b>598755</b>	0					290 × 12,5 (11,25)
3.3L	2001.1-2007.12	F	ATE 23640		<b>598415</b>	2		281 × 28 (25,3)	5	<b>197069</b>	
		F	ATE 23807		<b>598756</b>						
		R	KH 24036		<b>598755</b>	0					290 × 12,5 (11,25)
3.3L 4WD	2001.1-2007.12	F	ATE 23640		<b>598415</b>	2		281 × 28 (25,3)	5	<b>197069</b>	
		F	ATE 23807		<b>598756</b>						
		R	KH 24036		<b>598755</b>	0					290 × 12,5 (11,25)









															
<b>克莱斯勒 / Chrysler</b>															
<b>赛百灵 / Sebring</b>															
2.7L V6	2001.4-2006.8	F	ATE 23951		<b>598905</b>	0									
<b>雪铁龙 / Citroen</b>															
<b>C4 毕加索 / C4 Grand Picasso</b>															
2.0L 16V	2006.10-	F	ATE 24557		<b>598998</b>	0	 302 × 26 (24)	4+2	<b>197232</b>						
		R	LUC 24540		<b>598936</b>	0	 267 × 12	4	<b>197117</b>						
<b>塞纳 / Xsara</b>															
2.0L 16V	2003.3-2007.2	F	BOS 23600		<b>598465</b>	0	 283 × 26 (24)	4+2	<b>186693</b>						
		R	BDX 20635		<b>598396</b>	0									
		R	LUC 23409		<b>598501</b>	0									
<b>塞纳毕加索 / Xsara Picasso</b>															
1.8L 16V	2000.2-2005.3	F	BOS 23599		<b>598464</b>	0	 283 × 26 (24)	4+2	<b>186693</b>						
		F	BOS 23600		<b>598465</b>	0	 266 × 22 (20,4)	4+2	<b>186695</b>						
		R	LUC 20960		<b>598463</b>	0 (D)	 247 × 9 (7)	4+2	<b>186694</b>						
<b>雪铁龙 C3 / C3 Pluriel</b>															
1.4L	2003.5-2005.9	F	LUC 23409		<b>598501</b>	0	 266 × 13 (11)	4+2	<b>186599</b>						
							 266 × 22 (20,4)	4+2	<b>186695</b>						
		R			<b>562997</b> (刹车蹄 / Shoes)										
		R			<b>564006</b> (刹车蹄 / Shoes)										
<b>雪铁龙 C3 / C3</b>															
1.6L 16V	2002.2-	F	BOS 23599		<b>598464</b>	0	 283 × 26 (24)	4+2	<b>186693</b>						
		F	LUC 23409		<b>598501</b>	0									
		F	BOS 23600		<b>598465</b>	0	 266 × 22 (20,4)	4+2	<b>186695</b>						
		R	LUC 20960		<b>598463</b>	0 (D)	 247 × 9 (7)	4+2	<b>186694</b>						

		R F		WVA		Valeo		Valeo	
<b>雪铁龙 / Citroen</b>									
<b>雪铁龙 C4 / C4</b>									
1.6 THP 140	2008.7-	F	BOS 23600 	598465	0	283 × 26 (24)	4+2	186693	
		R	LUC 20960 	598463	0 (D)	249 × 9 (7)	4	197002	
<b>雪铁龙 C5 / C5</b>									
2.0L 16V	2004.8-	F	BOS 23277 	598419	4	283 × 26 (24)	4+2	186693	
		R	CIT 23305 	598418	0	275 × 14 (12)	4+2	186736	
3.0L V6	2004.9-	F	BOS 23273 	598416	4	288 × 28 (26)	4	197220	
		R	CIT 23305 	598418	0	275 × 14 (12)	4+2	186736	
<b>雪铁龙 C6 / C6</b>									
3.0L V6	2005.9-	F	LUC 24133 	598663	2	330 × 30 (28)	5+3	197046	
		R	LUC 24462 	598939	1				
<b>大字 / Daewoo</b>									
<b>旅行家 / Nubira</b>									
1.6L 16V	1997.5-2005.1	R		562078 (刹车蹄 / Shoes)					
<b>蓝龙 / Lanos</b>									
1.5L	1997.5-2003.9	F				236 × 19,9 (17)	6+1	186188	
		R		562078 (刹车蹄 / Shoes)					
1.6L 16V	1997.5-2003.9	F	ATE 21201 	598184	0	256 × 23,9 (21)	6+1	186189	
		R		562078 (刹车蹄 / Shoes)					
<b>道奇 / Dodge</b>									
<b>酷博 / Caliber</b>									
2.0L	2006.6-	R	AKE 24014 	598852	2				
<b>菲亚特 / Fiat</b>									
<b>博悦 (198) / Bravo II (198)</b>									
1.4L	2008.1-	F	BOS 23705 	598426	1	257 × 22 (20,5)	4	186590	
		R	BOS 23714 	598633	0	251,5 × 10 (9)	4+2	186146	
<b>朋多 / Punto Evo</b>									
1.6 柴油 / Diesel	2009.10-2012.2	R		601063					

									
		R	F	 WVA	 Valeo	 Valeo			 Valeo
<b>菲亚特 / Fiat</b>									
<b>朋多 (176) / Punto (176)</b>									
1.2L	1994.3-1999.9	F	BDX 21365 	<b>598012</b>	0		257,5 × 11,9 (10,2)	4+2	<b>186154</b>
							240,5 × 10,9 (9,2)	4+1	<b>186155</b>
<b>朋多 (188) / Punto (188)</b>									
1.2L	2003.9-	R		<b>562770</b> (刹车蹄 / Shoes)					
		R		<b>562990</b> (刹车蹄 / Shoes)					
1.2L 16V	1999.9-	F	ATE 21930 	<b>598605</b>	0				
1.4L	2009.1-	F	ATE 21927 	<b>601003</b>	0		257,4 × 20 (18,2)	4+2	<b>186153</b>
		R		<b>564083</b> (刹车蹄 / Shoes)					
1.9 柴油 / Diesel	2003.6-	F	ATE 21637 	<b>598990</b>	1		284 × 22 (20,2)	4	<b>186297</b>
		R	LUC 23661 	<b>598425</b>	0				
<b>大朋多 (199) / Grande Punto Van (199)</b>									
1.3 柴油 / Diesel	2008.4-	F		<b>601062</b>					
<b>大朋多 (199) / Grande Punto (199)</b>									
1.2L	2005.10-	F					257 × 12 (10)	4+4	<b>197028</b>
		R		<b>564076</b> (刹车蹄 / Shoes)					
1.4L 16V	2005.10-	F	BOS 23349 	<b>598721</b>	1		257 × 22 (20)	4+4	<b>197044</b>
		F		<b>601069</b>			284 × 22 (20)	4+4	<b>197045</b>
		R		<b>564064</b> (刹车蹄 / Shoes)			264 × 10 (8)	6+2	<b>197008</b>
1.9 柴油 / Diesel	2005.10-	R	BOS 24349 	<b>598722</b>	0				
<b>现代 / Hyundai</b>									
<b>君爵 / XG</b>									
3.0L	1998.12-2006.1	R	MDO 23543 	<b>598748</b>	2				
2.5L	1998.12-2006.1	R	MDO 23543 	<b>598748</b>	2		262 × 10(8,4)	5	<b>197290</b>
<b>圣达菲 / Santa Fe</b>									
2.4L 16V	2008.7-	R	MDO 23543 	<b>598748</b>	2				













									
		R	F		WVA				
<b>现代 / Hyundai</b>									
<b>特杰 / Trajet (FO)</b>									
2.0L	2000.3-2007.6	R		MDO 23543		<b>598748</b>	2		
2.7L V6	2000.9-2007.6	R		MDO 23543		<b>598748</b>	2		
<b>索纳塔 / Sonata IV (EF)</b>									
2.7L V6	2002.1-	R		MDO 23543		<b>598748</b>	2		
<b>美佳 / Matrix (FC)</b>									
1.6L	2001.6-	R		MDO 23543		<b>598748</b>	2		
1.8L	2001.6-	R		MDO 23543		<b>598748</b>	2		
<b>途胜 / Tucson (JM)</b>									
2.0L	2005.8-	R		MDO 23543		<b>598748</b>	2		
2.0L 4WD	2005.8-	R		MDO 23543		<b>598748</b>	2		
2.7L 4WD	2005.8-	R		MDO 23543		<b>598748</b>	2		
<b>雅尊 / GrandeUR (TG)</b>									
3.3L	2006.1-	R		MDO 23543		<b>598748</b>	2		
<b>捷豹 / Jaguar</b>									
<b>捷豹 / S-Type (CCX)</b>									
3.0L V6	1999.1-2008.3	F		LUC 23423		<b>598439</b>	0		
		R		LUC 23424		<b>598438</b>	0		
4.2L V8	2002.4-2008.3	F		LUC 23423		<b>598439</b>	0		
		R		LUC 23424		<b>598438</b>	0		
<b>捷豹 XF / XF</b>									
3.0L	2008.3-	R		ATE 24137		<b>598783</b>	0		
<b>捷豹 XJ / XJ</b>									
3.0L	2007.10-	F		LUC 23423		<b>598439</b>	0		
		R		LUC 23424		<b>598438</b>	0		
4.2L	2003.5-	F		LUC 23423		<b>598439</b>	0		
		R		LUC 23424		<b>598438</b>	0		

  		  			 			
<b>捷豹 / Jaguar</b>								
<b>捷豹 / X-Type (CF1)</b>								
2.0L V6	2002.3-2009.5	F	BOS 23279 	598433	0			197327
		R	BOS 23557 	598434	0	280 × 12 (10)	5	186834
2.5L V6	2001.6-2007.3	F	BOS 23279 	598433	0			197327
		R	BOS 23557 	598434	0	280 × 12 (10)	5	186834
<b>吉普 / Jeep</b>								
<b>切诺基 / Cherokee</b>								
3.7L V6	2005.6-	R	KH 24036 	598755	0	290 × 12,5 (11,25)	5	197022
<b>大切诺基 / Grand Cherokee</b>								
4.7L V8	2005.6-	F	AKE 24250 	598872	2			
		R	KH 24111 	598920	2			
5.7L V8	2005.6-	F	AKE 24250 	598872	2			
		R	KH 24111 	598920	2			
<b>指挥官 / Commander</b>								
4.7L V8	2005.9-	F	AKE 24250 	598872	2			
		R	KH 24111 	598920	2			
5.7L V8	2005.9-	F	AKE 24250 	598872	2			
		R	KH 24111 	598920	2			
<b>牧马人 / Wrangler</b>								
2.5L	1996.8-	F	KH 21822 	598491	0			
		R		562768 (刹车蹄 / Shoes)		290 × 12,5 (11,25)	5	197022
<b>起亚 / Kia</b>								
<b>佳乐 / Carens</b>								
1.6L CVT	2011.3-	F	MDO 24501 	598934	1			
		R	MDO 24491 	598945	1			
2.0L CVT	2006.9-	F	MDO 24501 	598934	1			
		R	MDO 24491 	598945	1			





















													
<b>起亚 / Kia</b>													
<b>狮跑 / Sportage</b>													
2.0L 16V 4WD	2004.9-	R	MDO 23543 	<b>598748</b>	2								
2.7L V6 4WD	2004.9-	R	MDO 23543 	<b>598748</b>	2								
<b>路虎 / Land Rover</b>													
<b>卫士 / Defender</b>													
2.4 柴油 / Diesel	2007.5-	R	AP 21237 	<b>598497</b>	1								
2.5 柴油 / Diesel 4WD	2007.1-	F	AP 21519 	<b>598623</b>	0								
		R	AP 21237 	<b>598497</b>	1								
<b>发现 / Discovery</b>													
2.7 TD	2007.1-	F	LUC 24191 	<b>598741</b>	0	 317 × 30 (27)	5+1	<b>197155</b>					
		R	LUC 24192 	<b>598742</b>	0	 325 × 20 (17)	5+2	<b>197156</b>					
4.4L	2004.7-	F	LUC 24191 	<b>598741</b>	0								
		R	LUC 24192 	<b>598742</b>	0								
<b>极光 / Evoque</b>													
2.0L	2011.6-	F				 300 × 28 (26)	5+1	<b>197055</b>					
<b>神行者 / Freelander</b>													
2.5L V6	2001.9-2007.3	F	LUC 23615 	<b>598514</b>	0	 277 × 20,9 (18)	5+2	<b>186871</b>					
		R		<b>564030</b> (刹车蹄 / Shoes)									
<b>神行者 2 / Freelander2</b>													
3.2L HSE 4WD	2007.3-	F	ATE 24123 	<b>598879</b>	0								
<b>路虎揽胜 / Range Rover</b>													
3.6 TD	2006.4-	F	ATE 23399 	<b>598658</b>	0								
		R	ATE 21487 	<b>598580</b>	0	 354 × 11,9 (10,4)	5+2	<b>197017</b>					
4.2L	2005.5-	F	ATE 23399 	<b>598658</b>	0								
		R	ATE 21487 	<b>598580</b>	0	 354 × 11,9 (10,4)	5+2	<b>197017</b>					
4.4L	2005.5-	F	ATE 23399 	<b>598658</b>	0								
		R	ATE 21487 	<b>598580</b>	0	 354 × 11,9 (10,4)	5+2	<b>197017</b>					























											
		R	F		WVA		Valeo				
<b>路虎 / Land Rover</b>											
<b>路虎运动版 / Range Rover Sport</b>											
4.4L	2007.3-	R	LUC 24192		598742	0					
<b>雷克萨斯 / Lexus</b>											
<b>GS300</b>											
3.0L	2005.4-	R	AKE 24323		598888	2					
<b>GS450h</b>											
3.5L	2006.2-	R	AKE 24323		598888	2					
<b>IS200</b>											
2.0L	1999.4-2005.7	F	SUM 21490		601023	2	 296 × 32 (30)	5+12	197194		
		R	SUM 23429		601025	2					
<b>IS250</b>											
2.5L	2008.12-	F	SUM 23983		601035	0					
		R	AKE 24323		598888	2					
<b>LX470</b>											
4.7L 4WD	1998.5-2007.8	F	SUM 23524		598535	2					
		R	AKE 23539		598865	0					
<b>RX300</b>											
3.0L V6	2003.2-	F	AKE 23703		598944	2					
<b>SC430</b>											
4.3L	2005.8-2010.7	F	SUM 21490		601023	2	 296 × 32 (30)	5+12	197194		
		R	SUM 23429		601025	2					
<b>马自达 / Mazda</b>											
<b>3 (BL)</b>											
1.6L MZR	2009.6-	F	ATE 23723		598649	0	 278 × 25 (23)	5	186872		
		R	AKE 23723		601008	0					







													
<b>马自达 / Mazda</b>													
<b>5 (CR19)</b>													
2.0L	2005.3-	F	ATE 23723		<b>598649</b>	0	278 × 25 (23)	5	<b>186872</b>				
		R	AKE 23723		<b>601008</b>	0							
		R			<b>601044</b>	0							
<b>RX-8(SE17)</b>													
1.3L	2003.10-2008.4	R	AKE 24039		<b>598831</b>	1							
<b>迷你 / Mini</b>													
<b>迷你 / Mini (R56)</b>													
1.6L Cooper	2006.10-	F	LUC 23915		<b>598699</b>	0	280 × 22 (20,4)	4+1	<b>197074</b>				
		R	LUC 24289		<b>601041</b>	0	259 × 9,9 (8,4)	4+1	<b>186812</b>				
1.6L Cooper S	2010.3-	F	LUC 23984		<b>598925</b>	2	294 × 22 (20,4)	4+1	<b>197160</b>				
		R	LUC 24289		<b>601041</b>	0	259 × 9,9 (8,4)	4+1	<b>186812</b>				
<b>三菱 / Mitsubishi</b>													
<b>太空旅行车 / Space Wagon</b>													
2.4 GDI	1998.10-2004.12	F	AKE 21370		<b>601020</b>	2							
2.4 GDI 4WD	1998.10-2004.12	F	AKE 21370		<b>601020</b>	2							
<b>帕杰罗 (V60, V70) / Pajero (V60, V70)</b>													
3.5 V6 GDI	2000.4-	F	SUM 21016		<b>598518</b>	2	290 × 26 (24,4)	6+2	<b>186813</b>				
		R	AKE 23582		<b>598520</b>	2							
<b>格兰迪斯 / Grandis</b>													
2.4L	2004.4-2009.3	F	SUM 21016		<b>598518</b>	2							
		R	AKE 23582		<b>598520</b>	2							
<b>欧蓝德 / Outlander II (CW_W)</b>													
3.0L 4WD	2007.10-2009.9	R	AKE 23582		<b>598520</b>	2	302 × 10 (8,4)	5+3	<b>197116</b>				





























									
		R	F						
<b>日产 / Nissan</b>									
<b>霹雳马 / Primera</b>									
2.2 柴油 /Diesel	2002.3-2010.8	R	ATE 23482 	<b>598472</b>	0				
<b>欧宝 / Opel</b>									
<b>威达 / Vectra C</b>									
2.0L 16V Turbo	2003.3-2008.10	F	ATE 23402 	<b>598678</b>	0	 302 × 28 (25)	5+3	<b>186880</b>	
		R	ATE 23482 	<b>598472</b>	0	 278 × 11,9 (10)	5+3	<b>186854</b>	
		R	ATE 24137 	<b>598783</b>	0				
2.2L 16V	2005.9-2008.8	F	ATE 23402 	<b>598678</b>	0	 285 × 24,9 (22,2)	5+3	<b>186881</b>	
		R	ATE 23482 	<b>598472</b>	0	 278 × 11,9 (10)	5+3	<b>186854</b>	
		R	ATE 24137 	<b>598783</b>	0				
3.2L V6	2008.8-2005.9	F				 302 × 28 (25)	5+3	<b>186880</b>	
		R	ATE 23482 	<b>598472</b>	0	 292 × 19,9 (18)	5+3	<b>186882</b>	
<b>威达 / Vectra B</b>									
2.2L 16V	2001.9-2005.9	F	ATE 21829 	<b>598305</b>	0	 288 × 25 (21)	5	<b>197226</b>	
		R	ATE 21051 	<b>598183</b>	0	 286 × 10 (8)	5+2	<b>186566</b>	
<b>欧米茄 / Omega B</b>									
2.2L 16V	1999.9-2003.7	F	LUC 21368 	<b>598256</b>	0				
		R	ATE 21051 	<b>598183</b>	0				
<b>赛飞利 / Aafira</b>									
1.8L	2005.7-	F	ATE 23832 	<b>598860</b>	2	 280 × 25 (22)	5+1	<b>186684</b>	
		R				 263,4 × 10 (8)	5+1	<b>186593</b>	
2.0L	2011.1-	F	ATE 23402 	<b>598678</b>	0	 321 × 28 (25)	5+3	<b>197150</b>	
		R	LUC 23417 	<b>598584</b>	2				
2.2L	2005.7-	F	ATE 23832 	<b>598860</b>	2	 308 × 25 (23)	5+3	<b>197244</b>	
		R				 263,4 × 10 (8)	5+1	<b>186593</b>	

															
<b>欧宝 / Opel</b>															
<b>雅特 / Astra G</b>															
1.6L	2004.3-2010.3	F	ATE 23063 	<b>598322</b>	4	256 × 24 (21)	4+1	<b>186592</b>							
		R	LUC 23417 	<b>598584</b>	2		240 × 10 (8)	4	<b>186594</b>						
		R	BOS 23258 	<b>598926</b>	2 (A)										
<b>雅特 / Astra H</b>															
1.7 柴油 /Diesel	2004.3-	R		<b>564103</b> (刹车蹄 / Shoes)											
1.8L	2007.2-2010.3	F	ATE 23832 	<b>598860</b>	2	280 × 25 (22)	4+3	<b>186869</b>							
							280 × 25 (22)	5+1	<b>186684</b>						
<b>雅特 / Astra J</b>															
1.4L Turbo	2009.12-	F		<b>601070</b>											
1.6L Turbo	2009.12-	F		<b>601071</b>											
		R		<b>601055</b>											
2.0 柴油 /Diesel	2009.12-	F	MDO 24412 	<b>601046</b>	2										
<b>标致 / Peugeot</b>															
<b>标致 206CC / 206 CC</b>															
1.6L 16V	2000.9-2007.3	F	BOS 23599 	<b>598464</b>	0	266 × 22 (20,4)	4+2	<b>186695</b>							
		R	BDX 20635 	<b>598396</b>	0										
<b>标致 207 / 207</b>															
1.6L 16V VTi	2007.2-	F	BOS 23600 	<b>598465</b>	0	283 × 26 (24)	4+2	<b>186693</b>							
		R	LUC 20960 	<b>598474</b>	0 (D+C)	249 × 9 (7)	4	<b>197002</b>							
		R	BOS 24150 	<b>598702</b>	0										
<b>标致 307CC / 307CC</b>															
2.0L 16V	2003.10-2005.5	F	BOS 23600 	<b>598465</b>	0	283 × 26 (24)	4+2	<b>186693</b>							
		R	LUC 20960 	<b>598463</b>	0 (D)	247 × 9 (7)	4+2	<b>186694</b>							
		R	BOS 24150 	<b>598702</b>	0	249 × 9 (8)	4	<b>186899</b>							

 				 <b>WVA</b>  			 		
<b>标致 / Peugeot</b>									
<b>标致 307SW / 307SW</b>									
2.0L 16V	2005.3-	F	BOS 23600		<b>598465</b>	0	283 × 26 (24)	4+2	<b>186693</b>
		R	LUC 20960		<b>598463</b>	0 (D)	249 × 9 (8)	4	<b>186899</b>
		R	BO 24150		<b>598702</b>	0	249 × 9 (7)	4	<b>197307</b> <b>197002</b>
<b>标致 308CC / 308CC</b>									
1.6L 16V	2009.6-	F	ATE 23589		<b>598715</b>	0			<b>197315</b>
		R	LUC 20960		<b>598463</b>	0 (D)	249 × 9 (8)	4	<b>197100</b>
<b>标致 308SW / 308SW</b>									
1.6L 16V	2009.9-	F	ATE 23589		<b>598715</b>	0			<b>197315</b>
		R	LUC 24765		<b>601042</b>	0	267 × 12	4	<b>197117</b>
<b>3008 / 3008</b>									
1.6L THP	2011.2-	F	ATE 23589		<b>598715</b>	0			<b>197315</b>
		R			<b>601061</b>		267 × 12	4	<b>197117</b>
<b>标致 406 / 406</b>									
1.8L 16V	2000.10-2004.5	R	ATE 21279		<b>598063</b>	0			
2.0L Turbo	2003.6-2009.12	R	ATE 21279		<b>598063</b>	0			
3.0L V6	2000.3-2003.4	R	ATE 21279		<b>598063</b>	0			
<b>标致 407 / 407</b>									
2.2L 16V	2005.9-2006.12	F	LUC 24133		<b>598663</b>	2	330 × 30 (28)	5+3	<b>197046</b>
		R	LUC 24135		<b>598664</b>	0	290 × 12 (10)	5+2	<b>186747</b>
3.0L	2004.5-2006.12	F	LUC 24133		<b>598663</b>	2	330 × 30 (28)	5+3	<b>197046</b>
		R	LUC 24135		<b>598664</b>	0	290 × 12 (10)	5+2	<b>186747</b>





														
<b>标致 / Peugeot</b>														
<b>标致 607 / 607</b>														
2.2L 16V	2000.2-2004.11	F							283 × 26 (24)	5+2	<b>186702</b>			
		R	ATE 21279		<b>598063</b>	0				289 × 10 (8)	5+3	<b>186785</b>		
3.0L V6 24V	2004.3-	F	LUC 24133		<b>598663</b>	2			330 × 30 (28)	5+3	<b>197046</b>			
		R	LUC 24135		<b>598664</b>	0				290 × 12 (10)	5+2	<b>186747</b>		
<b>保时捷 / Porsche</b>														
<b>卡雷拉 911(996) / 911 (996)</b>														
3.6L	2010.1-	F	BBO 23329		<b>598767</b>	0								
		R	BBO 21792		<b>598768</b>	0								
<b>博克斯特 (987) / Boxster (987)</b>														
2.7L	2004.11-	R	BBO 21792		<b>598768</b>	0								
2.7L	2011.5-	R	BBO 21792		<b>598768</b>	0								
S 3.2	2004.11-	F	BBO 23329		<b>598767</b>	0								
		R	BBO 21792		<b>598768</b>	0								
S 3.4	2009.6-	R	BBO 21792		<b>598768</b>	0								
Spyder 3.4	2011.2-	R	BBO 21792		<b>598768</b>	0								
<b>卡宴 (955) / Cayenne(955)</b>														
3.2L	2004.1-	F	BBO 23692		<b>598655</b>	0			330 × 32 (30)	5+1	<b>197087</b>			
		F	BBO 23693		<b>598656</b>	0						<b>197253</b>		
		R	BBO 23694		<b>598770</b>	0			330 × 28 (26)	5+2	<b>197090</b>			
3.6L	2007.2-	F	BBO 23692		<b>598655</b>	0			330 × 32 (30)	5+1	<b>197087</b>			
		F	BBO 23693		<b>598656</b>	0						<b>197253</b>		
		R	BBO 23694		<b>598770</b>	0			358 × 28 (26)	5+2	<b>197051</b>			
	330 × 28 (26)						5+2	<b>197090</b>						
<b>卡宴 / Cayenne</b>														
4.8L Turbo	2010.6-	R							358 × 28 (26)	5+2	<b>197051</b>			

										
		R	F		WVA					
<b>保时捷 / Porsche</b>										
<b>卡宴 S (955) / Cayenne S (955)</b>										
4.5 S	2004.1-	F	BBO 23693		598656	0				
		R	BBO 23694		598770	0		358 × 28 (26)	5+2	197051
4.8 Turbo S	2007.2-	F	BBO 23692		598655	0		330 × 32 (30)	5+1	197087
		F	BBO 23693		598656	0				197253
		R	BBO 23694		598770	0		358 × 28 (26)	5+2	197051
								330 × 28 (26)	5+2	197090
<b>卡曼 (987) / Cayman(987)</b>										
2.7L	2006.7-	R	BBO 21792		598768	0				
S 3.4	2006.7-	F	BBO 23329		598767	0				
		R	BBO 21792		598768	0				
<b>雷诺 / Renault</b>										
<b>拉古娜 III / Laguna III (BT0/1)</b>										
2.0L 16V	2007.10-	F			601066					
		R	ATE 24137		598783	0				
<b>拉古娜 II / Laguna II (BG0/1_)</b>										
2.0L 16V IDE	2001.4-2007.9	F	ATE 23659		598471	0		300 × 26 (22,8)	5+1	197221
		R	ATE 24137		598783	0		274 × 11 (9,5)	5	186896
										197312
<b>梅甘娜 I / Megane I (BA0/1_)</b>										
1.6L 16V	1999.3-	F	LUC 20916		598061	2				
1.9 柴油 /Diesel	1999.3-2003.7	F	LUC 20916		598473	0				
		R			562629 (刹车蹄 / Shoes)					197309
<b>梅甘娜 I / Megane I (DA0/1_)</b>										
1.4L 16V	1999.3-2003.8	F	LUC 20772		598002	2 (B)				
2.0L	1996.3-2003.8	F						259 × 20,6 (17,7)	4+2	186208

										
		R	F							
<b>雷诺 / Renault</b>										
<b>梅甘娜 I / Megane I (KA0/1_)</b>										
1.6L 16V	1999.3-	R							197311	
<b>梅甘娜 II / Meganell (BM0/1_, CM0/1_)</b>										
1.4L 16V	2002.11-	F	BOS 23934 	598557	0	 260 × 22 (19,8)	4+2	186764		
1.9 柴油 /Diesel	2002.11-	F	BOS 23930	598558	0					
<b>梅甘娜 II / Meganell (EM0/1_)</b>										
1.6L	2003.9-2009.10	F	LUC 23930 	598558	0	 280 × 24 (21,8)	4+2	186655		
		F	ATE 24535 	601012	0					
		R	LUC 20960 	598180	0 (D)			197308		
		R	LUC 20960 	598474	0 (D+C)					
2.0L	2003.9-2009.10	F	LUC 23930 	598558	0	 280 × 24 (21,8)	4+2	186655		
		F	ATE 24535 	601012	0					
		R	LUC 20960 	598180	0 (D)			197308		
		R	LUC 20960 	598474	0 (D+C)					
		R	ATE 20916 	598472	0					
<b>梅甘娜 II / Meganell (KM0/1_)</b>										
1.9 柴油 /Diesel	2003.8-	R				 270 × 10 (9)	4	186898		
		R						197305		
<b>梅甘娜 III / Meganell (BZ0_)</b>										
1.6L 16V	2008.11-	R	BBO 24820 	601000	0					
<b>梅甘娜 III / Meganell (DZ0/1_)</b>										
2.0L	2008.11-	F	BBO 24162 	598861	0					
<b>科雷傲 / Koleos (HY_)</b>										
2.5L	2008.9-	R	AKE 24632 	601009	1					
2.5L 4WD	2008.9-	R	AKE 24632 	601009	1					



































															
<b>雷诺 / Renault</b>															
<b>风景 II / Scenic II (JM0/1_)</b>															
1.9 柴油 /Diesel	2003.6-	F										 300 × 24 (21,8)	4+2	<b>197241</b>	
2.0 柴油 /Diesel	2005.9-	F										 300 × 24 (22)	4	<b>197215</b>	
2.0L	2003.6-	F	ATE 23245		<b>598993</b>	0									
<b>风景 III / Scenic III (JZ0/1_)</b>															
1.4L 16V	2009.2-	F	ATE 24710		<b>601050</b>	0									
1.5 柴油 /Diesel	2009.2-	F										 280 × 24 (21,8)	5+2	<b>197192</b>	
<b>萨博 / Saab</b>															
<b>萨博 9-3 / 9-3 (YS3D)</b>															
2.0L Turbo	2002.1-	F	ATE 23116		<b>598475</b>	2						 288 × 25 (21)	5	<b>197226</b>	
		R	ATE 21051		<b>598183</b>	0						 286 × 10 (8)	5+2	<b>186566</b>	
<b>萨博 9-3 / 9-3 (YS3F)</b>															
2.0L Turbo	2002.9-	F	ATE 20224		<b>598808</b>	0						 302 × 28 (25)	5+3	<b>186880</b>	
		R	ATE 23482		<b>598472</b>	0						 278 × 11,9 (10)	5+3	<b>186854</b>	
												 292 × 19,9 (18)	5+3	<b>186882</b>	
<b>萨博 9-5 / 9-5 (YS3E)</b>															
2.0T Biopower	2005.9-	F	ATE 23116		<b>598475</b>	2						 288 × 25 (21)	5	<b>197226</b>	
												 308 × 25 (23)	5+3	<b>197244</b>	
2.3L Turbo	2003.7-	R	ATE 21934		<b>598753</b>	0						 286 × 10 (8)	5+2	<b>197009</b>	
		F	ATE 23116		<b>598475</b>	2						 308 × 25 (23)	5+3	<b>197244</b>	
2.3L Turbo	2003.7-	R	ATE 21934		<b>598753</b>	0						 300 × 20 (18)	5+2	<b>197050</b>	
<b>斯柯达 / Skoda</b>															
<b>昊锐 / Superb (3U4)</b>															
1.8L Turbo	2002.2-	F										 312 × 25 (22)	5+5	<b>197242</b>	
		R	LUC 20960		<b>598463</b>	0 (D)									
2.8L V6	2002.2-	F										 312 × 25 (22)	5+5	<b>197242</b>	
		R	LUC 20960		<b>598463</b>	0 (D)									











































		 <b>WVA</b>			 <b>Valeo</b>				
<b>斯柯达 / Skoda</b>									
<b>明锐 / Octavia (1U2)</b>									
1.6L	2004.2-	F	ATE 21974 	<b>598332</b>	0	256 × 21,9 (19)	5+1	<b>186603</b>	
		F	ATE 21974 	<b>598408</b>	1				
		R	LUC 20960 	<b>598463</b>	0 (D)	232 × 9 (7)	5	<b>186597</b>	
2.0L	2005.10-	F	ATE 21974 	<b>598332</b>	0	280 × 22 (19)	5+1	<b>186604</b>	
		F	ATE 21974 	<b>598408</b>	1				
		R	LUC 20960 	<b>598463</b>	0 (D)	232 × 9 (7)	5	<b>186597</b>	
RS 1.8 T	2007.6-	F	ATE 21911 	<b>598486</b>	1	312 × 25 (23)	9+1	<b>197246</b>	
		R	LUC 20960 	<b>598463</b>	0 (D)	256 × 22 (20)	5+1	<b>197088</b>	
<b>晶锐 / Fabia (6Y2)</b>									
1.4L	2000.8-2003.10	F	ATE 21974 	<b>598332</b>	0	256 × 21,9 (19)	5+1	<b>186603</b>	
		F	ATE 21974 	<b>598408</b>	1				
		R		<b>562080</b> (刹车蹄 / Shoes)		232 × 9 (7)	5	<b>186597</b>	
1.4L 16V	2006.9-2007.8	F	ATE 21974 	<b>598408</b>	1	256 × 21,9 (19)	5+1	<b>186603</b>	
		R		<b>562080</b> (刹车蹄 / Shoes)		232 × 9 (7)	5	<b>186597</b>	
		R	LUC 20960 	<b>598463</b>	0 (D)				
<b>Smart / Smart</b>									
<b>Forfour / Forfour (454)</b>									
1.5L	2004.1-2006.6	F	LUC 21920 	<b>598318</b>	2	256 × 24 (21,5)	4	<b>197214</b>	
		R	LUC 21861 	<b>598319</b>	2	250 × 10 (8)	4+2	<b>197129</b>	
<b>双龙 / SsangYong</b>									
<b>雷斯特 / Rexton (GAB_)</b>									
2.7 柴油 / Diesel	2004.8-	F	SUM 29877 	<b>598870</b>	2				
		F	MDO 23726 	<b>598871</b>	2				
		R				299 × 10,4 (8,5)	6+2	<b>197122</b>	









<b>双龙 / SsangYong</b>								
<b>雷斯特 / Rexton (GAB_)</b>								
3.2L	2002.4-	F	SUM 29877	<b>598870</b>	2	278 × 23,8 (22)	6	<b>197195</b>
		F	MDO 23726	<b>598871</b>	2			
		R				299 × 10,4 (8,5)	6+2	<b>197122</b>
<b>斯巴鲁 / Subaru</b>								
<b>力狮 / Legacy II (BD, BG)</b>								
2.5L 4WD	1996.6-1998.11	F	AKE 23558	<b>598530</b>	2			
		R		<b>562611</b> (刹车蹄 / Shoes)				
<b>力狮 / Legacy IV (B13_)</b>								
3.0 R	2003.9-2009.5	F	AKE 23865	<b>598853</b>	2			
		R	AKE 23572	<b>598895</b>	1			
<b>森林人 / Forester (SG)</b>								
2.0 X	2005.9-2007.11	F	AKE 23865	<b>598853</b>	2			
		R		<b>562611</b> (刹车蹄 / Shoes)				
2.5 XT	2005.9-	F	AKE 23865	<b>598853</b>	2			
		R	AKE 24331	<b>598875</b>	2			
<b>铃木 / Suzuki</b>								
<b>吉姆尼 / Jimny (FJ)</b>								
1.3L 4WD	1998.9-	F	AKE 21142	<b>598021</b>	0	290 × 10 (8)	5+2	<b>186504</b>
		R		<b>562591</b> (刹车蹄 / Shoes)				
1.5 柴油 / Diesel 4WD	2003.12-	F				287 × 17 (15)	5+2	<b>186628</b>
<b>丰田 / Toyota</b>								
<b>RAV 4 / RAV 4 III</b>								
2.4L WTi	2005.11-	F				296 × 28 (25)	5+2	<b>197152</b>
<b>兰德酷路泽 100(UZJ100_) / Land Cruiser 100 (_J10_)</b>								
4.7L	1998.1-2007.9	F	SUM 23524	<b>598535</b>	2			
		R	AKE 23539	<b>598865</b>	0			



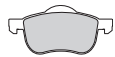





























													
<b>大众 / Volkswagen</b>													
<b>Eos / EOS (1F7, 1F8)</b>													
2.0 TFSI	2006.3-	F	ATE 23587 	<b>598635</b>	1	 312 × 25 (22)	5+5	<b>197242</b>					
		R	LUC 23914 	<b>598752</b>	0	 286 × 12 (10)	9+1	<b>197031</b>					
<b>尚酷 / Scirocco</b>													
1.4 TSI	2008.5-	F	ATE 23587 	<b>598635</b>	1				<b>197325</b>				
		R	LUC 23914 	<b>598752</b>	0	 260 × 12 (10)	9+1	<b>186833</b>					
2.0 TSI	2009.11-	F	ATE 23587 	<b>598635</b>	1	 312 × 25 (22)	5+5	<b>197242</b>					
<b>帕萨特 / Passat (3B3)</b>													
1.8 T 20V	2003.3-2005.5	R	LUC 20960 	<b>598463</b>	0 (D)								
2.0L	2000.11-2005.5	F						5+5	<b>186758</b>				
		R	LUC 20960 	<b>598463</b>	0 (D)								
<b>帕萨特 / Passat (3C2)</b>													
3.2 FSI 4motion	2005.11-	F	ATE 23801 	<b>598863</b>	1	 345 × 30 (27)	5+5	<b>197197</b>					
		R	LUC 23914 	<b>598752</b>	0	 310 × 22 (20)	5+5	<b>197139</b>					
<b>帕萨特 CC / Passat CC</b>													
2.0 TSI	2008.6-	F	ATE 23587 	<b>598635</b>	1	 312 × 25 (22)	5+5	<b>197242</b>					
		R	LUC 23914 	<b>598752</b>	0	 286 × 12 (10)	9+1	<b>197031</b>					
3.6 FSI 4motion	2008.6-	F	ATE 23801 	<b>598863</b>	1	 345 × 30 (27)	5+5	<b>197197</b>					
		R	LUC 23914 	<b>598752</b>	0	 310 × 22 (20)	5+5	<b>197139</b>					
<b>甲壳虫 / New Beetle</b>													
1.6L	2001.6-	F	ATE 21974 	<b>598408</b>	1	 280 × 22 (19)	5+1	<b>186604</b>					
1.8 T	2000.10-	F	ATE 21911 	<b>598486</b>	1	 288 × 24,9 (22)	5	<b>197230</b>					
		R				 256 × 22 (20)	5+1	<b>197088</b>					
2.0L	2001.6-	F	ATE 21974 	<b>598408</b>	1	 280 × 22 (19)	5+1	<b>186604</b>					
		R	LUC 20960 	<b>598463</b>	0 (D)	 232 × 9 (7)	5	<b>186597</b>					

													
<b>大众 / Volkswagen</b>													
<b>辉腾 / Phaeton</b>													
3.2L V6 4motion	2004.2-	F	ATE 23885		<b>598845</b>	2							
3.6L V6 4motion	2008.11-	F	ATE 23885		<b>598845</b>	2							
4.2L V8 4motion	2003.5-	F	ATE 23885		<b>598845</b>	2							
<b>途观 / Tiguan</b>													
2.0 TFSI	2008.5-	F							312 × 25 (22)	5+5	<b>197242</b>		
		R	LUC 23914		<b>598752</b>	0			286 × 12 (10)	9+1	<b>197031</b>		
<b>途锐 / Touareg</b>													
2.5 TDI	2003.8-2010.5	F	ATE 23467		<b>598940</b>	2							
		R							314 × 22 (18)	5+1	<b>197243</b>		
3.0L V6 TDI	2007.11-	F	BBO 24098		<b>598994</b>	0			330 × 32 (30)	5+1	<b>197087</b>		
		R							330 × 28 (26)	5+2	<b>197090</b>		
3.0L V6 TSI Hybrid	2010.4-	F							330 × 32 (30)	5+1	<b>197087</b>		
		R							330 × 28 (26)	5+2	<b>197090</b>		
3.2L V6	2004.5-2006.11	F	BBO 23692		<b>598655</b>	0					<b>197253</b>		
		F	BBO 24098		<b>598994</b>	0			330 × 32 (30)	5+1	<b>197087</b>		
		R	BBO 23694		<b>598770</b>	0			330 × 28 (26)	5+2	<b>197090</b>		
3.6L V6 FSI	2006.3-	F	BBO 24098		<b>598994</b>	0			330 × 32 (30)	5+1	<b>197087</b>		<b>197253</b>
		R							330 × 28 (26)	5+2	<b>197090</b>		
4.2L V8	2003.4-2006.11	F	BBO 23692		<b>598655</b>	0					<b>197253</b>		
		R	BBO 23694		<b>598770</b>	0			330 × 28 (26)	5+2	<b>197090</b>		
4.2L V8 FSI	2006.6-	F	BBO 24098		<b>598994</b>	0			330 × 32 (30)	5+1	<b>197087</b>		<b>197253</b>
		R	BBO 23694		<b>598770</b>	0			330 × 28 (26)	5+2	<b>197090</b>		

		R F		WVA Valeo		Valeo		Valeo	
<b>大众 / Volkswagen</b>									
<b>途锐 / Touareg</b>									
6.0 W12	2005.8-	F	BBO 23693		598656	0			
		R	BBO 23694		598770	0	330 × 28 (26)	5+2	197090
<b>高尔夫 / Golf V</b>									
1.4 TSI	2007.5-2009.5	F	ATE 21974		598408	1			
		R	LUC 20960		598463	0 (D)	255 × 10 (8)	9+1	186857
2.0 GTI	2004.10-	F	ATE 21974		598408	1	312 × 25 (22)	5+5	197242
		F	ATE 23587		598635	1			
		R	LUC 20960		598463	0 (D)	260 × 12 (10)	9+1	186833
		R	LUC 23914		598752	0	286 × 12 (10)	9+1	197031
<b>高尔夫 / Golf IV</b>									
1.6L 16V	2002.1-2005.6	F	ATE 21974		598408	1	256 × 21,9 (19)	5+1	186603
		R	LUC 20960		598463	0 (D)	232 × 9 (7)	5	186597
<b>沃尔沃 / Volvo</b>									
<b>沃尔沃 C30 / C30</b>									
2.0L	2006.10-	F	ATE 23723		598649	0	278 × 25 (23)	5	186819
							300 × 25 (23)	5	186863
		R	ATE 24137		598783	0	280 × 10,9 (9)	5	186843
2.4 i	2006.10-	F	ATE 23723		598649	0	278 × 25 (23)	5	186819
							300 × 25 (23)	5	186863
		R	ATE 24137		598783	0	280 × 10,9 (9)	5	186843
<b>沃尔沃 C70 / C70 II</b>									
2.4 柴油 /Diesel	2006.3-2010.2	F	ATE 23723		598649	0	278 × 25 (23)	5	186819
							320 × 25 (23)	5	197143
		F	ATE 23762		598822	0	300 × 25 (23)	5	186863

									
		R	F	 WVA	 Valeo	 Valeo			 Valeo
<b>沃尔沃 / Volvo</b>									
<b>沃尔沃 C70 / C70 II</b>									
2.5L	2007.3-2010.1	F	ATE 23723		<b>598649</b>	0	 278 × 25 (23)	5	<b>186819</b>
		F	ATE 23762		<b>598822</b>	0	 320 × 25 (23)	5	<b>197143</b>
		R	ATE 24137		<b>598783</b>	0	 300 × 25 (23)	5	<b>186863</b>
2.5L	2006.3-2007.3	F	ATE 23723		<b>598649</b>	0	 278 × 25 (23)	5	<b>186819</b>
		F	ATE 23762		<b>598822</b>	0	 320 × 25 (23)	5	<b>197143</b>
		R	ATE 24137		<b>598783</b>	0	 300 × 25 (23)	5	<b>186863</b>
<b>沃尔沃 S40 / S40 I (VS)</b>									
2.0T	2004.5-2007.7	F	LUC 21983		<b>598493</b>	0			
		R	LUC 21861		<b>598319</b>	2			
<b>沃尔沃 S40 / S40 II (MS)</b>									
2.4L	2004.1-2007.7	F	ATE 23723		<b>598649</b>	0	 278 × 25 (23)	5	<b>186819</b>
		F	ATE 23762		<b>598822</b>	0	 320 × 25 (23)	5	<b>197143</b>
		R	ATE 24137		<b>598783</b>	0	 300 × 25 (23)	5	<b>186863</b>
2.5L	2004.1-2007.7	F	ATE 23723		<b>598649</b>	0	 278 × 25 (23)	5	<b>186819</b>
		F	ATE 23762		<b>598822</b>	0	 320 × 25 (23)	5	<b>197143</b>
		F	ATE 23762		<b>598822</b>	0	 300 × 25 (23)	5	<b>186863</b>
		R	ATE 24137		<b>598783</b>	0	 280 × 10,9 (9)	5	<b>186843</b>
		R	ATE 23723		<b>601005</b>	0			

															
<b>沃尔沃 / Volvo</b>															
<b>沃尔沃 S40 / S40 II (MS)</b>															
2.5L 4WD	2004.4-2007.7	F	ATE 23723		598649	0		278 × 25 (23)	5	186819					
		F	ATE 23762		598822	0		320 × 25 (23)	5	197143					
		R	ATE 24137		598783	0		280 × 10,9 (9)	5	186843					
		R	ATE 23723		601005	0									
<b>沃尔沃 S60 / S60</b>															
2.4L	2000.11-2004.4	F	ATE 23072		598479	0		305 × 28 (25)	5+5	186741					
		R	ATE 23075		598480	0		288 × 12 (10)	5+5	186841					
2.5L 4WD	2004.4-2006.7	F	ATE 23072		598479	0		305 × 28 (25)	5+5	186741					
		R	ATE 23075		598480	0		288 × 12 (10)	5+5	186841					
<b>沃尔沃 S60 / S60 II</b>															
2.0L	2010.4-	F	ATE 24123		598879	0		300 × 28 (26)	5+1	197055					
<b>沃尔沃 S80 / S80 (TS, XY)</b>															
2.4L	1999.1-2006.7	F	ATE 23072		598479	0		305 × 28 (25)	5+5	186741					
		R	ATE 23075		598480	0		288 × 12 (10)	5+5	186841					
2.4 T	2000.6-2006.7	F	ATE 23072		598479	0		305 × 28 (25)	5+5	186741					
		R	ATE 23075		598480	0		288 × 12 (10)	5+5	186841					
2.5 T 4WD	2003.7-2006.7	F	ATE 23072		598479	0		305 × 28 (25)	5+5	186741					
		R	ATE 23075		598480	0		288 × 12 (10)	5+5	186841					
2.9L	1999.3-2006.7	F						305 × 28 (25)	5+5	186741					
		R						288 × 12 (10)	5+5	186841					

									
		R	F						
<b>沃尔沃 / Volvo</b>									
<b>沃尔沃 S80 / S80 II</b>									
2.5 T	2006.3-	F	ATE 24123 	<b>598879</b>	0		300 × 28 (26)	5+1	<b>197055</b>
		F	ATE 24142 	<b>601007</b>	0				
		R	LUC 24496 	<b>598928</b>	0				
3.2L	2006.3-	F	ATE 24123 	<b>598879</b>	0		300 × 28 (26)	5+1	<b>197055</b>
		F	ATE 24142 	<b>601007</b>	0				
		R	LUC 24496 	<b>598928</b>	0				
4.4L V8 AWD	2006.3-	F	ATE 24123 	<b>598879</b>	0		300 × 28 (26)	5+1	<b>197055</b>
		F	ATE 24142 	<b>601007</b>	0				
		R	LUC 24496 	<b>598928</b>	0				
3.0L AWD	2007.1-	F	ATE 24123 	<b>598879</b>	0		300 × 28 (26)	5+1	<b>197055</b>
		F	ATE 24142 	<b>601007</b>	0				
		R	LUC 24496 	<b>598928</b>	0				
<b>沃尔沃 XC60 / XC60</b>									
2.0 T	2010.3-	R	LUC 24496 	<b>598928</b>	0				
3.0L AWD	2008.5-2010.4	R	LUC 24496 	<b>598928</b>	0				
<b>沃尔沃 XC90 / XC90</b>									
2.5 T	2002.10-	F	ATE 24141 	<b>598657</b>	0		316 × 28 (25)	5+5	<b>197057</b>
		F	ATE 23590 	<b>601030</b>	0				
		R	ATE 24011 	<b>598829</b>	0				





**沃尔沃 / Volvo**

**沃尔沃 XC90 / XC90**

3.2L	2006.5-	F	ATE 24141		<b>598657</b>	0	316 × 28 (25)	5+5	<b>197057</b>
		F	ATE 23590		<b>601030</b>	0			
		R	ATE 24011		<b>598829</b>	0			
3.0L	2002.10-	F	ATE 24141		<b>598657</b>	0	316 × 28 (25)	5+5	<b>197057</b>
		F	ATE 23590		<b>601030</b>	0			
		R	ATE 24011		<b>598829</b>	0			
4.4L V8	2005.1-	F	ATE 24141		<b>598657</b>	0	316 × 28 (25)	5+5	<b>197057</b>
		F	ATE 23590		<b>601030</b>	0			
		R	ATE 24011		<b>598829</b>	0			





## 国产刹车片图片 Local Range Image

### Pads and Discs

Plaquettes et Disques

### Pastillas y Discos

Pastilas e Discos

### Pastiglie e Dischi

Blokjes en Schijven

### Bremsbeläge und Bremsscheiben

Klocki i Tarcze

### Balatalari ve Diskleri

Колодки и диски

Δισκόφρενα & Δισκόπλακες

刹车片和刹车盘

بطانات و قرص



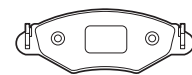

**601156**

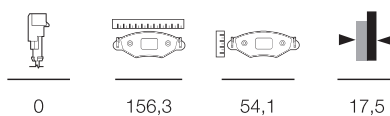
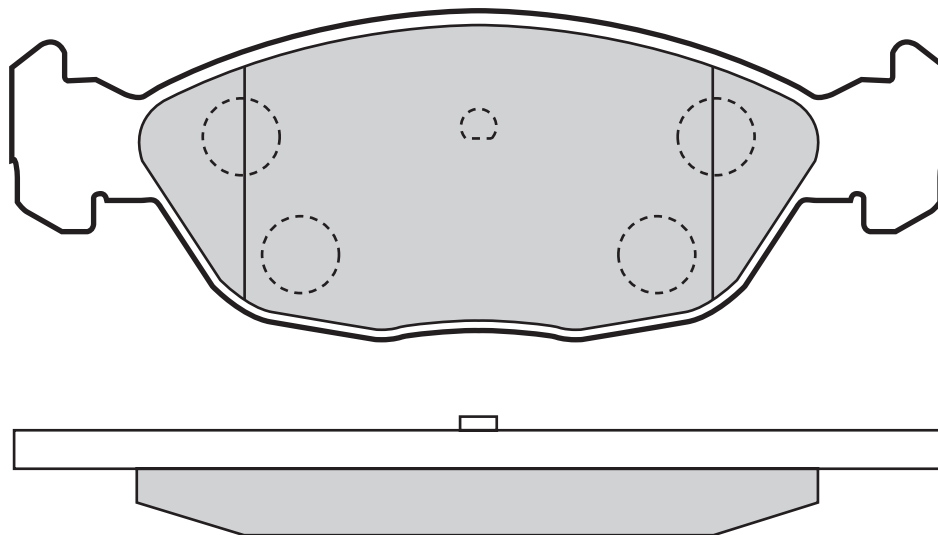

0

156,3

54,1

17,5

**601157**

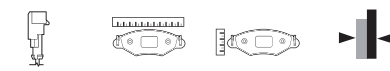
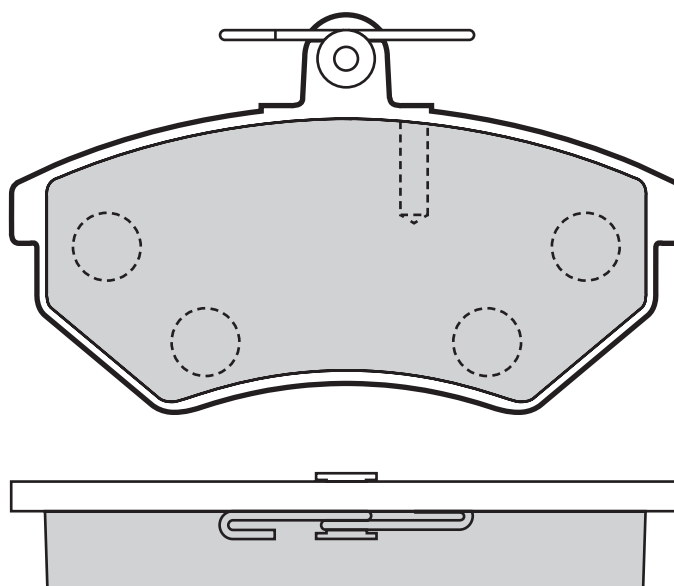

2

118,7

69,5

19



## 601158

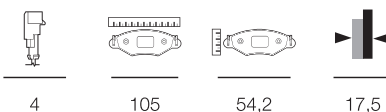
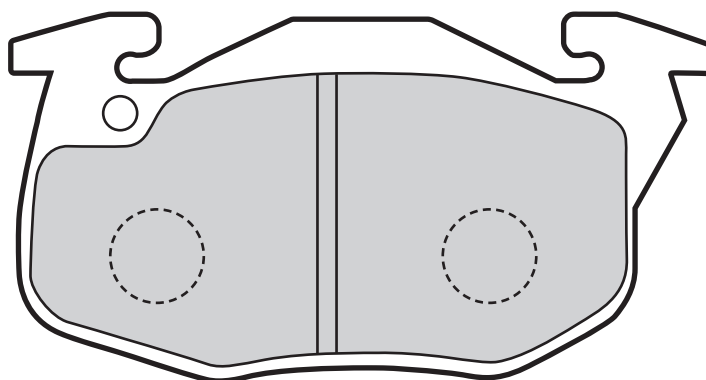

4

105

54,2

17,5

## 601161

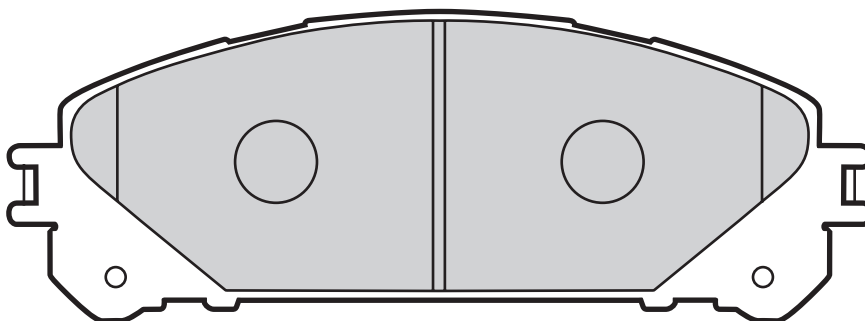

0

167

59,4

17,5



601162

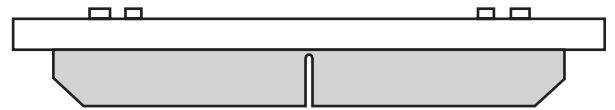
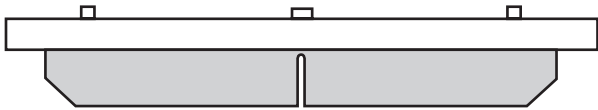
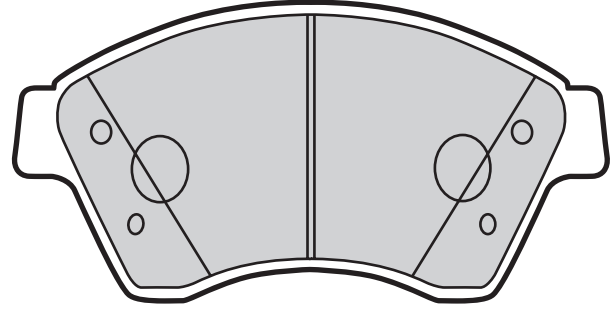
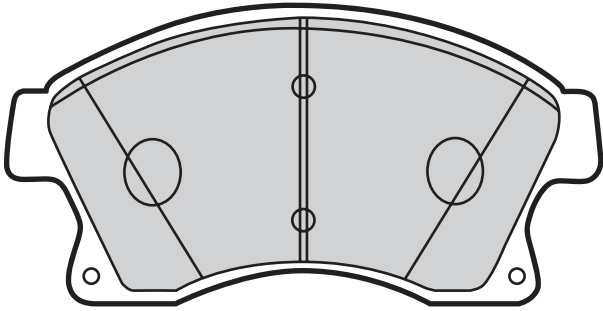

2



148,1



60,4



18,0

601163

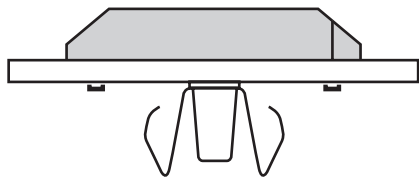
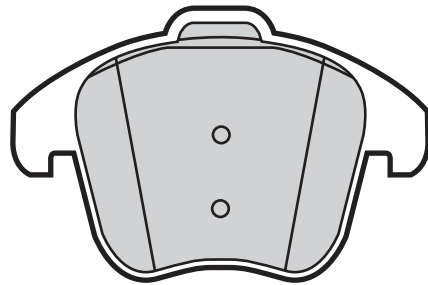
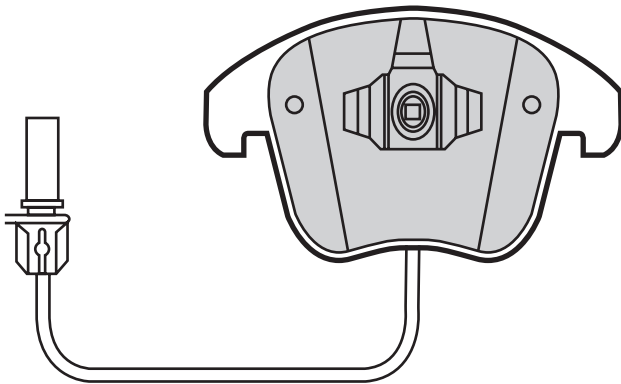

1



155,2



66,4/71,9



19,2



## 601164

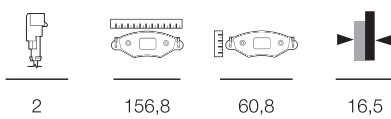
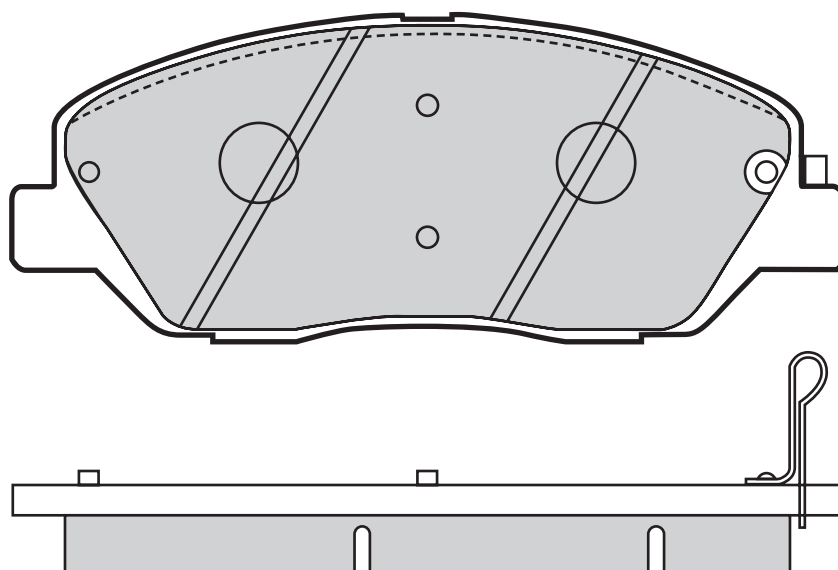

## 601165

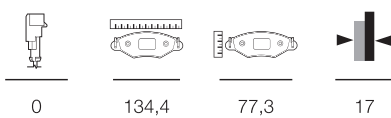
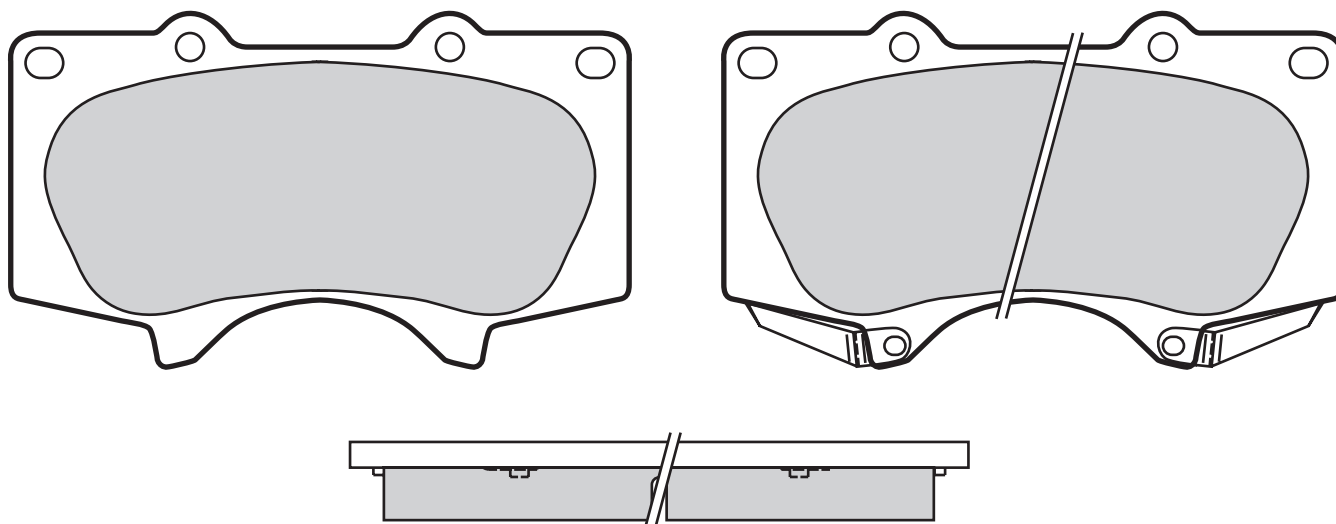



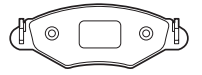



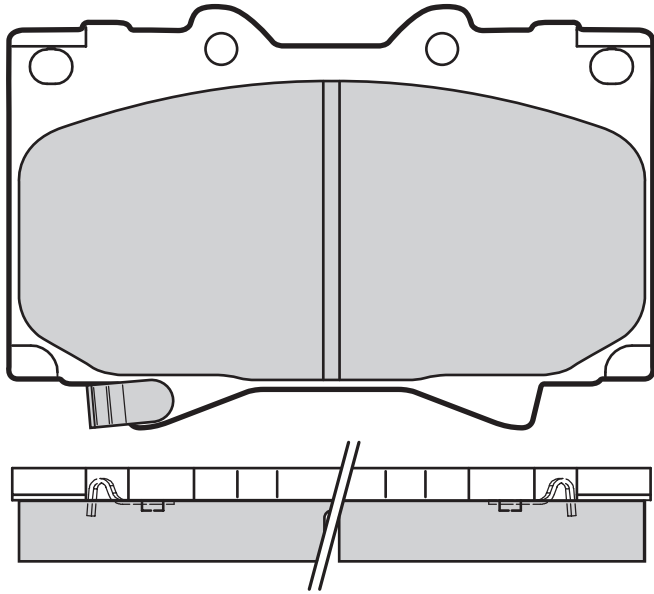





**601166**

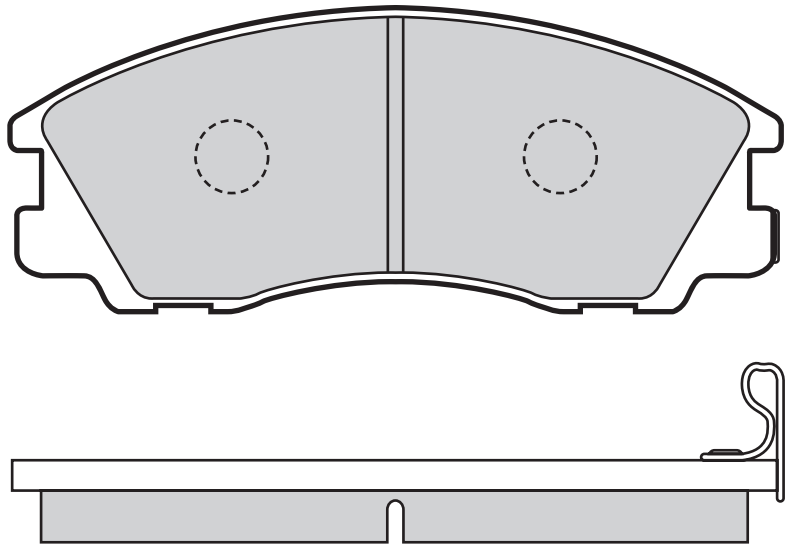

			
0	119,6	78	17

**601167**



			
2	149	57,9	16



## 601168

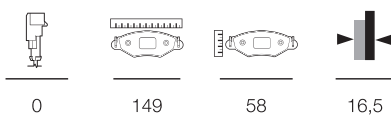
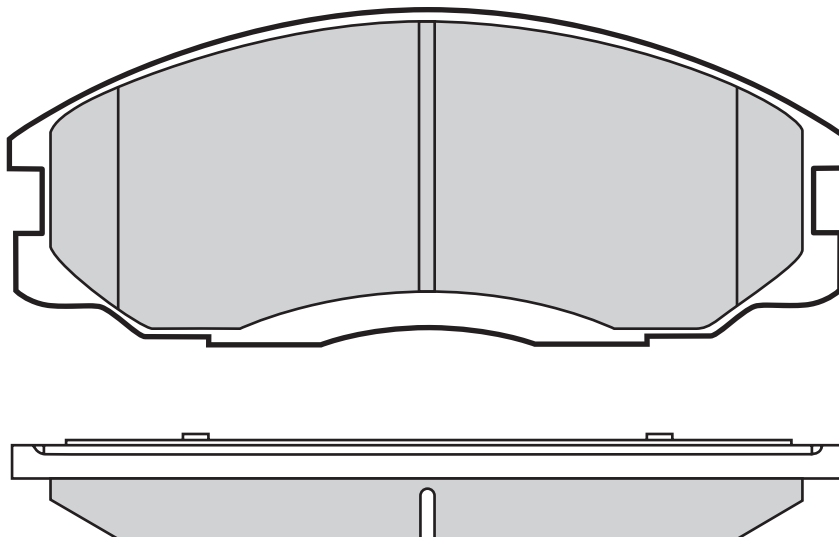

## 601169

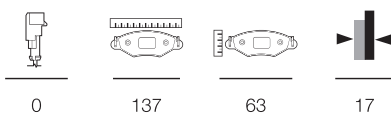
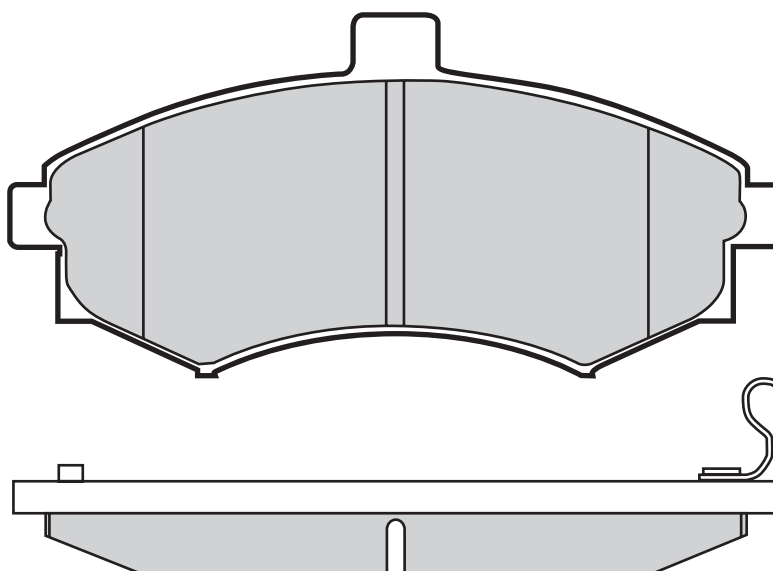

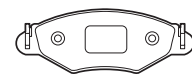

601172

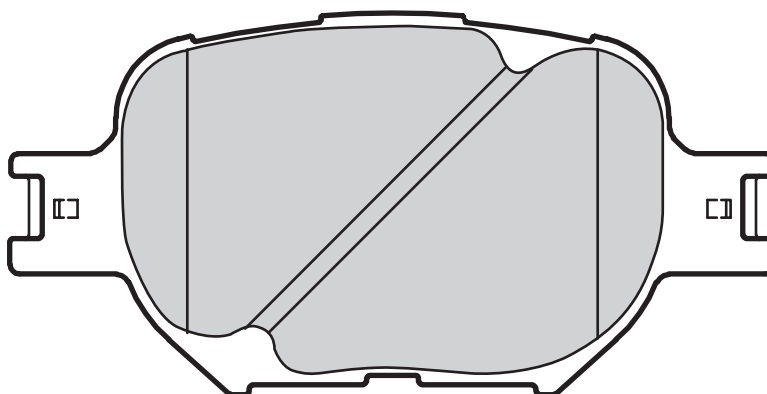

0	116,3	58,7	17,5

601173

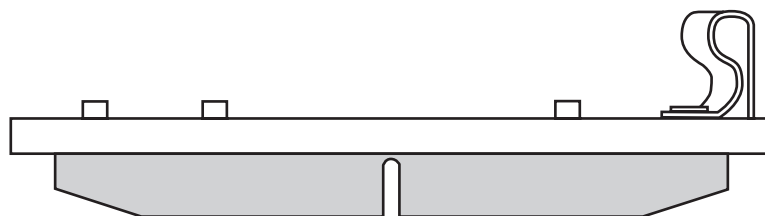
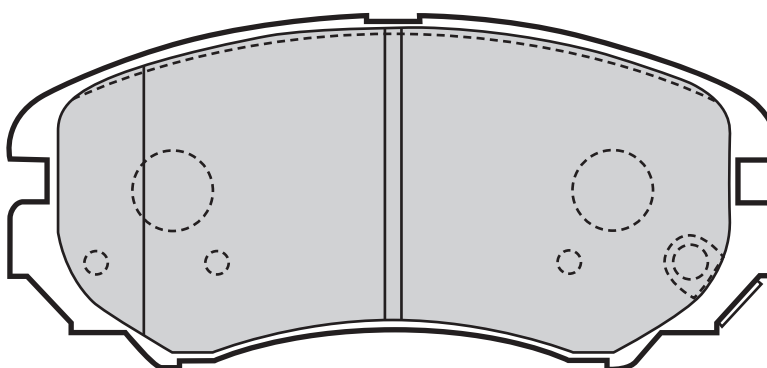

2	131,4	60	17



601175

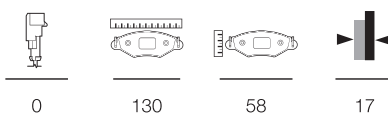
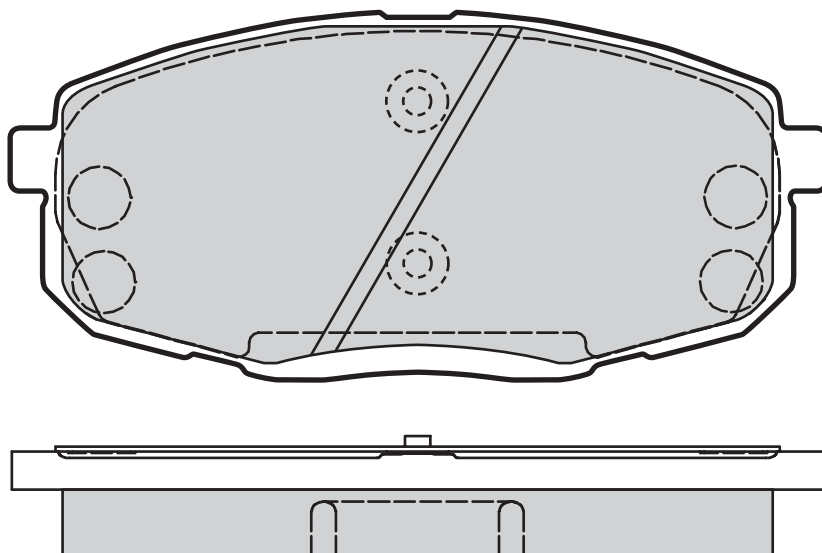

0

130

58

17

601176

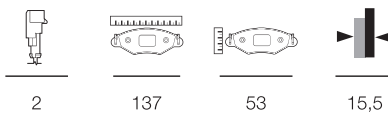
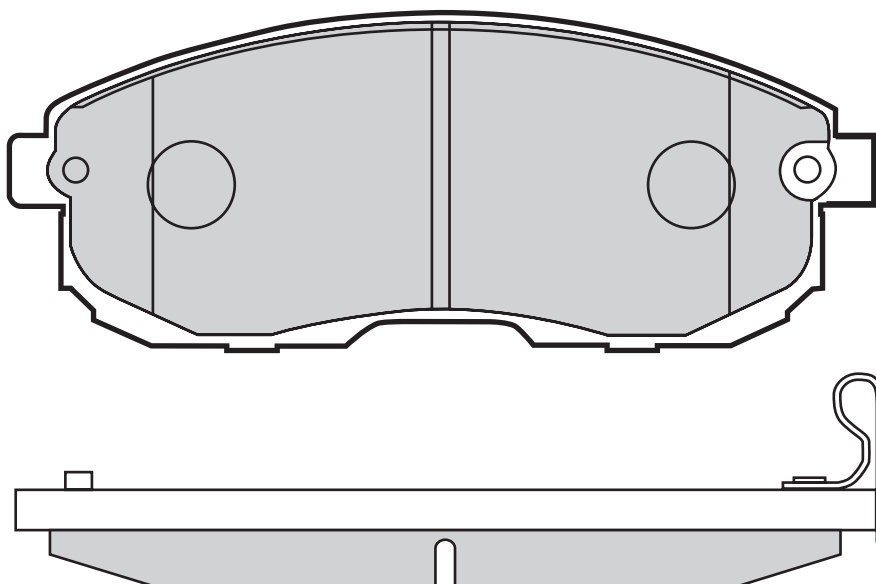

2

137



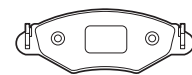

53

15,5

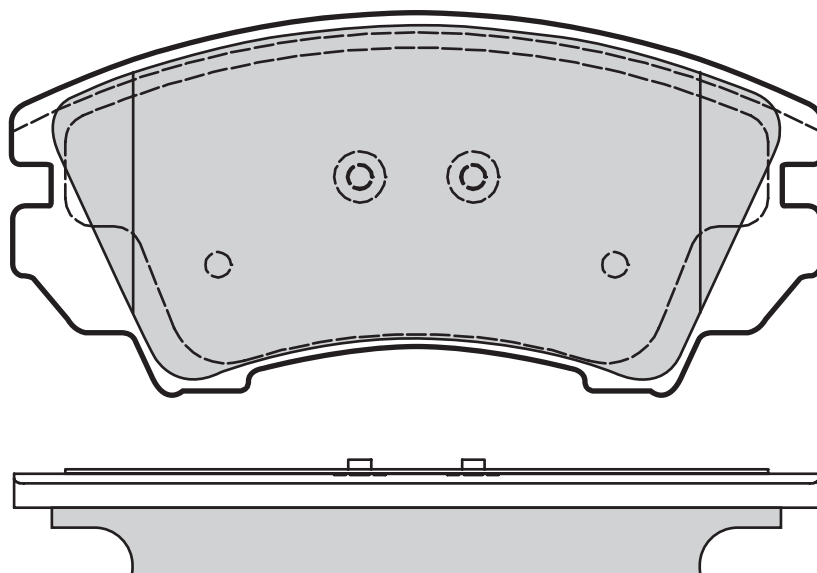





601177

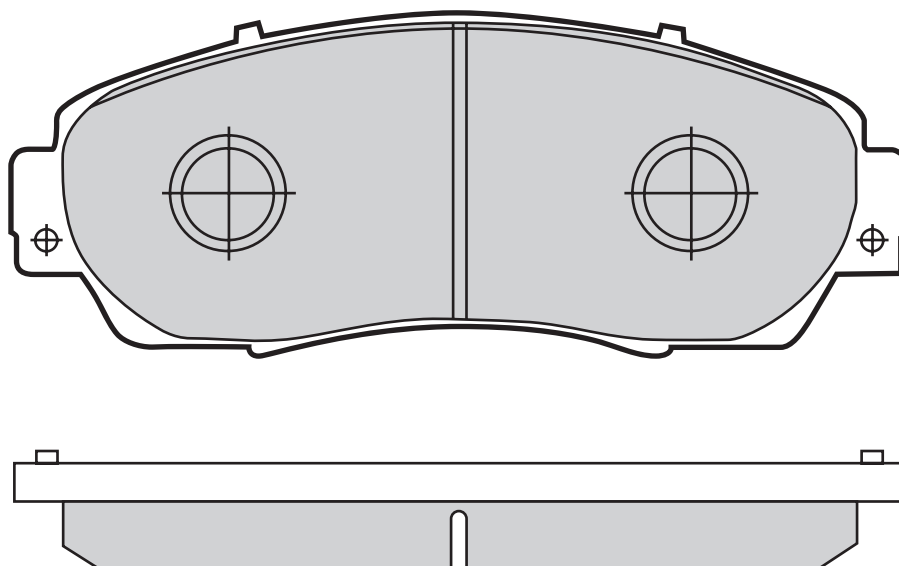

			
0	141,7	66,8	17,8

601179



			
2	154,7	58,4	18

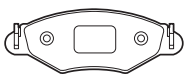

## 601180

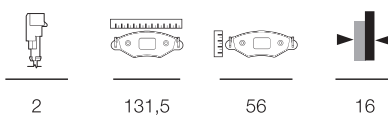
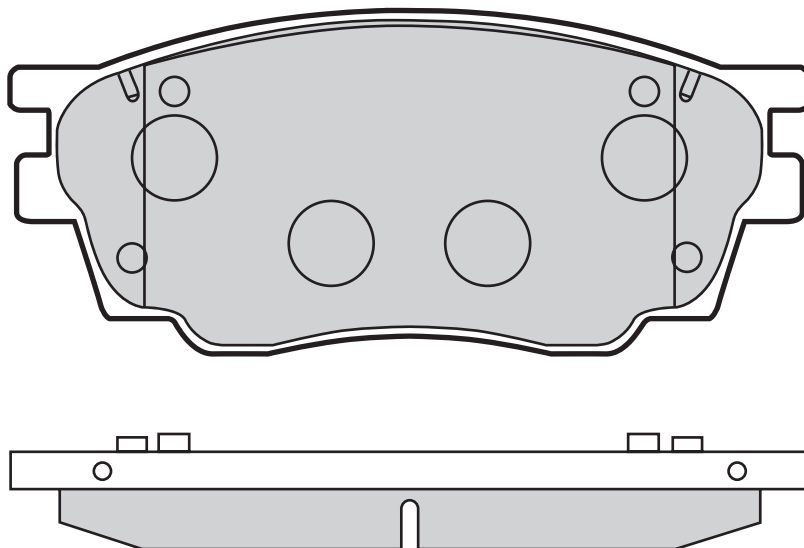



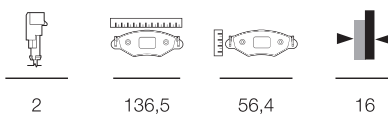
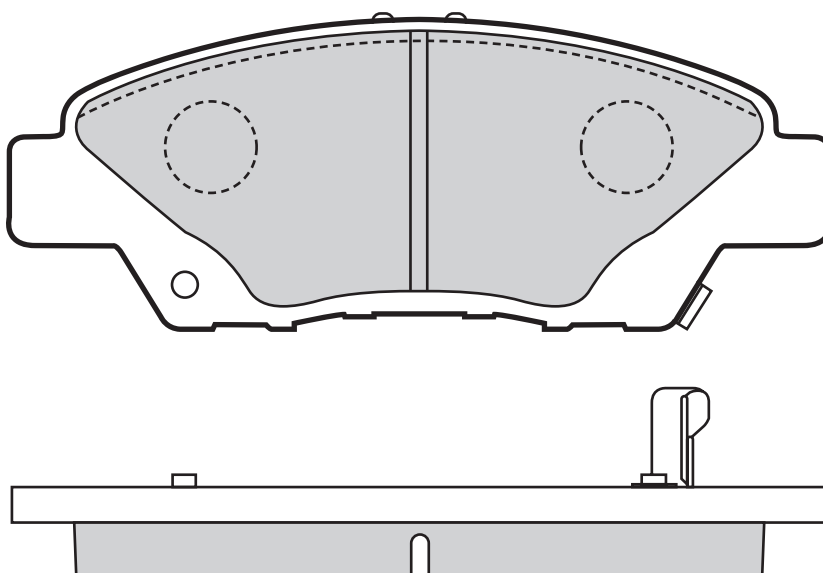

## 601181



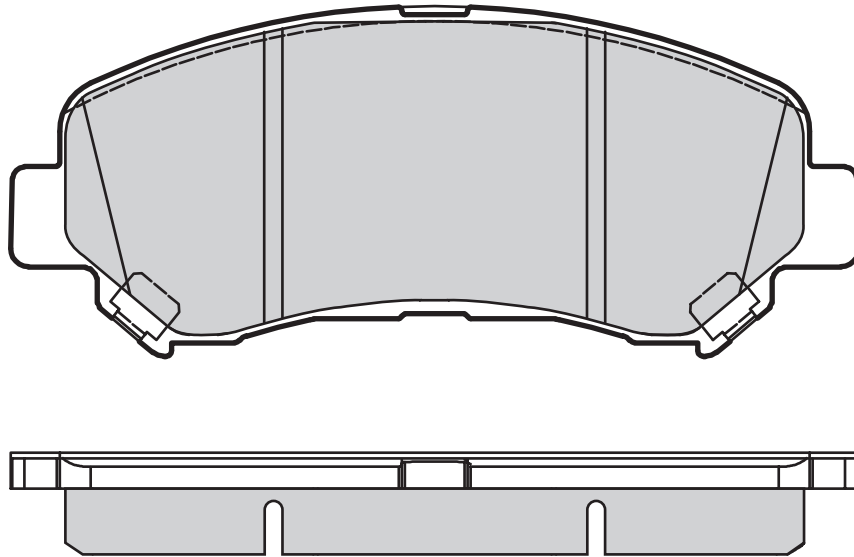





## 601182

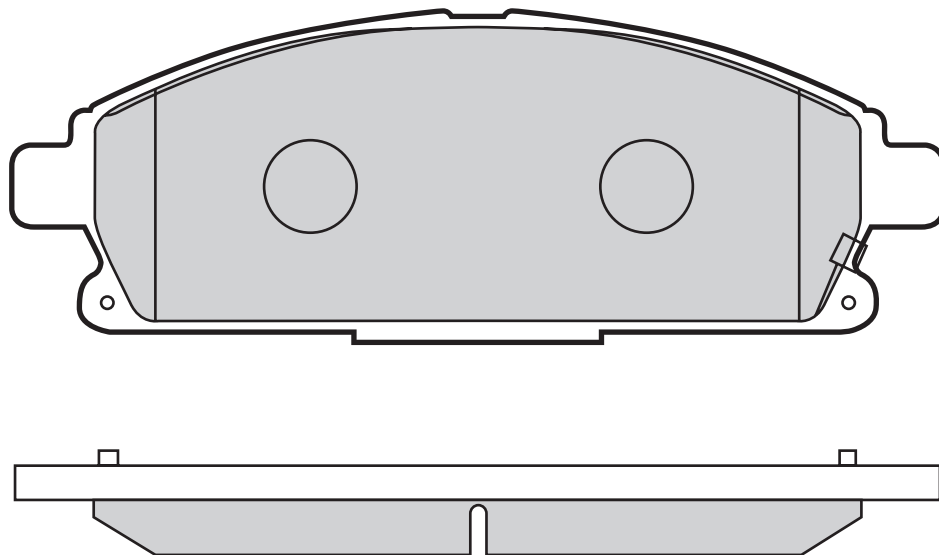

			
0	141,5	58,9	17

## 601183







			
1	158,8	56,1	15,3

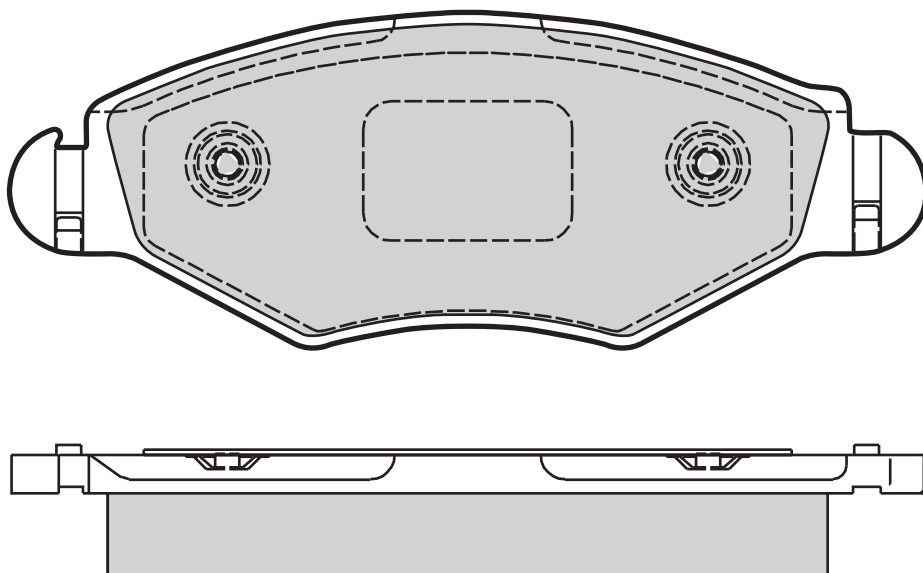





## 601184

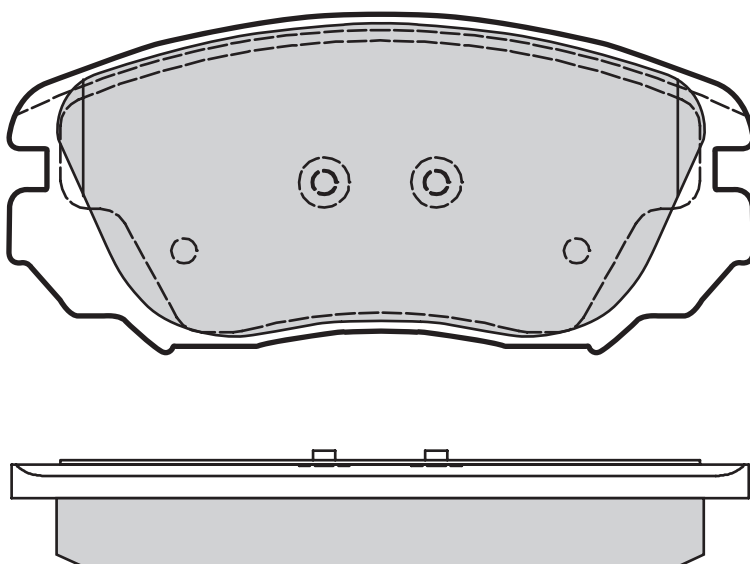

			
0	130,9	47,3	17

## 601185



			
0	131,4	59,8	16,9



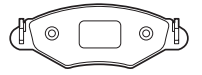

**601186**

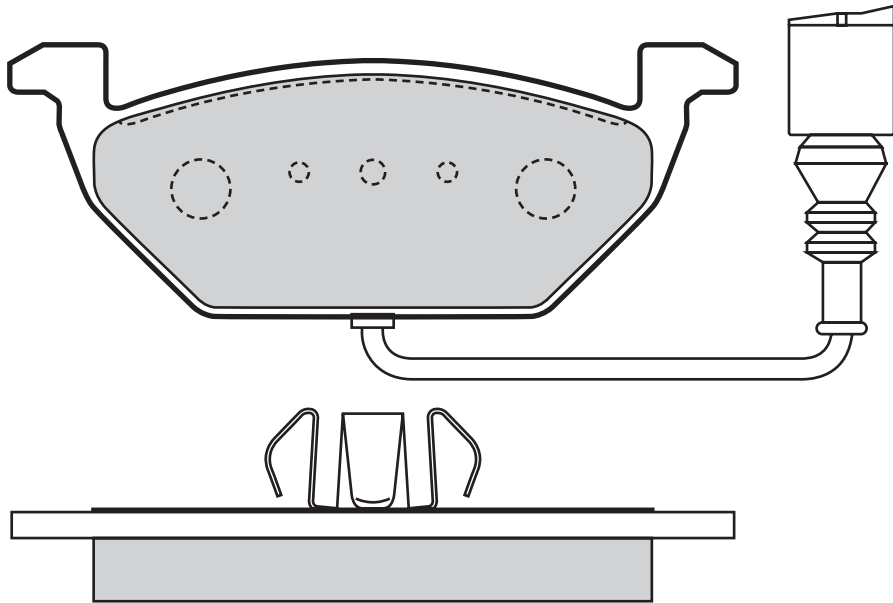

1	146	54,5	18,7

**601187**

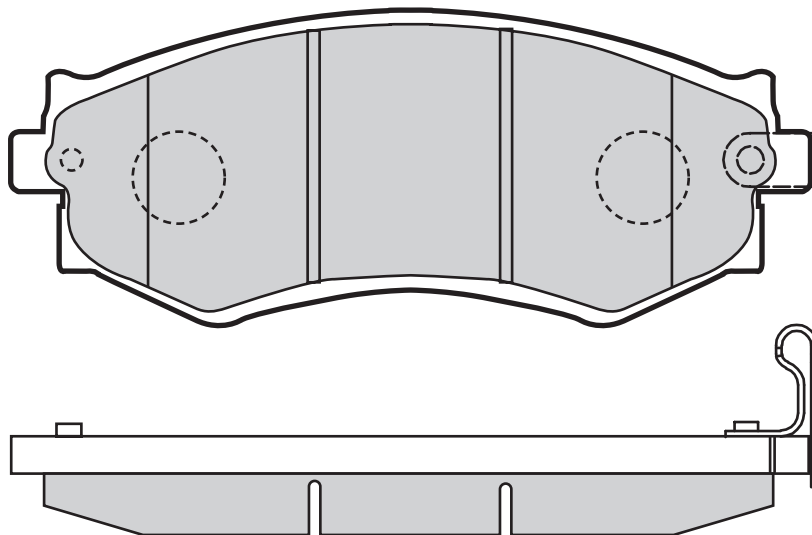

0	137	54	17



## 601188

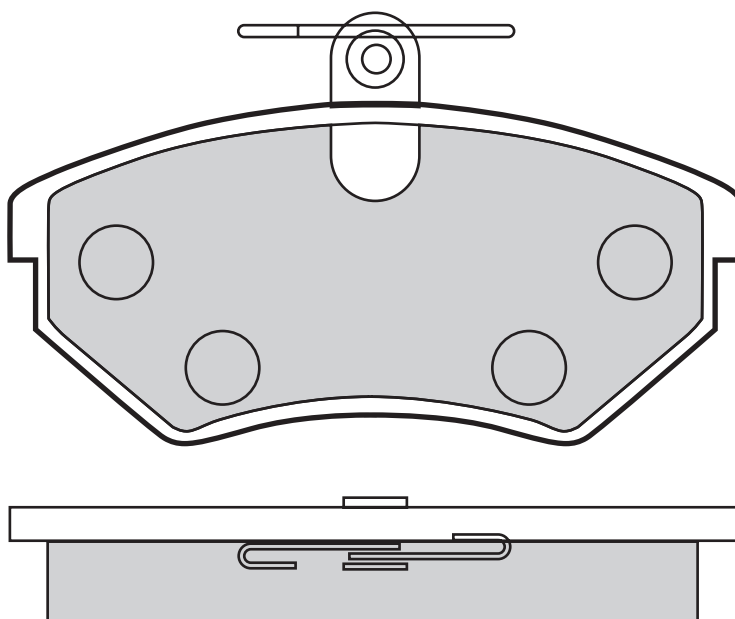

0	118,7	69,5	18,5

## 601191

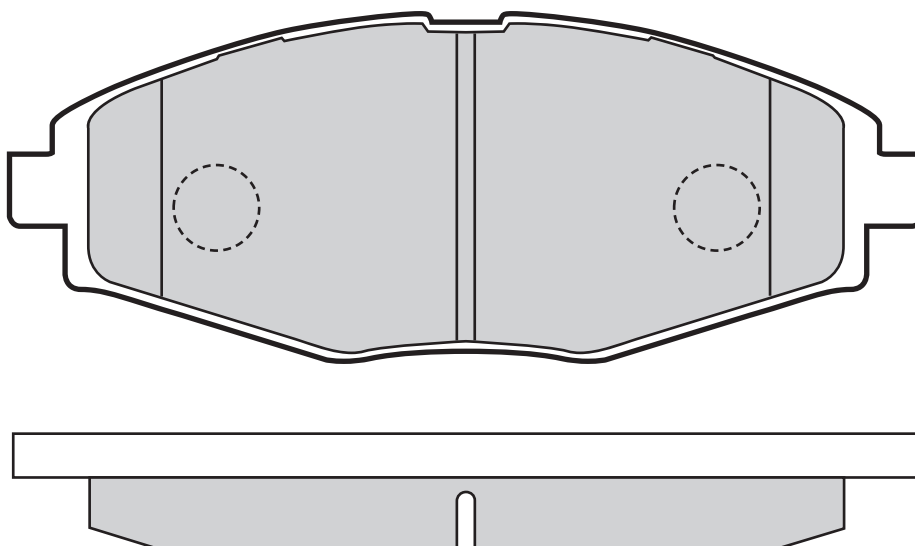

0	127	48	16

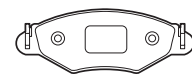

601194

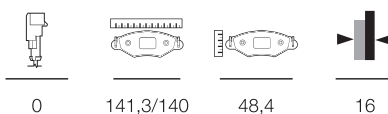
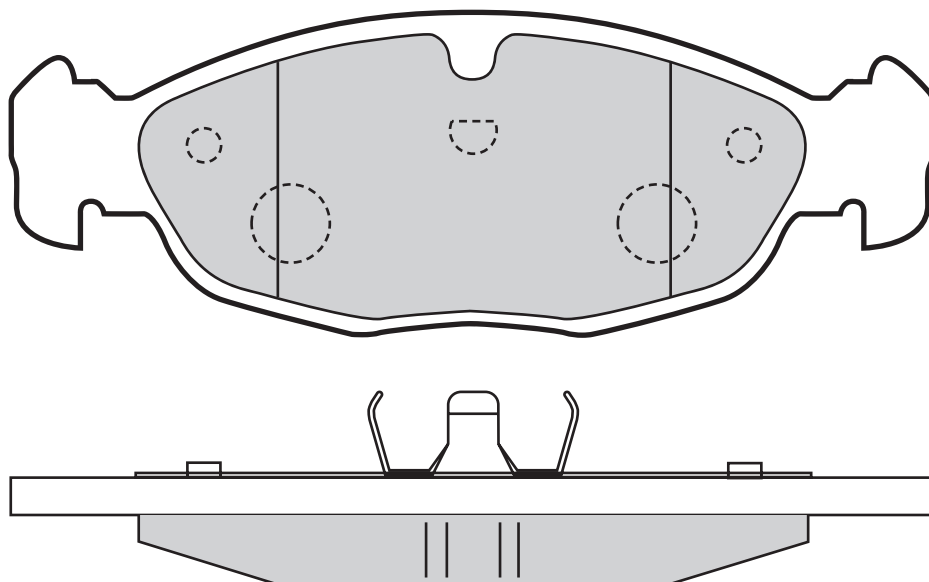

0 141,3/140 48,4 16

601195

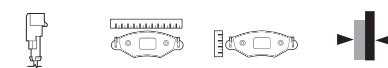
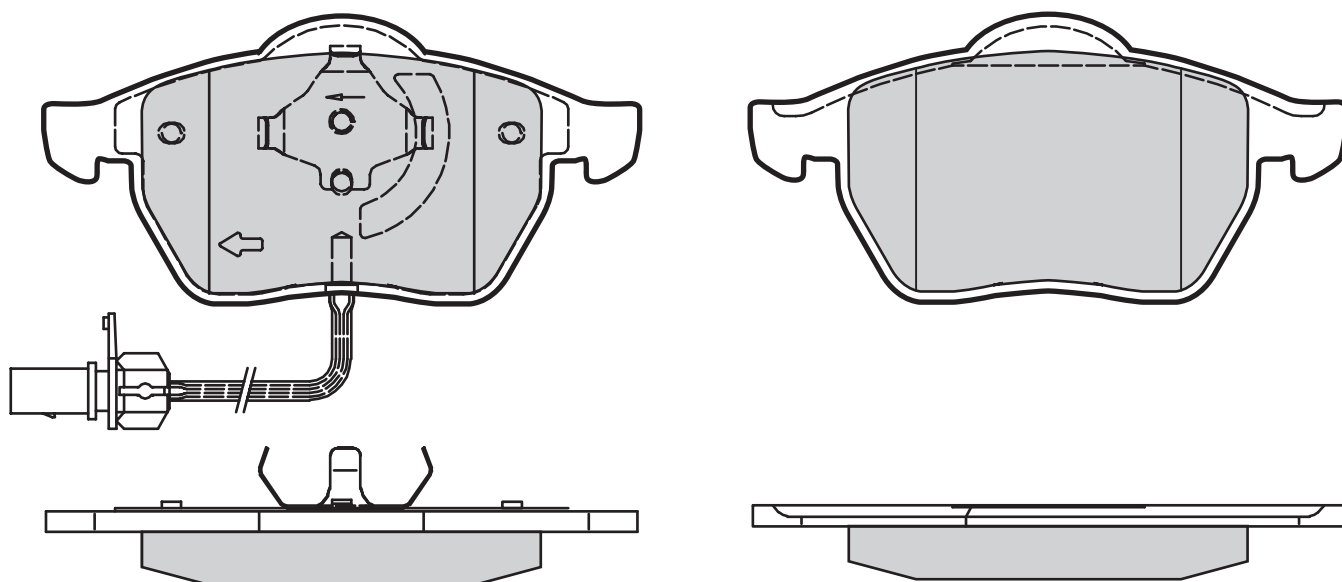

1 156,6 74,2 19,1



## 601196

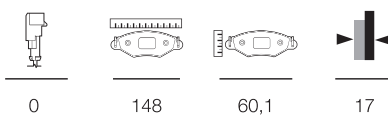
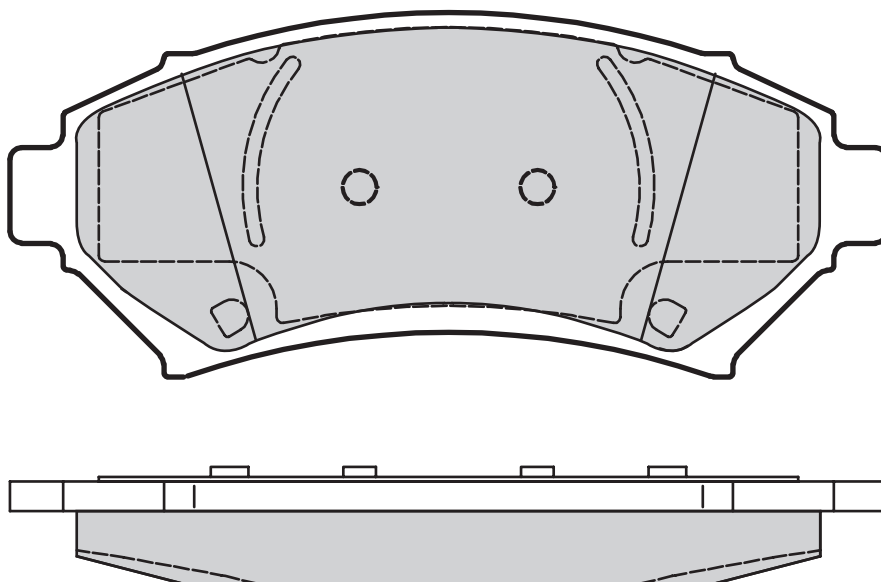



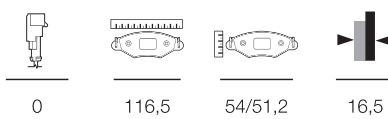
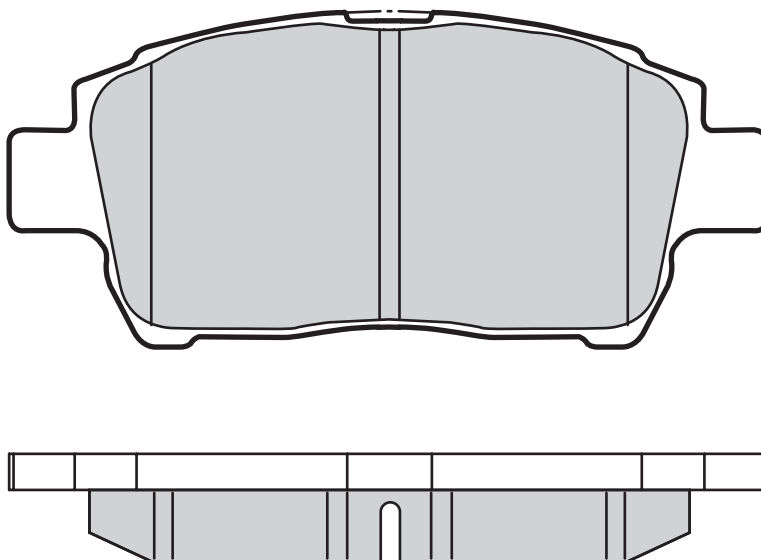

## 601198



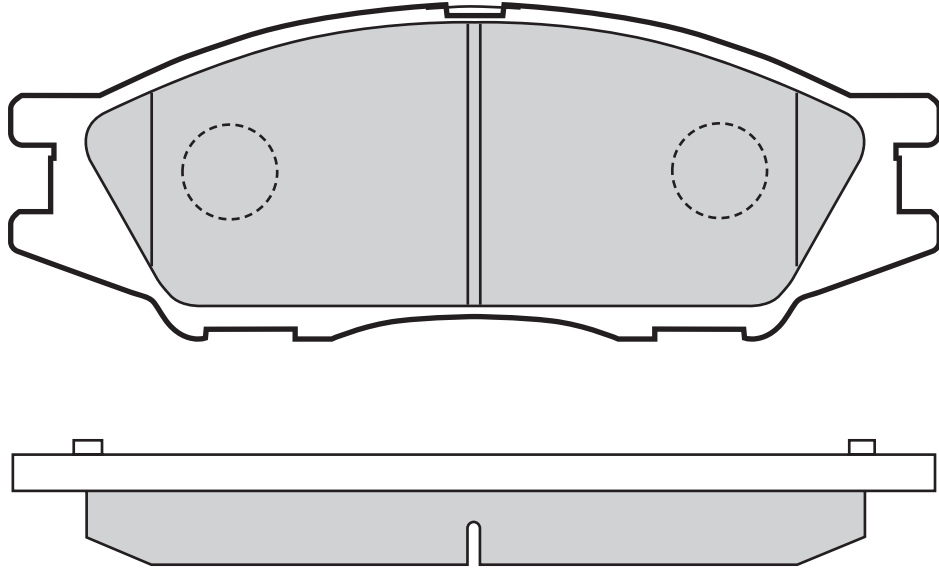





601201

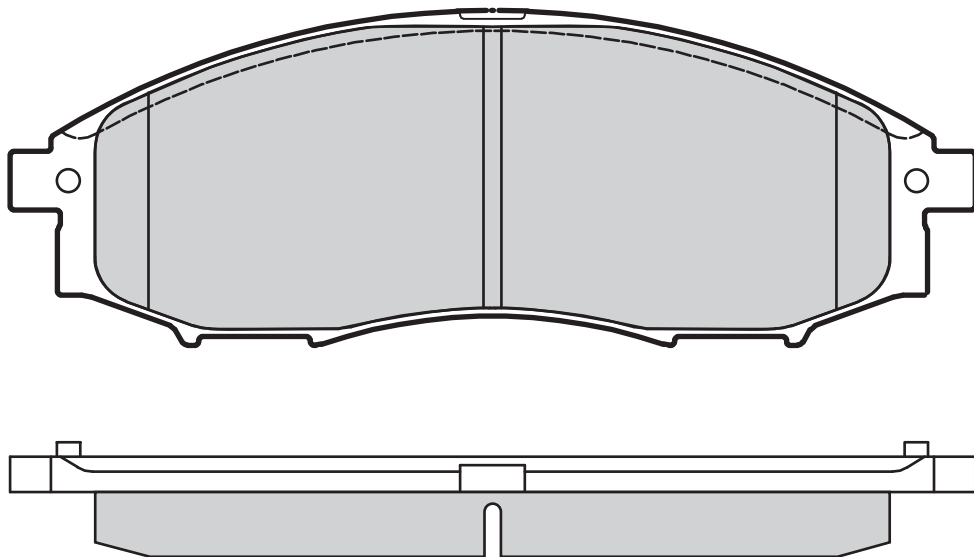

			
2	135	48	16

601204



			
0	164	56,9	16,8



## 601205

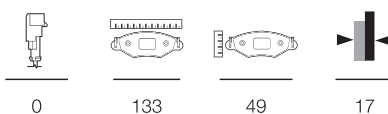
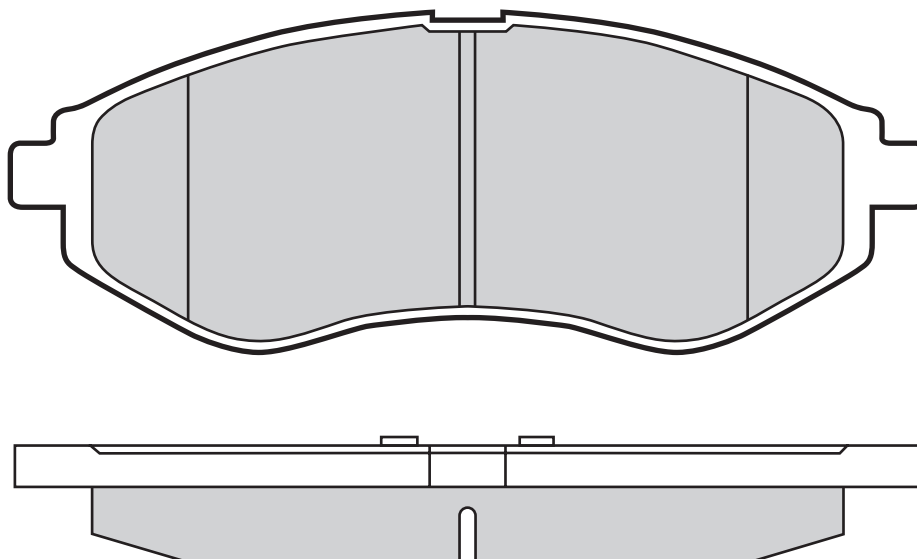

0

133

49

17

## 601206

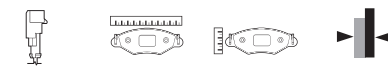
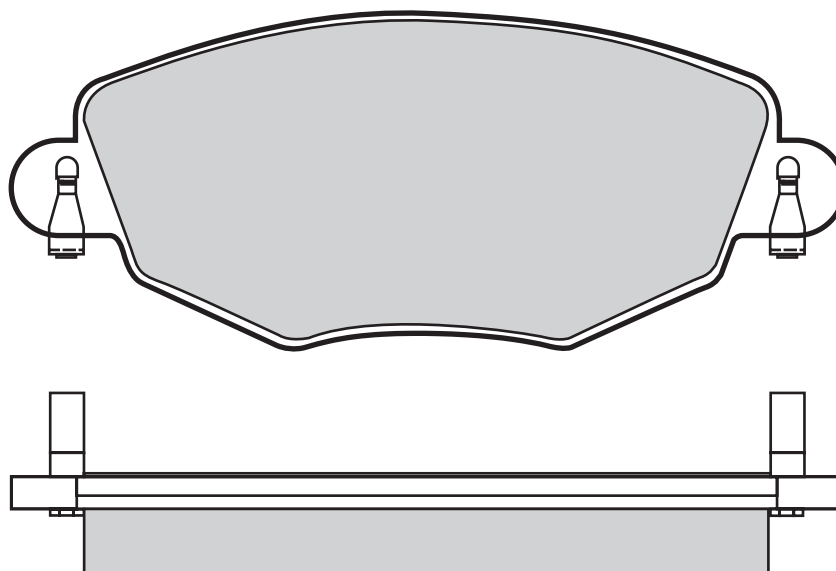

0

148,8

60

17,5

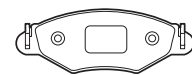

601207

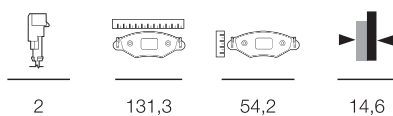
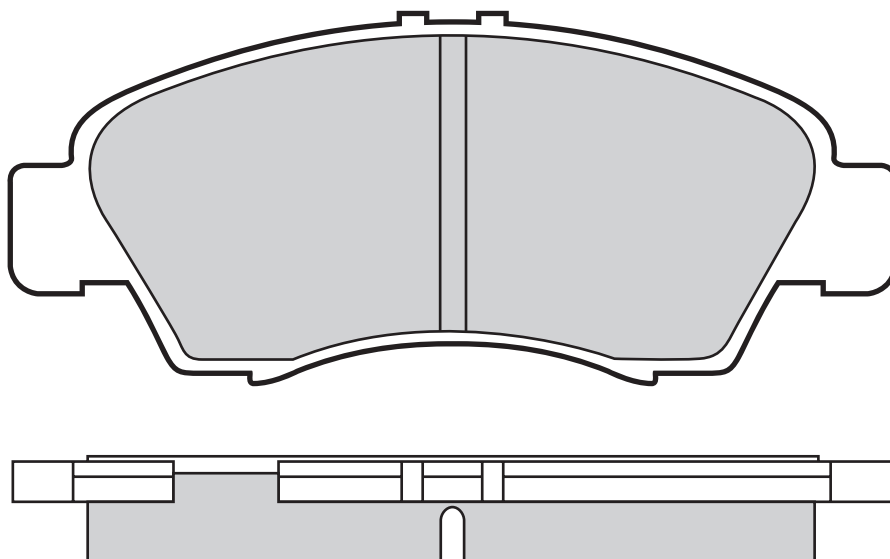

2



131,3



54,2



14,6

601208

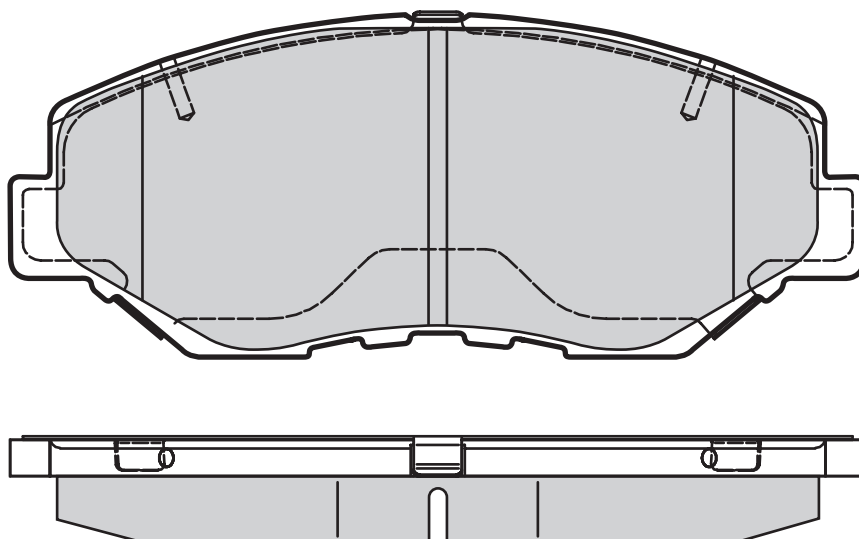

0



141,8



56,6



16,8

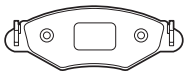

601209

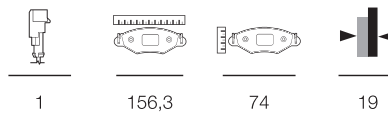
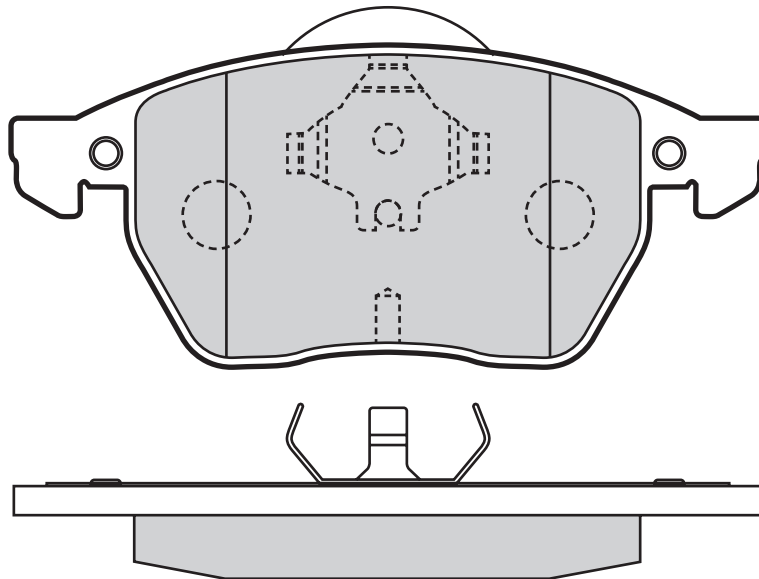

601210

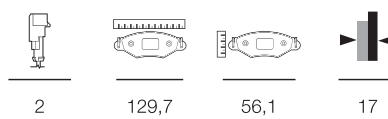
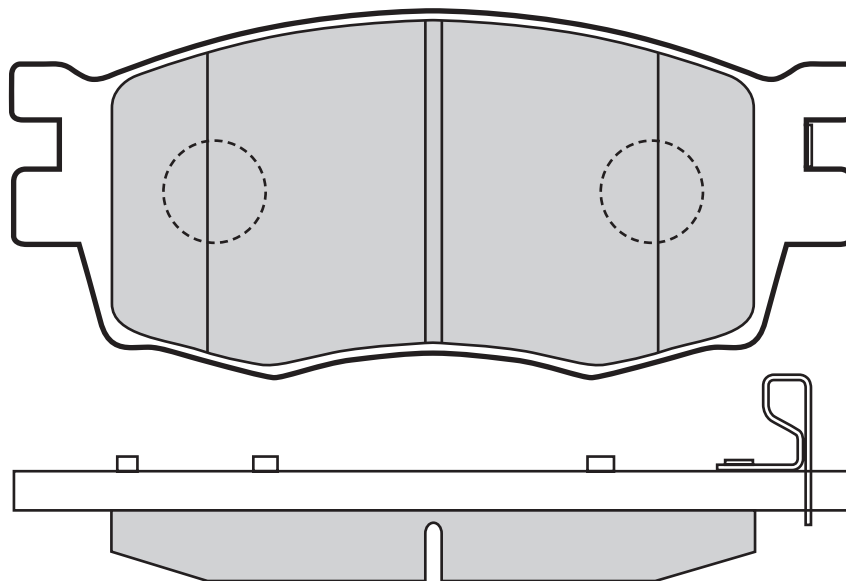



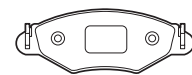

601211

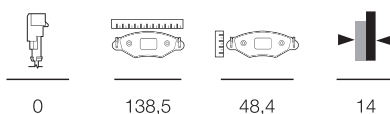
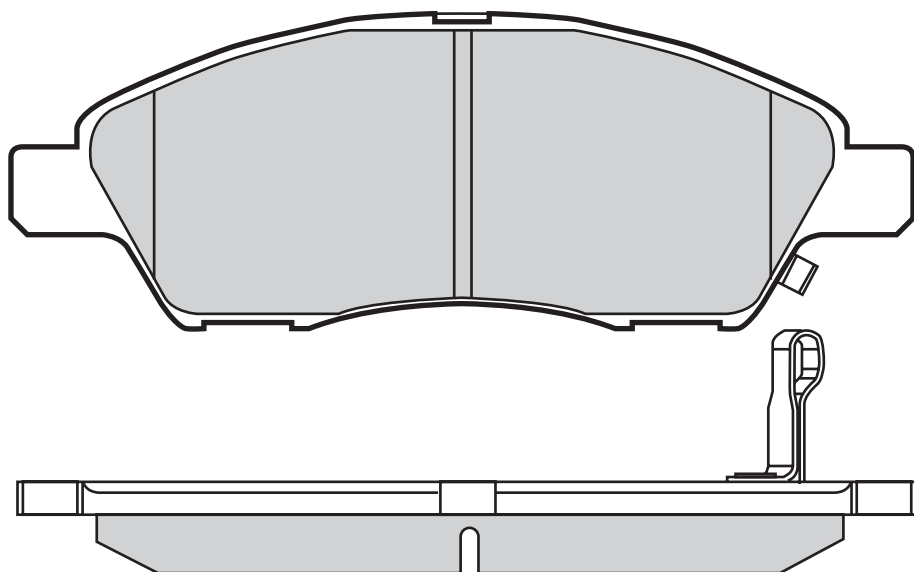

0

138,5

48,4

14

601213

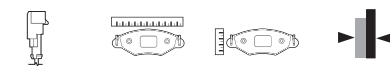
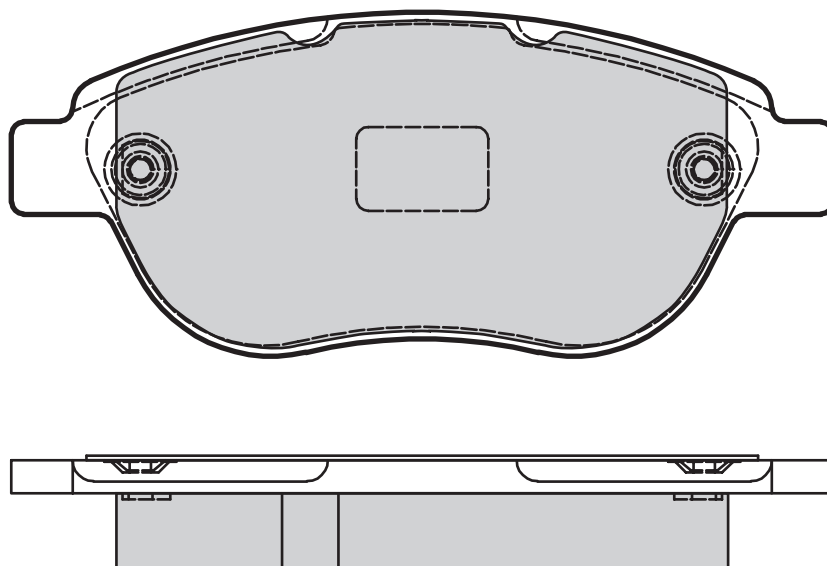

0

136,8

57,1

18,5



601214

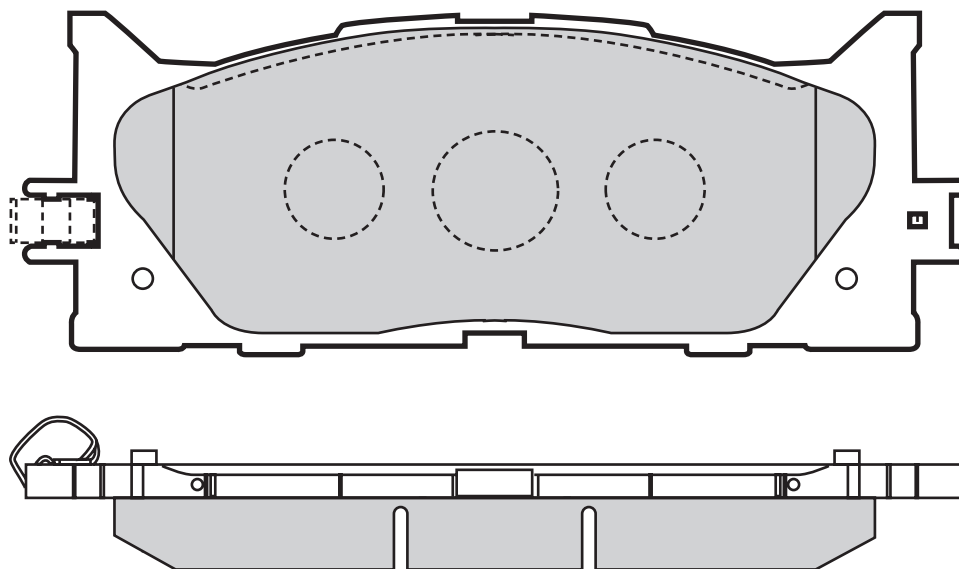

0	157,5	57	17,5

601217

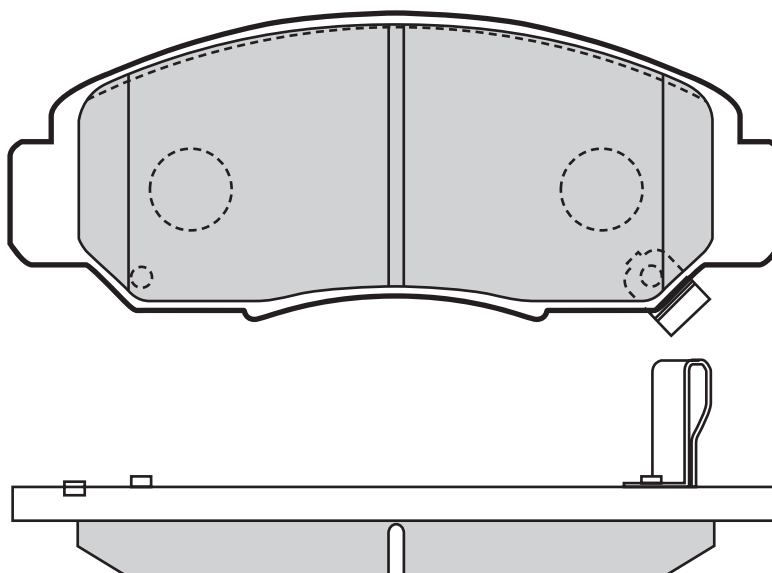



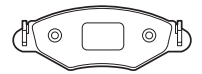

2	148,6	59,5	17

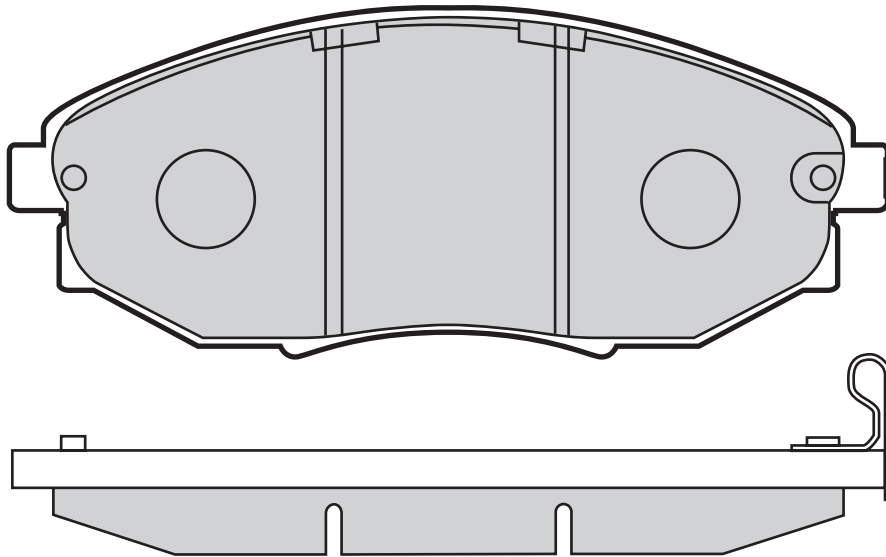





601220

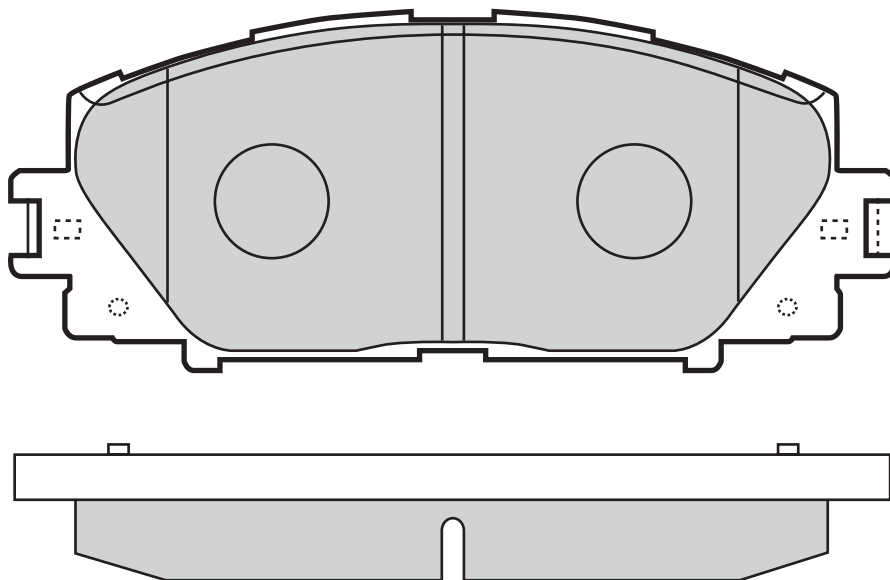

			
2	144	56,3	17

601221



			
0	122,5	49,8	17,5



## 601222

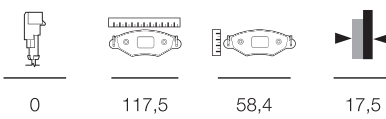
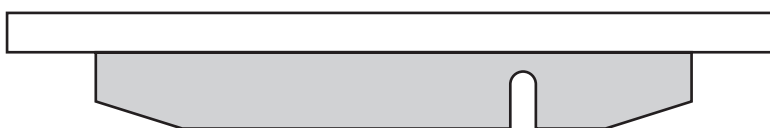
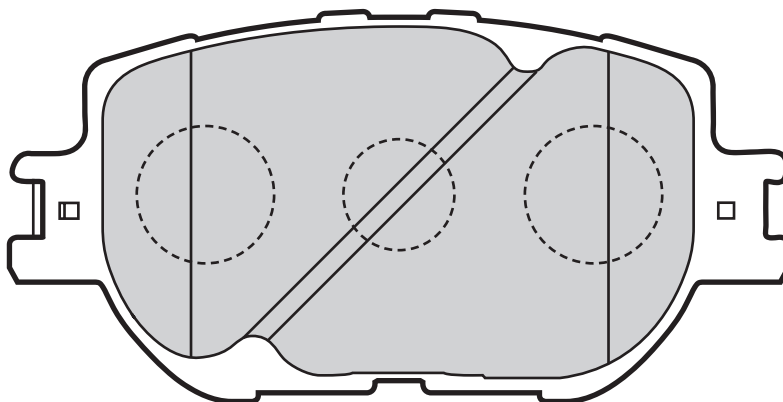

## 601223

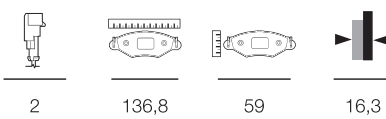
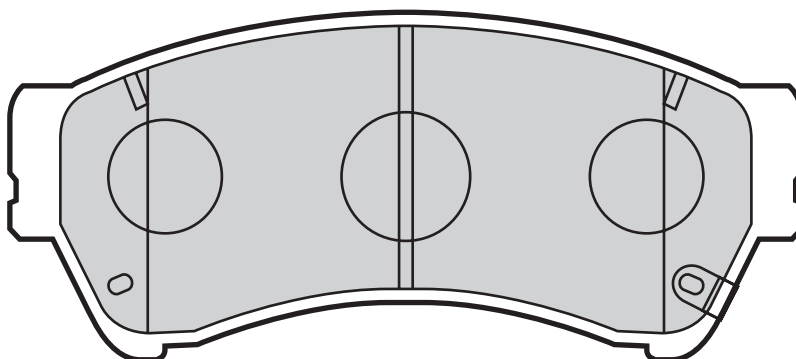

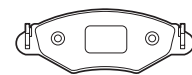

601224

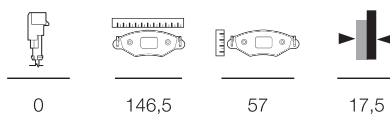
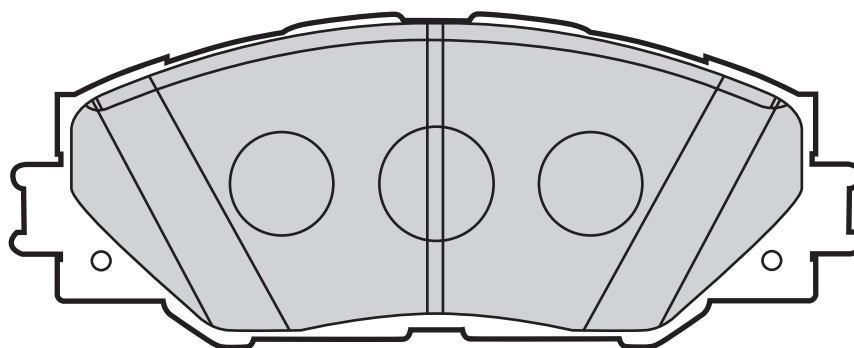

0      146,5      57      17,5

601225

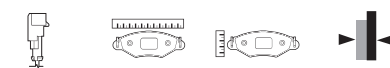
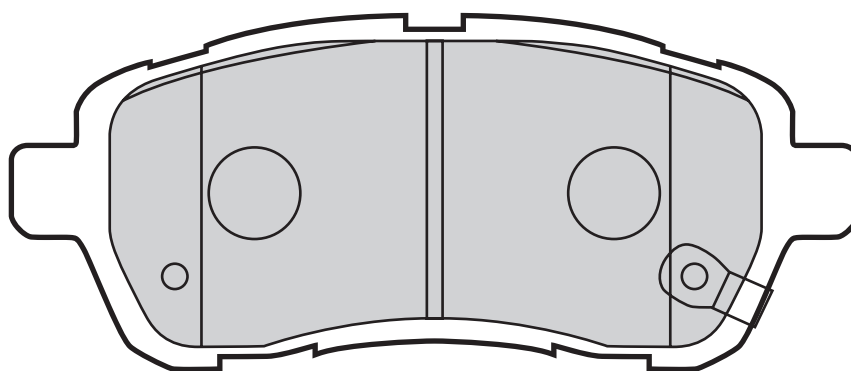

0      125,6      51,7      16,3



601228

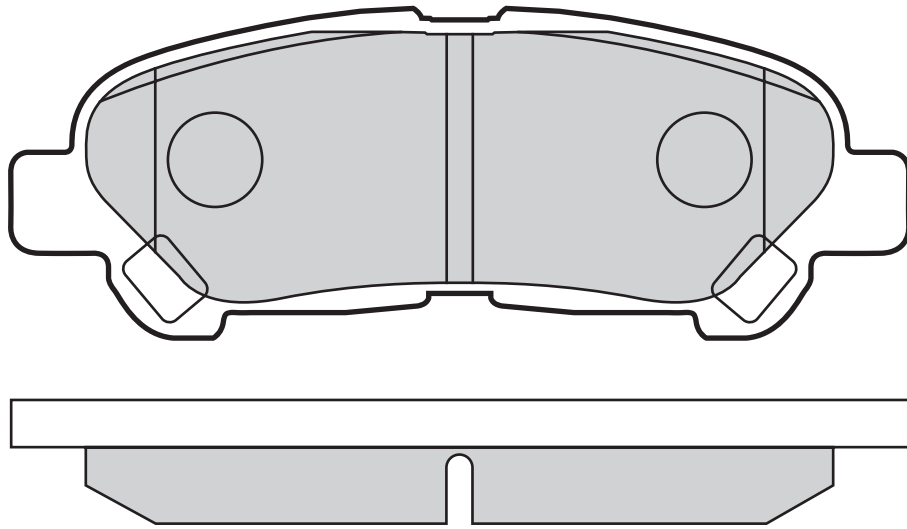

0	113,3	40,8	15,5

601229

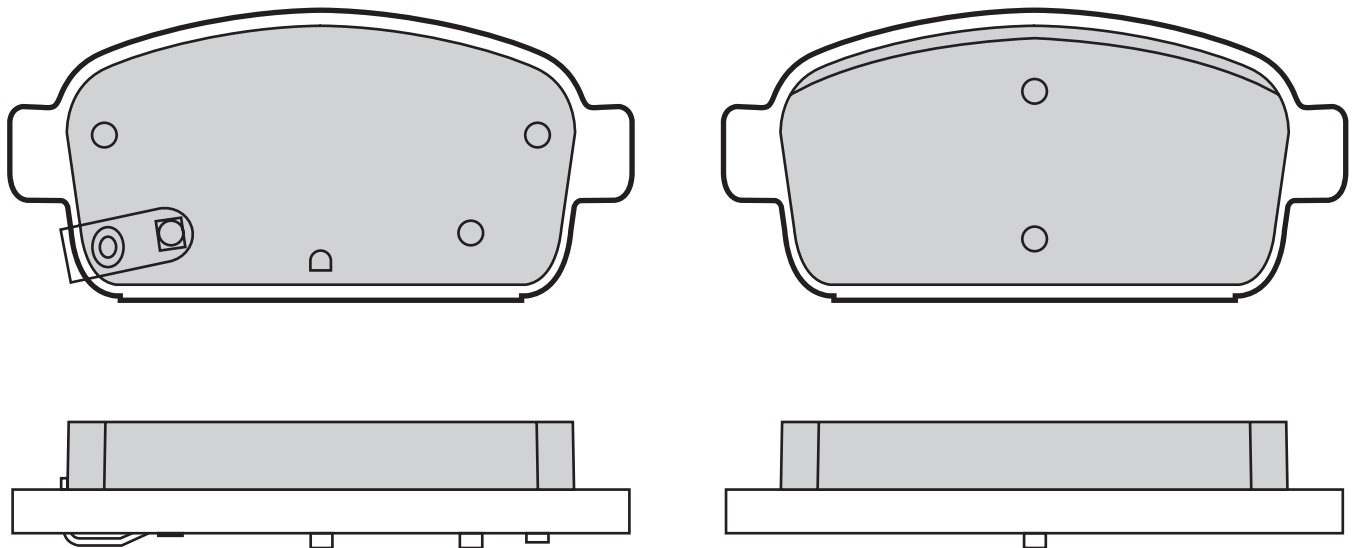

2	116,6	42,8	16,5

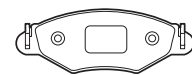

## 601230

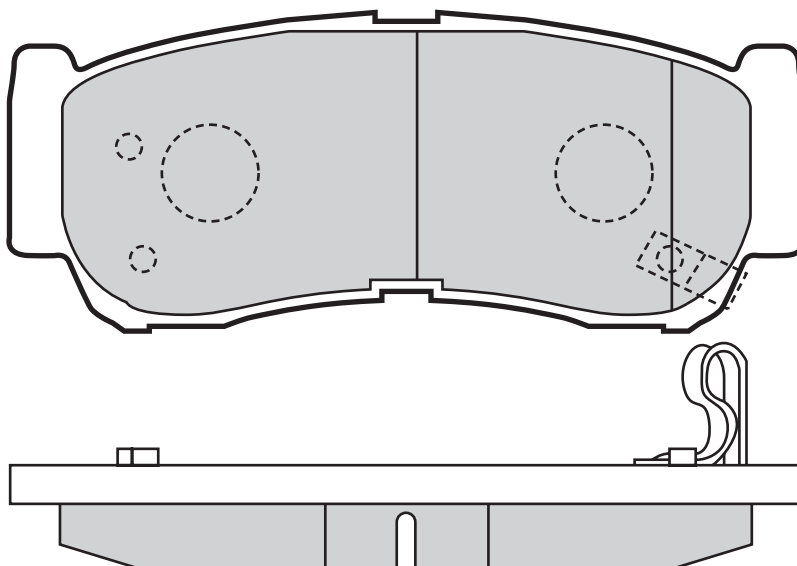

2	118,6	47,0	15,0

## 601231

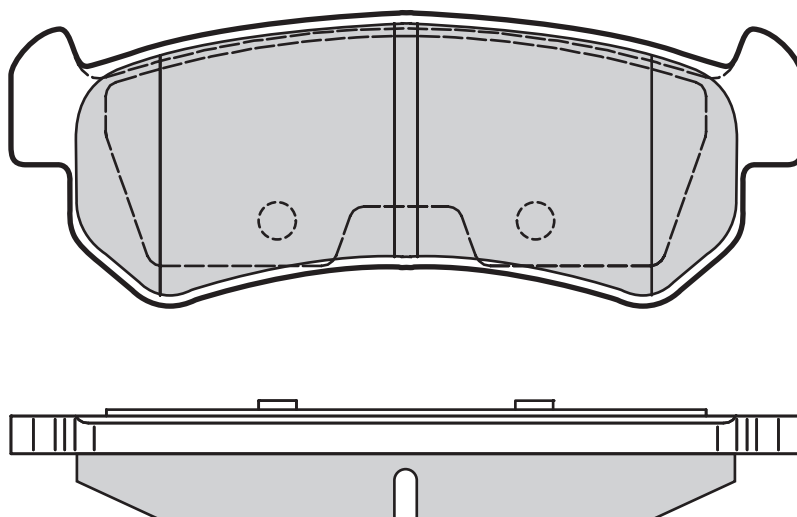

0	103,9	39	13,8



601232

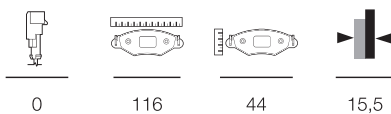
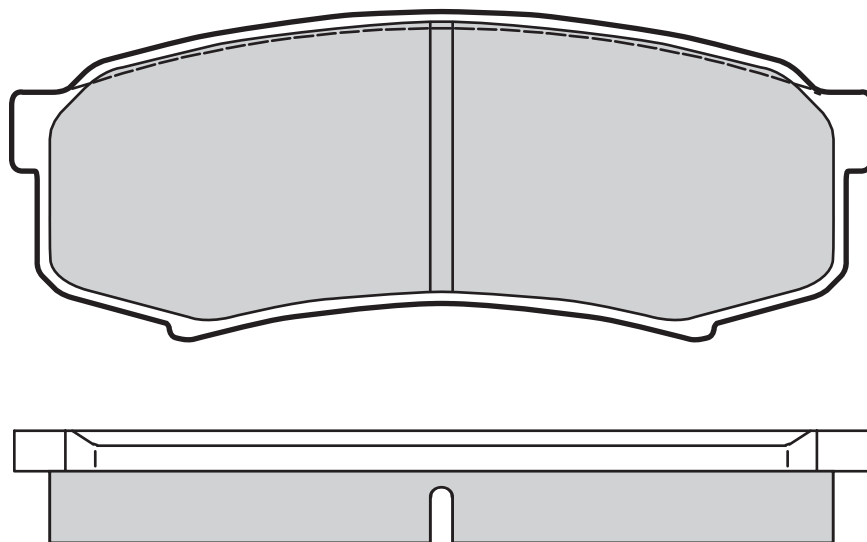

0

116

44

15,5

601233

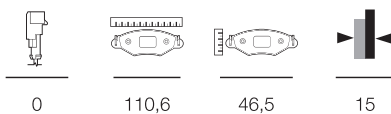
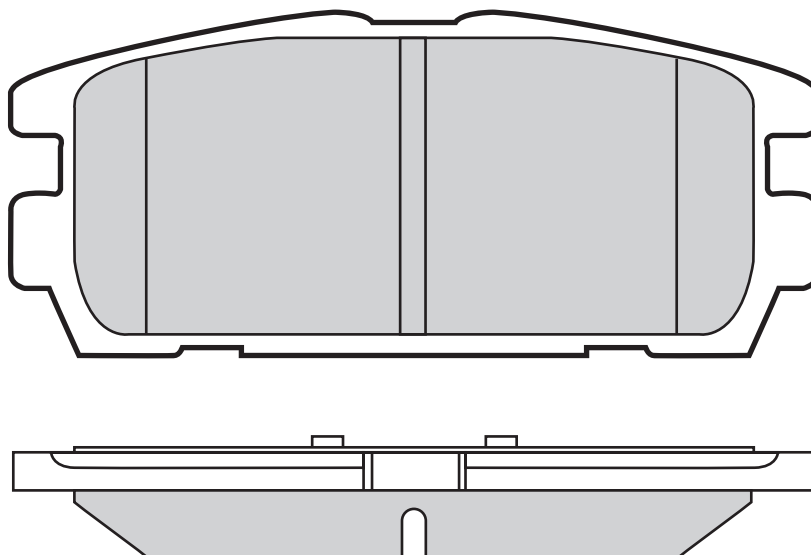

0

110,6

46,5

15



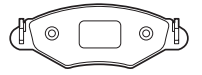

## 601235

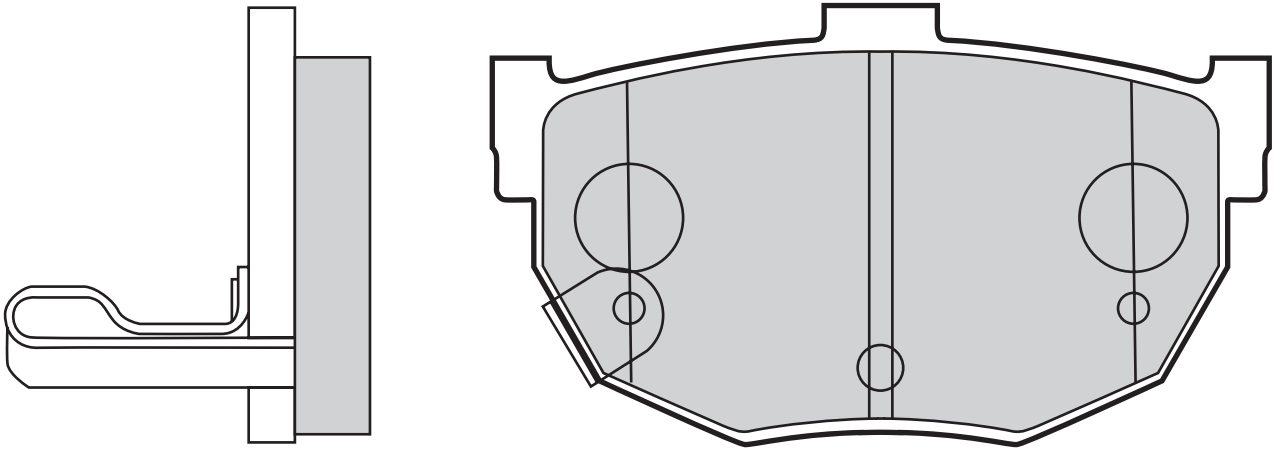

2	85,3	46,3	14

## 601236

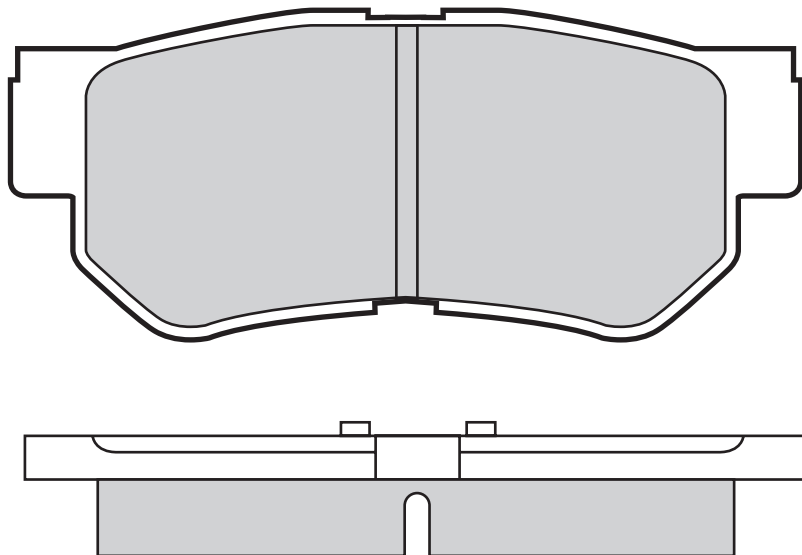

2	98,6	41	15



## 601239

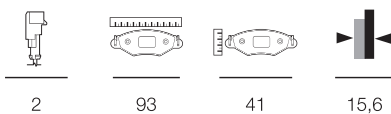
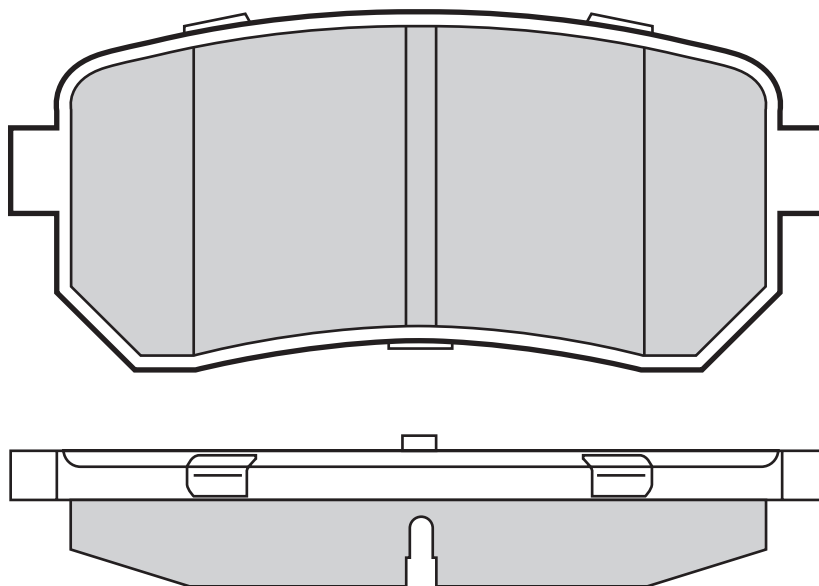

2

93

41

15,6

## 601240

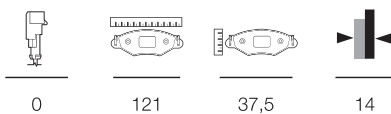
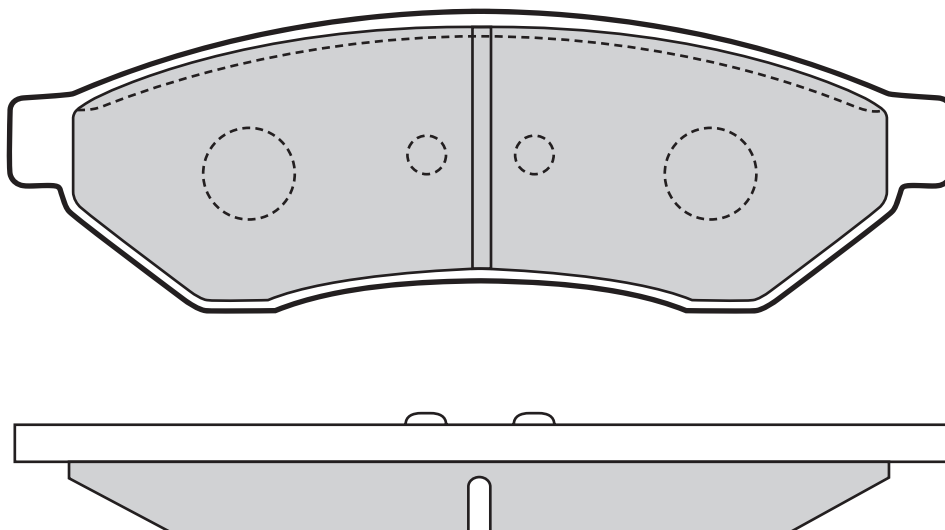

0

121

37,5

14

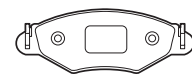

601241

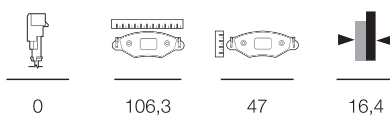
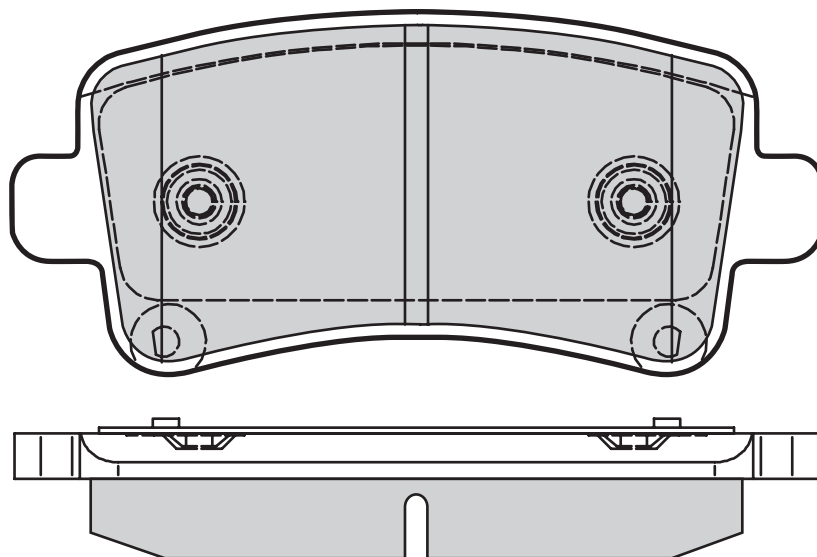

0

106,3

47

16,4

601242

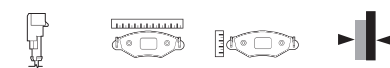
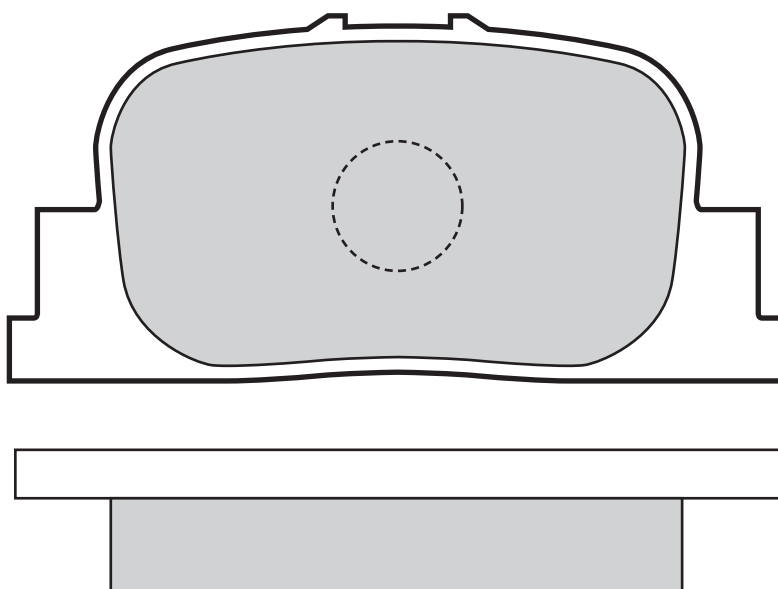

2

82,6

38,6

15



601243

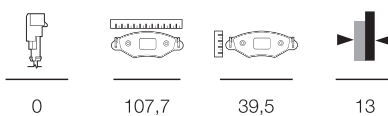
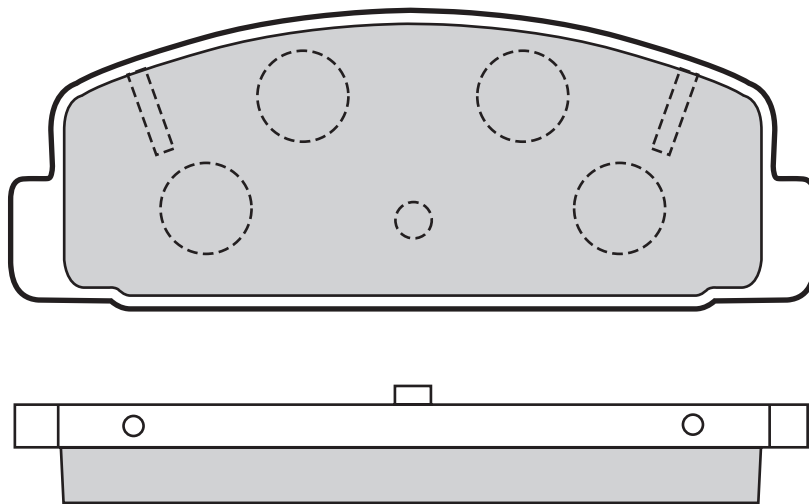

0

107,7

39,5

13

601244

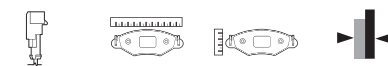
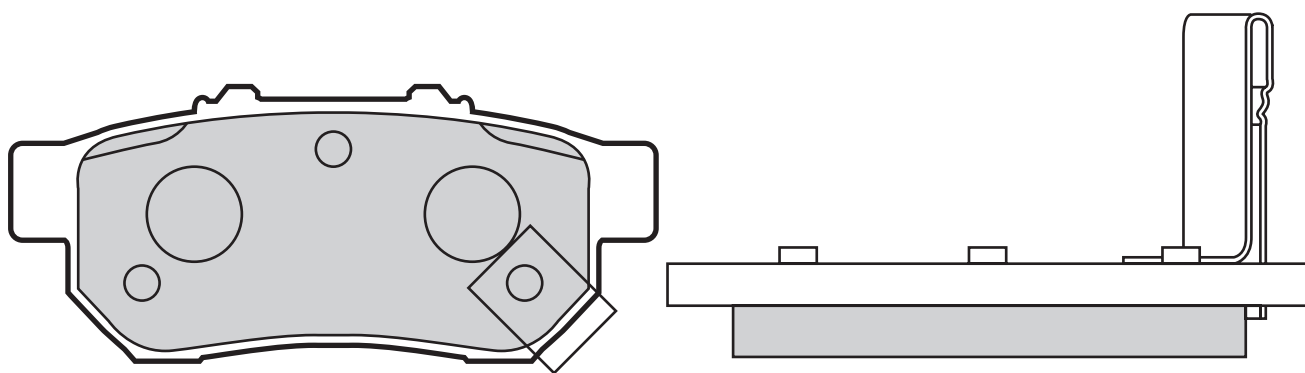

2

88,7

36,5

12,7

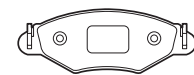

601245

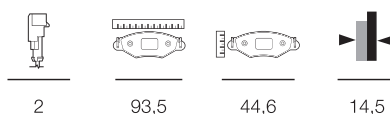
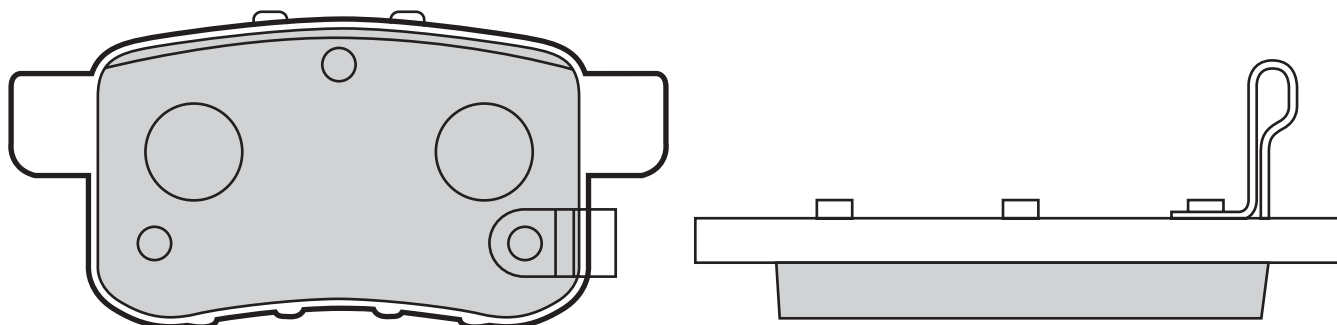

2

93,5

44,6

14,5

601246

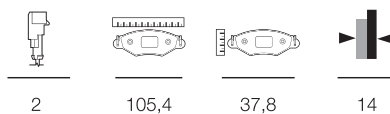
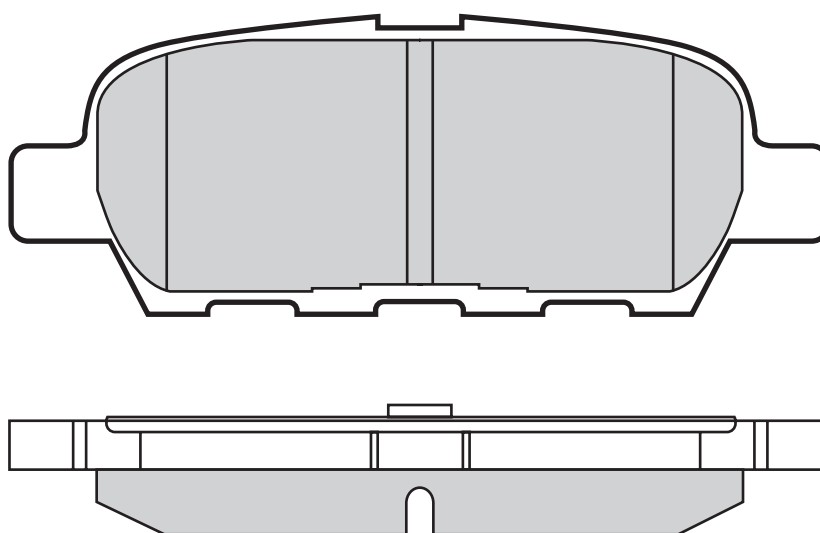

2

105,4

37,8

14



601247

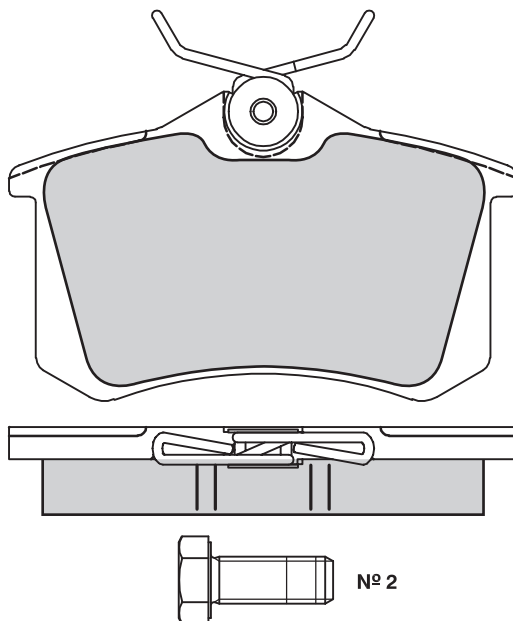

0	87,2	52,2	15

601248

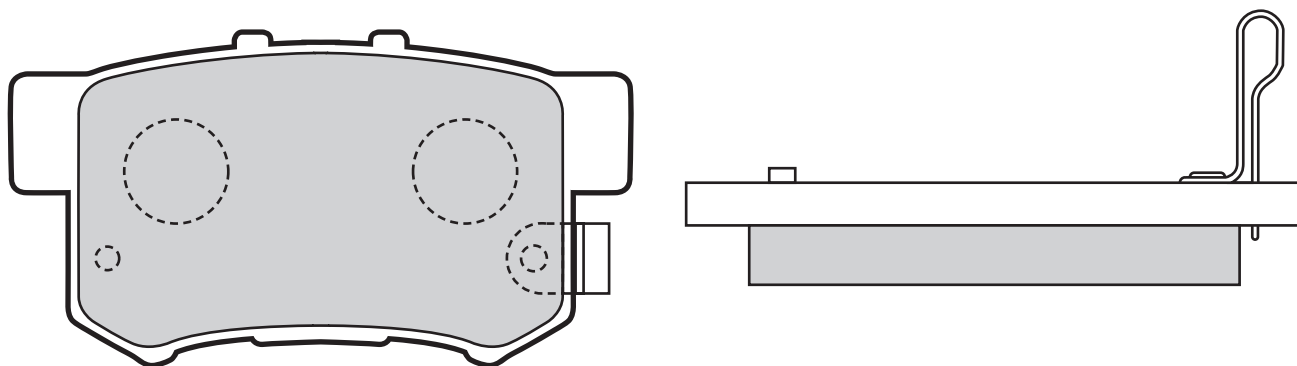

2	88,7	47,5	14,5

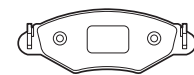

**601249**

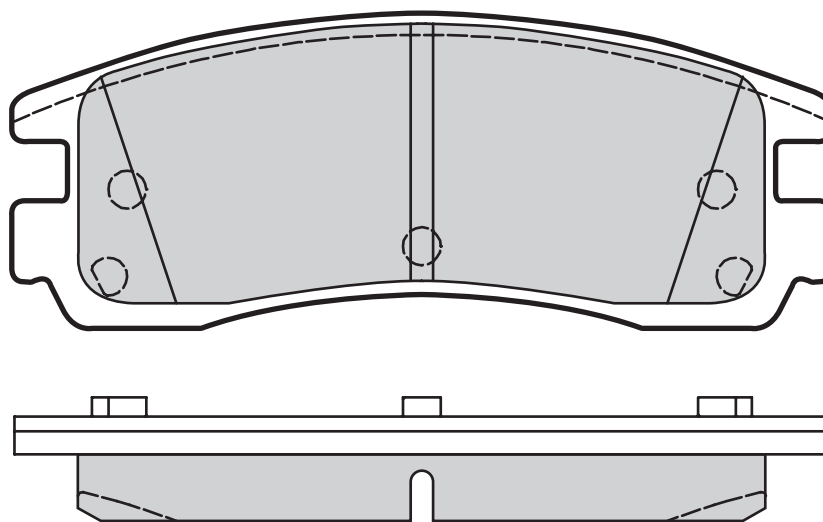

0	107,6	41,2	14

**601250**

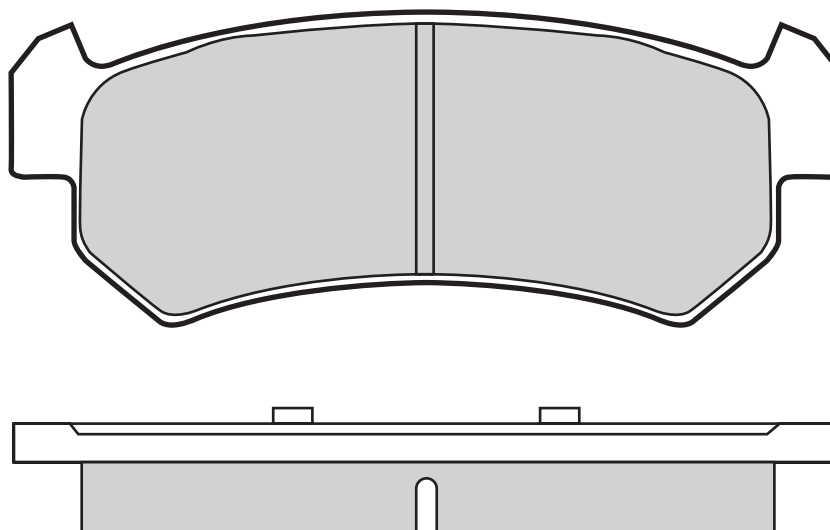

0	104,4	38,7	14



601251

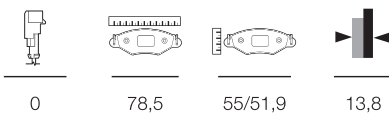
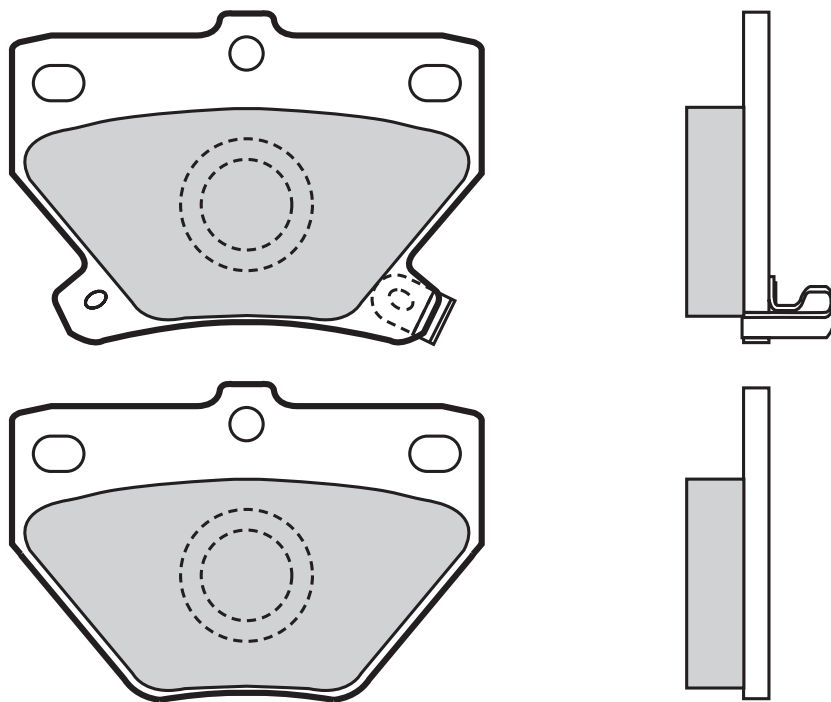



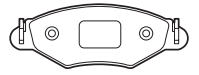

## 601255

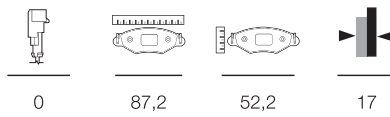
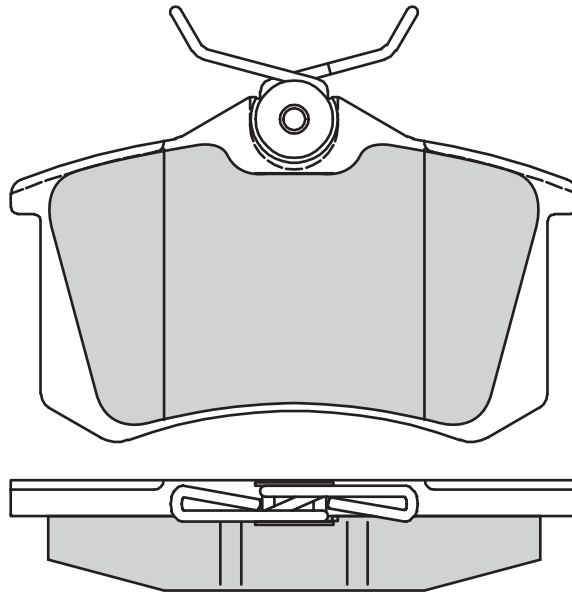

0

87,2

52,2

17

## 601256

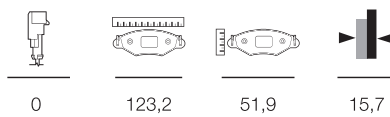
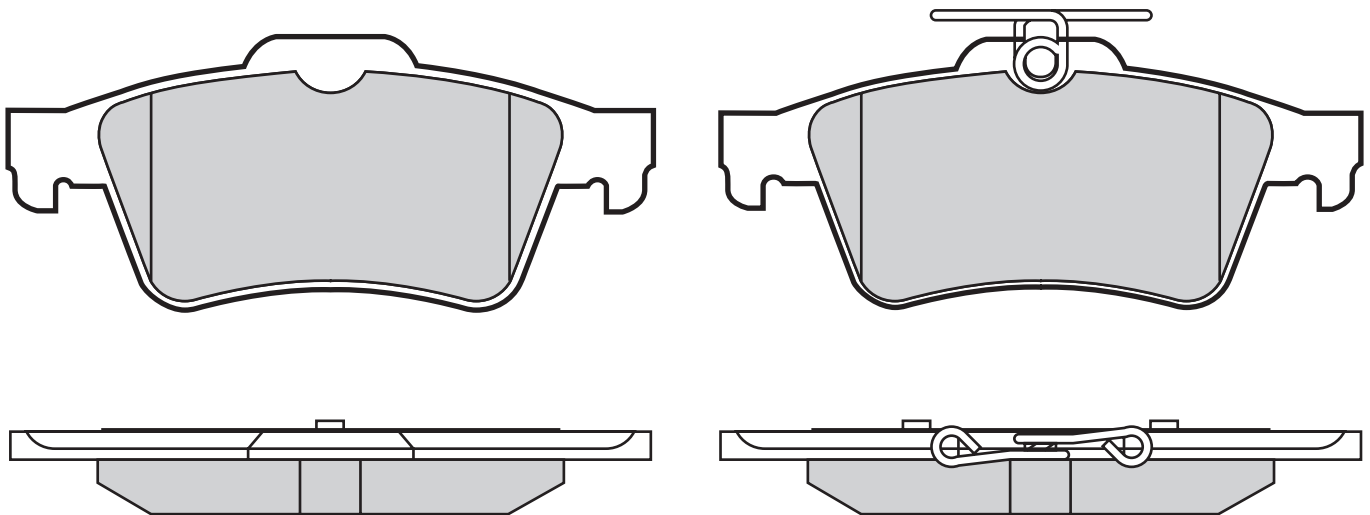

0

123,2





51,9

15,7

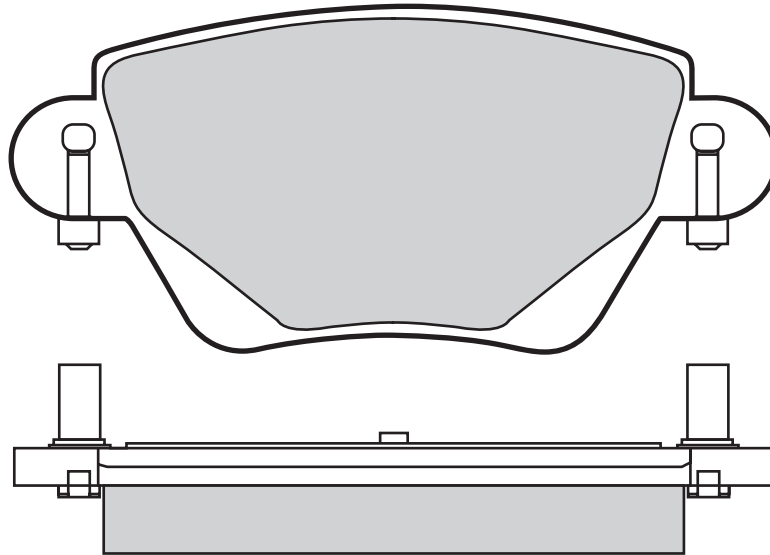





601257

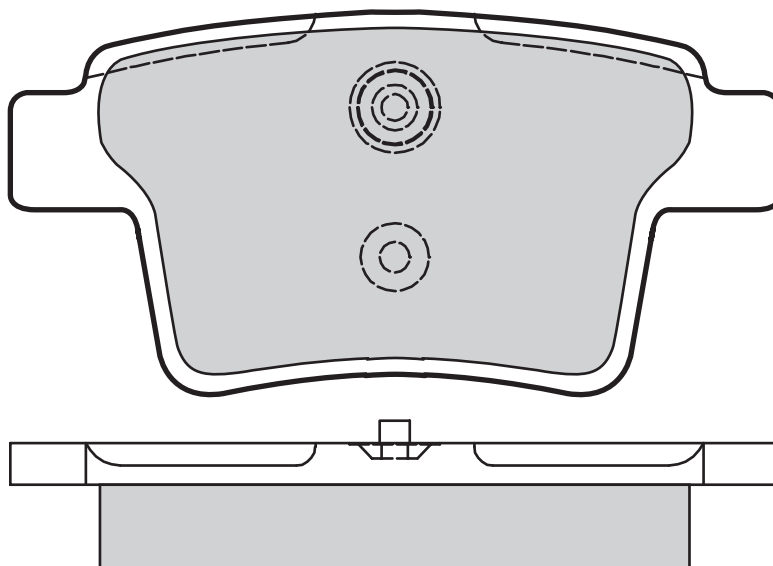

			
0	115,8	51,6	16

601258



			
0	101,9	50,3	16,2

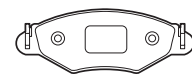

601259

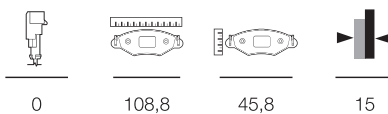
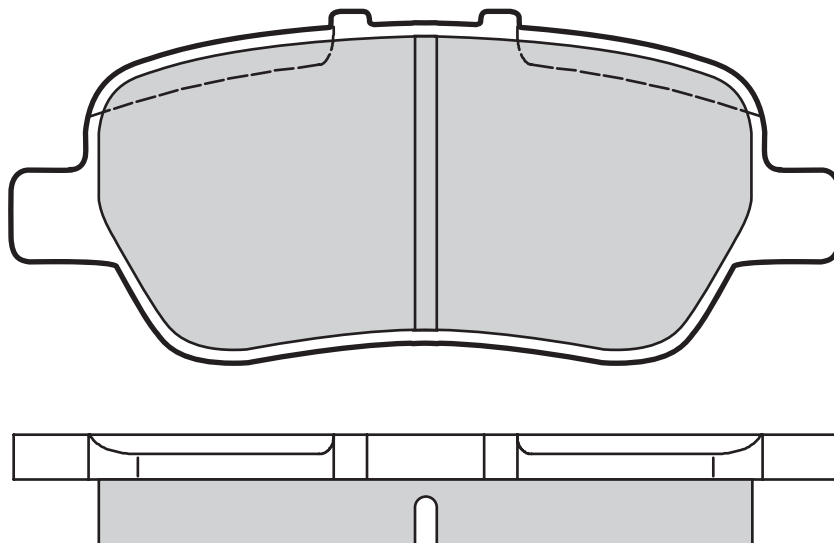

0 108,8 45,8 15

601261

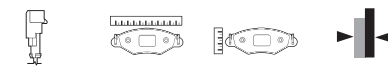
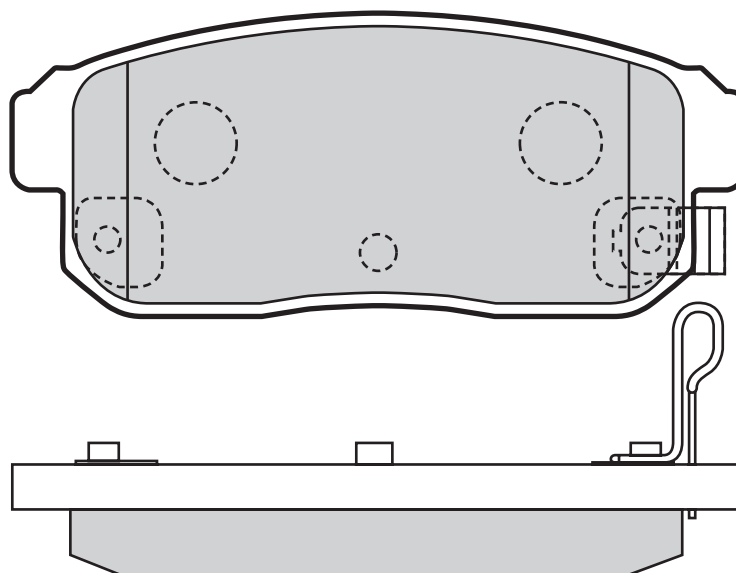

2 105,5 43 16



## 601263

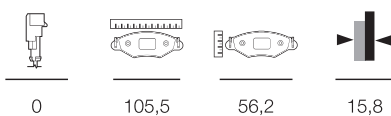
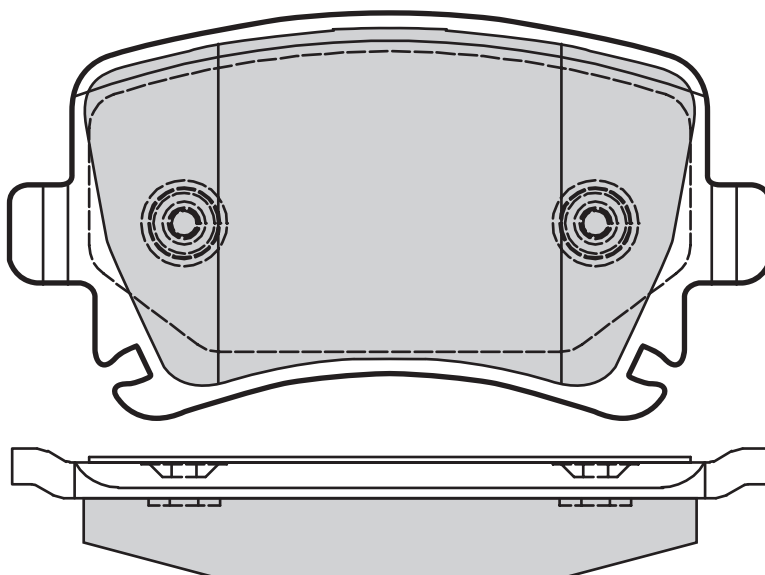

0

105,5

56,2

15,8

## 601264

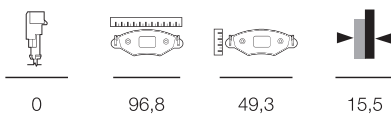
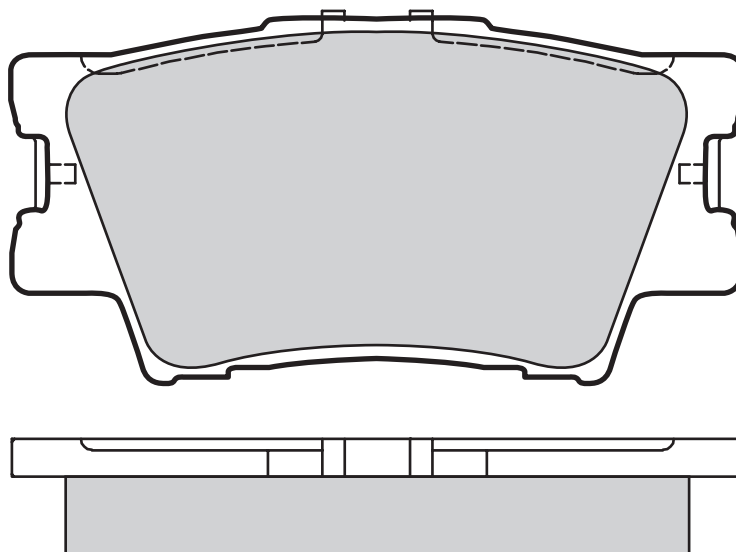

0

96,8

49,3

15,5

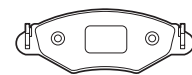

601266

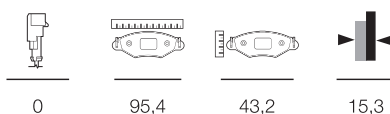
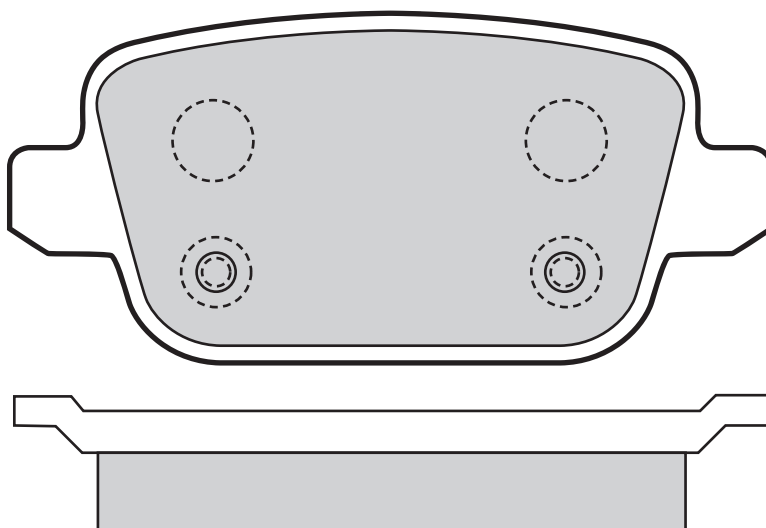

0      95,4      43,2      15,3

601267

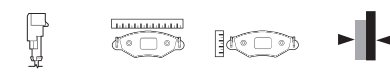
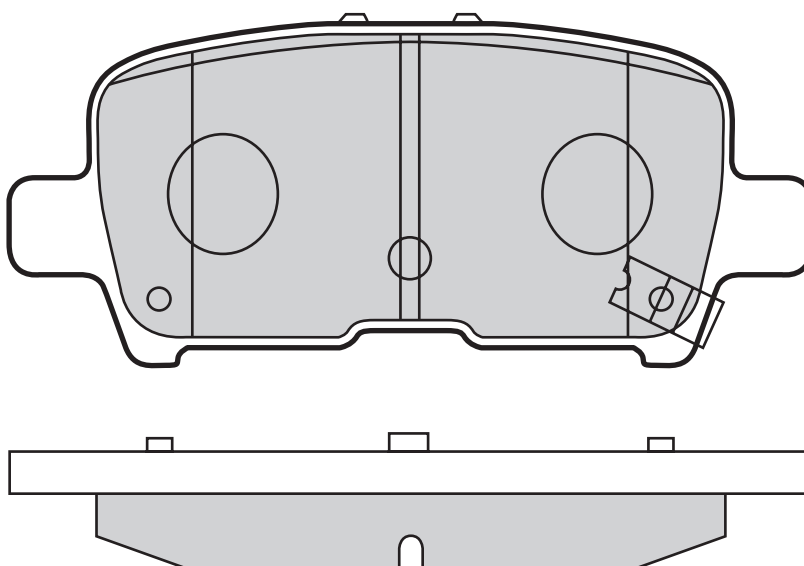

2      109      43      14



## 601268

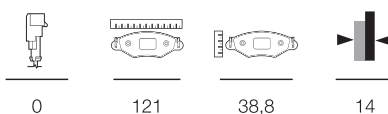
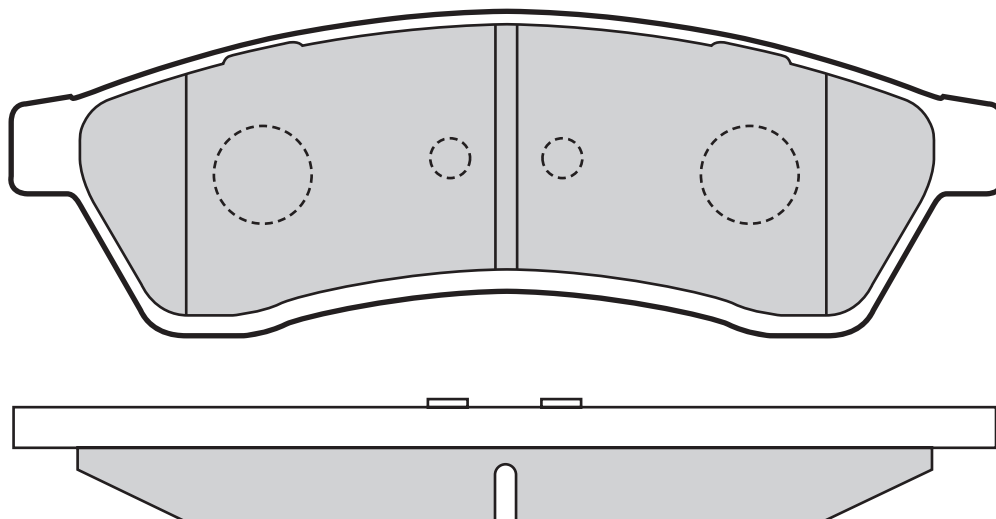

0

121

38,8

14

## 601269

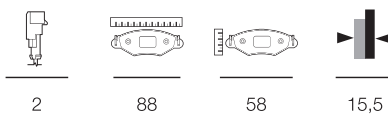
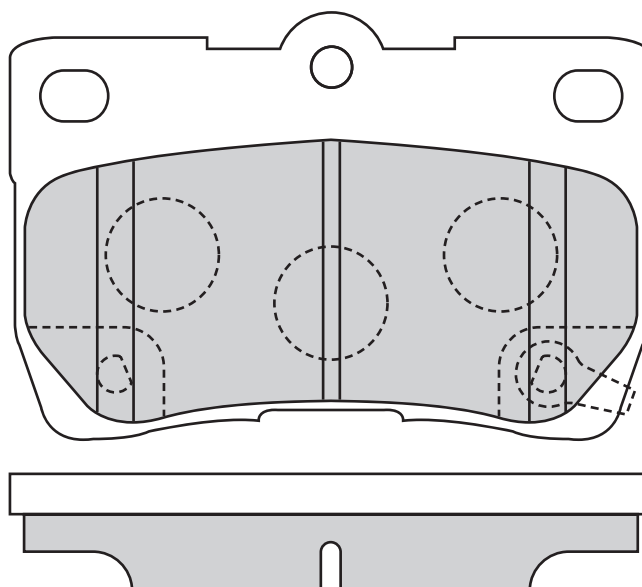

2

88

58

15,5

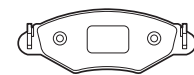

601270

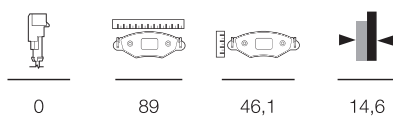
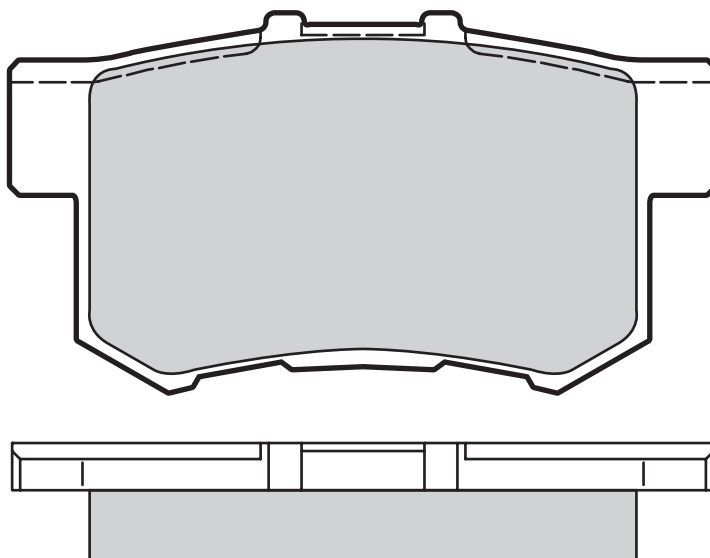

0

89

46,1

14,6

601271

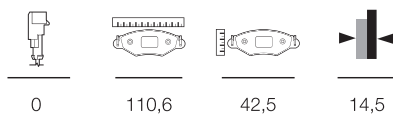
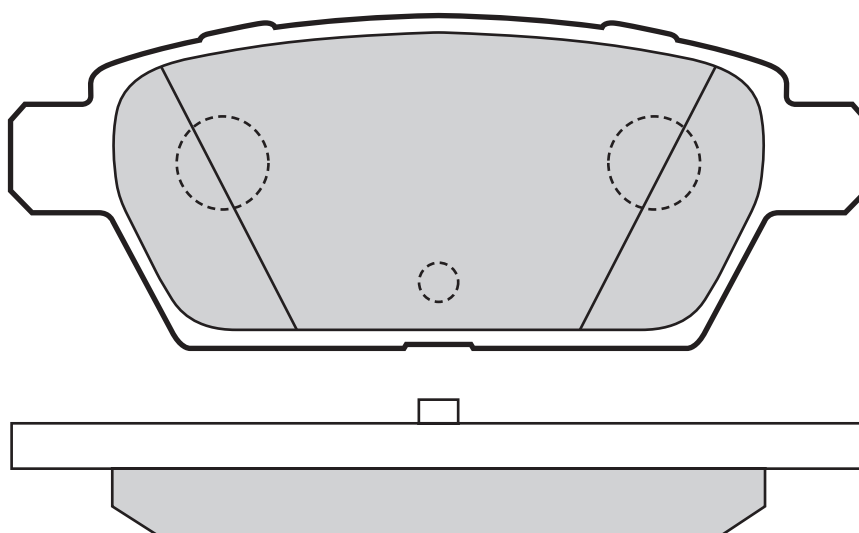

0

110,6

42,5

14,5



## 601273

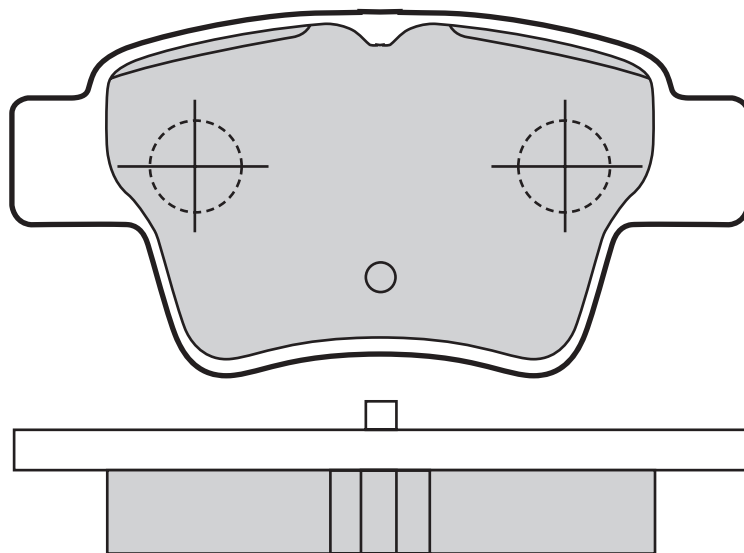

0	95,2	46,9	16,6

## 601274

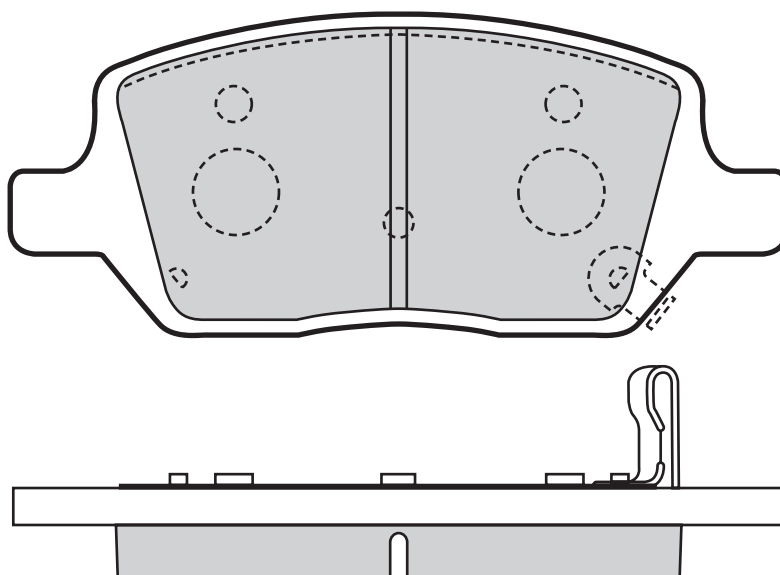

2	124,8	51	14,1





## 进口刹车片图片 Imported Range Image

### Pads and Discs

Plaquettes et Disques

### Pastillas y Discos

Pastilas e Discos

### Pastiglie e Dischi

Blokjes en Schijven

### Bremsbeläge und Bremsscheiben

Klocki i Tarcze

### Balatalari ve Diskleri

Κολοδκι и Дискки

Δισκόφρενα & Δισκόπλακες

刹车片和刹车盘

بطانات و قرص





20224 (WVA)

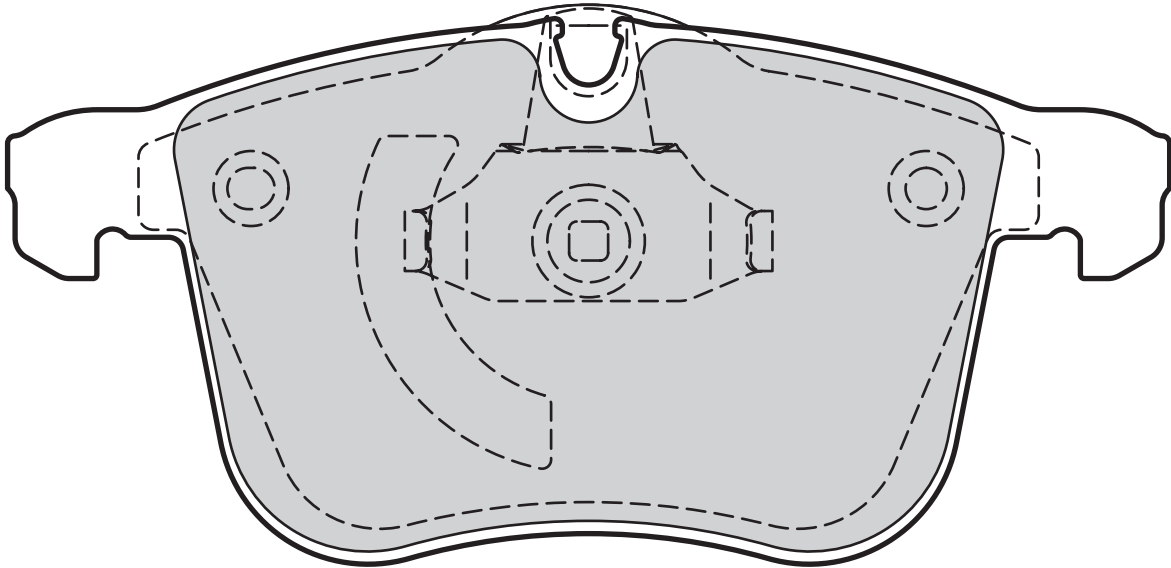
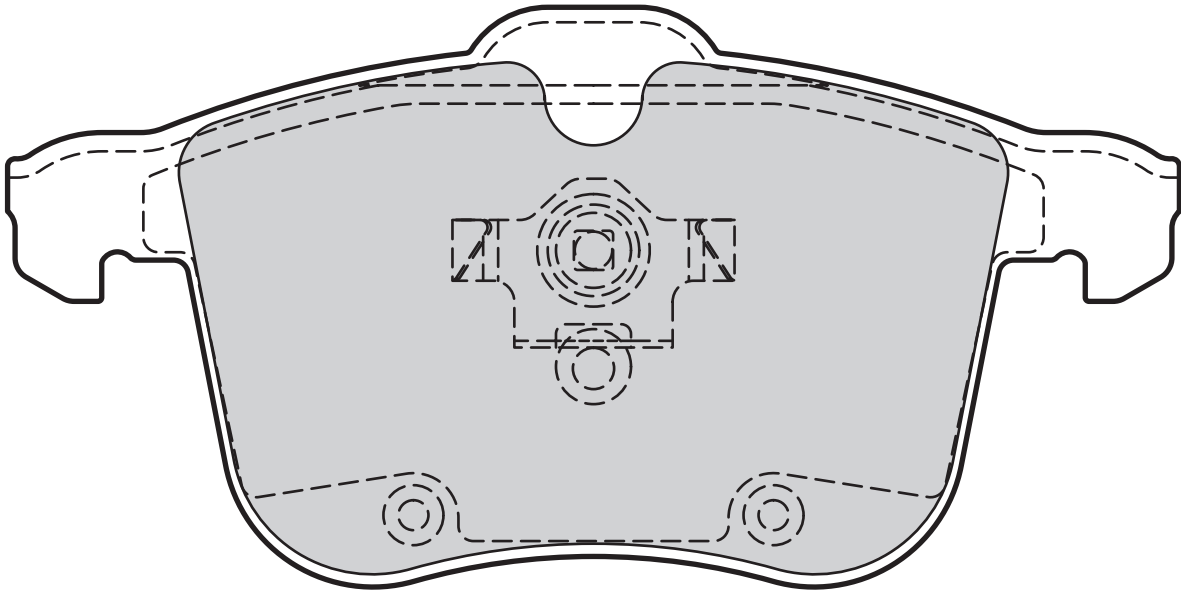

**Valeo**



598808

0



156,2



72,7



20,4



TEVES



# Valeo

## 20635 (WVA)

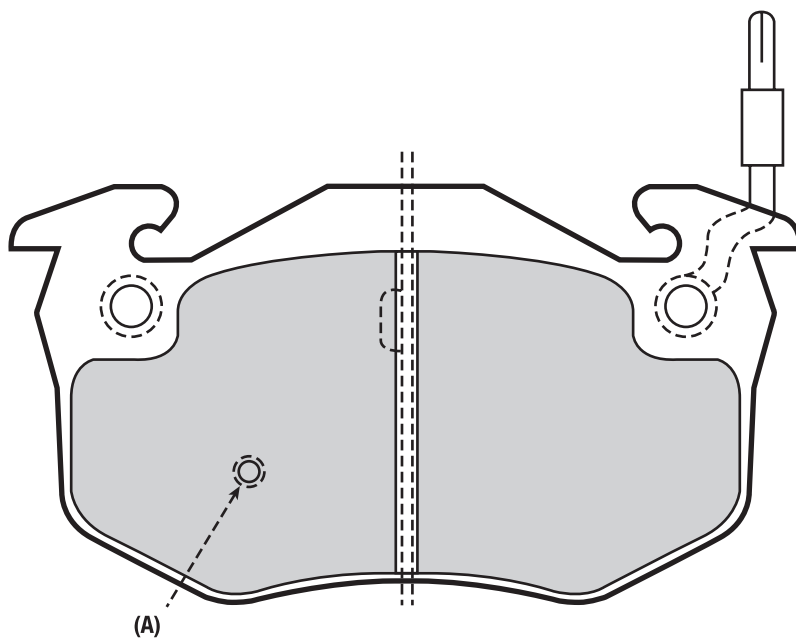

**Valeo**



598396

0

105

54,7

11

BENDIX

## 20772 (WVA)

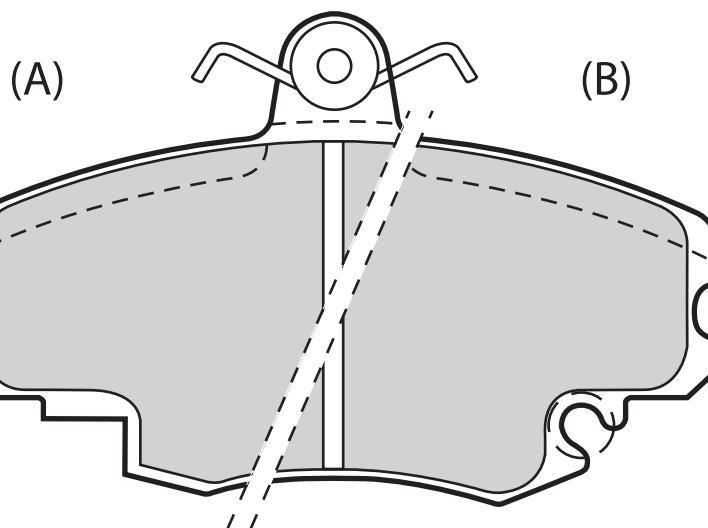

**Valeo**



598002

2(B)

100,2

64,9

18,2

LUCAS



## 20916 (WVA)

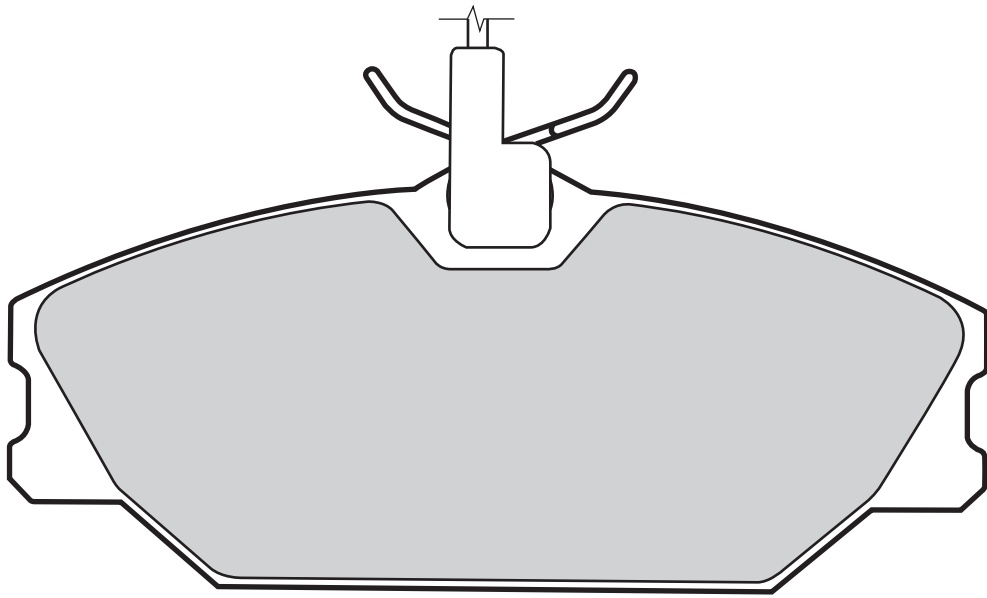

**Valeo**



598061

2

130

55

18

LUCAS

598473

0

129

55,6





18

LUCAS

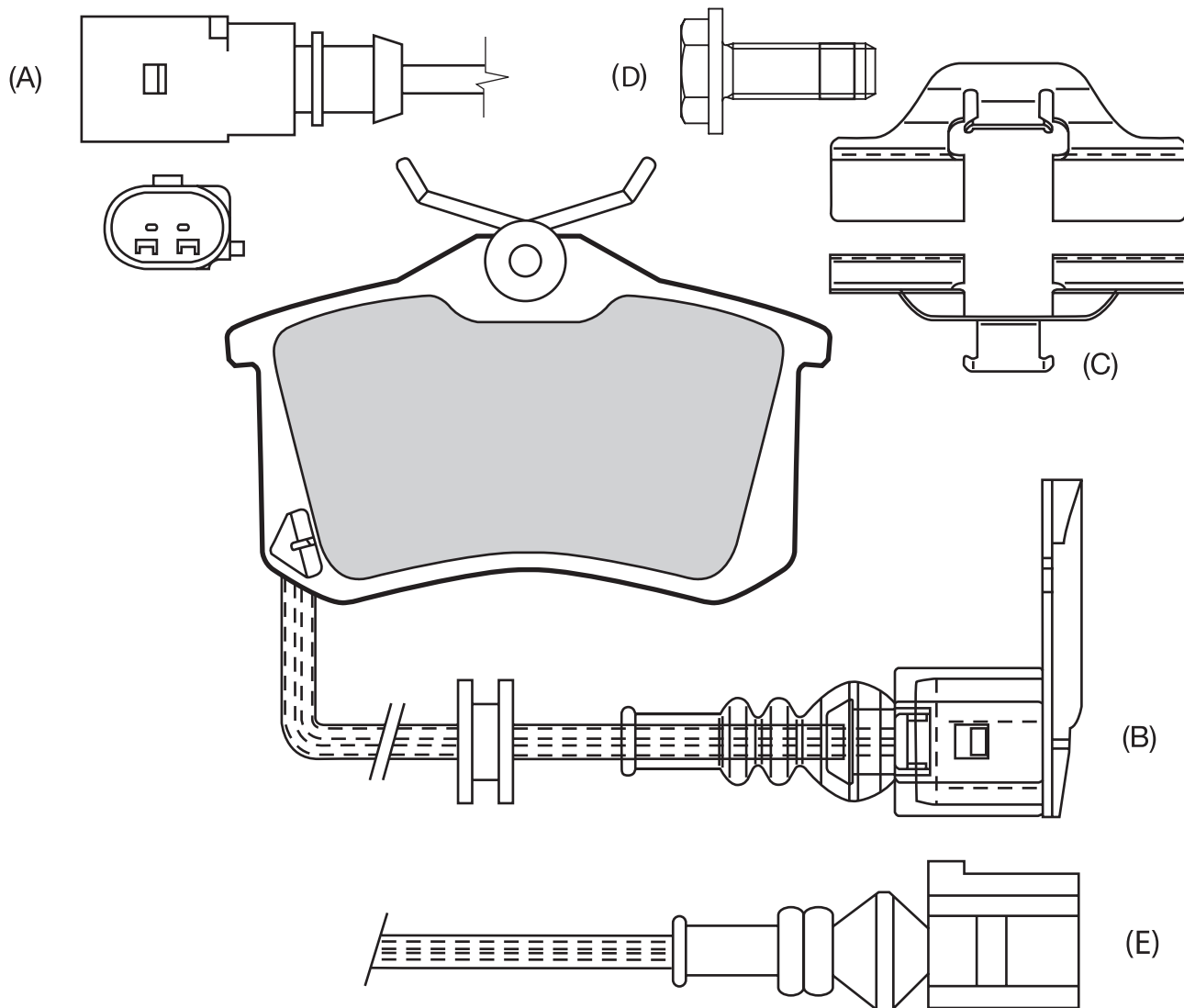

## 20960 (WVA)



Valeo					
598180	0(D)	87	53	15,2	LUCAS
598463	0(D)	87	53	17	LUCAS
598474	0(D+C)	87	53	16	LUCAS



## 21016 (WVA)

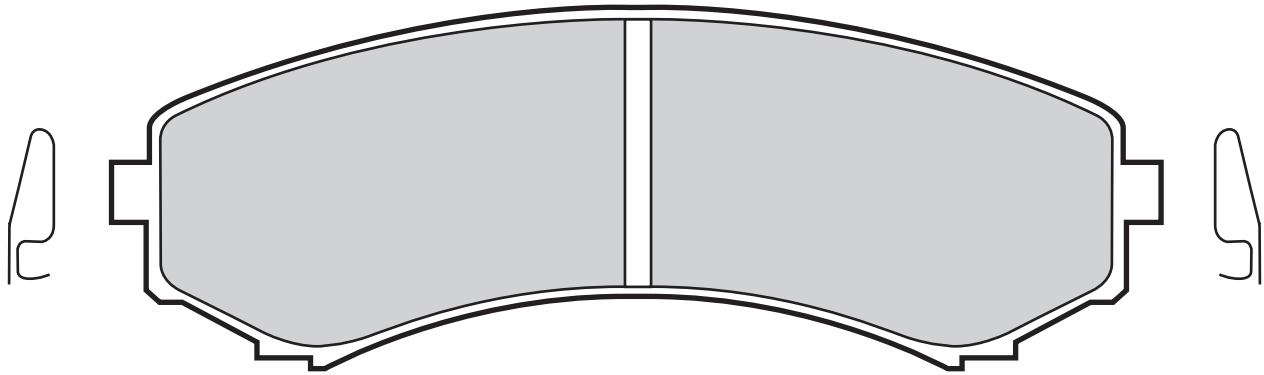

598518	2	139	58,5	16	SUMITOMO

## 21051 (WVA)

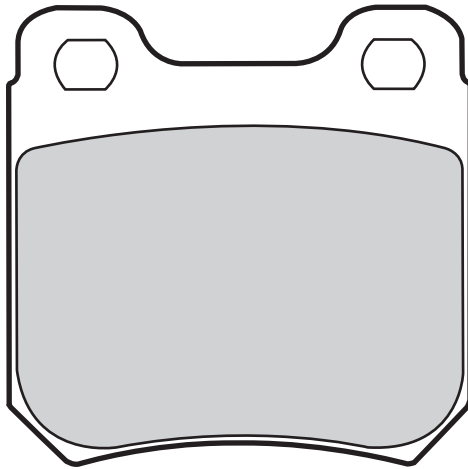

598183	0	61,7	61,2	15,7	TEVES



# Valeo

## 21064 (WVA)

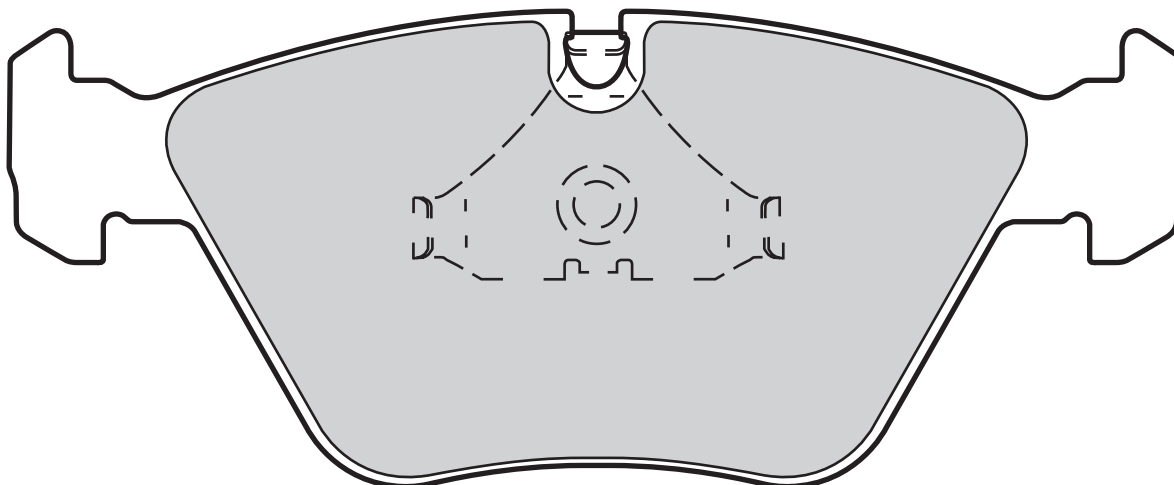

**Valeo**



598409

0

155,4

63,6

20

TEVES

## 21142 (WVA)

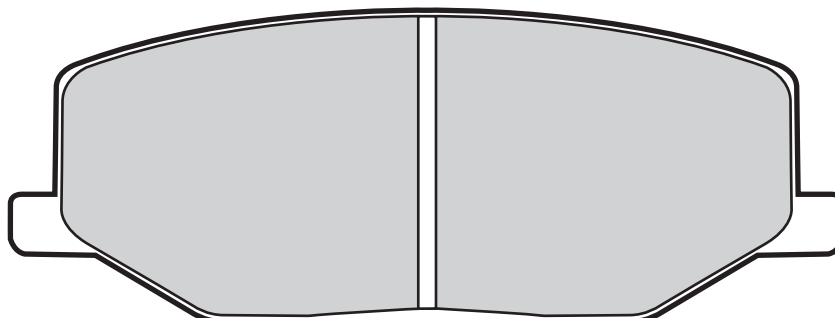

**Valeo**



598021

0

110,3

41,5

15

AKEBONO





## 21153 (WVA)

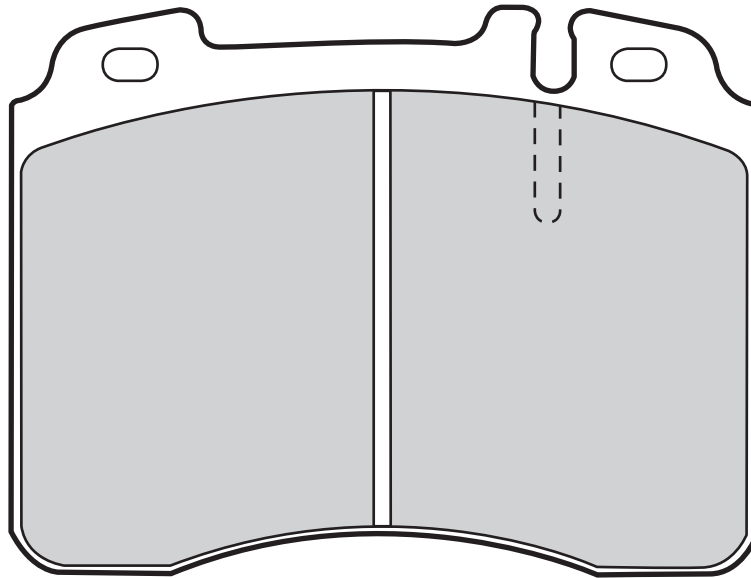

598601	0	98,8	73,5	16	TEVES

## 21195 (WVA)

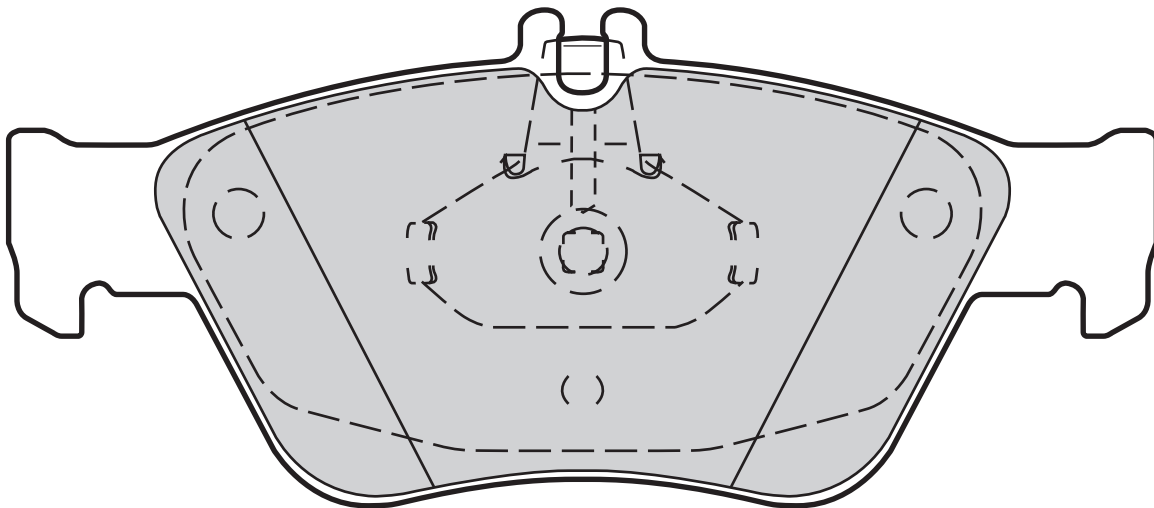

598357	0	151,4	66,1	19,3	TEVES



# Valeo

## 21197 (WVA)

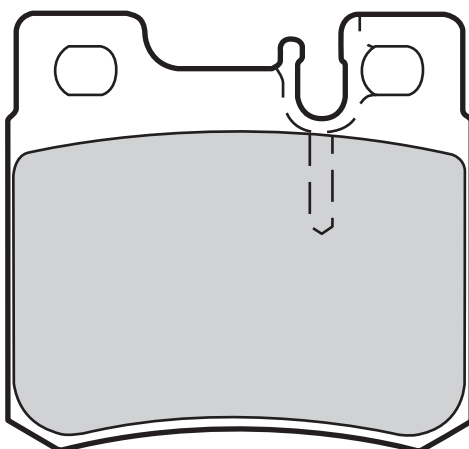

598272	0	61,6	58,6	15	TEVES

## 21201 (WVA)

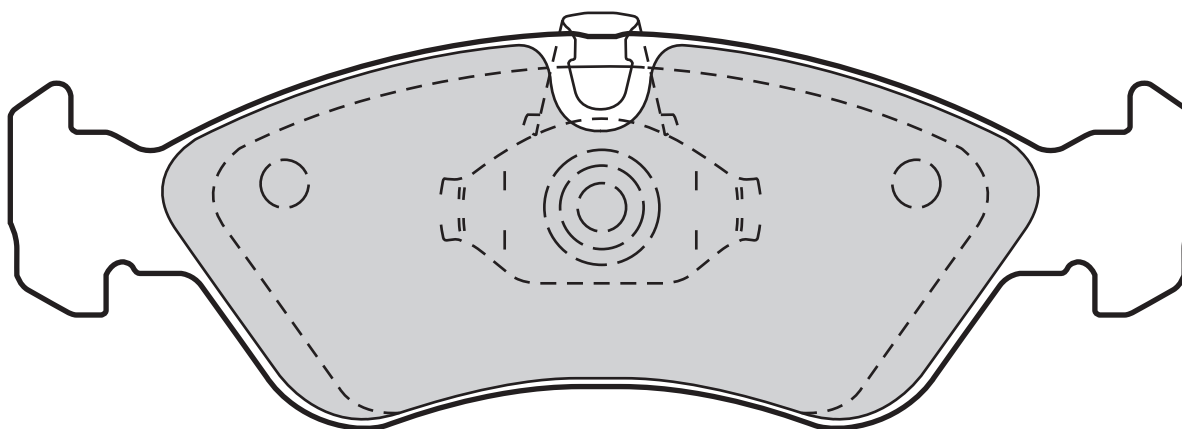

598184	0	156,3	52,6	17	TEVES

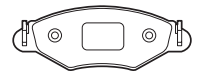

**21237 (WVA)**

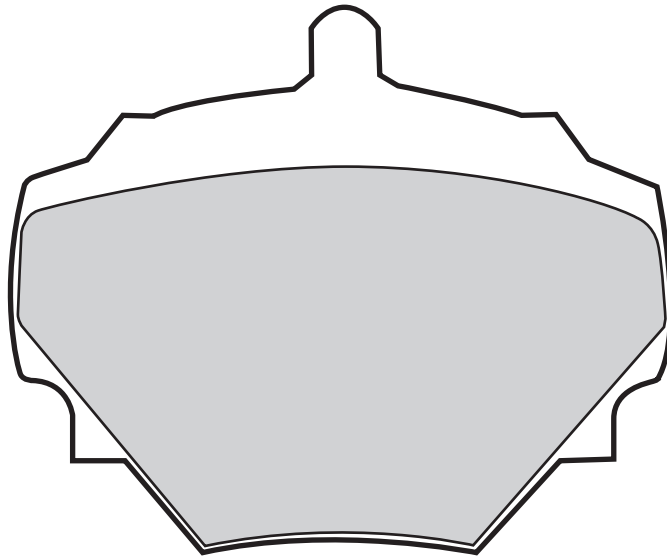

598497	1	88,6	72	15,5	AP

**21279 (WVA)**

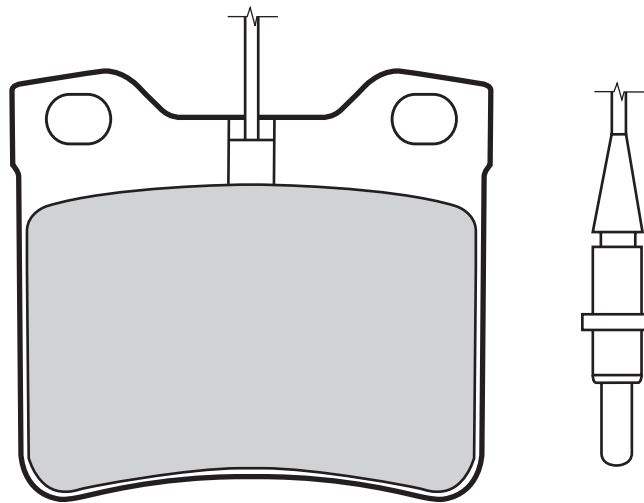

598063	0	63,5	57	16,4	TEVES



# Valeo

## 21282 (WVA)

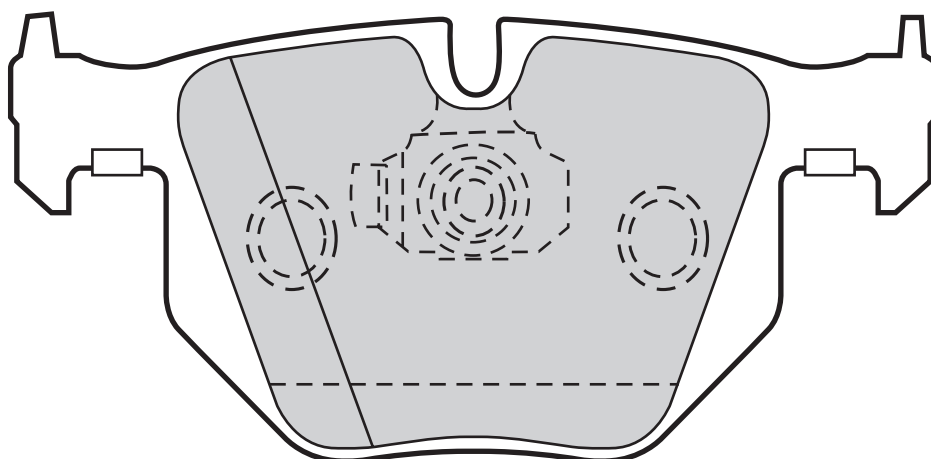
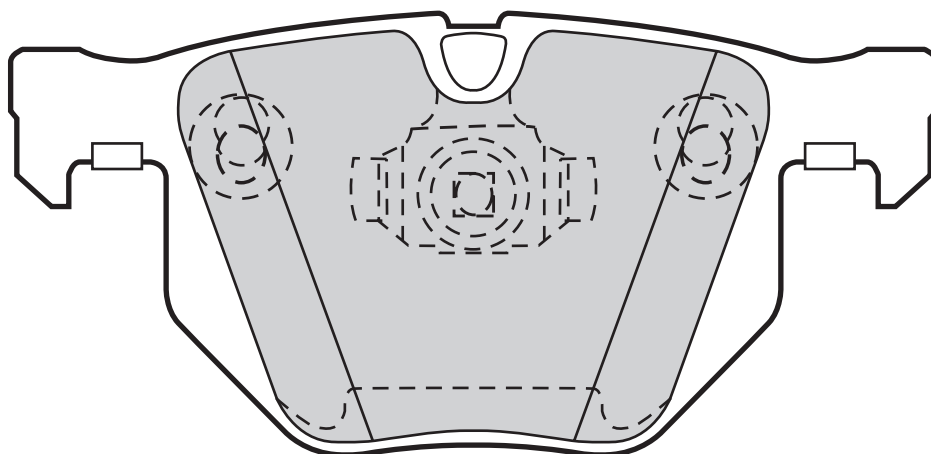

**Valeo**



598411

0

123,1

58,2

17

TEVES

## 21292 (WVA)

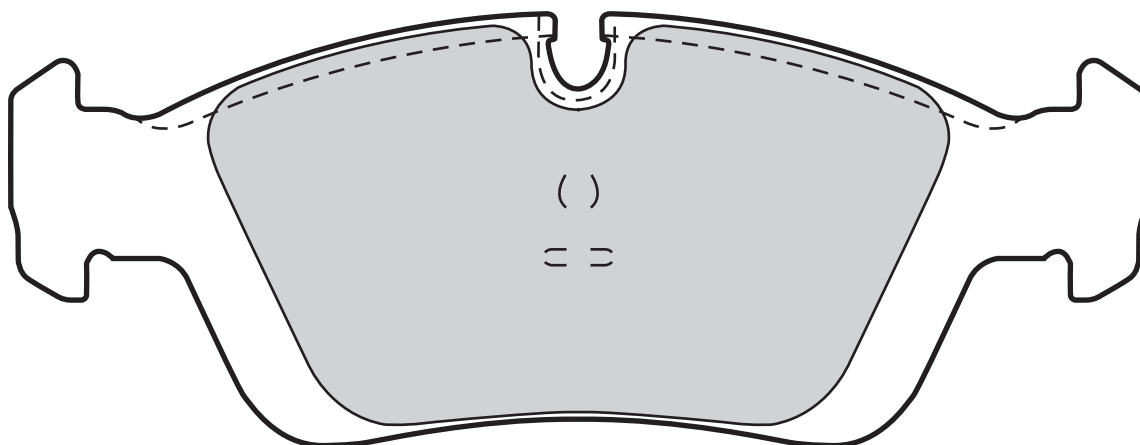

**Valeo**



598018

0

151,3

57

17,3

TEVES



## 21305 (WVA)

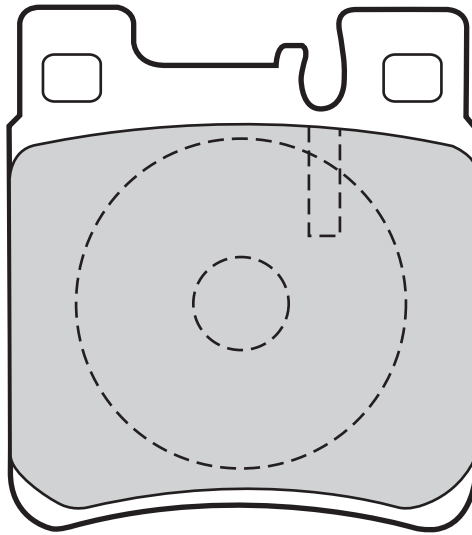

598617



0



61,7



69,6



15,5



TEVES

## 21365 (WVA)

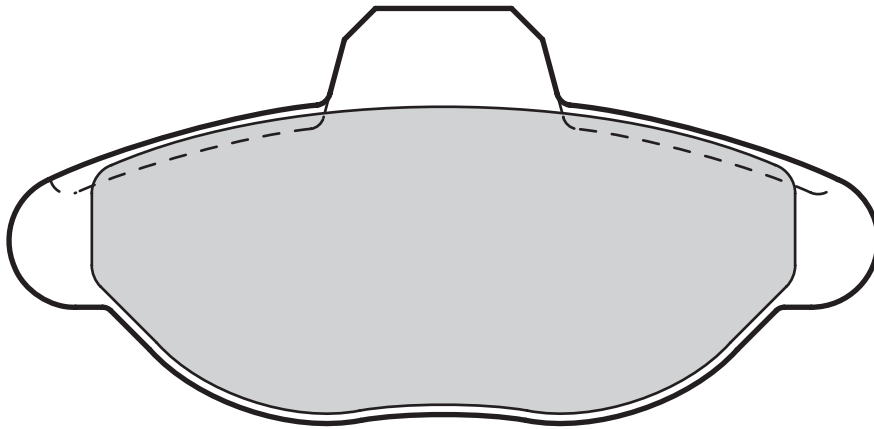

598012



0



115



55,3



17



BENDIX



# Valeo

## 21368 (WVA)

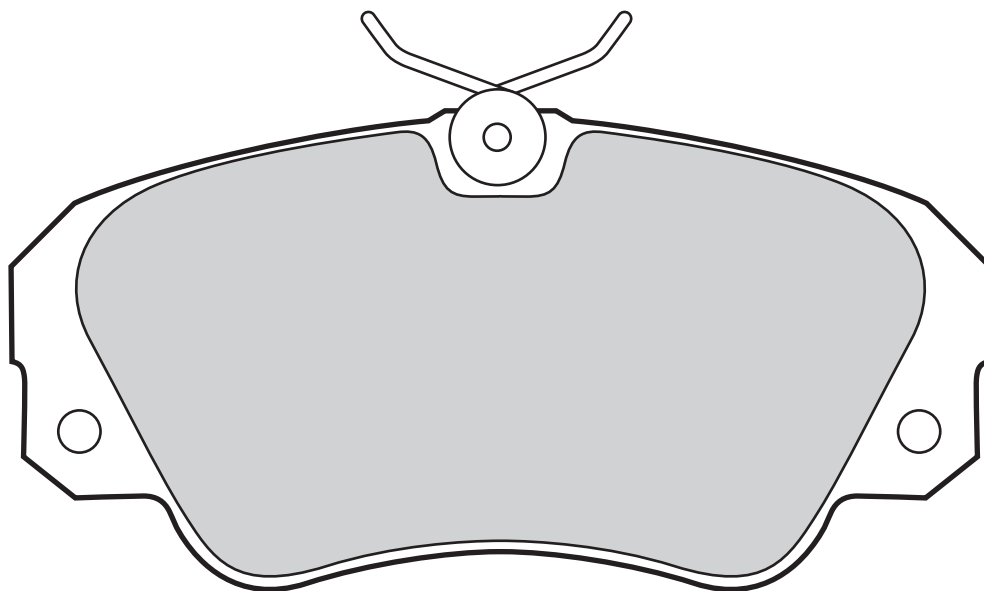

**Valeo**



598256

0

129,8

63,9

18,6

LUCAS

## 21370 (WVA)

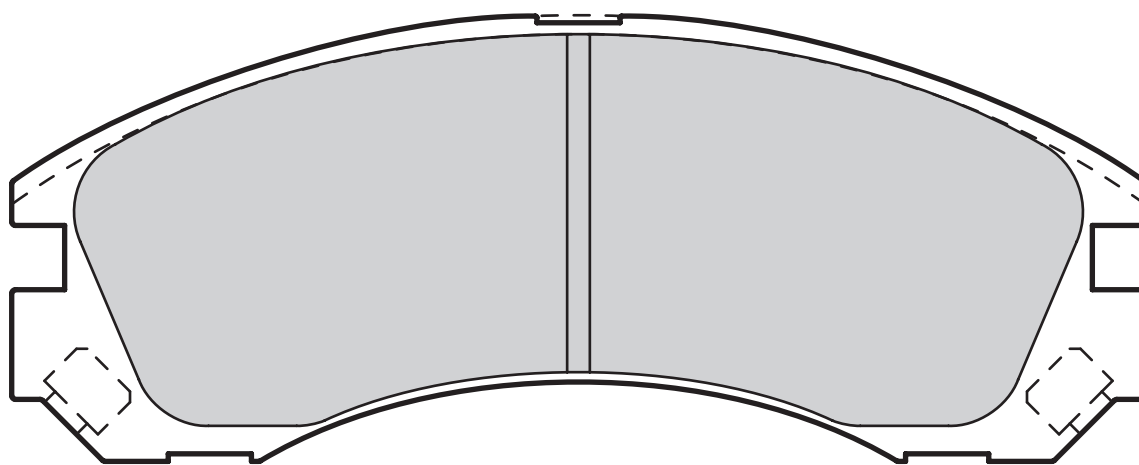

**Valeo**



601020

2

149,9

59

15,7

AKEBONO

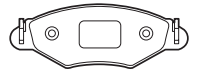

**21484 (WVA)**

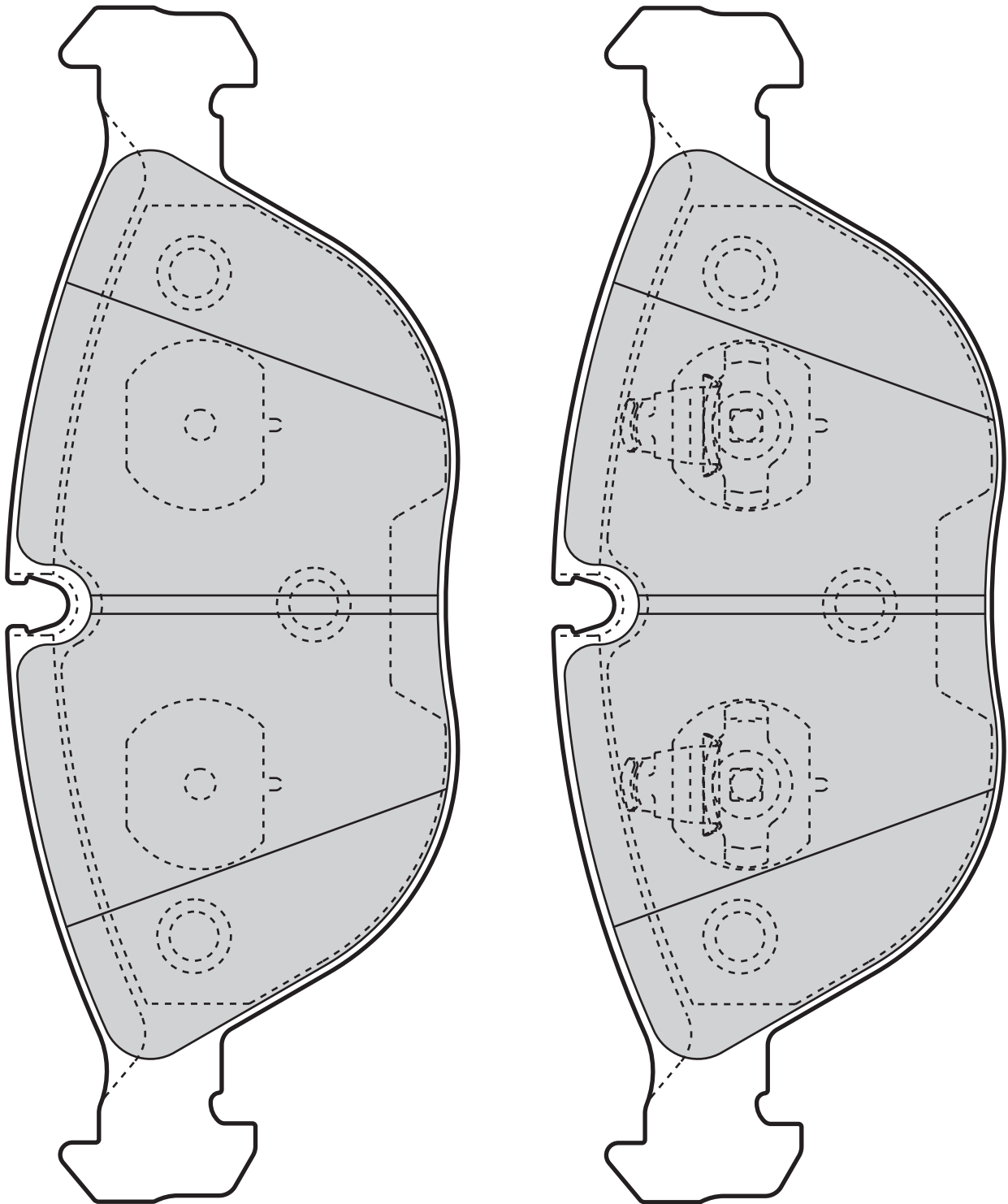

598712

1

194,5

73,5

20,5

TEVES



# Valeo

## 21487 (WVA)

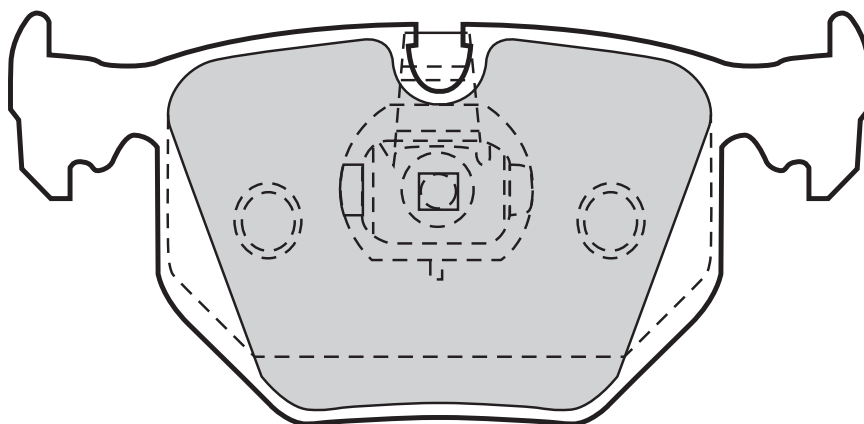

**Valeo**



598580

0

123,1

59,2

17

TEVES

## 21490 (WVA)

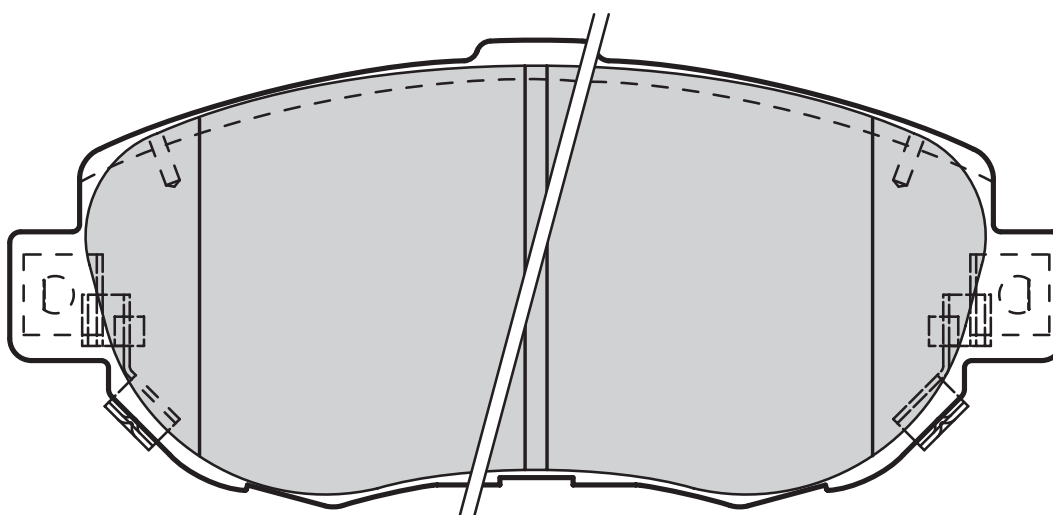
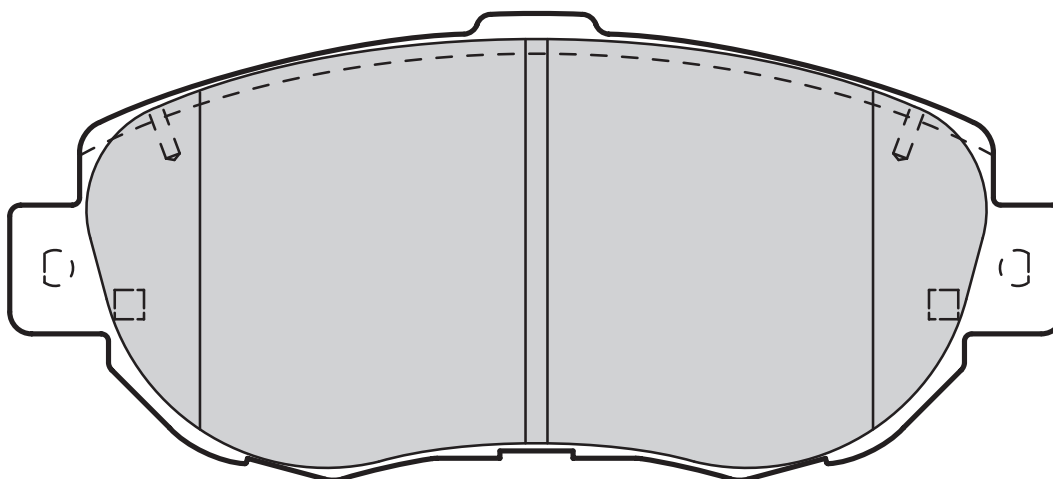

**Valeo**



601023

2

144

63,8

17

SUMITOMO



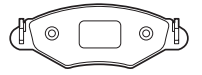

## 21519 (WVA)

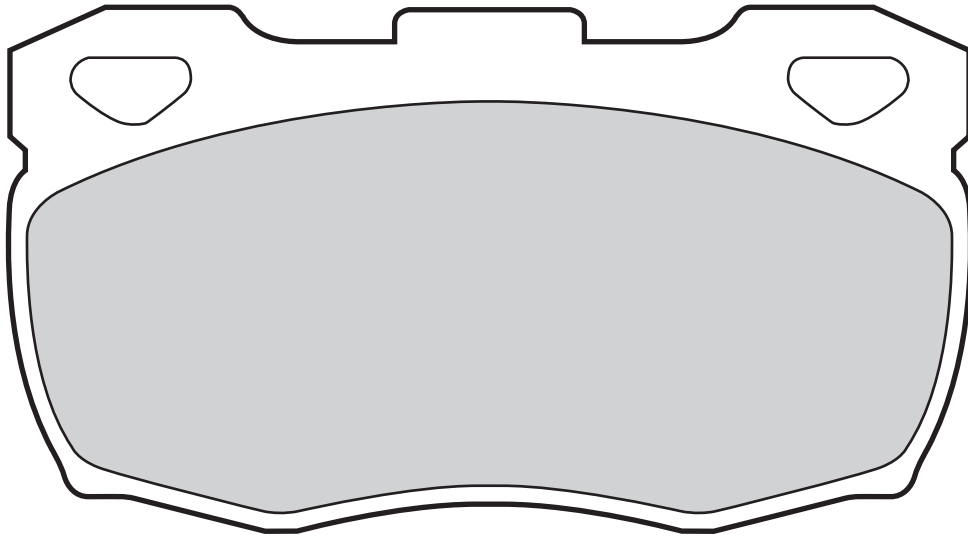

**Valeo**



598623

0

127

68,6

18

AP



# Valeo

## 21637 (WVA)

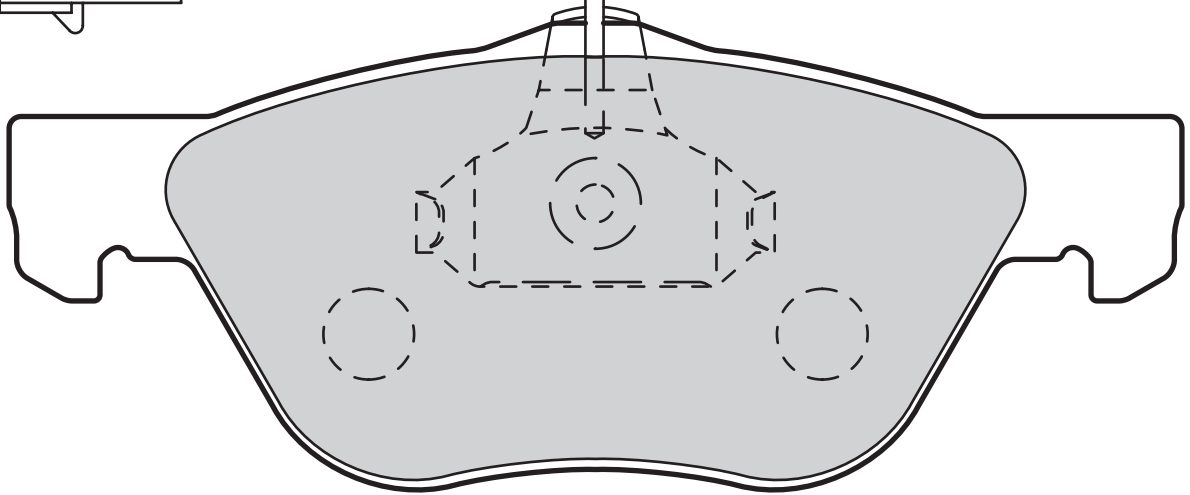
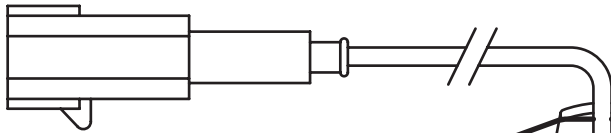
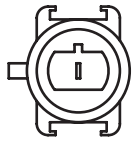
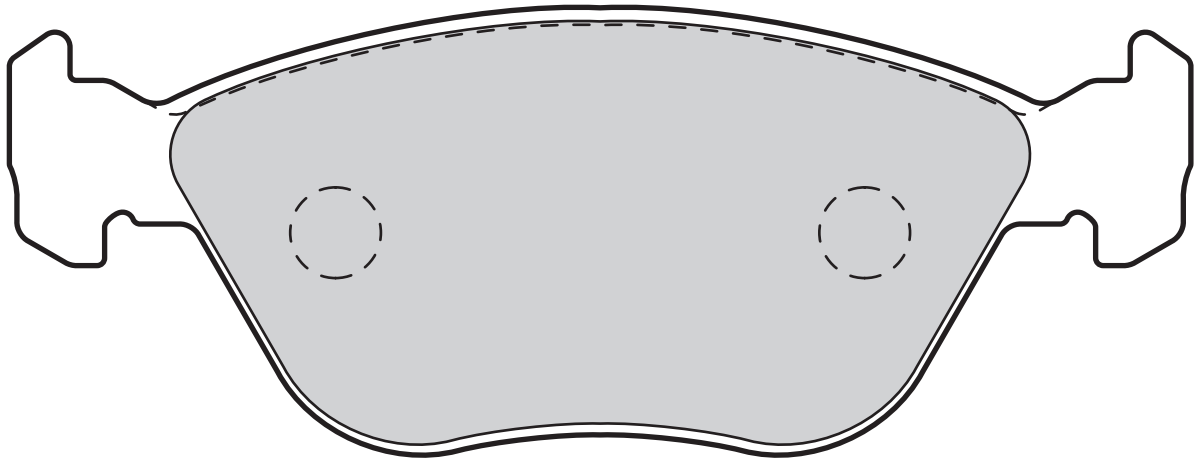

**Valeo**



598990

1

155,2

61,8

19,3

TEVES



21670 (WVA)

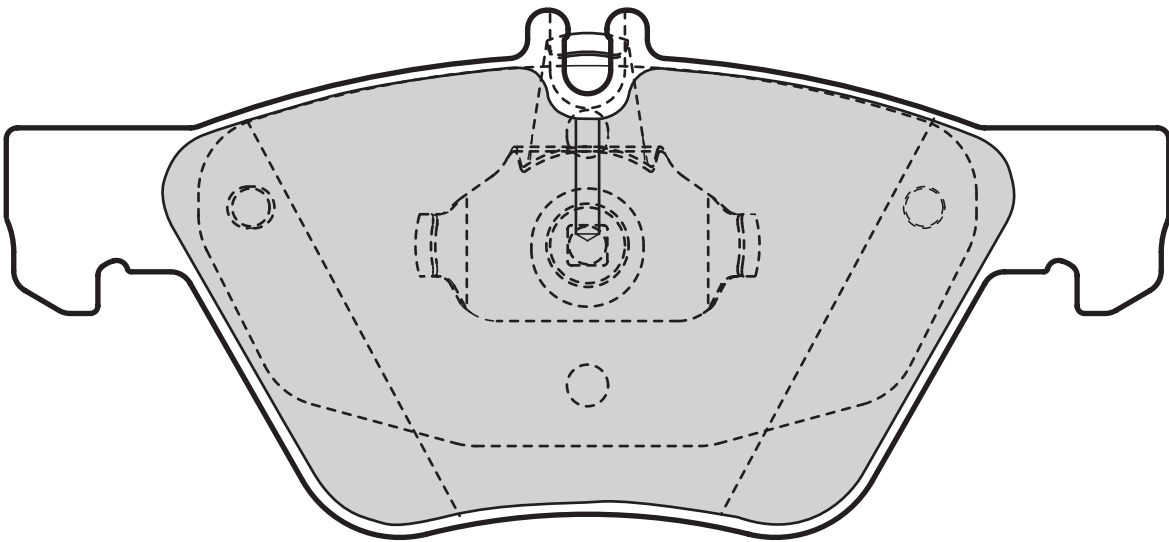
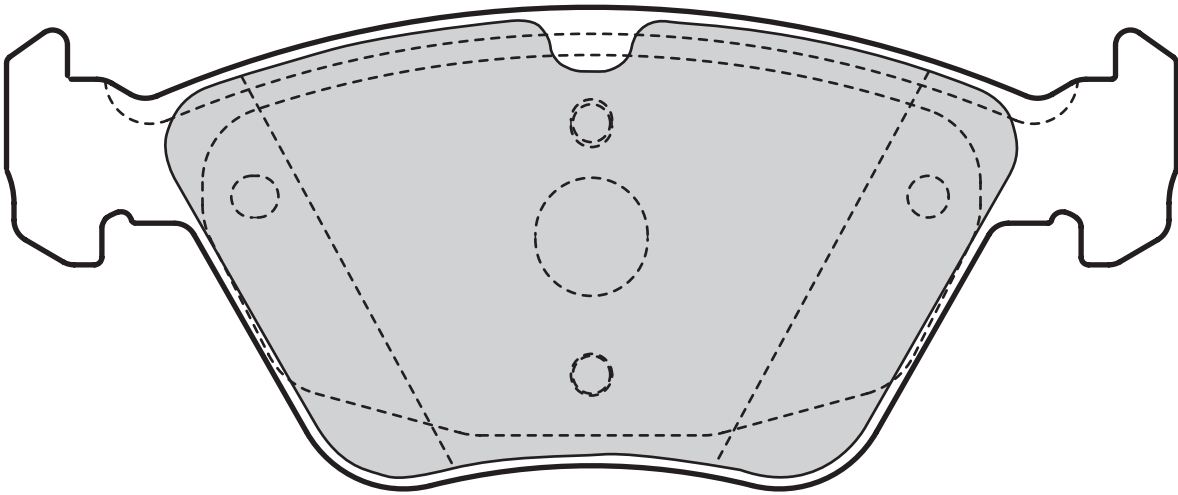

Valeo



598636

0



156,3



69,5



20,3



TEVES



# Valeo

## 21677 (WVA)

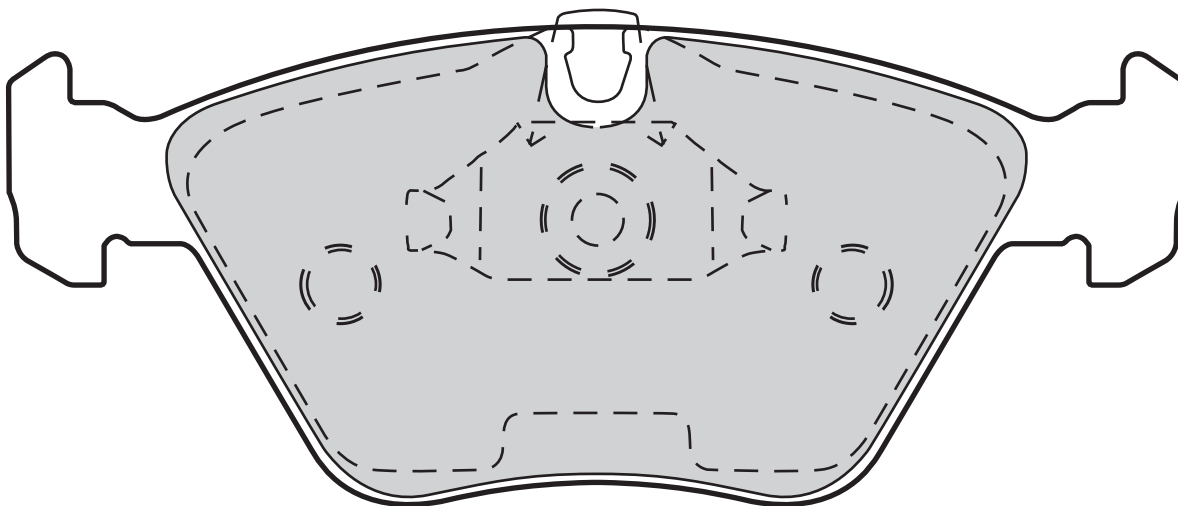

**Valeo**



598310

0

156,4

64

20,3

TEVES

## 21691 (WVA)

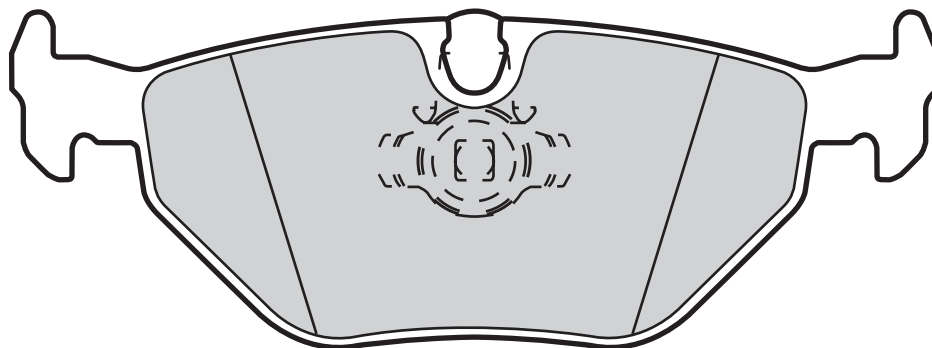

**Valeo**



598311

0

122

45

17,3

TEVES



## 21732 (WVA)

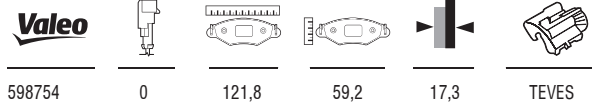
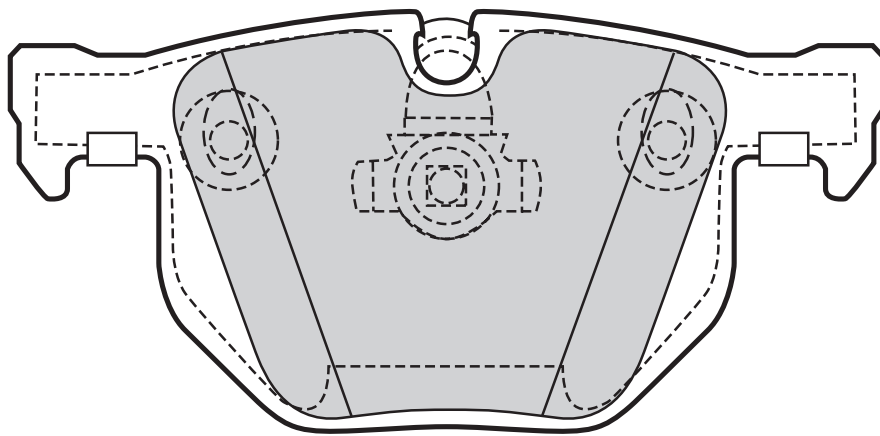
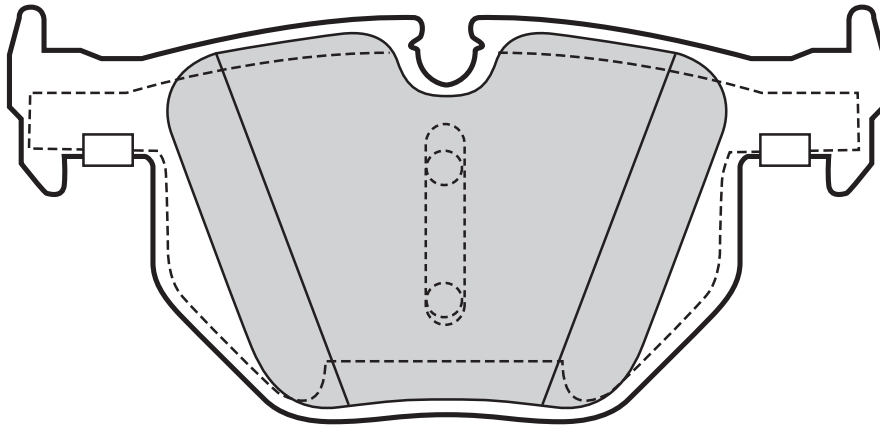

598754    0    121,8    59,2    17,3    TEVES

## 21792 (WVA)

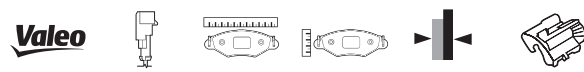
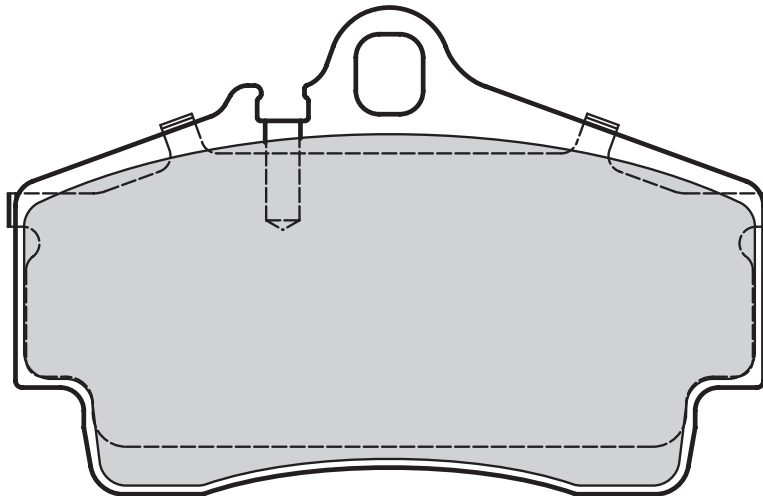

598768    0    112,2    73,2    16    BREMBO



# Valeo

## 21822 (WVA)

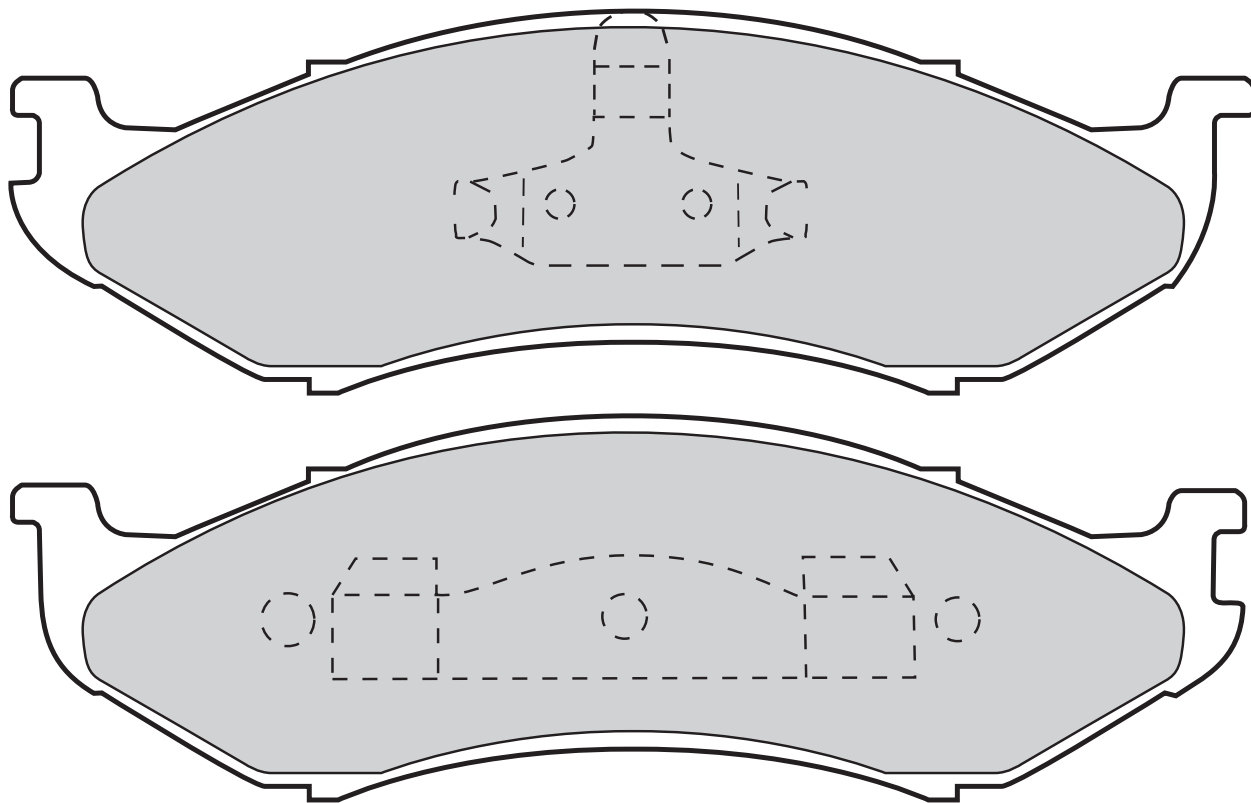

598491	0	177	55	17,1	KELSEY

## 21829 (WVA)

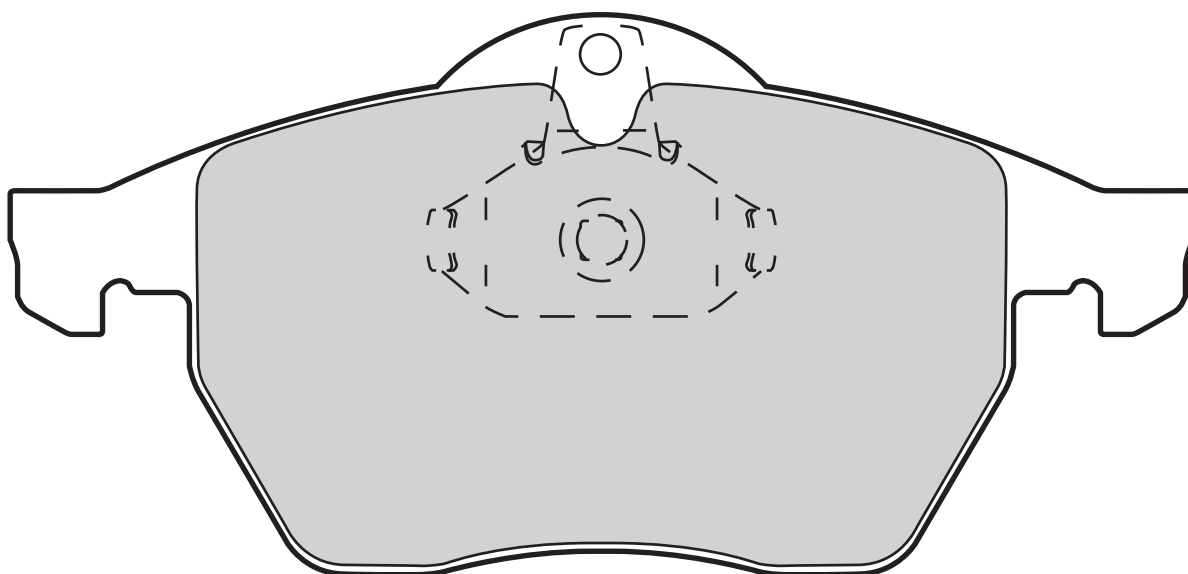

598305	0	156,3	74,2	20,3	TEVES



## 21861 (WVA)

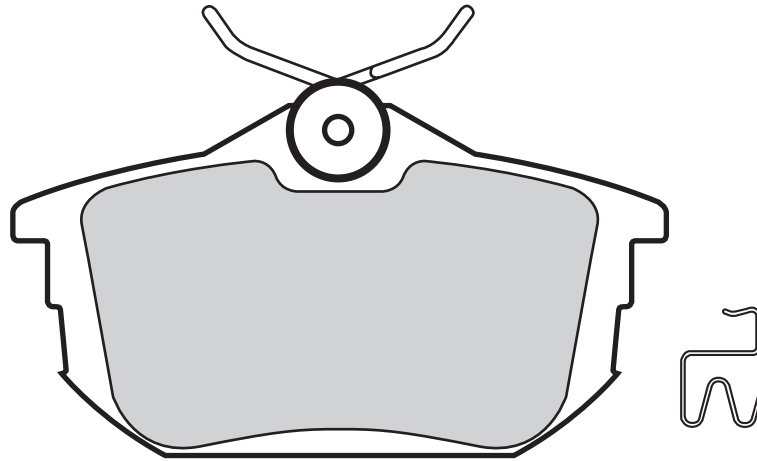

**Valeo**



598319

2

87,3

47

15,3

LUCAS

## 21899 (WVA)

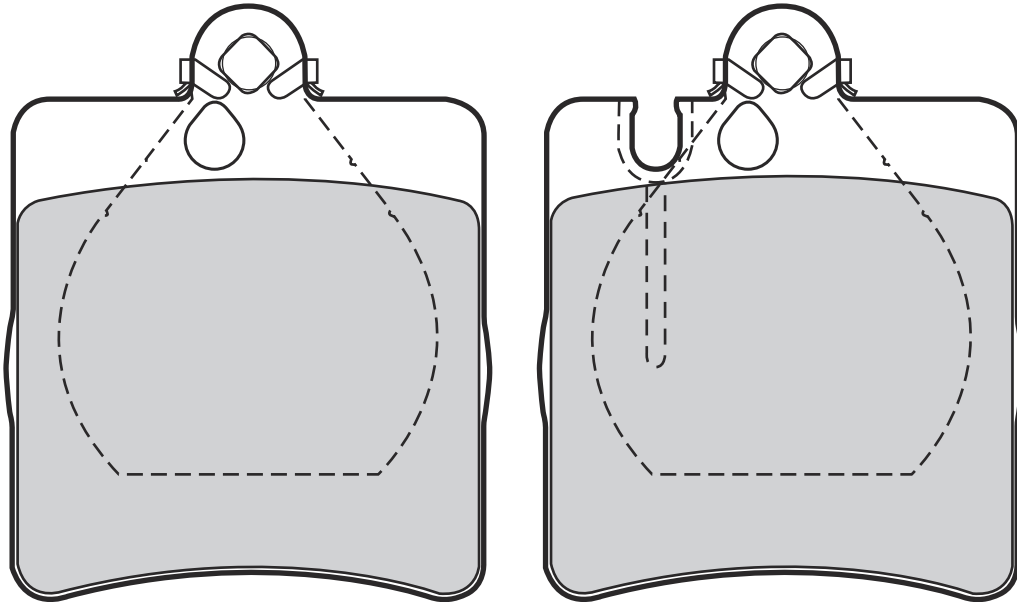

**Valeo**



598447

0

63,7

78,2

15,3

TEVES



# Valeo

## 21911 (WVA)

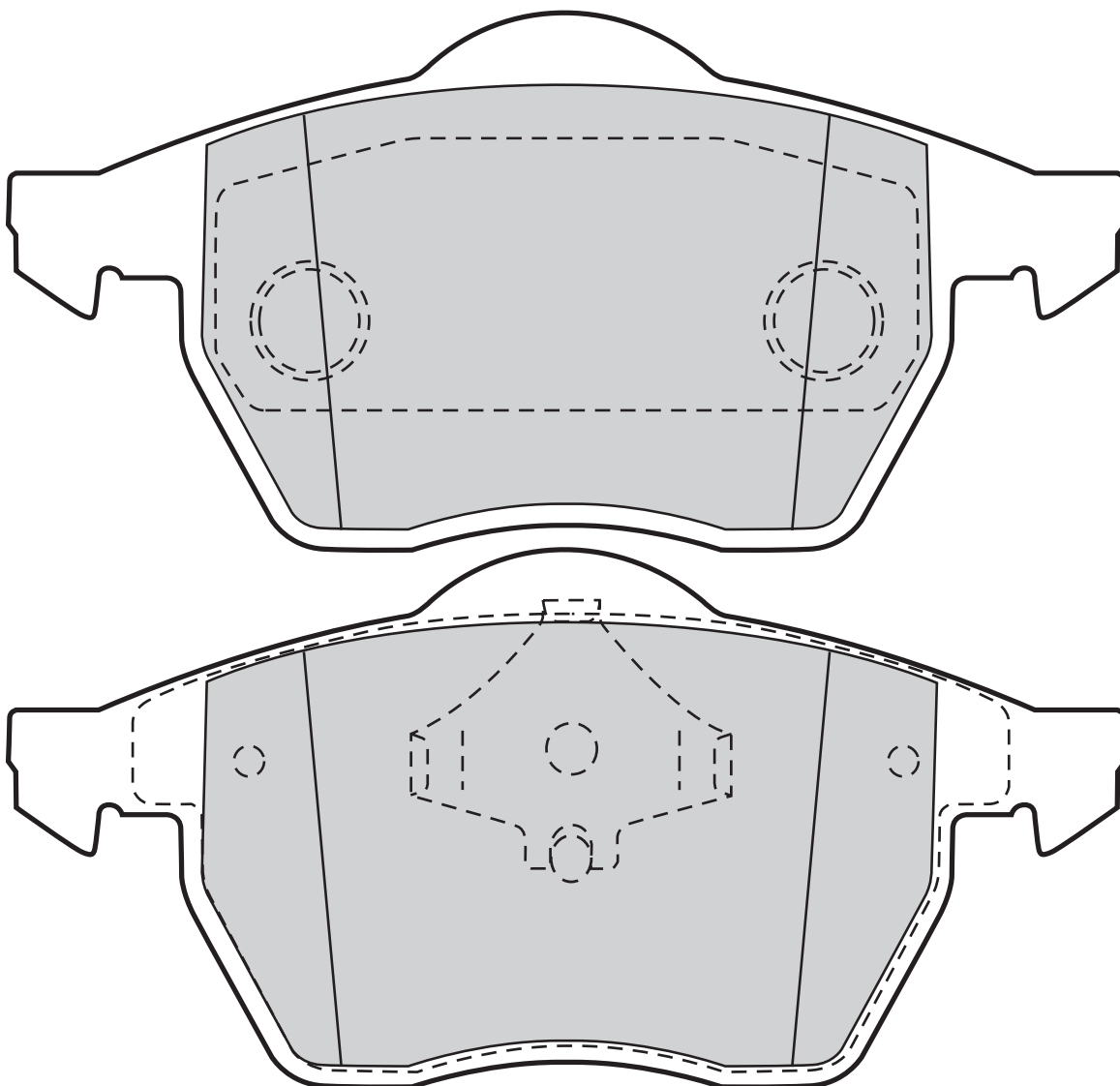

Valeo					
598303	0	156,3	74	19,8	TEVES
598486	1	156,4	74,2	20,3	TEVES



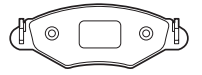

## 21919 (WVA)

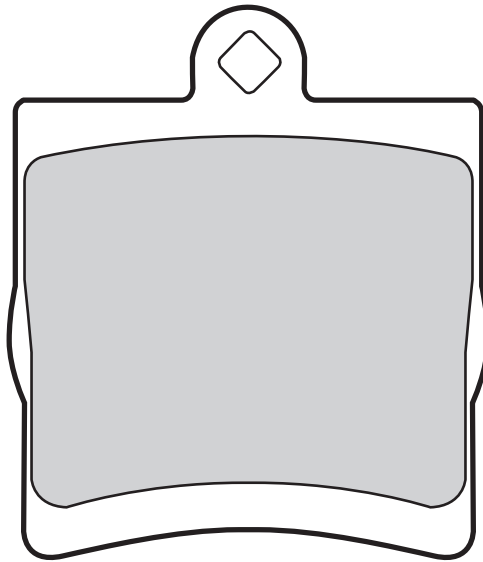

598444	0	63,7	73	15,3	TEVES

## 21920 (WVA)

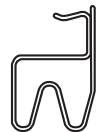
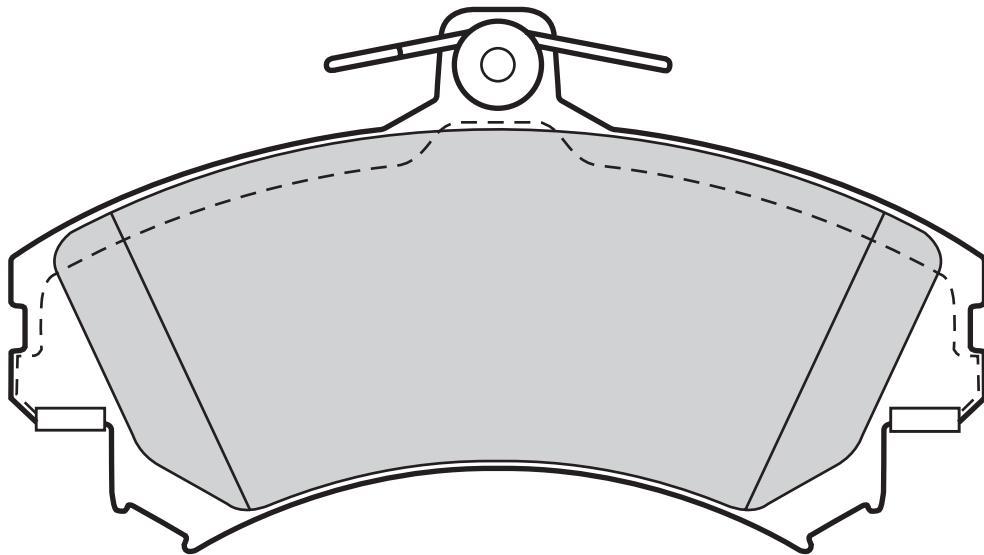

598318	2	130	72,6	15,1	LUCAS



**Valeo**

21927 (WVA)

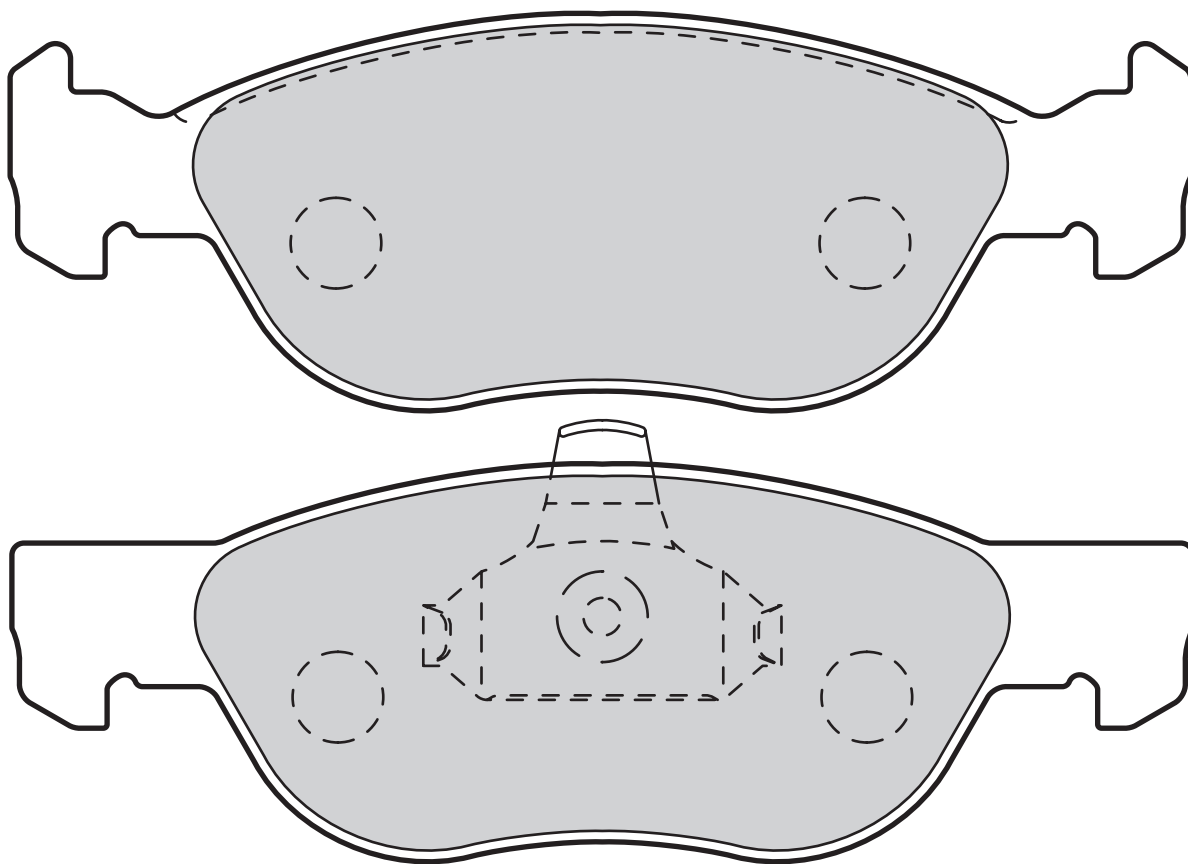

**Valeo**



601003

0

156,4

52,5

17,9

TEVES



## 21930 (WVA)

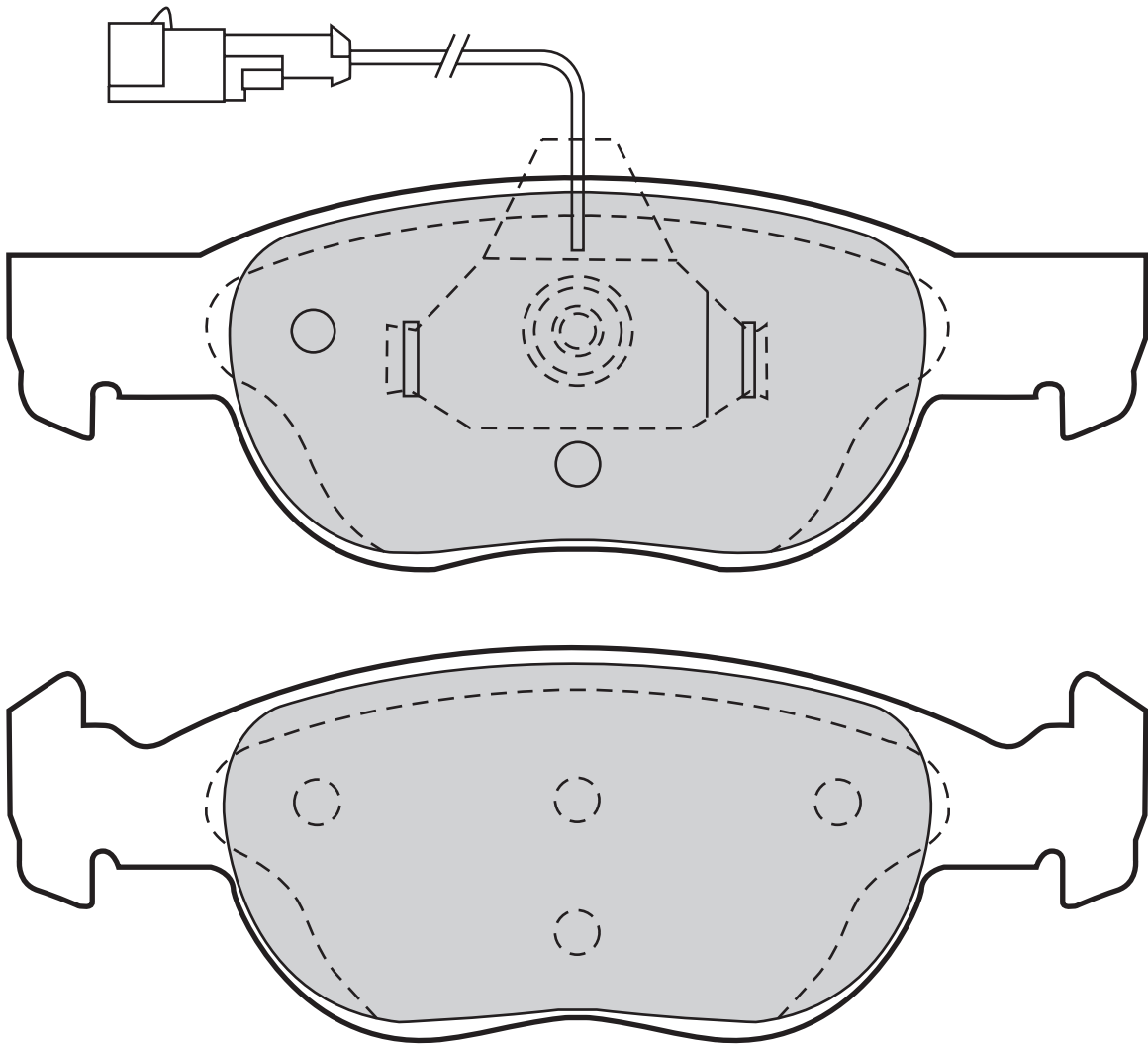

**Valeo**



598605

0



151,3



52



17,9



TEVES



**Valeo**

**21934 (WVA)**

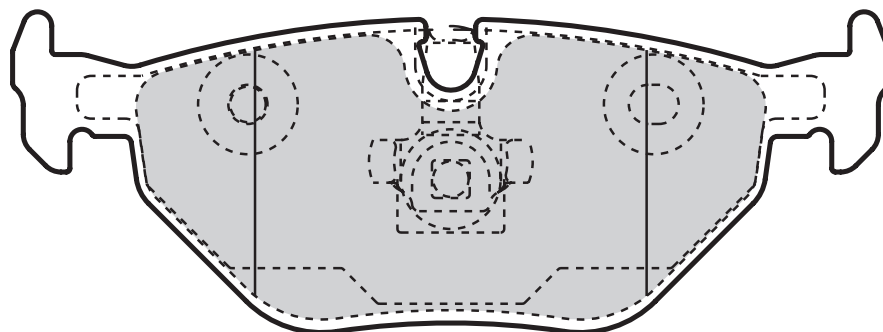
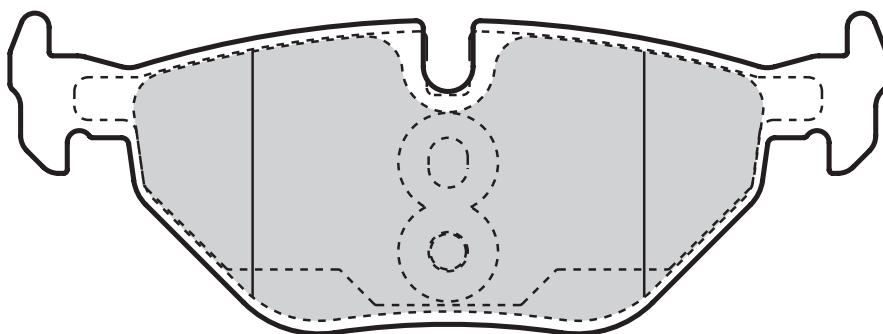

**Valeo**



598753

0

123

45

17

TEVES

**21974 (WVA)**

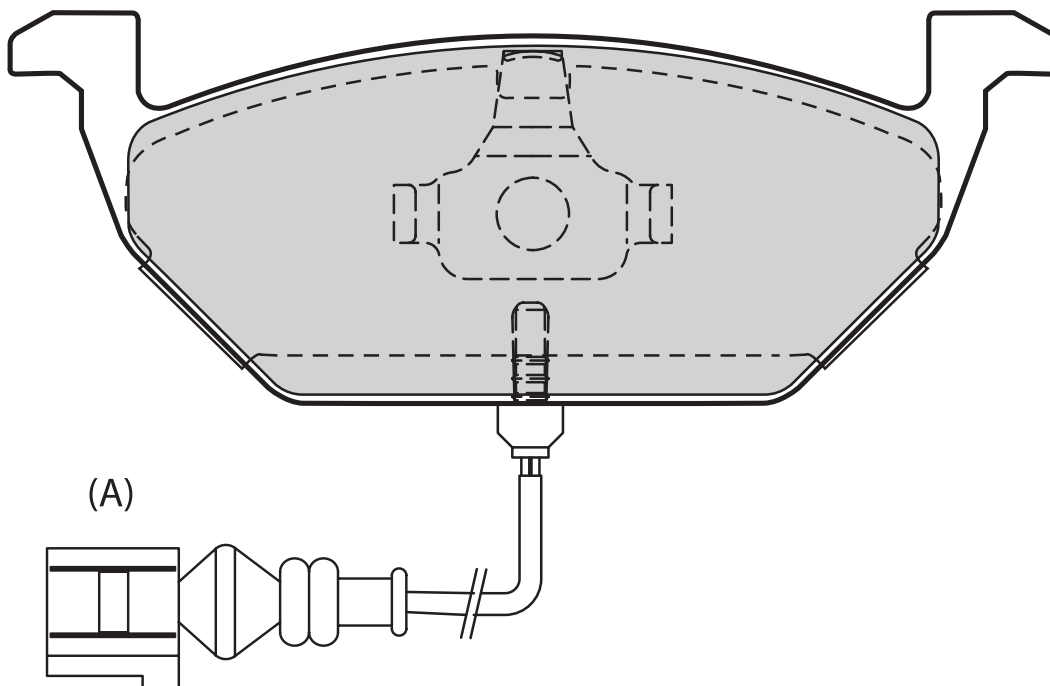

(A)

**Valeo**



598332

0

146

54,7

19,8

TEVES

598408

1

146

54,7

19,3

TEVES



**21983 (WVA)**

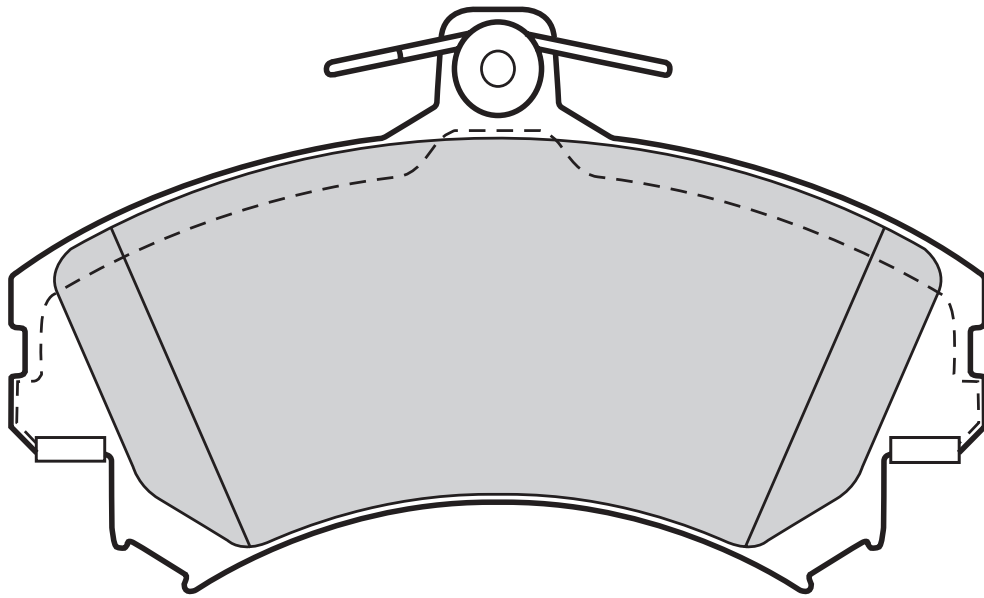

598493	0	130	77	17	LUCAS

**23021 (WVA)**

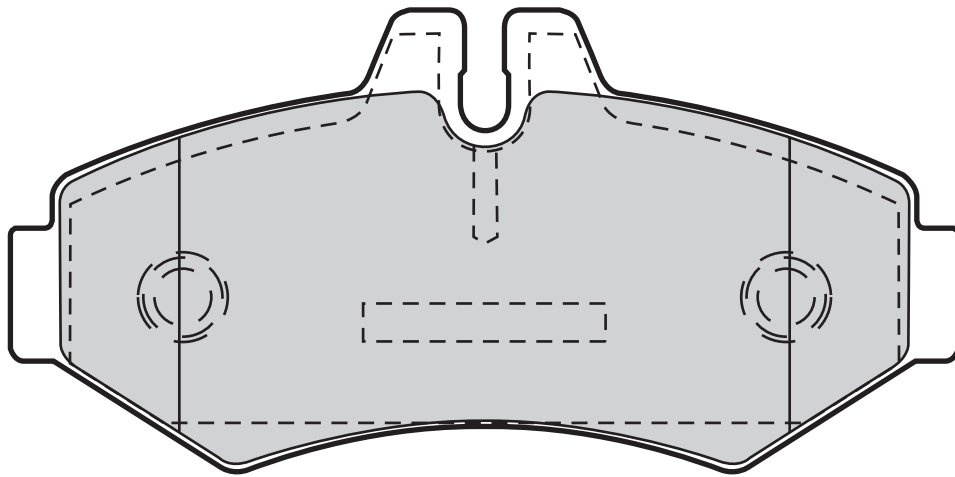

598300	0	125,7	61,8	18,4	BOSCH



# Valeo

## 23063 (WVA)

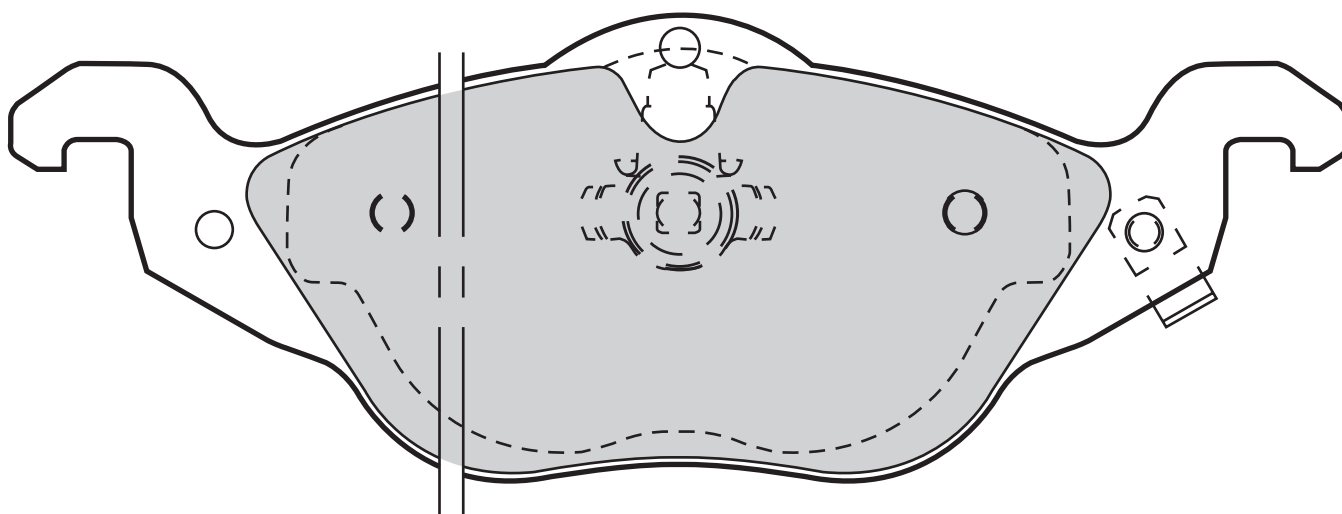
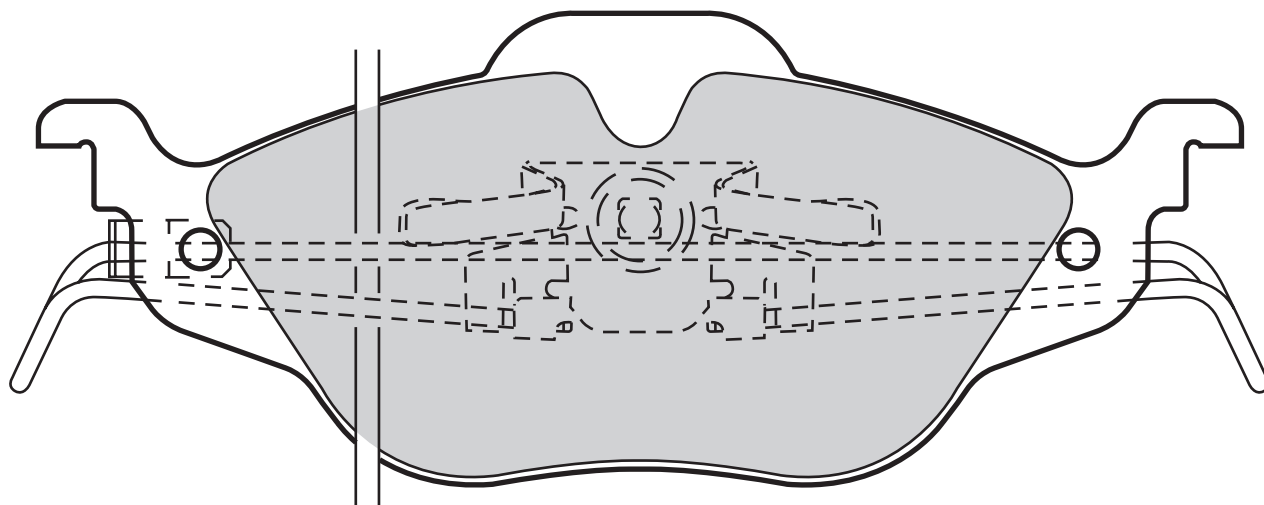

598322	4	160	62,1	18	TEVES

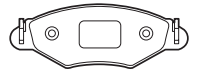

## 23072 (WVA)

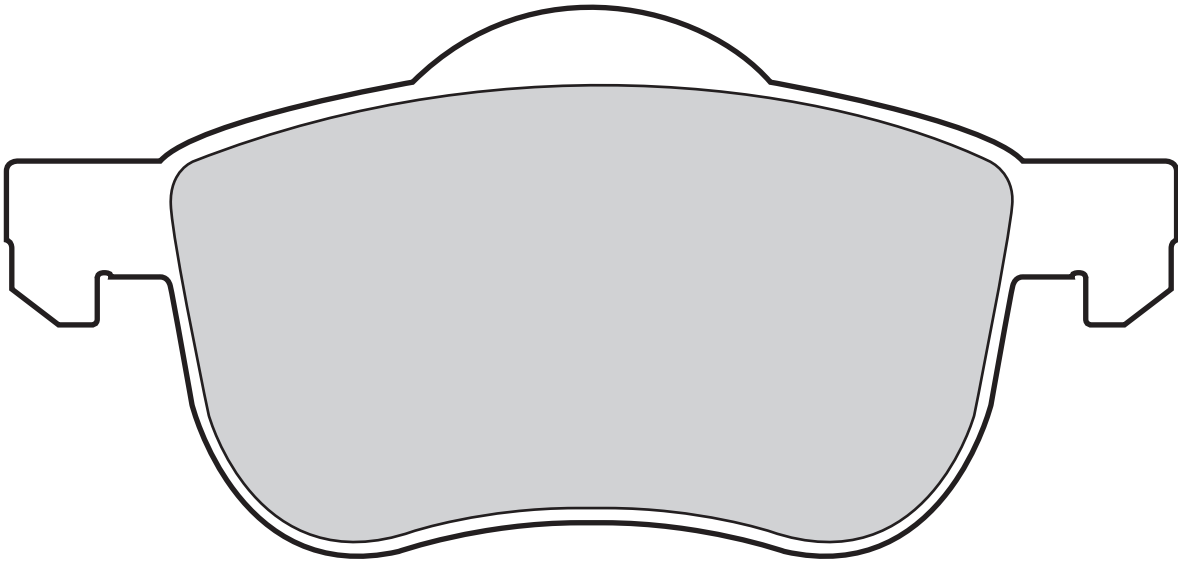

598479



0



155,4



69



18,5



TEVES

## 23075 (WVA)

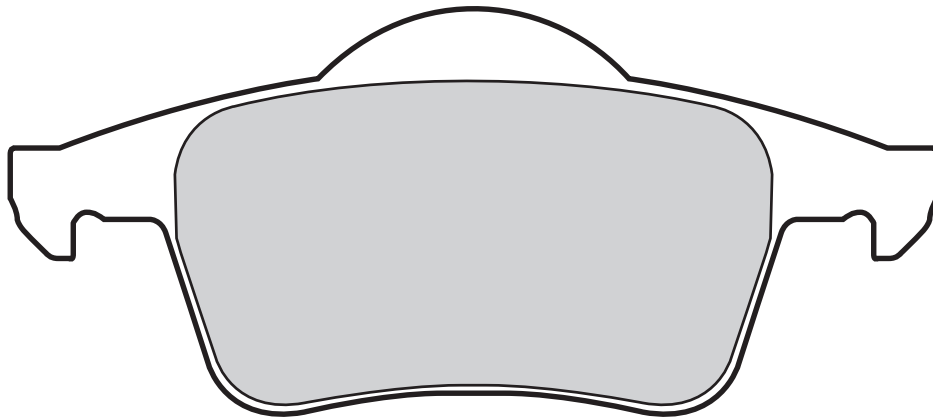

598480



0



122,6



53,8



17



TEVES



# Valeo

## 23078 (WVA)

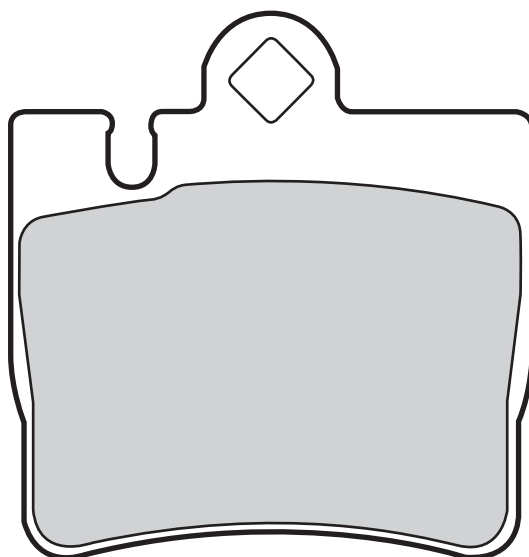

**Valeo**



598446

0

69

72

16

TEVES

## 23116 (WVA)

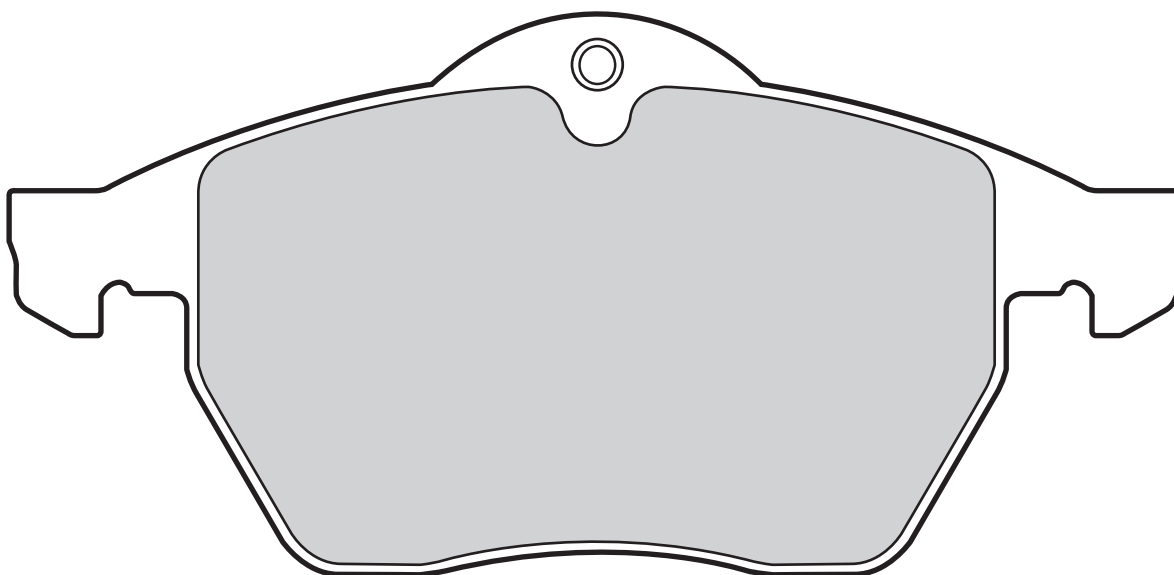

**Valeo**



598475

2

156,4

74,2

20,3

TEVES





## 23118 (WVA)

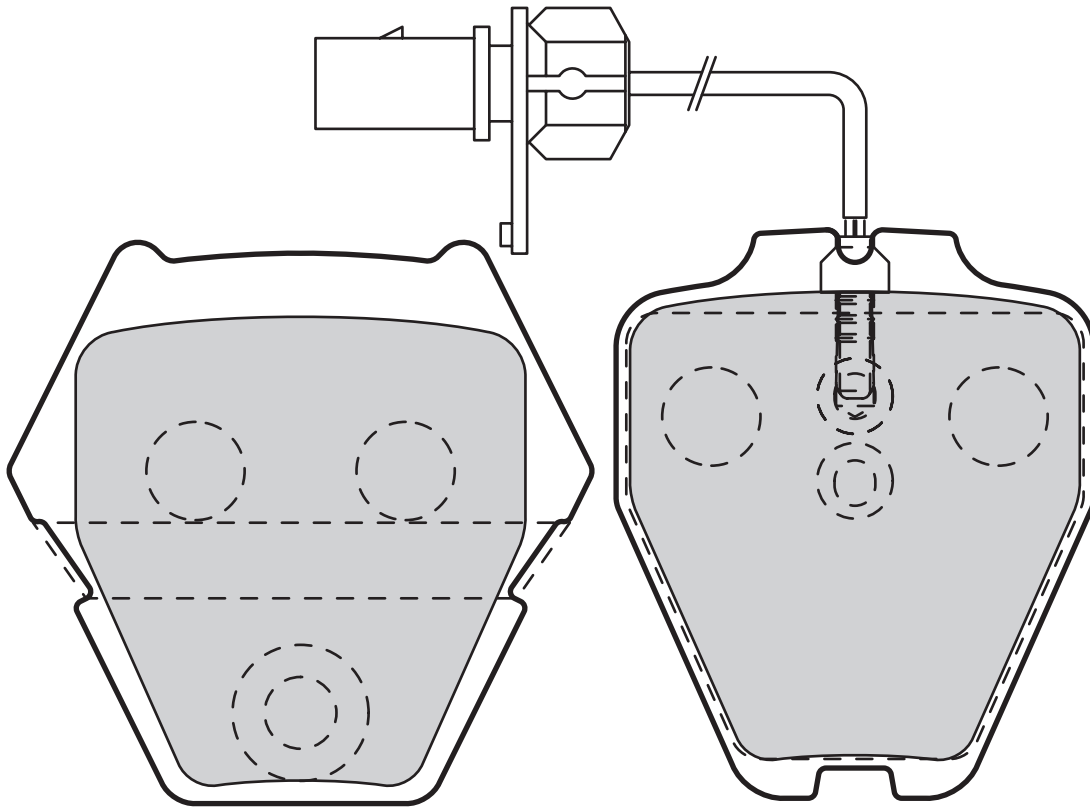

598992	2	63,2	75,2	17,5	LUCAS

## 23138 (WVA)

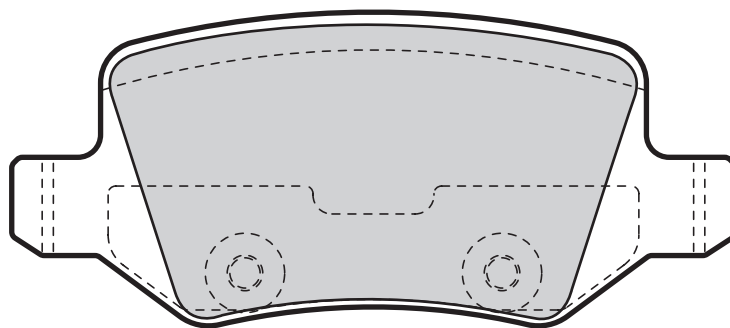

598583	0	95,8	41,5	14,3	LUCAS



# Valeo

## 23144 (WVA)

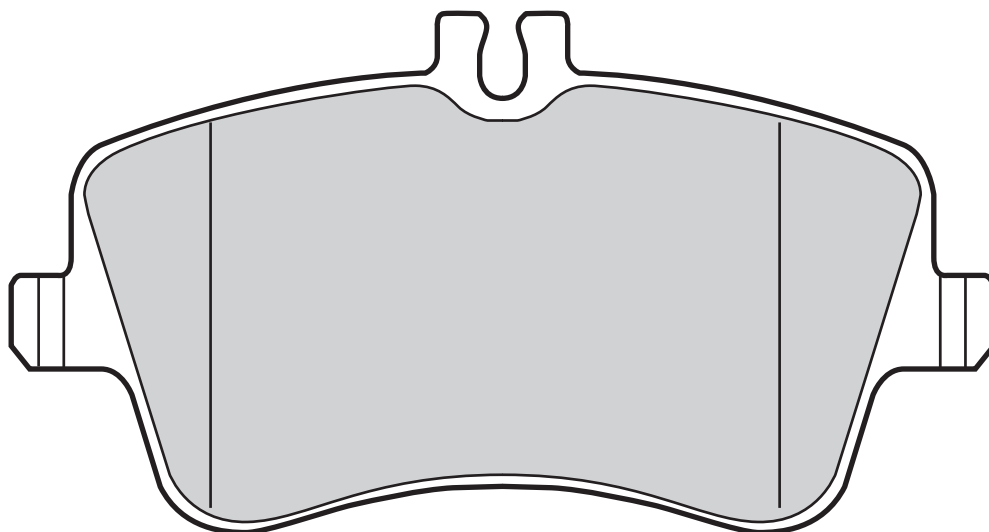

598448	0	131,1	69,8	19,5	LUCAS

## 23157 (WVA)

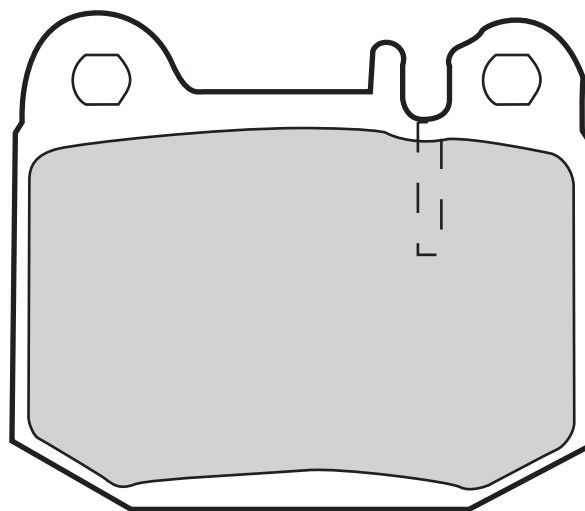

598719	0	76,5	65,5	16,8	BREMBO



## 23183 (WVA)

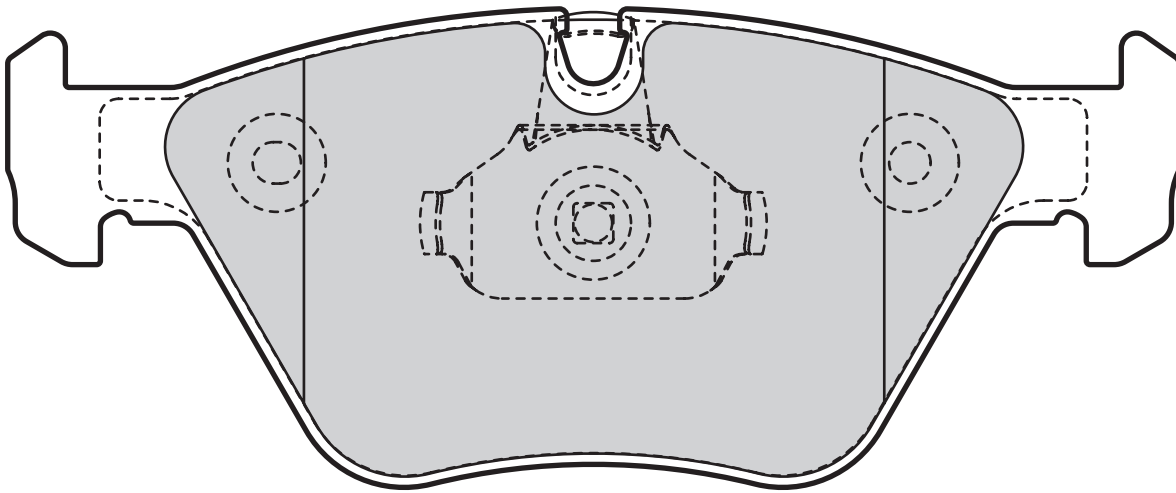
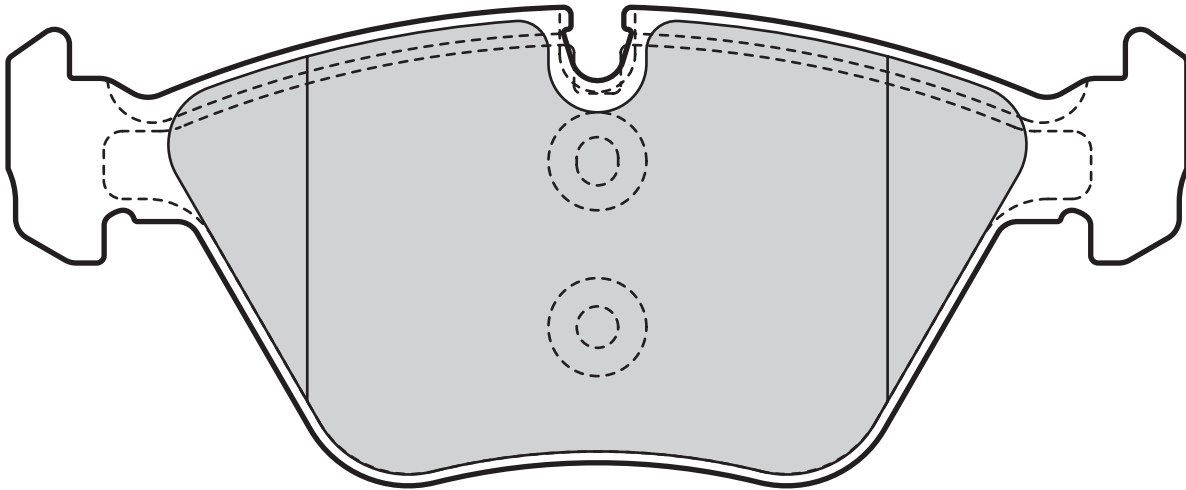

**Valeo**



598811

0

156,2

63,5

20,3

TEVES

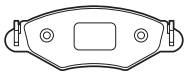

# Valeo

## 23189 (WVA)

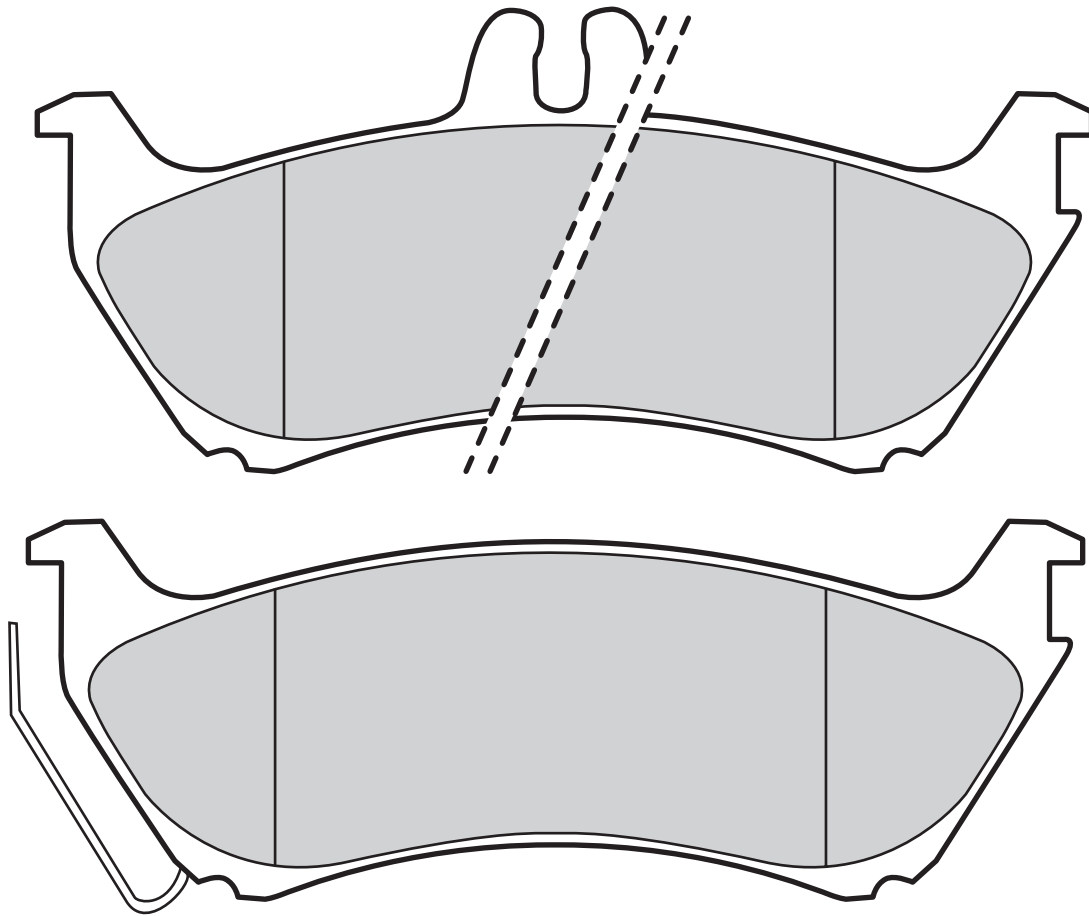

**Valeo**



598443

1

140,3

50,1

16,6

KELSEY

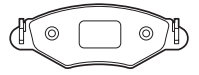

## 23189 (WVA)

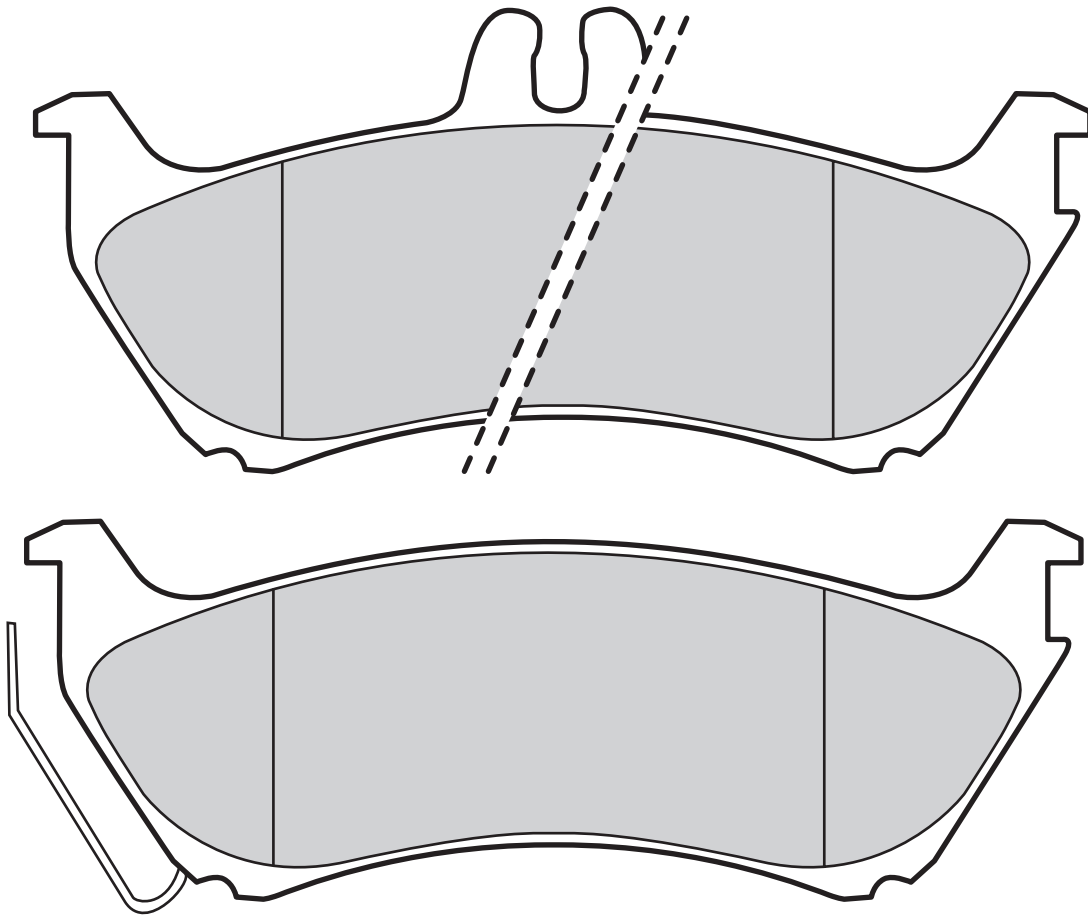

**Valeo**



598813

1

140

50/61

16,7

BOSCH

## 23193 (WVA)

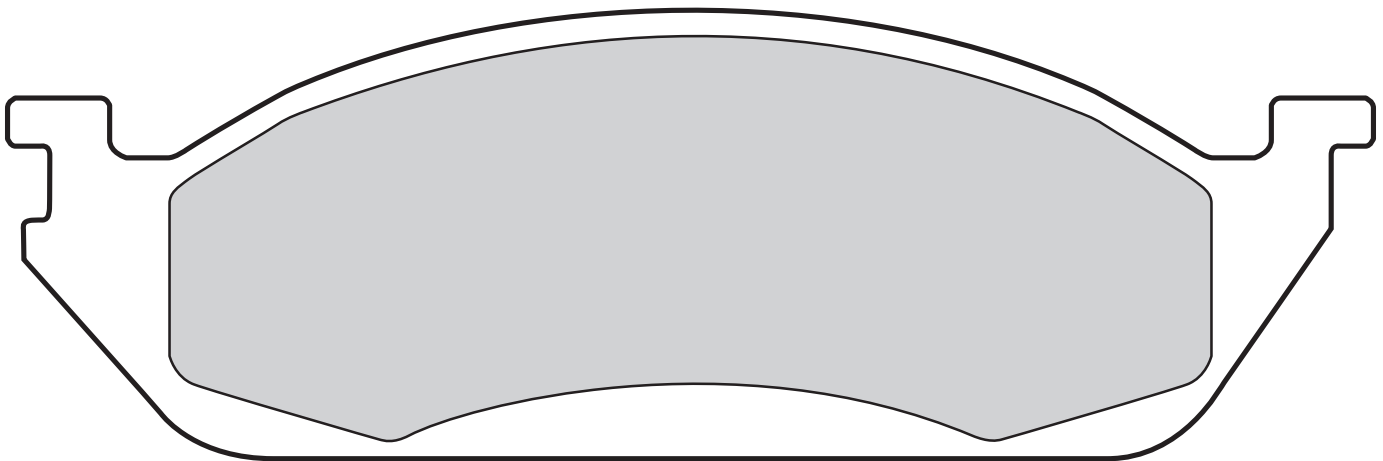

**Valeo**



598442

1

188

58,9

17

KELSEY



# Valeo

## 23245 (WVA)

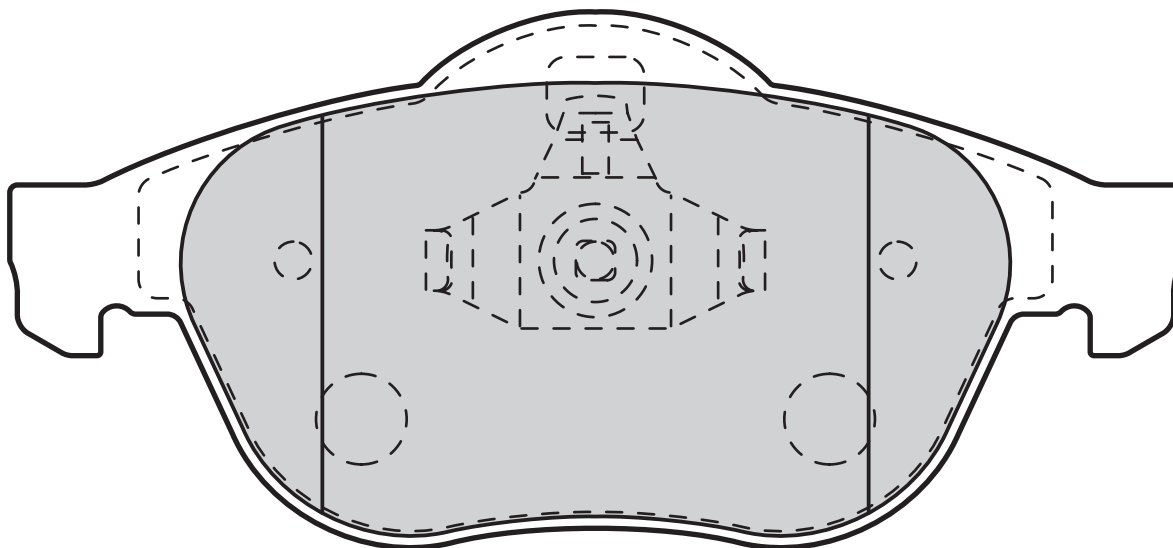
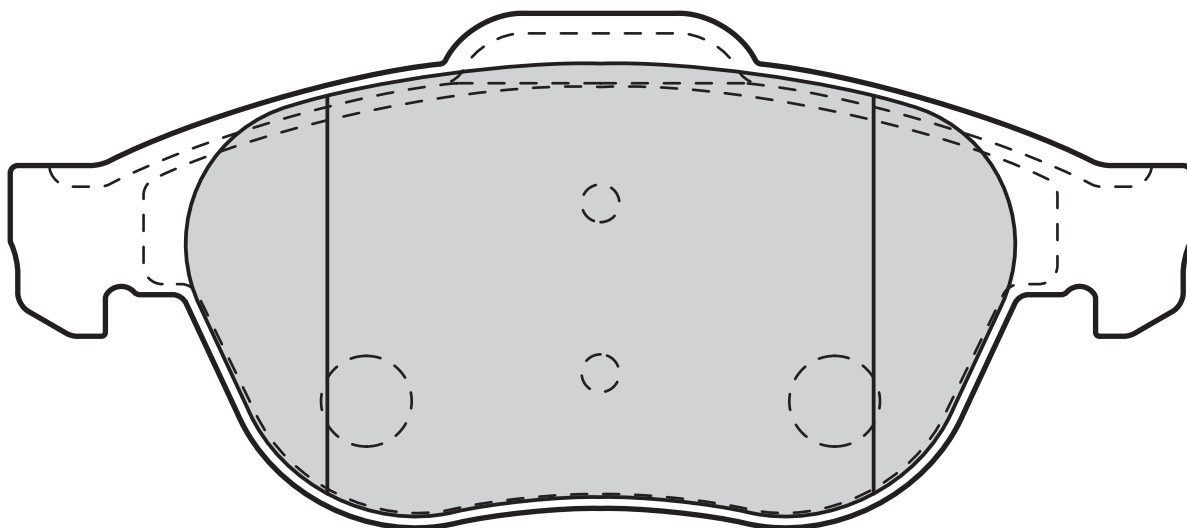

**Valeo**



598993

0

155,2

71

18,3

TEVES

## 23258 (WVA)

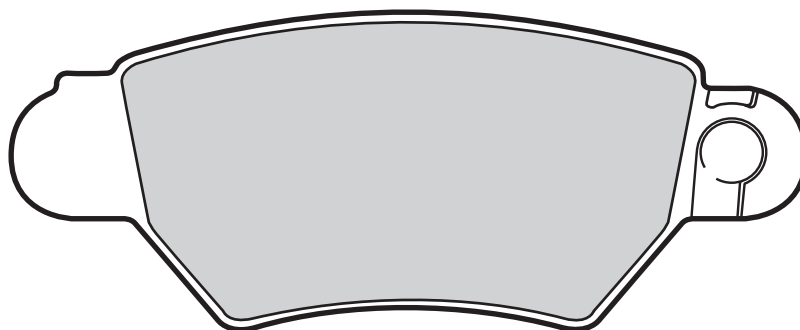

**Valeo**



598926

2(A)

105

42,7

17

BOSCH

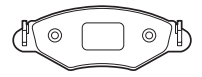

**23271 (WVA)**

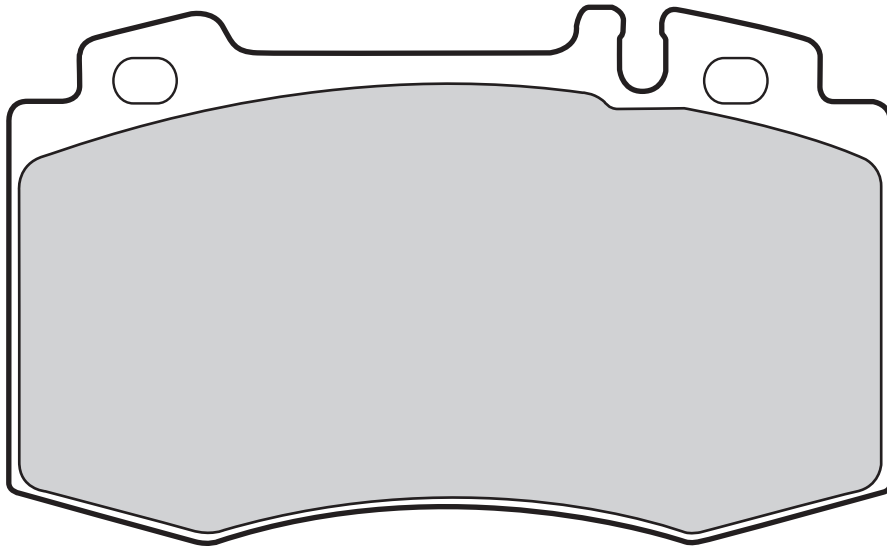

598445	0	117,8	71,6	17,2	BREMBO

**23273 (WVA)**

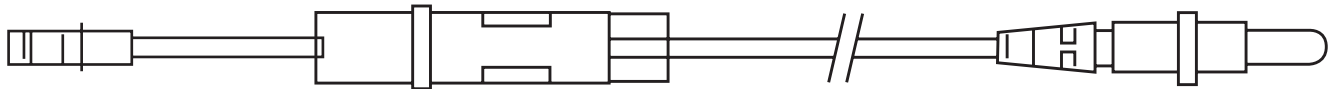
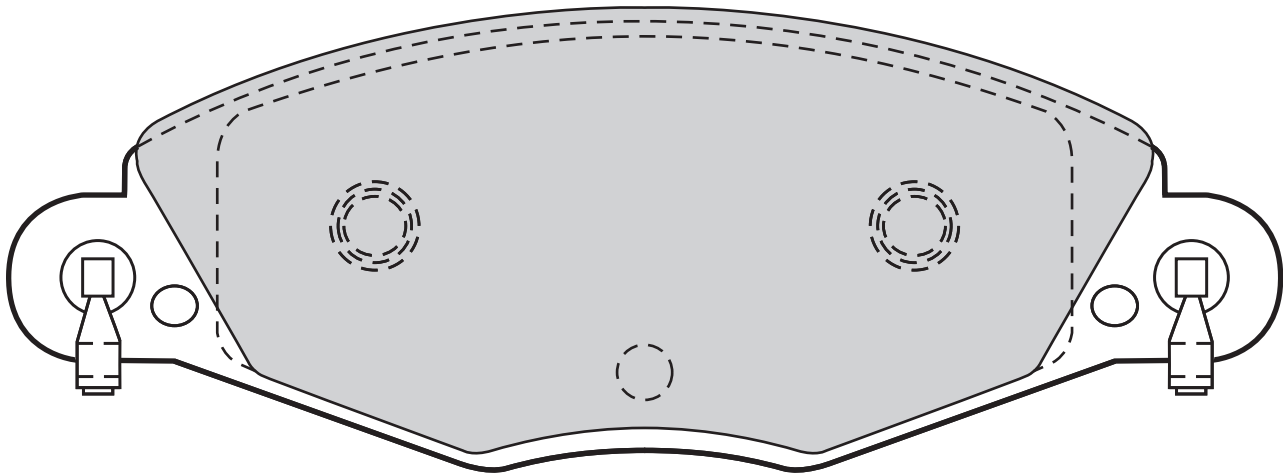

598416	4	168,8	61,3	17,8	BOSCH



# Valeo

## 23277 (WVA)

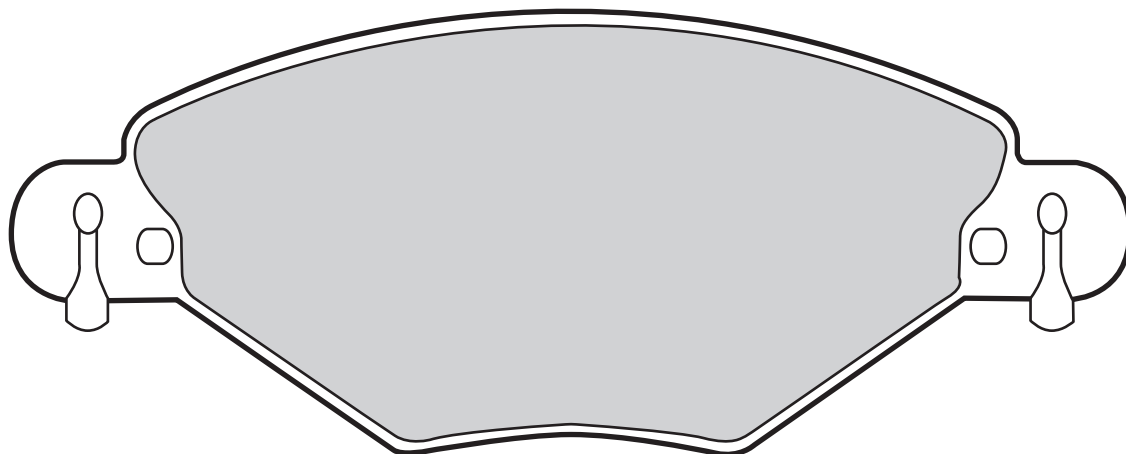

**Valeo**



598419

4

148,8

59

17,8

BOSCH

## 23279 (WVA)

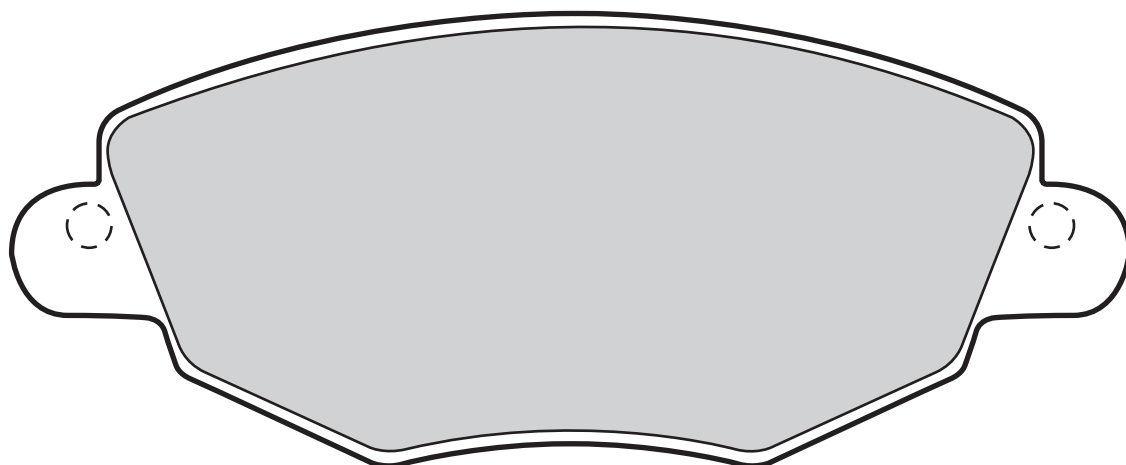

**Valeo**



598433

0

149

60,5

18

BOSCH



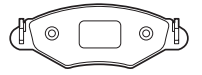

**23305 (WVA)**

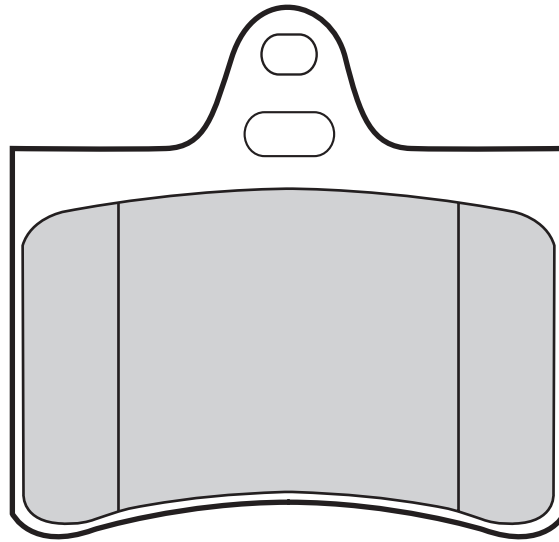

598418	0	73	70,8	15,2	CITROEN

**23312 (WVA)**

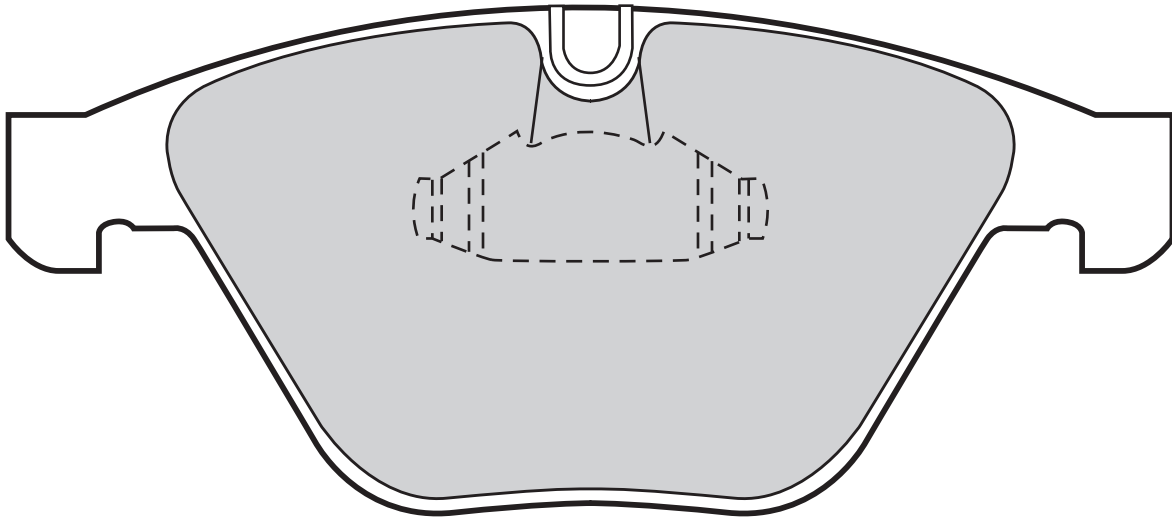

598410	0	155,3	68,5	19,8	TEVES



# Valeo

## 23313 (WVA)

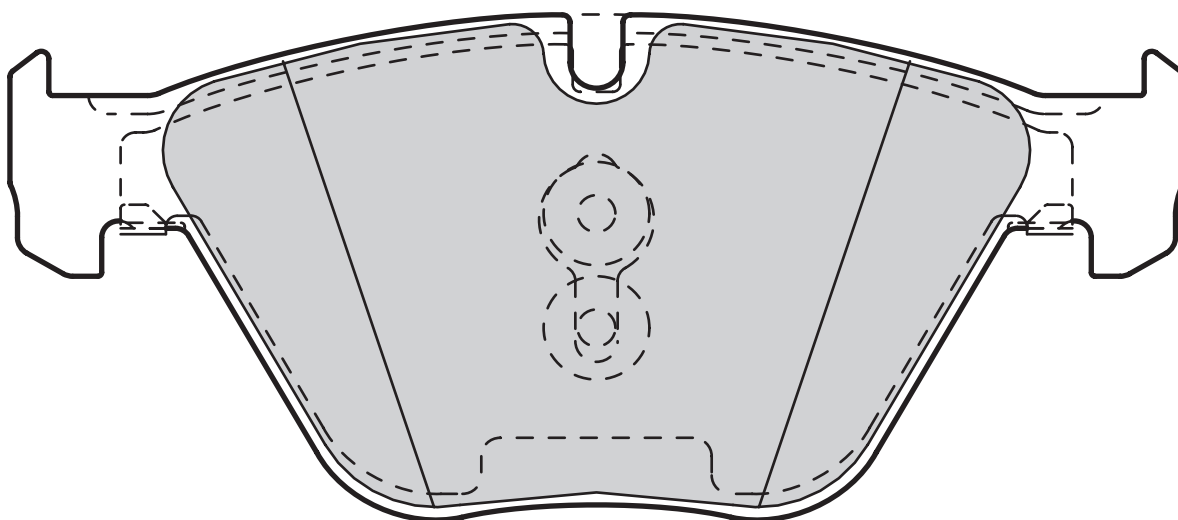
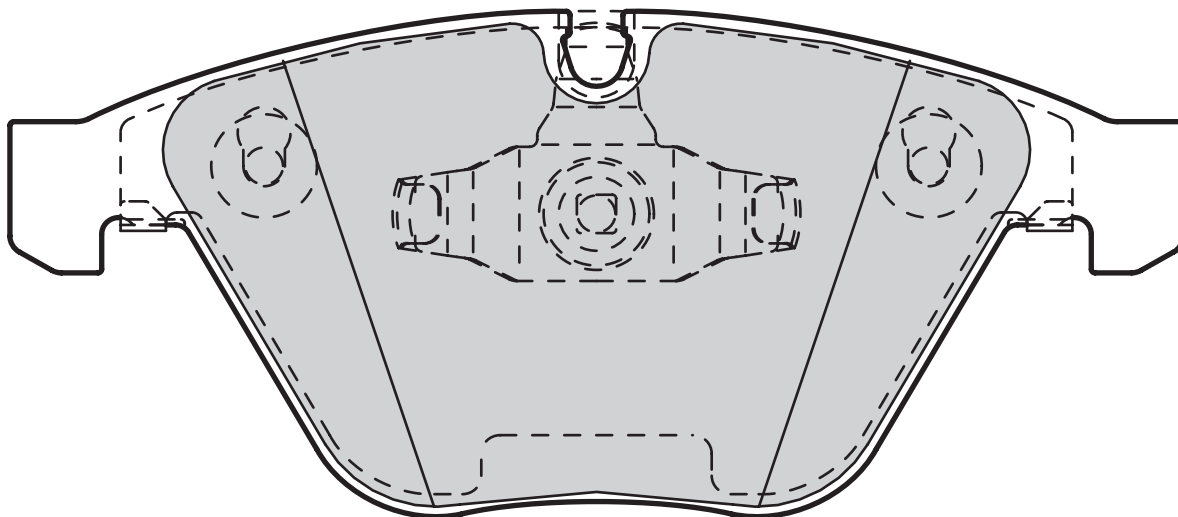

**Valeo**



601027

0

155,3

68,5

19,8

TEVES

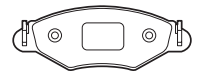

## 23326 (WVA)

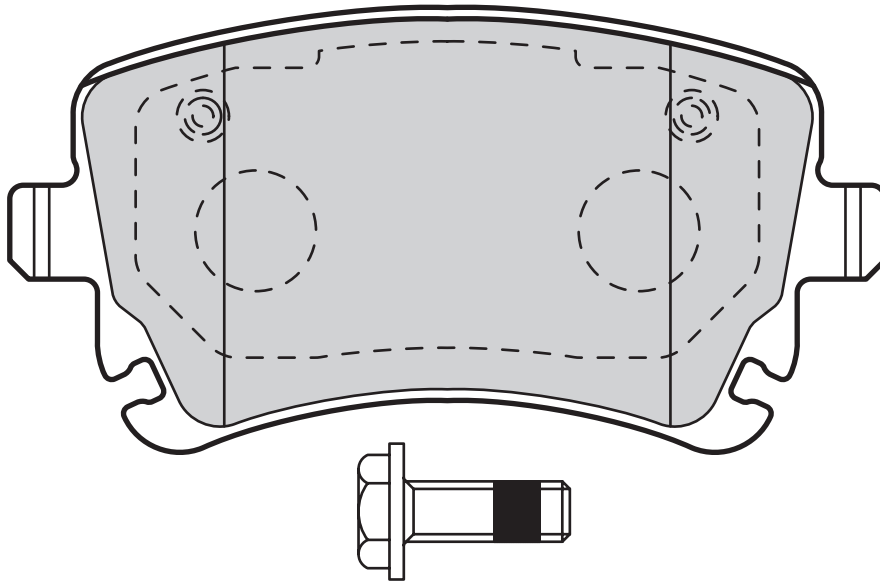

601004	0	115,95	58,92	17,4	LUCAS

## 23329 (WVA)

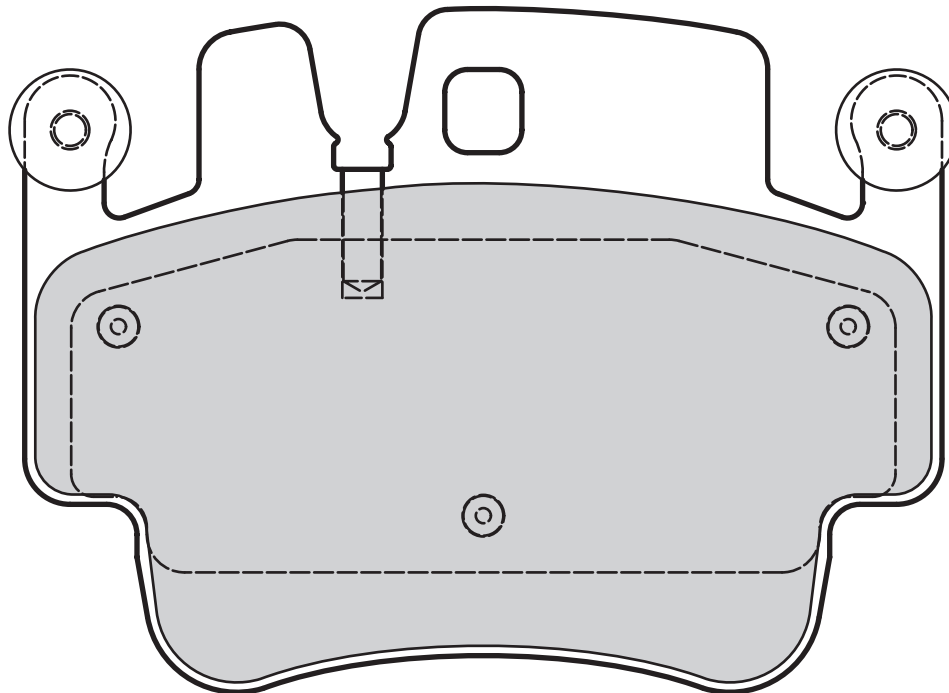

598767	0	125	90,2	17	BREMBO

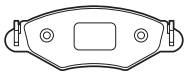

# Valeo

## 23334 (WVA)

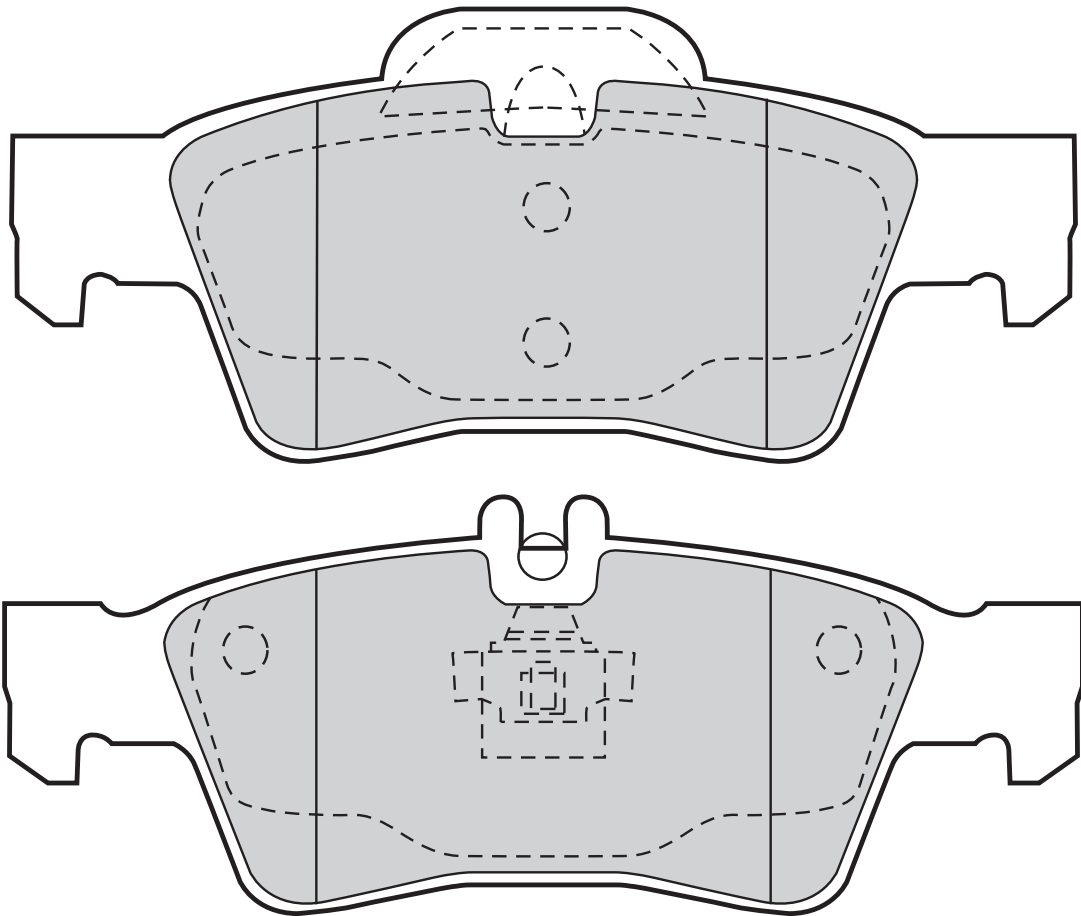

**Valeo**



598637

0

141,5

57,5

16,5

TEVES



23347 (WVA)

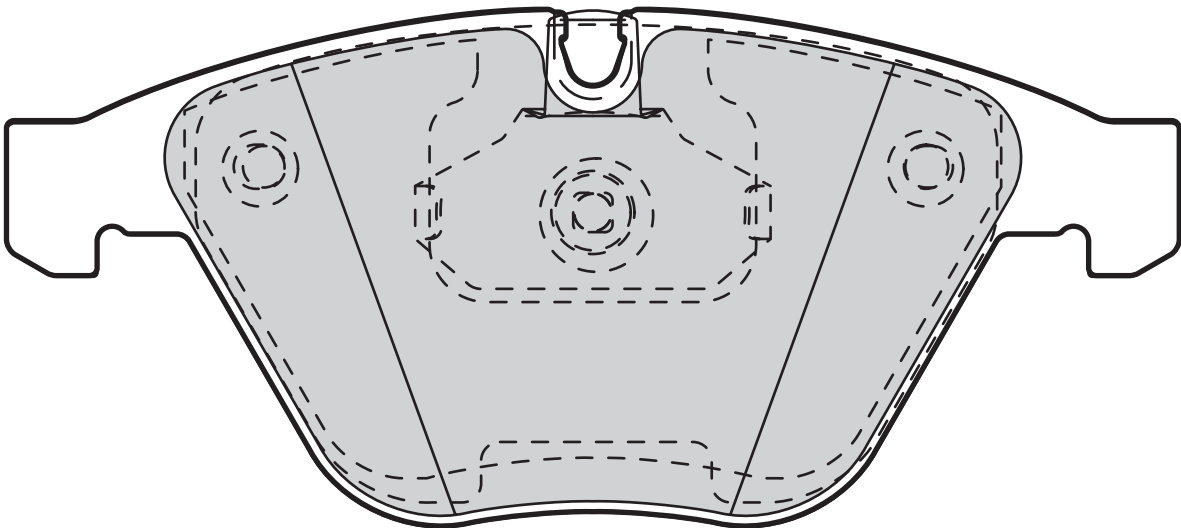
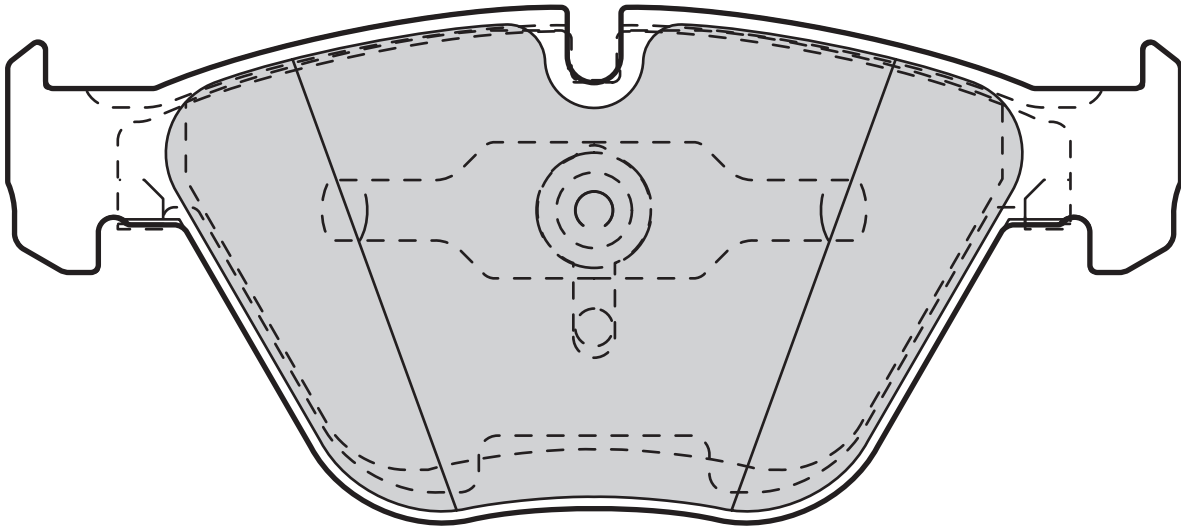

598898

0

155

68,27

20

TEVES



# Valeo

## 23349 (WVA)

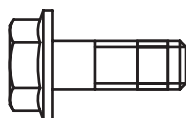
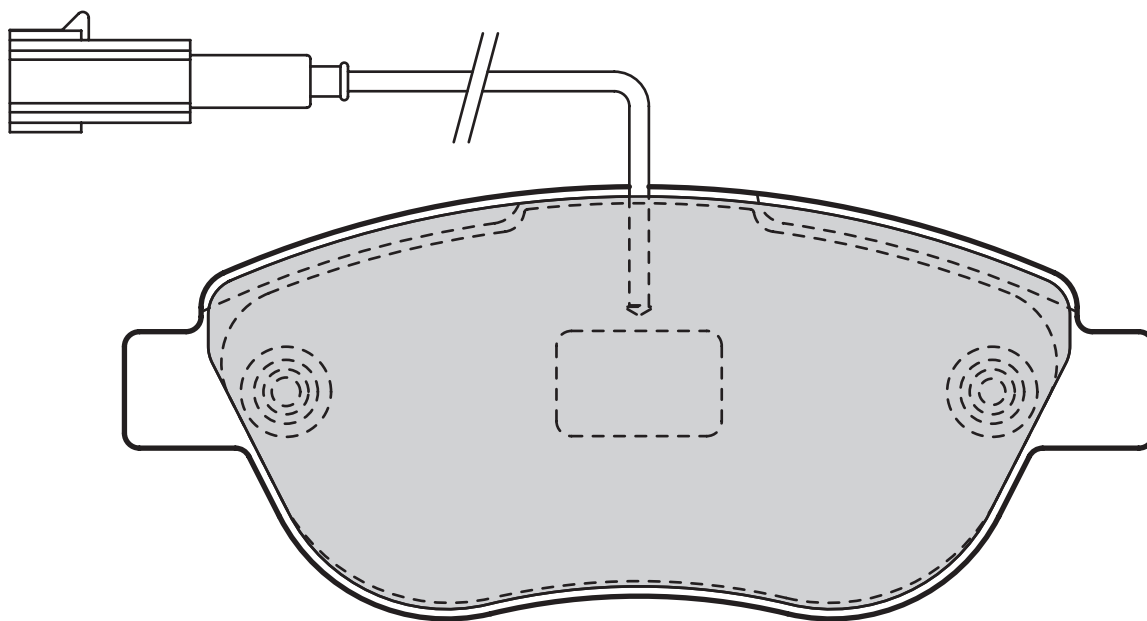

**Valeo**



598721

1

137

57,4

19

BOSCH

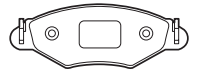

23399 (WVA)

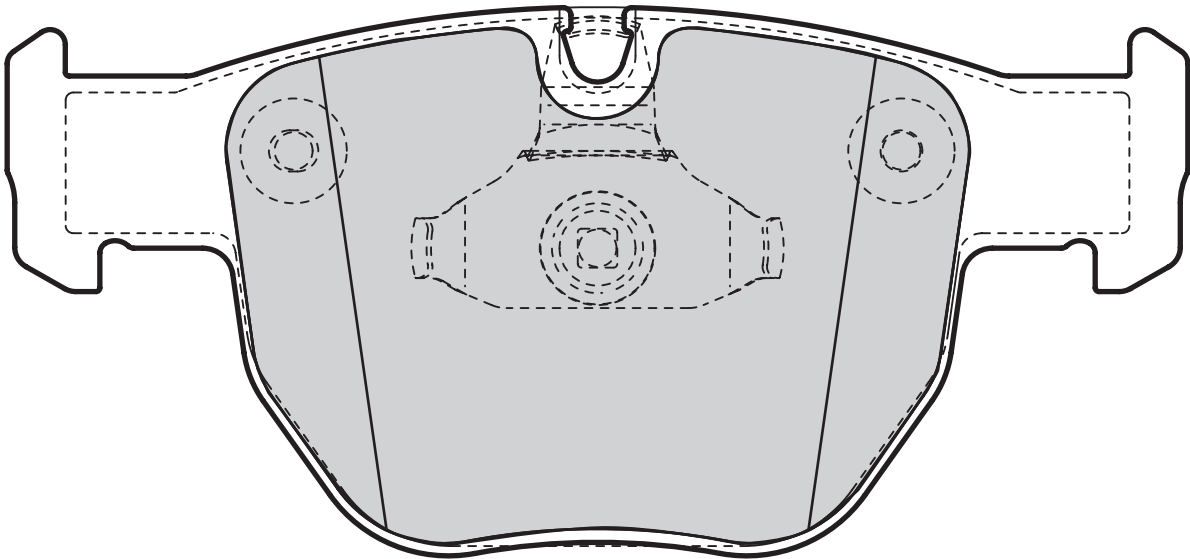
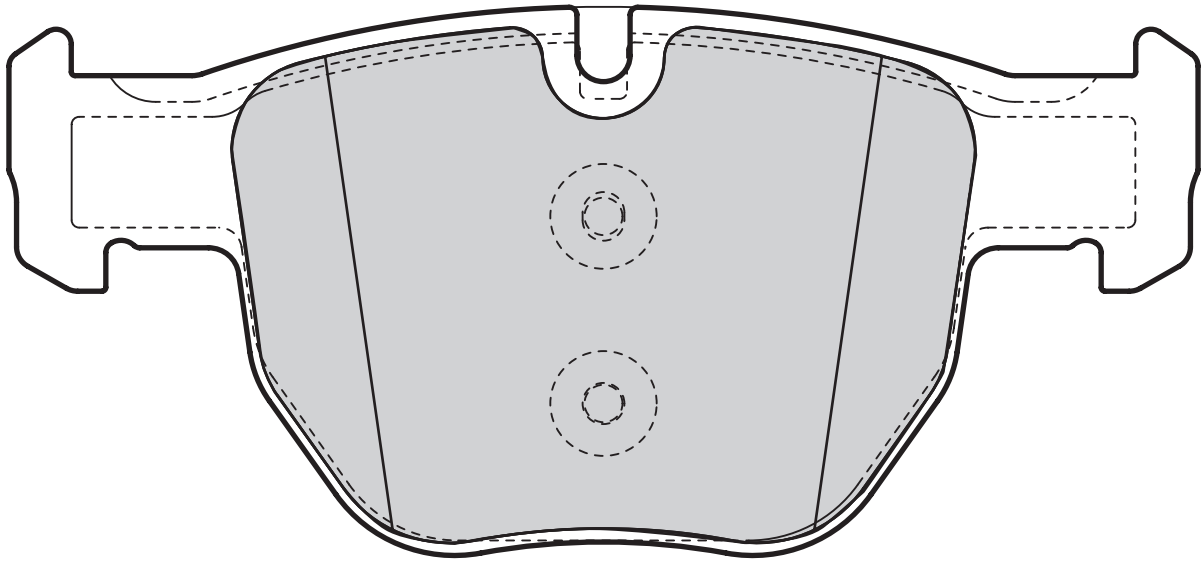

598658



0



156,3



73,5



19,4



TEVES

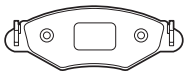

**Valeo**

23402 (WVA)

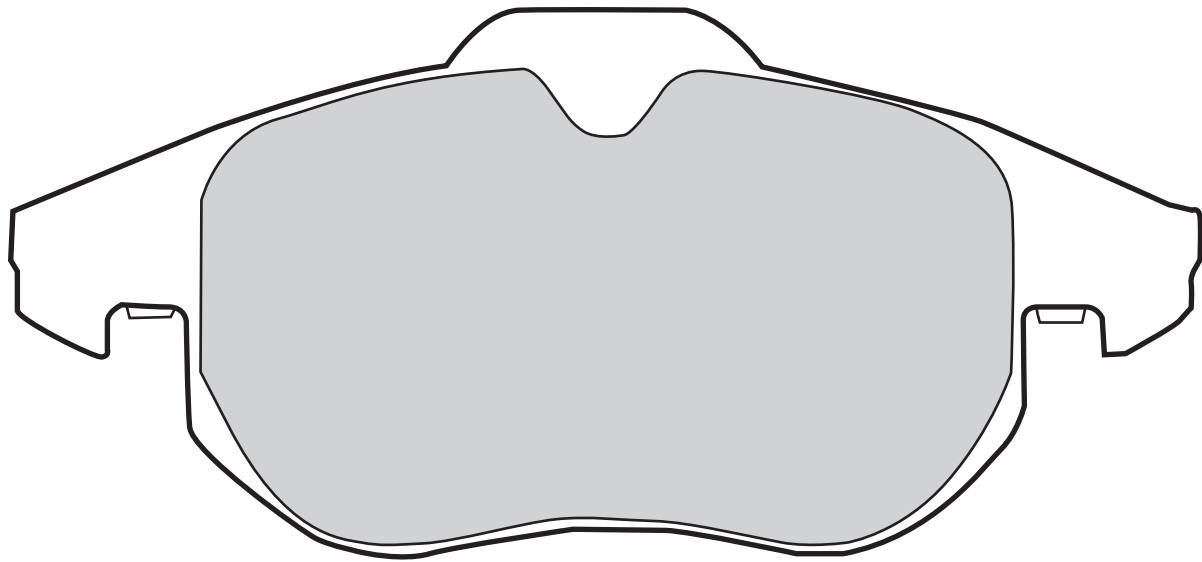
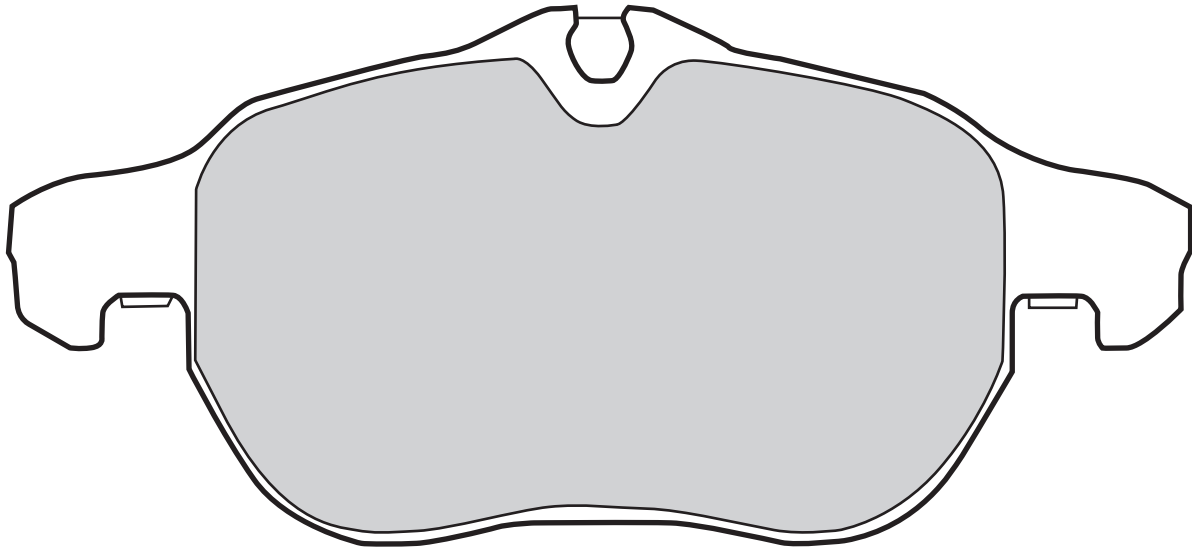

**Valeo**



598678

0

156,5

71

20,3

TEVES





## 23409 (WVA)

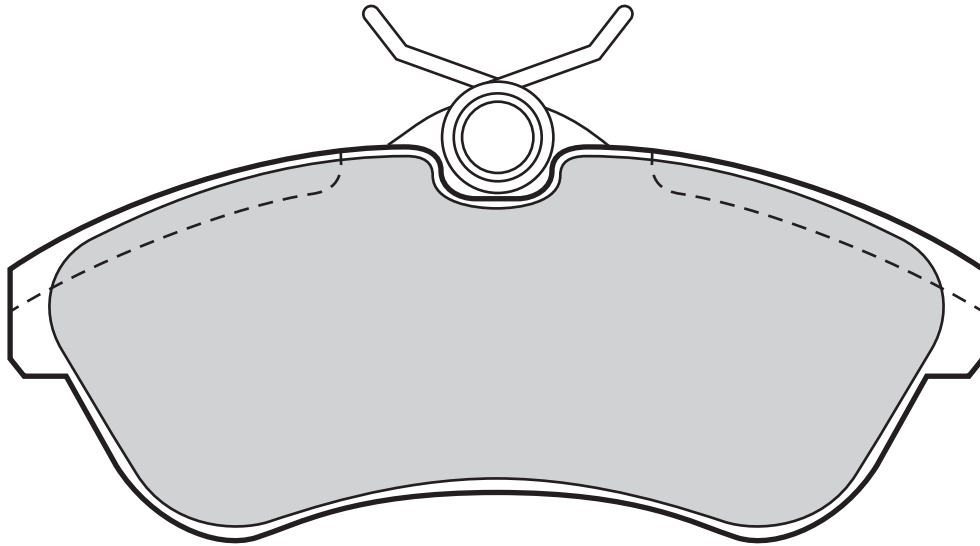

<b>Valeo</b>					
598501	0	129	56,2	19,3	LUCAS

## 23417 (WVA)

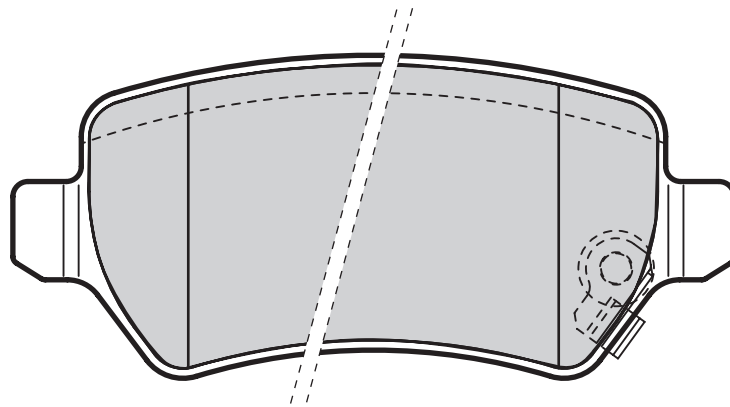

<b>Valeo</b>					
598584	2	95,5	42,7	15,2	LUCAS



# Valeo

## 23423 (WVA)

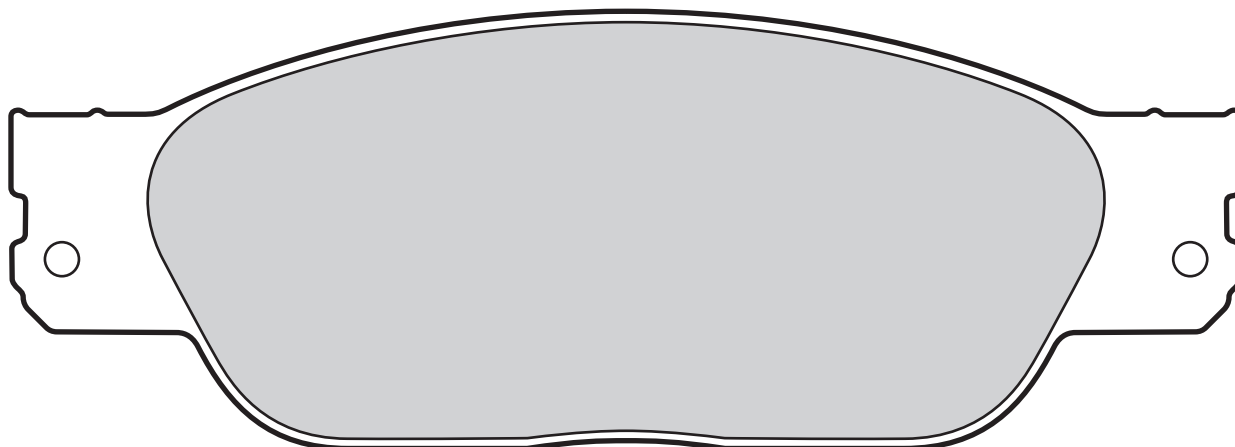

598439	0	163,3	58	17,8	LUCAS

## 23424 (WVA)

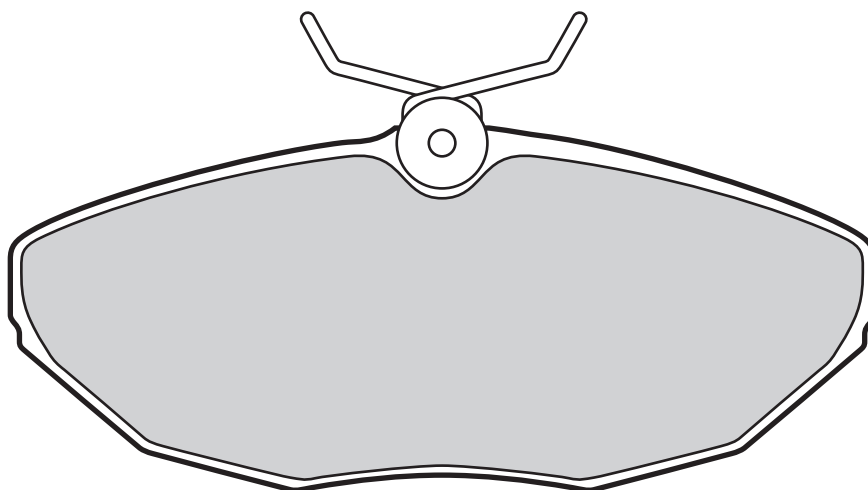

598438	0	114,3	49,6	17,8	LUCAS

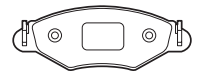

## 23429 (WVA)

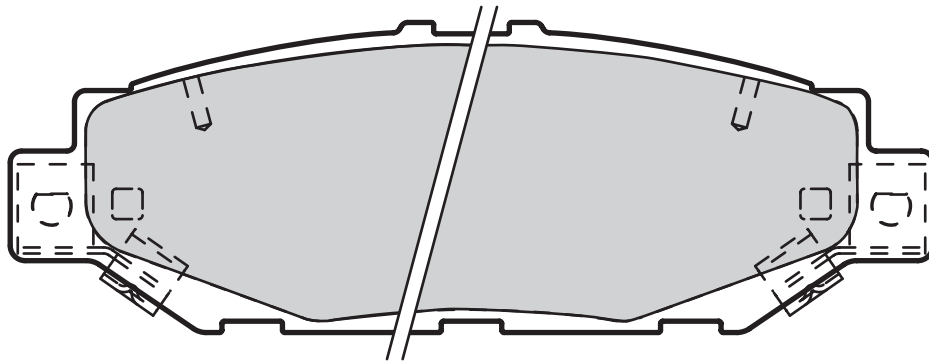

**Valeo**



601025

2

57,2

63,8

15,5

SUMITOMO

## 23449 (WVA)

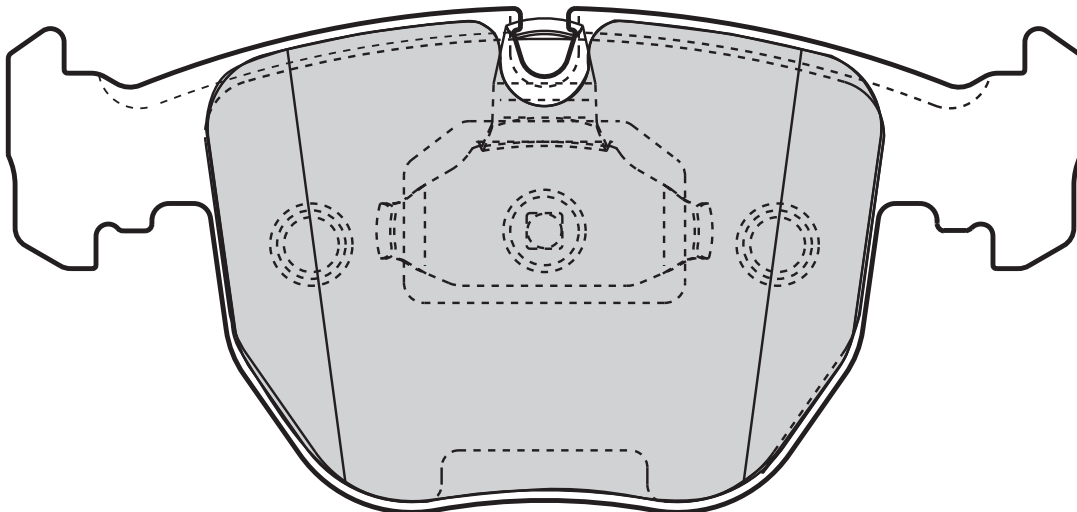
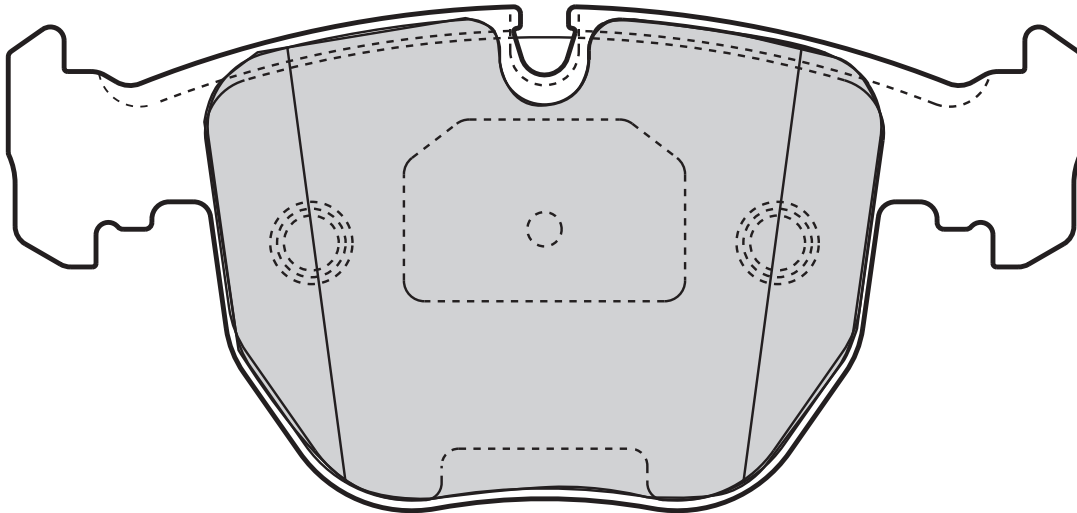

**Valeo**



598412

0

156,4

73,6

19

TEVES



# Valeo

## 23467 (WVA)

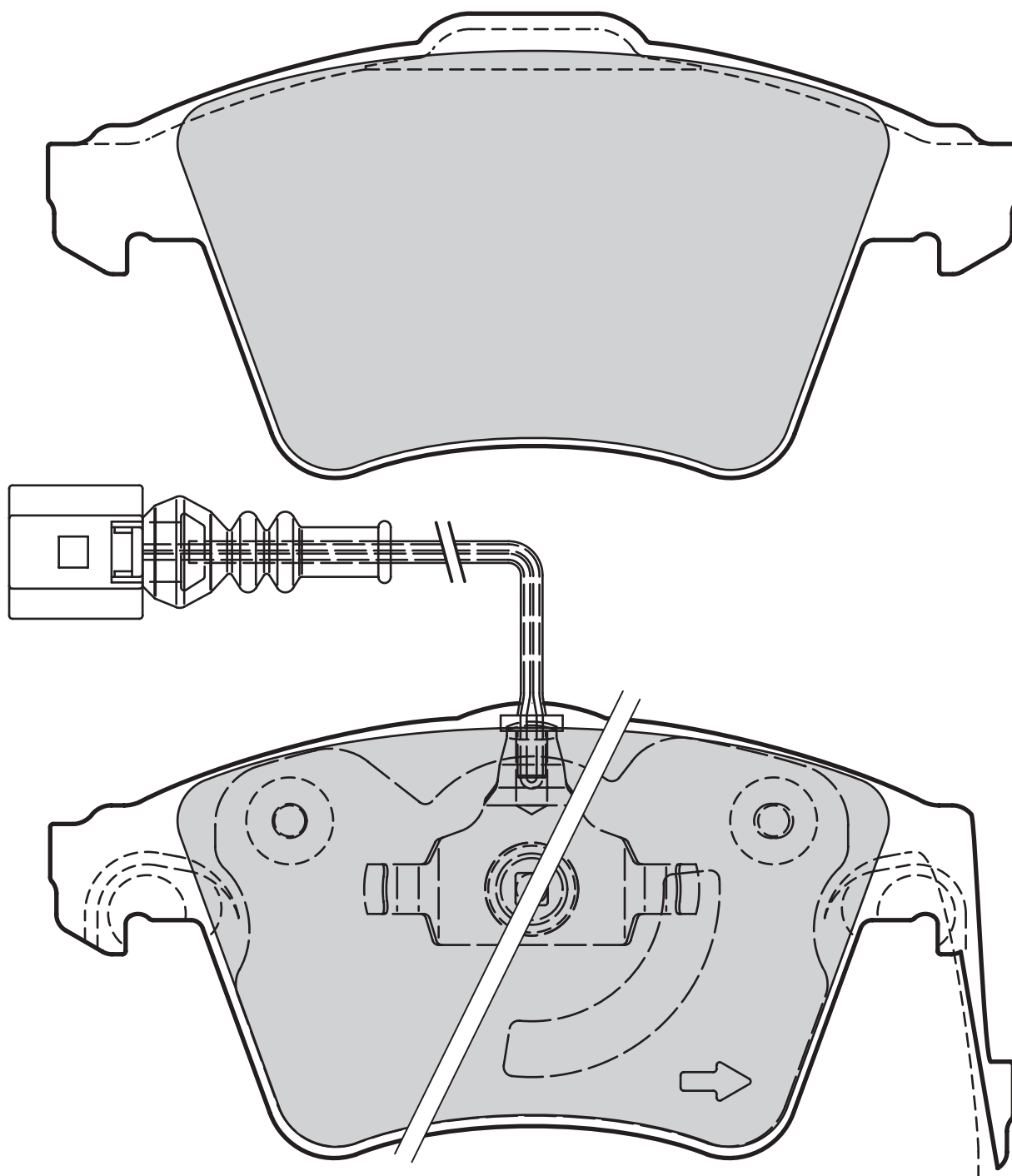

**Valeo**



598940

2



155



73



20



TEVES



**23482 (WVA)**

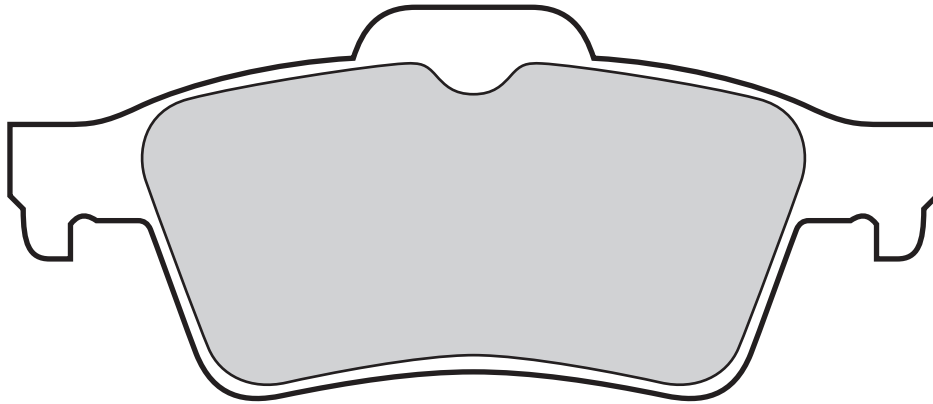

598472	0	123,1	52	16,6	TEVES

**23524 (WVA)**

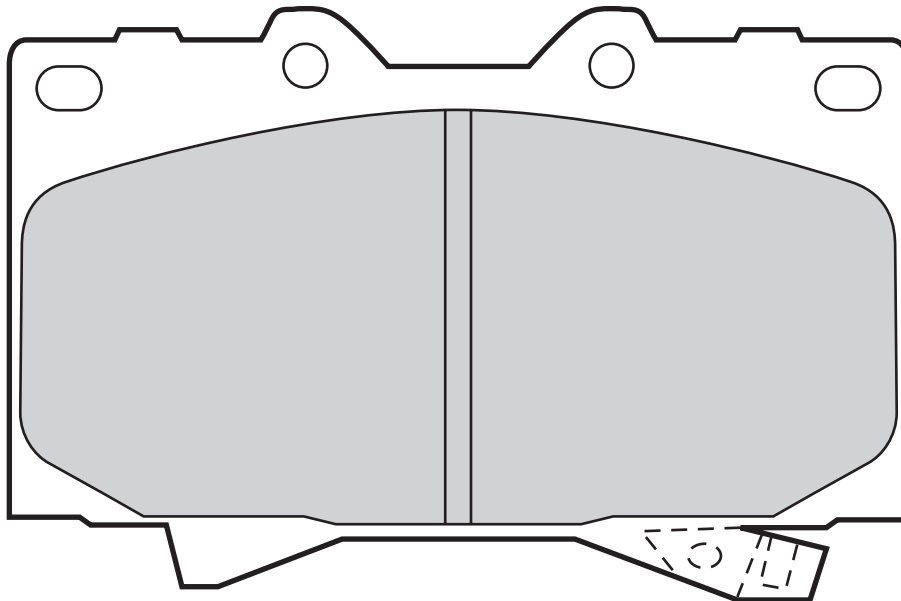

598535	2	119,6	78	15,5	SUMITOMO



# Valeo

## 23532 (WVA)

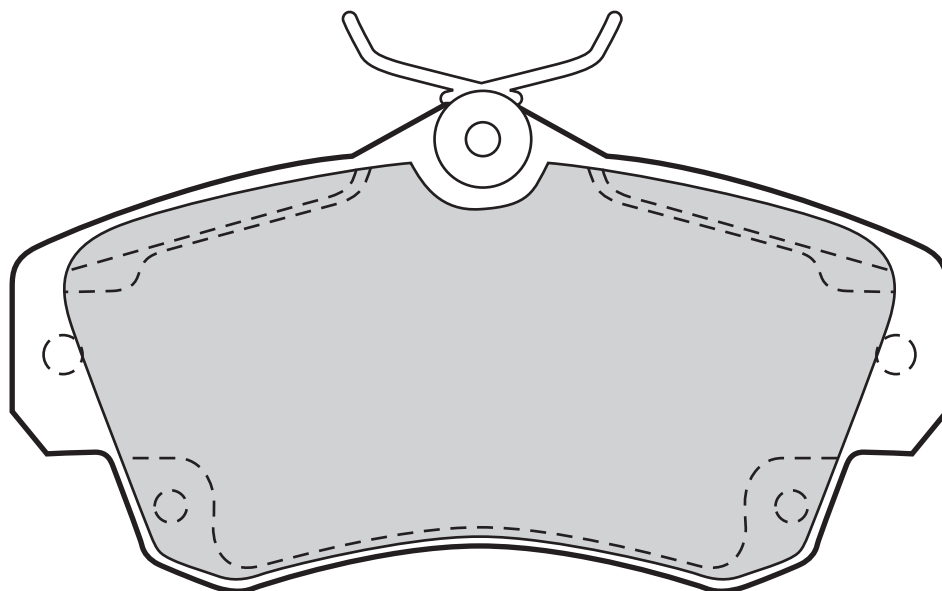

**Valeo**



598543

0

124

64,6

20

LUCAS

## 23539 (WVA)

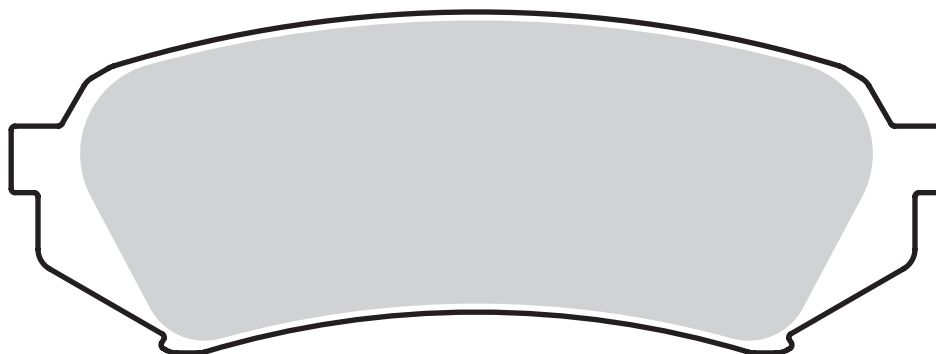

**Valeo**



598865

0

123,1

45,1

17,5

AKEBONO

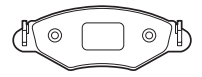

## 23543 (WVA)

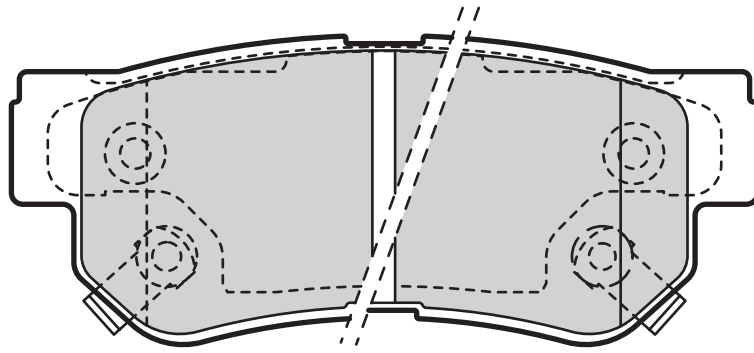

<b>Valeo</b>					
598748	2	98,7	40,8	15,7	MANDO

## 23550 (WVA)

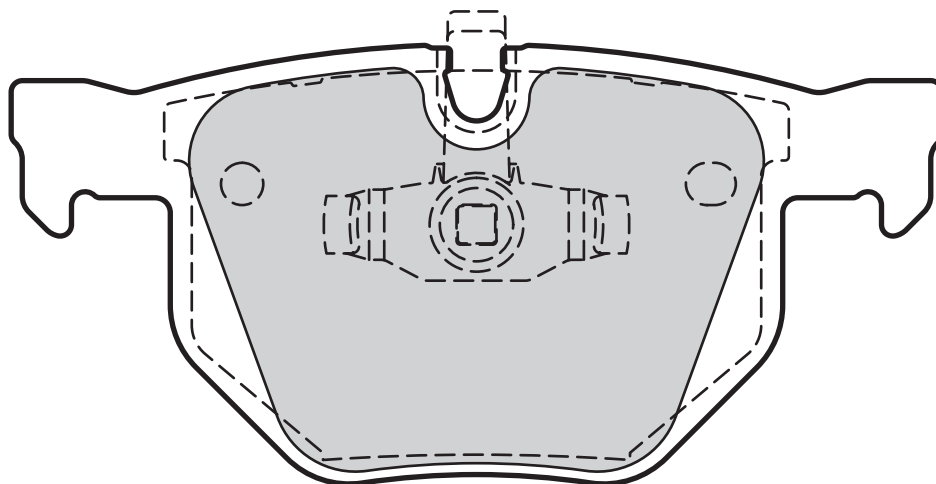
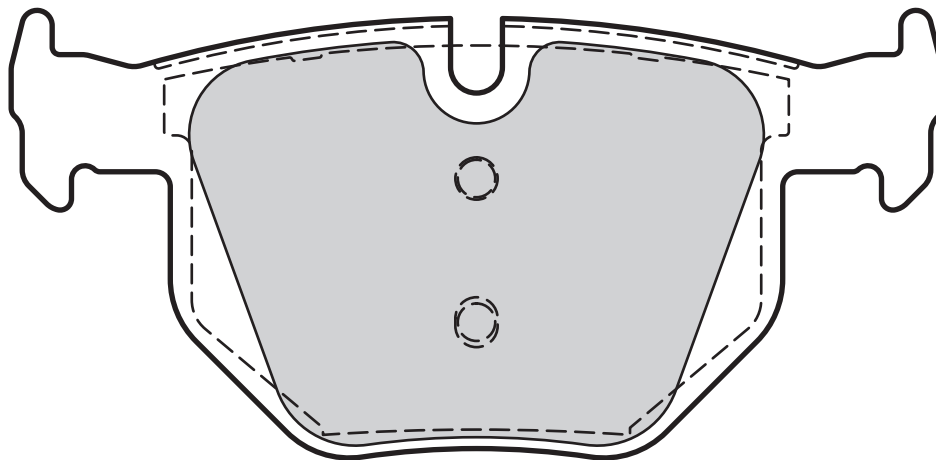

<b>Valeo</b>					
598885	0	123,1	59,2/58	17,3	TEVES



# Valeo

## 23557 (WVA)

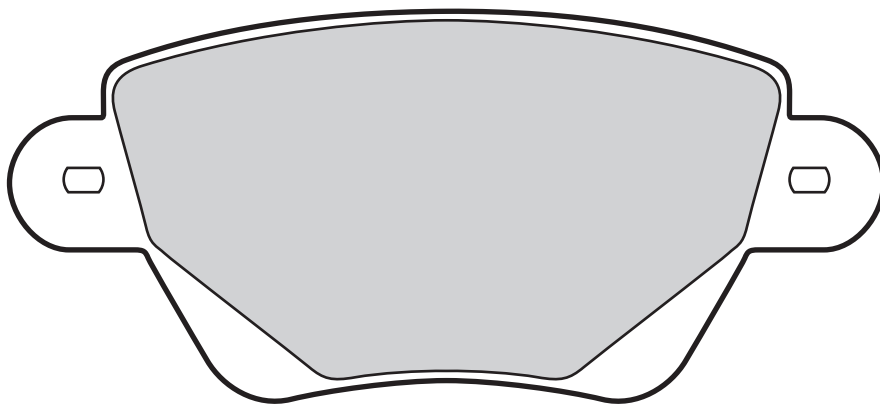

598434	0	115,9	51,9	16,8	BOSCH

## 23558 (WVA)

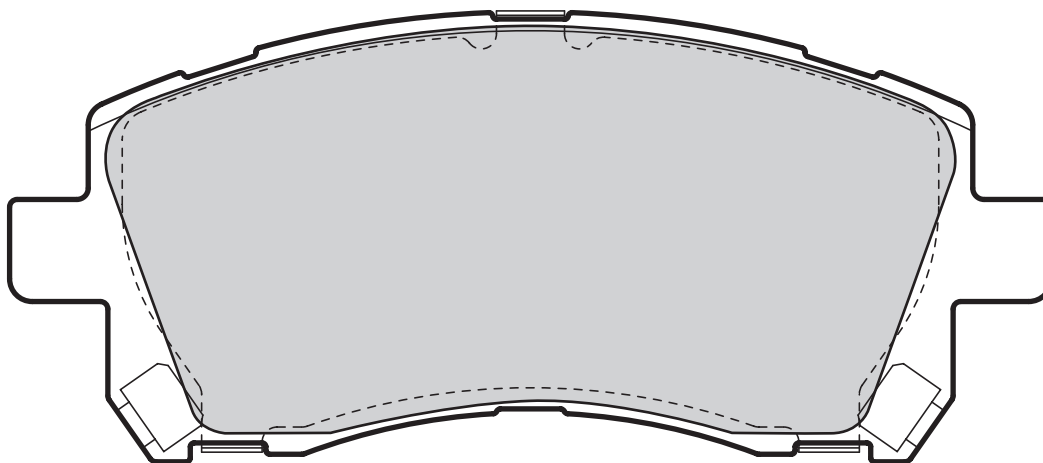

598530	2	137,5	59,5	17,8	AKEBONO





**23561 (WVA)**

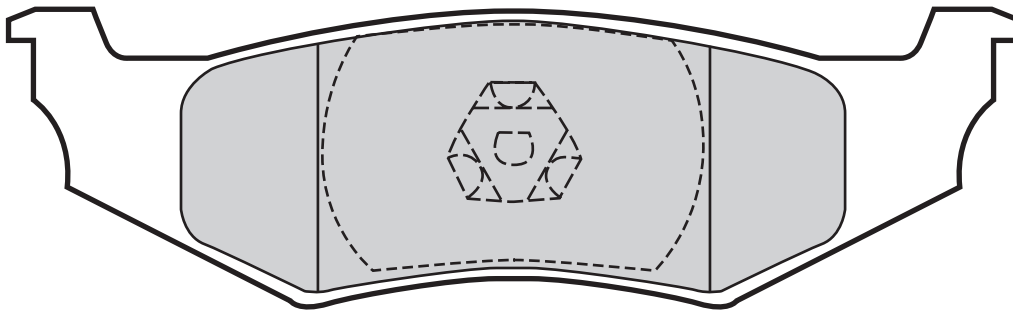

598544	0	133,6	39,9	18	KELSEY

**23572 (WVA)**

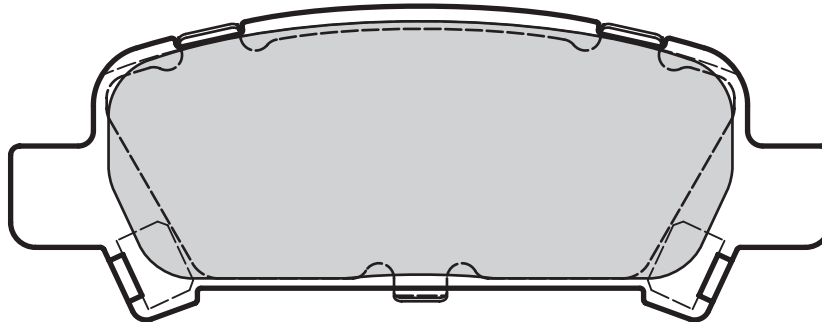

598895	1	108	41,7	14,5	AKEBONO



# Valeo

## 23582 (WVA)

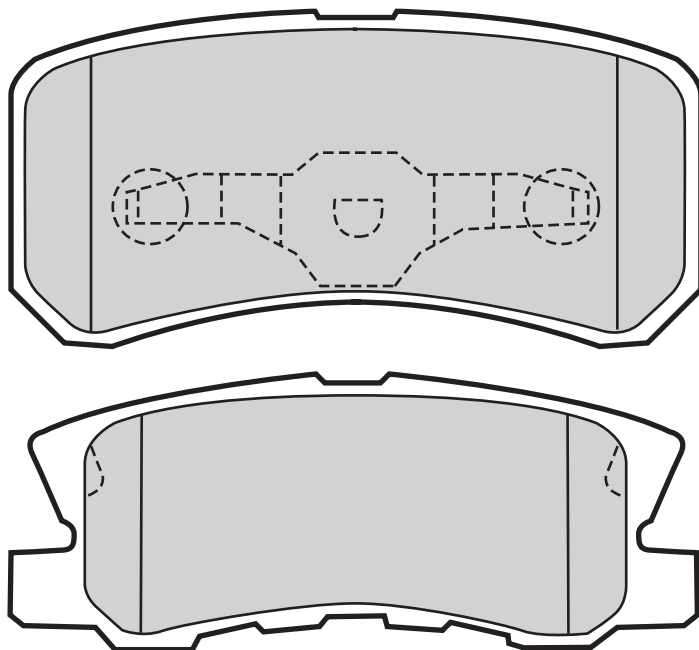

**Valeo**



598520

2

111,6

45

15,5

AKEBONO



## 23587 (WVA)

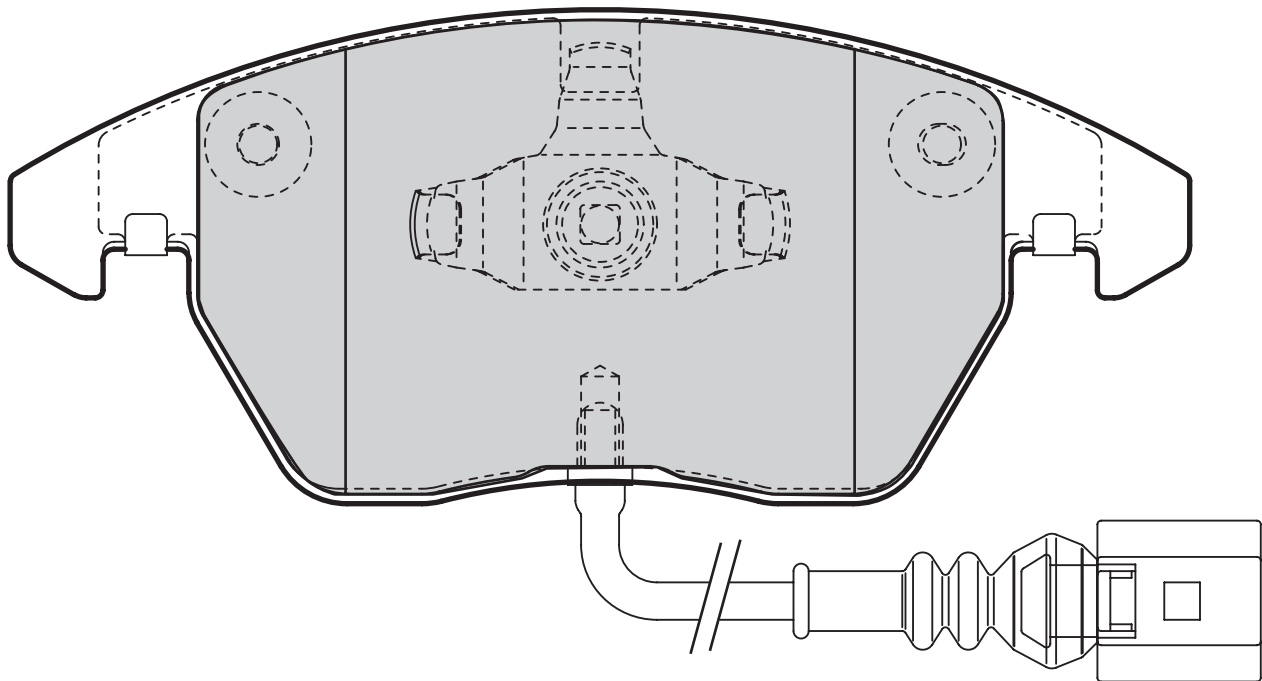
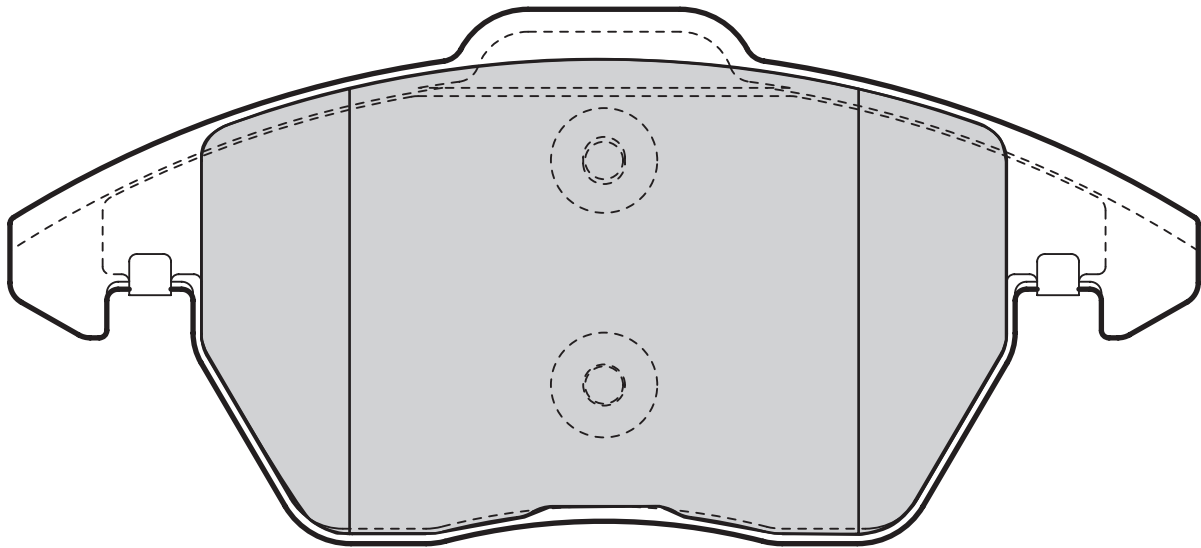

**Valeo**



598635

1

156,4

66/71,4

20,3

TEVES



# Valeo

## 23589 (WVA)

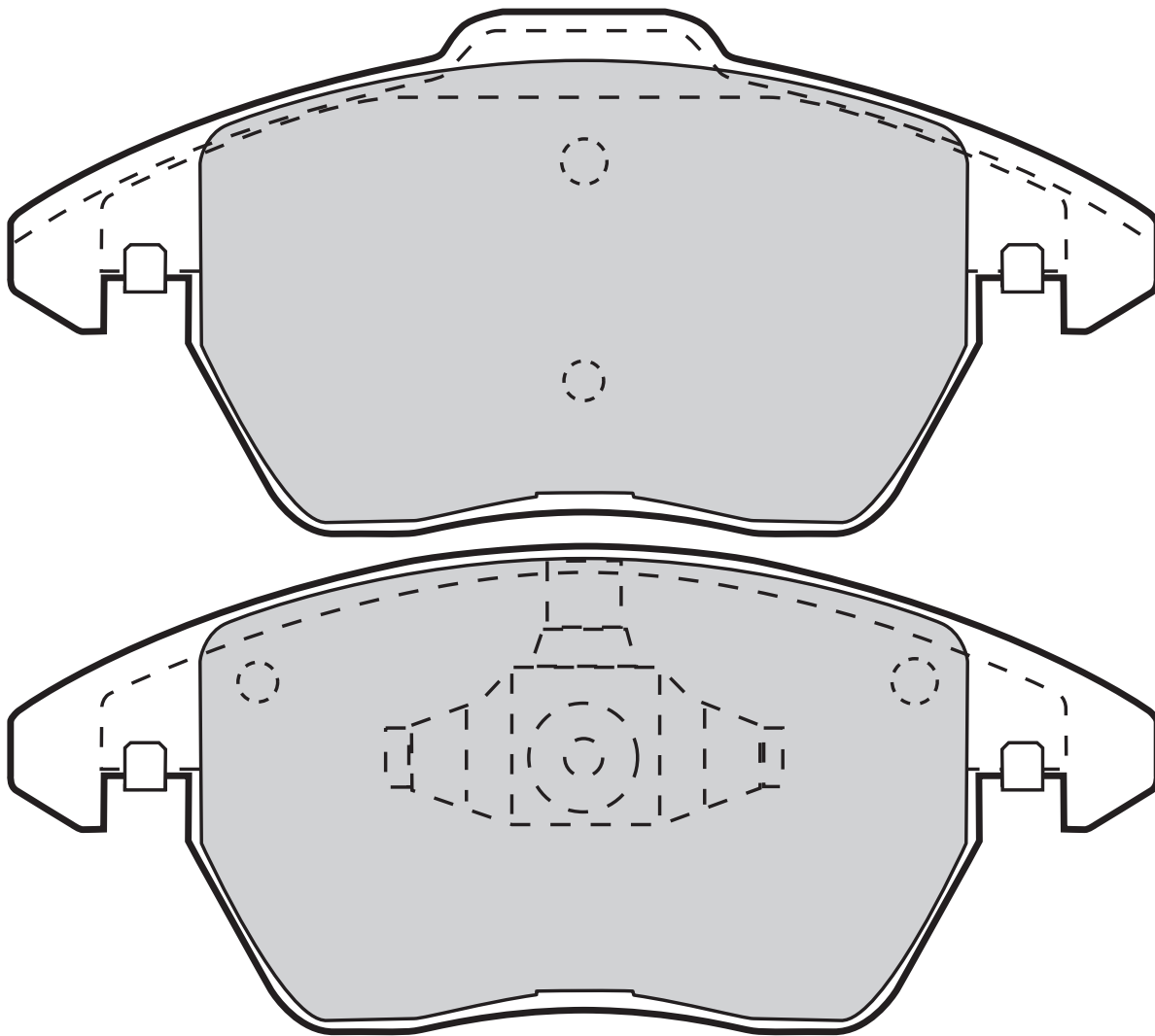

**Valeo**



598715

0

155/156

71,5

19

TEVES



## 23590 (WVA)

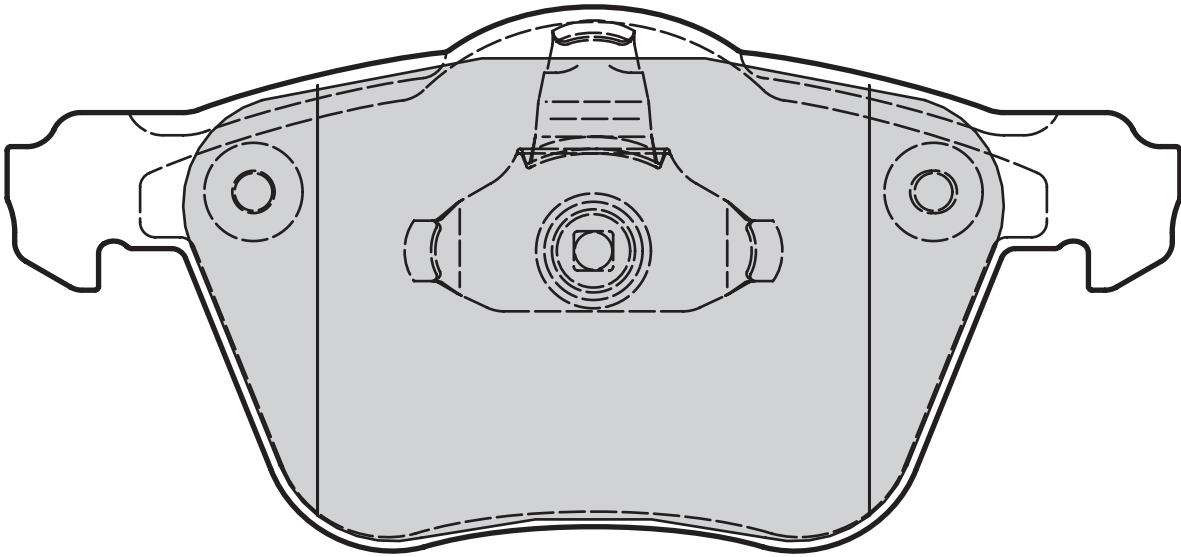
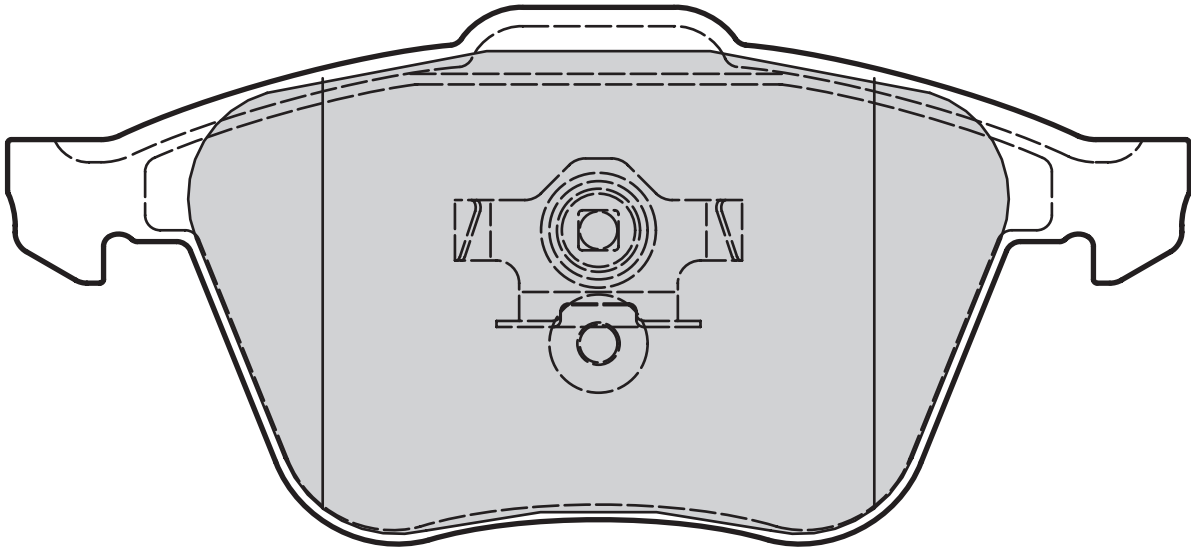

**Valeo**



601030

0

156,4

71/72

18,2

TEVES

601032

8

150,5

56,5

18,8

BOSCH



# Valeo

## 23599 (WVA)

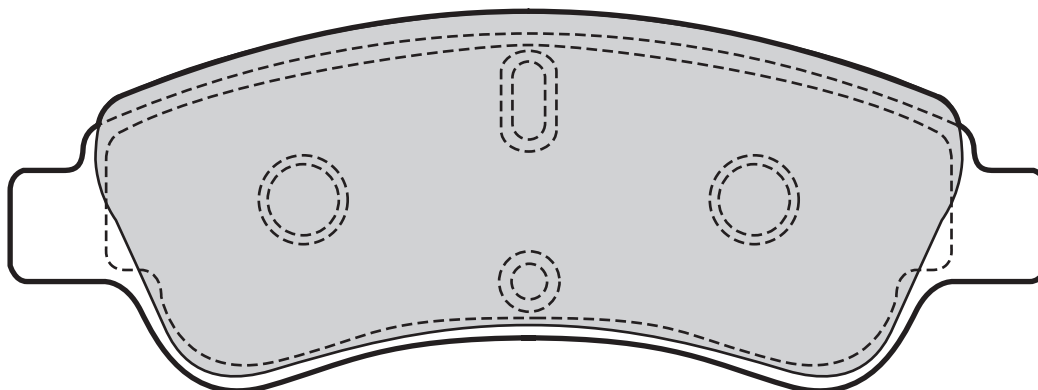

**Valeo**



598464

0

137

50

19

BOSCH

## 23600 (WVA)

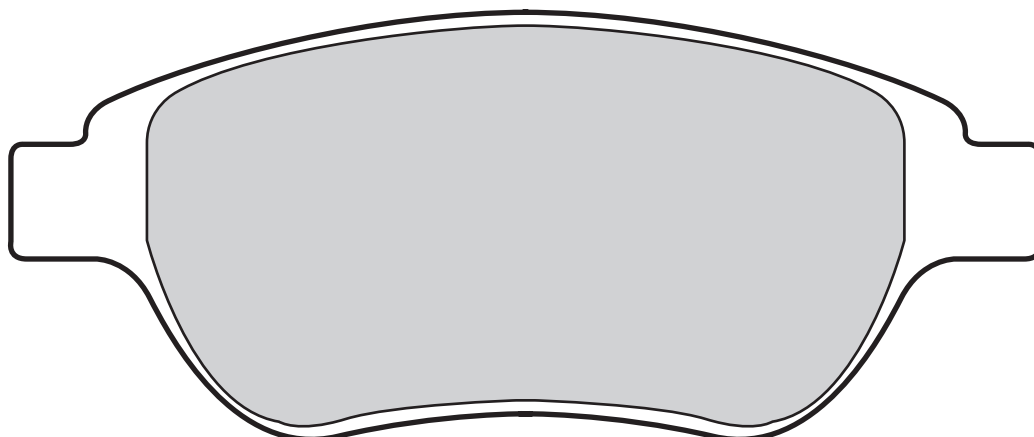

**Valeo**



598465

0

137

57,3

19

BOSCH

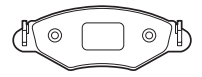

**23615 (WVA)**

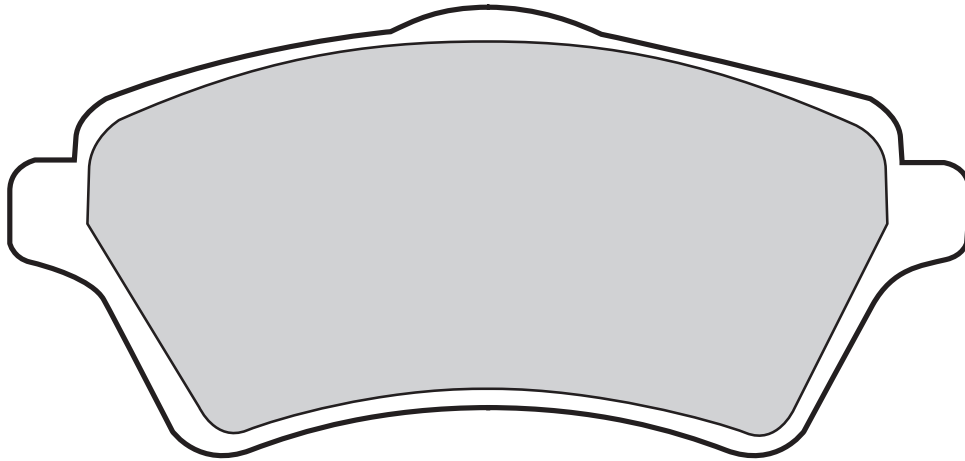

<b>Valeo</b>					
598514	0	131,5	62	18,2	LUCAS

**23623 (WVA)**

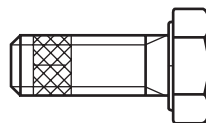
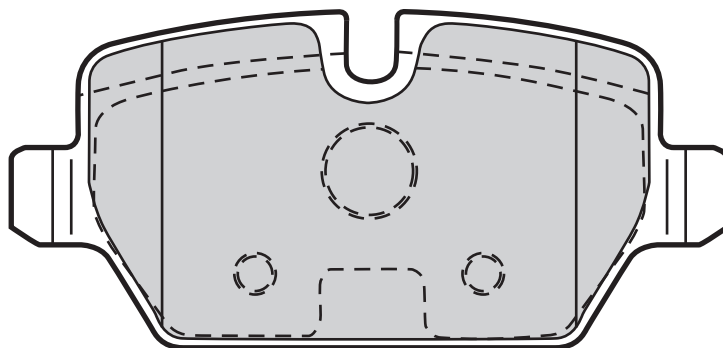
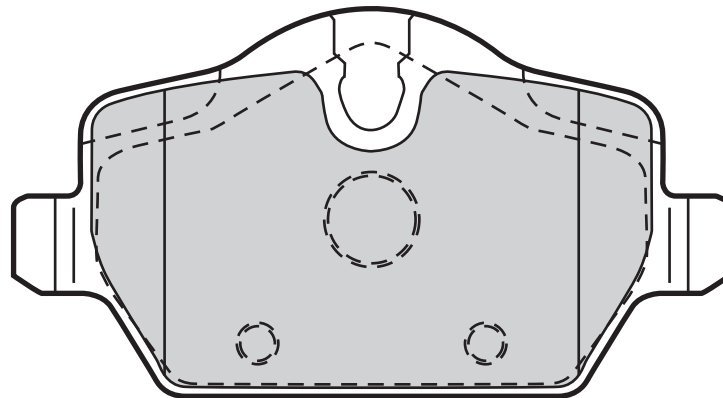

<b>Valeo</b>					
598701	0	95,2	44,7	17,5	LUCAS



# Valeo

## 23640 (WVA)

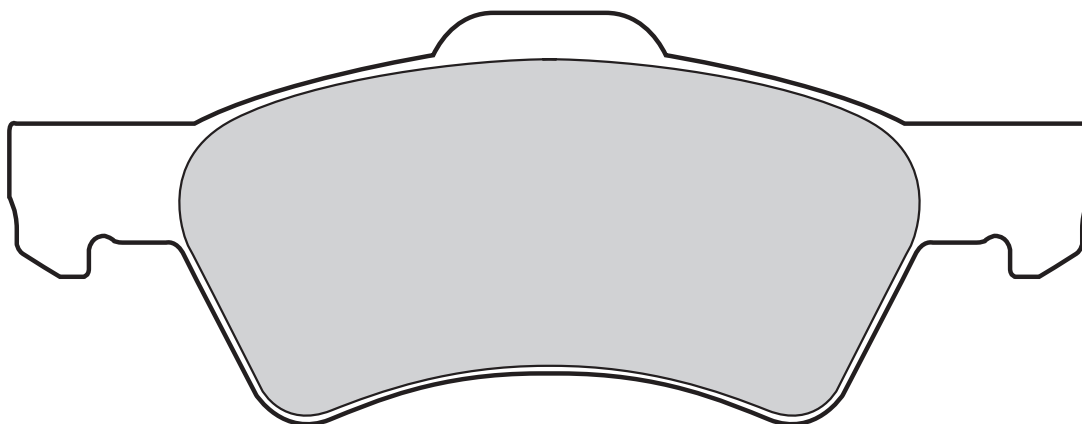

**Valeo**



598415

2

172,5

65,7

18,8

TEVES

## 23659 (WVA)

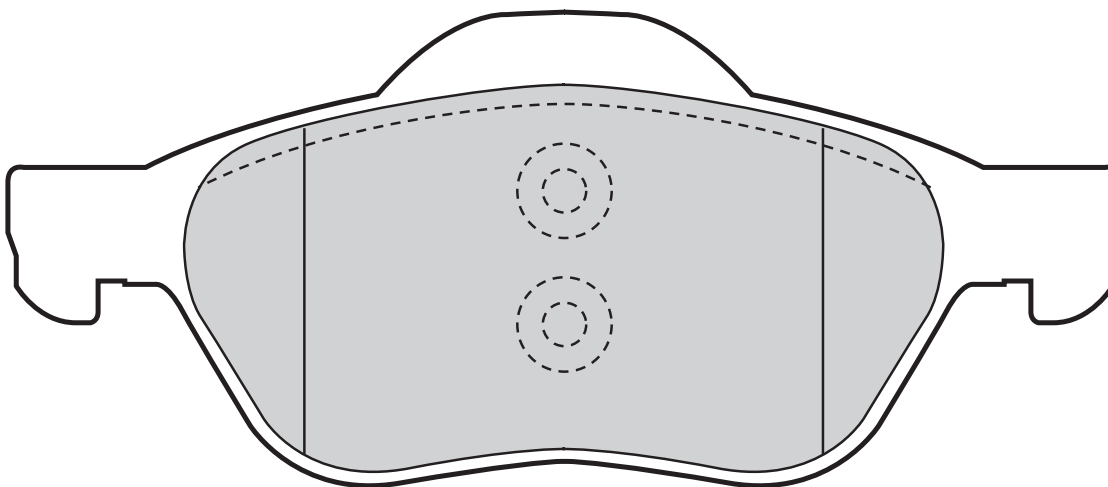
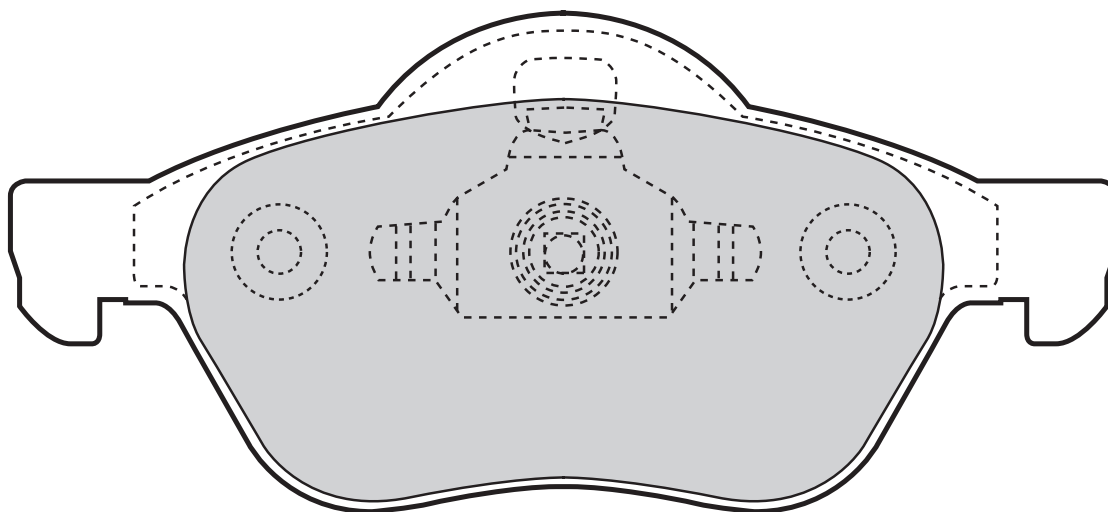

**Valeo**



598471

0

155,2

66,6

18

TEVES





## 23661 (WVA)

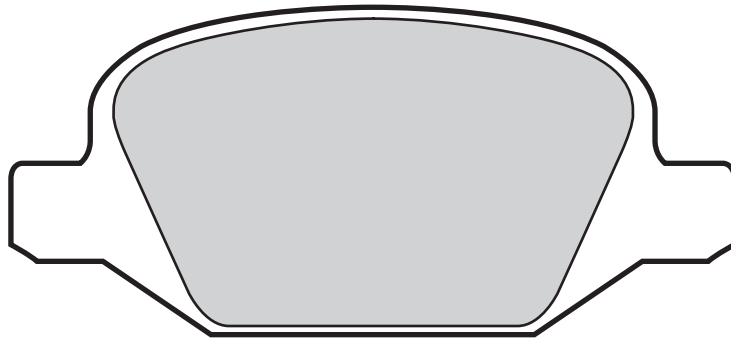

598425	0	95,8	43,9	13,7	LUCAS

## 23692 (WVA)

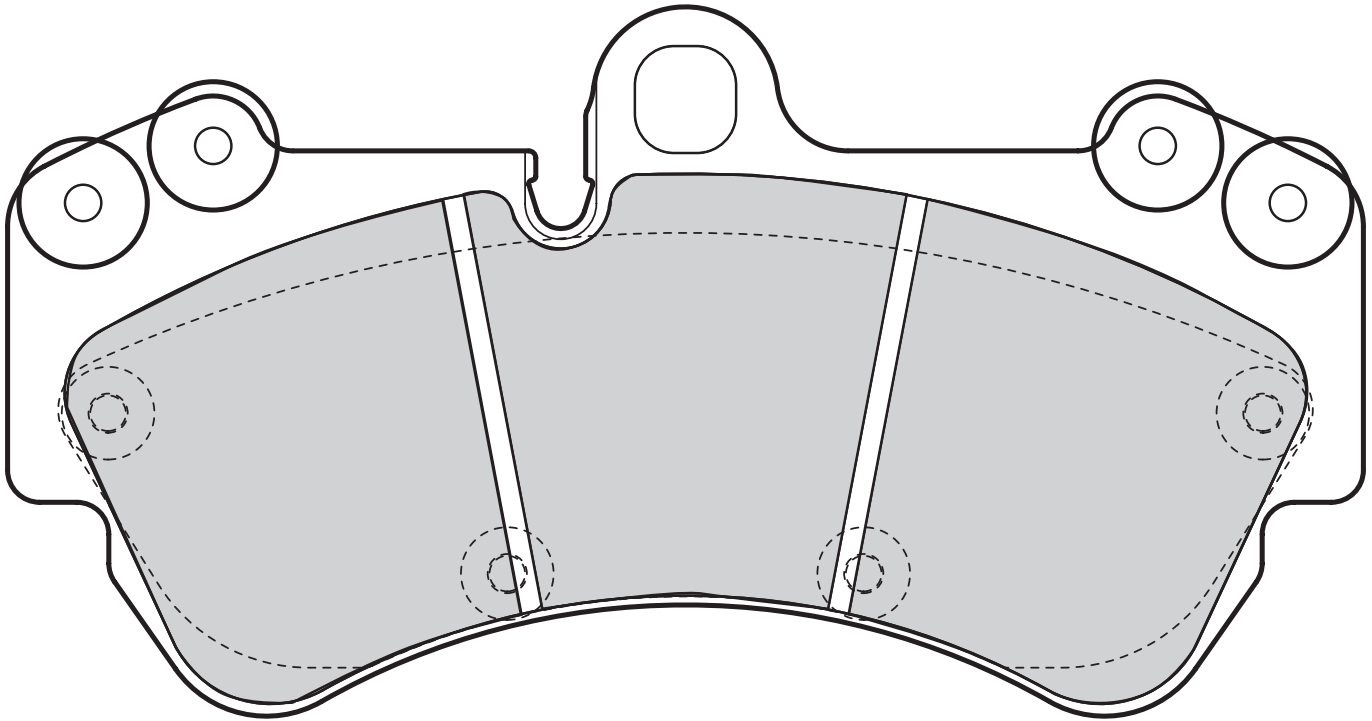

598655	0	190,2	99,5	16,6	BREMBO



**Valeo**

**23693** (WVA)

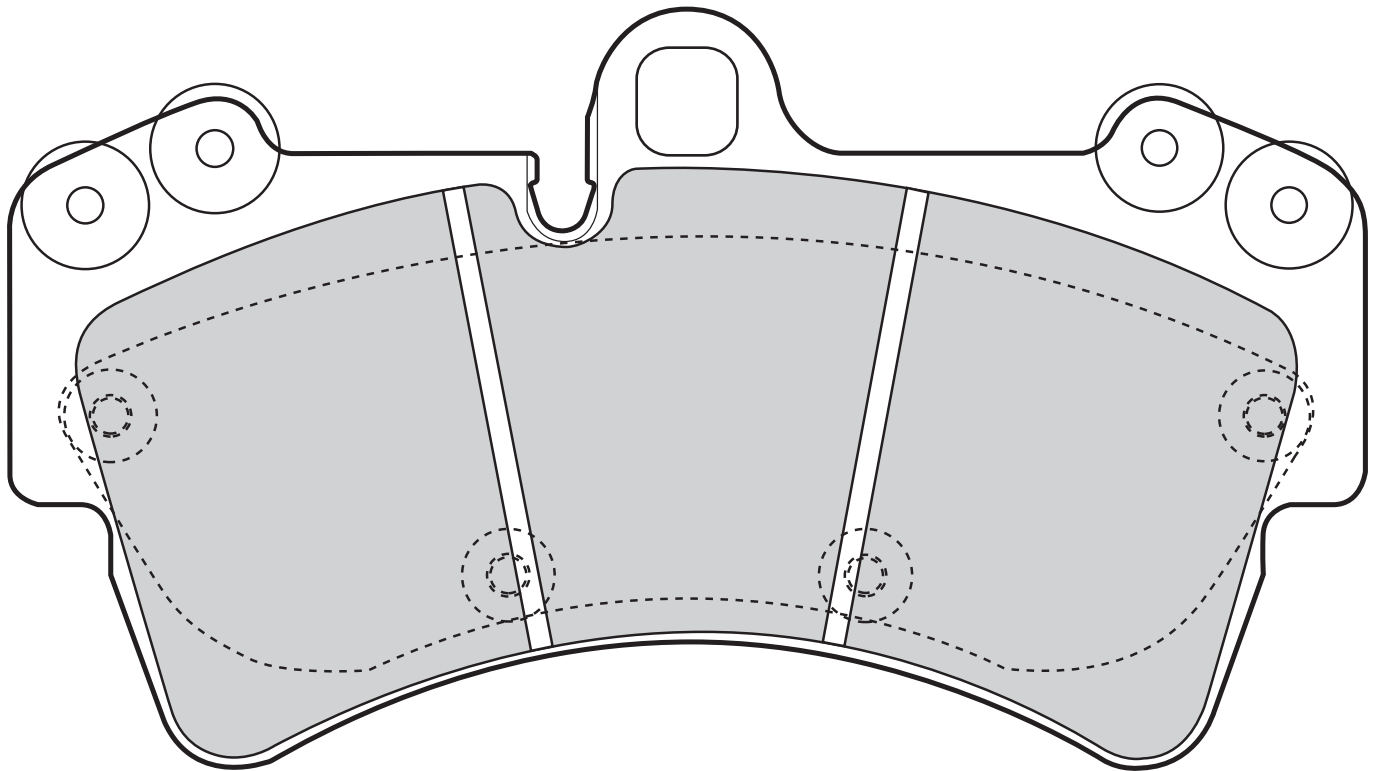

**Valeo**



598656

0

190,2

106,5

16,6

BREMBO

**23694** (WVA)

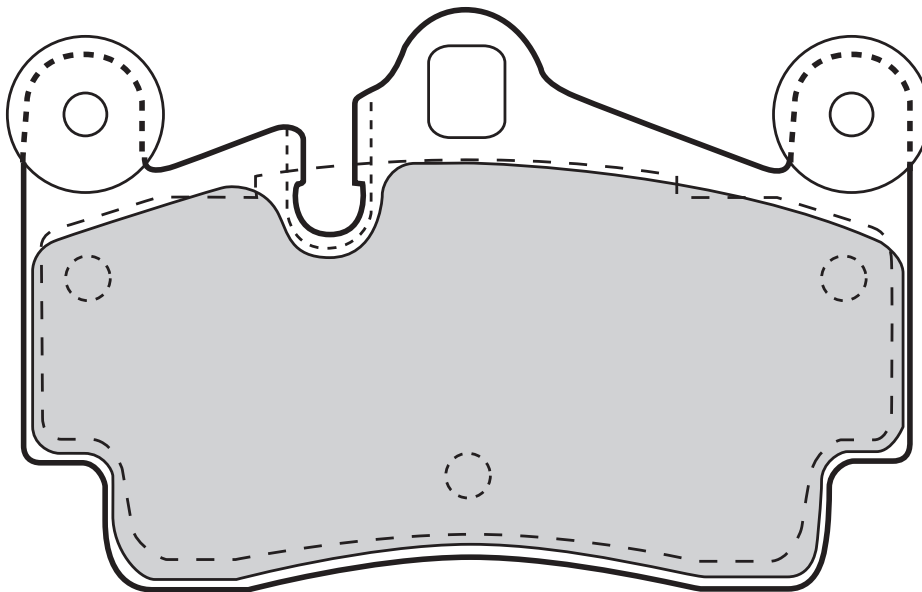

**Valeo**



598770

0

117,3

73,1

16,7

BREMBO

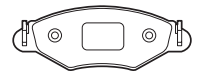

## 23703 (WVA)

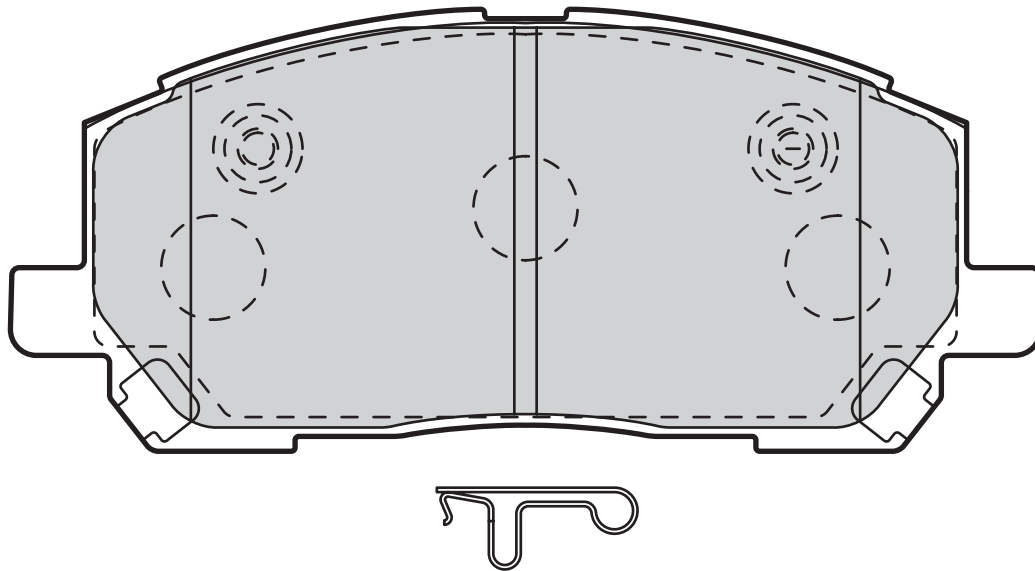

598944	2	138	60	18,6	AKEBONO

## 23705 (WVA)

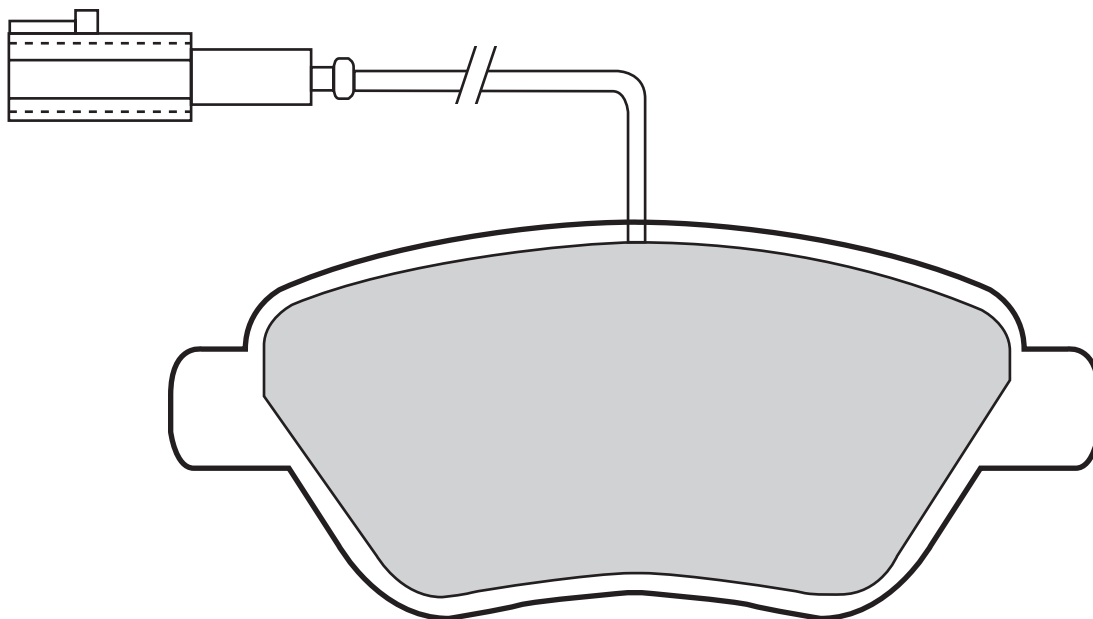

598426	1	123	53,3	17,8	BOSCH



# Valeo

## 23714 (WVA)

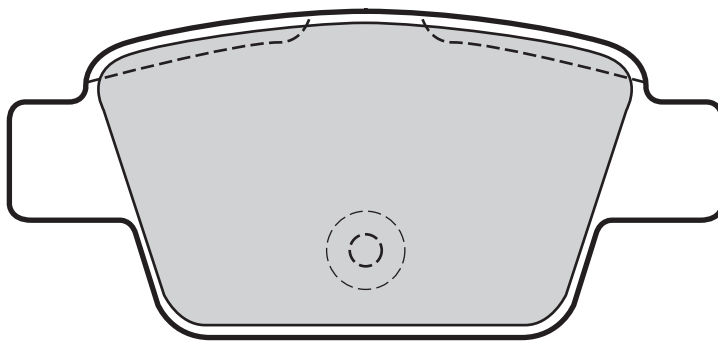

**Valeo**



598633

0

95

42,9

16

BOSCH

## 23723 (WVA)

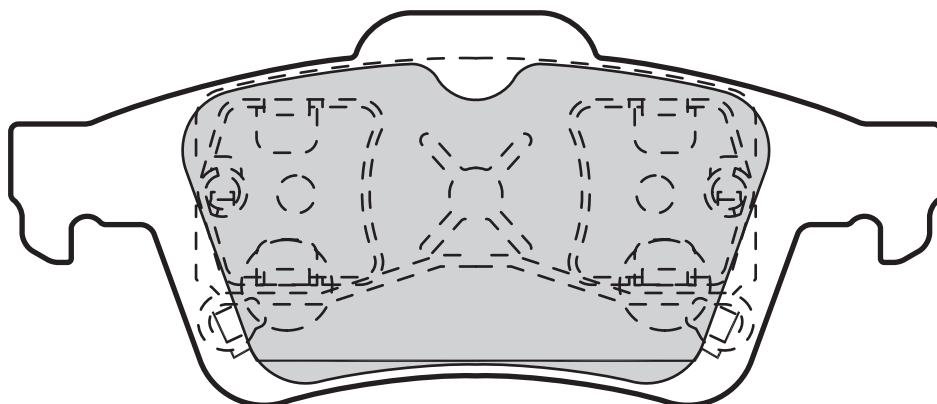
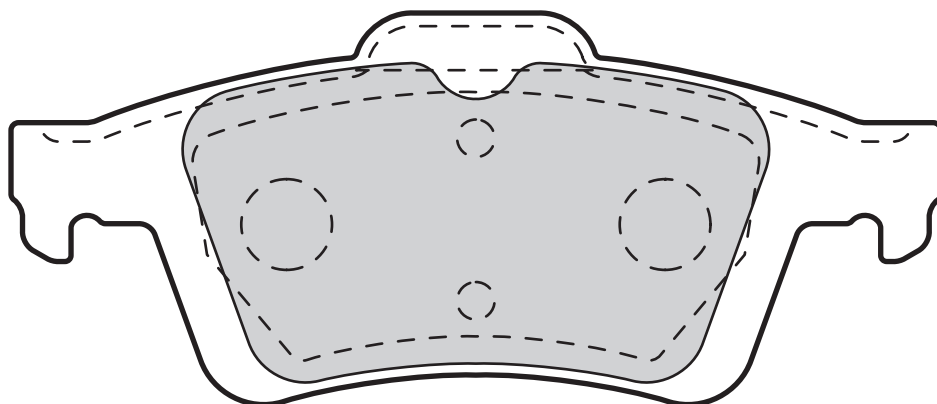

**Valeo**



598649

0

156,3

62,5/67

17,5

TEVES

601005

0

122,9

51,8

16,4

TEVES

601008

0

122,9

51,8

16,4

AKEBONO

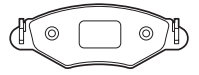

**23726 (WVA)**

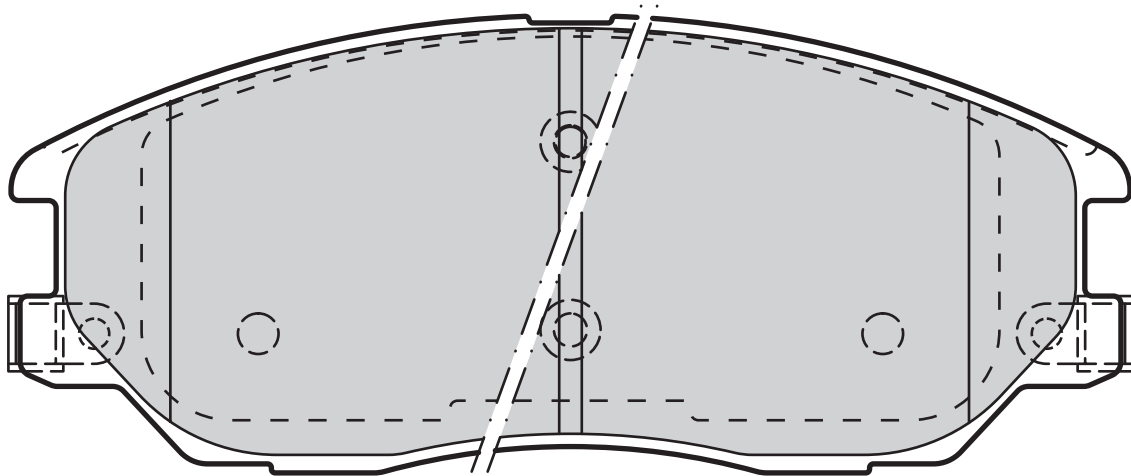

598871

2

148,7

60,8

17,2

MANDO

**23730 (WVA)**

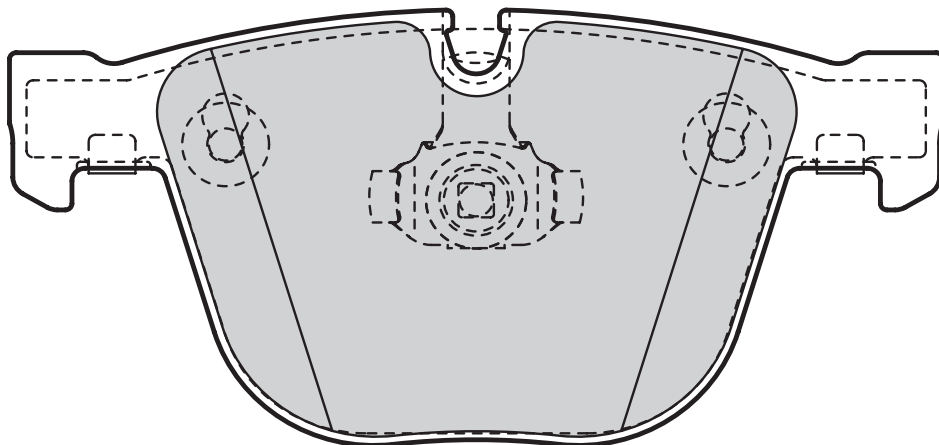
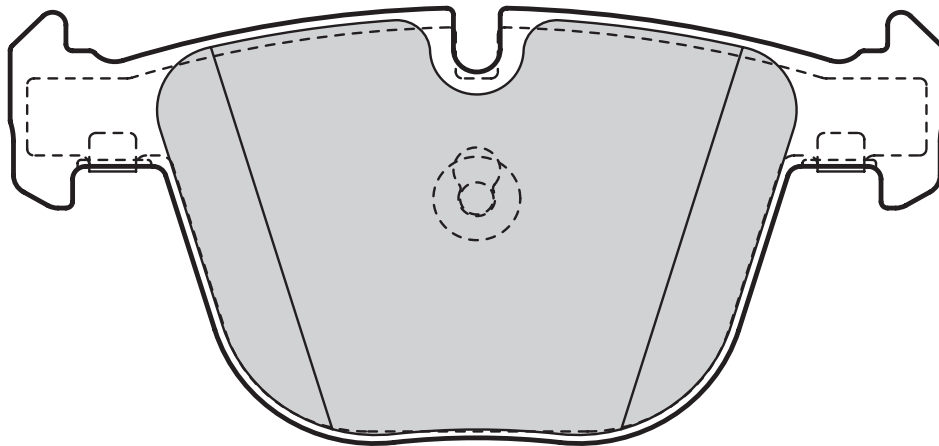

598820

0

137

63,4

18

TEVES



# Valeo

## 23743 (WVA)

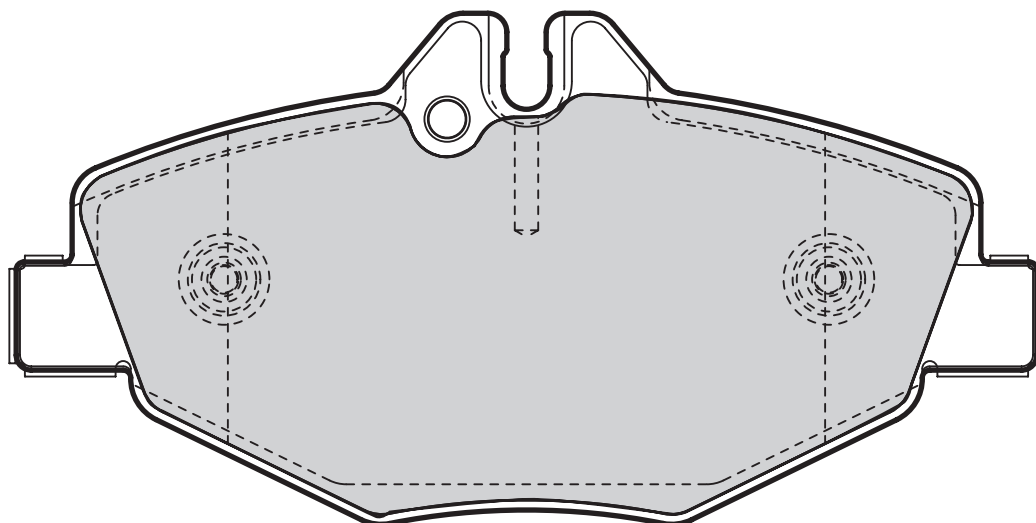

**Valeo**



598638

2



137



67,8



20



BOSCH

## 23745 (WVA)

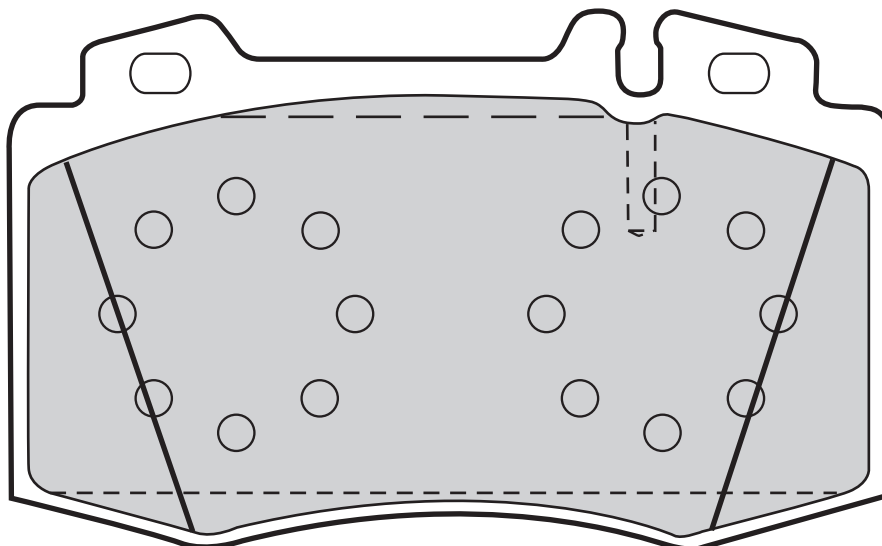
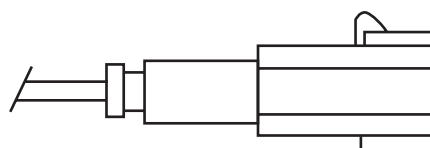

**Valeo**



598659

0



117,8



71,5



17,2



BREMBO

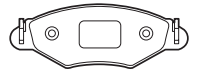

## 23762 (WVA)

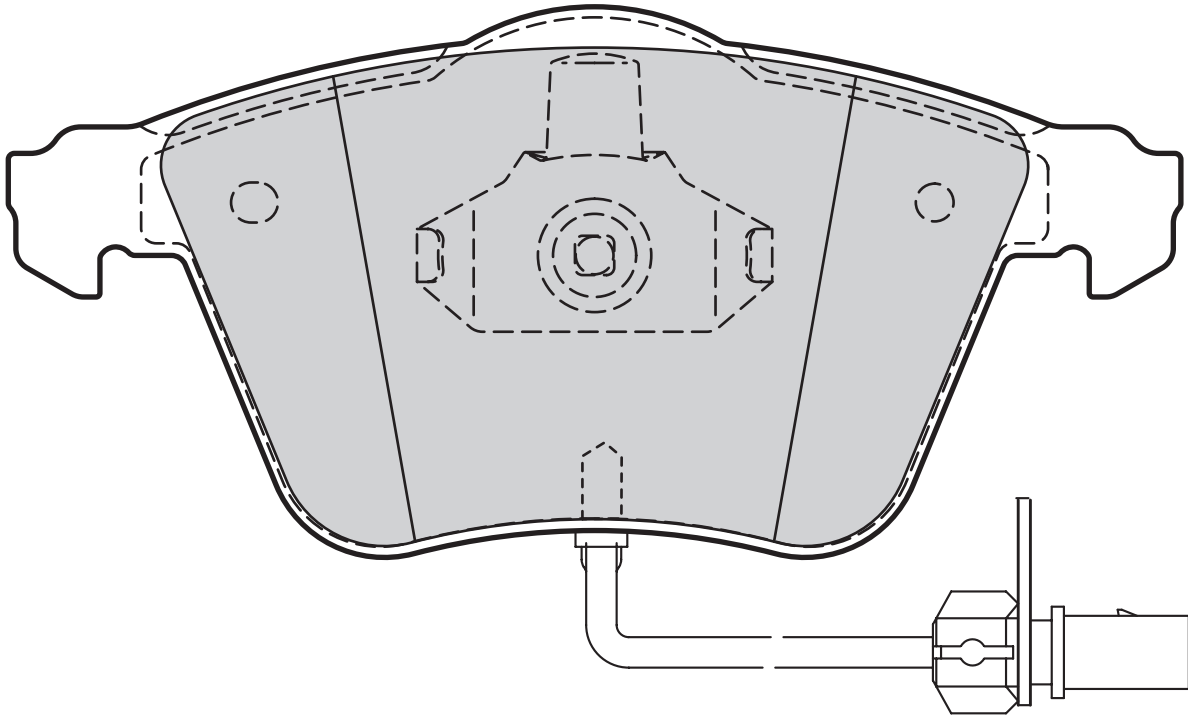
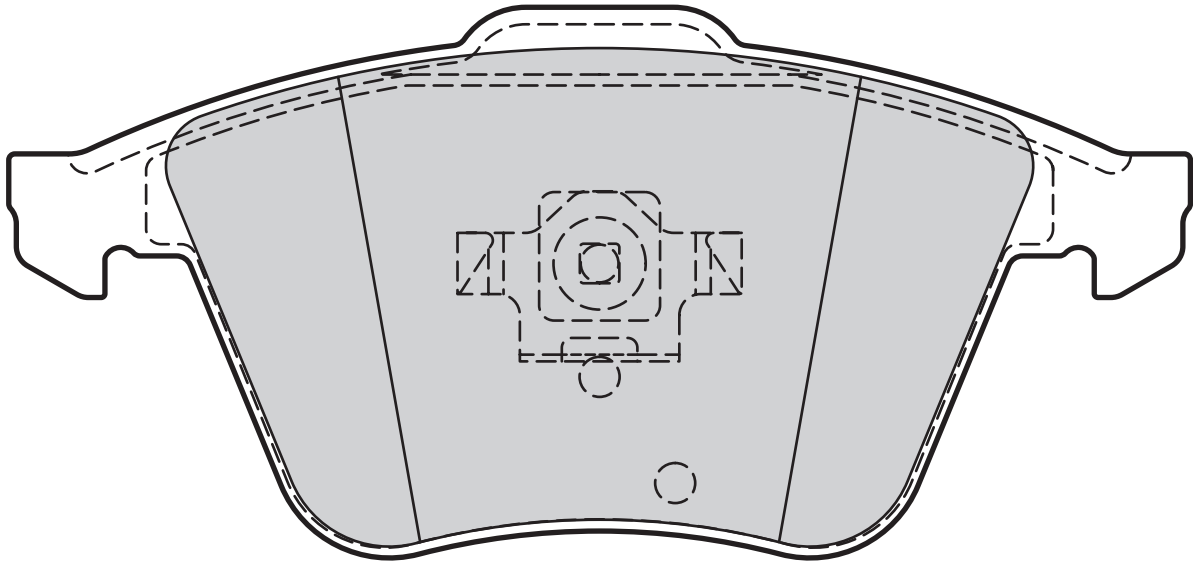

**Valeo**



598779

2

156,3

72,8

20,3

TEVES

598822

0

156,3

72,8

18,5

TEVES

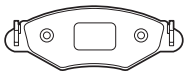

**Valeo**

**23794** (WVA)

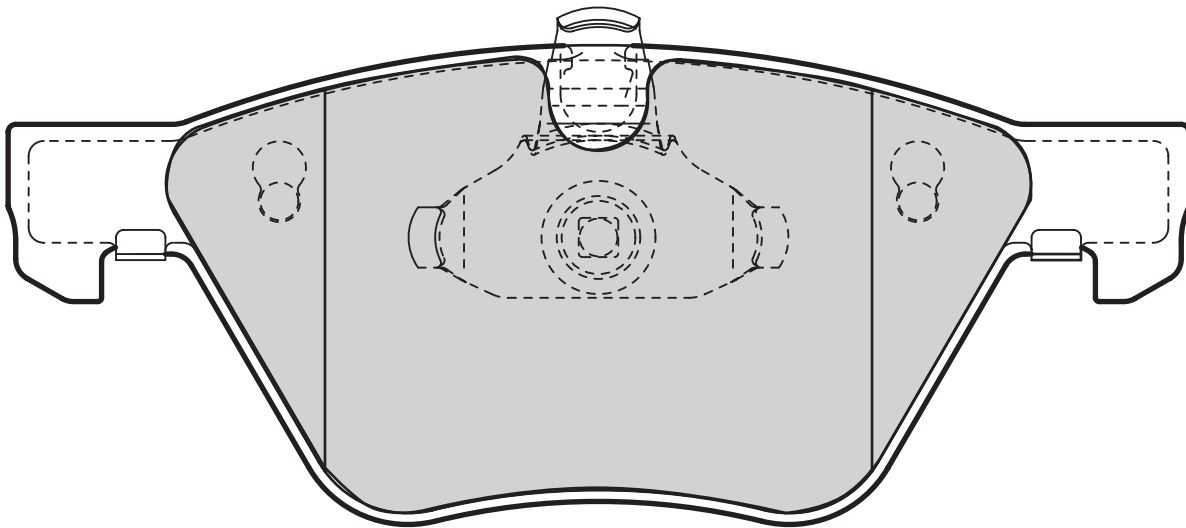
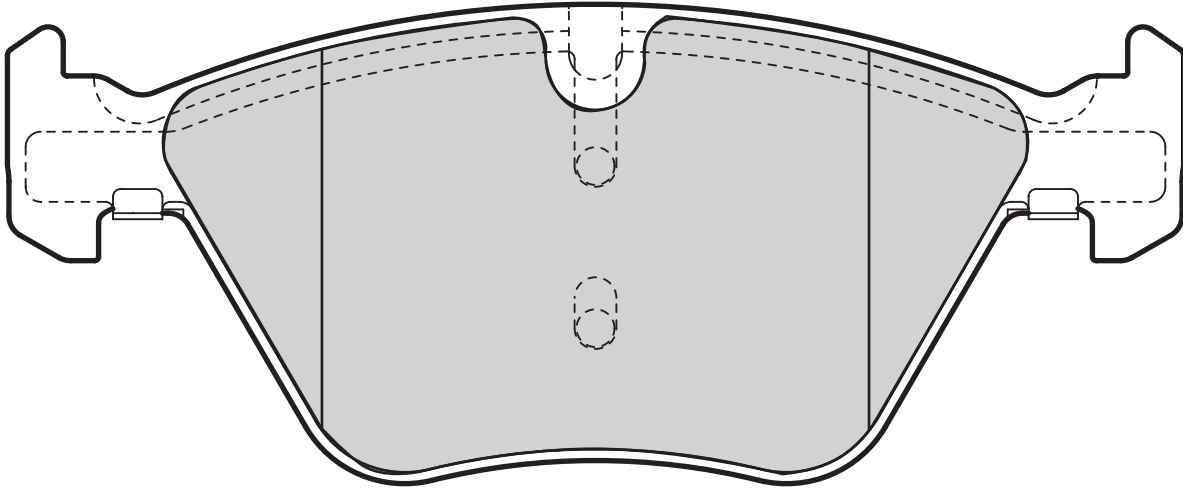

**Valeo**



598640

0

154,8

63,6

20

TEVES



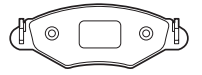

23801 (WVA)

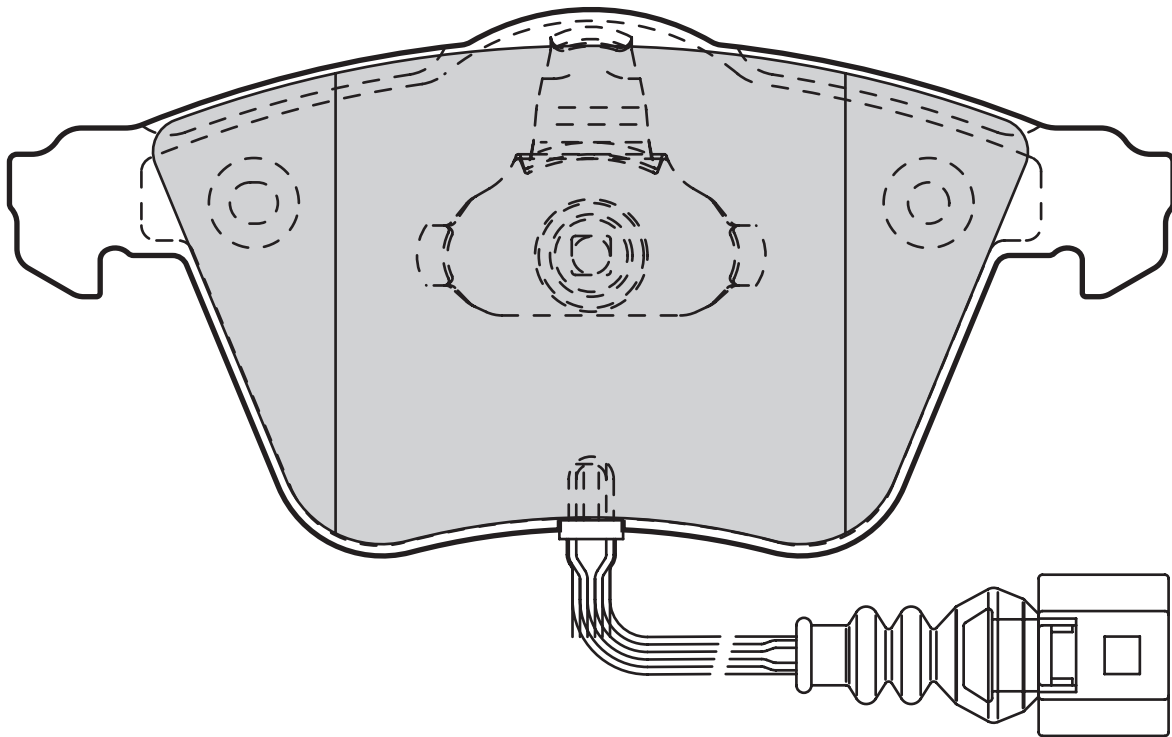
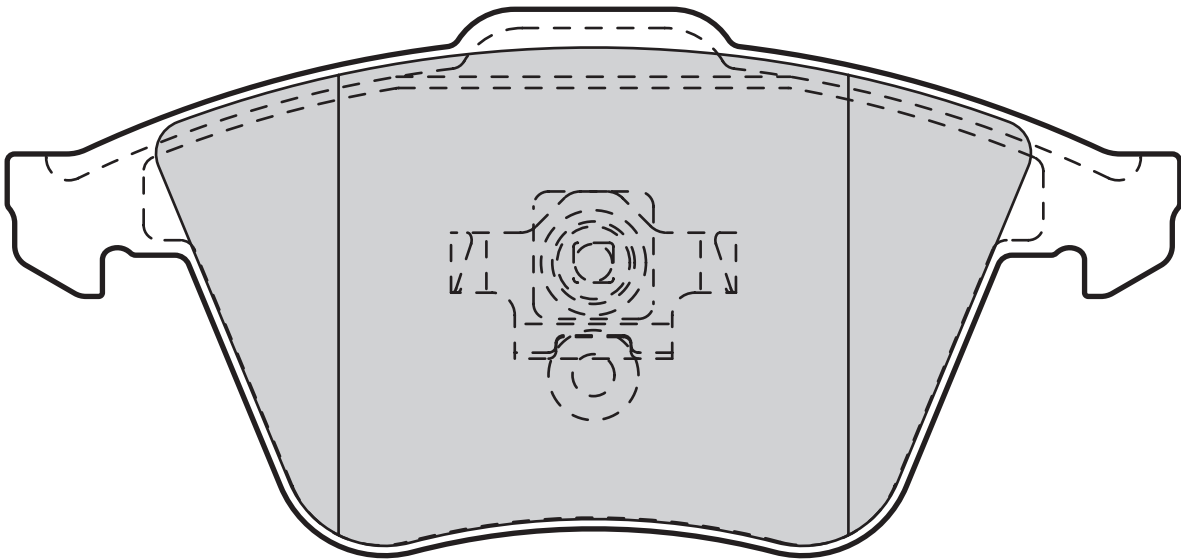

**Valeo**



598863

1



155,1



72,8



20,3



TEVES



# Valeo

23807 (WVA)

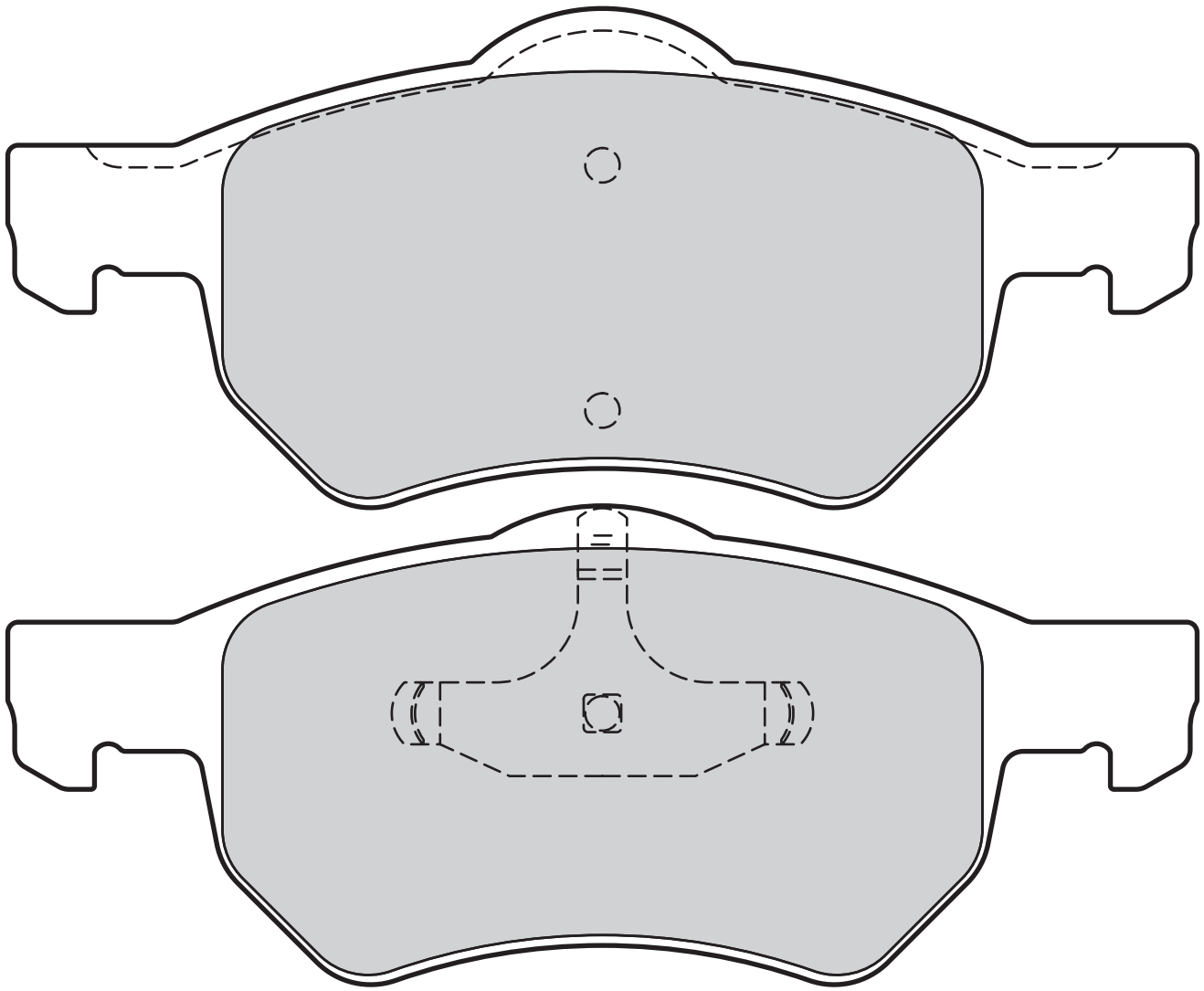

**Valeo**



598756

0

172,2

72,3

18,6

TEVES



23832 (WVA)

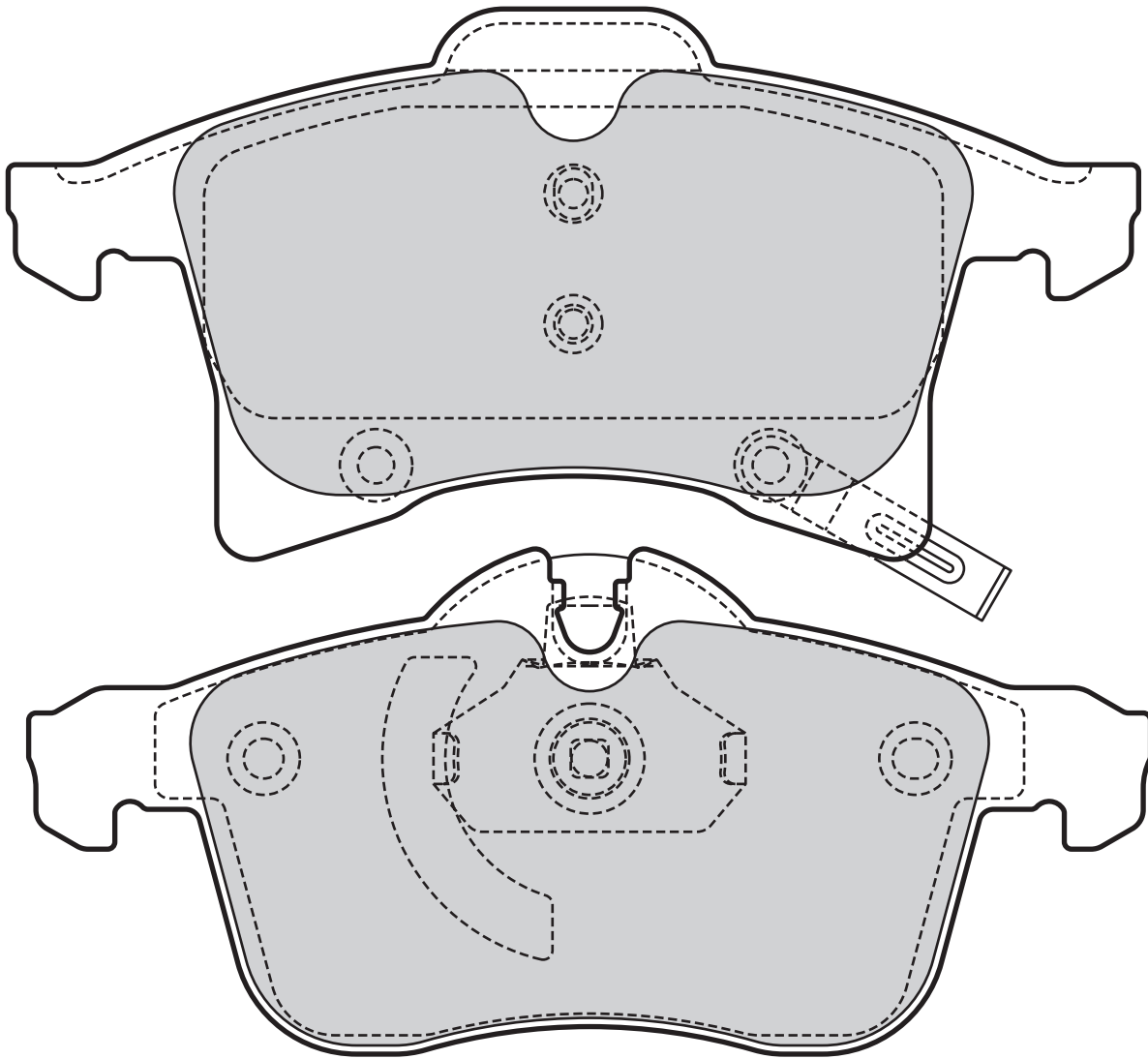

**Valeo**



598860

2

156,1

69,8

20,4

TEVES



# Valeo

## 23865 (WVA)

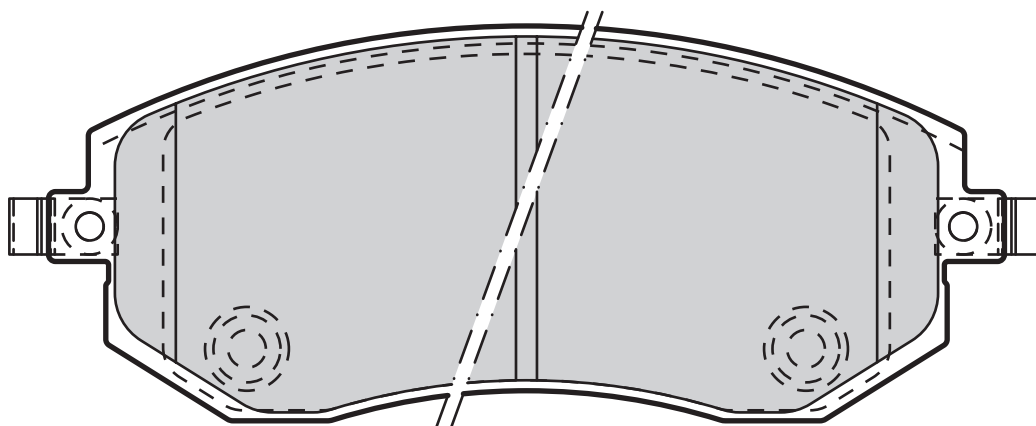

**Valeo**



598853

2

136,8

56,5

17,5

AKEBONO

## 23881 (WVA)

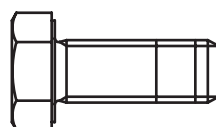
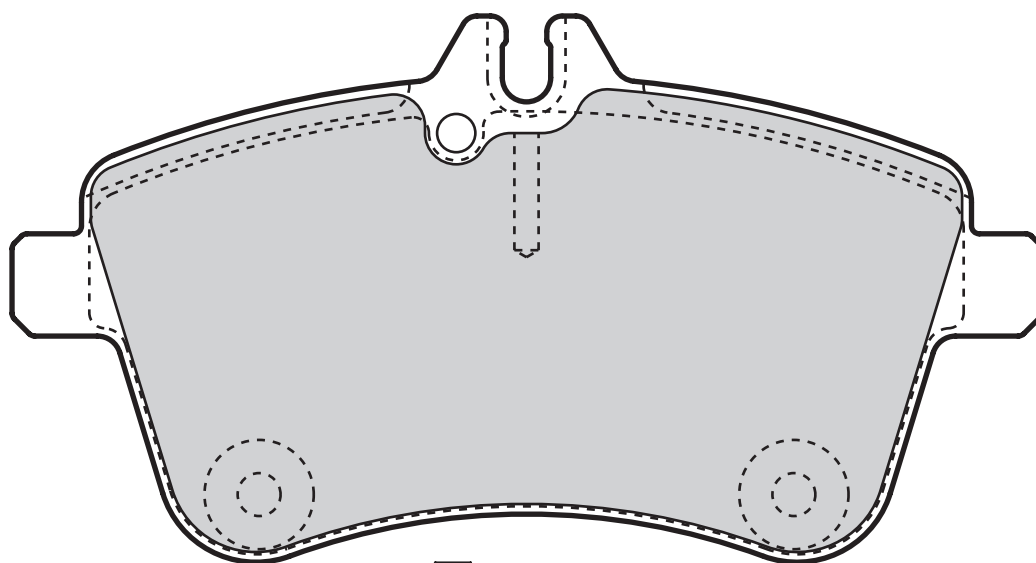

**Valeo**



598795

2

131,6

70

20,1

LUCAS



## 23885 (WVA)

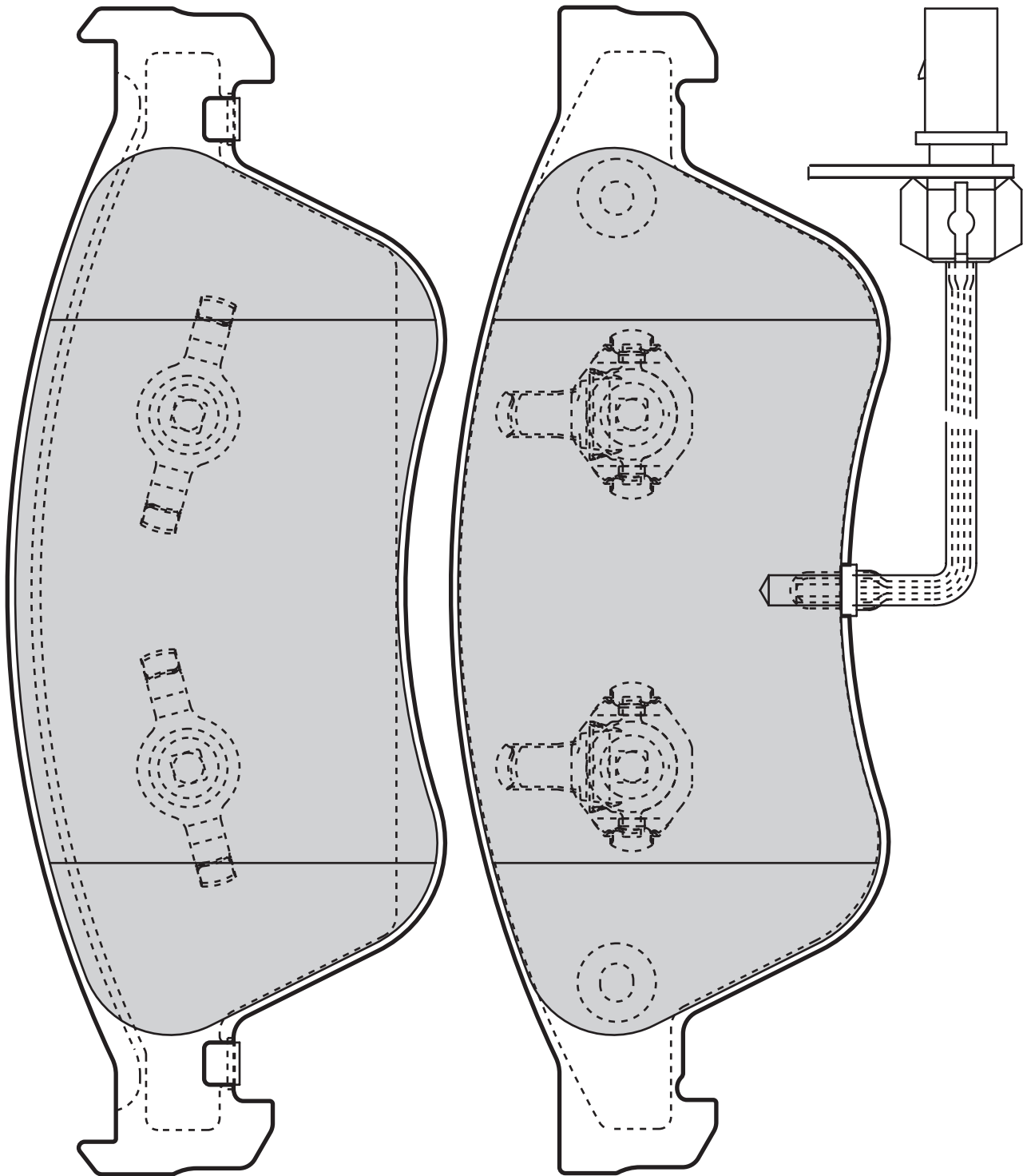

**Valeo**



598845

2

193,2

72,6

20,3

TEVES



**Valeo**

**23914 (WVA)**

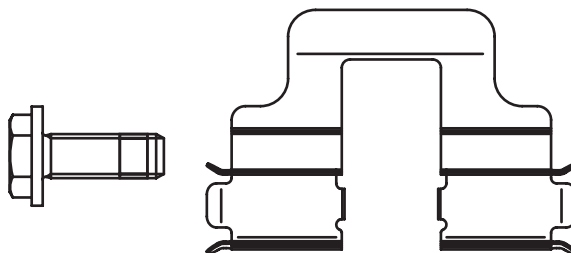
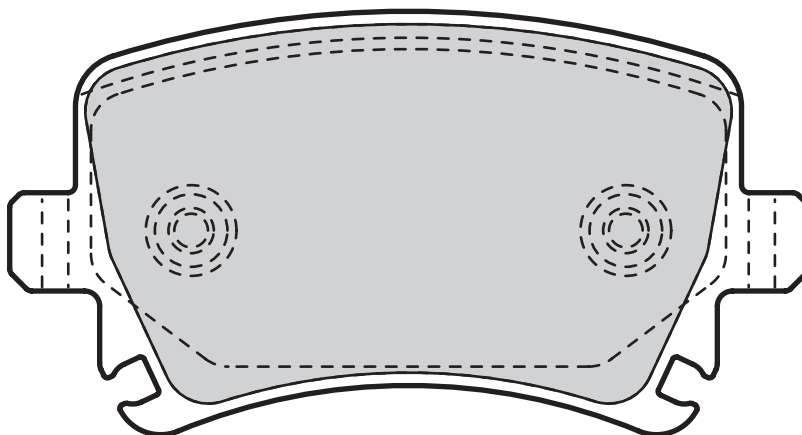

**Valeo**



598752

0

105,5

56

17

LUCAS

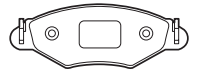

## 23915 (WVA)

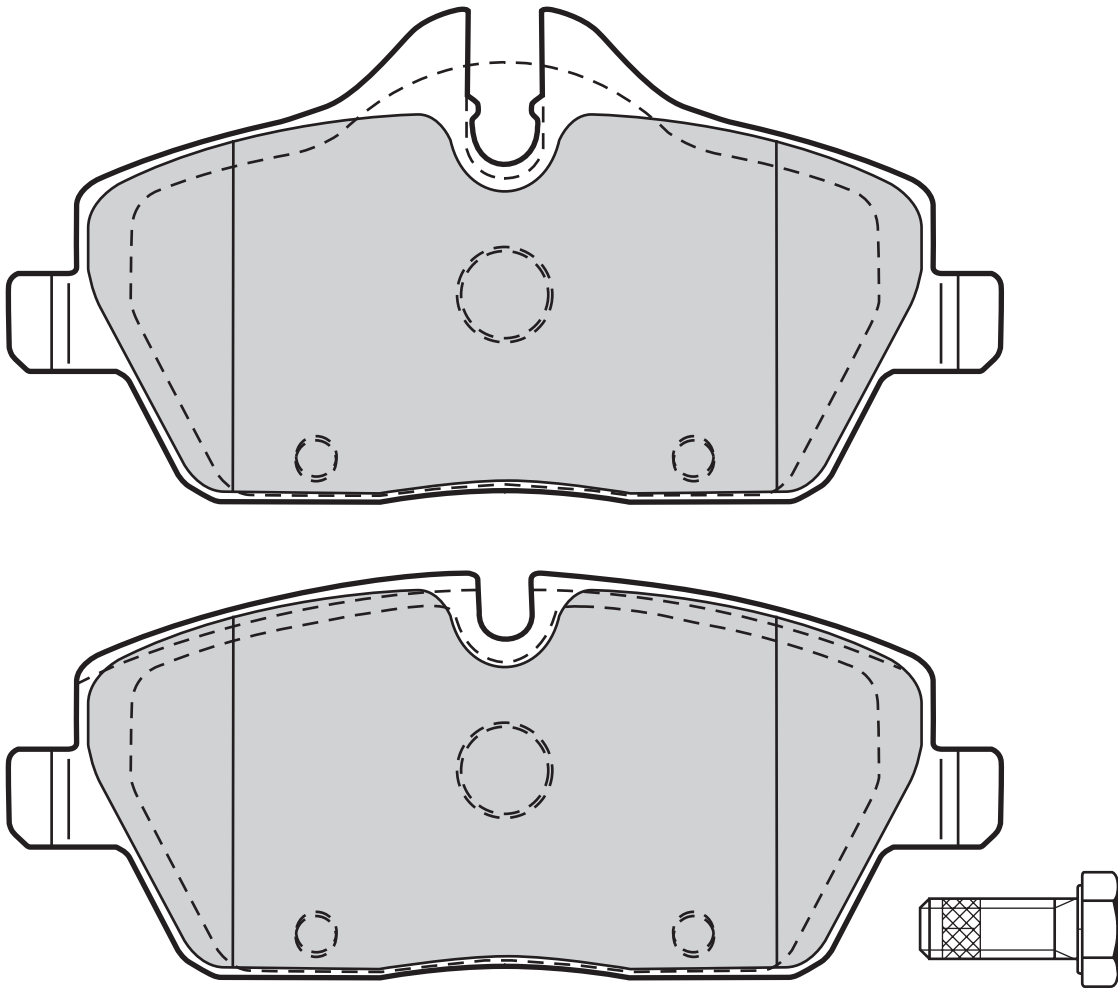

**Valeo**



598699

0



131,2



65/53,2



17,9



LUCAS



**Valeo**

23922 (WVA)

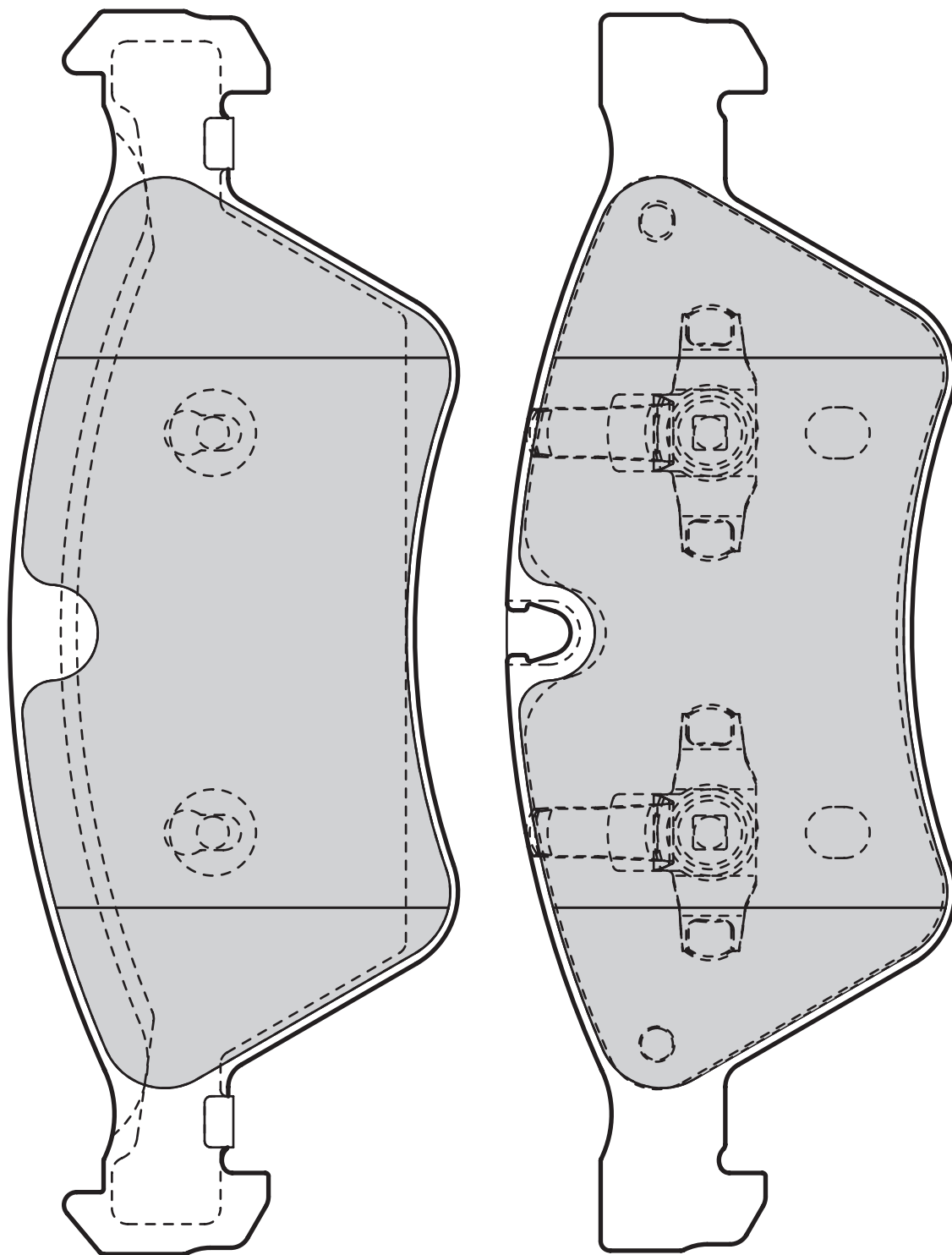

**Valeo**



598728

0

193,3

70

20,3

TEVES



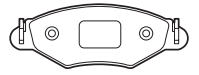

23923 (WVA)

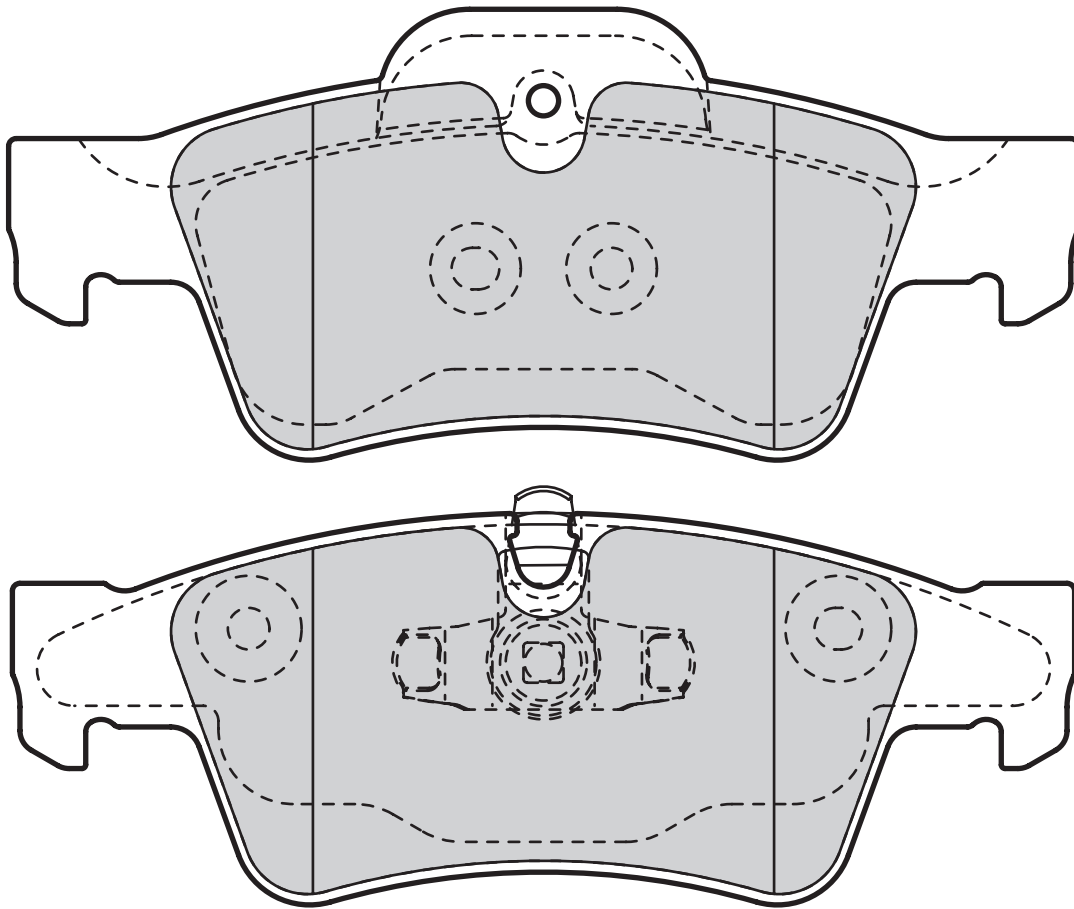

**Valeo**



598802

0



140,2



52



17,9



TEVES



# Valeo

## 23926 (WVA)

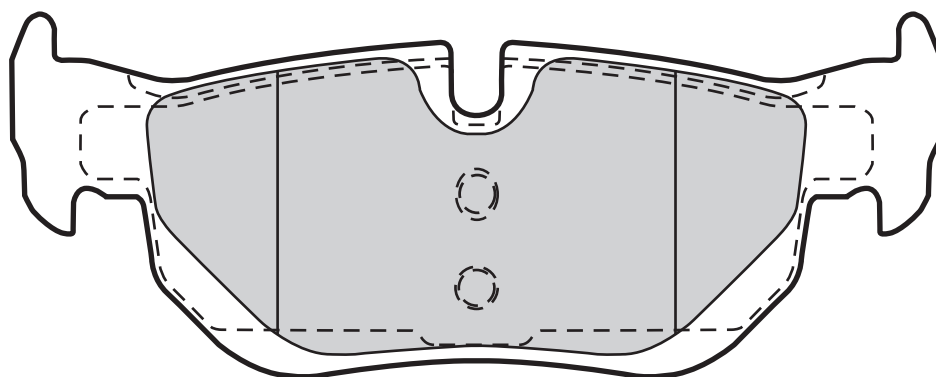
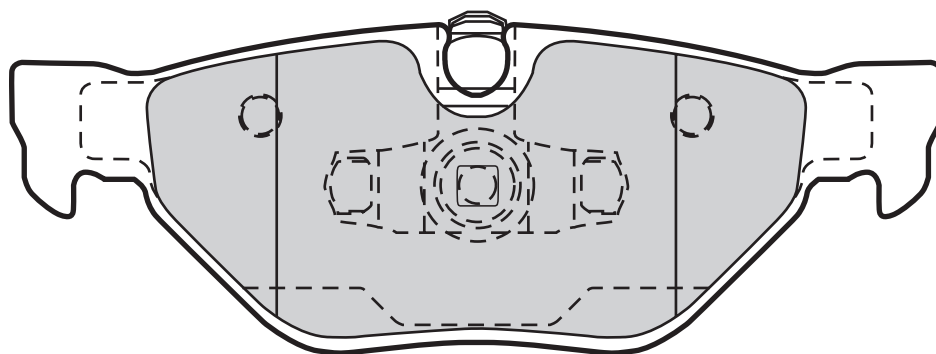

**Valeo**



598703

0

123

44,5

17,3

TEVES

## 23930 (WVA)

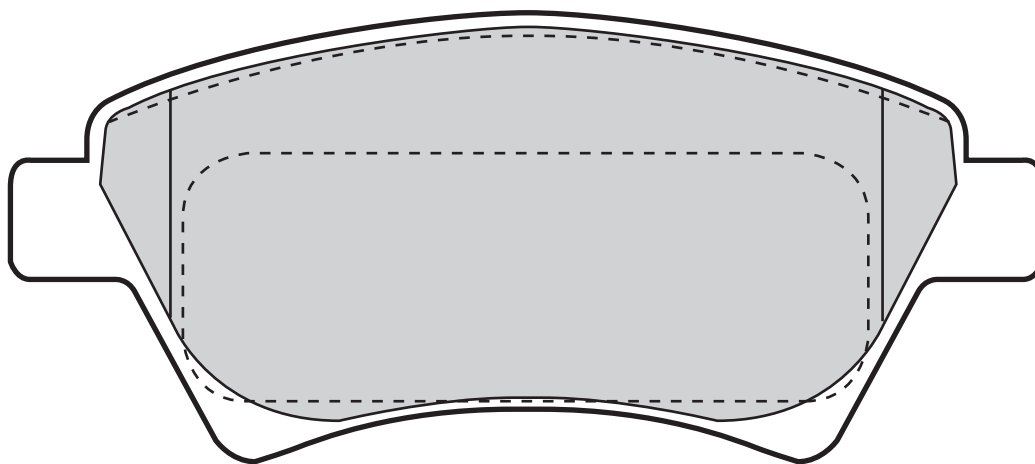

**Valeo**



598558

0

136,8

59,5

18,3

BOSCH

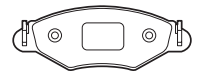

## 23934 (WVA)

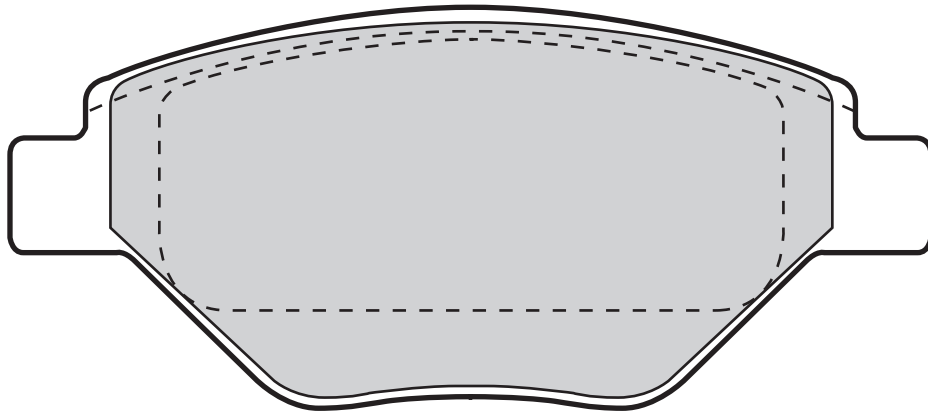

**Valeo**



598557

0

122,8

54,3

18,3

BOSCH

## 23935 (WVA)

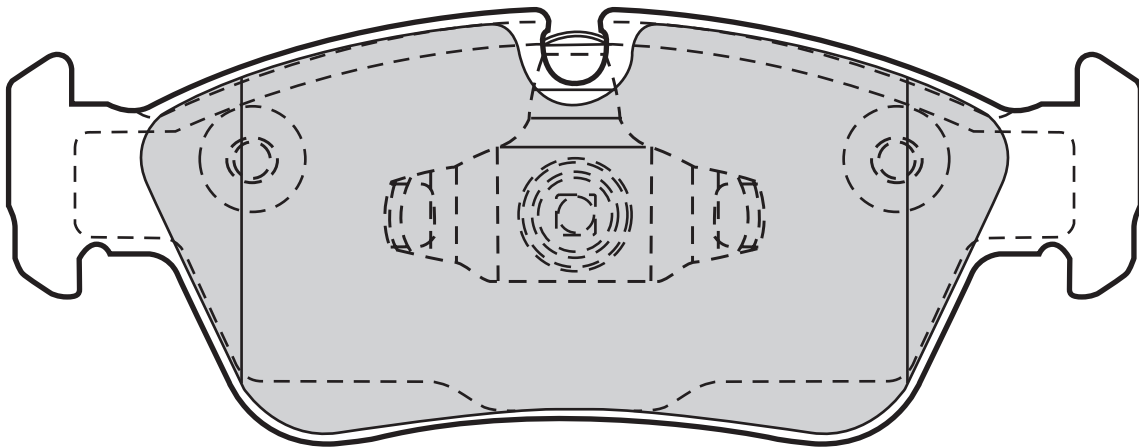
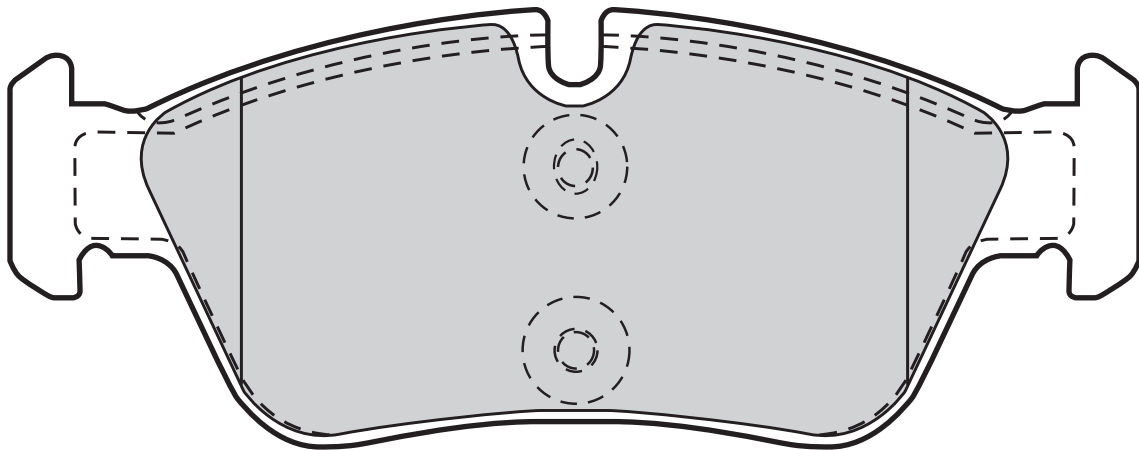

**Valeo**



598700

0

149,4

57,5

17,8

TEVES

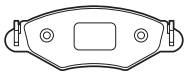

**Valeo**

**23945** (WVA)

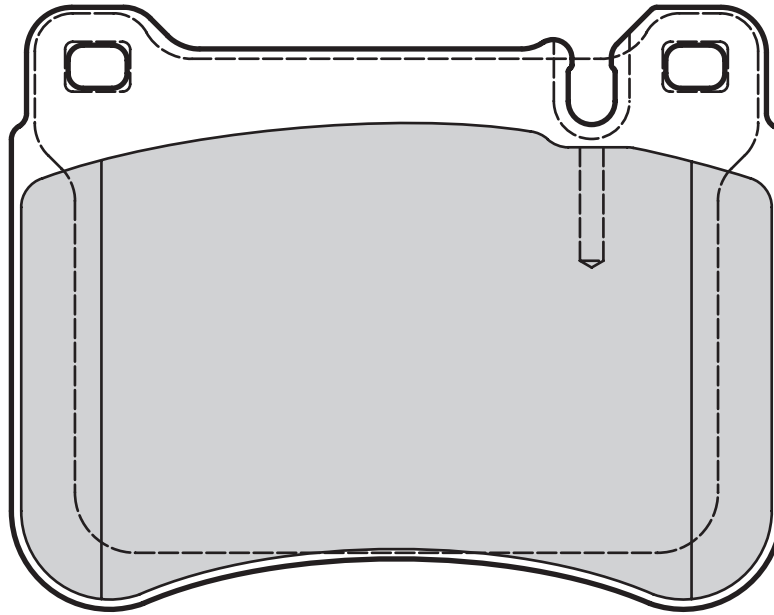

**Valeo**



601034

0

101,8

79,6

16,5

TEVES



23951 (WVA)

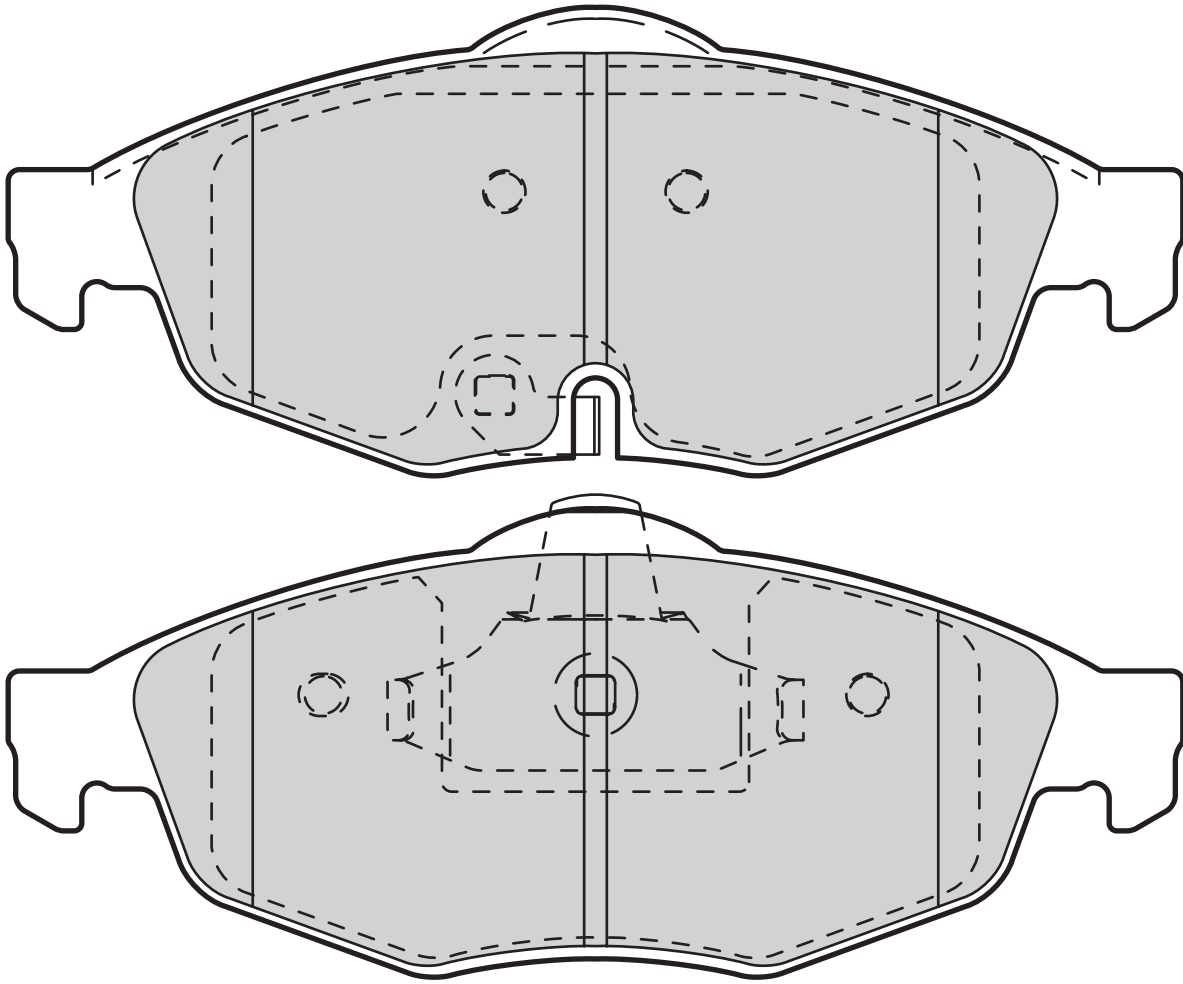

598905

0

155,45

62

20,5

TEVES



# Valeo

## 23960 (WVA)

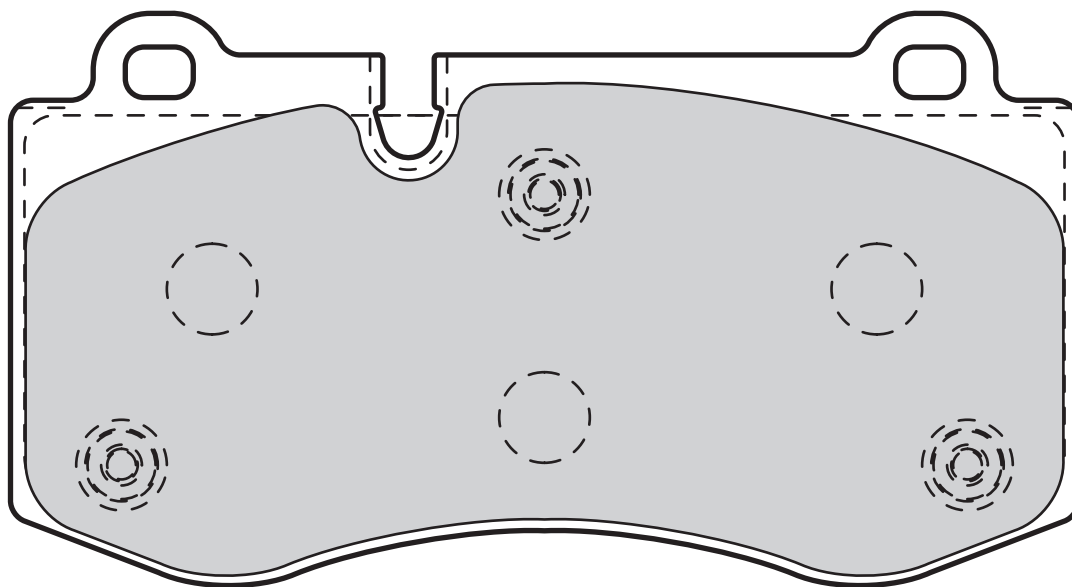

598995	0	141,4	75,8	17,8	BREMBO

## 23983 (WVA)

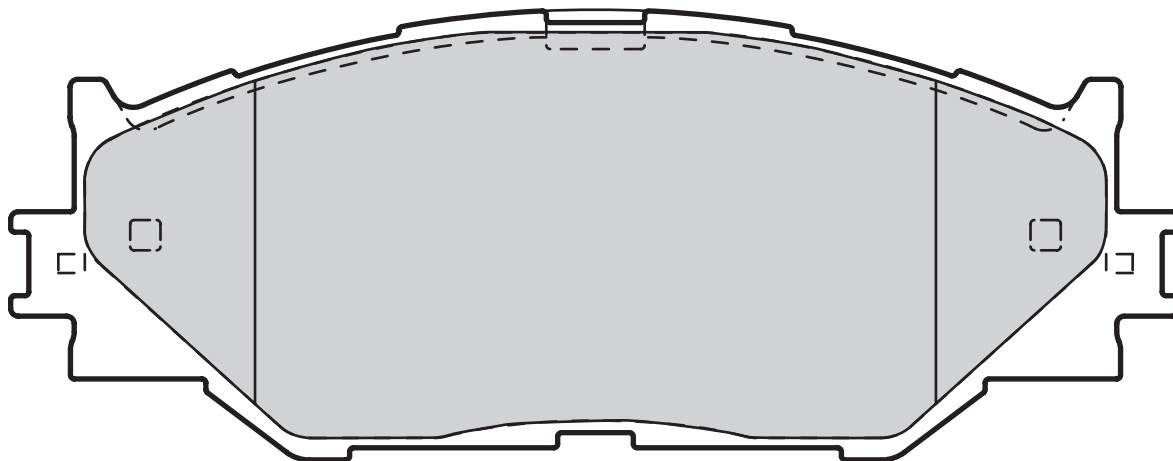

601035	0	154,6	59,5	17,7	SUMITOMO

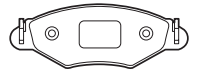

23984 (WVA)

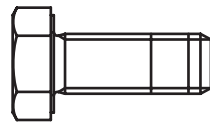
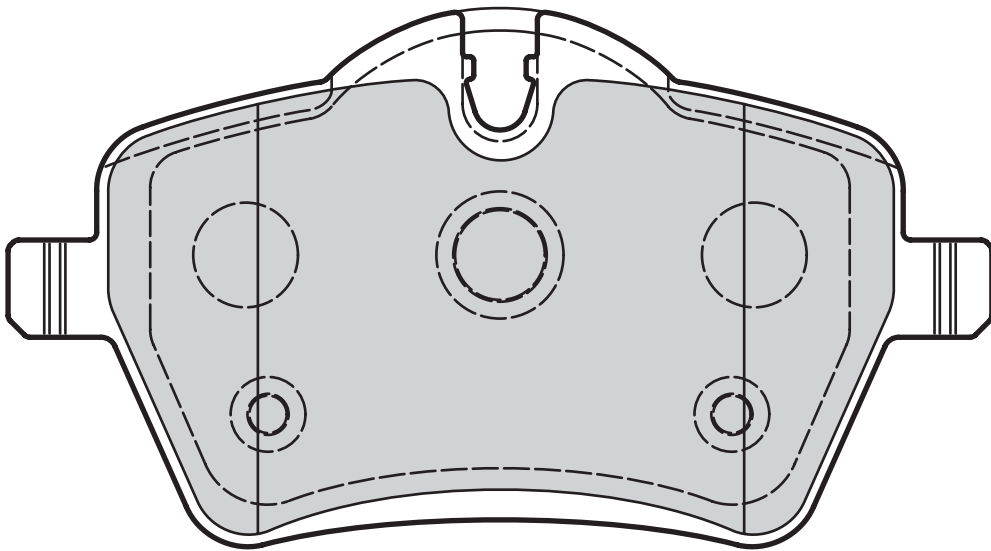
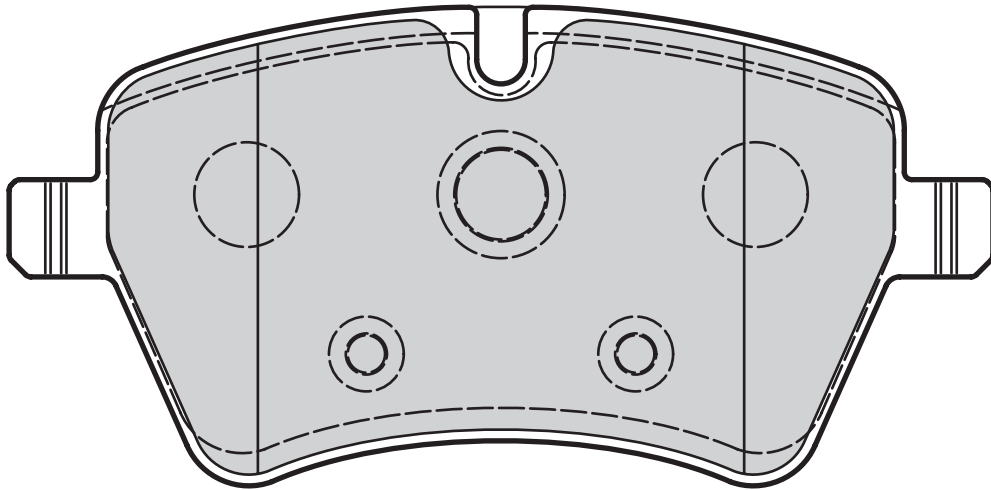

**Valeo**



598925

2



131,5



64/71,4



17,9



LUCAS



**Valeo**

**24008 (WVA)**

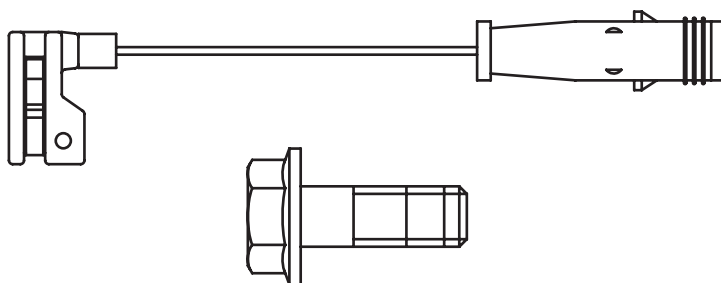
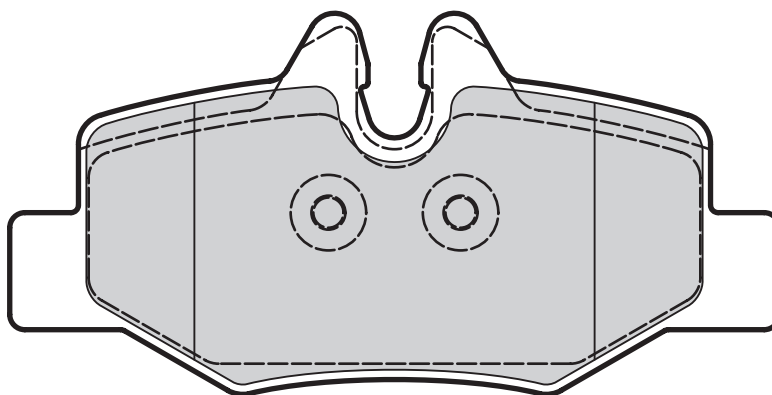

**Valeo**



598765

2

101,9

50,5

18,3

BOSCH



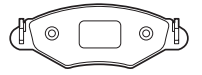

## 24011 (WVA)

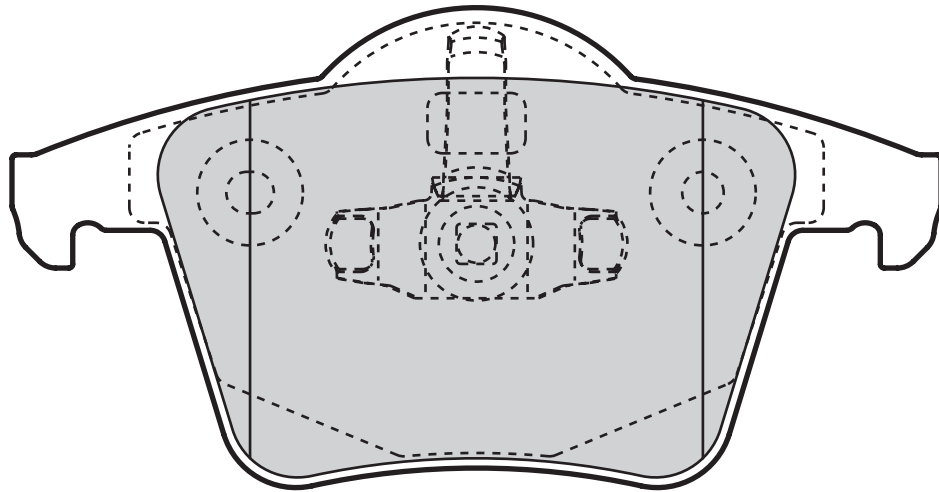
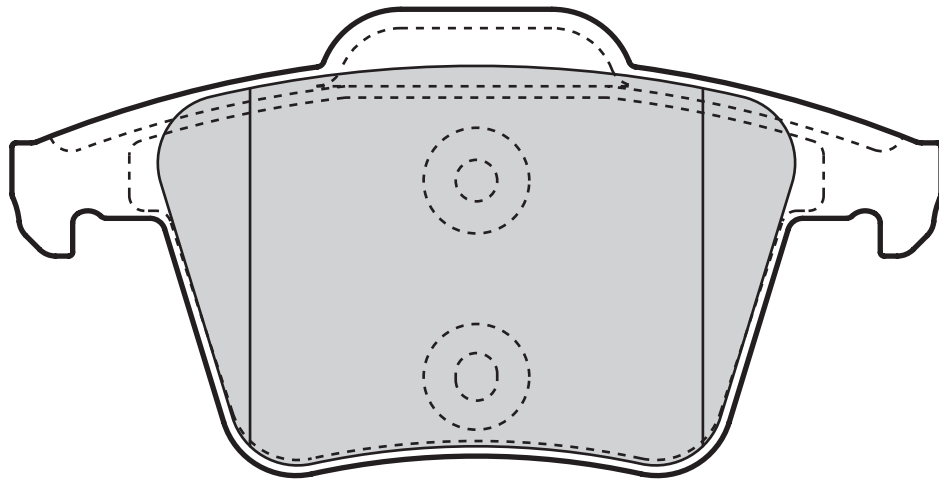

**Valeo**



598829

0



122,9



61,6



18,7



TEVES



# Valeo

## 24014 (WVA)

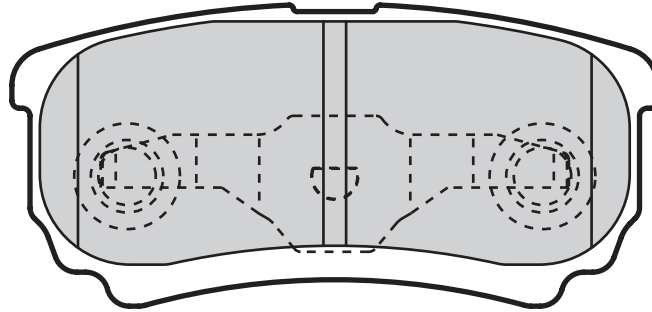
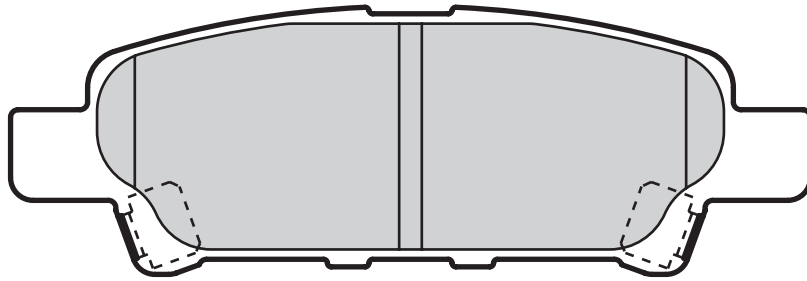

**Valeo**



598852

2

85,4

35,5

15,4

AKEBONO

## 24036 (WVA)

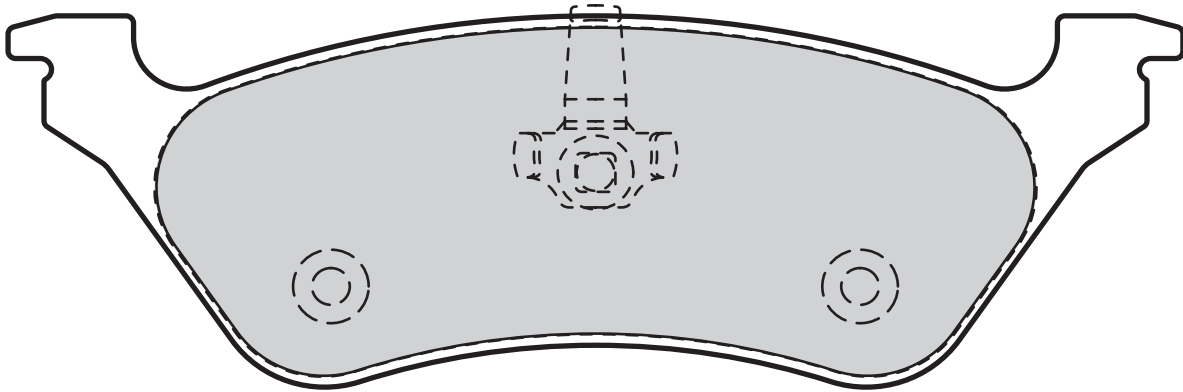

**Valeo**



598755

0

155,4

50,5

17

KELSEY



## 24039 (WVA)

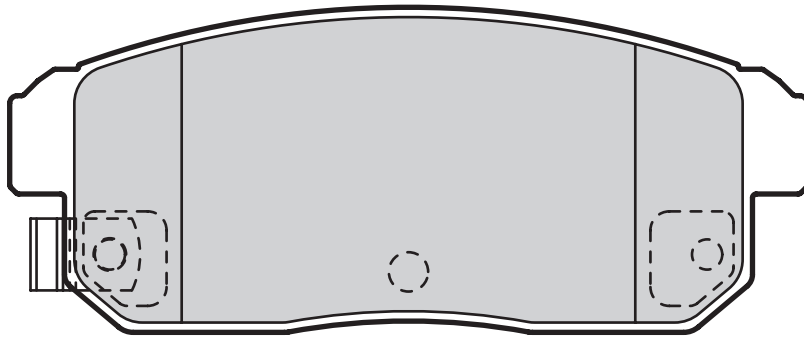

598831

1

105,5

43

15

AKEBONO

## 24077 (WVA)

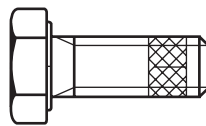
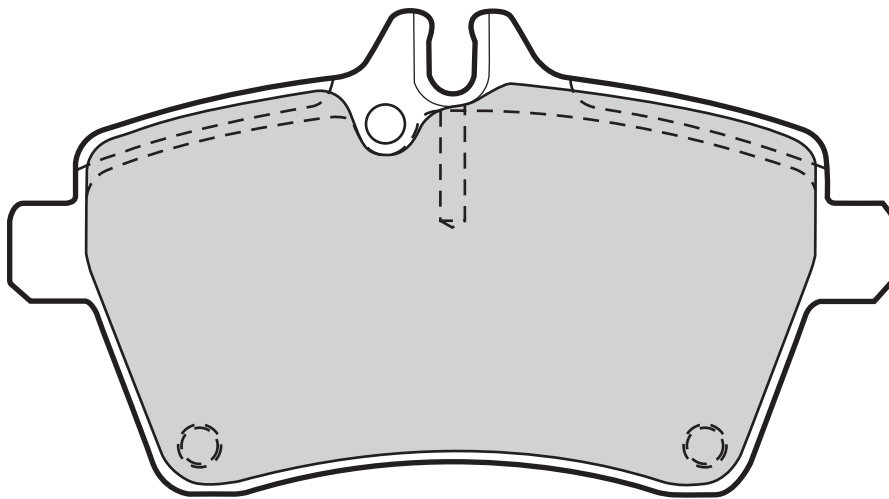

598704

0

116,5

63,8

19

LUCAS



# Valeo

## 24098 (WVA)

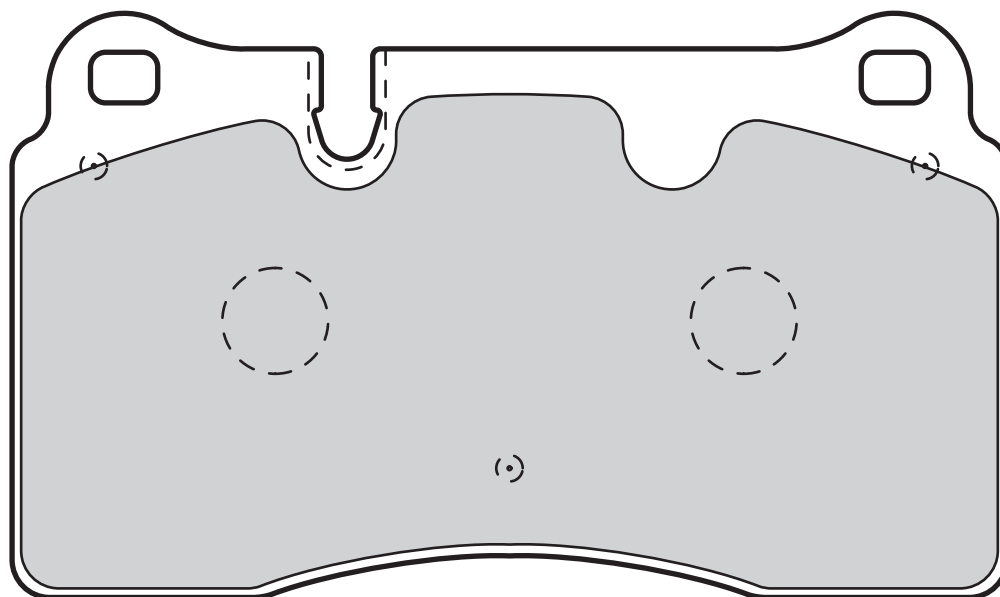

**Valeo**



598994

0

131,8

77,4

17,1

BREMBO

## 24111 (WVA)

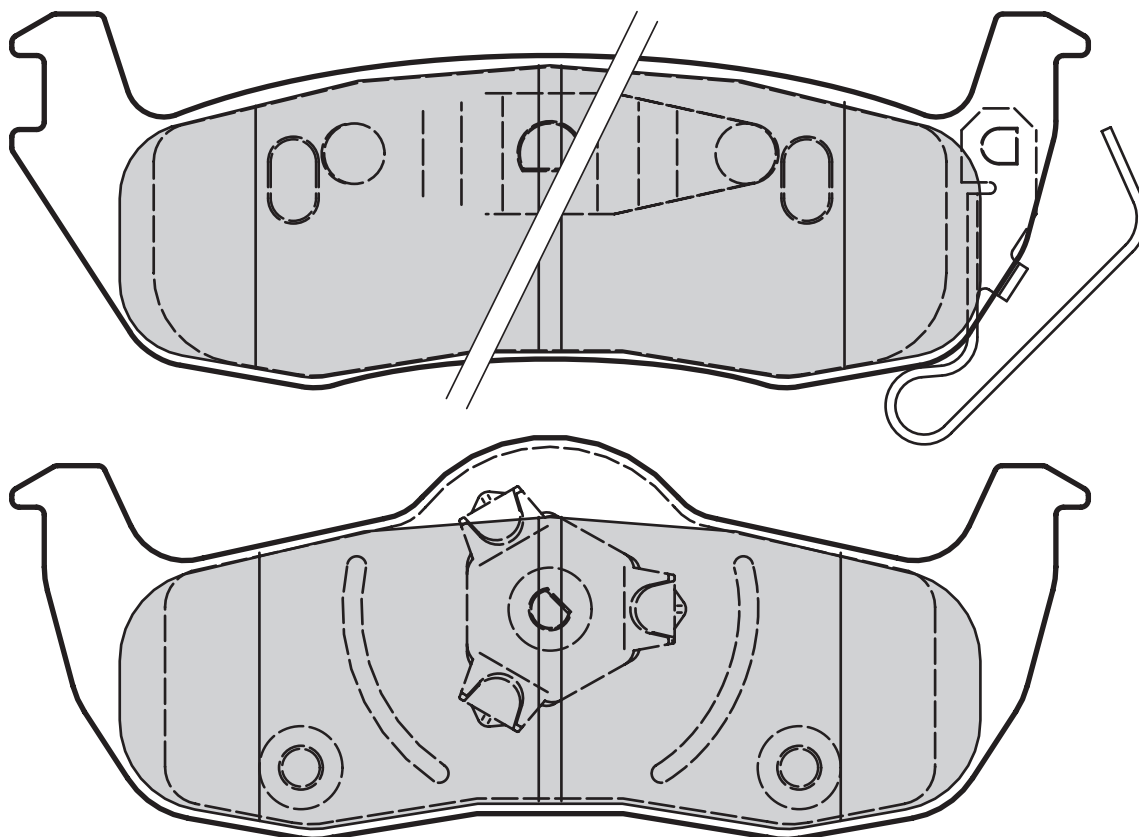

**Valeo**



598920

2

142

49/52,9

17,9

KELSEY



24123 (WVA)

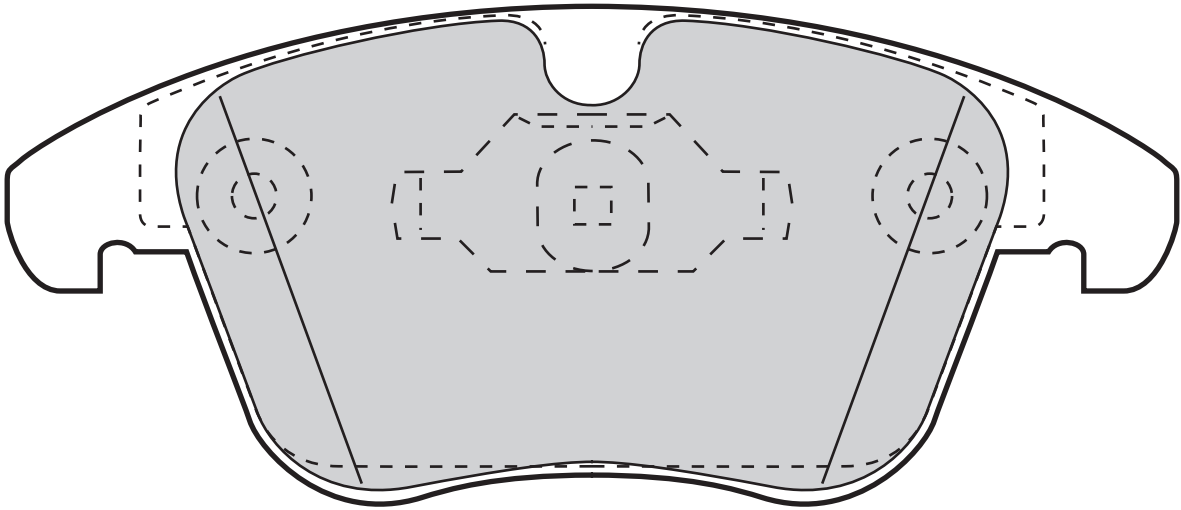
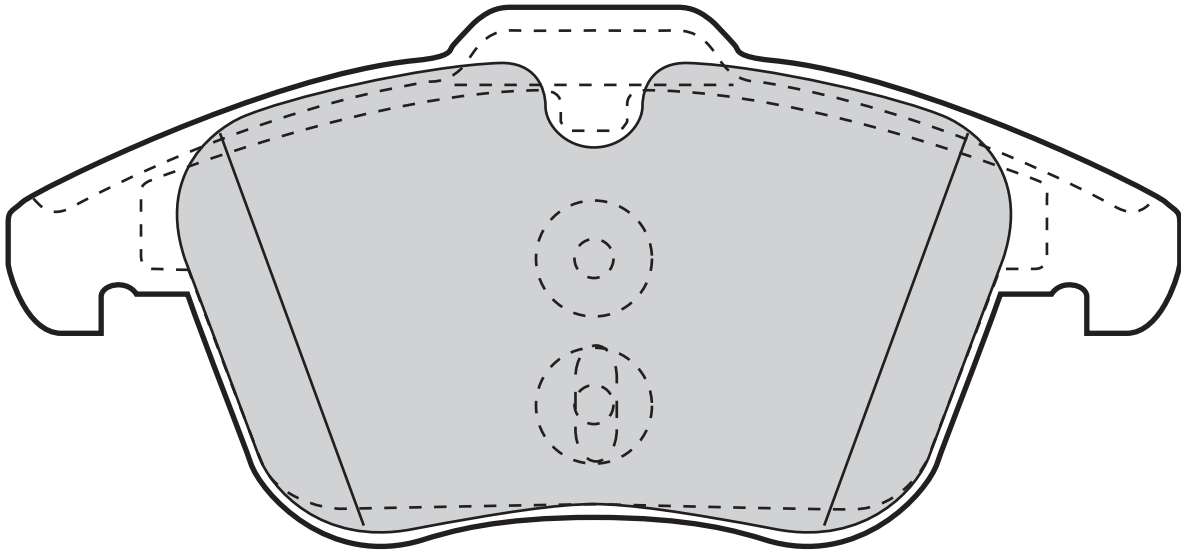

**Valeo**



598879

0

155,1

72/66,6

19,2

TEVES



# Valeo

## 24133 (WVA)

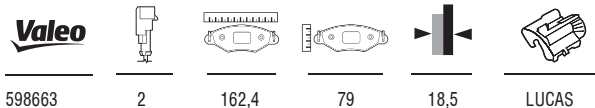
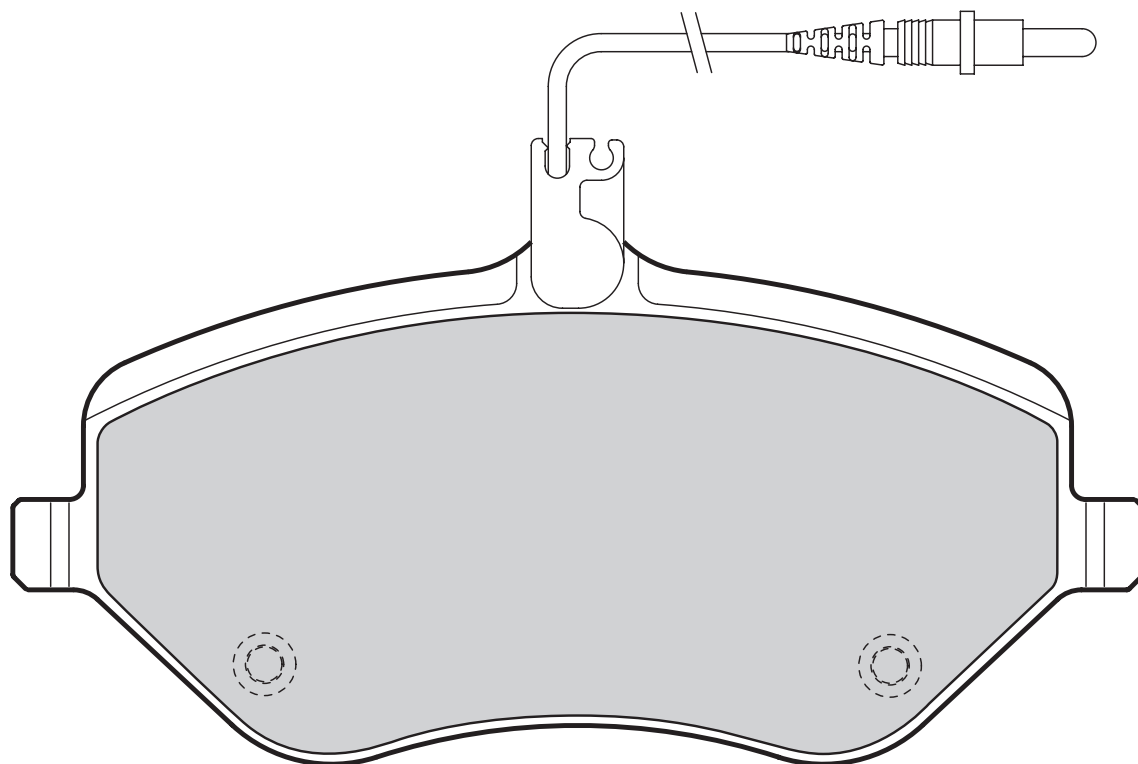

## 24135 (WVA)

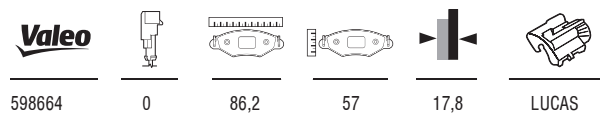
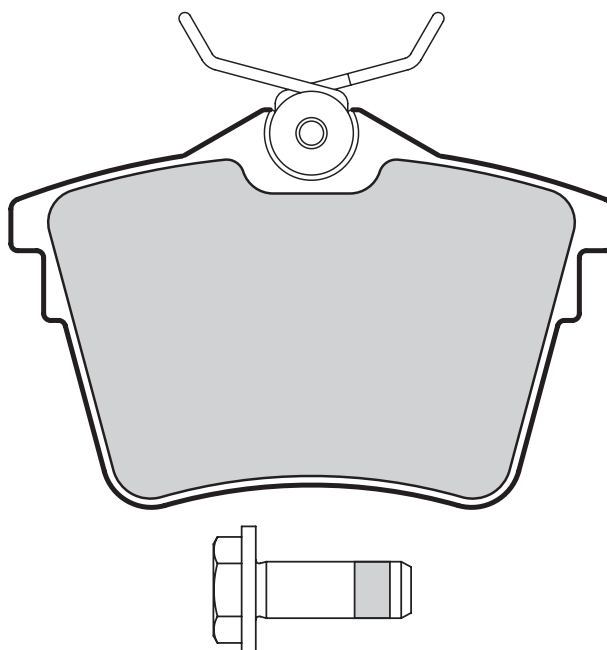



## 24137 (WVA)

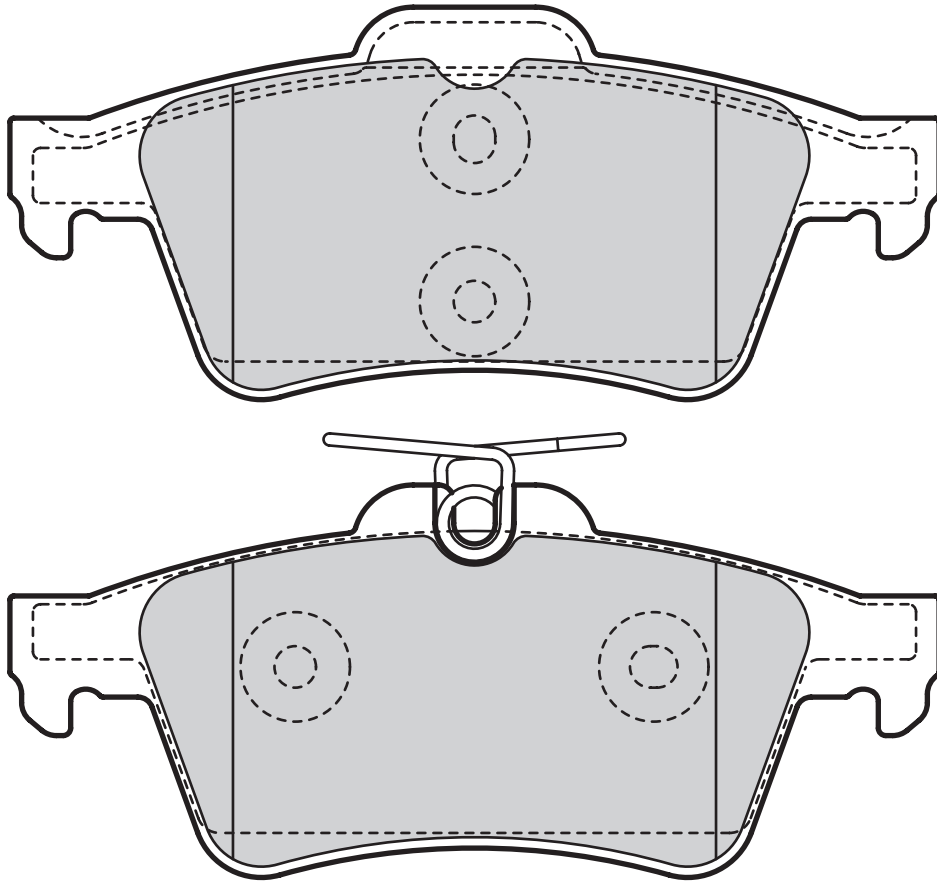

598783

0

122,9

51,7

16,4

TEVES



**Valeo**

**24141 (WVA)**

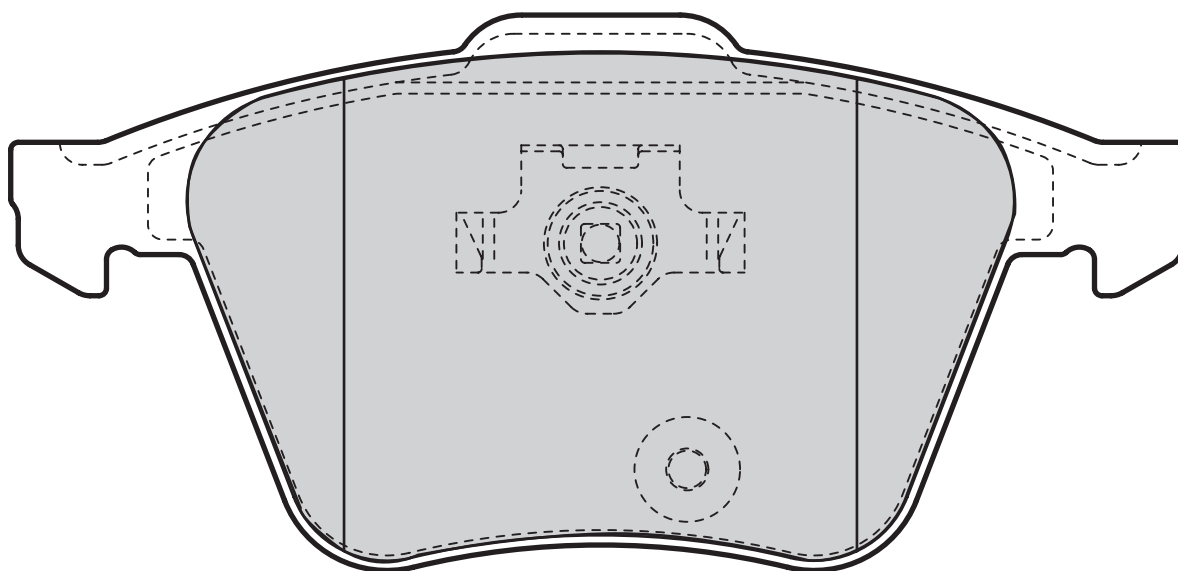
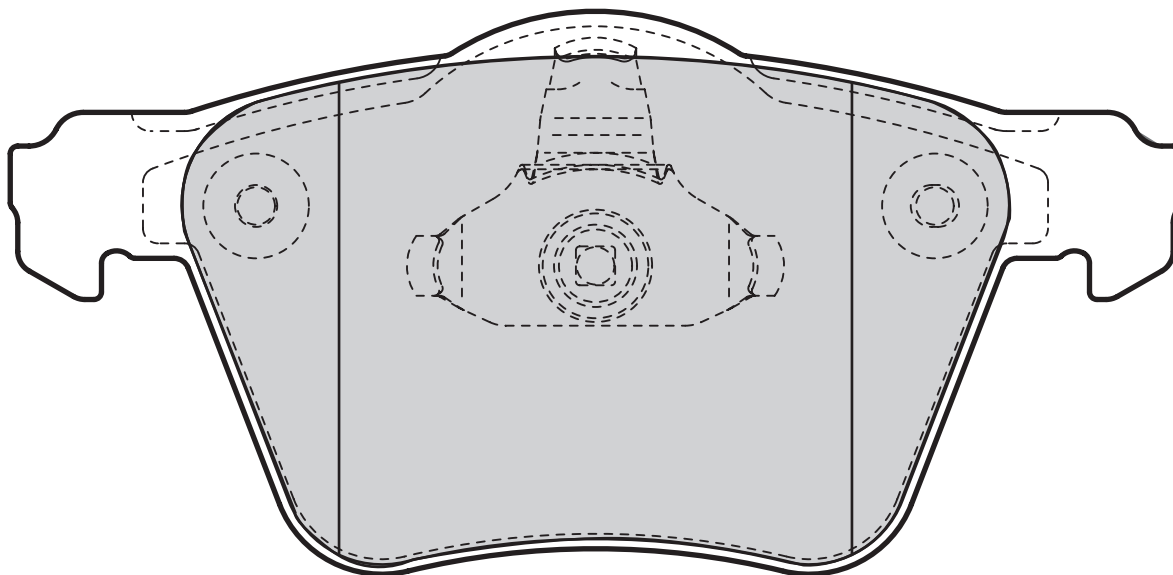

**Valeo**



598657

0

155,2

74/75

19

TEVES



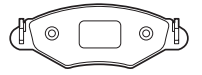

## 24142 (WVA)

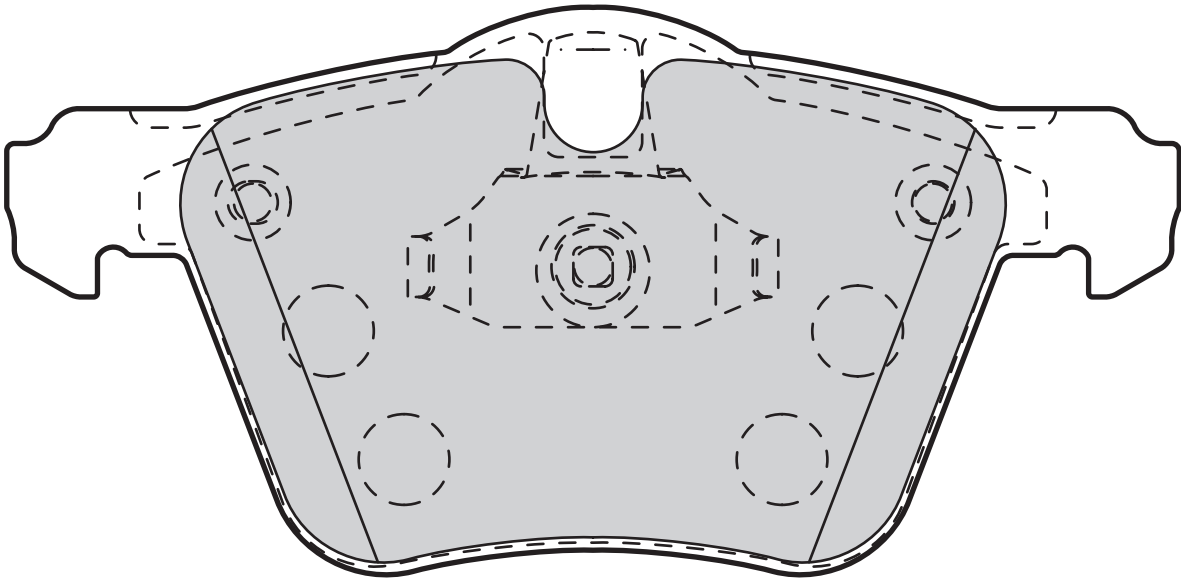
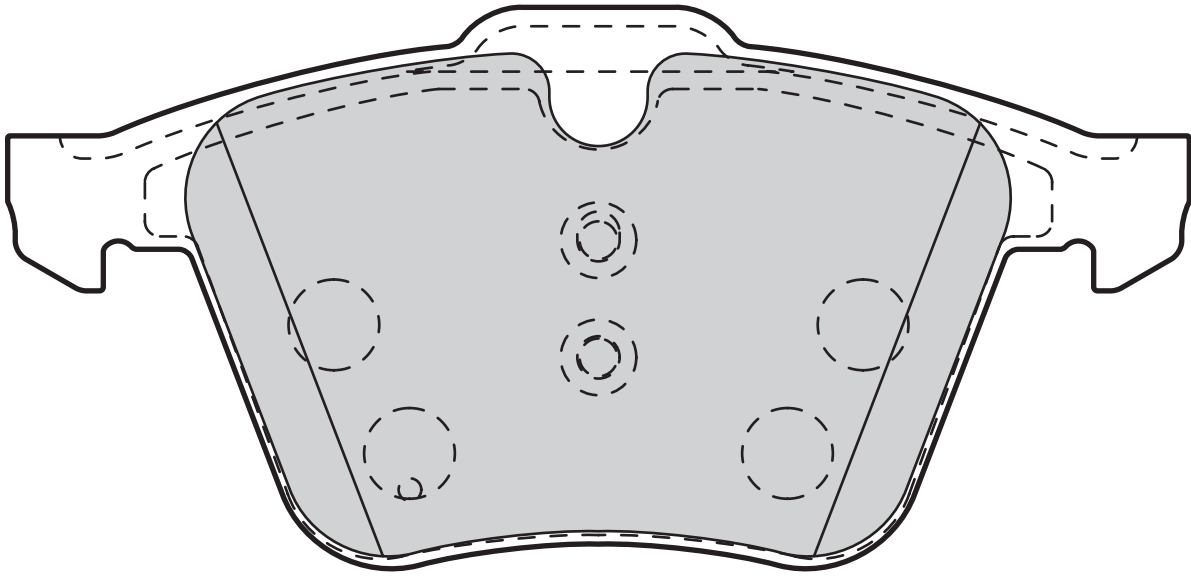

601007

0

155,2

75,1

20,1

TEVES



# Valeo

## 24150 (WVA)

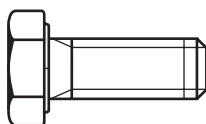
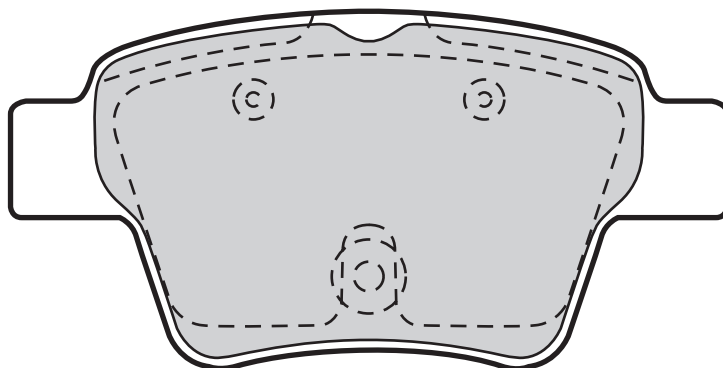

**Valeo**



598702

0

94,5

46,7

17,6

BOSCH

## 24162 (WVA)

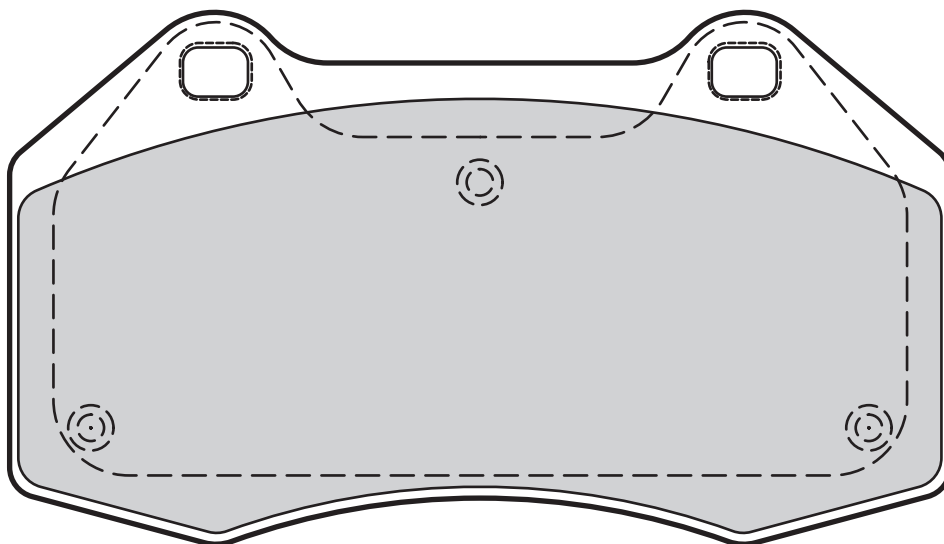

**Valeo**



598861

0

124,5

70,4

15,2

BREMBO

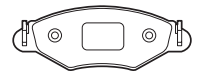

## 24191 (WVA)

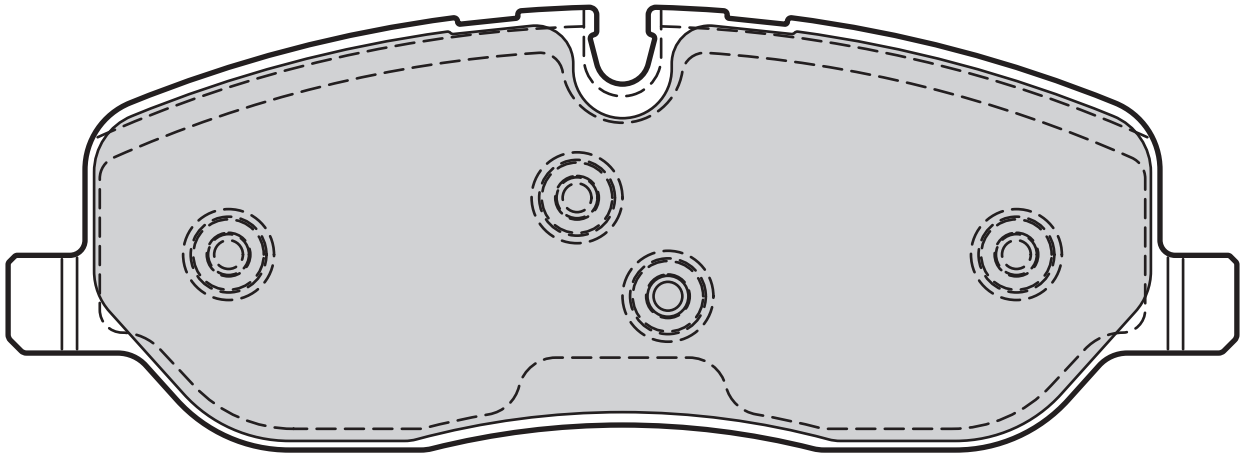

598741	0	162,5	58,5	18,1	LUCAS

## 24192 (WVA)

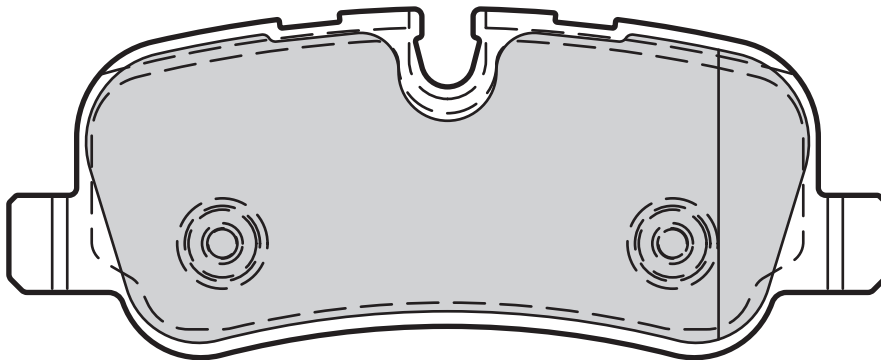

598742	0	116,5	46,3	17,5	LUCAS



# Valeo

## 24250 (WVA)

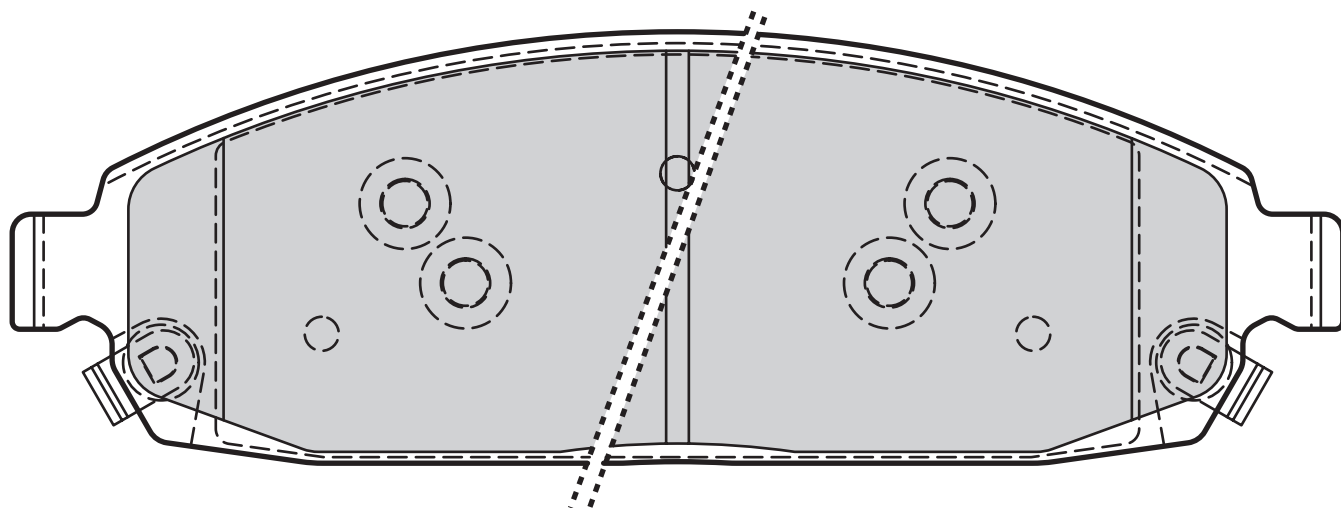

598872	2	176	57	18,8	AKEBONO

## 24253 (WVA)

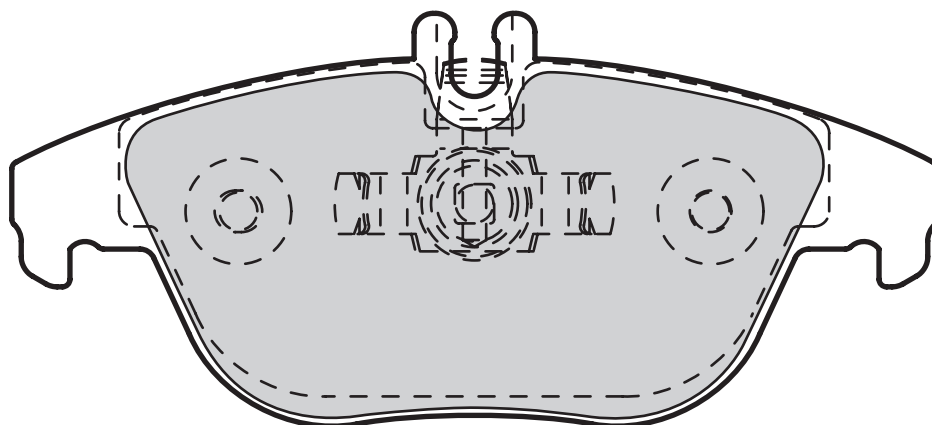
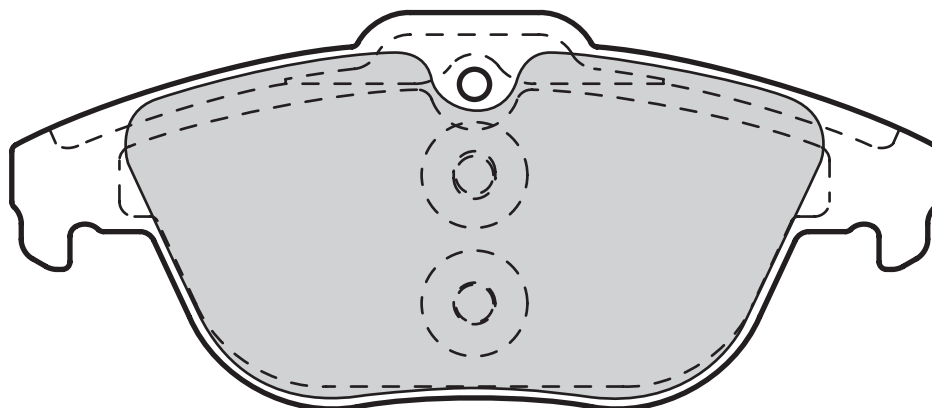

601051	0	122,5	52,5	17,6	TEVES



## 24289 (WVA)

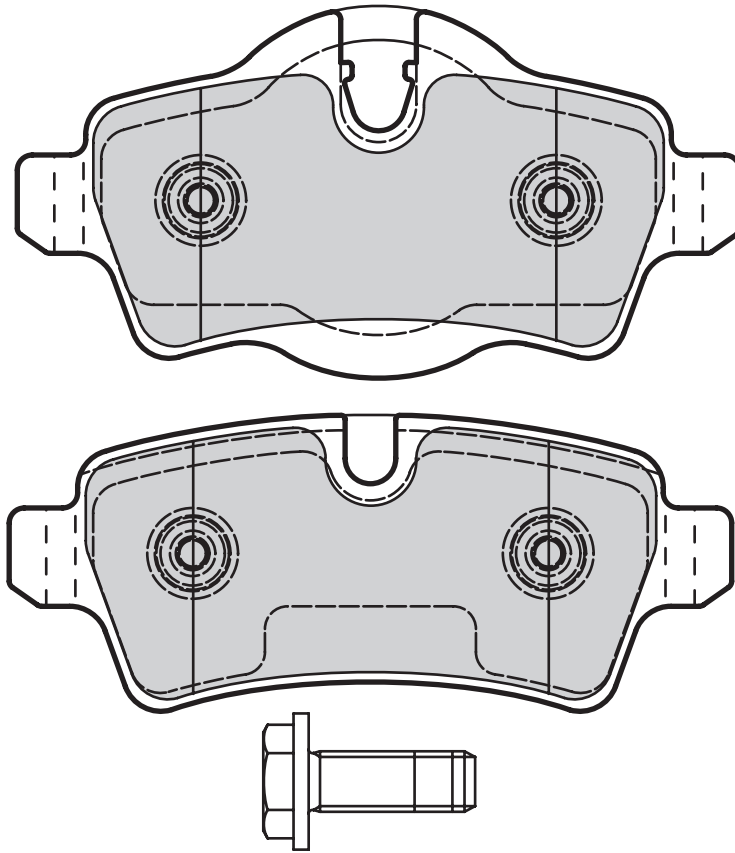

**Valeo**



601041

0

95,5

49,2

17

LUCAS



# Valeo

## 24323 (WVA)

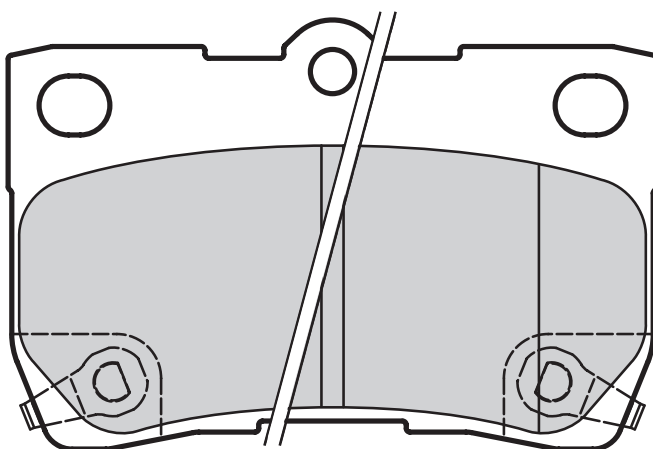
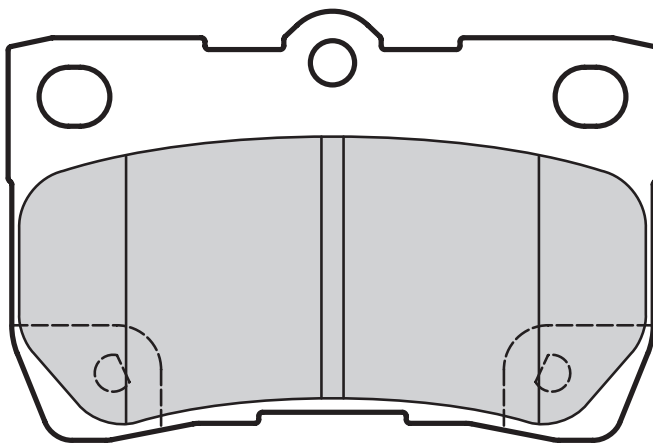

**Valeo**



598888

2

88

58,2

15,5

AKEBONO

## 24331 (WVA)

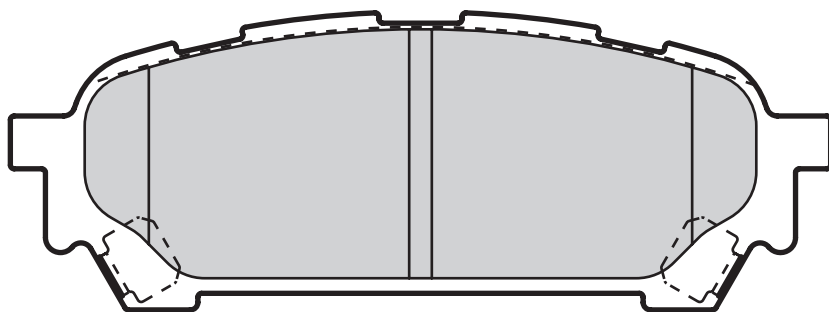

**Valeo**



598875

2

108,5

39,3

13,8

AKEBONO

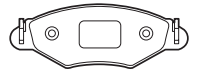

24349 (WVA)

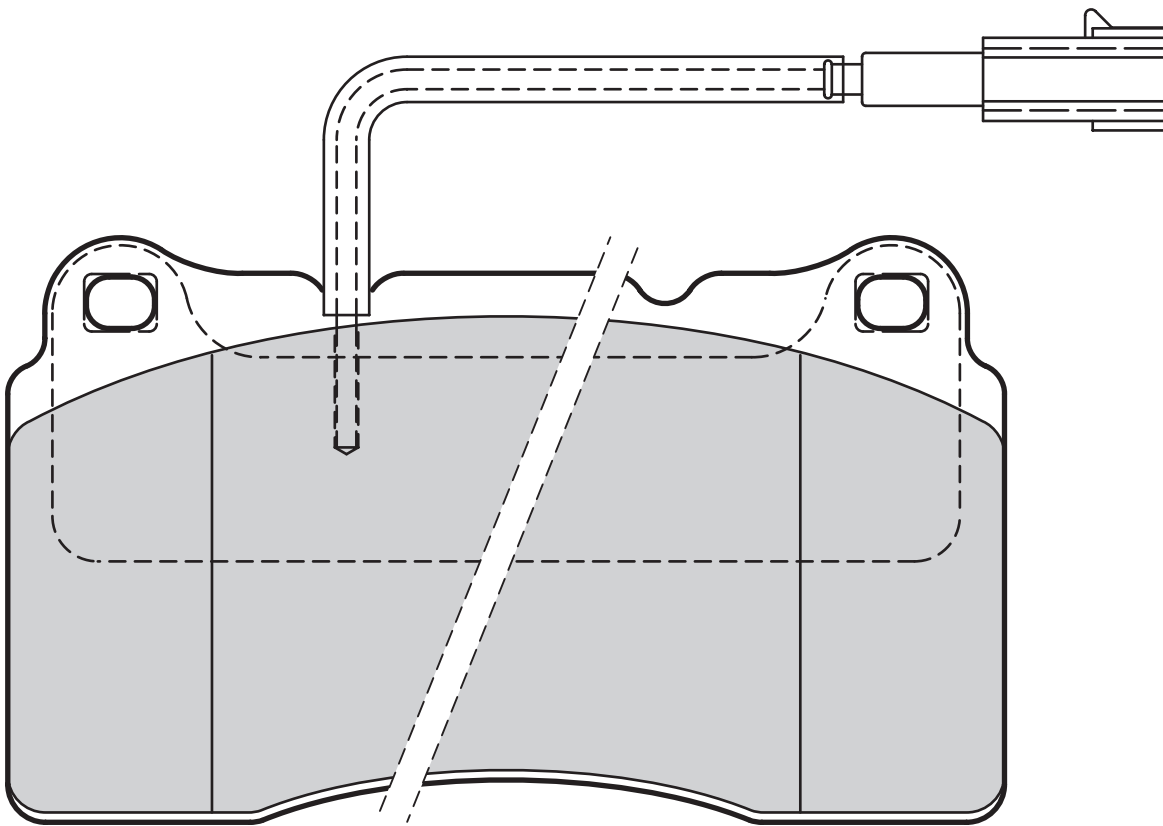
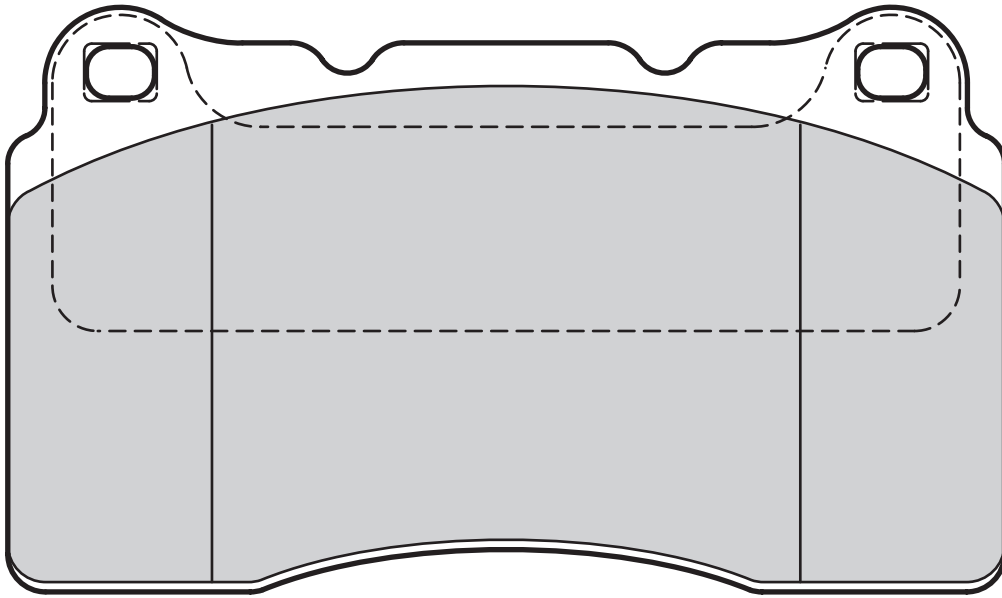

**Valeo**



598722

0

101,7

47,35

17,2

BOSCH



**Valeo**

24412 (WVA)

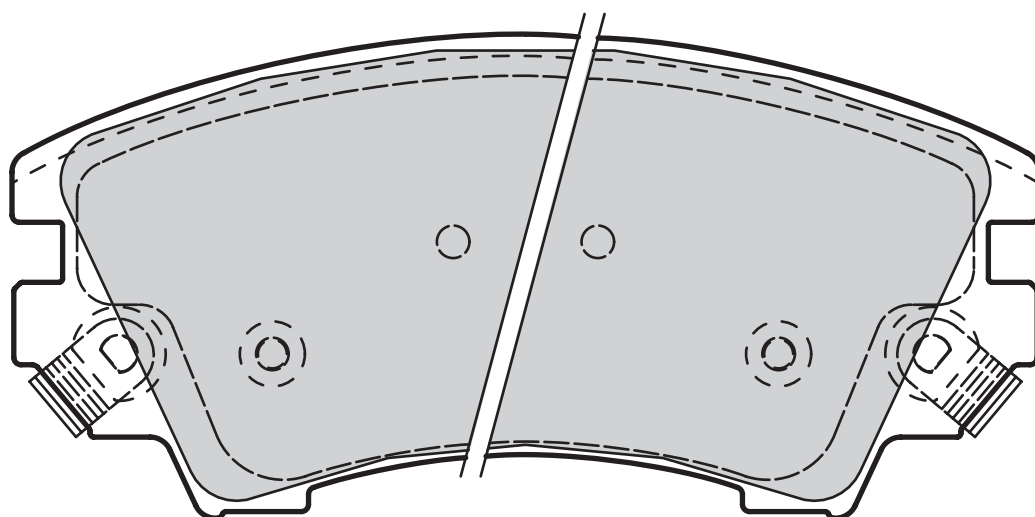
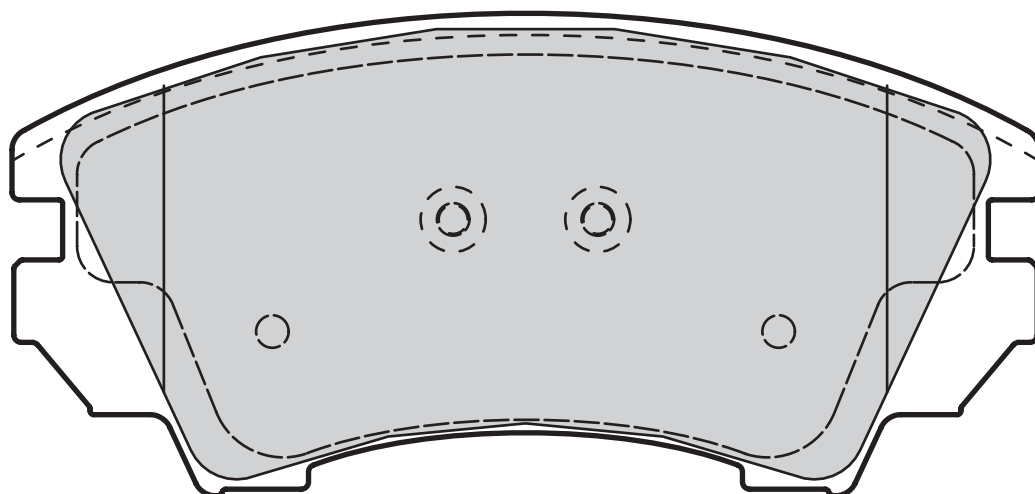

**Valeo**



601046

2

142

66,7

18,8

MANDO



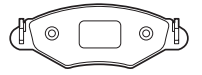

## 24462 (WVA)

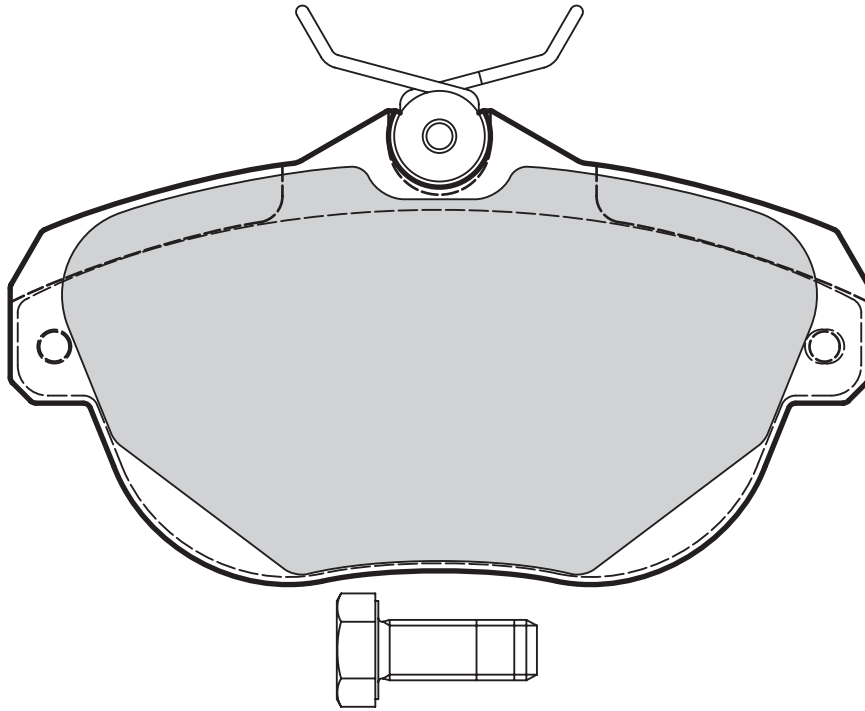

598939

1

114

63

17

LUCAS



**Valeo**

24491 (WVA)

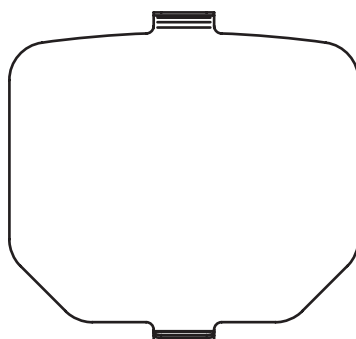
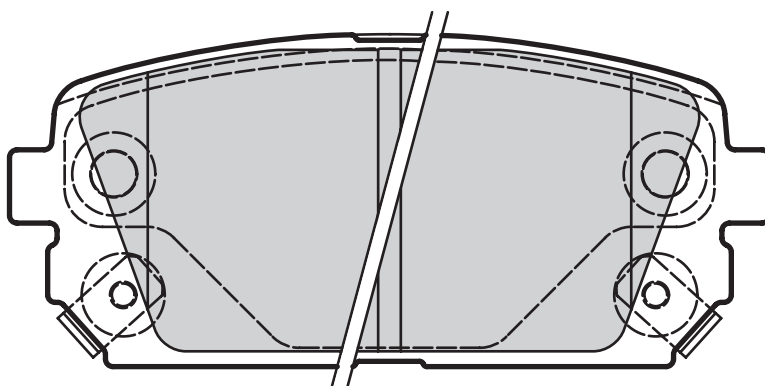
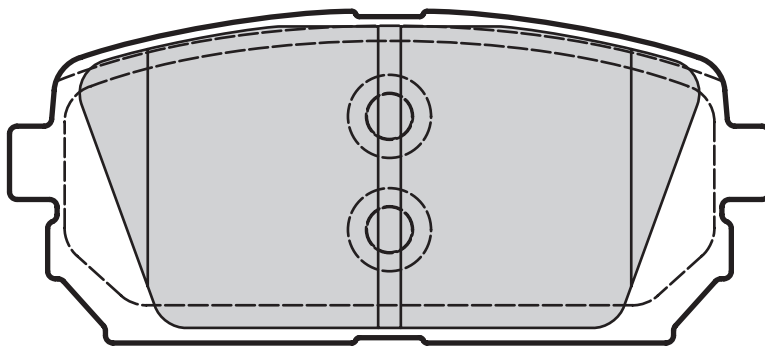

**Valeo**



598945

1

100

44

15

MANDO



## 24496 (WVA)

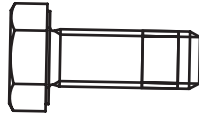
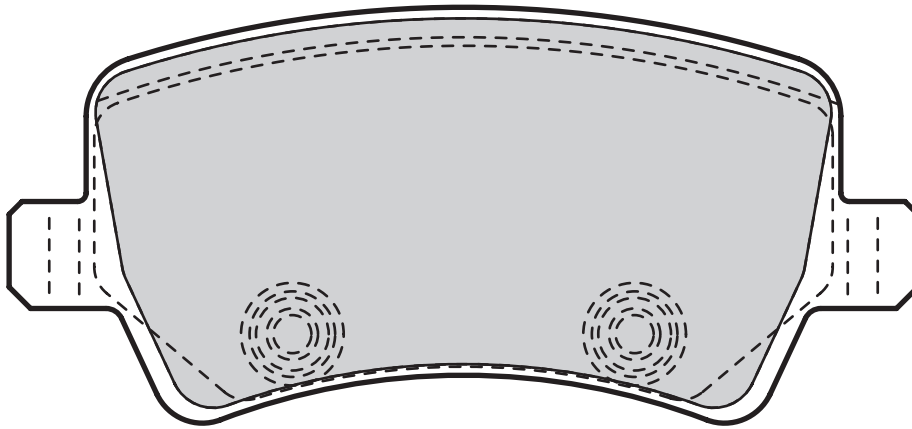

**Valeo**



598928

0

106

48,4

17

LUCAS



# Valeo

## 24498 (WVA)

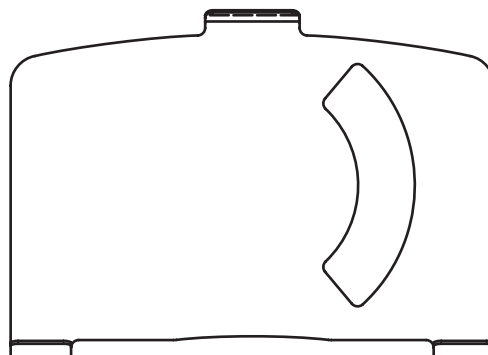
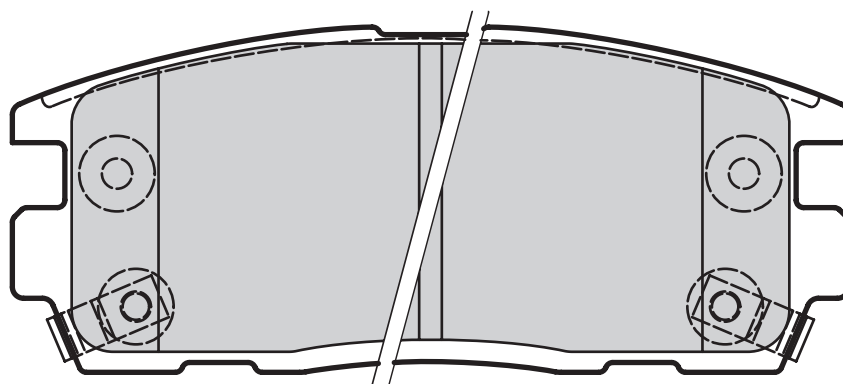
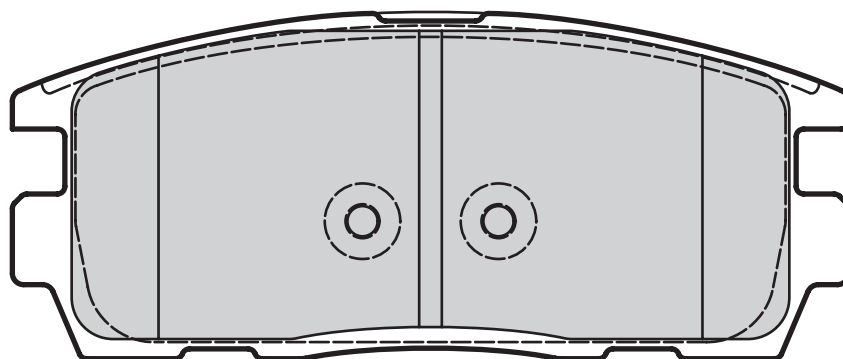

**Valeo**



598941

2

110

46

15

AKEBONO

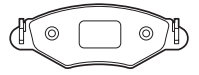

**24501 (WVA)**

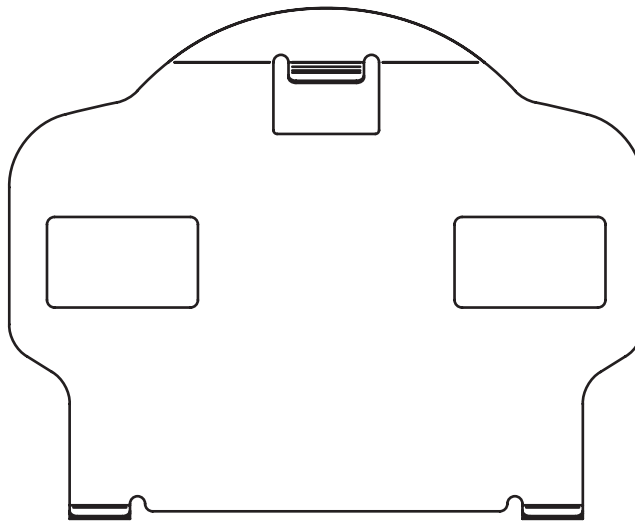
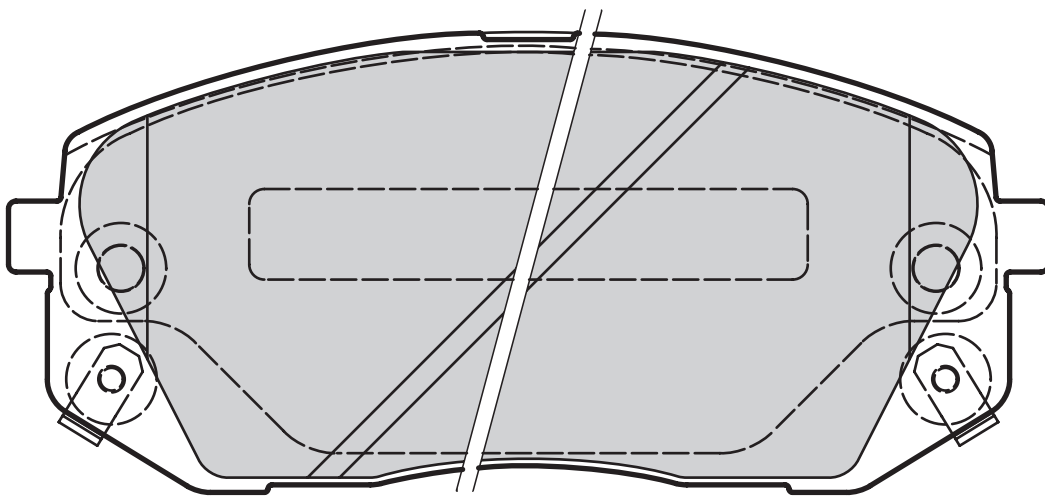
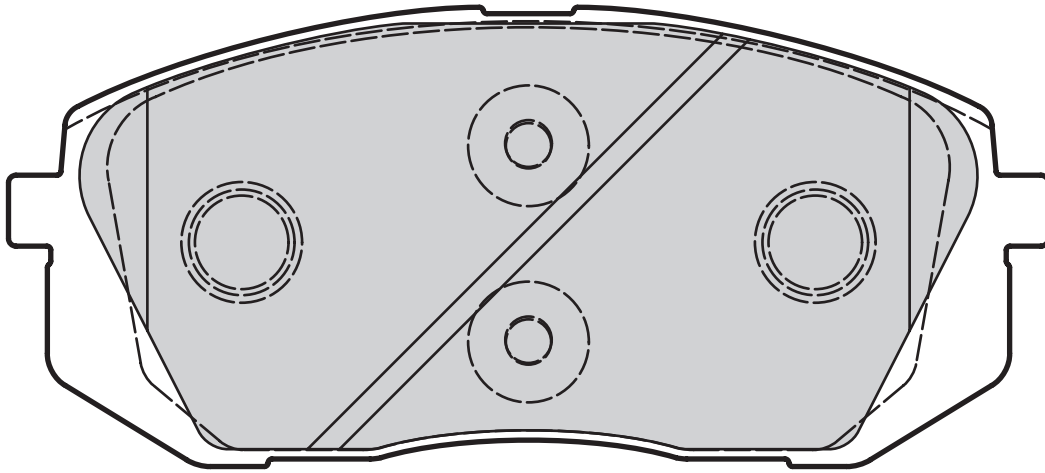

598934

1

138

61

16,5

MANDO



**Valeo**

24510 (WVA)

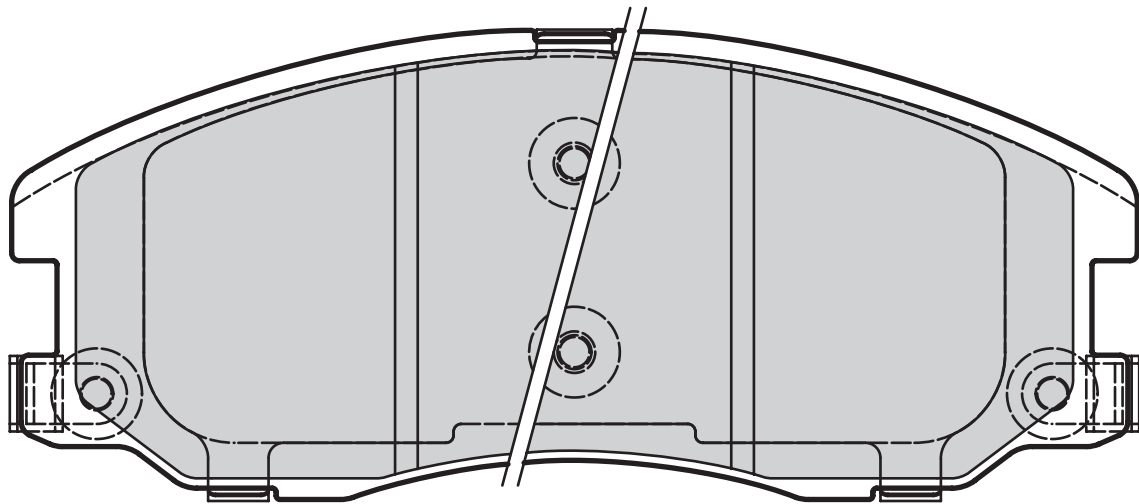
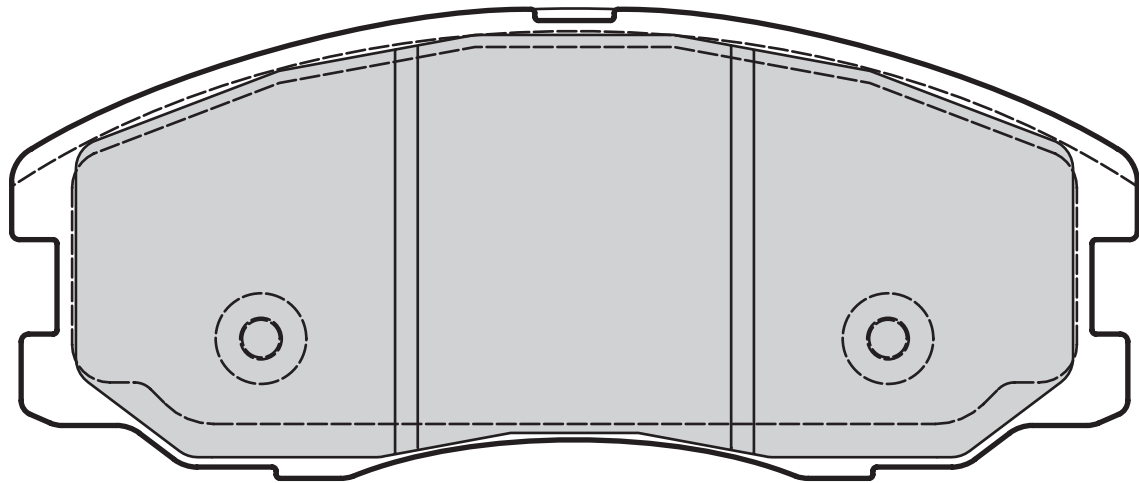

**Valeo**

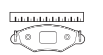

598942

2

149

62

17

MANDO

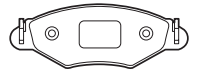

## 24535 (WVA)

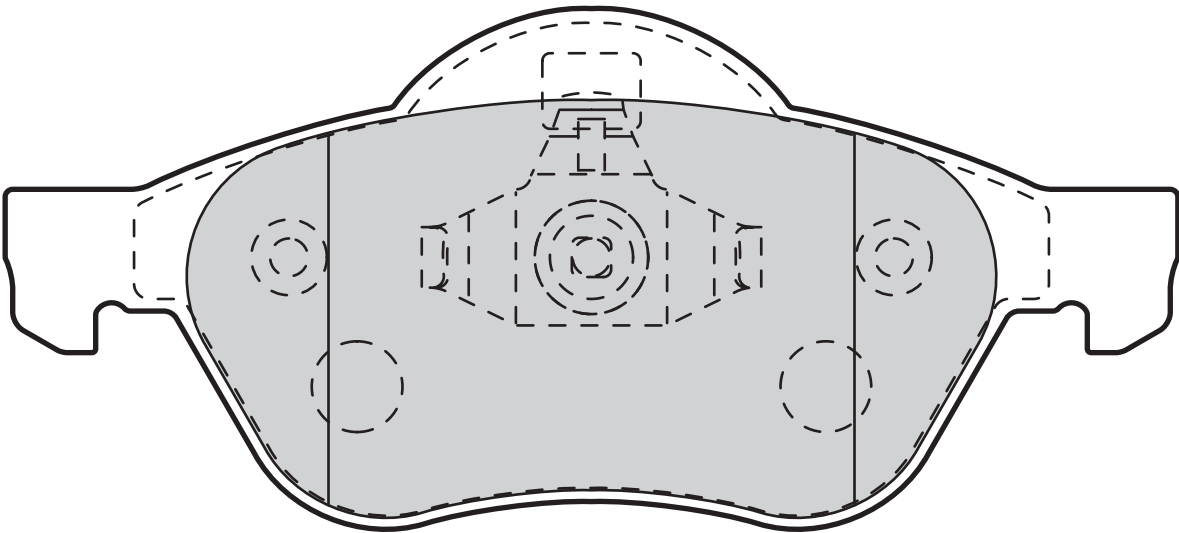
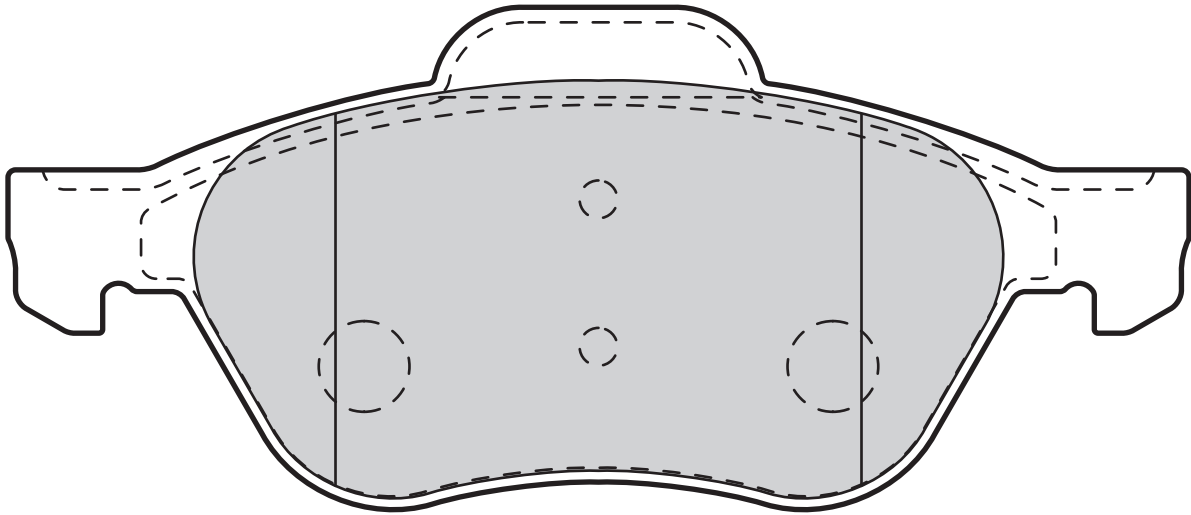

**Valeo**



601012

0

155,2

69

18,3

TEVES



# Valeo

## 24540 (WVA)

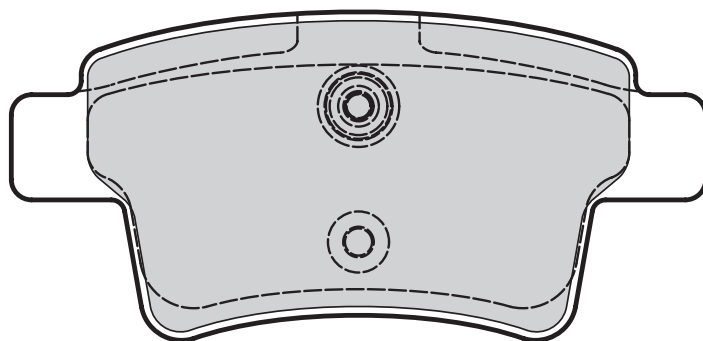

**Valeo**



598936

0

102

48

16

LUCAS

## 24557 (WVA)

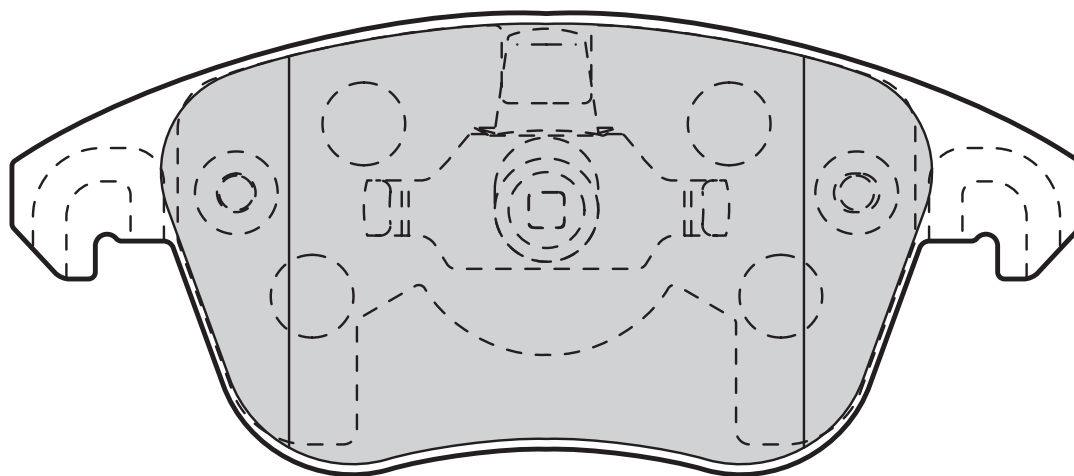
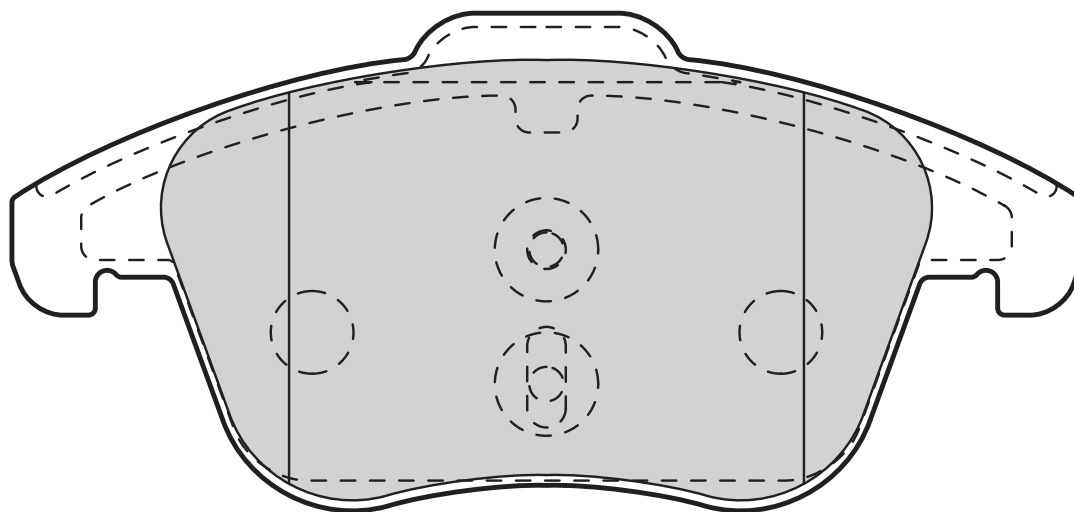

**Valeo**



598998

0

155,2

67

19,5

TEVES



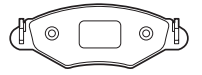

## 24632 (WVA)

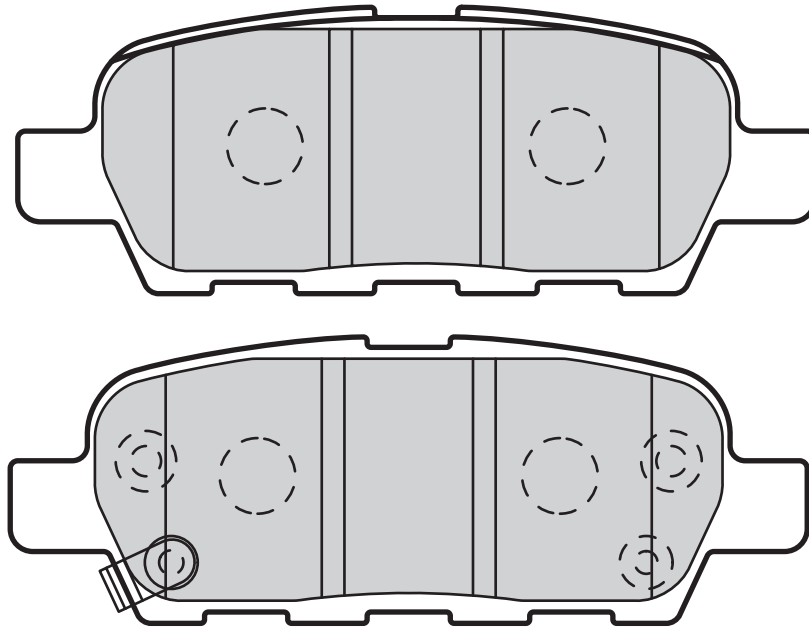

**Valeo**



601009

1

105,5

38

13,7

AKEBONO



# Valeo

## 24705 (WVA)

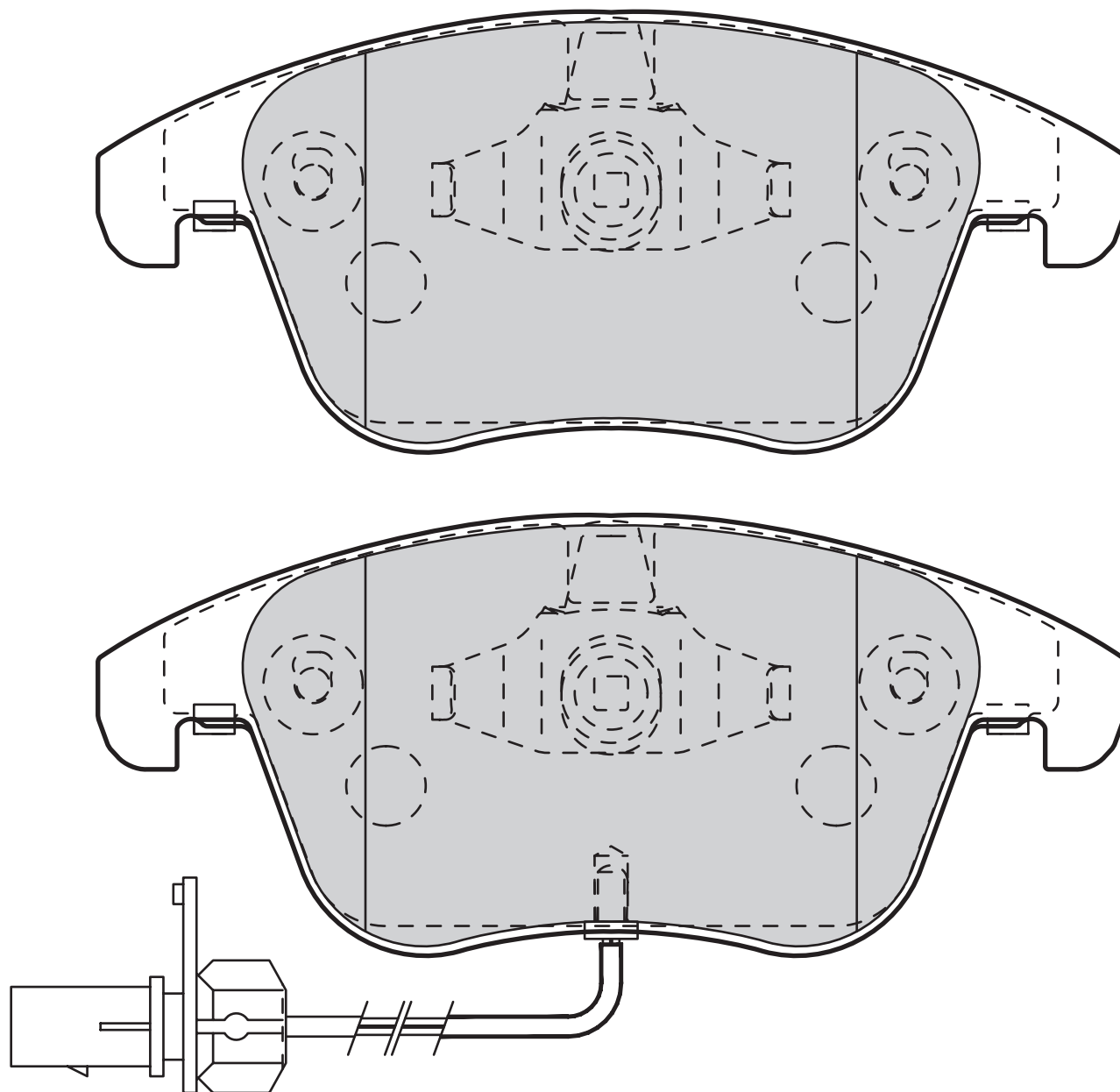

**Valeo**



598996

1



155,2



66,5



20,7



TEVES



24710 (WVA)

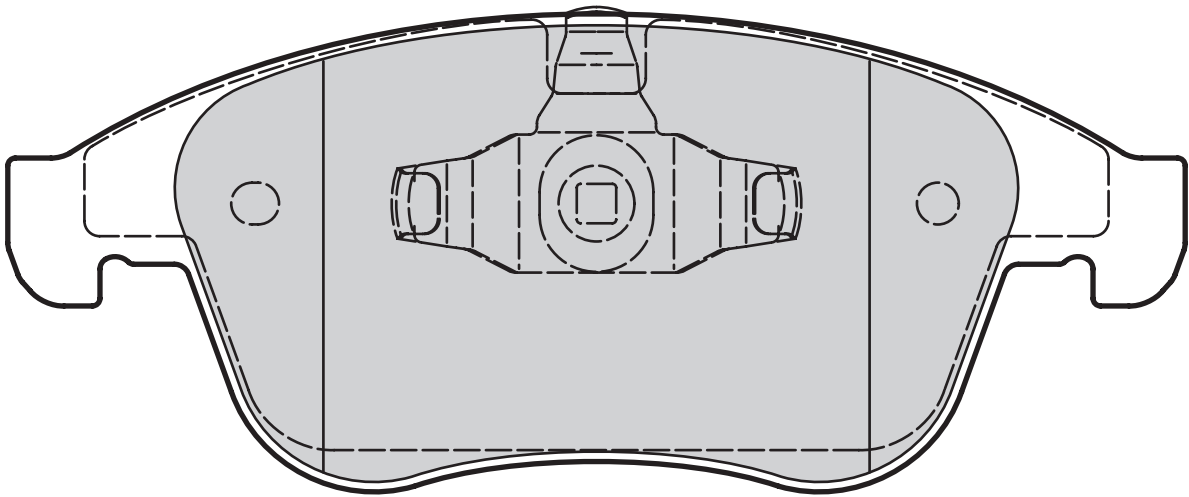
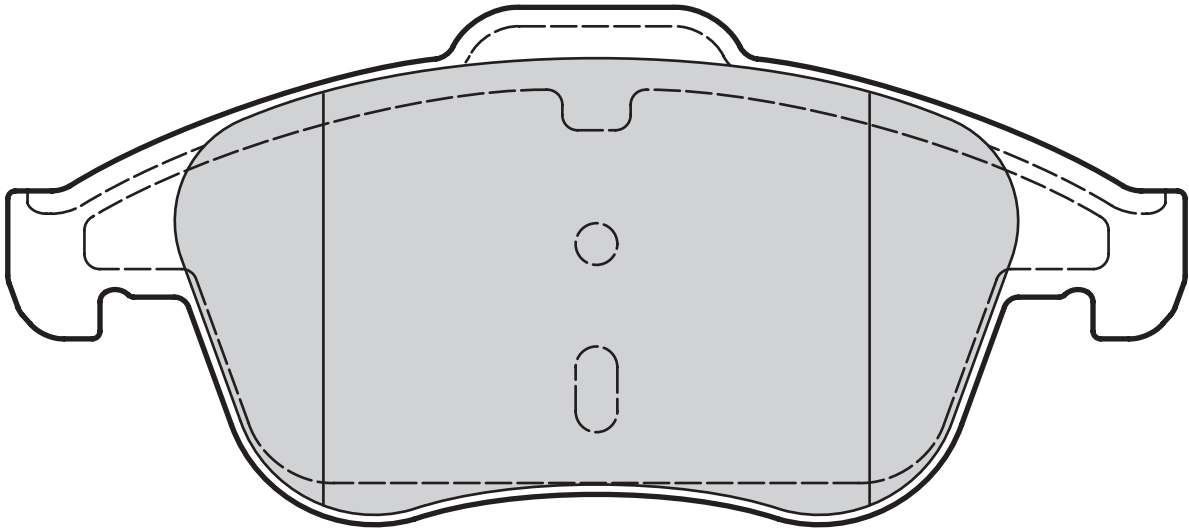

**Valeo**



601050

0

155,2

68,3

18

TEVES



**Valeo**

24765 (WVA)

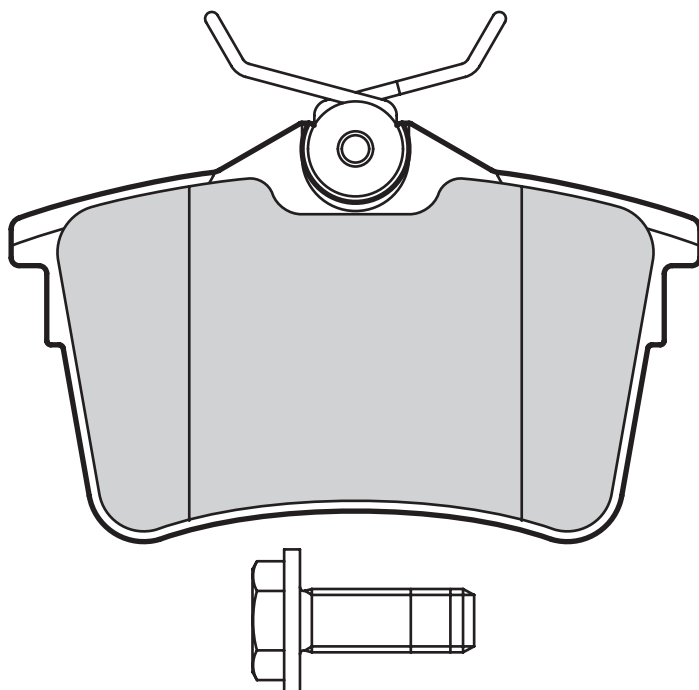

**Valeo**



601042

0

87

52,9

16,7

LUCAS

24820 (WVA)

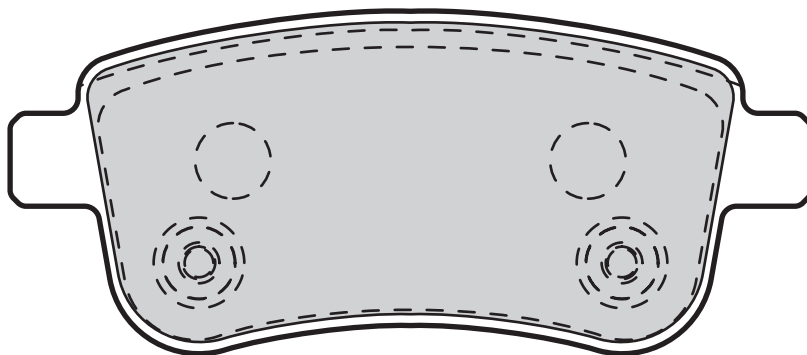

**Valeo**



598409

0

155,4

63,6

20

TEVES



29192 (WVA)

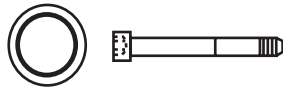
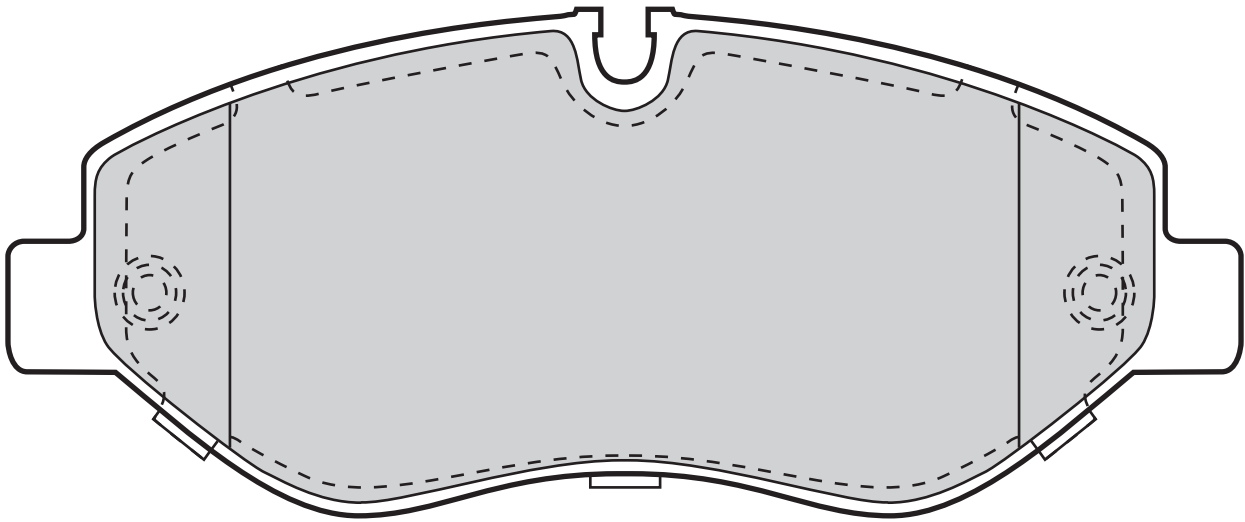

**Valeo**



598882

0

163,1

67,1

20,8

BREMBO



# Valeo

## 29877 (WVA)

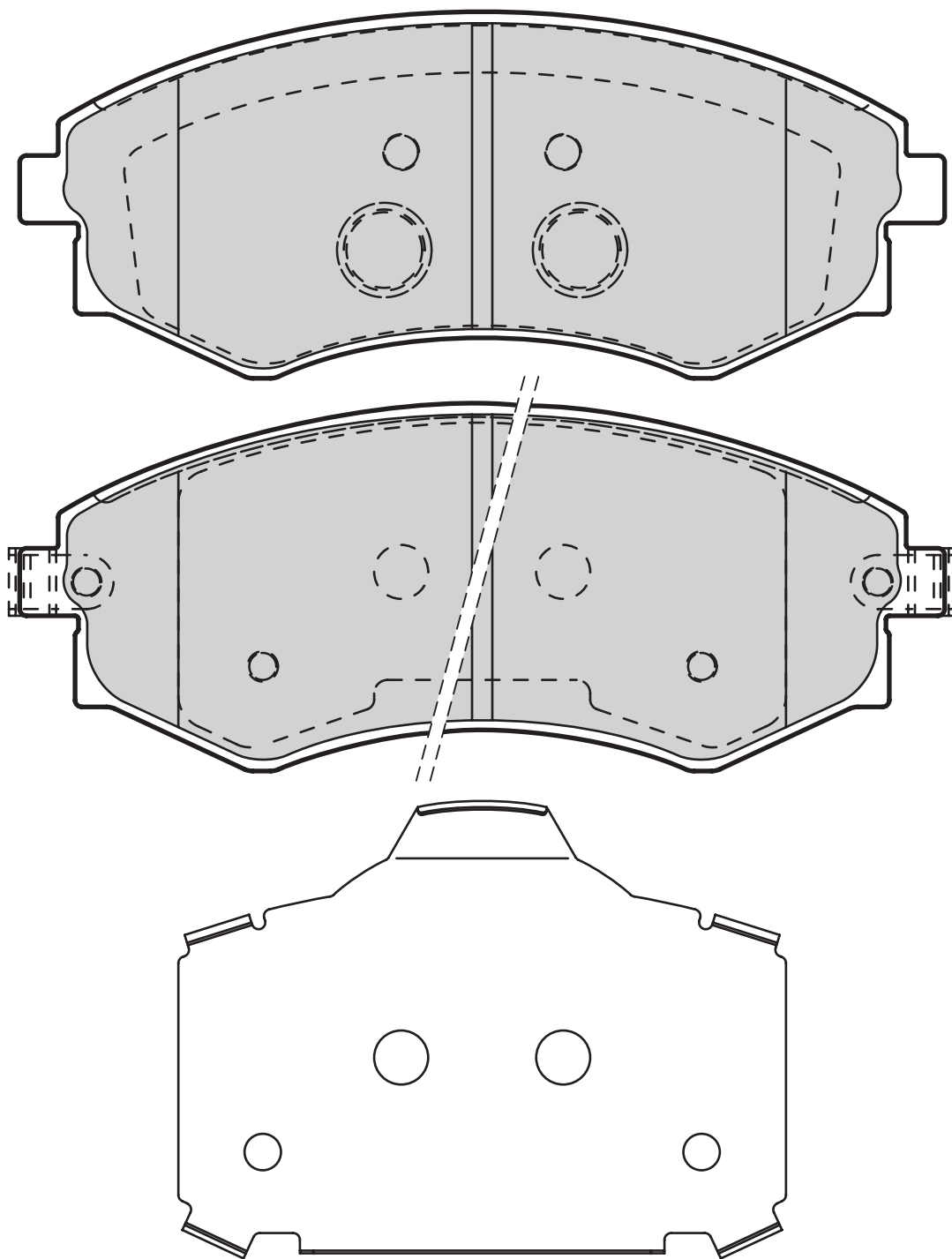

**Valeo**



598870

2

136,9

54

16,6

SUMITOMO



**国产/进口刹车盘图片**  
**Local/Imported Range**  
**Brake Disc Image**



**Pads and Discs**

Plaquettes et Disques

**Pastillas y Discos**

Pastilas e Discos

**Pastiglie e Dischi**

Blokjes en Schijven

**Bremsbeläge und Bremsscheiben**

Klocki i Tarcze

**Balatalari ve Diskleri**

Κολοδκι и Диски

Δισκόφρενα & Δισκόπλακες

刹车片和刹车盘

بطانات و قرص





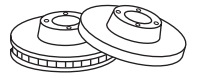

## 186146

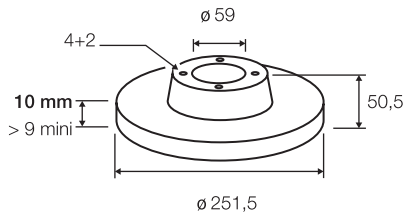

## 186153

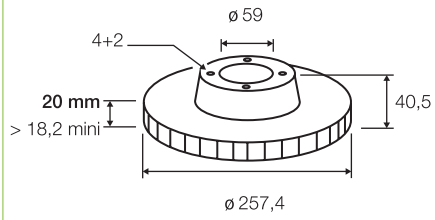

## 186154

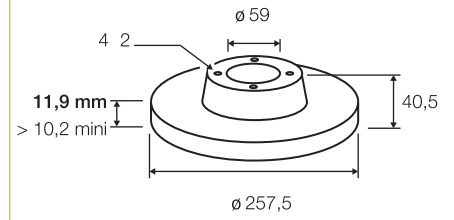

## 186155

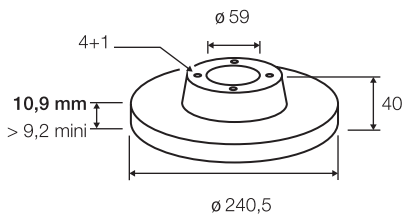

## 186188

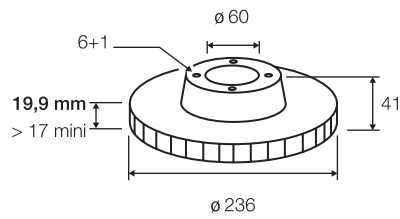

## 186189

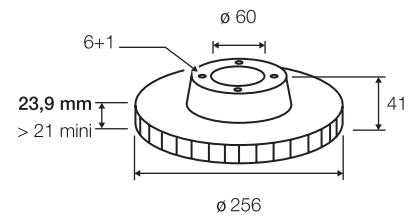

## 186194

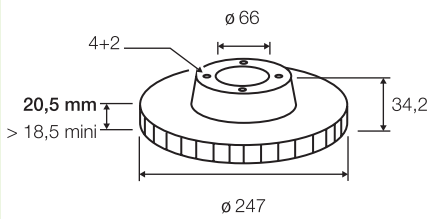

## 186208

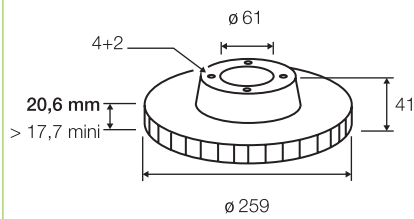

## 186245

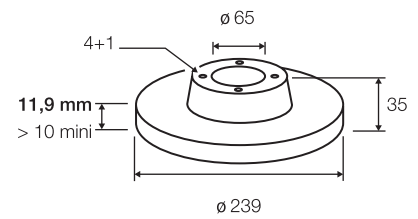

## 186247

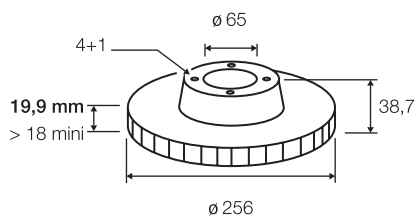

## 186271

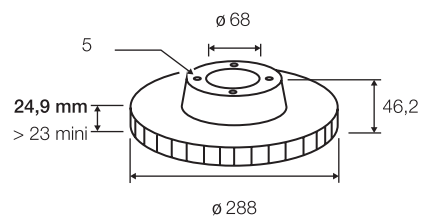

## 186275

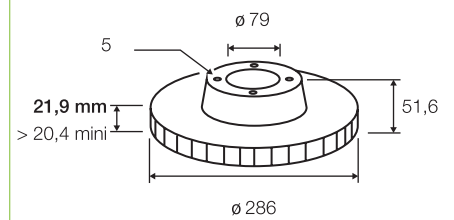

## 186294

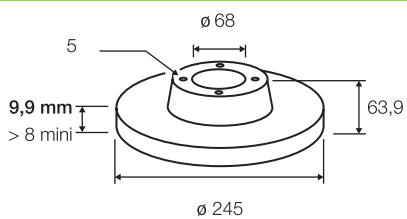

## 186295

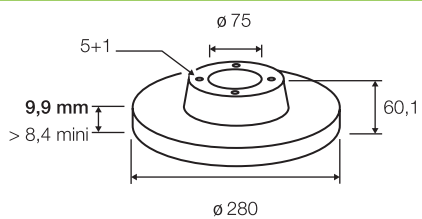

## 186297

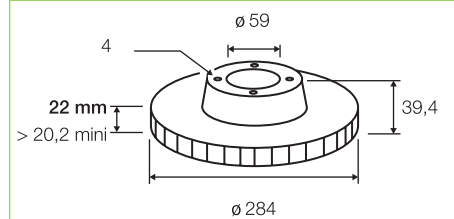

## 186457

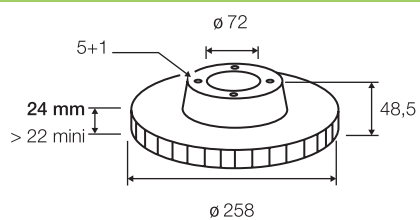

## 186467

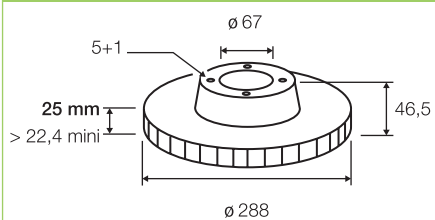

## 186469

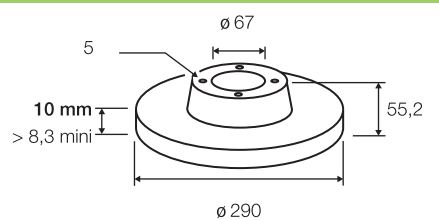

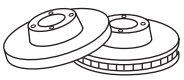

## 186470

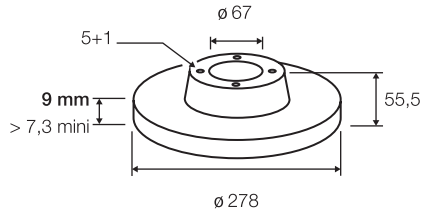

## 186485

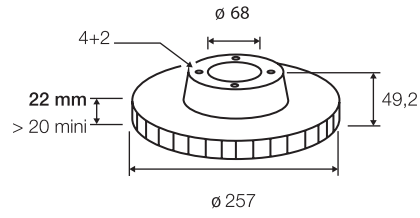

## 186504

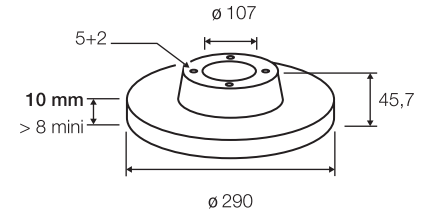

## 186559

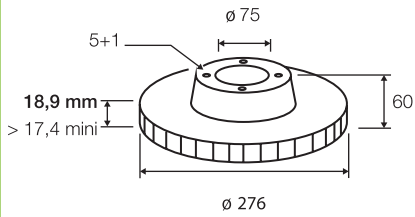

## 186566

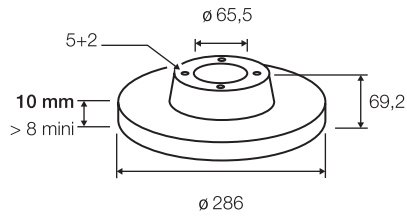

## 186568

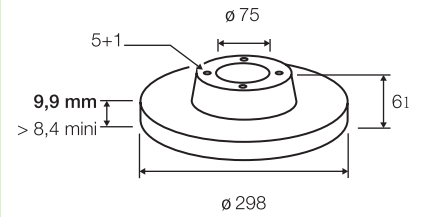

## 186582

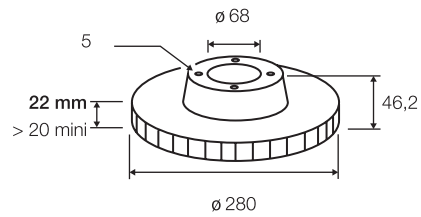

## 186590

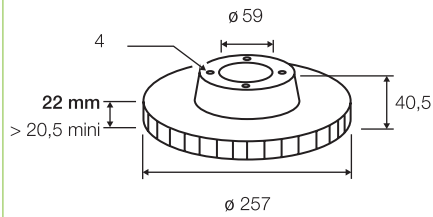

## 186592

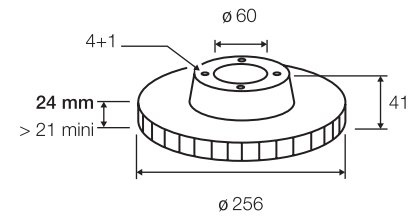

## 186593

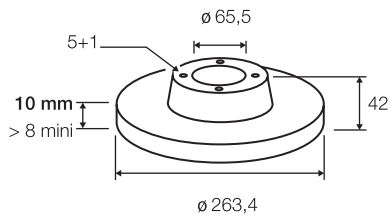

## 186594

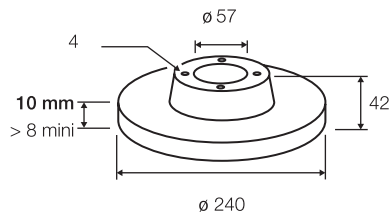

## 186597

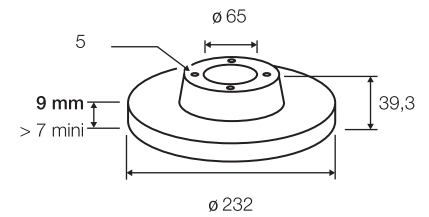

## 186599

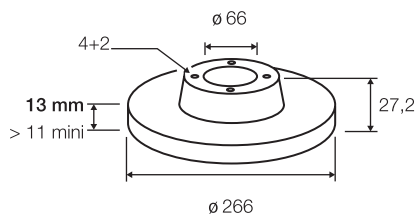

## 186603

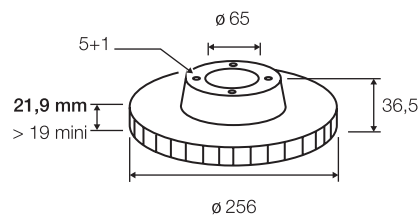

## 186604

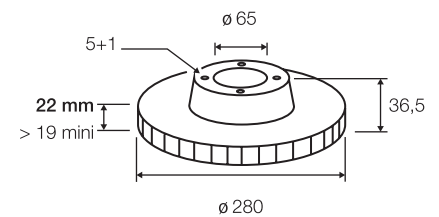

## 186628

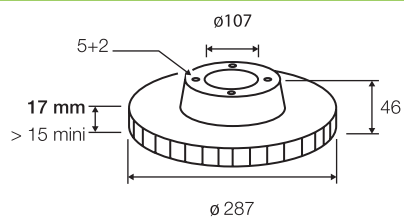

## 186655

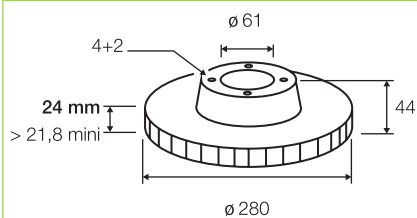

## 186684

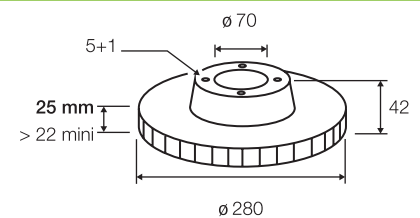

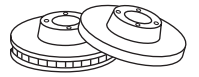

### 186693

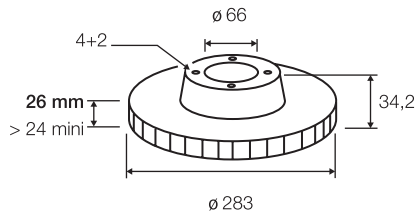

### 186695

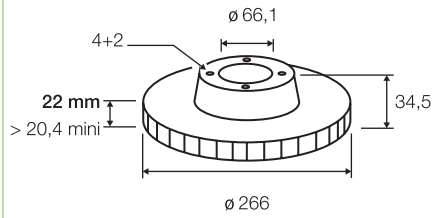

### 186702

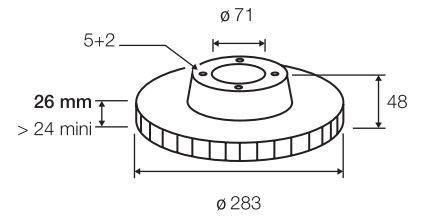

### 186731

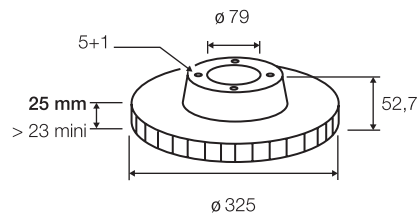

### 186732

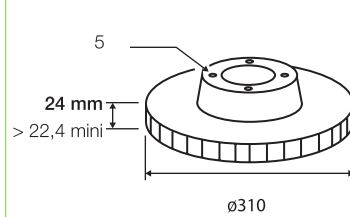

### 186734

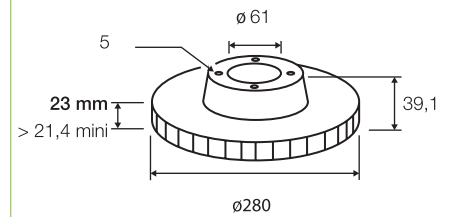

### 186736

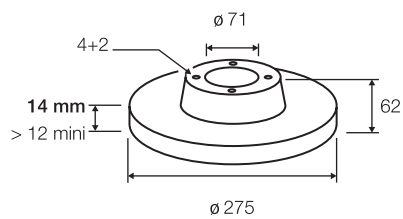

### 186741

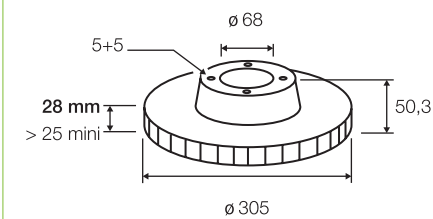

### 186747

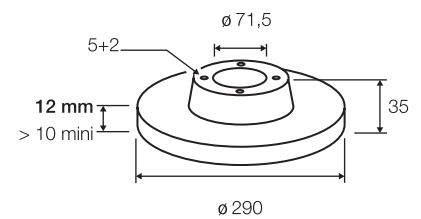

### 186753

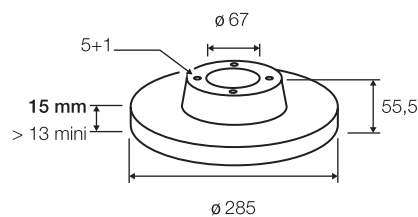

### 186754

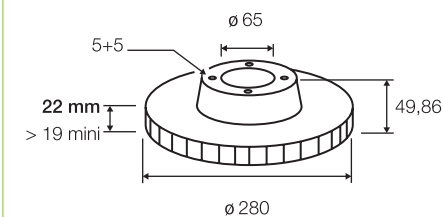

### 186758

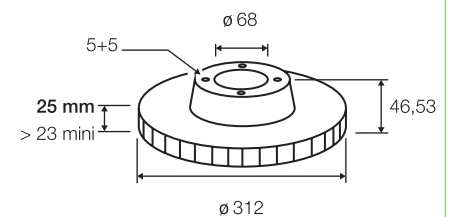

### 186764

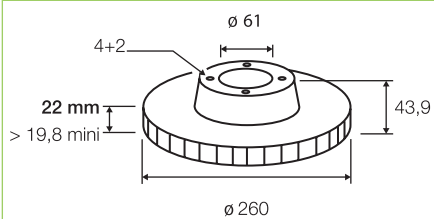

### 186785

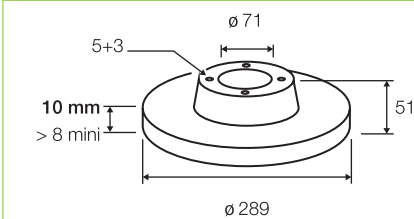

### 186789

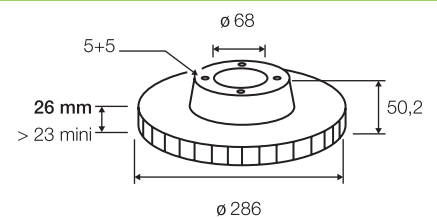

### 186798

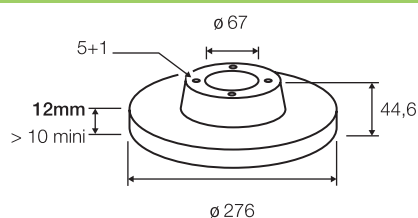

### 186799

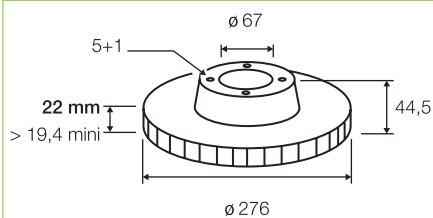

### 186808

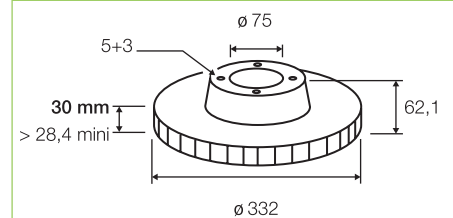

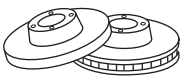

## 186809

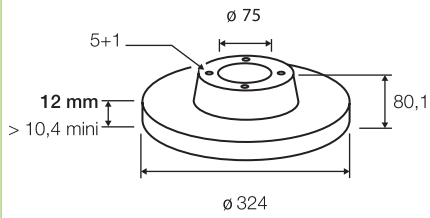

## 186811

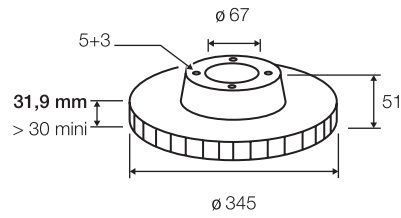

## 186812

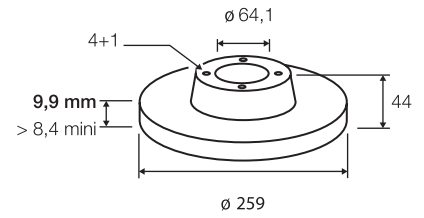

## 186813

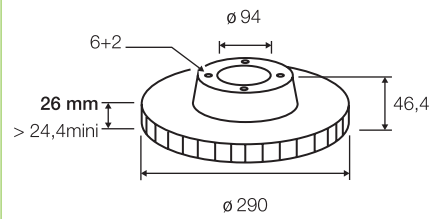

## 186815

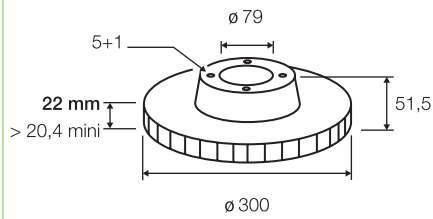

## 186816

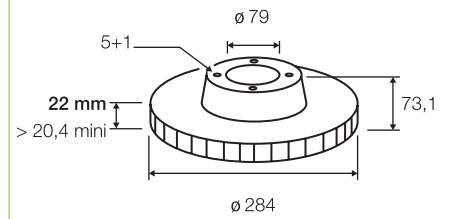

## 186817

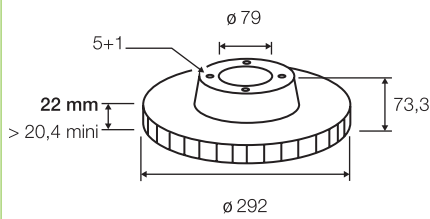

## 186819

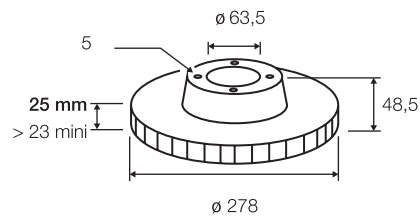

## 186825

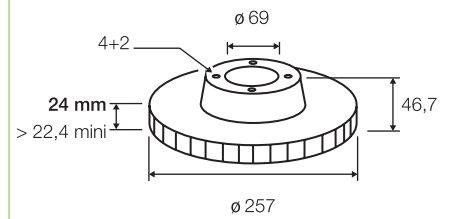

## 186833

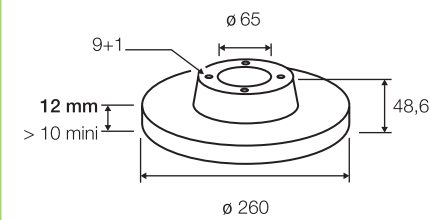

## 186834

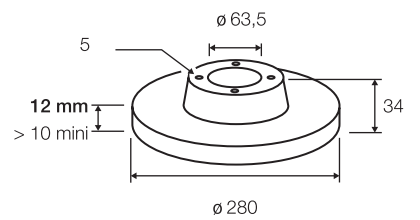

## 186841

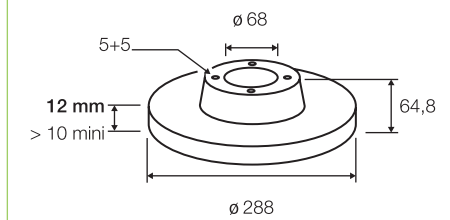

## 186843

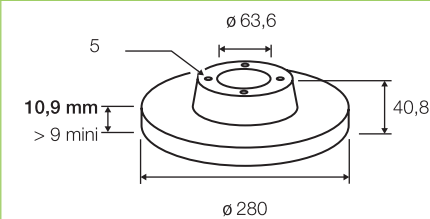

## 186854

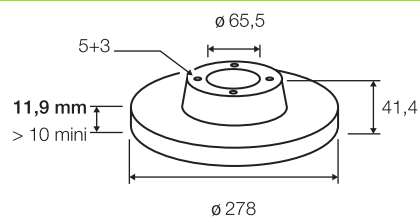

## 186857

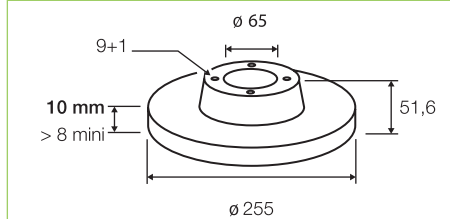

## 186860

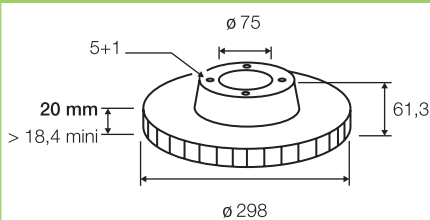

## 186861

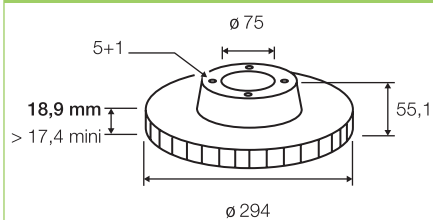

## 186863

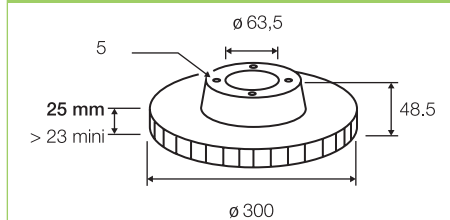

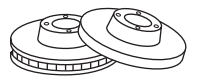

## 186864

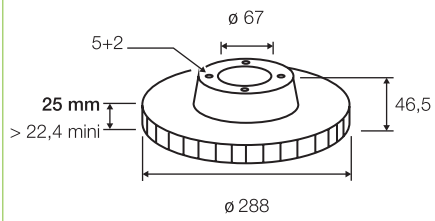

## 186869

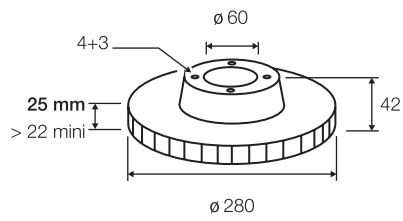

## 186871

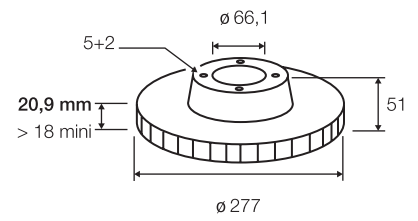

## 186872

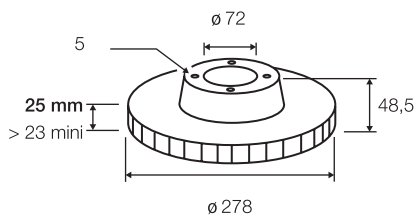

## 186880

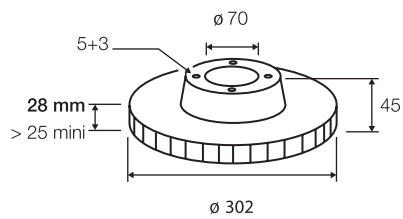

## 186881

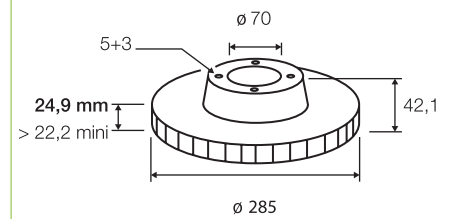

## 186882

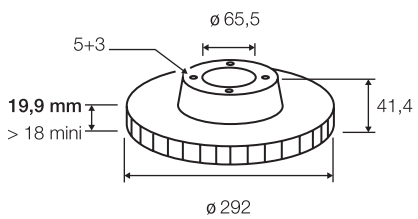

## 186890

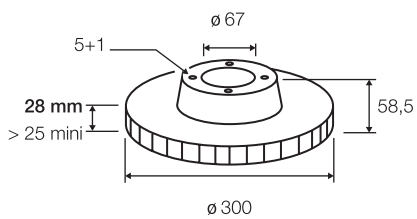

## 186896

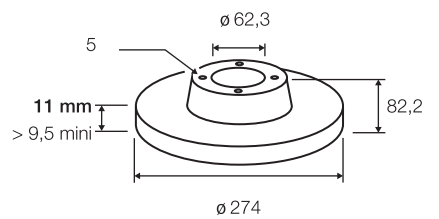

## 186898

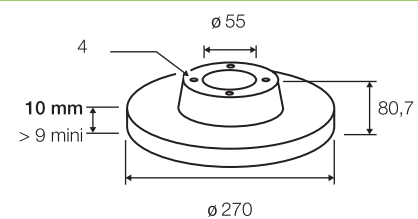

## 186899

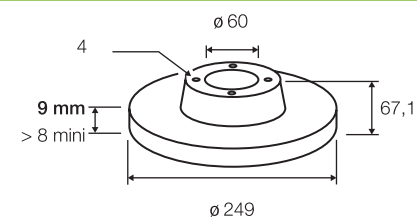

## 187045

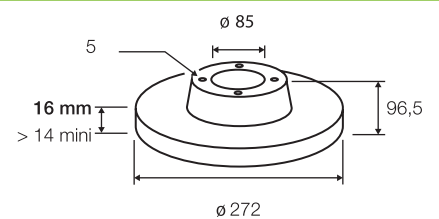

## 197002

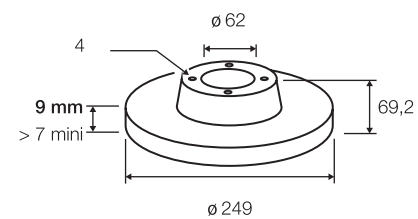

## 197008

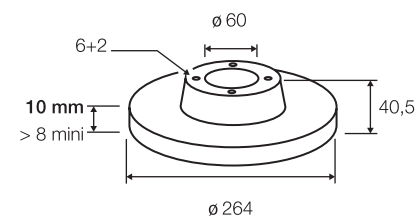

## 197009

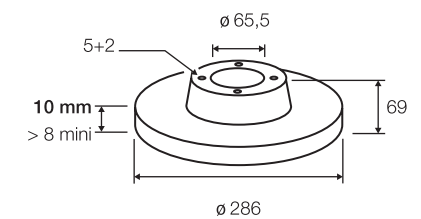

## 197011

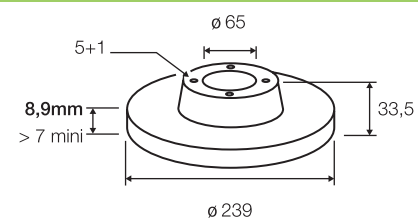

## 197017

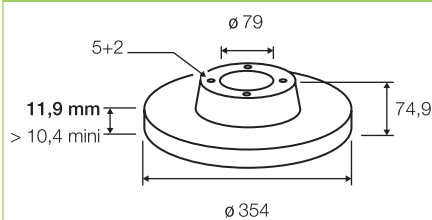

## 197022

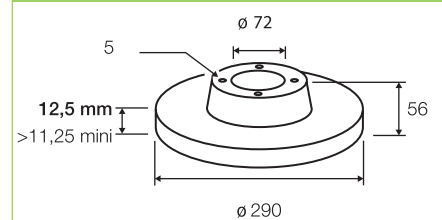

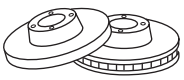

### 197028

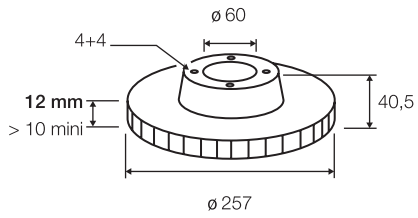

### 197029

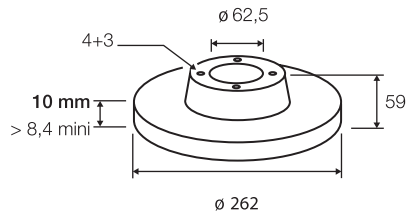

### 197031

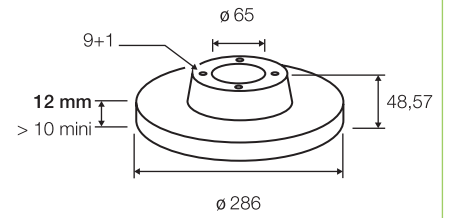

### 197035

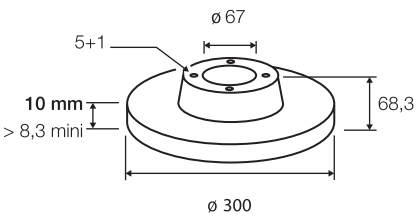

### 197036

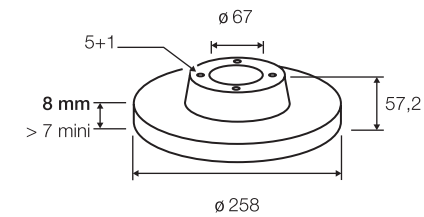

### 197038

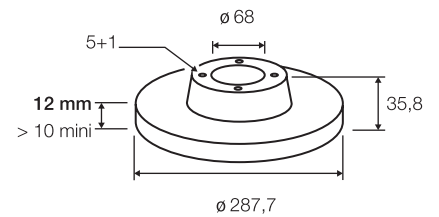

### 197044

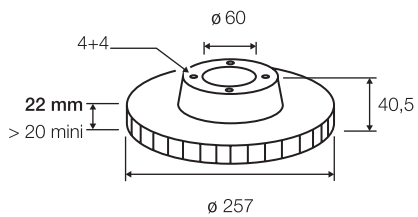

### 197045

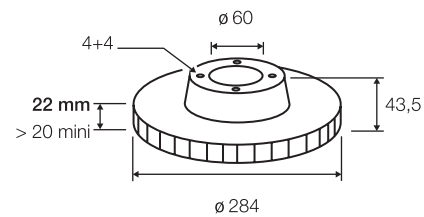

### 197046

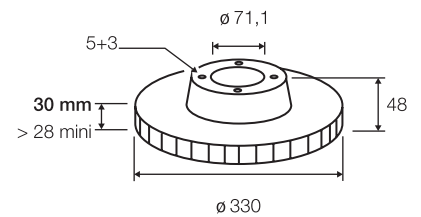

### 197049

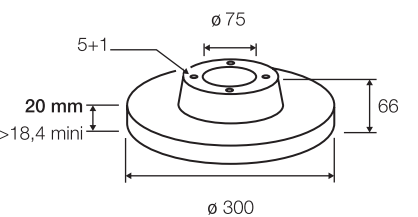

### 197050

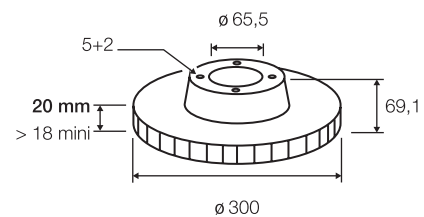

### 197051

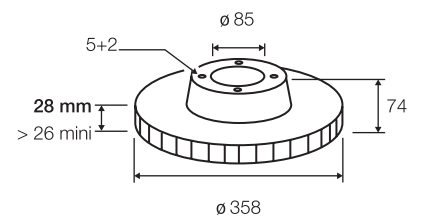

### 197055

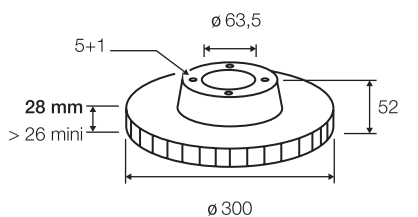

### 197057

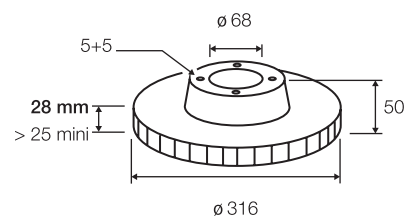

### 197069

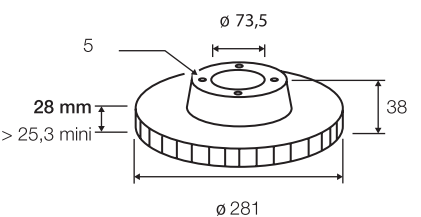

### 197073

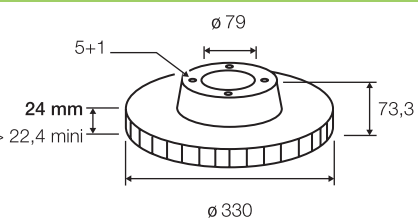

### 197074

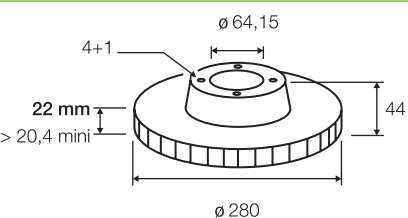

### 197083

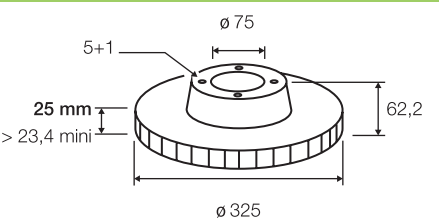

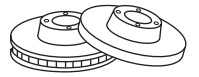

## 197087

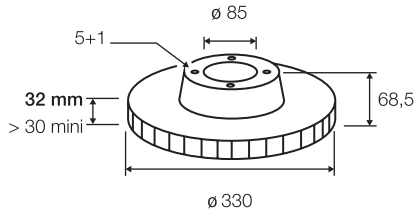

## 197088

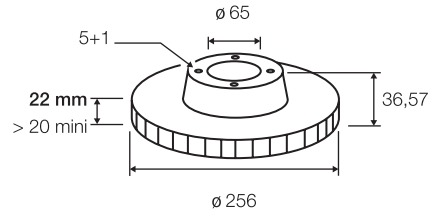

## 197090

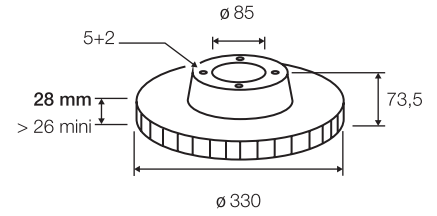

## 197091

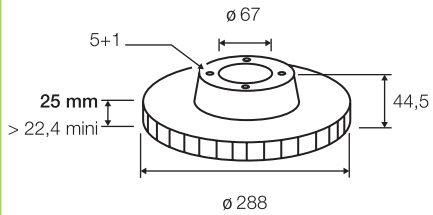

## 197092

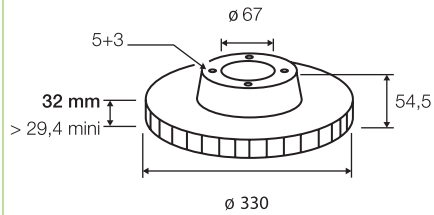

## 197093

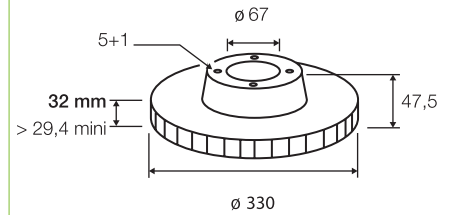

## 197094

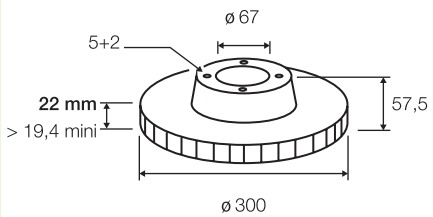

## 197100

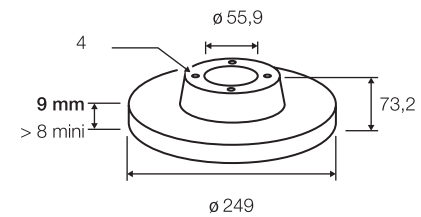

## 197116

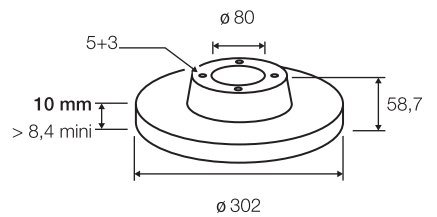

## 197117

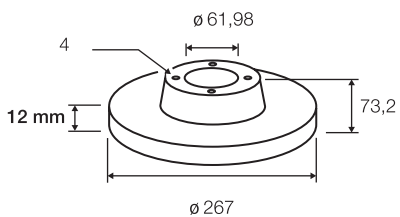

## 197122

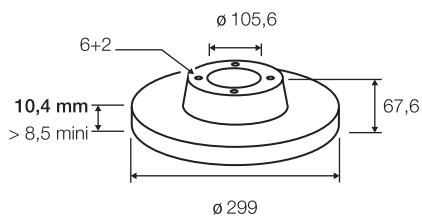

## 197126

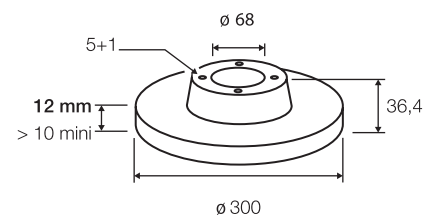

## 197127

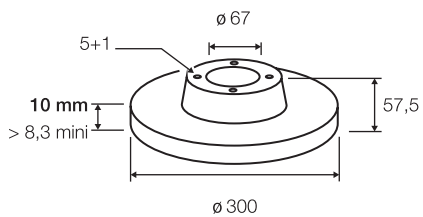

## 197128

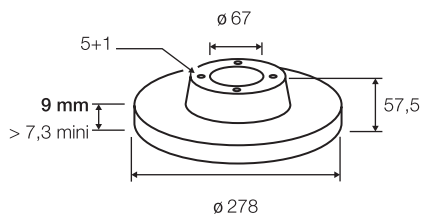

## 197129

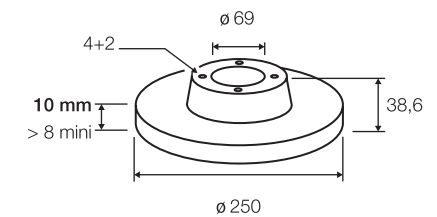

## 197139

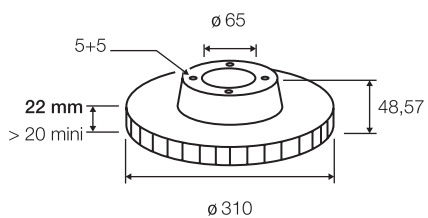

## 197143

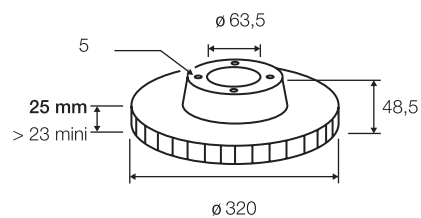

## 197150

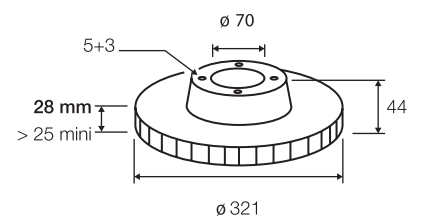

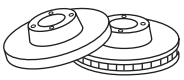

## 197152

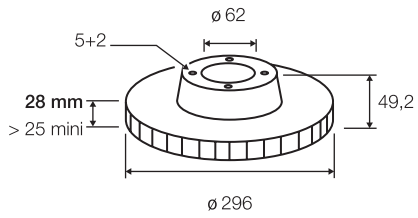

## 197155

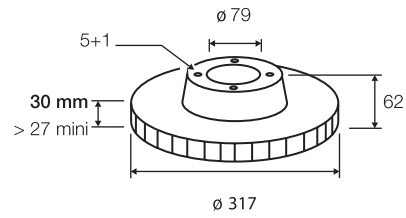

## 197156

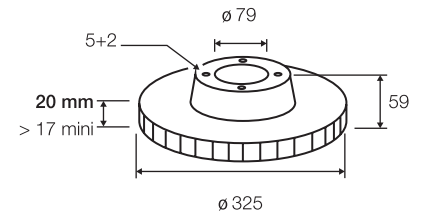

## 197158

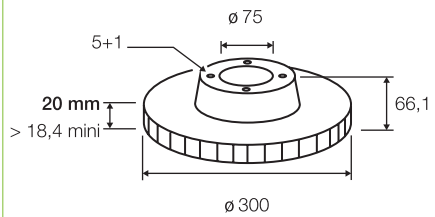

## 197159

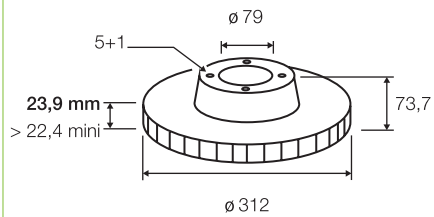

## 197160

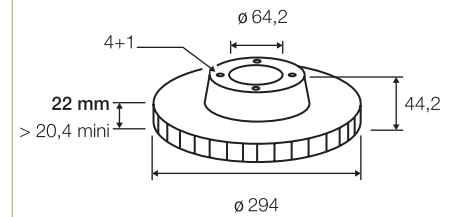

## 197175

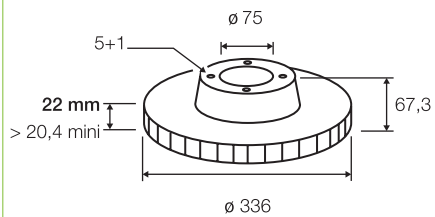

## 197176

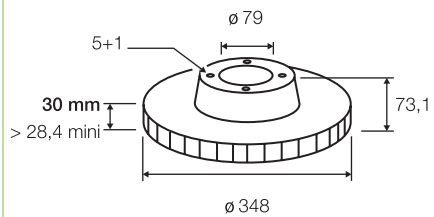

## 197177

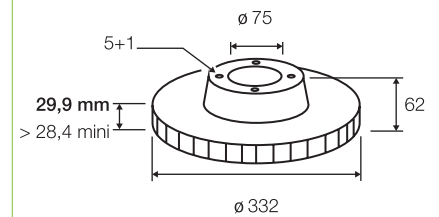

## 197178

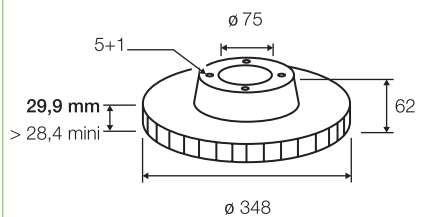

## 197179

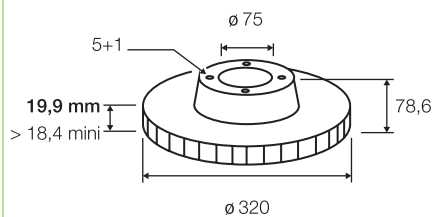

## 197180

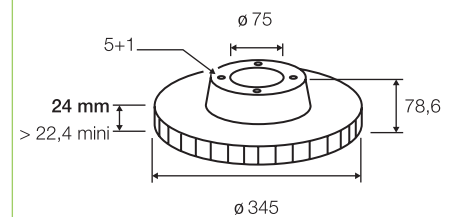

## 197181

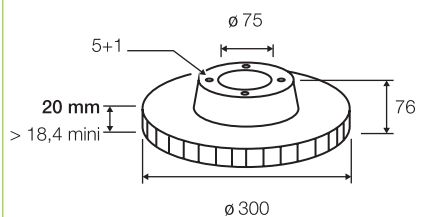

## 197190

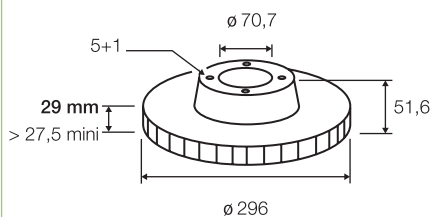

## 197191

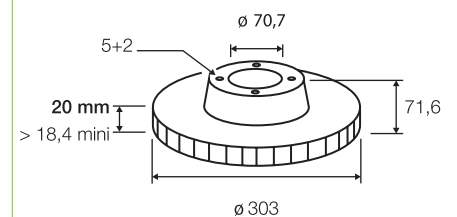

## 197192

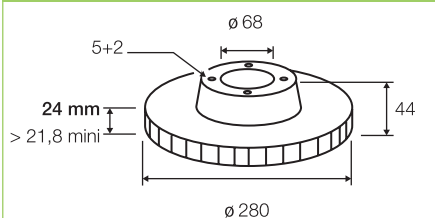

## 197193

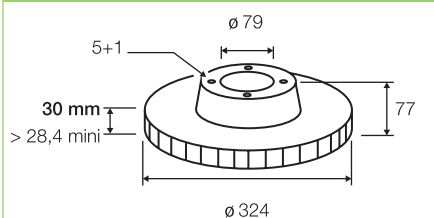

## 197194

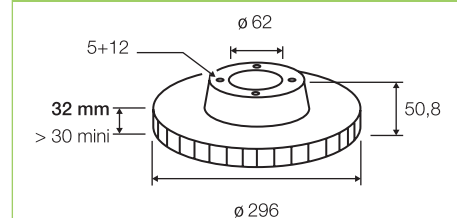



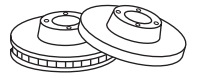

## 197195

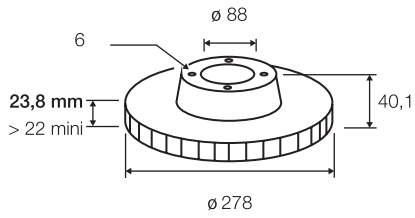

## 197197

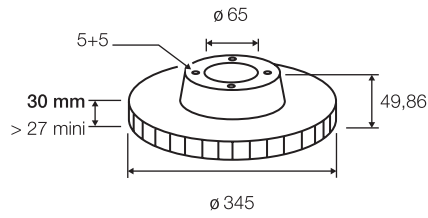

## 197199

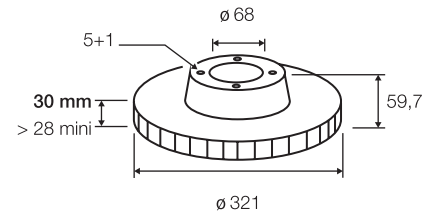

## 197200

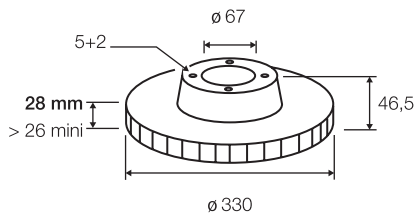

## 197201

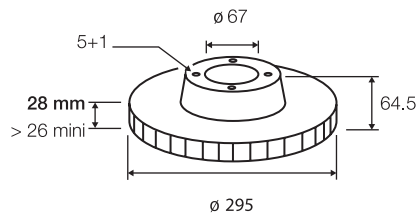

## 197202

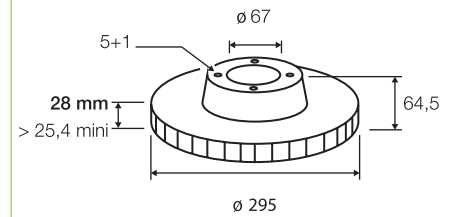

## 197213

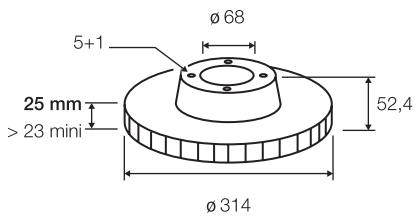

## 197214

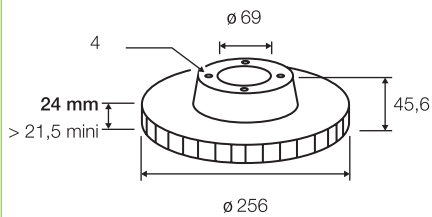

## 197215

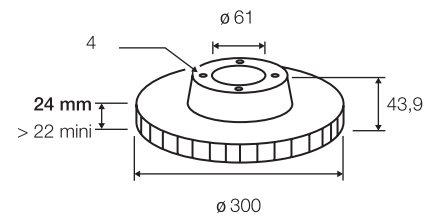

## 197220

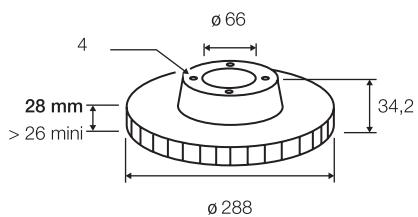

## 197221

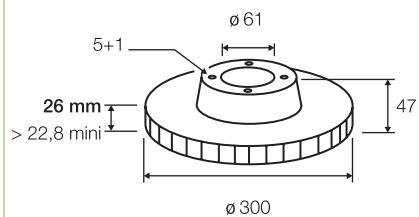

## 197226

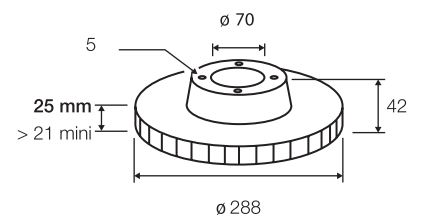

## 197227

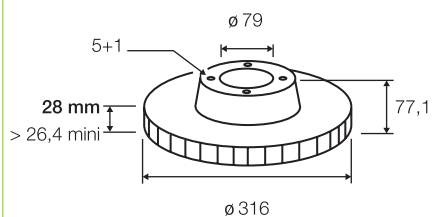

## 197230

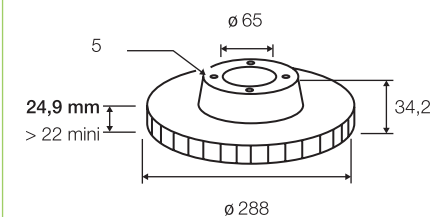

## 197232

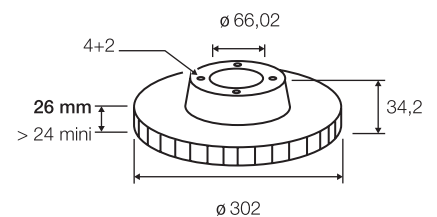

## 197234

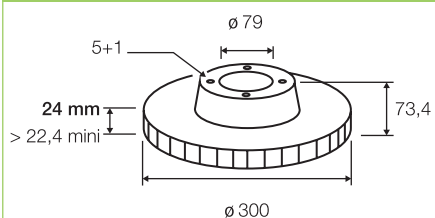

## 197237

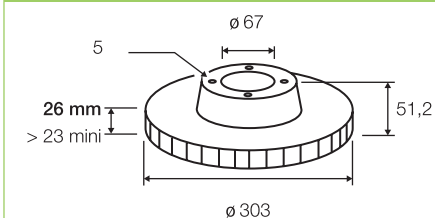

## 197241

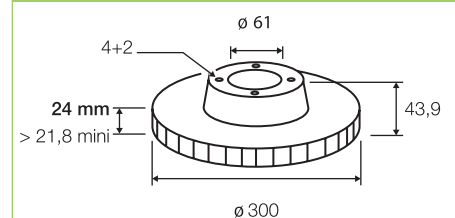

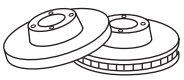

## 197242

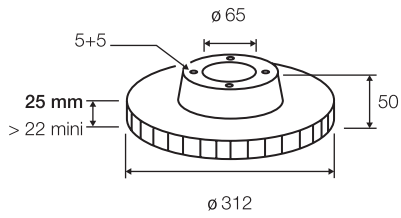

## 197243

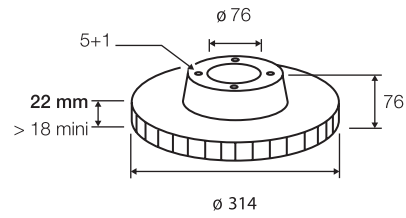

## 197244

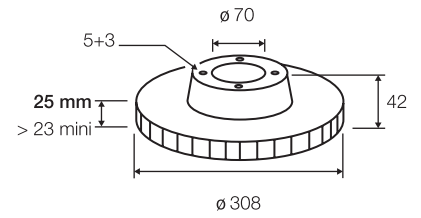

## 197246

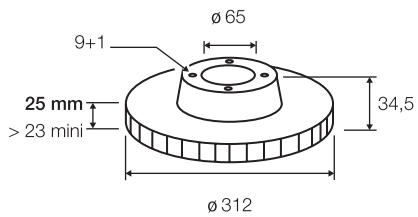

## 197251

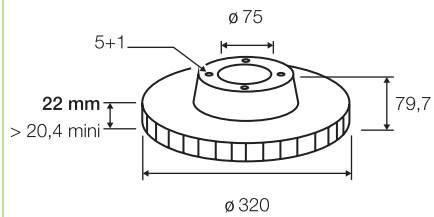

## 197264

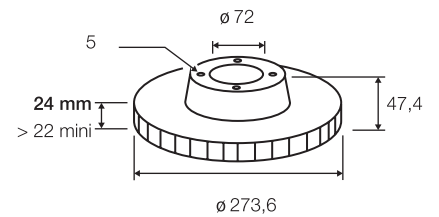

## 197267

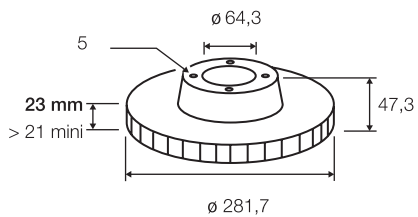

## 197294

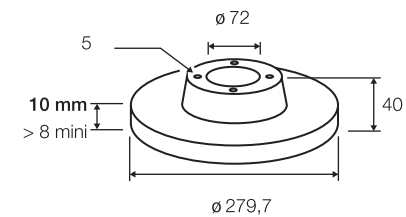

## 197384

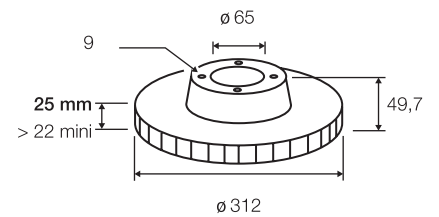

## 197387

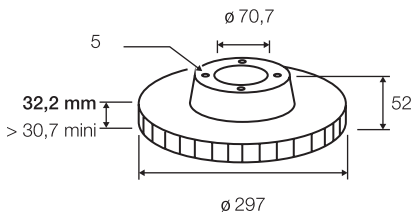

## 197388

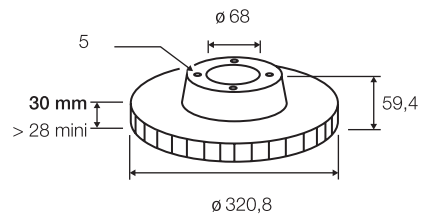

## 197389

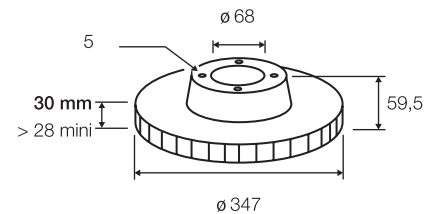

## 197390

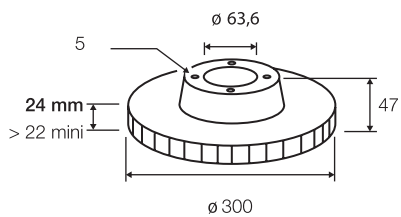

## 197392

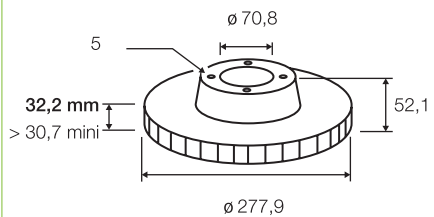

## 197393

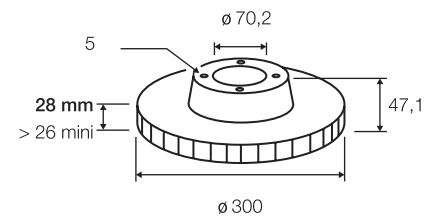

## 197394

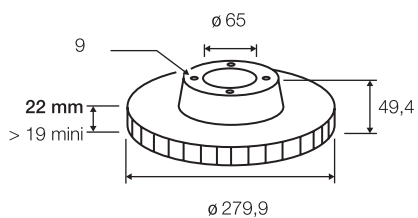

## 197397

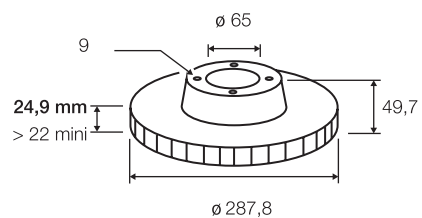

## 197399

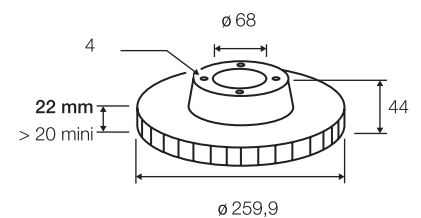

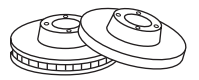

## 197400

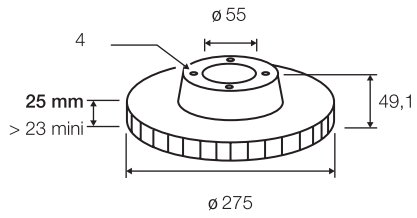

## 197404

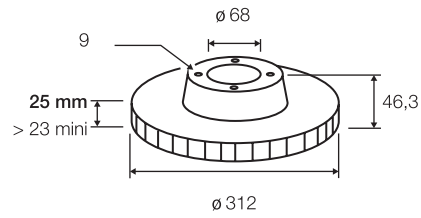

## 197406

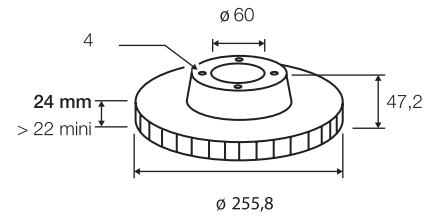

## 197412

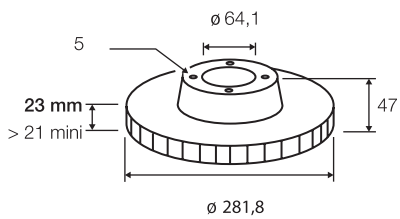

## 197418

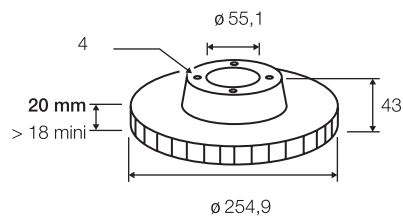

## 197420

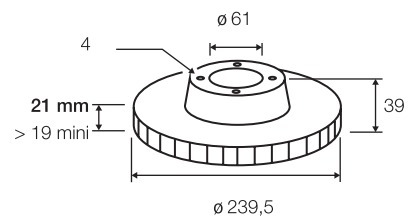

## 197423

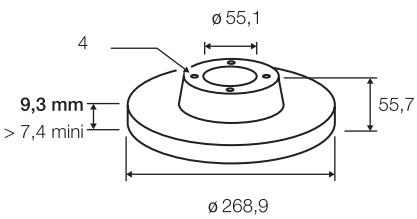

## 197426

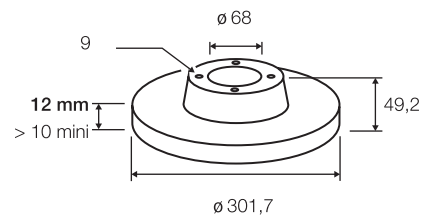

## 197427

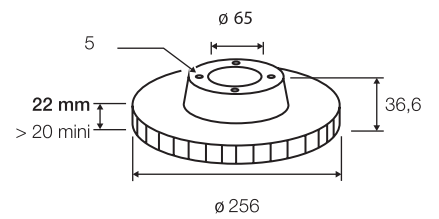

## 197429

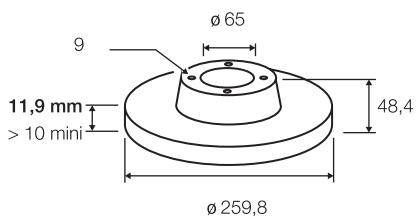

## 197430

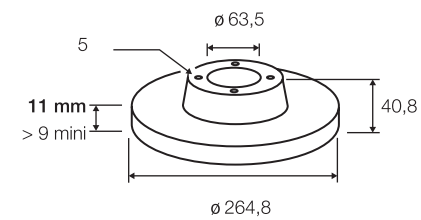

## 197431

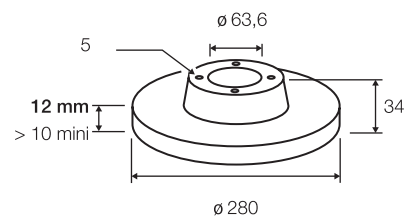

## 197432

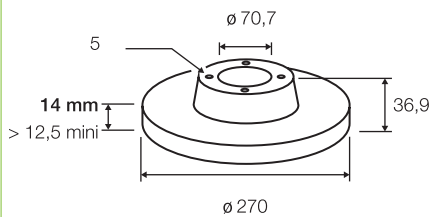

## 197433

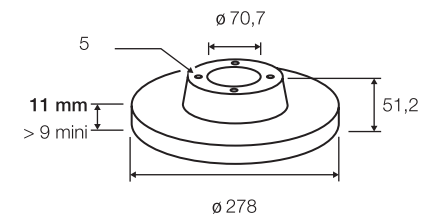

## 197438

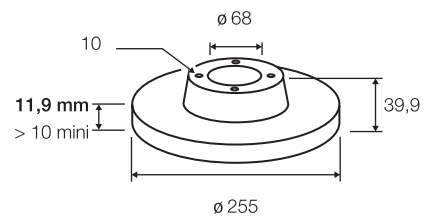

## 197440

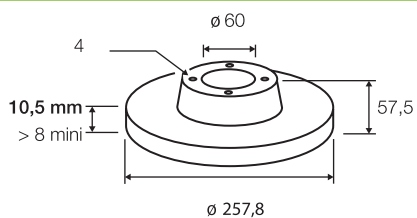

## 197441

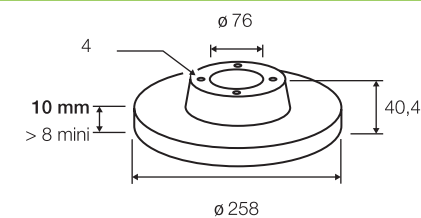

## 197442

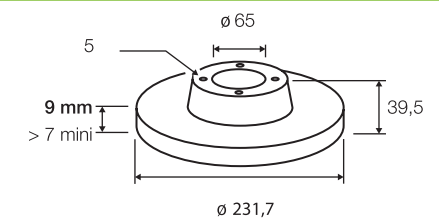



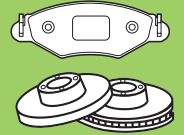

## 件号对照表 Part Number Cross List

### Pads and Discs

Plaquettes et Disques

### Pastillas y Discos

Pastilas e Discos

### Pastiglie e Dischi

Blokjes en Schijven

### Bremsbeläge und Bremsscheiben

Klocki i Tarcze

### Balatalari ve Diskleri



Колодки и диски



Δισκόφρενα & Δισκόπλακες



刹车片和刹车盘



بطانات و قرص







	
<b>BOSCH</b>	
0986424728	<b>598748</b>
0986424805	<b>598719</b>
0986424816	<b>598755</b>
0 986 424 005	<b>598392</b>
0 986 424 016	<b>598695</b>
0 986 424 026	<b>598145</b>
0 986 424 027	<b>598039</b>
0 986 424 027	<b>598502</b>
0 986 424 029	<b>598115</b>
0 986 424 030	<b>598070</b>
0 986 424 031	<b>598800</b>
0 986 424 033	<b>598064</b>
0 986 424 037	<b>598115</b>
0 986 424 044	<b>598129</b>
0 986 424 044	<b>598132</b>
0 986 424 044	<b>598380</b>
0 986 424 045	<b>598593</b>
0 986 424 046	<b>598594</b>
0 986 424 047	<b>598371</b>
0 986 424 049	<b>598351</b>
0 986 424 050	<b>598107</b>
0 986 424 069	<b>598591</b>
0 986 424 080	<b>598112</b>
0 986 424 081	<b>598091</b>
0 986 424 092	<b>598254</b>
0 986 424 093	<b>598116</b>
0 986 424 098	<b>598091</b>
0 986 424 100	<b>598093</b>
0 986 424 110	<b>598131</b>
0 986 424 117	<b>598130</b>
0 986 424 134	<b>598393</b>
0 986 424 135	<b>598052</b>
0 986 424 135	<b>598817</b>
0 986 424 144	<b>598596</b>
0 986 424 145	<b>598007</b>
0 986 424 145	<b>598139</b>
0 986 424 147	<b>598396</b>
0 986 424 151	<b>598118</b>
0 986 424 160	<b>598278</b>
0 986 424 167	<b>598006</b>
0 986 424 172	<b>598380</b>
0 986 424 172	<b>598391</b>
0 986 424 173	<b>598289</b>
0 986 424 175	<b>598135</b>
0 986 424 176	<b>540436</b>
0 986 424 178	<b>598271</b>
0 986 424 182	<b>598227</b>
0 986 424 183	<b>598177</b>
0 986 424 183	<b>598496</b>
0 986 424 184	<b>598005</b>
0 986 424 192	<b>598122</b>
0 986 424 200	<b>598619</b>
0 986 424 204	<b>598602</b>
0 986 424 211	<b>598476</b>
0 986 424 211	<b>598691</b>
0 986 424 214	<b>598022</b>
0 986 424 215	<b>598051</b>
0 986 424 215	<b>598574</b>
0 986 424 215	<b>598786</b>
0 986 424 217	<b>598599</b>



	
<b>BOSCH</b>	
0 986 424 218	<b>598044</b>
0 986 424 219	<b>598046</b>
0 986 424 223	<b>598069</b>
0 986 424 223	<b>598467</b>
0 986 424 227	<b>598068</b>
0 986 424 229	<b>598062</b>
0 986 424 230	<b>598266</b>
0 986 424 233	<b>598636</b>
0 986 424 234	<b>598357</b>
0 986 424 236	<b>598067</b>
0 986 424 237	<b>598120</b>
0 986 424 240	<b>598598</b>
0 986 424 244	<b>598019</b>
0 986 424 246	<b>598040</b>
0 986 424 248	<b>598065</b>
0 986 424 248	<b>598308</b>
0 986 424 248	<b>598990</b>
0 986 424 251	<b>598533</b>
0 986 424 260	<b>598227</b>
0 986 424 261	<b>598122</b>
0 986 424 264	<b>598815</b>
0 986 424 266	<b>598290</b>
0 986 424 267	<b>598497</b>
0 986 424 268	<b>598393</b>
0 986 424 268	<b>598897</b>
0 986 424 274	<b>598531</b>
0 986 424 277	<b>598035</b>
0 986 424 278	<b>598383</b>
0 986 424 284	<b>598491</b>
0 986 424 286	<b>598623</b>
0 986 424 287	<b>598129</b>
0 986 424 287	<b>598497</b>
0 986 424 287	<b>598498</b>
0 986 424 289	<b>598056</b>
0 986 424 295	<b>598780</b>
0 986 424 299	<b>598826</b>
0 986 424 313	<b>598777</b>
0 986 424 319	<b>598947</b>
0 986 424 340	<b>598523</b>
0 986 424 347	<b>598066</b>
0 986 424 348	<b>598989</b>
0 986 424 351	<b>598281</b>
0 986 424 352	<b>598630</b>
0 986 424 359	<b>598033</b>
0 986 424 359	<b>598120</b>
0 986 424 360	<b>598305</b>
0 986 424 360	<b>601006</b>
0 986 424 361	<b>598488</b>
0 986 424 362	<b>601003</b>
0 986 424 363	<b>598556</b>
0 986 424 364	<b>598332</b>
0 986 424 365	<b>598580</b>
0 986 424 366	<b>598460</b>
0 986 424 367	<b>598507</b>
0 986 424 368	<b>598634</b>
0 986 424 369	<b>598071</b>
0 986 424 369	<b>598697</b>
0 986 424 370	<b>598320</b>
0 986 424 371	<b>598318</b>
0 986 424 373	<b>598217</b>

	
<b>BOSCH</b>	
0 986 424 374	<b>598010</b>
0 986 424 375	<b>598482</b>
0 986 424 376	<b>598714</b>
0 986 424 379	<b>598011</b>
0 986 424 379	<b>598012</b>
0 986 424 381	<b>598169</b>
0 986 424 382	<b>598402</b>
0 986 424 382	<b>598540</b>
0 986 424 382	<b>598614</b>
0 986 424 382	<b>598947</b>
0 986 424 383	<b>598540</b>
0 986 424 383	<b>598983</b>
0 986 424 383	<b>598984</b>
0 986 424 394	<b>598085</b>
0 986 424 400	<b>598310</b>
0 986 424 400	<b>598409</b>
0 986 424 400	<b>598640</b>
0 986 424 402	<b>598675</b>
0 986 424 410	<b>598038</b>
0 986 424 410	<b>598074</b>
0 986 424 411	<b>598030</b>
0 986 424 411	<b>598156</b>
0 986 424 411	<b>598360</b>
0 986 424 414	<b>598326</b>
0 986 424 415	<b>598073</b>
0 986 424 416	<b>598043</b>
0 986 424 416	<b>598171</b>
0 986 424 418	<b>598817</b>
0 986 424 421	<b>598077</b>
0 986 424 427	<b>598319</b>
0 986 424 449	<b>598403</b>
0 986 424 450	<b>598317</b>
0 986 424 451	<b>598470</b>
0 986 424 452	<b>598074</b>
0 986 424 453	<b>598461</b>
0 986 424 455	<b>598726</b>
0 986 424 456	<b>598322</b>
0 986 424 457	<b>598454</b>
0 986 424 457	<b>598860</b>
0 986 424 458	<b>598271</b>
0 986 424 459	<b>598311</b>
0 986 424 460	<b>598303</b>
0 986 424 461	<b>598475</b>
0 986 424 462	<b>598212</b>
0 986 424 463	<b>598045</b>
0 986 424 464	<b>598844</b>
0 986 424 465	<b>598830</b>
0 986 424 466	<b>598458</b>
0 986 424 467	<b>598459</b>
0 986 424 468	<b>598330</b>
0 986 424 469	<b>598549</b>
0 986 424 469	<b>598582</b>
0 986 424 470	<b>598549</b>
0 986 424 470	<b>598582</b>
0 986 424 471	<b>598329</b>
0 986 424 472	<b>598431</b>
0 986 424 473	<b>598385</b>
0 986 424 474	<b>598361</b>
0 986 424 474	<b>598902</b>
0 986 424 475	<b>598445</b>

	
<b>BOSCH</b>	
0 986 424 476	<b>598299</b>
0 986 424 478	<b>598926</b>
0 986 424 480	<b>598490</b>
0 986 424 481	<b>598355</b>
0 986 424 482	<b>598483</b>
0 986 424 482	<b>598751</b>
0 986 424 483	<b>598018</b>
0 986 424 484	<b>598753</b>
0 986 424 485	<b>598310</b>
0 986 424 487	<b>598726</b>
0 986 424 488	<b>598305</b>
0 986 424 488	<b>598475</b>
0 986 424 489	<b>598806</b>
0 986 424 489	<b>601002</b>
0 986 424 490	<b>598057</b>
0 986 424 490	<b>598450</b>
0 986 424 492	<b>598037</b>
0 986 424 496	<b>598444</b>
0 986 424 497	<b>598763</b>
0 986 424 501	<b>598486</b>
0 986 424 502	<b>598735</b>
0 986 424 503	<b>598408</b>
0 986 424 506	<b>598581</b>
0 986 424 507	<b>598880</b>
0 986 424 508	<b>598017</b>
0 986 424 510	<b>598065</b>
0 986 424 511	<b>598420</b>
0 986 424 512	<b>598316</b>
0 986 424 514	<b>598423</b>
0 986 424 514	<b>601019</b>
0 986 424 515	<b>598424</b>
0 986 424 516	<b>598300</b>
0 986 424 517	<b>598448</b>
0 986 424 518	<b>598448</b>
0 986 424 519	<b>598444</b>
0 986 424 520	<b>598447</b>
0 986 424 522	<b>598583</b>
0 986 424 523	<b>598517</b>
0 986 424 523	<b>601020</b>
0 986 424 527	<b>598456</b>
0 986 424 528	<b>598457</b>
0 986 424 529	<b>598462</b>
0 986 424 531	<b>598470</b>
0 986 424 531	<b>598669</b>
0 986 424 531	<b>598861</b>
0 986 424 532	<b>598328</b>
0 986 424 533	<b>598473</b>
0 986 424 534	<b>598737</b>
0 986 424 534	<b>598917</b>
0 986 424 535	<b>598606</b>
0 986 424 535	<b>598737</b>
0 986 424 537	<b>598676</b>
0 986 424 539	<b>598480</b>
0 986 424 540	<b>598479</b>
0 986 424 541	<b>598493</b>
0 986 424 542	<b>598650</b>
0 986 424 542	<b>598681</b>
0 986 424 543	<b>598423</b>
0 986 424 543	<b>601019</b>
0 986 424 544	<b>598605</b>



	
<b>BOSCH</b>	
0 986 424 544	<b>598607</b>
0 986 424 545	<b>598142</b>
0 986 424 545	<b>598331</b>
0 986 424 546	<b>598433</b>
0 986 424 547	<b>598617</b>
0 986 424 549	<b>598453</b>
0 986 424 551	<b>598528</b>
0 986 424 551	<b>598988</b>
0 986 424 553	<b>598407</b>
0 986 424 554	<b>598422</b>
0 986 424 554	<b>598423</b>
0 986 424 554	<b>598424</b>
0 986 424 556	<b>598429</b>
0 986 424 556	<b>598430</b>
0 986 424 558	<b>598564</b>
0 986 424 558	<b>598639</b>
0 986 424 559	<b>598681</b>
0 986 424 560	<b>598478</b>
0 986 424 561	<b>598854</b>
0 986 424 563	<b>598497</b>
0 986 424 564	<b>598499</b>
0 986 424 565	<b>598441</b>
0 986 424 566	<b>598512</b>
0 986 424 567	<b>598129</b>
0 986 424 568	<b>598903</b>
0 986 424 569	<b>598768</b>
0 986 424 570	<b>598766</b>
0 986 424 571	<b>598464</b>
0 986 424 572	<b>598522</b>
0 986 424 575	<b>598575</b>
0 986 424 576	<b>598308</b>
0 986 424 577	<b>598309</b>
0 986 424 577	<b>598772</b>
0 986 424 578	<b>598065</b>
0 986 424 578	<b>598308</b>
0 986 424 578	<b>598990</b>
0 986 424 579	<b>598859</b>
0 986 424 579	<b>598988</b>
0 986 424 580	<b>598418</b>
0 986 424 581	<b>598416</b>
0 986 424 582	<b>598419</b>
0 986 424 583	<b>598398</b>
0 986 424 584	<b>598412</b>
0 986 424 585	<b>598544</b>
0 986 424 585	<b>598965</b>
0 986 424 586	<b>598543</b>
0 986 424 587	<b>598965</b>
0 986 424 590	<b>598850</b>
0 986 424 593	<b>598041</b>
0 986 424 594	<b>598633</b>
0 986 424 595	<b>598428</b>
0 986 424 596	<b>598427</b>
0 986 424 596	<b>598698</b>
0 986 424 596	<b>598721</b>
0 986 424 597	<b>598426</b>
0 986 424 597	<b>598670</b>
0 986 424 598	<b>598417</b>
0 986 424 610	<b>598548</b>
0 986 424 611	<b>598442</b>
0 986 424 614	<b>598537</b>



	
<b>BOSCH</b>	
0 986 424 616	<b>598471</b>
0 986 424 617	<b>598472</b>
0 986 424 617	<b>598783</b>
0 986 424 617	<b>601005</b>
0 986 424 617	<b>601044</b>
0 986 424 618	<b>598471</b>
0 986 424 618	<b>598993</b>
0 986 424 619	<b>598566</b>
0 986 424 619	<b>601012</b>
0 986 424 626	<b>598843</b>
0 986 424 630	<b>598577</b>
0 986 424 632	<b>598734</b>
0 986 424 633	<b>598489</b>
0 986 424 634	<b>598500</b>
0 986 424 635	<b>598501</b>
0 986 424 636	<b>598470</b>
0 986 424 636	<b>598545</b>
0 986 424 640	<b>598535</b>
0 986 424 640	<b>598777</b>
0 986 424 641	<b>598865</b>
0 986 424 642	<b>601024</b>
0 986 424 643	<b>598883</b>
0 986 424 644	<b>598172</b>
0 986 424 644	<b>598399</b>
0 986 424 645	<b>598563</b>
0 986 424 646	<b>598584</b>
0 986 424 648	<b>598443</b>
0 986 424 649	<b>598712</b>
0 986 424 650	<b>598895</b>
0 986 424 651	<b>598410</b>
0 986 424 651	<b>598898</b>
0 986 424 652	<b>598413</b>
0 986 424 653	<b>598411</b>
0 986 424 654	<b>598643</b>
0 986 424 656	<b>598906</b>
0 986 424 657	<b>598547</b>
0 986 424 658	<b>598466</b>
0 986 424 659	<b>598465</b>
0 986 424 660	<b>598461</b>
0 986 424 661	<b>598682</b>
0 986 424 661	<b>598758</b>
0 986 424 662	<b>598546</b>
0 986 424 663	<b>598436</b>
0 986 424 665	<b>598677</b>
0 986 424 666	<b>598510</b>
0 986 424 667	<b>598753</b>
0 986 424 668	<b>598756</b>
0 986 424 669	<b>598534</b>
0 986 424 670	<b>598908</b>
0 986 424 671	<b>598527</b>
0 986 424 672	<b>598814</b>
0 986 424 673	<b>598807</b>
0 986 424 674	<b>598484</b>
0 986 424 675	<b>598538</b>
0 986 424 676	<b>598305</b>
0 986 424 677	<b>598678</b>
0 986 424 679	<b>601001</b>
0 986 424 680	<b>598407</b>
0 986 424 681	<b>598767</b>
0 986 424 683	<b>598434</b>



	
<b>BOSCH</b>	
0 986 424 683	<b>598438</b>
0 986 424 684	<b>598374</b>
0 986 424 685	<b>598374</b>
0 986 424 687	<b>598658</b>
0 986 424 690	<b>598992</b>
0 986 424 691	<b>598432</b>
0 986 424 692	<b>598579</b>
0 986 424 693	<b>598841</b>
0 986 424 694	<b>598629</b>
0 986 424 695	<b>598453</b>
0 986 424 695	<b>598733</b>
0 986 424 695	<b>598832</b>
0 986 424 696	<b>598511</b>
0 986 424 697	<b>598856</b>
0 986 424 698	<b>598820</b>
0 986 424 699	<b>598637</b>
0 986 424 700	<b>598530</b>
0 986 424 701	<b>598639</b>
0 986 424 702	<b>598438</b>
0 986 424 703	<b>598568</b>
0 986 424 704	<b>598570</b>
0 986 424 705	<b>598659</b>
0 986 424 706	<b>598483</b>
0 986 424 706	<b>598751</b>
0 986 424 707	<b>598454</b>
0 986 424 707	<b>598860</b>
0 986 424 708	<b>598813</b>
0 986 424 709	<b>598518</b>
0 986 424 711	<b>598778</b>
0 986 424 713	<b>598521</b>
0 986 424 714	<b>598821</b>
0 986 424 715	<b>598452</b>
0 986 424 716	<b>598886</b>
0 986 424 717	<b>598520</b>
0 986 424 719	<b>598536</b>
0 986 424 720	<b>598784</b>
0 986 424 721	<b>598514</b>
0 986 424 722	<b>598887</b>
0 986 424 723	<b>598805</b>
0 986 424 726	<b>598821</b>
0 986 424 727	<b>598504</b>
0 986 424 727	<b>598574</b>
0 986 424 729	<b>598505</b>
0 986 424 729	<b>598759</b>
0 986 424 729	<b>598871</b>
0 986 424 732	<b>598697</b>
0 986 424 734	<b>598449</b>
0 986 424 735	<b>598679</b>
0 986 424 738	<b>598468</b>
0 986 424 739	<b>598656</b>
0 986 424 740	<b>598655</b>
0 986 424 741	<b>598770</b>
0 986 424 741	<b>598967</b>
0 986 424 743	<b>598808</b>
0 986 424 745	<b>598035</b>
0 986 424 747	<b>598482</b>
0 986 424 748	<b>598482</b>
0 986 424 750	<b>541705</b>
0 986 424 751	<b>598463</b>
0 986 424 751	<b>598474</b>



	
<b>BOSCH</b>	
0 986 424 756	<b>598425</b>
0 986 424 757	<b>598902</b>
0 986 424 758	<b>598632</b>
0 986 424 760	<b>598661</b>
0 986 424 761	<b>598541</b>
0 986 424 762	<b>598542</b>
0 986 424 764	<b>598410</b>
0 986 424 765	<b>598415</b>
0 986 424 766	<b>598754</b>
0 986 424 766	<b>598885</b>
0 986 424 767	<b>598231</b>
0 986 424 767	<b>598412</b>
0 986 424 767	<b>598811</b>
0 986 424 768	<b>598586</b>
0 986 424 769	<b>598569</b>
0 986 424 770	<b>598915</b>
0 986 424 771	<b>598682</b>
0 986 424 771	<b>598911</b>
0 986 424 774	<b>598557</b>
0 986 424 775	<b>601029</b>
0 986 424 777	<b>598565</b>
0 986 424 779	<b>598750</b>
0 986 424 780	<b>598801</b>
0 986 424 781	<b>598450</b>
0 986 424 782	<b>598835</b>
0 986 424 784	<b>598670</b>
0 986 424 784	<b>598913</b>
0 986 424 785	<b>598558</b>
0 986 424 786	<b>598696</b>
0 986 424 787	<b>598638</b>
0 986 424 788	<b>598736</b>
0 986 424 789	<b>598553</b>
0 986 424 790	<b>598680</b>
0 986 424 791	<b>598451</b>
0 986 424 792	<b>598761</b>
0 986 424 793	<b>598761</b>
0 986 424 794	<b>598649</b>
0 986 424 795	<b>598641</b>
0 986 424 795	<b>598847</b>
0 986 424 796	<b>598752</b>
0 986 424 796	<b>601004</b>
0 986 424 797	<b>598635</b>
0 986 424 798	<b>598812</b>
0 986 424 799	<b>598809</b>
0 986 424 800	<b>598642</b>
0 986 424 801	<b>598462</b>
0 986 424 803	<b>598737</b>
0 986 424 803	<b>598917</b>
0 986 424 804	<b>598991</b>
0 986 424 806	<b>598779</b>
0 986 424 806	<b>598845</b>
0 986 424 808	<b>598827</b>
0 986 424 809	<b>598757</b>
0 986 424 810	<b>598574</b>
0 986 424 810	<b>598781</b>
0 986 424 811	<b>598842</b>
0 986 424 812	<b>598820</b>
0 986 424 813	<b>598674</b>
0 986 424 814	<b>598852</b>
0 986 424 815	<b>598744</b>





	
<b>BOSCH</b>	
0 986 424 817	<b>598780</b>
0 986 424 818	<b>598644</b>
0 986 424 819	<b>598699</b>
0 986 424 820	<b>598701</b>
0 986 424 821	<b>598703</b>
0 986 424 822	<b>598640</b>
0 986 424 823	<b>598833</b>
0 986 424 824	<b>598752</b>
0 986 424 825	<b>598715</b>
0 986 424 826	<b>598435</b>
0 986 424 827	<b>598762</b>
0 986 424 828	<b>598440</b>
0 986 424 829	<b>598667</b>
0 986 424 830	<b>598446</b>
0 986 424 831	<b>598665</b>
0 986 424 832	<b>541664</b>
0 986 424 832	<b>598966</b>
0 986 424 833	<b>541662</b>
0 986 424 833	<b>541717</b>
0 986 460 002	<b>598301</b>
0 986 460 101	<b>598099</b>
0 986 460 101	<b>598187</b>
0 986 460 111	<b>598106</b>
0 986 460 113	<b>598111</b>
0 986 460 113	<b>598183</b>
0 986 460 113	<b>598256</b>
0 986 460 346	<b>598088</b>
0 986 460 346	<b>598099</b>
0 986 460 346	<b>598113</b>
0 986 460 346	<b>598187</b>
0 986 460 390	<b>598293</b>
0 986 460 736	<b>598090</b>
0 986 460 736	<b>598091</b>
0 986 460 736	<b>598603</b>
0 986 460 741	<b>598088</b>
0 986 460 881	<b>598338</b>
0 986 460 932	<b>598374</b>
0 986 460 935	<b>598021</b>
0 986 460 938	<b>598039</b>
0 986 460 938	<b>598356</b>
0 986 460 939	<b>598256</b>
0 986 460 941	<b>598025</b>
0 986 460 941	<b>598048</b>
0 986 460 942	<b>598006</b>
0 986 460 942	<b>598010</b>
0 986 460 942	<b>598985</b>
0 986 460 943	<b>598004</b>
0 986 460 943	<b>598016</b>
0 986 460 944	<b>598017</b>
0 986 460 944	<b>598252</b>
0 986 460 946	<b>598086</b>
0 986 460 947	<b>598000</b>
0 986 460 948	<b>598982</b>
0 986 460 949	<b>598172</b>
0 986 460 950	<b>598294</b>
0 986 460 951	<b>598280</b>
0 986 460 952	<b>598018</b>
0 986 460 953	<b>598082</b>
0 986 460 954	<b>598048</b>
0 986 460 955	<b>598253</b>



	
<b>BOSCH</b>	
0 986 460 956	<b>598029</b>
0 986 460 957	<b>598028</b>
0 986 460 957	<b>598294</b>
0 986 460 958	<b>598292</b>
0 986 460 960	<b>598020</b>
0 986 460 961	<b>598257</b>
0 986 460 962	<b>598037</b>
0 986 460 963	<b>598036</b>
0 986 460 964	<b>598386</b>
0 986 460 964	<b>598753</b>
0 986 460 965	<b>598617</b>
0 986 460 965	<b>598621</b>
0 986 460 966	<b>598601</b>
0 986 460 967	<b>598063</b>
0 986 460 967	<b>598295</b>
0 986 460 968	<b>601021</b>
0 986 460 969	<b>598034</b>
0 986 460 970	<b>598158</b>
0 986 460 970	<b>598396</b>
0 986 460 971	<b>598033</b>
0 986 460 971	<b>598619</b>
0 986 460 971	<b>598630</b>
0 986 460 972	<b>598047</b>
0 986 460 972	<b>598248</b>
0 986 460 973	<b>598135</b>
0 986 460 974	<b>598646</b>
0 986 460 975	<b>598629</b>
0 986 460 977	<b>598013</b>
0 986 460 978	<b>598597</b>
0 986 460 979	<b>598625</b>
0 986 460 980	<b>598626</b>
0 986 460 981	<b>598024</b>
0 986 460 982	<b>598382</b>
0 986 460 983	<b>598155</b>
0 986 460 983	<b>598181</b>
0 986 460 984	<b>598691</b>
0 986 460 984	<b>598915</b>
0 986 460 986	<b>598271</b>
0 986 460 989	<b>598015</b>
0 986 460 991	<b>598035</b>
0 986 460 993	<b>598057</b>
0 986 460 995	<b>598621</b>
0 986 460 996	<b>598291</b>
0 986 460 997	<b>598628</b>
0 986 460 998	<b>598138</b>
0 986 460 998	<b>598153</b>
0 986 460 998	<b>598179</b>
0 986 461 006	<b>598682</b>
0 986 461 006	<b>598911</b>
0 986 461 006	<b>601043</b>
0 986 461 106	<b>598258</b>
0 986 461 111	<b>598103</b>
0 986 461 115	<b>598230</b>
0 986 461 117	<b>598154</b>
0 986 461 117	<b>598353</b>
0 986 461 119	<b>598012</b>
0 986 461 121	<b>598051</b>
0 986 461 121	<b>598786</b>
0 986 461 122	<b>598014</b>
0 986 461 123	<b>598551</b>



	
<b>BOSCH</b>	
0 986 461 123	<b>598579</b>
0 986 461 123	<b>598809</b>
0 986 461 124	<b>598788</b>
0 986 461 126	<b>598495</b>
0 986 461 126	<b>598760</b>
0 986 461 127	<b>598051</b>
0 986 461 127	<b>598052</b>
0 986 461 129	<b>598050</b>
0 986 461 130	<b>598030</b>
0 986 461 130	<b>598156</b>
0 986 461 131	<b>598053</b>
0 986 461 131	<b>598437</b>
0 986 461 133	<b>598618</b>
0 986 461 133	<b>598851</b>
0 986 461 136	<b>598540</b>
0 986 461 136	<b>598984</b>
0 986 461 138	<b>598846</b>
0 986 461 139	<b>598787</b>
0 986 461 141	<b>598274</b>
0 986 461 142	<b>598627</b>
0 986 461 142	<b>598682</b>
0 986 461 143	<b>598828</b>
0 986 461 144	<b>598668</b>
0 986 461 145	<b>598519</b>
0 986 461 145	<b>598834</b>
0 986 461 146	<b>598624</b>
0 986 461 147	<b>598054</b>
0 986 461 148	<b>598055</b>
0 986 461 148	<b>598080</b>
0 986 461 149	<b>598158</b>
0 986 461 149	<b>598396</b>
0 986 461 149	<b>598077</b>
0 986 461 396	<b>598078</b>
0 986 461 396	<b>598085</b>
0 986 461 661	<b>598405</b>
0 986 461 731	<b>598099</b>
0 986 461 750	<b>598023</b>
0 986 461 752	<b>598616</b>
0 986 461 753	<b>598622</b>
0 986 461 757	<b>598031</b>
0 986 461 759	<b>598494</b>
0 986 461 760	<b>598840</b>
0 986 461 763	<b>598075</b>
0 986 461 763	<b>598081</b>
0 986 461 763	<b>598181</b>
0 986 461 764	<b>598038</b>
0 986 461 765	<b>598061</b>
0 986 461 766	<b>598269</b>
0 986 461 767	<b>598312</b>
0 986 461 768	<b>598519</b>
0 986 461 769	<b>598180</b>
0 986 461 769	<b>598463</b>
0 986 461 769	<b>598474</b>
0 986 461 770	<b>598125</b>
0 986 461 770	<b>598141</b>
0 986 462 001	<b>598337</b>
0 986 462 072	<b>598144</b>
0 986 462 282	<b>598099</b>
0 986 462 283	<b>598099</b>
0 986 462 532	<b>598193</b>



	
<b>BOSCH</b>	
0 986 462 803	<b>598109</b>
0 986 462 803	<b>598110</b>
0 986 462 850	<b>598362</b>
0 986 462 971	<b>598146</b>
0 986 463 412	<b>598110</b>
0 986 463 473	<b>598077</b>
0 986 463 473	<b>598078</b>
0 986 463 473	<b>598085</b>
0 986 463 490	<b>598077</b>
0 986 463 490	<b>598085</b>
0 986 463 561	<b>598147</b>
0 986 463 641	<b>598129</b>
0 986 463 641	<b>598391</b>
0 986 463 736	<b>598375</b>
0 986 463 890	<b>598207</b>
0 986 463 921	<b>598109</b>
0 986 464 221	<b>598165</b>
0 986 464 361	<b>598187</b>
0 986 464 372	<b>598107</b>
0 986 464 421	<b>598086</b>
0 986 464 421	<b>598366</b>
0 986 464 671	<b>598107</b>
0 986 464 671	<b>598187</b>
0 986 464 681	<b>598111</b>
0 986 464 801	<b>598076</b>
0 986 464 881	<b>598366</b>
0 986 464 914	<b>598168</b>
0 986 465 111	<b>598620</b>
0 986 465 141	<b>598182</b>
0 986 465 733	<b>598592</b>
0 986 465 744	<b>598205</b>
0 986 465 745	<b>598214</b>
0 986 465 751	<b>598148</b>
0 986 465 751	<b>598292</b>
0 986 465 881	<b>598108</b>
0 986 465 941	<b>598150</b>
0 986 466 311	<b>598077</b>
0 986 466 311	<b>598085</b>
0 986 466 311	<b>598175</b>
0 986 466 346	<b>598080</b>
0 986 466 350	<b>598151</b>
0 986 466 402	<b>598166</b>
0 986 466 402	<b>598212</b>
0 986 466 403	<b>598166</b>
0 986 466 403	<b>598334</b>
0 986 466 601	<b>598389</b>
0 986 466 683	<b>598180</b>
0 986 466 683	<b>598463</b>
0 986 466 683	<b>598474</b>
0 986 466 693	<b>598017</b>
0 986 466 698	<b>598004</b>
0 986 466 700	<b>598017</b>
0 986 466 751	<b>598103</b>
0 986 466 871	<b>598345</b>
0 986 466 874	<b>598105</b>
0 986 467 311	<b>598185</b>
0 986 467 400	<b>598221</b>
0 986 467 411	<b>598153</b>
0 986 467 570	<b>598104</b>
0 986 467 590	<b>598129</b>





 	
<b>BOSCH</b>	
0 986 467 602	<b>598612</b>
0 986 467 720	<b>598002</b>
0 986 467 720	<b>598084</b>
0 986 467 720	<b>598474</b>
0 986 467 760	<b>598091</b>
0 986 467 841	<b>598613</b>
0 986 467 930	<b>598168</b>
0 986 468 350	<b>541655</b>
0 986 468 380	<b>598095</b>
0 986 468 380	<b>598141</b>
0 986 468 380	<b>598219</b>
0 986 468 451	<b>598163</b>
0 986 468 520	<b>598921</b>
0 986 468 570	<b>598167</b>
0 986 468 613	<b>598217</b>
0 986 468 630	<b>598122</b>
0 986 468 701	<b>598266</b>
0 986 468 701	<b>598402</b>
0 986 468 870	<b>598128</b>
0 986 468 871	<b>598124</b>
0 986 468 871	<b>598128</b>
0 986 468 873	<b>598128</b>
0 986 468 890	<b>598127</b>
0 986 469 070	<b>598120</b>
0 986 469 070	<b>598335</b>
0 986 469 080	<b>598120</b>
0 986 469 111	<b>598113</b>
0 986 469 120	<b>598351</b>
0 986 469 191	<b>598061</b>
0 986 469 390	<b>598182</b>
0 986 469 410	<b>598315</b>
0 986 469 441	<b>598130</b>
0 986 469 550	<b>598220</b>
0 986 469 550	<b>598224</b>
0 986 469 570	<b>598384</b>
0 986 469 580	<b>598278</b>
0 986 469 580	<b>598296</b>
0 986 469 761	<b>598186</b>
0 986 469 790	<b>598027</b>
0 986 469 810	<b>598240</b>
0 986 469 820	<b>598121</b>
0 986 469 820	<b>598312</b>
0 986 469 860	<b>598075</b>
0 986 469 860	<b>598081</b>
0 986 469 860	<b>598177</b>
0 986 469 860	<b>598181</b>
0 986 469 860	<b>598338</b>
0 986 469 960	<b>598103</b>
0 986 469 960	<b>598259</b>
0 986 487 900	<b>564109</b>
0 986 487 901	<b>564110</b>
0 986 487 902	<b>564111</b>
0 986 487 903	<b>564112</b>
0 986 490 260	<b>598272</b>
0 986 490 410	<b>598239</b>
0 986 490 440	<b>598047</b>
0 986 490 500	<b>598183</b>
0 986 490 510	<b>598243</b>
0 986 490 550	<b>598241</b>
0 986 490 640	<b>598231</b>



 	
<b>BOSCH</b>	
0 986 490 640	<b>598811</b>
0 986 490 680	<b>598237</b>
0 986 490 680	<b>598269</b>
0 986 490 800	<b>598119</b>
0 986 490 800	<b>598176</b>
0 986 490 930	<b>598133</b>
0 986 490 930	<b>598134</b>
0 986 490 990	<b>598123</b>
0 986 491 030	<b>598125</b>
0 986 491 030	<b>598141</b>
0 986 491 030	<b>598142</b>
0 986 491 030	<b>598219</b>
0 986 491 030	<b>598331</b>
0 986 491 050	<b>598095</b>
0 986 491 250	<b>598964</b>
0 986 491 260	<b>598224</b>
0 986 491 330	<b>598126</b>
0 986 491 330	<b>598160</b>
0 986 491 410	<b>598032</b>
0 986 491 410	<b>598166</b>
0 986 491 441	<b>598125</b>
0 986 491 441	<b>598142</b>
0 986 491 900	<b>598182</b>
0 986 491 900	<b>598184</b>
0 986 492 020	<b>598043</b>
0 986 492 020	<b>598171</b>
0 986 492 090	<b>598179</b>
0 986 493 340	<b>598666</b>
0 986 493 360	<b>598532</b>
0 986 493 450	<b>598278</b>
0 986 493 450	<b>598296</b>
0 986 493 480	<b>598123</b>
0 986 493 480	<b>598618</b>
0 986 493 550	<b>598268</b>
0 986 493 720	<b>598266</b>
0 986 493 720	<b>598402</b>
0 986 493 790	<b>598250</b>
0 986 494 000	<b>598062</b>
0 986 494 001	<b>598636</b>
0 986 494 002	<b>598357</b>
0 986 494 003	<b>598067</b>
0 986 494 004	<b>598065</b>
0 986 494 004	<b>598308</b>
0 986 494 004	<b>598990</b>
0 986 494 005	<b>598488</b>
0 986 494 006	<b>598580</b>
0 986 494 007	<b>598310</b>
0 986 494 007	<b>598409</b>
0 986 494 007	<b>598640</b>
0 986 494 008	<b>598675</b>
0 986 494 009	<b>598311</b>
0 986 494 009	<b>598753</b>
0 986 494 010	<b>598330</b>
0 986 494 011	<b>598431</b>
0 986 494 012	<b>598445</b>
0 986 494 013	<b>598299</b>
0 986 494 014	<b>598926</b>
0 986 494 015	<b>598018</b>
0 986 494 016	<b>598444</b>
0 986 494 017	<b>598763</b>



 	
<b>BOSCH</b>	
0 986 494 018	<b>598486</b>
0 986 494 019	<b>598408</b>
0 986 494 020	<b>598581</b>
0 986 494 021	<b>598017</b>
0 986 494 021	<b>598484</b>
0 986 494 022	<b>598447</b>
0 986 494 023	<b>598583</b>
0 986 494 024	<b>598473</b>
0 986 494 025	<b>598650</b>
0 986 494 025	<b>598681</b>
0 986 494 026	<b>598433</b>
0 986 494 027	<b>598464</b>
0 986 494 028	<b>598412</b>
0 986 494 028	<b>598658</b>
0 986 494 029	<b>598543</b>
0 986 494 030	<b>598633</b>
0 986 494 031	<b>598537</b>
0 986 494 032	<b>598472</b>
0 986 494 032	<b>598783</b>
0 986 494 032	<b>601005</b>
0 986 494 033	<b>598471</b>
0 986 494 033	<b>598993</b>
0 986 494 034	<b>598566</b>
0 986 494 034	<b>601012</b>
0 986 494 035	<b>598489</b>
0 986 494 036	<b>598410</b>
0 986 494 036	<b>598898</b>
0 986 494 037	<b>598547</b>
0 986 494 038	<b>598465</b>
0 986 494 039	<b>598461</b>
0 986 494 040	<b>598546</b>
0 986 494 041	<b>598807</b>
0 986 494 042	<b>598484</b>
0 986 494 043	<b>598538</b>
0 986 494 044	<b>598678</b>
0 986 494 046	<b>598434</b>
0 986 494 046	<b>598438</b>
0 986 494 047	<b>598432</b>
0 986 494 048	<b>598568</b>
0 986 494 049	<b>598570</b>
0 986 494 050	<b>598483</b>
0 986 494 050	<b>598751</b>
0 986 494 051	<b>598482</b>
0 986 494 051	<b>598650</b>
0 986 494 052	<b>598638</b>
0 986 494 053	<b>598752</b>
0 986 494 054	<b>598665</b>
0 986 494 055	<b>598063</b>
0 986 494 055	<b>598295</b>
0 986 494 056	<b>598382</b>
0 986 494 057	<b>598258</b>
0 986 494 058	<b>598241</b>
0 986 494 059	<b>598016</b>
0 986 494 059	<b>598125</b>
0 986 494 059	<b>598142</b>
0 986 494 061	<b>598703</b>
0 986 494 062	<b>598463</b>
0 986 494 062	<b>598752</b>
0 986 494 063	<b>598643</b>
0 986 494 064	<b>598707</b>



 	
<b>BOSCH</b>	
0 986 494 065	<b>598718</b>
0 986 494 068	<b>598793</b>
0 986 494 070	<b>598426</b>
0 986 494 071	<b>598729</b>
0 986 494 072	<b>598722</b>
0 986 494 073	<b>598678</b>
0 986 494 074	<b>598698</b>
0 986 494 075	<b>601031</b>
0 986 494 076	<b>598740</b>
0 986 494 077	<b>598822</b>
0 986 494 078	<b>598647</b>
0 986 494 079	<b>598648</b>
0 986 494 080	<b>598836</b>
0 986 494 081	<b>598764</b>
0 986 494 082	<b>598765</b>
0 986 494 085	<b>598795</b>
0 986 494 087	<b>598704</b>
0 986 494 090	<b>598672</b>
0 986 494 090	<b>601009</b>
0 986 494 092	<b>598825</b>
0 986 494 094	<b>598722</b>
0 986 494 095	<b>598664</b>
0 986 494 096	<b>598700</b>
0 986 494 097	<b>598662</b>
0 986 494 098	<b>598663</b>
0 986 494 099	<b>598702</b>
0 986 494 101	<b>598896</b>
0 986 494 101	<b>601026</b>
0 986 494 102	<b>598829</b>
0 986 494 103	<b>598863</b>
0 986 494 104	<b>598779</b>
0 986 494 105	<b>598720</b>
0 986 494 107	<b>598651</b>
0 986 494 107	<b>598652</b>
0 986 494 108	<b>598671</b>
0 986 494 110	<b>598892</b>
0 986 494 111	<b>598891</b>
0 986 494 113	<b>598426</b>
0 986 494 114	<b>601015</b>
0 986 494 115	<b>598987</b>
0 986 494 118	<b>598640</b>
0 986 494 118	<b>601027</b>
0 986 494 119	<b>601004</b>
0 986 494 120	<b>598699</b>
0 986 494 121	<b>598882</b>
0 986 494 122	<b>541728</b>
0 986 494 122	<b>598876</b>
0 986 494 123	<b>541728</b>
0 986 494 124	<b>598727</b>
0 986 494 125	<b>598727</b>
0 986 494 126	<b>598727</b>
0 986 494 127	<b>598472</b>
0 986 494 127	<b>598783</b>
0 986 494 127	<b>601005</b>
0 986 494 127	<b>601008</b>
0 986 494 127	<b>601044</b>
0 986 494 129	<b>598804</b>
0 986 494 130	<b>601028</b>
0 986 494 132	<b>598427</b>
0 986 494 132	<b>598913</b>







	
<b>BOSCH</b>	
0 986 494 133	<b>598874</b>
0 986 494 134	<b>598873</b>
0 986 494 135	<b>598824</b>
0 986 494 136	<b>598803</b>
0 986 494 138	<b>598506</b>
0 986 494 139	<b>598868</b>
0 986 494 141	<b>598439</b>
0 986 494 143	<b>598654</b>
0 986 494 144	<b>598910</b>
0 986 494 145	<b>598706</b>
0 986 494 146	<b>598705</b>
0 986 494 146	<b>598910</b>
0 986 494 147	<b>598741</b>
0 986 494 148	<b>598742</b>
0 986 494 150	<b>598524</b>
0 986 494 151	<b>598738</b>
0 986 494 152	<b>598889</b>
0 986 494 153	<b>598857</b>
0 986 494 154	<b>598819</b>
0 986 494 155	<b>598575</b>
0 986 494 155	<b>598708</b>
0 986 494 157	<b>598825</b>
0 986 494 157	<b>598839</b>
0 986 494 158	<b>601030</b>
0 986 494 159	<b>598657</b>
0 986 494 160	<b>598847</b>
0 986 494 162	<b>601051</b>
0 986 494 163	<b>598899</b>
0 986 494 164	<b>598940</b>
0 986 494 165	<b>598728</b>
0 986 494 166	<b>601034</b>
0 986 494 167	<b>598995</b>
0 986 494 168	<b>598925</b>
0 986 494 169	<b>598879</b>
0 986 494 170	<b>598816</b>
0 986 494 171	<b>541736</b>
0 986 494 174	<b>601037</b>
0 986 494 175	<b>598928</b>
0 986 494 192	<b>601039</b>
0 986 494 194	<b>598881</b>
0 986 494 196	<b>601052</b>
0 986 494 197	<b>601017</b>
0 986 494 222	<b>598722</b>
0 986 494 261	<b>598927</b>
0 986 503 000	<b>601155</b>
0 986 503 001	<b>601156</b>
0 986 503 002	<b>601157</b>
0 986 503 003	<b>601158</b>
0 986 505 097	<b>598910</b>
0 986 505 402	<b>598862</b>
0 986 524 438	<b>598903</b>
0 986 524 444	<b>598391</b>
0 986 AB1 201	<b>598634</b>
0 986 AB1 202	<b>598051</b>
0 986 AB1 203	<b>598908</b>
0 986 AB1 222	<b>598506</b>
0 986 AB1 224	<b>598361</b>
0 986 AB1 233	<b>598708</b>
0 986 AB1 241	<b>598316</b>
0 986 AB1 255	<b>598874</b>



	
<b>BOSCH</b>	
0 986 AB1 264	<b>598511</b>
0 986 AB1 266	<b>598937</b>
0 986 AB1 268	<b>598870</b>
0 986 AB1 270	<b>598361</b>
0 986 AB2 027	<b>598393</b>
0 986 AB2 031	<b>598815</b>
0 986 AB2 041	<b>598540</b>
0 986 AB2 061	<b>598496</b>
0 986 AB2 082	<b>598984</b>
0 986 AB2 084	<b>601025</b>
0 986 AB2 085	<b>598827</b>
0 986 AB2 089	<b>598542</b>
0 986 AB2 090	<b>598577</b>
0 986 AB2 093	<b>598737</b>
0 986 AB2 096	<b>598857</b>
0 986 AB2 102	<b>598844</b>
0 986 AB2 104	<b>598520</b>
0 986 AB2 106	<b>598886</b>
0 986 AB2 109	<b>598853</b>
0 986 AB2 110	<b>598476</b>
0 986 AB2 111	<b>598907</b>
0 986 AB2 115	<b>598733</b>
0 986 AB2 115	<b>598832</b>
0 986 AB2 116	<b>598921</b>
0 986 AB2 119	<b>598402</b>
0 986 AB2 119	<b>598614</b>
0 986 AB2 123	<b>598809</b>
0 986 AB2 125	<b>598535</b>
0 986 AB2 126	<b>598865</b>
0 986 AB2 127	<b>598536</b>
0 986 AB2 130	<b>598888</b>
0 986 AB2 135	<b>601052</b>
0 986 AB2 136	<b>598933</b>
0 986 AB2 137	<b>598890</b>
0 986 AB2 138	<b>598819</b>
0 986 AB2 141	<b>598449</b>
0 986 AB2 145	<b>598524</b>
0 986 AB2 160	<b>598745</b>
0 986 AB2 168	<b>598929</b>
0 986 AB2 169	<b>598053</b>
0 986 AB2 171	<b>598788</b>
0 986 AB2 173	<b>598757</b>
0 986 AB2 176	<b>598760</b>
0 986 AB2 178	<b>598848</b>
0 986 AB2 217	<b>601002</b>
0 986 AB2 219	<b>598787</b>
0 986 AB2 224	<b>598628</b>
0 986 AB2 226	<b>598786</b>
0 986 AB2 238	<b>598618</b>
0 986 AB2 245	<b>598296</b>
0 986 AB2 250	<b>598452</b>
0 986 AB2 308	<b>598834</b>
0 986 AB2 313	<b>598519</b>
0 986 AB2 330	<b>598521</b>
0 986 AB2 460	<b>598646</b>
0 986 AB2 462	<b>598290</b>
0 986 AB2 463	<b>598629</b>
0 986 AB2 555	<b>598850</b>
0 986 AB2 561	<b>598856</b>
0 986 AB2 563	<b>598883</b>



	
<b>BOSCH</b>	
0 986 AB2 609	<b>598915</b>
0 986 AB2 651	<b>598047</b>
0 986 AB2 658	<b>598248</b>
0 986 AB2 663	<b>598682</b>
0 986 AB2 664	<b>598047</b>
0 986 AB2 666	<b>598760</b>
0 986 AB2 675	<b>598682</b>
0 986 AB2 675	<b>598911</b>
0 986 AB2 751	<b>598021</b>
0 986 AB2 758	<b>598830</b>
0 986 AB2 758	<b>598986</b>
0 986 AB2 760	<b>598023</b>
0 986 AB2 761	<b>598533</b>
0 986 AB2 761	<b>598534</b>
0 986 AB2 764	<b>598830</b>
0 986 AB2 765	<b>598534</b>
0 986 AB2 766	<b>598843</b>
0 986 AB2 844	<b>601159</b>
0 986 AB2 845	<b>601160</b>
0 986 AB2 846	<b>601161</b>
0 986 AB2 847	<b>601228</b>
0 986 AB2 849	<b>601162</b>
0 986 AB2 850	<b>601229</b>
0 986 AB2 852	<b>601163</b>
0 986 AB2 856	<b>601164</b>
0 986 AB2 857	<b>601230</b>
0 986 AB2 882	<b>601231</b>
0 986 AB2 883	<b>601165</b>
0 986 AB2 884	<b>601166</b>
0 986 AB2 885	<b>601232</b>
0 986 AB2 889	<b>601167</b>
0 986 AB2 890	<b>601233</b>
0 986 AB2 891	<b>601168</b>
0 986 AB2 893	<b>601169</b>
0 986 AB2 939	<b>601171</b>
0 986 AB2 948	<b>601172</b>
0 986 AB2 955	<b>601235</b>
0 986 AB2 958	<b>601173</b>
0 986 AB2 959	<b>601236</b>
0 986 AB2 977	<b>601175</b>
0 986 AB2 978	<b>601239</b>
0 986 AB3 742	<b>601176</b>
0 986 AB3 748	<b>601240</b>
0 986 AB3 749	<b>601177</b>
0 986 AB3 753	<b>601178</b>
0 986 AB3 759	<b>601241</b>
0 986 AB3 770	<b>601179</b>
0 986 AB3 772	<b>601242</b>
0 986 AB3 775	<b>601180</b>
0 986 AB3 776	<b>601243</b>
0 986 AB3 779	<b>601244</b>
0 986 AB3 780	<b>601181</b>
0 986 AB3 781	<b>601245</b>
0 986 AB3 784	<b>564113</b>
0 986 AB3 789	<b>601182</b>
0 986 AB3 790	<b>601246</b>
0 986 AB3 791	<b>601183</b>
0 986 AB3 793	<b>564114</b>
0 986 AB3 794	<b>601184</b>
0 986 AB3 800	<b>601185</b>

	
<b>BOSCH</b>	
0 986 AB3 802	<b>598408</b>
0 986 AB3 802	<b>601186</b>
0 986 AB3 803	<b>598463</b>
0 986 AB3 803	<b>601247</b>
0 986 AB3 804	<b>601187</b>
0 986 AB3 805	<b>598252</b>
0 986 AB3 805	<b>601188</b>
0 986 AB3 806	<b>601189</b>
0 986 AB3 807	<b>564115</b>
0 986 AB3 808	<b>598464</b>
0 986 AB3 808	<b>601190</b>
0 986 AB3 809	<b>601191</b>
0 986 AB3 810	<b>601192</b>
0 986 AB3 811	<b>598682</b>
0 986 AB3 811	<b>601248</b>
0 986 AB3 812	<b>601193</b>
0 986 AB3 814	<b>601194</b>
0 986 AB3 815	<b>564116</b>
0 986 AB3 816	<b>601195</b>
0 986 AB3 817	<b>601196</b>
0 986 AB3 818	<b>601249</b>
0 986 AB3 825	<b>564117</b>
0 986 AB3 831	<b>601197</b>
0 986 AB3 832	<b>601250</b>
0 986 AB3 834	<b>598917</b>
0 986 AB3 834	<b>601198</b>
0 986 AB3 835	<b>564118</b>
0 986 AB3 836	<b>601251</b>
0 986 AB3 837	<b>564119</b>
0 986 AB3 838	<b>598668</b>
0 986 AB3 838	<b>601252</b>
0 986 AB3 839	<b>598393</b>
0 986 AB3 840	<b>598777</b>
0 986 AB3 840	<b>601253</b>
0 986 AB3 841	<b>598535</b>
0 986 AB3 842	<b>598865</b>
0 986 AB3 855	<b>601201</b>
0 986 AB3 856	<b>564120</b>
0 986 AB3 862	<b>598523</b>
0 986 AB3 866	<b>601255</b>
0 986 AB3 868	<b>601202</b>
0 986 AB3 869	<b>564121</b>
0 986 AB3 901	<b>601204</b>
0 986 AB3 902	<b>564123</b>
0 986 AB3 904	<b>601256</b>
0 986 AB3 905	<b>601205</b>
0 986 AB3 906	<b>564124</b>
0 986 AB3 912	<b>601206</b>
0 986 AB3 913	<b>601257</b>
0 986 AB3 914	<b>601258</b>
0 986 AB3 915	<b>601207</b>
0 986 AB3 917	<b>601208</b>
0 986 AB3 918	<b>601259</b>
0 986 AB3 919	<b>601209</b>
0 986 AB3 920	<b>601210</b>
0 986 AB3 934	<b>601261</b>
0 986 AB3 935	<b>601211</b>
0 986 AB3 936	<b>564125</b>
0 986 AB3 937	<b>601212</b>
0 986 AB3 939	<b>601213</b>



 	
BOSCH	
0 986 AB3 940	<b>601263</b>
0 986 AB3 944	<b>601214</b>
0 986 AB3 945	<b>601264</b>
0 986 AB3 948	<b>601216</b>
0 986 AB3 949	<b>601217</b>
0 986 AB3 950	<b>601218</b>
0 986 AB3 951	<b>601266</b>
0 986 AB3 954	<b>601219</b>
0 986 AB3 955	<b>601267</b>
0 986 AB3 956	<b>601220</b>
0 986 AB3 957	<b>601268</b>
0 986 AB3 961	<b>601221</b>
0 986 AB3 962	<b>564126</b>
0 986 AB3 963	<b>601269</b>
0 986 AB3 965	<b>601270</b>
0 986 AB3 966	<b>601222</b>
0 986 AB3 967	<b>601223</b>
0 986 AB3 968	<b>601271</b>
0 986 AB3 970	<b>601273</b>
0 986 AB3 971	<b>601224</b>
0 986 AB3 972	<b>601225</b>
0 986 AB3 973	<b>564127</b>
0 986 AB3 977	<b>601227</b>
0 986 AB3 978	<b>601274</b>
0 986 AB4 026	<b>598921</b>
0 986 AB4 034	<b>598614</b>
0 986 AB4 036	<b>598122</b>
0 986 AB4 121	<b>598984</b>
0 986 AB4 150	<b>598777</b>
0 986 AB4 166	<b>598184</b>
0 986 AB4 166	<b>598356</b>
0 986 AB4 189	<b>598356</b>
0 986 AB4 275	<b>598834</b>
0 986 AB4 278	<b>598449</b>
0 986 AB4 279	<b>598625</b>
0 986 AB4 292	<b>598912</b>
0 986 AB4 297	<b>598305</b>
0 986 BB0 056	<b>598112</b>
0 986 BB0 161	<b>598142</b>
0 986 BB0 173	<b>598838</b>
0986AB2004	<b>598266</b>
0986AB2004	<b>598579</b>
0986AB2022	<b>598897</b>
0986AB2026	<b>598947</b>
0986AB2028	<b>598777</b>
0986AB2044	<b>601023</b>
0986AB2050	<b>598393</b>
0986AB2054	<b>601022</b>
0986AB2058	<b>598393</b>
0986AB2058	<b>598897</b>
0986AB2059	<b>598496</b>
0986AB2207	<b>598123</b>
0986AB2210	<b>598384</b>
0986AB2213	<b>598123</b>
0986AB2213	<b>598618</b>
0986AB2221	<b>598916</b>
0986AB2222	<b>598668</b>
0986AB2309	<b>598517</b>
0986AB2309	<b>601020</b>
0986AB2311	<b>598625</b>



 	
BOSCH	
0986AB2322	<b>598522</b>
0986AB2328	<b>598517</b>
0986AB2455	<b>598250</b>
0986AB2456	<b>598846</b>
0986AB2458	<b>598780</b>
0986AB2461	<b>598274</b>
0986AB2476	<b>598515</b>
0986AB2565	<b>601024</b>
0986AB2602	<b>598476</b>
0986AB2602	<b>598691</b>
0986AB2603	<b>598691</b>
0986AB2604	<b>598828</b>
0986AB2608	<b>598530</b>
0986AB2610	<b>598895</b>
0986AB2662	<b>598627</b>
0986AB2665	<b>598494</b>
0986AB3806	<b>598155</b>
0F026000014	<b>598018</b>
0F026000071	<b>598454</b>
0F026000079	<b>598737</b>
0F026000079	<b>598917</b>
0F026000120	<b>598053</b>
0F026000120	<b>598437</b>
F 005 X10 237	<b>598050</b>
F 01G 09G 03Y	<b>598710</b>
F 026 000 000	<b>598040</b>
F 026 000 001	<b>598065</b>
F 026 000 001	<b>598308</b>
F 026 000 001	<b>598990</b>
F 026 000 002	<b>598488</b>
F 026 000 003	<b>598675</b>
F 026 000 004	<b>598038</b>
F 026 000 004	<b>598074</b>
F 026 000 005	<b>598403</b>
F 026 000 006	<b>598074</b>
F 026 000 007	<b>598212</b>
F 026 000 008	<b>598018</b>
F 026 000 009	<b>598753</b>
F 026 000 010	<b>598172</b>
F 026 000 010	<b>598399</b>
F 026 000 011	<b>598563</b>
F 026 000 012	<b>598039</b>
F 026 000 012	<b>598356</b>
F 026 000 013	<b>598025</b>
F 026 000 013	<b>598048</b>
F 026 000 014	<b>598018</b>
F 026 000 015	<b>598258</b>
F 026 000 016	<b>598166</b>
F 026 000 016	<b>598212</b>
F 026 000 017	<b>598124</b>
F 026 000 017	<b>598128</b>
F 026 000 018	<b>598128</b>
F 026 000 019	<b>598127</b>
F 026 000 020	<b>598315</b>
F 026 000 022	<b>598011</b>
F 026 000 022	<b>598012</b>
F 026 000 023	<b>598156</b>
F 026 000 023	<b>598360</b>
F 026 000 024	<b>598319</b>
F 026 000 025	<b>598461</b>



 	
BOSCH	
F 026 000 026	<b>598549</b>
F 026 000 027	<b>598926</b>
F 026 000 028	<b>598457</b>
F 026 000 029	<b>598650</b>
F 026 000 029	<b>598681</b>
F 026 000 030	<b>598584</b>
F 026 000 031	<b>598090</b>
F 026 000 031	<b>598603</b>
F 026 000 032	<b>598338</b>
F 026 000 035	<b>598035</b>
F 026 000 036	<b>598012</b>
F 026 000 037	<b>598158</b>
F 026 000 037	<b>598396</b>
F 026 000 038	<b>598077</b>
F 026 000 038	<b>598085</b>
F 026 000 039	<b>598148</b>
F 026 000 039	<b>598292</b>
F 026 000 041	<b>598002</b>
F 026 000 041	<b>598084</b>
F 026 000 042	<b>598091</b>
F 026 000 043	<b>598182</b>
F 026 000 044	<b>598075</b>
F 026 000 044	<b>598081</b>
F 026 000 044	<b>598177</b>
F 026 000 044	<b>598181</b>
F 026 000 044	<b>598338</b>
F 026 000 045	<b>598243</b>
F 026 000 046	<b>598241</b>
F 026 000 047	<b>598141</b>
F 026 000 047	<b>598142</b>
F 026 000 047	<b>598331</b>
F 026 000 048	<b>598067</b>
F 026 000 049	<b>598317</b>
F 026 000 050	<b>598355</b>
F 026 000 051	<b>598070</b>
F 026 000 052	<b>598064</b>
F 026 000 053	<b>598254</b>
F 026 000 054	<b>598116</b>
F 026 000 055	<b>598091</b>
F 026 000 056	<b>598052</b>
F 026 000 056	<b>598817</b>
F 026 000 057	<b>598022</b>
F 026 000 058	<b>598069</b>
F 026 000 058	<b>598467</b>
F 026 000 060	<b>598019</b>
F 026 000 061	<b>598066</b>
F 026 000 063	<b>598332</b>
F 026 000 064	<b>598318</b>
F 026 000 065	<b>598217</b>
F 026 000 066	<b>598326</b>
F 026 000 067	<b>598073</b>
F 026 000 068	<b>598043</b>
F 026 000 068	<b>598171</b>
F 026 000 070	<b>598322</b>
F 026 000 071	<b>598454</b>
F 026 000 072	<b>598303</b>
F 026 000 073	<b>598330</b>
F 026 000 074	<b>598763</b>
F 026 000 075	<b>598017</b>
F 026 000 076	<b>598456</b>



 	
BOSCH	
F 026 000 078	<b>598473</b>
F 026 000 081	<b>598676</b>
F 026 000 081	<b>598858</b>
F 026 000 082	<b>598480</b>
F 026 000 083	<b>598479</b>
F 026 000 083	<b>601030</b>
F 026 000 084	<b>598493</b>
F 026 000 085	<b>598605</b>
F 026 000 085	<b>598607</b>
F 026 000 086	<b>598564</b>
F 026 000 087	<b>598577</b>
F 026 000 088	<b>598305</b>
F 026 000 092	<b>598256</b>
F 026 000 093	<b>598004</b>
F 026 000 093	<b>598016</b>
F 026 000 094	<b>598017</b>
F 026 000 094	<b>598252</b>
F 026 000 095	<b>598982</b>
F 026 000 096	<b>598172</b>
F 026 000 097	<b>598082</b>
F 026 000 098	<b>598048</b>
F 026 000 099	<b>598253</b>
F 026 000 100	<b>598292</b>
F 026 000 102	<b>598037</b>
F 026 000 103	<b>598036</b>
F 026 000 104	<b>598034</b>
F 026 000 105	<b>598396</b>
F 026 000 106	<b>598033</b>
F 026 000 106	<b>598619</b>
F 026 000 106	<b>598630</b>
F 026 000 107	<b>598013</b>
F 026 000 108	<b>598626</b>
F 026 000 111	<b>598057</b>
F 026 000 112	<b>598621</b>
F 026 000 113	<b>598291</b>
F 026 000 114	<b>598682</b>
F 026 000 114	<b>598911</b>
F 026 000 116	<b>598154</b>
F 026 000 116	<b>598353</b>
F 026 000 117	<b>598014</b>
F 026 000 118	<b>598551</b>
F 026 000 118	<b>598809</b>
F 026 000 119	<b>598030</b>
F 026 000 119	<b>598156</b>
F 026 000 120	<b>598053</b>
F 026 000 120	<b>598437</b>
F 026 000 122	<b>598274</b>
F 026 000 123	<b>598627</b>
F 026 000 123	<b>598682</b>
F 026 000 124	<b>598668</b>
F 026 000 125	<b>598055</b>
F 026 000 125	<b>598080</b>
F 026 000 126	<b>598077</b>
F 026 000 126	<b>598078</b>
F 026 000 126	<b>598085</b>
F 026 000 127	<b>598616</b>
F 026 000 128	<b>598622</b>
F 026 000 129	<b>598031</b>
F 026 000 130	<b>598075</b>
F 026 000 130	<b>598081</b>







	
<b>BOSCH</b>	
F 026 000 130	<b>598181</b>
F 026 000 131	<b>598038</b>
F 026 000 132	<b>598061</b>
F 026 000 133	<b>598180</b>
F 026 000 133	<b>598463</b>
F 026 000 135	<b>598099</b>
F 026 000 136	<b>598182</b>
F 026 000 137	<b>598205</b>
F 026 000 139	<b>598080</b>
F 026 000 140	<b>598151</b>
F 026 000 141	<b>598166</b>
F 026 000 142	<b>598180</b>
F 026 000 143	<b>598017</b>
F 026 000 144	<b>598017</b>
F 026 000 145	<b>598345</b>
F 026 000 146	<b>598105</b>
F 026 000 147	<b>598221</b>
F 026 000 148	<b>598095</b>
F 026 000 148	<b>598141</b>
F 026 000 148	<b>598219</b>
F 026 000 149	<b>598167</b>
F 026 000 150	<b>598266</b>
F 026 000 150	<b>598402</b>
F 026 000 151	<b>598128</b>
F 026 000 152	<b>598120</b>
F 026 000 152	<b>598335</b>
F 026 000 153	<b>598384</b>
F 026 000 154	<b>598240</b>
F 026 000 155	<b>598183</b>
F 026 000 156	<b>598119</b>
F 026 000 156	<b>598176</b>
F 026 000 157	<b>598123</b>
F 026 000 158	<b>598095</b>
F 026 000 159	<b>598125</b>
F 026 000 159	<b>598142</b>
F 026 000 161	<b>598182</b>
F 026 000 161	<b>598184</b>
F 026 000 162	<b>598043</b>
F 026 000 162	<b>598171</b>
F 026 000 163	<b>598179</b>
F 026 000 164	<b>598666</b>
<b>FERODO</b>	
FDB100	<b>598363</b>
FDB1000	<b>598064</b>
FDB1001	<b>598712</b>
FDB1002	<b>598073</b>
FDB1003	<b>598502</b>
FDB101	<b>598090</b>
FDB1011	<b>598836</b>
FDB1013	<b>598844</b>
FDB1015	<b>598460</b>
FDB1017	<b>598507</b>
FDB102	<b>598094</b>
FDB102	<b>598141</b>
FDB1020	<b>598533</b>
FDB1021	<b>598777</b>
FDB1021	<b>601232</b>
FDB1034	<b>598695</b>
FDB1038	<b>598044</b>



	
<b>FERODO</b>	
FDB1040	<b>598040</b>
FDB1040	<b>598607</b>
FDB1040B	<b>598040</b>
FDB1040B	<b>598607</b>
FDB1044	<b>598062</b>
FDB1049	<b>598357</b>
FDB105	<b>598099</b>
FDB1050	<b>598636</b>
FDB1052	<b>598065</b>
FDB1052	<b>598308</b>
FDB1052	<b>598990</b>
FDB1052B	<b>598065</b>
FDB1052B	<b>598308</b>
FDB1052B	<b>598990</b>
FDB1054	<b>598066</b>
FDB1055	<b>598067</b>
FDB1055	<b>598463</b>
FDB1056	<b>598040</b>
FDB1056	<b>598041</b>
FDB1056	<b>601003</b>
FDB1056B	<b>598040</b>
FDB1056B	<b>598041</b>
FDB1056B	<b>601003</b>
FDB106	<b>598077</b>
FDB106	<b>598078</b>
FDB106	<b>598085</b>
FDB1062	<b>598068</b>
FDB1063	<b>598069</b>
FDB1063	<b>598467</b>
FDB1067	<b>598184</b>
FDB1068	<b>598305</b>
FDB1069	<b>598385</b>
FDB1070	<b>598207</b>
FDB1072	<b>598258</b>
FDB1072G	<b>598258</b>
FDB1073	<b>598310</b>
FDB1073	<b>598409</b>
FDB1073	<b>598811</b>
FDB1075	<b>598311</b>
FDB1080	<b>601156</b>
FDB1081	<b>598212</b>
FDB1083	<b>598180</b>
FDB1083	<b>598463</b>
FDB1083	<b>601255</b>
FDB1085	<b>598061</b>
FDB1091	<b>598071</b>
FDB1092	<b>598320</b>
FDB1094	<b>598332</b>
FDB1096	<b>598450</b>
FDB1098	<b>598556</b>
FDB1099	<b>598965</b>
FDB11	<b>598017</b>
FDB11	<b>598111</b>
FDB1100	<b>598830</b>
FDB1101	<b>598488</b>
FDB1104	<b>598668</b>
FDB1109	<b>598156</b>
FDB1112	<b>598326</b>
FDB1113	<b>598125</b>
FDB1113	<b>598141</b>



	
<b>FERODO</b>	
FDB1113	<b>598142</b>
FDB1113	<b>598219</b>
FDB1113	<b>598331</b>
FDB1114	<b>598420</b>
FDB1116	<b>598361</b>
FDB1117	<b>598183</b>
FDB1117	<b>598187</b>
FDB1117B	<b>598183</b>
FDB1117B	<b>598187</b>
FDB1124	<b>598470</b>
FDB1129	<b>598906</b>
FDB113	<b>598077</b>
FDB113	<b>598078</b>
FDB113	<b>598085</b>
FDB1134	<b>598880</b>
FDB1135	<b>598726</b>
FDB114	<b>598077</b>
FDB114	<b>598085</b>
FDB1156	<b>598528</b>
FDB1157	<b>598854</b>
FDB116	<b>598108</b>
FDB1160	<b>598605</b>
FDB1162	<b>598329</b>
FDB1166	<b>598806</b>
FDB1166	<b>601002</b>
FDB1167	<b>598355</b>
FDB1168	<b>598074</b>
FDB11X	<b>598111</b>
FDB123	<b>598375</b>
FDB1254	<b>598904</b>
FDB126	<b>598147</b>
FDB1263	<b>598452</b>
FDB1264	<b>598459</b>
FDB1264	<b>601249</b>
FDB1265	<b>598458</b>
FDB1265	<b>601196</b>
FDB1276	<b>598399</b>
FDB1278	<b>598328</b>
FDB128	<b>598099</b>
FDB128	<b>598106</b>
FDB128	<b>598109</b>
FDB1285	<b>598616</b>
FDB1288	<b>598403</b>
FDB1289	<b>598017</b>
FDB1291	<b>598512</b>
FDB1293	<b>598322</b>
FDB1294	<b>598926</b>
FDB1295	<b>598454</b>
FDB130	<b>598174</b>
FDB130	<b>598375</b>
FDB1300	<b>598018</b>
FDB1301	<b>598753</b>
FDB1303	<b>598549</b>
FDB1304	<b>598299</b>
FDB1305	<b>598301</b>
FDB1307	<b>598766</b>
FDB1308	<b>598768</b>
FDB1310	<b>598763</b>
FDB1311	<b>598444</b>
FDB1312	<b>598330</b>

	
<b>FERODO</b>	
FDB1318	<b>598317</b>
FDB1319	<b>598431</b>
FDB1319B	<b>598431</b>
FDB1321	<b>598478</b>
FDB1322	<b>598447</b>
FDB1323	<b>598483</b>
FDB1323	<b>601195</b>
FDB1324	<b>598425</b>
FDB1325	<b>598406</b>
FDB1326	<b>598575</b>
FDB1327	<b>598530</b>
FDB1333	<b>598895</b>
FDB1334	<b>598772</b>
FDB1336	<b>598902</b>
FDB1337	<b>598316</b>
FDB1349	<b>598407</b>
FDB1355	<b>598632</b>
FDB1356	<b>598582</b>
FDB1357	<b>598549</b>
FDB1368	<b>598606</b>
FDB1370	<b>598462</b>
FDB1376	<b>598422</b>
FDB1376	<b>598424</b>
FDB1377	<b>598424</b>
FDB1378	<b>598461</b>
FDB1378	<b>601184</b>
FDB1379	<b>598466</b>
FDB1380	<b>598527</b>
FDB1382	<b>601030</b>
FDB1383	<b>598480</b>
FDB1392	<b>598737</b>
FDB1393	<b>598563</b>
FDB1394	<b>598564</b>
FDB1395	<b>598577</b>
FDB1395	<b>601251</b>
FDB1398	<b>598408</b>
FDB1398	<b>601186</b>
FDB1399	<b>598464</b>
FDB1399	<b>601160</b>
FDB1399	<b>601189</b>
FDB1399	<b>601190</b>
FDB1399	<b>601212</b>
FDB1400	<b>598442</b>
FDB1401	<b>598443</b>
FDB1407	<b>598750</b>
FDB1409	<b>598557</b>
FDB1410	<b>598417</b>
FDB1411	<b>598419</b>
FDB1412	<b>598416</b>
FDB1413	<b>598418</b>
FDB1414	<b>598638</b>
FDB1415	<b>598063</b>
FDB1415	<b>598664</b>
FDB1416	<b>598434</b>
FDB1416	<b>601257</b>
FDB1419	<b>598667</b>
FDB142	<b>598178</b>
FDB1420	<b>598473</b>
FDB1421	<b>598843</b>
FDB1422	<b>598522</b>



 	
FERODO	
FDB1423	598453
FDB1424	598456
FDB1425	598433
FDB1425	601206
FDB1426	598445
FDB1426	598659
FDB1427	598446
FDB1428	598448
FDB1429	598448
FDB143	598109
FDB1433	598476
FDB1434	598523
FDB1439	598436
FDB1440	598566
FDB1440	601012
FDB1441	598471
FDB1442	598543
FDB1444	598907
FDB1445	598515
FDB1446	598516
FDB1447	598653
FDB1451	598484
FDB1454	598449
FDB1455	598548
FDB1456	598535
FDB1457	598865
FDB1457	601253
FDB1458	598579
FDB1459	598991
FDB1460	598967
FDB1463	598180
FDB1463	598486
FDB1463	601209
FDB1466	598426
FDB1467	598427
FDB1467	598698
FDB1467	598721
FDB1468	598428
FDB1469	598633
FDB1470	601001
FDB1471	601029
FDB1472	598457
FDB1473	598514
FDB1475	598755
FDB1476	598465
FDB1476	601213
FDB1477	598398
FDB1481	598681
FDB1482	598482
FDB1482	598650
FDB1482	598681
FDB1483	598580
FDB1485	598439
FDB1486	598438
FDB149	598165
FDB1491	598180
FDB1493	598764
FDB1494	598765
FDB1495	598481
FDB1496	598489



 	
FERODO	
FDB1497	598565
FDB1499	598413
FDB1500	598643
FDB1501	598856
FDB1502	598393
FDB1505	598627
FDB1506	598758
FDB1508	598988
FDB1510	598415
FDB1511	598661
FDB1512	598719
FDB1513	598736
FDB1514	598536
FDB1515	598545
FDB1517	598735
FDB1520	598678
FDB1521	598584
FDB1523	598510
FDB1524	598677
FDB1526	598637
FDB1527	598784
FDB1528	598827
FDB1529	598541
FDB1530	598542
FDB1531	598673
FDB1532	598733
FDB1532	598832
FDB1533	598848
FDB1535	598475
FDB1536	598511
FDB1540	598472
FDB1541	598471
FDB1542	598500
FDB1543	598501
FDB1544	598558
FDB1545	598468
FDB1551	598697
FDB1554	598912
FDB1556	598553
FDB1556	598793
FDB1557	601180
FDB1559	598912
FDB1564	601023
FDB1565	598534
FDB1569	598841
FDB1570	598778
FDB1573	598679
FDB1574	598680
FDB1580	598451
FDB1581	598761
FDB1582	598761
FDB1593	598704
FDB1594	598649
FDB1594	601171
FDB1595	598821
FDB1596	598521
FDB1597	598658
FDB1599	598462
FDB160	598375
FDB1600	598745



 	
FERODO	
FDB1601	598435
FDB1603	598518
FDB1604	598520
FDB1605	598505
FDB1605	598759
FDB1605	601164
FDB1606	598748
FDB1606	601230
FDB1606	601236
FDB1607	598989
FDB1608	598813
FDB161	598107
FDB1610	601025
FDB1612	598915
FDB1613	598742
FDB1615	598741
FDB1617	598641
FDB162	598187
FDB1620	598862
FDB1621	598886
FDB1625	598655
FDB1626	598656
FDB1627	598770
FDB1628	598410
FDB1629	598652
FDB1629	598779
FDB1629	601163
FDB163	598107
FDB1630	598012
FDB1631	598657
FDB1632	598829
FDB1633	598734
FDB1634	598805
FDB1635	598408
FDB1636	598752
FDB1636	601263
FDB1637	598463
FDB1639	598853
FDB164	598107
FDB164	598187
FDB1640	598860
FDB1641	598635
FDB1641	601216
FDB1645	598674
FDB1646	598523
FDB1648	598665
FDB1649	598812
FDB1651	601003
FDB1652	598696
FDB1654	598801
FDB1655	601004
FDB1658	598757
FDB1658	601208
FDB1661	598659
FDB1662	598720
FDB1663	598772
FDB1666	598670
FDB1666	598913
FDB1667	598861
FDB1668	598483



 	
FERODO	
FDB1668	598751
FDB1669	598887
FDB1669	601217
FDB167	598168
FDB1670	598506
FDB1670	601167
FDB1670	601168
FDB1672	598820
FDB1673	598411
FDB1675	601005
FDB1676	598643
FDB1679	598682
FDB1679	601248
FDB1686	601242
FDB1691	601252
FDB1691	601261
FDB1692	601176
FDB1693	598672
FDB1698	598857
FDB1698	601166
FDB1699	598644
FDB1699	601205
FDB1700	598883
FDB1702	598855
FDB1703	601022
FDB1704	598824
FDB1706	598822
FDB1709	598992
FDB1711	598439
FDB1713	598438
FDB1717	598751
FDB1721	598780
FDB1725	598662
FDB1726	598663
FDB1727	598664
FDB1728	598715
FDB173	598182
FDB173	598356
FDB1733	598744
FDB1733	601173
FDB1735	598654
FDB1736	598823
FDB1737	598574
FDB1738	598318
FDB1742	598767
FDB1745	598889
FDB1745	601204
FDB1747	598699
FDB1749	598704
FDB175	598124
FDB175	598128
FDB175	598205
FDB1750	598795
FDB1751	598700
FDB1753	598035
FDB1757	598515
FDB176	598076
FDB1765	598863
FDB1766	598472
FDB1766	598783







	
FERODO	
FDB1770	598180
FDB1773	598640
FDB1781	598002
FDB1782	598583
FDB1783	598707
FDB1784	598702
FDB1784	601273
FDB1787	598553
FDB1788	598180
FDB1788	598463
FDB1790	598718
FDB1794	598772
FDB1795	601029
FDB1796	601029
FDB1797	598727
FDB1798	598727
FDB1805	598729
FDB1806	598701
FDB1807	598703
FDB1808	598885
FDB1826	598940
FDB1827	598484
FDB1827	598751
FDB1829	601221
FDB1830	598728
FDB1831	598802
FDB1832	598845
FDB1833	598808
FDB1835	598770
FDB1838	598939
FDB1839	598852
FDB1840	598781
FDB1840	601169
FDB1841	601233
FDB1858	598722
FDB1859	598803
FDB186	598614
FDB1861	598875
FDB1862	598849
FDB1865	598993
FDB1866	601012
FDB1867	598753
FDB1868	598710
FDB1869	598842
FDB1875	598804
FDB1877	598994
FDB1881	598738
FDB1885	598740
FDB1885	601258
FDB1889	598874
FDB1889	601250
FDB1890	601026
FDB1892	598819
FDB1892	601264
FDB1894	598746
FDB1895	598810
FDB1896	598859
FDB1897	598879
FDB1897	601218
FDB1898	601007



	
FERODO	
FDB190	598113
FDB1902	598706
FDB1905	601197
FDB1907	601034
FDB1910	598932
FDB1911	598944
FDB1912	601201
FDB1917	598935
FDB1917	601266
FDB1918	598928
FDB1919	598839
FDB192	598108
FDB1920	598825
FDB1922	598722
FDB1931	598472
FDB1931	598783
FDB1931	601044
FDB1931	601256
FDB1932	598935
FDB1933	598935
FDB1934	598942
FDB1935	598941
FDB1936	601035
FDB194	598377
FDB1944	598987
FDB1945	601015
FDB1946	598426
FDB1947	598929
FDB195	598389
FDB1950	598708
FDB1955	598868
FDB1955	601210
FDB1956	598867
FDB196	598207
FDB1968	598919
FDB1969	598361
FDB197	598364
FDB1970	598834
FDB1970	598866
FDB1971	598997
FDB1972	598998
FDB1973	598936
FDB1974	598699
FDB1976	601031
FDB198	598208
FDB1980	601051
FDB1982	598476
FDB1985	598917
FDB1985	601172
FDB1985	601198
FDB1986	601240
FDB1988	598873
FDB1990	598821
FDB1991	601214
FDB1992	598852
FDB1997	598738
FDB1999	598871
FDB201	598148
FDB203	598592
FDB206	598212



	
FERODO	
FDB208	598185
FDB212	598120
FDB212	598166
FDB212	598212
FDB22	598088
FDB221	598093
FDB222	598125
FDB225	598123
FDB225	598379
FDB230	598220
FDB235	598081
FDB240	598168
FDB241	598612
FDB243	598110
FDB253	598150
FDB256	598080
FDB256	598104
FDB257	598162
FDB264	598090
FDB268	598163
FDB272	598149
FDB274	598118
FDB275	598217
FDB276	598120
FDB276	598335
FDB284	598817
FDB285	598131
FDB286	598168
FDB288	598921
FDB289	598169
FDB29	598603
FDB293	598278
FDB296	598103
FDB2H	598050
FDB2H	598099
FDB2H	598270
FDB300	598047
FDB308	598266
FDB316	598384
FDB317	598221
FDB318	598402
FDB328	598105
FDB340	598123
FDB346	598091
FDB346	598219
FDB347	598351
FDB348	598113
FDB349	598130
FDB350	598093
FDB350	598168
FDB357	598224
FDB359	598160
FDB361	598094
FDB363	598091
FDB363	598093
FDB363	598271
FDB365	598167
FDB368	598220
FDB370	598091
FDB370	598141

	
FERODO	
FDB370	598219
FDB372	598780
FDB375	598182
FDB375	598356
FDB385	598127
FDB391	598115
FDB392	598124
FDB392	598127
FDB393	598002
FDB393	598075
FDB393	598081
FDB393	598177
FDB393	598181
FDB393D	598081
FDB396	598021
FDB398	598240
FDB3M	598099
FDB3M	598187
FDB4001	598888
FDB4001	601269
FDB4003	598927
FDB4004	598180
FDB4014	598705
FDB402	598175
FDB4023	598893
FDB4035	601017
FDB4041	601028
FDB4042	598933
FDB4045	598996
FDB4046	601040
FDB4051	601182
FDB4051	601183
FDB4055	598995
FDB4056	598709
FDB406	598061
FDB4060	598877
FDB4061	601271
FDB4062	601223
FDB4066	598464
FDB4074	598924
FDB4076	598052
FDB4077	598878
FDB408	598121
FDB4080	598925
FDB4081	601052
FDB410	598134
FDB4110	598999
FDB4110	601225
FDB412	598214
FDB4136	601037
FDB4136	601224
FDB4148	601013
FDB415	598315
FDB4160	601178
FDB4161	601179
FDB4177	598738
FDB4178	598463
FDB4179	598999
FDB4182	601000
FDB4183	598474



 	
FERODO	
FDB4184	601014
FDB4185	601010
FDB4188	598678
FDB419	598127
FDB419	598128
FDB419	598181
FDB4191	601027
FDB4192	598752
FDB4193	598945
FDB4198	601245
FDB42	598174
FDB420	598371
FDB4201	601222
FDB4202	601211
FDB4203	601267
FDB4204	601243
FDB4207	601185
FDB4208	601177
FDB4221	598898
FDB4227	601270
FDB423	598375
FDB424	598375
FDB4241	601239
FDB4242	601175
FDB4252	601241
FDB4262	601162
FDB4265	601229
FDB4272	601181
FDB4272	601207
FDB428	598151
FDB428B	598151
FDB4295	601231
FDB4304	601220
FDB4305	601268
FDB4318	601259
FDB4322	601219
FDB4322	601227
FDB4323	601274
FDB434	598119
FDB434	598714
FDB435	598052
FDB4354	601161
FDB4355	601228
FDB440	598080
FDB440	598396
FDB441	598130
FDB442	598126
FDB445	598227
FDB448	598115
FDB454	598248
FDB455	598084
FDB455	598119
FDB455	598176
FDB455	598181
FDB456	598125
FDB456	598141
FDB470	598983
FDB471	598497
FDB472	598053
FDB472	598437



 	
FERODO	
FDB478	598540
FDB478	598984
FDB487	598293
FDB507	598964
FDB509	598271
FDB519	598271
FDB520	598129
FDB520	598497
FDB520	598498
FDB524	598095
FDB525	598183
FDB527	598406
FDB534	598082
FDB535	598030
FDB535	598156
FDB536	598102
FDB540	598179
FDB540	598353
FDB541	598180
FDB541	601247
FDB542	598006
FDB546	598289
FDB55	601016
FDB550	598296
FDB556	598597
FDB558	598158
FDB558	598396
FDB558	598570
FDB565	598010
FDB576	598250
FDB577	598231
FDB577	598440
FDB578	598259
FDB579	598335
FDB58	598362
FDB581	598186
FDB584	598184
FDB585	598047
FDB586	598183
FDB586	598253
FDB588	598666
FDB589	598043
FDB590	598355
FDB593	598003
FDB595	598135
FDB597	598268
FDB598	598248
FDB600	598051
FDB600	598786
FDB602	598266
FDB603	598254
FDB604	598054
FDB608	598019
FDB609	598183
FDB609	598243
FDB613	598022
FDB614	598029
FDB614	598385
FDB615	598292
FDB617	598172



 	
FERODO	
FDB617	598399
FDB619	598063
FDB619	598295
FDB621	598053
FDB622	598237
FDB623	598294
FDB628	598257
FDB630	598846
FDB632	598039
FDB634	598620
FDB638	598817
FDB638	601235
FDB641	598123
FDB641	598618
FDB643	598122
FDB644	598272
FDB646	598601
FDB647	598005
FDB649	598809
FDB651	598135
FDB654	598290
FDB654	598624
FDB660	598241
FDB667	598024
FDB667	598054
FDB667	598450
FDB669	598241
FDB671	598015
FDB676	598621
FDB678	598020
FDB686	598256
FDB691	598051
FDB691	598786
FDB691	598787
FDB707	598057
FDB708	598052
FDB71	598193
FDB712	598023
FDB714	598646
FDB715	598274
FDB717	598123
FDB719	598155
FDB719	598181
FDB719	601158
FDB719	601159
FDB720	598154
FDB721	598859
FDB721	598988
FDB723	598108
FDB725	598018
FDB729	598075
FDB729	598081
FDB729	598155
FDB729	598177
FDB729	598181
FDB730	598075
FDB730	598155
FDB730	598181
FDB732	598039
FDB732	598356



 	
FERODO	
FDB742	598028
FDB745	598156
FDB746	598280
FDB749	601021
FDB759	598626
FDB761	601192
FDB763	598628
FDB764	598625
FDB765	598517
FDB765	601020
FDB766	598033
FDB766	598034
FDB766	598619
FDB767	598033
FDB774	598004
FDB774	598016
FDB774	598330
FDB775	598017
FDB775	598252
FDB775	601188
FDB776	598494
FDB777	598495
FDB777	598760
FDB779	598231
FDB780	598296
FDB789	598691
FDB790	598828
FDB796	598826
FDB797	598393
FDB797	598897
FDB799	598617
FDB804	598519
FDB815	598374
FDB817	598374
FDB819	598161
FDB819	598193
FDB819	598338
FDB840	598116
FDB844	598497
FDB845	598002
FDB845	598084
FDB846	598120
FDB850	598386
FDB854	598013
FDB857	598411
FDB859	598014
FDB867	598551
FDB869	598290
FDB871	598623
FDB872	598762
FDB874	598031
FDB875	598383
FDB876	598038
FDB876	598074
FDB877	598158
FDB877	598396
FDB878	598055
FDB880	598382
FDB881	598080
FDB884	598034





	
<b>FERODO</b>	
FDB901	598050
FDB904	598056
FDB905	598627
FDB909	598602
FDB915	598312
FDB917	598903
FDB925	598011
FDB925	598012
FDB930	598496
FDB937	598851
FDB939	598250
FDB940	598840
FDB943	598815
FDB950	598629
FDB950	601193
FDB951	598982
FDB953	598281
FDB954	598017
FDB954	601157
FDB956	598682
FDB956	598911
FDB956	601244
FDB96	598389
FDB969	598303
FDB972	598599
FDB973	598183
FDB974	601024
FDB977	598600
FDB979	598345
FDB98	598145
FDB980	598441
FDB981	598499
FDB985	598355
FDB99	598146
FDB992	598642
FDB993	598293
FDB994	598308
FDB995	598581
FDB997	598412
FDB998	598412
FSB222	564120
FSB334	564116
FSB4014	564125
FSB4014	601246
FSB4068	564119
FSB4068	564126
FSB519	564113
FSB519	564115
FSL1337	601191
FSL1961	601202
FSL419	601155
FSL732	601194
FSS191	564109
FSS337	564112
FSS408	564110
<b>TEXTAR</b>	
2138217305	598859
2148217005	598476
2148217005	598691



	
<b>TEXTAR</b>	
2180718005	598965
2181517005	598600
2307418905	598479
2308616005	598523
2361119005	598524
19706 1797 0 5 D7113	598112
19706 1797 0 5 T016	598112
19706 1797 0 5 T088	598112
20007 15.2 0 4	598374
20008 13.0 0 4	598624
20009 15.0 0 4	598099
20009 15.0 0 4	598187
20011 15.0 0 4	598111
20011 150 0 4 T424	598111
20011 150 0 4 T424	598183
20011 150 0 4 T424	598256
20011 19.0 0 4	598106
20011 19.0 0 4	598111
2001115004T400	598111
20031 130 0 4	598780
20034 15.0 0 4	598099
20034 15.0 0 4	598113
20034 15.0 0 4	598187
20034 15.0 0 4	598270
20034 15.0 0 5	598099
20034 15.0 0 5	598113
20034 15.0 0 5	598187
20034 15.0 0 5	598270
20038 13.8 0 4	598392
2003813804T4047	598392
20073 17.3 0 4	598090
20073 17.3 0 4	598603
2007317304T468	598603
20074 10.0 0 4	598088
20076 155 0 5	598983
20076 155 0 5	598984
2007615505T4067	598983
2007615505T4067	598984
20088 14.4 0 4	598161
20088 14.4 0 4	598270
20088 14.4 0 4	598338
20098 17.0 0 4	598851
2009817004T4067	598851
20124 19.0 1 4	598025
20124 19.0 1 4	598048
20126 15.0 0 4	598099
20140 14.0 0 5	598077
20140 14.0 0 5	598078
20140 14.0 0 5	598085
20145 17.0 0 5	598174
20153 16.0 0 4	598337
20162 15.4 0 4	598292
20164 18.2 1 4	598695
20164 182 0 4	598695
20166 16.0 0 4	598405
20168 16.2 1 4	598004
20168 16.2 1 4	598016
20168 19.6 1 4	598017
20168 19.6 1 4	598252
20168 196 1 5	598982



	
<b>TEXTAR</b>	
20173 14.5 0 4	598099
20180 16.8 0 5	598386
20207 13.0 0 4	598144
20224 209 0 5	598808
20228 15.2 0 4	598099
20228 18.5 0 4	598099
20236 18.2 1 5	598382
20253 16.4 0 5	598193
20260 15.2 0 4	598174
20260 15.2 0 4	598375
20260 15.2 0 5	598375
20260 165 0 4	598077
20260 165 0 4	598375
20260 18.5 0 4	598375
20261 193 1 5	598553
20285 07.1 0 4	598362
20288 16.0 0 4	598145
20292 17.0 0 5	598090
20292 17.0 1 4	598090
20293 12.0 0 4	598094
2029312004T4047	598094
20297 11.7 0 4	598146
20307 10.5 0 4	598363
20315 15.0 0 4	598396
20323 165 0 4	598108
20323 165 0 5	598115
20332 17.0 2 5	598000
20332 17.0 2 5	598005
20336 14.0 0 5	598085
20341 17.5 0 4	598110
20344 15.0 0 4	598497
20356 15.5 0 4	598147
20359 18.0 0 4	598129
20359 180 0 5	598129
20359 180 1 4	598129
20361 16.5 2 5	598008
20361 16.5 2 5	598289
20364 15.0 0 5	598391
20364 150 2 5	598129
20364 150 2 5	598391
20366 15.0 0 5	598593
20366 15.0 0 5	598594
20371 08.1 0 4	598364
20373 16.5 0 5	598115
20375 16.0 0 4	598371
20379 165 0 5	598115
20380 15.6 0 4	598374
20380 15.6 0 5	598374
20387 150 0 5	598351
20389 16.0 0 4	598207
20392 15.0 0 4	598109
20392 18.5 0 4	598109
20392 18.5 0 4	598110
20410 15.0 0 5	598055
20410 15.0 0 5	598080
20410 15.0 0 5	598396
20421 15.0 0 4	598081
20421 15.0 0 5	598081
20422 17.5 0 4	598165
20436 15.0 0 4	598187



	
<b>TEXTAR</b>	
2043615004T477	598187
20437 15.0 0 4	598107
20437 19.0 0 4	598107
2043715004T476	598107
2043719004T4078	598107
20442 18.5 0 5	598086
20442 18.5 0 5	598366
20455 19.0 0 5	598178
20455 19.0 0 5	598193
20468 150 0 4	598111
20480 15.5 0 4	598076
20480 15.5 0 4	598377
20488 18.5 0 5	598366
20491 15.1 0 4	598168
20494 14.0 0 5	598077
20494 14.0 0 5	598085
20547 16.8 0 5	598039
20547 16.8 0 5	598356
20573 15.0 1 4	598592
20574 15.3 1 4	598214
20574 19.6 1 4	598205
20575 17.0 0 4	598148
20575 17.0 0 4	598292
20576 155 0 4	601016
20579 14.4 0 5	598161
20579 14.4 0 5	598187
20588 16.5 0 4	598108
2058816504T4078	598108
20594 13.0 0 4	598150
20628 165 0 4	598122
20629 20.0 0 5	598104
2062920005T476	598104
20631 18.0 0 5	598077
20631 18.0 0 5	598085
20631 18.0 0 5	598175
20634 15.0 0 4	598080
20635 18.0 0 5	598151
20652 18.2 1 5	598048
20653 180 0 5	598129
20653 180 0 5	598132
20655 19.5 0 4	598591
20660 15.6 0 4	598389
20667 155 0 4	598145
20669 162 1 4	598004
20669 19.6 1 5	598017
20669 196 1 4	598017
20671 16.5 1 5	598377
20675 17.0 0 5	598103
20675 17.0 0 5	598291
2067517005T477	598103
20687 13.5 0 4	598105
20687 15.5 0 4	598345
20690 16.0 0 4	598149
20699 15.2 0 5	598620
20699 152 0 4	598620
20708 16.5 2 4	598093
20708 16.5 2 4	598531
20708 16.5 2 5	598093
20708 16.5 2 5	598133
20708 16.5 2 5	598603





	
<b>TEXTAR</b>	
2070816525T4047	<b>598093</b>
2070816525T4047	<b>598133</b>
20714 130 0 4	<b>598144</b>
20718 14.3 0 5	<b>598379</b>
20718 143 0 4	<b>598123</b>
20718 143 0 4	<b>598379</b>
2071814304T4047	<b>598379</b>
20719 19.6 2 5	<b>598219</b>
20724 15.5 0 4	<b>598220</b>
20729 15.0 0 5	<b>598614</b>
2072915005T4047	<b>598614</b>
20731 15.2 0 4	<b>598185</b>
2073115204T4047	<b>598185</b>
20735 15.1 0 4	<b>598208</b>
2073515104T4047	<b>598208</b>
20741 19.2 1 5	<b>598153</b>
20753 18.0 0 5	<b>598166</b>
20753 18.0 0 5	<b>598212</b>
2075318005T403	<b>598166</b>
2075318005T403	<b>598212</b>
20754 15.0 0 5	<b>598116</b>
20755 15.0 0 4	<b>598270</b>
20755 15.0 0 4	<b>598621</b>
20755 150 1 4	<b>598270</b>
20760 14.3 0 4	<b>598612</b>
20761 14.5 0 5	<b>598117</b>
20778 19.6 1 4	<b>598017</b>
20783 18.0 0 5	<b>598166</b>
20783 18.0 0 5	<b>598212</b>
20783 18.0 0 5	<b>598334</b>
20784 18.0 0 4	<b>598613</b>
20833 17.1 2 5	<b>598093</b>
20833 17.1 2 5	<b>598095</b>
20833 17.1 2 5	<b>598141</b>
20833 17.1 2 5	<b>598219</b>
20833 17.2 2 5	<b>598006</b>
20833 17.2 2 5	<b>598134</b>
20833 17.2 2 5	<b>598219</b>
2083317125T479	<b>598141</b>
2083317125T479	<b>598219</b>
20841 12.0 0 4	<b>598141</b>
20845 16.5 1 4	<b>598163</b>
20852 15.5 0 4	<b>598921</b>
2085215504T4047	<b>598921</b>
20857 17.5 0 5	<b>598167</b>
20861 17.7 1 4	<b>598217</b>
20861 17.7 1 5	<b>598169</b>
20863 17.2 0 4	<b>598122</b>
20863 17.2 0 4	<b>598123</b>
20863 17.2 0 5	<b>598122</b>
2086317204T4047	<b>598122</b>
20870 15.0 0 4	<b>598266</b>
20870 15.0 0 4	<b>598402</b>
20870 15.0 0 4	<b>598579</b>
2087015004T4047	<b>598266</b>
2087015004T4047	<b>598402</b>
2087015004T4047	<b>598551</b>
2087015004T4047	<b>598815</b>
20871 18.0 0 5	<b>598162</b>
20887 15.3 2 5	<b>598124</b>



	
<b>TEXTAR</b>	
20887 15.3 2 5	<b>598128</b>
20887 17.3 2 5	<b>598258</b>
20887 19.7 2 5	<b>598128</b>
20889 17.3 2 4	<b>598127</b>
20894 150 0 5	<b>598391</b>
20895 14.5 0 5	<b>598131</b>
20905 18.0 0 5	<b>598002</b>
20905 18.0 0 5	<b>598075</b>
20905 18.0 0 5	<b>598081</b>
20905 18.0 0 5	<b>598177</b>
20905 18.0 0 5	<b>598181</b>
20905 18.0 0 5	<b>598338</b>
20905 18.0 2 5	<b>598081</b>
20905 18.0 2 5	<b>598177</b>
20906 18.0 2 5	<b>598075</b>
20906 18.0 2 5	<b>598081</b>
20906 18.0 2 5	<b>598155</b>
20906 18.0 2 5	<b>598181</b>
20906 18.0 4 5	<b>598155</b>
20906 18.0 4 5	<b>598181</b>
20906 180 0 5	<b>598075</b>
20907 18.0 0 5	<b>598120</b>
20907 18.0 0 5	<b>598335</b>
20908 180 0 5	<b>598120</b>
20908 180 0 5	<b>598335</b>
20910 15.0 0 4	<b>598187</b>
20910 16.5 0 4	<b>598107</b>
20910 16.5 0 4	<b>598187</b>
20911 15.0 0 5	<b>598113</b>
20912 15.0 0 5	<b>598351</b>
20913 16.5 0 4	<b>598375</b>
20913 16.5 0 5	<b>598375</b>
20915 18.0 0 5	<b>598181</b>
20922 15.0 0 4	<b>598111</b>
20926 185 0 5	<b>598086</b>
20937 18.2 1 5	<b>598002</b>
20939 15.4 0 4	<b>598182</b>
20941 19.3 1 4	<b>598044</b>
20941 19.3 1 4	<b>598315</b>
20941 193 1 4 T4100	<b>598315</b>
20944 15.0 0 4	<b>598130</b>
20944 15.0 0 5	<b>598130</b>
20946 16.5 2 5	<b>598091</b>
20946 16.5 2 5	<b>598093</b>
20950 18.0 0 5	<b>598091</b>
2095018005T468	<b>598091</b>
20955 15.0 0 4	<b>598220</b>
20955 15.0 0 4	<b>598620</b>
20955 15.0 0 4	<b>598626</b>
20957 16.0 0 4	<b>598384</b>
20957 16.0 0 5	<b>598278</b>
20957 16.0 0 5	<b>598384</b>
20958 16.0 0 4	<b>598278</b>
2095816004T4047	<b>598278</b>
20959 14.0 0 4	<b>598047</b>
20959 150 0 4	<b>598047</b>
20959 150 0 5	<b>598047</b>
2095915004T4047	<b>598047</b>
2095915005T4047	<b>598047</b>
20961 15.2 1 4	<b>598180</b>



	
<b>TEXTAR</b>	
20961 15.2 3 4	<b>598180</b>
20961 17.2 1 4	<b>598463</b>
20961 17.2 3 4	<b>598180</b>
20961 17.2 3 4	<b>598463</b>
20961 17.3 1 4	<b>598180</b>
20961 17.3 1 4	<b>598463</b>
20961 174 1 4	<b>598463</b>
2096117215T456	<b>598681</b>
20968 17.5 0 5	<b>598440</b>
20968 20.3 0 5	<b>598231</b>
2096820305T476	<b>598231</b>
20973 11.0 0 5	<b>598158</b>
20973 11.0 0 5	<b>598396</b>
20974 110 0 4	<b>598396</b>
20979 19.7 1 4	<b>598027</b>
20981 137 1 4	<b>598240</b>
20989 17.7 0 5	<b>598119</b>
20989 17.7 0 5	<b>598176</b>
20989 17.7 0 5	<b>598714</b>
20990 20.3 0 5	<b>598409</b>
20995 17.3 0 5	<b>598103</b>
20995 17.3 0 5	<b>598259</b>
20995 17.3 0 5	<b>598311</b>
20997 16.5 0 5	<b>598115</b>
21000.15.0 0 5	<b>598077</b>
21010 15.8 1 4	<b>598102</b>
21012 14.0 0 4	<b>598052</b>
21012 14.8 0 4	<b>598052</b>
21012 14.8 0 5	<b>598052</b>
21012 14.8 0 5	<b>598817</b>
2101214804T4047	<b>598052</b>
2101214805T4047	<b>598052</b>
21016 170 1 4	<b>598082</b>
21035 15.5 0 4	<b>598099</b>
21041 15.0 0 5	<b>598239</b>
21045 150 0 4	<b>598208</b>
2104515004T4047	<b>598208</b>
21048 183 0 5	<b>598007</b>
21050 15.7 0 4	<b>598183</b>
21050 152 0 4	<b>598183</b>
21051 15.7 0 4	<b>598183</b>
21051 15.7 0 4	<b>598243</b>
21055 17.9 1 4	<b>598241</b>
21055 179 1 4 T4100	<b>598241</b>
21068 17.7 1 4	<b>598237</b>
21068 17.7 1 4	<b>598269</b>
21084 17.5 1 5	<b>598118</b>
21089 15.0 0 5	<b>598291</b>
21093 17.4 2 5	<b>598133</b>
21093 17.4 2 5	<b>598134</b>
21093 17.4 2 5	<b>598135</b>
2109317425T4078	<b>598133</b>
2109317425T4078	<b>598134</b>
21096 150 0 5	<b>598080</b>
21099 17.0 0 4	<b>598112</b>
21099 17.0 0 4	<b>598123</b>
21099 17.0 0 5	<b>598123</b>
2109917005T4047	<b>598123</b>
21100 17.0 2 5	<b>598095</b>
2110017025T479	<b>598095</b>



	
<b>TEXTAR</b>	
21103 14.4 1 4	<b>598142</b>
21107 12.0 0 4	<b>598141</b>
21122 15.0 0 4	<b>598817</b>
21125 14.5 0 4	<b>598964</b>
21126 15.0 0 4	<b>598224</b>
21127 14.5 0 5	<b>598131</b>
21131 15.0 0 4	<b>598126</b>
21131 15.0 0 4	<b>598160</b>
21131 15.0 0 5	<b>598126</b>
21131 15.0 0 5	<b>598160</b>
21138 19.5 1 5	<b>598230</b>
21140 15.7 0 4	<b>598183</b>
21140 15.7 0 4	<b>598253</b>
21141 18.0 0 4	<b>598032</b>
21142 155 0 4	<b>598021</b>
21144 16.6 1 4	<b>598016</b>
21144 16.6 1 4	<b>598125</b>
21144 16.6 1 4	<b>598142</b>
2114416614T425	<b>598125</b>
2114416614T425	<b>598142</b>
21147 19.3 2 5	<b>598006</b>
21147 19.3 2 5	<b>598985</b>
21153 17.5 0 4	<b>598601</b>
21154 19.5 0 5	<b>598269</b>
21156 17.4 2 5	<b>598003</b>
21158 156 0 4	<b>598402</b>
21158 156 0 4	<b>598614</b>
21158 156 0 4	<b>598947</b>
21158 16.0 0 4	<b>598402</b>
21158 16.0 0 4	<b>598614</b>
2115815604T4090	<b>598402</b>
2115815604T4090	<b>598947</b>
21160 18.0 0 5	<b>598380</b>
21160 18.0 0 5	<b>598391</b>
2116018005T4047	<b>598380</b>
21165 165 2 5	<b>598289</b>
21170.17.0 1 4	<b>598406</b>
21171 18.0 0 5	<b>598172</b>
21171 180 0 4	<b>598172</b>
2117118004T403	<b>598172</b>
2117118004T403	<b>598399</b>
21179 16.8 0 5	<b>598030</b>
21179 16.8 0 5	<b>598156</b>
21182 19.4 2 5	<b>598010</b>
21182 19.4 2 5	<b>598135</b>
21185 19.4 2 5	<b>598135</b>
21188 183 0 5	<b>598007</b>
21188 183 0 5	<b>598139</b>
21188 183 0 5	<b>598374</b>
21190 17.5 0 5	<b>598184</b>
21193 18.0 0 5	<b>598271</b>
2119318005T4047	<b>598271</b>
21195 18.0 0 5	<b>598271</b>
21197 15.0 0 4	<b>598272</b>
21202 17.8 0 5	<b>598043</b>
21202 17.8 0 5	<b>598171</b>
21205 19.4 1 5	<b>598138</b>
21209 19.4 1 5	<b>598179</b>
21209 19.4 1 5	<b>598353</b>
21211 18.7 0 5	<b>598281</b>







	
<b>TEXTAR</b>	
21217 17.5 1 4	<b>598015</b>
21217 181 1 4	<b>598015</b>
21225 17.5 0 5	<b>598186</b>
21225 17.5 1 5	<b>598186</b>
2122517515T490	<b>598186</b>
21233 16.7 1 4	<b>598222</b>
21233 16.7 1 4	<b>598257</b>
21237 15.0 0 5	<b>598497</b>
21237 15.0 0 5	<b>598499</b>
21245 17.4 0 5	<b>598227</b>
21266 17.4 1 4	<b>598221</b>
21267 17.6 0 5	<b>598156</b>
21267 17.6 0 5	<b>598360</b>
21273 19.5 0 5	<b>598616</b>
2127319505TX4005	<b>598616</b>
21275 16.9 0 5	<b>598039</b>
21275 16.9 0 5	<b>598502</b>
21275 169 1 5	<b>598502</b>
21277 15.0 1 5	<b>598293</b>
21277 150 0 5	<b>598293</b>
21278 17.0 0 5	<b>598063</b>
21278 17.0 0 5	<b>598295</b>
21278 170 1 5	<b>598063</b>
21280 16.0 0 4	<b>598024</b>
21280 16.0 0 4	<b>598123</b>
21282 17.3 0 5	<b>598103</b>
21296 17.0 0 5	<b>598029</b>
21296 17.0 0 5	<b>598294</b>
21298 17.0 1 4	<b>598294</b>
21305 15.5 0 4	<b>598617</b>
21305 155 0 4 T4023	<b>598617</b>
21305 155 0 4 T4140	<b>598617</b>
21305 155 0 4 T4250	<b>598617</b>
21305 160 0 4 T4210	<b>598617</b>
21312 13.0 0 5	<b>598053</b>
2131213005T4067	<b>598053</b>
21322 15.0 0 5	<b>598047</b>
21322 15.0 0 5	<b>598248</b>
2132215005T4047	<b>598248</b>
21333 15.0 0 5	<b>598666</b>
21336 150 0 5	<b>598532</b>
21344 16.0 0 5	<b>598296</b>
21347 17.0 0 5	<b>598123</b>
21347 17.0 0 5	<b>598618</b>
2134717005T4047	<b>598618</b>
21350 14.8 0 5	<b>598047</b>
21350 14.8 0 5	<b>598495</b>
21355 14.5 0 5	<b>598268</b>
21358 19.8 0 5	<b>598619</b>
21363 15.7 0 5	<b>598517</b>
21363 15.7 0 5	<b>601020</b>
21365 17.0 0 4	<b>601021</b>
21366 19.6 1 4	<b>598982</b>
21368 18.0 0 5	<b>598256</b>
21368 18.3 1 5	<b>598256</b>
2136818314T4136	<b>598256</b>
21369 15.5 0 5	<b>598496</b>
21370 157 1 4	<b>601020</b>
21372 15.0 0 4	<b>598266</b>
2137215004T4090	<b>598266</b>



	
<b>TEXTAR</b>	
21373 16.5 0 5	<b>598597</b>
21376 15.5 0 5	<b>598266</b>
21378 15.0 0 5	<b>598250</b>
21381 180 0 5	<b>598988</b>
21385 13.3 1 4	<b>598621</b>
21385 139 1 4	<b>598621</b>
21388 18.3 1 5	<b>598061</b>
21388 183 2 5	<b>598061</b>
21394 18.8 0 5	<b>598034</b>
21394 185 0 5	<b>598034</b>
2139418505T403	<b>598034</b>
21411 17.5 0 5	<b>598050</b>
21414 18.0 0 5	<b>598075</b>
21414 18.5 0 5	<b>598075</b>
21430 17.3 0 5	<b>598038</b>
21436 17.0 0 4	<b>598012</b>
21436 170 1 4	<b>598011</b>
21436 170 1 4	<b>598987</b>
2143617004T4078	<b>598012</b>
21439 20.3 2 4	<b>598013</b>
21446 17.5 0 5	<b>598056</b>
21446 17.5 0 5	<b>598227</b>
21454 185 1 5	<b>598483</b>
21459 18.5 0 5	<b>598129</b>
21459 18.5 0 5	<b>598498</b>
21460 18.0 2 5	<b>598154</b>
21463 18.2 2 4	<b>598002</b>
21463 18.2 2 4	<b>598084</b>
21463 18.2 3 4	<b>598002</b>
21463 18.2 3 4	<b>598084</b>
21463 182 1 4	<b>598002</b>
2146318224T4078	<b>598002</b>
2146318224T4078	<b>598084</b>
21468 15.5 0 4	<b>598947</b>
2146815504T4090	<b>598947</b>
21469 19.0 0 4	<b>598037</b>
21469 190 1 4	<b>598037</b>
2146919004T403	<b>598037</b>
21470 19.0 0 4	<b>598036</b>
21470 190 1 4	<b>598036</b>
2147019004T403	<b>598036</b>
21479 19.2 1 4	<b>598622</b>
21479 192 1 5	<b>598814</b>
21481 15.7 1 4	<b>598602</b>
21484 20.8 0 5	<b>598712</b>
2148420805T4205	<b>598712</b>
21486 19.3 0 5	<b>598412</b>
21486 193 0 5 T4374	<b>598412</b>
21486 193 0 5 T4383	<b>598412</b>
2148619305T4124	<b>598412</b>
21487 17.2 0 5	<b>598580</b>
21487 172 0 5 T4140	<b>598580</b>
21487 173 1 5	<b>598580</b>
2148717205T4001	<b>598580</b>
2148717205T4147	<b>598580</b>
2148717315T4071	<b>598580</b>
21490 171 0 5	<b>601023</b>
21491 155 0 5	<b>601022</b>
2149115505T4067	<b>601022</b>
21492 195 0 5	<b>598616</b>



	
<b>TEXTAR</b>	
2149219505TX4005	<b>598616</b>
21495 17.0 0 5	<b>598691</b>
2149517005T4047	<b>598915</b>
21497 18.0 0 5	<b>598788</b>
21500 14.8 0 5	<b>598023</b>
21500 14.8 0 5	<b>598531</b>
21504 17.0 1 5	<b>598028</b>
21504 17.0 1 5	<b>598294</b>
21507 17.0 1 4	<b>598280</b>
21515 18.0 0 5	<b>598022</b>
21515 180 0 4	<b>598512</b>
21515 180 1 5	<b>598022</b>
21518 17.0 1 4	<b>598254</b>
21519 18.0 0 4	<b>598623</b>
21520 18.0 1 5	<b>598019</b>
21526 17.0 0 5	<b>598051</b>
21526 17.0 0 5	<b>598786</b>
2152617005T4047	<b>598786</b>
21539 15.0 0 5	<b>598646</b>
21543 16.5 0 5	<b>598020</b>
2154316505T4047	<b>598020</b>
21545 15.6 1 4	<b>598057</b>
2154515614T4047	<b>598057</b>
21546 17.5 0 4	<b>598054</b>
2154617504T4047	<b>598054</b>
21553 14.0 0 5	<b>598817</b>
21557 19.3 2 5	<b>598010</b>
21557 19.3 2 5	<b>598985</b>
21558 13.0 0 4	<b>598780</b>
21558 13.0 0 4	<b>598846</b>
21559 12.5 0 4	<b>598624</b>
21559 12.5 0 4	<b>598835</b>
21561 17.0 0 5	<b>598787</b>
2156117005T4136	<b>598787</b>
21562 17.0 0 5	<b>601013</b>
21573 14.0 1 5	<b>598000</b>
21573 14.0 1 5	<b>598112</b>
21576 20.5 0 5	<b>598044</b>
21576 20.7 0 5	<b>541664</b>
21576 20.7 0 5	<b>598044</b>
21576 207 1 5	<b>598044</b>
21580 143 0 5	<b>598914</b>
2158014305T4018	<b>598914</b>
21586 157 1 4	<b>598035</b>
21589 145 1 4	<b>598180</b>
21592 18.8 0 5	<b>598046</b>
21592 188 1 5	<b>598046</b>
21595 18.3 2 5	<b>598599</b>
21597 110 1 5	<b>598158</b>
21601 17.6 0 5	<b>598551</b>
21601 17.6 0 5	<b>598579</b>
21601 17.6 0 5	<b>598809</b>
2160117605T4090	<b>598551</b>
2160117605T4090	<b>598809</b>
21606 16.6 2 4	<b>598581</b>
2160616624T4064	<b>598581</b>
21607 17.3 0 5	<b>598386</b>
21607 17.3 0 5	<b>598753</b>
2160717305T4060	<b>598386</b>
21614 18.0 0 5	<b>598714</b>

	
<b>TEXTAR</b>	
21621 17.3 0 5	<b>598045</b>
21621 173 1 5	<b>598045</b>
21624 20.4 0 5	<b>598067</b>
21624 20.4 0 5	<b>598355</b>
21625 18.0 0 5	<b>598120</b>
21626 15.8 0 4	<b>598014</b>
21631 17.0 1 4	<b>598031</b>
21632 16.0 1 4	<b>598383</b>
21635 182 1 5	<b>598048</b>
21636 19.3 0 5	<b>598065</b>
2163619305T4088	<b>598308</b>
21637 18.8 0 5	<b>598308</b>
21637 190 0 5	<b>598308</b>
2163718805T4088	<b>598308</b>
21643 17.8 0 5	<b>598018</b>
2164317805T4020	<b>598018</b>
21647 16.0 0 5	<b>598625</b>
21650 15.0 0 4	<b>598626</b>
21650 150 1 4	<b>598626</b>
21651 17.3 0 5	<b>598627</b>
21654 15.0 0 5	<b>598274</b>
21654 15.0 0 5	<b>601018</b>
21654 153 1 5	<b>598274</b>
21657 16.5 0 5	<b>598628</b>
21662 178 1 4	<b>598217</b>
21664 19.8 0 5	<b>598357</b>
21670 20.3 0 5	<b>598636</b>
21670 203 0 5 T4374	<b>598636</b>
21674 19.3 1 5	<b>598069</b>
21674 19.3 1 5	<b>598467</b>
21677 20.3 0 5	<b>598310</b>
21677 20.3 0 5	<b>598409</b>
21677 203 0 5 T4374	<b>598310</b>
21677 203 0 5 T4374	<b>598409</b>
2167720305T4070	<b>598310</b>
2167720305T4070	<b>598409</b>
21679 15.0 0 5	<b>598897</b>
2167915005T4067	<b>598393</b>
2167915005T4067	<b>598897</b>
21682 14.5 1 5	<b>598903</b>
21691 173 0 5	<b>598311</b>
21691 173 0 5 T4140	<b>598311</b>
21694 17.3 0 5	<b>598494</b>
2169417305T4047	<b>598494</b>
21697 158 0 5	<b>598495</b>
21697 158 0 5	<b>598760</b>
2169715805T4047	<b>598495</b>
2170018505T4047	<b>598627</b>
21703 15.0 0 5	<b>598828</b>
21706 15.5 0 5	<b>598519</b>
21706 15.5 0 5	<b>598834</b>
21713 16.4 0 5	<b>598668</b>
21713 16.4 0 5	<b>598826</b>
21716 15.9 0 5	<b>598840</b>
21719 14.6 0 5	<b>598682</b>
21719 14.6 0 5	<b>598911</b>
2171914605T4067	<b>598682</b>
2171914605T4067	<b>598911</b>
21724 19.3 1 5	<b>598068</b>
21725 156 0 5	<b>598870</b>



 	
TEXTAR	
21725 17.0 0 5	<b>598051</b>
21725 17.0 0 5	<b>598574</b>
21725 17.0 0 5	<b>598786</b>
2172517005T4047	<b>598051</b>
2172517005T4047	<b>598574</b>
21729 13.7 1 5	<b>598121</b>
21729 13.7 1 5	<b>598240</b>
21729 13.7 1 5	<b>598312</b>
21729 13.7 2 5	<b>598121</b>
21729 13.7 2 5	<b>598312</b>
21730 14.0 0 4	<b>598986</b>
21731 15.5 0 5	<b>598250</b>
21734 14.0 0 5	<b>598826</b>
2173414005T4067	<b>598826</b>
21738 13.0 0 5	<b>598437</b>
21754 16.5 0 5	<b>598629</b>
21759 15.3 0 5	<b>598983</b>
21763 15.6 0 5	<b>598266</b>
2176315605T819	<b>598266</b>
21766 13.7 1 4	<b>598290</b>
21766 14.8 0 4	<b>598290</b>
21775 15.0 0 5	<b>598393</b>
2177515005T4047	<b>598393</b>
21777 15.0 0 5	<b>598897</b>
21780 15.5 0 5	<b>598496</b>
21792 15.5 0 4	<b>598768</b>
2179215504T4045	<b>598768</b>
21797 19.7 2 5	<b>598070</b>
21799 19.7 2 5	<b>598800</b>
21801 19.3 2 5	<b>598064</b>
21815 19.3 0 5	<b>598600</b>
21820 15.5 0 5	<b>598595</b>
21822 17.2 0 5	<b>598491</b>
21827 17.3 0 5	<b>598038</b>
21827 17.3 0 5	<b>598074</b>
21829 20.3 0 5	<b>598305</b>
21830 15.7 0 5	<b>598906</b>
21833 15.5 0 5	<b>598540</b>
21833 15.5 0 5	<b>598984</b>
2183315505T4067	<b>598540</b>
2183315505T4067	<b>598984</b>
21836 15.5 0 5	<b>598496</b>
21840 14.0 0 5	<b>598519</b>
21845 16.5 0 5	<b>598460</b>
2184516505T4047	<b>598460</b>
21848 19.7 0 5	<b>598067</b>
21848 19.7 0 5	<b>598303</b>
21849 20.6 0 5	<b>598489</b>
21854 15.0 0 4	<b>598476</b>
21857 17.0 0 5	<b>598156</b>
21857 17.0 0 5	<b>598360</b>
21861 15.3 1 4	<b>598319</b>
2186116815T4127	<b>598319</b>
21862 18.0 0 5	<b>598184</b>
21862 18.3 0 5	<b>598184</b>
21866 15.3 0 5	<b>598403</b>
21866 17.2 0 5	<b>598488</b>
21866 17.3 0 5	<b>598488</b>
21866 19.7 0 5	<b>598066</b>
21868 17.2 0 5	<b>598805</b>



 	
TEXTAR	
21872 14.5 0 5	<b>598844</b>
21875 15.8 0 5	<b>598507</b>
21879 18.5 0 5	<b>598056</b>
21882 17.3 1 4	<b>598482</b>
21883 19.6 0 5	<b>598675</b>
21885 20.6 0 5	<b>598676</b>
21888 18.4 1 5	<b>598470</b>
21892 18.4 0 5	<b>598838</b>
21898 15.7 0 5	<b>598447</b>
21898 15.7 0 5 T4080	<b>598447</b>
21898 15.7 0 5 T4140	<b>598447</b>
21898 15.7 0 5 T4209	<b>598447</b>
21900 15.8 0 4	<b>598763</b>
21904 16.9 0 5	<b>598062</b>
21907 15.4 0 5	<b>598533</b>
21910 19.8 0 5	<b>598630</b>
2191019805T403	<b>598630</b>
21911 20.6 0 5	<b>598303</b>
21919 15.3 0 4	<b>598444</b>
21919 15.7 0 4	<b>598444</b>
21919 15.3 0 4 T4140	<b>598444</b>
21919 15.3 0 4 T4203	<b>598444</b>
21919 15.7 0 4 T4271	<b>598444</b>
21920 15.1 1 4	<b>598318</b>
21920 17.4 1 4	<b>598318</b>
21927 17.9 0 5	<b>598041</b>
21927 17.9 0 5	<b>601003</b>
21927 17.9 9 5	<b>601003</b>
21929 17.9 0 5	<b>598040</b>
21929 17.9 0 5	<b>598065</b>
21930 17.9 0 5	<b>598040</b>
21930 17.9 0 5	<b>598041</b>
21930 17.9 0 5	<b>598607</b>
21930 17.9 0 5	<b>601003</b>
21931 17.9 0 5	<b>598607</b>
21934 16.3 0 5	<b>598753</b>
21934 17.3 0 5	<b>598753</b>
21934 17.3 0 5	<b>598753</b>
21934 17.3 0 5 T4140	<b>598753</b>
2193417305T4147	<b>598753</b>
21937 15.5 0 4	<b>598766</b>
2193715504T4045	<b>598766</b>
21938 20.4 0 5	<b>598483</b>
21938 20.4 0 5	<b>598751</b>
21938 20.4 0 5 T4374	<b>598483</b>
21938 20.4 0 5 T4374	<b>598751</b>
21945 16.2 1 4	<b>598330</b>
21945 19.6 1 4	<b>598017</b>
21945 19.6 1 5	<b>598484</b>
21947 15.0 0 4	<b>598777</b>
2194715004T4067	<b>598777</b>
21948 13.6 0 5	<b>598815</b>
2194813605T4047	<b>598815</b>
21952 15.6 0 5	<b>598850</b>
2195215605T4067	<b>598850</b>
21955 16.0 0 5	<b>601022</b>
21957 17.0 0 5	<b>601023</b>
21961 15.5 1 4	<b>598809</b>
2196115504T4047	<b>598809</b>
21962 18.0 0 5	<b>598271</b>
21965 15.0 0 5	<b>598328</b>



 	
TEXTAR	
21968 14.0 0 5	<b>601024</b>
21975 18.2 0 5	<b>598478</b>
2197518205T4068	<b>598478</b>
21980 18.0 2 5	<b>598461</b>
21980 18.0 2 5	<b>598726</b>
21980 18.0 1 5	<b>598726</b>
21983 16.5 1 4	<b>598493</b>
21983 17.3 1 4	<b>598493</b>
2198317314T4095	<b>598493</b>
21990 20.3 0 5	<b>598409</b>
21999 15.8 1 5	<b>598329</b>
23004 15.5 0 5	<b>598071</b>
23018 20.4 0 5	<b>598483</b>
23018 20.4 0 5	<b>598751</b>
23020 17.9 0 4	<b>598301</b>
23021 18.9 0 4	<b>598300</b>
23021 18.9 1 4	<b>598300</b>
23022 20.9 0 4	<b>598299</b>
23022 20.9 1 4	<b>598299</b>
23023 15.0 0 5	<b>598449</b>
23032 15.5 0 5	<b>598496</b>
2303215505T4047	<b>598496</b>
23034 18.6 0 1	<b>598858</b>
23034 18.6 0 5	<b>598858</b>
23042 19.0 1 4	<b>598073</b>
2304219014T4059	<b>598073</b>
23043 18.6 0 5	<b>598556</b>
23055 17.9 1 4	<b>598301</b>
23057 20.4 0 5	<b>598454</b>
2305720405T4097	<b>598454</b>
23063 17.3 0 5	<b>598322</b>
2306317305T4097	<b>598322</b>
23070 16.5 1 4	<b>598549</b>
23070 16.5 2 4	<b>598549</b>
23070 17.0 1 4	<b>598549</b>
23070 17.0 2 4	<b>598549</b>
23070 19.0 2 4	<b>598582</b>
23071 18.5 1 5	<b>598033</b>
23073 18.9 0 5	<b>598479</b>
2307318905TX4005	<b>598479</b>
23076 17.5 0 5	<b>598480</b>
2307617505T4067	<b>598480</b>
23078 15.9 0 4	<b>598446</b>
23080 15.1 1 4	<b>598320</b>
23081 19.0 0 5	<b>598634</b>
2308119005T4047	<b>598634</b>
23086 17.0 0 5	<b>598523</b>
23091 15.2 1 4	<b>598183</b>
23092 15.0 0 5	<b>598919</b>
23092 16.0 0 5	<b>598309</b>
23092 16.0 0 5	<b>598772</b>
23094 17.0 0 5	<b>598436</b>
23094 17.0 0 5	<b>598451</b>
2309417005T4047	<b>598451</b>
23095 17.0 0 4	<b>598451</b>
23096 17.2 0 5	<b>598435</b>
23099 18.4 0 5	<b>598669</b>
23099 18.4 0 4	<b>598545</b>
2309918404T424	<b>598545</b>
23101 17.5 0 5	<b>598043</b>



 	
TEXTAR	
23101 17.5 0 5	<b>598171</b>
2310117505T403	<b>598043</b>
23103 17.5 0 5	<b>598212</b>
23106 18.9 0 5	<b>598481</b>
23112 19.1 0 5	<b>598632</b>
2311219105T4146	<b>598632</b>
23115 19.6 0 5	<b>598305</b>
23116 19.6 0 5	<b>598305</b>
23116 19.6 0 5	<b>598475</b>
23117 20.2 0 5	<b>598475</b>
2311720205T4139	<b>598475</b>
23124 19.0 1 5	<b>598326</b>
23124 19.3 1 5	<b>598326</b>
23126 17.5 0 5	<b>598440</b>
23130 19.7 0 5	<b>598332</b>
23131 19.7 0 5	<b>598332</b>
23131 19.7 0 5	<b>598408</b>
23135 18.0 1 5	<b>598420</b>
23138 14.6 1 4	<b>598583</b>
23138 14.6 1 4 T4051	<b>598583</b>
23138 14.6 1 4 T4099	<b>598583</b>
23140 19.3 0 5	<b>598880</b>
2314019305T4047	<b>598880</b>
23144 19.4 1 5	<b>598448</b>
23144 19.8 1 5	<b>598448</b>
23144 19.8 1 5 T4374	<b>598448</b>
23144 19.8 2 5	<b>598448</b>
23144 19.8 2 5 T4374	<b>598448</b>
23146 17.0 1 5	<b>598385</b>
23146 17.0 1 4	<b>598385</b>
23154 19.3 0 5	<b>598317</b>
23157 16.0 0 4	<b>598719</b>
23157 16.0 0 4 T4140	<b>598719</b>
23168 19.3 2 5	<b>598010</b>
23168 19.3 2 5	<b>598985</b>
2316819325T4005	<b>598010</b>
23169 19.4 1 5	<b>598353</b>
23172 18.3 1 4	<b>598473</b>
23176 18.2 1 5	<b>598807</b>
23177 14.4 1 4	<b>598142</b>
23177 14.4 1 4	<b>598331</b>
23178 16.0 0 5	<b>598907</b>
2317816005T4047	<b>598907</b>
23181 17.9 0 5	<b>598605</b>
23183 20.3 0 5	<b>598811</b>
23183 20.3 0 5 T4374	<b>598811</b>
2318320305T4217	<b>598811</b>
23184 14.5 0 5	<b>598912</b>
23189 16.7 1 5	<b>598443</b>
23190 16.7 1 5	<b>598813</b>
23193 16.5 1 5	<b>598442</b>
23193 16.3 1 5	<b>598442</b>
23200 18.8 0 5	<b>598563</b>
23202 18.8 0 5	<b>598564</b>
23215 18.3 1 5	<b>598566</b>
23215 18.3 1 5	<b>601012</b>
23218 18.0 0 5	<b>601019</b>
23219 18.0 0 5	<b>598423</b>
2321918005T4047	<b>598423</b>
23222 19.0 0 5	<b>598990</b>





	
<b>TEXTAR</b>	
2322219005T4292	<b>598990</b>
23224 17.3 1 4	<b>598650</b>
23224 173 1 5	<b>598482</b>
23224 173 1 5	<b>598650</b>
23225 17.0 1 5	<b>598456</b>
23227 18.0 0 5	<b>598422</b>
23227 18.0 0 5	<b>598424</b>
23229 180 0 5	<b>598006</b>
23230 158 0 5	<b>598528</b>
23230 158 0 5	<b>598988</b>
23234 16.9 0 5	<b>598361</b>
23237 14.5 1 4	<b>598902</b>
23238 160 0 5	<b>598575</b>
23241 15.4 0 4	<b>598316</b>
23241 165 0 4	<b>598316</b>
23242 14.2 1 5	<b>598854</b>
23245 183 1 5	<b>598471</b>
23248 183 1 5	<b>598471</b>
23250 165 0 5	<b>598661</b>
2325016505T4047	<b>598661</b>
23253 15.5 0 5	<b>598453</b>
2325315505T4047	<b>598453</b>
23258 16.9 2 5	<b>598926</b>
2325816925T428	<b>598926</b>
23269 20.1 0 5	<b>598565</b>
23271 17.7 0 5	<b>541655</b>
23271 17.7 0 5	<b>598445</b>
23271 177 0 5 T4374	<b>598445</b>
23273 180 1 4	<b>598416</b>
23276 17.5 1 4	<b>598417</b>
23277 17.7 1 4	<b>598419</b>
23279 18.4 0 4	<b>598433</b>
23279 184 1 4	<b>598433</b>
23280 183 0 5	<b>598992</b>
23281 18.3 0 5	<b>598413</b>
23281 183 0 5 T4374	<b>598413</b>
23284 14.0 1 4	<b>598457</b>
2328414014T4131	<b>598457</b>
23287 17.8 0 5	<b>598018</b>
23287 178 0 5 T4374	<b>598018</b>
2328717805T4146	<b>598018</b>
23289 19.3 0 5	<b>598065</b>
23289 19.3 0 5	<b>598308</b>
23289 190 0 5	<b>598065</b>
23289 190 0 5	<b>598308</b>
23289 190 0 5	<b>598990</b>
2328919305T4088	<b>598990</b>
23290 155 1 4	<b>598522</b>
23294 165 0 4	<b>598579</b>
2329416504T4047	<b>598579</b>
23296 150 0 5	<b>598991</b>
23300 18.0 0 5	<b>598399</b>
23302 175 0 4	<b>598490</b>
23305 15.4 0 4	<b>598418</b>
2330917305T4071	<b>598820</b>
23312 203 0 5	<b>598410</b>
2331220305T4165	<b>598410</b>
23313 203 0 5	<b>601027</b>
23314 14.5 1 4	<b>598534</b>
2331414514T4067	<b>598534</b>

	
<b>TEXTAR</b>	
23318 159 0 5	<b>598904</b>
23326 17.7 1 4	<b>601004</b>
23326 177 2 4	<b>598671</b>
23329 170 0 4	<b>598767</b>
2332917004T4045	<b>598767</b>
23331 160 0 4	<b>598944</b>
2333116005T4146	<b>598944</b>
23332 180 1 5	<b>598462</b>
23334 16.8 0 5	<b>598637</b>
23334 168 0 5 T4140	<b>598637</b>
23340 168 1 5	<b>598736</b>
2334016815T4018	<b>598736</b>
23346 19.3 1 4	<b>598398</b>
2334720305T4165	<b>598410</b>
23348 165 0 5	<b>598606</b>
2334816505T4047	<b>598606</b>
23353 14.0 1 4	<b>598431</b>
23354 136 1 4	<b>598836</b>
23358 180 0 5	<b>598458</b>
23361 150 0 5	<b>598459</b>
23384 180 0 5	<b>598989</b>
2338418005T4047	<b>598989</b>
23387 133 1 5	<b>598835</b>
2338713005T4067	<b>598835</b>
23392 20.6 0 5	<b>598486</b>
23394 145 0 5	<b>598735</b>
2339414505T4047	<b>598735</b>
23395 14.5 0 5	<b>598734</b>
23396 18.0 1 4	<b>598462</b>
23397 194 1 5	<b>598658</b>
2339719415T4070	<b>598658</b>
23400 16.5 1 4	<b>598830</b>
2340016514T4067	<b>598830</b>
23402 20.6 0 5	<b>598678</b>
2340220605T4139	<b>598678</b>
23404 20.4 0 5	<b>598678</b>
23404 20.4 0 5	<b>598808</b>
23404 204 1 5	<b>598808</b>
23407 19.3 1 5	<b>598500</b>
23409 19.3 1 5	<b>598501</b>
23417 15.2 1 5	<b>598584</b>
23417 152 1 4	<b>598584</b>
23418 196 0 5	<b>598801</b>
23420 165 0 5	<b>598452</b>
2342016505T4047	<b>598452</b>
23423 178 1 4	<b>598439</b>
23424 178 1 4	<b>598438</b>
23429 150 0 4	<b>601025</b>
2342915004T4051	<b>601025</b>
23434 185 1 5	<b>598547</b>
2343418515T4194	<b>598547</b>
23435 185 1 5	<b>541733</b>
23440 171 0 5	<b>598639</b>
23440 176 0 5	<b>598639</b>
2344017605T4149	<b>598639</b>
23442 160 0 5	<b>598511</b>
23446 16.5 1 5	<b>598650</b>
23446 16.5 1 5	<b>598681</b>
23447 173 0 5	<b>598411</b>
2344717305T4166	<b>598411</b>

	
<b>TEXTAR</b>	
23452 190 1 4	<b>598441</b>
2345219014T4047	<b>598441</b>
23454 150 0 4	<b>598642</b>
2345415004T4067	<b>598642</b>
23455 130 0 5	<b>598841</b>
23458 150 1 4	<b>598499</b>
2345815014T4047	<b>598499</b>
23463 166 0 4	<b>598450</b>
2346316604T4047	<b>598450</b>
23470 178 1 4	<b>598439</b>
23471 150 0 4	<b>598762</b>
2347115004T4047	<b>598762</b>
23482 16.8 0 5	<b>598472</b>
23482 16.8 0 5	<b>598783</b>
2348216805T4140	<b>598472</b>
2348216805T4140	<b>601005</b>
23487 155 0 4	<b>598521</b>
2348715504T4047	<b>598521</b>
23488 160 1 4	<b>598518</b>
2348816014T4067	<b>598518</b>
23490 150 1 4	<b>598548</b>
2349015014T4067	<b>598548</b>
23494 140 0 5	<b>598883</b>
23497 155 0 5	<b>598856</b>
23501 172 0 5	<b>598589</b>
2350117205T4136	<b>598589</b>
23502 160 0 5	<b>598806</b>
23502 160 0 5	<b>601002</b>
2350216005T4067	<b>598806</b>
23507 15.0 0 5	<b>598733</b>
23507 15.0 0 5	<b>598832</b>
2350715005T4047	<b>598453</b>
2350715005T4047	<b>598733</b>
2350715005T4047	<b>601002</b>
23510 15.5 0 5	<b>598737</b>
23510 15.5 0 5	<b>598917</b>
2351015505T4047	<b>598737</b>
2351015505T4047	<b>598917</b>
23515 160 1 4	<b>598515</b>
23517 16.5 0 4	<b>598407</b>
23517 165 1 4	<b>598407</b>
2351716504T4067	<b>598407</b>
2351817005T4047	<b>598504</b>
23521 14.0 0 5	<b>598577</b>
23521 14.0 0 5	<b>598737</b>
23524 177 0 5	<b>598535</b>
2352417705T4067	<b>598535</b>
2352417705T4067	<b>598777</b>
2352617504T4136	<b>598827</b>
23527 150 1 4	<b>598682</b>
23527 150 1 4	<b>598758</b>
2352715014T4067	<b>598682</b>
23532 200 0 5	<b>598543</b>
23536 155 0 5	<b>598908</b>
2353615505T4047	<b>598908</b>
23539 175 0 4	<b>598865</b>
23540 165 1 4	<b>598784</b>
23543 150 0 5	<b>598748</b>
2354315005T4067	<b>598748</b>
23549 168 1 5	<b>598319</b>

	
<b>TEXTAR</b>	
23550 173 0 5	<b>598885</b>
23550 173 0 5 T4140	<b>598885</b>
2355017305T4191	<b>598885</b>
23552 180 0 5	<b>598422</b>
23552 180 0 5	<b>598424</b>
23554 152 1 4	<b>598180</b>
23554 152 1 4	<b>598463</b>
23554 152 1 4	<b>598474</b>
23554 17.2 1 4	<b>598180</b>
23554 17.2 1 4	<b>598463</b>
23554 172 1 4 T4140	<b>598180</b>
23554 172 1 4 T4140	<b>598463</b>
23554 172 1 5	<b>598674</b>
23554 172 1 5	<b>598681</b>
23557 169 1 4	<b>598527</b>
23557 172 1 4	<b>598434</b>
23558 170 0 5	<b>598530</b>
23561 170 0 5	<b>598965</b>
23569 17.0 0 5	<b>598505</b>
23569 17.0 0 5	<b>598759</b>
23572 138 0 5	<b>598895</b>
23575 160 0 5	<b>598468</b>
2357516005T4194	<b>598468</b>
23577 18.5 1 5	<b>598432</b>
23581 190 1 4	<b>598667</b>
23581 190 1 5	<b>598720</b>
23582 155 1 5	<b>598520</b>
23582 155 1 5	<b>598852</b>
2358215515T4067	<b>598520</b>
23584 160 1 4	<b>598886</b>
2358416014T4047	<b>598886</b>
23585 17.0 0 5	<b>598536</b>
23587 203 0 5	<b>598635</b>
23589 19.0 0 5	<b>598715</b>
23590 190 0 5	<b>601030</b>
2359019005T4136	<b>601030</b>
23593 150 0 5	<b>598778</b>
2359315005T4067	<b>598778</b>
23597 180 1 5	<b>598461</b>
23599 19.0 1 4	<b>598464</b>
23600 19.0 1 4	<b>598465</b>
23601 13.7 0 4	<b>598425</b>
23601 137 1 4	<b>598425</b>
23602 197 2 5	<b>598429</b>
23602 197 2 5	<b>598430</b>
2360219725T4059	<b>598429</b>
23603 19.7 2 5	<b>598429</b>
23603 19.7 2 5	<b>598430</b>
23604 18.8 0 5	<b>598564</b>
23605 15.5 1 5	<b>598453</b>
23608 150 0 5	<b>598866</b>
23613 178 0 4	<b>598537</b>
2361317804T4136	<b>598537</b>
23615 175 0 4	<b>598514</b>
2361517504T4136	<b>598514</b>
23620 16.6 0 5	<b>598812</b>
23620 166 1 5	<b>598812</b>
23623 17.4 1 5	<b>598701</b>
23623 174 2 5	<b>598701</b>
23631 178 0 5	<b>598510</b>



 <b>Valeo</b>	
<b>TEXTAR</b>	
23638 175 0 5	<b>598414</b>
23640 180 0 5	<b>598415</b>
23646 160 0 5	<b>598542</b>
23649 162 0 5	<b>598821</b>
23652 14.8 0 5	<b>598682</b>
23656 14.0 0 5	<b>598673</b>
23662 15.0 1 4	<b>598843</b>
2366215014T4067	<b>598843</b>
23669 16.8 1 4	<b>598538</b>
23671 170 1 4	<b>598406</b>
23692 167 0 4	<b>598655</b>
23693 167 0 4	<b>598656</b>
23694 167 0 4	<b>598770</b>
23698 160 0 5	<b>598738</b>
23705 178 1 4	<b>598913</b>
23705 178 1 5	<b>598426</b>
23705 178 1 5	<b>598670</b>
2370517014T4047	<b>598913</b>
2370517015T4047	<b>598426</b>
2370517015T4047	<b>598670</b>
23708 18.2 0 4	<b>598698</b>
23708 18.2 0 5	<b>598427</b>
23708 182 1 4	<b>598465</b>
23708 182 1 4	<b>598698</b>
23708 182 1 5	<b>598427</b>
23708 182 1 5	<b>598721</b>
23711 182 1 5	<b>598428</b>
23714 15.5 0 4	<b>598633</b>
23714 155 1 4	<b>598633</b>
23716 163 0 5	<b>598643</b>
2371616305T4047	<b>598643</b>
23720 170 0 5	<b>598824</b>
23723 182 0 5	<b>598649</b>
2372318205T4370	<b>598649</b>
23729 170 0 5	<b>598887</b>
2372917005T4136	<b>598887</b>
23730 173 0 5	<b>598820</b>
23730 173 0 5 T4140	<b>598820</b>
2373017305T4166	<b>598820</b>
23732 173 0 5	<b>598754</b>
2373217305T4161	<b>598754</b>
23738 20.6 0 5	<b>598678</b>
23743 20.5 1 5	<b>598638</b>
23743 205 2 5	<b>598638</b>
23743 205 2 5 T4374	<b>598638</b>
23745 177 0 5	<b>598659</b>
23746 180 0 5	<b>598652</b>
23746 201 0 5	<b>598651</b>
23747 201 0 5	<b>598651</b>
23749 188 0 5	<b>598940</b>
23753 180 0 5	<b>598466</b>
23759 170 0 4	<b>598710</b>
2375917004T4242	<b>598710</b>
23760 17.8 1 4	<b>601029</b>
23760 178 2 4	<b>601029</b>
23761 188 1 4	<b>601001</b>
2376118814T4136	<b>601001</b>
23762 19.5 0 5	<b>598750</b>
23762 204 0 5	<b>598750</b>
23763 203 0 5	<b>598779</b>



 <b>Valeo</b>	
<b>TEXTAR</b>	
23766 178 0 5	<b>598679</b>
23768 19.0 0 5	<b>598665</b>
23768 192 1 5	<b>598665</b>
23775 180 0 5	<b>598423</b>
2377518005T4047	<b>598423</b>
23776 180 0 5	<b>601019</b>
23777 150 0 5	<b>598647</b>
23777 150 0 5	<b>598648</b>
23780 170 0 5	<b>598915</b>
23793 203 0 5	<b>598640</b>
23794 203 0 5	<b>598640</b>
23794 203 0 5 T4374	<b>598640</b>
2379420305T4190	<b>598640</b>
23795 150 0 5	<b>598697</b>
23798 203 0 5	<b>598475</b>
23801 204 0 5	<b>598863</b>
23816 15.8 1 4	<b>598680</b>
23817 17.0 0 5	<b>598848</b>
23832 196 0 5	<b>598860</b>
23832 20.4 0 5	<b>598860</b>
23836 167 1 4	<b>598541</b>
2383616714T4047	<b>598541</b>
23842 180 0 5	<b>598422</b>
23845 154 1 5	<b>598250</b>
23845 154 1 5	<b>598629</b>
23863 150 0 4	<b>598745</b>
23864 17.0 0 4	<b>598827</b>
23865 164 0 5	<b>598853</b>
23868 16.9 0 5	<b>598757</b>
23868 16.9 0 5	<b>598824</b>
23871 138 0 5	<b>598672</b>
23871 138 0 5	<b>601009</b>
2387113805T4051	<b>598672</b>
23873 150 0 5	<b>598910</b>
23879 155 0 5	<b>598855</b>
2387915505T4136	<b>598855</b>
23881 201 1 5	<b>598795</b>
23885 205 0 5	<b>598845</b>
23891 169 0 5	<b>598744</b>
23896 204 0 5	<b>598845</b>
23901 188 1 5	<b>598046</b>
23904 166 0 5	<b>598917</b>
23912 185 0 5	<b>598822</b>
23912 204 0 5	<b>598822</b>
23914 17.2 1 4	<b>598752</b>
23914 172 1 4 T4140	<b>598752</b>
23914 172 2 4	<b>598752</b>
23914 172 2 4 T4140	<b>598752</b>
23915 17.8 1 5	<b>598699</b>
23916 178 1 5	<b>598699</b>
23917 18.3 0 5	<b>598568</b>
23917 191 1 5	<b>598568</b>
23919 18.3 0 5	<b>598569</b>
23919 191 1 5	<b>598569</b>
23921 19.1 0 4	<b>598570</b>
23921 201 1 4	<b>598570</b>
23921 201 1 5	<b>541738</b>
23922 210 0 5	<b>598728</b>
23923 180 0 5	<b>598802</b>
23927 17.3 0 5	<b>598703</b>



 <b>Valeo</b>	
<b>TEXTAR</b>	
23927 173 0 5 T4140	<b>598703</b>
23928 170 0 4	<b>598862</b>
2392817004T4136	<b>598862</b>
23930 18.1 1 4	<b>598558</b>
2393018114T4047	<b>598558</b>
23934 181 1 4	<b>598557</b>
2393418114T4047	<b>598557</b>
23935 17.8 0 5	<b>598700</b>
23945 165 0 4	<b>601034</b>
23950 203 0 5	<b>598779</b>
23954 190 1 4	<b>598464</b>
23959 175 1 4	<b>598718</b>
23960 178 0 4	<b>598995</b>
23960 178 0 4 T4374	<b>598995</b>
23961 170 0 4	<b>598709</b>
23966 164 0 5	<b>598842</b>
23970 170 0 5	<b>598889</b>
2397017005T4136	<b>598889</b>
23973 17.3 1 4	<b>598641</b>
23973 173 1 5	<b>598847</b>
2397317314T4018	<b>598641</b>
23974 178 0 4	<b>598644</b>
2397417804T4018	<b>598644</b>
23979 178 1 5	<b>598426</b>
23979 178 1 5	<b>598913</b>
23980 170 1 4	<b>598546</b>
2398017014T4018	<b>598546</b>
23981 192 1 5	<b>598839</b>
23982 178 1 5	<b>598825</b>
23983 178 0 4	<b>601035</b>
23984 180 1 5	<b>598925</b>
23990 207 0 5	<b>598044</b>
23990 207 1 5	<b>598044</b>
23996 18.3 0 5	<b>598653</b>
2399618305T4018	<b>598653</b>
24007 20.2 0 4	<b>598764</b>
24007 202 1 4	<b>598764</b>
24008 17.7 0 4	<b>598765</b>
24008 177 1 4	<b>598765</b>
24010 167 0 4	<b>598770</b>
24011 177 0 5	<b>598829</b>
2401117705T4051	<b>598829</b>
24013 15.0 1 5	<b>598810</b>
24014 154 1 5	<b>598852</b>
2401415415T4051	<b>598852</b>
24022 177 0 5	<b>601026</b>
24024 178 0 5	<b>598857</b>
2402417805T4051	<b>598857</b>
24031 16.8 0 5	<b>598781</b>
24036 160 0 5	<b>598755</b>
24039 144 0 5	<b>598831</b>
2403914405T4051	<b>598831</b>
24040 144 0 5	<b>598831</b>
24043 163 0 5	<b>598643</b>
24043 163 0 5 T4140	<b>598643</b>
2404316305T4047	<b>598643</b>
24045 130 0 4	<b>598780</b>
24058 158 0 5	<b>598823</b>
24059 166 0 5	<b>598506</b>
24062 176 0 5	<b>598361</b>



 <b>Valeo</b>	
<b>TEXTAR</b>	
2406615404T4136	<b>598518</b>
24071 146 0 4	<b>598874</b>
2407114604T4051	<b>598874</b>
24072 177 1 4	<b>598696</b>
24072 177 1 5	<b>601015</b>
24073 164 1 4	<b>598761</b>
24073 164 1 5	<b>601031</b>
24073 164 2 4	<b>598761</b>
24073 164 2 5	<b>601031</b>
24077 190 1 4	<b>598704</b>
24077 190 2 4	<b>598704</b>
24083 192 1 4	<b>598833</b>
24086 157 1 5	<b>598849</b>
24087 175 1 5	<b>598803</b>
24092 173 0 5	<b>598654</b>
2409217305T4018	<b>598654</b>
24098 160 0 4	<b>598994</b>
24098 171 0 4	<b>598994</b>
24101 190 1 4	<b>598464</b>
24122 192 1 5	<b>598943</b>
24122 192 1 5	<b>601040</b>
24123 203 0 5	<b>598879</b>
24133 177 1 5	<b>598663</b>
24134 187 1 5	<b>598662</b>
24135 17.8 1 4	<b>598664</b>
24137 16.8 0 5	<b>601044</b>
24137 167 0 5	<b>598472</b>
24137 167 0 5	<b>598678</b>
24137 167 0 5	<b>598783</b>
24137 167 0 5	<b>601005</b>
24137 167 0 5	<b>601044</b>
24141 198 0 5	<b>598657</b>
2414119805T4136	<b>598657</b>
24142 187 0 5	<b>601007</b>
24143 150 0 5	<b>598859</b>
24150 17.6 1 4	<b>598702</b>
24155 206 0 5	<b>598678</b>
24161 203 0 5	<b>598898</b>
24162 153 0 4	<b>598861</b>
24163 178 0 4	<b>601033</b>
24166 188 0 4	<b>601032</b>
24190 165 1 4	<b>598438</b>
24191 181 1 4	<b>598741</b>
24192 173 1 4	<b>598742</b>
24218 172 0 5	<b>598705</b>
24227 165 0 5	<b>598738</b>
24229 153 1 5	<b>598873</b>
24240 160 0 5	<b>598730</b>
24253 179 0 5	<b>601051</b>
24260 163 1 4	<b>598740</b>
24271 147 1 5	<b>598929</b>
24273 160 0 5	<b>598772</b>
24275 168 0 5	<b>598707</b>
24276 148 0 5	<b>598706</b>
24277 165 0 5	<b>598708</b>
24283 165 0 5	<b>598999</b>
24289 170 1 5	<b>601041</b>
24294 193 1 5	<b>598793</b>
24298 140 0 5	<b>598746</b>
24301 164 0 4	<b>598878</b>







	
<b>TEXTAR</b>	
24317 175 0 5	<b>598868</b>
24320 159 0 5	<b>598867</b>
24323 155 0 5	<b>598888</b>
24331 140 1 4	<b>598875</b>
24333 199 0 5	<b>601036</b>
24336 175 0 4	<b>598943</b>
24338 154 0 4	<b>598819</b>
24339 205 0 5	<b>598729</b>
24346 171 1 4	<b>598877</b>
24348 168 1 4	<b>598727</b>
24348 168 2 4	<b>598727</b>
24349 175 1 4	<b>598722</b>
24350 176 0 4	<b>598890</b>
24355 140 0 5	<b>598755</b>
24367 190 0 5	<b>598946</b>
24367 190 0 5	<b>598967</b>
24369 170 0 5	<b>598739</b>
24391 160 1 5	<b>598804</b>
24412 191 1 5	<b>601046</b>
24415 191 1 5	<b>601047</b>
24418 172 1 5	<b>601048</b>
24421 167 1 5	<b>601049</b>
24462 167 1 4	<b>598939</b>
24465 188 1 4	<b>598892</b>
24483 172 1 4	<b>598752</b>
24483 172 2 4	<b>598752</b>
24484 189 1 4	<b>598816</b>
24485 189 1 4	<b>598818</b>
24486 173 1 4	<b>541736</b>
24491 160 0 5	<b>598945</b>
24496 169 2 4	<b>598928</b>
24498 154 0 5	<b>598941</b>
24501 166 0 5	<b>598934</b>
24510 169 0 5	<b>598942</b>
24523 164 0 5	<b>598894</b>
24529 160 0 5	<b>598893</b>
24535 183 0 5	<b>601012</b>
24536 183 0 5	<b>598993</b>
24537 157 1 4	<b>598935</b>
24537 157 2 4	<b>598935</b>
24538 188 0 5	<b>598997</b>
24540 164 1 4	<b>598936</b>
24541 155 0 4	<b>598768</b>
24557 190 0 5	<b>598998</b>
24574 150 0 5	<b>601028</b>
24578 166 1 4	<b>601039</b>
24586 178 1 5	<b>598744</b>
24595 183 1 5	<b>598899</b>
24610 143 0 5	<b>598933</b>
24632 170 0 4	<b>598738</b>
24635 165 1 5	<b>601038</b>
24638 190 1 5	<b>598901</b>
24660 178 1 4	<b>598927</b>
24663 140 0 4	<b>598531</b>
24673 180 0 5	<b>601017</b>
24692 150 1 4	<b>601011</b>
24693 187 1 4	<b>601010</b>
24693 187 2 4	<b>601010</b>
24703 16.4 2 4	<b>598761</b>
24706 200 0 5	<b>598996</b>



	
<b>TEXTAR</b>	
24708 176 0 4	<b>601052</b>
24710 180 0 5	<b>601050</b>
24722 190 0 5	<b>598636</b>
24727 200 0 5	<b>601014</b>
24737 176 1 4	<b>598702</b>
24739 173 0 5	<b>598045</b>
24765 166 1 4	<b>601042</b>
24820 157 1 4	<b>601000</b>
24862 163 0 5	<b>598637</b>
24864 170 0 5	<b>598361</b>
29001 20.0 0 5	<b>541641</b>
29001 200 0 5 T456	<b>541641</b>
29012 180 0 5 T3078	<b>540436</b>
29012 180 0 5 T3078	<b>598138</b>
29012 180 0 5 T3078	<b>598369</b>
29037 183 0 5 T4047	<b>598369</b>
29037 183 0 5 T4047	<b>598586</b>
29037 183 0 5 T4047	<b>598598</b>
29040 180 0 5 T3078	<b>540436</b>
29040 180 0 5 T3078	<b>598369</b>
29041 183 0 5 T4047	<b>598596</b>
29071 170 0 5 T4047	<b>598112</b>
29076 20.0 1 4	<b>541664</b>
29076 200 1 4 T3011	<b>541664</b>
29076 200 1 4 T3011	<b>598966</b>
29121 170 0 4 T3018	<b>541717</b>
29121 170 0 4 T3035	<b>541717</b>
29121 170 1 4	<b>541717</b>
29121 203 0 4 T3018	<b>541662</b>
29121 203 0 4 T3018	<b>541683</b>
29121 203 1 4	<b>541662</b>
29121 203 1 4	<b>541683</b>
29121 203 1 5 T3035	<b>541662</b>
29121 203 1 5 T3035	<b>541683</b>
29123 203 0 4 T3078	<b>541705</b>
29123 203 1 4	<b>541705</b>
29123 203 1 4 T3078	<b>541705</b>
29139 183 0 5 T4047	<b>598586</b>
29140 183 0 5 T4047	<b>598585</b>
29153 200 1 4 T3011	<b>541664</b>
29160 199 0 4 T3018	<b>541663</b>
29160 199 1 4	<b>541663</b>
29190 190 0 4	<b>541728</b>
29190 190 1 4	<b>541728</b>
29190 190 1 5 T3035	<b>541728</b>
29192 209 1 4	<b>598882</b>
29192 209 1 4 T3036	<b>598882</b>
29192 209 2 4 T3036	<b>598882</b>
29200 207 1 4	<b>598881</b>
29200 207 1 4 T3035	<b>598881</b>
29200 209 2 4 T3036	<b>598881</b>
29217 206 1 5 T3038	<b>598876</b>
29217 208 1 4	<b>598876</b>
29217 208 1 4 T3035	<b>598876</b>
29229 214 1 4	<b>541734</b>
29229 214 1 4 T4136	<b>541734</b>
29229 214 1 5 T4136	<b>541737</b>
29232 210 1 4	<b>541735</b>
29232 210 1 4 T4136	<b>541735</b>
29706 170 0 5 T4047	<b>598086</b>



	
<b>TEXTAR</b>	
29984 170 0 5 T4136	<b>598112</b>
<b>TRW</b>	
GDB100	<b>598111</b>
GDB1003	<b>598787</b>
GDB1003	<b>601176</b>
GDB1004	<b>598384</b>
GDB1005	<b>598024</b>
GDB1008	<b>598786</b>
GDB1008	<b>601187</b>
GDB1009	<b>601002</b>
GDB101	<b>598099</b>
GDB101	<b>598187</b>
GDB101	<b>598270</b>
GDB1010	<b>598817</b>
GDB1012	<b>598628</b>
GDB1013	<b>598840</b>
GDB1014	<b>598826</b>
GDB1017	<b>598618</b>
GDB102	<b>598099</b>
GDB102	<b>598187</b>
GDB1020	<b>598123</b>
GDB1022	<b>598589</b>
GDB1022	<b>598590</b>
GDB1023	<b>598834</b>
GDB1023	<b>598866</b>
GDB1024	<b>598274</b>
GDB1025	<b>598846</b>
GDB1027	<b>601243</b>
GDB1029	<b>598646</b>
GDB1030	<b>598061</b>
GDB1031	<b>598156</b>
GDB1033	<b>598155</b>
GDB1033	<b>598181</b>
GDB1033	<b>601158</b>
GDB1034	<b>598121</b>
GDB1034	<b>598312</b>
GDB1035	<b>598312</b>
GDB1036	<b>598239</b>
GDB1037	<b>598250</b>
GDB1038	<b>598185</b>
GDB1039	<b>598179</b>
GDB1039	<b>598353</b>
GDB1040	<b>598039</b>
GDB1040	<b>598356</b>
GDB1041	<b>598055</b>
GDB1043	<b>598496</b>
GDB1044	<b>598017</b>
GDB1044	<b>598252</b>
GDB1044	<b>601188</b>
GDB1045	<b>598000</b>
GDB1045	<b>598005</b>
GDB1048	<b>598016</b>
GDB1049	<b>598483</b>
GDB1050	<b>598125</b>
GDB1052	<b>598010</b>
GDB1054	<b>598003</b>
GDB1054	<b>598135</b>
GDB1055	<b>598463</b>
GDB1057	<b>598982</b>

	
<b>TRW</b>	
GDB1058	<b>598006</b>
GDB1058	<b>598010</b>
GDB1058	<b>598985</b>
GDB1059	<b>598014</b>
GDB106	<b>598090</b>
GDB106	<b>598603</b>
GDB1060	<b>598642</b>
GDB1061	<b>598056</b>
GDB1061	<b>598627</b>
GDB1063	<b>598682</b>
GDB1064	<b>598440</b>
GDB1066	<b>598338</b>
GDB1067	<b>598613</b>
GDB1068	<b>598291</b>
GDB107	<b>598088</b>
GDB1071	<b>598146</b>
GDB1073	<b>598180</b>
GDB1075	<b>598375</b>
GDB1078	<b>598081</b>
GDB1078	<b>598177</b>
GDB1079	<b>598080</b>
GDB1080	<b>598037</b>
GDB1083	<b>598022</b>
GDB1084	<b>598036</b>
GDB1085	<b>598028</b>
GDB1087	<b>598599</b>
GDB1092	<b>598622</b>
GDB1093	<b>598498</b>
GDB1094	<b>598013</b>
GDB1095	<b>598135</b>
GDB1098	<b>598281</b>
GDB1099	<b>601021</b>
GDB1100	<b>598018</b>
GDB1101	<b>598031</b>
GDB1102	<b>598383</b>
GDB1103	<b>598109</b>
GDB1103	<b>598110</b>
GDB1104	<b>598038</b>
GDB1104	<b>598074</b>
GDB1105	<b>598070</b>
GDB1106	<b>598800</b>
GDB1107	<b>598034</b>
GDB1108	<b>598033</b>
GDB1108	<b>598619</b>
GDB1111	<b>598598</b>
GDB1112	<b>598035</b>
GDB1113	<b>598602</b>
GDB1114	<b>598000</b>
GDB1115	<b>598011</b>
GDB1115	<b>598012</b>
GDB1117	<b>598985</b>
GDB1118	<b>598614</b>
GDB1119	<b>598103</b>
GDB112	<b>598375</b>
GDB1120	<b>598080</b>
GDB1120	<b>598396</b>
GDB1121	<b>598180</b>
GDB1123	<b>598617</b>
GDB1126	<b>598517</b>
GDB1127	<b>598519</b>



 	
TRW	
GDB1128	598625
GDB1129	598626
GDB1139	598629
GDB1139	601193
GDB114	598154
GDB114	601189
GDB1140	598290
GDB1143	598551
GDB1145	598809
GDB1147	598581
GDB1148	598064
GDB1152	598374
GDB1153	598491
GDB1154	598393
GDB1155	598499
GDB1156	598441
GDB1157	598600
GDB1159	598616
GDB1160	598270
GDB1163	598125
GDB1164	598495
GDB1164	601207
GDB1166	598050
GDB1168	598540
GDB1169	598022
GDB1169	598903
GDB1170	598628
GDB1174	598533
GDB1177	598515
GDB1179	598476
GDB1179	598691
GDB118	598077
GDB118	598078
GDB118	598085
GDB1180	598056
GDB1182	598777
GDB1182	601232
GDB1183	598494
GDB1184	601023
GDB1185	601022
GDB1186	598460
GDB1187	598507
GDB1189	598386
GDB1191	598859
GDB1193	598068
GDB1194	598069
GDB1195	598496
GDB1196	598463
GDB1197	598320
GDB1198	598318
GDB1200	598303
GDB1200	598355
GDB1201	598294
GDB1203	598382
GDB1204	598067
GDB1205	598357
GDB1207	598595
GDB1208	598120
GDB1209	598762
GDB1210	598040



 	
TRW	
GDB1212	598065
GDB1212	598308
GDB1213	598630
GDB1214	598254
GDB1215	598636
GDB1216	598073
GDB1217	598396
GDB1218	598066
GDB1219	598258
GDB1220	598044
GDB1221	598043
GDB1222	598212
GDB1223	598219
GDB1234	598965
GDB1236	598556
GDB1247	598292
GDB1250	598351
GDB1251	598008
GDB1252	598113
GDB1253	598115
GDB1258	598502
GDB1259	598069
GDB1260	598326
GDB1261	598412
GDB1262	598045
GDB1263	598046
GDB1264	598310
GDB1265	598311
GDB1266	598017
GDB1267	598463
GDB127	598144
GDB1270	598470
GDB1271	598305
GDB1274	598488
GDB1275	598303
GDB1276	598063
GDB1277	598075
GDB1278	598074
GDB1279	598360
GDB1280	598217
GDB1282	598675
GDB1283	598763
GDB1284	598207
GDB1285	598712
GDB1286	598522
GDB1288	541664
GDB1288	598966
GDB1289	598062
GDB129	598146
GDB1290	598041
GDB1291	598040
GDB1292	598549
GDB1293	598549
GDB1295	598398
GDB1297	598091
GDB1299	598012
GDB1300	598184
GDB1301	598385
GDB1302	598183
GDB1304	598580



 	
TRW	
GDB1305	598396
GDB1306	598403
GDB1307	598483
GDB1307	598751
GDB1307	601195
GDB1308	598458
GDB1308	601196
GDB1309	598459
GDB1310	598125
GDB1311	598463
GDB1312	598330
GDB1313	598493
GDB1314	598319
GDB1315	598581
GDB1317	598318
GDB1319	598512
GDB1321	598726
GDB1322	598074
GDB1324	598482
GDB1325	598482
GDB1326	598650
GDB1328	598180
GDB1330	598180
GDB1330	598463
GDB1330	601255
GDB1332	598002
GDB1333	598142
GDB1333	598331
GDB1334	598447
GDB1335	598444
GDB1336	598420
GDB1337	598065
GDB1338	598880
GDB1339	598605
GDB1340	598423
GDB1341	598424
GDB1342	598475
GDB1343	598386
GDB1344	598753
GDB1345	541662
GDB1346	598183
GDB1347	598271
GDB1348	598018
GDB1349	598399
GDB1350	598454
GDB1350	598860
GDB1351	598322
GDB1352	598926
GDB1353	598328
GDB1354	598431
GDB1356	598586
GDB1357	598332
GDB1358	598317
GDB1359	598466
GDB1360	598180
GDB1361	598461
GDB1362	598308
GDB1364	598065
GDB1365	598329
GDB1366	598484



 	
TRW	
GDB1367	598814
GDB1368	598807
GDB1369	598482
GDB1369	598650
GDB1372	598463
GDB1373	598299
GDB1374	598632
GDB1375	598735
GDB1376	598355
GDB1378	598442
GDB1379	598443
GDB1380	598490
GDB1381	598992
GDB1382	598607
GDB1383	598422
GDB1383	598424
GDB1384	598425
GDB1385	598462
GDB1386	598408
GDB1386	601186
GDB1388	598479
GDB1389	598480
GDB139	598077
GDB1390	598398
GDB1391	598676
GDB1392	598988
GDB1393	601019
GDB1394	598766
GDB1395	598768
GDB1396	598407
GDB1397	598408
GDB1398	598438
GDB1399	598300
GDB1401	598439
GDB1402	598726
GDB1403	598486
GDB1403	601209
GDB1404	598409
GDB1404	598811
GDB1405	598473
GDB1406	598616
GDB1407	598086
GDB1408	598301
GDB1411	598456
GDB1412	598457
GDB1413	598448
GDB1414	598667
GDB1415	598681
GDB1416	598463
GDB1418	598563
GDB1419	598564
GDB1419	598639
GDB1420	598453
GDB1421	598447
GDB1422	598408
GDB1423	598467
GDB1424	598432
GDB1425	598429
GDB1426	598430
GDB1427	598308





	
TRW	
GDB1429	598481
GDB1430	598753
GDB1431	598468
GDB1432	598063
GDB1433	598583
GDB1434	598433
GDB1434	601206
GDB1435	598434
GDB1436	598661
GDB1437	598330
GDB1439	598180
GDB1440	598489
GDB1441	598880
GDB1442	598537
GDB1443	598422
GDB1444	598880
GDB1445	598990
GDB1446	598406
GDB1447	598417
GDB1448	598419
GDB1449	598416
GDB145	598145
GDB1450	598418
GDB1451	598483
GDB1453	598772
GDB1454	598445
GDB1455	598446
GDB1456	598813
GDB1457	598719
GDB1459	598858
GDB146	598146
GDB1460	598565
GDB1461	598547
GDB1462	598464
GDB1463	598464
GDB1463	601159
GDB1463	601160
GDB1463	601190
GDB1463	601212
GDB1464	598465
GDB1464	601213
GDB1465	598002
GDB1466	598545
GDB1467	598180
GDB1467	598463
GDB1468	598471
GDB1469	598472
GDB1469	598783
GDB147	598085
GDB1470	598538
GDB1471	598926
GDB1472	598720
GDB1473	598514
GDB1474	598734
GDB1475	598674
GDB1476	598413
GDB1477	598643
GDB1478	598545
GDB1479	598546
GDB148	598077



	
TRW	
GDB148	598078
GDB148	598081
GDB148	598085
GDB1480	598582
GDB1481	598583
GDB1482	598426
GDB1483	598427
GDB1484	598428
GDB1485	598633
GDB1487	601003
GDB1488	598751
GDB1489	601001
GDB149	598085
GDB1490	601029
GDB1491	598436
GDB1492	598678
GDB1495	598500
GDB1496	598501
GDB1498	598410
GDB1499	598411
GDB1500	598461
GDB1500	601184
GDB1501	598462
GDB1502	598820
GDB1503	598553
GDB1504	598463
GDB1505	598992
GDB1509	598434
GDB151	598174
GDB151	598193
GDB1510	598439
GDB1511	598438
GDB1513	598480
GDB1514	598448
GDB1515	598584
GDB1516	601004
GDB1517	598568
GDB1518	598569
GDB1519	598988
GDB1520	598407
GDB1521	598570
GDB1522	598396
GDB1525	598527
GDB1525	601257
GDB1526	598658
GDB1527	598580
GDB1528	598750
GDB1530	598580
GDB1531	598811
GDB1532	598639
GDB1533	598423
GDB1534	541717
GDB1535	541705
GDB1538	598489
GDB1538	598801
GDB154	598090
GDB1540	598566
GDB1542	598638
GDB1543	598445
GDB1543	598659



	
TRW	
GDB1545	598444
GDB1546	598637
GDB1547	598655
GDB1548	598656
GDB1549	598770
GDB155	598094
GDB1550	598635
GDB1550	601216
GDB1551	598752
GDB1552	598558
GDB1553	598845
GDB1554	598779
GDB1555	598651
GDB1556	598652
GDB1557	598671
GDB1559	598640
GDB156	598193
GDB1560	598885
GDB1561	598643
GDB1562	598860
GDB1563	598464
GDB1565	598657
GDB1566	598829
GDB1567	598808
GDB1570	598456
GDB1571	598557
GDB1572	598036
GDB1573	598037
GDB1574	598669
GDB1576	601030
GDB1578	598463
GDB1579	598913
GDB1581	598035
GDB1582	598464
GDB1583	598649
GDB1583	601171
GDB1584	598318
GDB1586	598805
GDB1587	598463
GDB1589	598696
GDB159	598375
GDB1590	598670
GDB1590	598913
GDB1591	598698
GDB1592	598761
GDB1593	598761
GDB1594	598662
GDB1595	598663
GDB1596	598664
GDB1597	598558
GDB1600	598764
GDB1601	598765
GDB1602	598990
GDB1603	598772
GDB1604	598407
GDB1605	598715
GDB1606	598861
GDB1607	598822
GDB1609	541683
GDB1610	541663



	
TRW	
GDB1611	598699
GDB1612	598701
GDB1613	598678
GDB1614	598641
GDB1615	598075
GDB1616	598863
GDB1617	598779
GDB1618	598619
GDB1620	598702
GDB1621	598472
GDB1621	598783
GDB1621	601044
GDB1621	601256
GDB1622	598752
GDB1622	601263
GDB1623	598464
GDB1624	598465
GDB1625	598700
GDB1626	598703
GDB1628	598795
GDB1629	598704
GDB1630	598704
GDB1631	598741
GDB1632	598742
GDB1633	598718
GDB1634	598002
GDB1635	598002
GDB1636	598793
GDB1637	598727
GDB1638	598727
GDB164	598593
GDB1642	598728
GDB1643	598802
GDB1644	598859
GDB1646	598407
GDB1647	598729
GDB1648	598772
GDB1649	601029
GDB165	598147
GDB1650	601029
GDB1651	598940
GDB1652	598770
GDB1653	598770
GDB1654	598426
GDB1655	598721
GDB1656	598722
GDB1657	598678
GDB1658	598408
GDB1659	598779
GDB166	598364
GDB1661	601004
GDB1663	598663
GDB1664	598939
GDB1665	598740
GDB1665	601258
GDB1667	598995
GDB1668	598860
GDB1669	598465
GDB1670	598994
GDB1671	598946





 	
TRW	
GDB1672	598967
GDB1673	598804
GDB1676	598465
GDB1677	598464
GDB1678	598702
GDB1678	601273
GDB1681	598891
GDB1682	598892
GDB1683	598879
GDB1683	601178
GDB1683	601218
GDB1685	598928
GDB1686	598678
GDB1687	601012
GDB1690	598997
GDB1691	598998
GDB1692	598936
GDB1693	601034
GDB1695	541655
GDB1696	598881
GDB1697	541728
GDB1698	598882
GDB1700	598825
GDB1701	598839
GDB1708	598935
GDB1708	601266
GDB1715	598942
GDB1716	598941
GDB1719	598899
GDB172	598160
GDB1723	598818
GDB1724	598816
GDB1725	541736
GDB1727	598754
GDB173	598178
GDB1747	541734
GDB1749	601017
GDB1781	601048
GDB1782	601047
GDB1782	601185
GDB1783	601177
GDB1784	601049
GDB1784	601241
GDB1784	601267
GDB1789	601045
GDB1790	601050
GDB1814	601163
GDB1844	601229
GDB185	598208
GDB194	598220
GDB197	598123
GDB197	598379
GDB199	598182
GDB233	598614
GDB238	598166
GDB238	598171
GDB238	598212
GDB238	598334
GDB240	598113
GDB241	598592



 	
TRW	
GDB242	598109
GDB243	598366
GDB251	598122
GDB252	598612
GDB253	598117
GDB254	598185
GDB255	598120
GDB255	598166
GDB255	598212
GDB259	598187
GDB261	598107
GDB262	598207
GDB263	598148
GDB264	598110
GDB265	598389
GDB267	598111
GDB269	598375
GDB270	598107
GDB271	598362
GDB272	598363
GDB276	598150
GDB277	598144
GDB278	598146
GDB279	598375
GDB280	598175
GDB282	598162
GDB284	598052
GDB284	598131
GDB287	598149
GDB288	598278
GDB294	598105
GDB296	598090
GDB297	598091
GDB297	598219
GDB298	598104
GDB299	598103
GDB300	601016
GDB301	598120
GDB303	598384
GDB3045	598844
GDB3058	598983
GDB306	598817
GDB3071	598850
GDB308	598081
GDB3086	598496
GDB3088	598780
GDB3089	598634
GDB3091	598830
GDB3092	598057
GDB3101	598786
GDB3103	598836
GDB311	598167
GDB3110	598777
GDB3111	598668
GDB3114	598071
GDB3115	598449
GDB3116	598184
GDB3123	598838
GDB3124	598523
GDB3126	601024



 	
TRW	
GDB3129	598835
GDB313	598151
GDB3130	598496
GDB3131	598476
GDB3132	598534
GDB3133	598625
GDB3134	598528
GDB3135	598854
GDB314	598591
GDB3147	598551
GDB315	598145
GDB3151	601156
GDB3154	598682
GDB3154	601248
GDB3157	598496
GDB3159	598450
GDB3160	598437
GDB3161	598020
GDB3162	598460
GDB3163	598478
GDB3164	598540
GDB3165	598575
GDB3167	598452
GDB3168	598450
GDB3169	598051
GDB317	598613
GDB3170	598817
GDB3170	601235
GDB3171	598361
GDB3172	598902
GDB3175	598682
GDB3175	601244
GDB3176	598495
GDB3177	598627
GDB3178	598212
GDB318	598123
GDB3180	598071
GDB3181	598668
GDB3181	601252
GDB3182	598533
GDB3182	598534
GDB3183	598023
GDB3184	598266
GDB3186	598436
GDB3188	598627
GDB3189	598435
GDB3190	598682
GDB3190	598758
GDB3191	598682
GDB3192	598629
GDB3193	598548
GDB3195	598316
GDB3195	601191
GDB3196	598627
GDB3197	598535
GDB3197	601166
GDB3198	598865
GDB3200	601020
GDB3201	598908
GDB3202	598531



 	
TRW	
GDB3203	598841
GDB3204	598579
GDB3205	598691
GDB3205	598915
GDB3207	598551
GDB3208	598806
GDB3209	598629
GDB3210	598021
GDB3211	598574
GDB3212	598760
GDB3213	598393
GDB3213	598897
GDB3216	598361
GDB3217	598530
GDB3218	598606
GDB3219	598883
GDB3220	598856
GDB3221	598843
GDB3222	598524
GDB3223	598895
GDB3224	598989
GDB3227	598451
GDB323	598266
GDB3231	598780
GDB3232	598504
GDB3233	601025
GDB3235	601023
GDB3236	598733
GDB3238	598784
GDB3239	598778
GDB3240	598887
GDB3240	601217
GDB3241	598511
GDB3242	598737
GDB3243	598577
GDB3243	601251
GDB3244	598759
GDB3245	598910
GDB3246	598518
GDB3247	598520
GDB3249	598542
GDB325	598047
GDB3250	598907
GDB3251	598536
GDB3255	598515
GDB3256	598574
GDB3256	601169
GDB3257	598505
GDB3258	598748
GDB3259	598574
GDB3260	598834
GDB3260	598866
GDB3261	598821
GDB3262	598274
GDB3266	598856
GDB3267	598022
GDB3268	598887
GDB3269	598682
GDB3269	601043
GDB327	598002



	
TRW	
GDB327	598075
GDB327	598081
GDB327	598177
GDB3270	598521
GDB3271	598054
GDB3273	598912
GDB3274	598668
GDB3275	598697
GDB3276	598733
GDB3276	598832
GDB3278	601242
GDB3279	598673
GDB328	598080
GDB3280	598777
GDB3282	598748
GDB3283	598574
GDB3284	598748
GDB3284	601236
GDB3285	598910
GDB3286	598944
GDB3287	598886
GDB3288	598679
GDB3289	598680
GDB3290	598848
GDB3291	598451
GDB3292	598472
GDB3293	598452
GDB3293	601183
GDB3294	598672
GDB3294	601246
GDB3296	601233
GDB3297	598505
GDB3297	598871
GDB3297	601168
GDB3298	598748
GDB3299	598506
GDB3299	601167
GDB3300	598579
GDB3301	598821
GDB3302	598745
GDB3306	598809
GDB3307	598476
GDB3308	598916
GDB3309	598647
GDB3309	601180
GDB3310	598648
GDB3311	598780
GDB3312	598452
GDB3313	598602
GDB3314	598862
GDB3315	598541
GDB3316	598827
GDB3316	601172
GDB3316	601222
GDB3317	598917
GDB332	598392
GDB3324	598736
GDB3325	598757
GDB3325	601208
GDB3327	598523



	
TRW	
GDB3328	598853
GDB3330	598644
GDB3330	601205
GDB3331	598052
GDB3332	598641
GDB3334	598810
GDB3335	598653
GDB3336	598665
GDB3337	598812
GDB3340	598889
GDB3340	601204
GDB3341	598852
GDB3342	598842
GDB3343	598654
GDB3344	598823
GDB3345	598361
GDB3346	601240
GDB3347	601197
GDB3348	598874
GDB3348	601231
GDB3348	601250
GDB3349	598919
GDB3350	598914
GDB3351	598733
GDB3352	598744
GDB3352	601173
GDB3353	598784
GDB3355	598824
GDB3357	598831
GDB3358	598873
GDB3359	598733
GDB336	598116
GDB3363	598453
GDB3364	598857
GDB3364	601165
GDB3365	598870
GDB3367	598705
GDB3368	598817
GDB3369	598707
GDB3370	598706
GDB3371	598853
GDB3373	598929
GDB3377	598708
GDB3378	598781
GDB3380	598855
GDB3383	598393
GDB3386	598744
GDB3387	598748
GDB3389	598493
GDB339	598186
GDB3390	598787
GDB3392	598738
GDB3393	598672
GDB3395	598875
GDB3396	598847
GDB3399	598888
GDB340	598391
GDB3402	598746
GDB3405	598730
GDB3407	598803



	
TRW	
GDB3408	598849
GDB341	598129
GDB3410	601035
GDB3412	598871
GDB3414	598710
GDB3418	598937
GDB3418	601164
GDB3419	598932
GDB3419	601230
GDB342	598129
GDB3420	598868
GDB3420	601210
GDB3421	598867
GDB3421	601239
GDB3422	598744
GDB3423	598589
GDB3424	601037
GDB3425	598943
GDB3426	598819
GDB3426	601264
GDB3427	598894
GDB3429	598890
GDB3429	601214
GDB343	598007
GDB343	598374
GDB3431	598739
GDB3432	598748
GDB3433	598821
GDB3435	598893
GDB3437	601225
GDB3438	601270
GDB3439	541737
GDB344	598086
GDB3445	598901
GDB3450	601175
GDB3454	598933
GDB3457	601026
GDB3459	598896
GDB3459	601221
GDB3460	601052
GDB3464	601253
GDB3467	601182
GDB3481	598943
GDB3481	601040
GDB3484	601161
GDB349	598032
GDB349	598166
GDB3493	601181
GDB350	598131
GDB3501	601223
GDB351	598402
GDB351	598614
GDB352	598921
GDB353	598130
GDB354	598239
GDB355	598220
GDB358	598047
GDB359	598371
GDB360	598125
GDB360	598141



	
TRW	
GDB362	598113
GDB364	598115
GDB365	598224
GDB367	598123
GDB371	598120
GDB371	598335
GDB373	598052
GDB374	598293
GDB383	598021
GDB384	598983
GDB386	598175
GDB391	598270
GDB392	598291
GDB394	598129
GDB395	598623
GDB397	598594
GDB399	598027
GDB400	598002
GDB4010	598906
GDB4012	598965
GDB4016	598904
GDB403	598214
GDB404	598017
GDB404	601157
GDB405	598076
GDB405	598377
GDB407	598106
GDB4091	598556
GDB4098	601249
GDB4104	598491
GDB4118	598543
GDB4119	598544
GDB4120	598510
GDB4121	598556
GDB4122	598556
GDB4124	598509
GDB4125	598905
GDB4126	598414
GDB4127	598677
GDB4128	598756
GDB4129	598415
GDB4130	598755
GDB4133	598833
GDB4135	601033
GDB4139	598755
GDB4140	601032
GDB417	598093
GDB4172	601268
GDB422	598091
GDB422	598093
GDB425	598002
GDB425	598061
GDB428	598118
GDB430	598004
GDB440	598169
GDB442	598621
GDB443	598374
GDB446	598119
GDB446	598176
GDB446	598714











	
<b>BOSCH</b>	
0 204 173 008	<b>197070</b>
0 986 478 010	<b>186249</b>
0 986 478 011	<b>186245</b>
0 986 478 012	<b>186731</b>
0 986 478 016	<b>186113</b>
0 986 478 017	<b>186246</b>
0 986 478 018	<b>186112</b>
0 986 478 019	<b>186114</b>
0 986 478 024	<b>186884</b>
0 986 478 029	<b>186118</b>
0 986 478 032	<b>186115</b>
0 986 478 033	<b>186116</b>
0 986 478 034	<b>186117</b>
0 986 478 036	<b>186119</b>
0 986 478 046	<b>186200</b>
0 986 478 050	<b>186128</b>
0 986 478 051	<b>186142</b>
0 986 478 052	<b>186143</b>
0 986 478 058	<b>186180</b>
0 986 478 063	<b>186151</b>
0 986 478 065	<b>186520</b>
0 986 478 066	<b>186152</b>
0 986 478 067	<b>186205</b>
0 986 478 068	<b>186160</b>
0 986 478 072	<b>186158</b>
0 986 478 079	<b>186189</b>
0 986 478 080	<b>186186</b>
0 986 478 080	<b>197150</b>
0 986 478 081	<b>186187</b>
0 986 478 081	<b>186757</b>
0 986 478 086	<b>186490</b>
0 986 478 086	<b>197226</b>
0 986 478 089	<b>186197</b>
0 986 478 090	<b>186134</b>
0 986 478 091	<b>186202</b>
0 986 478 094	<b>186203</b>
0 986 478 103	<b>186226</b>
0 986 478 105	<b>186230</b>
0 986 478 105	<b>186803</b>
0 986 478 107	<b>186405</b>
0 986 478 109	<b>197069</b>
0 986 478 112	<b>186211</b>
0 986 478 113	<b>186218</b>
0 986 478 114	<b>186176</b>
0 986 478 115	<b>186433</b>
0 986 478 121	<b>186240</b>
0 986 478 124	<b>186208</b>
0 986 478 125	<b>186303</b>
0 986 478 128	<b>186291</b>
0 986 478 130	<b>186268</b>
0 986 478 131	<b>186269</b>
0 986 478 132	<b>186294</b>
0 986 478 136	<b>186771</b>
0 986 478 140	<b>186145</b>
0 986 478 141	<b>186144</b>
0 986 478 142	<b>186276</b>
0 986 478 143	<b>186256</b>
0 986 478 144	<b>186254</b>
0 986 478 146	<b>186257</b>
0 986 478 148	<b>186159</b>



	
<b>BOSCH</b>	
0 986 478 160	<b>186278</b>
0 986 478 166	<b>186537</b>
0 986 478 170	<b>186277</b>
0 986 478 174	<b>186438</b>
0 986 478 186	<b>186185</b>
0 986 478 187	<b>186182</b>
0 986 478 188	<b>186184</b>
0 986 478 189	<b>186692</b>
0 986 478 190	<b>186169</b>
0 986 478 192	<b>186188</b>
0 986 478 195	<b>186165</b>
0 986 478 196	<b>186424</b>
0 986 478 198	<b>186255</b>
0 986 478 200	<b>186206</b>
0 986 478 211	<b>186195</b>
0 986 478 216	<b>186292</b>
0 986 478 218	<b>186139</b>
0 986 478 224	<b>186770</b>
0 986 478 225	<b>186273</b>
0 986 478 227	<b>186457</b>
0 986 478 228	<b>186102</b>
0 986 478 229	<b>186272</b>
0 986 478 232	<b>186140</b>
0 986 478 234	<b>186136</b>
0 986 478 235	<b>186156</b>
0 986 478 236	<b>186150</b>
0 986 478 237	<b>186149</b>
0 986 478 238	<b>186146</b>
0 986 478 239	<b>186232</b>
0 986 478 240	<b>186234</b>
0 986 478 241	<b>186449</b>
0 986 478 246	<b>186130</b>
0 986 478 252	<b>186453</b>
0 986 478 255	<b>186281</b>
0 986 478 257	<b>186479</b>
0 986 478 262	<b>186298</b>
0 986 478 265	<b>186191</b>
0 986 478 266	<b>186192</b>
0 986 478 267	<b>186190</b>
0 986 478 268	<b>186198</b>
0 986 478 270	<b>186214</b>
0 986 478 273	<b>186228</b>
0 986 478 275	<b>186213</b>
0 986 478 276	<b>186229</b>
0 986 478 277	<b>186476</b>
0 986 478 278	<b>186221</b>
0 986 478 279	<b>186219</b>
0 986 478 280	<b>186224</b>
0 986 478 283	<b>186263</b>
0 986 478 284	<b>186564</b>
0 986 478 286	<b>186743</b>
0 986 478 288	<b>186300</b>
0 986 478 289	<b>186223</b>
0 986 478 295	<b>186509</b>
0 986 478 296	<b>186800</b>
0 986 478 297	<b>186311</b>
0 986 478 299	<b>186709</b>
0 986 478 301	<b>186280</b>
0 986 478 303	<b>186710</b>
0 986 478 307	<b>186776</b>



	
<b>BOSCH</b>	
0 986 478 308	<b>186247</b>
0 986 478 314	<b>186814</b>
0 986 478 319	<b>186124</b>
0 986 478 321	<b>186125</b>
0 986 478 325	<b>186183</b>
0 986 478 325	<b>186470</b>
0 986 478 326	<b>186625</b>
0 986 478 327	<b>186189</b>
0 986 478 328	<b>186302</b>
0 986 478 329	<b>186251</b>
0 986 478 330	<b>186177</b>
0 986 478 331	<b>186288</b>
0 986 478 332	<b>186517</b>
0 986 478 341	<b>186290</b>
0 986 478 342	<b>186155</b>
0 986 478 342	<b>186406</b>
0 986 478 343	<b>186154</b>
0 986 478 344	<b>186425</b>
0 986 478 345	<b>186168</b>
0 986 478 346	<b>186166</b>
0 986 478 350	<b>186435</b>
0 986 478 353	<b>186157</b>
0 986 478 357	<b>186178</b>
0 986 478 358	<b>197165</b>
0 986 478 359	<b>186199</b>
0 986 478 360	<b>186299</b>
0 986 478 370	<b>186194</b>
0 986 478 371	<b>186196</b>
0 986 478 374	<b>186498</b>
0 986 478 376	<b>197114</b>
0 986 478 377	<b>186374</b>
0 986 478 384	<b>186637</b>
0 986 478 385	<b>186511</b>
0 986 478 386	<b>186258</b>
0 986 478 388	<b>186264</b>
0 986 478 390	<b>186225</b>
0 986 478 391	<b>186231</b>
0 986 478 396	<b>186508</b>
0 986 478 397	<b>186696</b>
0 986 478 415	<b>186699</b>
0 986 478 420	<b>186565</b>
0 986 478 421	<b>186624</b>
0 986 478 422	<b>186628</b>
0 986 478 424	<b>186567</b>
0 986 478 425	<b>186568</b>
0 986 478 426	<b>186860</b>
0 986 478 427	<b>186401</b>
0 986 478 429	<b>186454</b>
0 986 478 430	<b>186497</b>
0 986 478 433	<b>187045</b>
0 986 478 434	<b>186418</b>
0 986 478 435	<b>186421</b>
0 986 478 436	<b>186566</b>
0 986 478 437	<b>186585</b>
0 986 478 438	<b>186875</b>
0 986 478 442	<b>186775</b>
0 986 478 447	<b>186234</b>
0 986 478 448	<b>186439</b>
0 986 478 450	<b>186827</b>
0 986 478 451	<b>186705</b>

	
<b>BOSCH</b>	
0 986 478 453	<b>186547</b>
0 986 478 454	<b>197056</b>
0 986 478 458	<b>186611</b>
0 986 478 459	<b>186577</b>
0 986 478 460	<b>186443</b>
0 986 478 461	<b>186294</b>
0 986 478 464	<b>186416</b>
0 986 478 467	<b>197246</b>
0 986 478 469	<b>186753</b>
0 986 478 474	<b>186783</b>
0 986 478 475	<b>186760</b>
0 986 478 478	<b>197009</b>
0 986 478 479	<b>186859</b>
0 986 478 480	<b>197032</b>
0 986 478 481	<b>197011</b>
0 986 478 482	<b>197088</b>
0 986 478 483	<b>197224</b>
0 986 478 485	<b>186563</b>
0 986 478 486	<b>197004</b>
0 986 478 487	<b>186488</b>
0 986 478 490	<b>186686</b>
0 986 478 491	<b>186874</b>
0 986 478 492	<b>186729</b>
0 986 478 493	<b>186707</b>
0 986 478 494	<b>186741</b>
0 986 478 495	<b>186841</b>
0 986 478 496	<b>186685</b>
0 986 478 497	<b>186642</b>
0 986 478 501	<b>186162</b>
0 986 478 502	<b>186163</b>
0 986 478 503	<b>186431</b>
0 986 478 505	<b>186500</b>
0 986 478 506	<b>186510</b>
0 986 478 508	<b>186519</b>
0 986 478 511	<b>186274</b>
0 986 478 512	<b>186148</b>
0 986 478 513	<b>186275</b>
0 986 478 515	<b>186153</b>
0 986 478 517	<b>186147</b>
0 986 478 521	<b>186265</b>
0 986 478 523	<b>186455</b>
0 986 478 524	<b>186446</b>
0 986 478 525	<b>186460</b>
0 986 478 526	<b>186461</b>
0 986 478 531	<b>186648</b>
0 986 478 533	<b>186482</b>
0 986 478 534	<b>186301</b>
0 986 478 535	<b>186282</b>
0 986 478 539	<b>186504</b>
0 986 478 541	<b>186652</b>
0 986 478 542	<b>186313</b>
0 986 478 544	<b>186770</b>
0 986 478 545	<b>186270</b>
0 986 478 546	<b>197222</b>
0 986 478 547	<b>186314</b>
0 986 478 548	<b>186315</b>
0 986 478 550	<b>186267</b>
0 986 478 555	<b>197059</b>
0 986 478 556	<b>186204</b>
0 986 478 557	<b>186768</b>



 	
BOSCH	
0 986 478 561	<b>186295</b>
0 986 478 564	<b>186487</b>
0 986 478 565	<b>186462</b>
0 986 478 566	<b>186465</b>
0 986 478 567	<b>186485</b>
0 986 478 568	<b>186436</b>
0 986 478 568	<b>186439</b>
0 986 478 569	<b>186801</b>
0 986 478 570	<b>186861</b>
0 986 478 571	<b>186815</b>
0 986 478 572	<b>186818</b>
0 986 478 578	<b>186701</b>
0 986 478 580	<b>186638</b>
0 986 478 582	<b>186587</b>
0 986 478 583	<b>186876</b>
0 986 478 584	<b>197169</b>
0 986 478 588	<b>197226</b>
0 986 478 590	<b>186655</b>
0 986 478 591	<b>186299</b>
0 986 478 593	<b>197225</b>
0 986 478 596	<b>186488</b>
0 986 478 598	<b>186304</b>
0 986 478 601	<b>186812</b>
0 986 478 603	<b>186526</b>
0 986 478 604	<b>186586</b>
0 986 478 605	<b>186426</b>
0 986 478 606	<b>186762</b>
0 986 478 608	<b>186694</b>
0 986 478 611	<b>186306</b>
0 986 478 613	<b>197218</b>
0 986 478 615	<b>186408</b>
0 986 478 618	<b>186695</b>
0 986 478 619	<b>186521</b>
0 986 478 620	<b>186581</b>
0 986 478 621	<b>186523</b>
0 986 478 622	<b>197227</b>
0 986 478 624	<b>186467</b>
0 986 478 624	<b>186864</b>
0 986 478 626	<b>186469</b>
0 986 478 627	<b>186788</b>
0 986 478 629	<b>186640</b>
0 986 478 632	<b>197166</b>
0 986 478 633	<b>186458</b>
0 986 478 634	<b>186439</b>
0 986 478 635	<b>186653</b>
0 986 478 638	<b>186451</b>
0 986 478 639	<b>186590</b>
0 986 478 641	<b>186839</b>
0 986 478 642	<b>186559</b>
0 986 478 643	<b>186612</b>
0 986 478 647	<b>186614</b>
0 986 478 649	<b>187029</b>
0 986 478 650	<b>186576</b>
0 986 478 652	<b>186648</b>
0 986 478 654	<b>186648</b>
0 986 478 656	<b>186310</b>
0 986 478 657	<b>186286</b>
0 986 478 664	<b>186572</b>
0 986 478 667	<b>186778</b>
0 986 478 668	<b>186605</b>



 	
BOSCH	
0 986 478 669	<b>197229</b>
0 986 478 671	<b>186427</b>
0 986 478 672	<b>186428</b>
0 986 478 673	<b>186440</b>
0 986 478 674	<b>186441</b>
0 986 478 675	<b>186617</b>
0 986 478 698	<b>186704</b>
0 986 478 701	<b>186452</b>
0 986 478 704	<b>197124</b>
0 986 478 706	<b>186664</b>
0 986 478 712	<b>186742</b>
0 986 478 713	<b>186691</b>
0 986 478 716	<b>186647</b>
0 986 478 717	<b>186496</b>
0 986 478 718	<b>186750</b>
0 986 478 719	<b>186220</b>
0 986 478 721	<b>186505</b>
0 986 478 725	<b>186652</b>
0 986 478 726	<b>197167</b>
0 986 478 727	<b>186777</b>
0 986 478 728	<b>186821</b>
0 986 478 729	<b>186784</b>
0 986 478 730	<b>186759</b>
0 986 478 731	<b>186791</b>
0 986 478 732	<b>186702</b>
0 986 478 733	<b>186785</b>
0 986 478 734	<b>186600</b>
0 986 478 736	<b>186110</b>
0 986 478 740	<b>186501</b>
0 986 478 742	<b>186170</b>
0 986 478 743	<b>197221</b>
0 986 478 744	<b>186718</b>
0 986 478 745	<b>186688</b>
0 986 478 746	<b>186172</b>
0 986 478 747	<b>186173</b>
0 986 478 749	<b>186135</b>
0 986 478 751	<b>186131</b>
0 986 478 757	<b>186307</b>
0 986 478 759	<b>186773</b>
0 986 478 760	<b>186103</b>
0 986 478 761	<b>186137</b>
0 986 478 770	<b>186207</b>
0 986 478 772	<b>197238</b>
0 986 478 774	<b>186823</b>
0 986 478 776	<b>186530</b>
0 986 478 781	<b>197208</b>
0 986 478 786	<b>186297</b>
0 986 478 787	<b>197161</b>
0 986 478 793	<b>197094</b>
0 986 478 794	<b>186287</b>
0 986 478 799	<b>186503</b>
0 986 478 802	<b>186665</b>
0 986 478 810	<b>186266</b>
0 986 478 811	<b>186495</b>
0 986 478 812	<b>186420</b>
0 986 478 813	<b>186613</b>
0 986 478 819	<b>186236</b>
0 986 478 824	<b>186284</b>
0 986 478 827	<b>186283</b>
0 986 478 830	<b>186532</b>



 	
BOSCH	
0 986 478 831	<b>186533</b>
0 986 478 834	<b>186296</b>
0 986 478 836	<b>186564</b>
0 986 478 837	<b>197016</b>
0 986 478 839	<b>197162</b>
0 986 478 840	<b>186621</b>
0 986 478 842	<b>197228</b>
0 986 478 843	<b>197217</b>
0 986 478 844	<b>186719</b>
0 986 478 846	<b>186682</b>
0 986 478 847	<b>186599</b>
0 986 478 848	<b>186697</b>
0 986 478 849	<b>186774</b>
0 986 478 852	<b>186604</b>
0 986 478 853	<b>186603</b>
0 986 478 854	<b>197223</b>
0 986 478 855	<b>186745</b>
0 986 478 856	<b>186529</b>
0 986 478 858	<b>186822</b>
0 986 478 859	<b>186681</b>
0 986 478 861	<b>186551</b>
0 986 478 863	<b>197033</b>
0 986 478 864	<b>186305</b>
0 986 478 865	<b>186654</b>
0 986 478 866	<b>186775</b>
0 986 478 867	<b>197230</b>
0 986 478 868	<b>186597</b>
0 986 478 869	<b>186582</b>
0 986 478 870	<b>186725</b>
0 986 478 872	<b>186583</b>
0 986 478 873	<b>186552</b>
0 986 478 874	<b>186562</b>
0 986 478 875	<b>186573</b>
0 986 478 877	<b>186579</b>
0 986 478 878	<b>186571</b>
0 986 478 879	<b>186569</b>
0 986 478 880	<b>186591</b>
0 986 478 881	<b>186592</b>
0 986 478 882	<b>186594</b>
0 986 478 883	<b>186684</b>
0 986 478 884	<b>186593</b>
0 986 478 885	<b>187058</b>
0 986 478 886	<b>187040</b>
0 986 478 887	<b>186598</b>
0 986 478 888	<b>186773</b>
0 986 478 889	<b>186620</b>
0 986 478 892	<b>186560</b>
0 986 478 893	<b>197236</b>
0 986 478 896	<b>186589</b>
0 986 478 897	<b>186648</b>
0 986 478 898	<b>186647</b>
0 986 478 963	<b>197137</b>
0 986 478 967	<b>197195</b>
0 986 478 968	<b>197168</b>
0 986 478 970	<b>186740</b>
0 986 478 970	<b>186868</b>
0 986 478 971	<b>186894</b>
0 986 478 971	<b>197003</b>
0 986 478 972	<b>186804</b>
0 986 478 973	<b>186808</b>



 	
BOSCH	
0 986 478 974	<b>186808</b>
0 986 478 975	<b>186883</b>
0 986 478 976	<b>197230</b>
0 986 478 979	<b>186693</b>
0 986 478 980	<b>197220</b>
0 986 478 981	<b>186736</b>
0 986 478 982	<b>186780</b>
0 986 478 983	<b>186730</b>
0 986 478 984	<b>197064</b>
0 986 478 985	<b>197198</b>
0 986 478 986	<b>186807</b>
0 986 478 987	<b>186856</b>
0 986 478 988	<b>186603</b>
0 986 478 989	<b>186810</b>
0 986 478 990	<b>186813</b>
0 986 478 991	<b>186687</b>
0 986 478 992	<b>186871</b>
0 986 478 993	<b>186442</b>
0 986 478 996	<b>197063</b>
0 986 478 999	<b>197122</b>
0 986 479 001	<b>186868</b>
0 986 479 006	<b>186743</b>
0 986 479 007	<b>186796</b>
0 986 479 012	<b>186766</b>
0 986 479 013	<b>197206</b>
0 986 479 014	<b>197103</b>
0 986 479 020	<b>197207</b>
0 986 479 024	<b>197231</b>
0 986 479 027	<b>186703</b>
0 986 479 029	<b>186734</b>
0 986 479 030	<b>186728</b>
0 986 479 033	<b>186866</b>
0 986 479 033	<b>197146</b>
0 986 479 036	<b>186888</b>
0 986 479 037	<b>197239</b>
0 986 479 038	<b>186751</b>
0 986 479 039	<b>186751</b>
0 986 479 041	<b>197035</b>
0 986 479 042	<b>186865</b>
0 986 479 054	<b>197086</b>
0 986 479 055	<b>186732</b>
0 986 479 056	<b>197084</b>
0 986 479 057	<b>186758</b>
0 986 479 058	<b>197242</b>
0 986 479 064	<b>186724</b>
0 986 479 066	<b>186708</b>
0 986 479 068	<b>186834</b>
0 986 479 069	<b>186748</b>
0 986 479 070	<b>197013</b>
0 986 479 071	<b>197060</b>
0 986 479 076	<b>186880</b>
0 986 479 077	<b>186869</b>
0 986 479 078	<b>186712</b>
0 986 479 083	<b>186893</b>
0 986 479 084	<b>186877</b>
0 986 479 086	<b>186848</b>
0 986 479 087	<b>186847</b>
0 986 479 088	<b>186755</b>
0 986 479 094	<b>197243</b>
0 986 479 095	<b>197090</b>







	
<b>BOSCH</b>	
0 986 479 096	<b>186885</b>
0 986 479 097	<b>186886</b>
0 986 479 098	<b>186754</b>
0 986 479 099	<b>186857</b>
0 986 479 100	<b>197138</b>
0 986 479 101	<b>186432</b>
0 986 479 102	<b>197022</b>
0 986 479 103	<b>186764</b>
0 986 479 104	<b>186846</b>
0 986 479 105	<b>186845</b>
0 986 479 106	<b>186854</b>
0 986 479 107	<b>186881</b>
0 986 479 108	<b>186720</b>
0 986 479 109	<b>197240</b>
0 986 479 111	<b>186765</b>
0 986 479 113	<b>197244</b>
0 986 479 114	<b>197219</b>
0 986 479 115	<b>197193</b>
0 986 479 117	<b>197233</b>
0 986 479 119	<b>197108</b>
0 986 479 120	<b>186797</b>
0 986 479 121	<b>186744</b>
0 986 479 124	<b>197172</b>
0 986 479 126	<b>197027</b>
0 986 479 127	<b>197207</b>
0 986 479 128	<b>197020</b>
0 986 479 131	<b>186851</b>
0 986 479 132	<b>197245</b>
0 986 479 135	<b>197200</b>
0 986 479 137	<b>186890</b>
0 986 479 138	<b>186858</b>
0 986 479 139	<b>186707</b>
0 986 479 142	<b>186882</b>
0 986 479 144	<b>186713</b>
0 986 479 146	<b>197062</b>
0 986 479 149	<b>197019</b>
0 986 479 155	<b>186833</b>
0 986 479 157	<b>197222</b>
0 986 479 161	<b>187148</b>
0 986 479 162	<b>187147</b>
0 986 479 163	<b>187149</b>
0 986 479 164	<b>186802</b>
0 986 479 165	<b>186803</b>
0 986 479 166	<b>197251</b>
0 986 479 167	<b>186809</b>
0 986 479 169	<b>186842</b>
0 986 479 170	<b>186843</b>
0 986 479 171	<b>186863</b>
0 986 479 173	<b>186819</b>
0 986 479 178	<b>197021</b>
0 986 479 179	<b>186872</b>
0 986 479 185	<b>186798</b>
0 986 479 186	<b>186799</b>
0 986 479 187	<b>197214</b>
0 986 479 189	<b>186757</b>
0 986 479 190	<b>186790</b>
0 986 479 191	<b>186855</b>
0 986 479 192	<b>197046</b>
0 986 479 193	<b>186746</b>
0 986 479 194	<b>186747</b>



	
<b>BOSCH</b>	
0 986 479 195	<b>186786</b>
0 986 479 196	<b>186853</b>
0 986 479 198	<b>186717</b>
0 986 479 199	<b>197079</b>
0 986 479 200	<b>197018</b>
0 986 479 204	<b>197197</b>
0 986 479 205	<b>197022</b>
0 986 479 206	<b>186879</b>
0 986 479 207	<b>186825</b>
0 986 479 209	<b>197241</b>
0 986 479 210	<b>186789</b>
0 986 479 211	<b>186756</b>
0 986 479 213	<b>186816</b>
0 986 479 214	<b>186817</b>
0 986 479 215	<b>197073</b>
0 986 479 216	<b>197234</b>
0 986 479 218	<b>197049</b>
0 986 479 219	<b>186840</b>
0 986 479 222	<b>197008</b>
0 986 479 223	<b>197044</b>
0 986 479 224	<b>197045</b>
0 986 479 225	<b>197104</b>
0 986 479 227	<b>197145</b>
0 986 479 229	<b>186829</b>
0 986 479 230	<b>197210</b>
0 986 479 232	<b>197209</b>
0 986 479 234	<b>197091</b>
0 986 479 235	<b>197036</b>
0 986 479 236	<b>197129</b>
0 986 479 239	<b>197047</b>
0 986 479 241	<b>197163</b>
0 986 479 242	<b>186849</b>
0 986 479 243	<b>186850</b>
0 986 479 244	<b>186587</b>
0 986 479 245	<b>197171</b>
0 986 479 247	<b>197031</b>
0 986 479 248	<b>197087</b>
0 986 479 252	<b>197038</b>
0 986 479 253	<b>186843</b>
0 986 479 254	<b>197101</b>
0 986 479 255	<b>197002</b>
0 986 479 257	<b>197125</b>
0 986 479 259	<b>197051</b>
0 986 479 260	<b>197142</b>
0 986 479 261	<b>197055</b>
0 986 479 262	<b>197149</b>
0 986 479 263	<b>197158</b>
0 986 479 265	<b>197176</b>
0 986 479 266	<b>197188</b>
0 986 479 267	<b>197190</b>
0 986 479 268	<b>197191</b>
0 986 479 269	<b>197092</b>
0 986 479 270	<b>186720</b>
0 986 479 271	<b>186713</b>
0 986 479 272	<b>186894</b>
0 986 479 273	<b>186718</b>
0 986 479 274	<b>186853</b>
0 986 479 275	<b>197002</b>
0 986 479 276	<b>186893</b>
0 986 479 277	<b>186720</b>



	
<b>BOSCH</b>	
0 986 479 278	<b>186796</b>
0 986 479 279	<b>186840</b>
0 986 479 280	<b>197003</b>
0 986 479 281	<b>186775</b>
0 986 479 286	<b>197096</b>
0 986 479 287	<b>197155</b>
0 986 479 288	<b>197232</b>
0 986 479 289	<b>197173</b>
0 986 479 290	<b>197130</b>
0 986 479 291	<b>197247</b>
0 986 479 292	<b>197098</b>
0 986 479 293	<b>197247</b>
0 986 479 294	<b>187141</b>
0 986 479 295	<b>197030</b>
0 986 479 296	<b>187146</b>
0 986 479 297	<b>186418</b>
0 986 479 297	<b>197043</b>
0 986 479 299	<b>197140</b>
0 986 479 300	<b>197199</b>
0 986 479 301	<b>197052</b>
0 986 479 303	<b>197139</b>
0 986 479 304	<b>197071</b>
0 986 479 307	<b>197054</b>
0 986 479 308	<b>197066</b>
0 986 479 310	<b>197143</b>
0 986 479 311	<b>197010</b>
0 986 479 312	<b>197043</b>
0 986 479 313	<b>197248</b>
0 986 479 314	<b>197131</b>
0 986 479 316	<b>197097</b>
0 986 479 317	<b>197105</b>
0 986 479 318	<b>197116</b>
0 986 479 322	<b>197057</b>
0 986 479 324	<b>197130</b>
0 986 479 326	<b>197132</b>
0 986 479 327	<b>197134</b>
0 986 479 331	<b>197201</b>
0 986 479 338	<b>197112</b>
0 986 479 340	<b>197072</b>
0 986 479 341	<b>197183</b>
0 986 479 345	<b>197121</b>
0 986 479 348	<b>197083</b>
0 986 479 358	<b>197164</b>
0 986 479 360	<b>197111</b>
0 986 479 362	<b>197106</b>
0 986 479 363	<b>197184</b>
0 986 479 370	<b>186805</b>
0 986 479 371	<b>197029</b>
0 986 479 375	<b>197156</b>
0 986 479 377	<b>197173</b>
0 986 479 378	<b>197098</b>
0 986 479 379	<b>197099</b>
0 986 479 380	<b>197133</b>
0 986 479 381	<b>197159</b>
0 986 479 382	<b>197126</b>
0 986 479 383	<b>197117</b>
0 986 479 387	<b>197117</b>
0 986 479 388	<b>197100</b>
0 986 479 390	<b>187152</b>
0 986 479 392	<b>197249</b>

	
<b>BOSCH</b>	
0 986 479 399	<b>197023</b>
0 986 479 400	<b>197100</b>
0 986 479 402	<b>197028</b>
0 986 479 403	<b>197135</b>
0 986 479 405	<b>186811</b>
0 986 479 406	<b>197203</b>
0 986 479 407	<b>197202</b>
0 986 479 409	<b>197128</b>
0 986 479 410	<b>197127</b>
0 986 479 418	<b>197110</b>
0 986 479 420	<b>197113</b>
0 986 479 425	<b>197185</b>
0 986 479 428	<b>197152</b>
0 986 479 429	<b>197194</b>
0 986 479 430	<b>197147</b>
0 986 479 431	<b>197182</b>
0 986 479 435	<b>186171</b>
0 986 479 436	<b>197178</b>
0 986 479 437	<b>197074</b>
0 986 479 438	<b>197160</b>
0 986 479 439	<b>197175</b>
0 986 479 442	<b>197179</b>
0 986 479 443	<b>197180</b>
0 986 479 449	<b>197102</b>
0 986 479 454	<b>197070</b>
0 986 479 457	<b>197212</b>
0 986 479 459	<b>186878</b>
0 986 479 460	<b>197205</b>
0 986 479 461	<b>197252</b>
0 986 479 467	<b>197213</b>
0 986 479 470	<b>197067</b>
0 986 479 484	<b>197120</b>
0 986 479 485	<b>197194</b>
0 986 479 486	<b>197065</b>
0 986 479 488	<b>186210</b>
0 986 479 490	<b>197148</b>
0 986 479 491	<b>186714</b>
0 986 479 494	<b>186295</b>
0 986 479 497	<b>197181</b>
0 986 479 504	<b>197015</b>
0 986 479 508	<b>197123</b>
0 986 479 518	<b>197107</b>
0 986 479 519	<b>197109</b>
0 986 479 534	<b>197144</b>
0 986 479 537	<b>197174</b>
0 986 479 540	<b>197204</b>
0 986 479 548	<b>197216</b>
0 986 479 553	<b>197192</b>
0 986 479 554	<b>197215</b>
0 986 479 560	<b>197187</b>
0 986 479 743	<b>186715</b>
0 986 AB6 001	<b>197302</b>
0 986 AB6 002	<b>197121</b>
0 986 AB6 002	<b>197290</b>
0 986 AB6 003	<b>197242</b>
0 986 AB6 003	<b>197384</b>
0 986 AB6 005	<b>197423</b>
0 986 AB6 040	<b>186701</b>
0 986 AB6 047	<b>186508</b>
0 986 AB6 048	<b>186652</b>

 	
BOSCH	
0 986 AB6 051	<b>186765</b>
0 986 AB6 083	<b>186699</b>
0 986 AB6 090	<b>186827</b>
0 986 AB6 091	<b>186829</b>
0 986 AB6 092	<b>197210</b>
0 986 AB6 095	<b>197027</b>
0 986 AB6 096	<b>197422</b>
0 986 AB6 099	<b>197029</b>
0 986 AB6 102	<b>186278</b>
0 986 AB6 103	<b>186537</b>
0 986 AB6 104	<b>186529</b>
0 986 AB6 105	<b>197022</b>
0 986 AB6 109	<b>197387</b>
0 986 AB6 112	<b>197052</b>
0 986 AB6 113	<b>197199</b>
0 986 AB6 113	<b>197388</b>
0 986 AB6 114	<b>197198</b>
0 986 AB6 115	<b>197142</b>
0 986 AB6 115	<b>197389</b>
0 986 AB6 116	<b>197140</b>
0 986 AB6 117	<b>186807</b>
0 986 AB6 118	<b>197125</b>
0 986 AB6 118	<b>197426</b>
0 986 AB6 119	<b>197038</b>
0 986 AB6 120	<b>186294</b>
0 986 AB6 121	<b>197124</b>
0 986 AB6 122	<b>186773</b>
0 986 AB6 123	<b>197011</b>
0 986 AB6 124	<b>197246</b>
0 986 AB6 125	<b>197088</b>
0 986 AB6 125	<b>197427</b>
0 986 AB6 126	<b>197031</b>
0 986 AB6 127	<b>186833</b>
0 986 AB6 127	<b>197429</b>
0 986 AB6 134	<b>197430</b>
0 986 AB6 138	<b>197200</b>
0 986 AB6 140	<b>186281</b>
0 986 AB6 143	<b>197096</b>
0 986 AB6 144	<b>186572</b>
0 986 AB6 145	<b>186551</b>
0 986 AB6 147	<b>186208</b>
0 986 AB6 148	<b>186884</b>
0 986 AB6 155	<b>186879</b>
0 986 AB6 156	<b>186878</b>
0 986 AB6 157	<b>197172</b>
0 986 AB6 160	<b>186130</b>
0 986 AB6 161	<b>186872</b>
0 986 AB6 170	<b>197431</b>
0 986 AB6 171	<b>186759</b>
0 986 AB6 172	<b>186163</b>
0 986 AB6 173	<b>186571</b>
0 986 AB6 175	<b>197390</b>
0 986 AB6 185	<b>186232</b>
0 986 AB6 222	<b>186188</b>
0 986 AB6 244	<b>186874</b>
0 986 AB6 271	<b>197170</b>
0 986 AB6 282	<b>197432</b>
0 986 AB6 289	<b>197433</b>
0 986 AB6 290	<b>197392</b>
0 986 AB6 306	<b>186728</b>

 	
BOSCH	
0 986 AB6 307	<b>186818</b>
0 986 AB6 310	<b>186648</b>
0 986 AB6 316	<b>197223</b>
0 986 AB6 317	<b>186235</b>
0 986 AB6 320	<b>186431</b>
0 986 AB6 322	<b>186439</b>
0 986 AB6 323	<b>197393</b>
0 986 AB6 325	<b>186437</b>
0 986 AB6 328	<b>186455</b>
0 986 AB6 329	<b>197063</b>
0 986 AB6 333	<b>186452</b>
0 986 AB6 344	<b>186547</b>
0 986 AB6 348	<b>197194</b>
0 986 AB6 351	<b>186640</b>
0 986 AB6 352	<b>186876</b>
0 986 AB6 363	<b>197018</b>
0 986 AB6 376	<b>186564</b>
0 986 AB6 386	<b>186696</b>
0 986 AB6 392	<b>186645</b>
0 986 AB6 395	<b>186866</b>
0 986 AB6 399	<b>186479</b>
0 986 AB6 400	<b>186511</b>
0 986 AB6 403	<b>186458</b>
0 986 AB6 491	<b>197394</b>
0 986 AB6 504	<b>186694</b>
0 986 AB6 560	<b>186245</b>
0 986 AB6 594	<b>186604</b>
0 986 AB6 821	<b>197397</b>
0 986 AB6 824	<b>186603</b>
0 986 AB6 830	<b>197399</b>
0 986 AB6 832	<b>197436</b>
0 986 AB6 835	<b>197400</b>
0 986 AB6 840	<b>197264</b>
0 986 AB6 851	<b>197294</b>
0 986 AB6 857	<b>197438</b>
0 986 AB6 860	<b>186194</b>
0 986 AB6 861	<b>197404</b>
0 986 AB6 863	<b>197440</b>
0 986 AB6 864	<b>186825</b>
0 986 AB6 868	<b>197406</b>
0 986 AB6 869	<b>197441</b>
0 986 AB6 871	<b>197442</b>
0 986 AB6 874	<b>186251</b>
0 986 AB6 876	<b>186695</b>
0 986 AB6 880	<b>186271</b>
0 986 AB6 881	<b>186294</b>
0 986 AB6 882	<b>197230</b>
0 986 AB6 886	<b>197412</b>
0 986 AB6 888	<b>186247</b>
0 986 AB6 890	<b>186198</b>
0 986 AB6 896	<b>186693</b>
0 986 AB6 918	<b>197267</b>
0 986 AB6 920	<b>186457</b>
0 986 AB6 946	<b>197418</b>
0 986 AB6 964	<b>186485</b>
0 986 AB6 989	<b>197420</b>
0 986 BB4 024	<b>186774</b>
0 986 BB4 039	<b>186198</b>
0 986 BB4 040	<b>186200</b>
0 986 BB4 041	<b>186130</b>

 	
BOSCH	
0 986 BB4 042	<b>186251</b>
0 986 BB4 046	<b>186153</b>
0 986 BB4 048	<b>186188</b>
0 986 BB4 054	<b>186245</b>
0 986 BB4 055	<b>186155</b>
0 986 BB4 055	<b>186745</b>
0 986 BB4 061	<b>186202</b>
0 986 BB4 063	<b>186228</b>
0 986 BB4 064	<b>186288</b>
0 986 BB4 068	<b>186194</b>
0 986 BB4 072	<b>186208</b>
0 986 BB4 075	<b>186173</b>
0 986 BB4 079	<b>186304</b>
0 986 BB4 081	<b>186199</b>
0 986 BB4 082	<b>186306</b>
0 986 BB4 083	<b>197222</b>
0 986 BB4 086	<b>186229</b>
0 986 BB4 087	<b>197165</b>
0 986 BB4 088	<b>187045</b>
0 986 BB4 091	<b>186195</b>
0 986 BB4 092	<b>186533</b>
0 986 BB4 093	<b>197217</b>
0 986 BB4 094	<b>186418</b>
0 986 BB4 096	<b>186134</b>
0 986 BB4 138	<b>186603</b>
0 986 BB4 164	<b>186282</b>
0 986 BB4 170	<b>186573</b>
0986AB6001	<b>197302</b>
0986AB6002	<b>197290</b>
0986AB6003	<b>197384</b>
0986AB6005	<b>197423</b>
0986AB6091	<b>186829</b>
0986AB6096	<b>197422</b>
0986AB6099	<b>197029</b>
0986AB6109	<b>197387</b>
0986AB6113	<b>197388</b>
0986AB6115	<b>197389</b>
0986AB6118	<b>197426</b>
0986AB6119	<b>197038</b>
0986AB6125	<b>197427</b>
0986AB6126	<b>197031</b>
0986AB6127	<b>197429</b>
0986AB6134	<b>197430</b>
0986AB6170	<b>197431</b>
0986AB6175	<b>197390</b>
0986AB6222	<b>186188</b>
0986AB6282	<b>197432</b>
0986AB6289	<b>197433</b>
0986AB6290	<b>197392</b>
0986AB6323	<b>197393</b>
0986AB6325	<b>186437</b>
0986AB6376	<b>186564</b>
0986AB6491	<b>197394</b>
0986AB6504	<b>186694</b>
0986AB6560	<b>186245</b>
0986AB6594	<b>186604</b>
0986AB6821	<b>197397</b>
0986AB6824	<b>186603</b>
0986AB6830	<b>197399</b>
0986AB6832	<b>197436</b>

 	
BOSCH	
0986AB6835	<b>197400</b>
0986AB6840	<b>197264</b>
0986AB6851	<b>197294</b>
0986AB6857	<b>197438</b>
0986AB6860	<b>186194</b>
0986AB6861	<b>197404</b>
0986AB6863	<b>197440</b>
0986AB6864	<b>186825</b>
0986AB6868	<b>197406</b>
0986AB6869	<b>197441</b>
0986AB6871	<b>197442</b>
0986AB6874	<b>186251</b>
0986AB6876	<b>186695</b>
0986AB6880	<b>186271</b>
0986AB6881	<b>186294</b>
0986AB6882	<b>197230</b>
0986AB6886	<b>197412</b>
0986AB6888	<b>186247</b>
0986AB6890	<b>186198</b>
0986AB6896	<b>186693</b>
0986AB6918	<b>197267</b>
0986AB6920	<b>186457</b>
0986AB6946	<b>197418</b>
0986AB6964	<b>186485</b>
0986AB6989	<b>197420</b>

FERODO	
DDF001	<b>186189</b>
DDF011	<b>186128</b>
DDF012	<b>186202</b>
DDF013	<b>186495</b>
DDF016	<b>186226</b>
DDF035	<b>186171</b>
DDF038	<b>186625</b>
DDF041	<b>186142</b>
DDF042	<b>186249</b>
DDF048	<b>186113</b>
DDF051	<b>186134</b>
DDF052	<b>186135</b>
DDF053	<b>186176</b>
DDF055	<b>186230</b>
DDF055	<b>186803</b>
DDF057	<b>186771</b>
DDF059	<b>186200</b>
DDF061	<b>186207</b>
DDF062	<b>186118</b>
DDF063	<b>186206</b>
DDF066	<b>186146</b>
DDF067	<b>186290</b>
DDF068	<b>186150</b>
DDF069	<b>186136</b>
DDF070	<b>186228</b>
DDF071	<b>186180</b>
DDF075	<b>186115</b>
DDF079	<b>186160</b>
DDF080	<b>186256</b>
DDF081	<b>186501</b>
DDF082	<b>186118</b>
DDF083	<b>186151</b>
DDF084	<b>186169</b>





<b>FERODO</b>	
DDF088	<b>186110</b>
DDF089	<b>186170</b>
DDF092	<b>186172</b>
DDF093	<b>186117</b>
DDF094	<b>186140</b>
DDF096	<b>186197</b>
DDF097	<b>186197</b>
DDF100	<b>186143</b>
DDF1000	<b>186599</b>
DDF1003	<b>186582</b>
DDF1006	<b>186304</b>
DDF1008	<b>186704</b>
DDF1009	<b>186686</b>
DDF1010	<b>186682</b>
DDF1011	<b>186725</b>
DDF1014	<b>186583</b>
DDF103	<b>186245</b>
DDF103	<b>197056</b>
DDF1030	<b>197004</b>
DDF1031	<b>197056</b>
DDF1033	<b>186294</b>
DDF1034	<b>186562</b>
DDF1035	<b>186573</b>
DDF1037	<b>186753</b>
DDF104	<b>186186</b>
DDF104	<b>197150</b>
DDF1040	<b>186591</b>
DDF1041	<b>186592</b>
DDF1042	<b>186684</b>
DDF1043	<b>186594</b>
DDF1044	<b>186593</b>
DDF1057	<b>186605</b>
DDF1058	<b>186846</b>
DDF1062	<b>197229</b>
DDF1064	<b>186705</b>
DDF1065	<b>197231</b>
DDF1066	<b>186815</b>
DDF1067	<b>186688</b>
DDF107	<b>186211</b>
DDF1072	<b>186560</b>
DDF1073	<b>186861</b>
DDF1076	<b>186742</b>
DDF1077	<b>186777</b>
DDF1078	<b>186741</b>
DDF1079	<b>186741</b>
DDF1080	<b>186814</b>
DDF1081	<b>197016</b>
DDF1082	<b>197226</b>
DDF1083	<b>186566</b>
DDF1084	<b>186587</b>
DDF1085	<b>186811</b>
DDF109	<b>186152</b>
DDF1094	<b>186875</b>
DDF1096	<b>186208</b>
DDF1097	<b>186743</b>
DDF1100	<b>186687</b>
DDF1104	<b>197161</b>
DDF1105	<b>186810</b>
DDF1106	<b>197220</b>
DDF1109	<b>186719</b>



<b>FERODO</b>	
DDF1112	<b>186710</b>
DDF1113	<b>186709</b>
DDF1114	<b>186703</b>
DDF1115	<b>186785</b>
DDF1116	<b>197009</b>
DDF1117	<b>197163</b>
DDF1118	<b>197246</b>
DDF1119	<b>186780</b>
DDF1122	<b>186745</b>
DDF1123	<b>186600</b>
DDF1124	<b>186655</b>
DDF1125	<b>186750</b>
DDF1126	<b>186834</b>
DDF1127	<b>186762</b>
DDF1128	<b>186812</b>
DDF1129	<b>186757</b>
DDF1130	<b>186790</b>
DDF1131	<b>186759</b>
DDF1132	<b>186702</b>
DDF1132	<b>186746</b>
DDF1135	<b>186864</b>
DDF1138	<b>186797</b>
DDF1139	<b>197240</b>
DDF1140	<b>186695</b>
DDF1140	<b>186198</b>
DDF1145	<b>186708</b>
DDF1148	<b>186784</b>
DDF1149	<b>186766</b>
DDF115	<b>186257</b>
DDF1151	<b>186871</b>
DDF1152	<b>186693</b>
DDF1154	<b>197088</b>
DDF1154	<b>197427</b>
DDF1155	<b>197011</b>
DDF1156	<b>186758</b>
DDF1157	<b>186736</b>
DDF1158	<b>186801</b>
DDF1159	<b>197239</b>
DDF116	<b>186187</b>
DDF116	<b>186757</b>
DDF1160	<b>186800</b>
DDF1161	<b>186788</b>
DDF1162	<b>197137</b>
DDF1163	<b>186789</b>
DDF1164	<b>186888</b>
DDF1165	<b>197219</b>
DDF1166	<b>197198</b>
DDF1167	<b>186305</b>
DDF1168	<b>197138</b>
DDF1169	<b>197238</b>
DDF117	<b>186202</b>
DDF117	<b>186205</b>
DDF1170	<b>186418</b>
DDF1171	<b>197228</b>
DDF1172	<b>186748</b>
DDF1173	<b>186783</b>
DDF1174	<b>186731</b>
DDF1176	<b>197120</b>
DDF1177	<b>197032</b>
DDF1178	<b>186694</b>



<b>FERODO</b>	
DDF1179	<b>186744</b>
DDF1181	<b>186724</b>
DDF1182	<b>186715</b>
DDF1183	<b>197136</b>
DDF1184	<b>197252</b>
DDF1190	<b>197124</b>
DDF1201	<b>186764</b>
DDF1202	<b>186884</b>
DDF1203	<b>186890</b>
DDF1204	<b>186712</b>
DDF1205	<b>197221</b>
DDF1210	<b>197245</b>
DDF1214	<b>197069</b>
DDF1215	<b>186880</b>
DDF1216	<b>186765</b>
DDF1217	<b>186868</b>
DDF1218	<b>186755</b>
DDF1218	<b>197397</b>
DDF1219	<b>186798</b>
DDF122	<b>186184</b>
DDF1220	<b>186799</b>
DDF1221	<b>197230</b>
DDF1222	<b>186819</b>
DDF1223	<b>186754</b>
DDF1223	<b>197394</b>
DDF1224	<b>186857</b>
DDF1225	<b>186863</b>
DDF1226	<b>186842</b>
DDF1227	<b>186843</b>
DDF1228	<b>186816</b>
DDF1229	<b>186817</b>
DDF123	<b>186236</b>
DDF1231	<b>186866</b>
DDF1231	<b>197146</b>
DDF1231	<b>197420</b>
DDF1232	<b>186807</b>
DDF1233	<b>186729</b>
DDF1234	<b>186858</b>
DDF1236	<b>186869</b>
DDF1238	<b>197142</b>
DDF1238	<b>197389</b>
DDF1239	<b>197172</b>
DDF124	<b>186182</b>
DDF1240	<b>197140</b>
DDF1241	<b>186732</b>
DDF1242	<b>197193</b>
DDF125	<b>186157</b>
DDF1252	<b>186751</b>
DDF1253	<b>186756</b>
DDF1254	<b>186885</b>
DDF1255	<b>186809</b>
DDF1256	<b>186808</b>
DDF1257	<b>197406</b>
DDF1258	<b>197036</b>
DDF1260	<b>197084</b>
DDF1261	<b>197244</b>
DDF1266	<b>197144</b>
DDF1268	<b>197096</b>
DDF1270	<b>186825</b>
DDF1271	<b>197083</b>



<b>FERODO</b>	
DDF1272	<b>186740</b>
DDF1274	<b>197046</b>
DDF1275	<b>186747</b>
DDF1276	<b>186833</b>
DDF1276	<b>197429</b>
DDF1277	<b>197199</b>
DDF1277	<b>197388</b>
DDF128	<b>186114</b>
DDF1280	<b>186883</b>
DDF1282	<b>197162</b>
DDF1283	<b>186791</b>
DDF1284	<b>186295</b>
DDF1286	<b>186886</b>
DDF1287	<b>197064</b>
DDF1288	<b>186854</b>
DDF1289	<b>186882</b>
DDF129	<b>186147</b>
DDF1290	<b>197210</b>
DDF1291	<b>197052</b>
DDF1292	<b>186824</b>
DDF1295	<b>186786</b>
DDF1296	<b>197239</b>
DDF1297	<b>197251</b>
DDF1298	<b>197045</b>
DDF1299	<b>197008</b>
DDF1302	<b>197108</b>
DDF1304	<b>197044</b>
DDF1305	<b>197242</b>
DDF1306	<b>197031</b>
DDF1307	<b>197035</b>
DDF1307	<b>197426</b>
DDF1308	<b>197035</b>
DDF1308	<b>197125</b>
DDF1309	<b>186877</b>
DDF131	<b>186192</b>
DDF1311	<b>186872</b>
DDF1313	<b>186855</b>
DDF1316	<b>197091</b>
DDF132	<b>186130</b>
DDF1346	<b>197195</b>
DDF135	<b>186158</b>
DDF1358	<b>186432</b>
DDF136	<b>186254</b>
DDF1361	<b>186839</b>
DDF1362	<b>186760</b>
DDF1363	<b>197060</b>
DDF1364	<b>186718</b>
DDF1365	<b>197086</b>
DDF1368	<b>197079</b>
DDF1369	<b>186796</b>
DDF137	<b>186288</b>
DDF1372	<b>197233</b>
DDF1374	<b>186869</b>
DDF1379	<b>197062</b>
DDF138	<b>186168</b>
DDF1380	<b>197018</b>
DDF1381	<b>186720</b>
DDF1384	<b>186813</b>
DDF1386	<b>186893</b>
DDF1386	<b>186894</b>



 	
FERODO	
DDF1399	197067
DDF140	186155
DDF140	186406
DDF1400	197122
DDF1401	197070
DDF1405	186804
DDF1406	186849
DDF141	186154
DDF1417	186847
DDF1417	197423
DDF1419	186848
DDF1420	197021
DDF1421	197019
DDF1423	197038
DDF1424	197145
DDF1425	186856
DDF1425	197438
DDF1426	197057
DDF1430	197155
DDF1431	197156
DDF1442	197232
DDF1443	186853
DDF1446	197168
DDF1447	197121
DDF1449	197247
DDF1450	197098
DDF1451	197247
DDF1452	197098
DDF1453	197130
DDF1454	197132
DDF1455	197130
DDF1456	197134
DDF1459	197233
DDF1461	197171
DDF1461	197400
DDF1466	197103
DDF148	186156
DDF1484	197170
DDF1486	197112
DDF1488	197015
DDF1489	186850
DDF149	186137
DDF1492	197022
DDF1493	197027
DDF1496	197267
DDF1497	186844
DDF1497	197013
DDF1498	186713
DDF1500	186851
DDF1502	186802
DDF1503	197139
DDF1508	197072
DDF1509	186805
DDF151	186188
DDF151	186790
DDF1511	186717
DDF1513	197241
DDF1514	186775
DDF1515	186775
DDF1516	186768

 	
FERODO	
DDF1517	186768
DDF1518	197017
DDF1520	197066
DDF1521	186727
DDF1522	186829
DDF1523	186840
DDF1526	186582
DDF1527	197047
DDF1529	186879
DDF1533	197092
DDF1535	197073
DDF1536	197234
DDF1537	187152
DDF154	186195
DDF1543	197209
DDF1549	197049
DDF1550	197175
DDF1554	197249
DDF1555	197054
DDF1557	197153
DDF1559	197239
DDF156	186265
DDF1560	197002
DDF1561	186840
DDF1564	197002
DDF1565	186743
DDF1566	197248
DDF1567	197055
DDF1569	186718
DDF157	186102
DDF1570	186853
DDF1571	186796
DDF1574	197097
DDF1577	186823
DDF1578	197107
DDF158	186229
DDF1580	197090
DDF1582	197200
DDF1587	197184
DDF1588	197111
DDF1589	197164
DDF159	186214
DDF1591	197087
DDF1594	197071
DDF160	186218
DDF1601	197188
DDF1602	197099
DDF1604	197050
DDF1606	197440
DDF1608	197102
DDF1615	197133
DDF1616	197101
DDF1617	197074
DDF1619	197205
DDF1620	197135
DDF1621	197214
DDF1622	197129
DDF1623	186712
DDF1623	186713
DDF1625	197190

 	
FERODO	
DDF1629	197211
DDF1632	197173
DDF1634	197176
DDF1636	186878
DDF1641	186720
DDF1644	197149
DDF1645	197109
DDF1646	197152
DDF1649	197143
DDF165	186116
DDF1653	197023
DDF1654	186893
DDF1655	186894
DDF1655	197003
DDF1656	186720
DDF1664	197196
DDF1668	197185
DDF1677	197222
DDF168	186103
DDF1687	197065
DDF1688	197203
DDF169	186139
DDF1690	197202
DDF1693	197201
DDF1707	197404
DDF172	186210
DDF174	186255
DDF175	186246
DDF176	186149
DDF177	186776
DDF178	186148
DDF180	186165
DDF181	186185
DDF182	186119
DDF1824	197387
DDF1827	197390
DDF1828	197431
DDF1829	186457
DDF183	186159
DDF1830	197430
DDF1831	197392
DDF1832	197433
DDF184	186213
DDF186	186221
DDF188	186191
DDF189	186613
DDF191	186177
DDF192	186198
DDF193	186112
DDF1938	197432
DDF194	186264
DDF1953	197436
DDF196	186263
DDF1970	197412
DDF198	186220
DDF199	186219
DDF201	186235
DDF202	186299
DDF203	186232
DDF205	186251

 	
FERODO	
DDF206	186189
DDF207	186247
DDF208	186162
DDF209	186166
DDF210	186124
DDF213	186258
DDF214	186194
DDF216	186292
DDF217	186625
DDF218	186479
DDF220	186266
DDF221	186125
DDF224	186183
DDF225	186178
DDF227	186482
DDF228	186145
DDF229	186131
DDF232	186424
DDF233	186374
DDF236	186287
DDF237	186224
DDF238	186199
DDF239	186190
DDF240	186406
DDF242	186302
DDF244	186416
DDF245	186204
DDF246	186283
DDF247	186144
DDF248	186274
DDF249	186295
DDF250	186692
DDF252	186297
DDF254	186614
DDF256	186273
DDF258	186275
DDF259	186301
DDF260	186485
DDF261	186286
DDF262	186284
DDF263	186196
DDF264	186303
DDF265	186114
DDF266	186517
DDF267	186487
DDF268	186461
DDF281	186425
DDF286	186495
DDF309	197004
DDF310	197028
DDF311	186272
DDF316	186276
DDF318	186268
DDF319	186267
DDF320	197222
DDF320	186271
DDF321	186294
DDF324	186270
DDF328	186282
DDF330	197225







FERODO	
DDF331	186490
DDF332	186313
DDF333	186768
DDF334	186775
DDF339	186519
DDF347	186637
DDF349	186267
DDF349	197165
DDF351	186504
DDF353	186223
DDF355	186498
DDF357	186665
DDF359	186530
DDF361	186567
DDF362	186306
DDF364	186277
DDF366	186570
DDF370	186159
DDF373	197114
DDF377	186431
DDF385	186488
DDF389	186441
DDF390	186440
DDF394	186446
DDF395	186455
DDF398	186500
DDF403	186509
DDF411	186508
DDF412	186510
DDF413	186511
DDF416	186696
DDF423	186427
DDF424	186770
DDF426	186314
DDF427	186315
DDF429	186454
DDF432	186311
DDF435	186428
DDF439	186231
DDF442	186300
DDF445	186768
DDF446	186140
DDF447	186433
DDF448	186234
DDF450	186436
DDF453	186235
DDF455	186446
DDF457	186460
DDF459	186664
DDF460	186653
DDF466	186508
DDF468	186435
DDF478	186225
DDF479	186426
DDF480	186611
DDF482	186617
DDF489	186296
DDF490	186586
DDF491	186496
DDF492	186438



FERODO	
DDF494	186439
DDF496	186457
DDF497	186449
DDF500	186652
DDF501	197166
DDF502	186652
DDF511	186699
DDF517	186291
DDF518	186269
DDF521	186153
DDF523	186452
DDF524	186458
DDF539	186281
DDF540	186298
DDF542	186770
DDF543	186807
DDF547	186520
DDF548	186462
DDF552	186528
DDF554	186621
DDF556	186307
DDF558	186596
DDF562	197218
DDF563	186114
DDF564	186453
DDF565	186437
DDF588	186280
DDF596	186547
DDF605	186526
DDF614	186640
DDF619	186439
DDF620	197169
DDF621	197148
DDF623	186505
DDF624	197227
DDF630	186465
DDF658	186648
DDF674	186564
DDF678	186503
DDF691	186476
DDF692	186476
DDF693	186585
DDF694	197223
DDF701	186645
DDF702	197167
DDF706	186521
DDF715	186691
DDF717	186564
DDF722	186563
DDF741	186648
DDF746	186628
DDF752	186775
DDF756	186497
DDF757	186421
DDF758	197217
DDF759	186408
DDF760	186420
DDF762	186590
DDF766	186163
DDF767	186418



FERODO	
DDF768	197228
DDF769	186638
DDF770	186299
DDF780	186514
DDF785	186435
DDF790	186654
DDF794	186701
DDF795	186581
DDF797	186643
DDF799	186822
DDF801	186401
DDF802	186443
DDF803	186442
DDF810	197226
DDF811	186566
DDF812	186523
DDF813	186714
DDF814	186565
DDF817	186467
DDF819	186470
DDF826	186572
DDF827	186644
DDF829	186778
DDF830	186773
DDF831	186559
DDF834	186697
DDF835	186568
DDF836	186860
DDF840	186569
DDF841	186533
DDF842	186589
DDF845	186529
DDF846	197236
DDF847	186624
DDF848	186278
DDF849	186537
DDF860	186551
DDF861	186552
DDF866	186576
DDF867	186577
DDF869	186579
DDF870	186532
DDF871	186286
DDF873	197224
DDF874	186642
DDF881	186511
DDF885	186648
DDF887	186163
DDF888	186571
DDF927	186603
DDF928	186604
DDF929	186597
DDF929	197442
DDF948	186874
DDF950	186432
DDF952	186773
DDF963	186469
DDF965	186839
DDF978	186827
DDF995	186598

FERODO	
DRF042	186249
DRF055	186230
DRF055	186803
DRF059	186200
DRF066	186146
DRF067	186290
DRF070	186228
DRF083	186151
DRF1003	186582
DRF1006	186304
DRF1014	186583
DRF103	186245
DRF103	197056
DRF1033	186294
DRF1035	186573
DRF104	186186
DRF104	197150
DRF1066	186815
DRF1072	186560
DRF1073	186861
DRF1078	186741
DRF1082	197226
DRF109	186152
DRF1096	186208
DRF1118	197246
DRF1122	186745
DRF1123	186600
DRF1124	186655
DRF1127	186762
DRF1128	186812
DRF1132	186702
DRF1132	186746
DRF1138	186797
DRF1140	186695
DRF1149	186766
DRF1154	197088
DRF1155	197011
DRF1156	186758
DRF116	186187
DRF116	186757
DRF1163	186789
DRF1167	186305
DRF1173	186783
DRF1174	186731
DRF1177	197032
DRF123	186236
DRF125	186157
DRF128	186114
DRF132	186130
DRF135	186158
DRF137	186288
DRF140	186155
DRF140	186406
DRF141	186154
DRF148	186156
DRF151	186188
DRF151	186790
DRF154	186195
DRF156	186265
DRF158	186229



 	
FERODO	
DRF175	186246
DRF176	186149
DRF183	186159
DRF189	186613
DRF192	186198
DRF193	186112
DRF201	186235
DRF205	186251
DRF206	186189
DRF207	186247
DRF208	186162
DRF209	186166
DRF210	186124
DRF214	186194
DRF216	186292
DRF220	186266
DRF221	186125
DRF240	186406
DRF242	186302
DRF244	186416
DRF248	186274
DRF249	186295
DRF252	186297
DRF256	186273
DRF258	186275
DRF260	186485
DRF261	186286
DRF263	186196
DRF266	186517
DRF281	186425
DRF286	186495
DRF316	186276
DRF319	186267
DRF321	186294
DRF324	186270
DRF328	186282
DRF331	186490
DRF332	186313
DRF334	186775
DRF339	186519
DRF364	186277
DRF390	186440
DRF423	186427
DRF439	186231
DRF447	186433
DRF450	186436
DRF479	186426
DRF482	186617
DRF489	186296
DRF491	186496
DRF492	186438
DRF494	186439
DRF497	186449
DRF500	186652
DRF501	197166
DRF511	186699
DRF517	186291
DRF518	186269
DRF521	186153
DRF588	186280



 	
FERODO	
DRF605	186526
DRF619	186439
DRF620	197169
DRF624	197227
DRF678	186503
DRF706	186521
DRF727S	186185
DRF752	186775
DRF756	186497
DRF759	186408
DRF762	186590
DRF766	186163
DRF794	186701
DRF795	186581
DRF797	186643
DRF798	186208
DRF799	186822
DRF801	186401
DRF810	197226
DRF812	186523
DRF817	186467
DRF829	186778
DRF830	186773
DRF831	186559
DRF834	186697
DRF841	186533
DRF845	186529
DRF870	186532
DRF927	186603
DRF928	186604
DRF929	186597
DRF952	186773
DRF995	186598
FCR104A	187029
FCR139A	187058
FCR140A	187040
FCR153A	186774
FCR154A	187045
FCR184A	187061
FCR191A	197059
FCR194A	187147
FCR195A	187148
FCR196A	187149
FCR221A	186178
FCR227A	197033
FCR228A	186774
FCR229A	187045
FCR230A	197033
FCR236A	187130
FCR310A	187141
FCR311A	197030
FCR312A	187146
TEXTAR	
407106	186140
408108	186768
410139	186226
410150	186117
410178	186114
410186	186424



 	
TEXTAR	
410190	186146
410209	186290
412126	186274
413128	186202
413166	186768
413167	186118
420111	186203
420147	186163
421102	186234
421105	186438
422141	186145
424120	186277
425100	186495
426100	186296
520128	186247
522145	186265
525105	197222
92005400	186189
92005700	197004
92009200	186142
92009200	186226
92009300	186249
92009500	186180
92010600	186245
92011400	186202
92011600	186115
92011600	186116
92011900	186160
92012100	186246
92012900	186139
92013500	186110
92014300	186140
92014400	186128
92014900	186169
92015100	186171
92016400	186142
92017200	186218
92018600	186255
92019200	186117
92019300	186151
92019900	186171
92019900	186172
92020300	186692
92020800	186186
92020900	186187
92020900	186757
92022000	186771
92022100	186143
92022800	186453
92022900	186159
92023000	186158
92025900	186113
92026000	186112
92026100	186114
92026200	186273
92026300	186292
92026400	186118
92026500	186119
92026900	186135
92027000	186152



 	
TEXTAR	
92027100	186202
92027100	186205
92027300	186166
92027400	186176
92029600	186188
92029600	186790
92029800	186199
92029800	186200
92029900	186134
92029900	186197
92031000	186257
92031300	186776
92031400	186256
92031800	186182
92031900	186185
92032000	186184
92032400	186424
92032700	186183
92032700	186470
92032703	186183
92032703	186470
92033100	186210
92033600	186103
92033800	186195
92034000	186150
92034200	186146
92034300	186156
92034300	186571
92034400	186206
92034500	186157
92035100	186299
92035600	186479
92036000	186228
92036100	186230
92036100	186803
92036200	186229
92036300	186224
92036400	186214
92036600	186374
92036800	186247
92037000	186770
92037200	186272
92037300	186114
92037900	186168
92038000	186192
92038100	186191
92038100	186192
92038200	186190
92038500	186130
92038600	186177
92038900	186178
92039100	186173
92039200	186189
92039300	186625
92040400	186223
92040600	186283
92041400	186155
92041500	186154
92041500	186155
92041700	186251







 	
<b>TEXTAR</b>	
92041800	<b>186288</b>
92041803	<b>186288</b>
92042000	<b>186302</b>
92042100	<b>186124</b>
92042300	<b>186125</b>
92042303	<b>186125</b>
92042900	<b>186136</b>
92043100	<b>186194</b>
92043200	<b>186196</b>
92043500	<b>186519</b>
92043800	<b>197114</b>
92044100	<b>186102</b>
92044200	<b>186149</b>
92044400	<b>186236</b>
92044500	<b>186613</b>
92046300	<b>186232</b>
92046800	<b>186265</b>
92046900	<b>186290</b>
92047400	<b>197165</b>
92048100	<b>186198</b>
92048200	<b>186199</b>
92048500	<b>186498</b>
92049200	<b>186231</b>
92049300	<b>186213</b>
92049400	<b>186219</b>
92049500	<b>186221</b>
92050400	<b>186696</b>
92050600	<b>186258</b>
92050900	<b>186162</b>
92051000	<b>186163</b>
92051200	<b>186263</b>
92051300	<b>186264</b>
92051500	<b>186225</b>
92051600	<b>186234</b>
92052100	<b>186148</b>
92052900	<b>186509</b>
92053000	<b>186770</b>
92053200	<b>186147</b>
92053500	<b>186266</b>
92053800	<b>186500</b>
92054000	<b>186131</b>
92054200	<b>186267</b>
92054400	<b>186145</b>
92054500	<b>186144</b>
92054900	<b>186208</b>
92055000	<b>186416</b>
92055003	<b>186416</b>
92055200	<b>186297</b>
92055400	<b>186289</b>
92055500	<b>186274</b>
92055503	<b>186274</b>
92055600	<b>186275</b>
92055605	<b>186275</b>
92055700	<b>186295</b>
92055703	<b>186295</b>
92055800	<b>186511</b>
92055900	<b>186314</b>
92056000	<b>186315</b>
92056200	<b>186301</b>
92056300	<b>186485</b>



 	
<b>TEXTAR</b>	
92056400	<b>186487</b>
92056500	<b>186282</b>
92056800	<b>186465</b>
92057000	<b>186490</b>
92057100	<b>186313</b>
92057200	<b>186517</b>
92057300	<b>186460</b>
92057400	<b>186270</b>
92057500	<b>186294</b>
92057503	<b>186294</b>
92057600	<b>197222</b>
92057605	<b>197222</b>
92057700	<b>197225</b>
92057800	<b>186268</b>
92057900	<b>186461</b>
92058000	<b>186462</b>
92058500	<b>197218</b>
92059300	<b>186298</b>
92059303	<b>186298</b>
92059400	<b>186280</b>
92059403	<b>186280</b>
92059500	<b>186281</b>
92059503	<b>186281</b>
92059600	<b>186296</b>
92059700	<b>186586</b>
92059900	<b>186621</b>
92060200	<b>186185</b>
92060400	<b>186269</b>
92060600	<b>186291</b>
92060700	<b>186431</b>
92060800	<b>186435</b>
92060900	<b>186438</b>
92061000	<b>186405</b>
92061100	<b>186155</b>
92061100	<b>186406</b>
92061103	<b>186155</b>
92061103	<b>186406</b>
92061300	<b>186284</b>
92061500	<b>186449</b>
92061600	<b>186451</b>
92061700	<b>186452</b>
92061800	<b>186446</b>
92061900	<b>186455</b>
92062000	<b>186457</b>
92062100	<b>186458</b>
92062600	<b>186441</b>
92062700	<b>186617</b>
92062800	<b>186440</b>
92063200	<b>186482</b>
92063300	<b>186300</b>
92063500	<b>186277</b>
92063600	<b>186426</b>
92064200	<b>197094</b>
92064300	<b>186427</b>
92064400	<b>186428</b>
92064500	<b>186303</b>
92064800	<b>186304</b>
92064900	<b>186306</b>
92065000	<b>186305</b>
92065100	<b>186307</b>



 	
<b>TEXTAR</b>	
92065500	<b>186510</b>
92065600	<b>186287</b>
92065700	<b>186530</b>
92065800	<b>186509</b>
92066000	<b>186504</b>
92066200	<b>186496</b>
92066500	<b>186454</b>
92066600	<b>186453</b>
92066700	<b>186526</b>
92066703	<b>186526</b>
92066800	<b>186528</b>
92066803	<b>186528</b>
92067300	<b>186276</b>
92067700	<b>186165</b>
92067800	<b>186520</b>
92068200	<b>186807</b>
92068500	<b>186153</b>
92068600	<b>186220</b>
92068700	<b>186567</b>
92068800	<b>186497</b>
92068900	<b>186652</b>
92069000	<b>186505</b>
92069500	<b>186652</b>
92069600	<b>186590</b>
92069800	<b>186299</b>
92070000	<b>186487</b>
92070300	<b>186768</b>
92070400	<b>186768</b>
92070500	<b>186285</b>
92070600	<b>186286</b>
92070700	<b>186508</b>
92071400	<b>197227</b>
92071403	<b>197227</b>
92071600	<b>186408</b>
92071603	<b>186408</b>
92071900	<b>186581</b>
92071903	<b>186581</b>
92072000	<b>186523</b>
92072003	<b>186523</b>
92072100	<b>186773</b>
92072103	<b>186773</b>
92072300	<b>186839</b>
92072303	<b>186839</b>
92072400	<b>186559</b>
92072403	<b>186559</b>
92072500	<b>186467</b>
92072505	<b>186467</b>
92072700	<b>186469</b>
92072703	<b>186469</b>
92072800	<b>186521</b>
92072900	<b>197124</b>
92073000	<b>186470</b>
92073400	<b>197033</b>
92073600	<b>187045</b>
92073700	<b>197217</b>
92073800	<b>186418</b>
92073800	<b>197043</b>
92073900	<b>197131</b>
92073900	<b>197228</b>
92074000	<b>186420</b>

 	
<b>TEXTAR</b>	
92074100	<b>186421</b>
92074200	<b>197236</b>
92074203	<b>197236</b>
92074300	<b>186624</b>
92074303	<b>186624</b>
92074400	<b>186551</b>
92074403	<b>186551</b>
92074500	<b>186552</b>
92074503	<b>186552</b>
92074600	<b>186653</b>
92074800	<b>186653</b>
92075000	<b>186697</b>
92075005	<b>186697</b>
92075100	<b>186860</b>
92075105	<b>186860</b>
92075300	<b>186529</b>
92075400	<b>186401</b>
92075500	<b>186565</b>
92075600	<b>197226</b>
92075700	<b>186566</b>
92075800	<b>186488</b>
92075900	<b>186585</b>
92076300	<b>186547</b>
92076300	<b>186640</b>
92076400	<b>186628</b>
92076500	<b>186875</b>
92076600	<b>186568</b>
92076603	<b>186568</b>
92076800	<b>186569</b>
92077200	<b>186701</b>
92077400	<b>197169</b>
92077500	<b>186822</b>
92077500	<b>197148</b>
92077500	<b>197169</b>
92077600	<b>197167</b>
92077700	<b>197166</b>
92077703	<b>197166</b>
92077800	<b>186433</b>
92077900	<b>186432</b>
92078000	<b>186286</b>
92078100	<b>186439</b>
92078200	<b>186699</b>
92078600	<b>186532</b>
92078700	<b>186533</b>
92079400	<b>186446</b>
92079600	<b>186665</b>
92079700	<b>186476</b>
92079800	<b>186719</b>
92079900	<b>186564</b>
92080000	<b>186654</b>
92080200	<b>186564</b>
92080400	<b>186637</b>
92080500	<b>186645</b>
92080600	<b>186638</b>
92080700	<b>186579</b>
92080800	<b>186514</b>
92081100	<b>186207</b>
92081200	<b>186775</b>
92081400	<b>186596</b>
92081500	<b>186436</b>

 	
TEXTAR	
92081500	<b>186439</b>
92081600	<b>186439</b>
92082000	<b>186503</b>
92082100	<b>186476</b>
92082200	<b>186603</b>
92082203	<b>186603</b>
92082300	<b>186604</b>
92082305	<b>186604</b>
92082400	<b>197230</b>
92082500	<b>186597</b>
92082503	<b>186597</b>
92082700	<b>186640</b>
92082800	<b>186311</b>
92082900	<b>186648</b>
92083100	<b>186644</b>
92083200	<b>186643</b>
92083500	<b>186582</b>
92083505	<b>186582</b>
92083600	<b>186583</b>
92083700	<b>186725</b>
92083703	<b>186725</b>
92083800	<b>186682</b>
92083803	<b>186682</b>
92087300	<b>186612</b>
92088000	<b>186589</b>
92088100	<b>186278</b>
92088200	<b>186537</b>
92088400	<b>186425</b>
92088403	<b>186425</b>
92088500	<b>186773</b>
92088503	<b>186773</b>
92089100	<b>186599</b>
92089400	<b>186818</b>
92089800	<b>197059</b>
92089803	<b>197059</b>
92090000	<b>186753</b>
92090003	<b>186753</b>
92090100	<b>186620</b>
92090200	<b>186681</b>
92090300	<b>186571</b>
92090400	<b>186714</b>
92090500	<b>186511</b>
92090800	<b>186294</b>
92090900	<b>186576</b>
92091000	<b>186577</b>
92091200	<b>186582</b>
92091203	<b>186582</b>
92091300	<b>186573</b>
92091303	<b>186573</b>
92091400	<b>186585</b>
92091400	<b>197223</b>
92091500	<b>197004</b>
92091600	<b>186685</b>
92091700	<b>186591</b>
92091800	<b>186592</b>
92091803	<b>186592</b>
92091900	<b>186684</b>
92091903	<b>186684</b>
92092000	<b>186594</b>
92092003	<b>186594</b>

 	
TEXTAR	
92092100	<b>186593</b>
92092103	<b>186593</b>
92092300	<b>197056</b>
92092600	<b>186495</b>
92092800	<b>186598</b>
92092803	<b>186598</b>
92093100	<b>186691</b>
92093200	<b>186827</b>
92093300	<b>186704</b>
92093500	<b>186686</b>
92093600	<b>197224</b>
92093700	<b>186572</b>
92093800	<b>186442</b>
92093900	<b>186443</b>
92094300	<b>197148</b>
92094500	<b>186611</b>
92094600	<b>186503</b>
92095000	<b>186664</b>
92095200	<b>186642</b>
92096200	<b>186163</b>
92096200	<b>186560</b>
92096203	<b>186560</b>
92096400	<b>186605</b>
92096500	<b>186846</b>
92096800	<b>197063</b>
92096900	<b>186705</b>
92096903	<b>186705</b>
92097100	<b>197231</b>
92097200	<b>186815</b>
92097205	<b>186815</b>
92097300	<b>186861</b>
92097305	<b>186861</b>
92097500	<b>197229</b>
92097600	<b>186859</b>
92097603	<b>186859</b>
92097700	<b>186688</b>
92097900	<b>186874</b>
92098100	<b>186801</b>
92098103	<b>186801</b>
92098200	<b>186729</b>
92098500	<b>197246</b>
92098600	<b>197088</b>
92098603	<b>197088</b>
92099600	<b>186783</b>
92099603	<b>186783</b>
92099700	<b>186760</b>
92099703	<b>186760</b>
92099800	<b>186488</b>
92100200	<b>197009</b>
92100300	<b>186742</b>
92100400	<b>186707</b>
92100500	<b>186789</b>
92100503	<b>186789</b>
92100600	<b>186741</b>
92100603	<b>186741</b>
92100700	<b>186841</b>
92100703	<b>186841</b>
92100900	<b>186208</b>
92101000	<b>186778</b>
92102600	<b>186743</b>

 	
TEXTAR	
92102800	<b>186777</b>
92102900	<b>186687</b>
92103000	<b>197161</b>
92103100	<b>186810</b>
92103200	<b>186811</b>
92103205	<b>186811</b>
92103400	<b>186814</b>
92103500	<b>197016</b>
92103600	<b>186587</b>
92103700	<b>197108</b>
92103800	<b>186710</b>
92103900	<b>186648</b>
92104100	<b>197124</b>
92104103	<b>197124</b>
92104400	<b>197207</b>
92105200	<b>197033</b>
92105300	<b>187045</b>
92105800	<b>197011</b>
92105803	<b>197011</b>
92105900	<b>186467</b>
92105900	<b>186864</b>
92105903	<b>186864</b>
92106100	<b>186758</b>
92106105	<b>186758</b>
92106200	<b>186807</b>
92106203	<b>186807</b>
92106300	<b>186856</b>
92106303	<b>186856</b>
92106400	<b>186788</b>
92106500	<b>186603</b>
92106600	<b>197230</b>
92106603	<b>197230</b>
92106700	<b>197198</b>
92106705	<b>197198</b>
92106800	<b>186888</b>
92106900	<b>186731</b>
92106905	<b>186731</b>
92107000	<b>186883</b>
92107003	<b>186883</b>
92107100	<b>186884</b>
92107105	<b>186884</b>
92107200	<b>186808</b>
92107203	<b>186808</b>
92107300	<b>186808</b>
92107400	<b>186809</b>
92107403	<b>186809</b>
92107500	<b>186762</b>
92107503	<b>186762</b>
92107600	<b>186812</b>
92107605	<b>186812</b>
92107700	<b>186745</b>
92107703	<b>186745</b>
92107800	<b>197220</b>
92107900	<b>186736</b>
92108200	<b>197233</b>
92108300	<b>197069</b>
92108400	<b>197022</b>
92108700	<b>186730</b>
92109200	<b>186781</b>
92109300	<b>186821</b>

 	
TEXTAR	
92109400	<b>186728</b>
92109600	<b>186750</b>
92109700	<b>186834</b>
92109800	<b>197239</b>
92109803	<b>197239</b>
92109900	<b>186800</b>
92109903	<b>186800</b>
92110000	<b>186709</b>
92110003	<b>186709</b>
92110100	<b>186780</b>
92110300	<b>186866</b>
92110300	<b>197146</b>
92110800	<b>186784</b>
92110803	<b>186784</b>
92110900	<b>197244</b>
92110903	<b>197244</b>
92111000	<b>186791</b>
92111003	<b>186791</b>
92111100	<b>186759</b>
92111103	<b>186759</b>
92111200	<b>186740</b>
92111300	<b>186757</b>
92111303	<b>186757</b>
92111400	<b>186790</b>
92111403	<b>186790</b>
92111500	<b>186695</b>
92111503	<b>186695</b>
92111600	<b>186693</b>
92111603	<b>186693</b>
92111700	<b>186694</b>
92111703	<b>186694</b>
92111800	<b>186702</b>
92111900	<b>186703</b>
92112000	<b>186785</b>
92112300	<b>197240</b>
92112700	<b>186647</b>
92113300	<b>197163</b>
92113600	<b>197238</b>
92113800	<b>186600</b>
92113900	<b>186655</b>
92113900	<b>186717</b>
92113903	<b>186655</b>
92114700	<b>186797</b>
92114900	<b>197206</b>
92115000	<b>197219</b>
92115100	<b>186751</b>
92115105	<b>186751</b>
92115200	<b>186751</b>
92115205	<b>186751</b>
92115400	<b>197035</b>
92115405	<b>197035</b>
92115500	<b>186865</b>
92115505	<b>186865</b>
92115600	<b>186766</b>
92115700	<b>186871</b>
92115800	<b>197137</b>
92115900	<b>186868</b>
92116000	<b>186712</b>
92116200	<b>186708</b>
92116600	<b>186418</b>







 <b>Valeo</b>	
<b>TEXTAR</b>	
92116700	<b>197228</b>
92116800	<b>197138</b>
92116900	<b>186454</b>
92117100	<b>197120</b>
92117300	<b>197032</b>
92117303	<b>197032</b>
92117900	<b>197157</b>
92118000	<b>186744</b>
92118200	<b>186724</b>
92118300	<b>186880</b>
92118303	<b>186880</b>
92118400	<b>186882</b>
92118403	<b>186882</b>
92118500	<b>186854</b>
92118503	<b>186854</b>
92118600	<b>186805</b>
92118700	<b>186881</b>
92118703	<b>186881</b>
92118900	<b>186715</b>
92119000	<b>197221</b>
92119100	<b>186718</b>
92119200	<b>186764</b>
92119203	<b>186764</b>
92119300	<b>186796</b>
92119400	<b>186804</b>
92119500	<b>186893</b>
92119503	<b>186894</b>
92119600	<b>197136</b>
92119700	<b>197252</b>
92119800	<b>197200</b>
92120500	<b>197242</b>
92120600	<b>197197</b>
92120700	<b>186754</b>
92120705	<b>186754</b>
92120800	<b>186755</b>
92120805	<b>186755</b>
92120900	<b>186857</b>
92120903	<b>186857</b>
92121000	<b>197222</b>
92121003	<b>197222</b>
92121100	<b>186833</b>
92121103	<b>186833</b>
92121200	<b>186756</b>
92121300	<b>186885</b>
92121303	<b>186885</b>
92121400	<b>186886</b>
92121403	<b>186886</b>
92121500	<b>197087</b>
92121505	<b>197087</b>
92121900	<b>197243</b>
92121903	<b>197243</b>
92122000	<b>197090</b>
92122005	<b>197090</b>
92122300	<b>186582</b>
92122305	<b>186582</b>
92122500	<b>186732</b>
92122505	<b>186732</b>
92122600	<b>197193</b>
92122605	<b>197193</b>
92122700	<b>197084</b>



 <b>Valeo</b>	
<b>TEXTAR</b>	
92122703	<b>197084</b>
92124400	<b>186783</b>
92124403	<b>186783</b>
92124500	<b>197060</b>
92124503	<b>197060</b>
92124600	<b>186869</b>
92124603	<b>186869</b>
92124700	<b>186855</b>
92124703	<b>186855</b>
92124800	<b>186748</b>
92124900	<b>197013</b>
92125000	<b>197144</b>
92125100	<b>197104</b>
92125300	<b>197103</b>
92125400	<b>197014</b>
92125500	<b>197245</b>
92125503	<b>197245</b>
92125600	<b>186851</b>
92125603	<b>186851</b>
92125800	<b>186877</b>
92126000	<b>197171</b>
92126100	<b>186848</b>
92126200	<b>186847</b>
92126300	<b>197019</b>
92126600	<b>197057</b>
92126603	<b>197057</b>
92128300	<b>197086</b>
92128500	<b>197173</b>
92128700	<b>186845</b>
92128800	<b>186813</b>
92129300	<b>186869</b>
92129303	<b>186869</b>
92129400	<b>186746</b>
92129500	<b>197046</b>
92129600	<b>186747</b>
92129700	<b>197062</b>
92130200	<b>197020</b>
92130300	<b>186872</b>
92130500	<b>197021</b>
92130800	<b>186823</b>
92131000	<b>197172</b>
92131200	<b>197064</b>
92131500	<b>186774</b>
92131503	<b>186774</b>
92131600	<b>186712</b>
92131603	<b>186713</b>
92131800	<b>186798</b>
92131803	<b>186798</b>
92131900	<b>186799</b>
92131903	<b>186799</b>
92132000	<b>197091</b>
92132003	<b>197091</b>
92132100	<b>197036</b>
92132103	<b>197036</b>
92132200	<b>197052</b>
92132205	<b>197052</b>
92132300	<b>197199</b>
92132305	<b>197199</b>
92132400	<b>197142</b>
92132405	<b>197142</b>



 <b>Valeo</b>	
<b>TEXTAR</b>	
92132500	<b>197125</b>
92132503	<b>197125</b>
92132600	<b>197140</b>
92132603	<b>197140</b>
92132700	<b>186816</b>
92132703	<b>186816</b>
92132800	<b>186817</b>
92133000	<b>197049</b>
92133003	<b>197049</b>
92133200	<b>197232</b>
92133300	<b>186840</b>
92133700	<b>186842</b>
92133703	<b>186842</b>
92133800	<b>186843</b>
92133803	<b>186843</b>
92134000	<b>197027</b>
92134100	<b>186879</b>
92134500	<b>197155</b>
92134800	<b>197214</b>
92134803	<b>197214</b>
92134900	<b>197129</b>
92134903	<b>197129</b>
92135300	<b>186805</b>
92135303	<b>186805</b>
92135400	<b>197166</b>
92135403	<b>197166</b>
92135500	<b>197072</b>
92135503	<b>197072</b>
92135700	<b>186849</b>
92135703	<b>186849</b>
92135800	<b>197168</b>
92135900	<b>186850</b>
92135903	<b>186850</b>
92136400	<b>186824</b>
92136600	<b>186829</b>
92136800	<b>197065</b>
92137000	<b>197038</b>
92137003	<b>197038</b>
92137300	<b>197071</b>
92137500	<b>197033</b>
92137503	<b>197033</b>
92137600	<b>187045</b>
92137603	<b>187045</b>
92137700	<b>197234</b>
92137800	<b>197073</b>
92137900	<b>197175</b>
92137903	<b>197175</b>
92138500	<b>197122</b>
92138600	<b>197015</b>
92139700	<b>186765</b>
92140700	<b>197139</b>
92140703	<b>197139</b>
92140800	<b>197031</b>
92140803	<b>197031</b>
92140900	<b>197145</b>
92141200	<b>186819</b>
92141203	<b>186819</b>
92141300	<b>186863</b>
92141303	<b>186863</b>
92141400	<b>186720</b>

 <b>Valeo</b>	
<b>TEXTAR</b>	
92141500	<b>197083</b>
92141600	<b>197251</b>
92141603	<b>197251</b>
92141900	<b>197047</b>
92141903	<b>197047</b>
92142000	<b>186876</b>
92142003	<b>186876</b>
92142200	<b>186718</b>
92144100	<b>197112</b>
92144200	<b>197018</b>
92144203	<b>197018</b>
92144700	<b>186878</b>
92145000	<b>197247</b>
92145003	<b>197247</b>
92145100	<b>197130</b>
92145200	<b>197098</b>
92145203	<b>197098</b>
92145300	<b>197132</b>
92145303	<b>197132</b>
92145305	<b>197134</b>
92145307	<b>197134</b>
92145700	<b>197044</b>
92145703	<b>197044</b>
92145800	<b>197045</b>
92145803	<b>197045</b>
92145900	<b>197008</b>
92145903	<b>197008</b>
92146000	<b>186295</b>
92146003	<b>186295</b>
92146600	<b>197153</b>
92147100	<b>197096</b>
92147300	<b>197210</b>
92147400	<b>197209</b>
92147600	<b>197156</b>
92148500	<b>197067</b>
92148900	<b>197066</b>
92149100	<b>197143</b>
92149500	<b>197241</b>
92149800	<b>197150</b>
92149803	<b>197150</b>
92150600	<b>197092</b>
92150605	<b>197092</b>
92151800	<b>197249</b>
92151900	<b>197054</b>
92152000	<b>187152</b>
92152200	<b>186582</b>
92153100	<b>186570</b>
92153700	<b>186712</b>
92153703	<b>186713</b>
92153800	<b>186517</b>
92153900	<b>186771</b>
92154000	<b>186768</b>
92154100	<b>186775</b>
92154200	<b>186288</b>
92154203	<b>186288</b>
92154300	<b>186773</b>
92154500	<b>186853</b>
92154900	<b>197158</b>
92155300	<b>197176</b>
92156100	<b>197147</b>

 	
TEXTAR	
92156200	197182
92156300	197113
92156400	197149
92156600	197135
92156900	197188
92157000	197133
92157100	197099
92157200	197248
92157400	197023
92157500	197097
92157600	197105
92157700	186717
92157905	197074
92158400	197070
92159200	197055
92159300	197101
92159600	197203
92160000	197196
92160100	197126
92161300	197029
92161600	197205
92161700	197123
92161900	197111
92162500	197102
92162700	197107
92163100	197128
92163103	197128
92163200	197202
92163203	197202
92163300	197127
92163700	197185
92163800	197183
92163900	197187
92164000	197109
92164100	197110
92164200	197184
92164900	197050
92165400	197190
92165500	197191
92166200	197174
92167000	197116
92167400	197164
92167500	197106
92168000	197070
92168600	197100
92168700	197117
92174100	197017
92175100	186802
92175700	186894
92175700	197003
93019400	186170
93042801	187029
93084400	186614
93089600	187040
93095100	187058
93104600	187147
93104700	187148
93104800	187149
93117600	187061
93123400	186890

 	
TEXTAR	
93123500	186858
93127300	187130
93143200	187141
93143300	197030
93143400	187146
98200 0054	186189
98200 0092 0 1	186226
98200 0093 0 1	186249
98200 0095 0 1	186180
98200 0106 0 1	186245
98200 0114 0 1	186202
98200 0116 0 1	186115
98200 0116 0 1	186116
98200 0119 0 1	186160
98200 0121 0 1	186246
98200 0129 0 1	186139
98200 0135 0 1	186110
98200 0143 0 1	186140
98200 0144 0 1	186128
98200 0149 0 1	186169
98200 0151 0 1	186171
98200 0164 0 1	186142
98200 0172 0 1	186218
98200 0186 0 1	186255
98200 0192 0 1	186117
98200 0193 0 1	186151
98200 0194 0 1	186170
98200 0199 0 1	186171
98200 0199 0 1	186172
98200 0203 0 1	186692
98200 0208 0 1	186186
98200 0209 0 1	186187
98200 0220 0 1	186771
98200 0221 0 1	186143
98200 0229 0 1	186159
98200 0230 0 1	186158
98200 0259 0 1	186113
98200 0260 0 1	186112
98200 0261 0 1	186114
98200 0262 0 1	186273
98200 0263 0 1	186292
98200 0264 0 1	186118
98200 0265 0 1	186119
98200 0269 0 1	186135
98200 0270 0 1	186152
98200 0271 0 1	186205
98200 0273 0 1	186166
98200 0274 0 1	186176
98200 0296 0 1	186188
98200 0298 0 1	186200
98200 0299 0 1	186134
98200 0299 0 1	186197
98200 0310 0 1	186257
98200 0313 0 1	186776
98200 0314 0 1	186256
98200 0318 0 1	186182
98200 0319 0 1	186185
98200 0320 0 1	186184
98200 0324 0 1	186424
98200 0327 0 1	186183

 	
TEXTAR	
98200 0327 0 1	186470
98200 0331 0 1	186210
98200 0336 0 1	186103
98200 0338 0 1	186195
98200 0340 0 1	186150
98200 0342 0 1	186146
98200 0343 0 1	186156
98200 0344 0 1	186206
98200 0345 0 1	186157
98200 0351 0 1	186299
98200 0356 0 1	186479
98200 0360 0 1	186228
98200 0361 0 1	186230
98200 0361 0 1	186803
98200 0362 0 1	186229
98200 0363 0 1	186224
98200 0364 0 1	186214
98200 0366 0 1	186374
98200 0368 0 1	186247
98200 0370 0 1	186770
98200 0372 0 1	186272
98200 0373 0 1	186114
98200 0379 0 1	186168
98200 0380 0 1	186192
98200 0381 0 1	186191
98200 0382 0 1	186190
98200 0385 0 1	186130
98200 0386 0 1	186177
98200 0389 0 1	186178
98200 0391 0 1	186173
98200 0392 0 1	186189
98200 0393 0 1	186625
98200 0404 0 1	186223
98200 0406 0 1	186283
98200 0414 0 1	186155
98200 0415 0 1	186154
98200 0417 0 1	186251
98200 0418 0 1	186288
98200 0420 0 1	186302
98200 0421 0 1	186124
98200 0423 0 1	186125
98200 0428 0 1	187029
98200 0429 0 1	186136
98200 0431 0 1	186194
98200 0432 0 1	186196
98200 0435 0 1	186519
98200 0441 0 1	186102
98200 0442 0 1	186149
98200 0444 0 1	186236
98200 0445 0 1	186613
98200 0463 0 1	186232
98200 0468 0 1	186265
98200 0469 0 1	186290
98200 0474 0 1	197165
98200 0481 0 1	186198
98200 0482 0 1	186199
98200 0485 0 1	186498
98200 0492 0 1	186231
98200 0493 0 1	186213
98200 0494 0 1	186219

 	
TEXTAR	
98200 0495 0 1	186221
98200 0504 0 1	186696
98200 0509 0 1	186162
98200 0510 0 1	186163
98200 0512 0 1	186263
98200 0513 0 1	186264
98200 0515 0 1	186225
98200 0516 0 1	186234
98200 0521 0 1	186148
98200 0529 0 1	186509
98200 0530 0 1	186770
98200 0532 0 1	186147
98200 0535 0 1	186266
98200 0538 0 1	186500
98200 0540 0 1	186131
98200 0542 0 1	186267
98200 0544 0 1	186145
98200 0545 0 1	186144
98200 0549 0 1	186208
98200 0550 0 1	186416
98200 0552 0 1	186297
98200 0554 0 1	186289
98200 0555 0 1	186274
98200 0556 0 1	186275
98200 0557 0 1	186295
98200 0558 0 1	186511
98200 0559 0 1	186314
98200 0560 0 1	186315
98200 0562 0 1	186301
98200 0563 0 1	186485
98200 0564 0 1	186487
98200 0565 0 1	186282
98200 0568 0 1	186465
98200 0570 0 1	186490
98200 0571 0 1	186313
98200 0572 0 1	186517
98200 0573 0 1	186460
98200 0574 0 1	186270
98200 0575 0 1	186294
98200 0576 0 1	197222
98200 0577 0 1	197225
98200 0578 0 1	186268
98200 0579 0 1	186461
98200 0580 0 1	186462
98200 0585 0 1	197218
98200 0593 0 1	186298
98200 0594 0 1	186280
98200 0595 0 1	186281
98200 0596 0 1	186296
98200 0597 0 1	186586
98200 0599 0 1	186621
98200 0602 0 1	186185
98200 0604 0 1	186269
98200 0606 0 1	186291
98200 0607 0 1	186431
98200 0608 0 1	186435
98200 0609 0 1	186438
98200 0610 0 1	186405
98200 0611 0 1	186155
98200 0611 0 1	186406





<b>TEXTAR</b>	
98200 0613 0 1	<b>186284</b>
98200 0615 0 1	<b>186449</b>
98200 0616 0 1	<b>186451</b>
98200 0617 0 1	<b>186452</b>
98200 0618 0 1	<b>186446</b>
98200 0619 0 1	<b>186455</b>
98200 0620 0 1	<b>186457</b>
98200 0621 0 1	<b>186458</b>
98200 0626 0 1	<b>186441</b>
98200 0627 0 1	<b>186617</b>
98200 0628 0 1	<b>186440</b>
98200 0632 0 1	<b>186482</b>
98200 0633 0 1	<b>186300</b>
98200 0635 0 1	<b>186277</b>
98200 0636 0 1	<b>186426</b>
98200 0642 0 1	<b>197094</b>
98200 0643 0 1	<b>186427</b>
98200 0644 0 1	<b>186428</b>
98200 0645 0 1	<b>186303</b>
98200 0648 0 1	<b>186304</b>
98200 0649 0 1	<b>186306</b>
98200 0650 0 1	<b>186305</b>
98200 0651 0 1	<b>186307</b>
98200 0655 0 1	<b>186510</b>
98200 0656 0 1	<b>186287</b>
98200 0657 0 1	<b>186530</b>
98200 0660 0 1	<b>186504</b>
98200 0662 0 1	<b>186496</b>
98200 0666 0 1	<b>186453</b>
98200 0667 0 1	<b>186526</b>
98200 0668 0 1	<b>186528</b>
98200 0673 0 1	<b>186276</b>
98200 0677 0 1	<b>186165</b>
98200 0678 0 1	<b>186520</b>
98200 0682 0 1	<b>186807</b>
98200 0685 0 1	<b>186153</b>
98200 0686 0 1	<b>186220</b>
98200 0687 0 1	<b>186567</b>
98200 0688 0 1	<b>186497</b>
98200 0689 0 1	<b>186652</b>
98200 0690 0 1	<b>186505</b>
98200 0695 0 1	<b>186652</b>
98200 0696 0 1	<b>186590</b>
98200 0698 0 1	<b>186299</b>
98200 0703 0 1	<b>186768</b>
98200 0704 0 1	<b>186768</b>
98200 0705 0 1	<b>186285</b>
98200 0706 0 1	<b>186286</b>
98200 0707 0 1	<b>186508</b>
98200 0714 0 1	<b>197227</b>
98200 0716 0 1	<b>186408</b>
98200 0719 0 1	<b>186581</b>
98200 0720 0 1	<b>186523</b>
98200 0721 0 1	<b>186773</b>
98200 0723 0 1	<b>186839</b>
98200 0724 0 1	<b>186559</b>
98200 0725 0 1	<b>186467</b>
98200 0727 0 1	<b>186469</b>
98200 0728 0 1	<b>186521</b>
98200 0730 0 1	<b>186470</b>



<b>TEXTAR</b>	
98200 0734 0 1	<b>197033</b>
98200 0736 0 1	<b>187045</b>
98200 0737 0 1	<b>197217</b>
98200 0738 0 1	<b>186418</b>
98200 0738 0 1	<b>197043</b>
98200 0739 0 1	<b>197131</b>
98200 0739 0 1	<b>197228</b>
98200 0740 0 1	<b>186420</b>
98200 0741 0 1	<b>186421</b>
98200 0742 0 1	<b>197236</b>
98200 0743 0 1	<b>186624</b>
98200 0744 0 1	<b>186551</b>
98200 0745 0 1	<b>186552</b>
98200 0746 0 1	<b>186653</b>
98200 0748 0 1	<b>186563</b>
98200 0750 0 1	<b>186697</b>
98200 0751 0 1	<b>186860</b>
98200 0753 0 1	<b>186529</b>
98200 0754 0 1	<b>186401</b>
98200 0755 0 1	<b>186565</b>
98200 0756 0 1	<b>197226</b>
98200 0757 0 1	<b>186566</b>
98200 0758 0 1	<b>186488</b>
98200 0759 0 1	<b>186585</b>
98200 0763 0 1	<b>186547</b>
98200 0764 0 1	<b>186628</b>
98200 0765 0 1	<b>186875</b>
98200 0766 0 1	<b>186568</b>
98200 0768 0 1	<b>186569</b>
98200 0772 0 1	<b>186701</b>
98200 0774 0 1	<b>197169</b>
98200 0775 0 1	<b>186822</b>
98200 0776 0 1	<b>197167</b>
98200 0777 0 1	<b>197166</b>
98200 0778 0 1	<b>186433</b>
98200 0779 0 1	<b>186432</b>
98200 0780 0 1	<b>186286</b>
98200 0781 0 1	<b>186439</b>
98200 0782 0 1	<b>186699</b>
98200 0786 0 1	<b>186532</b>
98200 0787 0 1	<b>186533</b>
98200 0794 0 1	<b>186446</b>
98200 0796 0 1	<b>186665</b>
98200 0797 0 1	<b>186476</b>
98200 0798 0 1	<b>186719</b>
98200 0799 0 1	<b>186564</b>
98200 0800 0 1	<b>186654</b>
98200 0802 0 1	<b>186564</b>
98200 0804 0 1	<b>186637</b>
98200 0805 0 1	<b>186645</b>
98200 0806 0 1	<b>186638</b>
98200 0807 0 1	<b>186579</b>
98200 0808 0 1	<b>186514</b>
98200 0811 0 1	<b>186207</b>
98200 0812 0 1	<b>186775</b>
98200 0814 0 1	<b>186596</b>
98200 0815 0 1	<b>186436</b>
98200 0815 0 1	<b>186439</b>
98200 0816 0 1	<b>186439</b>
98200 0820 0 1	<b>186503</b>



<b>TEXTAR</b>	
98200 0821 0 1	<b>186476</b>
98200 0822 0 1	<b>186603</b>
98200 0823 0 1	<b>186604</b>
98200 0824 0 1	<b>197230</b>
98200 0825 0 1	<b>186597</b>
98200 0827 0 1	<b>186640</b>
98200 0828 0 1	<b>186311</b>
98200 0829 0 1	<b>186648</b>
98200 0831 0 1	<b>186644</b>
98200 0832 0 1	<b>186643</b>
98200 0835 0 1	<b>186582</b>
98200 0836 0 1	<b>186583</b>
98200 0837 0 1	<b>186725</b>
98200 0838 0 1	<b>186682</b>
98200 0844 0 1	<b>186614</b>
98200 0873 0 1	<b>186612</b>
98200 0880 0 1	<b>186589</b>
98200 0881 0 1	<b>186278</b>
98200 0882 0 1	<b>186537</b>
98200 0884 0 1	<b>186425</b>
98200 0885 0 1	<b>186773</b>
98200 0891 0 1	<b>186599</b>
98200 0894 0 1	<b>186818</b>
98200 0896 0 1	<b>187040</b>
98200 0898 0 1	<b>197059</b>
98200 0900 0 1	<b>186753</b>
98200 0901 0 1	<b>186620</b>
98200 0902 0 1	<b>186681</b>
98200 0903 0 1	<b>186571</b>
98200 0904 0 1	<b>186714</b>
98200 0908 0 1	<b>186294</b>
98200 0909 0 1	<b>186576</b>
98200 0910 0 1	<b>186577</b>
98200 0912 0 1	<b>186562</b>
98200 0913 0 1	<b>186573</b>
98200 0914 0 1	<b>197223</b>
98200 0915 0 1	<b>197004</b>
98200 0916 0 1	<b>186685</b>
98200 0917 0 1	<b>186591</b>
98200 0918 0 1	<b>186592</b>
98200 0919 0 1	<b>186684</b>
98200 0920 0 1	<b>186594</b>
98200 0921 0 1	<b>186593</b>
98200 0923 0 1	<b>197056</b>
98200 0926 0 1	<b>186495</b>
98200 0928 0 1	<b>186598</b>
98200 0931 0 1	<b>186691</b>
98200 0932 0 1	<b>186827</b>
98200 0933 0 1	<b>186704</b>
98200 0935 0 1	<b>186686</b>
98200 0936 0 1	<b>197224</b>
98200 0937 0 1	<b>186572</b>
98200 0938 0 1	<b>186442</b>
98200 0939 0 1	<b>186443</b>
98200 0943 0 1	<b>197148</b>
98200 0945 0 1	<b>186611</b>
98200 0946 0 1	<b>186503</b>
98200 0950 0 1	<b>186664</b>
98200 0951 0 1	<b>187058</b>
98200 0952 0 1	<b>186642</b>



<b>TEXTAR</b>	
98200 0962 0 1	<b>186560</b>
98200 0964 0 1	<b>186605</b>
98200 0965 0 1	<b>186846</b>
98200 0968 0 1	<b>197063</b>
98200 0969 0 1	<b>186705</b>
98200 0971 0 1	<b>197231</b>
98200 0972 0 1	<b>186815</b>
98200 0973 0 1	<b>186861</b>
98200 0975 0 1	<b>197229</b>
98200 0976 0 1	<b>186859</b>
98200 0977 0 1	<b>186688</b>
98200 0979 0 1	<b>186874</b>
98200 0981 0 1	<b>186801</b>
98200 0982 0 1	<b>186729</b>
98200 0985 0 1	<b>197246</b>
98200 0986 0 1	<b>197088</b>
98200 0996 0 1	<b>186783</b>
98200 0997 0 1	<b>186760</b>
98200 0998 0 1	<b>186488</b>
98200 1002 0 1	<b>197009</b>
98200 1003 0 1	<b>186742</b>
98200 1004 0 1	<b>186707</b>
98200 1005 0 1	<b>186789</b>
98200 1006 0 1	<b>186741</b>
98200 1007 0 1	<b>186841</b>
98200 1009 0 1	<b>186208</b>
98200 1010 0 1	<b>186778</b>
98200 1026 0 1	<b>186743</b>
98200 1028 0 1	<b>186777</b>
98200 1029 0 1	<b>186687</b>
98200 1030 0 1	<b>197161</b>
98200 1031 0 1	<b>186810</b>
98200 1032 0 1	<b>186811</b>
98200 1034 0 1	<b>186814</b>
98200 1035 0 1	<b>197016</b>
98200 1036 0 1	<b>186587</b>
98200 1037 0 1	<b>197108</b>
98200 1038 0 1	<b>186710</b>
98200 1039 0 1	<b>186648</b>
98200 1041 0 1	<b>197124</b>
98200 1044 0 1	<b>197207</b>
98200 1046 0 1	<b>187147</b>
98200 1047 0 1	<b>187148</b>
98200 1048 0 1	<b>187149</b>
98200 1052 0 1	<b>197033</b>
98200 1058 0 1	<b>197011</b>
98200 1059 0 1	<b>186864</b>
98200 1061 0 1	<b>186758</b>
98200 1062 0 1	<b>186807</b>
98200 1063 0 1	<b>186856</b>
98200 1064 0 1	<b>186788</b>
98200 1065 0 1	<b>186603</b>
98200 1066 0 1	<b>197230</b>
98200 1067 0 1	<b>197198</b>
98200 1068 0 1	<b>186888</b>
98200 1069 0 1	<b>186731</b>
98200 1070 0 1	<b>186883</b>
98200 1071 0 1	<b>186884</b>
98200 1072 0 1	<b>186808</b>
98200 1073 0 1	<b>186808</b>





 	
TEXTAR	
98200 1074 0 1	<b>186809</b>
98200 1075 0 1	<b>186762</b>
98200 1076 0 1	<b>186812</b>
98200 1077 0 1	<b>186745</b>
98200 1078 0 1	<b>197220</b>
98200 1079 0 1	<b>186736</b>
98200 1082 0 1	<b>197233</b>
98200 1083 0 1	<b>197069</b>
98200 1084 0 1	<b>197022</b>
98200 1087 0 1	<b>186730</b>
98200 1092 0 1	<b>186781</b>
98200 1093 0 1	<b>186821</b>
98200 1094 0 1	<b>186728</b>
98200 1096 0 1	<b>186750</b>
98200 1097 0 1	<b>186834</b>
98200 1098 0 1	<b>197239</b>
98200 1099 0 1	<b>186800</b>
98200 1100 0 1	<b>186709</b>
98200 1101 0 1	<b>186780</b>
98200 1103 0 1	<b>186866</b>
98200 1103 0 1	<b>197146</b>
98200 1108 0 1	<b>186784</b>
98200 1109 0 1	<b>197244</b>
98200 1110 0 1	<b>186791</b>
98200 1111 0 1	<b>186759</b>
98200 1112 0 1	<b>186740</b>
98200 1113 0 1	<b>186757</b>
98200 1114 0 1	<b>186790</b>
98200 1115 0 1	<b>186695</b>
98200 1116 0 1	<b>186693</b>
98200 1117 0 1	<b>186694</b>
98200 1118 0 1	<b>186702</b>
98200 1119 0 1	<b>186703</b>
98200 1120 0 1	<b>186785</b>
98200 1123 0 1	<b>197240</b>
98200 1127 0 1	<b>186647</b>
98200 1133 0 1	<b>197163</b>
98200 1136 0 1	<b>197238</b>
98200 1138 0 1	<b>186600</b>
98200 1139 0 1	<b>186655</b>
98200 1147 0 1	<b>186797</b>
98200 1149 0 1	<b>197206</b>
98200 1150 0 1	<b>197219</b>
98200 1151 0 1	<b>186751</b>
98200 1152 0 1	<b>186751</b>
98200 1154 0 1	<b>197035</b>
98200 1155 0 1	<b>186865</b>
98200 1156 0 1	<b>186766</b>
98200 1157 0 1	<b>186871</b>
98200 1158 0 1	<b>197137</b>
98200 1159 0 1	<b>186868</b>
98200 1160 0 1	<b>186712</b>
98200 1162 0 1	<b>186708</b>
98200 1166 0 1	<b>186418</b>
98200 1168 0 1	<b>197138</b>
98200 1169 0 1	<b>186454</b>
98200 1171 0 1	<b>197120</b>
98200 1173 0 1	<b>197032</b>
98200 1176 0 1	<b>187061</b>
98200 1179 0 1	<b>197157</b>



 	
TEXTAR	
98200 1180 0 1	<b>186744</b>
98200 1182 0 1	<b>186724</b>
98200 1183 0 1	<b>186880</b>
98200 1184 0 1	<b>186882</b>
98200 1185 0 1	<b>186854</b>
98200 1186 0 1	<b>186805</b>
98200 1187 0 1	<b>186881</b>
98200 1189 0 1	<b>186715</b>
98200 1190 0 1	<b>197221</b>
98200 1191 0 1	<b>186718</b>
98200 1192 0 1	<b>186764</b>
98200 1193 0 1	<b>186796</b>
98200 1194 0 1	<b>186804</b>
98200 1195 0 1	<b>186893</b>
98200 1195 0 1	<b>186894</b>
98200 1196 0 1	<b>197136</b>
98200 1197 0 1	<b>197252</b>
98200 1198 0 1	<b>197200</b>
98200 1205 0 1	<b>197242</b>
98200 1206 0 1	<b>197197</b>
98200 1207 0 1	<b>186754</b>
98200 1208 0 1	<b>186755</b>
98200 1209 0 1	<b>186857</b>
98200 1210 0 1	<b>197222</b>
98200 1211 0 1	<b>186833</b>
98200 1212 0 1	<b>186756</b>
98200 1213 0 1	<b>186885</b>
98200 1214 0 1	<b>186886</b>
98200 1215 0 1	<b>197087</b>
98200 1219 0 1	<b>197243</b>
98200 1220 0 1	<b>197090</b>
98200 1223 0 1	<b>186582</b>
98200 1225 0 1	<b>186732</b>
98200 1226 0 1	<b>197193</b>
98200 1227 0 1	<b>197084</b>
98200 1234 0 1	<b>186890</b>
98200 1235 0 1	<b>186858</b>
98200 1244 0 1	<b>186783</b>
98200 1245 0 1	<b>197060</b>
98200 1246 0 1	<b>186869</b>
98200 1247 0 1	<b>186855</b>
98200 1248 0 1	<b>186748</b>
98200 1249 0 1	<b>197013</b>
98200 1250 0 1	<b>197144</b>
98200 1251 0 1	<b>197104</b>
98200 1253 0 1	<b>197103</b>
98200 1254 0 1	<b>197014</b>
98200 1255 0 1	<b>197245</b>
98200 1256 0 1	<b>186851</b>
98200 1258 0 1	<b>186877</b>
98200 1260 0 1	<b>197171</b>
98200 1261 0 1	<b>186848</b>
98200 1262 0 1	<b>186847</b>
98200 1263 0 1	<b>197019</b>
98200 1266 0 1	<b>197057</b>
98200 1273 0 1	<b>187130</b>
98200 1283 0 1	<b>197086</b>
98200 1285 0 1	<b>197173</b>
98200 1288 0 1	<b>186813</b>
98200 1293 0 1	<b>186869</b>



 	
TEXTAR	
98200 1294 0 1	<b>186746</b>
98200 1295 0 1	<b>197046</b>
98200 1296 0 1	<b>186747</b>
98200 1297 0 1	<b>197062</b>
98200 1302 0 1	<b>197020</b>
98200 1303 0 1	<b>186872</b>
98200 1305 0 1	<b>197021</b>
98200 1308 0 1	<b>186823</b>
98200 1310 0 1	<b>197172</b>
98200 1312 0 1	<b>197064</b>
98200 1315 0 1	<b>186774</b>
98200 1316 0 1	<b>186712</b>
98200 1316 0 1	<b>186713</b>
98200 1318 0 1	<b>186798</b>
98200 1319 0 1	<b>186799</b>
98200 1320 0 1	<b>197091</b>
98200 1321 0 1	<b>197036</b>
98200 1322 0 1	<b>197052</b>
98200 1323 0 1	<b>197199</b>
98200 1324 0 1	<b>197142</b>
98200 1325 0 1	<b>197125</b>
98200 1326 0 1	<b>197140</b>
98200 1327 0 1	<b>186816</b>
98200 1328 0 1	<b>186817</b>
98200 1330 0 1	<b>197049</b>
98200 1332 0 1	<b>197232</b>
98200 1333 0 1	<b>186840</b>
98200 1337 0 1	<b>186842</b>
98200 1338 0 1	<b>186843</b>
98200 1340 0 1	<b>197027</b>
98200 1341 0 1	<b>186879</b>
98200 1345 0 1	<b>197155</b>
98200 1348 0 1	<b>197214</b>
98200 1349 0 1	<b>197129</b>
98200 1353 0 1	<b>186805</b>
98200 1354 0 1	<b>197166</b>
98200 1355 0 1	<b>197072</b>
98200 1357 0 1	<b>186849</b>
98200 1358 0 1	<b>197168</b>
98200 1359 0 1	<b>186850</b>
98200 1364 0 1	<b>186824</b>
98200 1366 0 1	<b>186829</b>
98200 1368 0 1	<b>197065</b>
98200 1370 0 1	<b>197038</b>
98200 1373 0 1	<b>197071</b>
98200 1375 0 1	<b>197033</b>
98200 1376 0 1	<b>187045</b>
98200 1377 0 1	<b>197234</b>
98200 1378 0 1	<b>197073</b>
98200 1379 0 1	<b>197175</b>
98200 1385 0 1	<b>197122</b>
98200 1386 0 1	<b>197015</b>
98200 1397 0 1	<b>186765</b>
98200 1408 0 1	<b>197031</b>
98200 1409 0 1	<b>197145</b>
98200 1412 0 1	<b>186819</b>
98200 1413 0 1	<b>186863</b>
98200 1414 0 1	<b>186720</b>
98200 1415 0 1	<b>197083</b>
98200 1416 0 1	<b>197251</b>



 	
TEXTAR	
98200 1419 0 1	<b>197047</b>
98200 1420 0 1	<b>186876</b>
98200 1422 0 1	<b>186718</b>
98200 1432 0 1	<b>187141</b>
98200 1433 0 1	<b>197030</b>
98200 1434 0 1	<b>187146</b>
98200 1441 0 1	<b>197112</b>
98200 1442 0 1	<b>197018</b>
98200 1447 0 1	<b>186878</b>
98200 1450 0 1	<b>197247</b>
98200 1451 0 1	<b>197130</b>
98200 1452 0 1	<b>197098</b>
98200 1453 0 1	<b>197132</b>
98200 1453 0 1	<b>197134</b>
98200 1457 0 1	<b>197044</b>
98200 1458 0 1	<b>197045</b>
98200 1459 0 1	<b>197008</b>
98200 1460 0 1	<b>186295</b>
98200 1466 0 1	<b>197153</b>
98200 1471 0 1	<b>197096</b>
98200 1473 0 1	<b>197210</b>
98200 1474 0 1	<b>197209</b>
98200 1476 0 1	<b>197156</b>
98200 1485 0 1	<b>197067</b>
98200 1489 0 1	<b>197066</b>
98200 1491 0 1	<b>197143</b>
98200 1495 0 1	<b>197241</b>
98200 1498 0 1	<b>197150</b>
98200 1506 0 1	<b>197092</b>
98200 1518 0 1	<b>197249</b>
98200 1519 0 1	<b>197054</b>
98200 1520 0 1	<b>187152</b>
98200 1522 0 1	<b>186582</b>
98200 1531 0 1	<b>186570</b>
98200 1537 0 1	<b>186712</b>
98200 1537 0 1	<b>186713</b>
98200 1538 0 1	<b>186517</b>
98200 1539 0 1	<b>186771</b>
98200 1540 0 1	<b>186768</b>
98200 1541 0 1	<b>186775</b>
98200 1542 0 1	<b>186288</b>
98200 1543 0 1	<b>186773</b>
98200 1545 0 1	<b>186853</b>
98200 1549 0 1	<b>197158</b>
98200 1561 0 1	<b>197147</b>
98200 1562 0 1	<b>197182</b>
98200 1563 0 1	<b>197113</b>
98200 1566 0 1	<b>197135</b>
98200 1569 0 1	<b>197188</b>
98200 1570 0 1	<b>197133</b>
98200 1571 0 1	<b>197099</b>
98200 1572 0 1	<b>197248</b>
98200 1574 0 1	<b>197023</b>
98200 1575 0 1	<b>197097</b>
98200 1576 0 1	<b>197105</b>
98200 1577 0 1	<b>186717</b>
98200 1579 0 1	<b>197074</b>
98200 1584 0 1	<b>197070</b>
98200 1592 0 1	<b>197055</b>
98200 1593 0 1	<b>197101</b>







	
<b>TEXTAR</b>	
98200 1596 0 1	<b>197203</b>
98200 1600 0 1	<b>197196</b>
98200 1601 0 1	<b>197126</b>
98200 1613 0 1	<b>197029</b>
98200 1616 0 1	<b>197205</b>
98200 1617 0 1	<b>197123</b>
98200 1619 0 1	<b>197111</b>
98200 1625 0 1	<b>197102</b>
98200 1627 0 1	<b>197107</b>
98200 1631 0 1	<b>197128</b>
98200 1632 0 1	<b>197202</b>
98200 1633 0 1	<b>197127</b>
98200 1637 0 1	<b>197185</b>
98200 1638 0 1	<b>197183</b>
98200 1639 0 1	<b>197187</b>
98200 1640 0 1	<b>197109</b>
98200 1641 0 1	<b>197110</b>
98200 1642 0 1	<b>197184</b>
98200 1649 0 1	<b>197050</b>
98200 1654 0 1	<b>197190</b>
98200 1655 0 1	<b>197191</b>
98200 1662 0 1	<b>197174</b>
98200 1670 0 1	<b>197116</b>
98200 1674 0 1	<b>197164</b>
98200 1675 0 1	<b>197106</b>
98200 1680 0 1	<b>197070</b>
98200 1686 0 1	<b>197100</b>
98200 1741 0 1	<b>197017</b>
98200 1751 0 1	<b>186802</b>
98200 1757 0 1	<b>186894</b>
98200 1757 0 1	<b>197003</b>
<b>TRW</b>	
DB4220	<b>186694</b>
DF1001	<b>186142</b>
DF1002	<b>186218</b>
DF1005	<b>186226</b>
DF1010	<b>186211</b>
DF1012	<b>186210</b>
DF1013	<b>186230</b>
DF1013BP	<b>186230</b>
DF1015	<b>186228</b>
DF1016	<b>186229</b>
DF1016BP	<b>186229</b>
DF1017	<b>186214</b>
DF1018	<b>186213</b>
DF1019	<b>186221</b>
DF1020	<b>186224</b>
DF1021	<b>186220</b>
DF1022	<b>186223</b>
DF1023	<b>186231</b>
DF1025	<b>186276</b>
DF1026	<b>186567</b>
DF1027	<b>186596</b>
DF1029	<b>186306</b>
DF1029	<b>186307</b>
DF1030	<b>186306</b>
DF1031	<b>186214</b>
DF1031	<b>186225</b>
DF1032	<b>186304</b>



	
<b>TRW</b>	
DF1032	<b>186655</b>
DF1032BP	<b>186304</b>
DF1032BP	<b>186655</b>
DF1033	<b>186600</b>
DF1036	<b>186305</b>
DF1104	<b>186137</b>
DF1107	<b>186128</b>
DF1109	<b>186140</b>
DF1113	<b>186143</b>
DF1114	<b>186205</b>
DF1115	<b>186139</b>
DF1117	<b>186135</b>
DF1118	<b>186206</b>
DF1119	<b>186136</b>
DF1120	<b>186130</b>
DF1122	<b>186586</b>
DF1123	<b>186296</b>
DF1203	<b>186202</b>
DF1209	<b>186207</b>
DF1210	<b>186196</b>
DF1210	<b>186203</b>
DF1215	<b>186197</b>
DF1216	<b>186134</b>
DF1217	<b>186200</b>
DF1218	<b>186195</b>
DF1220	<b>186198</b>
DF1220BP	<b>186198</b>
DF1221	<b>186194</b>
DF1222	<b>186145</b>
DF1223	<b>186131</b>
DF1224	<b>186196</b>
DF1225	<b>186303</b>
DF1300	<b>186240</b>
DF1400	<b>186299</b>
DF1406	<b>186487</b>
DF1409	<b>186510</b>
DF1409	<b>186511</b>
DF1416	<b>186664</b>
DF1418	<b>186547</b>
DF1422	<b>186665</b>
DF1423	<b>186511</b>
DF1428	<b>186617</b>
DF1430	<b>197167</b>
DF1431	<b>197166</b>
DF1435	<b>186621</b>
DF1436	<b>186433</b>
DF1439	<b>186508</b>
DF1443	<b>186648</b>
DF1516	<b>186245</b>
DF1517	<b>186246</b>
DF1517BP	<b>186246</b>
DF1518	<b>186249</b>
DF1521	<b>186113</b>
DF1524S	<b>186771</b>
DF1526	<b>186114</b>
DF1529	<b>186288</b>
DF1529BP	<b>186288</b>
DF1530	<b>186112</b>
DF1530BP	<b>186112</b>
DF1531	<b>186273</b>



	
<b>TRW</b>	
DF1532	<b>186251</b>
DF1532BP	<b>186251</b>
DF1533	<b>186247</b>
DF1533BP	<b>186247</b>
DF1534	<b>186770</b>
DF1536	<b>186292</b>
DF1537	<b>186274</b>
DF1537BP	<b>186274</b>
DF1538	<b>186275</b>
DF1539	<b>186295</b>
DF1540	<b>186517</b>
DF1540BP	<b>186517</b>
DF1541	<b>186520</b>
DF1544	<b>186770</b>
DF1553	<b>186115</b>
DF1560	<b>186116</b>
DF1561	<b>186117</b>
DF1569	<b>186118</b>
DF1573	<b>186180</b>
DF1581	<b>186182</b>
DF1583	<b>186184</b>
DF1584	<b>186176</b>
DF1585	<b>186185</b>
DF1593	<b>186314</b>
DF1594	<b>186461</b>
DF1595	<b>186462</b>
DF1596	<b>186315</b>
DF1598	<b>186460</b>
DF1599	<b>186692</b>
DF1607	<b>186186</b>
DF1608	<b>186187</b>
DF1608BP	<b>186187</b>
DF1609	<b>186188</b>
DF1612	<b>186192</b>
DF1613	<b>186190</b>
DF1614	<b>186191</b>
DF1619	<b>197004</b>
DF1620	<b>186159</b>
DF1621	<b>186302</b>
DF1622	<b>186278</b>
DF1624	<b>186282</b>
DF1625	<b>186189</b>
DF1627	<b>186500</b>
DF1630	<b>186160</b>
DF1642	<b>186169</b>
DF1647	<b>186165</b>
DF1648	<b>186165</b>
DF1649	<b>186159</b>
DF1651	<b>186424</b>
DF1652	<b>186158</b>
DF1653	<b>186168</b>
DF1654	<b>186425</b>
DF1655	<b>186166</b>
DF1658	<b>186162</b>
DF1662	<b>186530</b>
DF1669	<b>186498</b>
DF1674	<b>186256</b>
DF1679	<b>186257</b>
DF1683	<b>186776</b>
DF1683S	<b>186776</b>

	
<b>TRW</b>	
DF1686	<b>186254</b>
DF1687	<b>186255</b>
DF1688	<b>186264</b>
DF1689	<b>186263</b>
DF1694	<b>186625</b>
DF1696	<b>186311</b>
DF1697	<b>186289</b>
DF1708	<b>186110</b>
DF1716	<b>186103</b>
DF1721	<b>186151</b>
DF1722	<b>186501</b>
DF1723	<b>186171</b>
DF1725	<b>186172</b>
DF1726S	<b>186170</b>
DF1727	<b>186152</b>
DF1734	<b>186102</b>
DF1736	<b>186156</b>
DF1739	<b>186290</b>
DF1740	<b>186155</b>
DF1740	<b>186406</b>
DF1742	<b>186149</b>
DF1743	<b>186148</b>
DF1744	<b>186147</b>
DF1745	<b>186155</b>
DF1745	<b>186406</b>
DF1747	<b>186154</b>
DF1747BP	<b>186154</b>
DF1748	<b>186173</b>
DF1749	<b>186265</b>
DF1757	<b>186297</b>
DF1758S	<b>186614</b>
DF1763S	<b>187029</b>
DF1769	<b>186405</b>
DF1788	<b>186150</b>
DF1790	<b>186146</b>
DF1790	<b>186147</b>
DF1791	<b>186157</b>
DF1802	<b>186310</b>
DF1803	<b>186284</b>
DF1807	<b>186285</b>
DF1810	<b>186232</b>
DF1811	<b>186234</b>
DF1812	<b>186235</b>
DF1828	<b>186236</b>
DF1829	<b>186613</b>
DF1833	<b>186283</b>
DF1856	<b>186495</b>
DF1925	<b>197114</b>
DF1927	<b>186696</b>
DF1953	<b>186374</b>
DF1956	<b>186234</b>
DF1958	<b>186441</b>
DF1963	<b>186431</b>
DF1967	<b>186479</b>
DF2001	<b>186607</b>
DF2002	<b>186611</b>
DF2008S	<b>186612</b>
DF2011	<b>186219</b>
DF2012	<b>186287</b>
DF2024	<b>186436</b>



 	
TRW	
DF2024	186439
DF2550	186119
DF2550BP	186119
DF2555	186124
DF2557	186125
DF2563	186183
DF2564	186258
DF2566	186266
DF2571	186455
DF2573	186235
DF2575	186440
DF2576	186482
DF2579	186178
DF2579S	186178
DF2580	186199
DF2581	186196
DF2581	186416
DF2582	186204
DF2583	186144
DF2586	186208
DF2587	186770
DF2588	186504
DF2590	186301
DF2591	186485
DF2592	186487
DF2596	186465
DF2597	186269
DF2598	186268
DF2599	186267
DF2601	186291
DF2606	186446
DF2607	186446
DF2609	197165
DF2611	186300
DF2614	186490
DF2619	186313
DF2622	186277
DF2623	186426
DF2626	186272
DF2631	186519
DF2639	186428
DF2645	197225
DF2646	186435
DF2647	186428
DF2650	186270
DF2651	186294
DF2652	197222
DF2652	186271
DF2652BP	197222
DF2653	186281
DF2654	186298
DF2655	186807
DF2656	186280
DF2657	186432
DF2657	186435
DF2658	186701
DF2660	186528
DF2662	186454
DF2665	197218
DF2667	186114



 	
TRW	
DF2668	186453
DF2669	186437
DF2671	186526
DF2674	186640
DF2678	186570
DF2678	186730
DF2679	186439
DF2681	186496
DF2682	186427
DF2683	197169
DF2684	197148
DF2686	186153
DF2687	197227
DF2688	186497
DF2702	186451
DF2703	186452
DF2704	186457
DF2705	186458
DF2706	186768
DF2706	186775
DF2708S	186775
DF2709S	186768
DF2715	186421
DF2716	186420
DF2717	186286
DF2719	186449
DF2721	186418
DF2722	197228
DF2723	186638
DF2726	186299
DF2728	197217
DF2729S	186775
DF2730	186408
DF2734	186598
DF2742	186822
DF2751	186401
DF2752	186529
DF2753	186163
DF2753BP	186163
DF2754	186589
DF2755	186581
DF2757	186470
DF2758	186521
DF2759	186643
DF2760	186442
DF2761	186420
DF2761	186443
DF2765	186681
DF2766	197224
DF2767	186559
DF2768	186568
DF2769	186697
DF2771	186773
DF2772	186565
DF2773	186566
DF2775	186714
DF2776	197236
DF2777	186624
DF2778S	197226
DF2779	186467



 	
TRW	
DF2780	186523
DF2781	186579
DF2782	186532
DF2783	186860
DF2784	186647
DF2784BP	186647
DF2785	186537
DF2786	186278
DF2787	187040
DF2788S	187058
DF2790	186774
DF2791S	186642
DF2792	186620
DF2794	186552
DF2795	186585
DF2796	186533
DF2797	186551
DF2798	186648
DF2799	186569
DF2803	186603
DF2803BP	186603
DF2804	186604
DF2804BP	186604
DF2805	186597
DF2805	197442
DF2805BP	186597
DF2806	186582
DF2808	186599
DF2809	186314
DF2809	186682
DF2810	186725
DF2813	186469
DF2814	186177
DF2815	186598
DF3018	186564
DF3021	186438
DF3027	186645
DF3028	186514
DF3031	186653
DF3032	186505
DF3035	186637
DF3037	186509
DF3037	186696
DF3049	186488
DF3084	186439
DF3092	186503
DF3093	186652
DF3095	186476
DF3109	186699
DF3112	186563
DF3115	186652
DF3118	186719
DF3119	186572
DF3165	186628
DF4000	186564
DF4004	186435
DF4006	186654
DF4007	186875
DF4018	186577
DF4019	186576



 	
TRW	
DF4022	186818
DF4025	186605
DF4026	186773
DF4027	197230
DF4028	186778
DF4029	197223
DF4030	186685
DF4032	186648
DF4034	186562
DF4035	186573
DF4036	186560
DF4037	186571
DF4038	186294
DF4039	197032
DF4041	197004
DF4041	197392
DF4042	186592
DF4042BP	186592
DF4043	186591
DF4045	186583
DF4046	186705
DF4048	186684
DF4049	186488
DF4049	197433
DF4050	186594
DF4051	186593
DF4052	197011
DF4053S	186741
DF4054	186707
DF4054BP	186707
DF4055	186815
DF4059	197229
DF4062	186729
DF4064	197246
DF4065	197088
DF4065	197427
DF4066	186841
DF4069	186861
DF4070	197108
DF4075	186691
DF4081	186648
DF4082	186647
DF4087	197033
DF4087S	197033
DF4088S	187045
DF4089	197059
DF4089S	197059
DF4093	186686
DF4100	186876
DF4103	186687
DF4108	186781
DF4109	186600
DF4110	186655
DF4111	186688
DF4112	186587
DF4113	186874
DF4115	186704
DF4117	186827
DF4119	186810
DF4120	197161





	
TRW	
DF4121	197063
DF4122	197120
DF4122	197441
DF4123	186742
DF4126	197124
DF4130	186785
DF4131	186784
DF4132	186777
DF4133	197122
DF4135	186859
DF4141	197220
DF4142	186702
DF4147	186750
DF4151	186780
DF4152	186866
DF4152	197146
DF4152	197420
DF4153	186637
DF4155	197064
DF4156	197162
DF4158	186823
DF4159	186813
DF4160	197170
DF4161	186765
DF4163	186766
DF4163	197418
DF4164	186600
DF4165	186759
DF4166	186731
DF4168	197195
DF4169	186821
DF4170	197238
DF4172	197207
DF4173	197208
DF4179	186715
DF4180	186864
DF4182	197194
DF4182S	197194
DF4183	186693
DF4183BP	186693
DF4184	186695
DF4184BP	186695
DF4185	186694
DF4186	186807
DF4187	186808
DF4187S	186808
DF4189	186809
DF4190	186734
DF4191	186432
DF4194S	197062
DF4195	186753
DF4197	186762
DF4198	186812
DF4200	186791
DF4202	186814
DF4203	197016
DF4204	197168
DF4205	186788
DF4208	186801
DF4209	197198

	
TRW	
DF4209S	197198
DF4211	186856
DF4211	197438
DF4212	186883
DF4213	186839
DF4215	186736
DF4216	186709
DF4217	186710
DF4218	186834
DF4218	197431
DF4220	197137
DF4221	186871
DF4222	186811
DF4222S	186811
DF4223	186760
DF4224	197060
DF4225	186757
DF4226	197231
DF4227	186718
DF4227BS	186718
DF4228	186894
DF4229	197221
DF4229S	197221
DF4230	197240
DF4231	186804
DF4231S	186804
DF4232	197086
DF4233	197056
DF4234	186740
DF4235	186603
DF4236	186790
DF4237	186703
DF4237S	186703
DF4238	186789
DF4240	186845
DF4245	186708
DF4246	197244
DF4246BP	197244
DF4248	186884
DF4248S	186884
DF4249S	186868
DF4253	186888
DF4255	186655
DF4256	186724
DF4257	197219
DF4258S	197198
DF4259S	186717
DF4260S	197079
DF4261	186751
DF4262S	186758
DF4262S	197404
DF4263	197035
DF4265	186880
DF4265S	186880
DF4266	186854
DF4267	186764
DF4270	186865
DF4271	186833
DF4271	197429
DF4272	186720

	
TRW	
DF4272BS	186720
DF4273	186713
DF4273BS	186713
DF4273S	186713
DF4274	186796
DF4275S	186712
DF4276	186857
DF4277	186748
DF4278	197020
DF4279	197009
DF4280S	186804
DF4281	197121
DF4281	197290
DF4283	197302
DF4284	186882
DF4286	197422
DF4287	197027
DF4288	197144
DF4291	197172
DF4293	186881
DF4294	186754
DF4294	197394
DF4295	186755
DF4295	197397
DF4300	186258
DF4301	186311
DF4306S	197087
DF4308S	186756
DF4309S	186885
DF4310S	186800
DF4312	186886
DF4313	186863
DF4314	186819
DF4315	197163
DF4316	186728
DF4317	197400
DF4318	186869
DF4321	186774
DF4322	186783
DF4323	197239
DF4328	197264
DF4331	187061
DF4335	186847
DF4335	197423
DF4336	197022
DF4337	197050
DF4339	197057
DF4344	186855
DF4346	197233
DF4350S	197197
DF4351	186747
DF4352	197089
DF4356	186858
DF4358	197199
DF4358S	197199
DF4358s	197388
DF4359	186732
DF4360	197084
DF4361	197193
DF4362	186746

	
TRW	
DF4363	197232
DF4364	186764
DF4367	186877
DF4369	186813
DF4371	197241
DF4372	186842
DF4372	197430
DF4373	186890
DF4375	186744
DF4376	186805
DF4377	186745
DF4379	186848
DF4381	186802
DF4382	186803
DF4383	186798
DF4384	186872
DF4386	197245
DF4392S	197083
DF4393	186799
DF4394	197209
DF4395	197210
DF4401	197014
DF4402	197103
DF4404	197019
DF4407	186844
DF4407	197013
DF4409	186878
DF4412	197166
DF4413	186893
DF4413BS	186893
DF4414	186853
DF4416	197072
DF4417	186849
DF4419	197021
DF4422	186843
DF4424	186863
DF4425	186843
DF4426	186869
DF4429	197153
DF4432	197145
DF4433	197046
DF4434	197125
DF4434	197426
DF4440	186797
DF4441	197112
DF4442	186851
DF4442	197294
DF4443	186824
DF4445	197070
DF4447	186816
DF4449	186817
DF4450	197049
DF4452	186840
DF4452BS	186840
DF4453	197036
DF4454	197091
DF4457	197214
DF4458	197096
DF4459	197234
DF4460	197073

 →	<b>Valeo</b>
<b>TRW</b>	
DF4461	<b>197175</b>
DF4461S	<b>197175</b>
DF4463	<b>197129</b>
DF4464	<b>197242</b>
DF4464S	<b>197384</b>
DF4465	<b>186819</b>
DF4469	<b>197047</b>
DF4470	<b>197052</b>
DF4471	<b>197092</b>
DF4471S	<b>197092</b>
DF4474	<b>197129</b>
DF4476	<b>197247</b>
DF4477	<b>197098</b>
DF4478	<b>197130</b>
DF4479	<b>197132</b>
DF4480	<b>186850</b>
DF4486	<b>197267</b>
DF4487	<b>197090</b>
DF4494	<b>197071</b>
DF4496	<b>197173</b>
DF4505	<b>186743</b>
DF4508	<b>186730</b>
DF4531	<b>186652</b>
DF4534	<b>197016</b>
DF4542	<b>186728</b>
DF4547	<b>186743</b>
DF4548	<b>186564</b>
DF4550	<b>197069</b>
DF4554	<b>197252</b>
DF4558	<b>197031</b>
DF4561	<b>197018</b>
DF4573	<b>186876</b>
DF4690	<b>186720</b>
DF4690BS	<b>186720</b>
DF4691	<b>186786</b>
DF4692	<b>197044</b>
DF4693	<b>197138</b>
DF4695	<b>197142</b>
DF4695S	<b>197389</b>
DF4698	<b>186825</b>
DF4704	<b>197214</b>
DF4710	<b>186829</b>
DF4713	<b>197104</b>
DF4714	<b>197015</b>
DF4718	<b>197243</b>
DF4737	<b>197045</b>
DF4750	<b>197105</b>
DF4754	<b>197139</b>
DF4756	<b>197038</b>
DF4796	<b>197044</b>
DF4803	<b>197029</b>
DF7162	<b>197393</b>
DF7168	<b>197436</b>
DF7183	<b>197412</b>
DF7218	<b>197406</b>
DF7291	<b>186829</b>
DF7368	<b>197399</b>
DF7381	<b>197440</b>
DF7422	<b>197387</b>
DF7464	<b>197390</b>

 →	<b>Valeo</b>
<b>TRW</b>	
DF7489	<b>197432</b>

 →	<b>Valeo</b>
---	--------------

 →	<b>Valeo</b>
---	--------------

我们尽一切努力确保本产品目录中所包含的信息在印刷时是正确的，但对于这些信息的准确性我们不提供陈述和担保，并且法雷奥销售公司不承担任何由于不准确信息所造成的赔偿责任。

法雷奥销售公司有权更改规格和/或产品的最终构造，恕不另行通知。

本目录中提到的产品件号不一定在所有国家适用。

法雷奥销售公司只接受遵守法雷奥销售公司条款和条件的产品订单。

照片和图纸对法雷奥销售公司不具有约束力。本目录的版权属于法雷奥销售公司。未经法雷奥销售公司事先授权，不得对本出版物的任何部分以任何方式进行复制。

*Every effort has been made to ensure that the information contained in this catalogue is correct at the time of printing, but no warranty or representation is given or made as to the accuracy of such information and Valeo Service does not accept any liability whatsoever for any inaccuracies.*

*Valeo Service reserves the right to alter specifications and/or the final construction of products without notice.*

*Product references referred to in this catalogue may not be available in all countries.*

*All orders for products are only accepted subject to the terms and conditions of Valeo Service.*

*Photographs and drawings are not binding on Valeo Service. The copyright in this publication belongs to Valeo Service exclusively. No part of this publication may be reproduced by any means without the prior authorisation of Valeo Service.*

*La aplicación de los productos sobre vehículos y las especificaciones de los productos que figuran en nuestros catálogos se refieren a la situación del parque de automóviles en la fecha de puesta en circulación de los productos.*

*Valeo Service no asume ninguna responsabilidad en caso de modificación, sustitución o supresión de dichas aplicaciones y/o especificaciones que pudieran producirse por iniciativa de los fabricantes de automóviles.*

*Las características técnicas de nuestros productos son susceptibles de evolucionar en cualquier momento para incorporar las mejoras técnicas y tecnológicas que se desarrollan.*

*Las referencias de productos mencionadas en este catalogo puede que no estén disponibles en todos los países.*

*Los pedidos se regiran por las condiciones generales de venta de Valeo Service.*

*Las fotografías y dibujos que aparecen en nuestros catálogos son meramente indicativas, por lo que no siempre coinciden exactamente con la apariencia externa de nuestros productos. Se prohíbe la reproducción de todo o parte de esta publicación sin la autorización expresa y escrita de Valeo Service.*

As prescrições e recomendações relativas ao uso ou utilidade dos produtos constantes de nossos catálogos levam em consideração o estado do parque automotivo à época do lançamento desses produtos.

A Valeo Service não será responsável por quaisquer modificações, substituições ou supressões incidentes sobre as prescrições e recomendações relativas ao uso ou utilidade de nossos produtos, que sejam decorrentes de ações dos construtores de veículos.

As características técnicas de nossos produtos são suscetíveis de alteração a qualquer momento para que sejam incorporadas melhorias técnicas e/ou tecnológicas.

Certas referências podem não estar disponíveis em todos os países.

Os pedidos feitos pelos clientes são regidos pelas condições gerais de venda da Valeo Service.

Fotos e desenhos não contratuais. A reprodução do todo ou de parte desta publicação é proibida sem a autorização expressa e por escrito da Valeo Service.

Назначение и рекомендации по эксплуатации продукции, содержащиеся в наших каталогах, указываются с учетом состояния автомобильного парка на день ее появления.

Компания «Valeo Service» не несет ответственности в случае внесения изменений в рекомендации по эксплуатации продукции или их устранения, произошедших, в частности, по инициативе производителей автомобилей.

Технические характеристики нашей продукции могут претерпевать изменения в любой момент, с учетом совершенствования технических и технологических процессов.

Некоторые виды продукции могут не иметься в наличии в отдельных странах.

Заказы осуществляются согласно общим правилам торговли, применяемым в компании «Valeo Service».

Фотографии и изображения продукции могут не в полной мере соответствовать оригиналам. Воспроизведение всей или части настоящей публикации запрещено без специального письменного согласия компании «Valeo Service».

Kataloglarımızda yer alan ürünlerin kullanım ve tanımları, otomobil parkının yayın tarihindeki duruma göredir.

Valeo Otomotiv Dağıtım AS, özellikle araç üreticilerinin inisiyatifli sonucu yapılan değişiklik, ikame veya kaldırılmalardan sorumlu tutulamaz.

Ürünlerimizin teknik özellikleri, teknik ve teknolojik gelişmelere paralel olarak geliştirilebilir.

Bazı referanslar bazı ülkelerde bulunmayabilir.

Siparişler, Valeo Otomotiv Dağıtım AS'un genel satış koşullarına uygun olarak ödenir.

Fotoğraf ve resimler akdi değildir. İşbu yayının Valeo Otomotiv Dağıtım AS'un önceden verilmiş yazılı izni olmaksızın kısmen veya tamamen çoğaltılması yasaktır.

## EUROPE

### FRANCE

VALEO SERVICE FRANCE  
70, RUE PLEYEL  
93285 SAINT-DENIS CEDEX - FRANCE  
TEL : (+33) 1 49 45 32 32  
FAX : (+33) 1 49 45 37 36  
S.A.S. au capital de 12 900 000 e  
RCS Bobigny B 306 486 408

### SPAIN, PORTUGAL

VALEO SERVICE ESPAÑA, S.A.  
CALLE RIO ALMANZORA, N°5  
AREA EMPRESARIAL ANDALUCIA C.L.A.  
28906 GETAFE (MADRID) - ESPAÑA  
TEL : (+34) 91 495 85 00  
FAX : (+34) 91 495 86 99  
TEL. ATENCIÓN TÉCNICA :  
902 011 799  
TEL. ATENCIÓN AL CLIENTE :  
900 122 657  
Valeo Service España Sociedad Anónima  
inscrita en el Registro Mercantil de Madrid,  
Tomo 972 - Libro 941 de la sección 8a ,  
Folio 25 - Hoja 65435 -Inscripción 1a NIF. A28772978

### ITALY

VALEO SERVICE ITALIA SPA  
VIA ASTI 89  
10026 SANTENA (TO) - ITALIA  
TEL : (+39) 011 94 95 1  
FAX : (+39) 011 94 95 280  
TEL. LINEA TECNICA : 800 805 046  
N. iscrizione al Tribunale di Torino 2009/88 reg. soc.  
C.C.I.A.A. 715107 - Capitale sociale e 2.600.000

### UNITED KINGDOM

VALEO SERVICE UK LTD  
HEMING ROAD - WASHFORD  
REDDITCH - WORCS B98 0DZ - ENGLAND  
TEL : (+44) 1527 838 300  
FAX : (+44) 1527 523 732  
Registration Number : 956685

### GERMANY

VALEO SERVICE DEUTSCHLAND GMBH  
BRANDENBURGER STRASSE 46  
40880 RATINGEN - DEUTSCHLAND  
TEL : (+49) 21 02 865 0  
FAX : (+49) 21 02 865 142  
Handelsregister Ratingen - HRB 3340

### BENELUX

VALEO SERVICE BENELUX B.V.  
HEIBLOEMWEG 1  
5704 BS HELMOND - THE NETHERLANDS  
TEL. BELGIUM (NL) : (+32) 2 366 99 17  
TEL. BELGIUM (FR) : (+32) 2 355 14 46  
TEL. NETHERLANDS : (+31) 492 580 894  
FAX BELGIUM : (+32) 2 366 04 47  
FAX NETHERLANDS : (+31) 492 580 828  
K.v.k. Eindhoven 33113859

## TURKEY

VALEO OTOMOTIV DAĞITIM A.Ş.  
AYDINEVLER SANAYI CADDESİ  
CENTRUM IS MERKEZI N°3  
KAT: 3, DAIRE N°302-303 KÜÇÜKYALI - MALTEPE  
34854 İSTANBUL - TURKEY  
TEL : (+90) 216 518 75 75  
FAX : (+90) 216 519 93 14

### POLAND, LITHUANIA, LATVIA, ESTONIA, MOLDAVIA, BELARUS, UKRAINE

VALEO SERVICE EASTERN EUROPE SP. ZO.O.  
UL. POSTĘPU 13  
02-676 WARSZAWA - POLSKA  
TEL : (+48) 22 543 43 00  
FAX : (+48) 22 543 43 05  
SP. Z O.O. O KAPITALE 4,637.000 PLN  
KRS 56793  
Sąd Rejonowy dla m.St. Warszawy

### RUSSIA

VALEO SERVICE CO LTD  
RUSSIA, 105055, MOSCOW  
RADIO STR, 24 - BUILD.2  
TEL : (+7) 495 981-06-96  
FAX : (+7) 495 787-59-92

### SWITZERLAND, AUSTRIA, SWEDEN, FINLAND, NORWAY, DENMARK, ICELAND, GREECE, EASTERN EUROPE, OTHERS

VALEO SERVICE EXPORT  
70, RUE PLEYEL  
93285 SAINT-DENIS CEDEX - FRANCE  
TEL : (+33) 01 49 45 32 32  
FAX : (+33) 01 49 45 36 59

LIAISON OFFICE IN AUSTRIA  
MÜHLGASSE 7  
2380 PERCHTOLDSDORF - AUSTRIA  
TEL : (+43) 1 480 42 46  
FAX : (+43) 1 480 42 34

LIAISON OFFICE IN CZECH REPUBLIC  
DEDINSKA 29  
16100 PRAGUE 6 - CZECH REPUBLIC  
TEL : (+420) 220 102 277  
FAX : (+420) 220 102 278

LIAISON OFFICE IN HUNGARY  
KOSSUTH UTCA 33  
8581 BAKONYJAKO- HUNGARY  
TEL : (+36) 89 350 156  
FAX : (+36) 89 350 156

LIAISON OFFICE IN ROMANIA  
STR.REGINA ELISABETA NR.15-19  
BL.2, SC.2, EJ.3, AP.13  
BUCURESTI - ROMANIA  
TEL : (+40) (0)7 54 07 07 65

LIAISON OFFICE IN GREECE  
18, KALAMAKIOU AVENUE  
174 55 ALIMOS - GREECE  
TEL : (+30) 210 45 27 447  
FAX : (+30) 210 45 27 449

## AMERICAS

### LATIN AMERICA

valeo cibie service ltda  
Rua sadae takagi, 2000  
bairro Cooperativa  
09852-070 - São Bernardo do Campo  
São Paulo - Brasil  
Tel : (+55) 11 43 93 33 54  
Fax : (+55) 11 43 93 33 55  
C.N.P.J. : 57.010.662/0008-36  
Inscrição Estadual : 635.331.124.114

### ASIA, AUSTRALIA NEW-ZEALAND

VALEO SERVICE EXPORT  
70, RUE PLEYEL  
93285 SAINT-DENIS CEDEX - FRANCE  
TEL : (+33) 01 49 45 32 32  
FAX : (+33) 01 49 45 36 59

法雷奥汽车零部件贸易(上海)有限公司  
上海市徐汇区漕河泾开发区桂平路391号  
新漕河泾国际商务中心B座33楼  
电话 : (+86) 21 51752618  
传真 : (+86) 21 51752619

### AFRICA, MIDDLE EAST, DOM-TOM

VALEO SERVICE EXPORT  
70, RUE PLEYEL  
93285 SAINT-DENIS CEDEX - FRANCE  
TEL : (+33) 01 49 45 32 32  
FAX : (+33) 01 49 45 36 59  
S.A.S. au capital de 12 900 000 e  
RCS Bobigny B 306 486 408

LIAISON OFFICE IN TUNISIA  
CENTRE D'AFFAIRES REGUS  
IMMEUBLE CARTHAGE  
RUE DU LAC DE CONSTANCE  
1053 TUNIS - TUNISIA  
TEL : (216) 71 965 002  
FAX : (216) 71 965 137  
MOB: (216) 98 34 91 38

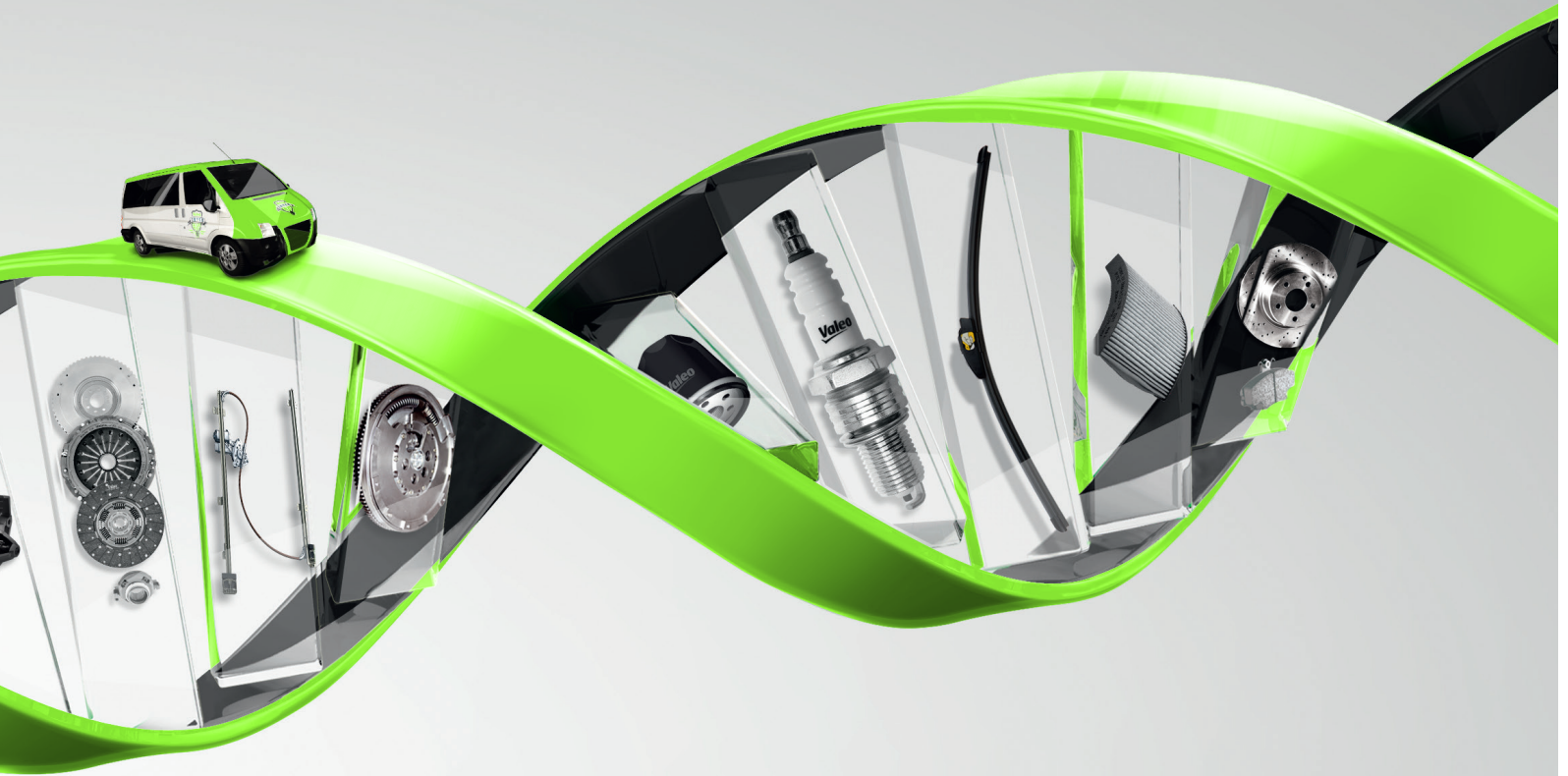

valeo added

驶于科技，融于自然  
Automotive technology, naturally

**Valeo**  
法雷奥

**Valeo**