



NORMFEST®



CATALOG

Products and service for
the automotive industry



Thank you
for your trust!



Dear Customer,

This is the brand new edition of the Normfest catalogue. You will not only find numerous new products and innovations to facilitate your daily work, but also profit from the improved layout and extensive tips and tricks to maximise your efficiency.

Normfest has specialised in the vehicle repair sector for almost 65 years - from scooters and cars to trucks and giant cranes. This is our field and what we have built our reputation on.

Our staff live and breathe mobility in their daily work and are specially trained at our Normfest Academy to meet the demands of our customers.

There are many ways to contact Normfest. The most important contact is and remains your sales representative.

The sales representative knows you and your special wishes and preferences. Furthermore, you can also call our friendly staff at our customer service centre. And last but not least, there is our Online Shop, which we have designed with you, the customer, in mind to make it user friendly, clear and concise.

We realise that without our customers we could not exist. Therefore, we would like to say a big thank you for your continuous loyalty and trust. We will not disappoint you!

Best regards,
Normfest GmbH

Bernhard Windrich
Geschäftsführer



Products and services for the automotive-industry

Normfest provides automotive specialists with everything they need to repair, maintain and service motor vehicles. Our range offers over 19,000 chemical and technical products.

Based in Velbert, Germany, Normfest also has offices in numerous European countries, e.g. Germany, Poland, Czech Republic, Slovakia, Croatia, Austria, Spain, Belgium, the Netherlands, Luxembourg, Great Britain and Bosnia and Herzegovina, where it employs around 400 people. Furthermore, we work closely with our specialist trade partners around the world and our sales network continues to expand.

We are naturally certified to DIN EN ISO 9001:2008 and tested to ISO/EC 27001.

Inspection & Maintenance



01 High-pressure adhesive lubricant
High-Press

- ▶ Item no. 2894-445-1
 - ▶ Contents: 400 ml
 - ▶ Packing unit: 24
- ▶ **Product description**
- Highly water repellent
 - Highly resistant to pressure
 - Free from sticky polymer thickeners that trap dirt
 - Silicone-free
 - Outstanding adhesive property
 - Excellent penetrating ability
 - Temperature range -20°C to +150°C
 - Colour: beige/transparent

02 Adhesive lubricating grease
High-Press Ultra

- ▶ Item no. 2894-445-3
 - ▶ Contents: 400 ml
 - ▶ Packing unit: 12
- ▶ **Product description**
- Lubricates all moving machine components, e.g. hinges, check straps, chains, gear wheels, wire ropes, slide rails, etc.
 - Excellent penetrating ability
 - Outstanding adhesive property
 - High pressure resistance
 - Resistant to salt and hot water
 - Temperature range -20°C to +200°C
 - Colour: light-blue

03 High-pressure adhesive lubricant
High-Press Black

- ▶ Item no. 2894-445-2
 - ▶ Contents: 400 ml
 - ▶ Packing unit: 24
- ▶ **Product description**
- Suitable for use in all technical applications
 - Excellent penetrating ability
 - Outstanding adhesive property
 - Water-repellent and protects against corrosion
 - Best running characteristics at high temperatures and speeds
 - Temperature range -20°C to +200°C
 - Colour: black



04 PTFE/Ceramic oil spray
Teflux

- ▶ Item no. 2894-445-4
 - ▶ Contents: 400 ml
 - ▶ Packing unit: 12
- ▶ Item no. 2894-445-415
- ▶ Contents: 150 ml
 - ▶ Packing unit: 12
- ▶ **Product description**
- Capable of extreme creep
 - Water repellent and protects against corrosion
 - High pressure resistance
 - Lubricates and oils all moving machine parts such as gear wheels, hinges, etc.
 - Excellent emergency-running properties thanks to PTFE and ceramic additives
 - Silicone-free
 - Colour: Beige
 - Fragrance: vanilla



01



02



03



04



01
Silicone grease
Siltron

- ▶ Item no. 2897-324
- ▶ Contents: 400 ml
- ▶ Packing unit: 12

- ▶ **Product description**
- Creates effective water-repellent film
 - Lubricates and seals
 - Fully compatible with elastomers
 - Does not resinify and is extremely resistant to ageing
 - Insulates surfaces against creeping currents and flashovers also at high and low temperatures



01

02
Dry lubricant
TT - Power

- ▶ Item no. 2897-447
- ▶ Contents: 400 ml
- ▶ Packing unit: 12

- ▶ **Product description**
- Oil-free, grease-free, silicone-free
 - Invisible, hardly noticeable lubricating film
 - Prevents dust formation
 - Anti-static



02

03
Silicone Premium
Siprem

- ▶ Item no. 2897-322
- ▶ Contents: 400 ml
- ▶ Packing unit: 12

- ▶ **Product description**
- At least 18% of high-quality silicone
 - Highly water repellent
 - Leaves no marks
 - Exceptional lubricating qualities



03

04
Passenger compartment spray
Soules

- ▶ Item no. 2897-449
- ▶ Contents: 300 ml
- ▶ Packing unit: 12

- ▶ **Product description**
- Silicone free
 - Eliminates moisture
 - Does not resinify and provides long-lasting UV protection
 - Anti-static
 - Prevents door seals freezing in winter



04

01

White lubricating grease

Bio-Top Protect

- ▶ Item no. 2894-446
- ▶ Contents: 400 ml
- ▶ Packing unit: 24

▶ Product description

- Water repellent
- Good lubrication properties
- Good abrasion resistance
- Penetrative
- Moisture displacing
- Universal use
- Pressure resistant
- Extremely durable
- Very good adhesion
- Thermally stable from -10°C to +150°C

02

Maintenance lubrication-oil spray

Multi Protect

- ▶ Item no. 2894-445-6
- ▶ Contents: 400 ml
- ▶ Packing unit: 12

▶ Product description

- Oxidation-resistant
- Capable of extreme creep
- Shear-stable
- Silicone-free
- Resistant to salt and hot water
- Optimal anti-corrosion properties
- Good high-pressure and high-temperature stability
- Thermally stable from -30°C to +150°C, +200°C in short term



01

02



What exactly is a product ID using the GHS system?

GHS stands for „Globally Harmonious System of Classification and Labelling of Chemicals“ and is an ordinance of the European Union (EU). It is a globally uniform system for classifying chemicals and identifying them on packaging and on safety data sheets.

The GHS system has replaced the previous classification and identification system of the EU. It is regulated through the CLP Ordinance (Classification, Labelling and Packaging). It has had to be bindingly applied to materials since 1 December 2012. The second step of GHS implementation now affects compounds and thus all chemical and technical products. For this, GHS/CLP labelling will be legally mandatory from 1 June 2015.

This directive is primarily to protect users. Through the expanded texts of hazards and symbols, users of products should be able to better identify and assess products that are a risk to health and the environment.





01
Silicone-free multifunctional spray
Multi Pose

- ▶ Item no. 2894-447
- ▶ Contents: 400 ml
- ▶ Packing unit: 12

- ▶ **Product description**
- Resistant to salt and hot water
 - For lubricating closing cylinders, locks, door handles, hinges, guide rails and much more.
 - As an installation spray for dismantling and fitting injection nozzles, lambda probes, exhaust systems and much more



01

02
Silicone spray
ECO

- ▶ Item no. 2897-322-2
- ▶ Contents: 600 ml
- ▶ Packing unit: 12

- ▶ **Product description**
- Reduces squeaks
 - Water repellent
 - Impregnating
 - Leaves no marks

03
Maintenance spray
ECO

- ▶ Item no. 2897-351-2
- ▶ Contents: 600 ml
- ▶ Packing unit: 12

- ▶ **Product description**
- Perfect lubrication at the most difficult-to-reach greasing points
 - Reduces friction
 - Water repellent



02



03



01
Penetrating oil
Oxim Protect

- ▶ Item no. 2894-444-1
- ▶ Contents: 400 ml
- ▶ Packing unit: 12

- ▶ Product description
- Thermally stable from -20°C to +250°C
- Use against rust, squeaks and creaks
- Prevents further rusting



01

02
Penetrating oil
Oxim Ultra

- ▶ Item no. 2894-444
- ▶ Contents: 400 ml
- ▶ Packing unit: 24

- ▶ Item no. 2894-441-1
- ▶ Contents: 5 litres
- ▶ Packing unit: 1

- ▶ Product description
- Excellent lubricating properties
- Provides good lubricity
- Water-repellent
- Shields against corrosive elements
- Temperature range -20°C to +250°C



02



03
Ice-rust remover
Super Crack Ultra

- ▶ Item no. 2894-442-1
- ▶ Contents: 400 ml
- ▶ Packing unit: 12

- ▶ Product description
- High-performance separating agent with silver-coloured aluminium particles
- Guarantees long-lasting lubrication
- Impressive freeze capacity, cools up to -40°C
- High penetrating capacity
- Rust dissolving properties



03

01

Brake cleaner

Bremtec

- ▶ Item no. 2897-333-600
- ▶ Contents: 600 ml
- ▶ Packing unit: 24

- ▶ Item no. 2897-333-5
- ▶ Contents: 5 litres
- ▶ Packing unit: 1

- ▶ Item no. 2897-333-30
- ▶ Contents: 30 litre
- ▶ Packing unit: 1

- ▶ Item no. 2897-333-60
- ▶ Contents: 60 litres
- ▶ Packing unit: 1

▶ **Product description**

- Contains acetone
- Degreasing action
- Carbon dioxide as the propellant



02

Pump spray bottle 1 litre

- ▶ Item no. 2897-333-100

▶ **Product description**

- Suitable for fluids containing solvents, such as Bremtec, Power-Star, Motor-Fit
- Working overpressure 3 bar
- Contents: 1 litre
- suitable surrogate sealant (optionally available): Art. no. 2897-333-101



01



02

03

Metal discharge tap, R3/4"

- ▶ Item no. 2000-000-062

Locking adapter for metal discharge tap

- ▶ Item no. 2000-000-061



03

04

Brake cleaner

Bremtec

- ▶ Item no. 2897-333-31
- ▶ Contents: 30 litres
- ▶ Packing unit: 1

▶ **Product description**

- Basis: Benzoles, alcohols
- Ideal for the rapid removal of oil, dirt and brake dust from brake discs, pads and linings, as well as in the area around the intake and throttle valve



04

05

Safety cleaner

Bremtec Safe

- ▶ Item no. 2897-333-700
- ▶ Contents: 500 ml
- ▶ Packing unit: 12

▶ **Product description**

- TÜV-tested fire behaviour
- TÜV-tested ingredients
- Flame-retarding propellant
- Lower explosion limit >1.5% Vol.
- Recommended product in accordance with the German Ordinance on Hazardous Materials (protection level 2)
- 25% naphtha- colourless



05



01
Brake cleaner
MC-1

- ▶ Item no. 2897-333-500
- ▶ Contents: 500 ml
- ▶ Packing unit: 30

- ▶ **Product description**
- Acetone-free quality cleaner
 - Very effectively removes oil, dirt, brake fluid and brake dust from brake discs, pads and linings and many other vehicle parts
 - Flushes out contaminants and deposits
 - Removes oil, grease, dust, resin residues/brake fluid/brake dust from disk brakes
 - The life of treated components is increased thanks to conditioning lubrication



01

02
Brake paste
Off-Shore Silver

- ▶ Item no. 2894-449-200
- ▶ Contents: 200 g
- ▶ Packing unit: 12

- ▶ **Product description**
- Special lubricant that provides reliable adhesion at high temperatures
 - Condensation, splash and salt water proof
 - Excellent and long-term lubrication
 - Lasting corrosion protection
 - Particularly suitable for vehicles with anti-lock brake system
 - Temperature resistant up to 1,400°C

03
Brake spray
Off-Shore Silver

- ▶ Item no. 2894-449
- ▶ Contents: 400 ml
- ▶ Packing unit: 12

- ▶ **Product description**
- Special lubricant that provides reliable adhesion at high temperatures
 - Condensation, splash and salt water proof
 - Excellent and long-term lubrication
 - Lasting corrosion protection
 - Particularly suitable for vehicles with anti-lock brake system
 - Temperature resistant up to 1,400°C



04
Off-Shore replacement brush

- ▶ Item no. 2894-448-201



04

02

03

01
Brake assembly paste
BMP

- ▶ Item no. 2894-400
- ▶ Contents: 5.50 ml
- ▶ Packing unit: 1

- ▶ Item no. 2894-405
- ▶ Contents: 250 g
- ▶ Packing unit: 1

- ▶ **Product description**
- Heat resistant to 1,100°C
- Resistant to alkalis and acids
- Can be universally used for assembly, screw fittings and as a lubricant



01

03
Brake fluid
DOT4

- ▶ Item no. 2894-420
- ▶ Contents: 500 ml
- ▶ Packing unit: 1

- ▶ Item no. 2894-410
- ▶ Contents: 5 litres
- ▶ Packing unit: 1

- ▶ Item no. 2894-410-30
- ▶ Contents: 30 litre
- ▶ Packing unit: 1

- ▶ **Product description**
- Suitable for all hydraulic braking systems using synthetic fluid
- Wet boiling point over +160°C
- Boiling point over +250°C

04
Brake fluid
DOT4 Plus

- ▶ Item no. 2894-415-05
- ▶ Contents: 500 ml
- ▶ Packing unit: 24

- ▶ Item no. 2894-415
- ▶ Contents: 5 litres
- ▶ Packing unit: 1

- ▶ Item no. 2894-415-30
- ▶ Contents: 30 litre
- ▶ Packing unit: 1

- ▶ **Product description**
- Suitable for all hydraulic braking systems using synthetic fluid
- Wet boiling point over +180°C
- Boiling point over +260°C

05
Spout for 5 litre containers

- ▶ Item no. 2000-000-005

Spout for 30 litre containers

- ▶ Item no. 2000-000-030

06
Brake fluid tester
Replacement battery 3722-24

- ▶ Item no. 8715-999-50

02
Copper grease
Cop

- ▶ Item no. 2894-451-1
- ▶ Contents: 250 g
- ▶ Packing unit: 1

- ▶ Item no. 2894-450
- ▶ Contents: 400 ml
- ▶ Packing unit: 12

- ▶ Item no. 2894-451
- ▶ Contents: 100 g
- ▶ Packing unit: 10

- ▶ **Product description**
- Thermally stable to +1,200°C
- Do not apply to friction surfaces
- NOT RECOMMENDED FOR ABS VEHICLES



02



03

04

06

05



01
High-performance brake fluid
DOT 4 LV High Performance

- ▶ Item no. 2894-435
- ▶ Contents: 5 litres
- ▶ Packing unit: 1

- ▶ Item no. 2894-430
- ▶ Contents: 30 litres
- ▶ Packing unit: 1

- ▶ Product description
- With special Ford licence
- Suitable for all hydraulic brake systems using synthetic fluid
- Can be mixed with brake fluid of the same specification
- Does not attack brake parts
- Increases safety thanks to reduced drop in boiling point
- Meets DOT-4 FMVSS 116 and SAEJ 1703
- Boiling point over +265° C
- Wet boiling point over +175° C



01

02
Airspray pressure cylinder for Bremtec A2

- ▶ Item no. 2897-910-1
- ▶ Contents: 400 ml
- ▶ Packing unit: 1



02

03
Airspray pressure cylinder for Bremtec

- ▶ Item no. 2897-910-2
- ▶ Contents: 400 ml
- ▶ Packing unit: 1



03

04
Airspray pressure cylinder for Oxim

- ▶ Item no. 2897-910-3
- ▶ Contents: 400 ml
- ▶ Packing unit: 1



04

05
Airspray automatic filler

- ▶ Item no. 2897-910-100
- ▶ Item no. 2897-910-106
- ▶ Spare parts service station material/air

Replacement parts for Airspray pressure cylinders

- ▶ Item no. 2897-910-101
- ▶ A valve with a vertical hose
- ▶ Item no. 2897-910-102
- ▶ Spray head, circular jet
- ▶ Item no. 2897-910-108
- ▶ Spray head, spot jet

Spare parts for Airspray automatic filling machine

- ▶ Item no. 2897-910-103
- ▶ Material air valve
- ▶ Item no. 2897-910-104
- ▶ Air valve
- ▶ Item no. 2897-910-105
- ▶ Seal holder, including grooved ring
- ▶ Item no. 2897-910-110
- ▶ Barrel connector, including accessories for 60 litres



01

Seal remover

Seal-Ex

- ▶ Item no. 2896-663
- ▶ Contents: 400 ml
- ▶ Packing unit: 12

▶ **Product description**

- Can be used on objects made from metal, wood, ceramic, glass, polyethylene, polypropylene
- Do not use on delicate plastics such as PVC, linoleum or synthetics
- Never use on painted surfaces!

02

Silicone black

Silon Black

- ▶ Item no. 2896-640-2
- ▶ Contents: 200 ml
- ▶ Packing unit: 12

▶ **Product description**

- Hardens practically without shrinking (< 3%) to a hard, rubber-like mass as soon as exposed to air humidity
- Adheres to metal, glass, painted surfaces, ceramic and to most plastic surfaces
- Resistant to weathering, vibrations, moisture
- Thermally stable from -50°C to +230°C

03

Silicone red

Silon Red

- ▶ Item no. 2896-640-1
- ▶ Contents: 200 ml
- ▶ Packing unit: 12

▶ **Product description**

- Hardens practically without shrinking (< 3%) to a hard, rubber-like mass as soon as exposed to air humidity
- Adheres to metal, glass, painted surfaces, ceramic and to most plastic surfaces
- Resistant to weathering, vibrations, moisture
- Thermally stable from -50°C to +300°C

04

Spare pistol grip

- ▶ Item no. 2896-640-3



01



04

02

03



01
Multi-purpose grease
BG-B

- ▶ Item no. 2986-02
 - ▶ Contents: 400 g
 - ▶ Packing unit: 12
-
- ▶ Product description
 - Colour: Black
 - Ideal for drive shafts
 - With graphite
 - Thermally stable from -30°C to +120°C
 - NLGI class 2

02
Multi-purpose grease
BG-Y

- ▶ Item no. 2986-021
 - ▶ Contents: 400 g
 - ▶ Packing unit: 12
-
- ▶ Product description
 - Color: Yellow
 - Temperature range -30°C to +120°C
 - NLGI class 2

03
Lever grease gun
M10 x 1

- ▶ Item no. 7986-0
-
- ▶ Product description
 - Suitable for 400 g cartridges or 500 g grease

06
Lever grease gun
For lube-shuttle system cartridges

- ▶ Item no. 7986-1
-
- ▶ Product description
 - With galvanized-steel grease container
 - Ergonomically shaped lever gear
 - Pressure approx. 300 bar
 - Open the cartridge without tools
 - Simple, quick and absolutely clean loading and removal of grease cartridges - without opening the gun
 - No venting required
 - Optimal emptying of cartridge residues

07
Multi-purpose grease
Greasal

- ▶ Item no. 2986-031
 - ▶ Contents: 400 g
 - ▶ Packing unit: 12
-
- ▶ Product description
 - Smooth texture
 - Soft consistency
 - Acid-free, shear-stable
 - Resistant to oxidation
 - Protects against rust
 - Thermally stable from -30°C to +120°C
 - NLGI class 2 (2K-30 to DIN 51 502)
 - Screw cartridge (lube-shuttle system cartridges)



04
Hydraulic claw mouthpiece

- ▶ Item no. 7986-04
-
- ▶ Product description
 - M10 x 1
 - to DIN 71412
 - for grease guns (7986-0)



05
High pressure reinforced tube

- ▶ Item no. 7986-03
-
- ▶ Product description
 - M10 x 1
 - For grease gun (7986-0)

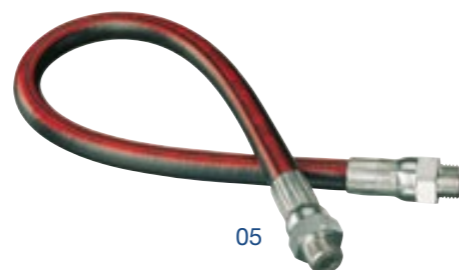

01
Surface sealant, green

- ▶ Item no. 2896-520
- ▶ Contents: 50 g
- ▶ Packing unit: 1

- ▶ Product description
- max. gap filling capacity: 0.3 mm
- Thermally stable from -55°C to +150°C
- Resistant to water, mineral oils, synthetic lubricants, fuels, organic solvents and coolants
- Solid in 20-40 mins.
- Work hard in 1-3 hours

02
Surface sealant, orange

- ▶ Item no. 2896-521
- ▶ Contents: 50 g
- ▶ Packing unit: 1

- ▶ Product description
- max. gap filling capacity: 0.5 mm
- Thermally stable from -55°C to +150°C
- Resistant to water, mineral oils, synthetic lubricants, fuels, organic solvents and coolants
- Solid in 15-30 mins.
- Work hard in 1-3 hours

03
Hydraulic and pneumatic sealant
Anaerobic sealing compound

- ▶ Item no. 2896-550-50
- ▶ Contents: 50 ml
- ▶ Packing unit: 10

- ▶ Product description
- Strength class (DIN 30661): 10-14
- max. gap filling capacity: 0.50 mm
- max. thread: (metr) M80
- Thermally stable from -55°C to +150°C
- Solid in 15-30 mins.
- Work hard in 1-3 hours
- Resistant to petrol, diesel, water, water-glycol mixtures, mineral oils, hydraulic fluids



04
Screw-Lock “medium-strength”

- ▶ Item no. 2896-531
- ▶ Contents: 24 ml
- ▶ Packing unit: 1

- ▶ Item no. 2896-531-50
- ▶ Contents: 50 ml
- ▶ Packing unit: 1

- ▶ Product description
- medium strength, strength class (DIN 30661)
- max. gap filling capacity: 0.25 mm
- max. thread (metric) M36
- Thermally stable from -55°C to +150°C
- Solid in 10-20 mins.
- Work hard in 1-3 hours

05
Screw-Lock “high-strength”

- ▶ Item no. 2896-530
- ▶ Contents: 24 ml
- ▶ Packing unit: 1

- ▶ Item no. 2896-530-50
- ▶ Contents: 50 ml
- ▶ Packing unit: 1

- ▶ Product description
- high-strength, strength class (DIN 30661)
- max. gap filling capacity: 0.15 mm
- max. thread (metric) M20
- Thermally stable from -55°C to +150°C
- Solid in 10-20 mins.
- Work hard in 1-3 hours



01



02



03



04



05

01
Pipe thread sealing

- ▶ Item no. 2896-550-51
- ▶ Contents: 50 ml
- ▶ Packing unit: 12

▶ **Product description**

- Strength class (DIN 30661): 10-14
- max. gap filling capacity: 0.50 mm
- Max. thread: (metr) M80
- Thermally stable from -55°C to +150°C
- Solid in 15-30 mins.
- Work hard in 1-3 hours
- Resistant to petrol, diesel, water, water-glycol mixtures, mineral oils, hydraulic fluids
- Exception: High-concentration acids and alkalis, and methylene chloride



01

02
fastening of the brass and bearing

- ▶ Item no. 2896-540
- ▶ Contents: 24 ml
- ▶ Packing unit: 12

▶ **Product description**

- Strength class (DIN 30661): 55-70
- max. gap filling capacity: 0.15 mm
- Max. thread: (metr) M20
- Thermally stable from -55°C to +175°C
- Solid in 2-5 mins.
- Work hard in 1-3 hours



02



03

03
Universal duroplastic seal
Plastomar

- ▶ Item no. 2896-502
- ▶ Contents: 85 g
- ▶ Packing unit: 10

▶ **Product description**

- Temperature range -55°C to +270°C
- Allow to evaporate for 10 minutes
- Max. gap filling capacity 0.2 mm

04
Engine sealer
MotSeal

- ▶ Item no. 2897-374
- ▶ Contents: 300 ml
- ▶ Packing unit: 12

▶ **Product description**

- Prevents exhaust bluing
- Replenishes rubber and plastic seals
- Stops environmentally-unfriendly oil leaks



04

05
Engine-oil circulation cleaner
MotClean

- ▶ Item no. 2897-375
- ▶ Contents: 500 ml
- ▶ Packing unit: 12

▶ **Product description**

- Gentle and quick cleaning
- Safe for seals and other engine materials
- Cost-effective
- Simple application



05



01

Radiator sealer

RadSeal

- ▶ Item no. 2897-372
- ▶ Contents: 150 ml
- ▶ Packing unit: 12

▶ **Product description**

- Seals hairline cracks and small leaks permanently and reliably
- Compatible with anti-freezes and coolants, does not attack rubber, plastics, light alloys or non-ferrous heavy metals
- No negative effects on water pumps or heating circuits

- Suitable for closed cooling systems
- Suitable for aluminium radiators
- Also suitable for precautionary use



01

03

Diesel additive

CT 60

- ▶ Item no. 2897-370
- ▶ Contents: 300 ml
- ▶ Packing unit: 12

▶ **Product description**

- Cleans and prevents deposits in the fuel system and combustion chamber
- Keeps the injector nozzles clean, improves combustion, resulting in less specific fuel consumption and maximum engine performance
- Prevents sticky deposits on the

- injector needles
- Increases lubrication when using low sulphur diesel fuels and protects the distributor fuel injection pumps against wear
- Fully compatible with all modern diesel oxidation catalysts



03



02

02

Radiator Cleaner

RadClean

- ▶ Item no. 2897-373
- ▶ Contents: 300 ml
- ▶ Packing unit: 12

▶ **Product description**

- Chemical conversion of lime
- Dissolves grease, lime and oil
- Disperses sludge
- Does not attack radiator materials
- Safe for rubber and plastic
- Compatible with anti-freezes
- Does not contain aggressive acids or alkalis

04

Petrol additive

OT 100

- ▶ Item no. 2897-371
- ▶ Contents: 300 ml
- ▶ Packing unit: 12

▶ **Product description**

- Suitable for all petrol injection systems
- Cleans carbon deposits from injection systems
- Removes coking and deposits from fuel distributors, injection valves, intake valves and other components of the fuel system
- Ensures optimum performance

- and fuel economy through accurate injection and atomization
- Guarantees low exhaust emissions



04



01

Diesel intake system cleaner

DC980

- ▶ Item no. 2897-369
- ▶ Contents: 400 ml
- ▶ Packing unit: 8

- ▶ Product description
- Special cleaner with CO₂ propellant
 - Simple and specific use
 - Colourless and residue free
 - Powerful solvent action
 - Over 95% active ingredients



02

Diesel soot-particle filter cleaner

DPF100

- ▶ Item no. 2897-380
- ▶ Contents: 400 ml
- ▶ Packing unit: 12

- ▶ Product description
- Outstanding at loosening carbon deposits
 - Non-flammable
 - Clean without having to dismantle the particle filter
 - Restore the full absorbency of the diesel particle filter



01



02

01
Throttle cleaner
VC 980

- ▶ Item no. 2897-368
- ▶ Contents: 400 ml
- ▶ Packing unit: 12

▶ **Product description**

- Cleans the carburettor from the inside and outside
- Rinses boreholes and nozzles
- Ideal for cleaning components in the intake area
- Exhaust gas regulation valve

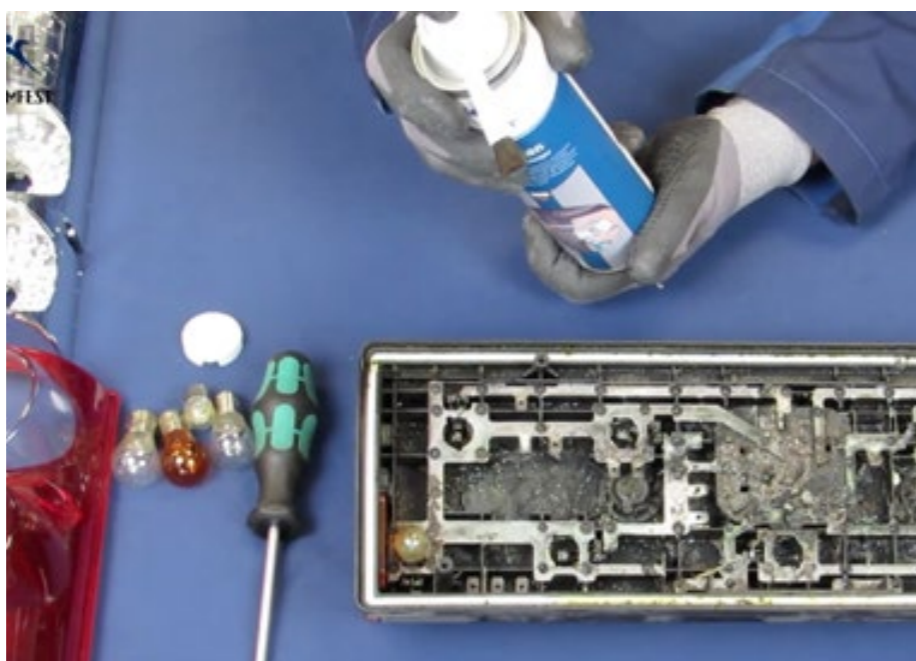

02
Long hose, incl. spray head for VC 980

- ▶ Item no. 2897-368-1



03
Electrical contact cleaner
TermClean

- ▶ Item no. 2897-334
- ▶ Contents: 400 ml
- ▶ Packing unit: 12

▶ **Product description**

- Cleans all contacts
- Facilitates the removal of greasy contamination and loosens old incrustations
- Safe to use on electrical and mechanical office machines, computers, cash registers, radios and televisions
- Comes with brush attachment
- Product not suitable for use on parts being used!



04
Leakfinder
Spy Plus

- ▶ Item no. 2896-661
- ▶ Contents: 400 ml
- ▶ Packing unit: 12

▶ **Product description**

- Approved by DVGB (test certificate NG-5170BQ0463)
- Meets the requirements of DIN EN 14291
- Non-flammable leak detection possible even of flammable gases
- Suitable for all technical gases in compressed-air, compressed-gas and air-conditioning systems, compressors, welding apparatus, compressed-air brake systems, tyres, hoses and transport tanks
- No stress corrosion cracking on plastics such as PVC or PE
- Temperature range: -15°C to +50°C
- Non-corrosive

05
Ice spray
Arctic

- ▶ Item no. 2897-325
- ▶ Contents: 200 ml
- ▶ Packing unit: 12

▶ **Product description**

- Metal structural parts such as ball bearings, sleeves, chain links, shafts, etc. can be inserted into the tightest of fits
- Can be used to easily find electrical faults in circuits (due to thermal overload) through local cooling
- Also excellent at removing dirt such as chocolate and chewing gum from upholstery

06
Marten protection
Wild-Life

- ▶ Item no. 2897-320
- ▶ Contents: 400 ml
- ▶ Packing unit: 12

▶ **Product description**

- Double action through taste and smell





01
Starting aid spray
Super Start Plus

- ▶ Item no. 2897-330-310
- ▶ Contents: 300 ml
- ▶ Packing unit: 12

- ▶ **Product description**
- Very high ignition properties
 - Facilitates cold starting even in extremely low temperatures
 - Improves starting when wet
 - Suitable for 2- and 4-stroke petrol engines
 - Also suitable for diesel engines (follow instructions for use on the product: ☑Start diesel engines at full throttle, do not preheat!☑)

02
Contact helper
Contac

- ▶ Item no. 2897-331
- ▶ Contents: 300 ml
- ▶ Packing unit: 12

- ▶ **Product description**
- Eliminates moisture
 - Improves electrical conductivity

03
Battery terminal protection blue
Poltec

- ▶ Item no. 2897-332-300
- ▶ Contents: 300 ml
- ▶ Packing unit: 12

- ▶ Item no. 2897-332-150
- ▶ Contents: 150 ml
- ▶ Packing unit: 1

- ▶ **Product description**
- insulates bright sheet connections and electrical connections against corrosion from environmental agents (salts, water, acids, alkalis, moisture, etc.)

04
Battery acid tester
▶ Item no. 8853-600-2





01
Intensive window cleaner
Topas

- ▶ Item no. 2897-310
- ▶ Contents:
- ▶ Packing unit: 24

- ▶ Item no. 2000-03
- ▶ Contents: 5 litres
- ▶ Packing unit: 1

- ▶ Product description
- Also suitable for polycarbonate glass
- Safe for surfaces
- Foam formation only after the surface has been coated with the product

02
Spout for 5 litre containers

- ▶ Item no. 2000-000-005



03
High-tech special cleaner
Terpanol Power

- ▶ Item no. 2897-323
- ▶ Contents: 400 ml
- ▶ Packing unit: 12

- ▶ Product description
- Contains orange terpenes
- Made from 100% renewable resources
- Optimally removes adhesive residues, oils, grease, wax, water-resistant permanent markers, graffiti
- Great ability to dissolve dirt
- Dissolves after a very short time (approx. 20 seconds)





01
Anti-freeze for windscreen washer systems
Frostex

- ▶ Item no. 2897-312
- ▶ Contents: 500 ml
- ▶ Packing unit: 20

- ▶ Item no. 2897-314
- ▶ Contents: 1000 ml
- ▶ Packing unit: 12

- ▶ Item no. 2897-318
- ▶ Contents: 30 litre
- ▶ Packing unit: 1

- ▶ Item no. 2897-319
- ▶ Contents: 60 litres
- ▶ Packing unit: 1

- ▶ Product description
- Methanol free
- Undiluted frost-proof up to -70°C
- Suitable for fan nozzles and polycarbonate windscreens



01

02
Concentrate for windscreen washer systems
Flash

- ▶ Item no. 2897-313-100
- ▶ Contents: 30 ml
- ▶ Packing unit: 100

- ▶ Item no. 2897-313-5
- ▶ Contents: 5 litres
- ▶ Packing unit: 1

- ▶ Product description
- Summer product – only suitable for temperatures above 7°C
- Suitable for fan nozzles and polycarbonate windscreens
- One bottle (30 ml) = 4 litres of water



03

03
Dosing pump for 5 litre containers

- ▶ Item no. 2897-313-509

- ▶ Product description
- 1 spray (2.5 ml)



02

04
Anti-freeze tester for cooling water

- ▶ Item no. 8853-600-1



04

05

05
Anti-freeze for windscreen washer systems

- ▶ Item no. 8853-600-3



06

06
Quick de-icer
Blizzard Ultra

- ▶ Item no. 2897-231
- ▶ Contents: 500 ml
- ▶ Packing unit: 6

- ▶ Product description
- De-ices windscreens quickly
- Leave no smears
- No need to scrape off frost, ice or snow

01
Super-fast superglue
Cyanoacrylate adhesives black

- ▶ Item no. 2898-555
- ▶ Contents: 5 g
- ▶ Packing unit: 1

- ▶ Item no. 2898-556
- ▶ Contents: 20 g
- ▶ Packing unit: 1

- ▶ Product description
- Suitable for smooth plastic surfaces
- Pinpoint application accuracy



01

02
Black cyanoacrylate adhesive Superfast

- ▶ Item no. 2898-560-20
- ▶ Contents: 20 g
- ▶ Packing unit: 1

- ▶ Product description
- Suitable for bonding rubber coatings, plastics and metals

- Ideal for bonding plastics, such as door clips
- Based on cyanoacrylate



02



03

03
Superglue filler
For cyanoacrylate adhesives

- ▶ Item no. 2898-560-30
- ▶ Contents: 30 g
- ▶ Packing unit: 1

- ▶ Product description
- Density: > 1.5g/cm³ 20°C

04
Instant glue Rapido

- ▶ Item no. 2898-555-100
- ▶ Contents: 20 g
- ▶ Packing unit: 12

- ▶ Product description
- For extreme loads
- Suitable for a wide range of materials subject to heavy vibrations
- based on cyanoacrylate



04

05
Superglue gel Fixit

- ▶ Item no. 2898-554
- ▶ Contents: 20 g
- ▶ Packing unit: 1

- ▶ Product description
- Does not run
- Can be used on horizontal and vertical surfaces
- Does not form strings
- For bonding metals, wood and plastics
- Based on cyanoacrylate



05

06
Accelerator Fixit Active

- ▶ Item no. 2898-554-150
- ▶ Contents: 200 ml
- ▶ Packing unit: 1

- ▶ Product description
- Suitable as a curing accelerator for all cyanoacrylate adhesives
- For leather, wood, cork, ceramics and all porous materials and for bonding plastics



06



07

07
Power spray glue Super-Glue

- ▶ Item no. 2898-552
- ▶ Contents: 400 ml
- ▶ Packing unit: 12

- ▶ Product description
- Foamed materials, jute, felt, expanded polystyrene
- Paper, cardboard, plastic films
- Various plastics
- Temperature range (permanent): -25°C to +70°C

08
Rubber profile adhesive Profix

- ▶ Item no. 2898-551
- ▶ Contents: 180 g
- ▶ Packing unit: 12

- ▶ Product description
- Ideal for gluing: Rubber profile, leather, plastic, imitation leather with textile backing and felt to metal, wood, rigid PVC, ABS, PA



08



01

Windscreen wiper replacement rubbers

Refex

▶ **Item no. 5850-63-610**

▶ **Product description**

- Length 610 mm
- Claw width 6.3 mm
- For passenger cars

▶ **Item no. 5850-63-750**

▶ **Product description**

- Length 750 mm
- Claw width 6.3 mm
- For passenger cars

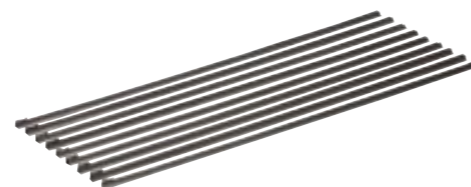

01

▶ **Item no. 5850-00-750**

▶ **Product description**

- Standard size for Bosch Aero wipers
- For passenger cars and vans

▶ **Item no. 5850-851-050**

▶ **Product description**

- Length 1050 mm
- Claw width 8.5 mm
- For buses, construction machinery, agricultural machinery

▶ **Item no. 5850-85-750**

▶ **Product description**

- Length 750 mm
- Claw width 8.5 mm
- For passenger cars, vans, trucks



02

02

▶ **Universal shears Item no. 8714-05**

▶ **Product description**

- Very robust
- Cuts sheet steel, wire, plastic, rubber, leather, cardboard, paper, carpet, flowers, branches, etc.
- Practical metal one-hand lock

03

Replacement wedge for adjusting the claw

▶ **Item no. 5850-63**

▶ **Product description**

- Claw width: 6.3 mm

▶ **Item no. 5850-85**

▶ **Product description**

- Claw width: 8.5 mm



03

04

Copper sealing rings DIN 7603 A, solid



Item no. Implementation

6460-5-9	5 x 9 x 1.0 mm
6460-6-10	6 x 10 x 1.0 mm
6460-6-12	6 x 12 x 1.0 mm
6460-8-12	8 x 12 x 1.0 mm
6460-8-14	8 x 14 x 1.0 mm
6460-10-12	10 x 12 x 1.0 mm
6460-10-14	10 x 14 x 1.0 mm
6460-10-16	10 x 16 x 1.5 mm
6460-10-18	10 x 18 x 1.5 mm
6460-12-16	12 x 16 x 1.5 mm
6460-12-18	12 x 18 x 1.5 mm
6460-14-18	14 x 18 x 1.5 mm
6460-14-20	14 x 20 x 1.5 mm
6460-14-22	14 x 22 x 1.5 mm
6460-16-20	16 x 20 x 1.5 mm
6460-16-22	16 x 22 x 1.5 mm

Item no. Implementation

6460-16-24	16 x 24 x 1.5 mm
6460-18-22	18 x 22 x 1.5 mm
6460-18-24	18 x 24 x 1.5 mm
6460-20-24	20 x 24 x 1.5 mm
6460-20-26	20 x 26 x 1.5 mm
6460-22-27	22 x 27 x 1.5 mm
6460-22-29	22 x 29 x 1.5 mm
6460-24-30	24 x 30 x 2.0 mm
6460-24-32	23 x 32 x 2.0 mm
6460-26-32	26 x 32 x 2.0 mm
6460-26-34	26 x 34 x 2.0 mm
6460-27-32	27 x 32 x 2.0 mm
6460-28-34	28 x 34 x 2.0 mm
6460-28-36	28 x 36 x 2.0 mm
6460-30-36	30 x 36 x 2.0 mm
6460-32-38	32 x 38 x 2.0 mm

06

Aluminium washers DIN 7603 A



Item no. Implementation

6463-6-10	6 x 10 x 1.0
6463-8-12	8 x 12 x 1.0
6463-8-14	8 x 14 x 1.0
6463-10-14	10 x 14 x 1.0
6463-10-16	1.0 x 16 x 1.0
6463-12-16	12 x 16 x 1.0
6463-12-18	12 x 17 x 1.5
6463-14-18	14 x 18 x 1.5
6463-14-20	14 x 20 x 1.5

Item no. Implementation

6464-114-22	14 x 22 x 2.0
6463-16-20	16 x 20 x 1.5
6463-16-22	16 x 22 x 1.5
6463-18-22	18 x 22 x 1.5
6463-18-24	18 x 24 x 1.5
6463-20-26	20 x 26 x 1.5
6463-22-27	22 x 27 x 1.5
6463-24-30	24 x 30 x 2.0
6463-26-32	26 x 32 x 2.0



01

Perbunan O-rings, metric



Item no.	Inner Ø mm	Ring thickness mm
6468-003-20	3	2,0
6468-004-20	4	2,0
6468-005-20	5	2,0
6468-006-20	6	2,0
6468-007-20	7	2,0
6468-008-20	8	2,0
6468-010-20	10	2,0
6468-010-25	10	2,5
6468-012-20	12	2,0
6468-012-25	12	2,5
6468-014-25	14	2,5
6468-015-25	15	2,5
6468-017-25	17	2,5

Item no.	Inner Ø mm	Ring thickness mm
6468-018-30	18	3,0
6468-019-25	19	2,5
6468-020-30	20	3,0
6468-022-30	22	3,0
6468-024-30	24	3,0
6468-025-30	25	3,0
6468-028-30	28	3,0
6468-030-30	30	3,0
6468-034-30	34	3,0
6468-035-35	35	3,5
6468-036-30	36	3,0
6468-038-30	38	3,0



02

Copper twin rings DIN 7603

► Item no. 6464-6-10

► Product description

- Developed for use on banjo bolts and banjo unions
- facilitates the assembly and increases security when fitted due to the washer connection



03

Copper fill sealing rings DIN 7603 C

Item no.	Implementation
6462-12-18	12 x 18 x 2.0
6462-14-20	14 x 20 x 2.0
6462-14-21	14 x 21 x 2.0
6462-14-22	14 x 22 x 2.0
6462-16-20	16 x 20 x 2.0
6462-16-22	16 x 22 x 2.0
6462-18-24	M18 x 24 x 2.0

04

Copper sealing ring assortment DIN 7603A

- Item no. 1957-460
- Contents: 1,190 pieces

Item no.	Quantity	Item no.	Quantity
6460-6-10	100	6460-14-22	50
6460-8-12	100	6460-16-22	50
6460-8-14	100	6460-18-24	50
6460-10-14	100	6460-20-26	50
6460-10-16	100	6460-22-27	50
6460-12-16	100	6460-22-29	50
6460-12-18	100	6460-24-30	30
6460-14-18	50	6460-26-32	30
6460-14-20	100	6460-28-34	30



05

Assortment of gaskets for oil-drain plugs

- Item no. 1957-462
- Contents: 1,000 pieces

Item no.	Quantity	Item no.	Quantity
6464-18-2	100	6463-12-18	100
6460-14-20	100	6464-012-242	50
6462-14-21	100	6462-18-24	100
6462-16-22	100	6464-14-22	100
6464-11-17	50	6464-128-225	50
6460-12-18	100	6464-16-24	50



06

Perbunan O-ring assortment

- Item no. 1957-468-1
- Contents: 1,050 pieces

Item no.	Quantity	Item no.	Quantity
6468-003-20	100	6468-012-25	50
6468-004-20	100	6468-014-25	50
6468-005-20	100	6468-015-25	50
6468-006-20	100	6468-017-25	25
6468-007-20	100	6468-018-30	25
6468-008-20	100	6468-019-25	25
6468-010-20	50	6468-020-30	25
6468-010-25	50	6468-022-30	25
6468-012-20	50	6468-024-30	25

07

Assortment of oil drain plugs

For BMW, Mercedes-Benz, Ford and Volkswagen

- Item no. 1957-240-1
- Contents: 60 pieces

Item no.	Quantity	Item no.	Quantity
6240-12-15	5	6242-14-15	5
6240-14-151	5	6243-014-15	5
6241-12-15	5	6243-12-15	5
6241-14-15	5	6243-14-159	5
6241-16-15	5	6243-14-160	5
6241-18-15	5	6243-14-161	5



Alfa Romeo

Ø screw	M18 x 1.5 x 12 mm Item no. 6242-18-15 Original no. 46476967		Ø gasket	18 x 24 x 1.5 mm Item no. 6460-18-24 Original no. 55196309	
---------	---	---	----------	--	---



Audi

Ø screw	M14 x 1.5 x 12 mm Item no. 6242-014-15		Ø gasket	14 x 20 x 1.5 mm Item no. 6460-14-20	
Ø screw	M14 x 1.5 x 17.5 mm Item no. 6240-14-151		Ø gasket	14 x 20 x 1.5 mm Item no. 6460-14-20	
Screw Ø including sealing ring	M14 x 1.5 x 22 mm Item no. 6243-14-161				

BMW

Ø screw	M12 x 1.5 x 18 mm Item no. 6243-12-15 Original no. 11131273093		Ø gasket	12 x 17 x 1.5 mm Item no. 6463-12-18	
Ø screw	M12 x 1.5 x 12 mm Item no. 6241-12-15 Original no. 29973430		Ø gasket	12 x 17 x 1.5 mm Item no. 6463-12-18	
Ø gasket	22 x 27 x 1.5 mm Item no. 6464-022-015				

Citroën

Ø screw	16 mm Item no. 6242-16-15		Ø gasket	16 x 22 x 2.0 Item no. 6462-16-22	
Ø gasket	16.7 x 24 x 1.5 mm Item no. 6464-016-724				

Daewoo

Ø gasket	14 x 20 x 1.5 mm Item no. 6460-14-20	
----------	---	---

Daihatsu

Ø gasket	12 x 24 x 2 mm Item no. 6464-012-242 Original no. 90430-12028	
----------	---	---

Ford

Ø screw	M14 x 1.5 x 16 mm Item no. 6243-14-15 Original no. 1005578/6157668		Ø sealing ring yellow vz	16.7 x 24 x 2 mm Item no. 6464-16-24	
Ø screw	M14 x 1.5 x 21 mm Item no. 6243-14-159 Original no. JHZ100062		Ø gasket	13 x 22.5 x 3 mm Item no. 6464-128-225	
Screw Ø including sealing ring	M12 x 1.75 x 28.5 mm Item no. 6243-012-15 Original no. 3051079				

Honda

Ø gasket	14 x 22 x mm Item no. 6464-114-22	
----------	--------------------------------------	---

Hyundai

Ø gasket	14 x 19 x 2.2 mm Item no. 6464-14-19 Original no. MD050317	
----------	--	---

Jaguar

Ø screw	M14 x 1.5 x 21 mm Item no. 6243-14-159 Original no. JHZ100062		Ø gasket	13 x 22.5 x 3 mm Item no. 6464-128-225	
---------	---	---	----------	---	---

Kia Ø gasket 14 x 19 x 2.2 mm
Item no. 6464-14-19
Original no. MD050317 

Land-Rover

Ø screw M14 x 1.5 x 16 mm
Item no. 6243-14-15 

Ø screw yellow vz M14 x 1.5 x 16 mm
Item no. 6243-014-15  Ø sealing ring 16.7 x 24 x 2 mm
yellow vz Item no. 6464-16-24 

Mazda

Ø gasket 14 x 20 x 1.5 mm
Item no. 6460-14-20 

Mitsubishi

Ø gasket 14 x 19 x 2.2 mm
Item no. 6464-14-19
Original no. MD050317 

Mini

Screw including sealing ring M14 x 1.5 x 20 mm
Item no. 6242-12-15
Original no. 11137513050 

Mercedes Benz

Ø screw M14 x 1.5 x 24 mm
Item no. 6242-14-15
Original no. 6019970230  Ø gasket 14 x 20 x 1.5 mm
Item no. 6460-14-20 

Ø screw M12 x 1.5 x 12 mm
Item no. 6241-12-15
Original no. 29973430  Ø gasket 12 x 17 x 1.5 mm
Item no. 6464-014-15 

Nissan

Ø gasket 12 x 17 x 3 mm
Item no. 6464-11-17
Original no. 1102601M02 

Opel

Ø screw M14 x 1.5 x 12 mm
Item no. 6242-014-15
Original no. 652475  Ø gasket 14 x 20 x 1.5 mm
Item no. 6460-14-20 

Ø screw M14 x 1.5 x 10.5 mm
Item no. 6243-14-160
Original no. 652477  Ø gasket 18 x 22 x 2 mm
Item no. 6464-18-2
Original no. 652540 

Ø screw M12 x 1.75 x 25 mm
Item no. 6243-12-160
Original no. 652736/652454  Ø gasket 11 x 21 x 2.5 mm
Item no. 6464-011-212 

Ø screw M18 x 1.5 x 21 mm
Item no. 6243-18-15
Original no. 652950  Ø gasket 15.5 x 26 x 2.5 mm
Item no. 6464-185-26 

Peugeot

Ø screw M10 x 1.25 x 13 mm
Item no. 6243-10-22
Original no. 311.29  Ø gasket 10.5 x 20.5 x 2 mm
Item no. 6464-10-10
Original no. 0313.33 

Ø screw M18 x 1.5 x 16 mm
Item no. 6243-018-22
Original no. 770305077  Ø gasket M18 x 24 x 2.0
Item no. 6462-18-24 

Ø screw M14 x 1.5 x 12.5 mm
Item no. 6243-014-22  Ø gasket 14 x 21 x 2.0
Item no. 6462-14-21 

Porsche

Ø gasket 22 x 27 x 1.5 mm
Item no. 6460-22-27 

Rover

Ø screw M12 x 1.5 x 18 mm
Item no. 6243-12-15
Original no. 11131273093  Ø gasket 12 x 17 x 1.5 mm
Item no. 6463-12-18 

Renault

Ø screw M16 x 1.5 x 13 mm
Item no. 6243-016-22
Original no. 7903075033  Ø gasket 16 x 22 x 2.0
Item no. 6462-16-22 

Ø screw M18 x 1.5 x 16 mm
Item no. 6243-018-22
Original no. 770305077  Ø gasket M18 x 24 x 2.0
Item no. 6462-18-24 

Saab

Ø screw yellow vz M14 x 1.5 x 16 mm
Item no. 6243-014-15
Original no. 1454117/6732529  Ø gasket 15 x 24 x 2 mm
Item no. 6464-15-15
Original no. 109132937 

Ø screw M14 x 1.5 x 16 mm
Item no. 6243-14-15
Original no. 1005578/6157668 

Seat

Ø gasket 22 x 27 x 1.5 mm
Item no. 6460-22-27 

Screw Ø including sealing ring M14 x 1.5 x 22 mm
Item no. 6243-14-161
Original no. N90813201 

Skoda

Ø screw M14 x 1.5 x 12 mm
Item no. 6242-014-15  Ø gasket 14 x 20 x 1.5 mm
Item no. 6460-14-20 

Screw Ø including sealing ring M14 x 1.5 x 22 mm
Item no. 6243-14-161
Original no. N90813201 

Subaru

Ø screw M20 x 1.5 x 14 mm
Item no. 6240-020-15  Ø gasket 20 x 26 x 2 mm
Item no. 6464-20-15
Original no. 11126AA000 

Suzuki

Ø gasket 14 x 20 x 1.5 mm
Item no. 6460-14-20 

Toyota

Ø gasket 12 x 24 x 2 mm
Item no. 6464-012-242
Original no. 90430-12028 

Volvo

Ø gasket 18 x 24 x 1.5 mm
Item no. 6463-18-24 

VW

Ø screw M14 x 1.5 x 12 mm
Item no. 6242-014-15
Original no. 652475  Ø gasket 14 x 20 x 1.5 mm
Item no. 6460-14-20 

Ø screw M14 x 1.5 x 17.5 mm
Item no. 6240-14-151
Original no. N90288901  Ø gasket 14 x 20 x 1.5 mm
Item no. 6460-14-20 

Screw Ø including sealing ring M14 x 1.5 x 22 mm
Item no. 6243-14-161
Original no. N90813201 

Vehicle body repair





01

Multipurpose primer

1K-Multi-Connector

- ▶ Item no. 2893-900
- ▶ Contents: 400 ml light grey
- ▶ Packing unit: 12



- ▶ Item no. 2893-900-20
- ▶ Contents: 400 ml dark grey
- ▶ Packing unit: 12



▶ **Product description**

- Recoatable without sanding
- With fan spray head
- Substrates: Galvanised sheet steel and aluminium, plastic, wood, etc.
- Particularly suitable for protecting the edges of filled areas
- Ideal for all difficult substrates, also suitable for plastic and wood



01

01

Zinc primer

Galva 97

- ▶ Item no. 2893-880
- ▶ Contents: 400 ml
- ▶ Packing unit: 12

▶ **Product description**

- Protects new sheet metal against rusting
- Weldable
- Abrasion resistant after drying
- High corrosion protection
- High percentage of active substances

02

Zinc-aluminium primer

Galva 97 Silver

- ▶ Item no. 2893-890
- ▶ Contents: 400 ml
- ▶ Packing unit: 12

▶ **Product description**

- Ideal for colour matching to galvanised sheet metal
- Protects new sheet metal against corrosion
- Weldable
- Abrasion resistant after drying
- High corrosion protection
- High percentage of active substances

03

Aluminium primerAlloy

- ▶ Item no. 2893-881
- ▶ Contents: 400 ml
- ▶ Packing unit: 12

▶ **Product description**

- Heat-resistant corrosion protection up to +600°C
- Weldable
- Overpaintable
- Protects new sheet metal against corrosion

04

Primer filler

2K Rapid Filler

- ▶ Item no. 2893-905
- ▶ Contents: 400 ml
- ▶ Packing unit: 6

▶ **Product description**

- Isocyanate-free
- Very rapid curing after 1 hour at 20°C
- or after 15-20 mins. at 60°C
- Universal use on old sanded paintwork and metallic substrates
- Simple and quick to use
- Very high filling capacity
- Very good adhesion on bright steel/plate
- Can be overpainted with any current 1K and 2K covering-paint systems



05

Base primer

Baso Plus

- ▶ Item no. 2893-889
- ▶ Contents: 400 ml
- ▶ Packing unit: 24

▶ **Product description**

- High filling properties
- Improved coverage due to increased number of pigments
- Temperature resistant up to 100°C
- Overpaintable with nitro, acrylic and water-based paints
- Fan spray head enables vertical and horizontal application



01

02

03

04

05

01

Thick film filler

One-component multi filler

- ▶ Item no. 2893-902
- ▶ Contents: 400 ml
- ▶ Packing unit: 10

▶ Product description

- High filling volume
- Easy to sand
- Quick drying
- With cone spray head

02

Primer filler

2-component epoxy primer filler

- ▶ Item no. 2800-760
- ▶ Contents: 400 ml
- ▶ Packing unit: 6

▶ Product description

- Gloss level: matt
- Colour: beige
- Long-lasting corrosion protection on all surfaces, e.g. zinc, aluminium, steel, etc.
- Proportion of solid particles: 50-53% by weight on diluted paint (without propellant gas)

03

Pistol grip

▶ Art. no.: 2893-900-2



04

Fan nozzle

▶ Art. no.: 2893-900-3

05

Rust stopper primer

Rednox

- ▶ Item no. 2893-888
- ▶ Contents: 400 ml
- ▶ Packing unit: 12

- ▶ Item no. 2893-888-25
- ▶ Contents: 2.5 kg
- ▶ Packing unit: 1

▶ Product description

- Quick drying
- Weldable
- Overpaintable
- Sprayable



01



02



03



01
Rust converter
Rostinator

- ▶ Item no. 2893-903
- ▶ Contents: 400 ml
- ▶ Packing unit: 12

- ▶ Product description
- Active pigments turn rust into iron sulphide
 - Forms a permanent weatherproof and moisture-resistant protective layer
 - Drying time: 14 hours
 - Compatible with all Normfest primers

02
Welding Primer
Elox Plus

- ▶ Item no. 2893-906
- ▶ Contents: 400 ml
- ▶ Packing unit: 12

- ▶ Product description
- 1K acrylic base
 - Very good corrosion protection
 - Can be over welded over
 - Very good ignitability & conductivity
 - Suitable for iron and steel
 - Quick drying
 - Visually matches stainless-steel parts

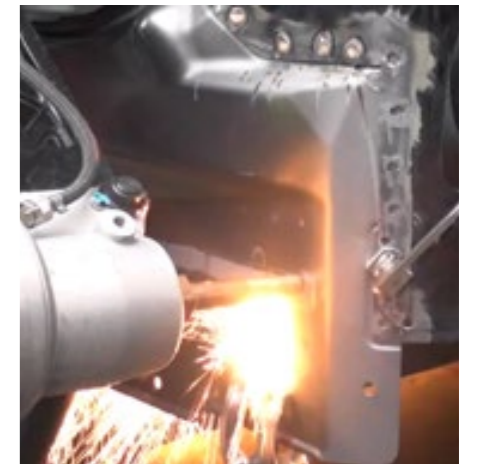

01

02

01

Underbody protection (overpaintable)

Bottom Guard Recoat

- ▶ Item no. 2892-881
- ▶ Contents: 500 ml
- ▶ Packing unit: 12



▶ **Product description**

- Provides optimum underbody protection with anti-rust and anti-corrosion properties
- Improves sound insulation
- Rust-protection spray dries quickly and is extremely resistant to abrasion
- Has very good adhesion to all substrates, such as bumpers / front and rear aprons
- The underbody spray can be overpainted after 60-90 minutes using two-component and basic paints

02

Underbody protection (overpaintable)

Bottom Guard Recoat

- ▶ Item no. 2892-882
- ▶ Contents: 1000 ml
- ▶ Packing unit: 12



▶ **Item no. 2892-883**

- ▶ Contents: 1000 ml
- ▶ Packing unit: 12



▶ **Product description**

- Provides optimum underbody protection with anti-rust and anti-corrosion properties
- Outstanding sound insulation
- Extremely resistant to abrasion
- Quick drying
- Can be overpainted with current two-component and basic paints after approx. 60-90 minutes (at 20°C, 65% rel. air humidity)
- Rubber base

03

Underbody protection (not overpaintable)

Bottom Guard

- ▶ Item no. 2892-990
- ▶ Contents: 1,000 ml black
- ▶ Packing unit: 12



▶ **Product description**

- Cannot be overpainted
- Contains solvents
- Bitumen base
- After curing, thanks to its combination of raw materials, the coating provides abrasion-resistant, permanently elastic corrosion protection with high resistance to ageing, which does not become brittle even when cold.

04

wax-based underbody protection

Bottom Guard Wax

- ▶ Item no. 2892-994-500
- ▶ Contents: 500 ml light brown
- ▶ Packing unit: 12



▶ **Item no. 2892-994**

- ▶ Contents: 1000 ml
- ▶ Packing unit: 12



▶ **Product description**

- Excellent corrosion protection with self-sealing property
- Highly resistant wax film
- Can be applied with airless spraying equipment as well as Airmix or pressure pot spray guns
- Touch-dry after (20°C, 65% RH): approx. 150 minutes
- Cured after (20°C, 65% RH): approx. 50 hours



01

02

03

04

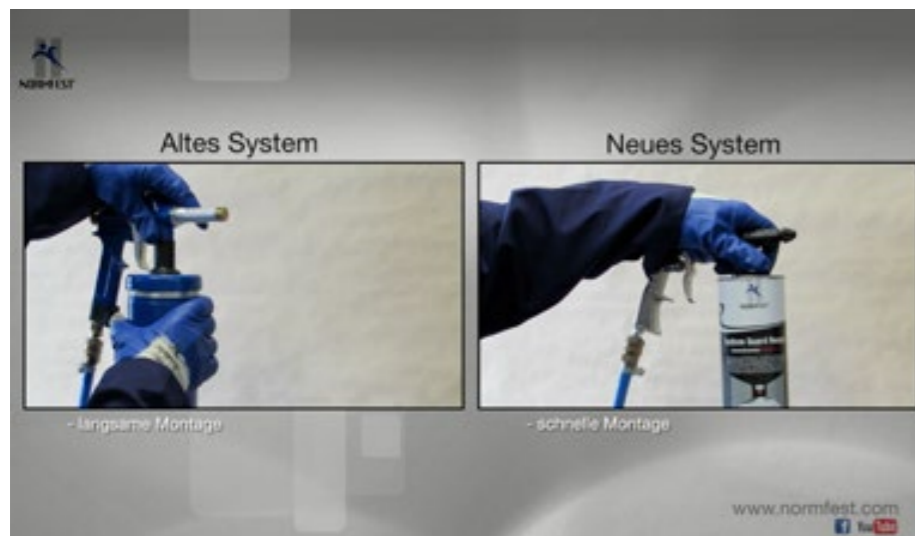

01 Pressure cup spray gun
for 1000 ml screw-top containers

- ▶ Art. no.: 2891-106-841
- ▶ Product description
 - Ideal for use of Bottom-Guard and Protector
 - Wide range of structures can be sprayed
 - Teflon seals
 - Suitable for metal



05 Cavity protection Protector

- ▶ Item no. 2892-997
- ▶ Contents: 400 ml
- ▶ Packing unit: 15
- ▶ Product description
 - Thermally stable -30°C to +90°C
 - The hose supplied ensures application even in hard-to-reach cavities
 - Facilitates optimal wetting of areas to be protected
 - Contains NO silicone!
 - transparent

06 Cavity protection Protector

- ▶ Item no. 2892-998
- ▶ Contents: 1000 ml
- ▶ Packing unit: 12
- ▶ Product description
 - Thermally stable -25°C to +160°C
 - Designed to protect and seal pillars, door sills, areas of the vehicle interior, etc..
 - Excellent penetration properties

07 Body protection Long-Life

- ▶ Item no. 2892-997-1
- ▶ Contents: 400 ml
- ▶ Packing unit: 12
- ▶ Product description
 - Displaces water
 - Capable of creep
 - Quick drying
 - Thermally stable from -50°C to +90°C
 - Extremely abrasion resistant
 - For sealing large areas of bodywork



02 UBS gun
Including nozzle and feed tube

- ▶ Art. no.: 2892-880
- ▶ Product description
 - Quick & easy to assemble
 - Accurately adjustable spray pattern
 - Quick & easy to change
 - No cleaning required

03 Nozzle set
For UBS gun (article no. 2892-880)

- ▶ Art. no.: 2892-880-1
- ▶ Product description
 - Nozzle set for UBS gun (article no. 2892-880)
 - Content:
 - 3 x nozzles
 - 3 x feed tubes

04 Body cavity spray hose set
For pneumatic pressure cup spray gun

- ▶ Art. no.: 2891-106-842
- ▶ Product description
 - Specially designed for Protector
 - Hose diameter: 6 mm
 - Hose length: 98 cm (with handle, incl. adapter), 116 cm (without handle, incl. adapter)



05

06

07

01

Body sealing compound

Basis: Polyurethane

Proton

- ▶ Item no. 2893-221-1
- ▶ Contents: 310 ml white
- ▶ Packing unit: 12

- ▶ Item no. 2893-221-2
- ▶ Contents: 310 ml black
- ▶ Packing unit: 12

- ▶ Item no. 2893-221-3
- ▶ Contents: 310 ml grey
- ▶ Packing unit: 12

▶ **Product description**

- Short thread break
- Forms a skin in 20 mins.
- Silicone-free
- Elastic
- Non-corrosive
- Broad adhesion spectrum: wood, metal, metal fillers, paintwork (2K systems), ceramic materials, glass and plastic
- Thermal stability: -40°C to +90°C (to +120°C in the short term)
- Approved for use in the food industry when cured
- Manufactured to quality assurance system DIN ISO 9001

02

Round nozzle

For aluminium cartridge, embossed, length: 8.2 cm

- ▶ Art. no.: 2891-02-25



03

Body sealing compound

Basis: Copolymer

Krypton

- ▶ Item no. 2893-222-1
- ▶ Contents: 290 ml white
- ▶ Packing unit: 12

- ▶ Item no. 2893-222-3
- ▶ Contents: 290 ml transparent
- ▶ Packing unit: 12

- ▶ Item no. 2893-222-4
- ▶ Contents: 290 ml grey
- ▶ Packing unit: 12

- ▶ Item no. 2893-222-5
- ▶ Contents: 290 ml black
- ▶ Packing unit: 12

▶ **Product description**

- UV-resistant
- Elastic
- Can be painted over wet-in-wet
- Can be sanded
- Silicone- and isocyanate-free
- Good adhesion on many metals (zinc, aluminium, steel), paints, primers, wooden materials, Duround thermoplastics (apart from PE, PP, PTFE) and mineral substrates
- Resistant to lime water, public waste water and weak acids and alkalis
- Thermal stability: -40°C to +90°C, to +120°C in the short term
- Solvent-free single-component adhesive and sealant
- Suitable for bodywork, container and vehicle construction

04

Round nozzle

Basis: polyurethane

- ▶ Art. no.: 2891-02-26



02

01

04

03

01

Sprayable seam sealant

Basis: Copolymer

Flexon

- ▶ Item no. 2893-300 
- ▶ Contents: 310 ml grey
- ▶ Packing unit: 12

- ▶ Item no. 2893-301 
- ▶ Contents: 310 ml black
- ▶ Packing unit: 12

▶ **Product description**

- UV-resistant
- Elastic
- Can be overpainted wet-in-wet
- Can be sanded
- Silicone-free
- Broad adhesive spectrum: many metals (zinc, aluminium, steel), paints, primers, glass, wood, plastics (apart from PE, PP, PTFE) and mineral substrates
- Thermal stability: -40°C to +80°C, to +120°C in the short term

02

For plastic cartridges

For use with body sealing compounds, windscreen adhesives and sprayable seam sealants

- ▶ Art. no.: 2891-03-1



01

03

Body adhesive

Pluton

- ▶ Item no. 2893-223-4 
- ▶ Contents: 280 ml grey
- ▶ Packing unit: 12

▶ **Product description**

- Very stable after 30 minutes
- Adheres without primer to steel, aluminium, galvanised sheet steel, GRP and plastics
- Can be overpainted
- Permanently thermally stable to +80°C



03



04

04

Static mixer
for Pluton

- ▶ Art. no.: 2893-223-30

▶ **Product description**

- Length: Static mixer 23.5 cm



06

06

Wing nozzle

For achieving wide and flat sealing compound seams

- ▶ Art. no.: 2891-02-27



05

05

Square spatula
for Pluton

- ▶ Art. no.: 2893-223-38

▶ **Product description**

- Length: Mixer rod 23 cm
- Diameter at tip: approx. 0.5 cm
- Diameter of adapter: 2.2 cm



07

07

Cartridge opener

- ▶ Art. no.: 2891-02-50

01

Pneumatic cartridge gun

Ideal for use with sprayable seam sealants, e.g. Flexon (2893-300)

► Art. no.: 2891-05

► Product description

- Content:
- 1 x pneumatic cartridge gun
- 1 x nozzle set (10 long nozzles, 20 short nozzles)
- 1 x spare nozzle cap



02

Spare small spray tubes

For pneumatic cartridge gun (2891-05)

► Art. no.: 2891-051

► Product description

- Packaging unit: 30 pieces

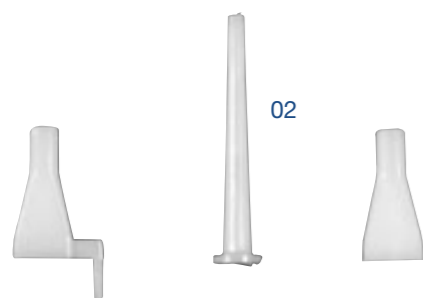

03

Brush

For body sealing compounds

► Art. no.: 4693-251-1

► Product description

- Model: 1,0"



04

Adherend cleaner

Glue-Ex

► Item no. 2893-200-10

► Contents: 1000 ml

► Packing unit: 12

► Product description

- The ideal cleaner for cleaning surfaces before being stuck
- Can be used on all substrates in the automotive area, apart from plastics
- Transparent



05

Adhesive cleaner

HR 150

► Item no. 2700-36

► Contents: 150 ml

► Packing unit: 1

► Product description

- Cleans and simultaneously primes
- Ideal for pre-treating non-absorbent metal and plastic substrates





01
Plastics repair adhesive
Repos fast

- ▶ Item no. 2700-15
 - ▶ Contents: 50 ml
 - ▶ Packing unit: 2
- ▶ **Product description**
- For sticking PVC, GRP, steel and aluminium
 - Dropping time: 90 seconds
 - Sandable after approx. 15 minutes.

02
Plastics repair adhesive
Repos

- ▶ Item no. 2700-10
 - ▶ Contents: 50 ml
 - ▶ Packing unit: 2
- ▶ **Product description**
- For sticking PVC, GRP, steel and aluminium
 - Dropping time: 5 minutes
 - Sandable after approx. 90 minutes.

03
Repair adhesive
Repos MMA

- ▶ Item no. 2700-20
 - ▶ Contents: 50 ml
 - ▶ Packing unit: 2
- ▶ **Product description**
- for the bonding of different substrates, such as: Sun visor bracket, plastic trims, carbon on steel, aluminium parts on steel substrate, etc.
 - Can be applied without chemical or mechanical pre-treatment
 - At 35 Mpa, has enormous tensile shear strength
 - Free of solvents and volatile organic compounds
 - Processing temperature: +10°C to +30°C
 - Thermally stable: -50°C bis +120°C
 - Dry to touch after approx. 15 minutes
 - Fully dry after approx. 24 hours



04
Plastics repair adhesive
Repos fast

- ▶ Item no. 2700-16
 - ▶ Contents: 25 ml
 - ▶ Packing unit: 1
- ▶ **Product description**
- Setting time: 90 seconds
 - Sandable after 15 minutes



01



02



03



04



01
Light-pressure metal gun
for plastic repair adhesive

► Art. no.: 2700-71

- Product description
- Easy to squeeze
 - Robust plastic/metal casing
 - Ready to use quickly and easily



02
Cartridge gun
For plastic repair adhesive

► Art. no.: 2700-70

- Product description
- Quickly ready for use
 - For 50 ml cartridges with two tubes
 - Made from plastic



03
Mixer rod
For plastic repair adhesive

► Art. no.: 2700-40

- Product description
- Suitable for Repos plastic repair adhesive
 - Improved mixing ratio due to new static mixing fabric
 - Length: 15 cm



04
Square spatula
for Repos and Repos Fast

► Art. no.: 2700-42

- Product description
- Suitable for Repos (2700-10) and Repos Fast (2700-15)
 - A very good mixing ratio is achieved through the new static mixer fabric



05
Reinforcing tape
Dimensions: 50mm x 4.0m

► Art. no.: 2700-60

- Product description
- For stabilizing the repair surface
 - 50 mm x 4.0 m



06
Contour foil
Dimensions: 125mm x 3.6m

► Art. no.: 2700-50

- Product description
- For simple smoothing of the adhesive mass
 - 125 x 3.6 mm



07
Plastic welding system
Repotec

► Art. no.: 2701-999-999

- Product description
- A welding wire for all plastics
 - No laborious testing of the plastic type
 - Temperature/air volume combinations can be saved in the device for each application
 - Ready in 30-60 mins.
 - Material costs below € 5 per repair
 - Immediately ready for smoothing and painting
 - Extremely durable and TÜV tested.

- Contents:
- 1 x Vehicle repair nozzle for plastic welding (art. no. 2701-10)
 - 1 x 9mm reducing nozzle, hot-air blower (art. no. 2701-11)
 - 1 x Hot-air blower temperature protector (art. no. 2701-12)
 - 1 x EEA/EVA welding wire set (20 pieces) (art. no. 2701-2)
 - 1 x Wire fabric set (10 pieces) (art. no. 2701-30)
 - 1 x Hot-air blower, 2300 W (art. no. 8697-000-991)



07

01

Dent repair set

Bodytec I

▶ Art. no.: 8714-999-999

▶ Product description

- Professional external dent repairs
- Disassembly of coverings not required

- Content: 13 pieces

- 1 x 2000-640-40 Microfiber cloth blue 40x40 cm
- 1 x 2893-200-10 Glue-Ex 1000 ml
- 1 x 2897-323 Terpanol Power 400 ml
- 1 x 2897-325 Arctic 200 ml
- 1 x 8714-600 Bodytec repair bridge
- 1 x 8714-607-1 Glue gun 230V / 200W
- 2 x 8714-611-7 Glue sticks set black PU: 5
- 1 x 8714-612-6 Nylon striker pin diam. 13 mm
- 1 x 8714-614-2 Pull tabs set 16 mm PU: 2
- 1 x 8714-614-3 Pull tabs set 21 mm PU: 2
- 1 x 8714-614-4 Pull tabs set 27 mm PU: 2
- 1 x 8714-614-5 Pull tabs set 32 mm PU: 2

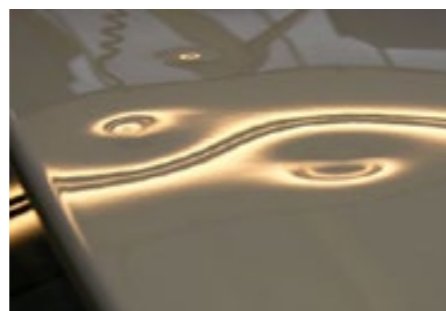

01

02

Inspection lamp for dent repairs

Incl. suction base

▶ Art. no.: 8714-610

▶ Product description

- Flexible use
- Can also be used as a hand lamp via the detachable flexible arm
- Paint-protecting 120 mm-diameter suction foot
- 300 mm long flexible arm with star handle
- Protects eyes thanks to prismatic protective glass

- 220/240 Volt with automatic switch-off

- 50/60 Hz
- 900 Lumen
- 210 mm light length
- Width: 38.5 mm
- Length: 65 mm
- 11 Watt fluorescent lamp
- 5m supply cable



02

03

Repair bridge

▶ Art. no.: 8714-600

▶ Product description

- Flexible feet
- Material: metal



03

04

Hot melt gun

Electronically controlled

▶ Art. no.: 8714-607-1

▶ Product description

- Changeable nozzle
- Adhesive point solid and can be fully loaded after just 2 minutes



04

05

Mushroom repair patches

Colour: blue, Contents: 2 pieces

▶ Item no. 8714-614-2
▶ Diameter 16 mm, blue

▶ Item no. 8714-614-3
▶ Diameter 21 mm, blue

▶ Item no. 8714-614-4
▶ Diameter 27 mm, blue

▶ Item no. 8714-614-5
▶ Diameter 32 mm, blue

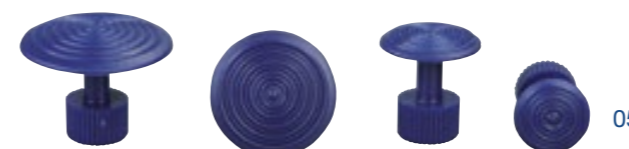

05

06

Nylon striker pin

Ø 13 mm

▶ Art. no.: 8714-612-6



06

07

Glue sticks

Colour: black, content: 5 sticks

▶ Art. no.: 8714-611-7

01

Dent repair set

Bodytec II

▶ Art. no.: 8714-999-998

▶ **Product description**

- In addition to the increased repair speed compared to Bodytec System I, it also enables the repair of large dents
- Furthermore, the flexible pull tabs (orange) can be moulded to various dent shapes
- Disassembly of covering not required

- Content: 18 pieces

- 1 x 2000-640-40 Microfiber cloth blue 40x40 cm
- 1 x 2893-200-10 Glue-Ex 1000 ml
- 1 x 2897-323 Terpanol Power 400 ml
- 1 x 2897-325 Arctic 200 ml
- 1 x 8714-601 Bodytec body dent puller
- 1 x 8714-606 Glue gun 230V / 200W
- 2 x 8714-611-9 Glue sticks set black PU: 5
- 1 x 8714-612-6 Nylon striker pin, diameter 13MM
- 1 x 8714-614-10 Pull tabs set, 40 mm, orange, PU: 22
- 1 x 8714-614-11 Pull tabs set 50x30 mm orange, PU: 2
- 1 x 8714-614-2 Pull tabs set 16 mm, PU: 2
- 1 x 8714-614-3 Pull tabs set 21 mm, PU: 2
- 1 x 8714-614-4 Pull tabs set 27 mm, PU: 2
- 1 x 8714-614-5 Pull tabs set 32 mm, PU: 2
- 1 x 8714-614-6 Pull tabs set 35 mm, BLUE, PU: 2
- 1 x 8714-614-7 Pull tabs set 40 mm, blue, PU: 2
- 1 x 8714-614-8 Pull tabs set 50x30 mm blue, PU: 2
- 1 x 8714-614-9 Pull tabs set 35 mm, orange, PU: 2



01

02

Body dent remover

▶ Art. no.: 8714-601

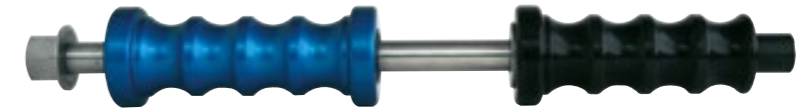

02

03

Nylon striker pin

Ø 13 mm

▶ Art. no.: 8714-612-6



03

04

Glue sticks HD

Colour: blue, content: 5 sticks

▶ Art. no.: 8714-611-9



04

05

Pull tabs

Colours: blue and orange

▶ Item no. 8714-614-2
▶ Diameter 16 mm, blue

▶ Item no. 8714-614-3
▶ Diameter 21 mm, blue

▶ Item no. 8714-614-4
▶ Diameter 27 mm, blue

▶ Item no. 8714-614-5
▶ Diameter 32 mm, blue

▶ Item no. 8714-614-6
▶ Diameter 35 mm, blue

▶ Item no. 8714-614-7
▶ Diameter 40 mm, blue

▶ Item no. 8714-614-8
▶ 50 x 30 mm, blue

▶ Item no. 8714-614-9
▶ Diameter 35 mm, orange (mouldable)

▶ Item no. 8714-614-10
▶ Diameter 40 mm, orange (mouldable)

▶ Item no. 8714-614-11
▶ 50 x 30 mm, orange (mouldable)



05



02

Cut off wheel

Twister

► **Product description**

- Width of cut 0.8 mm
- Suitable for high-strength thin sheet of the latest vehicle generation
- High flexibility
- Clean cut surfaces, less burr
- Suitable for plastics, thin high-alloyed sheets and steel
- Fast cutting action
- Less waste and dust
- Reduced machine load
- High break resistance
- Low thermal stress
- Max. 13,300 rpm
- Hole 22.2 mm
- Use with spacer disc



02

Item no.	Ø	Thickness	Bore hole	Packing unit
4667-115-8	115 mm	0,8 mm	22,2 mm	30
4667-125-8	125 mm	0,8 mm	22,2 mm	30

01

Cut off wheel

Snake Performance

► **Product description**

- Service life 20% higher than that of conventional cut off wheels
- Width of cut 1.0 mm
- Clean cut surfaces, less burr
- Less waste and dust
- Low thermal stress
- Suitable for plastics, high-alloyed sheets and steel
- Fast cutting action
- High break resistance
- Reduced machine load
- Max. 13,300 rpm



01

Item no.	Ø	Thickness	Bore hole	Packing unit
4667-063-1	63 mm	1,0 mm	6,0 mm	30
4667-115-1	115 mm	1,0 mm	22,2 mm	30
4667-125-1	125 mm	1,0 mm	22,2 mm	30

03

Cut-off wheel

Inox

► **Product description**

- Consists of a very strong composite resin that together with the fabric provides very good stability.



03

Item no.	Ø	Thickness	Bore hole	Packing unit
4667-115-12	115 mm	1,2 mm	22,2 mm	30
4667-115-25	115 mm	2,5 mm	22,2 mm	30
4667-125-12	125 mm	1,2 mm	22,2 mm	30
4667-125-25	125 mm	2,5 mm	22,2 mm	30
4667-180-25	180 mm	1,6 mm	22,2 mm	30
4667-230-25	230 mm	1,9 mm	22,2 mm	30
4667-060-20	60 mm	2,0 mm	6 mm	1
4667-100-1	Aufspannbolzen			1

01

Roughing disc

Inox

Item no.	Ø	Thickness
4669-063-60	63 mm	6,0 mm
4669-115-60	115 mm	6,0 mm
4669-125-60	125 mm	6,0 mm
4667-100-1	Work arbor for 6mm drill hole	



01

02

Vanish

Roughing disc and fan-type grinding wheel

► **Product description**

- Clear view of the surface being treated enables precise work and constant inspection
- Combines the sanding performance of roughing discs with the speed of a fan-type grinding wheel
- 25% less temperature development compared to conventional roughing discs
- Suitable for working of weld seams or removing rust, paint, etc.
- Max. 13,300 rpm



02

Item no.	Ø	Graining
4670-115-36	115 mm	36

03

Nylon fabric abrasive discs / drill

► **Product description**

- Black grinding wheel consisting of nylon fabric
- A grain resin is additionally applied to this fabric

Item no.	Ø	
4585-1-100	100 mm	Max. 8,000 rpm
4585-1-150	150 mm	Max. 5,500 rpm

Tensioning spindle

4585-110-01	6 mm for 4585-1-100
4585-115-01	8 mm for 4585-1-150



03

04

Nylon fabric grinding plate

Red, hard, cool grind

► **Product description**

- Very fast and aggressive cleaning
- Extremely long service life thanks to ceramic-corundum grain
- No geometric change to surface
- No corrosive residues on the workpiece surface

Item no.	Ø	Holder
4585-2-100	100 mm	for drill
4585-2-115	115 mm	for angle grinder
4585-2-150	150 mm	for drill



04

05

Nylon fabric abrasive discs / angle grinder

Item no.	Ø
4585-1-115	115 mm



05

01

Grinding mop plate

Heavy Duty

► Product description

- 100% pure zirconium corundum
- 72 grinding discs
- Very robust Y-shaped polyester support
- Very fast and aggressive cutting
- Very long service life
- Angled shape



Item no.	Ø	Graining
4663-115-040	115 mm	40
4663-115-060	115 mm	60
4663-115-080	115 mm	80
4663-125-040	125 mm	40
4663-125-060	125 mm	60
4663-125-080	125 mm	80



01

02

Sanding mop disc

bevelled shape

Item no.	Ø	Graining
4662-115-036	115 mm	36
4662-115-040	115 mm	40
4662-115-060	115 mm	60
4662-115-080	115 mm	80
4662-125-036	125 mm	36
4662-125-040	125 mm	40
4662-125-060	125 mm	60
4662-125-080	125 mm	80

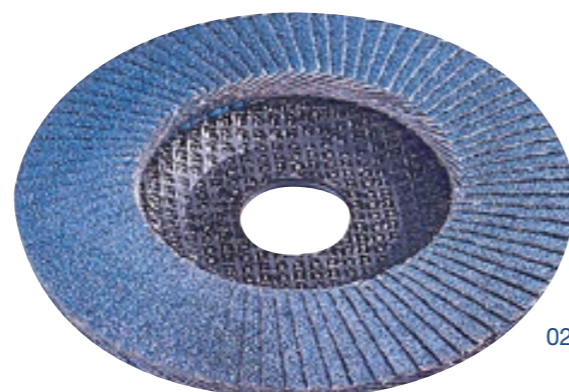

02

03

Vulcanised fibre discs

Item no.	Ø	Graining
4665-115-24	115 mm	24
4665-115-36	115 mm	36
4665-115-40	115 mm	40
4665-115-60	115 mm	60
4665-115-80	115 mm	80
4665-178-24	178 mm	24
4665-178-36	178 mm	36
4665-178-40	178 mm	40

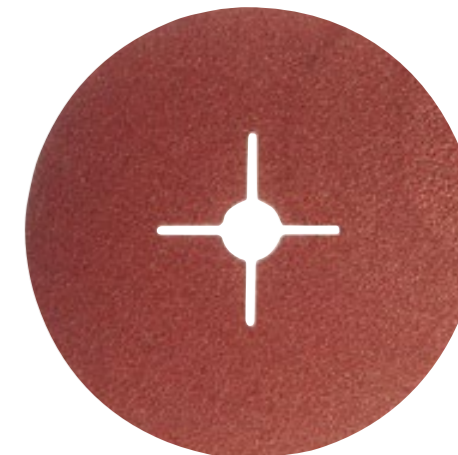

04

Rubber disc

For vulcanised fibre discs

Item no.	Ø
4666-115	115 mm
4666-178-14	178 mm

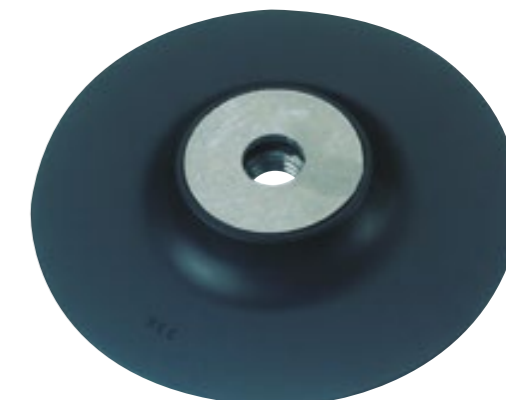



01
Mini serrated grinding discs
Flexloc

- ▶ **Product description**
- High-performance cutting
- Good service life
- Very flexible thanks to angled discs
- Ideal for hard-to-reach places

- Ideal for:
- Removing weld seams / spots
- Removing rust
- Removing old paint and primers
- Deburring sheets

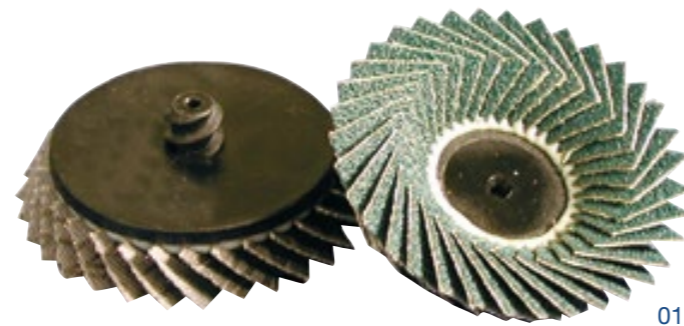

Item no.	Graining	Max. rpm
Ø 50 mm		
4679-50-36	36	30.000
4679-50-60	60	30.0000
4679-50-80	80	30.0000

Item no.	Graining	Max. rpm
Ø 75 mm		
4679-75-36	36	20.000
4679-75-60	60	20.000
4679-75-80	80	20.000

02
Zircoloc

- ▶ **Product description**
- Minimal heat generation due to additives in the binding agent
- The fabric backing ensures high flexibility
- Ideal for:
- Removing weld seams / spots
- Removing rust
- Removing old paint and primers



Item no.	Graining	Max. rpm
Ø 50 mm		
4679-02-24	24	30.000
4679-02-36	36	30.000
4679-02-60	60	30.000
4679-02-80	80	30.000
4679-02-120	120	30.000

Item no.	Graining	Max. rpm
Ø 75 mm		
4679-03-24	24	20.000
4679-03-36	36	20.000
4679-03-60	60	20.000
4679-03-80	80	20.000
4679-03-120	120	20.000

03
High-performance Zircoloc grinding discs

- ▶ **Product description**
- High-performance cutting
- Fast grinding
- Extremely long service life
- Low heat generation
- Little wear
- Colour: green

- Ideal for:
- Removing weld seams / spots
- Removing rust
- Grinding off old paint and primer
- Removing damage to aluminium rims



Item no.	Graining	Max. rpm
Ø 50 mm		
4679-04-24	24	30.000
4679-04-36	36	30.000
4679-04-60	60	30.000
4679-04-80	80	30.000
4679-04-120	120	30.000

Item no.	Graining	Max. rpm
Ø 75 mm		
4679-05-24	24	20.000
4679-05-36	36	20.000
4679-05-60	60	20.000
4679-05-80	80	20.000
4679-05-120	120	20.000

01

Fabric grinding disc

Sandloc

► **Product description**

- Extremely flexible fabric grinding discs with very low heat generation
- Ideal for sanding in tight spaces and curves
- Removing sealing compounds and any solid seal residues
- Sanding fillers
- Removing old paint and primers

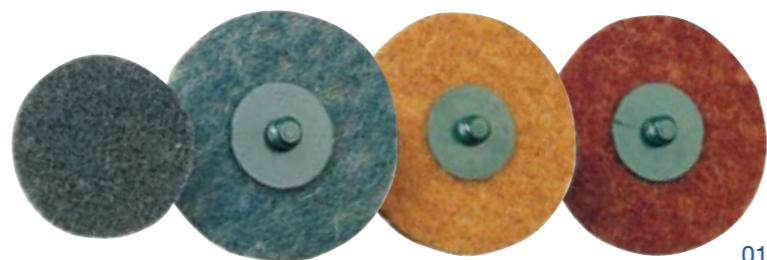

01

Item no.	Model	Max. rpm
Ø 50 mm		
4679-22-50	Fine (blue)	30.000
4679-23-50	Medium (red)	30.000
4679-25-50	Coarse (yellow)	30.000

Item no.	Model	Max. rpm
Ø 115 mm		
4679-22-115	Fine (blue)	10.000
4679-23-115	Medium (red)	10.000
4679-25-115	Coarse (yellow)	10.000

Ø 75 mm

4679-22-75	Fine (blue)	20.000
4679-23-75	Medium (red)	20.000
4679-25-75	Coarse (yellow)	20.000

02

Blackloc

► **Product description**

- Extremely open structure ensures long service life
- Extremely low heat generation
- Ideal for removing loose rust, old paint and underbody protection



02

Item no.	Max. rpm	Item no.	Max. rpm
Ø 50 mm		Ø 75 mm	
4679-47	30.000	4679-48	20.000

03

Mini one-hand right angle grinder

Low-noise and vibration-free

► **Art. no.: 8696-1-80**

► **Product description**

- Compressed air fitting: 1/4"
- Sound pressure: 83 dB/A
- Air pressure: 6.3 bar
- Weight: 0.8 kg
- Speed: 18,000 rpm
- Chuck: 6 mm
- Average air consumption: 220 l/min



04

Required air connection 1/4"

► **Art. no.: 8699-510-14**



03



05

Adapter for 8696-1-80

► **Art. no.: 4679-99-8**

06

Normloc reception system

Made from a hard polyurethane supporting disc

- **Item no. 4679-90-94**
- **Diameter 30 mm, max. rpm: 40,000**

- **Item no. 4679-90-92**
- **Diameter 50 mm, max. rpm: 30,000**

- **Item no. 4679-90-93**
- **Diameter 75 mm, max. rpm: 20,000**

- **Item no. 4679-99-6**
- **Ø 6 mm incl. mounting shank**



06

07

Bristle Disc 3M

► **Product description**

- Suitable for exposing weld spots and removing sealing compounds, underbody protection and solid seal residues

Item no.	Model	Max. rpm
Ø 50 mm		
4679-44	fine - white	25.000
4679-45	medium - yellow	25.000
4679-46	coarse - green	25.000

Ø 75 mm

4679-46-75	coarse - green	15.000
4679-90-931	Reception system	



07



01

Sanding roller

Very high sanding performance

► **Product description**

- Stainless steel, non-ferrous metals, construction and high-carbon steel as well as difficult-to-machine metal materials
- Sanding of casting skins, removing of welding seams, deburring
- Finishing of shaped surfaces
- Zirconia alumina, fabric with full resin bond

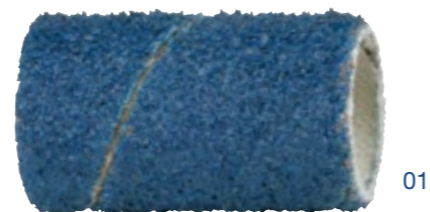

01

Item no.	Dimensions Ø x width	Graining	Min. rpm	Max. rpm
4675-15-50	15 x 30 mm	50	2.500	36.000
4675-15-150	15 x 30 mm	150	2.500	36.000
4675-22-50	22 x 20 mm	50	18.000	26.000
4675-22-150	22 x 20 mm	150	18.000	26.000
4675-30-50	30 x 30 mm	50	13.000	19.000
4675-30-150	30 x 30 mm	150	13.000	19.000
4675-45-50	45 x 30 mm	50	9.000	13.000

02

Fan roller

► **Product description**

- Precision grinding and polishing of stainless steel, steel and non-ferrous metals
- Ideal for deburring and fine polishing
- Achieves even and uniform surface quality

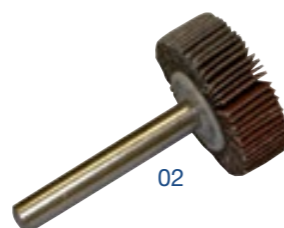

02

Item no.	Dimensions	Graining	Max. rpm
4675-30-60	30 x 10 x 6 mm	60	18.000
4675-30-80	30 x 10 x 6 mm	80	18.000
4675-30-120	30 x 10 x 6 mm	120	18.000
4675-40-60	40 x 20 x 6 mm	60	18.000
4675-40-80	40 x 20 x 6 mm	80	18.000
4675-60-120	40 x 20 x 6 mm	120	12.000
4675-60-60	60 x 30 x 6 mm	60	12.000
4675-60-80	60 x 30 x 6 mm	80	12.000
4675-80-60	80 x 50 x 6 mm	60	7.500
4675-80-80	80 x 50 x 6 mm	80	7.500

03

Retainer for sanding roller

For use with sanding rollers

► **Product description**

- Rubber body with 6 mm steel shaft
- Non-slip fit of the sanding roller guaranteed by the centrifugal force



03

Item no.	Dimensions
4675-15	15 x 30 mm
4675-22	22 x 30 mm
4675-30	30 x 30 mm
4675-45	45 x 30 mm
4675-60	60 x 30 mm

04

Wheel brush

Hardened steel wire, corrugated, diameter 50 mm

Item no.	Model	WIDTH mm	WIRE Ø mm	max. r/min.
4691-926-049	Opel	10 mm	0,3 mm	15.000
4691-926-050	normal	10 mm	0,5 mm	15.000
4691-926-051	narrow	7 mm	0,3 mm	15.000



05

Centrifugal brush

Steel wire, braided



Item no.	Ø	max. r/min.
4691-925-900	19 mm	20.000
4691-925-901	28 mm	20.000

06

Braided brush

M14



Item no.	Ø	max. r/min.
4691-925-941	65 mm	12.500

07

Long-time brush



Item no.	
4691-925-910	Thickness 7 mm
4691-925-920	Mounting shank Ø 13 mm

08

Universal braided brush

for machines with Ø 125 mm

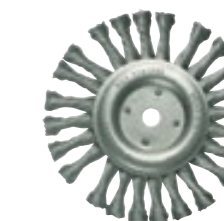

Item no.	Ø	max. r/min.
4691-925-911	115 mm	12.000

09

Retainer and adapter

for drill

► **Art. no.: 4691-927-15**



10

Shaft wheel brush

Hardened steel wire, braided, smooth



Item no.	Ø	max. r/min.
4691-925-905	70 mm	20.000

01

Pneumatic machine

ideal for stripe removal discs

▶ Art. no.: 4692-123

▶ Product description

- Weight: 1.1 kg
- Air pressure connection thread: 1/4" PT
- Rotational speed: 0-3,500 rpm
- Required flow pressure: 6.2 bar/90 psi
- Average air consumption: 17.5 CFM (500 l/min)



02

MBX starter kit

For the professional surface preparation

▶ Art. no.: 4692-900

▶ Product description

- Weight: 1.1 kg
 - Air pressure connection thread: Rp 1/4"
 - Hose diameter required: 3/8" ID (9.5 mm)
 - Rotational speed: 0-3,500 rpm
 - Required flow pressure: 6.2 bar/90 psi
 - Required internal tube diameter: 9,5 mm
 - Average air consumption: 17.5 CFM (500 l/min)
 - Sound pressure level: 83 dB (DIN 45635-21; ISO 3744)
- Contents:
- 1 x 4692-123 MBX compressed-air machine
 - 1 x 4692-211 MBX holder system 11 mm
 - 1 x 4692-223 MBX holder system 23 mm
 - 1 x 4692-523 MBX brush band, coarse 23 mm
 - 1 x 4692-411 MBX brush band, medium 11 mm
 - 1 x 4692 311 MBX brush band, fine 11 mm
 - 1 x 4692-800 MBX film grinder



For working on aluminium bodywork.



For removing paint from contours.



For removing films from metal surfaces and paint without damage.

03

Brush strip

▶ Product description

- For example, cleaning steel gaskets

Item no.	Model	Width
4692-311	fine	11 mm
4692-323	fine	23 mm
4692-411	medium	11 mm
4692-423	medium	23 mm
4692-511	coarse with elbow	11 mm
4692-523	coarse with elbow	23 mm



03

04

Brush strip made of high-grade steel

▶ Product description

- Ideal for aluminium bodywork

Item no.	Model	Width
4692-611	with elbow	11 mm
4692-623	with elbow	23 mm
4692-723	without elbow	23 mm



04

05

Stripe removal disc

▶ Product description

- Easy handling
- High speed
- No damage to paintwork
- High longevity

Item no.	Width
4692-800	23 mm



05

06

Reception system

▶ Product description

- The holder is for all brush bands and film grinders 11 mm wide that are used with the MBX processing machine
- The machine adapter is suitable for our patented MBX compressed-air device (art. no. 4692-123)

Item no.	Width
4692-211	11 mm
4692-223	23 mm



06



01

Stratus HSS-O spiral drill bits

Profile ground and right-hand cut, DIN 340



► **Product description**

- Special grind:
- Quiet concentric running
- No centre-punching
- Drilling possible on curved surfaces

- Properties:
- HSS-O drill bit
- All-round drill bit for almost all materials
- Ground from complete blank
- Greatest breaking strength in all diameters
- Low swarf curvature

- Point angle:
- Up to 50% faster than conventional spiral drill bits
- Lower energy demand
- Ideal for cordless drill/driver

02

Stratus drill bit box

- Item no. 4627-025-10
- Diameter 2.5 – 10.0 mm (0.5 mm increments)

- Item no. 4627-025-13
- Diameter 2.5 – 13.0 mm (0.5 mm increments)



02

03

Stratus set

- Item no. 1900-98
- Contents: 6-piece kit

- Product description
- Content sizes: 2.0; 3.0; 4.0; 5.0; 6.0; 8.0



03

Item no.	Ø
4627-10	1,0 mm
4627-15	1,5 mm
4627-20	2,0 mm
4627-25	2,5 mm
4627-30	3,0 mm
4627-33	3,3 mm
4627-35	3,5 mm
4627-40	4,0 mm
4627-45	4,5 mm
4627-50	5,0 mm
4627-55	5,5 mm
4627-60	6,0 mm
4627-65	6,5 mm
4627-68	6,8 mm

Item no.	Ø
4627-70	7,0 mm
4627-75	7,5 mm
4627-80	8,0 mm
4627-85	8,5 mm
4627-90	9,0 mm
4627-95	9,5 mm
4627-100	10,0 mm
4627-102	10,2 mm
4627-105	10,5 mm
4627-110	11,0 mm
4627-115	11,5 mm
4627-120	12,0 mm
4627-125	12,5 mm
4627-130	13,0 mm

Item no.	Ø
4627-135	13,5 mm
4627-140	14,0 mm
4627-145	14,5 mm
4627-150	15,0 mm
4627-155	15,5 mm
4627-160	16,0 mm
4627-165	16,5 mm
4627-170	17,0 mm
4627-175	17,5 mm
4627-180	18,0 mm
4627-185	18,5 mm
4627-190	19,0 mm
4627-195	19,5 mm
4627-200	20,0 mm

01

Platinum HSCO spiral drill bits

Profile ground and right-hand cut, DIN 1913



► **Product description**

- Material HSCO (special quality)
- Precision-ground
- Point angle 118°
- Good penetration
- 4-surface grinding
- Aggressive cutting
- High stability and long service life
- Quiet running
- High thermal stability
- Very good swarf removal

02

Platinum drill-bit box

- Item no. 4628-125-010
- Diameter 2.5-10.0 mm (0.5 mm increments)



02

03

Platinum set

- Item no. 1900-99
- Contents: 6-piece kit
- **Product description**
- Content sizes: 2.0; 3.0; 4.0; 5.0; 6.0; 8.0



03

Item no.	Ø
4628-1-25	2,5 mm
4628-1-30	3,0 mm
4628-1-32	3,2 mm
4628-1-35	3,5 mm
4628-1-40	4,0 mm
4628-1-42	4,2 mm
4628-1-45	4,5 mm
4628-1-50	5,0 mm
4628-1-55	5,5 mm

Item no.	Ø
4628-1-60	6,0 mm
4628-1-65	6,5 mm
4628-1-68	6,8 mm
4628-1-70	7,0 mm
4628-1-75	7,5 mm
4628-1-80	8,0 mm
4628-1-85	8,5 mm
4628-1-90	9,0 mm
4628-1-95	9,5 mm

Item no.	Ø
4628-1-100	10,0 mm
4628-1-105	10,5 mm
4628-1-110	11,0 mm
4628-1-115	11,5 mm
4628-1-120	12,0 mm
4628-1-125	12,5 mm
4628-1-130	13,0 mm

04

Night Line HSS spiral bits

Profile ground, DIN 338



► **Product description**

- Profile-ground
- Ground out from a complete blank
- HSS drill bit
- Suitable for manual drills
- Point angle 118°
- Relatively good penetration
- Reduced cross-cutting
- High stability
- Quiet running



05

Night Line drill-bit box

- Item no. 4626-001-10
- Diameter 1.0-10.0 mm (0.5 mm increments)
- Item no. 4626-001-13
- Diameter 1.0-13.0 mm (0.5 mm increments)



05

06

Night Line set

- Item no. 1900-97
- Contents: 13-piece kit
- **Product description**
- Content sizes: 2.0; 2.5; 3.0; 3.5; 4.0; 4.5; 5.0; 5.5; 6.0; 6.5; 7.0; 7.5; 8.0



06

Item no.	Ø
4626-10	1,0 mm
4626-100	10,0 mm
4626-105	10,5 mm
4626-110	11,0 mm
4626-115	11,5 mm
4626-120	12,0 mm
4626-125	12,5 mm
4626-130	13,0 mm
4626-135	13,5 mm
4626-140	14,0 mm
4626-15	1,5 mm

Item no.	Ø
4626-20	2,0 mm
4626-25	2,5 mm
4626-30	3,0 mm
4626-35	3,5 mm
4626-40	4,0 mm
4626-42	4,2 mm
4626-45	4,5 mm
4626-48	4,8 mm
4626-50	5,0 mm
4626-52	5,2 mm
4626-55	5,5 mm

Item no.	Ø
4626-60	6,0 mm
4626-62	6,2 mm
4626-65	6,5 mm
4626-68	6,8 mm
4626-70	7,0 mm
4626-75	7,5 mm
4626-80	8,0 mm
4626-85	8,5 mm
4626-90	9,0 mm
4626-95	9,5 mm

01

Stratus HSS-O twist drill bit assortment

Profile ground and right-hand cut, DIN 384

- ▶ Item no. 1957-627-1
- ▶ Contents: 120 pieces

Item no.	Quantity	Item no.	Quantity
4627-10	10	4627-60	5
4627-15	10	4627-65	5
4627-20	10	4627-70	5
4627-25	10	4627-75	5
4627-30	5	4627-80	5
4627-35	5	4627-85	5
4627-40	5	4627-90	5
4627-45	5	4627-95	5
4627-50	5	4627-100	5
4627-55	5	4627-105	5



01

02

Night Line HSS twist drill bit assortment

Basic assortment

- ▶ Item no. 1957-626
- ▶ Contents: 120 pieces

Item no.	Quantity	Item no.	Quantity
4626-10	10	4626-60	5
4626-15	10	4626-65	5
4626-20	10	4626-70	5
4626-25	10	4626-75	5
4626-30	5	4626-80	5
4626-35	5	4626-85	5
4626-40	5	4626-90	5
4626-45	5	4626-95	5
4626-50	5	4626-100	5
4626-55	5	4626-105	5



02

03

Spot weld cutter

HSS diam. 8mm (4710-112-900)

- ▶ Art. no.: 8696-112-900

▶ Product description

- Contents: 4-piece welding-spot miller HSCo Ø 8mm
- With automatic feed of the drill spindle
- Optimal pressure guaranteed
- No compressed-air connection
- Plug-in nipple with outer thread

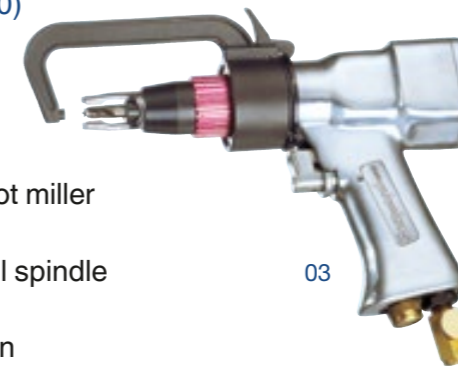

03



05

05

Solid carbide milling machine

For spot weld remover, for high strength sheet metal

- ▶ Item no. 4710-008-044
- ▶ 8 x 44 mm

- ▶ Item no. 4710-008-046
- ▶ 8 x 46 mm



06

06

Welding spot milling machine

HSS for drill

- ▶ Art. no.: 4698-1
- Spare core cutter for art. No.: 4698-1**

- ▶ Art. no.: 4698-01

04

Drilling and cutting helper

Easy-Cut

- ▶ Item no. 2894-443
- ▶ Contents: 350 ml
- ▶ Packing unit: 12

▶ Product description

- Supports swarf removal
- Reduces friction between drill bit and workpiece
- Drill bit and workpiece are lubricated and cooled
- Clear extension of service life
- Corrosion protection for the drill hole



04

07

Welding spot drill

HSCo-TICN for drill, for high-strength sheet metal

- ▶ Item no. 4710-006
- ▶ 6 x 70 mm

- ▶ Item no. 4710-008
- ▶ 8 x 80 mm

- ▶ Item no. 4710-010
- ▶ 10 x 90 mm



07

08

Welding spot drill

HSS for drill

- ▶ Item no. 4710-6
- ▶ Drill bit Ø: 6.0 mm

- ▶ Item no. 4710-8
- ▶ Drill bit Ø: 8.0 mm

- ▶ Item no. 4710-10
- ▶ Drill bit Ø: 10.0 mm



08

09

Welding spot milling machine

HSCo, cutter diameter: 8.0mm, length: 46mm, PU: 10

- ▶ Art. no.: 4710-112-900



09

01

Conical drill bits

HSS

► **Product description**

- Point grinding: Works standard
- Point thinning: DIN 1412 C
- Point angle: 118°
- Angle of taper: 20-30°
- Diameter tolerance: Works standard
- Shank: Triple clamping surface
- Surface: uncoated
- Right-hand cut

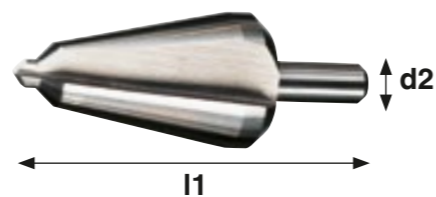

Item no.	Model	d2	L1
4694-015-41	Size 1: 3 – 14.0 mm	6 mm	58 mm
4694-015-42	Size 2: 5 – 20.0 mm	8 mm	71 mm
4694-015-43	Size 3: 16 – 30.5 mm	9 mm	76 mm
4694-015-44	Size 4, 24 - 40.0 mm	10 mm	89 mm
4694-015-46	Size 5, 36 - 50.0 mm	12 mm	97 mm

02

Conical drill bit set

HSS

► **Product description**

- Point grinding: Works standard
- Point thinning: DIN 1412 C
- Point angle: 118°
- Angle of taper: 20-30°
- Diameter tolerance: Works standard
- Shank: Triple clamping surface
- Surface: uncoated
- Right-hand cut



Item no.	Model	d2	L1
4694-015-41	Size 1: 3 – 14.0 mm	6 mm	58 mm
4694-015-42	Size 2: 5 – 20.0 mm	8 mm	71 mm
4694-015-43	Size 3: 16 – 30.5 mm	9 mm	76 mm

03

Unidrill conical drill bits

HSS, crosswise grinding

- **Item no. 4691-921-495**
- **5-31 mm, d2 = 9 mm, l1 = 103 mm**

► **Product description**

- Point grinding: Works standard
- Point thinning: DIN 1412 C
- Point angle: 118°
- Angle of taper: 20-30°
- Diameter tolerance: Works standard
- Shank: Triple clamping surface
- Surface: uncoated
- Right-hand cut



04

Unibit step drill

HSS-E

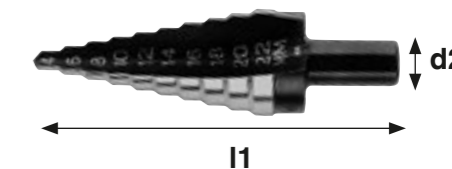

Item no.	Model	Grading	d2	L1
4691-921-302	4 - 22 mm	2 mm	10.0 mm	74,5 mm
4691-921-303	4 - 12 mm	2 mm	6.0 mm	81,5 mm
4691-921-304	5 - 35 mm	5 mm	13.0 mm	78,0 mm

05

Carbide end mill

Cylindrical with front end cut

► **Product description**

- 12,000 and 14,000 rpm
- Tool life up to four times that of uncoated tools
- Model: Shape A cylindrical with front end cut
- Tooth system: Cross tothing
- Cutting: KVZ 4/aluminium
- Surface: TiCN coating

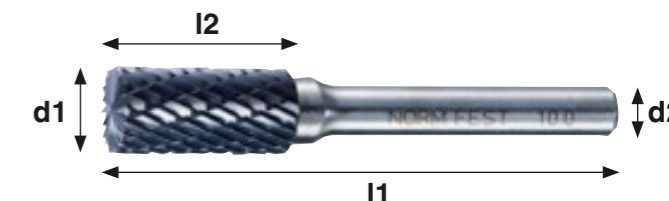

Item no.	d1 mm	d2 mm	L1 mm	L2 mm
4681-161-019	10	6	60	20

06

Carbide burrs

Arc pointed nose

► **Product description**

- 12,000 and 14,000 rpm
- Tool life up to four times that of uncoated tools
- Model: Shape G arc pointed nose (tree)
- Tooth system: Cross tothing
- Cutting: KVZ 4/aluminium
- Surface: TiCN coating

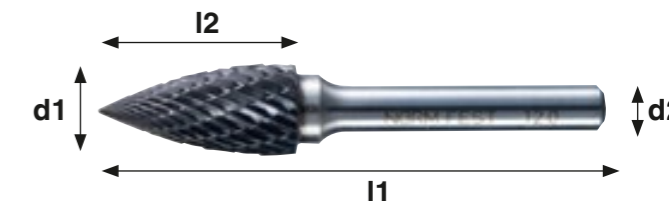

Item no.	d1 mm	d2 mm	L1 mm	L2 mm
4681-661-325	12	6	65	25

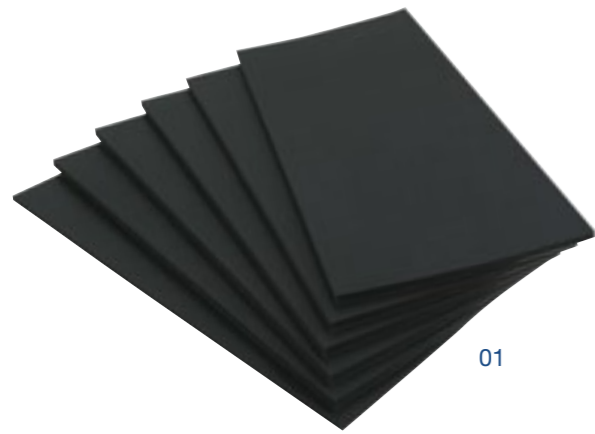

01

01 Silence Foam
Foam acoustic boards

- ▶ Art. no.: 4580-774
- ▶ Product description
 - Thermally stable from -25°C to +90°C
 - Abrasion-resistant surface
 - Dimensions: 550 x 250 x 10 mm
 - Colour: anthracite
 - PU: 6

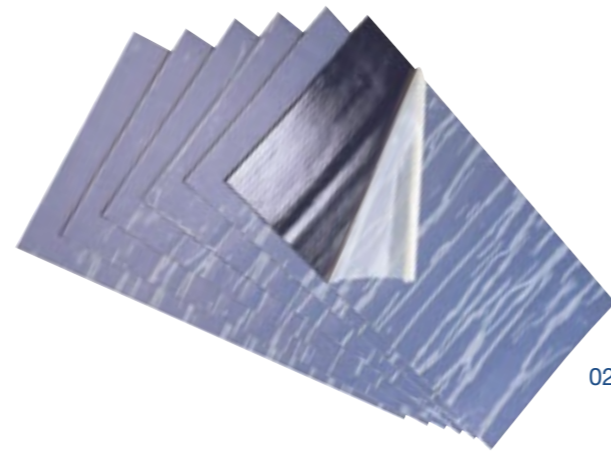

02

02 Sound-absorbing plate
Bitumen acoustic boards

- ▶ Art. no.: 4580-773
- ▶ Product description
 - Thermally stable to +90°C
 - Colour: Black
 - Dimensions: 550 x 250 x 2 mm
 - PU: 6



05

05 Trim strip tape
Rolls each 10 m

- ▶ Item no. 4991-06
 - ▶ 6 mm
- ▶ Item no. 4991-12
 - ▶ 12 mm
- ▶ Item no. 4991-19
 - ▶ 19 mm
- ▶ Item no. 4991-24
 - ▶ 24 mm
- ▶ Product description
 - Colour: black
 - Double-sided adhesion
 - High final strength

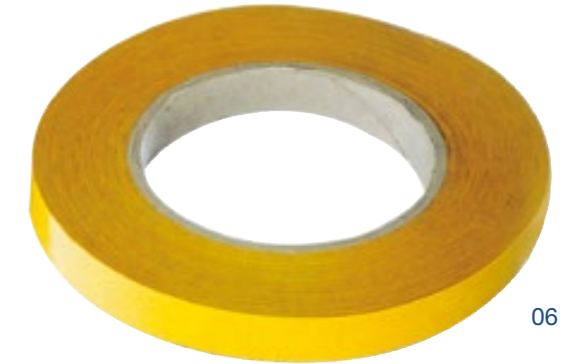

06

06 Adhesive tape for protective film
Rolls each 50 m

- ▶ Item no. 4991-50-19
 - ▶ 19 mm
- ▶ Item no. 4991-50-38
 - ▶ 38 mm
- ▶ Product description
 - Colour: transparent
 - Double-sided adhesion



03

03 Duroplastic sealing tape
Sealtape

- ▶ Art. no.: 4581-770
- ▶ Product description
 - Flat
 - Roll length: 26 m
 - Solvent-free
 - Temperature-resistant, non-ageing and weatherproof
 - Temperature range -30°C to +100°C
 - Eliminates annoying bodywork noises



04

04 Duroplastic sealing tape, black
Butylband Plus

- ▶ Art. no.: 4581-777
- ▶ Product description
 - Eliminates annoying bodywork noises
 - Cord diameter: 8 mm
 - Length: 10 m

07 Self-adhesive protective film tinted
0.6 x 100 m, thickness 90µ

- ▶ Art. no.: 7991-100
- ▶ Product description
 - Can also be used as door lining film



07

01 Super-fast superglue
Cyanoacrylate adhesives black

- ▶ Item no. 2898-555
- ▶ Contents: 5 g
- ▶ Packing unit: 1

- ▶ Item no. 2898-556
- ▶ Contents: 20 g
- ▶ Packing unit: 1

- ▶ Product description
- Suitable for smooth plastic surfaces
- Pinpoint application accuracy



01

02 Black cyanoacrylate adhesive Superfast

- ▶ Item no. 2898-560-20
- ▶ Contents: 20 g
- ▶ Packing unit: 1

- ▶ Product description
- Suitable for bonding rubber coatings, plastics and metals

- Ideal for bonding plastics, such as door clips
- Based on cyanoacrylate



02



03

03 Superglue filler
For cyanoacrylate adhesives

- ▶ Item no. 2898-560-30
- ▶ Contents: 30 g
- ▶ Packing unit: 1

- ▶ Product description
- Density: > 1.5g/cm³ 20°C

04 Instant glue Rapido

- ▶ Item no. 2898-555-100
- ▶ Contents: 20 g
- ▶ Packing unit: 12

- ▶ Product description
- For extreme loads
- Suitable for a wide range of materials subject to heavy vibrations
- based on cyanoacrylate



04

05 Superglue gel Fixit

- ▶ Item no. 2898-554
- ▶ Contents: 20 g
- ▶ Packing unit: 1

- ▶ Product description
- Does not run
- Can be used on horizontal and vertical surfaces
- Does not form strings
- For bonding metals, wood and plastics
- Based on cyanoacrylate



05

06 Accelerator Fixit Active

- ▶ Item no. 2898-554-150
- ▶ Contents: 200 ml
- ▶ Packing unit: 1

- ▶ Product description
- Suitable as a curing accelerator for all cyanoacrylate adhesives
- For leather, wood, cork, ceramics and all porous materials and for bonding plastics



06

08 Rubber profile adhesive Profix

- ▶ Item no. 2898-551
- ▶ Contents: 180 g
- ▶ Packing unit: 12

- ▶ Product description
- Ideal for gluing: Rubber profile, leather, plastic, imitation leather with textile backing and felt to metal, wood, rigid PVC, ABS, PA



08



07

07 Power spray glue Super-Glue

- ▶ Item no. 2898-552
- ▶ Contents: 400 ml
- ▶ Packing unit: 12

- ▶ Product description
- Foamed materials, jute, felt, expanded polystyrene
- Paper, cardboard, plastic films
- Various plastics
- Temperature range (permanent): -25°C to +70°C

01

Soldering tin

Bar, pressed

▶ Art. no.: 4982-1

▶ Product description

- PB (lead): 74%
- SN (tin): 25%
- SB (antimon): 1%
- Standard designation: DIN EN 29453

- Packaging unit: 5 kg (5 x 1kg rods)



01

02

Butane gas

▶ Item no. 8714-607-100

▶ Contents: 100 ml

▶ Packing unit: 12

▶ Product description

- Suitable for all common hot-melt and soldering guns



02

03

Tinning paste

Lead-free

▶ Item no. 4982-91

▶ Contents: 1 kg

▶ Packing unit: 1

▶ Product description

- Applied before the actual tin plating, to provide an ideal key for the bodywork on the metal
- Cleans and degreases



03

04

Liquid flux brush

Handle made of galvanised sheet metal

▶ Art. no.: 4693-500

▶ Product description

- Pale bristles
- Ø ferrule: 15 mm
- Length: 140 mm
- Height: 25 mm



04

05

Tinsol - Filling Solder Substitute

Tinsol is the new repair method for metal bodywork.

▶ Item no. 2893-224-1

▶ Contents: 250 ml

▶ Packing unit: 1

▶ Product description

- Pot life of 50 minutes at 23°C
- Moisture-resistant and weatherproof
- Temperature range -30°C to +120°C



05

07

Oxy-fuel gas

Extra hot

▶ Item no. 8714-608-600

▶ Contents: 600 ml

▶ Packing unit: 24

▶ Product description

- Max. temperature 2,000°C
- Mixture of propane, butane, acetone and isobutane
- Suitable for tin-plating and brazing
- Extra hot



07

08

Piezo burner nozzle ECO

▶ Art. no.: 8714-609-1

▶ Product description

- Soldering with tin-solder for aluminium
- Bending of rods, sheet metal and pipes
- Heating of objects
- Suitable for fuel gas (8714-608-600)



08

06

Square spatula

▶ Art. no.: 2893-223-38



06

01

High temperature protective blanket

Suitable for welding and bodywork repairs

▶ Art. no.: 4982-001

▶ Product description

- Resistant to sparks and spatter
- Material: Glass filament fabric (flame-resistant, non-combustible)
- Weight: 3.5 kg
- Dimensions: 160 x 230 cm with fastening straps
- Thickness: 0.5 mm
- Heat resistant: up to 750°C
- Elongation at break: 3%



01

02

Protective welding blanket

Designed to catch and hold spark and spatter

▶ Art. no.: 4982-000

▶ Product description

- Dimensions: 229 x 188.5 cm
- Heat resistant: up to 700°C
- Max. radiation temperature: up to 1,000°C
- Abrasion and knick-proof



02

03

Protective welding gloves

A combination of leather and split leather

▶ Item no. 7797-012-10

▶ Size 10

▶ Product description

- 5-finger welding gloves
- Cowhide/Split leather
- Split cuff
- Length: 35 cm
- TÜV-tested



03

04

PRO automatic helmet

Carbon look

▶ Art. no.: 4695-007-100

▶ Product description

- Anti-glare dark slide: 1/1/1/2
- Scale numbers DIN 4/5-8 and 9-13
- WIG-suitable from 5 amperes
- Grinding mode
- Large viewing field 53 x 100mm
- Four mutually independent sensors
- Smoothly adjustable
- Power supply using solar cell & replaceable support battery
- Standard attached pane 90 x 110mm
- Interchangeable replacement attached pane, art. no. 4695-007-110



04

05

Hand shield

▶ Product description

- Partly heat-resistant hand shield without attached pane
- The clear and green attached panes are interchangeable

Item no.	Model
4695-006-440	Shield (without glass)
4695-006-442	Cover lenses clear
4695-006-446	Green lens



05

06

Folding welder goggles

▶ Product description

- These goggles complete with flip-up front provide a clear view when welding.

Item no.	Model
4695-006-460	Goggles
4695-006-461	Spare lenses non shattering
4695-006-465	Spare lenses athermal



06

01
Gas pressure reducer
for inert gas welders

▶ Art. no.: 4983-108



01

02
adapter
for basket coils

▶ Art. no.: 4982-008-100

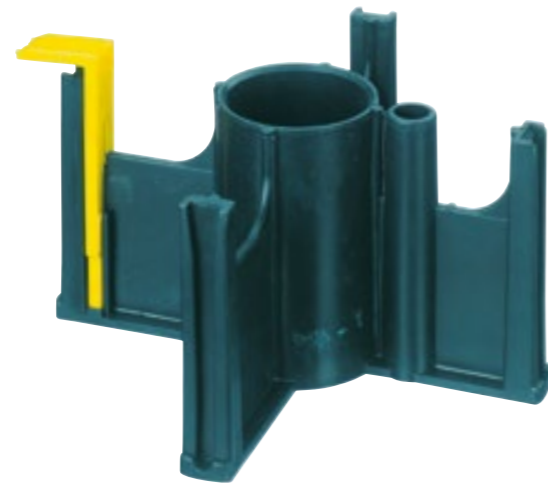

02

03
Inert gas welding wire
SG 2 for steel, each spool 15 kg

- ▶ Item no. 4982-008
- ▶ 0.8 mm

- ▶ Item no. 4982-010
- ▶ 1.0 mm

- ▶ Item no. 4982-012
- ▶ 1.2 mm



03

04
Inert gas welding wire
SG1 A for galvanised sheet steel,
each spool 15 kg

▶ Art. no.: 4982-018



04

05
Oerlikon welding electrodes
Overcord

- ▶ Item no. 4982-044-152
- ▶ 2.5 x 350 mm

- ▶ Item no. 4982-044-158
- ▶ 3.2 x 350 mm

- ▶ Product description
- Medium thick coated rutile cellulosic electrode
- Particularly suitable for vertical down welding



05

06
Oerlikon welding electrodes
Fincord, rutile type

- ▶ Item no. 4982-044-147
- ▶ 2.5 x 350 mm

- ▶ Item no. 4982-044-154
- ▶ 3.2 x 350 mm

- ▶ Product description
- Thickly coated rutile cellulosic electrode
- Minimum spatter formation
- Can be used for all positions, except vertical down welding



06

07
Autogenous filler wire
Rod, G1

- ▶ Item no. 4982-002
- ▶ 2.0 mm x 1,000 mm

- ▶ Item no. 4982-003
- ▶ 3.0 mm x 1,000 mm



07

08
Corrugated wire
For 6" claw

- ▶ Item no. 8714-821-079
- ▶ Length: 360 mm
- ▶ Ø 2 mm

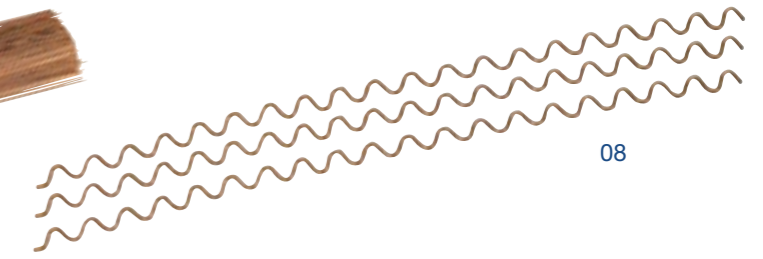

08

09
Welding nails

- ▶ Item no. 8714-821-077
- ▶ Ø 2.0 mm

- ▶ Item no. 8714-821-078
- ▶ Ø 2.6 mm



09

10
Washers untreated

- ▶ Item no. 6405-8
- ▶ Ø 8 mm

- ▶ Item no. 6405-10
- ▶ Ø 10 mm



10

01

Torch pipe 250 A

flexible, screwed, MIG/MAG

Item no.	model	illustration
4983-252-1	Gas nozzle, conical, screwed	1
4983-110-1	Nozzle fitting M6	2
4983-255-008	Current nozzle 0.8 mm, nickel-faced	3
4983-255-010	Current nozzle 1.0 mm, nickel-faced	4



04

Torch pipe 250 A

flexible, plugged, MIG/MAG

Item no.	model	illustration
4983-252	Gas nozzle, conical, connected	1
4983-251-2	Burner pipe, flexible, plugged	2
4983-110-1	Nozzle fitting M6	3
4983-255-008	Current nozzle 0.8 mm, nickel-faced	5
4983-255-010	Current nozzle 1.0 mm, nickel-faced	6

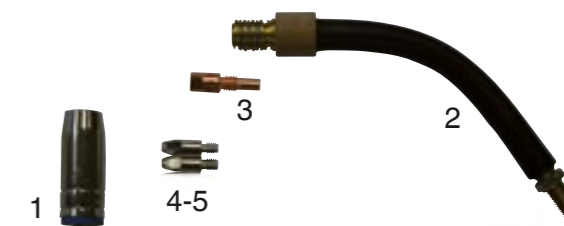

02

Torch pipe 250 A

inflexible, connected, MIG/MAG

Item no.	model	illustration
4983-252	Gas nozzle, conical, connected	1
4983-110-1	Nozzle fitting M6	2
4983-255-008	Current nozzle 0.8 mm, nickel-faced	3
4983-255-010	Current nozzle 1.0 mm, nickel-faced	4



04

Welding torch hose package

For standard MIG/MAG welding torches

► Art. no.: 4983-250

► Product description

- The 5 m cable makes it particularly suitable for vans
- Power rating 200 A for mixed gas or 230 A for CO²
- For insertion



03

Torch pipe 250 A

rigid, screwed, MIG/MAG

Item no.	model	illustration
4983-252-1	Gas nozzle, conical, screwed	1
4983-110-1	Nozzle fitting M6	2
4983-255-008	Current nozzle 0.8 mm, nickel-faced	3
4983-255-010	Current nozzle 1.0 mm, nickel-faced	4



06

Blast connection 250 A

For inserted gas nozzles

► Art. no.: 4983-110-1

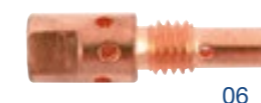

07

Gas nozzle spring inserted

For inserted torch systems 250 A

► Art. no.: 4983-253



01

Burner pipe 150 A

rigid, screwed, MIG/MAG

Item no.	model	illustration
4983-102-1	Gas nozzle, conical, screwed	1
4983-112-1	Burner pipe, rigid, screwed	2
4983-105-008	Current nozzle 0.8 mm, nickel-faced	3
4983-105-010	Current nozzle 1.0 mm, nickel-faced	4



02

Burner pipe 150 A

flexible, plugged, MIG/MAG

Item no.	model	illustration
4983-102	Gas nozzle, conical, pluggable	1
4983-103	Spot welding nozzle, can be inserted	2
4983-113	Burner pipe, flexible, plugged	3
4983-105-008	Current nozzle 0.8 mm, nickel-faced	4
4983-105-010	Current nozzle 1.0 mm, nickel-faced	5

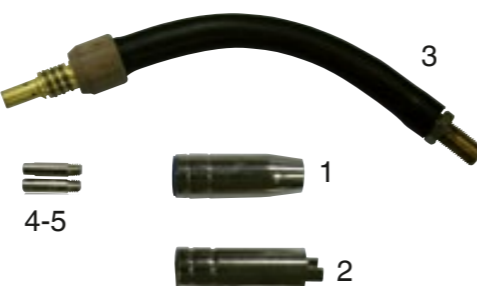

03

Burner pipe 150 A

flexible, screwed, MIG/MAG

Item no.	model	illustration
4983-102-1	Gas nozzle, conical, screwed	1
4983-113-1	Burner pipe, flexible, screwed	2
4983-105-008	Current nozzle 0.8 mm, nickel-faced	3
4983-105-010	Current nozzle 1.0 mm, nickel-faced	4



04

Torch pipe package 150A

For standard MIG/MAG welding torches

- ▶ Item no. 4983-101
- ▶ Length: 3 m

- ▶ Item no. 4983-101-5
- ▶ Length: 5 m

- ▶ Product description
- The 5 m cable makes it particularly suitable for vans
- Power rating 150 A for mixed gas or 180 A for CO2
- Contact nozzle 1.2 mm



05

Blast connection 150 A

- ▶ Item no. 4983-110
- ▶ M6

- ▶ Product description
- Suitable for: 4983-101, 4983-101-5, 4983-112



06

Gas jet

pluggable

- ▶ Art. no.: 4983-102

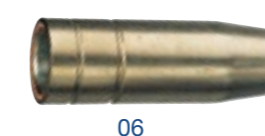

07

Burner pipe 150 A

rigid, pluggable

- ▶ Art. no.: 4983-112



08

Spot welding nozzle 150 A

pluggable

- ▶ Art. no.: 4983-103



09

Gas nozzle spring inserted

For inserted torch systems 150 A

- ▶ Art. no.: 4983-109



01

Blind rivet with flat round head

DIN 7337, rivet body: galvanised steel / rivet mandrel: galvanised steel



Item no.	Rivet sleeves Ø d1 mm	Sleeves L mm	Bore Ø mm	Rivetable material thickness	Head Ø d2 mm	Height of head mm
5938-48-8	4,8	8,0	4,9	2,5 - 4,5	9,5	1,1
5938-48-12	4,8	12,0	4,9	6,0 - 8,0	9,5	1,1
5938-48-14	4,8	14,0	4,9	8,0 - 10,0	9,5	1,1
5938-48-16	4,8	16,0	4,9	10,0 - 11,5	9,5	1,1
5938-64-12	6,4	12,0	6,5	3,0 - 6,0	13,0	1,8
5938-64-15	6,4	15	6,5	6,0 - 9,0	13,0	1,8
5938-64-18	6,4	18	6,5	9,0 - 12,0	13,0	1,8
5938-64-22	6,4	22	6,5	12,0 - 16,0	13,0	1,8

02

Blind rivet with flat round head

Aluminium, for soft or fragile material



Item no.	Rivet sleeves Ø d mm	Sleeves L mm	Bore hole Ø mm	Clamping range	d	dk	???	k	dm	Tensile- force (N)	Shearing force (N)
5937-040-188	4	18,8	4,2 - 4,4	3,0 - 7,0	≥ 27	8,0	≤ 1,7	~ 2,5	800	500	

03

Blind rivet with truss-head

Rivet body: aluminium, Rivet mandrel: aluminium



Item no.	Rivet sleeves Ø d1 mm	Sleeves L mm	Bore Ø mm	Rivetable material thickness	Head Ø d2 mm
5937-048-205	4,8	20,5	4,3	3,0 - 9,0	8,0

04

Blind rivet with flat round head

Rivet body: aluminium alloy, rivet mandrel: steel



Item no.	Rivet sleeves Ø d1 mm	Sleeves L mm	Bore Ø mm	Rivetable material thickness	Head Ø d2 mm	Height of head k/mm
5937-24-6	2,4	6,0	2,5	2,0 - 4,0	5,0	0,6
5937-24-8	2,4	8,0	2,5	4,0 - 6,0	5,0	0,6
5937-3-6	3	6,0	3,1	1,5 - 3,5	6,5	0,8
5937-3-8	3	8	3,1	3,5 - 5,5	6,5	0,8
5937-3-10	3	10	3,1	5,5 - 7,0	6,5	0,8
5937-3-16	3	16	3,1	9,0 - 13,0	6,5	0,8
5937-32-10	3,2	10	3,3	5,5 - 7,0	6,5	0,8
5937-4-6	4	6	4,1	0,5 - 3,0	8,0	1,0
5937-4-8	4	8	4,1	3,0 - 5,0	8,0	1,0
5937-4-10	4	10	4,1	5,0 - 6,5	8,0	1,0
5937-4-12	4	12	4,1	6,5 - 8,5	8,0	1,0
5937-4-16	4	16	4,1	8,5 - 12,5	8,0	1,0
5937-48-8	4,8	8	4,9	3,0 - 4,5	9,0	1,1
5937-48-10	4,8	10	4,9	4,5 - 6,0	9,0	1,1
5937-48-16	4,8	16	4,9	6,0 - 12,0	9,0	1,1
5937-5-8	5,0	8	5,1	3,0 - 4,5	9,0	1,1
5937-5-10	5,0	10	5,1	4,5 - 6,0	9,0	1,1
5937-5-12	5,0	12	5,1	6,0 - 8,0	9,0	1,1
5937-5-16	5,0	16	5,1	8,0 - 12,0	9,0	1,1
5937-5-20	5,0	20	5,1	12,0 - 16,0	9,0	1,1
5937-5-25	5,0	25	5,1	16,0 - 21,0	9,0	1,1
5937-5-40	5,0	40	5,1	30,0 - 35,0	9,0	1,1
5937-6-8	6,0	8	6,1	3,0 - 4,5	12,0	1,5
5937-6-10	6,0	10	6,1	4,5 - 6,0	12,0	1,5
5937-6-12	6,0	12	6,1	6,0 - 8,0	12,0	1,5
5937-6-16	6,0	16	6,1	8,0 - 12,0	12,0	1,5

05

Sealing blind rivet

air- and waterproof



Item no.	Rivet sleeves Ø d1 mm	Sleeves L mm	Bore Ø mm	Rivetable material thickness	Head Ø d2 mm
5937-048-12	4,8	12,5	4,9	6,5 - 8	9,5

01

Blind rivet with large snap-head

Rivet body: aluminium, rivet mandrel: galvanised steel

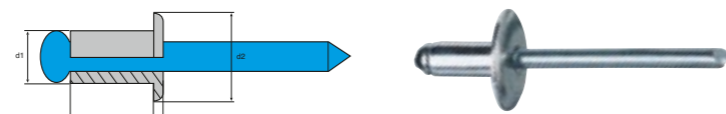

Item no.	Rivet sleeves Ø d1 mm	Sleeves L mm	Bore Ø mm	Rivetable material thickness	Head Ø d2 mm	Height of head k/mm
5944-4-85	4	8,5	4,1	4,5 - 6,0	12,0	1,4
5944-11-8	5	8,0	5,1	0,5 - 4,5	11,0	1,5
5944-11-10	5	10,0	5,1	4,5 - 6,0	11,0	1,5
5944-11-12	5	12,0	5,1	6,0 - 8,0	11,0	1,5
5944-11-16	5	16,0	5,1	8,0 - 12,0	11,0	1,5
5944-11-20	5	20	5,1	12,0 - 16,0	11,0	1,5
5944-11-25	5	25	5,1	16,0 - 21,0	11,0	1,5
5944-11-30	5	30	5,1	21,0 - 25,0	11,0	1,5
5944-14-8	5	8	5,1	0,5 - 4,5	14,0	1,5
5944-14-10	5	10	5,1	4,5 - 6,0	14,0	1,5
5944-14-12	5	12	5,1	6,0 - 8,0	14,0	1,5
5944-14-16	5	16	5,1	8,0 - 12,0	14,0	1,5
5944-14-20	5	20	5,1	12,0 - 16,0	14,0	1,5

02

Blind rivet, black

with truss-head/ according to DIN 7337

rivet sleeve: aluminium, black painted
rivet spike: steel, galvanised

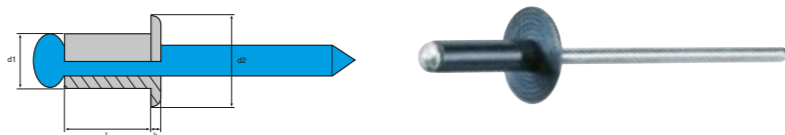

Item no.	Rivet sleeves Ø d1 mm	Sleeves L mm	Bore Ø mm	Rivetable material thickness	Head Ø d2 mm
5937-32-751	3,2	7,5	3,3	3,0 - 5,0	9,5
5937-4-81	4,0 (VW)	8,0	4,1	3,0 - 5,0	12,0
5937-4-141	4,0 (VW)	14,0	4,1	7,5 - 11,0	12,0
5937-48-141	4,8	14,0	4,9	7,5 - 11,0	12,0

03

Expansion blind rivet

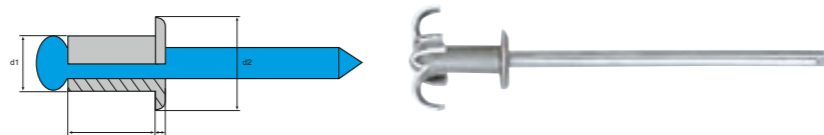

Item no.	Rivet sleeves Ø d1 mm	Sleeves L mm	Bore Ø mm	Rivetable material thickness	Head Ø d2 mm
5937-004-821	4,8	21	4,9	8,0 - 15,0	9,5

04

**Blind rivet nuts
with flat head**



Item no.	Rated measurement	Bore Ø mm	Rivetable material thickness	Shank length L mm	Outer Ø d1 mm	Head Ø d2 mm	?? ?
5949-4-115	M4 x 6 x 11,5	6,0	0,5 - 3,0	11,0	6	9,0	1,1
5949-5-12	M5 x 7 x 12,0	7,0	0,5 - 3,0	14,0	7	10,0	1,1
5949-6-145	M6 x 9 x 14,5	9,0	0,5 - 3,0	16,0	9	12,0	1,6
5949-8-16	M8 x 11 x 16,0	11,0	0,5 - 3,0	17,5	11	15,0	1,6
5949-8-185	M8 x 11 x 18,5	11,0	3,0 - 5,5	20,0	11	15,0	1,6
5949-10-17	M10 x 12 x 17,0	12	0,5 - 3,0	19,0	12	16,0	2,1
5949-10-22	M10 x 12 x 22,0	12	3,0 - 6,0	24,0	12	16,0	2,1
5949-12-23	M12 x 16 x 23,0	16	1,0 - 4,0	25,0	16	22,0	2,1

05

**Blind rivet nuts
with flat head**

6-edge, heavily galvanised

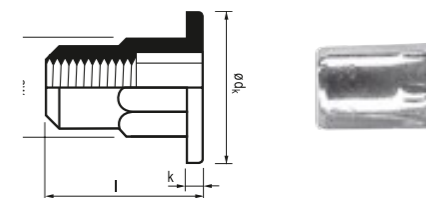

Item no.	Thread diameter	mm	Punched hole Ø mm	Clamping range	mm	Height of head k/mm	SWTensile strength [N]	Shear force [N]	
5950-4-97	M4	10,5	6	0,3 - 2,0	9	≤ 0,8	5,9	6.800	2.200
5950-5-13	M5	13,0	7	0,7 - 3,0	10	≤ 1,0	6,9	10.000	3.300
5950-6-145	M6	16,0	9	0,5 - 3,0	13	≤ 1,5	8,9	15.000	4.400
5950-8-155	M8	17,0	11	0,5 - 3,5	16	≤ 1,5	10,9	27.000	5.200

06

Blind rivet nuts

Flat round head, aluminium



Item no.	Female thread	Rivetable material thickness	Bore hole Ø mm
5948-14-20	M4	0,5 - 3,0	6,0
5948-15-30	M5	0,5 - 3,0	7,0
5948-16-30	M6	0,5 - 3,0	9,0
5948-18-30	M8	0,5 - 3,0	11,0
5948-18-55	M8	3,0 - 5,5	11,0
5948-10-175	M10	3,0 - 6,0	13,0

01

Assortment of blind rivets

DIN 7337, rivet body: Aluminium alloy, rivet mandrel: galvanised steel

- ▶ Item no. 1957-937-1
- ▶ Contents: 800 pieces

Item no.	Quantity
5937-3-6	100
5937-3-8	100
5937-3-10	100
5937-4-6	100
5937-4-8	100
5937-4-10	100
5937-4-12	100
5937-4-16	100



02

Blind rivet nut assortment

Aluminium

- ▶ Item no. 1957-948
- ▶ Contents: 600 pieces

Item no.	Quantity
5949-4-115	100
5949-5-12	100
5949-6-145	50
5949-8-185	50
5948-14-20	100
5948-15-30	100
5948-16-30	50
5948-18-30	50



03

Blind riveting tool

For diameters up to 4.8 mm

- ▶ Art. no.: 8949-50
- ▶ Product description
 - Head type: 360° rotating
 - Length: 250 mm
 - Width: 355 mm
 - Height: 30 mm
 - Weight: 0.818 kg



03

04

Lever riveting device

For diameters up to 6.4 mm

- ▶ Art. no.: 8949-20
- ▶ Product description
 - Weight: 1.85 kg
 - Total length: 570 mm
 - Stroke: 10 mm



04

05

Manual riveting pliers

Working area up to 5 mm Ø

- ▶ Art. no.: 8949-11
- ▶ Product description
 - Weight: 1.85 kg
 - Total length: 570 mm
 - Stroke: 10 mm



05

06

Blind rivet nut pliers

incl. M6, M8, M10, M12 thread pins and nuts

- ▶ Art. no.: 8948-800
- ▶ Product description
 - For processing blind rivet nuts, M6 M12, aluminium/steel/ stainless steel



06

07

07

Mandrel and nut

for blind rivet nut pliers 8948-800

- ▶ Item no. 8948-800-14
- ▶ M4
- ▶ Item no. 8948-800-15
- ▶ M5
- ▶ Item no. 8948-800-16
- ▶ M6
- ▶ Item no. 8948-800-18
- ▶ M8
- ▶ Item no. 8948-800-110
- ▶ M10
- ▶ Item no. 8948-800-112
- ▶ M12

08

Blind riveting nut pliers

incl. M3, M4, M5, M6 thread pins

- ▶ Art. no.: 8948-917
- ▶ Product description
 - Weight: 0.8 kg
 - Total length: 280 mm
 - Spare retrofit kit for: M3 8948-917-13 M4 8948-917-14 M5 8948-917-15 M6 8948-917-16



08

Car glazing



01 Cartridge of windscreen adhesive

Screenox Quantum

- ▶ Item no. 2893-506-10
- ▶ Contents: 300 ml
- ▶ Packing unit: 12

▶ **Product description**

- Single-component PUR windscreen adhesive
- Compatible with MS polymers and thus workable on cut-back residual MS adhesive bead
- Very easy ejection
- No activator needed
- 60 min. for double airbag in temperature range of -10°C to +35°C
- Processing time: 15 minutes
- Cures down to -10°C
- Very good stability
- Meets OEM/automotive manufacturer requirements
- Very short thread breaks
- Very strong
- Suitable for aerials
- Can be processed cold
- Non-conducting
- Solvent-free

02 Windscreen adhesive package

Screenox Quantum

- ▶ Item no. 2893-506-30
- ▶ Contents: 400 ml
- ▶ Packing unit: 12

▶ **Product description**

- Single-component PUR windscreen adhesive
- Compatible with MS polymers and thus workable on cut-back residual MS adhesive bead
- Very easy ejection
- No activator needed
- 60 min. for double airbag in temperature range of -10°C to +35°C
- Processing time: 15 minutes
- Cures down to -10°C
- Very good stability
- Meets OEM/automotive manufacturer requirements
- Very short thread breaks
- Very strong
- Suitable for aerials
- Can be processed cold
- Non-conducting
- Solvent-free



03 Windscreen adhesive set:

Cartridge

- ▶ Item no. 2893-506-20
- ▶ Contents: 5 pieces
- ▶ Packing unit: 24

▶ **Set contents:**

- 1 x Screenox Quantum windscreen adhesive, 300 ml cartridge
- 1 x 3 in 1 multiprimer in 5 ml snap ampoule
- 1 x primer brush
- 1 x cartridge point
- 1 x instructions

04 Windscreen adhesive set: Bag

- ▶ Item no. 2893-506-40
- ▶ Contents: 5 pieces
- ▶ Packing unit: 24

▶ **Set contents:**

- 1 x Screenox Quantum windscreen adhesive, 400 ml bag
- 1 x 3 in 1 multiprimer in 5 ml snap ampoule
- 1 x primer brush
- 1 x cartridge point
- 1 x instructions





01 Cartridge of windscreen adhesive
Screenox Cold - New Generation

- ▶ Item no. 2893-504-10
- ▶ Contents: 300 ml
- ▶ Packing unit: 12

- ▶ **Product description**
- Drive-away time: without airbag 60 minutes, with twin airbag 2 hours
 - Temperature range: -10°C to +30°C
 - Pot life: 15 minutes
 - high modulus
 - Suitable for aerials
 - Short cut-off string
 - Stability meets the requirements of OEMs (vehicle manufacturers)
 - Incl. tips

02 Windscreen adhesive-bag
Screenox Cold - New Generation

- ▶ Item no. 2893-504-30
- ▶ Contents: 400 ml
- ▶ Packing unit: 12

- ▶ **Product description**
- Drive-away time: without airbag 60 minutes, with twin airbag 2 hours
 - Temperature range: -10°C to +30°C
 - Pot life: 15 minutes
 - high modulus
 - Suitable for aerials
 - Short cut-off string
 - Stability meets the requirements of OEMs (vehicle manufacturers)
 - Incl. tips



03 Windscreen adhesive set Cartridge

- ▶ Item no. 2893-504-20
- ▶ Contents: 7 pieces
- ▶ Packing unit: 24

- ▶ **Set contents:**
- 1 x 300 ml cartridge of Screenox Cold - New Generation windscreen adhesive
 - 1 x 3in1 multiprimer in 5 ml snap ampoule
 - 1 x primer brush
 - 1 x cartridge point
 - 1 x instructions

04 Windscreen adhesive set Bag

- ▶ Item no. 2893-504-40
- ▶ Contents: 7 pieces
- ▶ Packing unit: 24

- ▶ **Set contents:**
- 1 x 400 ml bag of Screenox Cold - New Generation windscreen adhesive
 - 1 x 3in1 multiprimer in 5 ml snap ampoule
 - 1 x primer brush
 - 1 x bag adapter
 - 1 x instructions





01
3 in 1 combi primer
Colour: black

- ▶ Item no. 2893-580-30
- ▶ Contents: 30 ml
- ▶ Packing unit: 24
- ▶ Item no. 2893-580-100
- ▶ Contents: 100 ml
- ▶ Packing unit: 8

- ▶ Product description
- Adhesion promoter, rust protection, black primer (UV protection) and corrosion protection in one
- Quick to use and increased safety with just one pre-treatment product
- can be used on ceramic screen print, glass and bright metal



02
Repair brush

- ▶ Item no. 4693-311-5

03
Brush

For primer, made from cotton

- ▶ Item no. 2893-540

04
Windscreen sealing compound
Screenfit

- ▶ Item no. 2893-220
- ▶ Contents: 310 ml black
- ▶ Packing unit: 12

- ▶ Product description
- Can be dabbed
- Resistant to water, road salt and weathering
- After curing, thermally stable from -30°C to +80°C

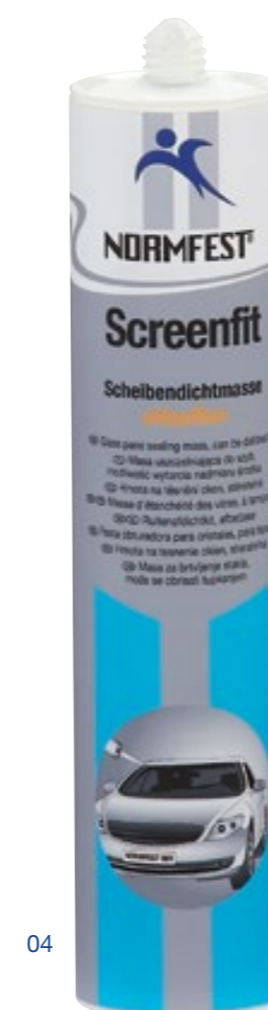

05
Glass Metal Adhesive
Mirrlock

- ▶ Item no. 2898-557

- ▶ Product description
- 2-component adhesive
- Temperature range: -55°C to +120°C
- Touch dry after approx. 20 seconds
- Curing: approx. 12 hours at 23°C and 55% air humidity
- Tensile strength: approx. 35 N/mm² (glass breaks)

- Note: Not suitable for Ford vehicles!



04

05

01
Intensive window cleaner
Topas

- ▶ Item no. 2897-310
- ▶ Contents:
- ▶ Packing unit: 24

- ▶ Item no. 2000-03
- ▶ Contents: 5 litres
- ▶ Packing unit: 1

- ▶ Product description
- Also suitable for polycarbonate glass
- Safe for surfaces
- Foam formation only after the surface has been coated with the product

02
Active cleaning cloths
Jumbo pail

- ▶ Item no. 2897-260-70
- ▶ Contents: 75 wipes
- ▶ Packing unit: 1

- ▶ Product description
- Lemon-scented
- Lint-free
- Dermatologically tested
- Cleaning cloths easily remove even bodywork, plastic and windscreen adhesive residue



03
Spout for 5 litre containers

- ▶ Item no. 2000-000-005

Spout for 30 litre containers

- ▶ Item no. 2000-000-030

04
Glass cleaner
Stries Protect

- ▶ Item no. 2897-340
- ▶ Contents: 500 ml
- ▶ Packing unit: 12

- ▶ Item no. 2897-340-5
- ▶ Contents: 5 litres
- ▶ Packing unit: 1

- ▶ Item no. 2897-340-30
- ▶ Contents: 30 litre
- ▶ Packing unit: 1

- ▶ Product description
- Removes dirt, marks, fingerprints, grease, nicotine, dead insects, etc.
- Free of silicone and ammonia
- Can be used on glass, polycarbonate glass, plastic surfaces



01

Screenout Easy

Screen cutting-out system

- ▶ Item no. 2893-699-999
- ▶ 11 pieces

▶ **Product description**

- Cutting out procedure does not require great strength or assistant
- Time saving thanks to easy and quick handling
- Clean and even cut
- No damage to paintwork or vehicle interior

- Content:

- 1 x cutting-out device
- 2 x cutting-out cord, each 65m (art. no. 2600-20)
- 1 x awl (art. no. 8715-57-68)
- 1 x cutter blade (art. no. 8715-57-600)
- 1 x decorative-strip wedge (art. no. 8715-57-700)
- 1 x pick
- 1 x adapter for bit inserts
- 2 x cutting-out protection
- 1 x instructions



02

Car glazing system

Screenout

- ▶ Item no. 2893-999-999
- ▶ 23 pieces

- Contents:

- 1 x puller (art. no. 8715-57-71)
- 1 x duct tape (art. no. 4992-380)
- 2 x vacuum lifting tools (art. no. 8715-57-61)
- 2 x pull handles (art. no. 8715-57-65)
- 1 x awls (art. no. 8715-57-68)
- 1 x handle (art. no. 8715-57-694)
- 10 x blades, 16 mm (art. no. 8715-57-692)
- 1 x cutting wire (art. no. 8715-57-63)
- 1 x installation and decorative strip wedge (art. no. 8715-57-700)
- 1 x vacuum gel (art. no. 2600-15)
- 1 x cutter blade (art. no. 8715-57-600)
- 1 x storage box (art. no. 1962-1-4)



01



02

01

Gaffer tape

- ▶ Item no. 4992-360
- ▶ Colour: silver

- ▶ Item no. 4992-370
- ▶ Colour: black

- ▶ Product description
- Width: 50 mm
- Length: 50 m
- reinforced



02

Cutter knife

Incl. one spare blade

- ▶ Item no. 8715-57-600

- ▶ Item no. 8715-57-601
- ▶ Spare blades 10 pieces.



03

03

Round nozzle

For aluminium cartridge, embossed, length: 8.2 cm

- ▶ Item no. 2891-02-25



04

04

Triangular nozzle

for windscreen adhesive

- ▶ Item no. 2891-02-30



05

05

Cartridge opener

- ▶ Item no. 2891-02-50

06

Bag adaptor and nozzle set
for 400 ml bags

- ▶ Item no. 2893-560

- ▶ Product description
- 1 x bag adaptor
- 2 x round nozzle (2891-02-25)



06

07

Windscreen cutter

- ▶ Item no. 8697-5

- ▶ Product description
- Ideal for windscreen specialists, vehicle repair workshops
- Fast, safe and easy-to-hand system
- Powerful 400 W motor for high cutting speeds
- Stepless electronic cutting frequency
- Hex tool holder with friction-locked connection between the machine and tool

- Scope of delivery:
- 1 x windscreen cutter Super Cut FSC
 - 1 x plastic tool case
 - 1 x whetstone (art no.:8697-5-1)
 - 1 x spanner wrench (art no.: 8697-600)
 - 1 x mounting bolt

- Technical data:
- Rated input: 400 W
 - Output: 220 W
 - Oscillations: 11,000-18,500 rpm
 - Cable with plug: 5 m
 - Weight: 1.25 kg

Spare grindstone

- ▶ Item no. 8697-5-1

08

Round saw blades

- ▶ Product description
- For further use of the special cutter when sawing sheet metal and GRP as well as cutting scrap bridges (bodywork saw)



08

Item no.	Ø mm	Sales unit
8697-580-2	63	1
8697-581-2	80	1



07





01
Suction cup handle
double-jointed

▶ Item no. 8715-57-61

▶ **Product description**

- With double joint
- Max. lift: 30 kg
- Suction cups: diameter 150 mm, with suck-on mechanism
- Safety lock
- High-grade ABS plastic, acid and oil resistant
- Ideal for curved glass
- Flexible

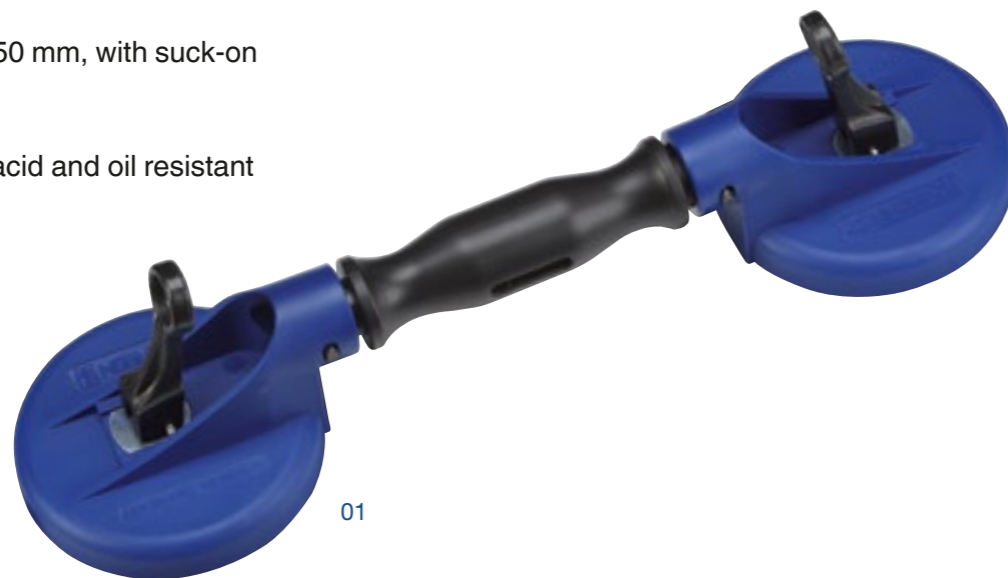

01

02
Fixing lifting tool

- ▶ Item no. 8715-57-69
- ▶ 1 packing unit = 6 pcs.

▶ **Product description**

- Suitable for fixing glued trim strips and windscreen frames



02

03
Clip releaser tool
2-pc. set

▶ Item no. 8715-57-700

▶ **Product description**

- Ideal for removing windscreen frames, interior trim panels and other trims
- Assembly wedge: 20.5 x 265 mm
- Trim wedge: 30 x 200 mm



03

04
Pump vacuum lifting tool

▶ Item no. 8715-57-610

▶ **Product description**

- Ideal for HGVs and CVs due to max. lift of 120 kg
- Tested by TÜV-Nord
- Non-slip rubber coating
- With safety marking



04

05
Windscreen stand
Also suitable for HGVs and vans

▶ Item no. 7714-200

▶ **Product description**

- Also suitable for HGVs and vans
- Non-slip due to special foam rubber padding
- Max. load capacity 120 kg
- Foldable



05

01
Cutting wire
Ideal for high modulus windscreen adhesive

- ▶ Item no. 8715-57-63
- ▶ Square profile, 50 m



01

02
Piano cutting wire
for sawing

- ▶ Item no. 8715-57-64
- ▶ drilled, 20 m



02

03
Traction handle
for windscreen removal wire

- ▶ Item no. 8715-57-65



03



04
Counter bracket
for windscreen removal wire

- ▶ Item no. 8715-57-67



04

05
Insert awls
for windscreen removal wire

- ▶ Item no. 8715-57-66

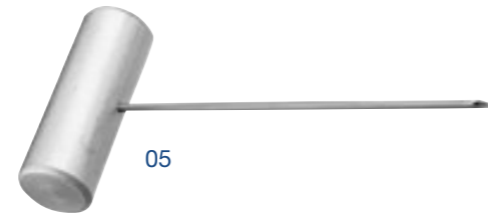

05

06
Insert awls (sword)
for windscreen removal wire

- ▶ Item no. 8715-57-68



06

07
Window scraper

- ▶ Item no. 8715-64-700

Spare blades

- ▶ Item no. 8715-64-71
- ▶ Spare blades, 10 pcs.



07

08
Cold knife
Ideal for side and rear windows

- ▶ Item no. 8697-603
- ▶ Knife, incl. 25 mm blade
- ▶ Item no. 8697-604
- ▶ Spare blade, 18 mm
- ▶ Item no. 8697-605
- ▶ Spare blade, 25 mm



08

09
PU scraper set
ideal for the cutting back of the remaining adhesive bead

- ▶ Item no. 8715-57-690

▶ Product description

Contents:

- 10 x 12 mm spare blade (art. no. 8715-57-691)
- 10 x 16 mm spare blade (art. no. 8715-57-692)
- 10 x 20 mm spare blade (art. no. 8715-57-693)
- 1 x Handle for PU scraper (art. no. 8715-57-694)



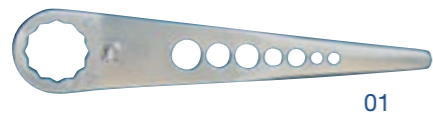

01
Window removal knife
Packing unit, 2 pieces

Item no.	Model
8697-002-099	16.0 mm
8697-002-123	32.0 mm
8697-002-168	45.0 mm
8697-002-160	54.0 mm
8697-002-097	58.0 mm
8697-002-081	60.0 mm
8697-002-125	70.0 mm
8697-002-171	70.0 mm
8697-002-194	110.0 mm



02
Window removal knife
Packing unit, 2 pieces

Item no.	Model
8697-004-152	39.0 mm
8697-003-072	45.0 mm
8697-003-143	16.0 – 35.0 mm
8697-004-195	32.0 – 46.0 mm
8697-004-182	42.0 – 60.0 mm
8697-004-169	60.0 – 76.0 mm



06
Windscreen cutter blade, toothed
Packing unit, 2 pieces

Item no.	Model
8697-009-208	19.0 mm
8697-009-207	25.4 mm
8697-009-209	38.0 mm



07
Window removal knife
Packing unit, 2 pieces

Item no.	Model
8697-006-120	14.0 mm
8697-006-103	35.0 mm



03
Window removal knife
Packing unit, 2 pieces

Item no.	Model
8697-005-083	10.0 mm
8697-005-108	16.0 mm
8697-005-118	19.5 mm
8697-005-115	22.0 mm
8697-005-076	24.0 mm
8697-005-163	28.0 mm
8697-005-114	32.0 mm
8697-005-147	32.0 mm
8697-005-191	32.0 mm
8697-005-079	36.0 mm
8697-005-110	40.0 mm
8697-005-156	40.0 mm
8697-005-154	45.0 mm
8697-005-155	60.0 mm
8697-005-157	60.0 mm
8697-005-101	60.0 mm
8697-005-107	60.0 mm



04
Window removal knife
Packing unit, 2 pieces

Item no.	Model
8697-001-121	26.0 mm
8697-001-073	35.0 mm
8697-001-176	90.0 mm



08
Blade for removing residual adhesive beads
Packing unit, 2 pieces

Item no.	Model
8697-007-129	12.0 mm
8697-007-146	18.0 mm



09
Blade for removing residual adhesive beads
Packing unit, 2 pieces

Item no.	Model
8697-007-113	25.0 mm
8697-007-131	25.0 mm



05
Windscreen cutter blade, toothed
Packing unit, 2 pieces

Item no.	Model
8697-005-211	25.5 mm
8697-005-212	38.0 mm

01

Window Repair Kit

Screen repair

► Item no. 2600-999-999

Item no.	Description
2600-01	10 x cutting blade
2600-04	1 x 12 V electric drill
2600-06	1 x jointed inspection mirror with suction pad
2600-07	2 x glass drill bit 1.2 mm
2600-08	1 x hardening film
2600-09	1 x lapping polisher
2600-10	1 x polish
2600-11	1 x repair resin
2600-12	1 x finish resin
2600-13	1 x 230 V UV lamp with timer
2600-15	1 x vacuum gel
2600-16	1 x tool holder with spring capsule
2600-045	1 x 230 V transformer
3721-503	1 x LED inspection lamp
2600-14	1 x spare lamp



01

02

12 V UV lamp with timer

► Item no. 2600-13-12

► Product description
- Only operate using 12V UV bulb with timer with 12 V adapter cable (art. no. 2600-17)

03

12 V adapter cable

► Item no. 2600-17

► Product description
- Suitable for UV lamp 12V (2600-13-12) and 12V electric drill (2600-04)

04

12 V electric drill with chuck

► Item no. 2600-04



02



03



04

01
Cutting blades, 10 pieces

- ▶ Item no. 2600-01



04
Glass drill bit 1.2 mm, 2 pieces

- ▶ Item no. 2600-07



07
Polish

- ▶ Item no. 2600-10



10
230 V UV lamp with timer

- ▶ Item no. 2600-13



13
Curing film

- ▶ Item no. 2600-08

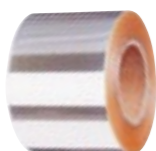

02
Vacuum gel

- ▶ Item no. 2600-15



05
Diamond milling cutter 1.2 mm

- ▶ Item no. 2600-05



08
Repair resin

- ▶ Item no. 2600-11



11
Tool holder with spring capsule

- ▶ Item no. 2600-16



14
LED inspection lamp

- ▶ Item no. 3721-503



03
Jointed inspection mirror with suction pad

- ▶ Item no. 2600-06



06
Lapping polisher

- ▶ Item no. 2600-09



09
Finish resin

- ▶ Item no. 2600-12



12
220 V transformer

- ▶ Item no. 2600-045



Spare UV tube

- ▶ Item no. 2600-14

15
WS-Scheibenstopp
BMW E36 / E38 / E39

- ▶ Item no. 5502-101-003
- ▶ 1 sales unit = 56 pieces = 1 pallet



17
Spacer
Universal

- ▶ Item no. 5502-100-001
- ▶ 1 packing unit = 5 pcs.

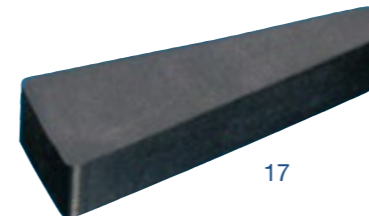

19
Retain profile
For side and rear windows, self-adhesive

- ▶ Item no. 5502-107-002
- ▶ 27 m roll

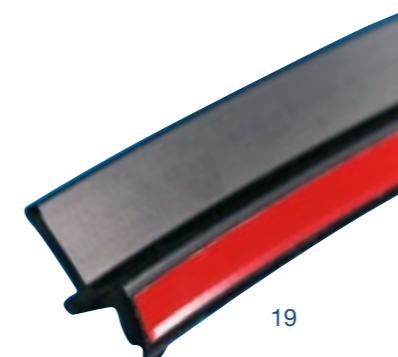

16
Spacer set
Mercedes

- ▶ Item no. 5502-103-005
- ▶ 1 packing unit = 11 pcs.

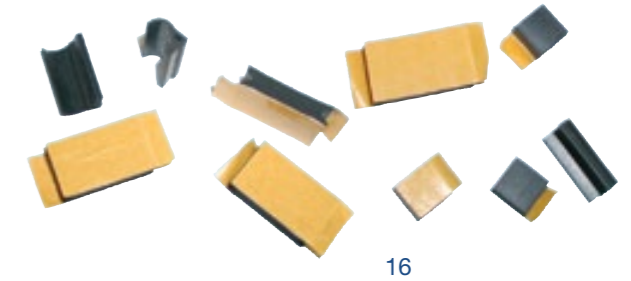

18
Moos ribbon
Incl. hard rubber block 5 x 7mm, self-adhesive

- ▶ Item no. 5502-107-001
- ▶ 15 m roll

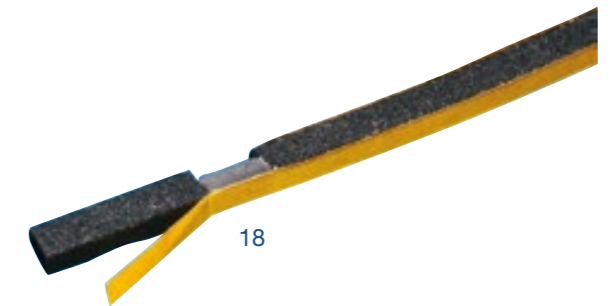

20
Moos ribbon
4 x 3mm, self-adhesive

- ▶ Item no. 5502-107-003
- ▶ 30 m roll



Vehicle reworking



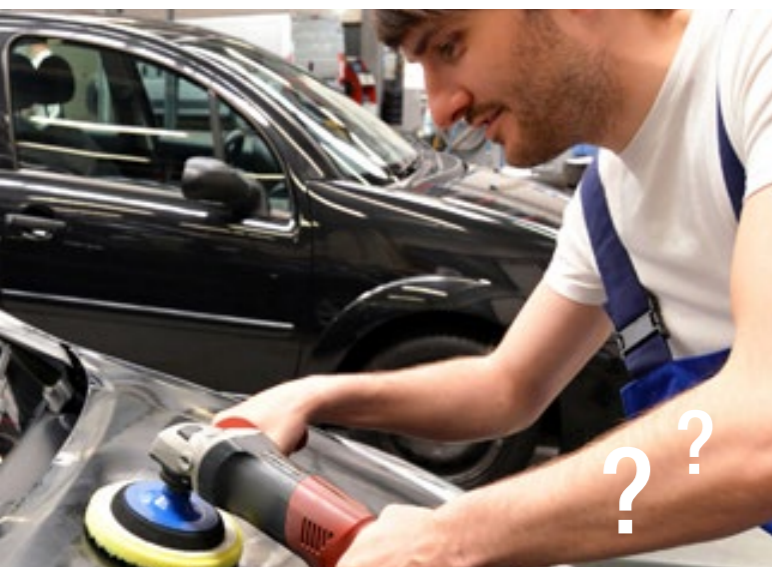

01
Abrasive paste coarse
 Scratch-Off Ultra

- ▶ Item no. 2000-325-1
- ▶ Contents: 1 kg
- ▶ Packing unit: 1

- ▶ **Product description**
- Suitable for HS and MS paints
 - Silicone-free
 - Ammonia-free
 - Can be overpainted
 - Free of cosmetic oils
 - Low heat generation
 - Can be mixed with water

USE ONLY WITH A MACHINE
 - Minor scratches: Lambswool, white (2000-204-150)
 - Medium scratches: hard polishing sponge, yellow (2000-205-150)



01

02
Grinding compound, fine
 Scratch-Off Fine Plus

- ▶ Item no. 2000-326-9
- ▶ Contents: 1 kg
- ▶ Packing unit: 1

- ▶ **Product description**
- Suitable for HS and MS paints
 - High level of abrasion and maximum shine
 - Solvent free
 - Does not contain silicone or ammonia
 - Free of cosmetic oils
 - Extended pot life and longer working time
 - Low heat generation
 - Leaves no residue on plastic surfaces

- Application: MACHINE ONLY
 - Medium scratches: Medium polishing sponge, orange (2000-206-150)



02

03
Polish
 Scratch Soft

- ▶ Item no. 2000-327-1
- ▶ Contents: 1 kg
- ▶ Packing unit: 1

- ▶ **Product description**
- Slight to medium signs of use can be polished out without leaving holograms
 - Suitable for HS and MS paints
 - Silicone-free

- Use: MACHINE ONLY
 - Minor marks: Polishing sponge medium, orange (2000-206-150)
 - Hologram remover: Soft polishing sponge, black (2000-207-150)
 - Wafer sponge, black (2000-208-150)



03

01

Quick sealant
Speed-Gloss-Nano

- ▶ Item no. 2000-316-1
- ▶ Contents: 1 litre
- ▶ Packing unit: 1

- ▶ Item no. 2000-316-5
- ▶ Contents: 5 litres
- ▶ Packing unit: 1

▶ **Product description**

- Perfect shine effect
- Effortless polishing without leaving any sticky residue
- Suitable for cleaning without water
- Contains carnauba wax

- Application: MANUAL ONLY

- Microfibre cloth, red (2000-740-40)
- Application sponge, black (2000-209-130)



01

02

Wax sealing
Speed-Wax

- ▶ Item no. 2000-330-1
- ▶ Contents: 1 kg
- ▶ Packing unit: 1

▶ **Product description**

- Premium car wax
- Natural carnauba wax, enriched with high-quality synthetic components
- For manual and machine application
- Permanent protection against the elements
- Long-lasting shine

- Application:

- Manual: Application sponge, black (2000-209-130)
- Machine: Wafer sponge, black (2000-208-150)



02

03

Long-time sealing
Paint-Guard

- ▶ Item no. 2000-331-1
- ▶ Contents: 1 litre
- ▶ Packing unit: 1

▶ **Product description**

- Special blend of PTFE and acrylic resins
- Extra UV protection for long-lasting good looks
- Unique water-based formula
- Free of volatile silicones
- Application:

- Manual: Microfibre cloth, red (2000-740-40)

- Machine: Soft polishing sponge, black (2000-207-150)



03



04

Long-term protective surface sealant
Pearl

- ▶ Item no. 2897-327
- ▶ Contents: 500 ml
- ▶ Packing unit: 6

▶ **Product description**

- Protective surface sealant & shine enhancer
- Increases resistance to scratches and repels dirt
- Easy to apply and polish out
- Surface protection cures in just 10 minutes
- Solvent-free



04

01

Cleaning polish

Twin

- ▶ Item no. 2000-304-1
- ▶ Contents: 1 litre
- ▶ Packing unit: 1

- ▶ Item no. 2000-304-5
- ▶ Contents: 5 litres
- ▶ Packing unit: 1

▶ **Product description**

- Cleans, refreshes and polishes in one step
- The low chalk content simplifies the polishing of dark colours
- Contains no volatile silicones
- Suitable for all paints, including metallic paints and water-soluble paints

02

High-gloss polish

High Gloss

- ▶ Item no. 2000-303-1
- ▶ Contents: 1 litre
- ▶ Packing unit: 1

- ▶ Item no. 2000-303-5
- ▶ Contents: 5 litres
- ▶ Packing unit: 1

▶ **Product description**

- Maximum shine effect
- Quick finish
- Contains no volatile silicones
- High viscosity
- For use on cars, buses, motorbikes, HGVs, aircraft, boats, caravans, etc.



01

02



01

Spray polish

Polit

- ▶ Item no. 2897-326
- ▶ Contents: 400 ml
- ▶ Packing unit: 12

▶ **Product description**

- Extremely quick and simple to use
- Anti-static
- Creates a unique deep shine
- Highly resistant to scratches and abrasion
- Ideal when combined with our Magic-Clean cleaning putty (article 2000-25)!

02

Sanding-Polishing-Sealing

Compact

- ▶ Item no. 2000-335-1
- ▶ Contents: 1 kg
- ▶ Packing unit: 1

▶ **Product description**

- Quick and professional treatment of older paintwork
- Cleaning and sealing in one application
- Free of volatile silicones



THE FULL PACKAGE



01



02

03

Paintwork reconditioning set

Starter set, content: 8 pieces

- ▶ Item no. 2000-999-997

Item no.	Description
2000-325-1	Coarse grinding paste 1 kg
2000-327-1	Polishing paste 1 kg
2000-330-1	Wax sealant 1 kg
2000-205-150	Polishing sponge hard, 150 mm
2000-206-150	Polishing sponge medium, 150 mm
2000-207-150	Polishing sponge soft, 150 mm
2000-740-40	Microfibre cloth (red), 400 x 400 mm
2000-745-40	Premium microfibre cloth, 400 x 400 mm



03

01
Power cleaner, exterior
All-Star

- ▶ Item no. 2000-312-5
- ▶ Contents: 5 litres
- ▶ Packing unit: 1

- ▶ Item no. 2000-312-30
- ▶ Contents: 30 litre
- ▶ Packing unit: 1

- ▶ **Product description**
- Ideal for universal application
- AOX free
- Effortlessly removes oil, grease, nicotine stains and dead insects
- Suitable for high-pressure cleaners
- Can be used warm or cold

02
Power cleaner, inside/outside
Uni-Star

- ▶ Item no. 2000-02
- ▶ Contents: 5 litres
- ▶ Packing unit: 1

- ▶ Item no. 2000-02-30
- ▶ Contents: 30 litre
- ▶ Packing unit: 1

- ▶ **Product description**
- Universal cleaner for inside and outside the vehicle
- AOX-free
- Gentle cleaner
- Effortlessly removes oil, grease, nicotine stains and dead insects

03
Tarpaulin Cleaner
Cover-Star

- ▶ Item no. 2000-313-30
- ▶ Contents: 30 litre
- ▶ Packing unit: 1

- ▶ **Product description**
- Suitable for use with high-pressure cleaners
- Contains no halogenated hydrocarbons
- Free of adsorbent organic halogen compounds (AOX)
- Biodegradable

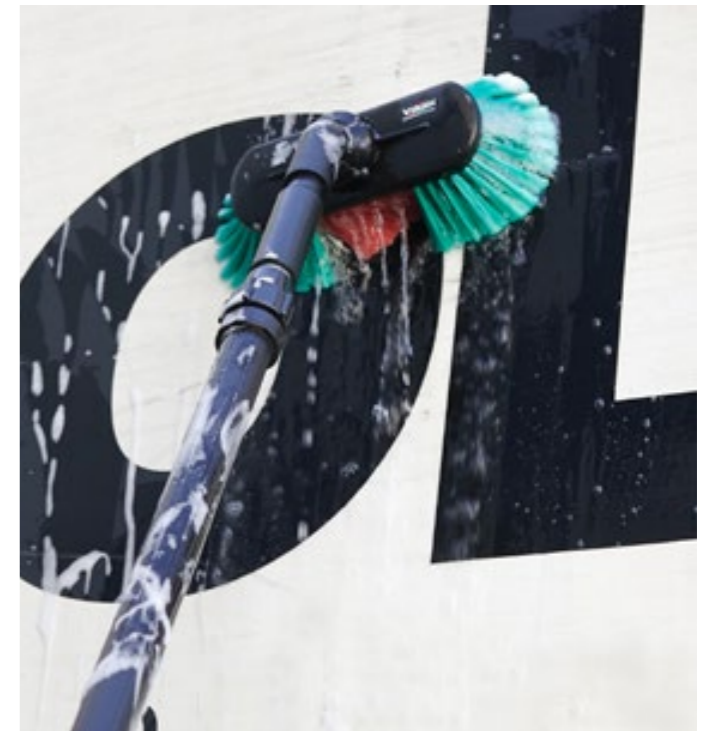

01



02



03

04
Spout for 5 litre containers

- ▶ Item no. 2000-000-005

Spout for 30 litre containers

- ▶ Item no. 2000-000-030



04



05

05
High pressure cleaner
HD 5/15 C Plus

- ▶ Item no. 2000-550-2



01

Insect remover
Insect-Star Extreme

- ▶ Item no. 2000-322-5
- ▶ Contents: 5 litres
- ▶ Packing unit: 1

- ▶ Item no. 2000-322-30
- ▶ Contents: 30 litre
- ▶ Packing unit: 1

- ▶ **Product description**
- Special cleaner for the fast removal of dead insects
- Suitable for paintwork, glass, plastic and alkaline-resistant surfaces on all PCVs, HGVs, vans and trains
- Silicone-free

02

Rust film remover
Mega-Star

- ▶ Item no. 2000-10
- ▶ Contents: 5 litres
- ▶ Packing unit: 1

- ▶ **Product description**
- Cleaning agent for extreme inorganic dirt, e.g. concrete residue
- Effortlessly removes stubborn road dirt, brake dust, limescale, hard deposits of oil, surface rust
- Also suitable for cleaning wheel rims and engines
- AOX-free

03

Tar remover
Power Star Ultra

- ▶ Item no. 2000-04
- ▶ Contents: 5 litres
- ▶ Packing unit: 1

- ▶ **Product description**
- Loosens road tar
- Removes stickers on new cars
- Removes adhesive and sealing residue from all external plastic parts, paintwork and glass

04

Spout for 5 litre containers

- ▶ Item no. 2000-000-005

Spout for 30 litre containers

- ▶ Item no. 2000-000-030



05

Active foam
Active Care

- ▶ Item no. 2000-401-30
- ▶ Contents: 30 litre
- ▶ Packing unit: 1

- ▶ **Product description**
- For soaking and cleaning heavy dirt and chemical pre-washes
- In car washes: Undiluted
- 1:1 using dosing pump (setting 8-20ml)

06

Drying accelerator
Speed Dry

- ▶ Item no. 2000-404-30
- ▶ Contents: 30 litre
- ▶ Packing unit: 1

- ▶ **Product description**
- Supports the drying process by tearing open the water film
- Set car wash system to: neat
- 1:1 via the dosing pump (setting 8-20 ml)



01

02

03

04

05

06



01

Car Shampoo

Wash & Ready

- ▶ Item no. 2000-321-5
- ▶ Contents: 5 litres
- ▶ Packing unit: 1

- ▶ Item no. 2000-321-30
- ▶ Contents: 30 litre
- ▶ Packing unit: 1

▶ **Product description**

- Shampoo concentrate (can be diluted to 1:100)
- pH value 7.7
- Effortlessly removes grime and road dirt
- Leaves a shiny, streak-free surface



01

02

High gloss shampoo

Wash & Drive

- ▶ Item no. 2000-300-5
- ▶ Contents: 5 litres
- ▶ Packing unit: 1

- ▶ Item no. 2000-300-30
- ▶ Contents: 30 litre
- ▶ Packing unit: 1

▶ **Product description**

- Leaves a shiny and streak-free surface
- Silicone free
- AOX free
- Effortlessly removes road dirt and traffic deposits
- Cleans and polishes the paintwork in one application
- Can be diluted to: 15ml to 10 litres of warm water



02

03

Shampoo

Power Wash

- ▶ Item no. 2000-402-30
- ▶ Contents: 30 litre
- ▶ Packing unit: 1

▶ **Product description**

- Ideal for vehicle cleaning and providing good lubricity
- Set vehicle wash system to: neat
- 1:1 via the dosing pump (setting 8-15 ml)
- Machine cleaning: dilute up to 1:5,000 (depending on the level of soiling)
- Manual cleaning: dilute up to 1:50 (depending on the level of soiling).



03

01

Scrubbing brushes

with water throughput

- ▶ Item no. 2000-810-3
- ▶ 130 x 260 mm (with pivot joint)

- ▶ Item no. 2000-810-4
- ▶ 90 x 400 mm

▶ **Product description**

- Brush type Soft/split
- Dimensions: 130mm x 260mm x 110mm
- Filament: 50mm
- Material: PP/PBT
- Thermal stability: 50°C



04

Telescopic handle

Without water throughput

- ▶ Item no. 2000-810-10
- ▶ 1,590 - 2,800 mm

▶ **Product description**

- Diameter 31 mm
- Height 45 mm
- Length 1590 mm
- Max. length 2800 mm
- Width 45 mm
- Material Aluminium, Polypropylene
- Max. temperature in use 50 °Celsius

05

Shafts

- ▶ Item no. 2000-810-5
- ▶ 1600 mm (aluminium, without water throughput)

- ▶ Item no. 2000-810-6
- ▶ 1600-2900 mm (water fed telescopic pole)

- ▶ **Product description**
- Material: Aluminium/PP



01



02



03

02

Rim brush

With water throughput

- ▶ Item no. 2000-810-9

▶ **Product description**

- Filament description: Soft/split
- Filament length: 50 mm
- Height: 105 mm
- Length: 240 mm
- Width: 150 mm
- Material: PP, PBT
- Max. temperature in use: 50 °Celsius

03

Rim brush, black

Soft for aluminium and chrome rims

- ▶ Item no. 2000-810-8

▶ **Product description**

- Filament description: Soft
- Filament length: 40 mm
- Colour: black
- Diameter: 65 mm
- Length: 330 mm
- Material: PP, hair/PP
- Max. temperature in use: 60 °Celsius

05

04



06



07



06

Squeegee

with stick attachment on the handle

- ▶ Item no. 2000-810-1
- ▶ 350 mm (passenger cars)

- ▶ Item no. 2000-810-2
- ▶ 450 mm (commercial vehicles)

- ▶ **Product description**
- Material: POM/rubber

07

Universal wall holder

- ▶ Item no. 2000-810-7
- ▶ 165 (D) x 55 (H) x 240 (W) mm

- ▶ **Product description**
- Dimensions (HxWxD): 60mm x 240mm x 170mm
- Material: PP/Rubber
- Thermal stability: 100°C

01 Acid-free aluminium rim cleaner
Rimol Gold Protect

- ▶ Item no. 2897-328-5
- ▶ Contents: 5 litres
- ▶ Packing unit: 6

- ▶ Item no. 2897-328-500
- ▶ Contents: 500 ml
- ▶ Packing unit: 1

- ▶ **Product description**
- Acid-free
- Consists of 70% renewable raw materials, so environmentally friendly
- Contains no materials hazardous to health when evaporating off
- Gel-type viscosity
- Non-toxic
- Does not burn the skin
- Gentle cleaning

02 Special aluminium wheel rim cleaner
Rimol Pro

- ▶ Item no. 2897-321-5
- ▶ Contents: 5 litres
- ▶ Packing unit: 1

- ▶ Item no. 2897-321-30
- ▶ Contents: 30 litre
- ▶ Packing unit: 1

- ▶ **Product description**
- Acidic
- Breaks down severe inorganic soiling such as brake dust, dirt from the street or surface rust

03 Aluminium Rim Cleaner
Rimol

- ▶ Item no. 2897-320-1
- ▶ Contents: 500 ml
- ▶ Packing unit: 6

- ▶ **Product description**
- Acidic
- Easily removes stubborn dirt (burnt in brake dust, rust film, abraded rubber, heavy oil incrustations, road dirt, etc.)

04 Silicone-free tyre care product
New Wheel Plus

- ▶ Item no. 2897-339-400
- ▶ Contents: 400 ml
- ▶ Packing unit: 12

- ▶ **Product description**
- Waterproof
- Quick drying
- Silicone-free

05 Silicone-based care product
New Wheel Extreme

- ▶ Item no. 2897-338-400
- ▶ Contents: 400 ml
- ▶ Packing unit: 12

- ▶ **Product description**
- Waterproof
- Quick drying
- Containing silicone



01
Care product for exterior plastic
Outplast

- ▶ Item no. 2000-319-500
- ▶ Contents: 500 ml
- ▶ Packing unit: 12

- ▶ **Product description**
- Provides long-lasting shine
 - Excellent surface protection against environmental damage
 - Silicone-free
 - Not suitable for interior plastic parts or painted plastics

02
Plastic dyer
Plast-PT

- ▶ Item no. 2897-041
- ▶ Contents: 75 ml, black
- ▶ Packing unit: 1

- ▶ **Product description**
- Resistant to car washes, high pressure cleaners and solvents
 - For dyeing plastic
 - Incl. sponge



03
Rubber care
Outdoor

- ▶ Item no. 2000-306-1
- ▶ Contents: 1 litre
- ▶ Packing unit: 1

- ▶ **Item no. 2000-306-5**
- ▶ Contents: 5 litres
 - ▶ Packing unit: 1
- ▶ **Product description**
- Provides a pleasant, matt and long-lasting shine
 - Has a high coverage rate and is quick drying
 - Does not leaves sticky residue on the surface
 - Leaves no marks in adjacent surfaces (paintwork, hub caps)
 - Silicone-based



04
Engine compartment preservation
Motor-Fit

- ▶ Item no. 2000-307-1
- ▶ Contents: 1 litre
- ▶ Packing unit: 1

- ▶ Item no. 2000-307-5
- ▶ Contents: 5 litres
- ▶ Packing unit: 1

- ▶ Item no. 2000-307-30
- ▶ Contents: 30 litre
- ▶ Packing unit: 1

- ▶ **Product description**
- High shine
 - Water dispersing
 - Contains silicone
 - Contains no aromatic solvents
 - Protects electronic components



01



02



03



04

01
Intensive window cleaner
Topas

- ▶ Item no. 2897-310
- ▶ Contents:
- ▶ Packing unit: 24

- ▶ Item no. 2000-03
- ▶ Contents: 5 litres
- ▶ Packing unit: 1

- ▶ **Product description**
- Also suitable for polycarbonate glass
- Safe for surfaces
- Foam formation only after the surface has been coated with the product

02
Cleaning putty
Magic Clean

- ▶ Item no. 2000-25
- ▶ Contents: 200 g
- ▶ Packing unit: 1

- ▶ **Product description**
- Effortlessly removes even the hardest dirt from painted surfaces
- Without aggressive solvents
- Removes industrial dust, surface rust, paint mist, dead insects, adhesive residue, tar and resin deposits



03
Spout for 5 litre containers

- ▶ Item no. 2000-000-005

Spout for 30 litre containers

- ▶ Item no. 2000-000-030

04
Glass cleaner
Stries Protect

- ▶ Item no. 2897-340
- ▶ Contents: 500 ml
- ▶ Packing unit: 12

- ▶ Item no. 2897-340-5
- ▶ Contents: 5 litres
- ▶ Packing unit: 1

- ▶ Item no. 2897-340-30
- ▶ Contents: 30 litre
- ▶ Packing unit: 1

- ▶ **Product description**
- Removes dirt, marks, fingerprints, grease, nicotine, dead insects, etc.
- Free of silicone and ammonia
- Can be used on glass, polycarbonate glass, plastic surfaces





01
Upholstery cleaner
Velvet

- ▶ Item no. 2897-307
- ▶ Contents: 400 ml
- ▶ Packing unit: 12

- ▶ Product description
- cleans and protects upholstery, carpets and roof lining
- removes greasy residue
- leaves a pleasant scent
- no vacuuming required



02
Leather care product
Ledanol

- ▶ Item no. 2000-310-1
- ▶ Contents: 1 litre
- ▶ Packing unit: 1

- ▶ Product description
- Cares for and protects leather
- Solvent-free
- Do not use on suede or similar surfaces



01



02

01
Intensive interior cleaner and care product
 Interno Protect

- ▶ Item no. 2000-05
- ▶ Contents: 500 ml
- ▶ Packing unit: 12

- ▶ Item no. 2000-05-5
- ▶ Contents: 5 litres
- ▶ Packing unit: 1

- ▶ **Product description**
- Treats hard and soft surfaces, such as plastic, vinyl, chrome, sealing strips, door sill protectors, car leather, upholstery and mats
 - Leaves a matt finish on plastic surfaces and a pleasantly fresh



- fragrance
- Not suitable for suede and ultrasuede
- Does not contain hydrocarbon solvents and is free of acids and silicone

02
Interior Detailer
 Crystal Ultra

- ▶ Item no. 2897-306
- ▶ Contents: 400 ml
- ▶ Packing unit: 6

- ▶ **Product description**
- Improved formula increases the cleaning and shine effect by up to 30%
 - Application in cockpits, on door trims, foot mats and seats (except displays and tachometers)
 - Loosens grease residue
 - Leaves the vehicle looking and smelling new
 - Acts anti-statically



03
Interior plastic care product
 Indoor

- ▶ Item no. 2000-308-1
- ▶ Contents: 1 litre
- ▶ Packing unit: 1

- ▶ Item no. 2000-308-5
- ▶ Contents: 5 litres
- ▶ Packing unit: 1

- ▶ **Product description**
- Easy to apply
 - Free of volatile silicones
 - Silk-matt finish



01

Odour destroyer and air freshener

Aerofit Power

- ▶ Item no. 2000-309-400
- ▶ Contents: 400 ml
- ▶ Packing unit: 12

▶ **Product description**

- Immediately eliminates smells and freshens the interior
- Long-lasting and economical
- A high-pressure system with an extremely concentrated active ingredient
- One squirt is sufficient for a large area
- Raspberry fragrance

02

Odour destructor

Aerofit Plus

- ▶ Item no. 2000-309-2
- ▶ Contents: 1 litre
- ▶ Packing unit: 1

▶ **Product description**

- Can be used on all fabric surfaces inside the vehicle as well in ventilation ducts without sensors
- Absorbs and eliminates all unpleasant odours, e.g. nicotine
- Solvent-free
- Can be applied using a normal spray or pump spray bottle
- Easy to apply using a wet vacuum cleaner or nebuliser



01

02

03

Manual sprayer flexible

- ▶ Item no. 2000-802-2

▶ **Product description**

- Suitable for overhead work
- Leak-proof, with Viton seal
- Steplessly adjustable nozzle – from fine spray to jet



03

04

Rubber protector pen

Rubber Fit

- ▶ Item no. 2897-335-75
- ▶ Contents: 75 ml
- ▶ Packing unit: 12

▶ **Product description**

- silicone-free
- splash- and saltwater resistant



04

01
Soft polishing sponge
black

- ▶ Item no. 2000-207-150
- ▶ Diameter 150 mm, height: 30 mm PU: 2

- ▶ Item no. 2000-207-175
- ▶ Diameter 75 mm, height: 25 mm PU: 4

- ▶ **Product description**
- Perfect for applying fine polishing pastes and surface sealants
- Suitable for removing holograms



01

02
Medium polishing sponge
orange

- ▶ Item no. 2000-206-150
- ▶ Diameter 150 mm, height: 30 mm PU: 2

- ▶ Item no. 2000-206-175
- ▶ Diameter 75 mm, height: 25 mm PU: 4

- ▶ **Product description**
- Medium-hard polishing sponge
- Perfect for treating used and weathered paintwork
- Suitable for use with grinding and polishing pastes
- Polish and seal in one step



02

03
Hard polishing sponge
yellow

- ▶ Item no. 2000-205-150
- ▶ Diameter 150 mm, height: 30 mm PU: 2

- ▶ Item no. 2000-205-175
- ▶ Diameter 75 mm, height: 25 mm PU: 4

- ▶ **Product description**
- High intake capacity for abrasive pastes
- Perfect for removing heavy scratches



03

05
Lambskin
white

- ▶ Item no. 2000-204-150
- ▶ Diam. 150 mm PU: 2

- ▶ Item no. 2000-204-175
- ▶ Diam. 75 mm PU: 4

- ▶ **Product description**
- With integrated interface pad
- Extremely aggressive abrasive medium
- High intake capacity for abrasive pastes
- Perfect for removing heavy scratches, orange peel effect and dust inclusions



05

06
Velcro disc

- ▶ Item no. 4666-150-1
- ▶ Ø 150 mm

- ▶ Item no. 4666-075-1
- ▶ Ø 75 mm

- ▶ **Product description**
- With Velcro-type attachment for polishing sponges
- M14 mounting thread



06

07
Application sponge
black

- ▶ Item no. 2000-209-130
- ▶ Ø 130 mm

- ▶ **Product description**
- Ergonomic handle for easy and safe use with:
- Speed-Wax wax sealant (art. no. 2000-330-1)
- Speed Gloss Nano rapid sealant (art. no. 2000-316)



07

04
Waffle sponge
black

- ▶ Item no. 2000-208-150
- ▶ Diameter 150 mm, height: 30 mm PU: 2

- ▶ **Product description**
- With integrated interface pad
- Extremely soft sponge
- Ideal for removing holograms



04



08
3in1 hook-and-loop polishing disks

- ▶ Item no. 4666-075-150

- ▶ **Product description**
- Consists of three different-sized hook-and-loop disks: 75mm, 120mm and 145 mm
- No more resetting of hook-and-loop holder disks to different sizes
- Suitable for all of our polishing sponges and sheepskins
- Provides high flexibility
- Has an M14 machine retainer



01

Polish Flex angle polisher

With powerful 1,400 Watt motor

▶ Item no. 8697-114-12

▶ Product description

- Max. polishing pad diameter: 200 mm
- Max. supporting disk Ø: 150 mm
- Idling speed: 380-2100 /min
- Power consumption: 1,400 W
- Power output: 880 Watt
- Tool retainer: M 14
- Dimensions (L x H): 402x117 mm
- Weight: 2.3 kg

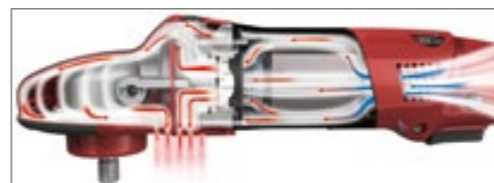

- A handle is included in the package
- The associated replacement carbon brushes are available under article number 8697-114-120

02

Mini angular polisher

With grip cover

▶ Item no. 8697-114-11

▶ Ø 160 mm

▶ Product description

- Max. supporting disk Ø: 125 mm
- Max. polishing pad diameter: 140 mm
- Weight: 1.9 kg
- Drive spindle: M14
- Power output 700 Watt
- Power consumption: 1,200 W
- Idle speed: 1,200 - 3,700 rpm



For the surface structuring of paints, fillers, coating varnishes, clear varnishes, plastics and composite plastics.

Self-cleaning

Water and air are set in motion by applying pressure to the Abralon disc.

Thus circulating the grinding material.

This results in the grinding debris and dust being transported into the foam underlay.

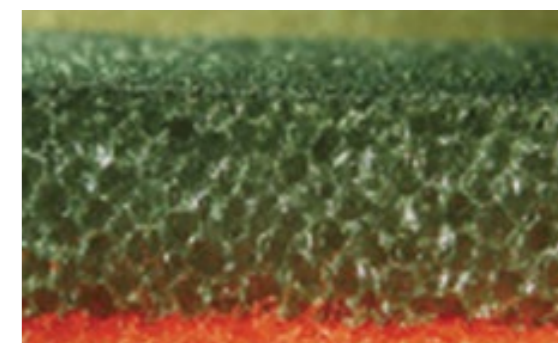

Item no.	Discs Ø	Graining
4587-360	150	360
4587-500	150	500
4587-600	150	600
4587-100-0	150	1000
4587-200-0	150	2000
4587-300-0	150	3000
4587-400-0	150	4000

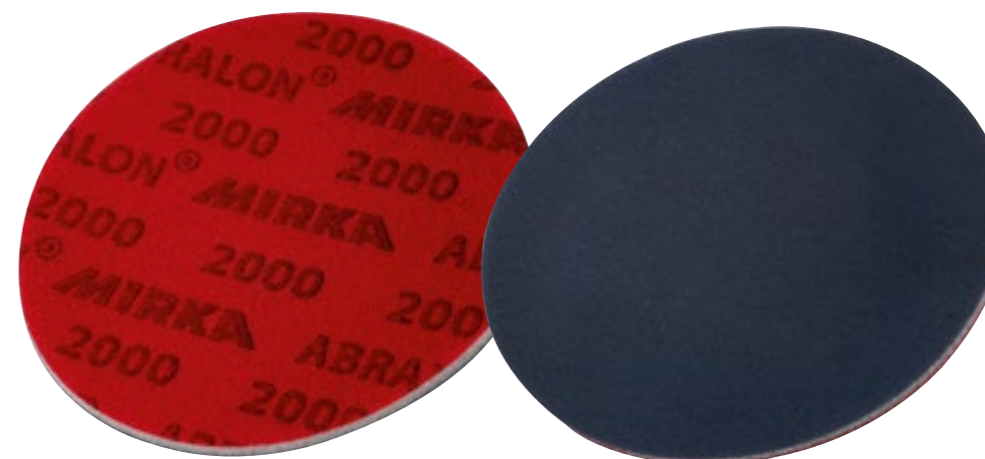

01
Insect sponge
extra strong

- ▶ Item no. 2000-601
- ▶ 110 x 70 x 40 mm



01

02
Car sponge
Classic

- ▶ Item no. 2000-602
- ▶ 180 x 120 x 65 mm



02

03
Car sponge
pressed viscose sponge

- ▶ Item no. 2000-604
- ▶ 130 x 90 x 10 mm

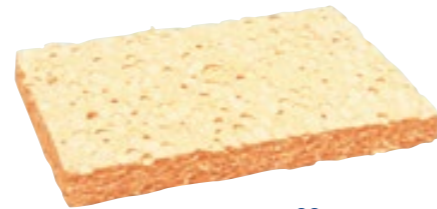

03

04
Wheel rim sponge

- ▶ Item no. 2000-603
- ▶ 165 x 105 x 53 mm

- ▶ Product description
- For special application with steel and aluminium wheel rims



04

05
Car sponge
Hydro

- ▶ Item no. 2000-602-1
- ▶ 195 x 120 x 70 mm

- ▶ Product description
- With ergonomic design
- Very absorbent



05

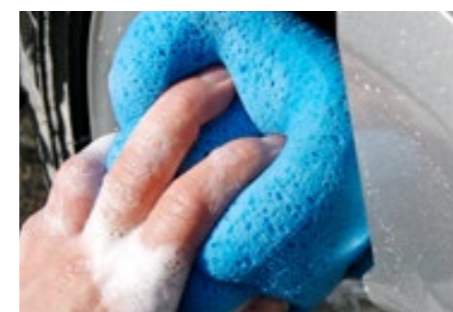

06
Microfibre cloth red

- ▶ Item no. 2000-740-40
- ▶ 400 x 400 mm

- ▶ Product description
- Microfibre hem
- Rounded corners



06

07
Microfibre cloth blue

- ▶ Item no. 2000-640-40
- ▶ 400 x 400 mm

- ▶ Product description
- Lint and dust-free microfibre cloth, even after frequent washing



07

08
Microfibre cloth
King Screen

- ▶ Item no. 2000-840-40
- ▶ 400 x 400 mm

- ▶ Product description
- Streak-free shine if a flash
- Reinforced weave with patterned surface
- Can be used wet and dry
- Lint free



08

09
Premium microfibre cloth
grey

- ▶ Item no. 2000-745-40
- ▶ 400 x 400 mm

- ▶ Product description
- Extremely soft plush cloth
- Scratch-free removal of polish residue



09

10
Microfibre washing glove

- ▶ Item no. 2000-605
- ▶ 230 x 180 x 40 mm

- ▶ Product description
- Very absorbent
- Super soft and fluffy
- Does not become rough and stiff
- Removes dirt gently and efficiently
- Machine washable



10

11
Tornador® Towel
Drying cloth

- ▶ Item no. 2000-766-43
- ▶ 660 x 430 mm

- ▶ Product description
- Very soft
- Washable at 30° C
- Resistant to most oils, grease and chemicals
- For gentle drying of all delicate surfaces
- Dries without streaking or lint



11

01

Abrasive fleece pads

Ultra fine, grey

- ▶ Item no. 4585-455
- ▶ Pads 152 mm x 229 mm

▶ Product description

- With 1,500 grit
- Highly flexible
- Greater performance due to innovative scattering
- For wet and dry applications
- Also suitable for pet hair
- Grit material: Aluminium oxide ultra fine
- Binding agent: Synthetic resin
- Carrier material: Fleece
- Coating: Total coating, three-dimensional
- Colour: Grey

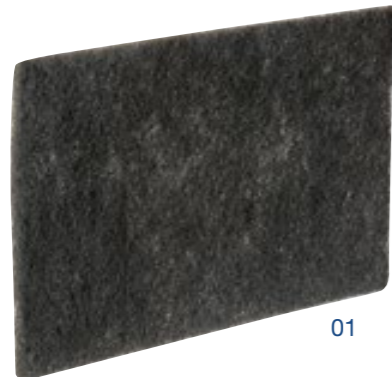

01

02

Carbon sanding block

- ▶ Item no. 4675-001-500
- ▶ 1,500 grit, yellow

- ▶ Item no. 4675-002-000
- ▶ 2,000 grit, green

- ▶ Item no. 4675-003-000
- ▶ 3,000 grit, red

▶ Product description

- For removing scratches levelling unevenness

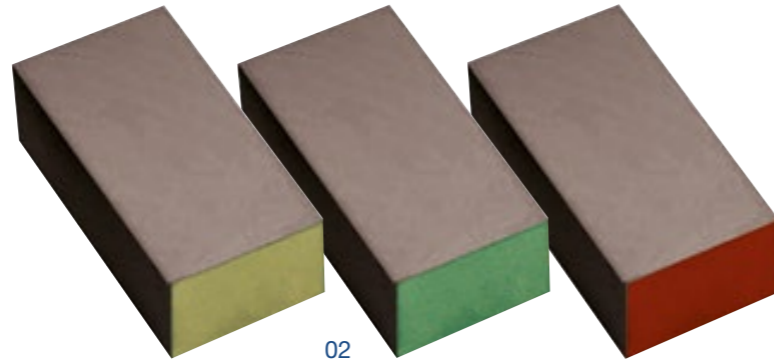

02



03

03

Dirt brush

with bow-type handle and scraping edge

- ▶ Item no. 2000-105

▶ Product description

- Length: 160 mm
- Bristle length: 25 mm



04

04

Pet hair removal brush

with rubber V bristles

- ▶ Item no. 2000-107

▶ Product description

- Completely removes animal hair, dust and other small particles
- Handle can be rotated 90°, facilitating work in corners
- With rubber lip for removing water and snow from windscreens

05

Cleaning paper roll

2-ply, 1,000 tear-off sheets

- ▶ Item no. 7875-502
- ▶ 22 x 36 cm embossed, fully coated

- ▶ Item no. 7875-503
- ▶ 36 x 38 cm embossed, fully coated

▶ Product description

- Colour: blue
- PU: 2



05

06

Cleaning paper roll

3-ply, 1,000 tear-off sheets

- ▶ Item no. 7875-504
- ▶ 38 x 36 cm

▶ Product description

- Roll length: 350m
- Roll diameter: 29cm
- Colour: Blue
- Embossed, fully bonded
- Pack size: 2 pieces



06



07

Fleece roll

perforated, 400 pcs. to tear off

- ▶ Item no. 7875-500
- ▶ 29 x 38 cm

▶ Product description

- Colour: white
- Very absorbent
- Excellent strength wet or dry, abrasion-resistant
- Washable and reusable
- Solvent-resistant
- Silicone-free
- Food safe



07

08

Cellulose pads roll

2-ply, 600 pcs. to tear off

- ▶ Item no. 7875-1
- ▶ 27 x 40 cm, PU: 2

▶ Product description

- Roll length: 255 m
- Colour: white



08

09

Fibre fleece cleaning cloth

perforated, 400 pcs. to tear off

- ▶ Item no. 7875-5
- ▶ 29 x 39 cm

▶ Product description

- Reusable towels with high cotton content
- Can be wrung out
- Resistant to most solvents



09

01

Pump spray bottle 1 litre

► Item no. 2897-333-100

► Product description

- Suitable for fluids containing solvents, such as Bremtec, Power-Star, Motor-Fit
- Working overpressure 3 bar
- Contents: 1 litre
- suitable surrogate sealant (optionally available): Art. no. 2897-333-101



01



02

02

Pump spray bottle 1 litre

► Item no. 2000-100

► Product description

- For universal cleaners, Uni-Star, All-Star, Interno, Stries
- Operating overpressure 3 bar
- Suitable replacement seal (optionally available): Art. no. 2000-101



03

03

Pump spray bottle for acidic liquids

► Item no. 2897-333-150

► Product description

- Colour: Transparent
- Especially suitable for acidic liquids such as Rimol rim cleaner, Rimol Profi rim cleaner, Mega-Star, Oxim
- No processed metal springs in the ascending tube that can dissolve through regular contact with the material
- The valve ascending tube through which the pressure is built up leads upwards so that no rim cleaner can enter the pressure circuit
- Suitable replacement seal: (optionally available): Art. no.: 2897-333-151

04

Hand sprayer

► Item no. 2000-802

► Product description

- Leak-proof
- Smoothly adjustable nozzle ☑ from fine spray to jet

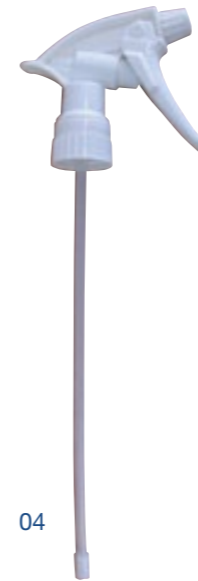

04

05

Hand sprayer

► Item no. 2000-802-1

► Product description

- For 1-litre bottles
- Leak-proof
- Smoothly adjustable nozzle ☑ from fine spray to jet

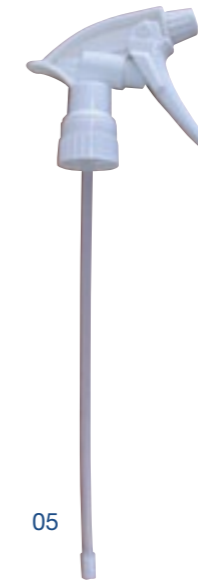

05



06

Bottle transparent

► Item no. 2000-803

- Contents: 500 ml
- Packing unit: 1

► Product description

- With filling level indicator



06

07

Bottle For polishes

► Item no. 2000-102

- Contents: 500 ml
- Packing unit: 1

► Product description

- PE material
- Pressure- and impact-resistant



07

08

Manual sprayer flexible

► Item no. 2000-802-2

► Product description

- Suitable for overhead work
- Leak-proof, with Viton seal
- Steplessly adjustable nozzle – from fine spray to jet



08



01
Pulse cleaning gun
Tornador Black

▶ Item no. 8696-2-83

- ▶ **Product description**
- Allows both dry and wet cleaning
 - Operating pressure: 4.5 - 6.3 bar
 - Low compressed-air consumption of 270 l/min at 6.0 bar
 - Perfect results together with Uni- and All-Star
 - Area of application: Dashboards, ventilation ducts, upholstery, mats, interior trims, convertible soft tops, etc.



02
Pulse cleaning gun
Tornador Gun

▶ Item no. 8696-1-83

- ▶ **Product description**
- Cleans both dry and damp
 - Perfect for Uni or All-Star
 - Compressed-air consumption of 237 l/min at 8 bar

Spare parts

- | | | | |
|------------|-----------------------------------|------------|-----------------------------|
| 8696-1-831 | A / Suction ball with uptake tube | 8696-1-835 | E / Funnel |
| 8696-1-832 | B / Lock valve | 8696-1-837 | F / Funnel with metal ring |
| 8696-1-833 | C / Inner guide hose | 8696-1-836 | G / Additional cup with cap |
| 8696-1-834 | D / Rotating hose | | |



03
Pressure sprayer
for all Normfest cleaners

- ▶ Item no. 2000-806
- ▶ Without hand pump; with closure

- ▶ **Product description**
- 5 litre plastic container
 - 4 bar operating pressure
 - with litre scale
 - Chemical-resistant Viton seals
 - 1.5 m chemical-resistant spray hose
 - 50 cm curved stainless steel spray tube
 - Flat spray nozzle with stainless steel head, diameter 0.91 mm
 - Relief valve
 - Compressed air connection
 - Integrated feed hopper
 - Stainless steel revolver valve

04
Spare closure

▶ Item no. 2000-806-2

05
Hand pump
For Uni-Star, All-Star and Topas

▶ Item no. 2000-806-1





01

High pressure cleaner
HD 5/15 C Plus

▶ Item no. 2000-550-2

- ▶ Product description
- Extended trigger gun, with Easy Press
 - Trigger gun with soft grip
 - High-pressure hose 10 m
 - Steel tube 850 mm
 - Triple nozzle manual (0° / 25° / 40°)
 - Anti-twist system
 - Pressure switch control



01

02

Spray-extraction cleaner
Puzzi 8/1 C

▶ Item no. 2000-550-3

- ▶ Product description
- Spray hose 2.5 m, with integrated water feed
 - Hand tool
 - Power cable 7.5 m
 - Upholstery nozzle



02

03

Wet and dry vacuum cleaner
NT 35/1 TACT TE

▶ Item no. 2000-550-1

- ▶ Product description
- Suction hose 2.5 m
 - Metal suction tube 2 x 0.5 m
 - Paper filter bag
 - Wet and dry floor tool 300 mm
 - Crevice tool
 - Connector for electric tools
 - Auto shutdown when max. level is reached
 - Safety class I
 - Maintenance-free suction turbines



03

Paper filter bags

- ▶ Item no. 2000-550-100
▶ PU: 5

Car air conditioning



01

Air conditioning system disinfection

Viro One Shot Plus

- ▶ Item no. 2897-301
- ▶ Contents: 100 ml
- ▶ Packing unit: 10

▶ **Product description**

- For quick, easy and hygienic cleaning
- Eliminates dead microorganisms thoroughly
- Prevents allergic reactions
- Leaves a pleasant smell that lasts
- Contents are sufficient for one application
- Basis: alcohol

02

Air conditioning and ventilation system disinfection

Viro Air Fresh Plus

- ▶ Item no. 2897-302
- ▶ Contents: 300 ml
- ▶ Packing unit: 12

▶ **Product description**

- Spray enters the ventilation system directly via the capillary tube
- Long-lasting disinfection
- Leaves a pleasant citrus fragrance
- Contents sufficient for up to three applications
- Basis: alcohol



03

Air conditioning system vaporizer disinfection

Viro Vaporizer

- ▶ Item no. 2897-303
- ▶ Contents: 400 ml
- ▶ Packing unit: 12

▶ **Product description**

- Performs high-pressure flushing
- Effective in every corner of the evaporator
- Kills germs, bacteria and moulds
- Prevents the growth of microorganisms
- Ensures healthy and pleasant smelling air inside the vehicle
- Incl. 60 cm hose with rotor nozzle
- Sufficient product for one A/C system





01

Trace-gas leak-testing set

Leak-testing set based on 95% nitrogen and 5% hydrogen

► Item no. 5000-5

► Product description

This trace-gas leak-testing system meets all requirements and allows a legally-compliant, environmentally-friendly and above all successful testing of leaks in climate-control systems.

The use of this trace-gas leak-testing system is also suitable for climate-control systems filled with either coolant R134a or the new HFO-1234yf coolants.

Contents:

- 1x electric hydrogen leak-testing device, excluding pump (incl. charger)
- 1x pressure reducer
- 1x test fitting
- 1x 2-litre gas bottle (up to 10 applications)
- 1x high-pressure rapid-action coupling
- 1x low-pressure rapid coupling
- 2x service hoses
- 1x operating instructions on CD-ROM



01

02

Quick coupling R1234YF BF

► Item no. 5000-5-002

► Product description

- High-pressure
- Connecting thread M12 x 1.5mm
- Colour: Red



02

03

Quick coupling R1234YF RF

► Item no. 5000-5-003

► Product description

- Low-pressure
- Connecting thread M12 x 1.5mm
- Colour: Blue



03

04

Adapter R1234YF

► Item no. 5000-5-001

► Product description

- Connecting thread: M12 X 1.5



04

05

Set of LED UV bulbs 3.6V 150W with UV glasses

► Item no. 5000-201

► Product description

- The UV bulb has a screened reflector and an electrical connection to the cigarette lighter
- An adapter for connection to the car battery is included
- The UV light of the LED bulb illuminates fluorescent leak-test liquid
- Contents: 1x UV bulb (incl. batteries), 1x UV glasses



05

06

UV safety goggles

► Item no. 5000-202

► Product description

- For work with fluorescent leak-test liquids



06

01
Climate-control compressor oil
 PAG46 OIL 1234yf / for coolant 1234yf

- ▶ Item no. 5000-218
 - ▶ Contents: 250 ml
 - ▶ Packing unit: 12
-
- ▶ Product description
- A multigrade compressor oil for all cars, trucks, buses and agricultural equipment filled with 1234yf coolant
 - For hybrid vehicles filled with 1234yf coolant
 - Perfectly lubricates and cools climate-control compressors
 - Guarantees thermal stability in compressors



01

04
UV leak search fluid
 Tracer

- ▶ Item no. 5000-303
 - ▶ Contents: 236 ml
 - ▶ Packing unit: 1
-
- ▶ Product description
- This leakfinder additive does not contain solvents
 - Ideal for use in combination with refrigerating oils (PAG, mineral oil, ester)
 - Safe for all vehicle A/C systems and A/C service instruments
 - Manufacturer approval
 - Sufficient for approx. 25 PCV applications



04



02
Oil-Fluid
 Fluorescent leakfinder fluid for engines and gearboxes

- ▶ Item no. 5000-205-1
 - ▶ Contents: 25 ml
 - ▶ Packing unit: 1
-
- ▶ Product description
- Sufficient for one vehicle/one application



02

03
Water-Fluid
 Fluorescent leakfinder fluid for cooling systems

- ▶ Item no. 5000-206-1
 - ▶ Contents: 25 ml
 - ▶ Packing unit: 1
-
- ▶ Product description
- Sufficient for one vehicle/one application



03

05
Fluorescent leak-test liquid
 UV hybrid

- ▶ Item no. 5000-304
 - ▶ Contents: 240 ml
 - ▶ Packing unit: 1
-
- ▶ Product description
- For use with coolant oils (PAG, mineral oils and esters)
 - Completely harmless for all climate-control systems in hybrid vehicles and servicing devices
 - Suitable for both coolants (R134a & HFO1234yf)
 - Does not attack O-rings or seals



05

01 Sealing compound for A/C systems

Quick-Seal Cold

- ▶ Item no. 5000-230
- ▶ Contents: 40 ml
- ▶ Packing unit: 1

▶ **Product description**

- Used to seal micro-leaks in shaft seals, hoses and O-rings in car climate-control systems
- Contents sufficient for one use
- The product contains 44 grams of R134A coolant
- CAUTION! Quick-Seal-Cold must not be used in hermetically-sealed systems!
- IMPORTANT! Use only possible with the adapter, available separately. (Art. no. 5000-230-1)

02 Multigrade compressor oil
Multi POE Oil Premium

- ▶ Item no. 5000-219
- ▶ Contents: 1 litre
- ▶ Packing unit: 1

▶ **Product description**

- A multigrade compressor oil for climate-control systems with R134a coolant
- Can also be used in climate-control systems filled with R134a coolant in hybrid vehicles
- For wear reduction, lubrication and cooling of climate-control compressors in the coolant range
- Compatible with all known mineral-, ester- and PAG oils

03 Refrigerant R134A

- ▶ Item no. 5000-225-9

- ▶ **Product description**
- 12.7 kg reusable bottle

04 Refrigerant R1234yf

- ▶ Item no. 5000-229

- ▶ **Product description**
- 5.6 kg reusable bottle

05 Adapter, 1/4" SAE outer thread with seal

- ▶ Item no. 5000-226-1

- ▶ **Product description**
- HD connector adapter for gaseous removal of coolant at service-station connections



06 Adapter hose for Quick-Seal Cold

- ▶ Item no. 5000-230-1

- ▶ **Product description**
- Hose for Quick-Seal Cold filling
- Re-usable

07 Thermal paper roll for air conditioning service equipment

- ▶ Item no. 5000-235

- ▶ **Product description**
- Special printer paper for ASC-series thermal printers
- Roll width: 58 mm
- Length: 10 m



01

02

03

06

07

Item no. **Model**
 5000-002 Inner diameter 7.50 mm
 Cross-section 2.00 mm
 Quantity 20 pieces



Item no. **Model**
 5000-009 Inner diameter 10.80 mm
 Cross-section 2.40 mm
 Quantity 20 pieces



Item no. **Model**
 5000-026 Inner diameter 15.68 mm
 Cross-section 1.93 mm
 Quantity 20 pieces



Item no. **Model**
 5000-043 Inner diameter 15.47 mm
 Cross-section 3.53 mm
 Quantity 20 pieces



Item no. **Model**
 5000-003 Inner diameter 4.47 mm
 Cross-section 1.78 mm
 Quantity 20 pieces



Item no. **Model**
 5000-012 Inner diameter 7.65 mm
 Cross-section 1.78 mm
 Quantity 20 pieces



Item no. **Model**
 5000-028 Inner diameter 17.17 mm
 Cross-section 1.78 mm
 Quantity 20 pieces



Item no. **Model**
 5000-047 Inner diameter 12.01 mm
 Cross-section 1.88 mm
 Quantity 20 pieces



Item no. **Model**
 5000-004 Inner diameter 8.00 mm
 Cross-section 2.00 mm
 Quantity 20 pieces



Item no. **Model**
 5000-013 Inner diameter 10.50 mm
 Cross-section 2.00 mm
 Quantity 20 pieces



Item no. **Model**
 5000-029 Inner diameter 17.00 mm
 Cross-section 2.00 mm
 Quantity 20 pieces



Item no. **Model**
 5000-050 Inner diameter 7.65 mm
 Cross-section 1.63 mm
 Quantity 20 pieces



Item no. **Model**
 5000-005 Inner diameter 9.25 mm
 Cross-section 2.39 mm
 Quantity 20 pieces



Item no. **Model**
 5000-016 Inner diameter 9.25 mm
 Cross-section 1.78 mm
 Quantity 20 pieces



Item no. **Model**
 5000-032 Inner diameter 6.02 mm
 Cross-section 2.62 mm
 Quantity 20 pieces



Item no. **Model**
 5000-052 Inner diameter 9.60 mm
 Cross-section 1.88 mm
 Quantity 20 pieces



Item no. **Model**
 5000-006 Inner diameter 8.92 mm
 Cross-section 1.83 mm
 Quantity 20 pieces



Item no. **Model**
 5000-017 Inner diameter 10.82 mm
 Cross-section 1.78 mm
 Quantity 20 pieces



Item no. **Model**
 5000-034 Inner diameter 10.77 mm
 Cross-section 2.62 mm
 Quantity 20 pieces



Item no. **Model**
 5000-060 Inner diameter 9.50 mm
 Cross-section 2.50 mm
 Quantity 20 pieces



Item no. **Model**
 5000-007 Inner diameter 6.07 mm
 Cross-section 1.78 mm
 Quantity 20 pieces



Item no. **Model**
 5000-021 Inner diameter 14.30 mm
 Cross-section 2.30 mm
 Quantity 20 pieces



Item no. **Model**
 5000-035 Inner diameter 12.37 mm
 Cross-section 2.62 mm
 Quantity 20 pieces



Item no. **Model**
 5000-061 Inner diameter 10.80 mm
 Cross-section 2.40 mm
 Quantity 20 pieces



Item no. **Model**
 5000-008 Inner diameter 10.00 mm
 Cross-section 2.50 mm
 Quantity 20 pieces



Item no. **Model**
 5000-023 Inner diameter 14.00 mm
 Cross-section 1.78 mm
 Quantity 20 pieces



Item no. **Model**
 5000-036 Inner diameter 13.94 mm
 Cross-section 2.62 mm
 Quantity 20 pieces



Item no. **Model**
 5000-062 Inner diameter 11.50 mm
 Cross-section 2.50 mm
 Quantity 20 pieces



Item no.	Model
5000-063	Inner diameter 13.40 mm Cross-section 1.78 mm Quantity 20 pieces

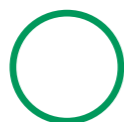

Item no.	Model
5000-069	Inner diameter 7.00 mm Cross-section 2.50 mm Quantity 20 pieces



Item no.	Model
5000-064	Inner diameter 13.80 mm Cross-section 2.40 mm Quantity 20 pieces



Item no.	Model
5000-070	Inner diameter 6.95 mm Cross-section 2.20 mm Quantity 20 pieces



Item no.	Model
5000-065	Inner diameter 14.25 mm Cross-section 2.40 mm Quantity 20 pieces



Item no.	Model
5000-071	Inner diameter 8.00 mm Cross-section 1.80 mm Quantity 20 pieces



Item no.	Model
5000-066	Inner diameter 14.50 mm Cross-section 2.50 mm Quantity 20 pieces



Item no.	Model
5000-072	Inner diameter 8.80 mm Cross-section 1.90 mm Quantity 20 pieces



Item no.	Model
5000-067	Inner diameter 6.70 mm Cross-section 1.70 mm Quantity 20 pieces



Item no.	Model
5000-073	Inner diameter 10.00 mm Cross-section 2.00 mm Quantity 20 pieces



Item no.	Model
5000-068	Inner diameter 7.50 mm Cross-section 2.50 mm Quantity 20 pieces



01

Assortment of universal O-rings

- ▶ Item no. 1957-500-1
- ▶ Contents: 360 pieces

Item no.	Quantity	Item no.	Quantity
5000-003	20	5000-050	20
5000-004	20	5000-060	20
5000-005	20	5000-067	20
5000-007	20	5000-068	20
5000-008	20	5000-069	20
5000-010	20	5000-070	20
5000-012	20	5000-071	20
5000-016	20	5000-072	20
5000-032	20	5000-073	20



01

02

Assortment of universal O-rings

- ▶ Item no. 1957-500-2
- ▶ Contents: 360 pieces

Item no.	Quantity	Item no.	Quantity
5000-009	20	5000-036	20
5000-017	20	5000-043	20
5000-021	20	5000-047	20
5000-023	20	5000-061	20
5000-026	20	5000-062	20
5000-028	20	5000-063	20
5000-029	20	5000-064	20
5000-034	20	5000-065	20
5000-035	20	5000-066	20



02

03

Assortment of universal valves

- ▶ Item no. 1957-500-4
- ▶ Contents: 51 pieces

Item no.	Quantity	Item no.	Quantity
5000-106	20	5000-124	5
5000-121	1	5000-125	5
5000-122	5	5000-126	5
5000-123	5	5000-127	5



03

Cap

- ▶ Item no. 5000-100
- ▶ Low-pressure side
Blue, 13 mm Standard VW
6 pieces



Cap

- ▶ Item no. 5000-101
- ▶ High-pressure side
Red, 16 mm Standard VW
6 pieces



Valve cap

- ▶ Item no. 5000-128
- ▶ High-pressure side
M10 x 0.75
6 pieces



Valve cap

- ▶ Item no. 5000-129
- ▶ Low-pressure side
M8 x 1
6 pieces



Ford Springlock

- ▶ Item no. 5000-114
- ▶ Tool 3/8" #148;
red, no. 6
1 piece



Ford Springlock

- ▶ Item no. 5000-115
- ▶ Tool 1/2" #148;
blue, no. 8
1 piece



Ford Springlock

- ▶ Item no. 5000-116
- ▶ Tool 5/8" #148;
black, no. 10
1 piece



Ford Springlock

- ▶ Item no. 5000-117
- ▶ Tool 3/4" #148;
white, no. 12
1 piece



Opel Springlock

- ▶ Item no. 5000-118
- ▶ Tool
red
1 piece



Opel Springlock

- ▶ Item no. 5000-119
- ▶ Tool
blue
1 piece



Valve

- ▶ Item no. 5000-122
- ▶ M8, Peugeot/Volvo
5 pieces



Valve

- ▶ Item no. 5000-125
- ▶ JRA HNBR
5 pieces



Valve

- ▶ Item no. 5000-123
- ▶ 8 mm, Eaton
5 pieces



Valve

- ▶ Item no. 5000-126
- ▶ Renault
5 pieces



Valve

- ▶ Item no. 5000-124
- ▶ 10 mm, Eaton
5 pieces

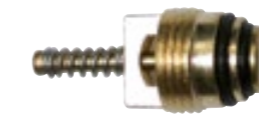

Valve

- ▶ Item no. 5000-127
- ▶ Audi
5 pieces



Valve core

- ▶ Item no. 5000-106
- ▶ Standard
20 pieces



Eaton SSV

- ▶ Item no. 5000-120
- ▶ Valve tool
Large
1 piece



adapter

- ▶ Item no. 5000-113
- ▶ R 134A, 16 mm
1 piece



JRA standard

- ▶ Item no. 5000-121
- ▶ Valve tool
Small
1 piece



Car light bulbs



H7

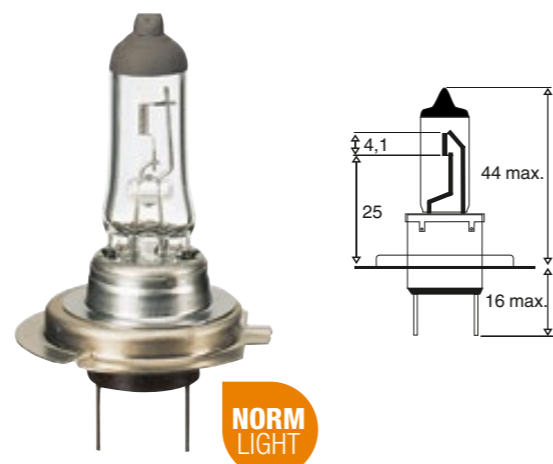
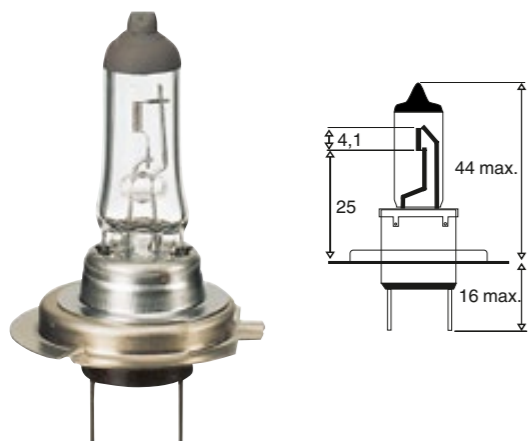

Item no.	Implementation	Base
3720-064-209	12V H7 55W Long-Life	Px26d
3720-064-252	12V Vision Plus +50%	Px26d
3720-064-265	12V H7 Set +90%	Px26d
3720-064-210	12V Osram Ultra Life	Px26d

Item no.	Implementation	Base
3723-064-201	12V H7 55W	Px26d
3723-064-209	12V H7 55W Long-Life	Px26d

H1

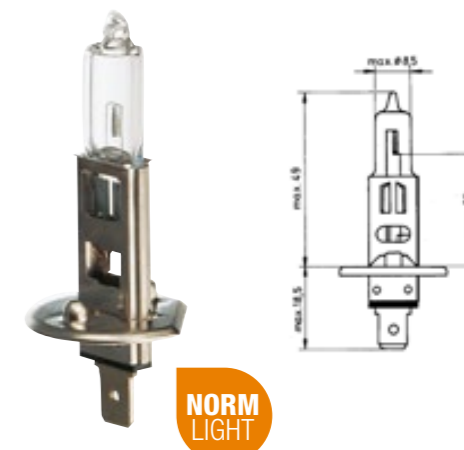
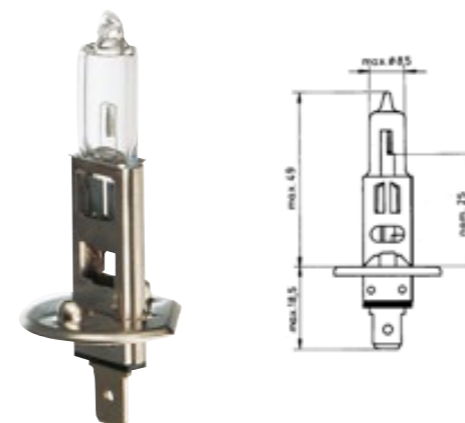

Item no.	Implementation	Base
3720-064-250	12V H1 55W Vision Plus +50%	14.5s
3720-064-150	12V H1 55W	14.5s
3720-064-221	12V H1 55W Premium +30%	14.5s
3720-064-202	12V H1 55W Spot	14.5s

Item no.	Implementation	Base
3723-064-150	12V H1 55W	14.5s

H4

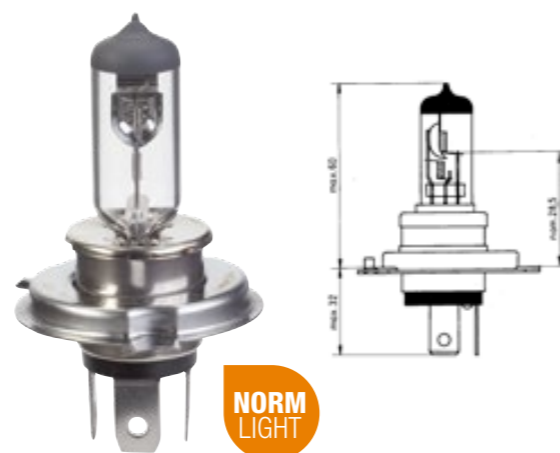
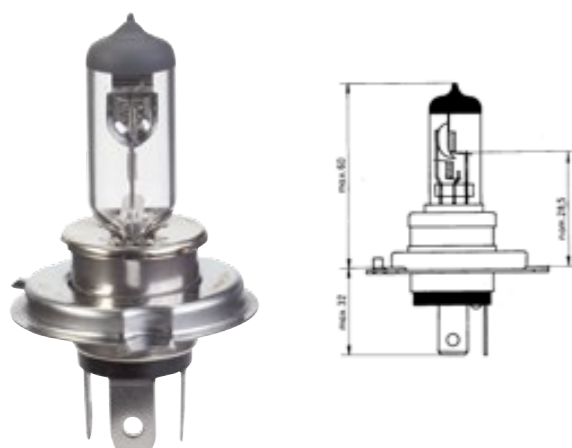

Item no.	Implementation	Base
3720-064-264	12V H4 set, +90%	P43t
3720-064-251	12V H4 60/55W Vision Plus +50%	P43t
3720-064-193	12V H4 60/55W	P43t
3720-064-220	12V H4 60/55W Premium +30%	P43t

Item no.	Implementation	Base
3723-064-193	12V H4 60/55W	P43t

H3

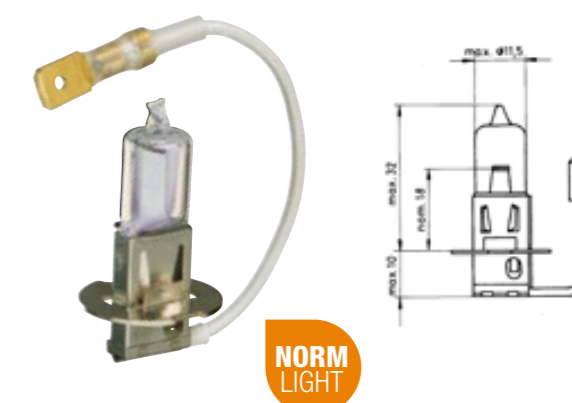
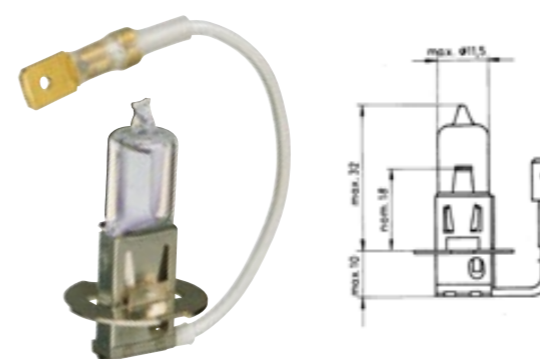

Item no.	Implementation	Base
3720-064-156	12V H3 55W	PK22s

Item no.	Implementation	Base
3723-064-156	12V H3 55W	PK22s

H8

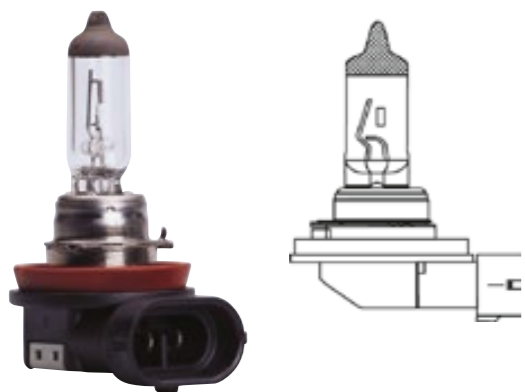

Item no.	Implementation	Base
3720-064-228	12V H8 35W	PGJ19-1

H9

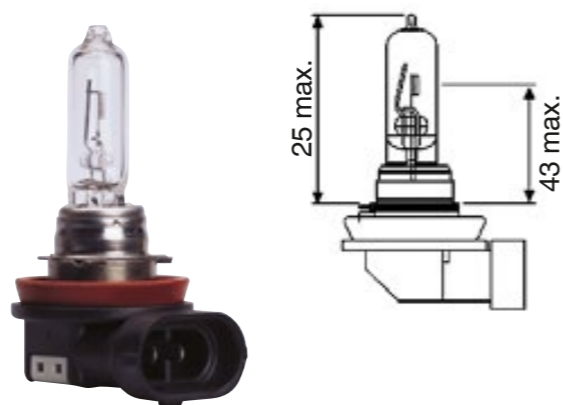

Item no.	Implementation	Base
3720-064-229	12V H9 65W	PGJ19-5

Duolux

► Product description
- Symmetrical

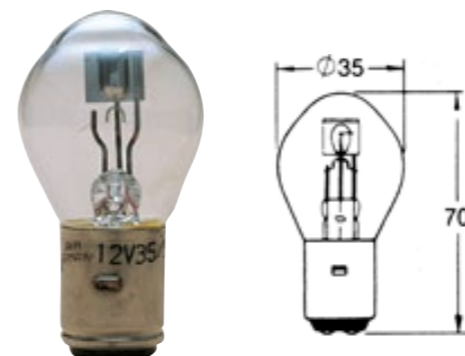

Item no.	Implementation	Base
3720-073-27	12V 35/35W	BA20d

Duolux

► Product description
- asymmetrical

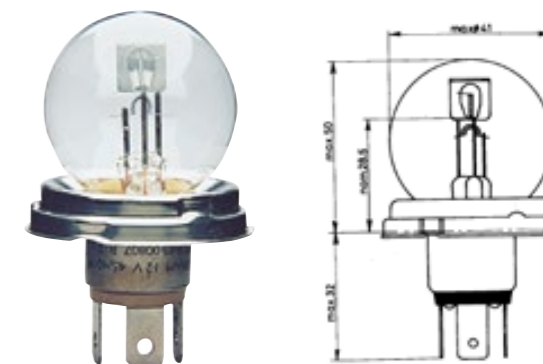

Item no.	Implementation	Base
3720-079-51	12V 45/40W	P45t

H11

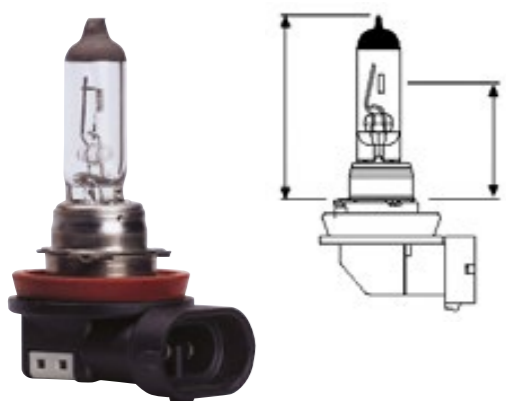

Item no.	Implementation	Base
3720-064-206	12V H11 55W	PGJ19-2

HIR2



Item no.	Implementation	Base
3720-064-216	12V HIR2 55W	Px22d

Halogen lamp

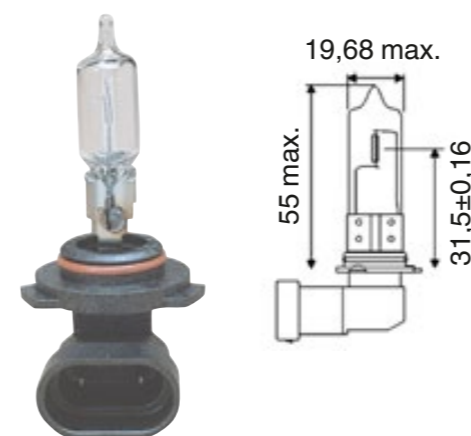

Item no.	Implementation	Base
3720-064-204	12V 60W HB3	P20d

Halogen lamp

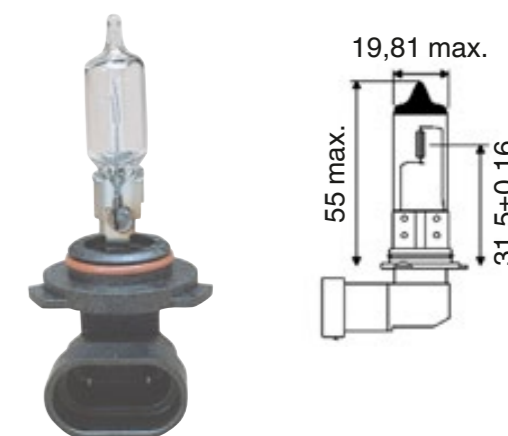

Item no.	Implementation	Base
3720-064-205	12V 51W HB4	P22d

01

Gas discharge headlight bulb D2S
XENON

► Art. no.: 3720-064-222

- Product description
- For projector headlights
 - Approx. 4,100 Kelvin
 - Voltage: 12 to 85
 - Base: D2S
 - Wattage: 35

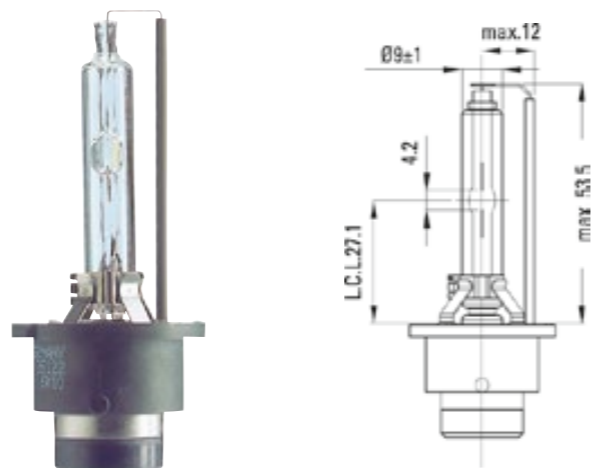

02

Gas discharge headlight bulb D2R
XENON

► Art. no.: 3720-064-223

- Product description
- For reflector headlights
 - Approx. 4,000 Kelvin
 - Voltage: 12 to 85
 - Base: D2R
 - Wattage: 35

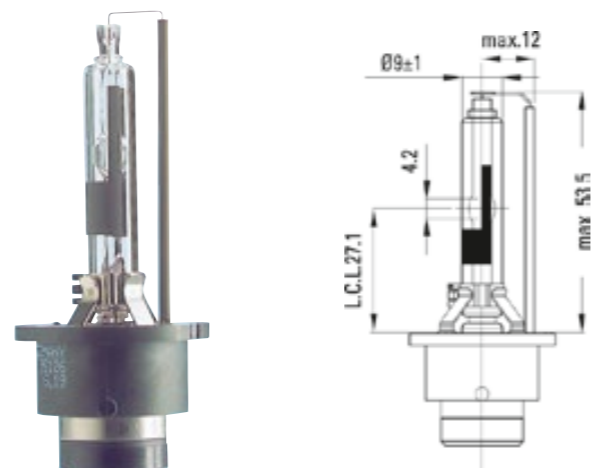

03

Gas discharge headlight bulb D1S
XENON

► Art. no.: 3720-064-224

- Product description
- Approx. 4,000 Kelvin
 - Voltage: 12 to 85
 - Base: D1S
 - Wattage: 35

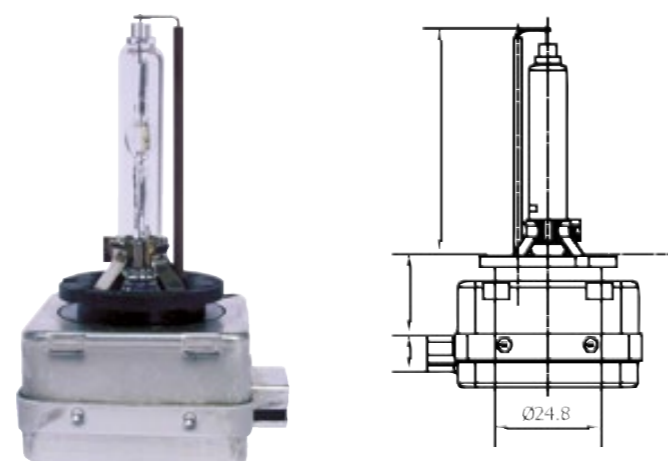

04

Electric discharge lamp

- Product description
- No mercury
 - Nominal voltage 42 Volt

Item no.	Implementation	Base
3720-064-225	D3S 35W 3200 Lumen	PK32d-5
3720-064-226	D4S 35W 3200 Lumen	P32d-5
3720-064-227	D4R 35W 2800 Lumen	P32d-6

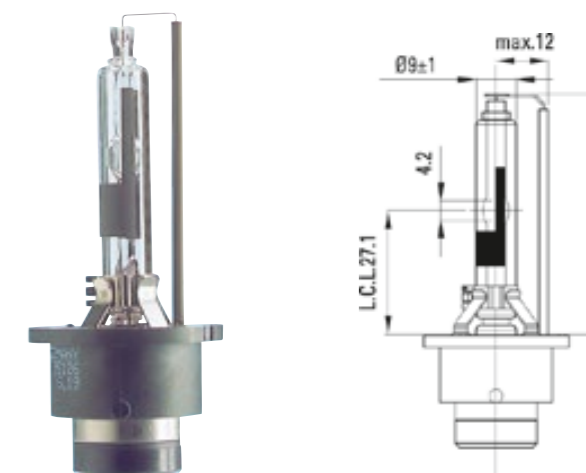

BA15s base

- ▶ Item no. 3720-075-27
- ▶ 18W

- ▶ Item no. 3720-075-06
- ▶ 21W

- ▶ Item no. 3723-075-06
- ▶ 21W Normlight

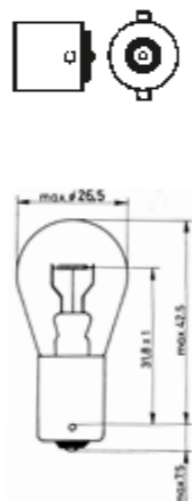

BA15s base

21 W, for special applications

- ▶ Art. no.: 3720-075-05



BA15s base

5 W

- ▶ Art. no.: 3720-054-07

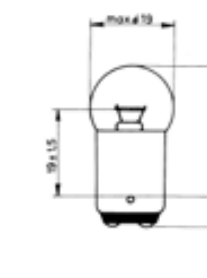

BA15s base

- ▶ Item no. 3720-050-07
- ▶ 5W

- ▶ Item no. 3720-050-08
- ▶ 10W

- ▶ Item no. 3723-050-07
- ▶ 5W Normlight

- ▶ Item no. 3723-050-08
- ▶ 10W Normlight

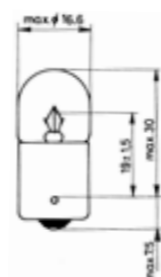

BAW15s base red Ford

- ▶ Item no. 3720-075-09
- ▶ 21W

- ▶ Item no. 3720-075-091
- ▶ 21/5W

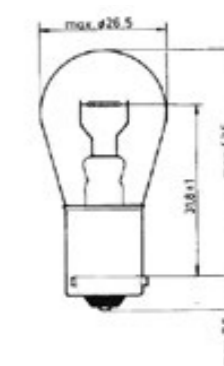

BAY15d base

21/5 W

- ▶ Item no. 3720-075-28
- ▶ 21/5W

- ▶ Item no. 3723-075-28
- ▶ 21/5W Normlight

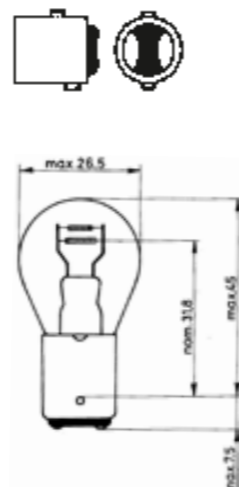

BAU15s base

- ▶ Item no. 3720-075-07
- ▶ 21W

- ▶ Item no. 3723-075-07
- ▶ amber (yellow) 21W Normlight

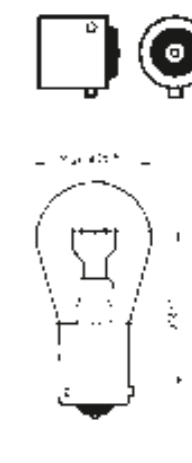

BAU 15s Silver Vision base

Glass colour silver, light colour yellow
21W, ideal for clear-glass indicators

- ▶ Art. no.: 3720-075-070



BAZ15d base

21/4 W

- ▶ Art. no.: 3720-075-08



W2,1x9:5d base

16 W

- ▶ Art. no.: 3720-028-30

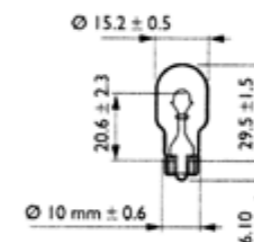

W2,1x9:5d base

- ▶ Item no. 3720-028-20
▶ 2W
- ▶ Item no. 3720-028-21
▶ 3W
- ▶ Item no. 3720-028-25
▶ 5W
- ▶ Item no. 3720-028-26
▶ 5W, blue
- ▶ Item no. 3723-028-25
▶ 5W Normlight

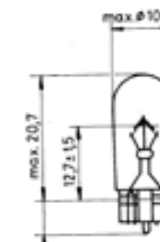

BA9s Halogen base

- ▶ Item no. 3720-064-190
▶ 5W
- ▶ Item no. 3720-064-191
▶ 10W
- ▶ Item no. 3720-064-192
▶ 20W

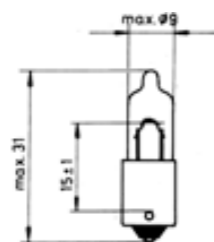

BAX9s Halogen base

Suitable for Audi/VW, BMW, Alfa Romeo, Mercedes Benz

- ▶ Item no. 3720-064-132
▶ 6W
- ▶ Item no. 3720-064-133
▶ 21W

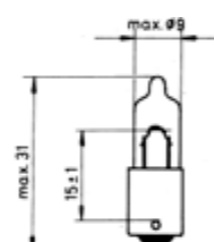

W3x16d base

21 W

- ▶ Item no. 3720-074-1
▶ 21W
- ▶ Item no. 3720-074-2
▶ 21/5W
- ▶ Item no. 3720-074-3
▶ 21W amber (yellow)

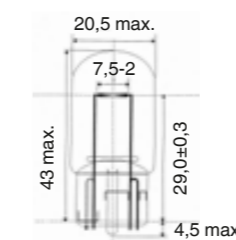

Halogen pin

- ▶ Item no. 3720-072-30
▶ 20W, G 4



BA9s base

- ▶ Item no. 3720-038-93
▶ 4W
- ▶ Item no. 3720-038-94
▶ 3W
- ▶ Item no. 3720-037-96
▶ 2W

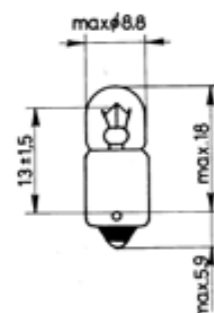

W2x4.6d base

- ▶ Item no. 3720-027-21
▶ 1.2W
- ▶ Item no. 3720-016-03
▶ 1.2W matt
- ▶ Item no. 3720-027-22
▶ 2W
- ▶ Item no. 3720-027-23
▶ 1.7W
- ▶ Item no. 3723-027-21
▶ 1.2W Normlight

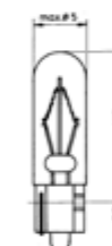

Tubular lamp 8.5x8

35 mm

- ▶ Item no. 3720-064-18
- ▶ 5W

- ▶ Item no. 3720-064-19
- ▶ 10W

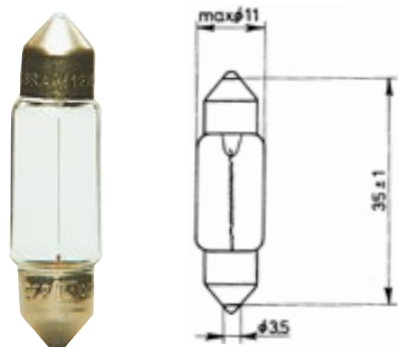

Festoon 8.5x8 Normlight

35 mm

- ▶ Item no. 3723-064-18
- ▶ 5W

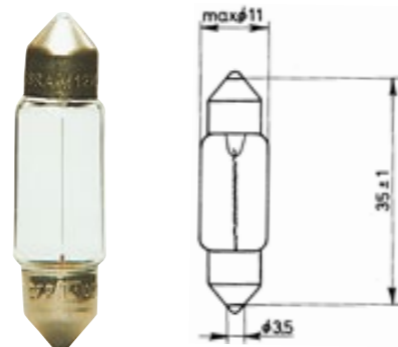

Tubular lamp 8.5x8

41 mm

- ▶ Item no. 3720-064-13
- ▶ 5W

- ▶ Item no. 3720-064-11
- ▶ 10W

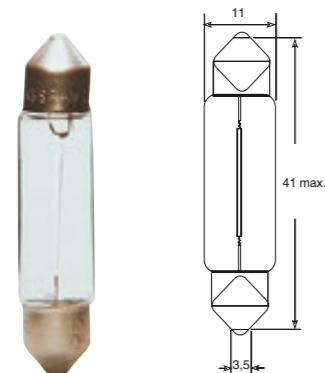

Festoon 8-8.5

41 mm

- ▶ Item no. 3720-064-75
- ▶ 18W

- ▶ Item no. 3720-064-76
- ▶ 21W

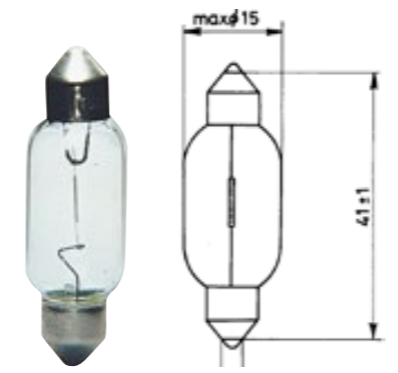

Tubular lamp 8.5x8

28 mm

- ▶ Item no. 3720-064-111
- ▶ 10W



Tubular lamp 6-7.5

28 mm

- ▶ Item no. 3720-064-28
- ▶ 3W

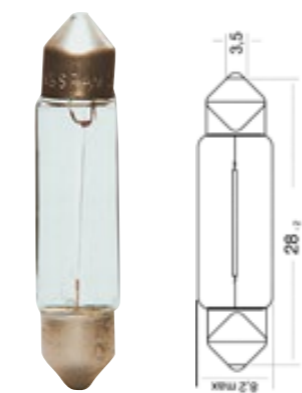

B8,4d

- ▶ Item no. 3720-027-401
- ▶ 1.2W black

- ▶ Item no. 3720-027-400
- ▶ 2.0W turquoise

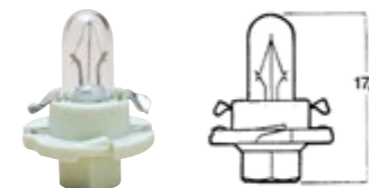

B8,3d

- ▶ Item no. 3720-027-405
- ▶ 1.2W black

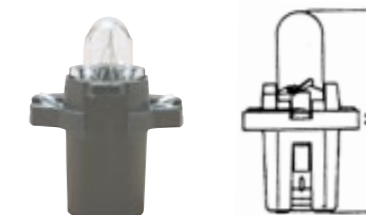

B10d

- ▶ Item no. 3720-064-188
- ▶ 3W Halogen

- ▶ Item no. 3720-064-189
- ▶ 5W Halogen



W2x4,6d

- ▶ Item no. 3720-027-500
- ▶ 0.5W grey

- ▶ Item no. 3720-027-501
- ▶ 1.2W white

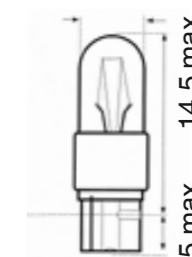

Ford

- ▶ Item no. 3720-027-423
- ▶ 14V 1CP white

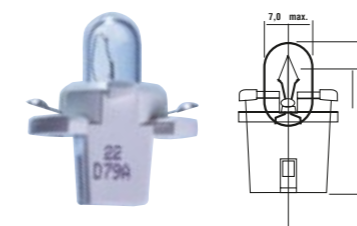

B8,7d

- ▶ Item no. 3720-027-409
- ▶ 1.2W grey

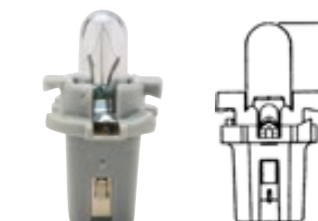

B8,5d

- ▶ Item no. 3720-027-402
- ▶ 2.0W green

- ▶ Item no. 3720-027-403
- ▶ 1.2W black

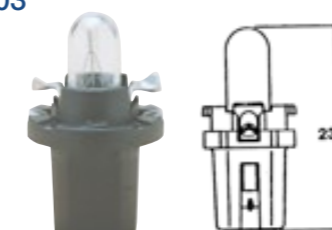

01

PCV bulb box H4

- ▶ Item no. 3720-02
- ▶ Contents: 9 pieces

▶ Product description

The 9-piece PCV spare bulb set comes in a handy and robust plastic box.

Item no.	Description	Quantity
3731-007-5	Blade fuse 7.5 A	1
3731-010	Blade fuse 10 A	1
3731-015	Blade fuse 15 A	1
3720-028-25	Glass base bulb 5W	1
3720-038-93	Parking light bulb 4W	1
3720-075-28	Brake light bulb 21/5W	1
3720-075-06	Indicator light bulb 2V 5W	1
3720-064-18	Number plate light 2V 5W	1
3720-064-193	H4 60/55W	1



02

PCV bulb box H7/H1

- ▶ Item no. 3720-020
- ▶ Contents: 11 pieces

▶ Product description

The 11-piece PCV spare bulb set comes in a handy and robust plastic box.

Item no.	Description	Quantity
3731-007-5	Blade fuse 7.5 A	1
3731-010	Blade fuse 10 A	1
3731-015	Blade fuse 15 A	1
3720-028-25	Glass base bulb 5W	1
3720-038-93	Parking light bulb 4W	1
3720-075-28	Brake light bulb 21/5W	1
3720-075-06	Indicator light bulb 2V 5W	1
3720-064-18	Number plate light 2V 5W	1
3720-075-07	Pilot bulb, yellow, 21W	1
3720-064-150	H1 55W	1



03

PCV bulb box H4 Normlight



- ▶ Item no. 3723-02
- ▶ Contents: 9 pieces

▶ Product description

The 9-piece PCV spare bulb set comes in a handy and robust plastic box.

Item no.	Description	Quantity
3731-007-5	Blade fuse 7.5 A	1
3731-010	Blade fuse 10 A	1
3731-015	Blade fuse 15 A	1
3723-028-25	Glass base bulb 5W	1
3720-038-93	Parking light bulb 4W	1
3723-075-28	Brake and tail light bulb, 21/5W	1
3723-075-06	Indicator and brake light bulb, 21W1	1
3723-064-193	H4 60/55W	1
3723-064-18	Festoon bulb, 5W	1



04

PCV bulb box H7/H1 Normlight



- ▶ Item no. 3723-020
- ▶ Contents: 11 pieces

▶ Product description

The 11-piece PCV spare bulb set comes in a handy and robust plastic box.

Item no.	Description	Quantity
3731-007-5	Blade fuse 7.5 A	1
3731-010	Blade fuse 10 A	1
3731-015	Blade fuse 15 A	1
3723-028-25	Glass base bulb 5W	1
3720-038-93	Parking light bulb 4W	1
3723-075-28	Brake and tail light bulb, 21/5W	1
3723-075-06	Indicator and brake light bulb, 21W1	1
3723-064-18	Festoon bulb, 5W	1
3723-075-07	Pilot bulb, yellow, 21W	1
3723-064-201	H7 12V 55W	1
3723-064-150	H1 12V 55W	1



01

Box for bulb cabinet Normlight 12V *



► Art. no.: 3720-555-12

► Product description

The bulb cabinet is made from very sturdy and high-quality cardboard, delivered fully assembled and fitted with 12 Volt Normlight bulbs.

Consists of the following 390 components

Dimensions (cabinet): 510x422x178mm

Contents:

- 40 x 3723-050-08 Tail light bulb 12V / 10W
- 40 x 3723-028-25 Wedge base bulb 12V / 5W
- 40 x 3723-027-21 Wedge base bulb 12V / 1.2W
- 30 x 3723-064-18 Festoon bulb 12V / 5W
- 50 x 3723-075-06 Indicator & brake light 12V / 21W
- 50 x 3723-075-28 Brake and tail light bulb 12V / 21/5W
- 40 x 3723-075-07 Pilot bulb 12V / 21W
- 10 x 3723-064-193 H4 12V / 60 / 55W
- 50 x 3723-050-07 Tail light bulb 12V / 5W
- 20 x 3723-064-201 H7 12V / 55W
- 20 x 3723-064-209 H7 long-life 12V / 55W

***Similar to image**



01

02

Box for bulb cabinet Normlight 24V *



► Art. no.: 3720-555-24

► Product description

The bulb cabinet is made from very sturdy and high-quality cardboard, delivered fully assembled and fitted with 24 Volt Normlight bulbs.

Dimensions (cabinet): 510x422x178mm

Consists of the following 370 components

Contents:

- 40 x 3723-028-45 Wedge base bulb 24V / 5W
- 10 x 3723-064-151 H3 24V / 70W
- 20 x 3723-064-155 H1 24V / 70W
- 10 x 3723-064-197 H4 24V / 75/70W HD
- 20 x 3723-064-211 H7 24V / 70W
- 20 x 3723-064-221 H7 24V / 70W HD LL
- 50 x 3723-075-37 Indicator and brake light bulb 24V / 21/5W
- 50 x 3723-393-0 Parking light bulb 24V / 4W HD
- 40 x 3723-562-7 Tail light bulb 24V / 5W HD
- 50 x 3723-563-7 Tail light bulb 24V / 10W HD
- 50 x 3723-751-1 Pilot light 24V / 21W HD

***Similar to image**



02



H7

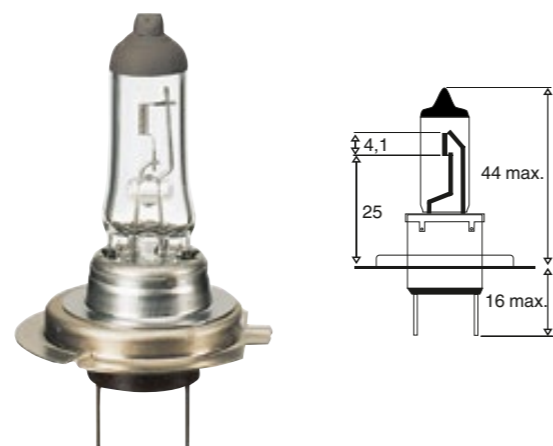

Item no.	Implementation	Base
3720-064-274	24V H7 70W HD LL Osram Truckstar Pro	Px26d

- Up to 100% more light on the road
- Up to 100% longer life (LL)

Item no.	Implementation	Base
3720-064-273	24V H7 70W HD LL	Px26d

Item no.	Implementation	Base
3723-064-211	24V H7 70W NORM LIGHT	Px26d

H1

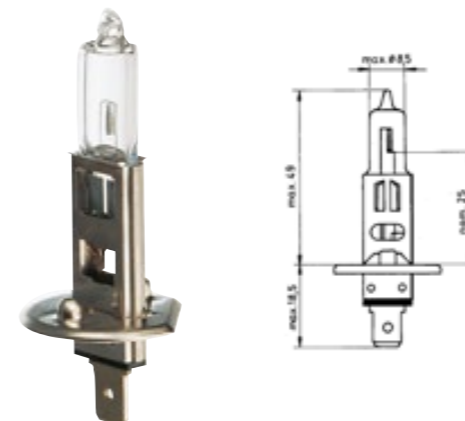

Item no.	Implementation	Base
3720-064-270	24V H1 70W HD LL	P14.5s

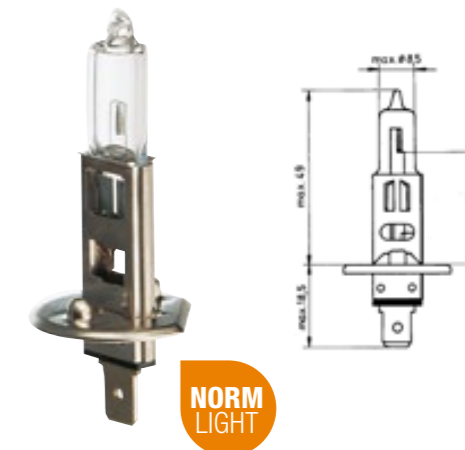

Item no.	Implementation	Base
3723-064-155	24V H1 70W NORM LIGHT	P14.5s

H4

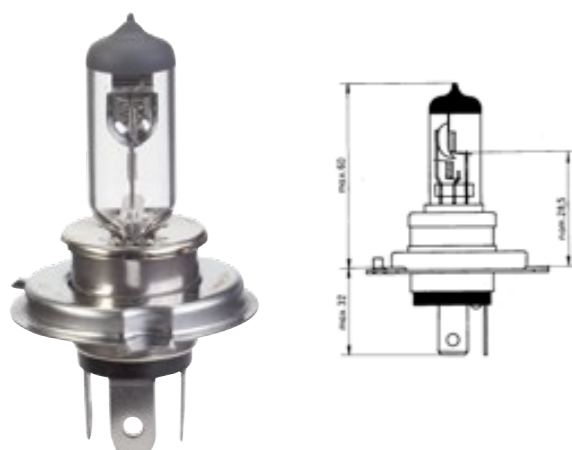

Item no.	Implementation	Base
3720-064-272	24V H4 70/75W HD LL	P43t

HD = heavy duty LL = long life

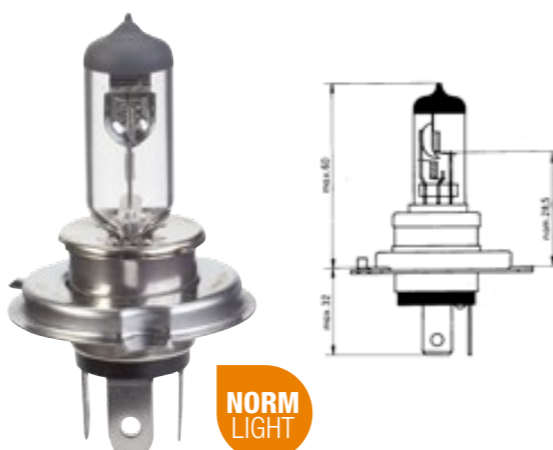

Item no.	Implementation	Base
3723-064-196	24V H4 70/75W NORM LIGHT	P43t
3723-064-197	24V H4 70/75W HD	P43t

H3

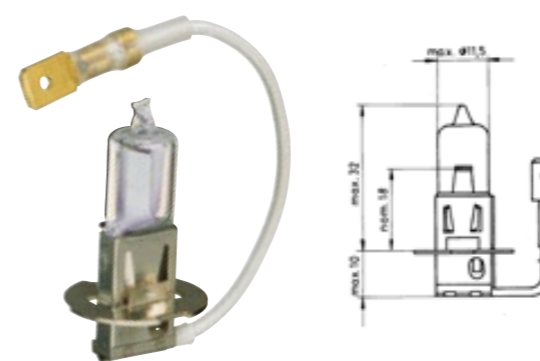

Item no.	Implementation	Base
3720-064-271	24V H3 70W HD LL	PK22s

HD = heavy duty LL = long life

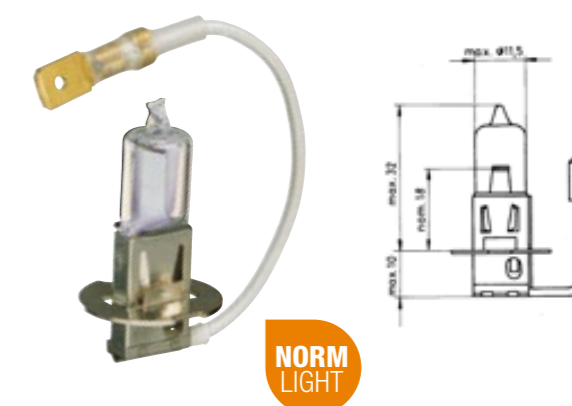

Item no.	Implementation	Base
3723-064-151	24V H3 70W NORM LIGHT	PK22s

01

Gas discharge headlight bulb D2S
XENON

► Art. no.: 3720-064-222

- Product description
- For projector headlights
 - Approx. 4,100 Kelvin
 - Voltage: 12 to 85
 - Base: D2S
 - Wattage: 35

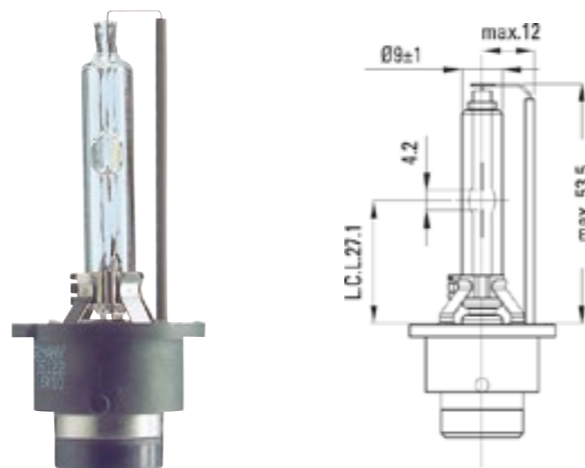

02

Gas discharge headlight bulb D2R
XENON

► Art. no.: 3720-064-223

- Product description
- For reflector headlights
 - Approx. 4,000 Kelvin
 - Voltage: 12 to 85
 - Base: D2R
 - Wattage: 35

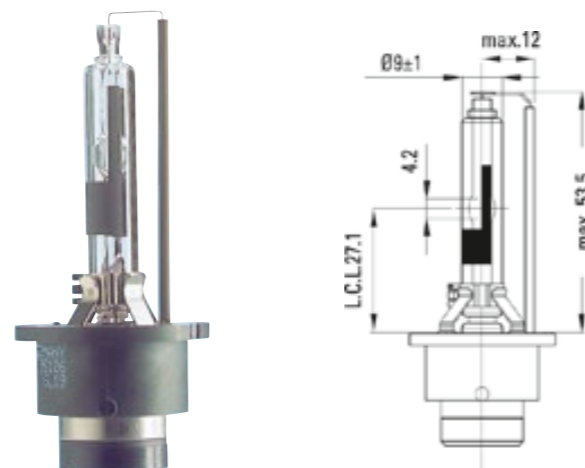

03

Gas discharge headlight bulb D1S
XENON

► Art. no.: 3720-064-224

- Product description
- Approx. 4,000 Kelvin
 - Voltage: 12 to 85
 - Base: D1S
 - Wattage: 35

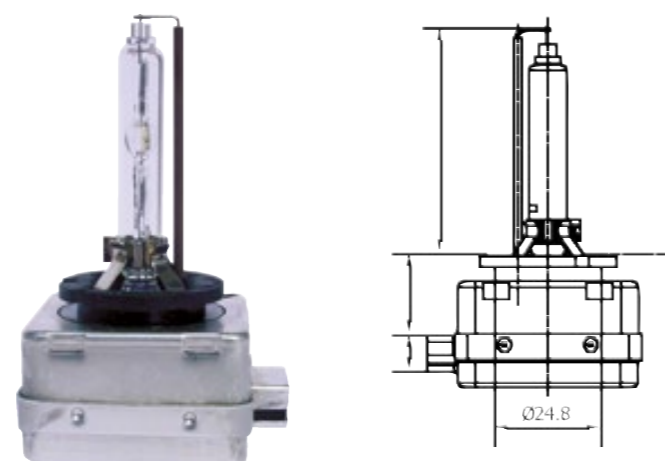

04

Electric discharge lamp

- Product description
- No mercury
 - Nominal voltage 42 Volt

Item no.	Implementation	Base
3720-064-225	D3S 35W 3200 Lumen	PK32d-5
3720-064-226	D4S 35W 3200 Lumen	P32d-5
3720-064-227	D4R 35W 2800 Lumen	P32d-6

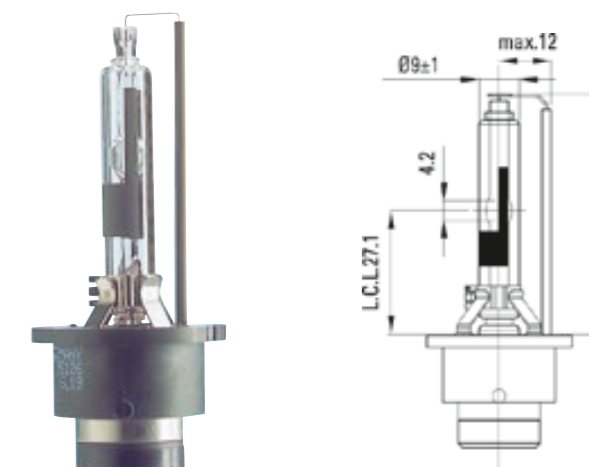

BA15s base

- ▶ Item no. 3720-075-35
- ▶ 18W

- ▶ Item no. 3720-075-11
- ▶ 21W

- ▶ Item no. 3720-752-1
- ▶ 21W HD LL

- ▶ Item no. 3723-075-11
- ▶ 21W Normlight

- ▶ Item no. 3723-751-1
- ▶ 21W HD Normlight

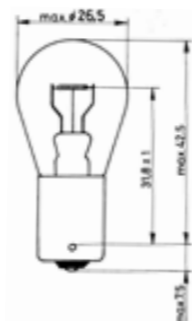

BAY15d base

- ▶ Item no. 3720-075-37
- ▶ 21/5W

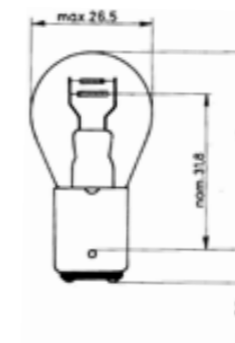

BAZ15D base

- ▶ Item no. 3720-075-47
- ▶ 21/4W

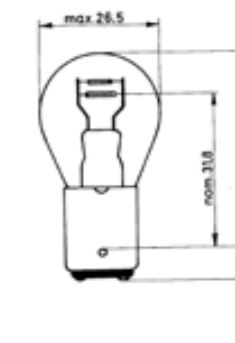

BA15s base

- ▶ Item no. 3720-056-27
- ▶ 5W

- ▶ Item no. 3720-752-3
- ▶ 5W HD LL

- ▶ Item no. 3720-056-37
- ▶ 10W

- ▶ Item no. 3720-752-5
- ▶ 10W HD LL

- ▶ Item no. 3723-562-7
- ▶ 5W HD Normlight

- ▶ Item no. 3723-563-7
- ▶ 10W HD Normlight

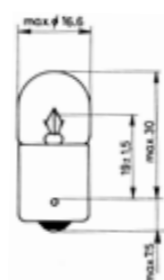

BA15s base

- ▶ Item no. 3720-752-7
- ▶ 21W HD LL

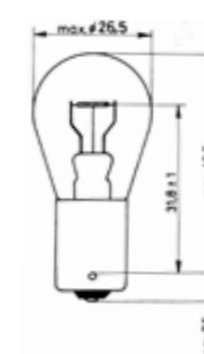

BA15s base

- ▶ Item no. 3720-056-26
- ▶ 5W

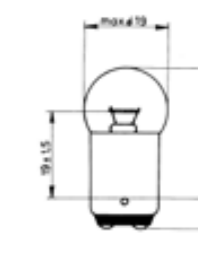

BAU15s base

- ▶ Item no. 3720-752-2
- ▶ 21W HD LL amber (yellow)



HD = heavy duty LL = long life

BAY15d base Normlight

- ▶ Item no. 3723-075-37
- ▶ 21/5W

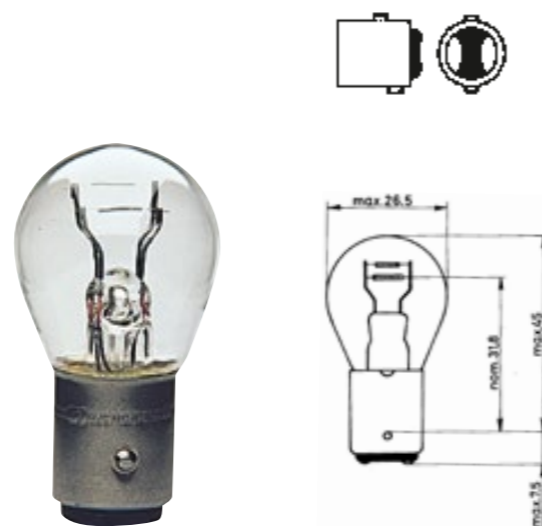

BA7s base

- ▶ Item no. 3720-038-99
- ▶ 3W

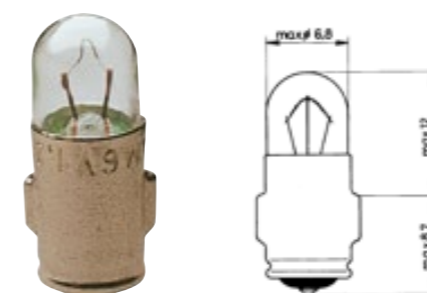

BAY9s base

- ▶ Item no. 3720-075-13
- ▶ 21W Halogen

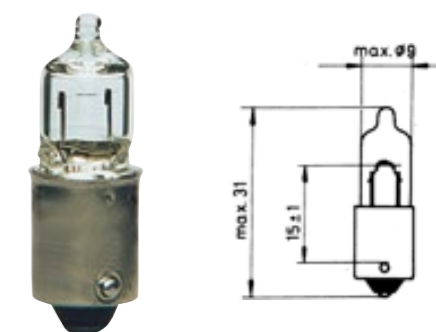

BA9s base

- ▶ Item no. 3720-039-30
- ▶ 4W
- ▶ Item no. 3720-752-6
- ▶ 4W HD LL
- ▶ Item no. 3720-037-97
- ▶ 2W

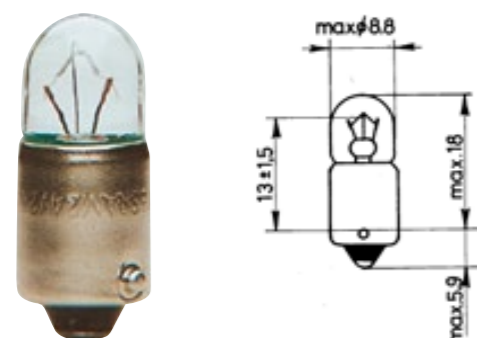

BA9s base

- ▶ Item no. 3723-393-0
- ▶ 4W HD

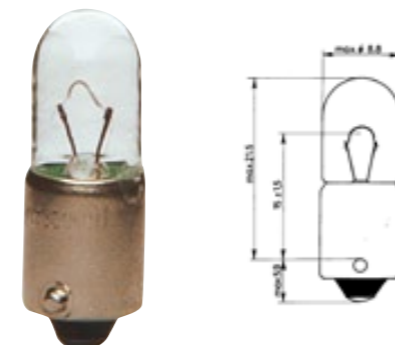

W2x4.6d base

- ▶ Item no. 3720-027-41
- ▶ 1.2W

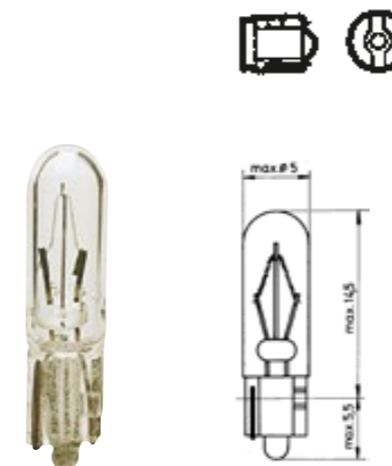

- ▶ W2,1x9:5d base Item no. 3720-028-40
- ▶ 2W
- ▶ Item no. 3720-028-41
- ▶ 3W
- ▶ Item no. 3720-028-45
- ▶ 5W

- ▶ Item no. 3723-028-45
- ▶ 5W Normlight

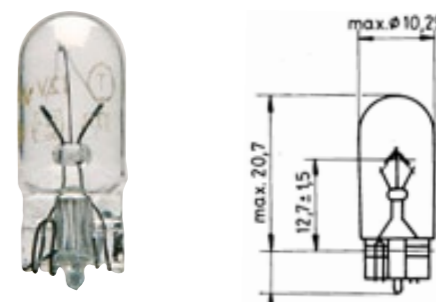

Soffitte 8, 5-8

41 mm

**Item no.
Implementation**

3720-064-24	5W
3720-064-29	10W

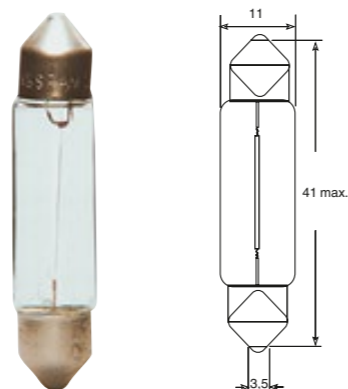

Soffitte 8, 5-8

35 mm

**Item no.
Implementation**

3720-064-23	5W
-------------	----

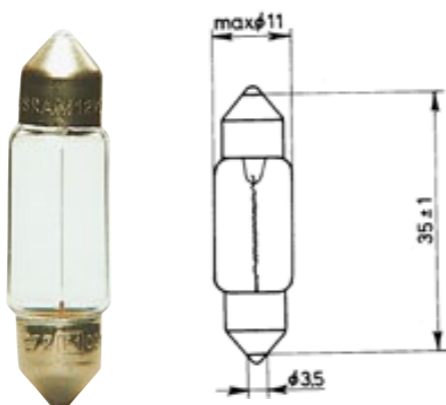

Soffitte 8, 5-8

41 mm

**Item no.
Implementation**

3720-064-80	18W
-------------	-----

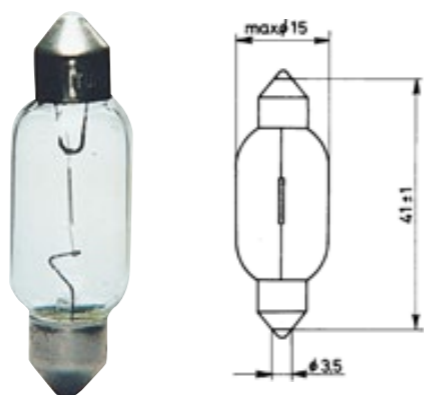

B8,3d

- ▶ Item no. 3720-027-404
- ▶ 1.2W grey

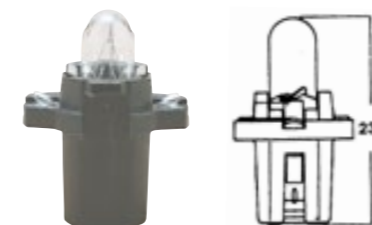

EBS R11

- ▶ Item no. 3720-027-420
- ▶ 1.2 W green suitable for Volvo

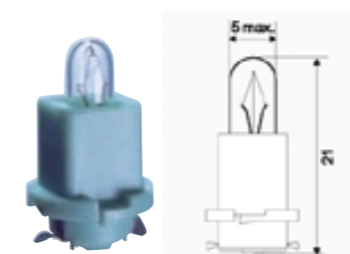

B8,5d

- ▶ Item no. 3720-027-419
- ▶ 1.2W, grey, suitable for tachographs

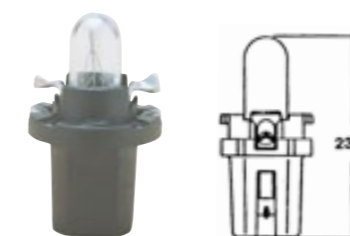

KW2x4,6D

- ▶ Item no. 3720-027-606
- ▶ 1W white



B9

- ▶ Item no. 3720-027-603
- ▶ 2.4W white

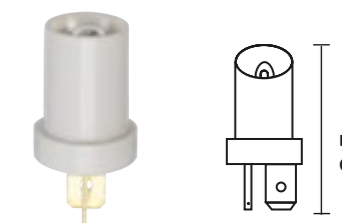

EBS R4

- ▶ Item no. 3720-027-605
- ▶ 1.2W, yellow

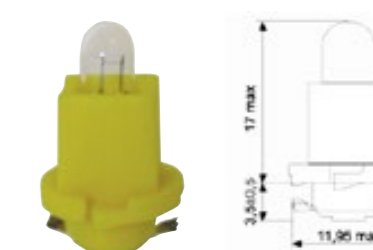

Bx8,5d

- ▶ Item no. 3720-027-600
- ▶ 1.2W, brown

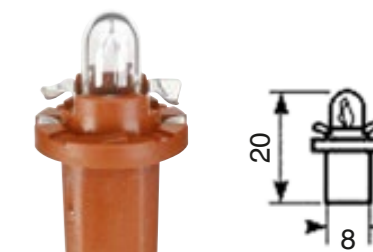

01

HGV bulb box H1 / H7

- ▶ Item no. 3720-03-000
- ▶ Contents: 20 pieces

▶ Product description

The 20-piece box of replacement HGV bulbs is fitted with OEM-quality bulbs. The bulbs are packed in a practical and robust plastic box.

Contents:

2 x 3731-010	Fuses 10A
2 x 3731-015	Fuses 15A
2 x 3731-020	Fuses 20A
2 x 3731-025	Fuses 25A
1 x 3720-064-155	Main headlight H1
1 x 3720-064-211	Main headlight H7
2 x 3720-039-30	Pilot light 4W
2 x 3720-056-37	Tail light 10W
2 x 3720-064-29	Number-plate light 10W
6 x 3720-075-11	Indicator and brake light 21W



01

02

Empty bulb box with foam insert for H1 and H7

- ▶ Art. no.: 3720-03-222

▶ Product description

Replacement bulb box for 24 V and 12 V lights
With liner for H7 and H1 bulbs and additional places for fuses and tail-light bulbs.



02

03

Box for replacement HGV bulbs 24 V H7/H1

- ▶ Item no. 3723-030
- ▶ Contents: 22 pieces

▶ Product description

Contents:

1 x 3723-064-155	Main headlight H1
1 x 3723-064-211	Main headlight H7
2 x 3723-393-0	Parking light 4 W HD
2 x 3723-563-7	Tail light 10 W HD
6 x 3723-075-11	Indicator and brake light 21 W
2 x 3720-064-29	Festoon 8.5-8 10 W
2 x 3731-010	Fuse 10 A
2 x 3731-015	Fuse 15 A
2 x 3731-020	Fuse 20 A
2 x 3731-025	Fuse 25 A



03

04

Glowpoint LED

With shatter-proof casing

- ▶ Art. no.: 3720-075-15

▶ Product description

- Voltage: 24
- Base: BA15s
- Wattage: 1 W
- Long service life: up to 10,000 operating hours
- Safety: is increased due to high luminance
- Saves energy and costs

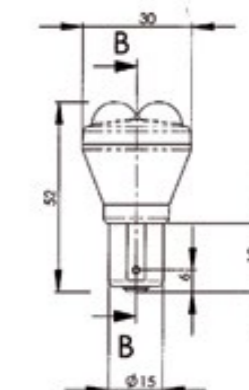

04

Auto electrics



Cable connectors with heat-shrinkable tubing insulation

100% waterproof

► Product description

- Min. shrinkage temperature: 100°C
- Continuous temperature range: -55°C to +125°C
- Shrinkage ratio: 3:1 / Material: Polyolefin
- Polyolefin shrinks 40% faster than polyamide
- Shrinkage temperature lower than for polyamides (100°C instead of 170°C)
- * VW special plug

0,1 - 0,5 mm²



3555-516-0

0,5 - 1,5 mm²



3555-516-1

1,5 - 2,5 mm²



3555-516-2

4,0 - 6,0 mm²



3555-516-4

*0,5 mm²



3555-516-5

Solder butt connector

Soldering, shrinking, waterproof connection in just one work step!

► Product description

- Continuous temperature resistance: -55°C up to +125°C
- Melting point above 85°C

3555-923-0



Ø 0.3 - 0.8

Length: 26 mm

3555-923-1



Ø 0.8 - 2.0

Length: 42 mm

3555-923-3



Ø 4.0 - 6.0

Length: 42 mm

3555-923-2



Ø 2.0 - 4.0

Length: 42 mm

0.5 - 1.0 mm²

3555-901-1
M4



3555-902-1
M5



3555-903-1
M6



3555-904-1
M8



3555-904-11
M10



3555-905-1
6,3



3555-944-1
6,3



1.5 - 2.5 mm²

3555-908-2
M4



3555-909-2
M5



3555-910-2
M6



3555-911-2
M8



3555-912-2
M10



3555-905-2
6,3



3555-945-2
6,3



4.0 - 6.0 mm²

3555-914-4
M4



3555-915-4
M5























3555-916-4
M6



















3555-917-4
M8















0.5 - 1.0 mm²

		
3558-900-1 M3	3558-901-1 M4	3558-902-1 M5
		
3558-903-1 M6	3558-904-1 M8	3558-960-1 2,8
		
3558-960 2,8	3558-976-1 4,8	3558-977-1 4,8
		
3558-905-1 6,3	3558-975-1 2,8	3558-939-1 4,8
		
3558-944-1 6,3	3558-905-11 6,3	3558-925-1
		
3558-946-1 M4	3558-947-1 M4	3558-942-1 6,3
		
3558-950-1	3558-955-1 M4	3558-954-1 M5



1.5 - 2.5 mm²

		
3558-907-2 M3,5	3558-908-2 M4	3558-909-2 M5
		
3558-910-2 M6		
		
3558-976-2 4,8	3558-905-2 6,3	3558-940-2 7,7
		
3558-945-2 6,3	3558-939-2 4,8	
		
3558-905-22 6,3	3558-926-2	
		
3558-948-2 M5	3558-949-2 M5	3558-943-2 6,3
		
3558-951-2	3558-953-2 M4	3558-954-2 M5

4.0 - 6.0 mm²

		
3558-914-4 M4	3558-915-4 M5	3558-916-4 M6
		
3558-917-4 M8	3558-918-4 M10	3558-905-4 6,3
		
3558-941-4 9,5	3558-927-4	3558-961 M5
		
3558-962 M5	3558-952-4	3558-921-4 M4
		
3558-906-4 6,3		

Cable quick connectors

					
3555-951 0.25 – 1.0 mm ²	3555-951-1 0.25 – 1.0 mm ²	3555-952 1.0 – 2.5 mm ²	3555-952-1 1.0 – 2.5 mm ²	3555-953 4.0 – 6.0 mm ²	3555-953-1 4.0 – 6.0 mm ²

Assortment of cable connectors waterproof

- ▶ Item no. 1957-555
- ▶ Contents: 400 pieces

Item no.	Quantity	Item no.	Quantity
3555-516-1	50	3555-909-2	25
3555-516-2	50	3555-911-2	25
3555-516-4	25	3555-923-1	50
3555-903-1	25	3555-923-2	50
3555-904-1	25	3555-923-3	25
3555-905-2	25	3555-945-2	25









Assortment of cable connectors Insulated

- ▶ Item no. 1957-558-1
- ▶ Contents: 530 pieces

Item no.	Quantity	Item no.	Quantity
3555-564	20	3558-925-1	25
3558-901-1	25	3558-926-2	25
3558-905-1	50	3558-943-2	25
3558-905-2	100	3558-944-1	25
3558-905-4	50	3558-945-2	25
3558-908-2	25	3558-946-1	15
3558-909-2	25	3558-947-1	15
3558-910-2	25	3558-948-2	15
3558-916-4	25	3558-949-2	15



















Cable quick connectors

					
3555-557 0.4 – 1.0 mm ²	3555-557-1 0.2 – 1.5 mm ²	3555-564-1 1.5–2.5 mm ²	3555-564 1.0 – 2.5 mm ²	3555-562-1 1.5–4.0 mm ²	3555-562 2.5–4.0 mm ²

Blade receptacles

universal

3558-631-2	4.8 x 0.8	1.5 – 2.5 with notch	MBL	
3558-531-2	4.8 x 0.8	1.50 – 2.5 pre-rolled	MVZ	
3558-504-0	6.3 x 0.8	0.50 – 1.0 with notch pre-rolled	MBL	
3558-991-6	6.3 x 0.8	0.50 – 1.0 with notch pre-rolled	MVZ	
3558-603-2	6.3 x 0.8	1.50 – 2.5 with notch pre-rolled	MBL	
3558-929	6.3 x 0.8	1.50 – 2.5 pre-rolled	MBL	
3558-991-7	6.3 x 0.8	1.50 – 2.5 with notch pre-rolled	MVZ	
3558-992-8	6.3 x 0.8	1.5 – 2.0 with notch pre-rolled	MSI	
3558-504-7	6.3 x 0.8	4.0 – 6.0 with notch pre-rolled	MBL	
3558-996-2	6.3 x 0.8	4.0 – 6.0 with notch pre-rolled	MVZ	
3558-992-6	6.3 x 0.8	4.0 – 6.0 with notch pre-rolled	MSI	
3558-502-0	7.7 x 0.8	2.0 x 1.0 with notch	MBL	
3558-526-6	9.5 x 1.2	4,0 - 6,0	MBL	
3558-526-7	9.5 x 1.2	4.0 – 6.0 with notch	MVZ	
3558-601-0	2.8 x 0.8	0.5 – 1.0 with notch pre-rolled	MVZ	
3558-87-1	Ø 0.35 - 0.50			
3558-87-2	Ø 0.75 - 1.50			













Cable lugs

3558-521-5	1.5 - 2.5 M4	MBL		
3558-521-7	1.5 - 2.5 M5	MVZ		
3558-521-9	1.5 - 2.5 M6	MVZ		
3558-522-1	1.5 - 2.5 M8	MBL		
3558-160-60	6.3 x 0.8	With MVZ hole	MVZ	
3558-160-61	6.3 x 0.8	With MVZ hole	MVZ	
3558-173-0	6.3 x 0.8	With MBL hole	MBL	

Key



- MBL = clear brass
- MVZ = brass tin plated
- BVZ = bronze tin plated
- MSI = brass silver
- BBL = clear bronze
- VGK = gold plated edges

Flat socket tongues
universal



3558-514-4	2,8	0.5 – 1.0 with hole	BVZ	
3558-505-41	2,8	1.5 – 2.5 with notch – with hole	BVZ	
3558-994-6	4,8	0.8 – 2.1 with notch	MVZ	
3558-996-0	6,3	0.5 – 1.0 with notch pre-rolled – with hole	MVZ	
3558-993-7	6,3	0.5 – 1.0 with notch pre-rolled – with hole	MSI	
3558-505-4	6,3	1.5 – 2.5 with notch pre-rolled – with hole	MBL	
3558-991-8	6,3	1.5 – 2.5 with notch pre-rolled – with hole	MVZ	
3558-501-9	6,3	1.5 – 2.5 pre-rolled – with hole	MBL	
3558-993-5	6,3	1.5 – 2.5 with notch pre-rolled – with hole	MSI	
3558-996-3	6,3	4.0 – 6.0 with notch – with hole	MVZ	
3558-87-11	Ø 0.35 - 0.50			
3558-87-21	Diameter 0.75 - 1.50			
3558-87-31	Ø 1.50 - 2.50			

Key
 MBL = clear brass
 MVZ = brass tin plated
 BVZ = bronze tin plated
 MSI = brass silver
 BBL = clear bronze
 VGK = gold plated edges

Angular blade receptacles
universal

3558-643-1	6.3 x 0.8	1.5 – 2.5 with notch MBL	
3558-994-1	6.3 x 0.8	1.5 – 2.5 pre-rolled MBL	
3558-643-6	9.5 x 1.2	2.5 – 4.0 with notch MVZ	

Patch panel

3558-928	6.3 x 0.8	6.3 x 0.8 MBL	
3558-514-3	6.3 x 0.8	scrolled up MBL	

VW special plug

3558-990-91	0.5 – 1.0 with notch pre-rolled		
3558-991-151	2,8/4,8 x 0,8	0.5 – 1.0 with notch pre-rolled	991-151 
3558-904-218	0.5 – 1.0 with notch pre-rolled	N904-218-02	
3558-904-220	2.5 – 4.0 with notch pre-rolled	N904-220-02	
3558-017-490	0.5 – 1.0 with notch pre-rolled	N017-490-7	
3558-102-116	0.5 – 1.0 with notch pre-rolled	N102-116-06	
3558-904-887	1.5 – 2.5 with notch pre-rolled	N904-887-03	
3558-904-890	1.5 – 2.5 with notch pre-rolled	N904-890-03	

Special plugs

3558-513-3	1.5 - 2.5 Ø 4		3558-997-3	1.5 - 2.5	
3558-990-9	0.5 - 1.5		3558-997-31	1.50 - 2.5	
3558-991-16	1.0 - 2.5		3558-993-2	0.50 - 1.0	
3558-994-7	0.8 - 2.1		3558-990-2	0.50 - 2.5	
3558-997-2	0.5 - 1.0		3558-990-8	0.75 - 1.5	
3558-990-5	1.00 - 2.5		3558-990-6	1.00 - 2.5	
3558-992-4	0.50 – 1.0 2.8 notch		3558-997-6	1.5 - 2.5	
3558-995-7	0.50 – 1.0 2.8 notch		3558-990-3	2.0 - 4.0	
3558-995-4	0.50 - 1.0		3558-997-7	4	
3558-995-8	0.50 - 1.5		3558-996-8	0.5 - 1.0	
3558-996-7	0.50 - 1.0		3558-996-4	0.5 - 1.0	
3558-996-9	1.50 - 2.5		3558-993-1	0.5 - 1.0	
3558-995-41	0.50 - 1.0		3558-998-1	0.5 - 0.75	
3558-997-0	0.50 - 1.0				
3558-990-7	0.75 - 1.5				
3558-997-1	1.50 - 2.5				
3558-990-1	0.50 - 2.5				

Multiple connector shell
for flat socket tongues

Item no.	Plug connections Quantity/Fig.
3555-100-1	1 / -
3555-100-2	2 / =
3555-100-22	2 / -
3555-100-4	4 / = =
3555-100-6	6 / = = =
3555-100-8	8 / = = = =

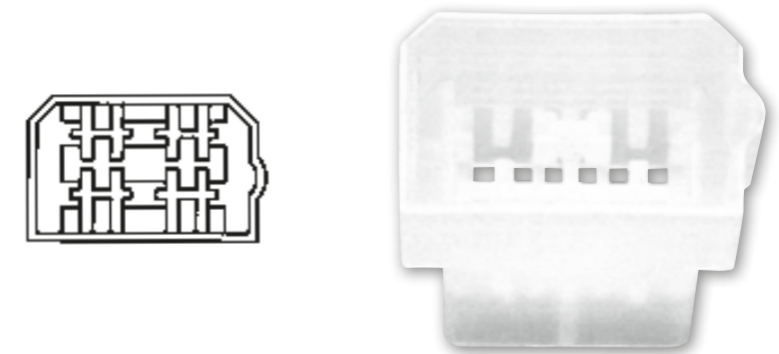

Flat socket tongues
with notch

Item no.	for cable Ø
3558-996-0	0,5 - 1,0
3558-991-8	1,5 - 2,5
3558-996-3	4,0 - 6,0



Multiple connector shell
for blade receptacles

Item no.	Plug connections Quantity/Fig.
3555-100-11	1 / -
3555-100-21	2 / =
3555-100-23	2 / -
3555-100-41	4 / = =
3555-100-61	6 / = = =
3555-100-81	8 / = = = =

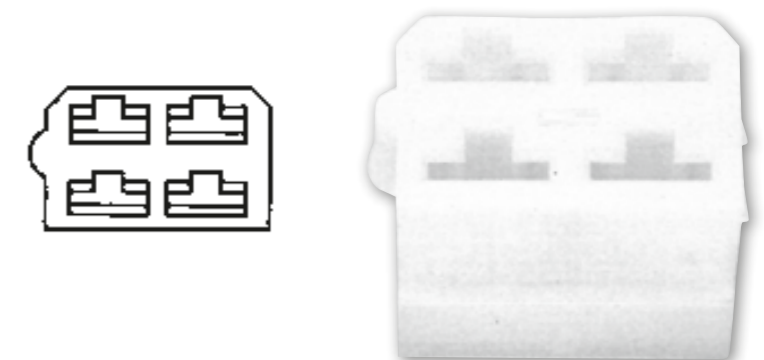

Blade receptacles
with notch

Item no.	for cable Ø
3558-991-6	0,5 - 1,0
3558-991-7	1,5 - 2,5



01
3-fold flat branch

► Art. no.: 3555-11

► Product description

- threefold
- for blade receptacles with 6.3 mm tab width
- max. voltage 300 V
- dimensions 54 mm x 21 mm

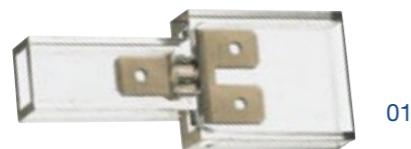

02
4-fold flat branch

► Art. no.: 3555-12

► Product description

- fourfold
- for blade receptacles with 6.3 mm tab width
- max. voltage 300 V
- dimensions 54 mm x 21 mm



03
Flat pin terminal boards

Blade receptacle with 6.3 mm tab width, max. voltage: 300 V

Item no.	Model	Dimensions
3555-2	short conductor insulation	125 x 25,8 mm
3555-4	long conductor insulation	144 x 48,0 mm



04
Luster terminals

Item no.	Cross section
3556-1	2.5 mm ²
3556-2	6.0 mm ²



05
Wire end ferrule
Insulated, galvanised, tin plated, tube length 8 mm

► Product description

- Temperature range: -35°C to 105°C
- Moulded funnel taper: polypropylene



Item no.	Cross section	Colour
3557-000-50	0.50 mm ²	orange
3557-000-75	0.75 mm ²	white
3557-001-00	1.00 mm ²	yellow
3557-001-50	1,5 mm ²	red
3557-002-50	2.50 mm ²	blue
3557-004-00	4.00 mm ²	grey
3557-006-00	6.00 mm ²	black

06
Wire end ferrule
insulated, galvanised



Item no.	Cross section	Length
3557-184-177	0.75 mm ²	6 mm
3557-184-189	0.50 mm ²	6 mm
3557-175-916	1.00 mm ²	6 mm
3557-184-098	4.00 mm ²	12 mm
3557-175-928	1.50 mm ²	7 mm
3557-184-191	2.50 mm ²	7 mm

07
Supporting housing
waterproof, black

► Product description

- 1-6 fold
- Polyamide casing 6.6



Item no.	Model
3558-81-1	1 time
3558-82-1	2 times
3558-83-1	3 times
3558-84-1	4 times
3558-85-1	5-fold
3558-86-1	6 times

08
Bolt housing
waterproof, black

► Product description

- 1-6 fold
- Polyamide casing 6.6



Item no.	Model
3558-81	1 time
3558-82	2 times
3558-83	3 times
3558-84	4 times
3558-85	5-fold
3558-86	6 times

09
Sealing plug

Item no.	Colour	Ø cable
3558-88-1	orange	0,35 - 0,50
3558-88-2	yellow	0,75 - 1,50
3558-88-3	red	1,50 - 2,50
3558-88-4	yellow	



Blade receptacles

3558-87-1	Ø 0.35 - 0.50
3558-87-2	Ø 0.75 - 1.50
3558-87-3	Diameter 1.5 - 2.5
3558-87-11	Ø 0.35 - 0.50
3558-87-21	Diameter 0.75 - 1.50
3558-87-31	Ø 1.50 - 2.50



10
Waterproof rack assortment

- Item no. 1957-560
- Contents: 440 pieces

Item no.	Quantity	Item no.	Quantity
3558-82	4	3558-85-1	4
3558-82-1	4	3558-86	4
3558-83	4	3558-86-1	4
3558-83-1	4	3558-87-2	100
3558-84	4	3558-87-21	100
3558-84-1	4	3558-88-2	100
3558-85	4	3558-88-3	100



01

Cable straps
with plastic tongue

► Product description

- Temperature range: -40°C to +85°C
- Material: Polyamide 6.6
- Silicone-free



Item no.	Length	Width mm	Colour	Load capacity in Nm
3502-11	98	2,5	natural	80
3502-111	98	2,5	black	80
3502-12	140	2,5	natural	180
3502-121	140	3,5	black	180
3502-13	200	3,5	natural	180
3502-131	200	3,5	black	180
3502-135	290	3,6	natural	180
3502-135-1	290	3,6	black	180
3502-14	178	4,5	natural	220
3502-141	178	4,5	black	220
3502-15	280	4,5	natural	220
3502-151	280	4,5	black	220
3502-16	350	4,5	natural	220
3502-161	350	4,5	black	220
3502-165-1	500	4,8	Black	220
3502-171	200	7,6	black	550
3502-18	360	7,5	natural	550
3502-181	360	7,5	black	550
3502-185-1	550	8,0	Black	600
3502-191	750	7,8	black	800

02

Coloured cable ties
4.8 mm x 282 mm

► Product description

- Load capacity in Nm: 220
- Material: Polyamide 6.6, halogen-free, silicone-free
- Thermally stable: -40°C to +85°C
- Flammability class: UL 94 V-2

Item no.	Colour
3502-401	red
3502-402	blue
3502-403	yellow
3502-404	green



03

Cable straps
with metal tongue, UV-resistant

► Product description

- Temperature range: -40°C to +85°C
- Material: Polyamide 6.6
- Silicone-free



Item no.	Length	Width mm	Colour	Load capacity in Nm
3502-211	92	2,4	black	80
3502-221	140	3,6	black	180
3502-231	186	4,8	black	220
3502-241-0	360	4,8	black	220
3502-251-0	338	7,6	black	540
3502-201	208	3,6	black	220

04

Cable straps
removable, UV-resistant

► Product description

- Temperature resistance: up to +85°C
- Material: Polyamide 6.6



Item no.	Length	Width mm	Colour	Load capacity in Nm
3502-341-0	275	4,6	black	222
3502-351-0	376	7,6	black	334

05

Base of cable ties
self-adhesive



Item no.	for cable bandwidth
3502-625	2,5 mm
3502-636	3,6 mm
3502-648	4,8 mm
3502-665	7,8 mm

06

Socket for cable
self-adhesive



Item no.	for cable bandwidth
3502-71	5.0 mm ²
3502-72	8.0 mm ²
3502-73	16.0 mm ²

01

Crimping tool set 5 in 1

With 5 interchangeable crimping dies, forced lock, 2-K insulated handle grip

► Art. no.: 8558-100

► Product description

- Pliers for all occasions
- Simply replace the dies
- Ball bearings ensure optimal hold of the die
- Gas-free pressing is possible when repairing gas installations
- Includes practical case



01

OVERVIEW OF DIES/JAWS

Die A:

Die for insulated cable lugs 0.5 mm - 6.0 mm
Cable: flexible, cross-section 0.5 - 6.0 mm



A



B

Die B:

Die for non-insulated cable lugs 0.5 mm - 10.0 mm
Ideal for non-insulated contacts with closed surface, Suitable for eyelet lugs, terminal pins, joint connectors and small cable lugs
Cable: flexible, cross-section 0.5 - 10.0 mm

Die C:

Die for blade terminal 0.5 mm - 6.0 mm, up to 6.3 mm wide



C



D

Die D:

Die for ferrules 0.5 mm - 4.0 mm
Cable: flexible, cross-section 0.5 - 4.0 mm

Die E:

Die for ferrules 6.0 mm - 16.0 mm
Cable: flexible, cross-section 6.0 - 16.0 mm



E

02

Multimeter

With voltage sensor and LED torch

► Art. no.: 8715-64-581

► Product description

- DC voltage: 2, 20, 200, 400 V
- AC voltage: 200, 400 V
- DC current: 4 A
- AC current: 4 A
- Operating temperature range: 0°C to +40°C
- Storage temperature range: -10 to +50°C

- Functions:

- Contactless voltage metering from 100-600V AC
- Diode test
- Auto power-off function (after 15 minutes)
- Integrated white LED torch
- Dimensions: 140 x 70 x 35mm
- Weight: 250g incl. batteries
- Tested by TÜV/GS: IEC/EN 61010-1
- with two glass fuses



02

03

Voltage tester

3 V - 48 V

► Art. no.: 8715-64-59



03

04

Test lamp

6 V - 24 V

► Art. no.: 8715-64-60



04

01

Self-welding tape

10 m x 19 mm

▶ Art. no.: 3985-5

▶ Product description

- Colour: black
- Temperature range -40°C to +90°C
- Water-resistant
- High elasticity
- Processing temperature: +5°C to 35°C



02

Fabric tape

25 m x 19 mm

▶ Art. no.: 3985-2

▶ Product description

- Colour: Black
- Weatherproof textile tape for manually wired engine compartment cable looms
- Abrasion-resistant, noise absorbing, flexible, highly tear-proof
- Non-ageing, highly adhesive
- Temperature range up to +150°C



03

Extra wide insulation tape

10 m x 30 mm

▶ Art. no.: 3985-10-30

▶ Product description

- Colour: Black
- Thickness: 0.15 mm
- Temperature: -10°C to +90°C



04

Insulating tape

10 m x 15 mm

▶ Item no. 3985-7

▶ yellow

▶ Item no. 3985-1

▶ red

▶ Item no. 3985-6

▶ black

▶ Product description

- Thickness: 0.15 mm
- Temperature: -10°C to +90°C

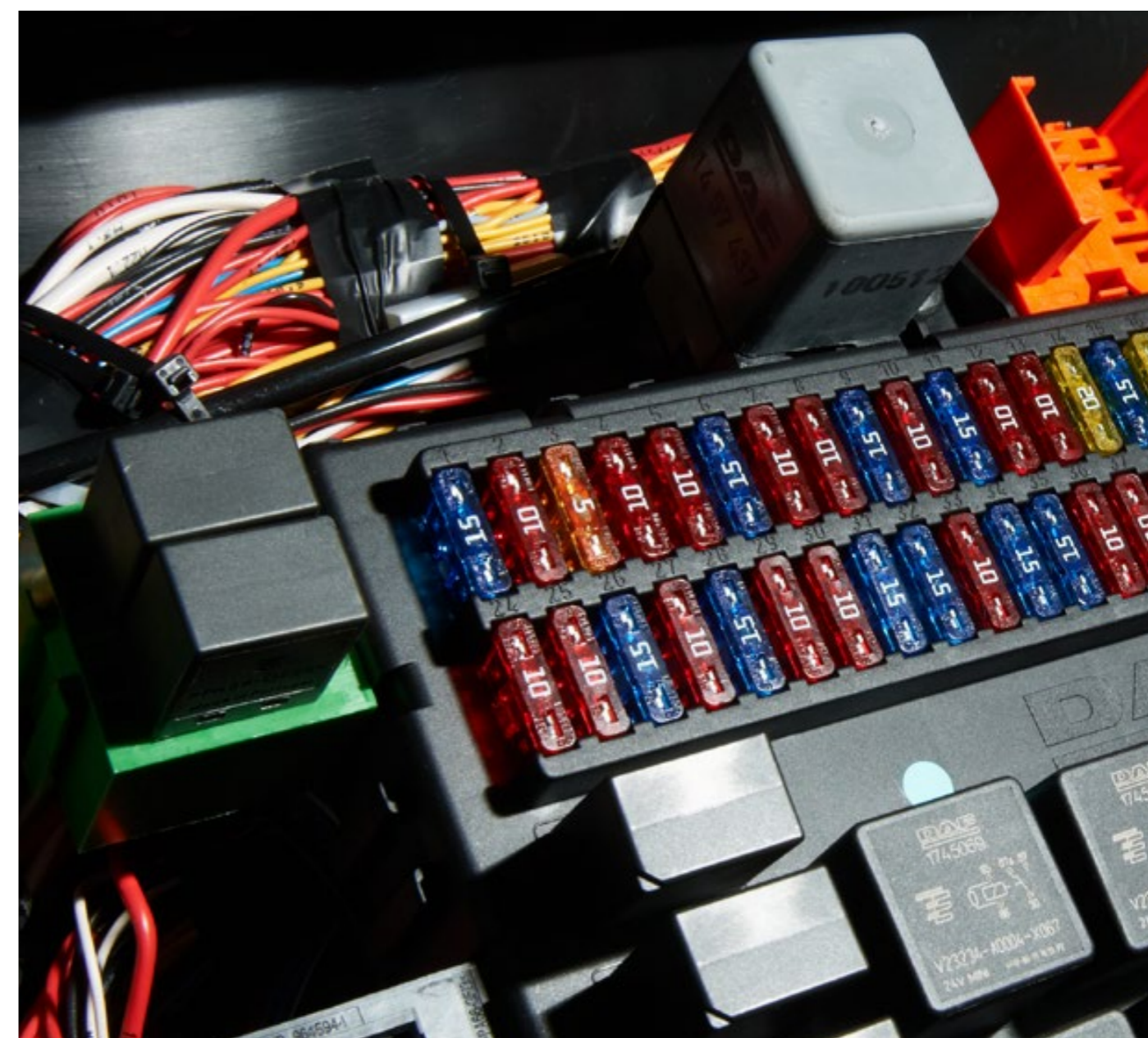

01

Heat-shrinkable tubing rods

coated with adhesive

► Product description

- Shrinkage ratio: 3:1
- Shrinkage temperature: 110°C
- Continuous temperature resistance: -55°C to +110°C

Item no.	Ø before shrinking	Ø after shrinking	Packaging	Rod length
3771-000-031	3,2 mm	1,0 mm	10 rods	60 cm
3771-000-062	6,4 mm	2,0 mm	10 rods	60 cm
3771-000-124	12,7 mm	4,0 mm	4 rods	60 cm
3771-000-248	25,4 mm	8,0 mm	4 rods	60 cm



01

02

Pieces of heat shrinkable tube

Length: 10 cm

► Product description

- Shrinkage ratio: 2:1
- Shrinkage temperature: above 90°C
- Continuous temperature resistance: -55°C to +135°C
- Approval: UL 224

Item no.	Ø before shrinking	Ø after shrinking
3771-200-24	2,4 mm	1,2 mm
3771-200-32	3,2 mm	1,6 mm
3771-200-48	4,8 mm	2,4 mm
3771-200-64	6,4 mm	3,2 mm
3771-200-95	9,5 mm	4,7 mm
3771-200-127	12,7 mm	6,4 mm
3771-200-190	19,0 mm	9,5 mm
3771-200-254	25,4 mm	12,7 mm



02

03

Heat-shrinkable tubing spools

► Product description

- Shrinkage ratio: 2:1
- Shrinkage temperature: 90°C
- Continuous temperature resistance: -55°C bis +125°C
- Material: Polyolefin

Item no.	Ø before shrinking	Ø after shrinking	Coil length
3771-001-2	1,2 mm	0,6 mm	20 m
3771-002-4	2,4 mm	1,2 mm	15 m
3771-003-2	3,2 mm	1,6 mm	15 m
3771-004-8	4,8 mm	2,4 mm	12 m
3771-006-4	6,4 mm	3,2 mm	12 m
3771-009-5	9,5 mm	4,7 mm	8 m
3771-012-7	12,7 mm	6,4 mm	8 m
3771-019-0	19,1 mm	9,5 mm	5 m
3771-025-4	25,4 mm	12,7 mm	5 m



03

04

Insulating corrugated pipe

synthetic material, with slot, coil 2 m

► Product description

- Temperature range -40°C to +120°C
- Material: Polypropylene
- Protects vehicle cables against external influences



04

Item no.	Interior Ø
3505-1-6	6 mm
3505-1-9	9 mm
3505-1-11	11 mm
3505-1-13	13 mm
3505-1-16	16 mm
3505-1-19	19 mm
3505-1-23	22 mm

05

Insulating corrugated pipe

Plastic, without slot, coil 50 m

► Product description

- Temperature range -40°C to +120°C
- Material: Polypropylene
- Protects vehicle cables against external influences



05

Item no.	Interior Ø
3505-4-10	10 mm
3505-4-13	13 mm
3505-4-17	17 mm
3505-4-22	22 mm

06

Insulating tube

Coil 25 m

► Product description

- Temperature range -40°C to +90°C
- Material: PVC
- Silicone-free
- Non-fibrous



06

Item no.	Interior Ø
3771-3	3 mm
3771-4	4 mm
3771-5	5 mm
3771-6	6 mm
3771-8	8 mm
3771-10	10 mm
3771-12	12 mm

01

Automotive wires

Ø 0.5 mm², 100 m, 1 core

Item no.	Colour
3770-050-0	black
3770-050-1	red
3770-050-2	blue



02

Automotive wires

Ø 0.75 mm², 100 m, 1 core

Item no.	Colour
3770-007-5	black
3770-007-51	red
3770-007-52	blue
3770-007-59	brown



05

Automotive wires

Ø 1.5 mm², 50 m, 1 core

Item no.	Colour
3770-020-11	grey-red
3770-020-12	black-red
3770-020-14	green-red
3770-020-16	black-white
3770-020-17	black-green

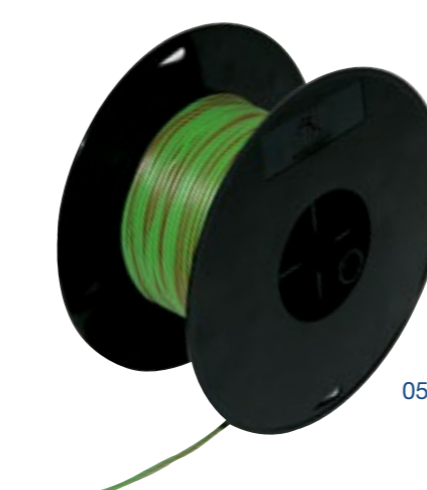

06

Automotive wires

Ø 2.5 mm², 50 m, 1 core

Item no.	Colour
3770-010-5	black
3770-010-6	red
3770-010-60	yellow
3770-010-7	blue
3770-010-99	brown



03

Automotive wires

Ø 1.0 mm², 100 m, 1 core

Item no.	Colour
3770-010	black
3770-009-01	red
3770-009-02	blue
3770-009-03	white
3770-009-05	yellow
3770-009-09	brown



04

Automotive wires

Ø 1.5 mm², 100 m, 1 core

Item no.	Colour
3770-010-0	black
3770-010-1	red
3770-010-2	blue
3770-010-3	yellow
3770-010-4	green
3770-010-40	brown
3770-010-42	white



07

Automotive wires

Ø 4.0 mm², 50 m, 1 core

Item no.	Colour
3770-040-1	black
3770-040-2	red



08

Automotive wires

Ø 6.0 mm², 50 m, 1 core

Item no.	Colour
3770-060-1	black
3770-060-2	red



01

Speaker cable

50 m, brown-red

Item no.	Cable cross-section
3770-030-0	2 x 0.75 mm ²
3770-011-5	2 x 1.50 mm ²



01

02

Speaker cable

25 m, red-black-white-blue

Item no.	Cable cross-section
3770-400	4 x 0.75 mm ²



02

03

Cable bushings

Double-sided, silicone-resistant

- ▶ Product description
- Protects against sharp edges

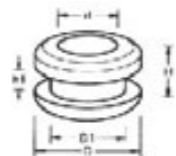

03

04

Plug

Thermoplastic rubber

- ▶ Product description
- Ideal for sealing holes in sheet metal



04

Item no.	d mm	D1 mm	D mm	H mm	H1 mm
3561-663-4	4	6	9	6	1,0
3561-663-2	6	9	11	6	1,0
3561-664-6	6	10	13	8	2,0
3561-664-8	9	11	16	6	1,0
3561-665-0	10	12	18	11	1,0
3561-665-2	12	20	24	10	4,0
3561-666-2	13	21	26	9	2,0
3561-666-3	16	24	3,0	11	3,0
3561-666-6	25	30	36	11	3,5
3561-666-5	21	31	38	11	1,5

Item no.	Outer diameter	Interior Ø
3561-700-1	27,5 mm	24,5 mm
3561-700-2	26,6 mm	22,0 mm
3561-700-3	22,1 mm	19,0 mm
3561-700-4	19,0 mm	15,5 mm
3561-700-5	18,4 mm	14,9 mm
3561-700-6	15,5 mm	12,7 mm
3561-700-7	12,8 mm	11,2 mm
3561-700-8	9,5 mm	6,4 mm
3561-700-9	9,3 mm	4,7 mm

05

Automotive wires

Single wire, red, with double insulation (double jacket)

Item no.	Cable cross-section	Length
3770-020-1	1.5 mm ²	50 m
3770-020-4	2.5 mm ²	25 m



05

06

Automotive wires

2-wire, double insulated
black-red

Item no.	Model	Cable cross-section	Length
3770-020-0	flat	0.75mm ²	50 m
3770-020-2	flat	1.50 mm ²	25 m
3770-020-22	Flat	1,50 mm ²	100 m
3770-020-3	flat	2.50mm ²	15 m
3770-020-5	round	2.50 mm ²	15 m



06

07

Automotive wires

Vehicle cables with double insulation (double jacket)

Item no.	Cable cross-section	Length
3770-121	2 x 0.75 mm ²	50 m
3770-120	2 x 1.50 mm ²	50 m
3770-116	3 x 1.50 mm ²	50 m
3770-119-50	4 x 1.50 mm ²	50 m
3770-118-50	7 x 1.50 mm ²	50 m
3770-4-075	4 x 0.75 mm ²	50 m



07

01
Blade fuse
Low profile



Item no.	Model	Colour
3731-302	2.0 A	grey
3731-303	3.0 A	Violet
3731-304	4.0 A	pink
3731-305	5.0 A	brownish
3731-307-5	7.5 A	brown
3731-310	10.0 A	red
3731-315	15.0 A	blue
3731-320	20.0 A	yellow
3731-325	25.0 A	transparent
3731-330	30.0 A	green

02
Blade fuse
Mini



Item no.	Model	Colour
3731-102	2,0 A	grey
3731-103	3,0 A	Violet
3731-104	4,0 A	pink
3731-105	5,0 A	brownish
3731-107-5	7,5 A	brown
3731-110	10,0 A	red
3731-115	15,0 A	blue
3731-120	20,0 A	yellow
3731-125	25,0 A	transparent
3731-130	30,0 A	green

05
Assortment of blade fuses
Mini and low-profile fuses

- ▶ Item no. 1957-730-2
- ▶ Contents: 280 pieces

Item no.	Quantity	Item no.	Quantity
3731-103	10	3731-303	25
3731-105	10	3731-305	25
3731-107-5	10	3731-307-5	25
3731-110	10	3731-310	25
3731-115	10	3731-315	25
3731-120	10	3731-320	25
3731-125	10	3731-325	25
3731-130	10	3731-330	25



03
Blade fuse
Normal



Item no.	Model	Colour
3731-002	2,0 A	grey
3731-003	3,0 A	Violet
3731-005	5,0 A	brownish
3731-007-5	7,5 A	brown
3731-010	10,0 A	red
3731-015	15,0 A	blue
3731-020	20,0 A	yellow
3731-025	25,0 A	transparent
3731-030	30,0 A	green
3731-040	40,0 A	orange

04
Blade fuse
Maxi



Item no.	Model	Colour
3731-220	20 A	yellow
3731-230	30 A	green
3731-240	40 A	orange
3731-250	50 A	red
3731-260	60 A	blue
3731-270	70 A	brownish
3731-280	80 A	transparent
3731-210-0	100 A	Violet

06
Assortment of blade fuses
Incl. tester and gripper set

- ▶ Item no. 1957-730-1
- ▶ Contents: 161 pieces

Item no.	Quantity	Item no.	Quantity
3731-103	10	3731-005	10
3731-105	10	3731-007-5	1
3731-107-5	10	3731-010	1
3731-110	10	3731-015	1
3731-115	10	3731-020	10
3731-120	10	3731-025	10
3731-125	10	3731-030	10
3731-130	10	3731-150	1
3731-003	10		



01

Screw type fuse mega

Mega, hole distance 51 mm



01

02

Screw type fuse midi

Midi, hole distance 30 mm



02

Item no.	Model	Colour
3731-9-100	100 A	yellow
3731-9-125	125 A	green
3731-9-150	150 A	red
3731-9-175	175 A	white
3731-9-200	200 A	blue
3731-9-225	225 A	brown
3731-9-250	250 A	pink
3731-9-300	300 A	grey

Item no.	Model	Colour
3731-8-30	30 A	orange
3731-8-40	40 A	green
3731-8-50	50 A	red
3731-8-60	60 A	yellow
3731-8-70	70 A	brown
3731-8-80	80 A	white
3731-8-100	100 A	blue

05

Blade fuse

OTO-J



05

Item no.	Model	Colour
3731-5-20	20 A	turquoise
3731-5-25	25 A	white
3731-5-30	30 A	pink
3731-5-40	40 A	green
3731-5-50	50 A	red
3731-5-60	60 A	yellow

06

Blade fuse

OTO-JLP



06

Item no.	Model	Colour
3731-6-20	20 A	turquoise
3731-6-25	25 A	white
3731-6-30	30 A	pink
3731-6-40	40 A	green
3731-6-50	50 A	red
3731-6-60	60 A	yellow

03

Fuse holder

for MIDI fuse

► Art. no.: 3731-8-000



03

04

Fuse holder

for MEGA fuse

► Art. no.: 3731-9-000



04

07

Blade fuse

OTO-B / BT



07

Item no.	Model	Colour
3731-7-30	30 A	pink
3731-7-40	40 A	green
3731-7-50	50 A	red
3731-7-60	60 A	yellow
3731-7-70	70 A	brown
3731-7-80	80 A	black
3731-7-100	100 A	blue
3731-7-120	120 A	white
3731-7-140	140 A	dark red

01 Fuse strip

Item no.	Model
3730-25-5	25
3730-25-8	50
3730-25-161	50
3730-25-25	25
3730-25-40	25



01

02 Metal strip fuse

Item no.	Model
3731-50	50 A
3731-80	80 A



02

03 Visible type fuse

Item no.	Model
3733-20-1	1,00 A
3733-20-2	2,00 A
3733-20-315	3,15 A
3733-20-4	4,00 A
3733-20-5	5,00 A



03

04 MSO fuses
Installed in almost all vehicles of the VW Group (Volkswagen, Skoda, Audi and Seat)

Item no.	Model
3731-10-30	30 A
3731-10-40	40 A
3731-10-50	50 A
3731-10-60	60 A
3731-10-70	70 A
3731-10-80	80 A
3731-10-100	100 A



04

05 Fuse distributor
incl. cable and plug

► Item no. 3731-000-400

► Item no. 3731-000-500

► Product description

- Designed for the installation of additional devices in vehicles, e.g LED daytime running light
- 2 fuse slots
- Easy and secure installation
- Cable length: 10 cm



05



06 Fuse holder

► Art. no.: 3555-625

► Product description

- incl. 8 A fuse
- with bayonet catch for strip fuses



06

07 Flat fuse holder for blade fuse

► Art. no.: 3731-000

► Product description

- with connection for 6.3mm wide blade receptacles



07

08 Flat fuse holder "maxi"

► Art. no.: 3731-200

► Product description

- for cable lugs and M5 bolts
- for cable cross-sections of between 2,5 mm² and 10 mm²



08

09 Blade fuse holder

► Art. no.: 3555-972

► Product description

- Rapid connector
- For cable cross-sections 0.75 mm² - 2.0 mm²



09

10 Cover
for flat fuse holder

► Art. no.: 3731-200-9



10

11 Tester and gripper set
for blade fuses

► Art. no.: 3731-150



11

12 Flat fuse holder for blade fuse

► Art. no.: 3731-000-200

► Product description

- Cable length: each 25 cm
- Cable cross-section: each 1.5 mm²
- For fuses up to 20 A



12

13 Flat fuse holder

► Art. no.: 3731-100

► Product description

- Cable length: each 13 cm
- Cable cross-section 3.3 mm²



13

14 Flat fuse holder for blade fuse

► Art. no.: 3731-000-300

► Product description

- Cable length: each 25 cm
- Cable cross-sections: each 2.5 mm²
- For fuses up to 30 A



14

01
Mini-short adaptor
7-pole to 13-pole

► Art. no.: 3555-310-112

- Product description
- Towing vehicle with 7-pole coupling
 - Trailer with 13-pole plug
 - Length: 50 mm
 - Material: PA6 GF30
 - 12 V



02
Short adapter
13-pole to 7-pole

► Art. no.: 3555-310-12

- Product description
- Towing vehicle with 13-pole coupling
 - Trailer with 7-pole plug
 - Length: 106 mm
 - Material: PA6 GF30
 - 12 V



05
Plug
7-pole

- Item no. 3555-305-517
► Light metal

- Item no. 3555-405-517
► Plastic

- Product description
- Length: 91.8 mm
 - Power rating: 20 A at 12 V
 - With screwed contact
 - For insertion



06
Plug
13-pole

► Art. no.: 3555-310-517

- Product description
- Plastic
 - Power rating: 20 A at 12 V
 - with bayonet catch
 - 12 V
 - 13-polig



03
Mini-short adaptor
13-pole to 7-pole

► Art. no.: 3555-310-119

- Product description
- 7-pole plug (tractor unit with 13-pole coupling (trailer))
 - Material: PA6 GF30
 - Total length: 52 mm
 - 12 V



04
Short adapter
13-pole DIN/ISO11446 box to 7-pole

► Art. no.: 3555-310-13

- Product description
- Length: 106 mm
 - Material: PA6 GF30
 - 13/7
 - WeSt-System
 - 12 V



07
Power outlet
7-pole

- Item no. 3555-305-117
► Light metal

- Item no. 3555-305-118
► Gasket

- Item no. 3555-405-117
► Plastic

- Item no. 3555-310-120
► Spare gasket

- Product description
- Length: 44 mm
 - Power rating: 20 A at 12 V
 - Screwed connection



08
Power outlet
13-pole, incl. grommet

- Item no. 3555-310-117
► Plastic

- Item no. 3555-310-120
► Spare gasket

- Product description
- Length: 50 mm
 - Power rating: 20 A at 12 V
 - OEM version
 - Material: PA6 GF30



01

Plug
15-pole

▶ Art. no.: 3555-310-150

- ▶ Product description
- With screwed contacts
 - GGVS/ADR tested
 - 15-pole
 - 24 V



02

Plug
7-pole

▶ Art. no.: 3555-310-70

- ▶ Product description
- With screwed contacts
 - GGVS/ADR tested
 - 7-pole
 - 24 V



03

Plug
7-pole

▶ Item no. 3555-305-589

▶ Plastic

▶ Item no. 3555-305-587

▶ Metal

- ▶ Product description
- Power rating: 20 A to 24 V
 - Length: 116 mm
 - Type N / "Light"
 - With screwed contacts



04

Plug
7-pole

▶ Item no. 3555-305-588

▶ Plastic

▶ Item no. 3555-305-586

▶ Metal

- ▶ Product description
- Power rating: 20 A to 24 V
 - Length: 116 mm
 - Type S / "Auxiliary consumer"
 - With screwed contacts



05

Plug
3 pole

▶ Item no. 3555-310-6

- ▶ Product description
- With screwed contacts
 - Type S
 - Power rating: 20 A to 24 V
 - Plastic
 - 3-pole
 - 24 V



07

Power outlet
7-pole

▶ Art. no.: 3555-305-287

- ▶ Product description
- With screwed contacts
 - Rubber seal in the cover
 - Type N
 - Load rating: 20 A to 24 V
 - ISO 1185 K-pin
 - 7-pole
 - 24 V



09

Power outlet
3 pole

▶ Art. no.: 3555-310-60

- ▶ Product description
- With screwed contacts
 - Type S
 - Power rating: 20 A to 24 V
 - Plastic
 - ISO 1185 K
 - 7-pole
 - 24 V



06

Socket
7-pole

▶ Art. no.: 3555-310-7

- ▶ Product description
- With screwed contacts
 - GGVS/ADR tested
 - 7-pole
 - 24 V



08

Power outlet
7-pole

▶ Art. no.: 3555-305-286

- ▶ Product description
- With screwed contacts
 - Rubber seal in the cover
 - Type S
 - Load rating: 20 A to 24 V
 - ISO 3731 K-jack
 - 7-pole
 - 24 V



10

Power outlet
15-pole

▶ Art. no.: 3555-310-15

- ▶ Product description
- With screwed contacts
 - GGVS/ADR tested
 - 15-pole
 - 24 V



01
Adapter helix cable
15 pole to 2 x 7 pole

► Art. no.: 3555-320-53

- Product description
- For the power supply from new truck tractors to older trailers
 - 13 pole wired according to standards
 - Overmoulded plug type „N“ and type „S“
 - Working length: 3.5 m
 - Material: PUR
 - Recoiling force complies with OEM regulations
 - Tightly wound
 - 24 V



02
Short adapter
15-pole to 7-pole

► Art. no.: 3555-320-52

- Product description
- Adapter from 15-pole to 7-pole
 - ISO 12098
 - Plastic
 - 24 V



05
Coil
7-pole

► Art. no.: 3555-320-42

- Product description
- Working length: 3.0 m
 - Material: PUR
 - Recoiling force complies with OEM regulations
 - With waterproof plugs
 - Type N
 - Tightly wound



06
EBS helix cable
7-pole

► Art. no.: 3555-320-45

- Product description
- Working length: 3.5 m
 - Material: PUR
 - Recoiling force complies with OEM regulations
 - Tightly wound



03
Adapter helix cable
15 pole to 2 x 7 pole

► Art. no.: 3555-320-51

- Product description
- 13 pole
 - Working length: 3,5 m
 - Type N/S
 - Material: PUR
 - Recoiling force complies with OEM regulations
 - Tightly wound
 - 24 V



04
Coil
7-pole

► Art. no.: 3555-320-43

- Product description
- Working length: 3.0 m
 - Material: PUR
 - Recoiling force complies with OEM regulations
 - With waterproof plugs
 - Type S - 3731
 - 6 sockets, 1 pin



07
Coil
15-pole

► Art. no.: 3555-320-50

- Product description
- Working length: 3.5 m
 - With clamped connection
 - Material: PUR
 - Recoiling force complies with OEM regulations
 - Tightly wound



08
Distribution box
16-fold

► Art. no.: 1004-100

- Product description
- GGVS/ADR inspected
 - 16-fold



01

Soldering cable lugs



Item no.	Bore hole	wire cross section d1	DIN Product name	d2
3557-921-9	M6	10 mm ²	6 x 4,3	11
3557-922-0	M8	10 mm ²	8 x 4,3	15
3557-922-4	M8	16 mm ²	8 x 5,4	15
3557-922-8	M8	25 mm ²	8 x 6,8	15
3557-922-81	M8	35 mm ²	8 x 8,2	15
3557-923-6	M8	50 mm ²	8 x 9,5	17
3557-922-1	M10	10 mm ²	10 x 4,3	19
3557-922-9	M10	25 mm ²	10 x 6,8	19
3557-923-3	M10	35 mm ²	10 x 8,2	19
3557-923-7	M10	50 mm ²	10 x 9,5	19
3557-924-0	M10	70 mm ²	10 x 11,2	21
3557-923-0	M12	25 mm ²	12 x 6,8	22
3557-923-8	M12	50 mm ²	12 x 9,5	22
3557-924-1	M12	70 mm ²	12 x 11,2	22

02

Soldering iron

230 V, 150 W

► Art. no.: 4982-900

► Product description

- Temperature range: 450°C
- Suitable for soldering tasks with high heat requirements, e.g. copper wires with a cross section up to 6 mm²
- Ideal for soldering tin sheet metal
- Warm-up time: 3 minutes



03

Soldering wire

Rolls 250 g each

► Item no. 4982-60

► Ø 2 mm

► Item no. 4982-50

► Ø 1 mm

► Product description

- Liquid agent quantity: 3.5%
- Alloy: PB6OSN40
- Melting range: 183°C - 238°C



Tyre mounting

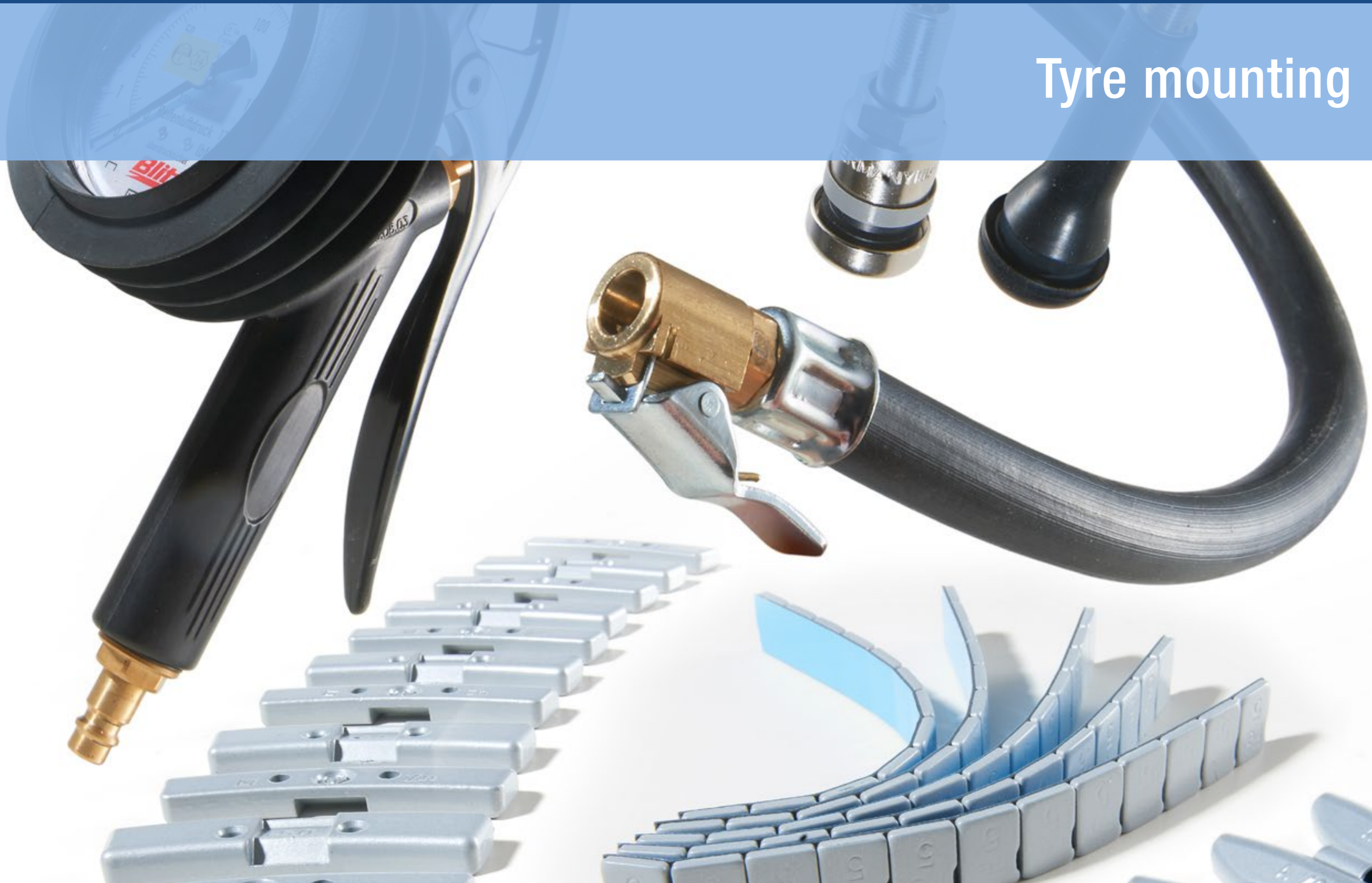

01

Zinc adhesive weights 45 g

Plastic coating

► Art. no.: 9834-14-745

► Product description

- Width: 19.0 mm
- Height: 3.8 mm
- Segments: 5 g + 10 g
- Impact-resistant plastic coating



01

02

Zinc adhesive weights 60 g ECO

powder coated

ECO

► Art. no.: 9837-67-60

► Product description

- Width: 19.0 mm
- Height: 4.0 mm
- Segments: 5 g



02

03

Adhesive zinc weights - 5 kg roll

powder coated

► Art. no.: 9836-15-700

► Product description

- Endless adhesive weight with 1,000 segments x 5 grams (5kg)
- With impact-resistant plastic coating in grey
- Width: 19 mm
- Height: 3.8 mm incl. adhesive tape
- Weight material: Zinc
- Adhesive tape: High-quality double-sided adhesive tape with blue liner
- Coating: High-quality powder coating / uncoated, galvanized
- Corrosion resistance: ≥ 250h in salt spray test to DIN EN ISO 9227



03

04

Cutter for adhesive wheel balancing weight rolls

with wall attachment

► Art. no.: 9836-5

► Product description

- Cutter for adhesive strips on a roll
- Scaling for 5.0 g and 2.5 g weights
- User-friendly cutter
- Replaceable blade
- Simple wall mounting (front or side)



04



01

Steel adhesive weights black 60 g

Impact-resistant plastic coating

► Art. no.: 9834-97-60

► Product description

- Width: 19.0 mm
- Height: 4.0 mm
- Segments: 5 g
- Impact-resistant black plastic coating
- OEM quality



01

02

Steel adhesive weights 60 g ECO

impact-resistant plastic coating



► Art. no.: 9834-397-60

► Product description

- Weight: 12 x 5g
- Width: 19 mm
- Height: 3.7 mm incl. adhesive tape
- Weight identification: Fe (iron)
- Area of application: Almost all light-metal rims



02

03

Adhesive steel weights - 5 kg roll

powder coated

► Art. no.: 9836-15-500

► Product description

- Endless adhesive weight with 1,000 segments x 5 grams (5kg)
- With impact-resistant plastic coating in grey
- Weight material: steel
- Height: 3.5 mm incl. adhesive tape
- Width: 19 mm
- Adhesive tape: High-quality double-sided adhesive tape with blue liner
- Coating: High-quality powder coating / uncoated, galvanized
- Corrosion resistance: ≥ 250h in salt spray test to DIN EN ISO 9227



03

04

Adhesive weight

Plastic coating

► Product description

- Above 25 g with one notch
- Above 45 g with two notches
- To facilitate moulding to the rim radius
- OEM quality



04

Item no.	Weight	Width x height
9834-912-5	5 g	15 mm x 3,8 mm
9834-912-10	10 g	15 mm x 3,8 mm
9834-912-15	15 g	19 mm x 3,8 mm
9834-912-20	20 g	19 mm x 3,8 mm
9834-912-25	25 g	19 mm x 3,8 mm
9834-912-30	30 g	19 mm x 3,8 mm

Item no.	Weight	Width x height
9834-912-35	35 g	19 mm x 3,8 mm
9834-912-40	40 g	19 mm x 3,8 mm
9834-912-45	45 g	19 mm x 3,8 mm
9834-912-50	50 g	19 mm x 3,8 mm
9834-912-55	55 g	19 mm x 3,8 mm
9834-912-60	60 g	19 mm x 3,8 mm

05

Adhesive lead strip 40 g

For motorcycles

► Art. no.: 9836-17-60

► Product description

- Width: 10 mm
- Height: 4.7 mm
- Segments: 8 x 5 g



05



01

Universal balance weights

for steel rims, powder-coated

▶ Product description

- OEM quality



Item no.	Weight	Item no.	Weight
9836-1-5	5 g	9836-1-35	35 g
9836-1-10	10 g	9836-1-40	40 g
9836-1-15	15 g	9836-1-45	45 g
9836-1-20	20 g	9836-1-50	50 g
9836-1-25	25 g	9836-1-55	55 g
9836-1-30	30 g	9836-1-60	60 g

02

Universal balance weights

For light-metal rims, powder coated

▶ Product description

- OEM quality



Item no.	Weight	Item no.	Weight
9836-3-5	5 g	9836-3-30	30 g
9836-3-10	10 g	9836-3-35	35 g
9836-3-15	15 g	9836-3-40	40 g
9836-3-20	20 g	9836-3-45	45 g
9836-3-25	25 g	9836-3-50	50 g

03

ECO wheel weights, black

For steel rims, powder coated, type 84B



▶ Product description

- The special shape of the weight means that it can be used universally on almost all steel rims; also suitable for French vehicles and light trucks



Item no.	Weight	Item no.	Weight
9837-7-5	5 g	9837-7-30	30 g
9837-7-10	10 g	9837-7-35	35 g
9837-7-15	15 g	9837-7-40	40 g
9837-7-20	20 g	9837-7-45	45 g
9837-7-25	25 g	9837-7-50	50 g

04

Plug-type wheel balance weight type 75

For Mercedes steel and aluminium wheel rims



Item no.	Weight	Item no.	Weight
9834-75-5	5 g	9834-75-40	40 g
9834-75-10	10 g	9834-75-45	45 g
9834-75-15	15 g	9834-75-50	50 g
9834-75-20	20 g	9834-75-55	55 g
9834-75-25	25 g	9834-75-60	60 g
9834-75-30	30 g	9834-75-001	For aluminium wheel rims
9834-75-35	35 g	9834-75-002	for steel rim



05

Universal balance weight ECO

For steel rims, coated

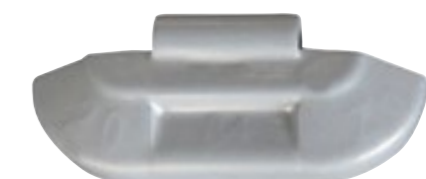

Item no.	Weight	Item no.	Weight
9837-5-5	5 g	9837-5-30	30 g
9837-5-10	10 g	9837-5-35	35 g
9837-5-15	15 g	9837-5-40	40 g
9837-5-20	20 g	9837-5-45	45 g
9837-5-25	25 g	9837-5-50	50 g

06

Universal balance weight ECO

 for alloy rims,
powder-coated

Item no.	Weight	Item no.	Weight
9837-3-5	5 g	9837-3-30	30 g
9837-3-10	10 g	9837-3-35	35 g
9837-3-15	15 g	9837-3-40	40 g
9837-3-20	20 g	9837-3-45	45 g
9837-3-25	25 g	9837-3-50	50 g

01

Rubber valve

Item no.	Total length (without cap)	Model
9879-412	33 mm	Alligator OEM quality
9879-413	43 mm	Alligator OEM quality
9879-414	48 mm	Alligator OEM quality
9879-418	61 mm	Alligator OEM quality
9879-413-4	43 mm	ECO
9879-414-4	48 mm	ECO
9879-418-4	61 mm	ECO



01

02

Metal valve

For vans, PCVs and vehicles with high tyre pressure

► Product description

- Pressure-resistant up to 14 bar
- Wrench size 11
- High-temperature seal for peak temperatures of over +150°C



02

Item no.	Total length (without cap)	Width across flats
9879-413-40	40 mm	11 mm
9879-414-47	47 mm	11 mm

03

Metal valve

Item no.	Model	Width across flats
9879-563	43 mm	14 mm
9879-563-1	with high nut	11 mm



03

04

Aluminium valve

Item no.	Model
9879-563-2	With high-profile nut, black 11 mm



04

05

Commercial vehicle valve

Alligator, CVV

- Item no. 9879-530-40
- 40 mm
- Item no. 9879-530-47
- 47 mm
- Item no. 9879-530-60
- 60 mm



05

07

Valve extension

- Item no. 9879-70
- 13 mm
- Item no. 9879-71
- 19 mm
- Item no. 9879-73
- 38 mm



07

09

Valve cap

Metal

- Art. no.: 9879-46
- Product description
- Prevents corrosion at the valve thread



09

10

Valve cap

Metal

- Art. no.: 9879-47
- Product description
- Prevents corrosion at the valve thread
- Made from nickel-plated brass with a seal
- With extractor for valve insert



10

06

Special Ford valve

Rubber valve

- Art. no.: 9879-414-2
- Product description
- Snap-in rim valve
- Valve length: 56.6 mm
- Rim thickness: 1.8 mm - 4 mm



06

08

Valve insert

short model

- Art. no.: 9879-44
- Product description
- Material: Nickel-plated brass
- Opening pressure: 3 bar +/- 25%
- Working pressure: < 20 bar
- Starting torque: 25 - 30 Ncm



08

11

Valve cap

Plastic

- Item no. 9879-45
- black
- Item no. 9879-48
- red
- Item no. 9879-49
- green with valve gasket



11



01
Tyre installation paste
TAP

- ▶ Item no. 2894-455
- ▶ Contents: 5 kg, colour: black
- ▶ Packing unit: 1

- ▶ Item no. 2894-457
- ▶ Contents: 5 kg, colour: white
- ▶ Packing unit: 1

- ▶ Product description
- Suitable for run-flat tyres
- Frost-proof
- Rapid drying, so that tyre cannot slip on rim
- Outstanding exhaust air behaviour
- High slip
- Biodegradable
- No risk of allergies for fitters

Brush for tyre installation paste

- ▶ Art. no.: 4693-080-0



01

02
Tyre bags
100 pcs.

- ▶ Item no. 7875-906
- ▶ 700 x 260 x 1,000 mm

- ▶ Item no. 7875-909
- ▶ 700 x 500 x 1,200 mm



02

03
Screwing tool
for all common valves

- ▶ Art. no.: 9879-54-00

- ▶ Product description
- Tightening torque: approx. 25-30 Nm



03

04
Adhesive weights remover
Plastic

- ▶ Art. no.: 8715-64-80



04

05
Tyre valve insert tool
Coated in plastic

- ▶ Art. no.: 9879-54-041

- ▶ Product description
- Length: 290 mm



05

01

Tyre chalk

- ▶ Item no. 9879-91-3
- ▶ white



- ▶ Item no. 9879-91-4
- ▶ yellow



01

02

Tyre chalk retainer

- ▶ Art. no.: 9879-91-5



02

03

Quick plug connection

With hose 18 x 1.5 mm

- ▶ Art. no.: 9879-54-08



03

04

Valve lever connector
for tyre hand-held gauges

- ▶ Art. no.: 9879-54-06

▶ Product description

- For hose inner diameter of 6 mm
- Total length approx. 40 mm
- Diameter of valve on inlet side approx. 18 mm



04

05

Service station air chucks

for tyre hand-held gauges

- ▶ Art. no.: 9879-54-07

▶ Product description

- For hose inner diameter of 7 mm
- Diameter of connector 8 mm
- Length about 355



05



06

Tyre hand-held gauges

Suitable for PCVs and HGVs, calibrated

- ▶ Art. no.: 9879-54-05

▶ Product description

- Calibrated (for two years from stamp date)
- Filling pressure: max. 12 bar
- For cars/HGVs
- Rubber protective cap protects mechanism from external impacts
- Overpressure safety protection
- Easy to read
- Weight-optimized design
- Integrated anti-kinking stabilizes the filling hose at the start
- 500 mm-long filling hose for valves hard to access
- With suspension loop
- Ergonomic structure
- Single-lever operation
- PTB approval
- Checks on compressed air possible even without pressurization



06

07

Tyre hand-held gauges

With digital display, calibrated

- ▶ Art. no.: 9879-54-04

▶ Product description

- Calibrated
- PTB approval
- Modern, light, impact-resistant construction
- Clear, easy-read display
- Single-stage valve design increases filling and deflating speed
- Overpressure warning if pressure exceeds 12 bar/174 PSI/1,200 kPa
- Warning light for weak battery
- Connecting thread: 1/4" internal thread
- Hose length: 180 cm
- Max. inlet pressure: 15 bar
- Max. inflation time: 910 i/min
- Inflation range: 0 - 12 bar
- Battery type art. no.: 3722-32 CR 2450
- Life of battery: up to 950h
- System-connected software increases accuracy, precision measurement and eliminates the possibility of incorrect readings



07





01

01

Wheel nuts Ford

OE no. 1007487, 6040307, 1447852

M12 x 1.5 galvanized

Quality 8 Wrench size 19

► Item no. 6395-12-15

OE no. 1470843

M12 x 1.5 galvanized

Quality 10, Wrench size 19

► Item no. 6395-12-151



02

02

Wheel nuts Mazda

Mazda, Mitsubishi, Toyota

OE no. Mazda 0603-26-161

OE no. Mitsubishi MA103087

OE no. Toyota 90942-01001-83

M12 x 1.5 yellow passivated

Quality 8 Wrench size 21

► Item no. 6395-012-15



03

03

Wheel bolts Renault

Renault OE no. 8200030701 M12 x 1.5 x 23 blue galvanized FK 10.9 Wrench size 19

► Item no. 6395-512-15



04

04

Wheel bolts Audi / VW

Volkswagen / Audi OE-no. 8D0 601 139 D M14 x 1.5 x 25.5 Geomet black FK 8.8 Wrench size 17

► Item no. 6395-214-15



05

Tyre repair kit up to 210 km/h

Tyron 6 mm

► Art. no.: 9879-970

► Product description

- 100% self-vulcanising bands
- Bands passed all TÜV endurance and high-speed tests with overload
- Extremely tear proof and shear resistant in tyres and steel belts thanks to leading-edge technology
- Can be used for straight and 45° punctures
- Suitable for all tubeless tyres on cars and vans
- For tyres up to 210 km/h!

- Set content:

- 50 x 6mm repair body (article no. 9879-972 - refill pack)
- 1 x pilot awl (article no. 9879-976)
- 1 x T-handle (article no. 9879-975)
- 1 x awl (article no. 9879-978)
- 1 x vulcanizing mass 25ml (article no. 9879-980)
- 1 x liquid patch 50ml (article no. 9879-979)
- 1 x scraper
- 1 x Allen key



05

01

Refill pack for H tyres

Tyron 6 mm up to 210 km/h

► Art. no.: 9879-972

► Product description

- 100% self-vulcanising bands
- Bands passed all TÜV endurance and high-speed tests with overload
- Extremely tear proof and shear resistant in tyres and steel belts thanks to leading-edge technology
- Can be used for straight and 45° punctures
- Suitable for all tubeless tyres on cars and vans
- For tyres up to 210km/h!

- Content:

- 50 x 6 mm repair body
- 1 x liquid patch 50 ml



01

02

Refill pack for V tyres

Tyron 3 mm above 210 km/h

► Art. no.: 9879-973

► Product description

- 100% self-vulcanising bands
- Bands passed all TÜV endurance and high-speed tests with overload
- Extremely tear proof and shear resistant in tyres and steel belts thanks to leading-edge technology
- Can be used for straight and 45° punctures
- Suitable for all tubeless trucks and motorbikes
- For tyres up to 270km/h!

- Content:

- 50 x 3 mm repair body
- 1 x liquid patch 50 ml



02

03

Tyre repair system

Tyrex starter kit

► Art. no.: 9879-921

► Product description

- Mushroom-shaped repair body, suitable for radial and diagonal tyres
- Licensed for speed class V
- Only use in association with vulcanizing mass (article no. 9879-94-250)

- Set content:

- 20 x 3mm repair body
- 15 x 6mm repair body
- 1 x 3mm burr
- 1 x 6mm burr
- 5 x vulcanizing mass 15g tube



03

04

Adhesive for tyre probes

Tyrex

- Item no. 9879-94-250
- Contents: 237 ml
- Packing unit: 1



04

05

Special rubber milling cutter

For roughening the inner surface of tyres

► Art. no.: 9879-91-1

06

Tread roller

for tyre probes

► Art. no.: 9879-91-2



05

06



02

Mobile multi-make diagnostic device

With 5.0" TFT-LCD touchscreen

▶ Art. no.: 9879-100-002

▶ **Product description**

- Mobile multi-make diagnostic device with 5.0" TFT-LCD touchscreen
- Cable-free working thanks to integrated WLAN and Bluetooth® modules
- Bluetooth® diagnostic interface with EOBD plug
- TPS expansion for reading, copying and programming TPMS sensors
- Multi-make diagnostic software „IDC4a FAST FIT“ for service work on vehicles:
- Chassis settings
- Changing brake linings
- Initiating lock angle sensor
- Resetting maintenance messages
- Changing language of on-board instruments
- Training vehicle batteries
- Setting Xenon headlights

- Expansion possible to include full TEXA car diagnostics!

- Scope of delivery:

- AXONE S
- TEXA IDC4a TPMS
- TEXA IDC4a FAST FIT
- TEXA TPMS Repair APP

- NAVIGATOR Nano S
- TPS-KEY
- USB power supply unit
- USB cable
- Operating instructions

01

Diagnostic device

TEXA TPS Standard

▶ Art. no.: 9879-100-001

▶ **Product description**

- Fast reading of the sensor ID and associated parameters
- Copying sensor IDs
- Writing of copied or manually entered sensor IDs
- Can be used with the free TPMS-Repair app on PCs, Axone 4 and Axone 4 Mini (if IDC4 CAR and Bluetooth® aerial present in PC)

- Package:
- TPS hand-held device
- USB power supply unit
- USB cable
- Operating instructions

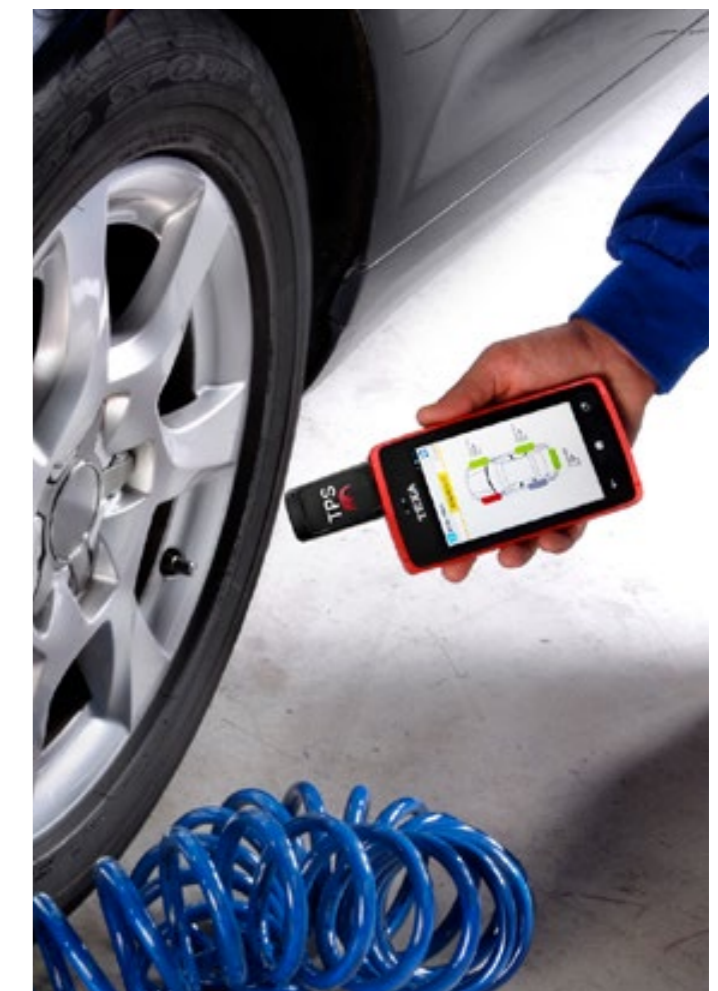

01

TPS Standard starter kit

Diagnostic device with accessories

► Art. no.: 9879-100-1

► Product description

This starter set includes the manual device for particularly quick reading, copying and programming of TPMS sensors, aluminium valves and the RS3 434MHz sensor ball joint that can be used on almost all steel and aluminium wheels currently on the market.

- Contents:

- 1x TEXA TPS Standard (art. no. 9879-100-001)
- 4x RS3 434MHz sensor ball joint (art. no. 9879-100-101)
- 4x RDKS 43LMS car valve, silver (art. no. 9879-100-201)



01

02

AXONE S TPS starter kit

Diagnostic device with accessories

► Art. no.: 9879-100-2

► Product description

This starter set includes the multi-make diagnostic device with TPMS expansion for quick reading, copying and programming of TPMS sensors, aluminium valves and the RS3 434MHz sensor ball joint that can be used on almost all steel and aluminium wheels currently on the market.

- Contents:

- 1x TEXA AXONE S TPS (art. no. 9879-100-002)
- 4x RS3 sensor 434MHz ball joint (art. no. 9879-100-101)
- 4x RDKS 43LMS car valve, silver (art. no. 9879-100-201)



02

03

Sensor valve

RS3 434MHz Ball-Joint

► Art. no.: 9879-100-101

► Product description

- Attachment: Universal ball joint
- Frequency: 434MHz
- Colour marking: Blue seal
- Sensor weight: 18 g
- Adjustable angle: 12° to 40°
- Nut torque: 3.3 Nm/29 inch lbs
- Bolt torque: 3.3 Nm/29 inch lbs



03

05

Rubber valve

Snap In

► Art. no.: 9879-100-203

► Product description

- Valve type: Snap-In
- Attachment: Clip pin
- Length: TR413
- Valve-hole diameter: 11.3+0.4mm
- Valve angle: 20°
- Max. speed: 210 km/h



05 Gummiventil RDKS Snap-In

06 Sensor RS4 434MHz Snap-In

04

RDKS aluminium valve

With universal ball joint construction

► Item no. 9879-100-201

► Colour: silver, PU: 12

► Item no. 9879-100-202

► Colour: black, PU: 12

► Product description

- Valve type: Screw valve
- Attachment: Universal ball joint
- Length: 43mm
- Valve hole: Ø 11.3+0.4mm
- Colour: Anodized silver



04

06

Sensor valve

Snap In

► Art. no.: 9879-100-102

► Product description

- Attachment: Clip pin
- Frequency: 434MHz
- Colour marking: Blue seal
- Sensor weight: 16 g



01

Tyre Repair Set
Tyron for HGVs

► Art. no.: 9879-971

► Product description

- 100% self-vulcanising bands
- Bands passed all TÜV endurance and high-speed test with overload
- Extremely tear-proof and shear resistant in tyres and steel belts thanks to leading-edge technology
- Can be used for straight and 45° punctures
- Suitable for all HGVs

- Set content:
- 25 x 6mm repair body (article no. 9879-974 - refill pack)
 - 1 x pilot awl (article no. 9879-976)
 - 1 x T-handle (article no. 9879-975)
 - 1 x awl (article no. 9879-978)
 - 1 x vulcanizing mass 25ml (article no. 9879-980)
 - 1 x liquid patch 50ml (article no. 9879-979)
 - 1 x scraper
 - 1 x Allen key



01

02

Refill pack for Tyron repair kit
Tyron

► Art. no.: 9879-974

► Product description

- 100% self-vulcanising bands
- Bands passed all TÜV endurance and high-speed tests with overload
- Extremely tear-proof and shear resistant in tyres and steel belts thanks to leading-edge technology
- Can be used for straight and 45° punctures
- Suitable for all HGV tyres

- Contents:

- 25 x 6 mm repair body
- 1 x liquid patch 50ml



02

03

Tyron
Liquid patch

- Item no. 9879-979
- Contents: 50 ml
- Packing unit: 1



03

04

Awl

► Art. no.: 9879-978



04

05

Vulcanising substance

- Item no. 9879-980
- Contents: 25 ml
- Packing unit: 1



05

06

T-handle

► Art. no.: 9879-975



06

07

Penetrating awls
Length: 19.5 cm

► Art. no.: 9879-976



07



01
Tyrex
Adhesive for tyre probes

- ▶ Item no. 9879-94-250
- ▶ Contents: 237 ml
- ▶ Packing unit: 1

02
Tyre probes
Diam. 10 mm, PU: 10

- ▶ Art. no.: 9879-92-10

03
Tyre probes
Diam. 4.5 mm, PU: 10

- ▶ Art. no.: 9879-92-04



04
Milling machine
10 mm

- ▶ Art. no.: 9879-93-10

05
Tread roller
for tyre probes

- ▶ Art. no.: 9879-91-2

06
Special rubber milling cutter
For roughening the inner surface
of tyres

- ▶ Art. no.: 9879-91-1





01

01

Valve

For tubeless commercial vehicle tyres, straight version

- ▶ Item no. 9879-800-41
- ▶ 9.7 x 41 mm

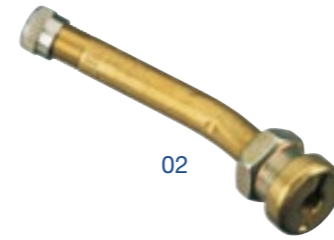

02

02

Valve

For tubeless commercial vehicle tyres, single bend 27°

- ▶ Item no. 9879-800-70
- ▶ 9.7 x 70 mm



05

05

Wheel balance weight for 15° tapered rims

Lead, from 22.5" x 6.75" to 26 inches

Item no.	Weight
9836-32-50	50 g
9836-32-75	75 g
9836-32-100	100 g
9836-32-150	150 g
9836-32-200	200 g



06

06

Striking weight for 15° tapered rims

Lead, from 22,5 x 6,75 to 26,50 x 12,00

Item no.	Weight	Item no.	Weight
9836-32-75	75 g	9836-32-250	250 g
9836-32-50	50 g	9836-32-300	300 g
9836-32-100	100 g	9836-32-350	350 g
9836-32-150	150 g	9836-32-400	400 g
9836-32-200	200 g		



03

03

Metal valve

For vans, PCVs and vehicles with high tyre pressure

- ▶ Item no. 9879-413-40
- ▶ 40 mm

- ▶ Item no. 9879-414-47
- ▶ 47 mm

- ▶ Product description
- Pressure-resistant up to 14 bar
- Wrench size 11
- High-temperature seal for peak temperatures of over +150°C



04

04

Commercial vehicle valve

Alligator, CVV

- ▶ Item no. 9879-530-40
- ▶ 40 mm

- ▶ Item no. 9879-530-47
- ▶ 47 mm

- ▶ Item no. 9879-530-60
- ▶ 60 mm

- ▶ Product description
- Safe sealing in rims
- Simple to install
- Easy to dismantle without special tools
- No rim damage when dismantling
- High pressure resistance

07

Valve extension

Air-Flexx, steel, flexible

- ▶ Item no. 9879-700-145
- ▶ 145 mm

- ▶ Item no. 9879-700-185
- ▶ 185 mm

- ▶ Item no. 9879-700-215
- ▶ 215 mm



07

08

Valve extension

Plastic, rigid

- ▶ Item no. 9879-74
- ▶ 115 mm

- ▶ Item no. 9879-75
- ▶ 150 mm

- ▶ Item no. 9879-76
- ▶ 170 mm



08

09

Extension cap with seal

Check valve

- ▶ Art. no.: 9879-66

- ▶ Product description
- Does not have to be removed for filling or pressure test
- Resistant to dirt and water
- Prevents pressure loss even when the valve insert is damaged or soiled
- Fits every standard valve



09

Painting



01

Multipurpose primer

1K-Multi-Connector

- ▶ Item no.2893-900
- ▶ Contents: 400 ml light grey
- ▶ Packing unit: 12



- ▶ Item no.2893-900-20
- ▶ Contents: 400 ml dark grey
- ▶ Packing unit: 12



▶ **Product description**

- Recoatable without sanding
- With fan spray head
- Substrates: Galvanised sheet steel and aluminium, plastic, wood, etc.
- Particularly suitable for protecting the edges of filled areas
- Ideal for all difficult substrates, also suitable for plastic and wood

02

Base primer

Baso Plus

- ▶ Item no.2893-889
- ▶ Contents: 400 ml
- ▶ Packing unit: 24



▶ **Product description**

- High filling properties
- Improved coverage due to increased number of pigments
- Temperature resistant up to 100°C
- Overpaintable with nitro, acrylic and water-based paints
- Fan spray head enables vertical and horizontal application

03

Thick film filler

One-component multi filler

- ▶ Item no.2893-902
- ▶ Contents: 400 ml
- ▶ Packing unit: 10

▶ **Product description**

- High filling volume
- Easy to sand
- Quick drying
- With cone spray head

04

Primer filler

2-component epoxy primer filler

- ▶ Item no.2800-760
- ▶ Contents: 400 ml
- ▶ Packing unit: 6

▶ **Product description**

- Gloss level: matt
- Colour: beige
- Long-lasting corrosion protection on all surfaces, e.g. zinc, aluminium, steel, etc.
- Proportion of solid particles: 50-53% by weight on diluted paint (without propellant gas)



01



02



03



04

01

Matte black

Kroma

- ▶ Item no.2893-884
- ▶ Contents: 400 ml
- ▶ Packing unit: 24

▶ **Product description**

- Very high coverage
- Light resistant
- High proportion of solid particles
- Scratch proof
- Resistant to petroleum

02

Shiny black

Spray paint

- ▶ Item no.2893-885
- ▶ Contents: 400 ml
- ▶ Packing unit: 24

▶ **Product description**

- this RAL spray paint is characterised by its fine flowing texture and good, colour-true coverage



03

Spray paint

Corona

- ▶ Item no.2893-886
- ▶ Contents: 400 ml black matt
- ▶ Packing unit: 6

▶ **Item no.2893-887**

- ▶ Contents: 400 ml silver
- ▶ Packing unit: 1

▶ **Product description**

- Heat resistant up to 650°C
- Weatherproof
- Resistant to wear and abrasion
- Free of heavy metals

04

Wheel rim silver

Silver Star

- ▶ Item no.2893-883
- ▶ Contents: 400 ml
- ▶ Packing unit: 24

▶ **Product description**

- weatherproof
- quick-drying
- resistant to petroleum
- abrasion resistant
- car wash-proof



01



02









03





04

Cargo

	RAL	Description	Area of application	
DB 129		Nova grey	Original Mercedes Benz colour	2893-830-009 6
RAL 9011		Graphite white	Deutsche Post, lubricant container and equipment	2893-860-002 6
DB 7329		Actros grey	Original colour Mercedes Benz commercial vehicles	2893-830-007 6
MB 7354		Argentit grey		2893-830-003 6
MB 9147		Arctic white	Original colour Mercedes Benz commercial vehicles	2893-830-008 6
RAL 906		White aluminium		2893-820-005 6
RAL 3002		Carmine red	Safety marking for Deutschen Bahn	2893-810-007 6





Municipal vehicles

	RAL	Description	Area of application	
RAL 3000		Fire red Silk	New Holland red, Massey Ferguson agricultural machine red	2893-810-001 6
RAL 9005		Jet black	Deutsche Bahn, warning plates, electrical cables (automotive engineering)	2893-810-008 6
RAL 2011		Deep orange	municipal vehicles	2893-850-006 6

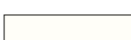

Fire brigade

	RAL	Description	Area of application	
RAL 3000		Fire red Silk	New Holland red, Massey Ferguson agricultural machine red	2893-810-001 6
RAL 9010		Pure white	Deutsche Bahn, metal processing, shelving, sanitary and heating installation	2893-810-006 6

German Railways

	RAL	Description	Area of application	
RAL 3000		Fire red Silk	New Holland red, Massey Ferguson agricultural machine red	2893-810-001 6
RAL 9010		Pure white	Deutsche Bahn, metal processing, shelving, sanitary and heating installation	2893-810-006 6
RAL 3002		Carmine red	Safety marking for Deutschen Bahn	2893-810-007 6
RAL 9005		Jet black	Deutsche Bahn, warning plates, electrical cables (automotive engineering)	2893-810-008 6
RAL 5010		Gentian blue	Ford agricultural machine blue, Safety marking	2893-810-009 6

Agriculture

	RAL	Description	Area of application	
RAL 3000		Fire red Silk	New Holland red, Massey Ferguson agricultural machine red	2893-810-001 6
RAL 5010		Gentian blue	Ford agricultural machine blue, Safety marking	2893-810-009 6

Aerosol can & accessories

- ▶ Item no. 2893-
Aerosol can
- ▶ Item no. 2893-900-1
Spray head (cone)
- ▶ Item no. 2893-900-2
Pistol grip
- ▶ Item no. 2893-900-3
Fan nozzle



01

High-gloss clear varnish

- ▶ Item no.2893-803
- ▶ Contents: 400 ml
- ▶ Packing unit: 6



01



02

2K-Clear varnish

- ▶ Item no.2800-770
- ▶ Contents: 400 ml
- ▶ Packing unit: 6

- ▶ Product description
- Weatherproof
- Resistant to chemicals
- Resistant to petroleum
- Excellent filling properties



02

03

Spot blender paint

- ▶ Item no.2800-780
- ▶ Contents: 400 ml
- ▶ Packing unit: 6

- ▶ Product description
- corrects paint transitions when filling paint



03

04

Silicone remover

- ▶ Item no.2800-720
- ▶ Contents: 400 ml
- ▶ Packing unit: 6

- ▶ Product description
- Suitable for all cleaning tasks prior to and after painting, e.g. tar spatter, diesel exhaust particles, etc.



04

01
Abrasive paste coarse
Scratch-Off Ultra

- ▶ Item no.2000-325-1
- ▶ Contents: 1 kg
- ▶ Packing unit: 1

- ▶ **Product description**
- Suitable for HS and MS paints
- Silicone-free
- Ammonia-free
- Can be overpainted
- Free of cosmetic oils
- Low heat generation
- Can be mixed with water

- Use **ONLY WITH A MACHINE**
- Deep scratches: Lambswool, white (2000-204-150)
- Deep scratches: hard polishing sponge, yellow (2000-205-150)

02
Grinding compound, fine
Scratch-Off Fine Plus

- ▶ Item no.2000-326-9
- ▶ Contents: 1 kg
- ▶ Packing unit: 1

- ▶ **Product description**
- Suitable for HS and MS paints
- High level of abrasion and maximum shine
- Solvent free
- Does not contain silicone or ammonia
- Free of cosmetic oils
- Extended pot life and longer working time
- Low heat generation
- Leaves no residue on plastic surfaces

- Application: **MACHINE ONLY**
- Medium scratches: Medium polishing sponge, orange (2000-206-150)

03
Polish
Scratch Soft

- ▶ Item no.2000-327-1
- ▶ Contents: 1 kg
- ▶ Packing unit: 1

- ▶ **Product description**
- Slight to medium signs of use can be polished out without leaving holograms
- Suitable for HS and MS paints
- Silicone-free

- Use: **MACHINE ONLY**
- Minor marks: Polishing sponge medium, orange (2000-206-150)
- Hologram remover: Soft polishing sponge, black (2000-207-150)
- Wafer sponge, black (2000-208-150)

04
Quick sealant
Speed-Gloss-Nano

- ▶ Item no.2000-316-1
- ▶ Contents: 1 litre
- ▶ Packing unit: 1

- ▶ **Item no.2000-316-5**
- ▶ **Contents: 5 litres**
- ▶ **Packing unit: 1**

- ▶ **Product description**
- Perfect shine effect
- Effortless polishing without leaving any sticky residue
- Suitable for cleaning without water
- Contains carnauba wax

- Application: **MANUAL ONLY**
- Microfibre cloth, red (2000-740-40)
- Application sponge, black (2000-209-130)

05
Wax sealing
Speed-Wax

- ▶ Item no.2000-330-1
- ▶ Contents: 1 kg
- ▶ Packing unit: 1

- ▶ **Product description**
- Premium car wax
- Natural carnauba wax, enriched with high-quality synthetic components
- For manual and machine application
- Permanent protection against the elements
- Long-lasting shine

- Application:
- Manual: Application sponge, black (2000-209-130)
- Machine: Wafer sponge, black (2000-208-150)

06
Long-time sealing
Paint-Guard

- ▶ Item no.2000-331-1
- ▶ Contents: 1 litre
- ▶ Packing unit: 1

- ▶ **Product description**
- Special blend of PTFE and acrylic resins
- Extra UV protection for long-lasting good looks
- Unique water-based formula
- Free of volatile silicones
- Application:

- Manual: Microfibre cloth, red (2000-740-40)
- Machine: Soft polishing sponge, black (2000-207-150)



01



02



03



04



05



06

01

Cleaning polish

Twin

- ▶ Item no.2000-304-1
- ▶ Contents: 1 litre
- ▶ Packing unit: 1

- ▶ Item no.2000-304-5
- ▶ Contents: 5 litres
- ▶ Packing unit: 1

▶ **Product description**

- Cleans, refreshes and polishes in one step
- The low chalk content simplifies the polishing of dark colours
- Contains no volatile silicones
- Suitable for all paints, including metallic paints and water-soluble paints

02

High-gloss polish

High Gloss

- ▶ Item no.2000-303-1
- ▶ Contents: 1 litre
- ▶ Packing unit: 1

- ▶ Item no.2000-303-5
- ▶ Contents: 5 litres
- ▶ Packing unit: 1

▶ **Product description**

- Maximum shine effect
- Quick finish
- Contains no volatile silicones
- High viscosity
- For use on cars, buses, motorbikes, HGVs, aircraft, boats, caravans, etc.

03

Sanding-Polishing-Sealing

Compact

- ▶ Item no.2000-335-1
- ▶ Contents: 1 kg
- ▶ Packing unit: 1

▶ **Product description**

- Quick and professional treatment of older paintwork
- Cleaning and sealing in one application
- Free of volatile silicones



01



02



03

04

Matting paste

Scraper

- ▶ Item no.2000-314-1
- ▶ Contents: 1 litre
- ▶ Packing unit: 1

▶ **Product description**

- Conditions surfaces for areas to be painted in
- designed specifically for use with non-woven web
- increases grinding



04

01
Fibre glass filler incl. hardener (2893-139)
 Compound

- ▶ Item no.2893-109-9
- ▶ Contents: 1.8 kg
- ▶ Packing unit: 4

- ▶ Product description
- Outstanding direct adhesion on metal substrates
- Ideal for filling small surfaces, unevenness and grooves



01

04
Fine filler with curing agent (2893-139)
 Finish

- ▶ Item no.2893-112-9
- ▶ Contents: 2 kg
- ▶ Packing unit: 4

- ▶ Product description
- for filling small areas, ridges and grooves
- adheres to aluminium, plastics, steel and galvanised steel



04

02
Multisoft filler with curing agent (2893-139)
 Multi

- ▶ Item no.2893-101-9
- ▶ Contents: 2 kg
- ▶ Packing unit: 4

- ▶ Product description
- For filling large cavities
- Adheres to aluminium, plastics, steel and galvanised steel



02

05
Aluminium filler with curing agent (2893-139)
 Aluminium

- ▶ Item no.2893-103-9
- ▶ Contents: 1.8 kg
- ▶ Packing unit: 4

- ▶ Product description
- For filling large cavities as well as parts exposed to vibrations and oscillations
- Adheres to aluminium, plastics and galvanised steel



05

03
Universal filler with curing agent (2893-139)
 Plain

- ▶ Item no.2893-106-9
- ▶ Contents: 2 kg
- ▶ Packing unit: 4

- ▶ Product description
- For filling small surfaces, unevenness and grooves
- Adheres to aluminium, plastics and steel (but not to galvanised steel)



03



06

07

06
Body filler application set

- ▶ Art. no.: 8715-65-00
- ▶ Product description
- 4 blades
- Acid-proof plastic grips

07
Plastic smoothing spatula

- ▶ Item no. 2893-164
- ▶ PU: 10

01

Velcro-type discs

Diameter 150 mm, Normfest, 15 perforated holes

Item no.	Graining
4515-010-0	100
4515-012-0	120
4515-015-0	150
4515-018-0	180
4515-022-0	220
4515-024-0	240
4515-032-0	320
4515-040	40
4515-040-0	400
4515-050-0	500
4515-060	60
4515-080	80

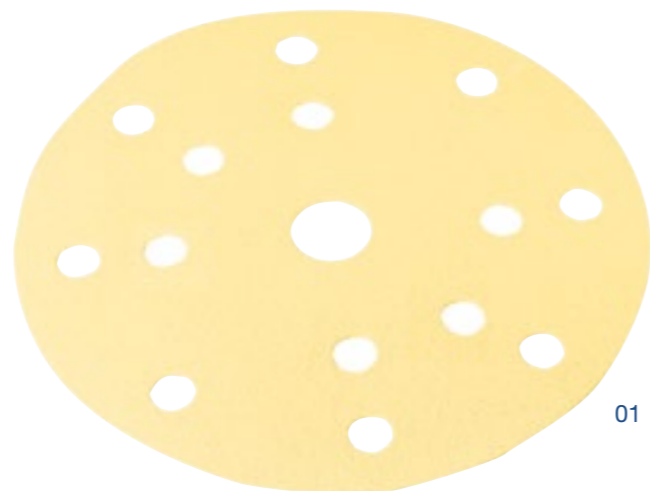

02

Hook & loop disks, 15 holes

Diameter 150 mm, Mirka Gold, 15 perforated holes

Item no.	Graining
4615-010-0	100
4615-012-0	120
4615-015-0	150
4615-018-0	180
4615-022-0	220
4615-024-0	240
4615-032-0	320
4615-040	40
4615-040-0	400
4615-050-0	500
4615-060	60
4615-080	80

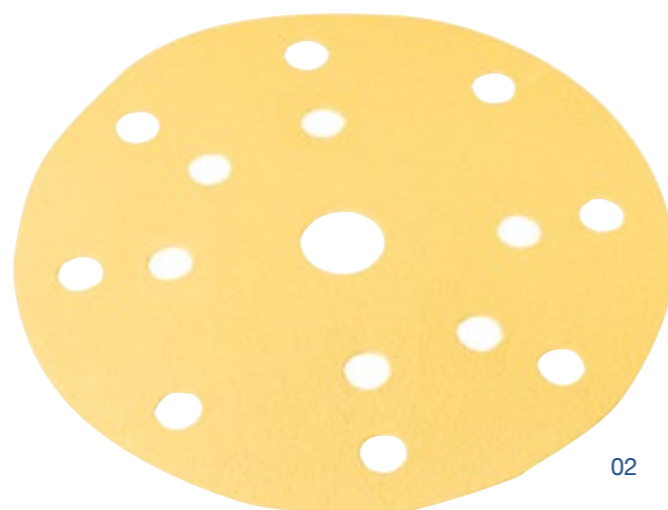

03

3in1 hook-and-loop polishing disks

▶ Item no. 4666-075-150

- ▶ Product description
- Consists of three different-sized hook-and-loop disks: 75mm, 120mm and 145 mm
 - No more resetting of hook-and-loop holder disks to different sizes
 - Suitable for all of our polishing sponges and sheepskins
 - Provides high flexibility
 - Has an M14 machine retainer



04

Polish Flex angle polisher

With powerful 1,400 Watt motor

▶ Item no. 8697-114-12

- ▶ Product description
- Max. polishing pad diameter: 200 mm
 - Max. supporting disk Ø: 150 mm
 - Idling speed: 380-2100 /min
 - Power consumption: 1,400 W
 - Power output: 880 Watt
 - Tool retainer: M 14
 - Dimensions (L x H): 402x117 mm
 - Weight: 2.3 kg

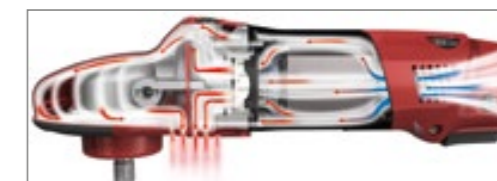

- A handle is included in the package
- The associated replacement carbon brushes are available under article number 8697-114-120

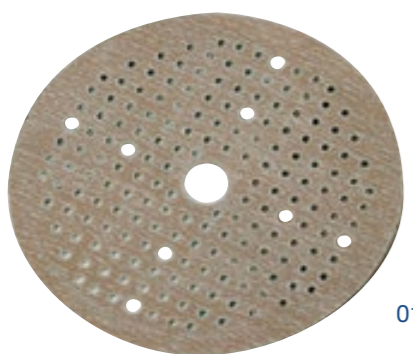

01

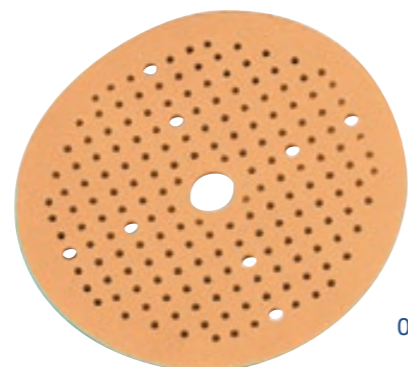

02

01
Velcro discs
 Diameter 150 mm Norton Multi-Air
 181 perforated holes Norgrip

02
Velcro discs
 ø 150 mm – Norton Multi-Air
 perforated 181-fold – Soft

Item no.	Graining
4651-080	80
4651-012-0	120
4651-015-0	150
4651-018-0	180
4651-022-0	220
4651-024-0	240
4651-032-0	320
4651-036-0	360
4651-040-0	400
4651-050-0	500
4651-060-0	600
4651-080-0	800

Item no.	Graining
4651-320	320
4651-400	400
4651-500	500
4651-800	800
4651-100-0	1000
4651-150-0	1500



03



04

04
Sanding discs-Velcro Multi
 Diameter 150 mm, medium

▶ Art. no.: 4666-150-69

▶ Product description
 Technical data:
 Thread 5/16"

- Sanding disc series E with dust extraction
- Extraction will all common hole patterns
- Contact surface for Velcro-type systems or self-adhesive sandpaper
- Micro Velcro type fastening

03
Sanding Disc Velcro Norton Multi-Air
 Ø 150 mm

- ▶ Item no. 4666-150-3
- ▶ medium
- ▶ Item no. 4666-150-4
- ▶ soft



For the surface structuring of paints, fillers, coating varnishes, clear varnishes, plastics and composite plastics.

Self-cleaning
 Water and air are set in motion by applying pressure to the Abralon disc.
 Thus circulating the grinding material.
 This results in the grinding debris and dust being transported into the foam underlay.

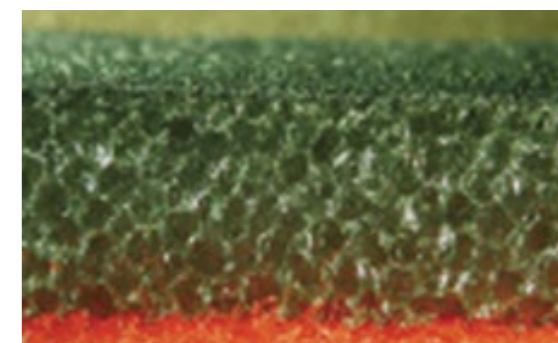

Item no.	Discs Ø	Graining
4587-360	150	360
4587-500	150	500
4587-600	150	600
4587-100-0	150	1000
4587-200-0	150	2000
4587-300-0	150	3000
4587-400-0	150	4000

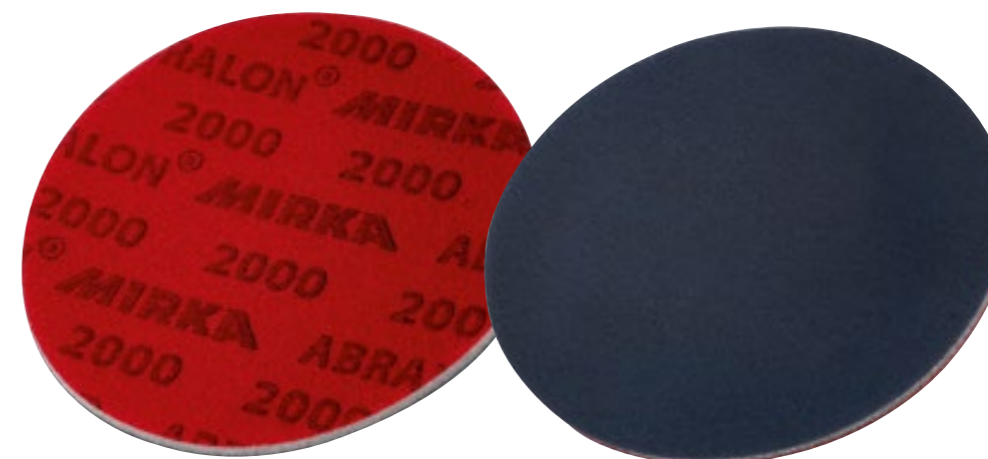

01

Vibrating grinding paper

Strips 115 x 280 mm,
yellow, perforated 10-fold

Item no.	Graining
4676-040	40
4676-060	60
4676-080	80
4676-010-0	100
4676-012-0	120
4676-018-0	180
4676-024-0	240



02

Vibrating grinding paper

Rolls each 50 m, width 115 mm,
yellow, non-perforated

Item no.	Graining
4677-040	40
4677-060	60
4677-080	80
4677-010-0	100
4677-012-0	120
4677-015-0	150
4677-018-0	180
4677-024-0	240



03

Vibrating grinding paper

Strips 115 x 280 mm,
yellow, non-perforated

Item no.	Graining
4676-40	40
4676-60	60
4676-80	80
4676-100	100
4676-120	120
4676-150	150
4676-180	180



04

Sanding block

For sanding strips

► Art. no.: 4652-70-400

► Product description

- Ergonomically designed to reduce fatigue and physical stress
- The moulded plastic body ensures high resistance and longevity
- With valve for regulating the suction power and optimising the air/dust extraction



05

Sanding strips

70 mm x 420 mm

► Product description

- For the quick stripping of old paint, sanding of body filler and removal of sharp edges and rough surfaces
- Excellent grain adhesion
- Long service life
- Flexible and robust

Item no.	Graining	Figure
4652-60	60	1
4652-80	80	2
4652-120	120	3



01

Sandpaper 3M 312

Sheet 230 x 280 mm
waterproof

Item no.	Graining
4685-240	240
4685-280	280
4685-320	320
4685-400	400
4685-500	500
4685-600	600
4685-800	800
4685-100-0	1000
4685-120-0	1200
4685-150-0	1500
4685-200-0	2000



01

02

Sandpaper

Sheet 230 x 280 mm
waterproof

Item no.	Graining
4673-80	80
4673-120	120
4673-180	180
4673-240	240
4673-320	320
4673-360	360
4673-400	400
4673-600	600
4673-800	800
4673-100-0	1000
4673-120-0	1200



02

03

Emery cloth, brown

25 m x 40 mm

Item no.	Graining
4674-40-40	40
4674-40-60	60
4674-40-80	80
4674-40-100	100
4674-40-120	120

50 m x 50 mm

Item no.	Graining
4674-50-40	40
4674-50-60	60
4674-50-80	80
4674-50-100	100
4674-50-120	120
4674-50-180	180



03

04

Sand cloths

blue, sheet 230 x 280 mm

Item no.	Graining
4671-40	40
4671-60	60
4671-80	80
4671-120	120
4671-180	180

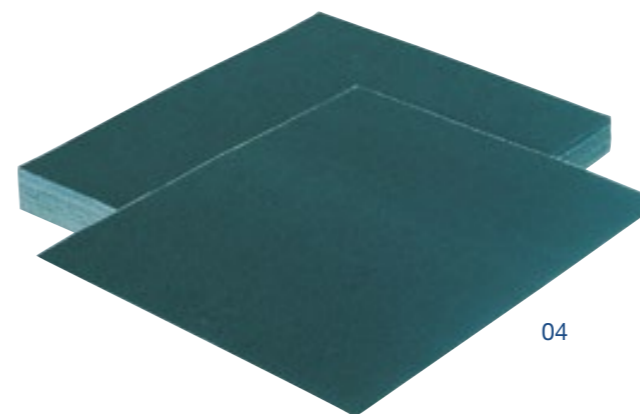

04

05

Abrasive fleece holder

empty

► Art. no.: 7100-002-07



05

01

Abrasive fleece

very fine, red

Item no.	Model	Figure
4585-451-10	Roll 115 mm x 10 m	1
4585-451	Pads 152 mm x 229 mm	2



01 / 1



01 / 2

02

Abrasive fleece

ultra fine, grey

Item no.	Model	Figure
4585-455-10	Roll 115 mm x 10 m	1
4585-455	Pads 152 mm x 229 mm	2



02 / 1



02 / 2

03

Soft abrasive paper roll

115 mm x 20 m

Item no.	Graining	Item no.	Graining
4586-150	150	4586-320	320
4586-180	180	4586-400	400
4586-220	220	4586-500	500
4586-240	240	4586-600	600
4586-280	280	4586-800	800



03

04

Carbon sanding block

- ▶ Item no. 4675-001-500
- ▶ 1,500 grit, yellow
- ▶ Item no. 4675-002-000
- ▶ 2,000 grit, green
- ▶ Item no. 4675-003-000
- ▶ 3,000 grit, red

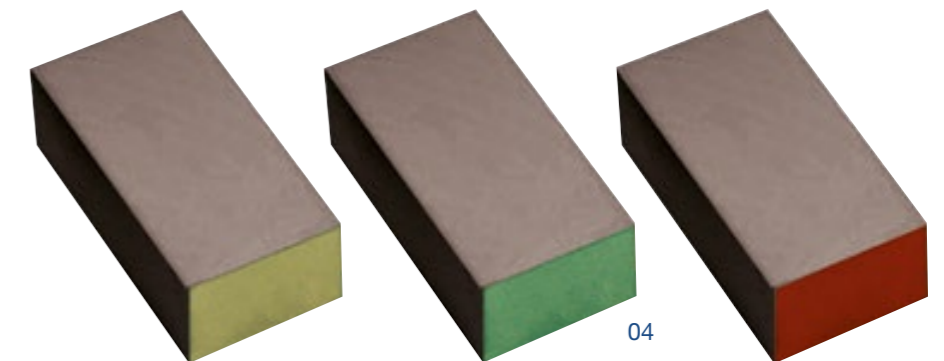

04

- ▶ Product description
- For removing scratches levelling unevenness



01

Thermo-tape 110 – brown

Rolls each 50 m

▶ Product description

Heat resistance

120°C > 30 minutes

100°C > 1 hour

- does not leave behind any adhesive residue on the vehicle body
- perfectly suitable for wet grinding work
- adhesive power works immediately
- resistant to solvents



01

Item no.	Tape width
4993-119	18 mm
4993-125	24 mm
4993-130	30 mm
4993-138	36 mm
4993-150	48 mm

02

Thermo-tape 80 – white

Rolls each 50 m

▶ Product description

Heat resistance

100°C > 30 minutes

80°C > 1 hour

- does not leave behind any adhesive residue on the vehicle body
- perfectly suitable for wet grinding work
- adhesive power works immediately
- resistant to solvents



02

Item no.	Tape width
4993-519	19 mm
4993-525	25 mm
4993-530	30 mm
4993-538	38 mm
4993-550	50 mm

03

Contour tape

Rolls each 50 m

▶ Art. no.: 4585-12

▶ Product description

- for masking doors prior to painting
- leaves no residue
- weatherproof
- heat resistant approx. 120°C for 1 hour
- designed to suit every shape
- no creases and wrinkles
- Width: 19 mm
- Length: 50 m
- Colour: yellow

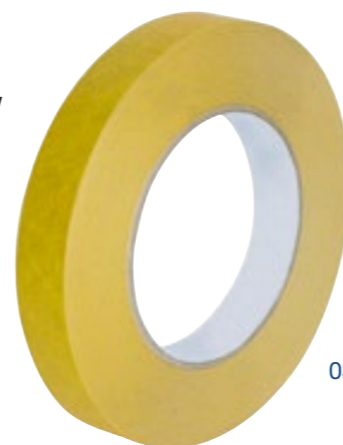

03

05

Foam Plus foam profile

self-adhesive

Item no.	Model
4582-13	50 m with 13 mm
4582-17	17 mm per 40 m



05

04

Contour tape

Rolls each 33 m

▶ Art. no.: 4585-11

▶ Product description

- Ideal for sticking down curves
- Particularly flexible
- Thermally stable to 70°C for one hour
- Solvent-proof and waterproof
- No edge warping when sticking curves
- Width: 6 mm
- Length: 33 m
- Colour: blue



04

06

Stego tape

self-adhesive

Item no.	Insertion depth
4682-009	9 mm 10 m
4682-018	18 mm 10 m
4682-025	25 mm 10 m
4682-1	Abroller



06

01

Masking paper

40 g/m², fully glued, length 450 m

▶ **Product description**

- Guaranteed length
- Good surface density and low air permeability (approx. 70 ml/min)
- DIN-tested quality
- Smooth on one side
- Fully glued

Item no.	Model
7875-450-20	20 cm
7875-450-60	60 cm
7875-450-90	90 cm
7875-450-120	120 cm



01

02

Protective cap for paintwork

25 pcs.to tear off

- ▶ Item no. 7875-912
- ▶ 630 x 400 cm



02

03

Rim-varnish protective film

30 tear-off sheets

- ▶ Item no. 7875-918
- ▶ 130 cm x 130 cm

▶ **Product description**

- Original Wondermask® WPS
- Excellent protection from varnish haze
- Save significant time and work
- Save cover tape and cover paper
- Highly-flexible polyethylene mix, free of heavy metals
- Tear-resistant, lint-free, waterproof and microsealed
- No touching-up required
- Colour: Blue



03

04

Paint protective film

- ▶ Item no. 7875-917
- ▶ 4 x 200 m

▶ **Product description**

- Tensile strength lengthwise 24 N/mm²
- Tensile strength crosswise 17 N/mm²
- Exceptional paint adhesion
- Highly flexible and tear resistant
- Electrostatic charge attracts dust and dirt
- Microporous film, therefore 100% impervious to paint and water
- 15µ thick
- Very good cutting behaviour



04

05

Painting knife

For cutting masking film and masking paper

- ▶ Art. no.: 7875-917-1



05

06

Paint protective film

9 µm

- ▶ Item no. 7875-915
- ▶ 4 m x 300 mm

▶ **Product description**

- Statically charged
- Paint absorbent
- Overpaintable



06

01

Protective overall for paintwork

- ▶ Item no. 4899-500-3
- ▶ 52/54 L

- ▶ Item no. 4899-500-4
- ▶ 56/58 XL

- ▶ Item no. 4899-500-5
- ▶ 60/62 XXL

- ▶ Product description
- Certified to type 5 (particle-proof protective clothing) and type 6 (limited spray-proof protective clothing)
- Protects against electrostatic charges in accordance with EN 1149-1
- Tyvek overall



01



02

Paint spraying set

In a plastic storage box

- ▶ Art. no.: 7200-002-000

- ▶ Product description
- content:
- 1 x reusable half mask
- 2 x gas filter class A2 against organic gases and vapours (art. no. 7315-000-100)
- 2 x pre-filter casing cover
- 20 x spray paint pre-filter (art. no. 7415-000-100)
- 1 x reusable plastic storage box



02

03

Fine dust filter mask

FFP3, with exhalation valve

- ▶ Art. no.: 7915-000-300

- ▶ Product description
- Standard EN 149:2001
- For use against solid and liquid aerosols
- Adjustable straps
- With exhalation valve
- With sealing lip
- Protection level FFP3
- Protection 30 times that of MAK value



03

04

Fine dust filter mask

FFP2, with exhalation valve

- ▶ Art. no.: 4899-12

- ▶ Product description
- Standard EN 149:2001
- Protection against fine dust, hazardous materials and carcinogenic dust
- With exhalation valve
- Protection level FFP2
- Protection 10 times that of MAK value



04

05

Fine dust filter mask

FFP1, without exhalation valve

- ▶ Art. no.: 4899-11

- ▶ Product description
- Standard EN 149:2001
- Protection against fine dust and non-toxic coarse particles
- Without exhalation valve
- Protection level FFP1
- Protection 30 times that of MAK value



05



01
Paint mixing cup

Item no.	Model
2891-603	325 ml, cup
2891-603-9	Cover for 350 ml cup
2891-607	600 ml, cup
2891-607-9	Cover for 600 ml cup
2891-614	1150 ml, cup
2891-614-9	Cover for 1150 ml cup
2891-623-0	2,300 ml cup
2891-623-9	Cover for 2000 ml cup



01

02
Dust bonding cloth
Standard

Item no.	Dimensions	Sales unit
2893-165	45 x 75 cm	5 cloths



02

03
Quick filter screen

Item no.	Dimensions
2893-163	190 µm ultra fine
2893-162	280 µm fine
2893-161	125 µm ultra fine



03

04
Dust bonding cloth
especially for water-based paints

Item no.	Dimensions	Sales unit
2893-166	38 x 43 cm	12 wipes



04

01

Mini random orbital sander

30 mm

- ▶ Item no. 8696-1-81
- ▶ Item no. 8699-520-14
- ▶ Required compressed-air supply
- ▶ Product description
 - No-load speed: 16,000 rpm
 - Pad diameter: 50 mm Velcro-type model
 - Stroke: 3.0 mm
 - Weight: 0.7 kg
 - Air pressure: 6.3 bar
 - Air fitting: 1/4"
 - Sound pressure: 80,4 dB/A
 - Velcro-type pad: Incl. diameter 30 mm (4679-81-30), incl. diameter 75 mm (4679-81-75)



02

Fineloc

With Velcro-type back

- For sanding scratches and varnish runs



Holder for mini sanding disks with hook & loop back

Diameter 30 mm

4679-90-91

Diameter 30 mm

4679-31-150 1.500

4679-31-200 2.000

Diameter 75 mm

4679-33-150 1.500

4679-33-200 2.000



03

Mini one-hand right angle grinder

Low-noise and vibration-free

- ▶ Art. no.: 8696-1-80
- ▶ Product description
 - Compressed air fitting: 1/4"
 - Sound pressure: 83 dB/A
 - Air pressure: 6.3 bar
 - Weight: 0.8 kg
 - Speed: 18,000 rpm
 - Chuck: 6 mm
 - Average air consumption: 220 l/min



04

Required air connection 1/4"

- ▶ Art. no.: 8699-510-14



05

Adapter for 8696-1-80

- ▶ Art. no.: 4679-99-8



06

Normloc reception system

Made from a hard polyurethane supporting disc

- ▶ Item no. 4679-90-94
- ▶ Diameter 30 mm, max. rpm: 40,000
- ▶ Item no. 4679-90-92
- ▶ Diameter 50 mm, max. rpm: 30,000
- ▶ Item no. 4679-90-93
- ▶ Diameter 75 mm, max. rpm: 20,000
- ▶ Item no. 4679-99-6
- ▶ Ø 6 mm incl. mounting shank



07

Lambswool cover, diameter 75 mm

POLISHLOC

- ▶ Art. no.: 4679-43



08

Velcro attachment

- ▶ Item no. 4679-91-93
- ▶ Ø 75 mm



01
Soft polishing sponge
black

- ▶ Item no. 2000-207-150
- ▶ Diameter 150 mm, height: 30 mm PU: 2

- ▶ Item no. 2000-207-175
- ▶ Diameter 75 mm, height: 25 mm PU: 4

- ▶ **Product description**
- Perfect for applying fine polishing pastes and surface sealants
- Suitable for removing holograms



01

02
Medium polishing sponge
orange

- ▶ Item no. 2000-206-150
- ▶ Diameter 150 mm, height: 30 mm PU: 2

- ▶ Item no. 2000-206-175
- ▶ Diameter 75 mm, height: 25 mm PU: 4

- ▶ **Product description**
- Medium-hard polishing sponge
- Perfect for treating used and weathered paintwork
- Suitable for use with grinding and polishing pastes
- Polish and seal in one step



02

03
Hard polishing sponge
yellow

- ▶ Item no. 2000-205-150
- ▶ Diameter 150 mm, height: 30 mm PU: 2

- ▶ Item no. 2000-205-175
- ▶ Diameter 75 mm, height: 25 mm PU: 4

- ▶ **Product description**
- High intake capacity for abrasive pastes
- Perfect for removing heavy scratches



03

05
Lambskin
white

- ▶ Item no. 2000-204-150
- ▶ Diam. 150 mm PU: 2

- ▶ Item no. 2000-204-175
- ▶ Diam. 75 mm PU: 4

- ▶ **Product description**
- With integrated interface pad
- Extremely aggressive abrasive medium
- High intake capacity for abrasive pastes
- Perfect for removing heavy scratches, orange peel effect and dust inclusions



05

06
Velcro disc

- ▶ Item no. 4666-150-1
- ▶ Ø 150 mm

- ▶ Item no. 4666-075-1
- ▶ Ø 75 mm

- ▶ **Product description**
- With Velcro-type attachment for polishing sponges
- M14 mounting thread



06

07
Application sponge
black

- ▶ Item no. 2000-209-130
- ▶ Ø 130 mm

- ▶ **Product description**
- Ergonomic handle for easy and safe use with:
- Speed-Wax wax sealant (art. no. 2000-330-1)
- Speed Gloss Nano rapid sealant (art. no. 2000-316)



07

04
Stripe removal disc
Plastic eraser
Ø 100 mm, width 15 mm
reception M10

- ▶ Item no. 4585-100-2
- ▶ With shaft for drill attachment



04

08
Decal remover ECO
Plastic eraser, diameter 88 mm,
width 15 mm, adaptor approx. 30 mm

- ▶ Item no. 4585-100-0

- ▶ Item no. 4585-100-3
- ▶ Drill adaptor for rubber disc



08

Vehicle parts passenger cars



01

ABA hose clamps

► Product description

- 50% greater tensile load compared to standard worm-drive hose clamps
- Weld- and rivet-free casing made from one piece
- Embossed band with high edges prevents damage to the hose wall
- Short casing saddle guarantees optimal positive locking
- Hexagon socket screw with slot



01

Item no.	Clamping range	Item no.	Clamping range
5538-008-012	8 - 12 mm	5538-020-032	20 - 32 mm
5538-010-016	10 - 16 mm	5538-025-040	25 - 40 mm
5538-012-020	12 - 20 mm	5538-032-050	32 - 50 mm
5538-016-025	16 - 25 mm		

02

Worm drive hose clamps

► Product description

- Tape and casing: stainless steel 1.4016
- Screw: steel, galvanised, bandwidth 9 mm,
- Wrench size 7 mm



02

Item no.	Clamping range	Item no.	Clamping range
5539-008-16	8 - 16 mm	5539-080-100	80 - 100 mm
5539-012-20	12 - 22 mm	5539-090-110	90 - 110 mm
5539-016-25	16 - 27 mm	5539-100-120	100 - 120 mm
5539-020-32	20 - 32 mm	5539-110-130	110 - 130 mm
5539-025-40	25 - 40 mm	5539-120-140	120 - 140 mm
5539-032-50	32 - 50 mm	5539-160-180	160 - 180 mm
5539-040-60	40 - 60 mm	5539-140-160	140 - 160 mm
5539-050-70	50 - 70 mm	5539-130-150	130 - 150 mm
5539-060-80	60 - 80 mm	5539-150-170	150 - 170 mm
5539-070-90	70 - 90 mm		

03

Hose clamps with worm drive and ondular washer

With integrated spring insert, entirely made from special steel, band width 12mm

► Product description

- Hex drive screw Spanner width 7 mm with slot
- Evens out fluctuating diameters
- Self-activating tensioning effect when hose relaxes
- Increased sealing reliability over wide temperature range



03

Item no.	Clamping range	Item no.	Clamping range
5539-216-27	16 - 27 mm	5539-235-50	35 - 50 mm
5539-220-32	20 - 32 mm	5539-240-60	40 - 60 mm
5539-225-40	25 - 40 mm	5539-250-70	50 - 70 mm
5539-230-45	30 - 45 mm	5539-260-80	60 - 80 mm

04

Breeze hose clamps

► Product description

- Band and casing: Special steel A2
- Screw: steel, galvanised, slotted hexagon screw
- Screw flight, bandwidth 14.3 mm
- Wrench size 8 mm



04

Item no.	Clamping range	Item no.	Clamping range
5547-11-20	10 - 20 mm	5547-60-80	60 - 80 mm
5547-16-25	16 - 25 mm	5547-70-90	70 - 90 mm
5547-20-32	20 - 32 mm	5547-80-100	80 - 100 mm
5547-25-40	25 - 40 mm	5547-90-110	90 - 110 mm
5547-32-50	35 - 50 mm	5547-100-120	100 - 120 mm
5547-40-60	40 - 60 mm	5547-110-130	110 - 130 mm
5547-50-70	50 - 70 mm	5547-120-140	120 - 140 mm

01

Single ear clamp

With rustproof insert ring



Item no.	Ø range	Band
5541-070	5,6 - 6,5 mm	6,4 mm
5541-087	7,0 - 8,2 mm	6,4 mm
5541-095	7,5 - 9,0 mm	7,4 mm
5541-010-5	8,5 - 10,0 mm	7, mm
5541-011-3	9,1 - 10,8 mm	7,4 mm
5541-012-3	9,8 - 11,8 mm	7,4 mm
5541-012-8	10,3 - 12,3 mm	7,4 mm
5541-013-3	10,6 - 12,6 mm	8,2 mm

Item no.	Ø range	Band
5541-013-8	11,1 - 13,1 mm	8,2 mm
5541-014-5	11,8 - 13,8 mm	8,2 mm
5541-015-0	12,3 - 14,3 mm	8,2 mm
5541-015-5	12,8 - 14,8 mm	8,2 mm
5541-016-0	13,1 - 15,3 mm	8,2 mm
5541-016-8	13,9 - 16,1 mm	8,2 mm
5541-017-5	14,6 - 16,8 mm	8,2 mm

02

Norma hose clamps with clamping jaw

All parts fully steel galvanised



Item no.	Ø range	Band
5540-6-7	6 mm	7 mm
5540-8-7	8 mm	7 mm
5540-10-9	10 mm	9 mm
5540-11-9	11 mm	9 mm
5540-12-9	12 mm	9 mm
5540-13-9	13 mm	9 mm
5540-14-9	14 mm	9 mm
5540-15-9	15 mm	9 mm

Item no.	Ø range	Band
5540-16-9	16 mm	9 mm
5540-18-9	18 mm	9 mm
5540-20-9	20 mm	9 mm
5540-22-9	22 mm	9 mm
5540-18-12	18 mm	12 mm
5540-19-12	19 mm	12 mm
5540-25-15	25 mm	15 mm

03

Hose-clamp display

► Item no. 5539-077-777

► Product description

- Tape and casing: stainless steel
- Screw: steel, galvanised
- Bandwidth 9 mm
- Wrench size 7 mm



Item no.	Model	Quantity
5539-008-16	8 - 16 mm	20 x
5539-012-20	12 - 22 mm	20 x
5539-016-25	16 - 27 mm	10 x
5539-020-32	20 - 32 mm	10 x
5539-025-40	25 - 40 mm	10 x
5539-032-50	32 - 50 mm	10 x
5539-040-60	40 - 60 mm	10 x
5539-050-70	50 - 70 mm	10 x
5539-060-80	60 - 80 mm	10 x
5539-070-90	70 - 90 mm	10 x
5539-85	Hazet hexagon screwdriver	1 x
7100-000-1	Die plate, 500 x 450 mm	1 x
7100-000-3	Tool holder tilted 150 mm	12 x
7100-000-5	Self-adhesive labelling bar, 430 mm	2 x
7100-000-305	Universal gripper clamp 19 mm	1 x
Mounting material, screws and dowel pins		

04

Mini hose clamp

Bandwidth 5 mm, pre-assembled

Item no.	Clamping range
5541-7-11	7 - 11 mm
5541-9-16	9 - 14 mm
5541-10-19	10 - 19 mm



01

Clic-R brackets

rustproof chrome nickel steel

► **Product description**

- Suitable for fuel, cooling-, oil- and ventilation-circuits, shaft sleeve collars, LPG installation, all rubber and silicone hoses and shipping

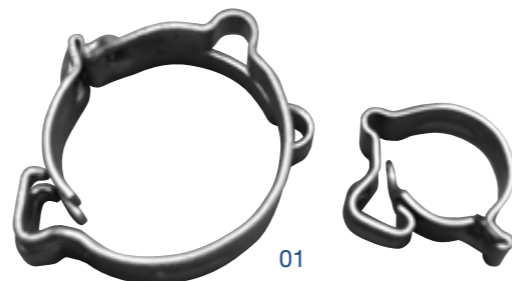

Item no.	Closed Ø	Ø range	Band width	Colour
5537-066-70	7,0 mm	7,5 - 9,0 mm	6 mm	black
5537-066-90	9,0 mm	9,5 - 11,0 mm	6 mm	purple
5537-066-105	10,5 mm	11,0 - 12,5 mm	6 mm	yellow
5537-086-115	11,5 mm	12,0 - 13,5 mm	8 mm	purple
5537-086-120	12,0 mm	12,5 - 14,0 mm	8 mm	black
5537-086-125	12,5 mm	13,0 - 14,5 mm	8 mm	white
5537-086-130	13,0 mm	13,5 - 15,0 mm	8 mm	yellow
5537-086-140	14,0 mm	14,5 - 16,0 mm	8 mm	purple
5537-086-150	15,0 mm	15,5 - 17,0 mm	8 mm	white
5537-086-160	16,0 mm	16,0 - 18,0 mm	8 mm	green
5537-086-165	16,5 mm	17,0 - 19,0 mm	8 mm	purple
5537-086-185	18,5 mm	19,0 - 21,0 mm	8 mm	green

02

Crimping tool straight

For Clic-R brackets

► **Item no. 5537-1-75**



03

Crimping tool curved

For Clic-R brackets

► **Item no. 5537-2-75**



04

Universal U-bolt clamp

Item no.	Ø in mm
5883-6	42
5883-7	45
5883-8	48
5883-85	50
5883-9	52
5883-11	58
5883-12	60



05

Audi pipe clamp

Complete with screw, nut and lock washer

Item no.	Ø in mm
5883-080	45,5
5883-082	42,5
5883-084	53,5
5883-086-2	46,7
5883-086-3	48,5
5883-086-5	51,5
5883-086-7	54,5



06

Ford pipe clamp

M10, copper-plated lock nut, fully installed

Item no.	Ø in mm	Item no.	Ø in mm
5883-043	43	5883-055	55
5883-045	45	5883-058	58
5883-048	48	5883-060	60
5883-050	50	5883-062	62
5883-051	51	5883-064	64
5883-053	53		



01

Pipe support clamps

► **Product description**

- Full galvanized steel
- RSGU
- Rubberized



Item no.	Pipe diameter	Band	Hole Ø
5542-6-12	6 mm	12 mm	5,3 mm
5542-6-15	6 mm	15 mm	6,4 mm
5542-8-12	8 mm	12 mm	5,3 mm
5542-8-15	8 mm	15 mm	6,4 mm
5542-8-20	8 mm	20 mm	8,4 mm
5542-9-12	9 mm	12 mm	5,3 mm
5542-10-12	10 mm	12 mm	5,3 mm
5542-10-15	10 mm	15 mm	6,4 mm
5542-12-12	12 mm	12 mm	5,3 mm
5542-12-15	12 mm	15 mm	6,4 mm
5542-15-12	15 mm	12 mm	5,3 mm
5542-15-15	15 mm	15 mm	6,4 mm
5542-15-20	15 mm	20 mm	8,4 mm
5542-18-15	18 mm	15 mm	6,4 mm
5542-20-15	20 mm	15 mm	6,4 mm
5542-20-20	20 mm	20 mm	8,4 mm
5542-25-12	25 mm	12 mm	5,3 mm
5542-25-15	25 mm	15 mm	6,4 mm
5542-25-20	25 mm	20 mm	8,4 mm
5542-30-15	30 mm	15 mm	6,4 mm
5542-30-20	30 mm	20 mm	8,4 mm
5542-35-15	35 mm	15 mm	6,4 mm
5542-40-20	40 mm	20 mm	8,4 mm
5542-50-15	50 mm	15 mm	6,4 mm

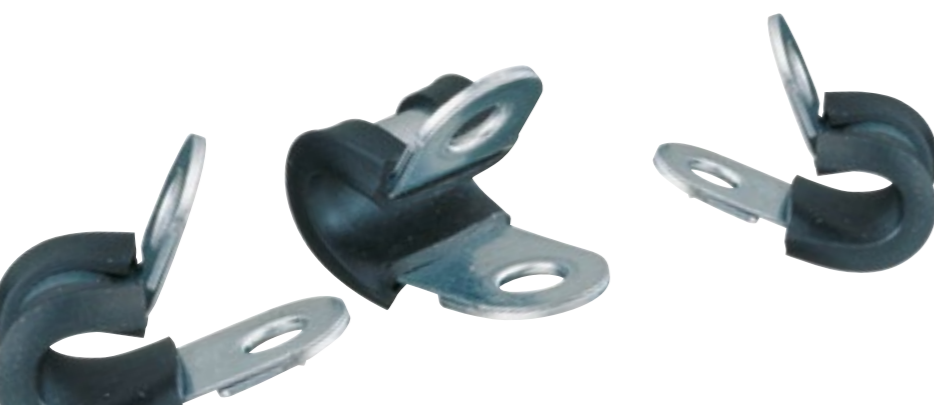

02

Fuel hose

Yarn braided



Item no.	Internal diameter	Wall thickness	Length
5895-145	4,5 mm	2,50 mm	15 m
5895-155	5,5 mm	2,50 mm	15 m
5895-170	7,0 mm	2,50 mm	15 m
5895-190	9,0 mm	2,50 mm	10 m
5895-095-151	9,5 mm	2,75 mm	10 m

04

Fuel hose

Compressor hose
PVC with fabric, transparent



Item no.	Internal diameter	Wall thickness	Length
5895-45-80	4,0 mm	3 mm	15 m

03

Vacuum hose

Temperature resistant up to +110°C



Item no.	Internal diameter	Wall thickness	Length
5895-355	5,5 mm	3,0 mm	20 m
5895-370	7,0 mm	3,0 mm	10 m
5895-375	7,5 mm	3,0 mm	10 m
5895-393	9,3 mm	3,0 mm	10 m

05

Fuel hose

Yarn braided, temperature range -40°C to +110°C,
suitable for biodiesel and biopetroleum, operating
pressure 10 bar



Item no.	Internal diameter	Wall thickness	Length
5895-205	3,0 mm	7,5 mm	10 m
5895-206	3,5 mm	7,5 mm	10 m

06

Universal petrol filter

KL 13

- Item no.5895-000-145
- PU: 25





01 Exhaust pipe repair paste
Asbestos-free

- ▶ Item no.2893-148
- ▶ Contents: 150 g
- ▶ Packing unit: 12

- ▶ Product description
- Quick drying
- Highly viscous
- Asbestos-free



01

02

02 Exhaust repair paste
Asbestos-free

- ▶ Item no.2893-149-1
- ▶ Contents: 150 g
- ▶ Packing unit: 12

- ▶ Product description
- Quick drying
- Highly viscous
- Asbestos-free
- For sealing junctions

03 Slotted round nuts
Thermag, DIN 14440,
normal width across flats



03

Item no.	Thread	Width across flats
6365-2	M8	13
6365-3	M10	17
6365-4	M12	19

04 Slotted round nuts
Thermag, DIN 14441,
reduced width across flats



04

Item no.	Thread	Width across flats
6366-1	M6	9
6366-2	M8	12
6366-3	M10	14
6366-7	M10 x 1,25	14
6366-8	M8 X 1	12

05 Exhaust pipe nuts
With flange 17 mm
Quality 8, copper-plated
Opel no. 8-54-906
Height 10 mm



05

Item no.	Thread	Width across flats
6365-6	M8	13 mm

06 Exhaust pipe nuts
With flange 21 mm
Self-locking
Quality 8, copper-plated
Opel no. 8-54-976
Height 10 mm



06

Item no.	Thread	Width across flats
6365-65	M10	15 mm

07 Exhaust pipe nuts
With flange 17 mm
Self-locking
Quality 8, copper-plated
Opel no. 20-66-156
Height 8 mm



07

Item no.	Thread	Width across flats
6365-61	M8	13 mm

08 Exhaust pipe nuts
With flange 17 mm
Quality 8, copper-plated
BMW no. 1162-1711-954
Height 8.6 mm



08

Item no.	Thread	Width across flats
6365-8	M8	12 mm



01

01
Wheel nuts Ford
OE no. 1007487, 6040307, 1447852
M12 x 1.5 galvanised
Quality 8 Wrench size 19

► Item no. 6395-12-15

OE no. 1470843
M12 x 1.5 galvanised
Quality 10, Wrench size 19

► Item no. 6395-12-151



02

02
Wheel nuts Mazda
Mazda, Mitsubishi, Toyota
OE no. Mazda 0603-26-161
OE no. Mitsubishi MA103087
OE no. Toyota 90942-01001-83
M12 x 1.5 yellow passivated
Quality 8 Wrench size 21

► Item no. 6395-012-15



05

05
Threaded inserts

Item no.	Internal thread model	External thread model
5660-3	M3 x 0,5	5,0 x 0,5
5660-4	M4 x 0,7	6,5 x 0,75
5660-5	M5 x 0,8	8,0 x 1,0
5660-6	M6 x 1,0	10,0 x 1,5
5660-8	M8 x 1,25	12,0 x 1,5
5660-10	M10 x 1,5	14,0 x 1,5
5660-12	M12 x 1,75	16,0 x 1,5
5660-14	M14 x 2,0	18,0 x 1,5



06

06
Inserting tool for manual assembly

Item no.	Internal thread model	External thread model
5660-103	M3 x 0,5	5,0 x 0,5
5660-104	M4 x 0,7	6,5 x 0,75
5660-105	M5 x 0,8	8,0 x 1
5660-106	M6 x 1,0	10,0 x 1,5
5660-108	M8 x 1,25	12,0 x 1,5
5660-110	M10 x 1,5	14,0 x 1,5
5660-112	M12 x 1,75	16,0 x 1,5
5660-114	M14 x 2,0	18 x 1,5



03

03
Wheel bolts Renault
Renault OE no. 8200030701 M12 x 1.5 x 23 blue galvanised FK 10.9 Wrench size 19

► Item no. 6395-512-15



04

04
Wheel bolts Audi / VW
Volkswagen / Audi OE-no. 8D0 601 139 D M14 x 1.5 x 25.5 Geomet black FK 8.8 Wrench size 17

► Item no. 6395-214-15



07

07
Spark plug inserts

Item no.	Model
5660-014	M14,1.25 / 9
5660-014-1	M14,1.25 / 15
5660-018	M18,1.50 / 9



08

08
Inserting tool for manual assembly

Item no.	Model
5660-114-1	M14 x 1.25
5660-118-1	M18 x 1.50



02

Drive shaft joint grease

Greasor

- ▶ Item no.5884-950
- ▶ Contents: 90 ml
- ▶ Packing unit: 1

▶ **Product description**

- High quality lithium soap grease with MoS2 as solid lubricant
- Specially designed for highly loaded constant velocity joints and is ideal for greasing and lubricating slip and fixed joints as well as ball bearings.



02

01

Universal joint gaiters Set

suitable for nearly every passenger car

Item no.	Ø in mm
5884-900	95
5884-901	105



01

03

Clamp for axel boot

Item no.	Ø in mm
5550-884-31	27,6 - 30,8
5550-884-33	29,9 - 33,1
5550-884-35	31,4 - 34,6
5550-884-88	84,3 - 87,5
5550-884-97	93,3 - 96,5



03

04

Steel cable ties

Item no.	Band	Length
5884-909	6,0 mm	380 mm



04

05

Steel cable ties

Item no.	Band	Length
5550-46-127	4,6 mm	127 mm
5550-46-201	4,6 mm	201 mm
5550-46-360	4,6 mm	360 mm
5550-79-201	7,9 mm	201 mm
5550-79-362	7,9 mm	362 mm



05



01
License plate screw
Plastic PA 6.6



Item no.	Colour	Model
6210-078	white	6 x 20 mm

06
Rubber gaskets



Item no.	Model
6422-65-17	6.5 x 17 x 2 mm
6422-65-20	6.5 x 20 x 3 mm

07
Plastic distance washers



Item no.	Model
6421-06-18	18 x 7 x 6 mm

02
License plate screw
Head: V shaped,
galvanised steel



Item no.	Model	Figure
6210-41	5 x 15 mm	02 / 2
6210-42	5 x 20 mm	02 / 2
6210-46	6 x 20 mm	02 / 2
6246-6-20	6 x 20 mm	02 / 1

03
License plate screw
Plastic PA 6.6,
completely assembled



Item no.	Colour	Model
6210-78	white	6 x 20 mm

08
Sheet metal screw with gripping groove for decorative caps
for the attachment of license plates,
thread according to DIN 7971,
steel, quality 4.8,
brightly galvanised



► Item no. 6103

09
License plate screw
with drill bit
drill and screw in one step
high level of corrosion
prevention



► 6211-0

04
Decorative caps
For 6210, 6246



Item no.	Colour
6590-132-2	white
6590-132-3	black

05
Decorative caps
for item no. 6103-

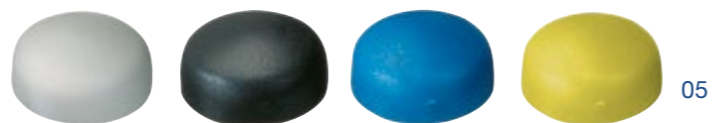

Item no.	Colour
6590-103	white
6590-10-6	black
6590-109	blue
6590-100	yellow

10
License plate screw
Opel, fixed grommet,
galvanised



► Item no. 6103-0

11
license plate screw A2
high-grade steel, DIN 7981



► Item no. 6119

01

Brake line

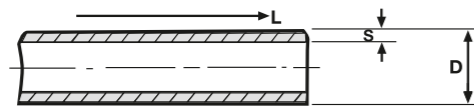

Item no.	Model	D	S	Length (L)
5885-090	Copper/Nickel alloy	4,75 mm	0,71 mm	5 m
5885-091	Copper/Nickel alloy	6,00 mm	0,71 mm	10 m

02

Brake line extension

Steel



Item no.	d1	d2	s x tl	Figure
5885-200	M10 x 1, Konus	Ø 3.5	14 x 24,0	02 / 2
5885-201	M12 x 1	Ø 4.0	17 x 29,0	02 / 2
5885-202	M10 x 1	Ø 3.2	11 x 28,0	02 / 1
5885-203	3/8" x 24UNF	Ø 3.1	14 x 33,2	02 / 2
5885-204	3/8" x 24UNF	Ø 3.2	11 x 28,0	02 / 1

03

Assortment of brake nipples

- ▶ Item no.1957-885
- ▶ Contents: 90 pieces



04

Brake line nipple steel

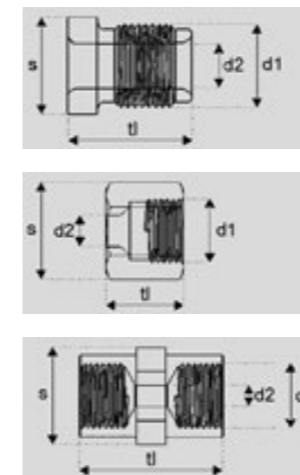

Item no.	d1	d2 Ø	s x tl	Vehicle type
5885-100	M10 x 1 AG	5,0	11 x 16,7	Alfa, Audi, BMW, Citroen, Dacia, Fiat, Ford, Honda, Mitsubishi, Mercedes, Nissan, Opel, Peugeot, Renault, Rover, Saab, Seat, Skoda, Talbot, Volvo, VW, Zastava
5885-101	M12 x 1 AG	5,0	12 x 20,0	Alfa, Audi, Citroen, Fiat, Ford, Honda, Opel, Peugeot, Renault, Rover, Seat, Skoda, Saab, Volvo, VW
5885-102	M10 x 1 AG	5,0	11 x 24,8	Fiat
5885-103	M10 x 1, Konus AG	5,0	10 x 16,7	Daihatsu, Hyundai, Nissan, Opel, Skoda, Toyota, Vauxhall, VW
5885-104	M10 x 1 AG	5,0	10 x 23,0	Toyota VW
5885-106	3/8" x 24UNF AG	5,0	11 x 21,0	Bedford, Renault, Rover, Saab, Talbot, Vauxhall, Volvo
5885-109	M10 x 1.25 AG	5,0	10 x 19,5	Autobianchi, Dacia, Fiat, Lada, Lancia, Zastava
5885-110	M10 x 1,25, Konus AG	5,0	10 x 14,2	Mazda
5885-111	1/2" x 20UNF AG	5,0	13 x 18,0	Peugeot
5885-112	M10 x 1, Konus AG	5,0	10 x 18,0	Daihatsu, Honda, Hyundai, Isuzu, Mazda, Mitsubishi, Nissan, Opel, Suzuki, Toyota, VW
5885-113	M12 x 1 AG	6,5	12 x 18,0	



01

01
Lubricator nipple
DIN 71412, H 1

Item no.	Model
6986-40	M6 x 1
6986-41	M8 x 1
6986-42	M10 x 1



02

02
Lubricator nipple
DIN 71412, H2

Item no.	Model
6986-50	M6 x 1
6986-51	M8 x 1
6986-52	M10 x 1



05

05
Assortment of clamping sleeves
DIN 1481, blank

- ▶ Item no.1957-476
- ▶ Contents: 985 pieces

Item no.	Quantity	Item no.	Quantity
6476-2-20	100	6476-5-60	50
6476-2-30	100	6476-6-40	50
6476-3-20	100	6476-6-50	50
6476-3-40	100	6476-6-60	50
6476-4-40	100	6476-8-40	25
6476-4-60	100	6476-8-50	25
6476-5-30	50	6476-8-60	25
6476-5-40	50	6476-10-60	20



03

03
Lubricator nipple
DIN 71412, H 3

Item no.	Model
6986-60	M6 x 1
6986-61	M8 x 1
6986-62	M10 x 1



04

04
Angle joints
DIN 71802, galvanised

Item no.	1 mm x 2 mm	Type
6268-208-16	13 x 8	A
6268-508-16	13 x 8	AS

- A = standard
- AS = with lock ring



06

06
Clamping sleeves
DIN 1481blank

Item no.	Quantity	Item no.	Quantity
6476-2-20	100	6476-5-60	50
6476-2-30	100	6476-6-40	50
6476-3-20	100	6476-6-50	50
6476-3-40	100	6476-6-60	50
6476-4-40	100	6476-8-40	25
6476-4-60	100	6476-8-50	25
6476-5-30	50	6476-8-60	25
6476-5-40	50	6476-10-60	20



01



02



05

**01
Hose connector
straight**

Item no.	For hose Ø
5896-103	3 mm
5896-104	4 mm
5896-105	5 mm
5896-106	6 mm
5896-108	8 mm
5896-110	10 mm

**02
T-shaped hose connector**

Item no.	For hose Ø
5896-203	3 mm
5896-204	4 mm
5896-205	5 mm
5896-206	6 mm
5896-208	8 mm
5896-210	10 mm

**05
Assortment of plastic hose connectors**

- ▶ Item no.1957-896
- ▶ Contents: 160 pieces

Item no.	Quantity	Item no.	Quantity
5896-103	10	5896-303	10
5896-104	10	5896-304	10
5896-105	10	5896-305	10
5896-106	10	5896-306	10
5896-203	10	5896-403	10
5896-204	10	5896-404	10
5896-205	10	5896-405	10
5896-206	10	5896-406	10



03

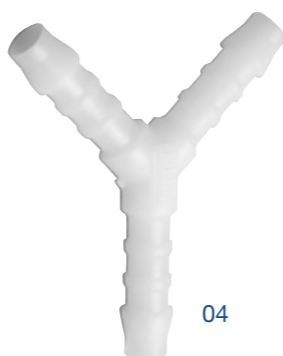

04



06

**03
Angled hose connector**

Item no.	For hose Ø
5896-303	3 mm
5896-304	4 mm
5896-305	5 mm
5896-306	6 mm

**04
Y-shaped hose connector**

Item no.	For hose Ø
5896-403	3 mm
5896-404	4 mm
5896-405	5 mm
5896-406	6 mm
5896-408	8 mm
5896-410	10 mm

**06
PVC hose, transparent**

Item no.	Inner ø mm	Wall thickness mm	Roll length m
5895-3	3,0	1,0	15
5895-4	4,0	1,0	15
5895-5	5,0	1,2	15
5895-6	6,0	1,2	15
5895-8	8,0	1,5	15
5895-10	10,0	1,5	10
5895-12	12,0	2,0	10

Commercial vehicles



BG-B
Mehrzweck-Fett

- Multi-purpose Grease
- Smar univerzálny
- Viečubelový tuk
- Grasso multuso
- Viacúčelové Mazadlo
- Grasa multiuso
- Všenamjenská mast
- Všenamjenská mast
- graisse universelle

BG-Y
Mehrzweck-Fett

- Multi-purpose Grease
- Smar univerzálny
- Viečubelový tuk
- Grasso multuso
- Viacúčelové Mazadlo
- Grasa multiuso
- Všenamjenská mast
- Všenamjenská mast
- graisse universelle

01

Multi-chamber light MAN

LC8 with rear reflector, blue lighting panel and side connector plug AMP 1.5

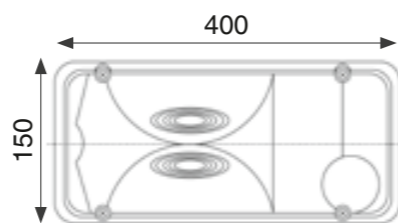

01

Item no.

1006-47-11	left with license plate lighting
1006-47-12	right without license plate lighting
1006-47-111	Light lens left red/blue
1006-47-121	Light lens right red/blue
1006-47-112	Light lens left red/white
1006-47-122	Light lens right red/white

02

6-chamber light MAN

Centre, with MAN compact plug, can be retrofitted to LED technology with Glowpoint base (3720-075-15)

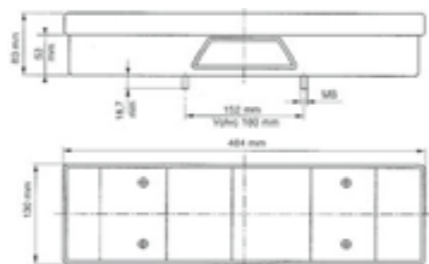

02

Item no.

1006-36-292	Lighting panel with rear reflector
1006-41-11	Right, with MAN compact plug without number plate light
1006-41-12	Left, with number plate light and with MAN compact plug

03

Light lens with rear reflector for 6-chamber TGA lights

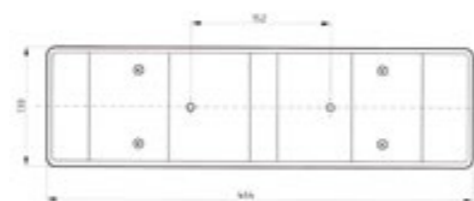

03

Item no.

1006-36-292	Lighting panel with rear reflector
-------------	------------------------------------

04

6-chamber light

Mercedes-Benz Actros with side compact plug, can be retrofitted to LED technology with Glowpoint base (3720-075-15)

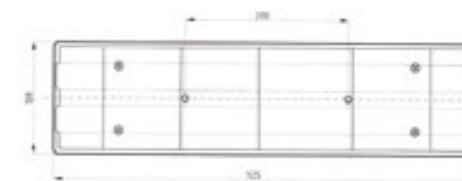

04

Item no.

1006-37-11	Left, with number plate light
1006-37-12	Right, without number plate light
1006-36-191	Lighting panel left
1006-36-192	Lighting panel right

05

Multi-chamber light

Mercedes-Benz Atego with plug connection on rear of housing

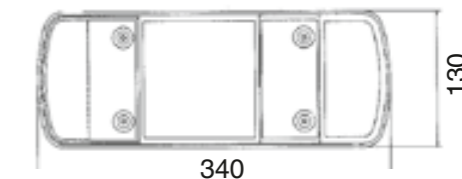

05

Item no.

1006-46-21	Right/Left without number plate light
1006-46-22	left with license plate lighting
1006-46-29	Lighting panel right/left

06

Multi-chamber light (Europoint I)

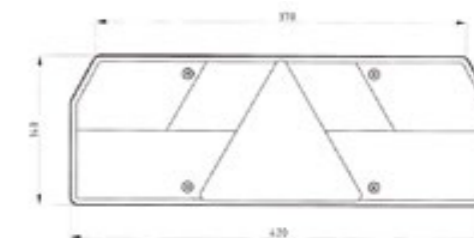

06

Item no.

1006-39-11	Left, with number plate light (gland seal)
1006-39-21	right (gland)
1006-39-31	Left, with compact plug and number plate light
1006-39-41	right with compact plug
1006-39-51	Light lens for Europoint multi-chamber light



01

Multi-chamber light (Europoint II)

With 7-pin central plug

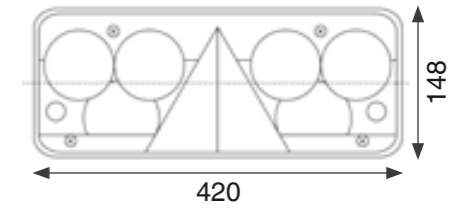

Item no.

1006-39-61	left
1006-39-71	right
1006-39-81	Lighting panel



01

02

Krone 5-chamber light

Rear light, with flexible clearance light arm



- ▶ Product description
- With integrated triangular rear reflector
- Central connection on the rear via 7-pin compact plug



02

Item no.

1006-46-32	right
1006-46-33	left
1006-46-321	Lighting panel right
1006-46-331	Lighting panel left

03

Light lens for Krone 5-chamber light

Reversing light



- ▶ Product description
- With orange side marker light
- With integrated triangle reflector
- Connection via compact plug on the rear



03

Item no.

1006-46-321	Lighting panel right
1006-46-331	Lighting panel left

01

5-chamber light

Universal, with gland

Item no.

1006-35-11	left with license plate lighting
1006-35-12	Left without number plate light
1006-35-13	right without license plate lighting
1006-35-19	Light lens for 5-chamber light

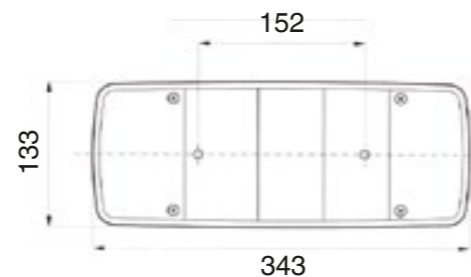

02

Light lens for 3-chamber light

Universal, with gland

Item no.

1006-33-19	Lighting panel
------------	----------------

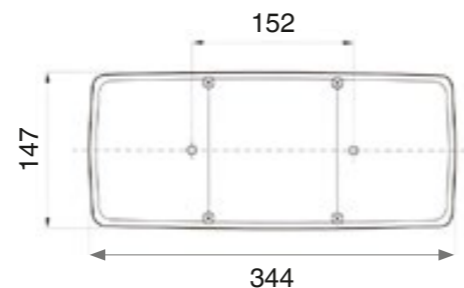

03

4-chamber light

MB-Krone-Schmitz

Item no.

1006-34-11	Left with rear fog light
1006-34-12	Right with reversing light

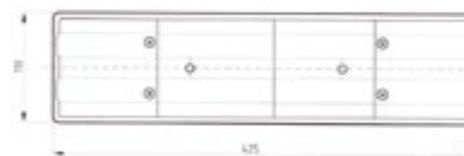

04

Multi-chamber light, Europoint II

Schmitz design, ADR tested

► **Product description**

- Clear glass appearance, with integrated triangular rear reflector
- Brake light, indicator light, rear fog light, reversing light with bulbs
- Tail light fitted with LED bulb
- All functions also available with LED technology
- 4 x 2-pin connections on the rear for additional functions (ASS1 / ASS2 plug)
- 1 x 7-pin central plug, central (ASS2 plug)

- Dimensions:

- W = 420 mm
- H = 148mm
- D = 85mm



Item no.

1006-48-11	Left
1006-48-12	Right

05

Multi-repair set plug

7 pole

► **Product description**

- These 7-pin compact plugs are required for mounting Europoint I and II rear lights
- and fit both the left (yellow) and right (green) sides
- Required for the following multi-chamber lights:
Europoint I multi-chamber light (article no.: 1006-39-31, 1006-39-41)
Europoint II multi-chamber light (article no.: 1006-39-61, 1006-39-71)

Item no.

1006-46-30	Left
1006-46-31	Right





01
LED chambered lighting unit
Universal, for trailers

Item no.	
1004-80-1	right
1004-80-2	left

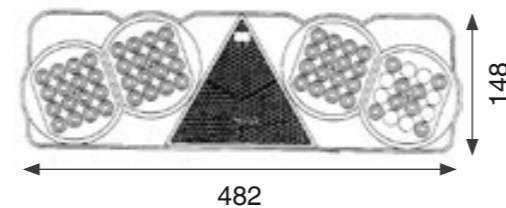

02
LED multi-chamber light
Universal

Item no.	
1004-70-1	Rear fog light
1004-70-2	Back-up light
1004-70-3	Multifunctional light (indicator, brake light, rear light) (Blinker, Bremslicht, Schlusslicht)

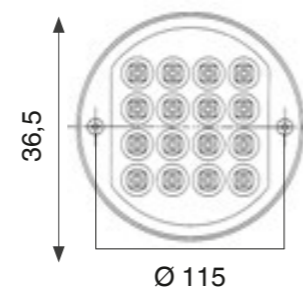

03
License plate lighting
12-24 V, black

► Art. no.: 1006-10-22

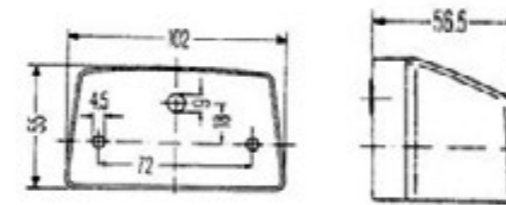

04
LED license plate lighting
12-24 V, right and left

► Art. no.: 1004-60-2

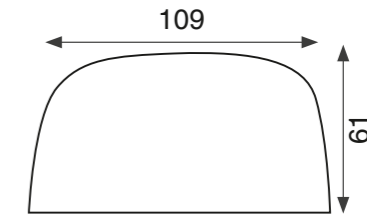

05
LED license plate lighting
24 V

► Art. no.: 1004-60-1

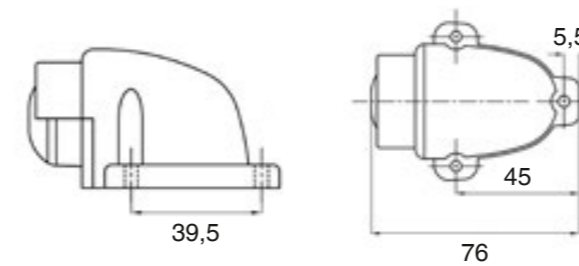

06
LED number-plate light, 12V and 24V
for cars and commercial vehicles

► Art. no.: 1006-10-23

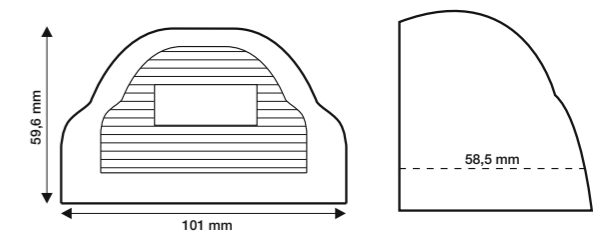

01

LED check device

Shunt resistor for vehicles with on-board computer

► Art. no.: 1006-46-34

► Product description

- For commercial vehicles with on-board computers and voltage monitoring
- for retrofitting to LED lights
- Nominal voltage: 24V
- Wattage at nominal voltage: 8.4W
- Cable length (2-core): 1 metre
- For replacing max. 3 bulbs (5W) with LED modules
- IMPORTANT! Becomes hot >100°C in continuous use. Select outside installation site!



01

02

H3 work light 12V/24V

With glass diffusion lens to illuminate large areas, u-shaped bracket

► Art. no.: 1006-38-3

► Product description

- No cables
- No bulbs
- With glass diffusion lens
- For large-scale, intensive near-field illumination
- U-bolt fastening
- Small, compact structure
- PK 22s / H3
- 12/24 Volt
- Connection on the rear of the housing
- ADR inspected, IP54

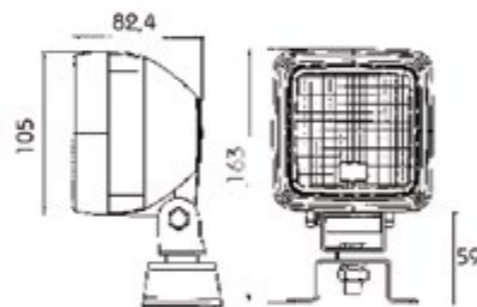

02

03

LED worklamp, 12/24 Volt

Operating voltage: 10 V to 36 V

► Art. no.: 1004-90-6

► Product description

- Fitted with 12 original Osram high-performance LEDs
- Light intensity: 2400 Lumen
- Diffuse light
- Power consumption: 17 Watts
- Impact-resistant PP plastic housing
- Low heat generation
- Waterproof IP66 IP68
- Factory wired (approx. 2.5 m supply cable)
- Includes universal assembly holder
- No permit required with E mark of conformity
- For cars and commercial vehicles

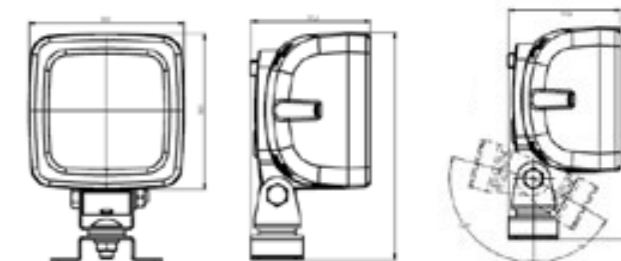

03

04

LED worklamp, 12V/24V

Operating voltage: 10 V to 36 V

► Art. no.: 1004-90-7

► Product description

- No permit required with E mark of conformity
- Fitted with 12 original Osram high-performance LEDs
- Light intensity: 2400 Lumen
- Diffuse light
- Power consumption: 17 Watts
- Impact-resistant PP plastic housing
- Low heat generation
- Waterproof IP66 IP68
- Factory wired (approx. 2.5 m supply cable)
- Includes universal assembly holder

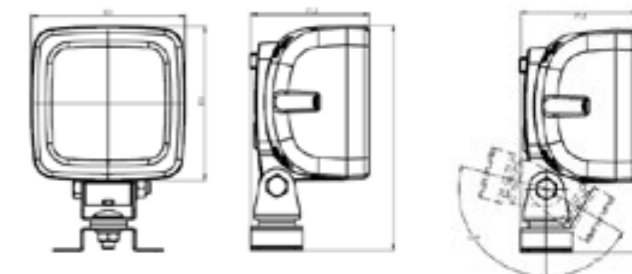

04

01
LED outline marker lighting
Block

► Art. no.: 1006-10-1

► Product description

- With screws
- M5
- Spacing 70 mm



01

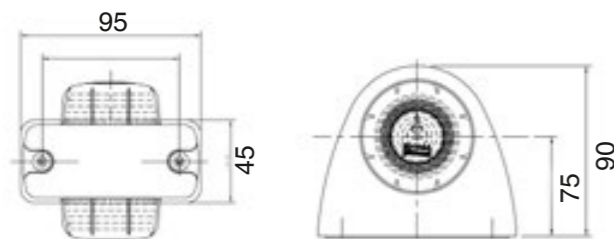

02
Outline marker lighting
flexible holder

► Art. no.: 1006-10-20

► Product description

- Spacing for M5/15 mm
- With bracket
- Light lens red/white



02

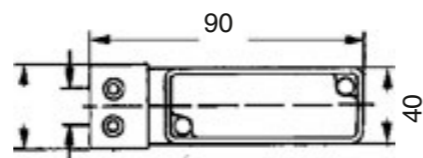

03
LED profile light
24V/0.8W

► Art. no.: 1006-10-33

► Product description

- Cable length 0.5 m
- Reflector
- White



03

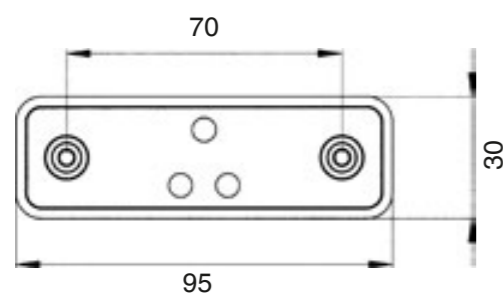

04
LED outline marker lighting
Block

► Art. no.: 1004-50-1

► Product description

- 12 V/24 V



04

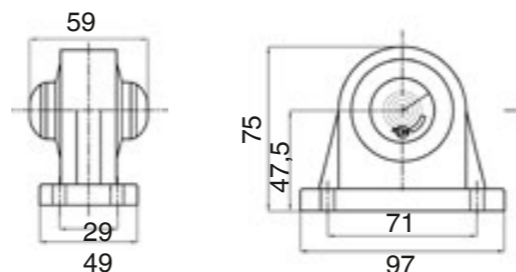

05
LED outline marker lighting
12V/24V

► Art. no.: 1004-90-1

► Product description

- With flexible pendular bracket
- Lateral
- Universal application
- Cable length approx. 20 cm

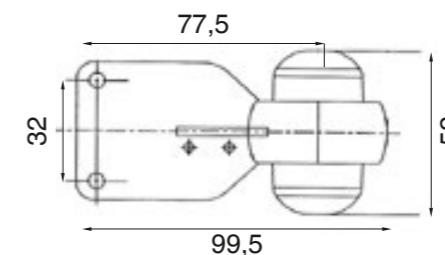

05

06
LED outline marker lighting set
waterproof, angular

► Art. no.: 1006-13-1

► Product description

- Waterproof
- Light emission: red/white/yellow
- Flexible mount housing
- Light lens made of break-proof polycarbonate
- ADR inspected
- 12-24 V / 24V-1W
- Hole spacing of fastening: 78 mm
- Cable length: 1.75 m

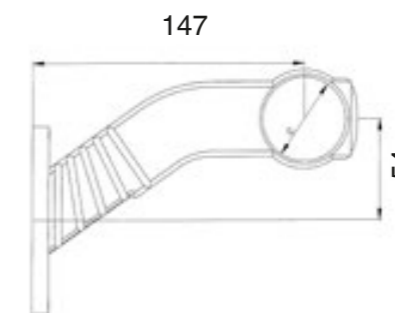

06

07
LED clearance light 12 V - 24 V

► Item no. 1004-90-3

► left

► Item no. 1004-90-4

► right



07

01

LED lights
waterproof

- ▶ Item no. 1006-12-110
- ▶ Angled

- ▶ Item no. 1006-10-3
- ▶ with mountable casing

- ▶ Item no. 1006-12-19
- ▶ LED light unit

- ▶ Product description
- With flexible mounting casing
- Light lens unit made from shatterproof PC
- For M6 fastening screws
- GGVS/ADR approved

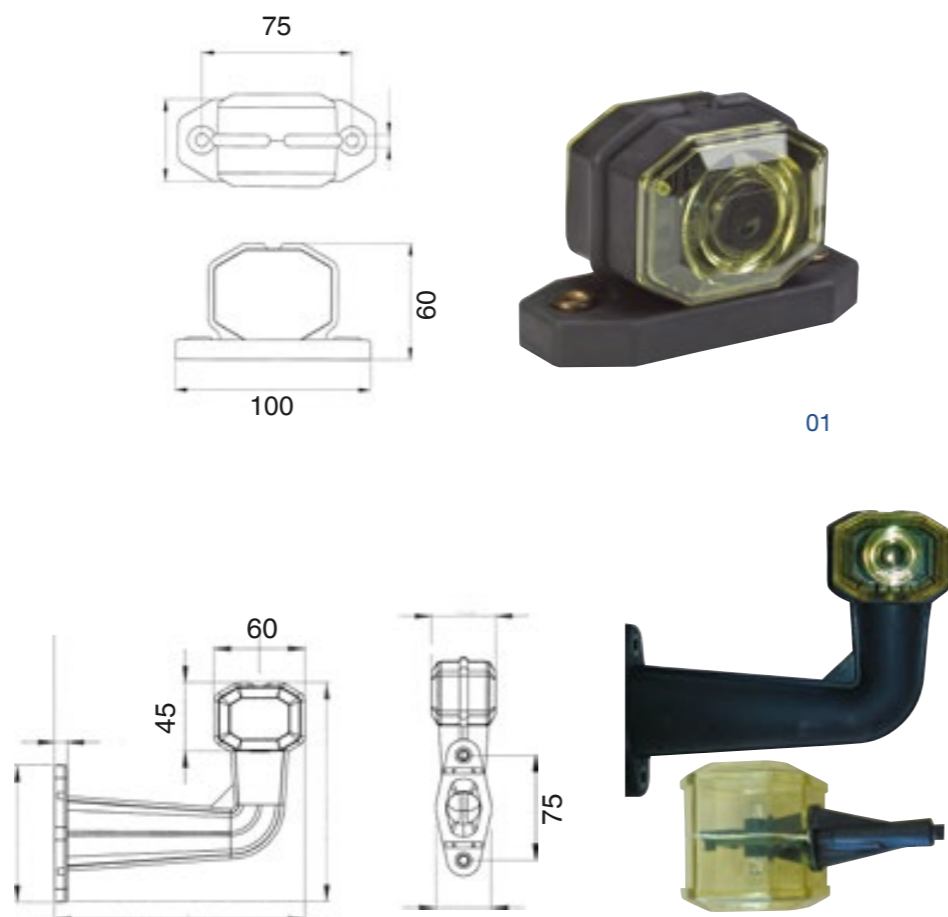

01

02

LED outline marker lighting

- ▶ Light emission red/white, with 1.75m ADR cable Item no. 1006-10-31
- ▶ with pendulum holder

- ▶ Item no. 1006-10-32
- ▶ with pendulum holder 90°

- ▶ Product description
- With flexible mounting case
- Light lens unit made from shatterproof PC
- Spacing 15 mm and 30 mm
- For M6 fastening screws
- GGVS approved

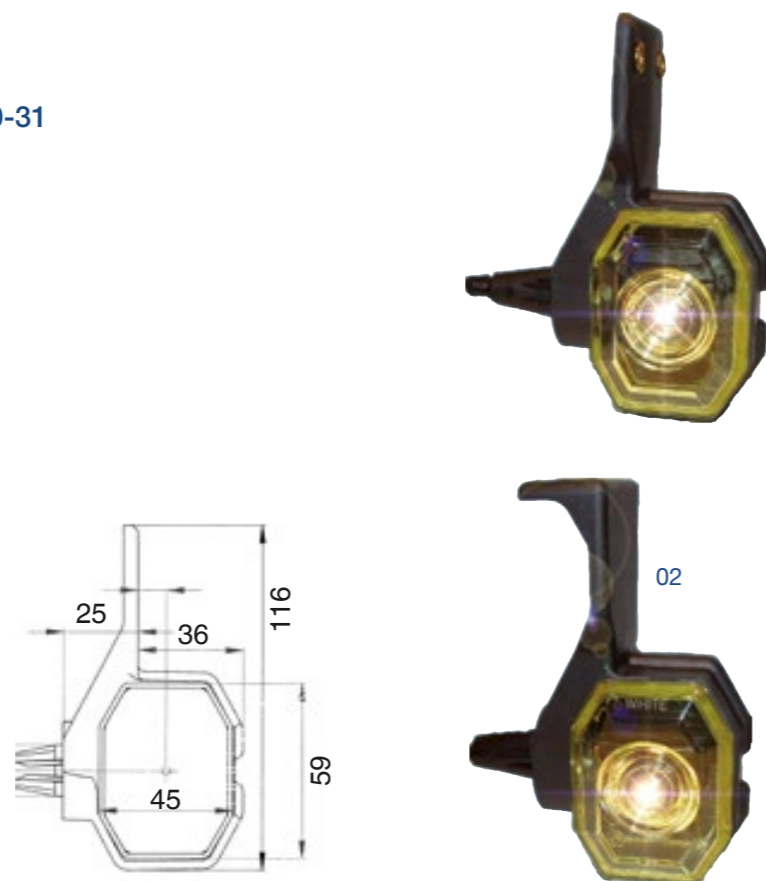

02



01
LED marker lighting 12 V + 24 V
angled

Item no.	
1004-50-3	left
1004-50-4	right

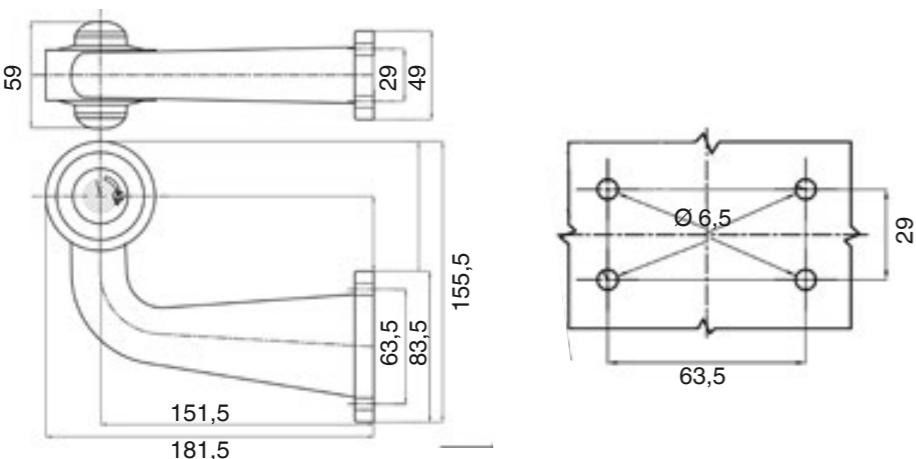

02
LED retrofit kit
12-24 V

► Art. no.: 1004-50-5

► Product description

- LED retrofit assembly for article nos.
1004-50-3, 1004-50-4, 1006-11-23, 1006-11-21



03
Marker lighting
Waterproof, for borehole M6

Item no.	
1006-12-100	Marker light with 0.5 m cable



04
Marker lighting

Item no.	
1006-11-23	angled
1006-11-24	Spare socket
1006-11-253	Light lens red diameter 55 mm
1006-11-254	Light lens transparent diameter 55 mm



05
Side lights
Angled, waterproof

► Art. no.: 1006-12-1

► Product description

- Light emission: red/white
- Flexible fixing arm
- Light lens unit made of break-proof PC
- Includes 24V/4W bulb
- Cable length 0.5 m
- 12V/24V
- 90° design

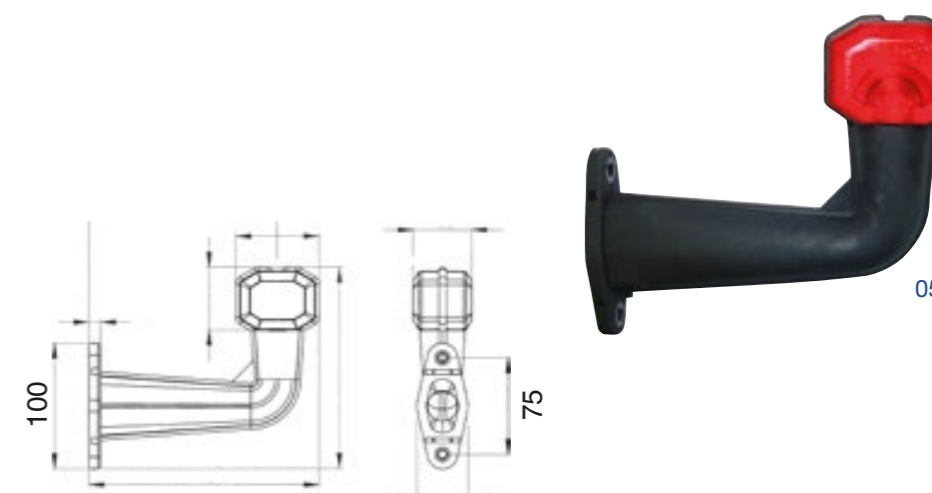

01

Flash warning signal lighting unit

With 2 LEDs

► Art. no.: 1001-186-1

► Product description

- Operating voltage: 12 V/24 V
- Power: 3 W
- Dimensions: 105 mm x 68 mm
- Connection: Cable 2x 0.75 mm², 0.20 m long, grey
- Installation height: 16 mm
- Two long slots for fastening
- Compatible with almost all LED platform lights

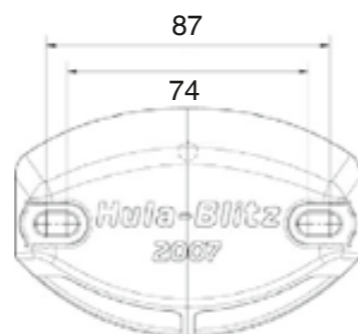

01

02

Blitz-hazard warning light mini

With 4 LEDs

► Art. no.: 1001-187-1

► Product description

- Flashes to the rear and the side
- Completely flat
- Operating voltage: 12 V/24 V
- Power: 4 W
- Dimensions: 85 mm x 85 mm x 110 mm
- Weight: 12 mm
- For securing tail-lifts

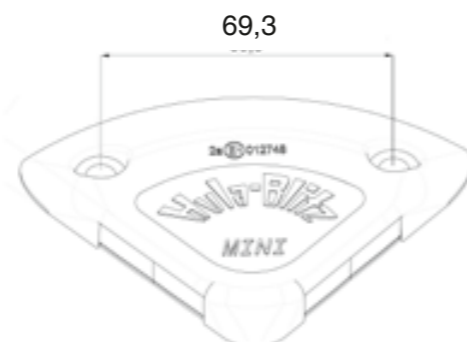

02

03

Flash warning signal lighting unit

with 12 LEDs, 24V

► Art. no.: 1001-185-1

► Product description

- Life of LED: over 10,000 operating hours
- Diode block: waterproof and dustproof
- Diecast zinc upper section
- 12 cm connection cable
- Tested to GGVS
- For securing platform lifts

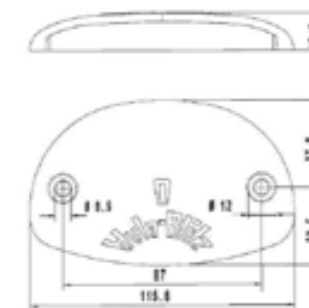

03

04

Flash warning signal lighting unit

Hula-Blitz

► Art. no.: 1001-184-1

► Product description

- Incl. lamp
- Zinc diecast upper part
- Tested to GGVS
- Quality: OEM
- For securing tail-lifts

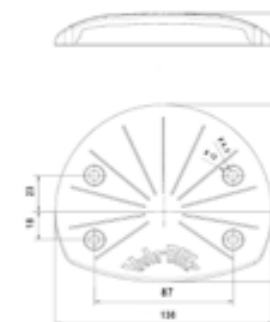

04

05

LED warning signal lighting

Operating mode: Flashing light/Permanent light/Battery test

► Art. no.: 1003-230

► Product description

- Power supply: 2 mono-cell batteries 1.5 V (NF art. no. 3722-01)
- Operating voltage: 1.8 V-3.1 V
- Approval: TÜV-tested K452, GGVS tested
- Dimensions: 90 mm x 208 mm x 30 mm
- Weight: 480 g

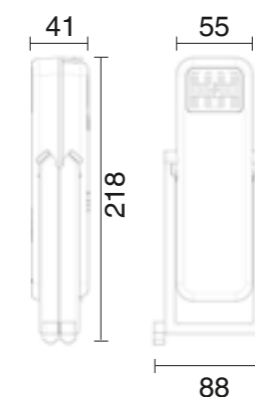

05

01
Triangular rear reflector
1-piece

▶ Art. no.: 1001-180-50

▶ Product description
- For M6 attachment
- Spacing: 75 mm

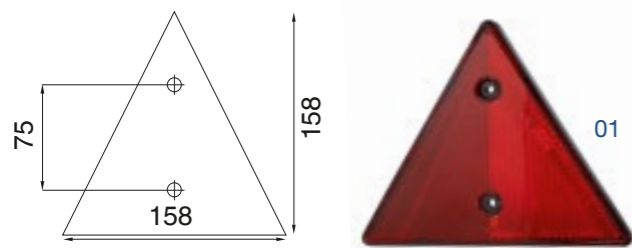

02
Triangular rear reflector
4-piece

▶ Art. no.: 1001-180-51

▶ Product description
- Spacing: 75 mm
- With two M5 bolts



03
Side reflector
Ø 60 mm, with adhesive backing, 6 mm drill hole

▶ Item no. 1001-180-43
▶ orange/yellow

▶ Item no. 1001-180-44
▶ red

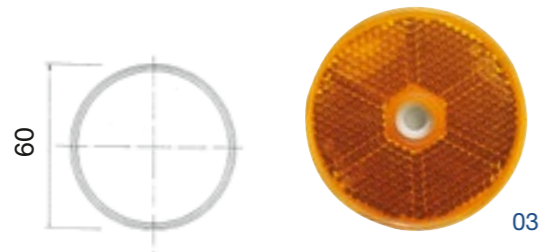

04
Rear reflector
Diameter 90 mm

▶ Art. no.: 1001-180-45

▶ Product description
- With M5 nut and bolt
- Red



05
Side reflector
90 x 40 mm, with adhesive back

▶ Item no. 1001-180-41
▶ orange/yellow

▶ Item no. 1001-180-42
▶ red

▶ Item no. 1001-180-421
▶ white

▶ Product description
- Spacing 70 mm
- M5 hole

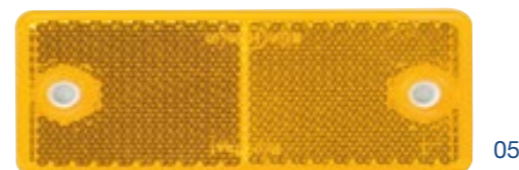
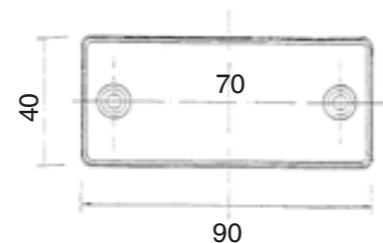

06
LED side marker lights
Universal, 12/24 V, with bracket, 12/24 V

▶ Art. no.: 1004-20-1

▶ Product description
- Hole spacing: 30 mm

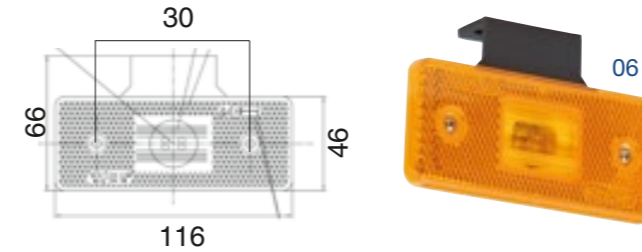

07
LED side marker lights
12-24 V, incl. holder and cable

▶ Art. no.: 1004-90-2

▶ Product description
- Diode light
- Wires: 22 cm - 0.75 mm²

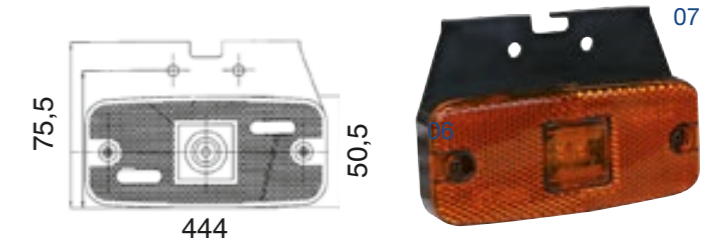

08
LED side marker lights
with bracket and cable (MAN), 24 V

▶ Art. no.: 1001-179-7

▶ Product description
- With rear reflector
- Repair variant
- Cable length 0.5 m



09
LED side marker lights
Universal, 12/24 V

▶ Art. no.: 1004-40-1

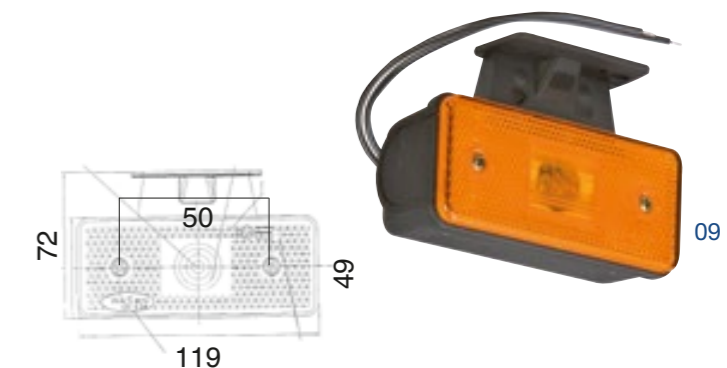

10
LED side marker lights
24V/1W

▶ Item no. 1001-179-6
▶ Lighting unit

▶ Item no. 1001-179-69
▶ Holder

- With cable
- Depth: 7 mm
- Borehole: M5
- Centre hole: 25 mm

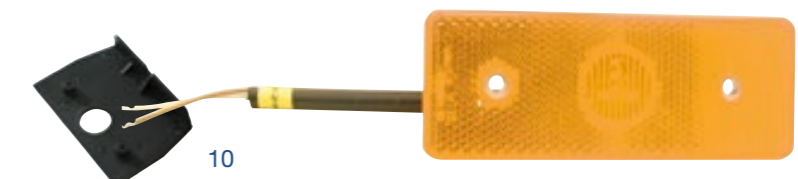
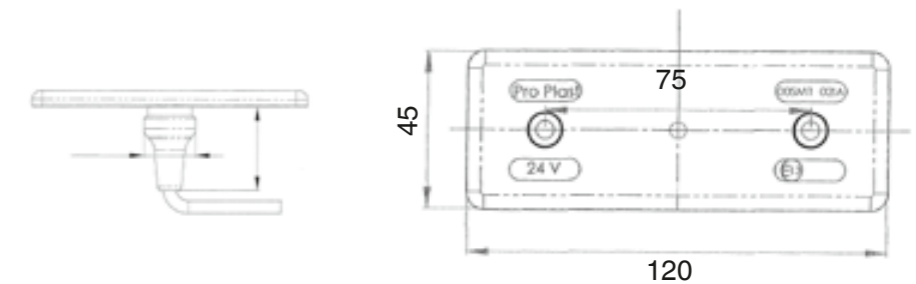

01

Warning mark

For containers

▶ Art. no.: 1001-181-1

▶ Product description

- According to Section 32 (1) no. 27, 49 (4) no. 4
- Film type: type II
- Colour: red/white
- Material: plastic film
- Contents: 4 x pointing left, 4 x pointing right
- 705 mm x 141 mm
- Original 3M
- Type II, DIN 67520, Colour DIN 6171



01

02

Warning mark ECE 70

For tractor units (class 2)

▶ Art. no.: 1001-181-4

▶ Product description

- Aluminium model
- Film type: type II
- Colour: yellow/orange
- Standard: ECE 70
- 565 mm x 130 mm x 1.0 mm



02

03

Warning marks

For trailers and semitrailers

▶ Item no. 1001-181-2

▶ Item no. 1001-181-3

▶ Product description

- Dimensions: L 570 mm/W 200 mm
- Film type: type II
- Colour: yellow/orange
- E4 007009



03

04

3M contour marking tape

According to the regulations UN/ECE R 104

▶ Item no. 1001-183-04

▶ Red

▶ Item no. 1001-183-05

▶ yellow

▶ Item no. 1001-183-06

▶ white

▶ Product description

- For solid structures
- Adheres to painted, smooth surfaces
- Width: 55 mm, roll length: 50 m



04



01

Hazard warning flag set

For tail-lifts

► **Product description**

- Dimensions: L 400 mm/W 250 mm
- According to Section 53b Paragraph 5 of the German Road Traffic Act (StVZO). 5
- Building authority approved
- Film type: type II
- Colour: red/white



01

Item no.

1001-182-9	Warning flag set with holder
1001-182-3	Aluminium holder
1001-182-1	Hazard warning flag (pointing left)
1001-182-2	Hazard warning flag (pointing right)

02

Warning mark

141 mm wide

► **Product description**

- According to Section 35 of the German Road Traffic Act (StVO)
- Design: Film
- Film type: Type II
- Colour: red/white
- Material: Plastic
- Attachment: self-adhesive
- 3M quality



02

Item no.

1001-183-02	Pointing right 45.7 m
1001-183-03	Pointing left 45.7 m
1001-183-0	Hazard warning mark set 144 mm x 9 m Contents: 1x9 m pointing left, 1x9 m pointing right

03

ADR warning sign

GGVS/ADR approved, foldable

► **Art. no.: 1001-181-5**

► **Product description**

- Colour: orange
- Film type: Type I
- Dimensions 400 mm x 300 mm
- With edge protection and hole at the top
- Material: Sheet steel



03

04

A warning sign

German waste warning sign

► **Art. no.: 1001-181-6**

► **Product description**

- Colour: White
- Film type: Type I
- Foldable
- With edge protection



04

05

Parking warning sign

foldable, 285 x 285 mm

► **Item no. 1001-180-1**

► **Front**

► **Item no. 1001-180-3**

► **Rear**

► **Product description**

- Parking warning sign according to StVZO (Road Traffic Licensing Regulations) § 22a STV20 section 1 number 9
- 8-prism rear reflector
- Film type: Type III
- Colour: red/white
- Material: aluminium

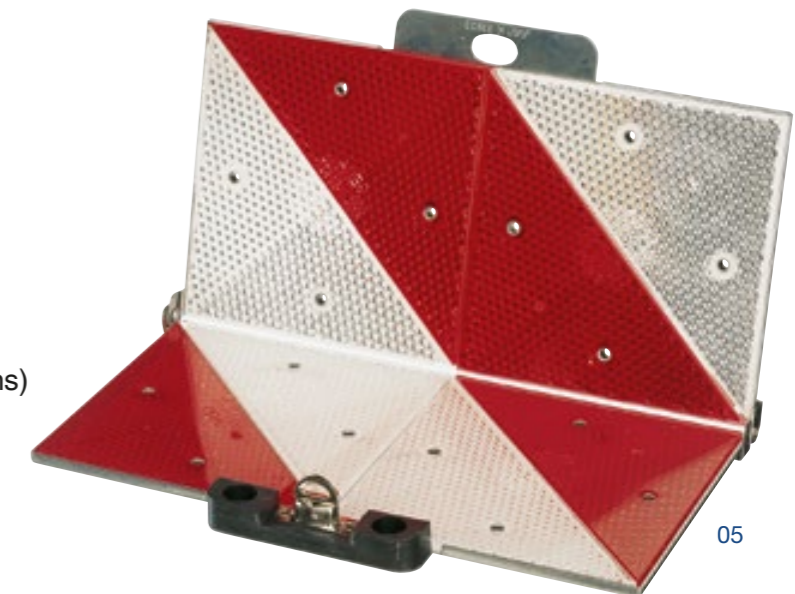

05

01

Plug
15-pole

▶ Art. no.: 3555-310-150

- ▶ Product description
- With screwed contacts
 - GGVS/ADR tested
 - 15-pole
 - 24 V



02

Plug
7-pole

▶ Art. no.: 3555-310-70

- ▶ Product description
- With screwed contacts
 - GGVS/ADR tested
 - 7-pole
 - 24 V



03

Plug
7-pole

- ▶ Item no. 3555-305-589
- ▶ Plastic
- ▶ Item no. 3555-305-587
- ▶ Metal

- ▶ Product description
- Power rating: 20 A to 24 V
 - Length: 116 mm
 - Type N / "Light"
 - With screwed contacts



04

Plug
7-pole

- ▶ Item no. 3555-305-588
- ▶ Plastic
- ▶ Item no. 3555-305-586
- ▶ Metal

- ▶ Product description
- Power rating: 20 A to 24 V
 - Length: 116 mm
 - Type S / "Auxiliary consumer"
 - With screwed contacts



05

Plug
3 pole

▶ Item no. 3555-310-6

- ▶ Product description
- With screwed contacts
 - Type S
 - Power rating: 20 A to 24 V
 - Plastic
 - 3-pole
 - 24 V



06

Socket
7-pole

▶ Art. no.: 3555-310-7

- ▶ Product description
- With screwed contacts
 - GGVS/ADR tested
 - 7-pole
 - 24 V



07

Power outlet
7-pole

▶ Art. no.: 3555-305-287

- ▶ Product description
- With screwed contacts
 - Rubber seal in the cover
 - Type N
 - Load rating: 20 A to 24 V
 - ISO 1185 K-pin
 - 7-pole
 - 24 V



08

Power outlet
7-pole

▶ Art. no.: 3555-305-286

- ▶ Product description
- With screwed contacts
 - Rubber seal in the cover
 - Type S
 - Load rating: 20 A to 24 V
 - ISO 3731 K-jack
 - 7-pole
 - 24 V



09

Power outlet
3 pole

▶ Art. no.: 3555-310-60

- ▶ Product description
- With screwed contacts
 - Type S
 - Power rating: 20 A to 24 V
 - Plastic
 - ISO 1185 K
 - 7-pole
 - 24 V



10

Power outlet
15-pole

▶ Art. no.: 3555-310-15

- ▶ Product description
- With screwed contacts
 - GGVS/ADR tested
 - 15-pole
 - 24 V



01

Adapter helix cable

15 pole to 2 x 7 pole

► Art. no.: 3555-320-53

► Product description

- For the power supply from new truck tractors to older trailers
- 13 pole wired according to standards
- Overmoulded plug type „N“ and type „S“
- Working length: 3.5 m
- Material: PUR
- Recoiling force complies with OEM regulations
- Tightly wound
- 24 V



02

Short adapter

15-pole to 7-pole

► Art. no.: 3555-320-52

► Product description

- Adapter from 15-pole to 7-pole
- ISO 12098
- Plastic
- 24 V



05

Coil

7-pole

► Art. no.: 3555-320-42

► Product description

- Working length: 3.0 m
- Material: PUR
- Recoiling force complies with OEM regulations
- With waterproof plugs
- Type N
- Tightly wound



06

EBS helix cable

7-pole

► Art. no.: 3555-320-45

► Product description

- Working length: 3.5 m
- Material: PUR
- Recoiling force complies with OEM regulations
- Tightly wound



03

Adapter helix cable

15 pole to 2 x 7 pole

► Art. no.: 3555-320-51

► Product description

- 13 pole
- Working length: 3,5 m
- Type N/S
- Material: PUR
- Recoiling force complies with OEM regulations
- Tightly wound
- 24 V



04

Coil

7-pole

► Art. no.: 3555-320-43

► Product description

- Working length: 3.0 m
- Material: PUR
- Recoiling force complies with OEM regulations
- With waterproof plugs
- Type S - 3731
- 6 sockets, 1 pin



07

Coil

15-pole

► Art. no.: 3555-320-50

► Product description

- Working length: 3.5 m
- With clamped connection
- Material: PUR
- Recoiling force complies with OEM regulations
- Tightly wound



08

Distribution box

16-fold

► Art. no.: 1004-100

► Product description

- GGVS/ADR inspected
- 16-fold



01

Battery clamps

Item no.	Model	Max. cable connection	Figure
3510-19	+ on the right	70 mm ²	1
3510-20	- on the left	70 mm ²	2



02

Battery clamps

Item no.	Model	Max. cable connection	Figure
3510-6	- on the right	70 mm ²	1
3510-7	+ on the left	70 mm ²	2



03

Lantern battery

Block 4R25 6 Volt - 7 Ah

► Art. no.: 3722-60

► Product description

- 4-R25
- 6V
- 7Ah
- For use in construction-site flashing lights



04

Coupling head

Standard, without valve, e.g. for trailers

Item no.	Colour	Model
1005-50-01	yellow	M16
1005-50-02	red	M16
1005-50-03	yellow	M22
1005-50-04	red	M22
1005-52-03		Spare gasket

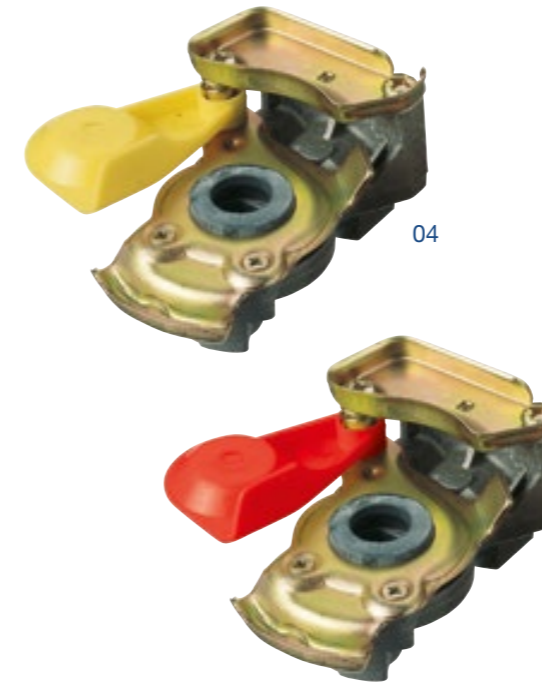

05

Coupling head

Automatic, with check valve

Item no.	Colour	Model
1005-51-01	yellow	M16
1005-51-02	red	M16
1005-51-03	yellow	M22
1005-51-04	red	M22



06

Handles

Set

► Art. no.: 1005-10-003

► Product description

- For M16 air coils

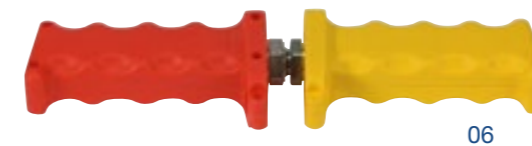

07

Threaded piece

with supply lines

Item no.	Model
1005-41-01	M16 short
1005-41-02	M22 short
1005-41-03	M16 long
1005-41-04	M18 long



01

PU coil

21 windings, hard-wearing and flexible

- ▶ Item no. 1005-10-001
- ▶ red

- ▶ Item no. 1005-10-002
- ▶ yellow

▶ Product description

- Max. working length: 4.5 m
- With threaded end piece M16
- Temperature range -40°C to +95°C



02

NF PU spiral

Hard wearing and flexible

- ▶ Item no. 1005-10-005
- ▶ red

- ▶ Item no. 1005-10-006
- ▶ yellow

- ▶ Item no. 1005-10-007
- ▶ Black

▶ Product description

- 21 windings (tightly wound diameter 80 mm)
- Steel anti-kink spring
- Max. working length 4.5 m
- Temperature range -40°C to +95°C
- Threaded piece M16 on both ends



01
Straight-line connector
Brass

Item no.	Model
1002-16-06	6 mm
1002-16-08	8 mm
1002-16-09	9 mm
1002-16-010	10 mm
1002-16-012	12 mm
1002-16-18	18 mm



01

02
Angle connector
Brass

Item no.	Model
1002-12-06	6 mm



02

03
T-connectorBrass

Item no.	Model
1002-14-06	6 mm
1002-14-08	8 mm



03

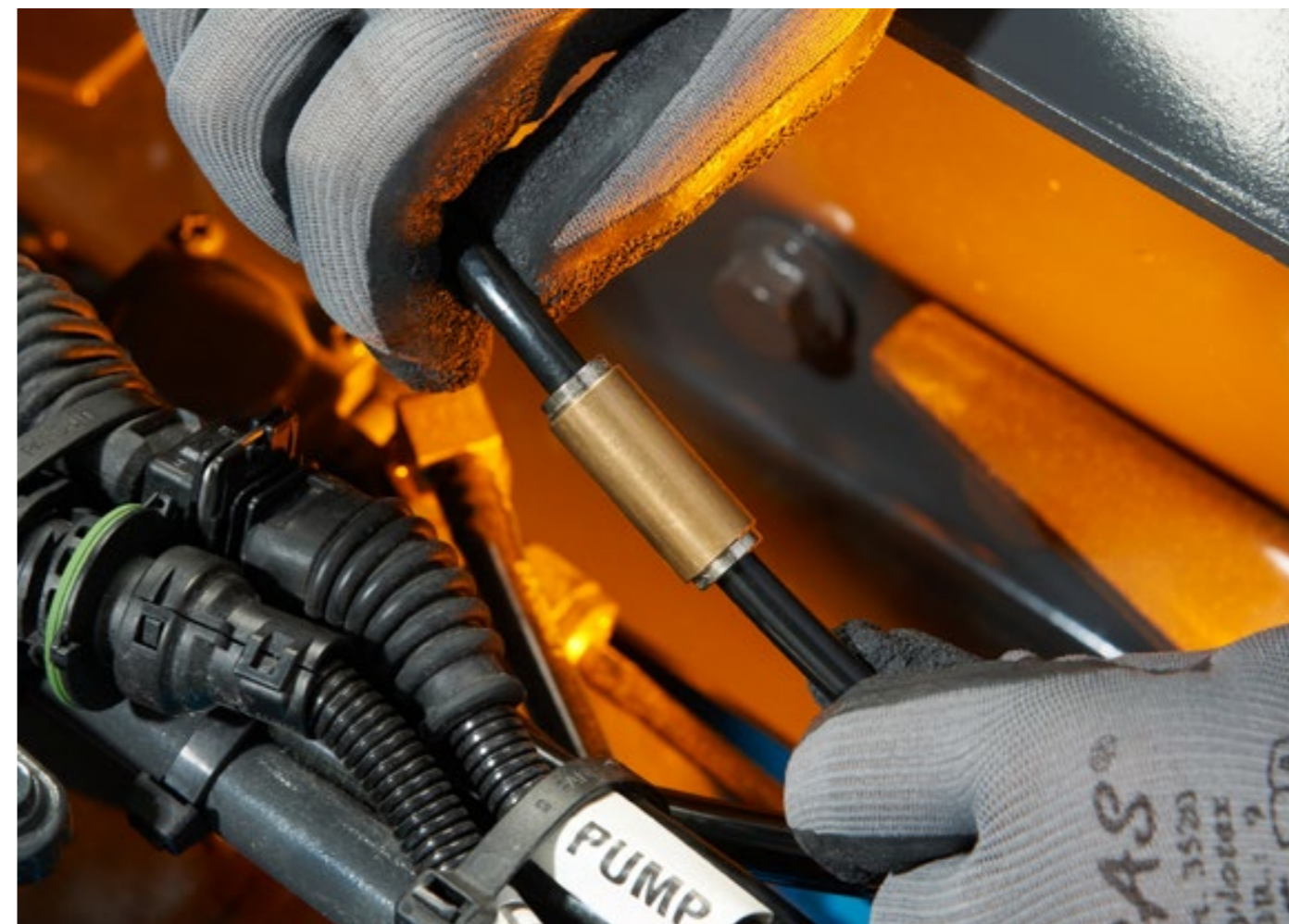

04
Straight-line connector
Plastic

Item no.	Model
1002-06-04	4 mm
1002-06-05	5 mm
1002-06-06	6 mm
1002-06-08	8 mm
1002-06-10	10 mm
1002-06-12	12 mm



04

05
Angle connector
Plastic

Item no.	Model
1002-02-06	6 mm
1002-02-08	8 mm



05

06
T-joint
Plastic

Item no.	Model
1002-04-04	4 mm
1002-04-06	6 mm
1002-04-08	8 mm



06

07
Reducer coupling
Brass

Item no.	Model
1002-8-6	8 mm to 6 mm
1002-10-6	10 mm to 6 mm
1002-10-8	10 mm to 8 mm
1002-12-8	12 mm to 8 mm
1002-12-10	12 mm to 10 mm



07

08
Assortment of direct connectors
Brass, plastic

- ▶ Item no. 1957-100-1
- ▶ Contents: 40 pieces

Item no.	Quantity	Item no.	Quantity
1002-06-04	5	1002-16-06	5
1002-06-05	5	1002-16-08	5
1002-06-06	5	1002-16-010	5
1002-06-08	5	1002-16-012	5



08



01
Cutting pliers for polyamide tubes

- ▶ Item no. 1002-08-100
- ▶ Item no. 1002-08-111
- ▶ Spare blades



02
Brake rings
HGV air brake, brake screw connection

Item no.	Ring model	Sealing ring model
6464-12-16	12 x 16	10 x 14
6464-14-18	14 x 18	12 x 17
6464-16-22	16 x 22	15 x 19
6464-18-22	18 x 22	16 x 20
6464-22-27	22 x 27	20 x 24



03
Pipe support clamps
Rubberised

- ▶ Product description
- Full galvanized steel
- RSGU
- Rubberized



Item no.	Pipe diameter	Band	Hole Ø
5542-6-12	6 mm	12 mm	5,3 mm
5542-6-15	6 mm	15 mm	6,4 mm
5542-8-12	8 mm	12 mm	5,3 mm
5542-8-15	8 mm	15 mm	6,4 mm
5542-8-20	8 mm	20 mm	8,4 mm
5542-9-12	9 mm	12 mm	5,3 mm
5542-10-12	10 mm	12 mm	5,3 mm
5542-10-15	10 mm	15 mm	6,4 mm
5542-12-12	12 mm	12 mm	5,3 mm
5542-12-15	12 mm	15 mm	6,4 mm
5542-15-12	15 mm	12 mm	5,3 mm
5542-15-15	15 mm	15 mm	6,4 mm
5542-15-20	15 mm	20 mm	8,4 mm
5542-18-15	18 mm	15 mm	6,4 mm
5542-20-15	20 mm	15 mm	6,4 mm
5542-20-20	20 mm	20 mm	8,4 mm
5542-25-12	25 mm	12 mm	5,3 mm
5542-25-15	25 mm	15 mm	6,4 mm
5542-25-20	25 mm	20 mm	8,4 mm
5542-30-15	30 mm	15 mm	6,4 mm
5542-30-20	30 mm	20 mm	8,4 mm
5542-35-15	35 mm	15 mm	6,4 mm
5542-40-20	40 mm	20 mm	8,4 mm
5542-50-15	50 mm	15 mm	6,4 mm

04
Polyamide tubes
Pressure-resistant to 15 bar, 25 metre coil, DIN 73378

Item no.	Ø x wall thickness
1002-54-06	6 x 1.0 mm
1002-54-08	8 x 1.0 mm
1002-54-09	9 x 1.5 mm
1002-54-10	10 x 1.0 mm
1002-54-11	11 x 1.5 mm
1002-54-12	12 x 1.5 mm
1002-54-15	15 x 1.5 mm



01
Support sleeves

Item no.	Tube
1002-54-061	6 x 1,0
1002-54-081	8 x 1,0
1002-54-101	10 x 1,0
1002-54-121	12 x 1,5
1002-54-151	15 x 1,5



02
Cutting rings

Item no.	Tube
1002-54-062	6 x 1,0
1002-54-082	8 x 1,0
1002-54-102	10 x 1,0
1002-54-122	12 x 1,5
1002-54-152	15 x 1,5



03
Nuts

Item no.	Tube
1002-54-063	6 x 1,0
1002-54-083	8 x 1,0
1002-54-103	10 x 1,0
1002-54-123	12 x 1,5
1002-54-153	15 x 1,5



04
Threaded fittings
incl. 2 cutting rings

Item no.	Tube
1002-54-064	6 x 1,0
1002-54-084	8 x 1,0
1002-54-104	10 x 1,0
1002-54-124	12 x 1,5
1002-54-154	15 x 1,5



05
Lubricator nipple
DIN 71412, H 1

Item no.	Model
6986-40	M6 x 1
6986-41	M8 x 1
6986-42	M10 x 1



06
Lubricator nipple
DIN 71412, H2

Item no.	Model
6986-50	M6 x 1
6986-51	M8 x 1
6986-52	M10 x 1



07
Lubricator nipple
DIN 71412, H 3

Item no.	Model
6986-60	M6 x 1
6986-61	M8 x 1
6986-62	M10 x 1



08
Assortment of screwed connections

- ▶ Item no. 1957-54-016
- ▶ Contents: 123 pieces

Item no.	Quantity	Item no.	Quantity
1002-54-061	10	1002-54-122	8
1002-54-081	10	1002-54-152	5
1002-54-101	8	1002-54-063	10
1002-54-121	8	1002-54-083	10
1002-54-151	5	1002-54-103	8
1002-54-062	10	1002-54-123	8
1002-54-082	10	1002-54-153	5
1002-54-102	8		

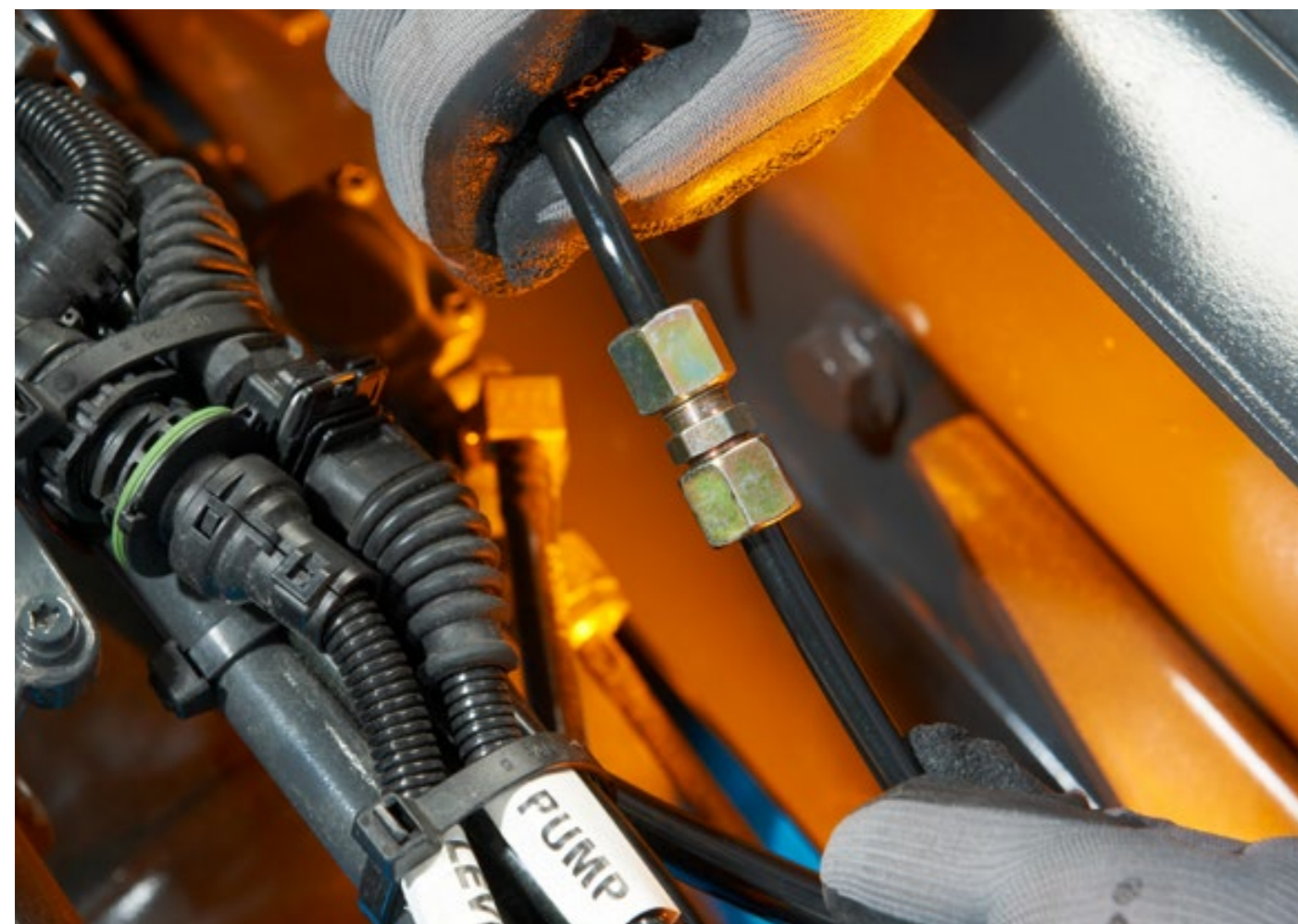

01

Tension belts

▶ Art. no.: 1002-55-155

▶ Product description

- Colour: orange
- Width: 50 mm
- Length: 8 m (7.5 m strap/0.5 m ratchet) with claw hooks
- Pre-tensioning force: SHF 50 daN/STF 300 daN
- Tractive force: 2,500 daN
- Tested to EN 12195-2
- Temperature range: -40°C to +100°C
- Made in Germany

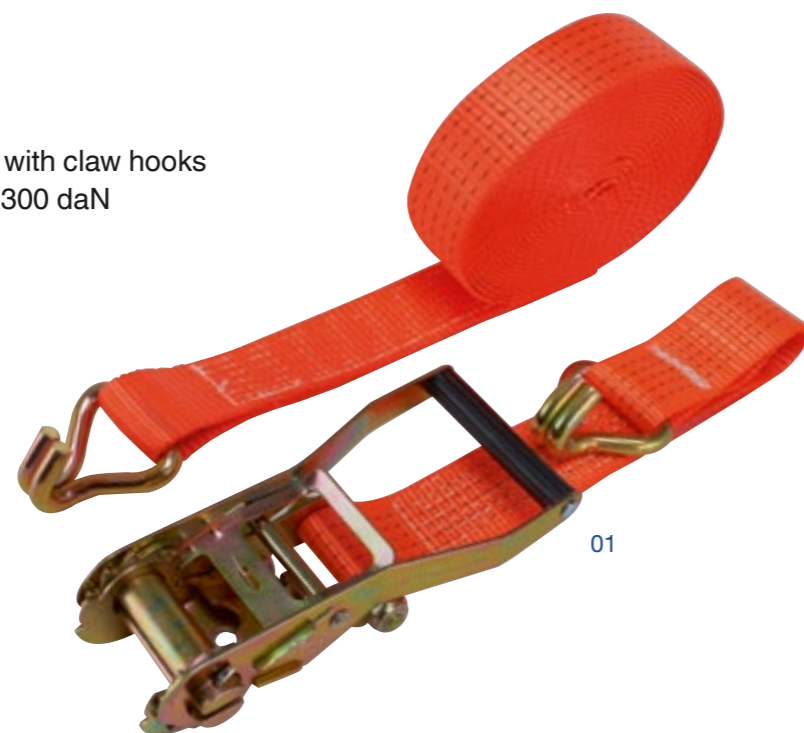

01

02

Long-lever tension belt

▶ Item no. 1002-55-158

▶ 8 m (STF 500 daN)

▶ Item no. 1002-55-159

▶ 10 m (STF 600 daN)

▶ Product description

- Colour: orange
- Width: 50mm
- Pre-tensioning force: STF 600 daN
- Manual force: SHF 50 daN
- Tractive force (holding force):
LC 2,500 daN (5,000 kg)
- Tested to DIN EN 12195-2
- Can be used at temperatures
from -40°C to +100°C as standard
- Elongation <=5%
- With optimum label protection



02

03

Anti-slip mat

Regupol 7210 LS

▶ Art. no.: 1002-56

▶ Product description

- Dimensions: 5 m long x 25 cm wide
- Thickness: 8 mm
- Resistant to: UV rays, sodium chloride, weak acids and alkalis
- Cleaning: shake out, vacuum, wash, possibly using a high-pressure cleaner
- Colour: black with dark green, light green and yellow colour particles
- Reusable



03

04

Edge protection for tension belts

Protection from sharp-edged loads

▶ Art. no.: 1002-55-2

▶ Product description

- Dimensions: 100 mm x 100 mm
- Can be used for 90° angles
- Slotted, 45° bevel for simple threading of the tension belt
- Protects the belt from sharp, rough edges
- The strap guide and side lugs prevent the edge-protection corners from slipping or falling off
- Better distribution of pre-tensioning forces



04



01

Tarpaulin repair plaster

Extreme adhesion

- ▶ Item no. 1001-190-1
- ▶ Colour: white

- ▶ Item no. 1001-190-2
- ▶ Colour: silver

▶ Product description

- Highly tear-resistant PVC fabric (OEM tarpaulin material)
- Extreme adhesion, self adhesive on one side
- Adhesive: Special adhesive resistant to weather and ageing
- Tear resistance: 2,500 N/5 cm to DIN EN ISO 1421/VI
- Tear-propagation resistance: 270 N (to DIN 53363)
- Weight: 650 g/m
- Thermal stability: -30°C to +70°C
- Best adhesion at temperatures from: +10°C to 25°C
- Weather-resistant and durable
- UV-resistant and resistant to washing brushes



02

Edge protection

45.7 m · 25 mm wide

- ▶ Art. no.: 1001-183-07

▶ Product description

- Edge-protection film, transparent
- Self-adhesive and simple to use
- For sealing vehicle warning marks, for example
- Protects against dirt, contamination and damage
- Weather-resistant and durable



01
Pressure roller
For tarpaulin welding

► Art. no.: 1010-100-1



02
Buckle strap
Width 20 mm

► Item no. 1010-60-350
► Length: 350 mm
Hole spacing: 22 mm

► Item no. 1010-60-500
► Length: 500 mm
Hole spacing: 22 mm



06
Rubber plug
Adjustable, 280 mm x 40 mm

► Art. no.: 1010-70-500



07
Rubber tension ring
Ø 8 mm, black

► Item no. 1010-70-200
► Length: 200 mm

► Item no. 1010-70-250
► Length: 250 mm

► Item no. 1010-70-400
► Length: 400 mm



03
Tarp hooks
For rotational lock, reinforced with rounded edges, polyamide 6

Item no.	Model	Hole spacing	Hole Ø
1010-30-01	silver	20 mm	3 mm



08
S-hooks
galvanised

Item no.	Model
1010-31-030	3.0 x 30 mm
1010-31-042	4.2 x 45 mm



04
Flat hooks
galvanised

Item no.	Model	Hole spacing	Hole Ø
1010-30-11	20 x 2 mm	20 mm	3 mm



09
Strap cramp
For 36 and 40 mm round eyelets and 42 x 22 mm oval eyelets, galvanised

Item no.	Height	Hole spacing	Hole Ø
1010-20-025	25 mm	51 mm	5 mm
1010-20-030	30 mm	51 mm	5 mm
1010-20-038	38 mm	51 mm	5 mm



05
Three-hole tarp hooks
Plastic, grey

Item no.	Model	Hole Ø
1010-30-21	45 x 40 mm	3 mm



10
Buckle strap
For 38 x 8 mm and 40 x 10 mm slotted eyelets, galvanised

Item no.	Height	Hole spacing	Hole Ø
1010-24-220	20 mm	51 mm	5 mm



01

Hollow punch

round

▶ Art. no.: 1010-91-040

▶ Product description

- Hollow punch, round forged version
- Diameter 40 mm



01

02

Die

round

▶ Art. no.: 1010-90-040

▶ Product description

- Ø 40 mm

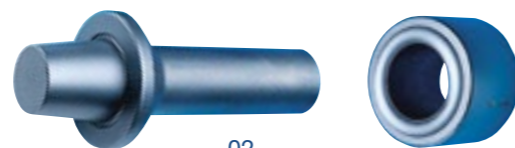

02

05

Twist clamp

for expander and tarp rope

▶ Item no. 1010-032-08

▶ 8 mm

▶ Item no. 1010-032-10

▶ 10 mm



05

06

Rope end closure

with simplex hook, galvanised

▶ Item no. 1010-50-008

▶ Ø 8 mm

▶ Item no. 1010-50-010

▶ Ø 10 mm



06

03

Round eyelet

Galvanised

▶ Art. no.: 1010-10-040

▶ Product description

- Diameter 40 mm
- In accordance with DIN 7332



03

04

Oval eyelet

galvanised

▶ Art. no.: 1010-11-042

▶ Product description

- 42 mm x 22 mm



04

07

Expander rope

100 m roll

▶ Item no. 1010-536-100

▶ Ø 8 mm

▶ Item no. 1010-537-100

▶ Ø 10 mm



07

08

Tarpaulin rope

Ø 8 mm

▶ Item no. 1010-532-100

▶ Transparent, length: 100 m

▶ Item no. 1010-535-100

▶ Sisal translucent, length: 100 m



08



01 Thermal paper rolls
for digital tachographs

► Art. no.: 1003-1-190

► Product description

- Tested by the German Federal Motor Transport Authority E1-190
- PU = 3 x 10 m rolls
- Width: 5.7 mm
- Paper weight: 60 g
- Top-coated (front and rear for optimum protection)

02 Speed-time chart
1 pack = 100 discs

Item no.	
1003-100-01	Universal, 100km/h
1003-125-01	Universal, 125 km/h
1003-140-01	Universal, 140 km/h
1003-125-05	Universal, 180 km/h
1003-125-02	electrical evaluation, 125 km/h



01



02

03 Overvoltage protection

► Art. no.: 4982-500

► Product description

- For commercial vehicles and cars
- Suppresses voltage peaks
- LED connection display
- No unclamping of battery when welding
- No reprogramming of radio, clock, etc.
- Significant time savings



03

04 Battery jumper cables

Item no.	Ø / mm ²	Length	Figure
7771-16	16	3,0 m	2
7771-35	35	4,5 m	1
		mit Überspannungsschutz	
7771-50	50	5,0 m	2



04.1



04.2

05 Battery charging clips

Item no.	Model
7771-16-200	Red 200 A PCV
7771-16-201	Black 200 A PCV
7771-35-600	Red 600 A CV
7771-35-601	Black 600 A CV



05



01

Tyre Repair Set

Tyron for HGVs

► Art. no.: 9879-971

► Product description

- 100% self-vulcanising bands
- Bands passed all TÜV endurance and high-speed test with overload
- Extremely tear-proof and shear resistant in tyres and steel belts thanks to leading-edge technology
- Can be used for straight and 45° punctures
- Suitable for all HGVs

- Set content:

- 25 x 6mm repair body (article no. 9879-974 - refill pack)
- 1 x pilot awl (article no. 9879-976)
- 1 x T-handle (article no. 9879-975)
- 1 x awl (article no. 9879-978)
- 1 x vulcanizing mass 25ml (article no. 9879-980)
- 1 x liquid patch 50ml (article no. 9879-979)
- 1 x scraper
- 1 x Allen key



01

02

Refill pack for Tyron repair kit

Tyron

► Art. no.: 9879-974

► Product description

- 100% self-vulcanising bands
- Bands passed all TÜV endurance and high-speed tests with overload
- Extremely tear-proof and shear resistant in tyres and steel belts thanks to leading-edge technology
- Can be used for straight and 45° punctures
- Suitable for all HGV tyres

- Contents:

- 25 x 6 mm repair body
- 1 x liquid patch 50ml



02

03

Tyron

Liquid patch

► Item no. 9879-979

► Contents: 50 ml

► Packing unit: 1



03

04

Awl

► Art. no.: 9879-978



04

05

Vulcanising substance

► Item no. 9879-980

► Contents: 25 ml

► Packing unit: 1



05

06

T-handle

► Art. no.: 9879-975



06

07

Penetrating awls

Length: 19.5 cm

► Art. no.: 9879-976



07



01
Tyrex
 Adhesive for tyre probes

- ▶ Item no. 9879-94-250
- ▶ Contents: 237 ml
- ▶ Packing unit: 1

02
Tyre probes
 Diam. 10 mm, PU: 10

- ▶ Art. no.: 9879-92-10

03
Tyre probes
 Diam. 4.5 mm, PU: 10

- ▶ Art. no.: 9879-92-04



04
Milling machine
 10 mm

- ▶ Art. no.: 9879-93-10

05
Tread roller
 for tyre probes

- ▶ Art. no.: 9879-91-2

06
Special rubber milling cutter
 For roughening the inner surface
 of tyres

- ▶ Art. no.: 9879-91-1



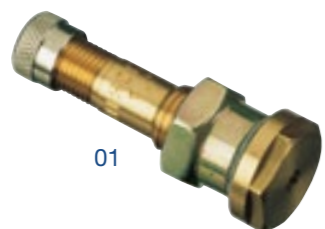

01

01

Valve

For tubeless commercial vehicle tyres, straight version

- ▶ Item no. 9879-800-41
- ▶ 9.7 x 41 mm

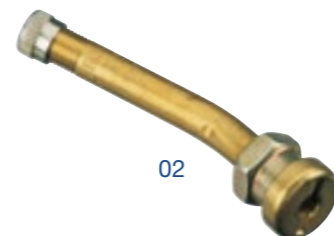

02

02

Valve

For tubeless commercial vehicle tyres, single bend 27°

- ▶ Item no. 9879-800-70
- ▶ 9.7 x 70 mm



05

05

Wheel balance weight for 15° tapered rims

Lead, from 22.5" x 6.75" to 26 inches

Item no.	Weight
9836-32-50	50 g
9836-32-75	75 g
9836-32-100	100 g
9836-32-150	150 g
9836-32-200	200 g



06

06

Striking weight for 15° tapered rims

Lead, from 22,5 x 6,75 to 26,50 x 12,00

Item no.	Weight	Item no.	Weight
9836-32-75	75 g	9836-32-250	250 g
9836-32-50	50 g	9836-32-300	300 g
9836-32-100	100 g	9836-32-350	350 g
9836-32-150	150 g	9836-32-400	400 g
9836-32-200	200 g		



03

03

Metal valve

For vans, PCVs and vehicles with high tyre pressure

- ▶ Item no. 9879-413-40
- ▶ 40 mm

- ▶ Item no. 9879-414-47
- ▶ 47 mm

- ▶ Product description
- Pressure-resistant up to 14 bar
- Wrench size 11
- High-temperature seal for peak temperatures of over +150°C



04

04

Commercial vehicle valve

Alligator, CVV

- ▶ Item no. 9879-530-40
- ▶ 40 mm

- ▶ Item no. 9879-530-47
- ▶ 47 mm

- ▶ Item no. 9879-530-60
- ▶ 60 mm

- ▶ Product description
- Safe sealing in rims
- Simple to install
- Easy to dismantle without special tools
- No rim damage when dismantling
- High pressure resistance

07

Valve extension

Air-Flexx, steel, flexible

- ▶ Item no. 9879-700-145
- ▶ 145 mm

- ▶ Item no. 9879-700-185
- ▶ 185 mm

- ▶ Item no. 9879-700-215
- ▶ 215 mm



07

08

Valve extension

Plastic, rigid

- ▶ Item no. 9879-74
- ▶ 115 mm

- ▶ Item no. 9879-75
- ▶ 150 mm

- ▶ Item no. 9879-76
- ▶ 170 mm



08

09

Extension cap with seal

Check valve

- ▶ Art. no.: 9879-66

- ▶ Product description
- Does not have to be removed for filling or pressure test
- Resistant to dirt and water
- Prevents pressure loss even when the valve insert is damaged or soiled
- Fits every standard valve



09

H7

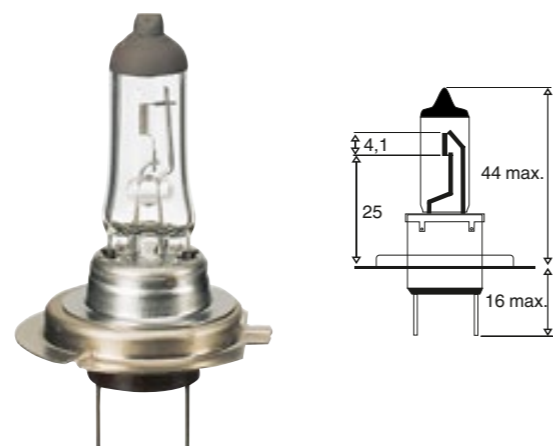

Item no.	Implementation	Base
3720-064-274	24V H7 70W HD LL Osram Truckstar Pro	Px26d

- Up to 100% more light on the road
- Up to 100% longer life (LL)

Item no.	Implementation	Base
3720-064-273	24V H7 70W HD LL	Px26d

Item no.	Implementation	Base
3723-064-211	24V H7 70W NORM LIGHT	Px26d

H1

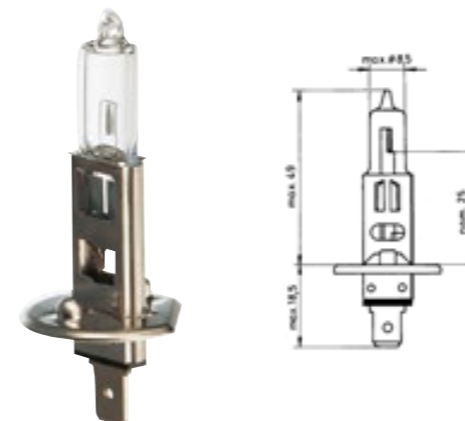

Item no.	Implementation	Base
3720-064-270	24V H1 70W HD LL	P14.5s

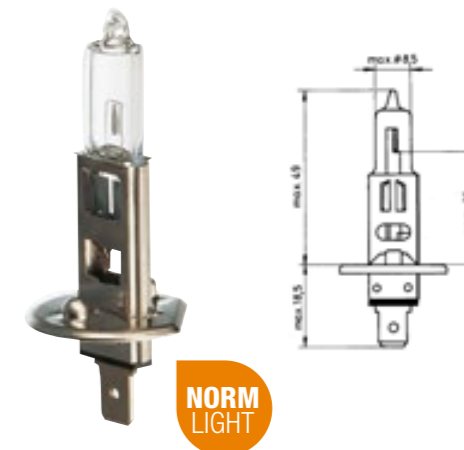

Item no.	Implementation	Base
3723-064-155	24V H1 70W NORM LIGHT	P14.5s

H4

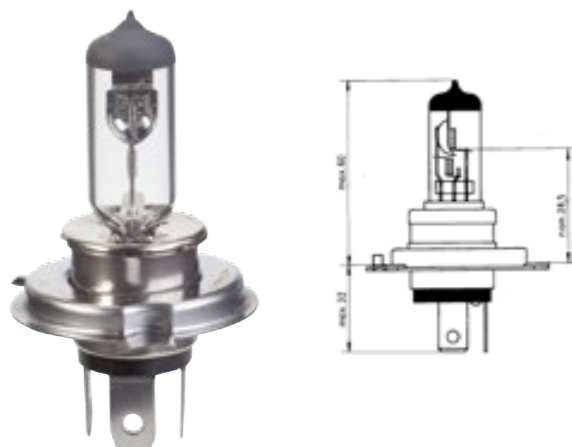

Item no.	Implementation	Base
3720-064-272	24V H4 70/75W HD LL	P43t

HD = heavy duty LL = long life

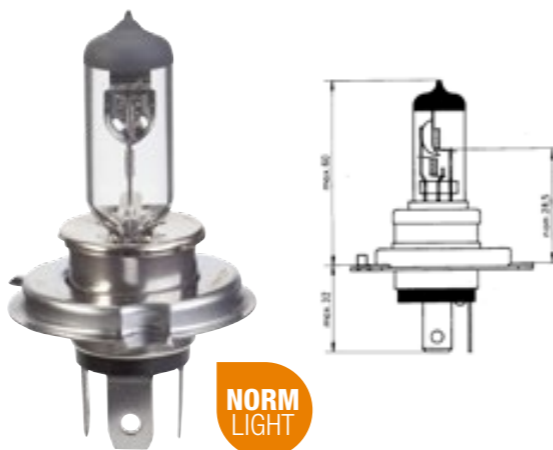

Item no.	Implementation	Base
3723-064-196	24V H4 70/75W NORM LIGHT	P43t
3723-064-197	24V H4 70/75W HD	P43t

H3

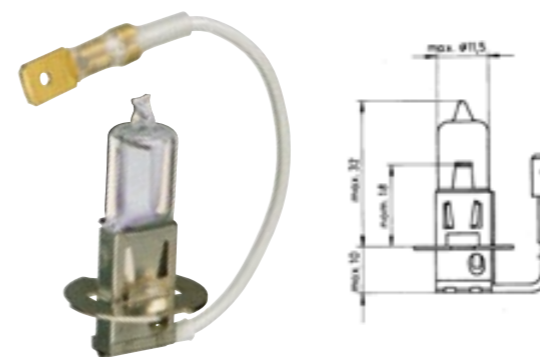

Item no.	Implementation	Base
3720-064-271	24V H3 70W HD LL	PK22s

HD = heavy duty LL = long life

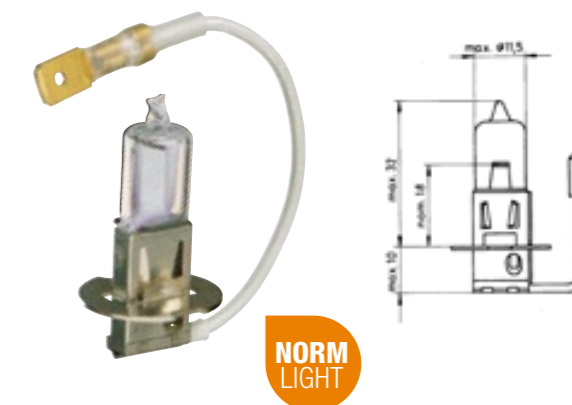

Item no.	Implementation	Base
3723-064-151	24V H3 70W NORM LIGHT	PK22s

01

Gas discharge headlight bulb D2S
XENON

► Art. no.: 3720-064-222

- Product description
- For projector headlights
 - Approx. 4,100 Kelvin
 - Voltage: 12 to 85
 - Base: D2S
 - Wattage: 35

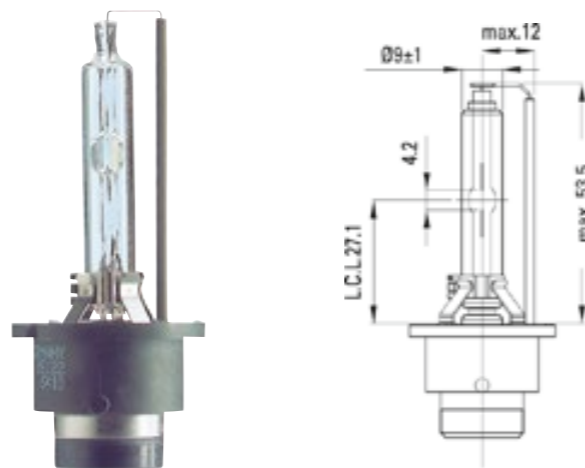

02

Gas discharge headlight bulb D2R
XENON

► Art. no.: 3720-064-223

- Product description
- For reflector headlights
 - Approx. 4,000 Kelvin
 - Voltage: 12 to 85
 - Base: D2R
 - Wattage: 35

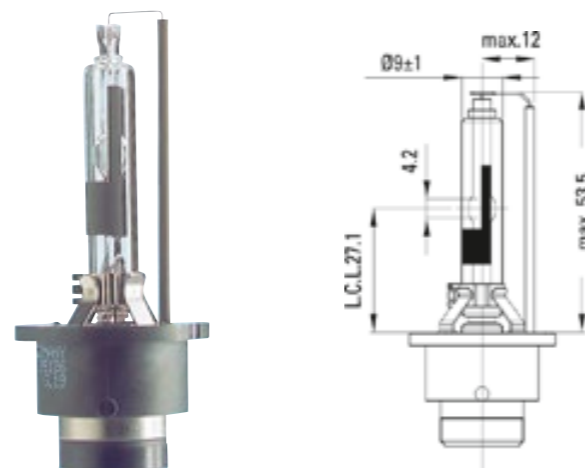

03

Gas discharge headlight bulb D1S
XENON

► Art. no.: 3720-064-224

- Product description
- Approx. 4,000 Kelvin
 - Voltage: 12 to 85
 - Base: D1S
 - Wattage: 35

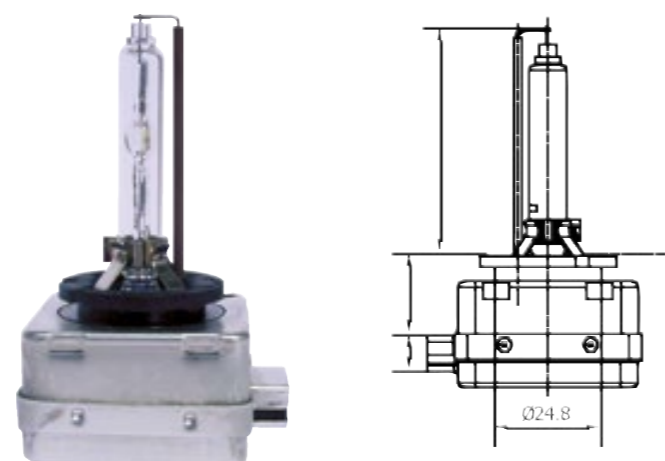

04

Electric discharge lamp

- Product description
- No mercury
 - Nominal voltage 42 Volt

Item no.	Implementation	Base
3720-064-225	D3S 35W 3200 Lumen	PK32d-5
3720-064-226	D4S 35W 3200 Lumen	P32d-5
3720-064-227	D4R 35W 2800 Lumen	P32d-6

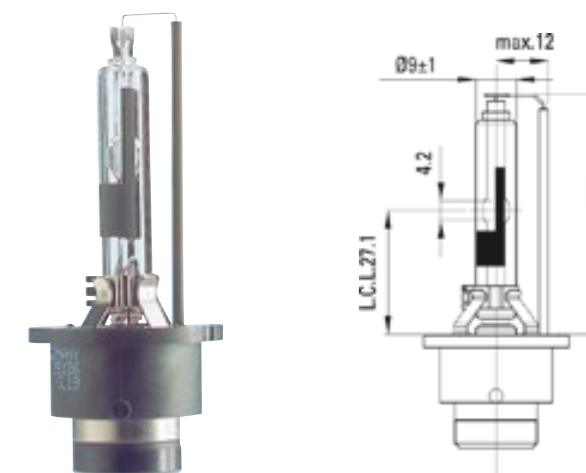

BA15s base

- ▶ Item no. 3720-075-35
- ▶ 18W

- ▶ Item no. 3720-075-11
- ▶ 21W

- ▶ Item no. 3720-752-1
- ▶ 21W HD LL

- ▶ Item no. 3723-075-11
- ▶ 21W Normlight



- ▶ Item no. 3723-751-1
- ▶ 21W HD Normlight

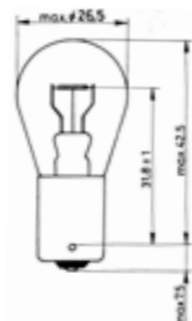

BAY15d base

- ▶ Item no. 3720-075-37
- ▶ 21/5W

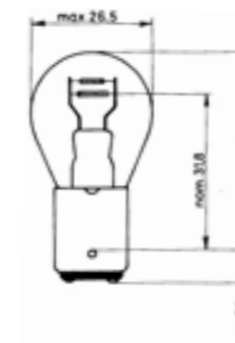

BAZ15D base

- ▶ Item no. 3720-075-47
- ▶ 21/4W

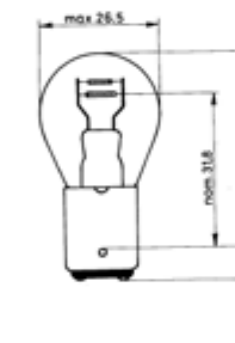

BA15s base

- ▶ Item no. 3720-056-27
- ▶ 5W

- ▶ Item no. 3720-752-3
- ▶ 5W HD LL

- ▶ Item no. 3720-056-37
- ▶ 10W

- ▶ Item no. 3720-752-5
- ▶ 10W HD LL

- ▶ Item no. 3723-562-7
- ▶ 5W HD Normlight



- ▶ Item no. 3723-563-7
- ▶ 10W HD Normlight

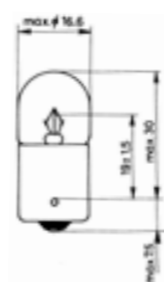

BA15s base

- ▶ Item no. 3720-752-7
- ▶ 21W HD LL

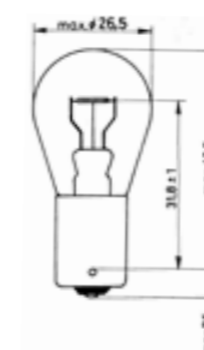

BA15s base

- ▶ Item no. 3720-056-26
- ▶ 5W



BAU15s base

- ▶ Item no. 3720-752-2
- ▶ 21W HD LL amber (yellow)



HD = heavy duty LL = long life

BAY15d base Normlight

- ▶ Item no. 3723-075-37
- ▶ 21/5W

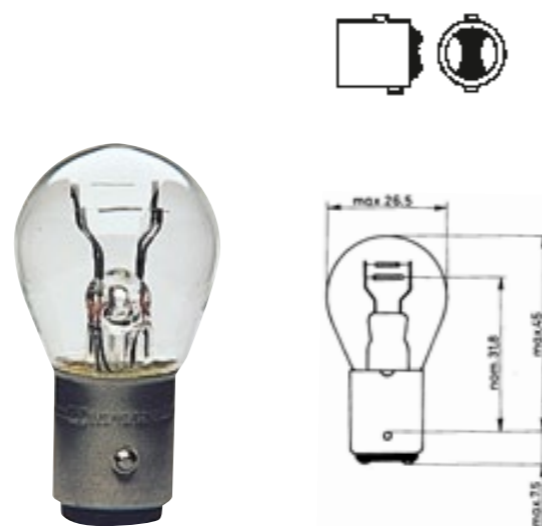

BA7s base

- ▶ Item no. 3720-038-99
- ▶ 3W



BAY9s base

- ▶ Item no. 3720-075-13
- ▶ 21W Halogen

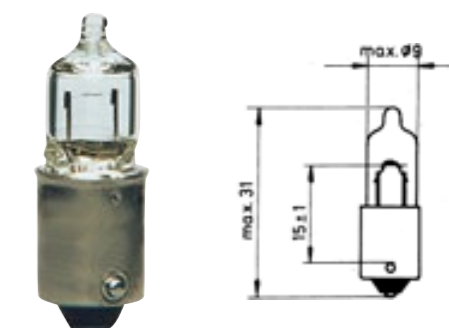

BA9s base

- ▶ Item no. 3720-039-30
- ▶ 4W
- ▶ Item no. 3720-752-6
- ▶ 4W HD LL
- ▶ Item no. 3720-037-97
- ▶ 2W

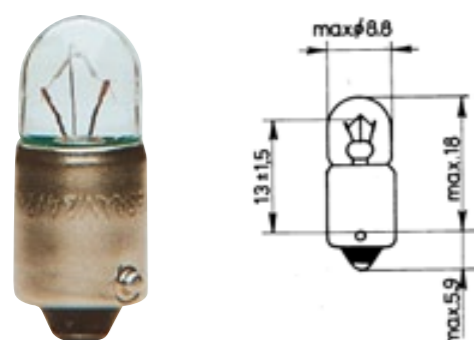

BA9s base

- ▶ Item no. 3723-393-0
- ▶ 4W HD

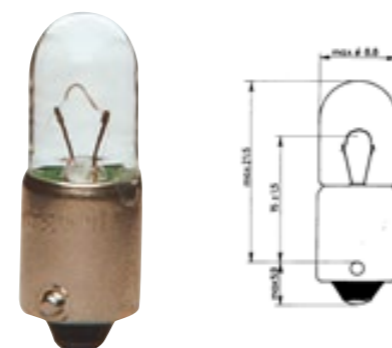

W2x4.6d base

- ▶ Item no. 3720-027-41
- ▶ 1.2W

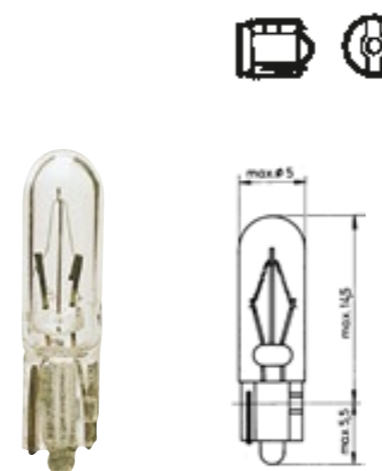

- ▶ W2,1x9:5d base Item no. 3720-028-40
- ▶ 2W
- ▶ Item no. 3720-028-41
- ▶ 3W
- ▶ Item no. 3720-028-45
- ▶ 5W

- ▶ Item no. 3723-028-45
- ▶ 5W Normlight

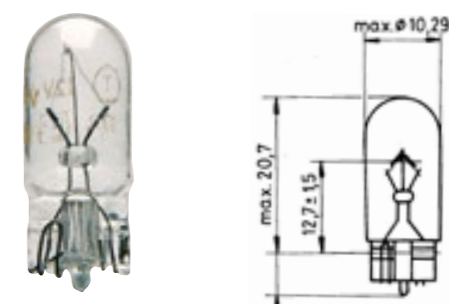

Soffitte 8, 5-8

41 mm

**Item no.
Implementation**

3720-064-24	5W
3720-064-29	10W

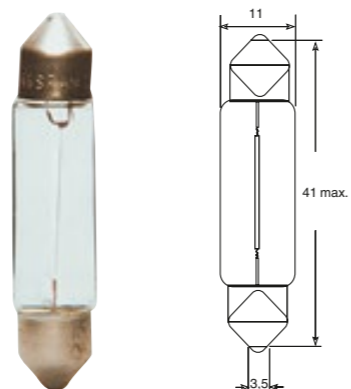

Soffitte 8, 5-8

35 mm

**Item no.
Implementation**

3720-064-23	5W
-------------	----

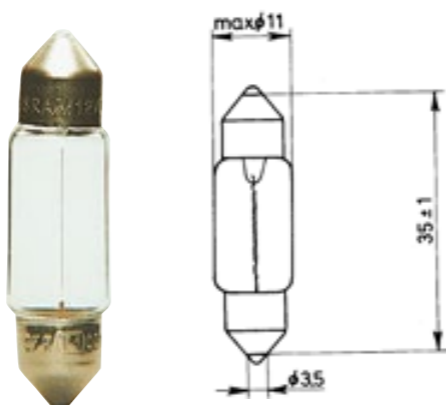

Soffitte 8, 5-8

41 mm

**Item no.
Implementation**

3720-064-80	18W
-------------	-----

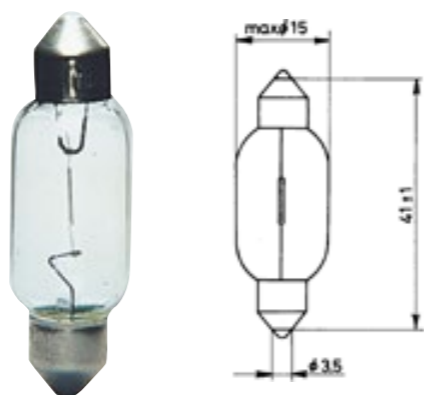

B8,3d

- ▶ Item no. 3720-027-404
- ▶ 1.2W grey



EBS R11

- ▶ Item no. 3720-027-420
- ▶ 1.2 W green suitable for Volvo

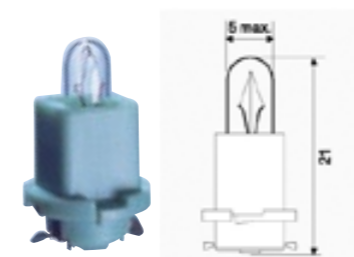

B8,5d

- ▶ Item no. 3720-027-419
- ▶ 1.2W, grey, suitable for tachographs



KW2x4,6D

- ▶ Item no. 3720-027-606
- ▶ 1W white

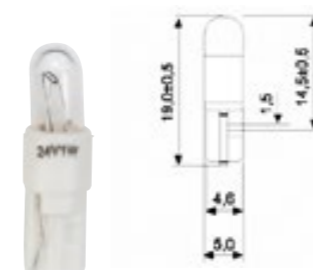

B9

- ▶ Item no. 3720-027-603
- ▶ 2.4W white

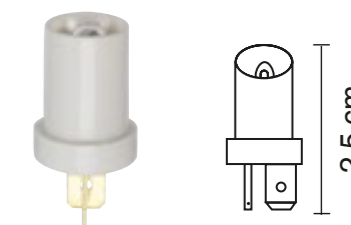

EBS R4

- ▶ Item no. 3720-027-605
- ▶ 1.2W, yellow

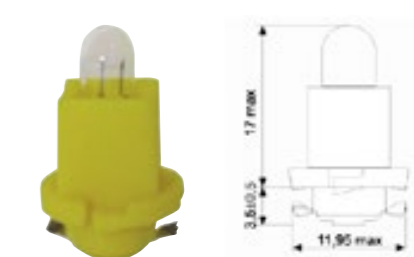

Bx8,5d

- ▶ Item no. 3720-027-600
- ▶ 1.2W, brown

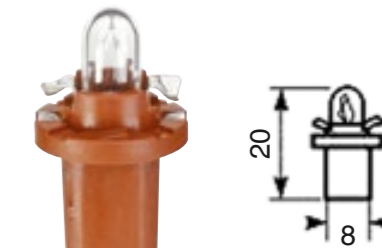

01

HGV bulb box H1 / H7

- ▶ Item no. 3720-03-000
- ▶ Contents: 20 pieces

▶ Product description

The 20-piece box of replacement HGV bulbs is fitted with OEM-quality bulbs. The bulbs are packed in a practical and robust plastic box.

Contents:

2 x 3731-010	Fuses 10A
2 x 3731-015	Fuses 15A
2 x 3731-020	Fuses 20A
2 x 3731-025	Fuses 25A
1 x 3720-064-155	Main headlight H1
1 x 3720-064-211	Main headlight H7
2 x 3720-039-30	Pilot light 4W
2 x 3720-056-37	Tail light 10W
2 x 3720-064-29	Number-plate light 10W
6 x 3720-075-11	Indicator and brake light 21W



01

02

Box for replacement HGV bulbs 24 V H7/H1

- ▶ Item no. 3723-030
- ▶ Contents: 22 pieces

▶ Product description

Contents:

1 x 3723-064-155	Main headlight H1
1 x 3723-064-211	Main headlight H7
2 x 3723-393-0	Parking light 4 W HD
2 x 3723-563-7	Tail light 10 W HD
6 x 3723-075-11	Indicator and brake light 21 W
2 x 3720-064-29	Festoon 8.5-8 10 W
2 x 3731-010	Fuse 10 A
2 x 3731-015	Fuse 15 A
2 x 3731-020	Fuse 20 A
2 x 3731-025	Fuse 25 A



02

03

Empty bulb box with foam insert for H1 and H7

- ▶ Art. no.: 3720-03-222

▶ Product description

Replacement bulb box for 24 V and 12 V lights
With liner for H7 and H1 bulbs and additional places for fuses and tail-light bulbs.



03

04

Glowpoint LED

With shatter-proof casing

- ▶ Art. no.: 3720-075-15

▶ Product description

- Voltage: 24
- Base: BA15s
- Wattage: 1 W
- Long service life: up to 10,000 operating hours
- Safety: is increased due to high luminance
- Saves energy and costs



04

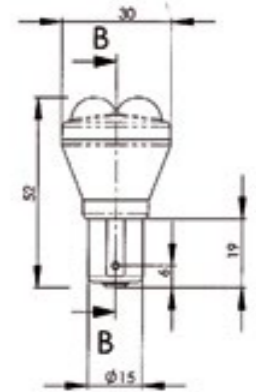

05

Box for bulb cabinet Normlight 24V *



- ▶ Art. no.: 3720-555-24

▶ Product description

The bulb cabinet is made from very sturdy and high-quality cardboard, delivered fully assembled and fitted with 24 Volt Normlight bulbs.

Dimensions (cabinet): 510x422x178mm
Consists of the following 370 components

Contents:

- 40 x 3723-028-45 Wedge base bulb 24V / 5W
- 10 x 3723-064-151 H3 24V / 70W
- 20 x 3723-064-155 H1 24V / 70W
- 10 x 3723-064-197 H4 24V / 75/70W HD
- 20 x 3723-064-211 H7 24V / 70W
- 20 x 3723-064-221 H7 24V / 70W HD LL
- 50 x 3723-075-37 Indicator and brake light bulb 24V / 21/5W
- 50 x 3723-393-0 Parking light bulb 24V / 4W HD
- 40 x 3723-562-7 Tail light bulb 24V / 5W HD
- 50 x 3723-563-7 Tail light bulb 24V / 10W HD
- 50 x 3723-751-1 Pilot light 24V / 21W HD

*Similar to image



05

Workshop equipment





► Item no. 7715-909-1



► Item no. 7715-908-1



- Lockable drawers
- Oil-resistant handles
- Innovative locking mechanism for the drawers



- Anti-static work surface
- Holding fixture for vacuum lifting tools/windcreens
- Paper roll holder



- Replaceable rubberised edge protectors
- Side compartment for aerosol cans



- Two swivel castors
- Smooth-running rubber wheels with brake

01

Tool and gear wagon

Available in blue or black

► **Product description**

- Dimensions: 1,010 mm (h) x 716 mm (w) x 495 mm (d)
- Empty weight: 65.5 kg
- Material: 1.2 mm sheet thickness
- Impact- and scratch-resistant coating
- 5 small drawers and 2 large drawers
- Non-tip

Item no.

7715-908-1	blue
7715-909-1	black



Drawers
Dimensions (internal)

Small drawers:
approx. 563 mm (w) x 393 mm (d) x 60 mm (h)

Large drawers:
approx. 563 mm (w) x 393 mm (d) x 140 mm (h)

Load capacity
Small drawers, max.: 40 kg
Large drawers, max.: 45 kg

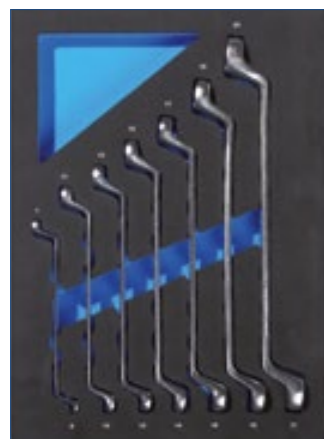

Double-ended ring spanner set
7 pieces 7/8 - 21/23
▶ Art. no.: 7715-910-2



Double open-ended spanner set 6/8 - 30/32 and 12-in-one 12 pieces
▶ Art. no.: 7715-910-3



Hammer and pliers set 6-pieces
▶ Art. no.: 7715-910-4

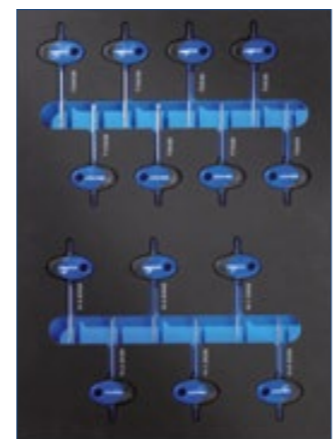

Mini screwdriver set 14 pieces
▶ Art. no.: 7715-910-5

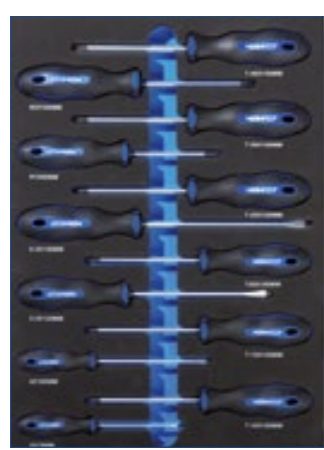

Screwdriver set 12 pieces
▶ Art. no.: 7715-910-6



Socket wrench set 1/4 79 pieces
▶ Art. no.: 7715-910-7



Socket wrench set 3/8 62 pieces
▶ Art. no.: 7715-910-8



Socket wrench set 1/2 38 pieces
▶ Art. no.: 7715-910-9



Combination spanner set 6 mm-32 mm 26-pieces
▶ Art. no.: 7715-910-1



4-piece liner
▶ Art. no.: 7715-910-10



2-piece liner
▶ Art. no.: 7715-910-11



01

Skin protection

Aquano Protect

- ▶ Item no. 2897-500-225
- ▶ Contents: 250 ml
- ▶ Packing unit: 1

- ▶ Item no. 2897-500-2
- ▶ Contents: 2 litres
- ▶ Packing unit: 1

▶ **Product description**

- Protects the skin when dealing with aqueous and non-aqueous materials such as cooling lubricants, dilute acids, alkalis, oils, grease, tar, paints, adhesives, etc.
- Quickly absorbed
- Non-greasy
- pH neutral
- Silicone-free
- Dermatologically tested
- Hypoallergenic

02

Aquano Protect Plus

Excellent skin protection

- ▶ Item no. 2897-500-825
- ▶ Contents: 250 ml
- ▶ Packing unit: 1

- ▶ Item no. 2897-500-8
- ▶ Contents: 2 litres
- ▶ Packing unit: 1

▶ **Product description**

- Dirt-repelling skin protection that can be washed off
- for strongly adhesive, non-aqueous materials, such as Oils, paints, bitumen, adhesives, resins, PU foams, etc.
- Made from raw materials with a natural basis
- Free from mineral oils, silicone oils and their derivatives, and preservatives



01



02

Skin Protection Plan Art. no.: 2897-500-7

1 HAUTSCHUTZ
→ vor der Arbeit

Aquano Protect
Der langanhaltende Hautschutz für alle Anwendungsbereiche.

- schützt die Haut vor wässrigen und nicht wässrigen Arbeitsstoffen
- dermatologisch getestet

▶ Art.-Nr. 2897-500-2

2 HAUTREINIGUNG
→ für die Verschmutzung

Aquano Clean
Die milde und neutrale Reinigungs-lotion für starke Verschmutzungen.

- reinigt powerful
- ist hautfreundlich mit Rückfettung

▶ Art.-Nr. 2897-500-1

3 HAUTPFLEGE
→ nach der Arbeit

Aquano Spezial
Die Reinigungs-lotion mit Doppelwirkung für extreme Verschmutzungen.

- sehr gute Hautverträglichkeit
- dermatologisch getestet

▶ Art.-Nr. 2897-500-4

Aquano Lotion
Die wirksame Hautpflege mit natürlichen Wärmern.

- revitalisiert die Haut
- wirkt gegen trockene, rissige und leicht entzündliche Haut

▶ Art.-Nr. 2897-500-3

03

Skin-care lotion

Aquano Lotion

- ▶ Item no. 2897-500-325
- ▶ Contents: 250 ml
- ▶ Packing unit: 1

- ▶ Item no. 2897-500-3
- ▶ Contents: 2 litres
- ▶ Packing unit: 1

▶ **Product description**

- Promotes the regeneration of affected areas of skin
- Suitable for the entire body
- With natural oils and vitamin E
- Non-replenishing
- pH neutral
- Slightly perfumed
- Silicone-free
- Dermatologically tested



03

01

Hand cleaner

Aquano Clean

- ▶ Item no. 2897-500-125
- ▶ Contents: 250 ml
- ▶ Packing unit: 1

- ▶ Item no. 2897-500-1
- ▶ Contents: 2 litres
- ▶ Packing unit: 1

- ▶ Product description
- Deep cleansing and long-lasting skin protection
- Hand cleaner easily removes tar, oil, dirt, bitumen and much more
- Aquano is sufficiently replenishing
- Does not block drains
- Silicone-free and dermatologically tested
- Hypoallergenic



01

02

Special hand cleaner

Aquano Spezial

- ▶ Item no. 2897-500-4
- ▶ Contents: 250 ml
- ▶ Packing unit: 1

- ▶ Item no. 2897-500-42
- ▶ Contents:
- ▶ Packing unit: 1

- ▶ Product description
- An intensive, skin-friendly special hand cleaner for extreme dirt such as dyes, acrylic paints, paints, etc.
- Deep cleansing
- Slightly replenishing
- Does not block drains
- No preservatives or fragrance
- Silicone-free
- Dermatologically tested



02

03

Dispenser

intended for use with 2 litre system bottles

- ▶ Art. no.: 2897-500-6

- ▶ Product description
- Comes with a pre-installed pump for dispensing hand protection products
- Made from plastic

- Scope of delivery:
- 1 x system dispenser
- 4 x 6 mm dowel, stainless-steel screws and washers
- 1 x key
- 1 x rotating head
- 1 x dosing piece
- 1 x set of installation and operating instructions



03

04

Hand cleaning Paste

Removes dirt, such as oil, grease, etc.

- ▶ Item no. 2897-240-8
- ▶ Contents: 10 kg jumbo pail
- ▶ Packing unit: 1

- ▶ Product description
- Dermatologically tested
- Silicone free
- Alkali free
- Wood flour based



04

01
Care Protect
The invisible glove

- ▶ Item no. 2897-240-1
- ▶ Contents: 1 litre of lotion
- ▶ Packing unit: 1

- ▶ **Product description**
- Lies on the skin like an invisible protective glove
- Protects the skin when dealing with various materials such as cooling lubricants, dilute acids, alkalis, oils, grease, tar, bitumen and much more
- Silicone-free
- pH skin neutral
- Dermatologically tested
- Non-greasy

02
Care Soft
Skin Cleaning Lotion

- ▶ Item no. 2897-240-3
- ▶ Contents: 1 litre
- ▶ Packing unit: 1

- ▶ **Product description**
- Particularly skin-friendly cleansing that seriously replenishes the skin thanks to high-quality ingredients
- Particularly suitable for sensitive skin and frequent washing
- pH skin neutral
- Dermatologically tested

03
Care Lotion
Skin care

- ▶ Item no. 2897-240-2
- ▶ Contents: 1 litre
- ▶ Packing unit: 1

- ▶ **Product description**
- Slightly moisturising skin care lotion, easy to apply and absorbed quickly
- Promotes the regeneration of stressed and dry skin
- Silicone free
- pH neutral
- Dermatologically tested

04
Care Clean
Hand cleaner

- ▶ Item no. 2897-240
- ▶ Contents: 3 litre bucket
- ▶ Packing unit: 1

- ▶ **Item no. 2897-240-010**
- ▶ Contents: 1 litre
- ▶ Packing unit: 10
- ▶ **Product description**
- Deep-cleanses the skin with a long-lasting protective effect and balanced replenishing of oils
- Easily removes oil, grease, tar, printing ink, bitumen, etc.
- pH skin neutral and dermatologically tested



05
Nail brush
Bristle type: hard

- ▶ Art. no.: 2897-500-9

- ▶ **Product description**
- Bristle length: 17 mm
- Colour: black
- Dimensions (H x L x W): 38 mm x 48 mm x 118 mm
- Max. cleaning temperature: +121° C
- Product meets EU Regulation no. 10/2011 regarding food contact: YES

01
Care Dispenser
For 1-litre bottle

► Art. no.: 2897-240-6

- Product description
- Dispenser for Care 1 litre bottles
 - Fits articles 2897-240-3, 2897-240-1 and 2897-240-2



02
Care Dispenser
For 3-litre pail of Care Clean

► Art. no.: 2897-240-7

- Product description
- Dispenser for Care Clean 3 litre tub
 - Fits article 2897-240



03
Care Dispenser
for Care Soft

► Art. no.: 2897-240-4

- Product description
- One dispenser unit for Care Soft 1 litre bottle (2897-240-3)



04
Care wall mount
for 1 litre bottles

► Art. no.: 2897-240-5

- Product description
- Wall holder for Care 1 litre bottles
 - Suitable for articles 2897-240-1, 2897-240-3 and 2897-240-2



05
Care wall mount & dispenser
for 3 litre tub of Care Clean

► Art. no.: 2897-240-10

- Product description
- Wall holder with integrated dispenser for Care Clean 3 litre tub
 - Suitable for article 2897-240.



06
Care wall-mounted combi cage
for the complete system

► Art. no.: 2897-240-15

- Product description
- Combined wall holder for Care Protect 1 litre bottle, Care Lotion 1 litre bottle and Care Clean 3 litre tub



01

Special „Flex-Pro“ gloves

Special black coating on palm and fingertips

► Product description

- Grey stretch fabric
- Elasticised wrist
- Anti-slip
- EN 420, EN 388 CAT 2 silicone free

Item no.	Model
7797-017-8	Size 8
7797-017-9	Size 9
7797-017-10	Size 10
7797-017-11	Size 11



01

02

Special „Flex-Pro“ Plus gloves

Seamless knitted gloves with special stretchy grey fabric

► Product description

- Bobbles on the palm
- Excellent fit
- EN420, EN388 CAT2

Item no.	Model
7797-021-8	Size 8
7797-021-9	Size 9
7797-021-10	Size 10
7797-021-11	Size 11



02

03

„Mechanic’s“ protective gloves

Nylon gloves, partially latex coated

► Product description

- Manufactured to EN 388 CAT 2
- Outstanding grip security in wet and dry working environments

Item no.	Model
7797-004-7	Size 7
7797-004-8	Size 8
7797-004-9	Size 9
7797-004-10	Size 10



03

04

Safety gloves „TOP“

PU coated on the palms and fingertips

► Product description

- Nylon gloves
- Seamless
- Great flexibility and touch
- Non-slip and non-abrasive
- Very good fit

Item no.	Model
7797-001-7	Size 7
7797-001-8	Size 8
7797-001-9	Size 9
7797-001-10	Size 10



04

05

Passenger compartment assembly gloves „Fine Knit“

Nylon/cotton, with blue PVC bobbles

► Product description

- Good grip thanks to rubber bobbles
- Manufactured to EN 388 CAT 2
- Circular knitted
- Secure grip
- Washable

Item no.	Model
7797-003-7	Size 7
7797-003-8	Size 8
7797-003-9	Size 9
7797-003-10	Size 10



05

01

Work gloves “Cut”

PU coated, Cut protection level 3

► **Product description**

- cut resistant and mechanically resilient
- manufactured according to EN 388

Item no.	Model
7797-005-8	Size 8
7797-005-9	Size 9
7797-005-10	Size 10



02

„Cut-Pro“ protective gloves

Black PU coating on palm and fingertips

► **Product description**

- Greatest cut protection, level: 5
- Special fibre knitted gloves
- Colour: grey
- Silicone-free
- EN 388, EN 407, CAT 2

Item no.	Model
7797-022-8	Size 8
7797-022-9	Size 9
7797-022-10	Size 10
7797-022-11	Size 11



03

Elastic adhesive bandage

Flexi-Tape

► **Art. no.: 7695-50-45**

► **Product description**

- Dimensions: Length 4.50 m, width 50 mm
- Adhesive bandage
- Ideal for injuries to hands and fingers
- Resistant to water and other liquids
- Elastic and tearable



01

„Elektro“ protective gloves

For hybrid vehicles

► Product description

- Insulated gloves made from natural red latex
- Category AZC
- Protection against voltages of up to 1,000 Volts
- Class 0

Item no.	Model
7797-020-9	Size 9
7797-020-10	Size 10



01

02

„Chemical“ butyl protective gloves

made from 100% butyl rubber, good grip

► Product description

- Highly impermeable against steam, gases and toxic chemicals
- Highly resistant to dipolar compounds such as esters, ketones, aldehydes, amines, saturated salt solutions and acids and alkalis
- EN 374 and EN 388

Item no.	Model
7797-028-10	Size 10



02

03

Cleaning glove „Chemicals“

Nitrile coated, length: 32 cm

► Product description

- manufactured to EN 388
- CAT 2 & EN 374 CAT 3
- Universal, light protection from chemicals and liquids, e.g. from numerous alkalis, acids, oils, etc.
- Secure grip thanks to diamond pattern
- Anti-bacterial
- Silicone-free

Item no.	Model
7797-009-8	Size 8
7797-009-9	Size 9
7797-009-10	Size 10



03

04

„Chemical“ PVC protective gloves

fully coated

► Product description

- Universal, light protection against chemicals and liquids, such as against numerous alkalis, acids, oils, etc.
- 100% impermeable to liquid
- Secure grip thanks to diamond pattern
- Anti-bacterial
- Silicone-free
- Length: 32 cm

Item no.	Model
7797-010-10	Size 10



04



01

Nitrile coated work gloves blue

Partly coated, ergonomic fit

► Product description

- Very good resistance to oils and grease
- Can be universally used; robust
- Outstanding abrasion resistance
- EN 388 Performance value 2121

Item no.	Model
7797-006-8	Size 8
7797-006-9	Size 9
7797-006-10	Size 10



01

02

Nitrile coated work gloves yellow

Partially coated, GS-tested

► Product description

- Manufactured to EN 420 CAT 2 + EN388
- Good dry grip
- Cotton jersey with knitted cuff

Item no.	Model
7797-007-7	Size 7
7797-007-8	Size 8
7797-007-9	Size 9
7797-007-10	Size 10



02

03

Disposable gloves Nitril black

100 pieces per box, silicone-free

► Product description

- No powder or latex
- Material thickness: 0.08mm
- Protects against chemicals, very light acids and alkalis

Item no.	Model
7797-029-8	Size M
7797-029-9	Size L
7797-029-10	Size XL



03

04

Disposable gloves “Nitrile”

100 per box

► Product description

- Nitrile
- Powder-free
- Manufactured according to EN 455

Item no.	Model
7797-016-8	Size M
7797-016-9	Size L
7797-016-10	Size XL



04

05

Disposable gloves „Vinyl“

100 pieces per box

► Product description

- Vinyl
- Powder-free
- Manufactured according to EN 455

Item no.	Model
7797-026-8	Size M
7797-026-9	Size L
7797-026-10	Size XL



05

06

Disposable gloves “Latex”

100 per box

► Product description

- Latex
- Powder-free
- Manufactured according to EN 455

Item no.	Model
7797-015-8	Size M
7797-015-9	Size L
7797-015-10	Size XL



06



01

Latex work gloves „Winter“

Palm PVC coated, lined

- ▶ Product description
- Palm PVC coated
- Latex coated fingertips
- With winter lining
- Cut-protection level 2
- Neon orange
- Water-repellent
- Waterproof for up to 30 minutes

Item no.	Model
7797-025-11	Size 11



01

02

Latex work gloves „Winter“

Latex dipped palm and fingertips, lined

- ▶ Product description
- Water repellent and insulating
- Manufactured according to EN 388 & EN 511
- Textured for better grip

Item no.	Model
7797-011-8	Size 8
7797-011-9	Size 9
7797-011-10	Size 10
7797-011-11	Size 11



02

03

Work gloves „Split Cowhide Leather“

Leather thickness: 1.0 mm

- ▶ Product description
- Manufactured to EN 388 CAT 2
- Double seams
- Lines palm
- White back and sailcloth gauntlet

Item no.	Model
7797-014-10	Size 10



03

04

Work gloves „100% Cowhide“

soft leather

- ▶ Product description
- Knuckle protection
- Reinforced palm
- TÜV/GS-tested
- Manufactured according to EN 420 & EN 388 CAT 2

Item no.	Model
7797-013-10	Size 10



04

05

Protective welding gloves

A combination of leather and split leather

- ▶ Product description
- 5-finger welding gloves
- Cowhide/Split leather
- Split cuff
- Length: 35 cm
- TÜV-tested

Item no.	Model
7797-012-10	Size 10



05

01

Imitation-leather gloves

Work gloves

- ▶ Product description
- With white back and white fingertips
- Lined palm
- Moisture-repellent

Item no.	Model
7797-027-10	Size 10



01

02

„Nappa“ mechanics gloves

Made from a selection of TOP nappa leather

- ▶ Product description
- Very supple and robust
- Breathable textile back
- Unlined for best-possible fingertip sensation
- Hook & loop closure at wrist
- EN 420, EN 388 CAT 2

Item no.	Model
7797-023-8	Size 8
7797-023-9	Size 9
7797-023-10	Size 10
7797-023-11	Size 11



02





01
Pro-Vision safety glasses
with compound glass

▶ Art. no.: 4695-006-500

- ▶ Product description
- The stylish, shatterproof glasses protect the eyes when working.



02
Safety glasses Astrospec
Polycarbonate lens

▶ Item no. 7794-002-0

- ▶ Item no. 7794-002-01
▶ Spare lenses

- ▶ Product description
- Anti-mist on the inside
 - Scratch-resistant on the outside
 - Soft components on the arms for extra wear comfort
 - Excellent fit thanks to adjustable arm length
 - Easy-to-change lenses
 - Highest UV protection (100%)



03
Safety glasses X-one
Anti-scratch coating

▶ Art. no.: 7794-001-0

- ▶ Product description
- Scratch-resistant coating
 - Lightweight glasses (28g)
 - Stylish design
 - Highest UV protection (100%)
 - Comfort fit in spite of simple arms



04
Nylon goggles
with compound glass

▶ Art. no.: 4695-006-433



05
Panorama full vision goggles
PC transparent lens, 100% UV protection

▶ Item no. 7794-003-0

- ▶ Item no. 7794-003-01
▶ Spare lenses

- ▶ Product description
- Ergonomically designed full view goggles
 - Anti-scratch coating on the outside
 - Anti-mist coating on the inside
 - Body: grey transparent
 - Headband: Uvex, 25 mm
 - Highest UV protection (100%)
 - Unlimited side vision



01

PRO automatic helmet

Carbon look

► Art. no.: 4695-007-100

► Product description

- Anti-glare dark slide: 1/1/1/2
- Scale numbers DIN 4/5-8 and 9-13
- WIG-suitable from 5 amperes
- Grinding mode
- Large viewing field 53 x 100mm
- Four mutually independent sensors
- Smoothly adjustable
- Power supply using solar cell & replaceable support battery
- Standard attached pane 90 x 110mm
- Interchangeable replacement attached pane, art. no. 4695-007-110



01

02

Hand shield

► Product description

- Partly heat-resistant hand shield without attached pane
- The clear and green attached panes are interchangeable

Item no.	Model
4695-006-440	Shield (without glass)
4695-006-442	Cover lenses clear
4695-006-446	Green lens



02

03

Folding welder goggles

► Product description

- These goggles complete with flip-up front provide a clear view when welding.

Item no.	Model
4695-006-460	Goggles
4695-006-461	Spare lenses non shattering
4695-006-465	Spare lenses athermal



03

04

Ear protection

► Art. no.: 7126-003-000

► Product description

- Extremely light and comfortable to wear
- Special plastic headband
- Very soft ear cups
- Gentle contact pressure
- SNR value 25 dB



04

06

Shield

► Product description

- Polypropylene headband
- Extremely high impact protection and chemical resistance

Item no.	Model
7936-000-000	Glass
7907-002-000	Head harness



06

05

Clip ear protection

► Item no. 7695-006-610

► Clip ear protection

► Item no. 7695-006-611

► Spare plugs

► Product description

- The handy headband ear defenders are ideal for rapid use in most noise situations
- The oval pads provide an improved fit on the auditory canal

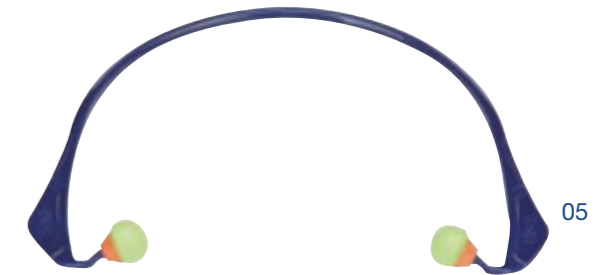

05



07

07

Ear plugs

► Art. no.: 7695-006-600

► Product description

- No strap
- Hygienically packed in pairs
- Dispenser box of 200 pairs

01

LED inspection lamp, 6 SMD LED

Swivels through up to 180°

► Art. no.: 7981-70-70

► Product description

- Very robust LED inspection lamp developed for efficient workshop use; can be placed anywhere using three strong magnetic holders
- All angles of illumination are possible thanks to the two folding and twisting suspension hooks and the flexible light head that can be swivelled through up to 180° on the articulated magnetic foot

- Technical data:

- LEDs, main light: 6 x 0.5 W high-performance SMD-LED
- LED, spotlight: 1 W high-performance LED
- Main light: 240 lumen / 400 lux @ 50 cm
- Spotlight: 60 Lumen / 800 Lux @ 50 cm
- Main light duration: 3 hours
- Spotlight duration: 8 hours
- Battery: 3.7 V/2100 mAh Li-Ion
- Charge time: 4 hours
- Charger operating voltage: 100-240 VAC/50-60 Hz
- Charger output voltage/current: 4.2 VDC / 1 A
- Temperature range: -10° to +40°C



Spotlight



01

02

26 LED inspection lamp

Head tilts 180°

► Art. no.: 7981-70-30

► Product description

- Super bright rechargeable inspection lamp and torch in one, head tilts up to 180°
- Two retractable hanging hooks
- Main light features 21 super bright LEDs, up to 4 hours of use
- Torch features 5 super bright LEDs, up to 15 hours of use
- With 3 strong magnets and 2 swivel hanging hooks
- Incl. 1,200 mAh li-ion high-capacity rechargeable battery
- Incl. 230 V-AC charger, charge time: 4 hours



12V-24V car charger

For the LED inspection lamp

► Art. no.: 7981-70-31

Spotlight



02



01

Inspection lamp COB-LED

Uniform, 190 x 63 x 38 mm

► Art. no.: 7981-70-46

► Product description

- 2-stage switching: 1st stage: 100 lumen, 2nd stage: 200 Lumen
- USB charging cable
- Practical belt holder, with integrated suspension hook
- With swivelling articulated foot, incl. strong magnet
- Waterproof (IP65)
- Bulb: 2.4 W COB-LED
- Light duration: 3 to 6 hours, depending on the stage
- Battery: 3.7V/2200 mAh Li-Ion
- Charge time: 4 hours
- Temperature range: -10° to +40 °C
- Weight: 280g



01

02

Inspection lamp COB-LED

Mini shape, 117 x 59 x 13 mm

► Art. no.: 7981-70-36

► Product description

- 2-stage switching: 1st stage: 55 lumen, 2nd stage: 110 Lumen
- USB charging cable
- Practical belt holder, with integrated suspension hook
- Light duration: 5 hours to 2.5 hours
- Battery: 3.7 V/1000 mAh Li-ion
- Charge time: 2.5 hours
- Temperature range: -10 ° to +40 °C
- Weight: 112g
- waterproof IP20



02

03

MAG PEN rechargeable pen lamp

Two different lamps

► Art. no.: 7981-70-5

► Product description

- Main light:
 - Light source: 7 x 0.06W SMD LEDs
 - Lumen: 40
 - Lux: 100
 - Light duration: 4 hours
- Spotlight:
 - Light source: 1 x 0.5W LED
 - Lumen: 30
 - Lux: 500
 - Light duration: 5 hours
- Battery: 3.7 V/750 mAh Li-ion
- Charge time: 3 hours
- Waterproof: IP20
- Diameter: 23mm
- Length: 168 mm
- Weight: 55g

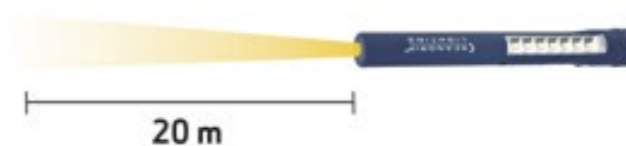

03

04

LED inspection lamp

For checking brake pads

► Art. no.: 3721-503

► Product description

- Length: 125 mm / Head diam. 12 mm
- Light source: 5 mm LED
- Comes with batteries
- Constant light efficiency
- With instantaneous clip connection
- Extra-strong clip (non-slip)
- Aluminium casing

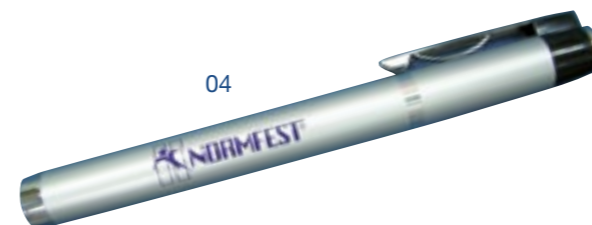

04

05

LED inspection lamp

Flashpen

► Art. no.: 7981-70-2

► Product description

- Extremely bright 100 Lumen LED
- Focus function with a light cone of 10° to 70°
- Light width up to 75mm
- Light duration up to 6 hours
- Waterproof to IP54
- Dimensions (WxH): 16mm x 148mm
- Weight: 59g
- incl. two AAA batteries



05

01

LED inspection lamp

Luminous power: approx 90 Lumen

► Art. no.: 7981-70-3

► Product description

- 1 Watt LED
- Aluminium casing
- Press switch shines in the dark
- Length: approx. 110 mm
- Includes batteries
- Luminous power: approx. 90 Lumen



01

02

LED torch

Original VARTA Type 16604

► Art. no.: 7981-70-4

► Product description

- Water-repellent high-performance torch
- Non-slip rubberized grip & suspension ring
- Break-proof LED with a life of up to 100,000 hours
- Resistant to chemical liquids such as oils, petrol and diesel
- Light cone can be focussed in 3 stages
- High-performance 0.5 Watt LED
- Light width of 52 metres
- Length 204 mm



02

04

Work lamp COB LED 30 W

Scangrip, 3300 Lumen

► Art. no.: 7981-70-60

► Product description

- Unbreakable, impact-, dust- and water-resistant
- Even illumination
- IP67 classification
- Includes flexible tripod
- Can be easily rotated or suspended
- Handle used for winding up the cable

Technical details:

30 W HIGH CRI COB LED
 3300 Lumen
 5000 Lux @ 50 cm
 LED life is at least 100,000 hours
 Operating voltage: 230 V AC
 Cable: 5 m (2x1 mm²HO5RN-F)
 Dimensions: 261 x 274 x 76,5 mm
 Weight 2800 g

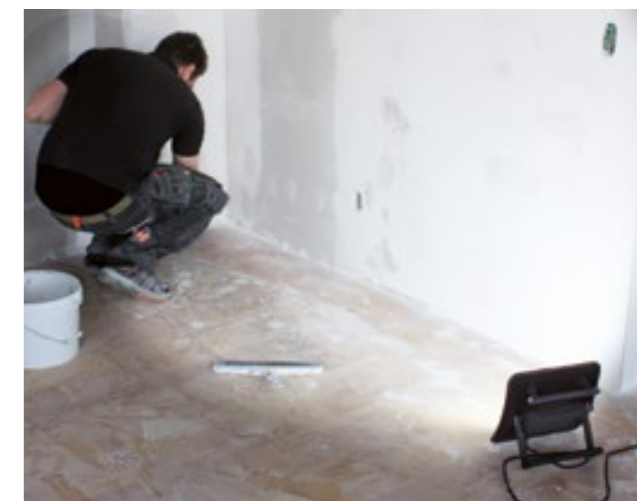

04

03

Work light

For indoor and outdoor use

► Art. no.: 7981-70-55

► Product description

- Powerful and robust 55 W worklamp for indoors and outdoors
- With adjustable stand, handle and 2 power tool sockets
- Robust rubber housing
- 5 m heavy duty rubber cable
- Waterproof to IP44
- Voltage: 230 V AC
- 3000 Lumen
- 3000g
- 295 x 295 x 90 mm



03



05

05

Tripod stand

Height adjustable from 1.1 to 2.5 m

► Art. no.: 7981-70-56

06

Holder for tripod stand

To fasten the work lamp COB LED (art. no. 7981-70-60)

► Art. no.: 7981-70-58



06

- Item no. 7981-70-57
- Spare fluorescent tube

- Item no. 7981-70-56
- Tripod, height adjustable from 1.1 to 2.5 m



01
Disposable hand lamp
8 W

► Art. no.: 7981-66

► Product description

- 8 W, 220-240 V
- Anti-roll hexagonal shape
- Swivel hanging hook
- UV, oil and petroleum resistant
- 220-230 V, 50-60 Hz



01

02

Inspection lamp for dent repairs

Incl. suction base

► Art. no.: 8714-610

► Product description

- Flexible use
- Can also be used as a hand lamp via the detachable flexible arm
- Paint-protecting 120 mm-diameter suction foot
- 300 mm long flexible arm with star handle
- Protects eyes thanks to prismatic protective glass

- 220/240 Volt with automatic switch-off
- 50/60 Hz
- 900 Lumen
- 210 mm light length
- Width: 38.5 mm
- Length: 65 mm
- 11 Watt fluorescent lamp
- 5m supply cable



02

03

LED engine-compartment lamp

Bonnet Light, Scangrip

► Art. no.: 7981-70-80

► Product description

- Diameter of just 25 mm
- Bright, pleasant, non-flicker lighting
- 75% more illumination
- Adjustable telescopic holder (1.2 m to 1.7 m)
- Paintwork protected by soft covering

- Technical details:
- 120 PLCC SMD LEDs
- 600 Lumen
- Illumination angle: 75°
- Dustproof and splashproof to IP54
- Life of LED is at least 100,000 hours
- 7.5 W power consumption
- Operating voltage: 230 V AC
- 24 VDC plug-in power supply
- Cable length: 5 m
- Weight: 1,480 g
- Includes adjustable telescopic holder (1.2 to 1.7m)



03



01
Oil binder
Oil-Catcher Indoor

- ▶ Item no. 7874-50
- ▶ Contents: 50 litres
- ▶ Packing unit: 1

- ▶ **Product description**
- An oil binder ideal for workshop interiors
- Absorbs easily without absorbing water

02
Oil binder
Oil-Catcher Outdoor

- ▶ Item no. 7874-40
- ▶ Contents: 40 litre
- ▶ Packing unit: 1

- ▶ **Product description**
- An oil binder specially developed for outside use
- Has such a high weight of its own that there is no more drifting

03
Workshop cleaner
Bio-Star

- ▶ Item no. 2897-250-5
- ▶ Contents: 5 litres
- ▶ Packing unit: 1

- ▶ Item no. 2897-250-30
- ▶ Contents: 30 litre
- ▶ Packing unit: 1

- ▶ **Product description**
- Highly active concentrate for cold and high-pressure cleaning
- Suitable for cleaning heavily soiled factory floors, walls and floor tiles
- Removes lubricating oil, grease, soot, pigments, resin and tar
- High-pressure cleaner mixing ratio: 1:3 to 1:5
- Mixing ratio for manual use: 1:1 to 1:5
- pH value: 11.2 (alkaline)
- AOX-free

Spout for 5 litre containers

- ▶ Item no. 2000-000-005

Spout for 30 litre containers

- ▶ Item no. 2000-000-030

04
Oil-stain remover
Oel-Ex

- ▶ Item no. 2897-341
- ▶ Contents: 400 ml
- ▶ Packing unit: 12

- ▶ **Product description**
- Effective aid against oil stains and old oil stains
- Removes oil stains from all absorbent and non-absorbent substrates, such as stone, natural stone and concrete blocks, clay and pumice, screed, clinker and ceramic
- Can also be used on carpets and textile flooring
- Colour: White
- Important: Do not use on bitumen, asphalt or slate!



04

03

01
Normfest-style batteries
Power, PU: 40 pieces

Item no.	Description	Voltage
3722-71	Mignon AA	1.5 V



01

02
Normfest-style batteries
Power, PU: 40 pieces

Item no.	Description	Voltage
3722-72	Micro AAA	1.5 V



02

03
Batteries

Item no.	Voltage	Model	Figure
3722-24	12 volts	A 23, MN 21	1
3722-29	1.5 volts	LR 1, 4001	2

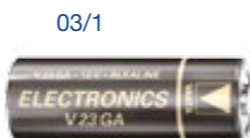

03/1



03/2

04
High-energy batteries

Item no.	Voltage	Model	Figure
3722-01	1.5 volts	Mono D	1
3722-02	1.5 volts	Baby C	2
3722-03	1.5 volts	Mignon AA	3
3722-04	1.5 volts	Micro AAA	4
3722-05	9.0 volts	Block E	5

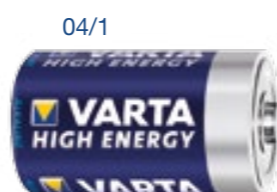

04/1



04/3

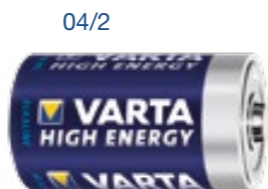

04/2



04/4



04/5

05
Rechargeable batteries

Item no.	Model	Figure
3722-40	800 mAh Micro AAA	1
3722-41	2100 mAh Mignon AA	2



05/1



05/2

06
Varta Easy Line charger
Scope of delivery does not include storage batteries

► Art. no.: 3722-50

► Product description

- For up to 4 batteries simultaneously
- Charges AA, AAA, C, D in pairs or 1 x 9-Volt battery
- Charge time from 5 hours



06

07
Button cell batteries

Item no.	Description	Voltage
3722-20	CR 2025	3 volts
3722-21	CR 2032	3 volts
3722-22	625 A, LR 9	1.5 volts
3722-23	CR 2016	3 volts
3722-25	CR 1620	3 volts
3722-26	CR 1616	3 volts

Item no.	Description	Voltage
3722-27	CR 1220	3 volts
3722-30	CR 1632	3 volts
3722-31	V13 GA, LR 44	1.5 volts
3722-32	CR 2450	3 volts
3722-33	CR 1/3 N	3 volts



08
Assortment of button cells

- Item no. 1957-580
- Contents: 75 pieces

Item no.	Quantity
3722-20	10
3722-21	10
3722-23	10
3722-27	10
3722-25	10
3722-26	10
3722-30	10
3722-29	5



01
Cleaning paper roll
2-ply, 1,000 tear-off sheets

- ▶ Item no. 7875-502
- ▶ 22 x 36 cm embossed, fully coated

- ▶ Item no. 7875-503
- ▶ 36 x 38 cm embossed, fully coated

- ▶ Product description
- Colour: blue
- PU: 2



01

02
Cleaning paper roll
3-ply, 1,000 tear-off sheets

- ▶ Item no. 7875-504
- ▶ 38 x 36 cm

- ▶ Product description
- Roll length: 350m
- Roll diameter: 29cm
- Colour: Blue
- Embossed, fully bonded
- Pack size: 2 pieces



02



06
Chrome wall mount
Max. roll width 75 cm

- ▶ Art. no.: 7875-901

- ▶ Product description
- For 3 compact rolls, max. roll width 75 cm
- Seat covers, compact rolls and rubbish bags
- H x W x D: 70 x 76 x 24 cm

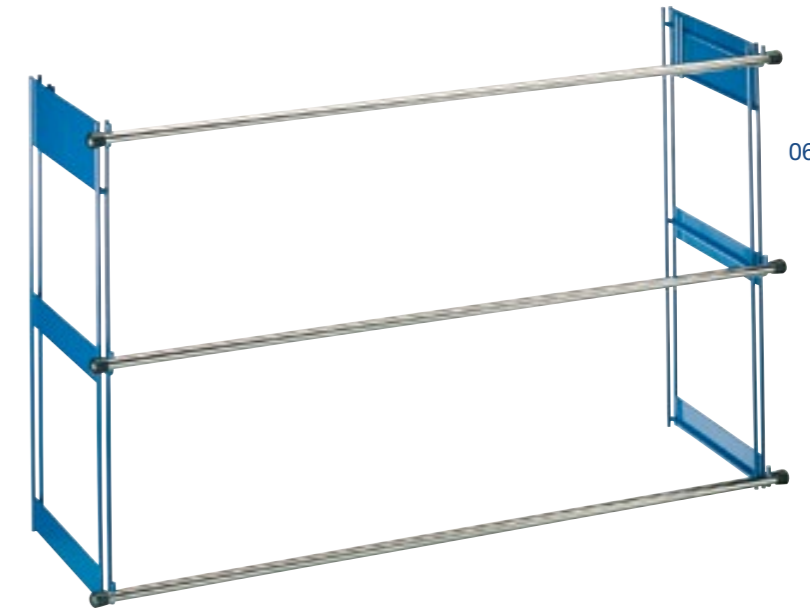

06

03
Fleece roll
perforated, 400 pcs. to tear off

- ▶ Item no. 7875-500
- ▶ 29 x 38 cm

- ▶ Product description
- Colour: white
- Very absorbent
- Excellent strength wet or dry, abrasion-resistant
- Washable and reusable
- Solvent-resistant
- Silicone-free
- Food safe



03

04
Cellulose pads roll
2-ply, 600 pcs. to tear off

- ▶ Item no. 7875-1
- ▶ 27 x 40 cm, PU: 2

- ▶ Product description
- Roll length: 255 m
- Colour: white



04

05
Fibre fleece cleaning cloth
perforated, 400 pcs. to tear off

- ▶ Item no. 7875-5
- ▶ 29 x 39 cm

- ▶ Product description
- Reusable towels with high cotton content
- Can be wrung out
- Resistant to most solvents



05

07
Cleaning paper floor stand
max. roll width 40 cm

- ▶ Art. no.: 7875-3



07

08
Chrome dispenser for cleaning paper
max. roll width 40 cm

- ▶ Art. no.: 7875-2



08

09
Workshop refuse bags
120 litres

- ▶ Item no. 7875-907
- ▶ Colour: transparent

- ▶ Item no. 7875-908
- ▶ Colour: blue

- ▶ Product description
- 100 pieces on each roll
- 60 µm



09

01

Compact roll 5 in 1

- ▶ Item no. 7875-911
- ▶ 250 sets on each roll

▶ Product description

- Seat cover PE white 840 x 1,400 mm
- Foot mat PE white non-slip 550 x 590 mm
- Steering wheel cover PE blue 490 x 150 mm
- With punched holes, gear lever and handbrake cover



01

02

Steering wheel covers roll

- ▶ Item no. 7875-900
- ▶ Steering wheel covers roll

▶ Item no. 7875-900-01

▶ Handle for steering wheel cover roll

▶ Product description

- Length: 300 cm
- Width: 14 cm
- Core inner diam.: 3.8 cm



02

03

Disposable foot mats

Plain

- ▶ Item no. 7875-510
- ▶ Roll each with 500 pcs.

▶ Product description

- Colour: white
- 70g/m²

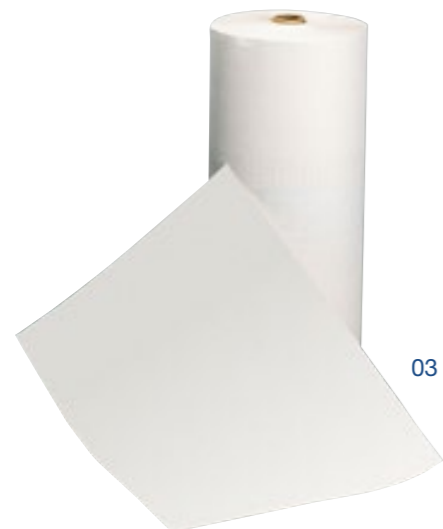

03

04

Duo foot mats

Disposable, perforated

- ▶ Item no. 7875-511
- ▶ 500 pcs. in a carton

▶ Product description

- No leakage of liquids and oils
- Very high tensile strength due to laminated, anti-static film
- 38 x 50 cm
- Paper: 70 g grey



04

05

Mudguard cover

Made from polyester

- ▶ Art. no.: 7875-921-8

▶ Product description

- With magnet
- 100 cm x 65 cm
- With two tool pockets



05

06

Mudguard cover

Made from imitation leather

- ▶ Art. no.: 7875-921-9

▶ Product description

- With magnet
- 100 cm x 65 cm



06

07

High temperature protective blanket

- ▶ Art. no.: 4982-001

▶ Product description

- Resistant to sparks and spatter
- Material: Glass filament fabric (flame-resistant, non-combustible)
- Weight: 3.5 kg
- Dimensions: 160 x 230 cm with fastening straps
- Thickness: 0.5 mm
- Heat resistant: up to 750°C
- Elongation at break: 3%



07

08

Protective welding blanket

- ▶ Art. no.: 4982-000

▶ Product description

- Dimensions: 229 x 188.5 cm
- Heat resistant: up to 700°C
- Max. radiation temperature: up to 1,000°C
- Abrasion and knick-proof



08



01

Protective seat covers

- ▶ Item no. 7875-902
- ▶ Roll each with 500 pcs.

- ▶ Item no. 7875-904
- ▶ Roll each with 100 pcs.

-
- ▶ **Product description**
- Dimensions: 82 cm x 130 cm
 - Strenth: 13my
 - Roll of 500
 - Perforated
 - Also approved for seats with side airbags



01

02

Protective seat covers
Made from imitation leather

- ▶ Art. no.: 7875-920-000

-
- ▶ **Product description**
- Approved for seats with airbag functions
 - Imitation leather
 - Washable to 40°C
 - Not suitable for pale leather seats!



02

03

Seat cover yellow

- ▶ Item no. 7875-905
- ▶ Roll each with 250 pcs.

-
- ▶ **Product description**
- antistatic
 - Dimensions: 840 x 1400mm
 - Permanently antistatic
 - Roll of 250
 - Approved for Daimlers



03



01
Electronic multifunctional battery charger
Telwin Doctor Charge 50

► Art. no.: 7771-12-30

► **Product description**

- Pulse Tronic automatic charging and trickle charging
- Meets the current-voltage characteristic (I/U characteristic)
- Battery test to determine, for example, the voltage present at the terminals or the starting capability (CCA) and to check the functionality of the vehicle's own three-phase dynamo
- Recharging and recovery of batteries, even when exhausted

- Protects on-board electronics when changing batteries, in diagnostics and in showroom mode
- Starting aid
- Effective charging current: 45 A
- Conventional charging current (according to EU Regulation): 40 A



02
Battery charging clips

Item no.	Model
7771-16-200	Red 200 A PCV
7771-16-201	Black 200 A PCV
7771-35-600	Red 600 A CV
7771-35-601	Black 600 A CV



03
Overvoltage protection

► Art. no.: 4982-500

► **Product description**

- For commercial vehicles and cars
- Suppresses voltage peaks
- LED connection display
- No unclamping of battery when welding
- No reprogramming of radio, clock, etc.
- Significant time savings



04
Battery jumper cables

Item no.	Ø / mm ²	Length	Figure
7771-16	16	3,0 m	2
7771-35	35	4,5 m	1
	mit Überspannungsschutz		
7771-50	50	5,0 m	2



01

Start booster - for cars and HGVs

▶ Art. no.: 7771-12-24

▶ Product description

- incl. charger 12-220 V (4.0 A)
- WITH pole protection
- Max. current: 12 V or 24 V, voltage selection per connector
- Peak power (SAE) 12 V/24 V: 7,000 A/3,500 A
- Start power 12 V/24 V: 2,300 A/1,150 A
- Charger voltage: 230 V
- Charging: 12 V 4 A
- Battery life*: 500 cycles (*based on 50% load shedding)
- Cable length: 182 cm
- Copper cable diameter: 50 mm²
- Number of integrated 500 A special batteries: 2
- Fully insulated terminal
- Protected against voltage peaks by 2x 500 A fuse
- Robust and impact-resistant ABS casing
- Flexible cable with fully insulated, solid copper tongs
- With LED load status tester



01

02

Start booster - for cars

▶ Item no. 7771-12

▶ Item no. 7771-12-10

▶ Spare charger for Start Booster passenger vehicles 12 V

▶ Product description

- incl. charger 12-220 V (1.5 A)
- NO pole protection
- Max. current: 2,200 A
- Start power: 700 A
- Capacity: 12 V 22 Ah
- Gel battery
- Copper cable: Diameter 28 mm²
- Fully insulated clamps
- Protected against voltage peaks
- Cable length: 182 cm
- Weight: 8.3 kg



02

03

Cable reel

With robust frame

▶ Art. no.: 7771-100

▶ Product description

- Material: Plastic
- Reel diameter: 285 mm
- Cable length: 40 m
- Cable cross-section: 3G x 1.5 mm²
- Integrated thermostatic switch
- Area of use: For continuous outside use
- Splash-proof
- Tested to EN 61242



03

04

Automatic pneumatic hose reel

with respective connector and couplings

▶ Art. no.: 8699-7

▶ Product description

- Impact and UV-resistant plastic casing
- Compressed air hose designed for operating pressure up to 15 bar
- Long compressed air hose: 10 m
- Compressed air hose diameter: 8 mm
- Connection hose length: 2 m
- Swivelling wall holder made from solid steel
- Includes compressed-air fittings NW 7.2
- Not suitable for continuous use in a spray booth



04

05

Transmission jack hydraulics

Load bearing capacity: 300 kg

▶ Art. no.: 7714-300

▶ Product description

- Mobile, universal hydraulic jack with foot pump and dead-man control
- Lift height: min. 1.23 m, max. 2.07 m
- Steplessly adjustable lift height via foot pedal
- Extra low, large and robust running gear



05

01

Parcel tape

66 m x 50 mm

- ▶ Item no. 4985-049
- ▶ Colour: brown

- ▶ Item no. 4985-050
- ▶ Colour: transparent



01

02

Parcel tape

„Caution - Glass“ warning tape

- ▶ Art. no.: 4985-052

- ▶ Product description
- For sealing and identification
- For fragile goods
- 66 m x 50 mm



02

03

Packaging tape dispenser with brake

- ▶ Art. no.: 4985-051

- ▶ Product description
- For rolls up to 50 mm
- or 75 mm x 66 m

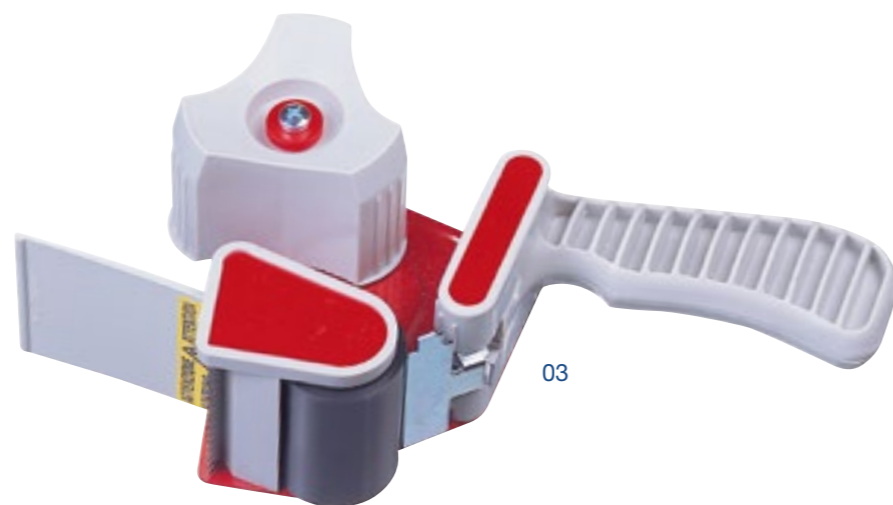

03



04

04

Cutter knife

incl. a spare blade

- Item no.
-
- 8715-57-600
-
- 8715-57-601 Spare blades 10 pieces.



05

05

Cutter knife

Material: sheet steel
length: 13 cm, width: 1 cm
blade width: 0.9 cm

- Item no.
-
- 8715-57-602
-
- 8715-57-603 Spare blades 10 pieces.

06

Replacement saw blades

For body saw (8696-1-60), optionally available

- ▶ Item no. 8696-112-551
- ▶ fine - 32 teeth, PU: 5

- ▶ Item no. 8696-112-552
- ▶ coarse - 24 teeth, PU: 5



06

07

Replacement saw blades-SIG

only for Wieländer and Schill saws

- ▶ Item no. 8696-112-554
- ▶ 24 teeth, PU: 5

- ▶ Item no. 8696-112-555
- ▶ 32 teeth, PU: 5



07

08

Replacement saw blades

For body saw (8696-1-60), optionally available

- ▶ Item no. 8696-113-71
- ▶ Sheet metal up to 2 mm (32 teeth), PU: 5

- ▶ Item no. 8696-113-72
- ▶ Steel/aluminium up to 5 mm (24 teeth), PU: 5

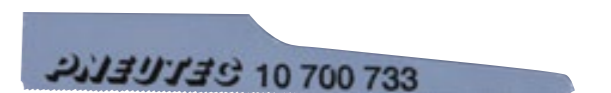

08

01

Paint roller

Content: 5 rolls

▶ Art. no.: 4693-999

▶ Product description

- Perfect, smooth primer surface thanks to macropores
- Width: approx. 10cm
- Diameter: approx. 3cm



01

02

Flat brush

▶ Item no. 4693-1

▶ 1.0"

▶ Item no. 4693-15

▶ 1.5"

▶ Item no. 4693-2

▶ 2.0"



02

03

Round brush

with plastic ferrule

▶ Item no. 4693-02

▶ Size 2, Ø 1,5 cm

▶ Item no. 4693-04

▶ Size 4, Ø 2.0 cm

▶ Item no. 4693-06

▶ Size 6, Ø 2.5 cm

▶ Item no. 4693-08

▶ Size 8, Ø 3.0 cm

▶ Item no. 4693-010

▶ Size 10, Ø 3.5 cm



03

04

Brush

For body sealing compounds, 1.0"

▶ Art. no.: 4693-251-1



04

05

Liquid flux brush

Handle made of galvanised sheet metal

▶ Art. no.: 4693-500

▶ Product description

- Pale bristles
- Ø ferrule: 15 mm
- Length: 140 mm
- Height: 25 mm



05

06

Flat brush

Angled head, 1.5"

▶ Art. no.: 4693-450-15



06

07

Brush

for tyre mounting paste

▶ Art. no.: 4693-080-0



07

08

Repair brush

▶ Art. no.: 4693-311-5



08

09

Touch-up brush

In protective cover

▶ Art. no.: 4693-311-2

▶ Product description

- With seamless, round nickel-plated ferrule
- With red coated handle and golden tip



09



01

Brake calliper brush

Smooth steel wire 0.35, particularly hard brush

- ▶ Item no. 8715-55-26
- ▶ For steel callipers

- ▶ Item no. 8715-55-27
- ▶ For aluminium callipers



01

02

Steel wire brush

- ▶ Item no. 4697-3
- ▶ 3-row

- ▶ Item no. 4697-4
- ▶ 4-row

- ▶ Item no. 4697-5
- ▶ 5-row



02

03

Oil can

White/Transparent, double-action brass pump, 0.2 litres

- ▶ Art. no.: 7713-000

- ▶ Product description
- Spray pipe, aluminium, curved



03

04

Funnel set

Oil, acid and petroleum resistant

- ▶ Art. no.: 2891-500-1

- ▶ Product description
- Resistant to oil, acid and fuel
- Versatile in use
- With handle
- Ø 50-75-100-120 mm



04

05

Funnel with strainer

Oil, acid and petroleum resistant

- ▶ Art. no.: 2891-500-5

- ▶ Product description
- With two-stage flexible outlet, detachable
- High overflow edge protects against splashes
- Interchangeable fine brass sieve
- Resistant to oil, acids and fuel



05

06

Measuring cups

oil-resistant and acidproof

- ▶ Item no. 2891-300-1
- ▶ 1 litre

- ▶ Item no. 2891-300-2
- ▶ 2 litres

- ▶ Item no. 2891-300-5
- ▶ 5 litres



06

07

Measuring cups

oil-resistant and acidproof

- ▶ Item no. 2891-400-05
- ▶ 0.5 litre, colour: orange

- ▶ Item no. 2891-400-1
- ▶ 1 litre

- ▶ Item no. 2891-400-2
- ▶ 2 litres

- ▶ Item no. 2891-400-3
- ▶ 3 litres

- ▶ Item no. 2891-400-5
- ▶ 5 litres



07

08

Gooseneck

for measuring cups with drain cocks

- ▶ Item no. 2891-400-050
- ▶ 0.5 litres

- ▶ Item no. 2891-400-10
- ▶ 1 litre

- ▶ Item no. 2891-400-20
- ▶ 2 litres

- ▶ Item no. 2891-400-30
- ▶ 3 litres



08

01

Mounting grid

Item no.	Dimensions Length x height	For storage boxes	
		Size 3	Size 4
7100-001-1	500 x 450 mm	9 x	16 x
7100-001-2	450 x 1000 mm	12 x	32 x
7100-001-3	1000 x 450 mm	18 x	36 x

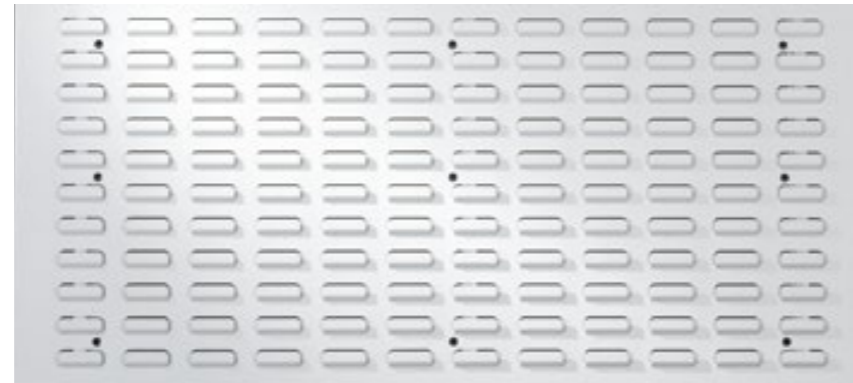

01

02

Perforated plate

Item no.	Dimensions Length x height
7100-000-2	1000 x 450 mm

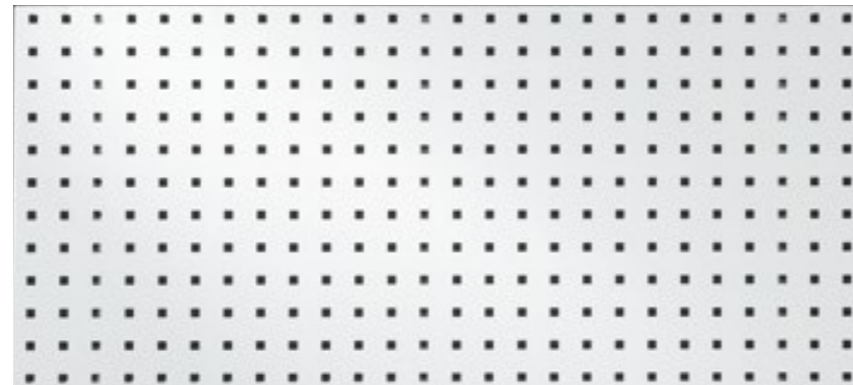

02



03

Cable dispenser

▶ Art. no.: 7100-002-02

▶ Product description

- Holds reels with up to 17 mm spindle size
- Colour: Aluminium colours
- Width: Max. 78/diameter 170 mm



03

04

Holder for petrol hose/shrink hose

▶ Art. no.: 7100-002-03

▶ Product description

- Dimensions: (WxD): 490 mm x 243 mm
- Colour: light grey



04

05

Abrasive fleece holder

empty

▶ Art. no.: 7100-002-07



05

06

Hose clamp display

empty

▶ Art. no.: 7100-000



06

07

Holder bar for cans and bottles

empty

▶ Art. no.: 7100-002-01

▶ Product description

- Dimensions (HxWxD):
50 mm x 500 mm x 80 mm
- 2 oval holes 22/31 x 57 mm
- 3 round holes 51 mm
- 2 oval holes 20/27 x 46 mm
- 1 round hole 31 mm



07

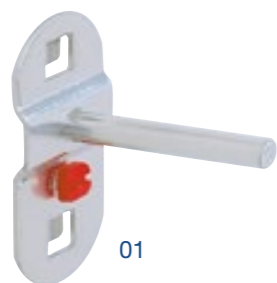

01
Tool holder
straight mandril

02
Tool clip
small

03
Tool holder
angled mandril

Item no.	Model
7100-000-304	150 mm

Item no.	Model
7100-000-305	19 mm

Item no.	Model
7100-000-301	50 mm
7100-000-302	100 mm
7100-000-3	150 mm
7100-000-303	200 mm

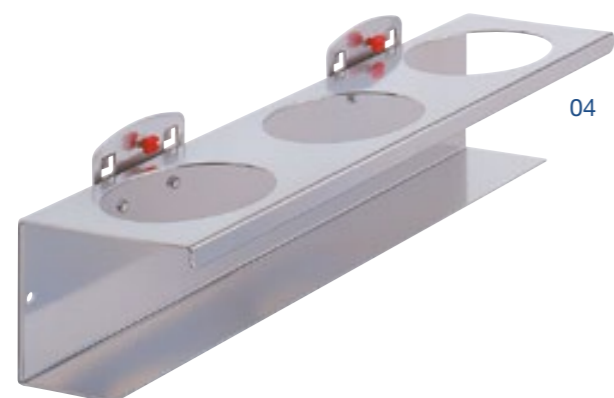

04
Can holder
Aluminium 3-fold

Item no.	Model
7100-000-6	300 x 70 mm

05
Inscription label strip self-adhesive

Item no.	Model
7100-000-5	Self-adhesive labelling bar, 430 mm
7100-000-7	940 mm

06
Magnetic tape roll
Length: 10.0 m, thickness: 0.65 mm

Item no.	Width
1961-004-201	20 mm
1961-004-251	25 mm

07
Velcro tape
Self-adhesive, 10 m x 20 mm

Item no.	Model
3985-80	1 double roll Hook and loop

08
Magnetic label
Length: 80 mm, width: 30 mm

Item no.	Model
1961-004-021	Magnetic label



09
Storage box size 1
Length: 500/450 mm, width: 300 mm, height: 180 mm

10
Storage box size 2
Length: 350/300 mm, width: 200 mm, height: 150 mm

11
Storage box size 3
Width: 140 mm, height: 130 mm

Item no.	Colour
1962-1-1	blue
1962-2-1	grey

Item no.	Colour
1962-1-2	blue
1962-2-2	grey

Item no.	Colour
1962-1-3	blue
1962-2-3	grey

11
Storage box size 4
Suitable for mounting grid, length: 160/140 mm width: 95 mm, height: 75 mm

Item no.	Colour
1962-1-4	blue
1962-2-4	grey

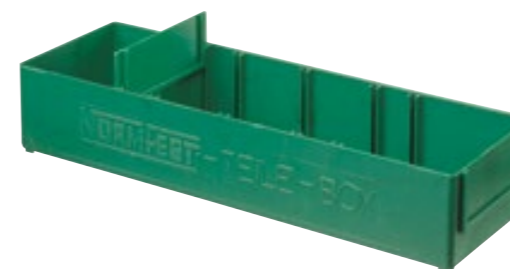

12
Storage boxes
Width: 188 mm, height: 80 mm

Item no.	Model	Length
1961-945-31	5-fold	
1961-945-30	7-fold	
1961-945-36	9-fold	
1961-945-34	Partition wall	
1961-945-291	Labels with protective film	

13
Storage boxes
Width: 94 mm, height: 80 mm

Item no.	Model	Length
1961-945-33	5-fold	
1961-945-32	7-fold	
1961-945-37	9-fold	
1961-945-35	Partition wall	
1961-945-29	Labels with protective film	

14
Parts box
Width: 90 mm, height: 50 mm, length: 270 mm

Item no.	Model
1961-0	Parts box
1961-01	Partition wall
1961-02	Labels

Pneumatic tools



01

Impact wrench 1/2"

Lightweight yet suitable for numerous applications

► Art. no.: 8696-1-112

► Product description

Technical data:

Drive torque (inch): 1/2"

Tightening torque: 900 Nm

Breakaway torque: 1,250 Nm

Speed: 8,200 rpm

Inlet diameter: 8 mm

Air inlet: 1/4" BSP

Vibration: 5.8 m/s²

- Lightweight (2 kg) yet powerful
- Forged DUOPACT impact mechanism
- Re-greasing port for impact mechanism
- Robust knob for forward/reverse shift with power controller



01



02

Maintenance oil

1 litre

► Item no. 8696-112-810

► Pneumatic motor oil

► Item no. 8696-112-820

► Impact mechanism oil



02

03

Mini one-hand right angle grinder

Low-noise and vibration-free

► Art. no.: 8696-1-80

► Product description

- Compressed air fitting: 1/4"

- Sound pressure: 83 dB/A

- Air pressure: 6.3 bar

- Weight: 0.8 kg

- Speed: 18,000 rpm

- Chuck: 6 mm

- Average air consumption: 220 l/min

04

Required air connection 1/4"

► Art. no.: 8699-510-14

05

Adapter for 8696-1-80

► Art. no.: 4679-99-8



04

03

05

06

Pneumatic one-hand axial grinder

Low-noise and vibration-free

► Art. no.: 8696-1-79

► Product description

- Air fitting: 1/4"

- Sound pressure: 82.9 dB/A

- Air pressure: 6.3 bar

- Weight: 0.7 kg

- Rotational speed: 22,000 rpm

- Chuck: 6 mm



06

01

Pneumatic machine

ideal for stripe removal discs

▶ Art. no.: 4692-123

▶ Product description

- Weight: 1.1 kg
- Air pressure connection thread: 1/4" PT
- Rotational speed: 0-3,500 rpm
- Required flow pressure: 6.2 bar/90 psi
- Average air consumption: 17.5 CFM (500 l/min)



01 / 02

02

MBX starter kit

For the professional surface preparation

▶ Art. no.: 4692-900

▶ Product description

- | | |
|--|---|
| <ul style="list-style-type: none"> - Weight: 1.1 kg - Air pressure connection thread: Rp 1/4" - Hose diameter required: 3/8" ID (9.5 mm) - Rotational speed: 0-3,500 rpm - Required flow pressure: 6.2 bar/90 psi - Required internal tube diameter: 9,5 mm - Average air consumption: 17.5 CFM (500 l/min) - Sound pressure level: 83 dB (DIN 45635-21; ISO 3744) | <p>- Contents:</p> <ul style="list-style-type: none"> - 1 x 4692-123 MBX compressed-air machine - 1 x 4692-211 MBX holder system 1 mm - 1 x 4692-223 MBX holder system 23 mm - 1 x 4692-523 MBX brush band, coarse 23 mm - 1 x 4692-411 MBX brush band, medium 11 mm - 1 x 4692 311 MBX brush band, fine 11 mm - 1 x 4692-800 MBX film grinder |
|--|---|



For working on aluminium body-work.



For removing paint from contours.



For removing films from metal surfaces and paint without damage.

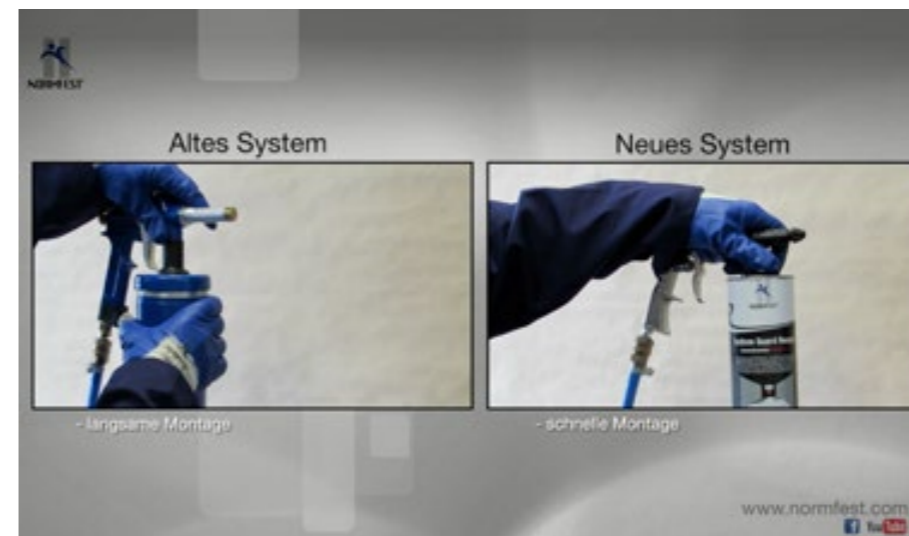

03

Pressure cup spray gun

for 1000 ml screw-top containers

▶ Art. no.: 2891-106-841

▶ Product description

- Ideal for use of Bottom-Guard and Protector
- Wide range of structures can be sprayed
- Teflon seals
- Suitable for metal



03

04

Body cavity spray hose set

For pneumatic pressure cup spray gun

▶ Art. no.: 2891-106-842

▶ Product description

- Specially designed for Protector
- Hose diameter: 6 mm
- Hose length: 98 cm (with handle, incl. adapter), 116 cm (without handle, incl. adapter)



04

01

UBS gun

Including nozzle and feed tube

► Art. no.: 2892-880

► Product description

- Quick & easy to assemble
- Accurately adjustable spray pattern
- Quick & easy to change
- No cleaning required



02

Nozzle set

For UBS gun (article no. 2892-880)

► Art. no.: 2892-880-1

► Product description

- Nozzle set for UBS gun (article no. 2892-880)

- Content:
- 3 x nozzles
- 3 x feed tubes



03

Safety coupling

European profile 7.2 – 7.4 mm

► Product description

- safe connection and disconnection due to decompression mechanism ISO 4414 – DIN EN 983
- minimum force required for connection
- optimum leak tightness
- excellent flow rate which adapts to all pneumatic tools
- anti-static, prevents the build-up of dust particles on the surface when applying paint
- energy-absorbing composite material protects against scratches
- high-level resistance to abrasion, impacts, crushing and vibrations
- max. operating pressure: 16 bar
- operating temperature: -15°C to +70°C

Item no.	Description	Fitting	Figure
8699-200-16	Safety coupling with hose fitting	6.0 mm	1
8699-200-19	Safety coupling with hose fitting	9.0 mm	1
8699-200-113	Safety coupling with hose fitting	13.0 mm	1
8699-200-214	Safety coupling with external thread	1/4"	2
8699-200-238	Safety coupling with external thread	3/8 "	2
8699-200-212	Safety coupling with external thread	1/2"	2
8699-200-314	Safety coupling with internal thread	1/4"	3
8699-200-338	Safety coupling with internal thread	3/8"	3
8699-200-312	Safety coupling with internal thread	1/2"	3



01

Universal pneumatic gun

▶ Art. no.: 2891-010

▶ Product description

- Application of various cartridges possible
- Universal application for the use of sealants and adhesives
- Quick-release valve stops the flow of material immediately
- 70% more force than conventional pneumatic guns due to the ram piston technology
- Fill quantity: 300 ml to 320 ml cartridges, up to 400 ml bagged products
- Max. pressure: 10 bar
- Operating pressure: 5-10 bar



Quantity preset screw

02

Pneumatic gun Multi

Ideal for use with body sealing compounds, windscreen adhesives and sprayable seam sealants

▶ Art. no.: 2891-03

▶ Product description

- Complete gun body, incl. quick connector DN 7.2
- Union nut for sprayable seam sealants
- Union nut for standard applications
- 1.65 kg



Lock ring for sprayable seam sealants

Lock ring for bodywork sealants (cartridges)

Circulating-air regulating screw for injectable seam sealants

Quantity preset screw

03

For plastic cartridges

For use with body sealing compounds, windscreen adhesives and sprayable seam sealants

▶ Art. no.: 2891-03-1



04

Pneumatic cartridge gun

Ideal for use with sprayable seam sealants, e.g. Flexon (2893-300)

▶ Art. no.: 2891-05

▶ Product description

- Content:
- 1 x pneumatic cartridge gun
- 1 x nozzle set (10 long nozzles, 20 short nozzles)
- 1 x spare nozzle cap



05

Spare small spray tubes

- ▶ Art. no.: 2891-051
- Packaging unit: 30 pieces

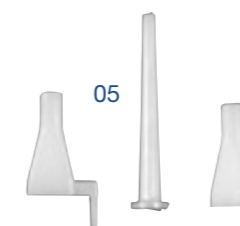

06

Pneumatic blow-out gun

With 1/4" fitting

Item no.	Nozzle length
8696-113-9	2,5 cm
8696-113-90	22,0 cm



07

Pneumatic blow-out gun

With metal nozzle

▶ Art. no.: 8696-113-900

▶ Product description

- Nozzle: 110 mm long
- Diameter 3 x 6 mm
- Lightweight
- Robust and scratch-proof
- Foot: 23 Nm 3/h at 6 bar
- Input thread with brass insert 1/4" BSP toothed



01

PVC hose

With thermoplastic layers

► Product description

- Temperature range -20°C to +60°C



Item no.	Diameter internal/external	Length
8699-66-50	6,3 mm x 11,0 mm	50 m
8699-69-50	9,0 mm x 14,5 mm	50 m
8699-613-50	12,7 mm x 19,0 mm	50 m



01

Max. operating pressure at 20°C = 20 bar

02

PVC hose set

With thermoplastic layers

► Product description

- With quick-lock coupling and plug-type grommet
- Temperature range -20°C to +60°C
- Long service life
- Wear, shock and crush-proof
- Lightweight and flexible



02

Item no.	Diameter internal/external	Length
8699-201-6	6,3 mm x 11,0 mm	10 m
8699-201-9	9,0 mm x 14,5 mm	10 m
8699-201-13	12,7 mm x 19,0 mm	10 m

Max. operating pressure at 20°C = 20 bar

Fittings

Item no.	Model
8699-200-16	6 mm coupling
8699-200-19	9 mm coupling
8699-200-113	13 mm coupling

Item no.	Model
8699-25-520	6 mm nipple
8699-25-521	9 mm nipple
8699-25-522	13 mm nipple



03

Anti-static hose

Suitable for paint shops

► Product description

- With quick-lock coupling and plug-type grommet



Item no.	Diameter internal/external	Length
8699-201-916	9,0 mm x 16,0 mm	10 m



03

04

Spiral hose

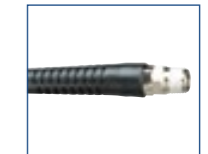

Item no.	Diameter internal/external	Fitting	Length
8699-201-65	6,5 mm x 10,0 mm	1/4"	6 m
8699-201-8	8,0 mm x 12,0 mm	3/8"	8 m

Can be rotated 360°

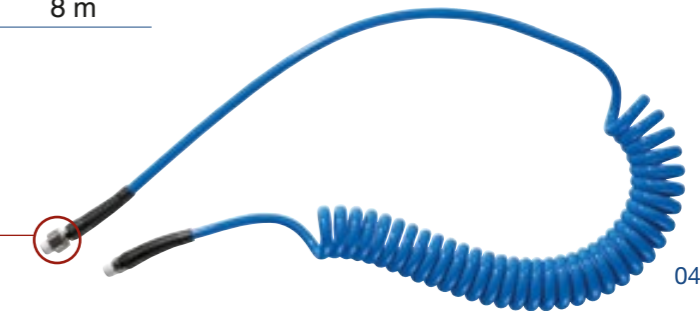

04

05

PTFE tape

for thread sealing

► Art. no.: 3985-030-160

► Product description

- Width: 12 mm
- Length: 12 m
- Thickness: 0.1 mm
- Heat resistant up to 240 - 250°C



05

Description	Item no.	Air connection mm	Spanner opening mm	Overall length mm	L1 mm	Fig.
Single-hand quick-connection coupler	8699-506	6	21	58		1
Single-hand quick-connection coupler	8699-509	9	21	58		1
One handed quick coupling with male thread	8699-541	G 1/4	22	39	9,0	2
One handed quick coupling with female thread	8699-514	G 1/4	22	41	9,0	3
Plug-type nipple with external thread	8699-520-14		17	33	9,0	4
Plug-type nipple with external thread	8699-520-38		19	33	9,0	4
Plug-type nipple with external thread	8699-520-12		24	38	12,0	4
Plug connection with female thread	8699-510-14	G 1/4	17	33	10,0	5
Double plug-type grommet DIN EN 560	8699-56	6		72	33,5	6
Double plug-type grommet DIN EN 560	8699-59	9		72	33,5	6
Double distributor internal thread	8699-530	G 3/8		67	18,0	7
Plug-type grommet hose connection	8699-526	6		48	25,0	8
Plug-type grommet hose connection	8699-529	9		48	25,0	8

Description	Item no.	Air connection mm	Spanner opening mm	Overall length mm	Fig.
Plug-type nipple with external thread	8699-25-531	1/4"	14	37,0	1
Plug-type nipple with external thread	8699-25-532	3/8"	17	37,0	1
Plug-type nipple with external thread	8699-25-533	1/2"	22	43,0	1
Plug connection with female thread	8699-200-714	1/4"	15	40,0	2
Plug connection with female thread	8699-200-738	3/8"	21	41,0	2
Plug connection with female thread	8699-200-712	1/2"	27	41,0	2
Double plug-type grommet	8699-25-551	Ø 9			3
Double plug-type grommet	8699-25-552	Ø 13			3
Plug-type grommet hose connection	8699-25-520	Ø 6		44,5	4
Plug-type grommet hose connection	8699-25-521	Ø 9		54,0	4
Plug-type grommet hose connection	8699-25-522	Ø 13		51,5	4
Double distributor internal thread	8699-200-701	1/2"	25	45,0	5 A
Double distributor exterior thread	8699-200-702	1/2"	25	53,0	5 B

1 inch = 25.4 mm = 2.54 cm

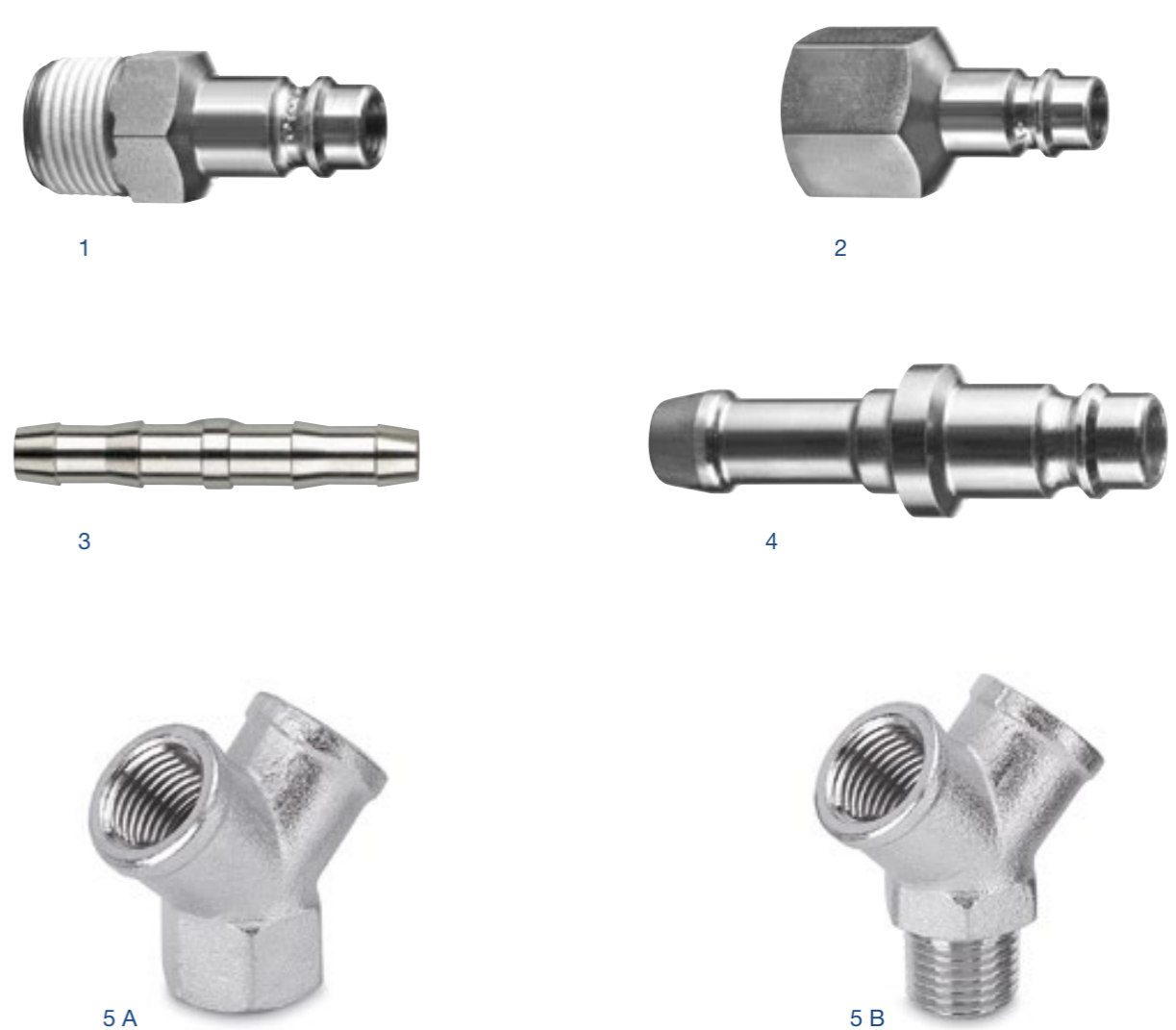
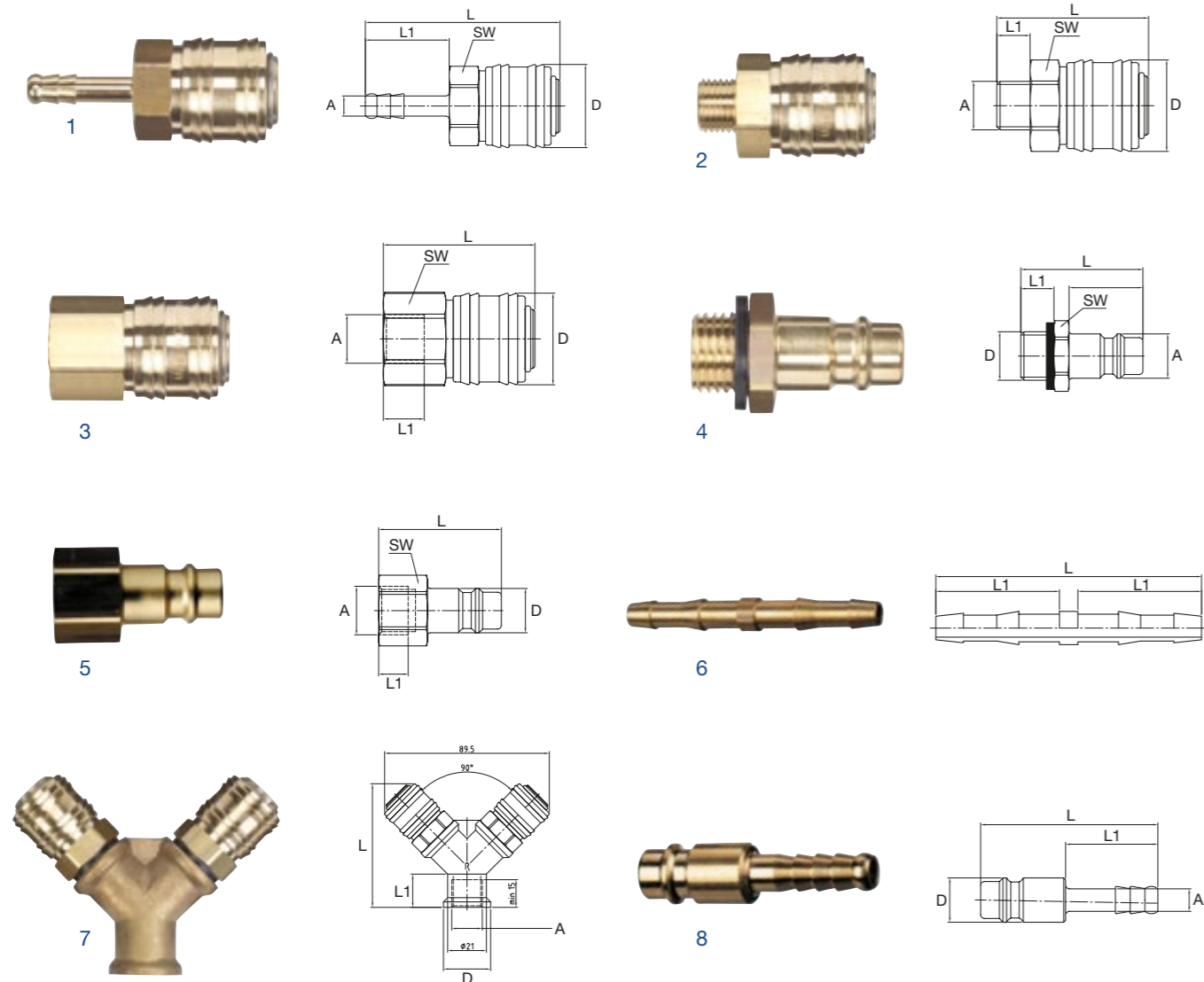



01

Windscreen cutter

▶ Item no. 8697-5

▶ Product description

- Ideal for windscreen specialists, vehicle repair workshops
- Fast, safe and easy-to-hand system
- Powerful 400 W motor for high cutting speeds
- Stepless electronic cutting frequency
- Hex tool holder with friction-locked connection between the machine and tool

Scope of delivery:

- 1 x windscreen cutter Super Cut FSC
- 1 x plastic tool case
- 1 x whetstone (art no.:8697-5-1)
- 1 x spanner wrench (art no.: 8697-600)
- 1 x mounting bolt

Technical data:

- Rated input: 400 W
- Output: 220 W
- Oscillations: 11,000-18,500 rpm
- Cable with plug: 5 m
- Weight: 1.25 kg

Spare grindstone

▶ Item no. 8697-5-1



01

02

Round saw blades

▶ Product description

- For further use of the special cutter when sawing sheet metal and GRP as well as cutting scrap bridges (bodywork saw)



02

Item no.	Ø mm	Sales unit
8697-580-2	63	1
8697-581-2	80	1

03

Cordless cartridge gun

▶ Item no. 8715-999-110

▶ Item no. 8715-999-111
▶ Replacement battery

▶ Product description

- Voltage: 10.8V
- Expulsion force: 450kp
- Speed (mm/sec): 10mm/sec
- Weight: 2.195kg (battery 0.185kg)
- Charge time: 1 hour, switches off automatically



03

04

Light pressure hand gun

For processing up to 400 ml sealant cartridges and bags

▶ Art. no.: 2891-04

▶ Product description

- Robust metal locking ring with bayonet fitting
- No jamming of the push rod due to reinforced push plate
- For plastic bags and cartridges



04



01

Hot melt gun

► Art. no.: 8714-607-1

► Product description

Electronically controlled hot glue gun with high melting capacity.

Technical data:

Dimensions (LxWxH): 185 x 30 x 160 mm

Weight: 320 g

Output: Warm-up approx. 200 W

Idle approx. 16 W

In use approx. 45 W

Mains voltage: 100 – 240 V

Warm-up time: 7 minutes

Glue stick diameter: 11 mm

Melt temperature: 206°C

Delivery rate: approx. 16 g/min

- Changeable nozzle

- Adhesive point solid and can be fully loaded after just 2 minutes



Glue-stick set

► Item no. 8714-611-7
► Glue stick set, black, PU: 5

► Item no. 8714-611-8
► Glue stick set, beige, PU: 6

► Item no. 8714-611-9
► Glue stick set, blue, PU: 6

02

REPO

LED display, electronically regulated blower with infinitely variable air quantity and temperature control

► Art. no.: 8697-000-991

► Product description

- double overheating protection: Thermostat and thermal fuse
- Air inlet with grid to prevent excess contamination
- Soft handle and soft foot for secure positioning
- Smooth speed and temperature control
- Individual adjustment of the four programs possible

- Dimensions (LxWxH): 260 x 90 x 205 mm

- Voltage: 230 V / 50 Hz

- Display type: LCD in 10° C steps

- Fan: smoothly controllable

- Programs: factory settings

- 1 = 250° C / approx. 350 l / min.

- 2 = 350° C / approx. 400 l / min.

- 3 = 450° C / approx. 500 l / min.

- 4 = 550° C / approx. 400 l / min.

- Memory button: for changing the preset programs



03

Blind rivet nut pliers

► Art. no.: 8948-800

► Product description

- Equipment and accessories:
- Threaded mandrels + nuts M6, M8, M10, M12

- Work range: up to Ø 12 mm

- Weight: 1.1 kg

- Total length: 210 mm

- For processing blind rivet nuts, M6 M12, aluminium/steel/stainless steel



Mandrel and nut

for blind rivet nut pliers 8948-800

► Item no. 8948-800-14
► M4

► Item no. 8948-800-16
► M6

► Item no. 8948-800-110
► M10

► Item no. 8948-800-15
► M5

► Item no. 8948-800-18
► M8

► Item no. 8948-800-112
► M12

01

Water pump pliers set

Cobra

► Art. no.: 8714-02-08

► Product description

Set contents:

- 1 x water pump pliers 180 mm (8714-02-05)
- 1 x water pump pliers 250 mm (8714-02-06)
- 1 x water pump pliers 400 mm (8714-02-07)

- Self-locking on pipes and nuts: No slipping on the workpiece, low hand force required
- Box-joint design: high stability due to double guide
- Guard prevents fingers being pinched
- Chrome vanadium, forged, oil-hardened



01

Item no.	Length	Tube Ø	Width across flats
8714-02-05	180 mm	1 ¼"	up to 30 mm
8714-02-06	250 mm	2"	up to 46 mm
8714-02-07	400 mm	3 ½"	up to 95 mm
8714-02-09	560 mm	4 ½"	up to 120 mm

02

Handsaw blade

HSS bi-metal, single-cutting edge

► Art. no.: 4601-300-13

► Product description

- Wear-proof, unbreakable, with excellent cutting edge retention
- Recommended for all materials

Length	Width	Height	TEETH TO 1"
300 mm	13 mm	0,6 mm	24



02

03

Handsaw blade

HSS bi-metal, double-cutting edge

► Art. no.: 4601-300-25

► Product description

- Wear-proof, unbreakable, with excellent cutting edge retention
- Recommended for all materials

Length	Width	Height	TEETH TO 1"
300 mm	25 mm	0,8 mm	22



03

04

Thread cutting unit

For metric thread in accordance with DIN 13, 44 parts

► Art. no.: 8639-02

- Contents: 44 pieces
- 3 of each manual thread cutters DIN 352, HSSG: M3, M4, M5, M6, M8, M10, M12
- 1 of each die nut DIN 223, HSS: M3, M4, M5, M6, M8, M10, M12
- 1 of each adjustable tap wrench DIN 1814: Size 1 and 2
- 1 of each tap-wrench holder DIN 225: 20 x 5 mm, 20 x 7 mm, 25 x 9 mm, 30 x 11 mm, 38 x 14 mm
- 1 of each core-removing twist drill DIN 338, HSS: 2.5 mm, 3.3 mm, 4.2 mm, 5.0 mm, 6.8 mm, 8.5 mm, 10.2 mm
- 1 of each screwdriver and thread gauge



04

05

Tap wrench adjustable

DIN 1814, for hand taps with square ends in accordance with DIN10 and ISO/R237



05

Item no.	For thread	For square-end	Length
8657-1	M1 - 10	2,1 - 5,5	180 mm
8657-2	M4 - 12	3,8 - 7,0	280 mm
8657-3	M5 - 20	4,9 - 12,0	390 mm

06

Tool holder with ratchet

Long version, for hand taps for right and left-hand threads



06

Item no.	For thread	For square-end	Length
8715-42-03	M3 - 8	2,4 - 4,9	250 mm
8715-42-04	M8 - 12	4,9 - 7,0	300 mm

07

Tool holder with ratchet

Short version, for hand taps for right and left-hand threads

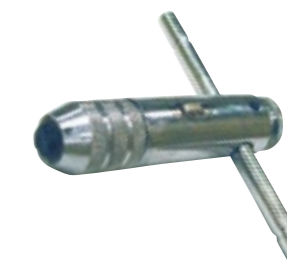

07

Item no.	For thread	For square-end	Length
8715-42-01	M3 - 8	2,4 - 4,9	85 mm
8715-42-02	M8 - 12	4,9 - 7,0	100 mm

01

Hand tap sets

DIN 352 HSS, ISO metric standard thread, taper tap, second tap, bottom tap

Item no.	Thread
8639-4	M4
8639-5	M5
8639-6	M6
8639-8	M8
8639-10	M10
8639-12	M12
8639-14	M14
8639-16	M16
8639-18	M18



02

Taper tap

DIN 352 HSS

Item no.	Thread
8640-1-6	M6
8640-1-7	M7
8640-1-8	M8
8640-1-10	M10
8640-1-20	M20
8640-1-22	M22
8640-1-24	M24



03

Second tap

DIN 352 HSS

Item no.	Thread
8640-2-5	M5
8640-2-6	M6
8640-2-8	M8
8640-2-10	M10
8640-2-18	M18
8640-2-20	M20
8640-2-24	M24



04

Bottoming tap

DIN 352 HSS

Item no.	Thread
8640-3-4	M4
8640-3-5	M5
8640-3-6	M6
8640-3-8	M8
8640-3-10	M10
8640-3-12	M12
8640-3-20	M20
8640-3-22	M22

**Thread specifications description**

DIN 352 HSS, for ISO metric standard thread

Thread	pitch mm	core hole diam. mm	L mm	threaded length mm	shaft mm	4 kt. diam.
M4	0.70	3.3	45	14	4.5	3.4
M5	0.80	4.2	48	16	6.0	4.9
M6	1.00	5.0	50	19	6.0	4.9
M7	1.00	6.0	50	19	6.0	4.9
M8	1.25	6.8	56	22	6.0	4.9
M10	1.50	8.5	70	24	7.0	5.5
M12	1.75	10.2	75	29	9.0	7.0
M14	2.00	12.0	80	30	11.0	9.0
M16	2.00	14.0	80	32	12.0	9.0
M18	2.50	15.5	95	40	14.0	11.0
M20	2.50	17.5	95	40	16.0	12.0
M22	2.50	19.5	100	40	18.0	14.5
M24	3.00	21.0	110	50	18.0	14.5

05

Fine-pitch thread taper tap

DIN 2181 HSS

Item no.	Thread
8642-118-15	M18 x 1,50
8642-120-15	M20 x 1,50
8642-124-15	M24 x 1,50



06

Fine-pitch thread bottoming tap

DIN 2181 HSS

Item no.	Thread
8642-310-1	M10 x 1,00
8642-310-125	M10 x 1,25
8642-312-125	M12 x 1,25
8642-312-15	M12 x 1,50
8642-314-125	M14 x 1,25
8642-314-15	M14 x 1,50



07

Hand tap sets

DIN 2181 HSS, ISO metric fine thread, taper tap, bottom tap

Item no.	Thread	Item no.	Thread
8641-8-1	M8 x 1,00	8641-14-125	M14 x 1,25
8641-10-1	M10 x 1,00	8641-14-15	M14 x 1,50
8641-10-125	M10 x 1,25	8641-16-15	M16 x 1,50
8641-12-125	M12 x 1,25	8641-18-15	M18 x 1,50
8641-12-15	M12 x 1,50		

**Thread specifications description**

DIN 2181 HSS, for ISO metric fine thread

Thread	pitch mm	core hole diam. mm	L mm	threaded length mm	shaft mm	4 kt. diam.
M4	0.70	3.3	45	14	4.5	3.4
M5	0.80	4.2	48	16	6.0	4.9
M6	1.00	5.0	50	19	6.0	4.9
M7	1.00	6.0	50	19	6.0	4.9
M8	1.00	6.8	56	22	6.0	4.9
M10	1.50	8.5	70	24	7.0	5.5
M12	1.75	10.2	75	29	9.0	7.0
M14	2.00	12.0	80	30	11.0	9.0
M16	2.00	14.0	80	32	12.0	9.0
M18	2.50	15.5	95	40	14.0	11.0
M20	2.50	17.5	95	40	16.0	12.0
M22	2.50	19.5	100	40	18.0	14.5
M24	3.00	21.0	110	50	18.0	14.5

01

Die nut

DIN 223 HSS, for ISO metric standard thread in accordance with DIN 13, type B (closed, pre-slotted)

Item no.	Thread	Pitch mm	Ø mm	Height mm
8652-6	M6	1,00	20	7
8652-8	M8	1,25	25	9
8652-10	M10	1,50	30	11
8652-12	M12	1,75	38	14



01

02

Die nut

DIN 223 HSS, for ISO metric fine thread in accordance with DIN 13, type B (closed, pre-slotted)

Item no.	Thread	Pitch mm	Ø mm	Height mm
8652-10-125	M10 x 1,25	1,25	30	11
8652-12-125	M12 x 1,25	1,25	38	11
8652-12-15	M12 x 1,50	1,50	38	10
8652-14-15	M14 x 1,50	1,50	38	10
8652-16-15	M16 x 1,50	1,50	45	14
8652-24-15	M24 x 1,50	1,50	55	16



02

03

Die holder

DIN 225 for direct mounting of dies

Item no.	Treading die Ø	Suitable for
8659-5	38 x 14,0	M12 - 14



03



DIN and standardised parts



01
Sheet metal screw
 Tallow-drop with cross head
 DIN 8041 / ISO 7049
 galvanized
 Strength class 4.8

► Item no. 6115



02
Chipboard screw
 ► With flat head and Torx (T-multidrive) T30 Galvanised
 Item no. 6198-0



03
Wing drilling screw
 Flat head, Torx drive T30
 galvanized
 ► Item no. 6212



06
Sheet metal screw
 Tallow-drop with collar and drive point
 with cross head
 DIN 7981 / ISO 7049
 black galvanized
 ► Item no. 6135-0



07
Sheet metal screw
 Tallow-drop with crosshead
 DIN 7981 / ISO 7049
 black galvanized
 ► Item no. 6134



04
Hexagon sheet metal bolt
 With washer
 galvanized
 yellow chromated
 DIN 7976
 ► Item no. 6129



05
Hexagon bolt
 with collar and countersunk head
 similar to DIN 7504-K
 galvanized
 ► Item no. 6214



This is how to measure screws correctly!
Countersunk screws = total length
Other screws = up to the head

08
Sheet metal screw
 with collar (flat head)
 similar to DIN 7981
 galvanized black
 ► Item no. 6134-0



09
Drilling screw
 Fillister head with cross slot
 DIN 7504
 galvanized
 ► Item no. 6211



01

Hexagon bolt

Thread to head
quality 8.8
DIN 933 / ISO 4017
galvanised

► Item no. 6057



01

02

Carriage bolt

With square and hex nut
Strength 4.8
DIN 603 / ISO 8677
galvanized

► Item no. 6223



02

03

Self-locking screw with serrated bearing surface

Quality 8.8
Gavanized
Strength class 8.8

► Item no. 6274



03

04

Frame screw

with fine-pitch thread
quality 10.9 / steel
galvanised

► Item no. 6273



04



05

Hexagon socket screw

Flat cheese head
quality 8.8
DIN 912 / ISO 4762
galvanised

► Item no. 6084



05

Features of hexagon socket screw:

M4 and M5 up to length 25 mm, only without shaft
M4 and M5 from length 30 mm, only with shaft
M6 to length 30 mm, only without shaft
M6 from length 35 mm, only with shaft
M8 to length 35 mm, only without shaft

M8 from length 40 mm, only with shaft
M10 to length 40 mm, only without shaft
M10 from length 45 mm, only with shaft
M12 to length 50 mm, only without shaft
M12 from length 55 mm, only with shaft

01
Hexagon bolts A2
 DIN 933
 thread up to the head

► Item no. 6096

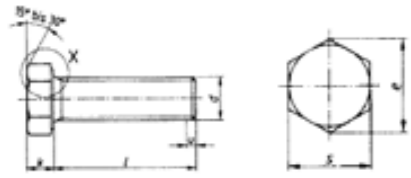

01

02
Flat head bolts A2
 DIN 965
 EN ISO 7046
 with Phillips crosshead

► Item no. 6281

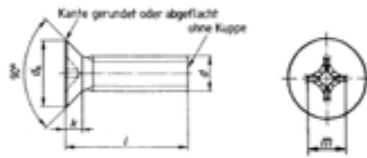

02

03
Hexagon socket A2
 DIN 912 cheese head – hexagon socket

► Item no. 6094

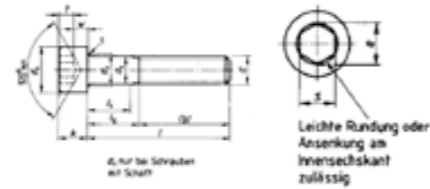

03

07
Hexagon cap nuts A2
 DIN 1587

► Item no. 6348

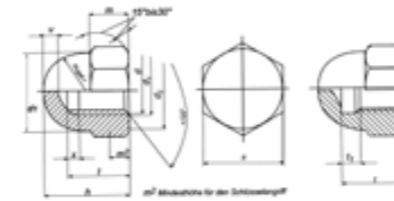

07

08
Hexagon nuts A2
 DIN 934

► Item no. 6322

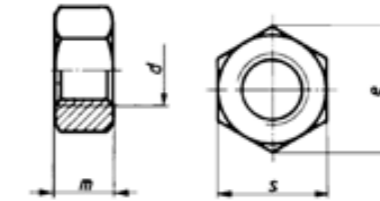

08

09
Poly lock nut A2
 DIN 985 / ISO 10511
 Self-locking
 Plastic ring

► Item no. 6391

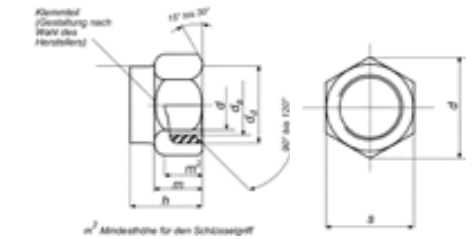

09

04
Oval head sheet metal screws A2
 DIN 7981
 DIN ISO 7049
 with Phillips crosshead

► Item no. 6119

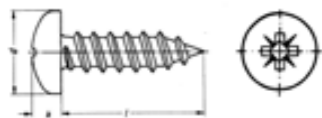

04

05
Tapping screws with countersunk head A2
 DIN 7982
 DIN ISO 7050
 with Phillips crosshead

► Item no. 6123

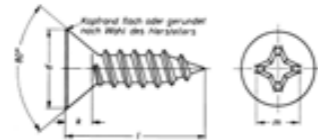

05

06
Flat head chipboard screws A2
 with Pozidrive crosshead

► Item no. 6199

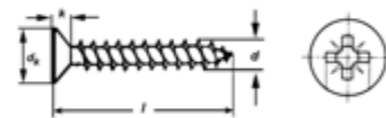

06

10
Washers A2
 DIN 125
 EN ISO 7089
 type A without chamfer

► Item no. 6409

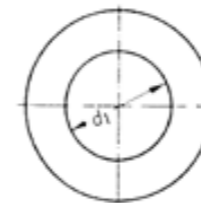

10

11
Plain washers A2
 DIN 9021
 EN ISO 7093
 external diameter ~3x
 hole diameter

► Item no. 6419



11

01
Poly lock nut
 DIN 985
 quality 8
 galvanised



▶ Item no. 6368 01

02
Poly lock nut
 DIN 985
 quality 10
 yellow chromated



▶ Item no. 6370 02

10
Spring washer
 corrugated
 DIN 137 B
 galvanised



▶ Item no. 6435 10

11
Serrated lock washer
 With fine-pitch thread DIN 6798 Galvanised steel

▶ Item no. 6429



11

03
Self-locking nut with serrated bearing
 yellow chromated Toothed



▶ Item no. 6394 03

04
Hexagon nut
 DIN 934
 quality 8 / ISO 4032
 galvanised



▶ Item no. 6317 04

12
Washer
 DIN 125 / ISO 7089
 galvanised, type A



▶ Item no. 6407 12

13
Mud guard washer
 galvanised

▶ Item no. 6411



13

05
Hexagon nut
 With loose corrugated
 washer Yellow chromated



▶ Item no. 6379 05

06
Hexagon cap nut
 high shape
 galvanised
 DIN 1587 / FK 6



▶ Item no. 6356 06

07
Full metal lock nut
 DIN 980
 quality 10
 galvanised



▶ Item no. 6369 07

08
Full metal lock nut
 DIN 980
 quality 10
 yellow chromated



▶ Item no. 6369-0 08

14
Split washer
 DIN 127
 galvanised



▶ Item no. 6441 14

09
Frame nut
 Toothed DIN 6798
 Grade A 10.9 Galvanised



▶ Item no. 6273-012 M12
 6273-014 M14
 6273-016 M16

Item no.	
6273-012	M12
6273-014	M14
6273-016	M16

01

Steel split pin
DIN 94 / ISO 1234
galvanised

► Item no. 6470

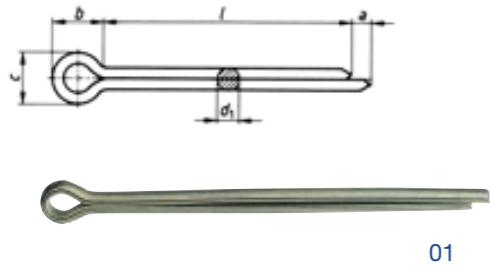

02

Linch pin
chromated yellow

Item no.	Shank \varnothing d mm	L in mm
6472-45	4,5	40
6472-6	6,0	40
6472-8	8,0	40
6472-10	10,0	40

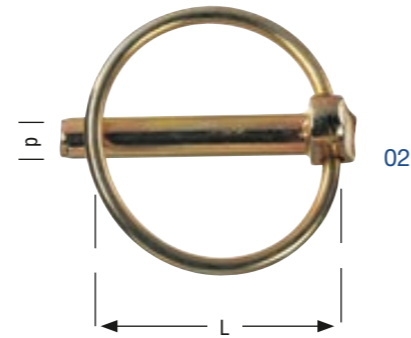

05

Cotter bolts
DIN 1434
quality 10.9
steel galvanised



Item no.	d \varnothing mm	L1 mm	L mm	D \varnothing mm
6260-001-4	14	35,0	40	14
6260-001-42	14	40,0	45	14

06

Threaded rods
DIN 975, 1 metre
quality 8.8
galvanised

Item no.	Thread
6958-5	M5
6958-6	M6
6958-8	M8
6958-10	M10
6958-12	M12



03

Spring cotter pin
single thread
galvanised

Item no.	d	Length (L)	D	Hole \varnothing	Axis o. shaft \varnothing D1
6473-2-1	2	50	10	2,5	9 - 14
6473-3-1	3	60	18	3,5	10 - 16
6473-4-1	4	60	20	4,5	16 - 20
6473-5-1	5	85	24	6,0	20 - 28
6473-6-1	6	105	30	7,0	28 - 40
6473-8-1	8	110	28	9,0	30 - 45

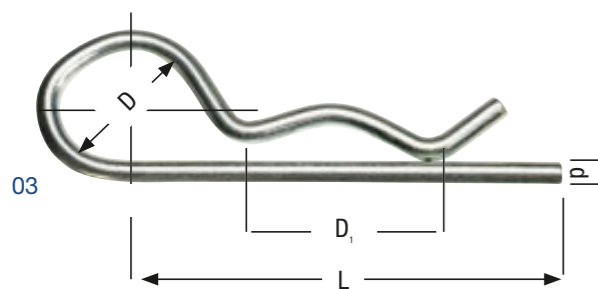

04

Spring cotter pin
double thread
galvanised

Item no.	d	Length (L)	D	Hole \varnothing	Axis o. shaft \varnothing D1
6473-2-3	2	50	10	2,5	8 - 14
6473-3-3	3	62	16	3,5	14 - 20
6473-4-3	4	78	23	4,5	17 - 24
6473-5-3	5	92	26	5,5	18 - 30
6473-6-3	6	120	30	6,5	24 - 36

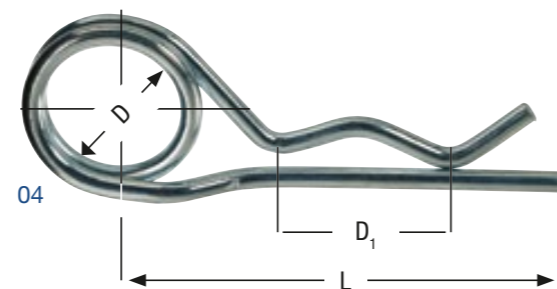

07

Clamping sleeves
DIN 1481blank

Item no.	Quantity	Item no.	Quantity
6476-2-20	100	6476-5-60	50
6476-2-30	100	6476-6-40	50
6476-3-20	100	6476-6-50	50
6476-3-40	100	6476-6-60	50
6476-4-40	100	6476-8-40	25
6476-4-60	100	6476-8-50	25
6476-5-30	50	6476-8-60	25
6476-5-40	50	6476-10-60	20



01

Assortment of clamping sleeves

DIN 1481, blank

- ▶ Item no. 1957-476
- ▶ Contents: 985 pieces

Item no.	Quantity	Item no.	Quantity
6476-2-20	100	6476-5-60	50
6476-2-30	100	6476-6-40	50
6476-3-20	100	6476-6-50	50
6476-3-40	100	6476-6-60	50
6476-4-40	100	6476-8-40	25
6476-4-60	100	6476-8-50	25
6476-5-30	50	6476-8-60	25
6476-5-40	50	6476-10-60	20



01

02

Assortment of steel split pins

DIN 94 / ISO 1234, galvanised

- ▶ Item no. 1957-470
- ▶ Contents: 1,100 pieces

Item no.	Quantity	Item no.	Quantity
6470-16-32	100	6470-32-40	100
6470-2-22	100	6470-4-32	100
6470-2-32	100	6470-4-40	100
6470-2-40	100	6470-4-50	100
6470-32-20	100	6470-5-40	50
6470-32-32	100	6470-5-50	50



02

03

Assortment of hex head sheet metal screws

with washers and sheet metal nuts

- ▶ Item no. 1957-129-1
- ▶ Contents: 800 pieces

Item no.	Quantity	Item no.	Quantity
5500-113-65	Speed nut 4.8 mm	200	
5500-113-69	Speed nut 6.5 mm	150	
5500-115-77	Speed nut 5.6 mm	100	
6129-48-16	Hex. head sheet metal screw with washer	100	
6129-48-19	Hex. head sheet metal screw with washer	50	
6129-55-16	Hex. head sheet metal screw with washer	50	
6129-65-16	Hex. head sheet metal screw with washer	50	
6129-65-20	Hex. head sheet metal screw with washer	100	



03

04

Assortment of washers

galvanised

- ▶ Item no. 1957-411
- ▶ Contents: 1,280 pieces

Item no.	Quantity	Item no.	Quantity
6411-4-12	100	6411-6-30	50
6411-4-20	100	6411-6-40	50
6411-5-15	100	6411-8-20	100
6411-5-20	100	6411-8-25	100
6411-6-15	100	6411-8-30	50
6411-6-18	100	6411-10-30	50
6411-6-20	100	6411-10-40	30
6411-6-25	100	6411-12-30	50



04

01

Assortment of oval head sheet metal screws

With Phillips recessed head (shape H),
DIN 7981 / ISO 7046 Galvanised, strength class 4.8

- ▶ Item no. 1957-115
- ▶ Contents: 1,600 pieces

Item no.	Quantity	Item no.	Quantity
6115-35-95	100	6115-42-19	100
6115-35-13	100	6115-42-22	100
6115-35-16	100	6115-42-25	100
6115-35-19	100	6115-48-13	100
6115-39-19	100	6115-48-16	100
6115-42-95	100	6115-48-19	100
6115-42-13	100	6115-48-22	100
6115-42-16	100	6115-48-25	100



01

03

Assortment of oval head sheet metal screws with collar and drill tip/crosshead similar to DIN 7504 black galvanised

- ▶ Item no. 1957-135-0
- ▶ Contents: 1,103 pieces

Item no.	Quantity	Item no.	Quantity
6135-042-13	200	6135-048-16	200
6135-042-16	200	6135-048-22	100
6135-042-19	200	6135-048-35	100
6135-042-25	100	8000-014-521 Bit set 3 pieces	



03

02

Assortment of sheet metal screws

with flat head and collar
similar to DIN 7981 / ISO 7049
black galvanised

- ▶ Item no. 1957-134-0
- ▶ Contents: 1,400 pieces

Item no.	Quantity	Item no.	Quantity
6134-039-95	100	6134-042-19	100
6134-039-13	100	6134-042-22	50
6134-039-16	100	6134-042-25	50
6134-039-19	100	6134-048-95	100
6134-039-22	50	6134-048-13	100
6134-039-25	50	6134-048-16	50
6134-042-95	100	6134-048-19	50
6134-042-13	100	6134-048-22	50
6134-042-16	100	6134-048-25	50



02

04

Assortment of oval head sheet metal screws with recessed head DIN 7981 / ISO 7049 black galvanised

- ▶ Item no. 1957-134
- ▶ Contents: 1,600 pieces

Item no.	Quantity	Item no.	Quantity
6134-35-13	100	6134-42-19	100
6134-35-16	100	6134-42-25	100
6134-35-19	100	6134-42-95	100
6134-35-95	100	6134-48-13	100
6134-39-13	100	6134-48-16	100
6134-39-16	100	6134-48-19	100
6134-39-19	100	6134-55-16	100
6134-42-13	100	6134-55-19	50
6134-42-16	100	6134-55-25	50



04

Assortments



01

Copper sealing ring assortment DIN 7603A

- ▶ Item no. 1957-460
- ▶ Contents: 1,190 pieces

Item no.	Quantity	Item no.	Quantity
6460-6-10	100	6460-14-22	50
6460-8-12	100	6460-16-22	50
6460-8-14	100	6460-18-24	50
6460-10-14	100	6460-20-26	50
6460-10-16	100	6460-22-27	50
6460-12-16	100	6460-22-29	50
6460-12-18	100	6460-24-30	30
6460-14-18	50	6460-26-32	30
6460-14-20	100	6460-28-34	30



01

02

Assortment of gaskets for oil-drain plugs

- ▶ Item no. 1957-462
- ▶ Contents: 1,000 pieces

Item no.	Quantity	Item no.	Quantity
6464-18-2	100	6463-12-18	100
6460-14-20	100	6464-012-242	50
6462-14-21	100	6462-18-24	100
6462-16-22	100	6464-14-22	100
6464-11-17	50	6464-128-225	50
6460-12-18	100	6464-16-24	50



02

03

Perbunan O-ring assortment

- ▶ Item no. 1957-468-1
- ▶ Contents: 1,050 pieces

Item no.	Quantity	Item no.	Quantity
6468-003-20	100	6468-012-25	50
6468-004-20	100	6468-014-25	50
6468-005-20	100	6468-015-25	50
6468-006-20	100	6468-017-25	25
6468-007-20	100	6468-018-30	25
6468-008-20	100	6468-019-25	25
6468-010-20	50	6468-020-30	25
6468-010-25	50	6468-022-30	25
6468-012-20	50	6468-024-30	25



03

04

Assortment of oil drain plugs

For BMW, Mercedes-Benz, Ford and Volkswagen

- ▶ Item no. 1957-240-1
- ▶ Contents: 60 pieces

Item no.	Quantity	Item no.	Quantity
6240-12-15	5	6242-14-15	5
6240-14-151	5	6243-014-15	5
6241-12-15	5	6243-12-15	5
6241-14-15	5	6243-14-159	5
6241-16-15	5	6243-14-160	5
6241-18-15	5	6243-14-161	5



04

05

Assortment of blind rivets

DIN 7337, rivet body: Aluminium alloy, rivet mandrel: galvanised steel

- ▶ Item no. 1957-937-1
- ▶ Contents: 800 pieces

Item no.	Quantity	Item no.	Quantity
5937-3-6	100	5937-4-8	100
5937-3-8	100	5937-4-10	100
5937-3-10	100	5937-4-12	100
5937-4-6	100	5937-4-16	100



05

06

Blind rivet nut assortment

Aluminium

- ▶ Item no. 1957-948
- ▶ Contents: 600 pieces

Item no.	Quantity	Item no.	Quantity
5949-4-115	100	5948-14-20	100
5949-5-12	100	5948-15-30	100
5949-6-145	50	5948-16-30	50
5949-8-185	50	5948-18-30	50



06

01

Stratus HSS-O twist drill bit assortment

Profile ground and right-hand cut, DIN 384

- ▶ Item no. 1957-627-1
- ▶ Contents: 120 pieces

Item no.	Quantity	Item no.	Quantity
4627-10	10	4627-60	5
4627-15	10	4627-65	5
4627-20	10	4627-70	5
4627-25	10	4627-75	5
4627-30	5	4627-80	5
4627-35	5	4627-85	5
4627-40	5	4627-90	5
4627-45	5	4627-95	5
4627-50	5	4627-100	5
4627-55	5	4627-105	5



02

Night Line HSS twist drill bit assortment

Basic assortment

- ▶ Item no. 1957-626
- ▶ Contents: 120 pieces

Item no.	Quantity	Item no.	Quantity
4626-10	10	4626-60	5
4626-15	10	4626-65	5
4626-20	10	4626-70	5
4626-25	10	4626-75	5
4626-30	5	4626-80	5
4626-35	5	4626-85	5
4626-40	5	4626-90	5
4626-45	5	4626-95	5
4626-50	5	4626-100	5
4626-55	5	4626-105	5



03

Assortment of universal O-rings

- ▶ Item no. 1957-500-1
- ▶ Contents: 360 pieces

Item no.	Quantity	Item no.	Quantity
5000-003	20	5000-050	20
5000-004	20	5000-060	20
5000-005	20	5000-067	20
5000-007	20	5000-068	20
5000-008	20	5000-069	20
5000-010	20	5000-070	20
5000-012	20	5000-071	20
5000-016	20	5000-072	20
5000-032	20	5000-073	20



04

Assortment of universal O-rings

- ▶ Item no. 1957-500-2
- ▶ Contents: 360 pieces

Item no.	Quantity	Item no.	Quantity
5000-009	20	5000-036	20
5000-017	20	5000-043	20
5000-021	20	5000-047	20
5000-023	20	5000-061	20
5000-026	20	5000-062	20
5000-028	20	5000-063	20
5000-029	20	5000-064	20
5000-034	20	5000-065	20
5000-035	20	5000-066	20



05

Assortment of universal valves

- ▶ Item no. 1957-500-4
- ▶ Contents: 51 pieces

Item no.	Quantity	Item no.	Quantity
5000-106	20	5000-124	5
5000-121	1	5000-125	5
5000-122	5	5000-126	5
5000-123	5	5000-127	5



01

Assortment of cable connectors
waterproof

- ▶ Item no. 1957-555
- ▶ Contents: 400 pieces

Item no.	Quantity	Item no.	Quantity
3555-516-1	50	3555-909-2	25
3555-516-2	50	3555-911-2	25
3555-516-4	25	3555-923-1	50
3555-903-1	25	3555-923-2	50
3555-904-1	25	3555-923-3	25
3555-905-2	25	3555-945-2	25



01

02

Assortment of cable connectors
Insulated

- ▶ Item no. 1957-558-1
- ▶ Contents: 530 pieces

Item no.	Quantity	Item no.	Quantity
3555-564	20	3558-925-1	25
3558-901-1	25	3558-926-2	25
3558-905-1	50	3558-943-2	25
3558-905-2	100	3558-944-1	25
3558-905-4	50	3558-945-2	25
3558-908-2	25	3558-946-1	15
3558-909-2	25	3558-947-1	15
3558-910-2	25	3558-948-2	15
3558-916-4	25	3558-949-2	15



02

03

Assortment of heat shrink tubing
Black, length: 10 cm, shrinkage ratio 2:1

- ▶ Item no. 1957-570
- ▶ Contents: 125 pieces

Item no.	Quantity	Item no.	Quantity
3771-200-127	10	3771-200-32	25
3771-200-190	10	3771-200-48	25
3771-200-24	25	3771-200-64	10
3771-200-254	10	3771-200-95	10



03

04

Assortment of blade fuses
Mini and low-profile fuses

- ▶ Item no. 1957-730-2
- ▶ Contents: 280 pieces

Item no.	Quantity	Item no.	Quantity
3731-103	10	3731-303	25
3731-105	10	3731-305	25
3731-107-5	10	3731-307-5	25
3731-110	10	3731-310	25
3731-115	10	3731-315	25
3731-120	10	3731-320	25
3731-125	10	3731-325	25
3731-130	10	3731-330	25



04

05

Assortment of blade fuses
Incl. tester and gripper set

- ▶ Item no. 1957-730-1
- ▶ Contents: 161 pieces

Item no.	Quantity	Item no.	Quantity
3731-103	10	3731-005	10
3731-105	10	3731-007-5	1
3731-107-5	10	3731-010	1
3731-110	10	3731-015	1
3731-115	10	3731-020	10
3731-120	10	3731-025	10
3731-125	10	3731-030	10
3731-130	10	3731-150	1
3731-003	10		



05

06

Assortment of button cells

- ▶ Item no. 1957-580
- ▶ Contents: 75 pieces

Item no.	Quantity	Item no.	Quantity
3722-20	10	3722-25	10
3722-21	10	3722-26	10
3722-23	10	3722-30	10
3722-27	10	3722-29	5



06

01

Assortment of clamping sleeves

DIN 1481, blank

- ▶ Item no. 1957-476
- ▶ Contents: 985 pieces

Item no.	Quantity	Item no.	Quantity
6476-2-20	100	6476-5-60	50
6476-2-30	100	6476-6-40	50
6476-3-20	100	6476-6-50	50
6476-3-40	100	6476-6-60	50
6476-4-40	100	6476-8-40	25
6476-4-60	100	6476-8-50	25
6476-5-30	50	6476-8-60	25
6476-5-40	50	6476-10-60	20



01

02

Assortment of screwed connections

- ▶ Item no. 1957-54-016
- ▶ Contents: 123 pieces

Item no.	Quantity	Item no.	Quantity
1002-54-061	10	1002-54-122	8
1002-54-081	10	1002-54-152	5
1002-54-101	8	1002-54-063	10
1002-54-121	8	1002-54-083	10
1002-54-151	5	1002-54-103	8
1002-54-062	10	1002-54-123	8
1002-54-082	10	1002-54-153	5
1002-54-102	8		



02

03

Assortment of direct connectors

Brass, plastic

- ▶ Item no. 1957-100-1
- ▶ Contents: 40 pieces

Item no.	Quantity	Item no.	Quantity
1002-06-04	5	1002-16-06	5
1002-06-05	5	1002-16-08	5
1002-06-06	5	1002-16-010	5
1002-06-08	5	1002-16-012	5



03

04

Assortment of plastic hose connectors

- ▶ Item no. 1957-896
- ▶ Contents: 160 pieces

Item no.	Quantity	Item no.	Quantity
5896-103	10	5896-303	10
5896-104	10	5896-304	10
5896-105	10	5896-305	10
5896-106	10	5896-306	10
5896-203	10	5896-403	10
5896-204	10	5896-404	10
5896-205	10	5896-405	10
5896-206	10	5896-406	10



04

05

Assortment of brake nipples

- ▶ Item no. 1957-885
- ▶ Contents: 90 pieces

Item no.	Quantity	Item no.	Quantity
5885-100	5	5885-109	5
5885-101	5	5885-110	5
5885-102	5	5885-111	5
5885-103	5	5885-112	5
5885-104	5	5885-200	5
5885-105	5	5885-201	5
5885-106	5	5885-202	5
5885-107	5	5885-203	5
5885-108	5	5885-204	5



05

06

Assortment of clips and clamps

- ▶ Item no. 1957-550
- ▶ Contents: 500 pieces

Item no.	Quantity	Item no.	Quantity
5501-103-015	50	5500-879-32	50
5500-940-5	50	5500-500-08	100
5500-127-10	50	5500-201-404	50
5500-130-11	50	5500-000-000	100



06

01

Assortment of oval head sheet metal screws

With Phillips recessed head (shape H),
DIN 7981 / ISO 7046 Galvanised, strength class 4.8

- ▶ Item no. 1957-115
- ▶ Contents: 1,600 pieces

Item no.	Quantity	Item no.	Quantity
6115-35-95	100	6115-42-19	100
6115-35-13	100	6115-42-22	100
6115-35-16	100	6115-42-25	100
6115-35-19	100	6115-48-13	100
6115-39-19	100	6115-48-16	100
6115-42-95	100	6115-48-19	100
6115-42-13	100	6115-48-22	100
6115-42-16	100	6115-48-25	100



01

03

Assortment of oval head sheet metal screws with collar and drill tip/crosshead similar to DIN 7504 black galvanised

- ▶ Item no. 1957-135-0
- ▶ Contents: 1,103 pieces

Item no.	Quantity	Item no.	Quantity
6135-042-13	200	6135-048-16	200
6135-042-16	200	6135-048-22	100
6135-042-19	200	6135-048-35	100
6135-042-25	100	8000-014-521 Bit set 3 pieces	



03

02

Assortment of sheet metal screws

with flat head and collar
similar to DIN 7981 / ISO 7049
black galvanised

- ▶ Item no. 1957-134-0
- ▶ Contents: 1,400 pieces

Item no.	Quantity	Item no.	Quantity
6134-039-95	100	6134-042-19	100
6134-039-13	100	6134-042-22	50
6134-039-16	100	6134-042-25	50
6134-039-19	100	6134-048-95	100
6134-039-22	50	6134-048-13	100
6134-039-25	50	6134-048-16	50
6134-042-95	100	6134-048-19	50
6134-042-13	100	6134-048-22	50
6134-042-16	100	6134-048-25	50



02

04

Assortment of oval head sheet metal screws with recessed head DIN 7981 / ISO 7049 black galvanised

- ▶ Item no. 1957-134
- ▶ Contents: 1,600 pieces

Item no.	Quantity	Item no.	Quantity
6134-35-13	100	6134-42-19	100
6134-35-16	100	6134-42-25	100
6134-35-19	100	6134-42-95	100
6134-35-95	100	6134-48-13	100
6134-39-13	100	6134-48-16	100
6134-39-16	100	6134-48-19	100
6134-39-19	100	6134-55-16	100
6134-42-13	100	6134-55-19	50
6134-42-16	100	6134-55-25	50



04

01

Assortment of steel split pins

DIN 94 / ISO 1234, galvanised

- ▶ Item no. 1957-470
- ▶ Contents: 1,100 pieces

Item no.	Quantity	Item no.	Quantity
6470-16-32	100	6470-32-40	100
6470-2-22	100	6470-4-32	100
6470-2-32	100	6470-4-40	100
6470-2-40	100	6470-4-50	100
6470-32-20	100	6470-5-40	50
6470-32-32	100	6470-5-50	50



01

02

Assortment of hex head sheet metal screws

with washers and sheet metal nuts

- ▶ Item no. 1957-129-1
- ▶ Contents: 800 pieces

Item no.		Quantity
5500-113-65	Speed nut 4.8 mm	200
5500-113-69	Speed nut 6.5 mm	150
5500-115-77	Speed nut 5.6 mm	100
6129-48-16	Hex. head sheet metal screw with washer	100
6129-48-19	Hex. head sheet metal screw with washer	50
6129-55-16	Hex. head sheet metal screw with washer	50
6129-65-16	Hex. head sheet metal screw with washer	50
6129-65-20	Hex. head sheet metal screw with washer	100



02

03

Assortment of washers

galvanised

- ▶ Item no. 1957-411
- ▶ Contents: 1,280 pieces

Item no.	Quantity	Item no.	Quantity
6411-4-12	100	6411-6-30	50
6411-4-20	100	6411-6-40	50
6411-5-15	100	6411-8-20	100
6411-5-20	100	6411-8-25	100
6411-6-15	100	6411-8-30	50
6411-6-18	100	6411-10-30	50
6411-6-20	100	6411-10-40	30
6411-6-25	100	6411-12-30	50



03

04

Assortment tower without parts

- ▶ Art. no.: 1958-100
- ▶ Product description
 - Stackable
 - For wall attachment
 - Lockable
 - 5 drawers
 - HxWxD= 360mm x 390mm x 256mm



04

06

Insert 20-fold

For plastic assortment case, can be used for drill bits

- ▶ Art. no.: 1958-001-20
- ▶ Product description
 - Width: 320 mm
 - Depth: 240 mm
 - Height: 49 mm



06

05

Assortment box

Plastic

- ▶ Art. no.: 1958-001
- ▶ Product description
 - H x W x D = 320 mm x 240 mm x 49 mm



05

07

Insert

with same sized boxes

Item no.	Model
1958-001-8	8-fold
1958-001-12	12-fold
1958-001-16	16-fold
1958-001-18	18-fold



07

01

Inspection & maintenance introductory package

► Art. no.: 2897-001

Item no.	Description	Quantity
2897-368	VC980, butterfly valve cleaner, 400 ml	2
2894-445-1	High-Press, high-pressure adhesive lubricant, 400 ml	2
2894-449	Off-Shore Silver, brake-protection spray, 400 ml	2
2894-442-1	Super Crack Ultra, ice-rust remover, 400 ml	2
2897-323	Terpanol Power, high-tech special cleaner, 400 ml	2



01

02

Vehicle treatment introductory package

► Art. no.: 2897-002

Item no.	Description	Quantity
2897-310	Topas, intensive window cleaner, 400 ml	2
2897-326	Polit, spray polish, 400 ml	2
2000-05	Interno, interior cleaner & care, 500 ml	2
2897-307	Velvet, upholstery cleaner, 400 ml	2
2000-309-400	Aerofit Power, odour neutralizer, 400 ml	2



02

03

Bodywork introductory package

► Art. no.: 2897-003

Item no.	Description	Quantity
2893-900	1K Multi-Connector, light grey, 400 ml	2
2893-888	Rednox, anti-rust primer 400 ml	2
2892-881	Bottom-Guard Recoat, underbody protection, black, 500 ml	2
2893-884	Kroma, spray paint black matt, 400 ml	2
2892-997	Protector, cavity protection, 400 ml	2



03

04

Repos starter kit - Plastic-repair adhesive

► Art. no.: 2700-001

Item no.	Description	Quantity
2700-10	Repos plastic adhesive, 50 ml	2
2700-15	Repos fast plastic adhesive, 50 ml	2
2700-20	Repos MMA, structural adhesive, 50 ml	2
2700-70	Cartridge gun	1
2700-42	Square mixer rod, blue	6



04

01

Aquano skin protection set

► Art. no.: 2897-500-001

Item no.	Description	Quantity
2897-500-1	Aquano Clean, hand cleaner, 2 litres	1
2897-500-2	Aquano Protect, hand protector, 2 litres	1
2897-500-3	Aquano Lotion, skin care, 2 litres	1
2897-500-7	Skin Protection Plan	1
2897-500-6	System dispenser for Aquano series	3



01



02

Cleeno interior cleaning set

► Art. no.: 2000-001

Item no.	Description	Quantity
2000-05	Interno, interior cleaner & care, 500 ml	3
2897-340	Stries, glass cleaner, 500 ml	3
2897-307	Velvet, upholstery cleaner, 400 ml	3
2000-640-40	Microfibre cloth, blue	6



02

03

Cleeno exterior cleaning set

► Art. no.: 2000-002

Item no.	Description	Quantity
2000-312-5	All Star, power cleaner, exterior, 5 litres	1
2897-321-5	Rimol Profi, aluminium rim cleaner, 5 litres	1
2000-000-005	Outlet valve for 5-litre container	2
2000-100	Pressure-pump spray bottle, 1 litre	1
2897-333-150	Pressure-pump spray bottle for Rimol Profi, 1 litre	1
7797-009-9	Chemie cleaning gloves, size 9	1 pair
7797-009-10	Chemie cleaning gloves, size 9	1 pair



03

01

Cable-tie set 1

► Art. no.: 3502-001

Item no.	Description	Quantity
3502-111	Cable tie, black, with plastic tongue, 2.5 x 98	300
3502-121	Cable tie, black, with plastic tongue, 3.5 x 140	300
3502-131	Cable tie, black, with plastic tongue, 3.5 x 200	300
3502-135-1	Cable tie, black, with plastic tongue, 3.6 x 290	300
3502-141	Cable tie, black, with plastic tongue, 4.5 x 178	300
3502-151	Cable tie, black, with plastic tongue, 4.5 x 280	300



02

Cable-tie set 2

► Art. no.: 3502-002

Item no.	Description	Quantity
3502-161	Cable tie, black, with plastic tongue, 4.5 x 350	300
3502-171	Cable tie, black, with plastic tongue, 7.6 x 200	300
3502-181	Cable tie, black, with plastic tongue, 7.5 x 360	300
3502-191	Cable tie, black, with plastic tongue, 7.8 x 750	300



03

12V Normlight bulb set for fitting in bulb cabinet



► Art. no.: 3723-001

Item no.	Description	Quantity
3723-050-08	Rear light bulb 10W	40
3723-028-25	Glass base bulb 5W	1
3723-027-21	Glass base bulb 1.2W	40
3723-064-18	Festoon bulb, 5W	1
3723-075-06	Indicator and brake light bulb, 21W	1
3723-075-28	Brake and tail light bulb, 21/5W	1
3723-075-07	Pilot bulb, yellow, 21W	1
3723-064-193	H4 60/55W	1
3723-050-07	Pilot bulb, 21W, yellow	50
3723-064-201	H7 12V 55W	1
3723-064-209	H7 12V Long-Life	20



04

24V Normlight bulb set for fitting in bulb cabinet



► Art. no.: 3723-002

Item no.	Description	Quantity
3723-028-45	Gas cap bulb, 5W	40
3723-064-151	H3 24V 70W	10
3723-064-155	H1 24V 70W	20
3723-064-197	H4 24V 70/75W HD	10
3723-064-211	H7 24V 70W	20
3720-064-273	H7 24V 70W HD LL	20
3723-075-37	Brake and tail light, 21/5W	50
3723-393-0	Normlight side light bulb, 4W HD	50
3723-562-7	Rear light bulb 5W HD	40
3723-563-7	Rear light bulb 10W HD	50
3723-751-1	Signal bulb 21W HD	50



Chemical products



01 High-pressure adhesive lubricant
High-Press

- ▶ Item no. 2894-445-1
 - ▶ Contents: 400 ml
 - ▶ Packing unit: 24
- ▶ **Product description**
- Highly water repellent
 - Highly resistant to pressure
 - Free from sticky polymer thickeners that trap dirt
 - Silicone-free
 - Outstanding adhesive property
 - Excellent penetrating ability
 - Temperature range -20°C to +150°C
 - Colour: beige/transparent

02 Adhesive lubricating grease
High-Press Ultra

- ▶ Item no. 2894-445-3
 - ▶ Contents: 400 ml
 - ▶ Packing unit: 12
- ▶ **Product description**
- Lubricates all moving machine components, e.g. hinges, check straps, chains, gear wheels, wire ropes, slide rails, etc.
 - Excellent penetrating ability
 - Outstanding adhesive property
 - High pressure resistance
 - Resistant to salt and hot water
 - Temperature range -20°C to +200°C
 - Colour: light-blue

03 High-pressure adhesive lubricant
High-Press Black

- ▶ Item no. 2894-445-2
 - ▶ Contents: 400 ml
 - ▶ Packing unit: 24
- ▶ **Product description**
- Suitable for use in all technical applications
 - Excellent penetrating ability
 - Outstanding adhesive property
 - Water-repellent and protects against corrosion
 - Best running characteristics at high temperatures and speeds
 - Temperature range -20°C to +200°C
 - Colour: black



04 PTFE/Ceramic oil spray
Teflux

- ▶ Item no. 2894-445-4
 - ▶ Contents: 400 ml
 - ▶ Packing unit: 12
- ▶ Item no. 2894-445-415
- ▶ Contents: 150 ml
 - ▶ Packing unit: 12
- ▶ **Product description**
- Capable of extreme creep
 - Water repellent and protects against corrosion
 - High pressure resistance
 - Lubricates and oils all moving machine parts such as gear wheels, hinges, etc.
 - Excellent emergency-running properties thanks to PTFE and ceramic additives
 - Silicone-free
 - Colour: Beige
 - Fragrance: vanilla



01



02



03



04



01
Silicone grease
Siltron

- ▶ Item no. 2897-324
- ▶ Contents: 400 ml
- ▶ Packing unit: 12

- ▶ **Product description**
- Creates effective water-repellent film
 - Lubricates and seals
 - Fully compatible with elastomers
 - Does not resinify and is extremely resistant to ageing
 - Insulates surfaces against creeping currents and flashovers also at high and low temperatures



01

02
Dry lubricant
TT - Power

- ▶ Item no. 2897-447
- ▶ Contents: 400 ml
- ▶ Packing unit: 12

- ▶ **Product description**
- Oil-free, grease-free, silicone-free
 - Invisible, hardly noticeable lubricating film
 - Prevents dust formation
 - Anti-static



02

03
Silicone Premium
Siprem

- ▶ Item no. 2897-322
- ▶ Contents: 400 ml
- ▶ Packing unit: 12

- ▶ **Product description**
- At least 18% of high-quality silicone
 - Highly water repellent
 - Leaves no marks
 - Exceptional lubricating qualities



03

04
Passenger compartment spray
Soules

- ▶ Item no. 2897-449
- ▶ Contents: 300 ml
- ▶ Packing unit: 12

- ▶ **Product description**
- Silicone free
 - Eliminates moisture
 - Does not resinify and provides long-lasting UV protection
 - Anti-static
 - Prevents door seals freezing in winter



04

01

White lubricating grease

Bio-Top Protect

- ▶ Item no. 2894-446
- ▶ Contents: 400 ml
- ▶ Packing unit: 24

▶ Product description

- Water repellent
- Good lubrication properties
- Good abrasion resistance
- Penetrative
- Moisture displacing
- Universal use
- Pressure resistant
- Extremely durable
- Very good adhesion
- Thermally stable from -10°C to +150°C

02

Maintenance lubrication-oil spray

Multi Protect

- ▶ Item no. 2894-445-6
- ▶ Contents: 400 ml
- ▶ Packing unit: 12

▶ Product description

- Oxidation-resistant
- Capable of extreme creep
- Shear-stable
- Silicone-free
- Resistant to salt and hot water
- Optimal anti-corrosion properties
- Good high-pressure and high-temperature stability
- Thermally stable from -30°C to +150°C, +200°C in short term



01



02



What exactly is a product ID using the GHS system?

GHS stands for „Globally Harmonious System of Classification and Labelling of Chemicals“ and is an ordinance of the European Union (EU). It is a globally uniform system for classifying chemicals and identifying them on packaging and on safety data sheets.

The GHS system has replaced the previous classification and identification system of the EU. It is regulated through the CLP Ordinance (Classification, Labelling and Packaging). It has had to be bindingly applied to materials since 1 December 2012. The second step of GHS implementation now affects compounds and thus all chemical and technical products. For this, GHS/CLP labelling will be legally mandatory from 1 June 2015.

This directive is primarily to protect users. Through the expanded texts of hazards and symbols, users of products should be able to better identify and assess products that are a risk to health and the environment.





01
Silicone-free multifunctional spray
Multi Pose

- ▶ Item no. 2894-447
- ▶ Contents: 400 ml
- ▶ Packing unit: 12

- ▶ **Product description**
- Resistant to salt and hot water
 - For lubricating closing cylinders, locks, door handles, hinges, guide rails and much more.
 - As an installation spray for dismantling and fitting injection nozzles, lambda probes, exhaust systems and much more



01

02
Silicone spray
ECO

- ▶ Item no. 2897-322-2
- ▶ Contents: 600 ml
- ▶ Packing unit: 12

- ▶ **Product description**
- Reduces squeaks
 - Water repellent
 - Impregnating
 - Leaves no marks

03
Maintenance spray
ECO

- ▶ Item no. 2897-351-2
- ▶ Contents: 600 ml
- ▶ Packing unit: 12

- ▶ **Product description**
- Perfect lubrication at the most difficult-to-reach greasing points
 - Reduces friction
 - Water repellent



02



03



01
Penetrating oil
Oxim Protect

- ▶ Item no. 2894-444-1
- ▶ Contents: 400 ml
- ▶ Packing unit: 12

- ▶ Product description
- Thermally stable from -20°C to +250°C
- Use against rust, squeaks and creaks
- Prevents further rusting



01

02
Penetrating oil
Oxim Ultra

- ▶ Item no. 2894-444
- ▶ Contents: 400 ml
- ▶ Packing unit: 24

- ▶ Item no. 2894-441-1
- ▶ Contents: 5 litres
- ▶ Packing unit: 1

- ▶ Product description
- Excellent lubricating properties
- Provides good lubricity
- Water-repellent
- Shields against corrosive elements
- Temperature range -20°C to +250°C



02



03
Ice-rust remover
Super Crack Ultra

- ▶ Item no. 2894-442-1
- ▶ Contents: 400 ml
- ▶ Packing unit: 12

- ▶ Product description
- High-performance separating agent with silver-coloured aluminium particles
- Guarantees long-lasting lubrication
- Impressive freeze capacity, cools up to -40°C
- High penetrating capacity
- Rust dissolving properties



03

01

Brake cleaner

Bremtec

- ▶ Item no. 2897-333-600
- ▶ Contents: 600 ml
- ▶ Packing unit: 24

- ▶ Item no. 2897-333-5
- ▶ Contents: 5 litres
- ▶ Packing unit: 1

- ▶ Item no. 2897-333-30
- ▶ Contents: 30 litre
- ▶ Packing unit: 1

- ▶ Item no. 2897-333-60
- ▶ Contents: 60 litres
- ▶ Packing unit: 1

▶ **Product description**

- Contains acetone
- Degreasing action
- Carbon dioxide as the propellant



02

Pump spray bottle 1 litre

- ▶ Item no. 2897-333-100

▶ **Product description**

- Suitable for fluids containing solvents, such as Bremtec, Power-Star, Motor-Fit
- Working overpressure 3 bar
- Contents: 1 litre
- suitable surrogate sealant (optionally available): Art. no. 2897-333-101



01



02

03

Metal discharge tap, R3/4"

- ▶ Item no. 2000-000-062

Locking adapter for metal discharge tap

- ▶ Item no. 2000-000-061



03

04

Brake cleaner

Bremtec

- ▶ Item no. 2897-333-31
- ▶ Contents: 30 litres
- ▶ Packing unit: 1

▶ **Product description**

- Basis: Benzoles, alcohols
- Ideal for the rapid removal of oil, dirt and brake dust from brake discs, pads and linings, as well as in the area around the intake and throttle valve



04

05

Safety cleaner

Bremtec Safe

- ▶ Item no. 2897-333-700
- ▶ Contents: 500 ml
- ▶ Packing unit: 12

▶ **Product description**

- TÜV-tested fire behaviour
- TÜV-tested ingredients
- Flame-retarding propellant
- Lower explosion limit >1.5% Vol.
- Recommended product in accordance with the German Ordinance on Hazardous Materials (protection level 2)
- 25% naphtha- colourless



05



01

Brake cleaner
MC-1

- ▶ Item no. 2897-333-500
- ▶ Contents: 500 ml
- ▶ Packing unit: 30

▶ **Product description**

- Acetone-free quality cleaner
- Very effectively removes oil, dirt, brake fluid and brake dust from brake discs, pads and linings and many other vehicle parts
- Flushes out contaminants and deposits
- Removes oil, grease, dust, resin residues/brake fluid/brake dust from disk brakes
- The life of treated components is increased thanks to conditioning lubrication



01

02

Brake paste
Off-Shore Silver

- ▶ Item no. 2894-449-200
- ▶ Contents: 200 g
- ▶ Packing unit: 12

▶ **Product description**

- Special lubricant that provides reliable adhesion at high temperatures
- Condensation, splash and salt water proof
- Excellent and long-term lubrication
- Lasting corrosion protection
- Particularly suitable for vehicles with anti-lock brake system
- Temperature resistant up to 1,400°C

03

Brake spray
Off-Shore Silver

- ▶ Item no. 2894-449
- ▶ Contents: 400 ml
- ▶ Packing unit: 12

▶ **Product description**

- Special lubricant that provides reliable adhesion at high temperatures
- Condensation, splash and salt water proof
- Excellent and long-term lubrication
- Lasting corrosion protection
- Particularly suitable for vehicles with anti-lock brake system
- Temperature resistant up to 1,400°C



04

Off-Shore replacement brush

- ▶ Item no. 2894-448-201



04

02

03

01

Brake assembly paste

BMP

- ▶ Item no. 2894-400
- ▶ Contents: 5.50 ml
- ▶ Packing unit: 1

- ▶ Item no. 2894-405
- ▶ Contents: 250 g
- ▶ Packing unit: 1

▶ **Product description**

- Heat resistant to 1,100°C
- Resistant to alkalis and acids
- Can be universally used for assembly, screw fittings and as a lubricant



01

03

Brake fluid

DOT4

- ▶ Item no. 2894-420
- ▶ Contents: 500 ml
- ▶ Packing unit: 1

- ▶ Item no. 2894-410
- ▶ Contents: 5 litres
- ▶ Packing unit: 1

- ▶ Item no. 2894-410-30
- ▶ Contents: 30 litre
- ▶ Packing unit: 1

▶ **Product description**

- Suitable for all hydraulic braking systems using synthetic fluid
- Wet boiling point over +160°C
- Boiling point over +250°C

04

Brake fluid

DOT4 Plus

- ▶ Item no. 2894-415-05
- ▶ Contents: 500 ml
- ▶ Packing unit: 24

- ▶ Item no. 2894-415
- ▶ Contents: 5 litres
- ▶ Packing unit: 1

- ▶ Item no. 2894-415-30
- ▶ Contents: 30 litre
- ▶ Packing unit: 1

▶ **Product description**

- Suitable for all hydraulic braking systems using synthetic fluid
- Wet boiling point over +180°C
- Boiling point over +260°C

05

Spout for 5 litre containers

- ▶ Item no. 2000-000-005

Spout for 30 litre containers

- ▶ Item no. 2000-000-030

06

Brake fluid tester

Replacement battery 3722-24

- ▶ Item no. 8715-999-50



02

02

Copper grease

Cop

- ▶ Item no. 2894-451-1
- ▶ Contents: 250 g
- ▶ Packing unit: 1

- ▶ Item no. 2894-450
- ▶ Contents: 400 ml
- ▶ Packing unit: 12

- ▶ Item no. 2894-451
- ▶ Contents: 100 g
- ▶ Packing unit: 10

▶ **Product description**

- Thermally stable to +1,200°C
- Do not apply to friction surfaces
- NOT RECOMMENDED FOR ABS VEHICLES



03

04

06

05



01
High-performance brake fluid
DOT 4 LV High Performance

- ▶ Item no. 2894-435
- ▶ Contents: 5 litres
- ▶ Packing unit: 1

- ▶ Item no. 2894-430
- ▶ Contents: 30 litres
- ▶ Packing unit: 1

- ▶ Product description
- With special Ford licence
- Suitable for all hydraulic brake systems using synthetic fluid
- Can be mixed with brake fluid of the same specification
- Does not attack brake parts
- Increases safety thanks to reduced drop in boiling point
- Meets DOT-4 FMVSS 116 and SAEJ 1703
- Boiling point over +265° C
- Wet boiling point over +175° C



01

02
Airspray pressure cylinder for Bremtec A2

- ▶ Item no. 2897-910-1
- ▶ Contents: 400 ml
- ▶ Packing unit: 1



02

03
Airspray pressure cylinder for Bremtec

- ▶ Item no. 2897-910-2
- ▶ Contents: 400 ml
- ▶ Packing unit: 1



03

04
Airspray pressure cylinder for Oxim

- ▶ Item no. 2897-910-3
- ▶ Contents: 400 ml
- ▶ Packing unit: 1



04

05
Airspray automatic filler

- ▶ Item no. 2897-910-100
- ▶ Item no. 2897-910-106
- ▶ Spare parts service station material/air

Replacement parts for Airspray pressure cylinders

- ▶ Item no. 2897-910-101
- ▶ A valve with a vertical hose
- ▶ Item no. 2897-910-102
- ▶ Spray head, circular jet
- ▶ Item no. 2897-910-108
- ▶ Spray head, spot jet

Spare parts for Airspray automatic filling machine

- ▶ Item no. 2897-910-103
- ▶ Material air valve
- ▶ Item no. 2897-910-104
- ▶ Air valve
- ▶ Item no. 2897-910-105
- ▶ Seal holder, including grooved ring
- ▶ Item no. 2897-910-110
- ▶ Barrel connector, including accessories for 60 litres



01

Seal remover

Seal-Ex

- ▶ Item no. 2896-663
- ▶ Contents: 400 ml
- ▶ Packing unit: 12

▶ **Product description**

- Can be used on objects made from metal, wood, ceramic, glass, polyethylene, polypropylene
- Do not use on delicate plastics such as PVC, linoleum or synthetics
- Never use on painted surfaces!

02

Silicone black

Silon Black

- ▶ Item no. 2896-640-2
- ▶ Contents: 200 ml
- ▶ Packing unit: 12

▶ **Product description**

- Hardens practically without shrinking (< 3%) to a hard, rubber-like mass as soon as exposed to air humidity
- Adheres to metal, glass, painted surfaces, ceramic and to most plastic surfaces
- Resistant to weathering, vibrations, moisture
- Thermally stable from -50°C to +230°C

03

Silicone red

Silon Red

- ▶ Item no. 2896-640-1
- ▶ Contents: 200 ml
- ▶ Packing unit: 12

▶ **Product description**

- Hardens practically without shrinking (< 3%) to a hard, rubber-like mass as soon as exposed to air humidity
- Adheres to metal, glass, painted surfaces, ceramic and to most plastic surfaces
- Resistant to weathering, vibrations, moisture
- Thermally stable from -50°C to +300°C

04

Spare pistol grip

- ▶ Item no. 2896-640-3



01



02

03



01
Multi-purpose grease
BG-B

- ▶ Item no. 2986-02
 - ▶ Contents: 400 g
 - ▶ Packing unit: 12
-
- ▶ Product description
 - Colour: Black
 - Ideal for drive shafts
 - With graphite
 - Thermally stable from -30°C to +120°C
 - NLGI class 2

02
Multi-purpose grease
BG-Y

- ▶ Item no. 2986-021
 - ▶ Contents: 400 g
 - ▶ Packing unit: 12
-
- ▶ Product description
 - Color: Yellow
 - Temperature range -30°C to +120°C
 - NLGI class 2

03
Lever grease gun
M10 x 1

- ▶ Item no. 7986-0
-
- ▶ Product description
 - Suitable for 400 g cartridges or 500 g grease

06
Lever grease gun
For lube-shuttle system cartridges

- ▶ Item no. 7986-1
-
- ▶ Product description
 - With galvanized-steel grease container
 - Ergonomically shaped lever gear
 - Pressure approx. 300 bar
 - Open the cartridge without tools
 - Simple, quick and absolutely clean loading and removal of grease cartridges - without opening the gun
 - No venting required
 - Optimal emptying of cartridge residues

07
Multi-purpose grease
Greasal

- ▶ Item no. 2986-031
 - ▶ Contents: 400 g
 - ▶ Packing unit: 12
-
- ▶ Product description
 - Smooth texture
 - Soft consistency
 - Acid-free, shear-stable
 - Resistant to oxidation
 - Protects against rust
 - Thermally stable from -30°C to +120°C
 - NLGI class 2 (2K-30 to DIN 51 502)
 - Screw cartridge (lube-shuttle system cartridges)



04
Hydraulic claw mouthpiece

- ▶ Item no. 7986-04
-
- ▶ Product description
 - M10 x 1
 - to DIN 71412
 - for grease guns (7986-0)

05
High pressure reinforced tube

- ▶ Item no. 7986-03
-
- ▶ Product description
 - M10 x 1
 - For grease gun (7986-0)



01
Surface sealant, green

- ▶ Item no. 2896-520
- ▶ Contents: 50 g
- ▶ Packing unit: 1

▶ **Product description**

- max. gap filling capacity: 0.3 mm
- Thermally stable from -55°C to +150°C
- Resistant to water, mineral oils, synthetic lubricants, fuels, organic solvents and coolants
- Solid in 20-40 mins.
- Work hard in 1-3 hours

02
Surface sealant, orange

- ▶ Item no. 2896-521
- ▶ Contents: 50 g
- ▶ Packing unit: 1

▶ **Product description**

- max. gap filling capacity: 0.5 mm
- Thermally stable from -55°C to +150°C
- Resistant to water, mineral oils, synthetic lubricants, fuels, organic solvents and coolants
- Solid in 15-30 mins.
- Work hard in 1-3 hours

03
Hydraulic and pneumatic sealant
Anaerobic sealing compound

- ▶ Item no. 2896-550-50
- ▶ Contents: 50 ml
- ▶ Packing unit: 10

▶ **Product description**

- Strength class (DIN 30661): 10-14
- max. gap filling capacity: 0.50 mm
- max. thread: (metr) M80
- Thermally stable from -55°C to +150°C
- Solid in 15-30 mins.
- Work hard in 1-3 hours
- Resistant to petrol, diesel, water, water-glycol mixtures, mineral oils, hydraulic fluids



04
Screw-Lock “medium-strength”

- ▶ Item no. 2896-531
- ▶ Contents: 24 ml
- ▶ Packing unit: 1

- ▶ Item no. 2896-531-50
- ▶ Contents: 50 ml
- ▶ Packing unit: 1

▶ **Product description**

- medium strength, strength class (DIN 30661)
- max. gap filling capacity: 0.25 mm
- max. thread (metric) M36
- Thermally stable from -55°C to +150°C
- Solid in 10-20 mins.
- Work hard in 1-3 hours

05
Screw-Lock “high-strength”

- ▶ Item no. 2896-530
- ▶ Contents: 24 ml
- ▶ Packing unit: 1

- ▶ Item no. 2896-530-50
- ▶ Contents: 50 ml
- ▶ Packing unit: 1

▶ **Product description**

- high-strength, strength class (DIN 30661)
- max. gap filling capacity: 0.15 mm
- max. thread (metric) M20
- Thermally stable from -55°C to +150°C
- Solid in 10-20 mins.
- Work hard in 1-3 hours



01



02



03



04



05

01
Pipe thread sealing

- ▶ Item no. 2896-550-51
- ▶ Contents: 50 ml
- ▶ Packing unit: 12

▶ **Product description**

- Strength class (DIN 30661): 10-14
- max. gap filling capacity: 0.50 mm
- Max. thread: (metr) M80
- Thermally stable from -55°C to +150°C
- Solid in 15-30 mins.
- Work hard in 1-3 hours
- Resistant to petrol, diesel, water, water-glycol mixtures, mineral oils, hydraulic fluids
- Exception: High-concentration acids and alkalis, and methylene chloride



01

02
fastening of the brass and bearing

- ▶ Item no. 2896-540
- ▶ Contents: 24 ml
- ▶ Packing unit: 12

▶ **Product description**

- Strength class (DIN 30661): 55-70
- max. gap filling capacity: 0.15 mm
- Max. thread: (metr) M20
- Thermally stable from -55°C to +175°C
- Solid in 2-5 mins.
- Work hard in 1-3 hours



02



03

03
Universal duroplastic seal
Plastomar

- ▶ Item no. 2896-502
- ▶ Contents: 85 g
- ▶ Packing unit: 10

▶ **Product description**

- Temperature range -55°C to +270°C
- Allow to evaporate for 10 minutes
- Max. gap filling capacity 0.2 mm

04
Engine sealer
MotSeal

- ▶ Item no. 2897-374
- ▶ Contents: 300 ml
- ▶ Packing unit: 12

▶ **Product description**

- Prevents exhaust bluing
- Replenishes rubber and plastic seals
- Stops environmentally-unfriendly oil leaks



04



05

05
Engine-oil circulation cleaner
MotClean

- ▶ Item no. 2897-375
- ▶ Contents: 500 ml
- ▶ Packing unit: 12

▶ **Product description**

- Gentle and quick cleaning
- Safe for seals and other engine materials
- Cost-effective
- Simple application



01

Radiator sealer

RadSeal

- ▶ Item no. 2897-372
- ▶ Contents: 150 ml
- ▶ Packing unit: 12

▶ **Product description**

- Seals hairline cracks and small leaks permanently and reliably
- Compatible with anti-freezes and coolants, does not attack rubber, plastics, light alloys or non-ferrous heavy metals
- No negative effects on water pumps or heating circuits

- Suitable for closed cooling systems
- Suitable for aluminium radiators
- Also suitable for precautionary use



01

03

Diesel additive

CT 60

- ▶ Item no. 2897-370
- ▶ Contents: 300 ml
- ▶ Packing unit: 12

▶ **Product description**

- Cleans and prevents deposits in the fuel system and combustion chamber
- Keeps the injector nozzles clean, improves combustion, resulting in less specific fuel consumption and maximum engine performance
- Prevents sticky deposits on the

- injector needles
- Increases lubrication when using low sulphur diesel fuels and protects the distributor fuel injection pumps against wear
- Fully compatible with all modern diesel oxidation catalysts



03



02

02

Radiator Cleaner

RadClean

- ▶ Item no. 2897-373
- ▶ Contents: 300 ml
- ▶ Packing unit: 12

▶ **Product description**

- Chemical conversion of lime
- Dissolves grease, lime and oil
- Disperses sludge
- Does not attack radiator materials
- Safe for rubber and plastic
- Compatible with anti-freezes
- Does not contain aggressive acids or alkalis

04

Petrol additive

OT 100

- ▶ Item no. 2897-371
- ▶ Contents: 300 ml
- ▶ Packing unit: 12

▶ **Product description**

- Suitable for all petrol injection systems
- Cleans carbon deposits from injection systems
- Removes coking and deposits from fuel distributors, injection valves, intake valves and other components of the fuel system
- Ensures optimum performance

- and fuel economy through accurate injection and atomization
- Guarantees low exhaust emissions



04



01

Diesel intake system cleaner
DC980

- ▶ Item no. 2897-369
- ▶ Contents: 400 ml
- ▶ Packing unit: 8

- ▶ **Product description**
- Special cleaner with CO₂ propellant
 - Simple and specific use
 - Colourless and residue free
 - Powerful solvent action
 - Over 95% active ingredients



02

Diesel soot-particle filter cleaner
DPF100

- ▶ Item no. 2897-380
- ▶ Contents: 400 ml
- ▶ Packing unit: 12

- ▶ **Product description**
- Outstanding at loosening carbon deposits
 - Non-flammable
 - Clean without having to dismantle the particle filter
 - Restore the full absorbency of the diesel particle filter



01



02

01
Throttle cleaner
VC 980

- ▶ Item no. 2897-368
- ▶ Contents: 400 ml
- ▶ Packing unit: 12

▶ **Product description**

- Cleans the carburettor from the inside and outside
- Rinses boreholes and nozzles
- Ideal for cleaning components in the intake area
- Exhaust gas regulation valve

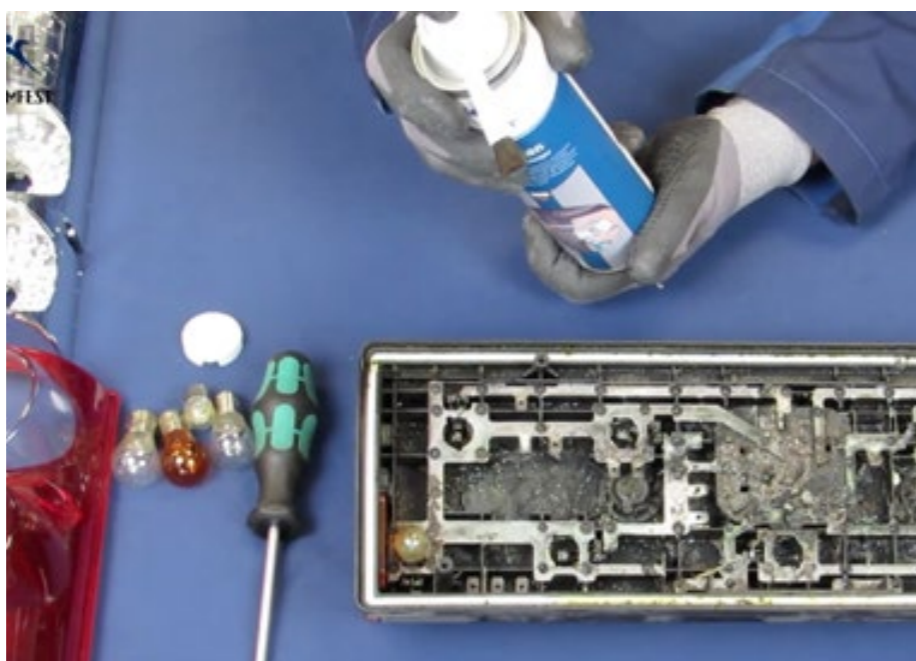

02
Long hose, incl. spray head for VC 980

- ▶ Item no. 2897-368-1



03
Electrical contact cleaner
TermClean

- ▶ Item no. 2897-334
- ▶ Contents: 400 ml
- ▶ Packing unit: 12

▶ **Product description**

- Cleans all contacts
- Facilitates the removal of greasy contamination and loosens old incrustations
- Safe to use on electrical and mechanical office machines, computers, cash registers, radios and televisions
- Comes with brush attachment
- Product not suitable for use on parts being used!



04
Leakfinder
Spy Plus

- ▶ Item no. 2896-661
- ▶ Contents: 400 ml
- ▶ Packing unit: 12

▶ **Product description**

- Approved by DVGB (test certificate NG-5170BQ0463)
- Meets the requirements of DIN EN 14291
- Non-flammable leak detection possible even of flammable gases
- Suitable for all technical gases in compressed-air, compressed-gas and air-conditioning systems, compressors, welding apparatus, compressed-air brake systems, tyres, hoses and transport tanks
- No stress corrosion cracking on plastics such as PVC or PE
- Temperature range: -15°C to +50°C
- Non-corrosive

05
Ice spray
Arctic

- ▶ Item no. 2897-325
- ▶ Contents: 200 ml
- ▶ Packing unit: 12

▶ **Product description**

- Metal structural parts such as ball bearings, sleeves, chain links, shafts, etc. can be inserted into the tightest of fits
- Can be used to easily find electrical faults in circuits (due to thermal overload) through local cooling
- Also excellent at removing dirt such as chocolate and chewing gum from upholstery

06
Marten protection
Wild-Life

- ▶ Item no. 2897-320
- ▶ Contents: 400 ml
- ▶ Packing unit: 12

▶ **Product description**

- Double action through taste and smell





01
Starting aid spray
Super Start Plus

- ▶ Item no. 2897-330-310
- ▶ Contents: 300 ml
- ▶ Packing unit: 12

- ▶ **Product description**
- Very high ignition properties
 - Facilitates cold starting even in extremely low temperatures
 - Improves starting when wet
 - Suitable for 2- and 4-stroke petrol engines
 - Also suitable for diesel engines (follow instructions for use on the product: ☑Start diesel engines at full throttle, do not preheat!☑)

02
Contact helper
Contac

- ▶ Item no. 2897-331
- ▶ Contents: 300 ml
- ▶ Packing unit: 12

- ▶ **Product description**
- Eliminates moisture
 - Improves electrical conductivity

03
Battery terminal protection blue
Poltec

- ▶ Item no. 2897-332-300
- ▶ Contents: 300 ml
- ▶ Packing unit: 12

- ▶ Item no. 2897-332-150
- ▶ Contents: 150 ml
- ▶ Packing unit: 1

- ▶ **Product description**
- insulates bright sheet connections and electrical connections against corrosion from environmental agents (salts, water, acids, alkalis, moisture, etc.)

04
Battery acid tester
▶ Item no. 8853-600-2





01
Intensive window cleaner
Topas

- ▶ Item no. 2897-310
- ▶ Contents:
- ▶ Packing unit: 24

- ▶ Item no. 2000-03
- ▶ Contents: 5 litres
- ▶ Packing unit: 1

- ▶ Product description
- Also suitable for polycarbonate glass
- Safe for surfaces
- Foam formation only after the surface has been coated with the product

02
Spout for 5 litre containers

- ▶ Item no. 2000-000-005



03
High-tech special cleaner
Terpanol Power

- ▶ Item no. 2897-323
- ▶ Contents: 400 ml
- ▶ Packing unit: 12

- ▶ Product description
- Contains orange terpenes
- Made from 100% renewable resources
- Optimally removes adhesive residues, oils, grease, wax, water-resistant permanent markers, graffiti
- Great ability to dissolve dirt
- Dissolves after a very short time (approx. 20 seconds)





01
Anti-freeze for windscreen washer systems
Frostex

- ▶ Item no. 2897-312
- ▶ Contents: 500 ml
- ▶ Packing unit: 20

- ▶ Item no. 2897-314
- ▶ Contents: 1000 ml
- ▶ Packing unit: 12

- ▶ Item no. 2897-318
- ▶ Contents: 30 litre
- ▶ Packing unit: 1

- ▶ Item no. 2897-319
- ▶ Contents: 60 litres
- ▶ Packing unit: 1

- ▶ Product description
- Methanol free
- Undiluted frost-proof up to -70°C
- Suitable for fan nozzles and polycarbonate windscreens



01

02
Concentrate for windscreen washer systems
Flash

- ▶ Item no. 2897-313-100
- ▶ Contents: 30 ml
- ▶ Packing unit: 100

- ▶ Item no. 2897-313-5
- ▶ Contents: 5 litres
- ▶ Packing unit: 1

- ▶ Product description
- Summer product – only suitable for temperatures above 7°C
- Suitable for fan nozzles and polycarbonate windscreens
- One bottle (30 ml) = 4 litres of water



03

03
Dosing pump for 5 litre containers

- ▶ Item no. 2897-313-509

- ▶ Product description
- 1 spray (2.5 ml)



02

04
Anti-freeze tester for cooling water

- ▶ Item no. 8853-600-1



04

05

05
Anti-freeze for windscreen washer systems

- ▶ Item no. 8853-600-3



06

06
Quick de-icer
Blizzard Ultra

- ▶ Item no. 2897-231
- ▶ Contents: 500 ml
- ▶ Packing unit: 6

- ▶ Product description
- De-ices windscreens quickly
- Leave no smears
- No need to scrape off frost, ice or snow

01
Super-fast superglue
Cyanoacrylate adhesives black

- ▶ Item no. 2898-555
- ▶ Contents: 5 g
- ▶ Packing unit: 1

- ▶ Item no. 2898-556
- ▶ Contents: 20 g
- ▶ Packing unit: 1

- ▶ Product description
- Suitable for smooth plastic surfaces
- Pinpoint application accuracy



01

02
Black cyanacrylate adhesive Superfast

- ▶ Item no. 2898-560-20
- ▶ Contents: 20 g
- ▶ Packing unit: 1

- ▶ Product description
- Suitable for bonding rubber coatings, plastics and metals

- Ideal for bonding plastics, such as door clips
- Based on cyanacrylate



02



03

03
Superglue filler
For cyanoacrylate adhesives

- ▶ Item no. 2898-560-30
- ▶ Contents: 30 g
- ▶ Packing unit: 1

- ▶ Product description
- Density: > 1.5g/cm³ 20°C

04
Instant glue Rapido

- ▶ Item no. 2898-555-100
- ▶ Contents: 20 g
- ▶ Packing unit: 12

- ▶ Product description
- For extreme loads
- Suitable for a wide range of materials subject to heavy vibrations
- based on cyanacrylate



04

05
Superglue gel Fixit

- ▶ Item no. 2898-554
- ▶ Contents: 20 g
- ▶ Packing unit: 1

- ▶ Product description
- Does not run
- Can be used on horizontal and vertical surfaces
- Does not form strings
- For bonding metals, wood and plastics
- Based on cyanacrylate



05

06
Accelerator Fixit Active

- ▶ Item no. 2898-554-150
- ▶ Contents: 200 ml
- ▶ Packing unit: 1

- ▶ Product description
- Suitable as a curing accelerator for all cyanoacrylate adhesives
- For leather, wood, cork, ceramics and all porous materials and for bonding plastics



06



07

07
Power spray glue Super-Glue

- ▶ Item no. 2898-552
- ▶ Contents: 400 ml
- ▶ Packing unit: 12

- ▶ Product description
- Foamed materials, jute, felt, expanded polystyrene
- Paper, cardboard, plastic films
- Various plastics
- Temperature range (permanent): -25°C to +70°C

08
Rubber profile adhesive Profix

- ▶ Item no. 2898-551
- ▶ Contents: 180 g
- ▶ Packing unit: 12

- ▶ Product description
- Ideal for gluing: Rubber profile, leather, plastic, imitation leather with textile backing and felt to metal, wood, rigid PVC, ABS, PA



08



01

Multipurpose primer

1K-Multi-Connector

- ▶ Item no. 2893-900
- ▶ Contents: 400 ml light grey
- ▶ Packing unit: 12



- ▶ Item no. 2893-900-20
- ▶ Contents: 400 ml dark grey
- ▶ Packing unit: 12



▶ **Product description**

- Recoatable without sanding
- With fan spray head
- Substrates: Galvanised sheet steel and aluminium, plastic, wood, etc.
- Particularly suitable for protecting the edges of filled areas
- Ideal for all difficult substrates, also suitable for plastic and wood



01

01

Zinc primer

Galva 97

- ▶ Item no. 2893-880
- ▶ Contents: 400 ml
- ▶ Packing unit: 12

▶ **Product description**

- Protects new sheet metal against rusting
- Weldable
- Abrasion resistant after drying
- High corrosion protection
- High percentage of active substances

02

Zinc-aluminium primer

Galva 97 Silver

- ▶ Item no. 2893-890
- ▶ Contents: 400 ml
- ▶ Packing unit: 12

▶ **Product description**

- Ideal for colour matching to galvanised sheet metal
- Protects new sheet metal against corrosion
- Weldable
- Abrasion resistant after drying
- High corrosion protection
- High percentage of active substances

03

Aluminium primerAlloy

- ▶ Item no. 2893-881
- ▶ Contents: 400 ml
- ▶ Packing unit: 12

▶ **Product description**

- Heat-resistant corrosion protection up to +600°C
- Weldable
- Overpaintable
- Protects new sheet metal against corrosion

04

Primer filler

2K Rapid Filler

- ▶ Item no. 2893-905
- ▶ Contents: 400 ml
- ▶ Packing unit: 6

▶ **Product description**

- Isocyanate-free
- Very rapid curing after 1 hour at 20°C
- or after 15-20 mins. at 60°C
- Universal use on old sanded paintwork and metallic substrates
- Simple and quick to use
- Very high filling capacity
- Very good adhesion on bright steel/plate
- Can be overpainted with any current 1K and 2K covering-paint systems



05

Base primer

Baso Plus

- ▶ Item no. 2893-889
- ▶ Contents: 400 ml
- ▶ Packing unit: 24

▶ **Product description**

- High filling properties
- Improved coverage due to increased number of pigments
- Temperature resistant up to 100°C
- Overpaintable with nitro, acrylic and water-based paints
- Fan spray head enables vertical and horizontal application



01

02

03

04

05

01

Thick film filler

One-component multi filler

- ▶ Item no. 2893-902
- ▶ Contents: 400 ml
- ▶ Packing unit: 10

▶ Product description

- High filling volume
- Easy to sand
- Quick drying
- With cone spray head

02

Primer filler

2-component epoxy primer filler

- ▶ Item no. 2800-760
- ▶ Contents: 400 ml
- ▶ Packing unit: 6

▶ Product description

- Gloss level: matt
- Colour: beige
- Long-lasting corrosion protection on all surfaces, e.g. zinc, aluminium, steel, etc.
- Proportion of solid particles: 50-53% by weight on diluted paint (without propellant gas)

03

Pistol grip

▶ Art. no.: 2893-900-2



04

Fan nozzle

▶ Art. no.: 2893-900-3



05

Rust stopper primer

Rednox

- ▶ Item no. 2893-888
- ▶ Contents: 400 ml
- ▶ Packing unit: 12

- ▶ Item no. 2893-888-25
- ▶ Contents: 2.5 kg
- ▶ Packing unit: 1

▶ Product description

- Quick drying
- Weldable
- Overpaintable
- Sprayable



01



02



03



01
Rust converter
Rostinator

- ▶ Item no. 2893-903
- ▶ Contents: 400 ml
- ▶ Packing unit: 12

- ▶ **Product description**
- Active pigments turn rust into iron sulphide
 - Forms a permanent weatherproof and moisture-resistant protective layer
 - Drying time: 14 hours
 - Compatible with all Normfest primers

02
Welding Primer
Elox Plus

- ▶ Item no. 2893-906
- ▶ Contents: 400 ml
- ▶ Packing unit: 12

- ▶ **Product description**
- 1K acrylic base
 - Very good corrosion protection
 - Can be over welded over
 - Very good ignitability & conductivity
 - Suitable for iron and steel
 - Quick drying
 - Visually matches stainless-steel parts



01

02

01

Underbody protection (overpaintable)

Bottom Guard Recoat

- ▶ Item no. 2892-881
- ▶ Contents: 500 ml
- ▶ Packing unit: 12



▶ **Product description**

- Provides optimum underbody protection with anti-rust and anti-corrosion properties
- Improves sound insulation
- Rust-protection spray dries quickly and is extremely resistant to abrasion
- Has very good adhesion to all substrates, such as bumpers / front and rear aprons
- The underbody spray can be overpainted after 60-90 minutes using two-component and basic paints

02

Underbody protection (overpaintable)

Bottom Guard Recoat

- ▶ Item no. 2892-882
- ▶ Contents: 1000 ml
- ▶ Packing unit: 12



▶ **Item no. 2892-883**

- ▶ Contents: 1000 ml
- ▶ Packing unit: 12



▶ **Product description**

- Provides optimum underbody protection with anti-rust and anti-corrosion properties
- Outstanding sound insulation
- Extremely resistant to abrasion
- Quick drying
- Can be overpainted with current two-component and basic paints after approx. 60-90 minutes (at 20°C, 65% rel. air humidity)
- Rubber base

03

Underbody protection (not overpaintable)

Bottom Guard

- ▶ Item no. 2892-990
- ▶ Contents: 1,000 ml black
- ▶ Packing unit: 12



▶ **Product description**

- Cannot be overpainted
- Contains solvents
- Bitumen base
- After curing, thanks to its combination of raw materials, the coating provides abrasion-resistant, permanently elastic corrosion protection with high resistance to ageing, which does not become brittle even when cold.

04

wax-based underbody protection

Bottom Guard Wax

- ▶ Item no. 2892-994-500
- ▶ Contents: 500 ml light brown
- ▶ Packing unit: 12



▶ **Item no. 2892-994**

- ▶ Contents: 1000 ml
- ▶ Packing unit: 12



▶ **Product description**

- Excellent corrosion protection with self-sealing property
- Highly resistant wax film
- Can be applied with airless spraying equipment as well as Airmix or pressure pot spray guns
- Touch-dry after (20°C, 65% RH): approx. 150 minutes
- Cured after (20°C, 65% RH): approx. 50 hours



01

02

03

04

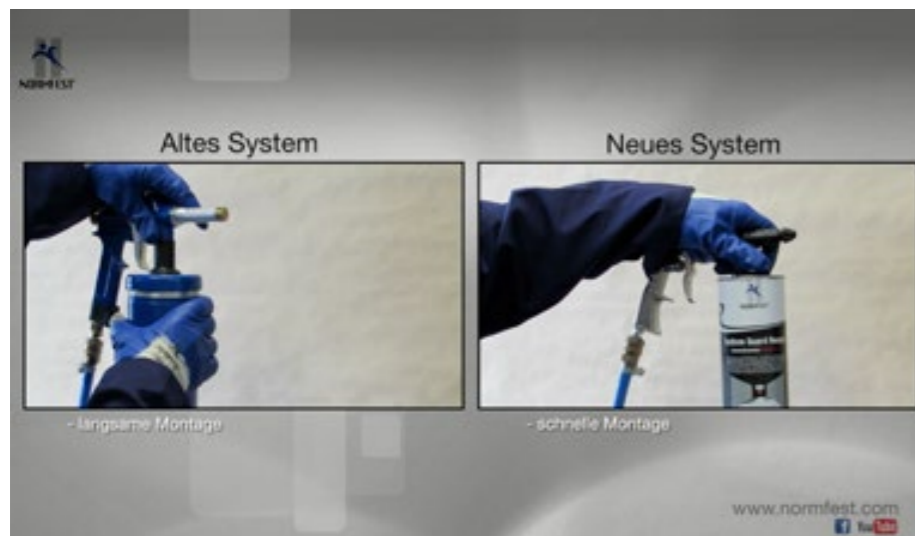

01 Pressure cup spray gun
for 1000 ml screw-top containers

- ▶ Art. no.: 2891-106-841
- ▶ Product description
 - Ideal for use of Bottom-Guard and Protector
 - Wide range of structures can be sprayed
 - Teflon seals
 - Suitable for metal



05 Cavity protection Protector

- ▶ Item no. 2892-997
- ▶ Contents: 400 ml
- ▶ Packing unit: 15
- ▶ Product description
 - Thermally stable -30°C to +90°C
 - The hose supplied ensures application even in hard-to-reach cavities
 - Facilitates optimal wetting of areas to be protected
 - Contains NO silicone!
 - transparent

06 Cavity protection Protector

- ▶ Item no. 2892-998
- ▶ Contents: 1000 ml
- ▶ Packing unit: 12
- ▶ Product description
 - Thermally stable -25°C to +160°C
 - Designed to protect and seal pillars, door sills, areas of the vehicle interior, etc..
 - Excellent penetration properties

07 Body protection Long-Life

- ▶ Item no. 2892-997-1
- ▶ Contents: 400 ml
- ▶ Packing unit: 12
- ▶ Product description
 - Displaces water
 - Capable of creep
 - Quick drying
 - Thermally stable from -50°C to +90°C
 - Extremely abrasion resistant
 - For sealing large areas of bodywork



02 UBS gun
Including nozzle and feed tube

- ▶ Art. no.: 2892-880
- ▶ Product description
 - Quick & easy to assemble
 - Accurately adjustable spray pattern
 - Quick & easy to change
 - No cleaning required

03 Nozzle set
For UBS gun (article no. 2892-880)

- ▶ Art. no.: 2892-880-1
- ▶ Product description
 - Nozzle set for UBS gun (article no. 2892-880)
 - Content:
 - 3 x nozzles
 - 3 x feed tubes

04 Body cavity spray hose set
For pneumatic pressure cup spray gun

- ▶ Art. no.: 2891-106-842
- ▶ Product description
 - Specially designed for Protector
 - Hose diameter: 6 mm
 - Hose length: 98 cm (with handle, incl. adapter), 116 cm (without handle, incl. adapter)



05

06

07

01

Body sealing compound

Basis: Polyurethane

Proton

- ▶ Item no. 2893-221-1
- ▶ Contents: 310 ml white
- ▶ Packing unit: 12

- ▶ Item no. 2893-221-2
- ▶ Contents: 310 ml black
- ▶ Packing unit: 12

- ▶ Item no. 2893-221-3
- ▶ Contents: 310 ml grey
- ▶ Packing unit: 12

▶ **Product description**

- Short thread break
- Forms a skin in 20 mins.
- Silicone-free
- Elastic
- Non-corrosive
- Broad adhesion spectrum: wood, metal, metal fillers, paintwork (2K systems), ceramic materials, glass and plastic
- Thermal stability: -40°C to +90°C (to +120°C in the short term)
- Approved for use in the food industry when cured
- Manufactured to quality assurance system DIN ISO 9001

02

Round nozzle

For aluminium cartridge, embossed, length: 8.2 cm

- ▶ Art. no.: 2891-02-25



03

Body sealing compound

Basis: Copolymer

Krypton

- ▶ Item no. 2893-222-1
- ▶ Contents: 290 ml white
- ▶ Packing unit: 12

- ▶ Item no. 2893-222-3
- ▶ Contents: 290 ml transparent
- ▶ Packing unit: 12

- ▶ Item no. 2893-222-4
- ▶ Contents: 290 ml grey
- ▶ Packing unit: 12

- ▶ Item no. 2893-222-5
- ▶ Contents: 290 ml black
- ▶ Packing unit: 12

▶ **Product description**

- UV-resistant
- Elastic
- Can be painted over wet-in-wet
- Can be sanded
- Silicone- and isocyanate-free
- Good adhesion on many metals (zinc, aluminium, steel), paints, primers, wooden materials, Duround thermoplastics (apart from PE, PP, PTFE) and mineral substrates
- Resistant to lime water, public waste water and weak acids and alkalis
- Thermal stability: -40°C to +90°C, to +120°C in the short term
- Solvent-free single-component adhesive and sealant
- Suitable for bodywork, container and vehicle construction

04

Round nozzle

Basis: polyurethane

- ▶ Art. no.: 2891-02-26



02

01

04

03

01

Sprayable seam sealant

Basis: Copolymer

Flexon

- ▶ Item no. 2893-300 
- ▶ Contents: 310 ml grey
- ▶ Packing unit: 12

- ▶ Item no. 2893-301 
- ▶ Contents: 310 ml black
- ▶ Packing unit: 12

▶ **Product description**

- UV-resistant
- Elastic
- Can be overpainted wet-in-wet
- Can be sanded
- Silicone-free
- Broad adhesive spectrum: many metals (zinc, aluminium, steel), paints, primers, glass, wood, plastics (apart from PE, PP, PTFE) and mineral substrates
- Thermal stability: -40°C to +80°C, to +120°C in the short term

02

For plastic cartridges

For use with body sealing compounds, windscreen adhesives and sprayable seam sealants

- ▶ Art. no.: 2891-03-1



01

03

Body adhesive

Pluton

- ▶ Item no. 2893-223-4 
- ▶ Contents: 280 ml grey
- ▶ Packing unit: 12

▶ **Product description**

- Very stable after 30 minutes
- Adheres without primer to steel, aluminium, galvanised sheet steel, GRP and plastics
- Can be overpainted
- Permanently thermally stable to +80°C



03



04

04

Static mixer
for Pluton

- ▶ Art. no.: 2893-223-30

▶ **Product description**

- Length: Static mixer 23.5 cm



06

06

Wing nozzle

For achieving wide and flat sealing compound seams

- ▶ Art. no.: 2891-02-27



05

05

Square spatula
for Pluton

- ▶ Art. no.: 2893-223-38

▶ **Product description**

- Length: Mixer rod 23 cm
- Diameter at tip: approx. 0.5 cm
- Diameter of adapter: 2.2 cm



07

07

Cartridge opener

- ▶ Art. no.: 2891-02-50

01

Pneumatic cartridge gun

Ideal for use with sprayable seam sealants, e.g. Flexon (2893-300)

► Art. no.: 2891-05

► Product description

- Content:
- 1 x pneumatic cartridge gun
- 1 x nozzle set (10 long nozzles, 20 short nozzles)
- 1 x spare nozzle cap



02

Spare small spray tubes

For pneumatic cartridge gun (2891-05)

► Art. no.: 2891-051

► Product description

- Packaging unit: 30 pieces

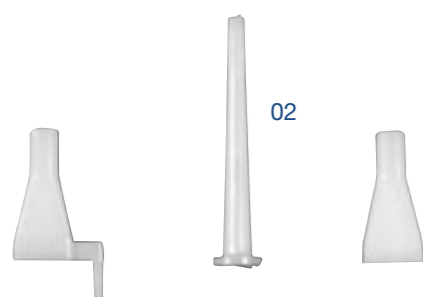

03

Brush

For body sealing compounds

► Art. no.: 4693-251-1

► Product description

- Model: 1,0"



04

Adherend cleaner

Glue-Ex

► Item no. 2893-200-10

► Contents: 1000 ml

► Packing unit: 12

► Product description

- The ideal cleaner for cleaning surfaces before being stuck
- Can be used on all substrates in the automotive area, apart from plastics
- Transparent



05

Adhesive cleaner

HR 150

► Item no. 2700-36

► Contents: 150 ml

► Packing unit: 1

► Product description

- Cleans and simultaneously primes
- Ideal for pre-treating non-absorbent metal and plastic substrates





01
Plastics repair adhesive
Repos fast

- ▶ Item no. 2700-15
 - ▶ Contents: 50 ml
 - ▶ Packing unit: 2
- ▶ **Product description**
- For sticking PVC, GRP, steel and aluminium
 - Dropping time: 90 seconds
 - Sandable after approx. 15 minutes.

02
Plastics repair adhesive
Repos

- ▶ Item no. 2700-10
 - ▶ Contents: 50 ml
 - ▶ Packing unit: 2
- ▶ **Product description**
- For sticking PVC, GRP, steel and aluminium
 - Dropping time: 5 minutes
 - Sandable after approx. 90 minutes.

03
Repair adhesive
Repos MMA

- ▶ Item no. 2700-20
 - ▶ Contents: 50 ml
 - ▶ Packing unit: 2
- ▶ **Product description**
- for the bonding of different substrates, such as: Sun visor bracket, plastic trims, carbon on steel, aluminium parts on steel substrate, etc.
 - Can be applied without chemical or mechanical pre-treatment
 - At 35 Mpa, has enormous tensile shear strength
 - Free of solvents and volatile organic compounds
 - Processing temperature: +10°C to +30°C
 - Thermally stable: -50°C bis +120°C
 - Dry to touch after approx. 15 minutes
 - Fully dry after approx. 24 hours



04
Plastics repair adhesive
Repos fast

- ▶ Item no. 2700-16
 - ▶ Contents: 25 ml
 - ▶ Packing unit: 1
- ▶ **Product description**
- Setting time: 90 seconds
 - Sandable after 15 minutes



01



02



03



04

01
Cartridge of windscreen adhesive
Screenox Quantum

- ▶ Item no. 2893-506-10
- ▶ Contents: 300 ml
- ▶ Packing unit: 12

- ▶ **Product description**
- Single-component PUR windscreen adhesive
 - Compatible with MS polymers and thus workable on cut-back residual MS adhesive bead
 - Very easy ejection
 - No activator needed
 - 60 min. for double airbag in temperature range of -10°C to +35°C
 - Processing time: 15 minutes
 - Cures down to -10°C
 - Very good stability
 - Meets OEM/automotive manufacturer requirements
 - Very short thread breaks
 - Very strong
 - Suitable for aerials
 - Can be processed cold
 - Non-conducting
 - Solvent-free

02
Windscreen adhesive package
Screenox Quantum

- ▶ Item no. 2893-506-30
- ▶ Contents: 400 ml
- ▶ Packing unit: 12

- ▶ **Product description**
- Single-component PUR windscreen adhesive
 - Compatible with MS polymers and thus workable on cut-back residual MS adhesive bead
 - Very easy ejection
 - No activator needed
 - 60 min. for double airbag in temperature range of -10°C to +35°C
 - Processing time: 15 minutes
 - Cures down to -10°C
 - Very good stability
 - Meets OEM/automotive manufacturer requirements
 - Very short thread breaks
 - Very strong
 - Suitable for aerials
 - Can be processed cold
 - Non-conducting
 - Solvent-free



03
Windscreen adhesive set:

Cartridge

- ▶ Item no. 2893-506-20
- ▶ Contents: 5 pieces
- ▶ Packing unit: 24

- ▶ **Set contents:**
- 1 x Screenox Quantum windscreen adhesive, 300 ml cartridge
 - 1 x 3 in 1 multiprimer in 5 ml snap ampoule
 - 1 x primer brush
 - 1 x cartridge point
 - 1 x instructions

04
Windscreen adhesive set: Bag

- ▶ Item no. 2893-506-40
- ▶ Contents: 5 pieces
- ▶ Packing unit: 24

- ▶ **Set contents:**
- 1 x Screenox Quantum windscreen adhesive, 400 ml bag
 - 1 x 3 in 1 multiprimer in 5 ml snap ampoule
 - 1 x primer brush
 - 1 x cartridge point
 - 1 x instructions



01

02

03

04



01
Cartridge of windscreen adhesive
Screenox Cold - New Generation

- ▶ Item no. 2893-504-10
- ▶ Contents: 300 ml
- ▶ Packing unit: 12

- ▶ Product description
- Drive-away time: without airbag 60 minutes, with twin airbag 2 hours
- Temperature range: -10°C to +30°C
- Pot life: 15 minutes
- high modulus
- Suitable for aerials
- Short cut-off string
- Stability meets the requirements of OEMs (vehicle manufacturers)
- Incl. tips

02
Windscreen adhesive-bag
Screenox Cold - New Generation

- ▶ Item no. 2893-504-30
- ▶ Contents: 400 ml
- ▶ Packing unit: 12

- ▶ Product description
- Drive-away time: without airbag 60 minutes, with twin airbag 2 hours
- Temperature range: -10°C to +30°C
- Pot life: 15 minutes
- high modulus
- Suitable for aerials
- Short cut-off string
- Stability meets the requirements of OEMs (vehicle manufacturers)
- Incl. tips



03
Windscreen adhesive set
Cartridge

- ▶ Item no. 2893-504-20
- ▶ Contents: 7 pieces
- ▶ Packing unit: 24

- ▶ Set contents:
- 1 x 300 ml cartridge of Screenox Cold - New Generation windscreen adhesive
- 1 x 3in1 multiprimer in 5 ml snap ampoule
- 1 x primer brush
- 1 x cartridge point
- 1 x instructions

04
Windscreen adhesive set
Bag

- ▶ Item no. 2893-504-40
- ▶ Contents: 7 pieces
- ▶ Packing unit: 24

- ▶ Set contents:
- 1 x 400 ml bag of Screenox Cold - New Generation windscreen adhesive
- 1 x 3in1 multiprimer in 5 ml snap ampoule
- 1 x primer brush
- 1 x bag adapter
- 1 x instructions





01
3 in 1 combi primer
Colour: black

- ▶ Item no. 2893-580-30
- ▶ Contents: 30 ml
- ▶ Packing unit: 24
- ▶ Item no. 2893-580-100
- ▶ Contents: 100 ml
- ▶ Packing unit: 8

- ▶ Product description
- Adhesion promoter, rust protection, black primer (UV protection) and corrosion protection in one
- Quick to use and increased safety with just one pre-treatment product
- can be used on ceramic screen print, glass and bright metal



02
Repair brush

- ▶ Item no. 4693-311-5

03
Brush

For primer, made from cotton

- ▶ Item no. 2893-540

04
Windscreen sealing compound
Screenfit

- ▶ Item no. 2893-220
- ▶ Contents: 310 ml black
- ▶ Packing unit: 12

- ▶ Product description
- Can be dabbed
- Resistant to water, road salt and weathering
- After curing, thermally stable from -30°C to +80°C



05
Glass Metal Adhesive
Mirrlock

- ▶ Item no. 2898-557

- ▶ Product description
- 2-component adhesive
- Temperature range: -55°C to +120°C
- Touch dry after approx. 20 seconds
- Curing: approx. 12 hours at 23°C and 55% air humidity
- Tensile strength: approx. 35 N/mm² (glass breaks)

- Note: Not suitable for Ford vehicles!



04

05

01
Intensive window cleaner
Topas

- ▶ Item no. 2897-310
- ▶ Contents:
- ▶ Packing unit: 24

- ▶ Item no. 2000-03
- ▶ Contents: 5 litres
- ▶ Packing unit: 1

- ▶ **Product description**
- Also suitable for polycarbonate glass
- Safe for surfaces
- Foam formation only after the surface has been coated with the product

02
Active cleaning cloths
Jumbo pail

- ▶ Item no. 2897-260-70
- ▶ Contents: 75 wipes
- ▶ Packing unit: 1

- ▶ **Product description**
- Lemon-scented
- Lint-free
- Dermatologically tested
- Cleaning cloths easily remove even bodywork, plastic and windscreen adhesive residue



03
Spout for 5 litre containers

- ▶ Item no. 2000-000-005

Spout for 30 litre containers

- ▶ Item no. 2000-000-030

04
Glass cleaner
Stries Protect

- ▶ Item no. 2897-340
- ▶ Contents: 500 ml
- ▶ Packing unit: 12

- ▶ Item no. 2897-340-5
- ▶ Contents: 5 litres
- ▶ Packing unit: 1

- ▶ Item no. 2897-340-30
- ▶ Contents: 30 litre
- ▶ Packing unit: 1

- ▶ **Product description**
- Removes dirt, marks, fingerprints, grease, nicotine, dead insects, etc.
- Free of silicone and ammonia
- Can be used on glass, polycarbonate glass, plastic surfaces



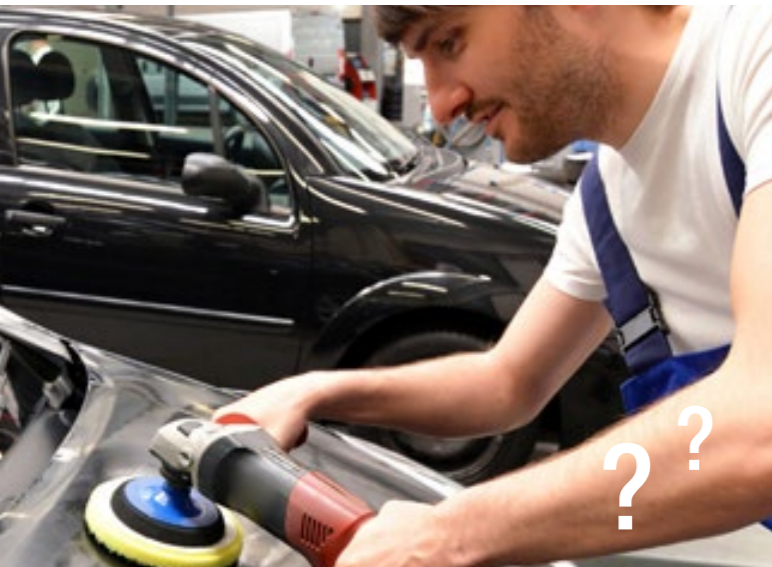

01
Abrasive paste coarse
 Scratch-Off Ultra

- ▶ Item no. 2000-325-1
- ▶ Contents: 1 kg
- ▶ Packing unit: 1

▶ **Product description**

- Suitable for HS and MS paints
- Silicone-free
- Ammonia-free
- Can be overpainted
- Free of cosmetic oils
- Low heat generation
- Can be mixed with water

- Use ONLY WITH A MACHINE

- Deep scratches: Lambswool, white (2000-204-150)
- Deep scratches: hard polishing sponge, yellow (2000-205-150)

02
Grinding compound, fine
 Scratch-Off Fine Plus

- ▶ Item no. 2000-326-9
- ▶ Contents: 1 kg
- ▶ Packing unit: 1

▶ **Product description**

- Suitable for HS and MS paints
- High level of abrasion and maximum shine
- Solvent free
- Does not contain silicone or ammonia
- Free of cosmetic oils
- Extended pot life and longer working time
- Low heat generation
- Leaves no residue on plastic surfaces

- Application: MACHINE ONLY

- Medium scratches: Medium polishing sponge, orange (2000-206-150)

03
Polish
 Scratch Soft

- ▶ Item no. 2000-327-1
- ▶ Contents: 1 kg
- ▶ Packing unit: 1

▶ **Product description**

- Slight to medium signs of use can be polished out without leaving holograms
- Suitable for HS and MS paints
- Silicone-free

- Use: MACHINE ONLY

- Minor marks: Polishing sponge medium, orange (2000-206-150)
- Hologram remover: Soft polishing sponge, black (2000-207-150)
- Wafer sponge, black (2000-208-150)



01



02



03

01

Quick sealant
Speed-Gloss-Nano

- ▶ Item no. 2000-316-1
- ▶ Contents: 1 litre
- ▶ Packing unit: 1

- ▶ Item no. 2000-316-5
- ▶ Contents: 5 litres
- ▶ Packing unit: 1

▶ **Product description**

- Perfect shine effect
- Effortless polishing without leaving any sticky residue
- Suitable for cleaning without water
- Contains carnauba wax

- Application: MANUAL ONLY
- Microfibre cloth, red (2000-740-40)
- Application sponge, black (2000-209-130)



01

02

Wax sealing
Speed-Wax

- ▶ Item no. 2000-330-1
- ▶ Contents: 1 kg
- ▶ Packing unit: 1

▶ **Product description**

- Premium car wax
- Natural carnauba wax, enriched with high-quality synthetic components
- For manual and machine application
- Permanent protection against the elements
- Long-lasting shine

- Application:

- Manual: Application sponge, black (2000-209-130)
- Machine: Wafer sponge, black (2000-208-150)



02

03

Long-time sealing
Paint-Guard

- ▶ Item no. 2000-331-1
- ▶ Contents: 1 litre
- ▶ Packing unit: 1

▶ **Product description**

- Special blend of PTFE and acrylic resins
- Extra UV protection for long-lasting good looks
- Unique water-based formula
- Free of volatile silicones
- Application:

- Manual: Microfibre cloth, red (2000-740-40)
- Machine: Soft polishing sponge, black (2000-207-150)



03



04

Long-term protective surface sealant
Pearl

- ▶ Item no. 2897-327
- ▶ Contents: 500 ml
- ▶ Packing unit: 6

▶ **Product description**

- Protective surface sealant & shine enhancer
- Increases resistance to scratches and repels dirt
- Easy to apply and polish out
- Surface protection cures in just 10 minutes
- Solvent-free



04

01

Cleaning polish

Twin

- ▶ Item no. 2000-304-1
- ▶ Contents: 1 litre
- ▶ Packing unit: 1

- ▶ Item no. 2000-304-5
- ▶ Contents: 5 litres
- ▶ Packing unit: 1

▶ Product description

- Cleans, refreshes and polishes in one step
- The low chalk content simplifies the polishing of dark colours
- Contains no volatile silicones
- Suitable for all paints, including metallic paints and water-soluble paints

02

High-gloss polish

High Gloss

- ▶ Item no. 2000-303-1
- ▶ Contents: 1 litre
- ▶ Packing unit: 1

- ▶ Item no. 2000-303-5
- ▶ Contents: 5 litres
- ▶ Packing unit: 1

▶ Product description

- Maximum shine effect
- Quick finish
- Contains no volatile silicones
- High viscosity
- For use on cars, buses, motorbikes, HGVs, aircraft, boats, caravans, etc.



01



02



01
Spray polish
Polit

- ▶ Item no. 2897-326
- ▶ Contents: 400 ml
- ▶ Packing unit: 12

- ▶ **Product description**
- Extremely quick and simple to use
 - Anti-static
 - Creates a unique deep shine
 - Highly resistant to scratches and abrasion
 - Ideal when combined with our Magic-Clean cleaning putty (article 2000-25)!

02
Sanding-Polishing-Sealing
Compact

- ▶ Item no. 2000-335-1
- ▶ Contents: 1 kg
- ▶ Packing unit: 1

- ▶ **Product description**
- Quick and professional treatment of older paintwork
 - Cleaning and sealing in one application
 - Free of volatile silicones

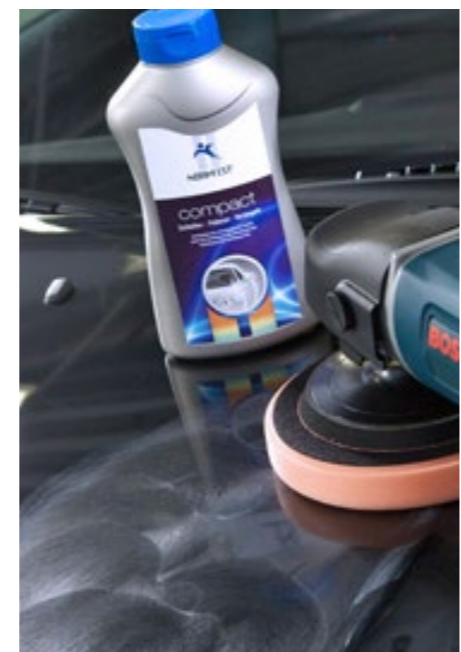

THE FULL PACKAGE



01



02

03
Paintwork reconditioning set
Starter set, content: 8 pieces

- ▶ Item no. 2000-999-997

Item no.	Description
2000-325-1	Coarse grinding paste 1 kg
2000-327-1	Polishing paste 1 kg
2000-330-1	Wax sealant 1 kg
2000-205-150	Polishing sponge hard, 150 mm
2000-206-150	Polishing sponge medium, 150 mm
2000-207-150	Polishing sponge soft, 150 mm
2000-740-40	Microfibre cloth (red), 400 x 400 mm
2000-745-40	Premium microfibre cloth, 400 x 400 mm



03

01
Power cleaner, exterior
All-Star

- ▶ Item no. 2000-312-5
- ▶ Contents: 5 litres
- ▶ Packing unit: 1

- ▶ Item no. 2000-312-30
- ▶ Contents: 30 litre
- ▶ Packing unit: 1

- ▶ **Product description**
- Ideal for universal application
- AOX free
- Effortlessly removes oil, grease, nicotine stains and dead insects
- Suitable for high-pressure cleaners
- Can be used warm or cold

02
Power cleaner, inside/outside
Uni-Star

- ▶ Item no. 2000-02
- ▶ Contents: 5 litres
- ▶ Packing unit: 1

- ▶ Item no. 2000-02-30
- ▶ Contents: 30 litre
- ▶ Packing unit: 1

- ▶ **Product description**
- Universal cleaner for inside and outside the vehicle
- AOX-free
- Gentle cleaner
- Effortlessly removes oil, grease, nicotine stains and dead insects

03
Tarpaulin Cleaner
Cover-Star

- ▶ Item no. 2000-313-30
- ▶ Contents: 30 litre
- ▶ Packing unit: 1

- ▶ **Product description**
- Suitable for use with high-pressure cleaners
- Contains no halogenated hydrocarbons
- Free of adsorbent organic halogen compounds (AOX)
- Biodegradable

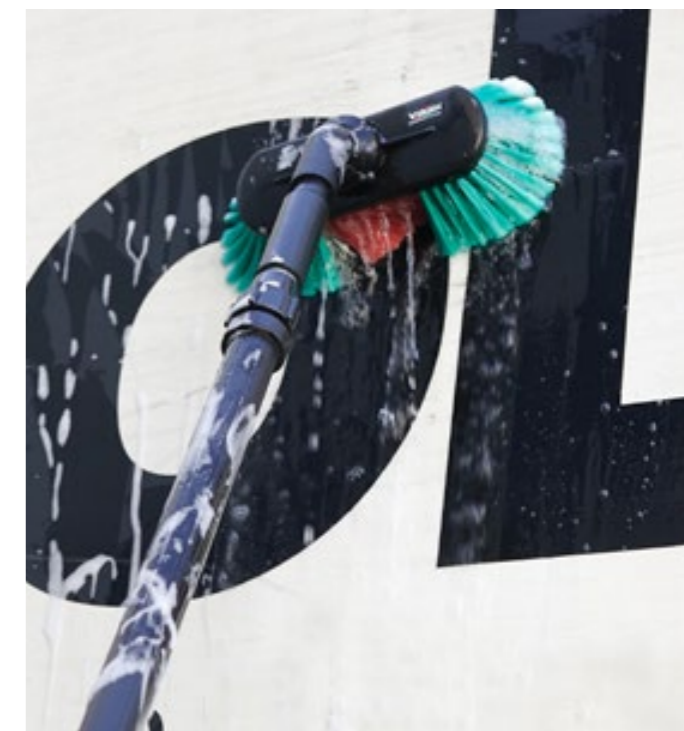

01



02



03

04
Spout for 5 litre containers

- ▶ Item no. 2000-000-005

Spout for 30 litre containers

- ▶ Item no. 2000-000-030



04



05

05
High pressure cleaner
HD 5/15 C Plus

- ▶ Item no. 2000-550-2



01

Insect remover
Insect-Star Extreme

- ▶ Item no. 2000-322-5
- ▶ Contents: 5 litres
- ▶ Packing unit: 1

- ▶ Item no. 2000-322-30
- ▶ Contents: 30 litre
- ▶ Packing unit: 1

- ▶ **Product description**
- Special cleaner for the fast removal of dead insects
- Suitable for paintwork, glass, plastic and alkaline-resistant surfaces on all PCVs, HGVs, vans and trains
- Silicone-free

02

Rust film remover
Mega-Star

- ▶ Item no. 2000-10
- ▶ Contents: 5 litres
- ▶ Packing unit: 1

- ▶ **Product description**
- Cleaning agent for extreme inorganic dirt, e.g. concrete residue
- Effortlessly removes stubborn road dirt, brake dust, limescale, hard deposits of oil, surface rust
- Also suitable for cleaning wheel rims and engines
- AOX-free

03

Tar remover
Power Star Ultra

- ▶ Item no. 2000-04
- ▶ Contents: 5 litres
- ▶ Packing unit: 1

- ▶ **Product description**
- Loosens road tar
- Removes stickers on new cars
- Removes adhesive and sealing residue from all external plastic parts, paintwork and glass

04

Spout for 5 litre containers

- ▶ Item no. 2000-000-005

Spout for 30 litre containers

- ▶ Item no. 2000-000-030



05

Active foam
Active Care

- ▶ Item no. 2000-401-30
- ▶ Contents: 30 litre
- ▶ Packing unit: 1

- ▶ **Product description**
- For soaking and cleaning heavy dirt and chemical pre-washes
- In car washes: Undiluted
- 1:1 using dosing pump (setting 8-20ml)

06

Drying accelerator
Speed Dry

- ▶ Item no. 2000-404-30
- ▶ Contents: 30 litre
- ▶ Packing unit: 1

- ▶ **Product description**
- Supports the drying process by tearing open the water film
- Set car wash system to: neat
- 1:1 via the dosing pump (setting 8-20 ml)



01

02

03

04

05

06



01

Car Shampoo

Wash & Ready

- ▶ Item no. 2000-321-5
- ▶ Contents: 5 litres
- ▶ Packing unit: 1

- ▶ Item no. 2000-321-30
- ▶ Contents: 30 litre
- ▶ Packing unit: 1

▶ **Product description**

- Shampoo concentrate (can be diluted to 1:100)
- pH value 7.7
- Effortlessly removes grime and road dirt
- Leaves a shiny, streak-free surface



01

02

High gloss shampoo

Wash & Drive

- ▶ Item no. 2000-300-5
- ▶ Contents: 5 litres
- ▶ Packing unit: 1

- ▶ Item no. 2000-300-30
- ▶ Contents: 30 litre
- ▶ Packing unit: 1

▶ **Product description**

- Leaves a shiny and streak-free surface
- Silicone free
- AOX free
- Effortlessly removes road dirt and traffic deposits
- Cleans and polishes the paintwork in one application
- Can be diluted to: 15ml to 10 litres of warm water



02

03

Shampoo

Power Wash

- ▶ Item no. 2000-402-30
- ▶ Contents: 30 litre
- ▶ Packing unit: 1

▶ **Product description**

- Ideal for vehicle cleaning and providing good lubricity
- Set vehicle wash system to: neat
- 1:1 via the dosing pump (setting 8-15 ml)
- Machine cleaning: dilute up to 1:5,000 (depending on the level of soiling)
- Manual cleaning: dilute up to 1:50 (depending on the level of soiling).



03

01

Acid-free aluminium rim cleaner

Rimol Gold Protect

- ▶ Item no. 2897-328-5
- ▶ Contents: 5 litres
- ▶ Packing unit: 6

- ▶ Item no. 2897-328-500
- ▶ Contents: 500 ml
- ▶ Packing unit: 1

▶ **Product description**

- Acid-free
- Consists of 70% renewable raw materials, so environmentally friendly
- Contains no materials hazardous to health when evaporating off
- Gel-type viscosity
- Non-toxic
- Does not burn the skin
- Gentle cleaning

02

Special aluminium wheel rim cleaner

Rimol Pro

- ▶ Item no. 2897-321-5
- ▶ Contents: 5 litres
- ▶ Packing unit: 1

- ▶ Item no. 2897-321-30
- ▶ Contents: 30 litre
- ▶ Packing unit: 1

▶ **Product description**

- Acidic
- Breaks down severe inorganic soiling such as brake dust, dirt from the street or surface rust

03

Aluminium Rim Cleaner

Rimol

- ▶ Item no. 2897-320-1
- ▶ Contents: 500 ml
- ▶ Packing unit: 6

▶ **Product description**

- Acidic
- Easily removes stubborn dirt (burnt in brake dust, rust film, abraded rubber, heavy oil incrustations, road dirt, etc.)

04

Silicone-free tyre care product

New Wheel Plus

- ▶ Item no. 2897-339-400
- ▶ Contents: 400 ml
- ▶ Packing unit: 12

▶ **Product description**

- Waterproof
- Quick drying
- Silicone-free

05

Silicone-based care product

New Wheel Extreme

- ▶ Item no. 2897-338-400
- ▶ Contents: 400 ml
- ▶ Packing unit: 12

▶ **Product description**

- Waterproof
- Quick drying
- Containing silicone



01
Care product for exterior plastic
Outplast

- ▶ Item no. 2000-319-500
- ▶ Contents: 500 ml
- ▶ Packing unit: 12

- ▶ **Product description**
- Provides long-lasting shine
 - Excellent surface protection against environmental damage
 - Silicone-free
 - Not suitable for interior plastic parts or painted plastics

02
Plastic dyer
Plast-PT

- ▶ Item no. 2897-041
- ▶ Contents: 75 ml, black
- ▶ Packing unit: 1

- ▶ **Product description**
- Resistant to car washes, high pressure cleaners and solvents
 - For dyeing plastic
 - Incl. sponge



03
Rubber care
Outdoor

- ▶ Item no. 2000-306-1
- ▶ Contents: 1 litre
- ▶ Packing unit: 1

- ▶ **Item no. 2000-306-5**
- ▶ Contents: 5 litres
 - ▶ Packing unit: 1
- ▶ **Product description**
- Provides a pleasant, matt and long-lasting shine
 - Has a high coverage rate and is quick drying
 - Does not leaves sticky residue on the surface
 - Leaves no marks in adjacent surfaces (paintwork, hub caps)
 - Silicone-based



04
Engine compartment preservation
Motor-Fit

- ▶ Item no. 2000-307-1
- ▶ Contents: 1 litre
- ▶ Packing unit: 1

- ▶ Item no. 2000-307-5
- ▶ Contents: 5 litres
- ▶ Packing unit: 1

- ▶ Item no. 2000-307-30
- ▶ Contents: 30 litre
- ▶ Packing unit: 1

- ▶ **Product description**
- High shine
 - Water dispersing
 - Contains silicone
 - Contains no aromatic solvents
 - Protects electronic components



01



02



03



04



01

Upholstery cleaner

Velvet

- ▶ Item no. 2897-307
- ▶ Contents: 400 ml
- ▶ Packing unit: 12

▶ **Product description**

- cleans and protects upholstery, carpets and roof lining
- removes greasy residue
- leaves a pleasant scent
- no vacuuming required



02

Leather care product

Ledanol

- ▶ Item no. 2000-310-1
- ▶ Contents: 1 litre
- ▶ Packing unit: 1

▶ **Product description**

- Cares for and protects leather
- Solvent-free
- Do not use on suede or similar surfaces



01



02

01
Intensive interior cleaner and care product
 Interno Protect

- ▶ Item no. 2000-05
- ▶ Contents: 500 ml
- ▶ Packing unit: 12

- ▶ Item no. 2000-05-5
- ▶ Contents: 5 litres
- ▶ Packing unit: 1

- ▶ **Product description**
- Treats hard and soft surfaces, such as plastic, vinyl, chrome, sealing strips, door sill protectors, car leather, upholstery and mats
 - Leaves a matt finish on plastic surfaces and a pleasantly fresh



- fragrance
- Not suitable for suede and ultrasuede
- Does not contain hydrocarbon solvents and is free of acids and silicone

02
Interior Detailer
 Crystal Ultra

- ▶ Item no. 2897-306
- ▶ Contents: 400 ml
- ▶ Packing unit: 6

- ▶ **Product description**
- Improved formula increases the cleaning and shine effect by up to 30%
 - Application in cockpits, on door trims, foot mats and seats (except displays and tachometers)
 - Loosens grease residue
 - Leaves the vehicle looking and smelling new
 - Acts anti-statically



03
Interior plastic care product
 Indoor

- ▶ Item no. 2000-308-1
- ▶ Contents: 1 litre
- ▶ Packing unit: 1

- ▶ Item no. 2000-308-5
- ▶ Contents: 5 litres
- ▶ Packing unit: 1

- ▶ **Product description**
- Easy to apply
 - Free of volatile silicones
 - Silk-matt finish



01

Odour destroyer and air freshener

Aerofit Power

- ▶ Item no. 2000-309-400
- ▶ Contents: 400 ml
- ▶ Packing unit: 12

▶ **Product description**

- Immediately eliminates smells and freshens the interior
- Long-lasting and economical
- A high-pressure system with an extremely concentrated active ingredient
- One squirt is sufficient for a large area
- Raspberry fragrance

02

Odour destructor

Aerofit Plus

- ▶ Item no. 2000-309-2
- ▶ Contents: 1 litre
- ▶ Packing unit: 1

▶ **Product description**

- Can be used on all fabric surfaces inside the vehicle as well in ventilation ducts without sensors
- Absorbs and eliminates all unpleasant odours, e.g. nicotine
- Solvent-free
- Can be applied using a normal spray or pump spray bottle
- Easy to apply using a wet vacuum cleaner or nebuliser



01

02

03

Manual sprayer flexible

- ▶ Item no. 2000-802-2

▶ **Product description**

- Suitable for overhead work
- Leak-proof, with Viton seal
- Steplessly adjustable nozzle – from fine spray to jet



03

04

Rubber protector pen

Rubber Fit

- ▶ Item no. 2897-335-75
- ▶ Contents: 75 ml
- ▶ Packing unit: 12

▶ **Product description**

- silicone-free
- splash- and saltwater resistant



04

01

Air conditioning system disinfection

Viro One Shot Plus

- ▶ Item no. 2897-301
- ▶ Contents: 100 ml
- ▶ Packing unit: 10

▶ Product description

- For quick, easy and hygienic cleaning
- Eliminates dead microorganisms thoroughly
- Prevents allergic reactions
- Leaves a pleasant smell that lasts
- Contents are sufficient for one application
- Basis: alcohol

02

Air conditioning and ventilation system disinfection

Viro Air Fresh Plus

- ▶ Item no. 2897-302
- ▶ Contents: 300 ml
- ▶ Packing unit: 12

▶ Product description

- Spray enters the ventilation system directly via the capillary tube
- Long-lasting disinfection
- Leaves a pleasant citrus fragrance
- Contents sufficient for up to three applications
- Basis: alcohol



03

Air conditioning system vaporizer disinfection

Viro Vaporizer

- ▶ Item no. 2897-303
- ▶ Contents: 400 ml
- ▶ Packing unit: 12

▶ Product description

- Performs high-pressure flushing
- Effective in every corner of the evaporator
- Kills germs, bacteria and moulds
- Prevents the growth of microorganisms
- Ensures healthy and pleasant smelling air inside the vehicle
- Incl. 60 cm hose with rotor nozzle
- Sufficient product for one A/C system



01

Climate-control compressor oil

PAG46 OIL 1234yf / for coolant 1234yf

- ▶ Item no. 5000-218
- ▶ Contents: 250 ml
- ▶ Packing unit: 12

▶ **Product description**

- A multigrade compressor oil for all cars, trucks, buses and agricultural equipment filled with 1234yf coolant
- For hybrid vehicles filled with 1234yf coolant
- Perfectly lubricates and cools climate-control compressors
- Guarantees thermal stability in compressors



01

04

UV leak search fluid

Tracer

- ▶ Item no. 5000-303
- ▶ Contents: 236 ml
- ▶ Packing unit: 1

▶ **Product description**

- This leakfinder additive does not contain solvents
- Ideal for use in combination with refrigerating oils (PAG, mineral oil, ester)
- Safe for all vehicle A/C systems and A/C service instruments
- Manufacturer approval
- Sufficient for approx. 25 PCV applications



04



02

Oil-Fluid

Fluorescent leakfinder fluid for engines and gearboxes

- ▶ Item no. 5000-205-1
- ▶ Contents: 25 ml
- ▶ Packing unit: 1

▶ **Product description**

- Sufficient for one vehicle/one application



02

03

Water-Fluid

Fluorescent leakfinder fluid for cooling systems

- ▶ Item no. 5000-206-1
- ▶ Contents: 25 ml
- ▶ Packing unit: 1

▶ **Product description**

- Sufficient for one vehicle/one application



03

05

Fluorescent leak-test liquid

UV hybrid

- ▶ Item no. 5000-304
- ▶ Contents: 240 ml
- ▶ Packing unit: 1

▶ **Product description**

- For use with coolant oils (PAG, mineral oils and esters)
- Completely harmless for all climate-control systems in hybrid vehicles and servicing devices
- Suitable for both coolants (R134a & HFO1234yf)
- Does not attack O-rings or seals



05

01 Sealing compound for A/C systems

Quick-Seal Cold

- ▶ Item no. 5000-230
- ▶ Contents: 40 ml
- ▶ Packing unit: 1

- ▶ **Product description**
- Used to seal micro-leaks in shaft seals, hoses and O-rings in car climate-control systems
 - Contents sufficient for one use
 - The product contains 44 grams of R134A coolant
 - CAUTION! Quick-Seal-Cold must not be used in hermetically-sealed systems!
 - IMPORTANT! Use only possible with the adapter, available separately. (Art. no. 5000-230-1)

02 Multigrade compressor oil
Multi POE Oil Premium

- ▶ Item no. 5000-219
- ▶ Contents: 1 litre
- ▶ Packing unit: 1

- ▶ **Product description**
- A multigrade compressor oil for climate-control systems with R134a coolant
 - Can also be used in climate-control systems filled with R134a coolant in hybrid vehicles
 - For wear reduction, lubrication and cooling of climate-control compressors in the coolant range
 - Compatible with all known mineral-, ester- and PAG oils

03 Refrigerant R134A

- ▶ Item no. 5000-225-9

- ▶ **Product description**
- 12.7 kg reusable bottle

04 Refrigerant R1234yf

- ▶ Item no. 5000-229

- ▶ **Product description**
- 5.6 kg reusable bottle



05 Tyre installation paste TAP

- ▶ Item no. 2894-455
- ▶ Contents: 5 kg, colour: black
- ▶ Packing unit: 1



- ▶ Item no. 2894-457
- ▶ Contents: 5 kg, colour: white
- ▶ Packing unit: 1



- ▶ **Product description**
- Suitable for run-flat tyres
 - Frost-proof
 - Rapid drying, so that tyre cannot slip on rim
 - Outstanding exhaust air behaviour
 - High slip
 - Biodegradable
 - No risk of allergies for fitters

Brush for tyre installation paste

- ▶ Art. no.: 4693-080-0



01

02

03

05

01

Matte black

Kroma

- ▶ Item no.2893-884
- ▶ Contents: 400 ml
- ▶ Packing unit: 24

▶ Product description

- Very high coverage
- Light resistant
- High proportion of solid particles
- Scratch proof
- Resistant to petroleum

02

Shiny black

Spray paint

- ▶ Item no.2893-885
- ▶ Contents: 400 ml
- ▶ Packing unit: 24

▶ Product description

- this RAL spray paint is characterised by its fine flowing texture and good, colour-true coverage



01



02



03

Spray paint

Corona

- ▶ Item no.2893-886
- ▶ Contents: 400 ml black matt
- ▶ Packing unit: 6

▶ Item no.2893-887

- ▶ Contents: 400 ml silver
- ▶ Packing unit: 1

▶ Product description

- Heat resistant up to 650°C
- Weatherproof
- Resistant to wear and abrasion
- Free of heavy metals

04

Wheel rim silver

Silver Star

- ▶ Item no.2893-883
- ▶ Contents: 400 ml
- ▶ Packing unit: 24

▶ Product description

- weatherproof
- quick-drying
- resistant to petroleum
- abrasion resistant
- car wash-proof









03





04

Cargo

	RAL	Description	Area of application	
DB 129		Nova grey	Original Mercedes Benz colour	2893-830-009 6
RAL 9011		Graphite white	Deutsche Post, lubricant container and equipment	2893-860-002 6
DB 7329		Actros grey	Original colour Mercedes Benz commercial vehicles	2893-830-007 6
MB 7354		Argentit grey		2893-830-003 6
MB 9147		Arctic white	Original colour Mercedes Benz commercial vehicles	2893-830-008 6
RAL 906		White aluminium		2893-820-005 6
RAL 3002		Carmine red	Safety marking for Deutschen Bahn	2893-810-007 6





Municipal vehicles

	RAL	Description	Area of application	
RAL 3000		Fire red Silk	New Holland red, Massey Ferguson agricultural machine red	2893-810-001 6
RAL 9005		Jet black	Deutsche Bahn, warning plates, electrical cables (automotive engineering)	2893-810-008 6
RAL 2011		Deep orange	municipal vehicles	2893-850-006 6

Fire brigade

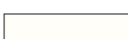
	RAL	Description	Area of application	
RAL 3000		Fire red Silk	New Holland red, Massey Ferguson agricultural machine red	2893-810-001 6
RAL 9010		Pure white	Deutsche Bahn, metal processing, shelving, sanitary and heating installation	2893-810-006 6

German Railways

	RAL	Description	Area of application	
RAL 3000		Fire red Silk	New Holland red, Massey Ferguson agricultural machine red	2893-810-001 6
RAL 9010		Pure white	Deutsche Bahn, metal processing, shelving, sanitary and heating installation	2893-810-006 6
RAL 3002		Carmine red	Safety marking for Deutschen Bahn	2893-810-007 6
RAL 9005		Jet black	Deutsche Bahn, warning plates, electrical cables (automotive engineering)	2893-810-008 6
RAL 5010		Gentian blue	Ford agricultural machine blue, Safety marking	2893-810-009 6

Agriculture

	RAL	Description	Area of application	
RAL 3000		Fire red Silk	New Holland red, Massey Ferguson agricultural machine red	2893-810-001 6
RAL 5010		Gentian blue	Ford agricultural machine blue, Safety marking	2893-810-009 6

Aerosol can & accessories

- ▶ Item no. 2893-
Aerosol can
- ▶ Item no. 2893-900-1
Spray head (cone)
- ▶ Item no. 2893-900-2
Pistol grip
- ▶ Item no. 2893-900-3
Fan nozzle



01

High-gloss clear varnish

- ▶ Item no.2893-803
- ▶ Contents: 400 ml
- ▶ Packing unit: 6



01



02

2K-Clear varnish

- ▶ Item no.2800-770
- ▶ Contents: 400 ml
- ▶ Packing unit: 6

- ▶ Product description
- Weatherproof
- Resistant to chemicals
- Resistant to petroleum
- Excellent filling properties



02

03

Spot blender paint

- ▶ Item no.2800-780
- ▶ Contents: 400 ml
- ▶ Packing unit: 6

- ▶ Product description
- corrects paint transitions when filling paint



03

04

Silicone remover

- ▶ Item no.2800-720
- ▶ Contents: 400 ml
- ▶ Packing unit: 6

- ▶ Product description
- Suitable for all cleaning tasks prior to and after painting, e.g. tar spatter, diesel exhaust particles, etc.



04

01

Fibre glass filler incl. hardener (2893-139)

Compound

- ▶ Item no.2893-109-9
- ▶ Contents: 1.8 kg
- ▶ Packing unit: 4

▶ **Product description**

- Outstanding direct adhesion on metal substrates
- Ideal for filling small surfaces, unevenness and grooves



01

04

Fine filler with curing agent (2893-139)

Finish

- ▶ Item no.2893-112-9
- ▶ Contents: 2 kg
- ▶ Packing unit: 4

▶ **Product description**

- for filling small areas, ridges and grooves
- adheres to aluminium, plastics, steel and galvanised steel



04

02

Multisoft filler with curing agent (2893-139)

Multi

- ▶ Item no.2893-101-9
- ▶ Contents: 2 kg
- ▶ Packing unit: 4

▶ **Product description**

- For filling large cavities
- Adheres to aluminium, plastics, steel and galvanised steel



02

05

Aluminium filler with curing agent (2893-139)

Aluminium

- ▶ Item no.2893-103-9
- ▶ Contents: 1.8 kg
- ▶ Packing unit: 4

▶ **Product description**

- For filling large cavities as well as parts exposed to vibrations and oscillations
- Adheres to aluminium, plastics and galvanised steel



05

03

Universal filler with curing agent (2893-139)

Plain

- ▶ Item no.2893-106-9
- ▶ Contents: 2 kg
- ▶ Packing unit: 4

▶ **Product description**

- For filling small surfaces, unevenness and grooves
- Adheres to aluminium, plastics and steel (but not to galvanised steel)



03



06

07

06

Body filler application set

- ▶ Art. no.: 8715-65-00

▶ **Product description**

- 4 blades
- Acid-proof plastic grips

07

Plastic smoothing spatula

- ▶ Item no. 2893-164
- ▶ PU: 10

01

Skin protection

Aquano Protect

- ▶ Item no. 2897-500-225
- ▶ Contents: 250 ml
- ▶ Packing unit: 1

- ▶ Item no. 2897-500-2
- ▶ Contents: 2 litres
- ▶ Packing unit: 1

▶ **Product description**

- Protects the skin when dealing with aqueous and non-aqueous materials such as cooling lubricants, dilute acids, alkalis, oils, grease, tar, paints, adhesives, etc.
- Quickly absorbed
- Non-greasy
- pH neutral
- Silicone-free
- Dermatologically tested
- Hypoallergenic

02

Aquano Protect Plus

Excellent skin protection

- ▶ Item no. 2897-500-825
- ▶ Contents: 250 ml
- ▶ Packing unit: 1

- ▶ Item no. 2897-500-8
- ▶ Contents: 2 litres
- ▶ Packing unit: 1

▶ **Product description**

- Dirt-repelling skin protection that can be washed off
- for strongly adhesive, non-aqueous materials, such as Oils, paints, bitumen, adhesives, resins, PU foams, etc.
- Made from raw materials with a natural basis
- Free from mineral oils, silicone oils and their derivatives, and preservatives



01



02

Skin Protection Plan Art. no.: 2897-500-7

1 HAUTSCHUTZ
→ vor der Arbeit

Aquano Protect
Der langanhaltende Hautschutz für alle Anwendungsbereiche.

- schützt die Haut vor wässrigen und nicht wässrigen Arbeitsstoffen
- dermatologisch getestet

▶ Art.-Nr. 2897-500-2

2 HAUTREINIGUNG
→ für die Verschmutzung

Aquano Clean
Die milde und neutrale Reinigungs-lotion für starke Verschmutzungen.

- reinigt potenteil
- ist hautfreundlich mit Rückfettung

▶ Art.-Nr. 2897-500-1

3 HAUTPFLEGE
→ nach der Arbeit

Aquano Spezial
Die Reinigungslotion mit Doppelwirkung für extreme Verschmutzungen.

- sehr gute Hautverträglichkeit
- dermatologisch getestet

▶ Art.-Nr. 2897-500-4

Aquano Lotion
Die wirksame Hautpflege mit natürlichen Wärmern.

- revitalisiert die Haut
- wirkt gegen trockene, rissige und leicht entzündliche Haut

▶ Art.-Nr. 2897-500-3

03

Skin-care lotion

Aquano Lotion

- ▶ Item no. 2897-500-325
- ▶ Contents: 250 ml
- ▶ Packing unit: 1

- ▶ Item no. 2897-500-3
- ▶ Contents: 2 litres
- ▶ Packing unit: 1

▶ **Product description**

- Promotes the regeneration of affected areas of skin
- Suitable for the entire body
- With natural oils and vitamin E
- Non-replenishing
- pH neutral
- Slightly perfumed
- Silicone-free
- Dermatologically tested



03

01

Hand cleaner

Aquano Clean

- ▶ Item no. 2897-500-125
- ▶ Contents: 250 ml
- ▶ Packing unit: 1

- ▶ Item no. 2897-500-1
- ▶ Contents: 2 litres
- ▶ Packing unit: 1

- ▶ Product description
- Deep cleansing and long-lasting skin protection
- Hand cleaner easily removes tar, oil, dirt, bitumen and much more
- Aquano is sufficiently replenishing
- Does not block drains
- Silicone-free and dermatologically tested
- Hypoallergenic



01

02

Special hand cleaner

Aquano Spezial

- ▶ Item no. 2897-500-4
- ▶ Contents: 250 ml
- ▶ Packing unit: 1

- ▶ Item no. 2897-500-42
- ▶ Contents:
- ▶ Packing unit: 1

- ▶ Product description
- An intensive, skin-friendly special hand cleaner for extreme dirt such as dyes, acrylic paints, paints, etc.
- Deep cleansing
- Slightly replenishing
- Does not block drains
- No preservatives or fragrance
- Silicone-free
- Dermatologically tested



02

03

Dispenser

intended for use with 2 litre system bottles

- ▶ Art. no.: 2897-500-6

- ▶ Product description
- Comes with a pre-installed pump for dispensing hand protection products
- Made from plastic

- Scope of delivery:
- 1 x system dispenser
- 4 x 6 mm dowel, stainless-steel screws and washers
- 1 x key
- 1 x rotating head
- 1 x dosing piece
- 1 x set of installation and operating instructions



03

04

Hand cleaning Paste

Removes dirt, such as oil, grease, etc.

- ▶ Item no. 2897-240-8
- ▶ Contents: 10 kg jumbo pail
- ▶ Packing unit: 1

- ▶ Product description
- Dermatologically tested
- Silicone free
- Alkali free
- Wood flour based



04

01
Care Protect
The invisible glove

- ▶ Item no. 2897-240-1
- ▶ Contents: 1 litre of lotion
- ▶ Packing unit: 1

- ▶ **Product description**
- Lies on the skin like an invisible protective glove
- Protects the skin when dealing with various materials such as cooling lubricants, dilute acids, alkalis, oils, grease, tar, bitumen and much more
- Silicone-free
- pH skin neutral
- Dermatologically tested
- Non-greasy

02
Care Soft
Skin Cleaning Lotion

- ▶ Item no. 2897-240-3
- ▶ Contents: 1 litre
- ▶ Packing unit: 1

- ▶ **Product description**
- Particularly skin-friendly cleansing that seriously replenishes the skin thanks to high-quality ingredients
- Particularly suitable for sensitive skin and frequent washing
- pH skin neutral
- Dermatologically tested

03
Care Lotion
Skin care

- ▶ Item no. 2897-240-2
- ▶ Contents: 1 litre
- ▶ Packing unit: 1

- ▶ **Product description**
- Slightly moisturising skin care lotion, easy to apply and absorbed quickly
- Promotes the regeneration of stressed and dry skin
- Silicone free
- pH neutral
- Dermatologically tested

04
Care Clean
Hand cleaner

- ▶ Item no. 2897-240
- ▶ Contents: 3 litre bucket
- ▶ Packing unit: 1

- ▶ **Item no. 2897-240-010**
- ▶ **Contents: 1 litre**
- ▶ **Packing unit: 10**
- ▶ **Product description**
- Deep-cleanses the skin with a long-lasting protective effect and balanced replenishing of oils
- Easily removes oil, grease, tar, printing ink, bitumen, etc.
- pH skin neutral and dermatologically tested



05
Nail brush
Bristle type: hard

- ▶ Art. no.: 2897-500-9

- ▶ **Product description**
- Bristle length: 17 mm
- Colour: black
- Dimensions (H x L x W): 38 mm x 48 mm x 118 mm
- Max. cleaning temperature: +121° C
- Product meets EU Regulation no. 10/2011 regarding food contact: YES



01
Oil binder
Oil-Catcher Indoor

- ▶ Item no. 7874-50
- ▶ Contents: 50 litres
- ▶ Packing unit: 1

- ▶ **Product description**
- An oil binder ideal for workshop interiors
- Absorbs easily without absorbing water

02
Oil binder
Oil-Catcher Outdoor

- ▶ Item no. 7874-40
- ▶ Contents: 40 litre
- ▶ Packing unit: 1

- ▶ **Product description**
- An oil binder specially developed for outside use
- Has such a high weight of its own that there is no more drifting

03
Workshop cleaner
Bio-Star

- ▶ Item no. 2897-250-5
- ▶ Contents: 5 litres
- ▶ Packing unit: 1

- ▶ Item no. 2897-250-30
- ▶ Contents: 30 litre
- ▶ Packing unit: 1

- ▶ **Product description**
- Highly active concentrate for cold and high-pressure cleaning
- Suitable for cleaning heavily soiled factory floors, walls and floor tiles
- Removes lubricating oil, grease, soot, pigments, resin and tar
- High-pressure cleaner mixing ratio: 1:3 to 1:5
- Mixing ratio for manual use: 1:1 to 1:5
- pH value: 11.2 (alkaline)
- AOX-free

Spout for 5 litre containers

- ▶ Item no. 2000-000-005

Spout for 30 litre containers

- ▶ Item no. 2000-000-030

04
Oil-stain remover
Oel-Ex

- ▶ Item no. 2897-341
- ▶ Contents: 400 ml
- ▶ Packing unit: 12

- ▶ **Product description**
- Effective aid against oil stains and old oil stains
- Removes oil stains from all absorbent and non-absorbent substrates, such as stone, natural stone and concrete blocks, clay and pumice, screed, clinker and ceramic
- Can also be used on carpets and textile flooring
- Colour: White
- Important: Do not use on bitumen, asphalt or slate!



04

03

GERMANY

Normfest GmbH
Siemensstr. 23
D-42551 Velbert
Tel: +49 2051 275 - 0
Fax: +49 2051 275 - 141
Email: info@normfest.de
www.normfest.com
www.normfest-shop.com

OUR SUBSIDIARIES

dress & safe
Im Lipperfeld 9
D-46047 Oberhausen
Tel: +49 208 60 70 - 0
Fax: +49 208 60 70 - 190
Email: info@dress-safe.de
www.dress-safe.de

CODESI GmbH
Im Lipperfeld 9
D-46047 Oberhausen
Tel.: +49 208 60 70 - 200
Fax: +49 208 60 70 - 290
E-mail: info@codesi.de
www.codesi.de

AUSTRIA

Kellner & Kunz AG
Boschstrasse 37
A-4601 Wels
Tel.: +43 1 61 029 - 0
Fax: +43 1 61 029 - 859 / 860
E-mail: info@normfest.at

CZECH REPUBLIC

Normfest s.r.o.
Pekařská 12
CZ-155 00 Praha 5
Tel: +420 257 013 280
Fax: +420 257 013 281
Email: info@normfest.cz

SPAIN

Servicios Completos Automocion y
Repuestos S.A
P.I.El Oliveral Fase 2 C/Pedrapiquers; Nave 2
ES-46190 Ribarroja del Turia / Valencia
Tel: +34 96 164 32 23
Fax: +34 96 166 54 67
Email: info@normfest.es

POLAND

Normfest Polska Sp. z o.o.
ul. Wichrowa 4/10
PL-60-449 Poznań
Phone:+48 61 8 439 140
Fax: +48 61 8 439 142
Email: info@normfest.pl

ITALY

Fime S.r.l.
Largo Leonardo da Vinci, 8
I - 37050 Belfiore (VR)
Tel: +39 045 6134225
Fax: +39 045 6134210
Email: info@fimesrl.it

© Normfest GmbH 2012

Subject to errors, misprints and technical changes.
Reprinting, duplication or reproduction,
in whole or in part, is only permitted following prior
approval by the publisher.

SLOVAKIA

RECA s.r.o.
Vajnorska 134 / B
SK-831 04 Bratislava
Tel: +421 2 444 55 916 - 8
Fax: +421 2 444 55 900
Email: reca@reca.sk

CROATIA

RECA D.O.O.
KUCANSKA BB
HR-42000 VARAZDIN
TEL: +385 42 350 813
FAX: +385 42 350 818
EMAIL: RECAOO@RECA.
CO.AT

BOSNIA AND HERZEGOVINA

RECA D.O.O. SARAJEVO
HIFZI BJELAVCA 11
BIH-71000 SARAJEVO
TEL: +387 33 261 900
FAX: +387 33 261 902
EMAIL: RECA@RECA.BA

SWITZERLAND

RECA AG
Heimstrasse 46
CH- 8953 Dietikon 1
Tel: +41 44 745 75 75
Fax: + 41 44 745 75 00
Email: info@reca.ch

GREAT BRITAIN

Euro Car Parts Limited
Fulton Road
Wembley Industrial
Estate Wembley Middlesex
UK-HA9 OTF
Tel: +44 20 8782 2583
Fax: +44 20 8956 5199



NORMFEST®