



ABOVE & BEYOND

[CONTENTS](#)

[SPECIFICATION](#)

[FIND A RETAILER](#)

[BUILD YOUR OWN](#)

# ALL-NEW DISCOVERY



ABOVE & BEYOND





ABOVE & BEYOND

CONTENTS

SPECIFICATION

FIND A RETAILER

BUILD YOUR OWN



BY APPOINTMENT TO  
HM THE QUEEN  
MANUFACTURERS OF  
MOTOR VEHICLES  
JAGUAR LAND ROVER LIMITED  
COVENTRY



BY APPOINTMENT TO  
HRH THE DUKE OF EDINBURGH  
MANUFACTURERS OF  
MOTOR VEHICLES  
JAGUAR LAND ROVER LIMITED  
COVENTRY



BY APPOINTMENT TO  
HRH THE PRINCE OF WALES  
MANUFACTURERS OF  
MOTOR VEHICLES  
JAGUAR LAND ROVER LIMITED  
COVENTRY



ABOVE & BEYOND

Ever since the first Land Rover vehicle was conceived in 1947, we have built vehicles that challenge what is possible. These in turn have challenged their owners to explore new territories and conquer difficult terrains. Our vehicles epitomise the values of the designers and engineers who have created them. Each one instilled with iconic British design cues, delivering capability with composure. Which is how we continue to break new ground, defy conventions and encourage each other to go further. Land Rover truly enables you to make more of your world, to go above and beyond.

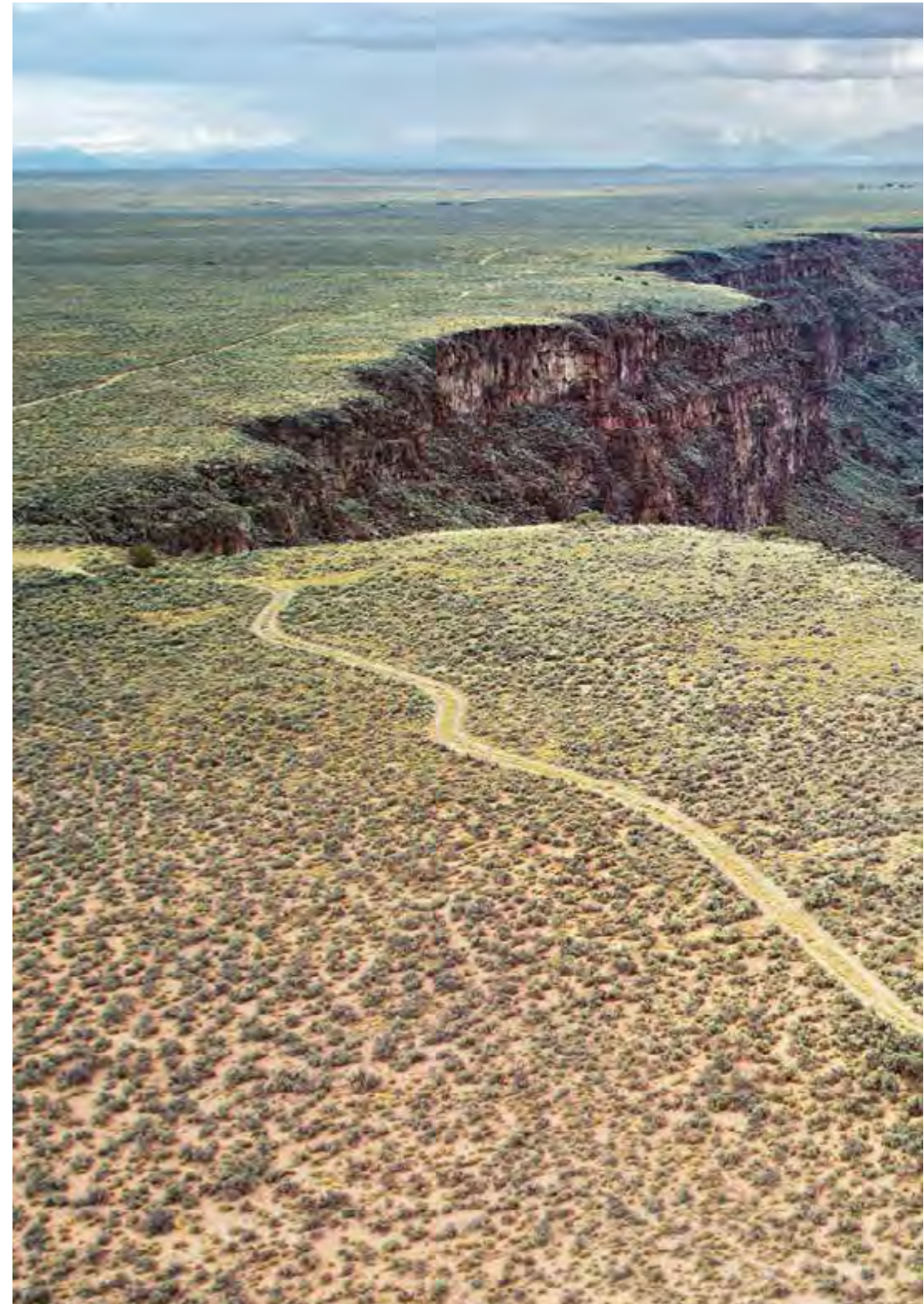



ABOVE & BEYOND

[CONTENTS](#)

[SPECIFICATION](#)

[FIND A RETAILER](#)

[BUILD YOUR OWN](#)





ABOVE & BEYOND

[CONTENTS](#)

[SPECIFICATION](#)

[FIND A RETAILER](#)

[BUILD YOUR OWN](#)





ABOVE & BEYOND

CONTENTS

SPECIFICATION

FIND A RETAILER

BUILD YOUR OWN

## CONTENTS

### INTRODUCTION

The Concept of All-New Discovery	6
All-New Discovery – The Facts	8

### DESIGN

Exterior	11
Interior	15
Seven Full-Size Seats	19
Intelligent Seat Fold	19
Space and Comfort	21
Stowage	22
Powered Inner Tailgate	24
Powered Gesture Tailgate	24
Loadspace Capacity	26

### DRIVING TECHNOLOGY

Testing	28
All-Terrain Technology	31
Terrain Response	31
All Terrain Progress Control	31
Hill Descent Control	32
Wade Sensing	33
Permanent 4 Wheel Drive Systems	35

Suspension	35
Efficient Technologies	37
On-Road Dynamics	38

### DRIVER ASSISTANCE

Driving Aids	40
Parking Aids	45
Towing Aids	46

### CONNECTIVITY.

Land Rover InControl	50
Audio Systems	54
Connectivity	57
Comfort For All	59
Activity Key	63

### ENTERTAINMENT. COMFORT

Land Rover InControl	50
Audio Systems	54
Connectivity	57
Comfort For All	59
Activity Key	63
8-Speed Automatic Transmission	65
Diesel Engine	66
Petrol Engine	67
Engine Performance	68

### TRANSMISSION AND ENGINES

### BODY AND CHASSIS

Strength and Stability	70
------------------------	----

### SAFETY

	72
--	----

### ENVIRONMENTAL

Sustainability	75
----------------	----

### SPECIFICATIONS

Choose Your Engine	78
Choose Your Model and Options	80
Choose Your Colour	102
Choose Your Wheels	106
Choose Your Interior	108
Choose Your Accessories	116

### TECHNICAL DETAILS

	122
--	-----

### A WORLD OF LAND ROVER

	124
--	-----



Scan to view the All-New Discovery in action.

Vehicles shown are from the Land Rover global range. Vehicles shown feature optional wheels and a number of optional features. Specifications, options and availability will vary between markets and should be verified with your nearest Land Rover Retailer. Vehicle shown left is HSE Luxury in Namib Orange.





ABOVE & BEYOND

CONTENTS

SPECIFICATION

FIND A RETAILER

BUILD YOUR OWN

## INTRODUCTION

# THE CONCEPT OF ALL-NEW DISCOVERY

Ever since it first took to the streets, mud tracks and deserts in 1989, Discovery has blazed its own trail. From Alaska to Zambia, it has become synonymous with capability and versatility, whether off-road or in the city. All-New Discovery takes those characteristics, together with several innovations pioneered by Land Rover, to uncharted territories.

All-New Discovery is a quantum leap forward in SUV Design. A radical and sharply focused approach to embodying Land Rover's vision of the most versatile and capable SUV.

All-New Discovery combines the flexibility of a beautifully crafted full-size seven seat interior, packed full of ingenious design details, with dramatic proportions, clean modern lines and a dynamic silhouette.

So wherever you want to go, whoever and whatever you want to take, All-New Discovery is every vehicle you'll ever need.

Vehicle shown right is HSE Luxury in Namib Orange.



DESIGN

DRIVING TECHNOLOGY

DRIVER ASSISTANCE

CONNECTIVITY. ENTERTAINMENT.  
COMFORT

TRANSMISSION AND ENGINES

BODY AND CHASSIS

SAFETY

ENVIRONMENTAL



ABOVE & BEYOND

CONTENTS

SPECIFICATION

FIND A RETAILER

BUILD YOUR OWN



INTRODUCTION 7

◀	DESIGN	DRIVING TECHNOLOGY	DRIVER ASSISTANCE	CONNECTIVITY. ENTERTAINMENT. COMFORT	▶
	TRANSMISSION AND ENGINES	BODY AND CHASSIS	SAFETY	ENVIRONMENTAL	



ABOVE & BEYOND

CONTENTS

SPECIFICATION

FIND A RETAILER

BUILD YOUR OWN

# ALL-NEW DISCOVERY – THE FACTS

Form, function and exemplary levels of finesse are brought together to help create one of Land Rover’s most compelling vehicles to date. Its inherent strength and off-road capabilities are matched only by its bold contemporary looks and alluring touches of luxury. Inside, astute use of space coupled with high quality design and use of premium materials enhance the vehicle’s bold horizontal and vertical lines.

The versatility of the cabin is highlighted by the easily configurable optional seven seat layout and plentiful stowage, with clever use of space and refined comfort.

## SEVEN FULL-SIZE SEATS\* WITH INTELLIGENT SEAT FOLD\*\*

All-New Discovery features three rows of seats with Intelligent Seat Fold allowing you to configure the second and third row seating using switches located in the loadspace or on the main Touchscreen.

## ACTIVITY KEY\*†

A first for Land Rover, the Activity Key lets you live life to the full. Housed in a robust and fully waterproof wristband, it allows you to pursue a range of activities from sailing to skydiving, safe in the knowledge that your vehicle is always protected. See page 63 for details.

## POWERED INNER TAILGATE\*

The first of its kind, this hands-free system provides a seating and loading platform and can also be used as a load retention barrier for when the tailgate is open. See page 24 for details.

## UNRIVALLED TOWING

Over the years, Discovery has earned many accolades around the world for its towing capabilities, which is why so many would naturally expect this vehicle to live up to the most demanding expectations. It doesn’t disappoint. All-New Discovery takes it to a new level, delivering an impressive towing capacity of up to 3,500kg, ensuring it measures up to the vehicle’s proud DNA. See page 46 for details.

## SUPREME CAPABILITY

The vehicle’s lineage and DNA are without question. Its all-terrain capability, wading ability and features such as Terrain Response 2\*† ensure All-New Discovery is always ready to get out there and tackle whatever comes over the horizon, no matter where that happens to be. See page 31 for details.

\*Optional \*\*Only available on the HSE and HSE Luxury †Not available on S. For full feature and option availability please refer to the accompanying Specification and Price Guide or visit your nearest Land Rover Retailer. Vehicle shown right is HSE Luxury in Namib Orange.

DESIGN

DRIVING TECHNOLOGY

DRIVER ASSISTANCE

CONNECTIVITY. ENTERTAINMENT. COMFORT

TRANSMISSION AND ENGINES

BODY AND CHASSIS

SAFETY

ENVIRONMENTAL





ABOVE & BEYOND

CONTENTS

SPECIFICATION

FIND A RETAILER

BUILD YOUR OWN

### UNCOMPROMISED LOADSPACE CAPACITY

With over 2,400 litres of loadspace, including generous underfloor stowage, ideal for wet or dirty gear, and the flexibility of optional seven seats, All-New Discovery is every vehicle you'll ever need. See page 26 for details.

### COMMAND DRIVING POSITION

For a clearer view of the road ahead, All-New Discovery has been designed with the legendary Land Rover Command Driving Position. See page 41 for details.



### CLEVER STOWAGE

From the fold down stowage behind the climate controls, to the upper and lower glove box and a comprehensive space below the centre console cupholders, All-New Discovery has stowage in places you simply would not expect. See page 22 for details.

### GENEROUS LEGROOM WITH STADIUM SEATING

Every passenger enjoys optimum comfort and unparalleled views. Those in the second row have 954mm legroom whilst, in the third row, 851mm is available. See page 21 for details.

### INTUITIVE CONNECTIVITY

All-New Discovery features the very latest suite of technologies, including InControl, a raft of USB ports and the latest in infotainment to keep you and your passengers connected and entertained. See page 50 for details.

DESIGN

DRIVING TECHNOLOGY

DRIVER ASSISTANCE

CONNECTIVITY. ENTERTAINMENT.  
COMFORT

TRANSMISSION AND ENGINES

BODY AND CHASSIS

SAFETY

ENVIRONMENTAL



ABOVE & BEYOND

CONTENTS

SPECIFICATION

FIND A RETAILER

BUILD YOUR OWN



DESIGN

DRIVING TECHNOLOGY

DRIVER ASSISTANCE

CONNECTIVITY. ENTERTAINMENT.  
COMFORT

TRANSMISSION AND ENGINES

BODY AND CHASSIS

SAFETY

ENVIRONMENTAL





ABOVE & BEYOND

CONTENTS

SPECIFICATION

FIND A RETAILER

BUILD YOUR OWN



## DESIGN

# EXTERIOR

The vehicle's exterior design is a revolutionary re-imagining of Discovery for the next generation.

All-New Discovery is beautifully proportioned for a full-size SUV, with sleek, wrap-around headlights and tail lights combining with short front and rear overhangs to reduce visual length. A fast windscreen angle, rising belt line and elegant, smoothly contoured shape, result in a streamlined and dynamic form which combines aerodynamic efficiency with class-leading interior space. The body-coloured c-pillar, stepped roof and asymmetric element on the rear number plate panel all refer to the rich lineage of previous Discovery design.

Vehicle shown left is HSE Luxury in Namib Orange.

DESIGN

DRIVING TECHNOLOGY

DRIVER ASSISTANCE

CONNECTIVITY. ENTERTAINMENT.  
COMFORT

TRANSMISSION AND ENGINES

BODY AND CHASSIS

SAFETY

ENVIRONMENTAL



ABOVE & BEYOND

CONTENTS

SPECIFICATION

FIND A RETAILER

BUILD YOUR OWN



Clean flush elements, a dynamic rising waistline and wrap-around lights convey a strong sense of modernity. Cleverly designed LED lights\* have been developed to wrap-around the side of the vehicle to enable the indicators to be more visible to improve safety.



\*Not available on S models.  
Vehicle shown is HSE Luxury in Namib Orange.

◀	DESIGN	DRIVING TECHNOLOGY	DRIVER ASSISTANCE	CONNECTIVITY. ENTERTAINMENT. COMFORT	▶
	TRANSMISSION AND ENGINES	BODY AND CHASSIS	SAFETY	ENVIRONMENTAL	



ABOVE & BEYOND

CONTENTS

SPECIFICATION

FIND A RETAILER

BUILD YOUR OWN



All-New Discovery introduces a new level of refinement as demonstrated by its beautifully crafted and sculpted surfaces. The distinctive roof and feature lines rising towards the rear of the vehicle give it an assertive, recognisable stance that is further enhanced by the front and rear graphics.

Sophisticated and urbane, All-New Discovery epitomises the most compelling contemporary British design.

DESIGN

DRIVING TECHNOLOGY

DRIVER ASSISTANCE

CONNECTIVITY. ENTERTAINMENT.  
COMFORT

TRANSMISSION AND ENGINES

BODY AND CHASSIS

SAFETY

ENVIRONMENTAL



ABOVE & BEYOND

CONTENTS

SPECIFICATION

FIND A RETAILER

BUILD YOUR OWN



DESIGN

DRIVING TECHNOLOGY

DRIVER ASSISTANCE

CONNECTIVITY. ENTERTAINMENT.  
COMFORT

TRANSMISSION AND ENGINES

BODY AND CHASSIS

SAFETY

ENVIRONMENTAL



ABOVE & BEYOND

CONTENTS

SPECIFICATION

FIND A RETAILER

BUILD YOUR OWN



## INTERIOR

The highly desirable interior is a re-imagining of the classic Discovery design elements with the striking use of strong horizontal and vertical lines connecting through the main fascia beam. The use of materials such as premium leather, authentic wood and metal finishers, coupled with focussed craftsmanship and precision, create an air of cultured modern living.

The 8", standard on S and SE, or 10", standard on HSE and HSE Luxury, infotainment Touchscreen helps you connect to the outside world and puts a wealth of entertainment and information at your fingertips. The clever use of both seating design and stowage space helps deliver class-leading capability for you, your family and friends.

Interior shown is HSE Luxury in Nimbus/Espresso.

DESIGN 15

DESIGN

DRIVING TECHNOLOGY

DRIVER ASSISTANCE

CONNECTIVITY. ENTERTAINMENT.  
COMFORT

TRANSMISSION AND ENGINES

BODY AND CHASSIS

SAFETY

ENVIRONMENTAL



ABOVE & BEYOND

CONTENTS

SPECIFICATION

FIND A RETAILER

BUILD YOUR OWN



16

DESIGN

DRIVING TECHNOLOGY

DRIVER ASSISTANCE

CONNECTIVITY. ENTERTAINMENT.  
COMFORT

TRANSMISSION AND ENGINES

BODY AND CHASSIS

SAFETY

ENVIRONMENTAL





ABOVE & BEYOND

CONTENTS

SPECIFICATION

FIND A RETAILER

BUILD YOUR OWN



### UNCOMPROMISING ATTENTION TO DETAIL

An eye for the minutiae. The finest materials. These are the qualities that our designers have carefully considered to help shape All-New Discovery's interior. Added to which, sumptuous leather, beautifully finished handcrafted wood veneers, Noble Chrome details, Brushed Aluminium finishers and crafted stitching can be incorporated throughout the interior for added luxury.



Interior shown is HSE Luxury in Nimbus/Espresso.

DESIGN

DRIVING TECHNOLOGY

DRIVER ASSISTANCE

CONNECTIVITY. ENTERTAINMENT.  
COMFORT

TRANSMISSION AND ENGINES

BODY AND CHASSIS

SAFETY

ENVIRONMENTAL



ABOVE & BEYOND

CONTENTS

SPECIFICATION

FIND A RETAILER

BUILD YOUR OWN



18 Interior shown is HSE Luxury in Nimbus/Espresso.

DESIGN

DRIVING TECHNOLOGY

DRIVER ASSISTANCE

CONNECTIVITY. ENTERTAINMENT.  
COMFORT

TRANSMISSION AND ENGINES

BODY AND CHASSIS

SAFETY

ENVIRONMENTAL



ABOVE & BEYOND

CONTENTS

SPECIFICATION

FIND A RETAILER

BUILD YOUR OWN



## SEVEN FULL-SIZE SEATS

All-New Discovery's optional seven full-size seats truly exemplify comfort and versatility. Divided across three rows and readily deployable, no other vehicle in its class is so well appointed. For instance, the second row enjoys a 60:40 slide and recline configuration, coupled with a load-through facility. Stadium seating ensures everyone can see the road ahead in the greatest comfort whilst the stepped roof allows for greater headroom in the second and third rows; such clever use of space ensures everyone travels first class. Added to which, there are a number of comfort features available including heated seats across all three rows and cooled seats on the first and second row: please refer to page 61 for a full list of available options.

## INTELLIGENT SEAT FOLD

On HSE and HSE Luxury, where third row seats are specified, there's a choice of ways you can easily deploy the seats with our optional Intelligent Seat Fold: from the Touchscreen or the switches located in the loadspace.

The powered seat folding mechanism uses an intelligent control system which ensures the seats, including the headrests, fold away seamlessly, safely and conveniently. The system understands when seats are occupied or have heavy items on them and, when folding, automatically adjusts their position to prevent a conflict.

DESIGN

DRIVING TECHNOLOGY

DRIVER ASSISTANCE

CONNECTIVITY. ENTERTAINMENT.  
COMFORT

TRANSMISSION AND ENGINES

BODY AND CHASSIS

SAFETY

ENVIRONMENTAL



ABOVE & BEYOND

CONTENTS

SPECIFICATION

FIND A RETAILER

BUILD YOUR OWN



◀	DESIGN	DRIVING TECHNOLOGY	DRIVER ASSISTANCE	CONNECTIVITY. ENTERTAINMENT. COMFORT	▶
	TRANSMISSION AND ENGINES	BODY AND CHASSIS	SAFETY	ENVIRONMENTAL	



ABOVE & BEYOND

CONTENTS

SPECIFICATION

FIND A RETAILER

BUILD YOUR OWN



1 Second row legroom 954mm

2 Third row legroom 851mm

## SPACE AND COMFORT

Each and every passenger in All-New Discovery enjoys a truly comfortable ride, with a generous amount of legroom offered. Those in the second row will find they have 954mm, whilst in the optional third row, a plentiful 851mm is provided.

Even a team of seven adults can travel in comfort. Added to which, when slide and recline is specified, you can configure the second row to optimise the available room even further.

Vehicle shown left is HSE Luxury in Silicon Silver.  
Interior shown above is HSE Luxury in Nimbus/Espresso.

DESIGN

DRIVING TECHNOLOGY

DRIVER ASSISTANCE

CONNECTIVITY. ENTERTAINMENT.  
COMFORT

TRANSMISSION AND ENGINES

BODY AND CHASSIS

SAFETY

ENVIRONMENTAL



ABOVE & BEYOND

CONTENTS

SPECIFICATION

FIND A RETAILER

BUILD YOUR OWN



## STORAGE

All-New Discovery is brimming with clever spaces in which to stow away all those electronic devices, travel guides and even VIPs – Very Important Passengers – such as our small friend here. From the upper and lower glove box on SE, HSE and HSE Luxury, to central armrest stowage with an optional chiller compartment and space for multiple tablets, you’ll find space in places you simply wouldn’t expect.

The central armrest cubby box can hinge back 180° to create a flat tray, should second row passengers require more stowage, whilst the door bins can also accommodate 1 litre bottles in the front and 0.5 litre bottles in second row. Standard on HSE and HSE Luxury, a neatly integrated push-operated hook to hang a small shopping bag sits flush in the front passenger footwell when not in use.

When optional third row seats are selected, third row passengers benefit from individual storage spaces including within the side panel. In fact, across all rows there’s more than enough space for even the most demanding of families.

DESIGN

DRIVING TECHNOLOGY

DRIVER ASSISTANCE

CONNECTIVITY. ENTERTAINMENT.  
COMFORT

TRANSMISSION AND ENGINES

BODY AND CHASSIS

SAFETY

ENVIRONMENTAL



ABOVE & BEYOND

CONTENTS

SPECIFICATION

FIND A RETAILER

BUILD YOUR OWN



Cubby box stowage with an optional chiller compartment



Centre console stowage behind the climate controls\*



Cupholders with additional stowage beneath\*



Upper\*\* and lower glove box



Push operated hook\*



Third row stowage with lid

\*Only available on HSE and HSE Luxury \*\*Only available on SE, HSE and HSE Luxury.

DESIGN

DRIVING TECHNOLOGY

DRIVER ASSISTANCE

CONNECTIVITY. ENTERTAINMENT.  
COMFORT

TRANSMISSION AND ENGINES

BODY AND CHASSIS

SAFETY

ENVIRONMENTAL



ABOVE & BEYOND

CONTENTS

SPECIFICATION

FIND A RETAILER

BUILD YOUR OWN



## POWERED INNER TAILGATE

Pioneered by Land Rover, All-New Discovery features a powered inner tailgate, which when deployed can provide a platform for use at social and sporting events coupled with greater protection from the elements. This platform also allows for easier loading and acts as a retainer when the loadspace area is filled. Powered inner tailgate is fitted as standard on HSE and HSE Luxury, and available as an option on S and SE.



## POWERED GESTURE TAILGATE

Powered gesture tailgate allows you to operate the tailgate (both to open and close) from outside the vehicle without needing to physically touch the vehicle or the smart key.

Provided that the smart key is detected, the tailgate may be operated by a kicking gesture underneath the rear of the vehicle.

Two sensors mounted on either side of the tailgate allow kerbside operation, rather than needing to be immediately behind the vehicle. And as the system is compatible with towing solutions, you can still open and close the tailgate with the least amount of fuss. Powered gesture tailgate is available as an option on SE and HSE, and is fitted as standard on HSE Luxury.

Additionally, a button located inside the tailgate or on the smart key allows the tailgate to be closed automatically with powered tailgate.



Vehicle shown is HSE Luxury in Silicon Silver.

DESIGN

DRIVING TECHNOLOGY

DRIVER ASSISTANCE

CONNECTIVITY. ENTERTAINMENT.  
COMFORT

TRANSMISSION AND ENGINES

BODY AND CHASSIS

SAFETY

ENVIRONMENTAL





ABOVE & BEYOND

CONTENTS

SPECIFICATION

FIND A RETAILER

BUILD YOUR OWN



DESIGN 25

DESIGN

DRIVING TECHNOLOGY

DRIVER ASSISTANCE

CONNECTIVITY. ENTERTAINMENT.  
COMFORT

TRANSMISSION AND ENGINES

BODY AND CHASSIS

SAFETY

ENVIRONMENTAL





ABOVE & BEYOND

CONTENTS

SPECIFICATION

FIND A RETAILER

BUILD YOUR OWN



## LOADSPACE CAPACITY

With a luggage-devouring 2,406 litres of space behind the first row of seats, All-New Discovery welcomes a greater load than any other SUV in its class. There's a generous 1,137 litres of space behind the second row of seats. Even when you utilise all seven seats you can still fit up to three cabin bags behind the optional third row. When it comes to carrying any load, having the option to fold all second and third row seats gives you more options, making life that bit easier.

Loadspace capacity figures represent 7 seat vehicles fitted with Two or Three-zone Climate Control only. Figures shown in brackets represent vehicles with 5 seats, with extra storage beneath the loadspace floor. Vehicle shown is HSE Luxury in Silicon Silver. Interior shown is HSE Luxury in Nimbus/Espresso.



7 SEATS  
258 LITRES

6 SEATS  
698 LITRES

DESIGN

DRIVING TECHNOLOGY

DRIVER ASSISTANCE

CONNECTIVITY. ENTERTAINMENT.  
COMFORT

TRANSMISSION AND ENGINES

BODY AND CHASSIS

SAFETY

ENVIRONMENTAL



ABOVE & BEYOND

CONTENTS

SPECIFICATION

FIND A RETAILER

BUILD YOUR OWN



**5 SEATS**  
1,137 (1,231) LITRES

**4 SEATS**  
1,473 (1,561) LITRES

**4 SEATS**  
1,607 (1,701) LITRES

**3 SEATS**  
1,937 (2,031) LITRES

**2 SEATS**  
2,406 (2,500) LITRES

DESIGN

DRIVING TECHNOLOGY

DRIVER ASSISTANCE

CONNECTIVITY. ENTERTAINMENT.  
COMFORT

TRANSMISSION AND ENGINES

BODY AND CHASSIS

SAFETY

ENVIRONMENTAL



ABOVE & BEYOND

CONTENTS

SPECIFICATION

FIND A RETAILER

BUILD YOUR OWN

## DRIVING TECHNOLOGY

# TESTING

Before any vehicle can carry the Land Rover badge, it must complete a series of rigorous tests to establish the very highest levels of luxury, performance and capability.



### SUSPENSION

You're unlikely to push any Land Rover harder than we have. To guarantee an unrivalled breadth of dynamic capability, both on and off-road, the vehicles have been exposed to ten years of the most extreme driving pressures in a fraction of the time using our state-of-the-art test rig.



### WIND SPEED

All-New Discovery was developed in state-of-the-art wind tunnels and a suite of climatic chambers to recreate some of the most challenging aerodynamic conditions it will face. Only by pushing all systems to their limits do we develop true reliability.



### HOT AND COLD CLIMATE

In real world environments and our climate chambers, we freeze vehicles to -40°C and bake them to 50°C. Key functions and systems are then scrutinised to our exacting standards. So even in the most remote locations, comfort and peace of mind are never far away.



### OFF-ROAD

From the icy proving grounds of Arjeplog, Sweden, to Dubai's unforgiving desert sands, we ensure our legendary all-terrain performance is innate in every vehicle. Prototypes are developed across approximately 8,500km of the most demanding off-road routes.



### SEMI-ANECHOIC CHAMBER

In the 'neutral sound' of our semi-anechoic chamber we precisely expose the cabin to a range of frequencies and vibrations, making certain that All-New Discovery sounds refined at every speed and across every surface.



### MONSOON

Using our monsoon simulator, we drench our vehicles with some 85,000 litres of specially dyed water, while tilting it by as much as 45°, checking for even the slightest leak with UV lights. Ensuring each vehicle can enter and exit a body of water without a single droplet entering the cabin.

DESIGN

DRIVING TECHNOLOGY

DRIVER ASSISTANCE

CONNECTIVITY. ENTERTAINMENT.  
COMFORT

TRANSMISSION AND ENGINES

BODY AND CHASSIS

SAFETY

ENVIRONMENTAL



ABOVE & BEYOND

CONTENTS

SPECIFICATION

FIND A RETAILER

BUILD YOUR OWN



◀	DESIGN	DRIVING TECHNOLOGY	DRIVER ASSISTANCE	CONNECTIVITY. ENTERTAINMENT. COMFORT	▶
	TRANSMISSION AND ENGINES	BODY AND CHASSIS	SAFETY	ENVIRONMENTAL	



ABOVE & BEYOND

CONTENTS

SPECIFICATION

FIND A RETAILER

BUILD YOUR OWN



DESIGN

DRIVING TECHNOLOGY

DRIVER ASSISTANCE

CONNECTIVITY. ENTERTAINMENT.  
COMFORT

TRANSMISSION AND ENGINES

BODY AND CHASSIS

SAFETY

ENVIRONMENTAL



ABOVE & BEYOND

CONTENTS

SPECIFICATION

FIND A RETAILER

BUILD YOUR OWN



## ALL-TERRAIN TECHNOLOGY

All-New Discovery not only looks truly at home in the city, but also drives impeccably off-road. Its optimised geometry coupled with unique Land Rover technologies ensure it delivers class-leading all-terrain capabilities.

## TERRAIN RESPONSE

With over 65 years of all-terrain expertise, this vehicle has Land Rover capability at its heart. Our unique Terrain Response systems enable the driver to optimise the vehicle's engine, gearbox, centre differential and chassis systems to match the demands of the terrain, by selecting one of the easily identifiable driving modes. It also includes additional Rock Crawl Mode when your vehicle is specified with electronic air suspension and twin-speed transfer box.

Introduced to Discovery for the first time, the optional Terrain Response 2\* system enhances this even further by monitoring driving conditions and automatically selecting the driving modes to achieve the best possible chassis and powertrain set up for the conditions.

## ALL TERRAIN PROGRESS CONTROL

All Terrain Progress Control (ATPC)\* is a state-of-the-art optional system that enables drivers to set and maintain a steady speed in challenging conditions.

Operating like a cruise control system, it functions at very low speeds between 2kph and 30kph, enabling the driver to maintain full concentration on steering and finding a path through obstacles.

Developed by Land Rover's industry-leading all-terrain specialists, the system works seamlessly alongside the Terrain Response 2 and 4 Wheel Drive (4WD) traction and braking systems.

Once ATPC is activated, the standard steering wheel +/- cruise control buttons are used to set the speed. Brake and accelerator pedals can still override the chosen settings, with gentle braking achieving a reduction in speed.

 General Driving

 Sand

 Grass, Gravel, Snow

 Rock Crawl

 Mud & Ruts

\*Not available on S models.

Features and their availability may differ by vehicle specification and market. Please see pages 86-101, or contact your nearest Land Rover Retailer, for more information. Vehicle shown left is HSE Luxury in Namib Orange.



ABOVE & BEYOND

CONTENTS

SPECIFICATION

FIND A RETAILER

BUILD YOUR OWN

# HILL DESCENT CONTROL

Land Rover's patented Hill Descent Control (HDC) is a standard feature. It assists the driver with controlled descents of difficult slopes by maintaining a constant speed and applying braking separately to each wheel.

Hill Start Assist ensures the vehicle doesn't roll backwards as it pulls away on an incline.

The vehicle also utilises Gradient Release Control (GRC) which is designed to prevent the vehicle accelerating too quickly on a steep incline when the driver releases the brake.



DESIGN

DRIVING TECHNOLOGY

DRIVER ASSISTANCE

CONNECTIVITY. ENTERTAINMENT. COMFORT

TRANSMISSION AND ENGINES

BODY AND CHASSIS

SAFETY

ENVIRONMENTAL





ABOVE & BEYOND

CONTENTS

SPECIFICATION

FIND A RETAILER

BUILD YOUR OWN



## WADE SENSING



All-New Discovery's improved geometry enables a significant improvement in wading capability when compared to its predecessor.

With a wading depth of up to 900mm, whether crossing streams, fords or flooded areas, the optional Wade Sensing feature can prove invaluable. Available as an option on HSE and HSE Luxury.

Unique to Land Rover, sensors located in the door mirrors give the driver pictorial real-time information about the water's depth in relation to the vehicle, as well as maximum wading capability via the Touchscreen.

DESIGN

DRIVING TECHNOLOGY

DRIVER ASSISTANCE

CONNECTIVITY. ENTERTAINMENT.  
COMFORT

TRANSMISSION AND ENGINES

BODY AND CHASSIS

SAFETY

ENVIRONMENTAL



ABOVE & BEYOND

CONTENTS

SPECIFICATION

FIND A RETAILER

BUILD YOUR OWN

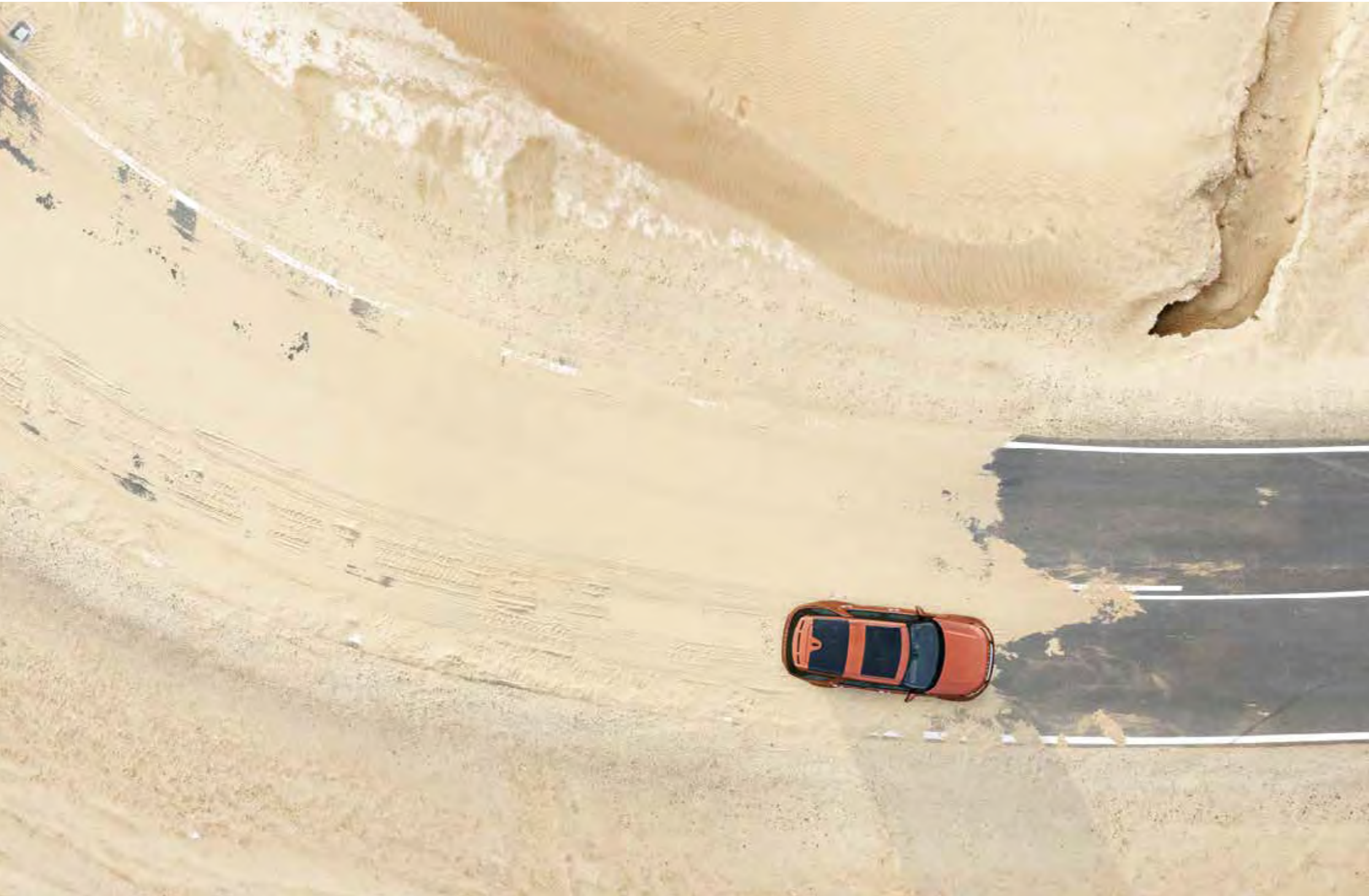

DESIGN

DRIVING TECHNOLOGY

DRIVER ASSISTANCE

CONNECTIVITY. ENTERTAINMENT.  
COMFORT

TRANSMISSION AND ENGINES

BODY AND CHASSIS

SAFETY

ENVIRONMENTAL



ABOVE & BEYOND

CONTENTS

SPECIFICATION

FIND A RETAILER

BUILD YOUR OWN

## PERMANENT 4 WHEEL DRIVE SYSTEMS



All-New Discovery features a choice of intelligent, permanent Land Rover 4 Wheel Drive (4WD) systems to deliver unrivalled, all-weather and all-surface capability. You can select from the following systems depending on capability requirements:

### SINGLE SPEED TRANSFER BOX\*

This system has a single set of high range, road biased gears with the intelligence to sense wheel slip and move torque to the other axle to provide additional traction. It normally delivers 42 percent drive to the front axle with 58 percent drive biased to the rear axle. The centre differential is reactive to wheel slip on one axle and can change the amount of bias to add more torque and traction to the other axle to support.

### TWIN-SPEED TRANSFER BOX

An additional set of lower gears can prove invaluable in challenging conditions such as steep inclines or declines, off-road driving or when towing. This system gives you precise speed and control in such instances. The heart of the twin-speed system is the electronic centre differential that offers a 50:50 torque split between front and rear axles with the ability to pre-emptively lock the axles before slip commences. Available as an option on Td6 S and standard on Td6 SE, HSE, HSE Luxury and Si6 engines.

### ACTIVE REAR LOCKING DIFFERENTIAL

The active rear electronic differential – an option when the vehicle has air suspension and twin-speed transfer box – offers an additional benefit of controlling the slip between the left and right wheels on the rear axle. This can be especially useful in low grip conditions such as on wet grass where the vehicle monitors the slip and torque between front and rear axles and also from one wheel to another on the rear axle to deliver effortless capability.

## SUSPENSION

### COIL SUSPENSION\*

All-New Discovery has a fully independent coil sprung suspension system that combines double wishbones at the front with an advanced multi-link rear suspension design to create an agile and responsive chassis.

Ride comfort and stability when heavily laden are optimised through the use of additional secondary springs incorporated within the rear suspension.

### ELECTRONIC AIR SUSPENSION

A sure-footed, composed drive is completed by the latest four-corner which provides exceptional wheel articulation and poise.

Capable of taking on tough situations, this system is designed to keep All-New Discovery stable no matter how rough the terrain. For unprecedented ride quality, it switches heights seamlessly when necessary.

Air suspension also allows for innovative new access features to enhance versatility and ease of use.

**Automatic Access Height** is a feature which automatically lowers the ride height by 40mm when the vehicle is parked.

**Rear Height Adjust** allows the use of switches in the loadspace or on the key fob to lower the rear ride height. See page 46 for more information.

Available as an option on Td6 S and standard on Td6 SE, HSE, HSE Luxury and Si6 engines.

\*Only available on TD6 S models.  
Features and their availability may differ by vehicle specification and market.  
Please see pages 86-101, or contact your nearest Land Rover Retailer, for more information.  
Vehicle shown left is HSE Luxury in Namib Orange.



ABOVE & BEYOND

CONTENTS

SPECIFICATION

FIND A RETAILER

BUILD YOUR OWN



DESIGN

DRIVING TECHNOLOGY

DRIVER ASSISTANCE

CONNECTIVITY. ENTERTAINMENT.  
COMFORT

TRANSMISSION AND ENGINES

BODY AND CHASSIS

SAFETY

ENVIRONMENTAL





ABOVE & BEYOND

CONTENTS

SPECIFICATION

FIND A RETAILER

BUILD YOUR OWN

# EFFICIENT TECHNOLOGIES

## SUSTAINABLE CONSTRUCTION

The aluminium alloy used for much of All-New Discovery's construction is from a high level of recycled aluminium. Using significantly less energy than primary aluminium to produce, it minimises the vehicle's environmental impact.

## STOP/START

All-New Discovery engines are all available with Stop/Start\*. This system shuts down the engine when you come to a complete halt and restarts the engine immediately when required, helping to save fuel, especially during urban driving.

## LIGHTWEIGHT MATERIALS

At every stage of the development process, engineers maximised weight saving across all the vehicle's elements. This produces an optimum balance between best performance and weight saving for greater efficiency. All-New Discovery adopts an advanced all-aluminium body structure, delivering significantly reduced weight, improved performance and enhanced sustainability. Its tailgate is made from a lightweight plastic composite material which is also very stiff and strong, whilst high-precision lightweight magnesium castings are used for some of the body and chassis components.

## LOW FRICTION TECHNOLOGIES

All-New Discovery's petrol and diesel engine range uses smart coating technologies on pistons, needle roller bearings and other mechanical parts. This helps to reduce friction, especially at low engine temperatures, so the vehicle performs at its efficient best.

## ADVANCED AERODYNAMICS

The modern streamlined design has been carefully optimised using advanced Computational Fluid Dynamics software and a state-of-the-art wind tunnel. This has led to an improvement of up to 15 percent drag reduction when compared to its predecessor whilst still maintaining stadium seating and two additional seats in the optional third row. An enhanced rear spoiler has been designed with slots to direct airflow over the tailgate to minimise rear screen soiling and produce a reduction in drag.

Vehicles equipped with electronic air suspension benefit from speed lowering where the vehicle automatically lowers by 13mm to reduce drag when cruising at motorway speeds.

\*Features and their availability may differ by vehicle specification and market. Vehicle shown left is HSE Luxury in Silicon Silver.

DESIGN

DRIVING TECHNOLOGY

DRIVER ASSISTANCE

CONNECTIVITY. ENTERTAINMENT. COMFORT

TRANSMISSION AND ENGINES

BODY AND CHASSIS

SAFETY

ENVIRONMENTAL



ABOVE & BEYOND

CONTENTS

SPECIFICATION

FIND A RETAILER

BUILD YOUR OWN



## ON-ROAD DYNAMICS

All-New Discovery has been designed to deliver a confident, comfortable and engaging driving experience to make the miles go by virtually unnoticed.

With its wide-spaced double-wishbone design at the front and advanced multi-link layout at the rear, the suspension delivers more responsive handling without compromising Land Rover's hallmark all-terrain capability.

Dynamic Stability Control (DSC) monitors All-New Discovery's dynamic behaviour, and intervenes if the system determines that the vehicle is not responding according to the driver's inputs.

The DSC system operates by reducing engine torque and/or applying the brakes on selected wheels to correct the vehicle's cornering attitude and in addition can counteract understeer or oversteer conditions effectively. This system is standard on all models.

All-New Discovery's sublime ride quality is heightened further by such features as Electronic Power Assisted Steering (EPAS), a variable ratio system and speed sensitive steering. Standard on all models, EPAS is integrated into driver and chassis systems, helping to reduce the engine load to aid efficiency and deliver a confident and intuitive drive.

The variable ratio system has been tuned by Land Rover engineers to provide ease of control, on or off-road, when driving in a straight line or when turning. Different gear ratios within the steering rack help to reduce steering sensitivity when driving straight, but compensate for less steering input when turning.

Speed sensitive steering increases the weight and feel of the steering as your speed increases to give stability and a greater feel of confidence. It also assists you at lower speeds to aid manoeuvrability by lightening the feel of steering. This system is standard on all models.

DESIGN

DRIVING TECHNOLOGY

DRIVER ASSISTANCE

CONNECTIVITY. ENTERTAINMENT.  
COMFORT

TRANSMISSION AND ENGINES

BODY AND CHASSIS

SAFETY

ENVIRONMENTAL



ABOVE & BEYOND

CONTENTS

SPECIFICATION

FIND A RETAILER

BUILD YOUR OWN



DESIGN

DRIVING TECHNOLOGY

DRIVER ASSISTANCE

CONNECTIVITY. ENTERTAINMENT.  
COMFORT

TRANSMISSION AND ENGINES

BODY AND CHASSIS

SAFETY

ENVIRONMENTAL



ABOVE & BEYOND

CONTENTS

SPECIFICATION

FIND A RETAILER

BUILD YOUR OWN

DRIVER ASSISTANCE

DRIVING AIDS



◀	DESIGN	DRIVING TECHNOLOGY	DRIVER ASSISTANCE	CONNECTIVITY. ENTERTAINMENT. COMFORT	▶
	TRANSMISSION AND ENGINES	BODY AND CHASSIS	SAFETY	ENVIRONMENTAL	





ABOVE & BEYOND

CONTENTS

SPECIFICATION

FIND A RETAILER

BUILD YOUR OWN



All-New Discovery has a wealth of parking and driving aids on hand. Featuring the most innovative thinking, engineering and technologies, these features will help you manage most traffic, motorway, road and parking situations with ease.

### COMMAND DRIVING POSITION

The Command Driving Position in All-New Discovery ensures a greater view of the road ahead so all terrains can be tackled with confidence.

### HEAD-UP DISPLAY

Head-up Display\* is an option on SE, HSE and HSE Luxury, that presents key vehicle data such as vehicle speed, gear position and navigation directions\*\* on the windscreen, without distraction or the need for you to take your eyes off the road.

The innovative laser system is more robust against issues such as 'washout' – the effect that the glare from sunlight has on inferior LED-based systems. The feature can be turned on and off dependent upon driver preference.



\*Requires infrared reflective windscreen.  
\*\*Requires InControl Touch or InControl Touch Pro Navigation.  
Vehicle shown left is HSE Luxury in Silicon Silver.  
Please contact your nearest Land Rover Retailer for further information.

◀	DESIGN	DRIVING TECHNOLOGY	DRIVER ASSISTANCE	CONNECTIVITY. ENTERTAINMENT. COMFORT	▶
	TRANSMISSION AND ENGINES	BODY AND CHASSIS	SAFETY	ENVIRONMENTAL	



ABOVE & BEYOND

CONTENTS

SPECIFICATION

FIND A RETAILER

BUILD YOUR OWN

# DRIVING AIDS



## LOW TRACTION LAUNCH

All-New Discovery features a dedicated launch function\*, which enables the vehicle to pull away smoothly and easily, even on tricky low-friction surfaces like ice, snow or wet grass. The software adapts the system's behaviour according to the current Terrain Response setting. When you pull away, you do so with certainty, composure and greater ease.

◀	DESIGN	DRIVING TECHNOLOGY	DRIVER ASSISTANCE	CONNECTIVITY. ENTERTAINMENT. COMFORT	▶
	TRANSMISSION AND ENGINES	BODY AND CHASSIS	SAFETY	ENVIRONMENTAL	



ABOVE & BEYOND

CONTENTS

SPECIFICATION

FIND A RETAILER

BUILD YOUR OWN



## ALL TERRAIN INFO CENTRE



The All Terrain Info Centre\*\* within your navigation system allows you to view and activate various features and provides access to 4 Wheel Drive (4WD) information and guidance features for off-road driving.

The Touchscreen displays information about the vehicle's wheels, suspension, transmission and driveline including suspension movements and articulation for vehicles with electronic air suspension.

The system can show the angle and pitch of the vehicle on slopes and inclines, advice on the vehicle's current and maximum wading depth and includes a useful compass together with current latitude, longitude and altitude details.

The Info Centre provides a host of other helpful guidance such as vehicle dimensions, useful for entering tighter spots and can be used to activate additional capability features, such as Low Traction Launch.

Using the optional Surround Camera System, the Info Centre can also show the area directly ahead of the vehicle that may not be visible to the driver to help ensure the vehicle isn't damaged on unseen terrain.

\*Low Traction Launch features as standard on SE, HSE and HSE Luxury models. Standard on S models when specified with optional InControl Touch Navigation and Land Rover Enhanced Sound System.

\*\*The number of features displayed on the All Terrain Info Centre is dependent upon the specification of the vehicle. Interior shown above is the HSE Luxury in Nimbus/Espresso.

DESIGN

DRIVING TECHNOLOGY

DRIVER ASSISTANCE

CONNECTIVITY. ENTERTAINMENT.  
COMFORT

TRANSMISSION AND ENGINES

BODY AND CHASSIS

SAFETY

ENVIRONMENTAL



ABOVE & BEYOND

CONTENTS

SPECIFICATION

FIND A RETAILER

BUILD YOUR OWN

## DRIVING AIDS



### DRIVER CONDITION MONITOR\*

Driver Condition Monitor detects if you're starting to feel drowsy and gives you an early warning when you need to take a break.



### ADAPTIVE CRUISE CONTROL WITH QUEUE ASSIST\*

When you're cruising on the motorway or travelling in slow-moving traffic, this system will keep your vehicle a safe distance from the one in front should it slow or stop. Should the vehicle in front stop completely, your vehicle will come to a smooth halt. Once the traffic moves, simply touch the accelerator and Adaptive Cruise Control will resume following the car in front. The system can be activated from 16kph up to motorway speeds. Feature is available as optional.



### BLIND SPOT MONITOR AND REVERSE TRAFFIC DETECTION\*

If your vehicle detects another car in your blind spot when you begin to change lanes, this system applies an appropriate amount of steering torque that helps to prevent the driver from steering into the approaching vehicle.

Using the same radar technology, our Reverse Traffic Detection system is particularly useful when reversing out of a parking bay. The system warns you of vehicles, pedestrians or other hazards, approaching from either side of your vehicle. It will alert you with both audio and visual warnings so you know what's behind you even when the view is obstructed.

DESIGN

DRIVING TECHNOLOGY

DRIVER ASSISTANCE

CONNECTIVITY. ENTERTAINMENT. COMFORT

TRANSMISSION AND ENGINES

BODY AND CHASSIS

SAFETY

ENVIRONMENTAL



ABOVE & BEYOND

CONTENTS

SPECIFICATION

FIND A RETAILER

BUILD YOUR OWN

## PARKING AIDS



### PARK ASSIST – PARALLEL PARK, PARKING EXIT AND PERPENDICULAR PARK

Our Park Assist system makes parallel and perpendicular parking easier than ever by steering your vehicle into a suitable space. You just have to select the appropriate gear and control the vehicle's speed with the brake and accelerator pedals. Park Assist will also steer you out of a space, taking all of the stress out of parking. Graphics and notifications guide you through the manoeuvres.



### SURROUND CAMERA SYSTEM

Giving a 360° exterior view via the Touchscreen, this helps with various manoeuvres from parking by a kerb, to getting in and out of tight spaces and junctions. Optional on S, SE and HSE. Standard on HSE Luxury.



### REAR VIEW CAMERA

To make parking in tight spots simpler, lines to represent the vehicle's outer perimeter and predicted path are superimposed on the rearward image displayed on your Touchscreen. Optional on S and not applicable on HSE Luxury.



### HOMELINK\*

The optional HomeLink® system is a universal transmitter fitted to the underside of the interior rear view mirror. This transmitter can be programmed to operate up to three home or office wireless controlled systems, such as garage doors, automatic gates, or security lighting. By replacing the individual remote control units normally required for each system, the driver no longer needs to search the car interior for the correct handset when needed.

HomeLink® is a registered trademark of Gentex Corporation. Features and their availability may differ by vehicle specification and market. Please see pages 86-101, or contact your nearest Land Rover Retailer, for more information.

DESIGN

DRIVING TECHNOLOGY

DRIVER ASSISTANCE

CONNECTIVITY. ENTERTAINMENT. COMFORT

TRANSMISSION AND ENGINES

BODY AND CHASSIS

SAFETY

ENVIRONMENTAL



ABOVE & BEYOND

CONTENTS

SPECIFICATION

FIND A RETAILER

BUILD YOUR OWN

# TOWING AIDS

All-New Discovery takes towing capability to a new level, with a capacity of up to 3,500kg and a suite of features available to help make towing effortless and assured.

## 1 ELECTRICALLY DEPLOYABLE TOW BAR

All-New Discovery has the option of an electrically deployable tow bar on SE, HSE and HSE Luxury. This is deployed using a convenient button in the loadspace compartment, or via the Touchscreen.

## 2 TOW HITCH ASSIST

Tow Hitch Assist makes coupling a trailer to the vehicle much easier by helping you visualise the hitching process; it displays the predicted path of the vehicle tow ball towards the trailer tow bar on the Touchscreen. Standard with Surround Camera System.

## 3 NOSE LOAD MEASUREMENT

HSE and HSE Luxury vehicles fitted with the electrically deployable tow bar feature Nose Load Measurement which allows you to quickly and easily measure the nose load of your trailer. This system can be operated via the Touchscreen.

## 4 REAR HEIGHT ADJUST

Rear Height Adjust allows the use of switches in the loadspace or on the key fob to lower the rear ride height – useful when loading or unloading cumbersome items, or when hitching, unhitching or loading a trailer. This feature is standard when electronic air suspension is specified.

## 5 TRAILER LIGHT TEST

This industry-first feature enables you to test your trailer lights without leaving your vehicle. When an optional electrically deployable tow bar is fitted, the automatic system is used to pulse the lights in a sequence, and is triggered via the Touchscreen or a button in the loadspace compartment.

## 6 TOW ASSIST

On the road, the Tow Assist feature helps with reversing by predicting the trailer's direction. You can even choose your trailer's width for precise guidelines displayed on the Touchscreen. Standard with Surround Camera System.



Towing regulations and feature applicability vary by market. Please ensure you comply with relevant legislation in your country. Vehicle shown is HSE Luxury in Namib Orange.

DESIGN

DRIVING TECHNOLOGY

DRIVER ASSISTANCE

CONNECTIVITY. ENTERTAINMENT. COMFORT

TRANSMISSION AND ENGINES

BODY AND CHASSIS

SAFETY

ENVIRONMENTAL



ABOVE & BEYOND

CONTENTS

SPECIFICATION

FIND A RETAILER

BUILD YOUR OWN



◀	DESIGN	DRIVING TECHNOLOGY	DRIVER ASSISTANCE	CONNECTIVITY. ENTERTAINMENT. COMFORT	▶
	TRANSMISSION AND ENGINES	BODY AND CHASSIS	SAFETY	ENVIRONMENTAL	



ABOVE & BEYOND

CONTENTS

SPECIFICATION

FIND A RETAILER

BUILD YOUR OWN

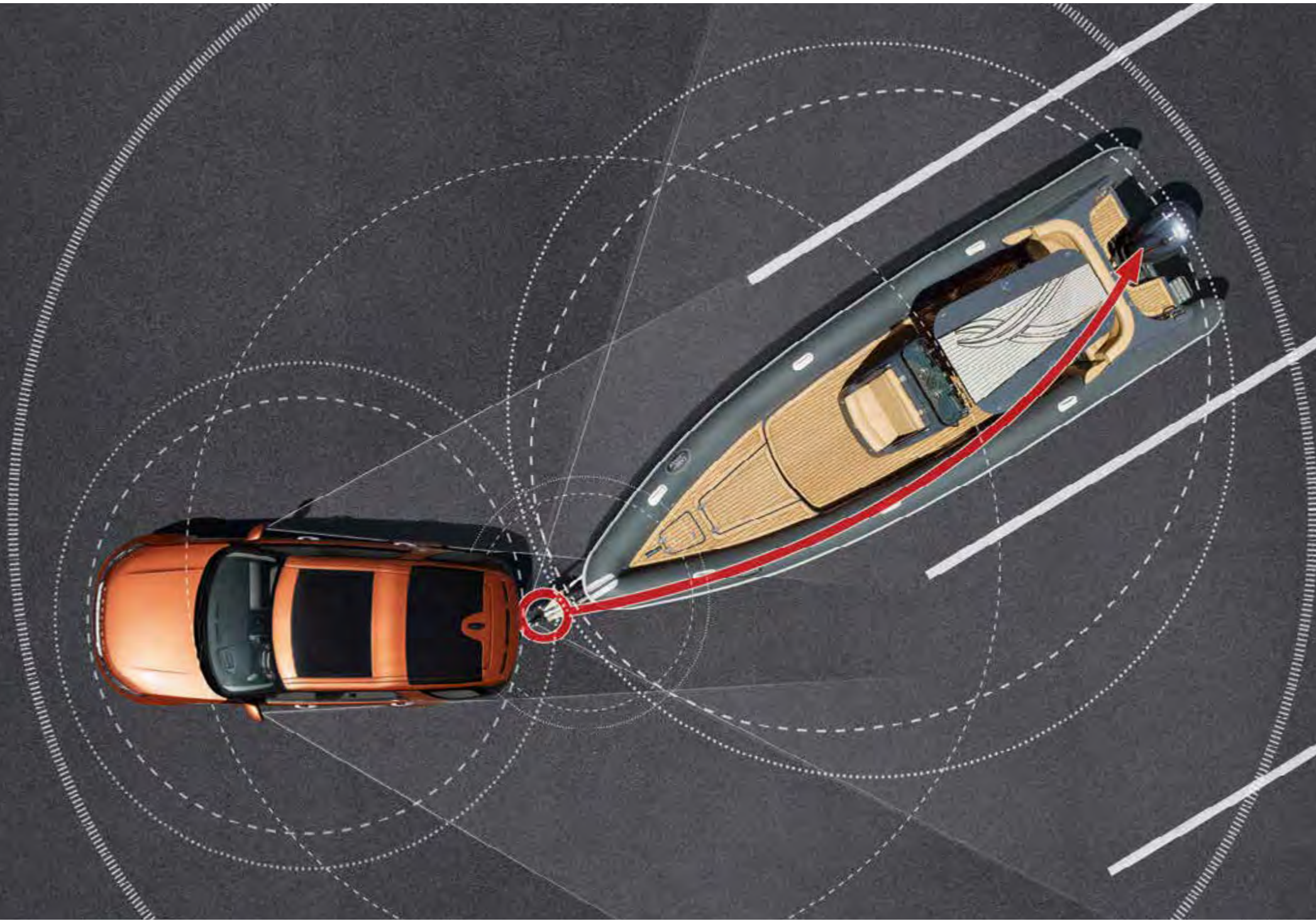

DESIGN

DRIVING TECHNOLOGY

DRIVER ASSISTANCE

CONNECTIVITY. ENTERTAINMENT.  
COMFORT

TRANSMISSION AND ENGINES

BODY AND CHASSIS

SAFETY

ENVIRONMENTAL





ABOVE & BEYOND

CONTENTS

SPECIFICATION

FIND A RETAILER

BUILD YOUR OWN



### ADVANCED TOW ASSIST

All-New Discovery features our most advanced trailer reversing aid to date. Advanced Tow Assist enables the driver to guide a trailer into position by simply following its trajectory on the main Touchscreen, and controlling its path using the rotary knob from the optional Terrain Response 2 system on the centre console. This is much more intuitive than using the steering wheel because within one field of vision it effectively steers the trailer along the desired path. This is rather than the opposing direction method which is what happens with conventional steering.

In addition to significantly reducing driver workload, the feature enhances manoeuvrability and safety when reversing, and will alert the driver when approaching a jack-knife situation.

Advanced Tow Assist is only available with Surround Camera, 360° Parking Aid and Terrain Response 2. A Land Rover approved tow bar is required in order to enable this feature.



### SURROUND CAMERA SYSTEM

For a complete, all-round view, the Surround Camera System incorporating T-Junction View helps to see everything clearly on the high-resolution full-colour Touchscreen. Using four digital cameras discreetly placed around the vehicle, the system provides an almost complete 360° view including a birds-eye overhead view. It is perfect for more complex driving assignments such as towing a yacht or a horsebox, as features such as Hitch and Load Assist work seamlessly through this system. Along with the ability to display several different views at the same time, this technology can also zoom and pan, ensuring objects and angles, normally below the line of sight, can be seen. Optional on S, SE and HSE. Available as standard on HSE Luxury.

### TRAILER STABILITY ASSIST

Trailer Stability Assist (TSA) monitors the vehicle to detect movements in the trailer and then uses selective braking to help correct potentially hazardous situations.

Towing regulations vary by market. Please ensure you comply with relevant legislation in your country. Vehicle shown is HSE Luxury in Namib Orange.

DESIGN

DRIVING TECHNOLOGY

DRIVER ASSISTANCE

CONNECTIVITY. ENTERTAINMENT. COMFORT

TRANSMISSION AND ENGINES

BODY AND CHASSIS

SAFETY

ENVIRONMENTAL



ABOVE & BEYOND

CONTENTS

SPECIFICATION

FIND A RETAILER

BUILD YOUR OWN

CONNECTIVITY. ENTERTAINMENT. COMFORT

# LAND ROVER INCONTROL



InControl is our suite of advanced technologies that links both you and your All-New Discovery to the wider world. Choose from two InControl infotainment systems: InControl Touch or InControl Touch Pro.

Get your life InControl at [landrover-me.com/incontrol](http://landrover-me.com/incontrol)

InControl features, options and their availability remain market and powertrain dependent – check with your Retailer for local market availability and full terms. Certain features require a Micro SIM with a suitable data contract which will require further subscription after the initial term advised by your Retailer. Mobile network connectivity cannot be guaranteed in all locations.

Image shown features InControl Apps which may not be available, please consult your local Land Rover retailer.

50

◀	DESIGN	DRIVING TECHNOLOGY	DRIVER ASSISTANCE	CONNECTIVITY. ENTERTAINMENT. COMFORT	▶
	TRANSMISSION AND ENGINES	BODY AND CHASSIS	SAFETY	ENVIRONMENTAL	



ABOVE & BEYOND

CONTENTS

SPECIFICATION

FIND A RETAILER

BUILD YOUR OWN



### INCONTROL TOUCH

#### AVAILABLE ON S AND SE MODELS



- 8" Touchscreen
- Land Rover Sound System 80W with 6 speakers (S models only)
- Land Rover Enhanced Sound System 250W with 10 speakers (optional on S models, standard on SE models).

#### OPTIONAL

- InControl Touch Navigation including Voice Recognition (optional on S models, standard on SE models)
- Digital Audio Broadcast (DAB) Radio\*.



### INCONTROL TOUCH PRO

#### AVAILABLE ON HSE AND HSE LUXURY MODELS



- 10" Touchscreen
- Meridian™ Sound System 380W with 10 speakers and subwoofer (HSE models only)
- Meridian™ Digital Surround Sound System 825W with 14 speakers and subwoofer (optional on HSE models, standard on HSE Luxury models)
- CD-DVD
- Digital Audio Broadcast (DAB) Radio\*
- Voice Recognition
- InControl Touch Pro Navigation.

#### OPTIONAL

- 10" Dual View Touchscreen
- Television\* (optional on HSE models, standard on HSE Luxury models)
- Rear Seat Entertainment (2 x 8" screens).

\*Market dependent.  
Features and their availability may differ by vehicle specification and market.  
Please see pages 86-101, or contact your nearest Land Rover Retailer, for more information.  
Vehicle shown left is HSE Luxury in Silicon Silver.

DESIGN

DRIVING TECHNOLOGY

DRIVER ASSISTANCE

CONNECTIVITY. ENTERTAINMENT.  
COMFORT

TRANSMISSION AND ENGINES

BODY AND CHASSIS

SAFETY

ENVIRONMENTAL



ABOVE & BEYOND

CONTENTS

SPECIFICATION

FIND A RETAILER

BUILD YOUR OWN

# GET YOUR LIFE INCONTROL

InControl Touch and InControl Touch Pro provide a wealth of information and entertainment. This intuitive InControl technology can help you find a parking space and stream your favourite music, making life more rewarding, hassle-free and enjoyable.



## STAYING FOCUSED

Our InControl Touch Pro Voice Recognition system understands normal spoken instructions. So you can concentrate on the road ahead without any distractions. Only available on HSE and HSE Luxury models.

InControl features, options and their availability remain market and powertrain dependent – check with your Retailer for local market availability and full terms. Certain features require the fitment of InControl Connect Pro and a Micro SIM with a suitable data contract which will require further subscription after the initial term advised by your Retailer. Apple Watch® is a registered trademark of Apple Inc., registered in the US and other countries. Mobile network connectivity cannot be guaranteed in all locations. InControl Apps will need to be downloaded from the Apple/Android Store, please contact your nearest Land Rover Retailer for further information.

DESIGN

DRIVING TECHNOLOGY

DRIVER ASSISTANCE

CONNECTIVITY. ENTERTAINMENT. COMFORT

TRANSMISSION AND ENGINES

BODY AND CHASSIS

SAFETY

ENVIRONMENTAL



ABOVE & BEYOND

CONTENTS

SPECIFICATION

FIND A RETAILER

BUILD YOUR OWN

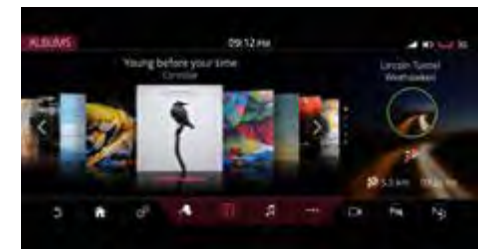
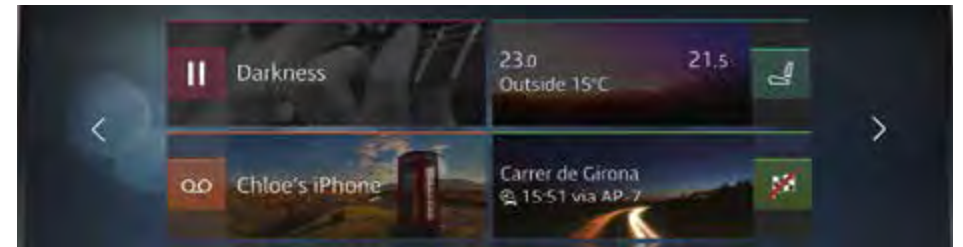

### FINDING PARKING

When you near your destination, InControl Touch Pro Navigation will suggest nearby parking from a database including space availability. With just one click, the car park is added and your route is updated. **Arrival Mode Parking** shows a 360° street level image to help you identify your destination. Only available on HSE and HSE Luxury models.

### MOVING FASTER

InControl Touch Pro brings you more processing power, thanks to a quad core processor plus an integrated Ethernet network.

Customisable homescreens let you arrange the screen, as you like, with up to four personalised homescreens and over 60 shortcuts. Only available on HSE and HSE Luxury models.

DESIGN

DRIVING TECHNOLOGY

DRIVER ASSISTANCE

CONNECTIVITY. ENTERTAINMENT.  
COMFORT

TRANSMISSION AND ENGINES

BODY AND CHASSIS

SAFETY

ENVIRONMENTAL



ABOVE & BEYOND

CONTENTS

SPECIFICATION

FIND A RETAILER

BUILD YOUR OWN



## AUDIO SYSTEMS

All-New Discovery has the option of four different audio systems to bring your music to life.

All-New Discovery S models feature the Land Rover 80W System as standard which provides an acoustic range through 6 speakers.

The Land Rover 250W Enhanced Sound System features 10 speakers and is standard on SE models and available as an optional upgrade on S models.

The 380W Meridian™ Sound System is standard on HSE models. Exceptional definition is achieved through 10 carefully arranged speakers and a dual channel subwoofer to deliver crystal clear highs and full, deep bass.

Also available as an optional upgrade on HSE and as standard on HSE Luxury, All-New Discovery features the Meridian Digital Surround Sound System which produces 825W through 14 speakers and a dual channel subwoofer.

This system also includes Meridian Trifield™ technology. This technology delivers the very best in world-class audio reproduction, bringing you closer to the original performance regardless of your position in the vehicle; everyone will feel and hear pure musical enjoyment. Dynamic Volume Control technology has been integrated on both Meridian systems to ensure that any unwanted noise detected in the cabin will be smoothly and automatically balanced out.



Meridian is a registered trademark of Meridian Audio Ltd. Trifield and the "three fields" device is a trademark of Trifield Productions Ltd. Interior shown left is HSE Luxury in Nimbus/Espresso with Meridian Surround Sound System and optional Rear Seat Entertainment. Vehicle shown right is HSE Luxury in Silicon Silver.

DESIGN

DRIVING TECHNOLOGY

DRIVER ASSISTANCE

CONNECTIVITY. ENTERTAINMENT. COMFORT

TRANSMISSION AND ENGINES

BODY AND CHASSIS

SAFETY

ENVIRONMENTAL



ABOVE & BEYOND

CONTENTS

SPECIFICATION

FIND A RETAILER

BUILD YOUR OWN

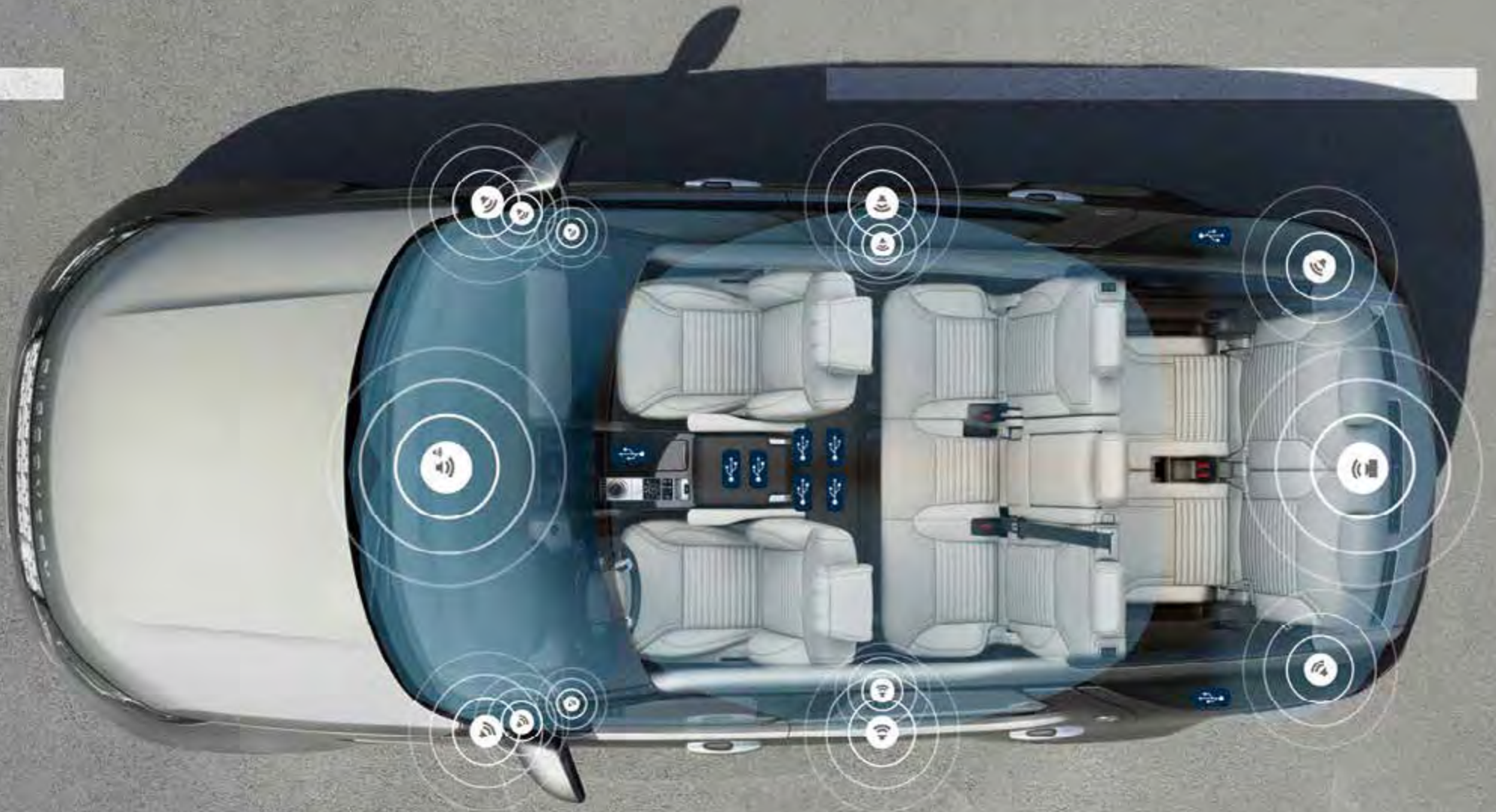

MERIDIAN DIGITAL SURROUND SOUND SYSTEM

825 WATTS

14 SPEAKERS

SUBWOOFER

USB CONNECTORS

CONNECTIVITY. ENTERTAINMENT. COMFORT 55

DESIGN

DRIVING TECHNOLOGY

DRIVER ASSISTANCE

CONNECTIVITY. ENTERTAINMENT.  
COMFORT

TRANSMISSION AND ENGINES

BODY AND CHASSIS

SAFETY

ENVIRONMENTAL



ABOVE & BEYOND

CONTENTS

SPECIFICATION

FIND A RETAILER

BUILD YOUR OWN



DESIGN

DRIVING TECHNOLOGY

DRIVER ASSISTANCE

CONNECTIVITY. ENTERTAINMENT.  
COMFORT

TRANSMISSION AND ENGINES

BODY AND CHASSIS

SAFETY

ENVIRONMENTAL





ABOVE & BEYOND

CONTENTS

SPECIFICATION

FIND A RETAILER

BUILD YOUR OWN

# CONNECTIVITY

## INTERIOR POWER POINTS

All-New Discovery is packed with the latest innovative technologies and USB charging points are available\* for all three rows of seats. So no matter where they sit, every single passenger can stay entertained; whether on their tablets, mobile phones or other devices.

## REAR SEAT ENTERTAINMENT

The optional Rear Seat Entertainment System provides two 8" screens built in to the rear of the front headrests. It includes 'Journey Status', a Navigation Summary screen which displays a pop-up for the rear occupant detailing the time and distance to destination. The system comes with a pair of WhiteFire® digital wireless headphones and HDMI, Mobile High-Definition Link and USB connections. This system is available as an option on HSE and HSE Luxury.



\*Availability is dependent upon vehicle specification. WhiteFire® is a registered trademark of Unwired Technology LLC and any use of such marks by Land Rover is under licence. Interior shown is HSE Luxury in Nimbus/Espresso.

DESIGN

DRIVING TECHNOLOGY

DRIVER ASSISTANCE

CONNECTIVITY. ENTERTAINMENT. COMFORT

TRANSMISSION AND ENGINES

BODY AND CHASSIS

SAFETY

ENVIRONMENTAL



ABOVE & BEYOND

CONTENTS

SPECIFICATION

FIND A RETAILER

BUILD YOUR OWN



◀	DESIGN	DRIVING TECHNOLOGY	DRIVER ASSISTANCE	CONNECTIVITY. ENTERTAINMENT. COMFORT	▶
	TRANSMISSION AND ENGINES	BODY AND CHASSIS	SAFETY	ENVIRONMENTAL	



ABOVE & BEYOND

CONTENTS

SPECIFICATION

FIND A RETAILER

BUILD YOUR OWN



## COMFORT FOR ALL

### AUTOMATIC ACCESS HEIGHT

It's always good to arrive in style, so that's why we've introduced Automatic Access Height\*. When you pull up at your chosen destination and the ignition is switched off or the seat belts are unclipped, the vehicle lowers by an initial 15mm. Then, as you open the door, it drops to its full access height of 40mm lower, making exit – and entry – that much more relaxed and elegant. The ride height automatically returns to its normal height as you pull away.

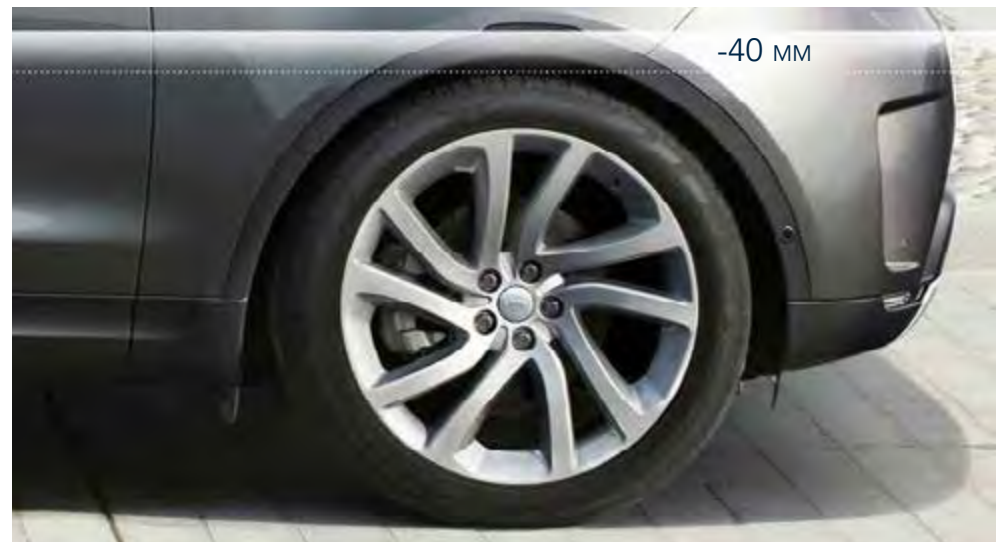
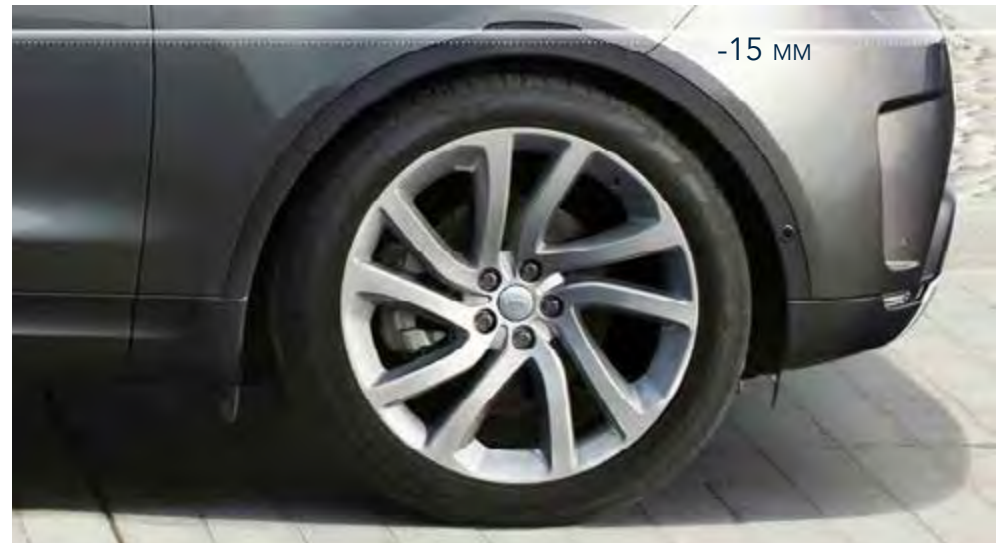

\*Standard with electronic air suspension.  
Vehicle shown is HSE Luxury in Silicon Silver.

DESIGN

DRIVING TECHNOLOGY

DRIVER ASSISTANCE

CONNECTIVITY. ENTERTAINMENT.  
COMFORT

TRANSMISSION AND ENGINES

BODY AND CHASSIS

SAFETY

ENVIRONMENTAL



ABOVE & BEYOND

CONTENTS

SPECIFICATION

FIND A RETAILER

BUILD YOUR OWN



DESIGN

DRIVING TECHNOLOGY

DRIVER ASSISTANCE

CONNECTIVITY. ENTERTAINMENT.  
COMFORT

TRANSMISSION AND ENGINES

BODY AND CHASSIS

SAFETY

ENVIRONMENTAL





ABOVE & BEYOND

CONTENTS

SPECIFICATION

FIND A RETAILER

BUILD YOUR OWN

# COMFORT FOR ALL

## PANORAMIC ROOF

The optional full glass fixed or front opening panoramic roof, on SE, HSE and HSE Luxury, enhances the sense of space in the vehicle's interior and floods it with natural light, benefiting all three rows where specified, as well as providing enhanced views of the surrounding environment.

Importantly, the toughened glass has a dark tint to maintain a comfortable temperature inside the cabin and protect occupants and the interior from the sun's rays. Powered interior blinds are also provided for added comfort when a panoramic roof is specified.

## CONFIGURABLE AMBIENT INTERIOR LIGHTING

New levels of ambient refinement and personalisation have been reached with the option of Configurable Ambient Interior Lighting, featuring as standard on HSE Luxury.

This feature allows you to vary the shade, changing the ambience of the cabin to suit your mood. There are five colours in total, ranging from Ice White through to Moon Light and Racing Red.

## CLIMATE CONTROL

To ensure that the interior is maintained at the perfect temperature, whatever the weather outside, All-New Discovery features a highly efficient Climate Control system. The result of an incredibly rigorous development programme, the system has been tested in real-world conditions in temperatures ranging from -40 to +50°C.

Four versions are available, ranging from Two-zone manual air conditioning or Two-zone automatic systems to a Three-zone automatic system, featuring separate temperature controls for driver, front passenger and rear seats. A premium Four-zone system is available as an option on HSE and HSE Luxury, which has separate climate controls for driver, front passenger and each side of the rear cabin.

With its independent heating and cooling capability, the Four-zone system offers a significant improvement in rear seat luxury, with multiple outlets at face and foot level.

## SEATING

Heated front and second row outboard seats are available as an option on S, SE and HSE. Optional first-in-class heated third row seats are also available on HSE.

No matter the temperature, optional heated and cooled front and second row outboard seats are also available on HSE and HSE Luxury. This enables both the driver and passenger to set their preferred temperature independently and is controlled via the Touchscreen.

For the ultimate in comfort, optional massage front seats are available on HSE Luxury allowing both the driver and front passenger to select individual programmes via the Touchscreen. Varying in intensity, there are five settings to choose from; each one delivers a soothing massage to improve both the driver and passenger's comfort.



Features and their availability may differ by vehicle specification and market. Please see pages 86-101, or contact your nearest Land Rover Retailer, for more information. Interior shown is HSE Luxury in Nimbus/Espresso.

CONNECTIVITY. ENTERTAINMENT. COMFORT 61

DESIGN

DRIVING TECHNOLOGY

DRIVER ASSISTANCE

CONNECTIVITY. ENTERTAINMENT. COMFORT

TRANSMISSION AND ENGINES

BODY AND CHASSIS

SAFETY

ENVIRONMENTAL



ABOVE & BEYOND

CONTENTS

SPECIFICATION

FIND A RETAILER

BUILD YOUR OWN



DESIGN

DRIVING TECHNOLOGY

DRIVER ASSISTANCE

CONNECTIVITY. ENTERTAINMENT.  
COMFORT

TRANSMISSION AND ENGINES

BODY AND CHASSIS

SAFETY

ENVIRONMENTAL



ABOVE & BEYOND

CONTENTS

SPECIFICATION

FIND A RETAILER

BUILD YOUR OWN



## ACTIVITY KEY

Activity Key makes living life to the full even easier. For extra convenience, you can wear the Activity Key if you prefer not to carry a key fob. The wristband is robust and fully waterproof, allowing you to enjoy a range of activities – from sailing to skydiving – and keep your car key with you. Activity Key has been tested in a number of extreme environments and is therefore capable in depths of up to 30m of water and in temperatures ranging from -40°C to +85°C.

You can use the Activity Key to lock and unlock your vehicle. When exiting, you can leave the conventional key fob in it and present the Activity Key to the tailgate to lock it. The conventional key fob is then automatically deactivated for security. Enjoy the Activity Key as an optional feature with SE, HSE and HSE Luxury, or as a Land Rover Retailer fit accessory.

Vehicle shown left is HSE Luxury in Silicon Silver.



CONNECTIVITY. ENTERTAINMENT. COMFORT 63

DESIGN

DRIVING TECHNOLOGY

DRIVER ASSISTANCE

CONNECTIVITY. ENTERTAINMENT.  
COMFORT

TRANSMISSION AND ENGINES

BODY AND CHASSIS

SAFETY

ENVIRONMENTAL



ABOVE & BEYOND

CONTENTS

SPECIFICATION

FIND A RETAILER

BUILD YOUR OWN



◀	DESIGN	DRIVING TECHNOLOGY	DRIVER ASSISTANCE	CONNECTIVITY. ENTERTAINMENT. COMFORT	▶
	TRANSMISSION AND ENGINES	BODY AND CHASSIS	SAFETY	ENVIRONMENTAL	





ABOVE & BEYOND

CONTENTS

SPECIFICATION

FIND A RETAILER

BUILD YOUR OWN

## TRANSMISSION AND ENGINES

# 8-SPEED AUTOMATIC TRANSMISSION

The petrol and diesel engines in All-New Discovery are paired with the advanced electronically controlled 8-speed Automatic Transmission, which has been tuned by Land Rover engineers to combine silky-smooth shifting with exceptionally rapid response. With eight closely spaced ratios, gear changes are almost imperceptible, with each shift completed in just 200 milliseconds.

Controls include steering wheel-mounted paddle shift as standard, enabling the driver to take control of gear shifting manually.

The optimised lightweight 8-speed Automatic Transmission is the perfect partner to the torque-rich petrol and diesel engines, and contributes to their notable fuel efficiency.

The transmission is tuned to select torque converter lock-up as early as possible to reduce slip and energy loss. Transmission Idle Control disengages 70 percent of the drive when the vehicle is stationary and the engine is idling in Drive, significantly reducing fuel consumption in urban conditions.

In cold conditions, the transmission selects a lower gear to promote fast warm up and get the engine up to its efficient operating temperature as soon as possible.

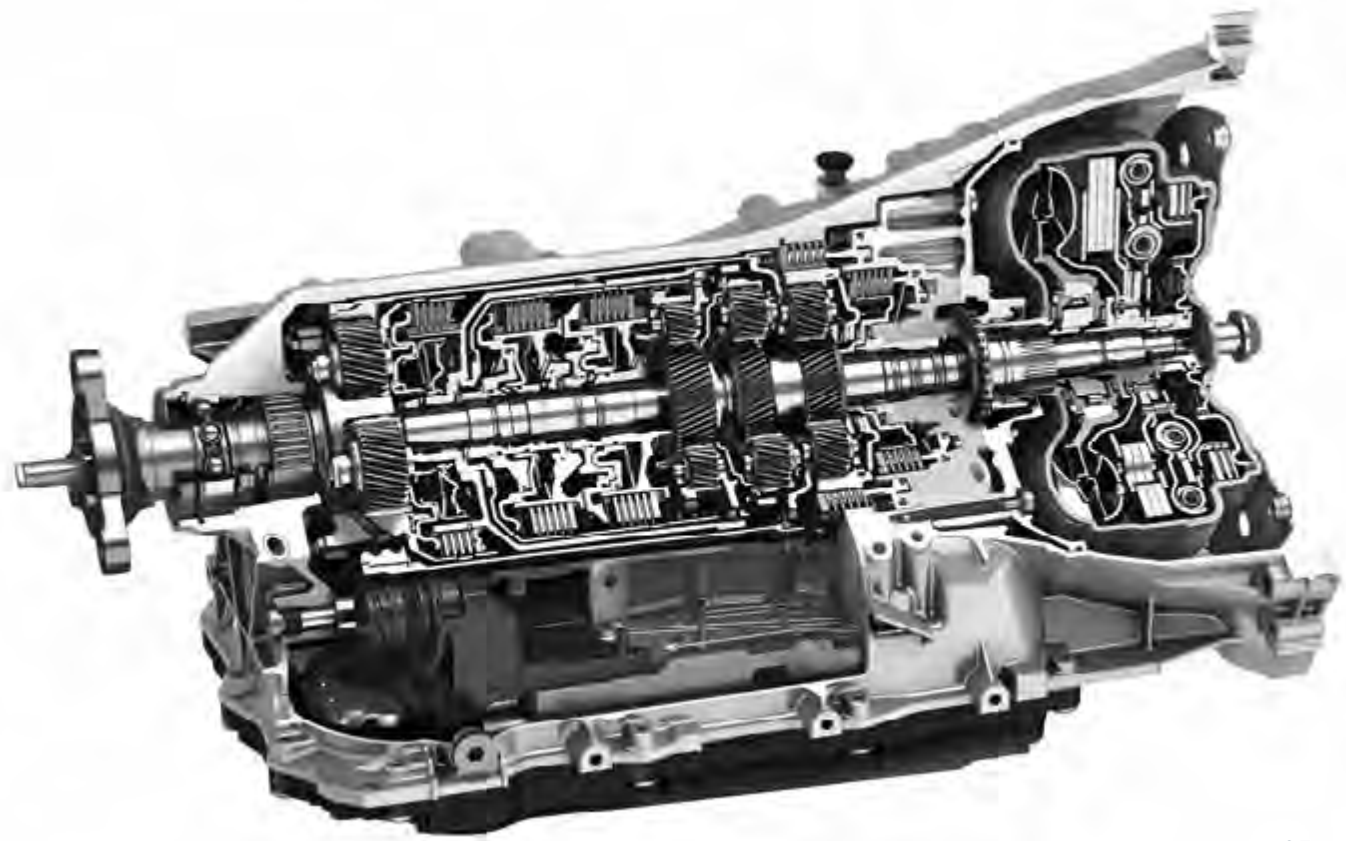

Vehicle shown left is HSE Luxury in Namib Orange.

DESIGN

DRIVING TECHNOLOGY

DRIVER ASSISTANCE

CONNECTIVITY. ENTERTAINMENT.  
COMFORT

TRANSMISSION AND ENGINES

BODY AND CHASSIS

SAFETY

ENVIRONMENTAL



ABOVE & BEYOND

CONTENTS

SPECIFICATION

FIND A RETAILER

BUILD YOUR OWN



## DIESEL ENGINE

### Td6 258PS

All-New Discovery features Land Rover's latest generation 3.0 litre Turbocharged Diesel engine. Its high-efficiency design utilises a single turbocharger and ceramic ball bearing technology to reduce friction for smooth, more immediate delivery of power at all engine speeds.

The engine uses an eight-nozzle low-flow injector designed for more precise injection and improved fuel atomisation. Delivering substantial maximum torque of 600Nm, the Td6 is capable of refined and smooth responsive performance.

The intake system with twin intercoolers ensures charge cooling. The engine also features the latest tandem solenoid intelligent Stop/Start system to reduce fuel consumption.

				<b>CO<sub>2</sub></b>	<b>CC</b>
	ACCELERATION 0-100KPH (SECONDS)	TOP SPEED (KPH)	FUEL CONSUMPTION (MPG)	CO <sub>2</sub> EMISSIONS (G/KM)	CAPACITY (CC)
3.0L Td6 Diesel 258PS	8.1	209	37.7	195	2,993

DESIGN

DRIVING TECHNOLOGY

DRIVER ASSISTANCE

CONNECTIVITY. ENTERTAINMENT.  
COMFORT

TRANSMISSION AND ENGINES

BODY AND CHASSIS

SAFETY

ENVIRONMENTAL



ABOVE & BEYOND

CONTENTS

SPECIFICATION

FIND A RETAILER

BUILD YOUR OWN



## PETROL ENGINE

### Si6 340PS

A Roots-type twin vortex supercharger is mounted in the 'V' between the two rows of cylinders for compact dimensions. Supercharging provides linear delivery of power and maximises responsiveness. This results in performance matching much larger engines, while optimising economy and reducing emissions.

The V6 engine also features dual independent variable cam timing to vary inlet and exhaust valve operation, working alongside lightweight pistons with ultra-low friction piston rings, for increased performance and efficiency. For added refinement there is a twin, contra-rotating balancer shaft system.



ACCELERATION 0-100KPH  
(SECONDS)



TOP SPEED  
(KPH)



FUEL CONSUMPTION  
(MPG)

CO<sub>2</sub>

CO<sub>2</sub> EMISSIONS  
(G/KM)

CC

CAPACITY  
(CC)

3.0L Si6 Petrol 340PS

7.1

215

26.0

254

2,995

DESIGN

DRIVING TECHNOLOGY

DRIVER ASSISTANCE

CONNECTIVITY. ENTERTAINMENT.  
COMFORT

TRANSMISSION AND ENGINES

BODY AND CHASSIS

SAFETY

ENVIRONMENTAL



ABOVE & BEYOND

CONTENTS

SPECIFICATION

FIND A RETAILER

BUILD YOUR OWN

# ENGINE PERFORMANCE

The two engines available on All-New Discovery have their own distinctive qualities. The torque and power curves below illustrate the differences between them. Use these to help inform your engine choice.

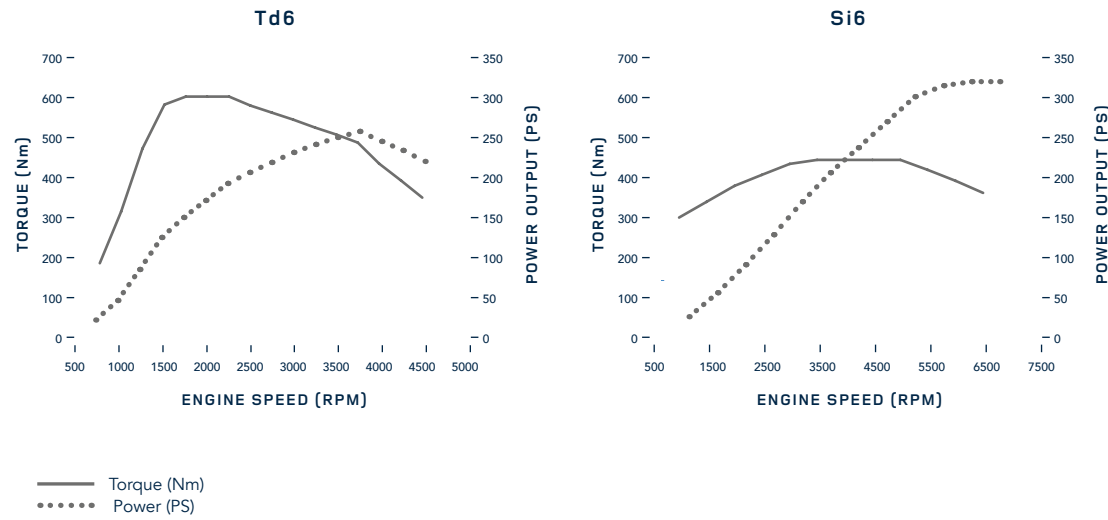

DESIGN

DRIVING TECHNOLOGY

DRIVER ASSISTANCE

CONNECTIVITY. ENTERTAINMENT. COMFORT

TRANSMISSION AND ENGINES

BODY AND CHASSIS

SAFETY

ENVIRONMENTAL



ABOVE & BEYOND

CONTENTS

SPECIFICATION

FIND A RETAILER

BUILD YOUR OWN

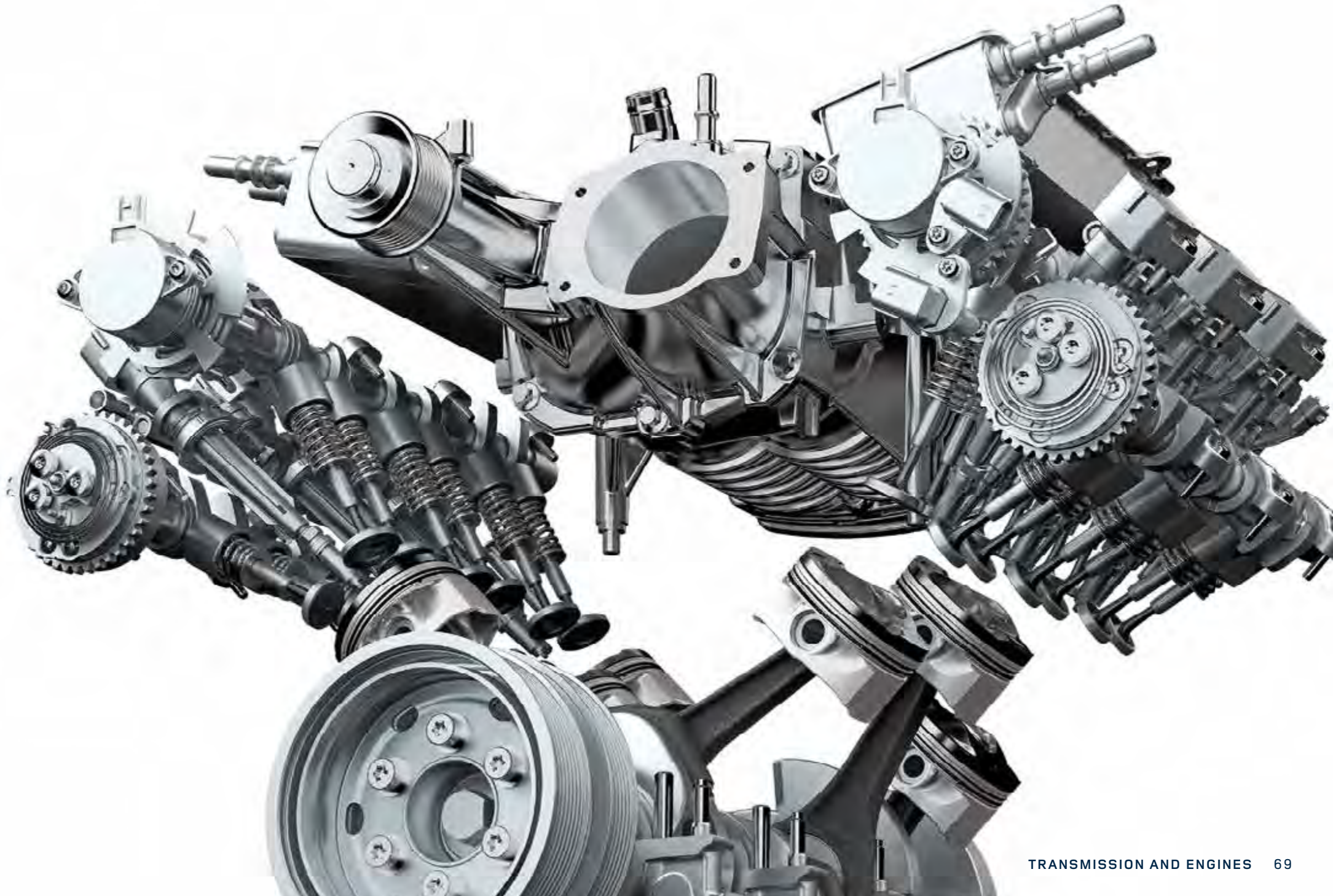

TRANSMISSION AND ENGINES 69

DESIGN

DRIVING TECHNOLOGY

DRIVER ASSISTANCE

CONNECTIVITY. ENTERTAINMENT.  
COMFORT

TRANSMISSION AND ENGINES

BODY AND CHASSIS

SAFETY

ENVIRONMENTAL



ABOVE & BEYOND

CONTENTS

SPECIFICATION

FIND A RETAILER

BUILD YOUR OWN

## BODY AND CHASSIS

# STRENGTH AND STABILITY

### LIGHTWEIGHT CONSTRUCTION

With a state-of-the-art aluminium monocoque body, All-New Discovery enjoys greater levels of performance, together with improved strength, sustainability and efficiency. At up to 480kg lighter than its predecessor\* – which equates to the average weight of five adults – it also benefits from a four-cylinder engine which delivers improved fuel economy. Added to which, thanks to utilising the latest in materials and build technologies, the vehicle can readily take the knocks and impacts associated with off-road driving.

### STATE-OF-THE-ART LIGHTWEIGHT SUSPENSION ARCHITECTURE

Another key factor in the driving capability of All-New Discovery is the lightweight suspension architecture.

Primarily constructed from lightweight aluminium components, the suspension is fully independent, with a wide-spaced double-wishbone design at the front and an advanced multi-link layout at the rear.

The suspension concept is specifically developed to maximise All-New Discovery's unrivalled breadth of capability, offering responsive and agile handling together with supreme ride quality and refinement.

To see the available suspension options on All-New Discovery please see page 35.

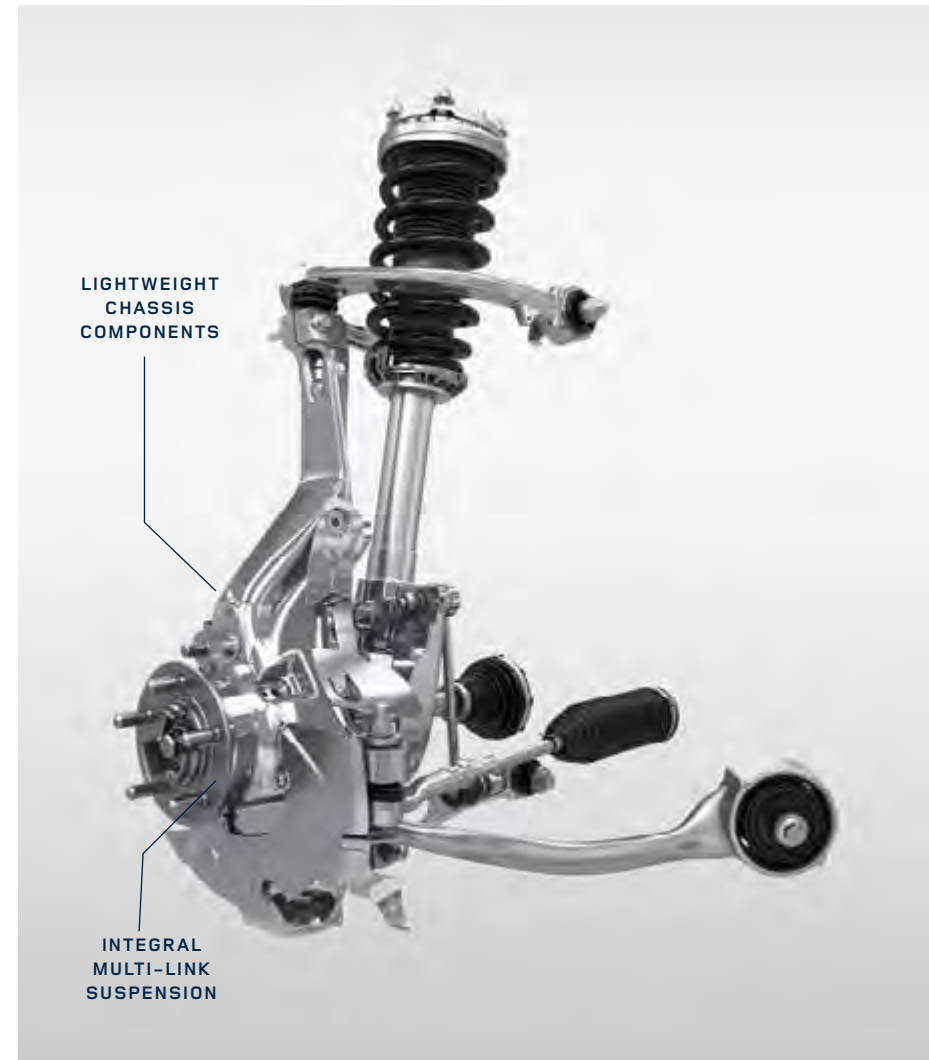



ABOVE & BEYOND

CONTENTS

SPECIFICATION

FIND A RETAILER

BUILD YOUR OWN



◀	DESIGN	DRIVING TECHNOLOGY	DRIVER ASSISTANCE	CONNECTIVITY. ENTERTAINMENT. COMFORT	▶
	TRANSMISSION AND ENGINES	BODY AND CHASSIS	SAFETY	ENVIRONMENTAL	



ABOVE & BEYOND

CONTENTS

SPECIFICATION

FIND A RETAILER

BUILD YOUR OWN

## SAFETY

### OCCUPANT SAFETY PROTECTION

All-New Discovery's optimised aluminium body structure protects occupants using an incredibly strong and stable safety cell. The crash structure is extensively optimised using computer simulation tools which allows engineers to conduct a significant number of 'virtual' crash tests long before physical prototypes are available.

The occupant safety package includes a comprehensive system of airbags and restraint systems including driver and passenger airbags, side curtain and thorax airbags and seat belt pretensioners\*.

All-New Discovery features 6 airbags as standard and 8 airbags when seven seats are specified.

### SEAT BELT PRETENSIONERS\*

Acting in conjunction with the airbags, they provide additional protection in the event of a front impact by reducing the forward movement of the occupant.

### ISOFIX POINTS

Up to four\* lower ISOFIX/i-Size mountings and associated top tether anchor points are featured on two rows of seats\*\*. These provide optimum safety for the fixing of child restraints. Please check local market for availability as standard.

### CURTAIN AIRBAGS WITH ROLLOVER SENSING

In the event of a side impact or rollover, these are deployed to provide greater protection against head injuries.

### DRIVING AND PARKING SAFETY AIDS

All-New Discovery has been designed with safety in mind. There are driving and parking safety aids available including Blind Spot Monitor and Reverse Traffic Detection, Park Assist and Surround Camera System. In addition, LED lights have been cleverly developed to wrap around the side of the vehicle to enable the indicators to be more visible to improve safety. Adaptive LED headlights, available as an option on SE, HSE and HSE Luxury, combine practicality with distinctive design. For more relaxed night-time driving, adaptive lighting varies the light cast ahead of the vehicle so that the beams follow the curve of the road.

To see the range of driving safety aids available please see pages 40-44.

To see the range of parking safety aids available please see page 45.

### PASSENGER SEAT BELT CHECK SYSTEM







ABOVE & BEYOND

CONTENTS

SPECIFICATION

FIND A RETAILER

BUILD YOUR OWN



SAFETY SYSTEMS

1 DRIVER AIRBAG

2 PASSENGER AIRBAG

3 CURTAIN AIRBAGS

4 SIDE THORAX AIRBAGS

5 AIRBAG DEACTIVATED SWITCH FOR FRONT PASSENGER

6 SEAT BELT PRETENSIONERS

7 SEAT BELT REMINDER

8 ISOFIX/I-SIZE POINTS

Vehicle shown above is HSE Luxury in Namib Orange with optional third row seats.

DESIGN

DRIVING TECHNOLOGY

DRIVER ASSISTANCE

CONNECTIVITY. ENTERTAINMENT. COMFORT

TRANSMISSION AND ENGINES

BODY AND CHASSIS

SAFETY

ENVIRONMENTAL



ABOVE & BEYOND

CONTENTS

SPECIFICATION

FIND A RETAILER

BUILD YOUR OWN



◀	DESIGN	DRIVING TECHNOLOGY	DRIVER ASSISTANCE	CONNECTIVITY. ENTERTAINMENT. COMFORT	▶
	TRANSMISSION AND ENGINES	BODY AND CHASSIS	SAFETY	ENVIRONMENTAL	



ABOVE & BEYOND

CONTENTS

SPECIFICATION

FIND A RETAILER

BUILD YOUR OWN



## ENVIRONMENTAL

# SUSTAINABILITY

All-New Discovery demonstrates Land Rover's continuing commitment to enhancing the sustainable performance of its products and operations and its determination to deliver vehicles that are both relevant and highly desirable. For example, as part of our commitment to reducing our environmental footprint, our Engine Manufacturing Centre in the UK features over 22,000 solar panels – the largest roof-mounted solar-array in the country.

All-New Discovery has been designed with a life cycle approach, aiming to use fewer resources, more environmentally sustainable materials and minimise the CO<sub>2</sub> emissions over the entire vehicle's life cycle. Its lightweight aluminium structure and optimised powertrains have reduced the environmental impact from material production and development, through to customer use.

All-New Discovery is built in state-of-the-art manufacturing facilities operating to some of the highest environmental standards anywhere in the world. By focusing on innovation and efficiency in every aspect of its processes, the company has achieved a 30 percent\* reduction in operational CO<sub>2</sub> per vehicle. Manufacturing waste to landfill has been reduced by 79 percent\* per vehicle and water use reduced by 34 percent\* per vehicle. Investment, commitment and focus in these areas continue to drive further efficiencies. Responsible resource management is integral to the company's long-term sustainability strategy.

## LIGHTWEIGHT AND SUSTAINABLE MATERIALS

All-New Discovery incorporates sustainable design with intelligent material choices. The use of aluminium in the body structure enables a 9 percent\*\* reduction in CO<sub>2</sub> emissions over its life cycle. Our closed-loop aluminium supply chain also ensures any surplus high-grade aluminium from our sheet stamping process is re-used. This reduces the need for primary aluminium production, conserving energy and reducing CO<sub>2</sub> emissions in material production whilst maintaining the highest quality aluminium for our vehicles.

Recycled materials have been used wherever possible, including up to 50 percent closed loop and recycled aluminium in the body. All-New Discovery HSE Luxury models use over 19kg of recycled plastics in the instrument panel, wheel arch liners and bumpers, helping to divert over 7,850 tonnes of plastic from landfill during the vehicle's production life. The vehicle is designed to meet a requirement of 85 percent Recyclability/Re-usability and 95 percent Recoverability at the end of the vehicle's life.

\*JLR Data 2014/15 vs. 2007

\*\*Based on Jaguar Land Rover Life Cycle Assessment results of Discovery TDV6 versus All-New Discovery Sd4 Ingenium. Vehicle shown is HSE Luxury in Namib Orange.

DESIGN

DRIVING TECHNOLOGY

DRIVER ASSISTANCE

CONNECTIVITY. ENTERTAINMENT.  
COMFORT

TRANSMISSION AND ENGINES

BODY AND CHASSIS

SAFETY

ENVIRONMENTAL



ABOVE & BEYOND

CONTENTS

SPECIFICATION

FIND A RETAILER

BUILD YOUR OWN

ALL-NEW DISCOVERY OFFERS YOU GREAT OPTIONS AND FLEXIBILITY TO PERSONALISE YOUR VEHICLE.

The following pages take you through a logical series of steps to make it suit your lifestyle. There are several choices: from selecting your engine and model to exterior and interior colours, wheels, finishes and those detailed touches to enable you to personalise your vehicle.

If you'd like to bring your options to life, go to our online configurator at [landrover-me.com](http://landrover-me.com)

78-79

1

**STEP 1  
CHOOSE YOUR ENGINE**

You can select from a petrol or diesel engine.

80-101

2

**STEP 2  
CHOOSE YOUR MODEL  
AND OPTIONS**

Compare the standard and optional features on each model. There's also a choice of pack options to personalise your vehicle.



ABOVE & BEYOND

CONTENTS

SPECIFICATION

FIND A RETAILER

BUILD YOUR OWN

102-105

3

**STEP 3  
CHOOSE YOUR COLOUR**

There's a wide range on offer to enable you to express yourself.

106-107

4

**STEP 4  
CHOOSE YOUR WHEELS**

There's a range of styles, each one designed to complement the bold exterior.

108-115

5

**STEP 5  
CHOOSE YOUR INTERIOR**

When you choose your interior, you can personalise it by selecting your optimum seat configuration, the ideal colour combination of seats, materials and your preferred finisher. These three considerations help celebrate and enhance a sense of your own style.

116-121

6

**STEP 6  
CHOOSE YOUR ACCESSORIES**

This range of stylish and practical accessories can be tailored to suit any lifestyle.

122-123

**TECHNICAL DETAILS**

Technical information and data for dimensions, performance and specifications.

Visit [landrover-me.com](http://landrover-me.com) to configure your vehicle online. 77

ENGINE

MODEL

COLOUR

WHEELS

INTERIOR

ACCESSORIES

TECHNICAL  
DETAILS



ABOVE & BEYOND

CONTENTS

SPECIFICATION

FIND A RETAILER

BUILD YOUR OWN

1



<	ENGINE	MODEL	COLOUR	WHEELS	INTERIOR	ACCESSORIES	TECHNICAL DETAILS	>
---	--------	-------	--------	--------	----------	-------------	-------------------	---



ABOVE & BEYOND

CONTENTS

SPECIFICATION

FIND A RETAILER

BUILD YOUR OWN

**STEP 1  
CHOOSE YOUR ENGINE**

## DRIVELINE, ENGINE PERFORMANCE AND FUEL ECONOMY

All-New Discovery delivers strong performance from its advanced line-up of refined and fuel-efficient petrol and diesel engines, which are paired with a smooth and responsive 8-speed Automatic Transmission.

	DIESEL		PETROL	
	3.0L Td6		3.0L Si6	
	AUTOMATIC		AUTOMATIC	
	258		340	
<b>POWER (PS)</b>	4WD		4WD	
Driveline	4WD		4WD	
Power kW (PS) / rpm	190 (258) / 3,750		250 (340) / 6,500	
Torque (Nm / rpm)	600 / 1,750-2,250		450 / 3,500-5,000	
Capacity (cc)	2,993		2,995	
No. of cylinders	6		6	
Valves per cylinder	4		4	
Cylinder layout	Longitudinal V6		Longitudinal V6	
<b>FUEL ECONOMY*</b>				
Seating	5 / 7		5 / 7	
Urban mpg	32.9 / 32.9		19.9 / 19.9	
Extra Urban mpg	41.5 / 41.5		30.4 / 30.4	
Combined mpg	37.7 / 37.7		26.0 / 26.0	
CO <sub>2</sub> Urban emissions g/km	225 / 225		326 / 326	
CO <sub>2</sub> Extra Urban emissions g/km	178 / 178		213 / 213	
CO <sub>2</sub> Combined emissions g/km	195 / 195		254 / 254	

## MODELS BY ENGINE

	S	SE	HSE	HSE LUXURY
3.0L Td6 Diesel 258PS	■	■	■	■
3.0L Si6 Petrol 340PS	■	■	■	■

■ Standard.

Official EU test figures. For comparison purposes only. Real world figures may differ. Low fuel warning at 9 litres approximately. Vehicle shown left is HSE Luxury in Namib Orange.

Visit [landrover-me.com](http://landrover-me.com) to configure your vehicle online. 79

ENGINE

MODEL

COLOUR

WHEELS

INTERIOR

ACCESSORIES

TECHNICAL  
DETAILS



ABOVE & BEYOND

CONTENTS

SPECIFICATION

FIND A RETAILER

BUILD YOUR OWN

# 2

## EACH MODEL HAS A CHOICE OF UNIQUE FEATURES

This guide will help you to select your ideal All-New Discovery. On the following pages you'll see the standard features for each model.

### DISCOVERY S



- Brunel grille with Narvik Black surround
- Narvik Black fender vents
- Body-coloured door handles
- Brunel Discovery script (bonnet and tailgate)
- Heated door mirrors
- Halogen headlights
- 19" 5 split-spoke 'Style 5021' alloy wheels
- Seat Pack 1 – cloth seats and 8-way manual front seats
- Land Rover Sound System 80W with 6 speakers (InControl Touch)
- Air Conditioning
- Ebony Finisher.

### DISCOVERY SE



- Contents of S, plus:**
- Interior Mood Lighting – Door Signature
  - Rain sensing windscreen wipers
  - Automatic headlights
  - Front Parking Aid
  - Rear Parking Aid
  - Rear View Camera.
- Replaces S content:**
- Dark Atlas grille with Narvik Black surround
  - Dark Atlas fender vent ingots with Narvik Black surround
  - Power fold, heated door mirrors
  - LED headlights with LED signature
  - Two-zone Climate Control
  - Gloss Black Finisher
  - Land Rover Enhanced Sound System 250W with 10 speakers (InControl Touch)
  - Seat Pack 2 – Grained leather seats and 12-way (10-way electric) front seats.

\*Whilst Land Rover continues to work closely with its partners to develop TV standards worldwide, we cannot guarantee the TV feature in all countries at all times. Standard features and their applicability may vary by engine and by market. To view the full list of standard and optional features available on each All-New Discovery derivative please see the accompanying Specification and Price Guide or visit [landrover-me.com](http://landrover-me.com)





ABOVE & BEYOND

CONTENTS

SPECIFICATION

FIND A RETAILER

BUILD YOUR OWN

## STEP 2 CHOOSE YOUR MODEL AND OPTIONS

### DISCOVERY HSE



**Contents of SE, plus:**

- Front fog lights
- Signature hi-line tail lights
- Auto High Beam Assist (AHBA)
- Keyless Entry
- Powered inner tailgate
- Powered tailgate.

**Replaces SE content:**

- Atlas grille with Narvik Black surround
- Atlas fender vent ingots with Narvik Black surround
- 20" 5 split-spoke 'Style 5011' alloy wheels
- Meridian™ Sound System 380W with 10 speakers plus subwoofer (InControl Touch Pro)
- Seat Pack 3 – grained leather seats and 12-way (10-way electric) front seats with driver seat memory
- Natural Shadow Oak Veneer
- Three-zone Climate Control
- Interior Mood Lighting – Door Signature and Door Bins.

### DISCOVERY HSE LUXURY



**Contents of HSE, plus:**

- Infrared reflective windscreen
- Electric sunroof (tilt/slide front glass) with fixed rear glass pano (including power blinds)
- Winged headrests
- Climate front seats
- Premium carpet mats
- Front centre cooled console compartment
- Digital TV\*
- Gesture tailgate
- Surround Camera System.

**Replaces HSE content:**

- Atlas Discovery script (bonnet and tailgate)
- Chrome door handles
- 20" 10 split-spoke 'Style 1011' alloy wheels
- Meridian™ Digital Surround Sound System 825W with 14 speakers plus subwoofer (InControl Touch Pro)
- Configurable Ambient Interior Lighting
- Seat Pack 4 – Windsor leather seats with 16-way (14-way electric) front seats with driver seat memory.

Visit [landrover-me.com](http://landrover-me.com) to configure your vehicle online.

ENGINE

MODEL

COLOUR

WHEELS

INTERIOR

ACCESSORIES

TECHNICAL  
DETAILS



ABOVE & BEYOND

CONTENTS

SPECIFICATION

FIND A RETAILER

BUILD YOUR OWN



82

<	ENGINE	MODEL	COLOUR	WHEELS	INTERIOR	ACCESSORIES	TECHNICAL DETAILS	>
---	--------	-------	--------	--------	----------	-------------	-------------------	---



ABOVE & BEYOND

CONTENTS

SPECIFICATION

FIND A RETAILER

BUILD YOUR OWN

## STEP 2 CHOOSE YOUR MODEL AND OPTIONS

### PERSONALISING YOUR ALL-NEW DISCOVERY

#### DYNAMIC DESIGN PACK

Bold. Arresting. This option, available on HSE and HSE Luxury models, allows you to enhance All-New Discovery's recognisable design cues even further.

A unique front bumper design gives the exterior a more sporty feel. 21" Satin Dark Grey or 22" Satin Dark Grey Diamond Turned finish alloy wheels and a choice of Black or Grey contrast roof\* add to the vehicle's undoubted presence. Narvik Black features include the unique mesh grille, fender vents, Discovery bonnet and tailgate script, tailgate appliqué, and mirror caps to further enhance the appearance.

Carefully selected interior touches add to the impact of the three colourway choices available in Windsor leather, with premium details including contrast stitching and micropiping. Dark Brushed Aluminium centre stack side rails and the distinctive Titanium Mesh trim finisher complete the look. The interior is further enhanced with bespoke premium carpet mats, Bright finish paddle shift and aluminium sport pedals. Please refer to page 97 for Dynamic Design Pack options.



Rear bumper finisher



Satin Dark Grey Diamond Turned finish alloy wheels



Ebony seat with Nimbus contrast micropiping

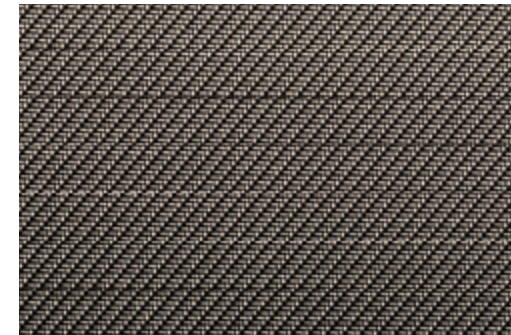

Titanium Mesh trim finisher

\*Contrast roof colour is dependent on exterior paint colour. Please refer to pages 102-105 for availability. Vehicle shown left is HSE Luxury in Namib Orange with Dynamic Design Pack, featuring 22" Satin Dark Grey Diamond Turned finish alloy wheels and additional optional features.

Visit [landrover-me.com](http://landrover-me.com) to configure your vehicle online. 83

ENGINE

MODEL

COLOUR

WHEELS

INTERIOR

ACCESSORIES

TECHNICAL  
DETAILS



ABOVE & BEYOND

CONTENTS

SPECIFICATION

FIND A RETAILER

BUILD YOUR OWN



<	ENGINE	MODEL	COLOUR	WHEELS	INTERIOR	ACCESSORIES	TECHNICAL DETAILS	>
---	--------	-------	--------	--------	----------	-------------	-------------------	---



ABOVE & BEYOND

CONTENTS

SPECIFICATION

FIND A RETAILER

BUILD YOUR OWN

## STEP 2 CHOOSE YOUR MODEL AND OPTIONS

### PERSONALISING YOUR ALL-NEW DISCOVERY

#### BLACK DESIGN PACK

For a striking effect All-New Discovery can be personalised with the optional Black Design Pack on SE, HSE and HSE Luxury models. The Black Design Pack is available with all exterior colour options and includes a Narvik Black grille, fender vents and mirror caps, with Black 'DISCOVERY' bonnet and tailgate script. A choice of 20", 21" and 22" Gloss Black alloy wheels is available\*.



Narvik Black grille



Gloss Black alloy wheels



Narvik Black mirror caps



Narvik Black fender vents

\*22" wheels only available on HSE and HSE Luxury models.  
Vehicle shown left is HSE Luxury in Silicon Silver with Black Design Pack, featuring 22" Gloss Black finish alloy wheels and additional optional features.

Visit [landrover-me.com](http://landrover-me.com) to configure your vehicle online. 85

ENGINE

MODEL

COLOUR

WHEELS

INTERIOR

ACCESSORIES

TECHNICAL  
DETAILS



ABOVE & BEYOND

CONTENTS

SPECIFICATION

FIND A RETAILER

BUILD YOUR OWN

## STANDARD AND OPTIONAL FEATURES

### Engine Transmission, Suspension and Driving Dynamics

	OPTION CODE	3.0L Td6	3.0L Si6	DESCRIPTION
8-speed Automatic Transmission		■	■	Please refer to page 65.
Single-speed transfer box (high range only)		■ (1)	–	
Twin-speed transfer box (high/low range)	043BF	■ (2)	■	Please refer to page 35.
Coil suspension (5 seat only)		■ (1)	–	Please refer to page 35.
Electronic air suspension		■ (2)	■	Please refer to page 35.
Active rear locking differential	027DB	□ (3)	□	Please refer to page 35.
Manual centre differential		■ (1)	–	Standard fitment with single-speed transfer box (high range) only.
Electronic centre differential		■ (2)	■	Standard fitment with twin-speed transfer box (high/low range) only.
Terrain Response 4-mode		■ (1)	–	Please refer to page 31.
Terrain Response 5-mode (including Rock Crawl mode)		■ (2)	■	Please refer to page 31.
Terrain Response 2	088IA	□ (3)	□	Please refer to page 31.
All Terrain Progress Control (ATPC) (4)	095CB	□ (3)	□	Please refer to page 31.
Hill Descent Control (HDC)		■	■	Please refer to page 32.
Anti-lock Braking System (ABS)		■	■	
Electric Power Assisted Steering (EPAS)		■	■	Please refer to page 38.
Electronic Traction Control (ETC)		■	■	
Hill Start Assist		■	■	Please refer to page 32.
Dynamic Stability Control (DSC)		■	■	Please refer to page 38.
Roll Stability Control (RSC)		■	■	
Electric Parking Brake (EPB)		■	■	
Emergency Brake Assist (EBA)		■	■	
Electronic Brake-Force Distribution (EBD)		■	■	
Gradient Acceleration Control (GAC)		■	■	
Trip computer		■	■	
Emergency stop signal		■	■	

■ Standard □ Optional – Not Available.

(1) Standard fitment on Td6 S models only (2) Standard fitment on Td6 SE, HSE and HSE Luxury models only. Optional on Td6 S model (3) Not available on S models (4) Only available as part of Capability Plus Pack. Features and their availability may differ by vehicle specification and market. Please see pages 86-101, or contact your nearest Land Rover Retailer, for more information.



ABOVE & BEYOND

CONTENTS

SPECIFICATION

FIND A RETAILER

BUILD YOUR OWN

**STEP 2**  
**CHOOSE YOUR MODEL AND OPTIONS**

**Exterior Features and Finishers**

	OPTION CODE	S	SE	HSE	HSE LUXURY	DESCRIPTION
<b>ROOF AND EXTERIOR DESIGN</b>						
Black contrast roof (5)	080AN	-	-	□	□	Please refer to pages 102-105.
Grey contrast roof (5)	080EE	-	-	□	□	Please refer to pages 102-105.
Electric sunroof (tilt/slide front glass) with fixed rear glass pano (including power blinds)	041CR	-	□	□	■	Includes rear reading lights. Please refer to page 61.
Fixed panoramic roof (including manual blinds)	041CS	-	□	□	△	Includes rear reading lights. Please refer to page 61.
Black roof rails	060AW	□	□	□	□	
Silver roof rails	060BC	□	□	□	□	
Brunel grille with Narvik Black grille surround		■	-	-	-	
Narvik Black fender vents (6)		■	-	-	-	
Dark Atlas grille with Narvik Black surround		-	■	-	-	
Dark Atlas fender vent ingots with Narvik Black surround		-	■	-	-	
Atlas grille with Narvik Black surround		-	-	■	■	
Atlas fender vent ingots with Narvik Black surround		-	-	■	■	
Body-coloured door handles	080AW	■	■	■	□ (7)	
Body-coloured door handles with Noble surround		-	-	-	■	
Gloss Black tailgate finisher		■	■	■	■	
Brunel Discovery script (bonnet and tailgate)		■	■	■	-	
Atlas Discovery script (bonnet and tailgate)		-	-	-	■	
Anthracite tow eye covers		■	-	-	-	
Dark Techno Silver tow eye covers (6)		-	■	-	-	
White Silver tow eye covers		-	-	■	■	

■ Standard □ Optional △ No Cost Option - Not Available.

(5) Only available as part of Dynamic Design Packs. Availability varies dependent upon exterior paint colour. Please refer to pages 102-105. Not available with Td4 Ingenium engine (6) Standard as part of Black Design Pack

(7) Standard as part of Dynamic Design Packs and Black Design Pack. Replaces body-coloured door handles with Noble surround.

Visit [landrover-me.com](http://landrover-me.com) to configure your vehicle online. 87

ENGINE

MODEL

COLOUR

WHEELS

INTERIOR

ACCESSORIES

TECHNICAL  
DETAILS



ABOVE & BEYOND

CONTENTS

SPECIFICATION

FIND A RETAILER

BUILD YOUR OWN

## STANDARD AND OPTIONAL FEATURES

### Exterior Features and Finishers (continued)

	OPTION CODE	S	SE	HSE	HSE LUXURY	DESCRIPTION
<b>GLASS AND EXTERIOR MIRRORS</b>						
Acoustic laminated windscreen		■	■	■	■	
Heated rear window with rear wash wiper		■	■	■	■	
Door puddle lights		■	■	■	■	
Heated windscreen	040AK	□	□	□	□	
Heated washer jets	040AQ	□	□	□	□	
Infrared reflective windscreen	047AP	□	□	□	■	This is a fine metallic coating made up of several layers of titanium and silver to create an infrared reflective coating, keeping the vehicle cooler in hot conditions.
Privacy glass	047AB	□	□	□	□	Provides increased privacy for rear passengers by restricting vision into the cabin.
Rain sensing windscreen wipers	030CQ	□ (1)	■	■	■	
Heated door mirrors		■	-	-	-	
Power fold, heated door mirrors with approach lights	030NB	□	■	■	■	
Auto-dimming exterior mirrors (2)	031EB	-	□	□	□	
<b>TOWING*</b>						
Trailer Stability Assist (TSA) (3)		■	■	■	■	Please refer to page 49.
Front and rear recovery hooks		■	■	■	■	
Advanced Tow Assist (3) (4)	062CE	-	□	□	□	Please refer to page 49.
Detachable tow bar	028GA	□	□	□	□	
Electrically deployable tow bar	028GC	-	□	□	□	Please refer to page 46.

■ Standard □ Optional - Not Available.

\*Towing regulations and feature applicability vary by market. Please ensure you comply with relevant legislation in your country.

(1) Option only available on S models with automatic headlights (2) Option only available with auto-dimming interior rear view mirror and Blind Spot Monitor (3) A Land Rover approved tow bar is required in order to enable this feature

(4) Only available with twin-speed transfer box (high/low range), electronic air suspension, All Terrain Progress Control (ATPC), Surround Camera System, 360° Parking Aid and Terrain Response 2.

Features and their availability may differ by vehicle specification and market. Please see pages 86-101, or contact your nearest Land Rover Retailer, for more information.





ABOVE & BEYOND

CONTENTS

SPECIFICATION

FIND A RETAILER

BUILD YOUR OWN

**STEP 2**  
**CHOOSE YOUR MODEL AND OPTIONS**

**Exterior Features and Finishers (continued)**

	OPTION CODE	S	SE	HSE	HSE LUXURY	DESCRIPTION
<b>WHEEL FEATURES</b>						
Reduced section alloy spare wheel	029QQ	<input type="checkbox"/>	<input type="checkbox"/>	<input type="checkbox"/>	<input type="checkbox"/>	Includes toolkit.
Full size spare wheel		<input checked="" type="checkbox"/>	<input checked="" type="checkbox"/>	<input checked="" type="checkbox"/>	<input checked="" type="checkbox"/>	Includes toolkit.
Tyre Pressure Monitoring System (TPMS)	062AD	<input type="checkbox"/>	<input type="checkbox"/>	<input type="checkbox"/>	<input type="checkbox"/>	
Locking wheel nuts	055AC	<input type="checkbox"/>	<input type="checkbox"/>	<input type="checkbox"/>	<input type="checkbox"/>	
<b>HEADLIGHTS AND LIGHTING</b>						
Daytime Running Lights (DRL)		<input checked="" type="checkbox"/>	<input checked="" type="checkbox"/>	<input checked="" type="checkbox"/>	<input checked="" type="checkbox"/>	
Front fog lights	064AP	<input type="checkbox"/>	<input type="checkbox"/>	<input checked="" type="checkbox"/>	<input checked="" type="checkbox"/>	
Halogen headlights		<input checked="" type="checkbox"/>	-	-	-	
LED headlights with LED signature	064GK	-	<input checked="" type="checkbox"/>	<input checked="" type="checkbox"/>	<input checked="" type="checkbox"/>	Signature design LED lights combine distinctive design with highly practical capabilities. Includes headlight power wash.
Adaptive LED headlights with LED signature	064GJ	-	<input type="checkbox"/> (5)	<input type="checkbox"/>	<input type="checkbox"/>	Adaptive LED headlights swivel to follow the road, while static cornering lights illuminate the kerbside area in tight bends to give the driver a greater sense of confidence during night-time driving.
Signature hi-line tail lights		-	<input type="checkbox"/> (6)	<input checked="" type="checkbox"/>	<input checked="" type="checkbox"/>	
Automatic headlights	064CY	<input type="checkbox"/> (7)	<input checked="" type="checkbox"/>	<input checked="" type="checkbox"/>	<input checked="" type="checkbox"/>	
Auto High Beam Assist (AHBA)	030NT	-	<input type="checkbox"/>	<input checked="" type="checkbox"/>	<input checked="" type="checkbox"/>	Automatic High Beam Assist headlights automatically dip when traffic is detected, reverting when vehicles have passed.
<b>PAINT</b>						
Solid paint – Fuji White		<input checked="" type="checkbox"/>	<input checked="" type="checkbox"/>	<input checked="" type="checkbox"/>	<input checked="" type="checkbox"/>	Please refer to pages 102-105.
Metallic paint		<input type="checkbox"/>	<input type="checkbox"/>	<input type="checkbox"/>	<input type="checkbox"/>	Please refer to pages 102-105.
Premium metallic paint		<input type="checkbox"/>	<input type="checkbox"/>	<input type="checkbox"/>	<input type="checkbox"/>	Please refer to pages 102-105.

■ Standard □ Optional – Not Available.

(5) Only available with signature hi-line tail lights (6) Standard when fitted with Adaptive LED headlights (7) Only available on S models with rain sensing windscreen wipers.

Visit [landrover-me.com](http://landrover-me.com) to configure your vehicle online. 89

ENGINE

MODEL

COLOUR

WHEELS

INTERIOR

ACCESSORIES

TECHNICAL  
DETAILS



ABOVE & BEYOND

CONTENTS

SPECIFICATION

FIND A RETAILER

BUILD YOUR OWN

## STANDARD AND OPTIONAL FEATURES

### Seating, Interior Features and Finishers

	OPTION CODE	S	SE	HSE	HSE LUXURY	DESCRIPTION
<b>SEATS</b>						
5 seats		■	■	■	■	
Third row seats (1)	033BI	□	□	□	□	Please refer to page 19.
Powered third row seats (2)	033QB	-	-	□	□	Please refer to page 19.
60:40 load through rear seats with manual slide and recline		■	■	■	■	Please refer to page 108.
Electrically reclining rear seats (2)	033IR	-	-	□	□	Please refer to page 108.
Winged front headrests	033QU	-	-	□(3)	■	
Seat Pack 1 – consists of cloth seats and 8-way manual front seats		■	-	-	-	
Seat Pack 2 – consists of grained leather seats and 12-way (10-way electric) front seats	033VJ	-	■	-	-	
Seat Pack 3 – consists of grained leather seats and 12-way (10-way electric) front seats with driver seat memory		-	-	■	-	
Seat Pack 4 – consists of Windsor leather seats with 16-way (14-way electric) front seats with driver seat memory	033VL	-	-	□	■	
Seat Pack 5 – consists of Windsor leather seats with 16-way electric front seats with driver seat memory and massage function (4)	033VN	-	-	-	□	
Heated front seats (5)	033BV	□	□	□	-	Please refer to page 61.
Heated front and rear seats (5)	033EQ	□	□	□	-	Please refer to page 61.
Heated front, rear and third row seats (6)	033BH	-	-	□	-	Please refer to page 61.
Heated and cooled front seats	033GP	-	-	□	■	Please refer to page 61.
Heated and cooled front and rear seats (7)	033IN	-	-	□	□	Please refer to page 61.
Heated and cooled front seats with heated rear seats (7)	033GQ	-	-	□	□	
Heated and cooled front seats with heated rear and third row seats (7) (8)	033BK	-	-	□	□	
Heated and cooled front and rear seats with heated third row seats (7) (8)	033BL	-	-	□	□	Please refer to page 61.
Intelligent Seat Fold (8)	095HB	-	-	□	□	Please refer to page 19.

■ Standard □ Optional - Not Available.

(1) Must be fitted with powered tailgate or powered gesture tailgate. Not available with coil suspension (2) Only available with third row seats (3) Only available on HSE models with Rear Seat Entertainment

(4) Only available with heated and cooled front seats (5) Only available with Two-zone Climate Control on S models and heated front windscreen (6) Only available with third row seats or powered third row seats, heated front windscreen, heated washer jets and heated steering wheel (7) Only available with Seat Pack 4 on HSE models and Seat Pack 4 or 5 on HSE Luxury models (8) Only available with third row seats, electrically reclining rear seats and powered third row seats.

Features and their availability may differ by vehicle specification and market. Please see pages 86-101, or contact your nearest Land Rover Retailer, for more information.



ABOVE & BEYOND

CONTENTS

SPECIFICATION

FIND A RETAILER

BUILD YOUR OWN

**STEP 2**  
**CHOOSE YOUR MODEL AND OPTIONS**

**Seating, Interior Features and Finishers (continued)**

	OPTION CODE	S	SE	HSE	HSE LUXURY	DESCRIPTION
<b>STEERING WHEEL</b>						
Manually adjustable steering column (4-way)		■	■	-	-	
Power adjustable steering column (4-way)		-	-	■	■	
Premium leather steering wheel with multi-functional controls and gearshift paddles		■	■	■	■	
Heated steering wheel	032DV	□	□	□	□	A heated leather steering wheel is available for the ultimate driver comfort.
<b>INTERIOR FINISHERS</b>						
Ebony finisher		■	-	-	-	Please refer to page 115.
Gloss Black finisher		-	■	-	-	Please refer to page 115.
Dark Satin Brushed Aluminium trim finisher	088HP	-	□	□	□	Please refer to page 115.
Natural Shadow Oak veneer	088JU	-	□	■	■	Please refer to page 115.
Natural Charcoal Oak veneer	088HY	-	-	□	□	Please refer to page 115.
High Gloss Charcoal Oak veneer	088JO	-	-	□	□	Please refer to page 115.
Titanium Mesh trim finisher (9)	088JV	-	-	□	□	Please refer to page 115.
Front and rear premium carpet mats	079BO	□	□	□	■	
<b>HEADLINING</b>						
Nimbus headlining (10)		■	■	■	■	Please refer to pages 110-111.
Ebony headlining (11)	005BJ	□	□	□	□	Please refer to pages 110-111.

■ Standard □ Optional - Not Available.

(9) Only available as part of Complete Dynamic Design Pack (10) Not available with Dynamic Design Packs (11) Standard as part of Complete Dynamic Design Pack. Not available with Nimbus/Espresso interior colourway.

Visit [landrover-me.com](http://landrover-me.com) to configure your vehicle online.



ABOVE & BEYOND

CONTENTS

SPECIFICATION

FIND A RETAILER

BUILD YOUR OWN

## STANDARD AND OPTIONAL FEATURES

### Seating, Interior Features and Finishers (continued)

	OPTION CODE	S	SE	HSE	HSE LUXURY	DESCRIPTION
<b>INTERIOR FEATURES</b>						
Driver and passenger sun visors with illuminated vanity mirrors		■	■	■	■	
Front and rear grab handles		■	■	■	■	
Illuminated glove box, overhead console downlight, loadspace light and map light		■	■	■	■	
Smoker's Pack	094AA	□	□	□	□	Includes ashtray and cigar lighter in front row.
Auto-dimming interior rear view mirror	031CG	□	■	■	■	
Ambient Interior Lighting	064LA / 064FB	-	■	■	-	
Configurable Ambient Interior Lighting		-	-	-	■	Please refer to page 61.
Rear reading lights	064MA	-	□(1)	■	■	
Twin front cupholders	026SA	■	■	-	-	
Twin front cupholders with cover	026SB	-	-	■	■	Please refer to page 23.
Shopping bag hook (curry hook)	095GB	-	-	■	■	Please refer to page 22.
Upper secondary glove box	030EC	-	■	■	■	Please refer to page 22.
Front centre console cooler compartment	038EA	□	□	□	■	Please refer to page 22.
Air Conditioning	022AM	■	-	-	-	Please refer to page 61.
Two-zone Climate Control	022AY	□	■	-	-	Please refer to page 61.
Three-zone Climate Control	022BC	-	-	■	■	Please refer to page 61.
Four-zone Climate Control	022BG	-	-	□	□	Please refer to page 61.
<b>STOWAGE</b>						
Overhead stowage for sunglasses (2)		■	■	■	-	
Rear armrest with twin cupholders		-	■	■	■	Please refer to page 22.
Cubby box with central hinged twin lidded stowage		■	■	■	■	Please refer to page 22.
Lower centre console stowage		■	■	■	■	Please refer to page 23.
Third row side stowage with lid and single 5V charging point (3)		■	■	■	■	Please refer to page 22.
In-facia stowage		-	-	■	■	Please refer to page 23.

■ Standard □ Optional - Not Available.

(1) Standard when fitted with Electric Sunroof or Fixed Panoramic roof (2) Not available when Rear Seat Entertainment is fitted (3) Only available with third row seats.

Features and their availability may differ by vehicle specification and market. Please see pages 86-101, or contact your nearest Land Rover Retailer, for more information.



ABOVE & BEYOND

CONTENTS

SPECIFICATION

FIND A RETAILER

BUILD YOUR OWN

## STEP 2 CHOOSE YOUR MODEL AND OPTIONS

### Safety and Security

	OPTION CODE	S	SE	HSE	HSE LUXURY	DESCRIPTION
Audible seat belt warning (including third row)		■	■	■	■	Please refer to page 72.
Front side impact airbags		■	■	■	■	Please refer to page 73.
Hazard lights under heavy braking		■	■	■	■	
Perimetric alarm		■	■	■	■	
Rollover deployment of restraints		■	■	■	■	Please refer to page 73.
Side curtain airbags		■	■	■	■	Please refer to page 72.
Third row ISOFIX		■	■	■	■	Standard when third row seats are specified. Please refer to page 72.
Advanced Alarm System	076EL	□	□	□	□	The Advanced Alarm System offers enhanced theft-protection, using ultrasonic sensors to detect any intrusion into the cabin area when the vehicle is locked. When the alarm is activated, the vehicle emits an acoustic warning and the hazard warning lights are automatically switched on.
First aid kit	056AZ	□	□	□	□	

■ Standard □ Optional.

Visit [landrover-me.com](http://landrover-me.com) to configure your vehicle online. 93

ENGINE

MODEL

COLOUR

WHEELS

INTERIOR

ACCESSORIES

TECHNICAL  
DETAILS



ABOVE & BEYOND

CONTENTS

SPECIFICATION

FIND A RETAILER

BUILD YOUR OWN

## STANDARD AND OPTIONAL FEATURES

### Driver Assistance, Convenience and Loadspace Features

	OPTION CODE	S	SE	HSE	HSE LUXURY	DESCRIPTION
Push Button Start		■	■	■	■	
Cruise Control		■	■	■	■	
Adaptive Cruise Control with Queue Assist	065AG	□	□	□	□	Please refer to page 44.
Driver Condition Monitor	086DH	□ (1)	□ (1)	□ (2)	□ (2)	Please refer to page 44.
Rear Parking Aid	086EH	□	■	■	■	
Front Parking Aid	086EG	□ (3)	■	■	■	
360° Parking Aid	036MB	□	□	□	□	Sensors located around the vehicle are automatically triggered when reverse is selected, or can be manually activated, with a graphic appearing on the Touchscreen showing an overhead view of the vehicle. As you park, the Touchscreen display and audio feedback indicates how close you are to obstacles.
Park Assist (4)	086HA	□	□	□	□	Please refer to page 45.
Rear View Camera	086FA	□	■	■	-	Please refer to page 45.
Surround Camera System	086GC	□ (5)	□	□	■	Please refer to page 45 and 49.
Blind Spot Monitor and Reverse Traffic Detection	086GF	-	-	□ (6)	□ (6)	Please refer to page 44.

■ Standard □ Optional - Not Available.

(1) Option only available as part of Drive Pro Pack (2) Option only available as part of Drive Pack or Drive Pro Pack (3) Only available with Rear Parking Aid (4) Requires 360° Parking Aid (5) Only available on S models with power fold, heated door mirrors (6) Option only available as part of Drive Pack.

Features and their availability may differ by vehicle specification and market. Please see pages 86-101, or contact your nearest Land Rover Retailer, for more information.



ABOVE & BEYOND

CONTENTS

SPECIFICATION

FIND A RETAILER

BUILD YOUR OWN

**STEP 2**  
**CHOOSE YOUR MODEL AND OPTIONS**

**Driver Assistance, Convenience and Loadspace Features (continued)**

	OPTION CODE	S	SE	HSE	HSE LUXURY	DESCRIPTION
Wade Sensing (7)	075EA	-	-	<input type="checkbox"/>	<input type="checkbox"/>	Please refer to page 33.
Keyless Entry	066AC	-	<input type="checkbox"/>	<input checked="" type="checkbox"/>	<input checked="" type="checkbox"/>	The driver is able to access the vehicle without the need to take the remote smart key out of a bag or pocket.
Activity Key	066CA	-	<input type="checkbox"/>	<input type="checkbox"/>	<input type="checkbox"/>	Please refer to page 63.
HomeLink®	025CT	<input type="checkbox"/> (8)	<input type="checkbox"/>	<input type="checkbox"/>	<input type="checkbox"/>	Please refer to page 45.
Remote Park Heat with Timed Climate	043AV	<input type="checkbox"/>	<input type="checkbox"/>	<input type="checkbox"/>	<input type="checkbox"/>	This pre-heats the engine, channelling residual heat into the cabin, so the vehicle is warm and comfortable by the time you leave the house.
<b>LOADSPACE FEATURES</b>						
Luggage retention loops		<input checked="" type="checkbox"/>	<input checked="" type="checkbox"/>	<input checked="" type="checkbox"/>	<input checked="" type="checkbox"/>	
Loadspace cover	063AH	<input checked="" type="checkbox"/>	<input checked="" type="checkbox"/>	<input checked="" type="checkbox"/>	<input checked="" type="checkbox"/>	
Loadspace storage rails (9)	135AH	<input type="checkbox"/>	<input type="checkbox"/>	<input type="checkbox"/>	<input type="checkbox"/>	
Loadspace partition net	026EU	-	<input type="checkbox"/>	<input type="checkbox"/>	<input type="checkbox"/>	
Powered tailgate	070AW	<input type="checkbox"/>	<input type="checkbox"/>	<input checked="" type="checkbox"/>	-	
Powered gesture tailgate (10)	070BA	-	<input type="checkbox"/>	<input type="checkbox"/>	<input checked="" type="checkbox"/>	
Powered inner tailgate (11)	079EC	<input type="checkbox"/>	<input type="checkbox"/>	<input checked="" type="checkbox"/>	<input checked="" type="checkbox"/>	

■ Standard □ Optional - Not Available.

(7) Only available with 360° Parking Aid, Blind Spot Monitor and Surround Camera System (8) Only available with auto-dimming interior rear view mirror (9) Only available with 5 seats

(10) Only available with Keyless Entry and includes powered tailgate (11) Only available with powered tailgate or powered gesture tailgate on S and SE models.

Visit [landrover-me.com](http://landrover-me.com) to configure your vehicle online. 95

ENGINE

MODEL

COLOUR

WHEELS

INTERIOR

ACCESSORIES

TECHNICAL  
DETAILS



ABOVE & BEYOND

CONTENTS

SPECIFICATION

FIND A RETAILER

BUILD YOUR OWN

## STANDARD AND OPTIONAL FEATURES

### Information, Communication and Entertainment

	OPTION CODE	S	SE	HSE	HSE LUXURY	DESCRIPTION
8" Touchscreen (InControl Touch)		■	■	-	-	
10" Touchscreen (InControl Touch Pro)		-	-	■	■	
Dual View Touchscreen (1)	087AS	-	-	□	□	
Land Rover Sound System 80W with 6 speakers		■	-	-	-	Please refer to page 54.
Land Rover Enhanced Sound System 250W with 10 speakers	025KM	□	■	-	-	Please refer to page 54.
Meridian™ Sound System 380W with 10 speakers plus subwoofer	025LM	-	-	■	-	Please refer to page 54.
Meridian™ Digital Surround Sound System 825W with 14 speakers plus subwoofer	025LN	-	-	□	■	Please refer to page 54.
Bluetooth® connectivity		■	■	■	■	
Rear Seat Entertainment (1)	129AH	-	-	□	□	Please refer to page 57.
Television	129AA	-	-	□	■	
InControl Touch Navigation	087AT	□(2)	■	-	-	Please refer to page 51.
InControl Touch Pro Navigation	087AU	-	-	■	■	Please refer to page 51.
Head-up Display (4)	039IB	-	□	□	□	Please refer to page 41.
Single 12V auxiliary charging point (upper glove box)		-	■	■	■	
Single 12V auxiliary charging point (second row)		■	-	-	-	
Twin 12V auxiliary charging points (second row)	054AM	-	■	□	□	
Twin USB sockets (second row)	054AN	-	□	■	■	Please refer to page 57.

■ Standard □ Optional - Not Available.

The Bluetooth® word mark and logos are owned by the Bluetooth SIG, Inc. and any use of such marks by Land Rover is under licence.

(1) Overhead stowage for sunglasses is not available with Rear Seat Entertainment and Dual View Touchscreen. HSE models require winged headrests with Rear Seat Entertainment

(2) Only available with Land Rover Enhanced Sound System 250W with 10 speakers. InControl Apps only available with InControl Touch Navigation (3) Only available as part of Remote Intelligent Seat Fold Pack and InControl Connect Pro Pack (4) Only available on SE and HSE models with infrared reflective windscreen.

Features and their availability may differ by vehicle specification and market. Please see pages 86-101, or contact your nearest Land Rover Retailer, for more information.





ABOVE & BEYOND

CONTENTS

SPECIFICATION

FIND A RETAILER

BUILD YOUR OWN

## STEP 2 CHOOSE YOUR MODEL AND OPTIONS

### Option Packs

	OPTION CODE	S	SE	HSE	HSE LUXURY
<b>COMPLETE DYNAMIC DESIGN PACK (5)</b>	032IN				
Black or Grey contrast roof (6)		-	-	<input type="checkbox"/>	<input type="checkbox"/>
Dynamic exterior		-	-	<input type="checkbox"/>	<input type="checkbox"/>
Dynamic interior (7)		-	-	<input type="checkbox"/>	<input type="checkbox"/>
21" 5 split-spoke 'Style 5025' with Satin Dark Grey finish alloy wheels		-	-	<input type="checkbox"/>	<input type="checkbox"/>
22" 5 split-spoke 'Style 5025' with Satin Dark Grey Diamond Turned finish alloy wheels		-	-	<input type="checkbox"/>	<input type="checkbox"/>
<b>DYNAMIC EXTERIOR DESIGN PACK (5)</b>	032IP				
Black or Grey contrast roof (6)		-	-	<input type="checkbox"/>	<input type="checkbox"/>
Dynamic exterior		-	-	<input type="checkbox"/>	<input type="checkbox"/>
21" 5 split-spoke 'Style 5025' with Satin Dark Grey finish alloy wheels		-	-	<input type="checkbox"/>	<input type="checkbox"/>
22" 5 split-spoke 'Style 5025' with Satin Dark Grey Diamond Turned finish alloy wheels		-	-	<input type="checkbox"/>	<input type="checkbox"/>
<b>BLACK DESIGN PACK</b>	074LN				
Black exterior		-	<input type="checkbox"/>	<input type="checkbox"/>	<input type="checkbox"/>
20" 5 split-spoke 'Style 5011' with Gloss Black finish alloy wheels		-	<input type="checkbox"/>	<input type="checkbox"/>	<input type="checkbox"/>
21" 5 split-spoke 'Style 1012' with Gloss Black finish alloy wheels		-	<input type="checkbox"/>	<input type="checkbox"/>	<input type="checkbox"/>
22" 5 split-spoke 'Style 5011' with Gloss Black finish alloy wheels		-	-	<input type="checkbox"/>	<input type="checkbox"/>

Optional - Not Available.

(5) Not available with Black Design Pack (6) Dependent on exterior paint colour. Please refer to pages 102-105 (7) Please refer to page 110 for available interior colourways.

Visit [landrover-me.com](http://landrover-me.com) to configure your vehicle online.

97

ENGINE

MODEL

COLOUR

WHEELS

INTERIOR

ACCESSORIES

TECHNICAL  
DETAILS



ABOVE & BEYOND

CONTENTS

SPECIFICATION

FIND A RETAILER

BUILD YOUR OWN

## STANDARD AND OPTIONAL FEATURES

### Option Packs (continued)

	OPTION CODE	S	SE	HSE	HSE LUXURY
<b>DRIVE PACK</b>	074VX				
Driver Condition Monitor		-	-	□	□
Blind Spot Monitor and Reverse Traffic Detection		-	-	□	□
<b>DRIVE PRO PACK</b>	074VY				
Driver Condition Monitor		□	□	□	□
Adaptive Cruise Control with Queue Assist		□	□	□	□
<b>7 SEAT PACK</b>	074SC				
Third row seats		□	-	-	-
Twin-speed transfer box (high/low Range) (Sd4 Ingenium only)		□	-	-	-
Electronic air suspension		□	-	-	-
Powered tailgate		□	-	-	-

□ Optional – Not Available.

Features and their availability may differ by vehicle specification and market. Please see pages 86-101, or contact your nearest Land Rover Retailer, for more information.



ABOVE & BEYOND

CONTENTS

SPECIFICATION

FIND A RETAILER

BUILD YOUR OWN

**STEP 2**  
**CHOOSE YOUR MODEL AND OPTIONS**

**Option Packs (continued)**

	OPTION CODE	S	SE	HSE	HSE LUXURY
<b>CAPABILITY PLUS PACK</b>	074PM				
Active rear locking differential		-	<input type="checkbox"/>	<input type="checkbox"/>	<input type="checkbox"/>
Terrain Response 2		-	<input type="checkbox"/>	<input type="checkbox"/>	<input type="checkbox"/>
All Terrain Progress Control (ATPC)		-	<input type="checkbox"/>	<input type="checkbox"/>	<input type="checkbox"/>
<b>COLD CLIMATE PACK (1)</b>	072AC				
Heated windscreen		<input type="checkbox"/>	<input type="checkbox"/>	<input type="checkbox"/>	<input type="checkbox"/>
Heated washer jets		<input type="checkbox"/>	<input type="checkbox"/>	<input type="checkbox"/>	<input type="checkbox"/>
Heated steering wheel		<input type="checkbox"/>	<input type="checkbox"/>	<input type="checkbox"/>	<input type="checkbox"/>
Heated front and rear seats		<input type="checkbox"/>	<input type="checkbox"/>	<input type="checkbox"/>	-
<b>7 SEAT COLD CLIMATE PACK (1) (2)</b>	072BN				
Heated windscreen		-	-	<input type="checkbox"/>	-
Heated washer jets		-	-	<input type="checkbox"/>	-
Heated steering wheel		-	-	<input type="checkbox"/>	-
Heated front, rear and third row seats		-	-	<input type="checkbox"/>	-
<b>CLIMATE COMFORT PACK (1)</b>	072BF				
Infrared reflective windscreen		-	-	<input type="checkbox"/>	-
Heated and cooled front seats		-	-	<input type="checkbox"/>	-
Front centre console cooler compartment		-	-	<input type="checkbox"/>	-

Optional - Not Available.

(1) Not available with other Climate Pack options (2) Only available with third row seats.

Visit [landrover-me.com](http://landrover-me.com) to configure your vehicle online. 99

ENGINE

MODEL

COLOUR

WHEELS

INTERIOR

ACCESSORIES

TECHNICAL  
DETAILS



ABOVE & BEYOND

CONTENTS

SPECIFICATION

FIND A RETAILER

BUILD YOUR OWN

## STANDARD AND OPTIONAL FEATURES

### Option Packs (continued)

	OPTION CODE	S	SE	HSE	HSE LUXURY
<b>VERSATILE CLIMATE COMFORT PACK (1)</b>	072BM				
Infrared reflective windscreen		-	-	□	-
Heated windscreen		-	-	□	□
Heated and cooled front seats with heated rear seats		-	-	□	□
Front centre console cooler compartment		-	-	□	-
Heated steering wheel		-	-	□	□
<b>LUXURY CLIMATE COMFORT PACK (1)</b>	072BL				
Heated and cooled front and rear seats		-	-	□	□
Four-zone Climate Control		-	-	□	□
Seat Pack 4		-	-	□	-
Seat Pack 5		-	-	-	□
Infrared reflective windscreen		-	-	□	-
Heated windscreen		-	-	□	□
Heated washer jets		-	-	□	□
Heated steering wheel		-	-	□	□
<b>7 SEAT LUXURY CLIMATE COMFORT PACK (1) (2)</b>	072BP				
Heated and cooled front and rear seats with heated third row seats		-	-	□	□
Four-zone Climate Control		-	-	□	□
Seat Pack 4		-	-	□	-
Seat Pack 5		-	-	-	□
Infrared reflective windscreen		-	-	□	□
Heated windscreen		-	-	□	-
Heated washer jets		-	-	□	□
Heated steering wheel		-	-	□	□

□ Optional – Not Available.

(1) Not available with other Climate Pack options (2) Only available with third row seats.

Features and their availability may differ by vehicle specification and market. Please see pages 86-101, or contact your nearest Land Rover Retailer, for more information.



ABOVE & BEYOND

CONTENTS

SPECIFICATION

FIND A RETAILER

BUILD YOUR OWN

## STEP 2 CHOOSE YOUR MODEL AND OPTIONS

### Option Packs (continued)

	OPTION CODE	S	SE	HSE	HSE LUXURY
<b>TECHNOLOGY PACK</b>	074KY				
Rear Parking Aid		<input type="checkbox"/>	-	-	-
Front Parking Aid		<input type="checkbox"/>	-	-	-
Powered tailgate		<input type="checkbox"/>	-	-	-
Land Rover Enhanced Sound System 250W with 10 speakers		<input type="checkbox"/>	-	-	-
InControl Touch Navigation		<input type="checkbox"/>	-	-	-
<b>TECHNOLOGY PLUS PACK (3)</b>	074QM				
Adaptive LED headlights with LED signature		-	<input type="checkbox"/>	<input type="checkbox"/>	-
Infrared reflective windscreen		-	<input type="checkbox"/>	<input type="checkbox"/>	-
Head-up Display		-	<input type="checkbox"/>	<input type="checkbox"/>	-
Powered gesture tailgate		-	<input type="checkbox"/>	<input type="checkbox"/>	-
<b>VISION ASSIST PACK (4)</b>	041CB				
Adaptive LED headlights with LED signature		-	<input type="checkbox"/>	<input type="checkbox"/>	-
Automatic headlights		<input type="checkbox"/>	-	-	-
Auto High Beam Assist (AHBA)		-	<input type="checkbox"/>	-	-
Rain sensing windscreen wipers		<input type="checkbox"/>	-	-	-
Auto-dimming exterior mirrors		-	<input type="checkbox"/>	<input type="checkbox"/>	-
Power fold, heated door mirrors with approach lights		<input type="checkbox"/>	-	-	-
Surround Camera System		<input type="checkbox"/>	<input type="checkbox"/>	<input type="checkbox"/>	-

Optional - Not Available.

(3) Not available with Versatile Climate Comfort Pack, Luxury Climate Comfort Pack, Vision Assist Pack or 7 Seat Luxury Climate Comfort Pack (4) Not available with Technology Plus Pack. Adaptive LED headlights with LED signature only available with signature hi-line tail lights.

Visit [landrover-me.com](http://landrover-me.com) to configure your vehicle online. 101

ENGINE

MODEL

COLOUR

WHEELS

INTERIOR

ACCESSORIES

TECHNICAL  
DETAILS



ABOVE & BEYOND

CONTENTS

SPECIFICATION

FIND A RETAILER

BUILD YOUR OWN

# 3

## CHOOSE YOUR COLOUR

Now you have chosen your All-New Discovery model, you can select your exterior paint colour. From rich, deep lustres to incandescent metallic patinas, our paints incorporate the latest in pigment technologies. Our solid paints produce a deep flat colour. Our metallics deliver a sparkle finish that is sure to catch the eye. And our premium metallic paints enhance both the colour and the intensity of the sparkle, or sleek metallic finish to give your vehicle even more presence.

### Fuji White (solid)

Optional Contrast Roof Colour\*

Black      Grey



### Yulong White (metallic)

Optional Contrast Roof Colour\*

Black      Grey



### Indus Silver (metallic)

Optional Contrast Roof Colour\*

Black      Grey



### Corris Grey (metallic)

Optional Contrast Roof Colour\*

Black



\*Contrast roof only available as part of Dynamic Design Packs.

The availability of exterior paint colours varies by model and by time of year. Please contact your nearest Land Rover Retailer for further details.



ENGINE

MODEL

COLOUR

WHEELS

INTERIOR

ACCESSORIES

TECHNICAL  
DETAILS





ABOVE & BEYOND

CONTENTS

SPECIFICATION

FIND A RETAILER

BUILD YOUR OWN

### STEP 3 CHOOSE YOUR COLOUR

Kaikoura Stone (metallic)

Optional Contrast Roof Colour\*

Black      Grey



Scotia Grey (metallic)

Optional Contrast Roof Colour\*

Black



Aintree Green (metallic)

Optional Contrast Roof Colour\*

Black      Grey



Loire Blue (metallic)

Optional Contrast Roof Colour\*

Black      Grey



Visit [landrover-me.com](http://landrover-me.com) to configure your vehicle online. 103

ENGINE

MODEL

COLOUR

WHEELS

INTERIOR

ACCESSORIES

TECHNICAL  
DETAILS



ABOVE & BEYOND

CONTENTS

SPECIFICATION

FIND A RETAILER

BUILD YOUR OWN

Santorini Black (metallic)

Optional Contrast Roof Colour\*  
Grey



Firenze Red (metallic)

Optional Contrast Roof Colour\*  
Black      Grey



Montalcino Red (metallic)

Optional Contrast Roof Colour\*  
Black



Namib Orange (premium metallic)

Optional Contrast Roof Colour\*  
Black      Grey



Silicon Silver (premium metallic)

Optional Contrast Roof Colour\*  
Black



\*Contrast roof only available as part of Dynamic Design Packs.

The availability of exterior paint colours varies by model and by time of year. Please contact your nearest Land Rover Retailer for further details.





ABOVE & BEYOND

CONTENTS

SPECIFICATION

FIND A RETAILER

BUILD YOUR OWN

### STEP 3 CHOOSE YOUR COLOUR

Aruba (premium metallic)

Optional Contrast Roof Colour\*

Black      Grey



Waitomo Grey (premium metallic)

Optional Contrast Roof Colour\*

Black



Carpathian Grey (premium metallic)

Optional Contrast Roof Colour\*

Black      Grey



Farallon Black (premium metallic)

Optional Contrast Roof Colour\*

Grey



Visit [landrover-me.com](http://landrover-me.com) to configure your vehicle online. 105



ENGINE

MODEL

COLOUR

WHEELS

INTERIOR

ACCESSORIES

TECHNICAL  
DETAILS





ABOVE & BEYOND

CONTENTS

SPECIFICATION

FIND A RETAILER

BUILD YOUR OWN

# 4

## CHOOSE YOUR WHEELS



19" 5 SPLIT-SPOKE  
'STYLE 5021'



20" 5 SPLIT-SPOKE  
'STYLE 5011'



20" 5 SPLIT-SPOKE  
'STYLE 5011'  
WITH GLOSS BLACK FINISH (1)



20" 10 SPLIT-SPOKE  
'STYLE 1011'



21" 9 SPOKE  
'STYLE 9002'



21" 9 SPOKE  
'STYLE 9002'  
WITH DIAMOND TURNED FINISH

	OPTION CODE	S	SE	HSE	HSE LUXURY
<b>WHEELS</b>					
19" 5 split-spoke 'Style 5021'		■	■	-	-
20" 5 split-spoke 'Style 5011'	031HG	□	□	■	-
20" 5 split-spoke 'Style 5011' with Gloss Black finish (1)	031HJ	-	□	□	□
20" 10 split-spoke 'Style 1011'	031HH	□	□	□	■
21" 9 spoke 'Style 9002'	031HK	-	□	□	□
21" 9 spoke 'Style 9002' with Diamond Turned finish	031HM	-	-	□	□

21" and 22" wheels only available with electronic air suspension.

■ Standard □ Optional - Not Available.

106 (1) Only available with Black Design Pack and will incur an additional cost.

ENGINE

MODEL

COLOUR

WHEELS

INTERIOR

ACCESSORIES

TECHNICAL  
DETAILS



ABOVE & BEYOND

CONTENTS

SPECIFICATION

FIND A RETAILER

BUILD YOUR OWN

## STEP 4 CHOOSE YOUR WHEELS



21" 10 SPLIT-SPOKE  
'STYLE 1012'



21" 10 SPLIT-SPOKE  
'STYLE 1012'  
WITH GLOSS BLACK FINISH (1)



21" 5 SPLIT-SPOKE  
'STYLE 5025'  
WITH SATIN DARK GREY FINISH (2)



22" 5 SPLIT-SPOKE  
'STYLE 5011'



22" 5 SPLIT-SPOKE  
'STYLE 5011'  
WITH GLOSS BLACK FINISH (1)



22" 5 SPLIT-SPOKE  
'STYLE 5025' WITH SATIN DARK GREY  
DIAMOND TURNED FINISH (2)



22" 5 SPLIT-SPOKE  
'STYLE 5025'  
WITH MACHINE POLISHED FINISH (3)

	OPTION CODE	S	SE	HSE	HSE LUXURY
<b>WHEELS</b>					
21" 10 split-spoke 'Style 1012'	031HL	-	<input type="checkbox"/>	<input type="checkbox"/>	<input type="checkbox"/>
21" 10 split-spoke 'Style 1012' with Gloss Black finish (1)	031HN	-	<input type="checkbox"/>	<input type="checkbox"/>	<input type="checkbox"/>
21" 5 split-spoke 'Style 5025' with Satin Dark Grey finish (2)	031GD	-	-	<input type="checkbox"/>	<input type="checkbox"/>
22" 5 split-spoke 'Style 5011'	031GE	-	<input type="checkbox"/>	<input type="checkbox"/>	<input type="checkbox"/>
22" 5 split-spoke 'Style 5011' with Gloss Black finish (1)	031GF	-	-	<input type="checkbox"/>	<input type="checkbox"/>
22" 5 split-spoke 'Style 5025' with Satin Dark Grey Diamond Turned finish (2)	031GH	-	-	<input type="checkbox"/>	<input type="checkbox"/>
22" 5 split-spoke 'Style 5025' with Machine Polished finish (3)	VPLRW0117	<input type="checkbox"/>	<input type="checkbox"/>	<input type="checkbox"/>	<input type="checkbox"/>

21" and 22" wheels only available with electronic air suspension.

■ Standard □ Optional - Not Available.

(2) Only available with Dynamic Design Pack and will incur an additional cost (3) Accessory wheels must be selected with either a standard or optional wheel and incur an additional cost. Requires 285 tyre.

Visit [landrover-me.com](http://landrover-me.com) to configure your vehicle online. 107

ENGINE

MODEL

COLOUR

WHEELS

INTERIOR

ACCESSORIES

TECHNICAL  
DETAILS



ABOVE & BEYOND

CONTENTS

SPECIFICATION

FIND A RETAILER

BUILD YOUR OWN

# 5

## CHOOSE YOUR INTERIOR – SEAT CONFIGURATION



### Electrically Reclining Rear Seats

Available as an option on HSE and HSE Luxury with optional third row seats, these seats have forwards/backwards movement of 160mm allowing truly flexible use of space for luggage or to maximise passenger legroom. The seats also power recline up to 27° and allow for load-through to provide even greater comfort and convenience.

### 60:40 Manual Slide and Recline Seats (not shown)

The standard 60:40 five-seat configuration features three comfortable seating positions and load through feature.



ENGINE

MODEL

COLOUR

WHEELS

INTERIOR

ACCESSORIES

TECHNICAL  
DETAILS





ABOVE & BEYOND

CONTENTS

SPECIFICATION

FIND A RETAILER

BUILD YOUR OWN

## STEP 5 CHOOSE YOUR INTERIOR



### Seven Full-Size Seats with Stadium Seating

A neatly integrated optional third row of seats gives you even more versatility, with the third row easily accessed at the touch of a button. On HSE and HSE Luxury models, the third row has the option of heating, a first for the

segment, as well as the capability of power folding. All-New Discovery makes light work of carrying you and six other adults in the most comfortable and contemporary surroundings.

Visit [landrover-me.com](http://landrover-me.com) to configure your vehicle online. 109



ENGINE

MODEL

COLOUR

WHEELS

INTERIOR

ACCESSORIES

TECHNICAL  
DETAILS





ABOVE & BEYOND

CONTENTS

SPECIFICATION

FIND A RETAILER

BUILD YOUR OWN

## CHOOSE YOUR INTERIOR – COLOUR COMBINATIONS

Now you have chosen your model, you can use this table to select the perfect combination of interior colour, exterior colour and interior finishers.

EXCLUSIVE TO COMPLETE DYNAMIC DESIGN PACK

	(A)	(B)	(C)	(D)	(E)	(F)	(G)	(H)
COLOURWAYS	EBONY / EBONY (page 112)	ACORN / EBONY (page 113)	NIMBUS / ESPRESSO (page 113)	VINTAGE TAN / EBONY (page 112)	GLACIER / EBONY (page 113)	EBONY / EBONY with Nimbus detail (page 114)	EBONY / EBONY with Pimento detail (page 114)	NIMBUS / EBONY with Reims Blue detail (page 114)
<b>INTERIOR COLOUR</b>								
Seat colour	Ebony	Acorn	Nimbus	Vintage Tan	Glacier	Ebony	Ebony	Nimbus
Carpet	Ebony	Ebony	Espresso	Ebony	Ebony	Ebony	Ebony	Ebony
<b>MODEL</b>								
S (Cloth)	○	–	–	–	–	–	–	–
SE (Grained leather)	○	○	–	–	–	–	–	–
HSE (Grained leather)	○	○	○	–	–	–	–	–
HSE (Windsor leather)	○	–	○	○	–	○	○	○
HSE LUXURY (Windsor leather)	○	–	○	○	○	○	○	○
<b>INTERIOR FINISHERS</b>								
Ebony finisher*	○	–	–	–	–	–	–	–
Gloss Black finisher**	○	○	–	–	–	–	–	–
Brushed Linear Aluminium trim finisher	○	○	○	○	○	–	–	–
Natural Shadow Oak veneer	○	○	○	○	○	–	–	–
Natural Charcoal Oak veneer†	○	○	○	○	○	–	–	–
High Gloss Charcoal Oak veneer†	○	○	○	○	○	–	–	–
Titanium Mesh trim finisher	–	–	–	–	–	○	○	○
<b>EXTERIOR COLOUR</b>								
Fuji White	○	○	○	▲	○	○	○	○
Yulong White	▲	○	○	▲	○	▲	▲	○
Indus Silver	▲	○	○	○	○	○	○	○
Corris Grey	▲	○	○	○	○	○	○	▲
Kaikoura Stone	○	▲	▲	▲	○	○	○	○
Scotia Grey	○	○	○	○	▲	○	○	○
Aintree Green	○	○	▲	○	○	○	○	○
Loire Blue	○	○	○	○	○	○	○	▲
Santorini Black	▲	▲	○	○	▲	▲	▲	○
Firenze Red	○	○	○	○	○	○	▲	○
Montalcino Red	○	○	○	–	–	–	○	○
Namib Orange	▲	○	▲	○	○	▲	○	○
Silicon Silver	○	▲	▲	○	▲	○	○	▲
Aruba	○	▲	▲	○	▲	○	○	▲
Waitomo Grey	○	○	▲	▲	○	○	○	○
Carpathian Grey	▲	○	○	▲	▲	▲	▲	○
Farallon Black	○	○	○	▲	○	○	○	▲

ENGINE

MODEL

COLOUR

WHEELS

INTERIOR

ACCESSORIES

TECHNICAL  
DETAILS



ABOVE & BEYOND

CONTENTS

SPECIFICATION

FIND A RETAILER

BUILD YOUR OWN

**STEP 5**  
**CHOOSE YOUR INTERIOR**



	1	2	3	4	5	6
COLOURWAYS	DOOR LOWER AND ARMREST UPPER	DOOR ROLL TOP	INSTRUMENT PANEL UPPER	CENTRE STACK SIDE RAILS	CUBBY BOX	INSTRUMENT MID-SECTION
(A) Ebony/Ebony	Ebony	Ebony	Ebony	Gloss Black*	Ebony	Ebony
(B) Acorn/Ebony	Ebony	Acorn	Ebony	Gloss Black**	Ebony	Acorn
(C) Nimbus/Espresso	Espresso	Nimbus	Espresso	Nimbus Brushed Aluminium	Espresso	Nimbus
(D) Vintage Tan/Ebony	Ebony	Vintage Tan <sup>†</sup>	Ebony	Satin Brushed Aluminium	Ebony	Vintage Tan <sup>†</sup>
(E) Glacier/Ebony	Ebony	Glacier	Ebony	Nimbus Brushed Aluminium	Ebony	Glacier
<b>EXCLUSIVE TO DYNAMIC DESIGN PACK</b>						
(F) Ebony/Ebony with Nimbus detail	Ebony	Ebony	Ebony	Dark Brushed Aluminium	Ebony	Ebony
(G) Ebony/Ebony with Pimento detail	Ebony	Ebony	Ebony	Dark Brushed Aluminium	Ebony	Ebony
(H) Nimbus/Ebony with Reims Blue detail	Ebony	Nimbus	Ebony	Dark Brushed Aluminium	Ebony	Nimbus

\*Satin Brushed Aluminium on HSE and HSE Luxury models \*\*Satin Brushed Aluminium on HSE (Grained leather) <sup>†</sup>Ebony on HSE (Windsor leather). Interior shown above is HSE Luxury in Nimbus/Espresso.

Visit [landrover-me.com](http://landrover-me.com) to configure your vehicle online. 111

ENGINE

MODEL

COLOUR

WHEELS

INTERIOR

ACCESSORIES

TECHNICAL  
DETAILS



ABOVE & BEYOND

CONTENTS

SPECIFICATION

FIND A RETAILER

BUILD YOUR OWN

## AVAILABLE INTERIOR COLOUR COMBINATIONS

The cabin in All-New Discovery embodies the finest of contemporary living. Bold horizontal and vertical lines and superb levels of comfort create a space in which you and your family and friends will want to spend time. A wide range of colourway and seat material choices are available to suit all tastes.

### A **Ebony / Ebony** (available on S, SE, HSE and HSE Luxury)



Interior shown: S interior in Ebony/Ebony with Seat Pack 1 Ebony cloth seats, and Ebony finisher.

### D **Vintage Tan / Ebony** (available on HSE and HSE Luxury)



Interior shown: HSE Luxury interior in Vintage Tan/Ebony with Seat Pack 4 Vintage Tan Windsor leather seats with Ebony contrast micropiping, and Natural Charcoal Oak veneer.

ENGINE

MODEL

COLOUR

WHEELS

INTERIOR

ACCESSORIES

TECHNICAL  
DETAILS





ABOVE & BEYOND

CONTENTS

SPECIFICATION

FIND A RETAILER

BUILD YOUR OWN

## STEP 5 CHOOSE YOUR INTERIOR

### B Acorn / Ebony (available on SE and HSE)

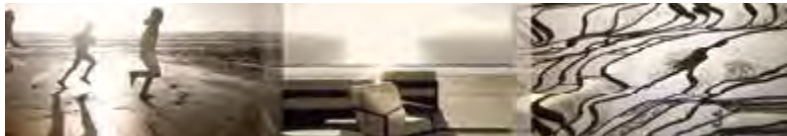

Interior shown: SE interior in Acorn/Ebony with Seat Pack 2 Acorn grained leather seats, and Gloss Black finisher.

### C Nimbus / Espresso (available on HSE and HSE Luxury)



Interior shown: HSE interior in Nimbus/Espresso with Seat Pack 3 Nimbus grained leather seats, and Natural Shadow Oak veneer.

### E Glacier / Ebony (available on HSE Luxury)



Interior shown: HSE Luxury interior in Glacier/Ebony with optional Seat Pack 5 Glacier Windsor leather seats with Ebony contrast micropiping, and Natural Shadow Oak veneer.

Visit [landrover-me.com](http://landrover-me.com) to configure your vehicle online. 113

ENGINE

MODEL

COLOUR

WHEELS

INTERIOR

ACCESSORIES

TECHNICAL  
DETAILS

**F** **Ebony / Ebony with Nimbus stitching and piping**  
(available on Complete Dynamic Design Pack only)



Interior shown: Ebony/Ebony Windsor leather interior, Ebony seats with Nimbus stitching and piping and Titanium Mesh trim finisher.

**G** **Ebony / Ebony with Pimento stitching and piping**  
(available on Complete Dynamic Design Pack only)



Interior shown: Ebony/Ebony Windsor leather interior, Ebony seats with Pimento stitching and piping and Titanium Mesh trim finisher.

**H** **Nimbus / Ebony with Reims Blue stitching and piping**  
(available on Complete Dynamic Design Pack only)



Interior shown: Ebony/Nimbus Windsor leather interior, Nimbus seats with Reims Blue stitching and piping and Titanium Mesh trim finisher.



ABOVE & BEYOND

CONTENTS

SPECIFICATION

FIND A RETAILER

BUILD YOUR OWN

## STEP 5 CHOOSE YOUR INTERIOR

### INTERIOR FINISHERS

Now you have chosen your interior colour combination, choose one of seven interior finishers. For full availability and designer's choices, please see the colour and trim matrix on pages 110 and 111.



High Gloss Charcoal Oak veneer



Brushed Linear Aluminium trim finisher



Gloss Black finisher



Titanium Mesh trim finisher

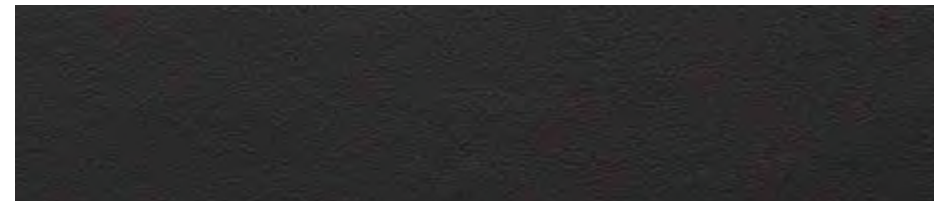

Ebony finisher

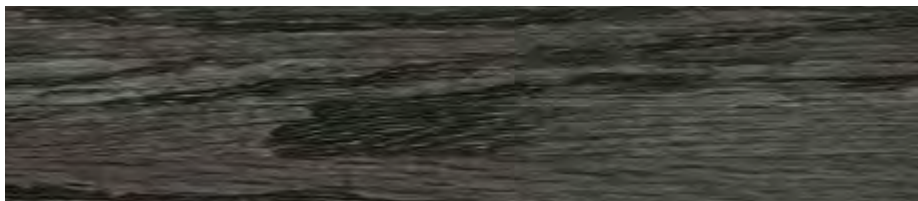

Natural Charcoal Oak veneer

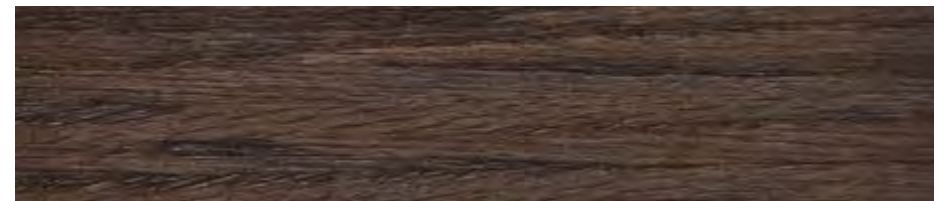

Natural Shadow Oak veneer

Visit [landrover-me.com](http://landrover-me.com) to configure your vehicle online. 115



ENGINE

MODEL

COLOUR

WHEELS

INTERIOR

ACCESSORIES

TECHNICAL  
DETAILS





ABOVE & BEYOND

CONTENTS

SPECIFICATION

FIND A RETAILER

BUILD YOUR OWN

# 6

## LAND ROVER APPROVED ACCESSORIES

All-New Discovery is so capable and adaptable it can get straight to work across a huge variety of vastly differing conditions and roles. Even so, some owners want to add their own stamp of individuality by tailoring their All-New Discovery to their specific needs with a range of stylish, practical accessories that are tough, versatile and bring an opportunity for personalisation.



Importantly, these accessories can be added by your Land Rover Retailer at any stage during the vehicle's life – not just when it's new. Naturally, Land Rover Approved Accessories are designed, tested and manufactured to the same exacting standards as the original equipment fitted to your vehicle.



ABOVE & BEYOND

CONTENTS

SPECIFICATION

FIND A RETAILER

BUILD YOUR OWN

## STEP 6 CHOOSE YOUR ACCESSORIES

### DESIGN



Loadspace Organiser  
VPLRS0355

Convenient loadspace organiser provides segregated compartments to stow wet, dirty or delicate items or separate shopping/luggage. The front and rear compartments also have flexible dividers to create smaller compartments within them. Featuring two lockable lids, it is secured via loadspace 'D' loops\*.



Stainless Steel Undershield – Front\*\*  
VPLRP0254

Stainless Steel Undershield – Rear\*\*  
VPLRP0255 – Non Tow Bar  
VPLRP0256 – Tow Bar  
VPLRP0257 – Electrically Deployable Tow Bar

The off-road designed undershield, manufactured from stainless steel, features a premium Bright Polished finish for the front and rear of the vehicle.



Sports Pedal Covers†  
VPLGS0160

Stainless steel Bright finish sports pedal covers are easy to fit and feature hidden fixings for a clean finish.



Bright Side Tubes†  
VPLRP0270

Highly polished stainless steel side tubes provide an off-road inspired appearance, designed to complement the vehicle's exterior design.



Styld Valve Caps  
LR027666 – Black Jack  
LR027664 – Union Jack  
LR027560 – Land Rover

This exclusive range of styled valve caps, available in a choice of designs, provide a subtle design enhancement to alloy wheels. Sold as a set of four.



Mirror covers  
VPLGB0073 – Noble Chrome  
VPLAB0132 – Chrome (not shown)

Noble plated mirror covers designed to enhance All-New Discovery's exterior design cues. This neat upgrade complements various Atlas and Bright finish exterior trim.

\*Available with both standard 5 seat and optional third row seats. Not available with other loadspace accessories. Where specified, third row seats must be stowed \*\*Not available with Dynamic Design Pack †Standard as part of Dynamic Design Pack †Fitting of side tubes may affect the off-road capability of the vehicle.

Visit [landrover-me.com/accessories](http://landrover-me.com/accessories) for more information. 117

ENGINE

MODEL

COLOUR

WHEELS

INTERIOR

ACCESSORIES

TECHNICAL  
DETAILS



ABOVE & BEYOND

CONTENTS

SPECIFICATION

FIND A RETAILER

BUILD YOUR OWN

## TOURING



Click and Go System  
VPLRS0388 – Click and Go Base  
VPLRS0389 – Click and Hook  
VPLRS0395 – Click and Work

Click and Hook is a universal hook that creates extra storage space for items to be hung. Click and Work is a folding table especially useful on long journeys and offers the rear passengers a practical surface providing some office space and a cupholder. Click and Go Base required for all attachments.

Click and Go System  
VPLRS0390 – Click and Hang  
VPLRS0391 – Click and Play (iPad® 2 – 4)  
VPLRS0392 – Click and Play (iPad® Air)  
VPLRS0393 – Click and Play (iPad® Mini)  
VPLRS0394 – Click and Play Samsung Galaxy Tab (10,1")

Click and Hang is a removable coat hanger allowing for shirts and jackets to be kept crease-free whilst transporting. Click and Play is a removable tablet holder attachment which is available for various tablets, and can be easily positioned in multiple angles for in cabin comfort and rear entertainment.

Centre Armrest Cooler/Warmer Box  
VPLVS0176

Food and drinks chiller and warmer that acts as a rear centre armrest. With a leather-covered top, it is held in place by the centre seat belt and powered from the rear auxiliary socket. Ideal for long journeys with the family.



Sunshades  
VPLRS0367 – Second row  
VPLRS0363 – Third row  
VPLRS0364 – Rear tailgate

Easy to install or remove these sun blinds provide increased comfort helping to protect the interior from heat and glare of the sun.



Roof Rails\*  
VPLRR0156 – Silver  
VPLRR0155 – Black (not shown)

Roof rails facilitate easy fitment of cross bars for roof carrying. Pre-set positioning points ensure cross bars are fixed in optimum position for weight distribution and dynamics. Maximum payload 80kg.\*\*

Cross Bars\*  
VPLRR0154

Elegant, durable Bright finish aluminium cross bars, with compact design which utilises the full length of the bars, providing space to mount multiple accessories. Aerodynamic profile minimises drag and wind noise. Maximum payload 74kg.\*\*



Roof Box\*  
VPLWR0100 – Large Sports Roof Box\*  
VPLVR0062 – Luggage Box\* (not shown)  
VPLVR0061 – Sports Roof Box\* (not shown)

Available in a range of sizes, all versions can be mounted either side for kerbside opening in any country and include integral locks for security and peace of mind. Carrying capacity ranges from 320 litres for the Sports Box to the 410 litre Luggage Box or the capacious 430 litre Large Sports Box. Maximum payload 57kg.\*\*

\*Roof rails and cross bars are required for all Land Rover roof mounted accessories. Ditch finishers (VPLRR0157) and alpine light kit (VPLRR0158) are required for fitment of roof rails. Objects placed above the roof mounted satellite antenna may reduce the quality of the signal received by the vehicle and could have a detrimental effect on the navigation and satellite radio system, if fitted \*\*Maximum payload equals the load capacity of the roof mounted accessory. iPad® is a registered trademark of Apple Inc., registered in the US and other countries.



ABOVE & BEYOND

CONTENTS

SPECIFICATION

FIND A RETAILER

BUILD YOUR OWN

## STEP 6 CHOOSE YOUR ACCESSORIES

### SPORTING



Towing System – Detachable Tow Bar  
VPLRT0171

The detachable tow bar system is easily removed to give the vehicle a clean look and can tow a trailer with a 3,500kg load capacity. Lockable for security. Requires tow eye cover.



Towing System – Multi-Height Tow Bar  
VPLRT0175

Multi-height tow hitch allows for three different tow-ball height positions. Simple to fit, once armature installed, and can be swapped between positions in seconds. 50mm tow ball is included and will take up to 3,500kg trailer load and 350kg nose weight. Requires tow eye cover.



VPLRT0172 – Towing System – Electrically Deployable Tow Bar  
VPLRT0192 – Electrically Deployable Tow Bar Module, Switch & Harness Kit

Operated via a switch in the rear loadspace or through infotainment systems. Sensitive to obstruction and will stow automatically if necessary. Stowed discreetly behind the rear bumper when not in use, providing a clean finish. The towing electrics are included and hidden until deployed. Approved for up to 3,500kg maximum towing capacity and 350kg nose weight.



Tow Bar Mounted Bike Carrier  
VPLVR0067 – 2 Bike Carrier†  
VPLVR0069 – 3 Bike Carrier† (not shown)

Tow bar mounted bike carrier available for two or three bikes. A quick release design for ease of use and lockable for security. Maximum load capacity 51kg (on the 3 bike carrier).



Ski/Snowboard Carrier\*  
LR006849

Carries four pairs of skis or two snowboards and incorporates slider rails for easy loading, is also lockable for security. Maximum payload 36kg.\*\*



Protective Seat Covers  
VPLRS0335PVJ – First Row – Ebony  
VPLRS0337LKP – First Row – Nimbus  
VPLRS0336PVJ – Second Row – Ebony (not shown)  
VPLRS0338LKP – Second Row – Nimbus (not shown)

Protects seats from wet, dirty clothes as well as general wear and tear. Simple to fit and easily wipeable. Includes headrest and armrest covers.



Body Side Mouldings  
VPLRP0286 – Bright finish  
VPLRP0285 – Black finish (not shown)

Enhances the side of your vehicle and provides protection for your door panels from accidental damage by adjacent vehicles.

\*Heat shield is required for two and three tow bar mounted bike carrier – VPLWR0124.

ENGINE

MODEL

COLOUR

WHEELS

INTERIOR

ACCESSORIES

TECHNICAL  
DETAILS



ABOVE & BEYOND

CONTENTS

SPECIFICATION

FIND A RETAILER

BUILD YOUR OWN

## ACTIVE



Fixed Side Steps\*  
VPLRP0269

The side step aids entry and exit to the vehicle and improve access to the roof. Design features include Bright stainless steel edge trim and a rubber tread mat.



Loadspace Partition  
VPLRS0374 – Full Height  
VPLRS0375 – Half Height  
VPLRS0376 – Luggage Partition Divider  
VPLRS0386 – Loadspace Liner Tray

Designed to prevent luggage from entering the passenger compartment. The design of the luggage partition has been optimised to second row seating featuring tilt functionality. The Luggage Partition Divider can be fitted to the luggage partition to separate the loadspace into two sections. Semi-rigid waterproof loadspace liner tray with a raised lip on three sides to protect loadspace floor and side wall carpets from dirt or wet equipment.



Loadspace Rubber Mat\*\*  
VPLRS0375PVJ – Ebony  
VPLRS0375AAM – Espresso (not shown)

The Land Rover branded waterproof rubber mat helps to protect the rear loadspace carpet from general dirt.



Passenger Footwell Net  
VPLRS0362PVJ - Ebony  
VPLRS0461AAM - Espresso (not shown)

Easily accessible by the passenger, the passenger footwell net provides additional storage space within the cabin, ideal for everyday small items such as maps and letters.



Mudflaps  
VPLRP0283 – Front  
VPLRP0282 – Rear

Mudflaps are a popular upgrade for reducing spray and ensuring paintwork is protected from debris and dirt. Engineered to complement the vehicle exterior design.



Rubber Floor Mats  
VPLRS0333PVJ – Ebony  
VPLRS0333AAM – Espresso (not shown)

Rubber footwell mats help provide protection from general dirt.





ABOVE & BEYOND

CONTENTS

SPECIFICATION

FIND A RETAILER

BUILD YOUR OWN

## STEP 6 CHOOSE YOUR ACCESSORIES

### OTHER



**iPhone® Connect and Charge Dock**  
VPLRV0119

The iPhone connect and charge dock has been designed to allow visibility of the phone whilst charging, utilising the cupholder space in the central console. When connected the iPhone media is accessible and has the ability to be controlled via the integrated infotainment system. The iPhone USB charger can be easily disconnected if the USB connection is required for other use. For use with iPhone 5, 5c, 5s, 6 and 6s.



**Wireless Phone Charging Cupholder†**  
VPLRV0118

The wireless phone charging cupholder has been designed to allow visibility of the phone whilst charging, utilising the cupholder space in the centre console. The holder will accommodate phones up to 73mm wide securely in place. The charger displays an LED light to indicate when charging, and turns off when complete.



**Luxury Carpet Mats**  
VPLR50331PVJ – Ebony  
VPLR50331AAM – Espresso

Luxurious, tailored, deep pile 2,050g carpet mat set, with Land Rover ingot branding and waterproof backing, provide a well appointed finishing touch to the interior.



**Snow Traction System**  
VPLGW0081

Snow traction system is designed to give improved steering and braking control on snow and ice, when fitted to front wheels. Easy-fit design, manufactured from high quality hardened galvanised steel, the chains are supplied in a tough vinyl carry bag for storage when not in use. Suitable for 19-21" wheels.



**Aqua Sports Carrier†**  
VPLGR0107

Carries one surfboard/sailboard, canoe or kayak (2 Kayak Carrier carries two kayaks or canoes). Includes lockable multi-purpose holder to carry a mast, oars or paddles. Tilts to facilitate easy loading/unloading. Features lockable straps and rubber supports to maintain optimum weight distribution whilst protecting the kayak and vehicle from scratches/scuffs. Maximum load capacity 45kg.

**Aqua Sports Carrier – 2 Kayaks (not shown)†**  
VPLWR0099



**Luggage Carrier†**  
VPLRR0159

Luggage carrier flexible rack system to facilitate roof carrying. When fitted maximum load capacity is 61kg<sup>A</sup>.

<sup>†</sup>The wireless phone charging cupholder does not provide a connection to InControl Apps <sup>‡</sup>Roof rails and cross bars are required for all Land Rover roof mounted accessories. Objects placed above the roof mounted satellite antenna may reduce the quality of the signal received by the vehicle and could have a detrimental effect on the navigation and satellite radio system, if fitted <sup>§</sup>Maximum payload equals the load capacity of the roof mounted accessory. iPhone® is a registered trademark of Apple Inc., registered in the US and other countries.

Visit [landrover-me.com/accessories](http://landrover-me.com/accessories) for more information. 121

ENGINE

MODEL

COLOUR

WHEELS

INTERIOR

ACCESSORIES

TECHNICAL  
DETAILS



ABOVE & BEYOND

CONTENTS

SPECIFICATION

FIND A RETAILER

BUILD YOUR OWN

## DIMENSIONS AND CAPABILITIES

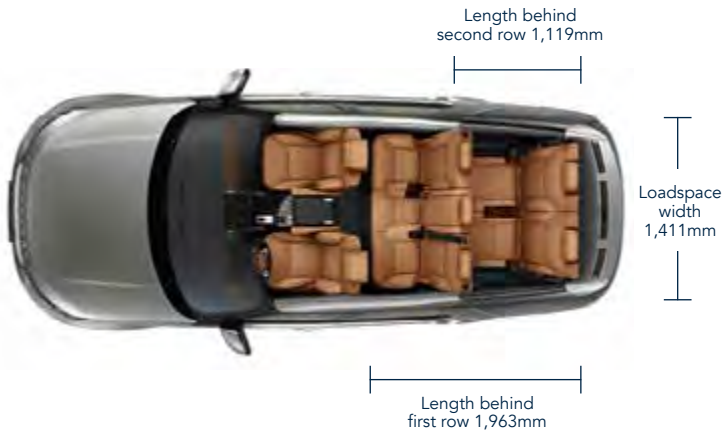

### Standard Ride Height

With roof antenna 1,888mm

### Headroom

Maximum front headroom with panoramic roof 1,016mm  
Rear headroom 991mm

### Loadspace Capacity

Rear seats upright  
Height 939mm, Width 1,411mm  
Maximum loadspace volume 1,137 litres  
Maximum length at floor 1,119mm  
Rear seats folded  
Length behind first row 1,963mm  
Height 939mm, Width 1,411mm  
Maximum loadspace volume 2,406 litres  
Maximum length at floor 1,963mm

### Obstacle Clearance

Air suspension 283mm  
Coil suspension 220mm



### Turning Circle

Kerb-to-kerb 12.3m  
Wall-to-wall 12.7m  
Turns lock-to-lock 2.7

### Wading Depth

Maximum wading depth  
Air suspension 900mm  
Coil suspension 850mm

Width 2,073mm mirrors folded  
Width 2,220mm mirrors out



	A	B	C
Ride Height			
Approach Angle	34.0°	27.5°	30.0°
Ramp Angle		22.2°	27.0°
Departure Angle			27.0°
Air suspension	29.0°		
Coil suspension			



ENGINE

MODEL

COLOUR

WHEELS

INTERIOR

ACCESSORIES

TECHNICAL  
DETAILS



ABOVE & BEYOND

CONTENTS

SPECIFICATION

FIND A RETAILER

BUILD YOUR OWN

## TECHNICAL DETAILS

### TECHNICAL SPECIFICATION, PERFORMANCE AND KEY DATA

	DIESEL	PETROL
	3.0L Td6	3.0L Si6
	AUTOMATIC	AUTOMATIC
	258	340
	5 / 7	5 / 7
<b>POWER (PS)</b>		
Seats		
<b>ENGINE DATA</b>		
Power kW (PS) / rpm	190 (258) / 3,750	250 (340) / 6,500
Torque (Nm / rpm)	600 / 1,750-2,250	450 / 3,500-5,000
Capacity (cc)	2,993	2,995
No. of cylinders	6	6
Valves per cylinder	4	4
Cylinder layout	Longitudinal V6	Longitudinal V6
<b>BRAKES</b>		
Front type	2 x 48mm sliding fist caliper	2 x 48mm sliding fist caliper
Front diameter (mm)	360	360
Rear type	43mm sliding fist caliper	43mm sliding fist caliper
Rear diameter (mm)	350	350
Park brake	Integrated motor-on caliper	Integrated motor-on caliper
<b>WEIGHTS (kg)</b>		
Weight	2,298	2,223
Gross vehicle weight	3,050 / 3,170	2,990 / 3,130
Maximum mass on each axle (front)	1,500	1,500
Maximum mass on each axle (rear)	1,775 / 1,900	1,775 / 1,900
<b>TOWING (kg)</b>		
Unbraked trailer	750	750
Maximum towing	3,500	3,500
Maximum coupling point* / nose weight	200 / 150	200 / 150
Maximum vehicle and trailer combination / Gross Train Weight	6,550 / 6,670	6,490 / 6,630
<b>ROOF CARRYING (kg)</b>		
Maximum roof load (including roof rack weight)	80	80
<b>PERFORMANCE</b>		
Maximum speed (kph)	209	209
Acceleration (secs) 0-100kph	8.1	7.1
Fuel tank capacity – usable (litres)	85	89
Diesel Particulate Filter (DPF)	■	–

■ Standard – Not Available.

\*With electrically deployable tow bar.

Visit [landrover-me.com](http://landrover-me.com) to configure your vehicle online. 123

ENGINE

MODEL

COLOUR

WHEELS

INTERIOR

ACCESSORIES

TECHNICAL  
DETAILS



ABOVE & BEYOND

CONTENTS

SPECIFICATION

FIND A RETAILER

BUILD YOUR OWN

## A WORLD OF LAND ROVER



### LAND ROVER EXPERIENCE

Ever since its inception, Land Rover has been ready for anything. Its legendary capability has seen it tackle the most demanding of terrains, in the most difficult conditions. Its versatile interior has become synonymous with comfort and greater loadspace. And its 'can do' attitude has made it the most welcome of vehicles across the globe.

You can be part of the Land Rover story at one of our Land Rover Experience Centres. You can see how each and every one of these iconic vehicles is built. You can take one out onto off-road tracks where your driving skills will be put to the test. Or you can go even further on one of our Adventure Travel holidays to such countries as Tanzania, Iceland or Morocco.

Adventure awaits.

For more information, visit [landrover-me.com/experiencedrives](http://landrover-me.com/experiencedrives)



### LAND ROVER ONELIFE

As a Land Rover owner, you can look forward to receiving a complimentary copy of Onelife magazine for three years. This award-winning Land Rover magazine is published twice a year and reaches customers in 40 countries. Each issue is filled with the latest Land Rover news and vehicles, insights into the technology and design that shape each vehicle, inspirational journeys and opinions from international experts.



### LAND ROVER FINANCIAL SERVICES

Getting the keys to your very own Land Rover has never been so simple. And it's more affordable than you might think. New or used, for personal or business use, we have an option that puts you in complete control. Please speak to your nearest Land Rover Retailer to find out more.

### FLEET & BUSINESS

Land Rover is dedicated to being the premium manufacturer of choice for fleets and businesses, by providing a highly attractive range of vehicles and exemplary customer service.

Distinctive, capable and versatile, all Land Rover vehicles deliver low total cost of ownership through strong residual values, competitive service, maintenance and repair costs, and impressive fuel economy and CO<sub>2</sub> emissions.

We are also committed to providing a totally customer-focused aftersales service, which will ensure every Land Rover vehicle is kept on the road and in top condition, in the easiest and most cost-efficient way for businesses.

For more information, visit [landrover-me.com/fleetandbusiness](http://landrover-me.com/fleetandbusiness)





ABOVE & BEYOND

CONTENTS

SPECIFICATION

FIND A RETAILER

BUILD YOUR OWN



## LAND ROVER COLLECTION

The vehicle is just the beginning. The latest Land Rover Collection is now available for you to discover.

A meticulous attention to detail doesn't stop with our vehicles. You'll find the same level of craftsmanship in all of our clothing, travel items and premium gift ideas. So whether you're shopping for yourself or a loved one, you know the quality is assured.

The Land Rover Collection includes ladies and gents clothing, an extensive range of small leather goods such as wallets, portfolios, iPad and iPhone cases along with briefcases and weekender bags. A range of cufflinks and ladies silk scarves add a luxury feel to the collection. There's a kids collection too, with colourful fun clothing, caps and replica model vehicles for them to enjoy.

Please contact your nearest Land Rover Retailer for more information.



## ROADSIDE ASSISTANCE

Land Rover Assistance provides assistance in motoring emergencies, from immobilisation due to breakdown or accident to minor problems such as punctures. You can rely on our roadside assistance, whatever the situation, wherever you happen to be.

For further details please consult your Warranty Benefits handbook, contact your nearest Land Rover Approved Service Centre or visit [landrover-me.com/ownership](http://landrover-me.com/ownership)

**IMPORTANT NOTICE:** Jaguar Land Rover Limited is constantly seeking ways to improve the specification, design and production of its vehicles and alterations take place continually. Whilst every effort is made to produce up to date literature, this brochure should not be regarded as an infallible guide to current specifications, nor does it constitute an offer for the sale of any particular vehicle. Distributors and Retailers are not agents of Jaguar Land Rover Limited by any express or implied undertaking or representation.

All Land Rover Approved Accessories fitted by a Land Rover Retailer within one month or 1.600 kilometres/1.000 miles (whichever occurs first) of the handover of a new registered vehicle will benefit from the same warranty terms and period of cover as the vehicle warranty. Accessories purchased outside of these parameters will be subject to a 12 month unlimited mileage warranty. All Land Rover Approved Accessories are rigorously tested to the same exacting standards as those applied to our vehicles. Performance in extreme hot and cold temperatures, corrosion resistance, impact and airbag deployment highlight some of the exhaustive product testing carried out to ensure accessories are both durable and importantly, continue to comply with current legislation. Some of the accessories featured are not available on all models. Please consult your nearest Land Rover Retailer for more information.

All our accessories are designed to be an integral part of Land Rover vehicles. While many items such as roof carriers are simple to fit, some products require specialist tools and diagnostic equipment to ensure correct integration with the vehicle structure and electrical systems. These products vary from market to market, please consult your Land Rover Retailer who will be pleased to advise you on current specifications and any query you may have.

The colours reproduced here are subject to the limitations of the printing process and may therefore vary slightly from the actual vehicle. The company reserves the right to alter or withdraw any colour finish without notice. Some of these colours may not be obtainable in your country. Please check availability of colours and current specifications with your Land Rover Retailer. Distributors and retailers are not agents of Jaguar Land Rover Limited and have absolutely no authority to bind Jaguar Land Rover Limited to any express or implied undertaking or representation.

Castrol EDGE Professional exclusively recommended by Land Rover.

Vehicle shown on front and back cover is HSE Luxury in Namib Orange.

**Jaguar Land Rover Limited** Registered Office:  
Floor 7, Wing E, HQ Building, Dubai Silicon Oasis,  
P.O. Box 32588, Dubai UAE

Registered in England: Number 1672070

[landrover-me.com](http://landrover-me.com)

© Jaguar Land Rover Limited 2016.

Publication Number: 1L4621710CCSBXMEN01P

\*Market delivery restrictions apply.

iPad and iPhone are trademarks of Apple Inc, registered in the US and other countries.





ABOVE & BEYOND

CONTENTS

SPECIFICATION

FIND A RETAILER

BUILD YOUR OWN

