

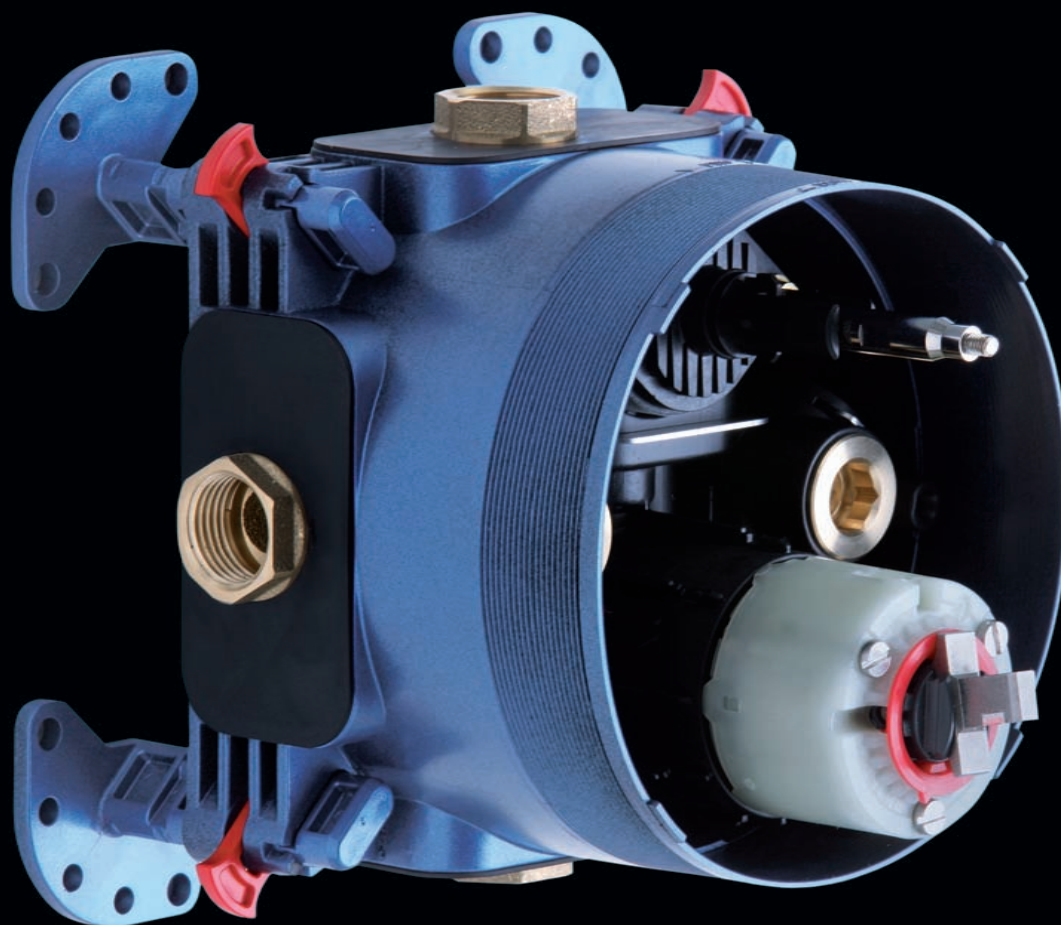

www.idealstandard.com

EASY-Box

Made by professionals
for professionals



The new EASY-Box

Ideal Standard leads the way with built-in advanced technology **for all installation possibilities.**

A1000NU

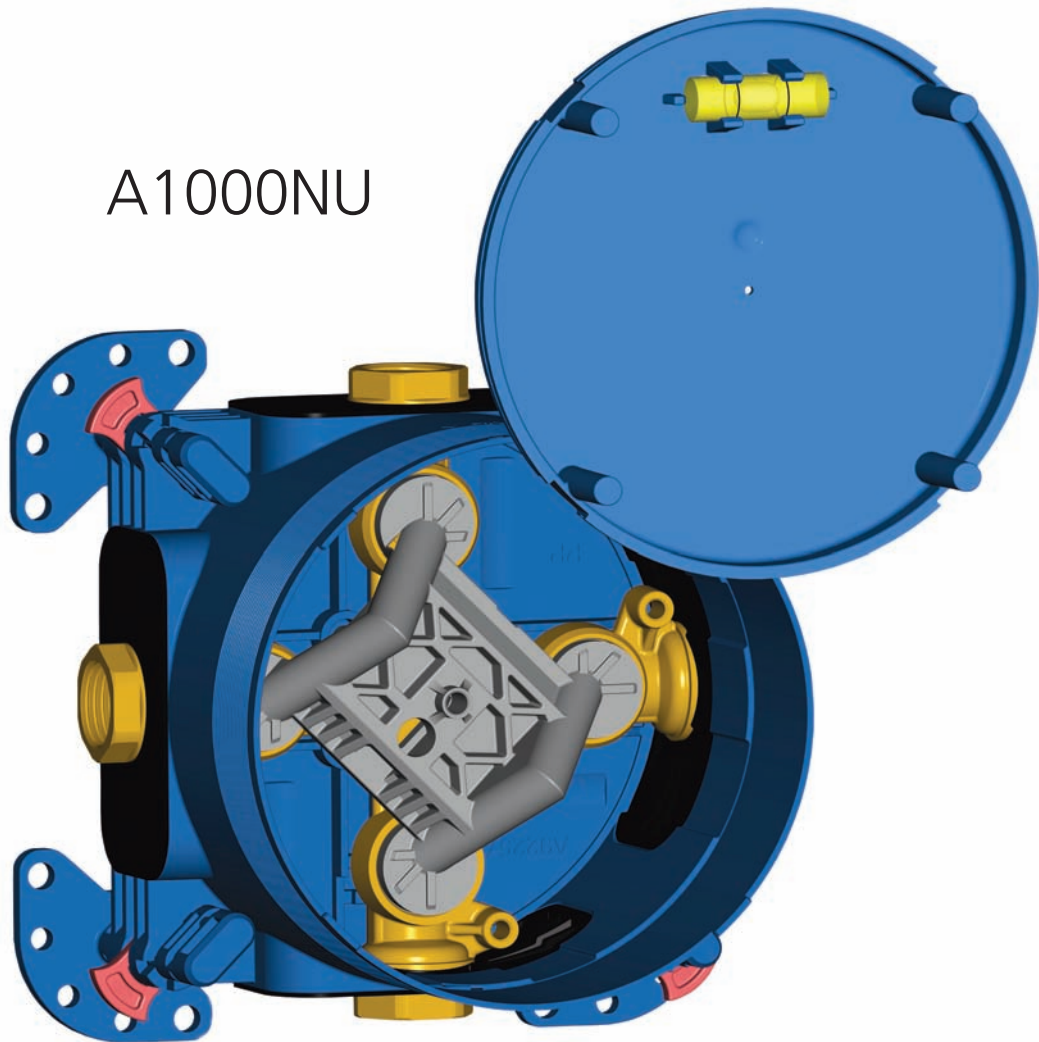

Ideal Standard has perfected its built-in installation technology in cooperation with a group of experts.* The new modular built-in EASY-Box leaves no room for further expectation. Thanks to its FAST-FIX mounting concept, installation is exceptionally easy and, above all, flexible. The DICHT-FIX waterproof system provides triple protection against water penetration both internally and externally, ensuring optimum sealing against damp. Choose between a single-lever mixer and a thermostat. Also available as an intrinsic safety version according to DIN EN 1717 standards (protection against pollution of drinking

water systems) with a bathtub outlet safety device.** It also meets DIN 4109 (sound insulation in high-rise buildings) noise control category I standards.



- Complies with the following norms and directives:
- DIN 4109 sound insulation in high-rise buildings, noise control category I.
 - DIN 1988-compliant pipe flushing.
 - Protects brickwork from damp.
 - DIN EN 1717 with intrinsic safety models.**

functionality

* Ideal Standard would like to thank all the experts and trade professionals who actively supported the development of EASY-Box.
** Only in conjunction with Ideal Standard connections.

Kit 1

Flexible basic built-in unit.

The small basic built-in unit is extremely flexible and adapts to all types of installation. Installation is effortless and requires no special tools. Bath/shower fittings and single thermostats can be mounted on the basic unit.

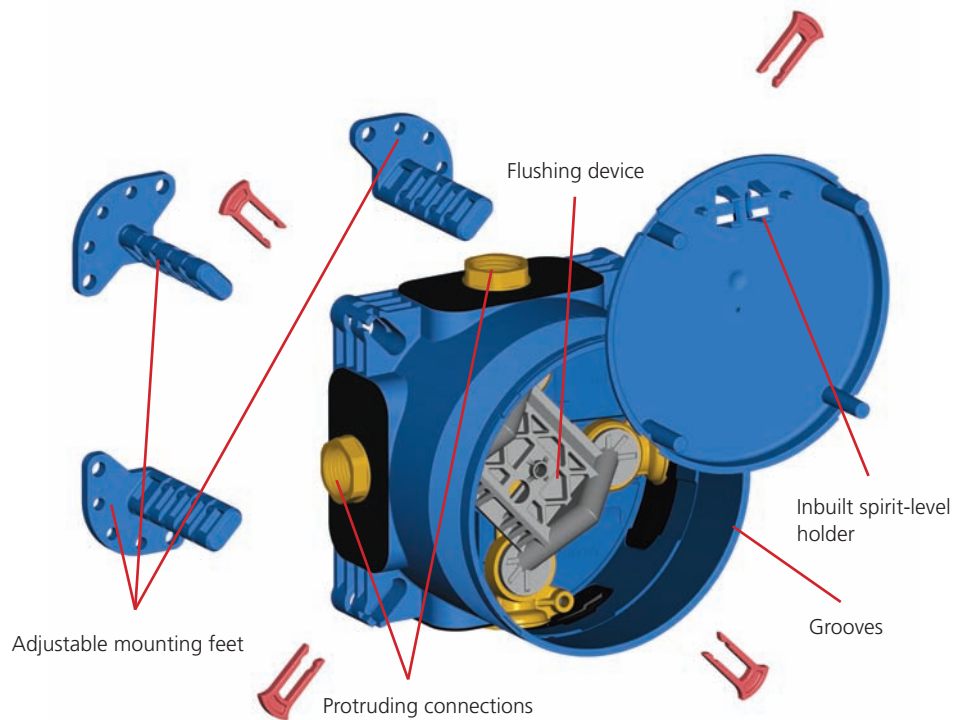

Kit 2

Kit 2 consists of a function built-in unit and visible design parts.

Function built-in unit: features technology specific to each model.

Cartridge, switching device, check valve, shut-off device (inbuilt on thermostats, optional on single-lever mixers) and inbuilt gaskets - this unit offers it all! Also available as an intrinsic safety version (only in conjunction with Ideal Standard connections).

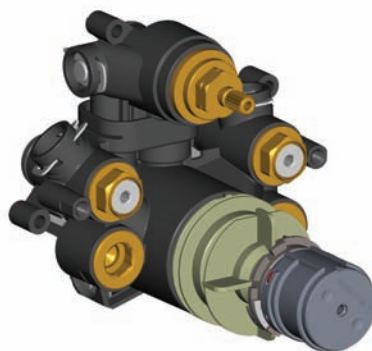

Thermostat
Long-lasting thermostat cartridge, side valves for pre-shut off with non return valve and DICHT-FIX.

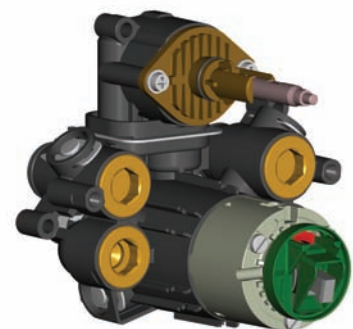

Single-lever mixer
Choose between a bath and shower or shower fitting with CLICK-cartridge, hot water temperature control, ECO-function and DICH-FIX.



Visible design parts: stylish fittings ranges.

The function built-in units can be combined with more than 30 fittings, offering total flexibility in design choice.



Shower single lever



Bath and shower single lever



Thermostat

FAST-FIX – the innovative fixation concept

FAST-FIX fixation concept ensures simple, effortless installation in every mounting possibility.

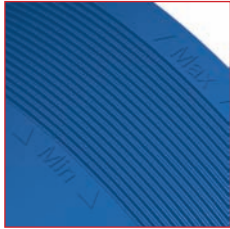

Grooves
The grooves facilitate trimming of the protruding parts of the box.

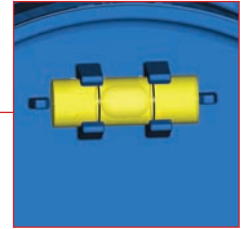

Cover
The cover contains a short installation guide and an integrated spirit-level holder to facilitate alignment of the EASY-Box.

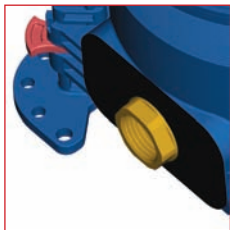

Pipe connections
The protruding connections facilitate the pipe attachment without needing any extension.

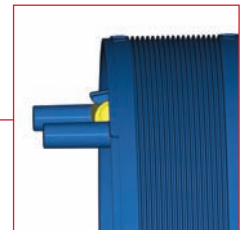

Support
The optimised spirit-level holder enables accurate and reliable positioning both horizontally and vertically.

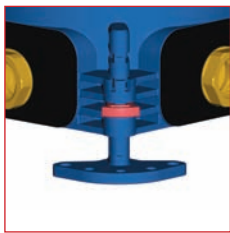

Fixation feet
The fixation feet enable simple mounting and progressive depth adjustment (up to 22 mm variation in the unit, plus 35 mm with the feet).



Fixation holes
The conveniently-positioned holes facilitate mounting in all installation positions.

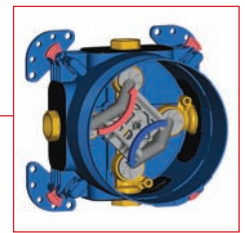

Flushing device
Loosening the internal hexagonal screw, the flushing device is released from the brass cross joint.

Installation possibilities

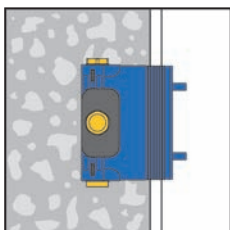

In-wall installation.

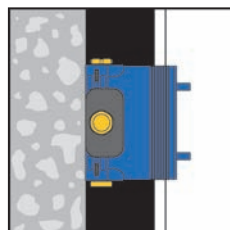

On-wall installation.

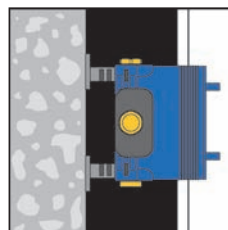

In-front-of-wall installation.

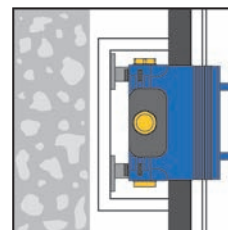

Installation on pre-carrier systems.

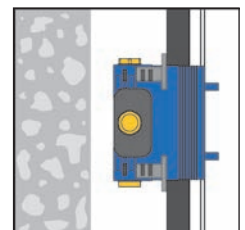

Installation on prefabricated cells.

DICHT-FIX – 100% waterproof

The time-tested DICHT-FIX waterproof system has been further developed and now provides triple sealing for concealed units.

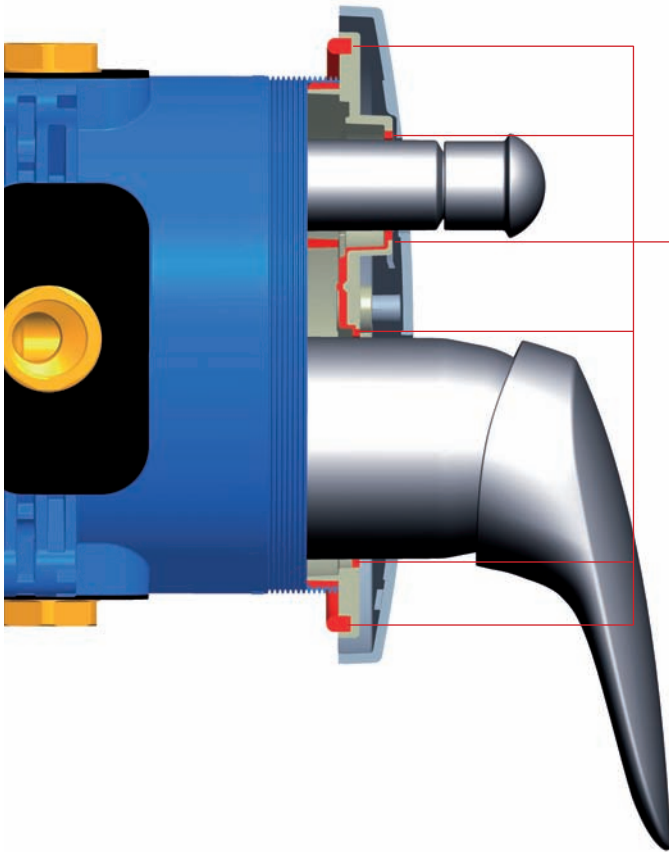

External waterproof – protection against splashing: the plate support protects the EASY-Box externally from splashing water. All openings are individually and reliably sealed.

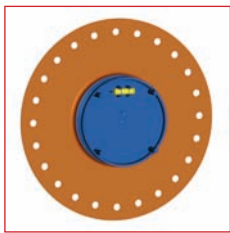

External waterproof – sealing fleece: the sealing fabric replaces the former sealing frames and prevents water from soaking in.

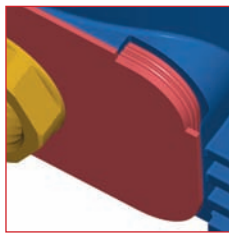

Internal waterproof - inlays: additional sealings around the protruding pipes prevent any water from soaking from the EASY-Box into the wall.



Intelligent solution – squirted sealings: the plate support is manufactured in a 2-component die-casting process. Direct injection moulding ensures that the joints remain perfectly watertight.

Structure sealant



EASY-Box enables careful showering enjoyment!

The most important issue, particularly for built-in installations, is to ensure that the brickwork is well sealed against water and dampness. When showering, no water should penetrate the wall e.g. through the gaps between the tiles. Therefore, the relatively large openings in the wall which hold the built-in unit's technology must be particularly well sealed.

Fast Installation

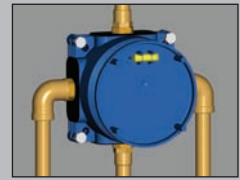

On-wall installation. Connect the pipes.

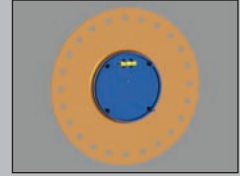

Fix sealing fabric on ready plastered and pre-treated wall.



Rinse pipes using a pre-assembled flushing device.



Trim the protruding part of the box, turn off the water and disassemble the flushing device.

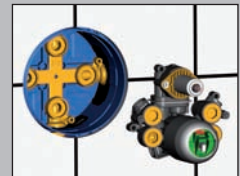

Assemble the function unit (thermostat or single lever body) from Kit 2 and verify watertightness.

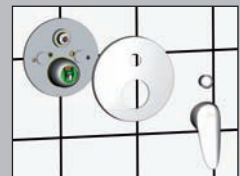

Slide the plate support over the cartridge and the diverter and screw into the right position. Then mount the visible design parts.



READY! EASY-Box combines modern design with advanced technology!

Variable installation depth

Between 73 and 95 mm

The Kit can be adapted to various depths without any difficulty. Additional depth adjustment (5 – 40 mm) is possible thanks to the variable height adjuster. For excessively deep installations, special distance frames and extension sets are available.

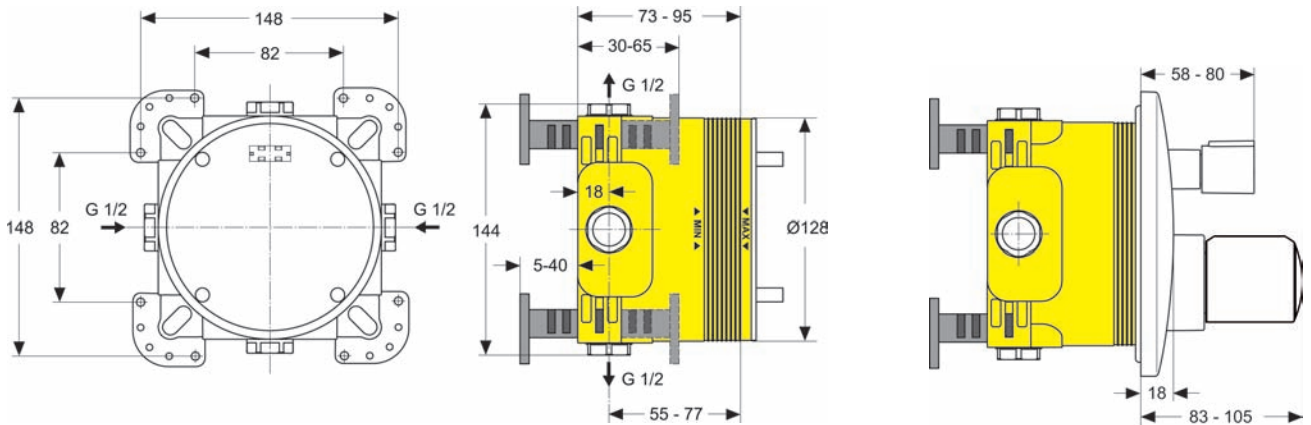

Flow rate

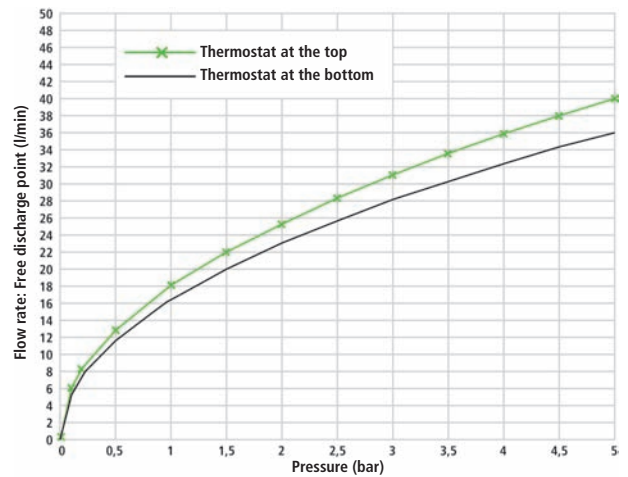
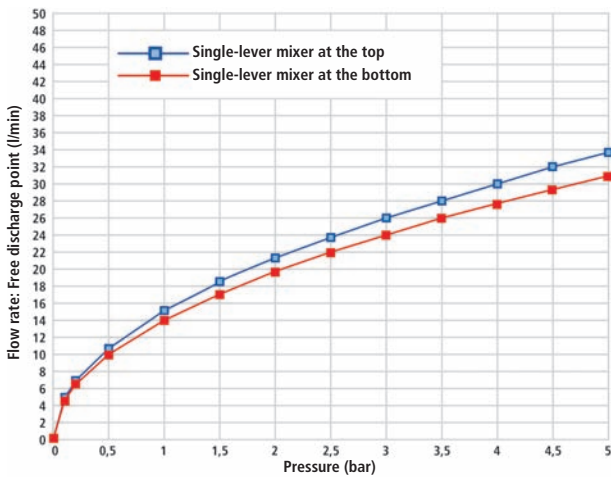

Accessories

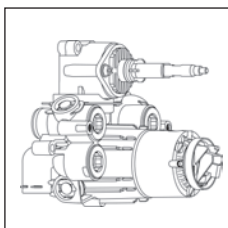

Intrinsic safety model variants:
For item code number see model overview.

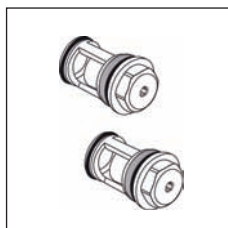

Shut-off devices for single-lever mixers:
A960706NU.

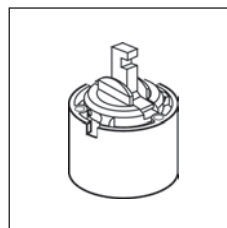

Cartridge for inverted connections:
EHM: A963462NU.
Thermostat: A963606NU.

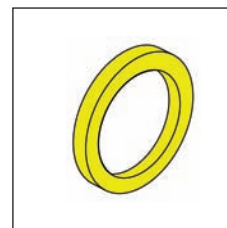

Distance frame for installations which are too flat:
A960705AA.

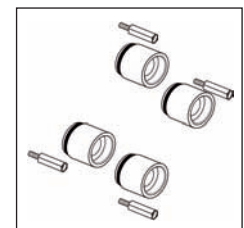

Extension set for installations which are too deep:
A960704NU.

Unlimited possibilities

The Ideal Standard EASY-Box concept is continuously being expanded and is the universal built-in solution for the future. It can be combined with more than 30 different fittings for maximum flexibility.

Kit 1 – EASY-Box

Basic built-in unit for wall installation:

G1/2 protruding connections, 4 height adjusters with locking devices (FAST-FIX), 1 flushing block and 1 stopper, sealing fleece, assembly instructions.

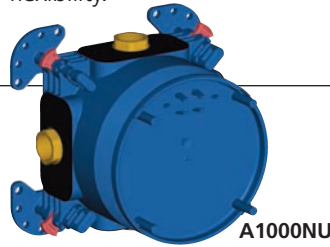

Complies with the following norms and directives:
 DIN 4109 sound insulation in buildings, noise control category I.
 DIN 1988 flushing of pipes in compliance with standards.
 Protects brickwork from damp.
 DIN EN 1717 with intrinsic safety models.*

functionality

Kit 2 – function built-in unit and visible design parts

Thermostat:

Thermostat cartridge, lateral shut-off valves with back-flow preventer, DICHT-FIX waterproof system and all visible design parts.



Moments
A4718AA



Celia
A4709AA



Melange
A4721AA

Bath and shower mixer:

Automatic diverter, CLICK cartridge with ceramic discs, hot water temperature control and ECO function, DICHT-FIX waterproof system and all visible design parts.



Moments
A4717AA
A4804AA**



Celia
A4711AA



Melange
A4720AA
A4805AA**



Attitude
A4758AA
A4806AA**



Ceramix Classic
A4723AA
A4807AA**



Cerasprint
A4714AA
A4808AA**



Active
B8652AA
B8991AA**



Ceraplan
A4712AA
A4809AA**



Ceraplan
A4712AA
A4809AA**



Ceraplan
A4712AA
A4809AA**

Shower mixer:

CLICK cartridge with ceramic discs, hot water temperature control and ECO function, DICHT-FIX waterproof system and all visible design parts.



Moments
A4716AA



Celia
A4710AA



Melange
A4719AA



Attitude
A4757AA



Ceramix Classic
A4722AA



Cerasprint
A4715AA



Active
B8651AA



Ceraplan
A4713AA



Ceraplan
A4713AA



Ceraplan
A4713AA

* Only in conjunction with Ideal Standard connections.
 ** Intrinsic safety models according to DIN EN 1717 standards.

**Direction
Commerciale,
Marketing et Centre
de Formation**

Paris Nord 2
165, av. du Bois de la Pie
Bâtiment H
Parc des Reflets
95920 Roissy CDG
T. 01 49 38 81 81
F. 01 49 38 81 50

**Centre d'exposition
et d'information**

41, rue Berger
75001 Paris
T. 01 44 88 96 96
F. 01 44 88 96 99

www.idealstandard.com

