

2014



Column switches

**Commutation  
sous volant**

Conmutador de volante

**Comutador de volante**

Devioguidasgancio

**Stuurkolomschakelaars**

Lenkstockschalte

**Przełączniki  
kolumny kierownicy**

Переключатель  
рулевой колонки

**Far-korna-silecek  
kumanda kolları**

Διακόπ της τιμονιού



**WANT TO  
KNOW MORE**



*\*Pour en savoir plus*

**valeo added** ■■■■■

www.valeoservice.com

\*La technologie automobile, naturellement

Automotive technology, naturally

**Valeo**

# A major actor in O.E. column switches



▶ The Valeo offer includes single levers and complete modules

**NEW**

▶ Clocksprings

▶ Wide range in I.A.M. for French and Italian brands, newly available applications for German car manufacturers in 2014

▶ Range listed in



## FR Un acteur majeur en Première Monte pour la commutation sous volant

100 % de l'offre commutation sous volant de Valeo répond aux critères de qualité Première Monte.

- ▶ Valeo offre une gamme de manettes individuelles et de modules complets.
- ▶ NOUVEAU : gamme de contacteurs tournants.
- ▶ Large gamme en Rechange Indépendante pour les marques françaises et italiennes. Nouvelles applications disponibles pour les constructeurs allemands en 2014.
- ▶ Publication sur TecDoc®.

### Des produits de sécurité et de confort

Les fonctions clignotant, essuie-glace et éclairage jouent un rôle primordial pour la sécurité du conducteur. Si les commutateurs tombent en panne, ils doivent être remplacés en conformité avec les spécifications du contrôle technique du véhicule. Il est vivement recommandé de les remplacer par des pièces d'origine Valeo.

### Les avantages de l'offre Valeo

- ▶ Produits à forte valeur ajoutée pour les garages, notamment lorsqu'il s'agit de remplacer des modules complets
- ▶ La durée moyenne d'installation est de 1 heure, avec le manuel du véhicule
- ▶ Le remplacement s'effectue sans réinitialisation

### Portefeuille Valeo

- ▶ Une gamme complète de 280 références pour véhicules de tourisme / utilitaires légers
- ▶ 130 modules complets pour : ALFA ROMEO, CITROËN, FIAT, IVECO, LANCIA, PEUGEOT, RENAULT
- ▶ 150 leviers à l'unité (commutateurs d'éclairage ou d'essuie-glace) pour : ALFA ROMEO, CITROËN, FIAT, IVECO, LANCIA, OPEL, PEUGEOT, RENAULT
- ▶ NOUVEAU 9 contacteurs tournants

## SP Actor principal en O.E. para Conmutadores de Volante

La gama completa I.A.M. de Conmutadores es calidad O.E.

- ▶ La oferta de Valeo incluye mandos y módulos completos.
- ▶ Contactores Rotativos: nueva categoría de productos en la gama.
- ▶ Amplia gama de recambios (I.A.M.) para marcas francesas e italianas y aplicaciones recientes de constructores alemanes.
- ▶ Gama disponible en TecDoc®.

### Productos de seguridad y confort

Las funciones de señalización, iluminación y limpiaparabrisas son claves para mejorar la seguridad del conductor.

Si los conmutadores se dañan, deben reemplazarse de acuerdo con las especificaciones técnicas del fabricante. Se recomienda reemplazar por productos originales.

### Ventajas de la oferta Valeo

- ▶ Productos con valor añadido para talleres, incluido módulos completos
- ▶ Utilizando el manual del vehículo el tiempo medio de montaje es una hora
- ▶ No necesaria codificación (salvo nuevas tecnologías) ni herramientas específicas

### Gama de productos Valeo

- ▶ Una gama completa con 280 referencias para Turismo y Vehículo Industrial.
- ▶ 130 Módulos completos para: ALFA ROMEO, CITROËN, FIAT, IVECO, LANCIA, PEUGEOT, RENAULT
- ▶ 150 Mandos (iluminación y limpiaparabrisas) para: ALFA ROMEO, CITROËN, FIAT, IVECO, LANCIA, OPEL, PEUGEOT, RENAULT
- ▶ NUEVO: 9 Contactores Rotativos

## DE Einer der bedeutendsten Erstausrüster Lenkstockschalter

100% der Lenkstockschalter von Valeo haben Originalteilqualität

- ▶ Das Valeo-Angebot umfasst sowohl einzelne Hebel als auch komplette Module
- ▶ Wickelfeder: eine neue Produktkategorie im Sortiment
- ▶ Ein umfangreiches Ersatzteilesortiment für französische und italienische Marken - neue Anwendungen für deutsche Hersteller ab 2014
- ▶ Vernetzt in der TecDoc® Datenbank

### Sicherheits- und Fahrkomfort-Produkte

Blinker, Scheibenwischer und Beleuchtungsfunktionen tragen entscheidend zur Erhöhung der Fahrsicherheit bei. Sind die Schalter defekt, so müssen sie gemäß den Spezifikationen der Fahrzeugprüfstellen ausgewechselt werden. Dabei wird die Verwendung von Originalprodukten empfohlen.

### Vorzüge des Valeo-Angebots

- ▶ Hochwertige Produkte für Werkstätten, besonders wenn ganze Module ausgewechselt werden müssen
- ▶ Durchschnittliche Einbauzeit: eine Stunde mit Hilfe der Fahrzeugunterlagen
- ▶ Auswechseln ohne elektronische Neuinitialisierung oder Spezialwerkzeug

### Valeo-Produktpalette

- ▶ Ein umfassendes Sortiment mit 280 Referenzen für Pkw und leichte Nfz
- ▶ 130 komplette Module für: ALFA ROMEO, CITROËN, FIAT, IVECO, LANCIA, PEUGEOT, RENAULT
- ▶ 150 einzelne Hebel (Beleuchtungs- oder Wischerschalter) für: ALFA ROMEO, CITROËN, FIAT, IVECO, LANCIA, OPEL, PEUGEOT, RENAULT
- ▶ NEU 9 Wickelfedern

## Safety & comfort products



The turn signal, wiper and lighting functions play a key role in enhancing driver safety.

If the switches are broken, they must be replaced in line with vehicle inspection centre specifications.

It is highly recommended to replace them with original products.

## Advantages of Valeo offer



- ▶ High-value products for garages, especially when the complete modules have to be replaced.
- ▶ Average fitting time is one hour, using the vehicle manual.
- ▶ Replacement without electronic re-initialization or specific tools.

## Valeo Portfolio

**280**  
part  
numbers

**130**  
complete  
modules

**150**  
single  
levers

**9**  
clocksprings



- ▶ A complete range of 280 part numbers for PCs / LCVs
- ▶ 130 complete modules for: ALFA ROMEO, CITROËN, FIAT, IVECO, LANCIA, PEUGEOT, RENAULT
- ▶ 150 single levers (lighting or wiper switch) for: ALFA ROMEO, CITROËN, FIAT, IVECO, LANCIA, OPEL, PEUGEOT, RENAULT
- ▶ **NEW** 9 clocksprings

### NL Een belangrijke speler in O.E. stuurkolomschakelaars

100% van de Valeo schakelaarsrange is van OE-kwaliteit

- ▶ Valeo's programma omvat afzonderlijke schakelaars en complete modules
- ▶ Clocksprings: een nieuwe productcategorie in het programma
- ▶ Breed IAM-programma voor Franse en Italiaanse merken; in 2014 nieuwe toepassingen voor Duitse fabrikanten
- ▶ Programma beschikbaar in TecDoc®

#### Veiligheids- en comfortproducten

Richtingaanwijzers, ruitenwissers en verlichting spelen een cruciale rol bij het verhogen van de veiligheid van de bestuurder. Als deze onderdelen kapot gaan, moeten ze vervangen worden volgens de specificaties van het keuringsstation. Het wordt sterk aangeraden ze te vervangen door originele producten.

#### Voordelen van het Valeo-programma

- ▶ Hoogwaardige producten voor garages, vooral als de volledige modules vervangen moeten worden
- ▶ De gemiddelde inbouwtijd is één uur, gebruikmakend van de handleiding van het voertuig
- ▶ Vervanging zonder elektronische herinitialisatie of speciaal gereedschap

#### Valeo programma

- ▶ Een volledig programma van 280 productcodes voor personenauto's en lichte bedrijfsauto's
- ▶ 130 complete modules voor: ALFA ROMEO, CITROËN, FIAT, IVECO, LANCIA, PEUGEOT, RENAULT
- ▶ 50 afzonderlijke hendels (schakelaar voor verlichting of ruitenwissers) voor: ALFA ROMEO, CITROËN, FIAT, IVECO, LANCIA, OPEL, PEUGEOT, RENAULT
- ▶ NIEUW 9 clocksprings

### TR Valeo öncü O.E. sağlayıcısı direksiyon çevresi kumanda kollarında

Valeo IAM'de, direksiyon çevresi kumandalar ürün gamının 100%'ü O.E. kalitedir

- ▶ Tekli anahtarları ve komple modülleri kapsayan geniş Valeo sunumu
- ▶ Direksiyon zembereği: Ürün grubunda yeni seri
- ▶ Fransız ve İtalyan araç markaları için geniş IAM sunumu ve 2014 yılından itibaren Alman üreticiler için yeni uygulamalar
- ▶ TecDoc® 'ta izlenebilir ürün grubu

#### Emniyet ve konfor ürünleri

Sinyal, silecek ve aydınlatma işlevleri sürüş emniyetinin artmasında önemli rol oynarlar.

Kilit, hasar gördüğü durumlarda aracı muayene eden merkezin verdiği bilgilere uygun olarak değiştirilmelidir. Bu elemanların mutlaka Orijinal Ürünler ile değiştirilmeleri tavsiye edilir.

#### Valeo sunumunun avantajları

- ▶ Bilhassa komple modül değişimleri için tamirhane ve servislere sunulan yüksek kaliteli ürünler
- ▶ Sıradan el aletleri kullanımıyla ortalama bir saatlik montaj süresi
- ▶ Resetleme veya özel elektronik aletler olmadan değişim

#### Valeo Portföyü

- ▶ Binek ve hafif ticari araçlar için 280 parça numarasını kapsayan ürün gamı
- ▶ ALFA ROMEO, CITROËN, FIAT, IVECO, LANCIA, PEUGEOT, RENAULT için 130 komple modül referansı
- ▶ ALFA ROMEO, CITROËN, FIAT, IVECO, LANCIA, OPEL, PEUGEOT, RENAULT için 150 aydınlatma - silecek kumanda kolu referansı
- ▶ YENİ 9 direksiyon zembereği referansı

### IT Primo fornitore mondiale di comandi sotto sterzo Moduli per Montanti

Il 100% della gamma aftermarket Valeo è di qualità originale

- ▶ L'offerta Valeo comprende le leve singole e i moduli completi
- ▶ Contatti spiralati: una nuova categoria di prodotti in gamma
- ▶ Un'ampia offerta aftermarket per i marchi francesi e italiani, nuove applicazioni disponibili per i costruttori tedeschi nel 2014
- ▶ Lista in TecDoc®

#### Prodotti per la sicurezza e il comfort

L'indicatore di direzione, il tergicristallo e le funzioni di illuminazione rivestono un ruolo essenziale nel miglioramento della sicurezza del guidatore.

Se i comandi si guastano, devono essere sostituiti conformemente alle specifiche del centro di controllo tecnico. Si raccomanda vivamente di sostituire questi pezzi con ricambi originali.

#### Vantaggi dell'offerta Valeo

- ▶ Prodotti di alta qualità per gli autoriparatori, specialmente per la sostituzione di moduli completi
- ▶ Il tempo di montaggio medio è di un'ora, con il manuale del veicolo
- ▶ Sostituzione senza reinizializzazione elettronica né attrezzi particolari

#### Portfolio Valeo

- ▶ Una gamma completa di 280 referenze per vetture passeggeri e veicoli commerciali leggeri
- ▶ 130 moduli completi per: ALFA ROMEO, CITROËN, FIAT, IVECO, LANCIA, PEUGEOT, RENAULT
- ▶ 150 leve (commutatori per illuminazione o tergicristalli) per: ALFA ROMEO, CITROËN, FIAT, IVECO, LANCIA, OPEL, PEUGEOT, RENAULT
- ▶ NUOVO 9 contatti spiralati

# A major actor in O.E. column switches

NEW

## Clocksprings



The clockspring enables the steering wheel to turn while maintaining the electrical connection between the steering wheel airbag, horn and the vehicle's electrical systems. It is generally located between the steering wheel and the steering column.



### Available for:

DACIA ▶ Logan

RENAULT ▶ Scénic II, Mégane I, Laguna II, Espace, Clio II, Master II, Twingo II

Valeo				
251642	Renault	Scénic II Grand Scénic II	05/2003 > 08/2009 05/2003 > 11/2009	7701060399
251643	Renault	Mégane I	03/1999 > 02/2003	7701047253
251644	Dacia	Logan	10/2006 > 10/2007	6001548105
251645	Dacia	Logan	10/2007 >	6001551352
251647	Renault	Laguna II Espace et Grand Espace	01/2001 > 02/2005 09/2002 >	7701048917
251648	Renault	Clio II	03/1998 > 03/2001	7701048953
251649	Renault	Master II	10/2003 > 10/2008	7701057611
251650	Renault	Twingo II	07/2007 >	7701063406
251651	Renault	Master II	10/2008 >	7701071600



## For Renault Scénic II

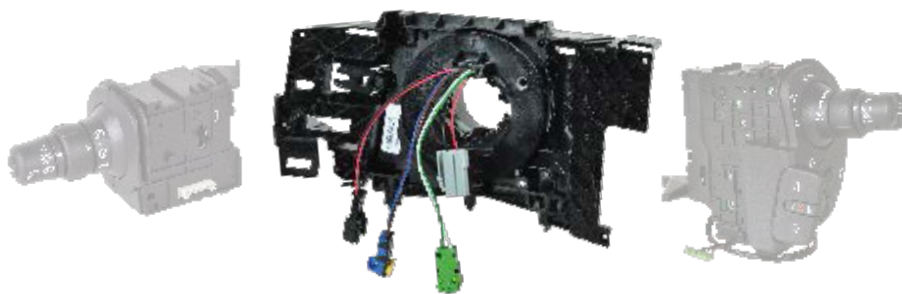

▶ 251639  
Lighting Switch



▶ 251642  
Clockspring



▶ 251638  
Wiper Switch

**FR** Contacteurs tournants

Le contacteur tournant permet de manoeuvrer le volant tout en maintenant la connexion électrique entre l'airbag du volant, le klaxon, les autres appareils, et les systèmes électriques du véhicule.

Il est généralement situé entre le volant et la colonne de direction.

## Disponible pour :

DACIA ▶ Logan

RENAULT ▶ Scénic II, Mégane I, Laguna II, Espace, Clio II, Master II, Twingo II

**NL** Clocksprings

Dankzij de clockspring kan het stuurwiel draaien en is er toch een elektrische verbinding tussen onderdelen als stuurwielairbag en claxon en het elektrische systeem van het voertuig.

De clockspring zit meestal tussen het stuurwiel en de stuurkolom.

## Leverbaar voor:

DACIA ▶ Logan

RENAULT ▶ Scénic II, Mégane I, Laguna II, Espace, Clio II, Master II, Twingo II

**SP** Contactores Rotativos

El contactor rotativo permite al volante seguir girando y mantener la conexión eléctrica entre el airbag del volante, el claxon y el resto de sistemas eléctricos del vehículo.

Se situa entre el volante y la columna de dirección.

## Disponible para:

DACIA ▶ Logan

RENAULT ▶ Scénic II, Mégane I, Laguna II, Espace, Clio II, Master II, Twingo II

**TR** Direksiyon zemberekleri

Direksiyon zemberekleri, direksiyon simidi üzerindeki hava yastığı, korna ve diğer kumandalar ile aracın elektrik sistemi arasındaki bağlantı kesilmeden direksiyonun döndürülebilmesini sağlar.

Çoklukla direksiyon simidi ve direksiyon mili arasında bulunur.

## Uygulamalar:

DACIA ▶ Logan

RENAULT ▶ Scénic II, Mégane I, Laguna II, Espace, Clio II, Master II, Twingo II

**DE** Wickelfeder

Die Wickelfeder (Schleifring + Schleifkontakte) gewährleistet die elektrische Verbindung zwischen dem Lenkrad-Airbag, der Hupe sowie anderen Ausrüstungen einerseits und den elektrischen Systemen des Fahrzeugs andererseits, während sich das Lenkrad dreht.

Sie ist generell zwischen Lenkrad und Lenkstock installiert.

## Erhältlich für:

DACIA ▶ Logan

RENAULT ▶ Scénic II, Mégane I, Laguna II, Espace, Clio II, Master II, Twingo II

**IT** I contatti spiraliati

Il contatto spiralato permette di girare lo sterzo mantenendo il collegamento elettrico con l'airbag dello sterzo, il claxon e altri dispositivi, nonché i sistemi elettrici del veicolo.























È generalmente collocato tra lo sterzo e il piantone.



























## Disponibile per:

DACIA ▶ Logan

RENAULT ▶ Scénic II, Mégane I, Laguna II, Espace, Clio II, Master II, Twingo II

# GENERAL SYMBOLS & ABBREVIATIONS

	Vehicle Vehículo Veículo Veicolo Voertuig Fahrzeug Pojazd Vozidlo Jármű Arac автомобиль Οχήμα		Convertible Cabriolet Descapotable Descapotável Cabriolet Cabriolet Cabrio Kabriolet КАБРИОЛЕТ Kabrio Cabrio	Electronic Stability Program Programme de Stabilité Electronique Programa de Estabilidad Electrónica Programa de Estabilidade Eletrónica Programma di Stabilità Elettronica Elektronisch Stabilitätsprogramm Elektronisches Stabilitätsprogramm System kontroli trakcji Система стабилизации курсовой устойчивости Elektronik denge sistemi Ηλεκτρονικό Σύστημα Σταθεροποίησης ESP
	Photo Photo Foto Foto Foto Foto Zdjęcie Φoto Fotograf Φωτογραφία		Coupe Coupe Coupe Coupe Coupe Coupe Coupe Coupe КУПЕ 2 Kaplı Coupe	GPS / Navigation system GPS / Système de navigation GPS / Sistema de navegación GPS / Radionavegação GPS / Sistema di navigazione GPS / Navigatiesysteem GPS / Navigationsverfahren GPS / Nawigacja GPS / Навигационная система GPS / Navigasyon sistemi GPS / Σύστημα πλοήγησης
	Wiring diagram Schéma technique Esquema Esquema Schema tecnico Bedradingsschema Montageanleitung Schemat Схема Çizim Τεχνικό Διάγραμμα		From chassis number Depuis N° de chassis Desde número de chasis Desde o n° de chassi Dal numero di telaio Van Chassisnummer Ab Fahrgestellnummer Nr. Od numeru nadwozia от номера шасси Şasi numarasinan itibaren Από Σασί	Multiplexing Multiplexage Multiplexado multiplexação Multiplazione Multiplexing Multiplexverfahren Multiplaksowanie Мультиплексирование Çoklu veri Πολυπλεξία
	OE reference Référence Constructeur Referencia constructor Referència constructor Riferimento Costruttore OE referentie OE-Nummer Referenja konstruktora OE номер OE referansı Κωδικός Κατασκευαστή		ch ▶	MPX
	Product Manufacturer reference Référence Equipementier Referencia competencia Referència fabricante Riferimento IAM IAM referentie Produktionsnummer Referenja producenta Номер производителя Parça üretici referansı Κωδικός Aftermarket		▶ ch	MPXC
	Date of application Période de fabrication Año Ano Data Bouwjaar Baujahr Lata produkcyj Rok výroby Gyártási év Uygulama tarihi выпуск Ημερομηνία κατασκευής		AC	MPXV
	Saloon Berline Berlina Berlina Berlina Berlina Berline Limousine Sedan СЕДАН Sedan Τετράθυρο		AIR	RESE
	Estete Break Break Break Station wagon Station wagon Kombi Kombi УНИВЕРСАЛ Station wagon Station wagon		AIR	RESE
	Power Assisted Steering Direction assistée Dirección asistida Direcção assistida Direzione assistita Stuurbevestiging Servolenkung Wspomaganie Kierownicy Усилитель рулевого управления Hidrolik direksiyon Υδραυλικό Τιμόνι		AIR	RESE
	Control on wheel (radio or cruise control) Comande sur volant (radio ou régulateur de vitesse) Mando en el volante (radio o limitador de velocidad) Comando no volante (radio ou controlo de velocidade) Mando sul volante (radio o controllo velocità) Switch op stuurwiel (Radiobediening of cruise control) Lenkradfernbedienung (Radio oder Tempomat) Sterowanie na kierownicy (radiem lub tempomatem) Пульт управление на рулевом колесе (аудио или климатическая системы) Direksiyon üzerindeki kumandalar (radio ve hız sabitleyici) Τηλεχειριστήριο στο τιμόνι (Ραδιοφώνου η ρύθμισης ταχύτητας)		AIR	RESE
			AIR	RESE

 <p>With / Without Avec / Sans Con / Sin Com / Sem Con / Senza Met / Zonder Mit / Ohne Z / Bez C / БЕЗ birlikte / ayrı Με / Χωρίς</p>	 <p>Intermittent wiper Essuyage intermittent Limpiaparabrisas intermitente Limpa-vidros intermitente Tergicristallo intermittente Ruitenwisser met interval Intervallschaltung Przerzywana praca wycieraczki Прерывание работы стеклоочистителя Fasilali silme <b>Διακοπτόμενος Καθαρισμός</b></p>	 <p>Rear-screen demist Lunette arrière chauffante Luneta térmica posterior Desembaciador traseiro Lunotto termico Achterruitverwarming Heckscheibenheizung Podgrzewanie tylnej szyby Обогрев заднего стекла Arka cam rezistansi <b>Θερμαινόμενο Πίσω Παρμπρίξ</b></p>
 <p>Lighting Eclairage Luces Luz Luci Verlichting Beleuchtung Światła Система освещения Aydınlatma <b>Φωτισμός</b></p>	 <p>Rain sensitive wiper system Essuyage automatique Limpiaparabrisas con sensor de lluvia Limpeza automática Tergicristallo automatico Ruitenwisser met regensensor Wischen mit Regensensor Wycieraczki automatyczne (czujnik deszczu) Думающий стеклоочиститель Otomatik silecek <b>Αυτόματος Καθαρισμός</b></p>	 <p>Hazard warning Feu de détresse Luces de emergencia Luz de emergência Emergenza Waarschuwingslicht Warnblinklicht Światła awaryjne Аварийный сигнал Υαγι ισιγι <b>Αλάρμ</b></p>
 <p>Automatic lighting (light sensor) Eclairage automatique Encendido automático luces Iluminação Automática (sensor de luz) Fari ad accensione automatica Automatische verlichting (sensor) Automatische Beleuchtung (Lichtsensor) Światła automatyczne (czujnik zmierzchu) Освещение автоматическое (датчик освещенности) Otomatik aydinlatma <b>Αυτόματος Φωτισμός (με Αισθητήρες)</b></p>	 <p>Rear-screen wiper / washer Essuie / lave-lunette arrière Lava / Limpialuneta posterior Lava / Limpa-vidros traseiro Tergi / lavalunotto Ruitenwisser achter / ruitensproeier Heckscheibenwaschanlage Tylna wycieraczka/spryskiwacz Стеклоочиститель/омыватель заднего стекла Arka cam silme/yıkama <b>Πίσω Υαλοκαθαριστήρες / Εκτοξευτής υγρού</b></p>	 <p>Angle sensor Capteur d'angle Captador de ángulo Ângulo do sensor Sensore d'angolo Hellingshoek Abstandsensor Czujnik kątowy Датчик угла Arka açilayıcı <b>Αισθητήρας Γωνίας</b></p>
 <p>Indicator Clignotant Indicador de dirección Indicador de direção Indicatore di direzione Richtingaanwijzer Blinker Kierunkowskaz Индикатор Sinyal <b>Φλάς</b></p>	 <p>Clockspring (for Airbag) Contacteur tournant (pour l'Airbag) Contactor giratorio (para Airbag) Contador giratorio (dispositivo de Airbag) Dispositivo Airbag Air Bag connector Drehkontakt Styk pierścieniowy Рулевой контакт Helezon bağlantı <b>Περιαστροφική επαφή (Ενεργοποιητής Αερόσακκου)</b></p>	 <p>Day running lights (4 lamps) Codes permanents (4 optiques) Luz de cruce permanente (4 faros) Luz de Intermitentes (4 faros) Luci di ingombro (4 lampade) Permanent stadslicht Tagfahrlicht (4 Lampen) Światła dzienne (4 żarówki) Фонари дневного света (4 лампы) 4 ampullu aydinlatma <b>Μόνιμα Φανάρια</b></p>
 <p>Horn Avertisseur Bocina Buzina Avvisatore acustico Claxon Hupe Sygnał dźwiękowy Звуковой сигнал Κορνα <b>Κόρνα</b></p>	 <p>Cruise control Régulateur de vitesse Control velocidad Controlo velocidade Cruise control Cruise control Tempomat Tempomatem Крузиз контроль Hız sabitleme sistemi <b>Σύστημα ρύθμισης ταχύτητας</b></p>	 <p>Fixed centred controls steering wheel Volant à commandes centrales fixes Volante Con Mandos Centralizados Fijos Volante com comandos centralizados fixos Volante con controlli centralizzati fissi Stuurwiel met vaste centrale bedieningen Lenkrad mit festzentrierten Steuerungen kierownica z nieruchomym centralnym zespołem przełączników Рулевое колесо с расположенными по центру элементами управления Sabit merkezli kumanda direksiyonu Τιμόνι με κεντρικά σταθερά χειριστήρια</p>
 <p>Front fog-light Feu brouillard avant Antiniebla delantero Anti-nevoeiro dianteiro Fendinebbia Mistlamp voor Nebelscheinwerfer vorne Lampa przeciwmiełna przednia Передняя противотуманная фара Ön sis lambası <b>Φανός Ομίχλης Εμπρός</b></p>	 <p>Radio control Commande radio Mando radio Comando rádio Comando radio Radio control Radiobediienung Pilot radia Радио контроль Radio kumandasi <b>Ρύθμιση Ραδιοφώνου</b></p>	 <p>Clockspring Contacteur tournant Contactor giratorio Contador giratorio Dispositivo Airbag Clockspring Drehkontakt Styk pierścieniowy Рулевой контакт Helezon bağlantı <b>Περιαστροφική επαφή</b></p>
 <p>Rear fog-light Feu brouillard arrière Antiniebla posterior Anti-nevoeiro posterior Retronebbia Mistlamp achter Nebelschussleuchte Lampa przeciwmiełna tylna Задняя противотуманная фара Arka sis lambası <b>Φανός Ομίχλης Οπίσθιος</b></p>	 <p>Other functions Autres fonctions Otras funciones Outras Funções Altre funzioni Andere functies Andere Funktionen Inne funkcje Другие функции Diğer işlevler <b>Άλλες Λειτουργίες</b></p>	 <p>Configurable key Clé configurable Llave configurable Chave configurável Chiave configurabile Instelbare sleutel Konfigurierbarer Schlüssel przycisk konfigurowalny Настраиваемый ключ Yapılandırılabilir anahtar <b>Διαμορφώσιμο κλειδί</b></p>
 <p>Windscreen wiper / washer Essuie / lave-vitre avant Lava / Limpiaparabrisas Lava / Limpa-vidros Tergi / lavacristallo Ruitenwisser en sproeier Scheibenwaschanlage Spryskiwacz szyby Омыватель ветрового стекла Ön cam yıkayıcı <b>Υαλοκαθαριστήρες / Εκτοξευτής υγρού Εμπρός</b></p>	 <p>Headlamp washer Lave-projecteur Lavafaros Limpa-faros Lavaarioiettori Koplamp sproeier Scheinwerfer-Waschanlage Spryskiwacz reflektorów Омыватель фар Far yıkayıcı <b>Εκτοξευτής υγρού φαναριού</b></p>	 <p>Parking stationnement Aparcamiento Estacionamento Parcheggio Parkeren Parken parkowanie Парковка Park <b>Στάθμευση</b></p>
 <p>Single wipe (1 single wipe) Petite vitesse momentané (1 seul balayage) Velocidad lenta momentánea (1 solo barrido) Velocidade lenta momentânea (1 só passagem) Bassa velocità momentanea (1 sola velocità) Enkele ruitenwisser Wischimpulsschalter Jednorazowe uruchomienie wycieraczki Разовая работа стеклоочистителя Silecek zamanlayıcısı - Düşük Hız (Tek silme) <b>Στιγμιαία αργή ταχύτητα (1 σκούπισμα)</b></p>	 <p>On-board computer Ordinateur de bord Ordenador de abordo Computador Computer di bordo Board computer Bordcomputer Komputer pokładowy Бортовой компьютер Yol bilgisayarı <b>Σύστημα πληροφοριών οδηγού</b></p>	

**GB**

Column switches can be replaced on vehicles accordingly

- either by **individual levers**



Lighting lever



Wiper lever



Radio control lever



Cruise control

- or by a **complete module** (product that cannot be dismantled)

- On recent vehicles, both solutions are equipped with clocksprings, ensuring the electrical link of the airbag or other functions on the wheel (horn, radio...).
- On complete module, the clockspring is integrated. On individual levers, the clockspring is an independent part.



**NEW:** Valeo Service proposes in its portfolio individual **clocksprings**

**FR**

Selon les véhicules, les commutateurs sous volant se remplacent :

- soit par **manette individuelle**



Commande éclairage



Commande essuyage



Commande radio



Régulateur de vitesse

- soit par **module complet** (ensemble non démontable)

- Sur les véhicules récents, les deux solutions sont équipées de contacteurs tournants, assurant la liaison électrique de l'airbag du véhicule ou éventuellement d'autres fonctions au volant (avertisseur, radio...).
- Sur les modules complets, le contacteur tournant est intégré. Sur les manettes individuelles, le contacteur tournant est une pièce indépendante.



**NOUVEAU :** Valeo service propose dans son portefeuille des **contacteurs tournants** individuels.

**SP**

Según los vehículos, los conmutadores se reemplazan :

- por **módulos individuales**



Mando de luces



Mando limpiaparabrisas



Mando radio



Control de velocidad

- por **módulos completos** (conjunto no desmontable)

- En vehículos recientes, ambas soluciones vienen equipadas con contactor rotativo, lo que garantiza la conexión eléctrica del airbag u otras funciones en el volante (bocina, radio...).
- En el módulo completo, se incluye el contactor rotativo. En palancas individuales, el contactor rotativo es una pieza independiente.



**NOVEDAD :** Valeo Service incluye en su oferta **contactores rotativos**.



Segundo os veículos, os comutadores substituem-se :

• por **módulos individuais**



Comando de luzes



Comando limpa-vidros



Comando radio



Controlo de velocidade

• por **módulos completos** (conjunto não desmontável)

- Nos veículos recentes, ambas as soluções estão equipadas com contator rotativo, assegurando a ligação elétrica do airbag ou outras funções no volante (buzina, rádio...).
- No módulo completo, o contator rotativo está integrado. Em alavancas individuais, o contator rotativo é uma peça independente.



**NOVIDADE:** A Assistência Valeo propõe **contator rotativo** individuais no seu portfolio .

A seconda dei veicoli, il devio può essere sostituito come :

• **leva individuale**



Comando luci



Comando tergi



Comando radio



Controllo della velocità

• **modulo completo** (insieme non smontabile)

- Nei nuovi veicoli, entrambe le soluzioni sono dotate di cavi spiralati che assicurano il collegamento elettrico dell'airbag o di altre funzioni disponibili sul volante (segnalatore acustico, radio...).
- Nel modulo completo, il cavo spiralato è integrato. Nelle leve individuali, il cavo spiralato costituisce una parte indipendente.



**NOVITÀ:** Valeo Service propone nel suo portfolio **cavi spiralati** individuali

Naar gelang het voertuig, kan de stuurkolomchakelaar vervangen worden door :

• **individuele stuurkolomchakelaars**



Verlichting



Ruitenwisser



Radiobediening



Cruise control

• of door een **complete module** (Produkt dat niet gedemonteerd kan worden)

- In recente voertuigen zijn beide oplossingen uitgerust met clocksprings, wat de elektrische koppeling van de airbag of andere functies op het stuurwiel (claxon, radio enz.) garandeert.
- In de volledige module is de clockspring geïntegreerd. In individuele hendels is de clockspring een onafhankelijk onderdeel.



**NIEUW:** Valeo Service stelt in zijn portfolio individuele **clocksprings** voor

DE

Je nach Fahrzeug lassen sich Lenkstockschalter folgendermaßen ersetzen:

- **einzeln** 
  -  Beleuchtung
  -  Wischer
  -  Radio
  -  Tempomat

- als **vollständiges Modul** (nicht in Einzelteile zerlegbar) 





- In neueren Fahrzeugen sind beide Lösungen mit Wickelfedern ausgestattet. Dies stellt den elektrischen Kontakt des Airbags oder anderer Funktionen im Lenkrad sicher (Hupe, Radio...).
- Bei vollständigen Modulen sind die Wickelfedern integriert. Bei einzelnen Hebeln ist der Schleifring ein eigenes Bauteil.



**NEU:** Valeo Service bietet in seinen Portfolios eigene **Wickelfedern** an.

PL

Zależnie od modelu samochodu, przełączniki kolumny kierowniczej mogą być wymieniane :

- **pojedynczo** 
  -  Przełącznik świateł
  -  Wycieraczek
  -  Sterowanie radiem
  -  Tempomatem

- lub jako **kompletny moduł** (produkt nierozbieralny) 

- W najnowszych pojazdach oba rozwiązania wyposażone zostały w styki pierścieniowe doprowadzające energię elektryczną do poduszki powietrznej lub innych funkcji na kierownicy (klakson, radio...).
- W kompletnym module styk pierścieniowy jest zintegrowany. W przypadku poszczególnych dźwigni, każdy styk jest niezależną częścią.



**Nowość:** VALEO SERVICE oferuje w swoim portfolio indywidualne **styki pierścieniowe**

TU

Kumanda kolları araç tiplerine göre farklılık gösterebilir :

- **Tekli kumanda kolu** 
  -  Aydınlatma kumandası
  -  Silecek kumandası
  -  Radyo kumandaları
  -  Hız sabitleyici

- Ya da parçalara ayrılmayan **komple bir modül** olabilir 

- Yeni araçlarda her iki çözüm de zamanlama yayıyla donatılmış olup bu sistem direksiyon üzerindeki hava yastığının veya diğer işlevlerin (korna, radyo...) elektriksel bağlantısını sağlar.
- Tam modülde zamanlama yayı entegre haldedir. Tek kollarda zamanlama yayı bağımsız bir parçadır.



**YENİ:** Valeo Servisi portföyünün bir parçası olarak bağımsız **direksiyon zemberekları** sunar

<b>251586</b>	<b>NISSAN</b> Kubistar (2003>) <b>RENAULT</b> Kangoo (97>2003) Kangoo (2003>2009)	
<b>251587</b>	<b>RENAULT</b> Twingo III (2007>)	
<b>251588</b>	<b>RENAULT</b> Twingo III (2007>)	
<b>251589</b>	<b>RENAULT</b> Twingo III (2007>)	
<b>251590</b>	<b>RENAULT</b> Master (2006>)	
<b>251591</b>	<b>RENAULT</b> Master (2006>)	
<b>251592</b>	<b>RENAULT</b> Espace IV (2006>) Espace IV (2010>) Laguna II (2005>2007) Vel Satis (2005>)	
<b>251593</b>	<b>DACIA</b> Logan (2004>) <b>RENAULT</b> Clio II (2001>2008)	
<b>251594</b>	<b>RENAULT</b> Clio II (2001>2008)	
<b>251595</b>	<b>DACIA</b> Logan (2004>)	
<b>251596</b>	<b>RENAULT</b> Clio II (2001>2008)	
<b>251597</b>	<b>RENAULT</b> Clio II (2001>2008)	
<b>251598</b>	<b>RENAULT</b> Twingo III (2007>)	
<b>251599</b>	<b>RENAULT</b> Twingo III (2007>)	
<b>251600</b>	<b>RENAULT</b> Master (2006>) <b>NISSAN</b> Interstar (2006>)	
<b>251601</b>	<b>RENAULT</b> Master (2006>) <b>NISSAN</b> Interstar (2006>)	
<b>251602</b>	<b>OPEL</b> Vivaro (2006>) <b>RENAULT</b> Trafic II (2006>) <b>VAUXHALL</b> Vivaro (2006>)	
<b>251603</b>	<b>OPEL</b> (2006>)	

<b>251603</b>	<b>RENAULT</b> Trafic II (2006>) <b>VAUXHALL</b> Vivaro (2006>)	
<b>251604</b>	<b>DACIA</b> Logan (2004>) Sandero (2008>)	
<b>251605</b>	<b>DACIA</b> Logan (2004>) Sandero (2008>)	
<b>251606</b>	<b>DACIA</b> Logan (2004>) Sandero (2008>)	
<b>251607</b>	<b>DACIA</b> Logan (2004>) Sandero (2008>)	
<b>251608</b>	<b>RENAULT</b> Mégane (95>99) Mégane (98>2003) Mégane Classic (96>99) Mégane Classic (99>2002) Kangoo (97>2003) Kangoo Extra (98>2003)	
<b>251609</b>	<b>RENAULT</b> Mégane (95>99) Mégane (98>2003) Kangoo (97>2003) Kangoo Extra (98>2003) Kangoo (2003>2009)	
<b>251610</b>	<b>RENAULT</b> Mégane (95>99) Mégane (98>2003)	
<b>251611</b>	<b>RENAULT</b> Kangoo (97>2003) Kangoo Extra (98>2003) Kangoo (2003>2009)	
<b>251612</b>	<b>RENAULT</b> Kangoo (97>2003) Kangoo Extra (98>2003) Kangoo (2003>2009)	



New Nouveau **Nuevo** Novo **Nuovo** Nieuw **Neu** Nowoóś **Yeni** Новый **Nέο** **Νονυ**

<b>Valeo</b>			<b>Valeo</b>			
<b>251613</b>	<b>OPEL</b>	Movano (2003>2006)	<b>251620</b>	<b>CITROËN</b>	C4 Picasso (2006>)	
		Vivaro (2001>2006)			<b>CITROËN</b>	C4 Picasso (2006>)
		Vivaro (2006>)		<b>CITROËN</b>		C4 Picasso (2006>)
	<b>RENAULT</b>	Trafic II (2001>2006)			<b>CITROËN</b>	C4 (2004>2011)
		<b>VAUXHALL</b>		Movano (2003>2006)		<b>ABARTH</b>
				Vivaro (2001>2006)	Punto Evo (2010>)	
Vivaro (2006>)	<b>FIAT</b>		Grande Punto (199) (2005>2008)			
		Grande Punto (199) (2008>2009)				
<b>251614</b>	<b>RENAULT</b>	Master (2003>2006)	<b>251625</b>	<b>ABARTH</b>	Grande Punto (2007>2010)	
		Master (2006>)			Punto Evo (2010>)	
		Trafic II (2001>2006)		<b>FIAT</b>	Grande Punto (199) (2005>2008)	
		Trafic II (2006>)			Grande Punto (199) (2008>2009)	
	<b>NISSAN</b>	Interstar (2003>2006)		<b>FIAT</b>	Grande Punto (199) (2009>)	
		Interstar (2006>)			Punto Evo (199) (2009>2011)	
<b>251615</b>	<b>OPEL</b>	Vivaro (2001>2006)	<b>251626</b>	<b>ABARTH</b>	Grande Punto (2007>2010)	
		Vivaro (2006>)			Punto Evo (2010>)	
	<b>RENAULT</b>	Espace IV (2002>2006)		<b>FIAT</b>	Grande Punto (199) (2005>2008)	
		Laguna II (2001>2005)			Grande Punto (199) (2008>2009)	
		Vel Satis (2002>2005)		<b>FIAT</b>	Grande Punto (199) (2009>)	
		Trafic II (2001>2006)			Punto Evo (199) (2009>2011)	
<b>VAUXHALL</b>	Vivaro (2001>2006)	<b>FIAT</b>	Grande Punto (199) (2005>2008)			
	Vivaro (2006>)		Grande Punto (199) (2008>2009)			
<b>251616</b>	<b>CITROËN</b>	C4 (2004>2011)	<b>251627</b>	<b>CITROËN</b>	C2 (2003>2010)	
		C4 Picasso (2006>)			C3 (2002>2005)	
<b>251617</b>	<b>CITROËN</b>	C4 (2004>2011)	<b>251628</b>	<b>CITROËN</b>	C2 (2003>2010)	
<b>251618</b>	<b>CITROËN</b>	C4 (2004>2011)	<b>251629</b>	<b>CITROËN</b>	C5 (2001>2008)	
		C4 Picasso (2006>)			<b>PEUGEOT</b>	407 (2004>2011)
<b>251619</b>	<b>CITROËN</b>	C4 (2004>2011)	<b>251630</b>	<b>CITROËN</b>		C5 (2001>2008)
		C4 Picasso (2006>)			<b>PEUGEOT</b>	407 (2004>2011)
<b>251620</b>	<b>CITROËN</b>	C4 (2004>2011)				

New Nouveau **Nuevo** Novo **Nuovo** Nieuw **Neu** Nowość **Yeni** Новый **Νέο** Нову

<b>251631</b>	<b>CITROËN</b> <b>PEUGEOT</b>	C5 (2001>2008) 407 (2004>2011)		<b>251650</b>	<b>RENAULT</b> Twingo II (2007>)	
<b>251632</b>	<b>CITROËN</b> <b>PEUGEOT</b>	C5 (2001>2008) 407 (2004>2011)		<b>251651</b>	<b>RENAULT</b> Master II (2008>)	
<b>251633</b>	<b>CITROËN</b> <b>PEUGEOT</b>	C6 (2005>) 407 (2004>2011)				
<b>251634</b>	<b>PEUGEOT</b>	207 (2006>) 1007 (2005>2010)				
<b>251635</b>	<b>PEUGEOT</b>	207 (2006>)				
<b>251636</b>	<b>CITROËN</b> <b>PEUGEOT</b>	C2 (2003>2010) C3 (2005>2011) 207 (2006>)				
<b>251637</b>	<b>PEUGEOT</b>	207 (2006>)				
<b>251638</b>	<b>RENAULT</b>	Scénic II (2003>2009) Grand Scénic II (2003>2009)				
<b>251639</b>	<b>RENAULT</b>	Scénic II (2003>2009) Grand Scénic II (2003>2009)				
<b>251640</b>	<b>RENAULT</b>	Mégane II (2002>2008)				
<b>251641</b>	<b>RENAULT</b>	Mégane II (2002>2009)				
<b>251642</b>	<b>RENAULT</b>	Scénic II (2003>2009) Grand Scénic II (2003>2009)				
<b>251643</b>	<b>RENAULT</b>	Mégane I (1999>2003)				
<b>251644</b>	<b>DACIA</b>	Logan (2006>2007)				
<b>251645</b>	<b>DACIA</b>	Logan (2007>)				
<b>251647</b>	<b>RENAULT</b>	Laguna II (2001>2005) Espace et Grand Espace (2002>)				
<b>251648</b>	<b>RENAULT</b>	Clio II (1998>2001)				
<b>251649</b>	<b>RENAULT</b>	Master II (2003>2008)				

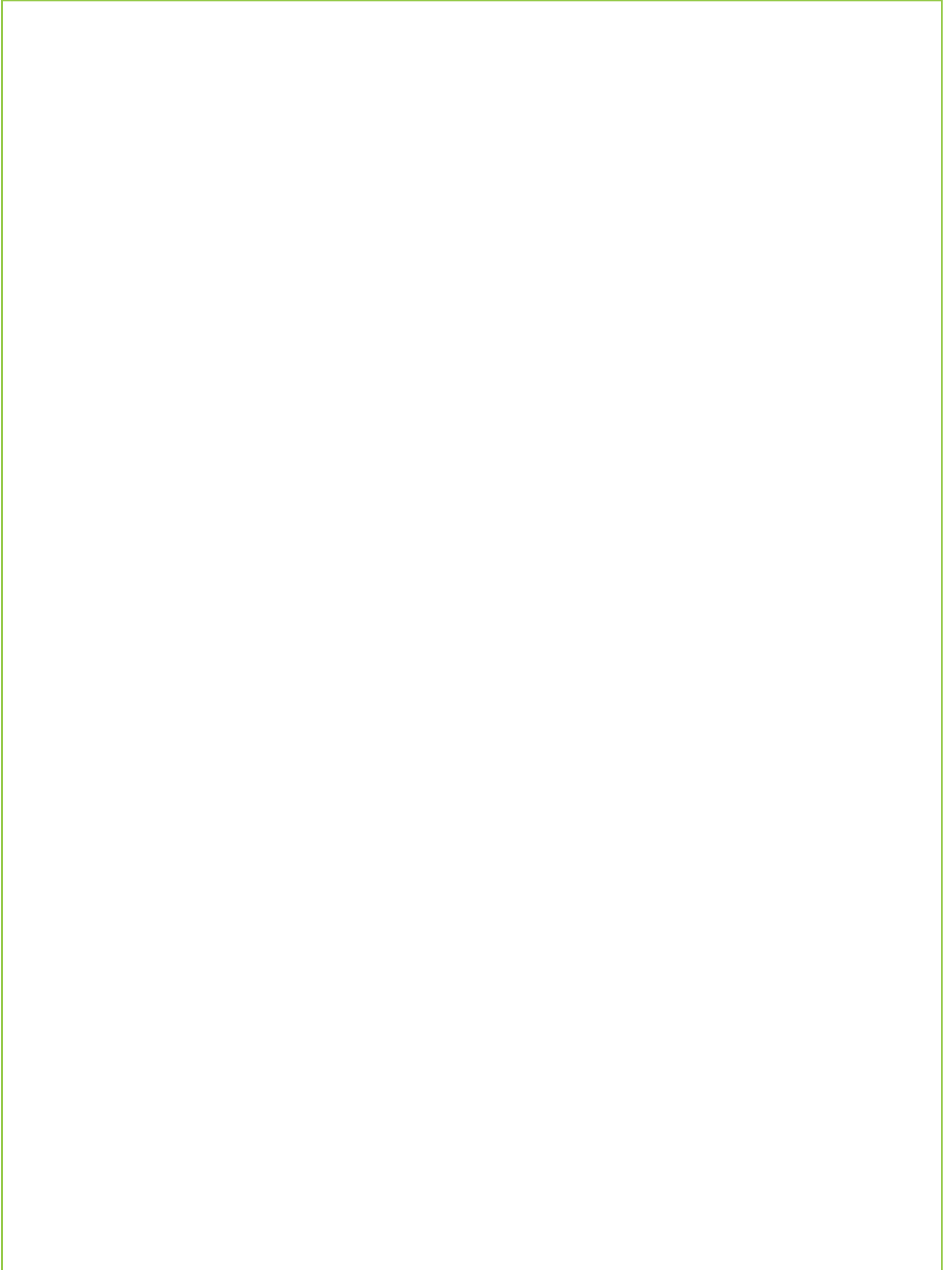



<b>ABARTH</b>	<b>14</b>
<b>ALFA ROMEO</b>	<b>14</b>
<b>CITROËN</b>	<b>15</b>
<b>DACIA</b>	<b>20</b>
<b>FIAT</b>	<b>20</b>
<b>IRISBUS</b>	<b>25</b>
<b>IVECO</b>	<b>26</b>
<b>LANCIA</b>	<b>27</b>
<b>NISSAN</b>	<b>28</b>
<b>OPEL</b>	<b>28</b>
<b>PEUGEOT</b>	<b>29</b>
<b>RENAULT</b>	<b>34</b>
<b>RENAULT TRUCKS</b>	<b>42</b>
<b>VAUXHALL</b>	<b>43</b>



<b>ABARTH</b>																	
<b>Grande Punto (2007&gt;2010)</b>																	
	09/07 ▶ 12/10	<b>251624</b>															
	09/07 ▶ 12/10	<b>251625</b>															
	09/07 ▶ 12/10	<b>251626</b>															
<b>Punto Evo (2010&gt;)</b>																	
	05/10 ▶	<b>251624</b>															
	05/10 ▶	<b>251625</b>															
	05/10 ▶	<b>251626</b>															
<b>ALFA ROMEO</b>																	
<b>145 (1994&gt;2001)</b>																	
	09/94 ▶ 06/96	<b>251337</b>															
	09/94 ▶ 06/96	<b>251348</b>															
	07/96 ▶ 06/01	<b>251347</b>															
<b>146 (1994&gt;2001)</b>																	
	12/94 ▶ 06/96	<b>251337</b>															
	12/94 ▶ 06/96	<b>251348</b>															
	10/95 ▶ 06/01	<b>251347</b>															
<b>155 (1991&gt;1997)</b>																	
<b>AIR (+)</b>	11/91 ▶ 08/97	<b>251343</b>															
<b>156 (1997&gt;2003)</b>																	
	09/97 ▶ 03/03	<b>251342</b>															
	01/99 ▶ 03/02	<b>251552</b>															
	04/00 ▶ 03/03	<b>251341</b>															
	09/00 ▶ 03/03	<b>251527</b>															
<b>156 (2003&gt;2007)</b>																	
, RTW (+)	04/03 ▶ 01/05	<b>251541</b>															
,  , ESP (+)	04/03 ▶ 01/06	<b>251520</b>															
, ESP (+)	04/03 ▶ 11/06	<b>251519</b>															
	04/03 ▶ 06/07	<b>251527</b>															
, ESP (+)	08/03 ▶ 01/05	<b>251523</b>															





				Valeo												
<b>ALFA ROMEO</b> (.../...)																
<b>156 (2003&gt;2007) (.../...)</b>																
	08/03 ▶ 01/06	<b>251538</b>														
	08/03 ▶ 11/06	<b>251521</b>														
, ESP (-)	08/03 ▶ 11/06	<b>251530</b>														
<b>166 (1998&gt;2003)</b>																
	10/98 ▶ 09/03	<b>251339</b>														
	10/98 ▶ 09/03	<b>251340</b>														
<b>166 (2003&gt;2007)</b>																
	10/03 ▶ 12/07	<b>251339</b>														
	10/03 ▶ 12/07	<b>251340</b>														
<b>CITROËN</b>																
<b>2 CV (1949&gt;1990)</b>																
	1949 ▶ 08/90	<b>251152</b>														
<b>AX (1986&gt;1991)</b>																
	09/86 ▶ 04/91	<b>251154</b>														
	09/86 ▶ 04/91	<b>251155</b>														
	09/86 ▶ 04/91	<b>251156</b>														
<b>AX (1991&gt;1998)</b>																
	05/91 ▶ 07/98	<b>251160</b>														
	05/91 ▶ 07/98	<b>251270</b>														
	05/91 ▶ 07/98	<b>251273</b>														
	05/91 ▶ 07/98	<b>251279</b>														
<b>BX (1982&gt;1994)</b>																
,	10/84 ▶ 12/94	<b>251154</b>														
,	10/84 ▶ 12/94	<b>251156</b>														
<b>C2 (2003&gt;2010)</b>																
MPXV (+)	09/03 ▶ 01/10	<b>251627</b>														
MPXC (+)	09/03 ▶ 01/10	<b>251628</b>														
ESP (+)	07/09 ▶ 01/10	<b>251636</b>														
<b>C3 (2002&gt;2005)</b>																
	03/03 ▶ 10/05	<b>251627</b>														





		Valeo														+ ...
<b>CITROËN</b> (.../...)																
<b>C3 (2002&gt;2005)</b> (.../...)																
	03/03 ▶ 10/05	<b>251628</b>														
<b>C3 (2005&gt;2011)</b>																
CPP (-)	07/09 ▶ 01/11	<b>251636</b>														
<b>C4 (2004&gt;2011)</b>																
	11/04 ▶ 01/11	<b>251616</b>														
,  , RTW (+)	11/04 ▶ 01/11	<b>251617</b>														
,	11/04 ▶ 01/11	<b>251618</b>														
,  , AC (+)	11/04 ▶ 01/11	<b>251619</b>														
,  , AC (+), RTW (+)	11/04 ▶ 01/11	<b>251620</b>														
,	11/04 ▶ 01/11	<b>251623</b>														
<b>C4 Picasso (2006&gt;)</b>																
	09/06 ▶	<b>251616</b>														
	09/06 ▶	<b>251618</b>														
AC (+)	09/06 ▶	<b>251619</b>														
AC (+), RTW (+)	09/06 ▶	<b>251620</b>														
AC (+)	09/06 ▶	<b>251621</b>														
AC (+), RTW (+)	09/06 ▶	<b>251622</b>														
<b>C5 (2001&gt;2008)</b>																
,	09/04 ▶ 06/08	<b>251629</b>														
,	09/04 ▶ 06/08	<b>251630</b>														
,	09/04 ▶ 06/08	<b>251632</b>														
,	01/06 ▶ 06/08	<b>251631</b>														
<b>C6 (2005&gt;)</b>																
	12/05 ▶	<b>251633</b>														
<b>C8 (2002&gt;)</b>																
ESP (-)	06/02 ▶	<b>*251492</b>														
<b>Evasion (1994&gt;1998)</b>																
	07/94 ▶ 04/96	<b>251162</b>														
	07/94 ▶ 09/98	<b>251266</b>														



			Valeo											
<b>CITROËN</b> (.../...)														
<b>Evasion (1994&gt;1998)</b> (.../...)														
	04/96 ▶ 09/98	<b>251259</b>												4
	04/96 ▶ 09/98	<b>251260</b>												4
<b>Evasion (1998&gt;2002)</b>														
	10/98 ▶ 05/02	<b>251259</b>												4
	10/98 ▶ 05/02	<b>251260</b>												4
	10/98 ▶ 05/02	<b>251266</b>												
<b>Fukang (1993&gt;1998)</b>														
	07/93 ▶ 1998	<b>251158</b>												4
	07/93 ▶ 1998	<b>251270</b>												
	07/93 ▶ 1998	<b>251273</b>												
	07/93 ▶ 1998	<b>251279</b>												
<b>Saxo (1996&gt;1999)</b>														
	03/96 ▶ 08/99	<b>251270</b>												
	03/96 ▶ 08/99	<b>251271</b>												
	03/96 ▶ 08/99	<b>251280</b>												
<b>Saxo (1999&gt;2005)</b>														
	09/99 ▶ 05/05	<b>251270</b>												
	09/99 ▶ 05/05	<b>251271</b>												
	09/99 ▶ 05/05	<b>251280</b>												
<b>Synergie (1995&gt;1998)</b>														
	10/95 ▶ 04/96	<b>251162</b>												4
	10/95 ▶ 09/98	<b>251266</b>												
	05/96 ▶ 09/98	<b>251259</b>												4
	05/96 ▶ 09/98	<b>251260</b>												4
<b>Synergie (1998&gt;2002)</b>														
	10/98 ▶ 05/02	<b>251259</b>												4
	10/98 ▶ 05/02	<b>251260</b>												4
	10/98 ▶ 05/02	<b>251266</b>												
<b>Visa (1978&gt;1988)</b>														
	03/81 ▶ 1988	<b>251154</b>												





	Valeo	
<b>CITROËN</b> (.../...)		
<b>Visa (1978&gt;1988)</b> (.../...)		
	03/81 ▶ 1988	<b>251156</b>
<b>Xantia (1993&gt;1997)</b>		
	03/93 ▶ 04/96	<b>251162</b>
	03/93 ▶ 12/97	<b>251266</b>
	04/96 ▶ 12/97	<b>251259</b>
	04/96 ▶ 12/97	<b>251260</b>
<b>Xantia (1997&gt;2002)</b>		
	12/97 ▶ 05/02	<b>251304</b>
	12/97 ▶ 05/02	<b>251305</b>
	12/97 ▶ 05/02	<b>251306</b>
	12/97 ▶ 05/02	<b>251307</b>
<b>Xsara (1997&gt;2000)</b>		
	07/97 ▶ 08/00	<b>251259</b>
	07/97 ▶ 08/00	<b>251260</b>
	07/97 ▶ 08/00	<b>251306</b>
	07/97 ▶ 08/00	<b>251307</b>
	07/97 ▶ 08/00	<b>251308</b>
	07/97 ▶ 08/00	<b>251309</b>
<b>Xsara (2000&gt;2005)</b>		
	09/00 ▶ 06/01	<b>251260</b>
, CPP (-)	09/00 ▶ 06/01	<b>251266</b>
<b>Xsara Picasso (1999&gt;2010)</b>		
MPX (-)	12/99 ▶ 08/03	<b>251266</b>
	12/99 ▶ 08/03	<b>251308</b>
	12/99 ▶ 08/03	<b>251309</b>
ESP (-)	12/99 ▶ 11/04	<b>*251492</b>
<b>ZX (1991&gt;1998)</b>		
	03/91 ▶ 07/98	<b>251158</b>
	03/91 ▶ 07/98	<b>251270</b>



<b>CITROËN</b> (.../...)																		
<b>ZX (1991&gt;1998)</b> (.../...)																		
	03/91 ▶ 07/98	<b>251273</b>																
	03/91 ▶ 07/98	<b>251279</b>																
<b>CITROËN</b>																		
<b>Berlingo (1996&gt;2002)</b>																		
	07/96 ▶ 12/02	<b>251270</b>																
	07/96 ▶ 12/02	<b>251271</b>																
	07/96 ▶ 12/02	<b>251273</b>																
	07/96 ▶ 12/02	<b>251280</b>																
<b>Berlingo (2002&gt;2010)</b>																		
	12/02 ▶ 05/08	<b>*251491</b>																
	12/02 ▶ 05/08	<b>*251496</b>																
<b>CCD (-)</b>	12/02 ▶ 05/08	<b>*251497</b>																
<b>ESP (-)</b>	12/02 ▶ 01/09	<b>*251499</b>																
<b>ESP (-)</b>	12/02 ▶ 09/10	<b>*251494</b>																
<b>ESP (-)</b>	12/02 ▶ 09/10	<b>*251495</b>																
<b>ESP (-)</b>	10/06 ▶ 01/09	<b>*251492</b>																
<b>C15 (1984&gt;2005)</b>																		
	10/84 ▶ 12/05	<b>251154</b>																
	10/84 ▶ 12/05	<b>251156</b>																
<b>Dispatch (1995&gt;2003)</b>																		
	09/95 ▶ 04/96	<b>251279</b>																
	09/95 ▶ 12/03	<b>251273</b>																
	09/95 ▶ 12/03	<b>251280</b>																
	04/96 ▶ 12/03	<b>251271</b>																
<b>Dispatch (2004&gt;2006)</b>																		
	01/04 ▶ 12/06	<b>251271</b>																
	01/04 ▶ 12/06	<b>251273</b>																
	01/04 ▶ 12/06	<b>251280</b>																
<b>Jumpy (1995&gt;2003)</b>																		
	09/95 ▶ 04/96	<b>251279</b>																



 		Valeo	           
<b>CITROËN</b>  (.../...)			
<b>Jumpy (1995&gt;2003) (.../...)</b>			
	09/95 ▶ 12/03	<b>251273</b>	      
	09/95 ▶ 12/03	<b>251280</b>	   
	04/96 ▶ 12/03	<b>251271</b>	   
<b>Jumpy (2004&gt;2006)</b>			
	01/04 ▶ 12/06	<b>251271</b>	   
	01/04 ▶ 12/06	<b>251273</b>	      
	01/04 ▶ 12/06	<b>251280</b>	   
<b>DACIA</b> 			
<b>Logan (2004&gt;)</b>			
	09/04 ▶	<b>251593</b>	   
	09/04 ▶	<b>251595</b>	   
	09/04 ▶	<b>251604</b>	   
	09/04 ▶	<b>251605</b>	   
	09/04 ▶	<b>251606</b>	  
	09/04 ▶	<b>251607</b>	  
<b>Logan (2006&gt;2007)</b>			
	10/06 ▶ 10/07	<b>251644</b>	
<b>Logan (2007&gt;)</b>			
	10/07 ▶	<b>251645</b>	
<b>Sandero (2008&gt;)</b>			
	06/08 ▶	<b>251604</b>	   
	06/08 ▶	<b>251605</b>	   
	06/08 ▶	<b>251606</b>	  
	06/08 ▶	<b>251607</b>	  
<b>FIAT</b> 			
<b>Brava (182) (1995&gt;2002)</b>			
DA (+), RESE (+)	06/95 ▶ 03/02	<b>251377</b>	         
DA (+/-), RESE (-)	03/98 ▶ 04/99	<b>251376</b>	      
AIR (+)	05/99 ▶ 03/02	<b>251375</b>	      



				Valeo												
<b>FIAT</b> (.../...)																
<b>Bravo (1995&gt;1998)</b>																
DA (+), RESE(+)	06/95 ▶ 09/98	<b>251377</b>														
DA (+/-), RESE (-)	02/96 ▶ 09/98	<b>251376</b>														
<b>Bravo (1998&gt;2002)</b>																
AIR (+)	10/98 ▶ 04/99	<b>251376</b>														
AIR (-)	10/98 ▶ 03/02	<b>251377</b>														
AIR (+)	05/99 ▶ 03/02	<b>251375</b>														
<b>Cinquecento (170)(1992&gt;1998)</b>																
AIR (-)	01/92 ▶ 09/97	<b>251354</b>														
AIR (+/-)	10/97 ▶ 02/98	<b>251355</b>														
<b>Croma (154) (1991&gt;1996)</b>																
AIR (+)	01/91 ▶ 12/96	<b>251372</b>														
AIR (-)	06/93 ▶ 12/96	<b>251373</b>														
<b>Grande Punto (199) (2005&gt;2008)</b>																
	10/05 ▶ 01/08	<b>251624</b>														
	10/05 ▶ 01/08	<b>251625</b>														
	10/05 ▶ 01/08	<b>251626</b>														
<b>Grande Punto (199) (2008&gt;2009)</b>																
	01/08 ▶ 12/09	<b>251624</b>														
	01/08 ▶ 12/09	<b>251625</b>														
	01/08 ▶ 12/09	<b>251626</b>														
<b>Grande Punto (199) (2009&gt;)</b>																
	01/09 ▶ 12/11	<b>251624</b>														
	01/09 ▶ 12/11	<b>251625</b>														
<b>Marea (185) (1996&gt;2002)</b>																
AIR (+)	06/98 ▶ 01/99	<b>251352</b>														
AIR (+)	06/98 ▶ 09/02	<b>251361</b>														
<b>Marengo (159) (1989&gt;1993)</b>																
ch 7215069	11/89 ▶ 02/93	<b>251392</b>														
	11/89 ▶ 02/93	<b>251399</b>														





			Valeo											
<b>FIAT</b> (.../...)														
<b>Marengo (159) (1993&gt;1995)</b>														
	03/93 ▶ 01/95	251389												
	03/93 ▶ 01/95	251392												
	03/93 ▶ 01/95	251399												
<b>Marengo (185) (1995&gt;2002)</b>														
	01/95 ▶ 09/02	251361												
<b>Multipla (186) (1998&gt;2003)</b>														
	11/98 ▶ 03/02	251353												
<b>Palio (1996&gt;2001)</b>														
,  , AIR (-)	09/97 ▶ 02/01	251511												
, AIR (+)	09/98 ▶ 02/01	251350												
<b>Panda (141/11A) (1986&gt;2003)</b>														
	03/86 ▶ 02/88	251359												
,	04/86 ▶ 09/92	251380												
,	04/91 ▶ 05/95	251369												
,	06/95 ▶ 08/03	251371												
<b>Panda (169) (2003&gt;2009)</b>														
	09/03 ▶ 04/08	251515												
<b>Panda (169) (2003&gt;)</b>														
AIR (+)	09/03 ▶	251513												
	09/03 ▶	251514												
, AIR (+)	09/03 ▶	251517												
<b>Panda (169) (2009&gt;2010)</b>														
	08/09 ▶ 06/10	251513												
	08/09 ▶ 06/10	251517												
<b>Panda (169) (2010&gt;2011)</b>														
	07/10 ▶ 12/11	251513												
	07/10 ▶ 12/11	251517												
<b>Panda (169) (2012&gt;)</b>														
	01/12 ▶	251513												





<b>FIAT (…/…)</b>																
<b>Panda (169) (2012&gt;) (…/…)</b>																
	01/12 ▶	<b>251517</b>														
<b>Punto (176) (1993&gt;1999)</b>																
	07/93 ▶ 09/99	<b>251393</b>														
AIR (+)	10/94 ▶ 09/99	<b>251394</b>														
<b>Punto II (188) (1999&gt;2003)</b>																
AIR (+)	07/99 ▶ 06/03	<b>251397</b>														
	07/99 ▶ 06/03	<b>251398</b>														
AIR (-)	07/99 ▶ 06/03	<b>251554</b>														
<b>Punto II (188) (2003&gt;2009)</b>																
	07/03 ▶ 08/09	<b>251475</b>														
	07/03 ▶ 08/09	<b>251476</b>														
ESP (+), RTW(+)	07/03 ▶ 08/09	<b>251480</b>														
ESP (+), RTW(+)	07/03 ▶ 08/09	<b>251483</b>														
RTW(+)	07/03 ▶ 08/09	<b>251500</b>														
ESP (+)	07/03 ▶ 08/09	<b>251501</b>														
RESE(+)	07/03 ▶ 08/09	<b>251504</b>														
RESE(+)	07/03 ▶ 08/09	<b>251505</b>														
<b>Punto Evo (199) (2009&gt;2011)</b>																
	10/09 ▶ 12/11	<b>251624</b>														
	10/09 ▶ 12/11	<b>251625</b>														
	10/09 ▶ 12/11	<b>251626</b>														
<b>Seicento (187) (1998&gt;2005)</b>																
AIR (-)	03/98 ▶ 08/00	<b>251357</b>														
AIR (-)	03/98 ▶ 08/00	<b>251358</b>														
AIR (+)	03/98 ▶ 08/00	<b>251363</b>														
AIR (-)	09/00 ▶ 08/05	<b>251555</b>														
AIR (-)	09/00 ▶ 08/05	<b>251572</b>														
<b>Tempra (160) (1989&gt;1996)</b>																
	11/89 ▶ 1996	<b>251399</b>														





<b>FIAT</b> (.../...)																
<b>Tempra (160) (1989&gt;1996) (.../...)</b>																
,  , AIR (-)	03/93 ▶ 1996	<b>251389</b>														
,  , AIR (-)	03/93 ▶ 1996	<b>251392</b>														
<b>Tipo (160) (1988&gt;1995)</b>																
	12/91 ▶ 10/95	<b>251386</b>														
AIR (+)	03/93 ▶ 10/95	<b>251385</b>														
AIR (+)	03/93 ▶ 10/95	<b>251581</b>														
<b>Ulysse (220) (1994&gt;1998)</b>																
	06/94 ▶ 05/96	<b>251162</b>														4
	06/94 ▶ 09/98	<b>251266</b>														
	06/96 ▶ 09/98	<b>251259</b>														4
	06/96 ▶ 09/98	<b>251260</b>														4
<b>Ulysse (220) (1998&gt;2002)</b>																
	10/98 ▶ 08/02	<b>251259</b>														4
	10/98 ▶ 08/02	<b>251260</b>														4
	10/98 ▶ 08/02	<b>251266</b>														
<b>Uno (146) (1989&gt;1993)</b>																
ch 0136/ch 7968831	10/89 ▶ 12/93	<b>251382</b>														
ch 0135/ch 7968830	10/89 ▶ 12/93	<b>251384</b>														
<b>Uno (146) (1989&gt;1995)</b>																
	10/89 ▶ 08/95	<b>251379</b>														
	10/89 ▶ 08/95	<b>251383</b>														
	10/89 ▶ 08/95	<b>251391</b>														
<b>Uno Mondo (146) (1998&gt;2010)</b>																
	01/98 ▶ 12/10	<b>251391</b>														
<b>FIAT</b>																
<b>Doblo (223) (2000&gt;2003)</b>																
AIR (-)	10/00 ▶ 12/03	<b>251472</b>														
AIR (+)	10/00 ▶ 12/03	<b>251473</b>														
AIR (-)	10/00 ▶ 12/03	<b>251474</b>														



			Valeo												
<b>FIAT</b> (.../...)															
<b>Doblo (223) (2000&gt;2003) (.../...)</b>															
AIR (+)	10/00 ▶ 12/03	251508													
<b>Doblo Cargo (223) (2000&gt;2003)</b>															
AIR (-)	10/00 ▶ 12/03	251472													
AIR (+)	10/00 ▶ 12/03	251473													
AIR (-)	10/00 ▶ 12/03	251474													
AIR (+)	10/00 ▶ 12/03	251508													
<b>Ducato (280) (1981&gt;1985)</b>															
	11/81 ▶ 05/85	251362													
<b>Ducato (230) (1994&gt;2001)</b>															
AIR (-)	02/94 ▶ 10/95	251370													
AIR (+)	02/94 ▶ 03/00	251368													
AIR (+)	02/94 ▶ 12/01	251367													
AIR (-)	10/95 ▶ 06/98	251378													
<b>Ducato (244) (2002&gt;2006)</b>															
	01/02 ▶ 06/06	251573													
AIR (+)	01/02 ▶ 06/06	251574													
<b>Fiorino (146) (1993&gt;2000)</b>															
AIR (-)	08/93 ▶ 09/00	251365													
<b>Scudo (220) (1995&gt;2003)</b>															
	07/95 ▶ 12/03	251273													
	07/95 ▶ 12/03	251279													
	07/95 ▶ 12/03	251280													
	02/96 ▶ 12/03	251271													
<b>Scudo (220) (2004&gt;2006)</b>															
	01/04 ▶ 12/06	251271													
	01/04 ▶ 12/06	251273													
	01/04 ▶ 12/06	251280													
<b>IRISBUS</b>															
<b>CityClass</b>															
		251557													





			Valeo												+ ...
<b>IRISBUS (.../...)</b>															
<b>CityClass (.../...)</b>															
			251558												
<b>EuroClass</b>															
			251557												
			251558												
<b>EuroRider</b>															
			251557												
			251558												
<b>TurboCity</b>															
	02/86 ▶		251547												
	02/86 ▶		251548												
<b>IVECO </b>															
<b>Daily (1978&gt;1989)</b>															
30-8	ch 311599 ▶ 12/89		251402												
35-8, OE n° 4802819	ch 431481 ▶ 12/89		251402												
35-10	ch 15141 ▶ 12/89		251402												
40-8	ch 311872 ▶ 12/89		251402												
40-10 / 49-10	01/78 ▶ 12/89		251402												
35-8, OE n° 93803258, 93803689	01/78 ▶ 12/89		251404												
<b>Daily (1989&gt;1996)</b>															
	03/89 ▶ 03/96		251403												
<b>Daily S2000</b>															
	05/97 ▶		251550												
	05/97 ▶		251551												
<b>IVECO </b>															
<b>EuroCargo</b>															
	01/83 ▶		251544												
	05/86 ▶ 10/91		251543												
	01/91 ▶		251557												
	01/91 ▶		251558												



				Valeo											
<b>IVECO</b> (.../...)															
<b>EuroFire</b>															
	01/91 ▶	<b>251557</b>													
	01/91 ▶	<b>251558</b>													
<b>TurboStar</b>															
	07/84 ▶	<b>251543</b>													
OE n° 4784774	07/84 ▶	<b>251544</b>													
<b>TurboTech</b>															
	07/88 ▶	<b>251544</b>													
	01/90 ▶	<b>251543</b>													
<b>LANCIA</b>															
<b>Dedra (835) (1989&gt;1994)</b>															
	ch 194304 ▶ ch 4008263 ch 223660 ▶ ch 4008263	<b>251406</b>													
<b>Dedra (835) (1994&gt;1999)</b>															
	07/94 ▶ 10/97	<b>251418</b>													
<b>Delta (1993&gt;1999)</b>															
	03/93 ▶ 08/99	<b>251417</b>													
<b>Kappa (838) (1994&gt;2001)</b>															
	10/94 ▶ 10/01	<b>251416</b>													
<b>Lybra (839) (1999&gt;2006)</b>															
, CPP (-)	09/99 ▶ 04/01	<b>251405</b>													
, CPP (+)	09/99 ▶ 04/01	<b>251412</b>													
, CPP (+)	09/99 ▶ 04/01	<b>251413</b>													
, CPP (-)	09/99 ▶ 04/01	<b>251414</b>													
<b>Ypsilon (840) (1995&gt;2000)</b>															
AIR (+)	06/98 ▶ 08/00	<b>251410</b>													
AIR (-)	06/98 ▶ 08/00	<b>251411</b>													
<b>Ypsilon (840) (2000&gt;2003)</b>															
	12/00 ▶ 09/03	<b>251410</b>													
<b>Y10 (156) (1989&gt;1995)</b>															
	01/89 ▶ 09/92	<b>251407</b>													





		Valeo											+ ...
<b>LANCIA</b> (.../...)													
<b>Y10 (156) (1989&gt;1995) (.../...)</b>													
ch 132896	01/89 ▶ 09/92	<b>251420</b>											
	11/91 ▶ 09/92	<b>251408</b>											
	09/92 ▶ 10/95	<b>251409</b>											
<b>Zeta (220) (1994&gt;2002)</b>													
	10/94 ▶ 05/96	<b>251162</b>											4
	10/94 ▶ 08/02	<b>251266</b>											
	06/96 ▶ 08/02	<b>251260</b>											4
<b>NISSAN</b>													
<b>Kubistar (2003&gt;)</b>													
	09/03 ▶	<b>251562</b>											
	09/03 ▶	<b>251586</b>											
<b>Interstar (2003&gt;2006)</b>													
	11/03 ▶ 09/06	<b>251614</b>											
<b>Interstar (2006&gt;)</b>													
	09/06 ▶ 10/08	<b>251614</b>											
	10/08 ▶	<b>251600</b>											
	10/08 ▶	<b>251601</b>											
<b>OPEL</b>													
<b>Movano (2003&gt;2006)</b>													
	10/03 ▶ 10/06	<b>251613</b>											
<b>Vivaro (2001&gt;2006)</b>													
	05/01 ▶ 07/06	<b>251444</b>											
	05/01 ▶ 07/06	<b>251563</b>											
	05/01 ▶ 07/06	<b>251613</b>											
	05/01 ▶ 07/06	<b>251615</b>											
<b>Vivaro (2006&gt;)</b>													
	07/06 ▶ 2009	<b>251444</b>											
<b>Made in Spain</b>	07/06 ▶ 2009	<b>251563</b>											
<b>CPP (+)</b>	07/06 ▶	<b>251566</b>											



			Valeo													
<b>OPEL  (.../...)</b>																
<b>Vivaro (2006&gt;) (.../...)</b>																
CPP (-)	07/06 ▶	251613														
	07/06 ▶	251615														
Made in UK	2009 ▶	251603														
	2009 ▶	251602														
<b>PEUGEOT </b>																
<b>104 (1972&gt;1988)</b>																
	07/79 ▶ 06/84	251203														
	07/84 ▶ 05/88	251154														
<b>106 (1991&gt;1996)</b>																
	09/91 ▶ 03/96	251219														
	09/91 ▶ 03/96	251222														
	09/91 ▶ 03/96	251287														
	09/91 ▶ 03/96	251290														
<b>106 (1996&gt;2003)</b>																
	03/96 ▶ 06/99	251267														
	03/96 ▶ 06/99	251268														
	03/96 ▶ 06/99	251269														
	07/99 ▶ 07/03	251270														
	07/99 ▶ 07/03	251271														
	07/99 ▶ 07/03	251280														
<b>205 (74) (1983&gt;1987)</b>																
	02/83 ▶ 06/85	251203														
	07/85 ▶ 07/87	251154														
<b>205 (20) (1987&gt;1998)</b>																
	08/87 ▶ 09/98	251209														
	08/87 ▶ 09/98	251210														
<b>206 (1998&gt;2010)</b>																
	09/98 ▶ 09/01	251270														
, MPX (-)	09/98 ▶ 09/01	251271														





		Valeo													
<b>PEUGEOT (…/…)</b>															
<b>206 (1998&gt;2010) (…/…)</b>															
	09/98 ▶ 09/01	<b>251310</b>													
	09/98 ▶ 09/01	<b>251311</b>													
	09/98 ▶ 09/01	<b>251312</b>													
	09/98 ▶ 09/01	<b>251314</b>													
	09/98 ▶ 01/03	<b>*251498</b>													
	09/98 ▶ 02/09	<b>*251492</b>													
	09/98 ▶ 02/09	<b>*251493</b>													
	09/98 ▶ 02/09	<b>*251494</b>													
	09/98 ▶ 02/09	<b>*251495</b>													
	09/98 ▶ 02/09	<b>*251496</b>													
	09/98 ▶ 02/09	<b>*251497</b>													
	09/98 ▶ 02/09	<b>*251499</b>													
<b>206+ (2009&gt;)</b>															
	03/09 ▶ 01/11	<b>*251485</b>													
<b>207 (2006&gt;)</b>															
	03/06 ▶ 07/08	<b>251635</b>													
	03/06 ▶	<b>251634</b>													
	04/09 ▶	<b>251636</b>													
	04/09 ▶	<b>251637</b>													
<b>305 (1977&gt;1990)</b>															
	03/80 ▶ 06/90	<b>251203</b>													
<b>306 (1993&gt;1997)</b>															
	02/93 ▶ 02/97	<b>251219</b>													
	02/93 ▶ 02/97	<b>251220</b>													
	02/93 ▶ 02/97	<b>251222</b>													
<b>306 (1997&gt;2002)</b>															
	03/97 ▶ 03/02	<b>251314</b>													
	03/97 ▶ 09/02	<b>251270</b>													
	03/97 ▶ 09/02	<b>251271</b>													





				Valeo													
<b>PEUGEOT</b> (.../...)																	
<b>306 (1997&gt;2002) (.../...)</b>																	
	03/97 ▶ 09/02	<b>251272</b>															4
	03/97 ▶ 09/02	<b>251280</b>															
	03/97 ▶ 09/02	<b>251281</b>															4
<b>307(2001&gt;2005)</b>																	
,  ,  , ESP (-)	03/01 ▶ 06/05	<b>*251485</b>															
,  ,  , ESP (-)	03/01 ▶ 06/05	<b>*251486</b>															
,  ,  , ESP (-)	03/01 ▶ 06/05	<b>*251487</b>															
,  ,  , ESP (-)	03/01 ▶ 06/05	<b>*251489</b>															
,  ,  , ESP (-)	03/01 ▶ 06/05	<b>*251490</b>															
<b>307 (2001&gt;2005)</b>																	
,  ,  , ESP (-)	03/01 ▶ 06/05	<b>*251492</b>															
<b>307(2001&gt;2005)</b>																	
,  ,  , ESP (-)	12/01 ▶ 06/05	<b>*251488</b>															
<b>309 (1985&gt;1989)</b>																	
	09/85 ▶ 07/89	<b>251154</b>															
	09/85 ▶ 07/89	<b>251283</b>															
<b>309 (1989&gt;1994)</b>																	
	07/89 ▶ 08/94	<b>251209</b>															
	08/89 ▶ 08/94	<b>251210</b>															
<b>405 (1987&gt;1992)</b>																	
,	06/87 ▶ 06/92	<b>251211</b>															
,	06/87 ▶ 06/92	<b>251212</b>															
	06/87 ▶ 06/92	<b>251213</b>															
	06/88 ▶ 06/92	<b>251209</b>															
<b>405 (1992&gt;1996)</b>																	
,	07/92 ▶ 10/96	<b>251223</b>															
<b>406 (1995&gt;2003)</b>																	
	10/95 ▶ 06/96	<b>251162</b>															4
,  ,	10/95 ▶ 04/99	<b>251261</b>															

\* IT Avvertenza: il costruttore automobilistico ha due diversi fornitori per questa applicazione. Occorre procedere a una verifica supplementare sulla compatibilità con le referenze OE e OES alla pag. 117 del catalogo.  
 DE Achtung: der Automobilhersteller hat zwei verschiedene Zulieferer für diese Applikation. Eine zusätzliche Überprüfung der Kompatibilität mit den OE- und OES-Teilenummern ist erforderlich: Seite 117 im Katalog.  
 TR İkaz: Otomobil üreticisi bu uygulamada iki farklı tedarikçiyi sahiptir. Katalogun 117 sayfasında, OE ve OES referansları ile uyuma ilişkin tamamlanmış bir kontrol gereklidir.



**PEUGEOT** (.../...)

**406 (1995>2003) (.../...)**

	10/95 ▶ 03/99	<b>251266</b>														
	10/95 ▶ 03/99	<b>251286</b>														
	10/95 ▶ 12/01	<b>251262</b>														
	06/96 ▶ 03/99	<b>251259</b>														
	06/96 ▶ 03/99	<b>251260</b>														
	04/99 ▶ 12/01	<b>251304</b>														
	12/01 ▶ 04/03	<b>*251491</b>														
	12/01 ▶ 04/03	<b>*251492</b>														

**406 (1999>2004)**

	04/99 ▶ 05/00	<b>251261</b>														
	04/99 ▶ 12/01	<b>251266</b>														
	04/99 ▶ 03/04	<b>251262</b>														
	04/99 ▶ 04/04	<b>251304</b>														
	04/99 ▶ 04/04	<b>251305</b>														
	04/99 ▶ 10/04	<b>*251492</b>														
	04/99 ▶ 10/04	<b>*251491</b>														

**407 (2004>2011)**

	04/04 ▶ 05/11	<b>251631</b>														
	04/04 ▶ 05/11	<b>251629</b>														
	04/04 ▶ 05/11	<b>251630</b>														
	04/04 ▶ 05/11	<b>251632</b>														
	09/05 ▶ 08/11	<b>251633</b>														

**505 (1979>1990)**

	05/79 ▶ 06/85	<b>251203</b>														
	05/79 ▶ 06/85	<b>251206</b>														
	07/85 ▶ 1990	<b>251283</b>														































































































































**605 (1989>1994)**

	10/89 ▶ 06/94	<b>251162</b>														
--	---------------	---------------	--	--	--	--	--	--	--	--	--	--	--	--	--	--

**605 (1994>1999)**

	07/94 ▶ 04/96	<b>251162</b>														
--	---------------	---------------	--	--	--	--	--	--	--	--	--	--	--	--	--	--



				<b>Valeo</b>														
<b>PEUGEOT</b>  (...)																		
<b>605 (1994&gt;1999) (.../...)</b>																		
	04/96 ▶ 05/99	<b>251259</b>													4 			
	04/96 ▶ 05/99	<b>251260</b>													4 			
	06/97 ▶ 05/99	<b>251262</b>																
<b>607 (2000&gt;2004)</b>																		
	05/00 ▶ 09/04	<b>251262</b>																
<b>806 (1994&gt;1998)</b>																		
	07/94 ▶ 04/96	<b>251162</b>													4 			
	07/94 ▶ 09/98	<b>251266</b>																
	04/96 ▶ 09/98	<b>251259</b>													4 			
	04/96 ▶ 09/98	<b>251260</b>													4 			
<b>806 (1998&gt;2002)</b>																		
	10/98 ▶ 05/02	<b>251259</b>													4 			
	10/98 ▶ 05/02	<b>251260</b>													4 			
	10/98 ▶ 05/02	<b>251266</b>																
<b>1007 (2005&gt;2010)</b>																		
	04/05 ▶ 11/07	<b>*251490</b>																
<b>MPXC (+)</b>	04/05 ▶ 07/10	<b>251634</b>																
<b>MPX (+)</b>	06/07 ▶ 06/09	<b>251210</b>													4 			
<b>MPX (+)</b>	06/09 ▶ 07/10	<b>251162</b>													4 			
<b>PEUGEOT</b> 																		
<b>Expert I (1995&gt;2003)</b>																		
	09/95 ▶ 04/96	<b>251279</b>																
	09/95 ▶ 12/03	<b>251273</b>																
	09/95 ▶ 12/03	<b>251280</b>																
	04/96 ▶ 12/03	<b>251271</b>																
<b>Expert I (2004&gt;2006)</b>																		
	01/04 ▶ 12/06	<b>251271</b>																
	01/04 ▶ 12/06	<b>251273</b>																
	01/04 ▶ 12/06	<b>251280</b>																

\* IT Avvertenza: il costruttore automobilistico ha due diversi fornitori per questa applicazione. Occorre procedere a una verifica supplementare sulla compatibilità con le referenze OE e OES alla pag. 117 del catalogo.  
 DE Achtung: der Automobilhersteller hat zwei verschiedene Zulieferer für diese Applikation. Eine zusätzliche Überprüfung der Kompatibilität mit den OE- und OES-Teilenummern ist erforderlich: Seite 117 im Katalog.  
 TR İkaz: Otomobil üreticisi bu uygulamada iki farklı tedarikçiye sahiptir. Katalogun 117 sayfasında, OE ve OES referansları ile uyuma ilişkin tamamlanmış bir kontrol gereklidir.



			Valeo												
<b>PEUGEOT</b> (.../...)															
<b>J9 (1980&gt;1991)</b>															
	08/86 ▶ 1991	<b>251154</b>													
<b>Partner (M49) (1996&gt;2002)</b>															
	06/96 ▶ 11/02	<b>251270</b>													
	06/96 ▶ 11/02	<b>251271</b>													
	06/96 ▶ 11/02	<b>251273</b>													
	06/96 ▶ 11/02	<b>251280</b>													
<b>Partner (M59) (2002&gt;2008)</b>															
	11/02 ▶ 05/08	<b>*251491</b>													
	11/02 ▶ 05/08	<b>*251494</b>													
	11/02 ▶ 05/08	<b>*251495</b>													
	11/02 ▶ 05/08	<b>*251496</b>													
<b>CCD (+)</b>	11/02 ▶ 05/08	<b>*251497</b>													
<b>ESP (-)</b>	11/02 ▶ 05/08	<b>*251499</b>													
<b>ESP (-)</b>	10/06 ▶ 05/08	<b>*251492</b>													
<b>Ranch (M49) (1996&gt;2002)</b>															
	06/96 ▶ 11/02	<b>251270</b>													
	06/96 ▶ 11/02	<b>251271</b>													
	06/96 ▶ 11/02	<b>251273</b>													
	06/96 ▶ 11/02	<b>251280</b>													
<b>Ranch (M59) (2002&gt;2008)</b>															
	11/02 ▶ 05/08	<b>*251494</b>													
	11/02 ▶ 05/08	<b>*251495</b>													
	11/02 ▶ 05/08	<b>*251496</b>													
<b>CCD (+)</b>	11/02 ▶ 05/08	<b>*251497</b>													
<b>ESP (-)</b>	11/02 ▶ 05/08	<b>*251499</b>													
<b>ESP (-)</b>	10/06 ▶ 05/08	<b>*251492</b>													
<b>RENAULT</b>															
<b>R5 (1972&gt;1985)</b>															
	01/72 ▶ 06/85	<b>251106</b>													



				Valeo															
<b>RENAULT</b> (.../...)																			
<b>R9 (1981&gt;1988)</b>																			
		10/81 ▶ 12/88	<b>251104</b>																
<b>R11 (1982&gt;1989)</b>																			
		07/82 ▶ 07/89	<b>251104</b>																
<b>R18 (1977&gt;1986)</b>																			
		06/82 ▶ 10/86	<b>251105</b>																
<b>R19 (1988&gt;1992)</b>																			
		07/88 ▶ 04/92	<b>251109</b>																
<b>R19 (1992&gt;1995)</b>																			
		05/92 ▶ 11/95	<b>251274</b>																
<b>R21 (1986&gt;1995)</b>																			
		03/86 ▶ 08/95	<b>251109</b>																
		03/86 ▶ 08/95	<b>251110</b>																
<b>Clio I (1990&gt;1998)</b>																			
		06/90 ▶ 02/98	<b>251274</b>																
<b>Clio II (1998&gt;2001)</b>																			
		03/98 ▶ 03/01	<b>251648</b>																
		03/98 ▶ 03/01	<b>251571</b>																
<b>Clio II (2001&gt;2008)</b>																			
		04/01 ▶ 09/08	<b>251570</b>																
		04/01 ▶ 09/08	<b>251571</b>																
		04/01 ▶ 09/08	<b>251593</b>																
		04/01 ▶ 09/08	<b>251594</b>																
		04/01 ▶ 09/08	<b>251596</b>																
		04/01 ▶ 09/08	<b>251597</b>																
<b>Espace I (1984&gt;1991)</b>																			
		09/84 ▶ 01/91	<b>251104</b>																
<b>Espace II (1991&gt;1996)</b>																			
		01/91 ▶ 08/96	<b>251274</b>																
<b>Espace IV (2002&gt;2006)</b>																			
		09/02 ▶ 02/06	<b>251444</b>																

\* IT Avvertenza: il costruttore automobilistico ha due diversi fornitori per questa applicazione. Occorre procedere a una verifica supplementare sulla compatibilità con le referenze OE e OES alla pag. 117 del catalogo.  
 DE Achtung: der Automobilhersteller hat zwei verschiedene Zulieferer für diese Applikation. Eine zusätzliche Überprüfung der Kompatibilität mit den OE- und OES-Teilenummern ist erforderlich: Seite 117 im Katalog.  
 TR İkaz: Otomobil üreticisi bu uygulamada iki farklı tedarikçiye sahiptir. Katalogun 117 sayfasında, OE ve OES referansları ile uyuma ilişkin tamamlayıcı bir kontrol gereklidir.



				<b>Valeo</b>													
<b>RENAULT</b> (.../...)																	
<b>Espace IV (2002&gt;2006) (.../...)</b>																	
<b>CPP (+)</b>	09/02 ▶ 02/06	<b>251563</b>															
	09/02 ▶ 02/06	<b>251566</b>															
	09/02 ▶ 02/06	<b>251615</b>															
<b>Espace IV (2006&gt;)</b>																	
	03/06 ▶	<b>251592</b>															
<b>Espace IV (2010&gt;)</b>																	
	09/10 ▶	<b>251592</b>															
<b>Espace &amp; Grand Espace (2002&gt;)</b>																	
	09/02 ▶	<b>251647</b>															
<b>Fuego (1979&gt;1985)</b>																	
	07/82 ▶ 1985	<b>251105</b>															
<b>Grand Scénic II (2003&gt;2009)</b>																	
	05/03 ▶ 11/09	<b>251638</b>															
	05/03 ▶ 11/09	<b>251639</b>															
	05/03 ▶ 11/09	<b>251642</b>															
<b>Laguna II (2001&gt;2005)</b>																	
	01/01 ▶ 02/05	<b>251444</b>															
	01/01 ▶ 02/05	<b>251563</b>															
	01/01 ▶ 02/05	<b>251566</b>															
	01/01 ▶ 02/05	<b>251615</b>															
	01/01 ▶ 02/05	<b>251647</b>															
<b>Laguna II (2005&gt;2007)</b>																	
	03/05 ▶ 09/07	<b>251592</b>															
<b>Lutecia (Japan) (1994&gt;1998)</b>																	
	10/94 ▶ 02/98	<b>251274</b>															
<b>Mégane I (1995&gt;1999)</b>																	
	11/95 ▶ 02/99	<b>*251436</b>															
	11/95 ▶ 02/99	<b>*251437</b>															
	11/95 ▶ 02/99	<b>251438</b>															



			<b>Valeo</b>												
<b>RENAULT (…/…)</b>															
<b>Mégane I (1995&gt;1999) (…/…)</b>															
	11/95 ▶ 02/99	<b>251439</b>													
	11/95 ▶ 02/99	<b>*251442</b>													
	11/95 ▶ 02/99	<b>251561</b>													
	11/95 ▶ 02/99	<b>251568</b>													
	11/95 ▶ 02/99	<b>251609</b>													
	11/95 ▶ 02/99	<b>251610</b>													
	11/95 ▶ 02/99	<b>251562</b>													
	02/97 ▶ 02/99	<b>251608</b>													
<b>Mégane I (1998&gt;2003)</b>															
	10/98 ▶ 02/03	<b>*251436</b>													
	10/98 ▶ 02/03	<b>*251437</b>													
	10/98 ▶ 02/03	<b>251438</b>													
	10/98 ▶ 02/03	<b>251439</b>													
	10/98 ▶ 02/03	<b>*251442</b>													
	10/98 ▶ 02/03	<b>251561</b>													
	10/98 ▶ 02/03	<b>251562</b>													
	10/98 ▶ 02/03	<b>251568</b>													
	10/98 ▶ 02/03	<b>251610</b>													
	02/99 ▶ 02/03	<b>251608</b>													
	02/99 ▶ 02/03	<b>251609</b>													
	03/99 ▶ 02/03	<b>251643</b>													
<b>Mégane II (2002&gt;2008)</b>															
	09/02 ▶ 10/08	<b>251640</b>													
<b>Mégane II (2002&gt;2009)</b>															
	09/02 ▶ 07/09	<b>251641</b>													
<b>Mégane Classic (1996&gt;1999)</b>															
	09/96 ▶ 02/99	<b>*251436</b>													
	09/96 ▶ 02/99	<b>*251437</b>													
	09/96 ▶ 02/99	<b>251438</b>													

\* IT Avvertenza: il costruttore automobilistico ha due diversi fornitori per questa applicazione. Occorre procedere a una verifica supplementare sulla compatibilità con le referenze OE e OES alla pag. 117 del catalogo.  
 DE Achtung: der Automobilhersteller hat zwei verschiedene Zulieferer für diese Applikation. Eine zusätzliche Überprüfung der Kompatibilität mit den OE- und OES-Teilenummern ist erforderlich: Seite 117 im Katalog.  
 TR İkaz: Otomobil üreticisi bu uygulamada iki farklı tedarikçiyi sahiptir. Katalogun 117 sayfasında, OE ve OES referansları ile uyuma ilişkin tamamlanmış bir kontrol gereklidir.



<b>RENAULT</b> (.../...)																	
<b>Mégane Classic (1996&gt;1999) (.../...)</b>																	
	09/96 ▶ 02/99	<b>251439</b>															
	09/96 ▶ 02/99	<b>251561</b>															
	09/96 ▶ 02/99	<b>251562</b>															
	09/96 ▶ 02/99	<b>251568</b>															
	09/96 ▶ 02/99	<b>251608</b>															
<b>Mégane Classic (1999&gt;2002)</b>																	
	03/99 ▶ 08/02	<b>*251436</b>															
	03/99 ▶ 08/02	<b>*251437</b>															
	03/99 ▶ 08/02	<b>251438</b>															
	03/99 ▶ 08/02	<b>251439</b>															
	03/99 ▶ 08/02	<b>251561</b>															
	03/99 ▶ 08/02	<b>251562</b>															
	03/99 ▶ 08/02	<b>251568</b>															
	03/99 ▶ 08/02	<b>251608</b>															
	03/99 ▶ 02/03	<b>251643</b>															
<b>Scénic II (2003&gt;2009)</b>																	
	05/03 ▶ 08/09	<b>251638</b>															
	05/03 ▶ 08/09	<b>251639</b>															
	05/03 ▶ 08/09	<b>251642</b>															
<b>Super 5 (1984&gt;1996)</b>																	
	07/84 ▶ 1996	<b>251104</b>															
	07/84 ▶ 12/96	<b>251282</b>															
<b>Twingo I (1993&gt;1998)</b>																	
	03/93 ▶ 08/98	<b>251430</b>															
<b>Twingo II (1998&gt;2004)</b>																	
	09/98 ▶ 08/04	<b>251298</b>															
<b>Twingo III (2007&gt;)</b>																	
	07/07 ▶	<b>251587</b>															
	07/07 ▶	<b>251588</b>															





<b>RENAULT</b>																	
<b>Twingo III (2007&gt;) (.../...)</b>																	
	07/07 ▶	<b>251589</b>															
	07/07 ▶	<b>251650</b>															
	10/08 ▶	<b>251598</b>															
	10/08 ▶	<b>251599</b>															
<b>Vel Satis (2002&gt;2005)</b>																	
	01/02 ▶ 02/03	<b>251615</b>															
	01/02 ▶ 01/05	<b>251444</b>															
	02/03 ▶ 01/05	<b>251566</b>															
<b>Vel Satis (2005&gt;)</b>																	
	02/05 ▶ 12/09	<b>251566</b>															
	02/05 ▶ 12/09	<b>251592</b>															
<b>RENAULT</b>																	
<b>Express (1985&gt;1991)</b>																	
	09/85 ▶ 08/91	<b>251104</b>															
	09/85 ▶ 08/91	<b>251282</b>															
<b>Express (1991&gt;2003)</b>																	
<b>AC(+)</b> <b>AC(-)</b>	09/91 ▶ 09/94	<b>251104</b>															
	09/91 ▶ 09/94	<b>251282</b>															
	07/94 ▶ 08/97	<b>251275</b>															
	09/94 ▶ 08/97	<b>251276</b>															
<b>Extra (1985&gt;1991)</b>																	
	09/85 ▶ 08/91	<b>251282</b>															
<b>Extra (1991&gt;1997)</b>																	
	09/91 ▶ 08/94	<b>251104</b>															
	09/91 ▶ 08/94	<b>251282</b>															
	09/94 ▶ 08/97	<b>251275</b>															
<b>Kangoo I (1997&gt;2003)</b>																	
	09/97 ▶ 07/01	<b>251438</b>															
	09/97 ▶ 07/01	<b>251439</b>															



**RENAULT** (.../...)

**Kangoo I (1997>2003) (.../...)**

	09/97 ▶ 07/01	<b>251608</b>															
	09/97 ▶ 07/01	<b>251609</b>															
	09/97 ▶ 02/03	<b>251611</b>															
	09/97 ▶ 02/03	<b>251612</b>															
	12/99 ▶ 02/03	<b>251565</b>															
	12/99 ▶ 02/03	<b>251586</b>															
	07/01 ▶ 02/03	<b>251562</b>															

**Kangoo I (2003>2009)**

	03/03 ▶ 06/09	<b>251562</b>															
	03/03 ▶ 06/09	<b>251586</b>															
	03/03 ▶ 06/09	<b>251609</b>															
	03/03 ▶ 06/09	<b>251611</b>															
	03/03 ▶ 06/09	<b>251612</b>															

**Kangoo Extra (1998>2003)**

	01/98 ▶ 07/01	<b>251438</b>															
	01/98 ▶ 07/01	<b>251439</b>															
	01/98 ▶ 07/01	<b>251608</b>															
	01/98 ▶ 02/03	<b>251611</b>															
	01/98 ▶ 02/03	<b>251612</b>															
	01/98 ▶ 02/03	<b>251609</b>															
	07/01 ▶ 02/03	<b>251562</b>															
	07/01 ▶ 02/03	<b>251565</b>															

**Master (1980>1989)**

	08/80 ▶ 02/89	<b>251328</b>															
	08/80 ▶ 02/89	<b>251334</b>															

**Master (1989>1994)**

	03/89 ▶ 09/94	<b>251328</b>															
	03/89 ▶ 09/94	<b>251334</b>															

**Master (1994>1997)**

	10/94 ▶ 09/97	<b>251328</b>															
--	---------------	---------------	--	--	--	--	--	--	--	--	--	--	--	--	--	--	--





<b>RENAULT</b> (.../...)																		
<b>Master (1994&gt;1997)</b> (.../...)																		
	10/94 ▶ 09/97	<b>251334</b>																
<b>Master II (2003&gt;2008)</b>																		
	10/03 ▶ 05/06	<b>251614</b>																
	10/03 ▶ 10/08	<b>251649</b>																
<b>Master II (2006&gt;)</b>																		
	06/06 ▶ 10/08	<b>251590</b>																
	06/06 ▶ 10/08	<b>251591</b>																
	06/06 ▶	<b>251614</b>																
	10/08 ▶	<b>251600</b>																
	10/08 ▶	<b>251601</b>																
	10/08 ▶	<b>251651</b>																
<b>Rapid (1985&gt;1991)</b>																		
	09/85 ▶ 08/91	<b>251104</b>																
<b>Trafic (1980&gt;1989)</b>																		
	07/80 ▶ 02/89	<b>251328</b>																
	07/80 ▶ 02/89	<b>251334</b>																
<b>Trafic (1989&gt;1994)</b>																		
	03/89 ▶ 07/92	<b>251334</b>																
	03/89 ▶ 09/94	<b>251328</b>																
<b>Trafic II (2001&gt;2006)</b>																		
	04/01 ▶ 07/06	<b>251444</b>																
	04/01 ▶ 07/06	<b>251563</b>																
	04/01 ▶ 07/06	<b>251613</b>																
	04/01 ▶ 07/06	<b>251614</b>																
	04/01 ▶ 07/06	<b>251615</b>																
<b>Trafic II (2006&gt;)</b>																		
	07/06 ▶ 10/08	<b>251444</b>																
	07/06 ▶ 10/08	<b>251563</b>																
	07/06 ▶	<b>251614</b>																





		Valeo	
<b>RENAULT</b> (.../...)			
<b>Trafic II (2006&gt;) (.../...)</b>			
	10/08 ▶	<b>251602</b>	
	10/08 ▶	<b>251603</b>	
<b>RENAULT TRUCKS</b>			
<b>CBH, CLM</b>			
280, 340, 350		<b>645050</b>	
<b>CLR</b>			
220		<b>645050</b>	
<b>G</b>			
<b>OE n° 5000789126</b>	10/82 ▶ 09/93	<b>645050</b>	
G170, G200, G210, G220, G230, G260 G270, G280, G290, <b>OE n° 5000788671</b>	10/82 ▶ 09/93	<b>645060</b>	
<b>JE</b>			
9, 11, 13, 15		<b>645130</b>	
<b>JK</b>			
<b>OE n° 5000623819</b>	03/76 ▶ 06/80	<b>645130</b>	
<b>JN</b>			
<b>OE n° 5000623819</b>	06/80 ▶ 06/84	<b>645130</b>	
<b>JP</b>			
	1983 ▶ 06/84	<b>645130</b>	
<b>JR/JX</b>			
<b>OE n° 5000623819</b>	06/80 ▶ 06/84	<b>645130</b>	
<b>Midliner</b>			
S90, S100, S110, S120, S130, S135, S150, S170, S220	10/82 ▶ 01/00	<b>645130</b>	
<b>PS</b>			
130, 150		<b>645130</b>	
<b>SH</b>			
		<b>645130</b>	
<b>Ra</b>			
R310, R360, R370	10/80 ▶ 08/84	<b>645010</b>	
	09/84 ▶	<b>645050</b>	



<b>VAUXHALL</b>																
<b>Movano (2003&gt;2006)</b>																
	10/03 ▶ 10/06	<b>251613</b>														
<b>Vivaro (2001&gt;2006)</b>																
	08/01 ▶ 06/06	<b>251444</b>														
	08/01 ▶ 06/06	<b>251563</b>														
	08/01 ▶ 06/06	<b>251613</b>														
	08/01 ▶ 06/06	<b>251615</b>														
<b>Vivaro (2006&gt;)</b>																
	07/06 ▶ 2009	<b>251444</b>														
	07/06 ▶ 2009	<b>251563</b>														
<b>CPP (+)</b>	07/06 ▶	<b>251566</b>														
<b>CPP (-)</b>	07/06 ▶	<b>251613</b>														
<b>CPP (-)</b>	07/06 ▶	<b>251615</b>														
	2009 ▶	<b>251602</b>														
<b>Made in UK</b>		<b>251603</b>														



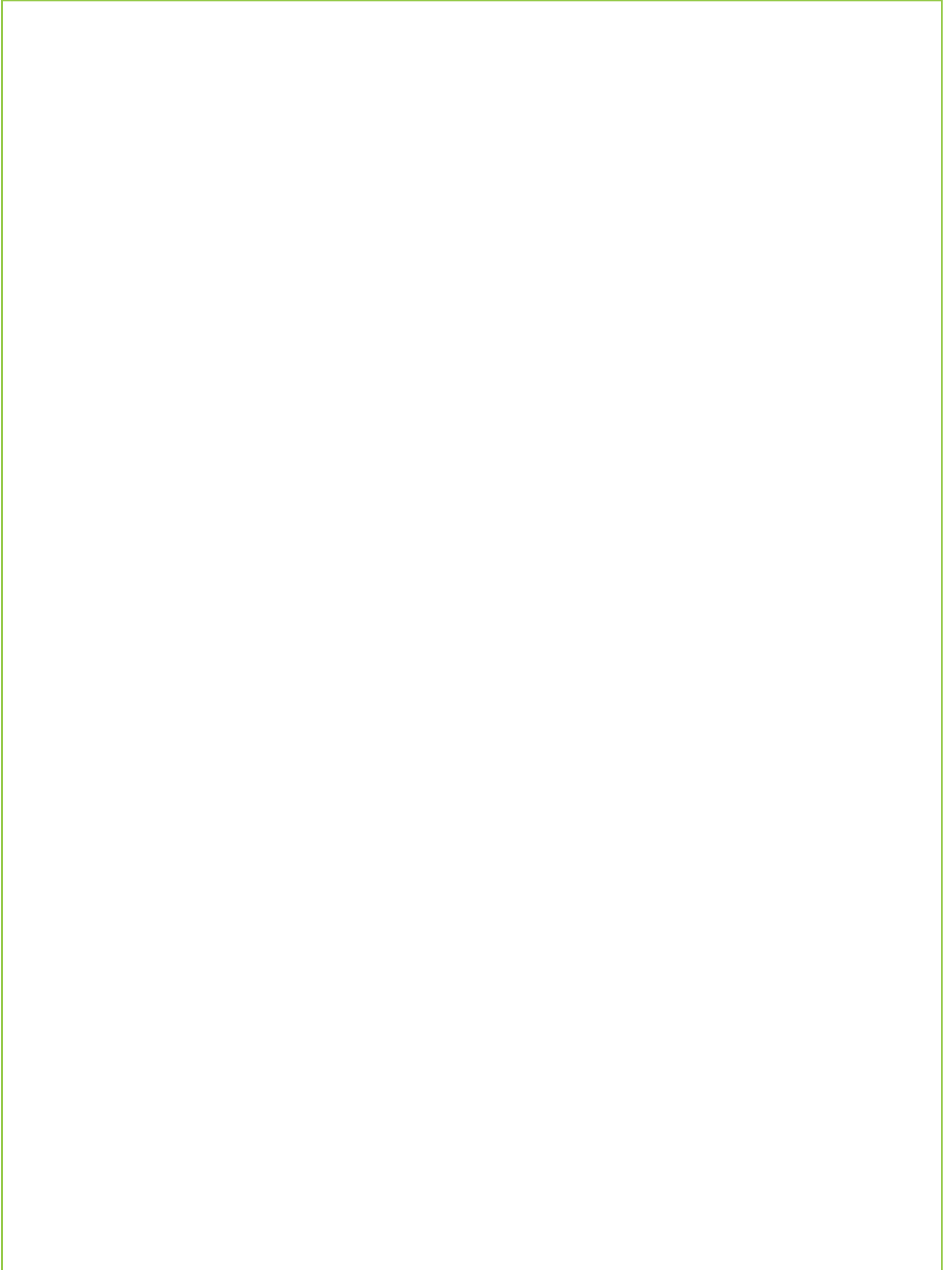





### 251104



RENAULT ESPACE I, EXPRESS, EXTRA, R9, R11, RAPID, SUPER 5

### 251109

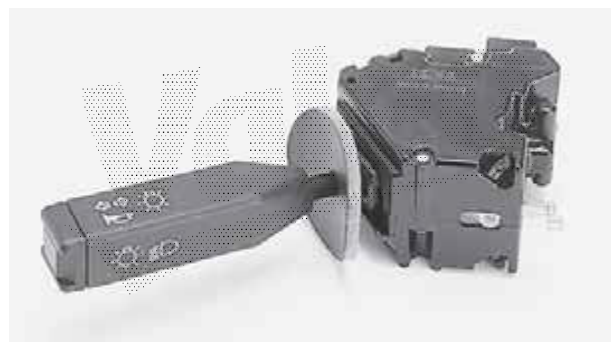

RENAULT R19, R21

### 251105



RENAULT FUEGO, R18

### 251110

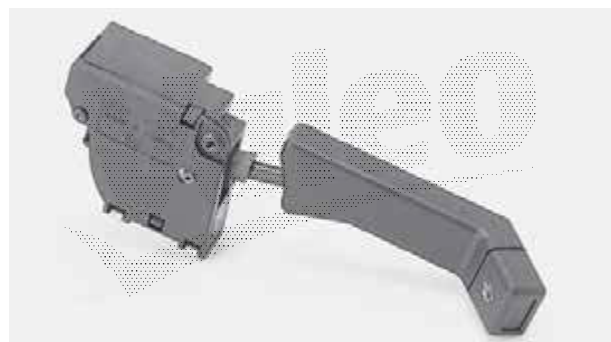
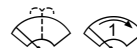

RENAULT R21

### 251106

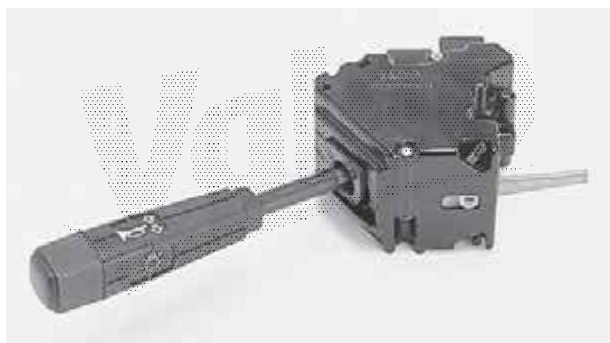

RENAULT R5

### 251152



CITROËN 2CV







251154



**CITROËN  
PEUGEOT**

AX, BX, C15, VISA  
104, 205, 309, J9

251158

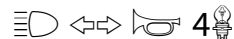

**CITROËN**

FUKANG, ZX

251155



**CITROËN**

AX

251160



**CITROËN**

AX

251156

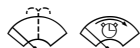

**CITROËN**

AX, BX, C15, VISA

251162

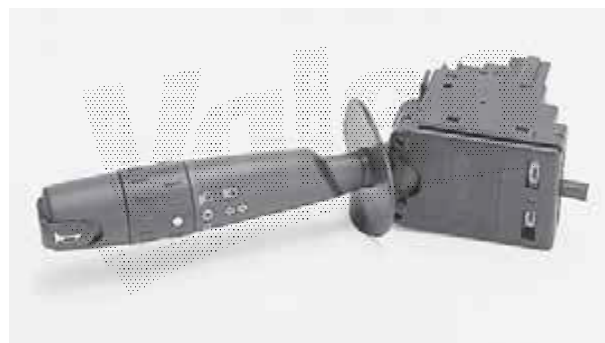

**CITROËN  
FIAT  
LANCIA  
PEUGEOT**

EVASION, SYNERGIE, XANTIA  
ULYSSE  
ZETA  
406, 605, 806, 1007





### 251203



PEUGEOT

104, 205, 305, 505

### 251210



PEUGEOT

205, 309, 1007

### 251206

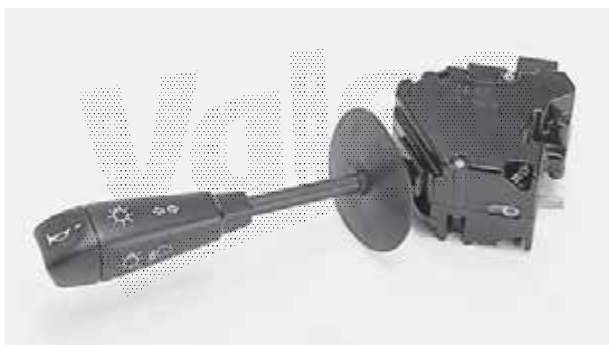

PEUGEOT

505

### 251211



PEUGEOT

405

### 251209

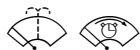

PEUGEOT

205, 309, 405

### 251212

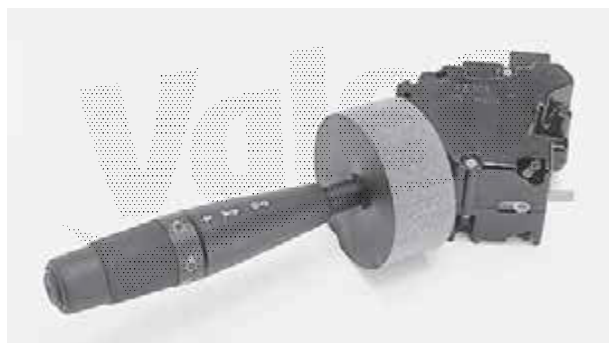

PEUGEOT

405





251213

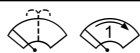

PEUGEOT 405

251222

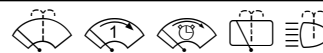

PEUGEOT 106, 306

251219

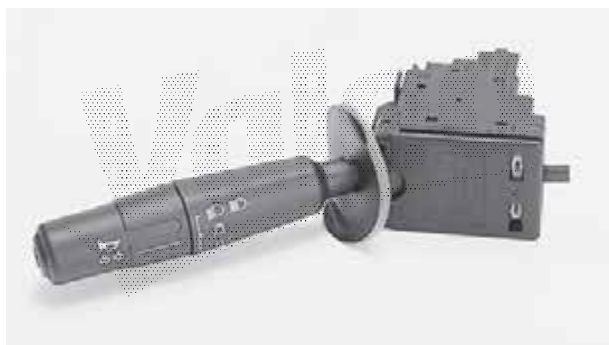

PEUGEOT 106, 306

251223

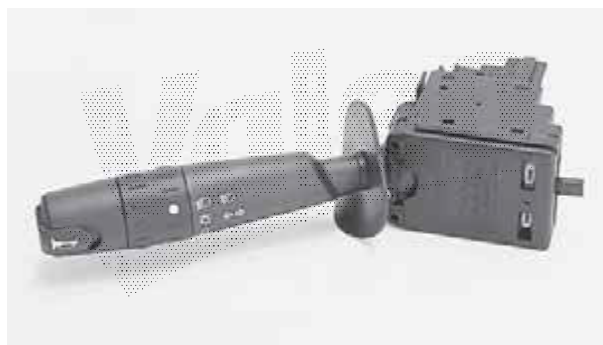

PEUGEOT 405

251220

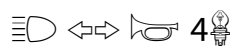

PEUGEOT 306

251259



CITROËN  
FIAT  
PEUGEOT  
EVASION, SYNERGIE, XANTIA, XSARA  
ULYSSE  
406, 605, 806





### 251260



**CITROËN**  
**FIAT**  
**LANCIA**  
**PEUGEOT**

EVASION, SYNERGIE, XANTIA, XSARA  
 ULYSSE  
 ZETA  
 406, 605, 806

### 251266



**CITROËN**  
**FIAT**  
**LANCIA**  
**PEUGEOT**

EVASION, SYNERGIE, XANTIA, XSARA, XSARA PICASSO  
 ULYSSE  
 ZETA  
 406, 806

### 251261

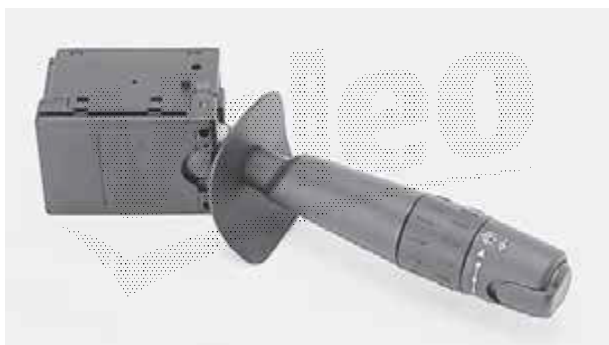

**PEUGEOT**  
 406

### 251267

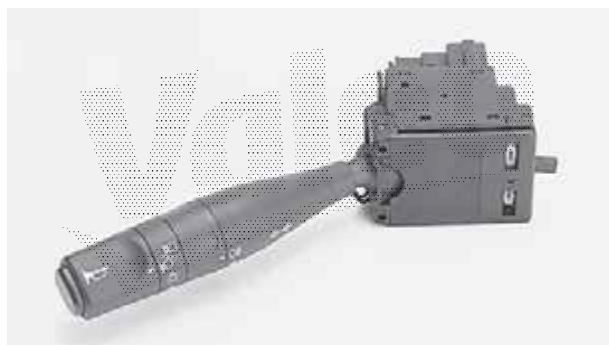
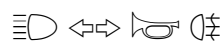

**PEUGEOT**  
 106

### 251262

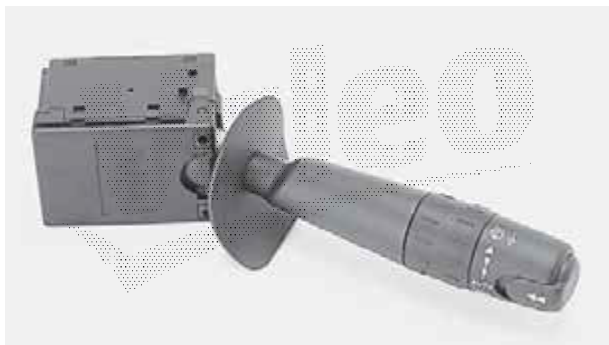
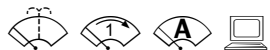

**PEUGEOT**  
 406, 605, 607

### 251268

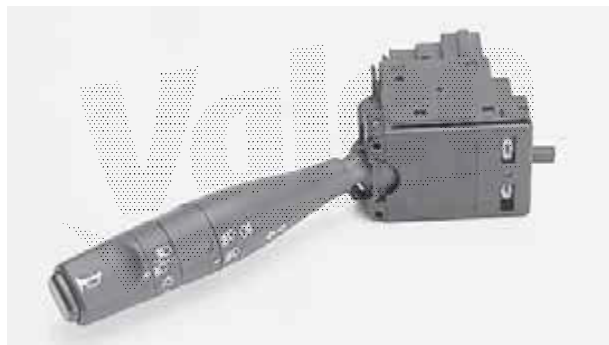

**PEUGEOT**  
 106





251269



PEUGEOT 106

251272

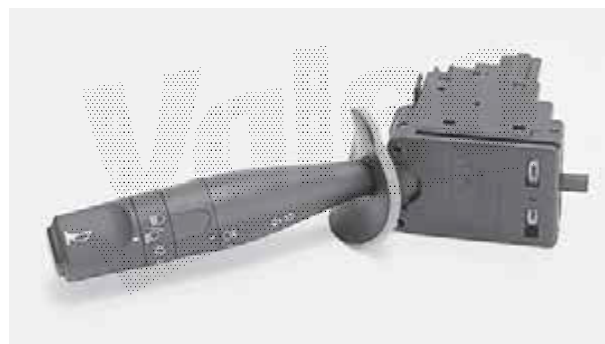

PEUGEOT 306

251270



CITROËN AX, BERLINGO, FUKANG, SAXO, ZX  
PEUGEOT 106, 206, 306, PARTNER, RANCH

251273

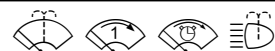

CITROËN AX, BERLINGO, DISPATCH, FUKANG, JUMPY, ZX  
FIAT SCUDO  
PEUGEOT EXPERT, PARTNER, RANCH

251271

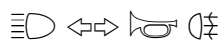

CITROËN BERLINGO, DISPATCH, JUMPY, SAXO  
FIAT SCUDO  
PEUGEOT 106, 206, 306, EXPERT, PARTNER, RANCH

251274

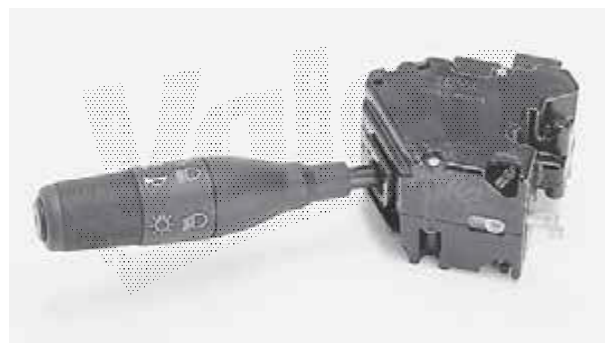

RENAULT CLIO I, ESPACE, LUTECIA, R19





### 251275

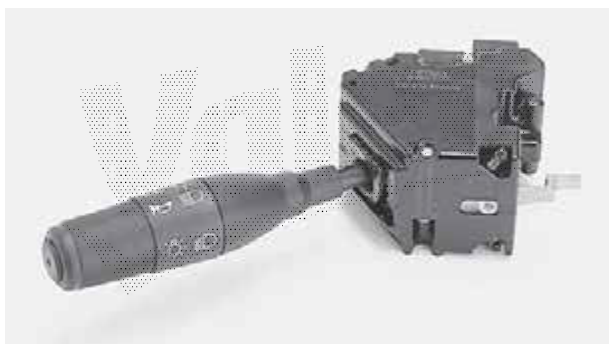

**RENAULT** EXPRESS, EXTRA

### 251280

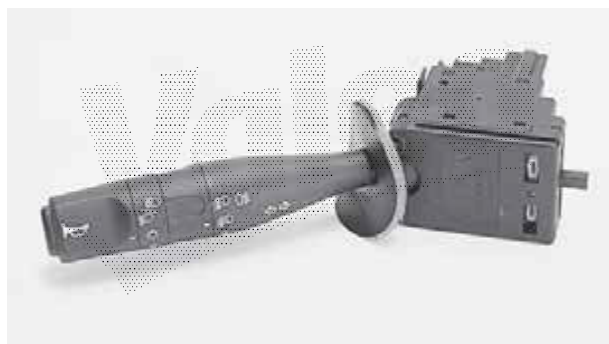

**CITROËN** BERLINGO, DISPATCH, JUMPY, SAXO  
**FIAT** SCUDO  
**PEUGEOT** 106, 306, EXPERT, PARTNER, RANCH

### 251276

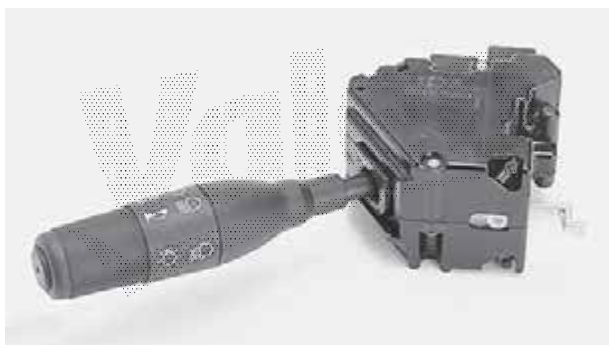

**RENAULT** EXPRESS

### 251281

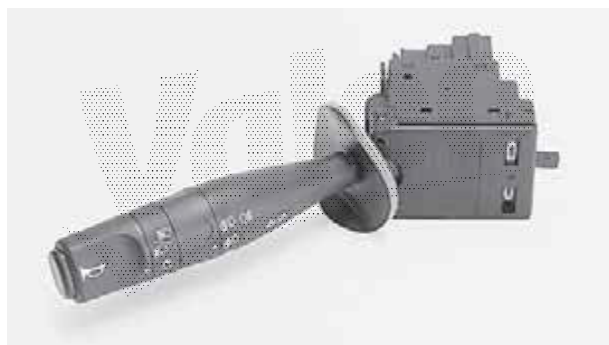

**PEUGEOT** 306

### 251279

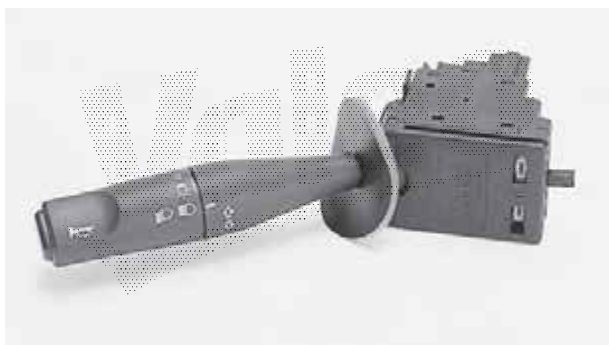

**CITROËN** AX, DISPATCH, FUKANG, JUMPY, ZX  
**FIAT** SCUDO  
**PEUGEOT** EXPERT I

### 251282

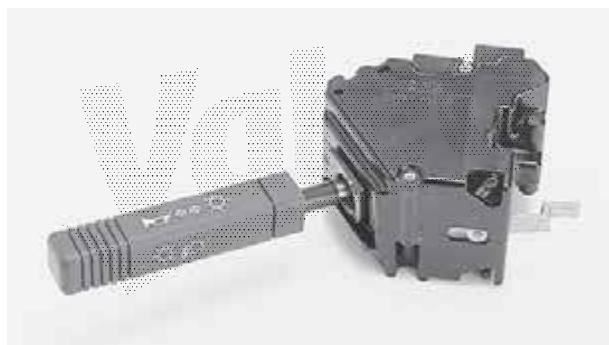

**RENAULT** EXPRESS I / II, EXTRA I / II, SUPER 5





**251283**

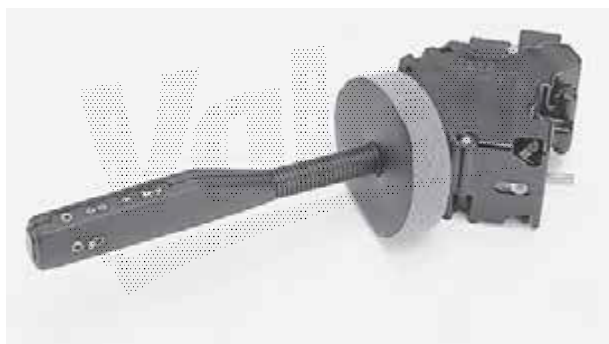

PEUGEOT 309, 505

**251290**

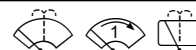

PEUGEOT 106

**251286**

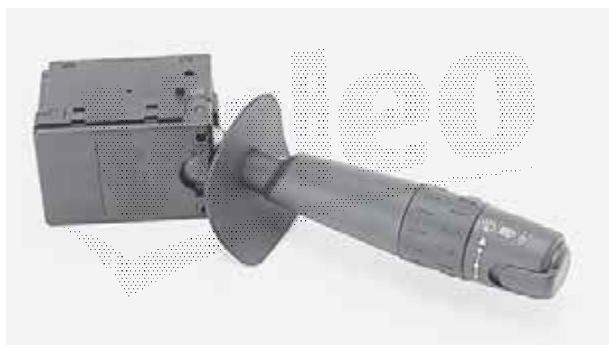

PEUGEOT 406

**251298**



RENAULT TWINGO II

**251287**



PEUGEOT 106

**251304**

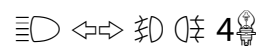

CITROËN XANTIA  
PEUGEOT 406





### 251305

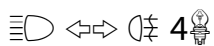

CITROËN  
PEUGEOT

XANTIA  
406

### 251308

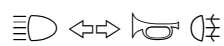

CITROËN

XSARA, XSARA PICASSO

### 251306



CITROËN

XANTIA, XSARA

### 251309



CITROËN

XSARA, XSARA PICASSO

### 251307



CITROËN

XANTIA, XSARA

### 251310

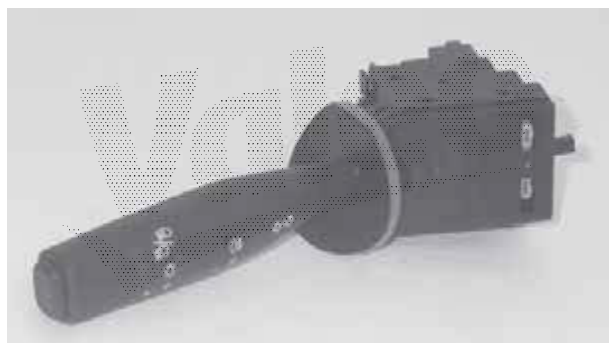

PEUGEOT

206







**251311**



PEUGEOT 206

**251328**



RENAULT MASTER, TRAFIC

**251312**

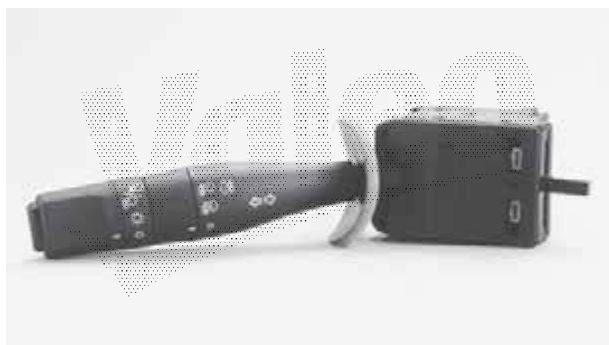
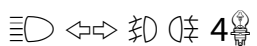

PEUGEOT 206

**251334**

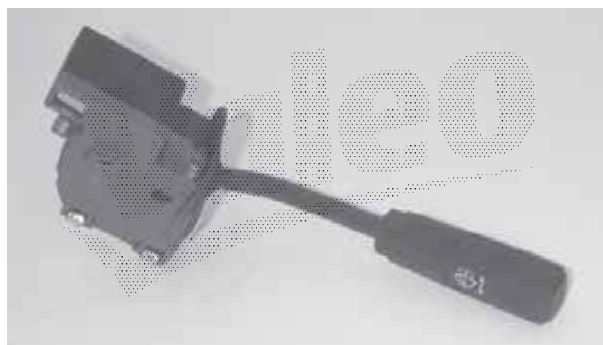
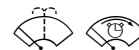

RENAULT MASTER, TRAFIC

**251314**



PEUGEOT 206, 306

**251337**

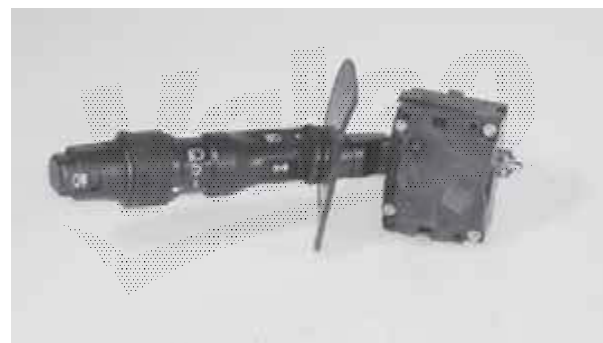

ALFA ROMEO 145, 146





### 251339

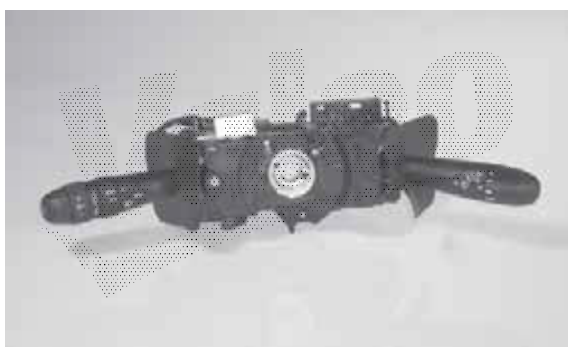

ALFA ROMEO 166

### 251342

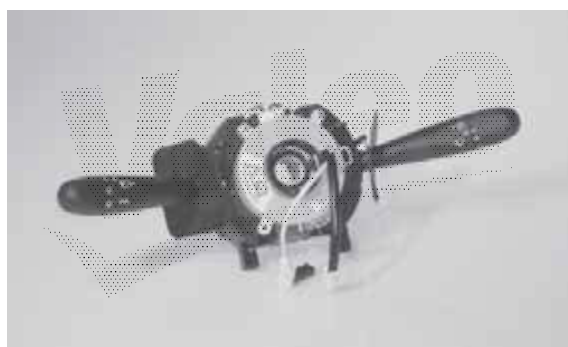

ALFA ROMEO 156

### 251340

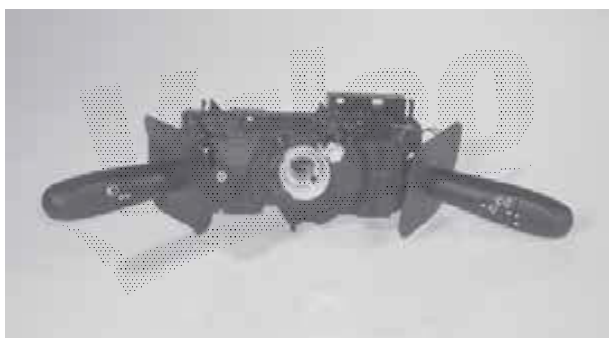

ALFA ROMEO 166

### 251343

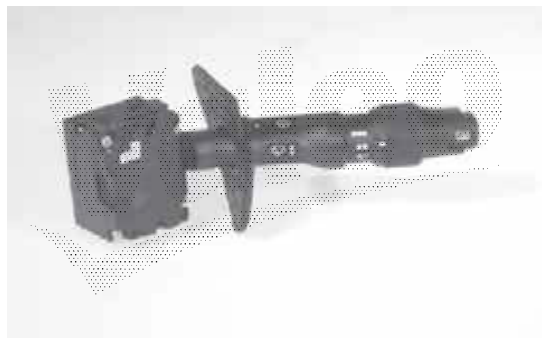
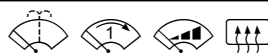

ALFA ROMEO 155

### 251341

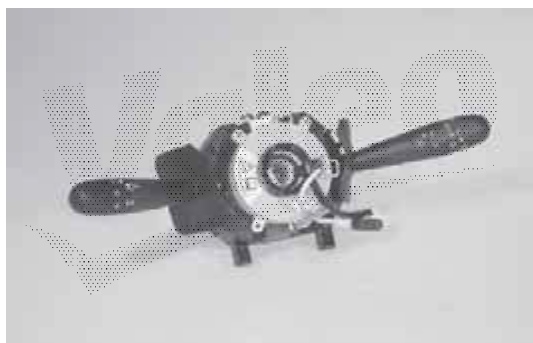
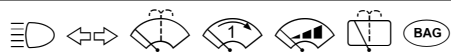

ALFA ROMEO 156

### 251347



ALFA ROMEO 145, 146





251348



ALFA ROMEO 145, 146

251353

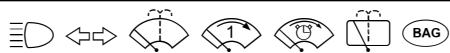

FIAT MULTIPLA

251350

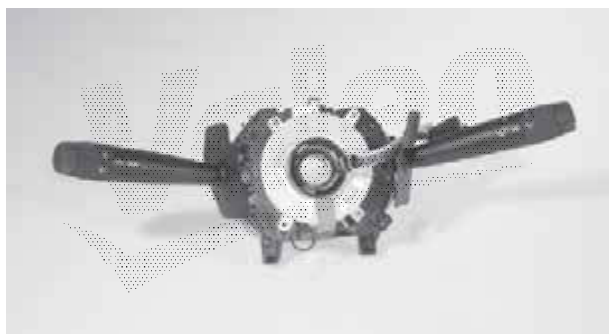
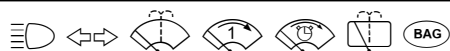

FIAT PALIO

251354



FIAT CINQUECENTO

251352

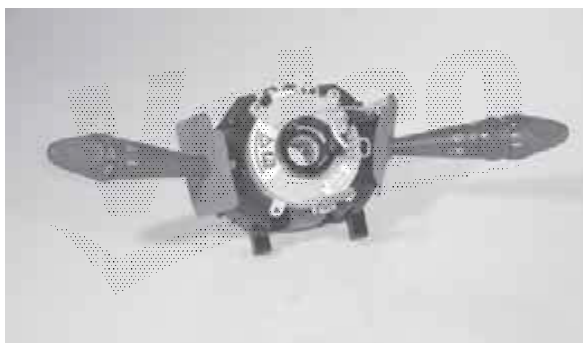

FIAT MAREA

251355



FIAT CINQUECENTO





251357



FIAT

SEICENTO

251361



FIAT

MAREA, MARENGO

251358



FIAT

SEICENTO

251362

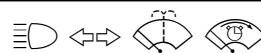

FIAT

DUCATO

251359

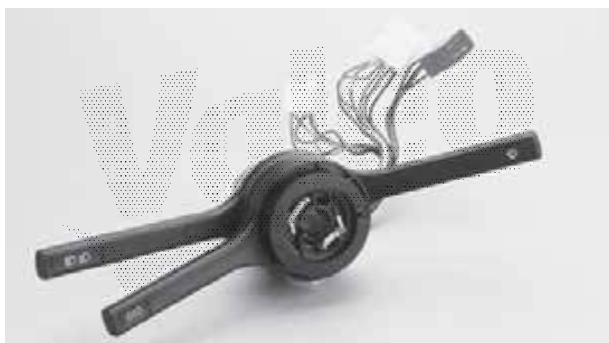
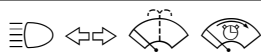

FIAT

PANDA

251363



FIAT

SEICENTO





251365

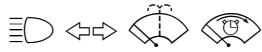

FIAT

FIORINO

251369

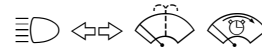

FIAT

PANDA

251367



FIAT

DUCATO

251370

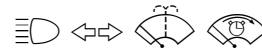

FIAT

DUCATO

251368



FIAT

DUCATO

251371

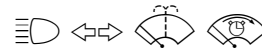

FIAT

PANDA





### 251372

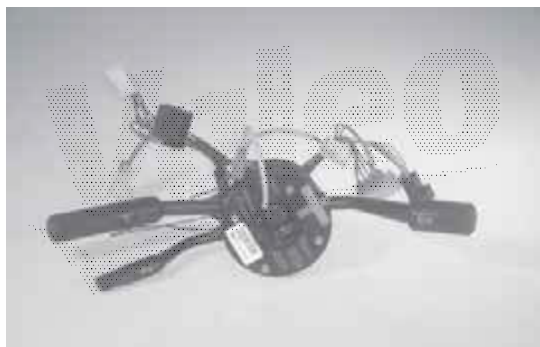

FIAT

CROMA

### 251376

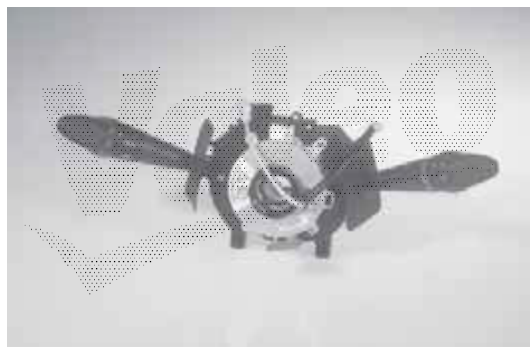

FIAT

BRAVA, BRAVO

### 251373

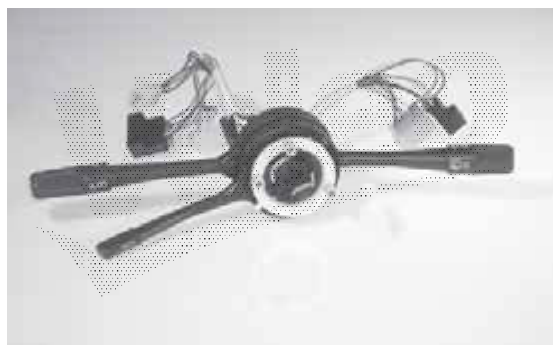

FIAT

CROMA

### 251377

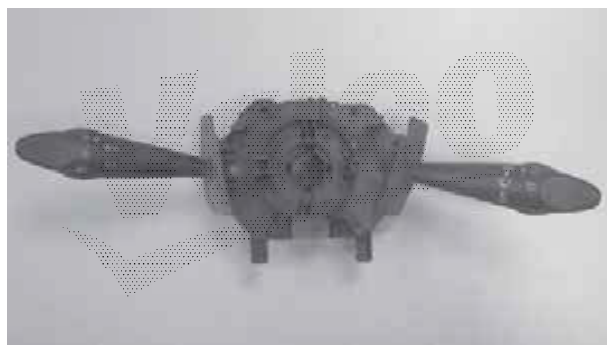
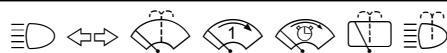

FIAT

BRAVA, BRAVO

### 251375

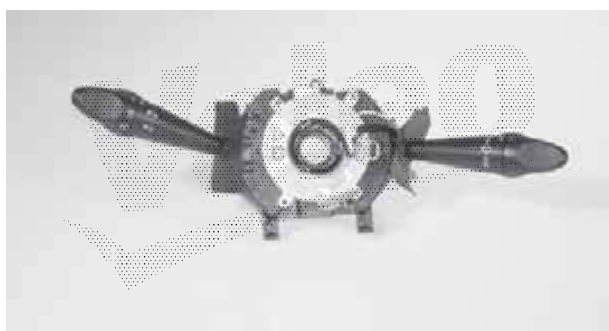

FIAT

BRAVA, BRAVO

### 251378

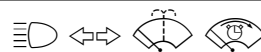

FIAT

DUCATO





**251379**

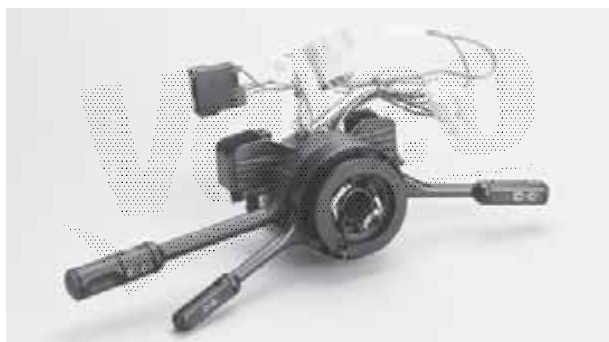

FIAT UNO

**251383**

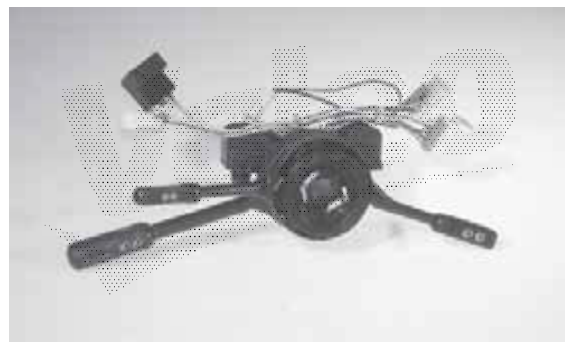

FIAT UNO

**251380**

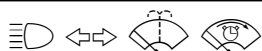

FIAT PANDA

**251384**

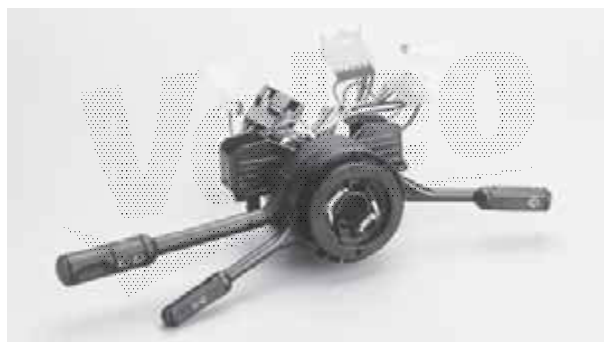
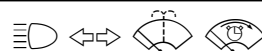

FIAT UNO

**251382**

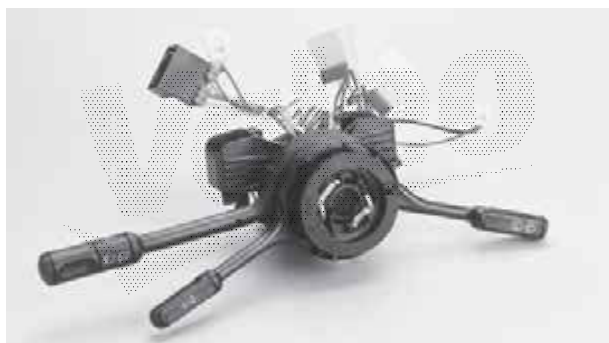

FIAT UNO

**251385**

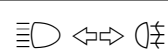

FIAT TIPO





### 251386



FIAT

TIPO

### 251392

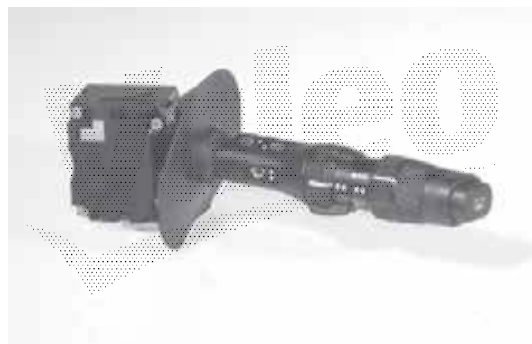

FIAT

MARENGO, TEMPRA

### 251389

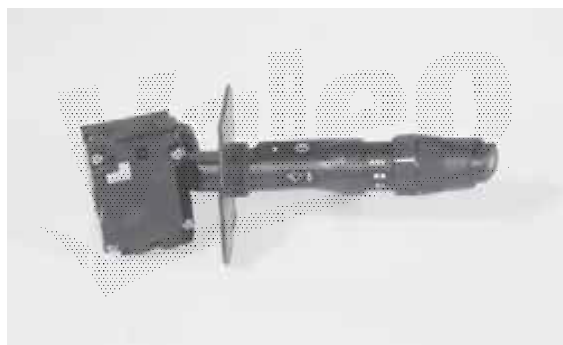

FIAT

MARENGO, TEMPRA

### 251393



FIAT

PUNTO I

### 251391

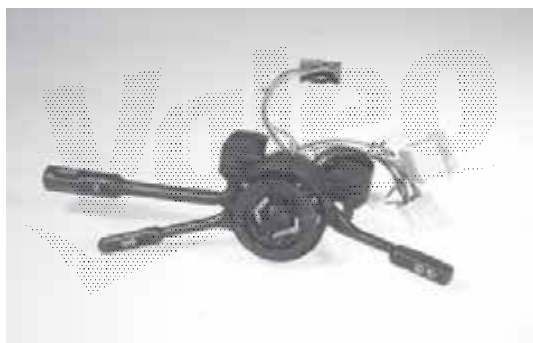

FIAT

UNO, UNO MONDO

### 251394



FIAT

PUNTO I







251397

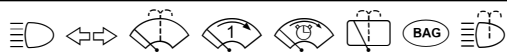

FIAT

PUNTO II

251402

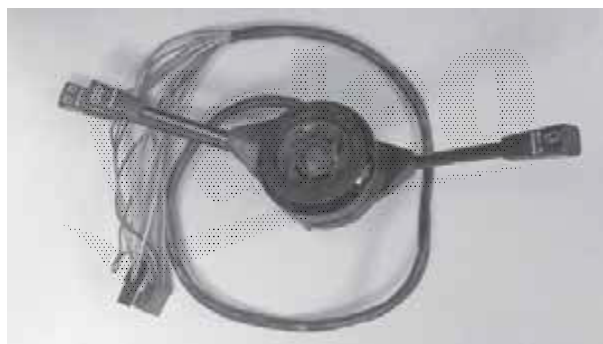

IVECO

DAILY

251398

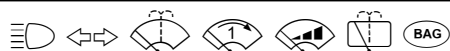

FIAT

PUNTO II

251403



IVECO

DAILY

251399



FIAT

MARENGO, TEMPRA

251404

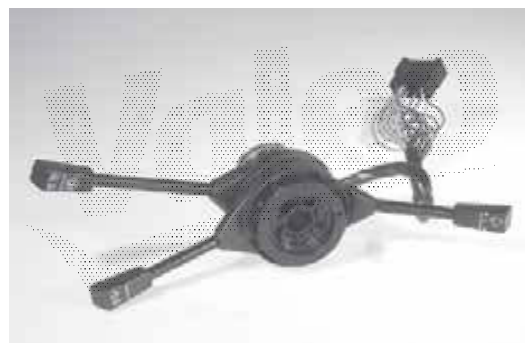

IVECO

DAILY





251405

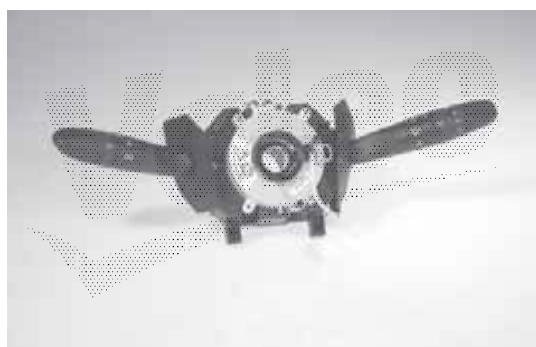

LANCIA LYBRA

251408

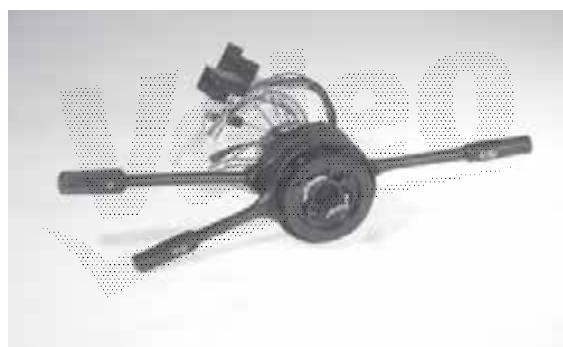

LANCIA Y10

251406



LANCIA DEDRA

251409



LANCIA Y10

251407



LANCIA Y10

251410

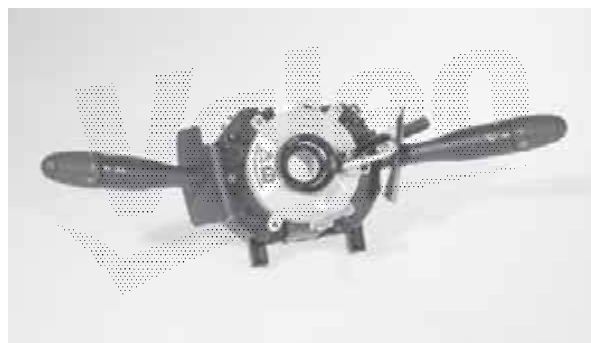

LANCIA YPSILON





251411



LANCIA YPSILON

251414

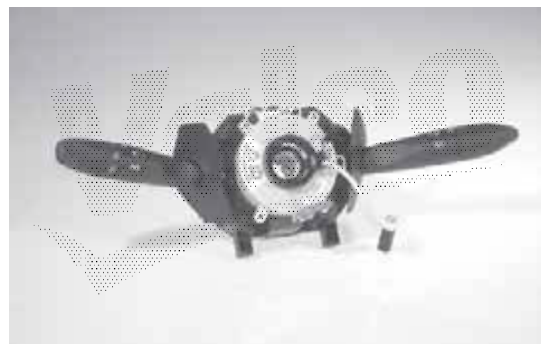

LANCIA LYBRA

251412

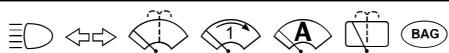

LANCIA LYBRA

251416



LANCIA KAPPA

251413



LANCIA LYBRA

251417



LANCIA DELTA





251418



LANCIA DEDRA

\*251436



RENAULT MEGANE I, MEGANE CLASSIC

251420

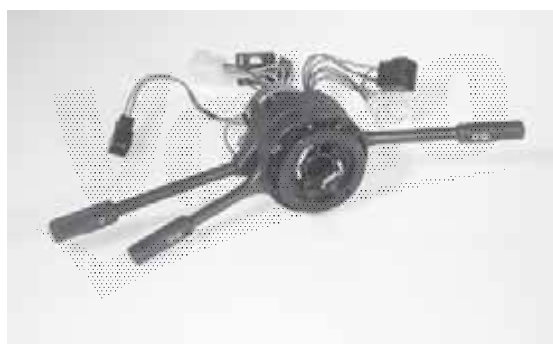

LANCIA Y10

\*251437



RENAULT MEGANE I, MEGANE CLASSIC

251430



RENAULT TWINGO I

251438

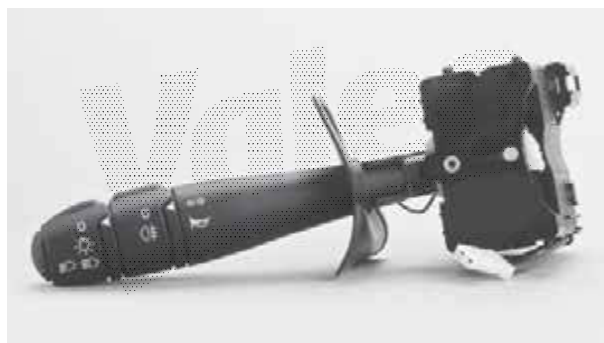

RENAULT KANGOO I, KANGOO EXTRA, MEGANE I, MEGANE CLASSIC





251439

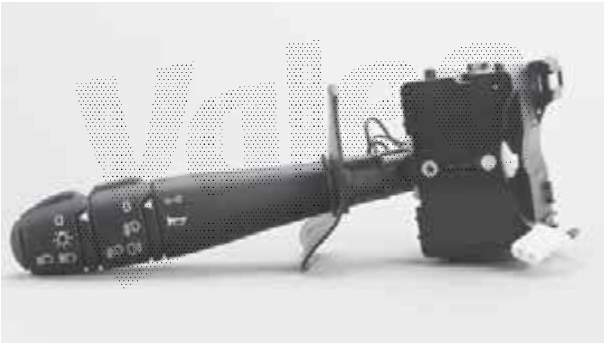

**RENAULT** KANGOO I, KANGOO EXTRA, MEGANE I, MEGANE CLASSIC

251472

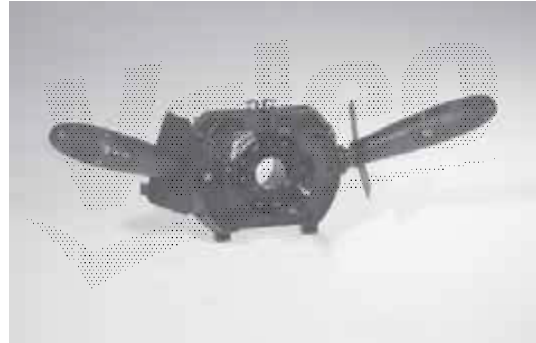

**FIAT** DOBLO, DOBLO CARGO

\*251442



**RENAULT** MEGANE I

251473

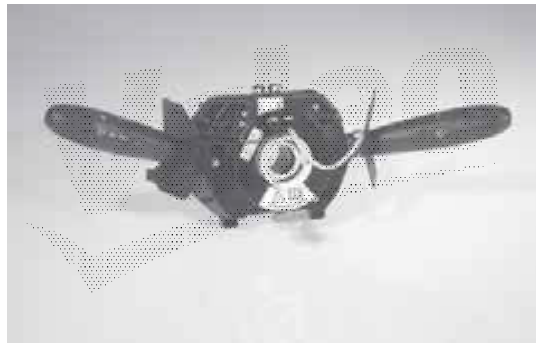
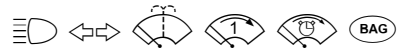

**FIAT** DOBLO, DOBLO CARGO

251444



**RENAULT** ESPACE IV, LAGUNA II, TRAFIC II, VEL SATIS  
**OPEL/VAUXHALL** VIVARO

251474

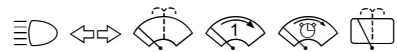

**FIAT** DOBLO, DOBLO CARGO





### 251475

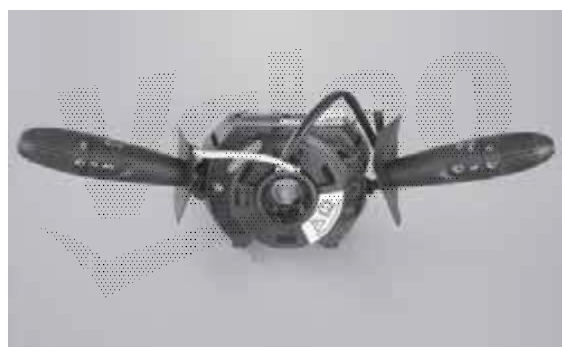
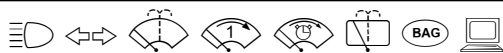

FIAT PUNTO II

### 251483

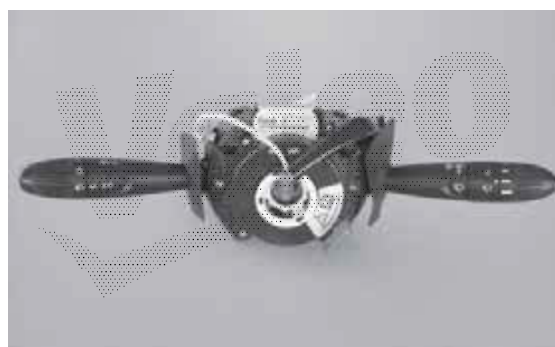

FIAT PUNTO II

### 251476

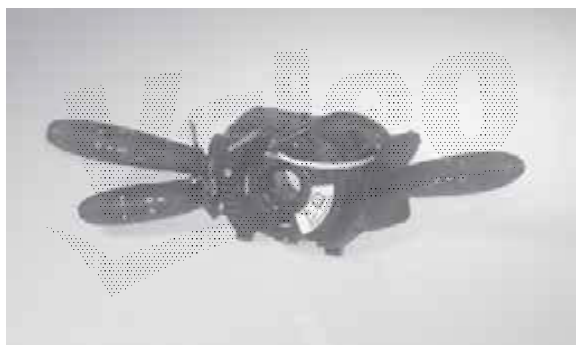

FIAT PUNTO II

### \*251485



PEUGEOT 206+, 307

### 251480

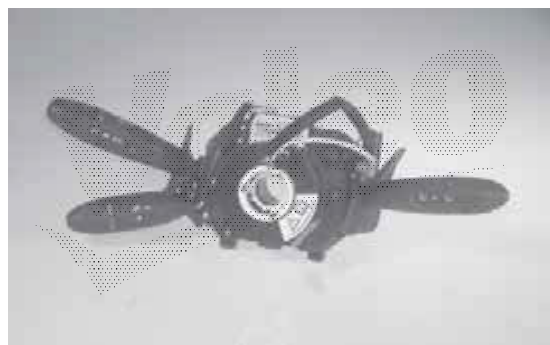

FIAT PUNTO II

### \*251486



PEUGEOT 307





**\*251487**

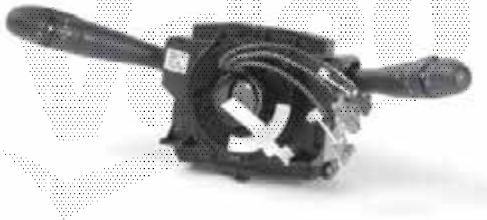
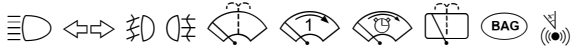

PEUGEOT 307

**\*251490**

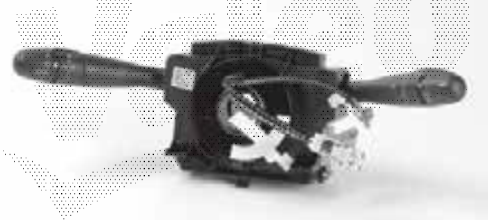

PEUGEOT 307, 1007

**\*251488**

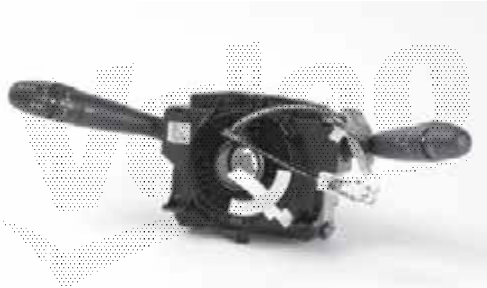
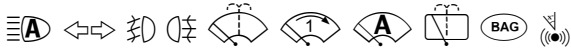

PEUGEOT 307

**\*251491**

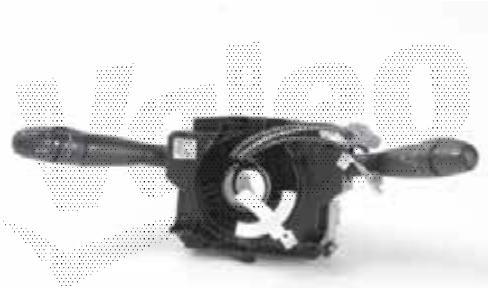
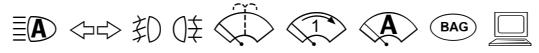

CITROËN BERLINGO  
PEUGEOT 406, PARTNER

**\*251489**

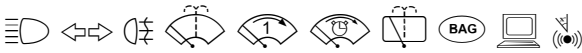

PEUGEOT 307

**\*251492**

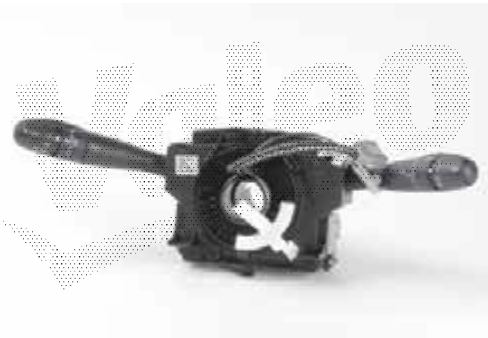
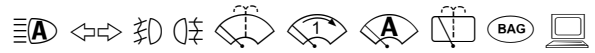

CITROËN BERLINGO, C8, XSARA PICASSO  
PEUGEOT 206, 307, 406, PARTNER, RANCH





**\*251493**

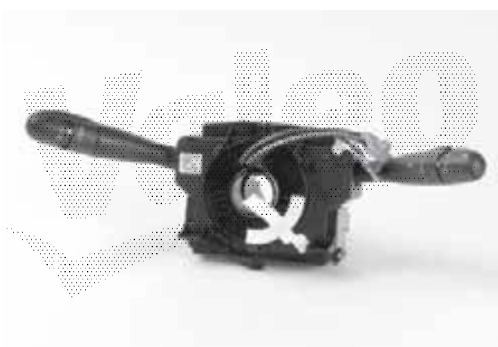

**PEUGEOT** 206

**\*251496**

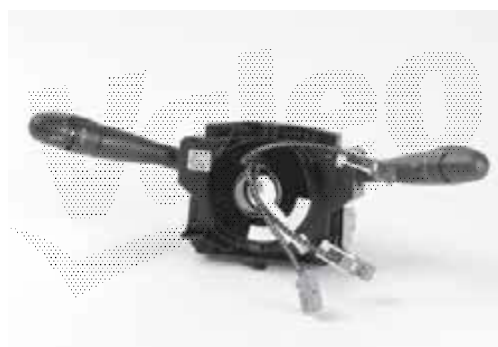

**CITROËN** BERLINGO  
**PEUGEOT** 206, PARTNER, RANCH

**\*251494**

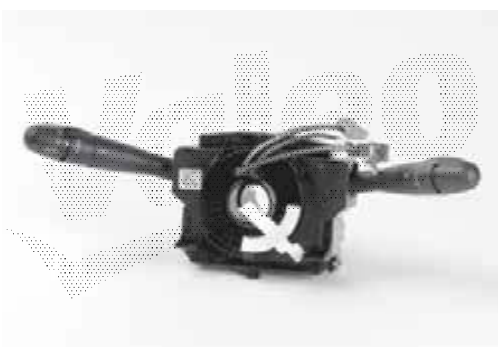

**CITROËN** BERLINGO  
**PEUGEOT** 206, PARTNER, RANCH

**\*251497**



**CITROËN** BERLINGO  
**PEUGEOT** 206, PARTNER, RANCH

**\*251495**



**CITROËN** BERLINGO  
**PEUGEOT** 206, PARTNER, RANCH

**\*251498**

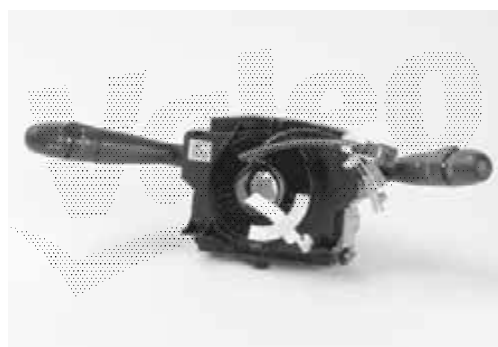
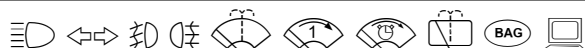

**PEUGEOT** 206







**\*251499**

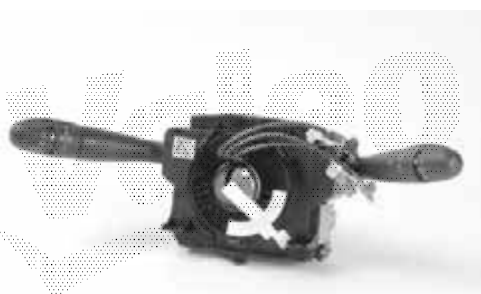
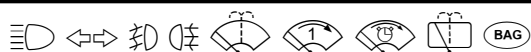

**CITROËN  
PEUGEOT**

BERLINGO  
206, PARTNER, RANCH

**251504**

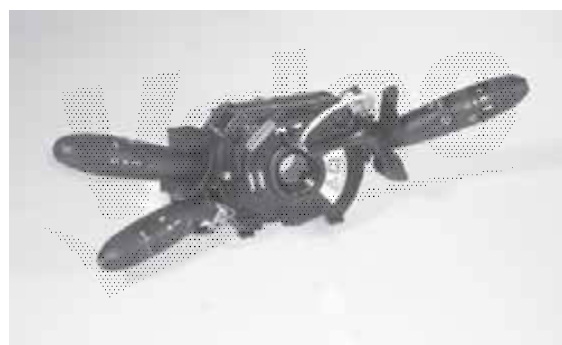

**FIAT**

PUNTO II

**251500**



**FIAT**

PUNTO II

**251505**



**FIAT**

PUNTO II

**251501**

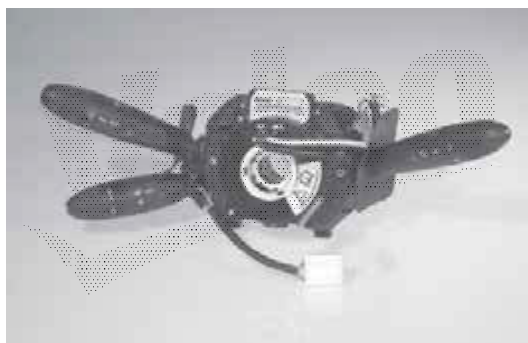

**FIAT**

PUNTO II

**251508**

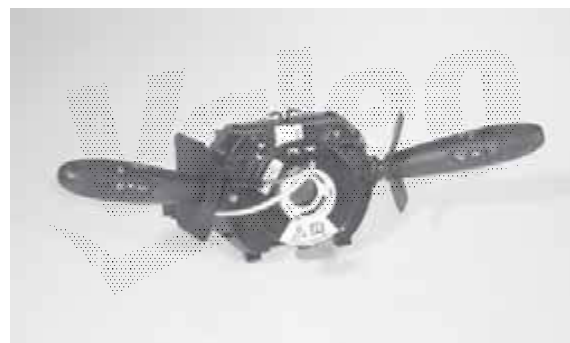
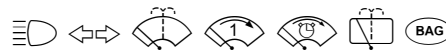

**FIAT**

DOBLO, DOBLO CARGO





### 251511



FIAT

PALIO

### 251515

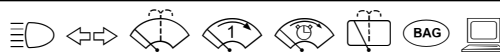

FIAT

PANDA

### 251513



FIAT

PANDA

### 251517

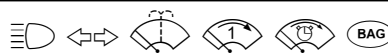

FIAT

PANDA

### 251514

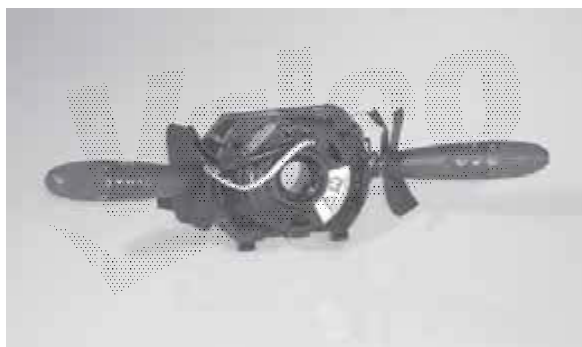
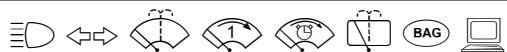

FIAT

PANDA

### 251519

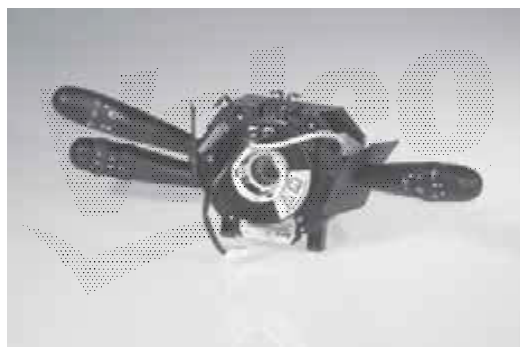

ALFA ROMEO

156





### 251520

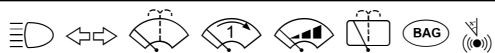

ALFA ROMEO 156

### 251527



ALFA ROMEO 156

### 251521

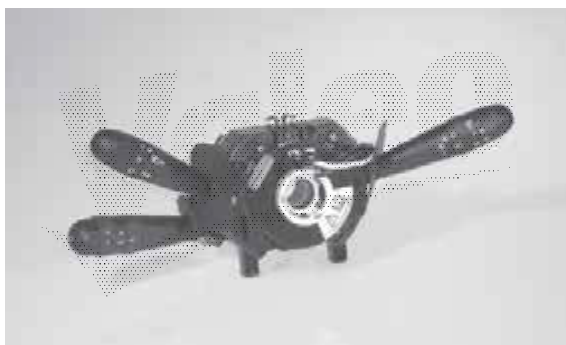
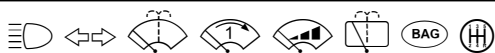

ALFA ROMEO 156

### 251530



ALFA ROMEO 156

### 251523



ALFA ROMEO 156

### 251538

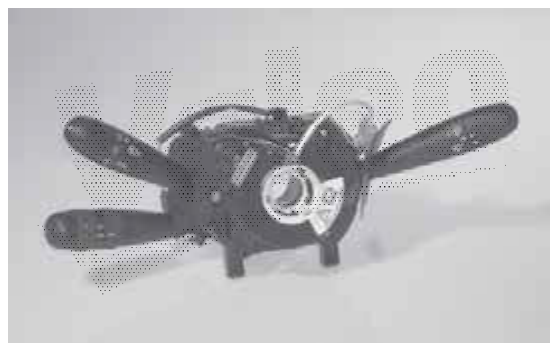

ALFA ROMEO 156





### 251541

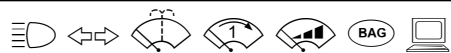

ALFA ROMEO 156

### 251547

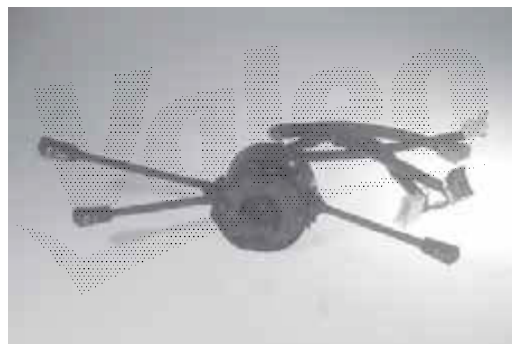

IRISBUS TURBOCITY

### 251543

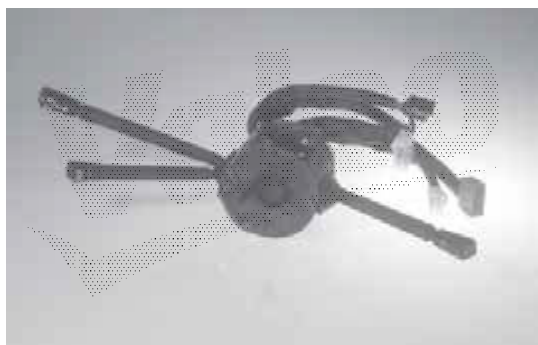

IVECO EUROCARGO, TURBOSTAR, TURBOTECH

### 251548



IRISBUS TURBOCITY

### 251544

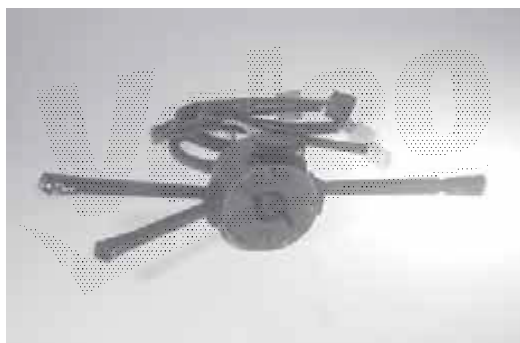

IVECO EUROCARGO, TURBOSTAR, TURBOTECH

### 251550



IVECO DAILY S2000





251551



IVECO

DAILY S2000

251555



FIAT

SEICENTO

251552

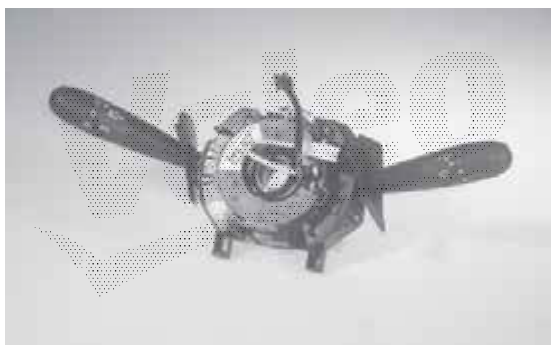

ALFA ROMEO

156

251557



IRISBUS  
IVECO

CITYCLASS, EUROCLASS, EURORIDER  
EUROCARGO, EUROFIRE

251554

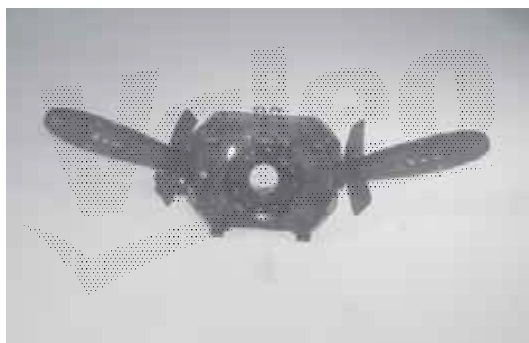

FIAT

PUNTO II

251558

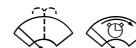

IRISBUS  
IVECO

CITYCLASS, EUROCLASS, EURORIDER  
EUROCARGO, EUROFIRE





### 251561

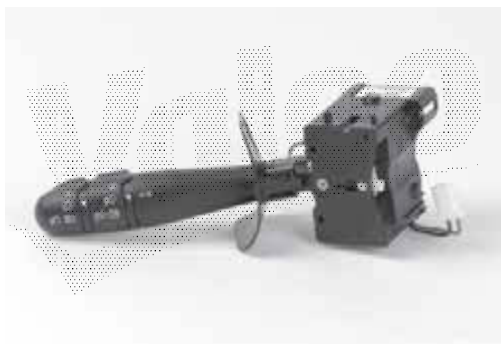

**RENAULT**

MEGANE I, MEGANE CLASSIC

### 251565

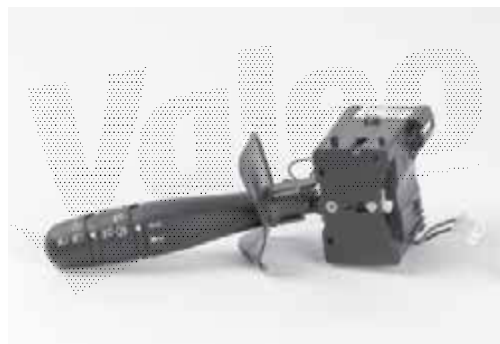

**RENAULT**

KANGOO I, KANGOO EXTRA

### 251562

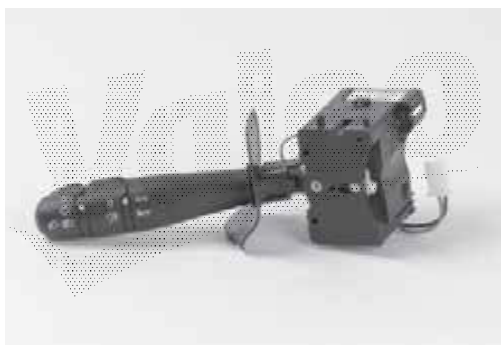
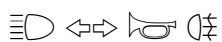

**NISSAN  
RENAULT**

KUBISTAR  
KANGOO I, KANGOO EXTRA, MEGANE I, MEGANE CLASSIC

### 251566



**RENAULT  
OPEL/VAUXHALL**

ESPACE IV, LAGUNA II, VEL SATIS  
VIVARO

### 251563



**RENAULT  
OPEL/VAUXHALL**

ESPACE IV, LAGUNA II, TRAFIC II  
VIVARO

### 251568

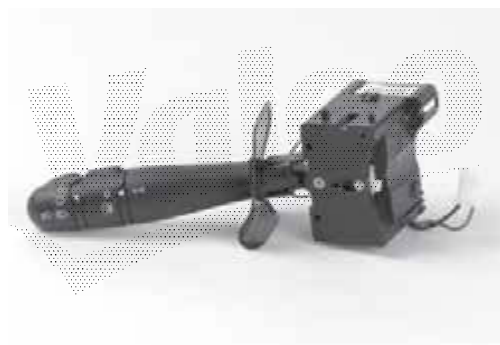

**RENAULT**

MEGANE I, MEGANE CLASSIC





251570



RENAULT

CLIO II

251573



FIAT

DUCATO

251571



RENAULT

CLIO II

251574



FIAT

DUCATO

251572

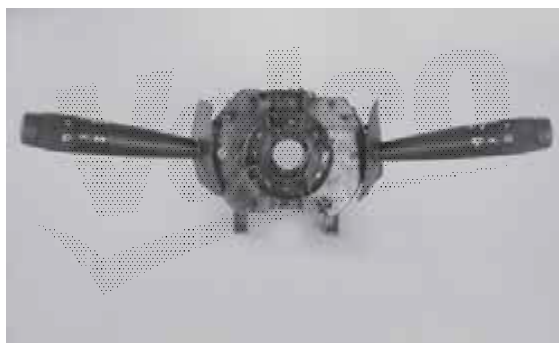

FIAT

SEICENTO

251581

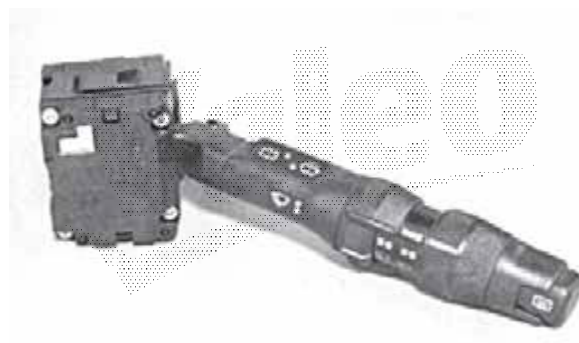

FIAT

TIPO





251586

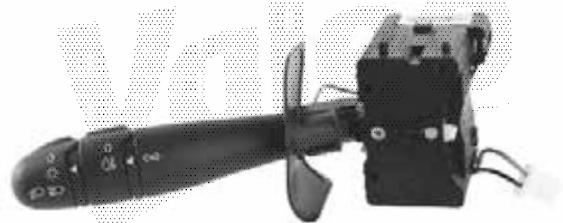
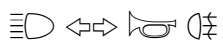

NISSAN  
RENAULT

KUBISTAR  
KANGOO I

251589



RENAULT

TWINGO III

251587

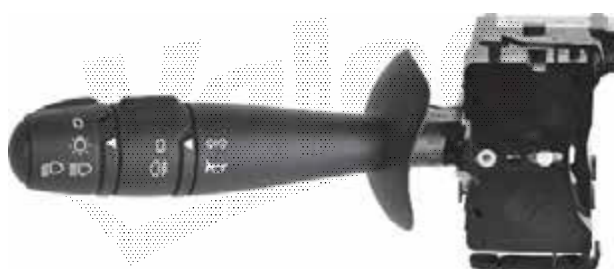

RENAULT

TWINGO III

251590

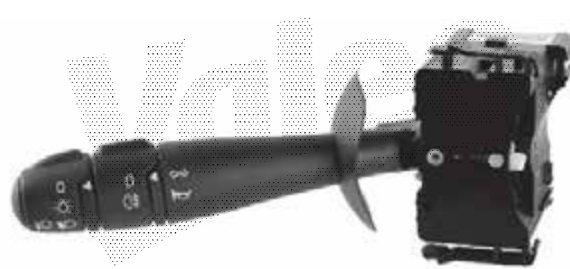
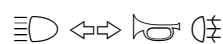

RENAULT

MASTER II

251588

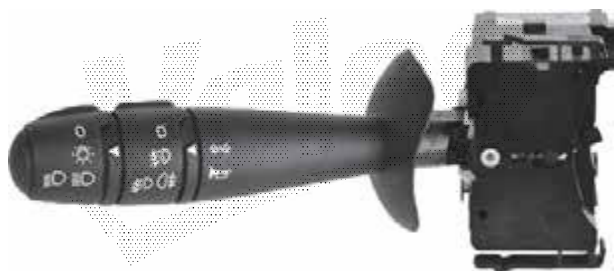

RENAULT

TWINGO III

251591



RENAULT

MASTER II







**251592**

☰Ⓜ ↔↔ ⓂⓂ

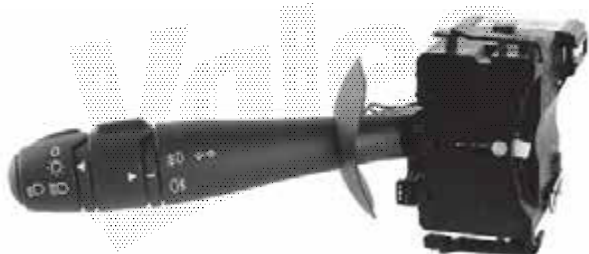

**RENAULT**

ESPACE IV, LAGUNA II, VEL SATIS

**251595**

☰Ⓜ ↔↔ ⓂⓂ ⓂⓂ



**DACIA**

LOGAN

**251593**

☰Ⓜ ↔↔ ⓂⓂ ⓂⓂ

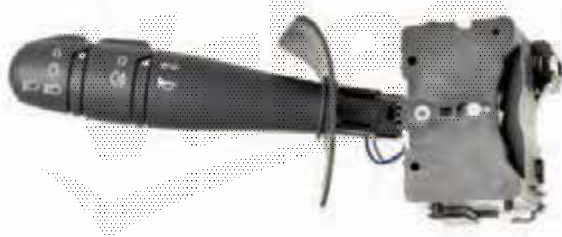

**DACIA  
RENAULT**

LOGAN  
CLIO II

**251596**

☰Ⓜ ↔↔ ⓂⓂ ⓂⓂ

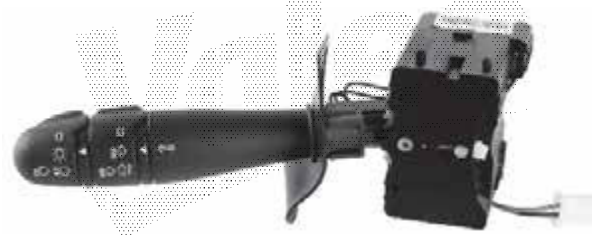

**RENAULT**

CLIO II

**251594**

☰Ⓜ ↔↔ ⓂⓂ ⓂⓂ



**RENAULT**

CLIO II

**251597**

☰Ⓜ ↔↔ ⓂⓂ

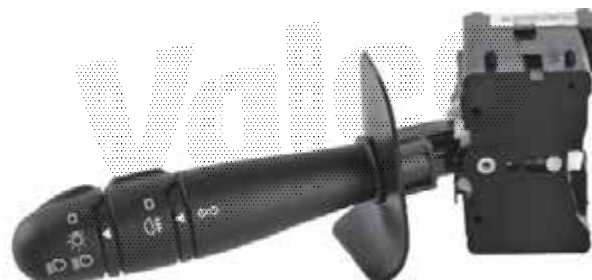

**RENAULT**

CLIO II





251598

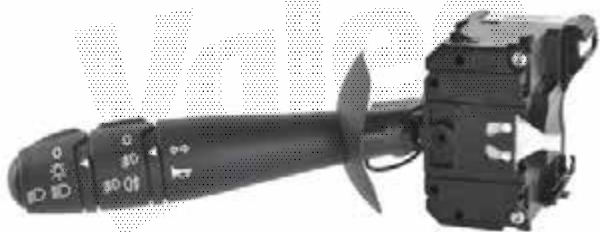
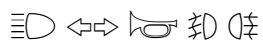

RENAULT

TWINGO III

251601

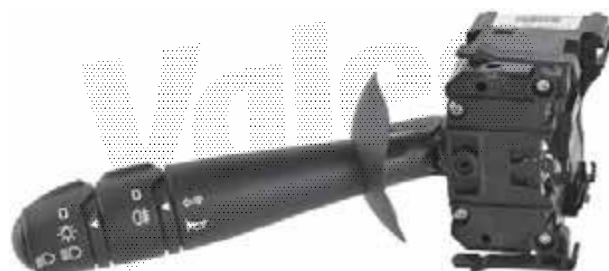
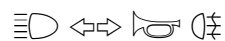

NISSAN  
RENAULT

INTERSTAR  
MASTER II

251599

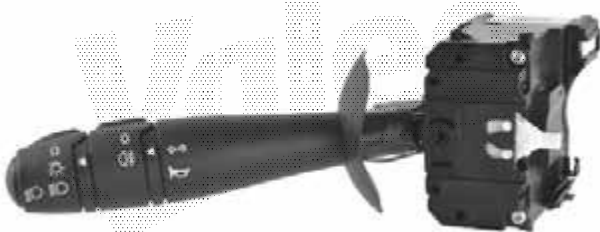

RENAULT

TWINGO III

251602

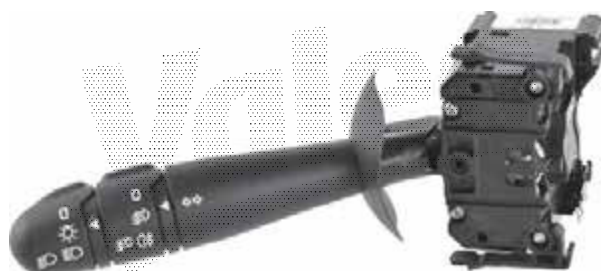

OPEL/VAUXHALL  
RENAULT

VIVARO  
TRAFIC II

251600

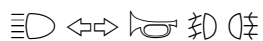

NISSAN  
RENAULT

INTERSTAR  
MASTER II

251603



OPEL/VAUXHALL  
RENAULT

VIVARO  
TRAFIC II





251604



DACIA

LOGAN, SANDERO

251607

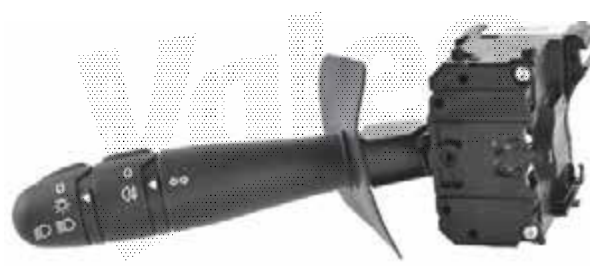

DACIA

LOGAN, SANDERO

251605

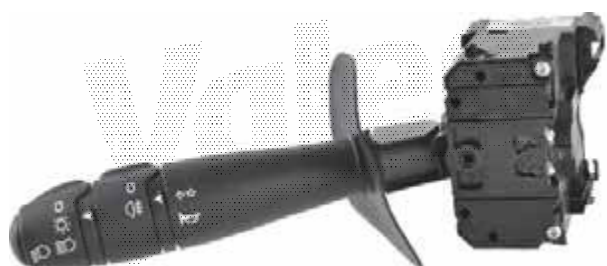
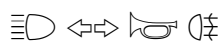

DACIA

LOGAN, SANDERO

251608

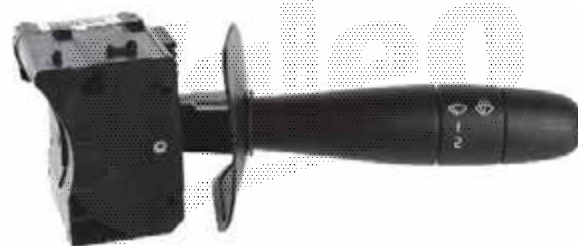

RENAULT

MEGANE, MEGANE CLASSIC, KANGOO I, KANGOO EXTRA

251606

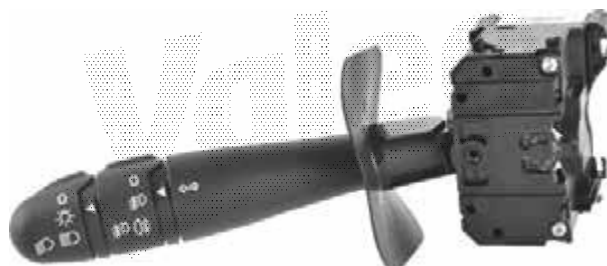

DACIA

LOGAN, SANDERO

251609



RENAULT

MEGANE I, KANGOO I, KANGOO EXTRA





251610

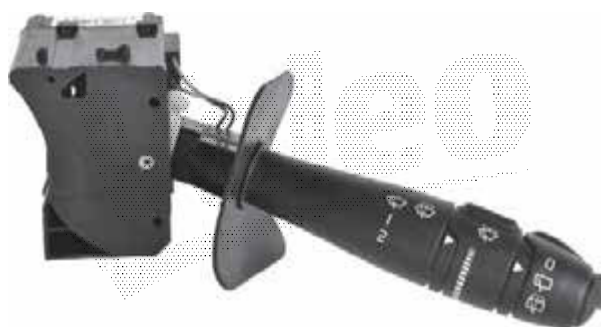

RENAULT

MEGANE

251613

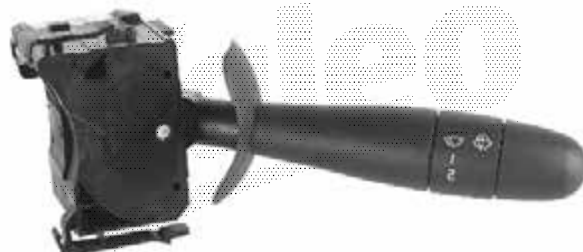

OPEL/VAUXHALL  
RENAULT

MOVANO, VIVARO  
TRAFIC II

251611

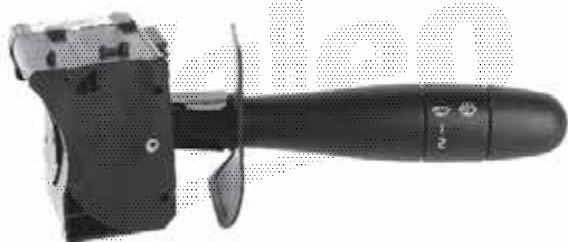

RENAULT

KANGOO I, KANGOO EXTRA

251614

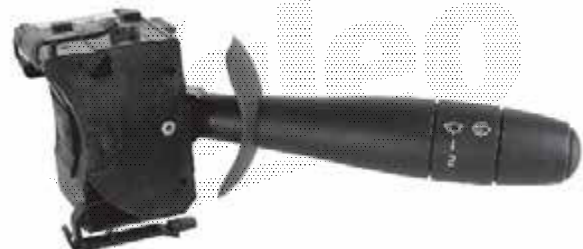

NISSAN  
RENAULT

INTERSTAR  
MASTER II, TRAFIC II

251612



RENAULT

KANGOO I, KANGOO EXTRA

251615

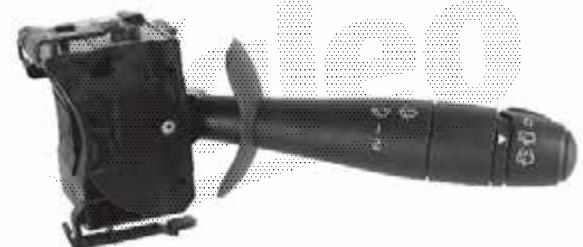

OPEL/VAUXHALL  
RENAULT

VIVARO  
ESPACE IV, LAGUNA II, VEL SATIS, TRAFIC II





251616

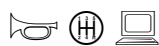

CITROËN

C4, C4 PICASSO

251619

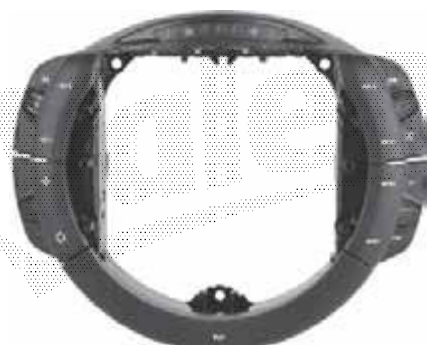

CITROËN

C4, C4 PICASSO

251617



CITROËN

C4

251620



CITROËN

C4, C4 PICASSO

251618



CITROËN

C4, C4 PICASSO

251621



CITROËN

C4 PICASSO





### 251622



CITROËN

C4 PICASSO

### 251625

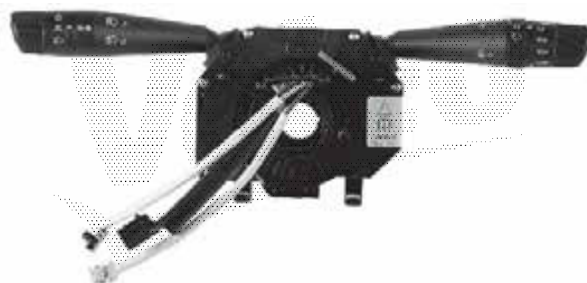

ABARTH/FIAT

PUNTO EVO, GRANDE PUNTO

### 251623

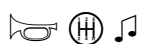

CITROËN

C4

### 251626

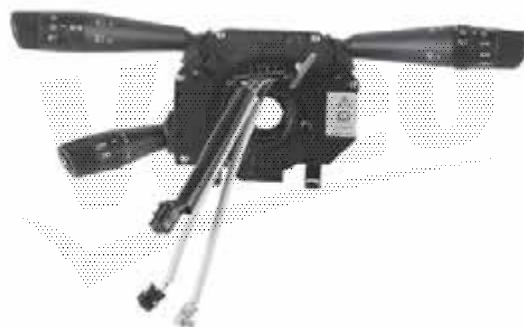

ABARTH/FIAT

PUNTO EVO, GRANDE PUNTO

### 251624

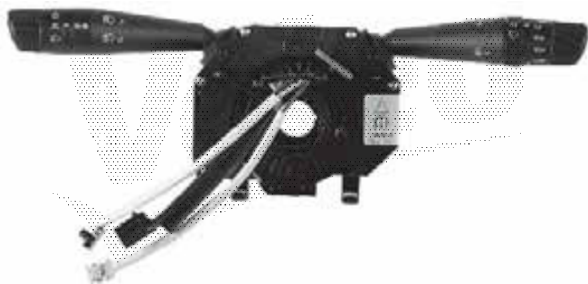

ABARTH/FIAT

PUNTO EVO, GRANDE PUNTO

### 251627

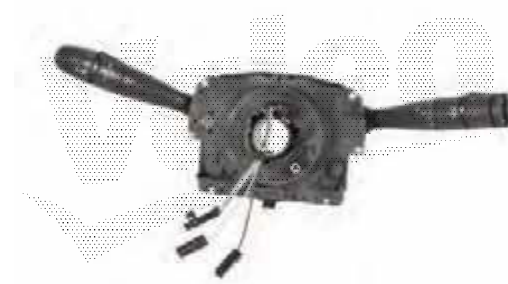

CITROËN

C2, C3





251628

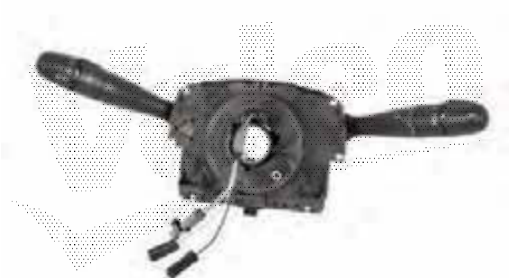

CITROËN C2,C3

251631

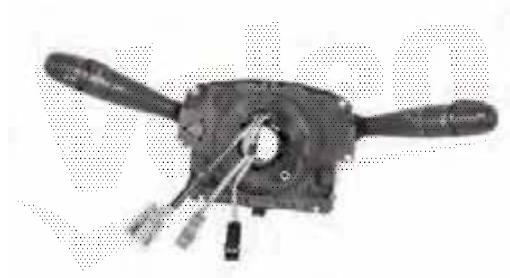

CITROËN PEUGEOT C5 407

251629

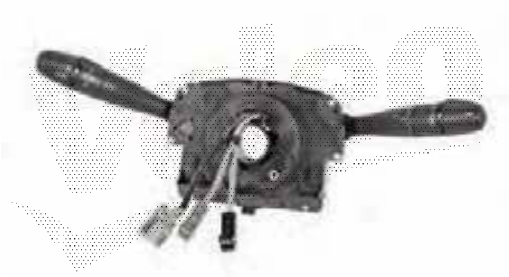

CITROËN PEUGEOT C5 407

251632

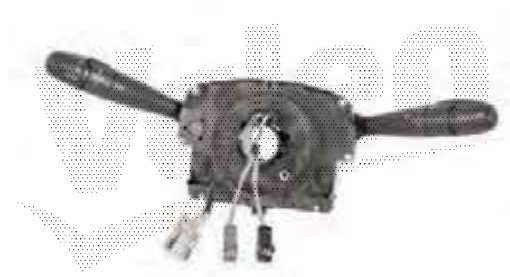
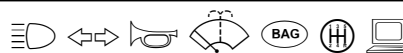

CITROËN PEUGEOT C5 407

251630

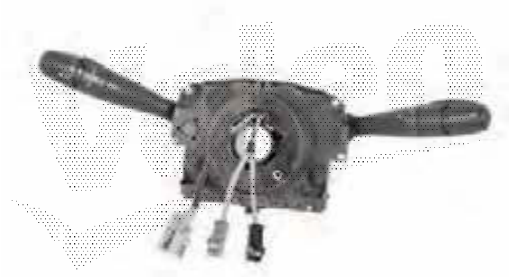

CITROËN PEUGEOT C5 407

251633

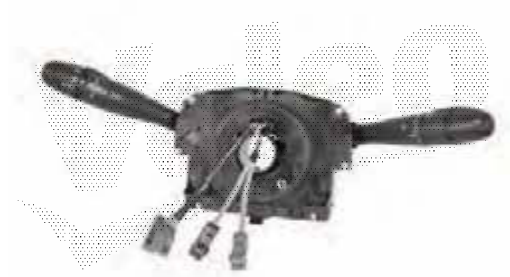
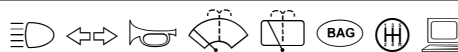

CITROËN PEUGEOT C6 407





### 251634

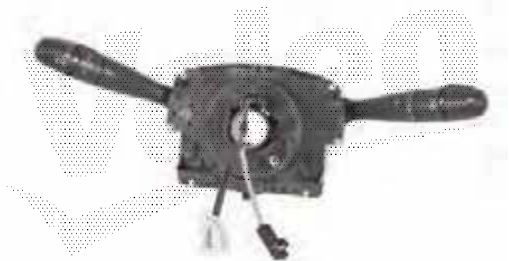

PEUGEOT

207, 1007

### 251637

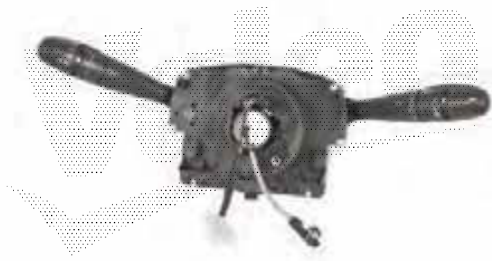

PEUGEOT

207

### 251635

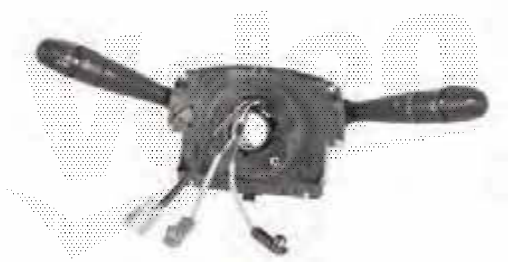

PEUGEOT

207

### 251638



RENAULT

SCENIC II, GRAND SCENIC II

### 251636



CITROËN  
PEUGEOT

C2, C3  
207

### 251639



RENAULT

SCENIC II, GRAND SCENIC II







### 251640

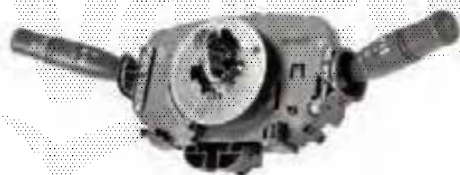

RENAULT

MEGANE II

### 251643

BAG

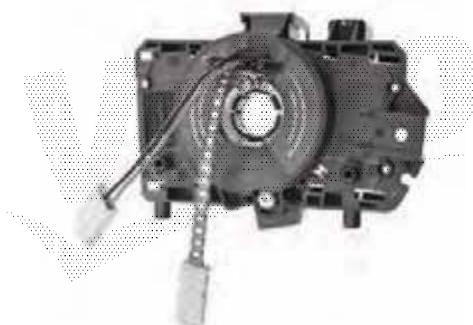

RENAULT

MEGANE I, MEGANE CLASSIC

### 251641

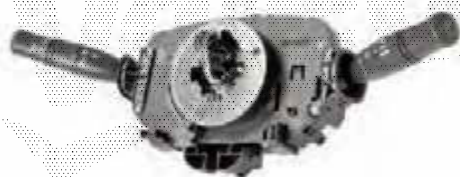

RENAULT

MEGANE II

### 251644

BAG

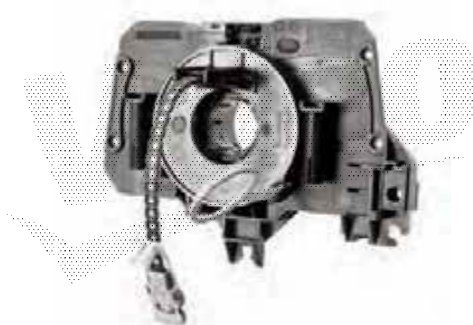

DACIA

LOGAN

### 251642

BAG

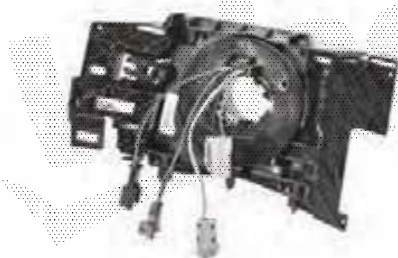

RENAULT

SCENIC II, GRAND SCENIC II

### 251645

BAG

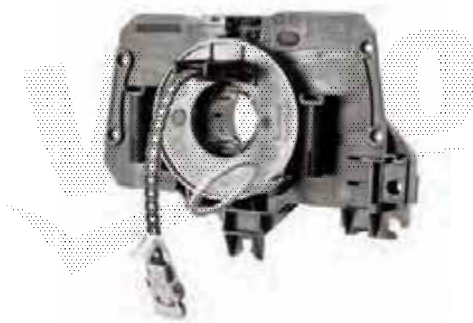

DACIA

LOGAN





251647

BAG

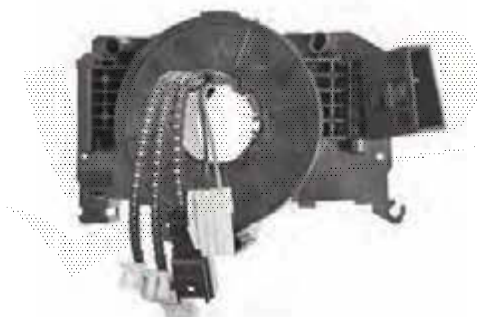

RENAULT

LAGUNA II, ESPACE & GRAND ESPACE

251650

BAG

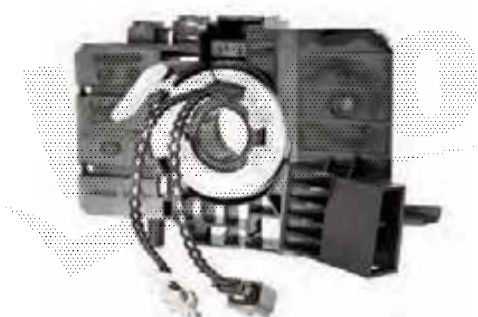

RENAULT

TWINGO III

251648

BAG



RENAULT

CLIO II

251651

BAG

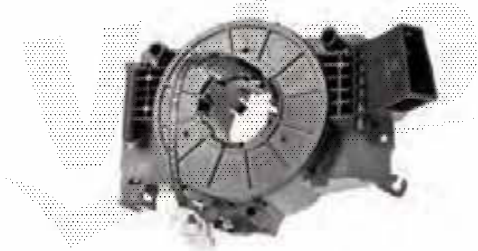

RENAULT

MASTER II

251649

BAG

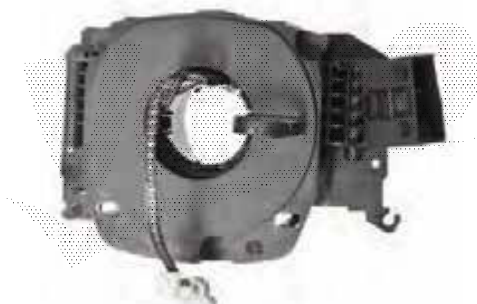

RENAULT

MASTER II

645010

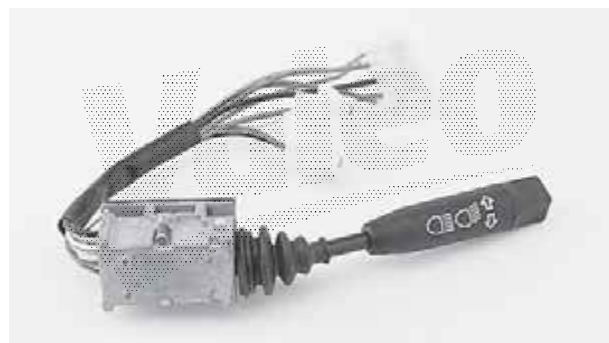

RENAULT TRUCKS R





645050

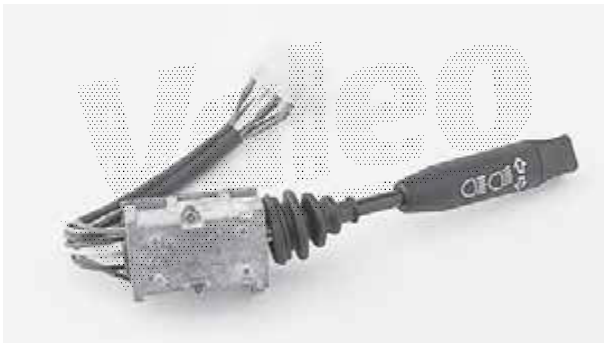

RENAULT TRUCKS CBH, CLM, CLR, G, R



645060



RENAULT TRUCKS G



645130



RENAULT TRUCKS JE, JK, JN, JP, JR/JX, MIDLINER, PS, SH



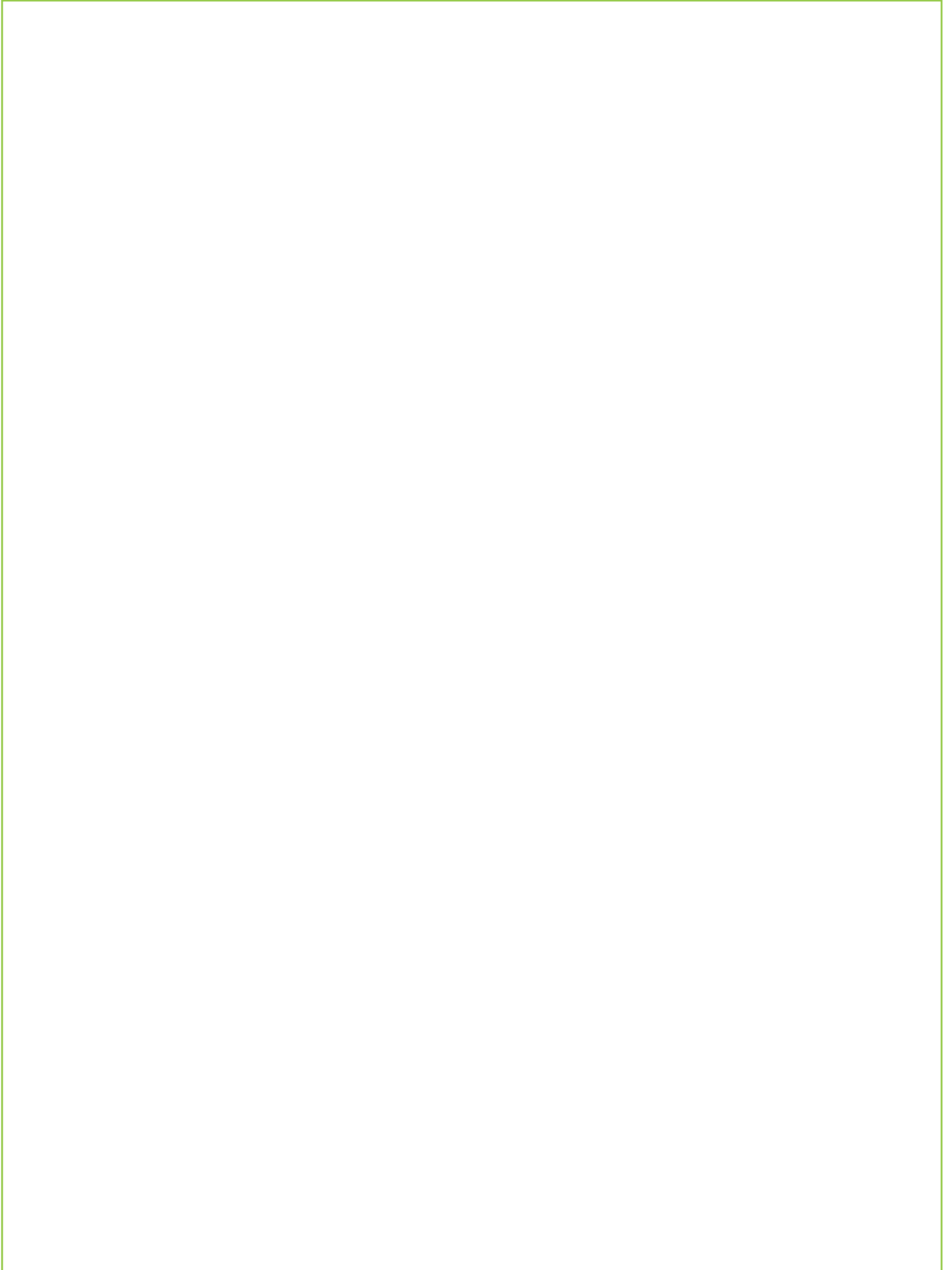





251104

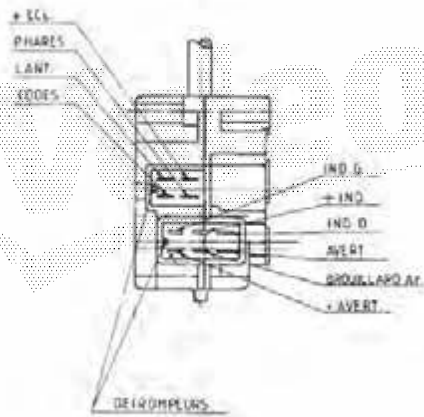

251109

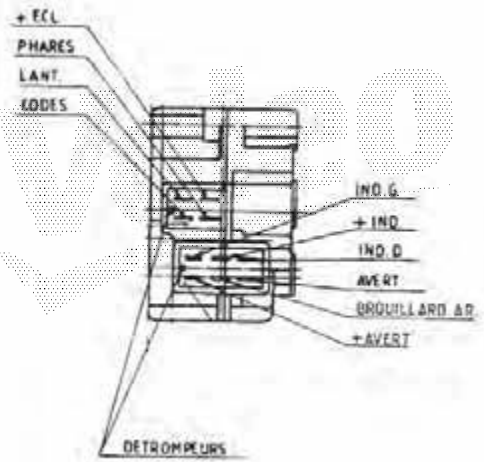

251105

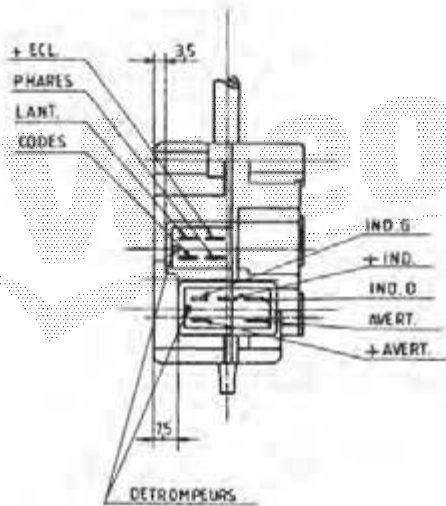

251110

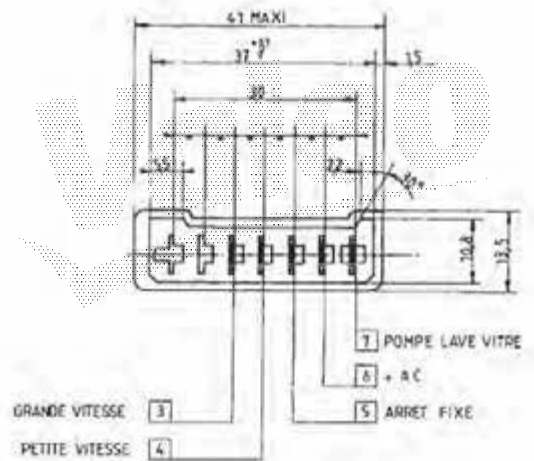

251106

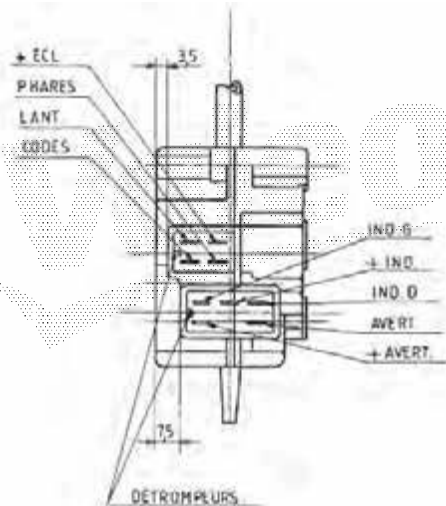

251154

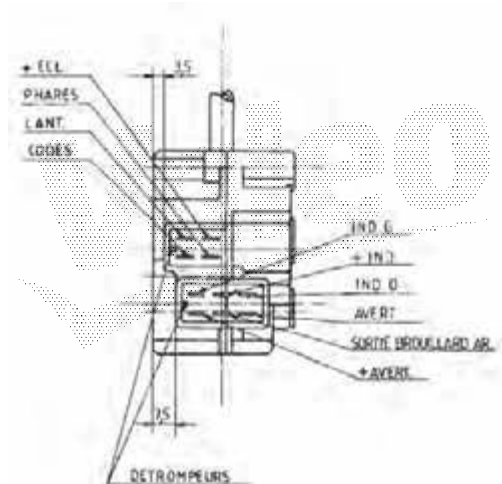



### 251155

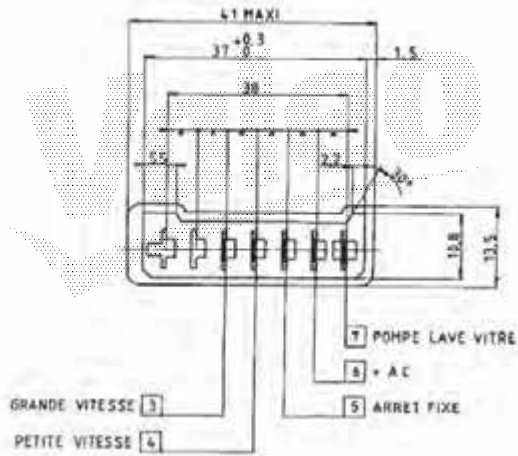

### 251160

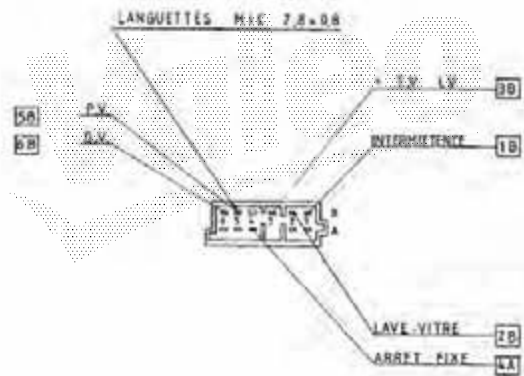

### 251156

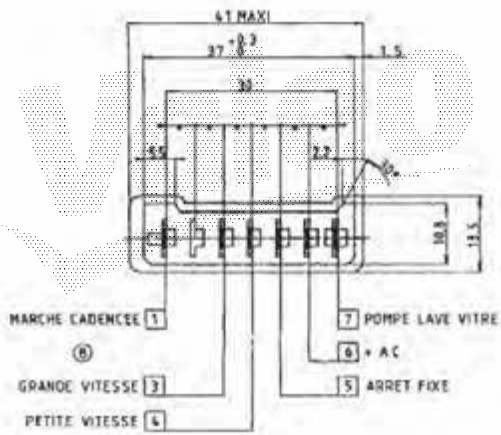

### 251162

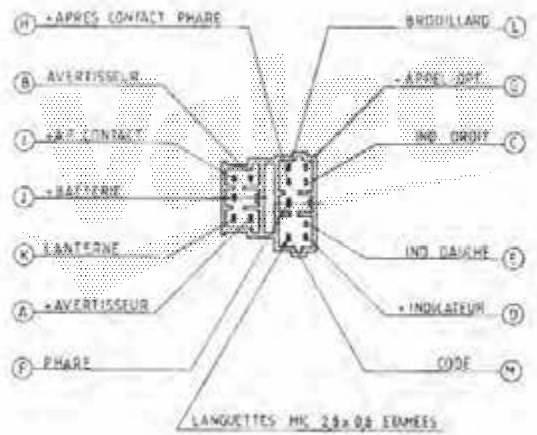

### 251158

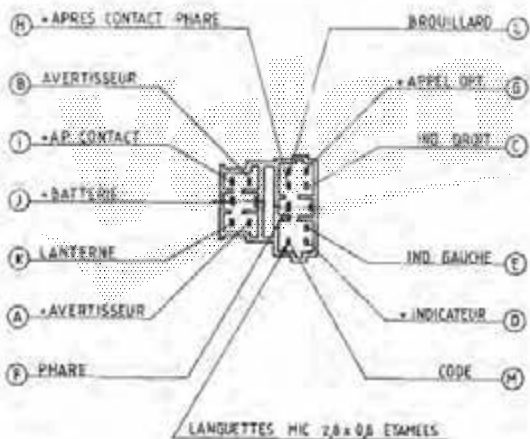

### 251164

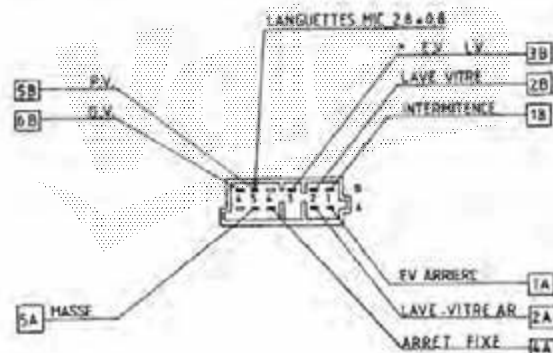



### 251203

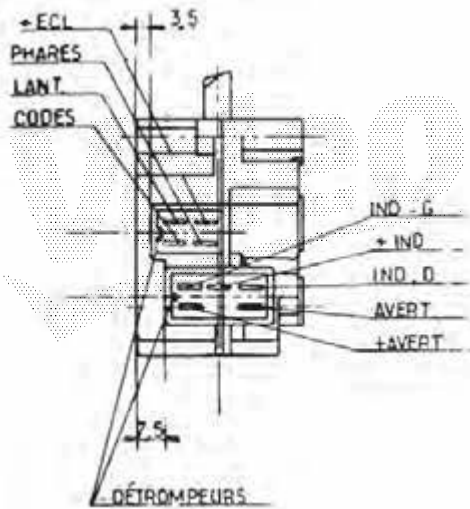

### 251209

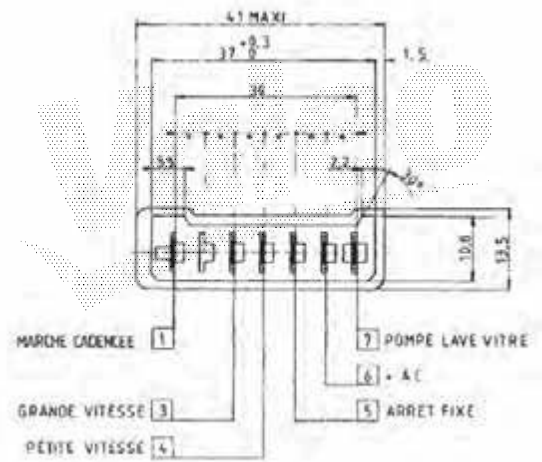

### 251206

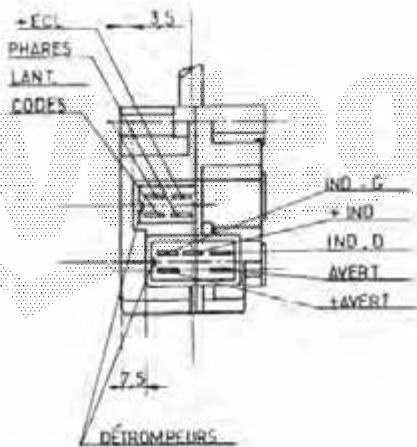

### 251211

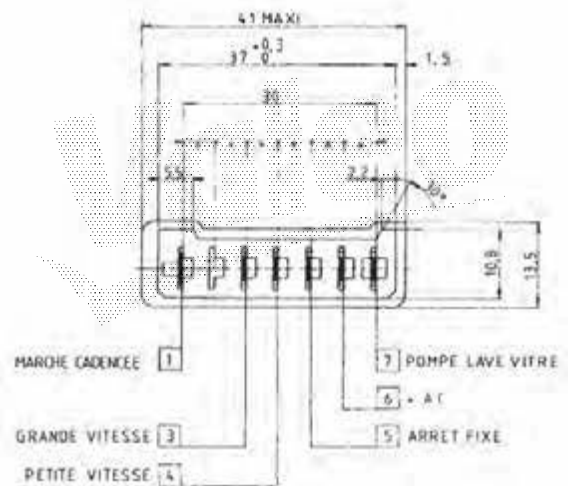

### 251208

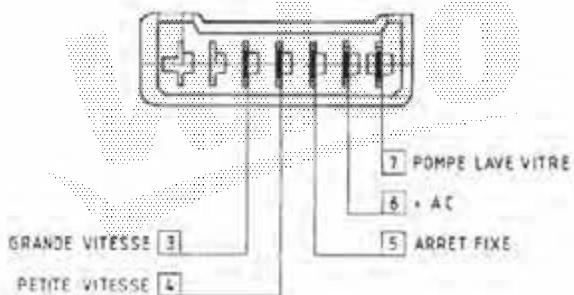

### 251212

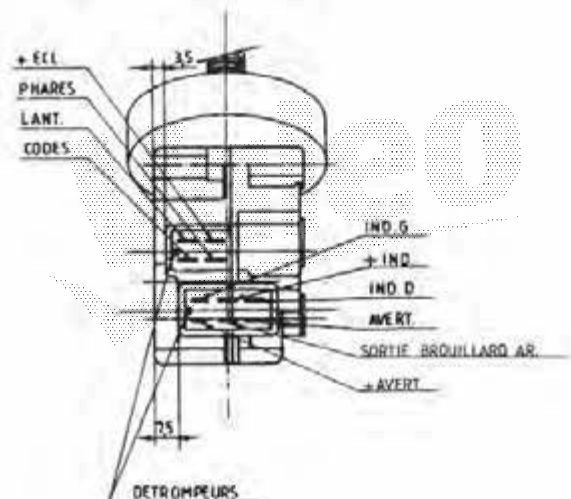





251213

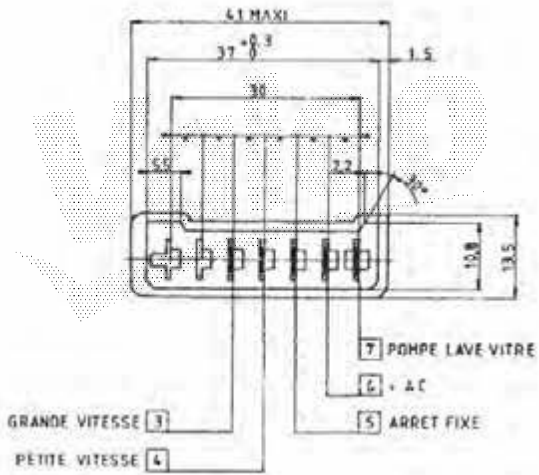

251222

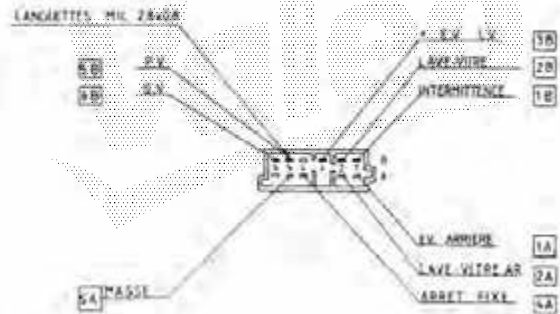

251219

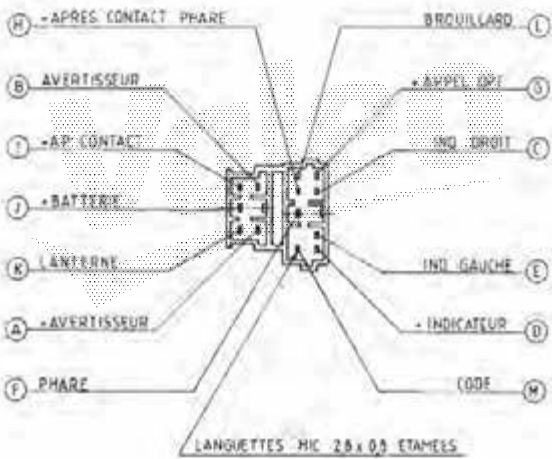

251223

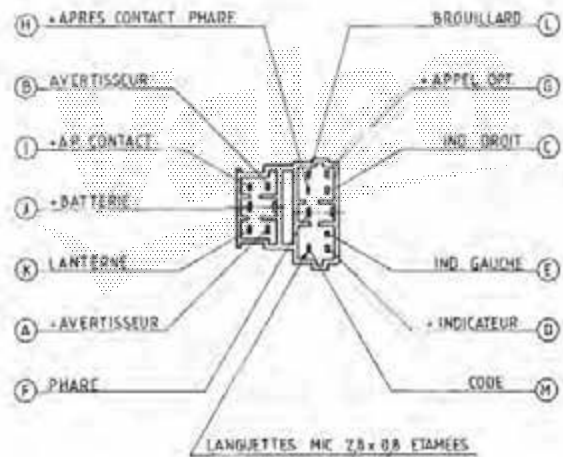

251220

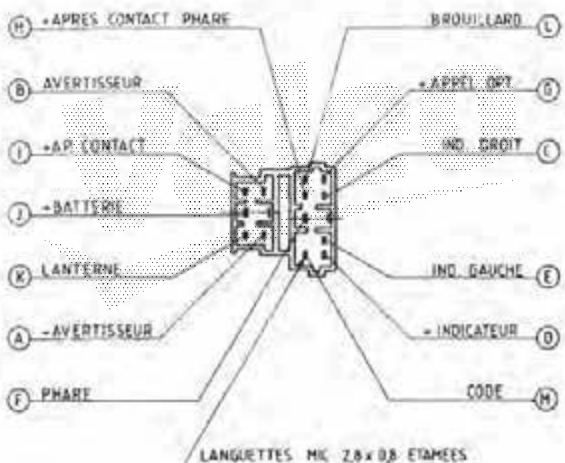

251225

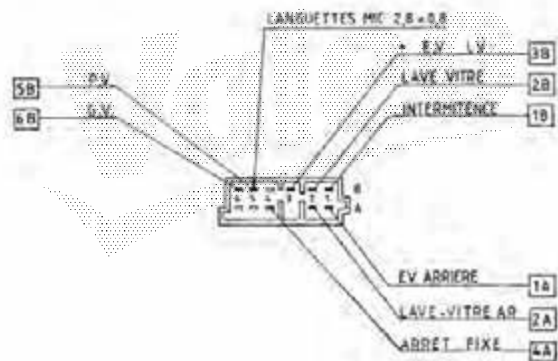



### 251259

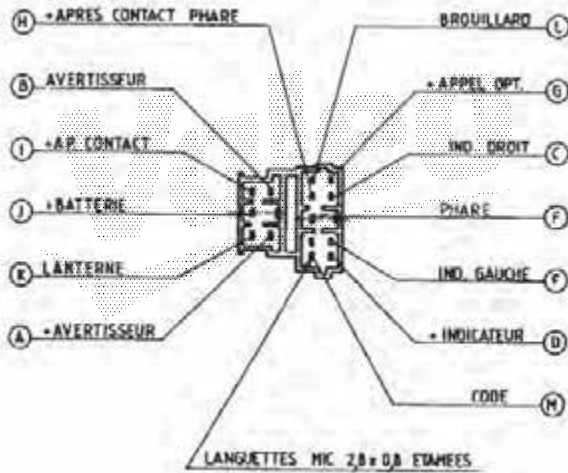

### 251262

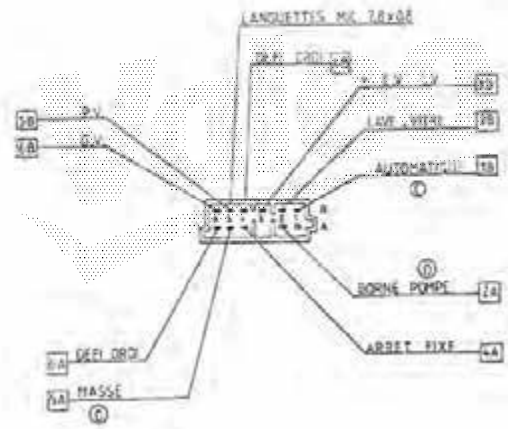

### 251260

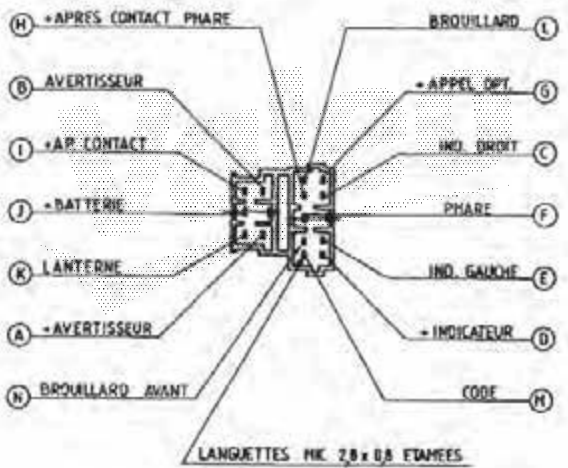

### 251266

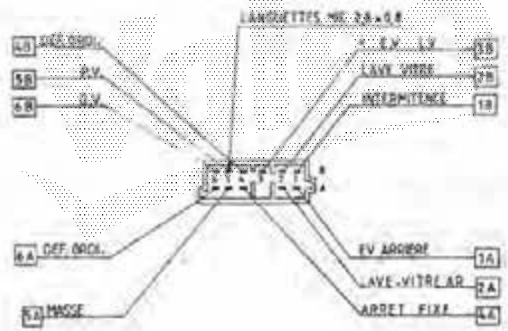

### 251261

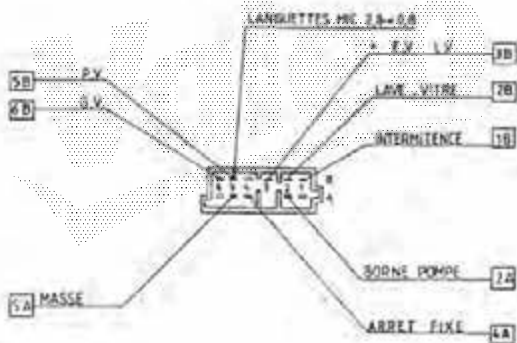

### 251267

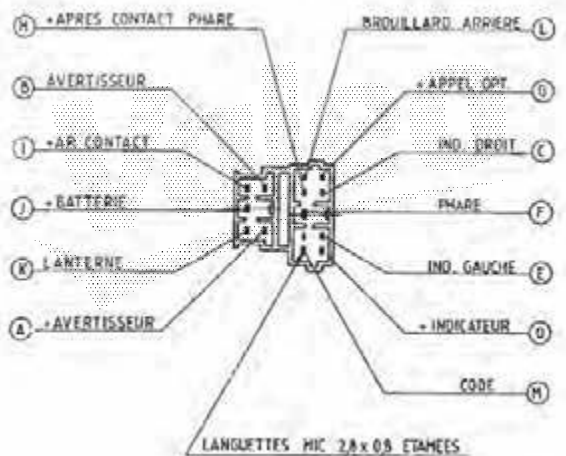



251268

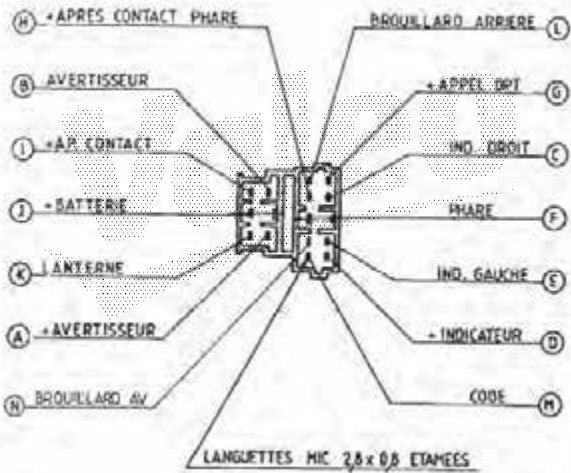

251271

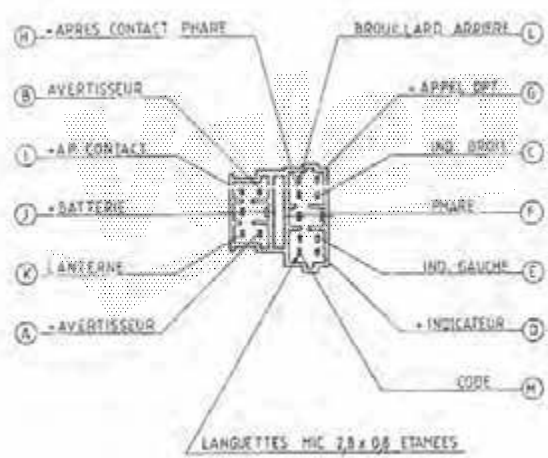

251269

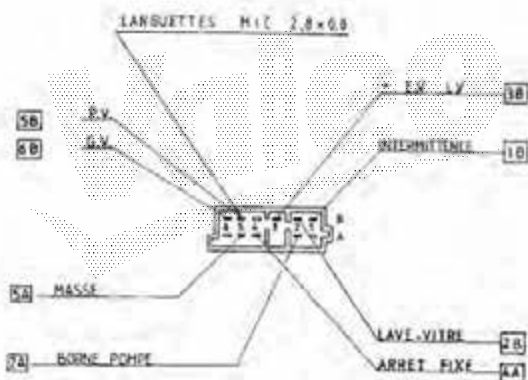

251272

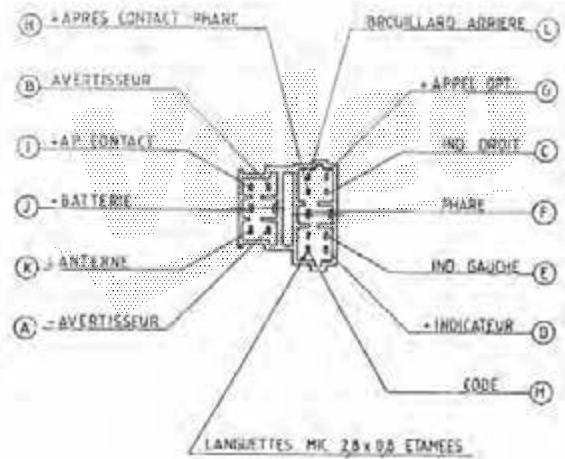

251270

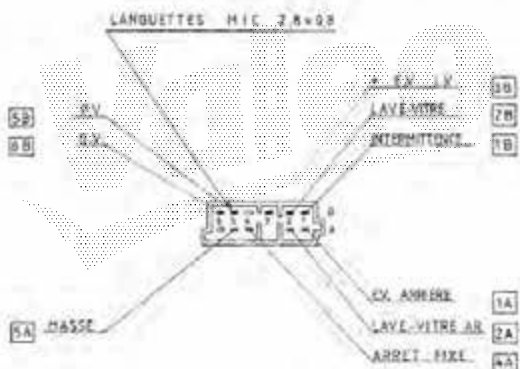

251273

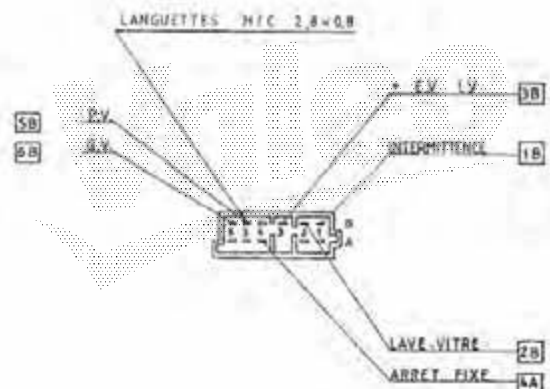



### 251275

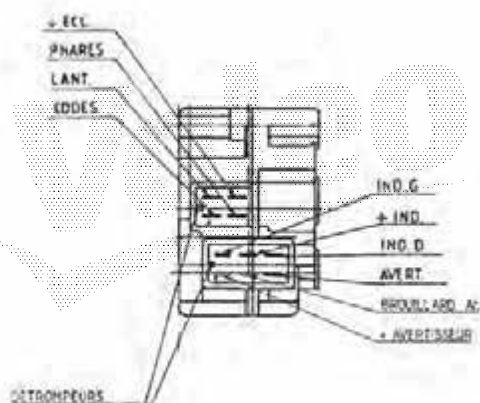

### 251280

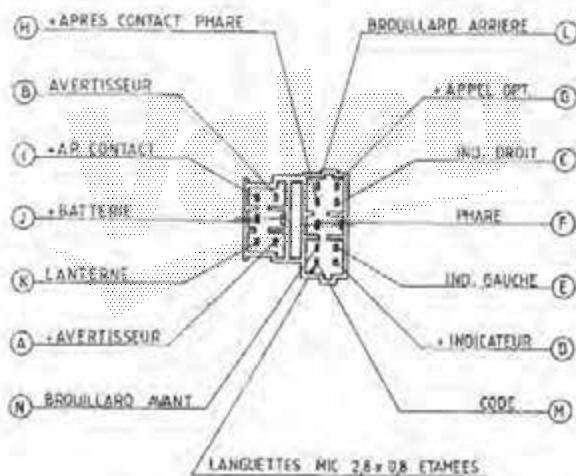

### 251276

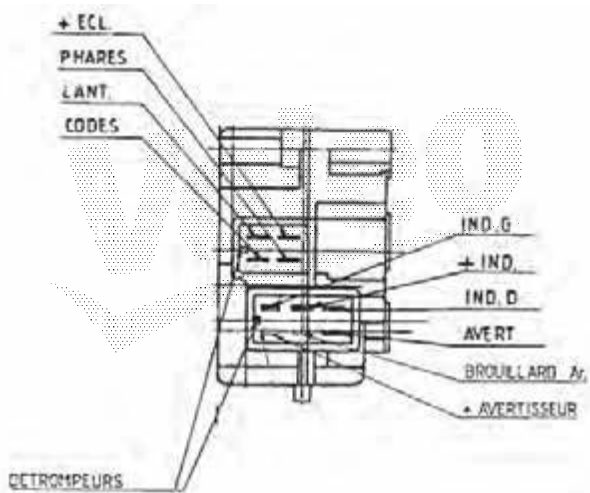

### 251281

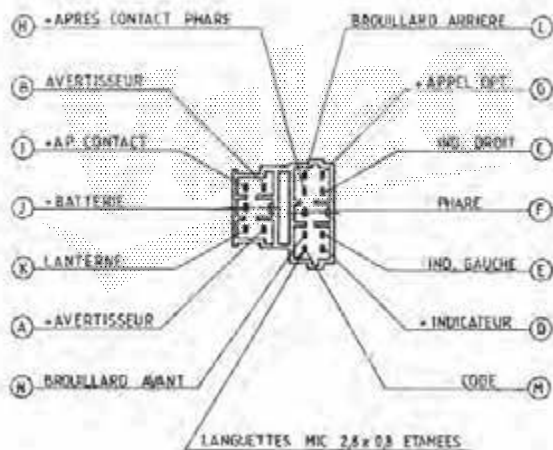

### 251279

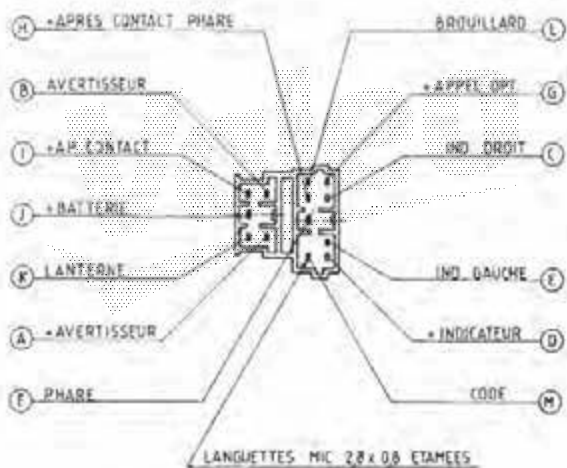

### 251282

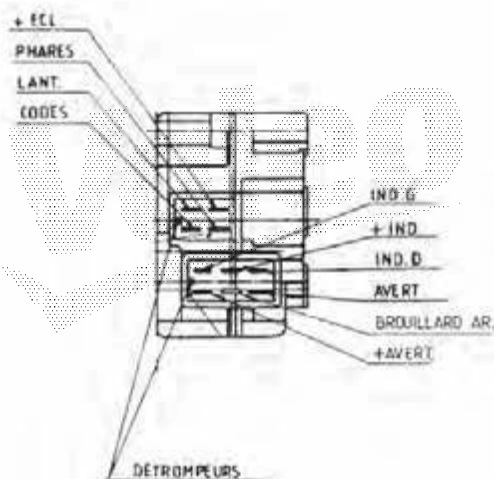



251283

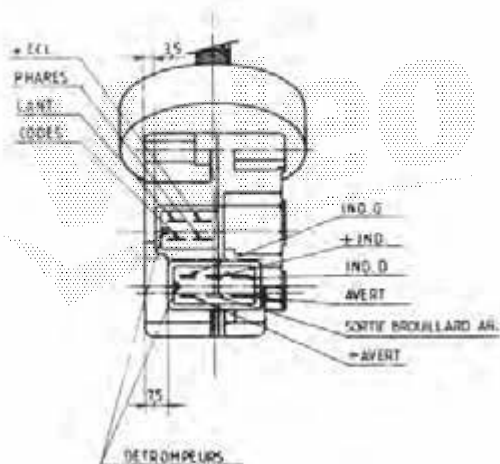

251290

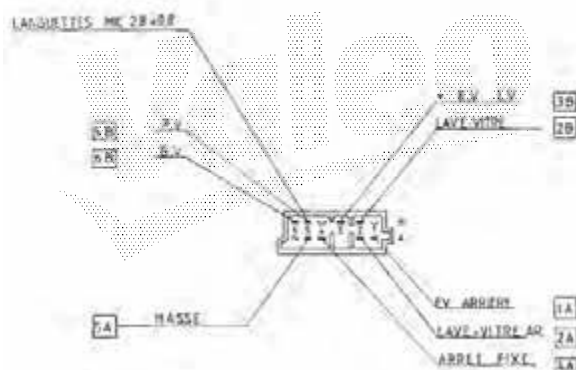

251286

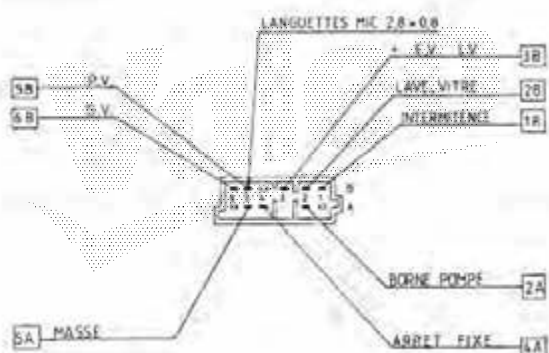

251298

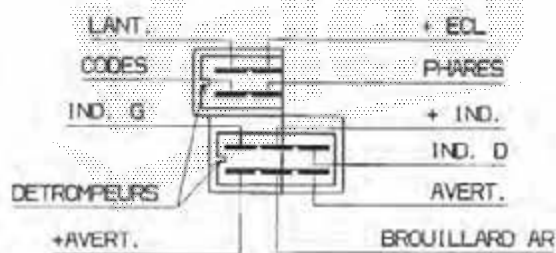

251287

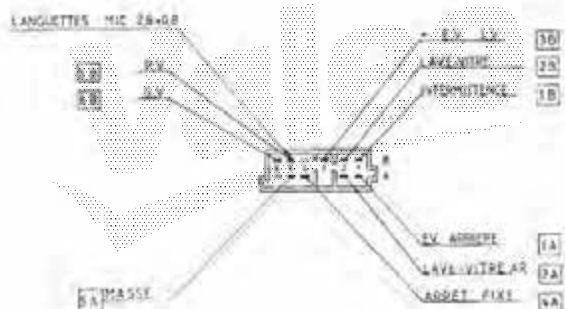

251304

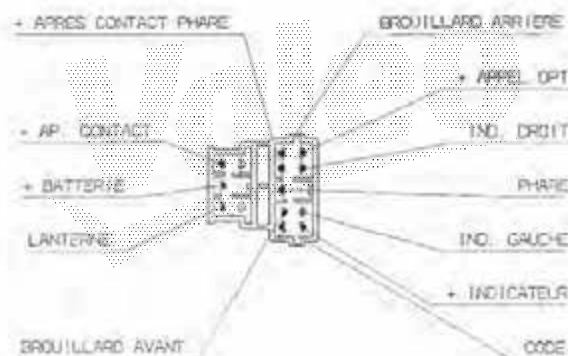



### 251305

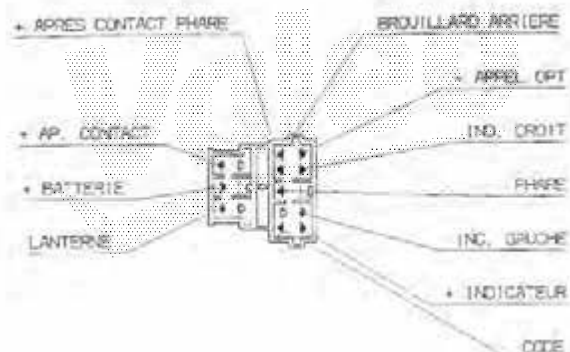

### 251308

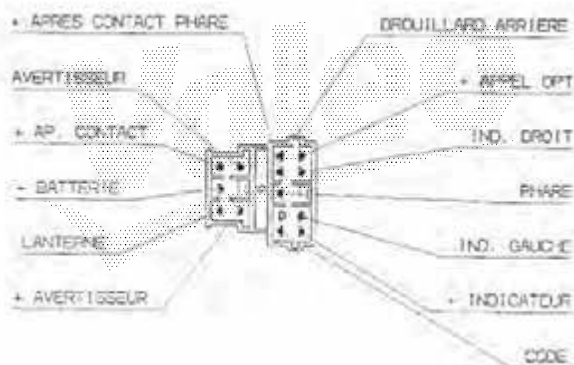

### 251306

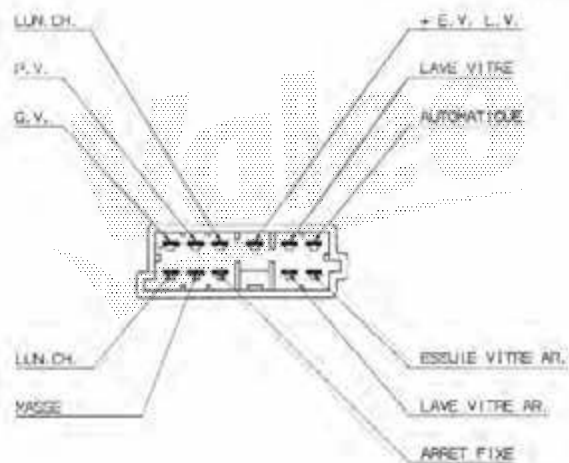

### 251309

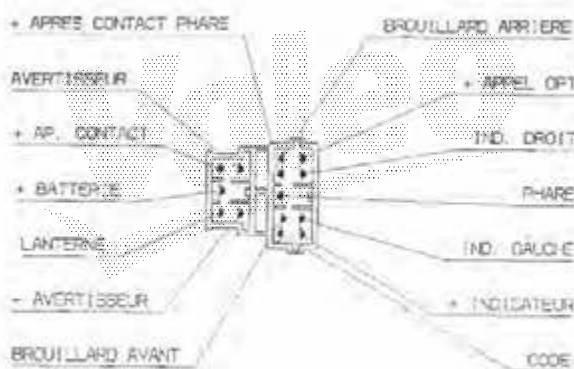

### 251307

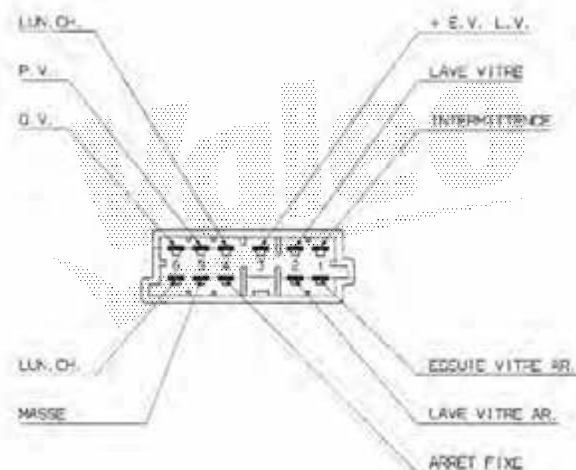

### 251310

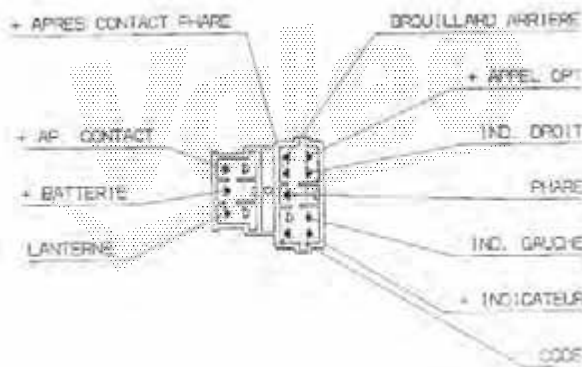



### 251311

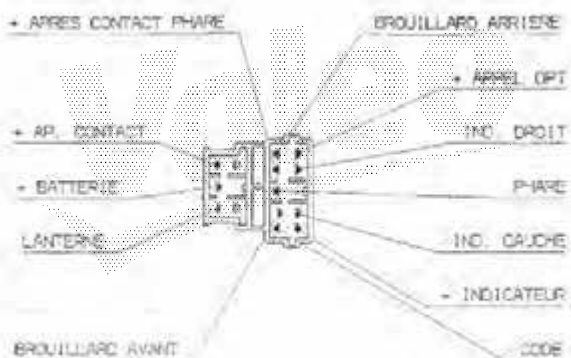

### 251314

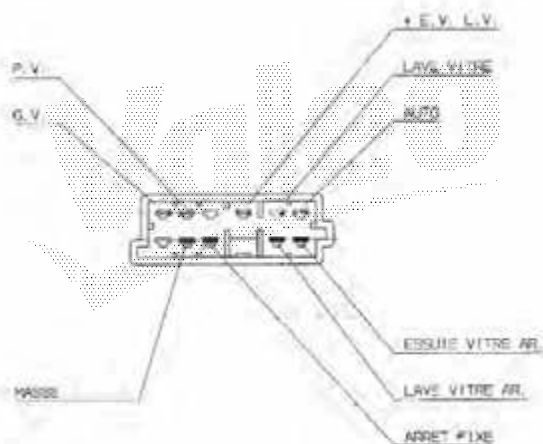

### 251312

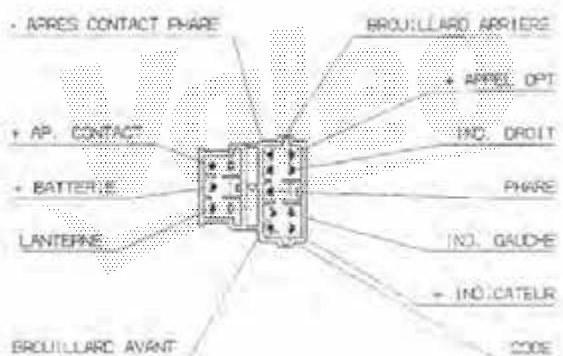

### 251315

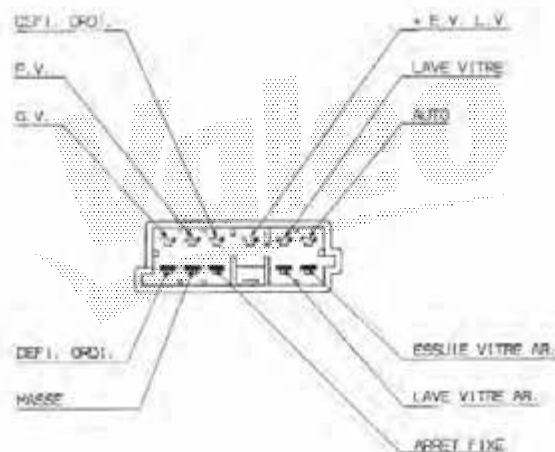

### 251313

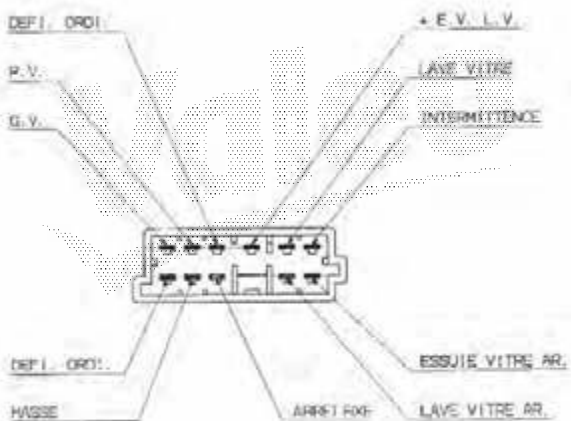

### 251326

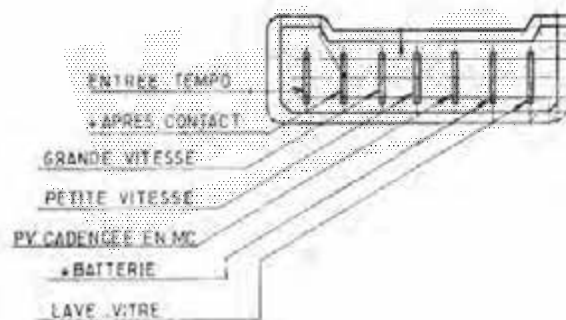



### 251328

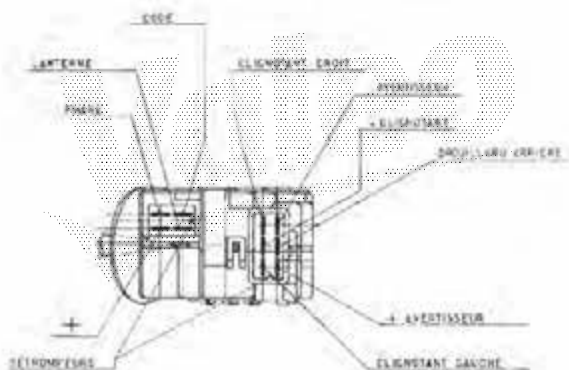

### 251332

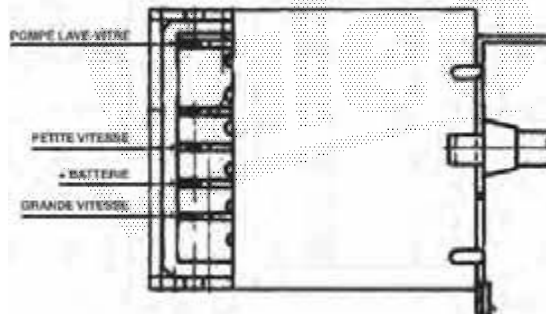

### 251329

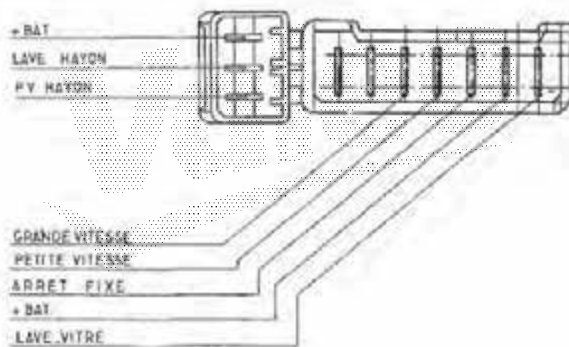

### 251334

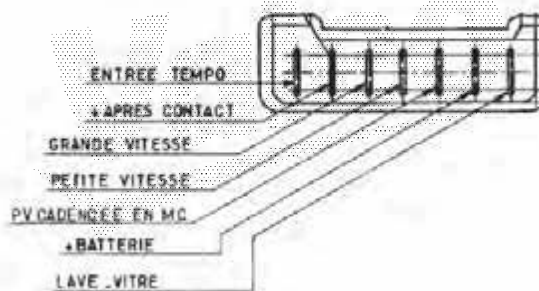

### 251330

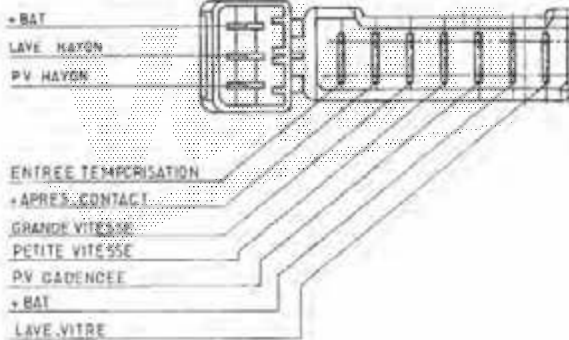

### 251337

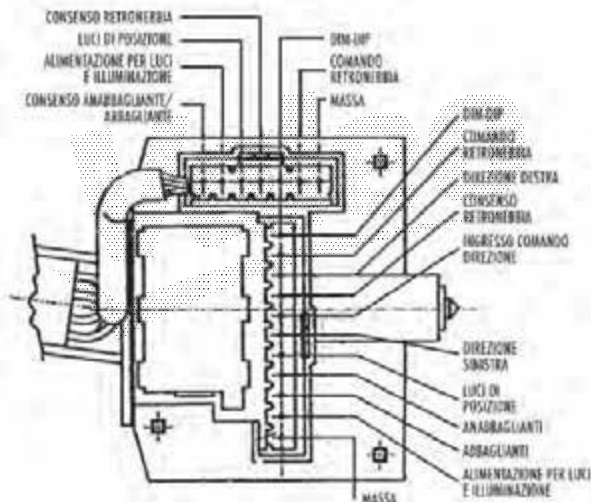





251343

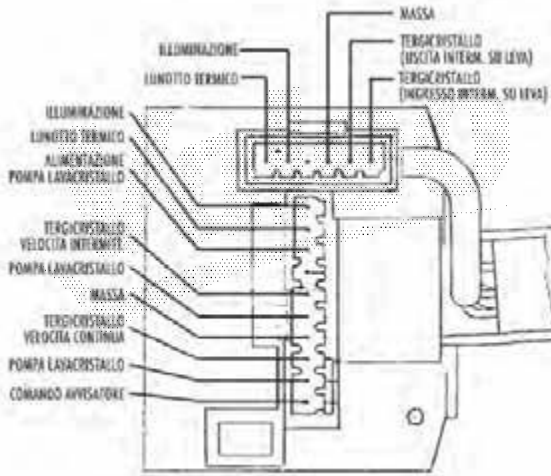

251348

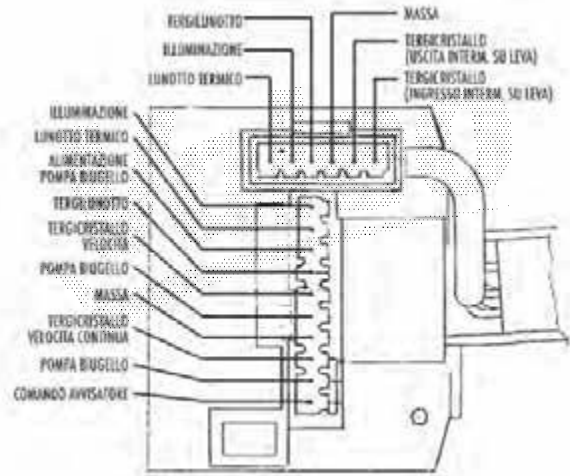

251346

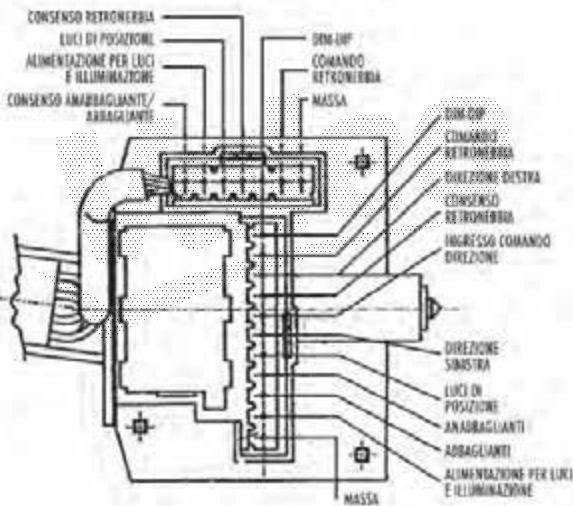

251349

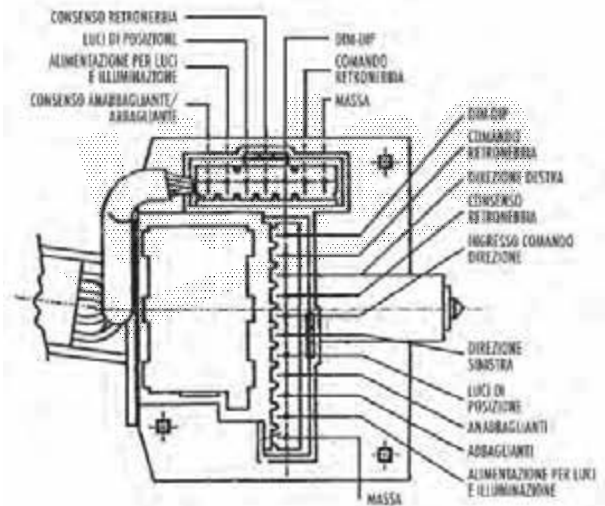

251347

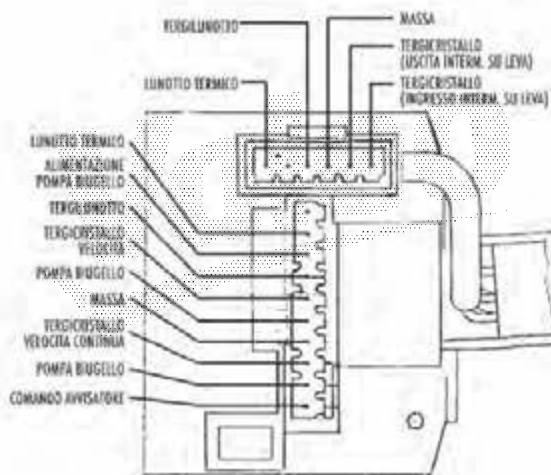

251385

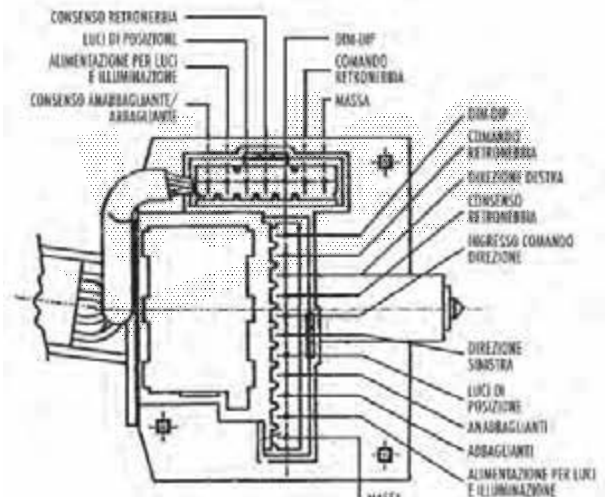



### 251386

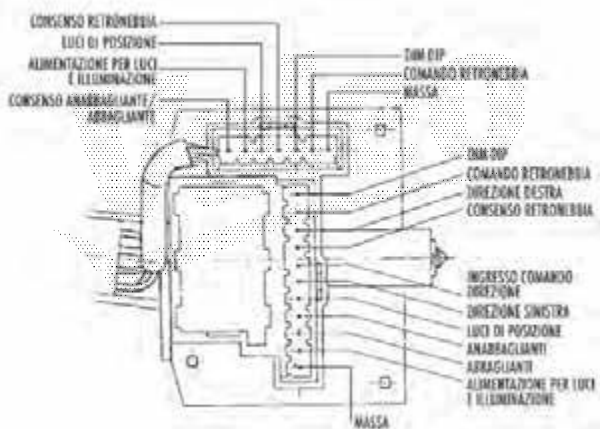

### 251389

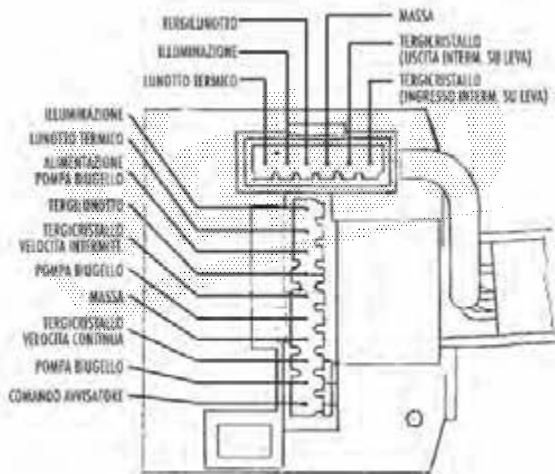

### 251387

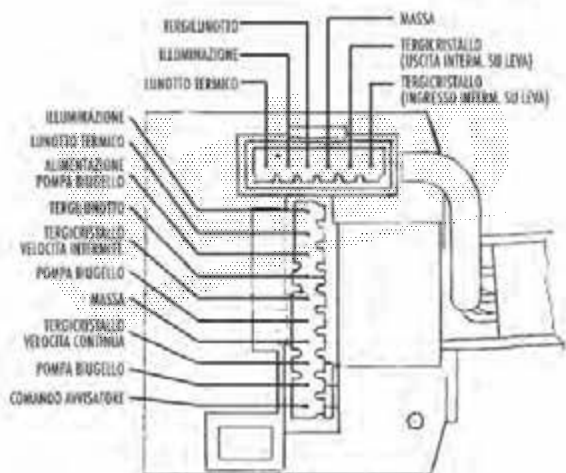

### 251392

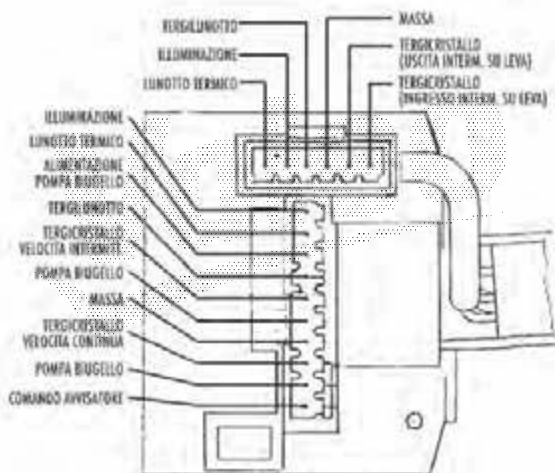

### 251388

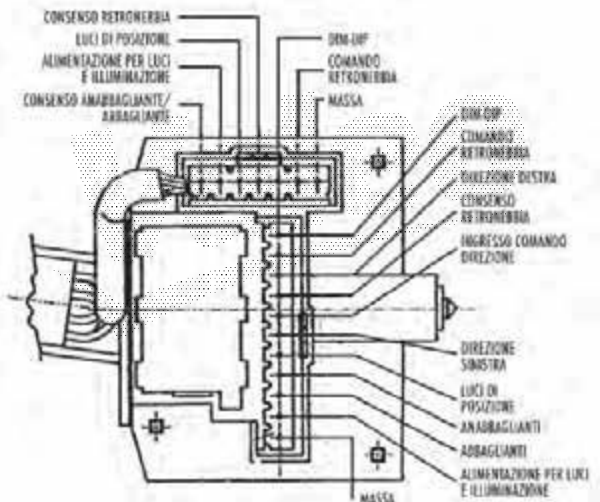

### 251399

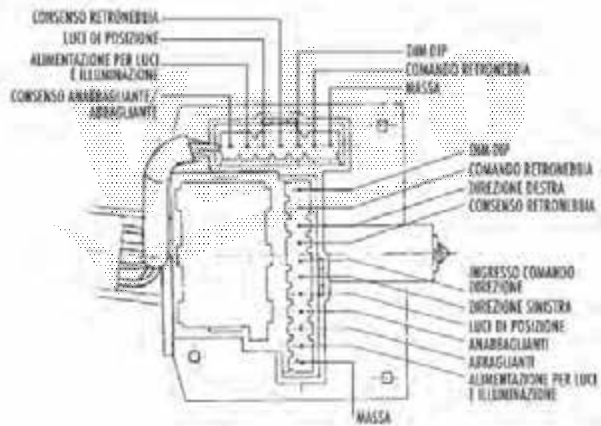





### 251436

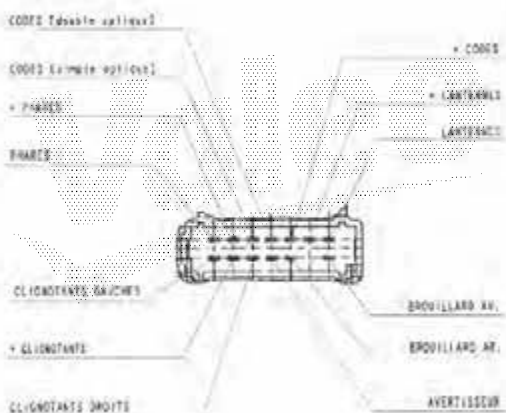

### 251439

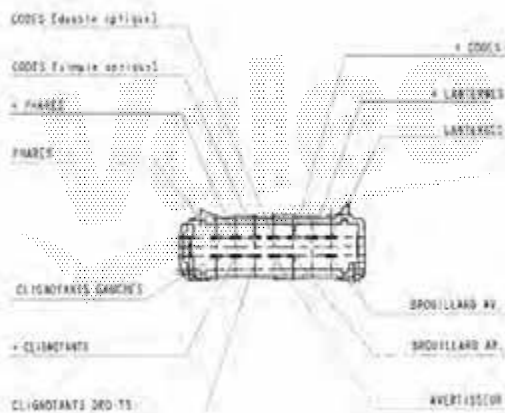

### 251437

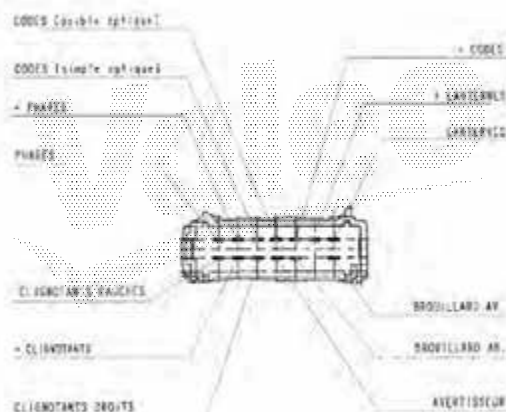

### 251442

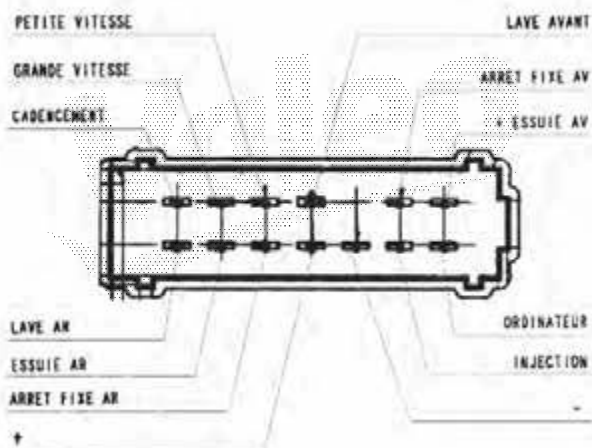

### 251438

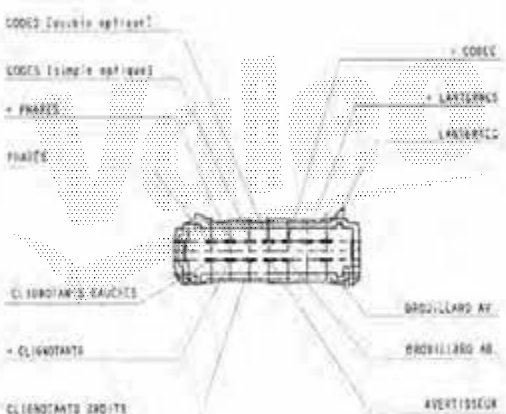

### 251444

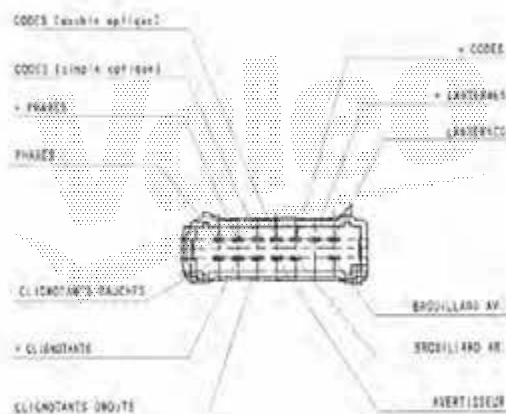



### 251561

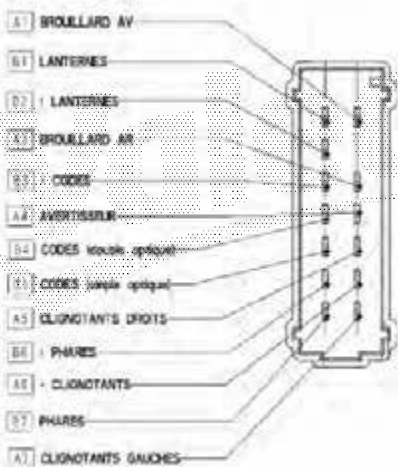

### 251565

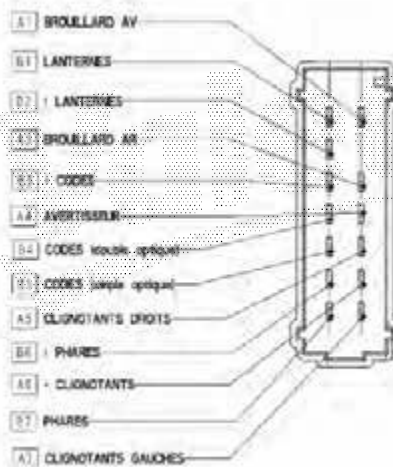

### 251562

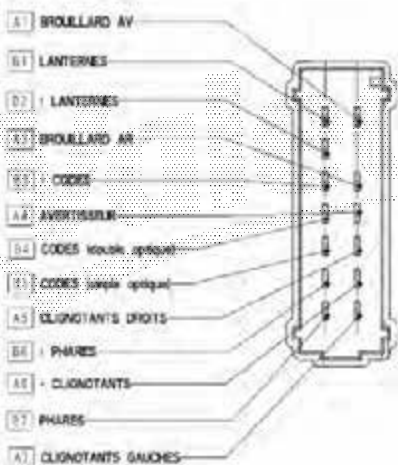

### 251566

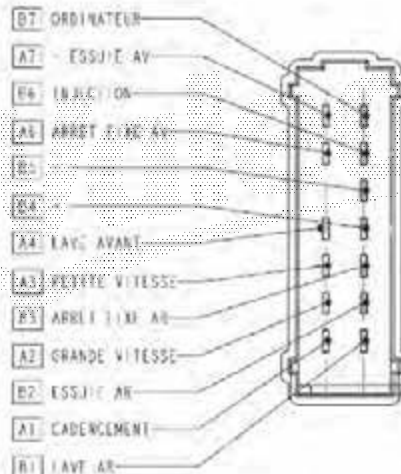

### 251563

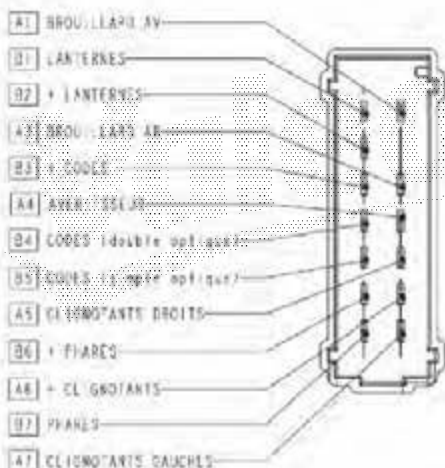

### 251568

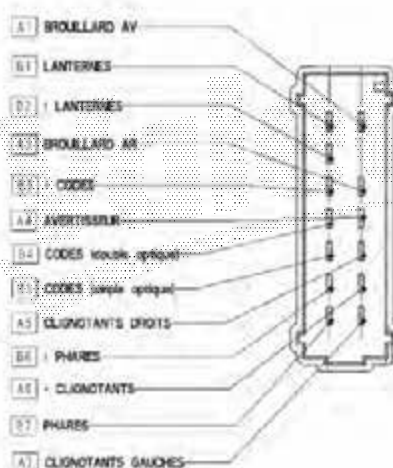



### 251570

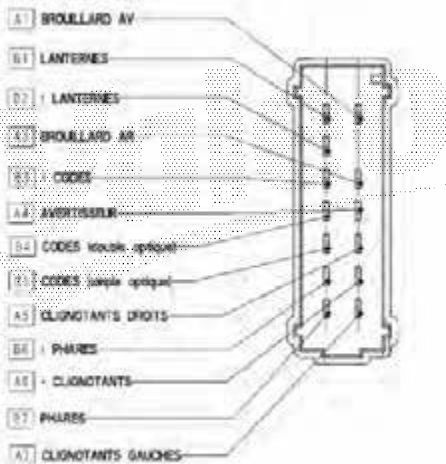

### 251581

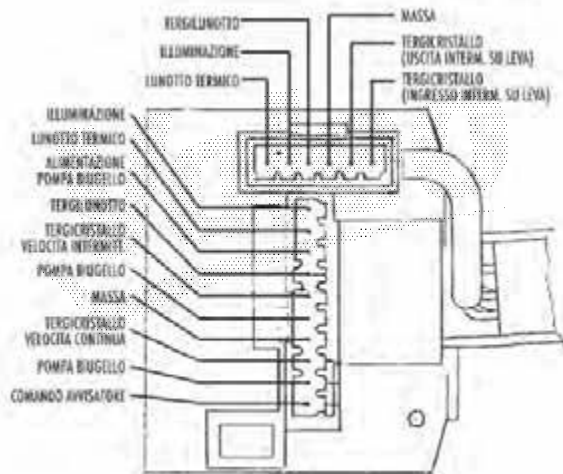

### 251571

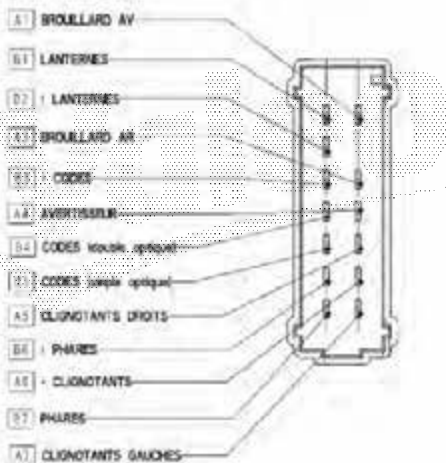

### 251578

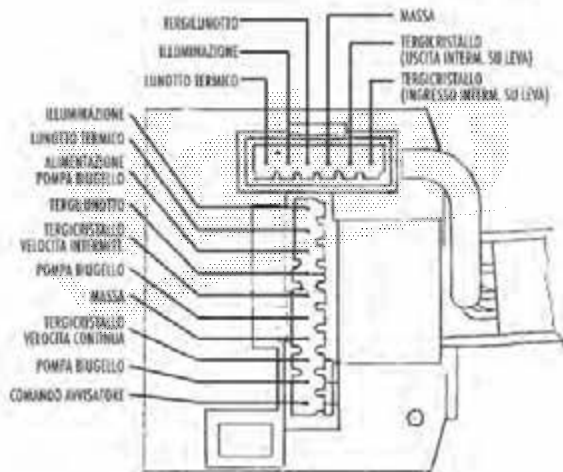









	Valeo		Valeo		Valeo		Valeo
<b>ABARTH</b>		<b>CITROËN (...)</b>		<b>CITROËN (...)</b>		<b>FIAT (...)</b>	
735471934	251624	624232	251494	6242T1	251633	182341980	251392
735471936	251625	624233	251496	6242Y7	251616	182342080	251389
735471939	251626	624263	251491	6242Y8	251621	182426980	251382
735521313	251624	625342	251154	6242Y9	251622	182427080	251379
735521315	251625	625354	251162	6242YN	251636	182494280	251386
735521318	251626	625359	251279	96049596ZL	251160	182904480	251369
<b>ALFA ROMEO</b>		625361	251280	96049597ZL	251270	183028480	251365
00113123480	251337	625367	251259	96049667ZL	251158	183160560	251393
00113123580	251348	625368	251260	96063790ZL	251162	183160860	251394
00113192580	251343	625369	251271	96211807ZL	251273	710630080	251385
00153426080	251347	625372	251308	96236415ZL	251271	710631080	251581
00156017526	251342	625373	251309	96236416ZL	251280	712160080	251391
156017526	251342	625374	251305	96247561ZL	251307	714569060	251393
00156017528	251342	625375	251304	96247562ZL	251306	714760060	251393
156017528	251342	75491742	251152	96251931ZL	251260	716662080	251371
00156018004	251340	96122254	251271	96251932ZL	251309	717247080	251355
00156018005	251339	97518149	251154	96251933ZL	251259	717681080	251372
00156020087	251342	97533660	251156	96251934ZL	251308	717756614	251377
156020087	251342	97533662	251155	96274721ZL	251305	735247261	251358
00156020088	251552	9753038580	251154	96274722ZL	251304	735249557	251357
156020088	251552	6239G6	251270	96605676XT	251491	735249956	251363
00156024516	251341	6239GZ	251628	96605677XT	251492	735251559	251377
156024516	251341	6239H5	251307	96605679XT	251495	735251561	251376
00156034639	251527	6239H6	251306	96605680XT	251496	735254007	251361
156034639	251527	6239HE	251627	96605910XT	251497	735254024	251352
156043386	251524	6239JK	251496	96624934ZD	251616	735260282	251375
156043388	251520	6239JP	251630	96624935ZD	251623	735267949	251554
156043395	251523	6239JQ	251629	96624936ZD	251618	735267951	251397
156043397	251342	6239JR	251491	96624937ZD	251617	735267952	251397
156046428	251521	6239P2	251491	96624938ZD	251619	735267953	251398
00156047960	251527	6239P3	251492	96624939ZD	251620	735272754	251353
156047960	251527	6239Q0	251494	96624940ZD	251621	735273580	251375
00156048338	251524	6239Q1	251495	96624941ZD	251622	735281947	251375
156048338	251524	6239Q2	251496	<b>DACIA</b>		735287450	251397
00156048339	251523	6239Q3	251497	6001548105	251644	735287480	251398
156048339	251523	6239QK	251495	6001548106	251593	735292034	251472
00156048346	251520	6239QY	251616	6001548108	251595	735292035	251473
156048346	251520	6239QZ	251623	6001549916	251597	735292037	251474
00156048347	251519	6239RA	251617	6001549917	251596	735292038	251508
156048347	251519	6239RC	251619	6001551352	251645	735293993	251572
156048595	251541	6239RE	251620	6001551360	251605	735302427	251555
00156048597	251540	6239RZ	251618	6001551361	251604	735309507	251573
156048597	251540	6239TT	251628	6001551365	251606	735309508	251574
00156048599	251538	6239VA	251627	6001551366	251607	735337940	251475
156048599	251538	6239VF	251490	<b>FIAT</b>		735337941	251476
00156048600	251530	6239WQ	251497	5996213	251362	735337943	251500
156048600	251530	6242EZ	251623	7550631	251359	735337946	251501
00156048602	251521	6242FA	251617	100151281	251511	735337948	251480
156048602	251521	6242N4	251618	100151283	251350	735337964	251483
<b>CITROËN</b>		6242N5	251620	177026880	251373	735360977	251514
623961	251266	6242P0	251619	181117880	251380	735360978	251513
623991	251273	6242S5	251629	181739980	251354	735360979	251515
624230	251491	6242S6	251630	181961580	251399	735360981	251517
624231	251492	6242S9	251631	181996880	251384	735374800	251574
		6242T0	251632	181997280	251383	735381038	251476





	Valeo		Valeo		Valeo		Valeo
<b>FIAT</b> (...)		<b>IVECO</b> (...)		<b>PEUGEOT</b> (...)		<b>PEUGEOT</b> (...)	
735381039	251475	93803689	251404	624272	251489	6239Q0	251494
735381040	251500	500321203	251550	624273	251487	6239Q1	251495
735381042	251501	500321204	251551	624274	251490	6239Q2	251496
735381044	251480			624275	251488	6239Q3	251497
735381047	251504			624276	251485	6239Q4	251493
		<b>LANCIA</b>					
735381050	251505	177127280	251406	625334	251206	6239QK	251495
735381110	251483	177255380	251416	625338	251283	6239QN	251493
735398128	251514	177337980	251417	625339	251203	6239V2	251486
735398129	251513	181482770	251420	625340	251212	6239V3	251489
735398130	251517	181482780	251407	625341	251210	6239V4	251487
		182191480	251408				
735400220	251476	182302980	251409	625342	251154	6239V5	251490
735400222	251475	710375080	251418	625345	251219	6239V6	251488
735400223	251501	735251851	251411	625354	251162	6239V7	251485
735410422	251626	735251853	251410	625356	251220	6239WF	251490
735410423	251625			625357	251219	6239WQ	251497
		735264768	251414				
735410424	251624	735264770	251413	625359	251279	6242P3	251635
735444633	251513	735264772	251405	625361	251280	6242S5	251629
735444636	251517	735264774	251412	625365	251268	6242S6	251630
735471934	251624	9606379069	251162	625366	251267	6242S9	251631
735471936	251625			625367	251259	6242T0	251632
		9617287569	251266				
735471939	251626	9625193169	251260	625368	251260	6242T1	251633
735521313	251624	96063790ZL	251162	625369	251271	6242YN	251636
735521315	251625	96251931ZL	251260	625370	251281	6242YP	251637
735521318	251626			625371	251272	96049597ZL	251270
1301756808	251370			625374	251305	96063790ZL	251162
		<b>NISSAN</b>					
1302631808	251378	2554000QAG	251562	625375	251304	96104981ZL	251220
1303037808	251368	2554000QAH	251586	625376	251310	96108100ZL	251223
1304147808	251367	2554000QAJ	251562	625377	251311	96171695ZL	251219
7701053874	251570	2554000QAK	251586	625379	251312	96186612ZL	251262
9606379069	251162			96122254	251271	96211807ZL	251273
		<b>OPEL</b>					
9612225469	251279	4408835	251613	97518149	251154	96236415ZL	251271
9617287569	251266	4410524	251563	9753038580	251154	96236416ZL	251280
9621180769	251273	4410525	251444	6239A2	251261	96238108ZL	251267
9623641569	251271	4410526	251615	6239A4	251286	96238109ZL	251268
9623641669	251280	4432044	251566	6239A8	251262	96247563ZL	251272
		4449396	251602				
9625193169	251260	4449397	251603	6239C1	251269	96247564ZL	251281
9625193369	251259			6239CP	251498	96250985ZL	251452
96063790ZL	251162	<b>PEUGEOT</b>		6239CQ	251499	96251280ZL	251286
96211807ZL	251273	623915	251211	6239G6	251270	96251931ZL	251260
96236415ZL	251271	623916	251213	6239G8	251457	96251933ZL	251259
		623921	251209				
96236416ZL	251280	623957	251287	6239J1	251314	96265115ZL	251269
96251931ZL	251260	623961	251266	6239J3	251313	96274721ZL	251305
96251933ZL	251259			6239J4	251452	96274722ZL	251304
		623971	251223	6239J5	251451	96279916ZL	251457
<b>IVECO</b>		623982	251290	6239JJ	251486	96291110ZL	251451
4764379	251547	623983	251222				
4784774	251544	623991	251273	6239JK	251496	96307459ZL	251310
4802819	251402	624230	251491	6239JR	251491	96307460ZL	251311
4813404	251543			6239L5	251485	96307462ZL	251312
4824230	251548	624231	251492	6239L6	251490	96307472ZL	251313
		624232	251494	6239L8	251486	96331043ZL	251314
4836417	251403	624233	251496				
4862412	251403	624235	251499	6239L9	251489	96530930XT	251486
93160486	251558	624235	251499	6239M0	251487	96605676XT	251491
93160488	251557	624258	251634	6239P2	251491	96605677XT	251492
93803258	251404	624263	251491	6239P3	251492	96605679XT	251495
		624271	251486	6239PL	251490	96605680XT	251496









	Valeo		Valeo		Valeo		Valeo
<b>PEUGEOT (...)</b>		<b>RENAULT (...)</b>					
96605681XT	251493	7701063405	251589				
96605691XT	251499	7701063406	251650				
96605910XT	251497	7701064224	251571				
		7701064225	251597				
		7701064226	251596				
<b>RENAULT</b>							
6001030184	251276	7701067948	251570				
6006000100	251334	7701068768	251586				
7700305346	251275	7701069597	251638				
7700760825	251104	7701071600	251651				
7700765532	251110	7701071602	251601				
7700766407	251109						
7700777226	251282	7701071896	251600				
7700779565	251328	7701072090	251602				
7700779566	251104	7701072091	251603				
7700822445	251430	7701072110	251598				
		7701072111	251599				
7700839681	251430						
7700842114	251274	7701349477	251106				
7701040729	251436	7701349479	251106				
7701040730	251437	7701349481	251105				
7701040732	251442	8200216462	251640				
		8200216465	251641				
7701044278	251438						
7701044279	251439	<b>RENAULT TRUCKS</b>					
7701044280	251608	500084872	645010				
7701045864	251438	5000084872	645010				
7701045865	251439	5000361688	645130				
		5000623819	645130				
7701046629	251298	5000788671	645060				
7701047253	251643						
7701047254	251568	5000789126	645050				
7701047255	251561						
7701047256	251610	<b>VAUXHALL</b>					
		91160123	251613				
7701048907	251593	93160239	251563				
7701048912	251563	93160240	251444				
7701048913	251444	93160241	251615				
7701048914	251615	93161921	251566				
7701048915	251566						
		93198617	251602				
7701048917	251647	93198618	251603				
7701048953	251648						
7701048955	251571						
7701048957	251594						
7701049615	251609						
7701050685	251613						
7701050688	251444						
7701053055	251612						
7701053056	251611						
7701053057	251562						
7701053058	251565						
7701053874	251570						
7701057611	251649						
7701057612	251590						
7701057613	251591						
7701059269	251614						
7701060396	251639						
7701061757	251592						
7701063403	251587						
7701063404	251588						







	Valeo		Valeo		Valeo		Valeo
<b>ERA</b>		<b>ERA (...)</b>		<b>ERA (...)</b>		<b>ERA (...)</b>	
440002	251155	440149	251382	440201	251363	440314	293274
440003	251105	440150	251379	440202	251365	440317	251571
440004	251113	440151	251408	440203	251370	440318	251570
440005	251160	440152	251369	440205	251397	440319	251437
440011	289979	440155	251391	440206	251398	440320	251565
440016	251343	440157	251104	440207	251404	440328	251515
440018	251510	440157	251325	440208	251410	440329	251279
440025	251209	440158	251109	440209	251411	440330	251333
440026	251472	440159	251154	440210	251438	440331	251355
440035	251339	440160	251158	440210	251440	440333	251331
440036	251340	440161	251162	440210	251562	440337	201681
440037	251405	440162	251210	440211	251439	440349	251498
440038	251412	440162	251321	440211	251441	440353	251476
440039	251473	440163	251212	440212	251508	440387	251556
440040	251474	440164	251214	440213	251353	440388	251557
440041	251349	440164	251219	440214	251341	440389	251558
440042	251572	440165	251220	440215	251364	440390	251559
440043	251377	440166	251222	440216	251576	440391	251517
440043	251470	440167	251223	440235	501538	440439	251444
440048	251313	440168	251259	440236	501392	440440	251625
440049	251581	440169	251260	440266	251543	440443	251499
440050	251106	440170	251266	440267	251403	440516	251626
440051	251156	440171	251267	440268	251550		
440052	251315	440172	251268	440269	251551	<b>FEBI BILSTEIN</b>	
440053	251334	440173	251161	440271	202024	15180	201727
440054	251430	440173	251270	440275		17941	251210
440059	251378	440174	251271	440275	202356	17943	251330
440060	251513	440175	251272	440275	202876	17947	251271
440061	251514	440176	251273	440276	203117	17949	251162
440065	251385	440177	251102	440277	203118		
440070	251362	440177	251274	440278	202339	18637	202876
440075	251420	440177	251322	440279		18638	202024
440076	251386	440178	251276	440281	202340	18716	202341
440077	251387	440179	251280	440282	201725	18964	202340
440078	251389	440180	251282	440283	251506	19697	202922
440079	251399	440181	251298	440291	290520	19722	251270
440080	251392	440182	251304	440292	291461	19727	251266
440081	251406	440183	251305	440293		19727	251266
440084	251381	440184	251306	440294	251348	21001	202647
440085	251388	440185	251307	440295	251573	21088	251330
440086	251578	440186	251308	440296	251367	21509	251274
440087	251421	440187	251309	440297	251368	21509	251322
440089	251393	440188	251310	440298	251574	22066	251219
440089	251401	440189	251311	440302	251577	22067	251314
440089	251471	440190	251312	440303	251475	22068	251222
440090	251371	440191	251314	440304	251487	22071	251280
440091	251394	440192	251323	440305	251485	22120	251259
440125	251400	440193	251328	440306	251486	22122	251260
440129	251359	440194	251330	440307	251488	22124	251310
440135	251380	440195	251332	440308	251489	22125	251311
440136	251384	440196	251337	440309	251490	22719	251370
440137	251383	440197	251342	440310	251491	22769	251273
440139	251354	440198	251357	440311	251492	22771	251312
440146	251407	440199	251358	440312	251493	22772	251308
440148	251409	440200	251361	440313	251494	22773	251309
					251495	22774	251307
					251496	22775	
					251497		251306







	Valeo		Valeo		Valeo		Valeo
<b>MAGNETI MARELLI</b> (.../...)		<b>VEMO</b> (.../...)					
DV41683	251553	V42-80-0003	251271				
DV42321	251548	V42-80-0004	251311				
DV42325	251543	V42-80-0005	251310				
DV42354	251403	V42-80-0006	251485				
DV42365	251546	V42-80-0007	251221				
DV43008	251559	V46-80-0001	251274				
		V46-80-0001	251322				
		V46-80-0002	251439				
		V46-80-0003	251438				
		V46-80-0004	251109				
<b>METZGER</b>		V46-80-0004	251318				
916041	251270	V46-80-0005	251298				
916042	251279	V46-80-0006	251568				
916078	251260	V46-80-0007	251570				
916097	251444	V46-80-0008	251437				
916113	251393						
916114	251375						
916119	251222						
916120	251474						
916121	251267						
916122	251268						
916123	251272						
916124	251280						
916125	251298						
916136	251439						
916137	251485						
916144	251219						
916145	251271						
916146	251311						
916148	251437						
916151	251438						
916171	251390						
916172	251377						
916185	251162						
916186	251259						
916187	251266						
916188	251273						
916225	251565						
<b>VEMO</b>							
V22-80-0001	251158						
V22-80-0002	251161						
V22-80-0002	251270						
V22-80-0003	251280						
V22-80-0004	251260						
V24-80-1419	251384						
V24-80-1425	251381						
V24-80-1426	251391						
V24-80-1448	251393						
V24-80-1462	251341						
V24-80-1464	251364						
V24-80-1465	251361						
V24-80-1466	251572						
V24-80-1467	251397						
V24-80-1468	251554						
V24-80-1469	251363						
V42-80-0001	251214						
V42-80-0001	251219						
V42-80-0002	251210						



**ADDITIONAL INFORMATION FOR APPLICATIONS WITH TWO DIFFERENT SUPPLIERS**  
**INFORMATION COMPLÉMENTAIRE POUR APPLICATIONS AVEC DEUX DIFFÉRENTS FOURNISSEURS**  
**INFORMACIÓN COMPLEMENTARIA PARA APLICACIONES CON DOS PROVEEDORES DIFERENTES**  
**ZUSÄTZLICHE INFORMATIONEN FÜR ANWENDUNGEN MIT ZWEI VERSCHIEDENEN ZULIEFERERN**  
**INFORMAZIONI COMPLEMENTARI PER APLICAZIONI CON DUE FORNITORI DIVERSI**  
**İKİ FARKLI TEDARİKÇİ İLE UYGULAMALARA YÖNELİK TAMAMLAYICI BİLGİLER**

If the OE or OES reference on the switch to be changed is on this list, the Valeo reference is compatible.

Si la référence OE ou OES sur le commutateur à changer est dans cette liste, la référence Valeo est compatible.



Si la referencia OE u OES en el conmutador que va a reemplazarse figura en esta lista, la referencia Valeo es compatible.



Wenn die auf dem auszuwechselnden Schalter erscheinende OE- oder OES-Teilenummer in dieser Liste aufgeführt ist, dann ist die Valeo-Teilenummer kompatibel.

Se la referencia OE o OES sul commutatore da cambiare è in questa lista, la referencia Valeo è compatibile.

Değiştirilecek komütatör üzerindeki OE veya OES referansı bu liste içinde mevcut ise, Valeo referansı uyumludur.

**For / Pour : PEUGEOT / CITROËN**

	OES		SOFTWARE	
96 436 866 ZL	6239Q2	251496	Soft 5.2	Berlingo, 206, Partner, Ranch
96 446 859 XT	6239Q0	251494	Soft 5.7	Berlingo, 206, Partner, Ranch
96 446 859 ZL	6239Q0	251494	Soft 5.2/5.4/5.6	Berlingo, 206, Partner, Ranch
96 446 860 XT	6239Q1	251495	Soft 5.7	Berlingo, 206, Partner, Ranch
96 446 860 ZL	6239Q1	251495	Soft 5.2/5.4/5.6	Berlingo, 206, Partner, Ranch
96 446 861 XT	6239Q2	251496	Soft 5.7	Berlingo, 206, Partner, Ranch
96 446 861 ZL	6239Q2	251496	Soft 5.4/5.6	Berlingo, 206, Partner, Ranch
96 446 862 XT	6239Q3	251497	Soft 5.7	Berlingo, 206, Partner, Ranch
96 446 862 ZL	6239Q3	251497	Soft 5.2/5.4/5.6	Berlingo, 206, Partner, Ranch
96 446 863 XT	6239Q4	251493	Soft 5.7	206
96 446 863 ZL	6239Q4	251493	Soft 5.2/5.4/5.6	206
96 450 911 XT	6239P2	251491	Soft 5.7	Berlingo, 406, Partner
96 450 911 ZL	6239P2	251491	Soft 5.2/5.6	Berlingo, 406, Partner
96 450 912 XT	6239P3	251492	Soft 5.7	Berlingo, C8, Xsara picasso, 206, 307, 406, Partner, Ranch
96 450 912 ZL	6239P3	251492	Soft 5.2/5.6	Berlingo, C8, Xsara picasso, 206, 307, 406, Partner, Ranch
96 466 653 XT	6239V2	251486	Soft 5.7	307
96 466 653 ZL	6239V2	251486	Soft 5.4/5.6	307
96 466 654 XT	6239V3	251489	Soft 5.7	307
96 466 654 ZL	6239V3	251489	Soft 5.4/5.6	307
96 466 655 XT	6239V4	251487	Soft 5.7	307
96 466 655 ZL	6239V4	251487	Soft 5.4/5.6	307
96 466 656 XT	6239V5	251490	Soft 5.7	307, 1007
96 466 656 ZL	6239V5	251490	Soft 5.4/5.6	307, 1007
96 466 657 XT	6239V6	251488	Soft 5.7	307
96 466 657 ZL	6239V6	251488	Soft 5.4/5.6	307
96 466 658 XT	6239V7	251485	Soft 5.7	206+, 307
96 466 658 ZL	6239V7	251485	Soft 5.4/5.6	206+, 307
96 492 197 XT	6239CP	251498	Soft 5.7	206
96 493 632 XT	6239CQ	251499	Soft 5.7	Berlingo, 206, Partner, Ranch
96 509 712 XT	6239JR	251491	Soft 5.7 With double spring	Berlingo, 406, Partner
96 509 713 XT	6239P3	251492	Soft 5.7 With double spring	Berlingo, C8, Xsara picasso, 206, 307, 406, Partner, Ranch
96 509 714 XT	6239Q0	251494	Soft 5.7 With double spring	Berlingo, 206, Partner, Ranch
96 509 715 XT	6239Q1	251495	Soft 5.7 With double spring	Berlingo, 206, Partner, Ranch
96 509 716 XT	6239JK	251496	Soft 5.7 With double spring	Berlingo, 206, Partner, Ranch
96 509 717 XT	6239Q3	251497	Soft 5.7 With double spring	Berlingo, 206, Partner, Ranch
96 509 718 XT	6239Q4	251493	Soft 5.7 With double spring	206
96 509 721 XT	6239JJ	251486	Soft 5.7 With double spring	307
96 509 722 XT	6239V3	251489	Soft 5.7 With double spring	307
96 509 723 XT	6239V4	251487	Soft 5.7 With double spring	307
96 509 724 XT	6239V5	251490	Soft 5.7 With double spring	307, 1007
96 509 725 XT	6239V6	251488	Soft 5.7 With double spring	307
96 509 726 XT	6239V7	251485	Soft 5.7 With double spring	206+, 307
96 509 727 XT	6239CP	251498	Soft 5.7 With double spring	206
96 509 728 XT	6239CQ	251499	Soft 5.7 With double spring	Berlingo, 206, Partner, Ranch
96 530 921 XT	6239JR	251491	Soft 6.0	Berlingo, 406, Partner
96 530 922 XT	6239P3	251492	Soft 6.0	Berlingo, C8, Xsara picasso, 206, 307, 406, Partner, Ranch
96 530 923 XT	6239Q0	251494	Soft 6.0	Berlingo, 206, Partner, Ranch
96 530 924 XT	6239Q1	251495	Soft 6.0	Berlingo, 206, Partner, Ranch
96 530 925 XT	6239JK	251496	Soft 6.0	Berlingo, 206, Partner, Ranch
96 530 926 XT	6239Q3	251497	Soft 6.0	Berlingo, 206, Partner, Ranch
96 530 927 XT	6239Q4	251493	Soft 6.0	206

	OES		SOFTWARE	
96 5309 30 XT	6239JJ	251486	Soft 6.0	307
96 530 931 XT	6239V3	251489	Soft 6.0	307
96 530 932 XT	6239V4	251487	Soft 6.0	307
96 530 933 XT	6239V5	251490	Soft 6.0	307, 1007
96 530 934 XT	6239V6	251488	Soft 6.0	307
96 530 935 XT	6239V7	251485	Soft 6.0	206+, 307
96 530 936 XT	6239CP	251498	Soft 6.0	206
96 530 937 XT	6239CQ	251499	Soft 6.0	Berlingo, 206, Partner, Ranch
96 574 402 XT	624230	251491	Soft 6.6	Berlingo, 406, Partner
96 574 403 XT	624231	251492	Soft 6.6	Berlingo, C8, Xsara picasso, 206, 307, 406, Partner, Ranch
96 574 404 XT	624232	251494	Soft 6.6	Berlingo, 206, Partner, Ranch
96 574 405 XT	6239QK	251495	Soft 6.6	Berlingo, 206, Partner, Ranch
96 574 406 XT	624233	251496	Soft 6.6	Berlingo, 206, Partner, Ranch
96 574 407 XT	6239WQ	251497	Soft 6.6	Berlingo, 206, Partner, Ranch
96 574 408 XT	6239QN	251493	Soft 6.6	206
96 574 411 XT		251486	Soft 6.6	307
96 574 412 XT		251489	Soft 6.6	307
96 574 413 XT		251487	Soft 6.6	307
96 574 414 XT		251490	Soft 6.6	307, 1007
96 574 415 XT		251488	Soft 6.6	307
96 574 416 XT		251485	Soft 6.6	206+, 307
96 574 417 XT		251498	Soft 6.6	206
96 574 418 XT	624235	251499	Soft 6.6	Berlingo, 206, Partner, Ranch
96 605 676 XT	624230	251491	Soft 6.6 HF	Berlingo, 406, Partner
96 605 677 XT		251492	Soft 6.6 HF	Berlingo, C8, Xsara picasso, 206, 307, 406, Partner, Ranch
96 605 678 XT	624232	251494	Soft 6.6 HF	Berlingo, 206, Partner, Ranch
96 605 679 XT	6239QK	251495	Soft 6.6 HF	Berlingo, 206, Partner, Ranch
96 605 680 XT	624233	251496	Soft 6.6 HF	Berlingo, 206, Partner, Ranch
96 605 681 XT	6239QN	251493	Soft 6.6 HF	206
96 605 684 XT	624271	251486	Soft 6.6 HF	307
96 605 685 XT	624272	251489	Soft 6.6 HF	307
96 605 686 XT	624273	251487	Soft 6.6 HF	307
96 605 687 XT	624274	251490	Soft 6.6 HF	307, 1007
96 605 688 XT	624275	251488	Soft 6.6 HF	307
96 605 689 XT	624276	251485	Soft 6.6 HF	206+, 307
96 605 690 XT	624277	251498	Soft 6.6 HF	206
96 605 691 XT	624235	251499	Soft 6.6 HF	Berlingo, 206, Partner, Ranch
96 605 910 XT	6239WQ	251497	Soft 6.6 HF	Berlingo, 206, Partner, Ranch

If the OE or OES reference on the switch to be changed is on this list, the Valeo reference is compatible.  
 If the logo of a manufacturer other than Valeo appears on the switch to be changed, the Valeo part is not compatible.

Si la référence OE ou OES sur le commutateur à changer est dans cette liste, la référence Valeo est compatible. Si le logo d'un fabricant autre que Valeo apparaît sur le commutateur à changer, la pièce Valeo n'est pas compatible.



Si la referencia OE u OES en el conmutador que va a reemplazarse figura en esta lista, la referencia Valeo es compatible. Si el logotipo de un fabricante diferente de Valeo aparece en el conmutador que va a reemplazarse, la pieza Valeo no es compatible.

Wenn die auf dem auszuwechselnden Schalter erscheinende OE- oder OES-Teilenummer in dieser Liste aufgeführt ist, dann ist die Valeo-Teilenummer kompatibel. Wenn das Logo eines anderen Herstellers als Valeo auf dem auszuwechselnden Schalter steht, dann ist das Valeo-Teil nicht kompatibel.

Se la referencia OE o OES sul commutatore da cambiare è in questa lista, la referencia Valeo è compatibile. Se sul commutatore da cambiare figura il logo di un fabbricante diverso da Valeo, il pezzo Valeo non è compatibile.

Değiştirilecek komütatör üzerindeki OE veya OES referansı bu liste içinde mevcut ise, Valeo referansı uyumludur. Değiştirilecek komütatör üzerinde Valeo dışında bir imalatçının logosu görülüyorsa, Valeo parçası uyumlu değildir.

**For / Pour : RENAULT**

OES		
7701040729	251436	Mégane I, Mégane classic
7701040730	251437	Mégane I, Mégane classic
7701040732	251442	Mégane I

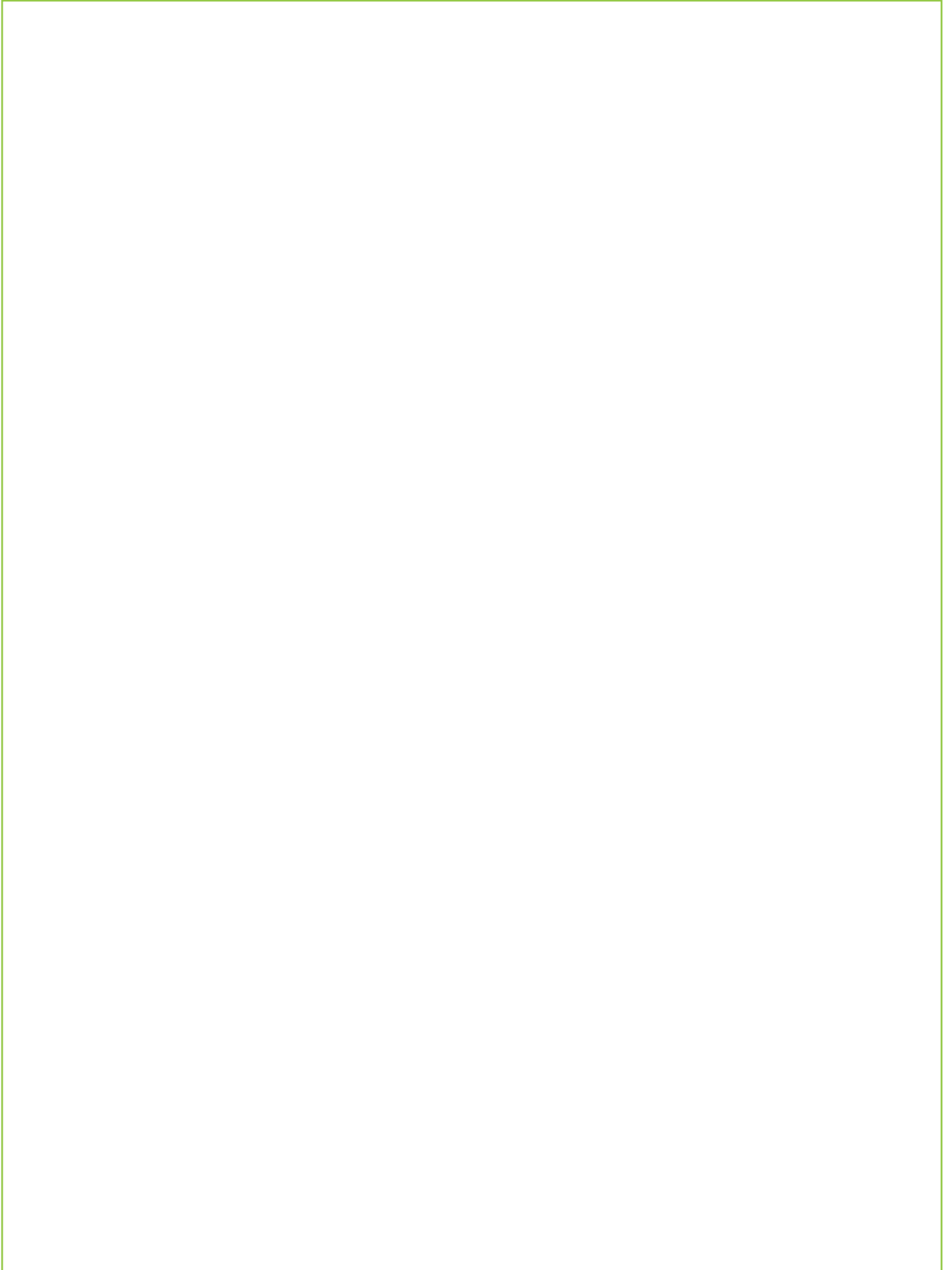







Every effort has been made to ensure that the information contained in this catalogue is correct at the time of printing, but no warranty or representation is given or made as to the accuracy of such information and Valeo Service UK Ltd does not accept any liability whatsoever for any inaccuracies.

Valeo Service UK Ltd reserves the right to alter specifications and/or the final construction of products without notice.

L'affectation et la préconisation des produits figurant dans nos catalogues prennent en compte l'état du parc automobile au jour de leur parution.

La responsabilité de Valeo Service ne saurait être engagée en cas de modification, substitution ou suppression des affectations ou préconisations qui pourraient intervenir notamment à l'initiative des constructeurs de véhicules.

Les caractéristiques techniques de nos produits sont susceptibles d'évoluer à tout moment pour tenir compte des améliorations techniques et technologiques.

La aplicación de los productos sobre vehículos y las especificaciones de los productos que figuran en nuestros catálogos se refieren a la situación del parque de automóviles en la fecha de puesta en circulación de los productos.

Valeo Service España SA no asume ninguna responsabilidad en caso de modificación, sustitución o supresión de dichas aplicaciones y/o especificaciones que pudieran producirse por iniciativa de los fabricantes de automóviles.

Las características técnicas de nuestros productos son susceptibles de evolucionar en cualquier momento para incorporar las mejoras técnicas y tecnológicas que se desarrollen.

As prescrições e recomendações relativas ao uso ou utilidade dos produtos constantes de nossos catálogos levam em consideração o estado do parque automotivo à época do lançamento desses produtos.

A Valeo Sistemas Automotivos Ltda (Valeo Cibié Service) não será responsável por quaisquer modificações, substituições ou supressões incidentes sobre as prescrições e recomendações relativas ao uso ou utilidade de nossos produtos, que sejam decorrentes de ações dos construtores de veículos.

As características técnicas de nossos produtos são suscetíveis de alteração a qualquer momento para que sejam incorporadas melhorias técnicas e/ou tecnológicas.

Le applicazioni e le specifiche dei prodotti che figurano nei nostri cataloghi si riferiscono alla situazione del parco circolante al momento della pubblicazione.

Valeo Service Italia S.p.A. declina qualsiasi responsabilità in caso di modifica, sostituzione o soppressione di applicazioni o specifiche eventualmente apportate, senza preavviso, da parte dei Costruttori.

Le caratteristiche tecniche dei nostri prodotti sono suscettibili di modifiche in qualsiasi momento, per apportare migliorie tecniche e tecnologiche.

De ter zake van de producten in onze catalogi aangegeven bestemmingen en gedane aanbevelingen zijn gebaseerd op het wagenpark ten tijde van publicatie.

Valeo Service Benelux B.V. sluit elke aansprakelijkheid uit met betrekking tot wijziging, vervanging of annulering van de bestemmingen of aanbevelingen, die met name op initiatief van de autofabrikanten kunnen worden doorgevoerd.

De technische eigenschappen van onze producten kunnen te allen tijde evolueren teneinde rekening te houden met technische en technologische verbeteringen.

Die Verwendungsempfehlungen zu den in diesem Katalog aufgeführten Produkten beziehen sich auf den zum Zeitpunkt des Erscheinens dieses Katalogs existierenden Fahrzeugbestand.

Valeo Service Deutschland GmbH übernimmt keine Haftung für Änderungen, Ersetzungen oder Streichungen der Fahrzeuganwendung oder -Empfehlungen, die besonders auf Initiative der Fahrzeughersteller auftreten können.

Die technischen Eigenschaften unserer Produkte unterliegen ständiger Entwicklung, um technischen und technologischen Verbesserungen Rechnung zu tragen.

Przeznaczenie i zalecenia dotyczące produktów figurujących w naszych katalogach biorą pod uwagę stan parku samochodowego w dniu ich wprowadzenia na rynek.

Firma «Valeo Service Eastern Europe Sp. z o.o.» nie może ponosić odpowiedzialności w przypadku zmiany, zastąpienia lub usunięcia wskazówek dotyczących przeznaczenia produktu i zaleceń, które mogą wystąpić z inicjatyw producentów samochodów.

Dane techniczne naszych produktów mogą być w każdej chwili zmienione w celu uwzględnienia ulepszeń technicznych i technologicznych.

Kataloglarımızda yer alan ürünlerin kullanım ve tanımları, otomobil parkının yayın tarihindeki durumuna göredir.

Valeo Otomotiv Dağıtım AS, özellikle araç, üreticilerinin inisiyatifli sonucu yapılan değişiklik, ikame veya kaldırmalardan sorumlu tutulamaz.

Ürünlerimizin teknik özellikleri, teknik ve teknolojik gelişmelere paralel olarak geliştirilebilir.

Назначение и рекомендации по эксплуатации продукции, содержащиеся в наших каталогах, указываются с учетом состояния автомобильного парка на день ее появления.

Компания «Valeo Service Eastern Europe Sp.zo.o» не несет ответственности в случае внесения изменений в рекомендации по эксплуатации продукции или их устранения, произошедших, в частности, по инициативе производителя автомобилей.

Технические характеристики нашей продукции могут претерпевать изменения в любой момент, с учетом усовершенствования технических и технологических процессов.

O catálogoс έχει συσταθεί λαμβάνοντας υπόψη τη σύσταση του στήλου αυτοκινήτων την ημέρα, της κυκλοφορίας του.

Η Valeo δε φέρει ευθύνη σε περίπτωση τροποποίησης, αλλαγής ή αντικατάστασης κάποιου από/του που περιέχεται στο κατάλογο, εξαιτίας πρωτοβουλίας του κατασκευαστή του οχήματος.

Τα τεχνικά χαρακτηριστικά των προϊόντων ενδέχεται να διαφοροποιηθούν ανά ώρα στιγμή λόγω τεχνολογικών εξελίξεων.

Μερικοί κωδικοί αντ/κων μπορεί να μην είναι διαθέσιμοι σε κάποιες χώρες.

Product references referred to in this catalogue may not be available in all countries.

All orders for products are only accepted subject to the terms and conditions of Valeo Service UK Ltd.

Photographs and drawings are not binding on Valeo Service UK Ltd. The copyright in this publication belongs to Valeo Service UK Ltd exclusively. No part of this publication may be reproduced by any means without the prior authorisation of Valeo Service UK Ltd.

Certaines références peuvent ne pas être disponibles dans tous les pays.

Les commandes sont régies par les conditions générales de vente de Valeo Service.

Photos et dessins non contractuels. La reproduction de tout ou partie de cette publication est interdite sans l'autorisation expresse et écrite de Valeo Service.

Las referencias de productos mencionadas en este catalogo puede que no estén disponibles en todos los países.

Los pedidos se regiran por las condiciones generales de venta de Valeo Service España SA.

Las fotografías y dibujos que aparecen en nuestros catálogos son meramente indicativas, por lo que no siempre coinciden exactamente con la apariencia externa de nuestros productos. Se prohíbe la reproducción de todo o parte de esta publicación sin la autorización expresa y escrita de Valeo Service España SA.

Certas referências podem não estar disponíveis em todos os países.

Os pedidos feitos pelos clientes são regidos pelas condições gerais de venda da Valeo Sistemas Automotivos Ltda (Valeo Cibié Service).

Fotos e desenhos não contratuais. A reprodução do todo ou de parte desta publicação é proibida sem a autorização expressa e por escrito da Valeo Sistemas Automotivos Ltda (Valeo Cibié Service).

Alcuni riferimenti presenti in questo catalogo non sono disponibili in tutti i paesi.

Gli ordini sono regolamentati dalle condizioni generali di vendita di Valeo Service Italia S.p.A.

Le Foto ed i disegni che appaiono nel catalogo sono puramente indicativi. E' vietata la riproduzione della totalità o di una parte della presente pubblicazione senza un'esplicita autorizzazione scritta da parte di Valeo Service Italia S.p.A.

Bepaalde artikelen kunnen in bepaalde landen niet beschikbaar zijn.

Orders zijn onderworpen aan de algemene verkoopvoorwaarden van Valeo Service Benelux B.V.

Foto's en tekeningen zijn niet bindend.

De gehele of gedeeltelijke vervoelvoudiging van deze uitgave zonder uitdrukkelijke voorafgaande schriftelijke toestemming van Valeo Service Benelux B.V. is verboden.

Die Fotos oder Zeichnungen in diesem Katalog dienen ausschliesslich der Veranschaulichung unserer Produkte. Rechtliche Ansprüche können daraus nicht abgeleitet werden.

Einige Produktreferenzen sind nicht in allen Ländern verfügbar.

Lieferungen unterliegen den Allgemeinen Verkaufsbedingungen von Valeo Service Deutschland GmbH.

Die Vervielfältigung dieses Katalogs oder Teilen davon ohne die schriftliche Erlaubnis von Valeo Service Deutschland GmbH ist nicht zulässig.

Niektóre modele mogą być niedostępne w niektórych krajach.

Zamówienia podlegają ogólnym warunkom umów «Valeo Service Eastern Europe Sp. z o.o.».

Wykorzystywanie w całości lub w części zdjęć i rysunków zamieszczonych w naszych katalogach wymaga pisemnej zgody «Valeo Service Eastern Europe Sp. z o.o.».

Bazı referanslar bazı ülkelerde bulunmayabilir.

Siparişler, Valeo Otomotiv Dağıtım AS'un genel satış koşullarına uygun olarak ödenir.

Fotoğraf ve resimler akdi değildir. İşbu yayının Valeo Otomotiv Dağıtım AS'un önceden verilmiş yazılı izni olmaksızın kısmen veya tamamen çoğaltılması yasaktır.

Некоторые виды продукции могут не иметься в наличии в отдельных странах.

Заказы осуществляются согласно общим правилам торговли, применяемым в компании «Valeo Service Eastern Europe Sp.zo.o».

Фотографии и изображения продукции могут не в полной мере соответствовать оригиналам. Воспроизведение всей или части настоящей публикации запрещено без специального письменного согласия компании «Valeo Service Eastern Europe Sp.zo.o».

Οι αναγγελίες υπήκεινται στους γενικούς ήρους πωλήσεων της Valeo.

Οι φωτογραφίες και τα σχέδια δεν είναι δεσμευτικά. Η αναπαραγωγή ολόκληρου ή τμήματος αυτού του καταλόγου αναγορεύεται να γίνει χωρίς τη ρητή και γραπτή άδεια της Valeo Service.

## EUROPE

### FRANCE

**VALEO SERVICE FRANCE**  
70, RUE PLEYEL  
93285 SAINT-DENIS CEDEX - FRANCE  
TEL.: (+33) 1 49 45 32 32  
FAX: (+33) 1 49 45 37 36  
S.A.S. au capital de 12 900 000 €  
RCS Bobigny B 306 486 408

### SPAIN, PORTUGAL

**VALEO SERVICE ESPAÑA, S.A.**  
CALLE RIO ALMANZORA, N°5  
AREA EMPRESARIAL ANDALUCIA C.L.A.  
28906 GETAFE (MADRID) - ESPAÑA  
TEL.: (+34) 91 495 85 00  
FAX: (+34) 91 495 86 99  
TEL. ATENCIÓN TÉCNICA:  
902 011 799  
TEL. ATENCIÓN AL CLIENTE:  
900 122 657

Valeo Service España Sociedad Anónima  
inscrita en el Registro Mercantil de Madrid,  
Tomo 972 - Libro 941 de la sección 8ª,  
Folio 25 - Hoja 65435 - Inscripción 1ª NIF. A28772978

### ITALY

**VALEO SERVICE ITALIA SPA (V.S. ADRIATIC)**  
VIA ASTI 89  
10026 SANTENA (TO) - ITALIA  
TEL.: (+39) 011 94 95 1  
FAX: (+39) 011 94 95 280  
TEL. LINEA TECNICA : 800 805 046  
N. iscrizione al Tribunale di Torino 2009/88 reg. soc.  
C.C.I.A.A. 715107 - Capitale sociale € 2.600.000

### UNITED KINGDOM

**VALEO SERVICE UK LTD**  
HEMING ROAD - WASHFORD  
REDDITCH - WORCS B98 ODZ - ENGLAND  
TEL.: (+44) 1527 838 300  
FAX: (+44) 1527 523 732  
Registration Number: 956685

### GERMANY

**VALEO SERVICE DEUTSCHLAND GMBH**  
BRANDENBURGER STRASSE 46  
40880 RATINGEN - DEUTSCHLAND  
TEL.: (+49) 21 02 865 0  
FAX: (+49) 21 02 865 142  
Handelsregister Ratingen - HRB 3340

### BENELUX

**VALEO SERVICE BENELUX B.V.**  
HEIBLOEMWEG 1  
5704 BS HELMOND - THE NETHERLANDS  
TEL. BELGIUM (NL): (+32) 2 366 99 17  
TEL. BELGIUM (FR): (+32) 2 355 14 46  
TEL. NETHERLANDS: (+31) 492 580 894  
FAX BELGIUM: (+32) 2 366 04 47  
FAX NETHERLANDS: (+31) 492 580 828  
K.v.K. Eindhoven 33113859

## POLAND, LITHUANIA, LATVIA, ESTONIA, MOLDAVIA, BELARUS, UKRAINE

**VALEO SERVICE EASTERN EUROPE Sp z o.o.**  
WOŁOSKA 9A  
02-583 WARSAW POLSKA  
TEL.: (+48) 22 543 43 00  
FAX: (+48) 22 543 43 05  
Valeo Service Eastern Europe Sp. z o.o.; NIP 521-11-44-572  
VAT UE PL5211144572 - REGON 011909673  
Wysokość kapitału zakładowego: 4 637 000 PLN - KRS  
56793 Sąd Rejonowy dla m. St. Warszawy w Warszawie,  
XIII Wydział Gospodarczy KRS

### RUSSIA

**VALEO SERVICE CO LTD**  
107140, MOSCOW  
RUSAKOVSKAYA ST. 13,  
3RD FLOOR, OFFICE 6  
TEL.: (+7) 495 981-06-96  
FAX: (+7) 495 787-59-92

## SWITZERLAND, AUSTRIA, SWEDEN, FINLAND, NORWAY, DENMARK, ICELAND, EASTERN EUROPE

**VALEO SERVICE EXPORT**  
70, RUE PLEYEL  
93285 SAINT-DENIS CEDEX - FRANCE  
TEL.: (+33) 1 49 45 32 32  
FAX: (+33) 1 49 45 36 59  
S.A.S. au capital de 12 900 000 €  
RCS Bobigny B 306 486 408

**LIAISON OFFICE IN AUSTRIA**  
MÜHLGASSE 7  
2380 PERCHTOLDSORF - AUSTRIA  
TEL.: (+43) 1 480 42 46  
FAX: (+43) 1 480 42 34

**LIAISON OFFICE IN CZECH REPUBLIC**  
DEDINSKA 29  
16101 PRAGUE 6 - CZECH REPUBLIC  
TEL.: (+420) 220 102 277  
FAX: (+420) 220 102 278

**LIAISON OFFICE IN HUNGARY**  
ROZSAKVARC UTCA 8  
1188 BUDAPEST- HUNGARY  
TEL.: (+36) 30 50 51 888  
FAX: (+43) 1 480 42 34

**LIAISON OFFICE IN SWEDEN**  
REGUS / VALEO  
MASTER SAMUELSGATAN 60, 8TR  
SE - 111 21 STOCKHOLM - SWEDEN  
TEL.: (+46) 8 50 51 65 50

## SOUTH AMERICA

### LATIN AMERICA (except Mexico)

**VALEO CIBIÉ SERVICE LTDA**  
RUA SADAÉ TAKAGI, 2000  
BAIRRO COOPERATIVA  
09852-070 - SÃO BERNARDO DO CAMPO  
SÃO PAULO - BRASIL  
TEL.: (+55) 11 43 93 33 54  
FAX: (+55) 11 43 93 33 55  
C.N.P.J.: 57.010.662/0008-36  
Inscrição Estadual : 635.331.124.114

**VALEO SERVICE ARGENTINA**  
RUA SADAÉ TAKAGI, 2000  
BAIRRO COOPERATIVA  
09852-070 - SÃO BERNARDO DO CAMPO  
SÃO PAULO - BRASIL+  
TEL.: (+55) 11 43 93 33 54  
FAX: (+55) 11 43 93 33 55  
C.N.P.J.: 57.010.662/0008-36  
Inscrição Estadual : 635.331.124.114

### MEXICO

**LIAISON OFFICE IN MEXICO**  
MONTECITO 38, PISO 14 OFICINA 38.  
TORRE WORLD TRADE CENTER  
COLONIA NÁPOLES | 03810 | MÉXICO, D.F.  
TEL.: +52 (55) 90001588

## ASIA, MIDDLE EAST, AUSTRALIA, NEW-ZEALAND

**VALEO SERVICE EXPORT**  
70, RUE PLEYEL  
93285 SAINT-DENIS CEDEX - FRANCE  
TEL.: (+33) 1 49 45 32 32  
FAX: (+33) 1 49 45 36 59

### CHINA

**VALEO AUTO PART TRADING  
(SHANGHAI) CO., LTD**  
201, BUILDING B, IBC TOWER (NEW  
INTERNATIONAL BUSINESS CENTER)  
391 GUI PING ROAD, SHANGHAI 200233, CHINA  
TEL: (+86) 21 5175 2618  
MP: (+86) 21 5175 2628

法雷奥汽车零部件贸易(上海)有限公司  
地址: 上海市徐汇区桂平路391号新漕河泾国际商务中心B座201  
电话: (+86) 21 5175 2618  
传真: (+86) 21 5175 2628

**TURKEY, IRAN, IRAQ, SYRIA, LEBANON,  
JORDAN, SAUDI ARABIA, UNITED ARABE  
EMIRATES, KUWAIT, BAHRAIN, QATAR,  
OMAN, YEMEN, EGYPT**

**VALEO OTOMOTIV DAĞITIM A.Ş.**  
AYDINEVLER SANAYI CADDESİ  
CENTRUM IS MERKEZİ N°3  
KAT: 3, DAIRE N°302-303 KÜÇÜKYALI - MALTEPE  
34854 ISTANBUL - TÜRKİYE  
TEL.: (+90) 216 518 75 75  
FAX.: (+90) 216 519 93 14

## AFRICA, DOM-TOM

**VALEO SERVICE EXPORT**  
70, RUE PLEYEL  
93285 SAINT-DENIS CEDEX - FRANCE  
TEL.: (+33) 1 49 45 32 32  
FAX: (+33) 1 49 45 36 59  
S.A.S. au capital de 12 900 000 €  
RCS Bobigny B 306 486 408

**LIAISON OFFICE IN TUNISIA**  
CENTRE D'AFFAIRES REGUS  
IMMEUBLE CARTHAGE RUE DU LAC DE CONSTANCE  
1053 TUNIS - TUNISIA  
TEL.: (216) 71 965 002  
FAX: (216) 71 965 137  
MOB: (216)98 34 91 38



valeo added 

Automotive technology, naturally

**Valeo**