

2014



中国市场适用  
FOR CHINA

起动机和发电机  
STARTERS AND ALTERNATORS

www.valeoservice.com

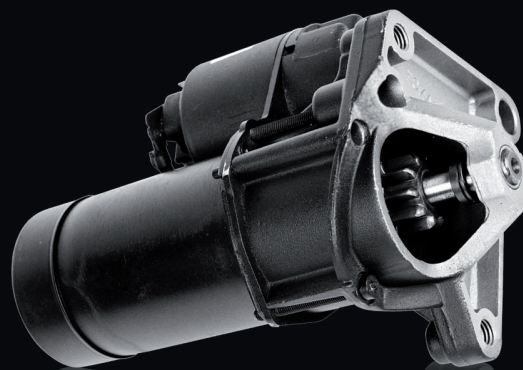
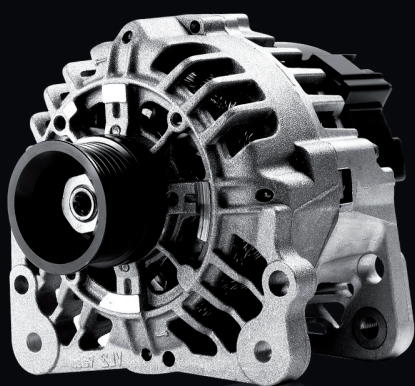

valeo added

驶于科技，融于自然  
Automotive technology, naturally



# 法雷奥, 起动机和发电机的专家和品质

Valeo, quality and expertise in Starters and Alternators

选择  
法雷奥

Choose  
Valeo products

原厂质量标准确保了安全性和耐久性  
Safety & durability thanks to O.E. quality standards

高效能的机器确保了最佳的性能和节省燃油  
Optimised performance and fuel savings thanks to power efficiency

噪音和振动的减少, 增加了驾驶舒适性  
Enhanced driving comfort thanks to reduced noise and vibrations



CN

## 发电机

高效的机器, 有效减少二氧化碳的排放和提高舒适性

最新的技术:

### FG发电机

- 提高功效
- 最佳级别的可靠性和平均寿命
- 创新型接口的稳压器

## 起动机

同样的尺寸, 更多的功率和更高的效率

最新的技术:

### TS起动机

- 减少自重
- 广泛的市场覆盖率
- 增加耐久性

EN

## Alternators

High-efficiency machines for CO<sub>2</sub> emissions reduction and enhanced comfort

Latest technology:

### FG alternators

- Improved power efficiency
- Best-in class reliability and life expectancy
- Innovative interfaced regulator

## Starters

More power & higher efficiency in the same package

Latest technology:







### TS Starters

- Reduced weight
- Wide market coverage
- Increased durability



<b>A</b>	自动变速箱 Automatic Transmission
<b>M</b>	手动变速箱 Manual Transmission
	车型 Vehicle
	新产品 New
	发动机型号 Engine Number
	车型年款 Date of application
	备注 Comments
	安装角度 Fixing angle

<b>30°</b> 	向右30° 30° right hand
<b>30°</b> 	向左30° 30° left hand
	齿数 No. Of teeth
	皮带轮槽数 No. Of pulley vee's
<b>Ø</b>	皮带轮直径 Pulley diameter
	旋转方向 Direction of rotation
	顺时针 Clockwise
	逆时针 Anti-clockwise

	电压 Tension
	功率 Power
	安培 Amps
	变速箱 Gearbox Type
	照片 Images
	调节器支架 Bracket
	接头 Connection
<b>INC</b>	整体式 With regulator
<b>SEP</b>	分体式 Without regulator

## EUROPE

### FRANCE

VALEO SERVICE FRANCE  
70, RUE PLEYEL  
93285 SAINT-DENIS CEDEX - FRANCE  
TEL. : (+33) 1 49 45 32 32  
FAX : (+33) 1 49 45 37 36  
S.A.S. au capital de 12 900 000 e  
RCS Bobigny B 306 486 408

### SPAIN, PORTUGAL

VALEO SERVICE ESPAÑA, S.A.  
CALLE RIO ALMANZORA, N°5  
AREA EMPRESARIAL ANDALUCIA C.L.A.  
28906 GETAFE (MADRID) - ESPAÑA  
TEL. : (+34) 91 495 85 00  
FAX : (+34) 91 495 86 99  
TEL. ATENCIÓN TÉCNICA :  
902 011 799  
TEL. ATENCIÓN AL CLIENTE :  
900 122 657  
Valeo Service España Sociedad Anónima  
inscrita en el Registro Mercantil de Madrid,  
Tomo 972 - Libro 941 de la sección 8a,  
Folio 25 - Hoja 65435 -Inscripción 1a NIF. A28772978

### ITALY

VALEO SERVICE ITALIA SPA  
VIA ASTI 89  
10026 SANTENA (TO) - ITALIA  
TEL. : (+39) 011 94 95 1  
FAX : (+39) 011 94 95 280  
TEL. LINEA TECNICA : 800 805 046  
N. iscrizione al Tribunale di Torino 2009/88 reg. soc.  
C.C.I.A.A. 715107 - Capitale sociale e 2.600.000

### UNITED KINGDOM

VALEO SERVICE UK LTD  
HEMING ROAD - WASHFORD  
REDDITCH - WORCS B98 0DZ - ENGLAND  
TEL. : (+44) 1527 838 300  
FAX : (+44) 1527 523 732  
Registration Number : 956685

### GERMANY

VALEO SERVICE DEUTSCHLAND GMBH  
BRANDENBURGER STRASSE 46  
40880 RATINGEN - DEUTSCHLAND  
TEL. : (+49) 21 02 865 0  
FAX : (+49) 21 02 865 142  
Handelsregister Ratingen - HRB 3340

### BENELUX

VALEO SERVICE BENELUX B.V.  
HEIBLOEMWEG 1  
5704 BS HELMOND - THE NETHERLANDS  
TEL. BELGIUM (NL) : (+32) 2 366 99 17  
TEL. BELGIUM (FR) : (+32) 2 355 14 46  
TEL. NETHERLANDS : (+31) 492 580 894  
FAX BELGIUM : (+32) 2 366 04 47  
FAX NETHERLANDS : (+31) 492 580 828  
K.v.K. Eindhoven 33113859

## TURKEY

VALEO OTOMOTIV DAĞITIM A.Ş.  
AYDINEVLER SANAYI CADDESİ  
CENTRUM İS MERKEZİ N°3  
KAT: 3, DAIRE N°302-303 KÜÇÜKYALI - MALTEPE  
34854 İSTANBUL - TURKEY  
TEL. : (+90) 216 518 75 75  
FAX : (+90) 216 519 93 14

### POLAND, LITHUANIA, LATVIA, ESTONIA, MOLDAVIA, BELARUS, UKRAINE

VALEO SERVICE EASTERN EUROPE SP. ZO.O.  
UL. POSTĘPU 13  
02-676 WARSZAWA - POLSKA  
TEL. : (+48) 22 543 43 00  
FAX : (+48) 22 543 43 05  
SP. Z O.O. O KAPITALE 4.637.000 PLN  
KRS 56793  
Sąd Rejonowy dla m.St. Warszawy

## RUSSIA

VALEO SERVICE CO LTD  
RUSSIA, 105055, MOSCOW  
RADIO STR, 24 - BUILD.2  
TEL. : (+7) 495 981-06-96  
FAX. : (+7) 495 787-59-92

### SWITZERLAND, AUSTRIA, SWEDEN, FINLAND, NORWAY, DENMARK, ICELAND, GREECE, EASTERN EUROPE, OTHERS

VALEO SERVICE EXPORT  
70, RUE PLEYEL  
93285 SAINT-DENIS CEDEX - FRANCE  
TEL. : (+33) 01 49 45 32 32  
FAX : (+33) 01 49 45 36 59

LIAISON OFFICE IN AUSTRIA  
MÜHLGASSE 7  
2380 PERCHTOLDSDORF - AUSTRIA  
TEL. : (+43) 1 480 42 46  
FAX. : (+43) 1 480 42 34

LIAISON OFFICE IN CZECH REPUBLIC  
DEDINSKA 29  
16100 PRAGUE 6 - CZECH REPUBLIC  
TEL. : (+420) 220 102 277  
FAX. : (+420) 220 102 278

LIAISON OFFICE IN HUNGARY  
KOSSUTH UTCA 33  
8581 BAKONYJAKO - HUNGARY  
TEL. : (+36) 89 350 156  
FAX : (+36) 89 350 156

LIAISON OFFICE IN ROMANIA  
STR.REGINA ELISABETA NR.15-19  
BL.2, SC.2, EJ.3, AP.13  
BUCURESTI - ROMANIA  
TEL. : (+40) (0)7 54 07 07 65

LIAISON OFFICE IN GREECE  
18, KALAMAKIOU AVENUE  
174 55 ALIMOS - GREECE  
TEL. : (+30) 210 45 27 447  
FAX.: (+30) 210 45 27 449

## AMERICAS

### LATIN AMERICA

valeo cibie service ltda  
Rua sadae takagi, 2000  
bairro Cooperativa  
09852-070 - São Bernardo do Campo  
São Paolo - Brasil  
Tel. : (+55) 11 43 93 33 54  
Fax : (+55) 11 43 93 33 55  
C.N.P.J. : 57.010.662/0008-36  
Inscrição Estadual : 635.331.124.114

### ASIA, AUSTRALIA NEW-ZEALAND

VALEO SERVICE EXPORT  
70, RUE PLEYEL  
93285 SAINT-DENIS CEDEX - FRANCE  
TEL. : (+33) 01 49 45 32 32  
FAX : (+33) 01 49 45 36 59

法雷奥汽车零部件贸易(上海)有限公司  
上海市徐汇区漕河泾开发区桂平路391号  
新漕河泾国际商务中心B座33楼  
电话: (+86) 21 51752618  
传真: (+86) 21 51752619

### VALEO SERVICE ASEAN (HEAD OFFICE)

700/424 MOO 7, AMATANAKORN INDUSTRIAL ESTATE,  
BANGNA-TRAD RD., T. DON-HUA-LOR  
A. MUANG CHONBURI, CHONBURI 20000, THAILAND  
Tel: +66 (0) 38 265 600  
Fax: +66 (0) 38 265 671

### VALEO SERVICE ASEAN

#### (SALES REPRESENTATIVE OFFICE)

NO. 1533, LEVEL 15.01, FIRST AVENUE,  
2A DATARAN BANDAR UTAMA, BANDAR UTAMA  
DAMANSARA, PETALING JAYA, SELANGOR, MALAYSIA  
TEL: +60 3 7651 7757, 7736  
FAX: +60 3 7651 7701

### AFRICA, MIDDLE EAST, DOM-TOM

VALEO SERVICE EXPORT  
70, RUE PLEYEL  
93285 SAINT-DENIS CEDEX - FRANCE  
TEL. : (+33) 01 49 45 32 32  
FAX : (+33) 01 49 45 36 59  
S.A.S. au capital de 12 900 000 e  
RCS Bobigny B 306 486 408

LIAISON OFFICE IN TUNISIA  
CENTRE D'AFFAIRES REGUS  
IMMEUBLE CARTHAGE  
RUE DU LAC DE CONSTANCE  
1053 TUNIS - TUNISIA  
TEL. : (216) 71 965 002  
FAX : (216) 71 965 137  
MOB: (216) 98 34 91 38

CN

### 法雷奥，原厂优势

法雷奥作为全球起动机、发电机市场的领导者，是众多知名汽车品牌的首选供应商，并且有着超过30年的再制造经验。同时，法雷奥也是售后市场产品最好的选择之一。今天，在全世界范围内几乎1/3的汽车上，法雷奥的产品正在良好地运行。

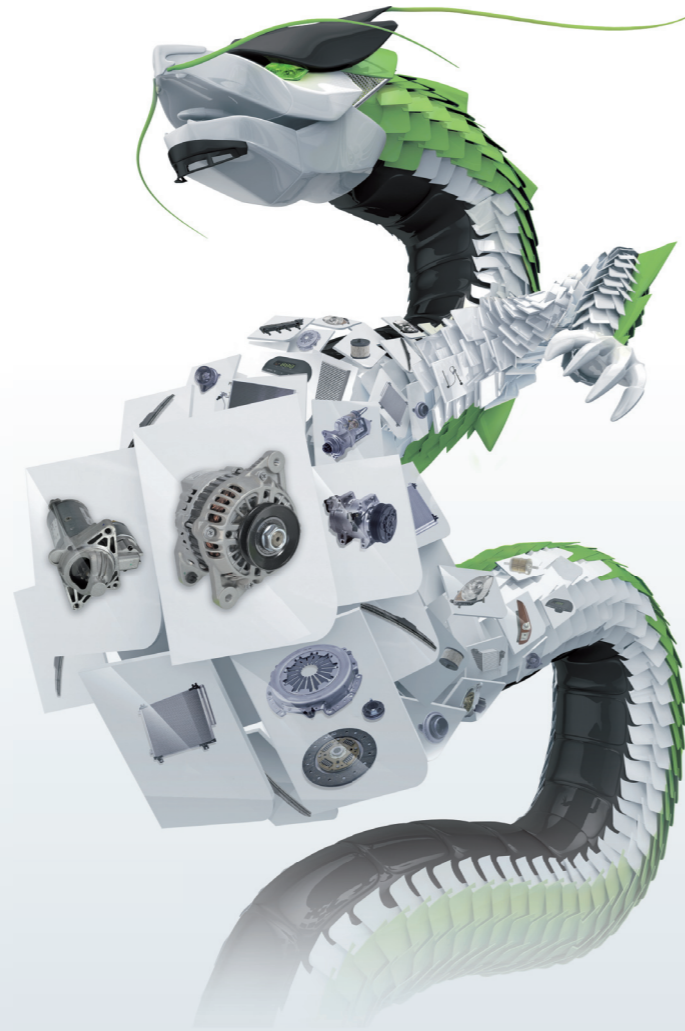

EN

### Valeo, Original Equipment's Strong Point

With a strong leadership in Original Equipment for famous car manufactures and more than 30 years of remanufacturing experience, Valeo provides to the Aftermarket one of the best offer in starters and alternators. Today, almost 1/3 of running cars in the world has equipped with Valeo products.

## 法雷奥起动机 Starters

- ✓ 经过40,000次起动机测试
- ✓ 即使在极端环境下，依然保持良好运行
- ✓ 噪音小，提供舒适驾驶环境

- ✓ Withstand up to 40,000 times starting test.
- ✓ Still working in good conditions even within extreme environment.
- ✓ Comfort driving experience thanks to low noise.

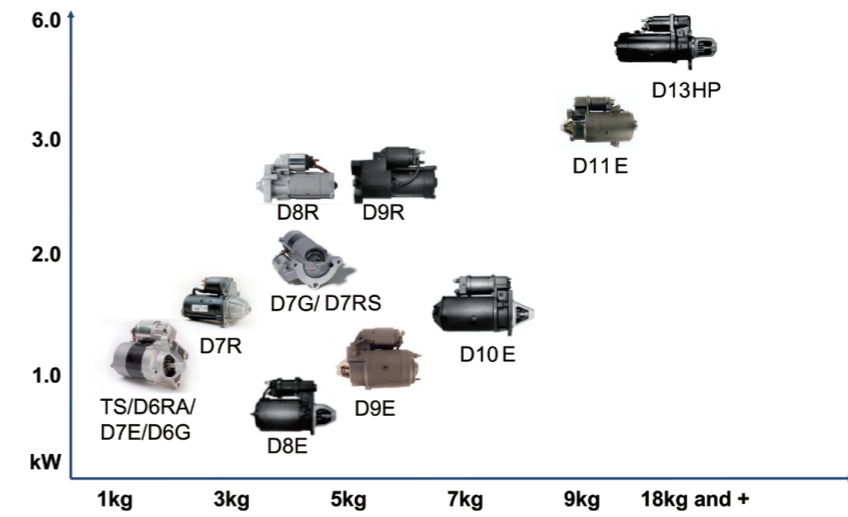

## 法雷奥发电机 Alternators

- ✓ 输出电流覆盖70A-250A，满足各种车型的电力需求
- ✓ 小震动、低噪音，创造舒适驾驶环境
- ✓ 测试不间断工作时间1,000小时

- ✓ Alternator current output is from 70A to 250A, cover almost all of vehicle requirements.
- ✓ Reduce voice and vibration, for comfortable driving.
- ✓ Continuing working up to 1,000 hrs, approved by OE testing.

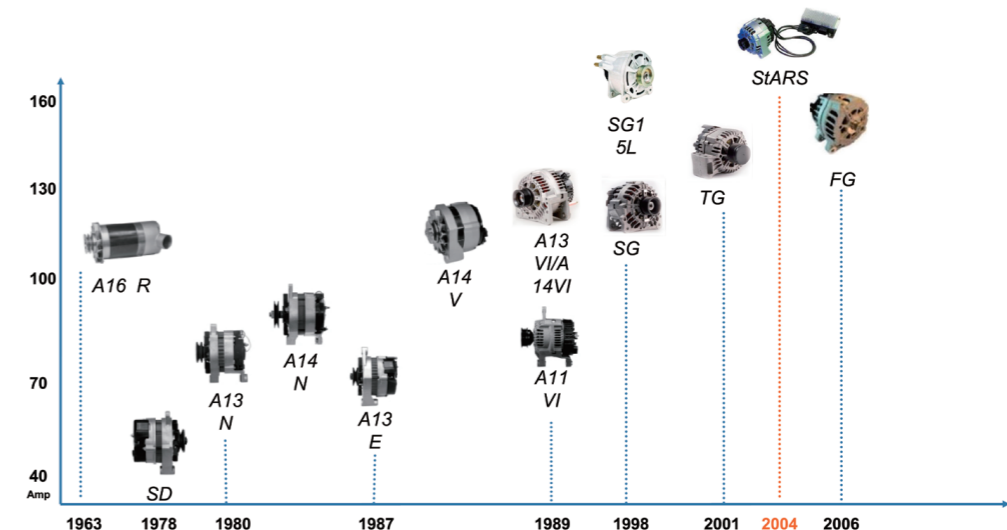

● 总部 / Head Quarter  
 ● 工厂 / Factory

法雷奥汽车电气系统全球足迹  
 Valeo, Electrical Systems Global Footprint



# 新包装为产品带来附加值 New package bring added value



**CN**

**创新设计**

- 最大程度保护：产品不与盒子直接接触，为皮带轮和接线头提供额外保护，全方位立体保护。
- 加强纸盒的关闭功能。
- 只用硬纸板，环保材质。
- 经过快递运输测试，重压测试和跌落测试。

**EN**

**Innovative**

- Max protection: no contact of the unit with the box, pulley and solenoid more protected, vertical and horizontal protection.
- Reinforced closing system.
- More environmental friendly.
- Validated in express delivery test, stacking test and crash test.

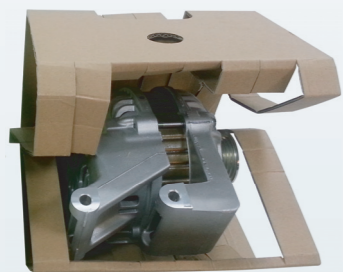

件号检索 / Part Number Index

1

1



7

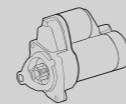

2



23

3



33



4



59

CROSS  
LISTS

5



79

起动机件号检索 / Starter Part Number Index

Valeo		
432592	玛莎拉蒂 / MASERATI	BITURBO/BITURBO (70, 77)
432621	雷诺 / RENAULT	拉古那 I/LAGUNA I, 梅甘娜 I/MEGANE I
432623	标致 / PEUGEOT	206CC / 206CC
	雪铁龙 / CITROEN	C3 / C3
432636	标致 / PEUGEOT	406 / 406
432644	奔驰 / MERCEDES-BENZ	C级/CLASSE C, S级/CLASSE S
432675	奔驰 / MERCEDES-BENZ	C级/CLASSE C, E级/CLASSE E CLK/ CLK, SLK/ SLK
438014	欧宝 / OPEL	威达/ VECTRA, 雅特/ ASTRA
438027	奔驰 / MERCEDES-BENZ	A级/CLASSE A, B级/CLASSE B
438076	奥迪 / AUDI	A3 / A3
438078	奔驰 / MERCEDES-BENZ	CL级/CL-Class, S级/CLASSE S
438079	奔驰 / MERCEDES-BENZ	A级/CLASSE A, B级/CLASSE B
438087	标致 / PEUGEOT	406/406, 407/407, 607/607
	雪铁龙 / CITROEN	C5/C5, C6/C6
438091	标致 / PEUGEOT	406/406, 407/407, 607/607
	雪铁龙 / CITROEN	C5 / C5
438092	标致 / PEUGEOT	406/406, 407/407
438094	宝马 / BMW	Z3/Z3, Z4/Z4
438110	雷诺 / RENAULT	拉古那/ LAGUNA 梅甘娜/MEGANE, 风景/SCENIC
438131	欧宝 / OPEL	雅特/ASTRA
438138	斯柯达 / SKODA	明锐/OCTAVIA
438146	奔驰 / MERCEDES-BENZ	A级/CLASSE A
438147	奔驰 / MERCEDES-BENZ	A级/CLASSE A
438152	大众 / VOLKSWAGEN	夏朗/SHARAN 甲壳虫/NEW BEETLE, 奥迪 / AUDI TT / TT
438157	奔驰 / MERCEDES-BENZ	S级/CLASSE S
438167	大众 / VOLKSWAGEN	途锐 / TOUAREG 奥迪 / AUDI A8 / A8
438171	大众 / VOLKSWAGEN	EOS/EOS, 尚酷/SCIROCCO 奥迪 / AUDI A3 / A3
438174	大众 / VOLKSWAGEN	尚酷 / SCIROCCO 奥迪 / AUDI TT / TT
438183	欧宝 / OPEL	威达/VECTRA, 欧捷利/AGILA 赛飞利/ZAFIRA, 雅特 /ASTRA
438190	奥迪 / AUDI	A4/A4, A6/A6

Valeo		
438192	丰田 / TOYOTA	AYGO/AYGO
	标致 / PEUGEOT	107 / 107
	雪铁龙 / CITROEN	C1 / C1
438197	标致 / PEUGEOT	406/406, 407/407
438199	奔驰 / MERCEDES-BENZ	C级/CLASSE C, E级/CLASSE E CLK/ CLK
438206	大众 / VOLKSWAGEN	甲壳虫 / NEW BEETLE 奥迪 / AUDI A3 / A3
438208	本田 / HONDA	雅阁/ACCORD, 思域/CIVIC
438260	大众 / VOLKSWAGEN	途锐 / TOUAREG
438272	宝马 / BMW	1系/1, 3系/3, 5系/5, 6系/6, 7系/7, X1/X1, X3/X3, Z4/Z4
442003	上海大众 / SVW-VOLKSWAGEN	桑塔纳/SANTANA 桑塔纳Vista志俊/SANTANA VISTA 高尔/GOL
442004	一汽大众 / FAW-VOLKSWAGEN	捷达王/JETTA KING
442005	一汽大众 / FAW-VOLKSWAGEN	捷达 /JETTA
442006	一汽大众 / FAW-VOLKSWAGEN	宝来/BORA, 高尔夫/GOLF
442009	一汽大众 / FAW-VOLKSWAGEN	宝来/BORA, 捷达/JETTA
442010	一汽大众 / FAW-VOLKSWAGEN	高尔夫 / GOLF
	上海大众 / SVW-VOLKSWAGEN	波罗/POLO, 朗逸/LAVIDA
	上海大众斯柯达 / SVW-SKODA	明锐/OCTAVIA, 晶锐/FABIA
442011	一汽大众 / FAW-VOLKSWAGEN	开迪/CADDY, 宝来/BORA, 速腾/SAGITAR, 迈腾/MAGOTAN
	上海大众 / SVW-VOLKSWAGEN	波罗/POLO, 朗逸/LAVIDA 途安/TOURAN, 途观/TIGUAN
	上海大众斯柯达 / SVW-SKODA	昊锐/SUPERB, 明锐/OCTAVIA, 晶锐/FABIA
442012	一汽大众 / FAW-VOLKSWAGEN	开迪/CADDY, 宝来/BORA 速腾/SAGITAR
	上海大众 / SVW-VOLKSWAGEN	朗逸/LAVIDA, 波罗/POLO
	上海大众斯柯达 / SVW-SKODA	明锐/OCTAVIA
442013	一汽大众 / FAW-VOLKSWAGEN	开迪/CADDY
	上海大众 / SVW-VOLKSWAGEN	途安/TOURAN
442014	一汽大众 / FAW-VOLKSWAGEN	CC/CC, 速腾/SAGITAR 迈腾/MAGOTAN, 高尔夫/GOLF
	上海大众 / SVW-VOLKSWAGEN	途安/TOURAN, 途观/TIGUAN
	上海大众斯柯达 / SVW-SKODA	昊锐/SUPERB
442015	一汽大众奥迪 / FAW-AUDI	100/100, A6/A6
	上海大众 / SVW-VOLKSWAGEN	帕萨特/PASSAT



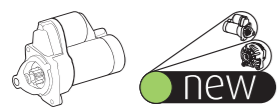

### 起动机件号检索 / Starter Part Number Index

Valeo		
442043	奇瑞汽车 / CHERY	V5/V5, 东方之子/EASTAR
442045	奇瑞汽车 / CHERY	A5/A5
442047	奇瑞汽车 / CHERY	A1/A1, QQ6/QQ6, 瑞麒M1/M1
442049	奇瑞汽车 / CHERY	风云 / FENGYUN
442052	江淮汽车 / JAC	瑞风 / REFINE
442055	东风悦达起亚 / DONGFENG YUEDA-KIA	福瑞迪/FORTE, 秀尔/SOUL
		赛拉图/CERATO
	北京现代 / BEIJING-HYUNDAI	伊兰特/ELANTRA
		雅绅特/ACCENT
442057	比亚迪 / BYD	F0/F0
442058	比亚迪 / BYD	F6/F6
442059	长城汽车 / GREAT WALL	炫丽/FLORID
442061	长城汽车 / GREAT WALL	赛弗/SAFE, 赛影/SING
		赛骏/PEGASUS, 迪尔/DEER
442065	一汽轿车 / FAW	红旗世纪星/CENTURY STAR
442067	一汽吉林 / FAW GROUP(JILIN)	森雅M80/XENIA M80
		森雅S80/XENIA S80
442068	一汽海马 / FAW-HAIMA	欢动/HUANDONG, 海马3/3
442069	一汽海马 / FAW-HAIMA	普力马/PREMACY
442070	南京菲亚特 / NANJING-FIAT	西耶那/SIENA
442072	东南汽车 / SOUTH EAST(FUJIAN)	菱帅/LIONCEL, 蓝瑟/LANCER
	哈飞汽车 / HAFEI AUTOMOBILE	赛豹3/SAIBAO 3
		赛豹5/SAIBAO 5, 赛马/SIGMA
	比亚迪 / BYD	F3 / F3
442076	上海汽车 / SAIC	荣威550/550, 荣威750/750
442077	上海汽车 / SAIC	名爵7 / MG7, 荣威550/550
		荣威750/750
442119	东风悦达起亚 / DONGFENG YUEDA-KIA	福瑞迪/FORTE, 秀尔/SOUL
	北京现代 / BEIJING-HYUNDAI	i30/i30, 伊兰特-悦动/YUE DONG
442128	东风雪铁龙 / DONGFENG-CITROEN	C5/C5
442197	奇瑞汽车 / CHERY	QQ3/QQ3
442198	上海汽车 / SAIC	荣威350/350
442199	比亚迪 / BYD	F3/F3
442200	一汽大众 / FAW-VOLKSWAGEN	迈腾/MAGOTAN, 高尔夫/GOLF
	上海大众斯柯达 / SVW-SKODA	昊锐/SUPERB, 明锐/OCTAVIA
442201	一汽大众 / FAW-VOLKSWAGEN	宝来/BORA
	上海大众 / SVW-VOLKSWAGEN	朗逸/LAVIDA
442202	一汽大众 / FAW-VOLKSWAGEN	CC/CC, 宝来/BORA
		速腾/SAGITAR
	上海大众 / SVW-VOLKSWAGEN	朗逸 / LAVIDA

Valeo		
442203	北京现代 / BEIJING-HYUNDAI	瑞纳/VERNA
442204	江铃汽车 / JIANGLING MOTORS	风尚/CV9
442205	上海大众 / SVW-VOLKSWAGEN	桑塔纳/SANTANA
442222	江淮汽车 / JAC	和悦/HE YUE
442223	比亚迪 / BYD	F6/F6
442240	一汽大众 / FAW-VOLKSWAGEN	捷达/JETTA, 高尔夫/GOLF
442241	长城汽车 / GREAT WALL	凌傲/LINGAO, 哈弗M1/HOVER M1
		哈弗M2/HOVER M2, 炫丽/FLORID
		腾翼C30/TENGYI C30 Saloon
		酷熊/COOLBEAR
442254	长安铃木 / CHANGAN-SUZUKI	天语SX4/SX4
600071	现代 / HYUNDAI	圣达菲/SANTA FE
		特拉卡/TERRACAN



### 发电机件号检索 / Alternator Part Number Index

Valeo		
433044	大众 / VOLKSWAGEN	开迪/CADDY, 高尔夫/GOLF
	奥迪 / AUDI	100/100
433138	奔驰 / MERCEDES-BENZ	E级/CLASSE E
433181	宝马 / BMW	3系/3
439007	宝马 / BMW	3系/3, 5系/5, Z3/Z3
439083	标致 / PEUGEOT	406/406
	雪铁龙 / CITROEN	桑蒂雅/XANTIA
439095	奔驰 / MERCEDES-BENZ	C级/CLASSE C, E级/CLASSE E
		M级/CLASSE M, CLK/ CLK
439166	标致 / PEUGEOT	406/406, 607/607
	雪铁龙 / CITROEN	C5 / C5
439206	奔驰 / MERCEDES-BENZ	A级/CLASSE A
439223	宝马 / BMW	3系/3, 5系/5, Z3/Z3
439232	奔驰 / MERCEDES-BENZ	A级/CLASSE A, Vaneo/Vaneo
439234	宝马 / BMW	3系/3, 5系/5, 7系/7, Z3/Z3
439237	宝马 / BMW	3系/3
439252	宝马 / BMW	5系/5
439271	大众 / VOLKSWAGEN	尚酷 / SCIROCCO
	奥迪 / AUDI	A3/A3, A4/A4, A6/A6
439285	雷诺 / RENAULT	拉古娜/LAGUNA
		梅甘娜/MEGANE
439286	雷诺 / RENAULT	太空/ESPACE, 拉古娜/LAGUNA
		梅甘娜/MEGANE
439287	雷诺 / RENAULT	太空/ESPACE, 拉古娜/LAGUNA
		梅甘娜/MEGANE
439292	沃尔沃 / VOLVO	S40/S40
	雷诺 / RENAULT	拉古娜/LAGUNA
439294	标致 / PEUGEOT	307CC /307CC, 406/406, 607/607
	雪铁龙 / CITROEN	C5/C5, 塞纳/XSARA
439296	奔驰 / MERCEDES-BENZ	C级/CLASSE C
439298	奔驰 / MERCEDES-BENZ	C级/CLASSE C, M级/CLASSE M
		CLK/ CLK
439299	奔驰 / MERCEDES-BENZ	C级/CLASSE C
439306	雷诺 / RENAULT	拉古娜/LAGUNA
		梅甘娜/MEGANE
439307	奔驰 / MERCEDES-BENZ	E级/CLASSE E, 唯雅诺/VIANO
		威霆/VITO
439310	大众 / VOLKSWAGEN	甲壳虫/NEW BEETLE
	奥迪 / AUDI	A3/A3, TT/TT

Valeo		
439311	大众 / VOLKSWAGEN	甲壳虫/NEW BEETLE
	奥迪 / AUDI	A3/A3, TT/TT
439312	大众 / VOLKSWAGEN	甲壳虫/NEW BEETLE
	奥迪 / AUDI	A3/A3, TT/TT
439317	宝马 / BMW	Z3/Z3
439318	雷诺 / RENAULT	风景/SCENIC
439326	大众 / VOLKSWAGEN	甲壳虫/NEW BEETLE
	奥迪 / AUDI	A3/A3, TT/TT
439338	奥迪 / AUDI	A4/A4, A6/A6
439391	奥迪 / AUDI	A4/A4, A6/A6, A8/A8
439393	大众 / VOLKSWAGEN	EOS/EOS
	奥迪 / AUDI	A3/A3, A4/A4
439394	雷诺 / RENAULT	拉古娜/LAGUNA
439397	宝马 / BMW	3系/3, 5系/5
439398	宝马 / BMW	3系/3, 5系/5
439420	奔驰 / MERCEDES-BENZ	C级/CLASSE C
439427	欧宝 / OPEL	欧米茄/OMEGA, 雅特/ASTRA
439435	标致 / PEUGEOT	406/406
	雪铁龙 / CITROEN	C5/C5
	大众 / VOLKSWAGEN	甲壳虫/NEW BEETLE
	奥迪 / AUDI	A3/A3, TT/TT
439454	欧宝 / OPEL	赛飞利/ZAFIRA, 雅特/ASTRA
439457	欧宝 / OPEL	欧米茄/OMEGA, 雅特/ASTRA
439464	雷诺 / RENAULT	拉古娜/LAGUNA
439467	雷诺 / RENAULT	拉古娜/LAGUNA
439468	路虎 / LAND ROVER	发现/DISCOVERY
439469	迷你 / MINI	迷你 / MINI
439470	标致 / PEUGEOT	406/406, 407/407
	雪铁龙 / CITROEN	C5/C5
439471	奔驰 / MERCEDES-BENZ	C级/CLASSE C, CLK/ CLK,
		SLK/SLK
439476	宝马 / BMW	1系/1, 3系/3
439478	雷诺 / RENAULT	梅甘娜/MEGANE, 风景/SCENIC
439479	雷诺 / RENAULT	梅甘娜/MEGANE, 风景/SCENIC
439485	宝马 / BMW	5系/5
439486	宝马 / BMW	5系/5, 7系/7, X3/X3
439487	宝马 / BMW	X3/X3
439489	大众 / VOLKSWAGEN	EOS/EOS, 尚酷R / SCIROCCO R
	奥迪 / AUDI	A3/A3, A4/A4, TT/TT



### 发电机件号检索 / Alternator Part Number Index

Valeo		
439496	雪铁龙 / CITROEN	塞纳/XSARA 塞纳毕加索/XSARA PICASSO
439498	奥迪 / AUDI	A4/A4
439507	宝马 / BMW	X5/X5
439510	宝马 / BMW	5系/5, 6系/7, 7系/7
439521	标致 / PEUGEOT	307CC/307 CC, 407/407
	雪铁龙 / CITROEN	C4/C4, C5/C5
439527	大众 / VOLKSWAGEN	途锐/TOUAREG
	奥迪 / AUDI	Q7 / Q7
439534	大众 / VOLKSWAGEN	EOS / EOS
	奥迪 / AUDI	A4 旅行车/A4 Avant
439535	奥迪 / AUDI	A6 / A6
439537	宝马 / BMW	X5 / X5
439541	奥迪 / AUDI	A6 / A6
439544	奔驰 / MERCEDES-BENZ	A级/CLASSE A, B级/CLASSE B
439551	奔驰 / MERCEDES-BENZ	A级/CLASSE A, B级/CLASSE B
439554	奥迪 / AUDI	A6 / A6
439555	奔驰 / MERCEDES-BENZ	S级/CLASSE S, SL/SL
439558	大众 / VOLKSWAGEN	帕萨特/PASSAT
439559	宝马 / BMW	M5 / M5
439560	宝马 / BMW	1系/1, 3系/3, 5系/5, 7系/7
439561	雷诺 / RENAULT	梅甘娜/MEGANE, 风景/SCENIC
439563	大众 / VOLKSWAGEN	尚酷/SCIROCCO, 途观/TIGUAN
	奥迪 / AUDI	A3 / A3
439564	奥迪 / AUDI	A4 / A4
439566	宝马 / BMW	5系/5, 7系/7
439567	宝马 / BMW	X3 / X3
439574	奥迪 / AUDI	A4/A4, A6/A6
439580	大众 / VOLKSWAGEN	高尔夫/GOLF
	奥迪 / AUDI	A3 / A3
439581	奥迪 / AUDI	A6 / A6
439587	雷诺 / RENAULT	梅甘娜/MEGANE
439588	雷诺 / RENAULT	梅甘娜/MEGANE
439594	欧宝 / OPEL	雅特/ASTRA, 欧米茄/OMEGA
439601	宝马 / BMW	X5 / X5
439602	宝马 / BMW	X5 / X5
439603	宝马 / BMW	X5 / X5
439610	奔驰 / MERCEDES-BENZ	C级/CLASSE C
439611	奔驰 / MERCEDES-BENZ	C级/CLASSE C

Valeo		
439617	迷你 / MINI	迷你 One / MINI, 迷你CLUBMAN/MINI CLUBMAN
439618	奥迪 / AUDI	S5 / S5
439624	奥迪 / AUDI	Q7/Q7
	大众 / VOLKSWAGEN	途锐/TOUAREG
439628	雷诺 / RENAULT	拉古娜 / LAGUNA
439634	雪铁龙 / CITROEN	C5 / C5
439636	宝马 / BMW	X6/X6, 5系/5, 7系/7
439639	奥迪 / AUDI	Q7 / Q7
439640	宝马 / BMW	7系/7, X6/X6
439645	雷诺 / RENAULT	拉古娜/LAGUNA
439647	雷诺 / RENAULT	拉古娜/LAGUNA 梅甘娜/MEGANE
439649	奔驰 / MERCEDES-BENZ	CLS/CLS, E级/CLASSE E S级/CLASSE S
439658	奥迪 / AUDI	A4/A4, A5/A5, Q5/Q5
439664	斯柯达 / SKODA	晶锐 / FABIA
439675	宝马 / BMW	M3 / M3
439692	标致 / PEUGEOT	407 / 407
	雪铁龙 / CITROEN	C4/C4, C5/C5
439713	大众 / VOLKSWAGEN	途锐/TOUAREG
439772	奔驰 / MERCEDES-BENZ	M级/CLASSE M, SLK/SLK
439773	奔驰 / MERCEDES-BENZ	C级/CLASSE C
439774	大众 / VOLKSWAGEN	途锐 / TOUAREG
439782	奥迪 / AUDI	A6 / A6
439784	大众 / VOLKSWAGEN	途锐 / TOUAREG
439798	奥迪 / AUDI	A5/A5, Q5/Q5
439816	奥迪 / AUDI	Q7 / Q7
439817	奥迪 / AUDI	Q7 / Q7
439821	奥迪 / AUDI	A1 / A1
442016	上海大众 / SVW-VOLKSWAGEN	桑塔纳2000 / SANTANA 2000
442018	一汽大众奥迪 / FAW-AUDI	100 / 100
	上海大众 / SVW-VOLKSWAGEN	桑塔纳 / SANTANA
442019	一汽大众 / FAW-VOLKSWAGEN	宝来/BORA, 捷达/JETTA
	上海大众 / SVW-VOLKSWAGEN	波罗 / POLO
442020	一汽大众 / FAW-VOLKSWAGEN	捷达王/JETTA
442022	一汽大众 / FAW-VOLKSWAGEN	宝来/BORA, 捷达/JETTA 高尔夫/GOLF
442023	上海大众 / SVW-VOLKSWAGEN	波罗 / POLO
442024	上海大众 / SVW-VOLKSWAGEN	波罗 / POLO



### 发电机件号检索 / Alternator Part Number Index

Valeo		
442025	一汽大众 / FAW-VOLKSWAGEN	高尔夫/GOLF, 波罗/POLO 明锐/OCTAVIA
442026	上海大众 / SVW-VOLKSWAGEN	高尔/GOL
442027	上海大众 / SVW-VOLKSWAGEN	朗逸/LAVIDA
442028	上海大众 / SVW-VOLKSWAGEN	帕萨特/PASSAT, 桑塔纳3000/SANTANA 3000 桑塔纳志俊/SANTANA VISTA
442029	上海大众 / SVW-VOLKSWAGEN	帕萨特领驭 / PASSAT LINGYU
442030	一汽大众 / FAW-VOLKSWAGEN	开迪/CADDY, 宝来/BORA 迈腾/MAGOTAN, 速腾/SAGITAR
	上海大众 / SVW-VOLKSWAGEN	朗逸/LAVIDA, 途安/TOURAN
	上海大众斯柯达 / SVW-SKODA	明锐/OCTAVIA
442031	一汽大众 / FAW-VOLKSWAGEN	速腾/SAGITAR, 迈腾/MAGOTAN
	一汽大众奥迪 / FAW-AUDI	A4 / A4
	上海大众斯柯达 / SVW-SKODA	昊锐/SUPERB, 明锐/OCTAVIA
442032	一汽大众奥迪 / FAW-AUDI	A4/A4, A6/A6
	上海大众 / SVW-VOLKSWAGEN	帕萨特领驭/PASSAT LINGYU
442034	一汽大众奥迪 / FAW-AUDI	A6/A6
442035	一汽大众奥迪 / FAW-AUDI	A6/A6
	上海大众 / SVW-VOLKSWAGEN	帕萨特/PASSAT
442041	东风标致 / DONGFENG-PEUGEOT	307/307, 408/408
	东风雪铁龙 / DONGFENG-CITROEN	世嘉/C-QUATRE 凯旋/C-TRIOMPHE, 赛纳/XSARA
442042	东风标致 / DONGFENG-PEUGEOT	206/206, 207/207
	东风雪铁龙 / DONGFENG-CITROEN	C2/C2, 毕加索/XSARA PICASSO 爱丽舍/ELYSEE
442056	东风悦达起亚 / DONGFENG YUEDA-KIA	赛拉图/CERATO
	北京现代 / BEIJING-HYUNDAI	i30/i30, 伊兰特/ELANTRA 名驭/MOINCA, 索纳塔/SONATA 途胜/TUCSON, 雅绅特/ACCENT
442062	长城汽车 / GREAT WALL	精灵CROSS / GWEROU CROSS
442066	一汽轿车 / FAW	红旗世纪星/CENTURY STAR
442071	南京菲亚特 / NANJING-FIAT	派力奥/PALIO, 西耶那/SIENA
442079	长安铃木 / CHANGAN-SUZUKI	长安奥拓 / ALTO
442081	长安汽车 / CHANGAN AUTOMOBILE	长安之星 / STAR
442082	吉利汽车 / GEELY	豪情/HAOQING
442083	东风柳汽 / LIUZHOU MOTOR	风行/FUTURE
442116	华晨汽车 / SHENYANG BRILLIANCE	海狮/HAISE Bus
442118	上海汽车 / SAIC	荣威750 / 750

Valeo		
442121	上海大众 / SVW-VOLKSWAGEN	CrossPolo / POLO CROSS 波罗 / POLO
	上海大众斯柯达 / SVW-SKODA	晶锐 / FABIA
442122	一汽大众 / FAW-VOLKSWAGEN	宝来/BORA, 速腾/SAGITAR 迈腾/MAGOTAN, 高尔夫/GOLF
442123	东风悦达起亚 / DONGFENG YUEDA-KIA	福瑞迪/FORTE, 秀尔/SOUL
	北京现代 / BEIJING-HYUNDAI	伊兰特·悦动 / YUE DONG 瑞纳/VERNA
442124	华晨汽车 / SHENYANG BRILLIANCE	尊驰/ZUNCHI, 酷宝/KUBAO 骏捷/JUNJIE
442125	长城汽车 / GREAT WALL	凌傲/LINGAO 哈弗M1/HOVR M1, 炫丽/FLORID
442126	长城汽车 / GREAT WALL	凌傲/LINGAO, 哈弗M2/HOVR M2 炫丽/FLORID, 腾翼C30/TENGYI C30 酷熊/COOLBEAR
442127	长城汽车 / GREAT WALL	迪尔/DEER
442134	一汽大众奥迪 / FAW-AUDI	A6L/A6L
442158	东南汽车 / SOUTH EAST(FUJIAN)	蓝瑟/LANCER
442188	比亚迪 / BYD	F6 / F6
442189	上海汽车 / SAIC	名爵7/MG7, 荣威550/550 荣威750/750
442190	上海汽车 / SAIC	荣威350/350
442191	上海汽车 / SAIC	荣威350/350
442192	上海大众 / SVW-VOLKSWAGEN	朗逸/LAVIDA
442193	一汽大众 / FAW-VOLKSWAGEN	CC/CC, 途观/TIGUAN
442194	北京现代 / BEIJING-HYUNDAI	i30/i30, 瑞纳/VERNA
442195	比亚迪 / BYD	F6 / F6
442196	一汽轿车 / FAW	奔腾B50 / BESTURN B50
442209	北京奔驰 / BEIJING BENZ	C级/CLASSE C
442210	北京奔驰 / BEIJING BENZ	C级/CLASSE C
442211	北京奔驰 / BEIJING BENZ	C级/CLASSE C
442212	北京奔驰 / BEIJING BENZ	E级/CLASSE E
442213	东风日产 / DONGFENG-NISSAN	奇骏/X-TRAIL, 逍客/QASHQAI
442214	一汽海马 / FAW-HAIMA	普力马/FREEMA
442215	江淮汽车 / JAC	瑞风/REFINE
442216	上海汽车 / SAIC	荣威750/750
442217	奇瑞汽车 / CHERY	A3/A3
442218	比亚迪 / BYD	M6/M6, S6/S6
442219	一汽吉林 / FAW GROUP(JILIN)	森雅M80/XENIA M80 森雅S80/XENIA S80



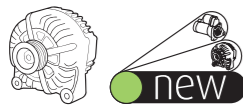

发电机件号检索 / Alternator Part Number Index

Valeo		
442220	一汽吉林 / FAW GROUP(JILIN)	森雅M80/XENIA M80 森雅S80/XENIA S80
600024	华泰现代 / HUATAI AUTOMOBILE	特拉卡/TERRACAN
600027	北京现代 / BEIJING-HYUNDAI	途胜/TUCSON
600029	北京现代 / BEIJING-HYUNDAI	索纳塔 御翔/SONATA (NF)
600093	东风悦达起亚 / DONGFENG YUEDA-KIA	嘉华/CARNIVAL 狮跑/SPORTAGE
	北京现代 / BEIJING-HYUNDAI	索纳塔/SONATA 途胜/TUCSON
	华泰现代 / HUATAI AUTOMOBILE	圣达菲/SANTA FE
	600102	东风悦达起亚 / DONGFENG YUEDA-KIA
	华泰现代 / HUATAI AUTOMOBILE	特拉卡/TERRACAN

Valeo		



国产车型检索  
Domestic Car Models Index

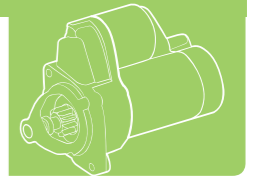

一汽大众奥迪 / FAW-AUDI	9
一汽大众 / FAW-VOLKSWAGEN	9
上海大众 / SVW-VOLKSWAGEN	10
上海大众斯柯达 / SVW-SKODA	12
上海汽车 / SAIC	12
一汽轿车 / FAW	12
东南汽车 / SOUTH EAST(FUJIAN)	12
北京现代 / BEIJING-HYUNDAI	12
华泰现代 / HUATAI AUTOMOBILE	13
东风悦达起亚 / DONGFENG YUEDA-KIA	13
东风雪铁龙 / DONGFENG-CITROEN	13
一汽海马 / FAW-HAIMA	13
长城汽车 / GREAT WALL	14
奇瑞汽车 / CHERY	14
比亚迪 / BYD	15
长安铃木 / CHANGAN-SUZUKI	15
江淮汽车 / JAC	15
哈飞汽车 / HAFEI AUTOMOBILE	15
南京菲亚特 / NANJING-FIAT	15
江铃汽车 / JIANGLING MOTORS	16
一汽吉林 / FAW GROUP(JILIN)	16

进口车型检索  
Import Car Models Index

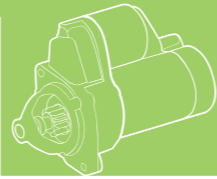

奥迪 / AUDI	17
宝马 / BMW	17
雪铁龙 / CITROEN	18
本田 / HONDA	18
现代 / HYUNDAI	18
玛莎拉蒂 / MASERATI	18
奔驰 / MERCEDES-BENZ	19
欧宝 / OPEL	20
标致 / PEUGEOT	21
雷诺 / RENAULT	22
斯柯达 / SKODA	22
丰田 / TOYOTA	22
大众 / VOLKSWAGEN	22

一汽大众奥迪 / FAW-AUDI		100 / 100 (443, 4A2)		442015		12	1,1	9	30
1.8L		JW	08/88 > 12/90						
A6(C5) / A6 Saloon (C5)		1.8T		442015		12	1,1	9	30
1.8T		AWL	07/00 > 12/05						
一汽大众 / FAW-VOLKSWAGEN		宝来 / BORA		442006		12	1,1	10	40
1.6L	M	BJH	06/02 > 09/06						
1.6L	A	BJH	06/02 > 09/06	圆插头 / round connector	442009	12	1,1	10	40
宝来 / BORA (1J2)		1.8T		442009		12	1,1	10	40
1.8T	A	BAE	12/01 > 12/06	圆插头 / round connector					
1.8L	M	BAF	12/01 > 12/06		442006	12	1,1	10	40
1.8L	A	BAF	12/01 > 12/06	圆插头 / round connector	442009	12	1,1	10	40
新宝来 / BORA		1.4TSI		442201		12	1,1	10	82
1.4TSI	M	CFB	06/10 >						
1.4TSI	A	CFB	06/10 >		442202	12	1,1	11	54.4
1.6L	A	BWH	11/08 >		442011	12	1,1	10	42
1.6L	M	BWH	11/08 >		442012	12	1,1	10	40
2.0L	A	CEN	11/08 > 12/10		442011	12	1,1	10	42
2.0L	M	CEN	11/08 > 12/10		442012	12	1,1	10	40
开迪 / CADDY Box		1.6L		442011		12	1,1	10	42
1.6L	A	BRY	03/05 > 12/07						
1.6L	M	BRY	03/05 > 12/07		442012	12	1,1	10	40
2.0D / 柴油	A		03/05 > 12/07		442011	12	1,1	10	42
2.0D / 柴油	M		03/05 > 12/07		442013	12	1,1	10	42
捷达王 (1G2, 1J2) / JETTA (1G2, 1J2)		1.6L		442004		12	1,1	9	43
1.6L	M		01/98 > 01/02						
捷达 / JETTA		1.6L		442009		12	1,1	10	40
1.6L	M	BJG	01/04 >	圆插头 / round connector					
1.6L	M	BJG	01/04 >	方插头 / square connector	442240	12	1,1	10	40
捷达 (1G2, 1J2) / JETTA (1G2, 1J2)		1.9TDI / 柴油		442005		12	2	11	40
1.9TDI / 柴油	A/M	ALH	08/98 > 04/00						
迈腾 (B6) / MAGOTAN (B6)		1.4TSI		442014		12	1,1	10	42
1.4TSI	M	CFB	01/10 > 07/11						
1.4TSI	A	CFB	01/10 > 07/11		442200	12	1,1	10	54.4
1.8TSI	A	BYJ	06/07 > 07/11		442011	12	1,1	10	42
1.8TSI	M	BYJ	06/07 > 07/11		442014	12	1,1	10	42
2.0TSi	A		04/08 > 07/11		442011	12	1,1	10	42
2.0TSi	M		04/08 > 07/11		442014	12	1,1	10	42
2.0L	A	BJZ	06/07 > 04/08		442011	12	1,1	10	42
2.0L	M	BJZ	06/07 > 04/08		442014	12	1,1	10	42



一汽大众 / FAW-VOLKSWAGEN									
CC / CC									
1.8T	M		07/10 >	442014	12	1,1		10	42°
1.8T	A		07/10 >	442202	12	1,1		11	54.4°
2.0T	M		07/10 >	442014	12	1,1		10	42°
速腾 / SAGITAR									
1.6L	A	BWH	02/06 >	442011	12	1,1		10	42°
1.6L	M	BWH	02/06 >	442012	12	1,1		10	40°
1.8T	A	BPL	04/06 > 04/08	442011	12	1,1		10	42°
1.8T	M	BPL	04/06 > 04/08	442014	12	1,1		10	42°
2.0L	A	BJZ	04/06 > 06/09	442011	12	1,1		10	42°
2.0L	M	BJZ	04/06 > 06/09	442012	12	1,1		10	40°
新速腾 / SAGITAR									
1.4TSI	M	CFB	09/09 >	442014	12	1,1		10	42°
1.4TSI	A	CFB	09/09 >	442202	12	1,1		11	54.4°
1.8TSI	A	BYJ	07/08 >	442011	12	1,1		10	42°
1.8TSI	M	BYJ	07/08 >	442014	12	1,1		10	42°
高尔夫 / GOLF									
1.6L	M	BFQ	08/03 > 01/05	442006	12	1,1		10	40°
1.6L	A	BFQ	08/03 > 01/05	442240	12	1,1		10	40°
1.8L	M	BAF	07/03 > 07/09	442006	12	1,1		10	40°
1.8L	A	BAF	07/03 > 07/09	442240	12	1,1		10	40°
高尔夫 6 / GOLF									
1.4TSI	M	CFB	08/09 >	442014	12	1,1		10	42°
1.4TSI	A	CFB	08/09 >	442200	12	1,1		10	54.4°
1.6L	M		08/09 >	442010	12	1,1		10	40°
上海大众 / SVW-VOLKSWAGEN									
波罗三厢 / POLO Saloon									
1.4L	M	BCC	06/03 > 03/06	442010	12	1,1		10	40°
1.4L	A	BCC	06/03 > 03/06	442011	12	1,1		10	42°
1.6L	M	BCD	01/02 > 01/06	442012	12	1,1		10	40°
1.6L	A	BCD	01/02 > 01/06	442011	12	1,1		10	42°
波罗两厢 / POLO Hatchback									
1.4L	M	BCC	01/02 > 03/06	442010	12	1,1		10	40°
1.4L	A	BCC	01/02 > 03/06	442011	12	1,1		10	42°
1.6L	M	BCD	01/02 > 01/06	442012	12	1,1		10	40°
1.6L	A	BCD	01/02 > 01/06	442011	12	1,1		10	42°
劲取 / POLO JINQU Saloon									
1.4L	M		06/06 >	442010	12	1,1		10	40°
1.4L	A		06/06 >	442011	12	1,1		10	42°
1.6L	M	CDE	12/07 >	442010	12	1,1		10	40°
1.6L	A	CDE	12/07 >	442011	12	1,1		10	42°

上海大众 / SVW-VOLKSWAGEN									
劲情 / POLO JINQIN Hatchback									
1.4L	M	CDD	06/06 >	442010	12	1,1		10	40°
1.4L	A	CDD	06/06 >	442011	12	1,1		10	42°
1.6L	M	CDE	06/06 > 12/07	442010	12	1,1		10	40°
1.6L	A	CDE	06/06 > 12/07	442011	12	1,1		10	42°
CrossPolo / POLO CROSS									
1.6L	M	CDE	12/07 >	442010	12	1,1		10	40°
1.6L	A	CDE	12/07 >	442011	12	1,1		10	42°
帕萨特 (B5) / PASSAT Saloon (B5)									
1.8T	A	AWL	01/01 > 04/09	442015	12	1,1		9	30°
1.8L	A/M	ANQ	04/00 > 02/03	442015	12	1,1		9	30°
2.0L	A/M	BFF	02/03 > 04/09	442015	12	1,1		9	30°
朗逸 / LAVIDA									
1.4TSi	M	CFB	03/10 >	442201	12	1,1		10	82°
1.4TSi	A	CFB	03/10 >	442202	12	1,1		11	54.4°
1.6L	M	CDE	04/08 >	442010	12	1,1		10	40°
1.6L	A	CDE	04/08 >	442011	12	1,1		10	42°
2.0L	A	CEN	04/08 >	442011	12	1,1		10	42°
2.0L	M	CEN	04/08 >	442012	12	1,1		10	40°
桑塔纳 / SANTANA									
1.6L			08/96 >	12/00 > 01/06	442205	12	1,1	9	28°
1.8L	M	JV	03/85 >	包括警车 /include police car	442003	12	1,1	9	28°
1.8L	M	AFE	08/96 >	包括警车 /include police car	442003	12	1,1	9	28°
桑塔纳 2000 / SANTANA 2000									
1.8L	M	JV /AFE /AYJ	04/95 > 03/04	442003	12	1,1		9	28°
桑塔纳 3000 / SANTANA 3000									
1.8L	M	AYJ /BKT	03/04 > 01/07	442003	12	1,1		9	28°
桑塔纳 Vista 志俊 / SANTANA VISTA									
1.6L	M		07/10 >	442003	12	1,1		9	28°
1.8L	M	BKT	01/08 >	442003	12	1,1		9	28°
2.0L	M		01/08 >	442003	12	1,1		9	28°
途安 / TOURAN MPV									
1.8T	A	BPL	05/05 >	442011	12	1,1		10	42°
1.8T	M	BPL	05/05 >	442014	12	1,1		10	42°
2.0L	A		11/04 > 01/08	442011	12	1,1		10	42°
2.0L	M		11/04 > 01/08	442013	12	1,1		10	42°
途观 / TIGUAN									
1.8TSI	A	CEA	03/10 >	442011	12	1,1		10	42°
1.8TSI	M	CEA	03/10 >	442014	12	1,1		10	42°
2.0TSI 4motion	A	CGM	03/10 >	442011	12	1,1		10	42°
高尔 / GOL									
1.6L	M	BHJ	12/03 > 02/05	442003	12	1,1		9	28°

上海大众斯柯达 / SVW-SKODA										
昊锐 / SUPERB										
1.4TSI	A	CFB	04/10 >	442200	12	1,1		10	54.4	↕
1.8TSI	A		08/09 >	442011	12	1,1		10	42	↕
1.8TSI	M		08/09 >	442014	12	1,1		10	42	↕
2.0TSI	A		08/09 >	442011	12	1,1		10	42	↕
明锐 / OCTAVIA										
1.4TSi	A	CFB	04/10 >	442200	12	1,1		10	54.4	↕
1.6L	M	CDF	06/07 > 04/10	442010	12	1,1		10	40	↕
1.6L	A	CDF	06/07 > 04/10	442011	12	1,1		10	42	↕
1.8TSI	A	BYJ	06/07 > 04/10	442011	12	1,1		10	42	↕
2.0L	A	BXX	06/07 > 04/10	442011	12	1,1		10	42	↕
2.0L	M	BXX	06/07 > 04/10	442012	12	1,1		10	40	↕
晶锐 / FABIA										
1.4L	M	CDD	12/08 >	442010	12	1,1		10	40	↕
1.4L	A	CDD	12/08 >	442011	12	1,1		10	42	↕
1.6L	M	CDE	12/08 >	442010	12	1,1		10	40	↕
1.6L	A	CDE	12/08 >	442011	12	1,1		10	42	↕
上海汽车 / SAIC										
MG7 / 7										
1.8T	A	18 K4K	07/07 >	442077	12	1,2		9	90	↕
荣威 350 / 350										
1.5L			04/10 >	442198	12	0,9		9	37.5	↕
荣威 550 / 550										
1.8T	M	18K4G	06/08 >	442076	12	1		11	70	↕
1.8T	A	18K4G	06/08 >	442077	12	1,2		9	90	↕
荣威 750 / 750										
1.8T	M		03/08 >	442076	12	1		11	70	↕
1.8T	A		03/08 >	442077	12	1,2		9	90	↕
一汽轿车 / FAW										
红旗世纪星 / CENTURY STAR (CA7202)										
2.4L		V6BFK	09/00 >	442065	12	1,1		9	39	↕
东南汽车 / SOUTH EAST(FUJIAN)										
菱帅 / LIONCEL										
1.6L		4 G 18	03/03 >	442072	12	1,1		8	54	↕
蓝瑟 / LANCER										
1.6L		4 G 18	05/06 >	442072	12	1,1		8	54	↕
北京现代 / BEIJING-HYUNDAI										
i30 / i30 Hatchback										
1.6L	A/M	GAMA	07/09 >	442119	12	0,8		8	53.5	↕
伊兰特三厢 / ELANTRA Saloon										
1.6L	M	G4GR /G4GA	12/03 >	442055	12	1		8	54	↕

北京现代 / BEIJING-HYUNDAI										
伊兰特两厢 / ELANTRA Hatchback										
1.6L	M	G4GR	03/07 >	442055	12	1		8	54	↕
伊兰特·悦动 / YUE DONG										
1.6L	A/M	GAMA	04/08 >	442119	12	0,8		8	53.5	↕
瑞纳三厢 / VERNA Saloon										
1.4L		G4FA	08/10 >	442203	12	0,8		8	53.5	↕
1.6L		G4FC	08/10 >	442203	12	0,8		8	53.5	↕
瑞纳两厢 / VERNA Hatchback										
1.4L		G4FA	12/10 >	442203	12	0,8		8	53.5	↕
1.6L		G4FC	12/10 >	442203	12	0,8		8	53.5	↕
雅绅特 / ACCENT										
1.4L	M	G4EE	02/06 >	442055	12	1		8	54	↕
华泰现代 / HUATAI AUTOMOBILE										
圣达菲 / SANTA FE Closed Off-Road Vehicle										
2.7 四驱 / All-wheel Drive		G6BA	01/06 >	600071	12	1,4		8	25.5	↕
特拉卡 / TERRACAN Closed Off-Road Vehicle										
3.5 四驱 / All-wheel Drive		G6CU	03/03 > 12/08	600071	12	1,4		8	25.5	↕
东风悦达起亚 / DONGFENG YUEDA-KIA										
秀尔 / SOUL Hatchback										
1.6L		G4FC	12/09 >	442055	12	1		8	54	↕
1.6L		GAMA	12/09 >	442119	12	0,8		8	53.5	↕
福瑞迪 / FORTE										
1.6L		G4FC	06/09 >	442055	12	1		8	54	↕
1.6L		GAMA	06/09 >	442119	12	0,8		8	53.5	↕
赛拉图 / CERATO										
1.6L	M	G4ED	05/05 >	442055	12	1		8	54	↕
赛拉图两厢 / CERATO Hatchback										
1.6L	M	G4ED	12/07 >	442055	12	1		8	54	↕
东风雪铁龙 / DONGFENG-CITROEN										
C5 / C5										
2.3L			01/10 >	442128	12	1,8		9	34	↕
一汽海马 / FAW-HAIMA										
普力马 / PREMACY MPV										
1.8L	A	HM483Q	03/07 > 01/09	442069	12	1,1		10	52	↕
欢动 / HUANDONG										
1.8L	A	HM483Q	12/08 > 12/10	442068	12	1,1		9	52	↕
海马 3 / 3										
1.6L	M	TRITEC 1,6	09/09 >	442068	12	1,1		9	52	↕
1.8L	M	FP-DE	06/07 > 12/10	442068	12	1,1		9	52	↕

<b>长城汽车 / GREAT WALL</b>									
<b>凌傲 / LINGAO</b>									
1.3L	M		11/09 >	442241	12	1,1		10	37
1.5L	M	GW4G15	11/09 >	442241	12	1,1		10	37
<b>哈弗 M1 / HOVER M1</b>									
1.3L	M		09/09 >	442241	12	1,1		10	37
<b>哈弗 M2 / HOVER M2</b>									
1.5L	M		03/10 >	442241	12	1,1		10	37
<b>腾翼 C30 / TENGYI C30 Saloon</b>									
1.5L	M	GW4G15	05/10 >	442241	12	1,1		10	37
<b>赛弗 / SAFE Closed Off-Road Vehicle</b>									
2.2L		GA4910E	05/02 > 01/08	442061	12	1,2		9	60
<b>赛影 / SING</b>									
2.2L		GA4910E	08/03 > 05/10	442061	12	1,2		9	60
<b>赛骏 / PEGASUS</b>									
2.2L		4910E	02/04 > 12/08	442061	12	1,2		9	60
<b>迪尔 / DEER Pickup</b>									
2.2L	M	GA4910E	05/96 >	442061	12	1,2		9	60
<b>酷熊 / COOLBEAR MPV</b>									
1.5L	M	GW4G15	03/09 >	442241	12	1,1		10	37
<b>炫丽 / FLORID</b>									
1.3L	M		05/09 >	442241	12	1,1		10	37
1.3L	M	GW413EF	09/08 >	442059	12	1,1		8	87
1.5L	M	GW4G15	02/09 >	442241	12	1,1		10	37
<b>奇瑞汽车 / CHERY</b>									
<b>A1 / A1</b>									
1.3L		SQR473F	04/07 >	442047	12	1,1		9	39
<b>A5 / A5</b>									
1.6L		SQR481F	01/06 > 01/09	442045	12	1,4		9	39
2.0L			01/06 >	442045	12	1,4		9	39
<b>QQ3 / QQ3</b>									
0.8L	M		03/04 >	442197	12	0,8		9	38
<b>QQ6 / QQ6</b>									
1.3L		SQR473F	09/06 >	442047	12	1,1		9	39
<b>V5 / V5</b>									
1.9TD / 柴油	M	SQR481A	09/09 >	442043	12	2,2		9	29.7
<b>东方之子 / EASTAR</b>									
1.9TDI / 柴油	M		06/10 >	442043	12	2,2		9	29.7
<b>瑞麒 M1 / M1</b>									
1.3L		SQR473	03/09 >	442047	12	1,1		9	39
<b>风云 / FENGYUN</b>									
1.6L		SQR480	03/01 > 12/06	442049	12	1,1		9	43

<b>比亚迪 / BYD</b>									
<b>F0 / F0 Hatchback</b>									
1.0L	M	3710A	09/08 >	442057	12	1,1		8	83
<b>F3 / F3</b>									
1.5L	M	4G15S /473QB	09/07 >	442199	12	1,1		9	46
1.6L	A/M	4G18	09/05 > 12/10	442072	12	1,1		8	54
<b>F3-R / F3R Hatchback</b>									
1.5L		4G15S /473QB	04/07 >	442199	12	1,1		9	46
1.6L		4G18	09/07 >	442072	12	1,1		8	54
<b>F6 / F6</b>									
1.8L	M	4830A	06/10 >	442058	12	1,2		9	66.6
1.8L	A	4830A	06/10 >	442223	12	1,1		9	38
2.0L	M	4830B	03/08 >	442058	12	1,2		9	66.6
<b>长安铃木 / CHANGAN-SUZUKI</b>									
<b>天语 SX4 三厢 / SX4 Saloon</b>									
1.6L		M16A	11/06 > 12/10	442254	12	1,2		8	40
1.8L		M18A	03/09 > 12/10	442254	12	1,2		8	40
<b>天语 SX4 两厢 / SX4 Hatchback</b>									
1.6L		M16A	04/07 >	442254	12	1,2		8	40
1.8L		M18A	03/09 >	442254	12	1,2		8	40
<b>江淮汽车 / JAC</b>									
<b>和悦 / HE YUE Saloon</b>									
1.5L			01/09 > 09/10	442222	12	1		10	43
<b>瑞风 / REFINE (M1)</b>									
2.0L		HFC4GA3-1B	01/02 >	442052	12	1,4		8	30
2.4L	A/M	G4JS	02/02 >	442052	12	1,4		8	30
<b>哈飞汽车 / HAFEI AUTOMOBILE</b>									
<b>赛豹 3 / SAIBAO 3 Saloon</b>									
1.6L	A/M	DA4G18	04/05 >	442072	12	1,1		8	54
<b>赛豹 5 / SAIBAO 5 Saloon</b>									
1.6L	A/M	DA4G18	01/07 >	442072	12	1,1		8	54
<b>赛马 / SIGMA / SAIMA</b>									
1.3L	A/M	DA471Q	06/00 >	442072	12	1,1		8	54
1.5L	A/M	4 G 15 S	04/09 >	442072	12	1,1		8	54
1.6L	A/M	DA476Q	09/00 >	442072	12	1,1		8	54
<b>南京菲亚特 / NANJING-FIAT</b>									
<b>西耶那 / SIENA</b>									
1.5L	M	178 E5.022	01/03 >	442070	12	1,3		9	35



江铃汽车 / JIANGLING MOTORS										
风尚 / CV9 (FENGSHANG)										
1.6L		JL475Q1	05/06 >		442204					
1.8L		4 G 93	01/08 >		442204					
2.0L		JL486Q	05/06 >		442204					
一汽吉林 / FAW GROUP(JILIN)										
森雅 M80 / XENIA M80										
1.5L		3SZ-VE2	06/07 >		442067	12	1,1		8	40 ⇄
森雅 S80 / XENIA S80										
1.5L			12/10 >		442067	12	1,1		8	40 ⇄

奥迪 / AUDI										
A3 (8P1) / A3										
1.8L		AGN/ APG	09/96 > 05/03		438206	12	1,1		10/11	42 °C
1.9TDI / 柴油	A/M	ATD/ AXR	01/00 > 05/03		438076	12	1,7		10/11	42 °C
S3 1.8 quattro	A/M	AMK/ APY	03/99 > 04/02		438076	12	1,7		10/11	42 °C
1.4TFSI	M	CAXC	06/10 >		438171	12	1,1		10	44 °C
1.8TFSI	A/M	BYT	06/10 >		438171	12	1,1		10	44 °C
A4 (B7) / A4										
2.0TFSI	A/M	BPJ	01/06 > 06/08		438190	12	1,1		9	31 ⇄
A6 (C5) / A6										
2.0TFSI	A/M	BPJ/ BYK	06/05 > 03/11		438190	12	1,1		9	31 ⇄
A8 / A8 (4E_)										
3.7 quattro	A	BFL	05/04 > 05/11		438167	12	1,7		9	39 ⇄
4.2FSI quattro	A	BVJ	06/06 > 07/10		438167	12	1,7		9	39 ⇄
4.2 quattro	A	BFM	05/04 > 05/11		438167	12	1,7		9	39 ⇄
TT / TT (8J3)										
2.0TFSI	A/M	BPY	08/06 >		438174	12	1,1		10	42 °C
2.0TFSI	A/M	CESA	05/10 >		438174	12	1,1		10	42 °C
2.0TFSI quattro	A/M	CCZA	06/08 >		438174	12	1,1		10	42 °C
TT / TT (8N3)										
1.8T quattro		AMU	04/02 > 06/06		438152	12	2		11	42 °C
TTS / TTS (8J3)										
2.0TFSI quattro	A/M	CDLB	01/11 >		438174	12	1,1		10	42 °C
宝马 / BMW										
130i / 130i (E81, E87)										
3.0L	A/M	N52 B30 A	03/05 > 08/09		438272	12	1,2		9	58 ⇄
325i / 325i (E90)										
2.5L	A/M	N52 B25	01/05 >		438272	12	1,2		9	58 ⇄
330i / 330i (E90)										
3.0L	A/M	N52 B30	01/05 >		438272	12	1,2		9	58 ⇄
530i / 530i (E60)										
3.0L	A/M	N52 B30	07/05 >		438272	12	1,2		9	58 ⇄
630i / 630i (E63)										
3.0L	A/M	N52 B30	09/04 > 07/10		438272	12	1,2		9	58 ⇄
730Li / 730Li (E65, E66)										
3.0L	A	N52 B30	03/05 > 01/08		438272	12	1,2		9	58 ⇄
740i / 740i (F01, F02, F03, F04)										
3.0L	A	N54 B30 A	01/08 >		438272	12	1,2		9	58 ⇄
X1 xDrive25i / X1 (E84)										
3.0L	A	N52 B30 A	01/10 >		438272	12	1,2		9	58 ⇄
X1 xDrive28i / X1 (E84)										
3.0L	A	N52 B30 A	02/10 >		438272	12	1,2		9	58 ⇄

<b>宝马 / BMW</b>										
<b>X3 xDrive28i / X3 (F25)</b>										
3.0L	A	N52 B30 A	04/11 >	438272	12	1,2		9	58	↗
<b>Z3 / Z3 (E36)</b>										
3.2L	M	S54 B32/ S54 B32 (32 6 S4)	06/01 > 01/03	438094	12	1,3		9	31	↗
<b>Z4 / Z4 (E85)</b>										
2.5i	A/M	N52 B25 A	01/06 >	438272	12	1,2		9	58	↗
2.5si	A/M	N52 B25 A	01/06 >	438272	12	1,2		9	58	↗
3.0si	A/M	N52 B30	01/06 >	438094	12	1,3		9	31	↗
3.2L	M	S54 326 S4/ S54 B32	03/06 >	438094	12	1,3		9	31	↗
<b>雪铁龙 / CITROEN</b>										
<b>C1 / C1 (PM_, PN_)</b>										
1.0L	M	1KR-FE	06/05 >	438192	12	1		8	80	↗
<b>C3 / C3 (FC_)</b>										
1.6L	A/M	NFU (TU5JP4)	02/02 >	432623	12	1,2		9	55	↗
<b>C3 / C3 Pluriel (HB_)</b>										
1.4L	A/M	KFV (TU3JP)	05/03 > 09/05	432623	12	1,2		9	55	↗
<b>C5 / C5 (DC_)</b>										
1.8L	A/M	6FZ (EW7J4)	03/01 > 08/04	438091	12	1,4		10	55	↗
2.0L	A/M	RFN (EW10J4)	08/04 >	438091	12	1,4		10	55	↗
<b>C5 / C5 (RC_)</b>										
3.0L	A	XFV (ES9A)	09/04 >	438087	12	1,3		10	0	↗
<b>C6 / C6 (TD_)</b>										
3.0L	A	ES9J4S	09/05 >	438087	12	1,3		10	0	↗
<b>本田 / HONDA</b>										
<b>雅阁 / ACCORD III</b>										
1.6 L (CA4)		A16A1	11/85 > 12/89	438208	12					
2.0 EX (CA5)		A20A1	11/85 > 12/89	438208	12					
<b>思域 两厢 / CIVIC IV Hatchback</b>										
1.6 i 16V (ED7)		D16Z2	10/87 > 09/91	438208	12					
<b>现代 / HYUNDAI</b>										
<b>圣达菲 / SANTA FE (SM)</b>										
2.7L		G6EA	11/00 > 11/09	600071	12	1,4		8	25.5	↗
<b>特拉卡 / TERRACAN (HP)</b>										
3.5i		G6CU	03/03 >	600071	12	1,4		8	25.5	↗
<b>玛莎拉蒂 / MASERATI</b>										
<b>BITURBO / BITURBO (70, 77)</b>										
2.0T	M	475	03/89 > 12/94	432592	12	1,2		9	9	↗

<b>奔驰 / MERCEDES-BENZ</b>										
<b>A140 / A140(W168)</b>										
1.6L	A/M	M 166.960	01/01 > 08/04	438147	12	0,8		8	32	↗
<b>A150 / A150 (W169)</b>										
1.5L	A/M	M 266.920	09/04 > 06/12	438027	12	1		8	32	↗
<b>A160 / A160(W169)</b>										
1.5L	A/M	M 266.920	04/09 > 06/12	438079	12	1,3		9/10	38	↗
<b>A160 / A160(W168)</b>										
1.6L	A/M	M 166.960	02/99 > 08/05	438027	12	1		8	32	↗
<b>A170 / A170(W169)</b>										
1.7L	A/M	M 266.940	09/04 > 06/12	438027	12	1		8	32	↗
<b>A180 / A180 (W169)</b>										
1.7L	A/M	M 266.940	11/10 >	438027	12	1		8	32	↗
<b>A190 / A190(W168)</b>										
1.9L	A/M	M 166.990	06/04 >	438079	12	1,3		9/10	38	↗
<b>190 / 190 (W201)</b>										
2.0L	A/M	M 102.962	01/85 > 08/93	432675	12	1,3		9	31	↗
2.3L	A/M	M 102.985	01/86 > 08/93	432675	12	1,3		9	31	↗
<b>A200 / A200(W169)</b>										
2.0L	A/M	M 266.960	09/04 > 06/12	438079	12	1,3		9/10	38	↗
<b>A210 / A210(W168)</b>										
2.1L	A/M	M 166.995	03/02 > 08/04	438146	12	1,3		10	37	↗
<b>B150 / B150(W245)</b>										
1.5L	A/M	M 266.920	03/05 > 11/11	438027	12	1		8	32	↗
<b>B170 / B170(W245)</b>										
1.7L	A/M	M 266.940	03/05 > 11/11	438027	12	1		8	32	↗
<b>B200 / B200(W245)</b>										
2.0L	A/M	M 266.960	01/09 >	438027	12	1		8	32	↗
2.0L	A/M	M 266.960	01/09 >	438079	12	1,3		9/10	38	↗
<b>C180 / C180(W202)</b>										
1.8L	A/M	M 111.920	03/93 > 05/00	432675	12	1,3		9	31	↗
<b>C220 / C220(W202)</b>										
2.2D / 柴油	A/M	OM 604.910	02/04 >	432644	12	2,2		11	30	↗
<b>C230/K / C230K(W202)</b>										
2.3L	A/M	M 111.975	03/00 > 04/04	432675	12	1,3		9	31	↗
<b>C230/K / C230K (W203)</b>										
2.5L		M 272.920	01/05 >	438199	12	1,7		10/11	30	↗
<b>C240 / C240(W203)</b>										
2.6L	A/M	M 112.916	07/02 >	438199	12	1,7		10/11	30	↗
<b>C280 / C280(W203)</b>										
3.0L		M 272.940	01/05 >	438199	12	1,7		10/11	30	↗

										
<b>奔驰 / MERCEDES-BENZ</b>										
<b>E200 Kompressor / E200(W210)</b>										
2.0L	A/M	M 111.947	06/97 > 03/02	432675	12	1,3		9	31	↗
<b>E230 / E230(W210)</b>										
2.3L	A/M	M 111.970	06/95 > 06/97	432675	12	1,3		9	31	↗
<b>E240 / E240(W211)</b>										
2.6L	A/M	M 112.913	03/02 >	438199	12	1,7		10/11	30	↗
<b>E320 / E320(W211)</b>										
3.2L	A	M 112.954	03/03 >	438199	12	1,7		10/11	30	↗
<b>E350 / E350(W211)</b>										
3.5L		M 272.964	03/05 >	438199	12	1,7		10/11	30	↗
<b>E500 / E500(W211)</b>										
5.0L	A	M 113.967	09/04 >	438199	12	1,7		10/11	30	↗
<b>S320 / S320(W220)</b>										
3.2CDI / 柴油	A	OM 648.960	12/05 >	432644	12	2,2		11	30	↗
<b>S600 / S600(W220)</b>										
5.8L	A	M 137.970	01/00 > 08/05	438078	12	2,2		10	0	↘
5.8L	A	M 137.970	01/00 > 08/05	438157	12	2,2		10	0	↘
<b>CL600 / CL600(C215)</b>										
5.8L	A	M 137.970	03/99 > 03/06	438078	12	2,2		10	0	↘
<b>CLK200 Kompressor / CLK200(C208)</b>										
2.0L	A/M	M 111.944	06/97 > 06/00	432675	12	1,3		9	31	↗
<b>CLK230 / CLK230(C208)</b>										
2.3L	A/M	M 111.973	06/97 > 01/02	432675	12	1,3		9	31	↗
<b>CLK240 / CLK240(C209)</b>										
2.6L	A/M	M 112.912	01/04 >	438199	12	1,7		10/11	30	↗
<b>SLK230 / SLK230(R170)</b>										
2.3L	A/M	M 111.983	04/04 >	432675	12	1,3		9	31	↗
<b>欧宝 / OPEL</b>										
<b>欧捷利 / AGILA (H00)</b>										
1.0L	M	Z10XE	09/00 > 12/07	438183	12	1,1		10	75	↗
1.2L	M	Z12XE	09/00 > 06/04	438183	12	1,1		10	75	↗
<b>雅特 F / ASTRA F (56_, 57_)</b>										
1.6L	M	16LZ2/16NZR	09/95 > 09/98	438014	12	1,1		10	38	↗
1.8i	A/M	C18NZ	03/92 > 09/98	438014	12	1,1		10	38	↗
1.8i	A/M	C18XEL/ X18XE	11/94 > 09/98	438131	12	1		9/10	30	↘
2.0 i	A/M	C20NE	03/92 > 09/98	438014	12	1,1		10	38	↗
2.0 i	A/M	X20XEV	02/95 > 09/98	438131	12	1		9/10	30	↘
<b>雅特 F / ASTRA F CLASSIC Saloon</b>										
1.4i	A/M	X14NZ	01/98 > 08/02	438183	12	1,1		10	75	↗
1.6i	A/M	X16SZR	01/98 > 08/02	438183	12	1,1		10	75	↗

										
<b>欧宝 / OPEL</b>										
<b>雅特 G / ASTRA G (F35_)</b>										
2.0L	A/M	X20XEV	02/98 > 07/04	438131	12	1		9/10	30	↘
<b>雅特 G / ASTRA G Saloon (F69_)</b>										
1.6L	A/M	Z16XEP	03/04 > 03/10	438183	12	1,1		10	75	↗
<b>威达 A / VECTRA A (86_, 87_)</b>										
1.6i	A/M	16LZ2	09/93 > 11/95	438014	12	1,1		10	38	↗
1.8i CAT	A/M	C18NZ	03/90 > 11/95	438014	12	1,1		10	38	↗
2.0 i	A/M	20SEH	09/88 > 09/92	438014	12	1,1		10	38	↗
<b>威达 B / VECTRA B (36_)</b>										
1.6i	M	16LZ2	01/95 > 04/02	438014	12	1,1		10	38	↗
2.0 i	A/M	20NEJ	01/95 > 04/02	438014	12	1,1		10	38	↗
<b>威达 C / VECTRA C</b>										
1.6L	M	Z16XE	06/04 >	438183	12	1,1		10	75	↗
1.8L		Z18XE	04/02 >	438183	12	1,1		10	75	↗
<b>赛飞利 / ZAFIRA (A05)</b>										
1.8L	M	A18XER	07/05 >	438183	12	1,1		10	75	↗
<b>标致 / PEUGEOT</b>										
<b>107 / 107</b>										
1.0L	M	1KR (384 F)	06/05 >	438192	12	1		8	80	↗
<b>206CC / 206 CC (2D)</b>										
1.6L	A/M	NFU (TU5JP4)	09/00 > 03/07	432623	12	1,2		9	55	↗
<b>406 / 406 (8B)</b>										
1.8L	M	6FZ (EW7J4)	01/00 > 05/04	438091	12	1,4		10	55	↗
1.8L	M	6FZ (EW7J4)	01/00 > 05/04	438092	12	0,85		9	55	↗
1.8L	M	6FZ (EW7J4)	01/00 > 05/04	438197	12	1,4		10	55	↗
2.0L	A/M	RFN (EW10J4)	08/00 > 05/04	438092	12	0,85		9	55	↗
2.0L	A/M	RFN (EW10J4)	08/00 > 05/04	438197	12	1,4		10	55	↗
2.0T	A/M	RGX (XU10J2TE)	06/03 > 12/09	432636	12	1,05		9	45	↗
2.2L	M	3FZ (EW12J4)	07/00 > 05/04	438092	12	0,85		9	55	↗
2.2L	M	3FZ (EW12J4)	07/00 > 05/04	438197	12	1,4		10	55	↗
<b>406 / 406 Coupe (8C)</b>										
3.0L	A/M	XFX (ES9J4S)	03/00 > 04/03	438087	12	1,3		10	0	↘
<b>407 / 407 (6D_)</b>										
1.8L	M	6FY (EW7A)	09/05 >	438091	12	1,4		10	55	↗
1.8L	M	6FZ (EW7J4)	05/04 >	438092	12	0,85		9	55	↗
1.8L	M	6FZ (EW7J4)	05/04 >	438197	12	1,4		10	55	↗
2.0L	A/M	RFN (EW10J4)	05/04 >	438092	12	0,85		9	55	↗
2.0L	A/M	RFN (EW10J4)	05/04 >	438197	12	1,4		10	55	↗
2.2L	A/M	3FZ (EW12J4)	05/04 >	438092	12	0,85		9	55	↗
2.2L	A/M	3FZ (EW12J4)	05/04 >	438197	12	1,4		10	55	↗



<b>标致 / PEUGEOT</b>									
<b>407 / 407 (6D_)</b>									
2.2L	A/M	3FY (EW12J4)	09/05 > 12/06	438091	12	1,4		10	55 ▷
3.0L	A/M	XFV (ES9A)	05/04 > 12/06	438087	12	1,3		10	0° ◁
<b>607 / 607 (9D, 9U)</b>									
2.2L	A/M	3FZ (EW12J4)	02/00 > 11/04	438091	12	1,4		10	55 ▷
3.0L	A/M	XFV (ES9A)	03/04 >	438087	12	1,3		10	0° ◁
<b>雷诺 / RENAULT</b>									
<b>拉古那 I / LAGUNA I (B56_, 556_)</b>									
2.0L	A/M	F3R 722/ F3R 723	11/93 > 03/01	432621	12	1,2		9	33 ▷
<b>拉古那 II / LAGUNA II (BG0/1_)</b>									
1.6L	A/M	K4M 710/ K4M 714	03/01 >	438110	12	0,85		8	50 ▷
<b>梅甘娜 I / MEGANE I (BA0/1_)</b>									
1.4L	M	K4J 714/ K4J 750	03/99 > 08/03	438110	12	0,85		8	50 ▷
1.6L	A/M	K4M 700/ K4M 701	03/99 > 08/03	438110	12	0,85		8	50 ▷
<b>梅甘娜 I / MEGANE I Classic (LA0/1_)</b>									
2.0i	A/M	F3R 750/ F3R 751	03/99 > 08/03	432621	12	1,2		9	33 ▷
<b>风景 I / SCENIC I (JA0/1_)</b>									
1.4L	M	K4J 714/ K4J 750	09/99 > 08/03	438110	12	0,85		8	50 ▷
1.6L	A/M	K4M 708/ K4M 709	03/01 > 08/03	438110	12	0,85		8	50 ▷
<b>斯柯达 / SKODA</b>									
<b>明锐 / OCTAVIA (1U2)</b>									
1.6L	A/M	AVU/ BFQ	11/00 > 12/10	438138	12	0,9		9	40 ◁
<b>丰田 / TOYOTA</b>									
<b>AYGO / AYGO (WNB1_, KGB1_)</b>									
1.0L	M	1KR-FE	07/05 >	438192	12	1		8	80 ▷
<b>大众 / VOLKSWAGEN</b>									
<b>EOS / EOS (1F7, 1F8)</b>									
2.0 FSI	M	BVY/ BVZ	03/06 > 05/08	438171	12	1,1		10	44 ◁
<b>甲壳虫 / NEW BEETLE (9C1, 1C1)</b>									
1.8T		AGU,APH,AWU,BKF	01/00 >	438152	12	2		11	42 ◁
2.0L	A/M	AEG,APK,AQY,BEJ,BHP,AZJ,CBPA	06/01 >	438206	12	1,1		10/11	42 ◁
<b>尚酷 / SCIROCCO (137)</b>									
1.4TSI	A/M	CAVD	05/08 >	438171	12	1,1		10	44 ◁
2.0TSI	M	CCZB	11/09 >	438174	12	1,1		10	42 ◁
<b>夏朗 / SHARAN (7M8, 7M9, 7M6)</b>									
1.8T		AJH	09/03 > 12/05	438152	12	2		11	42 ◁
2.8L	A/M	AYL	04/04 > 08/08	438152	12	2		11	42 ◁
<b>途锐 / TOUAREG (7LA, 7L6, 7L7)</b>									
4.2L	A	AXQ	04/03 > 11/06	438167	12	1,7		9	39 ▷
<b>途锐 / TOUAREG (7P5)</b>									
3.0TSI Hybrid/ 混合动力	A	CGEA	04/10 >	438260	12	2		13	144 ▷



432592



1.2 KW



12 V

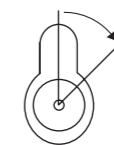

60° ◁

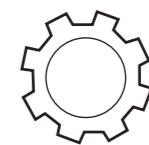









9

<b>432592</b>	1,2Kw	12V	9	9
				
玛莎拉蒂 / MASERATI	BITURBO/BITURBO (70, 77)			
<b>432621</b>	1,2Kw	12V	33	9
				
雷诺 / RENAULT	拉古那 I/LAGUNA I, 梅甘娜 I/MEGANE I			
<b>432623</b>	1,2Kw	12V	55	9
				
标致 / PEUGEOT 雪铁龙 / CITROEN	206CC / 206CC C3 / C3			
<b>432636</b>	1,05Kw	12V	45	9
				
标致 / PEUGEOT	406 / 406			
<b>432644</b>	2,2Kw	12V	30	11
				
奔驰 / MERCEDES-BENZ	C级/CLASSE C, S级/CLASSE S			





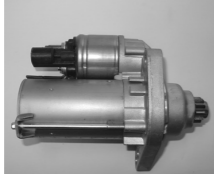

<b>432675</b>	1,3Kw	12V	31	9
				
奔驰 / MERCEDES-BENZ	C级/CLASSE C, E级/CLASSE E CLK/CLK, SLK/SLK			
<b>438014</b>	1,1Kw	12V	38	10
				
欧宝 / OPEL	威达 / VECTRA, 雅特 / ASTRA			
<b>438027</b>	1Kw	12V	32	8
				
奔驰 / MERCEDES-BENZ	A级/CLASSE A, B级/CLASSE B			
<b>438076</b>	1,7Kw	12V	42	10/11
				
奥迪 / AUDI	A3 / A3			
<b>438078</b>	2,2Kw	12V	0	10
				
奔驰 / MERCEDES-BENZ	CL级/CL-Class, S级/CLASSE S			





<b>438079</b>	1,3Kw	12V	38	9/10
				
奔驰 / MERCEDES-BENZ	A级/CLASSE A, B级/CLASSE B			
<b>438087</b>	1,3Kw	12V	0	10
				
标致 / PEUGEOT 雪铁龙 / CITROEN	406/406, 407/407, 607/607 C5/C5, C6/C6			
<b>438091</b>	1,4Kw	12V	55	10
				
标致 / PEUGEOT 雪铁龙 / CITROEN	406/406, 407/407, 607/607 C5 / C5			
<b>438092</b>	0,85Kw	12V	55	9
				
标致 / PEUGEOT	406/406, 407/407			
<b>438094</b>	1,3Kw	12V	31	9
				
宝马 / BMW	Z3/Z3, Z4/Z4			

<b>438110</b>	0,85Kw	12V	50	8
				
雷诺 / RENAULT	拉古那 / LAGUNA, 梅甘娜 / MEGANE 风景 / SCENIC			
<b>438131</b>	1Kw	12V	30	9/10
				
欧宝 / OPEL	雅特 / ASTRA			
<b>438138</b>	0,9Kw	12V	40	9
				
斯柯达 / SKODA	明锐 / OCTAVIA			
<b>438146</b>	1,3Kw	12V	37	10
				
奔驰 / MERCEDES-BENZ	A级/CLASSE A			
<b>438147</b>	0,8Kw	12V	32	8
				
奔驰 / MERCEDES-BENZ	A级/CLASSE A			

<b>438152</b>	2Kw	12V	42 °	11
		大众 / VOLKSWAGEN 奥迪 / AUDI		
夏朗/SHARAN, 甲壳虫/NEW BEETLE TT / TT				
<b>438157</b>	2,2Kw	12V	0 °	10
		奔驰 / MERCEDES-BENZ		
S级/CLASSE S				
<b>438167</b>	1,7Kw	12V	39 °	9
		大众 / VOLKSWAGEN 奥迪 / AUDI		
途锐 / TOUAREG A8 / A8				
<b>438171</b>	1,1Kw	12V	44 °	10
		大众 / VOLKSWAGEN 奥迪 / AUDI		
EOS/EOS, 尚酷/SCIROCCO A3 / A3				
<b>438174</b>	1,1Kw	12V	42 °	10
		大众 / VOLKSWAGEN 奥迪 / AUDI		
尚酷 / SCIROCCO TT / TT				

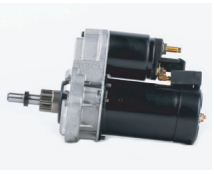
<b>438183</b>	1,1Kw	12V	75 °	10
		欧宝 / OPEL		
威达/VECTRA, 欧捷利/AGILA 赛飞利/ZAFIRA, 雅特 /ASTRA				
<b>438190</b>	1,1Kw	12V	31 °	9
		奥迪 / AUDI		
A4/A4, A6/A6				
<b>438192</b>	1Kw	12V	80 °	8
		丰田 / TOYOTA 标致 / PEUGEOT 雪铁龙 / CITROEN		
AYGO/AYGO 107 / 107 C1 / C1				
<b>438197</b>	1,4Kw	12V	55 °	10
		标致 / PEUGEOT		
406/406, 407/407				
<b>438199</b>	1,7Kw	12V	30 °	10/11
		奔驰 / MERCEDES-BENZ		
C级/CLASSE C, E级/CLASSE E, CLK/ CLK				

<b>438206</b>	1,1Kw	12V	42 °	10/11
		大众 / VOLKSWAGEN 奥迪 / AUDI		
甲壳虫 / NEW BEETLE A3 / A3				
<b>438208</b>	12V	无图		
本田 / HONDA				
雅阁/ACCORD, 思域/CIVIC				
<b>438260</b>	2Kw	12V	144 °	13
		大众 / VOLKSWAGEN		
途锐 / TOUAREG				
<b>438272</b>	1,2Kw	12V	58 °	9
		宝马 / BMW		
1系/1, 3系/3, 5系/5, 6系/6, 7系/7, X1/X1, X3/X3, Z4/Z4				
<b>442003</b>	1,1Kw	12V	28 °	9
		上海大众 / SVW-VOLKSWAGEN		
桑塔纳/SANTANA, 桑塔纳Vista 志俊/SANTANA VISTA, 高尔/GOL				

<b>442004</b>	1,1Kw	12V	43 °	9
		一汽大众 / FAW-VOLKSWAGEN		
捷达王/JETTA KING				
<b>442005</b>	2Kw	12V	40 °	11
		一汽大众 / FAW-VOLKSWAGEN		
捷达 /JETTA				
<b>442006</b>	1,1Kw	12V	40 °	10
		一汽大众 / FAW-VOLKSWAGEN		
宝来/BORA, 高尔夫/GOLF				
<b>442009</b>	1,1Kw	12V	40 °	10
		一汽大众 / FAW-VOLKSWAGEN		
宝来/BORA, 捷达/JETTA				
<b>442010</b>	1,1Kw	12V	40.2 °	10
		一汽大众 / FAW-VOLKSWAGEN 上海大众 / SVW-VOLKSWAGEN 上海大众斯柯达 / SVW-SKODA		
高尔夫 / GOLF 波罗/POLO, 朗逸/LAVIDA 明锐/OCTAVIA, 晶锐/FABIA				



<b>442011</b>	1,1Kw	12V	42 °	10
	一汽大众 / FAW-VOLKSWAGEN 开迪/CADDY, 宝来/BORA, 速腾/SAGITAR, 迈腾/MAGOTAN 上海大众 / SVW-VOLKSWAGEN 波罗/POLO, 朗逸/LAVIDA, 途安/TOURAN, 途观/TIGUAN 上海大众斯柯达 / SVW-SKODA 昊锐/SUPERB, 明锐/OCTAVIA, 晶锐/FABIA			
<b>442012</b>	1,1Kw	12V	40 °	10
	一汽大众 / FAW-VOLKSWAGEN 开迪/CADDY, 宝来/BORA, 速腾/SAGITAR 上海大众 / SVW-VOLKSWAGEN 朗逸/LAVIDA, 波罗/POLO 上海大众斯柯达 / SVW-SKODA 明锐/OCTAVIA			
<b>442013</b>	1,1Kw	12V	42 °	10
	一汽大众 / FAW-VOLKSWAGEN 开迪/CADDY 上海大众 / SVW-VOLKSWAGEN 途安/TOURAN			
<b>442014</b>	1,1Kw	12V	42 °	10
	一汽大众 / FAW-VOLKSWAGEN CC/CC, 速腾/SAGITAR, 迈腾/MAGOTAN, 高尔夫/GOLF 上海大众 / SVW-VOLKSWAGEN 途安/TOURAN, 途观/TIGUAN 上海大众斯柯达 / SVW-SKODA 昊锐/SUPERB			
<b>442015</b>	1,1Kw	12V	30 °	9
	一汽大众奥迪 / FAW-AUDI 100/100, A6/A6 上海大众 / SVW-VOLKSWAGEN 帕萨特/PASSAT			

<b>442043</b>	2,2Kw	12V	29.7 °	9
	奇瑞汽车 / CHERY V5/V5, 东方之子/EASTAR			
<b>442045</b>	1,4Kw	12V	39 °	9
	奇瑞汽车 / CHERY A5/A5			
<b>442047</b>	1,1Kw	12V	39 °	9
	奇瑞汽车 / CHERY A1/A1, QQ6/QQ6, 瑞麒M1/M1			
<b>442049</b>	1,1Kw	12V	43 °	9
	奇瑞汽车 / CHERY 风云 / FENGYUN			
<b>442052</b>	1,4Kw	12V	30 °	8
	江淮汽车 / JAC 瑞风 / REFINE			

<b>442055</b>	1Kw	12V	54 °	8
	东风悦达起亚 / DONGFENG YUEDA-KIA 福瑞迪/FORTE, 秀尔/SOUL, 赛拉图/CERATO 北京现代 / BEIJING-HYUNDAI 伊兰特/ELANTRA, 雅绅特/ACCENT			
<b>442057</b>	1,1Kw	12V	83 °	8
	比亚迪 / BYD F0/F0			
<b>442058</b>	1,2Kw	12V	66.6 °	9
	比亚迪 / BYD F6/F6			
<b>442059</b>	1,1Kw	12V	87 °	8
	长城汽车 / GREAT WALL 炫丽/FLORID			
<b>442061</b>	1,2Kw	12V	60 °	9
	长城汽车 / GREAT WALL 赛弗/SAFE, 赛影/SING, 赛骏/PEGASUS, 迪尔/DEER			

<b>442065</b>	1,1Kw	12V	39 °	9
	一汽轿车 / FAW 红旗世纪星/CENTURY STAR			
<b>442067</b>	1,1Kw	12V	40 °	8
	一汽吉林 / FAW GROUP(JILIN) 森雅M80/XENIA M80, 森雅S80/XENIA S80			
<b>442068</b>	1,1Kw	12V	52 °	9
	一汽海马 / FAW-HAIMA 欢动/HUANDONG, 海马3/3			
<b>442069</b>	1,1Kw	12V	52 °	10
	一汽海马 / FAW-HAIMA 普力马/PREMACY			
<b>442070</b>	1,3Kw	12V	35 °	9
	南京菲亚特 / NANJING-FIAT 西耶那/SIENA			

<b>442072</b>	1,1Kw	12V	54 °	8
				
东南汽车 / SOUTH EAST(FUJIAN) 菱帅/LIONCEL, 蓝瑟/LANCER 哈飞汽车 / HAFEI AUTOMOBILE 赛豹3/SAIBAO 3, 赛豹5/SAIBAO 5, 赛马/SIGMA 比亚迪 / BYD F3 / F3				
<b>442076</b>	1Kw	12V	70 °	11
				
上海汽车 / SAIC 荣威550/550, 荣威750/750				
<b>442077</b>	1,2Kw	12V	90 °	9
				
上海汽车 / SAIC 名爵7 / MG7, 荣威550/550, 荣威750/750				
<b>442119</b>	0,8Kw	12V	53.5 °	8
				
东风悦达起亚 / DONGFENG YUEDA-KIA 福瑞迪/FORTE, 秀尔/SOUL 北京现代 / BEIJING-HYUNDAI i30/i30, 伊兰特·悦动/YUE DONG				
<b>442128</b>	1,8Kw	12V	34 °	9
				
东风雪铁龙 / DONGFENG-CITROEN C5/C5				

<b>442197</b>	0,8Kw	12V	38 °	9
				
奇瑞汽车 / CHERY QQ3/QQ3				
<b>442198</b>	0,9Kw	12V	37.5 °	9
				
上海汽车 / SAIC 荣威350/350				
<b>442199</b>	1,1Kw	12V	46 °	9
				
比亚迪 / BYD F3/F3				
<b>442200</b>	1,1Kw	12V	54.4 °	10
				
一汽大众 / FAW-VOLKSWAGEN 迈腾/MAGOTAN, 高尔夫/GOLF 上海大众斯柯达 / SVW-SKODA 昊锐/SUPERB, 明锐/OCTAVIA				
<b>442201</b>	1,1Kw	12V	82 °	10
				
一汽大众 / FAW-VOLKSWAGEN 宝来/BORA 上海大众 / SVW-VOLKSWAGEN 朗逸/LAVIDA				

<b>442202</b>	1,1Kw	12V	54.4 °	11
				
一汽大众 / FAW-VOLKSWAGEN CC/CC, 宝来/BORA, 速腾/SAGITAR 上海大众 / SVW-VOLKSWAGEN 朗逸 / LAVIDA				
<b>442203</b>	0,8Kw	12V	53.5 °	8
				
北京现代 / BEIJING-HYUNDAI 瑞纳/VERNA				
<b>442205</b>	1,1Kw	12V	28 °	9
				
上海大众 / SVW-VOLKSWAGEN 桑塔纳/SANTANA				
<b>442222</b>	1Kw	12V	43 °	10
				
江淮汽车 / JAC 和悦/HE YUE				
<b>442223</b>	1,1Kw	12V	38 °	9
				
比亚迪 / BYD F6/F6				

<b>442240</b>	1,1Kw	12V	40 °	10
				
一汽大众 / FAW-VOLKSWAGEN 捷达/JETTA, 高尔夫/GOLF				
<b>442241</b>	1,1Kw	12V	37 °	10
				
长城汽车 / GREAT WALL 凌傲/LINGAO, 哈弗M1/HOVR M1 哈弗M2/HOVR M2, 炫丽/FLORID 腾翼C30/TENGYI C30 Saloon, 酷熊/COOLBEAR				
<b>442254</b>	1,2Kw	12V	40 °	8
				
长安铃木 / CHANGAN-SUZUKI 天语SX4/SX4				
<b>600071</b>	1,4Kw	12V	25.5 °	8
				
现代 / HYUNDAI 圣达菲/SANTA FE, 特拉卡/TERRACAN				



国产车型检索  
Domestic Car Models Index



一汽大众奥迪 / FAW-AUDI	35
一汽大众 / FAW-VOLKSWAGEN	35
上海大众 / SVW-VOLKSWAGEN	36
上海大众斯柯达 / SVW-SKODA	37
上海汽车 / SAIC	38
一汽轿车 / FAW	38
华晨汽车 / SHENYANG BRILLIANCE	38
北京奔驰 / BEIJING BENZ-DAIMLERCHRYSLER	38
东南汽车 / SOUTH EAST(FUJIAN)	39
北京现代 / BEIJING-HYUNDAI	39
华泰现代 / HUATAI AUTOMOBILE	40
东风悦达起亚 / DONGFENG YUEDA-KIA	40
东风雪铁龙 / DONGFENG-CITROEN	40
东风标致 / DONGFENG-PEUGEOT	41
东风日产 / DONGFENG-NISSAN	41
一汽海马 / FAW-HAIMA	42
长城汽车 / GREAT WALL	42
奇瑞汽车 / CHERY	42
比亚迪 / BYD	42
长安铃木 / CHANGAN-SUZUKI	43
江淮汽车 / JAC	43
长安汽车 / CHANGAN AUTOMOBILE	43
吉利汽车 / GEELY	43
南京菲亚特 / NANJING-FIAT	43
东风柳汽 / LIUZHOU MOTOR	43
一汽吉林 / FAW GROUP(JILIN)	43



### 进口车型检索 Import Car Models Index



奥迪 / AUDI	44
宝马 / BMW	46
雪铁龙 / CITROEN	50
现代 / HYUNDAI	50
路虎 / LAND ROVER	50
奔驰 / MERCEDES-BENZ	50
迷你 / MINI	53
欧宝 / OPEL	54
标致 / PEUGEOT	55
雷诺 / RENAULT	55
斯柯达 / SKODA	56
大众 / VOLKSWAGEN	56
沃尔沃 / VOLVO	58

一汽大众奥迪 / FAW-AUDI											
<b>100 / 100 (443, 4A2)</b>											
1.8L	M	JW	08/88 > 12/90		442018	14	100	SEP	73,5	1	60 ☺
<b>A4(B6) / A4 Saloon (B6)</b>											
1.8T		BFB	02/03 > 07/05		442031	14	140	SEP	57,2	6	
2.4L	A/M	BDV	01/04 > 07/05		442032	14	140	SEP	66	6	60 ☺
3.0 Quattro	A/M	BBJ	02/03 > 07/05		442032	14	140	SEP	66	6	60 ☺
<b>A4(B7) / A4 Saloon (B7)</b>											
1.8T		BKB	07/05 > 09/08		442031	14	140	SEP	57,2	6	
2.0T		BGB	07/05 > 09/08		442031	14	140	SEP	57,2	6	
<b>A6(C5) / A6 Saloon (C5)</b>											
1.8T	M	AWL	01/00 > 12/05		442034	14	120	SEP	57,2	5	60 ☺
1.8L	M	ADR	01/00 > 12/05		442034	14	120	SEP	57,2	5	60 ☺
2.4L	A/M	APS/BDV	09/99 > 12/05		442035	14	120	SEP	66	6	60 ☺
2.5D / 柴油	A/M	BND	08/04 > 12/05		442032	14	140	SEP	66	6	60 ☺
2.8L	A/M	ATX	09/00 > 07/05		442035	14	120	SEP	66	6	60 ☺
<b>A6L(C6) / A6L (C6)</b>											
2.0TFSI	A/M		09/05 > 12/11	2009-	442134	14	150	SEP	57,2	6	
<b>一汽大众 / FAW-VOLKSWAGEN</b>											
<b>宝来 / BORA</b>											
1.6L	A/M	BJH	06/02 > 09/06		442022	14	90	SEP	57,2	6	90 ☺
1.9TDI / 柴油	M	ATD	03/04 > 12/06		442019	14	120	SEP	57,2	6	90 ☺
<b>宝来 / BORA (1J2)</b>											
1.8T	A/M	BAE	12/01 > 12/06		442022	14	90	SEP	57,2	6	90 ☺
1.8L	A/M	BAF	12/01 > 12/06		442022	14	90	SEP	57,2	6	90 ☺
<b>新宝来 / BORA</b>											
1.4TSI		CFB	06/10 >		442122	14	140	SEP	53,2	6	90 ☺
1.6L	A/M	BWH	11/08 >		442030	14	140	SEP	57,2	6	90 ☺
1.6L	A/M		06/10 >		442030	14	140	SEP	57,2	6	90 ☺
2.0L	A/M	CEN	11/08 > 12/10		442030	14	140	SEP	57,2	6	90 ☺
<b>开迪 / CADDY Box</b>											
1.6L	M	BRY	03/05 > 12/07		442030	14	140	SEP	57,2	6	90 ☺
2.0D / 柴油	M		03/05 > 12/07		442030	14	140	SEP	57,2	6	90 ☺
<b>捷达 / JETTA</b>											
1.6L	M	BJG	01/04 >		442022	14	90	SEP	57,2	6	90 ☺
<b>捷达 (1G2, 1J2) / JETTA (1G2, 1J2)</b>											
1.9TDI / 柴油	A/M	ALH	08/98 > 04/00		442019	14	120	SEP	57,2	6	90 ☺
<b>捷达王 (1G2, 1J2) / JETTA (1G2, 1J2)</b>											
1.6L	M		01/98 > 01/02		442020	14	90	SEP	57,2	6	90 ☺

一汽大众 / FAW-VOLKSWAGEN										
迈腾 (B6) / MAGOTAN (B6)										
1.4TSI		CFB	01/10 > 07/11	442122	14	140	SEP	53,2	6	90 °
1.8TSI	A/M	BYJ	06/07 > 07/11	442031	14	140	SEP	57,2	6	
2.0TSI	A/M		04/08 > 07/11	442031	14	140	SEP	57,2	6	
2.0L	A/M	BJZ	06/07 > 04/08	442030	14	140	SEP	57,2	6	90 °
CC / CC										
1.8T			07/10 >	442193	14	140	SEP	57,2	6	
2.0T			07/10 >	442193	14	140	SEP	57,2	6	
速腾 / SAGITAR										
1.6L	A/M	BWH	02/06 >	442030	14	140		57,2	6	90 °
1.8T		BPL	04/06 > 04/08	442031	14	140	SEP	57,2	6	
2.0L	A/M	BJZ	04/06 > 06/09	442030	14	140	SEP	57,2	6	90 °
新速腾 / SAGITAR										
1.4TSI		CFB	09/09 >	442122	14	140	SEP	53,2	6	90 °
1.8TSI		BYJ	07/08 >	442031	14	140	SEP	57,2	6	
高尔夫 / GOLF										
1.6L	A/M	BFQ	08/03 > 01/05	442022	14	90	SEP	57,2	6	90 °
1.8L	A/M	BAF	07/03 > 07/09	442022	14	90	SEP	57,2	6	90 °
高尔夫 6 / GOLF										
1.4TSI		CFB	08/09 >	442122	14	140	SEP	53,2	6	90 °
1.6L	A/M		08/09 >	442025	14	110	SEP	50,5	6	90 °
上海大众 / SVW-VOLKSWAGEN										
波罗三厢 / POLO Saloon										
1.4L	A/M	BCC	06/03 > 03/06	442023	14	90	SEP	50,5	6	90 °
1.6L	A/M	BCD	01/02 > 01/06	442019	14	120	SEP	57,2	6	90 °
波罗两厢 / POLO Hatchback										
1.4L	A/M	BCC	01/02 > 03/06	442023	14	90	SEP	50,5	6	90 °
1.6L	A/M	BCD	01/02 > 01/06	442019	14	120	SEP	57,2	6	90 °
劲取 / POLO JINQU Saloon										
1.4L		BMG, BMH	06/06 >	442024	14	110	SEP	50,5	6	90 °
1.4L		CDD, CDE	06/06 >	442121	14	110	SEP	50,5	6	90 °
1.6L		BMG, BMH	12/07 >	442024	14	110	SEP	50,5	6	90 °
1.6L		CDD, CDE	12/07 >	442121	14	110	SEP	50,5	6	90 °
劲情 / POLO JINQIN Hatchback										
1.4L		BMG, BMH	06/06 >	442024	14	110	SEP	50,5	6	90 °
1.4L		CDD, CDE	06/06 >	442121	14	110	SEP	50,5	6	90 °
1.6L		BMG, BMH	06/06 > 12/07	442024	14	110	SEP	50,5	6	90 °
1.6L		CDD, CDE	06/06 > 12/07	442121	14	110	SEP	50,5	6	90 °

上海大众 / SVW-VOLKSWAGEN										
新波罗 / POLO										
1.6L	A/M		12/10 >	442025	14	110	SEP	50,5	6	90 °
CrossPolo / POLO CROSS										
1.6L	A/M	CDE	12/07 >	442121	14	110	SEP	50,5	6	90 °
帕萨特 (B5) / PASSAT Saloon (B5)										
1.8T	A	AWL	01/01 > 04/09	442028	14	100	SEP	57,2	5	60 °
1.8L	M	ANQ	04/00 > 02/03	442028	14	100	SEP	57,2	5	60 °
2.0L	M	BFF	02/03 > 04/09	442028	14	100	SEP	57,2	5	60 °
2.8L	A	BBG	12/01 > 12/06	442035	14	120	SEP	66	6	60 °
帕萨特领驭 (B5) / PASSAT LINGYU Saloon (B5)										
1.8T	A/M		01/09 >	442029	14	140	SEP	57,2	5	60 °
1.8T	A/M		11/05 > 04/09	442029	14	140	SEP	57,2	5	60 °
2.0L	A/M	BNL	04/06 >	442029	14	140	SEP	57,2	5	60 °
2.8L	A	BBG	11/05 >	442032	14	140	SEP	66	6	60 °
朗逸 / LAVIDA										
1.4TSi		CFB	03/10 >	442192	14	140	SEP	50,5	6	90 °
1.6L	A/M	CDE	04/08 >	442027	14	110	SEP	53,5	6	90 °
2.0L	A/M	CEN	04/08 >	442030	14	140	SEP	57,2	6	90 °
桑塔纳 / SANTANA										
1.8L	M	JV/AFE	03/85 >	442018	14	100	SEP	73,5	1	60 °
桑塔纳 2000 / SANTANA 2000										
1.8L	M	JV/AFE/AYJ	04/95 > 03/04	442016	14	90	SEP	57,2	5	60 °
桑塔纳 3000 / SANTANA 3000										
1.8L	M	AYJ/BKT	03/04 > 01/07	442028	14	100	SEP	57,2	5	60 °
2.0L	A	BTL	05/06 > 01/07	442028	14	100	SEP	57,2	5	60 °
桑塔纳 Vista 志俊 / SANTANA VISTA										
1.8L	A/M	BKT	01/08 >	442028	14	100	SEP	57,2	5	60 °
2.0L	A/M		01/08 >	442028	14	100	SEP	57,2	5	60 °
途安 / TOURAN MPV										
1.8T	A/M	BPL	05/05 >	442030	14	140	SEP	57,2	6	90 °
2.0L	A/M		11/04 > 01/08	442030	14	140	SEP	57,2	6	90 °
途观 / TIGUAN										
1.8TSI		CEA	03/10 >	442193	14	140	SEP	57,2	6	
2.0TSI 4motion		CGM	03/10 >	442193	14	140	SEP	57,2	6	
高尔 / GOL										
1.6L	M	BHJ	12/03 > 02/05	442026	14	90	SEP	58,7	6	60 °
上海大众斯柯达 / SVW-SKODA										
昊锐 / SUPERB										
1.8TSI	A/M		08/09 >	442031	14	140	SEP	57,2	6	
2.0TSI	A/M		08/09 >	442031	14	140	SEP	57,2	6	

<b>上海大众斯柯达 / SVW-SKODA</b>										
<b>明锐 / OCTAVIA</b>										
1.6L	A/M	CDF	06/07 > 04/10	442025	14	110	SEP	50,5	6	90 ◀
1.8TSI	A	BYJ	06/07 > 04/10	442031	14	140	SEP	57,2	6	
2.0L	A/M	BXX	06/07 > 04/10	442030	14	140	SEP	57,2	6	90 ◀
<b>晶锐 / FABIA</b>										
1.4L		CDD	12/08 >	442121	14	110	SEP	50,5	6	90 ◀
1.6L		CDE	12/08 >	442121	14	110	SEP	50,5	6	90 ◀
<b>上海汽车 / SAIC</b>										
<b>荣威 350 / 350</b>										
1.5L	M		04/10 >	442190	14	105	SEP	49,7	5	44 ▶
1.5L	A		04/10 >	442191	14	105	SEP	50	5	44 ▶
<b>荣威 550 / 550</b>										
1.8T		18K4G	06/08 >	442189	14	120	SEP	49,7	5	25 ◀
<b>荣威 750 / 750</b>										
1.8T			03/08 >	442189	14	120	SEP	49,7	5	25 ◀
2.5L		25K4F	01/07 >	442118	14	100	SEP	48	6	30 ◀
2.5L		25K4F	01/07 >	442216	14	120	SEP	49,7	6	30 ◀
<b>名爵 7 / MG7</b>										
1.8T		18 K4K	07/07 >	442189	14	120	SEP	49,7	5	25 ◀
<b>一汽轿车 / FAW</b>										
<b>奔腾 B50 / BESTURN B50</b>										
1.6L			05/09 >	442196	14	90	SEP	57,2	6	90 ◀
<b>红旗世纪星 / CENTURY STAR (CA7202)</b>										
2.4L		V6BFK	09/00 >	442066			SEP			
<b>华晨汽车 / SHENYANG BRILLIANCE</b>										
<b>尊驰 / ZUNCHI (M1)</b>										
1.8T		BL18T	03/07 >	442124	14	120	SEP	57,2	6	90 ◀
<b>酷宝 / KUBAO Coupe (M3)</b>										
1.8T		BL18T	09/07 >	442124	14	120	SEP	57,2	6	90 ◀
<b>骏捷 / JUNJIE Saloon (M2)</b>										
1.8T		BL18T	01/07 >	442124	14	120	SEP	57,2	6	90 ◀
<b>骏捷 Wagon / JUNJIE WAGON</b>										
1.8T		BL18T	12/08 >	442124	14	120	SEP	57,2	6	90 ◀
<b>海狮 (11 座) / HAISE Bus</b>										
2.2L		491QME	08/98 >	442116			SEP			
<b>北京奔驰 / BEIJING BENZ-DAIMLERCHRYSLER</b>										
<b>C180K / C180K (W204)</b>										
1.6L	A/M	M 271.910	07/10 >	442209	14	150	SEP	51	6	
<b>C200K / C200K (W204)</b>										
1.8L	A/M	M 271.950	03/08 >	442211	14	150	SEP	51	6	

<b>北京奔驰 / BEIJING BENZ-DAIMLERCHRYSLER</b>										
<b>C200K Turbo / C200K (W204)</b>										
1.8L		M 271.860	07/11 >	442211	14	150	SEP	51	6	
<b>C260 Turbo / C260 (W204)</b>										
1.8L		M 271.860	01/09 >	442211	14	150	SEP	51	6	
<b>C280 / C280 (W204)</b>										
3.0L	A/M	M 272.947	03/08 > 01/09	442210	14	150	SEP	51	6	
<b>C300 / C300 (W204)</b>										
3.0L	A	M 272.940	07/11 >	442210	14	150	SEP	51	6	
<b>E280 / E280 (W211)</b>										
3.0L		M 272.943	11/05 >	442212	14	180	SEP	51	6	
<b>E300L / E300L (W212)</b>										
3.0L	A	M 272.952	12/10 >	442212	14	180	SEP	51	6	
<b>东南汽车 / SOUTH EAST(FUJIAN)</b>										
<b>蓝瑟 / LANCER</b>										
1.6L		4 G 18	05/06 >	442158			SEP			
<b>北京现代 / BEIJING-HYUNDAI</b>										
<b>i30 / i30 Hatchback</b>										
1.6L		G4FC	07/09 >	442194	13,5	90	SEP	58	6	15 ▶
2.0L	A/M		07/09 >	442056	13,5	90	SEP	58	4	30 ▶
<b>伊兰特三厢 / ELANTRA Saloon</b>										
1.6L	A/M	G4GR/G4GA	12/03 >	442056	13,5	90	SEP	58	4	30 ▶
<b>伊兰特两厢 / ELANTRA Hatchback</b>										
1.6L	A	G4GR	03/07 >	442056	13,5	90	SEP	58	4	30 ▶
<b>伊兰特·悦动 / YUE DONG</b>										
1.6L	A/M	G4ED	04/08 >	442123	13,5	90	SEP	58	6	15 ▶
1.6L	A/M		11/09 >	442123	13,5	90	SEP	58	6	15 ▶
<b>名驭 / MOINCA</b>										
2.0L		G4GC	08/09 >	442056	13,5	90	SEP	58	4	30 ▶
<b>瑞纳三厢 / VERNA Saloon</b>										
1.4L		G4FA	08/10 >	442123	13,5	90	SEP	58	6	15 ▶
1.4L	A	G4FA	08/10 >	442194	13,5	90	SEP	58	6	15 ▶
1.6L	A/M	G4FC	08/10 >	442123	13,5	90	SEP	58	6	15 ▶
<b>瑞纳两厢 / VERNA Hatchback</b>										
1.4L		G4FA	12/10 >	442123	13,5	90	SEP	58	6	15 ▶
1.4L	A	G4FA	12/10 >	442194	13,5	90	SEP	58	6	15 ▶
1.6L	A/M	G4FC	12/10 >	442123	13,5	90	SEP	58	6	15 ▶
<b>索纳塔 / SONATA (EF)</b>										
2.0L		G4GC	12/02 > 07/07	442056	13,5	90	SEP	58	4	30 ▶
2.7L		G6BA	12/02 > 07/07	600093	14	120	SEP	62	6	24 ▶

北京现代 / BEIJING-HYUNDAI											
索纳塔 御翔 / SONATA (NF)											
2.4L		G4KC	09/05 >	600029	14	110	SEP	64	6	22	↕
领翔 / SONATA (NFC)											
2.0L		G4KD	12/08 >	442056	13.5	90	SEP	58	4	30	↕
途胜 / TUCSON Closed Off-Road Vehicle											
2.0L		G4GC	05/05 >	442056	13.5	90	SEP	58	4	30	↕
2.7 四驱 / All-wheel Drive		G6BA	05/05 >	600093	14	120	SEP	62	6	24	↕
2.7 四驱 / All-wheel Drive		G6BA	05/05 >	600027	14	110	SEP	62	6	35	↕
雅绅特 / ACCENT											
1.4L	M	G4EE	02/06 >	442056	13.5	90	SEP	58	4	30	↕
华泰现代 / HUATAI AUTOMOBILE											
圣达菲 / SANTA FE Closed Off-Road Vehicle											
2.7 四驱 / All-wheel Drive		G6BA	01/06 >	600093	14	120	SEP	62	6	24	↕
特拉卡 / TERRACAN Closed Off-Road Vehicle											
2.9DT / 柴油		J3	04/05 > 12/08	600024	14	110	SEP	64	5	30	↕
3.5L 四驱 / All-wheel Drive		G6CU	03/03 > 12/08	600102	14	120	SEP	59	6	44	↕
东风悦达起亚 / DONGFENG YUEDA-KIA											
赛拉图 / CERATO											
1.6L	M	G4ED	05/05 >	442056	13.5	90	SEP	58	4	30	↕
赛拉图两厢 / CERATO Hatchback											
1.6L	M	G4ED	12/07 >	442056	13.5	90	SEP	58	4	30	↕
嘉华 / CARNIVAL MPV											
2.7L		G6BA	04/06 > 12/10	600093	14	120	SEP	62	6	24	↕
3.5L		G6CU	07/04 > 12/10	600102	14	120	SEP	59	6	44	↕
狮跑 / SPORTAGE Closed Off-Road Vehicle											
2.7 四驱 / All-wheel Drive		G6BA	11/07 >	600093	14	120	SEP	62	6	24	↕
福瑞迪 / FORTE											
1.6L	A/M	G4FC	06/09 >	442123	13.5	90	SEP	58	6	15	↕
秀尔 / SOUL Hatchback											
1.6L	A/M	G4FC	12/09 >	442123	13.5	90	SEP	58	6	15	↕
东风雪铁龙 / DONGFENG-CITROEN											
C2 / C2 (T11)											
1.4L		TU3AF	01/06 >	442042	14	95	SEP	55,3	6	39.5	↕
1.6L		TU5JP4	01/06 >	442042	14	95	SEP	55,3	6	39.5	↕
世嘉三厢 / C-QUATRE - SHI JIA Saloon											
1.6L		N6A	06/09 >	442041	14	120	SEP	54,3	6	39.5	↕
2.0L		EW10A	06/09 >	442041	14	120	SEP	54,3	6	39.5	↕
世嘉两厢 / C-QUATRE - SHI JIA											
1.6L		N6A	01/08 >	442041	14	120	SEP	54,3	6	39.5	↕
2.0L		EW10A	01/08 >	442041	14	120	SEP	54,3	6	39.5	↕

东风雪铁龙 / DONGFENG-CITROEN											
凯旋 / C-TRIOMPHE											
2.0 Exclusive Limousine		EW10A	05/06 >	442041	14	120	SEP	54,3	6	39.5	↕
毕加索 / XSARA PICASSO MPV (N68)											
1.6 Chrono		TU5JPL4	09/01 > 03/07	442042	14	95	SEP	55,3	6	39.5	↕
爱丽舍三厢 / ELYSEE (7B)											
1.6L		TU5JPK/TU5JP4	06/02 > 04/08	442042	14	95	SEP	55,3	6	39.5	↕
1.6L		TU5JP4	04/08 >	442042	14	95	SEP	55,3	6	39.5	↕
爱丽舍两厢 / ELYSEE Hatchback											
1.6L			02/09 >	442042	14	95	SEP	55,3	6	39.5	↕
赛纳 / XSARA Saloon											
2.0L		EW10J4	05/03 > 12/05	442041	14	120	SEP	54,3	6	39.5	↕
东风标致 / DONGFENG-PEUGEOT											
206 / 206											
1.4L		TU3AF	07/06 > 02/09	442042	14	95	SEP	55,3	6	39.5	↕
1.6L		TU5JP4	01/06 > 02/09	442042	14	95	SEP	55,3	6	39.5	↕
207 三厢 / 207 Saloon											
1.4L		TU3AF	11/08 >	442042	14	95	SEP	55,3	6	39.5	↕
1.6L		TU5JP4	11/08 >	442042	14	95	SEP	55,3	6	39.5	↕
207 两厢 / 207											
1.4L		TU3AF	03/09 >	442042	14	95	SEP	55,3	6	39.5	↕
1.6L		TU5JP4	03/09 >	442042	14	95	SEP	55,3	6	39.5	↕
307 三厢 / 307 Saloon											
1.6L		TU5JP4	08/04 >	442041	14	120	SEP	54,3	6	39.5	↕
2.0L		EW10J4	08/04 > 05/06	442041	14	120	SEP	54,3	6	39.5	↕
2.0L		EW10A	05/06 >	442041	14	120	SEP	54,3	6	39.5	↕
307 两厢 / 307 Hatchback											
1.6L		TU5JP4	02/08 >	442041	14	120	SEP	54,3	6	39.5	↕
2.0L		EW10A	02/08 >	442041	14	120	SEP	54,3	6	39.5	↕
408 / 408 Saloon											
1.6L		TU5JP4	01/10 >	442041	14	120	SEP	54,3	6	39.5	↕
2.0L		EW10A	01/10 >	442041	14	120	SEP	54,3	6	39.5	↕
东风日产 / DONGFENG-NISSAN											
奇骏 / X-TRAIL											
2.0L		MR20	11/08 >	442213	14	120	SEP	53,9	6	45	↕
2.5L		QR25	11/08 >	442213	14	120	SEP	53,9	6	45	↕
逍客 / QASHQAI											
1.6L		HR16DE	11/08 > 12/10	442213	14	120	SEP	53,9	6	45	↕
2.0L		MR20DE	03/08 > 12/10	442213	14	120	SEP	53,9	6	45	↕



<b>一汽海马 / FAW-HAIMA</b>										
<b>普力马 / PREMACY MPV</b>										
1.8L		HM483Q	03/07 > 01/09	442214	14	85	SEP	55	4	0 ◀▶
<b>普力马 / FREEMA</b>										
1.8L			09/10 >	442214	14	85	SEP	55	4	0 ◀▶
<b>长城汽车 / GREAT WALL</b>										
<b>凌傲 / LINGAO</b>										
1.3L			11/09 >	442125	14	90	SEP	58	4	20 ◀▶
1.5L		GW4G15	11/09 >	442126	14	90	SEP	58	4	20 ◀▶
<b>哈弗 M1 / HOVER M1</b>										
1.3L			09/09 >	442125	14	90	SEP	58	4	20 ◀▶
<b>哈弗 M2 / HOVER M2</b>										
1.5L			03/10 >	442126	14	90	SEP	58	4	20 ◀▶
<b>精灵 CROSS / GWEROU CROSS</b>										
1.3L	M		03/08 > 01/10	442062	14	90	SEP	55,5	5	25 ◀▶
<b>腾翼 C30 / TENGYI C30 Saloon</b>										
1.5L		GW4G15	05/10 >	442126	14	90	SEP	58	4	20 ◀▶
<b>迪尔 / DEER Pickup</b>										
2.2L	M	GA491QE	05/96 >	442127	14	90	SEP	62,5	4	0 ◀▶
<b>酷熊 / COOLBEAR MPV</b>										
1.5L		GW4G15	03/09 >	442126	14	90	SEP	58	4	20 ◀▶
<b>炫丽 / FLORID</b>										
1.3L		GW413EF	09/08 >	442125	14	90	SEP	58	4	20 ◀▶
1.5L		GW4G15	02/09 >	442126	14	90	SEP	58	4	20 ◀▶
<b>炫丽 CROSS / FLORID CROSS</b>										
1.3L			01/09 >	442125	14	90	SEP	58	4	20 ◀▶
<b>奇瑞汽车 / CHERY</b>										
<b>A3 三厢 / A3 Saloon</b>										
1.6L		E4G16	08/10 >	442217	14	110	SEP	61	6	60 ◀▶
<b>A3 两厢 / A3 Hatchback</b>										
1.6L		E4G16	08/10 >	442217	14	110	SEP	61	6	60 ◀▶
<b>比亚迪 / BYD</b>										
<b>F6 / F6</b>										
1.8L	M	483QA	06/10 >	442195	14	110	SEP	65	4	20 ▶
2.0L		483QB	03/08 >	442188	14	110	SEP	65	4	20 ◀▶
2.0L		483QB	03/08 >	442195	14	110	SEP	65	4	20 ▶
<b>M6 / M6</b>										
2.0L		483QB	07/10 >	442218	14	110	SEP	56	4	20 ◀▶
<b>S6 / S6 Closed Off-Road Vehicle</b>										
2.0L		483QB	05/11 >	442218	14	110	SEP	56	4	20 ◀▶

<b>长安铃木 / CHANGAN-SUZUKI</b>											
<b>长安奥拓 / ALTO</b>											
0.8L		F8B	01/92 > 08/08	442079	14	70	SEP	58	1	0 ◀▶	
0.8L		JL368Q	11/93 > 06/96	442079	14	70	SEP	58	1	0 ◀▶	
<b>江淮汽车 / JAC</b>											
<b>瑞风 / REFINE (M1)</b>											
2.4L		G4JS	02/02 >	442215	14	110	SEP	60	4	40.2 ▶	
<b>长安汽车 / CHANGAN AUTOMOBILE</b>											
<b>长安之星 / STAR</b>											
0.8L		JL465Q4	01/07 >	多槽 /multi vee	442081	14	70	SEP	58	1	0 ◀▶
<b>吉利汽车 / GEELY</b>											
<b>豪情 / HAOQING</b>											
1.3L		8A-FE	01/00 > 04/03	442082			SEP				
<b>南京菲亚特 / NANJING-FIAT</b>											
<b>周末风 / PALIO Estate</b>											
1.5L	M	178 E5.022	01/02 >	442071	14	100	SEP	60	6	33 ◀▶	
<b>派力奥 / PALIO Hatchback</b>											
1.5L	M	178 E5.022	01/02 >	442071	14	100	SEP	60	6	33 ◀▶	
<b>西耶那 / SIENA</b>											
1.5L	M	178 E5.022	01/03 >	442071	14	100	SEP	60	6	33 ◀▶	
<b>东风柳汽 / LIUZHOU MOTOR</b>											
<b>风行 MPV / FUTURE</b>											
1.8L		4 G 93	12/07 >	442083	12	105	SEP	55	4	40.2 ◀▶	
<b>一汽吉林 / FAW GROUP(JILIN)</b>											
<b>森雅 M80 / XENIA M80</b>											
1.3L		K3-VE3	06/07 >	442219	14	70	SEP	55	4	4 ▶	
1.5L		3SZ-VE2	06/07 >	442220	14	70	SEP	55	6	4 ▶	
<b>森雅 S80 / XENIA S80</b>											
1.3L			12/10 >	442219	14	70	SEP	55	4	4 ▶	
1.5L			12/10 >	442220	14	70	SEP	55	6	4 ▶	

<b>奥迪 / AUDI</b>										
<b>100 / 100 (4A, C4)</b>										
2.0L	A	AAE	12/90 > 06/94	433044	14	55	INC	70	1	60
<b>A1 / A1 (8X1)</b>										
1.4TFSI	A/M	CPTA	04/12 >	439821	14	140	INC	50,5	6 RL	90
<b>A3 / A3 (8L1)</b>										
1.6L	A/M	AEH/ AKL	09/96 > 05/03	439445	14	90	INC	50,5	6	90
1.6L	A/M	AVU/ BFO	08/00 > 05/03	439310	14	70	INC	57	6	90
1.6L	A/M	AVU/ BFO	08/00 > 05/03	439326	14	120	INC	49	6	90
1.8L	A/M	AGN/ APG	09/96 > 05/03	439310	14	70	INC	57	6	90
1.8L	A/M	AGN/ APG	09/96 > 05/03	439311	14	90	INC	57,2	6	90
1.8L	A/M	AGN/ APG	09/96 > 05/03	439312	14	120	INC	57,2	6 RL	90
1.8L	A/M	AGN/ APG	09/96 > 05/03	439326	14	120	INC	49	6	90
1.8L	A/M	AGN/ APG	09/96 > 05/03	439445	14	90	INC	50,5	6	90
1.8T	A/M	AJQ/ APP	12/98 > 05/03	439310	14	70	INC	57	6	90
1.8T	A/M	AJQ/ APP	12/98 > 05/03	439311	14	90	INC	57,2	6	90
1.8T	A/M	AJQ/ APP	12/98 > 05/03	439312	14	120	INC	57,2	6 RL	90
1.8T	A/M	AJQ/ APP	12/98 > 05/03	439326	14	120	INC	49	6	90
1.8T	A/M	AJQ/ APP	12/98 > 05/03	439445	14	90	INC	50,5	6	90
<b>A3 / A3 (8P1)</b>										
1.4TFSI		CAXC/ CMSA	06/10 >	439563	14					
1.4TFSI	A	CAXC/ CMSA	06/10 >	439580	14	110	INC	50,5	6 RL	90
1.6 E-Power		CMXA	01/11 > 08/12	439489	14	140		57	6 RL	90
1.8TFSI	A/M	CDAA	11/06 > 08/12	439271	14	120	INC	57	5 RL	60
1.8TFSI	A/M	BYT/ BZB	11/06 > 08/12	439393	14	140	INC	57	6 RL	0°
1.8TFSI		BYT/ BZB	11/06 > 08/12	439489	14	140		57	6 RL	90
2.0 FSI		AXW/ BLR	05/03 > 06/08	439489	14	140		57	6 RL	90
2.0TFSI	A/M	AXX/ BWA	09/04 > 08/12	439271	14	120	INC	57	5 RL	60
2.0TFSI		AXX/ BWA	09/04 > 08/12	439393	14	140	INC	57	6 RL	0°
3.2 V6 quattro		BDB/ BMJ	07/03 > 05/09	439489	14	140		57	6 RL	90
<b>A4 / A4 (8D2, B5)</b>										
1.8T	A/M	AEB/ APU	01/95 > 11/00	439574	14	150	INC	66	6	60
<b>A4 / A4 (8E2, B6)</b>										
1.6L	M	ALZ	11/00 > 12/04	439393	14	140	INC	57	6 RL	0°
2.0L	A/M	ALT	11/00 > 12/04	439271	14	120	INC	57	5 RL	60
2.0L	A/M	ALT	11/00 > 12/04	439338	14	70	INC	57	5	60
2.0L	A/M	ALT	11/00 > 12/04	439393	14	140	INC	57	6 RL	0°
2.0L	A/M	ALT	11/00 > 12/04	439498	14	150	INC	57,2	6 RL	0°
2.4L	A/M	BDV	09/01 > 12/04	439574	14	150	INC	66	6	60
3.0L	A/M	ASN/ AVK	12/04 >	439391	14	120	INC	65	6	60
3.0L	A/M	ASN/ AVK	12/04 >	439574	14	150	INC	66	6	60

<b>奥迪 / AUDI</b>										
<b>A4 / A4 (8E2, B6)</b>										
1.8T	A/M	AMB	07/01 > 12/04	439271	14	120	INC	57	5 RL	60
1.8T	A/M	BFB	07/02 >	439338	14	70	INC	57	5	60
1.8T	A/M	BFB	07/02 >	439393	14	140	INC	57	6 RL	0°
1.8T	A/M	BFB	07/02 > 12/04	439498	14	150	INC	57,2	6 RL	0°
<b>A4 / A4 (8EC, B7)</b>										
1.8T		BFB	07/05 >	439489	14	140		57	6 RL	90
2.0TFSI	A/M	BGB/ BPG	11/04 > 06/08	439393	14	140	INC	57	6 RL	0°
2.0TFSI		BGB/ BPG	11/04 > 06/08	439489	14	140		57	6 RL	90
2.0TFSI	A/M	BGB/ BPG	11/04 > 06/08	439498	14	150	INC	57,2	6 RL	0°
3.2FSI	A/M	AUK	01/05 > 06/08	439564	14	150	INC	66	6 RL	0°
<b>A4 旅行车 / A4 Avant (8ED, B7)</b>										
2.0TDI 柴油		BPW/BVF	11/04 > 06/08	439534	14					
<b>A4 / A4 (8K2, B8)</b>										
3.2 FSI		CALA	09/08 >	439658	14	150	INC	61,8	6	0°
<b>A5 / A5 (8T3)</b>										
1.8TFSI	A/M	CABD	01/07 >	439798	14	180	INC	57,2	6	0°
2.0TFSI	A/M	CDNC	06/08 >	439798	14	180	INC	57,2	6	0°
3.2 FSI		CALA	06/07 >	439658	14	150	INC	61,8	6	0°
<b>S5 quattro / S5 (8T3)</b>										
4.2L	A/M	CAUA	06/07 >	439618	14	180	INC	77,7	5	82
<b>A6 / A6 (4B, C5)</b>										
2.4L		AGA	02/97 > 01/05	439271	14	120	INC	57	5 RL	60
2.4L	A/M	AGA	02/97 > 01/05	439338	14	70	INC	57	5	60
2.4L		AGA	02/97 > 01/05	439391	14	120	INC	65	6	60
2.8L	A/M	ATX/ BBG	07/99 > 01/05	439338	14	70	INC	57	5	60
2.8L	A/M	ATX/ BBG	07/99 > 01/05	439391	14	120	INC	65	6	60
3.0L	A/M	ASN	05/04 >	439391	14	120	INC	65	6	60
3.0L	A/M	ASN	05/04 >	439574	14	150	INC	66	6	60
1.8T	A/M	AEB/ APU	01/97 > 01/05	439271	14	120	INC	57	5 RL	60
1.8T	A/M	AEB/ APU	01/97 > 01/05	439338	14	70	INC	57	5	60
<b>A6 / A6 (4F2, C6)</b>										
2.4L	A/M	BDW	05/04 > 01/08	439535	14	150	INC	66	6 RL	0°
2.4L	A/M	BDW	05/04 > 01/08	439554	14	180	INC	66	6 RL	0°
2.0TFSI	A/M	BPJ/ BYK	06/05 > 03/11	439581	14	150	INC	57,2	6 RL	0°
2.8 FSI	A/M	BDX	11/06 > 01/08	439535	14	150	INC	66	6 RL	0°
3.0 quattro	A	BBJ	05/04 > 05/06	439541	14	180	INC	58	6	90
3.2FSI	A/M	AUK/ BKH	05/04 > 05/09	439535	14	150	INC	66	6 RL	0°
3.2FSI	A/M	AUK/ BKH	05/04 > 05/09	439554	14	180	INC	66	6 RL	0°

<b>奥迪 / AUDI</b>										
<b>A6 / A6 (4G2, C7)</b>										
2.0TFSI	A/M	CDNB	05/11 >	439782	14	150	INC	57,2	6 RL	0 °↕
<b>A8 / A8 (4E_)</b>										
3.0L	A	ASN	07/03 > 05/05	439391	14	120	INC	65	6	60 ⇄
<b>Q5 / Q5 (8R)</b>										
2.0TFSI quattro		CAEB	01/09 >	439798	14	180	INC	57,2	6	0 °↕
3.2 FSI quattro		CALB	11/08 >	439658	14	150	INC	61,8	6	0 °↕
<b>Q7 / Q7 (4L)</b>										
3.0TDI / 柴油		CASA/ CJGA	11/07 >	439527	14	180	INC	58	6	90 ⇄
3.0TDI / 柴油	A	CASA/ CJGA	11/07 >	439817	14	220	INC	57,2	6 RL	90 ⇄
3.0TFSI	A	CJTB/ CTWA	05/10 >	439816	14	220	INC	57,2	6	90 ⇄
3.6 FSI		BHK	08/06 > 05/10	439624	14	180	INC	57,2	7 RL	90 ⇄
3.6FSI	A/M	BHK	08/06 > 05/10	439639	14	180	INC	54,5	7	100 ⇄
4.2 TDI / 柴油		BTR	03/07 > 06/09	439527	14	180	INC	58	6	90 ⇄
<b>TT / TT (8J3)</b>										
2.0TFSI		BPY/ BWA	08/06 > 06/10	439489	14	140		57	6 RL	90 ⇄
<b>TT / TT (8N3)</b>										
1.8T quattro	A/M	AMU/ APX	04/02 >	439310	14	70	INC	57	6	90 ⇄
1.8T quattro	A/M	AMU/ APX	04/02 >	439311	14	90	INC	57,2	6	90 ⇄
1.8T quattro	A/M	AMU/ APX	04/02 >	439312	14	120	INC	57,2	6 RL	90 ⇄
1.8T quattro	A/M	AMU/ APX	04/02 >	439326	14	120	INC	49	6	90 ⇄
1.8T quattro	A/M	AMU/ APX	04/02 >	439445	14	90	INC	50,5	6	90 ⇄
<b>宝马 / BMW</b>										
<b>116i / 116i (E87)</b>										
1.6L	A/M	N43 B16 A	11/03 > 09/12	439476	14	140	INC	49	6 RL	0 °↕
<b>118i / 118i (E87)</b>										
2.0L	A/M	N43 B20 A	07/04 > 09/12	439476	14	140	INC	49	6 RL	0 °↕
<b>130i / 130i (E87)</b>										
3.0L	A/M	N52 B30 A	03/05 > 09/12	439560	14	180	INC	50,3	6 RL	0 °↕
<b>316i / 316i (E36)</b>										
1.6L	A/M	M43 B16	07/93 > 02/98	439007	14	80	INC	52	6	35 ⇄
<b>316i / 316i (E46)</b>										
1.6L	M	N45 B16/ N45 B16 A	06/02 > 02/05	439237	14	100	INC	52	6	60 ⇄
1.6L	A/M	N45 B16/ N45 B16 A	06/02 > 02/05	439476	14	140	INC	49	6 RL	0 °↕
1.9L	A/M	M43 B19 (194E1)	09/98 > 02/05	439237	14	100	INC	52	6	60 ⇄
<b>318i / 318i (E36)</b>										
1.8L	A/M	M43 B18	01/93 > 02/98	439007	14	80	INC	52	6	35 ⇄
<b>318i / 318i (E46)</b>										
1.9L	A/M	M43 B19/ M43 B19 TU	02/98 > 09/01	439237	14	100	INC	52	6	60 ⇄
2.0L	A/M	N42 B20/ N46 B20	09/01 > 02/05	439476	14	140	INC	49	6 RL	0 °↕

<b>宝马 / BMW</b>										
<b>320i / 320i (E36)</b>										
2.0L		M50 B(20 6 S1)/ M50 B(20 6 S2) Vanos	09/90 > 02/98	433181	14					
<b>320i / 320i (E46)</b>										
2.0L		M52 B(20 6 S3) Vanos/ M52 B20	03/98 > 09/00	433181	14					
2.0L	A/M	M52 B(20 6 S3) Vanos/ M52 B20	03/98 > 09/00	439223	14	90	INC	50	6	30 ⇄
2.0L	A/M	M52 B(20 6 S3) Vanos/ M52 B20	03/98 > 09/00	439234	14	120	INC	51	6	35 ⇄
2.2L	A/M	M54 226 S1/ M54 B22	09/00 > 02/05	439397	14	90	INC	51	6	90 ⇄
2.2L	A/M	M54 226 S1/ M54 B22	09/00 > 02/05	439398	14	120	INC	51	6	95 ⇄
<b>323i / 323i (E36)</b>										
2.5L		M52 B25 (Vanos)	03/95 > 02/98	433181	14					
<b>325i / 325i (E36)</b>										
2.5L		M50 B25/ M50 B25 (Vanos)	09/90 > 09/95	433181	14					
<b>325i / 325i (E46)</b>										
2.5L	A/M	M54 256 S5/ M54 B25	09/00 > 02/05	439397	14	90	INC	51	6	90 ⇄
2.5L	A/M	M54 256 S5/ M54 B25	09/00 > 02/05	439398	14	120	INC	51	6	95 ⇄
<b>325i / 325i (E90)</b>										
2.5L	A/M	N52 B25/ N52 B25 A	01/05 > 12/11	439560	14	180	INC	50,3	6 RL	0 °↕
<b>328i / 328i (E36)</b>										
2.8L		M52 B28/ M52 B28 TU	01/95 > 02/98	433181	14					
<b>328i / 328i (E46)</b>										
2.8L		M52 B28	02/98 > 06/00	433181	14					
<b>330i / 330i (E46)</b>										
3.0L	A/M	M54 306 S3/ M54 B30	06/00 > 02/05	439397	14	90	INC	51	6	90 ⇄
3.0L	A/M	M54 306 S3/ M54 B30	06/00 > 02/05	439398	14	120	INC	51	6	95 ⇄
<b>330i / 330i (E90)</b>										
3.0L	A/M	N52 B30/ N52 B30 A	01/05 > 12/11	439560	14	180	INC	50,3	6 RL	0 °↕
<b>M3 / M3 (E90)</b>										
4.0L		S65B40	03/07 > 12/11	439675	14	180	INC	54	6	95 ⇄
<b>M3 / M3 Coupe (E92)</b>										
4.0L		S65B40	03/07 >	439675	14	180	INC	54	6	95 ⇄
<b>518i / 518i (E34)</b>										
1.8L	A/M	M40 B18	08/89 > 09/95	439007	14	80	INC	52	6	35 ⇄
<b>520d / 520d (E39)</b>										
2.0D / 柴油	M	M47 204 D1/ M47 D20	02/00 > 06/03	439252	14	150	INC	54	5	35 ⇄
<b>520d / 520d (E60)</b>										
2.0D / 柴油	A/M	M47 D20 (204D4)	07/05 > 03/10	439485	14	170	INC	53,8	6	95 ⇄
<b>520i / 520i (E39)</b>										
2.0L	A/M	M52 B(20 6 S3) Vanos	04/99 > 06/03	439223	14	90	INC	50	6	30 ⇄
2.0L	A/M	M52 B(20 6 S3) Vanos	04/99 > 06/03	439234	14	120	INC	51	6	35 ⇄
2.2L	A/M	M54 B22	07/03 >	439397	14	90	INC	51	6	90 ⇄
2.2L	A/M	M54 B22	07/03 >	439398	14	120	INC	51	6	95 ⇄



<b>宝马 / BMW</b>										
<b>520i / 520i (E60)</b>										
2.2L	A/M	M54 226 S1/ M54 B22	07/03 > 03/10	439486	14	150	INC	50	6	47 ⇄
<b>523i / 523i (E39)</b>										
2.5L	A/M	M52 B25 (Vanos)/ M52 B25 TU	11/95 > 09/00	439223	14	90	INC	50	6	30 ⇄
2.5L	A/M	M52 B25 (Vanos)/ M52 B25 TU	11/95 > 09/00	439234	14	120	INC	51	6	35 ⇄
<b>523i / 523i (E60)</b>										
2.5L	A/M	N52 B25 A	01/07 > 03/10	439560	14	180	INC	50,3	6 RL	0 °⇄
<b>525d / 525d (E39)</b>										
2.5D / 柴油	A/M	M57 256 D1/ M57 D25	02/00 > 06/03	439252	14	150	INC	54	5	35 ⇄
<b>525d / 525d (E60)</b>										
2.5D / 柴油	A/M	M57 D25 TU/ M57N 256 D4	06/04 > 03/10	439485	14	170	INC	53,8	6	95 ⇄
<b>525i / 525i (E39)</b>										
2.5L	A/M	M54 256 S5/ M54 B25	09/03 >	439397	14	90	INC	51	6	90 ⇄
2.5L	A/M	M54 256 S5/ M54 B25	09/03 >	439398	14	120	INC	51	6	95 ⇄
<b>525i / 525i (E60)</b>										
2.5L	A/M	M54 256 S5/ M54 B25	09/03 > 03/10	439486	14	150	INC	50	6	47 ⇄
2.5L	A/M	N52 B25/ N52 B25 A	07/05 > 03/10	439560	14	180	INC	50,3	6 RL	0 °⇄
<b>528i / 528i (E39)</b>										
2.8L	A/M	M52 B28/ M52 B28 TU	11/95 > 09/00	439223	14	90	INC	50	6	30 ⇄
2.8L	A/M	M52 B28/ M52 B28 TU	11/95 > 09/00	439234	14	120	INC	51	6	35 ⇄
<b>530d / 530d (E60)</b>										
3.0D / 柴油	A/M	M57 306 D3	07/03 > 03/10	439485	14	170	INC	53,8	6	95 ⇄
<b>530i / 530i (E60)</b>										
3.0L	A/M	M54 306 S3/ M54 B30	07/03 > 03/10	439397	14	90	INC	51	6	90 ⇄
3.0L	A/M	M54 306 S3/ M54 B30	07/03 > 03/10	439398	14	120	INC	51	6	95 ⇄
3.0L	A/M	M54 306 S3/ M54 B30	07/03 > 03/10	439486	14	150	INC	50	6	47 ⇄
3.0L	A/M	N52 B30	07/05 > 03/10	439560	14	180	INC	50,3	6 RL	0 °⇄
<b>545i / 545i (E60)</b>										
4.4L	A/M	N62 B44	09/03 > 03/10	439510	14	180	INC	50	6	47 ⇄
4.4L	A/M	N62 B44	09/03 > 03/10	439566	14	180	INC	50	6	95 ⇄
<b>550i / 550i (F10)</b>										
4.4L		N63B44A	03/10 >	439636	14	230	INC	50	7	0 °⇄
<b>645 Ci / 645 Ci (E63)</b>										
4.4L	A/M	N62 B44/ N62 B44 A	01/04 >	439510	14	180	INC	50	6	47 ⇄
<b>728 i,iL / 728i (E38)</b>										
2.8L	A/M	M52 B28/ M52 B28 TU	08/95 > 11/01	439234	14	120	INC	51	6	35 ⇄
<b>730 i,Li / 730i (E65, E66)</b>										
3.0L	A	M54 306 S3/ M54 B30	03/03 >	439486	14	150	INC	50	6	47 ⇄
3.0L	A	N52 B30/ N52 B30 A	03/05 >	439560	14	180	INC	50,3	6 RL	0 °⇄

<b>宝马 / BMW</b>										
<b>735 i,Li / 735i (E65, E66)</b>										
3.6L	A	N62 B36	11/01 >	439510	14	180	INC	50	6	47 ⇄
3.6L	A	N62 B36	11/01 >	439566	14	180	INC	50	6	95 ⇄
<b>740 i / 740i (F01, F02, F03, F04)</b>										
3.0L	A	N54 B30 A	01/08 >	439640	14	230	INC	50	8	0 °⇄
<b>745 i,Li / 745i (E65, E66)</b>										
4.4L	A	N62 B44/ N62 B44 A	11/01 >	439566	14	180	INC	50	6	95 ⇄
<b>750i / 750i (F01, F02, F03, F04)</b>										
4.4L		N63B44A	10/08 >	439636	14	230	INC	50	7	0 °⇄
<b>760i / 760i (F01, F02, F03, F04)</b>										
6.0L		N74B60A	09/09 >	439636	14	230	INC	50	7	0 °⇄
<b>M5 / M5 (E60)</b>										
5.0L	M	S85 B50 A	01/05 >	439559	14	170	INC	54	6	48 ⇄
<b>X3 / X3 (E83)</b>										
2.5i	A/M	M54 256 S5/ M54 B25	01/04 >	439486	14	150	INC	50	6	47 ⇄
3.0i	A/M	M54 306 S3/ M54 B30	01/04 >	439486	14	150	INC	50	6	47 ⇄
<b>X3 xDrive 30i / X3 (E83)</b>										
3.0L	A/M	N52 B30 A	09/08 >	439487	14	150	INC	54	6	47 ⇄
3.0L	A/M	N52 B30 A	09/08 >	439567	14	150	INC	54	6	90 ⇄
<b>X5 / X5 (E53)</b>										
3.0i	A/M	M54 306 S3/ M54 B30	12/03 >	439507	14	140	INC	51	6	33 ⇄
4.4i	A	N62 B44/ N62 B44 A	12/03 >	439537	14	180	INC	51,5	6	47 ⇄
4.8is	A	N62 B48 A	04/04 >	439537	14	180	INC	51,5	6	47 ⇄
<b>X5 / X5 (E70)</b>										
3.0L		N52 B30	02/07 > 09/08	439601	14	180	INC	51,7	7	95 ⇄
3.0si	A	N52 B30	02/07 > 09/08	439602	14	230	INC	51,7	7	95 ⇄
3.0si	A	N52 B30	02/07 > 09/08	439603	14	230	INC	50,31	7 RL	0 °⇄
3.0D / 柴油		M57306D3	02/07 > 09/08	439601	14	180	INC	51,7	7	95 ⇄
4.8L		N62B48B	02/07 > 09/08	439601	14	180	INC	51,7	7	95 ⇄
4.8i	A	N62 B48 B	02/07 > 09/08	439602	14	230	INC	51,7	7	95 ⇄
<b>X6 xDrive 35i / X6 (E71, E72)</b>										
3.0L	A	N54 B30 A/ N55 B30 A	01/12 >	439640	14	230	INC	50	8	0 °⇄
<b>X6 / X6 (E71, E72)</b>										
4.4L		S63B44A	09/09 >	439636	14	230	INC	50	7	0 °⇄
<b>Z3 / Z3 (E36)</b>										
1.8L	A/M	M43 B18	01/95 > 01/98	439007	14	80	INC	52	6	35 ⇄
2.0L	A/M	M52 B(20 6 S4)/ M52 B20	04/99 > 01/03	439223	14	90	INC	50	6	30 ⇄
2.0L	A/M	M52 B(20 6 S4)/ M52 B20	04/99 > 01/03	439234	14	120	INC	51	6	35 ⇄
2.8L	A/M	M52 B28/ M52 B28 TU	04/97 > 06/00	439223	14	90	INC	50	6	30 ⇄
2.8L	A/M	M52 B28/ M52 B28 TU	04/97 > 06/00	439234	14	120	INC	51	6	35 ⇄
3.2L	M	S54 B32/ S54 B32 (32 6 S4)	06/01 > 01/03	439317	14	120	INC	54,2	6	95 ⇄

<b>雪铁龙 / CITROEN</b>										
<b>C4 / C4 (LC_)</b>										
1.6L 16V	A/M	NFU (TU5JP4)	11/04 >	439521	14	125	INC	54,3	6	78 ⇄
2.0L 16V	M	RFN (EW10J4)	11/04 >	439521	14	125	INC	54,3	6	78 ⇄
2.0L 16V	A/M	RFN (EW10J4)	11/04 >	439692	14	97	INC	54	6	80 ⇄
<b>C5 / C5 (DC_)</b>										
1.8L 16V (DC6FZB, DC6FZE)	A/M	6FZ (EW7J4)	03/01 > 08/04	439435	14	120	INC	57,5	6	40 ⇄
1.8L 16V (DC6FZB, DC6FZE)	A/M	6FZ (EW7J4)	03/01 > 08/04	439521	14	125	INC	54,3	6	78 ⇄
1.8L 16V (DC6FZB, DC6FZE)	A/M	6FZ (EW7J4)	03/01 > 08/04	439692	14	97	INC	54	6	80 ⇄
2.0L 16V (DCRFNC, DCRFNF)	A/M	RFN (EW10J4)	08/04 >	439294	14	150	INC	57,5	6 RL	79 ⇄
2.0L 16V (DCRFNC, DCRFNF)	A/M	RFN (EW10J4)	08/04 >	439435	14	120	INC	57,5	6	40 ⇄
2.0L 16V (DCRFNC, DCRFNF)	A/M	RFN (EW10J4)	08/04 >	439521	14	125	INC	54,3	6	78 ⇄
2.0L 16V (DCRFNC, DCRFNF)	A/M	RFN (EW10J4)	08/04 >	439692	14	97	INC	54	6	80 ⇄
3.0L V6 (DCXFXC, DCXFXF)	A/M	XFX (ES9J4S)	03/01 > 08/04	439166	14	150	INC	51	6	40 ⇄
<b>C5 / C5 (RC_)</b>										
3.0L V6 (RCXFUF)	A	XFV (ES9A) / XFX (ES9J4S)	09/04 >	439470	14	120	INC	51	6	40 ⇄
3.0L V6 (RCXFUF)	A	XFV (ES9A) / XFX (ES9J4S)	09/04 >	439634	14	150	INC	52,2	6	80 ⇄
<b>桑蒂雅 / XANTIA (X2)</b>										
1.8i	A/M	LFX (XU7JB)	01/98 > 04/03	439083	14	90	INC	56	6	45 ⇄
2.0i	A/M	RFX (XU10J2C)	01/98 > 04/03	439083	14	90	INC	56	6	45 ⇄
<b>塞纳毕加索 / XSARA PICASSO (N68)</b>										
1.8L 16V	M	6FZ (EW7J4)	02/00 >	439496	14	90	INC	51	6	34 ⇄
<b>塞纳 / XSARA (N1)</b>										
2.0L 16V	M	RFN (EW10J4)	09/00 > 03/05	439496	14	90	INC	51	6	34 ⇄
2.0L 16V	A/M	RFN (EW10J4)	03/03 >	439294	14	150	INC	57,5	6 RL	79 ⇄
<b>现代 / HYUNDAI</b>										
<b>途胜 / TUCSON (JM)</b>										
2.7L		G6BA-G	08/05 >	600027	14	110		62	6	35 ⇄
<b>路虎 / LAND ROVER</b>										
<b>发现 I / DISCOVERY I (LJ, LG)</b>										
3.9 V8	M	35 D / 36 D	09/93 > 01/98	439468	14	120	INC	53	7	60 ⇄
<b>发现 II / DISCOVERY II (LJ, LT)</b>										
4.0 V8	A/M	56 D	11/98 > 06/04	439468	14	120	INC	53	7	60 ⇄
<b>奔驰 / MERCEDES-BENZ</b>										
<b>A140 / A140 (W168)</b>										
1.4L	A/M	M 166.940	07/97 > 08/04	439206	14	90	INC	51	5	0 ⇄
<b>A150 / A150 (W169)</b>										
1.5L	A/M	M 266.920	09/04 > 06/12	439544	14	90	INC	53	5	0 ⇄
1.5L	A/M	M 266.920	09/04 > 06/12	439551	14	115	INC	53	5 RL	0 ⇄
<b>A160 / A160 (W169)</b>										
1.5L	A/M	M 266.920	04/09 > 06/12	439544	14	90	INC	53	5	0 ⇄

<b>奔驰 / MERCEDES-BENZ</b>										
<b>A160 / A160 (W168)</b>										
1.6L	A/M	M 166.960	02/99 >	439206	14	90	INC	51	5	0 ⇄
<b>A170 / A170 (W169)</b>										
1.7L	A/M	M 266.940	09/04 > 06/12	439544	14	90	INC	53	5	0 ⇄
1.7L	A/M	M 266.940	09/04 > 06/12	439551	14	115	INC	53	5 RL	0 ⇄
<b>A180 / A180 (W169)</b>										
1.7L	A/M	M 266.940	04/09 > 06/12	439551	14	115	INC	53	5 RL	0 ⇄
<b>A190 / A190 (W168)</b>										
1.9L	A/M	M 166.990	06/04 >	439232	14	90	INC	53	5 RL	0 ⇄
<b>A200 / A200 (W169)</b>										
2.0L	A/M	M 266.960	09/04 > 06/12	439551	14	115	INC	53	5 RL	0 ⇄
<b>A210 / A210 (W168)</b>										
2.1L	A/M	M 166.995	03/02 > 08/04	439232	14	90	INC	53	5 RL	0 ⇄
<b>B150 / B150 (W245)</b>										
1.5L	A/M	M 266.920	03/05 > 11/11	439544	14	90	INC	53	5	0 ⇄
1.5L	A/M	M 266.920	03/05 > 11/11	439551	14	115	INC	53	5 RL	0 ⇄
<b>B170 / B170 (W245)</b>										
1.7L	A/M	M 266.940	03/05 > 11/11	439544	14	90	INC	53	5	0 ⇄
1.7L	A/M	M 266.940	03/05 > 11/11	439551	14	115	INC	53	5 RL	0 ⇄
<b>B200 / B200 (W245)</b>										
2.0L	A/M	M 266.960	01/09 >	439544	14	90	INC	53	5	0 ⇄
2.0L	A/M	M 266.960	01/09 >	439551	14	115	INC	53	5 RL	0 ⇄
<b>C180 / C180 (W202)</b>										
1.8L	A/M	M 111.920	03/93 > 05/00	439095	14	90	INC	48	6	60 ⇄
<b>C180 / C180 (W203)</b>										
2.0L	A/M	M 111.951	01/00 > 05/02	439299	14	120	INC	49	6	60 ⇄
<b>C180 Kompressor / C180 (W203)</b>										
1.8L	A/M	M 271.946	05/02 > 02/07	439471	14	120	INC	57	7	0 ⇄
<b>C180 Kompressor / C180 (W204)</b>										
1.8L	A/M	M 271.952	01/07 >	439610	14	150	INC	57	7	0 ⇄
1.8L	A/M	M 271.952	01/07 >	439611	14	120	INC	57	7	0 ⇄
<b>C200 / C200 (W202)</b>										
2.0L	A/M	M 111.941 / M 111.945	01/94 > 05/00	439095	14	90	INC	48	6	60 ⇄
<b>C200 Kompressor / C200 (W203)</b>										
1.8L	A/M	M 271.940	05/02 > 02/07	439471	14	120	INC	57	7	0 ⇄
<b>C200 Kompressor / C200 (W204)</b>										
1.8L	A/M	M 271.950	01/07 >	439610	14	150	INC	57	7	0 ⇄
1.8L	A/M	M 271.950	01/07 >	439611	14	120	INC	57	7	0 ⇄
<b>C200 Kompressor / C200 (W203)</b>										
2.0L	A/M	M 111.955	05/00 > 05/02	439296	14	120	INC	57	6	60 ⇄

<b>奔驰 / MERCEDES-BENZ</b>										
<b>C230 Kompressor / C230 (W203)</b>										
1.8L	A/M	M 271.948	02/04 > 02/07	439471	14	120	INC	57	7	0 ⇄
<b>C230 Kompressor / C230 (CL203)</b>										
2.3L	A/M	M 111.981	03/01 > 05/02	439296	14	120	INC	57	6	60 ⇄
<b>C240 / C240 (W203)</b>										
2.6L	A/M	M 112.912	07/02 >	439298	14	120	INC	51	6	60 ⇄
<b>C250CGI / C250 (W204)</b>										
1.8L	A/M	M 271.860	07/09 >	439610	14	150	INC	57	7	0 ⇄
1.8L	A/M	M 271.860	07/09 >	439611	14	120	INC	57	7	0 ⇄
<b>C320 / C320 (W203)</b>										
3.2L	A/M	M 112.946	05/00 > 02/07	439298	14	120	INC	51	6	60 ⇄
<b>C350(204.088) / C350 (W204)</b>										
3.5L		M 276.957	01/11 >	439773	14	180	INC	51	6 RL	0 ⇄
<b>C32AMG Kompressor / C32AMG (W203)</b>										
3.2L	A	M 112.961	02/01 > 02/07	439420	14	120	INC	51	8	0 ⇄
<b>CLS350 / CLS350 (C219)</b>										
3.5L		M272.964	10/04 > 12/10	439649	14	180	INC	50	6	0 ⇄
<b>CLS550 / CLS550 (C219)</b>										
5.5L		M273.960	04/06 > 12/10	439649	14	180	INC	50	6	0 ⇄
<b>CLK200 / CLK200 (C208)</b>										
2.0L	A/M	M 111.941/ M 111.945	06/97 > 06/02	439095	14	90	INC	48	6	60 ⇄
<b>CLK200 Kompressor / CLK200 (C209)</b>										
1.8L	A/M	M 271.955	01/06 > 05/09	439471	14	120	INC	57	7	0 ⇄
<b>CLK240 / CLK240 (C209)</b>										
2.6L	A/M	M 112.912	01/04 >	439298	14	120	INC	51	6	60 ⇄
<b>CLK320 / CLK320 (C209)</b>										
3.2L	A	M 112.955	06/02 > 05/09	439298	14	120	INC	51	6	60 ⇄
<b>E200 / E200 (W124)</b>										
2.0D / 柴油	A/M	OM 601.912	06/93 > 06/95	433138	14	55	INC	56	6	60 ⇄
<b>E240 / E240 (W211)</b>										
2.6L	A/M	M 112.913/ M 112.917	03/02 > 12/08	439307	14	120	INC	51	6	60 ⇄
<b>E250 / E250 (W124)</b>										
2.5D / 柴油	A/M	OM 602.962	06/93 > 06/95	433138	14	55	INC	56	6	60 ⇄
<b>E280 / E280 (W210)</b>										
2.8L	A/M	M 112.921	12/96 > 03/02	439095	14	90	INC	48	6	60 ⇄
2.8L	A/M	M 112.921	12/96 > 03/02	439307	14	120	INC	51	6	60 ⇄
<b>E280 / E280 (W211)</b>										
3.0L		M272.943	03/05 > 12/08	439649	14	180	INC	50	6	0 ⇄
<b>E300 / E300 (W124)</b>										
3.0D / 柴油	A	OM 603.960	06/93 > 06/95	433138	14	55	INC	56	6	60 ⇄

<b>奔驰 / MERCEDES-BENZ</b>										
<b>E320 / E320 (W210)</b>										
3.2L	A	M 112.941	03/02 >	439095	14	90	INC	48	6	60 ⇄
3.2L	A	M 112.941	03/02 >	439307	14	120	INC	51	6	60 ⇄
<b>E350 / E350 (W211)</b>										
3.5L		M272.964	03/05 > 12/08	439649	14	180	INC	50	6	0 ⇄
<b>ML230 / ML230 (W163)</b>										
2.3L	M	M 111.977	02/98 > 06/05	439095	14	90	INC	48	6	60 ⇄
<b>ML350 / ML350 (166)</b>										
3.5L		M 276.955	06/11 >	439772	14	180	INC	51	6 RL	0 ⇄
<b>ML350 / ML350 (W163)</b>										
3.7L	A	M 112.970	08/02 > 06/05	439298	14	120	INC	51	6	60 ⇄
<b>S280 / S280 (W140)</b>										
2.8L	A/M	M 104.944	02/93 > 01/98	439555	14	120	INC	51,5	6	60 ⇄
<b>S350 / S350 (W221)</b>										
3.5L		M272.965	10/05 >	439649	14	180	INC	50	6	0 ⇄
<b>S450 / S450 (W221)</b>										
4.7L		M273.922	12/05 >	439649	14	180	INC	50	6	0 ⇄
<b>S500 / S500 (W221)</b>										
5.5L		M273.961	10/05 >	439649	14	180	INC	50	6	0 ⇄
<b>SL280 / SL280 (R129)</b>										
2.8L	A/M	M 104.943	08/93 > 01/01	439555	14	120	INC	51,5	6	60 ⇄
<b>SL320 / SL320 (R129)</b>										
3.2L	A	M 104.991	09/93 > 01/01	439555	14	120	INC	51,5	6	60 ⇄
<b>SLK200 Kompressor / SLK200 (R171)</b>										
1.8L	A/M	M 271.944	03/04 > 02/11	439471	14	120	INC	57	7	0 ⇄
<b>SLK350(172.457) / SLK350 (R172)</b>										
3.5L		M 276.956	02/11 >	439772	14	180	INC	51	6 RL	0 ⇄
<b>VANEO / VANE0 (414)</b>										
1.9L	A/M	M 166.991	02/02 > 07/05	439232	14	90	INC	53	5 RL	0 ⇄
<b>唯雅诺 / VIANO (W639)</b>										
3.2L	A	M 112.951	09/03 >	439307	14	120	INC	51	6	60 ⇄
<b>威霆 / VITO (W639)</b>										
3.2L	A	M 112.951	09/03 >	439307	14	120	INC	51	6	60 ⇄
<b>迷你 / MINI</b>										
<b>迷你 Cooper / MINI (R50, R53)</b>										
1.6L	A/M	W10B16A	09/06 >	439469	14	120	INC	48	6	0 ⇄
<b>迷你 One / MINI (R56)</b>										
1.4L	A/M	N12B14A	03/07 >	439617	14	120	INC	53,2	6 RL	0 ⇄
<b>迷你 One / MINI (R50, R53)</b>										
1.6L	A/M	W10B16A	06/01 > 09/06	439469	14	120	INC	48	6	0 ⇄

<b>迷你 / MINI</b>										
<b>迷你 CLUBMAN ONE / MINI CLUBMAN ONE (R56)</b>										
1.6L	A/M	N16 B16 A	01/12 >	439617	14	120	INC	53,2	6 RL	0
<b>迷你 CLUBMAN COOPER / MINI CLUBMAN (R55)</b>										
1.6L	A/M	N12B16A	01/12 >	439617	14	120	INC	53,2	6 RL	0
<b>欧宝 / OPEL</b>										
<b>雅特 F / ASTRA F (56_, 57_)</b>										
1.4L	A/M	14 SE	09/92 > 09/98	439457	14	70	INC	55	6	0
1.6L	A/M	16 LZ2/ 16 NZR	09/95 > 09/98	439427	14	100	INC	51	6	0
1.6L	A/M	16 LZ2/ 16 NZR	09/95 > 09/98	439457	14	70	INC	55	6	0
1.8i	A/M	C 18 NZ	03/92 > 09/98	439427	14	100	INC	51	6	0
1.8i	A/M	C 18 NZ	03/92 > 09/98	439457	14	70	INC	55	6	0
2.0i	A/M	C 20 NE	03/92 > 09/98	439427	14	100	INC	51	6	0
2.0i	A/M	C 20 NE	03/92 > 09/98	439457	14	70	INC	55	6	0
<b>雅特 F / ASTRA F Hatchback (53_, 54_, 58_, 59_)</b>										
1.4i		C14NZ	03/92 > 01/98	439594	14	120	INC	52	6	0
1.6i		X16SZ	05/93 > 07/96	439594	14	120	INC	52	6	0
<b>雅特 G / ASTRA G</b>										
1.4L	A/M	X 14 XE/ Z 14 XE	09/98 > 01/05	439454	14	70	INC	54	5	0
1.6L	A/M	X 16 XE/ Z 16 XE	09/98 > 01/05	439454	14	70	INC	54	5	0
2.0L	A/M	X 20 XEV	09/98 > 01/05	439454	14	70	INC	54	5	0
<b>欧米茄 A / OMEGA A (16_, 17_, 19_)</b>										
1.8L	A/M	E 18 NVR	09/87 > 03/94	439457	14	70	INC	55	6	0
2.0L	A/M	20 SE	09/86 > 03/94	439457	14	70	INC	55	6	0
2.0L		C20NEF	09/90 > 03/94	439594	14	120	INC	52	6	0
<b>欧米茄 B / OMEGA B (25_, 26_, 27_)</b>										
2.0L	A/M	20 SE	03/94 > 12/00	439457	14	70	INC	55	6	0
2.0L	A/M	X 20 XEV	03/94 > 09/99	439427	14	100	INC	51	6	0
2.2L	A/M	Y 22 XE/ Z 22 XE	09/99 > 07/03	439427	14	100	INC	51	6	0
2.2L	A/M	Y 22 XE/ Z 22 XE	09/99 > 07/03	439457	14	70	INC	55	6	0
<b>赛飞利 A / ZAFIRA Mk I (A)</b>										
1.6L	A/M	X 16 XE/ Z 16 XE	04/99 > 08/05	439454	14	70	INC	54	5	0
1.8L	A/M	X 18 XE1	05/99 > 08/00	439454	14	70	INC	54	5	0

<b>标致 / PEUGEOT</b>										
<b>307CC / 307 CC (3B)</b>										
2.0L 16V		RFN (EW10J4)	01/03 >	439294	14	150	INC	57,5	6 RL	79
2.0L 16V		RFN (EW10J4)	01/03 >	439521	14	125	INC	54,3	6	78
<b>406 / 406 (8B)</b>										
1.6L	M	BFZ (XU5JP)	11/95 > 05/04	439083	14	90	INC	56	6	45
1.8L			05/97 > 05/04	439083	14	90	INC	56	6	45
1.8L	A/M	6FZ (EW7J4)	01/00 > 05/04	439435	14	120	INC	57,5	6	40
2.0L	A/M	RFN (EW10J4)	08/00 > 05/04	439294	14	150	INC	57,5	6 RL	79
2.2L	M	3FZ (EW12J4)	05/04 >	439435	14	120	INC	57,5	6	40
3.0L		XFZ (ES9J4S)	05/04 >	439166	14	150	INC	51	6	40
3.0L	A/M	XFZ (ES9J4S)	05/04 >	439470	14	120	INC	51	6	40
<b>406 / 406 Coupe (8C)</b>										
2.0L	A/M	RFN (EW10J4)	06/03 >	439435	14	120	INC	57,5	6	40
<b>407 / 407 (6D_)</b>										
1.8L	M	6FZ (EW7J4)	05/04 >	439521	14	125	INC	54,3	6	78
1.8L	M	6FZ (EW7J4)	05/04 >	439692	14	97	INC	54	6	80
3.0L	A/M	XFV (ES9A)	05/04 >	439470	14	120	INC	51	6	40
<b>607 / 607 (9D, 9U)</b>										
2.0L	M	RFN (EW10J4)	02/00 >	439294	14	150	INC	57,5	6 RL	79
3.0L V6 24V	A/M	XFZ (ES9J4S)	02/00 >	439166	14	150	INC	51	6	40
<b>雷诺 / RENAULT</b>										
<b>太空 III / ESPACE III (JE0_)</b>										
2.0L	A/M	F3R 728/ F3R 729	11/96 > 01/00	439286	14	110	INC	55	6	35
2.0L	A/M	F3R 728/ F3R 729	11/96 > 01/00	439287	14	75	INC	55	6	0
<b>拉古娜 I / LAGUNA I (B56_, 556_)</b>										
1.6L	M	K4M 720	11/97 > 03/01	439306	14	95	INC	58	6	0
1.8L	M	F3P 674	06/95 > 02/01	439285	14	110	INC	55	6	0
1.8L	M	F3P 674	06/95 > 02/01	439286	14	110	INC	55	6	35
1.8L	M	F3P 674	06/95 > 02/01	439287	14	75	INC	55	6	0
1.8L	M	F4P 760	04/98 > 03/01	439306	14	95	INC	58	6	0
2.0L	A/M	F3R 768	06/95 > 02/01	439285	14	110	INC	55	6	0
2.0L	A/M	F3R 768	06/95 > 02/01	439286	14	110	INC	55	6	35
2.0L	A/M	F3R 768	06/95 > 02/01	439287	14	75	INC	55	6	0
2.0L	M	F4R 780	09/99 > 03/01	439306	14	95	INC	58	6	0
<b>拉古娜 II / LAGUNA II (BG0/1_)</b>										
1.8L	M	F4P 770/ F4P 774	03/01 >	439464	14	125	INC	50	6	90
1.8L	M	F4P 770/ F4P 774	03/01 >	439467	14	100	INC	50,5	6	90
1.8L	A/M	F4P 770/ F4P 773	03/01 >	439394	14	125	INC	56	6 RL	90
1.9 dCi (BG05) 柴油	A/M	F9Q 664	03/04 >	439292	14	120	INC	50	6/7RL	90
2.0L	A/M	F4R 712/ F4R 713	08/02 >	439464	14	125	INC	50	6	90
2.0L	A/M	F4R 712/ F4R 713	08/02 >	439467	14	100	INC	50,5	6	90
2.0L	A/M	F5R 700/ F5R 701	04/01 >	439394	14	125	INC	56	6 RL	90





## 雷诺 / RENAULT

### 拉古娜 III / LAGUNA III (BT0/1)

2.0L	M	M4R 704	01/07 >	439647	14	160	INC	52,6	6 RL	90 ⇄
2.0T	A/M	F4R 811	01/12 >	439628	14	150	INC	50,4	7	90 ⇄
2.0T		F4R811	10/07 >	439645	14	150	INC	50	7 RL	90 ⇄

### 梅甘娜 I / MEGANE I (BA0/1\_)

1.6L	A/M	K4M 700/ K4M 701	03/99 > 08/03	439306	14	95	INC	58	6	0 °⇄
1.8L	M	F4P 720/ F4P 722	01/01 > 08/03	439306	14	95	INC	58	6	0 °⇄
2.0i	A/M	F3R 750/ F3R 751	01/96 > 08/03	439285	14	110	INC	55	6	0 °⇄
2.0i	A/M	F3R 750/ F3R 751	01/96 > 08/03	439286	14	110	INC	55	6	35 ⇄
2.0i	A/M	F3R 750/ F3R 751	01/96 > 08/03	439287	14	75	INC	55	6	0 °⇄
2.0L	M	F7R 710/ F7R 714	07/96 > 08/03	439306	14	95	INC	58	6	0 °⇄

### 梅甘娜 II / MEGANE II (BM0/1\_ , CM0/1\_)

1.5dCi / 柴油	M	K9K 724	05/05 >	439561	14	110	INC	58,3	6	90 ⇄
1.9 dCi / 柴油	A/M	F9Q 804	11/02 >	439587	14	120	INC	50,5	7	90 ⇄
2.0T	A/M	F4R 776	05/04 >	439478	14	120	INC	50,5	7	90 ⇄
2.0T	A/M	F4R 776	05/04 >	439479	14	110	INC	52	7	90 ⇄
2.0L	A/M	F4R 770	11/02 >	439478	14	120	INC	50,5	7	90 ⇄
2.0L	A/M	F4R 770	11/02 >	439479	14	110	INC	52	7	90 ⇄

### 梅甘娜 II / MEGANE II Saloon (LM0/1\_)

1.9 dCi / 柴油	A	F9Q 803	05/05 >	439588	14	110	INC	50,5	7	90 ⇄
--------------	---	---------	---------	--------	----	-----	-----	------	---	------

### 梅甘娜 III / MEGANE III Grandtour (KZ0/1)

2.0 CVT	A/M	M4R 711/ M4R F 713	05/09 >	439647	14	160	INC	52,6	6 RL	90 ⇄
---------	-----	--------------------	---------	--------	----	-----	-----	------	------	------

### 风景 I / SCENIC I (JA0/1\_)

1.8L	M	F4P 720/ F4P 722	01/01 > 08/03	439318	14	120	INC	58	6	0 °⇄
2.0L	A/M	F4R 740/ F4R 741	07/00 > 08/03	439318	14	120	INC	58	6	0 °⇄

### 风景 II / SCENIC II (JM0/1\_)

1.5dCi / 柴油	M	K9K 732	05/05 >	439561	14	110	INC	58,3	6	90 ⇄
2.0T	A/M	F4R 776	05/04 >	439478	14	120	INC	50,5	7	90 ⇄
2.0T	A/M	F4R 776	05/04 >	439479	14	110	INC	52	7	90 ⇄
2.0L	A/M	F4R 770/ F4R 771	06/03 >	439478	14	120	INC	50,5	7	90 ⇄
2.0L	A/M	F4R 770/ F4R 771	06/03 >	439479	14	110	INC	52	7	90 ⇄

## 斯柯达 / SKODA

### 晶锐 / FABIA

1.6TDI / 柴油	M	CAYB	03/10 >	439664	14	140	INC	57,2	6	90 ⇄
-------------	---	------	---------	--------	----	-----	-----	------	---	------

## 大众 / VOLKSWAGEN

### 开迪 / CADDY I (14)

1.6L	A/M	EW	01/83 > 07/92	433044	14	55	INC	70	1	60 ⇄
1.8L	A/M	JH	08/85 > 07/92	433044	14	55	INC	70	1	60 ⇄



## 大众 / VOLKSWAGEN

### EOS / EOS (1F7, 1F8)

2.0TSI		BPY/ BWA	03/06 >	439534	14					
2.0TSI		BPY/ BWA	03/06 >	439489	14	140		57	6 RL	90 ⇄
2.0TSI	A/M	CCZB	01/12 >	439393	14	140	INC	57	6 RL	0 °⇄

### 高尔夫 II / GOLF II (19E, 1G1)

1.6L	A/M	PN	01/86 > 12/92	433044	14	55	INC	70	1	60 ⇄
1.8L	A/M	RH	08/86 > 01/90	433044	14	55	INC	70	1	60 ⇄

### 高尔夫 V / GOLF V (1K1)

1.4TSI	A/M	CAXA	05/07 > 11/08	439580	14	110	INC	50,5	6 RL	90 ⇄
--------	-----	------	---------------	--------	----	-----	-----	------	------	------

### 高尔夫 VI / GOLF VI (5K1)

1.4TSI	A	CAXA	01/08 > 11/12	439580	14	110	INC	50,5	6 RL	90 ⇄
--------	---	------	---------------	--------	----	-----	-----	------	------	------

### 甲壳虫 / NEW BEETLE (9C1, 1C1)

1.6L	A/M	AYD/ BFS	06/00 >	439310	14	70	INC	57	6	90 ⇄
1.6L	A/M	AYD/ BFS	06/00 >	439311	14	90	INC	57,2	6	90 ⇄
1.6L	A/M	AYD/ BFS	06/00 >	439312	14	120	INC	57,2	6 RL	90 ⇄
1.6L	A/M	AYD/ BFS	06/00 >	439326	14	120	INC	49	6	90 ⇄
1.6L	A/M	AYD/ BFS	06/00 >	439445	14	90	INC	50,5	6	90 ⇄
2.0L	A/M	AEG/ APK	06/01 >	439310	14	70	INC	57	6	90 ⇄
2.0L	A/M	AEG/ APK	06/01 >	439326	14	120	INC	49	6	90 ⇄
1.8T	A/M	AGU/ APH	01/99 >	439310	14	70	INC	57	6	90 ⇄
1.8T	A/M	AGU/ APH	01/99 >	439311	14	90	INC	57,2	6	90 ⇄
1.8T	A/M	AGU/ APH	01/99 >	439312	14	120	INC	57,2	6 RL	90 ⇄
1.8T	A/M	AGU/ APH	01/99 >	439326	14	120	INC	49	6	90 ⇄

### 帕萨特 / PASSAT (3C2)

2.0 FSI	A/M	AXX/ CAWB	02/08 >	439558	14	180	INC	57	6 RL	90 ⇄
3.2 FSI 4motion	A	AXZ	11/05 > 07/10	439558	14	180	INC	57	6 RL	90 ⇄

### 帕萨特 CC / PASSAT CC (357)

3.6 FSI 4motion	A	BWS	06/08 > 05/10	439558	14	180	INC	57	6 RL	90 ⇄
-----------------	---	-----	---------------	--------	----	-----	-----	----	------	------

### 尚酷 / SCIROCCO (137)

1.4TSI		CAVD/ CTHD	05/08 >	439563	14					
2.0TSI	A/M	CCZB	11/09 > 05/11	439271	14	120	INC	57	5 RL	60 ⇄

### 尚酷 R / SCIROCCO R (137)

2.0T		CDLC	01/12 >	439489	14	140		57	6 RL	90 ⇄
------	--	------	---------	--------	----	-----	--	----	------	------

### 途观 / TIGUAN (5N\_)

1.4TSI		BWK/ CAVA	05/08 >	439563	14					
--------	--	-----------	---------	--------	----	--	--	--	--	--

### 途锐 / TOUAREG (7LA, 7L6, 7L7)







3.0TDI / 柴油		CASA/ CASC	11/07 > 05/10	439527	14	180	INC	58	6	90 ⇄
-------------	--	------------	---------------	--------	----	-----	-----	----	---	------

大众 / VOLKSWAGEN											
途锐 / TOUAREG (7P5)											
3.0TDI / 柴油	A	CASA	01/10 >		439713	14	180	INC	58	6	90 ⇄
3.0TDI / 柴油	A	CASD	01/10 >		439774	14		INC			
3.0TDI / 柴油	A	CASD	01/10 >		439784	14		INC			
途锐 / TOUAREG (7LA, 7L6, 7L7)											
3.6 V6 FSI		BHK/BHL	10/05 > 05/10		439624	14	180	INC	57,2	7 RL	90 ⇄
沃尔沃 / VOLVO											
S40 I / S40 I (VS)											
1.9 DI / 柴油	M	D 4192 T4	07/00 > 12/03		439292	14	120	INC	50	6/7RL	90 ⇄

4





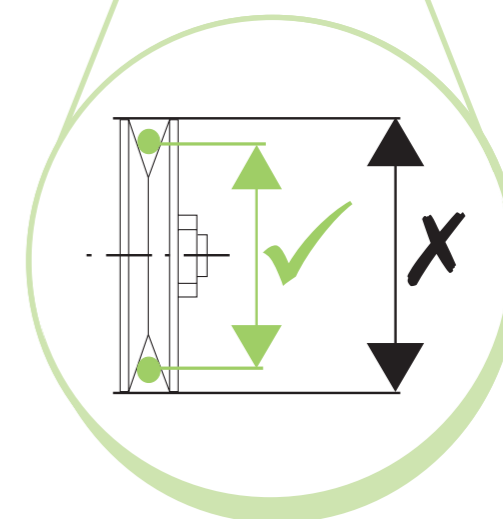

**Valeo** > 



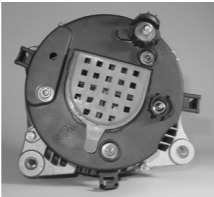
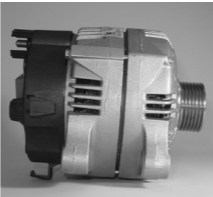

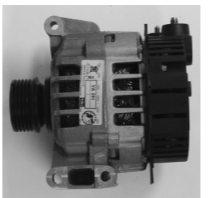



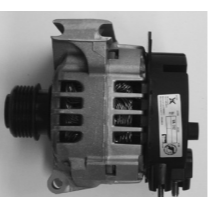



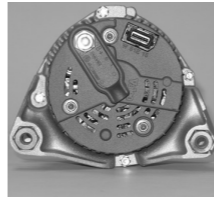

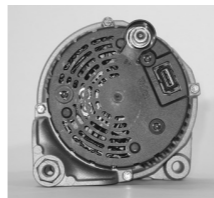

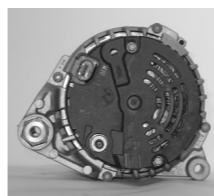
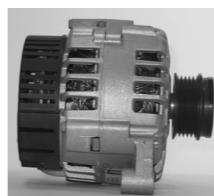



<b>442016</b>	<b>100</b>	<b>6</b>
		
		
<b>14 V</b>	<b>13-90°</b> ⇄	<b>57</b>

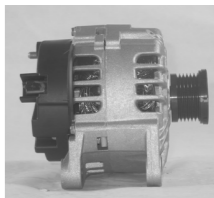

<b>433044</b>	55A	1
14V	60	Ø70
		
大众 / VOLKSWAGEN 奥迪 / AUDI	开迪/CADDY, 高尔夫/GOLF 100/100	
<b>433138</b>	55A	6
14V	60	Ø56
		
奔驰 / MERCEDES-BENZ	E级/CLASSE E	
<b>433181</b>		
14V		
		
宝马 / BMW	3系/3	
<b>439007</b>	80A	6
14V	35	Ø52
		
宝马 / BMW	3系/3, 5系/5, Z3/Z3	
<b>439083</b>	90A	6
14V	45	Ø56
		
标致 / PEUGEOT 雪铁龙 / CITROEN	406/406 桑蒂雅/XANTIA	

<b>439095</b>	90A	6
14V	60	Ø48
		
奔驰 / MERCEDES-BENZ	C级/CLASSE C, E级/CLASSE E M级/CLASSE M, CLK/CLK	
<b>439166</b>	150A	6
14V	40	Ø51
		
标致 / PEUGEOT 雪铁龙 / CITROEN	406/406, 607/607 C5 / C5	
<b>439206</b>	90A	5
14V	0	Ø51
		
奔驰 / MERCEDES-BENZ	A级/CLASSE A	
<b>439223</b>	90A	6
14V	30	Ø50
		
宝马 / BMW	3系/3, 5系/5, Z3/Z3	
<b>439232</b>	90A	5 RL
14V	0	Ø53
		
奔驰 / MERCEDES-BENZ	A级/CLASSE A, Vaneo/Vaneo	

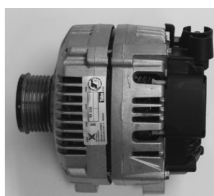
<b>439234</b>	120A	6
14V	35	Ø51
		
宝马 / BMW	3系/3, 5系/5, 7系/7, Z3/Z3	
<b>439237</b>	100A	6
14V	60	Ø52
		
宝马 / BMW	3系/3	
<b>439252</b>	150A	5
14V	35	Ø54
		
宝马 / BMW	5系/5	
<b>439271</b>	120A	5 RL
14V	60	Ø57
		
大众 / VOLKSWAGEN 奥迪 / AUDI	尚酷 / SCIROCCO A3/A3, A4/A4, A6/A6	
<b>439285</b>	110A	6
14V	0	Ø55
		
雷诺 / RENAULT	拉古娜/LAGUNA 梅甘娜/MEGANE	

<b>439286</b>	110A	6
14V	35	Ø55
		
雷诺 / RENAULT	太空/ESPACE, 拉古娜/LAGUNA 梅甘娜/MEGANE	
<b>439287</b>	75A	6
14V	0	Ø55
		
雷诺 / RENAULT	太空/ESPACE, 拉古娜/LAGUNA 梅甘娜/MEGANE	
<b>439292</b>	120A	6/7 RL
14V	90	Ø50
		
沃尔沃 / VOLVO 雷诺 / RENAULT	S40/S40 拉古娜/LAGUNA	
<b>439294</b>	150A	6 RL
14	79	Ø57,5
		
标致 / PEUGEOT 雪铁龙 / CITROEN	307CC /307CC, 406/406, 607/607 C5/C5, 塞纳/XSARA	
<b>439296</b>	120A	6
14	60	Ø57
		
奔驰 / MERCEDES-BENZ	C级/CLASSE C	



<b>439298</b>	120A	6
14	60	Ø51

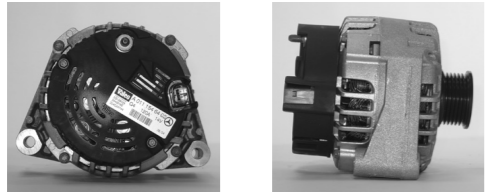

奔驰 / MERCEDES-BENZ  
C级/CLASSE C, M级/CLASSE M  
CLK/ CLK

<b>439299</b>	120A	6
14	60	Ø49

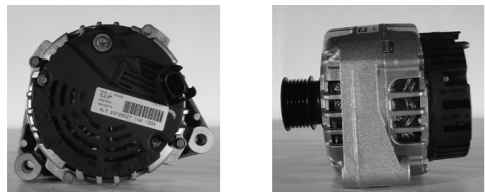

奔驰 / MERCEDES-BENZ  
C级/CLASSE C

<b>439306</b>	95A	6
14	0	Ø58

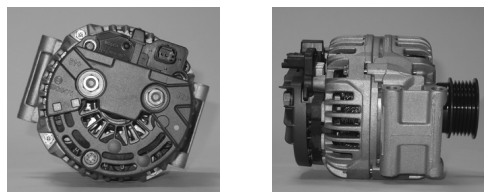

雷诺 / RENAULT  
拉古娜/LAGUNA, 梅甘娜/MEGANE

<b>439307</b>	120A	6
14	60	Ø51

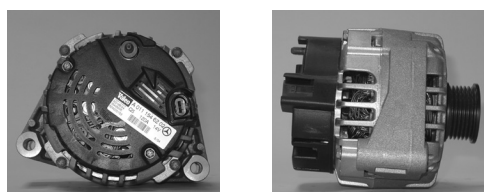

奔驰 / MERCEDES-BENZ  
E级/CLASSE E, 唯雅诺/MIANO  
威霆/VITO

<b>439310</b>	70A	6
14	90	Ø57

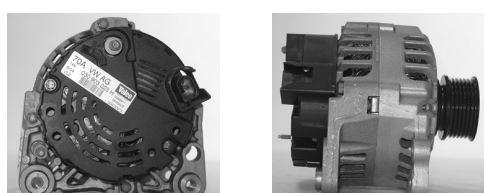

大众 / VOLKSWAGEN  
奥迪 / AUDI  
甲壳虫/NEW BEETLE  
A3/A3, TT/TT

<b>439311</b>	90A	6
14	90	Ø57,2

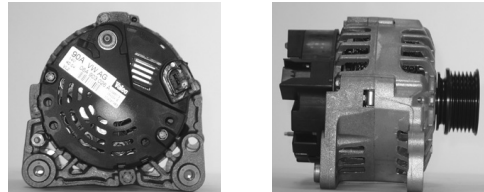

大众 / VOLKSWAGEN  
奥迪 / AUDI  
甲壳虫/NEW BEETLE  
A3/A3, TT/TT

<b>439312</b>	120A	6 RL
14	90	Ø57,2

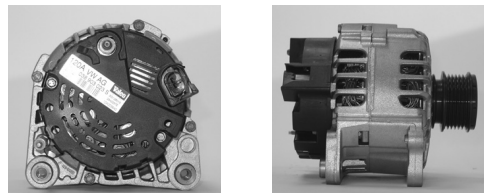

大众 / VOLKSWAGEN  
奥迪 / AUDI  
甲壳虫/NEW BEETLE  
A3/A3, TT/TT

<b>439317</b>	120A	6
14	95	Ø54,2

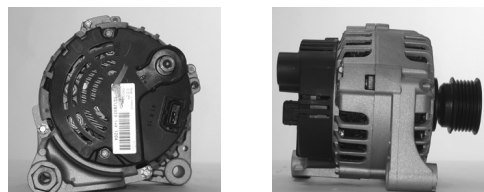

宝马 / BMW  
Z3/Z3

<b>439318</b>	120A	6
14	0	Ø58



雷诺 / RENAULT  
风景/SCENIC

<b>439326</b>	120A	6
14	90	Ø49

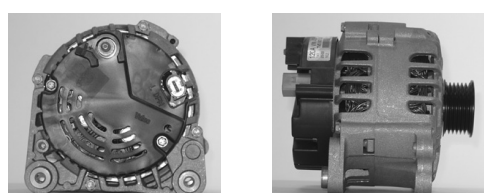

大众 / VOLKSWAGEN  
奥迪 / AUDI  
甲壳虫/NEW BEETLE  
A3/A3, TT/TT

<b>439338</b>	70A	5
14	60	Ø57



奥迪 / AUDI  
A4/A4, A6/A6

<b>439391</b>	120A	6
14	60	Ø65

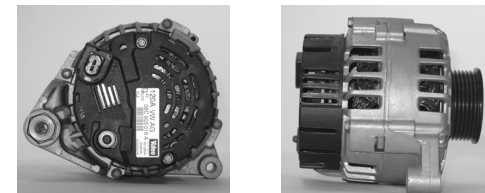

奥迪 / AUDI  
A4/A4, A6/A6, A8/A8

<b>439393</b>	140A	6 RL
14	0	Ø57

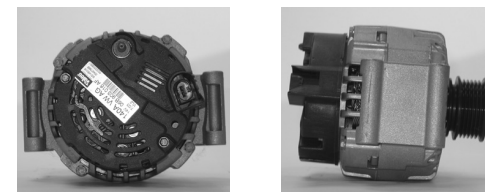

大众 / VOLKSWAGEN  
奥迪 / AUDI  
EOS/EOS  
A3/A3, A4/A4

<b>439394</b>	125A	6 RL
14	90	Ø56

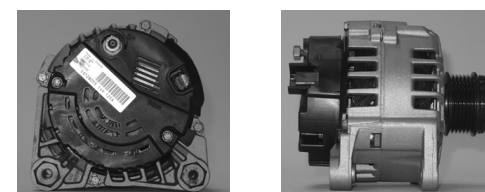

雷诺 / RENAULT  
拉古娜/LAGUNA

<b>439397</b>	90A	6
14	90	Ø51

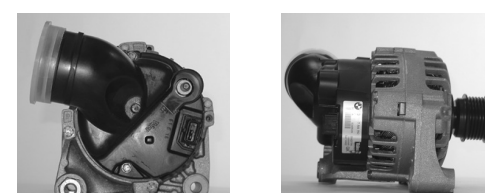

宝马 / BMW  
3系/3, 5系/5

<b>439398</b>	120A	6
14	95	Ø51

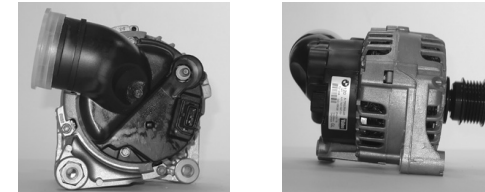

宝马 / BMW  
3系/3, 5系/5

<b>439420</b>	120A	8
14	0	Ø51

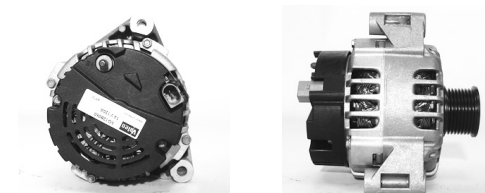

奔驰 / MERCEDES-BENZ  
C级/CLASSE C

<b>439427</b>	100A	6
14	0	Ø51

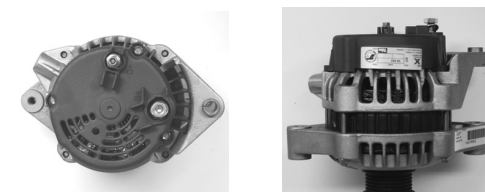

欧宝 / OPEL  
欧米茄/OMEGA, 雅特/ASTRA

<b>439435</b>	120A	6
14	40	Ø57,5

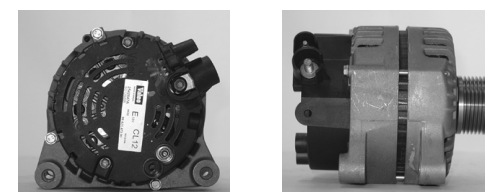

标致 / PEUGEOT  
雪铁龙 / CITROEN  
大众 / VOLKSWAGEN  
奥迪 / AUDI  
406/406  
C5/C5  
甲壳虫/NEW BEETLE  
A3/A3, TT/TT

<b>439445</b>	90A	6
14	90	Ø50,5

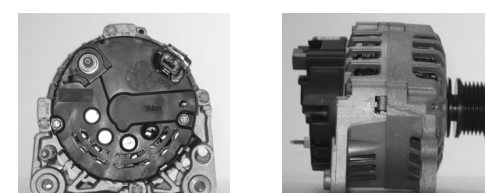

大众 / VOLKSWAGEN  
甲壳虫/NEW BEETLE, 夏朗/SHARAN

<b>439450</b>	120A	6
14	90	Ø51



大众 / VOLKSWAGEN  
甲壳虫/NEW BEETLE, 夏朗/SHARAN



<b>439454</b>	70A	5
14	0 °	Ø54

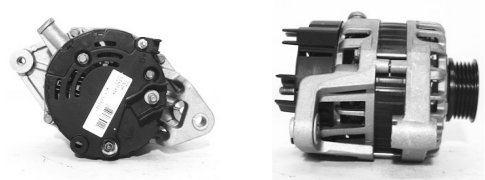

欧宝 / OPEL 赛飞利/ZAFIRA, 雅特/ASTRA

<b>439457</b>	70A	6
14	0 °	Ø55



欧宝 / OPEL 欧米茄/OMEGA, 雅特/ASTRA

<b>439464</b>	125A	6
14	90 °	Ø50

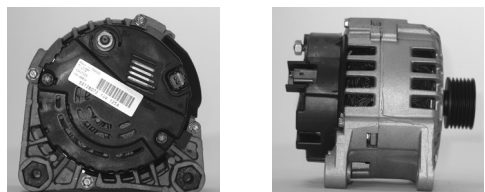

雷诺 / RENAULT 拉古娜/LAGUNA

<b>439467</b>	100A	6
14	90 °	Ø50,5

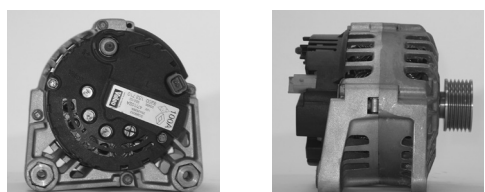

雷诺 / RENAULT 拉古娜/LAGUNA

<b>439468</b>	120A	7
14	60 °	Ø53

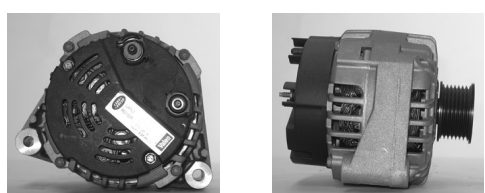

路虎 / LAND ROVER 发现/DISCOVERY

<b>439454</b>	70A	5
14	0 °	Ø54

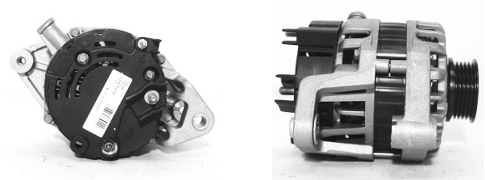

欧宝 / OPEL 赛飞利/ZAFIRA, 雅特/ASTRA

<b>439469</b>	120A	6
14	0 °	Ø48



迷你 / MINI 迷你 / MINI

<b>439470</b>	120A	6
14	40 °	Ø51

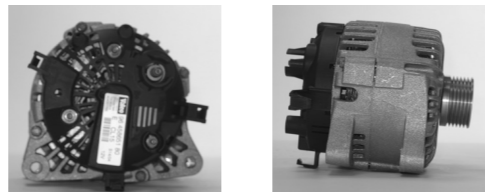

标致 / PEUGEOT 406/406, 407/407  
雪铁龙 / CITROEN C5/C5

<b>439471</b>	120A	7
14	0 °	Ø57



奔驰 / MERCEDES-BENZ C级/CLASSE C, CLK/CLK, SLK/SLK

<b>439476</b>	140A	6 RL
14	0 °	Ø49



宝马 / BMW 1系/1, 3系/3

<b>439478</b>	120A	7
14	90 °	Ø50,5



雷诺 / RENAULT 梅甘娜/MEGANE, 风景/SCENIC

<b>439479</b>	110A	7
14	90 °	Ø52

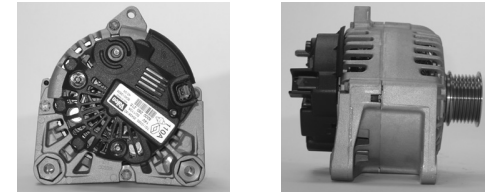

雷诺 / RENAULT 梅甘娜/MEGANE, 风景/SCENIC

<b>439485</b>	170A	6
14	95 °	Ø53,8

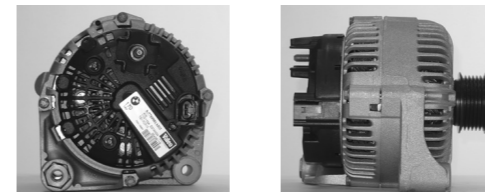

宝马 / BMW 5系/5

<b>439486</b>	150A	6
14	47 °	Ø50

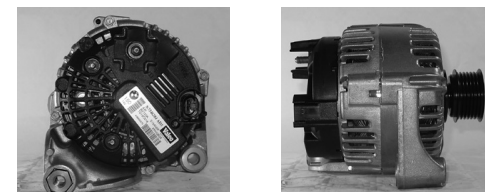

宝马 / BMW 5系/5, 7系/7, X3/X3

<b>439487</b>	150A	6
14	47 °	Ø54

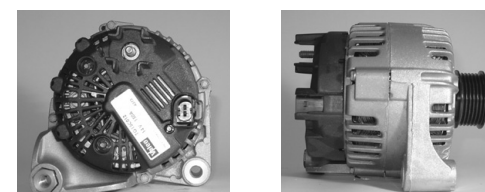

宝马 / BMW X3/X3

<b>439489</b>	140A	6 RL
14	90 °	Ø57

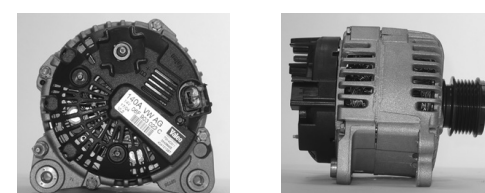

大众 / VOLKSWAGEN EOS/EOS, 尚酷R / SCIROCCO R  
奥迪 / AUDI A3/A3, A4/A4, TT/TT

<b>439496</b>	90A	6
14	34 °	Ø51



雪铁龙 / CITROEN 塞纳/XSARA, 塞纳毕加索/XSARA PICASSO

<b>439498</b>	150A	6 RL
14	0 °	Ø57,2



奥迪 / AUDI A4/A4

<b>439507</b>	140A	6
14	33 °	Ø51

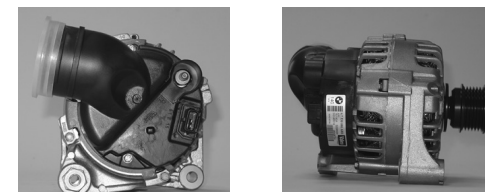

宝马 / BMW X5/X5

<b>439510</b>	180A	6
14	47 °	Ø50

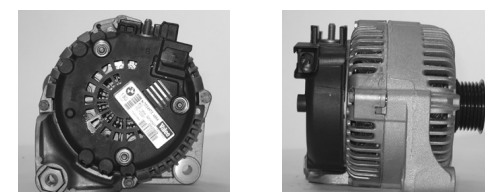

宝马 / BMW 5系/5, 6系/7, 7系/7

<b>439521</b>	125A	6
14	78 °	Ø54,3



标致 / PEUGEOT 307CC /307 CC, 407/407  
雪铁龙 / CITROEN C4/C4, C5/C5

<b>439496</b>	90A	6
14	34 °	Ø51



雪铁龙 / CITROEN 塞纳/XSARA, 塞纳毕加索/XSARA PICASSO

<b>439527</b>	180A	6
14	90 9	Ø58

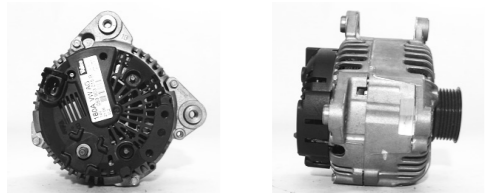

大众 / VOLKSWAGEN  
奥迪 / AUDI

途锐/TOUAREG  
Q7 / Q7

<b>439534</b>		
14		



大众 / VOLKSWAGEN  
奥迪 / AUDI

EOS / EOS  
A4 旅行车/A4 Avant

<b>439535</b>	150A	6 RL
14	0 9	Ø66



奥迪 / AUDI

A6 / A6

<b>439537</b>	180A	6
14	47 9	Ø51,5

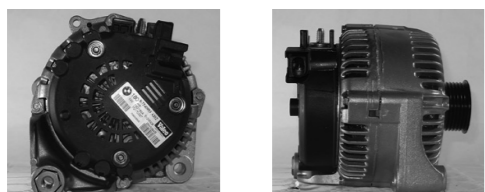

宝马 / BMW

X5 / X5

<b>439541</b>	180A	6
14	90 9	Ø58

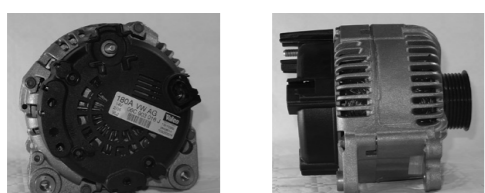

奥迪 / AUDI

A6 / A6

<b>439544</b>	90A	5
14	0 9	Ø53

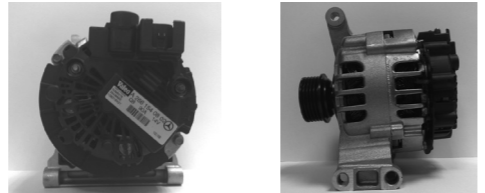

梅赛德斯奔驰 / MERCEDES-BENZ

A级/CLASSE A, B级/CLASSE B

<b>439551</b>	115A	5 RL
14	0 9	Ø53



梅赛德斯奔驰 / MERCEDES-BENZ

A级/CLASSE A, B级/CLASSE B

<b>439554</b>	180A	6 RL
14	0 9	Ø66



奥迪 / AUDI

A6 / A6

<b>439555</b>	120A	6
14	60 9	Ø51,5

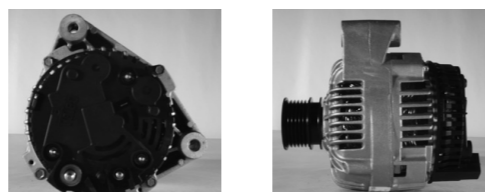

梅赛德斯奔驰 / MERCEDES-BENZ

S级/CLASSE S, SL/SL

<b>439558</b>	180A	6 RL
14	90 9	Ø57

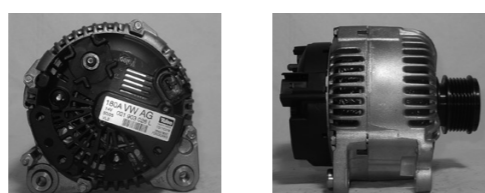

大众 / VOLKSWAGEN

帕萨特/PASSAT

<b>439559</b>	170A	6
14	48 9	Ø54

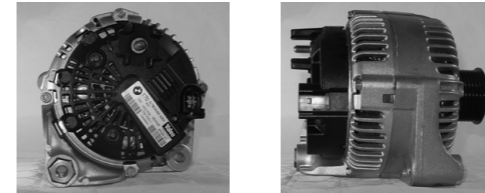

宝马 / BMW

M5 / M5

<b>439560</b>	180A	6 RL
14	0 9	Ø50,3

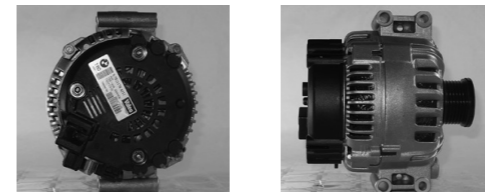

宝马 / BMW

1系/1, 3系/3, 5系/5, 7系/7

<b>439561</b>	110A	6
14	90 9	Ø58,3

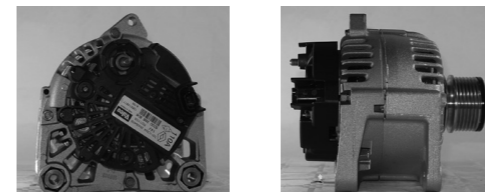

雷诺 / RENAULT

梅甘娜/MEGANE, 风景/SCENIC

<b>439563</b>		
14		



大众 / VOLKSWAGEN  
奥迪 / AUDI

尚酷/SCIROCCO, 途观/TIGUAN  
A3 / A3

<b>439564</b>	150A	6 RL
14	0 9	Ø66

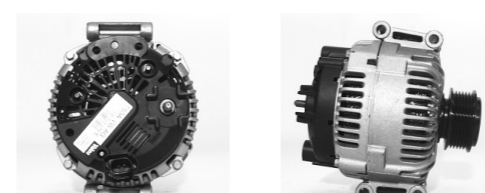

奥迪 / AUDI

A4 / A4

<b>439566</b>	180A	6
14	95 9	Ø50

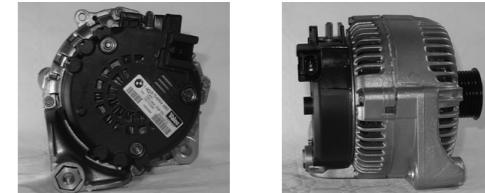

宝马 / BMW

5系/5, 7系/7

<b>439567</b>	150A	6
14	90 9	Ø54



宝马 / BMW

X3 / X3

<b>439574</b>	150A	6
14	60 9	Ø66



奥迪 / AUDI

A4/A4, A6/A6

<b>439580</b>	110A	6 RL
14V	90 9	Ø50,5



大众 / VOLKSWAGEN  
奥迪 / AUDI

高尔夫/GOLF  
A3 / A3



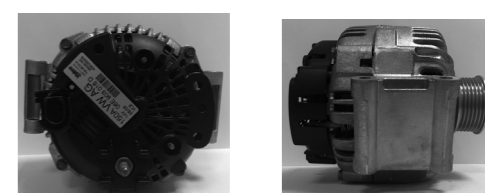

<b>439581</b>	150A	6 RL
14V	0 9	Ø57,2







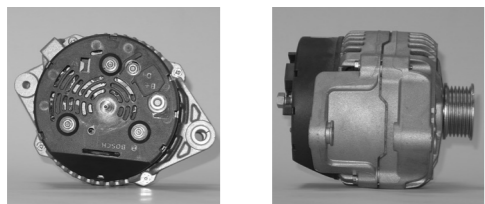

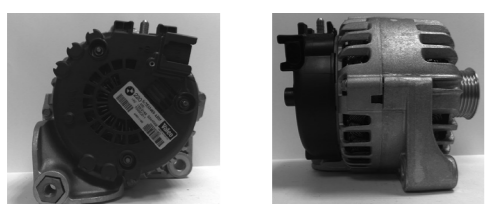

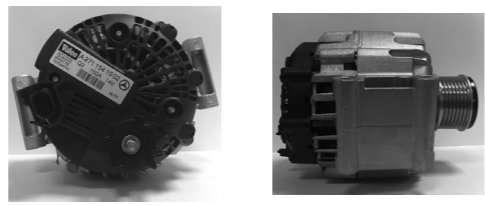
奥迪 / AUDI

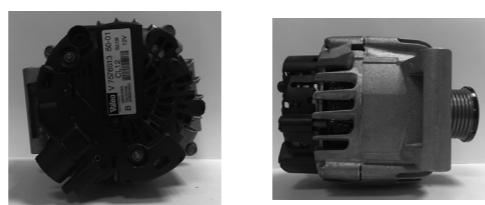



A6 / A6













<b>439587</b>	120A	7
14V	90	Ø50,5
		
雷诺 / RENAULT		梅甘娜/MEGANE
<b>439588</b>	110A	7
14V	90	Ø50,5
		
雷诺 / RENAULT		梅甘娜/MEGANE
<b>439594</b>	120A	6
14V	0	Ø52
		
欧宝 / OPEL		雅特/ASTRA, 欧米茄/OMEGA
<b>439601</b>	180A	7
14V	95	Ø51,7
		
宝马 / BMW		X5 / X5
<b>439602</b>	230A	7
14V	95	Ø51,7
		
宝马 / BMW		X5 / X5



<b>439603</b>	230A	7 RL
14V	0	Ø50,3
		
宝马 / BMW		X5 / X5
<b>439610</b>	150A	7
14V	0	Ø57
		
奔驰 / MERCEDES-BENZ		C级/CLASSE C
<b>439611</b>	120A	7
14V	0	Ø57
		
奔驰 / MERCEDES-BENZ		C级/CLASSE C
<b>439617</b>	120A	6 RL
14V	0	Ø53,2
		
迷你 / MINI		迷你 One / MINI, 迷你CLUBMAN/MINI CLUBMAN
<b>439618</b>	180A	5
14V	82	Ø77,7
		
奥迪 / AUDI		S5 / S5

<b>439624</b>	180A	7 RL
14V	90	Ø57,2
		
奥迪 / AUDI 大众 / VOLKSWAGEN		Q7/Q7 途锐/TOUAREG
<b>439628</b>	150A	7
14V	90	Ø50,4
		
雷诺 / RENAULT		拉古娜 / LAGUNA
<b>439634</b>	150A	6
14V	80	Ø52,2
		
雪铁龙 / CITROEN		C5 / C5
<b>439636</b>	230A	7
14V	0	Ø50
		
宝马 / BMW		X6/X6, 5系/5, 7系/7
<b>439639</b>	180A	7
14V	100	Ø54,5
		
奥迪 / AUDI		Q7 / Q7

<b>439640</b>	230A	8
14V	0	Ø50
		
宝马 / BMW		7系/7, X6/X6
<b>439645</b>	150A	7 RL
14V	90	Ø50
		
雷诺 / RENAULT		拉古娜/LAGUNA
<b>439647</b>	160A	6 RL
14V	90	Ø52,6
		
雷诺 / RENAULT		拉古娜/LAGUNA, 梅甘娜/MEGANEw
<b>439649</b>	180A	6
14V	0	Ø50
		
奔驰 / MERCEDES-BENZ		CLS/CLS, E级/CLASSE E S级/CLASS S
<b>439658</b>	150A	6
14V	0	Ø61,8
		
奥迪 / AUDI		A4/A4, A5/A5, Q5/Q5

<b>439664</b>	140A	6
14V	90 °	Ø57,2
		
斯柯达 / SKODA		晶锐 / FABIA
<b>439675</b>	180A	6
14V	95 °	Ø54
		
斯柯达 / SKODA		M3 / M3
<b>439692</b>	97A	6
14V	80 °	Ø54
		
标致 / PEUGEOT 雪铁龙 / CITROEN		407 / 407 C4/C4, C5/C5
<b>439713</b>	180A	6
14V	90 °	Ø58
		
大众 / VOLKSWAGEN		途锐/TOUAREG
<b>439772</b>	180A	6 RL
14V	0 °	Ø51
		
奔驰 / MERCEDES-BENZ		M级/CLASSE M, SLK/SLK

<b>439773</b>	180A	6 RL
14V	0 °	Ø51
		
奔驰 / MERCEDES-BENZ		C级/CLASSE C
<b>439774</b>		
14V		
		
大众 / VOLKSWAGEN		途锐 / TOUAREG
<b>439782</b>	150A	6 RL
14V	0 °	Ø57,2
		
奥迪 / AUDI		A6 / A6
<b>439784</b>		
14V		
		
大众 / VOLKSWAGEN		途锐 / TOUAREG
<b>439798</b>	180A	6
14V	0 °	Ø57,2
		
奥迪 / AUDI		A5/A5, Q5/Q5

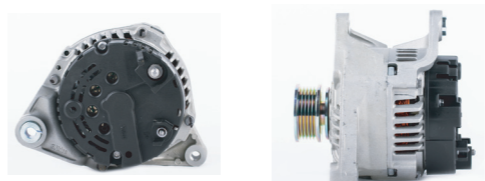
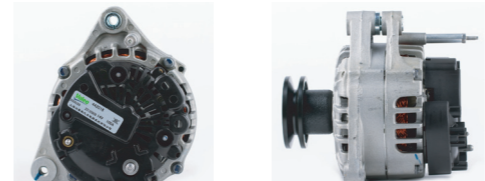
<b>439816</b>	220A	6
14V	90 °	Ø57,2
		
奥迪 / AUDI		Q7 / Q7
<b>439817</b>	220A	6 RL
14V	90 °	Ø57,2
		
奥迪 / AUDI		Q7 / Q7
<b>439821</b>	140A	6 RL
14V	90 °	Ø50,5
		
奥迪 / AUDI		A1 / A1
<b>442016</b>	90A	5
14V	60 °	Ø57,2
		
上海大众 / SVW-VOLKSWAGEN		桑塔纳2000 / SANTANA 2000
<b>442018</b>	100A	1
14V	60 °	Ø73,5
		
一汽大众奥迪 / FAW-AUDI 上海大众 / SVW-VOLKSWAGEN		100 / 100 桑塔纳 / SANTANA

<b>442019</b>	120A	6
14V	90 °	Ø57,2
		
一汽大众 / FAW-VOLKSWAGEN 上海大众 / SVW-VOLKSWAGEN		宝来/BORA, 捷达/JETTA 波罗/POLO
<b>442020</b>	90A	6
14V	90 °	Ø57,2
		
一汽大众 / FAW-VOLKSWAGEN		捷达王/JETTA
<b>442022</b>	90A	6
14V	90 °	Ø57,2
		
一汽大众 / FAW-VOLKSWAGEN		宝来/BORA, 捷达/JETTA 高尔夫/GOLF
<b>442023</b>	90A	6
14V	90 °	Ø50,5
		
上海大众 / SVW-VOLKSWAGEN		波罗/POLO
<b>442024</b>	110A	6
14V	90 °	Ø50,5
		
上海大众 / SVW-VOLKSWAGEN		波罗/POLO



<b>442025</b>	110A	6
14V	90°	Ø50,5
		
一汽大众 / FAW-VOLKSWAGEN 高尔夫/GOLF, 波罗/POLO, 明锐/OCTAVIA		
<b>442026</b>	90A	6
14V	60°	Ø58,7
		
上海大众 / SVW-VOLKSWAGEN 高尔/GOL		
<b>442027</b>	110A	6
14V	90°	Ø53,5
		
上海大众 / SVW-VOLKSWAGEN 朗逸/LAVIDA		
<b>442028</b>	100A	5
14V	60°	Ø57,2
		
上海大众 / SVW-VOLKSWAGEN 帕萨特/PASSAT, 桑塔纳3000/SANTANA 3000, 桑塔纳志俊/SANTANA VISTA		
<b>442029</b>	140A	5
14V	60°	Ø57,2
		
上海大众 / SVW-VOLKSWAGEN 帕萨特领驭 / PASSAT LINGYU		

<b>442030</b>	140A	6
14V	90°	Ø57,2
		
一汽大众 / FAW-VOLKSWAGEN 开迪/CADDY, 宝来/BORA, 迈腾/MAGOTAN, 速腾/SAGITAR 上海大众 / SVW-VOLKSWAGEN 朗逸/LAVIDA, 途安/TOURAN 上海大众斯柯达 / SVW-SKODA 明锐/OCTAVIA		
<b>442031</b>	140A	6
14V		Ø57,2
		
一汽大众 / FAW-VOLKSWAGEN 速腾/SAGITAR, 迈腾/MAGOTAN 一汽大众奥迪 / FAW-AUDI A4 / A4 上海大众斯柯达 / SVW-SKODA 昊锐/SUPERB, 明锐/OCTAVIA		
<b>442032</b>	140A	6
14V	60°	Ø66
		
一汽大众奥迪 / FAW-AUDI A4/A4, A6/A6 上海大众 / SVW-VOLKSWAGEN 帕萨特领驭/PASSAT LINGYU		
<b>442034</b>	120A	5
14V	60°	Ø57,2
		
一汽大众奥迪 / FAW-AUDI A6/A6		
<b>442035</b>	120A	6
14V	60°	Ø66
		
一汽大众奥迪 / FAW-AUDI A6/A6 上海大众 / SVW-VOLKSWAGEN 帕萨特/PASSAT		

<b>442041</b>	120A	6
14V	39,5°	Ø54,3
		
东风标致 / DONGFENG-PEUGEOT 307/307, 408/408 东风雪铁龙 / DONGFENG-CITROEN 世嘉/C-QUATRE, 凯旋/C-TRIOMPHE, 赛纳/XSARA		
<b>442042</b>	95A	6
14V	39,5°	Ø55,3
		
东风标致 / DONGFENG-PEUGEOT 206/206, 207/207 东风雪铁龙 / DONGFENG-CITROEN C2/C2, 毕加索/XSARA PICASSO, 爱丽舍/ELYSEE		
<b>442056</b>	90A	4
13,5V	30°	Ø58
		
东风悦达起亚 / DONGFENG YUEDA-KIA 赛拉图/CERATO 北京现代 / BEIJING-HYUNDAI i30/i30, 伊兰特/ELANTRA, 名驭/MOINCA, 索纳塔/SONATA, 途胜/TUCSON, 雅绅特/ACCENT		
<b>442062</b>	90A	5
14V	25°	Ø55,5
		
长城汽车 / GREAT WALL 精灵CROSS / GWEROU CROSS		
<b>442071</b>	100A	6
14V	33°	Ø60
		
南京菲亚特 / NANJING-FIAT 派力奥/PALIO, 西耶那/SIENA		







<b>442079</b>	70A	1
14V	0°	Ø58
		
长安铃木 / CHANGAN-SUZUKI 长安奥拓 / ALTO		
<b>442081</b>	70A	1
14V	0°	Ø58
		
长安汽车 / CHANGAN AUTOMOBILE 长安之星 / STAR		
<b>442083</b>	105A	4
12V	40,2°	Ø55
		
东风柳汽 / LIUZHOU MOTOR 风行/FUTURE		
<b>442118</b>	100A	6
14V	30°	Ø48
		
上海汽车 / SAIC 荣威750 / 750		
<b>442121</b>	110A	6
14V	90°	Ø50,5
		
上海大众 / SVW-VOLKSWAGEN CrossPolo / POLO CROSS, 波罗 / POLO 上海大众斯柯达 / SVW-SKODA 晶锐 / FABIA		



<b>442122</b>	140A	6
14V	90 °◁	Ø53,2
		
一汽大众 / FAW-VOLKSWAGEN	宝来/BORA, 速腾/SAGITAR 迈腾/MAGOTAN, 高尔夫/GOLF	
<b>442123</b>	90A	6
13,5	15 ▷	Ø58
		
东风悦达起亚 / DONGFENG YUEDA-KIA 北京现代 / BEIJING-HYUNDAI	福瑞迪/FORTE, 秀尔/SOUL 伊兰特悦动 / YUE DONG, 瑞纳/VERNA	
<b>442124</b>	120A	6
14V	90 °◁	Ø57,2
		
华晨汽车 / SHENYANG BRILLIANCE	尊驰/ZUNCHI, 酷宝/KUBAO 骏捷/JUNJIE	
<b>442125</b>	90A	4
14V	20 °◁	Ø58
		
长城汽车 / GREAT WALL	凌傲/LINGAO, 哈弗M1/HOVR M1, 炫丽/FLORID	
<b>442126</b>	90A	4
14V	20 °◁	Ø58
		
长城汽车 / GREAT WALL	凌傲/LINGAO, 哈弗M2/HOVR M2 炫丽/FLORID, 腾翼 C30/TENGYI C30, 酷熊/COOLBEAR	

<b>442127</b>	90A	4
14V	0° ▷◁	Ø62,5
		
长城汽车 / GREAT WALL		迪尔/DEER
<b>442134</b>	150A	6
14V		Ø57,2
		
一汽大众奥迪 / FAW-AUDI		A6L/A6L
<b>442188</b>	110A	4
14V	20 °◁	Ø65
		
比亚迪 / BYD		F6 / F6
<b>442189</b>	120A	5
14V	25 °◁	Ø49,7
		
上海汽车 / SAIC	名爵7/MG7, 荣威550/550 荣威750/750	
<b>442190</b>	105A	5
14V	44 ▷	Ø49,7
		
上海汽车 / SAIC		荣威350/350

<b>442191</b>	105A	5
14V	44 ▷	Ø50,3
		
上海汽车 / SAIC		荣威350 / 350
<b>442192</b>	140A	6
14V	90 °◁	Ø50,5
		
上海大众 / SVW-VOLKSWAGEN		朗逸/LAVIDA
<b>442193</b>	140A	6
14V		Ø57,2
		
一汽大众 / FAW-VOLKSWAGEN		CC/CC, 途观/TIGUAN
<b>442194</b>	90A	6
13,5	15 ▷	Ø58
		
北京现代 / BEIJING-HYUNDAI		i30/i30, 瑞纳/VERNA
<b>442195</b>	110A	4
14V	20 ▷	Ø65
		
比亚迪 / BYD		F6 / F6

<b>442196</b>	90A	6
14V	90 °◁	Ø57,2
		
一汽轿车 / FAW		奔腾B50 / BESTURN B50
<b>442204</b>	120A	6
14V	30 °◁	Ø57,2
		
<b>442209</b>	150A	6
14V		Ø51
		
北京奔驰 / BEIJING BENZ		C级/CLASSE C
<b>442210</b>	150A	6
14V		Ø51
		
北京奔驰 / BEIJING BENZ		C级/CLASSE C
<b>442211</b>	150A	6
14V		Ø51
		
北京奔驰 / BEIJING BENZ		C级/CLASSE C

<b>442212</b>	180A	6
14V		051
		
北京奔驰 / BEIJING BENZ		E级/CLASSE E
<b>442213</b>	120A	6
14V	45	053,9
 		
东风日产 / DONGFENG-NISSAN		奇骏/X-TRAIL, 逍客/QASHQAI
<b>442214</b>	85A	4
14V	0°	055
 		
一汽海马 / FAW-HAIMA		普力马/FREEMA
<b>442215</b>	110A	4
14V	40.2	060
 		
江淮汽车 / JAC		瑞风/REFINE
<b>442216</b>	120A	6
14V	30	049,7
 		
上海汽车 / SAIC		荣威750/750

<b>442217</b>	110A	6
14V	60	061
 		
奇瑞汽车 / CHERY		A3/A3
<b>442218</b>	110A	4
14V	20	056
 		
比亚迪 / BYD		M6/M6, S6/S6
<b>442219</b>	70A	4
14V	4	055
		
一汽吉林 / FAW GROUP(JILIN)		森雅M80/XENIA M80 森雅S80/XENIA S80
<b>442220</b>	70A	6
14V	4	055
 		
一汽吉林 / FAW GROUP(JILIN)		森雅M80/XENIA M80, 森雅S80/XENIA S80
<b>600024</b>	110A	5
14V	30	064
 		
华泰现代 / HUATAI AUTOMOBILE		特拉卡/TERRACAN

<b>600027</b>	110A	6
14V	35	062
 		
北京现代 / BEIJING-HYUNDAI		途胜/TUCSON
<b>600029</b>	110A	6
14V	22	064
 		
北京现代 / BEIJING-HYUNDAI		索纳塔 御翔/SONATA (NF)
<b>600093</b>	120A	6
14V	24	062
 		
东风悦达起亚 / DONGFENG YUEDA-KIA		嘉华/CARNIVAL, 狮跑/SPORTAGE
北京现代 / BEIJING-HYUNDAI		索纳塔/SONATA, 途胜/TUCSON
华泰现代 / HUATAI AUTOMOBILE		圣达菲/SANTA FE
<b>600102</b>	120A	6
14V	44	059
 		
东风悦达起亚 / DONGFENG YUEDA-KIA		嘉华/CARNIVAL
华泰现代 / HUATAI AUTOMOBILE		特拉卡/TERRACAN

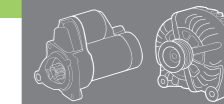



- |  |   |
|--|---|
| <p>             奥迪 / AUDI<br/>             宝马 / BMW<br/>             博世 / BOSCH<br/>             比亚迪 / BYD<br/>             CEVAM / CEVAM<br/>             长安 / CHANGAN<br/>             奇瑞 / CHERY<br/>             克莱斯勒 / CHRYSLER<br/>             DA SILVA / DA SILVA<br/>             大宇 / DAEWOO<br/>             德尔福 / DELPHI<br/>             东风柳州 / DONGFENG LIUZHOU<br/>             DRI / DRI<br/>             ELSTOCK / ELSTOCK<br/>             FARCOM / FARCOM<br/>             一汽大众 / FAW<br/>             菲亚特 / FIAT Group<br/>             福特 / FORD<br/>             FRIESEN / FRIESEN<br/>             通用 / GM<br/>             长城 / GREAT WALL<br/>             哈飞 / HAFEI<br/>             海马 / HAIMA<br/>             海拉 / HELLA<br/>             HERTH+BUSS / HERTH+BUSS<br/>             东芝 / HITACHI<br/>             红旗 / HONGQI<br/>             现代 / HYUNDAI<br/>             ISKRA / ISKRA<br/>             江淮 / JAC<br/>             JAPANPARTS / JAPANPARTS<br/>             JMC / JMC<br/>             起亚 / KIA         </p> | <p>             路虎 / LAND ROVER<br/>             LUCAS / LUCAS<br/>             马瑞利 / MAGNETI MARELLI<br/>             玛莎拉蒂 / MASERATI<br/>             马自达 / MAZDA<br/>             奔驰 / MERCEDES BENZ<br/>             名爵 / MG<br/>             三菱 / MITSUBISHI<br/>             NIPPARTS / NIPPARTS<br/>             尼桑 / NISSAN<br/>             保时捷 / PORSCHE<br/>             神龙 / PSA Group<br/>             QUINTON HAZELL / QUINTON HAZELL<br/>             REMY / REMY<br/>             雷诺 / RENAULT<br/>             路虎 / ROVER<br/>             荣威 / ROWE<br/>             萨博 / SAAB<br/>             上汽 / SAIC<br/>             西耶特 / SEAT<br/>             斯柯达 / SKODA<br/>             双龙 / SSANGYONG<br/>             斯巴鲁 / SUBARU<br/>             铃木 / SUZUKI<br/>             TALBOT / TALBOT<br/>             丰田 / TOYOTA<br/>             UNIPART / UNIPART<br/>             VAG Group / VAG Group<br/>             法雷奥 / VALEO<br/>             VEMO / VEMO<br/>             大众 / VOLKSWAGEN<br/>             沃尔沃 / VOLVO<br/>             中华 / ZHONGHUA         </p> |
|--|---|













CROSS	
<b>AC DELCO</b>	
31-30	<b>433044</b>
<b>AUDI</b>	
06B903016E	<b>442034</b>
078903016H	<b>442035</b>
06D903016D	<b>442134</b>
<b>BMW</b>	
12311738091	<b>433181</b>
12311738092	<b>433181</b>
12311738515	<b>433181</b>
12417830793	<b>438094</b>
12417832150	<b>438094</b>
12417832486	<b>438094</b>
12417834214	<b>438094</b>
12417616500	<b>438272</b>
12417616502	<b>438272</b>
12311247288	<b>439007</b>
12311247310	<b>439007</b>
12311247487	<b>439007</b>
12311247488	<b>439007</b>
12311432960	<b>439223</b>
12311432976	<b>439223</b>
12311432977	<b>439223</b>
12311432978	<b>439223</b>
12311432982	<b>439223</b>
12311432984	<b>439223</b>
12311740624	<b>439223</b>
12311740626	<b>439223</b>
12311432979	<b>439234</b>
12311432980	<b>439234</b>
12311432981	<b>439234</b>
12311432985	<b>439234</b>
12311432986	<b>439234</b>
12311432987	<b>439234</b>
12311435938	<b>439237</b>
12311435939	<b>439237</b>
12317509102	<b>439237</b>
12317509111	<b>439237</b>
12312248296	<b>439252</b>
12312248297	<b>439252</b>
12317792092	<b>439252</b>
12317792093	<b>439252</b>
12317830791	<b>439317</b>
12317831436	<b>439317</b>
12317501592	<b>439397</b>
12317501687	<b>439397</b>
12317501593	<b>439398</b>
12317501595	<b>439398</b>
12317501597	<b>439398</b>
12317501599	<b>439398</b>
12317501688	<b>439398</b>
12317501690	<b>439398</b>
12317501755	<b>439398</b>
12317515033	<b>439469</b>
12317515426	<b>439469</b>
12317516490	<b>439476</b>
12317516723	<b>439476</b>
12317516724	<b>439476</b>
12317521384	<b>439476</b>
12317521385	<b>439476</b>
12317521490	<b>439476</b>
12317521491	<b>439476</b>
12317522962	<b>439476</b>
12317788821	<b>439485</b>

CROSS	
<b>BMW</b>	
12317789981	<b>439485</b>
12317789984	<b>439485</b>
12317797521	<b>439485</b>
12317797522	<b>439485</b>
12317799204	<b>439485</b>
12318517261	<b>439485</b>
12317519721	<b>439486</b>
12317519723	<b>439486</b>
12317521135	<b>439486</b>
12317521136	<b>439486</b>
12317521137	<b>439486</b>
12317521138	<b>439486</b>
12317546284	<b>439486</b>
12317546285	<b>439486</b>
12317789980	<b>439487</b>
12317789983	<b>439487</b>
12317519621	<b>439496</b>
12317530086	<b>439507</b>
12317532627	<b>439507</b>
12317551252	<b>439507</b>
12317551253	<b>439507</b>
12317524972	<b>439510</b>
12317525440	<b>439510</b>
12317530086	<b>439510</b>
12317540990	<b>439510</b>
12317540992	<b>439510</b>
12317537959	<b>439537</b>
12317537962	<b>439537</b>
12317540993	<b>439537</b>
12317540994	<b>439537</b>
12317834160	<b>439559</b>
12317836592	<b>439559</b>
12317521178	<b>439560</b>
12317525376	<b>439560</b>
12317542934	<b>439566</b>
12317542935	<b>439566</b>
12317797660	<b>439567</b>
12317797661	<b>439567</b>
12317561003	<b>439601</b>
12317561004	<b>439601</b>
12317533469	<b>439602</b>
12317561002	<b>439602</b>
12317560988	<b>439603</b>
12317560989	<b>439603</b>
12317576513	<b>439617</b>
12317576514	<b>439617</b>
12317615484	<b>439617</b>
12317619254	<b>439617</b>
12314595890	<b>439636</b>
12314595891	<b>439636</b>
12317575344	<b>439636</b>
12317575347	<b>439636</b>
12317603779	<b>439636</b>
12317603782	<b>439636</b>
12317515426	<b>439640</b>
12317573754	<b>439640</b>
12317573755	<b>439640</b>
12317603778	<b>439640</b>
12317603778	<b>439640</b>
12317603781	<b>439640</b>
12317837981	<b>439675</b>
12317838656	<b>439675</b>

CROSS	
<b>BOSCH</b>	
0001112007	<b>432623</b>
0001112019	<b>432623</b>
0001112029	<b>432623</b>
0001112041	<b>432623</b>
0001116003	<b>432623</b>
0986017930	<b>432623</b>
SR454X	<b>432636</b>
0001107019	<b>432636</b>
0001107063	<b>432636</b>
0001208516	<b>432636</b>
0986012340	<b>432636</b>
0986012341	<b>432636</b>
0986012343	<b>432636</b>
0986013120	<b>432636</b>
0986016530	<b>432636</b>
0986016531	<b>432636</b>
0986016533	<b>432636</b>
SR47V	<b>432644</b>
SR47X	<b>432644</b>
0001109014	<b>432644</b>
0001109036	<b>432644</b>
0001109250	<b>432644</b>
0001218162	<b>432644</b>
0001218165	<b>432644</b>
0001218765	<b>432644</b>
0986016390	<b>432644</b>
0986016393	<b>432644</b>
0986017260	<b>432644</b>
0986017267	<b>432644</b>
0986020163	<b>432644</b>
SR46V	<b>432675</b>
SR46X	<b>432675</b>
SR456X	<b>432675</b>
SR0456X	<b>432675</b>
0001107037	<b>432675</b>
0001107048	<b>432675</b>
0001107072	<b>432675</b>
0001107096	<b>432675</b>
0001107403	<b>432675</b>
0001108003	<b>432675</b>
0001108120	<b>432675</b>
0001108124	<b>432675</b>
0001108149	<b>432675</b>
0986013010	<b>432675</b>
0986013013	<b>432675</b>
0986013387	<b>432675</b>
0986016380	<b>432675</b>
0986016383	<b>432675</b>
0986018850	<b>432675</b>
0986018857	<b>432675</b>
AL22X	<b>433044</b>
AL32X	<b>433044</b>
AL79X	<b>433044</b>
AL113X	<b>433044</b>
0120485007	<b>433044</b>
0120485008	<b>433044</b>
0120489003	<b>433044</b>
0120489080	<b>433044</b>
0120489185	<b>433044</b>
0120489362	<b>433044</b>
0120489363	<b>433044</b>
0120489364	<b>433044</b>
0120489365	<b>433044</b>

CROSS	
<b>BOSCH</b>	
0120489367	<b>433044</b>
0120489368	<b>433044</b>
0120489369	<b>433044</b>
0001112041	<b>433044</b>
0120489371	<b>433044</b>
0120489436	<b>433044</b>
0120489437	<b>433044</b>
0120489499	<b>433044</b>
0120489520	<b>433044</b>
0120489521	<b>433044</b>
0120489523	<b>433044</b>
0120489535	<b>433044</b>
0120489545	<b>433044</b>
0120489546	<b>433044</b>
0120489622	<b>433044</b>
0120489714	<b>433044</b>
0120489732	<b>433044</b>
0120489771	<b>433044</b>
0120489974	<b>433044</b>
0120489975	<b>433044</b>
0120489976	<b>433044</b>
0986030580	<b>433044</b>
0986030588	<b>433044</b>
0986031040	<b>433044</b>
0986031041	<b>433044</b>
0986031170	<b>433044</b>
0986031171	<b>433044</b>
0986031178	<b>433044</b>
0986031500	<b>433044</b>
0986031501	<b>433044</b>
0986031508	<b>433044</b>
0986031510	<b>433044</b>
0986031518	<b>433044</b>
0986034040	<b>433044</b>
0986034041	<b>433044</b>
0986034048	<b>433044</b>
0986034220	<b>433044</b>
0986034221	<b>433044</b>
0986034230	<b>433044</b>
0986034231	<b>433044</b>
0986034240	<b>433044</b>
0986034241	<b>433044</b>
0986034248	<b>433044</b>
0986034500	<b>433044</b>
0986034501	<b>433044</b>
0986034508	<b>433044</b>
0986034510	<b>433044</b>
0986034511	<b>433044</b>
0986034518	<b>433044</b>
0986034570	<b>433044</b>
9120080116	<b>433044</b>
9120080175	<b>433044</b>
9120080179	<b>433044</b>
AL65X	<b>433138</b>
AL67X	<b>433138</b>
AL80X	<b>433138</b>
0120489232	<b>433138</b>
0120489233	<b>433138</b>
0120489234	<b>433138</b>
0120489274	<b>433138</b>
0120489275	<b>433138</b>
0120489298	<b>433138</b>
0120489300	<b>433138</b>

CROSS	
<b>BOSCH</b>	
0120489301	<b>433138</b>
0120489302	<b>433138</b>
0120489323	<b>433138</b>
0120489324	<b>433138</b>
0120489325	<b>433138</b>
0120489326	<b>433138</b>
0120489331	<b>433138</b>
0120489332	<b>433138</b>
0120489333	<b>433138</b>
0120489354	<b>433138</b>
0120489355	<b>433138</b>
0986033280	<b>433138</b>
0986033288	<b>433138</b>
0986033290	<b>433138</b>
0986033298	<b>433138</b>
0986033740	<b>433138</b>
0986033743	<b>433138</b>
0986033750	<b>433138</b>
0986033811	<b>433138</b>
0986033813	<b>433138</b>
0986034050	<b>433138</b>
0986034053	<b>433138</b>
AL0739X	<b>433181</b>
AL0746X	<b>433181</b>
0120468104	<b>433181</b>
0120468105	<b>433181</b>
0001107015	<b>438014</b>
0001107044	<b>438014</b>
0986016280	<b>438014</b>
0986021933	<b>438014</b>
0986018571	<b>438027</b>
SR0408X	<b>438076</b>
SR0409X	<b>438076</b>
SR0418X	<b>438076</b>
0001110031	<b>438076</b>
0001110032	<b>438076</b>
0001124001	<b>438076</b>
0001124002	<b>438076</b>
0001125007	<b>438076</b>
0001125008	<b>438076</b>
0001125012	<b>438076</b>
0001125013	<b>438076</b>
0001125042	<b>438076</b>
0001125043	<b>438076</b>
0986015470	<b>438076</b>
0986016980	<b>438076</b>
0986017460	<b>438076</b>
0986019217	<b>438076</b>
0986023480	<b>438087</b>
0001108183	<b>438091</b>
0001108400	<b>438091</b>
09860183	

CROSS		CROSS		CROSS		CROSS		CROSS		CROSS		CROSS		CROSS		CROSS		CROSS		CROSS	
<b>DA SILVA</b>		<b>DA SILVA</b>		<b>DA SILVA</b>		<b>DAEWOO</b>		<b>DRI</b>		<b>DRI</b>		<b>ELSTOCK</b>		<b>ELSTOCK</b>		<b>FARCOM</b>		<b>FARCOM</b>		<b>FARCOM</b>	
020181	438014	A011501	439232	JA011653	439445	96550792	438183	625.032.082	438147	230.179.1252	439464	25-4093	438079	28-3657	439454	118501	433044	118963	439310		
020838	438014	010194	439234	011502	439454	<b>DELPHI</b>		311.077.102	438152	230.180.1252	439464	25-2490	438091	28-1691	439457	118166	433138	111032	439311		
D020181	438014	011587	439234	A011502	439454	SX0299	432623	325.056.102	438157	230.313.952	439467	25-3065	438110	28-1870	439457	118167	433138	118962	439311		
D020838	438014	A010194	439234	010628	439457	SX0194	432636	311.206.092	438167	215.174.1202	439469	25-2079	438131	28-1977	439457	118179	433138	112361	439312		
021228	438027	A011587	439234	010972	439457	SX0302	432636	311.208.102	438171	229.126.1202	439470	25-3216	438138	28-3988	439464	118180	433138	119073	439312		
D021228	438027	010099	439237	011156	439457	SX0197	432644	311.216.102	438174	230.165.1202	439470	25-3483	438146	28-4610	439464	118199	433138	119726	439312		
021085	438076	A010099	439237	A010628	439457	SX0235	432675	328.022.092	438183	230.165.1502	439470	25-3415	438147	28-5544	439467	118431	433181	111615	439317		
026050	438076	010491	439271	A010972	439457	SX0722	432675	328.033.102	438183	225.145.1202	439471	25-2376	438152	28-5579	439469	118469	433181	112180	439318		
D021085	438076	A010491	439271	A011156	439457	RM0083	433044	328.045.092	438183	215.150.1202	439476	25-4113	438157	28-3734	439470	103338	438014	119073	439326		
D026050	438076	010267	439287	JA010972	439457	RM0125	433044	311.250.092	438190	215.150.1502	439476	25-3316	438167	28-4912	439470	103729	438027	119726	439326		
JD021085	438076	A010267	439287	JA011156	439457	RM0642	433044	300.058.082	438192	230.301.1252	439478	25-3222	438171	28-4866	439471	103306	438076	111288	439338		
020695	438078	010117	439292	010198	439464	RM0652	433044	325.009.102	438199	230.301.1102	439479	25-3348	438174	28-4835	439476	103550	438076	119968	439338		
D020695	438078	010560	439292	010512	439464	RM0653	433044	311.045.102	438206	215.146.1502	439486	25-2128	438183	28-4836	439476	103629	438076	111259	439391		
020191	438091	A010117	439292	A010198	439464	RM0654	433044	311.266.132	438260	215.158.1502	439487	25-2248	438183	28-4919	439478	106294	438076	111562	439393		
D020191	438091	A010560	439292	A010512	439464	RM0677	433044	215.131.802	439007	211.324.1502	439498	25-3258	438183	28-4852	439479	106349	438078	112355	439393		
JD020191	438091	JA010117	439292	JA010198	439464	RM0678	433044	215.131.902	439007	215.127.1402	439507	25-4024	438190	28-4849	439486	104745	438087	111743	439394		
020556	438094	011664	439294	JA010512	439464	RM0623	433138	216.111.902	439083	215.178.1802	439510	25-3466	438192	28-5508	439487	103738	438091	119883	439398		
D020556	438094	A011664	439294	010718	439470	RM0624	433138	225.110.902	439095	211.334.1802	439527	25-1252	438199	28-4734	439498	104627	438110	112621	439420		
020990	438131	JA011664	439294	011503	439470	SX0682	438076	225.112.902	439095	211.346.1502	439535	25-1324	438206	28-3756	439507	103368	438131	112220	439427		
D020990	438131	010524	439296	A010718	439470	SX0329	438199	229.117.1502	439166	215.178.1802	439537	25-4147	438260	28-5635	439510	106018	438146	111734	439435		
021256	438147	A010524	439296	A011503	439470	SX0714	438206	225.129.902	439206	225.155.902	439544	28-2815	439007	28-4870	439527	106600	438146	119798	439445		
D021256	438147	010643	439298	010685	439471	RM0558	439427	215.127.802	439223	225.154.1152	439551	28-2986	439007	28-4947	439535	105539	438147	118983	439454		
021292	438152	A010643	439298	A010685	439471	RM0863	439427	215.140.902	439223	211.345.1802	439554	28-2687	439083	28-5635	439537	103741	438152	118225	439457		
D021292	438152	011588	439299	010656	439476	10479923	439427	225.130.902	439232	211.321.1802	439558	28-2550	439095	28-5509	439544	106514	438167	118441	439457		
020517	438167	A011588	439299	010657	439476	RM0840	439457	215.127.1202	439234	215.147.1702	439559	28-2893	439095	28-5503	439551	105141	438171	111343	439464		
D020517	438167	010503	439306	A010656	439476	10479947	439457	215.140.1202	439234	215.171.1702	439560	28-3916	439166	28-4871	439554	105277	438174	119777	439464		
020459	438171	011581	439306	A010657	439476	<b>DONGFENG LIUZHOU</b>		215.137.1002	439237	230.311.1102	439561	28-3867	439206	28-5545	439558	106499	438190	112332	439467		
D020459	438171	A010503	439306	010729	439478	DAGC370190	442083	215.138.1502	439252	211.354.1502	439564	28-2840	439223	28-4812	439559	103188	438199	112837	439469		
020526	438174	A011581	439306	A010729	439478	<b>DRI</b>		211.192.1202	439271	215.158.1502	439567	28-2927	439223	28-5583	439560	103340	438206	111611	439470		
D020526	438174	JA010503	439306	JA010729	439478	300.010.092	432623	230.146.1102	439285	211.329.1102	439580	28-3704	439232	28-5510	439561	103683	438206	111778	439470		
026056	438183	010643	439307	010670	439479	300.037.092	432623	230.149.1102	439286	211.348.1502	439581	28-3703	439234	28-5729	439564	118832	439007	111446	439471		
040031	438183	A010643	439307	A010670	439479	300.032.092	432636	230.148.802	439287	230.332.1102	439588	28-4669	439234	28-5508	439567	118974	439083	112068	439471		
D026056	438183	011547	439310	010666	439486	325.018.102	432644	230.171.1252	439292	228.122.1202	439594	28-3926	439237	28-5564	439580	118422	439095	111569	439476		
JD040031	438183	A011547	439310	A010666	439486	325.024.102	432644	229.122.1502	439294	225.182.1802	439649	28-4512	439252	28-5562	439581	118867	439095	112430	439478		
D026056	438183	011489	439311	010666	439487	325.039.112	432644	225.138.1202	439296	211.361.1502	439658	28-3900	439271	28-5720	439588	118952	439166	112178	439479		
025692	438190	A011489	439311	A010666	439487	325.023.092	432675	225.140.1202	439298	211.321.1402	439664	28-3955	439285	28-1977	439594	119677	439166	112529	439485		
D025692	438190	JA011489	439311	010604	439498	200.112.652	433044	225.141.1202	439299	215.190.1802	439675	28-3774	439287	28-5723	439649	119880	439206	111565	439486		
021130	438192	011505	439312	A010604	439498	211.102.552	433044	230.158.902	439306	229.120.802	439692	28-3891	439292	28-5827	439658	118827	439223	112880	439487		
D021130	438192	A011505	439312	010687	439527	211.102.652	433044	230.158.982	439306	229.120.902	439692	28-3837	439294	28-4773	439664	111614	439232	111433	439498		
025674	438199	010237	439318	A010687	439527	211.110.552	433044	225.142.1202	439307	229.120.902	439692	28-5632	439296	28-5912	439675	118966	439234	112739	439507		
D025674	438199	A010237	439318	010764	439535	211.110.652	433044	211.330.702	439310	25-1028	432623	28-5507	439298	28-3816	439692	119883	439234	112681	439510		
025672	438206	011505	439326	A010764	439535	211.113.452	433044	211.183.902	439311	25-1254	432623	28-4592	439299	28-3949	439692	111197	439237	111803	439521		
D025672	438206	A011505	439326	010688	439554	211.113.652	433044	211.187.1202	439312	25-1198	432636	28-3660	439306	<b>FARCOM</b>		119036	439237	112419	439527		
JD025672	438206	011656	439338	A01068																	



CROSS	
<b>FARCOM</b>	
111444	<b>439664</b>
119073	<b>439664</b>
118451	<b>439692</b>
<b>FAW</b>	
28100-BZ090	<b>442067</b>
FA02-18300	<b>442196</b>
27060-BZ180	<b>442219</b>
27060-BZ170	<b>442220</b>
<b>FIAT Group</b>	
00551872870L	<b>442070</b>
00517708100L	<b>442071</b>
9608719280	<b>432623</b>
1319121080	<b>432636</b>
71716554	<b>432636</b>
9613015980	<b>432636</b>
961323028	<b>432636</b>
9613230280	<b>432636</b>
9615519880	<b>432636</b>
9619310280	<b>432636</b>
9624291380	<b>432636</b>
9635501280	<b>438087</b>
1342792080	<b>438091</b>
71716563	<b>438091</b>
71719608	<b>438091</b>
71719609	<b>438091</b>
71723362	<b>438091</b>
71738330	<b>438091</b>
9625382580	<b>438091</b>
71719607	<b>438092</b>
96251686	<b>438092</b>
9625168680	<b>438092</b>
71739718	<b>438183</b>
9625168580	<b>438197</b>
9617861480	<b>439083</b>
9636254180	<b>439294</b>
9640878780	<b>439294</b>
9645907580	<b>439294</b>
9622410680	<b>439435</b>
9637185880	<b>439470</b>
9645865080	<b>439470</b>
9638275480	<b>439692</b>
9649611380	<b>439692</b>
<b>FORD</b>	
1059564	<b>438076</b>
1072559	<b>438076</b>
95VW11000CB	<b>438076</b>
97VW11000AA	<b>438076</b>
R95VW11000CC	<b>438076</b>
1111210	<b>438152</b>
1147432	<b>438152</b>
YM2111000BA	<b>438152</b>
YM2111000BB	<b>438152</b>
95VW11000AA	<b>438206</b>
95VW11000AC	<b>438206</b>
R95VW11000AC	<b>438206</b>
1100712	<b>439312</b>
1253624	<b>439312</b>
3M2110300BA	<b>439312</b>
6M2110346AA	<b>439312</b>
98VW10300EA	<b>439312</b>
YM2110300AA	<b>439326</b>
<b>FRIESEN</b>	
8013850	<b>432623</b>

CROSS	
<b>FRIESEN</b>	
F30-13851	<b>432623</b>
8012340	<b>432636</b>
8013120	<b>432636</b>
8016530	<b>432636</b>
F16-12340	<b>432636</b>
F16-16530	<b>432636</b>
8016390	<b>432644</b>
8017260	<b>432644</b>
8013010	<b>432675</b>
8016380	<b>432675</b>
F25-13010	<b>432675</b>
9030580	<b>433044</b>
9030590	<b>433044</b>
9031040	<b>433044</b>
9031170	<b>433044</b>
9031500	<b>433044</b>
9031510	<b>433044</b>
9033200	<b>433044</b>
9033210	<b>433044</b>
9034040	<b>433044</b>
9034020	<b>433044</b>
9034230	<b>433044</b>
9034240	<b>433044</b>
9034500	<b>433044</b>
9034510	<b>433044</b>
9034570	<b>433044</b>
F41-31170	<b>433044</b>
F41-31500	<b>433044</b>
F41-34230	<b>433044</b>
F41-34240	<b>433044</b>
F41-34500	<b>433044</b>
F41-34510	<b>433044</b>
F41-34570	<b>433044</b>
F99-30580	<b>433044</b>
9033280	<b>433138</b>
9033290	<b>433138</b>
9033740	<b>433138</b>
9033750	<b>433138</b>
9033810	<b>433138</b>
9034050	<b>433138</b>
F25-33280	<b>433138</b>
F25-33810	<b>433138</b>
9038310	<b>433181</b>
9039000	<b>433181</b>
F15-39000	<b>433181</b>
8016280	<b>438014</b>
8018571	<b>438027</b>
8015470	<b>438076</b>
8016980	<b>438076</b>
8017460	<b>438076</b>
F41-15470	<b>438076</b>
8018310	<b>438091</b>
8080109	<b>438092</b>
8016880	<b>438131</b>
8019890	<b>438138</b>
8020240	<b>438171</b>
8020230	<b>438174</b>
8017120	<b>438183</b>
8020870	<b>438183</b>
8013150	<b>438199</b>
F25-13150	<b>438199</b>
8016300	<b>438206</b>
F41-16300	<b>438206</b>

CROSS	
<b>FRIESEN</b>	
9040380	<b>439007</b>
9041401	<b>439083</b>
9039740	<b>439095</b>
9090072	<b>439206</b>
9040390	<b>439223</b>
9090380	<b>439237</b>
9045031	<b>439252</b>
9044320	<b>439271</b>
9090163	<b>439286</b>
9090166	<b>439292</b>
9044400	<b>439294</b>
9090144	<b>439294</b>
9042550	<b>439296</b>
9042570	<b>439298</b>
9042540	<b>439299</b>
9041850	<b>439306</b>
9042560	<b>439307</b>
9041510	<b>439310</b>
9041500	<b>439311</b>
9041860	<b>439312</b>
9090398	<b>439317</b>
9044340	<b>439338</b>
9090139	<b>439338</b>
9044330	<b>439391</b>
9046180	<b>439393</b>
9090340	<b>439397</b>
9041810	<b>439398</b>
9043680	<b>439427</b>
9045270	<b>439427</b>
9041920	<b>439445</b>
9041260	<b>439454</b>
9038600	<b>439457</b>
9039240	<b>439457</b>
9041620	<b>439457</b>
9090166	<b>439464</b>
9090169	<b>439464</b>
9045211	<b>439470</b>
9046511	<b>439470</b>
9045380	<b>439471</b>
9046270	<b>439476</b>
9090356	<b>439476</b>
9090318	<b>439479</b>
9090363	<b>439485</b>
9046220	<b>439486</b>
9090317	<b>439487</b>
9044910	<b>439498</b>
9090320	<b>439507</b>
9047170	<b>439510</b>
9090379	<b>439527</b>
9090400	<b>439541</b>
9090431	<b>439551</b>
9090392	<b>439554</b>
9037990	<b>439555</b>
9045350	<b>439558</b>
9090401	<b>439560</b>
9090317	<b>439567</b>
9039240	<b>439594</b>
9045340	<b>439664</b>
9090147	<b>439692</b>
<b>GM</b>	
1202100	<b>438014</b>
1202138	<b>438014</b>
1202144	<b>438014</b>

CROSS	
<b>GM</b>	
90444193	<b>438014</b>
90458462	<b>438014</b>
90512188	<b>438014</b>
90518628	<b>438014</b>
1202029	<b>438131</b>
1202140	<b>438131</b>
1202145	<b>438131</b>
6202076	<b>438131</b>
90449689	<b>438131</b>
90451825	<b>438131</b>
90487345	<b>438131</b>
90512189	<b>438131</b>
90518627	<b>438131</b>
9119794	<b>438131</b>
92064181	<b>438131</b>
92066449	<b>438131</b>
9512270	<b>438131</b>
R1040000	<b>438131</b>
1202003	<b>438183</b>
1202128	<b>438183</b>
1202137	<b>438183</b>
1202142	<b>438183</b>
1202172	<b>438183</b>
1202173	<b>438183</b>
1202174	<b>438183</b>
24436877	<b>438183</b>
6202016	<b>438183</b>
9192823	<b>438183</b>
6202075	<b>438183</b>
6202077	<b>438183</b>
6202079	<b>438183</b>
90341777	<b>438183</b>
90421877	<b>438183</b>
90508036	<b>438183</b>
90543871	<b>438183</b>
90543872	<b>438183</b>
9115191	<b>438183</b>
9115192	<b>438183</b>
9115197	<b>438183</b>
9130838	<b>438183</b>
9163856	<b>438183</b>
93171936	<b>438183</b>
93175996	<b>438183</b>
93184533	<b>438183</b>
93184535	<b>438183</b>
9512051	<b>438183</b>
96469963	<b>438183</b>
96952006	<b>438183</b>
R1040008	<b>438183</b>
6204117	<b>439252</b>
4433830	<b>439252</b>
93171935	<b>439252</b>
93175820	<b>439252</b>
R1530057	<b>439252</b>
4403540	<b>439292</b>
4416872	<b>439292</b>
4419076	<b>439292</b>
4433832	<b>439292</b>
9111540	<b>439292</b>
93189523	<b>439292</b>
93198179	<b>439292</b>
R1530103	<b>439292</b>
10480409	<b>439427</b>

CROSS	
<b>GM</b>	
1204145	<b>439427</b>
1204154	<b>439427</b>
24439410	<b>439427</b>
3493824	<b>439427</b>
6204000	<b>439427</b>
6204002	<b>439427</b>
6204109	<b>439427</b>
6204151	<b>439427</b>
90356897	<b>439427</b>
90443929	<b>439427</b>
9201489	<b>439427</b>
92059984	<b>439427</b>
93175788	<b>439427</b>
93175815	<b>439427</b>
93175963	<b>439427</b>
93278385	<b>439427</b>
9512800	<b>439427</b>
R1530052	<b>439427</b>
1204123	<b>439454</b>
24463063	<b>439454</b>
6204076	<b>439454</b>
6204155	<b>439454</b>
6204192	<b>439454</b>
6204206	<b>439454</b>
90561970	<b>439454</b>
9117931	<b>439454</b>
9133600	<b>439454</b>
9192823	<b>439454</b>
93175795	<b>439454</b>
93175942	<b>439454</b>
93180415	<b>439454</b>
93183891	<b>439454</b>
9512783	<b>439454</b>
R1530035	<b>439454</b>
1204108	<b>439457</b>
1204121	<b>439457</b>
3493721	<b>439457</b>
3493847	<b>439457</b>
3493848	<b>439457</b>
6204003	<b>439457</b>
6204008	<b>439457</b>
90356665	<b>439457</b>
90413760	<b>439457</b>
90443760	<b>439457</b>
90443930	<b>439457</b>
9163937	<b>439457</b>
9512120	<b>439457</b>
R1530001	<b>439457</b>
4419077	<b>439464</b>
4430595	<b>439464</b>
4433830	<b>439464</b>
4506176	<b>439464</b>
9201826	<b>439464</b>
93161427	<b>439464</b>
93198178	<b>439464</b>
R1530104	<b>439464</b>
4411072	<b>439467</b>
4431557	<b>439467</b>
93160649	<b>439467</b>
93161788	<b>439467</b>
10457160	<b>439594</b>
1204146	<b>439594</b>
24439411	<b>439594</b>

CROSS	
<b>GM</b>	
6204001	<b>439594</b>
6204041	<b>439594</b>
6204063	<b>439594</b>
6204110	<b>439594</b>
6204152	<b>439594</b>
90443931	<b>439594</b>
90540890	<b>439594</b>
90542981	<b>439594</b>
90566565	<b>439594</b>
9201491	<b>439594</b>
93175816	<b>439594</b>
93175964	<b>439594</b>
9512501	<b>439594</b>
R1030075	<b>439594</b>
R1530053	<b>439594</b>
<b>GREAT WALL</b>	
3708100-E10	<b>442059</b>
3708010-E00	<b>442061</b>
X6011720	<b>442241</b>
3701100-E10	<b>442062</b>
F26111261	<b>442125</b>
F47040641	<b>442126</b>
3701020A-E07	<b>442127</b>
<b>HAFEI</b>	
471Q-3708950	<b>442072</b>
<b>HAIMA</b>	
483Q-V2-18400	<b>442068</b>
483Q-18400A	<b>442069</b>
<b>HELLA</b>	
8EA 731 774-001	<b>432621</b>
8EA 726 138-001	<b>432623</b>
8EA 726 205-001	<b>432623</b>
8EA 737 537-001	<b>432623</b>
CS390	<b>432623</b>
CS581	<b>432623</b>
8EA 726 074-001	<b>432636</b>
8EA 726 111-001	<b>432636</b>
8EA 726 191-001	<b>432636</b>
8EA 731 759-001	<b>432636</b>
CS363	<b>432636</b>
CS566	<b>432636</b>
8EA 726 079-001	<b>432644</b>
8EA 737 293-001	<b>432644</b>
8EA 737 660-001	<b>432644</b>
CS331	<b></b>





CROSS	
<b>HERTH+BUSS</b>	
32437208	<b>439292</b>
32542653	<b>439292</b>
J5118022	<b>439292</b>
32437210	<b>439294</b>
J5118021	<b>439294</b>
32041850	<b>439306</b>
32041510	<b>439310</b>
32041500	<b>439311</b>
32437321	<b>439318</b>
32041860	<b>439326</b>
32044300	<b>439338</b>
32237595	<b>439338</b>
32046180	<b>439393</b>
32437361	<b>439394</b>
32041810	<b>439398</b>
32001240	<b>439427</b>
32437465	<b>439435</b>
32041920	<b>439445</b>
32041260	<b>439454</b>
32038600	<b>439457</b>
32437208	<b>439464</b>
32542653	<b>439464</b>
J5118022	<b>439464</b>
32045380	<b>439471</b>
32437437	<b>439478</b>
J5111108	<b>439478</b>
32437439	<b>439479</b>
32046180	<b>439498</b>
32002311	<b>439521</b>
32437544	<b>439551</b>
32437528	<b>439554</b>
32437557	<b>439560</b>
32039240	<b>439594</b>
32045340	<b>439664</b>
32437357	<b>439692</b>
<b>HITACHI</b>	
LR1120-701	<b>439312</b>
<b>HONGQI</b>	
3708010BJA	<b>442065</b>
<b>HYUNDAI</b>	
37300-26000	<b>442056</b>
36100-2B400	<b>442119</b>
37300-2B101	<b>442123</b>
37300-2B500	<b>442194</b>
36100-2B400	<b>442203</b>
3730037405	<b>600027</b>
3730025201	<b>600029</b>
3610037210	<b>600071</b>
3730037800	<b>600093</b>
37300-39405	<b>600102</b>
<b>ISKRA</b>	
IS0529	<b>432623</b>
11130233	<b>432636</b>
11130338	<b>432636</b>
11130418	<b>432636</b>
AZF3515	<b>432636</b>
AZF3528	<b>432636</b>
AZF3551	<b>432636</b>
IS0338	<b>432636</b>
IS1170	<b>432636</b>
IS9402	<b>432636</b>
IS9413	<b>438091</b>
IS0580	<b>438183</b>











CROSS	
<b>ISKRA</b>	
IS1174	<b>438183</b>
IS1265	<b>438183</b>
IS9405	<b>438183</b>
IS9430	<b>438199</b>
IA1418	<b>439292</b>
IA1163	<b>439312</b>
IA1434	<b>439464</b>
IA1341	<b>439692</b>
<b>JAC</b>	
1015201GA	<b>442052</b>
1015301GA	<b>442215</b>
1043100GG012	<b>442222</b>
<b>JAPANPARTS</b>	
AL201038	<b>439292</b>
ALZ421	<b>439294</b>
AL988	<b>439427</b>
AL988F	<b>439427</b>
<b>JMC</b>	
3701010-A02	<b>442204</b>
<b>KIA</b>	
36100-26000	<b>442055</b>
373004X503	<b>600024</b>
<b>LAND ROVER</b>	
YLE000090	<b>439468</b>
YLE500090	<b>439468</b>
<b>LUCAS</b>	
LRS00592	<b>432623</b>
LRS00737	<b>432623</b>
LRS00459	<b>432636</b>
LRS00749	<b>432636</b>
LRS02064	<b>432644</b>
LRS02091	<b>432644</b>
LRT00134	<b>432644</b>
LRS00185	<b>432675</b>
LRS00655	<b>432675</b>
LRA00300	<b>433044</b>
LRA00301	<b>433044</b>
LRA00620	<b>433044</b>
LRA00656	<b>433044</b>
LRA00696	<b>433044</b>
LRA00736	<b>433044</b>
LRA00783	<b>433044</b>
LRA00894	<b>433044</b>
LRA00918	<b>433044</b>
LRA02609	<b>433044</b>
LRB00121	<b>433044</b>
LRA00719	<b>433138</b>
LRA00720	<b>433138</b>
LRA00721	<b>433138</b>
LRA00722	<b>433138</b>
LRA01808	<b>433181</b>
LRT00121	<b>438014</b>
LRT00205	<b>438027</b>
LRS00895	<b>438076</b>
LRS00977	<b>438076</b>
LRT00179	<b>438076</b>
LRS02418	<b>438078</b>
LRS02421	<b>438079</b>
LRS02100	<b>438091</b>
LRS01566	<b>438110</b>
LRT00107	<b>438131</b>
LRS01670	<b>438138</b>
LRS02311	<b>438146</b>

CROSS	
<b>LUCAS</b>	
LRS02244	<b>438147</b>
LRT00218	<b>438152</b>
LRS02441	<b>438157</b>
LRS01749	<b>438167</b>
LRS01676	<b>438171</b>
LRS02174	<b>438174</b>
LRS00898	<b>438183</b>
LRS02115	<b>438183</b>
LRT00191	<b>438183</b>
LRS02352	<b>438190</b>
LRS02295	<b>438192</b>
LRS00656	<b>438199</b>
LRS02028	<b>438199</b>
LRS00791	<b>438206</b>
LRS02475	<b>438260</b>
LRA01721	<b>439007</b>
LRB00427	<b>439007</b>
LRB00333	<b>439083</b>
LRA02689	<b>439095</b>
LRB00193	<b>439095</b>
LRA02010	<b>439166</b>
LRB00458	<b>439206</b>
LRA01644	<b>439223</b>
LRB00392	<b>439223</b>
LRA01851	<b>439232</b>
LRA02204	<b>439234</b>
LRB00393	<b>439234</b>
LRA02017	<b>439237</b>
LRA02076	<b>439252</b>
LRA01996	<b>439271</b>
LRA02036	<b>439285</b>
LRA01901	<b>439287</b>
LRA01990	<b>439292</b>
LRB00452	<b>439294</b>
LRA03020	<b>439296</b>
LRA02890	<b>439298</b>
LRA02145	<b>439299</b>
LRA02751	<b>439306</b>
LRB00460	<b>439306</b>
LRA02315	<b>439307</b>
LRB00485	<b>439310</b>
LRB00486	<b>439311</b>
LRB00475	<b>439312</b>
LRA01965	<b>439317</b>
LRA02049	<b>439318</b>
LRA02862	<b>439326</b>
LRB00475	<b>439326</b>
LRA01968	<b>439338</b>
LRA01972	<b>439338</b>
LRA01987	<b>439391</b>
LRA02255	<b>439393</b>
LRA02148	<b>439394</b>
LRA01644	<b>439397</b>
LRA02204	<b>439398</b>
LRA03043	<b>439420</b>
LRB00196	<b>439427</b>
LRB00439	<b>439435</b>
LRB00481	<b>439445</b>
LRB00404	<b>439454</b>
LRA00871	<b>439457</b>
LRB00149	<b>439457</b>
LRB00166	<b>439457</b>
LRA02059	<b>439464</b>











CROSS	
<b>LUCAS</b>	
LRA02158	<b>439464</b>
LRA02930	<b>439467</b>
LRA02965	<b>439469</b>
LRA01872	<b>439470</b>
LRA02795	<b>439470</b>
LRA02362	<b>439471</b>
LRA02335	<b>439476</b>
LRA02336	<b>439476</b>
LRA02837	<b>439478</b>
LRA02350	<b>439479</b>
LRA02347	<b>439486</b>
LRA02891	<b>439487</b>
LRA02256	<b>439498</b>
LRA02784	<b>439507</b>
LRA03023	<b>439510</b>
LRA02364	<b>439527</b>
LRA02829	<b>439535</b>
LRA03023	<b>439537</b>
LRA02892	<b>439544</b>
LRA02886	<b>439551</b>
LRA02365	<b>439554</b>
LRA02931	<b>439558</b>
LRA02319	<b>439559</b>
LRA02969	<b>439560</b>
LRA02893	<b>439561</b>
LRA03117	<b>439564</b>
LRA02891	<b>439567</b>
LRA02950	<b>439580</b>
LRA02948	<b>439581</b>
LRA03108	<b>439588</b>
LRB00166	<b>439594</b>
LRA03111	<b>439649</b>
LRA03215	<b>439658</b>
LRA02291	<b>439664</b>
LRA03300	<b>439675</b>
LRA01930	<b>439692</b>
LRB00494	<b>439692</b>
<b>MAGNETI MARELLI</b>	
063521120410	<b>432623</b>
943251136010	<b>432623</b>
944280138500	<b>432623</b>
063521070630	<b>432636</b>
943251109	<b>432636</b>
943251109010	<b>432636</b>
943251423010	<b>432636</b>
943251488	<b>432636</b>
944280131200	<b>432636</b>
944280165300	<b>432636</b>
063521092500	<b>432644</b>
943251664	<b>432644</b>
943251664010	<b>432644</b>
943254050010	<b>432644</b>
944280163900	<b>432644</b>
944280172600	<b>432644</b>
943251694	<b>432675</b>
943251694010	<b>432675</b>
944280130100	<b>432675</b>
944280163800	<b>432675</b>
063534893700	<b>433044</b>
63305722	<b>433044</b>
943356001	<b>433044</b>
943356090	<b>433044</b>
943356090010	<b>433044</b>

CROSS	
<b>MAGNETI MARELLI</b>	
943356098	<b>433044</b>
943356098010	<b>433044</b>
943356275	<b>433044</b>
943356275010	<b>433044</b>
943356536	<b>433044</b>
943356536010	<b>433044</b>
943356605	<b>433044</b>
943356605010	<b>433044</b>
943356606	<b>433044</b>
943356606010	<b>433044</b>
943356607	<b>433044</b>
943356607010	<b>433044</b>
943356667	<b>433044</b>
943356668010	<b>433044</b>
943356673	<b>433044</b>
943356673010	<b>433044</b>
943356797	<b>433044</b>
943356797010	<b>433044</b>
943356816	<b>433044</b>
943356816010	<b>433044</b>
943356817	<b>433044</b>
944390342300	<b>433044</b>
944390342400	<b>433044</b>
943356206	<b>433138</b>
943356615	<b>433138</b>
943356615010	<b>433138</b>
943356621	<b>433138</b>
943356621010	<b>433138</b>
943356623	<b>433138</b>
943356623010	<b>433138</b>
943356632	<b>433138</b>
943356808	<b>433138</b>
943356809	<b>433138</b>
943356809010	<b>433138</b>
944303383	<b>433138</b>
944390425700	<b>433138</b>
944390425400	<b>433138</b>
943355138010	<b>433138</b>
944390418500	<b>433138</b>
944390427700	<b>433138</b>
944390425600	<b>433138</b>
944390475300	<b>433181</b>
943355062010	<b>433181</b>
944390415100	<b>433181</b>
943355013010	<b>433181</b>
943355061010	<b>438014</b>
944390415000	<b>438014</b>
943355139010	<b>438014</b>
944390418600	<b>438027</b>
944390903980	<b>438076</b>
944390443400	<b>438076</b>
944390901390	<b>438076</b>
944390443300	<b>438076</b>
944390461800	<b>438076</b>
944390903400	<b>438076</b>
944390418100	<b>438091</b>
944390903700	<b>438091</b>
063533479010	<b>438092</b>
063534150080	<b>438131</b>
943356554	<b>438131</b>
944390436800	<b>438131</b>
944390452700	<b>438131</b>
063533250130	<b>438138</b>

CROSS	
<b>MAGNETI MARELLI</b>	
944280801940	<b>438146</b>
944280801730	<b>438147</b>
063521250480	<b>438152</b>
063521214080	<b>438171</b>
944280202400	<b>438171</b>
063521214020	<b>438174</b>
944280202300	<b>438174</b>
943251576	<b>438183</b>
944280208700	<b>438183</b>
943251695	<b>438199</b>
943251695010	<b>438199</b>
944280131500	<b>438199</b>
063521070220	<b>438206</b>
943251327	<b>438206</b>
943251327010	<b>438206</b>
944280163000	<b>438206</b>
943355112010	<b>439007</b>
944390403800	<b>439007</b>
944390414010	<b>439083</b>
943356513010	<b>439095</b>
944390397400	<b>439095</b>
944390900720	<b>439206</b>
943355026010	<b>439223</b>
943355051010	<b>439234</b>
944390412900	<b>439234</b>
944390903800	<b>439237</b>
944390450310	<b>439252</b>
944390443200	<b>439271</b>
943346201010	<b>439285</b>
944390422010	<b>439286</b>
943346200010	<b>439287</b>
944390901660	<b>439292</b>
943355230010	<b>439294</b>
944390901440	<b>439294</b>
944390425500	<b>439294</b>
944390425700	<b>439298</b>
944390425400	<b>439299</b>
943355138010	<b>439306</b>
944390418500	<b>439306</b>

CROSS		CROSS		CROSS		CROSS		CROSS		CROSS		CROSS		CROSS		CROSS		CROSS	
<b>PSA Group</b>		<b>QUINTON HAZELL</b>		<b>REMY</b>		<b>REMY</b>		<b>REMY</b>		<b>RENAULT</b>		<b>UNIPART</b>		<b>VAG Group</b>		<b>VAG Group</b>		<b>VAG Group</b>	
5705-ER	439294	9038310	433181	DRA0580	433044	DRA3729	439287	DRA4269X	439551	9632489280	439470	GXE4626	432623	060903023E	433044	022911024P	438171	047903015H	439445
96408787	439294	9039000	433181	DRA0590	433044	DRB1351	439287	DRA0358	439554	7711153573	439470	GXE4756	432623	068903017C	433044	02M911021B	438174	047903018A	439445
5705-2D	439435	8016280	438014	DRA1040	433044	DRA3918	439292	DRA7990	439555	9637185880	439470	GXE4850	432644	068903017N	433044	02M911023G	438174	047903018AX	439445
5705-4Y	439435	8018571	438027	DRA1500	433044	DRA4194	439292	DRA0201	439558	23100-00Q0F	439478	GXE4698	432675	068903017NX	433044	02M911023GX	438174	06B903016AC	439498
5705-4Z	439435	8015470	438076	DRA1510	433044	DRA3823	439294	DRA0138	439559	23100-00Q0L	439478	GXE2056	433044	068903017SX	433044	02M911023M	438174	06B903016Q	439498
5705-8J	439435	8016980	438076	DRA4034	433044	DRB2550	439296	DRA0005	439560	23100-AW300	439478	GXE2307	433044	068903023A	433044	02M911023MX	438174	06D903016	439498
5705-FY	439435	8017460	438076	DRA4040	433044	DRB2570	439298	DRA0478	439561	7711135333	439478	GXE2368	433044	068903023G	433044	06D911023	438190	059903015R	439527
5702-C3	439470	8018310	438091	DRA4220	433044	DRB2540	439299	DRA0159	439564	8200086162	439478	GXE2548	433044	068903025E	433044	06D911023A	438190	06E903016F	439535
5702-C4	439470	8080109	438092	DRA4230	433044	DRA0304	439306	DRA0488	439566	8200290217	439478	GXE2627	433044	068903025F	433044	02A911023F	438206	06E903018E	439535
5705-1F	439470	8016880	438131	DRA4240	433044	DRA0305	439306	DRA4266	439567	8200495305	439478	GXE2436	433138	068903025FX	433044	02A911023FX	438206	06C903016J	439541
5705-6A	439470	8019890	438138	DRA4500	433044	DRA3754	439306	DRA0577	439580	8200538408	439478	GXE2453	433138	068903025L	433044	02A911023T	438206	06E903016G	439554
5705-7N	439470	8020240	438171	DRA4510	433044	DRA3923	439306	DRA0197	439581	7711135332	439479	GXE2464	433138	068903025P	433044	02A911023TV	438206	06E903016K	439554
5705-7P	439470	8020230	438174	DRA4570	433044	DRB7530	439307	DRA0647	439588	8200086161	439479	GXE4879	438076	068903027Q	433044	02A911023TX	438206	021903026L	439558
5705-AJ	439470	8020870	438183	DRA3740	433138	DRB1510	439310	DRA9240	439594	8200290215	439479	GXE4845	438131	068903027QX	433044	012911023J	438260	06E903016E	439564
5705-GT	439470	8016300	438206	DRS6280	438014	DRB1510N	439310	DRA0592	439601	8200495294	439479	GXE4793	438199	068903029R	433044	06B903016B	439271	06C903016B	439574
5705-JH	439470	9040380	439007	DRS6280N	438014	DRB1500	439311	DRA0625	439603	8200667618	439479	GXE4882	438206	068903029S	433044	06B903016E	439271	03C903023G	439580
9632489280	439470	9041401	439083	DRS8571	438027	DRB1860	439312	DRA0632	439610	7711368356	439479	GXE4932	438206	068903031J	433044	06B903016EX	439271	03C903023GX	439580
5702-A5	439521	9090072	439206	DRS5470	438076	DRA0251	439317	DRB7670	439649	8200386806	439561	GXE2719	439083	068903031JX	433044	028903028C	439310	06E903016D	439581
5705-6N	439521	9044320	439271	DRS6980	438076	DRA3809	439317	DRA0594	439658	8200667608	439561	GXE2572	439457	068903031K	433044	030903023H	439310	079903015F	439618
5705-8F	439521	9090166	439292	DRS7460	438076	DRA4048	439318	DRB5340	439664	7711368603	439587	<b>VAG Group</b>		068903031KX	433044	030903023HX	439310	021903016	439624
5705-HA	439521	9090144	439294	DRS0399	438078	DRA0101	439326	DRA3906	439692	8200410674	439587	069911023G	432675	068903033B	433044	038903023	439310	021903016L	439639
9642124980	439521	9042550	439296	DRS3893	438079	DRB4300	439338	DRA3906N	439692	8200667611	439587	069911023GX	432675	069903017	433044	06A903026C	439310	06E903016S	439658
5702-J0	439617	9042570	439298	DRS3737	438087	DRB4340	439338	DRA3907	439692	7711368602	439588	0175903023T	433044	069903017BX	433044	028903028D	439311	03L903023F	439664
5705-JW	439617	9042540	439299	DRS3617	438091	DRA4068	439391	DRA3907N	439692	8200410671	439588	025903023B	433044	069903023A	433044	028903028DX	439311	06F903023C	439664
5705-KG	439617	9041850	439306	DRS8310	438091	DRB6180	439393	<b>RENAULT</b>		8200410671	439588	026903015	433044	069903023E	433044	030903023J	439311	06F903023CX	439664
V 7 615484 80	439617	9042560	439307	DRS8310N	438091	DRA4049	439394	7700860915	432621	8200667610	439588	026903015A	433044	069903023F	433044	030903023JX	439311	06F903023F	439664
5705-JX	439634	9041510	439310	DRS0036	438092	DRB1810	439398	7711134529	438087	8200724133	439628	026903015D	433044	069903023X	433044	030903023N	439311	06F903023FX	439664
5702-E8	439692	9041500	439311	DRS0036N	438092	DRA0227	439420	9635501280	438087	8200846074	439628	026903015DX	433044	076903023G	433044	038903023A	439311	059903023H	439713
5702-F2	439692	9041860	439312	DRS0395	438094	10479923	439427	8200049826	438110	8200854117	439645	026903015E	433044	076903023I	433044	06A903023	439311	059903023L	439774
5705-4J	439692	9044340	439338	DRS3776	438110	DRA3479	439427	7700436625	439285	23100-0018R	439647	026903015EX	433044	076903023J	433044	06A903023X	439311	06H903016S	439782
5705-4K	439692	9090139	439338	DRS6880	438131	DRA3479N	439427	7701499605	439285	<b>ROVER</b>		026903017AX	433044	076903023K	433044	06A903026	439311	06H903017S	439782
5705-5B	439692	9044330	439391	DRS6880N	438131	DRA3804	439427	7700436626	439286	YLE000090	439468	026903017X	433044	076903023N	433044	06A903026A	439311	059903023K	439784
5705-5C	439692	9046180	439393	DRS9890	438138	DRA3903	439427	7700107124	439287	YLE500090	439468	026903023A	433044	175903023T	433044	06A903026AX	439311	059903019F	439817
5705-5U	439692	9041810	439398	DRS3894	438146	DRA3903N	439427	7700436623	439287	ROWE		026903023B	433044	02A911023B	438076	028903026E	439312	<b>VALEO</b>	
5705-5V	439692	9043680	439427	DRS0054	438147	DRA4195	439435	7700426849	439292	YLE90002C	442216	034903015G	433044	02A911023BX	438076	028903029G	439312	D9E138	432621
5705-7A	439692	9045270	439427	DRS8390	438152	DRB1920	439445	7711134316	439292	SAAB		034903015J	433044	02A911023J	438076	028903029GX	439312	D9E238	432621
5705-7C	439692	9041260	439454	DRS0401	438157	DRB1260	439454	7711368834	439292	5194758	438014	046903023H	433044	02A911023JX	438076	028903030	439312	182549	432623
5705-7E	439692	9038600	439457	DRS3886	438167	DRA4463	439457	8200162474	439292	93184914	438014	046903023HX	433044	02A911023R	438076	028903030A	439312	186502	432623
5705-7F	439692	9039240	439457	DRT0240	438171	DRA8600	439457	8200495302	439292	93184915	438014	049903015	433044	02A911023RX	438076	038903023S	439312	186848	432623
5705-AZ	439692	9090166	439464	DRT0230	438174	DRA8600N	439457	8200538407	439292	SAIC		049903015D	433044	02A911024	438076	038903024F	439312	187797	432623
5705-FC	439692	9090169	439464	DRS3836	438183	DRA4186	439464	8200690199	439292	10008330	442189	049903015E	433044	02A911024B	438076	038903024G	439312	188178	432623
5705-GP	439692	9046511	439470	DRS3836N	438183	DRA4208	439464	7700101274	439306	SEAT		049903015G	433044	02A911024BX	438076	038903024GX	439312	191711	432623
5705-GQ	439692	9045380	439471	DRS3837	438183	DRA0048	439467	7711134564	439306	03C903023C	442192	049903015GX	433044	02A911024D	438076	038903018Q	439326	D6G3	432623
9665577780	439692	9046220	439486	DRS3837N	438183	DRA0093	439468	8200030635	439306	SKODA		049903015J	433044	02A911024DX	438076	7M5903028	439326	D6RA37	432623
9639396580	442041	9044910	439498	DRS7120	438183	DRA0208	439469	7711134526	439318	03C903025D	442122	049903015L	433044	02A911024G	4				



CROSS		CROSS		CROSS		CROSS		CROSS		CROSS		CROSS		CROSS		CROSS		CROSS	
<b>VALEO</b>		<b>VALEO</b>		<b>VALEO</b>		<b>VALEO</b>		<b>VALEO</b>		<b>VALEO</b>		<b>VALEO</b>		<b>VALEO</b>		<b>VALEO</b>		<b>VOLKSWAGEN</b>	
VS741	432636	191724	438027	202152	438174	SG9B037	439206	SG9B033	439306	2569312	439445	TG11C049	439479	TG17C015	439560	2543436	439640	330911023B	442003
VS747	432636	D7E18	438027	D6GS14	438174	2541912	439223	SG9B113	439306	A13V1223	439445	TG11C061	439479	2542945	439561	2610240	439640	020911023N	442004
186267	432644	D7E38	438027	D6GS14M	438174	A13V160	439223	2542320	439307	SG9B024	439445	2542611	439485	2543562	439561	TG23C018	439640	020911024C	442005
186532	432644	D7E4	438027	182563	438183	NA529	439223	SG12B024	439307	VA783	439445	2543304	439485	TG11C034	439561	TG23C033	439640	02T911024E	442006
187500	432644	D7E8	438027	184727	438183	2542413	439232	2542240	439310	SG7S021	439454	TG17C010	439485	TG11C064	439561	2606189	439645	020911024D	442009
188873	432644	ND209	438027	186643	438183	2600438	439232	A11V182	439310	VA772	439454	TG17C010b	439485	2542894	439564	TG15C143	439645	02T911023S	442010
191851	432644	188253	438076	188332	438183	A13V1257	439232	SG8B011	439310	2542689	439457	2542685	439486	TG16C011	439564	2605121	439647	02M911023M	442011
726008	432644	191654	438076	190475	438183	NA535	439232	VA771	439310	SG7S025	439457	2543292	439486	2543221	439566	TG15C128	439647	02T911023T	442012
D7R19	432644	D7RS130	438076	191119	438183	SG9B038	439232	2542241	439311	VA377	439457	TG15C018	439486	TG17C035	439566	2543467	439649	0AH911023D	442013
D7R28	432644	D7RS30	438076	192382	438183	2541963	439234	2542571	439311	VA790	439457	TG15C018b	439486	2543236	439567	FG18S016	439649	02Z911023G	442014
D7R43	432644	VS707	438076	192383	438183	A14V122	439234	2542767	439311	2542393	439464	2542672	439487	TG15C064	439567	2543394	439658	06B911023	442015
D7R46	432644	188490	438078	D6RA162	438183	2541962	439237	2543320	439311	2542640	439464	TG15C012	439487	2542627	439574	TG15C094	439658	058903016E	442016
D9R149	432644	D7R36	438078	D6RA163	438183	2542516	439237	2543328	439311	2542722	439464	2542629	439496	2542878	439574	2542695	439664	330903015B	442018
186895	432675	188634	438079	D6RA249	438183	A13V1200	439237	A13V1181	439311	2543338	439464	SG9B052	439496	TG15C011	439574	2543282	439664	038903023S	442019
187794	432675	191760	438079	D6RA293	438183	A13V1287	439237	SG9B013	439311	2543386	439464	2542687	439498	TG15C043	439574	2607703	439664	037903025A	442020
D6RA168	432675	D6G5	438079	D6RA32	438183	NA532	439237	SG9B049	439311	2543557	439464	2543313	439498	2543291	439580	TG14C011	439664	030903023J	442022
D6RA68	432675	D6RA83	438079	D6RA62	438183	2542264	439252	SG9B059	439311	SG12B030	439464	TG15C017	439498	TG11C048	439580	TG14C016	439664	037903025T	442023
VS250	432675	188339	438087	D6RA93	438183	2542812	439252	SG9B087	439311	SG12B068	439464	TG15C065	439498	2543315	439581	TG14C026	439664	03C903023B	442024
VS717	432675	188575	438087	D6RA93	438183	A14S054	439252	SG9B088	439311	SG12B072	439464	2542875	439507	TG16C014	439581	2543424	439675	03C903023H	442025
VS720	432675	D6RA107	438087	VS700	438183	A14V129+	439252	VA776	439311	SG12B097	439464	2543237	439507	2543205	439587	FG18S014	439675	5XD903025A	442026
2541434	433044	D6RA70	438087	VS752	438190	VA821	439252	2542237	439312	SG12B107	439464	SG14B019	439507	2543559	439587	2542286	439692	03C903023L	442027
9AR2500K	433044	188842	438091	D6GS19	438190	2542232	439271	2542949	439312	SG12B122	439464	SG14B020	439507	SG12B092	439587	2542297	439692	33D903018	442028
9AR2506K	433044	D6RA109	438091	191205	438192	SG12B010	439271	SG12B015	439312	2542639	439467	2542785	439510	SG12B124	439587	2542396	439692	06B903019H	442029
9AR2520K	433044	VS706	438091	TS10E1	438192	VA788	439271	SG12B090	439312	2543341	439467	2543293	439510	2543207	439588	2542397	439692	06F903023C	442030
9AR2605L	433044	188685	438092	626002	438197	2542364	439285	VA775	439312	2543555	439467	TG17C021	439510	2543563	439588	2542487	439692	06D903016A	442031
9AR2622L	433044	D6RA74	438092	D6RA114	438197	A13V1264	439285	2542432	439317	SG9B053	439467	TG17C021b	439510	TG11C040	439588	2542490	439692	078903016AC	442032
9AR2779L	433044	VS702	438092	626692	438199	2542365	439286	SG12B039	439317	SG9B089	439467	2542526	439521	TG11C065	439588	2542793	439692	07N903016AC	442032
9AR2838L	433044	188973	438094	D7R65	438199	A13V1265	439286	2542411	439318	SG9B108	439467	2542742	439521	630836	439594	2542802	439692	STM 200001	442077
9AR5030L	433044	D6RA108	438094	VS308	438199	2541999	439287	SG10B016	439318	2542591	439468	SG12S051	439521	A13V1312	439594	2542922	439692	03C903023G	442121
9AR5046G	433044	190166	438110	D7RS301	438206	2542363	439287	2542461	439326	2542838	439468	SG12S077	439521	2543255	439601	2607210	439692	06J903023C	442193
9AR5047L	433044	193061	438110	VS340	438206	A11V1104	439287	SG12B042	439326	SG12B063	439468	2542784	439527	TG17C036	439601	A13V1236	439692	30005443	442198
9AR5099L	433044	D7E19	438110	197605	438260	A13V1224	439287	2542225	439338	SG12B082	439468	2610900	439527	2543218	439602	A13V1242	439692	0AM911023B	442200
9AR5107	433044	TS10E4	438110	ESW20ER6	438260	VA816	439287	2542238	439338	2542669	439469	TG17C020	439527	TG23C011	439602	A13V1276	439692	02Z911021A	442201
9AR5108	433044	VS705	438110	199890	438272	2542272	439292	SG8B010	439338	SG12S073	439469	TG17C072	439527	2543224	439603	A13V1277	439692	0AM911023K	442202
A13E06	433044	D6RA92	438131	TS12E36	438272	2542653	439292	SG9B010	439338	2541967	439470	2542916	439535	TG23C013	439603	SG10B022	439692	330911023	442205
A13E07	433044	VS347	438131	2541697	439007	2543339	439292	VA813	439338	2542298	439470	2606020	439535	TG43417	439610	SG8B021	439692	020911024B	442240
A13E12	433044	VS754	438131	A13V178	439007	2543384	439292	2542546	439391	2542679	439470	TG15C145	439535	TG15C075	439610	SG9B063	439692	<b>VOLVO</b>	
A13E13	433044	187880	438138	NA525	439007	2543558	439292	SG12B054	439391	2543525	439470	TG16C010	439535	2543296	439611	SG9B066	439692	8602185	439286
A13E45	433044	190396	438138	VA540	439007	SG12B017	439292	2542494	439393	A13V1201	439470	2542918	439537	TG12C026	439611	TG9B024	439692	30883627	439292
NA123	433044	D7E51	438138	2541784	439083	SG12B071	439292	2542739	439393	SG12S019	439470	2543294	439537	2605106	439617	TG9B064	439692	8251641	439292
VA155	433044	D7E55	438138	2542356	439083	SG12B096	439292	2543369	439393	TG15C015	439470	TG17C027	439537	2605290	439617	2610417	439713	8602806	439292
VA187	433044	VS708	438138	A13V1101	439083	SG12B110	439292	2606237	439393	TG15C117	439470	TG17C027b	439537	2612380	439617	FG18T071	439713	<b>ZHONGHUA</b>	
VA202	433044	190228	438146	A13V1233	439083	SG12B123	439292	SG14B010	439393	VA806	439470	2542801	439541	TG12C059	439617	2614200	439772	BL18T-3701010	442124
VA256	433044	D6RAD183	438146	A13V1263	439083	VA817	439292	SG14B016	439393	VA826	439470	TG17C022	439541	TG12C061	439617	FG18S098	439772		
VA823	433044	190227	438147	NA485	439083	2542351	439294	SG14B022	439393	2542582	439471	2542955	439544	TG12C120	439617	2614201	439773		
2518044	433138	192858	438147	VA336	439083	2542500	439294	TG14C025	439393	SG12B062	439471	2606293	439544	2543401	439618	FG18S099	439773		
2518046	433138	D7ED28	438147	2541911	439095	2542564	439294	VA842	439393	2542753	439476	SG9B079	439544	FG18S013	439618	2613166	43977		



我们尽一切努力确保本产品目录中所包含的信息在印刷时是正确的，但对于这些信息的准确性我们不提供陈述和担保，并且法雷奥销售公司不承担任何由于不准确信息所造成的赔偿责任。

法雷奥销售公司有权更改规格和/或产品的最终构造，恕不另行通知。

本目录中提到的产品件号不一定在所有国家适用。

法雷奥销售公司只接受遵守法雷奥销售公司条款和条件的产品订单。

照片和图纸对法雷奥销售公司不具有约束力。本目录的版权属于法雷奥销售公司。未经法雷奥销售公司事先授权，不得对本出版物的任何部分以任何方式进行复制。

*Every effort has been made to ensure that the information contained in this catalogue is correct at the time of printing, but no warranty or representation is given or made as to the accuracy of such information and Valeo Service does not accept any liability whatsoever for any inaccuracies.*

*Valeo Service reserves the right to alter specifications and/or the final construction of products without notice.*

*Product references referred to in this catalogue may not be available in all countries.*

*All orders for products are only accepted subject to the terms and conditions of Valeo Service.*

*Photographs and drawings are not binding on Valeo Service. The copyright in this publication belongs to Valeo Service exclusively. No part of this publication may be reproduced by any means without the prior authorisation of Valeo Service.*

*La aplicación de los productos sobre vehículos y las especificaciones de los productos que figuran en nuestros catálogos se refieren a la situación del parque de automóviles en la fecha de puesta en circulación de los productos.*

*Valeo Service no asume ninguna responsabilidad en caso de modificación, sustitución o supresión de dichas aplicaciones y/o especificaciones que pudieran producirse por iniciativa de los fabricantes de automóviles.*

*Las características técnicas de nuestros productos son susceptibles de evolucionar en cualquier momento para incorporar las mejoras técnicas y tecnológicas que se desarrollan.*

*Las referencias de productos mencionadas en este catalogo puede que no estén disponibles en todos los países.*

*Los pedidos se regiran por las condiciones generales de venta de Valeo Service.*

*Las fotografías y dibujos que aparecen en nuestros catálogos son meramente indicativas, por lo que no siempre coinciden exactamente con la apariencia externa de nuestros productos. Se prohíbe la reproducción de todo o parte de esta publicación sin la autorización expresa y escrita de Valeo Service.*

As prescrições e recomendações relativas ao uso ou utilidade dos produtos constantes de nossos catálogos levam em consideração o estado do parque automotivo à época do lançamento desses produtos.

A Valeo Service não será responsável por quaisquer modificações, substituições ou supressões incidentes sobre as prescrições e recomendações relativas ao uso ou utilidade de nossos produtos, que sejam decorrentes de ações dos construtores de veículos.

As características técnicas de nossos produtos são suscetíveis de alteração a qualquer momento para que sejam incorporadas melhorias técnicas e/ou tecnológicas.

Certas referências podem não estar disponíveis em todos os países.

Os pedidos feitos pelos clientes são regidos pelas condições gerais de venda da Valeo Service.

Fotos e desenhos não contratuais. A reprodução do todo ou de parte desta publicação é proibida sem a autorização expressa e por escrito da Valeo Service.

Назначение и рекомендации по эксплуатации продукции, содержащиеся в наших каталогах, указываются с учетом состояния автомобильного парка на день ее появления.

Компания «Valeo Service» не несет ответственности в случае внесения изменений в рекомендации по эксплуатации продукции или их устранения, произошедших, в частности, по инициативе производителей автомобилей.

Технические характеристики нашей продукции могут претерпевать изменения в любой момент, с учетом совершенствования технических и технологических процессов.

Некоторые виды продукции могут не иметься в наличии в отдельных странах.

Заказы осуществляются согласно общим правилам торговли, применяемым в компании «Valeo Service».

Фотографии и изображения продукции могут не в полной мере соответствовать оригиналам. Воспроизведение всей или части настоящей публикации запрещено без специального письменного согласия компании «Valeo Service».

ข้อมูลต่างๆในแคตตาล็อกนี้ ได้ผ่านการตรวจทาน และตรวจสอบแล้วเป็นอย่างดีจากทางบริษัทฯ อนึ่ง หากมีความผิดพลาดหรือบกพร่องใดๆ ที่อาจเกิดขึ้น ทางวาเลโอ เซอร์วิส ขอสงวนสิทธิ์ไม่ยอมรับผิดชอบในทุกกรณี

และขอสงวนสิทธิ์ในการที่จะเปลี่ยนแปลงแก้ไขข้อมูลจำเพาะใด ๆ และ/หรือในขั้นตอนกระบวนการผลิตภัณฑ์ต่างๆ โดยไม่ต้องแจ้งให้ทราบล่วงหน้า

ผลิตภัณฑ์ต่างๆ ตามที่ระบุไว้ในแคตตาล็อกนี้ อาจจะไม่มีความจำเป็นในทุกประเทศ

การรับคำสั่งซื้อสินค้าทั้งหมด ต้องเป็นไปตามข้อกำหนด และเงื่อนไขของวาเลโอ เซอร์วิสเท่านั้น

บรรดากาพย์ และภาพวาดต่าง ๆ ตามที่ปรากฏในแคตตาล็อกนี้ ไม่มีส่วนผูกพันตามกฎหมายต่อวาเลโอ เซอร์วิส

สิ่งตีพิมพ์นี้ลิขสิทธิ์ของเป็นของวาเลโอ เซอร์วิส แต่เพียงผู้เดียว ห้ามมิให้มีการทำซ้ำ หรือดัดแปลง แก้ไขสิ่งพิมพ์นี้โดยวิธีการใด ๆ ก็ตาม โดยมีได้รับอนุญาตจากวาเลโอ เซอร์วิส

*Segala upaya telah dilakukan untuk memastikan isi informasi didalam katalog adalah benar pada saat dicetak, akan tetapi tidak ada jaminan yang diberikan atau dibuat terhadap keakuratan dari informasi tersebut dan Valeo Service tidak dapat menerima segala bentuk ke tidak keakuratan tersebut*

*Valeo Service memiliki hak untuk mendapatkan spesifikasi lainnya dan atau konstruksi final dari produk-produk tanpa pemberitahuan terlebih dahulu*

*Referensi produk-produk dalam katalog kemungkinan tidak terdapat pada setiap negara*

*Semua pesanan produk-produk tersebut memiliki ketentuan yang berlaku dari Valeo Service*

*Foto-foto dan gambar-gambar tidak menjadi tanggung jawab Valeo Service, hak cipta eksklusif pada publikasi ini adalah milik Valeo Service. Tidak ada bagian bagian dari publikasi ini yang dapat dikeluarkan atau diperbanyak, tanpa seizin terlebih dahulu dari Valeo Service*



**法雷奥 -**  
**您的售后市场全产品线专家**  
从原厂配套领导者到售后市场的卓越表现

**Valeo Service -**  
**your aftermarket multi-specialist**  
From original equipment leadership to  
aftermarket excellence



valeo added 

驶于科技，融于自然  
Automotive technology, naturally

**Valeo**  
法雷奥