

ADORE

fashion, home design, decor



THE NEW ORLEANS
ADVOCATE



FROM THE ANTIQUE AND ESTATE COLLECTION OF
FRIEND & COMPANY
FINE JEWELERS EST. 1976



Friend & Company is proud to offer mint condition, pre-owned, high-grade watches for men and women. All of our watches are guaranteed authentic and come with our comprehensive in-house warranty.

7713 MAPLE STREET, NEW ORLEANS, LA 70118
504-866-5433 · WWW.FRIENDANDCOMPANY.COM



GIANNI BINI

Dillard's
The Style of Your Life.

Dylan Sweater, \$69 • Nina Skirt, \$99.

TABLE OF CONTENTS

FALL 2017 • ISSUE NUMBER 6 • VOLUME 1

- 6** **SPORT YOUR BEST LOOK**
Take Tailgating to the Next Level
- 14** **MID CENTURY MODERN**
Classic Pieces That Have Never Been More Relevant
- 18** **COQUETTE**
Changing the Paradigm in Contemporary Southern Cuisine
- 24** **MAKE YOUR CASE THIS FALL**
Styling an Envious Bookcase
- 30** **RAISING THE BARS**
Unique Spots to Grab a Drink This Fall
- 36** **AUTUMN AURA**
Statement Lamps For Every Style
- 40** **FASHION MIXOLOGY**
Unexpected Pairings Are in the Mix For Fall
- 46** **PLUSH PERFECTION**
Pillows to Take Your Home From Summer to Fall
- 48** **NAIL IT**
This Season's Polished Points

EDITOR: KATY DANOS | DESIGNER: EMILY SUCHERMAN

FOR ADVERTISING INQUIRIES:

SARA BARNARD | 504.636.7421 | SBARNARD@THEADVOCATE.COM



18



14

6



36



30

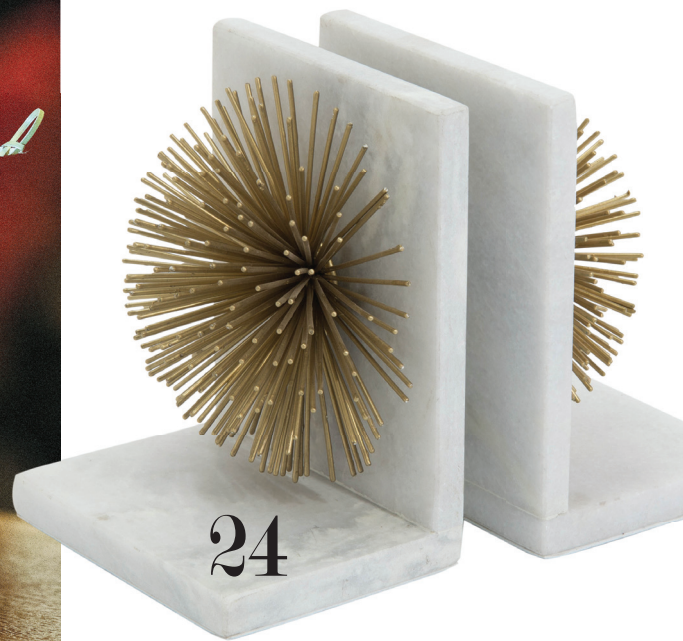

24



48

LE VERNIS

CHANEL



46

40



SPORT YOUR BEST LOOK

TAKE TAILGATING TO THE NEXT LEVEL

BY VICTOR ANDREWS

SAINTS ▶

①



②



1. Ralph Lauren Bell-Sleeve Cropped Crepe Blouse | \$115 | DILLARD'S | dillards.com

2. Metallic Reversible Tote Bag | \$60 | BABE NEW ORLEANS facebook.com/babe.neworleans/

3. Chanel Round Spring with 18-Karat Gold Mirror Lenses | \$520 | ST. CHARLES VISION stcharlesvision.com

4. Julie Vos Black Onyx Cairo Open Bangle | \$88 | HAZELNUT hazelnutneworleans.com

5. Julie Vos Black Onyx & Pearl Greek Key Cuff | \$330 | HAZELNUT hazelnutneworleans.com

③



Tailgating—what was once merely a chance to gather before the big game—has become a national pastime that rivals the football contest itself. Once relegated to the parking lots near the stadiums, it is now a serious and often sumptuous affair that can range from happening picnic hampers to catered culinary celebrations. Food, beverage, music, and merriment are the order of this first part of any gridiron contest. But there's so much more than making certain the noshing is posh and the potables are potent. Looking good is truly the goal for those who might only be enjoying the pregame festivities or are in it for the long haul of the entire game. It's a time you truly want to be on the Dean's List: the best-dressed list, a phi beta fashionista. And the look is inclusive, with opulent accessories and accouterments, and all the right goodies for gating with style for her and for him.



2016 JAMES BEARD AWARD



BEST CHEF: SOUTH

WWW.BALISE.COM

BALISE
TAVERN

640
CARONDELET
NOLA
7 0 1 1 5

DOWNTOWN
BALCONY DINING • HAPPY HOUR
PRIVATE EVENT SPACE
504 459 4449

HOURS
LUNCH
Tuesday – Friday 11:30 am – 2 pm

DINNER
Sunday – Thursday 4:30 pm – 10 pm
Friday – Saturday 4:30 pm – 11 pm

BRUNCH
Saturday & Sunday 10 am – 3 pm

HAPPY HOUR
Monday – Friday 4:30 pm – 7 pm
(Bar Room Only)

EST. 2004

LA PETITE GROCERY
RESTAURANT & BAR

HOURS

LUNCH TUESDAY–SATURDAY 11:30 AM – 2:30 PM
DINNER SUNDAY–THURSDAY 5:30 PM – 9:30 PM
FRIDAY–SATURDAY 5:30 PM – 10:30 PM
SUNDAY BRUNCH 10:30 AM – 2:30 PM

UPTOWN

4238 MAGAZINE STREET
504 891 3377
LAPETITEGROCERY.COM

RESTAURANTS ARE AVAILABLE FOR PRIVATE EVENTS
AND OFF-SITE COCKTAIL OR DINNER PARTIES.
INQUIRIES INFO@LAPETITEGROCERY.COM



①



②



③



④

1. Haybands Saints Tattoos | \$14 | HEAD OVER HEELS
headoverheelsonline.com

2. Bib Necklace | \$195 | HEAD OVER HEELS
headoverheelsonline.com

3. Martin Dingman Saints Belt | \$85 | IRON HORSE
ironhorsenola.com

4. Slashed Legging | \$89 | BABE NEW ORLEANS
facebook.com/babe.neworleans/

The look and feel of the 2017 tailgating season is a lux style that transcends merely boasting the proper colors, be it Tulane green, Tiger purple, or Saints gold. No tattered Ts or misshapen sweats. Fans Uptown, Downtown, and in Baton Rouge have a wave of options for stylish attire appropriate for the bleachers or the boxes that can go from tailgate to game to after-party chic.

Kickoff the season by scoring major style points as a fashionable fan.



5. Gold S'well Bottle | \$45 | IRON HORSE
ironhorsesnola.com

6. Scout Chillabuster | \$25 | SNAP
@shopsnap

5



6



SEE.
AND BE SEEN

St. Charles VISION

stcharlesvision.com

TULANE ▶



1



2



3



4



5



6

- 1. Green Wave Tie | \$65 |
NOLA COUTURE | nolacouture.com
- 2. Kelly Green Reversible Tote | \$98 |
HAZELNUT | hazelnutneworleans.com
- 3. Customizable Lily Tassel Earrings
| \$125 | ANGELIQUE
facebook.com/shopangeliqueboutique/
- 4. Ray Ban Cockpit Gold With Green
Flash Lenses | \$170 |
ST. CHARLES VISION
stcharlesvision.com
- 5. Quilted Crossbody Bag | \$60 |
BABE NEW ORLEANS
facebook.com/babe.neworleans/
- 6. Gemma Pleated Skirt | \$118 |
ANTHROPOLOGIE | anthropologie.com

1



1. Blue Tasc Performance Half Zip
| \$70 | IRON HORSE
ironhorsenola.com

2. Needlepoint Flask | \$65 |
SMATHERS & BRANSON
smathersandbranson.com

3. Checkerbox Uptown Socks
| \$15 | FOOT SOLUTIONS
footsolutions.com

4. Leather Campaign Chair
| \$1,200 | MOORE & GILES
mooreandgiles.com

2



3



4



HAZELNUT NEW ORLEANS



TRICENTENNIAL SANTA



NEW ORLEANS EXCLUSIVES



THE NEW ORLEANS TOTE



5525 MAGAZINE STREET
MON-SAT 10AM 'TIL 6PM
504.891.2424



1. Magnolia Lane Collection Serving Bowl | \$13.95 | ROSE LYNN'S HALLMARK roselynnshallmark.com

2. LSU Collegiate Glasses | \$16.25 | CAT STUDIO | catstudio.com

3. Tiger Pendant | From \$45 | MIMOSA | mimosahandcrafted.com

4. Purple Tassel Hoops | \$26 | HEAD OVER HEELS | headoverheelsonline.com

5. Ivetta Tie-Sleeve Dress | \$138 | ANTHROPOLOGIE | anthropologie.com



1. Peter Millar LSU Polo | \$79 | IRON HORSE | ironhorsesnola.com
2. Jonathan Wachtel LSU Cufflinks | \$85 | IRON HORSE | ironhorsesnola.com
3. Peter Millar LSU Mike the Tiger Belt | \$98 | IRON HORSE | ironhorsesnola.com

FRESH INGREDIENTS  AUTHENTIC RECIPES

FROM OUR TACO BAR TO A GALLON OF MARGARITAS, WE HAVE YOUR TAILGATE COVERED!

USE CODE **TAILGATE** TO GET 10% OFF YOUR CATERING ORDER.

FELIPE'S MEXICAN TAQUERIA | www.felipestaqueria.com | @FELIPESNOLA

GAME DAY STYLE

iron HORSE

ELEVATE YOUR GAME DAY GEAR AT IRON HORSE

OLD METAIRIE

 523 METAIRIE ROAD - 504-644-4800 

WWW.IRONHORSENOLA.COM

Mid Century MODERN

BY KATY DANOS

Mid-century modern is the catchall phrase for the decorative style that dominated American design from the 1930's to the 1960's. It's a broad term used for furniture, color trends, and the decorative tastes of a post-war population fueled by optimism, change, and innovation. With a palette of warm wood, burnished brass, and rich strokes of saturated color and a philosophy of form which follows function, the looks have stood the test of time. The design movement peaked in the fifties, but the high quality workmanship and pared down shapes were built to last.



1

1. Sputnik Brass Chandelier | \$1,995 |
JONATHAN ADLER | jonathanadler.com

2. Monroe Mid-Century Sofa | \$1,199 |
WEST ELM | westelm.com

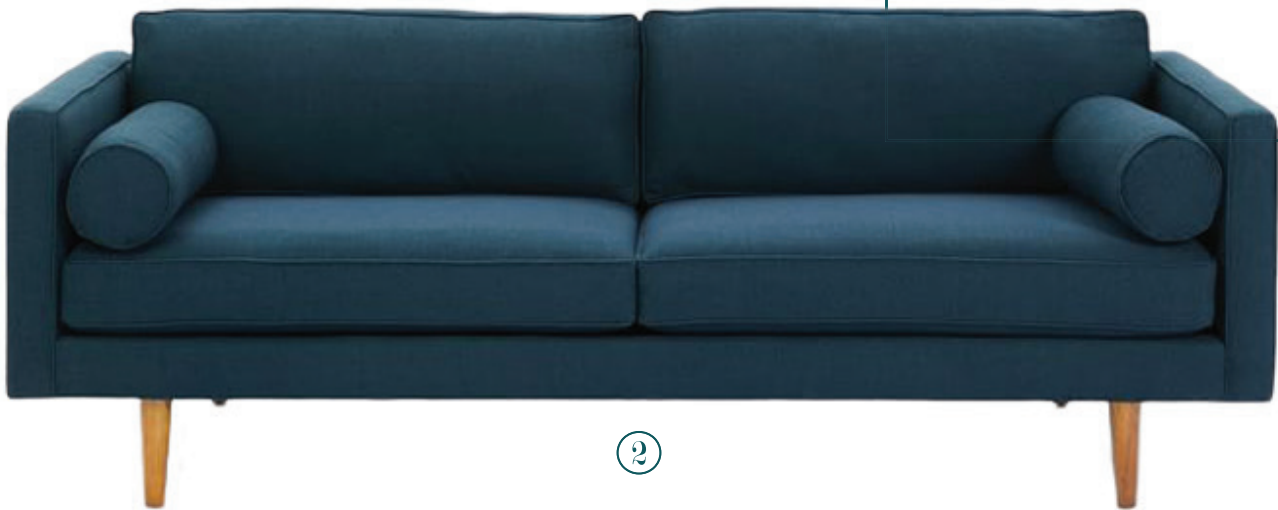

2



MATOUK

Introducing Chamant

Our new linen table collection for the modern home

sotre
Adornment For Inspired Living

3933 Magazine St • (504) 304-9475 • Monday-Saturday • 10am-5pm



With a country racing to space and fascinated by a booming Hollywood, sputnik-inspired designs and rat pack influences show up in everything from lighting, to fabrics, to home accessories. A deep connection to nature kept the look grounded with organic, handcrafted objects in an earthy array of burnt oranges, avocado green, and mustard. The modern but cozy vibe is an enduring aesthetic.

- 1. Seven Handed Vase | \$850 |
EPHRAIM POTTERY | ephraimpottery.com
- 2. Paolo Bent Ply Leather Chair | \$999 |
WEST ELM | westelm.com
- 3. Stickley Highlands Trestle Table | Starting at \$5,399 |
DOERR FURNITURE | doerrfurniture.com
- 4. Baccarat Havana Crystal Ashtray | \$750 |
FRIEND & COMPANY | friendandcompany.com

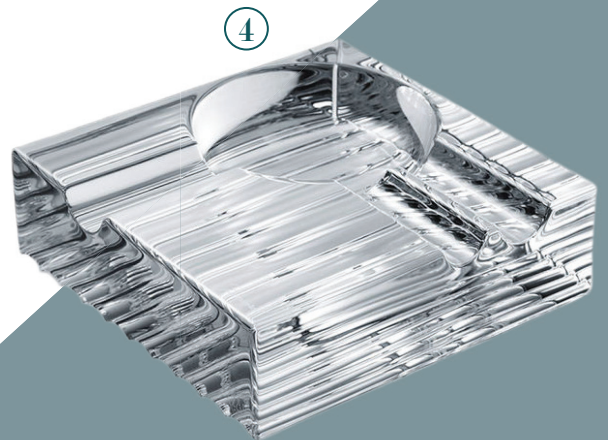



5



7



6

5. Kim Seybert Handcrafted Rosewood Placemat | \$98 | HAZELNUT | hazelnutneworleans.com

6. Sculptural Ceramic Vase | \$300 | KATIE KOCH HOME | katiekochhome.com

7. Archer Bookends | \$725 | AERIN | aerin.com



\$10 BOTTLE OF WINE

red, white, or sparkling

Enjoy one bottle of wine selected by our sommelier with the purchase of two entrées



Available throughout September 2017 at any Dickie Brennan & Co. restaurant

Must mention this ad
www.FrenchQuarter-Dining.com



Coquette

CHANGING THE PARADIGM IN CONTEMPORARY SOUTHERN CUISINE

BY KATY DANOS | PHOTOS BY JAMES GAFFNEY

Coquette, housed in an elegant two-story townhouse on Magazine Street in the Garden District, is the kind of restaurant that true foodies love. The menu is not pretentious, the dishes innovative with perfect execution, and the high beam is on the ingredients. In a city known for fantastic food, partners Kristen Essig and Michael Stolfus have gained a loyal following for what they call a food journey. The imaginative menu, which changes several times a week, is fully inspired by locally sourced and seasonal farm-fresh products. It's an ambitious approach for sure, but one that keeps the chefs on their

seriously creative toes and delivers quite a food adventure for diners. With a spectacular wine list, impeccable service, and many off-menu nights, it is easy to see why both locals and visitors alike place their trust in these capable hands.

The setting is casual with an authentic New Orleans vibe. Beautiful wood floors, walls of old brick, a pressed tin ceiling, and a chandelier or two deliver just the right amount of old school bling. The gleaming bar seats fourteen and many regulars consider that to be the best perch in the

It's a dream to get specialty items like strawberries and chanterelles locally.

-MICHAEL STOLZFUS



house. Local companies, farms, and growers deliver harvests weekly, Coquette has their own little herb garden, and everything including bread, pickles, and ice creams are house-made. The ingredients are flavorful and almost require no dolling up; but the elevated preparations and lively combinations served are delicious and you will savor every morsel.

Vegetables such as rainbow carrots, napa cabbage, and purple mezuna come from Covey Rise Farms, a fifty acre farm in Husser; Paradigm Gardens, an urban garden in Mid-City; and Pelican Produce, a grower on the edge of the Upper Ninth Ward. With strong relationships between the farmers and the restaurant owners (Kristen was once the market manager of the Crescent City Farmer's Market), everyone wins. The



3427 MAGAZINE ST.
NEW ORLEANS, LA 70115
504.309.5026



farm is sustainable, talented chefs don't have to look far for special ingredients, and with crop planning meetings chefs know exactly what they will have to work with each month and everything about the quality. This more direct route from farm to fork, with less packaging and less transport, increases profits for everyone involved and the pay-off for the diner is obvious with each and every bite.

Coquette summer desserts like peaches and shiso are made by pastry chef, James Kubie, featuring Alabama peaches, shiso



from Paradigm Gardens, and house-made sunflower seed pralines. It bursts with zesty flavor. Okra, a down home favorite from Covey Rise, is charred and treated to a tasty charred corn remoulade and ricotta salata topped with pickled lunchbox peppers; basil from their own garden is freshly picked to order. There is genuine excitement in the kitchen when the Monday deliveries happen. Smoked Catfish Dip is always on the menu, but Chef de Cuisine, Cesar Nunez, changes the variations and garnishes depending on the day's crop. Crates full of dancer eggplant, artisan varieties of squash, and heirloom tomatoes make their way into late summer dishes in all their just-picked glory. Humble lima beans from Covey Rise become aioli served with puffed rice and the catfish dip.

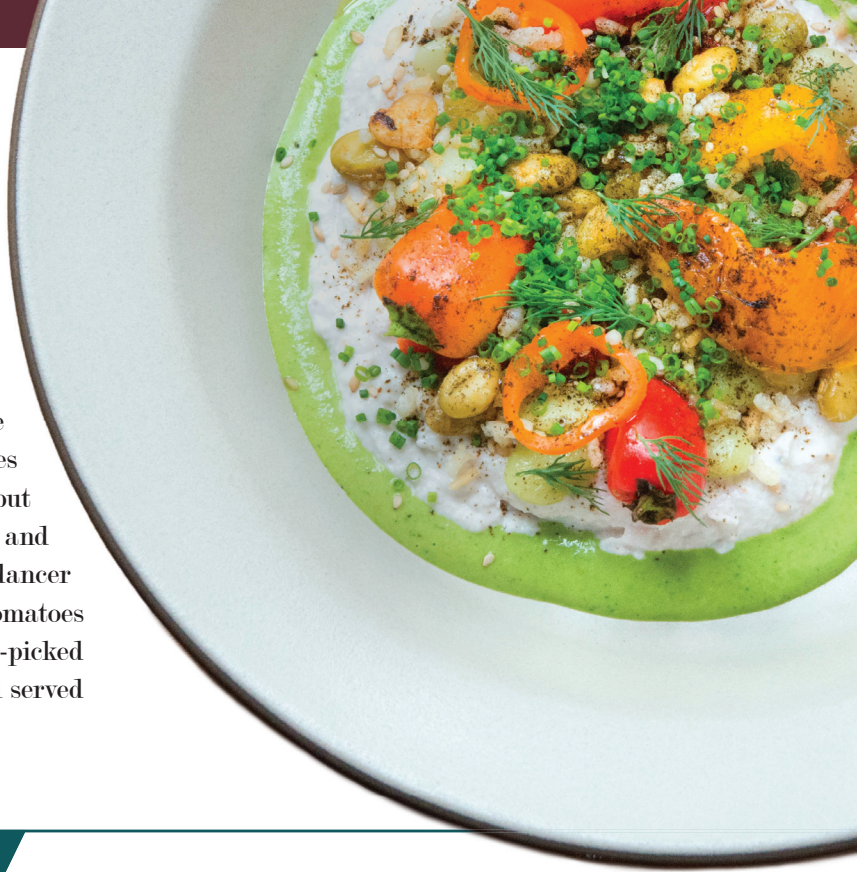

Fresh food sparkles. It has its own energy that inspires the work we love.

-KRISTEN ESSIG

CHARRED CORN REMOULADE

3/4 CUP CHARRED CORN
 3/4 CUP SOUR CREAM
 3/4 CUP MAYONNAISE
 ZEST AND JUICE OF TWO LIMES
 3 GREEN ONIONS, DICED

2 TABLESPOONS CHOPPED CILANTRO
 CRYSTAL HOT SAUCE, TO TASTE
 SALT AND FRESHLY GROUND BLACK PEPPER, TO TASTE

Mix all and store in the fridge. Yields about 2 cups.





PARADIGM GARDENS

A FARM TO FORK
EXPERIENCE



Even the drinks are fully on board the farm-fresh bandwagon. For example, bar manager, Christopher Brian, uses just ripe cantaloupe to create a garden to glass cocktail, the Tequila Daisy. A hint of smoky mezcal is perfect with the juicy goodness of the exuberant melon flavors. And of course, Kristen and Mike eagerly look forward to Fall. "In collaboration with Patois, we've planned crops with Paradigm Gardens; they have their concert series coming up in their outdoor event space; and we can't wait to see the beets, turnips, and radishes," they both explained. "It's going to be a very good season."



B A B E

CLOTHING & ACCESSORIES

5007 FRERET ST \ NEW ORLEANS \ 504.265.0432



SFERRA

CELEBRATING 125 YEARS

The Linen Registry
The World's Finest Linens
New Orleans

*"Luxury must be comfortable,
otherwise it is not luxury."*

— Coco Chanel

200 Metairie Road, Suite 102
Old Metairie · 504.831.8228

MAKED CAST



Many people have bookcase paralysis. They love their sentimental things, have various spots for books throughout their homes, but are stressed by all the seemingly pinterest-perfect examples of "proper" arrangements. Relax and enjoy your stuff. Your books and favorite decorative items can communicate your unique personality and sincere interests in a decorative way. Forget about the rules; with a few pointers, you can organize your bookcases in an intentional manner that leaves plenty of room for new arrivals and lots of room to grow.

Start with a clean empty shelf or two and gather your books, collectibles, and favorite objects. It's called "shop your

YOUR



THIS FALL

BY KATY DANOS
PHOTOS BY JAMES GAFFNEY

own house," but remember the lyric "these are a few of my favorite things." The idea is not to fill all the shelves at once with books in rows—that's called a library—but rather to create a gameplan for presenting your authentic style, color loves, and personal vibe. It should never feel finished and it will organically change over time. Clump your books in loose color groups, sort by size, and remove dust jackets if too worn. Don't worry about having enough books. It is better to be spare and collect books in real time. Big coffee table books are a treat and older books can be found at flea markets and tag sales. An insider tip: buy gently used books at a fraction of the cost on amazon.com.





Anything you love can be an objet d'art. For the collected look, mix found objects, like natural rocks or shells, with beloved acquired treasures, like antique plates and ceramic vases. Boxes are the secret weapon! They fill space in an uncluttered way—you can stash things like passports and spare keys—and they provide a pop of color. Just starting out? Display your wedding china or rummage through your grandparents' attic. Nothing supplies patina and charm better than vintage books, your family reads, or funky old bookends.



Small works of art, a few framed photographs, and even glass bottles or bowls add layers of color and visual interest to your bookcase. Modern and old, valuable and not so—everything will work together if the loot is sincerely yours.



Open for...

DINNER LUNCH DRINKS



Galatoire's
BAR & STEAK
215 Bourbon St.



Once you've done the hunting and gathering, you can place groups of books in various ways; start from the middle and branch out. Stack some in color combinations you like and some between bookends that can also act as art objects. Add fun accents and move things around until you find a balance of shape, color, and form. Travel books and even magazines are great beginner ways to fill your shelves and the pros know you can never go wrong with baskets for texture that serve a purpose.



BOOKCASE 1

Lacquered Green Box with Geode | PERCH | perch-home.com

Grey Box with Druzy | SOTRE | sotrenola.com

Bookends, Frames, Vases | HAZELNUT | hazelnutneworleans.com

Coffee Table Books | SHAUN SMITH HOME | shaunsmithhome.com

Malachite Box, Angel Sculpture | HAZELNUT | hazelnutneworleans.com



THE DETAILS
STYLED BY TOM CIANFICHI

BOOKCASE 2

African Straw Fans | SOTRE | sotrenola.com

Bookends, Orange Box, Pottery | HAZELNUT | hazelnutneworleans.com

Dancing Dragon, Crowned Wolf Ceramic Jar | PERCH | perch-home.com

Coffee Table Books | HAZELNUT | hazelnutneworleans.com

Create The Look

SAVVY STORAGE SOLUTIONS



L'Objet Gold Garland Frame | \$275 |
FRIEND & COMPANY
friendandcompany.com



Jim Piers Black Rectangular Stacking
Boxes | From \$110 | HAZELNUT
hazelnutneworleans.com



Chelsea Garden Accent Plate Royal Crown
Derby | \$195 | FRIEND & COMPANY
friendandcompany.com



Bronze Buddha Head | \$195 |
ECLECTIC HOME | eclectichome.net

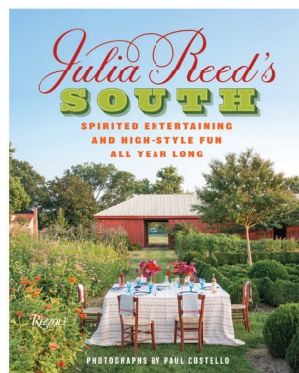

Julia Reed South | \$50 | GARDEN DISTRICT
BOOK SHOP | gardendistrictbookshop.com



Brass Doggie Bookends | \$249 for Set |
ECLECTIC HOME | eclectichome.net

Raising THE BARS

UNIQUE SPOTS TO
GRAB A DRINK THIS FALL

BY MISSY WILKINSON | PHOTOS BY JAMES GAFFNEY

HOME OF THE
NEW ORLEANS BOURBON SOCIETY

THE WHISKEY DESTINATION

1

BOURBON HOUSE

▶ 144 Bourbon St



The bourbon boom was years away when Dickie Brennan opened Bourbon House in 2002. Fifteen years later, its early focus on the trending spirit feels prescient. "(Brennan) had this foresight when we envisioned the restaurant originally," said Barry Himel, beverage director for Dickie Brennan Company. "We specialize in bourbon."

The seafood restaurant and whiskey bar recently released its own Maker's Mark bottling. "We custom-made our own bourbon," said bartender Will Fox. "It has a robust flavor. You can taste the French oak in there."



It's amazing, the number of bourbon fanatics that come through the door

-BARRY HIMEL



The unique bottling is one of 230 available whiskeys. About 20 "master tasters" have sampled every bourbon at Bourbon House, and more than 4,000 people are members of Bourbon House's New Orleans Bourbon Society (NOBS). The NOBS is free to join and offers tastings, dinners with master distillers, and complimentary pours for members.



THE NEIGHBORHOOD HANG

2

BARREL PROOF

▶ 1201 Magazine St.



When Liam Deegan and Robert Leblanc opened Barrel Proof in 2014, they envisioned it as a neighborhood joint with a laid-back, bourbon-heavy menu.

"(Barrel Proof) features the style of drinking we do when we're hanging out," Deegan said. "Beer and whiskey, mostly shots. We don't drink cocktails, even though we like them a lot."

Located in a dim, cypress-trimmed space that has housed bars for more than a century, Barrel Proof stocks 294 whiskeys. There's a wide array of craft beers and cocktails, plus elevated bar food and rotating pop-ups in the kitchen. However, Deegan said most people come for the Old Fashioned, which costs \$3 during happy hour (4 p.m. to 6 p.m. weekdays).

We do it simple and old school. Bitters, a dark sugar, bourbon, good ice and orange peel. I think our Old Fashioned is as classic as possible.

-LIAM DEEGAN



30th Annual Fall *The Pontchartrain*



September 8-10, 2017
Pontchartrain Center

Regular Admission - \$8
Free for Children Under 12

SHOW HOURS

Friday, September 8 · Noon-7pm
Saturday, September 9 · 10am-7pm
Sunday, September 10 · 10am-5pm

DISCOUNT COUPON

\$1.00 off Admission
2 For 1 on Friday

RENEW, REFRESH & REMODEL WITH THE NEWEST HOME PRODUCTS AND IDEAS!

Join us for the 30th Annual Fall Pontchartrain Home Show, the largest and longest running fall Home Show in Louisiana! This is the go-to event to shop for all your home improvement needs under one roof. This year's show will feature exhibits with the latest products in kitchens, remodeling, flooring, outdoor kitchens, spas, landscaping and more. Come enjoy cooking shows by local chefs and expert seminars given daily. Every participant has a chance

to win great door prizes, including spa days, restaurant certificates and much more! There is something for the entire family at the Pontchartrain Home Show.

SPECIAL FEATURES

The New Orleans School of Cooking Culinary Stage

Enjoy Great Food
and Special Recipes



The All-New Kids Zone

Play free games including Star Wars Pinball
and Pacman Arcade Party

PRESENTED BY 
Making Homes Happier



THE TROPICAL OASIS

3

TIKI TOLTECA

▶ 301 N Peters St.



Though its proximity to the Caribbean and history as a rum mecca make New Orleans a natural fit for tiki bars, the scene lay dormant for decades after Bali Hai shuttered in the mid-1980s. That changed in 2013, when Tiki Tolteca launched.

"(Tiki Tolteca) was the first tiki bar to open since then," said Charles Arinder, director of operations for Felipe's Mexican Taqueria. "The tiki scene had been nonexistent."

Perched above Felipe's Taqueria in the French Quarter, Tiki Tolteca is "literally an oasis," Arinder said. It features a thatch-roofed bamboo bar, tropical floral prints, tiki heads, glowing sea glass orbs and cowhide furniture handmade in Jalisco, Mexico—not to mention the fruity, flower-bedecked cocktails.

"When you give a guest a drink, you can see it's a little bit of a mind-blowing experience," said head bartender Michael Beaugez, who designed or tweaked every drink on the menu.

Tiki Tolteca stocks 120 rums. Every syrup and liqueur is made in house from scratch. From the drinks to the décor, tiki bars are all about a transportive, tropical experience—which may explain their recent renaissance.



Tiki is innately fun
-CHARLES ARINDER



AUTUMN AURA

ILLUMINATING IDEAS FOR A
SOPHISTICATED INTERIOR

BY KATY DANOS



A bold shaped lamp and equally bold shade equal instant drama.



Aerin Culloden Table Lamp | \$420 |
CIRCA LIGHTING | circalighting.com



Sham Beaux Turquoise Lamp | \$625 |
SOTRE | sotrenola.com



Chris Spitzmiller Double Gourd Lamp
| \$3,385 | SHAUN SMITH HOME
shaunsmithhome.com

Lamps deliver light, both task and ambient, to every room in the house. They are also an ideal opportunity to illuminate your personality and amplify your decorative style. A single sculptural lamp, metal or ceramic, can act as a distinctive art object and nothing beats handmade when it comes to adding unexpected flourishes to your space.



Eicholtz Las Palmas
Gold Table Lamp | \$1,095 |
OROA | oroa.com



Bloque Table Lamp | \$1,470 |
KELLY WEARSTLER
kellywearstler.com



Linden Table Lamp | \$840 |
KELLY WEARSTLER
kellywearstler.com



Puzzle Table Lamp | \$1,250 |
JONATHAN ADLER
jonathanadler.com



Monroe Table Lamp | \$595 |
WILLIAMS SONOMA
williamssonoma.com

For a vibrant splash of color, go for a strong shape and hue; organic shapes and natural materials work well. If you're itching for just a hint of retro glam, a lamp or two is a budget-friendly way to mix things up for a fresh look. Pairs on side tables bring pleasing symmetry to the room and an eye-catching statement lamp will always earn its keep.



Gold Leaf Palm Table Lamp
| \$965 | HAZELNUT
hazelnutneworleans.com



Marmont Table Lamp | \$630 |
KELLY WEARSTLER
kellywearstler.com

A bubble lamp in a shiny metallic finish is elegant without ever trying too hard.





NINA LOUP

cell: 504-650-7177

office: 504-887-7878

nloup@gardnerrealtors.com



REALTOR



EQUAL HOUSING OPPORTUNITY



Gardner Realtors
4509 Veterans Blvd.
Metairie, LA 70006



**43 Madera Ct
Kenner • \$529,000**

Driftwood corner lot, completely renovated. 5 bedrooms, 3 baths. Formal living and dining, with fireplace in den. Backyard entertaining with salt water pool.



**312 Roseland Pk
Harahan • \$438,000**

4 Bedrooms, 2 and 2 1/2 Baths, Master suite down, 2 story Den, Granite counters, Full Rec room with Kitchen and 1/2 Bath, separate central air and heat.



**1301 Nursery Place
Metairie • \$499,999**

3 bedrooms, 2.5 baths. Builder's own home. 3 years old, custom drapes, built in refrigerator & dishwasher with cabinet fronts. Trane air & dehumidifier. Total foam insulation. Large corner lot.



**2401 Iowa Ave
Kenner • 269,000**

3 spacious bdrms plus bonus rm converted garage for additional living area. Wood/gas fireplace in den with wall of windows. Outdoor brick patio, gas appliances.



**1857 Agriculture St
New Orleans • \$990,000**

Multiple bldgs (6) with showroom, offices, warehouse, dock doors, industrial & manufacturing plus 13,000 sq. ft. of extra land to build on.



**422-24 30th St
New Orleans • \$720,000**

3 bdrms & fireplace in den. Owners unit-424, fireplace in den & granite/ ss applications. 2 bds & 1 ba upstairs-bdrm/ba downstairs, patio & fenced in back yard. Dbl garage.



**329 Rue Saint Ann OT
Metairie • \$750,000**

3 story Townhouse with elevator, 4 Bedrooms, 3 1/2 Baths, Fireplace, Courtyard patio.



**24336 Chef Menteur Hwy
New Orleans/Venetian Isles • \$425,000**

3 Bedrooms, 2 Baths, on the lake with furniture, 2 jet skis, 2 boats, dock & pier. Turn Key Access.



**7457 Lillie Valley
Gonzales • \$980,000**

Home sits on 1.5 acres. All bedrooms have private baths. Plus 1/2 bath for guest. Multiple bonus rooms. Full home generator.

Fashion MIXOLOGY

From toughened-up pearls to gloriously mismatched metals, unexpected pairings are in the mix for fall

BY MISSY WILKINSON

NOT YOUR GRANDMOTHER'S PEARLS

Birthered in the briny depths, each iridescent pearl has a story to tell. The soft, organic gemstone looks surprisingly tough paired with leather and denim. Dangling from an earring, cuff, or necklace, the pearl's captivating tale becomes your own.

Pearled Denim Trucker Jacket | \$158 |
ANTHROPOLOGIE
anthropologie.com



Multicolor Pearl Necklace | \$7,500 |
FRIEND & COMPANY
friendandcompany.com



Gucci Dionysus Embroidered
Snakeskin Shoulder Bag | \$6,700 |
SAKS FIFTH AVENUE
saksfifthavenue.com



Feline Head Palm Cuff
with Crystals | \$1,150 | GUCCI
gucci.com



Julie Vos Baroque Pearl Earrings
| \$225 | HAZELNUT
hazelnutneworleans.com



Barton Perreira Dalziel in Ivory/Pearl
Sunglasses | \$475 | ST. CHARLES VISION
stcharlesvision.com

Nicholas Kirkwood Casati Pearl
Leather Boots | \$1,295 |
SAKS FIFTH AVENUE
saksfifthavenue.com



Roger Vivier Jaipur Pearly Fringe Minaudiere,
Black | \$3,750 | NEIMAN MARCUS
neimanmarcus.com

UNE FEMME EN ROUGE

More than any other pigment, red invokes desire. Just a glance at the hue is enough to raise the human metabolism and blood pressure. Is it any wonder that this season's must-have pieces are lovely, dark, and deep shades of red?



Attico Velvet Ankle Cuff | \$245 |
BERGDORF GOODMAN
bergdorfgoodman.com



Adidas Gazelle in Scarlett | \$105 |
ADIDAS | adidas.com



Johanna Ortiz Lorea One-Shoulder
Velvet Bodysuit | \$995 | NEIMAN
MARCUS | neimanmarcus.com



Red Lace Costarellos Dress
| \$1,545 | SOSUSU
sosusuboutique.com

Loewe Calfskin Leather Sling Bag
| \$2,850 | NORDSTROM
nordstrom.com



Prada Velluto Ricamo Trunk Shoulder Bag | \$2,710 | BERGDORF GOODMAN
bergdorfgoodman.com



Stuart Weitzman On the Fringe Velvet Bootie | \$575 | NEIMAN MARCUS
neimanmarcus.com





14K Geometric Bangle Diamond Bracelets
| \$9,000 each | FRIEND & COMPANY
friendandcompany.com



METALLIC BONDS

Forget the old rules of the past. Mixing silver and gold (or pewter and brass, or rose gold and copper) isn't just acceptable, it's on-trend. Stick to clean lines and classic shapes, and you've got a winning combination.

St. John Metallic Leather
Bomber Jacket | \$1,595 |
SAKS FIFTH AVENUE
saksfifthavenue.com



18K Rose, White, and Yellow Gold Stackable
Ring Set | \$5,000 | FRIEND & COMPANY
friendandcompany.com



Gold & Silver Strap Flat | \$545 |
SOSUSU | sosusu.com



Mini GG with Tiger Detail | \$575 |
SOSUSU | sosusuboutique.com



John Humphries Halo Faceted Bangles.
Available in Gold Plated, Green Gold, Rose
Gold, Sterling Silver and Stainless Steel
| \$125 each | MIGNON FAGET
mignonfaget.com



Suede Metallic Shoppers | \$198 |
HAZELNUT
hazelnutneworleans.com

Mixed Metal Sandal | \$102 |
BABE NEW ORLEANS
facebook.com/babe.neworleans/





PLUSH PERFECTION

SIMPLE TWEAKS FOR
A BIG TRANSFORMATION

BY KATY DANOS

Toss new accent pillows on your sofa and the vibe in the room changes instantly. You can indulge your current color crush or refresh the pattern play in the room by layering in new textures and prints. In love with a pricey designer fabric or itching to bring some animal print to the party? Pillows are a great way to transform any decor without making a big upholstery commitment. Go for the bold... or the gold!



7



7. Topanga Corded Pillow
| \$295 | JONATHAN ADLER
jonathanadler.com

8. Sferra Manto Decorative Pillow
| \$220 | THE LINEN REGISTRY
thelinenregistry.com

9. Beryl Pillow By Iosis
| \$130 | ISOIS | finelinens.com

10. Talitha Discs Throw Pillow
| \$255 | JONATHAN ADLER
jonathanadler.com

11. Zak & Fox Mustard Greek Key
Print Pillow | \$150 | SUNDAY
SHOP | sundayshop.co

8



1. Painted Large Lumbar Pillow
| \$70 | WELL & MARY
wellandmary.com

2. Hunt Slonem Bunny Pillow
| \$215 | HAZELNUT
hazelnutneworleans.com

3. John Robshaw Rato
Decorative Pillow | \$120 |
BELLADONNA DAY SPA
belladonnadayspa.com

4. Chocolate Brown Le Zebre Pillow
| \$225 | HAZELNUT
hazelnutneworleans.com

5. Channels Pillow | \$330 |
HAZELNUT
hazelnutneworleans.com

6. Navy Embroidered Ikat Pillow
| \$129 | WILLIAMS SONOMA
williamssonoma.com

9



10

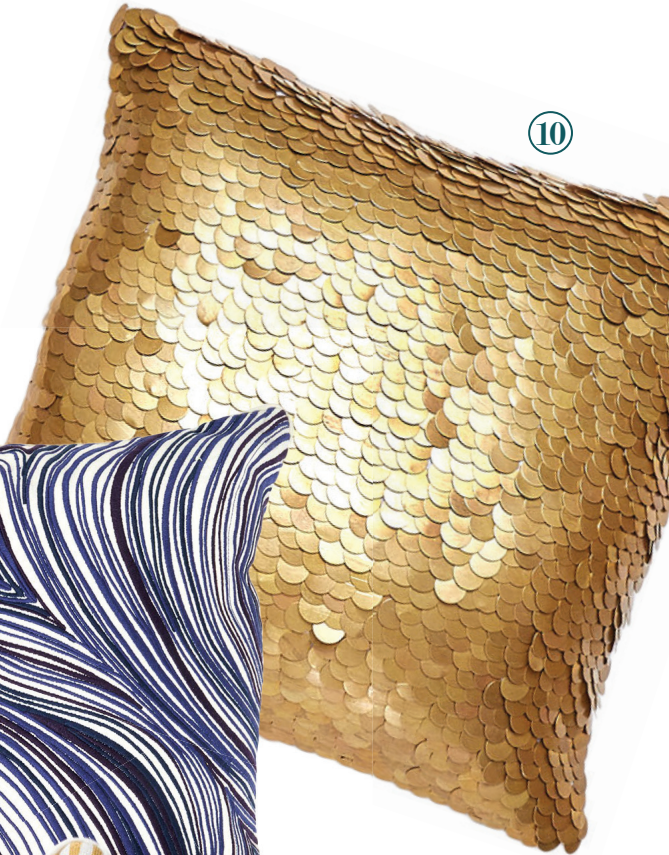

11



NAIL IT

THIS SEASON'S POLISHED POINTS

BY MISSY WILKINSON

What happens when luxury design houses meld their venerated senses of color with cutting-edge nail enamel technology? It's simple: long-lasting manicures that look fresh from the runway. Whether you drench your nails in luxe metallics or opulent hues like burgundy, navy blue, or hunter green, you can be sure your manicure is both trending and hi-tech. Dior blends in organic silicon for a high-gloss finish; Gucci includes a triangular bristle brush for precise application; and Chanel enriches its formula with nail-strengthening bioceramics. But perhaps the best thing about test-driving fall color trends via manicures is this: you don't have to wait for a cold snap to indulge in a rich, velvety-dark palette.

1. Chanel Le Vernis Longwear Nail
Colour in Mariniere 516 | \$28 |
SAKS FIFTH AVENUE
saksfifthavenue.com

2. Gucci Iconic Ottanio Bold High-Gloss
| \$29 | SAKS FIFTH AVENUE
saksfifthavenue.com



3. Dior Vernis Fall 2017 Limited
Edition in Metallics | \$27 |
SAKS FIFTH AVENUE
saksfifthavenue.com

4. Marc Jacobs Enamored Hi-Shine
Nail Lacquer in Blacquer | \$18 |
NET-A-PORTER | net-a-porter.com



1. Smith & Cult Opaque Bordeaux | \$18 | EMBODYMENT SALON & SPA | embodymentsalon.com



2. NARS Nail Polish in Milos | \$20 | BLUE MERCURY | bluemercury.com



3. Tom Ford Nail Lacquer in Bitter Bitch | \$36 | BLUE MERCURY | bluemercury.com



4. Smith & Cult Darling Darjeeling | \$18 | EMBODYMENT SALON & SPA | embodymentsalon.com

TOP LOCAL PICKS FOR YOUR NAIL FIX

MIA BELLA BEAUTY LOUNGE
miabellabeautylounge.com

BLANC BEAUTY BAR
blancbeautybar.com

THE WOODHOUSE DAY SPA
neworleans.woodhousespas.com/services



head over heels BOUTIQUE

introducing

THE MAUDE IN
LEOPARD CALFHAIR

BY DOLCE VITA



3112 MAGAZINE STREET
NEW ORLEANS, LA 70115
☎ 504.603.3234

VOODOO

MUSIC + ARTS EXPERIENCE



Watch Kendrick Lamar, Foo Fighters, The Killers, and More from Premium Viewing Areas
PLUS SHADED & RELAXED LOUNGE SEATING • ONSITE CONCIERGE SERVICES • UNIQUE FOOD OPTIONS & DRINK SPECIALS

VIP AND PLATINUM TICKETS ON SALE NOW AT [VOODOOFESTIVAL.COM](https://www.voodoofestival.com)

CERVEZA
Modelo

Produced by



FRED BURAS GROUP

SELLING HISTORICAL NEW ORLEANS



CHRIS AGUGLIA
EXEC. ASSISTANT /REALTOR®
(504) 250-0335



FRED BURAS
CERTIFIED RESIDENTIAL SPECIALIST
(504) 427-6292



JEANINE DAMARÉ
EXEC. ASSISTANT /REALTOR®
(504) 858-9028

Picture your house here next to our Solds

WWW.FREDBURASGROUP.COM

kw NEW ORLEANS
KELLERWILLIAMS REALTY

Licensed in Louisiana August 2017
Each office is independently owned and operated
8601 Leake Ave, NOLA 70118 - 504.862.0100



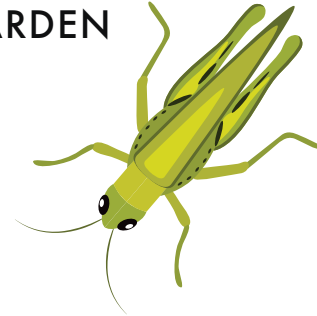
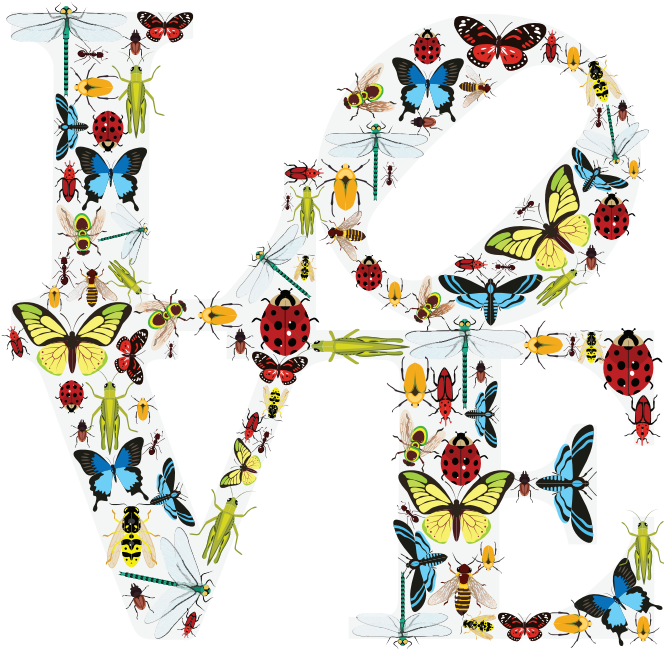

FRIDAY, SEPTEMBER 22

**SYDNEY AND WALDA
BESTHOFF SCULPTURE GARDEN**

7 PM UNTIL MIDNIGHT

PATRON PARTY | 7 PM

GARDEN PARTY | 8 PM

LATE NIGHT PARTY | 9 PM

**NEW ORLEANS MUSEUM *of* ART
LOVE IN THE GARDEN 2017**

presented by



WHITNEY BANK®

HONORING NEW ORLEANS ARTISTS

ANITA COOKE | SIMON GUNNING

KAROLINE SCHLEH | BOB SNEAD

ENTERTAINMENT BY

KINFOLK BRASS BAND | BRW | DJ BRICE NICE

PATRON AND GARDEN PARTY CUISINE

- Acme Oyster House
- Ancora Pizzeria
- Atchafalaya
- Aunt Sally's Pralines
- Baker Maid Products, Inc
- The Blue Crab Restaurant and Oyster Bar
- Blue Oak BBQ
- Bon Ton Café
- Boucherie
- Boulevard American Bistro
- Boulogny Tavern
- Brasa Churrasqueria
- Broussard's
- Byblos
- Café Degas
- Café NOMA
- Catering by Laura Arrowood
- Central City BBQ
- Chomp Nola
- City Greens
- Cornet
- Crescent City Brewhouse
- Crescent City Steak House

- Delachaise
- Desi Vega's Steakhouse
- Doris Metropolitan
- Galatoire's Restaurant
- Gordon Biersch
- Highly Seasoned Catering, LLC
- Houston's Restaurant
- Ice Cream 504
- Joel Catering and Special Events
- Louisiana Pizza Kitchen French Quarter
- Lula Restaurant Distillery
- Mandina's
- Martin Wine Cellar
- Maurice French Pastries
- Messina's Catering and Events/Messina's at the Terminal
- Mona's Café
- Mondo
- The Munch Factory
- Neyow's Creole Café
- Nonna Mia
- Nothing Bundt Cakes- Metairie
- P.F. Chang's China Bistro

- Porter and Luke's Restaurant
- Reginelli's Pizzeria
- The Ruby Slipper Café
- Santa Fe
- Satsuma Café
- Seaworthy
- Silk Road
- Southern Candymakers
- Southern Hospitality Catering
- Superior Seafood and Oyster Bar
- Ted Brennan's Decatur
- Tommy's Cuisine
- Vega Tapas Café and Catering
- Wayfare
- Yami Foods
- Zea's Rotisserie and Grill

LATE NIGHT PARTY CUISINE

- Cocoa and Cream
- Grita Tacos
- Morning Call in the Oaks
- Nola Snow Snowballs
- The Red Stove Food Truck

LOVE COCKTAIL CHALLENGE

presented by **SKYY.VODKA**

Featuring 11 craft cocktails from the city's most celebrated bartenders. Each bartender will create a unique drink inspired by a variation of LOVE.

THE CHALLENGERS

- TYLER CHAUVIN | Trèo
- MEGAN DEVINE | Twelve Mile Limit
- KIRK ESTOPINAL | Cure
- ALIA FAWAZ | Marcello's
- PAUL GUSTINGS | Tujague's
- HADI KTIRI | The Sazerac Bar
- BETH MCCASKEY | Kenton's
- CHRIS MCMILLIAN | Revel Cafe and Bar
- KIMBERLY PATTON-BRAGG | Latitude 29
- DANIEL VICTORY | Victory
- EVAN WOLF | Company Burger

FESTIVE ATTIRE | RAIN OR SHINE EVENT | [#LOVEINTHEGARDEN2017](https://www.noma.org)

TICKETS: www.noma.org | love@noma.org | 504.658.4121

NOMA

New Orleans Museum of Art