

Since 1952

Se Habla Español

# ALCO<sup>®</sup>

Sales & Service Co.

## Catalog AW3

ALCO Classic Wheelchairs  
2015-2016

# ALCO Classic™ Wheelchairs



Solid Folding Seat

**SAFETY FIRST** Removable & locking full arms for patient safety & easy transfer



700



Recliner



Transport



500



300



Flip-Back Arms



Phone: 800-323-4282

www.alcosales.com

Fax: 800-950-1167



Check out our Online Catalogs!



vendormate



# Comfort Classic™ Full Reclining Folding Solid Seat Wheelchairs

Buy 11  
**FREE**  
Get 1



## Institutional Heavy-Duty Folding Solid Seat



Recliner is Infinitely Adjustable from 90° Angle to Full 180° Recline



- ✓ All the features of the Comfort Classic Wheelchair shown on Page 7 plus the following:
- ✓ Full 180° recline
- ✓ Back extension with removable headrest
- ✓ Rear anti-tipper standard

Barrel Tested at 1,200 lbs!

Up To 700 lb. Capacity

### SPECIFICATIONS, PRICING & PART NUMBERS:

Description	Width Between Arms	Weight Capacity	Footrest (Includes Heel Loops)		Legrest	
			ALCO Part No.	Price Each	ALCO Part No.	Price Each
20" Removable Full Arm	21"	500 lbs.	AL-57488BL	<b>\$870</b>	AL-57594BL	<b>\$900</b>
20" Removable Desk Arm			AL-57489BL		AL-57595BL	
22" Removable Full Arm	23"	700 lbs.	AL-57590BL	<b>\$1019</b>	AL-57596BL	<b>\$1049</b>
22" Removable Desk Arm			AL-57591BL		AL-57597BL	
24" Removable Full Arm	25"	700 lbs.	AL-57592BL	<b>\$1126</b>	AL-57598BL	<b>\$1156</b>
24" Removable Desk Arm			AL-57593BL		AL-57599BL	



5-1/2" x 2" Front Caster Wheel  
(lowers seat 2" on 22-24" models only)  
**AL-64691 \$21.95 Ea**



AW3

#### STANDARD



**Front Caster Wheel—Hard Tread**  
Pushes 50% easier  
For 20" Wide Chairs  
8" x 1" • 5/16" Bearing • 1-13/16" Hub

#### STANDARD



**Front Caster Wheel—Hard Tread**  
Pushes 50% easier  
For 22" - 24" Wide Chairs  
8" x 2" • 5/16" Bearing • 2-5/16" Hub

#### Collar Locks



- ✓ Does not restrict front rigging swing-away movement
  - ✓ Makes legrest non-removable
- AL-2231 \$2.95 Each**





Up To  
700 lb.  
Capacity

# Comfort Classic™ Folding Solid Seat Wheelchairs



**SAFETY FIRST** Removable & locking full arms for patient safety & easy transfer



**Flip Back Arms are Locking and Non-Removable**



**Institutional Heavy-Duty Folding Solid Seat**

**Padded 2-1/2" Thick Seat**

**AL-70013BL**



**Anti-Theft**

**Folded Width 12"**

- ✓ Much more comfortable for patients restricted to a wheelchair for long periods of time and great for Rehabilitation/Therapy patients
- ✓ No need to buy expensive seat cushions
- ✓ Much easier to transfer patients from wheelchair to bed
- ✓ Double embossed and reinforced premium flame retardant upholstery; padded armrests
- ✓ Sturdy, one piece 24" composite rear wheels and chrome hand rims
- ✓ 8" x 1" or 8" x 2" heavy-duty, non-marking urethane, Black front wheels roll 50% easier
- ✓ 20" chairs have single X-brace, 22" and 24" chairs have double X-brace for added reinforcement and additional weight capacity
- ✓ Tool Kit
- ✓ Dual rear wheel positioning for hemi adjustability
- ✓ Sealed precision bearings for ease of mobility
- ✓ Outlasts hammock seats 5 to 1
- ✓ Folding seat aids in preventing theft
- ✓ Extended Warranty: Lifetime on Frames and Crossbraces; 5 year on Components
- ✓ Blue upholstery standard
- ✓ Burgundy (BU) and Black (BK) available for upcharge\* (See chart below)

**Barrel Tested at 1,200 lbs!**

**SPECIFICATIONS, PRICING & PART NUMBERS:**

Description	Width Between Arms	Weight Capacity	Footrest (Includes Heel Loops)		Legrest	
			ALCO Part No.	Price Each	ALCO Part No.	Price Each
20" Flip Back Desk Arm	21"	500 lbs.	AL-70000BL	\$699	AL-70001BL	\$729
20" Flip Back Full Arm			AL-70002BL		AL-70003BL	
20" Removable Desk Arm			AL-70004BL		AL-70005BL	
20" Removable Full Arm			AL-70006BL		AL-70007BL	
22" Flip Back Desk Arm	23"	700 lbs.	AL-70008BL	\$849	AL-70009BL	\$879
22" Flip Back Full Arm			AL-70010BL		AL-70011BL	
22" Removable Desk Arm			AL-70012BL		AL-70013BL	
22" Removable Full Arm			AL-70014BL		AL-70015BL	
24" Flip Back Desk Arm	25"	700 lbs.	AL-70016BL	\$949	AL-70017BL	\$979
24" Flip Back Full Arm			AL-70018BL		AL-70019BL	
24" Removable Desk Arm			AL-70020BL		AL-70021BL	
24" Removable Full Arm			AL-70022BL		AL-70023BL	

**\*Burgundy and Black Color Options**

Description	Burgundy Part No.	Black Part No.	Price Each
20" w/ Full Length Arms	AL-70024BU	AL-70024BK	\$189.00
22" w/ Full Length Arms	AL-70025BU	AL-70025BK	
24" w/ Full Length Arms	AL-70026BU	AL-70026BK	
20" w/ Desk Length Arms	AL-70027BU	AL-70027BK	
22" w/ Desk Length Arms	AL-70028BU	AL-70028BK	
24" w/ Desk Length Arms	AL-70029BU	AL-70029BK	

*Upholstery kits are available for new chair purchase*

**DIMENSIONS:**

Chair Width	Seat Dimensions	Overall Width (Handrim to Handrim)	Overall Depth (Front To Back)	Overall Height (Floor to Top of Back Cane)	Weight
20"	17-1/2"W x 15"D	29"	31.0"	39.0"	60 lb
22"	19-1/2"W x 18-1/4"D	31"	36.5"	39.0"	75 lb
24"	21"W x 18-1/4"D	33"	37.0"	39.0"	75 lb

Folded Width 12"

**Upholstery Kits Include: Seat, Back, Armrests & Calf Pads**

AW3

# Classic™ 700 Wheelchair 30" Width x 20" Depth



Great For All Bariatric Applications



**SAFETY FIRST** Removable & locking full arms for patient safety & easy transfer

**700 lb. Capacity**

Full Arm  
**AL-79002BK-FL**

2" Wide Hard Tread Wheels Standard. Push 50% Easier and will not fall in elevator slots

### Frame

- ✓ Reinforced heavy duty frame includes gusseted sides, caster journals and dual crossbraces
- ✓ Rust and chip resistant quadruple chrome plating process
- ✓ Heavy duty front fork
- ✓ Seat to floor height: 19"
- ✓ Sealed precision bearings on wheels, casters and journals
- ✓ 8" x 2" heavy duty front flat-free wheels won't fall in elevator slots and pushes 50% easier than other chairs
- ✓ 24" x 1" heavy duty steel spoke flat free rear wheel with chrome handrim
- ✓ Push to lock brake
- ✓ Metal skirt guards
- ✓ Overall open width: 38"
- ✓ Folded width 14"

### Upholstery

- ✓ Fire retardant, Reinforced, Black, heavy-duty, nylon upholstery
- ✓ Padded arm and calf pads are standard
- ✓ 20" seat depth; 18" back height
- ✓ Threaded seat screw inserts minimize stripping from upholstery changes
- ✓ Chart pocket on back (stenciling available—see page 14)

### Legrests

- ✓ Extra large, heavy duty footplate
- ✓ Ratchet bar to lock legrests securely into place
- ✓ Tool-free adjustable, shiny extra large footplate with nut and bolt lock to prevent twisting and falling off

### Extended Warranty

Frame & Crossbraces: Lifetime  
Components: 5 Years



### Features:



Double Bar Vertical Reinforcements

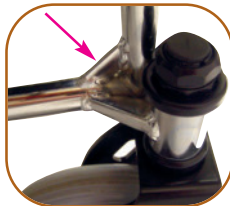

Two Caster Journal Gussets

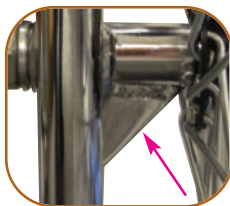

Rear Wheel Gusset



Rear Wheel Reinforcements

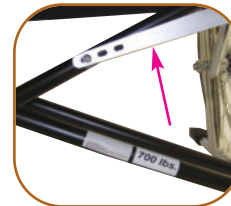

Steel Frame Reinforcements



Extra Large Footplate

### SPECIFICATIONS, PRICING & PART NUMBERS:

Description	Width Between Arms	Weight Capacity	Footrest (Includes Heel Loops)		Legrest	
			ALCO Part No.	Price Each	ALCO Part No.	Price Each
30" Removable Desk Arm	30"	700 lbs.	AL-79002BK-DF	<b>\$769</b>	AL-79002BK-DL	<b>\$779</b>
30" Removable Full Arm			AL-79002BK-FF		AL-79002BK-FL	

### Accessories

I.V. Pole (fixed height)	<b>AL-72293</b>	<b>\$79.95</b>
Oxygen Holder (fixed height)	<b>AL-72294</b>	<b>\$29.95</b>
Oxygen/I.V. Combo	<b>AL-72292</b>	<b>\$99.95</b>
Pushbar	<b>AL-69303</b>	<b>\$79.95</b>
Collar Locks	<b>AL-2231</b>	<b>\$2.95</b>

Additional Accessories Available.

See Pages 14, 20-23







# Classic™ 700 Wheelchair 28" Width x 20" Depth



Great For All Bariatric Applications

### Frame

- ✓ Reinforced heavy duty frame includes gusseted sides, caster journals and dual crossbraces
- ✓ Rust and chip resistant quadruple chrome plating process
- ✓ Heavy duty front fork
- ✓ Seat to floor height: 19"
- ✓ Sealed precision bearings on wheels, casters and journals
- ✓ 8" x 2" heavy duty front flat-free wheels won't fall in elevator slots and pushes 50% easier than other chairs
- ✓ 24" x 1" heavy duty steel spoke flat-free rear wheel with chrome handrim
- ✓ Push to lock brake
- ✓ Metal skirt guards
- ✓ Overall open width: 36"
- ✓ Folded width 14"

### Upholstery

- ✓ Fire retardant, Reinforced, Black, heavy-duty, nylon upholstery
- ✓ Padded arm and calf pads are standard
- ✓ 20" seat depth; 18" back height
- ✓ Threaded seat screw inserts minimize stripping from upholstery changes
- ✓ Chart pocket on back (stenciling available—see page 14)

### Legrests

- ✓ Extra large, heavy duty footplate
- ✓ Ratchet bar to lock legrests securely into place
- ✓ Tool-free adjustable, shiny extra large footplate with nut and bolt lock to prevent twisting and falling off

### Extended Warranty

Frame & Crossbraces: Lifetime  
Components: 5 Years

**SAFETY FIRST**

Removable & locking full arms for patient safety & easy transfer



700 lb. Capacity

Full Arm  
AL-79001BK-FL

2" Wide Hard Tread Wheels Standard. Push 50% Easier and will not fall in elevator slots



### Features:



Double Bar Vertical Reinforcements

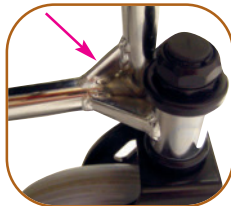

Two Caster Journal Gussets

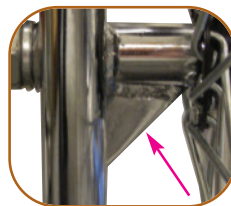

Rear Wheel Gusset



Rear Wheel Reinforcements

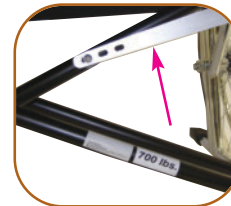

Steel Frame Reinforcements



Extra Large Footplate

### SPECIFICATIONS, PRICING & PART NUMBERS:

Description	Width Between Arms	Weight Capacity	Footrest (Includes Heel Loops)		Legrest	
			ALCO Part No.	Price Each	ALCO Part No.	Price Each
28" Removable Desk Arm	28"	700 lbs.	AL-79001BK-DF	\$749	AL-79001BK-DL	\$759
28" Removable Full Arm			AL-79001BK-FF		AL-79001BK-FL	

### Accessories

I.V. Pole (fixed height)	AL-72293	\$79.95
Oxygen Holder (fixed height)	AL-72294	\$29.95
Oxygen/I.V. Combo	AL-72292	\$99.95
Pushbar	AL-69303	\$79.95
Collar Locks	AL-2231	\$2.95

Additional Accessories Available.  
See Pages 14, 20-23



# Classic™ 700 Wheelchair 26" Width x 20" Depth



Great For All Bariatric Applications

**SAFETY FIRST** Removable & locking full arms for patient safety & easy transfer

**700 lb. Capacity**



Full Arm  
**AL-79000BK-FL**

2" Wide Hard Tread Wheels Standard. Push 50% Easier and will not fall in elevator slots

### Frame

- ✓ Reinforced heavy duty frame includes gusseted sides, caster journals and dual crossbraces
- ✓ Rust and chip resistant quadruple chrome plating process
- ✓ Heavy duty front fork
- ✓ Seat to floor height: 19"
- ✓ Sealed precision bearings on wheels, casters and journals
- ✓ 8" x 2" heavy duty front flat-free wheels won't fall in elevator slots and pushes 50% easier than other chairs
- ✓ 24" x 1" heavy duty steel spoke flat free rear wheel with chrome handrim
- ✓ Push to lock brake
- ✓ Metal skirt guards
- ✓ Overall open width: 34"
- ✓ Folded width 14"

### Upholstery

- ✓ Fire retardant, Reinforced, Black, heavy-duty, nylon upholstery
- ✓ Padded arm and calf pads are standard
- ✓ 20" seat depth; 18" back height
- ✓ Threaded seat screw inserts minimize stripping from upholstery changes
- ✓ Chart pocket on back (stenciling available—see page 14)

### Legrests

- ✓ Extra large, heavy duty footplate
- ✓ Ratchet bar to lock legrests securely into place
- ✓ Tool-free adjustable, shiny extra large footplate with nut and bolt lock to prevent twisting and falling off

### Extended Warranty

Frame & Crossbraces: Lifetime  
Components: 5 Years



Desk Arm  
**AL-79000BK-DF**



Full Arm  
**AL-79000BK-FF**



Desk Arm  
**AL-79000BK-DL**

### Features:



Double Bar Vertical Reinforcements

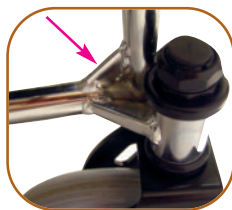

Two Caster Journal Gussets

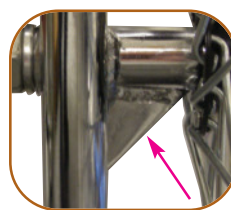

Rear Wheel Gusset



Rear Wheel Reinforcements



Steel Frame Reinforcements



Extra Large Footplate

AW3

### SPECIFICATIONS, PRICING & PART NUMBERS:

Description	Width Between Arms	Weight Capacity	Footrest (Includes Heel Loops)		Legrest	
			ALCO Part No.	Price Each	ALCO Part No.	Price Each
26" Removable Desk Arm	26"	700 lbs.	AL-79000BK-DF	<b>\$729</b>	AL-79000BK-DL	<b>\$739</b>
26" Removable Full Arm			AL-79000BK-FF		AL-79000BK-FL	

### Accessories

I.V. Pole (fixed height)	<b>AL-72293</b>	<b>\$79.95</b>
Oxygen Holder (fixed height)	<b>AL-72294</b>	<b>\$29.95</b>
Oxygen/I.V. Combo	<b>AL-72292</b>	<b>\$99.95</b>
Pushbar	<b>AL-69303</b>	<b>\$79.95</b>
Collar Locks	<b>AL-2231</b>	<b>\$2.95</b>

Additional Accessories Available.

6 See Pages 14, 20-23



Pushbar **AL-70703**



I.V./O2 Combo **AL-72292**



- ✓ Does not restrict front rigging swing-away movement
  - ✓ Makes legrest non-removable
- Collar Locks **AL-2231**





# Classic™ 500 Wheelchair 24" Width x 18" Depth



Great For All Bariatric Applications

### Frame

- ✓ Reinforced frame includes gusseted sides, caster journals and dual cross braces
- ✓ Seat height adjustable with rust and chip resistant quadruple chrome plating process
- ✓ Seat to floor height: 17-1/2" hemi or 19-1/2" standard
- ✓ Sealed precision bearings on wheels, casters and journals
- ✓ Detachable dual wheeled Anti-Tippers (chair will not tip backwards) optional: **AL-78441 \$15.95 Pair**
- ✓ 8" x 2" heavy-duty, non-marking urethane, Black front wheels wont fall in elevator slots and pushes 50% easier than other chairs
- ✓ 24" x 1" heavy-duty urethane rear wheel with composite handrim includes 5/8" (15mm) axle bolt
- ✓ Push to lock brake
- ✓ Metal skirt guards
- ✓ Overall open width: 32"
- ✓ Folded width 12-1/2"

### Upholstery

- ✓ Fire retardant, double embossed, Black, heavy-duty, vinyl upholstery
- ✓ Padded arm and calf pads are standard
- ✓ 18" seat depth: 17-1/2" back height
- ✓ Threaded seat screw inserts minimize stripping from upholstery changes
- ✓ Chart pocket on back (Stenciling available—see page 14)
- ✓ Blue and Burgundy upholstery available: CALL for details

### Legrests

- ✓ Ratchet bar to lock legrests securely in place
- ✓ Tool-free adjustable, shiny aluminum footplate with push button lock to prevent twisting and falling off
- ✓ Tool Kit

### Extended Warranty

Frame & Crossbraces: Lifetime  
Components: 5 Years

### Features:



Double Bar Vertical Reinforcements



Caster Journal Gussets



Additional Seat Gusset



Extra Hard Heavy Duty Tread Wheel Option

**600 lb**  
Capacity Available  
with Wheel Upgrade



Desk or Full Length Armrests



**SAFETY FIRST** Removable & locking full arms for patient safety & easy transfer

**Up To 600 lb. Capacity**

2" Wide Hard Tread Wheels Standard. Push 50% Easier and will not fall in elevator slots

Full Arm  
**AL-70033BK-FL**



Desk Arm  
**AL-70033BK-DF**



Full Arm  
**AL-70033BK-FF**



Desk Arm  
**AL-70033BK-DL**

### SPECIFICATIONS, PRICING & PART NUMBERS:

Description	Width Between Arms	Weight Capacity	Footrest (Includes Heel Loops)		Legrest	
			ALCO Part No.	Price Each	ALCO Part No.	Price Each
24" Removable Desk Arm	24 <sup>3</sup> / <sub>4</sub> "	500 lbs.	AL-70033BK-DF	<b>\$329</b>	AL-70033BK-DL	<b>\$339</b>
24" Removable Full Arm			AL-70033BK-FF		AL-70033BK-FL	
24" Removable Desk Arm	24 <sup>3</sup> / <sub>4</sub> "	600 lbs.	AL-70033BK-DFHD	<b>\$407</b>	AL-70033BK-DLHD	<b>\$417</b>
24" Removable Full Arm			AL-70033BK-FFHD		AL-70033BK-FLHD	

### Accessories

Anti-Fold Device	<b>AL-885</b>	<b>\$22.95</b>
Overhead Anti-Theft Device	<b>AL-63827</b>	<b>\$54.95</b>
I.V. Pole (fixed height)	<b>AL-72293</b>	<b>\$79.95</b>
Oxygen Holder (fixed height)	<b>AL-72294</b>	<b>\$29.95</b>
Oxygen/I.V. Combo	<b>AL-72292</b>	<b>\$99.95</b>
Pushbar 22" - 24"	<b>AL-76488</b>	<b>\$29.95</b>
Collar Locks	<b>AL-2231</b>	<b>\$2.95</b>

Additional Accessories Available.  
See Pages 14, 20-23



Pushbar **AL-76488**



I.V./O2 Combo **AL-72292**



- ✓ Does not restrict front rigging swing-away movement
  - ✓ Makes legrest non-removable
- Collar Locks **AL-2231**

AW3

# Classic™ 500 Wheelchair

## 22" Width x 18" Depth



Great For All Bariatric Applications



**SAFETY FIRST** Removable & locking full arms for patient safety & easy transfer

Up To 600 lb. Capacity

2" Wide Hard Tread Wheels Standard. Push 50% Easier and will not fall in elevator slots

Full Arm **AL-70032BK-FL**

**Frame**

- ✓ Reinforced frame includes gusseted sides, caster journals and dual cross braces
- ✓ Seat height adjustable with rust and chip resistant quadruple chrome plating process
- ✓ Seat to floor height: 17-1/2" hemi or 19-1/2" standard
- ✓ Sealed precision bearings on wheels, casters and journals
- ✓ Detachable dual wheeled Anti-Tippers (chair will not tip backwards) optional: **AL-78441 \$15.95 Pair**
- ✓ 8" x 2" heavy-duty, non-marking urethane, Black front wheels wont fall in elevator slots and pushes 50% easier than other chairs
- ✓ 24" x 1" heavy-duty urethane rear wheel with composite handrim includes 5/8" (15mm) axle bolt
- ✓ Push to lock brake
- ✓ Metal skirt guards
- ✓ Overall open width: 30"
- ✓ Folded width 12-1/2"

**Upholstery**

- ✓ Fire retardant, double embossed, Black, heavy-duty, vinyl upholstery
- ✓ Padded arm and calf pads are standard
- ✓ 18" seat depth: 17-1/2" back height
- ✓ Threaded seat screw inserts minimize stripping from upholstery changes
- ✓ Chart pocket on back (Stenciling available—see page 14)
- ✓ Blue and Burgundy upholstery available: CALL for details

**Legrests**

- ✓ Ratchet bar to lock legrests securely in place
- ✓ Tool-free adjustable, shiny aluminum footplate with push button lock to prevent twisting and falling off
- ✓ Tool Kit

**Extended Warranty**

Frame & Crossbraces: Lifetime  
Components: 5 Years



Desk Arm **AL-70032BK-DF**

Full Arm **AL-70032BK-FF**

Desk Arm **AL-70032BK-DL**

**Features:**



Double Bar Vertical Reinforcements



Caster Journal Gussets



Additional Seat Gusset



Extra Hard Heavy Duty Tread Wheel Option

**600 lb**  
Capacity Available with Wheel Upgrade



Desk or Full Length Armrests

AW3

**SPECIFICATIONS, PRICING & PART NUMBERS:**

Description	Width Between Arms	Weight Capacity	Footrest (Includes Heel Loops)		Legrest	
			ALCO Part No.	Price Each	ALCO Part No.	Price Each
22" Removable Desk Arm	22¾"	500 lbs.	AL-70032BK-DF	<b>\$319</b>	AL-70032BK-DL	<b>\$329</b>
22" Removable Full Arm			AL-70032BK-FF		AL-70032BK-FL	
22" Removable Desk Arm	22¾"	600 lbs.	AL-70032BK-DFHD	<b>\$397</b>	AL-70032BK-DLHD	<b>\$407</b>
22" Removable Full Arm			AL-70032BK-FFHD		AL-70032BK-FLHD	

**Accessories**

Anti-Fold Device	<b>AL-885</b>	<b>\$22.95</b>
Overhead Anti-Theft Device	<b>AL-63827</b>	<b>\$54.95</b>
I.V. Pole (fixed height)	<b>AL-72293</b>	<b>\$79.95</b>
Oxygen Holder (fixed height)	<b>AL-72294</b>	<b>\$29.95</b>
Oxygen/I.V. Combo	<b>AL-72292</b>	<b>\$99.95</b>
Pushbar 22" - 24"	<b>AL-76488</b>	<b>\$29.95</b>
Collar Locks	<b>AL-2231</b>	<b>\$2.95</b>

Additional Accessories Available. See Pages 14, 20-23



Pushbar **AL-76488**



I.V./O2 Combo **AL-72292**



- ✓ Does not restrict front rigging swing-away movement
  - ✓ Makes legrest non-removable
- Collar Locks **AL-2231**





# Classic™ 500 Wheelchair 20" Width x 18" Depth



### Frame

- ✓ Reinforced frame includes gusseted sides, caster journals and dual cross braces
- ✓ Seat height adjustable with rust and chip resistant quadruple chrome plating process
- ✓ Seat to floor height: 17-1/2" hemi or 19-1/2" standard
- ✓ Sealed precision bearings on wheels, casters and journals
- ✓ Detachable dual wheeled Anti-Tippers (chair will not tip backwards) optional: **AL-78441 \$15.95 Pair**
- ✓ 8" x 2" heavy-duty, non-marking urethane, Black front wheels wont fall in elevator slots and pushes 50% easier than other chairs
- ✓ 24" x 1" heavy-duty urethane rear wheel with composite handrim includes 5/8" (15mm) axle bolt
- ✓ Push to lock brake
- ✓ Metal skirt guards
- ✓ Overall open width: 28"
- ✓ Folded width 12-1/2"

### Upholstery

- ✓ Fire retardant, double embossed, Black, heavy-duty, vinyl upholstery
- ✓ Padded arm and calf pads are standard
- ✓ 18" seat depth: 17-1/2" back height
- ✓ Threaded seat screw inserts minimize stripping from upholstery changes
- ✓ Chart pocket on back (Stenciling available—see page 14)
- ✓ Blue and Burgundy upholstery available: CALL for details

### Legrests

- ✓ Ratchet bar to lock legrests securely in place
- ✓ Tool-free adjustable, shiny aluminum footplate with push button lock to prevent twisting and falling off
- ✓ Tool Kit

### Extended Warranty

Frame & Crossbraces: Lifetime  
Components: 5 Years

### Features:



Double Bar Vertical Reinforcements



Caster Journal Gussets



Additional Seat Gusset



Extra Hard Heavy Duty Tread Wheel Option



Desk or Full Length Armrests

AW3

### Great For All Bariatric Applications



### SPECIFICATIONS, PRICING & PART NUMBERS:

Description	Width Between Arms	Weight Capacity	Footrest (Includes Heel Loops)		Legrest	
			ALCO Part No.	Price Each	ALCO Part No.	Price Each
20" Removable Desk Arm	20 <sup>3</sup> / <sub>4</sub> "	500 lbs.	AL-70031BK-DF	<b>\$309</b>	AL-70031BK-DL	<b>\$319</b>
20" Removable Full Arm			AL-70031BK-FF		AL-70031BK-FL	
20" Removable Desk Arm	20 <sup>3</sup> / <sub>4</sub> "	600 lbs.	AL-70031BK-DFHD	<b>\$387</b>	AL-70031BK-DLHD	<b>\$397</b>
20" Removable Full Arm			AL-70031BK-FFHD		AL-70031BK-FLHD	

### Accessories

I.V. Pole (fixed height)	<b>AL-72293</b>	<b>\$79.95</b>
Oxygen Holder (fixed height)	<b>AL-72294</b>	<b>\$29.95</b>
Oxygen/I.V. Combo	<b>AL-72292</b>	<b>\$99.95</b>
Pushbar 20"	<b>AL-76487</b>	<b>\$29.95</b>
Collar Locks	<b>AL-2231</b>	<b>\$2.95</b>

Additional Accessories Available.  
See Pages 14, 20-23



# Classic™ 300 Removable Arm 16", 18" & 20" Width x 16" Depth

**Buy 11  
FREE  
Get 1**

**SAFETY FIRST** Removable & locking full arms for patient safety & easy transfer

**Up To  
350 lb.  
Capacity**



Full Arm  
**AL-70038BK-FL**

**Frame**

- ✓ Seat height Adjustable with rust and chip resistant quadruple chrome plating process
- ✓ Reinforced frame includes double bar reinforcement
- ✓ Single crossbar design
- ✓ Seat to floor height: 17-1/2" hemi or 19-1/2" standard
- ✓ Sealed precision bearings on wheels, casters and journals
- ✓ Detachable dual wheeled Anti-Tippers (chair will not tip backwards) optional: **AL-78441 \$15.95 Pair**
- ✓ 8" x 1" Non-marking urethane, Black front wheels
- ✓ 24" x 1" Urethane rear wheel with composite handrims includes 7/16" (11mm) axle bolt
- ✓ Push to lock brake
- ✓ Metal skirt guards
- ✓ Overall open width:  
16" - 24", Folded width: 12"  
18" - 26", Folded width: 12"  
20" - 28", Folded width: 12"

**Upholstery**

- ✓ Fire retardant double embossed, Black, heavy-duty, vinyl upholstery
- ✓ Padded vinyl arm and calf pads are standard
- ✓ 16" seat depth: 19" Back height
- ✓ Threaded seat screw inserts minimize stripping from upholstery changes
- ✓ Chart pocket on back (Stenciling available—see page 14)
- ✓ Blue and Burgundy upholstery available: CALL for details

**Legrest**

- ✓ Steel ratchet bar to lock legrests securely in place
- ✓ Tool-free adjustable, shiny aluminum footplate with push button lock to prevent twisting and falling off
- ✓ Tool Kit

**Extended Warranty**

Frame & Crossbraces: Lifetime  
Components: 5 Years



Desk Arm  
**AL-70038BK-DF**



Desk Arm  
**AL-70038BK-DL**



Full Arm  
**AL-70038BK-FF**

**Features:**



Double Bar Vertical Reinforcements (20" only)



Extra Hard Heavy Duty Tread Wheel Option

**350 lb**  
Capacity Available with  
Wheel Upgrade  
**AL-82128 \$39.00 Ea**



Full Arms  
Provides Patient Safety  
and Easy Transfer

Full Length Armrests



Desk Length Armrests



Optional Footrests  
w/Push Button Lock

**SPECIFICATIONS, PRICING & PART NUMBERS:**

Description	Width Between Arms	Weight Capacity (lbs)	Footrest (Includes Heel Loops)		Legrest	
			ALCO Part No.	Price Each	ALCO Part No.	Price Each
16" Removable Desk Arm	16½"	300	AL-70049BK-DF	<b>\$239</b>	AL-70049BK-DL	<b>\$249</b>
16" Removable Full Arm			AL-70049BK-FF		AL-70049BK-FL	
18" Removable Desk Arm	18½"	300	AL-70037BK-DF	<b>\$239</b>	AL-70037BK-DL	<b>\$249</b>
18" Removable Full Arm			AL-70037BK-FF		AL-70037BK-FL	
20" Removable Desk Arm	20½"	300 or 350	AL-70038BK-DF	<b>\$249</b>	AL-70038BK-DL	<b>\$259</b>
20" Removable Full Arm			AL-70038BK-FF		AL-70038BK-FL	

**Accessories**

Anti-Fold Device	<b>AL-885</b>	<b>\$22.95</b>
Overhead Anti-Theft Device	<b>AL-63827</b>	<b>\$54.95</b>
I.V. Pole (fixed height)	<b>AL-72293</b>	<b>\$79.95</b>
Oxygen Holder (fixed height)	<b>AL-72294</b>	<b>\$29.95</b>
Oxygen/I.V. Combo	<b>AL-72292</b>	<b>\$99.95</b>
Pushbar 18" - 20"	<b>AL-76487</b>	<b>\$29.95</b>
Collar Locks	<b>AL-2231</b>	<b>\$2.95</b>

**Additional Accessories Available.**  
See Pages 14, 20-23



Anti-Theft  
Pushbar **AL-76487**



Great For Infusion Pumps!  
Anti-Theft  
I.V./O2 Combo **AL-72292**



Does not restrict front rigging swing-away movement  
Makes legrest non-removable  
Collar Locks **AL-2231**





# Classic™ 300 Flip-Back Arm 18" & 20" Width x 16" Depth



## Frame

- ✔ Seat height adjustable with rust and chip resistant chrome and Black powder coating
- ✔ Single crossbar design with double crossbrace link
- ✔ Seat to floor height: 17-1/2" hemi or 19-1/2" standard
- ✔ Sealed precision bearings on wheels, casters and journals
- ✔ Detachable dual wheeled Anti-Tippers standard at no charge (chair will not tip backwards)
- ✔ 8" x 1" Non-marking urethane, Black front wheels
- ✔ 24" x 1" Urethane rear wheel with composite handrims includes 7/16" (11mm) axle bolt
- ✔ Push to lock brake
- ✔ Adjustable height back
- ✔ Super-saver, non-removable, locking, flip-back arms with rear-frame lock allowing for easy lateral transfers
- ✔ Composite skirt guards
- ✔ Overall open width:  
18" - 25", Folded width: 11"  
20" - 27", Folded width: 11"

## Upholstery

- ✔ Fire retardant heavy-duty Black nylon upholstery
- ✔ Padded vinyl arm and calf pads are standard
- ✔ 16" seat depth: 16" Back height
- ✔ Threaded seat screw inserts minimize stripping from upholstery changes
- ✔ Chart pocket on back (Stenciling available—see page 14)

## Legrest

- ✔ Steel ratchet bar to lock legrests securely in place
- ✔ Tool-free adjustable, shiny aluminum footplate with push button lock to prevent twisting and falling off
- ✔ Tool Kit

### Extended Warranty

Frame & Crossbraces: Lifetime  
Components: 5 Years

## Black Nylon Upholstery



Flip-Back Arms are Locking and Non-removable



## SPECIFICATIONS, PRICING & PART NUMBERS:

Description	Width Between Arms	Weight Capacity	Footrest (Includes Heel Loops)		Legrest	
			ALCO Part No.	Price Each	ALCO Part No.	Price Each
18" Flip Back Desk Arm	18"	300 lbs.	AL-70035BK-DF	\$269	AL-70035BK-DL	\$279
20" Flip Back Desk Arm			AL-70036BK-DF	\$279	AL-70036BK-DL	\$289

## Accessories

Anti-Fold Device	AL-885	\$22.95
Overhead Anti-Theft Device*	AL-63827	\$54.95
Pushbar 18" - 20"	AL-76487	\$29.95
Anti-Fold/Anti-Theft Bar	AL-67460	\$21.95
Collar Locks	AL-2231	\$2.95

\*Requires additional screw hole before attaching

**Additional Accessories Available.**  
See Pages 14, 20-23



# Classic™ 300E Removable Arm 18" & 20" Width x 16" Depth



Great For Long Term Care Facilities

**SAFETY FIRST** Removable & locking full arms for patient safety & easy transfer

**300 lb. Capacity**



Full Arm  
**AL-70040BK-FL**

**Frame**

- ✓ Rust and chip resistant Black Silver Vein powder coating
- ✓ Single crossbar design
- ✓ Seat to floor height: 19-1/2" standard
- ✓ Sealed precision bearings on wheels, casters and journals
- ✓ Detachable dual wheeled Anti-Tippers (chair will not tip backwards) optional: **AL-78443 \$15.95 Pair**
- ✓ 8" x 1" Non-marking urethane, Black front wheels
- ✓ 24" x 1" Urethane rear wheel with composite handrims
- ✓ Push to lock brake
- ✓ Metal skirt guards
- ✓ Overall open width:  
18" - 26", Folded width: 12"  
20" - 28", Folded width: 12"

**Upholstery**

- ✓ Fire retardant double embossed, Black, vinyl upholstery
- ✓ Padded vinyl arm and calf pads are standard
- ✓ 16" seat depth: 19" Back height
- ✓ Threaded seat screw inserts minimize stripping from upholstery changes
- ✓ Chart pocket on back (Stenciling available—see page 14)

**Legrest**

- ✓ Steel ratchet bar to lock legrests securely in place
- ✓ Tool-free adjustable black aluminum footplate with push button lock to prevent twisting and falling off
- ✓ Tool Kit



**Extended Warranty**

Frame & Crossbraces: Lifetime  
Components: 5 Years

**Features:**



Caster Journal Gussets



Anti-Tippers Optional  
**AL-78443 \$15.95 Pair**



Full Length Armrests



Desk Length Armrests



Lock Prevents Footplate Twisting



Optional Footrests w/Push Button Lock

AW3

**SPECIFICATIONS, PRICING & PART NUMBERS:**

Description	Width Between Arms	Weight Capacity	Footrest (Includes Heel Loops)		Legrest	
			ALCO Part No.	Price Each	ALCO Part No.	Price Each
18" Removable Desk Arm	18½"	300 lbs.	AL-70039BK-DF	<b>\$169</b>	AL-70039BK-DL	<b>\$179</b>
18" Removable Full Arm			AL-70039BK-FF		AL-70039BK-FL	
20" Removable Desk Arm	20½"	300 lbs.	AL-70040BK-DF	<b>\$179</b>	AL-70040BK-DL	<b>\$189</b>
20" Removable Full Arm			AL-70040BK-FF		AL-70040BK-FL	

**Accessories**

Anti-Fold Device	<b>AL-885</b>	<b>\$22.95</b>
Overhead Anti-Theft Device	<b>AL-63827</b>	<b>\$54.95</b>
I.V. Pole (fixed height)	<b>AL-72293</b>	<b>\$79.95</b>
Oxygen Holder (fixed height)	<b>AL-72294</b>	<b>\$29.95</b>
Oxygen/I.V. Combo	<b>AL-72292</b>	<b>\$99.95</b>
Pushbar 18" - 20"	<b>AL-76487</b>	<b>\$29.95</b>
Collar Locks	<b>AL-2231</b>	<b>\$2.95</b>

**Additional Accessories Available.**  
See Pages 14, 20-23







# Classic™ 300 Recliner 20" Width x 17" Depth



### Frame

- ✓ Infinite position recline goes from 90° to 140° with quick adjustable handles
- ✓ Detachable Anti-tippers (no wheels)
- ✓ 24" x 1" urethane rear wheel with composite handrims includes 7/16" (11mm) axle bolt
- ✓ 8" x 1" Non-marking urethane, Black front wheels
- ✓ Metal skirt guards
- ✓ Spreader bar
- ✓ Rust and chip resistant quadruple chrome plating process
- ✓ Overall open width: 28-1/2"
- ✓ Folded width 13"
- ✓ Desk arm only with long support for recline position
- ✓ Front caster journals include extra gusset

### Upholstery

- ✓ Full back and head support is provided by 19" high back and 11-1/2" removable headrest
- ✓ Fire retardant, double embossed, Black, heavy-duty, vinyl upholstery
- ✓ Padded arm and calf pads are standard
- ✓ 17" seat depth: 21" back height
- ✓ Threaded seat screw inserts minimize stripping from upholstery changes
- ✓ Blue upholstery available: CALL for details
- ✓ Stenciling available—see page 14

### Legrests

- ✓ Steel ratchet bar to lock legrests securely in place
- ✓ Tool-free, shiny aluminum footplate with push button lock to prevent twisting and falling off
- ✓ Tool Kit

Description	Width Between Arms	Weight Capacity	Legrest	
			ALCO Part No.	Wholesale Price
20" Removable Desk Arm	20 1/2"	300 lbs.	AL-70034BK-DL	\$359

### Accessories

Collar Locks **AL-2231 \$2.95**



# Classic™ 300 Transport Chair 20" Width x 16" Depth



### Frame

- ✓ Rust & chip resistant quadruple chrome plating process
- ✓ 8" x 1" Non-marking urethane, Black front and rear wheels
- ✓ Frame is light weight and durable
- ✓ Back folds down for easy storage and transport
- ✓ Weight: with Legrest 28 lbs / with Footrest 24 lbs
- ✓ Push to lock brake
- ✓ Overall open width: 22"
- ✓ Folded width 11"
- ✓ Front caster journals include extra gusset

### Upholstery

- ✓ Seat belt for safety
- ✓ Black Nylon upholstery, fire retardant
- ✓ Vinyl armpads
- ✓ 15-1/2" seat depth: 18-3/4" back height

### Front Riggings

- ✓ Legrest: Adjustable, tool-free, aluminum footplate
- ✓ Footrests: Aluminum footplate and heel loop

### Extended Warranty

Frame & Crossbraces: Lifetime  
Components: 5 Years

### Accessories

Collar Locks **AL-2231 \$2.95**  
Overhead Anti-Theft Device **AL-63827 \$54.95**



Description	Width Between Arms	Weight Capacity	Footrest (Includes Heel Loops)		Legrest	
			ALCO Part No.	Price Each	ALCO Part No.	Price Each
20" Chair	18"	300 lbs.	AL-70041BK-F	\$159	AL-70041BK-L	\$169

AW3

# Classic™ 300E Fixed Arm 18" Width x 16" Depth



Great For Long Term Care

**SAFETY FIRST** full arms for patient safety & easy transfer



Full Arm  
**AL-58048**

### Frame

- ✓ Rust and chip resistant Black silver vein powder coating
- ✓ Single crossbar design
- ✓ Seat to floor height: 19-1/2"
- ✓ Sealed precision bearings on wheels, casters and journals
- ✓ Detachable dual wheeled anti-tippers (chair will not tip backwards)
- Optional: **AL-78443 \$15.95 Pair**
- ✓ 8" x 1" front wheels
- ✓ 24" x 1" urethane rear wheel with composite handrim
- ✓ Metal skirtguards
- ✓ Overall open width: 25"
- ✓ Folded width 11"

### Upholstery

- ✓ Fire retardant double embossed, Black, vinyl upholstery
- ✓ Padded vinyl arm and calf pads are standard
- ✓ 16" seat depth; 19" back height
- ✓ Threaded screw inserts minimize stripping from upholstery changes
- ✓ Chart pocket on back
- ✓ Stenciling available (see below)

### Legrests

- ✓ Steel ratchet bar to lock legrests securely in place
- ✓ Tool-free adjustable black aluminum footplate with push button lock to prevent twisting and falling off
- ✓ Tool kit

### Extended Warranty

Frame & Crossbraces: Lifetime  
Components: 5 Years

### SPECIFICATIONS, PRICING & PART NUMBERS:

Description	Width Between Arms	Weight Capacity	Footrest (Includes Heel Loops)		Legrest	
			ALCO Part No.	Price Each	ALCO Part No.	Price Each
18" Chair	<b>16"</b>	<b>300 lbs.</b>	AL-58047	<b>\$159</b>	AL-58048	<b>\$169</b>



Caster Journal Gussets

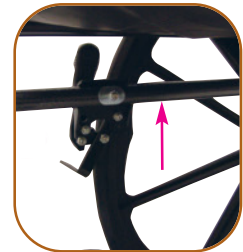

Sideframe Reinforcing Bar

### Vinyl Chart Bag

Fits 16"-24" Width Chairs



#### Vinyl Chart Bag

Specify color (see below)

**AL-314 \$29.95**

Economy Chart Bag, Black only, Laminated, Knitted Polyester HD Fabric

**AL-314E-A3 \$22.95**



A3 Black      A4 Dark Blue      A5 Red      A9 Royal Blue



A25 Burgundy      A31 Midnight Blue      A41 Ruby      A44 Navy



A47 Buckskin      A50 Dark Blue/Invacare      A54 Dove Gray

### Custom Silk Screening Available For Vinyl & Nylon Upholstery



AM3





## Bariatric Wheelchairs

- ✓ Steel, spoke wheels are strong and maintenance free
- ✓ Durable reinforced black nylon upholstery
- ✓ Extra large, padded armrests provide comfort and support
- ✓ Precision sealed wheel bearings in front and rear
- ✓ Extra large heavy-duty, aluminum footplates
- ✓ Heavy-duty, flat free 8" front casters are adjustable in 3 positions
- ✓ Extra heavy-duty front forks
- ✓ Reinforced side frame, caster journals and dual cross bars
- ✓ Seat to floor height: 17"-19"

Description	ALCO Part No.	Price Each
<b>26" Wide Seat w/o Front Riggings</b>		
Removable Desk Arms	AL-61453	\$899.00
Removable Full Arms	AL-66038	\$899.00
<b>28" Wide Seat w/o Front Riggings</b>		
Removable Desk Arms	AL-61455	\$999.00
Removable Full Arms	AL-66039	\$999.00
<b>30" Wide Seat w/o Front Riggings</b>		
Removable Desk Arms	AL-65564	\$1099.00
Removable Full Arms	AL-65565	\$1099.00
<b>Front Riggings (Sold in Pairs)</b>		
Footrests	AL-63933	\$149.00 Pr.
Legrests	AL-63934	\$169.00 Pr.

- ✓ 20" seat depth
- ✓ 8" x 2" semi-pneumatic casters
- ✓ Seat to floor height: 15"-18"
- ✓ Double square cross braces
- ✓ Height adjustable back (16", 17" or 18" from seat to top of back)
- ✓ 24" metal MAG rear wheels with steel handrims
- ✓ Black reinforced nylon upholstery
- ✓ Seat to floor height: 16", 17", 18"

Description	ALCO Part No.	Price Each
<b>32" Wide Seat</b>		
Removable full arm w/ footrest	AL-58123	\$2295.00
Removable full arm w/ legrest	AL-58124	\$2395.00
<b>34" Wide Seat</b>		
Removable full arm w/ footrest	AL-67741	\$2295.00
Removable full arm w/ legrest	AL-67742	\$2395.00

### ALCO 700 Lb Capacity Wheelchair



### ALCO 850 Lb Capacity Wheelchairs



## MRI Wheelchairs

### ALCO 20" Wide MRI Wheelchair



### ALCO 26" Wide MRI Wheelchair





# Invacare Tracer EX2, SX5 Wheelchairs & Recliner



## Tracer EX2



Up To  
250 lb.  
Capacity

AL-59201-67 With  
AL-59206 Footrests

Note: Cushion not included

- ✓ Powder coated frame
- ✓ Dual axle positions
- ✓ Urethane rear tires mounted on "no flex" wheels
- ✓ Dual-sealed precision bearings
- ✓ Seat to floor height: 17-1/2"-19-1/2"

### 18" Wide Seat - 250 lb capacity

Fixed Arm With Fixed Footrest	AL-59203-67	\$159.00
Fixed Arm W/O Front Rigging	AL-59200-67	\$189.00
Removable Desk Arm w/o Front Rigging	AL-59201-67	\$189.00
Removable Full Arm w/o Front Rigging	AL-59202-67	\$189.00

### 20" Wide Seat - 250 lb capacity

Removable Desk Arm w/o Front Rigging	AL-59204-67	\$189.00
Removable Full Arm w/o Front Rigging	AL-59205-67	\$189.00

### Front Riggings

Footrest (Pair)	AL-59206	\$49.00 Pr
Legrest, Black Calf Pad (Pair)	AL-73578-U67	\$99.00 Pr

## Tracer SX5



Up To  
300 lb.  
Capacity

AL-58110 With  
AL-59206 Footrests

Note: Cushion not included

- ✓ Powder coated frame
- ✓ Dual axle positions
- ✓ Urethane rear tires mounted on "no flex" wheels
- ✓ Flip-back padded armrests
- ✓ Dual-sealed precision bearings
- ✓ Seat to floor height: 17-1/2"-19-1/2"

### 18" Wide Seat - 250 lb capacity

Flip-back full arm w/o front rigging	AL-58109	\$219.00
Flip-back desk arm w/o front rigging	AL-58110	\$219.00

### 20" Wide Seat - 300 lb capacity

Flip-back full arm w/o front rigging	AL-58111	\$229.00
Flip-back desk arm w/o front rigging	AL-58112	\$229.00

### 22" Wide Seat - 300 lb capacity

Flip-back full arm w/o front rigging	AL-58113	\$279.00
Flip-back desk arm w/o front rigging	AL-58114	\$279.00

### Front Riggings

Footrest (Pair)	AL-59206	\$49.00 Pr
Legrest, Black Calf Pad (Pair)	AL-73578-U67	\$99.00 Pr

## Tracer SX5 Recliner



Up To  
300 lb.  
Capacity

AL-62274 With  
AL-73578-U67 Legrests

- ✓ Powder coated frame
- ✓ Dynamic range recline from 100 - 168 degrees
- ✓ Urethane rear tires mounted on "no flex" wheels
- ✓ Dual-sealed precision bearings
- ✓ Flip back padded armrests
- ✓ Seat to floor height: 17-1/2"-19-1/2"

### 18" Wide Seat - 250 lb capacity

Removable Full Arm W/O Front Rigging	AL-62273	\$419.00
Removable Desk Arm W/O Front Rigging	AL-62274	\$419.00

### 20" Wide Seat - 300 lb capacity

Removable Full Arm W/O Front Rigging	AL-62275	\$419.00
Removable Desk Arm W/O Front Rigging	AL-62276	\$419.00

### 22" Wide Seat - 300 lb capacity

Removable Full Arm W/O Front Rigging	AL-62277	\$469.00
Removable Desk Arm W/O Front Rigging	AL-62278	\$469.00

### Front Riggings

Footrest (Pair)	AL-59206	\$49.00 Pr
Legrest, Black Calf Pad (Pair)	AL-73578-U67	\$99.00 Pr

### Color Choices

Midnight Blue

Black



# Invacare Tracer IV & Topaz Wheelchairs



## Tracer IV

- ✓ Durable, low maintenance, powder coated frame
- ✓ Reinforced frame includes gusseted sides, caster journals and dual crossbraces
- ✓ Urethane rear tires mounted on "no flex" wheels
- ✓ Dual-sealed precision bearings
- ✓ Flame retardant, dual embossed vinyl upholstery
- ✓ Seat to floor height: 17-1/2"-19-1/2"

<b>18" Wide Seat - 350 lb Capacity</b>		
Removable Desk Arm w/o Front Rigging	AL-62280	\$309.00
Removable Full Arm w/o Front Rigging	AL-62281	\$309.00
<b>20" Wide Seat - 350 lb Capacity</b>		
Removable Desk Arm w/o Front Rigging	AL-49601	\$309.00
Removable Full Arm w/o Front Rigging	AL-49602	\$309.00
<b>22" Wide Seat - 350 lb Capacity</b>		
Removable Desk Arm w/o Front Rigging	AL-49599	\$309.00
Removable Full Arm w/o Front Rigging	AL-49600	\$309.00
<b>24" Wide Seat - 350 lb Capacity</b>		
Removable Desk Arm w/o Front Rigging	AL-49597	\$309.00
Removable Full Arm w/o Front Rigging	AL-49598	\$309.00

<b>18" Wide Seat - 450 lb Capacity</b>		
Removable Desk Arm w/o Front Rigging	AL-62280HD	\$419.00
Removable Full Arm w/o Front Rigging	AL-62281HD	\$419.00
<b>20" Wide Seat - 450 lb Capacity</b>		
Removable Desk Arm w/o Front Rigging	AL-49601HD	\$419.00
Removable Full Arm w/o Front Rigging	AL-49602HD	\$419.00
<b>22" Wide Seat - 450 lb Capacity</b>		
Removable Desk Arm w/o Front Rigging	AL-49599HD	\$419.00
Removable Full Arm w/o Front Rigging	AL-49600HD	\$419.00
<b>24" Wide Seat - 450 lb Capacity</b>		
Removable Desk Arm w/o Front Rigging	AL-49597HD	\$419.00
Removable Full Arm w/o Front Rigging	AL-49598HD	\$419.00

### Front Riggings

Footrest (Pair)	AL-49619	\$59.00 Pr.
Legrest, Black Calf Pad (Pair)	AL-49621-67	\$99.00 Pr.
Legrest, Midnight Blue Calf Pad (Pair)	AL-49621-550	\$99.00 Pr.
Legrest, Marina Blue Calf Pad (Pair)	AL-49621-60	\$99.00 Pr.
Legrest, Dove Grey Calf Pad (Pair)	AL-49621-75	\$99.00 Pr.
Legrest, Ruby Calf Pad (Pair)	AL-49621-86	\$99.00 Pr.
Legrest, Camel Calf Pad (Pair)	AL-49621-88	\$99.00 Pr.

### Color Choices

Midnight Blue (Std)	Black	Camel	Marina Blue	Ruby	Dove Grey
---------------------	-------	-------	-------------	------	-----------

## 9000 Topaz

- ✓ Durable, low maintenance, powder coat frame
- ✓ Reinforced frame includes gusseted sides, caster journals and dual crossbraces
- ✓ Heavy-duty front riggings
- ✓ Dual-sealed precision bearings
- ✓ Flame retardant, dual embossed, triple liner upholstery (Midnight Blue or Black)
- ✓ Dual axle positions
- ✓ Seat to floor height: 17-1/2"-19-1/2"

### Wet Black Frame

### Silver Vein Frame

<b>20" Wide Seat w/o Front Rigging</b>				
Removable Full Length Arm	AL-62282	\$1039.00	AL-62294	\$1039.00
Removable Desk Length Arm	AL-62283	\$1039.00	AL-62295	\$1039.00
<b>22" Wide Seat w/o Front Rigging</b>				
Removable Full Length Arm	AL-62284	\$1039.00	AL-62296	\$1039.00
Removable Desk Length Arm	AL-62285	\$1039.00	AL-62297	\$1039.00
<b>24" Wide Seat w/o Front Rigging</b>				
Removable Full Length Arm	AL-62286	\$1039.00	AL-62298	\$1039.00
Removable Desk Length Arm	AL-62287	\$1039.00	AL-62299	\$1039.00
<b>26" Wide Seat w/o Front Rigging</b>				
Removable Full Length Arm	AL-62288	\$1039.00	AL-62300	\$1039.00
Removable Desk Length Arm	AL-62289	\$1039.00	AL-62301	\$1039.00
<b>28" Wide Seat w/o Front Rigging</b>				
Removable Full Length Arm	AL-62290	\$1039.00	AL-62302	\$1039.00
Removable Desk Length Arm	AL-62291	\$1039.00	AL-62303	\$1039.00
<b>30" Wide Seat w/o Front Rigging</b>				
Removable Full Length Arm	AL-62292	\$1119.00	AL-62304	\$1119.00
Removable Desk Length Arm	AL-62293	\$1119.00	AL-62305	\$1119.00

### Front Riggings

Footrest (Pair)	AL-58137	\$99.00 Pr.
Legrest, Black Calf Pad (Pair)	AL-58138-U67	\$209.00 Pr.
Legrest, Midnight Blue Calf Pad (Pair)	AL-58138-U550	\$209.00 Pr.

### 350 lb Capacity



AL-49601 with  
AL-49619 Footrests

Note: Cushion not included

### 450 lb Capacity



AL-49601HD with  
AL-49619 Footrests

### 700 lb or 1000 lb Capacity



AL-62291 With  
AL-58137 Footrests

### Color Choices

Midnight Blue	Black
---------------	-------

1000 lb Capacity Available in 28" and 30" Width Only  
Add HD After Part Number and Call For Price

# Everest & Jennings® E&J Traveler® Wheelchairs

- ✓ Black vinyl upholstery
- ✓ Chart pocket on back
- ✓ Hammer tone paint provides a long lasting and durable finish
- ✓ Industry compatible front rigging
- ✓ "Tool Free" adjustable front rigging
- ✓ Seat to floor height: 17-3/4"-19-3/4"

Description	ALCO Part No.	Price Each
Traveler SE®, 18 x 16", Fixed Full Arm, Swingaway Footrest	AL-72464	\$179.00
Traveler SE®, 18 x 16", Fixed Full Arm, Elevating Legrest	AL-72465	\$189.00
Traveler SE®, 18 x 16", Removable Desk Arm, Swingaway Footrest	AL-72466	\$189.00
Traveler SE®, 18 x 16", Removable Desk Arm, Elevating Legrest	AL-72467	\$189.00
Traveler SE®, 18 x 16", Removable Full Arm, Swingaway Footrest	AL-71731	\$189.00
Traveler SE®, 18 x 16", Removable Full Arm, Elevating Legrest	AL-71732	\$199.00
Traveler SE®, 20 x 16", Removable Desk Arm, Swingaway Footrest	AL-72475	\$199.00
Traveler SE®, 20 x 16", Removable Desk Arm, Elevating Legrest	AL-72476	\$209.00
Traveler SE®, 20 x 16", Removable Full Arm, Swingaway Footrest	AL-71733	\$199.00
Traveler SE®, 20 x 16", Removable Full Arm, Elevating Legrest	AL-71734	\$209.00



**Now Available in Grey, Orange and Burgundy  
Call for Details**

**Need Accessories?  
See Pages  
14, 20-23**



- ✓ Embossed black leatherette upholstery with double inner lining for durability
- ✓ Hammer tone paint provides a long lasting and durable finish
- ✓ Reinforced frame at all critical load-bearing points
- ✓ "Tool Free" adjustable front rigging
- ✓ Chart pocket standard on back upholstery
- ✓ Seat to floor height: 17-3/4"-19-3/4"
- ✓ Durable aluminum black footplates
- ✓ 24" x 1" black plastic wheels with black handrims and non-marking polyurethane tires

20" Extra Wide Seat Fixed Back—500 lb. capacity	Black (Std)	Price Ea.
Removable Desk Arms w/Swinging Footrest	AL-52328BK	\$309.00
Removable Desk Arms w/Swinging Legrest	AL-52329BK	\$329.00
Removable Full Arms w/Swinging Footrest	AL-52330BK	\$309.00
Removable Full Arms w/Swinging Legrest	AL-52331BK	\$329.00
22" Extra Wide Seat Fixed Back—500 lb. capacity		
Removable Desk Arms w/Swinging Footrest	AL-52332BK	\$319.00
Removable Desk Arms w/Swinging Legrest	AL-52333BK	\$329.00
Removable Full Arms w/Swinging Footrest	AL-52334BK	\$319.00
Removable Full Arms w/Swinging Legrest	AL-52335BK	\$329.00
24" Extra Wide Seat Fixed Back—500 lb. capacity		
Removable Desk Arms w/Swinging Footrest	AL-52336BK	\$329.00
Removable Desk Arms w/Swinging Legrest	AL-52337BK	\$339.00
Removable Full Arms w/Swinging Footrest	AL-52338BK	\$329.00
Removable Full Arms w/Swinging Legrest	AL-52339BK	\$339.00

**Now Available in Grey, Orange and Burgundy.  
Call for Details**

Phone 800-323-4282 • 630-655-1900  
FAX 800-950-1167 • 630-655-1990

E-mail: [info@alcosales.com](mailto:info@alcosales.com)  
Website: [www.alcosales.com](http://www.alcosales.com)





# E&J Traveler Transport, Bariatric & Recliner Wheelchairs

Everest & Jennings®

## Traveler Transport Chair



**500 lb.  
Capacity**

- ✓ Fixed attendant push handle also functions as an anti-fold bar
- ✓ Fixed anti-theft post
- ✓ Embossed black leatherette upholstery with double inner lining for durability
- ✓ Rear mounted attendant wheel locks
- ✓ Fixed desk arms and lock nuts on the front rigging ensure inventory controls
- ✓ Hammer tone paint provides a long lasting and durable finish
- ✓ Anti-tippers standard
- ✓ "Tool Free" adjustable elevating front rigging
- ✓ Chart pocket standard on back upholstery
- ✓ 24" X 1" black plastic wheels with black handrims and non-marking polyurethane tires
- ✓ Durable aluminum black footplates

20"	<b>AL-81951-20</b>	<b>\$379.00</b>
22"	<b>AL-81951-22</b>	<b>\$389.00</b>
24"	<b>AL-81951-24</b>	<b>\$399.00</b>

- ✓ 19-1/2" Seat Depth
- ✓ Reinforced welds and gussets on frame
- ✓ Black reinforced upholstery
- ✓ Maximum weight capacity 650 lbs
- ✓ 8" x 2" Solid casters
- ✓ 24" Solid rear wheels
- ✓ Seat to floor height: 18-1/2"-20-1/2"

### 26" Wide Seat

Removable Desk Arm w/Footrest	<b>AL-69349</b>	<b>\$899.00</b>
Removable Desk Arm w/Legrest	<b>AL-69350</b>	<b>\$929.00</b>

### 30" Wide Seat

Removable Desk Arm w/Footrest	<b>AL-69351</b>	<b>\$1139.00</b>
Removable Desk Arm w/Legrest	<b>AL-69352</b>	<b>\$1169.00</b>

## Paramount XD Wheelchairs



**Up To  
650 lb.  
Capacity**

**AL-69351**

- ✓ Manual full reclining back 17" seat depth
- ✓ Removable full support head rest
- ✓ Detachable desk arms
- ✓ Hammer tone finish provides durability and style
- ✓ Low Maintenance black vinyl upholstery
- ✓ Anti-tippers standard
- ✓ Anti-fold bar standard
- ✓ "Tool-Free" adjustable elevating front rigging
- ✓ Chart pocket standard

16"	<b>AL-81876-16</b>	<b>\$369.00</b>
18"	<b>AL-81876-18</b>	<b>\$369.00</b>
20"	<b>AL-81876-20</b>	<b>\$369.00</b>

## Advantage Recliner



**300 lb.  
Capacity**

AW3

# Roho, Gel & Foam Wheelchair Cushions & Alarms



**BUY 11 GET 1 FREE!**

## ROHO® HIGH PROFILE®



Made of 4" interconnected air cells that provide an adjustable, low deformation, counter-pressure environment that assists in the healing of ischemic ulcers. Appropriate for the high risk client. 24-month limited warranty. Custom sizes available.

Description	Cell Configuration (W x D)	ALCO Part No.	Price Each
Fits 14"-15" wide x 14"-15" depth	8 x 8	AL-50240	\$349.00
Fits 14"-15" wide x 16"-17" depth	8 x 9	AL-50241	\$349.00
Fits 16"-17" wide x 14"-15" depth	9 x 8	AL-50242	\$349.00
Fits 16"-17" wide x 16"-17" depth	9 x 9	AL-50243	\$349.00
Fits 16"-17" wide x 18"-19" depth	9 x 10	AL-50244	\$349.00
Fits 18"-19" wide x 16"-17" depth	10 x 9	AL-50245	\$349.00
Fits 18"-19" wide x 18"-19" depth	10 x 10	AL-50246	\$349.00

## Gel-Pro Elite® Wheelchair Cushion

Up To 250 lb. Capacity



- ✓ Top made of low shear nylon and bottom made of waterproof vinyl which reduces heat and moisture build-up
- ✓ Fluid and stain resistant, anti-microbial and fire retardant
- ✓ High-density foam shell surrounds uniquely styled gel bladder

W x D x H	ALCO Part No.	Price Each
1" x 17" x 2-1/2"	AL-57989	\$53.00
16" x 16" x 2-1/2"	AL-57990	\$49.00
18" x 16" x 2-1/2"	AL-57991	\$56.00
20" x 16" x 2-1/2"	AL-57992	\$69.00
22" x 16" x 2-1/2"	AL-57993	\$99.00
24" x 16" x 2-1/2"	AL-57994	\$112.00
18" x 18" x 2-1/2"	AL-57995	\$80.00
20" x 18" x 2-1/2"	AL-57996	\$89.00
22" x 18" x 2-1/2"	AL-57997	\$112.00
24" x 18" x 2-1/2"	AL-57998	\$129.00

## Foam Wheelchair Cushion

250 lb. Capacity



- ✓ A unique construction of High Resilient (HR) molded foam provides optimum stabilization, position, pressure reduction and seating posture
- ✓ Stretch polyester knit cover is removable, washable and flame retardant
- ✓ Cover has a "Non-Slip" bottom for comfort and safety

W x D x H	ALCO Part No.	Price Each
18" x 16" x 1.75"	AL-74908	\$39.00 Each
20" x 18" x 1.75"	AL-74909	\$49.00 Each

## ALCO Economical Wheelchair/Bed Alarm



- ✓ Self-contained clip or hook and loop fastener
  - ✓ Adjustable 18" to 36" activation cord
  - ✓ Convenient on/off switch
  - ✓ 9 volt battery (not provided)
  - ✓ Two settings: soft (85 dB) or Loud (100dB)
- AL-56887 \$12.00

## Magnetic Pull Cord Alarm



- ✓ Cord Adjusts from 28" to 58"
- ✓ Requires two AAA batteries (included)

Magnetic Pull Cord Alarm	AL-65546	\$27.00 Ea.
Replacement Magnetic Pull Cord 3/Pk	AL-66243	\$26.00 3/Pk
Replacement Mounting Holster with Strap 24/Pk	AL-66250	\$19.95 2/Pk

## WE ACCEPT







# I.V. & O2 Holders & Urinary Drainage Bags

**BUY 11 GET 1 FREE!**

**Fixed Height Safety I.V./O2 Holder**

**Anti-Theft**

AL-72292      AL-72293

**MADE IN THE USA**

**Great For Infusion Pumps!**

- ✓ Accommodates I.V. Infusion Instruments and/or "D" or "E" Size Cylinders
- ✓ I.V. hooks are pointed away from I.V. pole to prevent I.V. bag from falling on patients
- ✓ 66-1/2" Fixed Height
- ✓ Fits 7/8" or 1" tubing
- ✓ Adjustable Bracket
- ✓ Anti-Theft

I.V./O2 Holder	<b>AL-72292</b>	<b>\$99.95</b>
I.V. only	<b>AL-72293</b>	<b>\$79.95</b>
Wheelchair Cylinder only	<b>AL-72294</b>	<b>\$29.95</b>

**Stainless Steel IV/O2**

**MADE IN THE USA**

- Hook **AL-59813** \$19.00
- Attaching Clamp **AL-74694** \$3.95
- Knob & Nut **AL-67008** \$3.95

- ✓ Telescoping
- ✓ One hook
- ✓ Accommodates I.V. infusion instruments and/or "D" or "E" cylinders
- ✓ Fits 7/8" or 1" tubing

**AL-48694**      **\$69.95**

**MADE IN THE USA**

- Dual Hook **AL-59814** \$29.95
- Knob & Nut **AL-67008** \$3.95
- Top Only **AL-46374**
- Strap **AL-74695** \$5.95
- Bottom Only **AL-6449B**

- ✓ Telescoping
- ✓ Two hook
- ✓ Accommodates I.V. infusion instruments and/or "D" or "E" cylinders
- ✓ Fits 7/8" or 1" tubing

Complete Unit	<b>AL-6449</b>	<b>\$119.95</b>
Top I.V. pole only (2 hooks)	<b>AL-46374</b>	<b>\$83.95</b>
Top I.V. pole only (4 hooks)	<b>AL-46375</b>	<b>\$89.95</b>
Bottom O2 holder only	<b>AL-6449B</b>	<b>\$79.95</b>

**Chrome I.V./O2**

- ✓ Telescoping
- ✓ Two hook
- ✓ Accommodates "D" or "E" cylinders
- ✓ Fits 7/8" or 1" tubing

**AL-56373**      **\$59.95**

**Chrome I.V.**

- ✓ Telescoping
- ✓ Two hook
- ✓ 7/8" or 1" tubing

**AL-56370**      **\$49.95**

**Chrome O2**

- ✓ Accommodates "D" or "E" Cylinders
- ✓ 7/8" or 1" tubing

Fits dual axle chairs only      **AL-56371**      **\$69.95**

Fits single axle chairs only      **AL-56372**      **\$49.00**

**Urinary Drainage Bags**

- ✓ Maintains dignity of catheterized patients
- ✓ Hangs under Wheelchairs, Geri-Chairs and from Bedrails
- ✓ Heat sealed vinyl to contain spills

Standard	<b>AL-62380</b>	<b>\$14.00</b>
Thru-View	<b>AL-62381</b>	<b>\$15.00</b>

**AL-62380**

**AL-62381**

AM3

# Anti-Rollback, Anti-Tippers & Seat Belts



## Wheelchair Anti-Rollback Device



As the user begins to stand, a pair of brake arms instantly grab the tires to prevent the chair from rolling back and away. The greater the rearward force exerted on the chair, the greater the holding power. Each unit includes an easy to install kit to compensate for the added weight of heavy seat cushions. Both models fit most full and hemi height chairs. Single or dual axle. Sling seat required.

Will not work on Quickie/Breezy wheelchairs.

Shown with optional integrated chair exit alarm

Description	ALCO Part No.	Price Each
Fits Chairs 16"-20"	<b>AL-60603</b>	<b>\$169.00</b>
Fits Chairs 16"-20" w/integrated Alarm	<b>AL-60604</b>	<b>\$239.00</b>
Fits Chairs 22"-24"	<b>AL-60605</b>	<b>\$169.00</b>
Fits Chairs 22"-24" w/integrated Alarm	<b>AL-60606</b>	<b>\$239.00</b>
Fits Invacare EX2 Only	<b>AL-71438</b>	<b>\$139.00</b>

Retrofit your existing Anti-Rollback device by purchasing the kits below. For example, purchase an AL-64614 to change from a 22"-24" model to a 16"-20" model.

16"-20" Retrofit Kit	<b>AL-64614</b>	<b>\$29.00</b>
22"-24" Retrofit Kit	<b>AL-64615</b>	<b>\$29.00</b>

## Anti-Tipper—Universal Fit!

### Front



#### Adjustable Height Front Anti-Tippers

- ✓ Fits 3/4", 7/8" or 1" tubing
- ✓ 5 height adjustments

**AL-72307 \$72.00 Pair**

### Rear



#### Adjustable Height Rear Anti-Tippers

- ✓ Fits 3/4", 7/8" or 1" tubing
- ✓ 2" easy gliding wheels

**AL-64620 \$49.95 Pair**

## Seat Belts (with hole & grommet to mount to back screw)

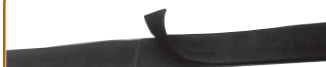

**AL-45312 & AL-45314**

With Velcro, Black, 48" Long, 2" Webbing **AL-45312 \$14.95**

With Velcro, Black, 60" Long, 2" Webbing **AL-45314 \$14.95**



**AL-45319 to 45322**

With Airline Buckle, Black, 48" Long, 2" Webbing **AL-45316 \$22.95**

With Airline Buckle, Black, 60" Long, 2" Webbing **AL-45318 \$22.95**



**AL-45316 & AL-45318**

With Airline Buckle, Black, 72" Long, 2" Webbing **AL-319XL \$22.95**

With Buckle & Pad, Black, 48" Long, 2" Webbing **AL-45320 \$34.95**

With Buckle & Pad, Black, 60" Long, 2" Webbing **AL-45322 \$34.95**

## Seat Belts



**AL-45324 & AL-45326**

### Seat Belts (with hole & grommet to mount to back screw)

With Push Button Buckle, Black, 48" Long, 2" Webbing **AL-45324 \$23.95**

With Push Button Buckle, Black, 60" Long, 2" Webbing **AL-45326 \$23.95**



**AL-45329 to AL-45331**

### Axle Mounts

Axle Mount, Black, w/Velcro **AL-45329 \$22.95**

Axle Mount, Black, w/Airline Buckle **AL-45330 \$39.95**

Axle Mount, Black, w/Push Button Buckle **AL-45331 \$39.95**

## Black Pinch Buckle



2" x 48" **AL-326 \$19.95**  
2" x 60" **AL-326A \$19.95**

## Velcro Catch



Includes loop to fasten around frame  
**AL-322 \$19.95**



# Wheelchair Pushbars & Anti-Theft Accessories

**BUY 11 GET 1 FREE!**

**ALCO Ergonomic Pushbar**



- ✓ One-hand operation
- ✓ 18 gauge black powder coated steel
- ✓ Includes set screw for Anti-theft
- ✓ Patent pending

Fits 18"-20"	<b>AL-76487</b>	<b>\$29.95</b>
Fits 22"-24"	<b>AL-76488</b>	<b>\$29.95</b>

**ALCO Heavy-Duty Pushbar**



Anti-Theft

- ✓ One-hand operation
- ✓ Safely secured with two easy-to-turn adjusting knobs
- ✓ Patent pending

18"-32"	<b>AL-69303</b>	<b>\$79.95</b>
---------	-----------------	----------------

**Please Specify Width of Chair (distance from center to center of Handgrips)**

**ALCO Ergonomic Pushbar**



- ✓ 304 Grade Stainless Steel
- ✓ Anti-Theft
- ✓ Slip Resistant Handgrips

**AL-82057 \$139.00**

**I.V. Pole**



I.V./O2 Holder <b>AL-72292</b>	<b>\$99.95</b>	I.V. Only <b>AL-72293</b>	<b>\$79.95</b>
-----------------------------------	----------------	------------------------------	----------------

**Anti-Theft Hoops**



**Adjustable Anti Theft Hoop**  
16"-24"  
**AL-63827 \$54.95**  
18"-24" with I.V. Hooks  
**AL-65527 \$89.95**

**Non-Adjustable Anti Theft Hoop**  
16"-18"  
**AL-25101 \$44.95**  
16"-18" with I.V. Holder  
**AL-25101A \$54.95**

**Anti-Fold**



Clamps between rear uprights just below seat  
**AL-885 \$22.95** fits 7/8" tubing and adjusts from 14" to 24"  
**AL-67460 \$21.95** fits 7/8" tubing and adjusts from 14" to 24"—includes center clamp  
**AL-885A \$24.95** fits 1" tubing and adjusts from 16" to 24"

**AL-67460 AL-885**

**Anti-Fold Bar • Anti Theft**



Fits wheelchair with cross bar bolt  
18"-20" wide  
**AL-45657 \$39.00**  
22"-24" wide  
**AL-45657A \$39.00**

**Anti-Theft Post**



- ✓ Color: Red
- ✓ Clamps onto Back Post
- ✓ Fits Most 7/8" Tubing Wheelchairs

**AL-72313 \$59.95**

AW3

**Low prices guaranteed!**  
**We will NOT be undersold!**

# Economy Wheelchair Upholstery Black Vinyl Only



Armpads

Calf Pads

Universal Armpads						
Description	Mounting Holes	Fits	EACH		PAIR	
			ALCO Part No.	Price Each	ALCO Part No.	Price Pair
Padded, full length, vinyl with black base	8	Universal, fits all 13-7/8" long	AL-135BK-A3	\$5.95	AL-66054BK-A3	\$9.95
Padded, desk length, vinyl with black base	4	Universal, fits all 10-1/8" long	AL-145BK-A3	\$5.95	AL-66055BK-A3	\$9.95



Seat



Back



Undrilled

Universal Calf Pads						
Type	Mounting Holes	Fits	EACH		PAIR	
			ALCO Part No.	Price Each	ALCO Part No.	Price Pair
Padded with black base	Universal 2" vertical + 1-1/2"	Universal	AL-422UBK-A3	\$13.95	AL-66068BK-A3	\$21.95

Upholstery Kits — Includes seat & back with FREE armpads!								
Description	18" Wide Embossed		18" Wide Flat		20" Wide Embossed		20" Wide Flat	
	ALCO Part No.	Price Per Kit	ALCO Part No.	Price Per Kit	ALCO Part No.	Price Per Kit	ALCO Part No.	Price Per Kit
<b>Fits E&amp;J</b>								
Plastic, full length	AL-01-A3	\$37.95	AL-05-A3	\$30.95	AL-17-A3	\$43.95	AL-21-A3	\$39.95
Plastic, desk length	AL-02-A3	\$37.95	AL-06-A3	\$30.95	AL-18-A3	\$43.95	AL-22-A3	\$39.95
Padded, full length	AL-03-A3	\$37.95	AL-07-A3	\$30.95	AL-19-A3	\$43.95	AL-23-A3	\$39.95
Padded, desk length	AL-04-A3	\$37.95	AL-08-A3	\$30.95	AL-20-A3	\$43.95	AL-24-A3	\$39.95
<b>Fits Invacare</b>								
Plastic, full length	AL-09-A3	\$37.95	AL-13-A3	\$30.95	AL-25-A3	\$43.95	AL-29-A3	\$39.95
Plastic, desk length	AL-10-A3	\$37.95	AL-14-A3	\$30.95	AL-26-A3	\$43.95	AL-30-A3	\$39.95
Padded, full length	AL-11-A3	\$37.95	AL-15-A3	\$30.95	AL-27-A3	\$43.95	AL-31-A3	\$39.95
Padded, desk length	AL-12-A3	\$37.95	AL-16-A3	\$30.95	AL-28-A3	\$43.95	AL-32-A3	\$39.95

## Back & Seat Upholstery

Upper Width	Lower Width	Height/Depth	Screw Holes	*	Screw Separation Center to Center	ALCO Part No.	Price Each	ALCO Part No.	Price Each	ALCO Part No.	Price Each
<b>E&amp;J Backs</b>						<b>Embossed</b>		<b>Flat</b>		<b>Undrilled</b>	
18-5/8"	18"	18-1/2"	8	1"	5-1/2, 5-1/2, 5-1/2"	AL-794-A3	\$22.95	AL-794F-A3	\$16.95	763NH-A3	\$28.95
16-5/8"	16"	18-1/2"	8	1"	5-1/2, 5-1/2, 5-1/2"	AL-792-A3	\$22.95	AL-792F-A3	\$16.95	N/A	N/A
20-5/8"	20"	18-1/2"	8	1"	5-1/2, 5-1/2, 5-1/2"	AL-795-A3	\$30.95	AL-795F-A3	\$23.95	765NH-A3	\$30.95
22-5/8"	22"	18-1/2"	8	1"	5-1/2, 5-1/2, 5-1/2"	AL-796-A3	\$34.95	AL-796F-A3	\$29.95	766NH-A3	\$34.95
24-5/8"	24"	18-1/2"	8	1"	5-1/2, 5-1/2, 5-1/2"	AL-797-A3	\$39.95	AL-797F-A3	\$33.95	767NH-A3	\$39.95
<b>E&amp;J Seats</b>											
18"		16"	8	2"	4, 4, 4"	AL-827-A3	\$22.95	AL-827F-A3	\$16.95	N/A	N/A
16"		16"	8	2"	4, 4, 4"	AL-825-A3	\$22.95	AL-825F-A3	\$16.95	N/A	N/A
20"		16"	8	2"	4, 4, 4"	AL-828-A3	\$30.95	AL-828F-A3	\$23.95	N/A	N/A
22"		16"	8	2"	4, 4, 4"	AL-829-A3	\$34.95	AL-829F-A3	\$29.95	N/A	N/A
24"		16"	8	2"	4, 4, 4"	AL-830-A3	\$39.95	AL-830F-A3	\$33.95	N/A	N/A
<b>Invacare Straight Backs</b>											
18"	18"	18"	8	1"	5-3/8, 5, 4-5/8"	AL-763-A3	\$17.95	AL-763F-A3	\$16.95	AL-763NH-A3	\$22.95
16"	16"	18"	8	1"	5-3/8, 5, 4-5/8"	AL-761-A3	\$22.95	AL-761F-A3	\$16.95	N/A	N/A
20"	20"	18"	8	1"	5-3/8, 5, 4-5/8"	AL-765-A3	\$18.95	AL-765F-A3	\$23.95	AL-765NH-A3	\$30.95
22"	22"	18"	8	1"	5-3/8, 5, 4-5/8"	AL-766-A3	\$26.95	AL-766F-A3	\$29.95	AL-766NH-A3	\$34.95
24"	24"	18"	8	1"	5-3/8, 5, 4-5/8"	AL-767-A3	\$27.95	AL-767F-A3	\$33.95	AL-767NH-A3	\$39.95
<b>Invacare Flared Backs</b>											
20"	18"	18"	8	1"	5-3/8, 5, 4-5/8"	AL-768-A3	\$24.95	AL-768F-A3	\$18.95	AL-768NH-A3	\$24.95
24"	22"	18"	8	1"	5-3/8, 5, 4-5/8"	AL-768X-A3	\$42.95	AL-768XF-A3	\$33.95	AL-768XNH-A3	\$59.95
<b>Invacare Semi-Flared Backs</b>											
19"	18"	18"	8	1"	5-3/8, 5, 4-5/8"	AL-769-A3	\$24.95	AL-769F-A3	\$23.95	AL-769NH-A3	\$28.95
<b>Invacare Seats (Hammock)</b>											
18"		16"	8	2"	3-5/8, 3-5/8, 4-3/4"	AL-779-A3	\$17.95	AL-779F-A3	\$16.95	AL-779NH-A3	\$22.95
16"		16"	8	2"	3-5/8, 3-5/8, 4-3/4"	AL-778-A3	\$22.95	AL-778F-A3	\$16.95	N/A	N/A
20"		16"	8	2"	3-5/8, 3-5/8, 4-3/4"	AL-781-A3	\$30.95	AL-781F-A3	\$23.95	AL-781NH-A3	\$30.95
22"		16"	8	2"	3-5/8, 3-5/8, 4-3/4"	AL-782-A3	\$34.95	AL-782F-A3	\$29.95	AL-782NH-A3	\$34.95
24"		16"	8	2"	3-5/8, 3-5/8, 4-3/4"	AL-783-A3	\$39.95	AL-783F-A3	\$33.95	AL-783NH-A3	\$39.95

\* Distance of 1st hole from top of back or front of seat





# Medline Upholstery



Seat Spacing: 2", 3-5/8", 3-5/8", 4-3/4", 3-3/8", 5/8"  
 Back Spacing: 1", 5-3/8", 5", 4-5/8" (2" Flare)  
 20" Back Spacing = 20" Bottom x 22" Top  
 22" Back Spacing = 22" Bottom x 24" Top  
 24" Back Spacing = 24" Bottom x 26" Top

Vinyl Upholstery—No Pocket				
Description	Navy		Black	
	ALCO Part No.	Price Each	ALCO Part No.	Price Each
20" Wide Back w/screws	AL-765-A44	\$41.95	AL-765-A3	\$30.95
22" Wide Back w/screws	AL-766-A44	\$51.95	AL-766-A3	\$34.95
24" Wide Back w/screws	AL-767-A44	\$59.95	AL-767-A3	\$39.95
20" Wide Seat w/screws	AL-64830-A44	\$39.95	AL-64830-A3	\$39.95
22" Wide Seat w/screws	AL-64831-A44	\$49.95	AL-64831-A3	\$49.95
24" Wide Seat w/screws	AL-64832-A44	\$49.95	AL-64832-A3	\$32.95

Vinyl Upholstery—With Pocket				
Description	Navy		Black	
	ALCO Part No.	Price Each	ALCO Part No.	Price Each
20" Wide Back w/screws	AL-74538-A44	\$36.95	AL-74538-A3	\$36.95
22" Wide Back w/screws	AL-74539-A44	\$47.95	AL-74539-A3	\$47.95
24" Wide Back w/screws	AL-74540-A44	\$47.95	AL-74540-A3	\$47.95
20" Wide Seat w/screws	AL-64830-A44	\$39.95	AL-64830-A3	\$39.95
22" Wide Seat w/screws	AL-64831-A44	\$49.95	AL-64831-A3	\$49.95
24" Wide Seat w/screws	AL-64832-A44	\$49.95	AL-64832-A3	\$49.95

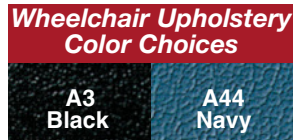

## Wheel Locks



Fig	Description	To Fit	ALCO Part No.	Price Each
1	Push To Lock 7/8" tubing	ALCO Classic, Medline, Sunrise Medical Removable Arm	AL-65861	\$23.95 pr
	Push To Lock 7/8" tubing	Invacare Removable Arm Tracer EX, SX, DLX	AL-76050	\$25.95 pr
2	Push To Lock 7/8" tubing	E&J Removable Arm	AL-76042	\$23.95 pr

## Side Panels



Fig# 1

Fig# 2

Fig# 3

Fig# 4

Fig# 5

Fig# 6

Fig	Description	To Fit	ALCO Part No.	Price Each
1	Composite, Clothing Guard, Full Length, R.H.	Tracer IV, EX2 & SX5, Invacare 9000/SL/XT and Patriot SL Space Saver	AL-64649	\$22.95
	Composite, Clothing Guard, Full Length, L.H.	Tracer IV, EX2 & SX5, Invacare 9000/SL/XT and Patriot SL Space Saver	AL-64648	\$22.95
2	Composite, Clothing Guard, Desk Length, R.H.	Tracer IV, EX2 & SX5	AL-64646	\$22.95
	Composite, Clothing Guard, Desk Length, L.H.	Tracer IV, EX2 & SX5	AL-64645	\$22.95
3	Metal, Fixed Arm, Full Length	E&J & Tuffcare 16" Seat Depth	AL-152E	\$16.95
	Metal, Fixed Arm, Full Length	Invacare 1000, 1000E, World Chair, Tracers, E&J, Vista & Traveler, Gendron	AL-152	\$16.95
	Metal, Detachable Arm, Full Length, Silver Vein	Invacare 1000, 1000E, World Chair, Tracers & E&J, Vista & Traveler	AL-158	\$16.95
4	Metal, Detachable Arm, Desk Length, Silver Vein	Invacare 1000, 1000E, World Chair, Tracers & E&J, Vista & Traveler	AL-155	\$16.95
5	Composite, Desk Length, R.H.	Invacare 2000, 9000, 9000XT/SL/ XDT Space Saver	AL-50128	\$25.95
	Composite, Desk Length, L.H.	Invacare 2000, 9000, 9000XT/SL/ XDT Space Saver	AL-50129	\$25.95
	Composite, Full Length, R.H.	Invacare 9000/SL/XT and Patriot SL Space Saver	AL-79719	\$31.95
	Composite, Full Length, L.H.	Invacare 9000/SL/XT and Patriot SL Space Saver	AL-79720	\$31.95
6	Invacare Clothing Guard, Adjustable Height	Tracer LX	AL-58036	\$22.95
NS	Tuffcare #AZVBK Clothing Guard, Black Plastic	Tuffcare 247/867	AL-59212	\$9.95
	Drive Chrome Panel	Drive Sentra EC and HD	AL-67034	\$18.95

AW3

**When Ordering, Specify Left (L) or Right (R)—Sitting in Chair**

# Arm Assemblies

**BUY 11 GET 1 FREE!**



Fig# 1



Fig# 2



Fig# 3



Fig# 4



Fig# 5



Fig# 6



Fig# 7



Fig# 8



Fig# 9



Fig# 9A



Fig# 10



Fig# 10B



Fig# 11



Fig# 12



Fig# 13



Fig# 14

Fig	Description	To Fit	ALCO Part No.	Price Each
1	Detachable, Full Length, R.H., w/Armpad, Specify Color	E&J, Traveler, Tuffcare	AL-978R	\$39.95
	Detachable, Full Length, L.H., w/Armpad, Specify Color	E&J, Traveler, Tuffcare	AL-978L	\$39.95
2	Detachable, Desk Length, R.H., w/Armpad, Specify Color	E&J, Traveler, Tuffcare	AL-980R	\$39.95
	Detachable, Desk Length, L.H., w/Armpad, Specify Color	E&J, Traveler, Tuffcare	AL-980L	\$39.95
3	Detachable, Desk Length, w/Armpad, Specify Color (Pair)	E&J, Traveler SE, Tuffcare	AL-73321	\$49.95 Pr.
4	Detachable, Full Length, w/Armpad, Specify Color (Pair)	E&J, Traveler SE, Tuffcare	AL-73322	\$49.95 Pr.
5	Detachable, Full Length, R.H., Black Plastic Armpads	Invacare 1000, 1000E, Tracers	See Figure #16 (P. 27)	
	Detachable, Full Length, L.H., Black Plastic Armpads			
6	Detachable, Desk Length, R.H., Black Plastic Armpads	Invacare 1000, 1000E, Tracers	See Figure #15 (P. 27)	
	Detachable, Desk Length, L.H., Black Plastic Armpads			
7	Detachable, Full Length, R.H., Black Padded Armpads	Invacare 2000 & 9000 Space Saver	AL-45861	Call
	Detachable, Full Length, L.H., Black Padded Armpads	Invacare 2000 & 9000 Space Saver	AL-45862	Call
8	Detachable, Desk Length, R.H., Black Padded Armpads	Invacare 2000 & 9000 Space Saver	AL-45859	Call
	Detachable, Desk Length, L.H., Black Padded Armpads	Invacare 2000 & 9000 Space Saver	AL-45860	Call
9	Adjustable Height, Desk Length, R.H., Black Padded Armpads	Invacare 2000 & 9000 Space Saver	AL-65558	\$79.95
	Adjustable Height, Desk Length, L.H., Black Padded Armpads	Invacare 2000 & 9000 Space Saver	AL-65559	\$79.95
9A	Adjustable Height, Full Length, R.H., Black Padded Armpads	Invacare 2000 & 9000 Space Saver	AL-65560	\$79.95
	Adjustable Height, Full Length, L.H., Black Padded Armpads	Invacare 2000 & 9000 Space Saver	AL-65561	\$79.95
10	Detachable, Full Length, R.H., No Armpad	Invacare 9000 XT/XDT Space Saver	AL-64295	\$69.95
	Detachable, Full Length, L.H., No Armpad	Invacare 9000 XT/XDT Space Saver	AL-64296	\$69.95
10B	Detachable, Desk Length, R.H., No Armpad	Invacare 9000 XT/XDT Space Saver	AL-64297	\$69.95
	Detachable, Desk Length, L.H., No Armpad	Invacare 9000 XT/XDT Space Saver	AL-64298	\$69.95
11	Detachable, Full Length, R.H., Black Padded Armpad	Invacare EX2, Tracer IV	AL-64656	\$74.95
	Detachable, Full Length, L.H., Black Padded Armpad	Invacare EX2, Tracer IV	AL-64655	\$74.95
12	Detachable, Desk Length, R.H., Black Padded Armrest	Invacare EX2, Tracer IV	AL-64654	\$74.95
	Detachable, Desk Length, L.H., Black Padded Armrest	Invacare EX2, Tracer IV	AL-64653	\$74.95
13	Detachable, Full Length, R.H., Black Padded Armpad	Invacare SX5	AL-64613	\$87.95
	Detachable, Full Length, L.H., Black Padded Armpad	Invacare SX5	AL-64612	\$87.95
14	Detachable, Desk Length, R.H., Black Padded Armpad	Invacare SX5	AL-64611	\$74.95
	Detachable, Desk Length, L.H., Black Padded Armpad	Invacare SX5	AL-64610	\$74.95

AW3

**When Ordering, Specify Left (L) or Right (R)—Sitting in Chair**





# Arm Assemblies

**BUY 11 GET 1 FREE!**



Fig# 1



Fig# 2



Fig# 3



Fig# 4

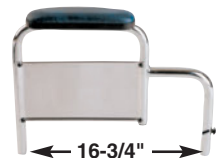

Fig# 5

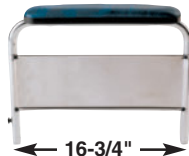

Fig# 6



Fig# 7



Fig# 8



Fig# 9



Fig# 10



Fig# 11



Fig# 12



Fig# 13



Fig# 14



Fig# 15



Fig# 16

Arm Assemblies				
Fig	Description	To Fit	ALCO Part No.	Price Each
1	Full, Black Padded Armpads (Pair)	Medline Excel, Standard, ExtraWide	AL-64741	\$79.95
2	Desk Black Padded Armpads (Pair)	Medline Excel, Standard, ExtraWide	AL-64740	\$79.95
3	Desk, Left, Black Padded Armpads	Drive Chrome Sport/Silver Sport II	AL-74162L	\$24.95
	Desk, Right, Black Padded Armpads	Drive Chrome Sport/Silver Sport II	AL-74162R	\$24.95
4	Full, Left, Black Padded Armpads	Drive Chrome Sport/Silver Sport II	AL-74163L	\$22.95
	Full, Right, Black Padded Armpads	Drive Chrome Sport/Silver Sport II	AL-74163R	\$22.95
5	Desk, Left, Black Padded Armpads	Drive Sentra EC, ALCO Classic Solid Seat (16-3/4" on centers; fits 7/8" Dia Tube)	AL-70065	\$44.95
	Desk, Right, Black Padded Armpads	Drive Sentra EC, ALCO Classic Solid Seat (16-3/4" on centers; fits 7/8" Dia Tube)	AL-70059	\$44.95
6	Full, Left, Black Padded Armpads	Drive Sentra EC, ALCO Classic Solid Seat (16-3/4" on centers; fits 7/8" Dia Tube)	AL-70066	\$44.95
	Full, Right, Black Padded Armpads	Drive Sentra EC, ALCO Classic Solid Seat (16-3/4" on centers; fits 7/8" Dia Tube)	AL-70060	\$44.95
7	Desk, Left, Black Padded Armpads	Drive Sentra Recliner & Heavy Duty (20", 22", 24")	AL-77661DL	\$36.95
	Desk, Right, Black Padded Armpads	Drive Sentra Recliner & Heavy Duty (20", 22", 24")	AL-77661DR	\$31.95
8	Full, Left, Black Padded Armpads	Drive Sentra Recliner & Heavy Duty (20", 22", 24")	AL-77661FL	\$39.95
	Full, Right, Black Padded Armpads	Drive Sentra Recliner & Heavy Duty (20", 22", 24")	AL-77661FR	\$39.95
9	Desk, Left, Black Padded Armpads	Drive Sentra Heavy Duty, XW (26", 28", 30")	AL-77723DL	\$89.95
	Desk, Right, Black Padded Armpads	Drive Sentra Heavy Duty, XW (26", 28", 30")	AL-77723DR	\$89.95
10	Full, Left, Black Padded Armpads	Drive Sentra Heavy Duty, XW (26", 28", 30")	AL-77723FL	\$79.95
	Full, Right, Black Padded Armpads	Drive Sentra Heavy Duty, XW (26", 28", 30")	AL-77723FR	\$79.95
11	Full, left, Black Padded Armpads	Gendron 6700 series	AL-77220L	\$87.00
	Full, right, Black Padded Armpads	Gendron 6700 series	AL-77220R	\$87.00
12	Desk, left, Black Padded Armpads	Gendron 6700 series	AL-77221L	\$82.00
	Desk, right, Black Padded Armpads	Gendron 6700 series	AL-77221R	\$82.00
13	Desk, Black Padded Armpads (Pair)	Sunrise Easy Care 2000 & 2000HD	AL-65841	\$59.95
14	Full, Black Padded Armpads (Pair)	Sunrise Easy Care 2000 & 2000HD	AL-65842	\$59.95
15	Desk, Black Padded Armpads (Pair)	ALCO Classic Series (17" on centers; fits 7/8" Dia Tube)	AL-70045	\$49.95
	Desk, Black Padded Armpads (Pair) (Black Frame)	ALCO Classic Series (17" on centers; fits 7/8" Dia Tube)	AL-78496D	\$39.95
16	Full, Black Padded Armpads (Pair)	ALCO Classic Series (17" on centers; fits 7/8" Dia Tube)	AL-70042	\$49.95
	Full, Black Padded Armpads (Pair) (Black Frame)	ALCO Classic Series (17" on centers; fits 7/8" Dia Tube)	AL-78496F	\$39.95

AW3

# Legrests & Footrests

**BUY 11 GET 1 FREE!**

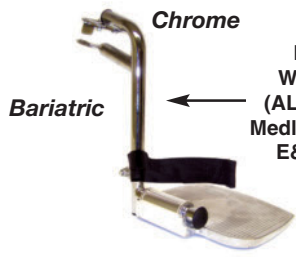

Fig #1

Fits Most Wheelchairs (ALCO Classic, Medline, Invacare, E&J & Drive)



Fig #2



Fig #3



Fig #4

## Footrests

Fig	Description	To Fit	ALCO Part No.	Price Pair
1	Swinging Cam Lock; XL metal footplate w/heel loop; Chrome; 1-3/8" hole spacing	ALCO, Invacare, Medline & Drive	AL-79730	\$69.00 pr
2	Swinging Cam Lock; metal footplate w/heel loop; Chrome; 1-3/8" hole spacing	ALCO, Invacare, Medline, E&J & Drive	AL-70043	\$39.00 pr
2	Swinging Cam Lock; metal footplate w/heel loop; Black; 1-3/8" hole spacing	ALCO, Invacare, Medline, E&J & Drive	AL-78482	\$39.00 pr
2	Swinging Cam Lock; plastic footplate w/heel loop; 1-3/8" hole spacing	ALCO, Invacare, Medline, E&J & Drive	AL-65463	\$39.00 pr
3	Swinging Cam Lock; metal footplate; 2-1/8" hole spacing	E&J	AL-64427	\$69.00 pr
4	Swinging Cam Lock; metal footplate; 3" hole spacing	E&J	AL-64426	\$59.00 pr

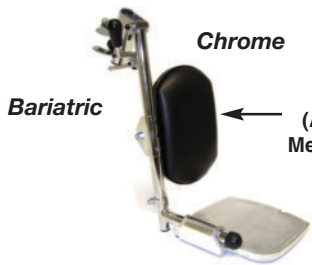

Fig #1

Fits Most Wheelchairs (ALCO Classic, Medline, Invacare, E&J & Drive)

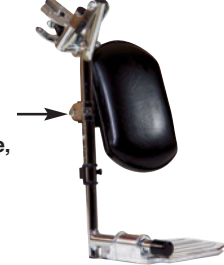

Fig #2



Fig #3



Fig #4

## Legrests

Fig	Description	To Fit	ALCO Part No.	Price Pair
1	Swinging Cam Lock; XL metal footplate w/heel loop; Black calf pad; Chrome; 1-3/8" hole spacing	ALCO, Invacare, Medline & Drive	AL-79729	\$129.00 pr
2	Swinging Cam Lock; metal footplate; Black calf pad; Chrome; 1-3/8" hole spacing	ALCO, Invacare, Medline, E&J & Drive	AL-70044	\$69.00 pr
2	Swinging Cam Lock; metal footplate; Black calf pad; Black; 1-3/8" hole spacing	ALCO, Invacare, Medline, E&J & Drive	AL-78480	\$69.00 pr
3	Swinging Cam Lock; metal footplate; Colored calf pad*; 2-1/8" hole spacing	E&J	AL-64419	\$159.00 pr
4	Swinging Cam Lock; metal footplate; Colored calf pad*; 3" hole spacing	E&J	AL-64417	\$114.00 pr

\*Specify Padded (AL-422UBK black base) or Plastic (AL-423U-BK). No additional charge

### E&J Ratchet Assembly



✓ Fits Left or Right  
AL-433 \$12.95 Each

### ALCO Classic Ratchet Assembly



AL-79003 \$23.95 Pair

### Invacare Ratchet Assembly



✓ Fits ALCO Classic, Drive, Invacare  
AL-49969 \$23.95 Pair

### Replacement Leg Rest Mounting Pin Kit



Are broken legrest mounting pins a problem in your facility?  
We have a solution...



✓ Fits all 1/4" Pins  
AL-76038 \$37.95



# Classic™ 500, 300, 300E Wheelchair Parts



**A** 

**B** 

**C** 

**D** 

**E** 

**F** 

**Footrest**

Chrome  
AL-70043  
\$39.00 Pr

**Legrest**

Chrome  
AL-70044  
\$69.00 Pr

1-3/8" Hole Spacing

**Footrest**

Black  
AL-78482  
\$39.00 Pr

**Legrest**

Black  
AL-78480  
\$69.00 Pr

AM3

Fig	Description	Fits Classic Model	ALCO Part No.	Price Each
1	Rear wheel complete with handrim and bearings	500	AL-78472	\$42.95
	Rear wheel complete with handrim and bearings	300, 300E	AL-78475	\$32.95
2	Handrim Only	500, 300, 300E	AL-78470	\$12.95
3	Hub cap	500	AL-78469	\$0.95
	Hub cap	300, 300E	AL-78473	\$0.95
3A	Bearing	500	AL-2228	\$4.95
	Bearing	300, 300E	AL-2228A	\$4.95
3B	Spacer	500	AL-78465	\$1.95
	Spacer	300, 300E	AL-78467	\$4.95
3C	Axle bolt and nut	500	AL-78464	\$4.95
	Axle bolt and nut	300, 300E	AL-78466	\$3.95
4	End cap	500, 300, 300E	AL-78512	\$1.95
5	Grip	ALL	AL-70116	\$1.95
6	Back Upholstery—18" width	300	AL-763-A3	\$22.95
	Back Upholstery—20" width	500 & 300	AL-765-A3	\$30.95
	Back Upholstery—22" width	500	AL-766-A3	\$34.95
	Back Upholstery—24" width	500	AL-767-A3	\$39.95
7	Seat Upholstery—18" width	300	AL-779-A3	\$22.95
	Seat Upholstery—20" width	500	AL-64830-A3	\$39.95
	Seat Upholstery—20" width	300	AL-781-A3	\$30.95
	Seat Upholstery—22" width	500	AL-64831-A3	\$49.95
	Seat Upholstery—24" width	500	AL-64832-A3	\$32.95
8	Armrest, Desk Length complete (Pair)*	700, 500, 300	AL-70045	\$49.95
	Armrest, Full Length complete (Pair)*	700, 500, 300	AL-70042	\$49.95
	Armrest, Desk Length complete Black Frame (Pair)*	300E	AL-78496D	\$39.95
	Armrest, Full Length complete Black Frame (Pair)*	300E	AL-78496F	\$39.95
	Armrest, Flip Back complete Black Frame (Pair)*	300	AL-78497	\$39.95
9	Armpad, Desk Length, Black (Pair)*	ALL	AL-66055BK-A3	\$9.95
	Armpad, Full Length, Black (Pair)*	ALL	AL-66054BK-A3	\$9.95
10	Armrest release spring	500, 300, 300E	AL-610	\$4.95
11	Skirtguard, Desk Length, Black	500, 300, 300E	AL-78489D	\$14.95
	Skirtguard, Full Length, Black	500, 300, 300E	AL-78489F	\$14.95
12	Fork, Adjustable, Black	500, 300	AL-78453	\$21.95
	Fork, Black	300E	AL-78454	\$19.95

Fig	Description	Fits Classic Model	ALCO Part No.	Price Each
13A	Axle bolt and nut	500, 300	AL-78455	\$5.95
	Axle bolt and nut	300E	AL-78456	\$4.95
13B	Bearing	500	AL-78460	\$4.95
	Bearing	300, 300E	AL-78462	\$4.95
14	8" x 2" wheel complete w/bearings	500	AL-78461A	\$22.95
	8" x 2" hard tread wheel complete w/bearings*	500, 300	AL-82128	\$39.00
14	8" x 1" wheel complete with bearings	300	AL-78463A	\$14.95
	8" x 1" wheel complete w/bearings	300E	AL-78463B	\$14.95
15	Journal cap	500, 300	AL-70120	\$4.95
	Journal cap	300E	AL-78459	\$1.95
15A	Journal bearings	500, 300	AL-78457	\$3.95
	Journal bearings	300E	AL-78458	\$3.95
16	Footplate, Aluminum	500, 300	AL-64218	\$19.95
	Footplate, Black	300E	AL-78478	\$14.95
17	Calf pad, Black (Pair)	ALL	AL-66068BK-A3	\$21.95
18	Cap	ALL	AL-1742B	\$1.95
19	Brake (Pair)	500, 300	AL-65861	\$23.95
	Brake (Pair)	300E	AL-78483	\$23.95
	Brake Tip	500, 300, 300E	AL-78486	\$2.95
N/S	Slide Tube	500	AL-78437	\$14.95
	Slide Tube	300	AL-78438	\$14.95
	Slide Tube, 18"	300E	AL-78439-18	\$14.95
	Slide Tube, 20"	300E	AL-78439-20	\$14.95
A	Plug button, 7/8" ID	ALL	AL-231B	\$0.95
B	Seat Guides, Rear, Black	300, 300E	AL-184B	\$1.95
N/S	"L" Tube & Footplate, Left, Chrome	ALL	AL-78476L	\$29.95
	"L" Tube & Footplate, Right, Chrome	ALL	AL-78476R	\$29.95
	"L" Tube & Footplate, Left, Black	ALL	AL-78477L	\$29.95
	"L" Tube & Footplate, Right, Black	ALL	AL-78477R	\$29.95
C	Cam Housing and lever	ALL	AL-64843	\$4.95
D	Calf Pad Plate, Black	ALL	AL-457	\$4.95
E	Handle release, Left	ALL	AL-78479L	\$1.95
	Handle release, right	ALL	AL-78479R	\$1.95
F	Ratchet Assembly Complete (Pair)	ALL	AL-79003	\$23.95

\*Pushes capacity of chair to 600 lbs or 350 lbs

# ALCO Comfort Classic Folding Solid Seat Wheelchair Parts Breakdown for 20" 22" & 24"

**BUY 11 GET 1 FREE!**

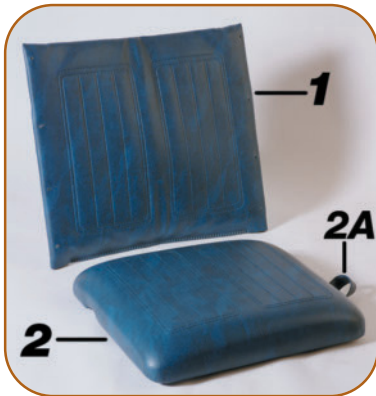

16-3/4"

16-3/4"

AM/3

## Upholstery

Fig.	Description	ALCO Part No.	Price Each
1	<b>Back Upholstery—Blue (Std)</b>		
	20" Wide*	AL-70050	\$59.95
	22" Wide*	AL-70051	\$65.95
	24" Wide*	AL-70052	\$65.95
	Replacement Screw and Washer (Black)	AL-66663	\$1.95
2	<b>Solid Seat—Blue (Std)</b>		
	20" Wide x 16" Deep*	AL-70053	\$89.95
	22" Wide x 18" Deep*	AL-70054	\$92.95
	24" Wide x 18" Deep*	AL-70055	\$92.95
2A	Replacement Carry Strap*	AL-78401	\$4.95
3	<b>Calfpads—Blue (Std)</b>		
	Padded Calfpads (Black Base)*	AL-70056	\$17.95
4	<b>Armpads—Blue (Std)</b>		
	Desk Length Padded (Black Base)*	AL-70057	\$5.95
	Full Length Padded (Black Base)*	AL-70058	\$5.95

\*Upholstery Available in Blue (BL), Black (BK) or Burgundy (BU)

## Upholstery Kits Include: Seat, Back, Armpads & Calf Pads

Description	Burgundy Part No.	Blue Part No.	Black Part No.	Price Each
20" w/Full Length Arms	AL-70024BU	AL-70024BL	AL-70024BK	\$189.00
22" w/Full Length Arms	AL-70025BU	AL-70025BL	AL-70025BK	
24" w/Full Length Arms	AL-70026BU	AL-70026BL	AL-70026BK	
20" w/Desk Length Arms	AL-70027BU	AL-70027BL	AL-70027BK	
22" w/Desk Length Arms	AL-70028BU	AL-70028BL	AL-70028BK	
24" w/Desk Length Arms	AL-70029BU	AL-70029BL	AL-70029BK	

## Arms and Arm Parts

Fig.	Description	ALCO Part No.	Price Each	
5	<b>Armrest Assembly*</b>			
	Right, Desk Arm (Removable) Fits 20" - 24"	AL-70059	\$44.95	
	Right, Full Arm (Removable) Fits 20" - 24"	AL-70060	\$44.95	
	Right, Desk Arm (Flip-Back) Fits 20"	AL-70061	\$59.95	
	Right, Full Arm (Flip-Back) Fits 20"	AL-70062	\$59.95	
	Right, Desk Arm (Flip-Back) Fits 22" & 24"	AL-70063	\$59.95	
	Right, Full Arm (Flip-Back) Fits 22" & 24"	AL-70064	\$59.95	
	Left, Desk Arm (Removable) Fits 20" - 24"	AL-70065	\$44.95	
	Left, Full Arm (Removable) Fits 20" - 24"	AL-70066	\$44.95	
	Left, Desk Arm (Flip-Back) Fits 20"	AL-70067	\$59.95	
	Left, Full Arm (Flip-Back) Fits 20"	AL-70068	\$59.95	
	Left, Desk Arm (Flip-Back) Fits 22" & 24"	AL-70069	\$59.95	
	Left, Full Arm (Flip-Back) Fits 22" & 24"	AL-70070	\$59.95	
	5A	<b>Arm Assembly Parts</b>		
Armrest Male Socket for Flip-Back Arms-Left		AL-70071L	\$12.95	
Armrest Male Socket for Flip-Back Arms-Right		AL-70071R	\$12.95	
5B		Flip-back Attachment Bracket	AL-70072	\$9.95
5C		Spring-Button Lock Mechanism	AL-70073	\$6.95
5D		H-Blocks / Arm Female Sockets Left	AL-70074L	\$15.95
		H-Blocks / Arm Female Sockets Right	AL-70074R	\$15.95
5E		Side Panel, Desk Length. Fits Removable Desk 20-24" and Flip Back Desk Arms 20-24"	AL-70075	\$18.95
		Side Panel, Full Length. Fits Removable Full (20-24") and Flip Back Full Arm (20")	AL-70076	\$18.95
		Side Panel, Full Length. Fits Flip Back Full Arms (22-24")	AL-70030	\$18.95

\*Armrest Upholstery Available in Blue (BL), Black (BK) or Burgundy (BU)  
16-3/4" on centers; fits 7/8" Dia Tube

**When Ordering Replacements Specify Left  
or Right As You Are Sitting In Chair**



# ALCO Comfort Classic Folding Solid Seat Wheelchair Parts Breakdown for 20" 22" & 24"

**BUY 11 GET 1 FREE!**

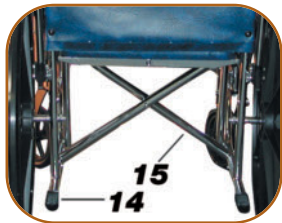
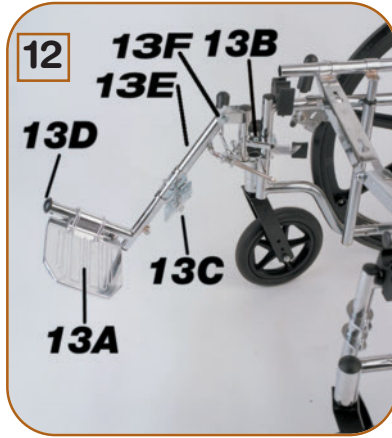
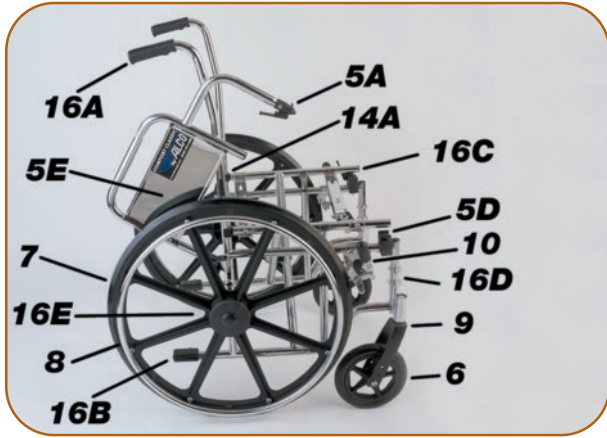

Single X-Brace  
20" Wide

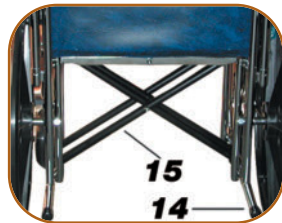

Double X-Brace  
22" to 24" Wide



6 x 2 Front Caster Wheel  
(lowers seat 2" on 22-24"  
Models only)

AL-64691 \$21.95 Ea.



AW3

Fig.	Description	ALCO Part No.	Price Each
6	<b>Wheels &amp; Wheel Parts</b>		
	<b>Front Caster Wheels—Soft</b>		
	8" x 1" for 20" Wide	AL-70077	\$10.00
	8" x 2" for 22" & 24" Wide	AL-70078	\$14.00
6	<b>Front Caster Wheels—Hard</b>		
	8" x 1" for 20" Wide	AL-65562	\$14.00
	8" x 2" for 22" & 24" Wide	AL-65563	\$34.00
7	<b>Rear Wheels w/Handrim &amp; Bearings</b>		
	20" Wide	AL-70079	\$89.00
	22" & 24" Wide	AL-70080	\$85.95
7	Snap-On Replacement Tire	AL-50165	\$23.95
	8	<b>Handrim</b>	
Chrome Handrim with Attaching Hardware		AL-70081C	\$19.95
N/S	<b>Axles</b>		
	Front Caster Axle for 20" Wide	AL-70082	\$14.95
	Front Caster Axle for 22" & 24" Wide	AL-70083	\$14.95
	20" Wide Rear Axle	AL-66957	\$14.95
	22" & 24" Wide Rear Axle	AL-67050	\$15.95
N/S	<b>Replacement Bearing</b>		
	Front Fork Stem Bearings for 20", 22" & 24" Wide	AL-54873	\$3.95
	Front Caster Bearings	AL-66977	\$7.95
	20" Wide Rear Wheel Bearings	AL-54878	\$6.95
9	22" & 24" Wide Rear Wheel Bearings	AL-70089	\$5.95
	<b>Forks</b>		
9	20" Wide	AL-70090-14	\$39.95
	22" & 24" Wide	AL-70090-22	\$39.95
10	<b>Wheel Locks</b>		
	Push-To-Lock, Flip-Back and Removable Arm Chairs, Left	AL-45575	\$13.95
	Push-To-Lock, Flip-Back and Removable Arm Chairs, Right	AL-45574	\$13.95
	Wheel Locks, Set	AL-76050	\$25.95
10	Wheel Lock Rubber Tips (Black)	AL-70094	\$3.95
	11	<b>Footrests, Legrests &amp; Parts</b>	
<b>Footrest Assembly</b>			
11	Footrest, (Pair)	AL-70043	\$39.00

Fig.	Description	ALCO Part No.	Price Each	
12	<b>Elevating Legrest Assembly</b>			
	Legrest, Right	AL-70097	\$59.95	
	Legrest, Left	AL-70098	\$59.95	
12	Legrest, Pair	AL-64694	\$99.95	
	13A	<b>Front Rigging Parts</b>		
		Chrome Footplate	AL-64218	\$19.95
13A	Tension Springs for Footplate	AL-2292	\$1.95	
	Heel Loops w/Attaching Hardware (Pair)	AL-316	\$10.95	
	Ratchet "L" Bar Only (with teeth) Left	AL-71866L	\$7.95	
	Ratchet "L" Bar Only (with teeth) Right	AL-71866R	\$7.95	
13B	Camlock Clip, Legrest, Right (w/o Spring)	AL-70101	\$15.95	
	Camlock Clip, Legrest, Left (w/o Spring)	AL-70102	\$15.95	
	Camlock Clip, Footrest, Right	AL-67066	\$8.95	
13B	Camlock Clip, Footrest, Left	AL-67067	\$8.95	
	13C	Legrest Panel Hardware	AL-443	\$18.95
13D	Footplate Bumper (Black)	AL-70104	\$3.95	
13E	Ratchet Handle Tip (Black)	AL-70105	\$6.95	
13F	Pivot Bolt	AL-77170	\$4.95	
14	<b>Frames</b>			
	20" Wide Side Frame, Left	AL-70106	Call	
	20" Wide Side Frame, Right	AL-70107	Call	
	22"-24" Wide Side Frame, Left	AL-70108	Call	
	22"-24" Wide Side Frame, Right	AL-70109	Call	
14A	Seat Rail Guides	AL-76194	\$3.95	
	Telescoping Tubes - 20" Wide	AL-67044	\$15.95	
14A	Telescoping Tube - 22" - 24" Wide	AL-67070	\$17.95	
15	<b>Crossbraces</b>			
	20" Wide (Pair)	AL-70113	\$79.00	
	22" Wide (Pair)	AL-70114	\$79.00	
15	24" Wide (Pair)	AL-70115	\$89.00	
16A	<b>Tips, Grips &amp; Miscellaneous Parts</b>			
	Hand Grips	AL-70116	\$1.95	
16B	Tipping Sleeves for Back Canes			
	20" Wide Only	AL-70117	\$4.95	
16C	Rear End Cap For Back Cane			
	22" - 24" Wide	AL-1742B	\$1.95	
16C	Seat Rail Tube Plugs			
16C	20", 22" & 24" Wide	AL-231B	\$0.95	
16D	Stem (Dust) Caps	AL-70120	\$4.95	
16E	Hub Cap Fits 22" & 24"	AL-70121	\$4.95	

# ALCO<sup>®</sup>

Sales & Service Co.

6851 High Grove Blvd.  
 Burr Ridge, IL 60527  
 Phone: 800-323-4282  
 Phone: 630-655-1900  
 Fax: 800-950-1167  
 Fax: 630-655-1990  
 www.alcosales.com  
 info@alcosales.com

## Hours

Monday - Friday  
 8:00 a.m. - 4:30 p.m.  
 Central Time

©Copyright 2015-2016  
 ALCO Sales & Service Co.  
 Printed in U.S.A.

PRSR STD  
 U.S. Postage Paid  
 ALCO Sales  
 & Service Co.

- Administrator
- Admitting Department
- Bio-Med or Clinical Eng.
- Central Supply - SPD
- Emergency Room
- Hemodialysis Dept.
- Housekeeping
- Maintenance/Engineering
- Materials Management
- Nursing Dept. Director
- Occupational Therapy
- OR/Recovery
- Patient Transportation
- Physical Therapy
- Purchasing Dept.
- Receiving
- Risk Management
- Supply Product Distribution
- Wheelchair Department

## 2015-2016 ALCO Classic Wheelchairs Catalog - AW3

PLEASE FORWARD TO PROPER PERSON

PRICES AND SPECIFICATIONS SUBJECT TO CHANGE WITHOUT NOTIFICATION - PRICES BASED ON U.S. CURRENCY - PLUS FREIGHT OR FREE PICK-UP AT OUR BURR RIDGE, IL LOCATION

### Models:



Solid Seat



700



300



300E



Flip-Back



Recliner



ALCO's  
 Classic 500  
 Wheelchair

Up to 30" Wide  
 Seat & 700 lb.  
 weight capacity!

#### Extended Warranty

Frame & Crossbraces: Lifetime  
 Components: 5 years

**SAFETY FIRST**

Removable & locking  
 full arms for patient safety  
 & easy transfer

Phone: 800-323-4282  
 Fax: 800-950-1167

**ALCO<sup>®</sup>**  
 Sales & Service Co.

info@alcosales.com  
 www.alcosales.com