

# ROCAST

## Capitolul 2

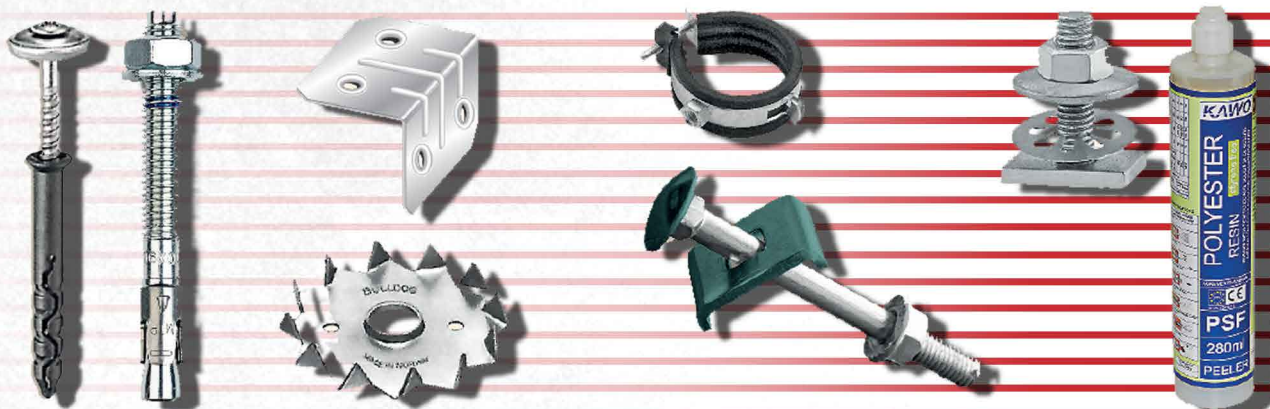

















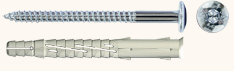

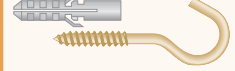

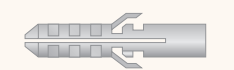

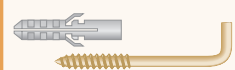



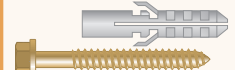



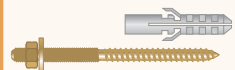

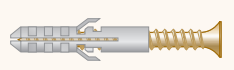

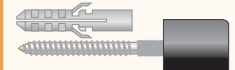

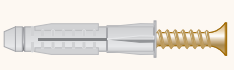

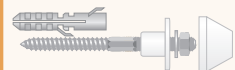

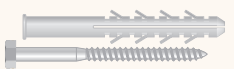



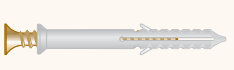







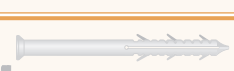













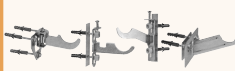





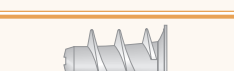



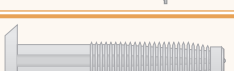



# Sisteme de fixare



















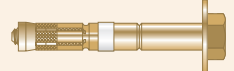

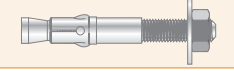

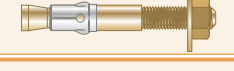



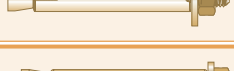







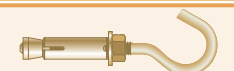

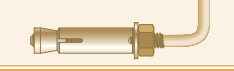
2015 - 2016











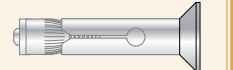







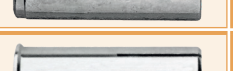



# Sisteme de fixare

Fixări cu dibluri			pag.	Fixări cu dibluri			pag.
		Set diblu din nailon și holzşurub cu cap teșit, certificare ETA-CE	2.2			Seturi de fixare "INDEX"	2.6
		Set diblu din nailon și holzşurub cu cap hexagonal, certificare ETA-CE	2.2			Set de fixare "Ochi" diblu standard + holzşurub "Ochi"	2.6
		Set diblu din nailon și holzşurub cu cap bombat, oțel zincat, certificare ETA-CE	2.2			Set de fixare "Cârlig" diblu standard + holzşurub "Cârlig"	2.6
		Dibluri standard (Eurodiblu)	2.3			Set de fixare "L" diblu standard + holzşurub "L"	2.6
		Dibluri multiscop	2.3			Seturi de fixare "HEX" diblu standard + holzşurub cu cap hexagonal și șaibă	2.7
		Dibluri pentru fixări grele	2.3			Seturi de fixare "Prezon" diblu standard + prezon pentru lemn	2.7
		Combinatii standard (diblu standard + holzşurub)	2.3			Opritoare pentru ușă	2.7
		Combinatii multiscop (diblu multiscop + holzşurub)	2.3			Seturi de fixare pentru obiecte sanitare	2.7
		Combinatii pentru fixări grele (diblu pentru fixări grele + holzşurub DIN 571)	2.3			Dibluri pentru izolație	2.7
		Combinatii pentru construcții (diblu + holzşurub)	2.4			Suporturi pentru izolație	2.8
		Combinatii pentru fixări adânci (diblu + holzşurub)	2.4			Rondelă suport din polietilenă	2.8
		Combinatii HEX lungi	2.4			Set diblu - suporturi pentru calorifere	2.8
		Combinatii pentru fixare rapidă diblu+cui (Nageldübel)	2.4			Suporturi pentru calorifere din aluminiu	2.8
		Combinatii "INDEX" pentru fixare rapidă	2.5			Seturi de suporturi pentru calorifere din aluminiu	2.8
		Seturi de fixare "Spitz"	2.5			Fixări basculante pentru plăci	2.8
		Diblu pentru gips carton	2.5			Fixări pentru plăci, cu clape și arc	2.8
		Diblu "Skorpion" cu cap plat	2.5			Dibluri metalice autoforante	2.9
		Diblu "Skorpion" pentru cabluri	2.5			Dibluri metalice	2.9
		Dibluri pentru plăci	2.6			Dibluri metalice de expansiune	2.9
		Isodibluri	2.6			Pistol pentru dibluri de expansiune	2.9
		Dibluri și combinații în cutii de plastic refozibile	2.6			Clește pentru dibluri de expansiune	2.9



# Sisteme de fixare



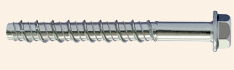

Fixări tip conexpand		pag.	
		Conexpand bolt, oțel zincat, omologat, certificare ETA-CE opțiunea 1, pentru beton fisurat și nefisurat	2.11
		Conexpand bolt, oțel zincat, omologat, certificare ETA-CE opțiunea 7, pentru beton nefisurat	2.11
		Conexpand bolt, inox A4 omologat, certificare ETA-CE opțiunea 7, pentru beton nefisurat	2.12
		Conexpand, oțel zincat, pentru încărcări grele, omologat, certificare ETA-CE opțiunea 7, pentru beton nefisurat	2.12
		Conexpand bolt din oțel inoxidabil A2	2.12
		Conexpand bolt standard cu inel de strângere din oțel zincat alb	2.13
		Conexpand clasic	2.14
		Conexpand de străpungere, tip 1	2.14
		Conexpand de străpungere, tip 8	2.15
		Conexpand pentru fixări distanțate	2.15
		Conexpand cu șurub, tip 2	2.15
		Conexpand "Ochi"	2.15
		Conexpand "Cârlig"	2.15
		Conexpand "L"	2.16
		Conexpand inviolabil cu șurub	2.16
		Conexpand inviolabil cu cap țeșit	2.16
		Conexpand inviolabil cu cap sferic	2.16
		Conexpand cu șurub cap înecat	2.16

Fixări tip conexpand		pag.	
		Conexpand cu șurub cap înecat, oțel inoxidabil A2	2.16
		Conexpand cu șurub, oțel zincat	2.17
		Conexpand cu șurub, oțel inoxidabil A2	2.17
		Conexpand ochi forjat, oțel inoxidabil A2	2.17
		Conexpand cârlig forjat, oțel inoxidabil A2	2.17
		Capsulă conexpand, oțel zincat	2.17
		Capsulă conexpand, oțel inoxidabil A2	2.17
		Piulițe expandabile din oțel zincat, omologate, cu certificare ETA-CE opțiunea 7 pentru beton nefisurat	2.18
		Piulițe expandabile din oțel zincat, pentru beton	2.18
		Piulițe expandabile cu guler, din oțel, omologat, certificare ETA-CE opțiunea 7 pentru beton nefisurat	2.18
		Piulițe expandabile din oțel inoxidabil, pentru beton	2.18
		Piulițe expandabile din alamă pentru marmură, gresie sau beton	2.18
		Dorn de expandare pentru piulițe expandabile	2.18
		Cui expandabil "Expres"	2.18
		Ancore standard	2.19
		Ancore din nailon	2.19
		Ancore pentru cavități	2.19
		Ancore tip "Cui"	2.19

Șuruburi pentru panouri de gard din plasă metalică		pag.	
		Șurub de gard model SG, oțel zincat	2.20















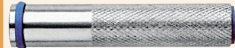























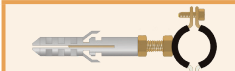



















Șuruburi pentru panouri de gard din plasă metalică		pag.	
		Șurub de gard model SG, oțel zincat, capul și cleva vopsite verde	2.20

Șuruburi pentru beton		pag.	
		Șurub cu cap hexagonal, oțel zincat, omologat cu certificare ETA-CE, opțiunea 1 pentru beton fisurat și nefisurat	2.22
		Prezcon cu șaibă și piuliță, oțel zincat, omologat, certificare ETA-CE, opțiunea 1 pentru beton fisurat și nefisurat	2.22





















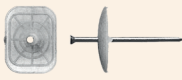





Șuruburi pentru beton		pag.	
		Șurub cu cap țeșit, oțel zincat, omologat, certificare ETA-CE, opțiunea 1 pentru beton fisurat și nefisurat	2.22
		Șurub cu cap hexagonal, pentru beton, oțel zincat	2.22



## Sisteme de fixare











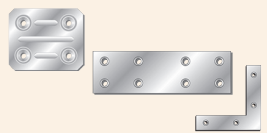

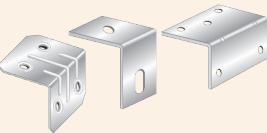
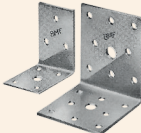

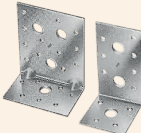
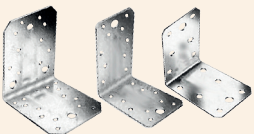



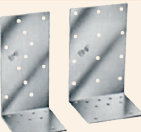

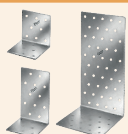

Fixări chimice			pag.	Fixări chimice			pag.
		Fiole SVA	2.24			Manșoane din sită metalică, L = 1 m	2.30
		Fiole SHP	2.25			Manșoane de injecție cu filet interior, oțel zincat	2.30
		Cartușe de injecție KAWO-PSF	2.28			Pistoale de injecție	2.30
		Cartușe de injecție KAWO-VSF	2.29			Pompă de curățare	2.30
		Cartușe de injecție SVM-VSF	2.30			Cap de cartuș (duză de amestecare)	2.30
		Manșoane din material plastic, cu căpăcel	2.30			Prezoane pentru fixări chimice	2.32
Suportți pentru țevi și cabluri			pag.	Suportți pentru țevi și cabluri			pag.
		Coliere standard	2.33			Colier rapid ușor cu protecție de cauciuc	2.35
		Coliere standard cu protecție de cauciuc	2.33			Colier dublu orizontal	2.35
		Set colier pentru gaze + diblu Ø10 x 50 mm	2.33			Colier dublu orizontal cu protecție de cauciuc	2.35
		Set colier standard + diblu Ø10 x 50 mm	2.33			Colier pentru montaj dublu vertical	2.35
		Set colier standard cu protecție de cauciuc + diblu Ø10 x 50 mm	2.33			Colier tip 30	2.35
		Colier ușor	2.33			Colier tip 22	2.35
		Colier greu	2.34			Colier tip 32	2.35
		Colier M6 pentru țevi de cupru, fără șurub	2.34			Colier "U" pentru țevi	2.36
		Colier greu cu protecție de cauciuc	2.34			Coliere pentru furtun	2.36
		Colier ranforsat fără protecție	2.34			Colier pentru furtun de înaltă presiune	2.36
		Colier ranforsat cu protecție de cauciuc	2.34			Bridă ușoară rapidă	2.37
		Colier special cu protecție de cauciuc	2.34			Bridă ușoară 1 x D	2.37
		Colier rapid standard cu protecție de cauciuc	2.35			Bridă ușoară 2 x D	2.37
		Colier rapid greu cu protecție de cauciuc	2.35			Bridă ușoară 3 x D	2.37

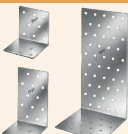
# Sisteme de fixare

Suporturi pentru țevi și cabluri		pag.	Suporturi pentru țevi și cabluri		pag.		
ROCAST		Bridă ușoară 4 x D	2.37	INDEX		Suport clip dublu cu bază, cu prefilet M6, polipropilenă gri	2.42
ROCAST		Bridă standard rapidă	2.37	INDEX		Suport clip universal, polipropilenă	2.42
ROCAST		Bridă de reținere standard	2.37			Console pentru aer condiționat	2.42
ROCAST		Bridă standard	2.37	RANIT		Suport multiplu pentru cabluri	2.43
ROCAST		Suport individual cu fixare dublă	2.37	RANIT		Suport "Clip" pentru cabluri	2.43
ROCAST		Suport individual cu fixare triplă	2.37			Clipsuri	2.43
INDEX		Șine de montaj perforate	2.39	HSK SCHULTE GRENZ		Suport "Clemfix" pentru cabluri	2.43
INDEX		Console suport	2.39	RANIT		Suport plat pentru cabluri	2.43
INDEX		Suporturi de șină	2.39	RANIT		Colier multiplu pentru cabluri	2.43
INDEX		Plăcuțe de fixare	2.39			Suport "Fix Ring" simplu	2.43
INDEX		Bride	2.39			Suport "Fix Ring" dublu	2.43
INDEX		Șaibe dreptunghiulare	2.40			Suport "Skorpion" simplu	2.43
INDEX		Prezoane sudate	2.40			Suport "Skorpion" dublu	2.43
INDEX		Placă unghiulară de legătură	2.40	ROCAST		Suport "Fix" simplu pentru țevi și cabluri - bandă 20 x 1.5 mm	2.44
INDEX		Placă de suspendare	2.40	ROCAST		Suport "Fix" dublu pentru țevi și cabluri - bandă 20 x 1.5 mm	2.44
ROCAST		Suport de susținere "V"	2.40	RANIT		Suporturi "Clip" pentru țevi, din polipropilenă	2.44
INDEX		Suporturi cu gaură lisă (Ø) / filetată metric (M), pentru prindere pe grindă	2.40	RANIT		Suporturi "Clip" pentru fixare pe tablă	2.44
INDEX		Suport clip simplu pentru șină 20 mm, nailon 6.6	2.42	RANIT		Suporturi "Clip" pentru fixare pe gips carton	2.44
INDEX		Suport clip dublu pentru șină 20 mm, nailon 6.6	2.42	ROCAST		Bandă de montaj, role de 10 m în casetă din PVC	2.44
INDEX		Suport clip simplu cu bază, cu prefilet M6, polipropilenă gri	2.42	ROCAST		Bandă de montaj, role de 10 m, fără casetă	2.44



## Sisteme de fixare

Elemente de fixare pentru structuri din lemn			pag.	Elemente de fixare pentru structuri din lemn			pag.
<b>ROCAST</b>		Plăcuțe	2.45	<b>SIMPSON</b> <b>Strong-Tie</b>		Legături de colț 40930	2.47
<b>ROCAST</b>		Colțare	2.45	<b>SIMPSON</b> <b>Strong-Tie</b>		Legături de colț 35350 - 55365	2.48
<b>ROCAST</b>		Colțare cu nervură	2.46	<b>SIMPSON</b> <b>Strong-Tie</b>		Legături de colț 90 x 48 x 3.0 x 48 / 76 / 116	2.48
<b>ROCAST</b>		Colțare drepte	2.46	<b>SIMPSON</b> <b>Strong-Tie</b>		Legături de colț 40312 - 40412 - 40314 - 40414	2.48
<b>ROCAST</b>		Piese "Z"	2.46	<b>SIMPSON</b> <b>Strong-Tie</b>		Legături de colț 90 x 35 x 2.5 x 40 - 160 x 50 x 3.0 x 40	2.48
<b>ROCAST</b>		Papuci de fixare	2.46	<b>SIMPSON</b> <b>Strong-Tie</b>		Legături de colț 60416 - 80416 - 99416	2.48
<b>ROCAST</b>		Colțar metalic universal (Euro-colțar)	2.46	<b>SIMPSON</b> <b>Strong-Tie</b>		Legături de colț 40 x 40 x 2.0 x 25 / 40 x 60 x 2.0 x 25 / 60 x 60 x 2.0 x 25	2.49
<b>ROCAST</b>		Colțar de legătură pentru picioare de masă	2.46	<b>SIMPSON</b> <b>Strong-Tie</b>		Legături de colț din tablă perforată 2.0 mm	2.49
<b>ROCAST</b>		Placă "DEMONTABIL" pentru pat	2.46	<b>SIMPSON</b> <b>Strong-Tie</b>		Legături de colț din tablă perforată 2.5 mm	2.49
<b>ROCAST</b>		Colțar "DEMONTABIL" pentru pat	2.46	<b>SIMPSON</b> <b>Strong-Tie</b>		Legături de colț pentru beton	2.49
<b>SIMPSON</b> <b>Strong-Tie</b>		Legături de colț fără nervură	2.47	<b>SIMPSON</b> <b>Strong-Tie</b>		Consolă	2.50
<b>SIMPSON</b> <b>Strong-Tie</b>		Legături de colț cu nervură	2.47	<b>SIMPSON</b> <b>Strong-Tie</b>		Papuci de grindă exteriori	2.50
<b>SIMPSON</b> <b>Strong-Tie</b>		Legături de colț 6090 - 6191	2.47	<b>SIMPSON</b> <b>Strong-Tie</b>		Papuci de grindă interiori	2.50

# Sisteme de fixare

Elemente de fixare pentru structuri din lemn		pag.	Elemente de fixare pentru structuri din lemn		pag.		
<b>SIMPSON</b> Strong-Tie		Papuci de grindă BSD	2.50	<b>SIMPSON</b> Strong-Tie		Piesă de îmbinare pt. grindă articulată "W"	2.53
<b>SIMPSON</b> Strong-Tie		Papuci de grindă BSDI	2.50	<b>SIMPSON</b> Strong-Tie		Ancoră pentru beton	2.53
<b>SIMPSON</b> Strong-Tie		Papuci de grindă reglabili pe 2 părți	2.51	<b>SIMPSON</b> Strong-Tie		Ancoră "H"	2.53
<b>SIMPSON</b> Strong-Tie		Piese de susținere pentru grindă	2.51	<b>SIMPSON</b> Strong-Tie		Șaibe "U"	2.53
<b>SIMPSON</b> Strong-Tie		Piese de legătură căprior - talpă	2.51	<b>SIMPSON</b> Strong-Tie		Papuci de reazem	2.54
<b>SIMPSON</b> Strong-Tie		Papuci de căprior "B"	2.51	<b>SIMPSON</b> Strong-Tie		Papuci de reazem reglabili	2.55
<b>SIMPSON</b> Strong-Tie		Papuci de căprior "H"	2.51	<b>SIMPSON</b> Strong-Tie		Ancoră "U" cu placă de bază	2.57
<b>SIMPSON</b> Strong-Tie		Plăci perforate	2.52	<b>SIMPSON</b> Strong-Tie		Ancoră de stâlp "H"	2.57
<b>SIMPSON</b> Strong-Tie		Plăci perforate de 2.0 și 2.5 mm	2.52	<b>SIMPSON</b> Strong-Tie		Ancoră de stâlp "HB"	2.57
<b>SIMPSON</b> Strong-Tie		Plăci perforate de montaj	2.52	<b>SIMPSON</b> Strong-Tie		Picioare de stâlp pentru batere	2.57
<b>SIMPSON</b> Strong-Tie		Benzi de contravântuire	2.52	<b>SIMPSON</b> Strong-Tie		Cuie crestate - DIN 1052	2.58
<b>SIMPSON</b> Strong-Tie		Unealtă de tensionare	2.52	<b>SIMPSON</b> Strong-Tie		Cuie căprior - DIN 1052	2.58
<b>SIMPSON</b> Strong-Tie		Piesă de îmbinare pt. grindă articulată "B"	2.53	<b>SIMPSON</b> Strong-Tie		Șaibe "BULLDOG"	2.58



## Sisteme de fixare

Cuie			pag.	Cuie			pag.
		Cuie pentru beton	2.59			Cuie spiralate, zincate	2.59
		Cuie cu saibă Ø15 mm, pentru beton	2.59			Cuie pentru rame, tratate termic, zincate	2.59
		Cuie "L" pentru beton	2.59			Cuie "Super" tratate termic	2.59
		Cuie bolț filetate	2.59			Cuie ornamentale colorate	2.59
		Cuie bolț standard	2.59			Agățători pentru tablouri	2.59
		Cuie striate, zincate	2.59				
Accesorii pentru armarea betonului			pag.	Accesorii pentru armarea betonului			pag.
		Distanțier "Clampfix"	2.60			Distanțier tubular din PVC	2.60
		Distanțier "Multifix"	2.60			Con de fixare	2.60
		Distanțier "Unifix"	2.60			Profil triunghiular	2.60
		Distanțier "Minifix"	2.60			Dop din PVC	2.60
Accesorii pentru construcții			pag.	Accesorii pentru construcții			pag.
		Ochi de blocare tip 1 DIN 5299, oțel zincat	2.61			Întinzătoare comerciale ochi - ochi, oțel zincat	2.62
		Ochi de blocare tip 2 DIN 5287, oțel nichelat	2.61			Întinzătoare comerciale cârlig - cârlig, oțel zincat	2.62
		Ochi de blocare tip 3 DIN 5299, oțel zincat	2.61			Întinzătoare comerciale cârlig - ochi, oțel inoxidabil	2.62
		Ochi de blocare tip 4, oțel zincat	2.61			Întinzătoare comerciale ochi - ochi, oțel inoxidabil	2.62
		Ochi de ridicare - verigă "D", tip comercial, oțel zincat	2.61			Întinzătoare comerciale cârlig - cârlig, oțel inoxidabil	2.62
		Ochi de ridicare - verigă arc, tip comercial, oțel zincat	2.61			Cleme de presare standard, EN 13411-3	2.62
		Ochi de ridicare - verigă "D", bolț filetat, oțel zincat la cald	2.61			Clipsuri pentru cabluri de tracțiune	2.62
		Ochi de ridicare - verigă "D", DIN 82101, oțel zincat	2.61			Ochi de cablu, DIN 6899	2.62
		Ochi lanț, oțel zincat	2.62			Cleme simple pentru cabluri metalice de tracțiune	2.63
		Întinzătoare de fir, oțel cromat galben	2.62			Cleme duble pentru cabluri metalice de tracțiune	2.63
		Întinzătoare comerciale cârlig - ochi, oțel zincat	2.62			Palane cu o roată din nailon, oțel zincat	2.63

# Sisteme de fixare

Accesorii pentru construcții			pag.	Accesorii pentru construcții			pag.
		Palane cu două roți din nailon, oțel zincat	2.63			Balamale pentru sudare, oțel	2.65
		Carabine tip 1, oțel nichelat	2.63			Balamale cu arc	2.65
		Carabine tip 2, oțel nichelat	2.63			Amortizor pneumatic pentru ușă	2.66
		Carabine tip 3, oțel nichelat	2.63			Opritor de ușă din inox, pentru podea	2.66
		Carabine tip 4, DIN 5287, oțel nichelat	2.63			Opritor de ușă, cap rotund, pentru podea	2.66
		Ochi de legătură, oțel nichelat	2.63			Zăvor de ușă	2.66
		Vizoare din alamă, Ø14 mm	2.64			Zăvoare aplicate, cu piedică, oțel zincat, pentru uși	2.66
		Rozete obturatoare din alamă pentru vizoare	2.64			Zăvoare aplicate, cu tijă dreaptă, oțel zincat, pentru uși	2.66
		Lanțuri din alamă pentru ușă	2.64			Zăvoare pentru mobilier, alamă nichelată	2.66
		Lanțuri din oțel cu încuietore pentru ușă	2.64			Zăvoare pentru mobilier, alamă lustruită	2.66
		Siguranțe pentru ușă	2.64			Șine de glisare	2.66
		Cilindrii de siguranță Euro Kraft, 30-30 mm	2.64			Console din oțel presat, alb lăcuit	2.66
		Rozetă pentru cilindrii de siguranță	2.64			Colier de întindere	2.67
		Cârlig de vânt pentru ferestre, galvanizat	2.64			Întinzător de fir	2.67
		Lacăte KRAFT	2.64			Șurub de tensionare	2.67
		Balamale aplicate pentru uși	2.64			Dop pentru garduri	2.67
		Balamale bandă	2.65			Colier pentru garduri	2.67
		Balamale cu știft, oțel zincat	2.65			Capac de fixare pentru garduri	2.67
		Balamale speciale 3 mm, oțel zincat	2.65			Lanțuri standard, zale scurte, tip 766, zincate	2.67
		Balamale aruncătoare 95°, oțel nichelat	2.65			Lanțuri standard, zale lungi, tip 763, zincate	2.67
		Balamale semiîngropate pentru uși și ferestre	2.65			Cabluri zincate	2.68
		Balamale stil cu 2 tije, pentru mobilă	2.65			Cabluri zincate acoperite cu PVC transparent	2.68
		Balamale cilindrice cu 2 tije, pentru mobilă	2.65			Cabluri inox	2.68



ROCAST oferă o gamă largă de elemente și sisteme de fixare care permit practic soluționarea oricărei probleme de fixare.

Pentru obținerea rezultatelor optime se impune o alegere atentă a soluției de fixare.

## Dibluri



**RANIT®**

Se utilizează pentru beton și pentru zidărie.  
Pentru zidărie cu goluri sau BCA sunt recomandate diblurile multiscop.  
Fixările rapide, cunoscute și sub denumirea de "dibluri cui" (Nageldübel) sunt recomandate în lucrările în care se dorește o fixare de calitate cu costuri reduse ale manoperei.  
Fixările adânci se utilizează pentru pereți din cărămidă cu goluri sau cu un strat gros de tencuială.

Pentru utilizări de foarte mare siguranță se recomandă fixările cu dibluri TECFI care sunt certificate ETA (European Technical Approval).



## Conexpanduri



**ROCAST**

Se utilizează pentru fixări în beton. Calitatea betonului influențează decisiv calitatea fixării.  
Utilizarea conexpandurilor este recomandată pentru fixări mai grele decât cele suportate de dibluri.

Pentru utilizări de foarte mare siguranță se recomandă conexpandurile TECFI și INDEX care sunt certificate ETA (European Technical Approval).



## Șuruburi pentru beton



Se utilizează pentru fixări în beton. Calitatea betonului influențează decisiv calitatea fixării.  
Este o fixare sigură cu costuri relativ scăzute.

Pentru utilizări de foarte mare siguranță se recomandă șuruburile pentru beton TECFI care sunt certificate ETA (European Technical Approval).



## Fixări chimice



Se utilizează atât pentru beton cât și pentru zidărie.  
Se obțin fixări de foarte mare siguranță, mult superioară celei obținute cu alte tipuri de fixări.  
În multe cazuri fixările chimice sunt mai ieftine și mai sigure decât fixările tradiționale.

Toate fixările chimice sunt certificate ETA (European Technical Approval).



Seturi de fixare "HandyPlug", certificate ETA-CE, cu dibluri speciale din nailon și holzșuruburi cu locaș Torx

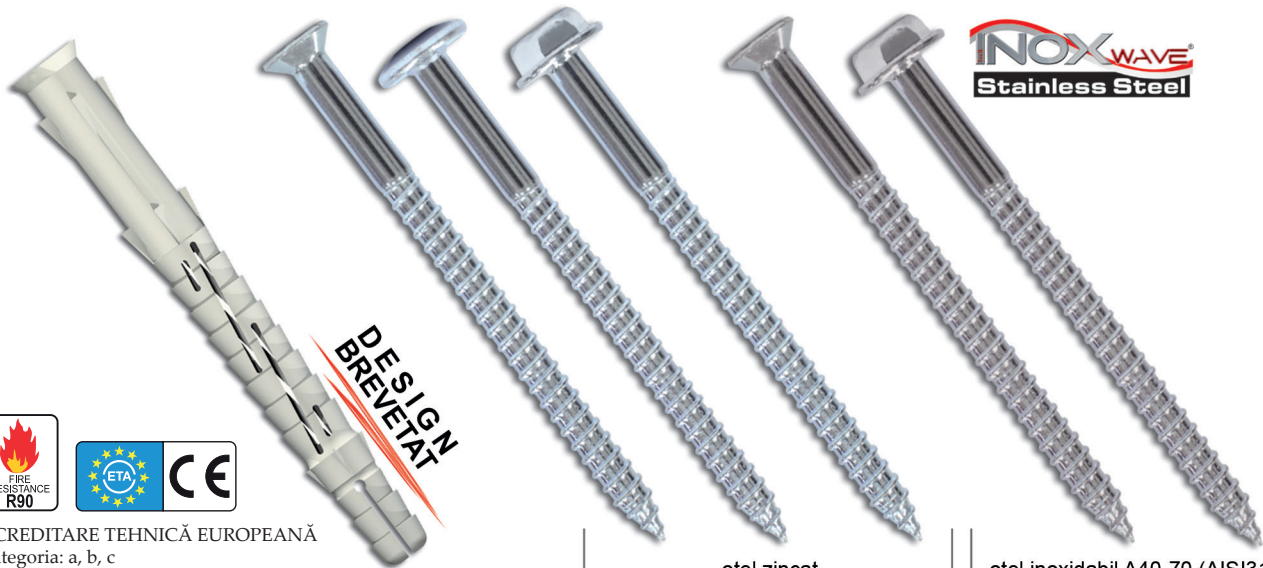

ACREDITARE TEHNICĂ EUROPEANĂ  
Categorii: a, b, c  
ETA-13/0135 - ETAG 020

oțel zincat

oțel inoxidabil A40-70 (AISI316)

## Seturi de fixare "HandyPlug" cu dibluri speciale din nailon și holzșuruburi cu locaș Torx



### Set diblu din nailon și holzșurub cu cap teșit, certificare ETA-CE

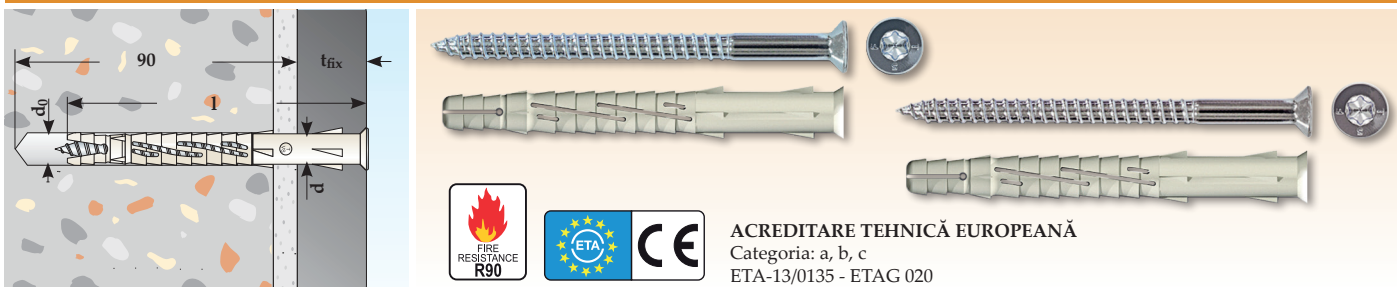

ACREDITARE TEHNICĂ EUROPEANĂ

Categoria: a, b, c

ETA-13/0135 - ETAG 020

Dimensiuni (mm)					oțel zincat						oțel inoxidabil A4-70 (AISI 316)		
diblu d x l	fixare		șurub ds x ls	T	ambalare STANDARD			ambalare la BLISTER			ambalare STANDARD		
	d0	tfix			buc./pac.	€/100 buc.	Cod articol	buc/blister	€/blister	Cod articol	buc./pac.	€/100 buc.	Cod articol
8 x 80	8	10	6 x 85	T30	100	17.83	T.VS1108080S	-	-	-	100	74.80	T.VS1308080S
8 x 100	8	30	6 x 105	T30	100	20.48	T.VS1108100S	4	0.94	T.VS1108100B	100	84.86	T.VS1308100S
8 x 120	8	50	6 x 125	T30	100	26.58	T.VS1108120S	-	-	-	100	99.01	T.VS1308120S
8 x 140	8	70	6 x 145	T30	50	36.28	T.VS1108140S	4	1.57	T.VS1108140B	50	141.20	T.VS1308140S
10 x 80	10	10	7 x 85	T40	50	23.29	T.VS1110080S	-	-	-	50	107.95	T.VS1310080S
10 x 100	10	30	7 x 105	T40	50	29.10	T.VS1110100S	-	-	-	50	119.81	T.VS1310100S
10 x 120	10	50	7 x 125	T40	50	34.93	T.VS1110120S	-	-	-	50	123.79	T.VS1310120S
10 x 140	10	70	7 x 145	T40	50	39.63	T.VS1110140S	-	-	-	50	158.35	T.VS1310140S
10 x 160	10	90	7 x 165	T40	50	48.04	T.VS1110160S	4	2.04	T.VS1110160B	50	202.26	T.VS1310160S
10 x 200	10	130	7 x 205	T40	50	63.20	T.VS1110200S	4	2.65	T.VS1110200B	50	256.85	T.VS1310200S
10 x 230	10	160	7 x 235	T40	25	107.56	T.VS1110230S	-	-	-	25	284.98	T.VS1310230S

### Set diblu din nailon și holzșurub cu cap hexagonal, certificare ETA-CE



ACREDITARE TEHNICĂ EUROPEANĂ

Categoria: a, b, c

ETA-13/0135 - ETAG 020

Dimensiuni (mm)					oțel zincat						oțel inoxidabil A4-70 (AISI 316)		
diblu d x l	fixare		șurub ds x ls	T	ambalare STANDARD			ambalare la BLISTER			ambalare STANDARD		
	d0	tfix			buc./pac.	€/100 buc.	Cod articol	buc/blister	€/blister	Cod articol	buc./pac.	€/100 buc.	Cod articol
8 x 80	8	10	6 x 85	T30	100	20.04	T.VS3108080S	-	-	-	100	84.13	T.VS3308080S
8 x 100	8	30	6 x 105	T30	100	24.46	T.VS3108100S	4	1.10	T.VS3108100B	100	104.36	T.VS3308100S
8 x 120	8	50	6 x 125	T30	100	30.60	T.VS3108120S	-	-	-	100	126.59	T.VS3308120S
8 x 140	8	70	6 x 145	T30	50	39.31	T.VS3108140S	4	1.69	T.VS3108140B	50	164.17	T.VS3308140S
10 x 80	10	10	7 x 85	T40	50	27.42	T.VS3110080S	-	-	-	50	120.17	T.VS3310080S
10 x 100	10	30	7 x 105	T40	50	33.98	T.VS3110100S	-	-	-	50	129.05	T.VS3310100S
10 x 120	10	50	7 x 125	T40	50	37.48	T.VS3110120S	-	-	-	50	145.72	T.VS3310120S
10 x 140	10	70	7 x 145	T40	25	48.03	T.VS3110140S	-	-	-	25	171.36	T.VS3310140S
10 x 160	10	90	7 x 165	T40	25	57.46	T.VS3110160S	4	2.42	T.VS3110160B	25	203.95	T.VS3310160S
10 x 200	10	130	7 x 205	T40	25	71.87	T.VS3110200S	4	2.99	T.VS3110200B	25	307.42	T.VS3310200S
10 x 230	10	160	7 x 235	T40	25	119.16	T.VS3110230S	-	-	-	25	354.07	T.VS3310230S

### Set diblu din nailon și holzșurub cu cap bombat, oțel zincat, certificare ETA-CE



ACREDITARE TEHNICĂ EUROPEANĂ

Categoria: a, b, c

ETA-13/0135 - ETAG 020

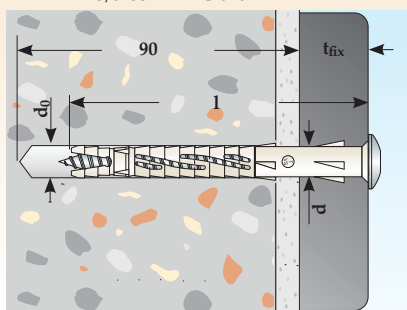
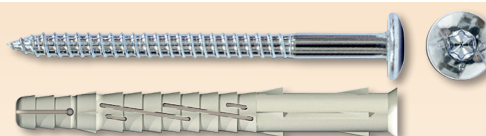

Dimensiuni (mm)					T	Ambalare (buc.)	€/100 buc.	Cod articol
diblu d x l	fixare		șurub ds x ls					
	d0	tfix						
8 x 80	8	10	6 x 85	T30	100	29.81	T.VS2108080S	
8 x 100	8	30	6 x 105	T30	100	36.08	T.VS2108100S	
8 x 120	8	50	6 x 125	T30	100	44.93	T.VS2108120S	
8 x 140	8	70	6 x 145	T30	50	56.98	T.VS2108140S	
10 x 80	10	10	7 x 85	T40	50	39.96	T.VS2110080S	
10 x 100	10	30	7 x 105	T40	50	52.06	T.VS2110100S	
10 x 120	10	50	7 x 125	T40	50	61.25	T.VS2110120S	
10 x 140	10	70	7 x 145	T40	25	80.91	T.VS2110140S	
10 x 160	10	90	7 x 165	T40	25	87.11	T.VS2110160S	
10 x 200	10	130	7 x 205	T40	25	125.91	T.VS2110200S	

## Fixări cu dibluri

### Dibluri standard (Eurodiblu)

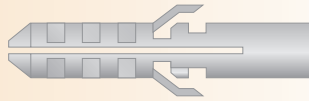

Dimensiuni (mm)		Ambalare STANDARD			Ambalare la BLISTER (BL)		
(Ø x L)diblu	Øșurub	buc. / pac	€/100 buc.	Cod articol	buc. / BL	€/ BL	Cod articol
5 x 25	2.5 - 3.5	500	0.30	AA.01005025S	50	0.27	AA.01005025B
6 x 30	4.0 - 4.5	500	0.32	AA.01006030S	25	0.20	AA.01006030B
8 x 40	4.5 - 6.0	250	0.70	AA.01008040S	15	0.22	AA.01008040B
10 x 50	6.0 - 8.0	250	1.20	AA.01010050S	15	0.30	AA.01010050B
12 x 60	8.0 - 10.0	100	4.86	AA.01012060S	5	0.36	AA.01012060B
14 x 75	10.0 - 12.0	25	6.26	AA.01014075S	2	0.25	AA.01014075B
16 x 80	12.0 - 14.0	25	13.23	AA.01016080S	2	0.38	AA.01016080B

### Combinatii standard (diblu standard + holșurub)

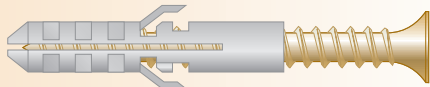

Dimensiuni (mm)		Ambalare STANDARD			Ambalare la BLISTER (BL)		
Ødiblu	(Ø x L)șurub	buc. / pac	€/100 buc.	Cod articol	buc. / BL	€/ BL	Cod articol
5	3.5 x 30	500	0.80	AA.01105035S	20	0.28	AA.01105035B
6	4.0 x 35	500	1.01	AA.01106040S	15	0.27	AA.01106040B
8	5.0 x 45	250	1.96	AA.01108050S	10	0.32	AA.01108050B
10	6.0 x 60	250	3.66	AA.01110060S	5	0.30	AA.01110060B

### Dibluri multiscop

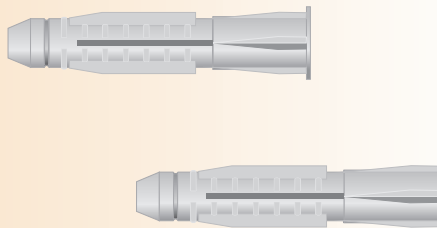

Dimensiuni (mm)		Ambalare STANDARD			Ambalare la BLISTER (BL)		
(Ø x L)diblu	Øșurub	buc. / pac	€/100 buc.	Cod articol	buc. / BL	€/ BL	Cod articol
<b>cu guler</b>							
6 x 36	3.0 - 4.0	200	0.60	AA.02006036S	25	0.27	AA.02006036B
8 x 50	4.5 - 6.0	100	1.02	AA.02008050S	10	0.22	AA.02008050B
10 x 60	6.0 - 7.0	50	1.74	AA.02010060S	6	0.22	AA.02010060B
12 x 70	8.0 - 9.0	25	4.88	AA.02012070S	-	-	-
14 x 75	10.0 - 12.0	10	6.49	AA.02014075S	-	-	-
<b>fără guler</b>							
6 x 36	3.0 - 4.0	200	0.60	AA.02106036S	-	-	-
8 x 50	4.5 - 6.0	100	1.02	AA.02108050S	-	-	-
10 x 60	6.0 - 7.0	50	1.74	AA.02110060S	-	-	-
12 x 70	8.0 - 9.0	25	4.88	AA.02112070S	-	-	-
14 x 75	10.0 - 12.0	10	6.49	AA.02114075S	-	-	-

### Combinatii multiscop (diblu multiscop + holșurub)

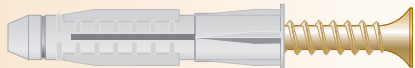

Dimensiuni (mm)		Ambalare STANDARD			Ambalare la BLISTER (BL)		
Ødiblu	(Ø x L)șurub	buc. / pac	€/100 buc.	Cod articol	buc. / BL	€/ BL	Cod articol
6	3.5 x 45	200	1.29	AA.02206035S	15	0.31	AA.02206035B
8	5.0 x 60	100	2.66	AA.02208050S	10	0.39	AA.02208050B
10	6.0 x 70	50	4.59	AA.02210060S	6	0.40	AA.02210060B

### Dibluri pentru fixări grele

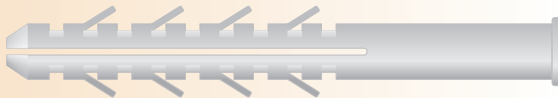

Dimensiuni (mm)		Ambalare STANDARD			Ambalare la BLISTER (BL)		
(Ø x L)diblu	Øșurub	buc. / pac	€/100 buc.	Cod articol	buc. / BL	€/ BL	Cod articol
14 x 75	10	20	10.12	I.TCSO14080S	-	-	-
14 x 100	10	20	13.25	I.TCSO14100S	-	-	-
14 x 130	10	20	24.69	I.TCSO14130S	-	-	-
14 x 160	10	20	28.94	I.TCSO14160S	-	-	-
16 x 140	12	20	54.14	I.TCSO16140S	-	-	-
16 x 160	12	20	60.35	I.TCSO16160S	-	-	-
16 x 200	12	20	61.36	I.TCSO16200S	-	-	-
16 x 240	12	20	65.96	I.TCSO16240S	-	-	-

### Combinatii pentru fixări grele (diblu pentru fixări grele + holșurub DIN 571)

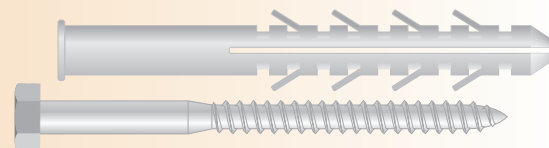

Dimensiuni (mm)		Ambalare STANDARD			Ambalare la BLISTER (BL)		
(Ø x L)diblu	(ØxL)șurub	buc. / pac	€/100 buc.	Cod articol	buc. / BL	€/ BL	Cod articol
14 x 75	10 x 80	20	22.51	I.TCTB14080S	2	0.57	I.TCTB14080B
14 x 100	10 x 100	20	26.40	I.TCTB14100S	2	0.65	I.TCTB14100B
14 x 130	10 x 130	20	41.66	I.TCTB14130S	2	0.95	I.TCTB14130B
14 x 160	10 x 160	20	51.20	I.TCTB14160S	2	1.14	I.TCTB14160B
16 x 140	12 x 140	20	81.32	I.TCTB16140S	-	-	-
16 x 160	12 x 160	20	91.87	I.TCTB16160S	2	1.96	I.TCTB16160B
16 x 200	12 x 200	20	101.09	I.TCTB16200S	-	-	-
16 x 240	12 x 240	20	114.14	I.TCTB16240S	2	2.40	I.TCTB16240B



## Fixări cu dibluri

### Combi-nații pentru construcții (diblu + holzșurub)

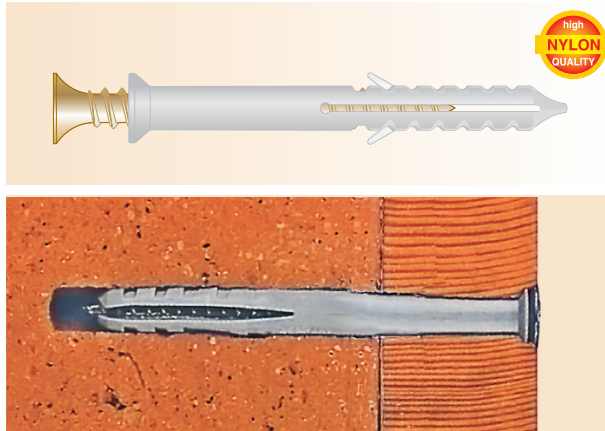

Dimensiuni (mm)			Ambalare STANDARD			Ambalare la BLISTER (BL)		
(Ø x L)diblu	S <sub>max</sub> *		buc. / pac	€/100 buc.	Cod articol	buc. / BL	€/ BL	Cod articol
5 x 30	10		100	1.32	AA.0405030S	-	-	-
5 x 40	20		100	1.39	AA.0405040S	12	0.29	AA.0405040B
5 x 50	30		100	2.01	AA.0405050S	-	-	-
6 x 40	10		100	1.64	AA.0406040S	8	0.25	AA.0406040B
6 x 60	20		100	3.02	AA.0406060S	8	0.36	AA.0406060B
8 x 60	15		100	4.66	AA.0408060S	8	0.49	AA.0408060B
8 x 80	35		100	3.90	AA.0408080S	6	0.35	AA.0408080B
8 x 100	55		100	5.08	AA.0408100S	4	0.32	AA.0408100B
8 x 120	75		100	6.32	AA.0408120S	4	0.37	AA.0408120B
8 x 140	95		100	8.61	AA.0408140S	4	0.46	AA.0408140B
10 x 85	40		50	16.18	AA.0410085S	4	0.77	AA.0410085B
10 x 105	60		50	18.28	AA.0410105S	4	0.85	AA.0410105B
10 x 120	75		50	20.18	AA.0410120S	4	0.93	AA.0410120B
10 x 140	95		50	24.02	AA.0410140S	4	1.08	AA.0410140B
10 x 160	120		50	31.27	AA.0410160S	4	1.37	AA.0410160B

\* S<sub>max</sub> = grosimea maximă de fixare

### Combi-nații pentru fixări adânci (diblu + holzșurub)

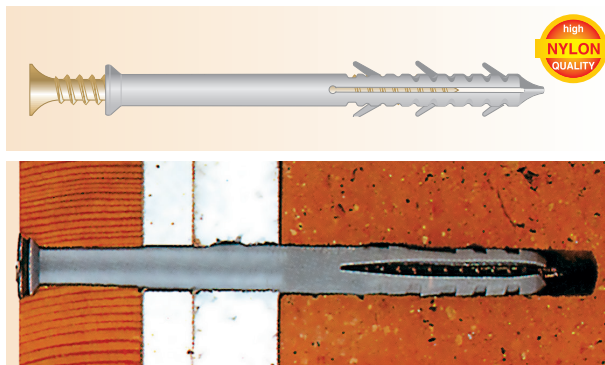

Se utilizează pentru fixări în pereți cu strat gros de material cu rezistență incertă

Dimensiuni (mm)			Ambalare STANDARD			Ambalare la BLISTER (BL)		
(Ø x L)diblu	S <sub>max</sub> *		buc. / pac	€/100 buc.	Cod articol	buc. / BL	€/ BL	Cod articol
10 x 85	15		50	16.20	AA.04110085S	4	0.77	AA.04110085B
10 x 105	35		50	18.30	AA.04110105S	4	0.85	AA.04110105B
10 x 120	50		50	20.20	AA.04110120S	-	-	-
10 x 140	70		50	24.04	AA.04110140S	4	1.08	AA.04110140B
10 x 160	90		50	31.30	AA.04110160S	4	1.37	AA.04110160B
10 x 200	125		25	66.36	I.TC6A10200S	-	-	-

\* S<sub>max</sub> = grosimea maximă de fixare

### Combi-nații HEX lungi

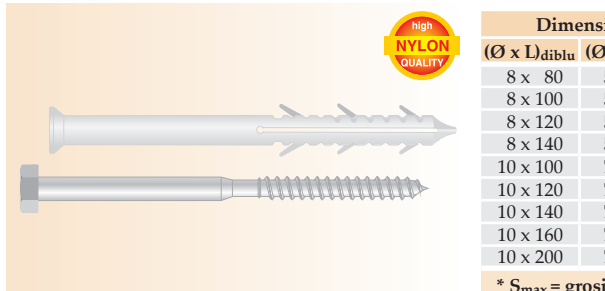

Dimensiuni (mm)			HEX	Ambalare STANDARD			Ambalare la BLISTER (BL)		
(Ø x L)diblu	(Ø x L)șurub	S <sub>max</sub> *		buc. / pac	€/100 buc.	Cod articol	buc. / BL	€/ BL	Cod articol
8 x 80	5 x 85	15	10	100	16.65	I.TC6E08080S	4	0.79	I.TC6E08080B
8 x 100	5 x 100	35	10	100	21.31	I.TC6E08100S	4	0.97	I.TC6E08100B
8 x 120	5 x 125	55	10	100	22.05	I.TC6E08120S	4	1.00	I.TC6E08120B
8 x 140	5 x 145	75	10	100	23.74	I.TC6E08140S	4	1.07	I.TC6E08140B
10 x 100	7 x 105	25	13	100	29.77	I.TC6E10100S	4	1.31	I.TC6E10100B
10 x 120	7 x 120	40	13	100	32.13	I.TC6E10120S	4	1.41	I.TC6E10120B
10 x 140	7 x 140	60	13	100	37.06	I.TC6E10140S	4	1.60	I.TC6E10140B
10 x 160	7 x 165	85	13	100	40.42	I.TC6E10160S	4	1.74	I.TC6E10160B
10 x 200	7 x 205	125	13	100	81.78	I.TC6E10200S	-	-	-

\* S<sub>max</sub> = grosimea maximă de fixare

### Combi-nații pentru fixare rapidă - diblu+cui (Nageldübel)

Avantajele sistemelor de fixare rapidă:

- găurirea se face simultan în ambele elemente care se îmbină;
- fixarea se realizează rapid, fără înșurubare, prin simpla introducerea a diblului și batere a cuiului;
- în cazul în care este necesară, demontarea se poate face prin deșurubare.

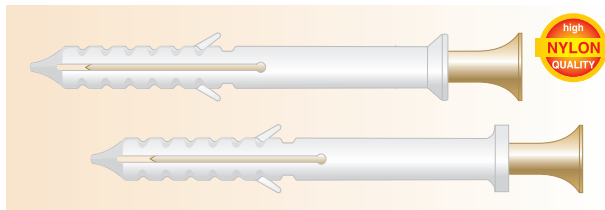

Dimensiuni (mm)			Ambalare STANDARD			Ambalare la BLISTER (BL)		
(Ø x L)diblu	S <sub>max</sub> *		buc. / pac	€/100 buc.	Cod articol	buc. / BL	€/ BL	Cod articol
<b>cu diblu cu cap teșit</b>								
5 x 30	10		100	2.36	AA.05005030S	12	0.40	AA.05005030B
5 x 40	20		100	2.56	AA.05005040S	-	-	-
5 x 50	30		100	2.76	AA.05005050S	-	-	-
6 x 40	10		100	2.83	AA.05006040S	8	0.35	AA.05006040B
6 x 60	20		100	3.97	AA.05006060S	8	0.44	AA.05006060B
6 x 75	30		100	5.28	AA.05006080S	8	0.54	AA.05006080B
8 x 60	15		100	5.99	AA.05008060S	8	0.60	AA.05008060B
8 x 80	35		100	6.77	AA.05008080S	6	0.53	AA.05008080B
8 x 100	55		100	7.88	AA.05008100S	4	0.44	AA.05008100B
8 x 120	75		100	10.02	AA.05008120S	4	0.52	AA.05008120B
8 x 140	95		100	13.81	AA.05008140S	4	0.67	AA.05008140B
<b>cu diblu cu cap cilindric</b>								
5 x 30	10		100	2.72	AA.05105030S	-	-	-
5 x 40	20		100	3.20	AA.05105040S	-	-	-
5 x 50	30		100	3.64	AA.05105050S	-	-	-
6 x 40	10		100	3.70	AA.05106040S	-	-	-
6 x 50	20		100	4.38	AA.05106050S	-	-	-
6 x 60	30		100	4.70	AA.05106060S	-	-	-
6 x 75	45		100	5.80	AA.05106080S	-	-	-
8 x 60	15		100	6.74	AA.05108060S	-	-	-
8 x 80	35		100	7.52	AA.05108080S	-	-	-
8 x 100	55		100	9.04	AA.05108100S	-	-	-

\* S<sub>max</sub> = grosimea maximă de fixare



## Fixări cu dibluri

Combinatii "INDEX" pentru fixare rapida



### Diblu + cui cap teșit



mm (Ø x L) <sub>diblu</sub>	S <sub>max</sub>	Ambalare (buc.)	€/100 buc.	Cod articol
5 x 25	5	100	2.01	ITCCA05025S
5 x 30	5	100	2.31	ITCCA05030S
5 x 35	10	100	2.37	ITCCA05035S
5 x 50	25	100	3.05	ITCCA05050S
6 x 35	5	100	3.02	ITCCA06035S
6 x 40	10	100	3.13	ITCCA06040S
6 x 50	20	100	3.69	ITCCA06050S
6 x 60	30	100	4.25	ITCCA06060S
6 x 70	40	100	4.36	ITCCA06070S
8 x 60	20	100	7.08	ITCCA08060S
8 x 80	40	100	8.71	ITCCA08080S
8 x 100	60	100	10.71	ITCCA08100S
8 x 120	80	100	12.41	ITCCA08120S
8 x 140	100	100	14.43	ITCCA08140S

### Diblu + cui cap cilindric



mm (Ø x L) <sub>diblu</sub>	S <sub>max</sub>	Ambalare (buc.)	€/100 buc.	Cod articol
5 x 25	5	100	1.94	LTCCC05025S
5 x 30	5	100	2.13	LTCCC05030S
5 x 35	10	100	2.05	LTCCC05035S
5 x 50	25	100	2.64	LTCCC05050S
6 x 35	5	100	2.51	LTCCC06035S
6 x 40	10	100	3.16	LTCCC06040S
6 x 50	15	100	3.47	LTCCC06050S
6 x 60	20	100	4.22	LTCCC06060S
6 x 70	30	100	5.19	LTCCC06070S
8 x 60	20	100	5.73	LTCCC08060S
8 x 80	40	100	8.11	LTCCC08080S
8 x 100	60	100	10.67	LTCCC08100S
8 x 120	80	100	11.71	LTCCC08120S
8 x 140	100	100	11.59	LTCCC08140S

### Diblu + cui cap teșit din inox



mm (Ø x L) <sub>diblu</sub>	S <sub>max</sub>	Ambalare (buc.)	€/100 buc.	Cod articol
5 x 30	5	100	8.34	ITCA205030S
6 x 40	10	100	12.54	ITCA206040S
6 x 60	30	100	16.98	ITCA206060S
8 x 60	20	100	27.12	ITCA208060S
8 x 80	40	100	33.37	ITCA208080S
8 x 100	60	100	40.02	ITCA208100S

## Seturi de fixare "Spitz"



Șurub din:	Dimensiuni (mm)		Ambalare (buc.)	€/100 buc.	Cod articol
	(Ø x L) <sub>diblu</sub>	S <sub>max</sub> *			
<b>1. Diblu "Spitz" + șurub, preasamblate</b>					
Oțel zincat	6 x 40	8	100	3.70	AA.09006040S
	6 x 60	28	100	3.96	AA.09006060S
	6 x 80	48	100	5.80	AA.09006080S
	8 x 60	13	100	6.74	AA.09008060S
	8 x 80	33	100	7.52	AA.09008080S
	8 x 100	53	100	9.04	AA.09008100S
	8 x 120	73	100	10.72	AA.09008120S
8 x 140	93	100	13.18	AA.09008140S	
<b>2. Diblu "Spitz" cu guler mărit + șurub</b>					
Oțel zincat	6 x 35	6	50	4.20	AA.09306035S
	6 x 45	16	50	4.90	AA.09306045S
	6 x 55	26	50	10.72	AA.09306055S
Oțel inoxidabil A2	6 x 35	6	25	8.18	AA.09406035S
	6 x 45	16	25	9.48	AA.09406045S
	6 x 55	26	25	11.46	AA.09406055S
<b>3. Diblu "Spitz" + șurub + capac de protecție</b>					
Oțel zincat	6 x 35	6	50	6.70	AA.09106035S
	6 x 45	16	50	7.04	AA.09106045S
	6 x 55	26	50	7.52	AA.09106055S
Oțel inoxidabil A2	6 x 35	6	25	9.82	AA.09206035S
	6 x 45	16	25	11.12	AA.09206045S
	6 x 55	26	25	12.06	AA.09206055S
<b>4. Diblu "Spitz" + șurub + șaibă cauciucată Ø15 mm</b>					
Oțel inoxidabil A2	6 x 35/15	6	25	11.22	AA.09506035S
	6 x 45/15	16	25	12.84	AA.09506045S
Oțel inoxidabil cuprat	6 x 35/15	6	25	14.20	AA.09606035S
	6 x 45/15	16	25	16.12	AA.09606045S

## Diblu pentru gips carton

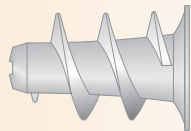

Dimensiuni (mm)		Ambalare STANDARD		Ambalare la BLISTER (BL)			
(Ø x L) <sub>diblu</sub>	Ø <sub>șurub</sub>	buc. / pac	€/100 buc.	Cod articol	buc. / BL	€/BL	Cod articol
6 x 23	4.0 x 5.0	200	1.50	AA.03006023S	10	0.27	AA.03006023B

## Diblu "Skorpion" cu cap plat

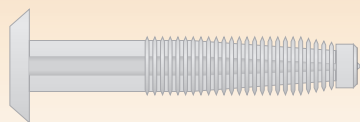

Ø x L (mm)	Ambalare (buc.)	€/100 buc.	Cod articol
6 x 40	100	2.80	AA.03106040S
6 x 65	100	4.18	AA.03106065S

## Diblu "Skorpion" pentru cabluri

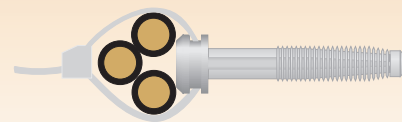

Ø x L (mm)	Ambalare (buc.)	€/100 buc.	Cod articol
6 x 40	100	2.80	AA.03206040S

Se livrează fără legătură de cablu

## Fixări cu dibluri

### Dibluri pentru plăci

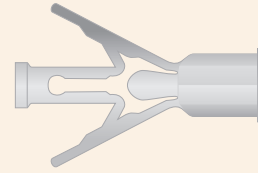
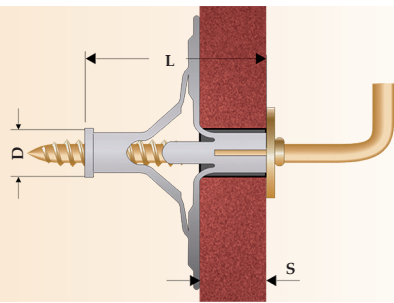

Dimensiuni (mm)		Ambalare STANDARD			Ambalare la BLISTER (BL)		
Ø x L	S <sub>max</sub> *	buc. / pac	€/100 buc.	Cod articol	buc. / BL	€/BL	Cod articol
10 x 40	4 - 12	100	4.37	I.ANCLA40S	10	0.56	I.ANCLA40B
10 x 47	15 - 19	100	4.81	I.ANCLA47S	10	0.60	I.ANCLA47B

### Isodibluri

Dibluri pentru utilizare în polistiren expandat, spumă poliuretanică sau materiale de construcție moi.



Ø x L) diblu (mm)	Șurub	Scula de înșurubat	Ambalare STANDARD			Ambalare la BLISTER (BL)		
			buc. / pac	€/100 buc.	Cod articol	buc. / BL	€/BL	Cod articol
20 x 50	Pal Ø 4 - 4.5	Torx 40	200	18.24	DB.0050S	2	0.48	DB.0050B
30 x 95	M8 sau holzșurub Ø8	Torx 55 sau Hex 17	100	60.50	DB.0095S	-	-	-

### Dibluri și combinații în cutii de plastic refolosibile



Dibluri standard				Combi-nații cu dibluri standard			
Diblu	buc./cutie	€/cutie	Cod articol	Combi-nație	buc./cutie	€/cutie	Cod articol
Diblu Ø 5	300	3.35	AA.13BX0000	Diblu Ø 5 + Hz 3.5 x 30	125	3.69	AA.13BX1000
Diblu Ø 6	200			Diblu Ø 6 + Hz 4.0 x 35	75		
Diblu Ø 8	90			Diblu Ø 8 + Hz 5.0 x 45	35		
Diblu Ø10	50			Diblu Ø10 + Hz 6.0 x 60	20		
Diblu Ø 6	900	3.46	AA.13BX0006	Diblu Ø 6 + Hz 4.0 x 35	300	3.55	AA.13BX1006
Diblu Ø 8	400	3.38	AA.13BX0008	Diblu Ø 8 + Hz 5.0 x 45	150	3.46	AA.13BX1008
Diblu Ø10	200	2.98	AA.13BX0010	Diblu Ø10 + Hz 6.0 x 60	75	3.26	AA.13BX1010
Diblu Ø12	100	5.44	AA.13BX0012				

### Seturi de fixare "INDEX"

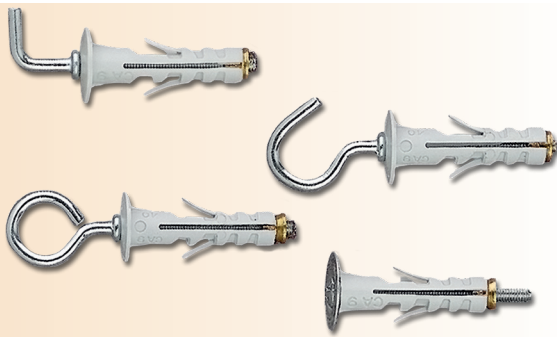

Dimensiuni (mm)	Ø orificiu (mm)	Ambalare STANDARD			Ambalare la BLISTER (BL)		
		buc. / pac	€/100 buc.	Cod articol	buc. / BL	€/BL	Cod articol
<b>"L"</b>							
M4 x 40	9	100	16.82	I.IPAGR09S	2	0.46	I.IPAGR09B
M5 x 45	12	100	22.00	I.IPAGR12S	2	0.56	I.IPAGR12B
<b>"Cârlig"</b>							
M4 x 40	9	100	19.00	I.IPAGN09S	2	0.50	I.IPAGN09B
M5 x 45	12	100	24.78	I.IPAGN12S	2	0.62	I.IPAGN12B
<b>"Ochi"</b>							
M4 x 40	9	100	19.42	I.IPAAR09S	2	0.51	I.IPAAR09B
M5 x 45	12	100	26.07	I.IPAAR12S	2	0.64	I.IPAAR12B
<b>Cu șurub</b>							
M4 x 40	9	100	14.93	I.IPATO09S	2	0.42	I.IPATO09B
M5 x 45	12	100	16.20	I.IPATO12S	2	0.44	I.IPATO12B

### Set de fixare "Ochi" diblu standard + holzșurub "Ochi" K10

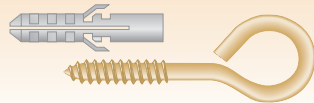

mm		Ambalare STANDARD		
d <sub>șurub</sub>	d <sub>diblu</sub>	buc. / pac	€/100 buc.	Cod articol
3	5	50	3.89	AA.08003005S
4	6	50	4.50	AA.08004006S
5	8	50	6.31	AA.08005008S
7	10	50	21.71	AA.08007010S
8	12	50	13.64	AA.08008012S
9	12	50	38.04	AA.08009012S
10	14	50	52.02	AA.08010014S

mm		Ambalare la BLISTER (BL)		
d <sub>șurub</sub>	d <sub>diblu</sub>	buc. / BL	€/BL	Cod articol
4	6	4	0.30	AA.08004006B
5	8	4	0.37	AA.08005008B
7	10	4	0.99	AA.08007010B
9	12	2	0.88	AA.08009012B

### Set de fixare "Cârlig" diblu standard + holzșurub "Cârlig" K10

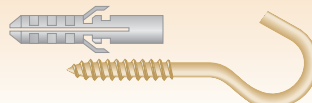

mm		Ambalare STANDARD		
d <sub>șurub</sub>	d <sub>diblu</sub>	buc. / pac	€/100 buc.	Cod articol
3	5	50	3.89	AA.08103005S
4	6	50	4.31	AA.08104006S
5	8	50	5.40	AA.08105008S
7	10	50	6.80	AA.08107010S
8	12	50	13.06	AA.08108012S
10	14	50	49.35	AA.08110014S

mm		Ambalare la BLISTER (BL)		
d <sub>șurub</sub>	d <sub>diblu</sub>	buc. / BL	€/BL	Cod articol
4	6	4	0.29	AA.08104006B
5	8	4	0.34	AA.08105008B

### Set de fixare "L" diblu standard + holzșurub "L" K10

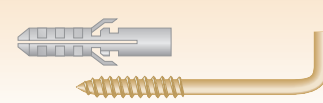

mm		Ambalare STANDARD		
d <sub>șurub</sub>	d <sub>diblu</sub>	buc. / pac	€/100 buc.	Cod articol
3	5	50	3.84	AA.08203005S
4	6	50	4.31	AA.08204006S
5	8	50	4.86	AA.08205008S
7	10	50	6.12	AA.08207010S

mm		Ambalare la BLISTER (BL)		
d <sub>șurub</sub>	d <sub>diblu</sub>	buc. / BL	€/BL	Cod articol
4	6	4	0.29	AA.08204006B
5	8	4	0.31	AA.08205008B

## Fixări cu dibluri

Seturi de fixare "HEX"  
diblu standard + holșurub cu cap hexagonal și șaibă

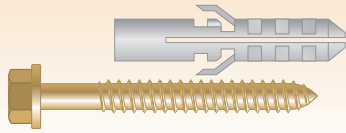

Dimensiuni (mm)			Ambalare STANDARD		
Holșurub	Diblu	S <sub>max</sub> *	buc. / pac	€/100 buc.	Cod articol
6 x 40	8 x 40	5	50	3.23	AA.06006040S
6 x 60	8 x 40	20	50	4.02	AA.06006060S
6 x 80	8 x 40	40	25	4.69	AA.06006080S
6 x 100	8 x 40	60	25	5.28	AA.06006100S
7 x 70	10 x 50	20	50	6.90	AA.06007070S
7 x 100	10 x 50	50	25	8.80	AA.06007100S
7 x 120	10 x 50	70	25	10.22	AA.06007120S
8 x 70	12 x 60	10	50	11.70	AA.06008070S
8 x 80	12 x 60	20	25	12.73	AA.06008080S
8 x 100	12 x 60	40	25	13.06	AA.06008100S
8 x 120	12 x 60	60	25	15.43	AA.06008120S
8 x 150	12 x 60	90	25	17.65	AA.06008150S
10 x 70	14 x 75	20	25	18.49	AA.06010070S
10 x 90	14 x 75	40	25	19.80	AA.06010090S
10 x 100	14 x 75	70	25	20.53	AA.06010100S
10 x 120	14 x 75	100	25	23.58	AA.06010120S
12 x 100	16 x 80	90	20	35.81	AA.06012100S
Dimensiuni (mm)			Ambalare la BLISTER (BL)		
Holșurub	Diblu	S <sub>max</sub> *	buc. / BL	€/BL	Cod articol
6 x 40	8 x 40	5	2	0.18	AA.06006040B
6 x 60	8 x 40	20	2	0.20	AA.06006060B
7 x 70	10 x 50	20	2	0.26	AA.06007070B
8 x 70	12 x 60	10	2	0.35	AA.06008070B
8 x 80	12 x 60	20	2	0.37	AA.06008080B
8 x 100	12 x 60	40	2	0.38	AA.06008100B
8 x 120	12 x 60	60	2	0.43	AA.06008120B
10 x 70	14 x 75	20	2	0.49	AA.06010070B

\* S<sub>max</sub> = grosimea maximă de fixare

Seturi de fixare "Prezon"  
diblu standard + prezon pentru lemn

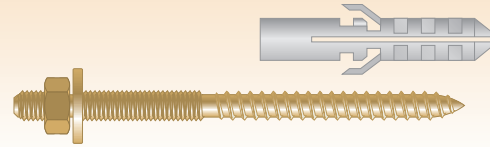

Dimensiuni (mm)			Ambalare STANDARD		
Prezon	Diblu	S <sub>max</sub> *	buc. / pac	€/100 buc.	Cod articol
M 6 x 60	8 x 40	10	50	4.30	AA.07006060S
M 6 x 80	8 x 40	30	50	5.06	AA.07006080S
M 6 x 100	8 x 40	50	50	5.89	AA.07006100S
M 8 x 70	10 x 50	10	50	7.54	AA.07008070S
M 8 x 90	10 x 50	30	50	9.77	AA.07008090S
M 8 x 100	10 x 50	40	50	9.35	AA.07008100S
M 8 x 120	10 x 50	60	50	10.31	AA.07008120S
M10 x 100	12 x 60	30	25	18.76	AA.07010100S
M10 x 120	12 x 60	50	25	20.26	AA.07010120S
M10 x 140	12 x 60	70	25	24.24	AA.07010140S
M10 x 160	12 x 60	90	25	29.58	AA.07010160S
M12 x 120	14 x 75	30	20	49.04	AA.07012120S
M12 x 140	14 x 75	50	20	49.45	AA.07012140S
M12 x 160	14 x 75	70	20	50.46	AA.07012160S
M12 x 180	14 x 75	90	20	51.64	AA.07012180S
Dimensiuni (mm)			Ambalare la BLISTER (BL)		
Holșurub	Diblu	S <sub>max</sub> *	buc. / BL	€/BL	Cod articol
M 8 x 70	10 x 50	10	2	0.27	AA.07008070B
M 8 x 100	10 x 50	40	2	0.31	AA.07008100B
M 8 x 120	10 x 50	60	2	0.33	AA.07008120B
M10 x 100	12 x 60	30	2	0.50	AA.07010100B

## Opritoare pentru ușă

K 10

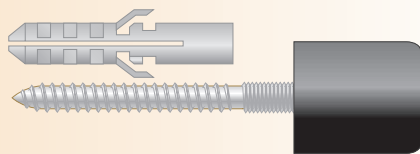

Culoare	Ambalare STANDARD			Ambalare la BLISTER (BL)		
	buc. / pac	€/100 buc.	Cod articol	buc. / BL	€/BL	Cod articol
Plastic negru	20	26.76	AA.10500000S	2	0.66	AA.10500000B
Plastic alb	20	26.76	AA.10510000S	2	0.66	AA.10510000B
Plastic gri	20	26.76	AA.10520000S	2	0.66	AA.10520000B

## Seturi de fixare pentru obiecte sanitare

K 10

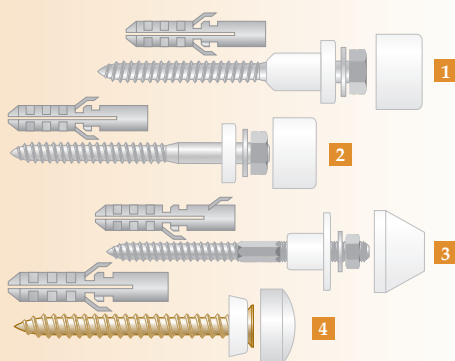

Tip	Dimensiuni (mm)	Ambalare STANDARD			Ambalare la BLISTER (BL)		
		buc. / pac	€/100 buc.	Cod articol	buc. / BL	€/BL	Cod articol
<b>1. Seturi de fixare pentru WC</b>							
WC 1	HEX 6 x 80 / 10	40	11.70	AA.10006080S	2	0.35	AA.10006080B
WC 2	HEX 7 x 70 / 10	40	13.76	AA.10007070S	2	0.40	AA.10007070B
<b>2. Set de fixare pentru etajera</b>							
	HEX 7 x 70 / 10	40	13.76	AA.10207070S	2	0.40	AA.10207070B
<b>3. Seturi de fixare pentru chiuveta</b>							
Chiuveta 1	M10 x 100 / 12	40	41.34	AA.10310100S	2	0.95	AA.10310100B
Chiuveta 2	M10 x 120 / 12	40	45.85	AA.10310120S	2	1.04	AA.10310120B
<b>4. Seturi de fixare pentru oglinda</b>							
Oglinda 1 capac din plastic alb	4.5 x 50 / 6	40	8.18	AA.10445050S	4	0.45	AA.10445050B
Oglinda 2/2 capac metalic auriu	3.5 x 35 / 5	40	7.25	AA.10435036S	4	0.41	AA.10435036B

## Fixări cu dibluri

### Dibluri pentru izolație

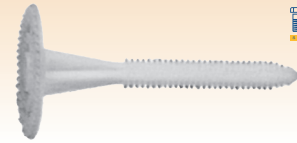
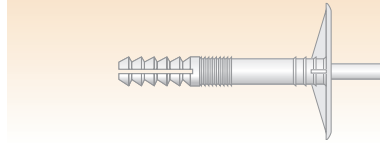
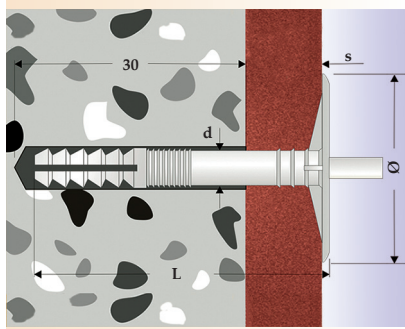

**INDEX**  
INDUSTRIAL SYSTEMS

cu nit						fără nit					
mm			Amb.	€/100 buc.	Cod articol	mm			Amb.	€/100 buc.	Cod articol
d x L	Ø	s	(buc.)			d x L	Ø	s	(buc.)		
10 x 70	55	30 - 40	50	7.70	AA.12010070S	8 x 80	38	20 - 50	50	6.59	I.AIS08080S
10 x 90	55	40 - 60	50	8.88	AA.12010090S	8 x 100	38	50 - 70	50	7.73	I.AIS08100S
10 x 110	55	70 - 90	50	9.37	AA.12010110S	8 x 120	38	70 - 90	50	9.45	I.AIS08120S
10 x 130	55	90 - 100	50	10.36	AA.12010130S	8 x 140	38	90 - 110	50	22.89	I.AIS08140S
10 x 150	55	100 - 120	50	20.35	AA.12010150S						

### Suporturi pentru izolație

K 10



Tip 1



Tip 2

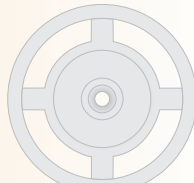

Rondelă suport

Dimensiuni (mm)			Ambalare	€/100 buc.	Cod articol
A	d	grosime	(buc.)		
<b>Suport tip 1, din tablă zincată</b>					
50	Ø 5.5	0.5	100	3.44	AA.12115050S
70	Ø 6.5	0.5	100	7.23	AA.12117070S
<b>Suport tip 2, din tablă zincată</b>					
Ø 60	Ø 5.5	0.5	100	4.42	AA.12116000S
Ø 80	Ø 6.5	0.5	100	9.96	AA.12118000S
<b>Rondelă suport din polietilenă</b>					
Ø 70	Ø 5.5	-	50	12.31	AA.12270000S
Ø 90	Ø 5.5	-	50	13.64	AA.12290000S

### Set diblu - suporturi pentru calorifere

K 10

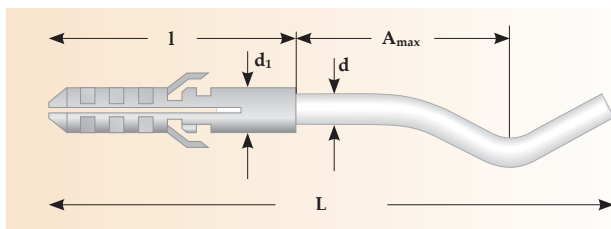

Dimensiuni (mm)			Ambalare	€/100 buc.	Cod articol
d x L	d1 x l	Amax	(buc.)		
<b>pentru calorifere din aluminiu</b>					
9 x 150	12 x 60	65	20	38.68	AA.11009150S
9 x 170	12 x 60	85	20	43.79	AA.11009170S
9 x 200	12 x 60	115	20	51.57	AA.11009200S
<b>pentru calorifere din fontă</b>					
12 x 190	16 x 80	85	20	70.17	AA.11112190S
12 x 220	16 x 80	115	20	79.71	AA.11112220S
12 x 250	16 x 80	145	20	91.91	AA.11112250S

### Suporturi pentru calorifere din aluminiu

**INDEX**  
INDUSTRIAL SYSTEMS

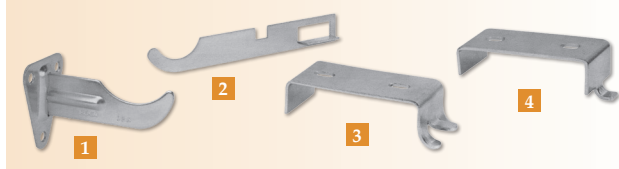

Model	(mm)	Ambalare	€/100 buc.	Cod articol
		(buc.)		
1. Suport triunghiular 1", RA-TRI	95	100	58.76	I.RATRI095S
2. Suporturi Ferroli pentru încadrare, RA-FEM	145	250	19.06	I.RAFEM145S
	175	250	24.68	I.RAFEM175S
3. Suport Rayco, RA-RAY	32 x 78	250	34.48	I.RARAY032S
4. Suport universal, RA-PES	32 x 78	250	24.11	I.RAPES032S

### Seturi de suporturi pentru calorifere din aluminiu

**INDEX**  
INDUSTRIAL SYSTEMS

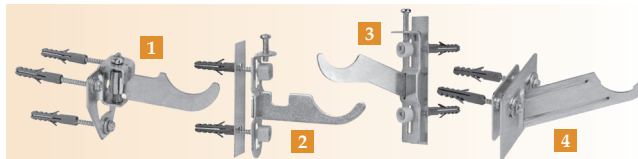

Model	(mm)	Ambalare	€/100 seturi	Cod articol
		(buc.)		
1. Suport triunghiular reglabil, RA-TRG	95	1	124.08	I.RATRG095S
2. Suport Ferroli drept, RA-FRE	95	1	96.16	I.RAFRE095S
3. Suport Ferroli înclinat, RA-FIN	100	1	136.42	I.RAFIN100S
4. Suport ROCA, RA-Ro	100	1	137.75	I.RARO100S

### Fixări pentru plăci

**INDEX**  
INDUSTRIAL SYSTEMS

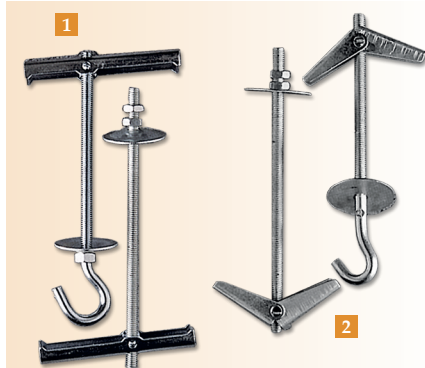

Tija	M x L (mm)	1. Fixări basculante				2. Fixări cu clape și arc			
		S <sub>max</sub> *	Ambalare (buc.)	€/100 buc.	Cod articol	S <sub>max</sub> *	Ambalare (buc.)	€/100 buc.	Cod articol
dreaptă	M4 x 100	50	50	22.68	I.BAESM04S	50	50	16.46	I.PAESM04S
	M5 x 100	60	50	24.98	I.BAESM05S	60	50	18.27	I.PAESM05S
	M6 x 100	70	50	31.35	I.BAESM06S	70	50	24.20	I.PAESM06S
	M8 x 100	50	50	46.31	I.BAESM08S	50	50	36.70	I.PAESM08S
cârlig	M4 x 75	45	50	23.07	I.BAGAM04S	50	50	18.07	I.PAGAM04S
	M5 x 80	45	50	28.56	I.BAGAM05S	60	50	20.94	I.PAGAM05S
	M6 x 85	45	50	34.96	I.BAGAM06S	70	50	25.89	I.PAGAM06S
	M8 x 90	20	50	49.92	I.BAGAM08S	50	50	36.08	I.PAGAM08S

\* S<sub>max</sub> = grosimea maximă de fixare



## Fixări cu dibluri metalice

### Dibluri metalice autoforante

Tip	Dimensiuni (mm)			S <sub>max</sub> *	Ambalare STANDARD			Ambalare la BLISTER (BL)		
	diblu	șurub	Grosimea peretelui		buc. / pac	€/100 buc.	Cod articol	buc. / BL	€/BL	Cod articol
ZAMAC-S	6 x 37	4.5 x 50	9 - 16	8	100	7.36	I.TAPLAZKS	10	0.86	I.TAPLAZKB
METALIC	15 x 29	4.5 x 30	9 - 16	8	100	8.13	I.TAPLAMES	10	0.93	I.TAPLAMEB

\* S<sub>max</sub> = grosimea maximă de fixare

### Dibluri metalice

Ø x L (mm)	Adâncime de găurire (mm)	Ambalare (buc)	€/100 buc.	Cod articol
5 x 30	5 x 35	100	3.00	I.TAME05030S
6 x 32	6 x 40	100	3.04	I.TAME06032S
8 x 38	8 x 50	100	4.93	I.TAME08038S
8 x 60	8 x 70	50	7.28	I.TAME08060S
10 x 60	10 x 70	50	8.27	I.TAME10060S

### Dibluri metalice de expansiune

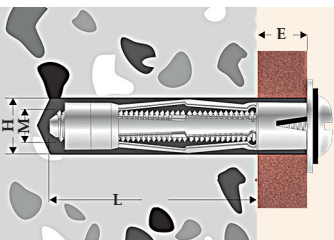

Diblurile metalice de expansiune sunt special proiectate pentru fixări pe materiale alveolare: cărămizi și blocuri de beton alveolare, pereți și plafoane cu goluri, gips carton etc.

Constituie soluția ideală pentru fixări ușoare în toate lucrările de construcții.

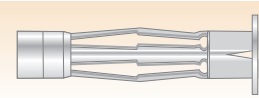
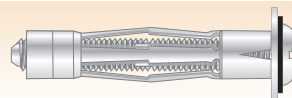

Filet	Dimensiuni (mm)			cu șurub						fără șurub		
	L	H	E	Ambalare STANDARD			Ambalare la BLISTER (BL)			Ambalare STANDARD		
				buc. / pac	€/100 buc.	Cod articol	buc. / BL	€/BL	Cod articol	buc. / pac	€/100 buc.	Cod articol
M4	21	8	1 - 4	100	6.44	I.INCO421S	-	-	-	100	5.43	I.INSI421S
M4	25	8	0 - 5	100	6.48	I.INCO425S	-	-	-	100	5.20	I.INSI425S
M4	32	8	3 - 9	100	8.23	I.INCO432S	-	-	-	100	5.28	I.INSI432S
M4	38	8	8 - 15	100	9.94	I.INCO438S	10	1.11	I.INCO438B	100	5.82	I.INSI438S
M4	46	8	16 - 21	100	10.29	I.INCO446S	10	1.15	I.INCO446B	100	6.11	I.INSI446S
M4	52	8	16 - 23	100	10.55	I.INCO452S	10	1.17	I.INCO452B	100	6.32	I.INSI452S
M4	59	8	32 - 38	100	11.12	I.INCO459S	-	-	-	100	6.77	I.INSI459S
M4	65	8	31 - 38	100	11.19	I.INCO465S	10	1.24	I.INCO465B	100	6.80	I.INSI465S
M5	37	10	5 - 13	100	11.27	I.INCO537S	-	-	-	100	11.15	I.INSI537S
M5	45	10	6 - 13	-	-	-	-	-	-	100	10.01	I.INSI545S
M5	52	10	5 - 16	100	15.35	I.INCO552S	-	-	-	100	10.11	I.INSI552S
M5	58	10	3 - 16	100	15.50	I.INCO558S	10	1.67	I.INCO558B	100	10.16	I.INSI558S
M5	65	10	16 - 32	100	17.22	I.INCO565S	-	-	-	100	10.10	I.INSI565S
M5	71	10	16 - 32	100	17.39	I.INCO571S	10	1.86	I.INCO571B	100	9.49	I.INSI571S
M5	80	10	32 - 45	100	16.46	I.INCO580S	-	-	-	100	9.57	I.INSI580S
M5	88	10	32 - 45	-	-	-	-	-	-	100	9.61	I.INSI588S
M6	37	12	5 - 13	100	14.13	I.INCO637S	-	-	-	100	10.54	I.INSI637S
M6	52	12	5 - 16	100	19.26	I.INCO652S	10	2.05	I.INCO652B	100	14.69	I.INSI652S
M6	58	12	3 - 16	100	19.46	I.INCO658S	10	2.07	I.INCO658B	100	15.45	I.INSI658S
M6	65	12	16 - 32	100	19.23	I.INCO665S	-	-	-	100	15.76	I.INSI665S
M6	71	12	16 - 32	-	-	-	-	-	-	100	11.20	I.INSI671S
M6	80	12	32 - 45	100	21.59	I.INCO680S	-	-	-	100	11.38	I.INSI680S
M6	88	12	32 - 45	-	-	-	-	-	-	100	15.80	I.INSI688S
M8	65	12	16 - 32	-	-	-	-	-	-	100	28.24	I.INSI865S

### Pistol pentru dibluri de expansiune



Ambalare (buc)	€/100 buc.	Cod articol
1	982.24	I.INPISANINS

### Clește pentru dibluri de expansiune

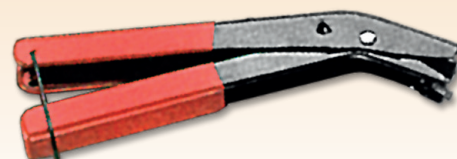

Ambalare (buc)	€/100 buc.	Cod articol
1	431.53	I.INPINZANIS

NOU LA ROCAST



**AEG** Producător de unelte  
**POWERTOOLS** electrice profesionale,  
din 1898

Pagina 9.3



## Conexpanduri

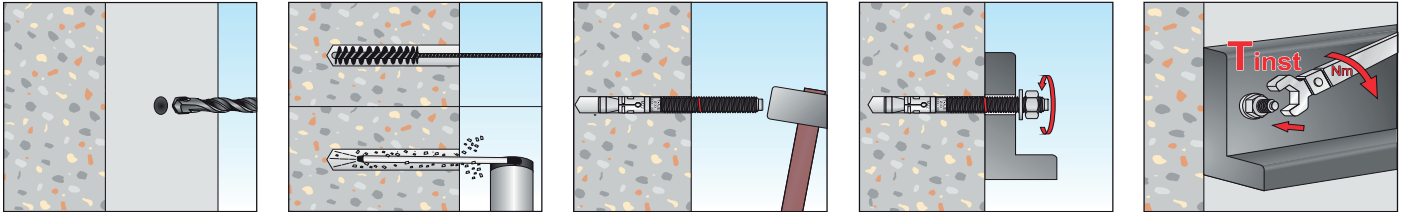

Conexpand bolt din oțel zincat, omologat, cu certificare ETA-CE Opt. 1, pentru beton fisurat și nefisurat

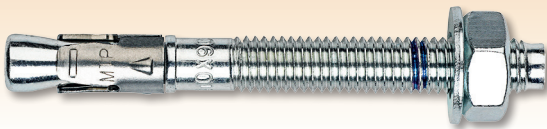
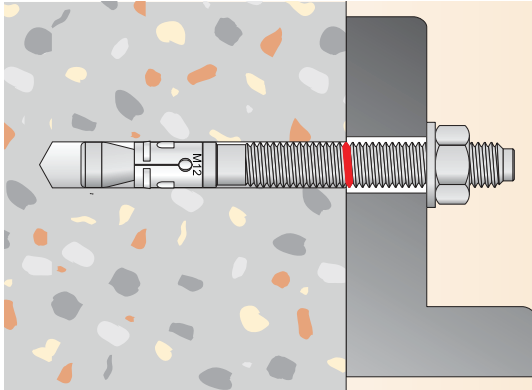

ACREDITARE TEHNICĂ EUROPEANĂ  
Opțiunea 1: pentru beton fisurat și nefisurat.  
ETA-12/0397 - ETAG 001 Partea 1 și 2

Dimensiuni (mm)				Ambalare (buc.)	€/100 buc.	Cod articol
M x L	d	l <sub>max</sub>	h <sub>min</sub>			
M 8 x 75	8	9	60	100	39.16	IAP08075S
M 8 x 95	8	29	60	100	42.46	IAP08095S
M 8 x 115	8	49	60	100	52.09	IAP08115S
M10 x 90	10	10	75	100	55.04	IAP10090S
M10 x 105	10	25	75	50	65.32	IAP10105S
M10 x 115	10	35	75	50	69.12	IAP10115S
M10 x 135	10	55	75	50	77.13	IAP10135S
M10 x 165	10	85	75	50	81.57	IAP10165S
M10 x 185	10	105	75	50	88.06	IAP10185S
M12 x 100	12	4	85	50	82.51	IAP12100S
M12 x 110	12	14	85	50	84.30	IAP12110S
M12 x 120	12	24	85	50	91.93	IAP12120S
M12 x 130	12	34	85	50	95.16	IAP12130S
M12 x 150	12	54	85	50	122.18	IAP12150S
M12 x 180	12	84	85	50	150.11	IAP12180S
M12 x 200	12	104	85	50	175.62	IAP12200S
M16 x 145	16	28	105	25	174.06	IAP16145S
M16 x 175	16	58	105	25	224.78	IAP16175S
M16 x 220	16	103	105	25	295.56	IAP16220S
M16 x 250	16	133	105	25	383.30	IAP16250S
M20 x 170	20	32	125	20	380.40	IAP20170S
M20 x 200	20	62	125	20	464.71	IAP20200S

Conexpand bolt din oțel zincat, omologat, cu certificare ETA-CE Opt. 7, pentru beton nefisurat

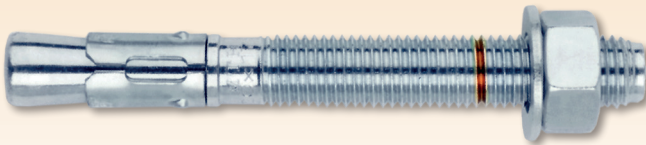

ACREDITARE TEHNICĂ EUROPEANĂ  
ETA 05/0242 Opțiunea 7  
CE 1219-CPR-0006

Dimensiuni (mm)				Ambalare (buc.)	€/100 buc.	Cod articol
M x L	d	l <sub>max</sub>	h <sub>min</sub>			
M 6 x 60	6	2	55	200	12.10	IAH06060S
M 6 x 70	6	12	55	200	13.38	IAH06070S
M 6 x 80	6	22	55	200	20.49	IAH06080S
M 6 x 90	6	32	55	200	21.04	IAH06090S
M 6 x 100	6	42	55	200	21.97	IAH06100S
M 6 x 110	6	52	55	200	24.96	IAH06110S
M 6 x 120	6	62	55	100	25.04	IAH06120S
M 6 x 130	6	72	55	100	18.91	IAH06130S
M 6 x 140	6	82	55	100	17.45	IAH06140S
M 6 x 150	6	92	55	100	21.07	IAH06150S
M 6 x 160	6	102	55	100	24.92	IAH06160S
M 6 x 170	6	112	55	100	27.25	IAH06170S
M 6 x 180	6	122	55	100	28.64	IAH06180S
M 8 x 60	8	3	50	100	17.09	IAH08060S
M 8 x 75	8	5	65	100	20.11	IAH08075S
M 8 x 90	8	20	65	100	20.78	IAH08090S
M 8 x 100	8	30	65	100	20.81	IAH08100S
M 8 x 115	8	45	65	100	21.00	IAH08115S
M 8 x 120	8	45	65	100	25.68	IAH08120S
M 8 x 130	8	60	65	100	26.36	IAH08130S
M 8 x 155	8	85	65	100	47.86	IAH08155S

Dimensiuni (mm)				Ambalare (buc.)	€/100 buc.	Cod articol
M x L	d	l <sub>max</sub>	h <sub>min</sub>			
M10 x 70	10	3	55	100	28.60	IAH10070S
M10 x 80	10	3	60	100	29.40	IAH10080S
M10 x 90	10	10	75	100	29.70	IAH10090S
M10 x 100	10	10	70	100	33.02	IAH10100S
M10 x 120	10	40	75	50	37.44	IAH10120S
M10 x 140	10	60	70	50	41.72	IAH10140S
M10 x 150	10	70	70	50	44.99	IAH10150S
M10 x 160	10	80	70	50	46.55	IAH10160S
M10 x 170	10	90	70	50	50.71	IAH10170S
M10 x 210	10	130	70	50	55.78	IAH10210S
M10 x 230	10	150	70	50	60.91	IAH10230S
M12 x 90	12	23	75	50	44.97	IAH12090S
M12 x 100	12	13	70	50	46.66	IAH12100S
M12 x 110	12	18	85	50	51.10	IAH12110S
M12 x 120	12	28	85	50	52.24	IAH12120S
M12 x 130	12	38	85	50	54.59	IAH12130S
M12 x 140	12	48	85	50	57.42	IAH12140S
M12 x 160	12	68	85	50	61.31	IAH12160S
M12 x 180	12	88	85	50	64.55	IAH12180S
M12 x 200	12	108	85	50	66.50	IAH12200S
M12 x 220	12	128	85	50	92.26	IAH12220S
M12 x 250	12	158	85	25	99.11	IAH12250S
M14 x 120	14	12	100	25	81.56	IAH14120S
M14 x 145	14	37	100	25	91.74	IAH14145S
M14 x 170	14	62	100	25	103.06	IAH14170S
M14 x 220	14	112	100	25	106.16	IAH14220S
M14 x 250	14	142	100	25	113.76	IAH14250S
M16 x 125	16	3	110	25	107.22	IAH16125S
M16 x 145	16	23	110	25	112.88	IAH16145S
M16 x 170	16	48	110	25	126.08	IAH16170S
M16 x 220	16	98	110	25	153.48	IAH16220S
M16 x 250	16	128	110	25	165.95	IAH16250S
M16 x 280	16	158	110	25	184.09	IAH16280S
M20 x 170	20	23	135	20	189.88	IAH20170S
M20 x 220	20	73	135	20	230.27	IAH20220S
M20 x 270	20	123	135	20	244.27	IAH20270S

## Conexpanduri



### Conexpand bolț din oțel inoxidabil A4 (AISI 316), omologat, cu certificare ETA-CE Opt. 7, pentru beton nefisurat

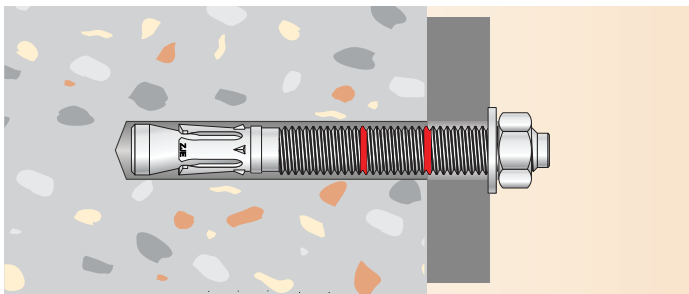

**ACREDITARE TEHNICĂ EUROPEANĂ**  
ETA 05/0242 Opțiunea 7  
CE 1219-CPR-0006

Dimensiuni (mm)				Ambalare (buc.)	€/100 buc.	Cod articol
M x L	d	l <sub>max</sub>	h <sub>min</sub>			
M 6 x 60	6.0	2.0	55.0	100.0	56.65	I.MIA406060S
M 6 x 80	6.0	22.0	55.0	100.0	62.20	I.MIA406080S
M 8 x 75	8.0	5.0	65.0	100.0	76.78	I.MIA408075S
M 8 x 90	8.0	20.0	65.0	100.0	91.15	I.MIA408090S
M 8 x 115	8.0	45.0	65.0	50.0	101.53	I.MIA408115S
M10 x 70	10.0	3.0	55.0	50.0	111.98	I.MIA410070S
M10 x 90	10.0	10.0	70.0	50.0	131.78	I.MIA410090S
M10 x 120	10.0	40.0	70.0	50.0	175.40	I.MIA410120S
M10 x 150	10.0	70.0	70.0	50.0	211.88	I.MIA410150S
M12 x 90	12.0	13.0	75.0	50.0	193.03	I.MIA412090S
M12 x 110	12.0	18.0	85.0	25.0	221.06	I.MIA412110S
M12 x 140	12.0	48.0	85.0	25.0	285.46	I.MIA412140S
M16 x 145	16.0	25.0	110.0	20.0	534.45	I.MIA416145S
M16 x 170	16.0	48.0	110.0	15.0	825.21	I.MIA416170S
M20 x 170	20.0	23.0	135.0	10.0	1008.51	I.MIA420170S
M20 x 220	20.0	73.0	135.0	5.0	1010.86	I.MIA420220S

### Conexpand din oțel zincat pentru încărcări grele, omologat, cu certificare ETA-CE opt. 7, pentru beton nefisurat

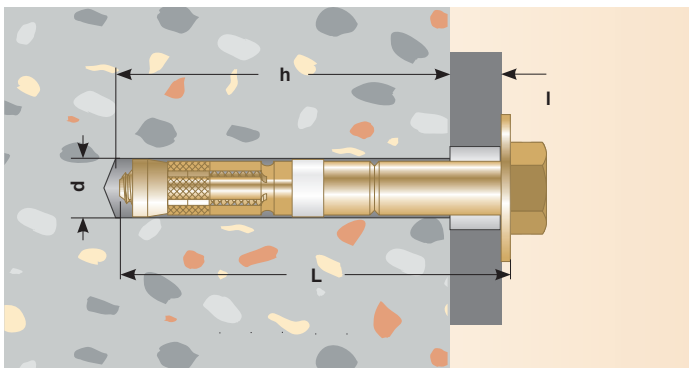

**ACREDITARE TEHNICĂ EUROPEANĂ**  
ETA 04/0100 Opțiunea 7  
CE 1219-CPR-0001

Dimensiuni (mm)					Forța de extracție (kN)	Ambalare (buc.)	€/100 buc.	Cod articol
M x L	d	l <sub>max</sub>	h	t <sub>fix</sub>				
M 8 x 100	12	20	85	90	10.35	15	111.28	I.SLVT08100S
M 8 x 120	12	40	85	90	10.35	15	111.46	I.SLVT08120S
M10 x 110	15	20	95	100	15.36	10	159.38	I.SLVT10110S
M10 x 130	15	40	95	100	15.36	10	161.43	I.SLVT10130S
M12 x 130	18	25	110	115	22.35	10	225.78	I.SLVT12130S
M12 x 160	18	55	110	115	22.34	10	274.40	I.SLVT12160S
M16 x 150	24	25	135	140	26.47	10	277.30	I.SLVT16150S
M16 x 180	24	55	135	140	26.47	10	296.94	I.SLVT16180S
M20 x 160	28	2	170	175	40.07	10	428.83	I.SLVT20160S
M20 x 190	28	30	170	175	40.07	8	510.59	I.SLVT20190S
M20 x 220	28	60	170	175	40.07	6	506.08	I.SLVT20220S
M24 x 210	32	30	190	195	46.75	6	747.28	I.SLVT24210S
M24 x 240	32	60	190	195	46.75	6	948.68	I.SLVT24240S

### Conexpand bolț din oțel inoxidabil A2

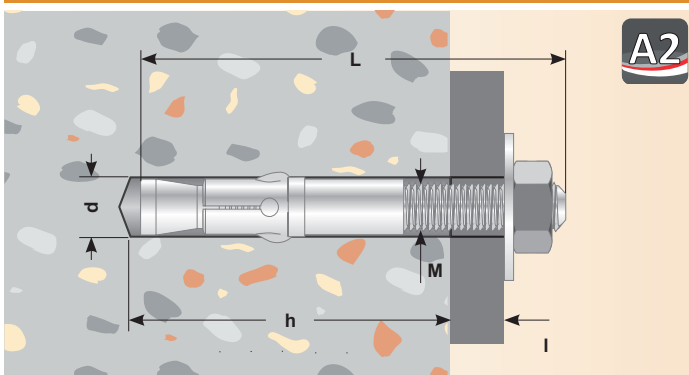

Dimensiuni (mm)				Ambalare (buc.)	€/100 buc.	Cod articol
M x L	d	l <sub>max</sub>	h <sub>min</sub>			
M 6 x 45	6	2	40	200	40.74	I.MI06045S
M 6 x 60	6	2	55	200	44.44	I.MI06060S
M 6 x 80	6	22	55	200	47.49	I.MI06080S
M 6 x 120	6	62	55	100	50.87	I.MI06120S
M 6 x 140	6	62	55	100	72.13	I.MI06140S
M 6 x 160	6	62	55	100	74.69	I.MI06160S

Dimensiuni (mm)				Ambalare (buc.)	€/100 buc.	Cod articol
M x L	d	l <sub>max</sub>	h <sub>min</sub>			
M 8 x 50	8	5	40	100	45.88	I.MI08050S
M 8 x 75	8	5	65	100	69.50	I.MI08075S
M 8 x 90	8	20	65	100	57.79	I.MI08090S
M 8 x 115	8	45	65	100	69.71	I.MI08115S
M10 x 70	10	3	55	100	75.37	I.MI10070S
M10 x 90	10	10	70	100	92.67	I.MI10090S
M10 x 120	10	40	70	50	114.18	I.MI10120S
M10 x 150	10	70	70	50	195.53	I.MI10150S
M12 x 75	12	5	60	50	120.95	I.MI12075S
M12 x 90	12	13	75	50	135.59	I.MI12090S
M12 x 110	12	18	85	50	152.24	I.MI12110S
M12 x 140	12	48	85	50	178.10	I.MI12140S
M16 x 90	16	5	75	25	250.77	I.MI16090S
M16 x 145	16	25	110	25	354.07	I.MI16145S
M16 x 170	16	48	110	25	371.67	I.MI16170S
M20 x 120	20	5	105	20	616.40	I.MI20120S
M20 x 170	20	23	135	20	515.48	I.MI20170S
M20 x 220	20	73	135	20	1086.86	I.MI20220S



## Conexpanduri

Conexpand bolț standard cu inel de strângere din oțel zincat alb

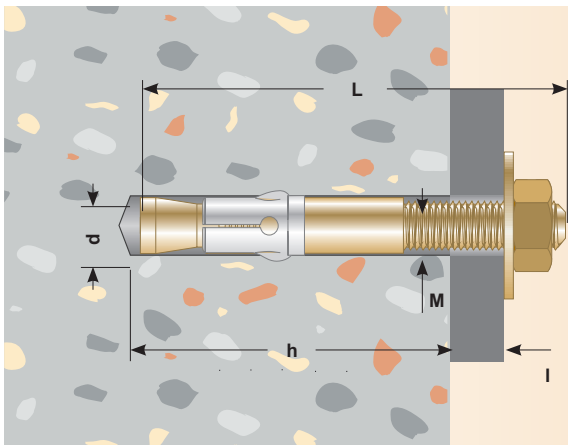

Dimensiuni (mm)				ambalare STANDARD		
M x L	d	l <sub>max</sub>	h <sub>min</sub>	buc. / pac.	€/100 buc.	Cod articol
M 6 x 45	6	2	40	200	10.65	I.AM06045S
M 6 x 60	6	2	55	200	11.62	I.AM06060S
M 6 x 70	6	12	55	200	12.02	I.AM06070S
M 6 x 80	6	22	55	200	13.28	I.AM06080S
M 6 x 90	6	32	55	200	13.52	I.AM06090S
M 6 x 100	6	42	55	200	14.44	I.AM06100S
M 6 x 110	6	52	55	200	20.50	I.AM06110S
M 6 x 120	6	62	55	100	14.57	I.AM06120S
M 6 x 130	6	72	55	100	14.91	I.AM06130S
M 6 x 140	6	82	55	100	21.15	I.AM06140S
M 6 x 150	6	92	55	100	22.97	I.AM06150S
M 6 x 160	6	102	55	100	25.45	I.AM06160S
M 6 x 170	6	112	55	100	24.88	I.AM06170S
M 6 x 180	6	122	55	100	28.68	I.AM06180S
M 8 x 50	8	5	40	100	14.12	I.AM08050S
M 8 x 60	8	3	50	100	15.47	I.AM08060S
M 8 x 75	8	5	65	100	16.73	I.AM08075S
M 8 x 90	8	20	65	100	17.99	I.AM08090S
M 8 x 115	8	45	65	100	18.72	I.AM08115S
M 8 x 120	8	50	65	100	21.18	I.AM08120S
M 8 x 130	8	60	65	100	22.37	I.AM08130S
M 8 x 155	8	85	65	100	35.98	I.AM08155S
M10 x 70	10	3	55	100	22.67	I.AM10070S
M10 x 90	10	10	70	100	25.29	I.AM10090S
M10 x 120	10	40	70	50	30.25	I.AM10120S
M10 x 140	10	60	70	50	32.36	I.AM10140S
M10 x 150	10	70	70	50	37.27	I.AM10150S
M10 x 170	10	90	70	50	39.92	I.AM10170S
M10 x 210	10	130	70	50	46.57	I.AM10210S
M10 x 230	10	150	70	50	49.17	I.AM10230S

Dimensiuni (mm)				ambalare STANDARD		
M x L	d	l <sub>max</sub>	h <sub>min</sub>	buc. / pac.	€/100 buc.	Cod articol
M12 x 75	12	5	60	50	31.56	I.AM12075S
M12 x 90	12	13	75	50	36.32	I.AM12090S
M12 x 110	12	18	85	50	40.44	I.AM12110S
M12 x 120	12	28	85	50	43.41	I.AM12120S
M12 x 140	12	48	85	50	47.04	I.AM12140S
M12 x 160	12	68	85	50	54.20	I.AM12160S
M12 x 180	12	88	85	50	59.31	I.AM12180S
M12 x 220	12	128	85	50	66.97	I.AM12220S
M12 x 250	12	158	85	25	72.65	I.AM12250S

M14 x 80	14	5	65	50	47.38	I.AM14080S
M14 x 100	14	5	85	50	51.93	I.AM14100S
M14 x 120	14	12	100	25	59.43	I.AM14120S
M14 x 145	14	37	100	25	64.88	I.AM14145S
M14 x 170	14	62	100	25	70.84	I.AM14170S
M14 x 220	14	112	100	25	89.00	I.AM14220S
M14 x 250	14	142	100	25	96.12	I.AM14250S

M16 x 90	16	4	75	25	64.88	I.AM16090S
M16 x 110	16	25	75	25	71.42	I.AM16110S
M16 x 125	16	3	110	25	77.87	I.AM16125S
M16 x 145	16	23	110	25	84.59	I.AM16145S
M16 x 170	16	48	110	25	91.87	I.AM16170S
M16 x 220	16	98	110	25	110.54	I.AM16220S
M16 x 250	16	128	110	25	125.28	I.AM16250S
M16 x 280	16	158	110	25	126.51	I.AM16280S

M20 x 120	20	5	105	20	113.24	I.AM20120S
M20 x 170	20	23	135	20	142.86	I.AM20170S
M20 x 220	20	73	135	20	173.21	I.AM20220S
M20 x 270	20	123	135	20	202.19	I.AM20270S

M24 x 180	24	4	160	10	460.68	I.AM24180S
M24 x 260	24	84	160	10	520.30	I.AM24260S

Dimensiuni (mm)				ambalare La BLISTER		
M x L	d	l <sub>max</sub>	h <sub>min</sub>	buc. / pac.	€/100 buc.	Cod articol
M 8 x 75	8	5	65	4	0.79	I.AM08075B
M 8 x 90	8	20	65	4	0.84	I.AM08090B
M 8 x 115	8	45	65	4	0.87	I.AM08115B

M10 x 70	10	3	55	4	1.03	I.AM10070B
M10 x 90	10	10	70	4	1.13	I.AM10090B
M10 x 120	10	40	70	4	1.33	I.AM10120B
M10 x 150	10	70	70	4	1.61	I.AM10150B

M12 x 90	12	13	75	2	0.85	I.AM12090B
M12 x 110	12	18	85	2	0.93	I.AM12110B
M12 x 140	12	48	85	2	1.06	I.AM12140B
M12 x 160	12	68	85	2	1.20	I.AM12160B

M16 x 125	16	3	110	2	1.68	I.AM16125B
-----------	----	---	-----	---	------	------------



### Conexpanduri

#### Conexpand clasic

K 10

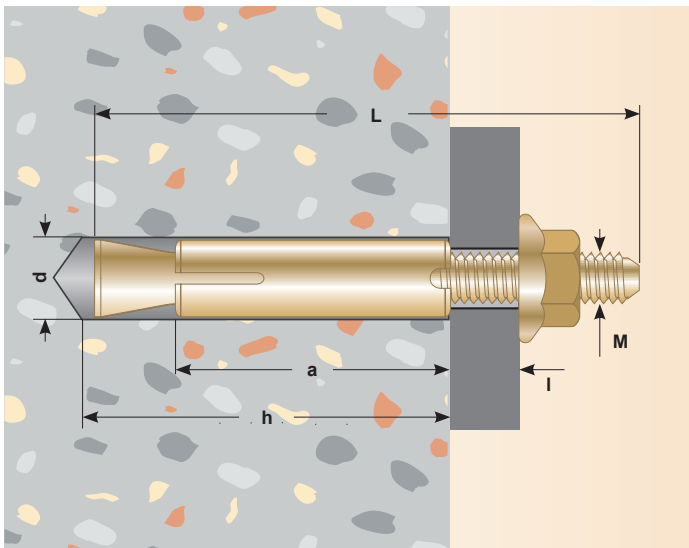

Dimensiuni (mm)						Ambalare (buc.)	€/100 buc.	Cod articol
M x L	d	I <sub>min</sub>	I <sub>max</sub>	a	h <sub>min</sub>			
M 5 x 40	8	0	5	25	30	100	6.60	AA.14005040S
M 6 x 40	10	0	5	25	30	100	9.05	AA.14006040S
M 6 x 50	10	0	5	30	35	100	9.84	AA.14006050S
M 6 x 60	10	0	15	30	35	100	10.78	AA.14006060S
M 6 x 80	10	0	25	40	45	100	13.68	AA.14006080S
M 6 x 100	10	5	50	40	45	100	15.50	AA.14006100S
M 6 x 120	10	5	60	50	55	25	18.55	AA.14006120S
M 6 x 160	10	40	95	50	55	25	22.36	AA.14006160S
M 8 x 50	12	0	5	25	30	100	16.41	AA.14008050S
M 8 x 60	12	0	5	35	40	100	18.27	AA.14008060S
M 8 x 70	12	0	15	35	40	100	19.70	AA.14008070S
M 8 x 80	12	0	25	35	40	100	21.11	AA.14008080S
M 8 x 90	12	0	35	35	40	100	22.61	AA.14008090S
M 8 x 100	12	0	40	45	50	100	25.51	AA.14008100S
M 8 x 120	12	0	60	45	50	100	28.23	AA.14008120S
M 8 x 160	12	10	75	70	75	25	36.84	AA.14008160S
M 8 x 180	12	30	95	70	75	25	39.56	AA.14008180S

Dimensiuni (mm)						Ambalare (buc.)	€/100 buc.	Cod articol
M x L	d	I <sub>min</sub>	I <sub>max</sub>	a	h <sub>min</sub>			
M10 x 60	14	0	5	35	45	50	25.17	AA.14010060S
M10 x 70	14	0	5	45	55	50	27.97	AA.14010070S
M10 x 80	14	0	15	45	55	50	30.33	AA.14010080S
M10 x 90	14	0	15	45	55	50	32.65	AA.14010090S
M10 x 100	14	0	25	55	65	50	35.77	AA.14010100S
M10 x 120	14	0	45	55	65	50	39.96	AA.14010120S
M10 x 140	14	0	65	55	65	50	43.99	AA.14010140S
M10 x 180	14	0	75	85	95	25	54.42	AA.14010180S
M10 x 200	14	15	95	85	95	25	57.95	AA.14010200S
M12 x 80	16	0	5	50	60	50	40.81	AA.14012080S
M12 x 90	16	0	15	50	60	50	44.56	AA.14012090S
M12 x 100	16	0	30	50	60	50	46.59	AA.14012100S
M12 x 110	16	0	30	60	70	50	50.71	AA.14012110S
M12 x 120	16	0	40	60	70	50	52.89	AA.14012120S
M12 x 140	16	0	60	60	70	50	59.19	AA.14012140S
M12 x 160	16	0	60	80	90	50	67.99	AA.14012160S
M12 x 180	16	0	60	100	110	50	76.69	AA.14012180S
M12 x 200	16	0	80	100	110	50	81.78	AA.14012200S
M12 x 220	16	10	100	100	110	25	86.37	AA.14012220S
M12 x 250	16	40	230	100	110	25	90.27	AA.14012250S
M12 x 300	16	85	180	100	110	25	106.37	AA.14012300S
M16 x 80	22	0	5	40	50	10	73.60	AA.14016080S
M16 x 90	22	0	15	40	50	10	78.11	AA.14016090S
M16 x 100	22	0	15	50	60	10	87.13	AA.14016100S
M16 x 120	22	0	25	60	70	10	101.39	AA.14016120S
M16 x 150	22	0	65	60	70	10	116.04	AA.14016150S
M16 x 200	22	0	70	100	110	10	152.28	AA.14016200S
M16 x 250	22	0	100	125	135	10	183.27	AA.14016250S
M16 x 300	22	15	145	125	135	10	215.20	AA.14016300S
M18 x 200	25	0	65	100	115	1	184.01	AA.14018200S
M18 x 250	25	0	90	125	140	1	220.45	AA.14018250S
M20 x 200	28	0	60	100	120	1	241.84	AA.14020200S
M20 x 250	28	0	80	125	145	1	292.17	AA.14020250S
M20 x 300	28	0	85	170	190	1	351.51	AA.14020300S
M24 x 250	32	0	75	125	150	1	454.40	AA.14024250S
M24 x 300	32	0	90	160	185	1	533.27	AA.14024300S
M24 x 350	32	0	90	210	230	1	636.40	AA.14024350S

#### Conexpand de străpungere - tip 1

K 10

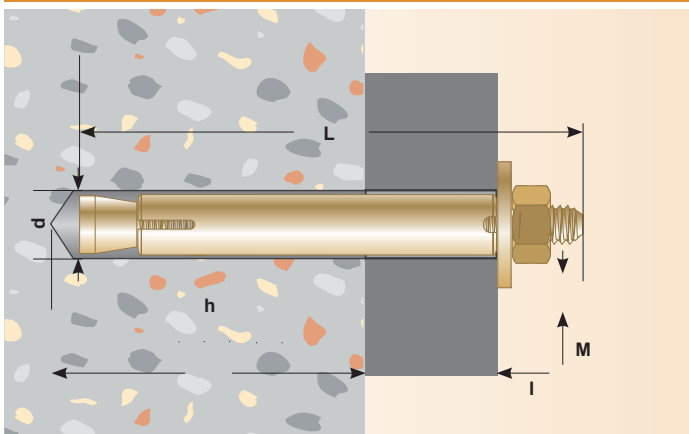

Dimensiuni (mm)					Ambalare (buc.)	€/100 buc.	Cod articol
M x L	d	I <sub>max</sub>	h <sub>min</sub>	h <sub>max</sub>			
M 6 x 60	10	10	45	55	25	15.42	AA.14106060S
M 6 x 80	10	25	45	75	25	18.56	AA.14106080S
M 6 x 100	10	45	45	95	25	23.05	AA.14106100S
M 6 x 120	10	60	45	115	25	27.30	AA.14106120S
M 6 x 160	10	100	45	155	25	36.48	AA.14106160S
M 8 x 80	12	10	55	75	25	28.29	AA.14108080S
M 8 x 100	12	30	55	95	25	31.82	AA.14108100S
M 8 x 120	12	50	55	115	25	37.75	AA.14108120S
M 8 x 160	12	90	55	155	25	48.60	AA.14108160S
M 8 x 180	12	110	55	175	25	53.78	AA.14108180S

Dimensiuni (mm)					Ambalare (buc.)	€/100 buc.	Cod articol
M x L	d	I <sub>max</sub>	h <sub>min</sub>	h <sub>max</sub>			
M10 x 100	14	20	65	95	25	46.20	AA.14110100S
M10 x 120	14	40	65	115	25	48.92	AA.14110120S
M10 x 140	14	60	65	135	25	58.25	AA.14110140S
M10 x 180	14	95	65	175	25	72.49	AA.14110180S
M10 x 200	14	115	65	195	25	79.74	AA.14110200S
M12 x 120	16	35	80	110	10	71.18	AA.14112120S
M12 x 140	16	55	80	130	10	82.68	AA.14112140S
M12 x 160	16	65	80	150	10	86.01	AA.14112160S
M12 x 180	16	85	80	170	10	92.45	AA.14112180S
M12 x 200	16	105	80	190	10	104.65	AA.14112200S
M12 x 220	16	125	80	210	10	111.78	AA.14112220S
M12 x 250	16	155	80	240	10	124.86	AA.14112250S
M12 x 300	16	195	80	290	10	151.04	AA.14112300S
M16 x 150	22	30	100	135	10	155.10	AA.14116150S
M16 x 200	22	80	100	185	10	197.62	AA.14116200S
M16 x 250	22	130	100	235	10	244.23	AA.14116250S
M16 x 300	22	180	100	285	10	290.77	AA.14116300S
M18 x 200	25	70	110	180	1	255.66	AA.14118200S
M18 x 250	25	120	110	230	1	303.81	AA.14118250S
M20 x 200	28	55	120	175	1	326.73	AA.14120200S
M20 x 250	28	105	120	225	1	389.98	AA.14120250S
M20 x 300	28	155	120	275	1	574.70	AA.14120300S
M24 x 250	32	65	150	220	1	587.50	AA.14124250S
M24 x 300	32	115	150	270	1	704.51	AA.14124300S
M24 x 350	32	165	150	320	1	798.08	AA.14124350S

Conexpanduri

**ROCAST**

Conexpand de străpungere - tip 8

K 10

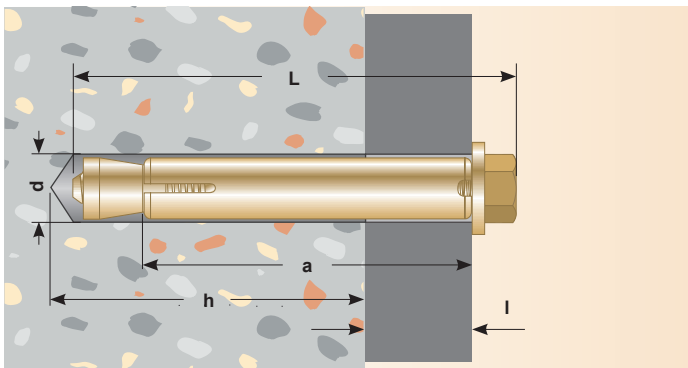

Dimensiuni (mm)					Ambalare (buc.)	€/100 buc.	Cod articol
M x L	d	l <sub>max</sub>	a	h <sub>min</sub>			
M 6 x 50	10	5	40	40	25	20.88	AA.14806050S
M 6 x 60	10	15	50	40	25	20.19	AA.14806060S
M 8 x 60	12	10	50	50	25	28.30	AA.14808060S
M 8 x 80	12	30	70	50	25	34.68	AA.14808080S
M10 x 80	14	20	65	65	25	42.00	AA.14810080S
M10 x 100	14	40	85	65	25	52.14	AA.14810100S
M12 x 100	16	30	80	75	10	74.50	AA.14812100S
M12 x 120	16	50	100	75	10	89.04	AA.14812120S

Conexpand pentru fixări distanțate

K 10

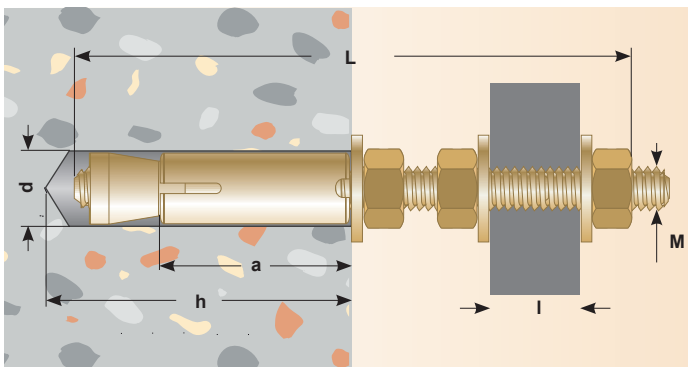

Dimensiuni (mm)					Ambalare (buc.)	€/100 buc.	Cod articol
M x L	d	l <sub>max</sub>	a	h <sub>min</sub>			
M 6 x 120	10	40	40	50	25	31.02	AA.14306120S
M 6 x 160	10	80	40	50	25	35.43	AA.14306160S
M 8 x 120	12	30	45	60	25	47.69	AA.14308120S
M 8 x 160	12	70	45	60	25	55.74	AA.14308160S
M 8 x 180	12	90	45	60	25	59.32	AA.14308180S
M10 x 140	14	30	55	75	10	67.83	AA.14310140S
M10 x 200	14	90	55	75	10	82.93	AA.14310200S
M12 x 160	16	35	60	85	10	106.19	AA.14312160S
M12 x 220	16	95	60	85	10	121.53	AA.14312220S

Conexpand cu șurub - tip 2

K 10

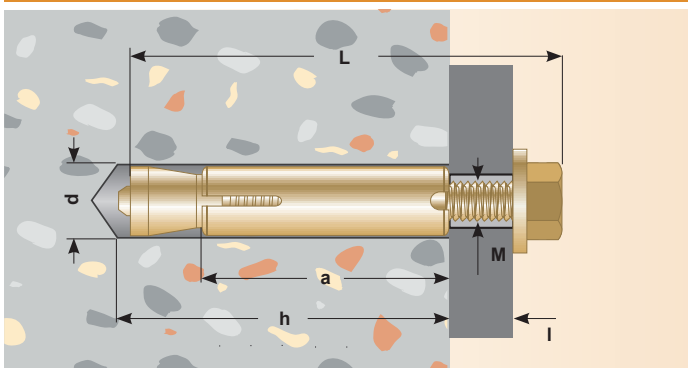

Dimensiuni (mm)					Ambalare (buc.)	€/100 buc.	Cod articol
M x L	d	l <sub>max</sub>	a	h <sub>min</sub>			
M 6 x 50	10	10	30	40	25	15.73	AA.14206050S
M 6 x 60	10	20	30	40	25	17.06	AA.14206060S
M 6 x 80	10	40	30	40	25	19.85	AA.14206080S
M 8 x 60	12	10	35	50	25	26.08	AA.14208060S
M 8 x 70	12	20	35	50	25	28.63	AA.14208070S
M 8 x 80	12	30	35	50	25	30.42	AA.14208080S
M10 x 80	14	15	45	65	25	47.46	AA.14210080S
M10 x 100	14	35	45	65	25	51.66	AA.14210100S
M12 x 100	16	25	50	75	10	62.80	AA.14212100S
M12 x 120	16	45	50	75	10	69.52	AA.14212120S

Conexpand "Ochi"

K 10

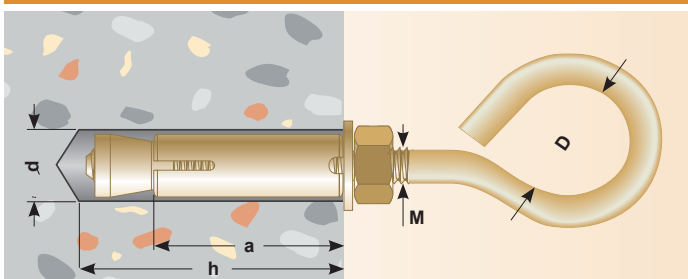

Dimensiuni (mm)					Ambalare (buc.)	€/100 buc.	Cod articol
M	d	D	a	h <sub>min</sub>			
M 6	10	16	30	40	10	25.89	AA.14406000S
M 8	12	20	35	50	10	40.00	AA.14408000S
M10	14	25	45	65	10	63.07	AA.14410000S
M12	16	30	50	85	10	98.60	AA.14412000S

Conexpand "Cârlig"

K 10

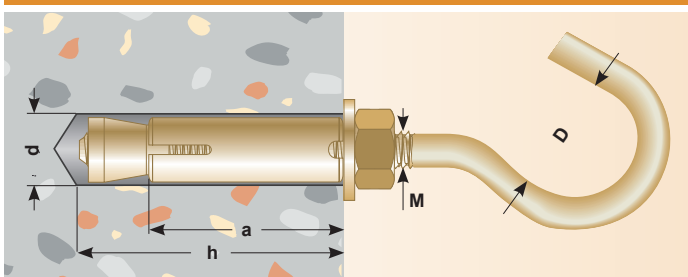

Dimensiuni (mm)					Ambalare (buc.)	€/100 buc.	Cod articol
M	d	D	a	h <sub>min</sub>			
M 6	10	16	30	40	10	24.45	AA.14506000S
M 8	12	20	35	50	10	37.21	AA.14508000S
M10	14	25	45	65	10	58.75	AA.14510000S
M12	16	30	50	85	10	91.78	AA.14512000S



## Conexpanduri

### Conexpand "L"

**ROCAST** K 10

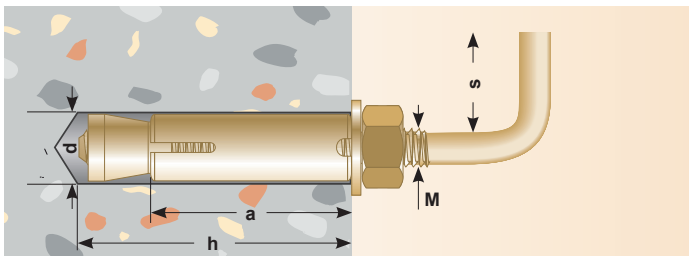

Dimensiuni (mm)					Ambalare (buc.)	€/100 buc.	Cod articol
M	d	D	a	h <sub>min</sub>			
M 6	10	15	30	40	10	19.79	AA.14606000S
M 8	12	20	35	50	10	29.08	AA.14608000S
M10	14	25	45	65	10	45.55	AA.14610000S
M12	16	30	50	85	10	70.82	AA.14612000S

### Conexpand invariabil cu șurub

**INDEX**

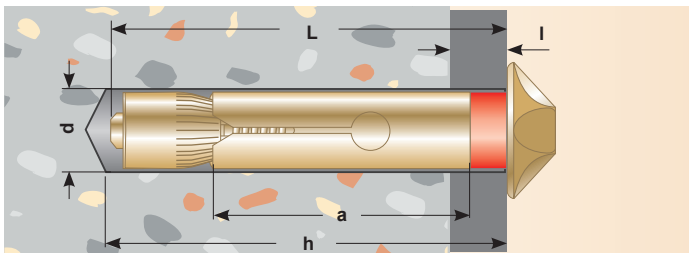

Dimensiuni (mm)					Ambalare (buc.)	€/100 buc.	Cod articol
M x L	d	l <sub>max</sub>	a	h <sub>min</sub>			
M 6 x 45	8	6.5	30	50	100	13.38	I.ACHINB08CS
M 6 x 60	8	16.5	35	60	100	16.35	I.ACHINB08LS
M 8 x 60	10	6.5	40	60	100	22.29	I.ACHINB10CS
M 8 x 80	10	16.5	52	80	100	25.84	I.ACHINB10LS

### Conexpand invariabil cu cap teșit

**INDEX**

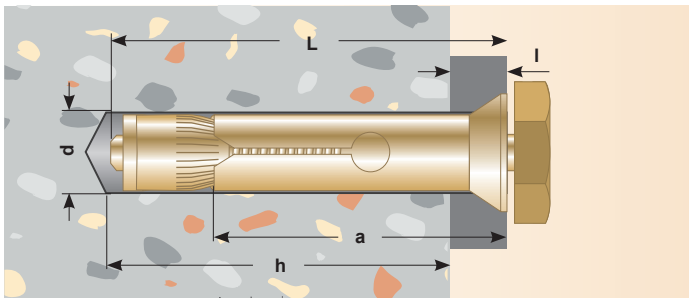

Dimensiuni (mm)					Ambalare (buc.)	€/100 buc.	Cod articol
M x L	d	l <sub>max</sub>	a	h <sub>min</sub>			
M 6 x 60	8	15	45	60	1	37.39	I.ACHTC308LS
M 8 x 60	10	5	40	60	1	50.51	I.ACHTC310CS
M 8 x 80	10	15	62	80	1	55.37	I.ACHTC310LS
M10 x 70	12	5	48	75	1	76.42	I.ACHTC312CS
M10 x 100	12	25	75	100	1	81.62	I.ACHTC312LS
M12 x 80	16	5	55	85	1	116.38	I.ACHTC316CS
M12 x 110	16	25	88	110	1	140.75	I.ACHTC316LS

### Conexpand invariabil cu cap sferic

**INDEX**

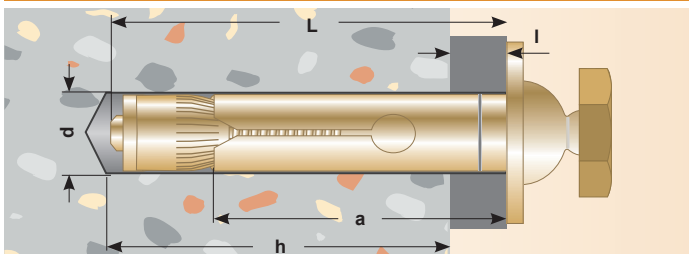

Dimensiuni (mm)					Ambalare (buc.)	€/100 buc.	Cod articol
M x L	d	l <sub>max</sub>	a	h <sub>min</sub>			
M 6 x 45	8	5	30	50	1	34.60	I.ACHTC408CS
M 6 x 60	8	15	45	60	1	35.48	I.ACHTC408LS
M12 x 80	16	5	55	85	1	91.06	I.ACHTC416CS
M12 x 110	16	25	88	110	1	115.42	I.ACHTC416LS

### Conexpand cu șurub cap înecat

**INDEX**

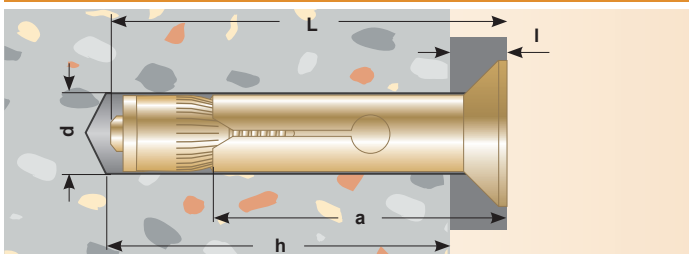

Dimensiuni (mm)					Ambalare (buc.)	€/100 buc.	Cod articol
M x L	d	l <sub>max</sub>	a	h <sub>min</sub>			
M 6 x 45	8.0	8.0	27.5	50.0	100	16.28	I.ACHTPL08CS
M 6 x 60	8.0	18.0	37.5	60.0	100	25.55	I.ACHTPL08LS
M 8 x 60	10.0	9.0	39.0	60.0	100	27.84	I.ACHTPL10CS
M 8 x 80	10.0	19.0	51.0	80.0	100	40.53	I.ACHTPL10LS
M10 x 70	12.0	10.0	48.0	75.0	50	46.21	I.ACHTPL12CS
M10 x 100	12.0	30.0	55.0	100.0	50	74.48	I.ACHTPL12LS

### Conexpand cu șurub cap înecat, oțel inoxidabil A2

**INDEX**

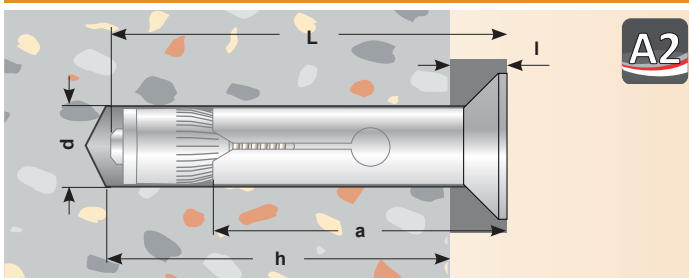

**A2**

Dimensiuni (mm)					Ambalare (buc.)	€/100 buc.	Cod articol
M x L	d	l <sub>max</sub>	a	h <sub>min</sub>			
M 6 x 45	8.0	8.0	27.5	50.0	100	30.80	I.ACHTPI08CS
M 6 x 60	8.0	18.0	37.5	60.0	100	35.72	I.ACHTPI08LS
M 8 x 60	10.0	9.0	39.0	60.0	100	51.13	I.ACHTPI10CS
M 8 x 80	10.0	19.0	51.0	80.0	100	62.88	I.ACHTPI10LS
M10 x 70	12.0	10.0	48.0	75.0	50	81.12	I.ACHTPI12CS
M10 x 100	12.0	30.0	55.0	100.0	50	112.42	I.ACHTPI12LS



## Conexpanduri

## Conexpand cu șurub, oțel zincat



Dimensiuni (mm)					Ambalare (buc.)	€/100 buc.	Cod articol
M x L	d	l <sub>max</sub>	a	h <sub>min</sub>			
M 6 x 60	8	15	35	60	200	13.78	I.ACHT08LS
M 8 x 80	10	15	52	80	100	22.57	I.ACHT10LS
M 8 x 80	11	15	52	80	100	25.07	I.ACHT11LS
M10 x 70	12	5	48	75	100	30.25	I.ACHT12CS
M10 x 100	14	25	48	100	50	47.82	I.ACHT14LS

## Conexpand cu șurub, oțel inoxidabil A2

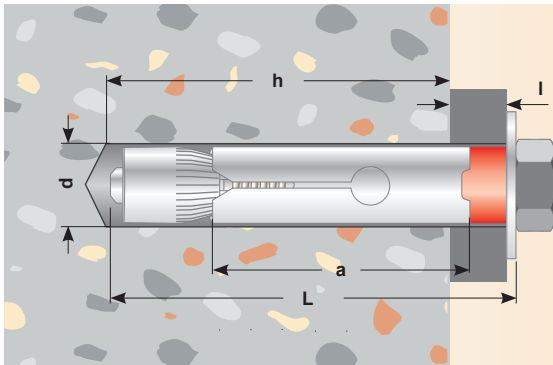

Dimensiuni (mm)					Ambalare (buc.)	€/100 buc.	Cod articol
M x L	d	l <sub>max</sub>	a	h <sub>min</sub>			
M 6 x 45	8	5	30	50	100	34.34	I.ACHTA208CS
M 6 x 60	8	15	35	60	100	37.96	I.ACHTA208LS
M 8 x 60	10	5	40	60	100	58.35	I.ACHTA210CS
M 8 x 80	10	15	52	80	100	69.71	I.ACHTA210LS
M10 x 70	12	5	48	75	100	102.27	I.ACHTA212CS
M10 x 100	12	25	55	100	50	123.67	I.ACHTA212LS
M12 x 80	16	5	55	85	50	202.45	I.ACHTA216CS
M12 x 110	16	25	67	110	50	256.54	I.ACHTA216LS
M16 x 110	20	15	72	110	25	471.36	I.ACHTA220CS

## Conexpand ochi forjat, oțel inoxidabil A2



Dimensiuni (mm)				Ambalare (buc.)	€/100 buc.	Cod articol
M x L	d	a	h <sub>min</sub>			
M 6 x 45	8	30	50	100	146.48	I.ACHAA208CS
M 6 x 45	9	30	50	100	112.30	I.ACHAA209CS
M 8 x 60	10	40	60	100	222.93	I.ACHAA210CS
M 8 x 60	11	40	60	100	194.42	I.ACHAA211CS
M10 x 70	12	48	75	50	259.87	I.ACHAA212CS

## Conexpand cârlig forjat, oțel inoxidabil A2

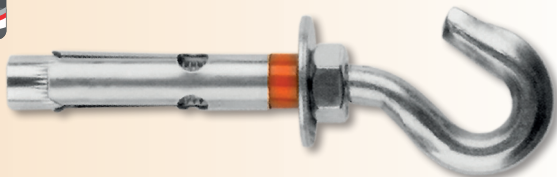

Dimensiuni (mm)				Ambalare (buc.)	€/100 buc.	Cod articol
M x L	d	a	h <sub>min</sub>			
M 6 x 45	8	30	50	100	110.54	I.ACHGA208CS
M 6 x 45	9	30	50	100	113.74	I.ACHGA209CS
M 8 x 60	10	40	60	100	144.56	I.ACHGA210CS
M 8 x 60	11	40	60	100	153.42	I.ACHGA211CS
M10 x 70	12	48	75	50	245.24	I.ACHGA212CS
M10 x 70	14	50	75	50	254.54	I.ACHGA214CS

## Capsulă conexpand, oțel zincat

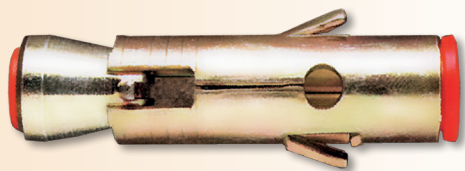

Dimensiuni (mm)			Ambalare (buc.)	€/100 buc.	Cod articol
M x L	d	Lungime totală			
M 6 x 45	12	60	100	23.70	I.AHICA0645S
M 8 x 55	14	65	50	29.05	I.AHICA0855S
M10 x 65	16	85	50	38.69	I.AHICA1065S
M12 x 75	20	98	25	56.30	I.AHICA1275S
M16 x 90	24	120	10	103.12	I.AHICA1690S

## Capsulă conexpand, oțel inoxidabil A2

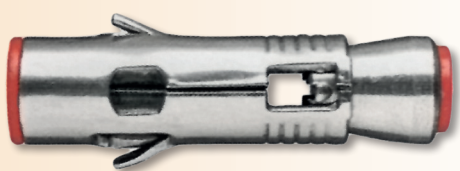

Dimensiuni (mm)			Ambalare (buc.)	€/100 buc.	Cod articol
M x L	d	Lungime totală			
M 6 x 45	12	60	25	223.89	I.AHICI0645S
M 8 x 55	14	65	25	229.34	I.AHICI0855S
M10 x 65	16	81	25	306.30	I.AHICI1065S

## Piulițe expandabile

Piulițe expandabile din oțel zincat, omologate cu certificare ETA-CE, opțiunea 7 pentru beton nefisurat



Dimensiuni (mm)		Ambalare STANDARD		
M x L	d	buc. / pac.	€/100 buc.	Cod articol
M 6 x 25	8	100	8.21	I.HEHOM06S
M 8 x 30	10	100	11.15	I.HEHOM08S
M10 x 40	12	50	17.79	I.HEHOM10S
M12 x 50	15	50	32.12	I.HEHOM12S
M16 x 65	20	25	78.93	I.HEHOM16S
M20 x 80	25	25	149.87	I.HEHOM20S

Piulițe expandabile din oțel zincat, pentru beton

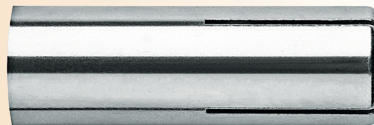

Dimensiuni (mm)		Ambalare STANDARD			Ambalare la BLISTER (BL)		
M x L	d	buc. / pac.	€/100 buc.	Cod articol	buc. / BL	€/BL	Cod articol
M 6 x 25	8	100	5.24	I.HENOM06S	4	0.33	I.HENOM06B
M 8 x 30	10	100	7.49	I.HENOM08S	4	0.42	I.HENOM08B
M10 x 40	12	50	12.03	I.HENOM10S	4	0.60	I.HENOM10B
M12 x 50	15	50	21.76	I.HENOM12S	2	0.56	I.HENOM12B
M16 x 65	20	25	52.08	I.HENOM16S	-	-	-
M20 x 80	25	25	89.69	I.HENOM20S	-	-	-

Piulițe expandabile cu guler, din oțel, omologate cu certificare ETA-CE, opțiunea 7 pentru beton nefisurat

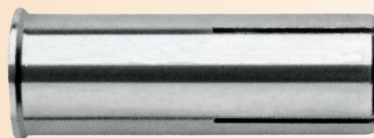

Dimensiuni (mm)		Ambalare STANDARD		
M x L	d	buc. / pac.	€/100 buc.	Cod articol
M 6 x 25	8	100	7.12	I.HECLOM06S
M 8 x 30	10	100	10.10	I.HECLOM08S
M10 x 40	12	50	16.19	I.HECLOM10S
M12 x 50	15	50	28.04	I.HECLOM12S
M16 x 65	20	25	70.66	I.HECLOM16S

Piulițe expandabile din oțel inoxidabil A4, pentru beton

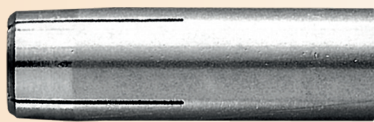

Dimensiuni (mm)		Ambalare STANDARD		
M x L	d	buc. / pac.	€/100 buc.	Cod articol
M 6 x 25	8	100	65.57	I.HEA4M06S
M 8 x 30	10	100	72.22	I.HEA4M08S
M10 x 40	12	50	122.72	I.HEA4M10S
M12 x 50	15	50	207.97	I.HEA4M12S
M16 x 65	20	25	427.83	I.HEA4M16S
M20 x 80	25	25	681.26	I.HEA4M20S

Piulițe expandabile din alamă pentru marmură, gresie sau beton



Dimensiuni (mm)		Ambalare STANDARD			Ambalare la BLISTER (BL)		
M x L	d	buc. / pac.	€/100 buc.	Cod articol	buc. / BL	€/BL	Cod articol
M 4 x 16	5	100	4.19	I.TALAM04S	-	-	-
M 5 x 18	6	100	6.30	I.TALAM05S	-	-	-
M 6 x 23	8	100	9.05	I.TALAM06S	4	0.48	I.TALAM06B
M 8 x 28	10	100	15.63	I.TALAM08S	4	0.75	I.TALAM08B
M10 x 34	12	100	23.67	I.TALAM10S	4	1.07	I.TALAM10B
M12 x 38	15	50	49.50	I.TALAM12S	-	-	-
M14 x 42	18	25	118.26	AA.16114042S	-	-	-
M16 x 44	20	25	134.21	AA.16116044S	-	-	-

Dorn de expandare pentru piulițe expandabile



Filet	Ambalare (buc.)	€/100 buc.	Cod articol
M 6	1	192.77	I.EXHBM06S
M 8	1	202.76	I.EXHBM08S
M10	1	216.08	I.EXHBM10S
M12	1	244.57	I.EXHBM12S
M16	1	452.88	I.EXHBM16S
M20	1	791.80	I.EXHBM20S

Cui expandabil "Expres"



M x L (mm)	Ambalare (buc.)	€/100 buc.	Cod articol
M6 x 30	200	4.48	I.TRA6030S
M6 x 60	200	6.79	I.TRA6060S
M6 x 80	200	8.29	I.TRA6080S
M8 x 70	100	10.12	I.TRA8070S
M8 x 90	100	13.41	I.TRA8090S
M8 x 110	100	15.67	I.TRA8110S
M8 x 130	100	16.17	I.TRA8130S
M8 x 150	100	18.37	I.TRA8150S
M8 x 180	100	18.37	AA.15008180S



Cantități mai mici decât cele incluse în ambalarea STANDARD se livrează la prețuri majorate cu 30%

## Ancore pentru ferestre și uși

Ancore standard

**INDEX**



Ø x L (mm)	Ambalare STANDARD			Ambalare la BLISTER (BL)		
	buc. / pac.	€/100 buc.	Cod articol	buc. / BL	€/BL.	Cod articol
10 x 72	100	15.60	I.EPS6072S	-	-	-
10 x 92	100	17.23	I.EPS6092S	4	0.81	I.EPS6092B
10 x 112	100	27.94	I.EPS6112S	4	1.24	I.EPS6112B
10 x 132	100	31.52	I.EPS6132S	4	1.38	I.EPS6132B
10 x 152	100	34.65	I.EPS6152S	4	1.51	I.EPS6152B
10 x 182	100	30.97	I.EPS6182S	-	-	-
10 x 202	50	32.41	AA.17010202S	-	-	-

Ancore din nailon

**INDEX**

Ancore pentru cavități

Ancore tip "Cui"



Ø x L (mm)	Ambalare (buc.)	€/100 buc.	Cod articol	Ø x L (mm)	Ambalare (buc.)	€/100 buc.	Cod articol	Ø x L (mm)	Ambalare (buc.)	€/100 buc.	Cod articol
8 x 80	100	14.79	I.EPN08080S	10 x 112	100	15.51	AA.17110112S	6 x 40	50	6.74	AA.15000001S
8 x 100	100	13.65	I.EPN08100S	10 x 132	100	19.88	AA.17110132S				
8 x 120	100	15.71	I.EPN08120S	10 x 152	100	18.09	AA.17110152S				
8 x 140	100	16.54	I.EPN08140S	10 x 182	100	27.74	AA.17110182S				
10 x 80	100	17.37	I.EPN10080S								
10 x 100	100	18.35	I.EPN10100S								
10 x 120	100	19.72	I.EPN10120S								
10 x 140	100	26.01	I.EPN10140S								
10 x 165	100	37.76	I.EPN10165S								

## NOU LA ROCAST



**AEG** Producător de unelte  
**POWERTOOLS** electrice profesionale,  
 din 1898

Pagina 9.3



## Șuruburi pentru prinderea panourilor de gard din plasă metalică

ROCAST execută o gamă largă de șuruburi pentru prinderea panourilor de gard din plasă metalică pe stâlpi metalici. Șurubul, clema și piulița sunt zincate. Capul șurubului și clema pot fi acoperite suplimentar prin vopsire în câmp electrostatic (verde - RAL 6020).

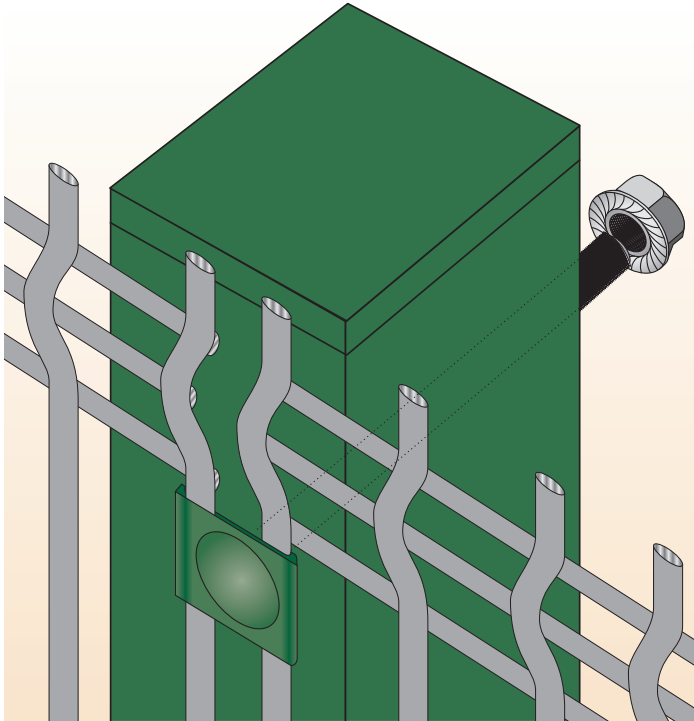

## Șuruburi de gard model SG

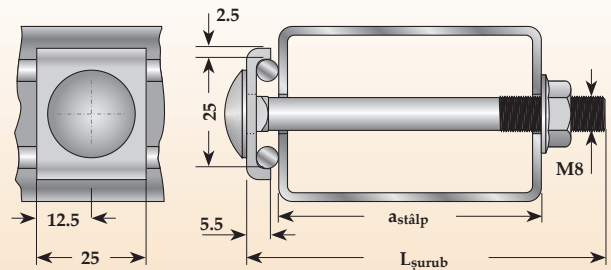
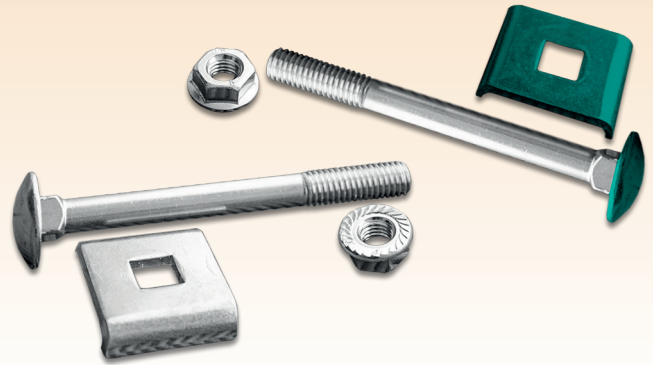

## Șurub de gard model SG, zincat

K 10

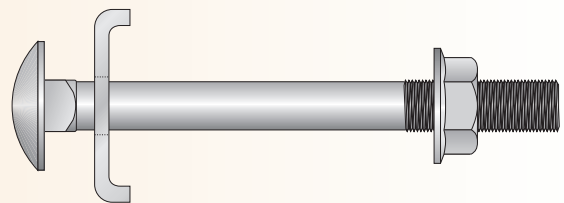
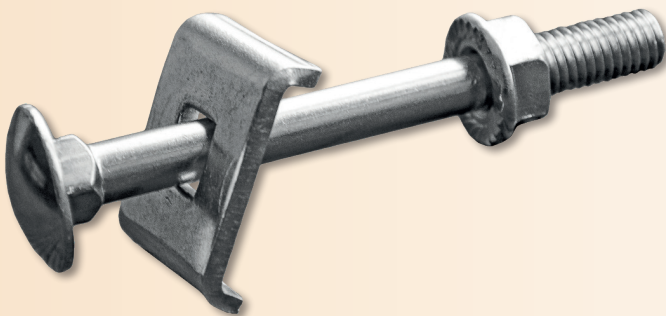

Lșurub (mm)	aștâlp (mm)	Ambalare (buc.)	€/100 buc.	Cod articol
60	40	50	16.21	SG860ZS
80	60	50	17.73	SG880ZS
100	80	50	19.18	SG8100ZS
120	100	25	20.58	SG8120ZS

## Șurub de gard model SG, zincat, capul și clema vopsite verde

K 10

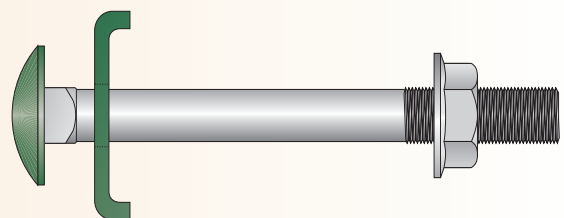
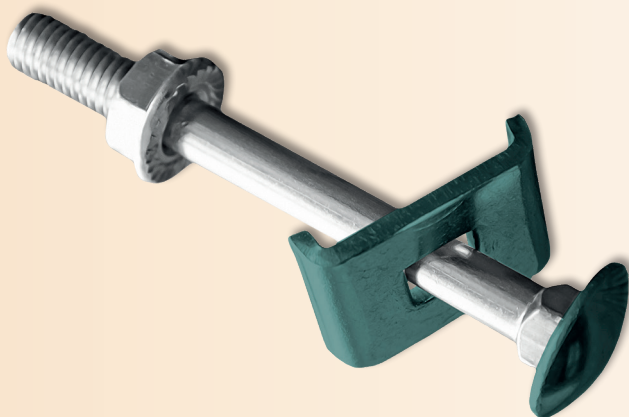

Lșurub (mm)	aștâlp (mm)	Ambalare (buc.)	€/100 buc.	Cod articol
60	40	50	17.69	SG860VS
80	60	50	19.37	SG880VS
100	80	50	20.96	SG8100VS
120	100	25	22.36	SG8120VS



# CONCRETO®



## Șuruburi și prezoane pentru beton cu certificare ETA-CE opt. 1



- ✓ Design brevetat
- ✓ Mărimi extra-lungi pentru fixări de grosimi mari
- ✓ Fixare complet demontabilă
- ✓ Nu necesită control de torsiune la fixare



ACREDITARE TEHNICĂ EUROPEANĂ  
Opțiunea 1 - pentru beton fisurat și nefisurat.  
ETA-11/0336 - ETAG 001 Partea 1 și 3

# CONCRETO®

Avantaje în comparație cu conexpandurile clasice cu bolț sau cu con de fixare

- 30% ✓ Spațiul și distanța dintre margine și conexpanduri
- +35% ✓ Forța de tracțiune admisibilă
- +30% ✓ Sarcină de forfecare admisibilă



Valorile reprezintă o comparație între un șurub CONCRETO și un conexpand clasic cu bolț grupa 8.8.

## HX 01 Șurub pentru beton, cap hexagonal, omologat cu certificare ETA-CE opt. 1

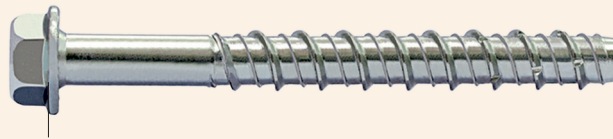
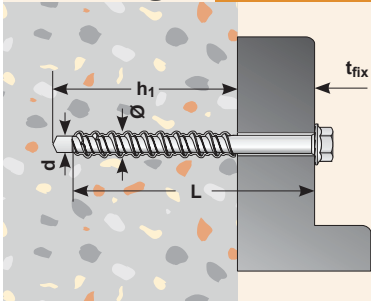

## HX 02 Prezon cu șaibă și piuliță, pentru beton, omologat cu certificare ETA-CE opt. 1

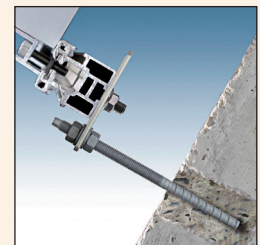
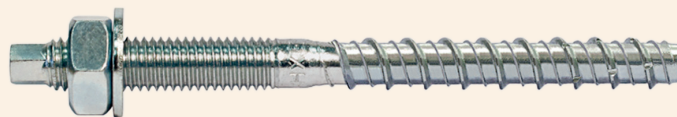
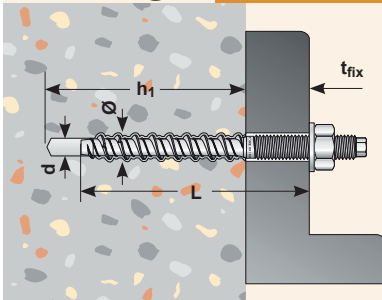

## HX 03 Șurub pentru beton, cap teșit, omologat cu certificare ETA-CE opt. 1

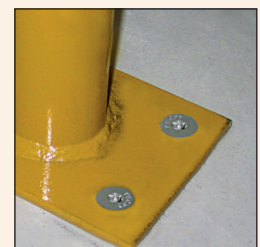
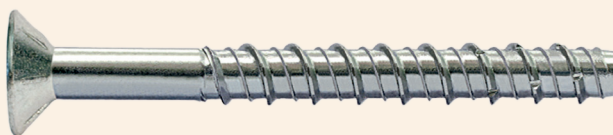
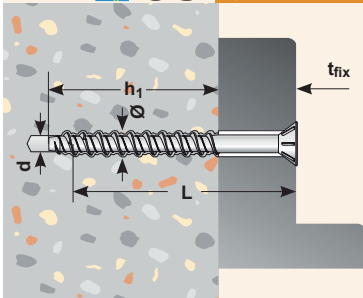

## Șuruburi și prezoane pentru beton cu certificare ETA-CE opt. 1

Șurub cu cap hexagonal, oțel zincat, omologat cu certificare ETA-CE, opțiunea 1 pentru beton fisurat și nefisurat



### HXE01

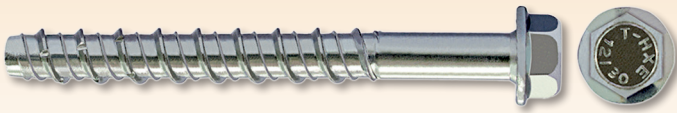

ACREDITARE TEHNICĂ EUROPEANĂ  
Opțiunea 1: pentru beton fisurat și nefisurat.  
ETA-11/0336 - ETAG 001 Partea 1 și 3

Dimensiuni (mm)						Ambalare (buc.)	€/100 buc.	Cod articol
Ø x L	d	h	h <sub>1</sub>	t <sub>fix</sub>	HEX			
8 x 80	6	60	75	20	10	50	43.48	T.HXE0108080S
8 x 100	6	60	75	40	10	50	46.74	T.HXE0108100S
8 x 120	6	60	75	60	10	50	50.41	T.HXE0108120S
8 x 140	6	60	75	80	10	50	62.39	T.HXE0108140S

Dimensiuni (mm)						Ambalare (buc.)	€/100 buc.	Cod articol
Ø x L	d	h <sub>1</sub>	t <sub>fix</sub>	HEX				
10 x 80	8	85	10	13	50	64.66	T.HXE0110080S	
10 x 100	8	85	30	13	25	66.37	T.HXE0110100S	
10 x 120	8	85	50	13	25	71.78	T.HXE0110120S	
10 x 140	8	85	70	13	25	85.46	T.HXE0110140S	
10 x 160	8	85	90	13	25	87.22	T.HXE0110160S	
12 x 90	10	100	10	15	25	86.43	T.HXE0112090S	
12 x 110	10	100	30	15	25	92.84	T.HXE0112110S	
12 x 130	10	100	50	15	25	112.08	T.HXE0112130S	
12 x 150	10	100	70	15	25	121.03	T.HXE0112150S	
12 x 190	10	100	110	15	20	182.51	T.HXE0112190S	
12 x 210	10	100	130	15	20	189.00	T.HXE0112210S	
12 x 250	10	100	170	15	15	240.45	T.HXE0112250S	
12 x 290	10	100	210	15	15	264.87	T.HXE0112290S	
16 x 130	14	140	20	21	10	292.51	T.HXE0116130S	
16 x 150	14	140	40	21	10	346.12	T.HXE0116150S	
16 x 180	14	140	70	21	10	538.72	T.HXE0116180S	

Prezon cu șaibă și piuliță, oțel zincat, omologat cu certificare ETA-CE, opțiunea 1 pentru beton fisurat și nefisurat



### HXE02



ACREDITARE TEHNICĂ EUROPEANĂ  
Opțiunea 1: pentru beton fisurat și nefisurat.  
ETA-11/0336 - ETAG 001 Partea 1 și 3

Dimensiuni (mm)						Ambalare (buc.)	€/100 buc.	Cod articol
Ø x L	d	h <sub>1</sub>	t <sub>fix</sub>	HEX				
8 x 90	6	75	10	5	100	74.20	T.HXE0208090S	
8 x 120	6	75	40	5	100	82.31	T.HXE0208120S	
8 x 160	6	75	80	5	50	95.20	T.HXE0208160S	
10 x 105	8	85	10	7	50	97.88	T.HXE0210105S	
10 x 125	8	85	30	7	50	104.85	T.HXE0210125S	
10 x 195	8	85	100	7	25	144.48	T.HXE0210195S	
12 x 118	10	100	10	8	25	136.96	T.HXE0212118S	
12 x 138	10	100	30	8	25	153.54	T.HXE0212138S	
12 x 208	10	100	100	8	25	249.06	T.HXE0212208S	
12 x 248	10	100	140	8	25	316.56	T.HXE0212248S	

Șurub cu cap teșit, oțel zincat, omologat cu certificare ETA-CE, opțiunea 1 pentru beton fisurat și nefisurat



### HXE03



ACREDITARE TEHNICĂ EUROPEANĂ  
Opțiunea 1: pentru beton fisurat și nefisurat.  
ETA-11/0336 - ETAG 001 Partea 1 și 3

Dimensiuni (mm)					Ambalare (buc.)	€/100 buc.	Cod articol
Ø x L	d	h <sub>1</sub>	t <sub>fix</sub>				
8 x 70	6	75	10	T30	100	43.52	T.HXE0308070S
8 x 100	6	75	40	T30	50	51.91	T.HXE0308100S
8 x 140	6	75	80	T30	25	73.18	T.HXE0308140S
10 x 80	8	85	10	T40	50	72.03	T.HXE0310080S
10 x 100	8	85	30	T40	50	76.49	T.HXE0310100S
10 x 160	8	85	90	T40	25	112.20	T.HXE0310160S
12 x 100	10	100	20	T50	25	108.83	T.HXE0312100S
12 x 120	10	100	40	T50	25	117.80	T.HXE0312120S
12 x 180	10	100	100	T50	25	228.57	T.HXE0312180S

Șurub cu cap hexagonal, pentru beton, oțel zincat

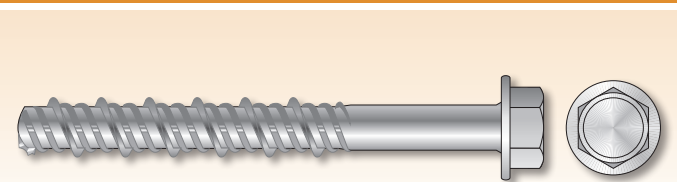

Dimensiuni (mm)		Ambalare (buc.)	€/100 buc.	Cod articol
Ø x L	d			
6 x 50	5	25	10.87	X0602650S
6 x 60	5	25	10.86	X0602660S
7.5 x 35	6	25	10.74	X06027535S
7.5 x 45	6	25	13.96	X06027545S
7.5 x 60	6	25	17.18	X06027560S
7.5 x 80	6	25	20.76	X06027580S
7.5 x 100	6	25	24.37	X060275100S

Dimensiuni (mm)		Ambalare (buc.)	€/100 buc.	Cod articol
Ø x L	d			
10 x 55	8	10	23.87	X06021055S
10 x 65	8	10	26.61	X06021065S
10 x 75	8	10	34.18	X06021075S
10 x 90	8	10	39.28	X06021090S
10 x 110	8	10	44.81	X060210110S
10 x 130	8	10	49.68	X060210130S
12 x 65	10	10	54.29	X06021265S
12 x 75	10	10	51.66	X06021275S
12 x 85	10	10	59.74	X06021285S
12 x 100	10	10	65.53	X060212100S
12 x 120	10	10	75.07	X060212120S
12 x 140	10	10	82.10	X060212140S
16 x 80	14	5	119.50	X06021680S
16 x 115	14	5	151.96	X060216115S
16 x 135	14	5	175.12	X060216135S
16 x 160	14	5	206.02	X060216160S



## Fixările chimice...

... economice, sigure, universale!

+ calitate europeană, garantată de producător!

Fixările chimice sunt utilizate pe scară largă în întreaga lume, în special pentru:

- sarcini mari și foarte mari;
- soluții ce necesită un grad sporit de siguranță;
- fixări în materiale cu rezistență incertă, cu goluri, cu fisuri etc;
- șuruburi de fundații;
- reparații și consolidări.

Față de metodele tradiționale de fixare fixările chimice sunt mai sigure și în multe situații, mai puțin costisitoare.

Procedeele de fixare chimică realizează îmbinarea între un material de bază și un element de fixare cu o rășină sintetică cu rol de masă de fixare, printr-o dublă legătură: între elementul de fixare și rășină și între rășină și materialul de bază.

Mase de fixare utilizate la fixările chimice prezentate:

- Rășini bicomponente poliesterice cu stiren - pentru fixările chimice cu fiole.
- Rășini bicomponente poliesterice fără stiren sau vinilesterice fără stiren - pentru fixările chimice prin injecție.

Materiale de bază:

- Zidărie solidă sau cu goluri
- Beton

Caracteristicile betonului conform EN 206		Tipul betonului						
		C20/25	C25/30	C30/37	C35/45	C40/50	C45/55	C50/60
Rezistența la compresiune	testul cilindric - $f_{ck}$ cilindric (N/mm <sup>2</sup> )	20	25	30	35	40	45	50
	testul cubic - $f_{ck}$ cubic (N/mm <sup>2</sup> )	25	30	37	45	50	55	60

Caracteristicile prezoanelor	Oțel		Oțel inoxidabil	
	gr. 4.6	gr. 8.8	A2 - 50	A4 - 70
Rezistența la rupere (N/mm <sup>2</sup> )	400	800	500	700
Limita de curgere (N/mm <sup>2</sup> )	240	640	210	450

### Elemente de fixare

Pentru fixări cu fiole standard:

Prezoane filetate M8÷M30, cu vârș teșit 2 x 45° și cep hexagonal, din oțel zincat gr. 4.6 și oțel inoxidabil A2-50.

Pentru fixări cu fiole prin batere și pentru fixări prin injecție:

Tije filetate M8÷M30, cu vârș drept și cap plat, din oțel zincat gr. 8.8 și oțel inoxidabil A4-70.

Pentru fixări cu fiole tip "Hammer" și pentru fixări prin injecție:

Bare din oțel beton "BST500S" DIN 488, Ø8÷32 mm.

Caracteristicile barelor de oțel beton BST 500S	
Rezistența la rupere (N/mm <sup>2</sup> )	min. 550
Limita de curgere (N/mm <sup>2</sup> )	min. 500
Alungirea (%)	min. 10

Alegerea elementului de fixare se face în funcție de rezistența mecanică necesară și de condițiile de mediu.

Montajul elementelor de fixare se face numai după realizarea prizei. Timpul de priză depinde de tipul rășinii utilizate și de temperatura de montaj.

În prezent ROCAST comercializează fixări chimice provenite de la doi furnizori europeni:

**STAHL:** - fixări chimice cu fiole standard-SVA, poliesterice cu stiren, cu aprobare ETA;  
- fixări chimice cu fiole prin batere, tip "HAMMER" - SHP, poliesterice cu stiren, cu aprobare ETA;  
- fixări chimice prin injecție SVM-VSF, vinilesterice fără stiren, cu aprobare ETA;

**KAWO:** - fixări chimice prin injecție PSF, poliesterice fără stiren, cu aprobare ETA;  
- fixări chimice prin injecție VSF, vinilesterice fără stiren, cu aprobare ETA;

### RECOMANDĂRI DE UTILIZARE

**Fixări cu fiole STAHL SVA (standard):** zidărie cu goluri și beton, prezoane M8÷M30, mediu uscat.

**Fixări cu fiole STAHL SHP (Hammer):** beton, tije filetate M8÷M30 și bare de oțel beton Ø10÷32 mm, mediu uscat.

Fixări prin injecție:

- vinilesterice fără stiren STAHL SVM-VSF: beton - tije filetate M8÷M30, mediu uscat și umed, cu aprobare ETA;
- poliesterice fără stiren KAWO PSF: zidărie solidă și zidărie cu goluri, tije filetate M8-M10-M12, mediu uscat și umed, cu aprobare ETA;  
beton, tije filetate M8-M10-M12-M16-M20, mediu uscat, fără aprobare ETA;
- vinilesterice fără stiren KAWO VSF: beton, tije filetate M8÷M30 și bare de oțel beton Ø16÷32 mm, mediu uscat sau umed, cu aprobare ETA;

Datele prezentate privind sarcinile de calcul au caracter de recomandare. Utilizatorul este responsabil pentru utilizarea corectă a acestor date, în concordanță cu reglementările în vigoare și cu condițiile concrete de lucru.

## Fixări chimice cu fiole

Metoda de fixare cu fiole utilizează ca masă de fixare rășini poliesterice cu stiren, bicomponente. Componentele, dozate corespunzător, sunt conținute în două fiole plasate una în alta. Prin spargerea fiolelor și amestecarea componentelor, în timpul fixării, se formează o masă de material cu priză rapidă în care se montează elementul de fixare.

### Fiole SVA



Fiolele STAHL SVA permit realizarea de fixări chimice cu prezoane filetate. Montarea se realizează prin rotirea elementului de fixare.



Prezon	Dimensiuni (mm)		Ambalare (buc.)	€/100 buc.	Cod articol
	Prezon	Fiolă			
M 8	9 x	80	1	73.50	AA.SVA08S
M10	11 x	80	1	77.88	AA.SVA10S
M12	13 x	95	1	80.44	AA.SVA12S
M16	17 x	95	1	90.10	AA.SVA16S
M20	22 x	170	1	172.60	AA.SVA20S
M24	24 x	210	1	208.72	AA.SVA24S
M30	33 x	265	1	450.80	AA.SVA30S

### Domeniu de utilizare și elemente de fixare

Fixare în zidărie cu goluri sau în beton, mediu uscat, cu prezoane filetate M8÷M30, cu vârf teșit 2 x 45° și cep hexagonal, din oțel zincat gr. 4.6 sau din oțel inoxidabil A2-50.

Pot fi utilizate și tije filetate M8÷M30, cu vârf drept și cap plat, din oțel zincat gr. 8.8 sau din oțel inoxidabil A4-70.

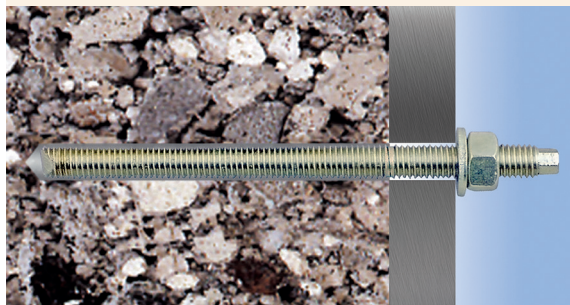

Date tehnice de montaj cu prezoane			Prezon						
			M8	M10	M12	M16	M20	M24	M30
Diametrul exterior al prezonului	d	(mm)	8	10	12	16	20	24	30
Diametrul găurii în materialul de bază	d <sub>o</sub>	(mm)	10	12	14	18	24	28	35
Diametrul găurii în elementul fixat	d <sub>f</sub>	(mm)	9	12	14	18	22	26	32
Adâncimea minimă a găurii	h <sub>o</sub>	(mm)	85	95	115	130	175	215	275
Lungimea nominală de montare	h <sub>nom</sub>	(mm)	80	90	110	125	170	210	270
Grosimea minimă a materialului de bază	h <sub>min</sub>	(mm)	120	130	140	180	230	270	340
Momentul de strângere la fixare	T <sub>inst</sub>	(Nm)	10	20	40	80	120	180	300

### Sucesiunea operațiilor la fixările chimice cu fiole



1 Perforarea suportului de fixare (zidărie, beton etc.)

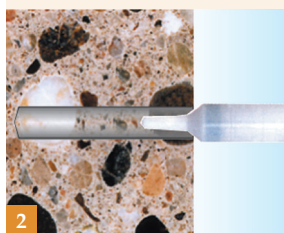

2 Curățarea orificiului prin periere și suflare sau aspirare



3 Introducerea fiolei



4 Introducerea elementului de fixare (prezon, piuliță) și spargerea fiolei. Amestecarea componentelor prin rotirea elementului de fixare.

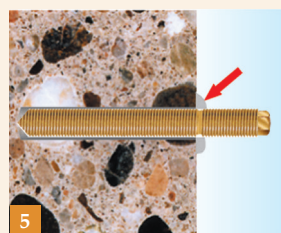

#### Verificare

Se consideră că operația a fost corect executată dacă elementul de fixare a pătruns până la semn și materialul din fiolă a ieșit pe lângă el.

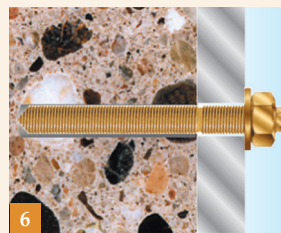

#### Montaj

Montajul se execută după terminarea prizei. Timpul de priză este puternic influențat de temperatură.

Temperatura rășinii	5°C	5°C	5°C	10°C	15°C	20°C	25°C	25°C
Temperatura de montaj	-5°C	0°C	5°C	10°C	15°C	20°C	30°C	40°C
Timpul de priză	8h	4h	2h 30'	2h	90'	45'	20'	10'



## Fixări chimice cu fiole

### Fiole SHP



Fiolele Stahl SPH permit realizarea eficientă de fixări chimice cu tije filetate și bare de oțel beton. Montare prin lovire cu ciocanul.



Tipul fiolei	Dimensiuni (mm)		Ambalare (buc.)	€/100 buc.	Cod articol
	Prezon	Fiolă			
SHP 10	M10	10 x 85	1	82.82	AA.SHPM10S
SHP 12	M12	12 x 95	1	86.30	AA.SHPM12S
SHP 16	M16	16 x 95	1	101.54	AA.SHPM16S
SHP 20	M20	20 x 175	1	279.42	AA.SHPM20S
SHP 24	M24	24 x 210	1	338.62	AA.SHPM24S
SHP 30	M30	30 x 280	1	571.42	AA.SHPM30S

### Domeniu de utilizare și elemente de fixare

Fixare în beton, mediu uscat, cu tije filetate M8÷M30, cu vârf drept și cap plat, din oțel zincat gr. 8.8 sau din oțel inoxidabil A4-70 și fixări cu bare de oțel beton Ø10÷32 mm.

Pot fi utilizate și prezoane M8÷M30, cu vârf teșit 2x45° și cep hexagonal, din oțel zincat gr. 4.6 sau din oțel inoxidabil A2-50.

### Montaj cu tije filetate

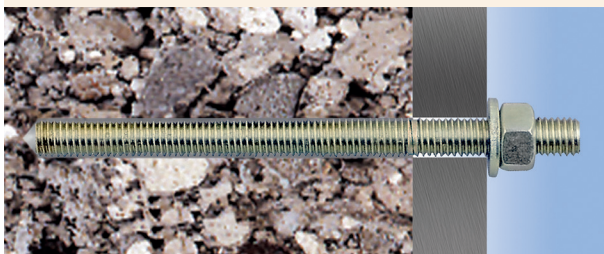

Date tehnice de montaj cu tije filetate		Tija filetată					
		M10	M12	M16	M20	M24	M30
Diametrul exterior al tije	d (mm)	10	12	16	20	24	30
Diametrul găurii în materialul de bază	d <sub>o</sub> (mm)	12	14	18	24	28	35
Diametrul găurii în elementul fixat	d <sub>f</sub> (mm)	12	14	18	22	26	32
Adâncimea minimă a găurii	h <sub>o</sub> (mm)	95	115	135	175	215	275
Lungimea nominală de montare	h <sub>nom</sub> (mm)	90	110	125	170	210	270
Grosimea minimă a materialului de bază	h <sub>min</sub> (mm)	130	140	180	230	270	340
Momentul de strângere la fixare	T <sub>inst</sub> (Nm)	20	40	80	120	180	300

### Montaj cu bare de oțel beton cu una sau mai multe fiole simultan



Tipul fiolei	Ø bară (mm)	Date de montaj	
		Ø orificiu	Adâncime
SHP 10	10	12	90
			150
			220
SHP 12	12	15	110
			180
			220
SHP 16	16	20	145
			240
			290
SHP 20	20	25	180
			300
			360
SHP 25	25	30	225
			375
			450
SHP 32	32	38	290
			480
			580

Utilizarea mai multor fiole simultan permite obținerea unor sarcini suportate mai mari.

### Sucesiunea operațiilor la fixările chimice cu fiole SHP prin batere



1 Perforarea suportului de fixare (zidărie, beton etc.)

2 Curățarea orificiului cu perie din nailon și prin aspirare

3 Introducerea fiolei

4 Introducerea elementului de fixare și spargerea fiolei prin lovire cu ciocanul.

5 Montajul se execută după terminarea prizei. Timpul de priză este puternic influențat de temperatură.

Temperatura rășinii	5°C	5°C	5°C	10°C	15°C	20°C	25°C	25°C
Temperatura de montaj	-5°C	0°C	5°C	10°C	15°C	20°C	30°C	40°C
Timpul de priză	24h	14h	4h	3h	90'	45'	20'	10'

## Fixări chimice prin injecție

Metoda de fixare chimică prin injecție utilizează ca masă de fixare rășini poliesterice fără stiren sau rășini vinilesterice fără stiren, bicomponente. Componentele sunt ambalate în cartușe speciale care asigură dozarea și amestecarea acestora în timpul injectării cu pistolul de injecție. Prin această metodă se pot realiza fixări cu o gamă foarte largă de elemente de fixare (prezoane, piulițe, bare) și cu geometrii diverse, de la platbande la țevi rectangulare. Fixările se pot realiza practic în orice material de construcții.

### Sucesiunea operațiilor la fixările chimice prin injecție

#### Fixarea prin injecție în materiale compacte

Fixarea chimică prin injecție în materiale compacte se realizează prin injectarea mortarului chimic direct în orificiul de fixare.

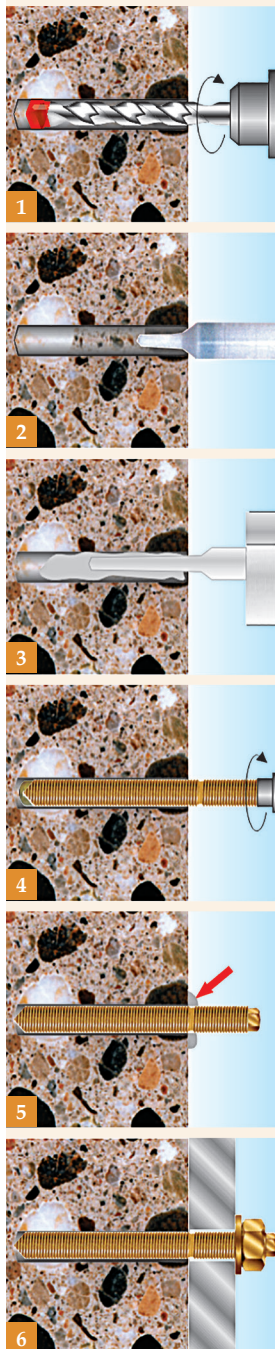

**1** Perforarea suportului de fixare (zidărie, beton etc.)

**2** Curățarea orificiului prin periere și suflare sau aspirare

**3** Introducerea fiolei

**4** Introducerea elementului de fixare (prezon, piuliță) și spargerea fiolei. Amestecarea componentelor prin rotirea elementului de fixare.

**5** **Verificare**  
Se consideră că operația a fost corect executată dacă elementul de fixare a pătruns până la semn și materialul din fiolă a ieșit pe lângă el.

**6** **Montaj**  
Montajul se execută după terminarea prizei. Timpul de priză este puternic influențat de temperatură.

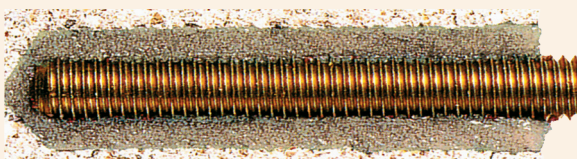

**ATENȚIE!** Se rotește ușor bara sau prezonul după introducere.

#### Fixarea prin injecție în materiale alveolare

Fixarea chimică prin injecție în materiale alveolare se bazează pe captușirea orificiului de fixare cu un manșon din material plastic sau din oțel inoxidabil. Acesta are rolul de a reține mortarul chimic cu scopul de a crea corp comun între elementul de fixare și zidărie.

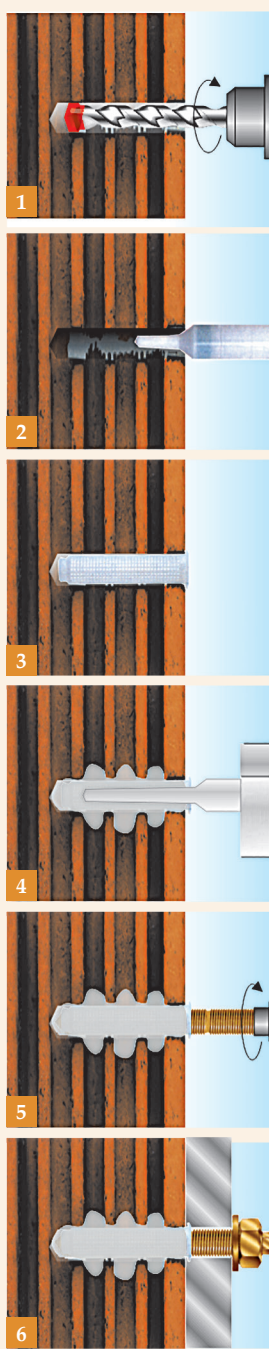

**1** Perforarea suportului de fixare (zidărie, beton etc.)

**2** Curățarea orificiului prin periere și suflare sau aspirare

**3** Introducerea manșonului

**4** Injectarea mortarului chimic

**5** Introducerea elementului de fixare (prezon, piuliță) și spargerea fiolei. Amestecarea componentelor prin rotirea elementului de fixare.

**6** **Montaj**  
Montajul se execută după terminarea prizei. Timpul de priză este puternic influențat de temperatură.



**ATENȚIE!** Se rotește ușor bara sau prezonul după introducere.



## Fixări chimice prin injecție - KAWO

Rocast comercializează două tipuri de fixări chimice prin injecție KAWO: PSF și VSF, ambele cu aprobare ETA. În unele cazuri sunt prezentate date pentru utilizări în afara acordurilor ETA.

Fixările chimice prin injecție KAWO utilizează mase de fixare din rășini poliesterice sau vinilesterice, fără stiren, bicomponente.

Oferă o gamă mai largă de soluții de fixare și mai multe posibilități privind sarcinile de lucru, temperatura și mediul în care se pot utiliza. Cele două componente sunt ambalate în **cartușe coaxiale** (două fiole una în alta), cu capacități de 280 ml sau 410 ml.

În cursul injectării cu pistolul de injecție și duza de amestecare, se asigură dozarea și amestecarea celor două componente. Cartușul de 280 ml este prevăzut cu împingător care permite utilizarea unui pistol de injecție pentru silicon.



### Indicații generale de utilizare

Tipul fixării	Material de bază					Material de lucru			Montaj orizontal și vertical
	Zidări din cărămizi cu goluri	Zidări din cărămizi cu goluri	Piatră	Tije filetate în beton	Bare în beton	Uscat	Umed	Inundat	
KAWO - PSF	●	●	●	●	●	●	●	●	●
KAWO - VSF	●	●	●	●	●	●	●	●	●

● recomandat cu aprobare ETA    ● posibil    ● posibil dar neindicat    ● neutilizabil



## Fixări chimice prin injecție - KAWO

### Cartușe de injecție KAWO-PSF



Cartușe de injecție KAWO-PSF cu aprobare ETA-13/0916 pentru fixări în zidărie solidă sau cu goluri. Cartușe coaxiale (două fiole una în alta) cu rășină poliesterică fără stiren, capacitate 280 ml și 410 ml. Cartușul de 280 ml este prevăzut cu împingător care permite utilizarea unui pistol de injecție pentru silicon.



#### Caracteristici

- **Culoare:** gri deschis (componenta A- bej, componenta B - neagră)
- **Greutate specifică:** 1.7 kg/l la 20°C
- **Rezistența la compresiune:** 57.9 N/mm<sup>2</sup>
- **Rezistența la îndoire:** 30.0 N/mm<sup>2</sup>
- **Priza:** rapidă

Tipul cartușului	Capacitate (ml)	Ambalare (buc.)	€/100 buc.	Cod articol
KAWO PSF 280 peeler - coaxial	280	1	518.00	KAWOPSF280S
KAWO PSF 410 - coaxial	410	1	573.50	KAWOPSF410S

### Domeniu de utilizare și elemente de fixare

#### a. Utilizare cu aprobare ETA

- **Fixare în zidărie cu goluri, mediu uscat și umed, încărcări statice, cu prezoane M8÷M12, cu vârf drept și cap plat, din oțel zincat gr. 8.8 sau din oțel inoxidabil A4-70.** Fixările de acest tip necesită utilizarea manșoanelor pentru injecție din plastic (v. pag. 2.31) În afara aprobării pot fi utilizate și prezoane M8÷M12, cu vârf țesit 2x45° și cep hexagonal, din oțel zincat gr. 4.6 sau din oțel inoxidabil A2-50.
- **Fixare în zidărie solidă, mediu uscat și umed, încărcări statice, cu prezoane M8÷M12, cu vârf drept și cap plat, din oțel zincat gr. 8.8 sau din oțel inoxidabil A4-70.** În afara aprobării pot fi utilizate și prezoane M8÷M12, cu vârf țesit 2x45° și cep hexagonal, din oțel zincat gr. 4.6 sau din oțel inoxidabil A2-50.

Fixările cu tije din oțel inoxidabil A4-70 sunt recomandate în structuri interioare, mediu uscat sau cu expunere la umiditate permanentă, fără agenți agresivi și în structuri exterioare, inclusiv în ambient industrial sau marin.

#### b. Utilizare fără aprobare ETA

- **Fixare în beton nefisurat C20/25÷C50/60, mediu uscat, încărcări statice, cu prezoane M8÷M20, cu vârf drept și cap plat, din oțel zincat gr. 8.8 sau din oțel inoxidabil A4-70.**

Se pot utiliza și prezoane M8÷M20, cu vârf țesit 2x45° și cep hexagonal, din oțel zincat gr. 4.6 sau din oțel inoxidabil A2-50.

Temperatura minimă de lucru	-40°C	
Temperatura maximă de lucru	80°C (pentru timp scurt)	50°C (pentru timp îndelungat)

Temperatura minimă de montaj	rășină	5°C
	material de bază	5°C

Temperatura materialului	5°C	10°C	15°C	20°C	25°C	30°C	35°C
Timpul de priză	mediu uscat	2h	1h 30'	1h	45'	30'	15'
	mediu umed	3h	2h 15'	1h 30'	68'	45'	23'
Timpul de procesare la montaj	20'	12'	9'	6'	4'	3'	2'

#### Număr de ancore executate cu un cartuș (informativ)

Prezon	Zidărie cu goluri					
	Manșon Ø16 x 85		Manșon Ø16 x 130		Beton	
	C artuș (ml)					
	280	410	280	410	280	410
M 8	11	15	7	10	64 / 71	87 / 90
M10	11	15	7	10	40 / 44	54 / 59
M12	11	15	7	10	24 / 26	32 / 36
M16	-	-	-	-	13 / 14	17 / 19
M20	-	-	-	-	5 / 6	7 / 8



Date tehnice de montaj		Prezon		
		M8	M10	M12
Diametrul găurii în materialul de bază	d <sub>o</sub> (mm)	10	12	14
Diametrul găurii în elementul fixat	d <sub>f</sub> (mm)	9	12	14
Adâncimea minimă a găurii	h <sub>o</sub> (mm)	85	95	115
Lungimea nominală de montare	h <sub>nom</sub> (mm)	80	90	115
Momentul de strângere la fixare	T <sub>inst</sub> (Nm)	10	8	10

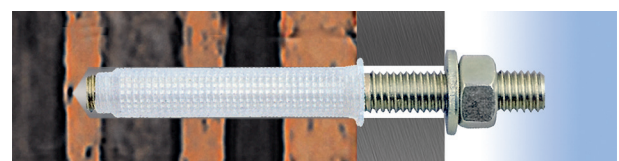

Date tehnice de montaj	Manșon de plastic	Prezon		
		M8	M10	M12
Gaura în materialul de bază	d x h (mm)	16 x 90	16 x 90	-
		16 x 130	16 x 133	-
		20 x 85	-	20 x 90
Moment de strângere la fixare pentru manșon cu L = 85 mm	T <sub>inst</sub> (Nm)	4	4	6



Date tehnice de montaj		Prezon				
		M8	M10	M12	M16	M20
Ø gaură în materialul de bază	d <sub>o</sub> (mm)	10	12	14	18	24
Adâncimea minimă a găurii	h <sub>o</sub> (mm)	85	95	115	130	175
Lungimea nominală de montare	h <sub>nom</sub> (mm)	80	90	115	125	170
Momentul de strângere la fixare	T <sub>inst</sub> (Nm)	10	8	10	60	100

## Fixări chimice prin injecție - KAWO

### Cartușe de injecție KAWO-VSF



#### Cartușe de injecție KAWO-VSF

- cu aprobare ETA-13/0851 (ETAG001, partea 1 și 5-TR029, metoda A), pentru tije filetate și bare în beton nefisurat.
- cu aprobare CE REBAR EN-1504/6



Cartușe coaxiale (două fiole una în alta) cu rășină vinilesterică fără stiren, capacitate 280 ml și 410 ml.

Cartușul de 280 ml este prevăzut cu împingător care permite utilizarea unui pistol de injecție pentru silicon.

#### Caracteristici

- Culoare: gri deschis (componenta A - bej, componenta B - neagră)
- Greutate specifică: 1.7 kg/l la 20°C

Tipul cartușului	Capacitate (ml)	Ambalare (buc.)	€/100 buc.	Cod articol
KAWO VSF 280 peeler - coaxial	280	1	666.00	KAWOVSF280S
KAWO VSF 410 - coaxial	410	1	795.50	KAWOVSF410S

### Domeniu de utilizare și elemente de fixare

#### a. Utilizare cu aprobare ETA

- Fixare în beton nefisurat C20/25÷C50/60, mediu uscat și umed, încărcări statice, cu prezoane M8÷M30, cu vârf drept și cap plat, din oțel zincat gr. 8.8 sau din oțel inoxidabil A4-70.  
În afara aprobării se pot utiliza și prezoane M8÷M30, cu vârf teșit 2x45° și cep hexagonal, din oțel zincat gr. 4.6 sau din oțel inoxidabil A2-50.
- Fixare în beton nefisurat C20/25÷C50/60, mediu uscat și umed, încărcări statice, cu bare de oțel beton "BTS500S" Ø16-32 mm

Fixările cu tije din oțel inoxidabil A4-70 sunt recomandate în structuri interioare, mediu uscat sau cu expunere la umiditate permanentă, fără agenți agresivi și în structuri exterioare, inclusiv în ambient industrial sau marin.

### Date tehnice de montaj

#### Fixare cu prezoane în beton nefisurat

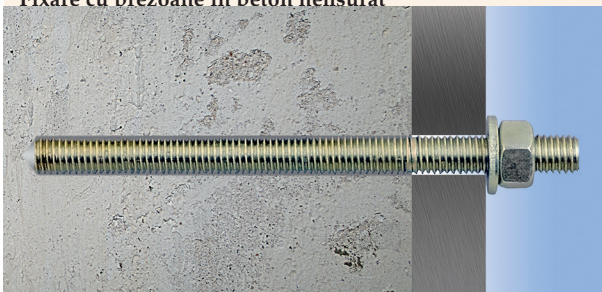

Date tehnice de montaj cu tije filetate		Prezon							
		M8	M10	M12	M16	M20	M24	M30	
Diametrul găurii în materialul de bază	$d_o$ (mm)	10	12	14	18	24	28	35	
Diametrul găurii în elementul fixat	$d_f$ (mm)	≤9	≤12	≤14	≤18	≤22	≤26	≤32	
Adâncimea găurii	minimă	$h_{ef,min}$ (mm)	60	70	80	100	120	140	165
	maximă	$h_{ef,max}$ (mm)	100	120	145	190	240	290	360
	tije ROCAST	$h_{nom}$ (mm)	80	90	110	125	170	210	270
Grosimea minimă a materialului de bază	$h_{min}$ (mm)	$h_{ef} + 30$ (min. 100)			$h_{ef} + 2d_o$				
Distanța minimă între ancore	$S_{min}$ (mm)	$0.5h_{ef} \geq 40$							
Distanța minimă la margini	$C_{min}$ (mm)	$0.5h_{ef} \geq 40$							
Momentul de strângere la fixare	$T_{inst}$ (Nm)	≤10	≤20	≤40	≤80	≤120	≤180	≤300	
Consum estimativ de mortar	ml/ancoră	3	4	5	8	28	41	63	

#### Fixare cu bare de oțel beton în beton nefisurat



Date tehnice de montaj cu bare de oțel beton		bare de oțel beton					
		Ø16	Ø20	Ø25	Ø28	Ø32	
Diametrul găurii în materialul de bază	$d_o$ (mm)	20	25	30	35	40	
Adâncimea găurii	minimă	$h_{ef,min}$ (mm)	80	90	100	112	128
	maximă	$h_{ef,max}$ (mm)	320	400	500	560	6240
Grosimea minimă a materialului de bază	$h_{min}$ (mm)	$h_{ef} + 2d_o$					
Distanța minimă între ancore	$S_{min}$ (mm)	$0.5h_{ef}$					
Distanța minimă la margini	$C_{min}$ (mm)	$0.5h_{ef}$					
Consum estimativ de mortar	pentru $h_{ef,min}$	11	19	26	47	69	
	pentru $h_{ef,max}$	43	85	130	233	347	

Temperatura materialului	0°C	5°C	10°C	15°C	20°C	25°C	30°C	35°C	Temperatura minimă de lucru	-40°C		
Timpul de priză	mediu uscat	12h	8h	5h	3h	2h	1h 30'	1h 15'	1h	Temperatura maximă de lucru	80°C (pt. timp scurt)	72°C (pt. timp îndelungat)
	mediu umed	24h	16h	10h	6h	4h	3h	2h 30'	2h			
Timpul de procesare la montaj	45'	30'	20'	12'	7'	4'	3'	2'	Temperatura minimă de montaj	rășină	5°C	
										material de bază	0°C (uscat)	

### Sarcini recomandate pentru încărcări la tracțiune și forfecare, la fixare individuală cu prezoane gr. 8.8, în beton nefisurat C20/25, fără a se ține seama de distanțele la margine sau între ancore.

- Valorile prezentate se referă la datele de montaj din catalog, respectiv  $d_o$ ,  $h_{ef} = h_{nom}$ ,  $h_{min}$  și  $c_{min}$ . Aceste valori sunt conforme cu **AGREMENTUL ETA-13/0851** și cu normativul de proiectare **EOTA TR 029 - Design of Bonded Anchors**
- Sarcinile prezentate au caracter de recomandare, pentru utilizare în condițiile menționate. Pentru condițiile concrete de utilizare, se vor determina sarcinile capabile conform datelor din **AGREMENTUL ETA-13/0851** și din norma de proiectare **EOTA TR 029**, care se pot pune la dispoziția utilizatorilor de către ROCAST.

Sarcini capabile recomandate	Prezon						
	M8	M10	M12	M16	M20	M24	M30
La tracțiune, $N_{cap}$ , t (kN)	10.42	13.11	19.31	25.58	42.36	53.18	78.21
La forfecare, $V_{cap}$ , t (kN)	9.25	14.69	21.38	40.08	62.61	90.18	143.94



## Fixări chimice prin injecție - STAHL

### Cartușe de injecție SVM-VSF



Cartușe de injecție STAHL SVM-VSF cu aprobare ETA-11/406 pentru fixări cu tije filetate în beton nefisurat.



Metoda de fixare prin injecție cu acest tip de cartușe utilizează rășini vinilesterice fără stiren, bicomponente. Componentele sunt ambalate în cartușe speciale, de diferite forme și capacități, care asigură dozarea și amestecarea acestora în timpul injectării cu pistolul de injecție.

Cartușele conțin 2 fiole care pot fi dispuse una în interiorul celeilalte (cartușe coaxiale) sau alăturate (cartușe duble).

Tipul cartușului	Capacitate (ml)	Ambalare (buc.)	€/100 buc.	Cod articol
SVM VSF 150 coaxial	150	1	900.00	AA.CI150S
SVM VSF 345 dublu	345	1	1190.00	AA.CI345S
SVM VSF 380 coaxial	380	1	1260.00	AA.CI380S

### Domeniu de utilizare și elemente de fixare

Fixare în beton C20/25-C50/60, mediu uscat și umed, încărcări statice, cu prezoane M8÷M30, cu vârf drept și cap plat, din oțel zincat gr. 8.8 sau din oțel inoxidabil A4-70.

În afara aprobării pot fi utilizate și prezoane M8÷M30, cu vârf teșit 2x45° și cep hexagonal, din oțel zincat gr. 4.6 sau din oțel inoxidabil A2-50.

Fixările cu tije din oțel inoxidabil A4-70 sunt recomandate în structuri interioare, mediu uscat sau cu expunere la umiditate permanentă fără agenți agresivi și în structuri exterioare, inclusiv în ambient industrial sau marin.

### Date tehnice de montaj

#### Fixare cu tije filetate în beton nefisurat

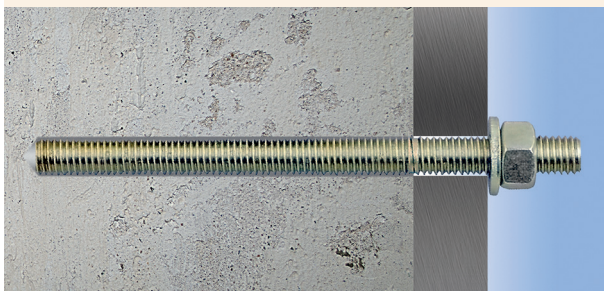

Date tehnice de montaj cu tije filetate		Prezon						
		M8	M10	M12	M16	M20	M24	M30
Diametrul găurii în materialul de bază	$d_o$ (mm)	10	12	14	18	24	28	35
Diametrul găurii în elementul fixat	$d_f$ (mm)	≤9	≤12	≤14	≤18	≤22	≤26	≤32
Adâncimea găurii	minimă $h_{ef,min}$ (mm)	60	70	80	100	120	140	165
	maximă $h_{ef,max}$ (mm)	100	120	145	190	240	290	360
	tije ROCAST $h_{nom}$ (mm)	80	90	110	125	170	210	270
Grosimea minimă a materialului de bază	$h_{min}$ (mm)	$h_{ef} + 30$ (min. 100)			$h_{ef} + 2d_o$			
Distanța minimă între ancore	$S_{min}$ (mm)	$0.5h_{ef} \geq 40$						
Distanța minimă la margini	$C_{min}$ (mm)	$0.5h_{ef} \geq 40$						
Momentul de strângere la fixare	$T_{inst}$ (Nm)	≤10	≤20	≤40	≤80	≤120	≤180	≤300

Temperatura minimă de lucru	-40°C
Temperatura maximă de lucru	80°C (pentru timp scurt) 50°C (pentru timp îndelungat)

Temperatura minimă de montaj	rășină	5°C
	material de bază	0°C (uscat)

Temperatura rășinii	5°C	5°C	5°C	10°C	15°C	20°C	20°C	25°C	
Temperatura de montaj	-5°C	0°C	5°C	10°C	15°C	20°C	30°C	40°C	
Timpul de priză	mediu uscat	6h	3h	2h	1h 20'	1h	45'	20'	10'
	mediu umed	12h	6h	4h	2h 40'	2h	1h 30'	40'	20'
Timpul de procesare la montaj	1h	40'	20'	12'	8'	5'	2'	30 sec.	



## Accesorii pentru fixări chimice prin injecție

### Manșoane din material plastic cu căpăcel



Ø x L (mm)	Ambalare (buc.)	€/100 buc.	Cod articol
12 x 50	1	19.20	AA.CI001S
15 x 85	1	17.00	AA.CI002S
15 x 130	1	25.00	AA.CI003S
20 x 85	1	27.00	AA.CI004S

### Manșoane din sită metalică, lungime 1 m

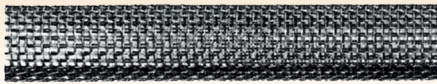

Ø <sub>ext</sub> x Ø <sub>int</sub> (mm)	Ambalare (buc.)	€/100 buc.	Cod articol
11 x 9	1	474.00	AA.CI005S
15 x 13	1	506.00	AA.CI006S
20 x 18	1	678.00	AA.CI007S

### Manșoane de injecție cu filet interior

oțel zincat

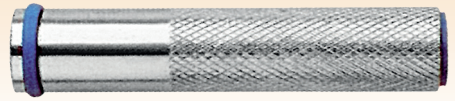

Filet	Ø x L (mm)	Ambalare (buc.)	€/100 buc.	Cod articol
M 8	12 x 80	1	62.72	LMOTRO08S
M10	14 x 80	1	86.93	LMOTRO10S
M12	16 x 80	1	105.83	LMOTRO12S

### Pistoale de injecție



Pentru cartușe de tip	Ambalare (buc.)	€/100 buc.	Cod articol
SVM-PSC-150	1	4600.00	AA.C201300S
SVM-PSC-345	1	5260.00	AA.C201235S
SVM-PSC-380	1	5260.00	AA.C201380S
KAWO-PSF-410			
KAWO-VSF-410	1	60.00	AA.C200590S
Adaptor pentru cartușe SVM-PSC-150			

### Pompă de curățare



Ambalare (buc.)	€/100 buc.	Cod articol
1	2224.00	AA.C200490S

### Cap de cartuș (duză de amestecare)



Ambalare (buc.)	€/100 buc.	Cod articol
1	22.20	AA.C200390S

### Suport de susținere "V" (pag. 2.40)



### Suport pentru prindere pe grindă (pag. 2.40)

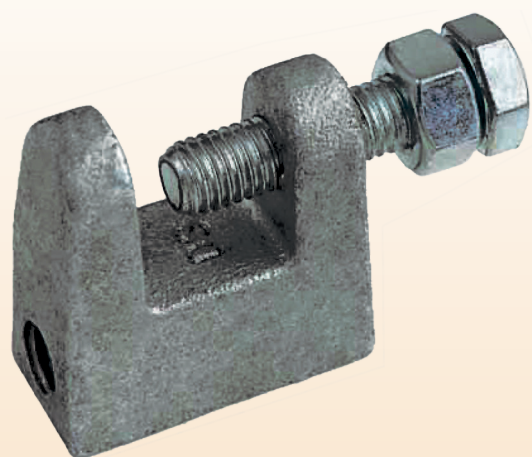

## Elemente de fixare pentru fixări chimice

Prezoane cu vârf țeșit 2x45° și cap cu cep hexagonal, pentru fixări chimice

K 10

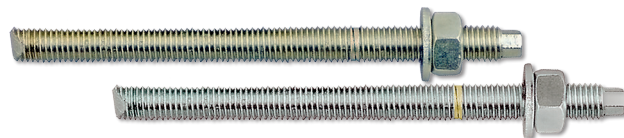
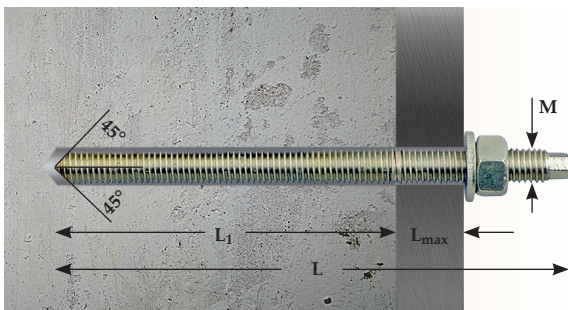

Prezoane recomandate pentru fixările chimice cu fiole, montate prin rotire.

Prezon:

oțel gr. 4.6, zincat electrochimic sau oțel inoxidabil A2-50

Șaibă plată forma "A", DIN 125:

oțel, zincat electrochimic sau oțel inoxidabil A2

Piuliță hexagonală, DIN 934:

oțel gr. 8, zincat electrochimic sau oțel inoxidabil A2

Pentru rotire utilizați chei tubulare sau bits magnetici.

Dimensiuni (mm)			Oțel zincat gr. 4.6			Oțel inoxidabil A2-50		
M x L	L <sub>1</sub>	L <sub>max</sub>	Ambalare (buc.)	€/100 buc.	Cod articol	Ambalare (buc.)	€/100 buc.	Cod articol
M 8 x 110	80	20	50	34.99	AA.PO211S	10	58.01	AA.PX211S
M 8 x 150	80	60	25	38.83	AA.PO215S	10	63.28	AA.PX215S
M 8 x 180	80	90	25	41.86	AA.PO218S	10	73.99	AA.PX218S
M10 x 115	90	10	50	50.18	AA.PO311S	10	87.25	AA.PX311S
M10 x 130	90	25	50	52.57	AA.PO313S	10	95.57	AA.PX313S
M10 x 165	90	60	25	57.37	AA.PO316S	10	109.79	AA.PX316S
M10 x 190	90	85	25	59.61	AA.PO319S	10	117.30	AA.PX319S
M10 x 250	90	145	25	76.39	AA.PO325S	10	155.97	AA.PX325S
M10 x 300	90	195	25	92.04	AA.PO330S	10	173.07	AA.PX330S
M12 x 135	110	10	25	57.84	AA.PO413S	10	119.21	AA.PX413S
M12 x 160	110	35	25	61.20	AA.PO416S	10	134.71	AA.PX416S
M12 x 180	110	55	25	69.67	AA.PO418S	10	151.17	AA.PX418S
M12 x 210	110	85	25	76.39	AA.PO421S	10	172.75	AA.PX421S
M12 x 250	110	125	25	83.58	AA.PO425S	10	211.75	AA.PX425S
M12 x 300	110	175	25	93.33	AA.PO430S	10	234.43	AA.PX430S
M16 x 150	125	8	10	100.36	AA.PO615S	5	211.11	AA.PX615S
M16 x 165	125	20	10	107.55	AA.PO616S	5	241.78	AA.PX616S
M16 x 190	125	45	10	114.10	AA.PO619S	5	264.80	AA.PX619S
M16 x 210	125	65	10	119.69	AA.PO621S	5	269.59	AA.PX621S
M16 x 230	125	85	10	135.19	AA.PO623S	5	310.50	AA.PX623S
M16 x 250	125	105	10	143.18	AA.PO625S	5	321.68	AA.PX625S
M16 x 300	125	155	10	154.53	AA.PO630S	5	380.02	AA.PX630S
M20 x 220	170	30	10	184.42	AA.PO722S	1	422.84	AA.PX722S
M20 x 260	170	70	10	215.42	AA.PO726S	1	554.21	AA.PX726S
M20 x 300	170	110	10	239.06	AA.PO730S	1	598.31	AA.PX730S
M20 x 350	170	160	10	278.54	AA.PO735S	1	812.93	AA.PX735S
M24 x 260	210	25	10	392.48	AA.PO826S	1	857.51	AA.PX826S
M24 x 300	210	65	5	422.53	AA.PO830S	1	927.51	AA.PX830S
M30 x 380	280	70	5	715.92	AA.PO938S	1	2090.24	AA.PX938S

Prezoane cu vârf drept și cap plat, pentru fixări chimice

K 10

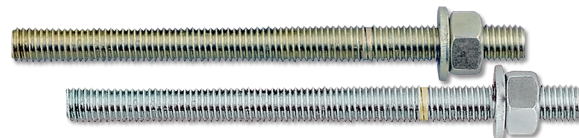
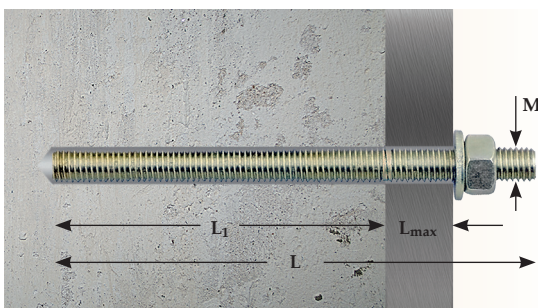

Prezoane recomandate pentru fixări chimice cu fiole, montate prin baterie și pentru fixări chimice prin injecție.

Prezon:

oțel gr. 8.8, zincat electrochimic sau oțel inoxidabil A4-70

Șaibă plată forma "A", DIN 125:

oțel, zincat electrochimic sau oțel inoxidabil A4

Piuliță hexagonală, DIN 934:

oțel gr. 8, zincat electrochimic sau oțel inoxidabil A4

Dimensiuni (mm)			Oțel zincat gr. 8.8			Oțel inoxidabil A4-70		
M x L	L <sub>1</sub>	L <sub>max</sub>	Ambalare (buc.)	€/100 buc.	Cod articol	Ambalare (buc.)	€/100 buc.	Cod articol
M 8 x 80	50	20	50	25.40	AA.TO208S	10	39.79	AA.TX208S
M 8 x 110	80	20	50	27.00	AA.TO211S	10	50.02	AA.TX211S
M 8 x 150	80	60	25	30.84	AA.TO215S	10	58.81	AA.TX215S
M 8 x 180	80	90	25	35.47	AA.TO218S	10	67.43	AA.TX218S
M 8 x 240	130	100	25	39.79	AA.TO224S	10	82.46	AA.TX224S
M10 x 115	90	10	50	38.19	AA.TO311S	10	77.35	AA.TX311S
M10 x 130	90	25	50	40.26	AA.TO313S	10	85.01	AA.TX313S
M10 x 165	90	60	25	47.63	AA.TO316S	10	106.59	AA.TX316S
M10 x 190	90	85	25	51.69	AA.TO319S	10	117.30	AA.TX319S
M10 x 260	130	115	25	66.00	AA.TO326S	10	161.88	AA.TX326S
M10 x 300	90	195	25	73.99	AA.TO330S	10	175.14	AA.TX330S
M12 x 125	85	25	25	49.06	AA.TO412S	10	116.02	AA.TX412S
M12 x 135	110	10	25	52.09	AA.TO413S	10	118.73	AA.TX413S
M12 x 160	110	35	25	55.29	AA.TO416S	10	131.20	AA.TX416S
M12 x 180	110	55	25	62.16	AA.TO418S	10	150.69	AA.TX418S
M12 x 210	110	85	25	71.27	AA.TO421S	10	179.62	AA.TX421S
M12 x 250	110	125	25	86.94	AA.TO425S	10	239.06	AA.TX425S
M12 x 300	110	175	25	95.57	AA.TO430S	10	260.79	AA.TX430S
M16 x 150	125	8	10	89.33	AA.TO615S	5	223.08	AA.TX615S
M16 x 165	125	20	10	100.99	AA.TO616S	5	246.41	AA.TX616S
M16 x 190	125	45	10	105.95	AA.TO619S	5	260.48	AA.TX619S
M16 x 210	125	65	10	116.97	AA.TO621S	5	295.00	AA.TX621S
M16 x 230	125	85	10	125.60	AA.TO623S	5	315.29	AA.TX623S
M16 x 250	125	105	10	152.46	AA.TO625S	5	382.57	AA.TX625S
M16 x 300	125	155	10	166.67	AA.TO630S	5	409.58	AA.TX630S
M20 x 220	170	30	10	207.10	AA.TO722S	1	477.82	AA.TX722S
M20 x 260	170	70	10	249.77	AA.TO726S	1	608.86	AA.TX726S
M20 x 300	170	110	10	270.71	AA.TO730S	1	671.49	AA.TX730S
M20 x 350	170	160	10	350.61	AA.TO735S	1	838.97	AA.TX735S
M24 x 260	210	25	10	382.89	AA.TO826S	1	901.30	AA.TX826S
M24 x 300	210	65	5	431.47	AA.TO830S	1	997.18	AA.TX830S
M30 x 380	280	70	5	783.68	AA.TO938S	1	2421.04	AA.TX938S

## Coliere

### Colier standard

**K 10**

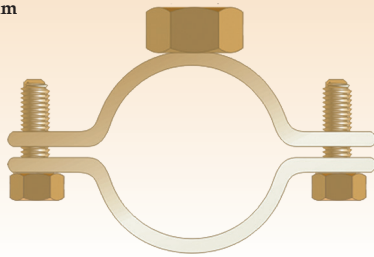
 bandă 20 x 2.0 mm  
piuliță M8

Ø <sub>teavă</sub> (mm)	Ø <sub>nominal</sub>	Ambalare (buc.)	€/100 buc.	Cod articol
15 - 19	3/8"	50	26.89	CM01038S
20 - 25	1/2"	50	29.93	CM02012S
25 - 30	3/4"	50	33.84	CM03034S
31 - 36	1"	50	36.52	CM04100S
37 - 45	1 1/4"	50	40.16	CM05114S
46 - 51	1 1/2"	25	45.96	CM06112S
59 - 64	2"	25	46.21	CM07200S
70 - 77	2 1/2"	25	51.67	CM07212S
83 - 90	3"	25	56.71	CM08300S
95 - 102	3 1/2"	25	62.72	CM08312S
108 - 115	4"	25	72.10	CM08400S

### Set colier standard + diblu Ø10 x 50 mm

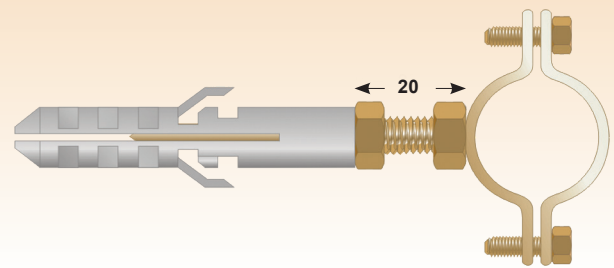
**K 10**

Ø <sub>teavă</sub> (mm)	Ø <sub>nominal</sub>	Ambalare (buc.)	€/100 buc.	Cod articol
15 - 19	3/8"	50	40.93	CS01038S
20 - 25	1/2"	50	43.97	CS02012S
25 - 30	3/4"	50	46.38	CS03034S
31 - 36	1"	50	50.67	CS04100S
37 - 45	1 1/4"	50	53.32	CS05114S
46 - 51	1 1/2"	25	59.62	CS06112S
59 - 64	2"	25	56.67	CS07200S
70 - 77	2 1/2"	25	60.78	CS07212S
83 - 90	3"	25	69.90	CS08300S
95 - 102	3 1/2"	25	75.27	CS08312S
108 - 115	4"	25	80.35	CS08400S

### Coliere standard cu protecție de cauciuc

**K 10**

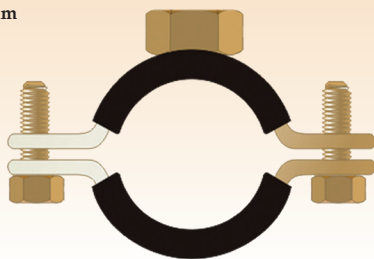
 bandă 20 x 2.0 mm  
piuliță M8

Ø <sub>teavă</sub> (mm)	Ø <sub>nominal</sub>	Ambalare (buc.)	€/100 buc.	Cod articol
9 - 13		50	33.11	CC01038S
14 - 19	3/8"	50	34.42	CC02012S
19 - 24	1/2"	50	37.95	CC03034S
25 - 30	3/4"	50	41.73	CC04100S
31 - 39	1"	50	47.04	CC05114S
40 - 45	1 1/4"	25	52.79	CC06112S
46 - 51	1 1/2"	25	62.25	CC06113S
53 - 58		25	65.89	CC07200S
59 - 64	2"	25	75.15	CC07201S
64 - 71		25	77.41	CC07212S
72 - 77	2 1/2"	25	82.01	CC07213S
77 - 84		25	85.41	CC08300S
89 - 96	3"	25	94.42	CC08312S
97 - 102	3 1/2"	25	101.93	CC08313S
102 - 109		25	105.03	CC08400S
110 - 115	4"	25	108.36	CC08401S

### Set colier standard cu protecție de cauciuc + diblu Ø10 x 50 mm

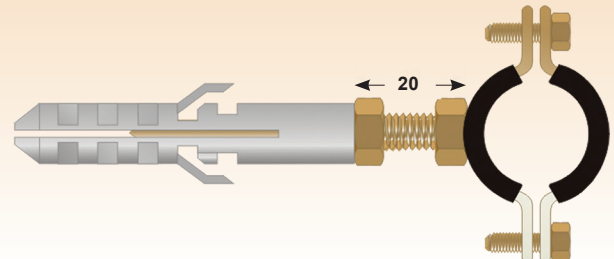
**K 10**

Ø <sub>teavă</sub> (mm)	Ø <sub>nominal</sub>	Ambalare (buc.)	€/100 buc.	Cod articol
9 - 13		50	46.93	CS31038S
14 - 19	3/8"	50	49.10	CS32012S
19 - 24	1/2"	50	52.23	CS33034S
25 - 30	3/4"	50	55.23	CS34100S
31 - 39	1"	50	63.34	CS35114S
40 - 45	1 1/4"	25	66.22	CS36112S
46 - 51	1 1/2"	25	75.02	CS36113S
53 - 58		25	77.18	CS37200S
59 - 64	2"	25	88.45	CS37201S
64 - 71		25	91.46	CS37212S
72 - 77	2 1/2"	25	95.36	CS37213S
77 - 84		25	98.66	CS38300S
89 - 96	3"	25	106.39	CS38312S
97 - 102	3 1/2"	25	110.56	CS38313S
102 - 109		25	115.84	CS38400S
110 - 115	4"	25	122.34	CS38401S

### Set colier pentru gaze + diblu Ø10 x 50 mm

**K 10**

bandă 20 x 1.5 mm

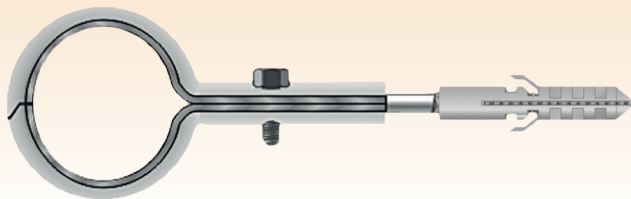

Ø <sub>nominal</sub>	(Ø x L) diblu (mm)	Ambalare (buc.)	€/100 buc.	Cod articol
3/8"	10 x 50	50	30.34	CS21038S
1/2"	10 x 50	50	33.80	CS22012S
3/4"	10 x 50	50	36.29	CS23034S
1"	10 x 50	50	39.21	CS24100S

### Colier ușor

**K 10**

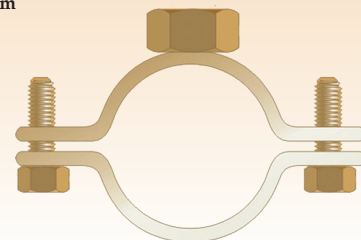
 bandă 20 x 1.5 mm  
piuliță M8

Ø <sub>teavă</sub> (mm)	Ø <sub>nominal</sub>	Ambalare (buc.)	€/100 buc.	Cod articol
15 - 20	3/8"	50	24.21	CM31038S
20 - 25	1/2"	50	26.94	CM32012S
25 - 31	3/4"	50	30.45	CM33034S
32 - 37	1"	50	32.86	CM34100S
39 - 44	1 1/4"	50	36.13	CM35114S
47 - 52	1 1/2"	25	41.37	CM36112S



## Coliere

### Colier greu

**K 10**

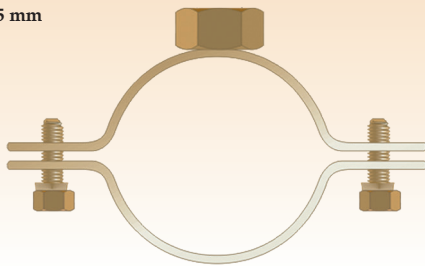
 bandă 25 x 2.5 mm  
piuliță M10

Ø <sub>feavă</sub> (mm)	Ø <sub>nominal</sub>	Ambalare (buc.)	€/100 buc.	Cod articol
31 - 36	1"	25	58.92	CM21100S
37 - 45	1 1/4"	25	62.80	CM22114S
46 - 51	1 1/2"	25	70.86	CM23112S
59 - 64	2"	25	73.74	CM24200S
75 - 80	2 1/2"	25	86.36	CM25212S
87 - 92	3"	25	95.13	CM26300S
98 - 105	3 1/2"	25	103.81	CM27312S
111 - 118	4"	25	112.76	CM28400S

### Colier greu cu protecție de cauciuc

**K 10**

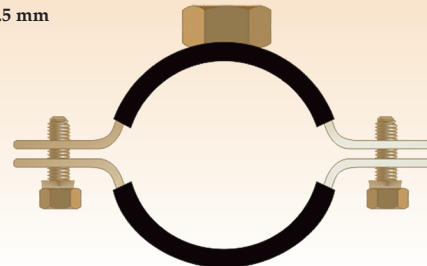
 bandă 25 x 2.5 mm  
piuliță M10

Ø <sub>feavă</sub> (mm)	Ø <sub>nominal</sub>	Ambalare (buc.)	€/100 buc.	Cod articol
25 - 30	3/4"	25	76.18	CC21100S
31 - 39	1"	25	81.54	CC22114S
40 - 46	1 1/4"	25	90.61	CC23112S
46 - 51	1 1/2"	25	102.56	CC23113S
53 - 58	2"	25	104.99	CC24200S
59 - 64	2"	25	110.23	CC24201S
69 - 74	2 1/2"	25	115.91	CC25212S
75 - 80	2 1/2"	25	125.59	CC25213S
81 - 86	3"	25	128.82	CC26300S
87 - 92	3"	25	139.12	CC26301S
92 - 99	3"	25	143.72	CC27312S
99 - 105	3 1/2"	25	150.26	CC27313S
105 - 112	4"	25	153.94	CC28400S
111 - 118	4"	25	160.45	CC28401S

### Colier M6 fără șurub, pentru țevi de cupru

Colier superior: 12 x 1.2 mm  
Colier bază: 15 x 1.2 mm  
Prindere: șurub cap Phillips M6 x 14 mm  
holzșurub: 4.8 x 30 mm

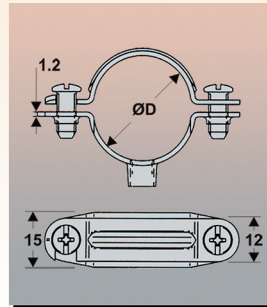

Ø <sub>interior</sub> (mm)	Ambalare (buc.)	€/100 buc.	Cod articol
8	25	8.25	I.ABM6008S
10	25	7.79	I.ABM6010S
12	25	8.86	I.ABM6012S
14	25	8.35	I.ABM6014S
15	25	8.43	I.ABM6015S
16	25	8.77	I.ABM6016S
18	25	9.60	I.ABM6018S
20	25	9.01	I.ABM6020S
22	25	8.91	I.ABM6022S
25	25	10.44	I.ABM6025S
26	25	9.83	I.ABM6026S
28	25	11.15	I.ABM6028S
32	25	12.39	I.ABM6032S
35	25	12.19	I.ABM6035S
37	10	13.52	I.ABM6037S
40	10	14.39	I.ABM6040S
42	10	14.47	I.ABM6042S
47	10	16.22	I.ABM6047S
50	10	16.83	I.ABM6050S
54	10	20.04	I.ABM6054S
60	10	20.86	I.ABM6060S
63	10	20.56	I.ABM6063S

### Colier ranforsat

**K 10**

 bandă 20 x 2.0 mm  
piuliță M10

Ø <sub>nominal</sub>		Ambalare (buc.)	fără protecție		cu protecție de cauciuc	
mm	țoli		€/100 buc.	Cod articol	€/100 buc	Cod articol
60	2"	10	59.80	CM9.060S	81.50	CC9.060S
75	2 1/2"	10	66.96	CM9.075S	92.75	CC9.075S
90	3"	10	75.84	CM9.090S	106.75	CC9.090S
110	4"	10	86.58	CM9.110S	123.11	CC9.110S
125	4 1/4"	10	96.60	CM9.125S	135.32	CC9.125S
140	5"	10	103.10	CM9.140S	150.22	CC9.140S
160	6"	10	113.66	CM9.160S	171.64	CC9.160S
200	6 1/2"	10	125.96	CM9.200S	211.70	CC9.200S

### Colier special cu protecție de cauciuc

**K 10**

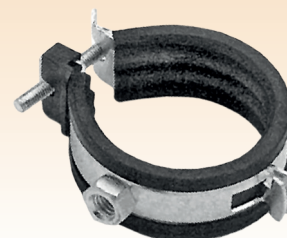
 bandă 20 x 2.0 mm  
șurub M8

Ø <sub>nominal</sub>		Ambalare (buc.)	€/100 buc	Cod articol
mm	țoli			
15	1/4"	25	36.41	JS.14015S
28	3/4"	25	47.06	JS.14028S
48	1 1/2"	25	57.11	JS.14048S
54	-	10	61.26	JS.14054S

## Coliere

### Colier rapid standard cu protecție de cauciuc **K 10**

bandă 20 x 2.0 mm  
piuliță M8

Fanta permite deschiderea rapidă a colierului.  
Este suficientă slăbirea șurubului.

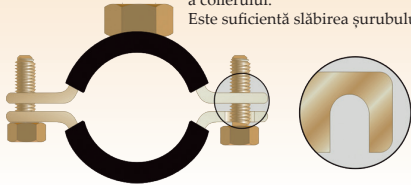

Øțevă (mm)	Ønominal	Ambalare (buc.)	€/100 buc.	Cod articol
20 - 26	1/2"	50	28.35	CC12012S

### Colier rapid greu cu protecție de cauciuc **K 10**

bandă 25 x 2.5 mm  
piuliță M10

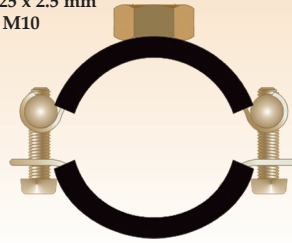

Øțevă (mm)	Ønominal	Ambalare (buc.)	€/100 buc.	Cod articol
58 - 67	2"	25	84.19	CC31063S
70 - 80	2 1/2"	25	91.96	CC32075S
85 - 96	3"	25	102.82	CC33090S
105 - 117	4"	25	116.09	CC34112S

### Colier rapid ușor cu protecție de cauciuc **K 10**

bandă 20 x 1.0 mm  
piuliță M8

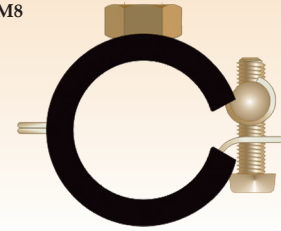

Øțevă (mm)	Ønominal	Ambalare (buc.)	€/100 buc.	Cod articol
19 - 24	1/2"	50	30.11	CC42012S
25 - 30	3/4"	50	32.43	CC43034S

### Colier dublu orizontal **K 10**

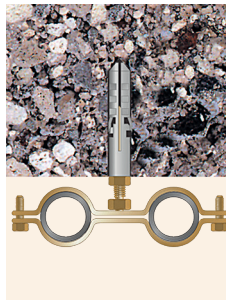
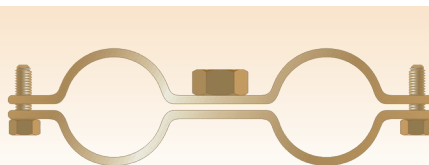

Øțevă (mm)	Ønominal	Ambalare (buc.)	€/100 buc.	Cod articol
15 - 19	3/8"	10	43.52	CM51038S
20 - 25	1/2"	10	51.13	CM52012S

### Colier pentru montaj dublu vertical **K 10**

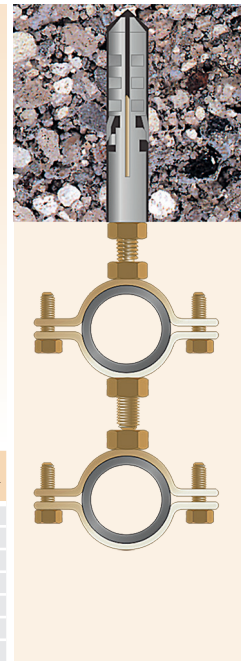
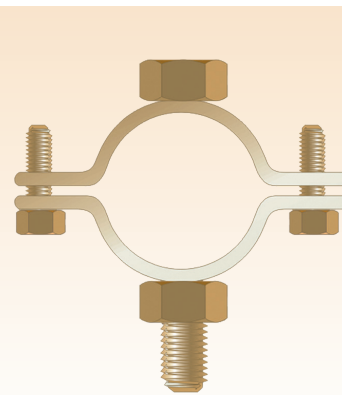

Øțevă (mm)	Ønominal	Ambalare (buc.)	€/100 buc.	Cod articol
15 - 19	3/8"	10	35.13	CM61038S
20 - 25	1/2"	10	38.20	CM62012S
26 - 30	3/4"	10	41.34	CM63034S
32 - 37	1"	10	43.40	CM64100S
38 - 44	1 1/4"	10	49.23	CM65114S
46 - 52	1 1/2"	10	54.14	CM66112S
58 - 64	2"	10	61.47	CM67200S

### Colier dublu orizontal cu protecție de cauciuc **K 10**

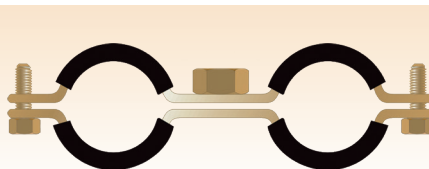

Øțevă (mm)	Ønominal	Ambalare (buc.)	€/100 buc.	Cod articol
15 - 19	3/8"	10	78.89	CC51038S
20 - 25	1/2"	10	83.35	CC52012S

### Colier tip 30 **K 10**

Bandă galvanizată: 30 x 1.0 mm  
Prindere: piuliță M8

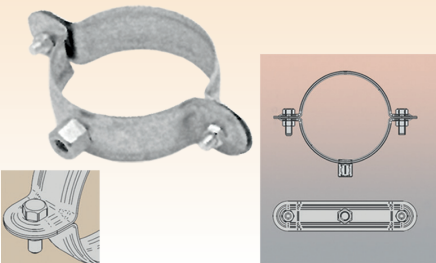

Øinterior	Ambalare (buc.)	€/100 buc.	Cod articol
50	10	44.30	CM30.0050S
63	10	48.88	CM30.0063S
75	10	54.14	CM30.0075S
80	10	59.29	CM30.0080S
90	10	60.13	CM30.0090S
100	10	63.88	CM30.0100S
110	10	67.89	CM30.0110S
125	10	74.62	CM30.0125S
140	10	81.05	CM30.0140S
160	10	87.76	CM30.0160S
200	10	111.37	CM30.0200S
250	10	127.19	CM30.0250S
315	10	152.58	CM30.0315S

### Colier tip 22 **K 10**

Bandă galvanizată: 20 x 2.0 mm  
Prindere: șurub cap HEX M6 x 20 mm, DIN 933;  
piuliță M6, DIN 934



Øinterior	Ambalare (buc.)	€/100 buc.	Cod articol
50	10	66.45	CM22.0050S
75	10	90.12	CM22.0075S
90	10	100.23	CM22.0090S
110	10	112.82	CM22.0110S
125	10	132.22	CM22.0125S
160	10	153.77	CM22.0160S
200	10	173.17	CM22.0200S
250	10	205.49	CM22.0250S
315	10	240.84	CM22.0315S

### Colier tip 32 **K 10**

Bandă galvanizată: 20 x 2.0 mm  
Prindere: șurub cap HEX M6 x 20 mm, DIN 933;  
piuliță M6, DIN 934



Øinterior	Ambalare (buc.)	€/100 buc.	Cod articol
75	10	93.30	CM32.0075S
90	10	99.51	CM32.0090S
110	10	109.20	CM32.0110S
125	10	123.50	CM32.0125S
160	10	148.51	CM32.0160S
200	10	168.80	CM32.0200S
250	10	182.83	CM32.0250S
315	10	237.48	CM32.0315S

## Coliere

### Colier "U" pentru țevi

K 10

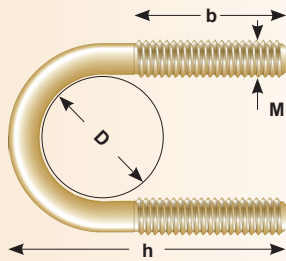

Dimensiuni (mm)				Ambalare (buc.)	€/100 buc.	Cod articol
M	D	h	b			
M 6	18	60	35	20	16.91	CU.06018S
M 6	22	60	35	20	17.09	CU.06022S
M 6	25	65	35	20	18.52	CU.06025S

Dimensiuni (mm)				Ambalare (buc.)	€/100 buc.	Cod articol
M	D	h	b			
M 8	28	65	35	20	23.78	CU.08028S
M 8	32	70	35	20	25.81	CU.08032S
M 8	34	70	35	20	25.96	CU.08034S
M 8	40	75	35	20	28.53	CU.08040S
M 8	43	75	35	20	29.21	CU.08043S
M10	30	70	40	10	35.57	CU.10030S
M10	38	76	40	10	39.16	CU.10038S
M10	46	86	50	10	44.29	CU.10046S
M10	52	92	50	10	48.77	CU.10052S
M12	56	109	50	10	70.42	CU.12056S
M12	64	109	50	10	72.51	CU.12064S
M12	70	120	50	10	79.77	CU.12070S
M12	78	120	50	10	81.02	CU.12078S
M12	82	125	50	10	85.17	CU.12082S
M12	94	138	50	10	94.73	CU.12094S

### Coliere pentru furtun



Øfurtun (mm)	oțel galvanizat						oțel inoxidabil		
	ambalare STANDARD			ambalare la BLISTER			ambalare STANDARD		
	buc./pac.	€/100 buc.	Cod articol	buc./blister	€/blister	Cod articol	buc./pac.	€/100 buc.	Cod articol
8 - 16	100	17.39	JS.00016S	4	0.82	JS.00016B	100	42.38	JS.01016S
12 - 20	100	18.32	JS.00020S	4	0.85	JS.00020B	100	43.66	JS.01020S
18 - 25	100	19.86	JS.00025S	4	0.91	JS.00025B	100	46.14	JS.01025S
20 - 32	100	21.06	JS.00032S	4	0.96	JS.00032B	100	50.42	JS.01032S
25 - 40	100	22.21	JS.00040S	2	0.56	JS.00040B	100	51.78	JS.01040S
35 - 50	50	23.97	JS.00050S	-	-	-	50	55.01	JS.01050S
40 - 60	50	26.10	JS.00060S	-	-	-	50	57.95	JS.01060S
50 - 70	50	33.50	JS.00070S	-	-	-	50	56.93	JS.01070S
60 - 80	24	30.96	JS.00080S	-	-	-	24	56.96	JS.01080S
70 - 90	24	35.86	JS.00090S	-	-	-	24	65.71	JS.01090S
80 - 100	24	36.80	JS.00100S	-	-	-	24	56.64	JS.01100S
90 - 110	24	30.90	JS.00110S	-	-	-	24	53.22	JS.01110S
100 - 120	24	34.93	JS.00120S	-	-	-	24	55.18	JS.01120S
110 - 130	24	20.43	JS.00130S	-	-	-	24	63.41	JS.01130S
120 - 140	24	28.94	JS.00140S	-	-	-	-	-	-
130 - 150	24	35.78	JS.00150S	-	-	-	-	-	-

### Colier pentru furtun de înaltă presiune

Bandă din oțel galvanizat: 24 x 1.5 mm  
Prindere: șurub M8

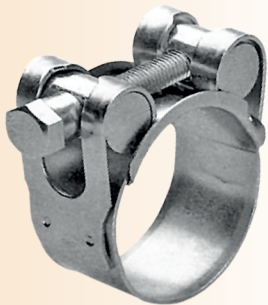

Øfurtun (mm)	Ambalare (buc.)	€/100 buc.	Cod articol	Øfurtun (mm)	Ambalare (buc.)	€/100 buc.	Cod articol
23 - 25	50	64.82	JS.02025S	92 - 97	5	205.54	JS.02097S
26 - 28	50	69.62	JS.02028S	98 - 103	5	185.78	JS.02103S
29 - 31	50	78.46	JS.02031S	104 - 112	5	208.51	JS.02112S
32 - 35	25	84.70	JS.02035S	113 - 121	5	139.97	JS.02121S
36 - 39	25	105.98	JS.02039S	122 - 130	5	119.63	JS.02130S
40 - 43	25	83.06	JS.02043S	131 - 139	5	204.70	JS.02139S
44 - 47	25	95.39	JS.02047S	140 - 148	5	173.15	JS.02148S
48 - 51	10	109.28	JS.02051S	149 - 161	5	176.85	JS.02161S
52 - 55	10	124.32	JS.02055S	162 - 174	5	181.86	JS.02174S
56 - 59	10	81.58	JS.02059S	175 - 187	5	186.83	JS.02187S
60 - 63	5	129.36	JS.02063S	188 - 200	5	192.00	JS.02200S
64 - 67	5	109.10	JS.02067S	201 - 213	5	175.30	JS.02213S
68 - 73	5	178.59	JS.02073S	214 - 226	5	202.83	JS.02226S
74 - 79	5	178.40	JS.02079S	227 - 239	5	208.32	JS.02239S
80 - 85	5	180.64	JS.02085S				

### Clește de prindere coliere - pagina 8.94.

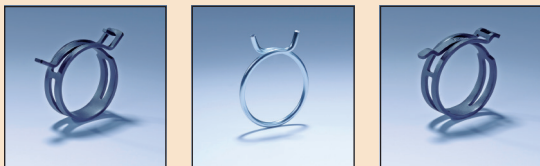



## Bride

### Bride ușoare

K 10

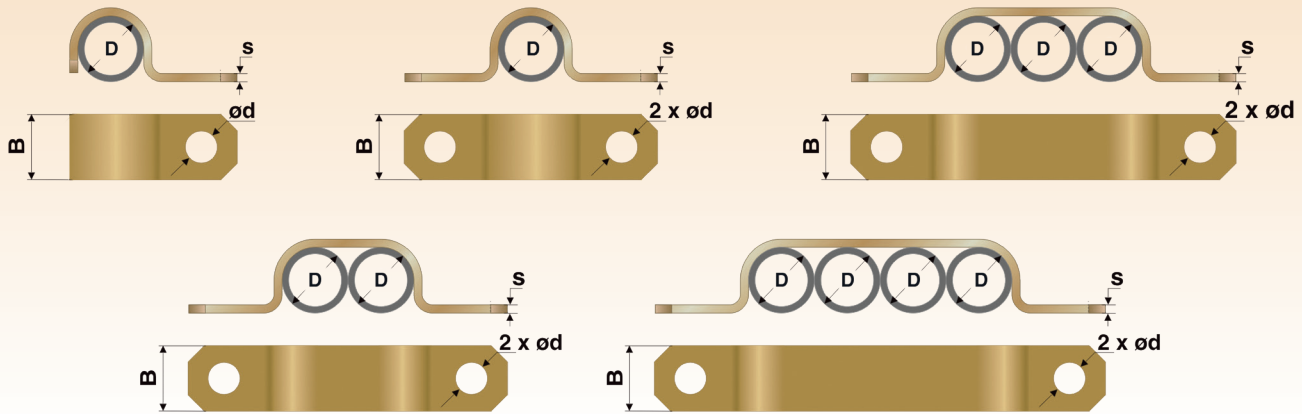

Dimensiuni (mm)				Amb. (buc.)	Bridă ușoară rapidă		Bridă ușoară 1 x D		Bridă ușoară 2 x D		Bridă ușoară 3 x D		Bridă ușoară 4 x D	
D	d	B	s		€/100 buc.	Cod articol	€/100 buc.	Cod articol	€/100 buc.	Cod articol	€/100 buc.	Cod articol	€/100 buc.	Cod articol
5	4.8	10	1.0	200	3.34	U005010S	3.93	U105010S	4.32	U205010S	4.85	U305010S	5.41	U405010S
6	4.8	10	1.0	200	3.62	U006010S	4.26	U106010S	4.60	U206010S	5.27	U306010S	6.30	U406010S
7	4.8	10	1.0	200	4.05	U007010S	4.47	U107010S	5.03	U207010S	5.84	U307010S	6.84	U407010S
8	4.8	10	1.0	200	3.83	U008010S	4.93	U108010S	5.62	U208010S	6.30	U308010S	7.48	U408010S
9	4.8	10	1.0	200	4.03	U009010S	5.11	U109010S	5.84	U209010S	6.90	U309010S	7.99	U409010S
10	4.8	10	1.0	200	4.25	U010010S	5.35	U110010S	6.41	U210010S	8.05	U310010S	8.45	U410010S
11	5.8	12	1.5	100	4.32	U011012S	6.30	U111012S	6.99	U211012S	8.14	U311012S	9.35	U411012S
12	5.8	12	1.5	100	4.60	U012012S	6.08	U112012S	7.33	U212012S	8.71	U312012S	10.01	U412012S
13	5.8	12	1.5	100	4.97	U013012S	6.87	U113012S	7.74	U213012S	9.14	U313012S	10.65	U413012S
15	5.8	12	1.5	100	5.47	U015012S	7.02	U115012S	8.57	U215012S	10.14	U315012S	11.72	U415012S
16	5.8	12	1.5	100	5.57	U016012S	7.23	U116012S	8.92	U216012S	10.57	U316012S	12.40	U416012S

### Bridă standard rapidă

K 10

### Bridă de reținere standard

K 10

### Bridă standard

K 10

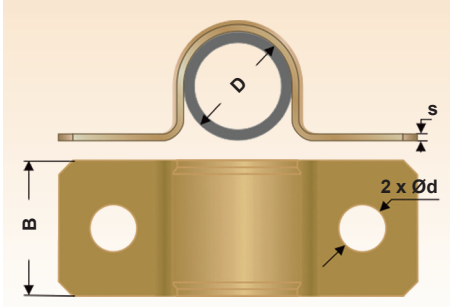
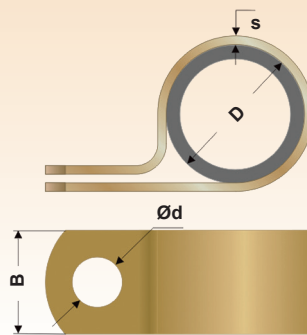
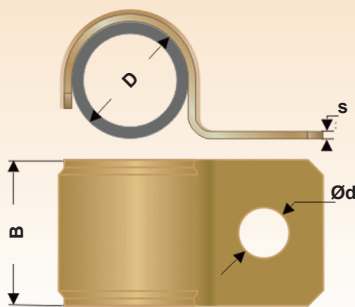

Dimensiuni (mm)				Amb. (buc.)	€/100 buc.	Cod articol	Dimensiuni (mm)				Amb. (buc.)	€/100 buc.	Cod articol	Dimensiuni (mm)				Amb. (buc.)	€/100 buc.	Cod articol												
D	d	B	s				D	d	B	s				D	d	B	s															
16	7.0	20	1.0	100	5.19	S016020S	6	5.8	10	1.0	200	5.99	R006012S	16	7.0	20	1.0	100	8.17	S116020S												
18	7.0	20	1.0	100	5.89	S018020S	8	5.8	10	1.0	200	7.12	R008012S	18	7.0	20	1.0	100	8.15	S118020S												
20	7.0	20	1.0	100	6.46	S020020S	10	5.8	10	1.0	200	8.05	R010012S	20	7.0	20	1.0	100	8.72	S120020S												
22	7.0	20	1.0	100	7.04	S022020S	12	5.8	10	1.0	200	4.53	R012012S	22	7.0	20	1.0	100	9.14	S122020S												
26	7.0	20	1.0	100	7.91	S026020S	14	5.8	10	1.0	200	4.99	R014012S	26	7.0	20	1.0	100	10.35	S126020S												
							16	5.8	10	1.0	200	5.54	R016012S	28	7.0	20	1.0	100	10.74	S128020S												
							18	7.0	20	1.0	100	7.96	R018020S	32	7.0	20	1.0	100	11.44	S132020S												
							20	7.0	20	1.0	100	8.35	R020020S	35	7.0	20	1.0	50	12.14	S135020S												
							22	7.0	20	1.0	100	9.05	R022020S	42	7.0	20	1.0	50	14.64	S142020S												
							26	7.0	20	1.0	100	10.22	R026020S	48	7.0	20	1.0	50	15.92	S148020S												
							28	7.0	20	1.0	100	10.92	R028020S	60	7.0	20	1.0	50	18.93	S160020S												
							32	7.0	20	1.0	100	12.41	R032020S	63	7.0	20	1.0	50	19.93	S163020S												
							35	7.0	20	1.0	100	12.81	R035020S																			
							42	7.0	20	1.0	100	16.00	R042020S																			

### Suport individual cu fixare dublă

K 10

### Suport individual cu fixare triplă

K 10

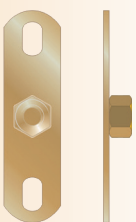

Ambalare (buc.)	€/100 buc.	Cod articol
1	19.98	SM703S

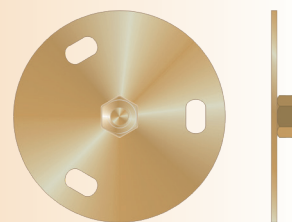

Ambalare (buc.)	€/100 buc.	Cod articol
1	39.95	SM702S

## Sisteme de susținere și fixare pentru coliere



- |   |                                |
|---|--------------------------------|
| 1 | consolă suport SPX             |
| 2 | șină perforată GPX             |
| 3 | șină perforată GPG             |
| 4 | prezon TG                      |
| 5 | placă de fixare EMZ45          |
| 6 | șaiță TUGX                     |
| 7 | colier cu protecție de cauciuc |
| 8 | colier de presiune             |
| 9 | tijă filetată                  |

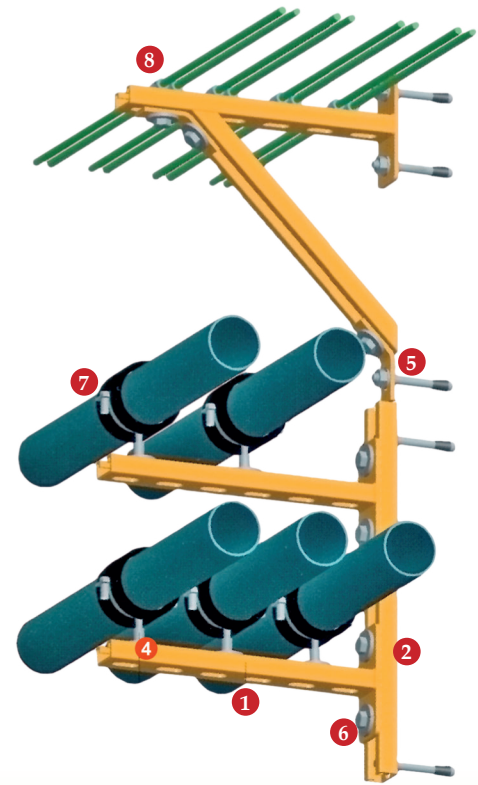
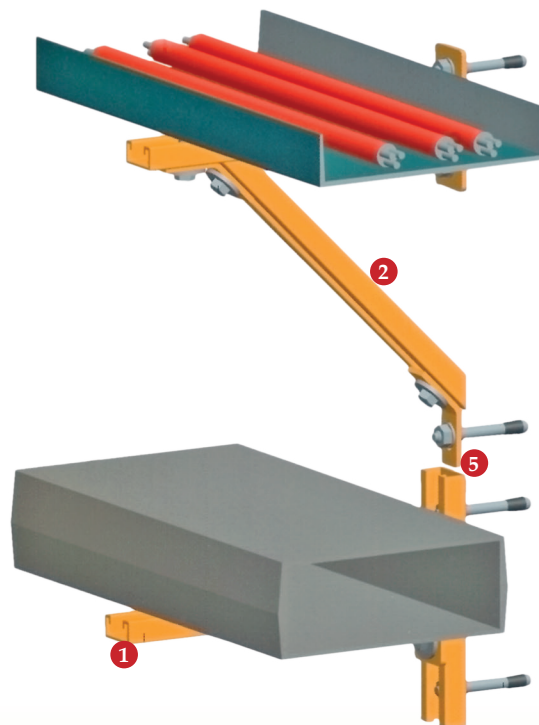
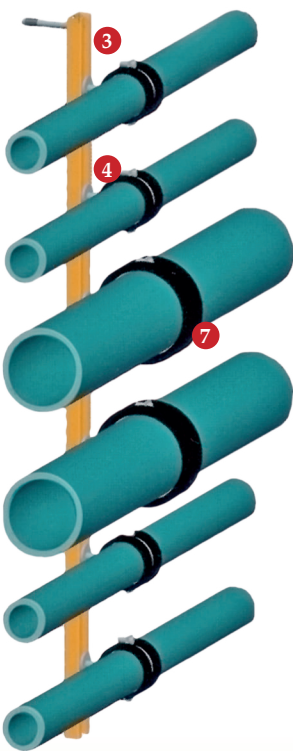
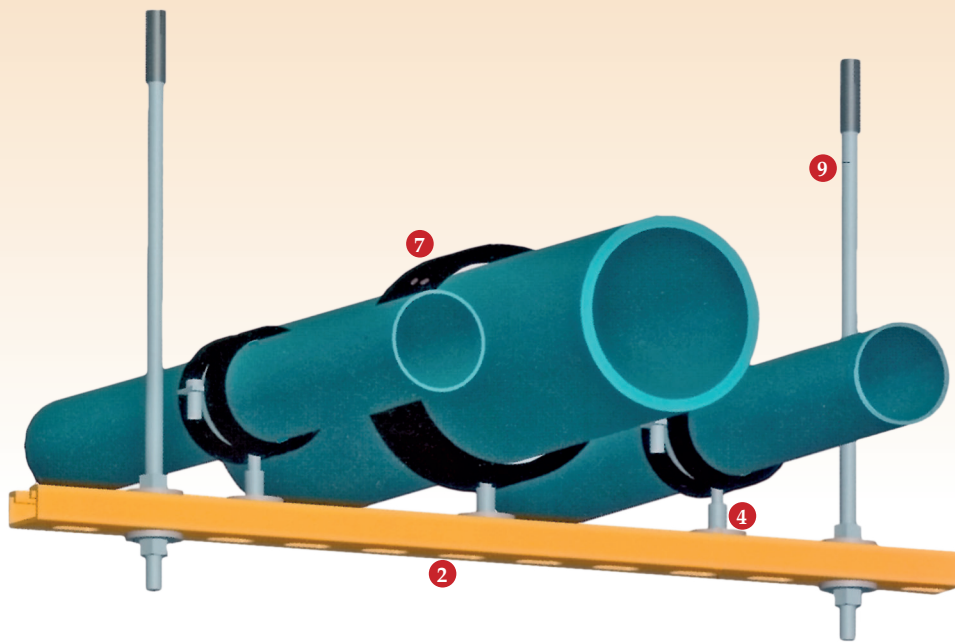

Sistemul de susținere și fixare INDEX cuprinde o gamă largă de șine perforate, suporturi și accesorii pentru utilizare în execuția instalațiilor electrice, sanitare, de telecomunicații sau pentru transportul fluidelor.

Prezintă o excelentă versatilitate în montaj: pot fi suspendate, fixate direct pe perete sau pe alte șine perforate. Sunt compatibile cu o gamă largă de coliere pentru conducte precum și cu alte elemente de fixare pentru instalații electrice sau sanitare.

Gama INDEX se prezintă în diverse variante de finisare:

- **Zincat:** pentru instalații de telecomunicații interioare.
- **Galvanizat:** pentru instalații electrice și instalații simple de transport a fluidelor cu corozivitate moderată.
- **Inox:** pentru utilizare în exterior sau în zone industriale poluante sau cu umiditate ridicată (fără clor).
- **Plastifiat galben:** elemente izolate, cu rezistență remarcabilă în medii corozive. Utile pentru identificarea instalațiilor de gaze.
- **PVC:** elemente pentru încărcări lejere, facil de debitat și montat. Prezintă o bună rezistență la agenți chimici.
- **INDEXTRUT:** profile galvanizate pentru instalații grele de transport a fluidelor.

## Sisteme de susținere și fixare pentru coliere

### Șine de montaj perforate

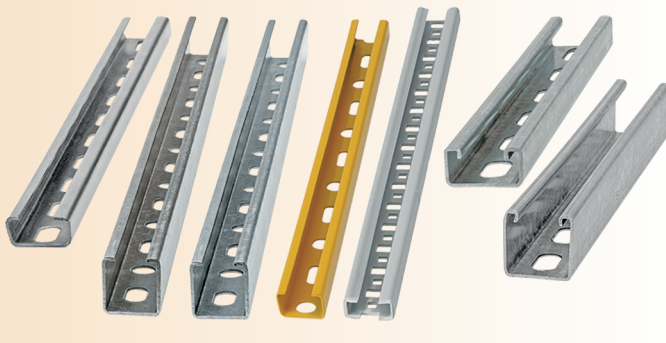

Tip	Secțiune (mm)	Lungime (mm)	Ambalare (buc.)	€/100 buc.	Cod articol
Zincat	20 x 10 x 1.00	2000	1	241.81	I.GPZ201010S
	25 x 8 x 0.80	1000	1	141.69	I.GPZ250808S
Galvanizat	27 x 18 x 1.25	2000	1	326.21	I.GPG271812S
	28 x 30 x 1.80	2000	1	595.52	I.GPG283018S
	38 x 40 x 2.00	2000	1	1062.86	I.GPG384020S
	40 x 20 x 1.50	2000	1	528.93	I.GPG402015S
Inox A2	27 x 18 x 1.25	2000	1	2812.20	I.GPI271812S
	28 x 30 x 1.50	2000	1	5293.28	I.GPI283015S
	38 x 40 x 2.00	2000	1	4699.26	I.GPI384020S
Plastifiat galben	27 x 18 x 1.25	1000	1	227.68	I.GPP271812S
PVC	25 x 11 x 2.00	1000	1	77.50	I.GPV251120S
Indextrut	41 x 21 x 2.50	3000	1	1553.54	I.GPX412125S
	41 x 41 x 2.50	3000	1	1989.64	I.GPX414125S

### Console suport

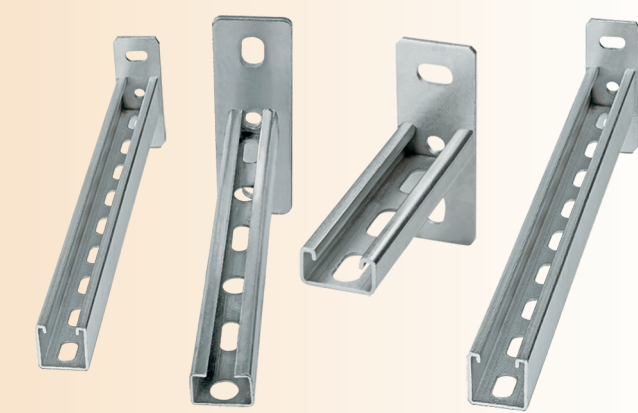

Tip	Secțiune (mm)	Lungime (mm)	Ambalare (buc.)	€/100 buc.	Cod articol
27 / 18	27 x 18 x 1.25	200	1	157.88	I.SPZ271820S
	27 x 18 x 1.25	300	1	216.54	I.SPZ271830S
38 / 40	38 x 40 x 2.00	200	1	337.91	I.SPZ2384020S
	38 x 40 x 2.00	250	1	296.60	I.SPZ2384025S
	38 x 40 x 2.00	300	1	330.60	I.SPZ2384030S
	38 x 40 x 2.00	350	1	388.22	I.SPZ2384035S
	38 x 40 x 2.00	400	1	475.59	I.SPZ2384040S
	38 x 40 x 2.00	500	1	553.83	I.SPZ2384050S
	38 x 40 x 2.00	600	1	626.75	I.SPZ2384060S
Indextrut 41 / 21	41 x 21 x 2.50	150	1	266.73	I.SPZ412115S
	41 x 21 x 2.50	300	1	275.21	I.SPZ412130S
	41 x 21 x 2.50	450	1	409.27	I.SPZ412145S
Indextrut 41 / 41	41 x 41 x 2.50	150	1	312.39	I.SPZ414115S
	41 x 41 x 2.50	300	1	429.45	I.SPZ414130S
	41 x 41 x 2.50	450	1	578.04	I.SPZ414145S
	41 x 41 x 2.50	600	1	769.86	I.SPZ414160S
	41 x 41 x 2.50	750	1	790.12	I.SPZ414175S

### Suporturi de șină

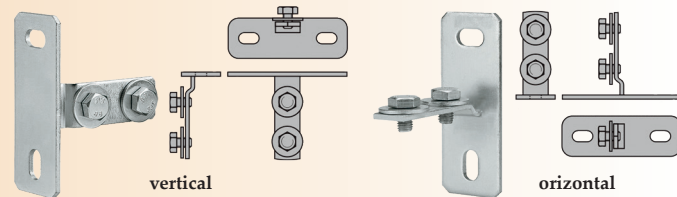

Tip	Prindere	pentru șină	Ambalare (buc.)	€/100 buc.	Cod articol
Vertical	M10	(27x18) - (28x30)	1	110.17	I.SPV2718S
	M10	38x40	1	125.93	I.SPV3840S
Orizontal	M10	(27x18) - (28x30)	1	136.52	I.SPH2718S
	M10	38x40	1	135.22	I.SPH3840S

### Plăcuțe de fixare

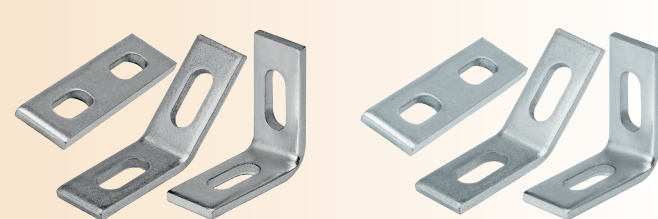

Tip	Formă	Ambalare (buc.)	€/100 buc.	Cod articol
Zincat	drept	1	38.33	I.EMZ00S
	45°	1	41.16	I.EMZ45S
	90°	1	41.16	I.EMZ90S
Inox A2	drept	1	123.28	I.EMI00S
	45°	1	125.27	I.EMI45S
	90°	1	126.29	I.EMI90S

### Bride

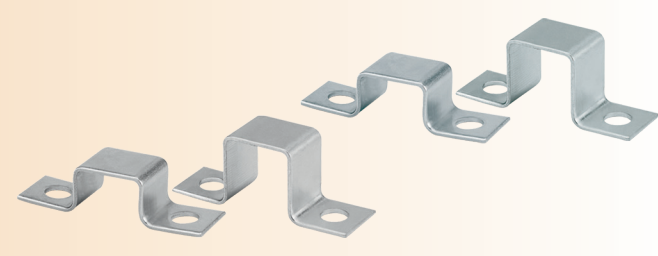

Tip	pentru șină	Ambalare (buc.)	€/100 buc.	Cod articol
Zincat	27 / 18	1	17.08	I.PGZ2718S
	28 / 30	1	20.83	I.PGZ2830S
	38 / 40	1	23.97	I.PGZ3840S
Inox A2	27 / 18	1	58.22	I.PGI2718S
	28 / 30	1	69.49	I.PGI2830S
	38 / 40	1	86.87	I.PGI3840S



## Sisteme de susținere și fixare pentru coliere

### Șaibe dreptunghiulare

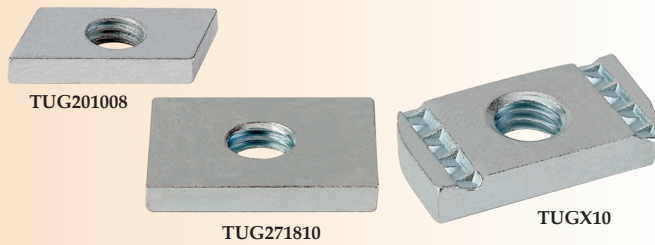

Tip	Filet	Pentru șină	Ambalare (buc.)	€/100 buc.	Cod articol	
zincat	M 6	20/10 - 25/8	100	4.73	I.TUG201006S	
	M 8		100	5.61	I.TUG201008S	
	M 8	25/8 - 27/18 - 28/30 - 38/40	100	11.58	I.TUG271808S	
	M10		100	11.56	I.TUG271810S	
	M 8		Indextrut 41/41 - 41/21	100	17.56	I.TUG208S
	M10			100	21.48	I.TUGX10S

### Prezoane sudate

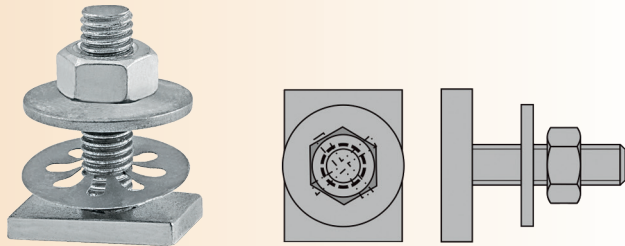

Tip	Filet	Pentru șină	Ambalare (buc.)	€/100 buc.	Cod articol
zincat	M 6 x 20	27/18 - 28/30-25/08	100	13.31	I.TG230620S
	M 6 x 30	20/18 - 28/30	100	14.25	I.TG230630S
	M 8 x 20	27/18 - 28/30-25/10	100	24.02	I.TG230820S
	M 8 x 30		100	25.28	I.TG230830S
	M10 x 30	20/18 - 28/30	100	25.33	I.TG231030S
	M 8 x 30	38/40-40/20	100	32.22	I.TG340830S
	M10 x 30		100	37.24	I.TG341030S

### Placă unghiulară de legătură



Tip	Mărime	Ambalare (buc.)	€/100 buc.	Cod articol
zincat	5	50	4.91	I.PCU0005S
	6	50	5.25	I.PCU0006S

### Placă de suspendare



Tip	Mărime	Ambalare (buc.)	€/100 buc.	Cod articol
zincat	5	50	6.26	I.PSU0005S
	6	50	6.22	I.PSU0006S

### Suport de susținere "V"

K 10

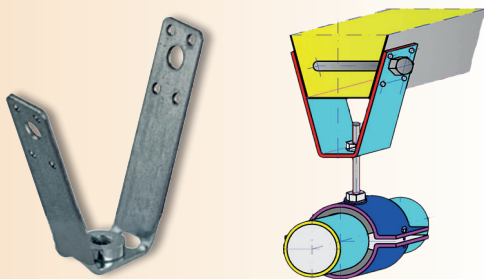

Tip	Dimensiuni (mm)						Amb. (buc.)	€/100 buc.	Cod articol	
	1	2	3	4	5	6				
M 8	92	28	88	25	2.5	M 8	6	10	61.87	AF.V9227S
M10	92	28	88	25	2.5	M10	7	10	61.87	AF.V9228S

Fixare cu: șuruburi autofiletante; șuruburi autoforante; pop-nituri 4 mm / șurub M8  
 Perforații: (2 x 4) Ø4.2 + (2 x 1) Ø9.5

### Suportți cu gaură lisă (Ø) / filetată metric (M), pentru prindere pe grindă

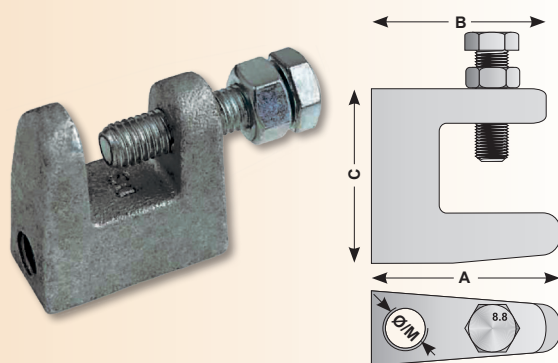

A x B x C	mm		Încărcare recomandată (Kg)	Ambalare (buc.)	€/100 buc.	Cod articol
	Grosimea grinzii	Gaură lisă (Ø) / cu filet (M)				
38 x 35 x 35	18	Ø 9	285	1	92.50	I.SUMOP09S
44 x 41 x 42	20	Ø11	357	1	127.65	I.SUMOP11S
58 x 48 x 54	26	Ø13	357	1	148.00	I.SUMOP13S
38 x 35 x 35	18	M 8	285	1	92.50	I.SUMOM08S
44 x 41 x 42	20	M10	357	1	127.65	I.SUMOM10S
58 x 48 x 54	26	M12	357	1	148.00	I.SUMOM12S

## Compatibilitatea elementelor de fixare "INDEX"

		Șine perforate											Console suport																						
Cod		GPZ201010	GPZ250808	GPG271812	GPG283018	GPG384020	GPG402015	GPI271812	GPI283015	GPI384020	GPP271812	GPV251120	GPX412125	GPX414125	SPZ271820	SPZ271830	SPZ2384020	SPZ2384025	SPZ2384030	SPZ2384035	SPZ2384040	SPZ2384050	SPZ2384060	SPZ412115	SPZ412130	SPZ412145	SPZ414115	SPZ414130	SPZ414145	SPZ414160	SPZ414175				
Secțiune (mm)		20 x 10 x 1.00	25 x 8 x 0.80	27 x 18 x 1.25	28 x 30 x 1.80	38 x 40 x 2.00	40 x 20 x 1.50	27 x 18 x 1.25	28 x 30 x 1.50	38 x 40 x 2.00	27 x 18 x 1.25	25 x 11 x 2.00	41 x 21 x 2.50	41 x 41 x 2.50	27 x 18 x 1.25	27 x 18 x 1.25	38 x 40 x 2.00	39 x 40 x 2.00	40 x 40 x 2.00	41 x 40 x 2.00	42 x 40 x 2.00	43 x 40 x 2.00	44 x 40 x 2.00	41 x 21 x 2.50	42 x 21 x 2.50	43 x 21 x 2.50	44 x 21 x 2.50	45 x 21 x 2.50	46 x 21 x 2.50	47 x 21 x 2.50	48 x 21 x 2.50				
L (mm)		2000	1000	2000	2000	2000	2000	2000	2000	2000	1000	1000	3000	3000	200	300	200	250	300	350	400	500	600	150	300	450	150	300	450	600	750				
Profil INDEXTRUT													✓										✓	✓	✓	✓	✓	✓	✓	✓	✓				
Finisaj	Cromat		✓																																
	Zincat															✓	✓	✓	✓	✓	✓	✓	✓	✓	✓	✓	✓	✓	✓	✓	✓	✓			
	Galvanizat		✓	✓	✓	✓							✓																						
	Inox A2							✓	✓	✓	✓	✓																							
	Plastifiat galben											✓	✓																						
	PVC											✓	✓																						
Suport	SPV2718 vertical M10			✓	✓	✓	✓				✓																								
	SPV3840 vertical M10					✓	✓																												
	SPH2718 vertical M10			✓	✓	✓	✓				✓																								
	SPH3840 orizontal M10					✓	✓																												
Plăcuțe de fixare	IEMZ00 45°		✓	✓	✓	✓	✓				✓	✓	✓																						
	IEMZ45 90°		✓	✓	✓	✓	✓				✓	✓	✓																						
	IEMZ90 drept		✓	✓	✓	✓	✓				✓	✓	✓																						
	EMI00 45° / inox							✓	✓	✓																									
	EMI45 90° / inox							✓	✓	✓																									
	EMI90 drept / inox							✓	✓	✓																									
Bride	PGZ2718			✓																															
	PGZ2830				✓																														
	PGZ3840					✓																													
	PGI2718							✓																											
	PGI2830								✓																										
	PGI3840									✓																									
Prezoane	TG230620 M 6 x 20		✓	✓	✓						✓				✓																				
	TG230820 M 8 x 20		✓	✓	✓						✓				✓																				
	TG230830 M 8 x 30		✓	✓	✓						✓				✓																				
	TG231030 M10 x 30		✓	✓	✓						✓				✓																				
	TG340830 M 8 x 30					✓										✓	✓	✓	✓	✓	✓	✓	✓	✓											
	TG341030 M10 x 30					✓	✓									✓	✓	✓	✓	✓	✓	✓	✓	✓											
TOPEABUG		✓										✓																							
Șaibe	TUG201006		✓																																
	TUG201008		✓																																
	TUG271808		✓	✓	✓	✓	✓				✓				✓	✓	✓	✓	✓	✓	✓	✓	✓	✓											
	TUG271810		✓	✓	✓	✓	✓				✓				✓	✓	✓	✓	✓	✓	✓	✓	✓	✓											
	TUG208												✓											✓	✓	✓	✓	✓	✓	✓	✓	✓	✓	✓	
	TUGX10												✓											✓	✓	✓	✓	✓	✓	✓	✓	✓	✓	✓	

## Suportți

### Suport clip simplu pentru șină 20 mm, nailon 6.6



ØD		Ambalare (buc.)	€/100 buc.	Cod articol
mm	țoli			
12	1/4"	100	13.39	I.ABIN012S
14 - 16	3/8"	100	14.10	I.ABIN014S
16 - 18		100	18.35	I.ABIN016S
20 - 22		100	19.13	I.ABIN020S
28	3/4"	50	24.85	I.ABIN028S

### Suport clip dublu pentru șină 20 mm, nailon 6.6

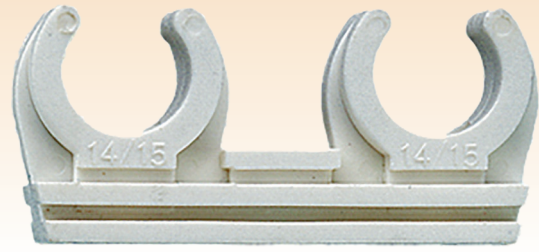

ØD		Ambalare (buc.)	€/100 buc.	Cod articol
mm	țoli			
12	1/4"	100	26.55	I.ABID012S
14 - 16	3/8"	100	28.05	I.ABID014S
16 - 18		100	35.74	I.ABID016S
20 - 22		100	37.76	I.ABID020S
28	3/4"	50	45.55	I.ABID028S

### Suport clip simplu cu bază, cu prefilet M6, polipropilenă gri

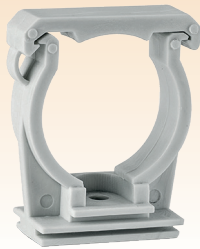

ØD		Ambalare (buc.)	€/100 buc.	Cod articol
mm	țoli			
12	1/4"	100	6.38	I.ABGUG12S
15	3/8"	100	6.85	I.ABGUG15S
18		100	7.27	I.ABGUG18S
20		100	7.77	I.ABGUG20S
22	1/2"	100	8.51	I.ABGUG22S
25		50	9.40	I.ABGUG25S
28		50	10.34	I.ABGUG28S
32	1"	25	12.91	I.ABGUG32S
40		25	16.28	I.ABGUG40S
50		25	21.02	I.ABGUG50S

### Suport clip dublu cu bază, cu prefilet M6, polipropilenă gri

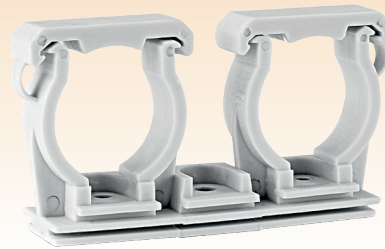

ØD		Ambalare (buc.)	€/100 buc.	Cod articol
mm	țoli			
15	3/8"	100	9.27	I.ABGUD15S
18		100	10.10	I.ABGUD18S
22		100	12.64	I.ABGUD22S
28		100	13.51	I.ABGUD28S

### Suport clip universal, polipropilenă



ØD (mm)	Ambalare (buc.)	€/100 buc.	Cod articol
12	100	8.15	I.ABMUG12S
15 - 16	100	8.35	I.ABMUG15S
18 - 20	100	10.63	I.ABMUG18S
22 - 25	100	12.63	I.ABMUG22S
26 - 28	50	15.78	I.ABMUG26S
32 - 35	50	20.36	I.ABMUG32S
40 - 42	50	27.55	I.ABMUG40S
48 - 50	25	33.12	I.ABMUG48S

### Console pentru aer condiționat

Culoare: crem  
Grosimea tablei: 2 mm  
Încărcare maximă: 25 Kg

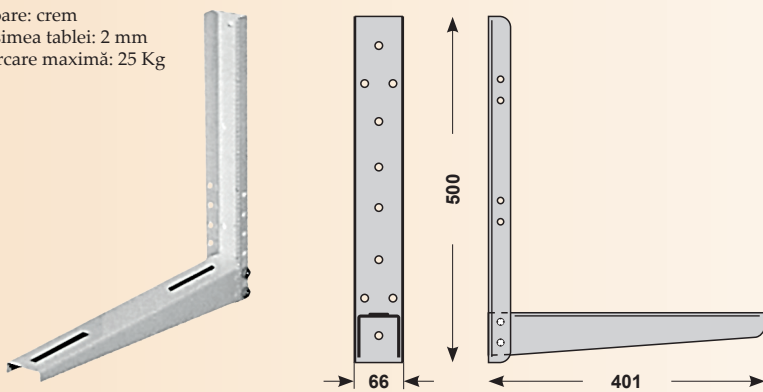

N x L (mm)	Ambalare (buc.)	€/100 buc.	Cod articol
500 x 400	1	1398.50	JS.205041S
500 x 450	1	1440.10	JS.205044S
500 x 500	1	1481.70	JS.205050S



## Suporturi

### Suport multiplu pentru cabluri

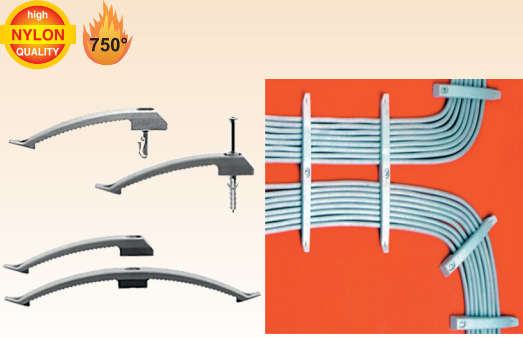

Tip	Ambalare (buc.)	€/100 buc.	Cod articol
Simplu - 8 cabluri	1	15.20	AB.04154002S
Dublu - 16 cabluri	1	29.20	AB.04154003S

### Colier multiplu pentru cabluri

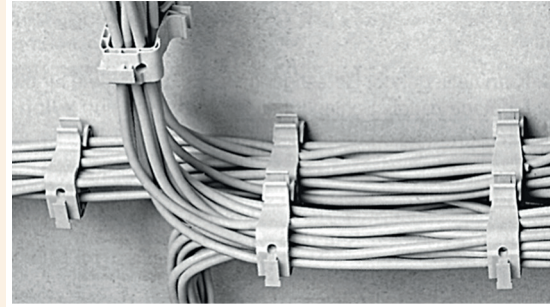
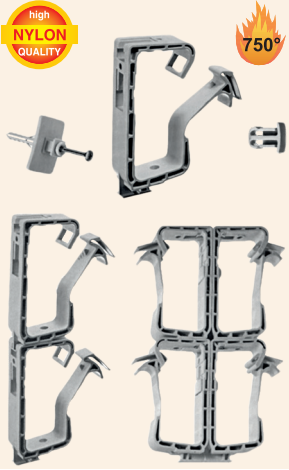

Tip	Ambalare (buc.)	€/100 buc.	Cod articol
Colier SH -15	1	51.12	AB.04061001S
Colier SH -30	1	89.16	AB.04061002S
Capac	1	7.68	AB.04061003S
Piesa de cuplare	1	7.68	AB.04061004S
Capac cu holşurub	1	16.16	AB.04061005S

### Suport "Clip" pentru cabluri

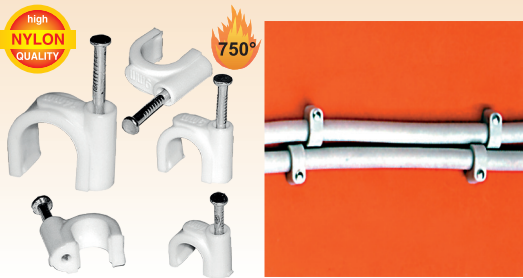

Ø cablu (mm)	Lcui (mm)	Ambalare (buc.)	€/100 buc.	Cod articol
5 - 7	20	250	1.46	AB.05707025S
7 - 12	25	250	1.58	AB.05712025S
10 - 14	30	250	2.06	AB.05714025S

### Clipsuri

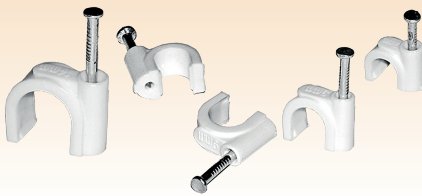

Ø (mm)	ambalare la BLISTER (BL)		
	buc/BL	€/BL	Cod articol
4	50	0.38	E022004B
5	50	0.32	E022005B
6	50	0.41	E022006B
7	50	0.48	E022007B
8	50	0.53	E022008B
10	50	0.65	E022010B

Ø (mm)	ambalare STANDARD		
	buc./pac.	€/100 buc.	Cod articol
4	100	0.38	E022004B
5	100	0.32	E022005B
6	100	0.41	E022006B
7	100	0.48	E022007B
8	100	0.53	E022008B
9	100	0.65	E022010B
10	100	1.06	E022010S
12	100	1.01	E022012S
14	100	1.55	E022014S
16	100	1.63	E022016S
18	100	2.03	E022018S
20	100	3.55	E022020S
22	100	4.22	E022022S

### Suport "Clemfix" pentru cabluri

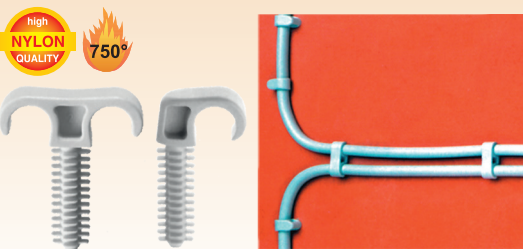

Pentru găurire în beton se recomandă  $\text{Ø}_{\text{burghiu}} = 6 \text{ mm}$   
 Pentru materiale uşoare (BCA)  $\text{Ø}_{\text{burghiu}} = 5 \text{ mm}$

Dimensiunile cablului (mm)	Ambalare (buc.)	€/100 buc.	Cod articol
1 x 7 - 12	200	5.80	AB.06008001S
2 x 7 - 12	100	7.36	AB.06008002S

### Suporturi "Fix Ring"

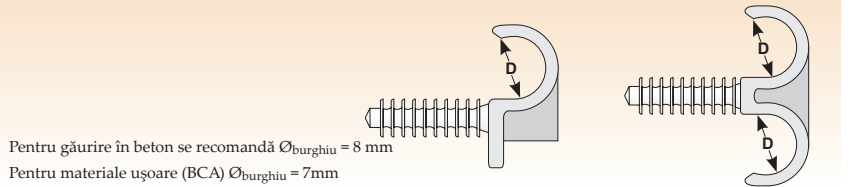

Pentru găurire în beton se recomandă  $\text{Ø}_{\text{burghiu}} = 8 \text{ mm}$   
 Pentru materiale uşoare (BCA)  $\text{Ø}_{\text{burghiu}} = 7 \text{ mm}$

D (mm)	suport simplu			suport dublu		
	Ambalare (buc.)	€/100 buc.	Cod articol	Amb. (buc.)	€/100 buc.	Cod articol
16	100	17.88	AB.03116000S	100	21.77	AB.03216000S
18	100	18.85	AB.03118000S	100	24.30	AB.03218000S
20	100	19.44	AB.03120000S	100	24.88	AB.03220000S
22	100	20.03	AB.03122000S	-	-	-
25	100	20.60	AB.03125000S	100	28.57	AB.03225000S
28	100	25.08	AB.03128000S	50	36.93	AB.03228000S

### Suport plat pentru cabluri

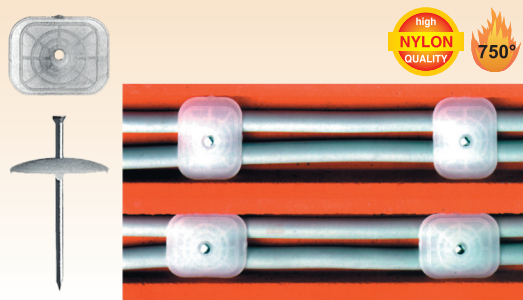

Dimensiunile cablului (mm)	Ambalare (buc.)	€/100 buc.	Cod articol
27 x 34 x 2 - 30	100	2.22	AB.07712030S
27 x 34 x 3 - 40	100	7.20	AB.07713040S

### Suporturi "Skorpion"

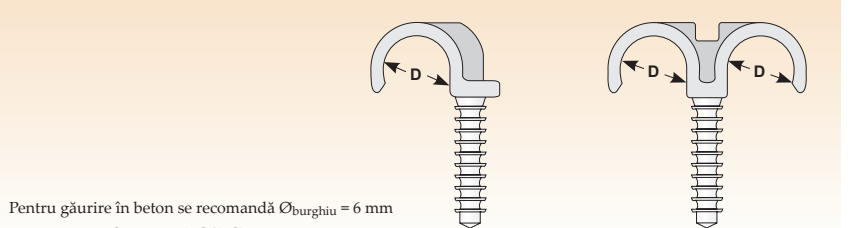

Pentru găurire în beton se recomandă  $\text{Ø}_{\text{burghiu}} = 6 \text{ mm}$   
 Pentru materiale uşoare (BCA)  $\text{Ø}_{\text{burghiu}} = 5 \text{ mm}$

D (mm)	suport simplu			suport dublu		
	Ambalare (buc.)	€/100 buc.	Cod articol	Amb. (buc.)	€/100 buc.	Cod articol
16	100	3.22	AB.24116000S	-	-	-
22	100	4.91	AB.24122000S	100	10.20	AB.24222000S
27	100	5.00	AB.24127000S	100	10.67	AB.24227000S

## Suportți

### Suportți "Fix" pentru țevi și cabluri - bandă 20 x 1.5 mm

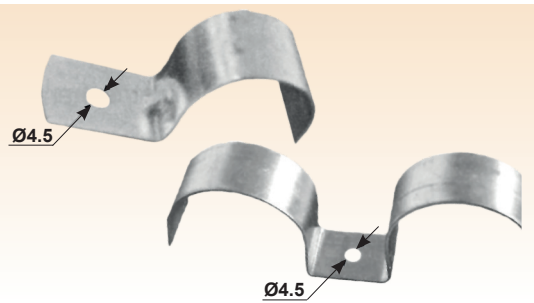

Tip	mm		suport simplu			suport dublu		
	Ø	Ø <sub>țeavă</sub>	Amb. (buc.)	€/100 buc.	Cod articol	Amb. (buc.)	€/100 buc.	Cod articol
PG 11	18	17 - 18	200	6.83	AB.02118000S	100	12.55	AB.02218000S
PG 13.5	20	19 - 20	200	7.47	AB.02120000S	100	13.89	AB.02220000S
PG 16	22	21 - 22	175	8.09	AB.02122000S	100	14.55	AB.02222000S
	24	23 - 24	150	8.69	AB.02124000S	100	16.38	AB.02224000S
PG 21	28	27 - 28	125	9.80	AB.02128000S	50	19.56	AB.02228000S
	35	34 - 35	-	-	-	50	23.58	AB.02235000S

### Suportți "Clip" pentru țevi

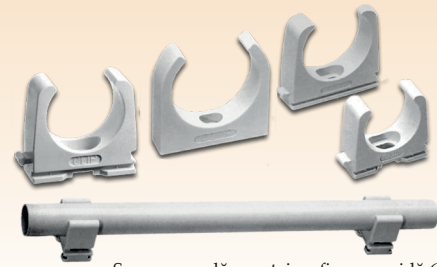
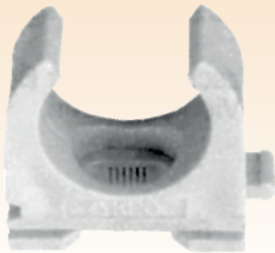

Se recomandă montaj cu fixare rapidă 6 x 40 mm sau șurub PAL 6 x 40 mm.  
Până la PG 29 clipurile se pot combina între ele

Tip	Ø <sub>țeavă</sub> (mm)	din polipropilenă, fără diblu			din polipropilenă, cu diblu pentru fixare rapidă			suport din nailon		
		Ambalare (buc.)	€/100 buc.	Cod articol	Ambalare (buc.)	€/100 buc.	Cod articol	Ambalare (buc.)	€/100 buc.	Cod articol
PG 9	15 - 16	100	7.14	AB.012PG090S	100	10.33	AB.011PG090S	100	5.52	AB.010PG090S
PG 11	18 - 19	-	-	-	-	-	-	100	6.88	AB.010PG110S
PG 13.5	20 - 21	100	7.81	AB.012PG135S	100	16.89	AB.011PG135S	100	7.44	AB.010PG135S
PG 16	22 - 23	100	7.40	AB.012PG160S	-	-	-	100	9.32	AB.010PG160S
PG 21	28 - 29	-	-	-	-	-	-	50	11.54	AB.010PG210S
PG 29	36 - 38	-	-	-	-	-	-	50	19.84	AB.010PG290S
PG 36	46 - 48	100	22.09	AB.012PG360S	100	26.36	AB.011PG360S	30	25.56	AB.010PG360S
PG 42	54 - 55	100	29.53	AB.012PG420S	-	-	-	25	32.92	AB.010PG420S
PG 48	55 - 61	100	30.57	AB.012PG480S	-	-	-	25	38.44	AB.010PG480S

### Suportți "Clip" pentru fixare pe tablă

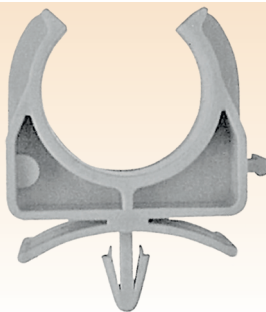

### Suportți "Clip" pentru fixare pe gips carton

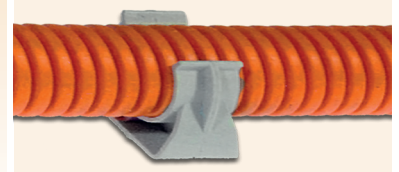

Tip	Ø <sub>țeavă</sub> (mm)	pentru țevi rigide			pentru țevi flexibile			Tip	Ø <sub>țeavă</sub> (mm)	pentru țevi rigide			pentru țevi flexibile		
		Amb. (buc.)	€/100 buc.	Cod articol	Amb. (buc.)	€/100 buc.	Cod articol			Amb. (buc.)	€/100 buc.	Cod articol	Amb. (buc.)	€/100 buc.	Cod articol
IEC M20	20 - 21	100	9.04	RA.30032S	100	9.04	RA.30042S	IEC M20	20 - 21	100	7.88	RA.30052S	100	7.88	RA.30062S
IEC M25	24 - 25	50	11.36	RA.30033S	50	11.36	RA.30043S	IEC M25	24 - 25	50	10.32	RA.30053S	50	10.32	RA.30063S

### Bandă de montaj, role de 10 m

K 10

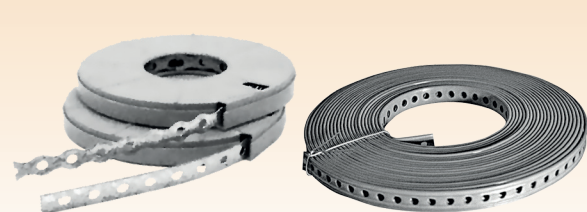

dantelată



lisă

Prezentare	Tip	Bandă	l x s (mm)	Amb. (buc.)	€/100 buc.	Cod articol
casetă din PVC	dantelată	oțel zincat	12 x 0.8	1	240.50	I.CIPE1208S
		oțel inoxidabil	17 x 0.8	1	387.88	E023401708S
		oțel zincat	17 x 0.8	1	1377.51	I.CIPEA21708S
fără casetă	dantelată	oțel zincat	17 x 0.8	1	387.88	E023411708S
	lisă	oțel zincat	17 x 0.8	1	365.78	E023421708S
			17 x 0.8	1	365.78	E023431708S

## Elemente din tablă

### Plăcuțe

K 10

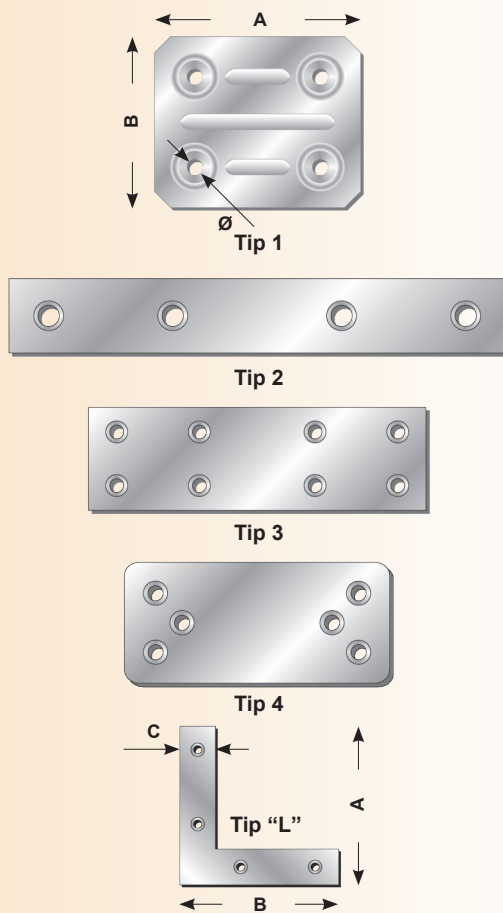

Tip	Dimensiuni (mm)				Perforații	Ambalare (buc.)	€/100 buc.	Cod articol	
	A	B	C	s					
1	40	40	-	1.0	4 x Ø5.0	1	6.69	AF.TP104S	
	50	40	-	1.0	4 x Ø5.0	1	8.59	AF.TP105S	
	40	15	-	2.0	2 x Ø5.0	1	3.97	AF.TP204S	
	60	15	-	2.0	4 x Ø5.0	1	5.96	AF.TP206S	
	80	15	-	2.0	4 x Ø5.0	1	7.96	AF.TP208S	
	100	15	-	2.0	4 x Ø5.0	1	9.84	AF.TP210S	
	120	15	-	2.0	4 x Ø5.0	1	12.48	AF.TP212S	
	140	15	-	2.0	4 x Ø5.0	1	14.47	AF.TP214S	
	160	15	-	2.0	4 x Ø5.0	1	16.63	AF.TP216S	
	180	15	-	2.0	4 x Ø5.0	1	18.32	AF.TP218S	
	2	180	20	-	2.0	6 x Ø5.5	1	20.19	AF.TP219S
		200	15	-	2.0	4 x Ø5.0	1	20.57	AF.TP220S
200		20	-	2.0	6 x Ø5.5	1	27.08	AF.TP221S	
220		15	-	2.0	6 x Ø5.0	1	24.60	AF.TP222S	
240		15	-	2.0	6 x Ø5.0	1	26.84	AF.TP224S	
250		25	-	2.0	6 x Ø5.5	1	47.36	AF.TP225S	
260		15	-	2.0	6 x Ø5.0	1	29.08	AF.TP226S	
280		15	-	2.0	6 x Ø5.0	1	31.30	AF.TP228S	
300		25	-	2.0	6 x Ø5.5	1	50.76	AF.TP230S	
3		40	30	-	2.0	4 x Ø5.0	1	8.29	AF.TP304S
		60	30	-	2.0	8 x Ø5.0	1	12.13	AF.TP306S
		80	30	-	2.0	8 x Ø5.0	1	15.67	AF.TP308S
	100	30	-	2.0	8 x Ø5.0	1	20.13	AF.TP310S	
	120	30	-	2.0	8 x Ø5.0	1	24.62	AF.TP312S	
	160	30	-	2.0	8 x Ø5.0	1	33.88	AF.TP316S	
	200	30	-	2.0	8 x Ø5.0	1	40.97	AF.TP320S	
	240	30	-	2.0	12 x Ø5.0	1	53.48	AF.TP324S	
	280	30	-	2.0	12 x Ø5.0	1	63.37	AF.TP328S	
	320	30	-	2.0	12 x Ø5.0	1	72.43	AF.TP332S	
	4	90	40	-	2.5	6 x Ø5.0	1	25.89	AF.TP409S
		100	40	-	2.5	6 x Ø5.0	1	31.27	AF.TP410S
110		40	-	2.5	6 x Ø5.0	1	34.41	AF.TP411S	
120		40	-	2.5	12 x Ø5.0	1	37.56	AF.TP412S	
140		40	-	2.5	12 x Ø5.0	1	44.49	AF.TP414S	
180		40	-	2.5	12 x Ø5.0	1	57.22	AF.TP418S	
L	80	80	18	2.0	4 x Ø5.0	1	19.64	AF.TL108S	
	100	100	18	2.0	6 x Ø5.0	1	25.84	AF.TL110S	
	120	120	18	2.0	6 x Ø5.0	1	30.99	AF.TL112S	
	140	140	18	2.0	6 x Ø5.0	1	33.01	AF.TL114S	
	160	160	18	2.0	6 x Ø5.0	1	35.15	AF.TL116S	
	180	180	18	2.0	6 x Ø5.0	1	37.87	AF.TL118S	
	200	200	18	2.0	6 x Ø5.0	1	42.19	AF.TL120S	

### Colțare

K 10

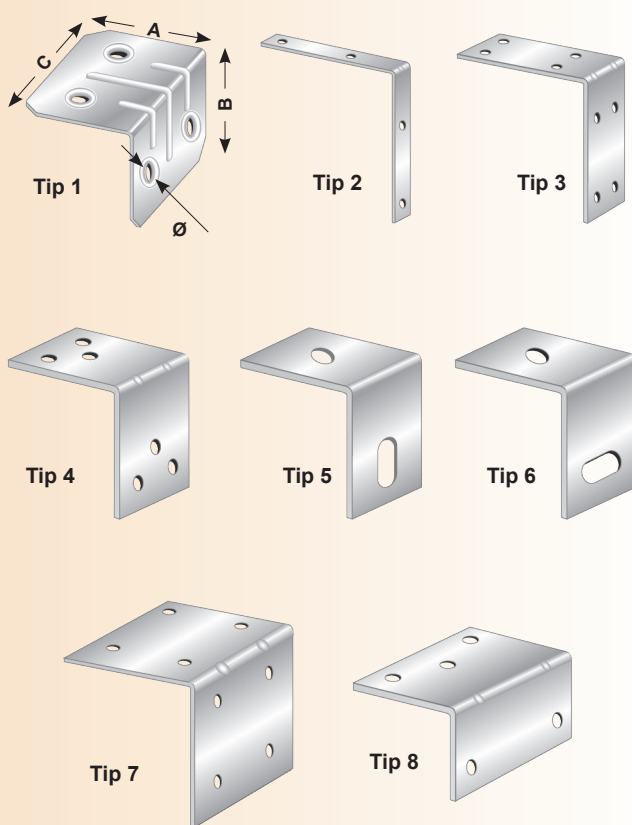

Tip	Dimensiuni (mm)				Perforații	Ambalare (buc.)	€/100 buc.	Cod articol	
	A	B	C	s					
1	20	20	40	1.0	4 x Ø5.0	1	6.70	AF.TC103S	
	25	25	40	1.0	4 x Ø5.0	1	8.39	AF.TC104S	
	20	20	15	2.0	2 x Ø5.0	1	4.09	AF.TC202S	
	30	30	15	2.0	4 x Ø5.0	1	6.26	AF.TC203S	
	40	40	15	2.0	4 x Ø5.0	1	7.62	AF.TC204S	
	50	50	15	2.0	4 x Ø5.0	1	9.55	AF.TC205S	
	60	60	15	2.0	4 x Ø5.0	1	11.48	AF.TC206S	
	70	70	15	2.0	4 x Ø5.0	1	13.17	AF.TC207S	
	80	80	15	2.0	4 x Ø5.0	1	15.49	AF.TC208S	
	90	90	15	2.0	4 x Ø5.0	1	15.99	AF.TC209S	
	2	90	90	20	2.0	6 x Ø5.5	1	23.46	AF.TC2091S
		100	100	15	2.0	4 x Ø5.0	1	19.81	AF.TC210S
100		100	20	2.0	6 x Ø5.5	1	26.06	AF.TC2101S	
110		110	15	2.0	6 x Ø5.0	1	23.70	AF.TC211S	
120		120	15	2.0	6 x Ø5.0	1	25.87	AF.TC212S	
125		125	25	2.5	6 x Ø5.5	1	45.60	AF.TC2121S	
130		130	15	2.0	6 x Ø5.0	1	28.02	AF.TC213S	
140		140	15	2.0	6 x Ø5.0	1	30.17	AF.TC214S	
150		150	25	2.5	6 x Ø5.5	1	48.87	AF.TC2151S	
3		20	20	30	2.0	4 x Ø5.0	1	7.70	AF.TC302S
		30	30	30	2.0	8 x Ø5.0	1	11.39	AF.TC303S
		40	40	30	2.0	8 x Ø5.0	1	14.98	AF.TC304S
	50	50	30	2.0	8 x Ø5.0	1	18.28	AF.TC305S	
	60	60	30	2.0	8 x Ø5.0	1	22.75	AF.TC306S	
	80	80	30	2.0	8 x Ø5.0	1	30.68	AF.TC308S	
	100	100	30	2.0	8 x Ø5.0	1	39.82	AF.TC310S	
	120	120	30	2.0	12 x Ø5.0	1	51.99	AF.TC312S	
4	140	140	30	2.0	12 x Ø5.0	1	60.67	AF.TC314S	
	160	160	30	2.0	12 x Ø5.0	1	70.40	AF.TC316S	
	45	45	40	2.5	6 x Ø5.0	1	25.78	AF.TC404S	
	50	50	40	2.5	6 x Ø5.0	1	31.15	AF.TC405S	
	55	55	40	2.5	6 x Ø5.0	1	34.29	AF.TC4051S	
	60	60	40	2.5	12 x Ø5.0	1	37.40	AF.TC406S	
	70	70	40	2.5	12 x Ø5.0	1	40.62	AF.TC407S	
	90	90	40	2.5	12 x Ø5.0	1	52.55	AF.TC409S	
5	17	21	25	1.5	1 x Ø5 + 1 x (13/5)	1	5.86	AF.TC501S	
6	17	21	25	1.5	1 x Ø5 + 1 x (13/5)	1	5.86	AF.TC601S	
7	60	60	60	2.0	8 x Ø5.0	1	89.33	AF.TC706S	
8	40	25	75	2.0	5 x Ø5.0	1	69.12	AF.TC804S	



## Elemente din tablă

### Colțare cu nervură

K 10

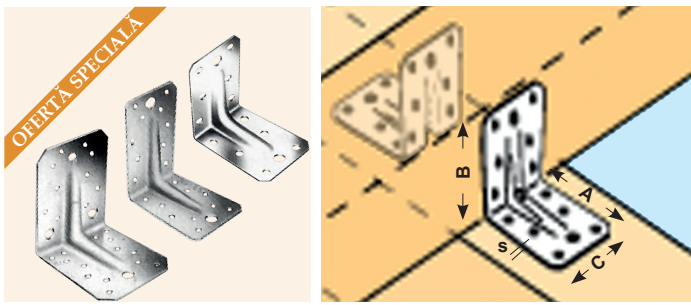

Tip	Dimensiuni (mm)				Perforații	Ambalare (buc.)	€/100 buc.	Cod articol
	A	B	C	s				
70N	70	70	50	1.5	(6+6) x Ø5.1 (1+1) x Ø9.0	1	20.01	AF.CN70S
90N	90	90	60	2.0	(10+10) x Ø5.1 (1+1) x Ø11.0	1	35.06	AF.CN90S
100N	100	100	90	2.0	(8+10) x Ø5.1 (3+1) x Ø11.0	1	53.97	AF.CN100S

### Colțare drepte

K 10

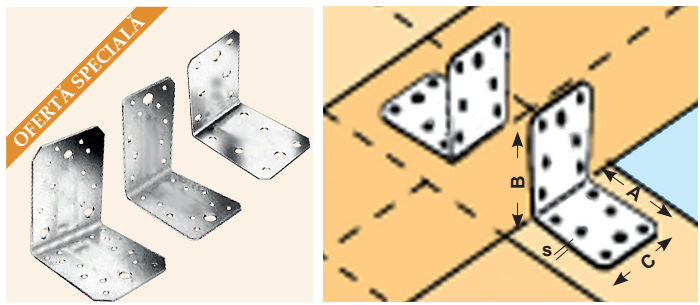

Tip	Dimensiuni (mm)				Perforații	Ambalare (buc.)	€/100 buc.	Cod articol
	A	B	C	s				
70	70	70	50	1.5	(6+6) x Ø5.1 (1+1) x Ø9.0	1	19.41	AF.CD70S
90	90	90	60	2.0	(10+10) x Ø5.1 (1+1) x Ø11.0	1	34.01	AF.CD90S
100	100	100	90	2.0	(8+10) x Ø5.1 (3+1) x Ø11.0	1	52.36	AF.CD100S

### Piese "Z"

K 10

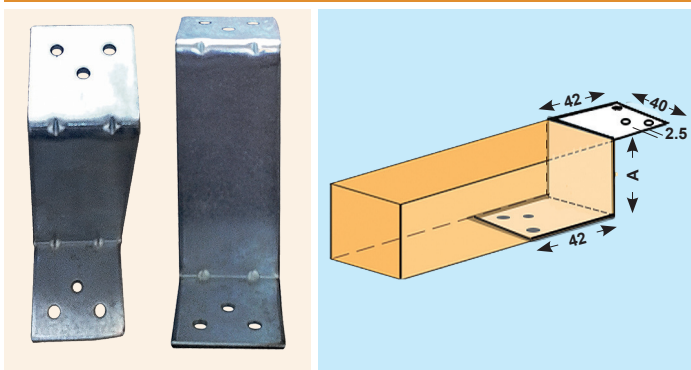

Tip	A (mm)	Perforații	Ambalare (buc.)	€/100 buc.	Cod articol
Z 50	50	(2 x 3) x Ø5	1	61.80	AF.Z50S
Z 60	60	(2 x 3) x Ø5	1	66.12	AF.Z60S
Z 80	80	(2 x 3) x Ø5	1	76.02	AF.Z80S
Z100	100	(2 x 3) x Ø5	1	85.89	AF.Z100S

Fixare: cui ancoră 4.0 / șurub Ø5

### Papuci de fixare

K 10

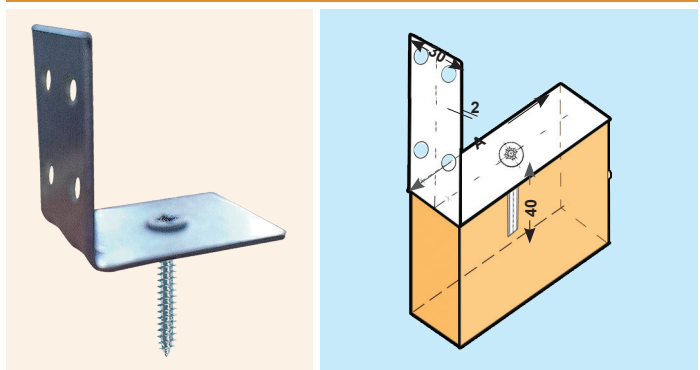

Tip	A (mm)	Perforații	Ambalare (buc.)	€/100 buc.	Cod articol
2020	20	2 x Ø8	1	11.74	AF.TC902S
4040	40	4 x Ø5	1	23.51	AF.TC904S

Holzșurub: Ø4.5  
Fixare: cui ancoră 4.0 / șurub Ø5

### Colțar metalic universal (Euro-colțar)

K 10

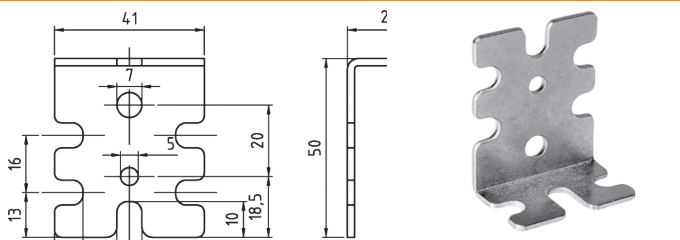

Acoperire	Ambalare (buc.)	€/100 buc.	Cod articol
zincat	10	14.64	VR.7820.01S

### Colțar de legătură pentru picioare de masă

K 10

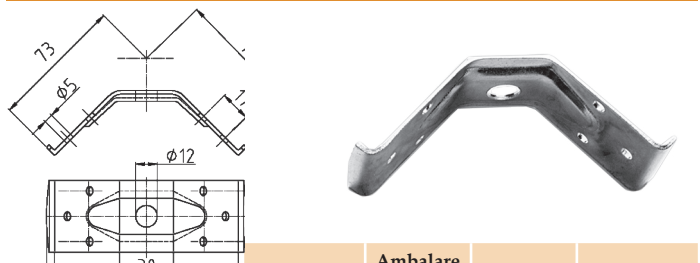

Acoperire	Ambalare (buc.)	€/100 buc.	Cod articol
zincat	10	33.07	VR.7916.01S

### Placă "DEMONTABIL" pentru pat

K 10

Se montează împreună cu colțarul VR.7927

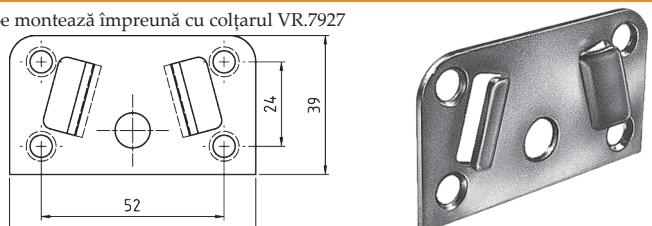

Acoperire	Ambalare (buc.)	€/100 buc.	Cod articol
zincat	10	24.68	VR.7926.01S

### Colțar "DEMONTABIL" pentru pat

K 10

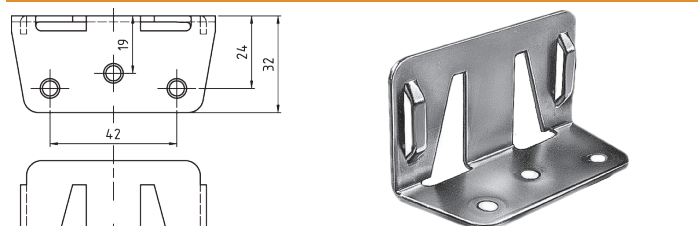

Acoperire	Ambalare (buc.)	€/100 buc.	Cod articol
zincat	10	24.65	VR.7927.01S

Elementele de fixare pentru structuri din lemn constituie o gamă nouă de elemente de îmbinare și fixare în construcții destinate legării și susținerii stâlpilor, a traverselor din lemn sau a fermelor de acoperiș, fără elemente suplimentare de susținere din zidărie.

**SIMPSON**

**Strong-Tie**

### Avantaje:

- Îmbunătățesc distribuția verticală și laterală a încărcării construcției;
- Permit realizarea acoperișului înainte sau în paralel cu ridicarea zidăriei reducând semnificativ timpul destinat construcției;
- Diminuează riscurile de îmbolnăvire sau accidentare asociate lucrărilor de construcții din zidărie.

ROCAST oferă o gamă largă de elemente de fixare pentru structuri din lemn care cuprinde:

- **Legături de colț** pentru îmbinarea grinzilor și a stâlpilor din lemn sau pentru fixarea lemnăriei pe structuri din beton;
- **Suporți de grindă;**
- **Suporți de stâlp;**
- **Ancore** pentru profile metalice și ferme de acoperiș;
- **Șaibe "BULLDOG"** pentru asamblări lemn-beton sau lemn-oțel care permit o eventuală demontare ulterioară.



## Legături de colț

### Legături de colț fără nervură

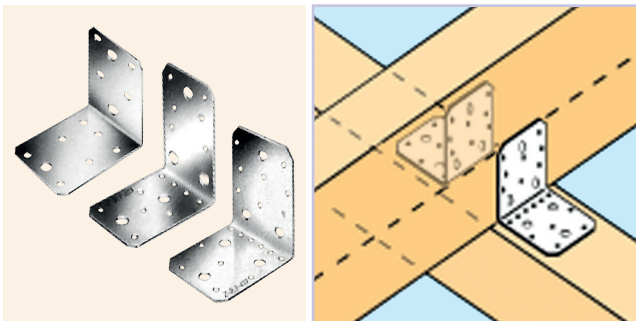

Tip	Dimensiuni (mm)				Ambalare (buc.)	€/100 buc.	Cod articol
70 f/n	70	70	55	2.0	10	31.14	BMF.7071S
90 f/n	88	88	65	2.5	10	46.75	BMF.7091S
105 f/n	103	103	90	3.0	10	89.63	BMF.7106S
Tip	70 f/n		90 f/n		105 f/n		
Fixare	cui ancoră Ø4 / șurub Ø5 / bolț						
Perforații	Ø5, Ø8.5		Ø5, Ø11		Ø5, Ø11		

### Legături de colț cu nervură

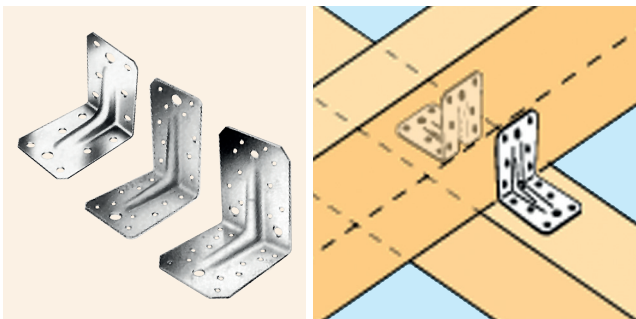

Tip	Dimensiuni (mm)				Ambalare (buc.)	€/100 buc.	Cod articol
70 c/n	70	70	55	2.0	10	32.40	BMF.7070S
90 c/n	90	90	65	2.5	10	48.21	BMF.7090S
105 c/n	105	105	90	3.0	10	92.41	BMF.7105S
Tip	70 c/n		90 c/n		105 c/n		
Fixare	cui ancoră Ø4 / șurub Ø5						
Perforații	Ø5, Ø9		Ø5, Ø11		Ø5, Ø11		

### Legături de colț 6090 - 6191

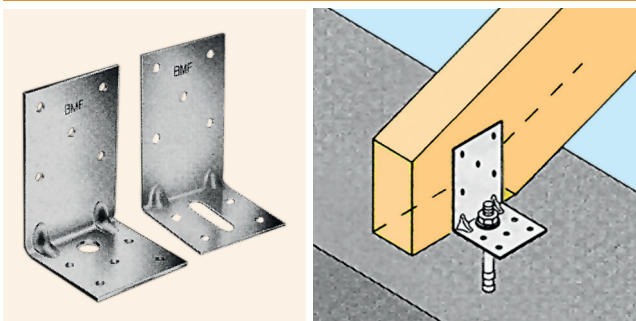

Tip	Dimensiuni (mm)				Ambalare (buc.)	€/100 buc.	Cod articol
6090	90	60	60	2.5	10	95.04	BMF.7690S
6091	90	60	60	2.5	10	97.42	BMF.7691S
Tip	6090			6091			
Fixare	cui ancoră Ø4 / șurub Ø5 / bolț						
Perforații	Ø5, Ø12			Ø5, 10.5/40			

### Legături de colț 40930

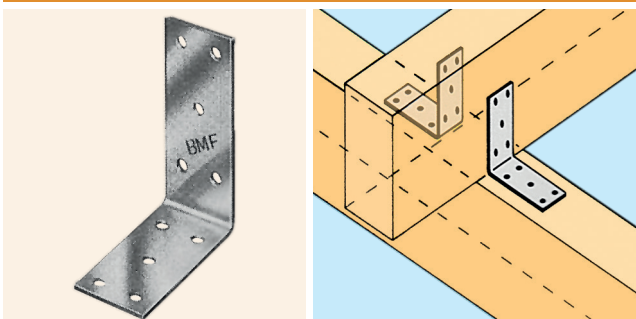

Tip	Dimensiuni (mm)				Ambalare (buc.)	€/100 buc.	Cod articol
40930	93	93	40	3.0	10	82.66	BMF.7390S
Tip	40930						
Fixare	cui ancoră Ø4 / șurub Ø5						
Perforații	Ø5						

## Legături de colț

### Legături de colț 35350 - 55365

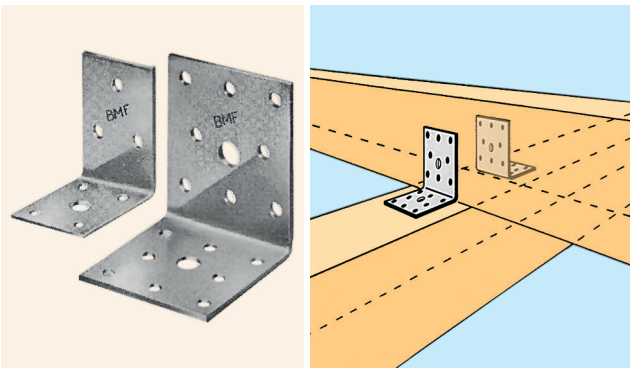

Tip	Dimensiuni (mm)				Ambalare (buc.)	€/100 buc.	Cod articol
35350	50	50	35	2.0	10	32.00	BMF.35350S
55365	65	65	550	2.5	10	81.56	BMF.55365S
Tip	70 f/n		90 f/n		105 f/n		
Fixare	cui ancoră Ø4 / șurub Ø5 / bolț						
Perforații	Ø5, Ø8.5		Ø5, Ø11		Ø5, Ø11		

### Legături de colț 90 x 48 x 3.0 x 48 / 76 / 116

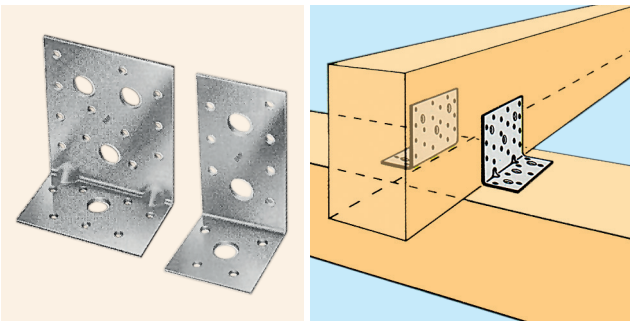

Tip	Dimensiuni (mm)				Ambalare (buc.)	€/100 buc.	Cod articol
90 x 48 x 3.0 x 48	90	48	48	3.0	10	94.24	BMF.7048S
90 x 48 x 3.0 x 76	90	48	76	3.0	10	141.76	BMF.7076S
90 x 48 x 3.0 x 116	90	48	116	3.0	10	209.10	BMF.7116S
Tip	90 x 48 x 3.0 x 48		90 x 48 x 3.0 x 76		90 x 48 x 3.0 x 116		
Fixare	cui ancoră Ø4 / șurub Ø5 / bolț						
Perforații	Ø5, Ø13						

### Legături de colț 40312 - 40412 - 40314 - 40414

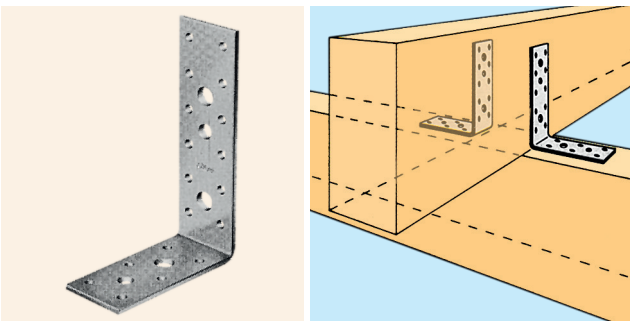

Tip	Dimensiuni (mm)				Ambalare (buc.)	€/100 buc.	Cod articol
40312	119	91	40	3.0	10	118.80	BMF.7312S
40412	120	92	40	4.0	10	149.70	BMF.7412S
40314	141	91	40	3.0	10	127.50	BMF.7314S
40414	142	92	40	4.0	10	162.36	BMF.7414S
Tip	40312		40412		40314		40414
Fixare	cui ancoră Ø4 / șurub Ø5 / bolț						
Perforații	Ø5, Ø8.5, Ø11						

### Legături de colț 90 x 35 x 2.5 x 40 - 160 x 50 x 3.0 x 40

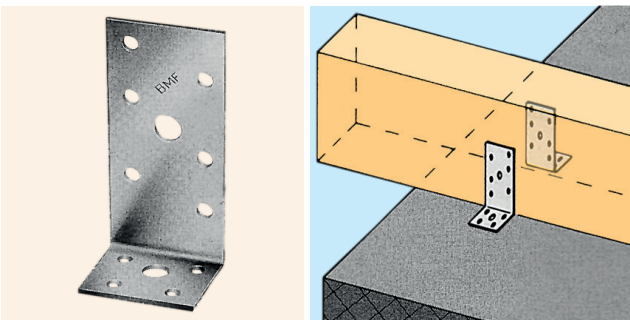

Tip	Dimensiuni (mm)				Ambalare (buc.)	€/100 buc.	Cod articol
90 x 35 x 2.5 x 40	90	35	40	2.5	10	65.74	BMF.7035S
160 x 50 x 3.0 x 40	160	50	40	3.0	10	137.82	BMF.7050S
Tip	90 x 35 x 2.5 x 40				160 x 50 x 3.0 x 40		
Fixare	cui ancoră Ø4 / șurub Ø5 / bolț						
Perforații	Ø5, Ø13						

### Legături de colț 60416 - 80416 - 99416

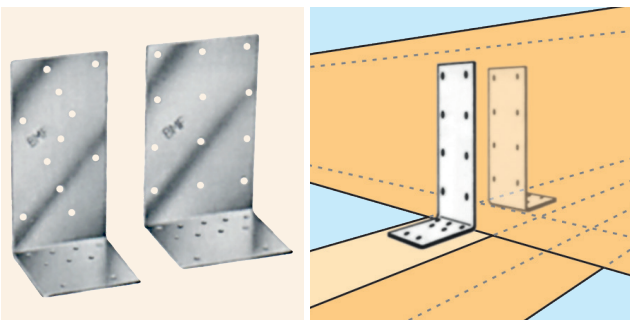

Tip	Dimensiuni (mm)				Ambalare (buc.)	€/100 buc.	Cod articol
60416	164	84	60	4.0	10	250.28	BMF.7060S
80416	164	84	80	4.0	10	338.18	BMF.7080S
99416	164	84	100	4.0	10	402.34	BMF.7099S
Tip	60416		80416		99416		
Fixare	cui ancoră Ø4 / șurub Ø5						
Perforații	Ø5						



## Legături de colț

### Legături de colț 40 x 40 x 2.0 x 25 / 40 x 60 x 2.0 x 25 / 60 x 60 x 2.0 x 25

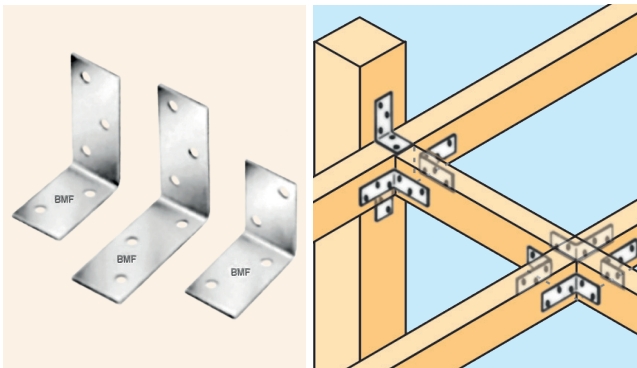

Tip	Dimensiuni (mm)				Ambalare (buc.)	€/100 buc.	Cod articol
40 x 40 x 2.0 x 25	40	40	25	2.0	10	26.14	BMF.30001S
40 x 60 x 2.0 x 25	40	60	25	2.0	10	30.90	BMF.30003S
60 x 60 x 2.0 x 25	60	60	25	2.0	10	30.90	BMF.30005S
Tip	40 x 40 x 2.0 x 25		40 x 60 x 2.0 x 25		60 x 60 x 2.0 x 25		
Fixare	cui ancoră Ø4 / șurub Ø5						
Perforații	Ø5						

### Legături de colț din tablă perforată 2.0 mm

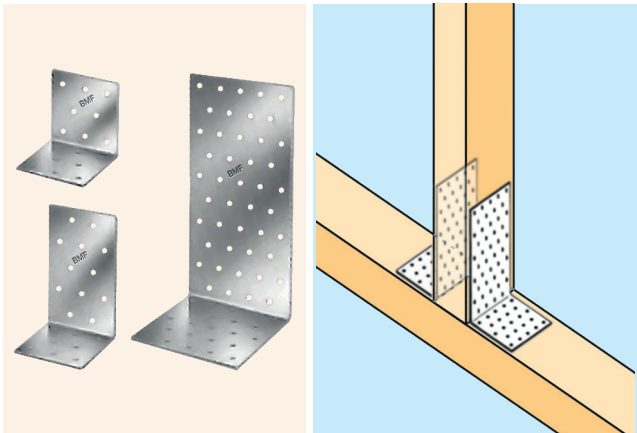

Tip	Dimensiuni (mm)				Ambalare (buc.)	€/100 buc.	Cod articol
40 x 40 x 2.0 x 40	40	40	40	2	10	24.05	BMF.30444S
40 x 40 x 2.0 x 60	40	40	60	2	10	27.84	BMF.30446S
60 x 60 x 2.0 x 40	60	60	40	2	10	30.77	BMF.30664S
60 x 60 x 2.0 x 50	60	60	50	2	10	34.45	BMF.30665S
60 x 60 x 2.0 x 60	60	60	60	2	10	33.30	BMF.30666S
60 x 60 x 2.0 x 80	60	60	80	2	10	53.48	BMF.30668S
80 x 80 x 2.0 x 60	80	80	60	2	10	52.76	BMF.30886S
80 x 80 x 2.0 x 80	80	80	80	2	10	64.47	BMF.30888S
Fixare	cui ancoră Ø4 / șurub Ø5						
Perforații	Ø5						

### Legături de colț din tablă perforată 2.5 mm

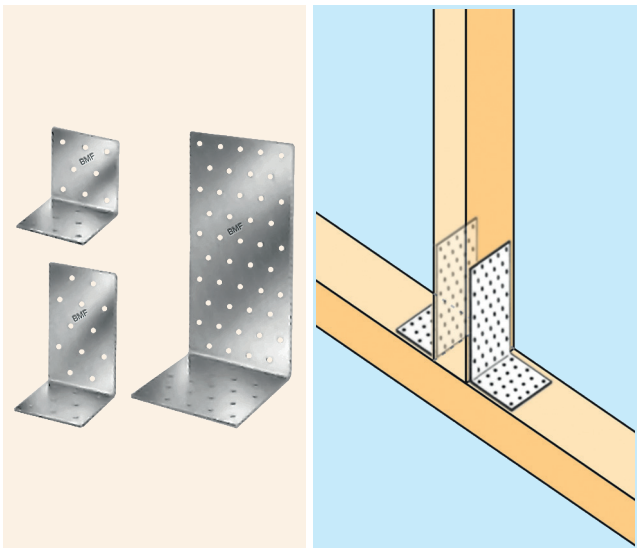

Tip	Dimensiuni (mm)				Ambalare (buc.)	€/100 buc.	Cod articol
40 x 40 x 2.5 x 40	40	40	40	2.5	10	61.76	BMF.8444S
40 x 40 x 2.5 x 60	40	40	60	2.5	10	53.86	BMF.8446S
60 x 60 x 2.5 x 40	60	60	40	2.5	10	51.48	BMF.8664S
60 x 60 x 2.5 x 50	60	60	50	2.5	10	55.44	BMF.8665S
60 x 60 x 2.5 x 60	60	60	60	2.5	10	58.62	BMF.8666S
60 x 60 x 2.5 x 80	60	60	80	2.5	10	102.96	BMF.8668S
60 x 60 x 2.5 x 100	60	60	100	2.5	10	125.14	BMF.8661S
80 x 80 x 2.5 x 60	80	80	60	2.5	10	74.44	BMF.8886S
80 x 80 x 2.5 x 80	80	80	80	2.5	10	97.42	BMF.8888S
80 x 80 x 2.5 x 100	80	80	100	2.5	10	154.44	BMF.8881S
100 x 100 x 2.5 x 80	100	100	80	2.5	10	159.98	BMF.8118S
100 x 100 x 2.5 x 100	100	100	100	2.5	10	167.90	BMF.8111S
100 x 200 x 2.5 x 100	100	200	100	2.5	10	343.72	BMF.8121S
Fixare	cui ancoră Ø4 / șurub Ø5						
Perforații	Ø5						

### Legături de colț pentru beton

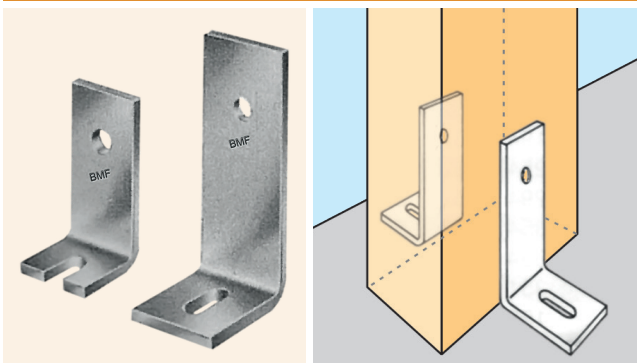

Tip	Dimensiuni (mm)				Ambalare (buc.)	€/100 buc.	Cod articol
P 75 x 75 x 8 x 50 d14	75	75	50	8	10	348.48	BMF.10010S
P100 x 75 x 8 x 60 d14	100	75	60	8	10	572.62	BMF.10030S
P150 x 75 x 8 x 60 d14	150	75	60	8	10	761.10	BMF.10040S
Tip	90 x 48 x 3.0 x 48		90 x 48 x 3.0 x 76		90 x 48 x 3.0 x 116		
Fixare	Bolț						
Perforații	Ø14, 14.0/38						

## Suporturi pentru grindă

### Consolă

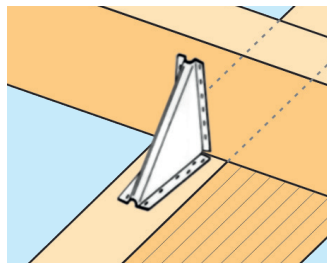
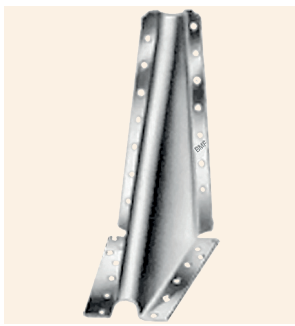

Fixare: cui ancoră Ø4 / șurub Ø5  
Perforații: Ø5

Tip	Dimensiuni (mm)				Ambalare (buc.)	€/100 buc.	Cod articol
90	90	90	65	2.0	5	199.58	BMF.19090S
130	125	125	80	2.0	5	356.40	BMF.19130S
170	160	160	95	2.0	5	534.60	BMF.19170S
210	200	200	100	2.0	5	712.80	BMF.19210S

### Papuci de grindă exteriori

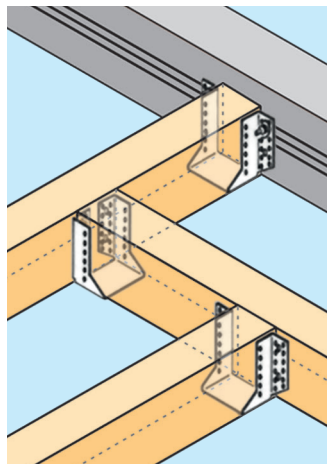

Fixare: cui ancoră Ø4 / șurub Ø5  
Perforații: Ø5, Ø8, Ø11

Tip	Dimensiuni (mm)					Ambalare (buc.)	€/100 buc.	Cod articol
40 x 99	40	99	37	72	2.0	1	176.62	BMF.03003S
51 x 93	51	93	37	72	2.0	1	176.62	BMF.03009S
51 x 135	51	135	40	80	2.0	1	116.00	BMF.03206S
60 x 130	60	130	40	80	2.0	1	200.36	BMF.03209S
60 x 160	60	160	40	80	2.0	1	146.00	BMF.03306S
64 x 128	64	128	40	80	2.0	1	200.36	BMF.03212S
70 x 125	70	125	40	80	2.0	1	154.00	BMF.03215S
80 x 120	80	120	40	80	2.0	1	100.00	BMF.03221S
80 x 150	80	150	40	80	2.0	1	144.00	BMF.03312S
80 x 180	80	180	42	87	2.0	1	182.00	BMF.03412S
80 x 210	80	210	39	85	2.0	1	365.10	BMF.03506S
90 x 145	90	145	40	80	2.0	1	172.66	BMF.03315S
100 x 90	100	90	40	80	2.0	1	160.00	BMF.03224S
100 x 170	100	170	42	87	2.0	1	324.72	BMF.03415S
100 x 200	100	200	39	85	2.0	1	365.10	BMF.03509S
120 x 119	120	119	42	87	2.0	1	208.00	BMF.03612S
120 x 190	120	190	39	85	2.0	1	365.10	BMF.03515S
140 x 180	140	180	39	85	2.0	1	204.34	BMF.03521S

### Papuci de grindă interiori

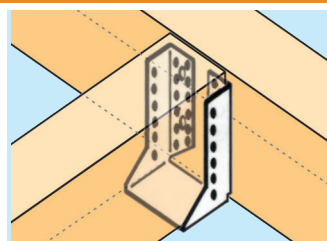
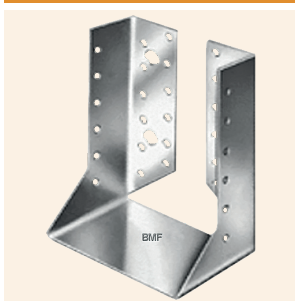

Fixare: cui ancoră Ø4 / șurub Ø5  
Perforații: Ø5, Ø8, Ø11

Tip	Dimensiuni (mm)					Ambalare (buc.)	€/100 buc.	Cod articol
40 x 110 I	40	110	20	72	2.0	1	201.96	BMF.04103S
60 x 100 I	60	100	20	72	2.0	1	160.76	BMF.04112S
64 x 98 I	64	98	20	72	2.0	1	180.56	BMF.04115S
70 x 125 I	70	125	20	80	2.0	1	224.92	BMF.04215S
80 x 120 I	80	120	40	80	2.0	1	171.08	BMF.04221S
100 x 140 I	100	140	40	80	2.0	1	207.50	BMF.04318S
120 x 160 I	120	160	42	87	2.0	1	278.78	BMF.04421S
140 x 180 I	140	180	39	85	2.0	1	309.68	BMF.04512S

### Papuci de grindă BSD

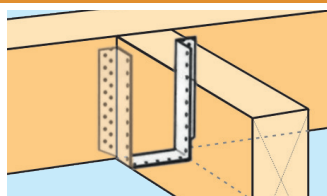

Fixare: cui ancoră Ø4 / șurub Ø5  
Perforații: Ø5, Ø13

Tip	Dimensiuni (mm)					Ambalare (buc.)	€/100 buc.	Cod articol
BSD120/240	120	240	32	52	2.0	1	848.24	BMF.06010S
BSD140/240	140	240	32	52	2.0	1	882.30	BMF.06012S
BSD160/160	160	160	32	52	2.0	1	716.76	BMF.06000S
BSD180/220	180	220	32	52	2.0	1	882.30	BMF.06002S
BSD200/200	200	200	32	52	2.0	1	845.06	BMF.06006S

### Papuci de grindă BSDI

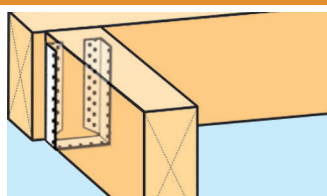

Fixare: cui ancoră Ø4 / șurub Ø5  
Perforații: Ø5, Ø13

Tip	Dimensiuni (mm)					Ambalare (buc.)	€/100 buc.	Cod articol
BSDI120/240	120	240	32	52	2.0	1	936.14	BMF.06110S
BSDI140/240	140	240	32	52	2.0	1	972.56	BMF.06112S
BSDI160/160	160	160	32	52	2.0	1	793.58	BMF.06100S
BSDI180/220	180	220	32	52	2.0	1	972.56	BMF.06102S
BSDI200/200	200	200	32	52	2.0	1	936.14	BMF.06106S

## Suportți pentru grindă

### Papuci de grindă reglabili pe 2 părți

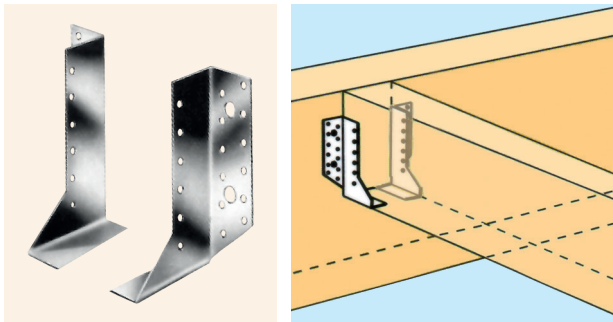

Tip	Dimensiuni (mm)					Ambalare (perechi)	€/100 perechi	Cod articol
30 x 98 2 părți	30	98	37.5	86	2.0	1	268.50	BMF.3010S
30 x 152 2 părți	30	152	40.0	86	2.0	1	350.86	BMF.3011S
30 x 182 2 părți	30	182	42.0	86	2.0	1	428.48	BMF.3012S

Tip	30 x 98 2 părți	30 x 152 2 părți	30 x 182 2 părți
Fixare	cui ancoră Ø4 / șurub Ø5		
Perforații	Ø5, Ø8	Ø5, Ø11	Ø5, Ø11

### Piese de susținere pentru grindă

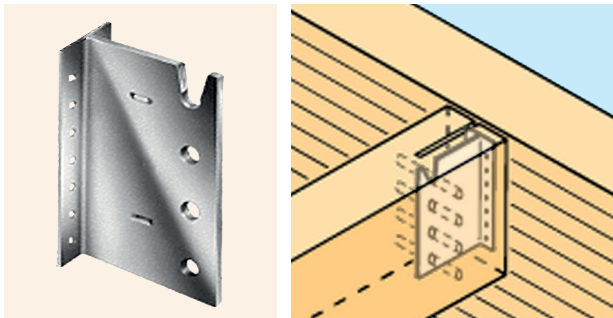

Tip	Dimensiuni (mm)					Ambalare (buc.)	€/100 buc.	Cod articol
90	90	103	46.0	6.0	3.0	1	477.56	BMF.34090S
120	120	103	46.0	6.0	3.0	1	616.16	BMF.34120S
160	160	103	46.0	6.0	3.0	1	761.10	BMF.34160S
200	200	103	46.0	6.0	3.0	1	902.88	BMF.34200S

Tip	90	120	160	200
Fixare	cui ancoră Ø4 / șurub Ø5 / bolțuri tip bară 8.0, 12.0			
Perforații	Ø5, Ø8.5	Ø5, Ø13	Ø5, Ø13	Ø5, Ø13

### Piese de legătură căprior - talpă

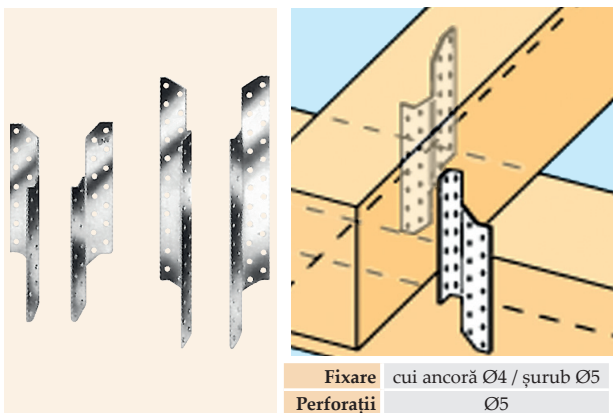

Tip	Dimensiuni (mm)			Ambalare (buc.)	€/100 buc.	Cod articol
170 stânga	170	34.5	2.0	1	30.10	BMF.2170S
210 stânga	210	34.5	2.0	1	40.00	BMF.2210S
250 stânga	250	34.5	2.0	1	102.96	BMF.2250S
290 stânga	290	34.5	2.0	1	129.10	BMF.2290S
330 stânga	330	34.5	2.0	1	186.12	BMF.2330S
370 stânga	370	34.5	2.0	1	229.68	BMF.2370S
170 dreapta	170	34.5	2.0	1	30.10	BMF.2171S
210 dreapta	210	34.5	2.0	1	40.00	BMF.2211S
250 dreapta	250	34.5	2.0	1	102.96	BMF.2251S
290 dreapta	290	34.5	2.0	1	129.10	BMF.2291S
330 dreapta	330	34.5	2.0	1	186.12	BMF.2331S
370 dreapta	370	34.5	2.0	1	229.68	BMF.2371S

Fixare	cui ancoră Ø4 / șurub Ø5			
Perforații	Ø5			

### Papuci de căprior "B"

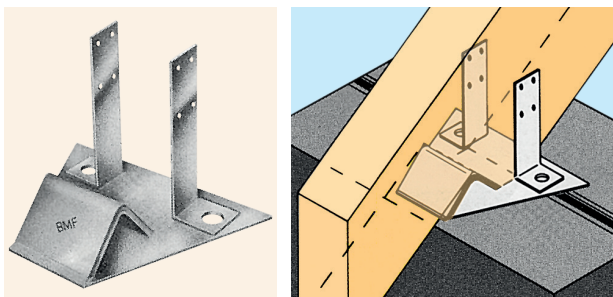

Tip	Dimensiuni (mm)					Ambalare (buc.)	€/100 buc.	Cod articol
B 80	84	170	220.0	140	2.5	1	1664.78	BMF.24080S
B100	104	170	240.0	140	2.5	1	1853.28	BMF.24100S
B120	124	170	260.0	140	2.5	1	2079.00	BMF.24120S

Tip	B80	B100	B120
Fixare	cui ancoră Ø4 / șurub Ø5		
Perforații	Ø5		

### Papuci de căprior "H"

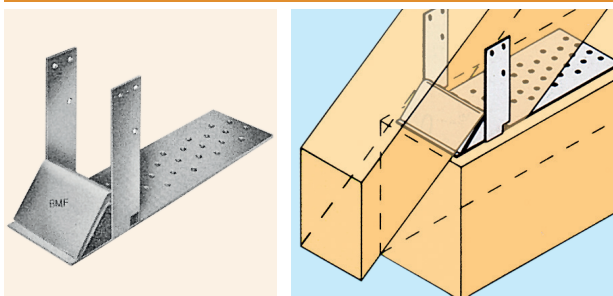

Tip	Dimensiuni (mm)				Ambalare (buc.)	€/100 buc.	Cod articol
H 80	84	300	140	2.5	1	1453.32	BMF.23080S
H100	104	280	140	2.5	1	1580.04	BMF.23100S
H120	124	260	140	2.5	1	1768.54	BMF.23120S

  

Tip	H80	H100	H120
Fixare	cui ancoră Ø4 / șurub Ø5		
Perforații	Ø5		



## Plăci și benzi perforate

### Plăci perforate

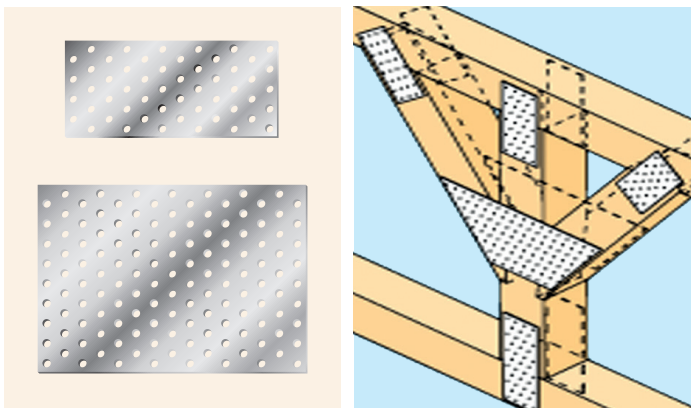

Dimensiuni (mm)			Ambalare (buc.)	€/100 buc.	Cod articol
40	60	80			
40	120	2.0	1	27.31	BMF.20525S
40	160	2.0	1	32.97	BMF.20530S
50	200	2.0	1	49.08	BMF.20535S
60	140	2.0	1	38.09	BMF.20540S
60	200	2.0	1	46.90	BMF.20545S
60	240	2.0	1	62.99	BMF.20550S
80	200	2.0	1	53.65	BMF.20555S
80	240	2.0	1	79.12	BMF.20560S
80	300	2.0	1	92.50	BMF.20565S
100	140	2.0	1	62.99	BMF.20570S
100	200	2.0	1	74.00	BMF.20575S
100	240	2.0	1	110.61	BMF.20580S
100	260	2.0	1	123.08	BMF.20585S
100	300	2.0	1	202.19	BMF.20590S
100	400	2.0	1	333.33	BMF.20592S
120	200	2.0	1	112.07	BMF.20595S
120	240	2.0	1	151.70	BMF.20600S
120	260	2.0	1	144.34	BMF.20605S
120	300	2.0	1	142.86	BMF.20610S
120	400	2.0	1	220.50	BMF.20614S
140	400	2.0	1	463.00	BMF.20615S
160	300	2.0	1	297.44	BMF.20612S
160	400	2.0	1	312.08	BMF.20617S
200	300	2.0	1	476.91	BMF.20620S

Fixare	cui ancoră Ø4 / șurub Ø5
Perforații	Ø5

### Plăci perforate de 2.0 și 2.5 mm



Dimensiuni (mm)			Ambalare (buc.)	€/100 buc.	Cod articol
40	60	80			
40	1200	2.0	1	396.00	BMF.20040S
60	1200	2.0	1	597.96	BMF.20060S
80	1200	2.0	1	715.96	BMF.20080S
100	1200	2.0	1	860.90	BMF.20100S
120	1200	2.0	1	1075.54	BMF.20120S
140	1200	2.0	1	1325.82	BMF.20140S
160	1200	2.0	1	1481.84	BMF.20160S
180	1200	2.0	1	1760.62	BMF.20180S
200	1200	2.0	1	1865.16	BMF.20200S
220	1200	2.0	1	2120.18	BMF.20220S
240	1200	2.0	1	2398.96	BMF.20240S
60	1200	2.5	1	822.10	BMF.25060S
80	1200	2.5	1	1091.36	BMF.25080S
100	1200	2.5	1	1346.40	BMF.25100S
120	1200	2.5	1	1555.50	BMF.25120S
140	1200	2.5	1	1747.16	BMF.25140S
160	1200	2.5	1	2019.60	BMF.25160S
180	1200	2.5	1	2259.56	BMF.25180S

Fixare	cui ancoră Ø4 / șurub Ø5
Perforații	Ø5

### Plăci perforate de montaj

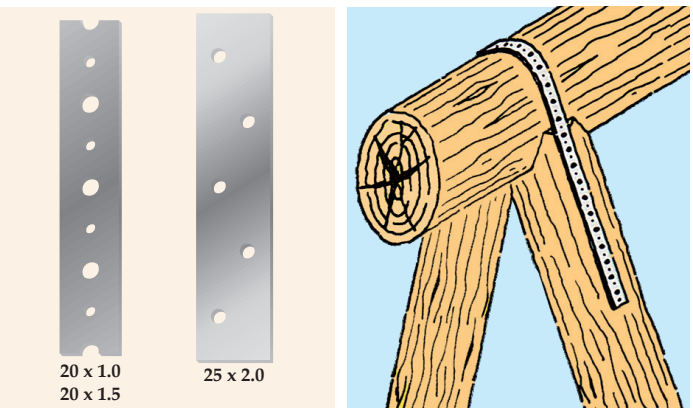

Dimensiuni (mm)			Ambalare (buc.)	€/100 buc.	Cod articol
20	20	25			
20	3 000	1.0	1	477.56	BMF.27103S
20	10 000	1.0	1	1210.96	BMF.27110S
20	25 000	1.0	1	2751.42	BMF.27210S
20	10 000	1.5	1	1562.62	BMF.27115S
20	25 000	1.5	1	3549.74	BMF.27215S
25	10 000	2.0	1	2413.24	BMF.27120S
25	25 000	2.0	1	4283.14	BMF.27252S

Tip	20 x 1.0	20 x 1.5	20. x 2.0
Fixare	cui ancoră 63.1 și Ø4 / șurub Ø4 / bolț		
Perforații	Ø4, Ø6.5	Ø4, Ø6.5	Ø5

### Benzi de contravântuire

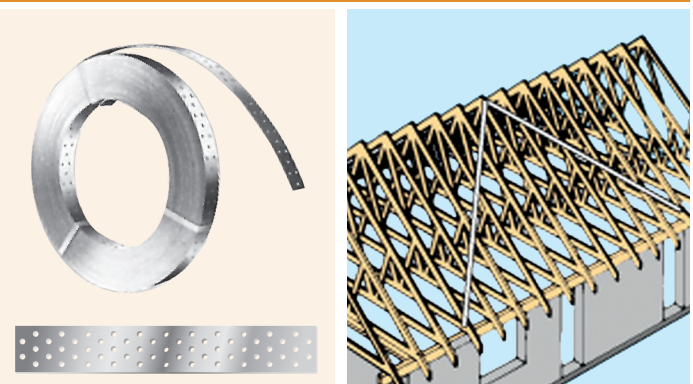

Dimensiuni (mm)			Ambalare (buc.)	€/100 buc.	Cod articol
40	60	80			
40	50 000	2.0	1	5735.00	BMF.27420S
40	50 000	3.0	1	19676.90	BMF.27430S
60	50 000	2.0	1	12022.69	BMF.27620S
80	25 000	2.0	1	15934.77	BMF.27820S

Fixare	cui ancoră Ø4 / șurub Ø5
Perforații	Ø5

### Unealtă de tensionare

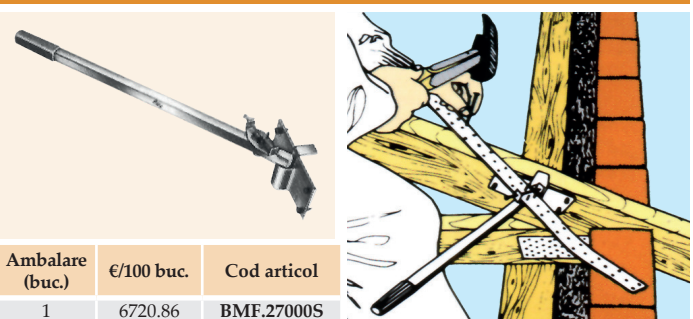

Ambalare (buc.)	€/100 buc.	Cod articol
1	6720.86	BMF.27000S

## Piese pentru îmbinare și articulare

### Piesă de îmbinare pentru grindă articulată "B"

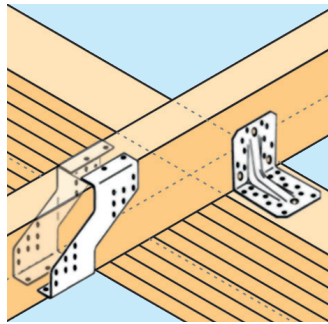
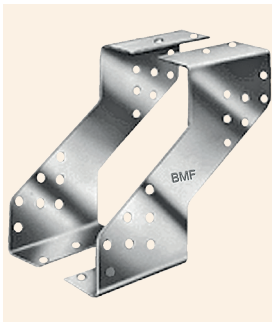

Tip	Dimensiuni (mm)				Ambalare (perechi)	€/100 perechi	Cod articol
125 B Oldali	129	90	27	2.0	1	428.48	BMF.11125S
150 B Oldali	154	90	29	2.0	1	396.78	BMF.11150S
160 B Oldali	160	90	30	2.0	1	396.78	BMF.11160S
180 B Oldali	180	90	33	2.0	1	441.14	BMF.11180S
200 B Oldali	201	90	33	2.0	1	483.12	BMF.11201S
<b>Fixare</b>	cui ancoră Ø4 / șurub Ø5						
<b>Perforații</b>	Ø5						

### Piesă de îmbinare pentru grindă articulată "W"

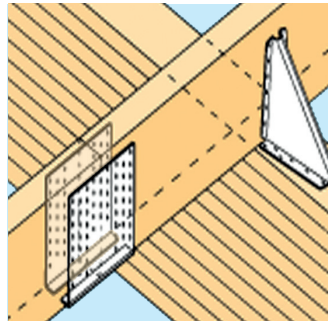
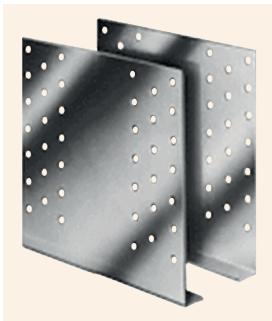

Tip	Dimensiuni (mm)				Ambalare (perechi)	€/100 perechi	Cod articol
140 W Oldali	140	180	20	2.0	1	705.68	BMF.28140S
180 W Oldali	180	180	20	2.0	1	1012.44	BMF.28180S
220 W Oldali	220	180	20	2.0	1	1022.48	BMF.28220S
260 W Oldali	260	180	20	2.0	1	1215.72	BMF.28260S
<b>Fixare</b>	cui ancoră Ø4 / șurub Ø5						
<b>Perforații</b>	Ø5						

### Ancoră pentru beton

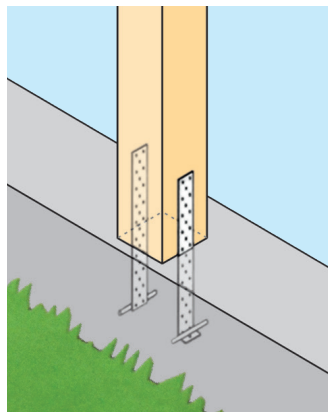
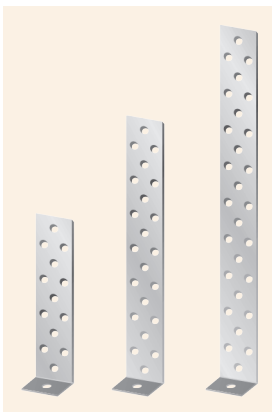

Tip	Dimensiuni (mm)				Ambalare (buc.)	€/100 buc.	Cod articol
200	40	180	20	2.0	1	80.78	BMF.17200S
300	40	280	20	2.0	1	110.88	BMF.17300S
400	40	380	20	2.0	1	168.70	BMF.17400S
500	40	480	20	2.0	1	242.36	BMF.17500S
600	40	580	20	2.0	1	371.70	BMF.17600S
200 t=4.0	40	180	20	4.0	1	178.20	BMF.17204S
300 t=4.0	40	280	20	4.0	1	273.24	BMF.17304S
400 t=4.0	40	380	20	4.0	1	326.30	BMF.17404S
500 t=4.0	40	480	20	4.0	1	433.24	BMF.17504S
600 t=4.0	40	580	20	4.0	1	488.66	BMF.17604S
<b>Fixare</b>	cui ancoră Ø4 / șurub Ø5						
<b>Perforații</b>	Ø5						

### Ancoră "H"

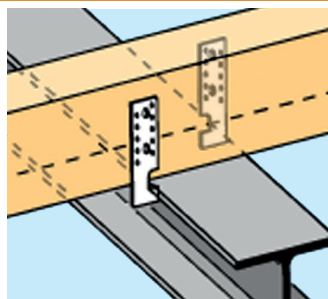
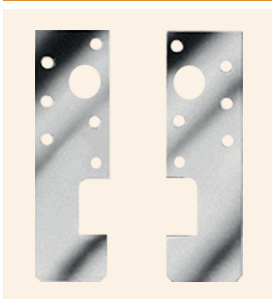

Tip	Dimensiuni (mm)					Ambalare (buc.)	€/100 buc.	Cod articol
175	175	40	30	15	4.0	1	114.84	BMF.16001S
135	135	40	30	15	4.0	1	104.54	BMF.16002S
<b>Tip</b>	175					135		
<b>Fixare</b>	cui ancoră Ø4 / șurub Ø5							
<b>Perforații</b>	Ø5, Ø13					Ø5		

### Șaibe "U"

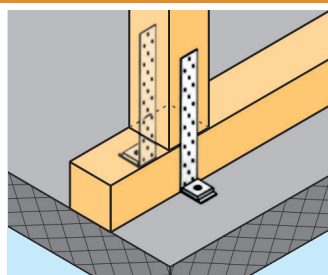

Tip	Dimensiuni (mm)			Ambalare (buc.)	€/100 buc.	Cod articol
40 x 40 x 10	40	40	10.0	10	159.18	BMF.07001S
40 x 50 x 10	40	50	10.0	10	186.12	BMF.07002S
<b>Tip</b>	40 x 40 x 10			40 x 50 x 10		
<b>Fixare</b>	cui ancoră Ø4 / șurub Ø5					
<b>Perforații</b>	Ø5, Ø13.5			13.5 / 25		



## Suporturi de stâlp

### Papuci de reazem

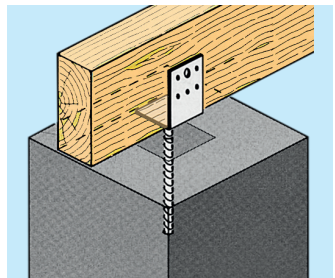

Tip	Dimensiuni (mm)					Ambalare (buc.)	€/100 buc.	Cod articol
B 40	45	40	121	250	5.0	1	570.24	BMF.26091S
B 70	70	70	125	250	5.0	1	760.00	BMF.26092S
Tijă striată						Ø16		
Fixare						cui ancoră Ø4		
Perforații						Ø5, Ø13.5		

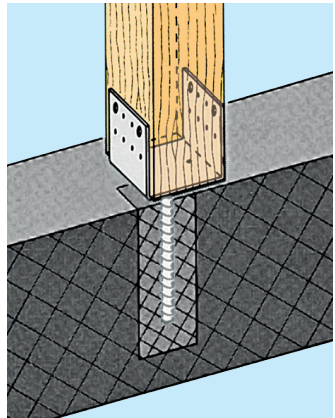

Tip	Dimensiuni (mm)					Ambalare (buc.)	€/100 buc.	Cod articol
D 80 x 70	80	70	126	250	5.0	1	1309.16	BMF.26807S
D100 x 40	100	40	125	250	5.0	1	1075.54	BMF.26104S
D100 x 70	100	70	126	250	5.0	1	1316.30	BMF.26107S
D 90 x 90	90	90	141	250	5.0	1	1854.86	BMF.26909S
D100 x 90	100	90	136	250	5.0	1	1854.86	BMF.26109S
D120 x 90	120	90	126	250	5.0	1	1804.16	BMF.26120S
D140 x 90	140	90	126	250	5.0	1	1831.90	BMF.26140S
Tip	D80 x 70	D100 x 40	D100 x 70	D90 x 90	D100 x 90	D120 x 90	D140 x 90	
Tijă striată	Ø16					Ø20		
Fixare	cui ancoră Ø4 / bolț							
Perforații	Ø5, Ø13.5							

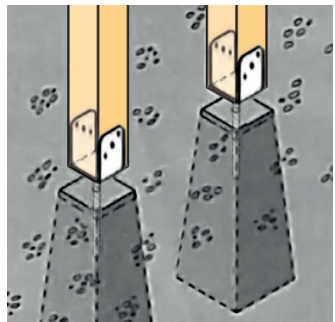

Tip	Dimensiuni (mm)					Ambalare (buc.)	€/100 buc.	Cod articol
DK 70 x 60	70	60	97	200	4.0	1	567.44	BMF.41070S
DK 80 x 60	80	60	92	200	4.0	1	385.70	BMF.41080S
DK 90 x 60	90	60	97	200	4.0	1	512.74	BMF.41090S
DK100 x 60	100	60	92	200	4.0	1	392.84	BMF.41100S
Tijă striată						Ø16		
Fixare						cui ancoră Ø4 / bolț		
Perforații						Ø8, Ø11		

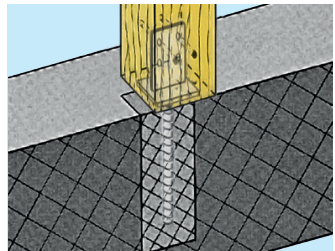

Tip	Dimensiuni (mm)					Ambalare (buc.)	€/100 buc.	Cod articol
I	90	60	110	260	8.0	1	1478.00	BMF.26000S
Tijă striată						Ø20		
Fixare						șurub Ø8		
Perforații						Ø8.5		

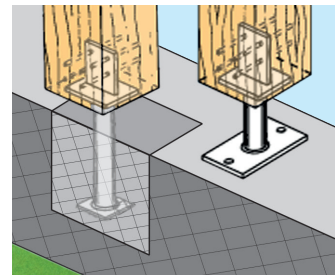

Tip	Dimensiuni (mm)						Ambalare (buc.)	€/100 buc.	Cod articol
IS	100	80	313	70	70	8.0	1	2532.04	BMF.31965S
ISB	100	80	168	100	160	8.0	1	3014.00	BMF.31960S
Tijă						Ø42			
Fixare						șurub Ø8 / bolț			
Perforații						Ø8.5			

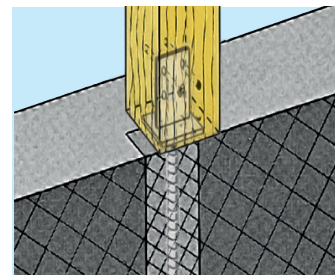

Tip	Dimensiuni (mm)						Ambalare (buc.)	€/100 buc.	Cod articol
IF 250	80	90	110	250	6.0	8.0	1	1648.18	IF.250S
Tijă striată						Ø22			
Fixare						șurub Ø8 / bolț			
Perforații						4 x Ø8.3			
Găuri talpă						4 x Ø8.5			



## Suporturi de stâlپ

### Papuci de reazem

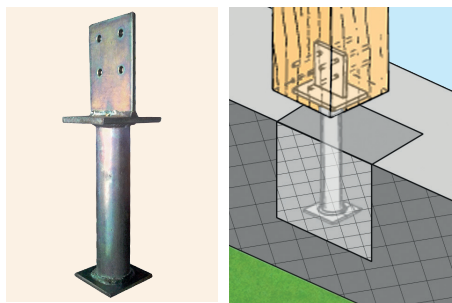

Tip	Dimensiuni (mm)								Ambalare (buc.)	€/100 buc.	Cod articol
IS 200	80	90	110	208	70	70	6.0	5.0	1	1241.63	IS.200S
IS 300	80	90	110	308	70	70	6.0	5.0	1	2241.52	IS.300S
IS 400	80	90	110	408	70	70	6.0	5.0	1	2549.19	IS.400S
Țeavă suport	Ø42										
Fixare	șurub Ø8 / bolț										
Perforații	4 x Ø8.3										

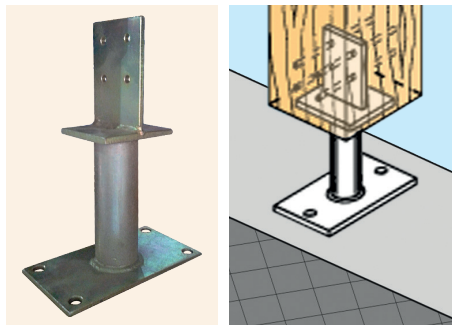

Tip	Dimensiuni (mm)								Ambalare (buc.)	€/100 buc.	Cod articol
ISB 68	80	90	110	68	100	180	6.0	5.0	1	1230.64	ISB.68S
ISB 108	80	90	110	108	100	180	6.0	5.0	1	2109.67	ISB.108S
ISB 158	80	90	110	158	100	180	6.0	5.0	1	2340.41	ISB.158S
Țeavă suport	Ø48										
Fixare	șurub Ø8 / bolț										
Perforații	4 x Ø8.3										
Găuri talpă	4 x Ø13										

### Papuci de reazem reglabili - Vario

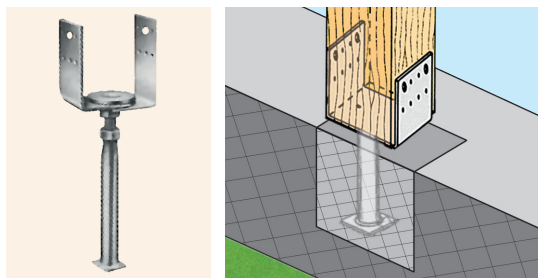

Tip	Dimensiuni (mm)					Ambalare (buc.)	€/100 buc.	Cod articol
D 80	80 - 120	120	70	248 - 298	8.0	1	3581.44	BMF.31950S
D120	120 - 160	120	70	248 - 298	8.0	1	3647.96	BMF.31948S
Fixare	cui ancoră Ø4 / șurub Ø8 pentru lemn							
Perforații	Ø5, Ø13.5							

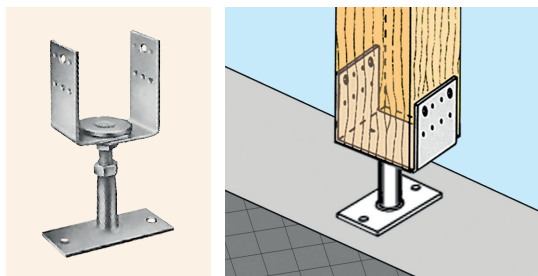

Tip	Dimensiuni (mm)					Ambalare (buc.)	€/100 buc.	Cod articol
DB 80	80 - 120	120	70	136 - 186	160	8.0	3868.92	BMF.31951S
DB120	120 - 160	120	70	136 - 186	160	8.0	4030.50	BMF.31949S
Fixare	cui ancoră Ø4 / șurub Ø8 pentru lemn							
Perforații	Ø5, Ø11, Ø13.5							

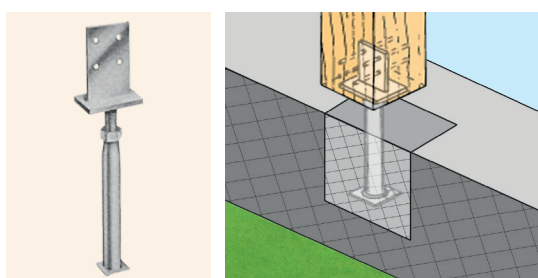

Tip	Dimensiuni (mm)					Ambalare (buc.)	€/100 buc.	Cod articol
I Vario	90	110	60	232 - 282	8.0	1	2725.28	BMF.31952S
Fixare	cui ancoră Ø4 / șurub Ø8 pentru lemn							
Perforații	Ø8.5							

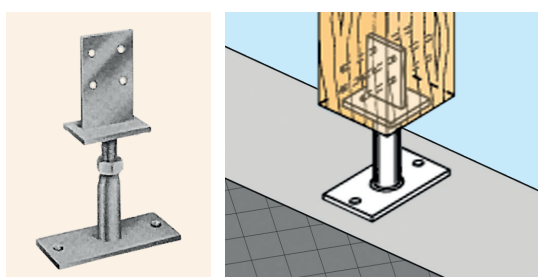

Tip	Dimensiuni (mm)					Ambalare (buc.)	€/100 buc.	Cod articol
IB Vario	90	110	60	120 - 170	8.0	1	3047.62	BMF.31953S
Fixare	cui ancoră Ø4 / șurub Ø8 pentru lemn							
Perforații	Ø8.5, Ø11							

## Suporturi de stâlp

### Papuci de reazem reglabili - Vario

Tip	Dimensiuni (mm)								Ambalare (buc.)	€/100 buc.	Cod articol
	80-160	120	80	150	180	100	4.0	6.0			
TBV150	80-160	120	80	150	180	100	4.0	6.0	1	2582.15	TBV.150S
TBV200	80-160	120	80	200	180	100	4.0	6.0	1	2801.91	TBV.200S
TBV250	80-160	120	80	250	180	100	4.0	6.0	1	2933.76	TBV.250S
Țeavă suport	Ø42										
Fixare	cui ancoră Ø4 / bolț										
Perforații	(2 x 4) x Ø5 + 2 x Ø12.5										
Găuri talpă	4 x Ø12.5										

Tip	Dimensiuni (mm)								Ambalare (buc.)	€/100 buc.	Cod articol
	80-150	120	80	300-350	70	70	4.0	5.0			
DV80	80-150	120	80	300-350	70	70	4.0	5.0	1	2692.03	DV.80S
Țeavă suport	Ø42										
Fixare	cui ancoră Ø4 / bolț										
Perforații	(2 x 4) x Ø5.5 + 2 x Ø13.5										

Tip	Dimensiuni (mm)					Ambalare (buc.)	€/100 buc.	Cod articol
	70-140	80	120	400	4.0			
DVZ400	70-140	80	120	400	4.0	1	2241.52	DKV.400S
Țeavă suport	Ø22							
Fixare	cui ancoră Ø4 / bolț							
Perforații	(4x 4) x Ø5 + 2 x Ø11.5							

### Papuci de reazem reglabili PB 80 și PS 80

Tip	Dimensiuni (mm)					Ambalare (buc.)	€/100 buc.	Cod articol
	80	208	140	100	8.0			
PB 80	80	208	140	100	8.0	1	1368.00	BMF.40605S
PS 80	80	350	-	-	8.0	1	1434.30	BMF.40610S
Tip	PB 80							Ps 80
Fixare	cui ancoră Ø4 / șurub Ø5							
Perforații	Ø5, Ø13							Ø5

### Papuci de reazem TB

Tip	Dimensiuni (mm)						Ambalare (buc.)	€/100 buc.	Cod articol
	48	60	106	39	100	4.0			
TB	48	60	106	39	100	4.0	1	1496.10	BMF.40700S
Fixare	cui ancoră Ø4 / bolț								
Perforații	Ø5, Ø9								

## Suportți de stâlp

### Ancoră "U" cu placă de bază

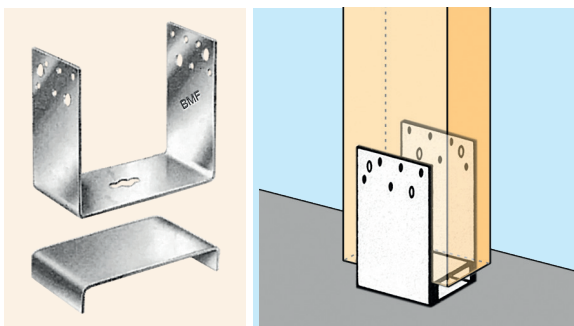

Fixare	Ø4 x 40 / bolț
Perforații	Ø5, Ø9

Tip	Dimensiuni (mm)					Ambalare (buc.)	€/100 buc.	Cod articol
<b>Ancoră "U"</b>								
60 x 120	61	120	-	70	3.0	1	359.58	BMF.29060S
80 x 100	81	110	-	70	3.0	1	359.58	BMF.29080S
100 x 110	101	110	-	70	3.0	1	373.04	BMF.29100S
120 x 110	121	110	-	70	3.0	1	392.04	BMF.29120S
<b>Placă de bază</b>								
57 x 20	57	-	20	70	3.0	1	159.18	BMF.29910S
77 x 20	77	-	20	70	3.0	1	168.76	BMF.29950S
97 x 20	97	-	20	70	3.0	1	183.74	BMF.29970S
117 x 20	115	-	20	70	3.0	1	201.16	BMF.29990S

### Ancoră de stâlp "H"

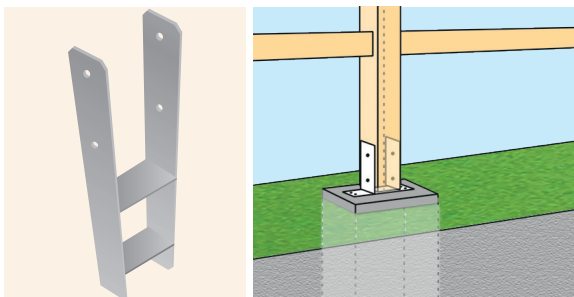

Tip	Dimensiuni (mm)					Ambalare (buc.)	€/100 buc.	Cod articol
H 90	90	60	300	600	6.0	1	1708.34	BMF.49009S
H 100	100	60	300	600	6.0	1	1802.58	BMF.49010S
H 120	120	60	300	600	6.0	1	1896.84	BMF.49012S

Fixare	Ø4 x 40 / bolț
Perforații	Ø11

### Ancoră de stâlp "HB"

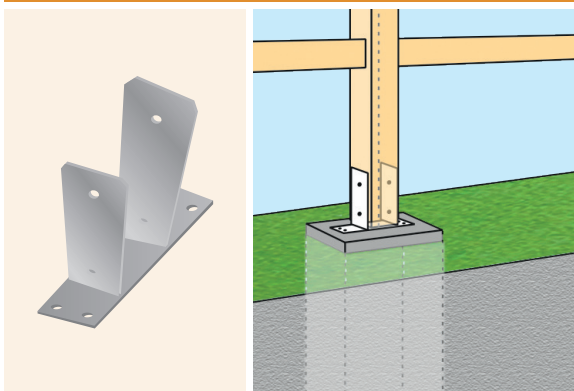

Tip	Dimensiuni (mm)						Ambalare (buc.)	€/100 buc.	Cod articol
HB 70	70	50	200	206	5.0	6.0	1	711.22	BMF.49107S
HB 90	90	50	200	206	5.0	6.0	1	711.22	BMF.49109S
HB 100	100	50	200	206	5.0	6.0	1	711.22	BMF.49110S
HB 120	120	50	200	206	5.0	6.0	1	711.22	BMF.49112S
HB 75	76	60	200	206	6.0	5.0	1	1593.24	HB.75S

Tip	HB 70	HB 90	HB 100	HB 120	HB 75
Fixare	Ø4 x 40 / bolț				bolț / șurub
Perforații	Ø11				(2 + 2) x Ø11
Găuri talpă	-				4 x Ø11

### Picioare de stâlp pentru batere

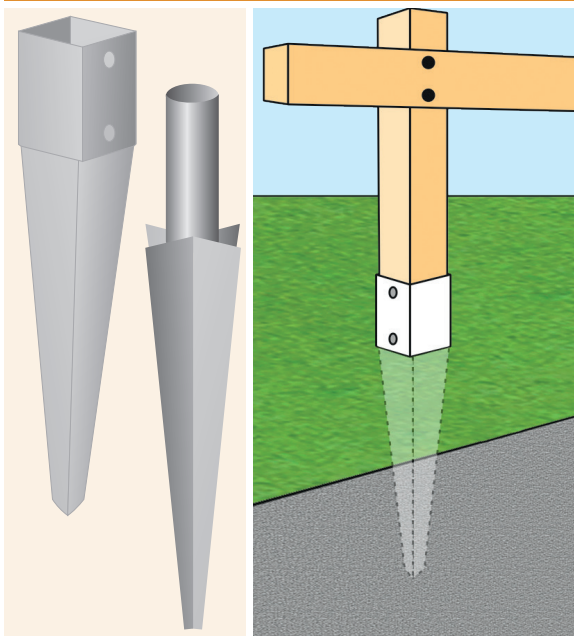

Tip	Dimensiuni (mm)					Ambalare (buc.)	€/100 buc.	Cod articol
50 x 50 x 750	50	50	150	750	2.0	1	938.52	BMF.49305S
70 x 70 x 750	70	70	150	750	2.0	1	948.04	BMF.49375S
90 x 90 x 750	90	90	150	750	2.0	1	1069.98	BMF.49391S
90 x 90 x 900	90	90	150	900	2.0	1	1198.30	BMF.49390S
100 x 100 x 750	100	100	150	750	2.0	1	1249.76	BMF.49330S

Fixare	Ø4 x 40 / bolț
Perforații	Ø11

Tip	Dimensiuni (mm)				Ambalare (buc.)	€/100 buc.	Cod articol
Ø38 x 380	Ø38	150	377	2.0	1	1270.36	BMF.49038S



## Cuie

### Cuie crestate - DIN 1052

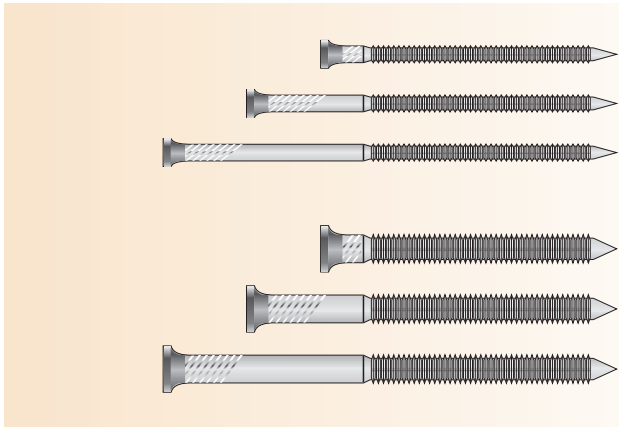

Dimensiuni (mm)		Ambalare (buc.)	€/100 buc.	Cod articol
Ø	Lungime			
2.5	35	50	1.54	BMF.CNA2535S
2.8	60	50	2.38	BMF.CNA2860S
3.1	22	50	1.15	BMF.CNA3122S
3.1	40	50	2.28	BMF.CNA3140S
3.1	60	50	2.76	BMF.CNA3160S
3.4	60	50	7.78	BMF.CNA3460S
3.7	50	50	4.42	BMF.CNA3750S
4.0	35	50	2.66	BMF.CNA435S
4.0	40	50	1.28	BMF.CNA440S
4.0	50	50	1.62	BMF.CNA450S
4.0	60	50	1.92	BMF.CNA460S
4.0	75	50	2.60	BMF.CNA475S
4.0	100	50	5.68	BMF.CNA4100S
6.0	60	50	18.36	BMF.CNA660S
6.0	80	50	10.68	BMF.CNA680S
6.0	100	50	13.66	BMF.CNA6100S

### Cuie căprior - DIN 1052

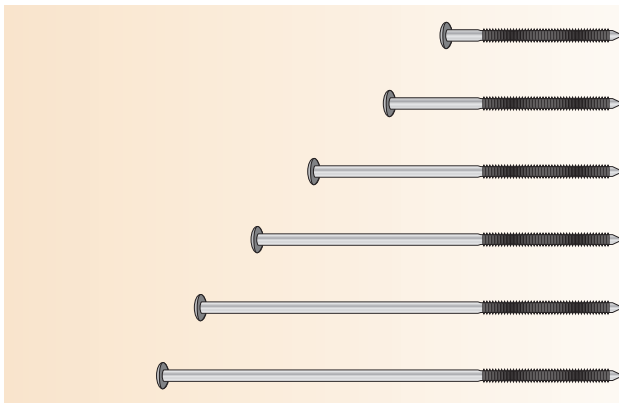

Dimensiuni (mm)		Ambalare (buc.)	€/100 buc.	Cod articol
Ø	Lungime			
6.0	80	50	11.52	BMF.SN680S
6.0	110	50	13.36	BMF.SN6110S
6.0	150	50	17.98	BMF.SN6150S
6.0	180	50	39.18	BMF.SN6180S
6.0	210	50	20.78	BMF.SN6210S
6.0	230	50	24.84	BMF.SN6230S
6.0	260	25	35.48	BMF.SN6260S
6.0	280	25	39.28	BMF.SN6280S
6.0	300	25	42.44	BMF.SN6300S
6.0	330	25	50.70	BMF.SN6330S
6.0	360	25	67.16	BMF.SN6350S

## Șaibe "BULLDOG"

### Șaibe "BULLDOG" cu dantură simplă



Tip	Dimensiuni (mm)		Ambalare (buc.)	€/100 buc.	Cod articol
E 50 M12	50.0	M12	1	42.76	BMF.80010S
E 62 M12	62.0	M12	1	69.70	BMF.80030S
E 75 M16	75.0	M16	1	90.30	BMF.80060S
E 95 M16	95.0	M16	1	165.52	BMF.80080S
E117 M20	117.0	M20	1	271.66	BMF.80100S

### Șaibe "BULLDOG" cu dantură dublă



Tip	Dimensiuni (mm)		Ambalare (buc.)	€/100 buc.	Cod articol
D 50 Ø17	50.0	Ø17	1	44.36	BMF.80210S
D 62 Ø21	62.0	Ø21	1	69.70	BMF.80220S
D 75 Ø26	75.0	Ø26	1	91.88	BMF.80230S
D 95 Ø33	95.0	Ø33	1	169.50	BMF.80240S
D117 Ø48	117.0	Ø48	1	280.36	BMF.80250S

## Cuie

### Cuie pentru beton

tratate termic, metalizate



mm	Ambalare STANDARD		
	buc./pac.	€/100 buc.	Cod articol
2.7 x 20	250	0.96	0.18027020S
2.7 x 25	250	1.12	0.18027025S
2.7 x 30	250	1.28	0.18027030S
2.7 x 35	250	1.36	0.18027035S
2.7 x 40	250	1.54	0.18027040S
2.7 x 50	250	1.70	0.18027050S
2.7 x 60	250	1.96	0.18027060S
2.7 x 70	250	2.14	0.18027070S
2.7 x 80	250	2.68	0.18027080S
3.5 x 35	250	2.32	0.18035035S
3.5 x 40	250	2.48	0.18035040S
3.5 x 45	250	2.62	0.18035045S
3.5 x 50	250	2.74	0.18035050S
3.5 x 55	250	3.00	0.18035055S
3.5 x 60	250	3.24	0.18035060S
3.5 x 65	250	3.38	0.18035065S
3.5 x 70	250	3.66	0.18035070S
3.5 x 75	250	3.96	0.18035075S
3.5 x 80	250	4.66	0.18035080S
4.5 x 40	250	3.62	0.18045040S
4.5 x 50	250	4.10	0.18045050S
4.5 x 60	250	4.46	0.18045060S
4.5 x 70	250	5.34	0.18045070S
4.5 x 80	250	5.96	0.18045080S
4.5 x 90	250	7.04	0.18045090S
4.5 x 100	250	7.66	0.18045100S
6.0 x 55	250	8.88	0.18060055S
6.0 x 65	250	10.46	0.18060065S
6.0 x 75	250	11.70	0.18060075S
6.0 x 85	250	12.82	0.18060085S
6.0 x 100	250	13.82	0.18060100S
6.0 x 120	100	18.16	0.18060120S
6.0 x 150	100	21.94	0.18060150S

mm	Ambalare la BLISTER (BL)		
	buc./BL	€/BL	Cod articol
3.5 x 50	25	0.80	0.18035050B
3.5 x 60	25	0.93	0.18035060B
3.5 x 70	25	1.03	0.18035070B
4.5 x 50	25	1.14	0.18045050B
4.5 x 60	25	1.23	0.18045060B
4.5 x 70	25	1.45	0.18045070B

### Cuie cu șaibă Ø15 mm, pentru beton

tratate termic, metalizate

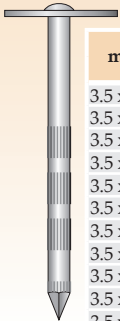

mm	Ambalare STANDARD		
	buc./pac.	€/100 buc.	Cod articol
3.5 x 15	250	3.66	0.18135015S
3.5 x 20	250	3.80	0.18135020S
3.5 x 25	250	4.38	0.18135025S
3.5 x 30	250	4.54	0.18135030S
3.5 x 35	250	4.74	0.18135035S
3.5 x 40	250	4.88	0.18135040S
3.5 x 50	250	5.14	0.18135050S
3.5 x 60	250	5.38	0.18135060S
3.5 x 70	125	6.50	0.18135070S
3.5 x 80	125	8.36	0.18135080S
3.5 x 100	125	10.56	0.18135100S

### Cuie "L" pentru beton

tratate termic, metalizate

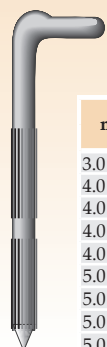

mm	Ambalare STANDARD		
	buc./pac.	€/100 buc.	Cod articol
3.0 x 30	100	3.16	0.18230030S
4.0 x 40	100	3.74	0.18240040S
4.0 x 50	100	4.40	0.18240050S
4.0 x 60	100	4.74	0.18240060S
4.0 x 70	100	5.40	0.18240070S
5.0 x 60	100	7.12	0.18250060S
5.0 x 75	100	8.56	0.18250075S
5.0 x 90	100	11.22	0.18250090S
5.0 x 100	100	14.04	0.18250100S

### Cuie bolț filetate

tratate termic, zincate



mm	Ambalare STANDARD		
	buc./pac.	€/100 buc.	Cod articol
M6 x 8 x 15	100	6.36	0.18406015S
M6 x 8 x 18	100	7.18	0.18406018S
M6 x 8 x 25	100	7.60	0.18406025S
M6 x 8 x 30	100	8.20	0.18406030S
M6 x 8 x 40	100	8.62	0.18406040S
M6 x 8 x 55	100	9.88	0.18406055S

### Cuie bolț standard

tratate termic, zincate



mm	Ambalare STANDARD		
	buc./pac.	€/100 buc.	Cod articol
4 x 15	200	5.14	0.18504015S
4 x 18	200	5.34	0.18504018S
4 x 25	200	6.16	0.18504025S
4 x 30	200	7.80	0.18504030S
4 x 40	200	8.42	0.18504040S

Sculă pentru bolț standard

1	1824.00	0.18500000S
---	---------	-------------

### Cuie striate, zincate

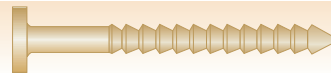

mm	Ambalare STANDARD		
	buc./pac.	€/100 buc.	Cod articol
3.1 x 40	500	1.86	0.18331040S
3.1 x 60	500	2.08	0.18331060S
4.0 x 40	250	1.98	0.18340040S
4.0 x 50	250	2.18	0.18340050S
4.0 x 60	250	2.42	0.18340060S
4.0 x 75	250	3.06	0.18340075S
4.0 x 100	250	4.04	0.18340100S
6.0 x 60	200	6.78	0.18360060S
6.0 x 80	200	9.18	0.18360080S
6.0 x 100	150	11.60	0.18360100S

### Cuie spirale, zincate



mm	Ambalare STANDARD		
	buc./pac.	€/100 buc.	Cod articol
3.0 x 25.0	500	1.60	0.18630025S
3.0 x 30.0	500	1.72	0.18630030S
3.0 x 35.0	500	1.76	0.18630035S
3.5 x 35.0	500	1.84	0.18635035S
3.5 x 40.0	500	1.94	0.18635040S
3.5 x 50.0	500	2.36	0.18635050S
3.5 x 60.0	500	2.76	0.18635060S
4.2 x 50.0	500	3.34	0.18642050S
4.2 x 60.0	500	4.46	0.18642060S
4.2 x 80.0	500	5.24	0.18642080S
4.6 x 90.0	250	6.80	0.18646090S
4.6 x 100.0	250	7.54	0.18646100S
5.0 x 85.0	250	12.26	0.18650085S
5.0 x 100.0	250	14.28	0.18650100S

### Cuie pentru rame, tratate termic, zincate

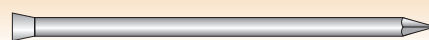

mm	Ambalare STANDARD		
	buc./pac.	€/100 buc.	Cod articol
1.4 x 20.0	1000	0.68	0.19114020S
1.4 x 25.0	1000	0.70	0.19114025S
1.4 x 30.0	1000	0.76	0.19114030S
1.4 x 35.0	1000	0.96	0.19114035S
1.4 x 45.0	1000	1.28	0.19114045S
1.4 x 50.0	1000	1.48	0.19114050S

### Cuie "Super" tratate termic

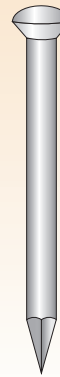

mm	Ambalare STANDARD		
	buc./pac.	€/100 buc.	Cod articol
<b>zincate</b>			
2.0 x 16	1000	0.56	0.18720016S
2.0 x 23	1000	0.62	0.18720023S
2.0 x 30	1000	0.76	0.18720030S
2.0 x 40	1000	0.94	0.18720040S
2.0 x 50	1000	1.14	0.18720050S
2.0 x 60	1000	1.38	0.18720060S
2.5 x 40	1000	1.66	0.18725040S
2.5 x 50	1000	1.90	0.18725050S
2.5 x 60	1000	2.26	0.18725060S
3.0 x 50	1000	2.46	0.18730050S
3.0 x 60	1000	2.92	0.18730060S
<b>alămite</b>			
2.0 x 16	1000	0.58	0.18820016S
2.0 x 23	1000	0.74	0.18820023S
2.0 x 30	1000	0.80	0.18820030S
2.0 x 40	1000	1.00	0.18820040S
2.0 x 50	1000	1.26	0.18820050S

### Cuie ornamentale colorate



Culoare	Ø x L (mm)	Amb. (buc.)	€/100 buc.	Cod articol
Maro închis	1.75 x 20	1000	1.20	0.18912001S
	1.75 x 32	1000	1.44	0.18913201S
	1.75 x 40	1000	1.92	0.18914001S
Maro	1.75 x 20	1000	1.20	0.18912005S
	1.75 x 32	1000	1.44	0.18913205S
	1.75 x 40	1000	1.92	0.18914005S
Maro deschis	1.75 x 20	1000	1.20	0.18912004S
	1.75 x 32	1000	1.44	0.18913204S
	1.75 x 40	1000	1.92	0.18914004S
Bej închis	1.75 x 20	1000	1.20	0.18912002S
	1.75 x 32	1000	1.44	0.18913202S
	1.75 x 40	1000	1.92	0.18914002S
Bej deschis	1.75 x 20	1000	1.20	0.18912003S
	1.75 x 32	1000	1.44	0.18913203S
	1.75 x 40	1000	1.92	0.18914003S
Alb	1.75 x 20	1000	1.20	0.18912006S
	1.75 x 32	1000	1.44	0.18913206S
	1.75 x 40	1000	1.92	0.18914006S
Gri	1.75 x 20	1000	1.20	0.18912007S
	1.75 x 32	1000	1.44	0.18913207S
	1.75 x 40	1000	1.92	0.18914007S
Negru	1.75 x 20	1000	1.20	0.18912008S
	1.75 x 32	1000	1.44	0.18913208S
	1.75 x 40	1000	1.92	0.18914008S
Roșu deschis	1.75 x 20	1000	1.20	0.18912010S
	1.75 x 32	1000	1.44	0.18913210S
	1.75 x 40	1000	1.92	0.18914010S
Roșu închis	1.75 x 20	1000	1.20	0.18912011S
	1.75 x 32	1000	1.44	0.18913211S
	1.75 x 40	1000	1.92	0.18914011S

### Agățatori pentru tablouri

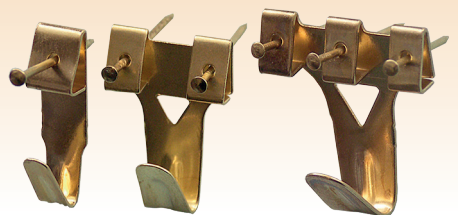

Număr de prinderi	Ambalare STANDARD		
	buc./pac.	€/100 buc.	Cod articol
1	100	8.94	0.19001802S
2	100	17.10	0.19002803S
3	100	26.42	0.19003804S
Număr de prinderi	Ambalare la BLISTER (BL)		
	buc./BL	€/BL	Cod articol
1	10	1.01	0.19001802B
2	10	1.83	0.19002803B

## Accesorii pentru armarea betonului

### Distanțier "Clampfix"

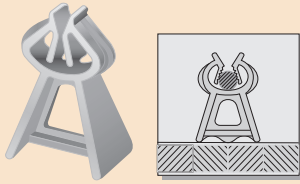

Distanțierele tip clips "Clampfix" sunt piese robuste utilizate în toate tipurile de aplicații, la prefabricare sau pe șantier. Se pot fixa în poziție verticală sau orizontală.

Strat de beton (mm)	Øarmătură (mm)	Ambalare (buc.)	€/100 buc.	Cod articol
15	4 - 12	50	2.01	SECL.15412S
20	4 - 16	50	2.24	SECL.20416S
25	4 - 18	50	2.79	SECL.25416S
30	4 - 18	50	2.94	SECL.30418S
40	4 - 18	50	3.83	SECL.40418S
50	4 - 18	50	5.86	SECL.50418S
60	4 - 18	50	10.42	SECL.60418S
65	4 - 18	50	10.81	SECL.65418S
75	6 - 20	50	12.29	SECL.75620S

### Distanțier "Multifix"

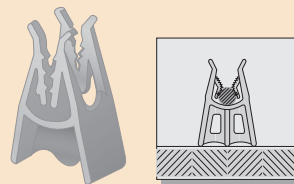

Distanțierele clemă "Multifix" se utilizează în punctele de intersecție ale armăturilor, mai ales în operații de prefabricare.

Strat de beton (mm)	Øarmătură (mm)	Ambalare (buc.)	€/100 buc.	Cod articol
10	≤12	50	1.90	SEMO.10S
15	≤12	50	2.34	SEMO.15S
20	≤12	50	2.55	SEMO.20S
25	≤12	50	5.44	SEMO.25S
30	≤12	50	5.99	SEMO.30S
35	≤12	50	9.64	SEMO.35S
40	≤12	50	6.69	SEMO.40S
45	≤12	50	13.28	SEMO.45S
50	≤12	50	13.62	SEMO.50S

### Distanțier "Unifix"

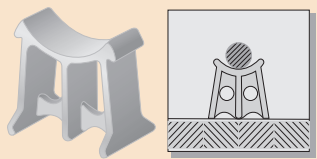

Distanțierele suport "Unifix" sunt utilizate pentru operații orizontale (ex. plăci și grinzi suspendate). Prezintă o bună stabilitate iar suprafața de sprijin concavă preia un domeniu larg de diametre ale barelor de armare.

Strat de beton (mm)	Ambalare (buc.)	€/100 buc.	Cod articol
10	50	2.79	SEUN.010S
15	50	2.37	SEUN.015S
20	50	2.89	SEUN.020S
25	50	3.70	SEUN.025S
30	50	4.27	SEUN.030S
35	50	7.19	SEUN.035S
40	50	9.92	SEUN.040S
60	50	10.47	SEUN.060S
150	50	57.19	SEUN.150S
165	50	66.38	SEUN.165S
180	50	75.37	SEUN.180S

### Distanțier "Minifix"

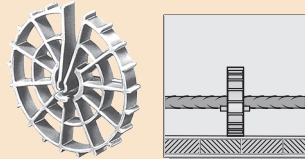

Distanțierele circulare "Minifix" cu suprafață redusă de contact cu betonul cresc capacitatea de încărcare și previn bascularea. Construcția deschisă permite o curgere corectă a betonului în timpul turnării. Contact redus cu cofrajul.

Strat de beton (mm)	Øarmătură (mm)	Ambalare (buc.)	€/100 buc.	Cod articol
10.0	4 - 8	50	1.97	SEMN.10408S
12.5	4 - 8	50	2.22	SEMN.12408S
15.0	4 - 8	50	2.17	SEMN.15408S
20.0	4 - 8	50	3.22	SEMN.20408S
20.0	4 - 18	50	6.75	SEMN.20418S
25.0	4 - 8	50	3.56	SEMN.25408S
25.0	4 - 18	50	6.10	SEMN.25418S
30.0	4 - 8	50	5.61	SEMN.30408S
30.0	4 - 18	50	7.27	SEMN.30418S
40.0	4 - 8	50	7.87	SEMN.40408S
40.0	4 - 18	50	10.57	SEMN.40418S
50.0	4 - 18	50	14.59	SEMN.50418S
60.0	4 - 18	50	27.33	SEMN.60418S
75.0	4 - 18	50	29.67	SEMN.75418S

### Distanțier tubular din PVC

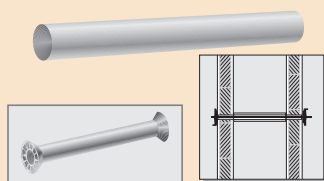

Distanțierele tubulare din PVC rigid se livrează la lungimea de 2m, fiind ușor de debitat la dimensiunea dorită. Se utilizează ca mănșoane expandabile pe tiranți, facilitând îndepărtarea acestora după punerea în operă și acționează ca distanțiere pentru poziționarea corectă a cofrajului.

Øinterior (mm)	Øexterior (mm)	Lungime (mm)	Ambalare (buc.)	€/100 buc.	Cod articol
22	26	2000	20	116.82	SEDS.2226S
26	30	2000	20	160.65	SEDS.2630S

### Con de fixare

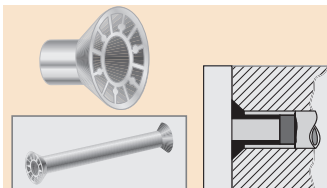

Conurile de fixare se utilizează pentru închiderea la capete a distanțierelor tubulare în vederea turnării betonului. Se pot extrage cu ușurință după îndepărtarea formei de cofrare, nișele conice rămase fiind utile pentru eventuale operații ulterioare.

Pentru Øinterior (mm)	Øarmătură (mm)	Ambalare (buc.)	€/100 buc.	Cod articol
22	10	100	2.84	SECF.22S
26	10	100	4.27	SECF.26S

### Profil triunghiular

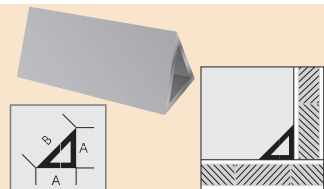

Profilele triunghiulare sunt realizate prin extruziune din PVC rezistent la impact. Se livrează la o lungime de 2m, fiind ușor de debitat la dimensiunea dorită. Se utilizează pentru formarea corectă a colțurilor la coloane, grinzi sau a îmbinărilor între pereți. Sunt reutilizabile.

A (mm)	B (mm)	Lungime (mm)	Ambalare (buc.)	€/100 buc.	Cod articol
11	15	2000	20	59.89	SEPV.11S
15	21	2000	20	66.26	SEPV.15S
20	28	2000	20	83.89	SEPV.20S
25	35	2000	20	120.54	SEPV.25S
15	21	2500	20	82.82	SEPV.15250S
20	28	2500	20	104.84	SEPV.20250S
25	35	2500	20	146.11	SEPV.25250S

### Dop din PVC

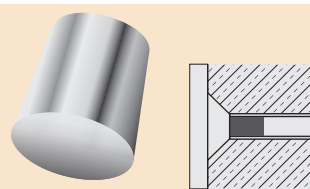

Dopuri pentru închiderea la capete a distanțierelor tubulare și umplerea orificiilor inutile rămase după îndepărtarea formelor de cofrare.

Pentru Øinterior (mm)	Ambalare (buc.)	€/100 buc.	Cod articol
22	100	2.01	SEDP.22S
26	100	4.27	SEDP.26S



## Sisteme pentru cabluri metalice și lanțuri

### Ochi de blocare tip 1 - DIN 5299, oțel zincat

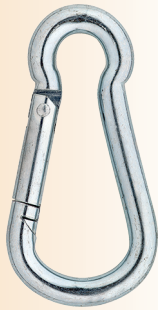

Dimensiuni (mm)	Ambalare STANDARD		
	buc. / pac.	€/100 buc.	Cod articol
4 x 40	100	17.00	DL.24804ES
5 x 50	100	19.00	DL.24805ES
6 x 60	100	22.40	DL.24806ES
7 x 70	50	30.00	DL.24807ES
8 x 80	50	39.20	DL.24808ES
9 x 90	25	53.80	DL.24809ES
10 x 100	25	67.20	DL.24810ES
11 x 120	20	97.60	DL.24811ES
12 x 140	15	131.20	DL.24812ES
13 x 160	5	187.40	DL.24813ES
14 x 180	1	242.00	DL.24814ES
15 x 200	1	428.00	DL.24815ES
Dimensiuni (mm)	Ambalare la BLISTER		
	buc. /BL.	€/BL	Cod articol
4 x 40	2	0.46	DL.24804EB
6 x 60	2	0.57	DL.24806EB
8 x 80	2	0.90	DL.24808EB

### Ochi de blocare tip 2 - DIN 5287, oțel nichelat



Dimensiuni (mm)	Ambalare STANDARD		
	buc. / pac.	€/100 buc.	Cod articol
25	100	6.00	DL.125025NS
30	100	6.60	DL.125030NS
40	100	9.00	DL.125040NS
50	100	11.60	DL.125050NS
60	100	17.40	DL.125060NS
70	100	21.20	DL.125070NS
80	50	35.60	DL.125080NS
90	50	73.80	DL.125090NS
100	50	89.40	DL.125100NS
120	50	109.60	DL.125120NS
Dimensiuni (mm)	Ambalare la BLISTER		
	buc. /BL.	€/BL	Cod articol
25	4	0.36	DL.125025NB
30	4	0.38	DL.125030NB
40	4	0.48	DL.125040NB
50	4	0.58	DL.125050NB

### Ochi de blocare tip 3 - DIN 5299, oțel zincat



Dimensiuni (mm)	Ambalare STANDARD		
	buc. / pac.	€/100 buc.	Cod articol
5 x 50	100	34.20	DL.24505SS
6 x 60	100	39.20	DL.24506SS
7 x 70	50	44.40	DL.24507SS
8 x 80	50	58.20	DL.24508SS
9 x 90	25	82.40	DL.24509SS
10 x 100	25	100.20	DL.24510SS
11 x 120	20	146.40	DL.24511SS
12 x 140	15	196.80	DL.24512SS
Dimensiuni (mm)	Ambalare la BLISTER		
	buc. /BL.	€/BL	Cod articol
6 x 60	2	0.90	DL.24506SB
8 x 80	2	1.28	DL.24508SB

### Ochi de blocare tip 4, oțel zincat

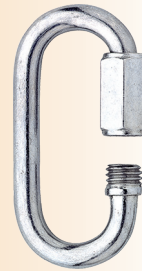

Dimensiuni (mm)	Ambalare STANDARD		
	buc. / pac.	€/100 buc.	Cod articol
3	100	16.80	DL.20003ES
4	100	18.80	DL.20004ES
5	100	23.40	DL.20005ES
6	100	28.40	DL.20006ES
7	50	43.20	DL.20007ES
8	50	51.60	DL.20008ES
9	30	79.00	DL.20009ES
10	25	83.00	DL.20010ES
12	15	145.60	DL.20012ES
Dimensiuni (mm)	Ambalare la BLISTER		
	buc. /BL.	€/BL	Cod articol
5	2	0.59	DL.20005EB
8	2	1.15	DL.20008EB

### Ochi de ridicare - verigă "D", tip comercial, oțel zincat



Dimensiuni (mm)	Ambalare (buc.)	€/100 buc.	Cod articol
4	50	17.00	DL.50004ES
5	100	17.40	DL.50005ES
6	100	20.80	DL.50006ES
8	50	33.20	DL.50008ES
10	25	57.60	DL.50010ES
11	25	75.00	DL.50011ES
12	25	88.20	DL.50012ES
14	10	128.00	DL.50014ES
16	1	182.40	DL.50016ES
19	1	298.00	DL.50019ES
22	1	432.00	DL.50022ES
25	1	628.00	DL.50025ES
28	1	928.00	DL.50028ES
32	1	1504.00	DL.50032ES
38	1	2508.00	DL.50038ES
50	1	8536.00	DL.50050ES

### Ochi de ridicare - verigă arc, tip comercial, oțel zincat

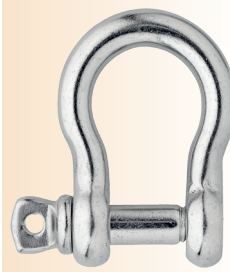

Dimensiuni (mm)	Ambalare (buc.)	€/100 buc.	Cod articol
5	100	18.20	DL.60005ES
6	100	21.40	DL.60006ES
8	50	33.80	DL.60008ES
10	25	60.40	DL.60010ES
11	25	79.80	DL.60011ES
12	25	93.80	DL.60012ES
14	10	138.80	DL.60014ES
16	1	194.00	DL.60016ES
19	1	320.00	DL.60019ES
22	1	474.00	DL.60022ES
25	1	672.00	DL.60025ES
28	1	1014.00	DL.60028ES
32	1	1660.00	DL.60032ES
38	1	2748.00	DL.60038ES
50	1	8910.00	DL.60050ES

### Ochi de ridicare - verigă "D", bolț filetat, oțel zincat la cald



Arc (mm)	Bolț (mm)	Sarcină maximă (kg)	Amb. (buc.)	€/100 buc.	Cod articol
5	6	330	1	61.20	DL.572033BPS
6	8	500	1	66.00	DL.572050BPS
8	10	750	1	96.20	DL.572075BPS
10	11	1000	1	124.00	DL.572100BPS
11	13	1500	1	154.00	DL.572150BPS
13	16	2000	1	216.00	DL.572200BPS
16	19	3250	1	348.00	DL.572325BPS
19	22	4750	1	588.00	DL.572475BPS
22	25	6500	1	842.00	DL.572650BPS
25	28	8500	1	1262.00	DL.572850BPS
28	32	9500	1	1810.00	DL.572950BPS
32	35	12000	1	2500.00	DL.5721200BPS

### Ochi de ridicare - verigă "D", DIN 82101, oțel zincat



Arc (mm)	Bolț (mm)	Sarcină maximă (kg)	Amb. (buc.)	€/100 buc.	Cod articol
4	5	100	1	24.20	DL.55004ES
5	6	160	1	28.80	DL.55005ES
7	8	250	1	39.40	DL.55007ES
8	10	400	1	65.40	DL.55008ES
10	12	630	1	93.40	DL.55010ES
13	16	1000	1	150.00	DL.55013ES
17	19	1600	1	258.00	DL.55017ES
19	21	2000	1	422.00	DL.55019ES
21	23	2500	1	542.00	DL.55021ES
24	26	3150	1	760.00	DL.55024ES
27	29	4000	1	1098.00	DL.55027ES
30	33	5000	1	1810.00	DL.55030ES

## Sisteme pentru cabluri metalice și lanțuri



### Ochi lanț, oțel zincat



Dimensiuni (mm)	Ambalare (buc.)	€/100 buc.	Cod articol
3	100	6.20	DL.25003ES
4	100	7.60	DL.25004ES
5	100	10.40	DL.25005ES
6	100	16.60	DL.25006ES
7	100	23.00	DL.25007ES
8	50	36.40	DL.25008ES
10	50	54.80	DL.25010ES

### Întinzătoare de fir, oțel cromat galben



Dimensiuni (mm)	Ambalare (buc.)	€/100 buc.	Cod articol
1 x 80	100	52.00	DL.40701GVS
2 x 90	100	56.60	DL.40702GVS
3 x 100	70	75.80	DL.40703GVS
4 x 125	50	121.40	DL.40704GVS

### Întinzătoare comerciale, oțel zincat

#### Cârlig - ochi

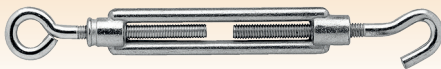

Dimensiuni (mm)	Ambalare (buc.)	€/100 buc.	Cod articol
5 x 50	100	47.20	DL.80005KAS
5 x 70	50	53.60	DL.80005AS
6 x 60	50	60.20	DL.80006KAS
6 x 100	50	80.40	DL.80006AS
8 x 70	25	83.40	DL.80008KAS
8 x 110	25	114.40	DL.80008AS
10 x 80	25	128.20	DL.80010KAS
10 x 120	10	165.20	DL.80010AS
12 x 130	10	324.00	DL.80012AS

#### Ochi - ochi

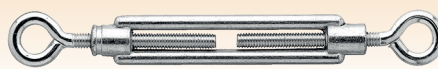

Dimensiuni (mm)	Ambalare (buc.)	€/100 buc.	Cod articol
5 x 50	50	47.60	DL.80005KBS
5 x 70	50	54.60	DL.80005BS
6 x 60	50	60.80	DL.80006KBS
6 x 100	50	80.60	DL.80006BS
8 x 70	25	84.20	DL.80008KBS
8 x 110	25	115.40	DL.80008BS
10 x 80	25	129.40	DL.80010KBS
10 x 120	20	165.20	DL.80010BS
12 x 130	10	324.00	DL.80012BS

#### Cârlig - cârlig

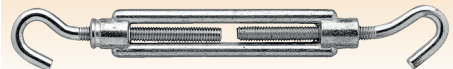

Dimensiuni (mm)	Ambalare (buc.)	€/100 buc.	Cod articol
5 x 50	50	48.00	DL.80005KCS
5 x 70	50	54.60	DL.80005CS
6 x 60	50	60.80	DL.80006KCS
6 x 100	50	80.40	DL.80006CS
8 x 70	25	84.20	DL.80008KCS
8 x 110	25	115.40	DL.80008CS
10 x 80	25	129.40	DL.80010KCS

### Întinzătoare comerciale, oțel inoxidabil

#### Cârlig - ochi

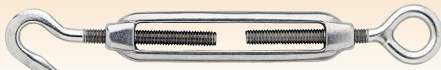

Dimensiuni (mm)	Ambalare (buc.)	€/100 buc.	Cod articol
5 x 70	10	212.00	DL.93005IAS
6 x 90	10	314.00	DL.93006IAS
8 x 120	5	552.00	DL.93008IAS
10 x 150	5	872.00	DL.93010IAS
12 x 200	5	1676.00	DL.93012IAS
16 x 250	1	3498.00	DL.93016IAS
20 x 300	1	6418.00	DL.93020IAS

#### Ochi - ochi

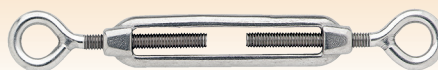

Dimensiuni (mm)	Ambalare (buc.)	€/100 buc.	Cod articol
5 x 70	10	210.00	DL.93005IBS
6 x 90	10	312.00	DL.93006IBS
8 x 120	5	538.00	DL.93008IBS
10 x 150	5	860.00	DL.93010IBS
12 x 200	5	1586.00	DL.93012IBS
16 x 250	1	3358.00	DL.93016IBS

#### Cârlig - cârlig

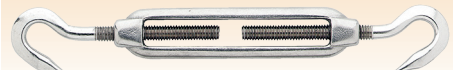

Dimensiuni (mm)	Ambalare (buc.)	€/100 buc.	Cod articol
6 x 90	10	330.00	DL.93006ICS
8 x 120	5	544.00	DL.93008ICS
10 x 150	5	1072.00	DL.93010ICS
12 x 200	5	1578.00	DL.93012ICS
16 x 250	1	5014.00	DL.93016ICS

### Cleme de presare standard, EN 13411-3

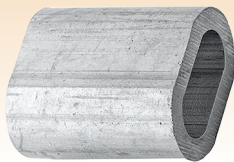

Dimensiuni (mm)	Ambalare (buc.)	€/100 buc.	Cod articol
1.5	100	4.40	DL.43015ALS
2.5	100	4.80	DL.43025ALS
3.0	100	5.20	DL.43030ALS
3.5	100	7.40	DL.43035ALS
4.0	100	8.60	DL.43040ALS
4.5	100	10.40	DL.43045ALS
5.0	100	12.40	DL.43050ALS
6.0	100	19.80	DL.43060ALS
6.5	50	23.00	DL.43065ALS
7.0	50	26.20	DL.43070ALS
8.0	50	31.00	DL.43080ALS
9.0	50	39.20	DL.43090ALS
10.0	50	50.40	DL.430100ALS
12.0	1	79.60	DL.430120ALS
14.0	1	126.60	DL.430140ALS
16.0	1	194.40	DL.430160ALS
18.0	1	280.00	DL.430180ALS

### Clipsuri pentru cabluri de tracțiune



Dimensiuni (mm)	Ambalare (buc.)	€/100 buc.	Cod articol
M 4 x 3.0	100	8.06	0741043S
M 5 x 5.0	100	9.65	0741055S
M 5 x 6.5	100	11.62	07410565S
M 6 x 8.0	100	14.82	0741068S
M 8 x 10.0	50	25.33	07410810S
M 8 x 11.0	50	26.09	07410811S
M10 x 13.0	50	50.69	074101013S
M12 x 16.0	25	75.83	074101216S
M12 x 19.0	25	95.04	074101219S
M14 x 22.0	25	120.02	074101422S
M14 x 25.4	25	155.51	0741014254S

### Ochi de cablu, DIN 6899



Dimensiuni (mm)	Ambalare (buc.)	€/100 buc.	Cod articol
2.5 - 3.0	100	7.40	DL.71002ES
3.5 - 4.0	100	9.40	DL.71003ES
4.0 - 5.0	100	11.80	DL.71004ES
5.0 - 6.0	100	14.20	DL.71005ES
6.0 - 7.0	100	16.00	DL.71006ES
7.0 - 8.0	50	19.40	DL.71007ES
9.0 - 10.0	50	23.80	DL.71009ES
11.0 - 12.0	25	40.80	DL.71011ES
13.0 - 14.0	25	56.40	DL.71013ES
15.0 - 16.0	15	69.20	DL.71015ES
16.0 - 18.0	15	84.60	DL.71016ES
18.0 - 20.0	1	184.40	DL.71018ES
20.0 - 22.0	1	232.00	DL.71020ES
24.0 - 26.0	1	376.00	DL.71024ES
26.0 - 28.0	1	510.00	DL.71026ES
28.0 - 30.0	1	672.00	DL.71028ES
30.0 - 32.0	1	772.00	DL.71030ES

## Sisteme pentru cabluri metalice și lanțuri

### Cleme simple pentru cabluri metalice de tracțiune

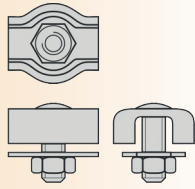

mm	Ambalare (buc.)	€/100 buc.	Cod articol
2	100	5.20	DL.41102ES
3	100	6.80	DL.41103ES
4	100	9.60	DL.41104ES
5	100	12.80	DL.41105ES
6	100	18.00	DL.41106ES

### Cleme duble pentru cabluri metalice de tracțiune

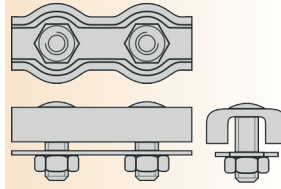

mm	Ambalare (buc.)	€/100 buc.	Cod articol
2	100	10.00	DL.41202ES
3	100	12.80	DL.41203ES
4	50	18.00	DL.41204ES
5	25	21.80	DL.41205ES
6	25	33.00	DL.41206ES
8	15	67.60	DL.41208ES

### Palane cu o roată din nailon, oțel zincat



Dimensiuni (mm)	Ambalare (buc.)	€/100 buc.	Cod articol
5 x 15	10	53.20	DL.95105ES
6 x 20	10	63.20	DL.95106ES
7 x 25	10	103.40	DL.95107ES
8 x 30	10	132.40	DL.95108ES
10 x 40	10	224.00	DL.95109ES
12 x 50	10	366.00	DL.95112ES
14 x 65	5	710.00	DL.95114ES

### Palane cu două roți din nailon, oțel zincat



Dimensiuni (mm)	Ambalare (buc.)	€/100 buc.	Cod articol
5 x 15	10	93.20	DL.95205ES
6 x 20	10	100.20	DL.95206ES
7 x 25	10	156.60	DL.95207ES
8 x 30	5	238.00	DL.95208ES
10 x 40	5	336.00	DL.95209ES
12 x 50	5	512.00	DL.95212ES

### Carabine tip 1, oțel nichelat



Dimensiuni		Ambalare STANDARD		
mm	țoli	buc. / pac.	€/100 buc.	Cod articol
10 / 50	3/8	100	33.60	DL.5010KS
10 / 75	3/8	100	45.60	DL.5010NS
12	1/2	100	71.60	DL.5012NS
16	5/8	100	73.00	DL.5016NS
20	3/4	100	73.00	DL.5020NS
25	1	50	93.20	DL.5025NS
28	1 1/8	25	127.60	DL.5028NS
Dimensiuni		Ambalare la BLISTER		
mm	țoli	buc. /BL.	€/BL	Cod articol
10 / 50	3/8	2	0.79	DL.5010KB
16	5/8	2	1.58	DL.5016NB
25	1	2	1.98	DL.5025NB

### Carabine tip 2, oțel nichelat



Dimensiuni		Ambalare STANDARD		
mm	țoli	buc. / pac.	€/100 buc.	Cod articol
16	5/8	50	88.40	DL.202Z16NS
20	3/4	50	88.40	DL.202Z20NS
Dimensiuni		Ambalare la BLISTER		
mm	țoli	buc. /BL.	€/BL	Cod articol
16	5/8	2	1.89	DL.202Z16NB

### Carabine tip 3, oțel nichelat



Dimensiuni		Ambalare STANDARD		
mm	țoli	buc. / pac.	€/100 buc.	Cod articol
25	1	50	107.40	DL.6025NS
Dimensiuni		Ambalare la BLISTER		
mm	țoli	buc. /BL.	€/BL	Cod articol
25	1	2	2.27	DL.6025NB

### Carabine tip 4, DIN 5287, oțel nichelat



Dimensiuni (mm)	Ambalare (buc.)	€/100 buc.	Cod articol
30	100	9.20	DL.125030WS
40	100	12.40	DL.125040WS
50	100	16.20	DL.125050WS
60	100	23.80	DL.125060WS
70	100	33.00	DL.125070WS
80	50	44.60	DL.125080WS
90	50	68.00	DL.125090WS
100	50	70.60	DL.125100WS
120	50	94.60	DL.125120WS

### Ochi de legătură, oțel nichelat



Dimensiuni mm	țoli	Ambalare (buc.)	€/100 buc.	Cod articol
12	1/2	100	53.40	DL.17813NS
16	5/8	100	60.40	DL.17816NS
20	3/4	100	62.40	DL.17820NS
22	7/8	100	75.40	DL.17822NS
25	1	50	80.20	DL.17825NS



## Accesorii pentru ferestre și uși

### Vizoare din alamă, Ø14 mm

Unghi de vedere: 200°  
Ajustabile, pentru uși cu grosime de 35 - 60 mm



Finisaj	Ambalare (buc.)	€/100 buc.	Cod articol
cromat	1	284.00	DL.DRS2140BS
lustruit	1	284.00	DL.DRS2141BS

### Rozete obturatoare din alamă pentru vizoare

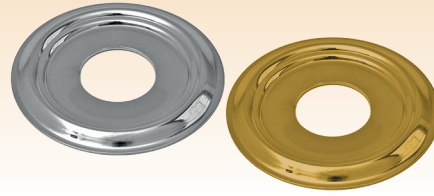

Finisaj	Ambalare (buc.)	€/100 buc.	Cod articol
cromat	1	87.40	DL.DRSP180BS
lustruit	1	87.40	DL.DRSP181BS

### Lanțuri din alamă pentru ușă

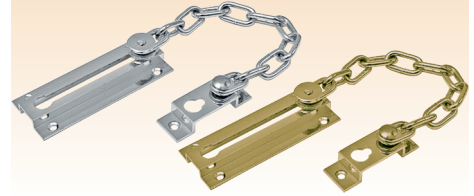

Finisaj	Ambalare (buc.)	€/100 buc.	Cod articol
cromat	1	402.00	DL.DRK930BS
lustruit	1	364.00	DL.DRK931BS

### Lanțuri din oțel cu încuietore pentru ușă

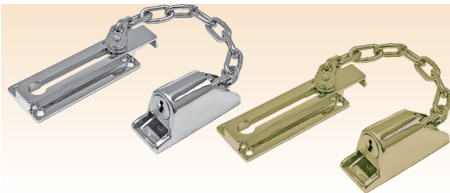

Finisaj	Ambalare (buc.)	€/100 buc.	Cod articol
cromat	1	746.00	DL.DKS604BS
alămit	1	746.00	DL.DKS605BS

### Siguranțe pentru ușă

Siguranț cu 2 suportți pentru uși cu deschidere spre interior și exterior



Finisaj	Ambalare (buc.)	€/100 buc.	Cod articol
cromat mat	1	454.00	DL.KSH940BS
alămit mat	1	454.00	DL.KSH941BS

### Cilindrii de siguranță Euro Kraft, 30-30 mm

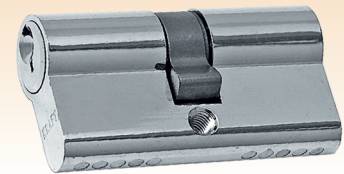

Finisaj	Amb. (buc.)	€/100 buc.	Cod articol
alamă nichelată	1	592.00	DL.PC30300KDS
alamă lustruită	1	588.00	DL.PC30301KDS

### Rozetă pentru cilindrii de siguranță

Model plat, universal



Finisaj	Ambalare (buc.)	€/100 buc.	Cod articol
F1 alu	1	1200.00	DL.VRZ44708BS

### Cârlig de vânt pentru ferestre, galvanizat

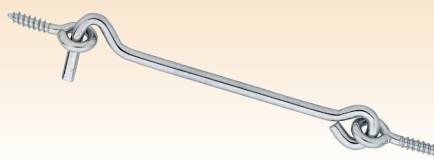

Dimensiuni (mm)	Ambalare (buc.)	€/100 buc.	Cod articol
50	1	42.60	DL.389050ES
80	1	48.60	DL.389080ES
120	1	59.00	DL.389120ES

### Lacăte KRAFT



Dimensiuni (mm)	Ambalare (buc.)	€/100 buc.	Cod articol
20	1	99.00	DL.BP920BKDS
25	1	123.40	DL.BP925BKDS
30	1	148.20	DL.BP930BKDS
40	1	236.00	DL.BP940BKDS

## Balamale aplicate pentru uși

### Tip 1

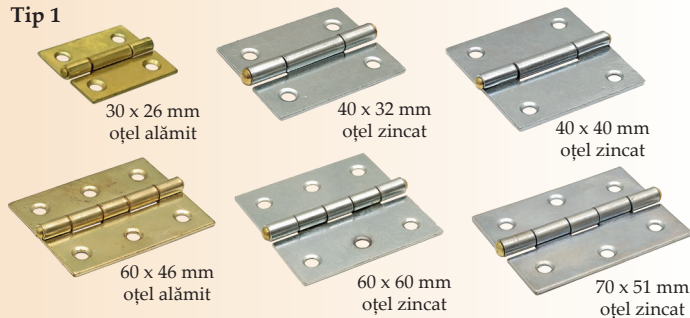

### Tip 2

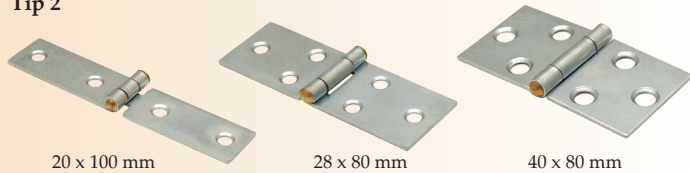

### Tip 3

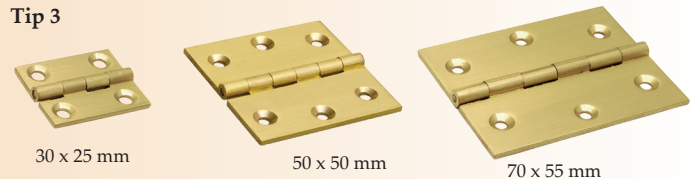

Tip	Execuție	Dimensiuni (mm)	Ambalare (buc.)	€/100 buc.	Cod articol
1	oțel alămit	20 x 15	1	14.00	DL.H16120152101S
		25 x 22	1	22.00	DL.H16125222101S
		30 x 26	1	21.80	DL.H16130262101S
		40 x 32	1	34.20	DL.H16140322101S
		50 x 39	1	50.60	DL.H16150392101S
		60 x 46	1	68.80	DL.H16160462101S
	oțel zincat	70 x 51	1	79.40	DL.H16170512101S
		25 x 22	1	19.60	DL.H16125222105S
		30 x 26	1	20.20	DL.H16130262105S
		40 x 32	1	31.60	DL.H16140322105S
		40 x 40	1	38.60	DL.H16140402105S
		50 x 39	1	42.80	DL.H16150392105S
		50 x 50	1	60.40	DL.H16150502105S
		60 x 46	1	66.20	DL.H16160462105S
2	oțel zincat	60 x 60	1	79.40	DL.H16160602105S
		70 x 51	1	72.40	DL.H16170512105S
		20 x 80	1	61.60	DL.H16620801105S
		20 x 100	1	66.20	DL.H16620991105S
	alamă	28 x 80	1	73.00	DL.H16628802105S
		40 x 80	1	78.60	DL.H16640802105S
		25 x 25	1	84.60	DL.H16125252102S
		30 x 25	1	84.60	DL.H16130252102S
		30 x 30	1	89.60	DL.H16130302102S
		35 x 35	1	104.60	DL.H16135352102S
3	alamă masivă	40 x 35	1	120.00	DL.H16140352102S
		40 x 40	1	143.80	DL.H16140402102S
		50 x 40	1	152.20	DL.H16150402102S
		50 x 50	1	228.00	DL.H16150502102S
		60 x 50	1	236.00	DL.H16160502102S
		70 x 55	1	324.00	DL.H16170552102S

## Accesorii pentru ferestre și uși

### Balamale bandă

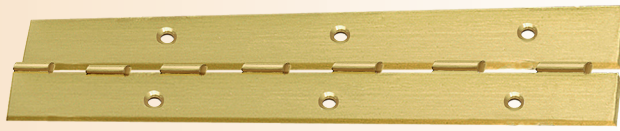

Execuție	Dimensiuni (mm)	Ambalare (buc.)	€/100 buc.	Cod articol
oăel alămit	0.7 x 32 x 500	1	175.20	DL.PI320500PBKS
	0.7 x 32 x 750	1	296.00	DL.PI320750PBKS
	0.7 x 32 x 1000	1	300.00	DL.PI321000PBKS
	0.7 x 32 x 1500	1	398.00	DL.PI321500PBKS
	0.7 x 32 x 2000	1	526.00	DL.PI322000PBKS

### Balamale cu știft, oțel zincat

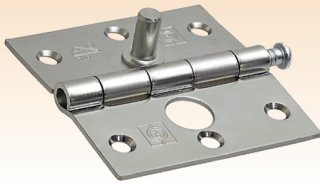

Dimensiuni (mm)	Amb. (buc.)	€/100 buc.	Cod articol
51 x 51	1	99.20	DL.H16151512005S
63 x 63	1	115.60	DL.H16163632005S
76 x 76	1	99.40	DL.H16176762005S
89 x 89	1	187.60	DL.H16189892005S

### Balamale speciale 3 mm, oțel zincat



Dimensiuni (mm)	Amb. (buc.)	€/100 buc.	Cod articol
76 x 76	1	270.00	DL.H16776762105S
89 x 89	1	324.00	DL.H16789892105S

### Balamale aruncătoare 95°, oțel nichelat

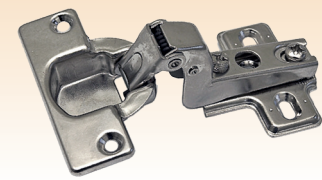

Dimensiuni (mm)	Amb. (buc.)	€/100 buc.	Cod articol
26	1	108.60	DL.MS26A095MBS
35	1	106.00	DL.MS35A095MBS

### Balamale semiîngropate pentru uși și ferestre

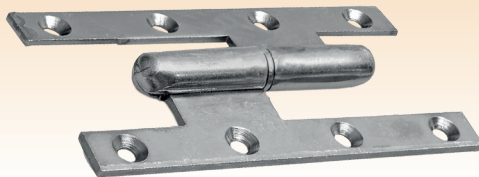

Dimensiuni (mm)	Deschidere	Ambalare (buc.)	€/100 buc.	Cod articol
110 x 70	stânga	1	236.00	DL.H16811700115S
110 x 70	dreapta	1	236.00	DL.H16811700125S
140 x 70	stânga	1	252.00	DL.H16814700115S
140 x 70	dreapta	1	252.00	DL.H16814700125S

### Balamale stil cu 2 tije, pentru mobilă



Execuție	Dimensiuni (mm)	Ambalare (buc.)	€/100 buc.	Cod articol
oțel alămit	9 x 65	1	56.60	DL.HPLMB09065PBS
	11 x 80	1	80.60	DL.HPLMB11080PBS

### Balamale cilindrice cu 2 tije, pentru mobilă

#### Tip 1



9 x 38 mm  
oțel galvanizat

#### Tip 2



9 x 25 mm  
oțel alămit

11 x 29 mm  
oțel galvanizat

13 x 35 mm  
oțel nichelat

Tip	Execuție	Dimensiuni (mm)	Ambalare (buc.)	€/100 buc.	Cod articol
1	oțel galvanizat	9 x 38	1	37.80	DL.HPLMA09038BVS
		11 x 40	1	52.00	DL.HPLMA11040BVS
2	oțel alămit	9 x 25	1	39.40	DL.HPLMC09025PBS
		11 x 29	1	49.40	DL.HPLMC11029PBS
		13 x 35	1	60.80	DL.HPLMC13035PBS
	oțel galvanizat	9 x 25	1	34.80	DL.HPLMC09025BVS
		11 x 29	1	46.00	DL.HPLMC11029BVS
		13 x 35	1	53.00	DL.HPLMC13035BVS
oțel nichelat	9 x 25	1	34.40	DL.HPLMC09025NIS	
	11 x 29	1	48.00	DL.HPLMC11029NIS	
	13 x 35	1	59.20	DL.HPLMC13035NIS	

### Balamale pentru sudare, oțel

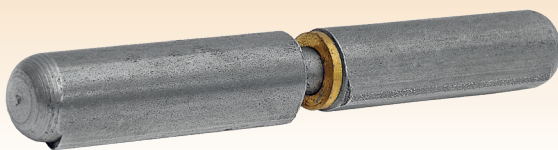

Execuție	Dimensiuni (mm)	Ambalare (buc.)	€/100 buc.	Cod articol
corp din oțel inel din alamă bolț din oțel	40 x 10	1	80.40	DL.HPLWR0040S
	60 x 10	1	82.60	DL.HPLWR0060S
	80 x 12	1	116.20	DL.HPLWR0080S
	100 x 14	1	147.00	DL.HPLWR0100S
	120 x 16	1	195.80	DL.HPLWR0120S
	140 x 16	1	214.00	DL.HPLWR0140S
	160 x 20	1	414.00	DL.HPLWR0160S
	180 x 22	1	548.00	DL.HPLWR0180S
	200 x 22	1	608.00	DL.HPLWR0200S

### Balamale cu arc

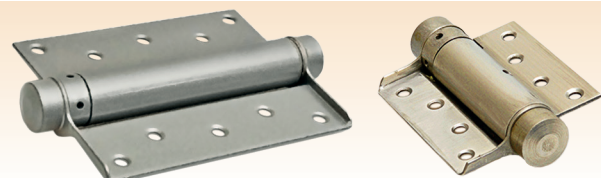

Execuție	Dimensiuni (mm)	Ambalare (buc.)	€/100 buc.	Cod articol
oțel zincat	29 - 75	1	660.00	DL.DVE07529BVS
	30 - 100	1	814.00	DL.DVE10030BVS
	33 - 125	1	1116.00	DL.DVE12533BVS
	36 - 150	1	1490.00	DL.DVE15036BVS
	39 - 175	1	2014.00	DL.DVE17539BVS
oăel alămit	29 - 75	1	772.00	DL.DVE07529PBS
	30 - 100	1	898.00	DL.DVE10030PBS
	33 - 125	1	1218.00	DL.DVE12533PBS
	36 - 150	1	1602.00	DL.DVE15036PBS
	39 - 175	1	2312.00	DL.DVE17539PBS

## Accesorii pentru ferestre și uși



### Amortizor pneumatic pentru ușă

- viteză de închidere reglabilă
- culoare argintie



Ambalare (buc.)	€/100 buc.	Cod articol
1	616.00	DL.PVS320BS

### Opritor de ușă din inox, pentru podea

Tampon lateral din cauciuc:  
- negru (DL.DSTVZB45SFS)  
- antracit (DL.DSTVZB85SFS)



### Opritor de ușă, cap rotund, pentru podea

Execuție:  
- alamă cromată (DL.DSTVRB25CPS)  
- alamă (DL.DSTVRB25PBS)



### Zăvor de ușă

Dimensiuni: 25 x 120 mm  
Bolț: 30 mm  
Pentru uși de max. 25 kg

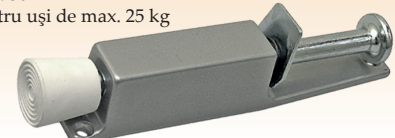

Dimensiuni (mm)	Amb. (buc.)	€/100 buc.	Cod articol
45 x 25	1	348.00	DL.DSTVZB45SFS
86 x 26	1	338.00	DL.DSTVZB85SFS

Dimensiuni (mm)	Amb. (buc.)	€/100 buc.	Cod articol
25 x 30	1	492.00	DL.DSTVRB25CPS
25 x 30	1	460.00	DL.DSTVRB25PBS

Finisaj	Amb. (buc.)	€/100 buc.	Cod articol
gri argintiu	1	284.00	DL.DVZV12025SES
alb	1	284.00	DL.DVZV12025WES
maron	1	316.00	DL.DVZV12025BRS
alama	1	318.00	DL.DVZV12025PBS

### Zăvoare aplicate, cu piedică, oțel zincat, pentru uși



Dimensiuni (mm)	Bolț	Ambalare (buc.)	€/100 buc.	Cod articol
20 x 40	2	1	60.20	DL.SG040BVS
25 x 60	3	1	77.40	DL.SG060BVS
25 x 80	3	1	82.60	DL.SG080BVS
35 x 100	4	1	107.00	DL.SG100BVS
35 x 120	4	1	128.00	DL.SG120BVS

### Zăvoare aplicate, cu tijă dreaptă, oțel zincat, pentru uși

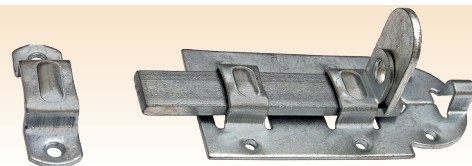

Dimensiuni (mm)	Bolț	Ambalare (buc.)	€/100 buc.	Cod articol
44 x 100	4	1	134.80	DL.ZG100BVS
56 x 120	5	1	173.00	DL.ZG120BVS
56 x 140	5	1	193.80	DL.ZG140BVS
66 x 160	6	1	260.00	DL.ZG160BVS
80 x 180	8	1	380.00	DL.ZG180BVS

### Zăvoare pentru mobilier, 25 mm, alamă nichelată

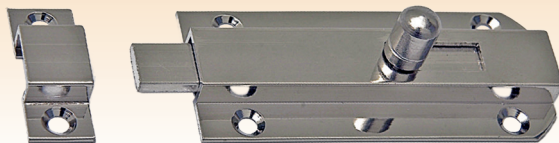

Finisaj	Dimensiuni (mm)	Ambalare (buc.)	€/100 buc.	Cod articol
nichelat	25 x 40	1	151.20	DL.PS640BS
	25 x 50	1	185.40	DL.PS650BS
	25 x 60	1	208.00	DL.PS660BS
	25 x 80	1	248.00	DL.PS680BS

### Zăvoare pentru mobilier, 25 mm, alamă lustruită



Finisaj	Dimensiuni (mm)	Ambalare (buc.)	€/100 buc.	Cod articol
lustruit	25 x 40	1	119.00	DL.PS641BS
	25 x 50	1	142.20	DL.PS651BS
	25 x 60	1	174.40	DL.PS661BS
	25 x 80	1	206.00	DL.PS681BS

### Șine de glisare

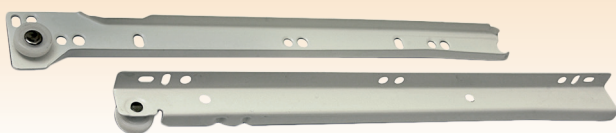

Finisaj	Dimensiuni (mm)	Ambalare (buc.)	€/100 buc.	Cod articol
alb lăcuit	300	1	244.00	DL.LGR302BS
	350	1	260.00	DL.LGR352BS
	400	1	274.00	DL.LGR402BS
	450	1	296.00	DL.LGR452BS
	500	1	322.00	DL.LGR502BS
	550	1	352.00	DL.LGR552BS
	600	1	374.00	DL.LGR602BS

### Console din oțel presat, alb lăcuit



Dimensiuni (mm)	Ambalare (buc.)	€/100 buc.	Cod articol
75 x 100	1	21.40	DL.ES11002S
100 x 125	1	28.80	DL.ES11252S
125 x 150	1	34.60	DL.ES11502S
150 x 200	1	49.00	DL.ES12002S
200 x 250	1	68.80	DL.ES12502S
250 x 300	1	109.00	DL.ES13002S
300 x 350	1	133.40	DL.ES13502S
350 x 400	1	204.00	DL.ES14002S
400 x 450	1	250.00	DL.ES14502S



## Accesorii metalice

### Colier de întindere



Dimensiuni		Amb. (buc.)	€/100 buc.	Cod articol
mm	țoli			
48	1 1/2	1	102.28	I.CMBRTEN48S

### Întinzător de fir

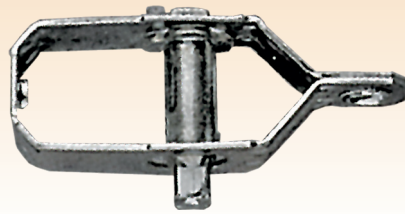

Dimensiuni		Amb. (buc.)	€/100 buc.	Cod articol
(mm)				
85 x 27		1	33.34	I.CMTENSOALS

### Șurub de tensionare

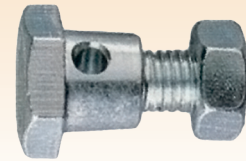

Filet	Amb. (buc.)	€/100 buc.	Cod articol
M10	1	37.00	I.CMTENSOTOS

### Dop pentru garduri



Øțeavă		Amb. (buc.)	€/100 buc.	Cod articol
mm	țoli			
33	1"	25	27.87	I.CMTAPON33S
40	-	25	30.60	I.CMTAPON40S
42	1 1/4"	25	31.77	I.CMTAPON42S
45	-	25	33.86	I.CMTAPON45S
48	1 1/2"	25	35.30	I.CMTAPON48S
50	-	25	36.50	I.CMTAPON50S
60	2"	25	43.58	I.CMTAPON60S

### Colier pentru garduri



Øțeavă		Amb. (buc.)	€/100 buc.	Cod articol
mm	țoli			
33	1"	25	52.15	I.CMBRPOS33S
40	-	25	54.00	I.CMBRPOS40S
42	1 1/4"	25	54.85	I.CMBRPOS42S
48	1 1/2"	25	56.76	I.CMBRPOS48S
50	-	25	57.61	I.CMBRPOS50S
60	2"	25	60.43	I.CMBRPOS60S

### Capac de fixare pentru garduri



Øțeavă		Amb. (buc.)	€/100 buc.	Cod articol
mm	țoli			
33	1"	25	74.88	I.CMTAPOS33S
40	-	25	78.58	I.CMTAPOS40S
42	1 1/4"	25	78.82	I.CMTAPOS42S
48	1 1/2"	25	82.72	I.CMTAPOS48S

## Lanțuri

### Lanțuri standard, zale scurte, tip 766 - zincate

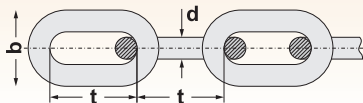

Dimensiuni (mm)			Prezentare		€/U.A.	Cod articol
d	t	b	U.A.	m/U.A.		
3.0	16.0	12.0	colac	30	22.92	HK.76603E
			rolă	50	40.10	HK.76603ER
4.0	16.0	14.0	colac	30	33.54	HK.76604E
			rolă	30	41.34	HK.76604ER
5.0	18.5	17.0	colac	30	51.36	HK.76605E
			rolă	25	48.26	HK.76605ER
6.0	18.5	20.0	colac	30	77.40	HK.76606E
			rolă	36	100.50	HK.76606ER
7.0	22.0	23.0	colac	30	112.80	HK.76607E
			rolă	28	107.50	HK.76607ER
8.0	24.0	26.0	colac	30	141.60	HK.76608E
			rolă	16	80.62	HK.76608ER
10.0	28.0	34.0	colac	30	228.60	HK.76610E
			rolă	10	81.50	HK.76610ER

### Lanțuri standard, zale lungi, tip 763 - zincate

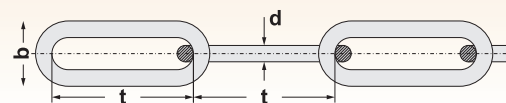



Dimensiuni (mm)			Prezentare		€/U.A.	Cod articol
d	t	b	U.A.	m/U.A.		
3.0	26.0	12.0	colac	30	17.04	HK.76303E
			rolă	45	31.52	HK.76303ER
4.0	32.0	16.0	colac	30	27.18	HK.76304E
			rolă	58	59.34	HK.76304ER
5.0	35.0	20.0	colac	30	42.66	HK.76305E
			rolă	50	77.94	HK.76305ER
6.0	42.0	24.0	colac	30	61.80	HK.76306E
			rolă	28	63.56	HK.76306ER
7.0	49.0	28.0	colac	30	84.60	HK.76307E
			rolă	26	79.74	HK.76307ER
8.0	52.0	32.0	colac	30	110.40	HK.76308E
			rolă	16	64.54	HK.76308ER
10.0	65.0	40.0	colac	30	171.00	HK.76310E
			rolă	12	75.18	HK.76310ER

## Cabluri de tracțiune

### Cabluri zincate

Structură	Ø (mm)	Forță de rupere (kN)	Prezentare		€/U.A.	Cod articol
			U.A.	m / U.A.		
 <p>6 x 7 + 1 twk (twk = miez textil)</p>	2	2.35	rolă 	50	8.46	HK.67102R50
	3	5.29		50	12.20	HK.67103R50
	4	9.41		50	23.72	HK.67104R50
	5	14.70		50	33.18	HK.67105R50
	6	21.10		50	49.32	HK.67106R50
	2	2.35		100	14.18	HK.67102R100
	3	5.29		100	21.38	HK.67103R100
	4	9.41		100	44.08	HK.67104R100
	5	14.70		100	62.44	HK.67105R100
6	21.10	100	94.46	HK.67106R100		
 <p>6 x 12 + 7 twk (twk = miez textil)</p>	3	3.30	rolă 	50	12.32	HK.612703R50
	4	5.90		50	26.30	HK.612704R50
	5	9.01		50	32.46	HK.612705R50
	6	13.30		50	43.56	HK.612706R50
	8	23.70		50	72.24	HK.612708R50
	3	3.30		100	22.18	HK.612703R100
	4	5.90		100	50.34	HK.612704R100
	5	9.01		100	62.74	HK.612705R100
	6	13.30		100	85.48	HK.612706R100
8	23.70	100	145.00	HK.612708R100		
 <p>6 x 7 + 1 WS (WS = miez de oțel)</p>	2	3.12	rolă 	100	13.18	WR.17214802
	3	7.12		100	23.92	WR.17214803
	4	11.83		100	46.58	WR.17214804
	5	17.45		100	59.83	WR.17214805
	6	25.12		100	85.73	WR.17214806
 <p>6 x 19 + 1 FC (FC = miez textil)</p>	2	2.17	rolă 	100	20.48	WR.17214302
	3	4.89		100	27.65	WR.17214303
	4	8.69		100	52.90	WR.17214304
	5	13.50		100	70.58	WR.17214305
	6	19.50		100	92.60	WR.17214306
	10	54.30		100	207.01	WR.17214310
	14	106.00		100	362.47	WR.17214314

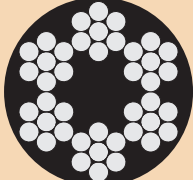
### Cabluri zincate acoperite cu PVC transparent

Structură	Ø (mm)	Forță de rupere (kN)	Prezentare		€/U.A.	Cod articol
			U.A.	m / U.A.		
 <p>6 x 7 + 1 twk (twk = miez textil)</p>	2/3	2.35	rolă 	50	11.20	HK.67123PR50
	3/5	5.29		50	21.88	HK.67135PR50
	4/6	9.41		50	37.40	HK.67146PR50
	2/3	2.35		100	19.60	HK.67123PR100
	3/4	5.29		100	30.64	HK.67134PR100
	3/5	5.29		100	40.74	HK.67135PR100
	4/6	9.41		100	70.80	HK.67146PR100

### Cabluri inox

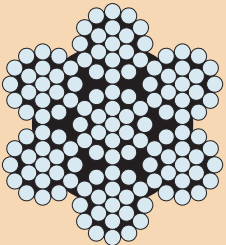
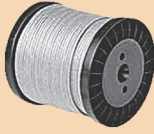
Structură	Ø (mm)	Forță de rupere (kN)	Prezentare		€/U.A.	Cod articol
			U.A.	m / U.A.		
 <p>7 x 19</p>	2	2.08	rolă 	50	31.44	HK.71902IR50
	3	4.69		50	43.08	HK.71903IR50
	4	8.34		50	70.08	HK.71904IR50
	5	13.00		50	108.00	HK.71905IR50
	6	18.80		50	141.00	HK.71906IR50
	8	33.40		50	245.50	HK.71908IR50
	2	2.08		100	60.48	HK.71902IR100
	3	4.69		100	83.70	HK.71903IR100
	4	8.34		100	138.50	HK.71904IR100
	5	13.00		100	205.50	HK.71905IR100
	6	18.80		100	279.50	HK.71906IR100
	8	33.40		100	478.50	HK.71908IR100

## Produsele ROCAST sunt distribuite de 57 agenți comerciali

### 45 în țară

<b>ALBA</b> 0729 997 216	<b>BRĂILA</b> 0729 997 210	<b>COVASNA</b> 0733 692 568	<b>HUNEDOARA</b> 0728 083 234	<b>OLT</b> 0729 997 219	<b>TIMIȘ</b> 0724 202 790 0730 707 883
<b>ARAD</b> 0729 997 234	<b>BRAȘOV</b> 0729 997 240	<b>DÂMBOVIȚA</b> 0729 997 227	<b>IALOMIȚA</b> 0729 997 226	<b>PRAHOVA</b> 0729 997 214 0733 692 592	<b>TULCEA</b> 0733 692 601
<b>ARGEȘ</b> 0729 997 228	<b>BUZĂU</b> 0730 654 992	<b>DOLJ</b> 0729 997 219	<b>IAȘI</b> 0731 220 434	<b>SĂLAJ</b> 0733 692 596	<b>VÂLCEA</b> 0729 997 236
<b>BACĂU</b> 0729 997 237 0728 083 236	<b>CĂLĂRAȘI</b> 0730 585 638	<b>GALAȚI</b> 0728 083 239	<b>MARAMUREȘ</b> 0729 997 221	<b>SATU-MARE</b> 0730 240 457 0733 692 572	<b>VASLUI</b> 0728 083 232
<b>BIHOR</b> 0729 997 223	<b>CARAȘ-SEVERIN</b> 0729 997 224	<b>GIURGIU</b> 0729 997 238	<b>MEHEDINȚI</b> 0733 692 580	<b>SIBIU</b> 0730 641 775 0733 692 582	<b>VRANCEA</b> 0729 997 217
<b>BISTRIȚA-NĂSĂUD</b> 0728 083 235	<b>CLUJ</b> 0728 083 231	<b>GORJ</b> 0729 997 213	<b>MUREȘ</b> 0729 997 232 0724 383 595	<b>SUCEAVA</b> 0721 250 543	
<b>BOTOȘANI</b> 0721 250 543	<b>CONSTANȚA</b> 0729 997 241	<b>HARGHITA</b> 0733 692 568	<b>NEAMȚ</b> 0729 997 239 0730 585 637	<b>TELEORMAN</b> 0729 997 238	

### 12 în București și Ilfov

<b>Sector 1</b> 0730 654 991 0731 220 432	<b>Sector 2</b> 0728 808 753 0728 808 755	<b>Sector 3</b> 0727 777 659 0728 808 754	<b>Sector 4</b> 0728 083 233 0733 692 602	<b>Sector 5</b> 0723 200 554 0727 777 658	<b>Sector 6</b> 0724 383 596 0728 808 756
---	---	---	---	---	---

Șos Pantelimon Nr. 1 - 3, 021591, București, S2  
Tel.: (021) 252 53 90 - 95; Fax: (021) 252 53 89  
Mobil: 0372 135 900; 0723 293 471  
Director vânzări: 0731 066 024  
Departament vânzări: 0724 383 597 (provincie)  
0724 383 593 (București)

email: [office@rocast.ro](mailto:office@rocast.ro)  
[www.rocast.ro](http://www.rocast.ro)  
<http://shop.rocast.ro>

Pentru promoții și oferte speciale  
abonați-vă la newsletter [www.rocast.ro](http://www.rocast.ro)

Prețurile din catalog sunt exprimate în Euro și nu includ TVA.

ROCAST nu răspunde pentru eventuale erori de tipar sau de prezentare. Fotografiele au caracter informativ și pot conține anumite accesorii care nu sunt incluse în pachetul standard de livrare sau se pot modifica fără notificare prealabilă.

Livrarea și plata produselor se face în conformitate cu condițiile ROCAST.

ROCAST poate modifica condițiile de livrare și prețurile din catalog fără notificare prealabilă.