

Fontini



DOMUSCLASSICA®
| Collection |

SÄHKÖTARVIKKEET

SISÄLTÖ

YHTEYSTIEDOT	3
UUTUUDET	4
F37	7
VENEZIA COLLECTION	25
GARBY COLONIA COLLECTION	47
GARBY COLLECTION	59
DIMBLER COLLECTION	69
PINTA-ASENNUSOSAT	75
GARBY JA DIMLER	76
F37	84
VENEZIA JA GARBY COLONIAL	86
LISÄTARVIKKEET	89
AUDIO	94
TEKNISET TIEDOT	97
HINNASTO	117



DOMUSCLASSICA®
| Eriäinen rautakauppa |

OLEMME YLPEITÄ TUOTTEISTAMME!

ME TÄÄLLÄ DOMUKSELLA TUNNEMME VANHAT RAKENNUKSET. HALUAMME AUTTAA TEITÄ LÖYTÄMÄÄN KOTIINNE PARHAAT MAHDOLLISET RAKENNUSOSAT, JOILLA VANHAN TALONNE TUNNELMA SÄILYY JUURI SELLAISENA KUIN SE ON AIEMMINKIN OLLUT. TARJOAMAMME TUOTTEET VALMISTETAAN KYMMENIÄ VUOSIA TOIMINEISSA VERSTAISSA, JOISSA TYÖHÖN SUHTAUDUTAAN KUNNIANHIMOISESTI JA LAATUUN VAHVASTI PANOSTAEN.

OLEMME ERITTÄIN YLPEITÄ VALIKOIMASTAMME!

HALUAMME OLLA APUNASI

PUHELIN

0400-23 24 25

ASIAKASPALVELUMME ON AVOINNA
MA-TO KLO 9-15 JA SU KLO 12-15

SÄHKÖPOSTI

DOMUS@DOMUSCLASSICA.COM

VERKKOKAUPPA

WWW.DOMUSCLASSICA.FI

MYYMÄLÄMME

HELSINKI

EROTTAJANKATU 11, 00130 HELSINKI

PUHELIN 044-715 4200

AVOINNA MA-PE 10-18, LA 11-16

HATTULA

METSÄNKYLÄNTIE 2, 13900 PEKOLA

PUHELIN 0400-23 24 25

AVOINNA MA-TO 9-15, SU 12-15

DOMUSCLASSICA®

Tiedustelut ja tilaukset: domus@domusclassica.com | p. 0400 23 24 25 (ma-to 9-15) | www.domusclassica.fi
Hinnat sisältävät arvonlisäveroä 24 % | Domus Classica Oy varaa oikeuden hinta- ja tuotetietomuutoksiin

Fontini



Fontini

FROM BARCELONA TO THE WORLD

**INSPIRATION, INNOVATION, CREATIVITY,
THIS IS THE SPIRIT THAT WE TRY TO CAPTURE IN OUR CREATIONS**

HEADQUARTERS
Pol. Ind. Can Bernades-Subirà C/ Anoia, 15
080130 SANTA PERPETUA DE MOGODA
(Barcelona) SPAIN

SHOWROOM
Ronda Segovia, 61
Portal 2, Local 3
28 005 MADRID (SPAIN)

TEL.: (+34) 93.574.33.30
FAX: (+34) 93.574.21.19
LET'S TALK:
(+34) 902.120.103

Fontini



Behind a successful company, there is always a great team. Professionals who with their daily determination make any project come true. In Fontini we have passion with our work, with the accomplished commitments.

We would like to thank you, clients and distributors for trusting us for more than 50 years. You make possible that we create one of the biggest brand of decorative mechanisms in the market.

Hinter einem großen Unternehmen steht immer ein Team von Fachleuten, das mit seinem täglichen Einsatz jedes Projekt zum Abschluss bringt. Bei Fontini sind wir stolz auf unsere Tätigkeit, auf solide Qualitätsarbeit und auf eingehaltene Verpflichtungen.

Wir möchten allen unseren Kunden und Händlern für das in den vergangenen, mehr als 50 Jahren in uns gesetzte Vertrauen danken. Mit Ihrer Hilfe konnten wir eine der prestigeträchtigsten und anerkanntesten Marken auf dem Markt für dekoratives Elektrozubehör aufbauen.

Успешная компания - это прежде всего сплоченная команда. Профессионалы, чей ежедневный упорный труд позволяет реализовать любые проекты. Сотрудники Fontini увлечены своей работой и гордятся достигнутыми результатами.

Мы хотим поблагодарить вас - наших клиентов и дистрибьюторов - за доверие, которое вы оказываете нам уже более 50 лет. Это ваша заслуга в том, что нам удалось создать один из крупнейших брендов декоративных механизмов в мире.

Roger Font - CEO Fontini Group

SUMMARY INHALTSVERZEICHNIS ЗАКЛЮЧЕНИЕ

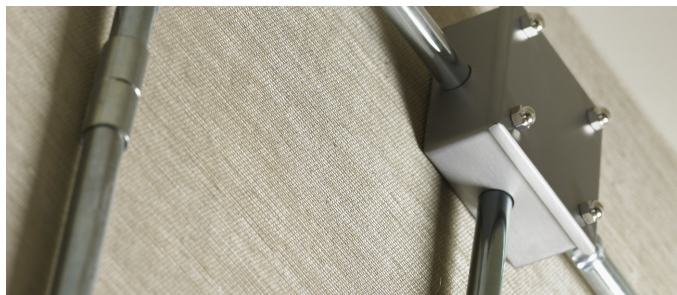

P.04
NOVELTIES
NEUHEITEN
НОВИНКИ



P.06
FITTING INSTALLATION COLLECTIONS
UNTERPUTZKOLLEKTIONEN
КОЛЛЕКЦИИ УСТАНОВОЧНОЙ АРМАТУРЫ

P.06 F-37 ROTARY & ROCKING SWITCHES COLLECTION
P.24 VENEZIA ROTARY & ROCKING SWITCHES COLLECTION
P.46 GARBY COLONIAL COLLECTION



P.58
SURFACE & FITTING INSTALLATION COLLECTIONS
ÜBERPUTZ-/UNTERPUTZKOLLEKTIONEN
КОЛЛЕКЦИИ АРМАТУРЫ ДЛЯ НАРУЖНОЙ
И ВНУТРЕННЕЙ УСТАНОВКИ

P.58 GARBY COLLECTION
P.68 DIMBLER COLLECTION



P.74
DECORATIVE SURFACE INSTALLATION SYSTEMS
DEKORATIVE ÜBERPUTZSYSTEME
ДЕКОРАТИВНЫЕ СИСТЕМЫ ДЛЯ
НАРУЖНОЙ УСТАНОВКИ

P.88
COMPLEMENTS & SOUND
ZUBEHÖR & AUDIO
ДОПОЛНИТЕЛЬНЫЕ ТОВАРЫ И ЗВУК

P.88 COMPLEMENTS
P.94 SOUND

P.96
TECHNICAL INFORMATION
TECHNISCHE DATEN
ТЕХНИЧЕСКАЯ ИНФОРМАЦИЯ

NOVELTIES NEUHEITEN НОВИНКИ





NEW FINISHES NEUE FINISHS *НОВЫЕ ПОКРЫТИЯ*

Golden and antique bronze F-37 Rocking & Rotary switches Mechanismen F-37 Rocking und Rotary Schalter in Gold und Antikbronze *Золото и античная бронза F-37 Кулисные и поворотные выключатели*

F37 Rocking switches with square key Mechanismen F-37 Rocking Schalter mit quadratischem Kipphebel *F37 Кулисные выключатели с квадратной клавишей*

Patinated cooper, antique cooper & anthracite Metal Venezia frames Rahmen Venezia Metall Kupferpatinierung, Altkupfer und Anthrazit *Металлические рамки Venezia, черненная медь, античная красная медь и антрацит*

Metal Venezia frames for F-37 mechanisms Rahmen Venezia Metall für Elektrozubehör F-37 *Металлические рамки Venezia для механизмов F-37*

Pickling wood Garby Colonial frames Rahmen Garby Colonial aus gebeiztem Holz *Рамки Garby Colonial из мореного дерева*

Black porcelain Garby & Garby Colonial Collections Kollektionen Garby und Garby Colonial in schwarzem Porzellan *Коллекции Garby и Garby Colonial из черного фарфора*

White porcelain case Dimbler Dimbler Porzellangehäuse weiß *Корпус Dimbler из белого фарфора*



NEW DECORATIVE SURFACE INSTALLATION SYSTEMS

NEUE DEKORATIVE ÜBERPUTZSYSTEME

НОВЫЕ ДЕКОРАТИВНЫЕ СИСТЕМЫ ДЛЯ НАРУЖНОЙ УСТАНОВКИ

Metallic boxes for F-37 Rocking & Rotary switches Collections surface installation Metallgehäuse mit vernickeltem satiniertem Finish für Überputzinstallationen der Kollektionen F-37 Rocking und Rotary Schalter *Металлические корпуса для наружной установки кулисных и поворотных выключателей коллекций F-37*

3 different size metallic connection boxes satin nickel-plated and aged metal finishes Anschlussdosen aus Metall in 3 unterschiedlichen Größen mit vernickeltem, satiniertem Finish sowie in gealtertem Metall *Металлические соединительные корпуса 3 различных размеров, покрытие - глянцевое никелированное и состаренный металл*

2 element metallic boxes for Venezia & Garby Colonial Collections mechanisms & accessories installation Metallgehäuse für 2 Elemente zur Installation des Elektrozubehörs und Accessoires der Kollektionen Venezia und Garby Colonial *Металлические корпуса из 2 элементов для коллекций механизмов и аксессуаров Venezia и Garby Colonial*



NEW FUNCTIONS NEUE FUNKTIONEN *НОВЫЕ ФУНКЦИИ*

Double telephone & 6 RJ category for all Fontini collections Doppelte Telefon- und doppelte RJ-Steckdosen der Kategorie 6 für alle Fontini-Kollektionen *Двухместные розетки телефон/6 RJ для всех коллекций Fontini*

Rocking Pushbutton Drucktaster des Typs Rocking *Нажимная кнопка кулисного типа*

Rocking double pushbutton Doppelter Drucktaster des Typs Rocking *Двойная нажимная кнопка кулисного типа*

Timer pushbutton Drucktaster-Zeitschalter *Нажимная кнопка таймера*

Luminous marker / Emergency marker Leuchtschalter/Notfall-Leuchtschalter *Светящийся маркер / Маркер для экстренных ситуаций*



Interior Design: Carmen Barasona
Innenausstattung: Carmen Barasona
Дизайн интерьера: Carmen Barasona

F-37 Rocking and Rotary switches Collection



Interior Design: Carmen Barasona – Photography: Benjamín Alcázar
Innenausstattung: Carmen Barasona – Fotografie: Benjamín Alcázar
Дизайн интерьера: Carmen Barasona – Фотографии: Benjamín Alcázar

Fitting installation.

10AX - 250V[~] mechanisms.

10/16A - 250V[~] earthing sockets.

Silver contacts with high breaking power.

Massif ash tree wood and melt glass frames.

Frames for vertical or horizontal installations,
fitted in universal boxes.

Installation in standard box with screws.

Unterputzinstallation.

Mechanismen 10 AX - 250 V[~]

Steckdose 16 A - 250 V[~]

Hochbruchsichere Silberkontakte.

Holzrahmen aus massiver Esche und
geschmolzenem Glas.

Rahmen für vertikale und horizontale Installation.

Installation in Universalgehäuse mit Schrauben.

Установка арматуры.

Механизмы 10 AX - 250 В[~].

Розетки 16 А - 250 В[~] с заземлением.

Серебряные контакты с высокой мощностью
размыкания цепи.

Рамки из массива ясеня и расплавленного стекла.

Рамки для вертикальной и горизонтальной
установки, вставленные в универсальные корпуса.

Установка в стандартную коробку с винтами.

F-37 ROCKING SWITCHES

NEW



Square chrome-plated key, white cover, white glass frame

Verchromter quadratischer Kipphebel, weiße Abdeckung, Glasrahmen weiß
Квадратная хромированная клавиша, белая накладка, белая стеклянная рамка

NEW



Square chrome-plated key, metallic cover, wengue wood frame

Verchromter quadratischer Kipphebel, Abdeckung metallisiert, Rahmen Wengeholz
Квадратная хромированная клавиша, накладка «металлик», деревянная рамка цвета «венге»



Chrome-plated key, white cover, blue reflex glass frame

Verchromter Kipphebel, Abdeckung weiß, Glasrahmen blau reflektierend
Хромированная клавиша, белая накладка, синяя зеркальная стеклянная рамка



Chrome-plated key, white cover, cherry tree wood frame

Verchromter Kipphebel, Abdeckung weiß,
Rahmen Kirschbaumholz
Хромированная клавиша, белая накладка,
деревянная рамка «вишня»



Golden key, brown cover, wengue wood frame

Vergoldeter Kipphebel, Abdeckung braun,
Rahmen Wengeholz
Золотистая клавиша, коричневая накладка,
деревянная рамка цвета «венге»



Antique bronze key, brown cover, tobacco wood frame

Kipphebel Antikbronze, Abdeckung braun,
Holzrahmen Tabak
Клавиша «античная бронза», коричневая
накладка, деревянная рамка табачного цвета

F-37 ROTARY SWITCHES



Stainless steel knob, white cover, white glass frame

Knopf Edelstahl, Abdeckung weiß, Glasrahmen weiß

Кнопка - нержавеющая сталь, белая накладка, белая стеклянная рамка



Stainless steel knob, white cover, reflex blue glass frame

Knopf Edelstahl, Abdeckung weiß, Glasrahmen blau reflektierend

Кнопка - нержавеющая сталь, белая накладка, синяя зеркальная стеклянная рамка



Stainless steel knob, metallic cover, wengue wood frame

Knopf Edelstahl, Abdeckung weiß, Rahmen Wengeholz

Кнопка - нержавеющая сталь, накладка «металлик», деревянная рамка цвета «венге»



Stainless steel knob, metallic cover, cherry tree wood frame

Knopf Edelstahl, Abdeckung metallisiert, Rahmen Kirschbaumholz
Кнопка - нержавеющая сталь, накладка «металлик», деревянная рамка «вишня»



Golden knob, brown cover, wengue wood frame

















Knopf vergoldet, Abdeckung braun, Rahmen Wengeholz
Золотистая кнопка, коричневая накладка, деревянная рамка цвета «венге»







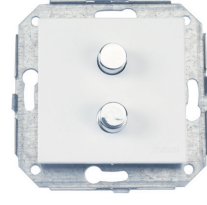



Antique bronze knob, brown cover, tobacco wood frame

Knopf Antikbronze, Abdeckung braun, Holzrahmen Tabak
Кнопка «античная бронза», коричневая накладка, деревянная рамка табачного цвета











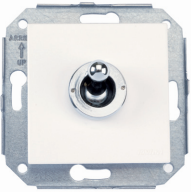

F-37 Rocking Switches
Collection

	Set Serie Серия	Code Code Код	Finish Finish Отделка	Packaging Verpackung Упаковка	
 	68	306	26 61	ref. 2 	
	68	308		ref. 2 	
	68	304		ref. 2 	
	68	314		ref. 2 	
	68	312		ref. 2 	1 Unit Einheit единица
 	68	300	26 61	ref. 2 	
	68	302	26 61	ref. 2 	1 Unit Einheit единица
 	68	342	26 61	ref. 2 	1 Unit Einheit единица
	37	343	26 61	ref. 2 	(*) Dimmer with pulsation control, using the 37347000 / 37346000 accessories (electronic dimmer 900 / 500W) from the page 50, every pushbutton could be used as electronic dimmer.
					(*) Tastregler, mit den Accessoires 37347000 / 37346000 (elektronischer Dimmer für 900 / 500 W) von Seite 50 wird jeder Drucktaster zu einem elektronischen Intensitätsregler. (*) Регулятор нажимного типа: используя вспомогательные устройства 37347000 / 37346000 (электронные диммеры 900 / 500Вт) со стр. 50, можно превратить любой нажимный выключатель в электронный регулятор освещенности.



	Set Serie Серия	Code Code Код	Finish Finish Отделка	Packaging Verpackung Упаковка	
	37	310	26 61	ref. 2 	<p>Dimmer with pulsation control, using the 37347000 / 37346000 accessories (electronic dimmer 900 / 500W) from the page 50, every pushbutton could be used as electronic dimmer.</p> <p>Tastregler, mit den Accessoires 37347000 / 37346000 (elektronischer Dimmer für 900 / 500 W) von Seite 50 wird jeder Drucktaster zu einem elektronischen Intensitätsregler.</p> <p>Регулятор нажимного типа: используя вспомогательные устройства 37347000 / 37346000 (электронные диммеры 900 / 500Вт) со стр. 50, можно превратить любой нажимный выключатель в электронный регулятор освещенности.</p>
	37	332	26 61	ref. 2 	<p>1 Unit Einheit единица</p>
	37	331	26 61	ref. 2 	<p>1 Unit Einheit единица</p>
	37	924	26 61	ref. 2 	<p>See technical information at page 110. Siehe technische Hinweise auf Seite 110. См. технические данные на стр. 110.</p>
	37	925	26 61		
					1 Unit Einheit единица

F-37 Rocking Switches
Collection

	Set Serie Серия	Code Code Код	Finish Finish Отделка	Packaging Verpackung Упаковка		
	One pole switch 10AX - 250V~ Einpoliger Unterbrecherschalter 10 AX - 250 V~ Однополюсный выключатель 10 AX - 250 В~	67	306	See finishes Siehe Finishs См. варианты отделки	ref. 2 	1 Unit Einheit единица
	Two-way switch 10AX - 250V~ Zweiwegschalter 10 AX - 250 V~ Двухпозиционный выключатель 10 AX - 250 В~	67	308		ref. 2 	
	Crossing switch 10AX - 250V~ Kreuzschalter 10 AX - 250 V~ Перекрестный выключатель 10 AX - 250 В~	67	304		ref. 2 	
	Two pole switch 10AX - 250V~ Zweipoliger Unterbrecherschalter 10 AX - 250 V~ Двухполюсный выключатель 10 AX - 250 В~	67	314		ref. 2 	
	Rocking pushbutton 10A 250V~ 24V DC* Drucktaster Rocking 10A - 250 V~ - 24 V DC*	67	312		ref. 2 	
	Нажимная кнопка кулисного типа 10 А - 250 В ~ 24 В пост. тока*					
	Double switch 10AX - 250V~ Doppelschalter 10 AX - 250 V~ Двойной выключатель 10 AX - 250 В~	67	300	See finishes Siehe Finishs См. варианты отделки	ref. 2 	1 Unit Einheit единица
	Double two-way switch 10AX - 250V~ Zweiwegschalter doppelt 10 AX - 250 V~ Двойной двухпозиционный выключатель 10 AX - 250 В~	67	302		ref. 2 	
	Double pushbutton 10A - 250V~ 24V DC Rocking* Doppelter Drucktaster 10 A - 250 V~ - 24 V DC Rocking* Сдвоенная нажимная кнопка 10 А - 250 В ~ 24 В пост. тока, кулисная*	67	345			
	Electric blinds mechanism 10A 250 V~ Rocking (2.5 A for motors). (without blockage system). Installation requires the use of relays. Mechanismus für Rollläden 10 A 250 V~ Rocking (2,5 A für Motoren) (ohne Verriegelung). Die Installation erfordert ein Steuergerät. Механизм для штор с электроприводом 10 А 250 В ~, кулисный (2,5 А для электродвигателей) (без системы блокировки). Для установки требуется реле.	67	342	See finishes Siehe Finishs См. варианты отделки	ref. 2 	1 Unit Einheit единица
	Pushbutton 10A - 250V~ 24V DC* Drucktaster 10 A - 250 V~ - 24 V DC* Нажимная кнопка 10 А - 250 В~ 24 В пост. тока*	37	310	See finishes Siehe Finishs См. варианты отделки	ref. 2 	(*)Dimmer with pulsation control, using the 37347000 / 37346000 accessories (electronic dimmer 900 / 500W) from the page 50, every pushbutton could be used as electronic dimmer. (*) Tastregler, mit den Accessoires 37347000 / 37346000 (elektronischer Dimmer für 900 / 500 W) von Seite 50 wird jeder Drucktaster zu einem elektronischen Intensitätsregler. (*) Регулятор нажимного типа: используя вспомогательные устройства 37347000 / 37346000 (электронные диммеры 900 / 500Вт) со стр. 50, можно превратить любой нажимный выключатель в электронный регулятор освещенности.
	Timer pushbutton 10 A 250V~ (30 sec. to 10 min.) (incandescence and halogen) Drucktaster mit Zeitschalter 10A - 250 V~ (30 Sek. bis 10 Min.) (Glüh- und Halogenlampen) Нажимная кнопка таймера 10 А 250В~ (30 сек. - 10 мин.) (для ламп накаливания и галогеновых ламп)	37	316			



54.
Golden/Brown
Gold/Braun
Золотистый/коричневый











57.
Antique bronze/Brown
Antikbronze/Braun
Античная бронза/коричневый

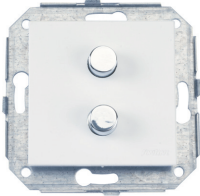









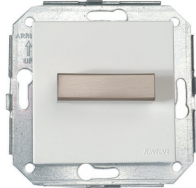

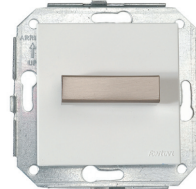

26.
Chrome-plated/White
Verchromt/Weiß
Хромированный/белый

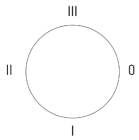









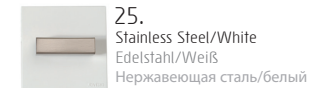

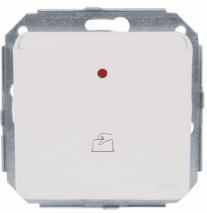

61.
Chrome-plated/Metallic
Verchromt/Metallisiert
Хромированный/«металлик»





	Set Serie Серия	Code Code Код	Finish Finish Отделка	Packaging Verpackung Упаковка	
	37	343	See finishes Siehe Finishes См. варианты отделки	ref. 2 	<p>Dimmer with pulsation control, using the 37347000 / 37346000 accessories (electronic dimmer 900 / 500W) from the page 50, every pushbutton could be used as electronic dimmer.</p> <p>Tastregler, mit den Accessoires 37347000 / 37346000 (elektronischer Dimmer für 900 / 500 W) von Seite 50 wird jeder Drucktaster zu einem elektronischen Intensitätsregler.</p> <p>Регулятор нажимного типа: используя вспомогательные устройства 37347000 / 37346000 (электронные диммеры 900 / 500Вт) со стр. 50, можно превратить любой нажимный выключатель в электронный регулятор освещенности.</p>
	37	332	See finishes Siehe Finishes См. варианты отделки	ref. 2 	1 Unit Einheit единица
	37	331	See finishes Siehe Finishes См. варианты отделки	ref. 2 	1 Unit Einheit единица
	37	924	See finishes Siehe Finishes См. варианты отделки	ref. 2 	See technical information at page 110. Siehe technische Hinweise auf Seite 110. См. технические данные на стр. 110.
	37	925	See finishes Siehe Finishes См. варианты отделки		1 Unit Einheit единица











	Set Serie Серия	Code Code Код	Finish Finish Отделка	Packaging Verpackung Упаковка	
	37	306	See finishes Siehe Finishes См. варианты отделки	ref. 2 	1 Unit Einheit единица
	37	308		ref. 2 	
	37	304		ref. 2 	
	37	314		ref. 2 	
	37	300	See finishes Siehe Finishes См. варианты отделки	ref. 2 	 <p>0 Both circuits Off I A circuit On II Both circuits On III B circuit On, A Off 0 Geschlossene Kreisläufe I Kreislauf A offen II Kreisläufe A und B offen II Kreislauf A geschlossen und B offen 0 Обе цепи выключены I Включена цепь A II Обе цепи включены III Цепь B включена, A выключена</p> <p>302 0 position depends on the position of the other two-way switch Die Position 0 variiert in Abhängigkeit der Position des anderen Schalters. Положение 0 зависит от положения второго двухпозиционного выключателя</p>
	37	302		ref. 2 	
	37	328			
	37	344			
	37	310	See finishes Siehe Finishes См. варианты отделки	ref. 2 	1 Unit Einheit единица
	37	316		ref. 2 	
	37	343	See finishes Siehe Finishes См. варианты отделки	ref. 2 	<p>(*)Dimmer with pulsation control, using the 37347000 / 37346000 accesories (electronic dimmer 900 / 500W) from the page 50, every pushbutton could be used as electronic dimmer.</p> <p>(*) Tastregler, mit den Accessoires 37347000 / 37346000 (elektronischer Dimmer für 900 / 500 W) von Seite 50 wird jeder Drucktaster zu einem elektronischen Intensitätsregler.</p> <p>(*) Регулятор нажимного типа: используя вспомогательные устройства 37347000 / 37346000 (электронные диммеры 900 / 500Вт) со стр. 50, можно превратить любой нажимный выключатель в электронный регулятор освещенности.</p>

FINISH FINISH ОТДЕЛКА

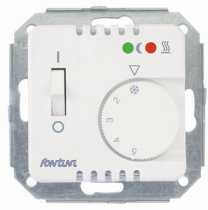

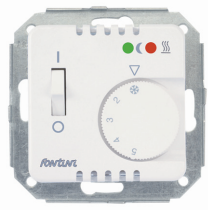
		Set Serie Серия	Code Code Код	Finish Finish Отделка	Packaging Verpackung Упаковка	
	Electric blinds mechanism 10A - 250V~ for 2,5 A motors Mechanismus für Rollläden 10 A - 250 V~ für Motoren 2,5 A Механизм для штор с электроприводом 10 А - 250 В~ для электродвигателей 2,5 А	37	342	See finishes Siehe Finishes См. варианты отделки	ref. 2 	
						1 Unit Einheit единица
	Card switch mechanism with luminous indicator Kartenschalter mit Leuchtanzeige Механизм карточного выключателя со светящимся индикатором	37	935	05 White Weiß Белый 03 Brown Braun Коричневый	ref. 2 	Installation with relays is recommended Es wird eine Installation mit Relais empfohlen При установке рекомендуется использовать реле
	Switch two way switch 1 micro 6A-250V~ Unterbrecher-Wechselschalter 1 Mikroschalter 6 A-250 V~ Двухпозиционный выключатель, 1 микропрерыватель 6 А - 250 В~ Switch two way switch 2 micro 6A-250V~ Unterbrecher-Wechselschalter 2 Mikroschalter 6 A-250 V~ Двухпозиционный выключатель, 2 микропрерывателя, 6 А-250 В~	37	936	50 Metallic Metallisiert Металлик	ref. 2 	
	Luminous marker 230V~ white - green - red Leuchtschalter 230 V~ weiß - grün - rot Светящийся маркер 230 В~ белый - зеленый - красный	37	755	05 White Weiß Белый	ref. 2 	1 Unit Einheit единица
	Luminous marker 12/24V DC white - green - red Leuchtschalter 12/24 V DC weiß - grün - rot Светящийся маркер 12/24 В пост. тока, белый - зеленый - красный	37	756	03 Brown Braun Коричневый	ref. 2 	
	Emergency marker 230V~ Notfall-Leuchtschalter 230 V~ Маркер для экстренных ситуаций 230 В~	37	760	50 Metallic Metallisiert Металлик	ref. 2 	
	Socket outlet 2 poles without earth 16A - 250V~ with shutters Steckdose 16 A - 250 V~ mit Einsteckschutz Розетка двухполюсная без заземления 16 А - 250 В~ со шторками	37	209	05 White Weiß Белый 03 Brown Braun Коричневый 50 Metallic Metallisiert Металлик	ref. 2 	Only for replacement Nur für Ersatz Только для замены
						1 Unit Einheit единица
	German 2 poles socket with earth 16A - 250V~ with shutters Schuko-Steckdose mit Einsteckschutz 16 A - 250 V~ Немецкая двухполюсная розетка с заземлением 16 А - 250 В~ со шторками	37	212	05 White Weiß Белый 03 Brown Braun Коричневый 50 Metallic Metallisiert Металлик	ref. 2 	
						1 Unit Einheit единица

		Set Serie Серия	Code Code Код	Finish Finish Отделка	Packaging Verpackung Упаковка	
	French 2 pole socket with earth pin 16A - 250V~ with shutters Steckdose mit französischem Erdungsstift 16 A - 250 V~ mit Einsteckschutz Французская двухполюсная розетка с контактом заземления 16 A - 250 В~, со шторками	37	208	05 White Weiß Белый 03 Brown Braun Коричневый 50 Metallic Metallisiert Металлик	ref. 2 	1 Unit Einheit единица
	6 ways double telephone socket Telefonsteckdose doppelt 6-polig 6-контактная двухместная телефонная розетка	37	706	05 White Weiß Белый 03 Brown Braun Коричневый 50 Metallic Metallisiert Металлик	ref. 2 	1 line and 2 ways. Possibility of 2 independent lines (see technical notes at page 108). 1 Leitung und 2 Ausgänge. 2 unabhängige Leitungen möglich (siehe technische Hinweise auf Seite 108). 1 линия, 2 выхода. Возможность подключения 2 отдельных линий (на стр. 108).
	Double 6 RJ45 CAT socket Doppelsteckdose RJ45 CAT 6 Двухместная розетка 6 RJ45 CAT	37	707	05 White Weiß Белый 03 Brown Braun Коричневый 50 Metallic Metallisiert Металлик	ref. 2 	1 Unit Einheit единица
	6 ways telephone socket + 6 RJ45 CAT Telefonsteckdose 6-polig + RJ45 CAT6 6-контактная телефонная розетка + 6 RJ45 CAT	37	708	05 White Weiß Белый 03 Brown Braun Коричневый 50 Metallic Metallisiert Металлик	ref. 2 	1 Unit Einheit единица
	R/TV and SAT socket outlets R/TV und SAT Steckdose, entzerrt Розетки R/TV и SAT	37	712	05 White Weiß Белый	ref. 2 	See technical information at page 107. Siehe technische Hinweise auf Seite 107. См. технические данные на стр. 107.
	Single socket Einfachsteckdose Одноместная розетка	37	713	03 Brown Braun Коричневый	ref. 2 	
	Intermediate A Durchgangsdose A Промежуточная A	37	714	50 Metallic Metallisiert Металлик	ref. 2 	
	Intermediate B Durchgangsdose B Промежуточная B	37	711		ref. 2 	
	Final socket Enddose Оконечная розетка	37	715		ref. 2 	
	Only cover Nur Deckel Только накладка	37	715		ref. 2 	1 Unit Einheit единица

	Set Serie Серия	Code Code Код	Finish Finish Отделка	Packaging Verpackung Упаковка	
	37	332	See finishes Siehe Finishes См. варианты отделки	ref. 2 	See technical information at page 106. Siehe technische Hinweise auf Seite 106. См. технические данные на стр. 106.
	37	331	See finishes Siehe Finishes См. варианты отделки	ref. 2 	
	37	721	05 White Weiß Белый	ref. 2 	
	37	722		ref. 2 	
	37	750	05 White Weiß Белый 50 Metallic Metallisiert Металлик	ref. 2 	

1 Unit Einheit единица

1 Unit Einheit единица

1 Unit Einheit единица

1 Unit Einheit единица

FINISH FINISH ОТДЕЛКА

54.
Golden/Brown
Gold/Braun
Золотистый/коричневый57.
Antique bronze/Brown
Antikbronze/Braun
Античная бронза/коричневый25.
Stainless Steel/White
Edelstahl/Weiß
Нержавеющая сталь/белый51.
Stainless steel/Metallic
Edelstahl/Metallisiert
Нержавеющая сталь/металлик

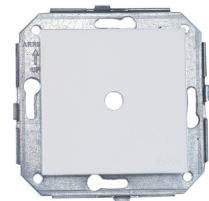
F-37
Collection

Cable outlet cover
Abdeckung Kabelausgang
Крышка кабельного вывода

Set
Serie Серия

37

Code
Code Код

927

Finish
Finish Отделка

05 White
Weiß
Белый
03 Brown
Braun
Коричневый
50 Metallic
Metallisiert
Металлик

Packaging
Verpackung Упаковка

ref. 2 

| 1 Unit Einheit единица



Blind cover
Blindabdeckung
Щиток

37

656

05 White
Weiß
Белый
03 Brown
Braun
Коричневый
50 Metallic
Metallisiert
Металлик

ref. 2 

| 1 Unit Einheit единица



Potentiometer for volume regulation
Potentiometer für die Lautstärkenregelung
Потенциометр регулировки громкости

37

924

See finishes
Siehe Finishes
См. варианты
отделки

ref. 2 

See technical notes at page 110.
Siehe technische Hinweise auf Seite 110.
См. технические данные на стр. 110.

| 1 Unit Einheit единица



Radio tuner & volume control
Radioempfänger und Lautstärkenregler
Радиотюнер и регулятор громкости

37

925

See finishes
Siehe Finishes
См. варианты
отделки

ref. 2 

| 1 Unit Einheit единица



Loudspeaker for universal box
Power 2W Impedance 16 Ω
Lautsprecher für Universalgehäuse
Leistung 2 W, Impedanz 16 Ω
Динамик для универсальной аудиосистемы
Мощность 2 Вт, сопротивление 16 Ω

37

926

05 White
Weiß
Белый
03 Brown
Braun
Коричневый
50 Metallic
Metallisiert
Металлик

ref. 2 

See technical notes at page 110.
Siehe technische Hinweise auf Seite 110.
См. технические данные на стр. 110.

| 1 Unit Einheit единица

FINISH FINISH ОТДЕЛКА



54.
Golden/Brown
Gold/Braun
Золотистый/коричневый











57.
Antique bronze/Brown
Antikbronze/Braun
Античная бронза/коричневый

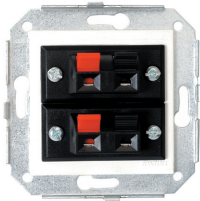



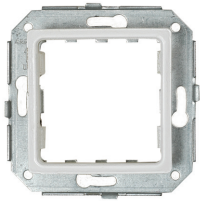





25.
Stainless Steel/White
Edelstahl/Weiß
Нержавеющая сталь/белый



51.
Stainless steel/Metallic
Edelstahl/Metallisiert
Нержавеющая сталь/металлик

	Set Serie Серия	Code Code Код	Finish Finish Отделка	Packaging Verpackung Упаковка	
	37	905	05 White Weiß Белый 03 Brown Braun Коричневый 50 Metallic Metallisiert Металлик	ref. 2 	1 Unit Einheit единица
	37	944	05 White Weiß Белый 10 Black Schwarz Черный	ref. 2 	1 Unit Einheit единица
	37	945	05 White Weiß Белый 10 Black Schwarz Черный	ref. 2 	1 Unit Einheit единица
	37	390	05 White Weiß Белый 03 Brown Braun Коричневый 50 Metallic Metallisiert Металлик	ref. 2 	See technical information at page 105. Siehe technische Hinweise auf Seite 105. См. технические данные на стр. 105. 1 Unit Einheit единица

		Set Serie Серия	Code Code Код	Finish Finish Отделка	Packaging Verpackung Упаковка	
	1 element wood frame Holzrahmen 1 Element Одноместная деревянная рамка 90x90x11mm	37	801	See finishes Siehe Finishes См. варианты отделки	ref. 2 	1 Unit Einheit единица
	2 elements wood frame Holzrahmen 2 Elemente Двухместная деревянная рамка 90x162x11mm	37	802	See finishes Siehe Finishes См. варианты отделки	ref. 2 	1 Unit Einheit единица
	3 elements wood frame Holzrahmen 3 Elemente Трехместная деревянная рамка 90x233x11mm	37	803	See finishes Siehe Finishes См. варианты отделки	ref. 2 	1 Unit Einheit единица
	4 elements wood frame Holzrahmen 4 Elemente Четырехместная деревянная рамка 90x299x11mm	37	804	See finishes Siehe Finishes См. варианты отделки	ref. 2 	1 Unit Einheit единица

FINISH FINISH ОТДЕЛКА











04.
Wengue
Wengeholz
Венге

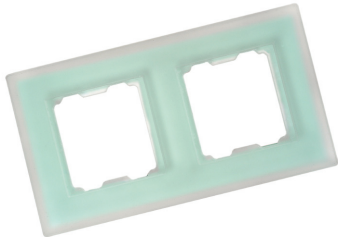

03.
Tobacco
Tabak
Табак

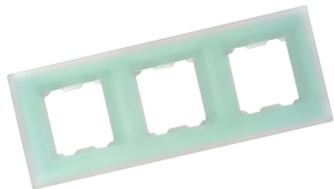

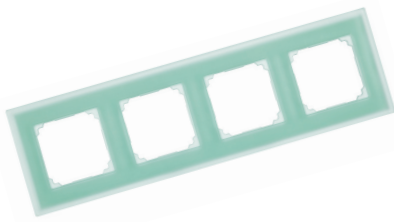
02.
Cherry tree
Kirschbaum
Вишня

		Set Serie Серия	Code Code Код	Finish Finish Отделка	Packaging Verpackung Упаковка	
	1 element glass frame Glasrahmen 1 Element Одноместная стеклянная рамка 90x90x12mm	37	801	See finishes Siehe Finishes См. варианты отделки	ref. 2 	1 Unit Einheit единица
	2 elements glass frame Glasrahmen 2 Elemente Двухместная стеклянная рамка 90x162x12mm	37	802	See finishes Siehe Finishes См. варианты отделки	ref. 2 	1 Unit Einheit единица
	3 elements glass frame Glasrahmen 3 Elemente Трехместная стеклянная рамка 90x233x12mm	37	803	See finishes Siehe Finishes См. варианты отделки	ref. 2 	1 Unit Einheit единица
	4 elements glass frame Glasrahmen 4 Elemente Рамка из стекла для 4 элементов 90x305x12mm	37	804	See finishes Siehe Finishes См. варианты отделки	ref. 2 	1 Unit Einheit единица



07.
Reflex Blue
Blau reflektierend
Синий зеркальный



66.
White
Weiß
Белый



66.
Apple Green
Apfelgrün
Зеленое яблоко



Interior Design: Carmen Barasona
Innenausstattung: Carmen Barasona
Дизайн интерьера: Carmen Barasona

Venezia Rocking and Rotary switches Collection



Interior Design: Pepe Leal – Photography: Benjamín Alcázar
Innenausstattung: Pepe Leal – Fotografie: Benjamín Alcázar
Дизайн интерьера: Pepe Leal – Фотографии: Benjamín Alcázar

Fitting installation.

10AX - 250V \sim mechanisms.

10/16A - 250V \sim earthing sockets.

Silver contacts with high breaking power.

Wooden, brass & porcelain frames.

Frames for vertical or horizontal installations.

Installation in standard box with screws.

Unterputzinstallation.

Mechanismen 10 AX - 250 V \sim

Steckdose 16 A - 250 V \sim

Hochbruchsichere Silberkontakte.

Rahmen aus Holz, Messing und Porzellan.

Rahmen für vertikale und horizontale Installation.

Installation in Universalgehäuse mit Schrauben.

Установка арматуры.

Механизмы 10 AX - 250 В \sim .

Розетки 16 А - 250 В \sim с заземлением.

Серебряные контакты с высокой мощностью
размыкания цепи.

Деревянные, медные и фарфоровые рамки.

Рамки для вертикальной и горизонтальной установки.

Установка в стандартную коробку с винтами.

VENEZIA ROCKING SWITCHES



Antique bronze key, square brown cover, antique bronze brass frame

Kipphebel Antikbronze, Abdeckung quadratisch, braun, Rahmen Messing in Antikbronzeeoptik
 Клавиша «античная бронза», квадратная коричневая накладка, медная рамка «античная бронза»



Square chrome-plated key, square metallic cover, satin nickel-plated brass frame

Kipphebel verchromt, quadratisch, Abdeckung quadratisch, metallisiert, Rahmen vernickeltes, satiniertes Messing
 Квадратная хромированная клавиша, квадратная накладка «металлик», глянцевая никелированная медная рамка



Antique bronze key, round brown cover, antique cooper brass frame

Kipphebel Antikbronze, Abdeckung rund, braun, Rahmen aus Messing in Antikkupferoptik
 Клавиша «античная бронза», круглая коричневая накладка, медная рамка «античная красная медь»



Golden key, round white cover, Oval walnut colored beech wood frame

Kipphebel vergoldet, Abdeckung rund, weiß, Holzrahmen oval, nussbraun

Золотистая клавиша, круглая белая накладка, овальная буковая рамка цвета «орех»



Antique bronze key, round white cover, Clásica sapelly wood frame

Kipphebel Antikbronze, Abdeckung rund, weiß, Holzrahmen klassisch, Sapelly

Клавиша «античная бронза», круглая белая накладка, деревянная рамка Clásica сапелли



Chrome-plated key, round white cover, Carré sapelly wood frame

Kipphebel verchromt, Abdeckung rund, weiß, Holzrahmen Carré Sapelly

Хромированная клавиша, круглая белая накладка, деревянная рамка Carré сапелли

VENEZIA ROTARY SWITCHES



Golden knob, square brown cover, golden brass frame

Knopf vergoldet, Abdeckung quadratisch, braun, Rahmen Messing vergoldet
Золотистая кнопка, квадратная коричневая накладка, золотистая медная рамка



Antique bronze knob, round brown cover, patinated cooper brass frame

Knopf Antikbronze, Abdeckung rund, braun, Rahmen Messing mit Kupferpatinierung
Кнопка «античная бронза», круглая коричневая накладка, медная рамка «черненная медь»



Wood knob, round white cover, Carré sapelly wood frame

Knopf Holz, Abdeckung rund, weiß, Holzrahmen Carré Sapelly
Деревянная кнопка, круглая белая накладка, деревянная рамка Carré сапелли



Golden knob, round white cover, Toscana walnut colored beech wood frame
Knopf vergoldet, Abdeckung rund, weiß, Holzrahmen Toscana nussbraun
Золотистая кнопка, круглая белая накладка, буковая рамка Toscana цвета «орех»











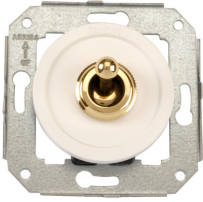



Golden knob, round white cover, green-gold wood frame
Knopf vergoldet, Abdeckung rund, weiß, Holzrahmen grün - vergoldet
Золотистая кнопка, круглая белая накладка, желто-зеленая деревянная рамка

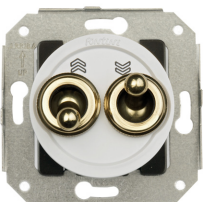

White porcelain knob, round white cover, grey - gold wood frame
Knopf Porzellan weiß, Abdeckung rund, weiß, Holzrahmen grau - vergoldet
Белая фарфоровая кнопка, круглая белая накладка, серо-желтая деревянная рамка

Venezia Rocking Switches
Collection

	Set Serie Серия	Code Code Код	Finish Finish Отделка	Packaging Verpackung Упаковка	
 <p>One pole switch 10AX - 250V~ Einpoliger Unterbrecherschalter 10 AX - 250 V~ Однополюсный выключатель 10 AX - 250 В~ Two-way switch 10AX - 250V~ Zweiwegschalter 10 AX - 250 V~ Двухпозиционный выключатель 10 AX - 250 В~ Crossing switch 10AX - 250V~ Kreuzschalter 10 AX - 250 V~ Перекрестный выключатель 10 AX - 250 В~ Two pole switch 10AX - 250V~ Zweipoliger Unterbrecherschalter 10 AX - 250 V~ Двухполюсный выключатель 10 AX - 250 В~ Rocking Pushbutton 10A - 250V~ 24V DC* Drucktaster Rocking 10 A - 250 V~ - 24 V DC* Кулисная нажимная кнопка 10 А - 250 В ~ 24 В пост. тока*</p>	65	306	See finishes Siehe Finishs См. варианты отделки	ref. 2 	
	65	308		ref. 2 	
	65	304		ref. 2 	
	65	314		ref. 2 	
	65	312		ref. 2 	
					ref. 2 
 <p>Double switch 10AX - 250V~ Doppelschalter 10 AX - 250 V~ Двойной выключатель 10 AX - 250 В~ Double two-way switch 10AX - 250V~ Zweiwegschalter doppelt 10 AX - 250 V~ Двойной двухпозиционный выключатель 10 AX - 250 В~ Rocking Double pushbutton 10A - 250V~ 24V DC* Doppelter Drucktaster Rocking 10 A - 250 V~ - 24 V DC* Совоенная нажимная кнопка 10 А - 250 В ~ 24 В пост. тока, кулисного типа*</p>	65	300	See finishes Siehe Finishs См. варианты отделки	ref. 2 	(*)Dimmer with pulsation control, using the 37347000 / 37346000 accessories (electronic dimmer 900 / 500W) from the page 50, every pushbutton could be used as electronic dimmer.
	65	302		ref. 2 	(*) Tastregler, mit den Accessoires 37347000 / 37346000 (elektronischer Dimmer für 900 / 500 W) von Seite 50 wird jeder Drucktaster zu einem elektronischen Intensitätsregler.
	65	345		ref. 2 	(*) Регулятор нажимного типа: используя вспомогательные устройства 37347000 / 37346000 (электронные диммеры 900 / 500Вт) со стр. 50, можно превратить любой нажимный выключатель в электронный регулятор освещенности.
					1 Unit Einheit единица
 <p>Electric blinds mechanism 10A 250 V~ Rocking (2.5 A for motors) (without blockage system). Installation requires the use of relays. Mechanismus für Rollläden 10 A 250 V~ Rocking (2,5 A für Motoren) (ohne Verriegelung). Die Installation erfordert ein Steuergerät. Механизм для штор с электроприводом 10 А 250 В ~, кулисный (2,5 А для электродвигателей) (без системы блокировки). Для установки требуется реле.</p>	65	342	See finishes Siehe Finishs См. варианты отделки	ref. 2 	

Mechanisms are combinable with Venezia frames and accessories
Kombinierbare Mechanismen mit Rahmen und Accessoires Venezia
Механизмы совместимы с рамками и аксессуарами серии Venezia



30.
Gold/White
Gold/Weiß
Золотистый/белый



59.
Antique bronze/White
Patiniert/Weiß
Античная бронза/белый



26.
Chrome-plated/White
Verchromt/Weiß
Хромированный/белый



54.
Golden/Brown
Gold/Braun
Золотистый/коричневый











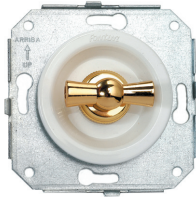

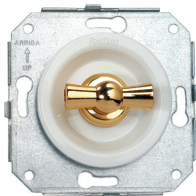

57.
Antique bronze/Brown
Patiniert/Braun
Античная бронза/коричневый

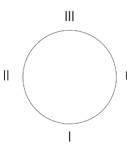

52.
Chrome-plated/Brown
Verchromt/Braun
Хромированный/коричневый

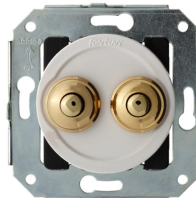
Venezia Rotary Switches Collection

	Set Serie Серия	Code Code Код	Finish Finish Отделка	Packaging Verpackung Упаковка	
	35	306	See finishes Siehe Finishs См. варианты отделки	ref. 2 	1 Unit Einheit единица
	35	308		ref. 2 	
	35	304		ref. 2 	
	35	314		ref. 2 	
	35	300	See finishes Siehe Finishs См. варианты отделк	ref. 2 	 <p>0 Both circuits Off I A circuit On II Both circuits On III B circuit On, A Off 0 Geschlossene Kreisläufe I Kreislauf A offen II Kreisläufe A und B offen III Kreislauf A geschlossen und B offen 0 Обе цепи выключены I Включена цепь A II Обе цепи включены III Цепь B включена, A выключена</p> <p>302 Position 0 depends on the position of the other two-way switch Die Position 0 variiert in Abhängigkeit der Position des anderen Schalters. Положение 0 зависит от положения второго двухпозиционного выключателя</p>
	35	302		ref. 2 	
	35	328			
	35	344			
	35	310	See finishes Siehe Finishs См. варианты отделк	ref. 2 	1 Unit Einheit единица
	35	316		ref. 2 	
	35	343	See finishes Siehe Finishs См. варианты отделк	ref. 2 	<p>(*)Dimmer with pulsation control, using the 37347000 / 37346000 accessories (electronic dimmer 900 / 500W) from the page 50, every pushbutton could be used as electronic dimmer.</p> <p>(*) Tastregler, mit den Accessoires 37347000 / 37346000 (elektronischer Dimmer für 900 / 500 W) von Seite 50 wird jeder Drucktaster zu einem elektronischen Intensitätsregler.</p> <p>(*) Регулятор нажимного типа: используя вспомогательные устройства 37347000 / 37346000 (электронные диммеры 900 / 500Вт) со стр. 50, можно превратить любой нажимный выключатель в электронный регулятор освещенности.</p>



Set Serie Серия	Code Code Код	Finish Finish Отделка	Packaging Verpackung Упаковка
--------------------	------------------	--------------------------	----------------------------------

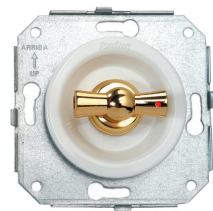

Electric blinds mechanism 10A - 250V~
for 1.66 A motors
Mechanismus für Rollläden 10 A - 250 V~
für Motoren 1,66 A
Механизм для штор с электроприводом 10 A - 250 В~
для электродвигателей 1,66 А

35

342

See finishes
Siehe Finishes
См. варианты
отделки

ref. 2

1 Unit Einheit единица



Card switch mechanism
with luminous indicator
Kartenschalter
mit Leuchanzeige
Механизм карточного
выключателя
со светящимся инди-
катором

Switch two way switch 1 micro
6A-250V~
Unterbrecher-Wechselschalter
1 Mikroschalter 6 A-250 V~
Двухпозиционный выключа-
тель, 1 микропрерыватель
6 А - 250 В~
Switch two way switch 2 micro
6A-250V~
Unterbrecher-Wechselschalter
2 Mikroschalter 6 A-250 V~
Двухпозиционный выключатель,
2 микропрерывателя, 6 А-250 В~

37

935

05 White
Weiß
Белый
03 Brown
Braun
Коричневый

ref. 2

ref. 2

Installation with relays is recommended
Es wird eine Installation mit Relais empfohlen
При установке рекомендуется
использовать реле

1 Unit Einheit единица



Luminous marker 230V~ white - green - red
Leuchtschalter 230 V~ weiß - grün - rot
Светящийся маркер 230 В~ белый - зеленый - красный

Luminous marker 12/24V DC white - green - red
Leuchtschalter 12/24 V DC weiß - grün - rot
Светящийся маркер 12/24 В пост. тока, белый -
зеленый - красный

Emergency marker 230V~
Notfall-Leuchtschalter 230 V~
Маркер для экстренных ситуаций 230 В~

35

755

05 White
Weiß
Белый
03 Brown
Braun
Коричневый

ref. 2

ref. 2

ref. 2

1 Unit Einheit единица

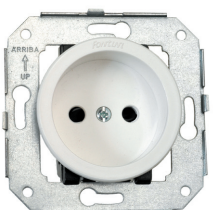

Socket outlet 2 pole without earth 16A - 250V~
with shutters
Steckdose 16 A - 250 V~ mit Einsteckschutz
Розетка двухполюсная без заземления 16 А - 250 В~
со шторками

35

209

05 White
Weiß
Белый
03 Brown
Braun
Коричневый

ref. 2

Only for replacement
Nur für Ersatz
Только для замены

1 Unit Einheit единица



German 2 pole socket with Earth 16A - 250V~
with shutters
Schuko-Steckdose mit Einsteckschutz
16A - 250 V~
Немецкая двухполюсная розетка с заземлением 16
А - 250 В~
со шторками

35

212

05 White
Weiß
Белый
03 Brown
Braun
Коричневый

ref. 2

1 Unit Einheit единица

FINISH FINISH ОТДЕЛКА



59.
Antique bronze/White
Patiniert/Weiß
Античная бронза/белый



57.
Antique bronze/Brown
Patiniert/Braun
Античная бронза/
коричневый















25.
Nickel-plated/White
Vernickelt/Weiß
Никелированный/
белый



52.
Nickel-plated/Brown
Vernickelt/Braun
Никелированный/
коричневый



23.
Retro/White
Retro/Weiß
Ретро/белый









		Set Serie Серия	Code Code Код	Finish Finish Отделка	Packaging Verpackung Упаковка	
	French 2 poles socket with earth pin 16A - 250V~ with shutters Steckdose mit französischem Erdungsstift 16 A - 250 V~ mit Einsteckschutz Французская двухполюсная розетка с контактом заземления 16 A - 250 В~, со шторками	35	208	05 White Weiß Белый 03 Brown Braun Коричневый	ref. 2 	
						1 Unit Einheit единица
	6 ways double telephone socket Telefonsteckdose doppelt 6-polig 6-контактная двухместная телефонная розетка	35	706	05 White Weiß Белый 03 Brown Braun Коричневый	ref. 2 	
						1 Unit Einheit единица
	Double socket 6 RJ45 CAT Doppelsteckdose RJ45 CAT6 Двухместная розетка 6 RJ45 CAT 6 ways telephone + 6 RJ45 CAT socket Telefonsteckdose 6-polig + RJ45 CAT6 6-контактная телефонная розетка+ 6 RJ45 CAT	35 35	707 708	05 White Weiß Белый 03 Brown Braun Коричневый	ref. 2 	
						1 Unit Einheit единица
	R/TV and SAT sockets outlets R/TV-Steckdosen SAT-Signal entzerrt R/TV и SAT розетки С усилителем сигнала	35	712	05 White Weiß Белый	ref. 2 	
	Single socket Einfachsteckdose Одноместная розетка	35	713	03 Brown Braun Коричневый	ref. 2 	
	Intermediate A Durchgangsdose A Промежуточная A	35	714		ref. 2 	
	Intermediate B Durchgangsdose B Промежуточная B	35	711		ref. 2 	
	Final socket Enddose Prise finale	35	715		ref. 2 	
	Only cover Nur Deckel Только накладка	35			ref. 2 	See technical information at page 107. Siehe technische Hinweise auf Seite 107. См. технические данные на стр. 107.
						1 Unit Einheit единица

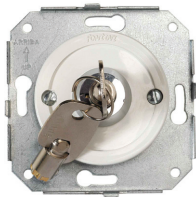

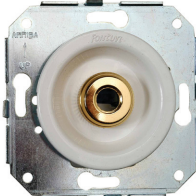
	Set Serie Серия	Code Code Код	Finish Finish Отделка	Packaging Verpackung Упаковка	
 <p>Dimmer two-way switch power 40-500W (for incandescence and halogen bulbs) Dimmerschalter Leistung 40 - 500 W Двухпозиционный переключатель регулирования освещенности, мощность 40-500 Вт (для ламп накаливания и галогеновых ламп)</p>	35	332	05 White Weiß Белый 03 Brown Braun Коричневый	ref. 2 	See technical information at page 104. Siehe technische Hinweise auf Seite 104. См. технические данные на стр. 104.
					1 Unit Einheit единица
 <p>Dimmer for motors 6A-250V~ Motorenregler 6A - 250 V~ Реостат для электромоторов 6 А-250 В~</p>	35	331	05 White Weiß Белый 03 Brown Braun Коричневый	ref. 2 	
					1 Unit Einheit единица
 <p>Floor heating thermostat with sensor cable Heizungsthermostat für Bodenheizung, einschließlich Sonde Термостат подогрева пола с кабелем датчика</p>	37	721	05 White Weiß Белый	ref. 2 	Install only on special frame for square elements ref. 35-821.., 36-821.., 36-831.., 38-821.., 31-821.. Nur in Spezialrahmen für quadratische Elemente installieren Art.-Nr. 35-821.., 36-821.., 36-831.., 38-821.., 31-821.. Устанавливать только на специальную рамку для квадратных элементов см. 35-821.., 36-821.., 36-831.., 38-821.., 31-821..
 <p>Room temperature thermostate Raumtemperatur-Thermostat Термостат регулировки температуры в помещении</p>	37	722	03 Brown Braun Коричневый	ref. 2 	
					1 Unit Einheit единица
 <p>Presence and sound detector 180° Schall- und Präsenzmelder 180° Детектор присутствия и звука 180°</p>	37	750	05 White Weiß Белый 50 Metallic Metallisiert Металлик	ref. 2 	Install only on special frame for square elements ref. 35-821.., 36-821.., 36-831.., 38-821.., 31-821.. Nur in Spezialrahmen für quadratische Elemente installieren Art.-Nr. 35-821.., 36-821.., 36-831.., 38-821.., 31-821.. Устанавливать только на специальную рамку для квадратных элементов см. 35-821.., 36-821.., 36-831.., 38-821.., 31-821..
					1 Unit Einheit единица

FINISH FINISH ОТДЕЛКА



	Set Serie Серия	Code Code Код	Finish Finish Отделка	Packaging Verpackung Упаковка	
	35	906	05 White Weiß Белый 03 Brown Braun Коричневый	ref. 2 	1 Unit Einheit единица
	35	927	See finishes Siehe Finishes См. варианты отделки	ref. 2 	1 Unit Einheit единица
	35	656	05 White Weiß Белый 03 Brown Braun Коричневый	ref. 2 	1 Unit Einheit единица
	35	924	05 White Weiß Белый 03 Brown Braun Коричневый	ref. 2 	See technical information at page 110. Siehe technische Hinweise auf Seite 110. См. технические данные на стр. 110. 1 Unit Einheit единица



30.
Gold/White
Gold/Weiß
Золотистый/белый





16.
Wood/White
Holz/Weiß
Дерево/белый







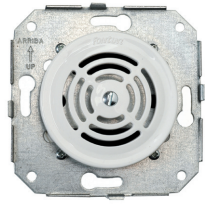

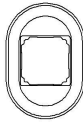

17.
Porcelain/White
Porzellan/Weiß
Фарфор/белый



54.
Gold/Brown
Gold/Braun
Золотистый/коричневый

	Set Serie Серия	Code Code Код	Finish Finish Отделка	Packaging Verpackung Упаковка	
	35	925	05 White Weiß Белый 03 Brown Braun Коричневый	ref. 2 	See technical information at page 110. Siehe technische Hinweise auf Seite 110. См. технические данные на стр. 110. 1 Unit Einheit единица
	35	926	05 White Weiß Белый 03 Brown Braun Коричневый	ref. 2 	See technical information at page 110. Siehe technische Hinweise auf Seite 110. См. технические данные на стр. 110. 1 Unit Einheit единица
	35	905	05 White Weiß Белый 03 Brown Braun Коричневый	ref. 2 	1 Unit Einheit единица
	35	390	05 White Weiß Белый 03 Brown Braun Коричневый	ref. 2 	1 Unit Einheit единица

	Set Serie Серия	Code Code Код	Finish Finish Отделка	Packaging Verpackung Упаковка	
 	35	801	See finishes Siehe Finishs См. варианты отделки	ref. 2 	
	35	821	See finishes Siehe Finishs См. варианты отделки	ref. 2 	1 Unit Einheit единица
	35	802	See finishes Siehe Finishs См. варианты отделки	ref. 2 	1 Unit Einheit единица
	35	803	See finishes Siehe Finishs См. варианты отделки	ref. 2 	<p>Possible custom-made finishes with natural wood frames Kundenspezifisches Finish der Rahmen in Naturholz möglich Возможно использование покрытия по заказу покупателя с рамками из натурального дерева</p>
	35	804	See finishes Siehe Finishs См. варианты отделки	ref. 2 	<p>Sapelly wood frames are traditional finished. Treated with colourless varnish they keep their natural beauty. Each piece is exclusive and never presents the same evenness as a plastic product. It is unique and different depending on the wood cut and its wood grain. Die Rahmen aus Sapelly-Holz werden von Hand bearbeitet und mit transparentem Lack behandelt, damit sie ihre natürliche Schönheit beibehalten. Jedes Stück ist daher ein exklusives Einzelstück und hebt sich von der Gleichförmigkeit von Kunststoffprodukten ab. Der Zuschnitt des Holzes und die Maserung machen jedes Stück einzigartig. Рамки из дерева сапелли имеют традиционное покрытие. Они обра- ботаны бесцветным лаком, что позволяет сохранить естественную красоту материала. Каждое изделие, в отличие от пластиковой про- дукции, уникально и неповторимо. Это объясняется тем, что каждый срез дерева и его текстура имеют индивидуальный рисунок.</p>
					1 Unit Einheit единица

FINISH FINISH ОТДЕЛКА



20.
Beech Walnut Colored
Buche Farbe Nussbaum
Цвет - бук/орех



16.
Sapelly
Sapelly
Сапелли











15.
Beech Oak Colored
Buche Farbe Eiche
Цвет - бук/дуб













00.
Natural Beech
Buche natur
Натуральный бук



05.
Beech White lacquered
Buche weiß lackiert
Бук белый лакированный









	Set Serie Серия	Code Code Код	Finish Finish Отделка	Packaging Verpackung Упаковка	
 	36	801	See finishes Siehe Finishs См. варианты отделки	ref. 2 	
	36	821		ref. 2 	
	36	802	See finishes Siehe Finishs См. варианты отделки	ref. 2 	1 Unit Einheit единица
	36	803	See finishes Siehe Finishs См. варианты отделки	ref. 2 	<p>Possible custom-made finishes with natural wood frames Kundenspezifisches Finish der Rahmen in Naturholz möglich Возможно использование покрытия по заказу покупателя с рамками из натурального дерева</p>
	36	804	See finishes Siehe Finishs См. варианты отделки	ref. 2 	<p>Sapelly wood frames are traditional finished. Treated with colourless varnish they keep their natural beauty. Each piece is exclusive and never presents the same evenness as a plastic product. It is unique and different depending on the wood cut and its wood grain. Die Rahmen aus Sapelly-Holz werden von Hand bearbeitet und mit transparentem Lack behandelt, damit sie ihre natürliche Schönheit beibehalten. Jedes Stück ist daher ein exklusives Einzelstück und hebt sich von der Gleichförmigkeit von Kunststoffprodukten ab. Der Zuschnitt des Holzes und die Maserung machen jedes Stück einzigartig. Рамки из дерева сапелли имеют традиционное покрытие. Они обработаны бесцветным лаком, что позволяет сохранить естественную красоту материала. Каждое изделие, в отличие от пластиковой продукции, уникально и неповторимо. Это объясняется тем, что каждый срез дерева и его текстура имеют индивидуальный рисунок.</p>
					1 Unit Einheit единица

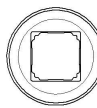







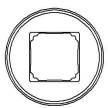

	Set Serie Серия	Code Code Код	Finish Finish Отделка	Packaging Verpackung Упаковка		
 	1 element frame Rahmen 1 Element Одноместная рамка 90x90x12 mm	36	811	See finishes Siehe Finishes См. варианты отделки	ref. 2 	
	Special frame for 1 square element (use with refs 37 721., 37 722., 37 750.) Spezialrahmen für 1 quadratisches Element (für Art.-Nr. 37 721., 37 722., 37 750.) Специальная рамка для 1 квадратного эле- мента (использовать с поз. 37 721., 37 722., 37 750.)	36	831		ref. 2 	1 Unit Einheit единица
	2 elements frame Rahmen 2 Elemente Двухместная рамка 175x90x12 mm	36	812	See finishes Siehe Finishes См. варианты отделки	ref. 2 	1 Unit Einheit единица
	3 elements frame Rahmen 3 Elemente Трехместная рамка 245x90x12 mm	36	813	See finishes Siehe Finishes См. варианты отделки	ref. 2 	Possible custom-made finishes with natural wood frames Kundenspezifisches Finish der Rahmen in Naturholz möglich Возможно использование покрытия по заказу покупателя с рамками из натурального дерева
	4 elements frame Rahmen 4 Elemente Четырехместная рамка 316x90x12 mm	36	814	See finishes Siehe Finishes См. варианты отделки	ref. 2 	Sapelly wood frames are traditional finished. Treated with colourless varnish they keep their natural beauty. Each piece is exclusive and never presents the same evenness as a plastic product. It is unique and different depending on the wood cut and its wood grain. Die Rahmen aus Sapelly-Holz werden von Hand bearbeitet und mit transparentem Lack behandelt, damit sie ihre natürliche Schönheit beibehalten. Jedes Stück ist daher ein exklusives Einzelstück und hebt sich von der Gleichförmigkeit von Kunststoffprodukten ab. Der Zuschnitt des Holzes und die Maserung machen jedes Stück einzigartig. Рамки из дерева сапелли имеют традиционное покрытие. Они обработаны бесцветным лаком, что позволяет сохранить естественную красоту материала. Каждое изделие, в отличии от пластиковой продукции, уникально и неповторимо. Это объясняется тем, что каждый срез дерева и его текстура имеют индивидуальный рисунок.

FINISH FINISH ОТДЕЛКА

16.
Sapelly
Sapelly
Сапелли00.
Natural Beech
Buche natur
Натуральный бук

	Set Serie Серия	Code Code Код	Finish Finish Отделка	Packaging Verpackung Упаковка	
 	38	801	20 00	ref. 2 	
	38	821	20 00	ref. 2 	
	38	802	20 00	ref. 2 	1 Unit Einheit единица
	38	803	20 00	ref. 2 	1 Unit Einheit единица
	38	804	20 00	ref. 2 	Possible custom-made finishes with natural wood frames Kundenspezifisches Finish der Rahmen in Naturholz möglich Возможно использование покрытия по заказу покупателя с рамками из натурального дерева
					1 Unit Einheit единица



	Set Serie Серия	Code Code Код	Finish Finish Отделка	Packaging Verpackung Упаковка	
 	31	801	See finishes Siehe Finishes См. варианты отделки	ref. 2 	
	31	821		ref. 2 	
	31	802	See finishes Siehe Finishes См. варианты отделки	ref. 2 	1 Unit Einheit единица
	31	803	See finishes Siehe Finishes См. варианты отделки	ref. 2 	Possible custom-made finishes with natural wood frames Kundenspezifisches Finish der Rahmen in Naturholz möglich Возможно использование покрытия по заказу покупателя с рамками из натурального дерева
	31	804	See finishes Siehe Finishes См. варианты отделки	ref. 2 	Sapelly wood frames are traditional finished. Treated with colourless varnish they keep their natural beauty. Each piece is exclusive and never presents the same evenness as a plastic product. It is unique and different depending on the wood cut and its wood grain. Die Rahmen aus Sapelly-Holz werden von Hand bearbeitet und mit transparentem Lack behandelt, damit sie ihre natürliche Schönheit beibehalten. Jedes Stück ist daher ein exklusives Einzelstück und hebt sich von der Gleichförmigkeit von Kunststoffprodukten ab. Der Zuschnitt des Holzes und die Maserung machen jedes Stück einzigartig. Рамки из дерева сапелли имеют традиционное покрытие. Они обработаны бесцветным лаком, что позволяет сохранить естественную красоту материала. Каждое изделие, в отличии от пластиковой продукции, уникально и неповторимо. Это объясняется тем, что каждый срез дерева и его текстура имеют индивидуальный рисунок.
					1 Unit Einheit единица

FINISH FINISH ОТДЕЛКА



19.
Honey wood
Holz Honigfarbe
Дерево цвета
«мёд»



21.
Old wood
Holz gealtert
Старое дерево



00.
Natural beech wood
Naturholz
Натуральный бук



33.
Green-gold wood
Holz grün/gold
Желто-зеленое дерево







35.
White-blue wood
Holz weiß/blau
Бело-синее дерево





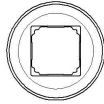



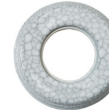

34.
Black silver-plated wood
Holz schwarz/silber
Черное дерево



36.
Grey-gold wood
Holz grau/gold
Желто-серое дерево

	Set Serie Серия	Code Code Код	Finish Finish Отделка	Packaging Verpackung Упаковка	
 	31	801	See finishes Siehe Finishs См. варианты отделки	ref. 2 	
	31	821			1 Unit Einheit единица
	31	802	See finishes Siehe Finishs См. варианты отделки	ref. 2 	1 Unit Einheit единица
	31	803	See finishes Siehe Finishs См. варианты отделки	ref. 2 	1 Unit Einheit единица



		Set Serie Серия	Code Code Код	Finish Finish Отделка	Packaging Verpackung Упаковка	
	1 element frame Rahmen 1 Element Одноместная рамка 125x91x12 mm	39	801	See finishes Siehe Finishes См. варианты отделки	ref. 2 	1 Unit Einheit единица
	2 elements frame Rahmen 2 Elemente Двухместная рамка 181,5x91x12 mm	39	802	See finishes Siehe Finishes См. варианты отделки	ref. 2 	1 Unit Einheit единица
	3 elements frame Rahmen 3 Elemente Трехместная рамка 253x91x12 mm	39	803	See finishes Siehe Finishes См. варианты отделки	ref. 2 	1 Unit Einheit единица
	4 elements frame Rahmen 4 Elemente Четырехместная рамка 324x91x12 mm	39	804	See finishes Siehe Finishes См. варианты отделки	ref. 2 	1 Unit Einheit единица

FINISH FINISH ОТДЕЛКА



50. Golden
Gold
Золотой



53. Antikbrunze
Antikbrunze
Античная бронза



51. Satin nickel-plated
Nickel satiniert
Глянцевый
никелированный



62. Patinated cooper
Kupfer patiniert
Черная медь



46. Antikcooper
Antikkupfer
Античная
красная медь



49. Anthracite
Anthrazit
Антрацит



New F-37 Rotary mechanism + New Venezia metal frame (for F-37)
Neuer Mechanismus Rotary F-37 + neuer Rahmen Venezia Metall (für F-37)
Новый поворотный механизм F-37 + новая металлическая рамка Venezia (для F-37)

New metal Venezia frames to install with F-37 mechanisms and accessories, Rocking and Rotary systems









Important note: These frames can not be installed with the mechanisms and accessories of the Venezia collection (round cover). They only can be installed with the references that appear on the pages 12-21 (F-37 square cover).

Neue Rahmen Venezia Metall zum Installieren mit Mechanismen und Accessoires von F-37 Rocking & Rotary

Wichtiger Hinweis: Diese Rahmen können nicht mit den Mechanismen und Accessoires der Reihe Venezia (runde Abdeckung) installiert werden. Können nur mit den Artikelnummern installiert werden, die auf den Seiten 12-21 angegeben sind (F-37 quadratische Abdeckung).

Новые металлические рамки Venezia для установки на механизмы и аксессуары F-37, кулисные и поворотные системы

Важное примечание: эти рамки не устанавливаются с механизмами и аксессуарами из коллекции Venezia (с круглой накладкой). Их можно устанавливать только с изделиями, на которые имеются ссылки на страницах 12-21 (с квадратной накладкой F-37).

		Set Serie Серия	Code Code Код	Finish Finish Отделка	Packaging Verpackung Упаковка	
	1 element frame Rahmen 1 Element Одноместная рамка 125x91x12 mm	39	821	See finishes Siehe Finishes См. варианты отделки	ref. 2 	1 Unit Einheit единица
	2 elements frame Rahmen 2 Elemente Двухместная рамка 181,5x91x12 mm	39	822	See finishes Siehe Finishes См. варианты отделки	ref. 2 	1 Unit Einheit единица
	3 elements frame Rahmen 3 Elemente Трехместная рамка 253x91x12 mm	39	823	See finishes Siehe Finishes См. варианты отделки	ref. 2 	1 Unit Einheit единица
	4 elements frame Rahmen 4 Elemente Четырехместная рамка 324x91x12 mm	39	824	See finishes Siehe Finishes См. варианты отделки	ref. 2 	1 Unit Einheit единица

FINISH FINISH ОТДЕЛКА

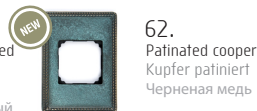
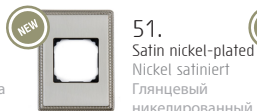
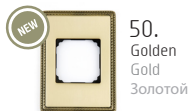



Interior Design: Carmen Barasona
Innenausstattung: Carmen Barasona
Дизайн интерьера: Carmen Barasona

Collection Garby Colonial



Interior Design: Carmen Barasona
Innenausstattung: Carmen Barasona
Дизайн интерьера: Carmen Barasona

Fitting installation.
10AX - 250V[~] mechanisms.
10/16A - 250V[~] earthing sockets.
Silver contacts with high breaking power.
Manufactured with porcelain and technical thermoplastic materials.
Wood and porcelain frames, possible custom-made finishes with natural wood frames.
Frames for vertical or horizontal installations, fitted in universal boxes.

Unterputzinstallation.
Mechanismen 10 AX - 250 V[~]
Steckdose 16 A - 250 V[~]
Hochbruchsichere Silberkontakte.
Aus Porzellan und technischen Kunststoffen gefertigt.
Holz- und Porzellanrahmen, mit Möglichkeit zur Personalisierung mit Naturrahmen.
Rahmen für vertikale und horizontale Installation.

Установка арматуры.
Механизмы 10 AX - 250 В[~].
Розетки 16 А - 250 В[~] с заземлением.
Серебряные контакты с высокой мощностью размыкания цепи.
Изготовлены из фарфора и технических термoplastов.
Возможно создание покрытия по индивидуальному заказу покупателя
с рамками из натурального дерева.
Рамки для вертикальной и горизонтальной установки, вставленные в универсальные короба.

Garby Colonial Collection



White porcelain knob - old wood frame

Knopf Porzellan weiß - Rahmen Holz gealtert

Кнопка из белого фарфора – рамка «старое дерево»



Honey wood knob - honey wood frame

Knopf Holz Honigfarbe - Rahmen Honigfarbe

Деревянная кнопка цвета «мёд» – деревянная рамка цвета «мёд»



Old wood knob - old wood frame

Knopf Holz gealtert - Rahmen Holz gealtert

Кнопка «старое дерево» – рамка «старое дерево»



White porcelain knob, grey - gold wood frame

Knopf Porzellan weiß - Rahmen grau/gold

Кнопка из белого фарфора, серо-желтая деревянная рамка



White porcelain retro knob, white - blue wood frame

Knopf Retro Porzellan weiß - Rahmen weiß/blau

Кнопка «ретро» из белого фарфора, рамка из белого-синего фарфора



White porcelain knob, green - gold wood frame

Knopf Porzellan weiß - Rahmen grün/gold

Кнопка из белого фарфора, желто-зеленая деревянная рамка



White porcelain knob - craquelé porcelain frame

Knopf Porzellan weiß - Rahmen Craquelée-Porzellan
Кнопка из белого фарфора – рамка из фарфора с эффектом «кракле»



White porcelain knob - decor porcelain frame

Knopf Porzellan weiß - Rahmen Porzellan mit Dekor
Кнопка из белого фарфора – рамка из декоративного фарфора



White porcelain retro knob - white porcelain frame

Knopf Retro Porzellan weiß - Rahmen Porzellan weiß
Кнопка «ретро» из белого фарфора – рамка из белого фарфора



Black porcelain knob - black porcelain frame

Knopf Porzellan schwarz - Rahmen Porzellan schwarz
Кнопка из черного фарфора – рамка из черного фарфора



Black retro porcelain knob - black porcelain frame















Knopf Retro Porzellan schwarz - Rahmen Porzellan schwarz
Кнопка «ретро» из черного фарфора – рамка из черного фарфора

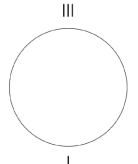

Old wood knob - black porcelain frame

Knopf Holz gealtert - Rahmen Porzellan schwarz
Кнопка «старое дерево» – рамка из черного фарфора

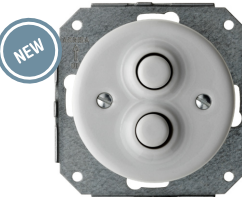
Garby Colonial Collection

	Set Serie Серия	Code Code Код	Finish Finish Отделка	Packaging Verpackung Упаковка		
	31	306	See finishes Siehe Finishs См. варианты отделки	ref. 2 	1 Unit Einheit единица	
	31	308		ref. 2 		
	31	304		ref. 2 		
	31	314		ref. 2 		
	31	300	See finishes Siehe Finishs См. варианты отделки	ref. 2 	0 position depends on the position of the other two-way switch Die Position 0 variiert in Abhängigkeit der Position des anderen Schalters. II Положение 0 зависит от положения второго двухпозиционного выключателя	
	31	302				 <ul style="list-style-type: none"> 0 Both circuits Off I A circuit On II Both circuits On III B circuit On, A Off 0 Geschlossene Kreisläufe I Kreislauf A offen II Kreisläufe A und B offen II Kreislauf A geschlossen und B offen 0 Обе цепи выключены I Включена цепь A II Обе цепи включены III Цепь B включена, A выключена
	31	328				
	31	344				
	31	310	17 27	ref. 2 	1 Unit Einheit единица	
	31	316		ref. 2 		
	31	343	25 Nickel-plated nuts Muffern vernickelt Никелированные гайки	ref. 2 	(*)Dimmer with pulsation control, using the 37347000 / 37346000 accessories (electronic dimmer 900 / 500W) from the page 50, every pushbutton could be used as electronic dimmer. (*) Tastregler, mit den Accessoires 37347000 / 37346000 (elektronischer Dimmer für 900 / 500 W) von Seite 50 wird jeder Drucktaster zu einem elektronischen Intensitätsregler. (*) Регулятор нажимного типа: используя вспомогательные устройства 37347000 / 37346000 (электронные диммеры 900 / 500Вт) со стр. 50, можно превратить любой нажимный выключатель в электронный регулятор освещенности.	



17. White porcelain
Porzellan weiß
Белый фарфор



18. White porcelain/Honey wood
Porzellan weiß/Holz Honigfarbe
Белый фарфор/дерево цвета «мёд»















27. Black porcelaine
Porzellan schwarz
Черный фарфор



28. Black retro porcelain
Porzellan Retro schwarz
Черный фарфор «ретро»

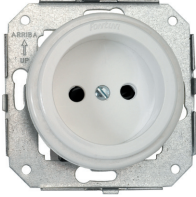

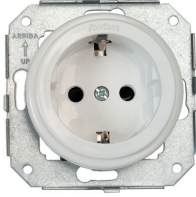
29. Black porcelain/Old wood
Porzellan schwarz/Holz gealtert
Черный фарфор/старое дерево

		Set Serie Серия	Code Code Код	Finish Finish Отделка	Packaging Verpackung Упаковка	
	Electric blinds mechanism 10A - 250V~ (for 1.66A motors) Mechanismus für Rollläden 10 A - 250 V~ (für Motoren 1,66 A) Механизм для штор с электроприводом 10 А - 250 В~ (для электродвигателей 1,66 А)	31	342	See finishes Siehe Finishs См. варианты отделки	ref. 2 	
	Card switch with luminous indicator Mechanismus für Karten mit Leuchtanzeige Карточный выключатель со светящимся индикатором	37	935	05 White Weiß Белый	ref. 2 	Installation with relays is recommended Es wird eine Installation mit Relais empfohlen При установке рекомендуется использовать реле
	Switch - Two way switch 1 microruptor 6A-250V~ Unterbrecher-Wechselschalter 1 Mikroschalter 6 A-250 V~ Выключатель - двухпозиционный выключатель 1 микропрерыватель 6 А-250 В~	37	936		ref. 2 	
	Luminous marker 230V~ white - green - red Leuchtschalter 230 V~ weiß - grün - rot Светящийся маркер 230 В~ белый - зеленый - красный	35	755	05 White Weiß Белый	ref. 2 	1 Unit Einheit единица
	Luminous marker 12/24V DC white - green - red Leuchtschalter 12/24 V DC weiß - grün - rot Светящийся маркер 12/24 В пост. тока, белый - зеленый - красный	35	756		ref. 2 	
	Emergency marker 230V~ Notfall-Leuchtschalter 230 V~ Маркер для экстренных ситуаций 230 В~	35	760		ref. 2 	
	Plastic two-pole socket outlet without earth 16A - 250V~ with shutters Steckdose 16 A - 250 V~ aus Kunststoff mit Einsteckschutz Пластиковая двухполюсная розетка без заземления 16 А - 250 В~ со шторками	31	209	05 White Weiß Белый 02 Black Schwarz Черный	ref. 2 	Only for replacement Nur für Ersatz Только для замены
	Plastic two-pole socket with earth 16A - 250V~ with shutters Schuko-Steckdose aus Kunststoff 16 A - 250 V~ mit Einsteckschutz Пластиковая двухполюсная розетка с заземлением 16 А - 250 В~ со шторками	31	212	05 White Weiß Белый 02 Black Schwarz Черный	ref. 2 	1 Unit Einheit единица











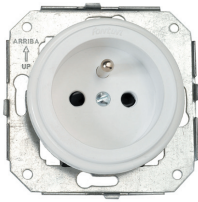





21.
White porcelain/Old wood
Porzellan weiß/Holz gealtert
Белый фарфор/старое дерево



23.
White retro porcelain
Porzellan Retro weiß
Белый фарфор „ретро“

Garby Colonial Collection

	Set Serie Серия	Code Code Код	Finish Finish Отделка	Packaging Verpackung Упаковка	
	31	208	05 White Weiß Белый 02 Black Schwarz Черный	ref. 2  ref. 2 	1 Unit Einheit единица
	31	209	17 White porcelain Porzellan weiß Белый фарфор 27 Black porcelain Porzellan schwarz Черный фарфор	ref. 2  ref. 2 	1 Unit Einheit единица
	31	212	17 27	ref. 2  ref. 2 	1 Unit Einheit единица
	31	208	17 27	ref. 2  ref. 2 	1 Unit Einheit единица
	31	706	12 27	ref. 2  ref. 2 	1 Unit Einheit единица



17. White porcelain
Porzellan weiß
Белый фарфор



18. White porcelain/Honey wood
Porzellan weiß/Holz Honigfarbe
Белый фарфор/дерево цвета "мёд"



















27. Black porcelain
Porzellan schwarz
Черный фарфор



28. Black retro porcelain
Porzellan Retro schwarz
Черный фарфор "ретро"

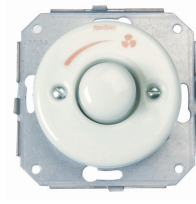

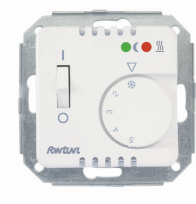
29. Black porcelain/Old wood
Porzellan schwarz/Holz gealtert
Черный фарфор/старое дерево

		Set Serie Серия	Code Code Код	Finish Finish Отделка	Packaging Verpackung Упаковка	
	Double RJ45 CAT 6 socket Doppelsteckdose RJ45 CAT 6 Двухместная розетка RJ45 CAT 6 CAT	31	707	17 White porcelain Porzellan weiß Белый фарфор	ref. 2 	1 Unit Einheit единица
	6 ways telephone + 6 RJ45 CAT socket Telefonsteckdose 6-polig + RJ45 CAT6 6-контактная телефонная розетка + 6 RJ45 CAT			27 Black porcelain Porzellan schwarz Черный фарфор	ref. 2 	
					ref. 2 	
	R/TV and SAT sockets outlets R/TV-Steckdosen SAT-Signal entzerrt R/TV и SAT розетки С усилителем сигнала	35	712	05 White Weiß Белый	ref. 2 	See technical information at page 107. Siehe technische Daten auf Seite 107. См. технические данные на стр. 107.
	Single socket Einfachsteckdose Одноместная розетка	35	713	02 Black Schwarz Черный	ref. 2 	
	Intermediate A Durchgangsdose A Промежуточная A	35	714		ref. 2 	
	Intermediate B Durchgangsdose B Промежуточная B	35	711		ref. 2 	
	Final socket Enddose Оконечная розетка	35	715		ref. 2 	
	Dimmer two-way switch power 40-500W (for incandescence and halogen bulbs) Dimmerschalter Leistung 40 - 500 W (Glüh- und Halogenlampen) Двухпозиционный переключатель регулирования освещенности, мощность 40-500 Вт (для ламп накаливания и галогеновых ламп)	31	332	17 White porcelain Porzellan weiß Белый фарфор	ref. 2 	1 Unit Einheit единица
				27 Black porcelain Porzellan schwarz Черный фарфор	ref. 2 	
	Dimmer for motors 6A-250V~ Motorenregler 6A - 250 V~ Реостат для электромоторов 6 А-250 В~	31	331	17 27	ref. 2 	1 Unit Einheit единица
	Floor heating thermostate with sensor cable Thermostat für Bodenheizung, einschließlich Sonde Термостат подогрева пола с кабелем датчика	37	721	05 White Weiß Белый	ref. 2 	Install only on special frame for square elements ref. 31-821.. Nur in Spezialrahmen für quadratische Elemente installieren, Art.-Nr. 31-821.. Устанавливать только на специальную рамку для квадратных элементов, см. 31-821..
	Room temperature thermostate Raumtemperatur-Thermostat Термостат регулировки температуры в помещении	37	722		ref. 2 	





21.
White porcelain/Old wood
Porzellan weiß/Holz gealtert
Белый фарфор/старое дерево



23.
White retro porcelain
Porzellan Retro weiß
Белый фарфор "ретро"

Garby Colonial Collection

	Set Serie Серия	Code Code Код	Finish Finish Отделка	Packaging Verpackung Упаковка	
	37	750	05	ref. 2 	<p>Presence and sound detector 180° Schall- und Präsenzmelder 180° Детектор присутствия и звука 180°</p> <p>Install only on special frame for square elements ref. 31-821. Nur in Spezialrahmen für quadratische Elemente installieren, Art.-Nr. 31-821.. Устанавливать только на специальную рамку для квадратных элементов, см. 31-821..</p>
	31	906	05 White Weiß Белый	ref. 2 	<p>Switch mechanism with key Unterbrecherschalter mit Schlüssel Механизм переключения с ключом</p>
	31	927	17 White porcelain Porzellan weiß Белый фарфор 27 Black porcelain Porzellan schwarz Черный фарфор	ref. 2 	<p>Cable outlet cover Abdeckung Kabelausgang Крышка кабельного вывода</p>
	31	656	17 27	ref. 2 	<p>Blind cover Blindabdeckung Щиток</p>
	31	924	17 27	ref. 2 	<p>Potentiometer for volume regulation Potentiometer für die Lautstärkenregelung Потенциометр регулировки громкости</p> <p>See technical notes at page 110. Siehe technische Hinweise auf Seite 110. См. технические данные на стр. 110.</p>

1 Unit Einheit единица

1 Unit Einheit единица

1 Unit Einheit единица

1 Unit Einheit единица

1 Unit Einheit единица



17. White porcelain
Porzellan weiß
Белый фарфор



18. White porcelain/Honey wood
Porzellan weiß/Holz Honigfarbe
Белый фарфор/дерево цвета "мед"











27. Black porcelain
Porzellan schwarz
Черный фарфор

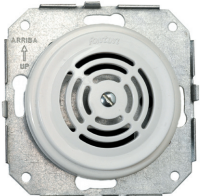

28. Black retro porcelain
Porzellan Retro schwarz
Черный фарфор "ретро"

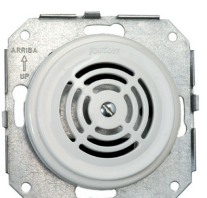

29. Black porcelain/Old wood
Porzellan schwarz/Holz gealtert
Черный фарфор/старое дерево

	Set Serie Серия	Code Code Код	Finish Finish Отделка	Packaging Verpackung Упаковка	
	31	925	17 White porcelain Porzellan weiß Белый фарфор 27 Black porcelain Porzellan schwarz Черный фарфор	ref. 2 	See technical notes at page 110. Siehe technische Hinweise auf Seite 110. См. технические данные на стр. 110.
	31	926	05 White Weiß Белый 02 Black Schwarz Черный	ref. 2 	See technical notes at page 110. Siehe technische Hinweise auf Seite 110. См. технические данные на стр. 110.
	31	905	05 02	ref. 2 	See technical notes at page 110. Siehe technische Hinweise auf Seite 110. См. технические данные на стр. 110.
	31	390	05 02	ref. 2 	See technical notes at page 110. Siehe technische Hinweise auf Seite 110. См. технические данные на стр. 110.



21.
White porcelain/Old wood
Porzellan weiß/Holz gealtert
Белый фарфор/старое дерево



23.
White retro porcelain
Porzellan Retro weiß
Белый фарфор "ретро"









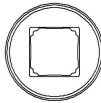

05.
White
Weiß
Белый











02.
Black
Schwarz
Черный

Garby Colonial Collection

	Set Serie Серия	Code Code Код	Finish Finish Отделка	Packaging Verpackung Упаковка	
 	31	801	See finishes Siehe Finishes См. варианты отделки	ref. 2 	1 Unit Einheit единица
	31	821		ref. 2 	
	31	802	See finishes Siehe Finishes См. варианты отделки	ref. 2 	1 Unit Einheit единица
	31	803	See finishes Siehe Finishes См. варианты отделки	ref. 2 	1 Unit Einheit единица
	31	804	See finishes Siehe Finishes См. варианты отделки	ref. 2 	Possible custom-made finishes with natural wood frames Kundenspezifisches Finish der Rahmen in Naturholz möglich Возможно использование покрытия по заказу покупателя с рамками из натурального дерева



		Set Serie Серия	Code Code Код	Finish Finish Отделка	Packaging Verpackung Упаковка	
 	<p>1 element porcelain frame Porzellanrahmen 1 Element Одноместная фарфоровая рамка ø100x12 mm</p>	31	801	See finishes Siehe Finishes См. варианты отделки	ref. 2 	1 Unit Einheit единица
	<p>Special frame for 1 square element (use with refs 37 721.., 37 722.., 37 750..) Spezialrahmen für 1 quadratisches Element (für Art.-Nr. 37 721.., 37 722.., 37 750..) Специальная рамка для 1 квадратного элемента (использовать с поз. 37 721.., 37 722.., 37 750..)</p>	31	821		ref. 2 	
	<p>2 elements porcelain frame Porzellanrahmen 2 Elemente Двухместная фарфоровая рамка 175x100x12 mm</p>	31	802	See finishes Siehe Finishes См. варианты отделки	ref. 2 	1 Unit Einheit единица
	<p>3 elements porcelain frame Porzellanrahmen 3 Elemente Трехместная фарфоровая рамка 246x100x12 mm</p>	31	803	See finishes Siehe Finishes См. варианты отделки	ref. 2 	1 Unit Einheit единица



17.
White porcelain
Porzellan weiß
Белый фарфор



09.
Craquelé porcelain
Craquelée-Porzellan
Фарфор с эффектом
"кракле"



11.
Porcelain decor
Porzellan mit Dekor
Фарфоровый декор



27.
Black porcelain
Porzellan schwarz
Черный фарфор



Interior Design: Carmen Barasona – Photography: Jordi Canosa
Innenausstattung: Carmen Barasona – Fotografie: Jordi Canosa
Дизайн интерьера: Carmen Barasona – Фотографии: Jordi Canosa

Garby Collection



Interior Design: Carmen Barasona – Photography: Jordi Canosa
Innenausstattung: Carmen Barasona – Fotografie: Jordi Canosa
Дизайн интерьера: Carmen Barasona – Фотографии: Jordi Canosa

Surface installation.

10AX - 250V \sim mechanisms.

10/16A - 250V \sim earthing sockets.

Silver contacts with high breaking power.

Manufactured with porcelain and technical thermoplastic materials.

Wood and porcelain frames, possible custom-made finishes with natural wood frames.

Frames for vertical or horizontal installations, fitted in universal boxes.

Frames for surface installation and fitting in standard box installation with screws and special adaptor.

Überputzinstallation.

Mechanismen 10 AX - 250 V \sim

Steckdose 16 A - 250 V \sim

Hochbruchsichere Silberkontakte.

Aus Porzellan und technischen Kunststoffen gefertigt.

Holz- und Porzellanrahmen, mit Möglichkeit zur Personalisierung mit Naturrahmen.

Rahmen für vertikale und horizontale Installation.

Rahmen für Überputzinstallationen und Installationen in Universalgehäusen mit Schrauben und Spezialadapter.

Наружная установка.

Механизмы 10 AX - 250 В \sim .

Розетки 16 А - 250 В \sim с заземлением.

Серебряные контакты с высокой мощностью размыкания цепи.

Изготовлены из фарфора и технических термопластов.

Возможно использование покрытия по индивидуальному заказу покупателя с рамками из натурального дерева.

Рамки для вертикальной и горизонтальной установки, вставленные в универсальные корпуса.

Рамки для наружной установки и установки в стандартные корпуса с винтами и специальным адаптером.

Garby Collection



White porcelain – white porcelain knob
Porzellan weiß – Knopf Porzellan weiß
Белый фарфор – кнопка из белого фарфора



Blue decor porcelain – white porcelain knob
Porzellan Dekor blau – Knopf Porzellan weiß
Голубой декоративный фарфор – кнопка из белого фарфора



Brown decor porcelain – white porcelain knob
Porzellan Dekor braun – Knopf Porzellan weiß
Коричневый декоративный фарфор – кнопка из белого фарфора



White porcelain – white porcelain retro knob
Porzellan weiß – Knopf Retro Porzellan weiß
Белый фарфор – кнопка «ретро» из белого фарфора



Brown decor porcelain – honey wood knob
Porzellan Dekor braun – Knopf Holz Honigfarbe
Коричневый декоративный фарфор – деревянная кнопка цвета «мёд»



White porcelain – old wood knob
Porzellan weiß – Knopf Holz gealtert
Белый фарфор – кнопка «старое дерево»



Blue decor porcelain – old wood knob
Porzellan Dekor blau – Knopf Holz gealtert
Голубой декоративный фарфор – кнопка «старое дерево»



Brown decor porcelain – old wood knob
Porzellan Dekor braun – Knopf Holz gealtert
Коричневый декоративный фарфор – кнопка «старое дерево»



Blue decor porcelain – white porcelain retro knob
 Porzellan Dekor blau - Knopf Retro Porzellan weiß
 Голубой декоративный фарфор – кнопка из белого фарфора «ретро»



Brown decor porcelain – white porcelain retro knob
 Porzellan Dekor braun - Knopf Retro Porzellan weiß
 Коричневый декоративный фарфор – кнопка из белого фарфора «ретро»



White porcelain – honey wood knob
 Porzellan weiß - Knopf Holz Honigfarbe
 Белый фарфор – деревянная кнопка цвета «мёд»



Blue decor porcelain – honey wood knob
 Porzellan Dekor blau - Knopf Holz Honigfarbe
 Голубой декоративный фарфор – деревянная кнопка цвета «мёд»



Reggia porcelain – antique bronze knob
 Porzellan Reggia - Knopf Antikbrunze
 Фарфор Reggia – кнопка «античная бронза»













Black porcelain – black porcelain knob
 Porzellan schwarz - Knopf Porzellan schwarz
 Черный фарфор – кнопка из черного фарфора



Black porcelain – black porcelain retro knob
 Porzellan schwarz - Knopf Retro Porzellan schwarz
 Черный фарфор – кнопка «ретро» из черного фарфора













Black porcelain – old wood knob
 Porzellan schwarz - Knopf Holz gealtert
 Черный фарфор – кнопка «старое дерево»

	Set Serie Серия	Code Code Код	Finish Finish Отделка	Packaging Verpackung Упаковка	
	Switch 10AX - 250V~ Unterbrecherschalter 10 AX - 250 V~ Выключатель 10 AX - 250 В~	30	306	See finishes Siehe Finishes См. варианты отделки	ref. 2 
	Two-way switch 10AX - 250V~ Zweiwegschalter 10 AX - 250 V~ Двухпозиционный выключатель 10 AX - 250 В~	30	308		ref. 2 
	Crossing switch 10AX - 250V~ Kreuzschalter 10 AX - 250 V~ Перекрестный выключатель 10 AX - 250 В~	30	304		ref. 2 
	Two-pole switch 10AX - 250V~ Zweipoliger Unterbrecherschalter 10 AX - 250 V~ Двухполюсный выключатель 10 AX - 250 В~	30	314		ref. 2 
1 Unit Einheit единица					
	Electric blinds mechanism 10A - 250V~ Mechanismus für Rollläden 10 A - 250 V~ Механизм для штор с электроприводом 10 А - 250 В~	30	342	See finishes Siehe Finishes См. варианты отделки	ref. 2 
	Rotary pushbutton 10AX - 250 V~ Drehschalter 10 AX - 250 V~ Поворотно-нажимный выключатель 10AX - 250В~	30	328		
	Double rotary pushbutton 10AX - 250 V~ Doppelter Drehschalter 10 AX - 250 V~ Двойной поворотно-нажимный выключатель 10AX - 250В~	30	344		
	Dimmer with pulsation control 500W (for incandescence & halogen bulbs). Tastregler 500 W (Glüh- und Halogenlampen) Регулятор освещенности нажимного типа 500Вт (для обычных ламп накаливания и галогенных ламп)	30	333		
	Dimmer with pulsation control 900W (for incandescence & halogen bulbs) Tastregler 900 W (Glüh- und Halogenlampen) Регулятор освещенности нажимного типа 900Вт (для обычных ламп накаливания и галогенных ламп)	30	334		
1 Unit Einheit единица					
	Porcelain two-pole socket 16A - 250V~ with shutters Überputzsteckdose aus Porzellan 16 A - 250 V~ mit Einsteckschutz Фарфоровая двухполюсная розетка 16 А - 250 В~ со шторками	30	205	17 11 13 15 27	ref. 2 
Only for replacement Nur für Ersatz Только для замены					
1 Unit Einheit единица					
	German two-pole socket With shutters With earth 16A - 250V~ Schuko-Steckdose, Überputz 16 A - 250 V~ mit Einsteckschutz Немецкая двухполюсная розетка со шторками, с заземлением 16 А - 250 В~	30	204	17 11 13 15 27	ref. 2 
1 Unit Einheit единица					

FINISH FINISH ОТДЕЛКА



		Set Serie Серия	Code Code Код	Finish Finish Отделка	Packaging Verpackung Упаковка		
	French two-pole socket With earth pin 16A - 250V~ With shutters Schuko-Steckdose, Überputz 16A - 250 V~ mit französischem Erdungsstift und Einsteckschutz Французская двухполюсная розетка С контактом заземления 16A - 250 В~, со шторками	30	208	17 11 13 15 27	ref. 2 	1 Unit Einheit единица	
	German two-pole socket with earth 16A.-250V~. Porcelain case. Schuko-Steckdose, Überputz 16A - 250 V~ Gehäuse und Innenteil aus Porzellan Немецкая двухполюсная розетка с заземлением 16 A - 250 В~. Фарфоровый корпус.	30	202	17 11 13 15 27	ref. 2 	1 Unit Einheit единица	
	French two-pole socket With earth pin 16A - 250V~ With shutters Schuko-Steckdose, Überputz 16A - 250 V~ mit französischem Erdungsstift und Einsteckschutz Французская двухполюсная розетка С контактом заземления 16 A - 250 В~, со шторками	30	211	17 11 13 15 27	ref. 2 	1 Unit Einheit единица	
	Pushbutton 10A 250V~ 24V DC* Klingeltaster 10A 250V~ 24V DC ohne Kabeldurchzug* Нажимная кнопка 10 A 250 в~ 24 В пост. тока без выемки под кабель*	30	310	17 11 13 15 27	ref. 2 	1 Unit Einheit единица	
	Pushbutton 10A 250V~ 24V DC* Drucktaster 10 A 250 V~ 24 V DC* Нажимный выключатель 10A 250В~ 24В постоянного тока	30	312	17 11 13 15 27	ref. 2 	<p>(*)Dimmer with pulsation control, using the 37347000 / 37346000 acesories (electronic dimmer 900 / 500W) from the page 50, every pushbutton could be used as electronic dimmer.</p> <p>(*) Tastregler, mit den Accessoires 37347000 / 37346000 (elektronischer Dimmer für 900 / 500 W) von Seite 50 wird jeder Drucktaster zu einem elektronischen Intensitätsregler.</p> <p>(*) Регулятор нажимного типа: используя вспомогательные устройства 37347000 / 37346000 (электронные диммеры 900 / 500Вт) со стр. 50, можно превратить любой нажимный выключатель в электронный регулятор освещенности.</p>	1 Unit Einheit единица



14.



21.



23.



24.



15.













27.



28.



29.

	Set Serie Серия	Code Code Код	Finish Finish Отделка	Packaging Verpackung Упаковка		
 <p>Double pushbutton 10A - 250V~ 24V DC Doppelter Drucktaster 10 A - 250 V~ - 24 V DC Сдвоенная нажимная кнопка 10 А - 250 В ~ 24 В пост. тока</p>	30	343	11 13 15 17 27	ref. 2 	<p>Dimmer with pulsation control, using the 37347000 / 37346000 accessories (electronic dimmer 900 / 500W) from the page 50, every pushbutton could be used as electronic dimmer.</p> <p>Tastregler, mit den Accessoires 37347000 / 37346000 (elektronischer Dimmer für 900 / 500 W) von Seite 50 wird jeder Drucktaster zu einem elektronischen Intensitätsregler.</p> <p>Регулятор нажимного типа: используя вспомогательные устройства 37347000 / 37346000 (электронные диммеры 900 / 500Вт) со стр. 50, можно превратить любой нажимный выключатель в электронный регулятор освещенности.</p>	
 <p>RTV/SAT sockets outlets Steckdosen RTV/SAT-Signal entzerrt Розетки RTV/SAT</p>	<p>Single socket Einfachsteckdose Одноместная розетка</p> <p>Intermediate A Durchgangsdose A Промежуточная A</p> <p>Intermediate B Durchgangsdose B Промежуточная B</p> <p>Final socket Enddose Оконечная розетка</p>	30 30 30 30	712 713 714 709	11 13 15 17 27	ref. 2 	<p>See technical information at page 107. Siehe technische Daten auf Seite 107. См. технические данные на стр. 107.</p>
 <p>6 ways double telephone socket Telefonsteckdose doppelt 6-polig 6-контактная двухместная телефонная розетка</p>	30	706	11 13 15 17 27	ref. 2 		
 <p>Double RJ45 socket Doppelsteckdose RJ45 Двухместная розетка RJ45</p> <p>6 ways double Telephone + RJ45 CAT 6 socket Telefonsteckdose 6-polig + RJ45 CAT6 6-контактная двухместная телефонная розетка RJ45 CAT 6</p>	30 30	707 708	11 13 15 17 27	ref. 2 		
 <p>Blind cover Blindabdeckung Щиток</p>	30	656	11 13 15 17 27	ref. 2 		

1 Unit Einheit единица

1 Unit Einheit единица

1 Unit Einheit единица









1 Unit Einheit единица

1 Unit Einheit единица

FINISH FINISH ОТДЕЛКА









		Set Serie Серия	Code Code Код	Finish Finish Отделка	Packaging Verpackung Упаковка	
	Cable outlet cover Kabelausgang Крышка кабельного вывода	30	927	11 13 15 17 27	ref. 2 	1 Unit Einheit единица
	Lamps medaillon size ø100x34 mm Rosefette für Lampen, Maß ø100 x 34 mm Потолочная розетка для люстр ø100x34 мм	30	940	17	ref. 2 	1 Unit Einheit единица
	Claws support for universal box without screws Rahmen mit Klammer für Universalgehäuse ohne Schrauben Опора с зажимами для универсального короба без винтов	20	901	97 Metallic Metall Металлик	ref. 0 	Only for wood bases ref. 30.80x... Nur für Holzsockel Art.-Nr. 30.80x.. Только для деревянных оснований, см. 30.80x... ref. 0 - 25 Units Einheiten единиц
	Find intertwined PVC wire on the section "surface installation decorative systems" page.76 Die verseilten, einzeln umflochtenen PVC-Kabel finden Sie im Abschnitt "Dekorative Systeme für Überputzinstallationen" auf Seite 76. Витой провод из ПВХ см. в разделе "Декоративные системы для наружной установки" на стр.76					

		Set Serie Серия	Code Code Код	Finish Finish Отделка	Packaging Verpackung Упаковка	
	Beech wood base 1 element surface mounting $\varnothing 100 \times 12$ mm Holzsockel Buche Überputz für 1 Element $\varnothing 100 \times 12$ mm Одноместное основание, бук, для наружной установки, $\varnothing 100 \times 12$ мм	30	811	00 19 21	ref. 2 	Screws included for fixing mechanism on wood plate Einschließlich Schrauben zum Befestigen des Mechanismus am Sockel В комплект входят шурупы для крепления механизма к деревянной пластине
						1 Unit Einheit единица
	Beech wood base 2 elements surface mounting $175 \times 100 \times 12$ mm Holzsockel Buche Überputz für 2 Elemente $175 \times 100 \times 12$ mm Двухместное основание, бук, для наружной установки, $175 \times 100 \times 12$ мм	30	812	00 19 21	ref. 2 	Screws included for fixing mechanism on wood plate Einschließlich Schrauben zum Befestigen des Mechanismus am Sockel В комплект входят шурупы для крепления механизма к деревянной пластине
						1 Unit Einheit единица
	Beech wood base 3 elements surface mounting $246,5 \times 100 \times 12$ mm Holzsockel Buche Überputz für 3 Elemente $246,5 \times 100 \times 12$ mm Трехместное основание, бук, для наружной установки, $246,5 \times 100 \times 12$ мм	30	813	00 19 21	ref. 2 	Screws included for fixing mechanism on wood plate Einschließlich Schrauben zum Befestigen des Mechanismus am Sockel В комплект входят шурупы для крепления механизма к деревянной пластине
						1 Unit Einheit единица
	Beech wood base 1 element $\varnothing 95 \times 22$ mm for universal box or surface installations Holzsockel aus Buche für 1 Element $\varnothing 95 \times 22$ mm für die Installation in Universalgehäuse oder Überputz Одноместное основание, бук, $\varnothing 95 \times 22$ мм для универсального короба или наружной установки	30	801	00 19 21	ref. 2 	Screws included for fixing mechanism-wood base and wood base on fitting box Einschließlich Schrauben zum Befestigen des Mechanismus am Sockel und des Sockels am Unterputzgehäuse В комплект входят шурупы для крепления механизма к деревянному основанию и деревянного основания к установочному коробу Possible custom-made finishes with natural wood frames Kundenspezifisches Finish der Rahmen in Naturholz möglich Возможно использование покрытия по заказу покупателя с рамками из натурального дерева
						1 Unit Einheit единица

FINISH FINISH ОТДЕЛКА

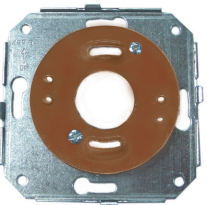
00.
Natural
Natur
Натуральный19.
Honey
Honig
Мёд21.
Old wood
Gealtert
Старое дерево

		Set Serie Серия	Code Code Код	Finish Finish Отделка	Packaging Verpackung Упаковка	
	Beech wood base 2 elements 181x95.5x22 mm for universal box or tube installations Holzsockel aus Buche für 2 Elemente 181 x 95,5 x 22 mm für Installation mit Universalgehäuse oder Rohr Двухместное основание, бук, 181x95,5x22 мм для универсального короба или установки на трубе	30	802	00 19 21	ref. 2 	Screws included for fixing mechanism-wood plate and wood plate on fitting box. Einschließlich Schrauben zum Befestigen des Mechanismus am Sockel und des Sockels am Unterputzgehäuse В комплект входят шурупы для крепления механизма к деревянной пластине и деревянной пластины к установочному коробу
						1 Unit Einheit единица
	Beech wood base 3 elements 252.5x95.5x22 mm for universal box or tube installations Holzsockel aus Buche für 3 Elemente 252,5 x 95,5 x 22 mm für Installation mit Universalgehäuse oder Rohr Трехместное основание, бук 252,5x95,5x22 мм для универсального короба или установки на трубе	30	803	19 21 00	ref. 2 	Screws included for fixing mechanism-wood plate and wood plate on fitting box. Einschließlich Schrauben zum Befestigen des Mechanismus am Sockel und des Sockels am Unterputzgehäuse. В комплект входят шурупы для крепления механизма к деревянной пластине и деревянной пластины к установочному коробу 4 Elements frames available, contact us. Rahmen für 4 Elemente auf Anfrage lieferbar. Имеются в наличии 4-местные рамки, за информацией обращайтесь, пожалуйста, к нам. Possible custom-made finishes with natural wood frames. Kundenspezifisches Finish der Rahmen in Naturholz möglich. Возможно использование покрытия по заказу покупателя с рамками из натурального дерева
						1 Unit Einheit единица
	Adaptor for frames in surface installations suitable for: Garby Colonial, Venezia Clasica, Venezia Toscana, Venezia Metal and Venezia Carré. Adapter für Überputzrahmen geeignet für: Garby Colonial, Venezia Clasica, Venezia Toscana, Venezia Metal und Venezia Carré. Адаптер для рамок при наружной установке, для серий: Garby Colonial, Venezia Clasica, Venezia Toscana, Venezia Metal и Venezia Carré.	30	950	98	ref. 2 	
						6 Units Einheiten единиц
	Adaptor for frames in surface installations suitable for: Garby Colonial, Venezia Clasica, Venezia Toscana, Venezia Metal and Venezia Carré. Adapter für Überputzrahmen geeignet für: Garby Colonial, Venezia Clasica, Venezia Toscana, Venezia Metal und Venezia Carré. Адаптер для рамок при наружной установке, для серий: Garby Colonial, Venezia Clasica, Venezia Toscana, Venezia Metal и Venezia Carré.	30	951	98	ref. 2 	See installation instructions at page 100. Siehe Montageschaubild auf Seite 100. См. инструкции по установке на стр. 100.
						6 Units Einheiten единиц



Interior Design: Salvador Fresneda – Photography: Jordi Canosa
Innenausstattung: Salvador Fresneda – Fotografie: Jordi Canosa
Дизайн интерьера: Salvador Fresneda – Фотографии: Jordi Canosa

Dimbler Collection

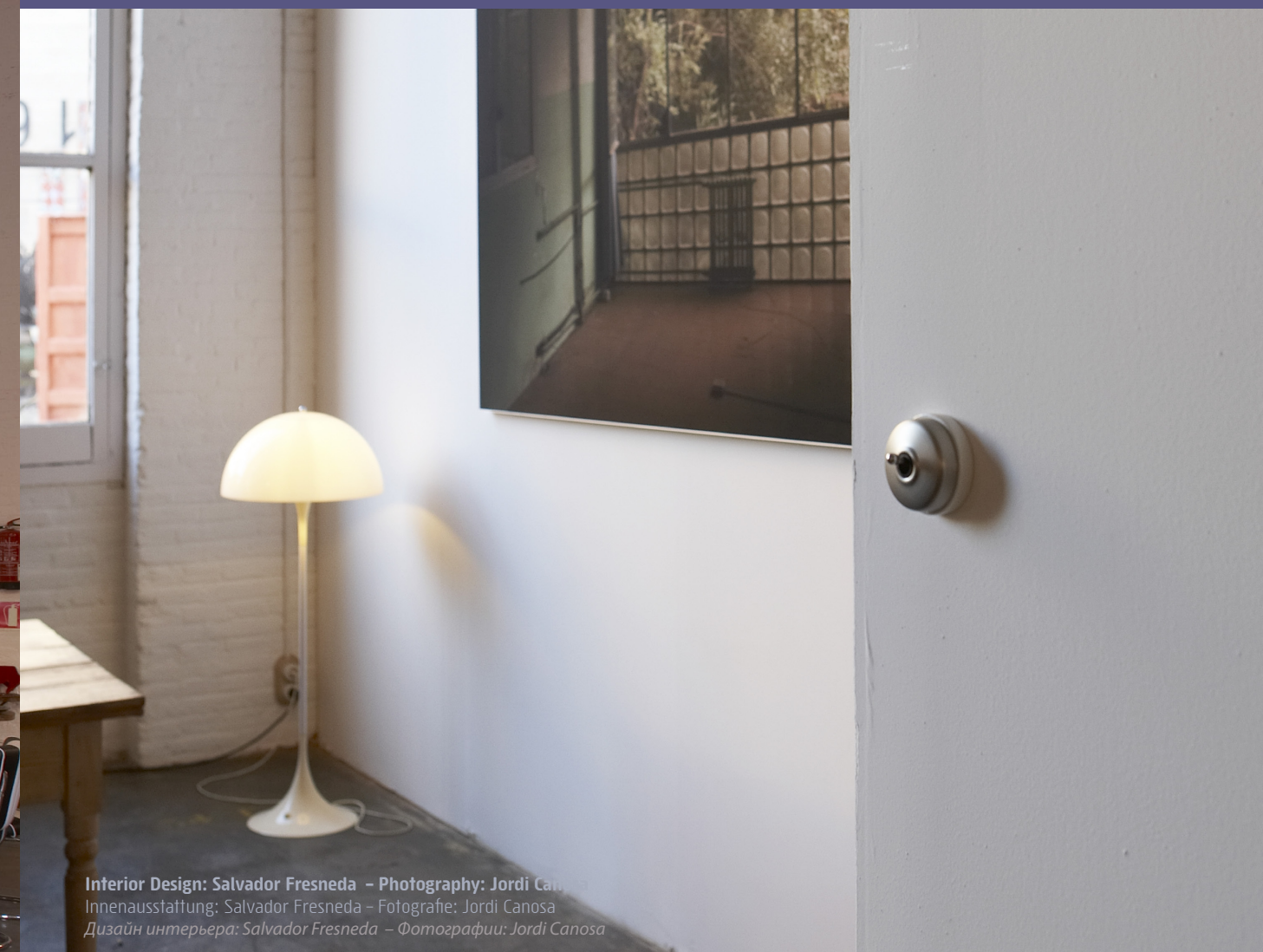

Interior Design: Salvador Fresneda – Photography: Jordi Canosa
Innenausstattung: Salvador Fresneda – Fotografie: Jordi Canosa
Дизайн интерьера: Salvador Fresneda – Фотографии: Jordi Canosa

Fitting or surface installation.
10AX - 250V~ mechanisms.
Silver contacts with high breaking power.
Made of porcelain and brass.
Usable with Garby, Garby Colonial and Venezia frames.

Überputz- oder Unterputzinstallation.
Mechanismen 10 AX - 250 V~
Hochbruchsichere Silberkontakte.
Aus Porzellan und Messing gefertigt.
Kombinierbar mit Sockeln Garby und Rahmen
Garby Colonial und Venezia.

Внутренняя или наружная установка.
Механизмы 10 AX - 250 В~.
Серебряные контакты с высокой мощностью
размыкания цепи.
Изготавливается из фарфора и желтой меди.
Для использования с рамками серий Garby, Garby

Dimbler Collection



White porcelain - golden key
Porzellan weiß - Kipphebel vergoldet
Белый фарфор - золотистая клавиша



White porcelain, chrome-plated key
Porzellan weiß - Kipphebel verchromt
Белый фарфор, хромированная клавиша



White porcelain - antique bronze key
Porzellan weiß - Kipphebel Antikbrunze
Белый фарфор - клавиша «античная бронза»



White porcelain - golden brass case - golden key
Porzellan weiß - Messing vergoldet - Kipphebel vergoldet
Белый фарфор - корпус из золотистой меди - золотистая клавиша



White porcelain, nickel-plated brass case - chrome-plated key
Porzellan weiß - Messing vernickelt, satiniert - Kipphebel verchromt
Белый фарфор, никелированный медный корпус - хромированная клавиша



White porcelain - antique bronze case - antique bronze key
Porzellan weiß - Messing vergoldet - Kipphebel Antikbrunze
Белый фарфор - корпус «античная бронза» - клавиша «античная бронза»



Combinable mechanisms with frames and accessories of Garby and Garby Colonial Collections and Venezia Collection frames.

Mechanismen kombinierbar mit den Rahmen und dem Zubehör der Kollektionen Garby und Garby Colonial und den Rahmen der Kollektion Venezia.

Механизмы сочетаются с рамками и аксессуарами коллекций Garby и Garby Colonial, а также с рамками коллекции Venezia.

New porcelain Dimbler + New porcelain Garby socket + Old wood Garby frame for tube installation

Neu Dimbler Porzellan + neue Steckdose Garby Porzellan + Sockel Garby aus gealtertem Holz für die Installation in Röhre

Новый фарфор Dimbler + Новая фарфоровая розетка Garby + рамка Garby «старое дерево» для установки с трубкой



Porcelain antique bronze Dimbler + Garby Colonial socket + Venezia Toscana frame

Dimble Porzellan Antikbronze + Steckdose Garby Colonial + Rahmen Venezia Toscana

Фарфор Dimbler «античная бронза» + розетка Garby Colonial + рамка Venezia Toscana



Gold porcelain Dimbler + Venezia Carré frame

Dimble Porzellan vergoldet + Rahmen Venezia Carré

Золотистый фарфор Dimbler + рамка Venezia Carré



Interior Design: Héctor Ruiz – Photograph: Benjamín Alcázar
Innenausstattung: Héctor Ruiz – Fotografie: Benjamín Alcázar
Дизайн интерьера: Héctor Ruiz – Фотографии: Benjamín Alcázar

Dimbler
Collection



One pole switch 10AX - 250V~
Einpoliger Unterbrecherschalter 10 AX - 250 V~
Однополюсный выключатель 10 AX - 250 В~

Two-way switch 10AX - 250V~
Zweiwegschalter 10 AX - 250 V~
Двухпозиционный выключатель 10 AX - 250 В~

Crossing switch 10AX - 250V~
Kreuzschalter 10 AX - 250 V~
Перекрестный выключатель 10 AX - 250 В~

Two-pole switch 10AX - 250V~
Zweipoliger Unterbrecherschalter 10 AX - 250 V~
Двухполюсный выключатель 10 AX - 250 В~

Rocking Pushbutton 10A - 250V~ 24V DC*
Drucktaster Rocking 10 A - 250 V~ - 24 V DC*
Кулисная нажимная кнопка 10 А - 250 В ~ 24 В пост. тока*

Set
Serie Серия

Code
Code Код

Finish
Finish Отделка

Packaging
Verpackung Упаковка

ref. 2

ref. 2

ref. 2

ref. 2

ref. 2

1 Unit Einheit единица



Pushbutton 10A -250 V ~ 24v DC*
Drucktaster 10 A -250 V~ 24 V DC*
Нажимная кнопка 10 А -250 В ~ 24 В пост. тока*

60

310

See finishes
Siehe Finishes
См. варианты
отделки

ref. 2

(*)Dimmer with pulsation control, using the 37347000 / 37346000
acesories (electronic dimmer 900 / 500W) from the page 50, every
pushbutton could be used as electronic dimmer.

(*) Tastregler, mit den Accessoires 37347000 / 37346000
(elektronischer Dimmer für 900 / 500 W) von Seite 50 wird jeder
Drucktaster zu einem elektronischen Intensitätsregler.

(*) Регулятор нажимного типа: используя вспомогательные устройства
37347000 / 37346000 (электронные диммеры 900 / 500Вт) со стр. 50,
можно превратить любой нажимный выключатель в электронный
регулятор освещенности.

1 Unit Einheit единица

FINISH FINISH ОТДЕЛКА

Without cable inlet
Ohne Kabeldurchzug
Без выемки для кабеля



55.
Golden
Gold
Золотой



56.
Satin nickel-plated
Nickel satiniert
Глянцевый
никелированный



57.
Antique bronze
Antikbrnze
Античная бронза

NEW



63.
Golden
Gold
Золотой

NEW



64.
Chrome
Verchromt
Хром

NEW



65.
Antique bronze
Antikbrnze
Античная бронза

With cable inlet
Mit Kabeldurchzug
С выемкой для кабеля



50.
Golden
Gold
Золотой



51.
Satin nickel-plated
Nickel satiniert
Глянцевый
никелированный



53.
Antique bronze
Antikbrnze
Античная бронза

NEW



43.
Golden
Gold
Золотой

NEW



44.
Chrome
Verchromt
Хром

NEW



45.
Antique bronze
Antikbrnze
Античная бронза



Interior Design: Carmen Barasona – Photography: Benjamín Alcázar
Innenausstattung: Carmen Barasona – Fotografie: Benjamín Alcázar
Дизайн интерьера: Carmen Barasona – Фотографии: Benjamín Alcázar

Surface installation decorative systems

Dekorative Systeme für Überputzinstallationen

Декоративные системы для наружной установки



Interior Design: Antioquia / Belén Lopez – Photography: Benjamín Alcázar
Innenausstattung: Antioquia / Belén Lopez – Fotografie: Benjamín Alcázar
Дизайн интерьера: Antioquia / Belén Lopez – Фотографии: Benjamín Alcázar

Fontini launches a wide range of surface installation systems for any decorative style. From intertwined cable and insulators installations for country atmospheres, up to metallic tubes and boxes for industrial loft atmospheres.

Fontini präsentiert ein breites Angebot an Systemen für Überputzinstallationen für jeden Dekorationsstil. Von der Installation von umflochtenen Kabeln und Isolationen für rustikale Umgebungen bis zu Installationen mit Rohren und Metallgehäusen für industrielle Umgebungen wie Lofts.

Компания Fontini представляет широкий ассортимент новых систем наружной установки для любого декоративного стиля. От витого провода и изоляционных систем для сельских интерьеров до металлических трубок и коробов для помещений в стиле промышленных лофтов.

For Garby & Dimbler
collections

Intertwined PVC wire 750 V
with cotton coating
Leiter PVC 750 V
mit Baumwolle umflochten
Витой провод из ПВХ 750 В
в хлопчатобумажной оболочке

2x1 mm
2x1,5 mm
2x2,5 mm
3x1 mm
3x1,5 mm

Set
Serie Серия
Code Код

30
30
30
30
30

970
976
977
978
979

Finish
Finish Отделка

05 White
Weiß
Белый

Packaging
Verpackung Упаковка

ref. 2

Fontini recommends checking the electrical regulations of your country before installing intertwined cable. Fixed installations may not be allowed using the cable without an extra protection,

Fontini empfiehlt, vor der Installation von geflochtenen Kabeln die in Ihrem Land geltenden Bestimmungen für elektrische Installationen zu prüfen. Die feste Installation ist unter Umständen ohne einen zusätzlichen Schutz nicht erlaubt.

Компания Fontini рекомендует перед началом установки витого кабеля уточнить действующие в вашей стране правила электробезопасности. Стационарная установка может быть разрешена только при использовании кабеля с дополнительной защитой.

Intertwined pvc wire 750 V with
mineral fireproof coating
Leiter PVC mineralbeschichtet,
feuerfest, 750 V, geflochten
Витой провод из ПВХ 750 В с
покрытием из огнестойкого минераль-
ного материала

2x1,5 mm
2x2,5 mm
3x1,5 mm
3x2,5 mm
4x1,5 mm

30
30
30
30
30

971
972
974
975
980*

05 White
Weiß
Белый
03 Brown
Braun
Коричневый

ref. 2

Rolls 50 m Rollen 50 m Бухты 50 м
*980 Rolls 25 m *980 Rollen 25 m *980 Бухты 25 м



Porcelain connection box for cable or tube Ø 16,20 mm.
External size: Ø 72 mm (includes wall plugs and screws
for assembly).
Anschlussdose aus Porzellan, klein, für Kabel oder Rohr
Ø 16,20 mm. Außenmaß Ø 72 mm (einschließlich Dübel
und Schrauben für Wandmontage).
Фарфоровая соединительная коробка для кабеля
или трубы Ø 16,20 мм. Наружный размер: Ø 72 мм (в
комплекте дюбели и винты для установки).

30

399

17

ref. 2

1 Unit Einheit единица



Porcelain connection box for cable or tube Ø 16,20 and
25 mm. External size: Ø 116 x 56mm (includes wall plugs
and screws for assembly).
Anschlussdose aus Porzellan für Kabel oder Rohr Ø 16,20
und 25 mm. Außenmaß Ø 116 x 56 mm (einschließlich
Dübel und Schrauben für Wandmontage).
Фарфоровая соединительная коробка для кабеля или
трубы Ø 16,20 и 25 мм. Наружный размер: Ø 116 x 56
мм (в комплекте дюбели и винты для установки).









30

401

17

ref. 2

1 Unit Einheit единица





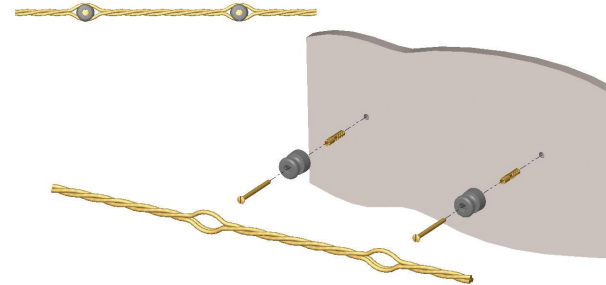
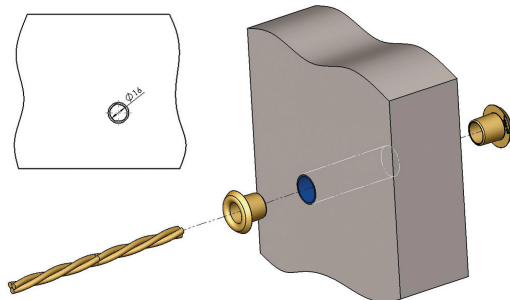

	Set Serie Серия	Code Code Код	Finish Finish Отделка	Packaging Verpackung Упаковка	
	30	913	05	ref. 0  ref. 2 	
	30	913	17		ref. 0 - 25 Units Einheiten единиц ref. 2 - 5 Units Einheiten единиц
	30	913	03	ref. 0  ref. 2 	
	30	913	47		ref. 0 - 25 Units Einheiten единиц ref. 2 - 5 Units Einheiten единиц
	30	938	05 03	ref. 2 	2 Units Einheiten единиц







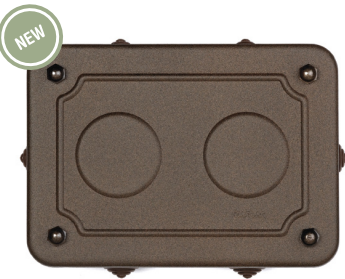

Use of the wall-passing cap
Anwendung der Tülle zur
Wanddurchführung
Использование втулок для
сквозных отверстий в стене



Installation of intertwined cable with insulators
Installation von geflochtenem Kabel mit Isolatoren
Установка витого кабеля с изоляцией

For Garby & Dimbler
collections

	Set Serie Серия	Code Code Код	Finish Finish Отделка	Packaging Verpackung Упаковка	
	30	399	22	ref. 2 	<p>Screws included for fixing mechanism on wood base Einschließlich Schrauben zum Befestigen des Mechanismus am Sockel В комплект входят шурупы для крепления механизма к деревянному основанию</p>
	30	401	22	ref. 2 	<p>Screws included for fixing mechanism-wood base and wood base on fitting box Einschließlich Schrauben zum Befestigen des Mechanismus am Sockel und des Sockels am Unterputzgehäuse В комплект входят шурупы для крепления механизма к деревянному основанию и деревянного основания к установочному коробу</p>
	30	402	22	ref. 2 	<p>1 Unit Einheit единица</p>

	Set Serie Серия	Code Code Код	Finish Finish Отделка	Packaging Verpackung Упаковка	
	30	016	22	ref. 2 	Pack: 4 tubes x 3m (total 12mts) Pack: 4 Rohre x 3 m (insgesamt 12 m) Упаковка: 4 трубы x 3 м (общая длина 12 м)
	30	020	22		
	30	025	22		
	30	716	03	ref. 2 	25 Units Einheiten единиц
	30	720	03		
	30	725	03		
	30	816	03	ref. 2 	25 Units Einheiten единиц
	30	820	03		
	30	825	03		
	30	516	22	ref. 2 	10 Units Einheiten единиц 10 Units Einheiten единиц 5 Units Einheiten единиц
	30	520	22		
	30	525	22		

FINISH FINISH ОТДЕЛКА





22.
Aged metal
Metall gealtert
Старый металл













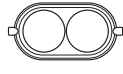

03.
Brown
Braun
Коричневый

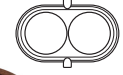
For Garby & Dimbler
collections

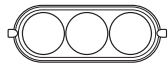
	Set Serie Серия	Code Code Код	Finish Finish Отделка	Packaging Verpackung Упаковка	
	30	116	22	ref. 2 	
	30	120	22		
	30	125	22		
	1 Unit Einheit единица				
	30	416	22	ref. 2 	
	30	420	22		
	30	425	22		
	1 Unit Einheit единица				
	30	616	22	ref. 2 	
	30	620	22		
	30	625	22		
	1 Unit Einheit единица				
	60	952	03	ref. 2 	
	6 Units Einheiten единиц				

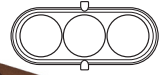

		Set Serie Серия	Code Code Код	Finish Finish Отделка	Packaging Verpackung Упаковка	
		30	821	See finishes Siehe Finishes См. варианты отделки	ref. 2 	
		30	841			1 Unit Einheit единица
		30	822	See finishes Siehe Finishes См. варианты отделки	ref. 2 	
		30	842			1 Unit Einheit единица
		30	832	See finishes Siehe Finishes См. варианты отделки	ref. 2 	
		30	852			1 Unit Einheit единица
		30	823	See finishes Siehe Finishes См. варианты отделки	ref. 2 	
		30	843			1 Unit Einheit единица
		30	833	See finishes Siehe Finishes См. варианты отделки	ref. 2 	4 Elements frames available, contact us. Rahmen für 4 Elemente auf Anfrage lieferbar. Имеются в наличии 4-местные рамки, за информацией обращайтесь, пожалуйста, к нам.
		30	853			Possible custom-made finishes with natural wood frames. Kundenspezifisches Finish der Rahmen in Naturholz möglich. Возможно использование покрытия по заказу покупателя с рамками из натурального дерева.

FINISH FINISH ОТДЕЛКА

00.
Natural
Natur
Натуральный19.
Honey
Honig
Мёд21.
Old wood
Gealtert
Старое дерево

For Garby & Dimbler
collectionsSet
Serie СерияCode
Code КодFinish
Finish ОтделкаPackaging
Verpackung Упаковка

Adaptor for tube Ø20 mm installation in wood frame
Adapter für Rohrinstallation Ø 20 mm auf Holzsockel
Адаптер для труб Ø20 мм, устанавливаемых в
деревянную рамку

30

007

03

ref. 2



See installation instructions at page 99.
Siehe Montageschaubild auf Seite 99.
См. инструкции по установке на стр. 99.

1 Unit Einheit единица



Aged metal paint repair spray 200ml
Reparaturfarbspray für gealtertes Metall 200 ml
Спрей для подкраски, "старый металл", 200 мл

30

001

22

ref. 2



1 Unit Einheit единица



Interior Design: Carmen Barasona - Photography: Benjamín Alcázar
Innenausstattung: Carmen Barasona - Fotografie: Benjamín Alcázar
Дизайн интерьера: Carmen Barasona - Фотографуи: Benjamín Alcázar

For F37
Collection

NEW



F-37 1 element surface box 86x86x40mm
Anschlussdose Überputz F-37 1 Element 86 x 86 x 40 mm
F-37 Одноместная наружная коробка 86x86x40 мм

Set
Serie Серия

37

Code
Code Код

401

Finish
Finish Отделка

51 Satin nickel-plated
Nickel satiniert
Глянцевый
никелиро-
ванный

Packaging
Verpackung Упаковка

ref. 2



1 Unit Einheit единица

NEW



F-37 2 elements surface box for vertical installation
86x160x40mm
Anschlussdose Überputz vertikale Installation F-37 2
Elemente 86 x 160 x 40 mm
F-37 Двухместная наружная коробка для
вертикальной установки 86x160x40 мм

37

402

51 Satin nickel-plated
Nickel satiniert
Глянцевый
никелиро-
ванный

ref. 2



F-37 2 elements surface box for horizontal installation
86x160x40mm
Anschlussdose Überputz horizontale Installation F-37 2
Elemente 86 x 160 x 40 mm
F-37 Двухместная наружная коробка для
горизонтальной установки 86x160x40 мм

37

405

51 Satin nickel-plated
Nickel satiniert
Глянцевый
никелиро-
ванный

1 Unit Einheit единица

NEW



F-37 3 elements surface box for vertical installation
86x230x40mm
Anschlussdose Überputz vertikale Installation F-37 3
Elemente 86 x 230 x 40 mm
F-37 Трехместная наружная коробка для вертикальной
установки 86x230x40 мм

37

403

51 Satin nickel-plated
Nickel satiniert
Глянцевый
никелиро-
ванный

ref. 2











F-37 3 elements surface box for horizontal installation
86x230x40mm
Anschlussdose Überputz horizontale Installation
F-37 3 Elemente 86 x 230 x 40 mm
F-37 Трехместная наружная коробка для
горизонтальной установки 86x230x40 мм

37

406

51 Satin nickel-plated
Nickel satiniert
Глянцевый
никелиро-
ванный

1 Unit Einheit единица

		Set Serie Серия	Code Code Код	Finish Finish Отделка	Packaging Verpackung Упаковка	
 	F-37 1 element wall connection box 86x86x40mm Anschlussdose F-37 1 Element 86 x 86 x 40 mm F-37 Одноместная настенная соединительная коробка 86x86x40 мм	37	400	51 Satin nickel-plated Nickel satiniert Глянцевый никелиро- ванный	ref. 2 	
						1 Unit Einheit единица
 	F-37 2 elements wall connection box 86x160x40mm Anschlussdose F-37 2 Elemente 86 x 160 x 40 mm F-37 Двухместная настенная соединительная коробка 86x160x40 мм	37	399	51 Satin nickel-plated Nickel satiniert Глянцевый никелиро- ванный	ref. 2 	
						1 Unit Einheit единица
 	Rectangular wall connection box 175x125x50 mm Anschlussdose rechteckig 175 x 125 x 50 mm Прямоугольная настенная соединительная коробка 175x125x50 мм	30	402	51 Satin nickel-plated Nickel satiniert Глянцевый никелиро- ванный	ref. 2 	
						1 Unit Einheit единица

For Venezia & Garby Colonial Collections

NEW

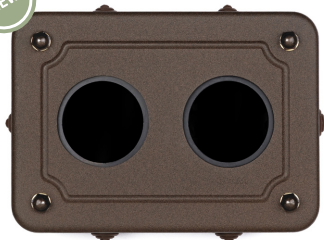

Venezia & Garby Colonial 2 elements aged metal surface box for horizontal installation
Anschlussdose Überputz 2 Elemente Venezia und Garby Colonial, Metall gealtert für horizontale Installation
Двухместная наружная коробка Venezia и Garby Colonial «старый металл» для горизонтальной установки

Set
Serie Серия

35

Code
Code Код

408

Finish
Finish Отделка22 Aged metal
Metall gealtert
Старый металлPackaging
Verpackung Упаковкаref. 2 

Venezia & Garby Colonial 2 elements aged metal surface box for vertical installation
Anschlussdose Überputz 2 Elemente Venezia und Garby Colonial, Metall gealtert für vertikale Installation
Двухместная наружная коробка Venezia и Garby Colonial «старый металл» для вертикальной установки

35

409

22 Aged metal
Metall gealtert
Старый металл

1 Unit Einheit единица

NEW



Venezia & Garby Colonial 2 elements nickel-plated surface box for horizontal installation
Anschlussdose Überputz 2 Elemente Venezia und Garby Colonial, Nickel satiniert für horizontale Installation
Двухместная никелированная наружная коробка Venezia и Garby Colonial для горизонтальной установки

35

408

51 Satin nickel-plated
Nickel satiniert
Глянцевый
никелиро-
ванныйref. 2 

Venezia & Garby Colonial 2 elements nickel-plated surface box for vertical installation
Anschlussdose Überputz 2 Elemente Venezia und Garby Colonial, Nickel satiniert für vertikale Installation
Двухместная никелированная наружная коробка Venezia и Garby Colonial для вертикальной установки

35

409

51 Satin nickel-plated
Nickel satiniert
Глянцевый
никелиро-
ванный

1 Unit Einheit единица



**Two elements metallic boxes to install Rocking and Rotary Venezia and Garby Colonial mechanisms and accessories.
Photo: Aged metal Box + Porcelain Garby Colonial switches.**

Anschlussdosen Metall für zwei Elemente für die Installation von Mechanismen und Accessoires Venezia Rocking & Rotary und Garby Colonial.
Foto: Anschlussdose Metall gealtert + Porzellanschalter Garby Colonial.

Двухместные металлические коробки для установки кулисных и поворотных механизмов и аксессуаров серий Venezia и Garby Colonial.

На фото: коробка «старый металл» + фарфоровые выключатели Garby Colonial.

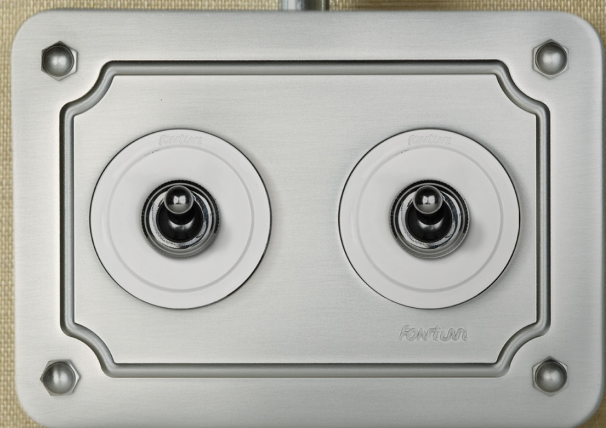

Interior Design: Carmen Barasona
Innenausstattung: Carmen Barasona
Дизайн интерьера: Carmen Barasona





Interior Design: Salvador Fresneda – Photography: Jordi Canosa
Innenausstattung: Salvador Fresneda – Fotografie: Jordi Canosa
Дизайн интерьера: Salvador Fresneda – Фотографии: Jordi Canosa

COMPLEMENTS ACCESSOIRES *ДОПОЛНИТЕЛЬНЫЕ ТОВАРЫ*

Fontini
Complements

Set	Code	Finish	Packaging
Serie Серия	Code Код	Finish Отделка	Verpackung Упаковка



Oak wood and brass retro door bell with batteries (not included)
Retro-Klingel aus Eichenholz mit Messingglocke, batteriebetrieben (Batterien nicht enthalten)
Дверной звонок "ретро" из дуба и желтой меди, на батареях (приобретаются дополнительно)

30

680

15 Oak
Eiche
Дуб

ref. 2

Oak wood and brass retro door bell (with transformer for 230 V)
Retro-Klingel aus Eichenholz mit Messingglocke (mit 230-V-Transformator)
Дверной звонок "ретро" из дуба и желтой меди (с трансформатором на 230 В)

30

681

15 Oak
Eiche
Дуб

1 Unit Einheit единица



Pushbutton 1A-250 V with chain and knob
Drucktaster 1 A - 250 V mit Kettenzug und Metallknopf
Нажимная кнопка 1 А-250 В с цепочкой и ручкой

30

330

02 Black
Schwarz
Черный

ref. 2

1 Unit Einheit единица



Pushbutton switch 10A - 250V~
Klingeltaster 10 A - 250 V~
Кнопочный выключатель 10 А - 250 В~

14

310

50 Golden
Gold
Золотой
51 Nickel-plated
Vernickelt
Никелиро-
ванный

ref. 2

1 Unit Einheit единица



Pushbutton switch 10A - 250V~
Klingeltaster 10 A - 250 V~
Кнопочный выключатель 10 А - 250 В~

14

010

02 Black
Schwarz
Черный
50 Golden
Gold
Золотой
51 Nickel-plated
Vernickelt
Никелиро-
ванный

ref. 2

25 Units Einheiten единиц



Dimmer power 500W (for incandescence & halogen bulbs)
Leistungsregler 500 W (Glüh- und Halogenlampen)
Регулятор освещенности 500Вт (для обычных ламп накаливания и галогенных ламп)

37

346

00

ref. 0

Dimmer power 900W (for incandescence & halogen bulbs)
Leistungsregler 900 W (Glüh- und Halogenlampen)
Регулятор освещенности 900Вт (для обычных ламп накаливания и галогенных ламп)









37

347

00

ref. 0

1 Unit Einheit единица













		Set Serie Серия	Code Code Код	Finish Finish Отделка	Packaging Verpackung Упаковка	
	Pushbutton switch 10A - 250V~ - 24V DC with metallic chassis Klingeltaster Porzellan 10 A - 250 V~24 V DC mit Metallrahmen Кнопочный выключатель 10 А - 250 В~ - 24 В пост. тока с металлическим каркасом	14	011	17 Porcelain Porzellan Фарфор	ref. 2 	For fitting in universal box Unterputzmontage in Universaldose Для установки в универсальную коробку
	Porcelain pushbutton with golden decor 10A - 250V~ 24V DC with metallic chassis Drucktaster Porzellan mit Goldverzierung 10 A - 250 V~24 V DC mit Metallrahmen Фарфоровая нажимная кнопка с золотым декором 10 А - 250 В~ 24 В пост. тока, с металлическим каркасом	14	011	30 Gold/White Gold/Weiß Золотистый/белый	ref. 2 	For fitting in universal box Unterputzmontage in Universaldose Для установки в универсальную коробку
	Wood pushbutton 10A - 24V DC with metallic chassis 110x85 mm 28 depth Klingeltaster Holz 10 A - 24 V DC mit Metallrahmen, 110 x 85 mm 28 Tiefe Деревянная нажимная кнопка 10 А - 24 В пост. тока с металлическим каркасом 110x85 мм 28 (глубина)	14	013	00 Natural Beech Buche natur Натуральный бук 20 Beech Walnut Colored Buche gefärbt Nussbaum Бук/орех цветной	ref. 2 	For fitting in universal box Unterputzmontage in Universaldose Для установки в универсальную коробку
	Wood pushbutton 10A - 24V DC ø 98 mm with metallic chassis Klingeltaster Holz 10 A - 24 V DC ø 98 mm mit Metallrahmen Деревянная нажимная кнопка 10 А - 24 В пост. тока ø98 мм с металлическим каркасом	14	014	00 Natural Beech Buche natur Натуральный бук 20 Beech Walnut Colored Buche gefärbt Nussbaum Бук/орех цветной	ref. 2 	Possible custom-made finishes with natural wood frames Kundenspezifisches Finish der Rahmen in Naturholz möglich Возможно использование покрытия по индивидуальному заказу покупателя с рамками из натурального дерева See installation instructions at page 103. Siehe Montageschaubild auf Seite 103. См. инструкции по установке на стр. 103. For fitting in universal box Unterputzmontage in Universaldose Для установки в универсальную коробку

1 Unit Einheit единица

1 Unit Einheit единица









1 Unit Einheit единица

1 Unit Einheit единица

Fontini Complements	Code Code Код	Finish Finish Отделка		Code Code Код	Finish Finish Отделка		Code Code Код	Finish Finish Отделка
	35 · 928 · 212	Old wood Holz gealtert Старое дерево For Garby, Garby Colonial and Venezia Collections		35 · 928 · 002	Natural wood Naturholz Натуральное дерево For Garby, Garby Colonial and Venezia Collection		35 · 928 · 192	Honey colour wood Holz Honigfarbe Дерево цвета "мёд" For Garby, Garby Colonial and Venezia Collections
	35 · 928 · 302	Gold-plated brass Messing vergoldet Золочёная медь For Garby, Garby Colonial and Venezia Collections		35 · 928 · 512	Nickel-plated brass Messing vernickelt Никелированная медь For Garby, Garby Colonial and Venezia Collections		35 · 928 · 592	Antique bronze brass Messing Antikbronze Медь "античная бронза" For Garby, Garby Colonial and Venezia Collections
	37 · 928 · 252	Stainless steel Edelstahl Нержавеющая сталь For F37 and Venezia Collections		37 · 928 · 302	Golden brass Messing vergoldet Золотистая медь For F37 and Venezia Collections		37 · 928 · 592	Antique bronze brass Messing Antikbronze Медь "античная бронза" For F37 and Venezia Collections
	35 · 928 · 172	Porcelain Porzellan Фарфор For Garby, Garby Colonial and Venezia Collections		35 · 928 · 272	Black porcelain Porzellan schwarz Черный фарфор For Garby, Garby Colonial and Venezia Collections			
	35 · 930 · 172	Porcelain retro key Porzellan Retro Фарфоровый выключатель "ретро" For Garby, Garby Colonial and Venezia Collections		35 · 930 · 272	Black porcelain retro key Porzellan schwarz Retro Выключатель "ретро" из черного фарфора For Garby, Garby Colonial and Venezia Collections			

	Code Code Код	Finish Finish Отделка		Code Code Код	Finish Finish Отделка		Code Code Код	Finish Finish Отделка
	35 · 929 · 302	Gold-plated brass Messing vergoldet Золочёная медь For Venezia Rotary Collection		35 · 929 · 512	Nickel-plated brass Messing vernickelt Никелированная медь For Venezia Rotary Collection		35 · 929 · 592	Antique bronze brass Messing Antikbronze Медь "античная бронза" For Venezia Rotary Collection
	67 · 929 · 302	Gold-plated brass Messing vergoldet Золочёная медь For F37 and Venezia Rocking Collections		67 · 929 · 262	Chrome-plated brass Messing verchromt Хромированная медь For F37 and Venezia Rocking Collections		67 · 929 · 592	Antique bronze brass Messing Antikbronze Медь "античная бронза" For F37 and Venezia Rocking Collections
	65 · 929 · 302	Gold-plated brass Messing vergoldet Золочёная медь For Venezia Rocking Collection		65 · 929 · 262	Chrome-plated brass Messing verchromt Хромированная медь For Venezia Rocking Collection		65 · 929 · 592	Antique bronze brass Messing Antikbronze Медь «античная бронза» For Venezia Rocking Collection

SOUND AUDIO 3BYK

		Set Serie Серия	Code Code Код	Finish Finish Отделка	Packaging Verpackung Упаковка			
	<p>Sound central for 1 channel Low impedance stereo input from 1V to 20V Self-controlled stereo output Switch to connect/disconnect speakers Power 220V/40VA Fuses of automatic rearm Power supply for 12 digital controls Amplifier for 15 analogue controls</p>	95	946	05	ref. 2 	<p>1-Kanal-Audiozentrale Stereosignaleingang mit geringer Impedanz von 1 V bis 20 V Autom. gesteuerter Stereoausgang Fernsteuerung zum Trennen von externen Quellen Schalter zum Verbinden und Trennen von Lautsprechern Stromversorgung 220 V/40 VA Automatische Sicherung Netzteil für 12 digitale Schaltungen Verstärker für 15 analoge Schaltungen</p>	<p>Аудиосистема для 1 канала Стереовход с низким полным сопротивлением от 1 до 20 вольт Стереовыход с автоматическим управлением Переключатель для подключения/ отключения динамиков Питание 220 В/40 В-А Предохранители для автоматического повторного включения Питание для 12 цифровых регулировок Усилитель для 15 аналоговых регулировок</p>	1 Unit Einheit единица
	<p>Sound central for 1 channel with FM tuner Same features than ref. 95.946.. FM tuner included Switch between music source/FM tuner</p> <p>1-Kanal-Audiozentrale mit FM-Empfänger Gleiche Eigenschaften wie Art.-Nr. 95.946.. Integrierter FM-Empfänger Umschalter Musikquelle / FM-Empfänger</p> <p>Аудиосистема для 1 канала с FM-тюнером Характеристики такие же, как для поз. 95.946.. FM-тюнер входит в комплект поставки Переключение между музыкальным центром/ FM-тюнером</p>	95	947	05	ref. 2 			1 Unit Einheit единица
	<p>Frontal frame for sound central Frontabdeckung für Audiozentrale Передняя рамка для аудиосистемы</p>	95	802	05	ref. 2 			1 Unit Einheit единица
	<p>Box for surface installation Dose für Oberputzinstallation Коробка для наружной установки</p>	95	910	05	ref. 2 			1 Unit Einheit единица

TECHNICAL INFORMATION TECHNISCHE DATEN *ТЕХНИЧЕСКАЯ ИНФОРМАЦИЯ*

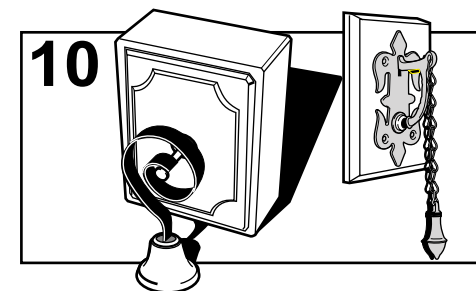
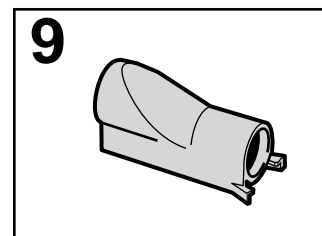
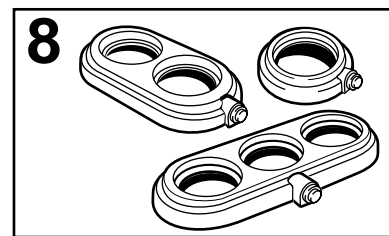
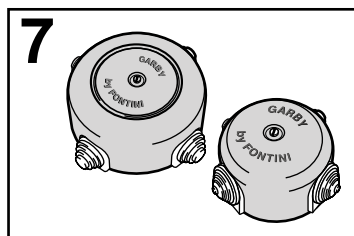
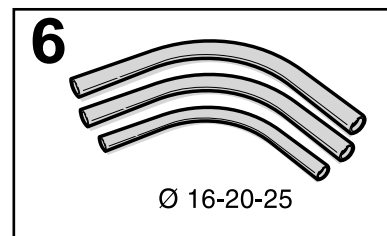
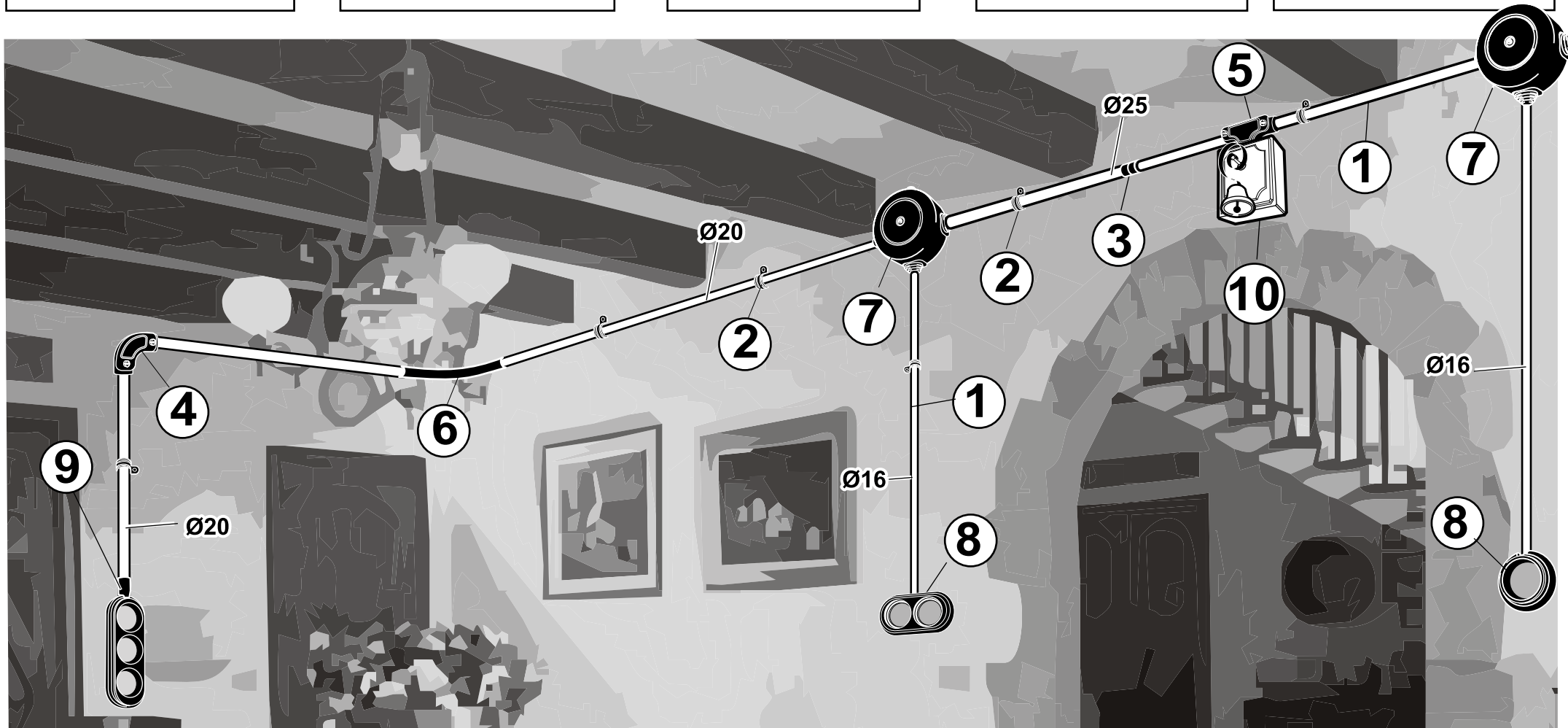
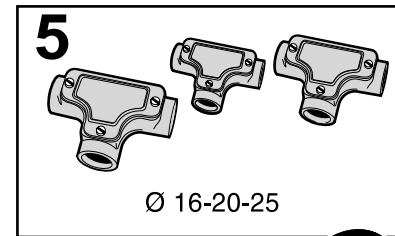
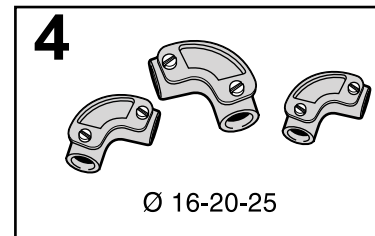
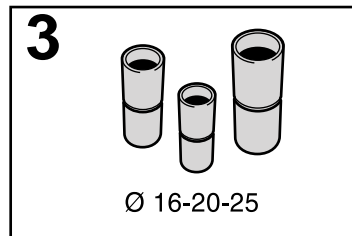
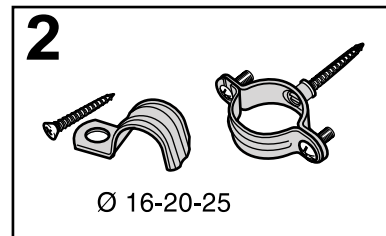
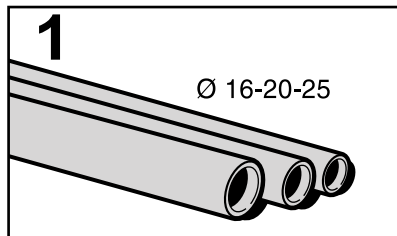

7

CARACTERISTICAS GENERALES

Ø16
Ø20
Ø25

Ø16
Ø20

2

h

4-5

8

Ø16-20-~~25~~

Ø16

Ø20

Ø 20

h

1

10

Instrucciones mecanismos / Instructions pour mécanismes Instructions for Mechanisms

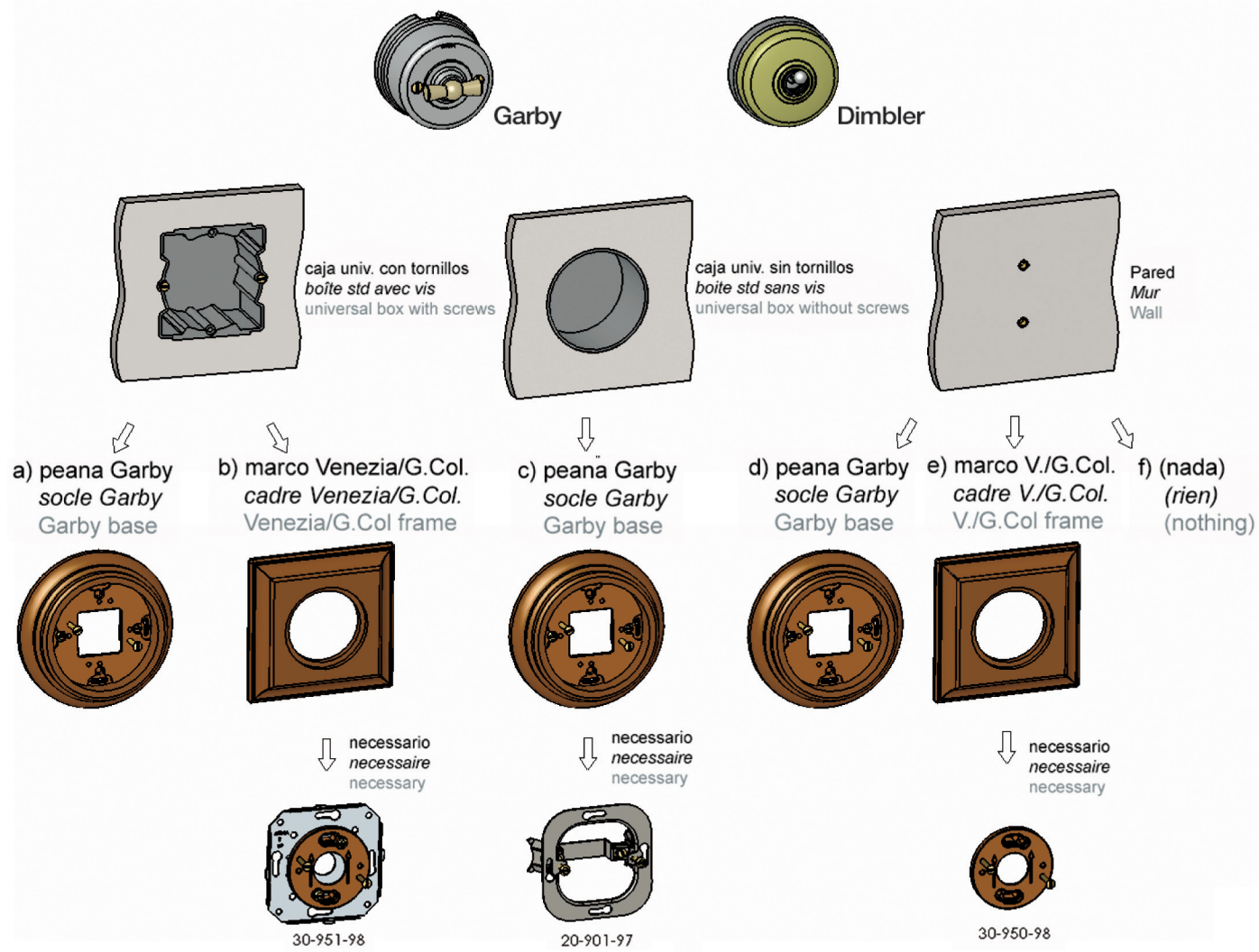

A Con peana Garby en caja universal con tornillos
Avec socle Garby sur boîte standard avec vis
 With Garby base on universal box with screws

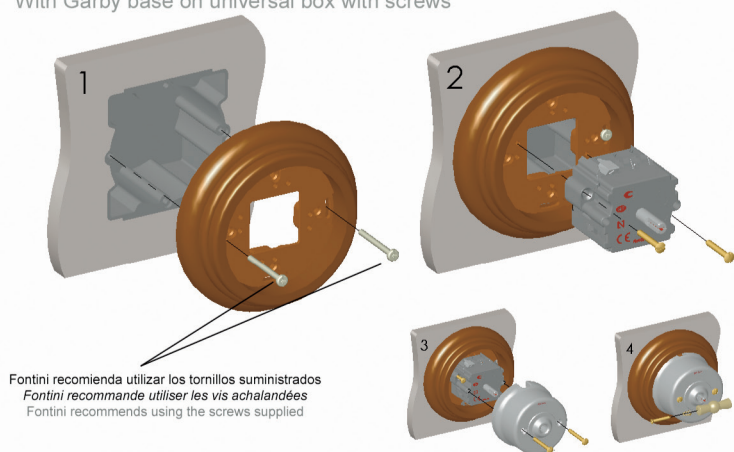

B Con marco Venezia* o Garby Colonial en caja universal con tornillos
Avec cadre Venezia ou Garby Colonial sur boîte standard avec vis*
 With Venezia* or Garby Colonial frame on universal box with screws

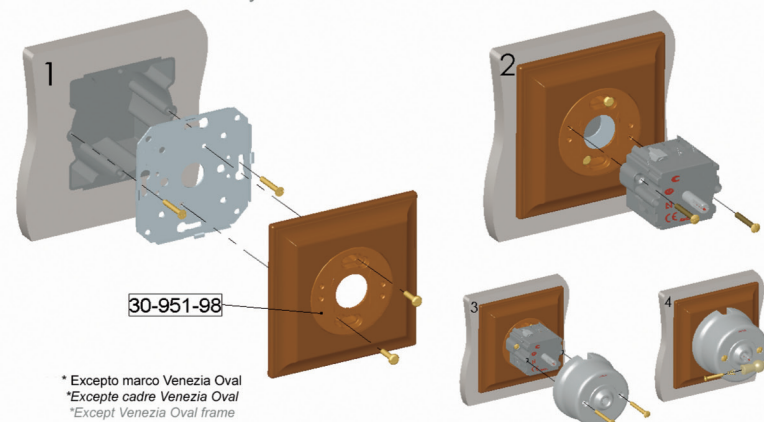

C Con peana Garby en caja universal Sin tornillos
Avec socle Garby sur boîte standard sans vis
 With Garby base on universal box without screws

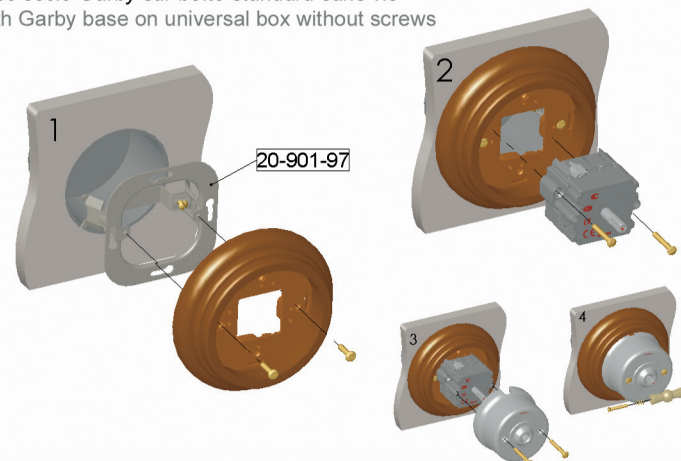

D Con peana Garby en pared
Avec socle Garby sur mur
 With Garby base on wall

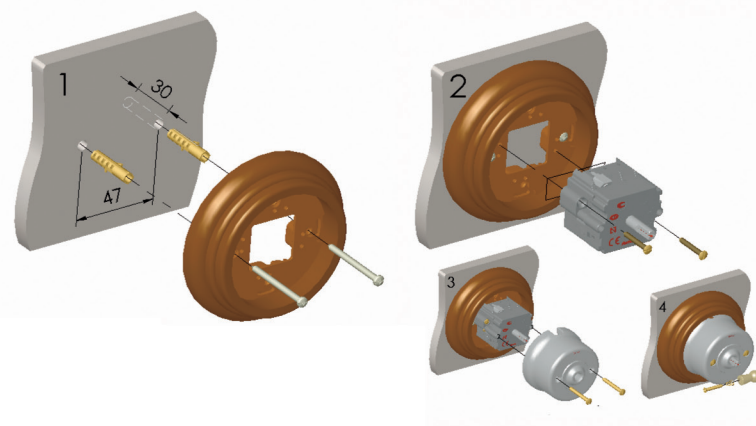

GARBY

E Con marco Venezia* o Garby Colonial en pared
 Avec cadre Venezia* ou Garby Colonial sur mur
 With Venezia* or Garby Colonial frame on wall

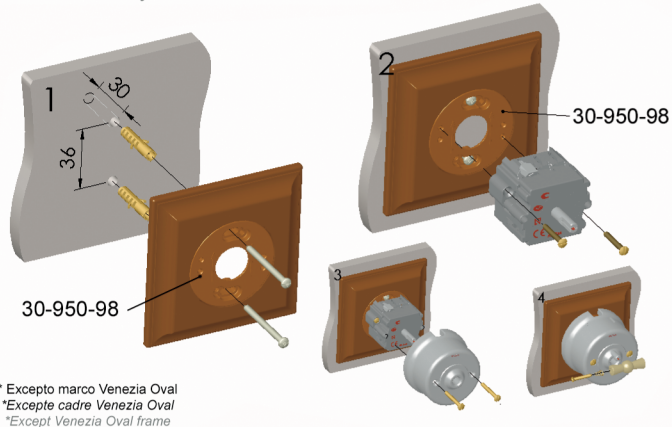

* Excepto marco Venezia Oval
 *Excepte cadre Venezia Oval
 *Except Venezia Oval frame

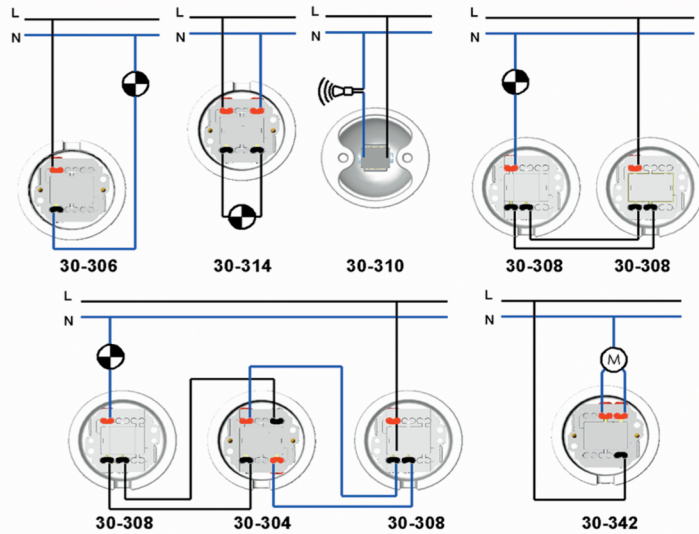

Esquemas de conexión Garby
 Schèmes de connexion Garby
 Garby connection schemes

F Instalacion en pared / Installation sur mur
 Installation on wall

30-306, 30-308, 30-304, 30-314,
 30-342, 30-343, 30-700/2 o 30-927

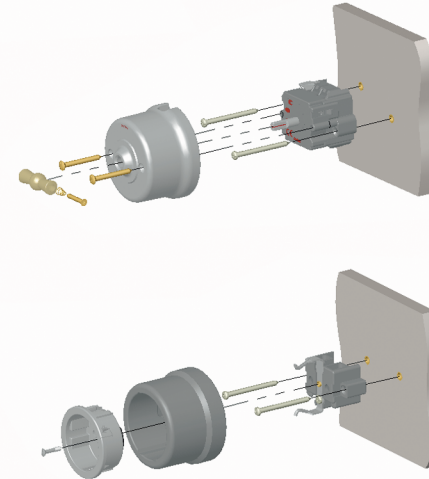

30-209, 30-204,
 30-208, 30-310 o 30-710/1

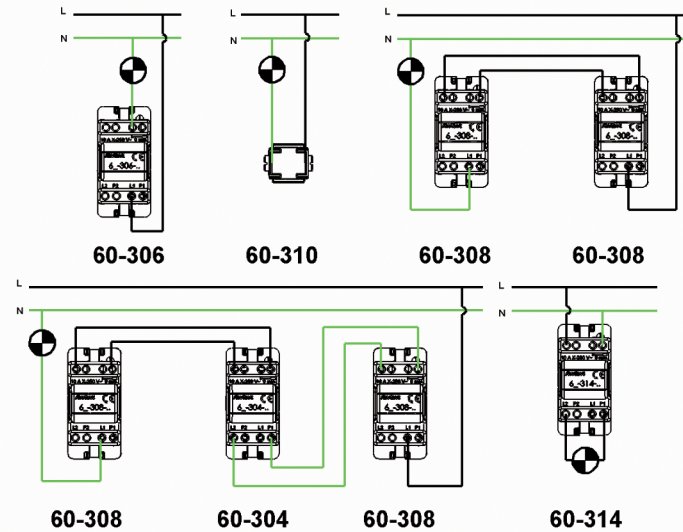

Esquemas de conexión Dimbler
 Schèmes de connexion Dimbler
 Dimbler connection schemes

VENEZIA / GARBY COLONIAL / F-37

A Montaje de mecanismo Venezia
Assembling of Venezia mechanism
Montage du mécanisme Venezia

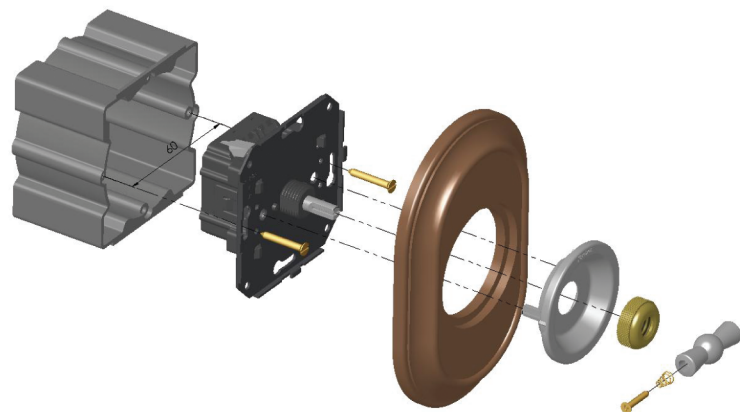

C Montaje de mecanismo Garby Colonial
Assembling of Garby Colonial mechanism
Montage du mécanisme Garby Colonial

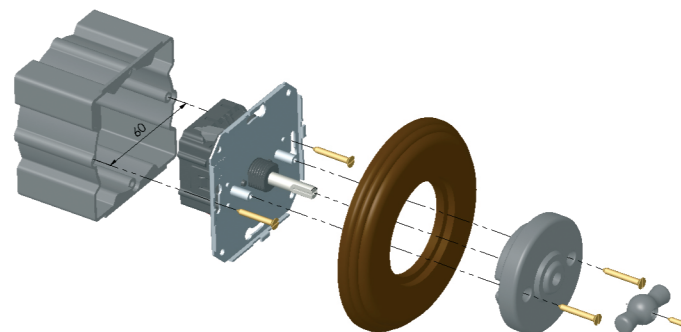

B Montaje de mecanismo F-37
Assembling of F-37 mechanism
Montage du mécanisme F-37

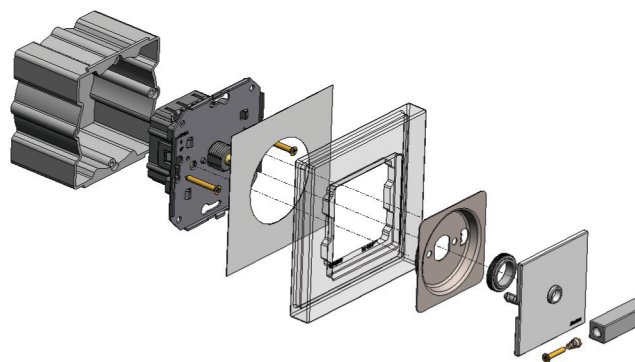

VENEZIA / GARBY COLONIAL / F-37

Esquemas de conexión
Connection schemes

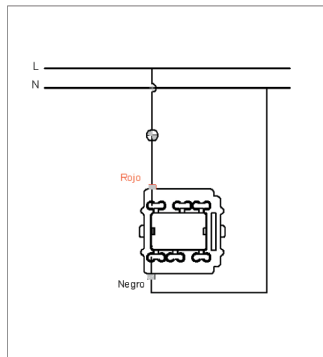

Interruptor Switch

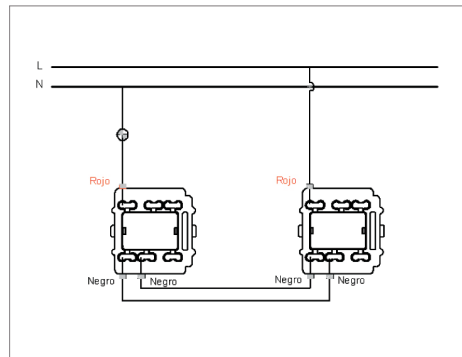

Conmutador Two-way Switch

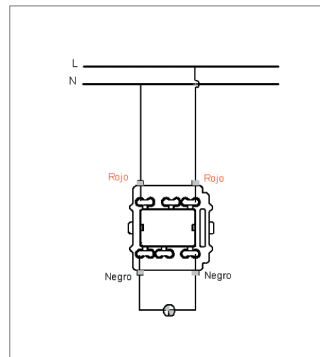

Interruptor bipolar Two-pole Switch

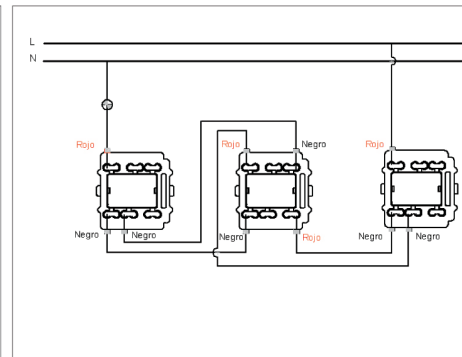

Cruzamiento Crossing Switch

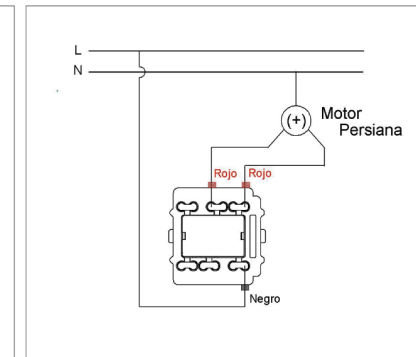

Mecanismos para persianas
Electric blinds mechanism

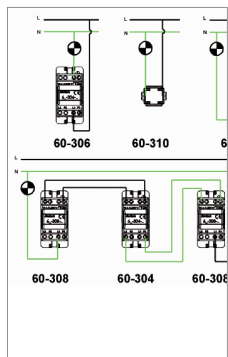

Pulsador Pushbutton

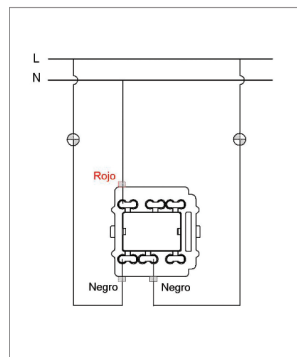

Doble interruptor Double switch

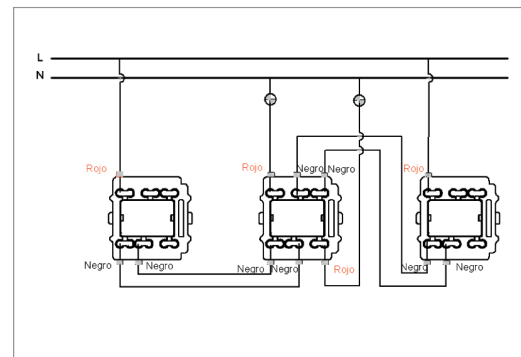

Doble conmutador Double two-way switch

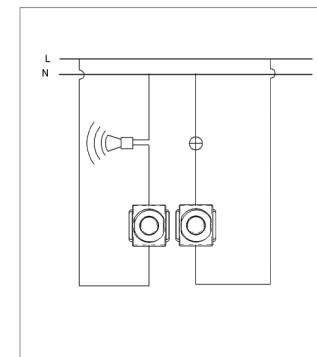

Doble pulsador Double pushbutton

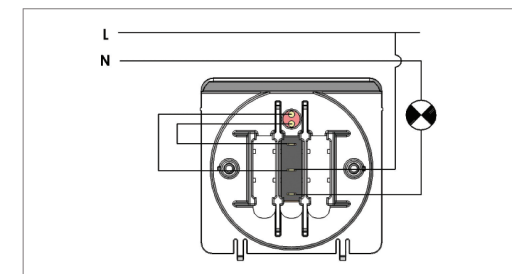

Tarjetero Cards mechanism

ROCKING SWITCHES

Montaje de mecanismo F-37
 Assembling of F-37 mechanism
 Montage du mécanisme F-37

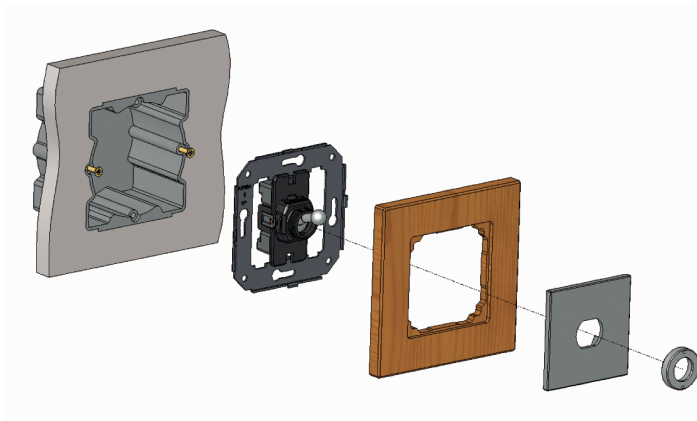

Montaje de mecanismo Venezia
 Assembling of Venezia mechanism
 Montage du mécanisme Venezia

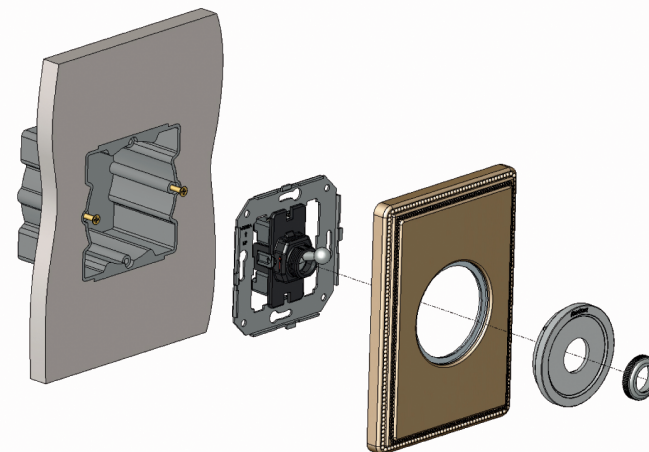

Esquemas de conexión Venezia/ F-37
 Schèmes de connexion Venezia/ F-37
 Venezia/ F-37 connection schemes

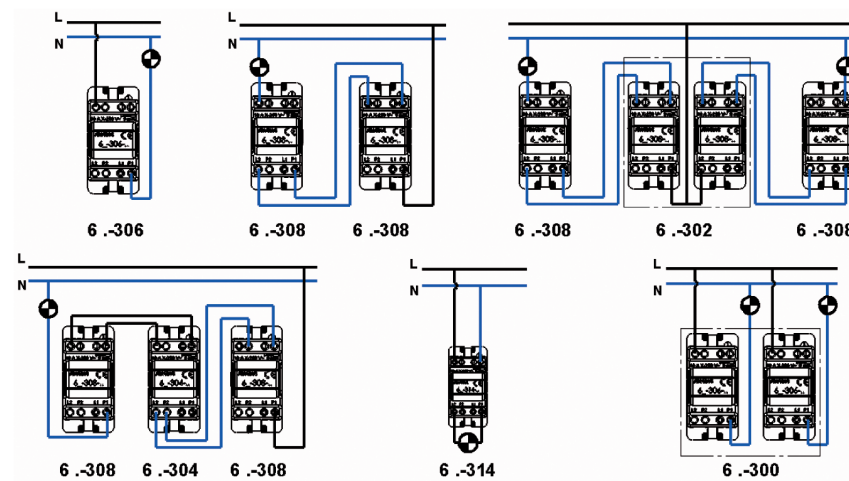

VENEZIA / GARBY COLONIAL / F-37

Ref. 31-332, Ref. 35-332 y Ref. 37-332

Esquemas de conexión regulador-conmutador

Descripción

Consumo lo que usted necesita, regulando la intensidad de la lámpara a su gusto. Sustituye a los conmutadores convencionales, es adaptable a las cajas universales de empotrar, sin necesidad de modificar la instalación actual.

Es válido para:

- Lámparas de incandescencia y halógenas de 40W a 500W.
- Transformadores toroidales desde 50W a 500W.
- Transformadores electromecánicos de 90W a 500W.
- Funciona como simple interruptor, como conmutador y en combinación de conmutador y cruzamiento.

Características

- Clase II
- IP 20
- IRC > 450 V
- Protegido mediante fusible rápido F 2.5 A

Connection schemes of dimmer - two-way switch

Description

Only consumes what you need, regulating the lamp intensity as you like. It substitutes the conventional switches and adaptable to fitting standard boxes.

The current installation does not have to be modified.

Suitable for:

- Incandescence and halogen bulbs from 40W to 500W.
- Toroidal transformers from 50W to 500W
- Electromechanical transformers from 90W to 500W
- Works as a simple switch, as a two way switch or combined with a two way switch and a crossing switch

Characteristics

- II Class
- IP 20
- IRC > 450 V
- Protected with a fast fuse F 2.5 A

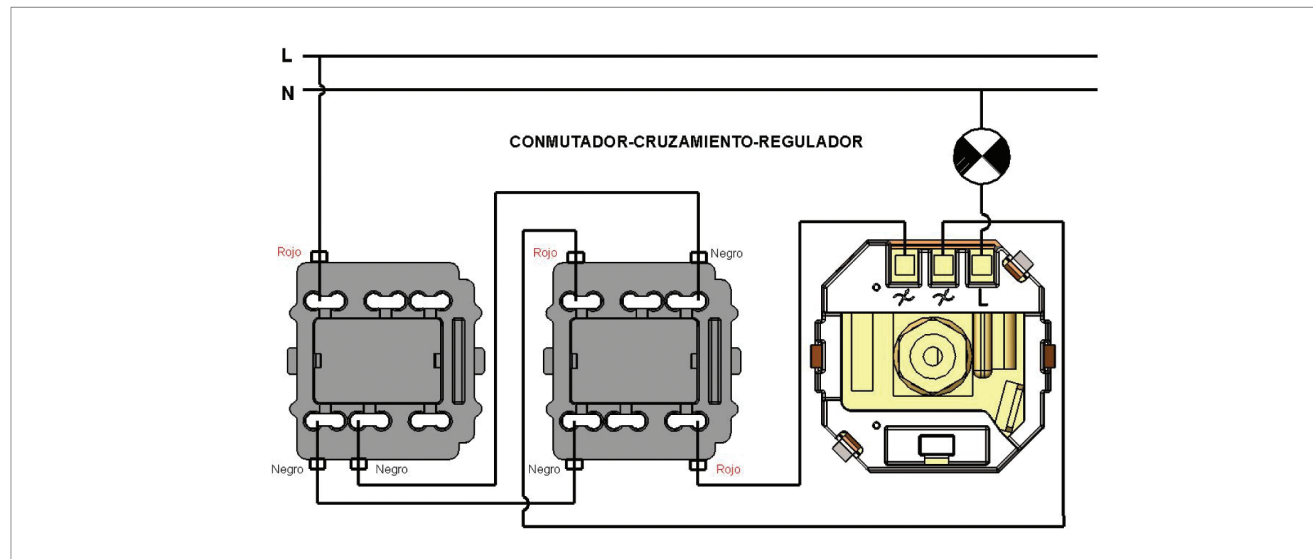
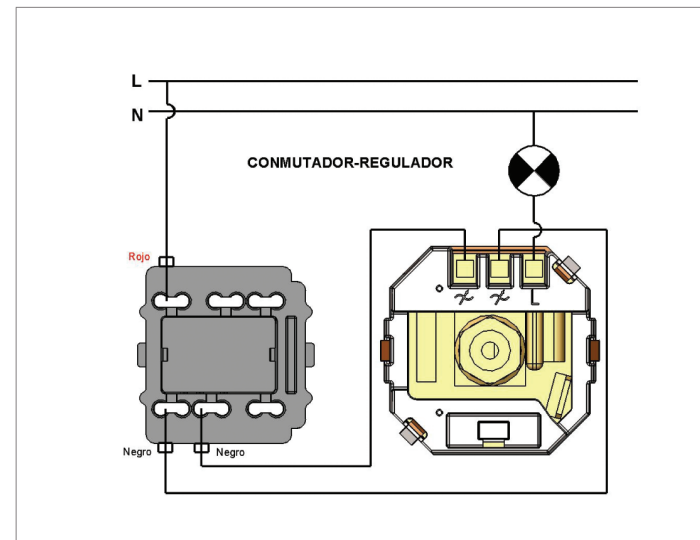
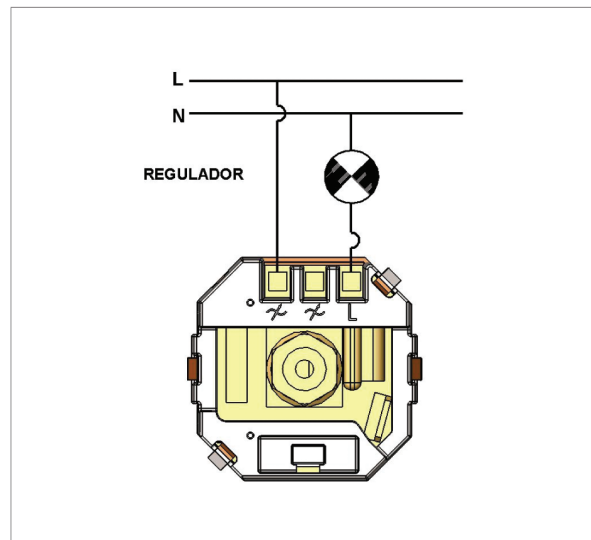

NOTA: En un mismo circuito sólo puede conectarse un regulador-conmutador en combinación con un conmutador simple, pero nunca con otro regulador-conmutador.
IMPORTANT: At the same circuit only one dimmer-two-way switch can be used, combined with a simple two-way switch. Never use two dimmers together!

RTV - SAT

Toma señal TV, Radio y FI ecualizada
TV, Radio and FI equalized signal socket

F-37 · Venezia · Garby Colonial · Garby
Refs. 35-711, 35-712, 35-713, 35-714
30-712, 30-714, 30-713, 30-709
37-711, 37-712, 37-713, 37-714

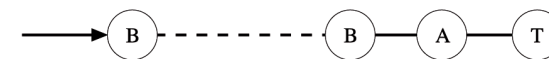

Referencia Reference	Tipo Type	Pérd. inserción (dB) Insertion loss (dB)		SALIDA OUT	Pérd. inserción (dB) Insertion loss (dB)	
		MATV	SAT-FI		MATV	SAT-FI
		5-862 MHz	950-2150 MHz		5-862 MHz	950-2150 MHz
30-712 35-712 37-712	Única Single	-	-	R/TV	0,6	-
				SAT	-	1,5
30-714 35-714 37-714	Intermedia B Intermediate B	1,02	2	R/TV	13	13,5
				SAT	13	14
30-713 35-713 37-713	Intermedia A Intermediate A	3,5	5	R/TV	8,5	9
				SAT	7,5	10
30-709 35-711 37-711	Final T	-	-	R/TV	4	5
				SAT	4	5

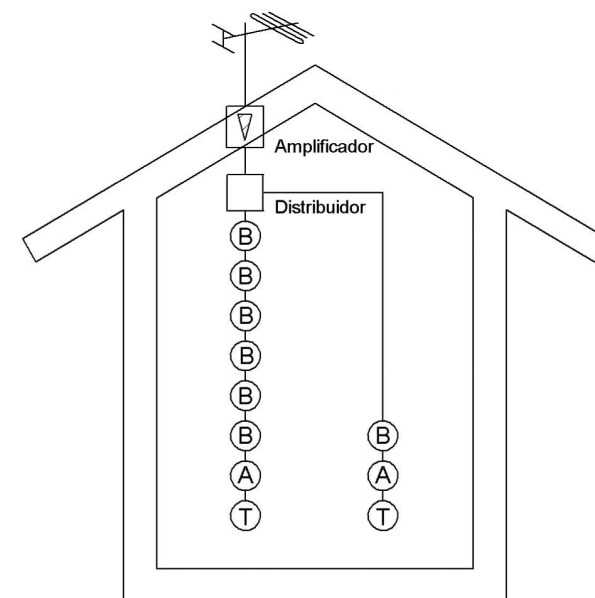

Máximo número de tomas: 8 (dependiendo de la potencia de la señal de entrada).
Maximum number of sockets: 8 (depending on the entering signal power).

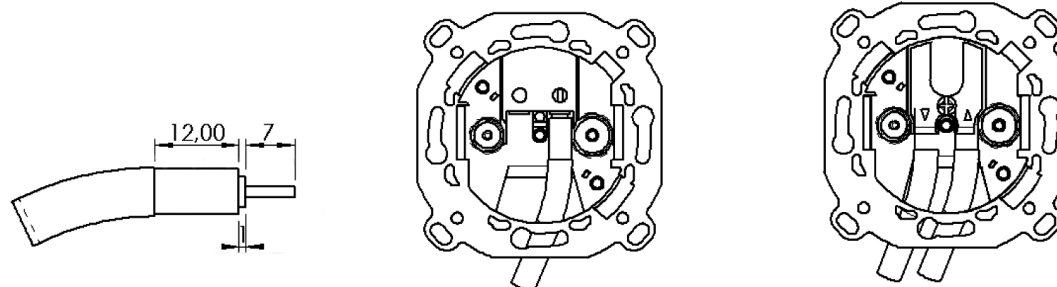

F-37

Doble toma teléfono 4-6 vías. Esquema de conexión.
 Double telephone socket 4-6 ways. Connection schemes.

1 línea (las dos tomas la misma línea) 1 line (two sockets in the same line)

2 líneas independientes 2 independent lines

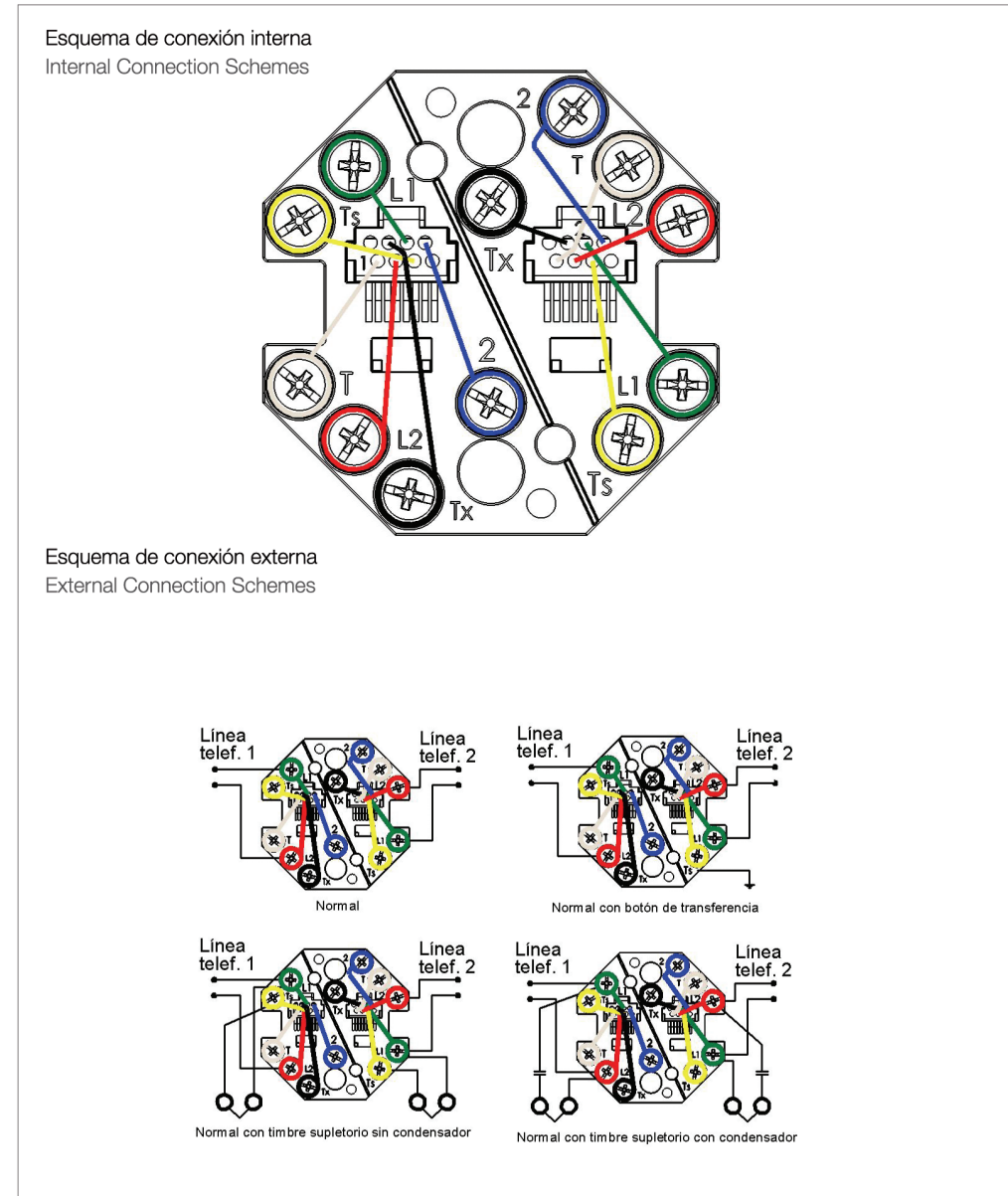
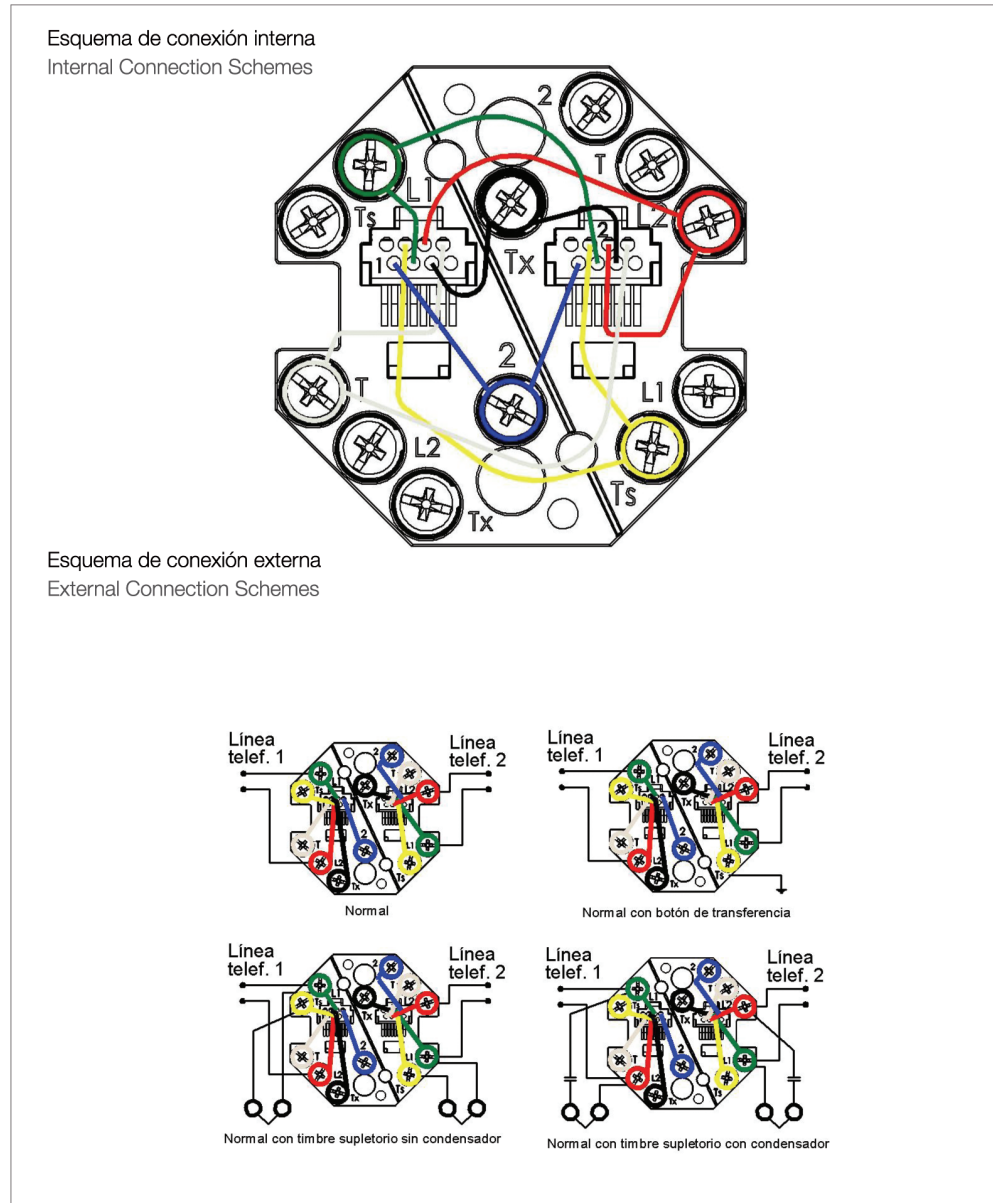

TELEPHONE / TELEFON / ΤΗΛΕΦΩΝ

WIRING DIAGRAM TELEPHONE SOCKETS

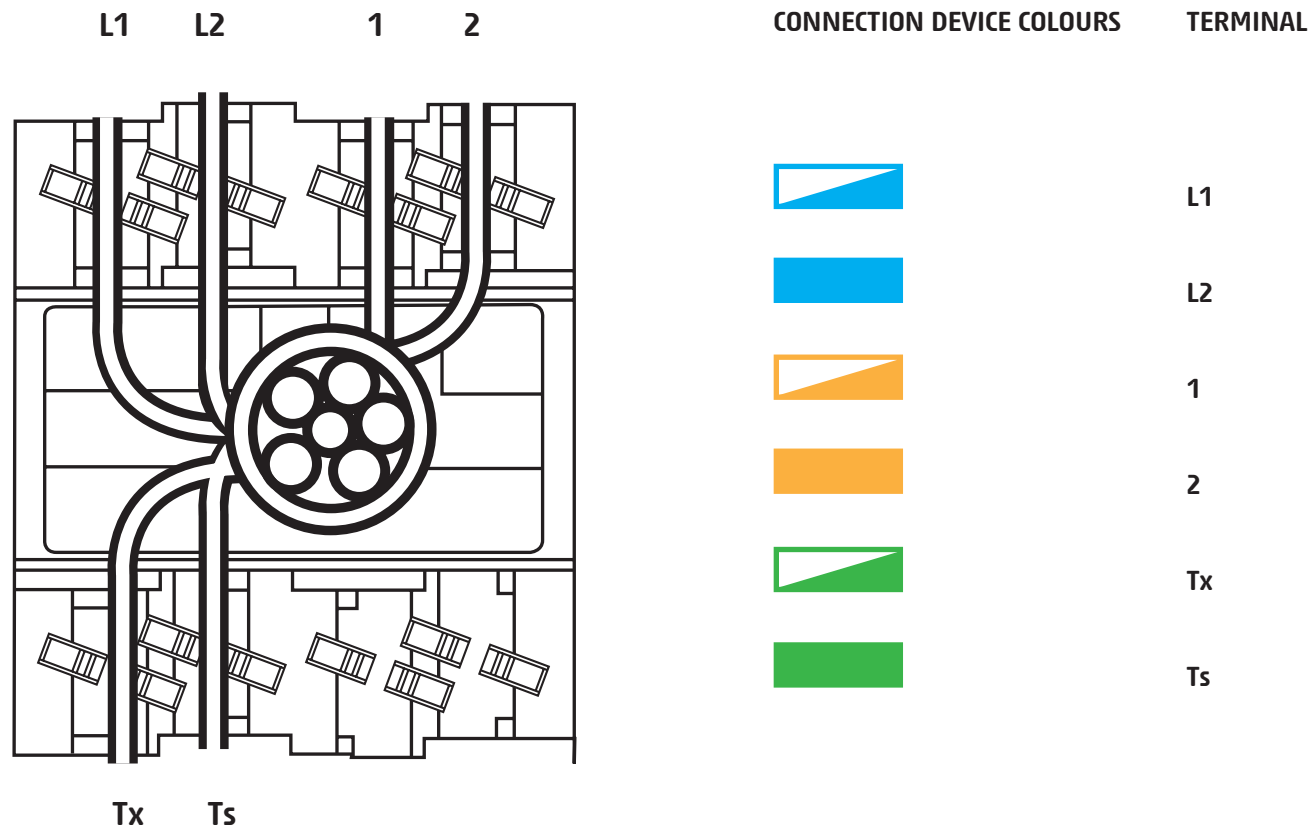

SOUND AUDIO 3BYK

Sonido · Ficha técnica y esquemas de conexión

Sound · Technical file and connection schemes

Sistema de sonido colecciones Garby Colonial, F-37 y Venezia

Garby Colonial, F-37 and Venezia collections sound system

DESCRIPCIÓN

Sintonizador de radio (Ref. 31-925, 35-925)

- Compatible únicamente con centrales de sonido. Ref. 95947050
- Búsquedas de emisoras SCAN (sintoniza la emisora desde el mando) mediante pulsación.
- Regulador de volumen mediante giro del mando.
- Instalación estereofónica o monofónica.
- Impedancia mínima de carga: 8 Ω.
- Máximo número de altavoces en paralelo por canal:
 - De 1 a 4 altavoces de 32 Ω.
 - De 1 a 2 altavoces de 16 Ω.
 - De 1 de 8 Ω.
- Máximo número de altavoces en serie por canal:
 - 1 altavoz de 32 Ω.
 - De 1 a 2 de 16 Ω.
 - De 1 a 4 de 8 Ω.
- Margen de regulación: 32 dB.

Potenciómetro (Ref. 31-924, 35-924 y 37-924)

- Compatible con Ref. 95946050 o con cualquier amplificador.
- Regulador de volumen.
- Instalación estereofónica o monofónica.
- Impedancia mínima de carga: 8 Ω.
- De 1 a 4 altavoces de 32 Ω, 1 ó 2 de 16 Ω ó 1 de 8 Ω por canal.
- Margen de regulación: 32 dB.

Altavoz para caja universal (Ref. 31-926, 35-926 y 37-926)

- Potencia 2 W.
- Impedancia 16 Ω.
- Sensibilidad: 82 dB.
- Respuesta: 150-16.000 Hz.
- Ángulo de cobertura: 155°.

DESCRIPTION

Radio Tuner (Refs. 31-925, 35-925)

- Only compatible with sound centrals. Ref. 95947050
- Seek of radio stations with SCAN system (tunes automatically with one touch).
- Regulates the volume by turning the control right or left.
- Stereo or Mono installations.
- Minimal load impedance: 8 Ω.
- Maximum number of loudspeakers in parallel by channel:
 - From 1 to 4 of 32 Ω.
 - From 1 to 2 of 16 Ω.
 - One loudspeakers of 8 Ω.
- Maximum number of loudspeakers in serial by channel:
 - One Loudspeaker of 32 Ω.
 - From 1 to 2 of 16 Ω.
 - From 1 to 4 of 8 Ω.
- Regulation range: 32 dB.

Potentiometer (Refs. 31-924, 35-924, 37-924)

- Compatible with Ref. 95946050 or any amplifier.
- Volume regulator.
- Stereo or Mono installation.
- Minimal load impedance: 8 Ω.
- From 1 to 4 loudspeakers of 32 Ω, 1 or 2 of 16 Ω or 1 of 8 Ω by channel.
- Regulation range: 32 dB.

Loudspeaker for universal box 65x65x40 (Ref.31-926, 35-926, 37-926)

- Power 2 W.
- Impedance 16 Ω.
- Sensitivity: 82 dB.
- Response: 150-16.000 Hz
- Coverage angle: 155°.

Refs.

31-92X

35-92X

37-92X

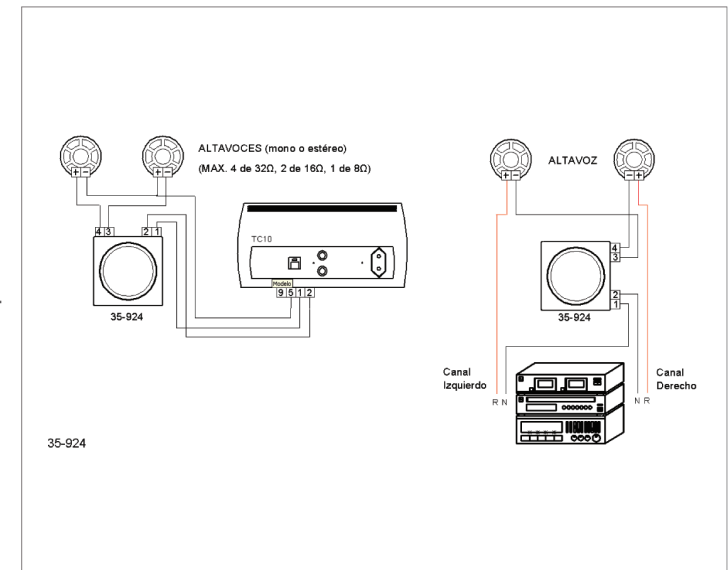
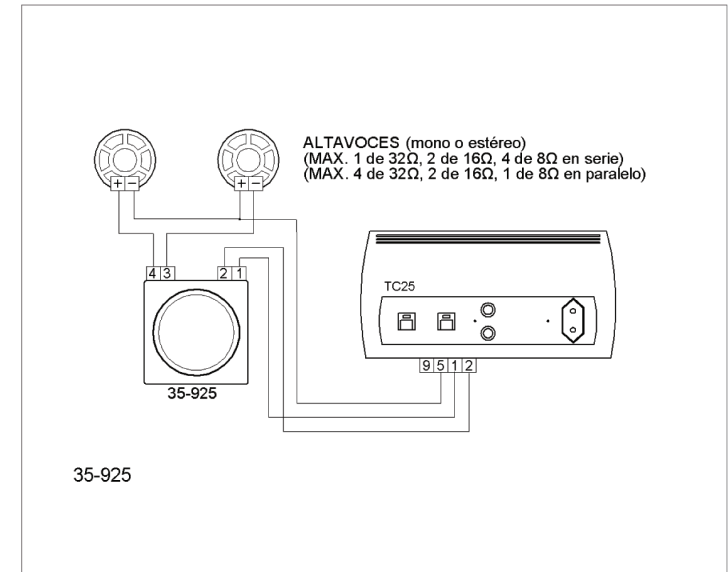



Interior Design: **Xavier Cruz** - Photography: **Jordi Canosa**
Innenhausstattung: **Xavier Cruz** - Fotografie: **Jordi Canosa**
Дизайн интерьера: **Xavier Cruz** - Фотография: **Jordi Canosa**

SERVICES DIENSTLEISTUNGEN УСЛУГИ

Collections · News · Novelties · Events · Trade fairs

www.Fontini.com

An easy tool to find the best interior design solution for your needs.

Mit diesem einfachen Werkzeug finden Sie die dekorativen Lösungen, die Ihren Bedürfnissen am Besten entsprechen.

Простой способ подобрать наилучшее решение в области дизайна интерьера.



Fontini EXPRESS SERVICE 24H

Fontini LET'S TALK
+34 902 120 103

CERTIFICATIONS ZERTIFIZIERUNGEN CERTIFICAZIONI

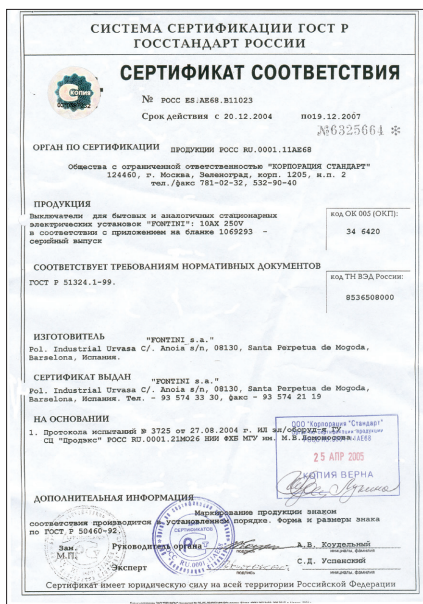

Quality, reliability and safety of our products are essential. We hold ISO 9001:2000 quality certificates and AENOR, NF and GOST product certificates, fulfilling the European laws of Low Voltage Electrotechnical Regulation.

Require quality. require Fontini

Die Qualität, Zuverlässigkeit und Sicherheit unserer Produkte sind uns sehr wichtig. Mit den Qualitätszertifizierungen ISO 9001:2000 und den Produktzertifizierungen AENOR, NF und GOST erfüllen wir die Niederspannungsrichtlinien der EG.

Verlangen Sie Qualität, verlangen Sie Fontini

Качество, надежность и безопасность наших изделий являются нашими приоритетами.

Мы располагает сертификатами качества ISO 9001:2000 и товарными сертификатами AENOR, NF и GOST, свидетельствующими о выполнении европейских норматив безопасности низковольтного электротехнического оборудования.

Требуйте качества – заказывайте Fontini!

CUSTOMIZING PERSONALISIERUNG ПЕРСОНАЛИЗАЦИЯ



CUSTOMIZE YOUR PRODUCT:

In Fontini we adapt ourselves to your needs offering the possibility to customize your collections:

From a special hotel logo-brand name, up to a color, a texture, a material or a limited edition design project.

Therefore, we have an exclusive service of personal attention at your disposal to advise you on the adjustment or the development of the product.

Photo: Pushbutton - Villamagna Hotel, Madrid (special limited edition)
Design: Thomas Urquijo - Resco Decoración

PERSONALISIEREN SIE IHR PRODUKT:

Bei Fontini passen wir uns Ihren Bedürfnissen an. Sie haben die Möglichkeit, unsere Kollektionen nach Ihren persönlichen Anforderungen anzupassen, sei es mit einer spezifischen Marke für ein Hotel, einer bestimmten Farbe, einer Oberflächenbeschaffenheit, einem Material oder einem umfassenden Design-Projekt für limitierte Auflagen.

Unser Mitarbeiterteam und unsere Techniker stehen Ihnen bei der Ausarbeitung oder Anpassung Ihres Produkts für beste Ergebnisse zur Verfügung.

Foto: Drucktaster - Hotel Villamagna, Madrid (limitierte Spezialauflage)
Design: Thomas Urquijo - Resco Decoración

ПЕРСОНАЛИЗИРУЙТЕ ПРИОБРЕТАЕМОЕ ИЗДЕЛИЕ:

В Fontini мы учитываем Ваши потребности и предлагаем Вам возможность персонализировать наши коллекции: от нанесения фирменного знака отеля или изменения колорита, текстуры и материала до персонального проекта дизайна ограниченных серий продукции.

К Вашим услугам – наша команда профессионалов и техническая помощь, направленная на достижение оптимальных результатов адаптации или разработки изделия.

Фото: нажимный выключатель – отель «Вильямагна» (Villamagna), г. Мадрид (специальный ограниченный выпуск)
Дизайн: Томас Уркихо - Resco Decoración

©2009 Fontini, S.A.

Supervisión técnica: Roger Font / Elodie Posso

Creación y diseño: Dlab Advertising

Impresión: Impresiones Generales, S.A.

D. Legal: B-15.336-2009

Catálogo 23

Los colores de los productos fotografiados en este catálogo están sujetos a los cambios de tonalidades propios de los materiales naturales con que están fabricados, así como a las desviaciones cromáticas de la reproducción impresa.

Todas las referencias, códigos y medidas son válidos salvo error tipográfico.

Fontini, S.A. se reserva el derecho a modificar el contenido de este catálogo sin previo aviso.

EL PAPEL QUE SIRVE COMO SOPORTE PARA ESTA PUBLICACIÓN
HA SIDO FABRICADO A PARTIR DE PASTAS PRODUCIDAS BAJO
EL PROCESO KRAFT BEKP (UWF UNCOATED WOOD FREE)
Y ECF (ELEMENTAL CHLORINE FREE)

Fontini

Tel. Atención Profesional:
902 120 103

Pol. Ind. Can Bernades-Subirà C/ Anoia, 15 080130
Santa Perpetua de Mogoda (Barcelona) Spain
Tel.: (+34) 93.574.33.30 Fax: (+34) 93.574.21.19
Mail: info@fontini.com www.fontini.com



DOMUSCLASSICA®
| Collection |

HINNASTO

Fontini

TUOTENUMEROT

Fontini



Pushbutton 10A - 250V~ 24V DC
Drucktaster 10 A - 250 V~ - 24 V DC
Нажимная кнопка 10 А - 250 В~ - 24 В пост. тока

Set
Serie Серия

37

Code
Code Код

310

Finish
Finish Отделка

26

61

Packaging
Verpackung Упаковка

ref. 2



Dimmer with pulsation control, using the 37347000 / 37346000 accessories (electronic dimmer 900 / 500W) from the page 50, every pushbutton could be used as electronic dimmer.

Tastregler, mit den Accessoires 37347000 / 37346000 (elektronischer Dimmer für 900 / 500 W) von Seite 50 wird jeder Drucktaster zu einem elektronischen Intensitätsregler.

Регулятор нажимного типа: используя вспомогательные устройства 37347000 / 37346000 (электронные диммеры 900 / 500Вт) со стр. 50, можно превратить любой нажимный выключатель в электронный регулятор освещенности.

1 Unit Einheit единица

Valmistajan tuotenumerot muodostettu seuraavasti: **37-310-26-2**

Domus Classican tuotennumero voi poiketa valmistajan numerosta.

Hinnastossa tuotteet luetteloitu valmistajan tuotenumeron mukaisessa nousevassa järjestyksessä.

Rivi	Valmistajan tuotenro *)	Tuotenimi	Selite	Domus Classican tuotenro	Yks.	Hinta (0%)	Hinta (24%)
1.		Erikoissähkörasia		517-099	kpl		
2.		Johdonohjain, valkoinen	1 kpl	519-005-15	kpl	1,77	2,20
3.		Johdonohjain, tummanruskea	1 kpl	519-005-25	kpl	2,02	2,50
4.		Pintavetojohto, tummanruskea	4x1,5 mm (m)	503-020-7	kpl	12,50	15,50
5.		Pintavetojohto, valkoinen	3x2,5mm (m)	503-021-3	kpl	7,66	9,50
6.		Pintavetojohto, tummanruskea	3x2,5 mm (m)	503-021-5	kpl	8,06	10,00
7.		Pintavetojohto, valkoinen	3x1,5mm (m)	503-021-13	kpl	6,85	8,50
8.		Pintavetojohto, tummanruskea	3x1,5 mm (m)	503-021-15	kpl	7,26	9,00
9.		Pintavetojohto, valkoinen	4x1,5 mm (m)	503-021-17	kpl	11,69	14,50
10.	01-081-97-0	Asennussarja, promo (DO)		01-081-97-0	kpl	14,92	18,50
11.	10-426-02-2	Lampunkanta, lankakatkaisimella	Musta	518-031-9	kpl	9,27	11,50
12.	10-427-02-2	Lampunkanta, varjostinrenkaalla	Valkoinen	518-031-7	kpl	6,85	8,50
13.	10-427-05-2	Lampunkanta, varjostinrenkaalla	Musta	518-031-8	kpl	6,85	8,50
14.	10-429-02-2	Lampunkanta	Musta	518-030-8	kpl	6,05	7,50
15.	10-429-05-2	Lampunkanta	Valkoinen	518-030-7	kpl	6,05	7,50
16.	10-431-02-2	Seinä- tai kattovalaisin, bakeliitti	Suora	504-006-5	kpl	5,65	7,00
17.	10-431-05-2	Seinä- tai kattovalaisin, valkoinen	Suora	504-006-1	kpl	5,65	7,00
18.	10-432-02-2	Seinävalaisin, bakeliitti	Vino	504-006-6	kpl	6,45	8,00
19.	10-432-05-2	Seinävalaisin, valkoinen	Vino	504-006-2	kpl	6,45	8,00
20.	10-433-05-2	Seinävalaisin, valkoinen	Vino, kytkimellä	504-006-3	kpl	9,68	12,00
21.	10106012	Pistoke, maadoitettu	Valkoinen	518-033-1	kpl	2,82	3,50
22.	10106022	Pistoke, maadoitettu	Musta	518-033-2	kpl	2,82	3,50
23.	10137022	Pistoke, maadoittamaton	Musta	518-033-5	kpl	2,02	2,50
24.	10137052	Pistoke, maadoittamaton	Valkoinen	518-033-4	kpl	2,02	2,50
25.	10201012	Pistorasia, kulmikas	Pinta-asennettava	517-103-12	kpl	7,26	9,00
26.	10204012	Pistorasia, pyöreä	Pinta-asennettava	517-103-11	kpl	7,26	9,00
27.	14-010-022	Ovikello, painettava, messinki	Musta	14-010-022	kpl	13,71	17,00
28.	14-010-50-2	Ovikello, painettava, messinki	Kulta	14-010-50-2	kpl	16,13	20,00
29.	14-010-51-2	Ovikello, painettava, messinki	Kromattu	14-010-51-2	kpl	16,13	20,00
30.	14-310-50-2	Impulssikytkin	Kulta (pähkinä)	14-310-50-2	kpl	6,05	7,50
31.	14-310-51-2	Impulssikytkin	Kromattu (pähkinä)	14-310-51-2	kpl	6,05	7,50
32.	20-901-97-0	Uppoasennettavaan kojerasian adapteri	Pinta-asennettavalle sähkörasialle	518-061-1	kpl	1,69	2,10
33.	20-901-97-2	Adapteri	-	20-901-97-2	kpl	2,02	2,50
34.	30-001-22-2	Spraymaali	Metalli, patinoitu	30-001-22-2	kpl	21,77	27,00
35.	30-007-03-2	Adapteri	Ruskea	30-007-03-2	kpl	0,81	1,00
36.	30-016-22-2	Putki 16 mm	Metalli, patinoitu	30-016-22-2	kpl	131,45	163,00
37.	30-020-22-2	Putki 20 mm	Metalli, patinoitu	30-020-22-2	kpl	160,08	198,50
38.	30-025-22-2	Putki 25 mm	Metalli, patinoitu	30-025-22-2	kpl	192,34	238,50
39.	30-116-22-2	Liitososa 16 mm	Metalli, patinoitu	30-116-22-2	kpl	31,05	38,50
40.	30-120-22-2	Liitososa 20 mm	Metalli, patinoitu	30-120-22-2	kpl	33,47	41,50

Rivi	Valmistajan tuotenro *)	Tuotenimi	Selite	Domus Classican tuotenro	Yks.	Hinta (0%)	Hinta (24%)
41.	30-125-22-2	Liitososa 25 mm	Metalli, patinoitu	30-125-22-2	kpl	35,89	44,50
42.	30-202-11-2	Pistorasia	Valkoinen, posliini ja sininen koristemaalau	30-202-11-2	kpl	32,66	40,50
43.	30-202-13-2	Pistorasia	Valkoinen, posliini ja ruskea koristemaalau	30-202-13-2	kpl	32,66	40,50
44.	30-202-15-2	Pistorasia	Krakeloitu	30-202-15-2	kpl	36,69	45,50
45.	30-202-17-2	Pistorasia	Pinta-asennettava, sisäosa posliinia	517-003-2	kpl	26,61	33,00
46.	30-202-27-2	Pistorasia	Pinta-asennettava, sisäosa posliinia	517-004-2	kpl	33,87	42,00
47.	30-204-11-2	Pistorasia (sisäosa muovia)	Valkoinen, posliini ja sininen koristemaalau	30-204-11-2	kpl	22,18	27,50
48.	30-204-13-2	Pistorasia (sisäosa muovia)	Valkoinen, posliini ja valkoinen muovi	30-204-13-2	kpl	22,18	27,50
49.	30-204-15-2	Pistorasia (sisäosa muovia)	Krakeloitu	30-204-15-2	kpl	24,19	30,00
50.	30-204-17-2	Pistorasia	Pinta-asennettava, sisäosa muovia	517-003-1	kpl	17,74	22,00
51.	30-204-27-2	Pistorasia	Pinta-asennettava, sisäosa muovia	517-004-1	kpl	21,77	27,00
52.	30-205-11-2	Pistorasia	Valkoinen, posliini ja sininen koristemaalau	30-205-11-2	kpl	26,21	32,50
53.	30-205-13-2	Pistorasia	Valkoinen, posliini ja ruskea koristemaalau	30-205-13-2	kpl	26,21	32,50
54.	30-205-15-2	Pistorasia	Krakeloitu	30-205-15-2	kpl	29,44	36,50
55.	30-205-17-2	Pistorasia	Valkoinen, posliini	30-205-17-2	kpl	23,79	29,50
56.	30-205-27-2	Pistorasia	Musta, posliini	30-205-27-2	kpl	28,23	35,00
57.	30-208-11-2	Pistorasia, ranskalainen	Valkoinen, posliini ja sininen koristemaalau	30-208-11-2	kpl	23,39	29,00
58.	30-208-13-2	Pistorasia, ranskalainen	Valkoinen, posliini ja ruskea koristemaalau	30-208-13-2	kpl	23,39	29,00
59.	30-208-15-2	Pistorasia, ranskalainen	Krakeloitu	30-208-15-2	kpl	25,40	31,50
60.	30-208-17-2	Pistorasia, ranskalainen	Valkoinen, posliini ja valkoinen muovi	30-208-17-2	kpl	19,76	24,50
61.	30-208-27-2	Pistorasia, ranskalainen	Musta, posliini ja musta muovi	30-208-27-2	kpl	24,19	30,00
62.	30-211-11-2	Pistorasia, ranskalainen	Valkoinen, posliini ja sininen koristemaalau	30-211-11-2	kpl	31,45	39,00
63.	30-211-13-2	Pistorasia, ranskalainen	Koristemaalau, ruskea	30-211-13-2	kpl	31,45	39,00
64.	30-211-15-2	Pistorasia, ranskalainen	Krakeloitu	30-211-15-2	kpl	34,68	43,00
65.	30-211-17-2	Pistorasia, ranskalainen	Valkoinen, posliini	30-211-17-2	kpl	29,44	36,50
66.	30-211-27-2	Pistorasia, ranskalainen	Musta, posliini	30-211-27-2	kpl	34,68	43,00
67.	30-304-11-2	Ristikytkin	Valkoinen, posliini ja sininen koristemaalau	30-304-11-2	kpl	38,71	48,00
68.	30-304-12-2	Ristikytkin	Valkoinen, posliini ja sininen koristemaalau	30-304-12-2	kpl	38,71	48,00
69.	30-304-13-2	Ristikytkin	Valkoinen, posliini ja ruskea koristemaalau	30-304-13-2	kpl	38,71	48,00
70.	30-304-14-2	Ristikytkin	Valkoinen, posliini ja ruskea koristemaalau	30-304-14-2	kpl	38,71	48,00
71.	30-304-15-2	Ristikytkin	Krakeloitu	30-304-15-2	kpl	41,13	51,00
72.	30-304-17-2	Ristikytkin	Valkoinen, posliini	30-304-17-2	kpl	35,08	43,50
73.	30-304-18-2	Ristikytkin	Valkoinen, posliini	30-304-18-2	kpl	35,08	43,50
74.	30-304-21-2	Ristikytkin	Valkoinen, posliini ja puu (patinoitu)	30-304-21-2	kpl	35,08	43,50
75.	30-304-23-2	Ristikytkin	Valkoinen, posliini ja sininen koristemaalau	30-304-23-2	kpl	38,71	48,00
76.	30-304-24-2	Ristikytkin	Valkoinen, posliini ja ruskea koristemaalau	30-304-24-2	kpl	38,71	48,00
77.	30-304-27-2	Ristikytkin	Musta, posliini	30-304-27-2	kpl	39,92	49,50
78.	30-304-28-2	Ristikytkin	Pinta-asennettava	516-003-4	kpl	38,31	47,50
79.	30-304-29-2	Ristikytkin	Musta, posliini ja puu (patinoitu)	30-304-29-2	kpl	39,92	49,50
80.	30-304-30-2	Ristikytkin	Pinta-asennettava	516-002-4	kpl	33,47	41,50

Rivi	Valmistajan tuotenro *)	Tuotenimi	Selite	Domus Classican tuotenro	Yks.	Hinta (0%)	Hinta (24%)
81.	30-304-31-2	Ristikytkin	Valkoinen, posliini ja sininen koristemaalau	30-304-31-2	kpl	38,71	48,00
82.	30-304-32-2	Ristikytkin	Valkoinen, posliini ja ruskea koristemaalau	30-304-32-2	kpl	38,71	48,00
83.	30-306-11-2	Ykköskytkin	Valkoinen, posliini ja sininen koristemaalau	30-306-11-2	kpl	29,84	37,00
84.	30-306-12-2	Ykköskytkin	Nuppi puinen	30-306-12-2	kpl	29,84	37,00
85.	30-306-13-2	Ykköskytkin	Nuppi posliinia	30-306-13-2	kpl	29,84	37,00
86.	30-306-14-2	Ykköskytkin	Nuppi puinen	30-306-14-2	kpl	29,84	37,00
87.	30-306-15-2	Ykköskytkin	Krakeloitu	30-306-15-2	kpl	32,26	40,00
88.	30-306-17-2	Ykköskytkin	Nuppi posliinia	30-306-17-2	kpl	26,21	32,50
89.	30-306-18-2	Ykköskytkin	Nuppi puinen	30-306-18-2	kpl	26,21	32,50
90.	30-306-21-2	Ykköskytkin	Puu, patinoitu	30-306-21-2	kpl	26,21	32,50
91.	30-306-23-2	Ykköskytkin	Koristemaalau, sininen ja puu (patinoitu)	30-306-23-2	kpl	29,84	37,00
92.	30-306-24-2	Ykköskytkin	Koristemaalau, ruskea ja puu (patinoitu)	30-306-24-2	kpl	29,84	37,00
93.	30-306-27-2	Ykköskytkin	Musta, posliini	30-306-27-2	kpl	31,05	38,50
94.	30-306-28-2	Ykköskytkin	Pinta-asennettava	516-003-1	kpl	30,65	38,00
95.	30-306-29-2	Ykköskytkin	Musta, posliini ja puu (patinoitu)	30-306-29-2	kpl	31,05	38,50
96.	30-306-30-2	Ykköskytkin	Pinta-asennettava	516-002-1	kpl	26,61	33,00
97.	30-306-31-2	Ykköskytkin	Koristemaalau, sininen	30-306-31-2	kpl	29,84	37,00
98.	30-306-32-2	Ykköskytkin	Koristemaalau, ruskea	30-306-32-2	kpl	29,84	37,00
99.	30-308-11-2	Vaihtokytkin	Nuppi posliinia	30-308-11-2	kpl	32,26	40,00
100.	30-308-12-2	Vaihtokytkin	Nuppi puinen	30-308-12-2	kpl	32,26	40,00
101.	30-308-13-2	Vaihtokytkin	Nuppi posliinia	30-308-13-2	kpl	32,26	40,00
102.	30-308-14-2	Vaihtokytkin	Nuppi puinen	30-308-14-2	kpl	32,26	40,00
103.	30-308-15-2	Vaihtokytkin	Krakeloitu	30-308-15-2	kpl	35,08	43,50
104.	30-308-17-2	Vaihtokytkin	Nuppi posliinia	30-308-17-2	kpl	29,03	36,00
105.	30-308-18-2	Vaihtokytkin	Nuppi posliinia	30-308-18-2	kpl	29,03	36,00
106.	30-308-21-2	Vaihtokytkin	Puu, patinoitu	30-308-21-2	kpl	29,03	36,00
107.	30-308-23-2	Vaihtokytkin	Koristemaalau, sininen ja puu (patinoitu)	30-308-23-2	kpl	32,26	40,00
108.	30-308-24-2	Vaihtokytkin	Koristemaalau, ruskea ja puu (patinoitu)	30-308-24-2	kpl	32,26	40,00
109.	30-308-27-2	Vaihtokytkin	Musta, posliini	30-308-27-2	kpl	33,87	42,00
110.	30-308-28-2	Vaihtokytkin	Pinta-asennettava	516-003-2	kpl	33,06	41,00
111.	30-308-29-2	Vaihtokytkin	Musta, posliini ja puu (patinoitu)	30-308-29-2	kpl	33,87	42,00
112.	30-308-30-2	Vaihtokytkin	Pinta-asennettava	516-002-2	kpl	29,03	36,00
113.	30-308-31-2	Vaihtokytkin	Koristemaalau, sininen ja puu (patinoitu)	30-308-31-2	kpl	32,26	40,00
114.	30-308-32-2	Vaihtokytkin	Koristemaalau, ruskea ja puu (patinoitu)	30-308-32-2	kpl	32,26	40,00
115.	30-310-11-2	Impulssikytkin	Koristemaalau, sininen	30-310-11-2	kpl	20,56	25,50
116.	30-310-13-2	Impulssikytkin	Koristemaalau, ruskea	30-310-13-2	kpl	20,56	25,50
117.	30-310-15-2	Impulssikytkin	Krakeloitu	30-310-15-2	kpl	22,98	28,50
118.	30-310-17-2	Impulssikytkin	Valkoinen, posliini	30-310-17-2	kpl	18,95	23,50
119.	30-310-27-2	Impulssikytkin	Musta, posliini	30-310-27-2	kpl	22,18	27,50
120.	30-312-11-2	Impulssikytkin	Koristemaalau, sininen	30-312-11-2	kpl	20,56	25,50

Rivi	Valmistajan tuotenro *)	Tuotenimi	Selite	Domus Classican tuotenro	Yks.	Hinta (0%)	Hinta (24%)
121.	30-312-13-2	Impulssikytkin	Koristemaalaus, ruskea	30-312-13-2	kpl	20,56	25,50
122.	30-312-15-2	Impulssikytkin	Valkoinen, posliini	30-312-15-2	kpl	21,77	27,00
123.	30-312-17-2	Impulssikytkin, pinta-asennettava	Valkoinen, posliini	30-312-17-2	kpl	18,95	23,50
124.	30-312-27-2	Impulssikytkin, pinta-asennettava	Musta, posliini	30-312-27-2	kpl	21,77	27,00
125.	30-314-11-2	Kruunukytkin	Nuppi puinen	30-314-11-2	kpl	33,47	41,50
126.	30-314-12-2	Kruunukytkin	Nuppi posliinia	30-314-12-2	kpl	33,47	41,50
127.	30-314-13-2	Kruunukytkin	Nuppi posliinia	30-314-13-2	kpl	33,47	41,50
128.	30-314-14-2	Kruunukytkin	Nuppi puinen	30-314-14-2	kpl	33,47	41,50
129.	30-314-15-2	Kruunukytkin	Krakeloitu	30-314-15-2	kpl	37,90	47,00
130.	30-314-17-2	Kruunukytkin	Nuppi posliinia	30-314-17-2	kpl	29,44	36,50
131.	30-314-18-2	Kruunukytkin	Nuppi puinen	30-314-18-2	kpl	29,44	36,50
132.	30-314-21-2	Kruunukytkin	Puu, patinoitu	30-314-21-2	kpl	29,44	36,50
133.	30-314-23-2	Kruunukytkin	Koristemaalaus, sininen ja puu (patinoitu)	30-314-23-2	kpl	33,47	41,50
134.	30-314-24-2	Kruunukytkin	Koristemaalaus, ruskea ja puu (patinoitu)	30-314-24-2	kpl	33,47	41,50
135.	30-314-27-2	Kruunukytkin	Musta, posliini	30-314-27-2	kpl	36,69	45,50
136.	30-314-28-2	Kruunukytkin	Musta, posliini	30-314-28-2	kpl	36,69	45,50
137.	30-314-29-2	Kruunukytkin	Musta, posliini ja puu (patinoitu)	30-314-29-2	kpl	36,69	45,50
138.	30-314-30-2	Kruunukytkin	Posliini	30-314-30-2	kpl	29,44	36,50
139.	30-314-31-2	Kruunukytkin	Koristemaalaus, sininen	30-314-31-2	kpl	33,47	41,50
140.	30-314-32-2	Kruunukytkin	Koristemaalaus, ruskea	30-314-32-2	kpl	33,47	41,50
141.	30-328-11-2	Impulssikytkin, kierrettävä	Nuppi posliinia	30-328-11-2	kpl	35,08	43,50
142.	30-328-12-2	Impulssikytkin, kierrettävä	Nuppi puinen	30-328-12-2	kpl	35,08	43,50
143.	30-328-13-2	Impulssikytkin, kierrettävä	Nuppi posliinia	30-328-13-2	kpl	35,08	43,50
144.	30-328-14-2	Impulssikytkin, kierrettävä	Nuppi puinen	30-328-14-2	kpl	35,08	43,50
145.	30-328-15-2	Impulssikytkin, kierrettävä	Krakeloitu	30-328-15-2	kpl	45,16	56,00
146.	30-328-17-2	Impulssikytkin, kierrettävä	Valkoinen, posliini	30-328-17-2	kpl	34,27	42,50
147.	30-328-18-2	Impulssikytkin, kierrettävä	Nuppi puinen	30-328-18-2	kpl	34,27	42,50
148.	30-328-21-2	Impulssikytkin, kierrettävä	Puu, patinoitu	30-328-21-2	kpl	34,27	42,50
149.	30-328-23-2	Impulssikytkin, kierrettävä	Koristemaalaus, sininen ja puu (patinoitu)	30-328-23-2	kpl	35,08	43,50
150.	30-328-24-2	Impulssikytkin, kierrettävä	Koristemaalaus, ruskea ja puu (patinoitu)	30-328-24-2	kpl	35,08	43,50
151.	30-328-27-2	Impulssikytkin, kierrettävä	Musta, posliini	30-328-27-2	kpl	43,55	54,00
152.	30-328-28-2	Impulssikytkin, kierrettävä	Musta, posliini, retro	30-328-28-2	kpl	43,55	54,00
153.	30-328-29-2	Impulssikytkin, kierrettävä	Musta, posliini ja puu (patinoitu)	30-328-29-2	kpl	43,55	54,00
154.	30-328-30-2	Impulssikytkin, kierrettävä	Posliini	30-328-30-2	kpl	34,27	42,50
155.	30-328-31-2	Impulssikytkin, kierrettävä	Koristemaalaus, sininen ja puu (patinoitu)	30-328-31-2	kpl	35,08	43,50
156.	30-328-32-2	Impulssikytkin, kierrettävä	Koristemaalaus, ruskea ja puu (patinoitu)	30-328-32-2	kpl	35,08	43,50
157.	30-333-11-2	Himmennin 500W	Nuppi posliinia	30-333-11-2	kpl	128,63	159,50
158.	30-333-12-2	Himmennin 500W	Nuppi puinen	30-333-12-2	kpl	128,63	159,50
159.	30-333-13-2	Himmennin 500W	Nuppi posliinia	30-333-13-2	kpl	128,63	159,50
160.	30-333-14-2	Himmennin 500W	Nuppi puinen	30-333-14-2	kpl	128,63	159,50

Rivi	Valmistajan tuotenro *)	Tuotenimi	Selite	Domus Classican tuotenro	Yks.	Hinta (0%)	Hinta (24%)
161.	30-333-15-2	Himmennin 500W	Krakeloitu	30-333-15-2	kpl	142,34	176,50
162.	30-333-17-2	Himmennin 500W	Valkoinen, posliini	30-333-17-2	kpl	124,60	154,50
163.	30-333-18-2	Himmennin 500W	Nuppi puinen	30-333-18-2	kpl	124,60	154,50
164.	30-333-21-2	Himmennin 500W	Puu, patinoitu	30-333-21-2	kpl	124,60	154,50
165.	30-333-23-2	Himmennin 500W	Koristemaalaus, sininen ja puu (patinoitu)	30-333-23-2	kpl	128,63	159,50
166.	30-333-24-2	Himmennin 500W	Koristemaalaus, ruskea ja puu (patinoitu)	30-333-24-2	kpl	128,63	159,50
167.	30-333-27-2	Himmennin 500W	Musta, posliini	30-333-27-2	kpl	137,10	170,00
168.	30-333-28-2	Himmennin 500W	Musta, posliini	30-333-28-2	kpl	137,10	170,00
169.	30-333-29-2	Himmennin 500W	Musta, posliini ja puu (patinoitu)	30-333-29-2	kpl	137,10	170,00
170.	30-333-30-2	Himmennin 500W	Posliini	30-333-30-2	kpl	124,60	154,50
171.	30-333-31-2	Himmennin 500W	Koristemaalaus, sininen ja puu (patinoitu)	30-333-31-2	kpl	128,63	159,50
172.	30-333-32-2	Himmennin 500W	Koristemaalaus, ruskea ja puu (patinoitu)	30-333-32-2	kpl	128,63	159,50
173.	30-334-11-2	Himmennin 500W	Nuppi posliinia	30-334-11-2	kpl	151,61	188,00
174.	30-334-12-2	Himmennin 500W	Nuppi puinen	30-334-12-2	kpl	151,61	188,00
175.	30-334-13-2	Himmennin 500W	Nuppi posliinia	30-334-13-2	kpl	151,61	188,00
176.	30-334-14-2	Himmennin 500W	Nuppi puinen	30-334-14-2	kpl	151,61	188,00
177.	30-334-15-2	Himmennin 500W	Krakeloitu	30-334-15-2	kpl	183,87	228,00
178.	30-334-17-2	Himmennin 500W	Valkoinen, posliini	30-334-17-2	kpl	149,60	185,50
179.	30-334-18-2	Himmennin 500W	Nuppi puinen	30-334-18-2	kpl	149,60	185,50
180.	30-334-21-2	Himmennin 500W	Puu (patinoitu)	30-334-21-2	kpl	149,60	185,50
181.	30-334-23-2	Himmennin 500W	Koristemaalaus, sininen ja puu (patinoitu)	30-334-23-2	kpl	151,61	188,00
182.	30-334-24-2	Himmennin 500W	Koristemaalaus, ruskea ja puu (patinoitu)	30-334-24-2	kpl	151,61	188,00
183.	30-334-27-2	Himmennin 500W	Musta, posliini	30-334-27-2	kpl	177,42	220,00
184.	30-334-28-2	Himmennin 500W	Musta, posliini	30-334-28-2	kpl	177,42	220,00
185.	30-334-29-2	Himmennin 500W	Musta, posliini ja puu (patinoitu)	30-334-29-2	kpl	177,42	220,00
186.	30-334-30-2	Himmennin 500W	Posliini	30-334-30-2	kpl	149,60	185,50
187.	30-334-31-2	Himmennin 500W	Koristemaalaus, sininen ja puu (patinoitu)	30-334-31-2	kpl	151,61	188,00
188.	30-334-32-2	Himmennin 500W	Koristemaalaus, ruskea ja puu (patinoitu)	30-334-32-2	kpl	151,61	188,00
189.	30-342-11-2	Kytkin sähköiselle markiisille	Nuppi posliinia	30-342-11-2	kpl	35,48	44,00
190.	30-342-12-2	Kytkin sähköiselle markiisille	Nuppi puinen	30-342-12-2	kpl	35,48	44,00
191.	30-342-13-2	Kytkin sähköiselle markiisille	Nuppi posliinia	30-342-13-2	kpl	35,48	44,00
192.	30-342-14-2	Kytkin sähköiselle markiisille	Nuppi puinen	30-342-14-2	kpl	35,48	44,00
193.	30-342-15-2	Kytkin sähköiselle markiisille		30-342-15-2	kpl	39,11	48,50
194.	30-342-17-2	Kytkin sähköiselle markiisille	Valkoinen, posliini	30-342-17-2	kpl	33,87	42,00
195.	30-342-18-2	Kytkin sähköiselle markiisille	Nuppi puinen	30-342-18-2	kpl	33,87	42,00
196.	30-342-21-2	Kytkin sähköiselle markiisille	Puu (patinoitu)	30-342-21-2	kpl	33,87	42,00
197.	30-342-23-2	Kytkin sähköiselle markiisille	Koristemaalaus, sininen ja puu (patinoitu)	30-342-23-2	kpl	35,48	44,00
198.	30-342-24-2	Kytkin sähköiselle markiisille	Koristemaalaus, ruskea ja puu (patinoitu)	30-342-24-2	kpl	35,48	44,00
199.	30-342-27-2	Kytkin sähköiselle markiisille	Musta, posliini	30-342-27-2	kpl	37,90	47,00
200.	30-342-28-2	Kytkin sähköiselle markiisille	Musta, posliini	30-342-28-2	kpl	37,90	47,00

Rivi	Valmistajan tuotenro *)	Tuotenimi	Selite	Domus Classican tuotenro	Yks.	Hinta (0%)	Hinta (24%)
201.	30-342-29-2	Kytkin sähköiselle markiisille	Musta, posliini ja puu (patinoitu)	30-342-29-2	kpl	37,90	47,00
202.	30-342-30-2	Kytkin sähköiselle markiisille	Posliini	30-342-30-2	kpl	33,87	42,00
203.	30-342-31-2	Kytkin sähköiselle markiisille	Koristemaalaus, sininen ja puu (patinoitu)	30-342-31-2	kpl	35,48	44,00
204.	30-342-32-2	Kytkin sähköiselle markiisille	Koristemaalaus, ruskea ja puu (patinoitu)	30-342-32-2	kpl	35,48	44,00
205.	30-343-11-2	Impulssikytkin, tupla	Koristemaalaus, sininen	30-343-11-2	kpl	29,03	36,00
206.	30-343-13-2	Impulssikytkin, tupla	Koristemaalaus, ruskea	30-343-13-2	kpl	29,03	36,00
207.	30-343-15-2	Impulssikytkin, tupla		30-343-15-2	kpl	33,87	42,00
208.	30-343-17-2	Impulssikytkin, tupla, pinta-as.	Valkoinen, posliini	30-343-17-2	kpl	25,40	31,50
209.	30-343-27-2	Impulssikytkin, tupla, pinta-as.	Musta, posliini	30-343-27-2	kpl	32,66	40,50
210.	30-344-11-2	Impulssikytkin, kierrettävä, tupla	Nuppi posliinia	30-344-11-2	kpl	41,53	51,50
211.	30-344-12-2	Impulssikytkin, kierrettävä, tupla	Nuppi puinen	30-344-12-2	kpl	41,53	51,50
212.	30-344-13-2	Impulssikytkin, kierrettävä, tupla	Nuppi posliinia	30-344-13-2	kpl	41,53	51,50
213.	30-344-14-2	Impulssikytkin, kierrettävä, tupla	Nuppi puinen	30-344-14-2	kpl	41,53	51,50
214.	30-344-15-2	Impulssikytkin, kierrettävä, tupla		30-344-15-2	kpl	52,02	64,50
215.	30-344-17-2	Impulssikytkin, kierrettävä, tupla	Valkoinen, posliini	30-344-17-2	kpl	40,73	50,50
216.	30-344-18-2	Impulssikytkin, kierrettävä, tupla	Nuppi puinen	30-344-18-2	kpl	40,73	50,50
217.	30-344-21-2	Impulssikytkin, kierrettävä, tupla	Puu (patinoitu)	30-344-21-2	kpl	40,73	50,50
218.	30-344-23-2	Impulssikytkin, kierrettävä, tupla	Koristemaalaus, sininen ja puu (patinoitu)	30-344-23-2	kpl	41,53	51,50
219.	30-344-24-2	Impulssikytkin, kierrettävä, tupla	Koristemaalaus, ruskea ja puu (patinoitu)	30-344-24-2	kpl	41,53	51,50
220.	30-344-27-2	Impulssikytkin, kierrettävä, tupla	Musta, posliini	30-344-27-2	kpl	50,00	62,00
221.	30-344-28-2	Impulssikytkin, kierrettävä, tupla	Musta, posliini	30-344-28-2	kpl	50,00	62,00
222.	30-344-29-2	Impulssikytkin, kierrettävä, tupla	Musta, posliini ja puu (patinoitu)	30-344-29-2	kpl	50,00	62,00
223.	30-344-30-2	Impulssikytkin, kierrettävä, tupla	Posliini	30-344-30-2	kpl	40,73	50,50
224.	30-344-31-2	Impulssikytkin, kierrettävä, tupla	Koristemaalaus, sininen	30-344-31-2	kpl	41,53	51,50
225.	30-344-32-2	Impulssikytkin, kierrettävä, tupla	Koristemaalaus, ruskea	30-344-32-2	kpl	41,53	51,50
226.	30-399-17-2	Jakorasia, posliininen	Halk. 7,2 cm	519-002-1	kpl	21,77	27,00
227.	30-399-22-2	Jakorasia, ns. ruostutettu	Halk. 7,2 cm	519-003-1	kpl	17,34	21,50
228.	30-401-17-2	Jakorasia, posliininen	Halk. 11,6 cm	519-002-2	kpl	25,81	32,00
229.	30-401-22-2	Jakorasia, ns. ruostutettu	Halk. 11,6 cm	519-003-2	kpl	21,77	27,00
230.	30-402-22-2	Jakorasia	Metalli, patinoitu	30-402-22-2	kpl	75,40	93,50
231.	30-402-51-2	Jakorasia	Niklattu, satiinpintainen	30-402-51-2	kpl	82,26	102,00
232.	30-416-22-2	90 aste halk. 16 mm	Metalli, patinoitu	30-416-22-2	kpl	9,68	12,00
233.	30-420-22-2	90 aste halk. 20 mm	Metalli, patinoitu	30-420-22-2	kpl	10,89	13,50
234.	30-425-22-2	90 aste halk. 25 mm	Metalli, patinoitu	30-425-22-2	kpl	12,10	15,00
235.	30-516-22-2	Jatkos halk. 16 mm	Metalli, patinoitu	30-516-22-2	kpl	46,77	58,00
236.	30-520-22-2	Jatkos halk. 20 mm	Metalli, patinoitu	30-520-22-2	kpl	50,40	62,50
237.	30-525-22-2	Jatkos halk. 25 mm	Metalli, patinoitu	30-525-22-2	kpl	29,84	37,00
238.	30-616-22-2	T-osa halk. 16 mm	Metalli, patinoitu	30-616-22-2	kpl	35,89	44,50
239.	30-620-22-2	T-osa halk. 20 mm	Metalli, patinoitu	30-620-22-2	kpl	38,31	47,50
240.	30-625-22-2	T-osa halk. 25 mm	Metalli, patinoitu	30-625-22-2	kpl	39,52	49,00

Rivi	Valmistajan tuotenro *)	Tuotenimi	Selite	Domus Classican tuotenro	Yks.	Hinta (0%)	Hinta (24%)
241.	30-656-11-2	Peiterasia, reikä johdolle	Koristemaalaus, sininen	30-656-11-2	kpl	13,31	16,50
242.	30-656-13-2	Peiterasia, reikä johdolle	Koristemaalaus, ruskea	30-656-13-2	kpl	13,31	16,50
243.	30-656-15-2	Peiterasia, reikä johdolle	Krakeloitu	30-656-15-2	kpl	15,73	19,50
244.	30-656-17-2	Peiterasia	Pinta-asennettava	517-003-9	kpl	11,29	14,00
245.	30-656-27-2	Peiterasia	Pinta-asennettava	517-004-9	kpl	15,32	19,00
246.	30-706-11-2	Puhelin, tupla	Koristemaalaus, sininen	30-706-11-2	kpl	41,13	51,00
247.	30-706-13-2	Puhelin, tupla	Koristemaalaus, ruskea	30-706-13-2	kpl	41,13	51,00
248.	30-706-15-2	Puhelin, tupla	Krakeloitu	30-706-15-2	kpl	49,19	61,00
249.	30-706-17-2	Puhelin, tupla	Valkoinen, posliini	30-706-17-2	kpl	39,11	48,50
250.	30-706-27-2	Puhelin, tupla	Musta, posliini	30-706-27-2	kpl	47,18	58,50
251.	30-707-11-2	RJ45 CAT 6, tupla	Koristemaalaus, sininen	30-707-11-2	kpl	77,82	96,50
252.	30-707-13-2	RJ45 CAT 6, tupla	Koristemaalaus, ruskea	30-707-13-2	kpl	77,82	96,50
253.	30-707-15-2	RJ45 CAT 6, tupla	Krakeloitu	30-707-15-2	kpl	87,50	108,50
254.	30-707-17-2	RJ45 CAT 6, tupla	Valkoinen, posliini	30-707-17-2	kpl	76,61	95,00
255.	30-707-27-2	RJ45 CAT 6, tupla	Musta, posliini	30-707-27-2	kpl	84,27	104,50
256.	30-708-11-2	Puhelin ja RJ45 CAT 6	Koristemaalaus, sininen	30-708-11-2	kpl	59,27	73,50
257.	30-708-13-2	Puhelin ja RJ45 CAT 6	Koristemaalaus, ruskea	30-708-13-2	kpl	59,27	73,50
258.	30-708-15-2	Puhelin ja RJ45 CAT 6	Krakeloitu	30-708-15-2	kpl	68,55	85,00
259.	30-708-17-2	Puhelin ja data	Pinta-asennettava	517-003-5	kpl	58,06	72,00
260.	30-708-27-2	Puhelin ja data	Pinta-asennettava	517-004-5	kpl	63,71	79,00
261.	30-709-11-2	TV/SAT, päättävä	Koristemaalaus, sininen	30-709-11-2	kpl	39,52	49,00
262.	30-709-13-2	TV/SAT, päättävä	Koristemaalaus, ruskea	30-709-13-2	kpl	39,52	49,00
263.	30-709-15-2	TV/SAT, päättävä	Krakeloitu	30-709-15-2	kpl	43,15	53,50
264.	30-709-17-2	TV/SAT, päättävä	Valkoinen, posliini	30-709-17-2	kpl	38,31	47,50
265.	30-709-27-2	TV/SAT, päättävä	Musta, posliini	30-709-27-2	kpl	41,53	51,50
266.	30-712-11-2	TV/SAT, yksittäinen	Koristemaalaus, sininen	30-712-11-2	kpl	39,52	49,00
267.	30-712-13-2	TV/SAT, yksittäinen	Koristemaalaus, ruskea	30-712-13-2	kpl	39,52	49,00
268.	30-712-15-2	TV/SAT, yksittäinen	Krakeloitu	30-712-15-2	kpl	43,15	53,50
269.	30-712-17-2	R+TV+SAT	Pinta-asennettava	517-003-4	kpl	38,71	48,00
270.	30-712-27-2	R+TV+SAT	Pinta-asennettava	517-004-4	kpl	39,52	49,00
271.	30-713-11-2	R+TV+SAT, ketju A	Koristemaalaus, sininen	30-713-11-2	kpl	39,52	49,00
272.	30-713-13-2	R+TV+SAT, ketju A	Koristemaalaus, ruskea	30-713-13-2	kpl	39,52	49,00
273.	30-713-15-2	R+TV+SAT, ketju A	Krakeloitu	30-713-15-2	kpl	43,15	53,50
274.	30-713-17-2	R+TV+SAT, ketju A	Valkoinen, posliini	30-713-17-2	kpl	38,31	47,50
275.	30-713-27-2	R+TV+SAT, ketju A	Musta, posliini	30-713-27-2	kpl	41,53	51,50
276.	30-714-11-2	R+TV+SAT, ketju B	Koristemaalaus, sininen	30-714-11-2	kpl	39,52	49,00
277.	30-714-13-2	R+TV+SAT, ketju B	Koristemaalaus, ruskea	30-714-13-2	kpl	39,52	49,00
278.	30-714-15-2	R+TV+SAT, ketju B	Krakeloitu	30-714-15-2	kpl	43,15	53,50
279.	30-714-17-2	R+TV+SAT, ketju B	Valkoinen, posliini	30-714-17-2	kpl	38,31	47,50
280.	30-714-27-2	R+TV+SAT, ketju B	Musta, posliini	30-714-27-2	kpl	41,53	51,50

Rivi	Valmistajan tuotenro *)	Tuotenimi	Selite	Domus Classican tuotenro	Yks.	Hinta (0%)	Hinta (24%)
281.	30-716-03-2	Kiinnike halk. 16 cm	Ruskea	30-716-03-2	kpl	16,53	20,50
282.	30-720-03-2	Kiinnike halk. 20 cm	Ruskea	30-720-03-2	kpl	17,74	22,00
283.	30-725-03-2	Kiinnike halk. 25 cm	Ruskea	30-725-03-2	kpl	20,56	25,50
284.	30-801-00-2	Puinen kehys, pinta-asennettavalle rasialle	Yhdelle kytkimelle tai pistorasialle	518-060-1	kpl	9,68	12,00
285.	30-801-19-2	Kehys yhdelle kytkimelle tai pistorasialle	Hunaja (puu)	30-801-19-2	kpl	12,10	15,00
286.	30-801-21-2	Pinta-asennettavan sähkörasian kehys	Puu, sävytetty	518-060-12	kpl	12,90	16,00
287.	30-802-00-2	Puinen kehys, pinta-asennettavalle rasialle	Kahdelle kytkimelle tai pistorasialle	518-060-2	kpl	14,52	18,00
288.	30-802-19-2	Kehys kahdelle kytkimelle tai pistorasialle	Hunaja (puu)	30-802-19-2	kpl	17,34	21,50
289.	30-802-21-2	Kehys kahdelle kytkimelle tai pistorasialle	Puu, patinoitu	30-802-21-2	kpl	22,18	27,50
290.	30-803-00-2	Puinen kehys, pinta-asennettavalle rasialle	Kolmelle kytkimelle tai pistorasialle	518-060-3	kpl	19,76	24,50
291.	30-803-19-2	Kehys kolmelle kytkimelle tai pistorasialle	Hunaja (puu)	30-803-19-2	kpl	24,19	30,00
292.	30-803-21-2	Kehys kolmelle kytkimelle tai pistorasialle	Puu, patinoitu	30-803-21-2	kpl	31,05	38,50
293.	30-804-00-2	Kehys neljälle kytkimelle tai pistorasialle	Puu (käsittelemätön)	30-804-00-2	kpl	38,31	47,50
294.	30-804-19-2	Kehys neljälle kytkimelle tai pistorasialle	Hunaja (puu)	30-804-19-2	kpl	43,95	54,50
295.	30-804-21-2	Kehys neljälle kytkimelle tai pistorasialle	Puu, patinoitu	30-804-21-2	kpl	52,02	64,50
296.	30-811-00-2	Kehys yhdelle kytkimelle tai pistorasialle	Puu (käsittelemätön)	30-811-00-2	kpl	10,48	13,00
297.	30-811-19-2	Kehys yhdelle kytkimelle tai pistorasialle	Hunaja (puu)	30-811-19-2	kpl	10,89	13,50
298.	30-811-21-2	Kehys yhdelle kytkimelle tai pistorasialle	Puu, patinoitu	30-811-21-2	kpl	14,92	18,50
299.	30-812-00-2	Kehys kahdelle kytkimelle tai pistorasialle	Puu (käsittelemätön)	30-812-00-2	kpl	15,73	19,50
300.	30-812-19-2	Kehys kahdelle kytkimelle tai pistorasialle	Hunaja (puu)	30-812-19-2	kpl	16,53	20,50
301.	30-812-21-2	Kehys kahdelle kytkimelle tai pistorasialle	Puu, patinoitu	30-812-21-2	kpl	22,18	27,50
302.	30-813-00-2	Kehys kolmelle kytkimelle tai pistorasialle	Puu (käsittelemätön)	30-813-00-2	kpl	20,16	25,00
303.	30-813-19-2	Kehys kolmelle kytkimelle tai pistorasialle	Hunaja (puu)	30-813-19-2	kpl	21,77	27,00
304.	30-813-21-2	Kehys kolmelle kytkimelle tai pistorasialle	Puu, patinoitu	30-813-21-2	kpl	29,03	36,00
305.	30-816-03-2	Kiinnike halk. 16 mm	Ruskea	30-816-03-2	kpl	24,19	30,00
306.	30-820-03-2	Kiinnike halk. 20 mm	Ruskea	30-820-03-2	kpl	25,40	31,50
307.	30-821-00-2	Kehys yhdelle kytkimelle tai pistorasialle	Puu (käsittelemätön)	30-821-00-2	kpl	14,52	18,00
308.	30-821-19-2	Kehys yhdelle kytkimelle tai pistorasialle	Hunaja (puu)	30-821-19-2	kpl	15,73	19,50
309.	30-821-21-2	Kehys yhdelle kytkimelle tai pistorasialle	Puu, patinoitu	30-821-21-2	kpl	18,55	23,00
310.	30-822-00-2	Kehys yhdelle kytkimelle tai pistorasialle	Puu (käsittelemätön)	30-822-00-2	kpl	20,97	26,00
311.	30-822-19-2	Kehys yhdelle kytkimelle tai pistorasialle	Hunaja (puu)	30-822-19-2	kpl	22,18	27,50
312.	30-822-21-2	Kehys yhdelle kytkimelle tai pistorasialle	Puu, patinoitu	30-822-21-2	kpl	27,02	33,50
313.	30-823-00-2	Kehys kolmelle kytkimelle tai pistorasialle	Puu (käsittelemätön)	30-823-00-2	kpl	29,44	36,50
314.	30-823-19-2	Kehys kolmelle kytkimelle tai pistorasialle	Hunaja (puu)	30-823-19-2	kpl	31,85	39,50
315.	30-823-21-2	Kehys kolmelle kytkimelle tai pistorasialle	Puu, patinoitu	30-823-21-2	kpl	38,31	47,50
316.	30-824-00-2	Kehys neljälle kytkimelle tai pistorasialle	Puu (käsittelemätön)	30-824-00-2	kpl	47,18	58,50
317.	30-824-19-2	Kehys neljälle kytkimelle tai pistorasialle	Hunaja (puu)	30-824-19-2	kpl	52,42	65,00
318.	30-824-21-2	Kehys neljälle kytkimelle tai pistorasialle	Puu, patinoitu	30-824-21-2	kpl	59,27	73,50
319.	30-825-03-2	Kiinnike halk. 25 mm	Ruskea	30-825-03-2	kpl	27,42	34,00
320.	30-832-00-2	Kehys kahdelle kytkimelle tai pistorasialle	Puu (käsittelemätön)	30-832-00-2	kpl	20,97	26,00

Rivi	Valmistajan tuotenumero *)	Tuotenumero	Selite	Domus Classican tuotenumero	Yks.	Hinta (0%)	Hinta (24%)
321.	30-832-19-2	Kehys kahdelle kytkimelle tai pistorasialle	Hunaja (puu)	30-832-19-2	kpl	22,18	27,50
322.	30-832-21-2	Kehys kahdelle kytkimelle tai pistorasialle	Puu, patinoitu	30-832-21-2	kpl	27,02	33,50
323.	30-833-00-2	Kehys kolmelle kytkimelle tai pistorasialle	Puu (käsittelemätön)	30-833-00-2	kpl	29,44	36,50
324.	30-833-19-2	Kehys kolmelle kytkimelle tai pistorasialle	Hunaja (puu)	30-833-19-2	kpl	31,85	39,50
325.	30-833-21-2	Kehys kolmelle kytkimelle tai pistorasialle	Puu, patinoitu	30-833-21-2	kpl	38,31	47,50
326.	30-834-00-2	Kehys neljälle kytkimelle tai pistorasialle	Puu (käsittelemätön)	30-834-00-2	kpl	47,18	58,50
327.	30-834-19-2	Kehys neljälle kytkimelle tai pistorasialle	Hunaja (puu)	30-834-19-2	kpl	52,42	65,00
328.	30-834-21-2	Kehys neljälle kytkimelle tai pistorasialle	Puu, patinoitu	30-834-21-2	kpl	59,27	73,50
329.	30-841-00-2	Kehys yhdelle kytkimelle tai pistorasialle	Puu (käsittelemätön)	30-841-00-2	kpl	18,55	23,00
330.	30-841-19-2	Kehys yhdelle kytkimelle tai pistorasialle	Hunaja (puu)	30-841-19-2	kpl	20,56	25,50
331.	30-841-21-2	Kehys yhdelle kytkimelle tai pistorasialle	Puu, patinoitu	30-841-21-2	kpl	23,79	29,50
332.	30-842-00-2	Kehys kahdelle kytkimelle tai pistorasialle	Puu (käsittelemätön)	30-842-00-2	kpl	26,61	33,00
333.	30-842-19-2	Kehys kahdelle kytkimelle tai pistorasialle	Hunaja (puu)	30-842-19-2	kpl	28,63	35,50
334.	30-842-21-2	Kehys kahdelle kytkimelle tai pistorasialle	Puu, patinoitu	30-842-21-2	kpl	33,87	42,00
335.	30-843-00-2	Kehys kolmelle kytkimelle tai pistorasialle	Puu (käsittelemätön)	30-843-00-2	kpl	33,06	41,00
336.	30-843-19-2	Kehys kolmelle kytkimelle tai pistorasialle	Hunaja (puu)	30-843-19-2	kpl	35,89	44,50
337.	30-843-21-2	Kehys kolmelle kytkimelle tai pistorasialle	Puu, patinoitu	30-843-21-2	kpl	41,94	52,00
338.	30-844-00-2	Kehys neljälle kytkimelle tai pistorasialle	Puu (käsittelemätön)	30-844-00-2	kpl	51,61	64,00
339.	30-844-19-2	Kehys neljälle kytkimelle tai pistorasialle	Hunaja (puu)	30-844-19-2	kpl	57,66	71,50
340.	30-844-21-2	Kehys neljälle kytkimelle tai pistorasialle	Puu, patinoitu	30-844-21-2	kpl	65,32	81,00
341.	30-852-00-2	Kehys kahdelle kytkimelle tai pistorasialle	Puu (käsittelemätön)	30-852-00-2	kpl	26,61	33,00
342.	30-852-19-2	Kehys kahdelle kytkimelle tai pistorasialle	Hunaja (puu)	30-852-19-2	kpl	28,63	35,50
343.	30-852-21-2	Kehys kahdelle kytkimelle tai pistorasialle	Puu, patinoitu	30-852-21-2	kpl	33,87	42,00
344.	30-853-00-2	Kehys kolmelle kytkimelle tai pistorasialle	Puu (käsittelemätön)	30-853-00-2	kpl	31,85	39,50
345.	30-853-19-2	Kehys kolmelle kytkimelle tai pistorasialle	Hunaja (puu)	30-853-19-2	kpl	35,89	44,50
346.	30-853-21-2	Kehys kolmelle kytkimelle tai pistorasialle	Puu, patinoitu	30-853-21-2	kpl	41,94	52,00
347.	30-854-00-2	Kehys neljälle kytkimelle tai pistorasialle	Puu (käsittelemätön)	30-854-00-2	kpl	51,61	64,00
348.	30-854-19-2	Kehys neljälle kytkimelle tai pistorasialle	Hunaja (puu)	30-854-19-2	kpl	57,66	71,50
349.	30-854-21-2	Kehys neljälle kytkimelle tai pistorasialle	Puu, patinoitu	30-854-21-2	kpl	65,32	81,00
350.	30-913-03-0	Johdonohjain	Ruskea (muovi)	30-913-03-0	kpl	29,84	37,00
351.	30-913-03-2	Johdonohjain	Ruskea (muovi)	30-913-03-2	kpl	6,45	8,00
352.	30-913-05-0	Johdonohjain	Valkoinen (muovi)	30-913-05-0	kpl	29,84	37,00
353.	30-913-05-2	Johdonohjain	Valkoinen (muovi)	30-913-05-2	kpl	6,45	8,00
354.	30-913-17-0	Johdonohjain, valkoinen	25 kpl	519-005-1	kpl	44,35	55,00
355.	30-913-17-2	Johdonohjain	Valkoinen, posliini	30-913-17-2	kpl	7,26	9,00
356.	30-913-47-0	Johdonohjain, tummanruskea	25 kpl	519-005-2	kpl	48,39	60,00
357.	30-913-47-2	Johdonohjain	Ruskea, posliini	30-913-47-2	kpl	7,66	9,50
358.	30-927-11-2	Kattokuppi	Koristemaalaus, sininen	30-927-11-2	kpl	12,90	16,00
359.	30-927-13-2	Kattokuppi	Koristemaalaus, ruskea	30-927-13-2	kpl	12,90	16,00
360.	30-927-15-2	Kattokuppi	Krakeloitu	30-927-15-2	kpl	16,94	21,00

Rivi	Valmistajan tuotenro *)	Tuotenimi	Selite	Domus Classican tuotenro	Yks.	Hinta (0%)	Hinta (24%)
361.	30-927-17-2	Kattokuppi, posliininen	Valkoinen	518-009-17	kpl	9,68	12,00
362.	30-927-27-2	Kattokuppi, posliininen	Musta	518-009-18	kpl	11,29	14,00
363.	30-938-03-2	Seinän läpivientikappale	Ruskea (muovi)	30-938-03-2	kpl	2,02	2,50
364.	30-938-05-2	Johdon läpivientikappale, 2 kpl	Sisähalkaisija 1,2 cm	519-009-1	kpl	2,02	2,50
365.	30-940-17-2	Kattokuppi, halk. 100 mm	Valkoinen, posliini	30-940-17-2	kpl	14,52	18,00
366.	30-950-98-2	Adapteri	-	30-950-98-2	kpl	1,61	2,00
367.	30-951-98-2	Adapteri	-	30-951-98-2	kpl	4,03	5,00
368.	30-952-02-2	Suoja pinta-asennettavalle rasialle	Posliiniset sähkökojeet	518-200-1	kpl	0,65	0,80
369.	30-971-03-2	Pintavetojohto 2x1,5 mm	Ruskea	30-971-03-2	kpl	220,56	273,50
370.	30-971-05-2	Pintavetojohto 2x1,5 mm	Valkoinen	30-971-05-2	kpl	214,92	266,50
371.	30-974-03-2	Pintavetojohto, tummanruskea	3x1,5 mm (50 m)	503-020-15	kpl	298,39	370,00
372.	30-974-05-2	Pintavetojohto, valkoinen	3x1,5 mm (50 m)	503-020-13	kpl	294,35	365,00
373.	30-975-03-2	Pintavetojohto, tummanruskea	3x2,5 mm (50 m)	503-020-5	kpl	358,87	445,00
374.	30-975-05-2	Pintavetojohto, valkoinen	3x2,5 mm (50 m)	503-020-3	kpl	338,71	420,00
375.	30-976-05-2	Pintavetojohto 2x1,5 mm	Valkoinen	30-976-05-2	kpl	189,92	235,50
376.	30-977-05-2	Pintavetojohto 3x2,5 mm	Valkoinen	30-977-05-2	kpl	259,27	321,50
377.	30-979-05-2	Pintavetojohto 3x1,5 mm	Valkoinen	30-979-05-2	kpl	254,84	316,00
378.	30-980-03-2	Pintavetojohto, tummanruskea	4x1,5 mm (25 m)	503-021-7	kpl	282,26	350,00
379.	30-980-05-2	Pintavetojohto, valkoinen	4x1,5 mm (25 m)	503-020-17	kpl	274,19	340,00
380.	31-208-02-2	Pistorasia, ranskalainen	Musta (muovi)	31-208-02-2	kpl	12,50	15,50
381.	31-208-05-2	Pistorasia, ranskalainen	Valkoinen (muovi)	31-208-05-2	kpl	12,50	15,50
382.	31-208-17-2	Pistorasia, ranskalainen	Valkoinen, posliini	31-208-17-2	kpl	22,98	28,50
383.	31-208-27-2	Pistorasia, ranskalainen	Musta, posliini	31-208-27-2	kpl	27,02	33,50
384.	31-209-02-2	Pistorasia	Musta (muovi)	31-209-02-2	kpl	10,89	13,50
385.	31-209-05-2	Pistorasia	Valkoinen (muovi)	31-209-05-2	kpl	10,89	13,50
386.	31-209-17-2	Pistorasia	Valkoinen, posliini	31-209-17-2	kpl	20,16	25,00
387.	31-209-27-2	Pistorasia	Musta, posliini	31-209-27-2	kpl	22,98	28,50
388.	31-212-02-2	Pistorasia	Musta (muovi)	31-212-02-2	kpl	11,29	14,00
389.	31-212-02-2	Pistorasia (ilman kehystä)	Uppoasennettava, muovi	517-042-1	kpl	12,10	15,00
390.	31-212-02-2 / 31-801-27-2	Pistorasia	Uppoasennettava, sisäosa muovina	517-027-1	kpl	26,21	32,50
391.	31-212-05-02 / 31-801-17-2	Pistorasia	Uppoasennettava, sisäosa muovina	517-026-1	kpl	24,19	30,00
392.	31-212-05-2	Pistorasia	Valkoinen (muovi)	31-212-05-2	kpl	11,29	14,00
393.	31-212-05-2	Pistorasia (ilman kehystä)	Uppoasennettava, muovi	517-041-1	kpl	11,69	14,50
394.	31-212-17-2	Pistorasia (ilman kehystä)	Uppoasennettava, posliini	517-041-11	kpl	19,35	24,00
395.	31-212-17-2 / 31-801-17-2	Pistorasia	Uppoasennettava, sisäosa posliinia	517-026-11	kpl	32,66	40,50
396.	31-212-27-2	Pistorasia	Musta, posliini	31-212-27-2	kpl	24,60	30,50
397.	31-212-27-2	Pistorasia (ilman kehystä)	Uppoasennettava, posliini	517-042-11	kpl	21,37	26,50
398.	31-212-27-2 / 31-801-27-2	Pistorasia	Uppoasennettava, sisäosa posliinia	517-027-11	kpl	35,48	44,00
399.	31-300-17-2	Ykköskytkin, tupla	Valkoinen, posliini	31-300-17-2	kpl	35,08	43,50
400.	31-300-18-2	Ykköskytkin, tupla	Puu	31-300-18-2	kpl	35,08	43,50

Rivi	Valmistajan tuotenro *)	Tuotenimi	Selite	Domus Classican tuotenro	Yks.	Hinta (0%)	Hinta (24%)
401.	31-300-21-2	Ykköskytkin, tupla	Puu, patinoitu	31-300-21-2	kpl	35,08	43,50
402.	31-300-23-2	Kruunukytkin (ilman kehystä)	Uppoasennettava	516-040-3	kpl	34,27	42,50
403.	31-300-23-2 / 31-801-17-2	Kruunukytkin	Uppoasennettava	516-025-3	kpl	47,58	59,00
404.	31-300-27-2	Ykköskytkin, tupla	Nuppi musta	31-300-27-2	kpl	36,69	45,50
405.	31-300-28-2	Kruunukytkin (ilman kehystä)	Uppoasennettava	516-041-3	kpl	35,89	44,50
406.	31-300-28-2 / 31-801-27-2	Kruunukytkin	Uppoasennettava	516-026-3	kpl	50,00	62,00
407.	31-300-29-2	Ykköskytkin, tupla	Musta, puu (patinoitu)	31-300-29-2	kpl	36,69	45,50
408.	31-302-17-2	Vaihtokytkin, tupla	Valkoinen, posliini	31-302-17-2	kpl	37,10	46,00
409.	31-302-18-2	Vaihtokytkin, tupla	Nuppi puinen	31-302-18-2	kpl	37,10	46,00
410.	31-302-21-2	Vaihtokytkin, tupla	Puu, patinoitu	31-302-21-2	kpl	37,10	46,00
411.	31-302-23-2	Vaihtokytkin, tupla	Nuppi "retro"	31-302-23-2	kpl	37,10	46,00
412.	31-302-27-2	Vaihtokytkin, tupla	Nuppi musta	31-302-27-2	kpl	38,31	47,50
413.	31-302-28-2	Vaihtokytkin, tupla	Nuppi musta	31-302-28-2	kpl	38,31	47,50
414.	31-302-29-2	Vaihtokytkin, tupla	Musta, puu (patinoitu)	31-302-29-2	kpl	38,31	47,50
415.	31-304-17-2	Ristikytkin	Nuppi posliinia	31-304-17-2	kpl	37,10	46,00
416.	31-304-18-2	Ristikytkin	Nuppi puinen	31-304-18-2	kpl	37,10	46,00
417.	31-304-21-2	Ristikytkin	Puu, patinoitu	31-304-21-2	kpl	37,10	46,00
418.	31-304-23-2	Ristikytkin (ilman kehystä)	Uppoasennettava	516-040-4	kpl	36,69	45,50
419.	31-304-23-2/ 31-801-17-2	Ristikytkin	Uppoasennettava	516-025-4	kpl	50,00	62,00
420.	31-304-27-2	Ristikytkin	Nuppi musta	31-304-27-2	kpl	38,71	48,00
421.	31-304-28-2	Ristikytkin (ilman kehystä)	Uppoasennettava	516-041-4	kpl	37,90	47,00
422.	31-304-28-2/ 31-801-27-2	Ristikytkin	Uppoasennettava	516-026-4	kpl	52,02	64,50
423.	31-304-29-2	Ristikytkin	Musta, puu (patinoitu)	31-304-29-2	kpl	38,71	48,00
424.	31-306-17-2	Ykköskytkin	Nuppi posliinia	31-306-17-2	kpl	30,65	38,00
425.	31-306-18-2	Ykköskytkin	Nuppi puinen	31-306-18-2	kpl	30,65	38,00
426.	31-306-21-2	Ykköskytkin	Puu, patinoitu	31-306-21-2	kpl	30,65	38,00
427.	31-306-23-2	Ykköskytkin (ilman kehystä)	Uppoasennettava	516-040-1	kpl	29,84	37,00
428.	31-306-23-2 / 31-801-17-2	Ykköskytkin	Uppoasennettava	516-025-1	kpl	43,15	53,50
429.	31-306-27-2	Ykköskytkin	Nuppi musta	31-306-27-2	kpl	31,85	39,50
430.	31-306-28-2	Ykköskytkin (ilman kehystä)	Uppoasennettava	516-041-1	kpl	31,05	38,50
431.	31-306-28-2 / 31-801-27-2	Ykköskytkin	Uppoasennettava	516-026-1	kpl	44,76	55,50
432.	31-306-29-2	Ykköskytkin	Musta, puu (patinoitu)	31-306-29-2	kpl	31,85	39,50
433.	31-308-17-2	Vaihtokytkin	Nuppi posliinia	31-308-17-2	kpl	31,45	39,00
434.	31-308-18-2	Vaihtokytkin	Nuppi puinen	31-308-18-2	kpl	31,45	39,00
435.	31-308-21-2	Vaihtokytkin	Puu, patinoitu	31-308-21-2	kpl	31,45	39,00
436.	31-308-23-2	Vaihtokytkin (ilman kehystä)	Uppoasennettava	516-040-2	kpl	31,05	38,50
437.	31-308-23-2/ 31-801-17-2	Vaihtokytkin	Uppoasennettava	516-025-2	kpl	44,35	55,00
438.	31-308-27-2	Vaihtokytkin	Nuppi musta	31-308-27-2	kpl	32,66	40,50
439.	31-308-28-2	Vaihtokytkin (ilman kehystä)	Uppoasennettava	516-041-2	kpl	31,85	39,50
440.	31-308-28-2/ 31-801-27-2	Vaihtokytkin	Uppoasennettava	516-026-2	kpl	45,97	57,00

Rivi	Valmistajan tuotenro *)	Tuotenimi	Selite	Domus Classican tuotenro	Yks.	Hinta (0%)	Hinta (24%)
441.	31-308-29-2	Vaihtokytkin	Musta, puu (patinoitu)	31-308-29-2	kpl	32,66	40,50
442.	31-310-17-2	Impulssikytkin, uppoasennettava	Valkoinen	31-310-17-2	kpl	15,73	19,50
443.	31-310-27-2	Impulssikytkin, uppoasennettava	Musta, posliini	31-310-27-2	kpl	17,34	21,50
444.	31-314-17-2	Kruunukytkin	Nuppi posliinia	31-314-17-2	kpl	35,08	43,50
445.	31-314-18-2	Kruunukytkin	Nuppi puinen	31-314-18-2	kpl	35,08	43,50
446.	31-314-21-2	Kruunukytkin	Puu, patinoitu	31-314-21-2	kpl	35,08	43,50
447.	31-314-23-2	Kruunukytkin	Nuppi "retro"	31-314-23-2	kpl	35,08	43,50
448.	31-314-27-2	Kruunukytkin	Nuppi musta	31-314-27-2	kpl	36,69	45,50
449.	31-314-28-2	Kruunukytkin	Nuppi musta	31-314-28-2	kpl	36,69	45,50
450.	31-314-29-2	Kruunukytkin	Musta, puu (patinoitu)	31-314-29-2	kpl	36,69	45,50
451.	31-316-17-2	Impulssikytkin, ajastin	Valkoinen, posliini	31-316-17-2	kpl	72,98	90,50
452.	31-316-27-2	Impulssikytkin, ajastin	Musta, posliini	31-316-27-2	kpl	74,19	92,00
453.	31-328-17-2	Impulssikytkin, kierrettävä	Nuppi posliinia	31-328-17-2	kpl	35,08	43,50
454.	31-328-18-2	Impulssikytkin, kierrettävä	Nuppi puinen	31-328-18-2	kpl	35,08	43,50
455.	31-328-21-2	Impulssikytkin, kierrettävä	Puu, patinoitu	31-328-21-2	kpl	35,08	43,50
456.	31-328-23-2	Impulssikytkin, kierrettävä	Nuppi "retro"	31-328-23-2	kpl	35,08	43,50
457.	31-328-27-2	Impulssikytkin, kierrettävä	Nuppi musta	31-328-27-2	kpl	39,92	49,50
458.	31-328-28-2	Impulssikytkin, kierrettävä	Nuppi musta	31-328-28-2	kpl	39,92	49,50
459.	31-328-29-2	Impulssikytkin, kierrettävä	Musta, puu (patinoitu)	31-328-29-2	kpl	39,92	49,50
460.	31-331-17-2	Himmennin 6A	Valkoinen, posliini	31-331-17-2	kpl	89,11	110,50
461.	31-331-27-2	Himmennin 6A	Musta, posliini	31-331-27-2	kpl	90,32	112,00
462.	31-332-17-2	Vaihtokytkin, himmennin (ilman kehystä)	Uppoasennettava	516-040-6	kpl	84,68	105,00
463.	31-332-17-2 / 31-801-17-2	Vaihtokytkin, himmentimellä	Uppoasennettava	516-025-6	kpl	97,98	121,50
464.	31-332-27-2	Vaihtokytkin, himmennin (ilman kehystä)	Uppoasennettava	516-041-6	kpl	86,29	107,00
465.	31-332-27-2 / 31-801-27-2	Vaihtokytkin, himmentimellä	Uppoasennettava	516-026-6	kpl	100,40	124,50
466.	31-342-17-2	Kytkin sähköiselle markiisille	Nuppi posliinia	31-342-17-2	kpl	34,68	43,00
467.	31-342-18-2	Kytkin sähköiselle markiisille	Nuppi puinen	31-342-18-2	kpl	34,68	43,00
468.	31-342-21-2	Kytkin sähköiselle markiisille	Puu, patinoitu	31-342-21-2	kpl	34,68	43,00
469.	31-342-23-2	Kytkin sähköiselle markiisille	Nuppi "retro"	31-342-23-2	kpl	34,68	43,00
470.	31-342-27-2	Kytkin sähköiselle markiisille	Nuppi musta	31-342-27-2	kpl	35,89	44,50
471.	31-342-28-2	Kytkin sähköiselle markiisille	Nuppi musta	31-342-28-2	kpl	35,89	44,50
472.	31-342-29-2	Kytkin sähköiselle markiisille	Musta, puu (patinoitu)	31-342-29-2	kpl	35,89	44,50
473.	31-343-17-2	Impulssikytkin, tupla, uppo-as.	Valkoinen, posliini	31-343-17-2	kpl	23,79	29,50
474.	31-343-27-2	Impulssikytkin, tupla, uppo-as.	Musta, posliini	31-343-27-2	kpl	32,66	40,50
475.	31-344-17-2	Impulssikytkin, kierrettävä, tupla	Nuppi posliinia	31-344-17-2	kpl	37,10	46,00
476.	31-344-18-2	Impulssikytkin, kierrettävä, tupla	Nuppi puinen	31-344-18-2	kpl	37,10	46,00
477.	31-344-21-2	Impulssikytkin, kierrettävä, tupla	Puu, patinoitu	31-344-21-2	kpl	37,10	46,00
478.	31-344-23-2	Impulssikytkin, kierrettävä, tupla	Nuppi "retro"	31-344-23-2	kpl	37,10	46,00
479.	31-344-27-2	Impulssikytkin, kierrettävä, tupla	Nuppi musta	31-344-27-2	kpl	40,32	50,00
480.	31-344-28-2	Impulssikytkin, kierrettävä, tupla	Nuppi musta	31-344-28-2	kpl	40,32	50,00

Rivi	Valmistajan tuotenro *)	Tuotenimi	Selite	Domus Classican tuotenro	Yks.	Hinta (0%)	Hinta (24%)
481.	31-344-29-2	Impulssikytkin, kierrettävä, tupla	Musta, puu (patinoitu)	31-344-29-2	kpl	40,32	50,00
482.	31-390-02-2	Hälytin 80 dB	Musta	31-390-02-2	kpl	25,40	31,50
483.	31-390-05-2	Hälytin 80 dB	Valkoinen, posliini	31-390-05-2	kpl	25,40	31,50
484.	31-656-17-2	Peiterasia (ilman kehystä)	Uppoasennettava	517-041-16	kpl	11,29	14,00
485.	31-656-27-2	Peiterasia (ilman kehystä)	Uppoasennettava	517-042-16	kpl	12,90	16,00
486.	31-706-17-2	Puhelin, tupla	Valkoinen, posliini	31-706-17-2	kpl	35,89	44,50
487.	31-706-27-2	Puhelin, tupla	Musta, posliini	31-706-27-2	kpl	37,50	46,50
488.	31-707-17-2	Puhelin ja RJ45 CAT 6, tupla	Valkoinen, posliini	31-707-17-2	kpl	70,97	88,00
489.	31-707-27-2	Puhelin ja RJ45 CAT 6, tupla	Musta, posliini	31-707-27-2	kpl	72,58	90,00
490.	31-708-17-2	Puhelin ja data (ilman kehystä)	Uppoasennettava	517-041-5	kpl	50,00	62,00
491.	31-708-17-2 /31-801-17-2	Puhelin ja data	Uppoasennettava	517-026-5	kpl	63,31	78,50
492.	31-708-27-2	Puhelin ja data (ilman kehystä)	Uppoasennettava	517-042-5	kpl	50,81	63,00
493.	31-708-27-2 /31-801-27-2	Puhelin ja data	Uppoasennettava	517-027-5	kpl	64,92	80,50
494.	31-801-00-2	Kehys yhdelle kytkimelle tai pistorasialle	Puu (käsittelemätön)	31-801-00-2	kpl	10,48	13,00
495.	31-801-09-2	Kehys yhdelle kytkimelle tai pistorasialle	Valkoinen, posliini	31-801-09-2	kpl	22,18	27,50
496.	31-801-11-2	Kehys yhdelle kytkimelle tai pistorasialle	Valkoinen, posliini	31-801-11-2	kpl	18,55	23,00
497.	31-801-17-2	Posliinikehys, valkoinen	Yhdelle kytkimelle tai pistorasialle	518-050-1	kpl	13,31	16,50
498.	31-801-19-2	Kehys yhdelle kytkimelle tai pistorasialle	Hunaja (puu)	31-801-19-2	kpl	11,69	14,50
499.	31-801-21-2	Kehys yhdelle kytkimelle tai pistorasialle	Puu, patinoitu	31-801-21-2	kpl	14,52	18,00
500.	31-801-27-2	Posliinikehys, musta	Yhdelle kytkimelle tai pistorasialle	518-051-1	kpl	14,11	17,50
501.	31-801-33-2	Kehys yhdelle kytkimelle tai pistorasialle	Vihreä (kulta)	31-801-33-2	kpl	18,55	23,00
502.	31-801-34-2	Kehys yhdelle kytkimelle tai pistorasialle	Musta (hopea)	31-801-34-2	kpl	18,55	23,00
503.	31-801-35-2	Kehys yhdelle kytkimelle tai pistorasialle	Valkoi-sininen	31-801-35-2	kpl	18,55	23,00
504.	31-801-36-2	Kehys yhdelle kytkimelle tai pistorasialle	Harmaa (kulta)	31-801-36-2	kpl	18,55	23,00
505.	31-802-00-2	Kehys kahdelle kytkimelle tai pistorasialle	Puu (käsittelemätön)	31-802-00-2	kpl	15,32	19,00
506.	31-802-09-2	Kehys kahdelle kytkimelle tai pistorasialle	Valkoinen, posliini	31-802-09-2	kpl	31,05	38,50
507.	31-802-11-2	Kehys kahdelle kytkimelle tai pistorasialle	Valkoinen, posliini	31-802-11-2	kpl	26,61	33,00
508.	31-802-17-2	Posliinikehys, valkoinen	Kahdelle kytkimelle tai pistorasialle	518-050-2	kpl	19,35	24,00
509.	31-802-19-2	Kehys kahdelle kytkimelle tai pistorasialle	Hunaja (puu)	31-802-19-2	kpl	16,53	20,50
510.	31-802-21-2	Kehys kahdelle kytkimelle tai pistorasialle	Puu, patinoitu	31-802-21-2	kpl	21,77	27,00
511.	31-802-27-2	Posliinikehys, musta	Kahdelle kytkimelle tai pistorasialle	518-051-2	kpl	20,56	25,50
512.	31-802-33-2	Kehys kahdelle kytkimelle tai pistorasialle	Vihreä (kulta)	31-802-33-2	kpl	27,02	33,50
513.	31-802-34-2	Kehys kahdelle kytkimelle tai pistorasialle	Musta (hopea)	31-802-34-2	kpl	27,02	33,50
514.	31-802-35-2	Kehys kahdelle kytkimelle tai pistorasialle	Valkoi-sininen	31-802-35-2	kpl	27,02	33,50
515.	31-802-36-2	Kehys kahdelle kytkimelle tai pistorasialle	Harmaa (kulta)	31-802-36-2	kpl	27,02	33,50
516.	31-803-00-2	Kehys kolmelle kytkimelle tai pistorasialle	Puu (käsittelemätön)	31-803-00-2	kpl	20,16	25,00
517.	31-803-09-2	Kehys kolmelle kytkimelle tai pistorasialle	Valkoinen, posliini	31-803-09-2	kpl	58,47	72,50
518.	31-803-11-2	Kehys kolmelle kytkimelle tai pistorasialle	Valkoinen, posliini	31-803-11-2	kpl	39,92	49,50
519.	31-803-17-2	Posliinikehys, valkoinen	Kolmelle kytkimelle tai pistorasialle	518-050-3	kpl	28,63	35,50
520.	31-803-19-2	Kehys kolmelle kytkimelle tai pistorasialle	Hunaja (puu)	31-803-19-2	kpl	22,18	27,50

Rivi	Valmistajan tuotenro *)	Tuotenimi	Selite	Domus Classican tuotenro	Yks.	Hinta (0%)	Hinta (24%)
521.	31-803-21-2	Kehys kolmelle kytkimelle tai pistorasialle	Puu, patinoitu	31-803-21-2	kpl	28,63	35,50
522.	31-803-27-2	Posliinikehys, musta	Kolmelle kytkimelle tai pistorasialle	518-051-3	kpl	37,50	46,50
523.	31-803-33-2	Kehys kolmelle kytkimelle tai pistorasialle	Vihreä (kulta)	31-803-33-2	kpl	37,10	46,00
524.	31-803-34-2	Kehys kolmelle kytkimelle tai pistorasialle	Musta (hopea)	31-803-34-2	kpl	37,10	46,00
525.	31-803-35-2	Kehys kolmelle kytkimelle tai pistorasialle	Valkoinen (sininen)	31-803-35-2	kpl	37,10	46,00
526.	31-803-36-2	Kehys kolmelle kytkimelle tai pistorasialle	Harmaa (kulta)	31-803-36-2	kpl	37,10	46,00
527.	31-804-00-2	Kehys neljälle kytkimelle tai pistorasialle	Puu, luonnollinen	31-804-00-2	kpl	28,63	35,50
528.	31-804-19-2	Kehys neljälle kytkimelle tai pistorasialle	Hunaja (puu)	31-804-19-2	kpl	30,24	37,50
529.	31-804-21-2	Kehys neljälle kytkimelle tai pistorasialle	Puu, patinoitu	31-804-21-2	kpl	32,66	40,50
530.	31-804-33-2	Kehys neljälle kytkimelle tai pistorasialle	Vihreä (kulta)	31-804-33-2	kpl	47,98	59,50
531.	31-804-34-2	Kehys neljälle kytkimelle tai pistorasialle	Musta (hopea)	31-804-34-2	kpl	47,98	59,50
532.	31-804-35-2	Kehys neljälle kytkimelle tai pistorasialle	Valkoinen (sininen)	31-804-35-2	kpl	47,98	59,50
533.	31-804-36-2	Kehys neljälle kytkimelle tai pistorasialle	Harmaa (kulta)	31-804-36-2	kpl	47,98	59,50
534.	31-821-00-2	Erikoiskehys yhdelle	Puu (käsittelemätön)	31-821-00-2	kpl	11,69	14,50
535.	31-821-09-2	Erikoiskehys yhdelle	Krakeloitu, posliini	31-821-09-2	kpl	22,18	27,50
536.	31-821-11-2	Erikoiskehys yhdelle	Koristemaalaus	31-821-11-2	kpl	20,56	25,50
537.	31-821-17-2	Erikoiskehys yhdelle	Valkoinen, posliini	31-821-17-2	kpl	19,35	24,00
538.	31-821-19-2	Erikoiskehys yhdelle	Hunaja (puu)	31-821-19-2	kpl	12,90	16,00
539.	31-821-21-2	Erikoiskehys yhdelle	Puu, patinoitu	31-821-21-2	kpl	16,13	20,00
540.	31-821-27-2	Erikoiskehys yhdelle	Musta, posliini	31-821-27-2	kpl	24,19	30,00
541.	31-821-33-2	Erikoiskehys yhdelle	Vihreä (kulta)	31-821-33-2	kpl	18,55	23,00
542.	31-821-34-2	Erikoiskehys yhdelle	Musta (hopea)	31-821-34-2	kpl	18,55	23,00
543.	31-821-35-2	Erikoiskehys yhdelle	Valkoinen (sininen)	31-821-35-2	kpl	18,55	23,00
544.	31-821-36-2	Erikoiskehys yhdelle	Harmaa (kulta)	31-821-36-2	kpl	18,55	23,00
545.	31-905-02-2	Kaiutinpistorasia	Musta	31-905-02-2	kpl	9,68	12,00
546.	31-905-05-2	Kaiutinpistorasia	Valkoinen	31-905-05-2	kpl	9,27	11,50
547.	31-906-05-2	Mekanismi, avaimella	Valkoinen	31-906-05-2	kpl	48,39	60,00
548.	31-924-17-2	Volyymisäätökytkin	Valkoinen, posliini	31-924-17-2	kpl	104,44	129,50
549.	31-924-27-2	Volyymisäätökytkin	Musta, posliini	31-924-27-2	kpl	105,24	130,50
550.	31-925-17-2	Volyymisäätökytkin, radio	Valkoinen, posliini	31-925-17-2	kpl	109,27	135,50
551.	31-925-27-2	Volyymisäätökytkin, radio	Musta, posliini	31-925-27-2	kpl	110,48	137,00
552.	31-926-02-2	Kaiutinpistorasia 2W	Musta	31-926-02-2	kpl	58,47	72,50
553.	31-926-05-2	Kaiutinpistorasia 2W	Valkoinen	31-926-05-2	kpl	58,47	72,50
554.	31-927-17-2	Kattokuppi	Valkoinen, posliini	31-927-17-2	kpl	13,31	16,50
555.	31-927-27-2	Kattokuppi	Musta, posliini	31-927-27-2	kpl	15,32	19,00
556.	33-212-17-2	Pistorasia	Valkoinen, posliini	33-212-17-2	kpl	35,08	43,50
557.	33-212-27-2	Pistorasia	Musta, posliini	33-212-27-2	kpl	37,90	47,00
558.	33-302-17-2	Vaihtokytkin	Valkoinen, posliini	33-302-17-2	kpl	27,42	34,00
559.	33-302-27-2	Vaihtokytkin	Musta, posliini	33-302-27-2	kpl	30,24	37,50
560.	33-304-17-2	Ristikytkin	Valkoinen, posliini	33-304-17-2	kpl	27,42	34,00

Rivi	Valmistajan tuotenro *)	Tuotenimi	Selite	Domus Classican tuotenro	Yks.	Hinta (0%)	Hinta (24%)
561.	33-304-27-2	Ristikytkin	Musta, posliini	33-304-27-2	kpl	29,84	37,00
562.	33-308-17-2	Vaihtokytkin	Valkoinen, posliini	33-308-17-2	kpl	26,21	32,50
563.	33-308-27-2	Vaihtokytkin	Musta, posliini	33-308-27-2	kpl	28,63	35,50
564.	33-314-17-2	Kruunukytkin	Valkoinen, posliini	33-314-17-2	kpl	26,21	32,50
565.	33-314-27-2	Kruunukytkin	Musta, posliini	33-314-27-2	kpl	29,03	36,00
566.	33-328-17-2	Impulssikytkin, kierrettävä	Valkoinen, posliini	33-328-17-2	kpl	27,42	34,00
567.	33-328-27-2	Impulssikytkin, kierrettävä	Musta, posliini	33-328-27-2	kpl	29,84	37,00
568.	33-342-17-2	Kytkin sähköiselle markiisille	Valkoinen, posliini	33-342-17-2	kpl	23,79	29,50
569.	33-342-27-2	Kytkin sähköiselle markiisille	Musta, posliini	33-342-27-2	kpl	26,21	32,50
570.	33-344-17-2	Impulssikytkin, kierrettävä, tupla	Valkoinen, posliini	33-344-17-2	kpl	29,44	36,50
571.	33-344-27-2	Impulssikytkin, kierrettävä, tupla	Musta, posliini	33-344-27-2	kpl	31,85	39,50
572.	33-706-17-2	Puhelin, tupla	Valkoinen, posliini	33-706-17-2	kpl	46,77	58,00
573.	33-706-27-2	Puhelin, tupla	Musta, posliini	33-706-27-2	kpl	49,60	61,50
574.	33-707-17-2	RJ-45 CAT6, tupla	Valkoinen, posliini	33-707-17-2	kpl	87,90	109,00
575.	33-707-27-2	RJ-45 CAT6, tupla	Musta, posliini	33-707-27-2	kpl	90,73	112,50
576.	33-708-17-2	Puhelin ja RJ45 CAT6	Valkoinen, posliini	33-708-17-2	kpl	67,34	83,50
577.	33-708-27-2	Puhelin ja RJ45 CAT6	Musta, posliini	33-708-27-2	kpl	70,16	87,00
578.	33-711-17-2	RTV/SAT, päättyvä	Valkoinen, posliini	33-711-17-2	kpl	47,58	59,00
579.	33-711-27-2	RTV/SAT, päättyvä	Musta, posliini	33-711-27-2	kpl	50,00	62,00
580.	33-712-17-2	RTV/SAT, yksittäinen	Valkoinen, posliini	33-712-17-2	kpl	45,16	56,00
581.	33-712-27-2	RTV/SAT, yksittäinen	Musta, posliini	33-712-27-2	kpl	47,98	59,50
582.	33-713-17-2	RTV/SAT, ketju A	Valkoinen, posliini	33-713-17-2	kpl	47,18	58,50
583.	33-713-27-2	RTV/SAT, ketju A	Musta, posliini	33-713-27-2	kpl	50,00	62,00
584.	33-714-17-2	RTV/SAT, ketju B	Valkoinen, posliini	33-714-17-2	kpl	37,10	46,00
585.	33-714-27-2	RTV/SAT, ketju B	Musta, posliini	33-714-27-2	kpl	39,92	49,50
586.	33-801-17-2	Kehys yhdelle kytkimelle tai pistorasialle	Valkoinen, posliini	33-801-17-2	kpl	25,81	32,00
587.	33-801-27-2	Kehys yhdelle kytkimelle tai pistorasialle	Musta, posliini	33-801-27-2	kpl	28,23	35,00
588.	33-801-80-2	Kehys yhdelle kytkimelle tai pistorasialle	Pyökki, petsattu	33-801-80-2	kpl	22,18	27,50
589.	33-801-81-2	Kehys yhdelle kytkimelle tai pistorasialle	Pyökki, käsittelemätön	33-801-81-2	kpl	22,18	27,50
590.	33-801-82-2	Kehys yhdelle kytkimelle tai pistorasialle	Pähkinäpuu	33-801-82-2	kpl	30,24	37,50
591.	33-802-17-2	Kehys kahdelle kytkimelle tai pistorasialle	Valkoinen, posliini	33-802-17-2	kpl	43,15	53,50
592.	33-802-27-2	Kehys kahdelle kytkimelle tai pistorasialle	Musta, posliini	33-802-27-2	kpl	45,16	56,00
593.	33-802-80-2	Kehys kahdelle kytkimelle tai pistorasialle	Pyökki, petsattu	33-802-80-2	kpl	32,66	40,50
594.	33-802-81-2	Kehys kahdelle kytkimelle tai pistorasialle	Pyökki, käsittelemätön	33-802-81-2	kpl	32,66	40,50
595.	33-802-82-2	Kehys kahdelle kytkimelle tai pistorasialle	Pähkinäpuu	33-802-82-2	kpl	45,97	57,00
596.	33-803-17-2	Kehys kolmelle kytkimelle tai pistorasialle	Valkoinen, posliini	33-803-17-2	kpl	75,00	93,00
597.	33-803-27-2	Kehys kolmelle kytkimelle tai pistorasialle	Musta, posliini	33-803-27-2	kpl	83,87	104,00
598.	33-803-80-2	Kehys kolmelle kytkimelle tai pistorasialle	Pyökki, petsattu	33-803-80-2	kpl	65,32	81,00
599.	33-803-81-2	Kehys kolmelle kytkimelle tai pistorasialle	Pyökki, käsittelemätön	33-803-81-2	kpl	65,32	81,00
600.	33-803-82-2	Kehys kolmelle kytkimelle tai pistorasialle	Pähkinäpuu	33-803-82-2	kpl	88,71	110,00

Rivi	Valmistajan tuotenro *)	Tuotenimi	Selite	Domus Classican tuotenro	Yks.	Hinta (0%)	Hinta (24%)
601.	33-811-80-2	Taustalevy yhdelle kytkimelle tai pistorasialle	Pyökki, petsattu	33-811-80-2	kpl	17,34	21,50
602.	33-811-81-2	Taustalevy yhdelle kytkimelle tai pistorasialle	Pyökki, käsittelemätön	33-811-81-2	kpl	17,34	21,50
603.	33-811-82-2	Taustalevy yhdelle kytkimelle tai pistorasialle	Pähkinäpuu	33-811-82-2	kpl	20,16	25,00
604.	33-812-80-2	Kehys kahdelle kytkimelle tai pistorasialle	Pyökki, petsattu	33-812-80-2	kpl	40,73	50,50
605.	33-812-81-2	Kehys kahdelle kytkimelle tai pistorasialle	Pyökki, käsittelemätön	33-812-81-2	kpl	40,73	50,50
606.	33-812-82-2	Kehys kahdelle kytkimelle tai pistorasialle	Pähkinäpuu	33-812-82-2	kpl	53,23	66,00
607.	33-813-80-2	Kehys kolmelle kytkimelle tai pistorasialle	Pyökki, petsattu	33-813-80-2	kpl	68,55	85,00
608.	33-813-81-2	Kehys kolmelle kytkimelle tai pistorasialle	Pyökki, käsittelemätön	33-813-81-2	kpl	68,55	85,00
609.	33-813-82-2	Kehys kolmelle kytkimelle tai pistorasialle	Pähkinäpuu	33-813-82-2	kpl	90,73	112,50
610.	33-966-26-2	Ruuvisarja Torx M3x18	Kromattu	33-966-26-2	kpl	12,90	16,00
611.	33-966-30-2	Ruuvisarja Torx M3x18	Niklattu (tumma)	33-966-30-2	kpl	12,90	16,00
612.	33-966-31-2	Ruuvisarja Torx M3x18	Kuparipinnoitettu	33-966-31-2	kpl	12,90	16,00
613.	33-967-26-2	Kromattu nuppi ja ruuvit	Kromattu	33-967-26-2	kpl	9,68	12,00
614.	33-967-30-2	Niklattu nuppi ja ruuvit	Niklattu (tumma)	33-967-30-2	kpl	15,73	19,50
615.	33-967-31-2	Kuparinuppi ja ruuvit	Kuparipinnoitettu	33-967-31-2	kpl	15,73	19,50
616.	33-969-26-2	Ruuvisarja Torx 3,5X12	Kromattu	33-969-26-2	kpl	12,90	16,00
617.	33-969-30-2	Ruuvisarja Torx 3,5X12	Niklattu (tumma)	33-969-30-2	kpl	12,90	16,00
618.	33-969-31-2	Ruuvisarja Torx 3,5X12	Kuparipinnoitettu	33-969-31-2	kpl	12,90	16,00
619.	34-212-17-2	Pistorasia	Valkoinen, posliini	34-212-17-2	kpl	27,82	34,50
620.	34-212-27-2	Pistorasia	Musta, posliini	34-212-27-2	kpl	30,24	37,50
621.	34-302-99-2	Vaihtokytkinmekanismi	–	34-302-99-2	kpl	19,76	24,50
622.	34-304-99-2	Ristikytkinmekanismi	–	34-304-99-2	kpl	19,35	24,00
623.	34-308-99-2	Vaihtokytkinmekanismi	–	34-308-99-2	kpl	17,34	21,50
624.	34-314-99-2	Kruunukytkinmekanismi	–	34-314-99-2	kpl	18,55	23,00
625.	34-328-99-2	Impulssikytkinmekanismi	–	34-328-99-2	kpl	19,35	24,00
626.	34-342-99-2	Kaihtimien säätökytkinmekanismi	–	34-342-99-2	kpl	15,73	19,50
627.	34-344-99-2	Impulssikytkinmekanismi, tupla	–	34-344-99-2	kpl	21,37	26,50
628.	34-706-17-2	Puhelin, tupla	Musta, posliini	34-706-17-2	kpl	41,94	52,00
629.	34-706-27-2	Puhelin, tupla	Musta, posliini	34-706-27-2	kpl	44,35	55,00
630.	34-707-17-2	RJ-45 CAT6	Valkoinen, posliini	34-707-17-2	kpl	77,82	96,50
631.	34-707-27-2	RJ-45 CAT6	Musta, posliini	34-707-27-2	kpl	80,24	99,50
632.	34-708-17-2	Puhelin ja RJ-45 CAT6	Valkoinen, posliini	34-708-17-2	kpl	53,23	66,00
633.	34-708-27-2	Puhelin ja RJ-45 CAT6	Musta, posliini	34-708-27-2	kpl	55,65	69,00
634.	34-711-17-2	R+TV+SAT, päättyvä	Valkoinen, posliini	34-711-17-2	kpl	36,69	45,50
635.	34-711-27-2	R+TV+SAT, päättyvä	Musta, posliini	34-711-27-2	kpl	39,11	48,50
636.	34-712-17-2	R+TV+SAT, yksittäinen	Valkoinen, posliini	34-712-17-2	kpl	34,68	43,00
637.	34-712-27-2	R+TV+SAT, yksittäinen	Musta, posliini	34-712-27-2	kpl	37,50	46,50
638.	34-713-17-2	R+TV+SAT, ketju A	Valkoinen, posliini	34-713-17-2	kpl	36,69	45,50
639.	34-713-27-2	R+TV+SAT, ketju A	Musta, posliini	34-713-27-2	kpl	39,11	48,50
640.	34-714-17-2	R+TV+SAT, ketju B	Valkoinen, posliini	34-714-17-2	kpl	36,69	45,50

Rivi	Valmistajan tuotenro *)	Tuotenimi	Selite	Domus Classican tuotenro	Yks.	Hinta (0%)	Hinta (24%)
641.	34-714-27-2	R+TV+SAT, ketju B	Musta, posliini	34-714-27-2	kpl	39,11	48,50
642.	34-801-17-2	Kehys yhdelle kytkimelle tai pistorasialle	Valkoinen, posliini	34-801-17-2	kpl	23,39	29,00
643.	34-801-27-2	Kehys yhdelle kytkimelle tai pistorasialle	Musta, posliini	34-801-27-2	kpl	25,81	32,00
644.	34-801-80-2	Kehys yhdelle kytkimelle tai pistorasialle	Pyökki, petsattu	34-801-80-2	kpl	19,76	24,50
645.	34-801-81-2	Kehys yhdelle kytkimelle tai pistorasialle	Pyökki, käsittelemätön	34-801-81-2	kpl	19,76	24,50
646.	34-801-82-2	Kehys yhdelle kytkimelle tai pistorasialle	Pähkinäpuu	34-801-82-2	kpl	28,23	35,00
647.	34-802-17-2	Kehys kahdelle kytkimelle tai pistorasialle	Valkoinen, posliini	34-802-17-2	kpl	38,31	47,50
648.	34-802-27-2	Kehys kahdelle kytkimelle tai pistorasialle	Musta, posliini	34-802-27-2	kpl	40,73	50,50
649.	34-802-80-2	Kehys kahdelle kytkimelle tai pistorasialle	Pyökki, petsattu	34-802-80-2	kpl	27,82	34,50
650.	34-802-81-2	Kehys kahdelle kytkimelle tai pistorasialle	Pyökki, käsittelemätön	34-802-81-2	kpl	27,82	34,50
651.	34-802-82-2	Kehys kahdelle kytkimelle tai pistorasialle	Pähkinäpuu	34-802-82-2	kpl	41,13	51,00
652.	34-803-17-2	Kehys kolmelle kytkimelle tai pistorasialle	Valkoinen, posliini	34-803-17-2	kpl	67,74	84,00
653.	34-803-27-2	Kehys kolmelle kytkimelle tai pistorasialle	Musta, posliini	34-803-27-2	kpl	77,42	96,00
654.	34-803-80-2	Kehys kolmelle kytkimelle tai pistorasialle	Pyökki, petsattu	34-803-80-2	kpl	56,85	70,50
655.	34-803-81-2	Kehys kolmelle kytkimelle tai pistorasialle	Pyökki, käsittelemätön	34-803-81-2	kpl	56,85	70,50
656.	34-803-82-2	Kehys kolmelle kytkimelle tai pistorasialle	Pähkinäpuu	34-803-82-2	kpl	80,24	99,50
657.	34-968-01-2	Varaosakuori (DO)	Musta, posliini (kromattu)	34-968-01-2	kpl	19,35	24,00
658.	34-968-02-2	Varaosakuori (DO)	Musta, posliini (tumma niklaus)	34-968-02-2	kpl	26,21	32,50
659.	34-968-03-2	Varaosakuori (DO)	Musta, posliini (kupari)	34-968-03-2	kpl	26,21	32,50
660.	34-968-11-2	Varaosakuori (DO)	Valkoinen, posliini (kromattu)	34-968-11-2	kpl	18,15	22,50
661.	34-968-12-2	Varaosakuori (DO)	Valkoinen, posliini (tumma niklaus)	34-968-12-2	kpl	25,00	31,00
662.	34-968-13-2	Varaosakuori (DO)	Valkoinen, posliini (kupari)	34-968-13-2	kpl	25,00	31,00
663.	35-208-03-2	Pistorasia, ranskalainen	Ruskea	35-208-03-2	kpl	12,50	15,50
664.	35-208-05-2	Pistorasia, ranskalainen	Valkoinen	35-208-05-2	kpl	12,50	15,50
665.	35-209-03-2	Pistorasia	Ruskea	35-209-03-2	kpl	7,66	9,50
666.	35-209-05-2	Pistorasia	Valkoinen	35-209-05-2	kpl	7,66	9,50
667.	35-212-03-2	Pistorasia	Ruskea	35-212-03-2	kpl	9,27	11,50
668.	35-212-05-2	Pistorasia	Valkoinen	35-212-05-2	kpl	9,27	11,50
669.	35-300-16-2	Ykköskytkin, tupla	Puu (valkoinen)	35-300-16-2	kpl	27,82	34,50
670.	35-300-17-2	Ykköskytkin, tupla	Valkoinen, posliini	35-300-17-2	kpl	30,24	37,50
671.	35-300-23-2	Ykköskytkin, tupla	Valkoinen, posliini	35-300-23-2	kpl	30,24	37,50
672.	35-300-25-2	Ykköskytkin, tupla	Niklattu (valkoinen)	35-300-25-2	kpl	30,24	37,50
673.	35-300-30-2	Ykköskytkin, tupla	Kulta (valkoinen)	35-300-30-2	kpl	30,24	37,50
674.	35-300-52-2	Ykköskytkin, tupla	Niklattu (ruskea)	35-300-52-2	kpl	30,24	37,50
675.	35-300-54-2	Ykköskytkin, tupla	Kulta (ruskea)	35-300-54-2	kpl	30,24	37,50
676.	35-300-57-2	Ykköskytkin, tupla	Antiikkipronssi (ruskea)	35-300-57-2	kpl	30,24	37,50
677.	35-300-59-2	Ykköskytkin, tupla	Antiikkipronssi (valkoinen)	35-300-59-2	kpl	30,24	37,50
678.	35-302-16-2	Vaihtokytkin, tupla	Puu (valkoinen)	35-302-16-2	kpl	29,84	37,00
679.	35-302-17-2	Vaihtokytkin, tupla	Valkoinen, posliini	35-302-17-2	kpl	32,26	40,00
680.	35-302-23-2	Vaihtokytkin, tupla	Valkoinen, posliini	35-302-23-2	kpl	32,26	40,00

Rivi	Valmistajan tuotenro *)	Tuotenimi	Selite	Domus Classican tuotenro	Yks.	Hinta (0%)	Hinta (24%)
681.	35-302-25-2	Vaihtokytkin, tupla	Niklattu (valkoinen)	35-302-25-2	kpl	32,26	40,00
682.	35-302-30-2	Vaihtokytkin, tupla	Kulta (valkoinen)	35-302-30-2	kpl	32,26	40,00
683.	35-302-52-2	Vaihtokytkin, tupla	Niklattu (ruskea)	35-302-52-2	kpl	32,26	40,00
684.	35-302-54-2	Vaihtokytkin, tupla	Kulta (ruskea)	35-302-54-2	kpl	32,26	40,00
685.	35-302-57-2	Vaihtokytkin, tupla	Pronssi (ruskea)	35-302-57-2	kpl	32,26	40,00
686.	35-302-59-2	Vaihtokytkin, tupla	Pronssi (ruskea)	35-302-59-2	kpl	32,26	40,00
687.	35-304-16-2	Ristikytkin	Puu (valkoinen)	35-304-16-2	kpl	29,84	37,00
688.	35-304-17-2	Ristikytkin	Valkoinen, posliini	35-304-17-2	kpl	32,26	40,00
689.	35-304-23-2	Ristikytkin	Valkoinen, posliini	35-304-23-2	kpl	32,26	40,00
690.	35-304-25-2	Ristikytkin	Niklattu (valkoinen)	35-304-25-2	kpl	32,26	40,00
691.	35-304-30-2	Ristikytkin	Kulta (valkoinen)	35-304-30-2	kpl	32,26	40,00
692.	35-304-52-2	Ristikytkin	Niklattu (ruskea)	35-304-52-2	kpl	32,26	40,00
693.	35-304-54-2	Ristikytkin	Kulta (ruskea)	35-304-54-2	kpl	32,26	40,00
694.	35-304-57-2	Ristikytkin	Antiikkipronssi (ruskea)	35-304-57-2	kpl	32,26	40,00
695.	35-304-59-2	Ristikytkin	Antiikkipronssi (valkoinen)	35-304-59-2	kpl	32,26	40,00
696.	35-306-16-2	Ykköskytkin	Puu (valkoinen)	35-306-16-2	kpl	23,39	29,00
697.	35-306-17-2	Ykköskytkin	Valkoinen, posliini	35-306-17-2	kpl	25,81	32,00
698.	35-306-23-2	Ykköskytkin	Valkoinen, posliini	35-306-23-2	kpl	25,81	32,00
699.	35-306-25-2	Ykköskytkin	Niklattu (valkoinen)	35-306-25-2	kpl	25,81	32,00
700.	35-306-30-2	Ykköskytkin	Kulta (valkoinen)	35-306-30-2	kpl	25,81	32,00
701.	35-306-52-2	Ykköskytkin	Niklattu (ruskea)	35-306-52-2	kpl	25,81	32,00
702.	35-306-54-2	Ykköskytkin	Kulta (ruskea)	35-306-54-2	kpl	25,81	32,00
703.	35-306-57-2	Ykköskytkin	Antiikkipronssi (ruskea)	35-306-57-2	kpl	25,81	32,00
704.	35-306-59-2	Ykköskytkin	Antiikkipronssi (valkoinen)	35-306-59-2	kpl	25,81	32,00
705.	35-308-16-2	Vaihtokytkin	Puu (valkoinen)	35-308-16-2	kpl	24,19	30,00
706.	35-308-17-2	Vaihtokytkin	Valkoinen, posliini	35-308-17-2	kpl	27,02	33,50
707.	35-308-23-2	Vaihtokytkin	Retro	35-308-23-2	kpl	27,02	33,50
708.	35-308-25-2	Vaihtokytkin	Niklattu (valkoinen)	35-308-25-2	kpl	27,02	33,50
709.	35-308-30-2	Vaihtokytkin	Kulta (valkoinen)	35-308-30-2	kpl	27,02	33,50
710.	35-308-52-2	Vaihtokytkin	Niklattu (ruskea)	35-308-52-2	kpl	27,02	33,50
711.	35-308-54-2	Vaihtokytkin	Kulta (ruskea)	35-308-54-2	kpl	27,02	33,50
712.	35-308-57-2	Vaihtokytkin	Antiikkipronssi (ruskea)	35-308-57-2	kpl	27,02	33,50
713.	35-308-59-2	Vaihtokytkin	Antiikkipronssi (valkoinen)	35-308-59-2	kpl	27,02	33,50
714.	35-310-25-2	Impulssikytkin	Niklattu (valkoinen)	35-310-25-2	kpl	10,48	13,00
715.	35-310-26-2	Impulssikytkin	Kromattu (valkoinen)	35-310-26-2	kpl	10,48	13,00
716.	35-310-30-2	Impulssikytkin	Kulta (valkoinen)	35-310-30-2	kpl	10,48	13,00
717.	35-310-52-2	Impulssikytkin	Niklattu (ruskea)	35-310-52-2	kpl	10,48	13,00
718.	35-310-54-2	Impulssikytkin	Kulta (ruskea)	35-310-54-2	kpl	10,48	13,00
719.	35-310-57-2	Impulssikytkin	Antiikkipronssi (ruskea)	35-310-57-2	kpl	10,48	13,00
720.	35-310-58-2	Impulssikytkin	Kromattu (ruskea)	35-310-58-2	kpl	10,48	13,00

Rivi	Valmistajan tuotenro *)	Tuotenimi	Selite	Domus Classican tuotenro	Yks.	Hinta (0%)	Hinta (24%)
721.	35-310-59-2	Impulssikytkin	Antiikkipronssi (valkoinen)	35-310-59-2	kpl	10,48	13,00
722.	35-314-16-2	Kruunukytkin	Puu (valkoinen)	35-314-16-2	kpl	27,82	34,50
723.	35-314-17-2	Kruunukytkin	Valkoinen, posliini	35-314-17-2	kpl	30,65	38,00
724.	35-314-23-2	Kruunukytkin	Retro	35-314-23-2	kpl	30,65	38,00
725.	35-314-25-2	Kruunukytkin	Nikalattu (valkoinen)	35-314-25-2	kpl	30,65	38,00
726.	35-314-30-2	Kruunukytkin	Kulta (valkoinen)	35-314-30-2	kpl	30,65	38,00
727.	35-314-52-2	Kruunukytkin	Nikalattu (ruskea)	35-314-52-2	kpl	30,65	38,00
728.	35-314-54-2	Kruunukytkin	Kulta (ruskea)	35-314-54-2	kpl	30,65	38,00
729.	35-314-57-2	Kruunukytkin	Pronssi (ruskea)	35-314-57-2	kpl	30,65	38,00
730.	35-314-59-2	Kruunukytkin	Pronssi (ruskea)	35-314-59-2	kpl	30,65	38,00
731.	35-316-25-2	Impulssikytkin, ajastin	Nikalattu (valkoinen)	35-316-25-2	kpl	59,68	74,00
732.	35-316-30-2	Impulssikytkin, ajastin	Kulta (valkoinen)	35-316-30-2	kpl	59,68	74,00
733.	35-316-52-2	Impulssikytkin, ajastin	Nikalattu (ruskea)	35-316-52-2	kpl	59,68	74,00
734.	35-316-54-2	Impulssikytkin, ajastin	Kulta (ruskea)	35-316-54-2	kpl	59,68	74,00
735.	35-316-57-2	Impulssikytkin, ajastin	Antiikkipronssi (ruskea)	35-316-57-2	kpl	59,68	74,00
736.	35-316-59-2	Impulssikytkin, ajastin	Antiikkipronssi (valkoinen)	35-316-59-2	kpl	59,68	74,00
737.	35-328-16-2	Impulssikytkin, kierrettävä	Puu (valkoinen)	35-328-16-2	kpl	28,63	35,50
738.	35-328-17-2	Impulssikytkin, kierrettävä	Valkoinen, posliini	35-328-17-2	kpl	30,65	38,00
739.	35-328-23-2	Impulssikytkin, kierrettävä	Retro	35-328-23-2	kpl	30,65	38,00
740.	35-328-25-2	Impulssikytkin, kierrettävä	Nikalattu (valkoinen)	35-328-25-2	kpl	30,65	38,00
741.	35-328-30-2	Impulssikytkin, kierrettävä	Kulta (valkoinen)	35-328-30-2	kpl	30,65	38,00
742.	35-328-52-2	Impulssikytkin, kierrettävä	Nikalattu (ruskea)	35-328-52-2	kpl	30,65	38,00
743.	35-328-54-2	Impulssikytkin, kierrettävä	Kulta (ruskea)	35-328-54-2	kpl	30,65	38,00
744.	35-328-57-2	Impulssikytkin, kierrettävä	Pronssi (ruskea)	35-328-57-2	kpl	30,65	38,00
745.	35-328-59-2	Impulssikytkin, kierrettävä	Pronssi (ruskea)	35-328-59-2	kpl	30,65	38,00
746.	35-331-03-2	Himmennin 6A	Ruskea	35-331-03-2	kpl	79,84	99,00
747.	35-331-05-2	Himmennin 6A	Valkoinen	35-331-05-2	kpl	79,84	99,00
748.	35-332-03-2	Vaihtokytkin, himmennin 500 W	Ruskea	35-332-03-2	kpl	79,44	98,50
749.	35-332-05-2	Vaihtokytkin, himmennin 500 W	Valkoinen	35-332-05-2	kpl	79,44	98,50
750.	35-342-16-2	Kytkin sähköiselle markiisille	Puu (valkoinen)	35-342-16-2	kpl	27,42	34,00
751.	35-342-17-2	Kytkin sähköiselle markiisille	Valkoinen, posliini	35-342-17-2	kpl	29,84	37,00
752.	35-342-25-2	Kytkin sähköiselle markiisille	Nikalattu (valkoinen)	35-342-25-2	kpl	29,84	37,00
753.	35-342-30-2	Kytkin sähköiselle markiisille	Kulta (valkoinen)	35-342-30-2	kpl	29,84	37,00
754.	35-342-52-2	Kytkin sähköiselle markiisille	Nikalattu (ruskea)	35-342-52-2	kpl	29,84	37,00
755.	35-342-54-2	Kytkin sähköiselle markiisille	Kulta (ruskea)	35-342-54-2	kpl	29,84	37,00
756.	35-342-57-2	Kytkin sähköiselle markiisille	Pronssi (ruskea)	35-342-57-2	kpl	29,84	37,00
757.	35-342-59-2	Kytkin sähköiselle markiisille	Pronssi (valkio)	35-342-59-2	kpl	29,84	37,00
758.	35-343-25-2	Impulssikytkin, tupla	Nikalattu (valkoinen)	35-343-25-2	kpl	20,56	25,50
759.	35-343-26-2	Impulssikytkin, tupla	Kromattu (valkoinen)	35-343-26-2	kpl	20,56	25,50
760.	35-343-30-2	Impulssikytkin, tupla	Kulta (valkoinen)	35-343-30-2	kpl	20,56	25,50

Rivi	Valmistajan tuotenro *)	Tuotenimi	Selite	Domus Classican tuotenro	Yks.	Hinta (0%)	Hinta (24%)
761.	35-343-52-2	Impulssikytkin, tupla	Niklattu (ruskea)	35-343-52-2	kpl	20,56	25,50
762.	35-343-54-2	Impulssikytkin, tupla	Kulta (ruskea)	35-343-54-2	kpl	20,56	25,50
763.	35-343-57-2	Impulssikytkin, tupla	Pronssi (ruskea)	35-343-57-2	kpl	20,56	25,50
764.	35-343-58-2	Impulssikytkin, tupla	Kromattu (ruskea)	35-343-58-2	kpl	20,56	25,50
765.	35-343-59-2	Impulssikytkin, tupla	Pronssi (valkoinen)	35-343-59-2	kpl	20,56	25,50
766.	35-344-16-2	Impulssikytkin, kierrettävä, tupla	Puu (valkoinen)	35-344-16-2	kpl	29,03	36,00
767.	35-344-17-2	Impulssikytkin, kierrettävä, tupla	Valkoinen, posliini	35-344-17-2	kpl	30,65	38,00
768.	35-344-23-2	Impulssikytkin, kierrettävä, tupla	Retro	35-344-23-2	kpl	30,65	38,00
769.	35-344-25-2	Impulssikytkin, kierrettävä, tupla	Niklattu (valkoinen)	35-344-25-2	kpl	30,65	38,00
770.	35-344-30-2	Impulssikytkin, kierrettävä, tupla	Kulta (valkoinen)	35-344-30-2	kpl	30,65	38,00
771.	35-344-52-2	Impulssikytkin, kierrettävä, tupla	Niklattu (ruskea)	35-344-52-2	kpl	30,65	38,00
772.	35-344-54-2	Impulssikytkin, kierrettävä, tupla	Kulta (ruskea)	35-344-54-2	kpl	30,65	38,00
773.	35-344-57-2	Impulssikytkin, kierrettävä, tupla	Pronssi (ruskea)	35-344-57-2	kpl	30,65	38,00
774.	35-344-59-2	Impulssikytkin, kierrettävä, tupla	Pronssi (ruskea)	35-344-59-2	kpl	30,65	38,00
775.	35-390-03-2	Hälytin 80 dB	Ruskea	35-390-03-2	kpl	23,39	29,00
776.	35-390-05-2	Hälytin 80 dB	Valkoinen	35-390-05-2	kpl	23,39	29,00
777.	35-408-22-2	Kehyslaatikko kahdelle kytkimelle tai pistorasialle		35-408-22-2	kpl	74,60	92,50
778.	35-408-51-2	Kehyslaatikko kahdelle kytkimelle tai pistorasialle	Niklattu, satiipintainen	35-408-51-2	kpl	90,32	112,00
779.	35-409-22-2	Kehyslaatikko kahdelle kytkimelle tai pistorasialle		35-409-22-2	kpl	74,60	92,50
780.	35-409-51-2	Kehyslaatikko kahdelle kytkimelle tai pistorasialle	Niklattu, satiipintainen	35-409-51-2	kpl	90,32	112,00
781.	35-656-03-2	Sokea kehyslaatikko	Ruskea	35-656-03-2	kpl	5,24	6,50
782.	35-656-05-2	Sokea kehyslaatikko	Valkoinen	35-656-05-2	kpl	5,24	6,50
783.	35-706-03-2	Puhelin, tupla	Ruskea	35-706-03-2	kpl	31,05	38,50
784.	35-706-05-2	Puhelin, tupla	Valkoinen	35-706-05-2	kpl	31,05	38,50
785.	35-707-03-2	RJ-45 CAT6, tupla	Ruskea	35-707-03-2	kpl	65,73	81,50
786.	35-707-05-2	RJ-45 CAT6, tupla	Valkoinen	35-707-05-2	kpl	65,73	81,50
787.	35-708-03-2	Puhelin ja RJ45 CAT6	Ruskea	35-708-03-2	kpl	47,98	59,50
788.	35-708-05-2	Puhelin ja RJ45 CAT6	Valkoinen	35-708-05-2	kpl	47,98	59,50
789.	35-711-02-2	R/TV -SAT, päättyvä	Musta	35-711-02-2	kpl	30,24	37,50
790.	35-711-03-2	R/TV -SAT, päättyvä	Ruskea	35-711-03-2	kpl	30,24	37,50
791.	35-711-05-2	R/TV -SAT, päättyvä	Valkoinen	35-711-05-2	kpl	30,24	37,50
792.	35-712-02-2	R/TV -SAT	Musta	35-712-02-2	kpl	30,24	37,50
793.	35-712-02-2	R+TV+SAT (ilman kehystä)	Uppoasennettava	517-042-4	kpl	31,05	38,50
794.	35-712-02-2 /31-801-27-2	R+TV+SAT	Uppoasennettava	517-027-4	kpl	45,16	56,00
795.	35-712-03-2	R/TV -SAT	Ruskea	35-712-03-2	kpl	30,24	37,50
796.	35-712-05-2	R+TV+SAT (ilman kehystä)	Uppoasennettava	517-041-4	kpl	29,84	37,00
797.	35-712-05-2 /31-801-17-2	R+TV+SAT	Uppoasennettava	517-026-4	kpl	43,15	53,50
798.	35-713-02-2	R/TV -SAT, ketju A	Musta	35-713-02-2	kpl	30,24	37,50
799.	35-713-03-2	R/TV -SAT, ketju A	Musta	35-713-03-2	kpl	30,24	37,50
800.	35-713-05-2	R/TV -SAT, ketju A	Valkoinen	35-713-05-2	kpl	30,24	37,50

Rivi	Valmistajan tuotenro *)	Tuotenimi	Selite	Domus Classican tuotenro	Yks.	Hinta (0%)	Hinta (24%)
801.	35-714-02-2	R/TV -SAT, ketju B	Musta	35-714-02-2	kpl	30,24	37,50
802.	35-714-03-2	R/TV -SAT, ketju B	Ruskea	35-714-03-2	kpl	30,24	37,50
803.	35-714-05-2	R/TV -SAT, ketju B	Valkoinen	35-714-05-2	kpl	30,24	37,50
804.	35-715-02-2	Varaosakuori R/TV-SAT	Musta	35-715-02-2	kpl	2,42	3,00
805.	35-715-03-2	Varaosakuori R/TV-SAT	Ruskea	35-715-03-2	kpl	2,42	3,00
806.	35-715-05-2	Varaosakuori R/TV-SAT	Valkoinen	35-715-05-2	kpl	2,42	3,00
807.	35-755-03-2	Merkkivalo valkoinen-vihreä-punainen	Ruskea	35-755-03-2	kpl	75,00	93,00
808.	35-755-05-2	Merkkivalo valkoinen-vihreä-punainen	Valkoinen	35-755-05-2	kpl	75,00	93,00
809.	35-756-03-2	Merkkivalo valkoinen-vihreä-punainen	Ruskea	35-756-03-2	kpl	71,77	89,00
810.	35-756-05-2	Merkkivalo valkoinen-vihreä-punainen	Valkoinen	35-756-05-2	kpl	71,77	89,00
811.	35-760-03-2	Varauloskäynti 230V	Ruskea	35-760-03-2	kpl	112,50	139,50
812.	35-760-05-2	Varauloskäynti 230V	Valkoinen	35-760-05-2	kpl	112,50	139,50
813.	35-801-00-2	Kehys yhdelle kytkimelle tai pistorasialle	Puu (käsittelemätön)	35-801-00-2	kpl	11,29	14,00
814.	35-801-05-2	Kehys yhdelle kytkimelle tai pistorasialle	Valkoinen, lakattu	35-801-05-2	kpl	13,71	17,00
815.	35-801-15-2	Kehys yhdelle kytkimelle tai pistorasialle	Tammi	35-801-15-2	kpl	12,50	15,50
816.	35-801-16-2	Kehys yhdelle kytkimelle tai pistorasialle	Mahonki	35-801-16-2	kpl	13,31	16,50
817.	35-801-20-2	Kehys yhdelle kytkimelle tai pistorasialle	Pähkinäpuu	35-801-20-2	kpl	13,31	16,50
818.	35-802-00-2	Kehys kahdelle kytkimelle tai pistorasialle, soikea	Puu (käsittelemätön)	35-802-00-2	kpl	17,34	21,50
819.	35-802-05-2	Kehys kahdelle kytkimelle tai pistorasialle, puu	Valkoinen, lakattu	35-802-05-2	kpl	19,35	24,00
820.	35-802-15-2	Kehys kahdelle kytkimelle tai pistorasialle, soikea	Tammi	35-802-15-2	kpl	18,15	22,50
821.	35-802-16-2	Kehys kahdelle kytkimelle tai pistorasialle, soikea	Mahonki	35-802-16-2	kpl	20,97	26,00
822.	35-802-20-2	Kehys kahdelle kytkimelle tai pistorasialle, soikea	Pähkinäpuu	35-802-20-2	kpl	18,15	22,50
823.	35-803-00-2	Kehys kahdelle kytkimelle tai pistorasialle, soikea	Puu (käsittelemätön)	35-803-00-2	kpl	22,58	28,00
824.	35-803-05-2	Kehys kolmelle kytkimelle tai pistorasialle, puu	Valkoinen, lakattu	35-803-05-2	kpl	25,81	32,00
825.	35-803-15-2	Kehys kolmelle kytkimelle tai pistorasialle, soikea	Tammi	35-803-15-2	kpl	24,19	30,00
826.	35-803-16-2	Kehys kolmelle kytkimelle tai pistorasialle, soikea	Mahonki	35-803-16-2	kpl	27,82	34,50
827.	35-803-20-2	Kehys kolmelle kytkimelle tai pistorasialle, soikea	Pähkinäpuu	35-803-20-2	kpl	25,00	31,00
828.	35-804-00-2	Kehys neljälle kytkimelle tai pistorasialle	Puu (käsittelemätön)	35-804-00-2	kpl	29,84	37,00
829.	35-804-05-2	Kehys neljälle kytkimelle tai pistorasialle	Valkoinen, lakattu	35-804-05-2	kpl	33,47	41,50
830.	35-804-15-2	Kehys neljälle kytkimelle tai pistorasialle	Tammi	35-804-15-2	kpl	31,05	38,50
831.	35-804-16-2	Kehys neljälle kytkimelle tai pistorasialle	Mahonki	35-804-16-2	kpl	36,69	45,50
832.	35-804-20-2	Kehys neljälle kytkimelle tai pistorasialle	Pähkinäpuu	35-804-20-2	kpl	32,26	40,00
833.	35-821-00-2	Erikoiskehys yhdelle	Puu (käsittelemätön)	35-821-00-2	kpl	13,71	17,00
834.	35-821-05-2	Erikoiskehys yhdelle	Valkoinen, lakattu	35-821-05-2	kpl	14,52	18,00
835.	35-821-15-2	Erikoiskehys yhdelle	Tammi	35-821-15-2	kpl	14,52	18,00
836.	35-821-16-2	Erikoiskehys yhdelle	Mahonki	35-821-16-2	kpl	14,92	18,50
837.	35-821-20-2	Erikoiskehys yhdelle	Pähkinäpuu	35-821-20-2	kpl	14,92	18,50
838.	35-905-03-2	Kaiutinpistorasia	Ruskea	35-905-03-2	kpl	7,66	9,50
839.	35-905-05-2	Kaiutinpistorasia	Valkoinen	35-905-05-2	kpl	7,66	9,50
840.	35-906-03-2	Mekanismi, avaimella	Ruskea	35-906-03-2	kpl	33,87	42,00

Rivi	Valmistajan tuotenro *)	Tuotenimi	Selite	Domus Classican tuotenro	Yks.	Hinta (0%)	Hinta (24%)
841.	35-906-05-2	Mekanismi, avaimella	Kulta (valkoinen)	35-906-05-2	kpl	33,87	42,00
842.	35-924-03-2	Volyymisäätökytkin	Ruskea	35-924-03-2	kpl	95,16	118,00
843.	35-924-05-2	Volyymisäätökytkin	Valkoinen	35-924-05-2	kpl	95,16	118,00
844.	35-925-03-2	Volyymisäätökytkin, radio	Ruskea	35-925-03-2	kpl	99,60	123,50
845.	35-925-05-2	Volyymisäätökytkin, radio	Valkoinen	35-925-05-2	kpl	99,60	123,50
846.	35-926-03-2	Kaiutinpistorasia 2W	Ruskea	35-926-03-2	kpl	56,45	70,00
847.	35-926-05-2	Kaiutinpistorasia 2W	Valkoinen	35-926-05-2	kpl	56,45	70,00
848.	35-927-25-2	Kattokuppi	Niklattu (valkoinen)	35-927-25-2	kpl	9,27	11,50
849.	35-927-26-2	Kattokuppi	Kromattu (valkoinen)	35-927-26-2	kpl	9,27	11,50
850.	35-927-30-2	Kattokuppi	Kulta (valkoinen)	35-927-30-2	kpl	9,27	11,50
851.	35-927-52-2	Kattokuppi	Niklattu (ruskea)	35-927-52-2	kpl	9,27	11,50
852.	35-927-54-2	Kattokuppi	Kulta (ruskea)	35-927-54-2	kpl	9,27	11,50
853.	35-927-57-2	Kattokuppi	Antiikkipronssi (ruskea)	35-927-57-2	kpl	9,27	11,50
854.	35-927-58-2	Kattokuppi	Kromattu (ruskea)	35-927-58-2	kpl	9,27	11,50
855.	35-927-59-2	Kattokuppi	Antiikkipronssi (valkoinen)	35-927-59-2	kpl	9,27	11,50
856.	35-928-00-2	Nuppi	Puu (käsittelemätön)	35-928-00-2	kpl	5,65	7,00
857.	35-928-17-2	Nuppi	Valkoinen, posliini	35-928-17-2	kpl	5,65	7,00
858.	35-928-19-2	Nuppi	Hunaja (puu)	35-928-19-2	kpl	5,65	7,00
859.	35-928-21-2	Nuppi	Puu, patinoitu	35-928-21-2	kpl	5,65	7,00
860.	35-928-27-2	Nuppi	Musta, posliini	35-928-27-2	kpl	5,65	7,00
861.	35-928-30-2	Nuppi	Kulta	35-928-30-2	kpl	5,65	7,00
862.	35-928-51-2	Nuppi	Niklattu, satiipintainen	35-928-51-2	kpl	5,65	7,00
863.	35-928-59-2	Nuppi	Antiikkipronssi	35-928-59-2	kpl	5,65	7,00
864.	35-929-30-2	Vipukytkimen kehysrengas	Kulta	35-929-30-2	kpl	3,63	4,50
865.	35-929-51-2	Vipukytkimen kehysrengas	Niklattu, satiipintainen	35-929-51-2	kpl	3,63	4,50
866.	35-929-59-2	Vipukytkimen kehysrengas	Pronssi (patinoitu)	35-929-59-2	kpl	3,63	4,50
867.	35-930-17-2	Nuppi, retro	Valkoinen, posliini	35-930-17-2	kpl	6,05	7,50
868.	35-930-27-2	Nuppi, retro	Musta, posliini	35-930-27-2	kpl	6,05	7,50
869.	36-801-00-2	Kehys yhdelle kytkimelle tai pistorasialle	Puu (käsittelemätön)	36-801-00-2	kpl	12,10	15,00
870.	36-801-16-2	Kehys yhdelle kytkimelle tai pistorasialle	Kirsikkapuu	36-801-16-2	kpl	13,31	16,50
871.	36-802-00-2	Kehys kahdelle kytkimelle tai pistorasialle	Puu (käsittelemätön)	36-802-00-2	kpl	19,35	24,00
872.	36-802-16-2	Kehys kahdelle kytkimelle tai pistorasialle	Kirsikkapuu	36-802-16-2	kpl	20,97	26,00
873.	36-803-00-2	Kehys kolmelle kytkimelle tai pistorasialle	Puu (käsittelemätön)	36-803-00-2	kpl	25,40	31,50
874.	36-803-16-2	Kehys kolmelle kytkimelle tai pistorasialle	Kirsikkapuu	36-803-16-2	kpl	27,82	34,50
875.	36-804-00-2	Kehys kolmelle kytkimelle tai pistorasialle	Puu (käsittelemätön)	36-804-00-2	kpl	34,27	42,50
876.	36-804-16-2	Kehys neljälle kytkimelle tai pistorasialle	Kirsikkapuu	36-804-16-2	kpl	37,50	46,50
877.	36-811-00-2	Kehys yhdelle kytkimelle tai pistorasialle	Puu (käsittelemätön)	36-811-00-2	kpl	12,10	15,00
878.	36-811-16-2	Kehys yhdelle kytkimelle tai pistorasialle	Kirsikkapuu	36-811-16-2	kpl	13,31	16,50
879.	36-812-00-2	Kehys kahdelle kytkimelle tai pistorasialle	Puu (käsittelemätön)	36-812-00-2	kpl	19,35	24,00
880.	36-812-16-2	Kehys kahdelle kytkimelle tai pistorasialle	Kirsikkapuu	36-812-16-2	kpl	20,97	26,00

Rivi	Valmistajan tuotenro *)	Tuotenimi	Selite	Domus Classican tuotenro	Yks.	Hinta (0%)	Hinta (24%)
881.	36-813-00-2	Kehys kolmelle kytkimelle tai pistorasialle	Puu (käsittelemätön)	36-813-00-2	kpl	25,40	31,50
882.	36-813-16-2	Kehys kolmelle kytkimelle tai pistorasialle	Kirsikkapuu	36-813-16-2	kpl	27,82	34,50
883.	36-814-00-2	Kehys neljälle kytkimelle tai pistorasialle	Puu (käsittelemätön)	36-814-00-2	kpl	36,29	45,00
884.	36-814-16-2	Kehys neljälle kytkimelle tai pistorasialle	Kirsikkapuu	36-814-16-2	kpl	39,52	49,00
885.	36-821-00-2	Erikoiskehys yhdelle	Puu (käsittelemätön)	36-821-00-2	kpl	13,71	17,00
886.	36-821-16-2	Erikoiskehys yhdelle	Kirsikkapuu	36-821-16-2	kpl	14,92	18,50
887.	36-831-00-2	Erikoiskehys yhdelle	Puu (käsittelemätön)	36-831-00-2	kpl	13,71	17,00
888.	36-831-16-2	Erikoiskehys yhdelle	Kirsikkapuu	36-831-16-2	kpl	14,92	18,50
889.	37-208-03-2	Pistorasia, ranskalainen	Ruskea	37-208-03-2	kpl	11,29	14,00
890.	37-208-05-2	Pistorasia, ranskalainen	Valkoinen	37-208-05-2	kpl	11,29	14,00
891.	37-208-50-2	Pistorasia, ranskalainen	Metalli	37-208-50-2	kpl	12,90	16,00
892.	37-209-03-2	Pistorasia	Ruskea	37-209-03-2	kpl	8,06	10,00
893.	37-209-05-2	Pistorasia	Valkoinen	37-209-05-2	kpl	8,06	10,00
894.	37-209-50-2	Pistorasia	Metalli	37-209-50-2	kpl	9,68	12,00
895.	37-212-03-2	Pistorasia	Ruskea	37-212-03-2	kpl	9,27	11,50
896.	37-212-05-2	Pistorasia	Valkoinen	37-212-05-2	kpl	9,27	11,50
897.	37-212-50-2	Pistorasia	Metalli	37-212-50-2	kpl	10,48	13,00
898.	37-300-25-2	Ykköskytkin, tupla	Teräs (valkoinen)	37-300-25-2	kpl	34,27	42,50
899.	37-300-51-2	Ykköskytkin, tupla	Teräs (metallinen)	37-300-51-2	kpl	35,08	43,50
900.	37-300-54-2	Ykköskytkin, tupla	Kulta (ruskea)	37-300-54-2	kpl	34,27	42,50
901.	37-300-57-2	Ykköskytkin, tupla	Pronssi (ruskea)	37-300-57-2	kpl	34,27	42,50
902.	37-302-25-2	Vaihtokytkin, tupla	Teräs (valkoinen)	37-302-25-2	kpl	37,50	46,50
903.	37-302-51-2	Vaihtokytkin, tupla	Teräs (metallinen)	37-302-51-2	kpl	38,31	47,50
904.	37-302-54-2	Vaihtokytkin, tupla	Kulta (ruskea)	37-302-54-2	kpl	37,50	46,50
905.	37-302-57-2	Vaihtokytkin, tupla	Pronssi (ruskea)	37-302-57-2	kpl	37,50	46,50
906.	37-304-25-2	Ristikytkin	Teräs (valkoinen)	37-304-25-2	kpl	37,50	46,50
907.	37-304-51-2	Ristikytkin	Teräs (metallinen)	37-304-51-2	kpl	38,31	47,50
908.	37-304-54-2	Ristikytkin	Kulta (ruskea)	37-304-54-2	kpl	37,50	46,50
909.	37-304-57-2	Ristikytkin	Pronssi (ruskea)	37-304-57-2	kpl	37,50	46,50
910.	37-306-25-2	Ykköskytkin	Teräs (valkoinen)	37-306-25-2	kpl	30,24	37,50
911.	37-306-51-2	Ykköskytkin	Teräs (metallinen)	37-306-51-2	kpl	31,45	39,00
912.	37-306-54-2	Ykköskytkin	Kulta (ruskea)	37-306-54-2	kpl	30,24	37,50
913.	37-306-57-2	Ykköskytkin	Pronssi (ruskea)	37-306-57-2	kpl	30,24	37,50
914.	37-308-25-2	Vaihtokytkin	Teräs (valkoinen)	37-308-25-2	kpl	32,26	40,00
915.	37-308-51-2	Vaihtokytkin	Teräs (metallinen)	37-308-51-2	kpl	33,47	41,50
916.	37-308-54-2	Vaihtokytkin	Kulta (ruskea)	37-308-54-2	kpl	32,26	40,00
917.	37-308-57-2	Vaihtokytkin	Pronssi (ruskea)	37-308-57-2	kpl	32,26	40,00
918.	37-310-25-2	Impulssikytkin	Teräs (valkoinen)	37-310-25-2	kpl	23,79	29,50
919.	37-310-26-2	Impulssikytkin	Kromattu (valkoinen)	37-310-26-2	kpl	23,79	29,50
920.	37-310-51-2	Impulssikytkin	Kromattu (metallinen)	37-310-51-2	kpl	26,21	32,50

Rivi	Valmistajan tuotenro *)	Tuotenimi	Selite	Domus Classican tuotenro	Yks.	Hinta (0%)	Hinta (24%)
921.	37-310-54-2	Impulssikytkin	Kulta (ruskea)	37-310-54-2	kpl	23,79	29,50
922.	37-310-57-2	Impulssikytkin	Pronssi (ruskea)	37-310-57-2	kpl	23,79	29,50
923.	37-310-61-2	Impulssikytkin	Kromattu (metallinen)	37-310-61-2	kpl	26,21	32,50
924.	37-314-25-2	Kruunukytkin	Teräs (valkoinen)	37-314-25-2	kpl	33,87	42,00
925.	37-314-51-2	Kruunukytkin	Teräs (metallinen)	37-314-51-2	kpl	34,68	43,00
926.	37-314-54-2	Kruunukytkin	Kulta (ruskea)	37-314-54-2	kpl	33,87	42,00
927.	37-314-57-2	Kruunukytkin	Pronssi (ruskea)	37-314-57-2	kpl	33,87	42,00
928.	37-316-25-2	Impulssikytkin, ajastin	Teräs (valkoinen)	37-316-25-2	kpl	64,11	79,50
929.	37-316-26-2	Impulssikytkin, ajastin	Kromattu (valkoinen)	37-316-26-2	kpl	64,11	79,50
930.	37-316-51-2	Impulssikytkin, ajastin	Teräs (metallinen)	37-316-51-2	kpl	65,32	81,00
931.	37-316-54-2	Impulssikytkin, ajastin	Kulta (ruskea)	37-316-54-2	kpl	64,11	79,50
932.	37-316-57-2	Impulssikytkin, ajastin	Pronssi (ruskea)	37-316-57-2	kpl	64,11	79,50
933.	37-316-61-2	Impulssikytkin, ajastin	Kromattu (metallinen)	37-316-61-2	kpl	65,32	81,00
934.	37-328-25-2	Impulssikytkin, kierrettävä	Teräs (valkoinen)	37-328-25-2	kpl	34,68	43,00
935.	37-328-51-2	Impulssikytkin, kierrettävä	Teräs (metallinen)	37-328-51-2	kpl	39,11	48,50
936.	37-328-54-2	Impulssikytkin, kierrettävä	Kulta (ruskea)	37-328-54-2	kpl	34,68	43,00
937.	37-328-57-2	Impulssikytkin, kierrettävä	Pronssi (ruskea)	37-328-57-2	kpl	34,68	43,00
938.	37-331-25-2	Himmennin 6A	Teräs (valkoinen)	37-331-25-2	kpl	91,13	113,00
939.	37-331-26-2	Himmennin	Kromattu (valkoinen)	37-331-26-2	kpl	91,13	113,00
940.	37-331-51-2	Himmennin 6A	Teräs (metallinen)	37-331-51-2	kpl	92,74	115,00
941.	37-331-54-2	Himmennin 6A	Kulta (ruskea)	37-331-54-2	kpl	91,13	113,00
942.	37-331-57-2	Himmennin 6A	Pronssi (ruskea)	37-331-57-2	kpl	91,13	113,00
943.	37-331-61-2	Himmennin	Kromattu (metallinen)	37-331-61-2	kpl	92,74	115,00
944.	37-332-25-2	Vaihtokytkin, himmennin 500 W	Teräs (valkoinen)	37-332-25-2	kpl	89,92	111,50
945.	37-332-26-2	Vaihtokytkin, himmennin 500 W	Kromattu (valkoinen)	37-332-26-2	kpl	89,92	111,50
946.	37-332-51-2	Vaihtokytkin, himmennin 500 W	Teräs (metallinen)	37-332-51-2	kpl	91,53	113,50
947.	37-332-54-2	Vaihtokytkin, himmennin 500 W	Kulta (ruskea)	37-332-54-2	kpl	89,92	111,50
948.	37-332-57-2	Vaihtokytkin, himmennin 500 W	Pronssi (ruskea)	37-332-57-2	kpl	89,92	111,50
949.	37-332-61-2	Vaihtokytkin, himmennin 500 W	Kromattu (metallinen)	37-332-61-2	kpl	91,53	113,50
950.	37-342-25-2	Kytkin sähköiselle markiisille	Teräs (valkoinen)	37-342-25-2	kpl	34,27	42,50
951.	37-342-51-2	Kytkin sähköiselle markiisille	Teräs (metallinen)	37-342-51-2	kpl	35,48	44,00
952.	37-342-54-2	Kytkin sähköiselle markiisille	Kulta (ruskea)	37-342-54-2	kpl	34,27	42,50
953.	37-342-57-2	Kytkin sähköiselle markiisille	Pronssi (ruskea)	37-342-57-2	kpl	34,27	42,50
954.	37-343-25-2	Impulssikytkin, tupla	Teräs (valkoinen)	37-343-25-2	kpl	41,13	51,00
955.	37-343-26-2	Impulssikytkin, tupla	Kromattu (valkoinen)	37-343-26-2	kpl	41,13	51,00
956.	37-343-51-2	Impulssikytkin, tupla	Teräs (metallinen)	37-343-51-2	kpl	42,34	52,50
957.	37-343-54-2	Impulssikytkin, tupla	Kulta (ruskea)	37-343-54-2	kpl	41,13	51,00
958.	37-343-57-2	Impulssikytkin, tupla	Pronssi (ruskea)	37-343-57-2	kpl	41,13	51,00
959.	37-343-61-2	Impulssikytkin, tupla	Kromattu (metalli)	37-343-61-2	kpl	42,34	52,50
960.	37-344-25-2	Impulssikytkin, kierrettävä, tupla	Teräs (valkoinen)	37-344-25-2	kpl	39,92	49,50

Rivi	Valmistajan tuotenro *)	Tuotenimi	Selite	Domus Classican tuotenro	Yks.	Hinta (0%)	Hinta (24%)
961.	37-344-51-2	Impulssikytkin, kierrettävä, tupla	Teräs (metallinen)	37-344-51-2	kpl	43,95	54,50
962.	37-344-54-2	Impulssikytkin, kierrettävä, tupla	Kulta (ruskea)	37-344-54-2	kpl	39,92	49,50
963.	37-344-57-2	Impulssikytkin, kierrettävä, tupla	Pronssi (ruskea)	37-344-57-2	kpl	39,92	49,50
964.	37-346-00-0	Himmennin 500W	N/C	37-346-00-0	kpl	96,77	120,00
965.	37-347-00-0	Himmennin 500W	N/C	37-347-00-0	kpl	115,73	143,50
966.	37-390-03-2	Hälytin 80 dB	Ruskea	37-390-03-2	kpl	21,37	26,50
967.	37-390-05-2	Hälytin 80 dB	Valkoinen	37-390-05-2	kpl	21,37	26,50
968.	37-390-50-2	Hälytin 80 dB	Metalli	37-390-50-2	kpl	22,18	27,50
969.	37-399-51-2	Jakorasia	Niklattu, satiipintainen	37-399-51-2	kpl	60,48	75,00
970.	37-400-51-2	Jakorasia	Niklattu, satiipintainen	37-400-51-2	kpl	46,37	57,50
971.	37-401-51-2	Kehyslaatikko yhdelle kytkimelle tai pistorasialle	Niklattu, satiipintainen	37-401-51-2	kpl	28,23	35,00
972.	37-402-51-2	Kehyslaatikko kahdelle kytkimelle tai pistorasialle	Niklattu, satiipintainen	37-402-51-2	kpl	35,89	44,50
973.	37-403-51-2	Kehyslaatikko kolmelle kytkimelle tai pistorasialle	Niklattu, satiipintainen	37-403-51-2	kpl	43,55	54,00
974.	37-405-51-2	Kehyslaatikko kahdelle kytkimelle tai pistorasialle	Niklattu, satiipintainen	37-405-51-2	kpl	35,89	44,50
975.	37-406-51-2	Kehyslaatikko kolmelle kytkimelle tai pistorasialle	Niklattu, satiipintainen	37-406-51-2	kpl	43,55	54,00
976.	37-656-03-2	Peiterasia F-37	Ruskea	37-656-03-2	kpl	6,05	7,50
977.	37-656-05-2	Peiterasia F-37	Valkoinen	37-656-05-2	kpl	6,05	7,50
978.	37-656-50-2	Peiterasia F-37	Metalli	37-656-50-2	kpl	7,66	9,50
979.	37-706-03-2	Puhelin, tupla 4-6	Ruskea	37-706-03-2	kpl	11,29	14,00
980.	37-706-05-2	Puhelin, tupla 4-6	Valkoinen	37-706-05-2	kpl	11,29	14,00
981.	37-706-50-2	Puhelin, tupla 4-6	Metalli	37-706-50-2	kpl	12,50	15,50
982.	37-707-03-2	RJ-45 CATEG. 5E, tupla	Ruskea	37-707-03-2	kpl	50,40	62,50
983.	37-707-05-2	RJ-45 CATEG. 5E, tupla	Valkoinen	37-707-05-2	kpl	50,40	62,50
984.	37-707-50-2	RJ-45 CATEG. 5E, tupla	Metalli	37-707-50-2	kpl	51,21	63,50
985.	37-708-03-2	RJ45 + 6W	Ruskea	37-708-03-2	kpl	38,31	47,50
986.	37-708-05-2	RJ45 + 6W	Valkoinen	37-708-05-2	kpl	38,31	47,50
987.	37-708-50-2	Puhelin ja RJ45 CAT6	Metalli	37-708-50-2	kpl	39,52	49,00
988.	37-711-03-2	TV, pääte "T"	Ruskea	37-711-03-2	kpl	29,84	37,00
989.	37-711-05-2	TV, pääte "T"	Valkoinen	37-711-05-2	kpl	29,84	37,00
990.	37-711-50-2	TV, pääte "T"	Metalli	37-711-50-2	kpl	31,05	38,50
991.	37-712-03-2	TV, yksittäinen	Ruskea	37-712-03-2	kpl	29,84	37,00
992.	37-712-05-2	TV, yksittäinen	Valkoinen	37-712-05-2	kpl	29,84	37,00
993.	37-712-50-2	TV, yksittäinen	Metalli	37-712-50-2	kpl	31,05	38,50
994.	37-713-03-2	TV, ketju A	Ruskea	37-713-03-2	kpl	29,84	37,00
995.	37-713-05-2	TV, ketju A	Valkoinen	37-713-05-2	kpl	29,84	37,00
996.	37-713-50-2	TV, ketju A	Metalli	37-713-50-2	kpl	31,05	38,50
997.	37-714-03-2	TV, ketju B	Ruskea	37-714-03-2	kpl	29,84	37,00
998.	37-714-05-2	TV, ketju B	Valkoinen	37-714-05-2	kpl	29,84	37,00
999.	37-714-50-2	TV, ketju B	Metalli	37-714-50-2	kpl	31,05	38,50
1 000.	37-715-03-2	Tv, vain kuori	Ruskea	37-715-03-2	kpl	2,02	2,50

Rivi	Valmistajan tuotenro *)	Tuotenimi	Selite	Domus Classican tuotenro	Yks.	Hinta (0%)	Hinta (24%)
1 001.	37-715-05-2	Tv, vain kuori	Valkoinen	37-715-05-2	kpl	2,02	2,50
1 002.	37-715-50-2	Tv, vain kuori	Metalli	37-715-50-2	kpl	3,23	4,00
1 003.	37-721-05-2	Lattialämmitystermostaatti	Valkoinen	37-721-05-2	kpl	192,34	238,50
1 004.	37-721-05-2/ 31-821-17-2	Lattialämmityksen säätökytkin	Uppoasennettava	516-025-9	kpl	200,00	248,00
1 005.	37-722-05-2	Huoneilmatermostaatti	Valkoinen	37-722-05-2	kpl	173,39	215,00
1 006.	37-750-03-2	Liike- ja äänitunnistin, 180 astetta	Ruskea	37-750-03-2	kpl	173,39	215,00
1 007.	37-750-05-2	Liike- ja äänitunnistin, 180 astetta	Valkoinen	37-750-05-2	kpl	173,39	215,00
1 008.	37-750-50-2	Liike- ja äänitunnistin, 180 astetta	Metalli	37-750-50-2	kpl	174,60	216,50
1 009.	37-755-03-2	Merkkivalo valkoinen-vihreä-punainen	Ruskea	37-755-03-2	kpl	79,44	98,50
1 010.	37-755-05-2	Merkkivalo valkoinen-vihreä-punainen	Valkoinen	37-755-05-2	kpl	79,44	98,50
1 011.	37-755-50-2	Merkkivalo valkoinen-vihreä-punainen	Metalli	37-755-50-2	kpl	80,65	100,00
1 012.	37-756-03-2	Merkkivalo valkoinen-vihreä-punainen	Ruskea	37-756-03-2	kpl	73,39	91,00
1 013.	37-756-05-2	Merkkivalo valkoinen-vihreä-punainen	Valkoinen	37-756-05-2	kpl	73,39	91,00
1 014.	37-756-50-2	Merkkivalo valkoinen-vihreä-punainen	Metalli	37-756-50-2	kpl	74,60	92,50
1 015.	37-760-03-2	Varauskäynti 230V	Ruskea	37-760-03-2	kpl	114,52	142,00
1 016.	37-760-05-2	Varauskäynti 230V	Valkoinen	37-760-05-2	kpl	114,52	142,00
1 017.	37-760-50-2	Varauskäynti 230V	Metalli	37-760-50-2	kpl	115,73	143,50
1 018.	37-801-02-2	Kehys yhdelle kytkimelle tai pistorasialle	Kirsikkapuu	37-801-02-2	kpl	13,31	16,50
1 019.	37-801-03-2	Kehys yhdelle kytkimelle tai pistorasialle	Tupakka	37-801-03-2	kpl	13,31	16,50
1 020.	37-801-04-2	Kehys yhdelle kytkimelle tai pistorasialle	Wengue	37-801-04-2	kpl	13,31	16,50
1 021.	37-802-02-2	Kehys kahdelle kytkimelle tai pistorasialle	Kirsikkapuu	37-802-02-2	kpl	20,56	25,50
1 022.	37-802-03-2	Kehys kahdelle kytkimelle tai pistorasialle	Tupakka	37-802-03-2	kpl	20,56	25,50
1 023.	37-802-04-2	Kehys kahdelle kytkimelle tai pistorasialle	Wengue	37-802-04-2	kpl	20,56	25,50
1 024.	37-803-02-2	Kehys kolmelle kytkimelle tai pistorasialle	Kirsikkapuu	37-803-02-2	kpl	28,23	35,00
1 025.	37-803-03-2	Kehys kolmelle kytkimelle tai pistorasialle	Tupakka	37-803-03-2	kpl	28,23	35,00
1 026.	37-803-04-2	Kehys kolmelle kytkimelle tai pistorasialle	Wengue	37-803-04-2	kpl	28,23	35,00
1 027.	37-905-03-2	Kaiutinpistorasia	Ruskea	37-905-03-2	kpl	10,48	13,00
1 028.	37-905-05-2	Kaiutinpistorasia	Valkoinen	37-905-05-2	kpl	10,48	13,00
1 029.	37-905-50-2	Kaiutinpistorasia	Metalli	37-905-50-2	kpl	11,69	14,50
1 030.	37-924-25-2	Volyymisäätökytkin	Teräs (valkoinen)	37-924-25-2	kpl	112,10	139,00
1 031.	37-924-26-2	Volyymisäätökytkin	Kromattu (valkoinen)	37-924-26-2	kpl	112,10	139,00
1 032.	37-924-51-2	Volyymisäätökytkin	Teräs (metallinen)	37-924-51-2	kpl	113,31	140,50
1 033.	37-924-54-2	Volyymisäätökytkin	Kulta (ruskea)	37-924-54-2	kpl	112,10	139,00
1 034.	37-924-57-2	Volyymisäätökytkin	Pronssi (ruskea)	37-924-57-2	kpl	112,10	139,00
1 035.	37-924-61-2	Volyymisäätökytkin	Kromattu (metallinen)	37-924-61-2	kpl	113,31	140,50
1 036.	37-925-25-2	Radio	Teräs (valkoinen)	37-925-25-2	kpl	122,58	152,00
1 037.	37-925-26-2	Radio	Kromattu (valkoinen)	37-925-26-2	kpl	122,58	152,00
1 038.	37-925-51-2	Radio	Teräs (metallinen)	37-925-51-2	kpl	123,79	153,50
1 039.	37-925-54-2	Radio	Kulta (ruskea)	37-925-54-2	kpl	122,58	152,00
1 040.	37-925-57-2	Radio	Pronssi (ruskea)	37-925-57-2	kpl	122,58	152,00

Rivi	Valmistajan tuotenro *)	Tuotenimi	Selite	Domus Classican tuotenro	Yks.	Hinta (0%)	Hinta (24%)
1 041.	37-925-61-2	Radio	Kromattu (metalli)	37-925-61-2	kpl	123,79	153,50
1 042.	37-926-03-2	Kaiutinpistorasia 2W	Ruskea	37-926-03-2	kpl	58,87	73,00
1 043.	37-926-05-2	Kaiutinpistorasia 2W	Valkoinen	37-926-05-2	kpl	58,87	73,00
1 044.	37-926-50-2	Kaiutinpistorasia 2W F-37	Metalli	37-926-50-2	kpl	59,68	74,00
1 045.	37-927-03-2	Kattokuppi	Ruskea	37-927-03-2	kpl	12,10	15,00
1 046.	37-927-05-2	Kattokuppi	Valkoinen	37-927-05-2	kpl	12,10	15,00
1 047.	37-927-50-2	Kattokuppi	Metalli	37-927-50-2	kpl	12,90	16,00
1 048.	37-928-25-2	F-37 Kierrettävä	Ruostumaton teräs	37-928-25-2	kpl	10,48	13,00
1 049.	37-928-30-2	F-37 Kierrettävä	Kulta	37-928-30-2	kpl	10,48	13,00
1 050.	37-928-59-2	F-37 Kierrettävä	Pronssi	37-928-59-2	kpl	10,48	13,00
1 051.	37-935-03-2	Kortinlukulaite	Ruskea	37-935-03-2	kpl	29,03	36,00
1 052.	37-935-05-2	Kortinlukulaite	Valkoinen	37-935-05-2	kpl	29,03	36,00
1 053.	37-935-50-2	Kortinlukulaite	Metalli	37-935-50-2	kpl	30,24	37,50
1 054.	37-936-03-2	Kortinlukulaite	Ruskea	37-936-03-2	kpl	31,45	39,00
1 055.	37-936-05-2	Kortinlukulaite	Valkoinen	37-936-05-2	kpl	31,45	39,00
1 056.	37-936-50-2	Kortinlukulaite	Metalli	37-936-50-2	kpl	32,66	40,50
1 057.	37-944-05-2	Adapteri "Egi"	Valkoinen	37-944-05-2	kpl	3,23	4,00
1 058.	37-944-10-2	Adapteri "Egi"	Musta	37-944-10-2	kpl	3,23	4,00
1 059.	37-945-05-2	Adapteri "Egi"	Valkoinen	37-945-05-2	kpl	4,03	5,00
1 060.	37-945-10-2	Adapteri "Egi"	Musta	37-945-10-2	kpl	4,03	5,00
1 061.	38-801-00-2	Kehys yhdelle kytkimelle tai pistorasialle	Puu (käsittelemätön)	38-801-00-2	kpl	12,50	15,50
1 062.	38-801-20-2	Kehys yhdelle kytkimelle tai pistorasialle	Pähkinäpuu	38-801-20-2	kpl	13,31	16,50
1 063.	38-802-00-2	Kehys kahdelle kytkimelle tai pistorasialle	Puu (käsittelemätön)	38-802-00-2	kpl	18,15	22,50
1 064.	38-802-20-2	Kehys kahdelle kytkimelle tai pistorasialle	Pähkinäpuu	38-802-20-2	kpl	19,76	24,50
1 065.	38-803-00-2	Kehys kolmelle kytkimelle tai pistorasialle	Puu (käsittelemätön)	38-803-00-2	kpl	22,58	28,00
1 066.	38-803-20-2	Kehys kolmelle kytkimelle tai pistorasialle	Pähkinäpuu	38-803-20-2	kpl	26,61	33,00
1 067.	38-821-00-2	Kehys yhdelle kytkimelle tai pistorasialle	Puu (käsittelemätön)	38-821-00-2	kpl	13,71	17,00
1 068.	38-821-20-2	Kehys yhdelle kytkimelle tai pistorasialle	Pähkinäpuu	38-821-20-2	kpl	14,92	18,50
1 069.	39-801-46-2	Kehys yhdelle kytkimelle tai pistorasialle	Antiikkikupari	39-801-46-2	kpl	45,56	56,50
1 070.	39-801-49-2	Kehys yhdelle kytkimelle tai pistorasialle	Antrasiitti	39-801-49-2	kpl	45,56	56,50
1 071.	39-801-50-2	Kehys yhdelle kytkimelle tai pistorasialle	Kulta	39-801-50-2	kpl	43,95	54,50
1 072.	39-801-51-2	Kehys yhdelle kytkimelle tai pistorasialle	Niklattu, satiipintainen	39-801-51-2	kpl	45,56	56,50
1 073.	39-801-53-2	Kehys yhdelle kytkimelle tai pistorasialle	Antiikkipronssi	39-801-53-2	kpl	43,95	54,50
1 074.	39-801-62-2	Kehys yhdelle kytkimelle tai pistorasialle	Kupari, patinoitu	39-801-62-2	kpl	45,56	56,50
1 075.	39-802-46-2	Kehys kahdelle kytkimelle tai pistorasialle	Antiikkikupari	39-802-46-2	kpl	59,68	74,00
1 076.	39-802-49-2	Kehys kahdelle kytkimelle tai pistorasialle	Antrasiitti	39-802-49-2	kpl	59,68	74,00
1 077.	39-802-50-2	Kehys kahdelle kytkimelle tai pistorasialle	Kulta	39-802-50-2	kpl	57,66	71,50
1 078.	39-802-51-2	Kehys kahdelle kytkimelle tai pistorasialle	Niklattu, satiipintainen	39-802-51-2	kpl	59,68	74,00
1 079.	39-802-53-2	Kehys kahdelle kytkimelle tai pistorasialle	Antiikkipronssi	39-802-53-2	kpl	57,66	71,50
1 080.	39-802-62-2	Kehys kahdelle kytkimelle tai pistorasialle	Kupari, patinoitu	39-802-62-2	kpl	59,68	74,00

Rivi	Valmistajan tuotenro *)	Tuotenimi	Selite	Domus Classican tuotenro	Yks.	Hinta (0%)	Hinta (24%)
1 081.	39-803-46-2	Kehys kolmelle kytkimelle tai pistorasialle	Antiikkikupari	39-803-46-2	kpl	86,69	107,50
1 082.	39-803-49-2	Kehys kolmelle kytkimelle tai pistorasialle	Antrasiitti	39-803-49-2	kpl	86,69	107,50
1 083.	39-803-50-2	Kehys kolmelle kytkimelle tai pistorasialle	Kulta	39-803-50-2	kpl	79,84	99,00
1 084.	39-803-51-2	Kehys kolmelle kytkimelle tai pistorasialle	Niklattu, satiipintainen	39-803-51-2	kpl	86,69	107,50
1 085.	39-803-53-2	Kehys kolmelle kytkimelle tai pistorasialle	Antiikkipronssi	39-803-53-2	kpl	79,84	99,00
1 086.	39-803-62-2	Kehys kolmelle kytkimelle tai pistorasialle	Kupari, patinoitu	39-803-62-2	kpl	86,69	107,50
1 087.	39-804-46-2	Kehys neljälle kytkimelle tai pistorasialle	Antiikkikupari	39-804-46-2	kpl	123,79	153,50
1 088.	39-804-49-2	Kehys neljälle kytkimelle tai pistorasialle	Antrasiitti	39-804-49-2	kpl	123,79	153,50
1 089.	39-804-50-2	Kehys neljälle kytkimelle tai pistorasialle	Kulta	39-804-50-2	kpl	119,76	148,50
1 090.	39-804-51-2	Kehys neljälle kytkimelle tai pistorasialle	Niklattu, satiipintainen	39-804-51-2	kpl	123,79	153,50
1 091.	39-804-53-2	Kehys neljälle kytkimelle tai pistorasialle	Antiikkipronssi	39-804-53-2	kpl	119,76	148,50
1 092.	39-804-62-2	Kehys neljälle kytkimelle tai pistorasialle	Kupari, patinoitu	39-804-62-2	kpl	123,79	153,50
1 093.	39-821-46-2	Kehys yhdelle kytkimelle tai pistorasialle	Antiikkikupari	39-821-46-2	kpl	45,56	56,50
1 094.	39-821-49-2	Kehys yhdelle kytkimelle tai pistorasialle	Antrasiitti	39-821-49-2	kpl	45,56	56,50
1 095.	39-821-50-2	Kehys yhdelle kytkimelle tai pistorasialle	Kulta	39-821-50-2	kpl	43,95	54,50
1 096.	39-821-51-2	Kehys yhdelle kytkimelle tai pistorasialle	Niklattu, satiipintainen	39-821-51-2	kpl	45,56	56,50
1 097.	39-821-53-2	Kehys yhdelle kytkimelle tai pistorasialle	Antiikkipronssi	39-821-53-2	kpl	43,95	54,50
1 098.	39-821-62-2	Kehys yhdelle kytkimelle tai pistorasialle	Kupari, patinoitu	39-821-62-2	kpl	45,56	56,50
1 099.	39-822-46-2	Kehys kahdelle kytkimelle tai pistorasialle	Antiikkikupari	39-822-46-2	kpl	59,68	74,00
1 100.	39-822-49-2	Kehys kahdelle kytkimelle tai pistorasialle	Antrasiitti	39-822-49-2	kpl	59,68	74,00
1 101.	39-822-50-2	Kehys kahdelle kytkimelle tai pistorasialle	Kulta	39-822-50-2	kpl	57,66	71,50
1 102.	39-822-51-2	Kehys kahdelle kytkimelle tai pistorasialle	Niklattu, satiipintainen	39-822-51-2	kpl	59,68	74,00
1 103.	39-822-53-2	Kehys kahdelle kytkimelle tai pistorasialle	Antiikkipronssi	39-822-53-2	kpl	57,66	71,50
1 104.	39-822-62-2	Kehys kahdelle kytkimelle tai pistorasialle	Kupari, patinoitu	39-822-62-2	kpl	59,68	74,00
1 105.	39-823-46-2	Kehys kolmelle kytkimelle tai pistorasialle	Antiikkikupari	39-823-46-2	kpl	86,69	107,50
1 106.	39-823-49-2	Kehys kolmelle kytkimelle tai pistorasialle	Antrasiitti	39-823-49-2	kpl	86,69	107,50
1 107.	39-823-50-2	Kehys kolmelle kytkimelle tai pistorasialle	Kulta	39-823-50-2	kpl	80,24	99,50
1 108.	39-823-51-2	Kehys kolmelle kytkimelle tai pistorasialle	Niklattu, satiipintainen	39-823-51-2	kpl	86,69	107,50
1 109.	39-823-53-2	Kehys kolmelle kytkimelle tai pistorasialle	Antiikkipronssi	39-823-53-2	kpl	80,24	99,50
1 110.	39-823-62-2	Kehys kolmelle kytkimelle tai pistorasialle	Kupari, patinoitu	39-823-62-2	kpl	86,69	107,50
1 111.	39-824-46-2	Kehys neljälle kytkimelle tai pistorasialle	Antiikkikupari	39-824-46-2	kpl	123,79	153,50
1 112.	39-824-49-2	Kehys neljälle kytkimelle tai pistorasialle	Antrasiitti	39-824-49-2	kpl	123,79	153,50
1 113.	39-824-50-2	Kehys neljälle kytkimelle tai pistorasialle	Kulta	39-824-50-2	kpl	119,76	148,50
1 114.	39-824-51-2	Kehys neljälle kytkimelle tai pistorasialle	Niklattu, satiipintainen	39-824-51-2	kpl	123,79	153,50
1 115.	39-824-53-2	Kehys neljälle kytkimelle tai pistorasialle	Antiikkipronssi	39-824-53-2	kpl	119,76	148,50
1 116.	39-824-62-2	Kehys neljälle kytkimelle tai pistorasialle	Kupari, patinoitu	39-824-62-2	kpl	123,79	153,50
1 117.	60-304-43-2	Ristikytkin Dimbler, reikä johdolle	Posliini (kulta)	60-304-43-2	kpl	34,27	42,50
1 118.	60-304-44-2	Ristikytkin Dimbler, reikä johdolle	Posliini (kromi)	60-304-44-2	kpl	34,27	42,50
1 119.	60-304-45-2	Ristikytkin Dimbler, reikä johdolle	Posliini (messinki)	60-304-45-2	kpl	34,27	42,50
1 120.	60-304-50-2	Ristikytkin Dimbler, posliini-messinki, reikä johdolle	Kulta	60-304-50-2	kpl	44,76	55,50

Rivi	Valmistajan tuotenro *)	Tuotenimi	Selite	Domus Classican tuotenro	Yks.	Hinta (0%)	Hinta (24%)
1 121.	60-304-51-2	Ristikytkin Dimbler, posliini-messinki, reikä johdolle	Niklattu, satiipintainen	60-304-51-2	kpl	44,76	55,50
1 122.	60-304-53-2	Ristikytkin Dimbler, posliini-messinki, reikä johdolle	Antiikkipronssi	60-304-53-2	kpl	44,76	55,50
1 123.	60-304-55-2	Ristikytkin Dimbler, posliini-messinki	Kulta	60-304-55-2	kpl	44,76	55,50
1 124.	60-304-56-2	Ristikytkin Dimbler, posliini-messinki	Niklattu, satiipintainen	60-304-56-2	kpl	44,76	55,50
1 125.	60-304-57-2	Ristikytkin Dimbler, posliini-messinki	Antiikkipronssi	60-304-57-2	kpl	44,76	55,50
1 126.	60-304-63-2	Ristikytkin Dimbler	Posliini (kulta)	60-304-63-2	kpl	34,27	42,50
1 127.	60-304-64-2	Ristikytkin Dimbler, valkoinen (kromattu)	Pinta-asennettava (ilman johtoreikää)	516-005-4	kpl	34,27	42,50
1 128.	60-304-65-2	Ristikytkin Dimbler	Posliini (messinki)	60-304-65-2	kpl	34,27	42,50
1 129.	60-306-43-2	Kytkin Dimbler, johtoaukolla	Posliini (kulta)	60-306-43-2	kpl	27,42	34,00
1 130.	60-306-44-2	Kytkin Dimbler, johtoaukolla	Posliini (kromi)	60-306-44-2	kpl	27,42	34,00
1 131.	60-306-45-2	Kytkin Dimbler, johtoaukolla	Posliini (messinki)	60-306-45-2	kpl	27,42	34,00
1 132.	60-306-50-2	Kytkin Dimbler, posliini-messinki, reikä johdolle	Kulta	60-306-50-2	kpl	39,52	49,00
1 133.	60-306-51-2	Kytkin Dimbler, posliini-messinki, reikä johdolle	Niklattu, satiipintainen	60-306-51-2	kpl	39,52	49,00
1 134.	60-306-53-2	Kytkin Dimbler, posliini-messinki, reikä johdolle	Antiikkipronssi	60-306-53-2	kpl	39,52	49,00
1 135.	60-306-55-2	Kytkin Dimbler, posliini-messinki	Kulta	60-306-55-2	kpl	39,52	49,00
1 136.	60-306-56-2	Kytkin Dimbler, posliini-messinki	Niklattu, satiipintainen	60-306-56-2	kpl	39,52	49,00
1 137.	60-306-57-2	Kytkin Dimbler, posliini-messinki	Antiikkipronssi	60-306-57-2	kpl	39,52	49,00
1 138.	60-306-63-2	Kytkin Dimbler	Posliini (kulta)	60-306-63-2	kpl	27,42	34,00
1 139.	60-306-64-2	Kytkin Dimbler	Posliini (messinki)	60-306-64-2	kpl	27,42	34,00
1 140.	60-306-65-2	Kytkin Dimbler	Posliini (messinki)	60-306-65-2	kpl	27,42	34,00
1 141.	60-308-43-2	Vaihtokytkin Dimbler, johtoaukolla	Posliini (kulta)	60-308-43-2	kpl	29,03	36,00
1 142.	60-308-44-2	Vaihtokytkin Dimbler, johtoaukolla	Posliini (kromi)	60-308-44-2	kpl	29,03	36,00
1 143.	60-308-45-2	Vaihtokytkin Dimbler, johtoaukolla	Posliini (messinki)	60-308-45-2	kpl	29,03	36,00
1 144.	60-308-50-2	Vaihtokytkin, posliini-messinki, reikä johdolle	Kulta	60-308-50-2	kpl	40,32	50,00
1 145.	60-308-51-2	Vaihtokytkin, posliini-messinki, reikä johdolle	Niklattu, satiipintainen	60-308-51-2	kpl	40,32	50,00
1 146.	60-308-53-2	Vaihtokytkin Dimbler, valkoinen (antiikkipronssi)	Pinta-asennettava	516-005-3	kpl	40,32	50,00
1 147.	60-308-55-2	Vaihtokytkin, posliini-messinki	Kulta	60-308-55-2	kpl	40,32	50,00
1 148.	60-308-56-2	Vaihtokytkin, posliini-messinki	Niklattu, satiipintainen	60-308-56-2	kpl	40,32	50,00
1 149.	60-308-57-2	Vaihtokytkin, posliini-messinki	Antiikkipronssi	60-308-57-2	kpl	40,32	50,00
1 150.	60-308-63-2	Vaihtokytkin Dimbler	Posliini (kulta)	60-308-63-2	kpl	29,03	36,00
1 151.	60-308-64-2	Vaihtokytkin Dimbler, valkoinen (kromattu)	Pinta-asennettava (ilman johtoreikää)	516-005-2	kpl	29,03	36,00
1 152.	60-308-65-2	Vaihtokytkin Dimbler	Posliini (messinki)	60-308-65-2	kpl	29,03	36,00
1 153.	60-310-50-2	Impulssikytkin	Kulta	60-310-50-2	kpl	33,87	42,00
1 154.	60-310-51-2	Impulssikytkin	Niklattu, satiipintainen	60-310-51-2	kpl	33,87	42,00
1 155.	60-310-53-2	Impulssikytkin	Antiikkipronssi	60-310-53-2	kpl	33,87	42,00
1 156.	60-310-55-2	Impulssikytkin	Kulta	60-310-55-2	kpl	33,87	42,00
1 157.	60-310-56-2	Impulssikytkin	Niklattu, satiipintainen	60-310-56-2	kpl	33,87	42,00
1 158.	60-310-57-2	Impulssikytkin	Antiikkipronssi	60-310-57-2	kpl	33,87	42,00
1 159.	60-312-43-2	Keinukytkin	Posliini (kulta)	60-312-43-2	kpl	31,05	38,50
1 160.	60-312-44-2	Impulssikytkin Dimbler	Posliini (kromi)	60-312-44-2	kpl	31,05	38,50

Rivi	Valmistajan tuotenro *)	Tuotenimi	Selite	Domus Classican tuotenro	Yks.	Hinta (0%)	Hinta (24%)
1 161.	60-312-45-2	Impulssikytkin Dimbler	Posliini (messinki)	60-312-45-2	kpl	31,05	38,50
1 162.	60-312-50-2	Impulssikytkin Dimbler	Kulta	60-312-50-2	kpl	39,52	49,00
1 163.	60-312-51-2	Impulssikytkin Dimbler	Niklattu, satiipintainen	60-312-51-2	kpl	39,52	49,00
1 164.	60-312-53-2	Impulssikytkin Dimbler	Antiikkipronssi	60-312-53-2	kpl	39,52	49,00
1 165.	60-312-55-2	Impulssikytkin Dimbler	Kulta	60-312-55-2	kpl	39,52	49,00
1 166.	60-312-56-2	Impulssikytkin Dimbler	Niklattu, satiipintainen	60-312-56-2	kpl	39,52	49,00
1 167.	60-312-57-2	Impulssikytkin Dimbler	Antiikkipronssi	60-312-57-2	kpl	39,52	49,00
1 168.	60-312-63-2	Impulssikytkin Dimbler	Posliini (kulta)	60-312-63-2	kpl	31,05	38,50
1 169.	60-312-64-2	Impulssikytkin Dimbler	Posliini (kromi)	60-312-64-2	kpl	31,05	38,50
1 170.	60-312-65-2	Impulssikytkin Dimbler	Posliini (messinki)	60-312-65-2	kpl	31,05	38,50
1 171.	60-314-43-2	Kruunukytkin Dimbler, johtoaukolla	Posliini (kulta)	60-314-43-2	kpl	33,06	41,00
1 172.	60-314-44-2	Kruunukytkin Dimbler, johtoaukolla	Posliini (kromi)	60-314-44-2	kpl	33,06	41,00
1 173.	60-314-45-2	Kruunukytkin Dimbler, johtoaukolla	Posliini (messinki)	60-314-45-2	kpl	33,06	41,00
1 174.	60-314-50-2	Kruunukytkin Dimbler, posliini-messinki, reikä johdolle	Kulta	60-314-50-2	kpl	43,55	54,00
1 175.	60-314-51-2	Kruunukytkin Dimbler, posliini-messinki, reikä johdolle	Niklattu, satiipintainen	60-314-51-2	kpl	43,55	54,00
1 176.	60-314-53-2	Kruunukytkin Dimbler, posliini-messinki, reikä johdolle	Antiikkipronssi	60-314-53-2	kpl	43,55	54,00
1 177.	60-314-55-2	Kruunukytkin Dimbler, posliini-messinki	Kulta	60-314-55-2	kpl	43,55	54,00
1 178.	60-314-56-2	Kruunukytkin Dimbler, posliini-messinki	Niklattu, satiipintainen	60-314-56-2	kpl	43,55	54,00
1 179.	60-314-57-2	Kruunukytkin Dimbler, posliini-messinki	Antiikkipronssi	60-314-57-2	kpl	43,55	54,00
1 180.	60-314-63-2	Kruunukytkin Dimbler	Posliini (kulta)	60-314-63-2	kpl	33,06	41,00
1 181.	60-314-64-2	Kruunukytkin Dimbler	Posliini (kromi)	60-314-64-2	kpl	33,06	41,00
1 182.	60-314-65-2	Kruunukytkin Dimbler	Posliini (messinki)	60-314-65-2	kpl	33,06	41,00
1 183.	60-952-03-2	Adapteri Dimbler	Ruskea	60-952-03-2	kpl	2,02	2,50
1 184.	65-300-26-2	Ykköskytkin, tupla	Kromattu (valkoinen)	65-300-26-2	kpl	38,31	47,50
1 185.	65-300-30-2	Ykköskytkin, tupla	Kulta (valkoinen)	65-300-30-2	kpl	38,31	47,50
1 186.	65-300-52-2	Ykköskytkin, tupla	Kromattu (ruskea)	65-300-52-2	kpl	38,31	47,50
1 187.	65-300-54-2	Ykköskytkin, tupla	Kulta (ruskea)	65-300-54-2	kpl	38,31	47,50
1 188.	65-300-57-2	Ykköskytkin, tupla	Pronssi (ruskea)	65-300-57-2	kpl	38,31	47,50
1 189.	65-300-59-2	Ykköskytkin, tupla	Pronssi (valkoinen)	65-300-59-2	kpl	38,31	47,50
1 190.	65-302-26-2	Vaihtokytkin, tupla	Kromattu (valkoinen)	65-302-26-2	kpl	41,53	51,50
1 191.	65-302-30-2	Vaihtokytkin, tupla	Kulta (valkoinen)	65-302-30-2	kpl	41,53	51,50
1 192.	65-302-52-2	Vaihtokytkin, tupla	Kromattu (ruskea)	65-302-52-2	kpl	41,53	51,50
1 193.	65-302-54-2	Vaihtokytkin, tupla	Kulta (ruskea)	65-302-54-2	kpl	41,53	51,50
1 194.	65-302-57-2	Vaihtokytkin, tupla	Pronssi (ruskea)	65-302-57-2	kpl	41,53	51,50
1 195.	65-302-59-2	Vaihtokytkin, tupla	Pronssi (valkoinen)	65-302-59-2	kpl	41,53	51,50
1 196.	65-304-26-2	Ristikytkin	Kromattu (valkoinen)	65-304-26-2	kpl	31,05	38,50
1 197.	65-304-30-2	Ristikytkin	Kulta (valkoinen)	65-304-30-2	kpl	31,05	38,50
1 198.	65-304-52-2	Ristikytkin	Kromattu (ruskea)	65-304-52-2	kpl	31,05	38,50
1 199.	65-304-54-2	Ristikytkin	Kulta (ruskea)	65-304-54-2	kpl	31,05	38,50
1 200.	65-304-57-2	Ristikytkin	Pronssi (ruskea)	65-304-57-2	kpl	31,05	38,50

Rivi	Valmistajan tuotenro *)	Tuotenimi	Selite	Domus Classican tuotenro	Yks.	Hinta (0%)	Hinta (24%)
1 201.	65-304-59-2	Ristikytkin	Pronssi (valkoinen)	65-304-59-2	kpl	31,05	38,50
1 202.	65-306-26-2	Kytkin	Kromattu (valkoinen)	65-306-26-2	kpl	23,79	29,50
1 203.	65-306-30-2	Kytkin	Kulta (valkoinen)	65-306-30-2	kpl	23,79	29,50
1 204.	65-306-52-2	Kytkin	Kromattu (ruskea)	65-306-52-2	kpl	23,79	29,50
1 205.	65-306-54-2	Kytkin	Kulta (ruskea)	65-306-54-2	kpl	23,79	29,50
1 206.	65-306-57-2	Kytkin	Pronssi (ruskea)	65-306-57-2	kpl	23,79	29,50
1 207.	65-306-59-2	Kytkin	Pronssi (valkoinen)	65-306-59-2	kpl	23,79	29,50
1 208.	65-308-26-2	Vaihtokytkin	Kromattu (valkoinen)	65-308-26-2	kpl	25,81	32,00
1 209.	65-308-30-2	Vaihtokytkin	Kulta (valkoinen)	65-308-30-2	kpl	25,81	32,00
1 210.	65-308-52-2	Vaihtokytkin	Kromattu (ruskea)	65-308-52-2	kpl	25,81	32,00
1 211.	65-308-54-2	Vaihtokytkin	Kulta (ruskea)	65-308-54-2	kpl	25,81	32,00
1 212.	65-308-57-2	Vaihtokytkin	Pronssi (ruskea)	65-308-57-2	kpl	25,81	32,00
1 213.	65-308-59-2	Vaihtokytkin	Pronssi (valkoinen)	65-308-59-2	kpl	25,81	32,00
1 214.	65-312-26-2	Impulssikytkin	Kromattu (valkoinen)	65-312-26-2	kpl	25,81	32,00
1 215.	65-312-30-2	Impulssikytkin	Kulta (valkoinen)	65-312-30-2	kpl	25,81	32,00
1 216.	65-312-52-2	Impulssikytkin	Kromattu (ruskea)	65-312-52-2	kpl	25,81	32,00
1 217.	65-312-54-2	Impulssikytkin	Kulta (ruskea)	65-312-54-2	kpl	25,81	32,00
1 218.	65-312-57-2	Impulssikytkin	Pronssi (ruskea)	65-312-57-2	kpl	25,81	32,00
1 219.	65-312-59-2	Impulssikytkin	Pronssi (valkoinen)	65-312-59-2	kpl	25,81	32,00
1 220.	65-314-26-2	Kruunukytkin	Kromattu (valkoinen)	65-314-26-2	kpl	29,84	37,00
1 221.	65-314-30-2	Kruunukytkin	Kulta (valkoinen)	65-314-30-2	kpl	29,84	37,00
1 222.	65-314-52-2	Kruunukytkin	Kromattu (ruskea)	65-314-52-2	kpl	29,84	37,00
1 223.	65-314-54-2	Kruunukytkin	Kulta (ruskea)	65-314-54-2	kpl	29,84	37,00
1 224.	65-314-57-2	Kruunukytkin	Pronssi (ruskea)	65-314-57-2	kpl	29,84	37,00
1 225.	65-314-59-2	Kruunukytkin	Pronssi (valkoinen)	65-314-59-2	kpl	29,84	37,00
1 226.	65-342-26-2	Kytkin sähköiselle markiisille	Kromattu (valkoinen)	65-342-26-2	kpl	42,74	53,00
1 227.	65-342-30-2	Kytkin sähköiselle markiisille	Kulta (valkoinen)	65-342-30-2	kpl	42,74	53,00
1 228.	65-342-52-2	Kytkin sähköiselle markiisille	Kromattu (ruskea)	65-342-52-2	kpl	42,74	53,00
1 229.	65-342-54-2	Kytkin sähköiselle markiisille	Kulta (ruskea)	65-342-54-2	kpl	42,74	53,00
1 230.	65-342-57-2	Kytkin sähköiselle markiisille	Pronssi (ruskea)	65-342-57-2	kpl	42,74	53,00
1 231.	65-342-59-2	Kytkin sähköiselle markiisille	Pronssi (valkoinen)	65-342-59-2	kpl	42,74	53,00
1 232.	65-345-26-2	Impulssikytkin, tupla	Kromattu (valkoinen)	65-345-26-2	kpl	41,94	52,00
1 233.	65-345-30-2	Impulssikytkin, tupla	Kulta (valkoinen)	65-345-30-2	kpl	41,94	52,00
1 234.	65-345-52-2	Impulssikytkin, tupla	Kromattu (ruskea)	65-345-52-2	kpl	41,94	52,00
1 235.	65-345-54-2	Impulssikytkin, tupla	Kulta (ruskea)	65-345-54-2	kpl	41,94	52,00
1 236.	65-345-57-2	Impulssikytkin, tupla	Pronssi (ruskea)	65-345-57-2	kpl	41,94	52,00
1 237.	65-345-59-2	Impulssikytkin, tupla	Pronssi (valkoinen)	65-345-59-2	kpl	41,94	52,00
1 238.	65-929-26-2	Vipunuppi	Teräs (kromattu)	65-929-26-2	kpl	4,03	5,00
1 239.	65-929-30-2	Vipunuppi	Teräs (kulta)	65-929-30-2	kpl	4,03	5,00
1 240.	65-929-59-2	Vipunuppi	Antiikkipronssi	65-929-59-2	kpl	4,03	5,00

Rivi	Valmistajan tuotenro *)	Tuotenimi	Selite	Domus Classican tuotenro	Yks.	Hinta (0%)	Hinta (24%)
1 241.	67-300-26-2	Ykköskytkin, tupla	Kromattu (valkoinen)	67-300-26-2	kpl	37,50	46,50
1 242.	67-300-54-2	Ykköskytkin, tupla	Kulta (ruskea)	67-300-54-2	kpl	37,50	46,50
1 243.	67-300-57-2	Ykköskytkin, tupla	Pronssi (ruskea)	67-300-57-2	kpl	37,50	46,50
1 244.	67-300-61-2	Ykköskytkin, tupla	Kromattu(metalli)	67-300-61-2	kpl	38,71	48,00
1 245.	67-302-26-2	Vaihtokytkin, tupla	Kromattu (valkoinen)	67-302-26-2	kpl	40,73	50,50
1 246.	67-302-54-2	Vaihtokytkin, tupla	Kulta (ruskea)	67-302-54-2	kpl	40,73	50,50
1 247.	67-302-57-2	Vaihtokytkin, tupla	Pronssi (ruskea)	67-302-57-2	kpl	40,73	50,50
1 248.	67-302-61-2	Vaihtokytkin, tupla	Kromattu(metalli)	67-302-61-2	kpl	42,34	52,50
1 249.	67-304-26-2	Ristikytkin	Kromattu (valkoinen)	67-304-26-2	kpl	30,24	37,50
1 250.	67-304-54-2	Ristikytkin	Kulta (ruskea)	67-304-54-2	kpl	30,24	37,50
1 251.	67-304-57-2	Ristikytkin	Pronssi (ruskea)	67-304-57-2	kpl	30,24	37,50
1 252.	67-304-61-2	Ristikytkin	Kromattu(metalli)	67-304-61-2	kpl	31,85	39,50
1 253.	67-306-26-2	Ykköskytkin	Kromattu (valkoinen)	67-306-26-2	kpl	22,98	28,50
1 254.	67-306-54-2	Ykköskytkin	Kulta (ruskea)	67-306-54-2	kpl	22,98	28,50
1 255.	67-306-57-2	Ykköskytkin	Pronssi (ruskea)	67-306-57-2	kpl	22,98	28,50
1 256.	67-306-61-2	Ykköskytkin	Kromattu(metalli)	67-306-61-2	kpl	24,19	30,00
1 257.	67-308-26-2	Vaihtokytkin	Kromattu (valkoinen)	67-308-26-2	kpl	25,40	31,50
1 258.	67-308-54-2	Vaihtokytkin	Kulta (ruskea)	67-308-54-2	kpl	25,40	31,50
1 259.	67-308-57-2	Vaihtokytkin	Pronssi (ruskea)	67-308-57-2	kpl	25,40	31,50
1 260.	67-308-61-2	Vaihtokytkin	Kromattu(metalli)	67-308-61-2	kpl	26,61	33,00
1 261.	67-312-26-2	Impulssikytkin	Kromattu (valkoinen)	67-312-26-2	kpl	23,79	29,50
1 262.	67-312-54-2	Impulssikytkin	Kulta (ruskea)	67-312-54-2	kpl	23,79	29,50
1 263.	67-312-57-2	Impulssikytkin	Pronssi (ruskea)	67-312-57-2	kpl	23,79	29,50
1 264.	67-312-61-2	Impulssikytkin	Kromattu(metalli)	67-312-61-2	kpl	25,40	31,50
1 265.	67-314-26-2	Kruunukytkin	Kromattu (valkoinen)	67-314-26-2	kpl	29,44	36,50
1 266.	67-314-54-2	Kruunukytkin	Kulta (ruskea)	67-314-54-2	kpl	29,44	36,50
1 267.	67-314-57-2	Kruunukytkin	Pronssi (ruskea)	67-314-57-2	kpl	29,44	36,50
1 268.	67-314-61-2	Kruunukytkin	Kromattu(metalli)	67-314-61-2	kpl	30,65	38,00
1 269.	67-342-26-2	Kytkin sähköiselle markiisille	Kromattu (valkoinen)	67-342-26-2	kpl	42,34	52,50
1 270.	67-342-54-2	Kytkin sähköiselle markiisille	Kulta (ruskea)	67-342-54-2	kpl	42,34	52,50
1 271.	67-342-57-2	Kytkin sähköiselle markiisille	Pronssi (ruskea)	67-342-57-2	kpl	42,34	52,50
1 272.	67-342-61-2	Kytkin sähköiselle markiisille	Kromattu(metalli)	67-342-61-2	kpl	43,95	54,50
1 273.	67-345-26-2	Impulssikytkin, tupla	Kromattu (valkoinen)	67-345-26-2	kpl	41,53	51,50
1 274.	67-345-54-2	Impulssikytkin, tupla	Kulta (ruskea)	67-345-54-2	kpl	41,53	51,50
1 275.	67-345-57-2	Impulssikytkin, tupla	Pronssi (ruskea)	67-345-57-2	kpl	41,53	51,50
1 276.	67-345-61-2	Impulssikytkin, tupla	Kromattu (metalli)	67-345-61-2	kpl	42,74	53,00
1 277.	67-929-26-2	Vipunuppi	Teräs (kromattu)	67-929-26-2	kpl	6,05	7,50
1 278.	67-929-30-2	Vipunuppi	Teräs (kulta)	67-929-30-2	kpl	6,05	7,50
1 279.	67-929-59-2	Vipunuppi	Antiikkipronssi	67-929-59-2	kpl	6,05	7,50



DOMUSCLASSICA®
| Eriäinen rautakauppa |

DOMUSCLASSICA®

Tiedustelut ja tilaukset: domus@domusclassica.com | p. 0400 23 24 25 (ma-to 9-15) | www.domusclassica.fi
Hinnat sisältävät arvonlisäveroa 24 % | Domus Classica Oy varaa oikeuden hinta- ja tuotetietomuutoksiin