

ROCAST

Chei profesionale

Stahlwille

Unelte create de profesioniști.
Pentru profesioniști.

Chei fixe

Chei tubulare

Chei dinamometrice

Truse de chei

Extractoare de rulmenți

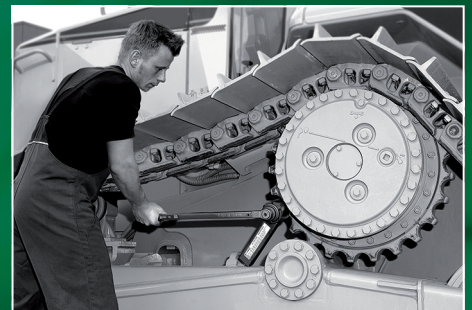

Produse noi - Iunie 2016

Stahlwille

Unelte create de profesioniști.
Pentru profesioniști.



De decenii, Stahlwille a contribuit la crearea etichetei "Made in Germany" și asta deoarece calitatea a fost încă de la început prima prioritate. Astfel fiecare produs trebuie să depășească cerințele impuse de standarde.



Calitatea - prima prioritate

La Stahlwille fiecare etapă a producției se află în mâinile companiei. Fiecare parte a procesului de fabricație a fost perfecționat pentru un maximum de calitate. Lucru care poate fi găsit în fiecare unealtă. **Așa a fost dintotdeauna.**

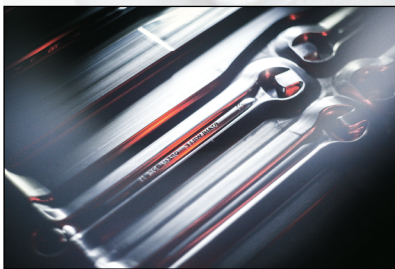

Detaliile care fac diferența

Stahlwille nu face niciun compromis privind precizia și urmărește cu atenție fiecare detaliu al procesului de fabricație. Acest lucru se aplică încă din faza de proiectare, combinând ergonomia cu excelențele calitatii fizice. Toate matricele utilizate pentru scule sunt produse numai de Stahlwille utilizând ultimele tehnologii computerizate.



Responsabilitate

3.5 miliarde de pasageri au călătorit cu avionul în 2015. Toți au zburat cu companii care se bazează zilnic pe Stahlwille - și aceasta pentru că ar fi extrem de dificil să găsești o companie aeriană care nu utilizează unelte Stahlwille.

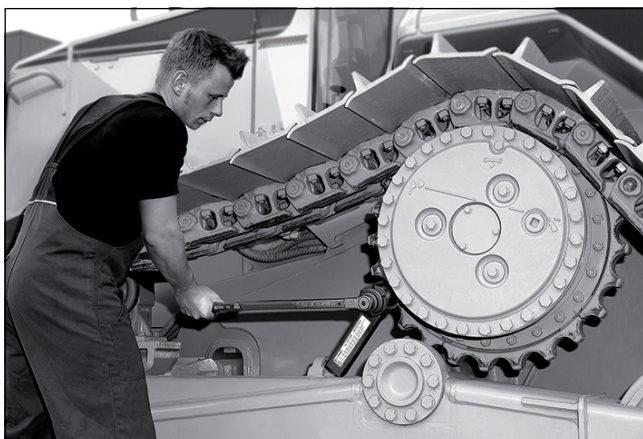

Chei profesionale

Cheile Stahlwille

extrem de rezistente, remarcabil de durabile

Fabricate din oțel de înaltă calitate, tratat termic, fără decarburarea suprafeței.

Detaliile care fac diferența

Pentru a reduce riscul ruperii Stahlwille a adăugat mai mult material în zonele cu încărcarea cea mai mare.

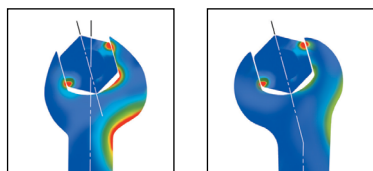

Standard

Stahlwille

Precizie de 0.3 mm.

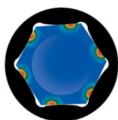
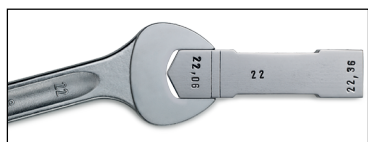

Sistemul de acționare "AS-Drive" împiedică alunecarea.

Acest lucru permite o forță mai mare imprimată suruburilor și piulitelor fără a le deteriora.

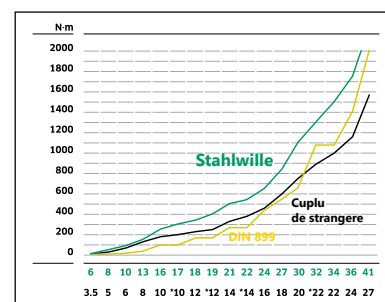

Chei fixe profesionale, duble - DIN 3110

DIN 3110, ISO 10102
Material: oțel aliat, cromat

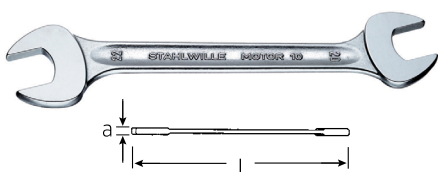

Ø (mm)	L (mm)	a (mm)	€/buc.	Cod articol
4 x 5	100	3.4	4.44	ST.40030405
5.5 x 7	120	3.7	4.25	ST.40035507
6 x 7	120	3.7	3.49	ST.40030607
7 x 8	140	4.0	4.56	ST.40030708
8 x 9	140	4.0	3.79	ST.40030809
8 x 10	140	4.5	4.21	ST.40030810
10 x 11	155	4.8	3.75	ST.40031011
10 x 12	170	5.3	5.17	ST.40031012
10 x 13	170	5.3	5.02	ST.40031013
11 x 13	170	5.3	5.63	ST.40031113
12 x 13	170	5.3	4.56	ST.40031213

Ø (mm)	L (mm)	a (mm)	€/buc.	Cod articol
12 x 14	170	5.3	5.48	ST.40031214
13 x 14	190	5.3	5.67	ST.40031314
13 x 15	190	5.3	5.86	ST.40031315
13 x 17	205	5.8	6.01	ST.40031317
14 x 15	190	5.3	4.86	ST.40031415
14 x 17	205	5.8	6.12	ST.40031417
16 x 17	205	5.8	5.32	ST.40031617
16 x 18	220	6.7	6.74	ST.40031618
17 x 19	220	6.7	6.35	ST.40031719
18 x 19	220	6.7	6.20	ST.40031819
18 x 21	235	7.3	8.42	ST.40031821
19 x 22	235	7.3	7.62	ST.40031922
20 x 22	235	7.3	7.20	ST.40032022
21 x 23	250	7.8	7.96	ST.40032123
21 x 24	250	7.8	9.87	ST.40032124
22 x 24	250	7.8	8.65	ST.40032224
24 x 26	270	8.3	10.33	ST.40032426
24 x 27	280	8.3	9.64	ST.40032427
25 x 28	285	8.3	12.02	ST.40032528
27 x 30	300	9.4	14.46	ST.40032730
27 x 32	300	9.4	14.46	ST.40032732
30 x 32	300	9.4	13.55	ST.40033032
30 x 34	300	9.4	15.99	ST.40033034

Ø (mm)	L (mm)	a (mm)	€/buc.	Cod articol
32 x 36	325	10.0	24.41	ST.40033236
34 x 36	325	10.0	26.00	ST.40033436
36 x 41	375	11.0	32.60	ST.40033641
41 x 46	425	12.0	44.80	ST.40034146

Ø (inch)	L (mm)	a (mm)	€/buc.	Cod articol
1/4 x 5/16	140	4.0	4.06	ST.40431620
5/16 x 3/8	140	4.5	6.39	ST.40432024
3/8 x 7/16	155	4.8	4.79	ST.40432428
7/16 x 1/2	170	5.3	6.81	ST.40432832
1/2 x 9/16	190	5.3	5.93	ST.40433234
9/16 x 5/8	205	5.8	6.58	ST.40433436
19/32 x 11/16	205	5.8	7.08	ST.40433538
5/8 x 11/16	205	5.8	7.08	ST.40433638
5/8 x 3/4	220	6.7	7.31	ST.40433640
11/16 x 3/4	220	6.7	8.65	ST.40433840
11/16 x 13/16	235	7.3	8.42	ST.40433842
3/4 x 7/8	235	7.3	9.03	ST.40434044
25/32 x 13/16	235	7.3	9.03	ST.40434142
7/8 x 15/16	250	7.8	10.49	ST.40434446
15/16 x 1	270	8.3	11.94	ST.40434648
1 1/8 x 1 1/16	300	9.4	16.15	ST.40435258

Seturi de chei profesionale fixe, duble - DIN 3110

DIN 3110, ISO 10102
Material: oțel aliat, cromat
Husa textilă din material rezistent.



*Ambalaj din carton

Nr. de piese	Componenta	€/set	Cod articol
8	6 x 7; 8 x 9; 10 x 11; 12 x 13; 14 x 15; 16 x 17; 18 x 19; 20 x 22	34.90	ST.96400305
9*)	6 x 7; 8 x 9; 10 x 11; 12 x 13; 14 x 15; 16 x 17; 18 x 19; 20 x 22; 21 x 24	44.10	ST.96400314
10	6 x 7; 8 x 9; 10 x 11; 12 x 13; 14 x 15; 16 x 17; 18 x 19; 20 x 22; 24 x 27; 30 x 32	55.60	ST.96400307
12	6 x 7; 8 x 9; 10 x 11; 12 x 13; 14 x 15; 16 x 17; 18 x 19; 20 x 22; 21 x 23; 24 x 27; 25 x 28; 30 x 32	73.50	ST.96400306
7	1/4 x 5/16; 3/8 x 7/16; 1/2 x 9/16; 5/8 x 3/4; 11/16 x 13/16; 7/8 x 15/16; 1 1/8 x 1 5/16	51.50	ST.96404306
11	1/4 x 5/16; 3/8 x 7/16; 1/2 x 9/16; 5/8 x 3/4; 11/16 x 13/16; 7/8 x 15/16; 1 1/8 x 1 5/16	80.00	ST.96404307

Chei profesionale

Chei combinate, profesionale - DIN 3113, forma A

DIN 3113, ISO 7738, forma A
Material: otel aliat, cromat

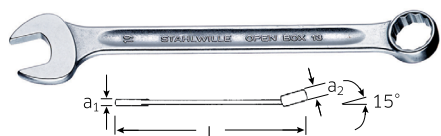

Ø (mm)	L (mm)	a1 (mm)	a2 (mm)	€/buc.	Cod articol
5.5	100	3.5	5.8	5.86	ST.40085500
6	105	3.6	6.0	5.28	ST.40080606
7	110	3.9	6.0	5.28	ST.40080707
8	115	4.2	7.0	5.21	ST.40080808
9	120	4.5	7.0	5.97	ST.40080909
10	125	4.8	7.0	5.90	ST.40081010
11	135	4.8	8.0	6.28	ST.40081111
12	140	5.3	8.5	6.58	ST.40081212
13	160	5.3	8.5	7.16	ST.40081313
14	165	5.3	8.5	7.20	ST.40081414
15	170	5.3	8.5	8.65	ST.40081515
16	180	5.8	10.0	9.41	ST.40081616
17	190	5.8	10.0	9.57	ST.40081717
18	200	6.7	11.5	10.79	ST.40081818
19	230	6.7	11.5	11.33	ST.40081919
20	230	7.0	13.0	13.39	ST.40082020
21	260	7.3	13.0	14.00	ST.40082121

Ø (mm)	L (mm)	a1 (mm)	a2 (mm)	€/buc.	Cod articol
22	260	7.3	13.0	13.70	ST.40082222
23	280	7.8	14.0	18.82	ST.40082323
24	280	7.8	14.0	15.53	ST.40082424
25	300	8.4	14.5	19.89	ST.40082525
26	300	8.4	14.5	20.51	ST.40082626
27	300	8.4	14.5	19.44	ST.40082727
28	320	8.4	14.5	24.18	ST.40082828
29	330	8.9	16.0	25.30	ST.40082929
30	330	8.9	16.0	23.26	ST.40083030
32	360	9.4	16.5	25.50	ST.40083232
34	450	9.4	17.0	37.30	ST.40083434
36	460	10.0	18.0	43.30	ST.40083636
38	480	11.0	19.0	56.70	ST.40083838
41	480	11.0	19.0	55.50	ST.40084141
46	500	13.0	20.0	78.80	ST.40084646
50	530	14.0	21.0	104.00	ST.40085050
55	560	15.0	22.0	128.00	ST.40085555
60	590	16.0	24.0	170.00	ST.40086060

Ø (inch)	L (mm)	a1 (mm)	a2 (mm)	€/buc.	Cod articol
11/32	120	4.5	7.0	6.81	ST.40482222
3/8	125	4.8	7.0	6.70	ST.40482424
7/16	135	4.8	8.0	7.01	ST.40482828
1/2	160	5.3	8.5	7.65	ST.40483232
9/16	165	5.3	8.5	8.65	ST.40483434
19/32	170	5.3	8.5	10.71	ST.40483535
5/8	180	5.8	10.0	9.64	ST.40483636
11/16	200	6.7	11.5	11.79	ST.40483838
3/4	230	6.7	11.5	12.55	ST.40484040
25/32	235	7.0	13.0	14.85	ST.40484141
13/16	260	7.3	13.0	14.23	ST.40484242
7/8	260	7.3	13.0	15.61	ST.40484444
15/16	280	7.8	14.0	18.21	ST.40484646
1	300	8.4	14.5	17.45	ST.40484848
1 1/16	300	8.4	14.5	20.51	ST.40485050
1 1/8	330	8.9	16.0	24.03	ST.40485252
1 3/16	332	8.9	16.5	28.90	ST.40485454
1 1/4	360	9.4	16.5	27.90	ST.40485656
1 3/8	450	9.6	17.0	35.20	ST.40485858
1 3/8	460	10.0	18.0	48.60	ST.40486060
1 7/16	461	10.0	18.0	48.60	ST.40486262
1 1/2	480	11.0	19.0	57.40	ST.40486464
1 5/8	480	11.0	19.0	62.40	ST.40486666
1 13/16	500	13.0	20.0	85.00	ST.40486969
1 7/8	530	14.0	21.0	96.40	ST.40487070
2	530	14.0	21.0	112.00	ST.40487272

Seturi de chei combinate, profesionale - DIN 3113, forma A

DIN 3113, ISO 7738, forma A
Material: otel aliat, cromat
Husa textila din material rezistent.



*Ambalaj din carton

Nr. de piese	Componenta	€/set	Cod articol
6	7; 8; 10; 13; 17; 19	45.00	ST.96400813
9	9; 10; 11; 12; 13; 14; 17; 19; 22	66.30	ST.96400801
10*)	8; 9; 10; 11; 12; 13; 14; 15; 17; 19	71.30	ST.96400808
11	8; 9; 10; 11; 12; 13; 14; 15; 17; 19; 22	78.10	ST.96400802
15	6; 7; 8; 9; 10; 11; 12; 13; 17; 19; 22; 24; 27; 30; 32	150.00	ST.96400803
16*)	7; 8; 9; 10; 11; 12; 13; 14; 15; 16; 17; 18; 19; 21; 22; 24	129.00	ST.96400816
17	6; 7; 8; 9; 10; 11; 12; 13; 14; 15; 16; 17; 18; 19; 20; 21; 22	131.00	ST.96400804
26*)	6; 7; 8; 9; 10; 11; 12; 13; 14; 15; 16; 17; 18; 19; 20; 21; 22; 23; 24; 25; 26; 27; 28; 29; 30; 32	302.00	ST.96400805
8	7/16; 1/2; 9/16; 5/8; 11/16; 3/4; 13/16; 7/8	78.50	ST.96404803
10*)	1/4; 5/16; 11/32; 3/8; 7/16; 1/2; 9/16; 5/8; 11/16; 3/4	79.00	ST.96404812
20*)	1/4; 9/32; 5/16; 11/32; 3/8; 7/16; 1/2; 9/16; 19/32; 5/8; 11/16; 3/4; 25/32; 13/16; 7/8; 15/16; 1; 1 1/16; 1 1/8; 1 1/4	228.00	ST.96404804

Chei combinate lungi, profesionale - DIN 3113, forma B

DIN 3113 / ISO 7738, forma B
Material: otel aliat, cromat



Ø (mm)	L (mm)	a1 (mm)	a2 (mm)	€/buc.	Cod articol
6	125	4.5	6	6.05	ST.40100606
7	135	5.0	7	5.51	ST.40100707
8	145	5.0	7	5.48	ST.40100808
9	155	5.5	8	6.78	ST.40100909
10	165	5.5	8	6.12	ST.40101010
11	180	6.0	9	6.51	ST.40101111
12	180	6.0	9	7.01	ST.40101212
13	195	6.5	10	7.62	ST.40101313
14	210	6.5	10	7.73	ST.40101414
15	215	7.0	11	9.03	ST.40101515
16	230	7.0	11	9.64	ST.40101616
17	240	7.5	12	9.95	ST.40101717
18	255	7.5	12	11.40	ST.40101818
19	265	8.0	13	11.86	ST.40101919

Ø (mm)	L (mm)	a1 (mm)	a2 (mm)	€/buc.	Cod articol
20	280	8.0	13	12.86	ST.40102020
21	280	8.5	13	13.55	ST.40102121
22	300	8.5	14	14.31	ST.40102222
24	330	9.5	14	16.30	ST.40102424
27	385	10.5	16	18.29	ST.40102727
30	415	12.0	18	23.49	ST.40103030
32	430	12.0	18	25.50	ST.40103232
34	460	13.0	18	36.30	ST.40103434
36	480	13.0	19	46.30	ST.40103636
41	560	14.0	20	55.10	ST.40104141
65	710	22	33	324.00	ST.40146565
70	760	24	35	365.00	ST.40147070
75	810	26	38	430.00	ST.40147575
80	860	28	41	514.00	ST.40148080

Chei profesionale

Seturi de chei combinate lungi, profesionale - DIN 3113, forma B

DIN 3113, ISO 7738, forma B

Material: otel aliat, cromat

Husa textila din material rezistent.



¹⁾ in husa de plastic, transparenta
²⁾ ambalaj din carton



Nr. de piese	Componenta	€/set	Cod articol
6 ^{d)}	10; 13; 17; 19; 22; 24	59.60	ST.96401008
9 ^{d)}	10; 11; 13; 17; 19; 22; 24; 27; 30	103.00	ST.96401009
10 ^{d)}	8; 10; 11; 12; 13; 14; 16; 17; 18; 19	79.90	ST.96401007
11	8; 9; 10; 11; 12; 13; 14; 15; 17; 19; 22	83.10	ST.96401006
15	6; 7; 8; 9; 10; 11; 12; 13; 17; 19; 22; 24; 27; 30; 32	154.00	ST.96401004
16 ^{d)}	10; 11; 12; 13; 14; 15; 16; 17; 18; 19; 21; 22; 24; 27; 30	156.00	ST.96401010
17	6; 7; 8; 9; 10; 11; 12; 13; 14; 15; 16; 17; 18; 19; 20; 21; 22	137.00	ST.96401005

Chei duble inelare, profesionale - DIN 838

DIN 838 / ISO 10104

Material: otel aliat, cromat

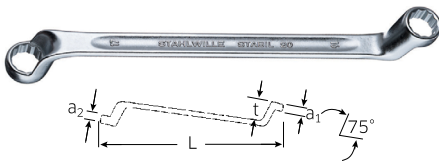

Ø (mm)	L (mm)	a1 / a2 (mm)	€/buc.	Cod articol
6 x 7	165	6	6.85	ST.41040607
8 x 9	180	7	7.08	ST.41040809
8 x 10	180	7	8.96	ST.41040810
10 x 11	200	9	7.65	ST.41041011
10 x 13	220	9	9.57	ST.41041013
12 x 13	220	9	8.27	ST.41041213

Ø (mm)	L (mm)	a1 / a2 (mm)	€/buc.	Cod articol
13 x 17	245	10	11.02	ST.41041317
14 x 15	245	10	8.88	ST.41041415
16 x 17	255	11	9.80	ST.41041617
17 x 19	270	12	11.40	ST.41041719
18 x 19	275	12	11.17	ST.41041819
18 x 21	300	12	15.61	ST.41041821
19 x 22	300	13	14.31	ST.41041922
20 x 22	300	13	13.09	ST.41042022
21 x 23	315	13	16.45	ST.41042123
21 x 24	330	13	18.14	ST.41042124
22 x 24	330	14	17.75	ST.41042224
24 x 26	330	14	19.67	ST.41042426
24 x 27	330	14	17.22	ST.41042427
25 x 28	350	14	20.97	ST.41042528
27 x 30	360	15	24.10	ST.41042730
27 x 32	360	15	23.26	ST.41042732
30 x 32	365	15	21.81	ST.41043032
30 x 34	365	15	25.80	ST.41043034

Ø (mm)	L (mm)	a1 / a2 (mm)	€/buc.	Cod articol
36 x 41	440	17	48.20	ST.41043641
46 x 50	535	19	89.60	ST.41044650
Ø (inch)	L (mm)	a1 / a2 (mm)	€/buc.	Cod articol
1/4 x 5/16	180	7	8.34	ST.41441620
3/8 x 7/16	200	9	9.41	ST.41442428
1/2 x 9/16	220	9	10.49	ST.41443234
5/16 x 3/8	245	10	11.10	ST.41443436
19/32 x 11/16	255	11	11.71	ST.41443538
5/8 x 3/4	270	12	12.55	ST.41443640
11/16 x 13/16	300	12	15.92	ST.41443842
3/4 x 7/8	300	13	15.61	ST.41444044
25/32 x 13/16	300	13	17.22	ST.41444142
7/8 x 15/16	330	14	18.67	ST.41444446
15/16 x 1	330	14	20.66	ST.41444648
1 1/8 x 1 1/16	365	15	26.00	ST.41445258

Seturi de chei duble inelare, profesionale - DIN 838

DIN 838 / ISO 10104

Material: otel aliat, cromat

Ambalaj din carton.

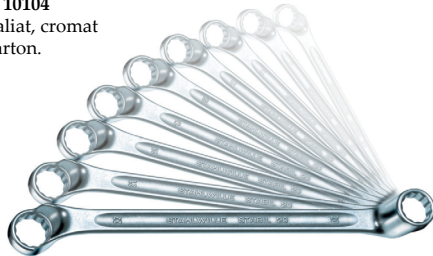

Nr. de piese	Componenta	€/buc.	Cod articol
7	6 x 7; 8 x 9; 10 x 11; 12 x 13; 14 x 15; 16 x 17; 18 x 19;	53.80	ST.96410408
8	6 x 7; 8 x 9; 10 x 11; 12 x 13; 14 x 15; 16 x 17; 18 x 19; 20 x 22	65.00	ST.96410405

Nr. de piese	Componenta	€/buc.	Cod articol
9	6 x 7; 8 x 9; 10 x 11; 12 x 13; 14 x 15; 16 x 17; 18 x 19; 20 x 22; 21 x 24	81.80	ST.96410409
10	6 x 7; 8 x 9; 10 x 11; 12 x 13; 14 x 15; 16 x 17; 18 x 19; 20 x 22; 24 x 27; 30 x 32	99.80	ST.96410407
12	6 x 7; 8 x 9; 10 x 11; 12 x 13; 14 x 15; 16 x 17; 18 x 19; 20 x 22; 21 x 23; 24 x 27; 25 x 28; 30 x 32	134.00	ST.96410406
6	1/4 x 5/16; 3/8 x 7/16; 1/2 x 9/16; 5/8 x 3/4; 11/16 x 13/16; 7/8 x 15/16	67.90	ST.96414402
10	1/4 x 5/16; 3/8 x 7/16; 1/2 x 9/16; 9/16 x 5/8; 19/32 x 11/16; 5/8 x 3/4; 11/16 x 13/16; 3/4 x 7/8; 25/32 x 13/16; 7/8 x 15/16	118.00	ST.96414405

Chei rotative combinate, cu clichet, profesionale

Reversibila, 72 dinti. Ideala pentru spatii inguste.

Material: otel aliat, cromat.

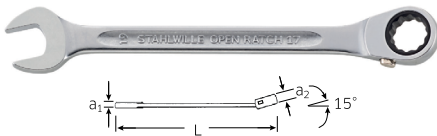

Husa textila din material rezistent.

Ø (mm)	L (mm)	a1 (mm)	a2 (mm)	€/buc.	Cod articol
8	144	4.7	7.4	12.24	ST.41170808
9	150	5.3	7.4	12.86	ST.41170909
10	158	5.7	8.4	13.24	ST.41171010
11	165	6.1	8.4	14.31	ST.41171111
12	173	6.4	8.4	14.77	ST.41171212
13	182	6.6	8.4	14.92	ST.41171313
14	190	7.3	8.4	15.99	ST.41171414
15	202	7.5	8.4	17.06	ST.41171515
16	215	7.7	10.0	17.98	ST.41171616
17	229	7.9	10.0	18.52	ST.41171717
18	240	8.4	11.5	20.28	ST.41171818
19	252	8.7	11.5	20.89	ST.41171919
Piese	Seturi de chei rotative combinate cu clichet	€/set	Cod articol		
5	8; 10; 13; 17; 19	71.30	ST.96411705		
12	8; 9; 10; 11; 12; 13; 14; 15; 16; 17; 18; 19	173.00	ST.96411712		

Chei profesionale

Chei rotative inelare, duble, cu clichet, profesionale

22 dinti. Material: oțel aliat, cromat.



Husa textila din material rezistent.

Ø (mm)	L (mm)	a (mm)	€/buc.	Cod articol	Ø (mm)	L (mm)	a (mm)	€/buc.	Cod articol
7 x 8	109	9	11.79	ST.41130708	1/4 x 5/16	109	9	11.94	ST.41561620
9 x 10	139	9	14.39	ST.41130910	5/16 x 11/32	109	9	22.04	ST.41562022
10 x 11	170	12	18.44	ST.41131011	3/8 x 7/16	139	9	13.70	ST.41562428
12 x 13	170	12	17.91	ST.41131213	1/2 x 9/16	174	12	16.68	ST.41563234
14 x 15	170	12	18.82	ST.41131415	5/8 x 11/16	205	12	20.12	ST.41563638
16 x 18	205	12	20.58	ST.41131618	3/4 x 7/8	235	13	21.42	ST.41564044
17 x 19	205	12	22.88	ST.41131719	13/16 x 15/16	235	12	22.65	ST.41564246

Piese	Seturi de chei rotative inelare, duble, cu clichet	€/set	Cod articol
4	9 x 10; 12 x 13; 14 x 15; 17 x 19	66.60	ST.96411302
7	7 x 8; 9 x 10; 10 x 11; 12 x 13; 14 x 15; 16 x 18; 17 x 19	113.00	ST.96411301
4	3/8 x 7/16; 1/2 x 9/16; 5/8 x 11/16; 3/4 x 7/8	64.80	ST.96415602
7	1/4 x 5/16; 5/16 x 11/32; 3/8 x 7/16; 1/2 x 9/16; 5/8 x 11/16; 3/4 x 7/8; 13/16 x 15/16	116.00	ST.96415601

Chei duble pentru electricieni, profesionale

Material: oțel aliat, cromat

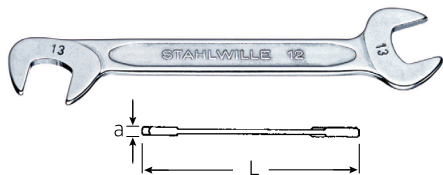

Husa textila din material rezistent.

Ø (mm)	L (mm)	a (mm)	€/buc.	Cod articol	Ø (mm)	L (mm)	a (mm)	€/buc.	Cod articol
3.2	70	2	5.97	ST.40063232	5/32	70	2	6.24	ST.40461010
3.5	70	2	5.97	ST.40063535	3/16	70	2	6.24	ST.40461212
4.0	70	2	5.86	ST.40060404	13/64	78	2	6.24	ST.40461313
4.5	70	2	5.86	ST.40064545	7/32	78	2	6.24	ST.40461414
5.0	78	2	5.86	ST.40060505	15/64	78	2	6.24	ST.40461515
5.5	78	2	5.86	ST.40065555	1/4	91	2	6.24	ST.40461616
6.0	78	2	5.86	ST.40060606	9/32	91	2	6.24	ST.40461818
7.0	91	2	5.86	ST.40060707	5/16	96	3	6.24	ST.40462020
8.0	96	3	5.86	ST.40060808	11/32	103	3	6.35	ST.40462222
9.0	103	3	5.86	ST.40060909	3/8	105	3	6.35	ST.40462424
10.0	105	3	5.86	ST.40061010	7/16	116	3	6.39	ST.40462828
11.0	116	3	6.05	ST.40061111	1/2	131	3	7.65	ST.40463232
12.0	116	3	6.51	ST.40061212	9/16	131	3	8.50	ST.40463434
13.0	131	3	6.85	ST.40061313					
14.0	131	3	7.65	ST.40061414					

Piese	Seturi de chei duble, pentru electricieni	€/set	Cod articol
10	4.0; 4.5; 5.0; 5.5; 6.0; 7.0; 8.0; 9.0; 10; 11	52.90	ST.96400653
15	3.2; 3.5; 4.0; 4.5; 5.0; 5.5; 6.0; 7.0; 8.0; 9.0; 10; 11; 12; 13; 14	82.50	ST.96400651
13	5/32; 3/16; 13/64; 7/32; 15/64; 1/4; 9/32; 5/16; 11/32; 3/8; 7/16; 1/2; 9/16	76.60	ST.96404654

Chei inelare duble, cotite, profesionale - ISO 3318

ISO 3318

Material: oțel aliat, cromat.



Ø (mm)	L (mm)	a (mm)	€/buc.	Cod articol
10 x 12	150	6.5	16.22	ST.41091012
11 x 13	150	6.5	15.30	ST.41091113
14 x 16	179	7.5	19.74	ST.41091416
14 x 17	179	7.5	19.36	ST.41091417
15 x 17	184	7.5	19.28	ST.41091517
16 x 18	200	8.5	23.41	ST.41091618
19 x 22	225	9.0	24.56	ST.41091922

Chei duble inelare, profesionale

Pentru Torx exterior.

Material: oțel aliat, cromat



Ø (mm)	L (mm)	a1 (mm)	a2 (mm)	€/buc.	Cod articol
E 6 x E 8	155.5	4.5	5.5	9.80	ST.41250608
E10 x E12	149.5	6.5	7.5	10.49	ST.41251012
E14 x E18	185.0	8.0	9.5	12.47	ST.41251418
E20 x E24	227.0	10.5	12.5	16.83	ST.41252024

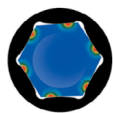

Sistemul de acționare "AS-Drive" împiedică alunecarea.

Acest lucru permite o forță mai mare imprimată suruburilor și piulitelor fără a le deteriora.

Chei profesionale

Chei inelare pentru actionari grele, profesionale

Material: oțel aliat, cromat.
Se livrează fără teava de acționare.

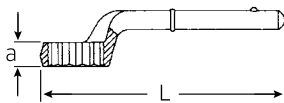

Ø (mm)	L (mm)	a (mm)	€/buc.	Cod articol
24	180	17.0	26.70	ST.42020024
27	190	17.0	28.00	ST.42020027
30	200	18.0	30.10	ST.42020030
32	235	18.0	35.50	ST.42020032
36	245	20.0	37.10	ST.42020036
38	250	21.0	52.50	ST.42020038
41	265	22.0	44.40	ST.42020041
42	265	22.0	50.50	ST.42020042
46	280	23.0	49.80	ST.42020046
50	290	25.5	59.30	ST.42020050

Ø (mm)	L (mm)	a (mm)	€/buc.	Cod articol
55	300	28.0	64.70	ST.42020055
60	345	30.5	83.40	ST.42020060
65	355	33.0	91.10	ST.42020065
70	365	35.5	101.00	ST.42020070
75	375	38.0	118.00	ST.42020075
80	385	40.5	137.00	ST.42020080
85	385	40.5	140.00	ST.42020085
90	410	45.0	260.00	ST.42020090
95	410	45.0	279.00	ST.42020095
100	412	45.0	307.00	ST.42020100

Tevi de acționare

Pentru chei inelare pentru acționari grele.
Material: oțel aliat, cromat.



Marime	Ø (mm)	L (mm)	€/buc.	Cod articol
1	24 - 30	460	23.11	ST.48030001
2	32 - 42	610	26.90	ST.48030002
3	46 - 55	760	45.90	ST.48030003
4	60 - 100	860	60.50	ST.48030004

Chei inelare pentru lovire, profesionale - DIN 7444

DIN 7444
Material: oțel special de scule cu finisare gri.

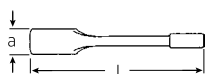

Ø (mm)	L (mm)	a (mm)	€/buc.	Cod articol
24	160	15.0	19.21	ST.42050024
26	160	15.0	23.49	ST.42050026
27	180	16.0	23.49	ST.42050027
28	180	15.5	23.49	ST.42050028
30	190	16.5	28.00	ST.42050030
32	195	16.5	28.70	ST.42050032
33	195	16.5	28.70	ST.42050033
36	205	19.5	36.80	ST.42050036
37	205	19.5	36.80	ST.42050037
38	205	19.5	36.80	ST.42050038
41	225	20.5	48.20	ST.42050041
42	225	20.5	53.60	ST.42050042
46	240	22.5	50.90	ST.42050046

Ø (mm)	L (mm)	a (mm)	€/buc.	Cod articol
47	240	22.5	50.90	ST.42050047
48	240	22.5	50.90	ST.42050048
50	250	23.5	59.00	ST.42050050
52	250	23.5	59.00	ST.42050052
55	270	25.0	66.60	ST.42050055
56	270	25.0	74.30	ST.42050056
60	270	26.0	71.60	ST.42050060
64	290	29.0	92.60	ST.42050064
65	290	29.0	92.60	ST.42050065
70	320	33.0	104.00	ST.42050070
75	325	34.0	111.00	ST.42050075
80	345	35.0	164.00	ST.42050080
85	360	37.0	198.00	ST.42050085
90	400	41.5	238.00	ST.42050090
95	400	41.5	268.00	ST.42050095
100	400	41.5	303.00	ST.42050100
105	435	47.5	347.00	ST.42050105
110	435	47.5	398.00	ST.42050110
115	435	47.5	434.00	ST.42050115
120	480	54.0	691.00	ST.42050120
130	520	58.0	974.00	ST.42050130
135	520	58.0	1015.00	ST.42050135
145	580	64.0	1547.00	ST.42050145
160	580	64.0	1822.00	ST.42050160
165	650	70.0	1947.00	ST.42050165

Ø (mm)	L (mm)	a (mm)	€/buc.	Cod articol
170	650	70.0	2377.00	ST.42050170
175	650	70.0	2585.00	ST.42050175
180	650	70.0	2828.00	ST.42050180
210	750	80.0	3423.00	ST.42050210

Ø (inch)	L (mm)	a (mm)	€/buc.	Cod articol
1 1/4	190	17	33.50	ST.42450056
1 3/16	190	17	33.50	ST.42450058
1 1/2	205	18	42.90	ST.42450064
1 5/8	230	20	56.30	ST.42450066
1 11/16	230	20	56.30	ST.42450067
1 13/16	240	22	59.70	ST.42450069
1 7/8	240	22	59.70	ST.42450070
2	255	24	68.90	ST.42450072
2 1/16	255	24	68.90	ST.42450073
2 3/16	270	25	77.30	ST.42450075
2 1/4	270	25	77.30	ST.42450076
2 3/8	280	26	83.40	ST.42450078
2 7/16	280	26	83.40	ST.42450079
2 9/16	300	30	108.00	ST.42450081
2 5/8	300	30	108.00	ST.42450082
2 3/4	330	33	121.00	ST.42450084
2 13/16	330	33	121.00	ST.42450085
2 15/16	330	33	127.00	ST.42450087

Chei fixe pentru lovire, profesionale - DIN 133

DIN 133
Material: oțel special de scule cu finisare gri.



Ø (mm)	L (mm)	a (mm)	€/buc.	Cod articol
27	180	16.0	15.76	ST.42040027
30	190	17.0	16.76	ST.42040030
32	190	17.0	18.06	ST.42040032
36	215	17.5	24.26	ST.42040036
41	235	18.5	29.80	ST.42040041
46	255	20.0	41.00	ST.42040046
50	275	21.0	45.60	ST.42040050
55	300	23.0	54.40	ST.42040055
60	320	24.5	58.60	ST.42040060

Ø (mm)	L (mm)	a (mm)	€/buc.	Cod articol
65	342	27.0	77.30	ST.42040065
70	375	30.0	95.70	ST.42040070
75	375	30.0	105.00	ST.42040075
80	408	34.0	134.00	ST.42040080
85	408	34.0	144.00	ST.42040085
90	445	38.0	174.00	ST.42040090
95	445	38.0	189.00	ST.42040095
100	485	44.0	303.00	ST.42040100
105	485	44.0	349.00	ST.42040105

Chei reglabile, profesionale - DIN 3117, forma B

DIN 3117, ISO 6687, forma B
Material: oțel crom-vanadium, cromat.
Pe dreapta.

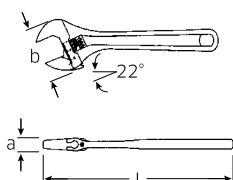

Ø (mm)	Dimensiuni (mm)			€/buc.	Cod articol
	L	b	a		
13	114	33	9	16.76	ST.40250004
20	159	48	12	17.98	ST.40250006
24	206	60	13	21.42	ST.40250008
29	257	71	16	26.60	ST.40250010
34	309	83	19	36.30	ST.40250012
43	384	103	25	57.80	ST.40250015
53	460	120	30	90.30	ST.40250018

Chei profesionale

Chei fixe simple, profesionale - DIN 894

DIN 894

Material: oțel special de scule cu finisare gri.

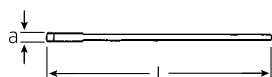

Ø (mm)	L (mm)	a (mm)	€/buc.	Cod articol	Ø (mm)	L (mm)	a (mm)	€/buc.	Cod articol
24	215	8.9	5.55	ST.40040240	80	645	22.0	75.00	ST.40040800
27	238	9.8	6.28	ST.40040270	85	690	23.0	96.40	ST.40040850
30	261	10.8	7.27	ST.40040300	90	690	23.0	113.00	ST.40040900
32	273	11.8	8.34	ST.40040320	95	847	25.0	161.00	ST.40040950
36	300	12.8	11.56	ST.40040360	100	847	25.0	167.00	ST.40041000
41	335	12.8	14.85	ST.40040410	105	1000	28.0	225.00	ST.40041050
46	369	14.8	18.67	ST.40040460	110	1000	28.0	241.00	ST.40041100
50	412	17.0	23.87	ST.40040500	115	1000	28.0	275.00	ST.40041150
55	457	18.0	25.80	ST.40040550	120	1000	28.0	305.00	ST.40041200
60	492	18.0	33.10	ST.40040600	125	1000	28.0	368.00	ST.40041250
65	528	19.0	41.70	ST.40040650	130	1000	28.0	379.00	ST.40041300
70	572	20.0	48.20	ST.40040700	135	1000	28.0	427.00	ST.40041350
75	608	21.0	61.60	ST.40040750					

Chei tubulare profesionale

Stahlwille - siguranta garantata si eficienta

Profesionistii din industrie lucreaza rapid, cu acuratete si eficient, tocmai de aceea au asteptari ridicate de la uneltele lor.



- 1 Maner ergonomic bicomponent, rezistent la impact.
- 2 Toate partile metalice sunt fabricate din oțel aliat, cromat.
- 3 Fixare sigura a cheilor si adaptoarelor.
- 4 Sistem ergonomic pentru schimbarea sensului de rotatie.



AS-drive

Sistemul de actionare "AS-Drive" impiedica alunecarea.

Acest lucru permite o forta mai mare imprimata suruburilor si piulitelor fara a le deteriora



QuickRelease
Sistem de eliberare rapida

Fixarea in sistemul "QuickRelease" asigura o conexiune rapida a tuturor componentelor - nimic nu poate scapa accidental (imaginati-va ce se poate intampla cand o unealta scapa intr-un loc greu accesibil).

Pentru eliberarea sculei este necesara apasarea butonului in mod deliberat.



High Performance Quality

Cheile tubulare **HPQ** sunt fabricate din oțel aliat, special selectat: aceste chei nu vor aluneca de pe capul surubului, rezista la sarcini extrem de ridicate.

Calitate de inalta performanta

Aliajul nu contine cadmiu poate fi utilizat pentru piesele din titan in industria aeronautica unde siguranta este un factor crucial.

Chei tubulare, prindere 1/4, 6 laturi, profesionale, DIN 3124

DIN 3124 / ISO 2725-1

Material: oțel de inalta performanta, cromat.



1/4

6



Ø (mm)	L (mm)	t (mm)	€/buc.	Cod articol	Ø (inch)	L (mm)	t (mm)	€/buc.	Cod articol
3.0	23	15.0	4.02	ST.01010003	1/8	23	15.0	3.49	ST.01410008
3.2	23	15.0	4.02	ST.010100032	3/32	23	15.0	3.79	ST.01410010
3.5	23	15.0	3.83	ST.010100035	3/16	23	15.0	3.64	ST.01410012
4.0	23	15.0	3.41	ST.01010004	7/32	23	15.0	3.68	ST.01410014
4.5	23	15.0	3.56	ST.010100045	1/4	23	15.0	3.68	ST.01410016
5.0	23	15.0	3.41	ST.01010005	3/32	23	13.2	3.68	ST.01410018
5.5	23	15.0	3.41	ST.010100055	3/16	23	13.1	3.72	ST.01410020
6.0	23	15.0	3.41	ST.01010006	11/32	23	13.3	3.75	ST.01410022
7.0	23	13.4	3.41	ST.01010007	3/8	23	13.3	3.75	ST.01410024
8.0	23	13.1	3.41	ST.01010008	7/16	23	14.6	3.98	ST.01410028
9.0	23	12.8	3.56	ST.01010009	1/2	23	14.1	4.33	ST.01410032
10.0	23	14.9	3.52	ST.01010010	3/8	24	14.7	4.44	ST.01410034
11.0	23	14.6	3.56	ST.01010011					
12.0	23	14.3	4.02	ST.01010012					
13.0	23	14.0	3.75	ST.01010013					
14.0	24	14.7	4.40	ST.01010014					

Chei tubulare profesionale

Chei tubulare, prindere 1/4, 12 laturi, profesionale, DIN 3124

DIN 3124 / ISO 2725-1

Material: otel de inalta performanta, cromat.



1/4

12



Ø (mm)	L (mm)	t (mm)	€/buc.	Cod articol
5.0	23	15.0	3.45	ST.01030005
5.5	23	15.0	3.49	ST.010300055
6.0	23	15.0	3.49	ST.01030006
7.0	23	13.4	3.41	ST.01030007
8.0	23	13.1	3.41	ST.01030008
9.0	23	12.8	3.60	ST.01030009
10.0	23	14.9	3.60	ST.01030010
11.0	23	14.6	3.64	ST.01030011
12.0	23	14.3	4.25	ST.01030012
13.0	23	14.0	4.18	ST.01030013
14.0	24	14.7	4.37	ST.01030014

Ø (inch)	L (mm)	t (mm)	€/buc.	Cod articol
5/32	23	15.0	3.83	ST.01530010
3/16	23	15.0	3.52	ST.01530012
7/32	23	15.0	3.60	ST.01530014
1/4	23	15.0	3.60	ST.01530016
9/32	23	13.2	3.60	ST.01530018
5/16	23	13.1	3.72	ST.01530020
11/32	23	13.3	3.75	ST.01530022
3/8	23	13.3	3.75	ST.01530024
7/16	23	14.6	3.98	ST.01530028
1/2	23	14.1	4.18	ST.01530032
9/16	24	14.7	4.37	ST.01530034

Chei tubulare lungi, prindere 1/4, 6 laturi, profesionale, DIN 3124

DIN 3124 / ISO 2725-1

Material: otel de inalta performanta, cromat.



1/4

6

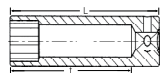

Ø (mm)	L (mm)	t (mm)	€/buc.	Cod articol
4.0	50	42.0	12.32	ST.01020004
4.5	50	42.0	12.32	ST.010200045
5.0	50	42.0	11.63	ST.01020005
5.5	50	42.0	11.63	ST.010200055
6.0	50	42.0	11.63	ST.01020006
7.0	50	40.9	10.87	ST.01020007
8.0	50	40.1	11.02	ST.01020008
9.0	50	39.8	12.17	ST.01020009
10.0	50	41.9	11.10	ST.01020010
11.0	50	41.6	12.17	ST.01020011
12.0	50	41.3	11.48	ST.01020012
13.0	50	41.0	11.33	ST.01020013



Chei tubulare lungi, prindere 1/4, 12 laturi, profesionale, DIN 3124

DIN 3124 / ISO 2725-1

Material: otel de inalta performanta, cromat.



1/4

12

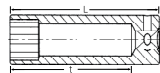

Ø (mm)	L (mm)	t (mm)	€/buc.	Cod articol
5.0	50	42.0	10.79	ST.01240005
5.5	50	42.0	10.87	ST.012400055
6.0	50	42.0	10.79	ST.01240006
7.0	50	40.9	10.79	ST.01240007
8.0	50	40.1	10.79	ST.01240008
9.0	50	39.8	10.79	ST.01240009
10.0	50	41.9	10.79	ST.01240010
11.0	50	41.6	11.33	ST.01240011
12.0	50	41.3	11.33	ST.01240012
13.0	50	41.0	11.33	ST.01240013
14.0	50	40.7	11.33	ST.01240014

Ø (inch)	L (mm)	t (mm)	€/buc.	Cod articol
5/32	50	42.0	10.41	ST.01640010
3/16	50	42.0	10.41	ST.01640012
7/32	50	42.0	10.41	ST.01640014
1/4	50	42.0	10.41	ST.01640016
9/32	50	40.2	10.41	ST.01640018
5/16	50	40.1	10.41	ST.01640020
11/32	50	39.7	10.41	ST.01640022
3/8	50	39.7	10.79	ST.01640024
7/16	50	41.6	10.79	ST.01640028
1/2	50	41.1	10.79	ST.01640032
9/16	50	40.7	10.79	ST.01640034

Chei tubulare cardanice, prindere 1/4, 12 laturi, profesionale

Material: otel de inalta performanta, cromat.



1/4

12

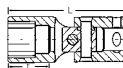

Ø (mm)	L (mm)	t (mm)	€/buc.	Cod articol
6	32.0	10.0	27.10	ST.01140006
7	33.5	11.5	27.10	ST.01140007
8	35.0	13.0	27.10	ST.01140008
9	36.0	12.0	27.10	ST.01140009
10	38.0	14.0	27.10	ST.01140010

Ø (inch)	L (mm)	t (mm)	€/buc.	Cod articol
7/32	32.0	10.0	27.70	ST.01540014
1/4	32.0	10.0	27.10	ST.01540016
9/32	32.0	10.0	27.70	ST.01540018
5/16	35.0	13.0	27.10	ST.01540020
11/32	35.0	11.5	27.70	ST.01540022
3/8	38.0	13.1	27.10	ST.01540024
7/16	39.5	15.0	27.10	ST.01540028
1/2	41.5	16.5	27.10	ST.01540032

Chei tubulare E-Torx, prindere 1/4, profesionale

Pentru suruburi Torx exterior.

Material: otel de inalta performanta, cromat.



1/4



Marime	Ø (mm)	L (mm)	t (mm)	€/buc.	Cod articol
E 4	3.8	23	15	4.82	ST.01270004
E 5	4.7	23	15	4.82	ST.01270005
E 6	5.7	23	15	4.82	ST.01270006
E 7	6.2	23	15	4.82	ST.01270007
E 8	7.5	23	15	4.82	ST.01270008
E 10	9.4	23	15	5.44	ST.01270010



Chei tubulare, prindere 3/8, 6 laturi, profesionale, DIN 3124

DIN 3124 / ISO 2725-1

Material: otel de inalta performanta, cromat.



3/8

6



Ø (mm)	L (mm)	t (mm)	€/buc.	Cod articol
7	24	12.5	5.28	ST.02110007
8	25	13.5	5.09	ST.02110008
9	25	13.5	5.05	ST.02110009
10	27	15.5	5.09	ST.02110010
11	27	13.7	5.17	ST.02110011
12	28	14.4	5.09	ST.02110012
13	30	16.1	5.02	ST.02110013
14	30	15.8	5.32	ST.02110014

Ø (mm)	L (mm)	t (mm)	€/buc.	Cod articol
15	31	19.2	5.48	ST.02110015
16	31	18.9	5.55	ST.02110016
17	31	18.6	5.36	ST.02110017
18	32	19.3	5.55	ST.02110018
19	32	19.0	5.36	ST.02110019
20	34	20.7	7.12	ST.02110020
21	34	20.5	6.58	ST.02110021
22	35	21.2	6.58	ST.02110022

Chei tubulare profesionale

Chei tubulare, prindere 3/8, 12 laturi, profesionale, DIN 3124

DIN 3124 / ISO 2725-1
Material: otel de inalta performanta, cromat.



Ø (mm)	L (mm)	t (mm)	€/buc.	Cod articol	Ø (inch)	L (mm)	t (mm)	€/buc.	Cod articol
7	24	12.5	5.36	ST.02010007	1/4	24	12.5	5.32	ST.02410016
8	25	13.5	4.94	ST.02010008	5/16	25	13.5	5.32	ST.02410020
9	25	13.5	5.02	ST.02010009	11/32	25	13.5	5.32	ST.02410022
10	27	15.5	5.02	ST.02010010	3/8	27	15.5	5.32	ST.02410024
11	27	13.7	5.02	ST.02010011	7/16	28	15.1	5.48	ST.02410028
12	28	14.4	5.02	ST.02010012	1/2	30	16.5	5.48	ST.02410032
13	30	16.1	4.94	ST.02010013	9/16	31	16.8	5.36	ST.02410034
14	30	15.8	5.25	ST.02010014	19/32	31	19.2	6.47	ST.02410035
15	31	19.2	5.32	ST.02010015	5/8	31	18.9	5.82	ST.02410036
16	31	18.9	5.32	ST.02010016	11/16	32	19.5	5.82	ST.02410038
17	31	18.6	5.25	ST.02010017	3/4	32	19.0	6.51	ST.02410040
18	32	19.3	5.32	ST.02010018	13/16	34	20.5	7.62	ST.02410042
19	32	19.0	5.32	ST.02010019	7/8	35	21.0	7.01	ST.02410044
20	34	20.7	6.89	ST.02010020	15/16	35	20.7	8.50	ST.02410046
21	34	20.5	6.32	ST.02010021	1	35	20.2	8.80	ST.02410048
22	35	21.2	6.20	ST.02010022					
24	35	21.2	8.96	ST.02010024					

Chei tubulare lungi, prindere 3/8, 12 laturi, profesionale, DIN 3124

DIN 3124 / ISO 2725-1
Material: otel de inalta performanta, cromat.



Ø (mm)	L (mm)	t (mm)	€/buc.	Cod articol	Ø (inch)	L (mm)	t (mm)	€/buc.	Cod articol
8	54	42.5	11.02	ST.02020008	1/4	54	42.5	11.02	ST.02420016
10	54	42.5	10.26	ST.02020010	5/16	54	42.5	11.02	ST.02420020
11	54	40.7	11.79	ST.02020011	3/8	54	42.5	10.03	ST.02420024
12	54	40.4	10.87	ST.02020012	7/16	54	40.7	10.71	ST.02420028
13	54	40.1	10.26	ST.02020013	1/2	54	40.2	11.25	ST.02420032
14	60	45.8	11.79	ST.02020014	9/16	60	45.8	12.09	ST.02420034
15	60	48.2	12.17	ST.02020015	19/32	60	48.2	12.24	ST.02420035
16	60	47.9	12.40	ST.02020016	5/8	60	47.9	12.09	ST.02420036
17	65	52.6	12.86	ST.02020017	11/16	65	52.5	12.70	ST.02420038
18	65	52.3	14.39	ST.02020018	3/4	65	52.0	12.70	ST.02420040
19	65	52.0	13.62	ST.02020019	13/16	65	51.6	12.40	ST.02420042
21	65	51.5	15.46	ST.02020021	7/8	65	51.2	12.40	ST.02420044
22	65	51.2	15.61	ST.02020022	15/16	65	50.7	13.24	ST.02420046
					1	65	50.2	13.24	ST.02420048

Chei tubulare cardanice, prindere 3/8, 12 laturi, profesionale

Material: otel de inalta performanta, cromat.

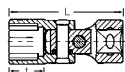

Ø (mm)	L (mm)	t (mm)	€/buc.	Cod articol
10	45.5	12.0	25.80	ST.02040010
11	47.5	14.0	29.80	ST.02040011
12	48.0	14.5	30.00	ST.02040012
13	48.0	14.5	29.30	ST.02040013
14	48.5	14.5	29.00	ST.02040014
15	48.5	14.5	29.00	ST.02040015
16	51.5	17.0	33.40	ST.02040016
17	53.5	18.5	32.70	ST.02040017
18	54.5	18.5	34.20	ST.02040018
19	57.0	21.0	34.20	ST.02040019

Chei tubulare E-Torx, prindere 3/8, profesionale

Pentru suruburi Torx exterior.
Material: otel de inalta performanta, cromat.



Marime	Ø (mm)	L (mm)	t (mm)	€/buc.	Cod articol
E 5	4.7	28	16.5	7.08	ST.02270005
E 6	5.7	28	16.5	7.08	ST.02270006
E 7	6.2	28	16.5	7.08	ST.02270007
E 8	7.5	28	16.5	7.08	ST.02270008
E 10	9.4	28	16.5	7.08	ST.02270010
E 12	11.1	28	16.5	7.08	ST.02270012
E 14	12.9	28	16.5	7.27	ST.02270014



Chei tubulare, prindere 1/2, 6 laturi, profesionale, DIN 3124

DIN 3124 / ISO 2725-1
Material: otel de inalta performanta, cromat.



Ø (mm)	L (mm)	t (mm)	€/buc.	Cod articol	Ø (mm)	L (mm)	t (mm)	€/buc.	Cod articol
8	38	22.0	5.82	ST.03030008	20	42	25.5	6.70	ST.03030020
9	38	22.0	5.93	ST.03030009	21	42	25.2	6.58	ST.03030021
10	38	22.0	4.79	ST.03030010	22	42	24.9	6.09	ST.03030022
11	38	22.0	5.36	ST.03030011	23	42	25.4	7.96	ST.03030023
12	38	22.0	5.28	ST.03030012	24	42	24.9	6.74	ST.03030024
13	38	22.0	4.71	ST.03030013	25	42	24.6	9.26	ST.03030025
14	38	20.5	5.44	ST.03030014	26	42	24.3	8.42	ST.03030026
15	38	20.2	5.21	ST.03030015	27	45	27.0	8.50	ST.03030027
16	38	19.6	5.25	ST.03030016	28	45	26.7	10.56	ST.03030028
17	38	19.6	5.55	ST.03030017	30	45	26.1	9.11	ST.03030030
18	38	19.1	5.93	ST.03030018	32	47	27.6	9.34	ST.03030032
19	38	21.7	5.55	ST.03030019	34	47	27.0	11.48	ST.03030034

Chei tubulare profesionale

Chei tubulare, prindere 1/2, 12 laturi, profesionale, DIN 3124

DIN 3124 / ISO 2725-1

Material: otel de inalta performanta, cromat.

1/2

12



Ø (mm)	L (mm)	t (mm)	€/buc.	Cod articol
8	38	22.0	6.05	ST.03010008
9	38	22.0	6.24	ST.03010009
10	38	22.0	4.79	ST.03010010
11	38	22.0	5.28	ST.03010011

Ø (mm)	L (mm)	t (mm)	€/buc.	Cod articol
12	38	22.0	5.09	ST.03010012
13	38	22.0	4.79	ST.03010013
14	38	20.5	5.21	ST.03010014
15	38	20.2	5.32	ST.03010015
16	38	19.6	5.32	ST.03010016
17	38	19.6	5.67	ST.03010017
18	38	19.1	6.01	ST.03010018
19	38	21.7	5.67	ST.03010019
20	42	25.5	6.66	ST.03010020
21	42	25.2	6.70	ST.03010021
22	42	24.9	6.39	ST.03010022
23	42	25.4	7.96	ST.03010023
24	42	24.9	6.74	ST.03010024
25	42	24.6	9.41	ST.03010025
26	42	24.3	8.65	ST.03010026
27	45	27.0	8.88	ST.03010027
28	45	26.7	10.56	ST.03010028
30	45	26.1	9.49	ST.03010030
31	47	27.9	12.93	ST.03010031
32	47	27.6	9.49	ST.03010032
34	47	27.0	13.47	ST.03010034

Ø (inch)	L (mm)	t (mm)	€/buc.	Cod articol
3/8	38	22.0	5.63	ST.03410024
7/16	38	22.0	5.63	ST.03410028
1/2	38	22.0	5.59	ST.03410032
9/16	38	20.2	5.97	ST.03410034
19/32	38	20.1	6.05	ST.03410035
5/8	38	19.6	5.86	ST.03410036
11/16	38	19.2	6.20	ST.03410038
3/4	38	21.7	6.20	ST.03410040
29/32	41	24.6	6.66	ST.03410041
13/16	41	24.3	6.93	ST.03410042
7/8	42	24.9	7.04	ST.03410044
15/16	42	24.4	7.43	ST.03410046
1	42	24.0	7.58	ST.03410048
1 1/16	45	26.5	9.64	ST.03410050
1 1/8	45	26.0	9.34	ST.03410052
1 3/16	45	25.9	10.03	ST.03410054
1 1/4	45	25.1	10.03	ST.03410056
1 5/16	47	26.7	12.63	ST.03410058
1 3/8	50	29.2	15.61	ST.03410060
1 7/16	54	33.1	17.60	ST.03410062
1 1/2	54	32.8	17.91	ST.03410064

Chei tubulare lungi, prindere 1/2, 12 laturi, profesionale, DIN 3124

DIN 3124 / ISO 2725-1

Material: otel de inalta performanta, cromat.

1/2

12

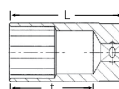

Ø (mm)	L (mm)	t (mm)	€/buc.	Cod articol
10	83	67.0	14.16	ST.03020010
13	83	67.0	12.24	ST.03020013
14	83	65.2	13.77	ST.03020014
15	83	64.9	14.77	ST.03020015
16	83	64.6	14.69	ST.03020016
17	83	64.3	14.08	ST.03020017
18	83	64.1	15.08	ST.03020018
19	83	66.7	13.55	ST.03020019
21	83	66.2	15.61	ST.03020021
22	83	65.5	15.08	ST.03020022
24	83	66.1	15.08	ST.03020024
26	83	65.3	19.89	ST.03020026
27 ^y	83	60.0	16.99	ST.03020027
30 ^y	83	65.0	17.60	ST.03020030
32	83	63.9	19.44	ST.03020032

Ø (inch)	L (mm)	t (mm)	€/buc.	Cod articol
3/8	83	67.0	16.30	ST.03420024
7/16	83	67.0	16.30	ST.03420028
1/2	83	67.0	15.08	ST.03420032
9/16	83	65.2	15.08	ST.03420034
5/8	83	64.6	16.68	ST.03420036
11/16	83	64.2	17.52	ST.03420038
3/4	83	66.7	18.06	ST.03420040
13/16	83	66.3	18.29	ST.03420042
7/8	83	65.9	18.67	ST.03420044
15/16	83	65.7	19.44	ST.03420046
1	83	65.0	21.12	ST.03420048
1 1/16	83	64.5	23.72	ST.03420050
1 1/8	83	64.0	25.10	ST.03420052
1 3/16	83	63.9	22.80	ST.03420054
1 1/4	83	63.1	24.64	ST.03420056
1 5/16	83	62.7	24.26	ST.03420058
1 3/8	83	62.2	25.80	ST.03420060
1 7/16	83	62.1	26.00	ST.03420062
1 1/2	83	61.8	27.10	ST.03420064

Chei tubulare cardanice, 1/2, 6 laturi

Material: otel cromat.

1/2

6

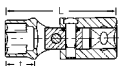

Ø (mm)	L (mm)	t (mm)	€/buc.	Cod articol
10	70	20.0	27.70	ST.03040010
13	70	20.0	29.40	ST.03040013
16	69	17.0	29.10	ST.03040016
17	70	18.0	30.80	ST.03040017
18	70	18.0	29.10	ST.03040018
19	70	17.5	29.00	ST.03040019

Chei tubulare E-Torx, prindere 1/2, profesionale

Material: otel de inalta performanta, cromat.

1/2

E



1/2

E



Marime	Ø (mm)	L (mm)	t (mm)	€/buc.	Cod articol
E 10	9.4	38.0	22.0	7.39	ST.03270010
E 11	10.1	38.0	22.0	7.54	ST.03270011
E 12	11.1	38.0	22.0	7.39	ST.03270012
E 14	12.9	38.0	22.0	7.96	ST.03270014
E 16	14.7	38.0	22.0	7.96	ST.03270016
E 18	16.6	38.0	22.0	8.42	ST.03270018
E 20	18.4	38.0	22.0	8.42	ST.03270020
E 24	22.1	41.2	23.6	11.71	ST.03270024

Set de 8 piese in cutie de plastic.

Set de chei tubulare profesionale E-Torx, 1/2	€/set	Cod articol
E10; E11; E12; E14; E16; E18; E20; E24	82.80	ST.96033704

Chei tubulare, prindere 3/4, 6 laturi, profesionale, DIN 3124

DIN 3124 / ISO 2725-1

Material: otel de inalta performanta, cromat.

AS-Drive si HPQ - pana la marimea 38.

3/4

6



Ø (mm)	L (mm)	t (mm)	€/buc.	Cod articol
19	50	26.0	9.87	ST.05010019
21	50	26.0	10.94	ST.05010021
22	51	25.2	9.87	ST.05010022
24	51	24.6	10.71	ST.05010024
27	54	26.8	11.79	ST.05010027
30	58	33.6	13.09	ST.05010030
32	58	33.0	13.24	ST.05010032
33	60	34.7	17.52	ST.05010033

Ø (mm)	L (mm)	t (mm)	€/buc.	Cod articol
34	60	34.4	15.46	ST.05010034
36	60	33.9	15.76	ST.05010036
38	64	37.3	17.37	ST.05010038
41	67	37.5	22.95	ST.05010041
46	73	43.5	24.56	ST.05010046
50	80	48.5	29.00	ST.05010050
55	80	49.5	39.10	ST.05010055
60	80	50.5	46.70	ST.05010060

Chei tubulare profesionale

Chei tubulare, prindere 3/4, 12 laturi, profesionale

Material: oțel de înaltă performanță, cromat.
AS-Drive și HPQ - până la mărimea 1 1/2.



3/4

12



Ø (inch)	L (mm)	t (mm)	€/buc.	Cod articol	Ø (inch)	L (mm)	t (mm)	€/buc.	Cod articol
3/4	50	26.0	12.17	ST.05410040	1 3/8	59	32.7	17.60	ST.05410060
13/16	51	25.1	12.78	ST.05410042	1 1/16	60	33.2	19.13	ST.05410062
7/8	51	24.5	12.47	ST.05410044	1 1/2	64	36.8	18.21	ST.05410064
15/16	51	24.2	12.47	ST.05410046	1 5/8	67	37.5	27.40	ST.05410066
1	52	24.8	12.63	ST.05410048	1 11/16	70	40.5	28.10	ST.05410067
1 1/16	54	26.2	13.24	ST.05410050	1 3/4	70	40.5	29.40	ST.05410068
1 1/8	57	32.5	15.15	ST.05410052	1 13/16	73	43.5	31.30	ST.05410069
1 1/4	58	32.6	15.99	ST.05410056	1 7/8	76	45.0	31.90	ST.05410070
1 3/16	59	33.1	16.76	ST.05410058	2	80	48.5	33.40	ST.05410072

Chei tubulare, lungi, prindere 3/4, 6 laturi, profesionale, DIN 3124

DIN 3124 / ISO 2725-1
Material: oțel de înaltă performanță, cromat.
AS-Drive și HPQ - până la mărimea 36.



3/4

6

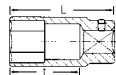

Ø (mm)	L (mm)	t (mm)	€/buc.	Cod articol
22	90	64.2	23.87	ST.05020022
24	90	63.6	22.50	ST.05020024
27	90	62.8	24.79	ST.05020027
30	90	65.6	27.90	ST.05020030
32	90	65.0	29.40	ST.05020032
34	90	64.4	31.10	ST.05020034
36	90	63.9	34.10	ST.05020036
41	90	58.5	42.10	ST.05020041

Chei tubulare, prindere 1", 12 laturi, profesionale, DIN 3124

DIN 3124 / ISO 2725-1
Material: oțel de înaltă performanță, cromat.
AS-Drive și HPQ - până la mărimea 36.



1

12



Ø (mm)	L (mm)	t (mm)	€/buc.	Cod articol
30	65	33.1	19.89	ST.06010030
32	67	34.6	19.97	ST.06010032
34	67	34.0	22.95	ST.06010034
36	67	33.4	21.20	ST.06010036
41	70	37.5	33.60	ST.06010041
46	75	43.5	39.10	ST.06010046
50	80	47.5	45.60	ST.06010050
55	85	49.5	57.80	ST.06010055
60	90	56.5	66.20	ST.06010060

Chei tubulare, prindere 1", 6 laturi, profesionale, DIN 3124

DIN 3124
Material: oțel aliat, cromat.

1

12



Ø (mm)	L (mm)	t (mm)	€/buc.	Cod articol
65	105	68.5	82.70	ST.06010065
70	110	72.5	99.50	ST.06010070
75	115	78.5	111.00	ST.06010075
80	120	83.5	126.00	ST.06010080

Bits cu soclu tubular - prindere 1/4

Slot	Marime	L (mm)	€/buc.	Cod articol
Oțel crom-vanadiu, cromat.	0.6 x 3.5	28	4.94	ST.01280006
	0.8 x 4.0	28	4.94	ST.01280008
	1.0 x 5.5	28	4.94	ST.01280010
	1.2 x 8.0	28	4.94	ST.01280012

Philips	Marime	L (mm)	€/buc.	Cod articol
Oțel crom-vanadiu, cromat.	Ph 1	28	4.94	ST.01290001
	Ph 2	28	4.94	ST.01290002
	Ph 3	28	4.94	ST.01290003
	Ph 4	28	4.94	ST.01290004

Pozidriv	Marime	L (mm)	€/buc.	Cod articol
Oțel crom-vanadiu, cromat.	Pz 1	28	5.44	ST.01300001
	Pz 2	28	5.44	ST.01300002

Torx	Marime	L (mm)	€/buc.	Cod articol
Oțel crom-vanadiu, cromat.	T 8	28	5.82	ST.01350008
	T 9	28	5.82	ST.01350009
	T 10	28	5.82	ST.01350010
	T 15	28	5.82	ST.01350015
	T 20	28	5.82	ST.01350020
	T 25	28	5.82	ST.01350025
	T 27	28	5.78	ST.01350027
	T 30	28	5.82	ST.01350030
	T 40	28	6.47	ST.01350040

TorxTR	Marime	L (mm)	€/buc.	Cod articol
Oțel crom-vanadiu, cromat.	TR 8	28	5.97	ST.01351008
	TR 9	28	5.97	ST.01351009
	TR 10	28	5.97	ST.01351010
	TR 15	28	5.97	ST.01351015
	TR 20	28	5.97	ST.01351020
	TR 25	28	5.97	ST.01351025
	TR 27	28	6.09	ST.01351027
	TR 30	28	5.97	ST.01351030
	TR 40	28	6.09	ST.01351040

Inbus	Marime	L (mm)	€/buc.	Cod articol
Oțel crom-vanadiu, cromat.	SW 3	28	4.94	ST.01120003
	SW 4	28	4.94	ST.01120004
	SW 5	28	4.94	ST.01120005
	SW 6	28	4.94	ST.01120006
	SW 8	28	4.94	ST.01120008
	SW 3	55	7.50	ST.01050003
	SW 4	55	7.50	ST.01050004
	SW 5	55	7.50	ST.01050005
	SW 6	55	7.50	ST.01050006
	SW 1/16	55	9.11	ST.01450004
	SW 5/64	55	8.88	ST.01450005
	SW 3/32	55	8.88	ST.01450006
	SW 1/8	55	8.88	ST.01450007
	SW 3/16	55	8.88	ST.01450008
	SW 1/4	55	8.88	ST.01450009
	SW 5/32	55	8.88	ST.01450010
	SW 3/16	55	8.88	ST.01450012
	SW 7/32	55	8.88	ST.01450014
	SW 1/4	55	8.88	ST.01450016

Antrenor, prindere 1/4, DIN 3122

Maner bicomponent

1/4



Model	Lungime (mm)	€/buc.	Cod articol
Standard	150	7.54	ST.11050010
QuickRelease (eliberare rapidă)	150	8.80	ST.11051010
Flexibil	240	15.23	ST.11051002

Chei tubulare profesionale

Bits cu soclu tubular - prindere 3/8

Inbus	Marime	L (mm)	€/buc.	Cod articol
Otel crom-vanadiu, cromat.				
SW 3	52	7.12	ST.02050003	
SW 4	52	6.85	ST.02050004	
SW 5	52	6.70	ST.02050005	
SW 6	52	6.70	ST.02050006	
SW 7	52	6.85	ST.02050007	
SW 8	52	7.24	ST.02050008	
SW 10	52	7.39	ST.02050010	
SW 4	100	8.34	ST.02151004	
SW 5	100	8.34	ST.02151005	
SW 6	100	8.34	ST.02151006	
SW 8	120	8.65	ST.02151208	
SW 10	120	9.11	ST.02151210	
SW 1/8	52	8.65	ST.02450008	
SW 9/64	52	8.88	ST.02450009	
SW 3/32	52	8.65	ST.02450010	
SW 3/16	52	8.42	ST.02450012	
SW 7/32	52	8.65	ST.02450014	
SW 1/4	52	8.65	ST.02450016	
SW 5/16	52	9.49	ST.02450020	
SW 3/8	52	9.80	ST.02450024	

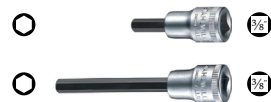

Inbus - lungimi speciale	Marime	L (mm)	€/buc.	Cod articol
Otel crom-vanadiu, cromat.				
SW 7	100	12.86	ST.02151007	
SW 8	24	8.19	ST.02152408	
SW 9	57	7.62	ST.02151009	

Torx	Marime	L (mm)	€/buc.	Cod articol
Otel crom-vanadiu, cromat.				
T 9	49	8.42	ST.02100009	
T 10	49	8.27	ST.02100010	
T 15	49	8.27	ST.02100015	
T 20	49	8.27	ST.02100020	
T 25	49	8.27	ST.02100025	
T 27	49	8.27	ST.02100027	
T 30	49	8.27	ST.02100030	
T 40	49	8.27	ST.02100040	
T 45	49	8.50	ST.02100045	

XZN	Marime	L (mm)	€/buc.	Cod articol
Otel crom-vanadiu, cromat.				
M 5	52	9.18	ST.02060005	
M 6	52	9.18	ST.02060006	
M 8	52	9.18	ST.02060008	
M 10	52	10.33	ST.02060010	
M 8	120	10.18	ST.02261208	
M 10	120	11.02	ST.02261210	



Bits cu soclu tubular - prindere 1/2

Inbus	Marime	L (mm)	€/buc.	Cod articol
Otel crom-vanadiu, cromat.				
SW 4	60	7.16	ST.03050004	
SW 5	60	7.16	ST.03050005	
SW 6	60	7.16	ST.03050006	
SW 7	60	7.16	ST.03050007	
SW 8	60	7.43	ST.03050008	
SW 10	60	8.34	ST.03050010	
SW 12	60	8.80	ST.03050012	
SW 14	60	10.10	ST.03050014	
SW 17	60	11.33	ST.03050017	
SW 19	60	15.53	ST.03050019	
SW 5	120	7.65	ST.03151205	
SW 6	120	7.65	ST.03151206	
SW 7	120	8.34	ST.03151207	
SW 8	120	8.65	ST.03151208	
SW 10	140	9.18	ST.03151410	
SW 12	140	10.79	ST.03151412	
SW 14	140	11.40	ST.03151414	
SW 7/32	60	7.46	ST.03450014	
SW 1/4	60	7.46	ST.03450016	
SW 5/16	60	7.73	ST.03450020	
SW 3/8	60	7.73	ST.03450024	
SW 7/16	60	9.03	ST.03450028	
SW 1/2	60	8.73	ST.03450032	
SW 9/16	60	9.95	ST.03450034	
SW 5/8	60	11.17	ST.03450036	
SW 3/4	60	17.68	ST.03450040	



Inbus - lungimi speciale	Marime	L (mm)	€/buc.	Cod articol
Otel crom-vanadiu, cromat.				
SW5	180	14.77	ST.03151805	
SW6	70	7.65	ST.03150706	
SW6*)	100	13.32	ST.03151006	
SW6	220	15.84	ST.03152206	
SW7	100	13.32	ST.03151007	
SW8	80	11.63	ST.03150808	
SW8	140	14.16	ST.03151408	
SW13	70	20.12	ST.03150713	

Inbus-Pin	Marime	L (mm)	€/buc.	Cod articol
Otel crom-vanadiu, cromat.				
SW 5	60	8.50	ST.03070005	
SW 6	60	8.50	ST.03070006	
SW 8	60	9.41	ST.03070008	
SW 10	60	9.87	ST.03070010	
SW 12	60	11.48	ST.03070012	
SW 14	60	11.79	ST.03070014	

Inbus cu cap sferic	Marime	L (mm)	€/buc.	Cod articol
Otel crom-vanadiu, cromat.				
SW 5	100	9.57	ST.03280005	
SW 6	100	9.57	ST.03280006	
SW 7	100	10.56	ST.03280007	
SW 8	100	10.18	ST.03280008	
SW 10	100	11.17	ST.03280010	
SW 5	238	15.69	ST.03310005	
SW 8	238	17.60	ST.03310008	



Bits cu soclu tubular - prindere 1/2

Torx	Marime	L (mm)	€/buc.	Cod articol
Otel crom-vanadiu, cromat.				
TX 20	55	9.57	ST.03100020	
TX 25	55	9.11	ST.03100025	
TX 27	55	9.11	ST.03100027	
TX 30	55	8.73	ST.03100030	
TX 40	55	10.10	ST.03100040	
TX 45	55	10.10	ST.03100045	
TX 50	55	9.95	ST.03100050	
TX 55	58	13.09	ST.03100055	
TX 60	58	12.93	ST.03100060	
TX 70	60	17.75	ST.03100070	
TX 30	120	10.18	ST.03131230	
TX 40	120	14.85	ST.03131240	
TX 40	140	11.56	ST.03131440	
TX 45	120	14.92	ST.03131245	
TX 45	140	11.56	ST.03131445	
TX 50	140	12.47	ST.03131450	
TX 55	140	12.93	ST.03131455	
TX 60	140	15.53	ST.03131460	
TX 70	107	20.51	ST.03131070	



TorxTR	Marime	L (mm)	€/buc.	Cod articol
Otel crom-vanadiu, cromat.				
20	55	10.56	ST.03110020	
25	55	10.41	ST.03110025	
27	55	10.41	ST.03110027	
30	55	10.41	ST.03110030	
40	55	10.79	ST.03110040	
45	55	10.79	ST.03110045	
50	55	11.56	ST.03110050	
55	58	13.55	ST.03110055	
60	58	14.85	ST.03110060	

XZN	Marime	L (mm)	€/buc.	Cod articol
Otel crom-vanadiu, cromat.				
M 5	60	8.88	ST.03060005	
M 6	60	8.88	ST.03060006	
M 8	60	8.88	ST.03060008	
M 10	60	10.41	ST.03060010	
M 12	60	11.33	ST.03060012	
M 14	60	11.86	ST.03060014	
M 16	60	12.93	ST.03060016	
M 8	80	12.24	ST.03160808	
M 8	120	13.39	ST.03161208	
M 8	140	9.41	ST.03261408	
M 10	110	12.78	ST.03161110	
M 10	140	13.24	ST.03261410	
M 12	110	14.31	ST.03161112	
M 12	140	12.63	ST.03261412	
M 14	140	14.77	ST.03261414	

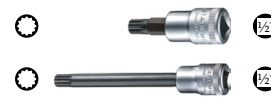

Chei tubulare profesionale

Cap de prindere pentru bits

DIN 3126, ISO 1176 D6.3
Otel de inalta performanta.
Cu arc de retinere.



$\frac{1}{4}$ Pentru bits C 6.3 (1/4")

\square	Lungime (mm)	€/buc.	Cod articol
$\frac{1}{4}$	25	12.40	ST.11180010
$\frac{3}{8}$	32	13.93	ST.12180026
$\frac{1}{2}$	38	17.45	ST.13180010

Suport metalic pentru chei tubulare

Pentru fixarea cheilor tubulare.
Se livreaza fara chei.



\square	Lungime (mm)	€/buc.	Cod articol
$\frac{1}{4}$	200	4.75	ST.80400001
	300	4.75	ST.80400002
$\frac{3}{8}$	200	4.75	ST.80450001
	300	4.75	ST.80450002
$\frac{1}{2}$	200	4.59	ST.80500001
	300	4.59	ST.80500002

Prelungitoare pentru chei tubulare, profesionale

DIN 3123, ISO 3316
Otel crom-vanadiu, cromat.

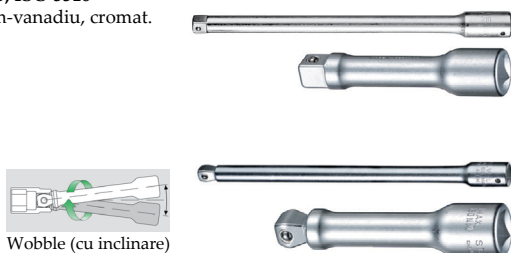

Wobble (cu inclinare)

Mama \square	Tata \square	Tip	Lungime (mm)	€/buc.	Cod articol
$\frac{1}{4}$	$\frac{1}{4}$	Standard	54	5.25	ST.11010001
			100	5.44	ST.11010006
			150	5.82	ST.11010002
			254	7.96	ST.11010010
			356	9.41	ST.11010014
		Wobble (16°)	54	6.09	ST.11010011
			100	7.01	ST.11010016
			150	7.24	ST.11010012
			254	9.41	ST.11010020
			356	10.87	ST.11010024
$\frac{3}{8}$	$\frac{3}{8}$	Standard	38	8.34	ST.12010005
			76	8.57	ST.12010001
			125	9.11	ST.12010006
			160	9.64	ST.12010002
			240	10.87	ST.12010003
		Wobble (30°)	455	30.30	ST.12010004
			76	10.56	ST.12010007
			125	11.94	ST.12010008
			160	12.63	ST.12010009
			255	11.79	ST.13010003
$\frac{1}{2}$	$\frac{1}{2}$	Standard	52	8.04	ST.13010001
			75	8.57	ST.13010004
			130	8.88	ST.13010002
			255	11.79	ST.13010003
		Wobble (30°)	52	9.87	ST.13010005
			75	10.79	ST.13010006
			130	12.32	ST.13010007
			255	15.08	ST.13010008
$\frac{3}{4}$	$\frac{3}{4}$	Standard	95	20.12	ST.15010003
			200	21.65	ST.15010001
			400	34.50	ST.15010002
1	1	Standard	200	43.70	ST.16010001
			410	60.90	ST.16010002

Intermediar cardanic profesional

DIN 3123, ISO 3316
Otel crom-vanadiu, cromat.



\square	Lungime (mm)	€/buc.	Cod articol
$\frac{1}{4}$	37	16.91	ST.11020000
$\frac{3}{8}$	46	19.44	ST.12020000
$\frac{1}{2}$	71	20.35	ST.13020000
$\frac{3}{4}$	109	70.40	ST.15020000

Adaptoare pentru chei tubulare, profesionale

DIN 3123, ISO 3316
Otel de inalta performanta.



Mama \square	Tata \square	Lungime (mm)	€/buc.	Cod articol
$\frac{1}{4}$	$\frac{3}{8}$	25	6.74	ST.11030002
$\frac{1}{4}$	$\frac{1}{2}$	28	9.95	ST.11030003
$\frac{3}{8}$	$\frac{1}{4}$	28	7.50	ST.12030001
$\frac{3}{8}$	$\frac{1}{2}$	31	7.46	ST.12030003
$\frac{1}{2}$	$\frac{3}{8}$	35	7.88	ST.13030002
$\frac{1}{2}$	$\frac{3}{4}$	44	9.95	ST.13030005
$\frac{3}{4}$	$\frac{1}{2}$	55	19.28	ST.15030003
$\frac{3}{4}$	1	61	20.58	ST.15030006
1	$\frac{3}{4}$	70	25.80	ST.16030005

Adaptoare pentru chei tubulare



Setul este compus din:
 $\frac{1}{4}$ mama / $\frac{3}{8}$ tata
 $\frac{3}{8}$ mama / $\frac{1}{2}$ tata
 $\frac{1}{2}$ mama / $\frac{3}{4}$ tata

Mama \square	Tata \square	Lungime (mm)	€/buc.	Cod articol
$\frac{1}{4}$	$\frac{3}{8}$	13	12.24	ST.11030010
$\frac{3}{8}$	$\frac{1}{2}$	16	14.77	ST.12030010
$\frac{1}{2}$	$\frac{3}{4}$	22	18.82	ST.13030010
Set de 3 adaptoare			45.90	ST.96121002

Coarba de actionare profesionala

DIN 3123, ISO 3316
Pentru o putere axiala marita
Maner detasabil.



\square	Lungime (mm)	Raza de lucru (mm)	€/buc.	Cod articol
$\frac{1}{4}$	140	70	44.80	ST.11100001
$\frac{3}{8}$	408	85	57.80	ST.12100002
$\frac{1}{2}$	456	105	75.00	ST.13100002

Prelungitor flexibil profesional

DIN 3123



\square	Lungime (mm)	Cuplu max. (Nm)	€/buc.	Cod articol
$\frac{1}{4}$	152	5	13.70	ST.11040000
$\frac{3}{8}$	194	7	20.28	ST.12040000

Antrenoare "T" pentru chei tubulare, profesionale

DIN 3122, ISO 3315
Otel crom-vanadiu, cromat.



\square	Tip	Lungime (mm)	€/buc.	Cod articol
$\frac{1}{4}$	Sistem complet	116	7.20	ST.11070000
$\frac{3}{8}$		165	10.87	ST.12070000
$\frac{1}{2}$		300	14.16	ST.13070000
$\frac{3}{4}$	Cap de antrenare	61	17.68	ST.15070000
	Bara de actionare	510	20.91	ST.15170000
	Cap de antrenare	80	30.10	ST.16070000
1	Bara de actionare	700	37.80	ST.16170000

Chei tubulare profesionale

Antrenor cardanic profesional

DIN 3122, ISO 3315
Maner bicomponent.



□	Lungime (mm)	€/buc.	Cod articol
¼	154	22.11	ST.11061010
⅜	253	31.80	ST.12061010
½	397	37.20	ST.13061015
	469	55.10	ST.13061018
	610	62.00	ST.13061024

Antrenor cu clicket, dinti fini, profesional

DIN 3122, ISO 3315

Permite schimbarea sensului de rotatie.
Ideal pentru utilizarea in spatii inguste.
60 de dinti.
Angrenare la o miscare de 6°.
Maner bicomponent.

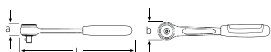

□	Dimensiuni (mm)			Dinti	€/buc.	Cod articol
	L	b	a			
¼	118	24	19.5	60	30.30	ST.11231011
⅜	194	32	24.0	60	35.30	ST.12231011
½	265	40	26.2	60	39.10	ST.13231011

Antrenor cu clicket, reversibil, profesional

DIN 3122, ISO 3315

Cu parghie de actionare pentru schimbarea sensului de rotatie.
Maner bicomponent.

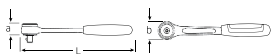

□	Dimensiuni (mm)			Dinti	€/buc.	Cod articol
	L	b	a			
¼	117	22	13	22	38.10	ST.11111010
⅜	193	29	18	30	42.50	ST.12111010
½	265	41	22	36	48.20	ST.13111010
	380				67.00	ST.13121010

Antrenor cu clicket, reversibil, cu eliberare rapida, profesional

DIN 3122, ISO 3315

Cu parghie de actionare pentru schimbarea sensului de rotatie.
Eliberare rapida.
Maner bicomponent.

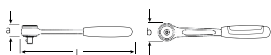

□	Dimensiuni (mm)			Dinti	€/buc.	Cod articol
	L	b	a			
¼	117	22	13	22	41.40	ST.11110020
	153				50.50	ST.11110153
⅜	193	29	18	30	45.20	ST.12110020

Antrenor cu clicket, reversibil, cu eliberare rapida, profesional

DIN 3122, ISO 3315

Cu parghie de actionare pentru schimbarea sensului de rotatie.
Eliberare rapida.



□	Dimensiuni (mm)			Dinti	€/buc.	Cod articol
	L	b	a			
¼	117	22	13	22	42.90	ST.11110030
⅜	193	29	18	30	47.90	ST.12110030
½	265	41	22	36	55.10	ST.13110030

Antrenor cardanic cu clicket, reversibil, profesional

Permite schimbarea sensului de rotatie.
60 de dinti.
Manerul poate fi ridicat sau coborat.

Pozitii de blocare:
drept, sus 30° sau 60°, jos 30°.



□	Dimensiuni (mm)			Dinti	€/buc.	Cod articol
	L	b	a			
¼	170	25	19	60	58.60	ST.11260001
⅜	300	34	24	60	58.20	ST.12260001
½	415	43	26	60	66.60	ST.13260001

Antrenor cu clicket, dinti fini, reversibil, cu eliberare rapida, profesional

DIN 3122, ISO 3315



- Cu parghie de actionare pentru schimbarea sensului de rotatie.
- Ideal pentru utilizarea in spatii inguste.
- 80 de dinti.
- Angrenare la o miscare de 4.5°.
- Constructie capsulata, fara suruburi (protectie sporita impotriva prafului).
- Eliberare rapida.
- Maner bicomponent.

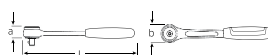

□	Dimensiuni (mm)			Dinti	€/buc.	Cod articol
	L	b	a			
¼	117	22	10.7	80	43.70	ST.11111020
⅜	193	30	15.0	80	48.20	ST.12111020
½	265	41	23.0	80	54.30	ST.13111020



Sisteme de actionare

Bara de actionare este compatibila cu oricare din capetele de antrenare.



Capul de antrenare cu clicket este reversibil, 36 dinti, cu parghie de actionare pentru schimbarea sensului de rotatie. Eliberare rapida.

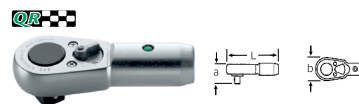

Cap de antrenare cardanic.



Cap de antrenare glisant.



Denumire	□	Dimensiuni (mm)			€/buc.	Cod articol
		L	b	a		
Bara de actionare	¼	510	-	-	20.91	ST.15170000
	1	700	-	-	37.80	ST.16170000
Cap de antrenare glisant	¼	61	-	-	17.68	ST.15070000
	1	80	-	-	30.10	ST.16070000
Cap de antrenare cu clicket	¼	165	70	55	107.00	ST.15110000
	1	185	70	60	135.00	ST.16110000
Cap de antrenare cardanic	¼	132	-	-	41.40	ST.15060000
	1	195	-	-	93.40	ST.16060000

Chei tubulare profesionale

Trusa de chei tubulare - antrenor 1/4 - 40/20/4 SCI

Trusa cu 24 piese in husa textila.

- 10 chei tubulare HEX, 6 laturi: 5; 5.5; 6; 7; 8; 9; 10; 11; 12; 13 mm
- 10 bits: Ph1; Ph2; SW 4; SW 5; SW 6 T10; T15; T20; T25; T30
- 1 antrenor cu clichet reversibil, 22 dinti, cu eliberare rapida
- 2 extensii 54 / 150 mm
- 1 cap magnetic pentru bits



6	1/4	€/trusa	Cod articol
		139.00	ST.96010127

Trusa de chei tubulare - antrenor 1/4 - 40/9/4

Trusa cu 13 piese in cutie de plastic.

Continut:

- 9 chei tubulare HEX, 6 laturi: 4; 5; 5.5; 6; 7; 8; 10; 11; 13 mm
- 1 antrenor profesional cu clichet, reversibil
- 2 prelungitoare profesionale pentru chei tubulare (54 / 150 mm)
- 1 intermediar cardanic profesional



6	1/4	€/trusa	Cod articol
		113.00	ST.96011119

Trusa de chei tubulare - antrenor 1/4 - 40/13/6

Trusa cu 19 piese in cutie de plastic.

Continut:

- 13 chei tubulare HEX cu 6 laturi: 3.5; 4; 4.5; 5; 5.5; 6; 7; 8; 9; 10; 11; 12; 13 mm
- 1 antrenor profesional cu clichet, reversibil
- 2 prelungitoare profesionale pentru chei tubulare (54 / 150 mm)
- 1 intermediar cardanic profesional
- 1 antrenor 1/4
- 1 antrenor "T" profesional pentru chei tubulare



6	1/4	€/trusa	Cod articol
		141.00	ST.96011124

Trusa de chei tubulare - antrenor 1/4 - 40/44/17/5

Trusa cu 22 piese in cutie de plastic.

Continut:

- 13 chei tubulare HEX, 6 laturi: 3.5; 4; 4.5; 5; 5.5; 6; 7; 8; 9; 10; 11; 12; 13 mm
- 4 chei tubulare pentru bits Inbus: SW3; SW4; SW5; SW6 mm
- 1 antrenor profesional cu clichet, reversibil
- 1 prelungitor profesional pentru chei - 150 mm
- 1 intermediar cardanic profesional
- 1 antrenor 1/4
- 1 antrenor "T" profesional pentru chei tubulare



6	1/4	€/trusa	Cod articol
		167.00	ST.96011113



QuickRelease
Sistem de eliberare rapida

Fixarea in sistemul "QuickRelease" asigura o conexiune rapida a tuturor componentelor - nimic nu poate scapa accidental (imaginati-va ce se poate intampla cand o unealta scapa intr-un loc greu accesibil).

Pentru eliberarea sculei este necesara apasarea butonului in mod deliberat.

Trusa de chei tubulare - antrenor 1/4 - 40D/9/4

Trusa cu 13 piese in cutie de plastic.

Continut:

- 9 chei tubulare HEX, 12 laturi: 4; 5; 5.5; 6; 7; 8; 10; 11; 13 mm
- 1 antrenor profesional cu clichet, reversibil
- 2 prelungitoare profesionale pentru chei tubulare (54 / 150 mm)
- 1 intermediar cardanic profesional

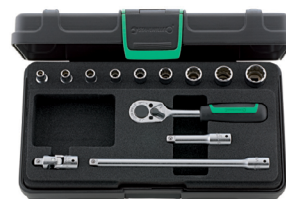

12	1/4	€/trusa	Cod articol
		114.00	ST.96011304

Trusa de chei tubulare - antrenor 1/4 - 40/13/6QR

Trusa cu 19 piese in cutie de plastic.

Continut:

- 13 chei tubulare HEX cu 6 laturi: 3.5; 4; 4.5; 5; 5.5; 6; 7; 8; 9; 10; 11; 12; 13 mm
- 4 chei tubulare pentru bits Inbus: SW3; SW4; SW5; SW6 mm
- 1 antrenor profesional cu clichet, dinti fini, reversibil, cu eliberare rapida
- 2 prelungitoare profesionale pentru chei tubulare (54 / 150 mm)
- 1 intermediar cardanic profesional cu eliberare rapida
- 1 antrenor 1/4 cu eliberare rapida
- 1 antrenor "T" profesional pentru chei tubulare cu eliberare rapida



QR	6	1/4	€/trusa	Cod articol
			153.00	ST.96011180

Trusa de chei tubulare - antrenor 1/4 - 40/44/17/5QR

Trusa cu 22 piese in cutie de plastic.

Continut:

- 13 chei tubulare HEX, 6 laturi: 3.5; 4; 4.5; 5; 5.5; 6; 7; 8; 9; 10; 11; 12; 13 mm
- 4 chei tubulare pentru bits Inbus: SW3; SW4; SW5; SW6 mm
- 1 antrenor profesional cu clichet, dinti fini, reversibil, cu eliberare rapida
- 1 prelungitor profesional pentru chei - 150 mm
- 1 intermediar cardanic profesional cu eliberare rapida
- 1 antrenor cu eliberare rapida
- 1 antrenor "T" profesional pentru chei tubulare cu eliberare rapida



QR	6	1/4	€/trusa	Cod articol
			176.00	ST.96011181

Chei tubulare profesionale

Trusa de chei tubulare - antrenor 1/4 - 40/23/7

Trusa cu 30 piese in cutie de plastic.

Continut:

- 12 chei tubulare HEX, 6 laturi: 4; 4.5; 5; 5.5; 6; 7; 8; 9; 10; 11; 12; 13 mm
- 4 chei tubulare pentru bits Inbus: SW3; SW4; SW5; SW6 mm
- 3 bits Pozidriv - Ph1, Ph2, Ph3
- 4 bits Slot: 0.6 x 3.5; 0.8 x 4.0; 1.0 x 5.5; 1.6 x 8.0 mm
- 1 antrenor profesional cu clicket, reversibil
- 2 prelungitoare profesionale pentru chei tubulare (54 / 150 mm)
- 1 intermediar cardanic profesional
- 1 antrenor 1/4
- 1 antrenor "T" profesional pentru chei tubulare
- 1 cap de prindere pentru bits



6	1/4	€/trusa	Cod articol
		196.00	ST.96011134

Trusa de chei tubulare - antrenor 1/4 - 40D/23/7

Trusa cu 30 piese in cutie de plastic.

Continut:

- 12 chei tubulare HEX, 12 laturi: 4; 4.5; 5; 5.5; 6; 7; 8; 9; 10; 11; 12; 13 mm
- 4 chei tubulare pentru bits Inbus: SW3; SW4; SW5; SW6 mm
- 3 bits Pozidriv - Ph1, Ph2, Ph3
- 4 bits Slot: 0.6 x 3.5; 0.8 x 4.0; 1.0 x 5.5; 1.6 x 8.0 mm
- 1 antrenor profesional cu clicket, reversibil
- 2 prelungitoare profesionale pentru chei tubulare (54 / 150 mm)
- 1 intermediar cardanic profesional
- 1 antrenor 1/4
- 1 antrenor "T" profesional pentru chei tubulare
- 1 cap de prindere pentru bits

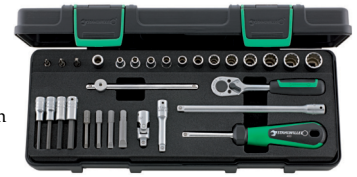

12	1/4	€/trusa	Cod articol
		196.00	ST.96011305

Trusa de chei tubulare - antrenor 1/4 - 40/24/6

Trusa cu 30 piese in cutie de plastic.

Continut:

- 12 chei tubulare HEX, 6 laturi: 4; 5; 5.5; 6; 7; 8; 9; 10; 11; 12; 13; 14 mm
- 3 bits slot: 0.6 x 3.5; 1.0 x 5.5; 1.2 x 8 mm
- 5 bits Inbus: SW3; SW4; SW5; SW6; SW8 mm
- 2 bits Ph1; Ph2
- 2 bits Pz1; Pz2
- 1 antrenor profesional cu clicket, cu dinti fini, reversibil
- 2 prelungitoare profesionale pentru chei tubulare (54 / 150 mm)
- 1 intermediar cardanic profesional
- 1 antrenor 1/4
- 1 antrenor "T" profesional pentru chei tubulare



6	1/4	€/trusa	Cod articol
		198.00	ST.96011138

Trusa de chei tubulare - antrenor 1/4 - 40/24/6QR

Trusa cu 30 piese in cutie de plastic.

Continut:

- 12 chei tubulare HEX, 6 laturi: 4; 5; 5.5; 6; 7; 8; 9; 10; 11; 12; 13; 14 mm
- 3 bits Slot: 0.6 x 3.5; 1.0 x 5.5; 1.2 x 8 mm
- 5 bits Inbus: SW3; SW4; SW5; SW6; SW8 mm
- 2 bits Philips: Ph1; Ph2
- 2 bits Pozidriv: Pz1; Pz2
- 1 antrenor profesional cu clicket, cu dinti fini, reversibil, cu eliberare rapida
- 2 prelungitoare profesionale pentru chei tubulare, cu eliberare rapida (54 / 150 mm)
- 1 intermediar cardanic profesional cu eliberare rapida
- 1 antrenor 1/4 cu eliberare rapida
- 1 antrenor "T" profesional pentru chei tubulare cu eliberare rapida



QR	6	1/4	€/trusa	Cod articol
			206.00	ST.96011182

Trusa de chei tubulare - antrenor 1/4 - 40ma/25/8

Trusa cu 33 piese in cutie de plastic.

Continut:

- 25 chei tubulare HEX, 6 laturi: 3.2; 3.5; 4; 4.5; 5; 5.5; 6; 7; 8; 9; 10; 11; 12; 13; 14 mm; 3/16; 7/32; 1/4; 5/32; 3/16; 11/32; 3/8; 7/16; 1/2; 5/8 inch.
- 1 antrenor profesional cu clicket, reversibil
- 2 prelungitoare profesionale pentru chei tubulare (54 / 150 mm)
- 1 prelungitor flexibil profesional (152 mm)
- 1 intermediar cardanic profesional
- 1 antrenor 1/4
- 1 antrenor flexibil
- 1 antrenor "T" profesional pentru chei tubulare



6	1/4	€/trusa	Cod articol
		236.00	ST.96011162

Trusa de chei tubulare - antrenor 1/4 - 88TX

Trusa cu 36 piese in cutie de plastic.

Continut:

- 10 chei tubulare HEX, 6 laturi: 5; 5.5; 6; 7; 8; 9; 10; 11; 12; 13 mm
- 6 chei tubulare, Torx exterior: E4; E5; E6; E7; E8; E10
- 5 bits Inbus: SW3; SW4; SW5; SW6; SW8 mm
- 9 bits Torx: T8; T9; T10; T15; T20; T25; T27; T30; T40
- 1 antrenor profesional cu clicket, reversibil
- 2 prelungitoare profesionale pentru chei tubulare (54 / 150 mm)
- 1 intermediar cardanic profesional
- 1 antrenor 1/4
- 1 antrenor "T" profesional pentru chei tubulare



6	1/4	€/trusa	Cod articol
		235.00	ST.98819801

Trusa de chei tubulare - antrenor 1/4 - 40a/9/4

Trusa cu 13 piese in cutie de plastic.

Continut:

- 9 chei tubulare HEX, 6 laturi: 3/16; 7/32; 1/4; 5/32; 3/16; 11/32; 3/8; 7/16; 1/2 inch
- 1 antrenor profesional cu clicket, reversibil
- 2 prelungitoare profesionale pentru chei tubulare (54 / 150 mm)
- 1 intermediar cardanic profesional



6	1/4	€/trusa	Cod articol
		114.00	ST.96015107

Trusa de chei tubulare - antrenor 1/4 - 40aD/9/4

Trusa cu 13 piese in cutie de plastic.

Continut:

- 9 chei tubulare HEX, 6 laturi: 3/16; 7/32; 1/4; 5/32; 3/16; 11/32; 3/8; 7/16; 1/2 inch
- 1 antrenor profesional cu clicket, reversibil
- 2 prelungitoare profesionale pentru chei tubulare (54 / 150 mm)
- 1 intermediar cardanic profesional



12	1/4	€/trusa	Cod articol
		114.00	ST.96016302

Chei tubulare profesionale

Trusa de chei tubulare - antrenor 1/4 - 40aD/12/7QR

Trusa cu 19 piese in cutie de plastic.

Continut:

- 1 cheie tubulara HEX, 6 laturi: 1/8 inch
- 11 chei tubulare HEX, 12 laturi: 5/32; 3/16; 7/32; 1/4; 5/32; 5/16; 11/32; 3/8; 7/16; 1/2; 5/8 inch
- 1 antrenor cu clichet reversibil, cu eliberare rapida
- 3 prelungitoare profesionale pentru chei tubulare cu eliberare rapida (2 x 54 / 1 x 150 mm)
- 1 intermediar cardanic profesional cu eliberare rapida
- 1 antrenor 1/4 cu eliberare rapida
- 1 cap de prindere pentru bits



€/trusa	Cod articol
168.00	ST.96015208

Trusa de chei tubulare - antrenor 1/4 - 40aD/30/7QR

Trusa cu 37 piese in cutie de plastic.

Continut:

- 1 cheie tubulara HEX, 6 laturi: 1/8 inch
- 11 chei tubulare HEX, 12 laturi: 5/32; 3/16; 7/32; 1/4; 5/32; 5/16; 11/32; 3/8; 7/16; 1/2; 5/8 inch
- 11 chei tubulare HEX lungi, 12 laturi: 5/32; 3/16; 7/32; 1/4; 5/32; 5/16; 11/32; 3/8; 7/16; 1/2; 5/8 inch
- 7 chei tubulare cardanice, 12 laturi: 1/4; 5/32; 3/16; 11/32; 3/8; 7/16; 1/2 inch
- 1 antrenor cu clichet reversibil, cu eliberare rapida
- 3 prelungitoare profesionale pentru chei tubulare cu eliberare rapida (2 x 54 / 1 x 150 mm)
- 1 intermediar cardanic profesional cu eliberare rapida
- 1 antrenor 1/4 cu eliberare rapida
- 1 cap de prindere pentru bits

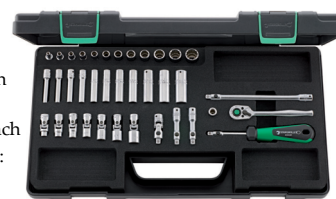

€/trusa	Cod articol
480.00	ST.96015205

Trusa de chei tubulare - antrenor 1/4; 3/8 - 40/45/36/12

Trusa cu 48 piese in cutie de plastic.

Continut:

- 8 chei tubulare HEX, 6 laturi - **prindere 1/4**: 4; 4.5; 5; 5.5; 6; 7; 8; 9 mm
- 12 schein tubulare HEX, 12 laturi - **prindere 1/4**: 10; 11; 12; 13; 14; 15; 16; 17; 18; 19; 21; 22 mm
- 1 cheie pentru bujii de 16 mm - **prindere 3/8**
- 3 bits Philips: Ph1; Ph2; Ph3: size 1; 1222:
- 1 bit Pozidriv: Pz2
- 6 bits Slot: 0.5 x 3; 0.6 x 3.5; 0.8 x 4; 1.0 x 5.5; 1.2 x 6.5; 1.6 x 8
- 5 bits Inbus: SW3; SW4; SW5; SW6; SW8
- 1 antrenor cu clichet, reversibil - **prindere 1/4**

- 1 antrenor cu clichet, reversibil - **prindere 3/8**
- 1 prelungitor profesional pentru chei tubulare - **prindere 1/4** (150 mm)
- 2 prelungitoare profesionale pentru chei tubulare - **prindere 3/8** (76, 240 mm)
- 1 intermediar cardanic profesional - **prindere 1/4**
- 1 intermediar cardanic profesional - **prindere 3/8**
- 1 antrenor - **prindere 1/4**
- 1 antrenor "T" - **prindere 1/4**
- 1 cap de prindere pentru bits - **prindere 1/4**
- 1 cap de prindere pentru bits - **prindere 3/8**
- 1 adaptor de la 3/8 la 1/4

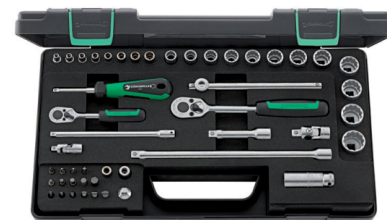

€/trusa	Cod articol
348.00	ST.96012047

Trusa de chei tubulare - antrenor 1/4; 1/2 - 40/52/27/11

Trusa cu 38 piese in cutie de plastic.

Continut:

- 9 chei tubulare HEX, **prindere 1/4**: 4; 5; 5.5; 6; 7; 8; 9; 10; 11 mm
- 10 chei tubulare HEX, **prindere 1/2**: 13; 16; 17; 18; 19; 21; 22; 24; 27; 30 mm
- 3 chei tubulare pentru bits Inbus - **prindere 1/4**: SW3; SW4; SW5 mm
- 5 chei tubulare pentru bits Inbus - **prindere 1/2**: SW6; SW8; SW10; SW12; SW14 mm
- 1 antrenor cu clichet, reversibil - **prindere 1/4**
- 1 antrenor cu clichet, reversibil - **prindere 1/2**

- 2 prelungitoare profesionale pentru chei tubulare - **prindere 1/4** (54, 150 mm)
- 2 prelungitoare profesionale pentru chei tubulare - **prindere 1/2** (130, 255 mm)
- 1 intermediar cardanic profesional - **prindere 1/4**
- 1 intermediar cardanic profesional - **prindere 1/2**
- 1 antrenor 1/4
- 1 antrenor "T" - **prindere 1/4**
- 1 antrenor "T" - **prindere 1/2**



€/trusa	Cod articol
375.00	ST.96011160

Trusa de chei tubulare - antrenor 1/4; 1/2 - 86TX

Trusa cu 63 piese in cutie de plastic.

Continut:

- 9 chei tubulare HEX - **prindere 1/4**: 4; 5; 5.5; 6; 7; 8; 9; 10; 11 mm
- 10 chei tubulare HEX - **prindere 1/2**: 13; 16; 17; 18; 19; 21; 22; 24; 27; 30 mm
- 5 chei tubulare, E-Torx - **prindere 1/4**: E4; E5; E6; E7; E8
- 7 chei tubulare, E-Torx - **prindere 1/2**: E10; E12; E14; E16; E18; E20; E24
- 3 chei tubulare pentru bits Inbus - **prindere 1/4**: SW3; SW4; SW5 mm
- 5 chei tubulare pentru bits Inbus - **prindere 1/2**: SW6; SW8; SW10; SW12; SW14 mm
- 6 bits cu soclu tubular Torx - **prindere 1/4**: T8; T9; T10; T15; T20; T25

- 7 bits cu soclu tubular Torx - **prindere 1/2**: T27; T30; T40; T45; T50; T55; T60
- 1 antrenor cu clichet, reversibil - **prindere 1/4**
- 1 antrenor cu clichet, reversibil - **prindere 1/2**
- 2 prelungitoare profesionale pentru chei tubulare - **prindere 1/4** (54, 150 mm)
- 2 prelungitoare profesionale pentru chei tubulare - **prindere 1/2** (130, 255 mm)
- 1 intermediar cardanic profesional - **prindere 1/4**
- 1 intermediar cardanic profesional - **prindere 1/2**
- 1 antrenor 1/4
- 1 antrenor "T" - **prindere 1/4**
- 1 antrenor "T" - **prindere 1/2**



€/trusa	Cod articol
573.00	ST.96013702

Chei tubulare profesionale

Trusa de chei tubulare - antrenor 1/4; 3/8; 1/2 - 89TX

Trusa cu 35 piese in cutie de plastic.

Continut:

- 3 chei tubulare E-Torx - **prindere 1/4**: E4; E5; E6
- 2 bits Torx cu soclu tubular - **prindere 1/4**: T8; T9
- 4 chei tubulare E-Torx - **prindere 3/8**: E7; E8; E10; E12
- 5 bits Torx cu soclu tubular - **prindere 3/8**: T10; T15; T20; T25; T27
- 6 chei tubulare E-Torx - **prindere 1/2**: E11; E14; E16; E18; E20; E24
- 6 bits Torx cu soclu tubular - **prindere 1/2**: T30; T40; T45; T50; T55; T60
- 7 bits TorxTR: TR10; TR15; TR20; TR25; TR27; TR30; TR40
- 1 cap de prindere pentru bits - **prindere 3/8**
- 1 set Torx-Controller: E6; E7; E8; E10; E12; E14; E16; T10; T15; T20; T25; T27; T30; T40; T45; T47; T50; T55; T60

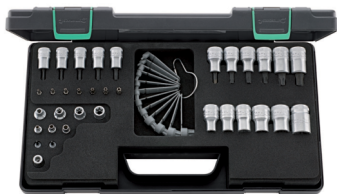

			€/trusa	Cod articol
			290.00	ST.98811908

Trusa de chei tubulare - antrenor 3/8 - 45/14/5iQR

Trusa cu 19 piese in cutie de plastic.

Continut:

- 14 chei tubulare HEX, 12 laturi: 8; 9; 10; 11; 12; 13; 14; 15; 16; 17; 18; 19; 21; 22 mm
- 1 antrenor cu clichet, reversibil, cu eliberare rapida
- 2 prelungitoare profesionale pentru chei tubulare cu eliberare rapida (76, 240 mm)
- 1 antrenor "T" cu eliberare rapida
- 1 intermediar cardanic profesional cu eliberare rapida



			€/trusa	Cod articol
			191.00	ST.96021180

Trusa de chei tubulare - antrenor 3/8 - 45/14/5i

Trusa cu 19 piese in cutie de plastic.

Continut:

- 14 chei tubulare HEX, 12 laturi: 8; 9; 10; 11; 12; 13; 14; 15; 16; 17; 18; 19; 21; 22 mm
- 1 antrenor cu clichet, reversibil
- 2 prelungitoare profesionale pentru chei tubulare (76, 240 mm)
- 1 antrenor "T"
- 1 intermediar cardanic profesional



		€/trusa	Cod articol
		183.00	ST.96024132

Trusa de chei tubulare - antrenor 3/8 - 456/14/5i

Trusa cu 19 piese in cutie de plastic.

Continut:

- 14 chei tubulare HEX, 6 laturi: 8; 9; 10; 11; 12; 13; 14; 15; 16; 17; 18; 19; 21; 22 mm
- 1 antrenor cu clichet, reversibil
- 2 prelungitoare profesionale pentru chei tubulare (76, 240 mm)
- 1 antrenor "T"
- 1 intermediar cardanic profesional



		€/trusa	Cod articol
		183.00	ST.96023132

Trusa de chei tubulare - antrenor 3/8 - 45/11/4

Trusa cu 15 piese in cutie de plastic.

Continut:

- 11 chei tubulare HEX, 12 laturi: 8; 10; 11; 12; 13; 14; 15; 16; 17; 18; 19 mm
- 1 antrenor cu clichet, reversibil
- 2 prelungitoare profesionale pentru chei tubulare (76, 240 mm)
- 1 intermediar cardanic profesional



		€/trusa	Cod articol
		151.00	ST.96021109

Trusa de chei tubulare - antrenor 3/8 - 456/11/4

Trusa cu 15 piese in cutie de plastic.

Continut:

- 11 chei tubulare HEX, 6 laturi: 8; 10; 11; 12; 13; 14; 15; 16; 17; 18; 19 mm
- 1 antrenor cu clichet, reversibil
- 2 prelungitoare profesionale pentru chei tubulare (76, 240 mm)
- 1 intermediar cardanic profesional



		€/trusa	Cod articol
		153.00	ST.96022133

Trusa de chei tubulare - antrenor 3/8 - 45/13/5

Trusa cu 18 piese in cutie de plastic.

Continut:

- 12 chei tubulare HEX, 12 laturi: 8; 9; 10; 11; 12; 13; 14; 15; 16; 17; 18; 19 mm
- 1 cheie pentru bujii de 16 mm
- 1 antrenor cu clichet, reversibil
- 2 prelungitoare profesionale pentru chei tubulare (76, 240 mm)
- 1 antrenor "T"
- 1 intermediar cardanic profesional



		€/trusa	Cod articol
		183.00	ST.96021234

Trusa de chei tubulare - antrenor 3/8 - 456/13/5

Trusa cu 18 piese in cutie de plastic.

Continut:

- 12 chei tubulare HEX, 6 laturi: 8; 9; 10; 11; 12; 13; 14; 15; 16; 17; 18; 19 mm
- 1 cheie pentru bujii de 16 mm
- 1 antrenor cu clichet, reversibil
- 2 prelungitoare profesionale pentru chei tubulare (76, 240 mm)
- 1 antrenor "T"
- 1 intermediar cardanic profesional



		€/trusa	Cod articol
		183.00	ST.96021202

Chei tubulare profesionale

Trusa de chei tubulare - antrenor 3/8 - 45/49/19/5

Trusa cu 24 piese in cutie de plastic.

Continut:

- 11 chei tubulare HEX, 12 laturi: 8; 10; 11; 12; 13; 14; 15; 16; 17; 18; 19 mm
- 1 cheie pentru bujii de 16 mm
- 7 chei tubulare pentru bits Inbus: SW3; SW4; SW5; SW6; SW7; SW8; SW10
- 1 antrenor cu clichet, reversibil
- 2 prelungitoare profesionale pentru chei tubulare (76, 240 mm)
- 1 antrenor "T"
- 1 intermediar cardanic profesional

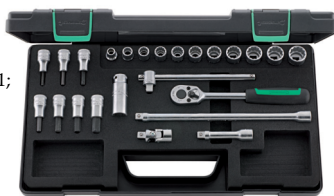

12 3/8

€/trusa	Cod articol
236.00	ST.96021223

Trusa de chei tubulare - antrenor 3/8 - 456/49/19/5

Trusa cu 24 piese in cutie de plastic.

Continut:

- 11 chei tubulare HEX, 6 laturi: 8; 10; 11; 12; 13; 14; 15; 16; 17; 18; 19 mm
- 1 cheie pentru bujii de 16 mm
- 7 chei tubulare pentru bits Inbus: SW3; SW4; SW5; SW6; SW7; SW8; SW10 mm
- 1 antrenor cu clichet, reversibil
- 2 prelungitoare profesionale pentru chei tubulare (76, 240 mm)
- 1 antrenor "T"
- 1 intermediar cardanic profesional



6 3/8

€/trusa	Cod articol
235.00	ST.96021236

Trusa combinata de chei - antrenor 3/8 - 89

Trusa cu 44 piese in cutie de plastic.

Continut:

- 15 chei tubulare HEX, 12 laturi: 7; 8; 9; 10; 11; 12; 13; 14; 15; 16; 17; 18; 19; 21; 22 mm
- 1 cheie pentru bujii de 16 mm
- 1 cheie pentru bujii de 20.8 mm
- 7 chei tubulare pentru bits Inbus: SW3; SW4; SW5; SW6; SW7; SW8; SW10
- 15 chei combinate: 7; 8; 9; 10; 11; 12; 13; 14; 15; 16; 17; 18; 19; 21; 22 mm
- 1 antrenor cu clichet, reversibil
- 2 prelungitoare profesionale pentru chei tubulare (76, 240 mm)
- 1 antrenor "T"
- 1 intermediar cardanic profesional

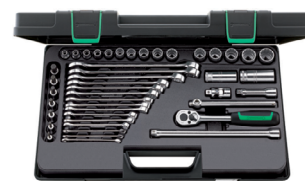

12 3/8

€/trusa	Cod articol
413.00	ST.96023128

Trusa de chei tubulare - antrenor 3/8 - 45/41/9

Trusa cu 50 piese in cutie metalica.

Continut:

- 11 chei tubulare HEX, 12 laturi: 8; 10; 11; 12; 13; 14; 15; 16; 17; 18; 19 mm
- 9 chei tubulare lungi HEX, 12 laturi: 10; 11; 12; 13; 14; 15; 17; 18; 19 mm
- 1 cheie pentru bujii de 16 mm
- 1 cheie pentru bujii de 20.8 mm
- 10 Chei tubulare cardanice profesionale: 10; 11; 12; 13; 14; 15; 16; 17; 18; 19 mm
- 5 chei tubulare pentru bits Inbus: SW4; SW5; SW6; SW8; SW10
- 4 bits Philips: Ph1; Ph2; Ph3; Ph4
- 1 antrenor cu clichet, reversibil
- 2 prelungitoare profesionale pentru chei tubulare (76, 240 mm)
- 1 antrenor cardanic profesional
- 1 antrenor "T"
- 1 intermediar cardanic profesional
- 1 prelungitor flexibil profesional
- 1 cap de prindere pentru bits



12 3/8

€/trusa	Cod articol
775.00	ST.96020108

Trusa de chei - 45/49/32/5TX

Trusa cu 37 piese in cutie de plastic.

Continut:

- 11 chei tubulare HEX, 12 laturi: 8; 10; 11; 12; 13; 14; 15; 16; 17; 18; 19 mm
- 7 chei tubulare, E-Torx: E5; E6; E7; E8; E10; E12; E14
- 6 chei tubulare pentru bits Inbus: SW4; SW5; SW6; SW7; SW8; SW10 mm
- 8 bits Torx cu soclu tubular: T9; T10; T15; T20; T25; T27; T30; T40
- 1 antrenor cu clichet, reversibil
- 2 prelungitoare profesionale pentru chei tubulare (76, 240 mm)
- 1 antrenor "T"
- 1 intermediar cardanic profesional



12 3/8

€/trusa	Cod articol
329.00	ST.96022119

Trusa de chei tubulare - antrenor 3/8 - 45TX/49TX/15/5

Trusa cu 20 piese in cutie de plastic.

Continut:

- 7 chei tubulare, E-Torx: E5; E6; E7; E8; E10; E12; E14
- 8 bits Torx cu soclu tubular: T9; T10; T15; T20; T25; T27; T30; T40
- 1 antrenor cu clichet, reversibil
- 2 prelungitoare profesionale pentru chei tubulare (125, 240 mm)
- 1 antrenor "T"
- 1 intermediar cardanic profesional

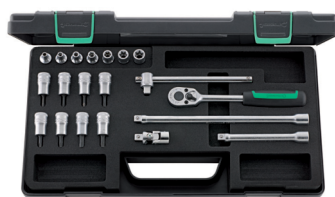

12 3/8

€/trusa	Cod articol
229.00	ST.96023703

Trusa de chei tubulare - antrenor 3/8 - 45a/12/5

Trusa cu 17 piese in cutie de plastic.

Continut:

- 11 chei tubulare HEX, 12 laturi: 1/4; 3/16; 1/32; 3/8; 7/16; 1/2; 5/16; 5/8; 11/16; 3/4; 13/16 inch
- 1 cheie pentru bujii de 16 mm
- 1 antrenor cu clichet, reversibil
- 2 prelungitoare profesionale pentru chei tubulare (76, 240 mm)
- 1 antrenor "T"
- 1 intermediar cardanic profesional



€/trusa	Cod articol
183.00	ST.96025204

Chei tubulare profesionale

Trusa de chei tubulare - antrenor 3/8 - 456/14/5i

Trusa cu 33 piese in cutie de plastic.

Continut:

- 28 chei tubulare HEX, 12 laturi:
mm: 7; 8; 9; 10; 11; 12; 13; 14; 15;
16; 17; 18; 19; 20; 21; 22
inch: 1/4; 5/16; 11/32; 3/8; 7/16; 1/2; 9/16;
5/8; 11/16; 3/4; 13/16; 7/8
- 1 antrenor cu clichet, reversibil
- 2 prelungitoare profesionale pentru chei tubulare (76, 240 mm)
- 1 antrenor "T"
- 1 intermediar cardanic profesional



		€/trusa	Cod articol
		274.00	ST.96021122

Trusa de chei tubulare - antrenor 3/8 - 45a/14/8QR

Trusa cu 22 piese in cutie de plastic.

Continut:

- 14 chei tubulare HEX, 12 laturi:
1/4; 5/16; 11/32; 3/8; 7/16; 1/2; 9/16; 5/8; 11/16;
3/4; 13/16; 7/8; 15/16; 1 inch
- 1 antrenor cu clichet, reversibil cu eliberare rapida
- 3 prelungitoare profesionale pentru chei tubulare cu eliberare rapida (76, 160, 240 mm)
- 1 intermediar cardanic profesional cu eliberare rapida
- 2 capete de prindere 3/8 pentru bits de 1/4 si 5/16
- o coarba de actionare profesionala



			€/trusa	Cod articol
			313.00	ST.96025206

Trusa de chei tubulare - antrenor 3/8 - 45a/22/8QR

Trusa cu 30 piese in cutie metalica.

Continut:

- 14 chei tubulare HEX, 12 laturi:
1/4; 5/16; 11/32; 3/8; 7/16; 1/2; 9/16; 5/8; 11/16; 3/4; 13/16; 7/8; 15/16; 1 inch
- 8 chei tubulare cardanice:
3/16; 3/8; 7/16; 1/2; 9/16; 5/8; 11/16; 3/4 inch
- 1 antrenor cu clichet, reversibil cu eliberare rapida
- 3 prelungitoare profesionale pentru chei tubulare cu eliberare rapida (76, 160, 240 mm)
- 1 intermediar cardanic profesional cu eliberare rapida
- 1 cap de prindere pentru bits 1/4
- 1 cap de prindere pentru bits 5/16
- o coarba de actionare profesionala



			€/trusa	Cod articol
			541.00	ST.96025207

Trusa de chei tubulare - antrenor 3/8 - 45a/33/13

Trusa cu 46 piese in cutie metalica.

Continut:

- 10 chei tubulare HEX, 12 laturi: 1/4; 5/16; 11/32; 3/8; 7/16; 1/2; 9/16; 5/8; 11/16; 3/4 inch
- 1 cheie pentru bujii de 16 mm
- 1 cheie pentru bujii de 20.8 mm
- 7 chei tubulare lungi HEX, 12 laturi: 3/8; 7/16; 1/2; 9/16; 11/16; 3/4; 7/8 inch
- 7 chei tubulare cardanice 3/8; 7/16; 1/2; 9/16; 5/8; 11/16; 3/4 inch
- 3 bits Inbus cu soclu tubular: 1/8; 5/32; 3/16 inch
- 4 bits Philips: Ph1; Ph2; Ph3; Ph4
- 1 antrenor cu clichet, reversibil - prindere 1/4
- 1 antrenor cu clichet, reversibil - prindere 3/8
- 1 adaptor cu clichet, 20 dinti
- 3 prelungitoare profesionale pentru chei tubulare (76, 160, 240 mm)
- 1 prelungitor flexibil profesional (194 mm)
- 1 adaptor 3/8 - 1/4
- o coarba de actionare profesionala
- 1 antrenor cardanic profesional
- 1 antrenor "T"
- 1 intermediar cardanic profesional
- 1 cap de prindere pentru bits

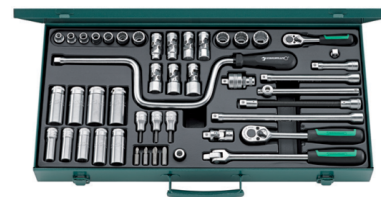

		€/trusa	Cod articol
		777.00	ST.96024113

Set de bits tubulari prindere 1/2 - 54TXB/10

Set cu 10 piese in caseta de plastic.

Componenta:

- 10 bits TorxTR cu soclu tubular: TR20; TR25; TR27; TR30; 2 x TR40; TR45; TR50; TR55; TR60



	€/set	Cod articol
	130.00	ST.96032008

Set de bits tubulari prindere 1/2 - 54TX/10

Trusa cu 10 piese in caseta de plastic.

Componenta:

- bits Torx cu soclu tubular: T20; T25; T27; T30; T40 (2x); T45; T50; T55; T60



	€/set	Cod articol
	117.00	ST.96032005

Set de bits tubulari prindere 1/2 - 54/10

Set cu 10 piese in caseta de plastic.

Componenta:

- 10 bits Inbus cu soclu tubular: SW4; SW5; SW6; SW7; SW8; SW10; SW12; SW14; SW17; SW19



	€/set	Cod articol
	106.00	ST.96031508

Trusa de chei tubulare - antrenor 1/2 - 54/8/4

Set cu 12 piese in cutie de plastic.

Continut:

- 8 bits Inbus cu soclu tubular: SW4; SW5; SW6; SW8; SW10; SW12; SW14; SW17
- 1 antrenor cu clichet, reversibil
- 2 prelungitoare profesionale pentru chei tubulare (130, 255 mm)
- 1 antrenor "T"

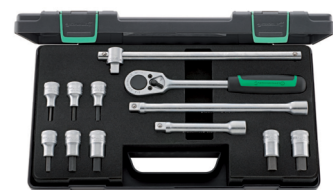

	€/trusa	Cod articol
	183.00	ST.96031501

Chei tubulare profesionale

Trusa de chei tubulare - antrenor 1/2 - 52/9/3

Trusa cu 12 piese in cutie de plastic.

Continut:

- 9 chei tubulare HEX, 6 latari: 10; 13; 16; 17; 18; 19; 21; 22; 24 mm
- 1 antrenor cu clichet, reversibil
- 2 prelungitoare profesionale pentru chei tubulare (130, 255 mm)



6	1/2	€/trusa	Cod articol
		153.00	ST.96031343

Trusa de chei tubulare - antrenor 1/2 - 52/16/5

Trusa cu 21 piese in cutie de plastic.

Continut:

- 15 chei tubulare HEX, 6 latari: 10; 11; 12; 13; 14; 15; 16; 17; 18; 19; 21; 22; 24; 27; 30 mm
- 1 cheie pentru bujii de 16 mm
- 1 antrenor cu clichet, reversibil
- 2 prelungitoare profesionale pentru chei tubulare (130, 255 mm)
- 1 antrenor "T"
- 1 intermediar cardanic profesional



6	1/2	€/trusa	Cod articol
		245.00	ST.96031406

Trusa de chei tubulare - antrenor 1/2 - 50/12/3

Trusa cu 15 piese in cutie de plastic.

Continut:

- 12 chei tubulare HEX, 12 latari: 10; 13; 16; 17; 18; 19; 21; 22; 24; 27; 30; 32 mm
- 1 antrenor cu clichet, reversibil
- 2 prelungitoare profesionale pentru chei tubulare (130, 255 mm)



12	1/2	€/trusa	Cod articol
		182.00	ST.96031435

Trusa de chei tubulare - antrenor 1/2 - 52/12/3

Trusa cu 15 piese in cutie de plastic.

Continut:

- 12 chei tubulare HEX, 6 latari: 10; 13; 16; 17; 18; 19; 21; 22; 24; 27; 30; 32 mm
- 1 antrenor cu clichet, reversibil
- 2 prelungitoare profesionale pentru chei tubulare (130, 255 mm)



6	1/2	€/trusa	Cod articol
		176.00	ST.96031436

Trusa de chei tubulare - antrenor 1/2 - 50/16/6

Trusa cu 22 piese in cutie de plastic.

Continut:

- 16 chei tubulare HEX, 12 latari: 10; 11; 12; 13; 14; 15; 16; 17; 18; 19; 21; 22; 24; 27; 30; 32 mm
- 1 antrenor cu clichet, reversibil
- 3 prelungitoare profesionale pentru chei tubulare (75, 130, 255 mm)
- 1 antrenor "T"
- 1 intermediar cardanic profesional



12	1/2	€/trusa	Cod articol
		245.00	ST.96031447

Trusa de chei tubulare - antrenor 1/2 - 52/16/6

Trusa cu 22 piese in cutie de plastic.

Continut:

- 16 chei tubulare HEX, 6 latari: 10; 11; 12; 13; 14; 15; 16; 17; 18; 19; 21; 22; 24; 27; 30; 32 mm
- 1 antrenor cu clichet, reversibil
- 3 prelungitoare profesionale pentru chei tubulare (75, 130, 255 mm)
- 1 antrenor "T"
- 1 intermediar cardanic profesional

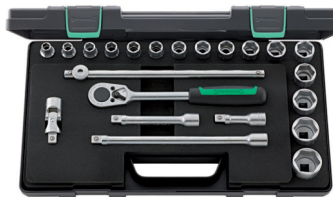

6	1/2	€/trusa	Cod articol
		243.00	ST.96031448

Trusa de chei tubulare - antrenor 1/2 - 52/16/6QR

Trusa cu 22 piese in cutie de plastic.

Continut:

- 16 chei tubulare HEX, 6 latari: 10; 11; 12; 13; 14; 15; 16; 17; 18; 19; 21; 22; 24; 27; 30; 32 mm
- 1 antrenor cu clichet, reversibil cu eliberare rapida
- 3 prelungitoare profesionale pentru chei tubulare cu eliberare rapida (75, 130, 255 mm)
- 1 antrenor "T" cu eliberare rapida
- 1 intermediar cardanic profesional cu eliberare rapida



QR	6	1/2	€/trusa	Cod articol
			252.00	ST.96031480

Trusa de chei tubulare - antrenor 1/2 - 50/22/6

Trusa cu 28 piese in cutie de plastic.

Continut:

- 22 chei tubulare HEX, 12 latari: 8; 9; 10; 11; 12; 13; 14; 15; 16; 17; 18; 19; 20; 21; 22; 23; 24; 26; 27; 28; 30; 32 mm
- 1 antrenor cu clichet, reversibil
- 3 prelungitoare profesionale pentru chei tubulare (75, 130, 255 mm)
- 1 antrenor "T"
- 1 intermediar cardanic profesional

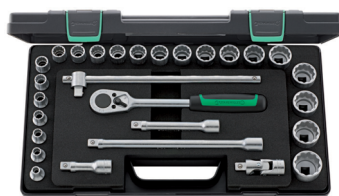

12	1/2	€/trusa	Cod articol
		296.00	ST.96031407

Trusa de chei tubulare - antrenor 1/2 - 52/22/6

Trusa cu 28 piese in cutie de plastic.

Continut:

- 22 chei tubulare HEX, 6 latari: 8; 9; 10; 11; 12; 13; 14; 15; 16; 17; 18; 19; 20; 21; 22; 23; 24; 26; 27; 28; 30; 32 mm
- 1 antrenor cu clichet, reversibil
- 3 prelungitoare profesionale pentru chei tubulare (75, 130, 255 mm)
- 1 antrenor "T"
- 1 intermediar cardanic profesional

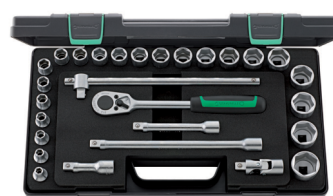

6	1/2	€/trusa	Cod articol
		288.00	ST.96031409

Chei tubulare profesionale

Trusa de chei tubulare - antrenor 1/2 - 50/54/25/6

Trusa cu 31 piese in cutie de plastic.

Continut:

- 17 chei tubulare HEX, 12 laturi: 8; 10; 11; 12; 13; 14; 15; 16; 17; 18; 19; 21; 22; 24; 27; 30; 32 mm
- 8 bits Inbus cu soclu tubular: SW4; SW5; SW6; SW7; SW8; SW10; SW12; SW14
- 1 antrenor cu clichet, reversibil
- 3 prelungitoare profesionale pentru chei tubulare (75, 130, 255 mm)
- 1 antrenor "T"
- 1 intermediar cardanic profesional

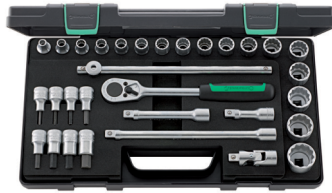

12	1/2	€/trusa	Cod articol
		327.00	ST.96031439

Trusa de chei tubulare - antrenor 1/2 - 52/54/25/6

Trusa cu 31 piese in cutie de plastic.

Continut:

- 17 chei tubulare HEX, 12 laturi: 8; 10; 11; 12; 13; 14; 15; 16; 17; 18; 19; 21; 22; 24; 27; 30; 32 mm
- 8 bits Inbus cu soclu tubular: SW4; SW5; SW6; SW7; SW8; SW10; SW12; SW14
- 1 antrenor cu clichet, reversibil
- 3 prelungitoare profesionale pentru chei tubulare (75, 130, 255 mm)
- 1 antrenor "T"
- 1 intermediar cardanic profesional



6	1/2	€/trusa	Cod articol
		318.00	ST.96031239

Trusa combinata de chei - antrenor 1/2 - 87

Trusa cu 47 piese in cutie de plastic.

Continut:

- 19 chei tubulare HEX, 12 laturi: 8; 9; 10; 11; 12; 13; 14; 15; 16; 17; 18; 19; 21; 22; 24; 27; 30; 32; 34 mm
- 1 cheie pentru bujii de 16 mm
- 1 cheie pentru bujii de 20.8 mm
- 7 bits Inbus cu soclu tubular: SW4; SW5; SW6; SW7; SW8; SW10; SW12
- 13 chei combinate: 10; 11; 12; 13; 14; 15; 16; 17; 18; 19; 21; 22; 24 mm
- 1 antrenor cu clichet, reversibil
- 3 prelungitoare profesionale pentru chei tubulare (75, 130, 255 mm)
- 1 antrenor "T"
- 1 intermediar cardanic profesional



12	1/2	€/trusa	Cod articol
		497.00	ST.96031101

Trusa combinata de chei - antrenor 1/2 - 876

Trusa cu 47 piese in cutie de plastic.

Continut:

- 19 chei tubulare HEX, 12 laturi: 8; 9; 10; 11; 12; 13; 14; 15; 16; 17; 18; 19; 21; 22; 24; 27; 30; 32; 34 mm
- 1 cheie pentru bujii de 16 mm
- 1 cheie pentru bujii de 20.8 mm
- 7 bits Inbus cu soclu tubular: SW4; SW5; SW6; SW7; SW8; SW10; SW12
- 13 chei combinate: 10; 11; 12; 13; 14; 15; 16; 17; 18; 19; 21; 22; 24 mm
- 1 antrenor cu clichet, reversibil
- 3 prelungitoare profesionale pentru chei tubulare (75, 130, 255 mm)
- 1 antrenor "T"
- 1 intermediar cardanic profesional



6	1/2	€/trusa	Cod articol
		497.00	ST.96032301

Trusa de chei tubulare - antrenor 1/2 - 876TX

Trusa cu 21 piese in cutie de plastic.

Continut:

- 12 chei tubulare HEX, 6 laturi: 8; 10; 13; 16; 17; 18; 19; 21; 22; 24; 27; 30 mm
- 6 bits Inbus cu soclu tubular: SW5; SW6; SW8; SW10; SW12; SW14
- 7 chei tubulare E-Torx: E10; E12; E14; E16; E18; E20; E24
- 9 bits Torx cu soclu tubular: T20; T25; T27; T30; T40; T45; T50; T55; T60
- 1 antrenor cu clichet, reversibil
- 2 prelungitoare profesionale pentru chei tubulare (130, 255 mm)
- 1 antrenor "T"
- 1 intermediar cardanic profesional

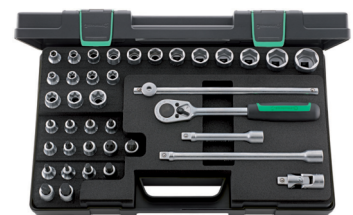

12	1/2	€/trusa	Cod articol
		420.00	ST.98811909

Trusa de chei tubulare - antrenor 1/2 - 50TX/16/5

Trusa cu 21 piese in cutie de plastic.

Continut:

- 7 chei tubulare E-Torx: E10; E12; E14; E16; E18; E20; E24
- 9 bits Torx cu soclu tubular: T20; T25; T27; T30; T40; T45; T50; T55; T60
- 1 antrenor cu clichet, reversibil
- 3 prelungitoare profesionale pentru chei tubulare (52, 130, 255 mm)
- 1 intermediar cardanic profesional



12	1/2	€/trusa	Cod articol
		283.00	ST.96033702

Trusa de chei tubulare - antrenor 1/2 - 52/16/5

Trusa cu 45 piese in cutie metalica.

Continut:

- 39 chei tubulare HEX, 12 laturi: **mm:** 10; 11; 12; 13; 14; 15; 16; 17; 18; 19; 20; 21; 22; 23; 24; 25; 26; 27; 28; 30; 32; 34 **inch:** 3/8; 7/16; 1/2; 9/16; 5/8; 11/16; 3/4; 25/32; 13/16; 7/8; 15/16; 1; 1 1/16; 1 1/8; 1 3/16; 1 1/4
- 1 antrenor cu clichet, reversibil
- 3 prelungitoare profesionale pentru chei tubulare (75, 130, 255 mm)
- 1 antrenor "T"
- 1 intermediar cardanic profesional



12	1/2	€/trusa	Cod articol
		443.00	ST.96030140

Chei tubulare profesionale

Trusa de chei tubulare - antrenor 1/2 - 50/43/7

Trusa cu 50 piese in cutie metalica.

Continut:

- 23 chei tubulare HEX, 12 laturi: 8; 10; 11; 12; 13; 14; 15; 16; 17; 18; 19; 20; 21; 22; 23; 24; 25; 26; 27; 28; 30; 32; 34 mm
- 7 chei tubulare lungi HEX, 12 laturi: 13; 17; 18; 19; 22; 24; 27 mm
- 1 cheie pentru bujii de 16 mm
- 1 cheie pentru bujii de 20.8 mm
- 6 chei tubulare cardanice: 10; 13; 16; 17; 18; 19 mm
- 5 bits Inbus cu soclu tubular: SW4; SW5; SW6; SW8; SW10 mm
- 1 antrenor cu clichet, reversibil
- 3 prelungitoare profesionale pentru chei tubulare (75, 130, 255 mm)
- 1 antrenor cardanic
- 1 antrenor "T"
- 1 intermediar cardanic profesional

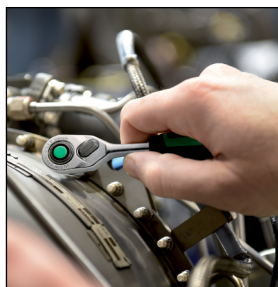

12	1/2	€/trusa	Cod articol
		710.00	ST.96030136

Trusa combinata de chei - antrenor 1/2 - 87a

Trusa cu 40 piese in cutie de plastic.

Continut:

- 15 chei tubulare HEX, 12 laturi: 3/8; 7/16; 1/2; 5/16; 3/8; 13/16; 3/4; 13/16; 7/8; 15/16; 1; 1 1/16; 1 1/8; 1 3/16; 1 1/4 inch
- 1 cheie pentru bujii de 16 mm
- 1 cheie pentru bujii de 20.8 mm
- 5 bits Inbus cu soclu tubular: 7/32; 1/4; 5/16; 3/8; 1/2 inch
- 12 chei combinate: 1/4; 5/16; 11/32; 3/8; 7/16; 1/2; 5/16; 3/8; 11/16; 3/4; 13/16; 7/8 inch
- 1 antrenor cu clichet, reversibil
- 3 prelungitoare profesionale pentru chei tubulare (52, 130, 255 mm)
- 1 antrenor "T"
- 1 intermediar cardanic profesional



12	1/2	€/trusa	Cod articol
		451.00	ST.96035101

Trusa de chei tubulare - antrenor 1/2 - 50a/17/6

Trusa cu 23 piese in cutie de plastic.

Continut:

- 17 chei tubulare HEX, 12 laturi: 3/8; 7/16; 1/2; 5/16; 13/32; 3/8; 11/16; 3/4; 25/32; 13/16; 7/8; 15/16; 1; 1 1/16; 1 1/8; 1 3/16; 1 1/4 inch
- 1 antrenor cu clichet, reversibil
- 3 prelungitoare profesionale pentru chei tubulare (52, 130, 255 mm)
- 1 antrenor "T"
- 1 intermediar cardanic profesional

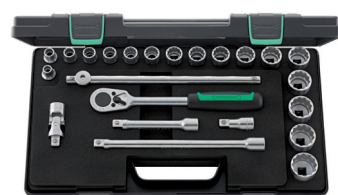

12	1/2	€/trusa	Cod articol
		267.00	ST.96035125

Trusa de chei tubulare - antrenor 3/4 - 55/10/6

Trusa cu 16 piese in cutie metalica.

Continut:

- 10 chei tubulare HEX, 6 laturi: 22; 24; 27; 30; 32; 34; 36; 41; 46; 50 mm
- 1 cap de antrenare cu clichet
- 2 prelungitoare profesionale pentru chei tubulare (200, 400 mm)
- 1 cap de antrenare cardanic
- 1 cap de antrenare glisant
- o bara de actionare



6	3/4	€/trusa	Cod articol
		468.00	ST.96050104

Trusa de chei tubulare - antrenor 3/4 - 55a/10/5

Trusa cu 15 piese in cutie metalica.

Continut:

- 10 chei tubulare HEX, 12 laturi: 1 1/16; 1 1/8; 1 1/4; 1 3/8; 1 1/2; 1 5/8; 1 3/4; 1 7/8; 1 7/8 inch
- 1 cap de antrenare cu clichet
- 2 prelungitoare profesionale pentru chei tubulare (200, 400 mm)
- 1 cap de antrenare glisant
- o bara de actionare



12	3/4	€/trusa	Cod articol
		476.00	ST.96054101

Trusa de chei tubulare - antrenor 3/4 - 55/9/6N

Trusa cu 15 piese in cutie metalica.

Continut:

- 9 chei tubulare HEX, 6 laturi: 32; 34; 36; 38; 41; 46; 50; 55; 60 mm
- 1 cap de antrenare cu clichet
- 2 prelungitoare profesionale pentru chei tubulare (200, 400 mm)
- 1 cap de antrenare cardanic
- 1 cap de antrenare glisant
- o bara de actionare



6	3/4	€/trusa	Cod articol
		530.00	ST.96050103

Trusa de chei tubulare - antrenor 3/4 - 55a/16/6

Trusa cu 22 piese in cutie metalica.

Continut:

- 16 chei tubulare HEX, 12 laturi: 7/8; 15/16; 1; 1 1/16; 1 1/8; 1 1/4; 1 5/16; 1 3/8; 1 7/16; 1 1/2; 1 5/8; 1 11/16; 1 3/4; 1 13/16; 1 7/8; 2 inch
- 1 cap de antrenare cu clichet
- 2 prelungitoare profesionale pentru chei tubulare (200, 400 mm)
- 1 cap de antrenare cardanic
- 1 cap de antrenare glisant
- o bara de actionare



12	3/4	€/trusa	Cod articol
		641.00	ST.96054103

Chei tubulare profesionale

Trusa de chei tubulare - antrenor 1" - 60/6/6/882

Trusa cu 12 piese in cutie metalica.

Continut:

- 6 chei tubulare HEX, 12 laturi: 36; 41; 46; 50; 55; 60 mm
- 1 cap de antrenare cu clichet
- 2 prelungitoare profesionale pentru chei tubulare (200, 400 mm)
- 1 cap de antrenare cardanic
- 1 cap de antrenare glisant
- o bara de actionare



€/trusa	Cod articol
737.00	ST.96060101

Trusa de chei tubulare - antrenor 1" - 60/8/6/882

Trusa cu 14 piese in cutie metalica.

Continut:

- 4 chei tubulare HEX, 12 laturi: 46; 50; 55; 60 mm
- 4 chei tubulare HEX, 6 laturi: 65; 70; 75; 80 mm
- 1 cap de antrenare cu clichet
- 2 prelungitoare profesionale pentru chei tubulare (200, 400 mm)
- 1 cap de antrenare cardanic
- 1 cap de antrenare glisant
- o bara de actionare



€/trusa	Cod articol
1122.00	ST.96060103

Chei tubulare de impact, profesionale

Chei tubulare de impact, prindere 1/2, profesionale - DIN 3129

DIN 3129 / ISO 1711-2

Actionate de masini.

Otel crom-vanadiu, brunat.



Ø (mm)	L (mm)	t (mm)	€/buc.	Cod articol	Ø (mm)	L (mm)	t (mm)	€/buc.	Cod articol
8	38	21.5	7.81	ST.23010008	19	40	24.6	7.81	ST.23010019
10	38	21.5	7.58	ST.23010010	21	40	23.0	9.41	ST.23010021
11	38	21.5	7.58	ST.23010011	22	42	25.0	9.41	ST.23010022
12	38	21.5	7.58	ST.23010012	23	40	24.5	9.41	ST.23010023
13	38	21.5	7.58	ST.23010013	24	44	28.0	9.18	ST.23010024
14	38	21.5	7.58	ST.23010014	25	44	25.0	9.95	ST.23010025
15	38	23.0	7.96	ST.23010015	27	45	29.0	11.56	ST.23010027
16	38	23.0	8.27	ST.23010016	30	50	34.0	12.02	ST.23010030
17	38	22.9	8.27	ST.23010017	32	50	34.0	12.02	ST.23010032
18	38	22.6	8.27	ST.23010018	36	49	28.0	19.59	ST.23011036

Set de chei tubulare de impact 1/2 - DIN 3129

- 6 chei tubulare de impact HEX: 13; 1719; 21; 22; 24 mm
- 1 prelungitor profesional pentru chei tubulare de impact - 130 mm
- 1 intermediar cardanic de impact, profesional

€/set

Cod articol

126.00

ST.96231101

Chei tubulare de impact, Inbus, prindere 1/2, profesionale

Actionate de masini.

Otel crom-vanadiu, brunat.



Ø (mm)	L (mm)	€/buc.	Cod articol	Ø (mm)	L (mm)	€/buc.	Cod articol
SW 5	15	7.96	ST.23050005	SW 12	19	9.95	ST.23050012
SW 6	15	7.96	ST.23050006	SW 14	20	10.49	ST.23050014
SW 7	15	7.96	ST.23050007	SW 17	22	12.09	ST.23050017
SW 8	15	8.65	ST.23050008	SW 19	27	17.37	ST.23050019
SW 10	17	8.80	ST.23050010				

Set de chei tubulare de impact, Inbus, profesionale, 1/2

9 chei tubulare de impact, Inbus, profesionale
SW5; SW6; SW7; SW8; SW10; SW12; SW14; SW17; SW19

€/set

Cod articol

107.00

ST.96231501

Chei tubulare de impact, lungi, prindere 1/2, profesionale

ISO 1711-2

Actionate de masini.

Otel crom-vanadiu, brunat.



Ø (mm)	L (mm)	t (mm)	€/buc.	Cod articol
13	85	68.5	18.06	ST.23020013
15	85	68.0	18.06	ST.23020015
16	85	68.0	18.06	ST.23020016
17	85	68.0	17.37	ST.23020017
18	85	68.0	18.06	ST.23020018
19	85	67.5	17.37	ST.23020019
21	85	66.5	20.51	ST.23020021
22	85	66.5	20.58	ST.23020022
24	85	66.0	20.05	ST.23020024
27	85	65.0	23.80	ST.23020027

Chei tubulare de impact pentru roti, prindere 1/2, profesionale

Cu mansoa de protectie din plastic.

Actionate de masini.

Otel crom-vanadiu, brunat.



Ø (mm)	L (mm)	t (mm)	€/buc.	Cod articol
17.0	86	27	28.00	ST.23091017
19.0	86	29	29.20	ST.23091019
20.8	86	31	29.00	ST.23091208

Chei tubulare profesionale

Chei tubulare de impact, E-Torx, prindere 1/2, profesionale

Actionate de masini.
Otel crom-vanadiu, brunat.



Marime	Ø (mm)	L (mm)	€/buc.	Cod articol
E 10	9.4	38.0	11.33	ST.23080010
E 12	11.1	38.0	11.33	ST.23080012
E 14	12.9	38.0	11.10	ST.23080014
E 16	14.7	38.0	11.17	ST.23080016
E 18	16.6	38.0	11.86	ST.23080018
E 20	18.4	38.0	12.78	ST.23080020
E 24	22.1	41.2	14.92	ST.23080024

Chei tubulare de impact, Torx, prindere 1/2, profesionale

Actionate de masini.
Otel crom-vanadiu, brunat.

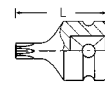

Marime	Ø (mm)	L (mm)	€/buc.	Cod articol
T 30	5.5	40	15.23	ST.23070030
T 40	6.6	40	16.45	ST.23070040
T 45	7.8	40	16.99	ST.23070045
T 50	8.8	40	17.06	ST.23070050
T 55	11.2	40	21.35	ST.23070055
T 60	13.2	40	21.35	ST.23070060

Chei tubulare de impact, prindere 3/4, profesionale - DIN 3129

DIN 3129 / ISO 1711-2
Actionate de masini.
Otel crom-vanadiu, brunat.

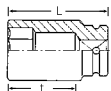

Ø (mm)	L (mm)	t (mm)	€/buc.	Cod articol
17	48	23.0	19.05	ST.25010017
18	48	23.0	18.98	ST.25010018
19	48	23.0	19.05	ST.25010019
21	50	25.0	19.89	ST.25010021
22	50	25.0	19.89	ST.25010022
24	50	24.5	20.28	ST.25010024
27	51	24.5	21.58	ST.25010027
28	54	27.0	21.58	ST.25010028
29	54	26.5	22.50	ST.25010029
30	54	26.5	21.81	ST.25010030
32	54	26.0	25.10	ST.25010032
33	54	25.5	27.30	ST.25010033
34	54	29.0	29.60	ST.25010034
36	57	32.0	28.40	ST.25010036
38	58	33.0	33.60	ST.25010038
41	59	34.0	33.90	ST.25010041
46	64	36.5	42.90	ST.25010046

Chei tubulare de impact, lungi, prindere 3/4, profesionale

ISO 1711-2
Actionate de masini.
Otel crom-vanadiu, brunat.

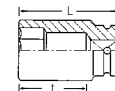

Ø (mm)	L (mm)	t (mm)	€/buc.	Cod articol
17	100	75.0	29.40	ST.25020017
19	100	75.0	29.40	ST.25020019
21	100	75.0	29.00	ST.25020021
22	100	75.0	29.00	ST.25020022
24	100	74.5	29.00	ST.25020024
27	100	72.5	30.00	ST.25020027
30	100	72.5	36.50	ST.25020030
32	100	72.0	38.70	ST.25020032
34	100	71.5	47.50	ST.25020034
36	100	71.0	48.60	ST.25020036
41	100	75.0	49.40	ST.25020041
46	100	75.0	56.30	ST.25020046

Chei tubulare de impact, prindere 1", profesionale - DIN 3129

DIN 3129 / ISO 1711-2
Actionate de masini.
Otel crom-vanadiu, brunat.

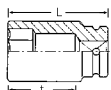

Ø (mm)	L (mm)	t (mm)	€/buc.	Cod articol
24	58	28.0	27.30	ST.26010024
27	60	30.0	25.80	ST.26010027
30	62	32.0	31.30	ST.26010030
32	63	32.0	30.20	ST.26010032
33	63	31.5	31.90	ST.26010033
36	67	34.5	36.80	ST.26010036
38	70	37.0	39.10	ST.26010038
41	70	36.5	39.40	ST.26010041
42	73	39.0	47.10	ST.26010042
46	76	41.0	47.50	ST.26010046
50	82	52.0	59.70	ST.26010050
55	87	57.0	74.30	ST.26010055
60	91	61.0	86.50	ST.26010060
65	85	55.0	91.10	ST.26010065
70	88	58.0	94.90	ST.26010070
75	92	62.0	105.00	ST.26010075
80	97	67.0	134.00	ST.26010080

Chei tubulare de impact, lungi, prindere 1", profesionale

ISO 1711-2
Actionate de masini.
Otel crom-vanadiu, brunat.

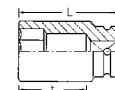

Ø (mm)	L (mm)	t (mm)	€/buc.	Cod articol
24	110	80.0	43.30	ST.26020024
27	110	80.0	44.00	ST.26020027
30	110	79.5	46.30	ST.26020030
32	110	79.0	47.90	ST.26020032
33	110	78.5	50.90	ST.26020033
36	110	78.0	50.50	ST.26020036
38	110	77.0	54.40	ST.26020038
41	110	76.0	57.80	ST.26020041
46	110	72.0	72.70	ST.26020046



Chei tubulare profesionale

Chei tubulare de impact, prindere 1½, profesionale - DIN 3129

DIN 3129 / ISO 1711-2
Actionate de masini.
Otel crom-vanadiu, brunat.



Ø (mm)	L (mm)	t (mm)	€/buc.	Cod articol
55	89	42	82.70	ST.27010055
60	92	50	101.00	ST.27010060
65	96	54	112.00	ST.27010065
70	101	59	153.00	ST.27010070
75	105	63	183.00	ST.27010075
80	110	68	213.00	ST.27010080
85	116	74	225.00	ST.27010085
90	118	76	247.00	ST.27010090
95	118	76	376.00	ST.27010095
100	125	83	421.00	ST.27010100
105	125	83	469.00	ST.27010105
110	137	95	520.00	ST.27010110
115	137	95	520.00	ST.27010115
120	145	103	579.00	ST.27010120

Chei tubulare de impact, prindere 2½, profesionale - DIN 3129

DIN 3129 / ISO 1711-2
Actionate de masini.
Otel crom-vanadiu, brunat.



Ø (mm)	L (mm)	t (mm)	€/buc.	Cod articol
75	125	67	477.00	ST.28010075
80	125	67	490.00	ST.28010080
85	130	67	536.00	ST.28010085
90	132	74	605.00	ST.28010090
95	132	74	649.00	ST.28010095
100	141	83	688.00	ST.28010100
105	141	83	742.00	ST.28010105
110	150	92	834.00	ST.28010110
115	150	92	926.00	ST.28010115
120	158	100	980.00	ST.28010120

Accesorii pentru chei tubulare de impact

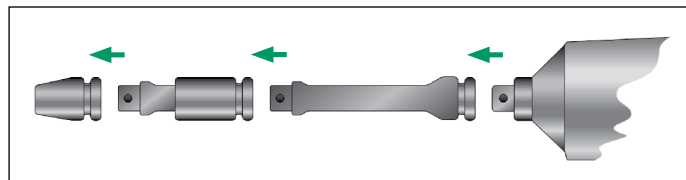

Prelungitoare pentru chei tubulare de impact, profesionale

Otel crom-vanadiu, brunat.



Mama	Tata	Lungime (mm)	€/buc.	Cod articol
½	½	52	17.29	ST.33010001
		130	20.35	ST.33010002
		255	25.60	ST.33010003
¾	¾	180	52.50	ST.35010001
		250	60.10	ST.35010002
1	1	330	71.20	ST.35010003
		180	75.00	ST.36010001
1 ½	1 ½	330	96.40	ST.36010002
		254	241.00	ST.37010001
2 ½	2 ½	330	310.00	ST.37010002
		381	350.00	ST.37010003
		305	649.00	ST.38010001
		457	926.00	ST.38010002
		610	1139.00	ST.38010003

Adaptoare pentru chei tubulare de impact, profesionale



Mama	Tata	Lungime (mm)	€/buc.	Cod articol
½	¾	37	14.31	ST.33030002
	¾	49	16.45	ST.33030005
¾	½	56	23.64	ST.35030003
	1	65	27.10	ST.35030006
1	¾	70	44.40	ST.36030005
	1 ½	85	72.70	ST.36030007
1 ½	1	95	283.00	ST.36030006
	2 ½	93	216.00	ST.37030006
2 ½	1 ½	138	451.00	ST.38030005

Intermediar cardanic pentru chei tubulare de impact, profesional



Ø	Lungime (mm)	€/buc.	Cod articol
½	52	38.10	ST.33020000
¾	99	64.30	ST.35020000
1	125	110.00	ST.36020000
1 ½	125	335.00	ST.37020000

Dulapuri mobile si module de stocare a sculelor

Dulap mobil pentru scule - 90/6A

Dulapul mobil pentru scule este sistemul de stocare perfect. Culoare gri, RAL 7016. Greutate: 53.2 kg.



- 1 Partea superioara este fabricata din plastic ABS dur, rezistent la ulei.
- 2 Sistem de inchidere centralizat dublu.
 - Inchidere centrala - blocare totala
 - Blocare individuala ce previne deschiderea sertarelor atunci cand se afla in miscare.
- 3 6 sertare ce pot fi deschise complet. Acestea pot fi echipate cu modulele de stocare a sculelor Stahlwille.
- 4 Roti rezistente la ulei si acizi, de dimensiuni mari (Ø 100 mm), cu sistem de blocare.

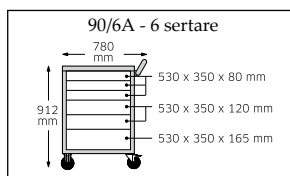
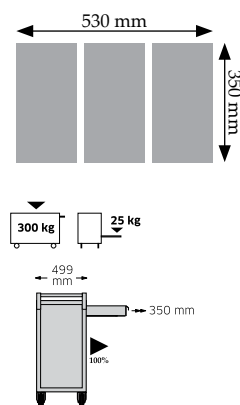

Model	Culoare	Nr. de sertare	€/buc.	Cod articol
90/6A	gri	6	533.00	ST.81200000

Dulapuri mobile pentru scule - 95/6; 95/7; 95/8

Modelul 95 - mult mai durabil. Manerul este fabricat din otel inoxidabil. Cadrul dulapului este ramforsat in zona de prindere a manerului. Greutate: 65.5 kg.



- 1 Sistem de inchidere centralizat triplu.
 - Inchidere centrala - blocare totala.
 - Blocare individuala ce previne deschiderea sertarelor atunci cand se afla in miscare.
 - Nu poate fi deschis decat un singur sertar odata - sistem ce impiedica rasturnarea dulapului.
- 2 Colturile dulapului sunt protejate cu bumpere rezistente la impact.
- 3 6, 7 sau 8 sertare (in functie de model) ce pot fi deschise complet. Acestea pot fi echipate cu modulele de stocare a sculelor Stahlwille. Sinele de glisare sunt echipate cu rulmenti.
- 4 Roti rezistente la ulei si acizi, de dimensiuni mari (Ø 100 mm), cu sistem de blocare pe doua roti.

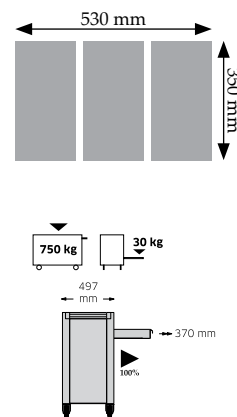

Culori disponibile:

- Verde Stahlwille
- Rosu (RAL 3020)
- Albastru (RAL 2703035)
- Gri (RAL 7016)
- Alb (RAL 9010).

Model	Culoare	Nr. de sertare	€/buc.	Cod articol
95/6	verde	6	901.00	ST.81200010
	rosu		901.00	ST.81200011
	albastru		901.00	ST.81200012
	gri		901.00	ST.81200013
95/7	verde	7	969.00	ST.81200015
	rosu		969.00	ST.81200016
	albastru		969.00	ST.81200017
	gri		969.00	ST.81200018
95/8	alb	8	969.00	ST.81200019
	verde		1024.00	ST.81200020
	rosu		1024.00	ST.81200021
	albastru		1024.00	ST.81200022
	gri	1024.00	ST.81200023	
	alb	1024.00	ST.81200024	

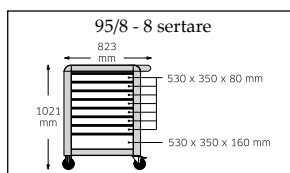
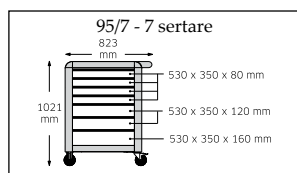
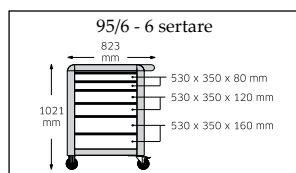

Dulapuri mobile si module de stocare a sculelor

Dulapuri mobile pentru scule - 98VA/6; 98VA/7; 98VA/8

Cu 100% mai mult spatiu de depozitare fata de modelele 90 si 95. Manerul este fabricat din otel inoxidabil. Cadrul dulapului este ramforsat in zona de prindere a manerului. Greutate: 65.5 kg.



- 1** Sistem de inchidere centralizat triplu.
 - Inchidere centrala - blocare totala.
 - Blocare individuala ce previne deschiderea sertarelor atunci cand se afla in miscare.
 - Nu poate fi deschis decat un singur sertar odata - sistem ce impiedica rasturnarea dulapului.
- 2** Colturile dulapului sunt protejate cu bumpere rezistente la impact.
- 3** 6, 7 sau 8 sertare (in functie de model) ce pot fi deschise complet. Acestea pot fi echipate cu modulele de stocare a sculelor Stahlwille si pot sustine sarcini de pana la 40kg. Sinele de glisare sunt echipate cu rulmenti.
- 4** Roti rezistente la ulei si acizi, de dimensiuni mari (Ø 125 mm), cu sistem de blocare pe doua roti.

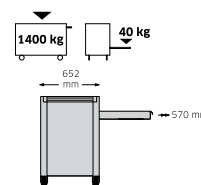
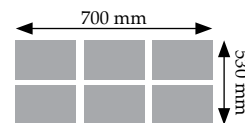

Culori disponibile:

- Verde Stahlwille
- Rosu (RAL 3020)
- Albastru (RAL 2703035)
- Gri (RAL 7016)
- Alb (RAL 9010).

Model	Culoare	Nr. de sertare	€/buc.	Cod articol
98VA/6	verde	6	1488.00	ST.81200099
	rosu		1488.00	ST.81200100
	albastru		1488.00	ST.81200101
	gri		1488.00	ST.81200102
	alb		1488.00	ST.81200103
98VA/7	verde	7	1471.00	ST.81200104
	rosu		1471.00	ST.81200105
	albastru		1471.00	ST.81200106
	gri		1471.00	ST.81200107
	alb		1471.00	ST.81200108
98VA/8	verde	8	1638.00	ST.81200109
	rosu		1638.00	ST.81200110
	albastru		1638.00	ST.81200111
	gri		1638.00	ST.81200112
	alb		1638.00	ST.81200113

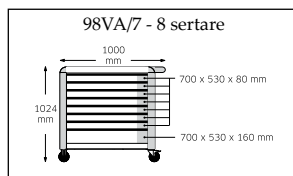
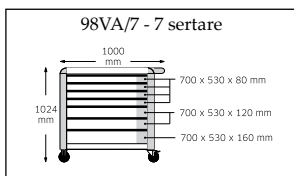
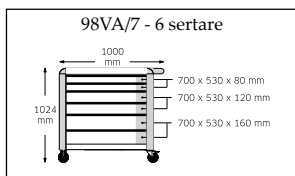

Acesorii pentru dulapuri mobile pentru scule

Tava pentru componente de dimensiuni mici - 912

Rezistenta la ulei.
 - 8 compartimente 60 x 80 mm
 - 8 compartimente 80 x 80 mm
 - 1 compartiment 100 x 165 mm
 - 1 compartiment 50 x 330 mm



Pentru	€/buc.	Cod articol
Dulapurile mobile pentru scule modelele 90 si 95	15.23	ST.83812070

Suport pentru spray-uri si surubelnite - SDH 95



Suport pentru 5 surubelnite si 4 spray-uri pt. modelul 95

Suport pentru 7 surubelnite si 6 spray-uri pt. modelul 98VA

Pentru	€/buc.	Cod articol
Dulapul mobil pentru scule 95	31.40	ST.81490003
Dulapul mobil pentru scule 98VA	34.10	ST.89010049

Suport cabluri - KH 91



Pentru	€/buc.	Cod articol
Dulapurile mobile pentru scule modelele 95 si 98VA	32.30	ST.89010040

Separator sertare - VE 50-150

Permite divizarea sertarelor.
 Constructie din otel galvanizat.



Pentru	€/buc.	Cod articol
Dulapurile mobile pentru scule modelele 95 si 98VA	17.91	ST.81484001

Cos deseuri - AB 98



9 litri

14 litri

Pentru	€/buc.	Cod articol
Dulapul mobil pentru scule modelul 95 - 9 litri	54.40	ST.89010052
Dulapul mobil pentru scule modelul 98VA - 14 litri	57.80	ST.89010053



Dulapuri mobile si module de stocare a sculelor

Module de stocare a sculelor

Initial sistemul modular de stocare a sculelor TCS - Tool Control System, a fost dezvoltat de Stahlwille impreuna cu British Aerospace pentru industria aerospatiala. Astazi acest sistem este din ce in ce mai apreciat in toate celelalte industrii mecanice. Sistemul garanteaza un inalt nivel de organizare si securitate.

Avantaje: toate sculele sunt asezate intr-un suport din spuma rezistenta chimic.

Stratul inferior este de culoare galbena (se poate detecta usor lipsa unei scule sau pozitionarea gresita)

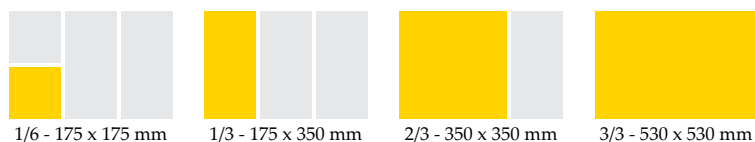
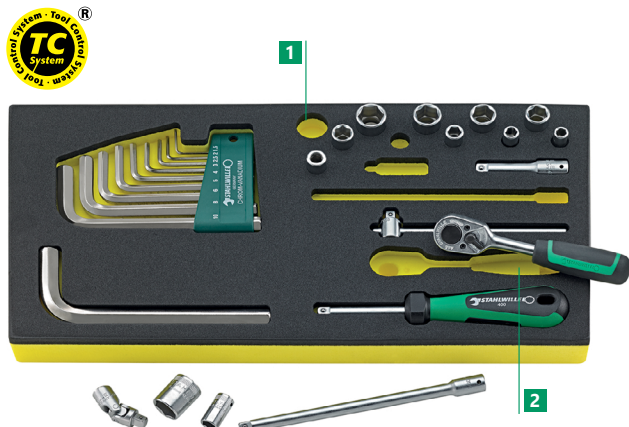

1 Stratul de spuma este decupat individual utilizand o tehnologie computerizata pentru a asigura fiecarei scule locul perfect.

2 Stratul inferior este de culoare galbena (se poate detecta usor lipsa unei scule sau pozitionarea gresita).



Modul - TCS 10/10



350 x 350 x 30 mm

Componenta	€/buc.	Cod articol
6 x 7; 8 x 9; 10 x 11; 12 x 13; 14 x 15; 16 x 17; 18 x 19; 20 x 22; 24 x 27; 30 x 32	75.90	ST.96838182

Modul - TCS 10/11



175 x 350 x 82 mm

Componenta	€/buc.	Cod articol
6 x 7; 8 x 9; 10 x 11; 12 x 13; 14 x 15; 16 x 17; 18 x 21; 19 x 22; 24 x 27; 30 x 32; 34 x 36	95.40	ST.96830167

Modul - TCS 13/17



350 x 350 x 60 mm

Componenta	€/buc.	Cod articol
6; 7; 8; 9; 10; 11; 12; 13; 14; 15; 16; 17; 18; 19; 21; 22; 24	159.00	ST.96830351

Modul - TCS 13a/19



350 x 350 x 55 mm

Componenta	€/buc.	Cod articol
3/16; 7/32; 1/4; 9/32; 5/16; 11/32; 3/8; 7/16; 1/2; 9/16; 19/32; 5/8; 11/16; 3/4; 25/32; 13/16; 7/8; 15/16; 1	201.00	ST.96838778

Dulapuri mobile si module de stocare a sculelor

Modul - TCS 20/8



175 x 350 x 45 mm

Componenta	€/buc.	Cod articol
6 x 7; 8 x 9; 10 x 11; 12 x 13; 14 x 15; 16 x 17; 18 x 21; 19 x 22	84.20	ST.96838192

Modul - TCS 24/7



175 x 350 x 35 mm

Componenta	€/buc.	Cod articol
8 x 10; 10 x 11; 11 x 13; 12 x 14; 14 x 17; 17 x 19; 19 x 22	102.00	ST.96838758

Modul - TCS 20/10



350 x 350 x 45 mm

Componenta	€/buc.	Cod articol
6 x 7; 8 x 9; 10 x 11; 12 x 13; 14 x 15; 16 x 17; 18 x 21; 19 x 22; 24 x 27; 30 x 32	126.00	ST.96830166

Modul - TCS 17/12



175 x 350 x 45 mm

Componenta	€/buc.	Cod articol
8; 9; 10; 11; 12; 13; 14; 15; 16; 17; 18; 19	189.00	ST.96830649

Modul - TCS 13/17, 6-24 mm



350 x 350 x 60 mm

Componenta	€/buc.	Cod articol
6; 7; 8; 9; 10; 11; 12; 13; 14; 15; 16; 17; 18; 19; 21; 22; 24	154.00	ST.96830164

Modul - TCS 10+13+24/30



530 x 350 x 75 mm

Componenta	€/buc.	Cod articol
6 x 7; 8 x 9; 10 x 11; 12 x 13; 14 x 15; 16 x 17; 18 x 19; 20 x 22; 21 x 24	275.00	ST.96830605
6; 7; 8; 9; 10; 11; 12; 13; 14; 15; 16; 17; 18; 19; 21; 22; 24; 27; 30; 32		
10 x 11		

Modul - TCS 14/21



530 x 350 x 75 mm

Componenta	€/buc.	Cod articol
6; 7; 8; 9; 10; 11; 12; 13; 14; 15; 16; 17; 18; 19; 21; 22; 24; 27; 30; 32; 36	275.00	ST.96838771

Modul - TCS 456/16/4 MF



175 x 350 x 45 mm

Componenta	€/buc.	Cod articol
3/8" \bigcirc 7; 8; 9; 10; 11; 12; 13; 14; 15; 16; 17; 18; 19; 20; 21; 22	189.00	ST.96830357
3/8" \blacksquare \bigcirc 125 mm		
3/8" \blacksquare \bigcirc 240 mm		
3/8" \blacksquare \bigcirc 46 mm		
3/8" \blacksquare		

Modul - TCS 50TX/54TX/17

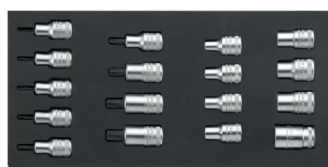

175 x 350 x 40 mm

Componenta	€/buc.	Cod articol
1/2" \bigcirc Torx exterior: E10; E11; E12; E14; E16; E18; E20; E24	174.00	ST.96838763
1/2" \bigcirc Torx: T20; T25; T27; T30; T40; T45; T50; T55; T60		

Dulapuri mobile si module de stocare a sculelor

Modul - TCS 40/41/44/8



175 x 350 x 45 mm

Componenta	€/buc.	Cod articol
¼ ⌀ 5; 5.5; 6; 7; 8; 9; 10; 11; 12; 13; 14	219.00	ST.96830217
¼ ⌀ 0.6 x 3.5; 1.0 x 5.5; 1.2 x 8		
¼ ⌀ SW3; SW4; SW5; SW6; SW8		
¼ ⌀ Ph1; Ph 2; Ph 3; Ph 4		
¼ ⌀ Pz1; Pz2		
¼ ■ 150 mm		
¼ ■ 116 mm		
¼ ■ ⌀ 54 mm		
¼ ■ ⌀ 150 mm		
¼ ■ ⌀ 38 mm		
⅜ ■ ¼ ⌀		
¼ ⌀ ⌀		
¼ ■		

Modul - TCS 52/14/4



175 x 350 x 50 mm

Componenta	€/buc.	Cod articol
½ ⌀ 10; 11; 12; 13; 14; 15; 16; 17; 18; 19; 22; 24; 27; 30	190.00	ST.96838781
½ ■ ⌀ 130 mm		
½ ■ ⌀ 255 mm		
½ ■ ⌀ 71 mm		
½ ■		

Modul - TCS ¼ + 10760CV

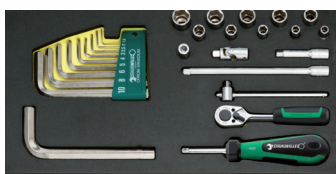

175 x 350 x 43 mm

Componenta	€/buc.	Cod articol
¼ ⌀ 5.5; 6; 7; 8; 9; 10; 11; 12; 13; 14	157.00	ST.96838176
¼ ■ 150 mm		
¼ ■ 116 mm		
¼ ■ ⌀ 54 mm		
¼ ■ ⌀ 150 mm		
¼ ■ ⌀ 38 mm		
¼ ⌀ ⌀		
¼ ■		
SW 1.5; SW2; SW2.5; SW3; SW4; SW5; SW6; SW8; SW10; SW12		

Modul - TCS 54/54X/16



175 x 350 x 35 mm

Componenta	€/buc.	Cod articol
½ ⌀ SW 4; SW 5; SW 6; SW 7; SW 8; SW10; SW12; SW14; SW17	163.00	ST.96838762
½ ⌀ T5; T6; T8; T10; T12; T14; T16		

Modul - TCS 4660/4665



175 x 350 x 40 mm

Componenta	€/buc.	Cod articol
0.4 x 2.5 x 75; 0.6 x 3.5 x 100	56.10	ST.96838766
1.0 x 5.5 x 125; 1.2 x 6.5 x 150 mm		
Ph1; Ph2		

Modul - TCS 4620/4630



175 x 350 x 35 mm

Componenta	€/buc.	Cod articol
0.6 x 3.5 x 75; 0.8 x 4.0 x 100	56.70	ST.96838278
1.0 x 5.5 x 125; 1.2 x 6.5 x 150		
Ph1; Ph2; Ph3		

Modul - TCS 4650



175 x 350 x 35 mm

Componenta	€/buc.	Cod articol
T8; T9; T10; T15; T20; T25; T27; T30	71.30	ST.96838767

Modul - TCS 6501-6602/4



175 x 350 x 35 mm

Componenta	€/buc.	Cod articol
Cleste combinat - 180 mm	99.50	ST.96838179
Cleste cheie reglabil - 240 mm		
Cleste diagonal de taiere - 160 mm		
Cleste de prindere cu falci plate-lungi - 200 mm		

Dulapuri mobile si module de stocare a sculelor

Modul - TCS 40/456/50/78/19



530 x 350 x 60 mm

Componenta	€/buc.	Cod articol
¼ ⌀ 5; 5.5; 6; 7; 8; 9; 10; 11; 12; 13; 14 mm	835.00	ST.96832095
¼ ⌀ 3; 4; 5; 6; 8 mm		
⅜ ⌀ 8; 9; 10; 11; 12; 13; 14; 15; 16; 17; 18; 19; 20; 21; 22 mm		
⅜ ⌀ 5; 6; 8 mm		
½ ⌀ 10; 11; 12; 13; 14; 15; 16; 17; 18; 19; 21; 22; 24; 27; 30; 32; 34 mm		
½ ⌀ 10; 12 mm		
¼ ⌀ E8; E10;		
¼ ⌀ T8; T10; T15; T20; T25; T27; T30; T40		
⅜ ⌀ E8; E10; E12; E14		
⅜ ⌀ T25; T45		
½ ⌀ T40; T50; T55; T60		
½ ⌀ T40; T45; T50; T55		
¼ ■ 150 mm		
¼ ■ 116 mm		
¼ ■ ⌀ 54; 100 mm		
¼ ■ ⌀ 38 mm		
¼ ○ ○		
¼ ■		
⅜ ■ 165 mm		
⅜ ■ ⌀ 76 mm		
⅜ ■ ⌀ 240 mm		
⅜ ■ ⌀ 46 mm		
¼ ■ ⅜ ○		
¼ ■ ⅜ ○		
⅜ ■		
½ ■ 300 mm		
½ ■ ⌀ 130 mm		
½ ■ ⌀ 255 mm		
½ ■ ⌀ 71 mm		
½ ■		
⅜ ■ ½ ○		

Modul - TCS 4620/4660VDE



530 x 350 x 40 mm

Componenta	€/buc.	Cod articol
0.6 x 3.5 x 75; 0.8 x 4.0 x 100; 1.2 x 6.5 x 150; 1.6 x 8.0 x 175; 1.6 x 10.0 x 200; 2.0 x 12.0 x 200 mm	156.00	ST.96831179
0.4 x 2.5 x 60 mm		
Ph1; Ph2; Ph3		
Ph 4		
Pz0; Pz1; Pz2		
0.4 x 2.5 x 60 mm		
1.0 x 5.5 x 75 mm		
Ph1; Ph2		

Modul - TCS 102-108/10956/10960/18



530 x 350 x 55 mm

Componenta	€/buc.	Cod articol
150 mm	212.00	ST.96830620
150 mm		
120 x 10 mm		
150 x 2.5; 150 x 3.0; 150 x 4.0; 150 x 5.0; 150 x 6.0; 150 x 8.0		
Ø50 mm		
300; 500 g		
285 mm		
20 x 315		
Perie		
Subler		
Cutter		

Modul - TCS 4622/4650+10760+10766

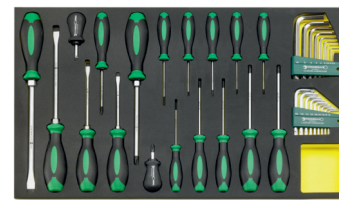

530 x 350 x 40 mm

Componenta	€/buc.	Cod articol
1.0 x 5.5 x 100; 1.2 x 6.5 x 125; 1.6 x 10.0 x 175; 2.0 x 12.0 x 200 mm	203.00	ST.96831196
Ph1; Ph3		
T6; T7; T8; T9; T10; T15; T20; T25; T27; T30		
1.0 x 5.5 x 25 mm		
Ph2		
1.5; 2.0; 2.5; 3.0; 4.0; 5.0; 6.0; 8.0; 10 mm		
T8; T9; T10; T15; T20; T25; T27; T30		

Modul - TCS 6543-6546/4 - clesti pentru inele de siguranta

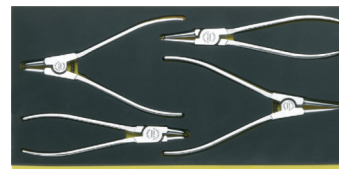

Pentru inele de siguranta de 19-60 mm, Ø 1.8 mm.

175 x 350 x 35 mm

Componenta	€/buc.	Cod articol
Cleste pentru inele de siguranta interioare, falci drepte	76.50	ST.96830608
Cleste pentru inele de siguranta interioare, falci la 90°		
Cleste pentru inele de siguranta exterioare, falci drepte		
Cleste pentru inele de siguranta exterioare, falci la 90°		

Dulapuri mobile si module de stocare a sculelor

Cutie pentru scule - 13217



- Cutie pentru scule extrem de robusta din polipropilena cu o capacitate de incarcare de 60 kg.
- Este ideala pentru uzul profesional.
- 5 sertare blocabile cu capace transparente (2 buc.); 3 inaltimi diferite: 30, 60, 95 mm.
- Atat capacul frontal cat si cel superior sunt rabatabile.
- O tava cu doua manere, detasabila, si doua capace transparente situate sub capacul superior.

- Sertarele pot fi utilizate ca si cutii de scule separate montand capacele transparente.
- 2 perechi de roti si maner telescopic in dotarea standard. Optional se pot adauga 4 perechi de roti pivotante pentru un transport usor.
- Manere laterale.
- Rezistent la acetona, benzina si uleiuri hidraulice in mod special Skydrol.
- 3 locasuri pentru inchidere cu lacat.

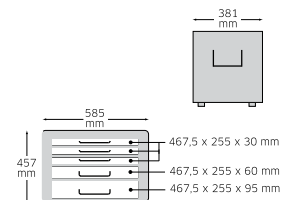

Culoare	€/buc.	Cod articol
Galben	452.00	ST.81091301
Portocaliu	452.00	ST.81091302
Rosu	452.00	ST.81091304
Negru	452.00	ST.81091306

Set de 4 module pentru trusele 13217

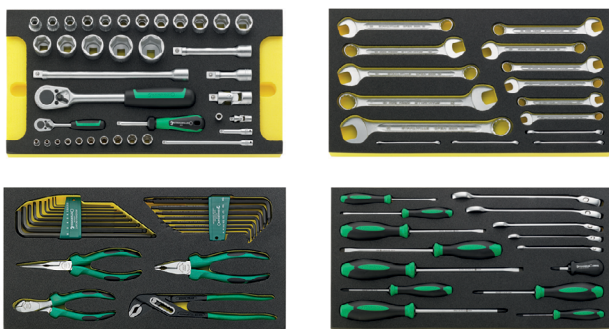

Componenta - 4 module	€/set	Cod articol
6; 7; 8; 10; 11; 12; 13; 14; 15; 16; 17; 18; 19; 22; 24 mm	901.00	ST.97842803
8; 10; 13; 17; 19 mm		
¼ ⌀ 5; 5.5; 6; 7; 8; 9; 10; 11; 12; 13 mm		
¼ ■ 150 mm		
¼ ■ ⌀ 54 mm		
¼ ■ ⌀ 150 mm		
¼ ■ ⌀ 38 mm		
¼ ○ ⌀		
¼ ■		
½ ⌀ 10; 11; 12; 13; 14; 15; 16; 17; 18; 19; 20; 21; 22; 24; 27; 30; 32 mm		
½ ■ ⌀ 75 mm		
½ ■ ⌀ 130 mm		
½ ■ ⌀ 255 mm		
½ ■ ⌀ 71 mm		
½ ■		
0.6 x 3.5 x 75; 0.8 x 4.0 x 100 1.0 x 5.5 x 125; 1.2 x 6.5 x 150 1.6 x 8.0 x 175 mm		
0.4 x 2.5 x 60 mm		
Ph1; Ph2; Ph3		
Ph2		
1.5; 2.0; 2.5; 3.0; 4.0; 5.0; 6.0; 8.0; 10.0 mm		
T9; T10; T15; T20; T25; T27; T30; T40		
Cleste combinat - 180 mm		
Cleste de prindere cu falci lungi - 200 mm		
Cleste cheie reglabil - 240 mm		
Cleste diagonal de taiere - 160 mm		

Modul pentru trusa 13217 - TCS WT 102-109/16



Componenta modul	€/buc.	Cod articol
175 mm	205.00	ST.96830119
120 x 12 mm		
115 x 2; 150 x 3; 150 x 4; 150 x 5; 150 x 6; 150 x 8 mm		
100 x 3.4 mm		
Ø 27 mm		
300g		
Briceag		
Ø 32 mm		
3 m		
300 mm		
Lanterna		

Set de 4 roti pivotante



€/buc.	Cod articol
57.70	ST.96894805



Chei dinamometrice

Cheie dinamometrica mecanica - 730 N

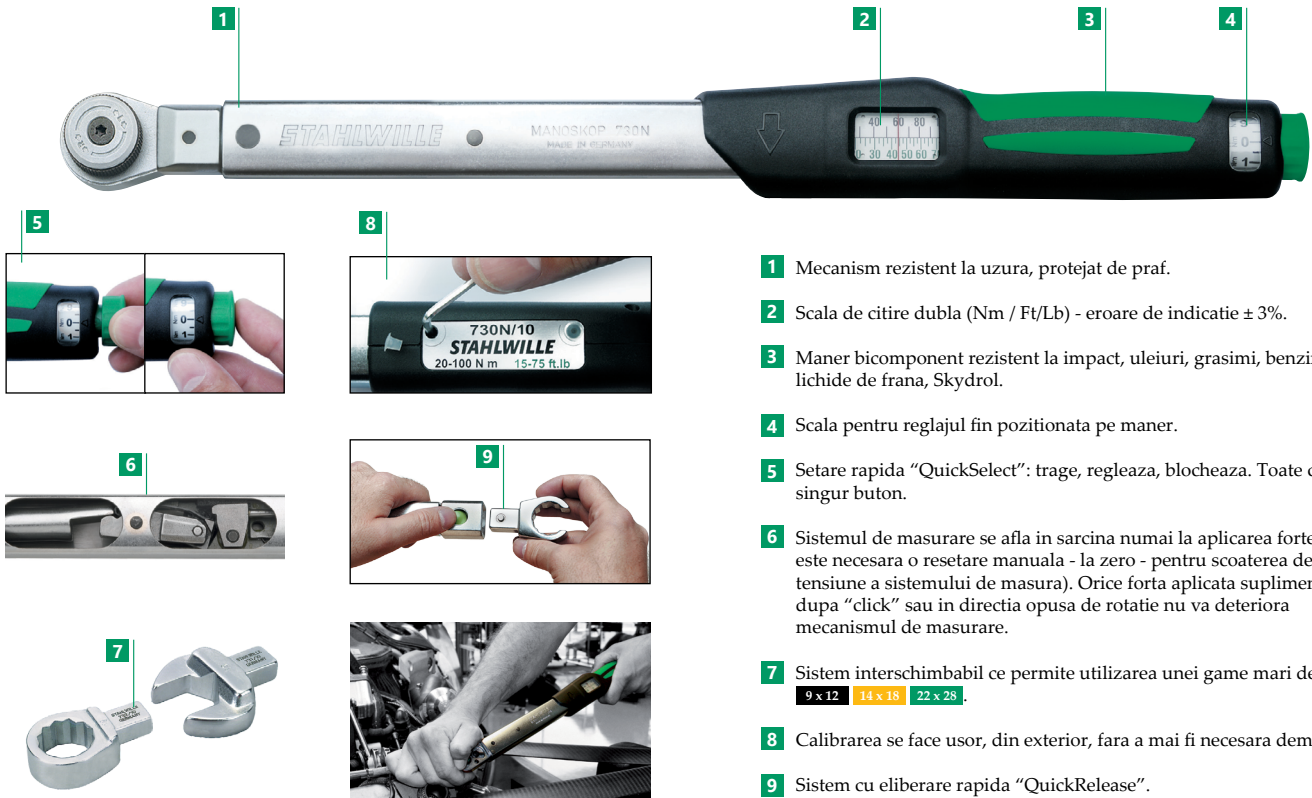

- 1 Mecanism rezistent la uzura, protejat de praf.
- 2 Scala de citire dubla (Nm / Ft/Lb) - eroare de indicatie ± 3%.
- 3 Maner bicomponent rezistent la impact, uleiuri, grasimi, benzina, lichide de frana, Skydrol.
- 4 Scala pentru reglajul fin positionata pe maner.
- 5 Setare rapida "QuickSelect": trage, regleaza, blocheaza. Toate cu un singur buton.
- 6 Sistemul de masurare se afla in sarcina numai la aplicarea fortei (nu este necesara o resetare manuala - la zero - pentru scoaterea de sub tensiune a sistemului de masura). Orice forta aplicata suplimentar dupa "click" sau in directia opusa de rotatie nu va deteriora mecanismul de masurare.
- 7 Sistem interschimbabil ce permite utilizarea unei game mari de capete
9 x 12 14 x 18 22 x 28
- 8 Calibrarea se face usor, din exterior, fara a mai fi necesara demontarea.
- 9 Sistem cu eliberare rapida "QuickRelease".

Atentie: Cheile dinamometrice sunt instrumente de masura. Acestea trebuie recalibrate in mod regulat in centre specializate (conform DIN EN ISO 6789, 5.3 recalibrare). In curand ROCAST va putea asigura recalibrarea tuturor cheilor dinamometrice Stahlwille.

Maner - Manoskop 730 N

Se livreaza cu numar de serie si certificat.

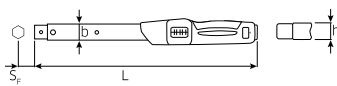

Pentru capete compatibile consultati paginile 37-39.

v	→	→	→	→	Dimensiuni (mm)				€/buc.	Cod articol
					(Nm)	(Nm)	Scala fina (Nm)	(mm)		
2 - 20	1	0.20	9 x 12	28	23	275	17	189.00	ST.50181002	
10 - 50	5	0.25				330		199.00	ST.50181005	
20 - 100	10	0.50				386		216.00	ST.50181010	
25 - 130	10	0.50				421		228.00	ST.50181012	
40 - 200	10	1.00	14 x 18	28	23	467	25	246.00	ST.50181020	
80 - 400	20	2.00				607		369.00	ST.50181040	
130 - 650	50	2.50				890		534.00	ST.50181065	
130 - 650	50	2.50	22 x 28	30	25	911	55	555.00	ST.50181365	
160 - 800	100	5.00				1178		661.00	ST.50181080	
200 - 1000	100	5.00				1363		869.00	ST.50181100	
20 - 180	10	2.00	9 x 12	28	23	275	17	207.00	ST.50581002	
90 - 450	50	2.50				330		206.00	ST.50581005	
180 - 900	100	5.00				386		223.00	ST.50581010	
350 - 1800	100	10.00				467		248.00	ST.50581020	
60 - 300	20	2.00	14 x 18	28	23	607	25	361.00	ST.50581040	

Cheie dinamometrica cu clichet cu cap fix - 730NR

Se livreaza cu numar de serie si certificat.
 Precizie ± 4% din forta de strangere conforma.
 Se livreaza in cutie de plastic.



QR

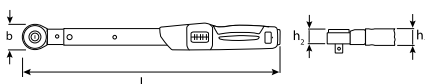

→	→	→	■	Dimensiuni (mm)				€/buc.	Cod articol
				(Nm)	(Nm)	Scala fina (Nm)	(mm)		
10 - 50	5	0.25	3/8	33	23	24	364	292.00	ST.96503105
20 - 100	10	0.50	1/2	33	23	24	420	302.00	ST.96503110
40 - 200	10	1.00	1/2	43	23	26	513	337.00	ST.96503120
80 - 400	20	2.00	3/4	50	23	31	657	481.00	ST.96502140
130 - 650	50	2.50	3/4	58	25	36	944	715.00	ST.96502265
Cu sistem QR (cu eliberare rapida)									
10 - 50	5	0.25	3/8	29	23	14	372	305.00	ST.96502105
20 - 100	10	0.50	1/2	29	23	14	428	315.00	ST.96502110
40 - 200	10	1.00	1/2	41	23	18	526	353.00	ST.96502120

Chei dinamometrice

Cheie dinamometrica electro-mecanica - Manoskop 730 D



- 1 Sistem interschimbabil ce permite utilizarea unei game mari de capete **9 x 12** **14 x 18** **22 x 28**
- 2 Cand valoarea cuplului pre-setat este atinsa, cheia decupleaza si indica acest lucru (audio/tactil).
- 3 Display usor de citit. Notificare automata privind data urmatoarei calibrari. Scala de citire dubla (Nm / Ft/Lb) - eroare de indicatie ± 2%.
- 4 Setare rapida si usoara cu ajutorul butoanelor de control.
- 5 Alimentare cu 2 baterii AA de 1.5 V.
- 6 Sistem cu eliberare rapida "QuickRelease".
- 7 Interfata USB.
- 8 Maner bicomponent rezistent la impact, uleiuri, grasimi, benzina, lichide de frana, Skydrol.
- 9 Optional se poate controla strangerea unghiulara prin atasarea Modulului unghiular 7395-1 si conectarea acestuia.



Atentie: Cheile dinamometrice sunt instrumente de masura. Acestea trebuie recalibrate in mod regulat in centre specializate (conform DIN EN ISO 6789, 5.3 recalibrare). In curand ROCAST va putea asigura recalibrarea tuturor cheilor dinamometrice Stahlwille.

Maner - Manoskop 730 D

Se livreaza cu numar de serie si certificat.

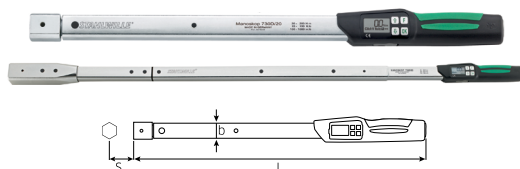

Pentru capete compatibile consultati paginile 37-39.

Scara (Nm)	Setari display (Nm)	Capetă (mm)	Dimensiuni (mm)				€/buc.	Cod articol
			b	h	L	S _F		
10 - 100	0.2 / 0.1	9 x 12	28	23	467	17	338.00	ST.96501710
20 - 200	0.5 / 0.1	14 x 18	28	23	548	25	363.00	ST.96501720
40 - 400	1.0 / 0.1		28	23	688	25	529.00	ST.96501740
65 - 650	1.0 / 0.1		30	25	870	25	661.00	ST.96501765
65 - 650	1.0 / 0.1	22 x 28	30	25	892	55	789.00	ST.96501965
80 - 800	1.0 / 1.0		30	25	1160	55	1056.00	ST.96502080
100 - 1000	1.0 / 1.0		30	25	1344	55	1304.00	ST.96502100

Cheie dinamometrica cu clichet cu cap fix - 730DR

Se livreaza cu numar de serie si certificat.
Precizie ± 2% din forta de strangere conforma.
Se livreaza in cutie de plastic.



Scara (Nm)	Setari display/rezolutie (Nm)	Capetă (mm)	Capetă (mm)	€/buc.	Cod articol
10 - 100	0.2 / 0.1	1/2	9 x 12	397.00	ST.96501810
20 - 200	0.5 / 0.1	1/2	14 x 18	424.00	ST.96501820
40 - 400	1.0 / 0.1	3/4	14 x 18	620.00	ST.96501840
65 - 650	1.0 / 0.1	3/4	14 x 18	760.00	ST.96501865
65 - 650	1.0 / 0.1	3/4	22 x 28	928.00	ST.96502065
80 - 800	1.0 / 0.1	3/4	22 x 28	1359.00	ST.96501880
100 - 1000	1.0 / 0.1	3/4	22 x 28	1607.00	ST.96501800

Modul unghiular pentru 730DR - 7395-1



In momentul in care unghiul pre-setat este atins, cheia se va decupla in mod automat.



€/buc.	Cod articol
344.00	ST.96584628



Cheie dinamometrice

Cheie dinamometrica mecanica - Manoskop 721 / 720

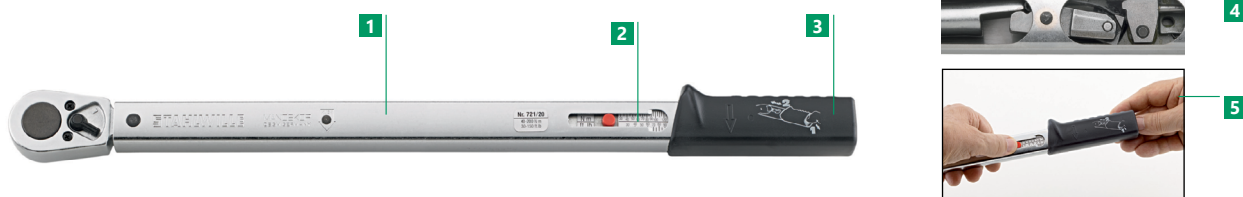

- 1 Cand valoarea cuplului pre-setat este atinsa, cheia decupleaza si indica acest lucru.
- 2 Scala de citire dubla (Nm / Ft/Lb) - eroare de indicatie $\pm 4\%$.
- 3 Maner rezistent la impact, uleiuri, grasimi, benzina, lichide de frana, Skydrol.
- 4 Sistemul de masurare se afla in sarcina numai la aplicarea fortei (nu este necesara o resetare manuala - la zero - pentru scoaterea de sub tensiune a sistemului de masura). Orice forta aplicata suplimentar dupa "click" sau in directia opusa de rotatie nu va deteriora mecanismul de masurare.
- 5 Setare rapida a cuplului.

Atentie: Cheile dinamometrice sunt instrumente de masura. Acestea trebuie recalibrate in mod regulat in centre specializate (conform DIN EN ISO 6789, 5.3 recalibrare). In curand ROCAST va putea asigura recalibrarea tuturor cheilor dinamometrice Stahlwille.

Cheie dinamometrica cu clichet cu cap fix - 721 / 721QR

Se livreaza cu numar de serie si certificat.

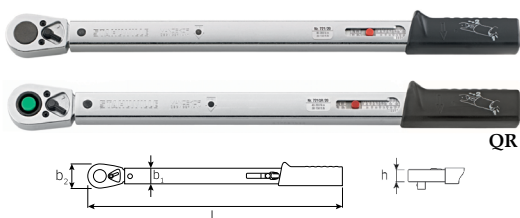

(Nm)	(Nm)	(mm)	Dimensiuni (mm)				€/buc.	Cod articol
			b ₁	b ₂	L	h		
6 - 50	2	3/8	28	27	352	14	222.00	ST.50200005
30 - 150	5	1/2	28	41	452	18	223.00	ST.50200015
40 - 200	5	1/2	28	41	483	18	238.00	ST.50200020
60 - 300	10	1/2	28	44	553	27	275.00	ST.50200030
Cu sistem QR (cu eliberare rapida)								
40 - 200	5	1/2	28	41	483	18	241.00	ST.50201020

Trusa pentru roti - 721QR/20/3/1

Se livreaza cu numar de serie si certificat.

Componenta:

- Cheie dinamometrica cu clichet cu cap fix 721QR (antrenor 1/2 cu eliberare rapida)
- 3 chei tubulare de impact cu protectie marimile: 17 mm (verde), 19 mm (albastru), 20.8 mm (rosu)
- 1 prelungitor cu eliberare rapida 1/2 - 130 mm



Cheie dinamometrica cu clichet cu cap fix - 720 Nf / 721 Nf

Se livreaza cu numar de serie si certificat.

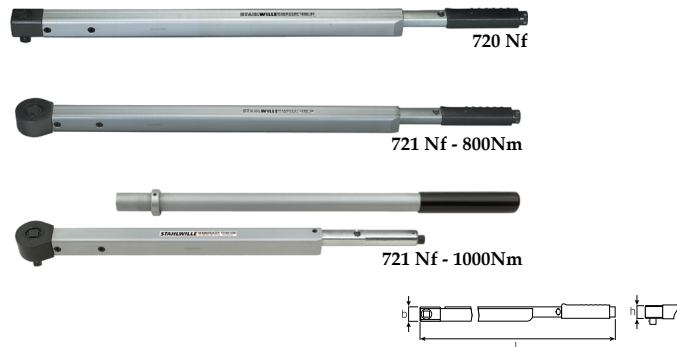

Denumire	€/trusa	Cod articol	Model	(Nm)	(Nm)	(mm)	Dimensiuni (mm)			€/buc.	Cod articol
							b	L	h		
Trusa pentru roti 721QR/20/3/1	335.00	ST.96507213	720 Nf	160 - 800	20	3/4	45	1034	42	650.00	ST.50190081
			721 Nf	160 - 800	20	3/4	76	1051	42	854.00	ST.50200081
				200 - 1000	25	3/4	76	1504	42	985.00	ST.96502001

Capete pentru chei dinamometrice

Cap pentru chei dinamometrice - 725-4

Reversibil.
22 dinti.



(inch)	(mm)	Cuplu (Nm)	€/buc.	Cod articol
1/4	9 x 12	40	50.20	ST.58254004

Cap pentru chei dinamometrice - 725QR

Reversibil.
Cu eliberare rapida.



(inch)	(mm)	Nr. dinti	Cuplu (Nm)	€/buc.	Cod articol
1/4	9 x 12	22	40	66.20	ST.58253004
3/8		30	100	66.20	ST.58253005
1/2		30	100	69.70	ST.58253010
1/2	14 x 18	36	200	72.00	ST.58253020

Chei dinamometrice

Cap pentru chei dinamometrice - 735

Reversibil.
60 de dinti.



Cap pentru chei dinamometrice - 734



■ (inch)	■ (mm)	Cuplu (Nm)	€/buc.	Cod articol
3/8	9 x 12	100	54.60	ST.58250005
1/2		100	56.10	ST.58250010
1/2	14 x 18	300	58.00	ST.58250020
3/4		400	85.70	ST.58250040
3/4	22 x 28	650	98.00	ST.58250065
3/4		-	140.00	ST.58251065

■ (inch)	■ (mm)	Cuplu (Nm)	€/buc.	Cod articol
1/4	9 x 12	40	22.65	ST.58240004
3/8		80	22.65	ST.58240005
1/2	14 x 18	100	23.18	ST.58240010
1/2		300	25.20	ST.58240020
3/4	22 x 28	650	41.40	ST.58240040
3/4		-	-	-

Cap fix pentru chei dinamometrice - 731/40



○ (mm)	■ (mm)	€/buc.	Cod articol
7	9 x 12	26.70	ST.58211007
8		24.10	ST.58211008
9		26.10	ST.58211009
10		22.50	ST.58211010

○ (mm)	■ (mm)	€/buc.	Cod articol
11	9 x 12	23.49	ST.58211011
12		24.71	ST.58211012
13		22.50	ST.58211013
14		22.50	ST.58211014
15		24.10	ST.58211015
16		22.50	ST.58211016
17		22.50	ST.58211017
18		23.26	ST.58211018
19		22.50	ST.58211019
13	14 x 18	26.40	ST.58214013
14		27.10	ST.58214014
15		29.20	ST.58214015
16		26.90	ST.58214016
17		25.80	ST.58214017
18		26.90	ST.58214018
19		25.80	ST.58214019
21		31.80	ST.58214021
22		31.30	ST.58214022
24		31.30	ST.58214024

○ (mm)	■ (mm)	€/buc.	Cod articol
25	14 x 18	35.20	ST.58214025
27		31.30	ST.58214027
30		34.90	ST.58214030
32		34.90	ST.58214032
34		39.40	ST.58214034
36		38.30	ST.58214036
38		40.20	ST.58214038
41	39.40	ST.58214041	
24	22 x 28	37.00	ST.58211024
27		39.40	ST.58211027
30		41.40	ST.58211030
32		43.70	ST.58211032
34		45.90	ST.58211034
36		48.20	ST.58211036
41		76.50	ST.58211041
46		78.80	ST.58211046
50		80.40	ST.58211050
55		83.40	ST.58211055
60	85.70	ST.58211060	

Cap inelar pentru chei dinamometrice - 731/40



○ (mm)	■ (mm)	€/buc.	Cod articol
7	9 x 12	25.10	ST.58221007
8		24.41	ST.58221008
10		24.48	ST.58221010
11		25.10	ST.58221011

○ (mm)	■ (mm)	€/buc.	Cod articol
12	9 x 12	25.10	ST.58221012
13		24.48	ST.58221013
14		25.10	ST.58221014
15		24.41	ST.58221015
16		24.48	ST.58221016
17		24.48	ST.58221017
18		24.48	ST.58221018
19		24.48	ST.58221019
21		25.70	ST.58221021
22		24.48	ST.58221022
13	14 x 18	26.50	ST.58224013
14		26.50	ST.58224014
15		27.10	ST.58224015
16		28.50	ST.58224016
17		26.50	ST.58224017
18		26.50	ST.58224018
19		26.50	ST.58224019
21		31.60	ST.58224021
22		31.60	ST.58224022

○ (mm)	■ (mm)	€/buc.	Cod articol
24	14 x 18	31.60	ST.58224024
27		31.60	ST.58224027
28		38.30	ST.58224028
30		35.70	ST.58224030
32		35.70	ST.58224032
34		38.30	ST.58224034
36		38.30	ST.58224036
41	38.30	ST.58224041	
24	22 x 28	37.00	ST.58221024
27		39.40	ST.58221027
30		41.40	ST.58221030
32		43.70	ST.58221032
34		45.90	ST.58221034
36		48.20	ST.58221036
41		76.50	ST.58221041
46		78.80	ST.58221046
50		80.40	ST.58221050
55		83.40	ST.58221055
60	85.70	ST.58221060	

Chei dinamometrice

Adaptor pentru chei



Cap inelar pentru suruburi E-Torx



Cap inelar deschis



Ø (mm)	Ø (mm)	€/buc.	Cod articol
9 x 12	14 x 8	38.70	ST.58290010
14 x 18	9 x 12	61.60	ST.58290040

Marime	Ø (mm)	€/buc.	Cod articol
E 6	9 x 12	23.80	ST.58291006
E 8		23.80	ST.58291008
E10		23.80	ST.58291010
E12		23.80	ST.58291012
E14		23.80	ST.58291014
E14	14 x 18	31.60	ST.58294014
E18		31.60	ST.58294018
E20		31.60	ST.58294020
E24		35.70	ST.58294024

Ø (mm)	Ø (mm)	€/buc.	Cod articol
10	9 x 12	25.80	ST.58231010
11		25.80	ST.58231011
12		25.80	ST.58231012
13		25.80	ST.58231013
14		25.80	ST.58231014
16		26.70	ST.58231016
17		25.80	ST.58231017
18		28.00	ST.58231018
19		25.80	ST.58231019
21		28.00	ST.58231021
22		25.80	ST.58231022
24		25.80	ST.58231024



Amplificatoare de cuplu - Multipower

Stahlwille Multipower - amplificatorul de cuplu cu sistem planetar reduce considerabil efortul strangerii sau desfacerii suruburilor de mari dimensiuni, astfel nu mai este necesar un maner lung.

Combinat cu cheile dinamometrice Stahlwille sistemul "Multipower" isi arata adevarata valoare, astfel se poate atinge la un cuplu maxim de **5000 Nm**.

Dispozitivele de peste 2000 Nm au in dotare sisteme de anti-revenire.

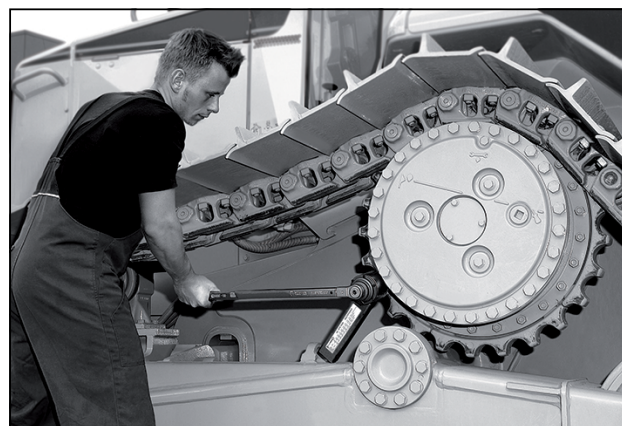

Amplificatoare de cuplu - Multipower MP300

MP300 cu protectie la suprasarcina.
Se livreaza in geanta de transport.
Eroare de indicatie ± 5%.



- Trusa compacta cu sistem cu clichet, 45 de dinti.
- Se poate utiliza cu o cheie dinamometrica cu antrenor de 1/2.
- Se livreaza in cutie de transport.
- Sunt incluse in set 3 chei hexagonale de 30, 32, 36 mm.
- Eroare de indicatie ± 5%.

Cuplu (Nm)		Raport de transmisie	Raport de cuplu	■	□	Dimensiuni (mm)			€/buc.	Cod articol
Aplicat	Dezvoltat					b	h	L		
229	800	4 : 1	1 : 3.5	1/2	3/4	66	85	215	560.00	ST.53030800
375	1350	4 : 1	1 : 3.6	3/4	3/4	90	106	265	817.00	ST.53031350
160	2000	16 : 1	1 : 12.5	1/2	1	95	161	330	1939.00	ST.53032000
240	3000	16 : 1	1 : 12.5	3/4	1	95	161	330	2298.00	ST.53033000
294	5000	20 : 1	1 : 17.0	3/4	1 1/2	120	180	400	3259.00	ST.53035000

Trusa - Multipower MP100-1500

Cuplu (Nm)		Raport de transmisie	Raport de cuplu	□	Dimensiuni (mm)			€/trusa	Cod articol
Aplicat	Dezvoltat				b	h	L		
300	1500	5.62 : 1	1 : 5	1/2	105	30	165	2498.00	ST.96531500

Extractoare

Extractoarele Stahlwille

Proiectate pentru toate aplicatiile practice, fabricate din otel forjat de inalta calitate si executate pe masini de ultima generatie. Sunt apoi testate in sarcina.

Acestea sunt uneltele ideale pentru extragerea rotilor dintate, rulmentilor, axelor etc.

- Rezistenta ridicata la incovoiere datorita profilelor lonjeroanelor calculate cu precizie.
- Bratele extractoare sunt realizate din otel crom-vanadiu, calit. Au geometrie de prindere special conceputa pentru a fi utilizate in spatiile cu acces redus.
- Extractia se face cu usurinta, chiar si in cazul in care exista forte de frecare datorita filetului executat cu precizie de CNC.

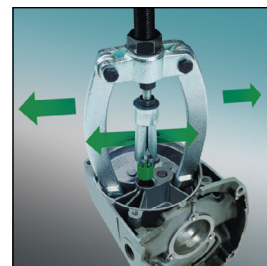
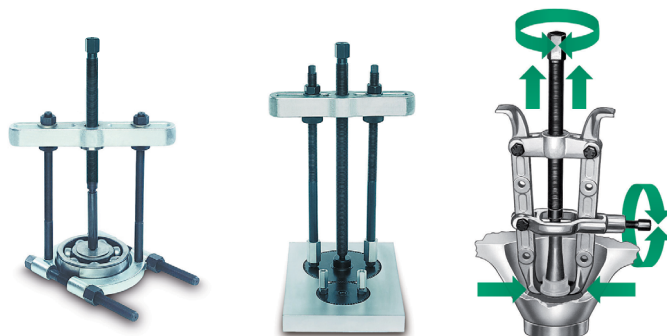

Extractoare cu 2 sau cu 3 brate?
Extractoarele cu 3 brate sunt preferate chiar daca necesita un spatiu mai mare de lucru deoarece forta de extractie este distribuita mai bine.

Extractoare standard - 11053 / 11054

Otel forjat, zincat.

Cu 2 sau 3 brate.

Se pot utiliza atat ca si extractoare exterioare cat si interioare.



Nr. brate	Prindere (mm)		Sarcina maxima (t)	Cuplu maxim (Nm)	€/buc.	Cod articol
	Latime	Adancime max.				
2	50 - 300	270	6	120	134.00	ST.71150211
	50 - 400	400	6	120	160.00	ST.71150212
3	50 - 300	270	12	220	174.00	ST.71150311
	50 - 400	400	12	220	214.00	ST.71150312

Extractoare cu brate reversibile - 12150 / 12152

Otel forjat, zincat.

Cu 2 sau 3 brate.

Se pot utiliza atat ca si extractoare exterioare cat si interioare.



Nr. brate	Prindere (mm)		Sarcina maxima (t)	Cuplu maxim (Nm)	€/buc.	Cod articol
	Latime	Adancime max.				
2	20 - 150	80	3.5	50	59.70	ST.71140211
	40 - 220	130	4.0	60	104.00	ST.71140212
3	20 - 150	80	4.0	60	78.80	ST.71140311
	40 - 220	130	4.5	70	134.00	ST.71140312

Extractoare standard cu brate glisante - 11050 / 11051

Otel forjat, zincat.

Cu 2 sau 3 brate.

Se pot utiliza atat ca si extractoare exterioare cat si interioare.

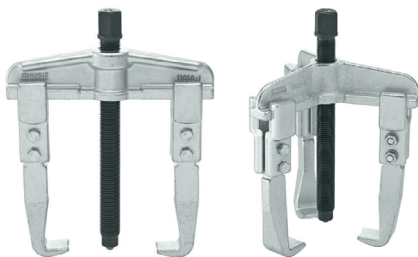

Nr. brate	Prindere (mm)		Sarcina maxima (t)	Cuplu maxim (Nm)	€/buc.	Cod articol
	Latime	Adancime max.				
2	25 - 80	100	4.5	80	66.60	ST.71130011
	25 - 130	100	4.5	80	70.80	ST.71130012
	50 - 160	150	6.5	150	121.00	ST.71130013
	60 - 200	150	6.5	150	134.00	ST.71130014
	80 - 250	200	11.0	320	223.00	ST.71130015
	80 - 350	200	11.0	320	253.00	ST.71130016
3	25 - 80	100	5.5	55	92.60	ST.71080011
	25 - 120	100	5.5	55	97.20	ST.71080012
	25 - 160	150	7.0	70	178.00	ST.71080013
	25 - 200	150	7.0	70	195.00	ST.71080014

Set de extractoare cu brate glisante - 11056

Otel forjat, zincat.

Cu 2 si 3 brate.

Se pot utiliza atat ca si extractoare exterioare cat si interioare.

Se livreaza in cutie metalica



Latime de prindere: 120 mm
Adancime max.: 100, 200, 250 mm

€/set	Cod articol
451.00	ST.96711311

Extractoare

Extractoare de rulmenti cu strangere laterala - 11055

Otel forjat, zincat.
Cu 2 brate.

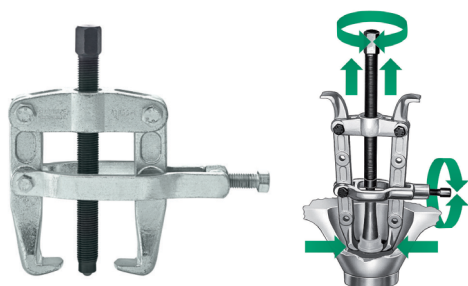

Tip	Prindere (mm)		Sarcina maxima (t)	Cuplu maxim (Nm)	€/buc.	Cod articol
	Latime	Adancime max.				
1	20 - 70	85	5.0	120	101.00	SW.71190011
2	20 - 100	100	6.0	120	118.00	SW.71190012
3	30 - 150	150	8.0	150	158.00	SW.71190013



Extractoare de rulmenti - 12614

Otel forjat, zincat.

Se pot utiliza impreuna cu placile extractoare 12613 si eventual cu extensiile V12614 de acelasi tip.



Extensie



Tip	Latime (mm)	Bolturi de extragere	Sarcina maxima (t)	Cuplu maxim (Nm)	€/buc.	Cod articol
0	45 - 110	110	2.0	30	47.90	ST.71040010
1	55 - 140	155	2.5	40	76.50	ST.71040011
2	60 - 215	200	4.0	70	118.00	ST.71040012
3	85 - 295	315	5.0	90	174.00	ST.71040013

Tip Extensii - V12614

1	Lungime 100 mm - pentru tipurile 0, 1	13.39	ST.79440011
2	Lungime 150 mm - pentru tipul 2	22.04	ST.79440012
3	Lungime 150 mm - pentru tipul 3	25.40	ST.79440013

Placi separatoare - 12613

Otel forjat, zincat.

Avantajul fata de extractoarele cu gheara consta in faptul ca nu deterioreaza inelul rulmentului sau suprafata piesei extrase, forta fiind distribuita pe o suprafata mai mare.

Se pot utiliza impreuna cu placile extractoare 12613 si eventual cu extensiile V12614 de acelasi tip.

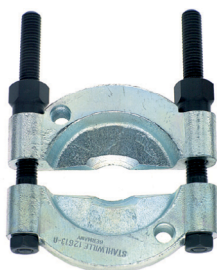

Tip	Prindere (mm)		Sarcina maxima (t)	Cuplu maxim (Nm)	€/buc.	Cod articol
	Latime	Deschidere				
0	5 - 60	60	2.0	30	51.30	ST.71030010
1	12 - 75	75	2.5	40	64.70	ST.71030011
2	22 - 115	115	4.0	70	99.50	ST.71030012
3	30 - 155	155	5.0	90	157.00	ST.71030013

Extractoare de rulmenti - 11040 / 11042

Otel forjat, zincat.
Cu 2 sau 3 brate.
Autocentrare rapida.



Nr. brate	Prindere (mm)		Sarcina maxima (t)	Cuplu maxim (Nm)	€/buc.	Cod articol
	Latime	Adancime max.				
2	10 - 60	45	2.5	25	31.60	ST.71120011
	10 - 70	65	3.0	35	31.80	ST.71120012
	10 - 100	80	3.5	45	39.80	ST.71120013
3	10 - 60	45	2.5	25	48.60	ST.71180011
	10 - 70	65	3.0	35	49.40	ST.71180012
	10 - 100	80	3.5	45	52.80	ST.71180013

Extractoare interioare de rulmenti - 11060

Otel forjat.

Se pot utiliza cu accesoriul de extragere 11061 sau cu ciocanul glisant 11062.



Accesoriu de extragere 11061



Ciocan glisant 11062



Tip	Cuplu maxim (Nm)	Deschidere (mm)	€/buc.	Cod articol
0	30	8 - 12	39.40	ST.71160010
1		12 - 16	40.20	ST.71161011
1a		16 - 20	41.40	ST.71160021
2		20 - 27	43.70	ST.71160012
3	60	27 - 36	45.90	ST.71160013
5		36 - 46	63.20	ST.71160015
6		46 - 58	81.90	ST.71160016
7		58 - 70	104.00	ST.71160017
8		70 - 100	160.00	ST.71160018

Accesorii

Denumirea	Pentru tipul	€/buc.	Cod articol
Accesoriu de extragere	0; 1; 2	36.50	ST.71170011
	3; 5; 6; 7	56.70	ST.71170012
	8	114.00	ST.71170013
Ciocan glisant	0; 1; 2	42.10	ST.71161001
	3; 5	68.50	ST.71161002

Extractoare butuci roti - 11030

Otel forjat, zincat.
Extractor cu 3 brate.

Se pot utiliza pentru orificii cu un diametru maxim de 225 mm



Tip	Nr. de brate	Sarcina maxima (t)	Cuplu maxim (Nm)	€/buc.	Cod articol
1	3	14.0	280	134.00	ST.71110013
2	5	14.0	280	170.00	ST.71110015
Brat de rezerva (1 buc.)				20.81	ST.79100010

Extractoare

Extractor de pivoti - 11041

Otel forjat, zincat.

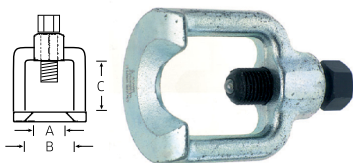

Tip	Dimensiuni (mm)			Cuplu max. (Nm)	€/buc.	Cod articol
	A	B	C			
1	18	37	37	50	33.00	ST.71230011
2	23	45	45	120	44.00	ST.71230012
3	29	55	60	160	56.70	ST.71230013
4	39	70	80	280	74.30	ST.71230014

Axe de schimb - 11040-12150

Ax	Pentru extractor	€/buc.	Cod articol
SP 11040-1	11040-1; 11042-1	12.55	ST.79281011
SP 11040-2	11040-2; 11042-2	16.15	ST.79281111
SP 11040-3	11040-3; 11042-3	12.17	ST.79281012
SP 11050-1	11050-1; 11050-2; 11051-1; 11051-2; 11056; 12150-1; 12152-1; 12614-0; 12614-1	27.10	ST.79281013
SP 11050-3	11050-3, -4; 11051-3, -4; 12614-2	41.70	ST.79281014
SP 11050-5	11050-5, -6	79.60	ST.79281015
SP 11055-1	11055-1	36.50	ST.79281016
SP 11055-2	11055-2	41.00	ST.79281017
SP 11055-3	11055-3	75.40	ST.79281018
SP 11041-1	11041-1	16.30	ST.79281019
SP 11041-2	11041-2	16.30	ST.79281020
SP 11041-3	11041-3	47.50	ST.79281021
SP 11041-4	11041-4	63.20	ST.79281022
SP 11053-1	11053-1, 11053-2; 11054-1, 11054-2	69.70	ST.79281023
SP 12150-2	12150-2; 12152-2	45.20	ST.79281034

Extractor de pivoti - 12616 (diametre 18-22 mm)

Otel forjat, zincat.



Deschidere furca Ø (mm)	Inaltime (h)	Sarcina maxima (t)	Cuplu maxim (Nm)	€/buc.	Cod articol
18 - 22	20-50	3.5	70	64.70	ST.71050010

Extractor de pivoti - 12623 (diametru 20 mm)

Otel forjat, zincat.

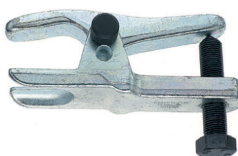

Deschidere furca Ø (mm)	Inaltime (h)	Sarcina maxima (t)	Cuplu maxim (Nm)	€/buc.	Cod articol
20	12-50	3.5	40	83.40	ST.71050011

Extractor de pivoti - 12623-1 (diametru 24 mm)

Otel forjat, zincat.



Deschidere furca Ø (mm)	Inaltime (h)	Sarcina maxima (t)	Cuplu maxim (Nm)	€/buc.	Cod articol
24	60-80	3.5	40	115.00	ST.71050012

Extractor de pivoti - 12623-3 (diametre 35 - 45 mm)

Otel forjat, zincat.



Deschidere furca Ø (mm)	Inaltime (h)	Sarcina maxima (t)	Cuplu maxim (Nm)	€/buc.	Cod articol
35 - 45	115	20	200	251.00	ST.71050014

Extractor de pivoti - 12623-4 (diametre 27 - 36 mm)

Otel forjat, zincat.



Deschidere furca Ø (mm)	Inaltime (h)	Sarcina maxima (t)	Cuplu maxim (Nm)	€/buc.	Cod articol
27 - 36	90	10	100	131.00	ST.71050015



Colector magnetic

Utilizare pana la 80°C.

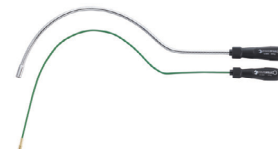

Capacitate de ridicare (g)	Ø (mm)	L (mm)	€/buc.	Cod articol
270	5	500	6.12	ST.77260027
500	8	460	17.85	ST.77260025
1800	15	525	27.30	ST.77260060
3000	19	535	42.50	ST.77260200

Oglinzi telescopice - otel inoxidabil

Oglinda poate fi inclinata +/-90°.
Maner din plastic rezistent chimic.



Tip	L (mm)	Dimensiune oglinda (mm)	€/buc.	Cod articol
1	171 - 699	Ø 32	20.57	ST.77401032
2	178 - 927	45 x 70	21.42	ST.77401045
3	178 - 921	Ø 57	20.57	ST.77401057
4	178 - 914	25 x 50	20.66	ST.77402550

Oglinzi de schimb

Tipul 1	Tipul 2	Tipul 3	Tipul 4
Ø 32	45 x 70	Ø 57	25 x 50
14.92	14.69	14.69	14.92
ST.79401032	ST.79401045	ST.79401057	ST.79402550

Ciocane

Ciocane din cauciuc - DIN 5128



Dimensiuni (mm)			Greutate (g)	€/buc.	Cod articol
Ø	L1	L2			
55	320	90	317	4.82	ST.70140001
65	350	115	527	6.28	ST.70140002
75	350	130	780	9.80	ST.70140003
90	380	140	1193	14.31	ST.70140004

Ciocane din plastic

Material: acetat de celuloza rezistent la impact.
Cu capete interschimbabile.



Dimensiuni (mm)			Greutate (g)	€/buc.	Cod articol
Ø	L1	L2			
27	265	90	225	7.96	ST.70160027
32	280	100	320	10.56	ST.70160032
35	290	105	376	12.70	ST.70160035
40	320	110	545	15.23	ST.70160040
50	340	115	873	23.26	ST.70160050

Capete de schimb*

27	-	-	14	1.04	ST.79040027
32	-	-	22	1.46	ST.79040032
35	-	-	29	1.88	ST.79040035
40	-	-	39	2.22	ST.79040040
50	-	-	69	3.95	ST.79040050

Ciocane din nylon

Material: poliamida (nylon), vestamida.
Cu capete interschimbabile.



Dimensiuni (mm)			Greutate (g)	€/buc.	Cod articol
Ø	L1	L2			
27	265	90	232	14.16	ST.70171027
32	280	100	336	16.61	ST.70171032
35	290	105	413	19.36	ST.70171035
40	320	110	546	23.64	ST.70171040
50	340	115	898	34.20	ST.70171050
60	380	135	1339	46.30	ST.70171060

Capete de schimb*

27	-	-	11	1.80	ST.79050027
32	-	-	18	2.68	ST.79050032
35	-	-	23	3.29	ST.79050035
40	-	-	31	4.06	ST.79050040
50	-	-	53	7.27	ST.79050050
60	-	-	83	9.64	ST.79050060

*Pentru montaj trebuie incalzite usor si apoi fixate.

Ciocane din poliuretan durificat

Material: poliuretan durificat.
Ciocane anti-recul. In cavitatea capului ciocanului s-a adaugat metal pentru a mari greutatea si a reduce reculul.



Ø	Dimensiuni (mm)		Greutate (g)	€/buc.	Cod articol
	L1	L2			
25	320	108	320	32.70	ST.70190025
30	350	115	460	35.60	ST.70190030
35	355	118	580	39.10	ST.70190035
40	375	125	760	45.90	ST.70190040
50	385	135	1250	57.40	ST.70190050
60	420	165	1900	110.00	ST.70190060

Capete de schimb

25	-	-	14	4.71	ST.79090025
30	-	-	19	6.16	ST.79090030
35	-	-	26	7.58	ST.79090035
40	-	-	38	9.26	ST.79090040
50	-	-	72	13.32	ST.79090050
60	-	-	118	21.81	ST.79090060

Ciocane pentru mecanic - DIN 1041



Greutate (g)	Dimensiuni (mm)		€/buc.	Cod articol
	L1	L2		
100	260	82	9.95	ST.70110005
200	280	95	11.02	ST.70110001
300	300	105	12.86	ST.70110004
500	320	118	14.39	ST.70110002
800	350	130	20.35	ST.70110006
1000	360	135	22.27	ST.70110003
1500	380	145	28.70	ST.70110007
2000	400	155	37.90	ST.70110008

Ciocane pentru mecanic



Dimensiuni (mm)		Greutate (g)	€/buc.	Cod articol
L1	L2			
270	67	176	13.70	ST.70120001
290	82	320	15.76	ST.70120005
310	93	454	16.91	ST.70120006
320	99	572	17.60	ST.70120002
350	118	790	23.64	ST.70120004
380	126	1044	27.10	ST.70120003

Ciocan din aluminiu



Dimensiuni (mm)			Greutate (g)	€/buc.	Cod articol
Ø	L1	L2			
40	340	155	648	28.00	ST.70240040

Produsele ROCAST sunt distribuite de 58 agenți comerciali

45 în țară

ALBA 0729 997 216	BRĂILA 0729 997 210	COVASNA 0733 692 568	HUNEDOARA 0728 083 234	OLT 0729 997 219	TIMIȘ 0724 202 790 0730 707 883
ARAD 0729 997 234	BRAȘOV 0729 997 240	DÂMBOVIȚA 0729 997 227	IALOMIȚA 0729 997 226	PRAHOVA 0729 997 214 0733 692 592	TULCEA 0733 692 601
ARGEȘ 0729 997 228	BUZĂU 0730 654 992	DOLJ 0729 997 219	IAȘI 0731 220 434 0730 641 776	SATU-MARE 0730 240 457 0733 692 572	VÂLCEA 0729 997 236
BACĂU 0729 997 237 0728 083 236	CARAȘ-SEVERIN 0729 997 224	GALAȚI 0728 083 239	MARAMUREȘ 0729 997 221	SĂLAJ 0733 692 596	VASLUI 0728 083 232
BIHOR 0729 997 223	CĂLĂRAȘI 0730 585 638	GIURGIU 0729 997 238	MEHEDINȚI 0733 692 580	SIBIU 0730 641 775 0733 692 582	VRANCEA 0729 997 217
BISTRIȚA-NĂSĂUD 0728 083 235	CLUJ 0728 083 231 0733 692 570	GORJ 0729 997 213	MUREȘ 0729 997 232 0724 383 595	SUCEAVA 0721 250 543 0730 641 776	
BOTOȘANI 0721 250 543	CONSTANȚA 0729 997 241	HARGHITA 0733 692 568	NEAMȚ 0729 997 239 0730 585 637	TELEORMAN 0729 997 238	

13 în București și Ilfov

Sector 1 0730 654 991 0731 220 432	Sector 2 0728 808 753 0728 808 755	Sector 3 0727 777 659 0728 808 754	Sector 4 0728 083 233 0733 692 602	Sector 5 0723 200 554 0727 777 658	Sector 6 0724 383 596 0728 808 756
---	---	---	---	---	---

ROCAST

Șos. Pantelimon Nr. 1-3, 021591, București, S2
Tel.: (021) 252 53 90 - 95; Fax: (021) 252 53 89
Mobil: 0372 135 900; 0723 293 471
Director vânzări: 0731 066 024
Departament vânzări: 0724 383 597 (provincie)
0724 383 593 (București)

email: office@rocast.ro
www.rocast.ro
<http://shop.rocast.ro>

Prentu promoții și oferte speciale
abonați-vă la newsletter www.rocast.ro

Prețurile din catalog sunt exprimate în Euro și nu includ TVA.

ROCAST nu răspunde pentru eventuale erori de tipar sau de prezentare. Fotografii au caracter informativ și pot conține anumite accesorii care nu sunt incluse în pachetul standard de livrare sau se pot modifica fără notificare prealabilă.

Livrarea și plata produselor se face în conformitate cu condițiile ROCAST.

ROCAST poate modifica condițiile de livrare și prețurile din catalog fără notificare prealabilă. Aceste modificări vor fi operate periodic și prezentate pe www.rocast.ro