



# 2016 LIST PRICE BOOK



# 2016



## LIST PRICE BOOK

# TABLE OF CONTENTS

Product Quick Reference..... I-VIII

Affordable Style Designer Series..... 2

### SANITARYWARE

#### Toilets & Bidet

Designer Two-Piece Toilets .....	6
One-Piece Toilets.....	10
Bidet.....	11
Two-Piece Toilets:	
Pressure-Assist Toilets.....	12
Gravity Toilets.....	15
SmartPak™ Complete Toilet Kits.....	23
Tank Options / Tank Options Reference Chart.....	24

#### Lavatories

Self-Rimming Lavatories .....	25
Undercounter Lavatories.....	28
Above Counter Vessels.....	29
Pedestal Lavatories.....	31
Vanity Top.....	33

#### Commercial

Elementary Toilet.....	34
Flushometer Toilets.....	34
Urinals .....	37
Wall-Mount Lavatories .....	38
Clinical Sink.....	39
Flushometer Valves and Packages.....	40

### Bathware

Whirlpool / Air Bath System Review .....	42
Showroom Series	
Oval Models.....	44
Rectangular Models.....	63
Corner Models .....	83
Walk-in Models .....	88
Pro-fit Builder Series	
Oval Models.....	90
Rectangular Models.....	94
Corner Models .....	105
Shower Bases.....	107

### Parts & Accessories

Toilet Seats.....	108
Trip Levers.....	109
Trip Lever, Flush Valve & Fill Valve	
Cross Reference Chart.....	113
Fill Valve / Flush Valve / Ballcock	
Parts & Accessories.....	114
Toilets / Urinal Parts & Accessories.....	118
Ballcock / Flush Valve / Misc. Carded Parts.....	120
Bathware Parts & Accessories – Showroom Series .....	122
Bathware Parts & Accessories – Builder Series .....	123

### General Information

Terms & Conditions.....	124
Warranty Information .....	125
Bathware Order Change / Cancellation Policy .....	127
Freight Policy .....	128
Product Index.....	129
Discontinued Products .....	136
Color Charts.....	inside back cover

## SANITARYWARE – Toilets, Lavatories, Bidet & Commercial

Model #	Description	White	Standard	Page #
106LID	BARRETT LID 106/3106 WHT	\$69.98	\$80.27	7
106	BARRETT TANK 106	\$158.33	\$197.93	7
108LID	MONTCLAIR LID 108/3108 WHT	\$77.74	\$89.24	9
115	BARRETT BOWL 115CT EL ADA	\$269.44	\$335.85	7
115-106	BARRETT EL ADA COMBO	\$427.77	\$533.78	7
117	ALTO BOWL 117 RF 16-1/2" SMARTH	\$147.29	\$184.13	21
117-160	ALTO RF SMTHGT COMBO	\$215.05	\$268.82	21
117CTK	CTK PRO-FIT 4 RF ADA 1.6	\$245.40	\$309.13	23
122LID	QUANTUM LID 122 WHT	\$70.68	\$81.89	12
122	QUANTUM TANK 122 CTR	\$342.90	\$358.36	14
123	QUANTUM TANK 123 LH	\$301.76	\$332.02	14
123RH	QUANTUM TANK 123 RH	\$301.76	\$332.02	14
125LID	QUANTUM LID 119/123/125/153 WHT	\$70.00	\$81.50	12
125	ALTO TANK 125	\$142.30	\$177.89	21
130	ALTO BOWL 130 RD	\$63.37	\$79.22	20
130-3173	ALTO RF COMBO 1.28	\$131.13	\$163.92	20
130-160	ALTO RF COMBO	\$131.13	\$163.92	21
130CTK	CTK PRO-FIT 1 RD	\$162.60	\$202.75	23
130LTCTK	CTK PRO-FIT 1 RD LT CLR MTCH	\$186.95	N/A	23
131	ALTO BOWL 131 RD 10"	\$124.89	\$156.17	20
131-3173	ALTO RF 10"RI COMBO 1.28	\$192.65	\$240.86	20
131-160	ALTO RF 10"RI COMBO	\$192.65	\$240.86	21
131CTK	CTK ALTO RF 10" ROUGH-IN	\$224.60	N/A	23
135	ALTO BOWL 135 EL	\$90.11	\$112.54	20
135-3173	ALTO EL COMBO 1.28	\$157.87	\$197.23	20
135-160	ALTO EL COMBO	\$157.87	\$197.23	21
135CTK	CTK PRO-FIT 2 EL	\$186.59	\$231.85	23
135LTCTK	CTK PRO-FIT 2 EL LT CLR MTCH	\$216.53	N/A	23
137	ALTO BOWL 137 EL ADA	\$161.30	\$202.11	20
137-3173	ALTO EL ADA COMBO 1.28	\$229.07	\$286.81	20
137-160	ALTO EL ADA COMBO	\$229.07	\$286.81	21
137LTCTK	CTK PRO-FIT 3 ADA LT CLR MTCH	\$280.94	N/A	23
137CTK	CTK PRO-FIT 3 EL ADA	\$249.37	\$306.72	23
138	ALTO BOWL 138 EL 10"	\$158.11	\$197.64	20
138-3173	ALTO EL 10"RI COMBO 1.28	\$225.87	\$282.33	20
138-160	ALTO EL 10"RI COMBO	\$225.87	\$282.33	21
139NS	ALTO BOWL 139NS EL ADA 10"	\$245.92	\$307.41	20
139NS-3173	ALTO EL ADA 10"RI COMBO 1.28	\$313.68	\$392.10	20
139NS-160	ALTO EL ADA 10"RI COMBO	\$313.68	\$392.10	21
146	QUANTUM BOWL 146 RD	\$126.20	\$185.17	12
146-153	QUANTUMONE RF COMBO	\$427.96	\$517.19	12
146-155	QUANTUM 1.28 RF COMBO	\$427.96	\$517.19	13
146-123	QUANTUM RF COMBO	\$427.96	\$517.19	14
147	QUANTUM BOWL 147 EL	\$130.56	\$208.40	12
147-153	QUANTUMONE EL COMBO	\$432.32	\$540.42	12
147-155	QUANTUM 1.28 EL COMBO	\$432.32	\$540.42	13
147-10-123	QUANTUM EL 10" RI COMBO	\$511.63	\$594.36	14
147-123	QUANTUM EL COMBO	\$432.32	\$540.42	14
147-10	QUANTUM BOWL 147-10 EL	\$209.87	\$262.34	14
148	QUANTUM BOWL 148 EL ADA	\$202.16	\$285.56	12
148-153	QUANTUMONE EL ADA COMBO	\$503.91	\$617.58	12
148-155	QUANTUM 1.28 EL ADA COMBO	\$503.91	\$617.58	13
148-123	QUANTUM EL ADA COMBO	\$503.91	\$617.58	14
148-10	QUANTUM BOWL 148-10 EL ADA	\$296.28	\$370.38	14
148-10-123	QUANTUM EL 10" RI ADA COMBO	\$598.03	\$702.40	14
149	QUANTUM BOWL 149 EL	\$324.00	\$451.67	12
149-153	QUANTUMONE EL ROFM COMBO	\$625.76	\$783.69	12
149-155	QUANTUM 1.28 EL ROFM COMBO	\$625.76	\$783.69	13
149-123	QUANTUM EL ROFM COMBO	\$625.76	\$783.69	14
151	QUANTUM BOWL 151 EL ADA	\$390.17	\$501.96	12
151-153	QUANTUMONE EL ADA ROFM COMBO	\$691.92	\$833.98	12
151-155	QUANTUM 1.28 EL ADA ROFM COMBO	\$691.92	\$833.98	13

Model #	Description	White	Standard	Page #
151-123	QUANTUM EL ADA ROFM COMBO	\$691.92	\$833.98	14
153	QUANTUMONE TANK 153 LH	\$301.76	\$332.02	12
153RH	QUANTUMONE TANK 153 RH	\$301.76	\$332.02	12
154	QUANTUMONE TANK 154 CTR	\$342.90	\$358.36	12
155	QUANTUM 1.28 TANK 155 LH	\$301.76	\$332.02	13
155RH	QUANTUM 1.28 TANK 155 RH	\$301.76	\$332.02	13
160	ALTO TANK 160	\$67.76	\$84.69	21
160RH	ALTO TANK 160 RH	\$67.76	\$84.69	21
160LID	ALTO LID 160 WHT	\$42.58	\$53.28	22
161	ALTO TANK 161	\$75.52	\$94.40	21
165	ALTO TANK 165 W/CVR LK	\$83.87	N/A	21
165LID	ALTO LID 165/175 W/LOCK WHT	\$54.08	N/A	22
170	ALTO TANK 170 LINED	\$98.18	\$122.75	21
171	ALTO TANK 171 LINED	\$110.05	\$134.60	21
172	ALTO TANK 172	\$67.76	\$84.69	21
172RH	ALTO TANK 172 RH	\$67.76	\$84.69	21
173	ALTO TANK 173	\$67.76	\$84.69	21
173FM	ALTO TANK 173 F/M	\$75.52	\$94.40	21
173FM RH	ALTO TANK 173 F/M RH	\$79.80	N/A	21
173RH	ALTO TANK 173 RH	\$67.76	N/A	21
174	ALTO TANK 174 LINED	\$98.18	\$122.75	21
175	ALTO TANK 175 LINED CVR LK	\$133.71	N/A	21
177	ENSO BOWL 177 EL SMART HEIGHT CT	\$295.17	\$356.60	6
177-178	ENSO EL SMT HGT COMBO	\$461.90	\$558.02	6
178LID	ENSO LID 178 WHT	\$67.81	\$78.40	6
178	ENSO TANK 178 DUAL FLUSH	\$166.72	\$201.43	6
180	ALTO TANK 180	\$67.76	\$84.69	21
181	ALTO TANK 181	\$75.52	\$94.40	21
190	ALTO TANK 190 LINED	\$98.18	\$122.75	21
195LID	WAVERLY LID 195/3195 WHT	\$70.34	\$81.50	9
216NS	PETITE MAPLE LAV 216NS	\$57.40	\$68.89	28
217	MAPLE LAV 217	\$67.08	\$80.48	28
218NS	PETITE COVINGTON LAV 218NS	\$142.64	\$171.15	28
230	VERONA PED-LAV COMBO	\$121.98	N/A	33
232-4	VERONA LAV 232 4"	\$69.70	N/A	33
233	VERONA PEDESTAL 233	\$52.28	N/A	33
234	BRENTWOOD LAV 234	\$149.73	\$185.66	28
237-1	MS OVAL 20X17 LAV 237 1H	\$40.43	\$46.09	27
237-4	MS OVAL 20X17 LAV 237 4"	\$40.43	\$46.09	27
237-8	MS OVAL 20X17 LAV 237 8"	\$40.43	N/A	27
239-1	MS ROUND 19" LAV 239 1H	\$40.43	\$46.09	27
239-4	MS ROUND 19" LAV 239 4"	\$40.43	\$46.09	27
239-8	MS ROUND 19" LAV 239 8"	\$40.43	N/A	27
242	ENSO LAV 242	\$149.73	\$179.68	25
249-1	MAVERICK I LAV 249 1H	\$76.42	N/A	26
249-4	MAVERICK I LAV 249 4"	\$76.42	\$92.11	26
249-8	MAVERICK I LAV 249 8"	\$76.42	N/A	26
251-4	ALTO II LAV 251 4"	\$75.42	\$90.97	27
251-8	ALTO II LAV 251 8"	\$75.42	\$90.97	27
251-LO	ALTO II LAV 251 L/O 4"	\$75.42	N/A	27
254-1	BRENTWOOD LAV 254 1H	\$178.53	\$221.38	25
254-4	BRENTWOOD LAV 254 4"	\$178.53	\$221.38	25
254-8	BRENTWOOD LAV 254 8"	\$178.53	\$221.38	25
257-4	WAVERLY LAV 257 4"	\$130.92	N/A	26
259-1	ESSENCE LAV 259 1H	\$138.21	\$165.86	26
259-4	ESSENCE LAV 259 4"	\$138.21	\$165.86	26
259-8	ESSENCE LAV 259 8"	\$138.21	\$165.86	26
267-1	MAVERICK II LAV 267 1H	\$76.42	\$92.11	26
267-4	MAVERICK II LAV 267 4"	\$76.42	\$92.11	26
267-8	MAVERICK II LAV 267 8"	\$76.42	\$92.11	26
268-1	BARRETT LAV 268 1H	\$170.78	\$207.33	25
268-4	BARRETT LAV 268 4"	\$170.78	\$207.33	25
268-8	BARRETT LAV 268 8"	\$170.78	\$207.33	25
269-1	MONTCLAIR LAV 269 1H	\$143.91	N/A	25

# Product Quick Reference

List Price Effective January 1, 2016

Model #	Description	White	Standard	Page #
269-4	MONTCLAIR LAV 269 4"	\$143.91	N/A	25
269-8	MONTCLAIR LAV 269 8"	\$143.91	\$172.71	25
270	WEST HAMPTON PED-LAV COMBO	\$151.21	\$173.88	33
272-8	LAVATORY 272 8"	\$88.15	N/A	33
272-4	LAVATORY 272 4"	\$88.15	\$101.37	33
273	PEDESTAL 273	\$63.06	\$72.51	33
290	ALTO IV PED-LAV COMBO	\$193.25	\$222.24	32
292-4	LAVATORY 292 4"	\$123.00	\$141.45	32
292-1	LAVATORY 292 1H	\$123.00	\$141.45	32
292-8	LAVATORY 292 8"	\$123.00	\$141.45	32
293	ALTO IV PEDESTAL 293	\$70.25	\$80.79	32
310	ENSO PED-LAV COMBO	\$322.89	N/A	31
311	ENSO LAV 311 1H	\$189.93	\$227.92	30
312	ENSO PEDESTAL 312	\$132.96	N/A	31
315-4	WHEELCHAIR LAV 315 4"	\$267.66	N/A	40
315-8	WHEELCHAIR LAV 315 8"	\$267.66	N/A	40
315-L0	WHEELCHAIR LAV 315L/O 4" OR 8"	\$267.66	N/A	40
3173RH	ALTO TANK 3173 RH CTL 1.28	\$67.76	N/A	20
318-1	ESSENCE LAV 318 1H	N/A	\$166.35	31
318-4	ESSENCE LAV 318 4"	\$138.64	\$166.35	31
318-8	ESSENCE LAV 318 8"	\$138.64	\$166.35	31
319	ESSENCE PEDESTAL 319	\$91.20	\$109.43	31
320	ESSENCE PED-LAV COMBO	\$229.84	\$275.78	31
328-1	BARRETT LAV 328 1H	\$177.54	\$215.55	31
328-4	BARRETT LAV 328 4"	\$177.54	\$215.55	31
328-8	BARRETT LAV 328 8"	\$177.54	\$215.55	31
329	BARRETT PEDESTAL 329	\$135.27	\$164.22	31
330	BARRETT PED-LAV COMBO	\$312.81	\$379.77	31
333-1	MONTCLAIR LAV 333 1H	\$151.26	\$181.52	31
333-4	MONTCLAIR LAV 333 4"	\$151.26	\$181.52	31
333-8	MONTCLAIR LAV 333 8"	\$151.26	\$181.52	31
334	MONTCLAIR PEDESTAL 334	\$90.76	\$108.92	31
335	MONTCLAIR PED-LAV COMBO	\$242.02	\$290.44	31
338-1	WAVERLY LAV 338 1H	N/A	\$171.57	32
338-4	WAVERLY LAV 338 4"	\$137.26	\$171.57	32
338-8	WAVERLY LAV 338 8"	\$137.26	\$171.57	32
339	WAVERLY PEDESTAL 339	\$83.41	\$100.08	32
340	WAVERLY PED-LAV COMBO	\$220.67	\$271.65	32
344	MAVERICK PEDESTAL 344	\$63.60	\$73.13	32
348-1	MAVERICK LAV 348 1H	\$99.43	N/A	32
348-4	MAVERICK LAV 348 4"	\$99.43	\$114.34	32
348-8	MAVERICK LAV 348 8"	\$99.43	\$114.34	32
349	MAVERICK PED-LAV COMBO	\$163.03	\$187.47	32
361-3	ALTO BIDET 361 3-HOLE	\$242.92	\$303.71	11
380	SUMMIT BOWL 380 RD	\$103.67	\$132.93	16
380-387	SUMMIT RF 1.28 COMBO	\$190.04	\$240.93	16
380-386	SUMMIT RD COMBO	\$190.04	\$240.93	17
380-3386	SUMMIT DUAL RD COMBO	\$211.53	\$262.51	18
380CTK	CTK SUMMIT 380 RF 1.6	\$220.89	\$274.39	23
382	SUMMIT BOWL 382 EL	\$138.12	\$172.64	16
382-387	SUMMIT EL 1.28 COMBO	\$224.49	\$280.63	16
382-386	SUMMIT EL COMBO	\$224.49	\$280.63	17
382-3386	SUMMIT DUAL EL COMBO	\$245.98	\$302.21	18
382CTK	CTK SUMMIT 382 EL 1.6	\$254.96	\$318.38	23
384	SUMMIT BOWL 384 ADA	\$186.44	\$219.82	16
384-387	SUMMIT EL ADA 1.28 COMBO	\$272.81	\$327.82	16
384-386	SUMMIT EL ADA COMBO	\$272.81	\$327.82	17
384-3386	SUMMIT DUAL EL ADA COMBO	\$294.30	\$349.40	18
384CTK	CTK SUMMIT 384 ADA 1.6	\$287.84	\$355.72	23
385	SUMMIT BOWL 385 EL SMARTHT 10" ROUGH-IN	\$234.00	\$260.12	17
385-386	SUMMIT EL SMARTHEIGHT 16 1/2" 10" COMBO	\$320.37	\$368.11	17
386LID	SUMMIT LID 386 WHT	\$78.87	\$90.53	17
386	SUMMIT TANK 386	\$86.37	\$107.99	17
386FM	SUMMIT TANK 386 F/M	\$97.12	\$118.74	17

Model #	Description	White	Standard	Page #
386FMRH	SUMMIT TANK 386 F/M RH	\$103.79	N/A	17
386LT	SUMMIT TANK 386 LT	\$100.24	\$123.64	17
386RH	SUMMIT TANK 386 RH	\$93.05	N/A	17
387	SUMMIT 1.28 TANK 387	\$86.37	\$107.99	16
387LT	SUMMIT TANK 387 LT 1.28	\$100.24	\$123.64	16
387RH	SUMMIT TANK 387 RH 1.28	\$93.05	\$109.58	16
388	SUMMIT BOWL 388 RF 16 1/2" SMARTHEIGHT	\$157.54	\$172.52	16
388-387	SUMMIT RF 16 1/2 1.28 COMBO	\$243.91	\$280.51	16
388-386	SUMMIT RF 16 1/2" SMARTHEIGHT COMBO	\$243.91	\$280.51	17
388-3386	SUMMIT DUAL RF 16 1/2 COMBO	\$265.40	\$302.09	18
388CTK	CTK SUMMIT 388 RF ADA 1.6	\$277.78	\$322.00	23
401HE	ADAM URINAL 401HE 0.5 GPF	\$125.01	\$161.68	39
410HE	CASCADE URINAL 410HE 0.5 GPF	\$306.07	N/A	39
410HE RS	CASCADE URINAL 410HE R/S 0.5GPF	\$316.16	N/A	39
422	URINAL 422 BREVITY ADA	\$280.47	N/A	39
422RS	URINAL 422R/S BREVITY ADA	\$290.94	N/A	39
436	POTENZA PEDESTAL 436	\$68.23	N/A	32
437-1	POTENZA LAV 437 1H	\$141.61	N/A	29
437-4	POTENZA LAV 437 4"	\$141.61	N/A	29
437-8	POTENZA LAV 437 8"	\$141.61	N/A	29
438	POTENZA PED-LAV COMBO	\$209.85	N/A	32
475	SUBURBAN URINAL 475	\$197.83	\$247.45	39
705LID	AEGEAN LID 705NS/708 WHT	\$76.52	\$92.90	10
705NS	AEGEAN ONE-PIECE 705NS EL 1.6	\$443.21	\$531.86	10
708	AEGEAN ONE-PIECE 708 EL ADA 1.28	\$467.17	\$560.60	10
802	LUNA VESSEL LAV 802	\$134.58	N/A	30
805NS	TEMPO LAV 805NS	\$163.85	\$198.15	29
807	RAZIONALE LAV 807	\$215.25	N/A	29
825	MONET LAV 825	\$172.70	N/A	29
826	REO LAV 826	\$139.78	\$167.50	29
872	MEDAJEAN RIM GUARD 872 SET	\$93.37	N/A	41
882	ESSENCE TOWEL BAR 882	\$95.84	N/A	31
884	ENSO VANITY - WOOD	\$420.00	N/A	30
1012LID	LID 1012/3012 MAV 1.0 WHT	\$78.87	N/A	15
1012	MAVERICK TANK 1012 1.0	\$126.78	N/A	15
1013	MAVERICK 1.0 BOWL 1013 RD	\$152.62	N/A	15
1013-1012	MAVERICK RD 1.0 COMBO	\$279.40	N/A	15
1014	MAVERICK 1.0 BOWL 1014 EL ADA	\$213.41	N/A	15
1014-3012	MAVERICK 1.0 EL SMARTHEIGHT COMBO	\$340.18	N/A	15
1301BPL	ERIE BOWL 1301 BPL WALL 1.28	\$166.45	N/A	38
1301	ERIE BOWL 1301 WALL 1.28	\$146.50	N/A	38
1311NS	BALTIC BOWL 1311NS EL 10"	\$163.81	\$215.01	37
1312	1312 BOWL	\$361.43	N/A	37
1313	1313 ADA BOWL	\$431.44	N/A	37
1319	ADRIATIC BOWL 1319 EL 10" 1.28	\$220.68	N/A	36
1319RS	ADRIATIC BOWL 1319 R/S EL 10" 1.28	\$232.04	N/A	36
1319BPL	ADRIATIC BOWL 1319BPL EL 10" 1.28	\$231.59	N/A	36
1613NS-4	SPRUCE COVE LAV 1613NS 4"	\$84.78	N/A	41
1917C-4	WILLOW RUN LAV 1917C 4"	\$83.79	\$101.73	41
1917C-L0	WILLOW RUN LAV 1917C L/O 4"	\$83.79	N/A	41
2008-4	WALNUT KNOLL LAV 2008 4"	\$86.01	N/A	41
2017	CITY I VANITY TOP 20" x 17"	\$106.94	N/A	33
2018C-4	CAPE CHARLES LAV 2018C 4"	N/A	\$111.17	40
2018C-8	CAPE CHARLES LAV 2018C 8"	\$92.64	N/A	40
2018HBNS-1	GRANDE ISLE LAV 2018HB-NS 1-HOLE	\$105.29	N/A	40
2018HBNS-4	GRANDE ISLE LAV 2018HB-NS 4"	\$105.29	N/A	40
2018HBNS-8	GRANDE ISLE LAV 2018HB-NS 8"	\$105.29	\$126.37	40
2018HBNS-L0	GRANDE ISLE LAV 2018HB-NS L/O 4" OR 8"	\$105.29	N/A	40
2038-4	PAMLICO LAV 2038 4"	\$178.92	N/A	40
2038-1	PAMLICO LAV 2038 1-HOLE	\$178.92	N/A	40
2038-8	PAMLICO LAV 2038 8"	\$178.92	N/A	40
2038-L0	PAMLICO LAV 2038L0 4" W/O OVRFLW	\$178.92	N/A	40
2039	PAMLICO SHROUD 2039	\$119.27	N/A	40
2040	PAMLICO SHROUD LAV COMBO	\$298.20	N/A	40



Model #	Description	White	Standard	Page #
3012	MAVERICK 1.0 TANK 3012 FOR 1014 BOWL	\$126.78	N/A	15
3072	MEDAJEAN CLINICAL SINK 3072	\$1,328.00	N/A	41
3106	BARRETT 1.28 TANK 3106	\$158.33	\$197.93	8
3108	MONTCLAIR 1.28 TANK 3108	\$145.09	\$181.36	9
3120	ALTO 1.28 TANK 3120	\$75.52	\$94.40	20
3120RH	ALTO 1.28 TANK 3120RH	\$79.80	\$98.69	20
3121	ALTO 1.28 TANK 3121 CTL	\$75.52	\$94.40	20
3121RH	ALTO 1.28 TANK 3121RH CTL	\$79.80	N/A	20
3122	ALTO 1.28 TANK 3122 LT CTL	\$110.05	\$134.60	20
3125	ALTO TANK 3125 14" 1.28	\$142.30	\$177.89	20
3147	BRENTWOOD 1.6 TANK 3147	\$162.16	\$203.42	6
3147LID	BRENTWOOD LID 3147 WHT	\$71.69	\$82.23	6
3148	BRENTWOOD 1.28 TANK 3148	\$162.16	\$203.42	7
3172	ALTO TANK 3172 1.28	\$67.76	N/A	20
3173	ALTO TANK 3173 CTL 1.28	\$67.76	\$84.69	20
3173	ALTO TANK 3173 CTL 1.28	\$67.76	\$84.69	20
3173	ALTO TANK 3173 CTL 1.28	\$67.76	\$84.69	20
3173	ALTO TANK 3173 CTL 1.28	\$67.76	\$84.69	20
3174	ALTO TANK 3174 LINED 1.28	\$98.18	N/A	20
3185	ESSENCE 1.28 TANK 3185	\$145.80	\$184.26	8
3185LID	ESSENCE LID 3185 WHT	\$77.74	\$89.24	8
3195	WAVERLY 1.28 TANK 3195	\$122.53	N/A	9
3386LID	SUMMIT DF LID 3386 WHT	\$82.20	\$90.44	16
3386	SUMMIT DUAL FLUSH TANK 3386	\$107.86	\$129.57	18
3386	SUMMIT DUAL FLUSH TANK 3386	\$107.86	\$129.57	18
3386	SUMMIT DUAL FLUSH TANK 3386	\$107.86	\$129.57	18
3816	CASCADE 1.28 TANK 3816	\$82.00	N/A	19
3816RH	CASCADE 1.28 TANK 3816RH	\$85.98	N/A	19
3816LID	CASCADE LID 3816 WHT	\$42.81	N/A	19
4107-3108	MONTCLAIR 1.28 EL ADA COMBO	\$406.24	\$507.81	9
4107	MONTCLAIR BOWL 4107 ADA 1.28	\$261.15	\$326.46	9
4115	BARRETT BOWL 4115 ADA 1.28	\$269.44	\$335.85	8
4115-3106	BARRETT EL ADA 1.28 COMBO	\$427.77	\$533.78	8
4130CTK	CTK PRO-FIT 1 RD 1.28	\$162.60	\$202.75	23
4130LTCTK	CTK PRO-FIT 1 RD LT 1.28	\$186.95	N/A	23
4135CTK	CTK PRO-FIT 2 EL 1.28	\$186.59	\$231.85	23
4135LTCTK	CTK PRO-FIT 2 EL LT 1.28	\$216.53	N/A	23
4137CTK	CTK PRO-FIT 3 EL ADA 1.28	\$249.37	\$306.72	23
4137LTCTK	CTK PRO-FIT 3 EL LT ADA 1.28	\$280.94	N/A	23
4147	BRENTWOOD BOWL 4147 EL ADA 1.6	\$275.92	\$346.15	6
4147-3147	BRENTWOOD EL ADA COMBO 1.6	\$438.08	\$549.58	6
4147CTK	CTK BRENTWOOD EL ADA 1.6	\$485.68	N/A	23
4148	BRENTWOOD BOWL 4148 ADA 1.28	\$275.92	\$346.15	7
4148-3148	BRENTWOOD EL ADA COMBO 1.28	\$438.08	\$549.58	7
4184-3185	ESSENCE 1.28 EL ADA COMBO	\$417.37	\$523.46	8
4184	ESSENCE BOWL 4184 ADA 1.28	\$271.58	\$339.21	8
4184CTK	CTK ESSENCE EL ADA 1.28	\$462.58	N/A	23
4197	WAVERLY BOWL 4197 ADA 1.28	\$184.46	N/A	9
4197-3195	WAVERLY EL ADA COMBO	\$307.00	N/A	9
4197CTK	CTK WAVERLY EL ADA 1.28	\$354.02	N/A	23
4320	ELEMENTARY TANK 4320	\$150.00	N/A	36
4320LID	LID 4320 ELEMENTARY	\$62.40	N/A	36
4380CTK	CTK SUMMIT 380 DUAL FLUSH RD	\$238.13	\$297.67	23
4381LTCTK	CTK SUMMIT 380 LT RF 1.28	\$245.89	N/A	23
4381CTK	CTK SUMMIT 380 RF 1.28	\$220.89	\$274.39	23
4382CTK	CTK SUMMIT 382 DUAL FLUSH EL	\$261.44	\$326.14	23
4383CTK	CTK SUMMIT 382 EL 1.28	\$254.96	\$318.38	23
4384CTK	CTK SUMMIT 384 DUAL FLUSH SMHT	\$327.81	\$396.94	23
4385CTK	CTK SUMMIT 384 ADA 1.28	\$287.84	\$355.72	23
4388CTK	CTK SUMMIT 388 RF ADA 1.28	\$277.78	\$322.00	23
4810	CASCADE BOWL 4810 RD	\$84.49	N/A	19
4810-3816	CASCADE RD 1.28 COMBO	\$166.49	N/A	19
4817	CASCADE BOWL 4817 EL ADA	\$134.83	N/A	19
4817-3816	CASCADE EL ADA 1.28 COMBO	\$216.83	N/A	19

Model #	Description	White	Standard	Page #
5326	ELEMENTARY BOWL 5326 RD	\$230.00	N/A	36
5326-4320	ELEMENTARY TOILET COMBO	\$380.00	N/A	36
CP-410-05	CASCADE COMMERCIAL PACK 410 0.5 GPF	\$498.97	N/A	42
CP-422-125	BREVITY COMMERCIAL PACK 422 0.125	\$473.37	N/A	42
CP-1301-128	ERIE COMMERCIAL PACK 1301 1.28	\$391.33	N/A	42
CP-1311-128	BALTIC COMMERCIAL PACK 1311 1.28	\$408.63	N/A	42
CP-1312-128	COMMERCIAL PACK 1312 1.28	\$606.25	N/A	42
CP-1313-128	COMMERCIAL PACK 1313 1.28	\$676.26	N/A	42
CP-1319-128	ADRIATIC COMMERCIAL PACK 1319 1.28	\$465.49	N/A	42
ELEM	ELEMENTARY TOILET SEAT	\$87.98	N/A	36

## SANITARYWARE – Parts & Accessories

Model #	Description	Standard	Price	Page #
08-10	BALLCOCK 08 10 BOX	\$13.58	N/A	114
08-10-20	BALLCOCK 08 10 BOX	\$12.35	N/A	114
08-10-P	BALLCOCK 08 10 POP	\$14.84	N/A	114
08-10-P-10	BALLCOCK 08 10 POP	\$13.58	N/A	114
08-1034	BALLCOCK 08 10-3/4 BOX	\$13.58	N/A	114
08-1034-20	BALLCOCK 08 10-3/4 BOX	\$12.35	N/A	114
08-1112	BALLCOCK 08 11-1/2 BOX	\$13.58	N/A	114
08-1112-20	BALLCOCK 08 11-1/2 BOX	\$12.35	N/A	114
08ULF-10	BALLCOCK 08 10 ULF BOX	\$13.58	N/A	114
08ULF-20	BALLCOCK 08 10 ULF BOX	\$12.35	N/A	114
08ULF-1034	BALLCOCK 08 10-3/4 ULF BOX	\$13.58	N/A	114
08ULF-1034-20	BALLCOCK 08 10-3/4 ULF BOX	\$12.35	N/A	114
08ULF-1112	BALLCOCK 08 11-1/2 ULF BOX	\$13.58	N/A	114
08ULF-1112-20	BALLCOCK 08 11-1/2 ULF BOX	\$12.35	N/A	114
08ULF-1112-P	PAK 08ULF BALLCOCK 11-1/2" POP	\$14.84	N/A	114
08ULF-1112-P-10	PAK 08ULF BALLCOCK 11-1/2" POP	\$13.58	N/A	114
23	SPUD "23" 1 X 1/2 BULK	\$5.61	N/A	120
24	SPUD "24" 1 X 3/4 BULK	\$6.85	N/A	120
31BISC	ASSY 31 TNK LVR BISC	\$6.12	N/A	109
31BONE	ASSY 31 TNK LVR BONE	\$6.12	N/A	109
31CH	ASSY 31 TNK LVR CH	\$6.12	N/A	109
31RHCH	ASSY 31 TNK RH LVR CH	\$6.12	N/A	109
31RHWHT	ASSY 31 TNK RH LVR WHT	\$6.12	N/A	109
31WHT	ASSY 31 TNK LVR WHT	\$6.12	N/A	109
33CH	LEVER PUSH BUTTON 33 CH DUALFL	\$33.16	N/A	109
40BISC-20	LEVER TANK 40 BISC BULK W/NUT	\$3.35	N/A	109
40BISC-P	PAK 40 LEVER BISCUIT POP	\$6.12	N/A	109
40BISC-P-5	PAK 40 LEVER BISCUIT POP	\$5.36	N/A	109
40BONE-20	LEVER TANK 40 BONE BULK W/NUT	\$3.35	N/A	109
40BONE-P	PAK 40 LEVER BONE POP	\$6.12	N/A	109
40BONE-P-5	PAK 40 LEVER BONE POP	\$5.36	N/A	109
40CH-20	LEVER TANK 40 CH BULK W/NUT	\$3.30	N/A	109
40CH-50	LEVER TANK 40 CH BULK W/NUT	\$3.19	N/A	109
40CH-P	PAK 40 LEVER CP POP	\$6.12	N/A	109
40CH-P-10	PAK 40 LEVER CP POP	\$5.36	N/A	109
40CH-P-20	PAK 40 LEVER CP POP	\$5.10	N/A	109
40RHCH	LEVER TANK 40 RH CH BULK W/NUT	\$3.87	N/A	109
40WHT-20	LEVER TANK 40 WHITE BULK W/NUT	\$3.35	N/A	109
40WHT-P	LEVER TANK 40 WH POP	\$6.12	N/A	109
40WHT-P-5	LEVER TANK 40 WH POP	\$5.36	N/A	109
41CH-20	LEVER TANK 41 CH BULK W/NUT	\$3.30	N/A	109
41CH-50	LEVER TANK 41 CH BULK W/NUT	\$3.19	N/A	109
41CH-P	LEVER TANK 41 CP POP	\$6.12	N/A	109
41CH-P-10	LEVER TANK 41 CP POP	\$5.36	N/A	109
41CH-P-20	LEVER TANK 41 CP POP	\$5.10	N/A	109
42CH-20	LEVER TANK 42 CH BULK W/NUT	\$3.49	N/A	109
42CH-50	LEVER TANK 42 CH BULK W/NUT	\$3.35	N/A	109
42CH-P	PAK 42 LEVER CP POP	\$6.12	N/A	109
42CH-P-10	PAK 42 LEVER CP POP	\$5.36	N/A	109
42CH-P-20	PAK 42 LEVER CP POP	\$5.10	N/A	109



# Product Quick Reference

List Price Effective January 1, 2016

Model #	Description	White	Standard	Page #
43CH-20	LEVER TANK 43 CH BULK W/NUT	\$3.49	N/A	109
43CH-50	LEVER TANK 43 CH BULK W/NUT	\$3.35	N/A	109
43CH-P	PAK 43 LEVER CP POP	\$6.12	N/A	109
43CH-P-10	PAK 43 LEVER CP POP	\$5.36	N/A	109
43CH-P-20	PAK 43 LEVER CP POP	\$5.10	N/A	109
44CH	LEVER TANK 44 CP BULK	\$6.91	N/A	110
45CH	LEVER 45 LH CHROME	\$12.19	N/A	110
46BC	LEVER TANK 46 BC INDV	\$35.77	N/A	110
46BISC	LEVER TANK 46 BISC INDV	\$27.68	N/A	110
46BONE	LEVER TANK 46 BONE INDV	\$27.68	N/A	110
46CH	LEVER TANK 46 CH INDV	\$27.68	N/A	110
46SB	LEVER TANK 46 SB INDV	\$35.77	N/A	110
46SN	LEVER TANK 46 SN INDV	\$35.77	N/A	110
46WHT	LEVER TANK 46 WHITE INDV	\$27.68	N/A	110
47CH	LEVER PUSH BUTTON 47 CH-BULK	\$33.16	N/A	110
48CH	LEVER PUSH BUTTON 48 CH-BULK	\$34.02	N/A	110
49CH	LEVER 49 RH CHROME	\$13.84	N/A	110
50CH	LEVER ECO 50 CH INDV LH/RH	\$21.95	N/A	110
50SN	LEVER ECO 50 SN ETCHED INDV LH	\$46.88	N/A	110
51CH	LEVER TANK 51 CH BULK	\$20.95	N/A	110
51RHCH	LEVER TANK 51RH CH BULK	\$20.95	N/A	110
51SN	LEVER TANK 51 SN INDV	\$43.45	N/A	110
55CH-P	PAK 55 LEVER CP POP	\$14.08	N/A	111
55CH-P-10	PAK 55 LEVER CP POP	\$10.61	N/A	111
55CH-P-5	PAK 55 LEVER CP POP	\$12.19	N/A	111
55RHCH	LEVER FL 55 RH CH UNIVERSAL	\$11.71	N/A	111
55SB-P	PAK 55 LEVER SB POP	\$45.75	N/A	111
55SN-P	PAK 55 LEVER SN POP	\$45.87	N/A	111
55SN-P-10	PAK 55 LEVER SN POP	\$38.27	N/A	111
55SN-P-5	PAK 55 LEVER SN POP	\$39.89	N/A	111
56BISC	LEVER 56 BISC IND	\$5.80	N/A	111
56BONE	LEVER 56 BONE IND	\$5.80	N/A	111
56WHT	LEVER 56 WHT IND	\$5.80	N/A	111
58CH	LEVER 58 CHROME IND CASCADE	\$19.14	N/A	111
58CHRH	LEVER 58 RH CHROME IND CASCADE	\$20.44	N/A	111
66CH	LEVER 66 CH W/METAL ARM	\$30.34	N/A	111
66SB	LEVER 66 SB W/METAL ARM	\$52.79	N/A	111
66SN	LEVER 66 SN W/METAL ARM	\$52.79	N/A	111
69CH	LEVER 69 CH W/METAL ARM	\$19.77	N/A	111
69SB	LEVER 69 SB W/METAL ARM	\$42.26	N/A	111
69SN	LEVER 69 SN W/METAL ARM	\$42.26	N/A	111
70CH	LEVER TANK 70 CH INDV	\$23.43	N/A	111
70SN	LEVER TANK 70 SN INDV	\$49.86	N/A	111
72CHBISC	LEVER 72 CH W/BISCUIT INSERT	\$30.34	N/A	111
72CHBONE	LEVER 72 CH W/BONE INSERT	\$30.34	N/A	111
72CHWHT	LEVER 72 CH W/WHITE INSERT	\$30.34	N/A	111
72SNBISC	LEVER 72 SN W/BISC INSERT	\$52.79	N/A	111
72SNWHT	LEVER 72 SN W/WHITE INSERT	\$52.79	N/A	111
73CH	LEVER 73 CH INDV	\$29.46	N/A	112
76CH	LEVER 76 CH W/METAL ARM	\$30.36	N/A	112
76SB	LEVER 76 SN W/METAL ARM	\$52.83	N/A	112
76SN	LEVER 76 SB W/METAL ARM	\$52.83	N/A	112
78CH	LEVER PUSH BUTTON 78 CH ENSO	\$33.16	N/A	112
78SN	LEVER PUSH BUTTON 78 SN ENSO	\$55.70	N/A	112
79CH	LVR PUSH BUTTON 79 CH MAV 1.0	\$27.45	N/A	112
85CH	LEVER 85 CH ESSENCE	\$19.77	N/A	112
87CH	LEVER 87 CH REO	\$19.77	N/A	112
89-1012	BALLCOCK 89 GRIVAL	\$14.84	N/A	116
90	BALLCOCK MODEL 90 ENSO	\$17.21	N/A	116
90-9000	BALLCOCK MODEL 90-9" MAV 1.0	\$17.21	N/A	116
106LID	BARRETT LID 106/3106 WHT	\$69.98	\$80.27	7
108LID	MONTCLAIR LID 108/3108 WHT	\$77.74	\$89.24	9
122LID	QUANTUM LID 122 WHT	\$70.68	\$81.89	12
123-0216-20	ASSY FLOAT 210 FV 11-1/2 IN	\$2.49	N/A	115

Model #	Description	White	Standard	Page #
123-0216-50	ASSY FLOAT 210 FV 11-1/2 IN	\$2.12	N/A	115
123-7838	ASSY BLUE CAP/BLUE LEVER 08 BC	\$3.48	N/A	114
123-7838-20	ASSY BLUE CAP/BLUE LEVER 08 BC	\$3.14	N/A	114
123-8577	ANCHOR FLOOR KIT ENSO WHITE	\$6.75	N/A	118
123-8984-20	ASSY FLOAT 211 ULF FL V 11-1/2	\$2.42	N/A	115
123-8984-50	ASSY FLOAT 211 ULF FL V 11-1/2	\$2.07	N/A	115
125LID	QUANTUM LID 119/123/125/153 WHT	\$70.00	\$81.50	12
160LID	ALTO LID 160 WHT	\$42.58	\$53.28	22
165LID	ALTO LID 165/175 W/LOCK WHT	\$54.08	N/A	22
178LID	ENSO LID 178 WHT	\$67.81	\$78.40	6
195LID	WAVERLY LID 195/3195 WHT	\$70.34	\$81.50	9
202-1012	FLSH-VLV 202 10.5 2" FLAPPER	\$21.07	N/A	116
203A	FLSH-VLV 203A 2" FLAPPER W/CHN	\$8.69	N/A	117
204	FL-VLV #204 3" FLAPR 705NS/722	\$12.68	N/A	117
206-1112	FLSH-VLV 11.5 #206 FLAPPER 3"	\$12.68	N/A	117
206-1112	FV #206 11.5 FLAPPER 3" BOX	\$12.68	N/A	117
206-1212	FLSH-VLV 12.5 #206 FLAPPER 3"	\$13.25	N/A	117
206-1212	FV #206 12.5 FLAPPER 3" BOX	\$13.25	N/A	117
208E	FLSH-VLV MODEL 208E 3" ENSO	\$19.61	N/A	117
209	FLSH-VLV MODEL 209M MAV 1.0	\$17.13	N/A	117
210-1034	FLUSH VALVE 210 10-3/4 BOX	\$9.48	N/A	115
210-1034-10	FLUSH VALVE 210 10-3/4 BOX	\$8.61	N/A	115
210-1112	FLUSH VALVE 210 11-1/2 BOX	\$9.48	N/A	115
210-1112-10	FLUSH VALVE 210 11-1/2 BOX	\$8.61	N/A	115
210-1112-P	PAK 210 FV 11-1/2" POP UPDATE	\$10.35	N/A	115
210-1112-P-4	PAK 210 FV 11-1/2" POP UPDATE	\$9.73	N/A	115
211-1000	FLUSH VALVE 211 10 BOX	\$9.48	N/A	115
211-1000-10	FLUSH VALVE 211 10 BOX	\$8.61	N/A	115
211-1034	FLUSH VALVE 211 10-3/4 BOX	\$9.48	N/A	115
211-1034-10	FLUSH VALVE 211 10-3/4 BOX	\$8.61	N/A	115
211-1112	FLUSH VALVE 211 11-1/2 BOX	\$9.48	N/A	115
211-1112-10	FLUSH VALVE 211 11-1/2 BOX	\$8.61	N/A	115
211-1112-P	PAK 211 FV 11-1/2" POP UPDATE	\$10.35	N/A	115
211-1112-P-4	PAK 211 FV 11-1/2" POP UPDATE	\$9.73	N/A	115
212-1034	ASSY 212 FV 10-3/4" 700/705	\$11.10	N/A	115
212-1034-10	ASSY 212 FV 10-3/4" 700/705	\$9.97	N/A	115
216	FLSH-VLV 216 FLAPPER 3"	\$14.63	N/A	118
225-2511	CAP CONTROL STOP FM SERIES	\$6.58	N/A	115
225-5907-100	CAP FV STOP CAP LRG HOLE	\$0.38	N/A	115
225-5907-20	CAP FV STOP CAP LRG HOLE	\$0.63	N/A	115
228	FV 10.2 #228 HB FLAPPER 3"102"	\$12.68	N/A	118
308	FLSH-VLV #308 DF 3" 10.75	\$19.60	N/A	118
342-1685-20	DIAPHRAM 208/209 FL VLV PLSTC	\$2.49	N/A	119
342-1685-50	DIAPHRAM 208/209 FL VLV PLSTC	\$1.98	N/A	119
342-2067-100	DIAPHRAM 08 BALLCOCK	\$0.63	N/A	114
342-2067-50	DIAPHRAM 08 BALLCOCK	\$0.76	N/A	114
386LID	SUMMIT LID 386 WHT	\$78.87	\$90.53	17
447-0200-50	GASKET 205/210/211 FL VALVE	\$0.99	N/A	115
447-6955-50	GASKET TANK/BOWL 3-BOLT	\$1.87	N/A	115
471-3261	HANGER LAV/475/401 URINAL STL	\$4.12	N/A	120
471-3265	HANGER 410 URINAL	\$0.99	N/A	120
531-0016	KIT-475 URINAL OUTLET	\$24.30	N/A	120
531-0017	KIT-410 URINAL OUTLET	\$26.93	N/A	120
609-5414-20	NUT CAP TO BODY GRAY - 08 BC	\$1.13	N/A	114
609-7740	NUT FLUSH LEVER	\$0.99	N/A	119
630-0030	KIT-FV 211 SEAL POP UPDATE	\$2.98	N/A	121
630-0030-10	KIT-FV 211 SEAL POP UPDATE	\$2.75	N/A	121
630-0030-50	KIT-FV 211 SEAL POP UPDATE	\$2.49	N/A	121
630-0034	PAK TNK/BWL QUANTUM	\$7.22	N/A	118
630-0107	PAK TNK/BWL 3" SMTFASTEN KIT	\$8.73	N/A	118
630-0173	PAK UNIVERSAL 2" FLAPPER	\$2.94	N/A	116
630-0204	PAK TNK/BWL 2" SMTFASTEN KIT	\$6.18	N/A	118
630-0207	PAK WATERSENSE FLPR 3" UPDATE	\$8.73	N/A	116
630-0207-12	PAK WATERSENSE FLPR 3" UPDATE	\$7.85	N/A	116



Model #	Description	White	Standard	Page #
630-0207-3	PAK WATERSENSE FLPR 3" UPDATE	\$8.37	N/A	116
630-1681	PAK HANDLE FM SERIES	\$36.13	N/A	40
630-2206	PAK SERVICE-2206 FILL VLV POP	\$4.12	N/A	114
630-2206-20	PAK SERVICE-2206 FILL VLV POP	\$3.49	N/A	114
630-2511	PAK DIAPHRAGM FM-U1 1 GPF	\$44.17	N/A	40
630-2515	PAK DIAPHRAGM FM-U5 .5 GPF	\$44.17	N/A	40
630-2518	PAK DIAPHRAGM FM-U8 1 PT	\$44.17	N/A	40
630-2522	PAK DIAPHRAGM FM-T2 1.28 GPF	\$44.17	N/A	40
630-2526	PAK DIAPHRAGM FM-T6 1.6 GPF	\$44.17	N/A	40
630-4837	KIT-FV 208/9 SEAL POP UPDATE	\$6.13	N/A	121
630-4837-12	KIT-FV 208/9 SEAL POP UPDATE	\$5.53	N/A	121
630-4837-3	KIT-FV 208/9 SEAL POP UPDATE	\$5.76	N/A	121
630-5907	KIT-210/211 FV STOP TOP	\$2.13	N/A	121
630-5907-12	KIT-210/211 FV STOP TOP	\$1.81	N/A	121
630-5907-3	KIT-210/211 FV STOP TOP	\$1.97	N/A	121
630-6001	PAK TANK BOLTS POP	\$5.85	N/A	121
630-6001-10	PAK TANK BOLTS POP	\$4.86	N/A	121
630-6002	PAK TANK TO BOWL GASKET POP	\$4.49	N/A	121
630-6002-10	PAK TANK TO BOWL GASKET POP	\$3.74	N/A	121
630-6003	PAK TANK TRIM REBUILD POP	\$9.59	N/A	120
630-6003-10	PAK TANK TRIM REBUILD POP	\$7.98	N/A	120
630-6004	PAK O8 BALLCOCK CAP/LEVER POP	\$6.85	N/A	40
630-6004-10	PAK O8 BALLCOCK CAP/LEVER POP	\$5.74	N/A	40
630-6005-20	PAK FLOAT BALL POP	\$1.38	N/A	119
630-6204-P	KIT-2Inch SmartFasten POP	\$7.70	N/A	121
630-6204-P-4	KIT-2Inch SmartFasten POP	\$7.23	N/A	121
630-6601	PAK CONTROL STOP FM SERIES	\$36.34	N/A	40
630-7984	KIT-BALLCOCK O8 SERVICE POP	\$4.12	N/A	121
630-7984-10	KIT-BALLCOCK O8 SERVICE POP	\$3.49	N/A	121
630-9291	PAK VBKR FM SERIES	\$7.07	N/A	40
660-3718-100	PLUNGER O8 NO PARTING LINE	\$0.43	N/A	114
660-3718-50	PLUNGER O8 NO PARTING LINE	\$0.49	N/A	114
705LID	AEGEAN LID 705NS/708 WHT	\$76.52	\$92.90	10
714-0424	ROD AL FLOAT 7-1/2" LENGTH	\$0.87	N/A	119
741-0011-100	SEAL 210/211 FL V EPDM 55A	\$0.87	N/A	115
741-0011-50	SEAL 210/211 FL V EPDM 55A	\$0.99	N/A	115
741-0016	SEAL FV MODEL 208E ENSO	\$2.82	N/A	119
741-0308	SEAL 308 DUAL FLUSH VALVE	\$1.60	N/A	118
918-4007	TUBE REFILL LARGE 7" LENGTH	\$1.93	N/A	119
936-2069-100	SEAL LOWER DIAPHRAGM-O8/12 BC	\$0.76	N/A	114
936-2069-50	SEAL LOWER DIAPHRAGM-O8/12 BC	\$0.87	N/A	114
1012LID	LID 1012/3012 MAV 1.0 WHT	\$78.87	N/A	15
2206-1112	BALLCOCK 2206 11.5 ADJUSTABLE	\$17.19	N/A	114
2206-1212	BALLCOCK 2206 12.5 ADJUSTABLE	\$17.19	N/A	114
3147LID	BRENTWOOD LID 3147 WHT	\$71.69	\$82.23	6
3185LID	ESSENCE LID 3185 WHT	\$77.74	\$89.24	8
3386LID	SUMMIT DF LID 3386 WHT	\$82.20	\$90.44	16
3816LID	CASCADE LID 3816 WHT	\$42.81	N/A	19
4320LID	LID 4320 ELEMENTARY	\$62.40	N/A	36
BCBISC	BOLT CAP SET-BISCUIT	\$1.13	N/A	119
BCBISC-10	BOLT CAP SET-BISCUIT	\$0.99	N/A	119
BCBONE	BOLT CAP SET-BONE	\$1.13	N/A	119
BCBONE-10	BOLT CAP SET-BONE	\$0.99	N/A	119
BCWHT	BOLT CAP SET-WHITE	\$1.13	N/A	119
BCWHT-20	BOLT CAP SET-WHITE	\$0.87	N/A	119
CLIPS	CLIPS UNDER MOUNT LAV	\$16.56	N/A	28
ELEM	TOILET SEAT ELEMENTARY	\$87.98	N/A	34
FM-T2	FM-T2 DURAFLO TV 1.28 GPF	\$192.16	N/A	40
FM-U5	FM-U5 DURAFLO UV .5 GPF	\$192.16	N/A	40
FM-U8	FM-U8 DURAFLO UV 1 PINT	\$192.16	N/A	40
SB100	SEAT SB100 ROUND WHITE	\$21.46	N/A	108
SB100	SEAT SB100 ROUND BONE	\$21.46	N/A	108
SB100	SEAT SB100 ROUND BISCUIT	\$21.46	N/A	108
SB200	SEAT SB200 EL WHITE	\$26.05	N/A	108

Model #	Description	White	Standard	Page #
SB200	SEAT SB200 EL BONE	\$26.05	N/A	108
SB200	SEAT SB200 EL BISCUIT	\$26.05	N/A	108
SB400	SEAT SB400 EL SMART CL BONE	\$37.39	N/A	108
SB400	SEAT SB400 EL SMART CL BISC	\$37.39	N/A	108
SB700	SEAT SB700 EL SMART CL WHT	\$53.01	N/A	108
SB700	SEAT SB700 EL SMART CL BONE	\$53.01	N/A	108
SB700	SEAT SB700 EL SMART CL BISC	\$53.01	N/A	108
SB800	SEAT SB800 EL SMART CL WHT	\$61.09	N/A	108
SB800	SEAT SB800 EL SMART CL BONE	\$61.09	N/A	108
SB800	SEAT SB800 EL SMART CL BISC	\$61.09	N/A	108
SB900	SEAT SB900 EL COMMERCIAL WHT	\$46.22	N/A	108
SB1500	SEAT SB1500 NEW ENSO WHT	\$110.61	N/A	108
SB1500	SEAT SB1500 NEW ENSO BISC	\$110.61	N/A	108
SB1600	SEAT SB1600 ENSO WHT	\$105.28	N/A	108
SB1600	SEAT SB1600 ENSO BISC	\$105.28	N/A	108
SB1700	SEAT SB1700 ESSENCE WHT	\$87.26	N/A	108
SB1700	SEAT SB1700 ESSENCE BONE	\$87.26	N/A	108
SB1700	SEAT SB1700 ESSENCE BISC	\$87.26	N/A	108
SB1800	SEAT SB1800 REO WHITE	\$93.48	N/A	108
SB1800	SEAT SB1800 REO BONE	\$93.48	N/A	108
SB1800	SEAT SB1800 REO BISC	\$93.48	N/A	108

## BATHWARE – Bathtubs, Whirlpools, Air Baths, MicroDerm Systems & Shower Bases

Model #	Name	Measurements	Standard	Premium	Page #
5002 BAS	Baywood 5.0 - SW Bas Whripl	60" x 36" x 19 3/4"	\$2,502.00	\$2,742.00	70
5002 LUX	Baywood 5.0 - SW Lux Whripl	60" x 36" x 19 3/4"	\$4,323.00	\$4,563.00	70
5004 BAS	Baywood 6.0 - SW Bas Whripl	72" x 36" x 19 3/4"	\$2,703.00	\$2,943.00	68
5004 LUX	Baywood 6.0 - SW Lux Whripl	72" x 36" x 19 3/4"	\$4,462.00	\$4,702.00	68
5008 BAS	Barrett 3666 - SW Bas Whripl	66" x 36" x 24"	\$2,653.00	\$2,893.00	66
5008 LUX	Barrett 3666 - SW Lux Whripl	66" x 36" x 24"	\$4,412.00	\$4,652.00	66
5010 BAS	Barrett 3672 - SW Bas Whripl	72" x 36" x 24"	\$2,703.00	\$2,943.00	64
5010 LUX	Barrett 3672 - SW Lux Whripl	72" x 36" x 24"	\$4,462.00	\$4,702.00	64
5011 BAS	Romanesque - SW Bas Whripl	68" x 42" x 22"	\$2,903.00	\$3,143.00	81
5011 LUX	Romanesque - SW Lux Whripl	68" x 42" x 22"	\$4,725.00	\$4,965.00	81
5017 BAS	Waverly - SW Bas Whripl	70" x 47" x 20 1/4"	\$2,903.00	\$3,143.00	62
5017 LUX	Waverly - SW Lux Whripl	70" x 47" x 20 1/4"	\$4,725.00	\$4,965.00	62
5018 BAS	Barrett 4272 - SW Bas Whripl	72" x 42" x 24"	\$2,903.00	\$3,143.00	63
5018 LUX	Barrett 4272 - SW Lux Whripl	72" x 42" x 24"	\$4,663.00	\$4,903.00	63
5022 BAS	Barrett 4266 - SW Bas Whripl	66" x 42" x 24"	\$2,752.00	\$2,992.00	65
5022 LUX	Barrett 4266 - SW Lux Whripl	66" x 42" x 24"	\$4,512.00	\$4,752.00	65
5024L BAS	Barrett Alcove LH - SW Bas Whripl	60" x 32" x 21 1/2"	\$1,816.00	\$2,056.00	67
5024L LUX	Barrett Alcove LH - SW Lux Whripl	60" x 32" x 21 1/2"	\$3,493.00	\$3,733.00	67
5024R BAS	Barrett Alcove RH - SW Bas Whripl	60" x 32" x 21 1/2"	\$1,816.00	\$2,056.00	67
5024R LUX	Barrett Alcove RH - SW Lux Whripl	60" x 32" x 21 1/2"	\$3,493.00	\$3,733.00	67
5025 BAS	Montclair - SW Bas Whripl	71 1/2" x 41 1/2" x 23 1/2"	\$2,903.00	\$3,143.00	88
5025 LUX	Montclair - SW Lux Whripl	71 1/2" x 41 1/2" x 23 1/2"	\$4,663.00	\$4,903.00	88
5027 BAS	Essence 3666 - SW Bas Whripl	66" x 36" x 24"	\$2,653.00	\$2,893.00	53
5027 LUX	Essence 3666 - SW Lux Whripl	66" x 36" x 24"	\$4,412.00	\$4,652.00	53
5028 BAS	Baywood 5.5 - SW Bas Whripl	66" x 36" x 19 3/4"	\$2,653.00	\$2,893.00	69
5028 LUX	Baywood 5.5 - SW Lux Whripl	66" x 36" x 19 3/4"	\$4,412.00	\$4,652.00	69
5030 BAS	Essence 3672 - SW Bas Whripl	71 1/2" x 36" x 24"	\$2,703.00	\$2,943.00	51
5030 LUX	Essence 3672 - SW Lux Whripl	71 1/2" x 36" x 24"	\$4,463.00	\$4,703.00	51
5031 BAS	Essence 4260 - SW Bas Whripl	60" x 41 1/2" x 24"	\$2,703.00	\$2,943.00	54
5031 LUX	Essence 4260 - SW Lux Whripl	60" x 41 1/2" x 24"	\$4,463.00	\$4,703.00	54
5033 BAS	Essence 4266 - SW Bas Whripl	66" x 41 1/2" x 24"	\$2,752.00	\$2,992.00	52
5033 LUX	Essence 4266 - SW Lux Whripl	66" x 41 1/2" x 24"	\$4,512.00	\$4,752.00	52
5035 BAS	Essence 4272 - SW Bas Whripl	71 1/2" x 41 1/2" x 24"	\$2,903.00	\$3,143.00	50
5035 LUX	Essence 4272 - SW Lux Whripl	71 1/2" x 41 1/2" x 24"	\$4,663.00	\$4,903.00	50
5039 BAS	Ambria - SW Bas Whripl	59 1/2" x 59 1/2" x 21 1/4"	\$3,052.00	\$3,292.00	83
5039 LUX	Ambria - SW Lux Whripl	59 1/2" x 59 1/2" x 21 1/4"	\$4,878.00	\$5,118.00	83
5040 BAS	Brighton - SW Bas Whripl	72" x 48" x 24"	\$3,202.00	\$3,442.00	76
5040 LUX	Brighton - SW Lux Whripl	72" x 48" x 24"	\$5,028.00	\$5,268.00	76

# Product Quick Reference

List Price Effective January 1, 2016

Model #	Name	Measurements	Standard	Premium	Page #
5045 BAS	Bristol Bay - SW Bas Whripl	60" x 60" x 22"	\$3,052.00	\$3,292.00	84
5045 LUX	Bristol Bay - SW Lux Whripl	60" x 60" x 22"	\$4,878.00	\$5,118.00	84
5048 BAS	Covington C Round front - SW Bas Whripl	60" x 60" x 23"	\$3,052.00	\$3,292.00	87
5048 LUX	Covington C Round front - SW Lux Whripl	60" x 60" x 23"	\$4,878.00	\$5,118.00	87
5051 BAS	Savannah - SW Bas Whripl	72" x 48" x 24"	\$3,202.00	\$3,442.00	82
5051 LUX	Savannah - SW Lux Whripl	72" x 48" x 24"	\$5,028.00	\$5,268.00	82
5053 BAS	Camden - SW Bas Whripl	59 1/2" x 32" x 21 1/2"	\$2,405.00	\$2,645.00	77
5053 LUX	Camden - SW Lux Whripl	59 1/2" x 32" x 21 1/2"	\$4,157.00	\$4,397.00	77
5058 BAS	Heathrow R - SW Bas Whripl	72" x 42" x 23"	\$2,903.00	\$3,143.00	80
5058 LUX	Heathrow R - SW Lux Whripl	72" x 42" x 23"	\$4,663.00	\$4,903.00	80
5062 BAS	Covington C - SW Bas Whripl	60" x 60" x 23"	\$3,052.00	\$3,292.00	86
5062 LUX	Covington C - SW Lux Whripl	60" x 60" x 23"	\$4,878.00	\$5,118.00	86
5067 BAS	Brentwood 3260 - SW Bas Whripl	60" x 32" x 20 3/4"	\$2,405.00	\$2,645.00	75
5067 LUX	Brentwood 3260 - SW Lux Whripl	60" x 32" x 20 3/4"	\$4,157.00	\$4,397.00	75
5069 BAS	Brentwood 3660 - SW Bas Whripl	60" x 36" x 22 1/2"	\$2,502.00	\$2,742.00	74
5069 LUX	Brentwood 3660 - SW Lux Whripl	60" x 36" x 22 1/2"	\$4,323.00	\$4,563.00	74
5072 BAS	Hampton R - SW Bas Whripl	72" x 42" x 23 1/2"	\$2,903.00	\$3,143.00	79
5072 LUX	Hampton R - SW Lux Whripl	72" x 42" x 23 1/2"	\$4,663.00	\$4,903.00	79
5073 BAS	Brentwood 3666 - SW Bas Whripl	66" x 36" x 22 1/2"	\$2,653.00	\$2,893.00	73
5073 LUX	Brentwood 3666 - SW Lux Whripl	66" x 36" x 22 1/2"	\$4,412.00	\$4,652.00	73
5074 BAS	Brentwood 3672 - SW Bas Whripl	72" x 36" x 22 1/2"	\$2,703.00	\$2,943.00	72
5074 LUX	Brentwood 3672 - SW Lux Whripl	72" x 36" x 22 1/2"	\$4,462.00	\$4,702.00	72
5075 BAS	Brentwood 4272 - SW Bas Whripl	72" x 42" x 22 1/2"	\$2,903.00	\$3,143.00	71
5075 LUX	Brentwood 4272 - SW Lux Whripl	72" x 42" x 22 1/2"	\$4,663.00	\$4,903.00	71
5077 BAS	Heathrow OV - SW Bas Whripl	72" x 42" x 23"	\$2,903.00	\$3,143.00	56
5077 LUX	Heathrow OV - SW Lux Whripl	72" x 42" x 23"	\$4,663.00	\$4,903.00	56
5078 BAS	Hampton OV - SW Bas Whripl	68" x 42" x 23 1/2"	\$2,903.00	\$3,143.00	55
5078 LUX	Hampton OV - SW Lux Whripl	68" x 42" x 23 1/2"	\$4,663.00	\$4,903.00	55
5081 BAS	Avalon - SW Bas Whripl	71 3/4" x 40 1/2" x 29"	\$2,903.00	\$3,143.00	44
5081 LUX	Avalon - SW Lux Whripl	71 3/4" x 40 1/2" x 29"	\$4,663.00	\$4,903.00	44
5084 BAS	Elba R - SW Bas Whripl	59 1/2" x 42" x 23"	\$2,703.00	\$2,943.00	78
5084 LUX	Elba R - SW Lux Whripl	59 1/2" x 42" x 23"	\$4,463.00	\$4,703.00	78
5085 BAS	Elba OV - SW Bas Whripl	59 1/2" x 42" x 23"	\$2,703.00	\$2,943.00	45
5085 LUX	Elba OV - SW Lux Whripl	59 1/2" x 42" x 23"	\$4,463.00	\$4,703.00	45
5089 BAS	Castille - SW Bas Whripl	66" x 66" x 23 1/2"	\$3,253.00	\$3,493.00	85
5089 LUX	Castille - SW Lux Whripl	66" x 66" x 23 1/2"	\$5,080.00	\$5,320.00	85
5092 BAS	Enso 3666 - SW Bas Whripl	66" x 36" x 22 1/4"	\$2,653.00	\$2,893.00	49
5092 LUX	Enso 3666 - SW Lux Whripl	66" x 36" x 22 1/4"	\$4,412.00	\$4,652.00	49
5093 BAS	Enso 3672 - SW Bas Whripl	72" x 36" x 22 1/4"	\$2,703.00	\$2,943.00	47
5093 LUX	Enso 3672 - SW Lux Whripl	72" x 36" x 22 1/4"	\$4,462.00	\$4,702.00	47
5094 BAS	Enso 4266 - SW Bas Whripl	66" x 42" x 22 1/4"	\$2,752.00	\$2,992.00	48
5094 LUX	Enso 4266 - SW Lux Whripl	66" x 42" x 22 1/4"	\$4,512.00	\$4,752.00	48
5095 BAS	Enso 4272 - SW Bas Whripl	72" x 42" x 22 1/4"	\$2,903.00	\$3,143.00	46
5095 LUX	Enso 4272 - SW Lux Whripl	72" x 42" x 22 1/4"	\$4,663.00	\$4,903.00	46
5096 BAS	Reo 3660 - SW Bas Whripl	60" x 36" x 24"	\$2,502.00	\$2,742.00	88
5096 LUX	Reo 3660 - SW Lux Whripl	60" x 36" x 24"	\$4,323.00	\$4,563.00	88
5097 BAS	Reo 3666 - SW Bas Whripl	66" x 36" x 24"	\$2,653.00	\$2,893.00	88
5097 LUX	Reo 3666 - SW Lux Whripl	66" x 36" x 24"	\$4,412.00	\$4,652.00	88
5098 BAS	Reo 3672 - SW Bas Whripl	72" x 36" x 24"	\$2,703.00	\$2,943.00	88
5098 LUX	Reo 3672 - SW Lux Whripl	72" x 36" x 24"	\$4,462.00	\$4,702.00	88
5099 BAS	Reo 4272 - SW Bas Whripl	72" x 42" x 24"	\$2,903.00	\$3,143.00	88
5099 LUX	Reo 4272 - SW Lux Whripl	72" x 42" x 24"	\$4,663.00	\$4,903.00	88
5202	Baywood 5.0 - MicroDerm	60" x 36" x 19 3/4"	\$3,186.00	\$3,426.00	70
5204	Baywood 6.0 - MicroDerm	72" x 36" x 19 3/4"	\$3,239.00	\$3,479.00	68
5208	Barrett 3666 - MicroDerm	66" x 36" x 24"	\$3,213.00	\$3,453.00	66
5210	Barrett 3672 - MicroDerm	72" x 36" x 24"	\$3,239.00	\$3,479.00	64
5218	Barrett 4272 - MicroDerm	72" x 42" x 24"	\$3,318.00	\$3,558.00	63
5222	Barrett 4266 - MicroDerm	66" x 42" x 24"	\$3,265.00	\$3,505.00	65
5227	Essence 3666 - MicroDerm	66" x 36" x 24"	\$3,213.00	\$3,453.00	53
5228	Baywood 5.5 - MicroDerm	66" x 36" x 19 3/4"	\$3,213.00	\$3,453.00	69
5230	Essence 3672 - MicroDerm	71 1/2" x 36" x 24"	\$3,239.00	\$3,479.00	51
5231	Essence 4260 - MicroDerm	60" x 41 1/2" x 24"	\$3,239.00	\$3,479.00	54
5233	Essence 4266 - MicroDerm	66" x 41 1/2" x 24"	\$3,265.00	\$3,505.00	52

Model #	Name	Measurements	Standard	Premium	Page #
5235	Essence 4272 - MicroDerm	71 1/2" x 41 1/2" x 24"	\$3,318.00	\$3,558.00	50
5245	Bristol Bay - MicroDerm	60" x 60" x 22"	\$3,370.00	\$3,610.00	84
5253	Camden - MicroDerm	59 1/2" x 32" x 21 1/2"	\$3,150.00	\$3,390.00	77
5258	Heathrow R - MicroDerm	72" x 42" x 23"	\$3,318.00	\$3,558.00	80
5262	Covington C - MicroDerm	60" x 60" x 23"	\$3,370.00	\$3,610.00	86
5267	Brentwood 3260 - MicroDerm	60" x 32" x 20 3/4"	\$3,150.00	\$3,390.00	75
5269	Brentwood 3660 - MicroDerm	60" x 36" x 22 1/2"	\$3,186.00	\$3,426.00	74
5272	Hampton R - MicroDerm	72" x 42" x 23 1/2"	\$3,318.00	\$3,558.00	79
5273	Brentwood 3666 - MicroDerm	66" x 36" x 22 1/2"	\$3,213.00	\$3,453.00	73
5274	Brentwood 3672 - MicroDerm	72" x 36" x 22 1/2"	\$3,239.00	\$3,479.00	72
5275	Brentwood 4272 - MicroDerm	72" x 42" x 22 1/2"	\$3,318.00	\$3,558.00	71
5277	Heathrow OV - MicroDerm	72" x 42" x 23"	\$3,318.00	\$3,558.00	56
5278	Hampton OV - MicroDerm	68" x 42" x 23 1/2"	\$3,265.00	\$3,505.00	55
5281	Avalon - MicroDerm	71 3/4" x 40 1/2" x 29"	\$3,318.00	\$3,558.00	44
5502	Baywood 5.0 - SW Bath	60" x 36" x 19 3/4"	\$1,331.00	\$1,571.00	70
5504	Baywood 6.0 - SW Bath	72" x 36" x 19 3/4"	\$1,386.00	\$1,626.00	68
5508	Barrett 3666 - SW Bath	66" x 36" x 24"	\$1,359.00	\$1,599.00	66
5510	Barrett 3672 - SW Bath	72" x 36" x 24"	\$1,386.00	\$1,626.00	64
5518	Barrett 4272 - SW Bath	72" x 42" x 24"	\$1,468.00	\$1,708.00	63
5522	Barrett 4266 - SW Bath	66" x 42" x 24"	\$1,413.00	\$1,653.00	65
5524L	Barrett Alcove LH - SW Bath	60" x 32" x 21 1/2"	\$1,359.00	\$1,599.00	67
5524R	Barrett Alcove RH - SW Bath	60" x 32" x 21 1/2"	\$1,359.00	\$1,599.00	67
5525	Montclair - SW Bath	71 1/2" x 41 1/2" x 23 1/2"	\$1,468.00	\$1,708.00	88
5527	Essence 3666 - SW Bath	66" x 36" x 24"	\$1,359.00	\$1,599.00	53
5528	Baywood 5.5 - SW Bath	66" x 36" x 19 3/4"	\$1,359.00	\$1,599.00	69
5530	Essence 3672 - SW Bath	71 1/2" x 36" x 24"	\$1,386.00	\$1,626.00	51
5531	Essence 4260 - SW Bath	60" x 41 1/2" x 24"	\$1,386.00	\$1,626.00	54
5533	Essence 4266 - SW Bath	66" x 41 1/2" x 24"	\$1,413.00	\$1,653.00	52
5535	Essence 4272 - SW Bath	71 1/2" x 41 1/2" x 24"	\$1,468.00	\$1,708.00	50
5539	Ambria - SW Bath	59 1/2" x 59 1/2" x 21 1/4"	\$1,521.00	\$1,761.00	83
5540	Brighton - SW Bath	72" x 48" x 24"	\$1,521.00	\$1,761.00	76
5545	Bristol Bay - SW Bath	60" x 60" x 22"	\$1,521.00	\$1,761.00	84
5548	Covington C Round front - SW Bath	60" x 60" x 23"	\$1,521.00	\$1,761.00	87
5551	Savannah - SW Bath	72" x 48" x 24"	\$1,521.00	\$1,761.00	82
5553	Camden - SW Bath	59 1/2" x 32" x 21 1/2"	\$1,294.00	\$1,534.00	77
5558	Heathrow R - SW Bath	72" x 42" x 23"	\$1,468.00	\$1,708.00	80
5562	Covington C - SW Bath	60" x 60" x 23"	\$1,521.00	\$1,761.00	86
5567	Brentwood 3260 - SW Bath	60" x 32" x 20 3/4"	\$1,294.00	\$1,534.00	75
5569	Brentwood 3660 - SW Bath	60" x 36" x 22 1/2"	\$1,331.00	\$1,571.00	74
5572	Hampton R - SW Bath	72" x 42" x 23 1/2"	\$1,468.00	\$1,708.00	79
5573	Brentwood 3666 - SW Bath	66" x 36" x 22 1/2"	\$1,359.00	\$1,599.00	73
5574	Brentwood 3672 - SW Bath	72" x 36" x 22 1/2"	\$1,386.00	\$1,626.00	72
5575	Brentwood 4272 - SW Bath	72" x 42" x 22 1/2"	\$1,468.00	\$1,708.00	71
5577	Heathrow OV - SW Bath	72" x 42" x 23"	\$1,468.00	\$1,708.00	56
5578	Hampton OV - SW Bath	68" x 42" x 23 1/2"	\$1,413.00	\$1,653.00	55
5581	Avalon - SW Bath	71 3/4" x 40 1/2" x 29"	\$1,468.00	\$1,708.00	44
5584	Elba R - SW Bath	59 1/2" x 42" x 23"	\$1,386.00	\$1,626.00	78
5585	Elba OV - SW Bath	59 1/2" x 42" x 23"	\$1,386.00	\$1,626.00	45
5589	Castille - SW Bath	66" x 66" x 23 1/2"	\$1,576.00	\$1,816.00	85
5592	Enso 3666 - SW Bath	66" x 36" x 22 1/4"	\$1,359.00	\$1,599.00	49
5593	Enso 3672 - SW Bath	72" x 36" x 22 1/4"	\$1,386.00	\$1,626.00	47
5594	Enso 4266 - SW Bath	66" x 42" x 22 1/4"	\$1,413.00	\$1,653.00	48
5595	Enso 4272 - SW Bath	72" x 42" x 22 1/4"	\$1,468.00	\$1,708.00	46
5596	Reo 3660 - SW Bath	60" x 36" x 24"	\$1,331.00	\$1,571.00	88
5597	Reo 3666 - SW Bath	66" x 36" x 24"	\$1,359.00	\$1,599.00	88
5598	Reo 3672 - SW Bath	72" x 36" x 24"	\$1,386.00	\$1,626.00	88
5599	Reo 4272 - SW Bath	72" x 42" x 24"	\$1,468.00	\$1,708.00	88
6015	4260 OV - Pro-fit Whripl	60" x 42" x 20 1/4"	\$1,385.00	N/A	91
6018	3660 - Pro-fit Whripl	59 3/4" x 35 3/4" x 21 1/4"	\$1,263.00	N/A	96
6019	3660 OV - Pro-fit Whripl	60" x 36" x 22"	\$1,263.00	N/A	90
6021	3672 - Pro-fit Whripl	71 1/2" x 35 1/2" x 20"	\$1,325.00	N/A	98
6024	4260 - Pro-fit Whripl	60" x 42" x 20 1/4"	\$1,385.00	N/A	100
6027	4272 - Pro-fit Whripl	71 1/2" x 42" x 19 3/4"	\$1,445.00	N/A	103
6028C	4268 OV CD - Pro-fit Whripl	68" x 42" x 19 3/4"	\$1,405.00	N/A	93



www.mansfieldplumbing.com | Customer Service: phone 877-850-3060, fax 419-938-6234



Model #	Name	Measurements	Standard	Premium	Page #
6028E	4268 OV ED - Pro-fit Whripl	68" x 42" x 20"	\$1,405.00	N/A	92
6033	4872 - Pro-fit Whripl	71 1/2" x 47 5/8" x 22 1/2"	\$1,505.00	N/A	104
6039	6060 - Pro-fit Whripl	59 3/4" x 59 3/4" x 21 1/4"	\$1,520.00	N/A	105
6041	6060 DL - Pro-fit Whripl	60" x 60" x 20"	\$1,520.00	N/A	106
6053	3260 - Pro-fit Whripl	59 3/4" x 32" x 19 1/4"	\$1,208.00	N/A	94
6118	3660 TFS RH - Pro-fit Whripl	60" x 35 3/4" x 23"	\$1,444.00	N/A	97
6118A	3660 TFS RH - Pro-fit Whripl w/Acc	60" x 35 3/4" x 23"	\$1,677.00	N/A	97
6119	3660 TFS LH - Pro-fit Whripl	60" x 35 3/4" x 23"	\$1,444.00	N/A	97
6119A	3660 TFS LH - Pro-fit Whripl w/Acc	60" x 35 3/4" x 23"	\$1,677.00	N/A	97
6122	3672 TFS RH - Pro-fit Whripl	71 1/2" x 35 1/2" x 23"	\$1,530.00	N/A	99
6122A	3672 TFS RH - Pro-fit Whripl w/Acc	71 1/2" x 35 1/2" x 23"	\$1,763.00	N/A	99
6123	3672 TFS LH - Pro-fit Whripl	71 1/2" x 35 1/2" x 23"	\$1,530.00	N/A	99
6123A	3672 TFS LH - Pro-fit Whripl w/Acc	71 1/2" x 35 1/2" x 23"	\$1,763.00	N/A	99
6124	4260 TFS LH - Pro-fit Whripl	59 3/4" x 42" x 21 1/4"	\$1,609.00	N/A	101
6124A	4260 TFS LH - Pro-fit Whripl w/Acc	59 3/4" x 42" x 21 1/4"	\$1,843.00	N/A	101
6125	4260 TFS RH - Pro-fit Whripl	59 3/4" x 42" x 21 1/4"	\$1,609.00	N/A	101
6125A	4260 TFS RH - Pro-fit Whripl w/Acc	59 3/4" x 42" x 21 1/4"	\$1,843.00	N/A	101
6126A	4260 TFS CD - Pro-fit Whripl w/Acc	60" x 42" x 21 1/4"	\$1,843.00	N/A	102
6153	3260 TFS LH - Pro-fit Whripl	59 3/4" x 31 3/4" x 20 3/4"	\$1,398.00	N/A	95
6153A	3260 TFS LH - Pro-fit Whripl w/Acc	59 3/4" x 31 3/4" x 20 3/4"	\$1,632.00	N/A	95
6154	3260 TFS RH - Pro-fit Whripl	59 3/4" x 31 3/4" x 20 3/4"	\$1,398.00	N/A	95
6154A	3260 TFS RH - Pro-fit Whripl w/Acc	59 3/4" x 31 3/4" x 20 3/4"	\$1,632.00	N/A	95
6515	4260 OV - Pro-fit Bath	60" x 42" x 20 1/4"	\$901.00	N/A	91
6518	3660 - Pro-fit Bath	59 3/4" x 35 3/4" x 21 1/4"	\$780.00	N/A	96
6519	3660 OV - Pro-fit Bath	60" x 36" x 22"	\$780.00	N/A	90
6521	3672 - Pro-fit Bath	71 1/2" x 35 1/2" x 20"	\$846.00	N/A	98
6524	4260 - Pro-fit Bath	60" x 42" x 20 1/4"	\$901.00	N/A	100
6527	4272 - Pro-fit Bath	71 1/2" x 42" x 19 3/4"	\$957.00	N/A	103
6528E	4268 OV ED - Pro-fit Bath	68" x 42" x 20"	\$947.00	N/A	92
6533	4872 - Pro-fit Bath	71 1/2" x 47 5/8" x 22 1/2"	\$977.00	N/A	104
6539	6060 - Pro-fit Bath	59 3/4" x 59 3/4" x 21 1/4"	\$1,230.00	N/A	105
6541	6060 DL - Pro-fit Bath	60" x 60" x 20"	\$1,231.00	N/A	106
6553	3260 - Pro-fit Bath	59 3/4" x 32" x 19 1/4"	\$715.00	N/A	94
6618	3660 TFS RH - Pro-fit Bath	60" x 35 3/4" x 23"	\$971.00	N/A	97
6618A	3660 TFS RH - Pro-fit Bath w/Acc	60" x 35 3/4" x 23"	\$1,204.00	N/A	97
6619	3660 TFS LH - Pro-fit Bath	60" x 35 3/4" x 23"	\$971.00	N/A	97
6619A	3660 TFS LH - Pro-fit Bath w/Acc	60" x 35 3/4" x 23"	\$1,204.00	N/A	97
6622	3672 TFS RH - Pro-fit Bath	71 1/2" x 35 1/2" x 23"	\$1,112.00	N/A	99
6622A	3672 TFS RH - Pro-fit Bath w/Acc	71 1/2" x 35 1/2" x 23"	\$1,345.00	N/A	99
6623	3672 TFS LH - Pro-fit Bath	71 1/2" x 35 1/2" x 23"	\$1,112.00	N/A	99
6623A	3672 TFS LH - Pro-fit Bath w/Acc	71 1/2" x 35 1/2" x 23"	\$1,345.00	N/A	99
6624	4260 TFS LH - Pro-fit Bath	59 3/4" x 42" x 21 1/4"	\$1,156.00	N/A	101
6624A	4260 TFS LH - Pro-fit Bath w/Acc	59 3/4" x 42" x 21 1/4"	\$1,390.00	N/A	101
6625	4260 TFS RH - Pro-fit Bath	59 3/4" x 42" x 21 1/4"	\$1,156.00	N/A	101
6625A	4260 TFS RH - Pro-fit Bath w/Acc	59 3/4" x 42" x 21 1/4"	\$1,390.00	N/A	101
6627A	4260 TFS CD - Pro-fit Bath w/Acc	60" x 42" x 21 1/4"	\$1,390.00	N/A	102
6653	3260 TFS LH - Pro-fit Bath	59 3/4" x 31 3/4" x 20 3/4"	\$915.00	N/A	95
6653A	3260 TFS LH - Pro-fit Bath w/Acc	59 3/4" x 31 3/4" x 20 3/4"	\$1,149.00	N/A	95
6654	3260 TFS RH - Pro-fit Bath	59 3/4" x 31 3/4" x 20 3/4"	\$915.00	N/A	95
6654A	3260 TFS RH - Pro-fit Bath w/Acc	59 3/4" x 31 3/4" x 20 3/4"	\$1,149.00	N/A	95
6715	4260 OV - Pro-fit Air Bath	60" x 42" x 20 1/4"	\$1,788.00	N/A	91
6718	3660 - Pro-fit Air Bath	59 3/4" x 35 3/4" x 21 1/4"	\$1,666.00	N/A	96
6719	3660 OV - Pro-fit Air Bath	60" x 36" x 22"	\$1,727.00	N/A	90
6721	3672 - Pro-fit Air Bath	71 1/2" x 35 1/2" x 20"	\$1,727.00	N/A	98
6724	4260 - Pro-fit Air Bath	60" x 42" x 20 1/4"	\$1,788.00	N/A	100
6727	4272 - Pro-fit Air Bath	71 1/2" x 42" x 19 3/4"	\$1,808.00	N/A	103
6728E	4268 OV ED - Pro-fit Air Bath	68" x 42" x 20"	\$1,807.00	N/A	92
6739	6060 - Pro-fit Air Bath	59 3/4" x 59 3/4" x 21 1/4"	\$1,847.00	N/A	105
6755	3260 - Pro-fit Air Bath	59 3/4" x 32" x 19 1/4"	\$1,611.00	N/A	94
7501	3232 ST - Shwr Base, Cntr Drain	32" x 32"	\$694.00	\$934.00	107
7502	3636 ST - Shwr Base, Cntr Drain	36" x 36"	\$727.00	\$967.00	107
7503	3642 STSS - Shwr Base, Cntr Drain	36" x 42"	\$763.00	\$1,003.00	107
7504	4236 STLS - Shwr Base, Cntr Drain	42" x 36"	\$763.00	\$1,003.00	107
7505	4832 STLS - Shwr Base, Cntr Drain	48" x 32"	\$763.00	\$1,003.00	107

Model #	Name	Measurements	Standard	Premium	Page #
7506	4834 STLS - Shwr Base, Cntr Drain	48" x 34"	\$763.00	\$1,003.00	107
7507	6034 STLS - Shwr Base, Cntr Drain	60" x 34"	\$831.00	\$1,071.00	107
7508	3636 DT - Shwr Base, Cntr Drain	36" x 36"	\$727.00	\$967.00	107
7509	3636 TTNA - Shwr Base, Cntr Drain	36" x 36"	\$778.00	\$1,018.00	107
7510	3838 TTNA - Shwr Base, Cntr Drain	38" x 38"	\$778.00	\$1,018.00	107
7514	6032 STLS RH - Shwr Base, End Drain	60" x 32"	\$831.00	\$1,071.00	107
7515	6032 STLS LH - Shwr Base, End Drain	60" x 32"	\$831.00	\$1,071.00	107
7530	4242 TTNA - Shwr Base, Cntr Drain	42" x 42"	\$831.00	\$1,071.00	107
7531	4242 ST - Shwr Base, Cntr Drain	42" x 42"	\$763.00	\$1,003.00	107
8010	Restore Walk-in - RH Whirlpool	51 1/2" x 30" x 40"	\$6,652.00	N/A	88
8110	Restore Walk-in - LH Whirlpool	51 1/2" x 30" x 40"	\$6,652.00	N/A	88
8210	Restore Walk-in - RH Soaking tub	51 1/2" x 30" x 40"	\$5,433.00	N/A	88
8310	Restore Walk-in - LH Soaking tub	51 1/2" x 30" x 40"	\$5,433.00	N/A	88
8410	Restore Walk-in - RH Air bath	51 1/2" x 30" x 40"	\$6,873.00	N/A	88
8510	Restore Walk-in - LH Air bath	51 1/2" x 30" x 40"	\$6,873.00	N/A	88
8610	Restore Walk-in - RH Combination	51 1/2" x 30" x 40"	\$8,094.00	N/A	88
8710	Restore Walk-in - LH Combination	51 1/2" x 30" x 40"	\$8,094.00	N/A	88
9003	Bristol Bay - HT Air Bath	60" x 60" x 22"	\$3,973.00	\$4,213.00	84
9004	Baywood 5.0 - HT Air Bath	60" x 36" x 19 3/4"	\$3,054.00	\$3,294.00	70
9005	Baywood 6.0 - HT Air Bath	72" x 36" x 19 3/4"	\$3,283.00	\$3,523.00	68
9008	Barrett 3666 - HT Air Bath	66" x 36" x 24"	\$3,394.00	\$3,634.00	66
9010	Barrett 3672 - HT Air Bath	72" x 36" x 24"	\$3,448.00	\$3,688.00	64
9018	Barrett 4272 - HT Air Bath	72" x 42" x 24"	\$3,729.00	\$3,969.00	62
9022	Barrett 4266 - HT Air Bath	66" x 42" x 24"	\$3,502.00	\$3,742.00	65
9024L	Barrett Alcove LH - HT Air Bath	60" x 32" x 21 1/2"	\$3,416.00	\$3,656.00	67
9024R	Barrett Alcove RH - HT Air Bath	60" x 32" x 21 1/2"	\$3,416.00	\$3,656.00	67
9025	Montclair - HT Air Bath	71 1/2" x 41 1/2" x 23 1/2"	\$3,394.00	\$3,634.00	88
9027	Essence 3666 - HT Air Bath	66" x 36" x 24"	\$3,645.00	\$3,885.00	53
9028	Baywood 5.5 - HT Air Bath	66" x 36" x 19 3/4"	\$3,169.00	\$3,409.00	69
9030	Essence 3672 - HT Air Bath	71 1/2" x 36" x 24"	\$3,448.00	\$3,688.00	51
9031	Essence 4260 - HT Air Bath	60" x 41 1/2" x 24"	\$3,448.00	\$3,688.00	54
9033	Essence 4266 - HT Air Bath	66" x 41 1/2" x 24"	\$3,502.00	\$3,742.00	52
9035	Essence 4272 - HT Air Bath	71 1/2" x 41 1/2" x 24"	\$3,557.00	\$3,797.00	50
9040	Brighton - HT Air Bath	72" x 48" x 24"	\$3,832.00	\$4,072.00	76
9048	Covington C Round front - HT Air Bath	60" x 60" x 23"	\$3,995.00	\$4,235.00	87
9051	Savannah - HT Air Bath	72" x 48" x 24"	\$3,832.00	\$4,072.00	82
9053	Camden - HT Air Bath	59 1/2" x 32" x 21 1/2"	\$2,948.00	\$3,188.00	77
9058	Heathrow R - HT Air Bath	72" x 42" x 23"	\$3,645.00	\$3,885.00	80
9062	Covington C - HT Air Bath	60" x 60" x 23"	\$3,995.00	\$4,235.00	86
9067	Brentwood 3260 - HT Air Bath	60" x 32" x 20 3/4"	\$2,948.00	\$3,188.00	75
9069	Brentwood 3660 - HT Air Bath	60" x 36" x 22 1/2"	\$3,036.00	\$3,276.00	74
9072	Hampton R - HT Air Bath	72" x 42" x 23 1/2"	\$3,394.00	\$3,634.00	79
9073	Brentwood 3666 - HT Air Bath	66" x 36" x 22 1/2"	\$3,169.00	\$3,409.00	73
9074	Brentwood 3672 - HT Air Bath	72" x 36" x 22 1/2"	\$3,283.00	\$3,523.00	72
9075	Brentwood 4272 - HT Air Bath	72" x 42" x 22 1/2"	\$3,400.00	\$3,640.00	71
9077	Heathrow OV - HT Air Bath	72" x 42" x 23"	\$3,645.00	\$3,885.00	56
9078	Hampton OV - HT Air Bath	68" x 42" x 23 1/2"	\$3,394.00	\$3,634.00	55
9081	Avalon - HT Air Bath	71 3/4" x 40 1/2" x 29"	\$3,349.00	\$3,589.00	44
9084	Elba R - HT Air Bath	59 1/2" x 42" x 23"	\$3,283.00	\$3,523.00	78
9085	Elba OV - HT Air Bath	59 1/2" x 42" x 23"	\$3,283.00	\$3,523.00	45
9089	Castille - HT Air Bath	66" x 66" x 23 1/2"	\$3,886.00	\$4,126.00	85
9092	Enso 3666 - HT Air Bath	66" x 36" x 22 1/4"	\$3,394.00	\$3,634.00	49
9093	Enso 3672 - HT Air Bath	72" x 36" x 22 1/4"	\$3,448.00	\$3,688.00	47
9094	Enso 4266 - HT Air Bath	66" x 42" x 22 1/4"	\$3,502.00	\$3,742.00	48
9095	Enso 4272 - HT Air Bath	72" x 42" x 22 1/4"	\$3,557.00	\$3,797.00	46
9096	Reo 3660 - HT Air Bath	60" x 36" x 24"	\$2,902.00	\$3,142.00	88
9097	Reo 3666 - HT Air Bath	66" x 36" x 24"	\$3,119.00	\$3,359.00	88
9098	Reo 3672 - HT Air Bath	72" x 36" x 24"	\$3,339.00	\$3,579.00	88
9099	Reo 4272 - HT Air Bath	72" x 42" x 24"	\$3,448.00	\$3,688.00	88
9103	Bristol Bay - GT Air Bath	60" x 60" x 22"	\$4,266.00	\$4,506.00	84
9104	Baywood 5.0 - GT Air Bath	60" x 36" x 19 3/4"	\$3,343.00	\$3,583.00	70
9105	Baywood 6.0 - GT Air Bath	72" x 36" x 19 3/4"	\$3,576.00	\$3,816.00	68
9108	Barrett 3666 - GT Air Bath	66" x 36" x 24"	\$3,576.00	\$3,816.00	66
9110	Barrett 3672 - GT Air Bath	72" x 36" x 24"	\$3,630.00	\$3,870.00	64

# Product Quick Reference

List Price Effective January 1, 2016

Model #	Name	Measurements	Standard	Premium	Page #
9118	Barrett 4272 - GT Air Bath	72" x 42" x 24"	\$3,794.00	\$4,034.00	63
9122	Barrett 4266 - GT Air Bath	66" x 42" x 24"	\$3,685.00	\$3,925.00	65
9125	Montclair - GT Air Bath	71 1/2" x 41 1/2" x 23 1/2"	\$3,685.00	\$3,925.00	88
9127	Essence 3666 - GT Air Bath	66" x 36" x 24"	\$3,937.00	\$4,177.00	53
9128	Baywood 5.5 - GT Air Bath	66" x 36" x 19 3/4"	\$3,459.00	\$3,699.00	69
9130	Essence 3672 - GT Air Bath	71 1/2" x 36" x 24"	\$3,630.00	\$3,870.00	51
9131	Essence 4260 - GT Air Bath	60" x 41 1/2" x 24"	\$3,630.00	\$3,870.00	54
9133	Essence 4266 - GT Air Bath	66" x 41 1/2" x 24"	\$3,685.00	\$3,925.00	52
9135	Essence 4272 - GT Air Bath	71 1/2" x 41 1/2" x 24"	\$3,738.00	\$3,978.00	50
9140	Brighton - GT Air Bath	72" x 48" x 24"	\$4,124.00	\$4,364.00	76
9148	Covington C Round front - GT Air Bath	60" x 60" x 23"	\$4,289.00	\$4,529.00	87
9151	Savannah - GT Air Bath	72" x 48" x 24"	\$4,124.00	\$4,364.00	82
9153	Camden - GT Air Bath	59 1/2" x 32" x 21 1/2"	\$3,225.00	\$3,465.00	77
9158	Heathrow R - GT Air Bath	72" x 42" x 23"	\$3,937.00	\$4,177.00	80
9162	Covington C - GT Air Bath	60" x 60" x 23"	\$4,289.00	\$4,529.00	86
9167	Brentwood 3260 - GT Air Bath	60" x 32" x 20 3/4"	\$3,225.00	\$3,465.00	75
9169	Brentwood 3660 - GT Air Bath	60" x 36" x 22 1/2"	\$3,311.00	\$3,551.00	74
9172	Hampton R - GT Air Bath	72" x 42" x 23 1/2"	\$3,685.00	\$3,925.00	79
9173	Brentwood 3666 - GT Air Bath	66" x 36" x 22 1/2"	\$3,459.00	\$3,699.00	73
9174	Brentwood 3672 - GT Air Bath	72" x 36" x 22 1/2"	\$3,576.00	\$3,816.00	72
9175	Brentwood 4272 - GT Air Bath	72" x 42" x 22 1/2"	\$3,693.00	\$3,933.00	71
9177	Heathrow OV - GT Air Bath	72" x 42" x 23"	\$3,937.00	\$4,177.00	56
9178	Hampton OV - GT Air Bath	68" x 42" x 23 1/2"	\$3,685.00	\$3,925.00	55
9181	Avalon - GT Air Bath	71 3/4" x 40 1/2" x 29"	\$3,641.00	\$3,881.00	44
9184	Elba R - GT Air Bath	59 1/2" x 42" x 23"	\$3,576.00	\$3,816.00	78
9185	Elba OV - GT Air Bath	59 1/2" x 42" x 23"	\$3,576.00	\$3,816.00	45
9189	Castille - GT Air Bath	66" x 66" x 23 1/2"	\$4,279.00	\$4,519.00	85
9192	Enso 3666 - GT Air Bath	66" x 36" x 22 1/4"	\$3,576.00	\$3,816.00	49
9193	Enso 3672 - GT Air Bath	72" x 36" x 22 1/4"	\$3,630.00	\$3,870.00	47
9194	Enso 4266 - GT Air Bath	66" x 42" x 22 1/4"	\$3,685.00	\$3,925.00	48
9195	Enso 4272 - GT Air Bath	72" x 42" x 22 1/4"	\$3,738.00	\$3,978.00	46
9196	Reo 3660 - GT Air Bath	60" x 36" x 24"	\$3,080.00	\$3,320.00	88
9197	Reo 3666 - GT Air Bath	66" x 36" x 24"	\$3,300.00	\$3,540.00	88
9198	Reo 3672 - GT Air Bath	72" x 36" x 24"	\$3,520.00	\$3,760.00	88
9199	Reo 4272 - GT Air Bath	72" x 42" x 24"	\$3,630.00	\$3,870.00	88
9203	Bristol Bay - DT Air Bath	60" x 60" x 22"	\$5,638.00	\$5,878.00	84
9204	Baywood 5.0 - DT Air Bath	60" x 36" x 19 3/4"	\$4,695.00	\$4,935.00	70
9205	Baywood 6.0 - DT Air Bath	72" x 36" x 19 3/4"	\$4,922.00	\$5,162.00	68
9208	Barrett 3666 - DT Air Bath	66" x 36" x 24"	\$4,809.00	\$5,049.00	66
9210	Barrett 3672 - DT Air Bath	72" x 36" x 24"	\$4,922.00	\$5,162.00	64
9218	Barrett 4272 - DT Air Bath	72" x 42" x 24"	\$5,153.00	\$5,393.00	63
9222	Barrett 4266 - DT Air Bath	66" x 42" x 24"	\$5,039.00	\$5,279.00	65
9225	Montclair - DT Air Bath	71 1/2" x 41 1/2" x 23 1/2"	\$5,153.00	\$5,393.00	88
9227	Essence 3666 - DT Air Bath	66" x 36" x 24"	\$4,809.00	\$5,049.00	53
9228	Baywood 5.5 - DT Air Bath	66" x 36" x 19 3/4"	\$4,809.00	\$5,049.00	69
9230	Essence 3672 - DT Air Bath	71 1/2" x 36" x 24"	\$4,922.00	\$5,162.00	51
9231	Essence 4260 - DT Air Bath	60" x 41 1/2" x 24"	\$4,926.00	\$5,166.00	54
9233	Essence 4266 - DT Air Bath	66" x 41 1/2" x 24"	\$5,039.00	\$5,279.00	52
9235	Essence 4272 - DT Air Bath	71 1/2" x 41 1/2" x 24"	\$5,153.00	\$5,393.00	50
9240	Brighton - DT Air Bath	72" x 48" x 24"	\$5,486.00	\$5,726.00	76
9248	Covington C Round front - DT Air Bath	60" x 60" x 23"	\$5,638.00	\$5,878.00	87
9251	Savannah - DT Air Bath	72" x 48" x 24"	\$5,486.00	\$5,726.00	82
9253	Camden - DT Air Bath	59 1/2" x 32" x 21 1/2"	\$4,525.00	\$4,765.00	77
9258	Heathrow R - DT Air Bath	72" x 42" x 23"	\$5,153.00	\$5,393.00	80
9262	Covington C - DT Air Bath	60" x 60" x 23"	\$5,638.00	\$5,878.00	86
9267	Brentwood 3260 - DT Air Bath	60" x 32" x 20 3/4"	\$4,525.00	\$4,765.00	75
9269	Brentwood 3660 - DT Air Bath	60" x 36" x 22 1/2"	\$4,695.00	\$4,935.00	74
9272	Hampton R - DT Air Bath	72" x 42" x 23 1/2"	\$5,153.00	\$5,393.00	79
9273	Brentwood 3666 - DT Air Bath	66" x 36" x 22 1/2"	\$4,809.00	\$5,049.00	73
9274	Brentwood 3672 - DT Air Bath	72" x 36" x 22 1/2"	\$4,922.00	\$5,162.00	72
9275	Brentwood 4272 - DT Air Bath	72" x 42" x 22 1/2"	\$5,153.00	\$5,393.00	71
9277	Heathrow OV - DT Air Bath	72" x 42" x 23"	\$5,153.00	\$5,393.00	56
9278	Hampton OV - DT Air Bath	68" x 42" x 23 1/2"	\$5,153.00	\$5,393.00	55
9281	Avalon - DT Air Bath	71 3/4" x 40 1/2" x 29"	\$5,153.00	\$5,393.00	44

Model #	Name	Measurements	Standard	Premium	Page #
9284	Elba R - DT Air Bath	59 1/2" x 42" x 23"	\$4,926.00	\$5,166.00	78
9285	Elba OV - DT Air Bath	59 1/2" x 42" x 23"	\$4,926.00	\$5,166.00	45
9289	Castille - DT Air Bath	66" x 66" x 23 1/2"	\$5,900.00	\$6,140.00	85
9292	Enso 3666 - DT Air Bath	66" x 36" x 22 1/4"	\$4,809.00	\$5,049.00	49
9293	Enso 3672 - DT Air Bath	72" x 36" x 22 1/4"	\$4,922.00	\$5,162.00	47
9294	Enso 4266 - DT Air Bath	66" x 42" x 22 1/4"	\$5,039.00	\$5,279.00	48
9295	Enso 4272 - DT Air Bath	72" x 42" x 22 1/4"	\$5,153.00	\$5,393.00	46
9296	Reo 3660 - DT Air Bath	60" x 36" x 24"	\$4,695.00	\$4,935.00	88
9297	Reo 3666 - DT Air Bath	66" x 36" x 24"	\$4,809.00	\$5,049.00	88
9298	Reo 3672 - DT Air Bath	72" x 36" x 24"	\$4,922.00	\$5,162.00	88
9299	Reo 4272 - DT Air Bath	72" x 42" x 24"	\$5,153.00	\$5,393.00	88

## BATHWARE – Parts & Accessories

Model #	Name	Measurements	Standard	Premium	Page #
7002	Removable Apron - Baywood 5.0	60" x 16 1/4" x 2"	\$463.00	\$703.00	122
7004	Removable Apron - Baywood 6.0	72" x 16 1/4" x 2"	\$483.00	\$723.00	122
7028	Removable Apron - Baywood 5.5	66" x 16 1/4" x 2"	\$472.00	\$712.00	122
7039	Removable Apron - Ambria	85" x 19 1/2" x 21 1/4"	\$989.00	\$1,229.00	122
7053	Removable Apron - Camden	60" x 16 1/4" x 2"	\$463.00	\$703.00	122
7218	3660 Removable Apron	59 1/2" x 21 1/2" x 2"	\$463.00	N/A	123
7221	3672 Removable Apron	72 1/2" x 16 1/4" x 2"	\$483.00	N/A	123
7224	4260 Removable Apron	59 1/2" x 21 1/2" x 2"	\$463.00	N/A	123
7227	4272 Removable Apron	72 1/2" x 16 1/4" x 2"	\$483.00	N/A	123
7233	4872 Removable Apron	72 1/2" x 16 1/4" x 2"	\$483.00	N/A	123
7239	6060 Removable Apron	59 3/4" x 59 3/4" x 21 1/4"	\$989.00	N/A	123
7253	3260 Removable Apron	59 1/2" x 21 1/2" x 2"	\$463.00	N/A	123
AR1200	Blower Relocation Kit	N/A	\$169.00	N/A	122
PF1320	Lift & Turn Drain - Polished Chrome	N/A	\$50.00	N/A	123
PF1321	Lift & Turn Drain - Everbrass (PVD)	N/A	\$80.00	N/A	123
PF1322	Lift & Turn Drain - Brushed Nickel	N/A	\$80.00	N/A	123
PF1323	Lift & Turn Drain - Oil Rubbed Bronze	N/A	\$85.00	N/A	123
PF1335	Metal Trim Upgrade - Polished Chrome	Installed option	\$150.00	N/A	123
PF1336	Metal Trim Upgrade - Everbrass (PVD)	Installed option	\$247.00	N/A	123
PF1337	Metal Trim Upgrade - Brushed Nickel	Installed option	\$247.00	N/A	123
PF1338	Metal Trim Upgrade - Oil Rubbed Bronze	Installed option	\$263.00	N/A	123
PF2335	Air button - Polished Chrome	Installed option	\$45.00	N/A	123
PF2336	Air button - Everbrass (PVD)	Installed option	\$57.00	N/A	123
PF2337	Air button - Brushed Nickel	Installed option	\$57.00	N/A	123
PF2338	Air button - Oil Rubbed Bronze	Installed option	\$67.00	N/A	123
RS151	Tranquility - Heater for bathtubs	Installed option	\$533.00	N/A	122
SB1420	Drain Kit - Polished Chrome	N/A	\$22.00	N/A	107
SB1421	Drain Kit - Polished Brass	N/A	\$40.00	N/A	107
SW1319	Cable Drain - Standard Colors	N/A	\$132.00	N/A	122
SW1320	Cable Drain - Polished Chrome	N/A	\$174.00	N/A	122
SW1321	Cable Drain - Everbrass (PVD)	N/A	\$313.00	N/A	122
SW1322	Cable Drain - Brushed Nickel	N/A	\$313.00	N/A	122
SW1323	Cable Drain - Oil Rubbed Bronze	N/A	\$334.00	N/A	122
SW1335	Metal Trim Upgrade - Polished Chrome	Installed option	\$366.00	N/A	122
SW1336	Metal Trim Upgrade - Everbrass (PVD)	Installed option	\$366.00	N/A	122
SW1337	Metal Trim Upgrade - Brushed Nickel	Installed option	\$366.00	N/A	122
SW1338	Metal Trim Upgrade - Oil Rubbed Bronze	Installed option	\$392.00	N/A	122
SWA100	Pillow - Common	N/A	\$57.00	N/A	122
SWA200	Pillow - Exclusive	N/A	\$57.00	N/A	122
SWAP00	Nailing Flange Kit	N/A	\$65.00	N/A	122
SWP150 L	Factory Installed Nailing Flange - Left Hand Drain	Installed option	\$164.00	N/A	123
SWP150 R	Factory Installed Nailing Flange - Right Hand Drain	Installed option	\$164.00	N/A	123
SWP150 S	Factory Installed Nailing Flange - Special, Diagram Required	Installed option	\$164.00	N/A	123
SWP151	Factory Installed Inline Heater	Installed option	\$533.00	N/A	122
WIT-001	Restore Extension Box	18" x 33" x 41"	\$367.00	N/A	122
WIT-002	Restore End Panel	32" x 33" x 4"	\$347.00	N/A	122

Welcome to style.  
Welcome to *mansfield*.<sup>®</sup>



## 2016 Product Offering

Effective January 1, 2016



Essence Suite

Many Mansfield products meet "Made in America" requirements for construction projects funded under the American Recovery and Reinvestment Act of 2009. We feature a full range of quality USA-made products – just look for this symbol.



A F F O R D A B L E  
*Style*  
D E S I G N E R S E R I E S

**S**tyl(e), performance and price. Our diverse collections offer the beautiful design and reliable performance of high end bathroom brands at a much more affordable price. Mansfield lets you maintain your style, standards and budget without compromise.

Mansfield has created six beautifully designed, well-made bathroom suites, so when you see a design you like, you'll actually be able to take it home with you.

Individually, each piece is a functional work of art. Together, our bathroom suites elevate everyday living to luxurious indulgence. Choose from our coordinated collections of high-performance toilets, lavatories, and baths created to bring a bathroom together beautifully.

- Brentwood®**  
Traditional
- Barrett**  
Traditional
- Essence**  
Transitional
- Montclair**  
Traditional
- Waverly**  
Traditional
- Enso®**  
Contemporary



## Brentwood® Suite

Brentwood's traditional design features a concealed trapway toilet for a more aesthetic look that is easy to clean and appeals to the largest percentage of the market. The suite includes five size choices of tubs (bath only, whirlpool systems or air systems), self-rimming and undercounter lavatories and matching concealed trapway elongated, SmartHeight™ toilet.

### Brentwood Suite

#### Two-Piece Toilet

4147-3147 Brentwood &  
4148-3148 Brentwood HET,  
Elongated Front,  
SmartHeight™

See page 6



4148-3148



#### Bathtub/ Whirlpool / Air Massage

72" x 42" x 22-1/2" Brentwood  
72" x 36" x 22-1/2" Brentwood  
66" x 36" x 22-1/2" Brentwood  
60" x 36" x 22-1/2" Brentwood  
60" x 32" x 20-3/4" Brentwood

See pages 71-75



#### Self-Rimming Lavatory

254 Brentwood

See page 25



#### Undercounter Lavatory

234 Brentwood

See page 28







## Barrett Suite

With an inviting and warm look, the Barrett Suite, with concealed trapway toilet, is a classic style choice filled with architectural details. It's not surprising that this line is one of the more universally appealing suites. The suite includes five size choices of tubs (bath only, whirlpool systems or air systems), a pedestal and self-rimming lavatory, and the concealed trapway elongated, SmartHeight™ toilet.

### Barrett Suite

#### Two-Piece Toilets

115-106 Barrett & 4115-3106 Barrett  
HET Elongated Front, SmartHeight™,  
Concealed Trapway

See pages 7 & 8

Concealed  
Trapway



4115-3106



#### Bathtub / Whirlpool / Air Massage

72" x 42" x 24" Barrett  
72" x 36" x 24" Barrett  
66" x 42" x 24" Barrett  
66" x 36" x 24" Barrett  
60" x 32" x 21-1/2"  
(skirted)

See pages 63-67



#### Pedestal Lavatory

330 Barrett

See page 31



#### Self-Rimming Lavatory

268 Barrett

See page 25



## Essence Suite

Style with a softer edge. Clean and timeless, the Essence Suite is the perfect blend of style and warmth. The suite includes five size choices of tubs (bath only, whirlpool systems or air systems), pedestal lavatory with optional towel bar, self-rimming lavatory, and matching elongated, SmartHeight™ HET toilet.



### Essence Suite

#### Two-Piece Toilet

4184-3185 Essence HET  
Elongated Front,  
SmartHeight™

See page 8

Concealed  
Trapway



#### Bathtub / Whirlpool / Air Massage

71-1/2" x 42" x 24" Essence  
71-1/2" x 36" x 24" Essence  
66" x 42" x 24" Essence  
66" x 36" x 24" Essence  
60" x 42" x 24" Essence

See pages 50-54



#### Pedestal Lavatory

320 Essence  
with Optional  
Towel Bar

See page 31



#### Self-Rimming Lavatory

259 Essence

See page 26





## Montclair Suite

The perfect balance between traditional and modern elements describes the eclectic personality of the Montclair Suite. Simple lines combined with classic design make the Montclair a popular choice. The suite includes a bathtub (bath only, whirlpool system or air system), pedestal and self-rimming lavatories and matching elongated, SmartHeight™ HET toilet.

### Montclair Suite

#### Two-Piece Toilet

4107-4108 Montclair HET  
Elongated Front,  
SmartHeight™

See page 9

Concealed  
Trapway



#### Bathtub / Whirlpool / Air Massage

71-1/2 x 41-1/2" x 23-1/2"  
Montclair

See page 57



#### Pedestal Lavatory

335 Montclair  
Montclair

See page 31



#### Self-Rimming Lavatory

269 Montclair  
Montclair

See page 25



## Waverly Suite

Clean and crisp, yet warm rich lines characterize this traditional English-inspired design. The round, soft curves present in all elements of the Waverly Suite create a soft environment that invites relaxation. The suite includes a whirlpool, pedestal and self-rimming lavatories and matching, elongated SmartHeight™ HET toilet.

### Waverly Suite

#### Two-Piece Toilet

4197-3195 Waverly  
Elongated front, SmartHeight™

See page 9



#### Whirlpool

70" x 47" x 20-1/4"  
Waverly

See page 62



#### Pedestal Lavatory

340 Waverly  
Waverly

See page 32



#### Self-Rimming Lavatory

257 Waverly  
Waverly

See page 26





## Enso® Suite



The Enso Suite is a part of the stylish, yet attainable Mansfield collection. The toilet features a concealed trap that enables its zen-like features to flow. Its smooth, sleek lines give it the modern look that so many consumers are looking for today. The suite includes four size choices of tubs (bath only, whirlpool systems or air systems), self-rimming and pedestal lavatories, matching elongated SmartHeight™ toilet and a wood vanity to use with the above-counter vessel.

### Enso Suite

**Two-Piece Toilet/Dual Flush**  
 177-178 Enso  
 Elongated Front,  
 SmartHeight™,  
 with Toilet Seat  
 See page 6

Concealed  
 Trapway



**Bathtub/ Whirlpool / Air Massage**  
 72" x 42" x 22-1/4" Enso  
 72" x 36" x 22-1/4" Enso  
 66" x 42" x 22-1/4" Enso  
 66" x 36" x 22-1/4" Enso  
 See pages 46-49



**Above Counter Vessel**  
 311 Enso  
  
**Vanity**  
 884 Enso  
 See page 30



**Pedestal Lavatory**  
 310 Enso  
 See page 31



**Self-rimming Lavatory**  
 242 Enso  
 See page 25



## DESIGNER TWO-PIECE TOILETS – DUAL FLUSH

### Enso®

- Elongated dual flush toilet combination
- 1.1 Gpf / 1.6 Gpf (4.0 Lpf / 6.0 Lpf)
- Concealed trapway
- Pilot operated anti siphon fill valve
- Dual Flush flushing technology with 3" flush tower
- Chrome metal push button actuator
- Includes SmartClose toilet seat



SmartClose™ Toilet Seat closes gently and quietly with a simple touch



ELONGATED FRONT



SmartHeight™



177-178 Enso with Concealed Trapway Elongated Front, SmartHeight™ 12" Rough-in

\*\*Less supply

Model Number	Description	List Price		Approx Ship Wt (lbs)	Pallet Qty
		White	Standard		
12" Rough-In					
177-178	Enso Elongated front SmartHeight™ combination**	\$461.90	\$558.02	130	-
177	Elongated Bowl SmartHeight™ (16-7/8" high)	\$295.17	\$356.60	90	8
178	Tank and Lid	\$166.72	\$201.43	40	30
<b>Parts and Accessories</b>					
78 Actuator	CH - Chrome	\$33.16		See pages 108-121	
	SN - Satin Nickel	\$55.70			
90	Fill Valve	\$17.21			
208E	Dual Flush Tower	\$19.61			
123-8577	Anchor Floor Kit	\$6.75			
178-LID	Tank Lid Fits model 178	\$67.81	\$78.40		
SB1500	Enso SmartClose™ Toilet Seat	\$110.61	110.61		
Colors: WHT - White, BISC - Biscuit					

## DESIGNER TWO-PIECE TOILETS – 1.6 GPF / 6.0 LPF

### Brentwood®

- Elongated toilet combination
- 1.6 Gpf / 6.0 Lpf
- Concealed trapway
- Pilot operated anti siphon fill valve
- MagnaFlush high performance flushing technology with 3" flush valve
- Chrome metal trip lever
- Does not include toilet seat



ELONGATED FRONT



SmartHeight™



4147-3147 Brentwood with Concealed Trapway Elongated Front, SmartHeight™ 12" Rough-in

\*Less toilet seat and supply

Model Number	Description	List Price		Approx Ship Wt (lbs)	Pallet Qty
		White	Standard		
12" Rough-In					
4147-3147	Brentwood Elongated front SmartHeight™ combination* ADA	\$438.08	\$549.58	105	-
4147	Elongated Bowl SmartHeight™ (16-5/8" high)	\$275.92	\$346.15	63	12
3147	Tank and Lid	\$162.16	\$203.42	42	30
<b>Parts and Accessories</b>					
76 Trip Lever	CH - Chrome	\$30.36		See pages 108-121	
	SN - Satin Nickel	\$52.83			
	SB - Sicilian Bronze	\$52.83			
2206	Pilot Operated Fill Valve	\$17.19			
630-0207	Replacement Flapper Kit	\$8.73			
3147-LID	Tank Lid Fits model 3147	\$71.69	\$82.23		
BC	Plastic Bolt Caps Set of two (Specify Color)	\$1.13	\$1.13		
Colors: WHT - White Standard: BISC - Biscuit, BONE - Bone					



**DESIGNER TWO-PIECE TOILETS – 1.6 GPF / 6.0 LPF**

**Barrett**



115-106 Barrett with Concealed Trapway Elongated Front, SmartHeight™ 12" Rough-In

\*Less toilet seat and supply

- Elongated toilet combination
- 1.6 Gpf / 6.0 Lpf
- Concealed trapway
- Pilot operated anti siphon fill valve
- MagnaFlush high performance flushing technology with 3" flush valve
- Chrome metal trip lever
- Does not include toilet seat

Model Number	Description	List Price		Approx Ship Wt (lbs)	Pallet Qty
		White	Standard		
12" Rough-In					
<b>115-106</b>	Barrett Elongated front SmartHeight™ combination* <b>ADA</b>	\$427.77	\$533.78	100	-
<b>115</b>	Elongated Bowl SmartHeight™ (16-1/4" high)	\$269.44	\$335.85	60	12
<b>106</b>	Tank and Lid	\$158.33	\$197.93	40	30
<b>Parts and Accessories</b>					
<b>69 Trip Lever</b>	CH - Chrome	\$19.77	See pages 108-121		
	SB - Sicilian Bronze	\$42.26			
	SN - Satin Nickel	\$42.26			
<b>2206</b>	Pilot Operated Fill Valve	\$17.19			
<b>630-0207</b>	Replacement Flapper Kit	\$8.73			
<b>106-LID</b>	Tank Lid Fits model 106	\$69.98	\$80.27		
<b>BC</b>	Plastic Bolt Caps Set of two (Specify Color)	\$1.13	\$1.13		
Colors: WHT - White Standard: BISC - Biscuit, BONE - Bone					

**DESIGNER HIGH EFFICIENCY (HET) TWO-PIECE TOILETS – 1.28 GPF / 4.86 LPF**

**Brentwood® HET**



4148-3148 Brentwood HET with Concealed Trapway Elongated Front, SmartHeight™ 12" Rough-In

\*Less toilet seat and supply

- Elongated toilet combination
- 1.28 Gpf / 4.86 Lpf
- Concealed trapway
- Pilot operated anti siphon fill valve
- MagnaFlush high performance flushing technology with 3" flush valve
- Chrome metal trip lever
- Does not include toilet seat



Model Number	Description	List Price		Approx Ship Wt (lbs)	Pallet Qty
		White	Standard		
12" Rough-In					
<b>4148-3148</b>	Brentwood Elongated front SmartHeight™ combination* <b>ADA</b>	\$438.08	\$549.58	105	-
<b>4148</b>	Elongated Bowl SmartHeight™ (16-5/8" high)	\$275.92	\$346.15	63	12
<b>3148</b>	Tank and Lid	\$162.16	\$203.42	42	30
<b>Parts and Accessories</b>					
<b>76 Trip Lever</b>	CH - Chrome	\$30.36	See pages 108-121		
	SN - Satin Nickel	\$52.83			
	SB - Sicilian Bronze	\$52.83			
<b>2206</b>	Pilot Operated Fill Valve	\$17.19			
<b>630-0207</b>	Replacement Flapper Kit	\$8.73			
<b>3147-LID</b>	Tank Lid Fits model 3148	\$71.69	\$82.23		
<b>BC</b>	Plastic Bolt Caps Set of two (Specify Color)	\$1.13	\$1.13		
Colors: WHT - White Standard: BISC - Biscuit					



4115-3106 Barrett HET  
Elongated Front, SmartHeight™  
12" Rough-in

\*Less toilet seat and supply

## Barrett HET

- Elongated toilet combination
- 1.28 Gpf / 4.86 Lpf
- Concealed trapway
- Pilot operated anti siphon fill valve
- MagnaFlush high performance flushing technology with 3" flush valve
- Chrome metal trip lever
- Does not include toilet seat



Model Number	Description	List Price		Approx Ship Wt (lbs)	Pallet Qty
		White	Standard		
12" Rough-In					
4115-3106	Barrett HET combination* <b>ADA</b>	\$427.77	\$533.78	100	-
4115	Elongated Bowl SmartHeight™ (16-1/4" high)	\$269.44	\$335.85	60	12
3106	Tank and Lid	\$158.33	\$197.93	40	30
<b>Parts and Accessories</b>					
69 Trip Lever	CH - Chrome	\$19.77	See pages 108-121		
	SB - Sicilian Bronze	\$42.26			
	SN - Satin Nickel	\$42.26			
2206	Pilot Operated Fill Valve	\$17.19			
630-0207	Replacement Flapper Kit	\$8.73			
106-LID	Tank Lid Fits model 3106	\$69.98	\$80.27		
BC	Plastic Bolt Caps Set of two (Specify Color)	\$1.13	\$1.13		
Colors: WHT - White Standard: BISC - Biscuit, BONE - Bone					



4184-3185 Essence HET  
Elongated Front, SmartHeight™  
12" Rough-in

\*Less toilet seat and supply

## Essence HET

- Elongated toilet combination
- 1.28 Gpf / 4.86 Lpf
- Concealed trapway
- Pilot operated anti siphon fill valve
- MagnaFlush high performance flushing technology with 3" flush valve
- Chrome trip lever
- Does not include toilet seat



Model Number	Description	List Price		Approx Ship Wt (lbs)	Pallet Qty	
		White	Standard			
12" Rough-In						
4184-3185	Essence Elongated front SmartHeight™ combination** <b>ADA</b>	\$417.37	\$523.46	82	-	
4184	Elongated Bowl SmartHeight™ (16-1/2" high)	\$271.58	\$339.21	51	12	
3185	Tank and Lid	\$145.80	\$184.26	31	30	
<b>Parts and Accessories</b>						
85 Trip Lever	CH - Chrome	\$19.77	See pages 108-121			
	2206	Pilot Operated Fill Valve				\$17.19
	630-0207	Replacement Flapper Kit				\$8.73
3185-LID	Tank Lid Fits model 3185	\$77.74				\$89.24
BC	Plastic Bolt Caps Set of two (Specify Color)	\$1.13	\$1.13			
Colors: WHT - White Standard: BISC - Biscuit, BONE - Bone						

**DESIGNER HIGH EFFICIENCY (HET) TWO-PIECE TOILETS – 1.28 GPF / 4.86 LPF**



4107-3108 Montclair HET  
Elongated Front, SmartHeight™  
12" Rough-in

\*Less toilet seat and supply

**Montclair HET**

- Elongated toilet combination
- 1.28 Gpf / 4.86 Lpf
- Concealed trapway
- Pilot operated anti siphon fill valve
- MagnaFlush high performance flushing technology with 3" flush valve
- Chrome trip lever
- Does not include toilet seat



Model Number	Description	List Price		Approx Ship Wt (lbs)	Pallet Qty
		White	Standard		
12" Rough-In					
<b>4107-3108</b>	Montclair Elongated front SmartHeight™ combination* <b>ADA</b>	\$406.24	\$507.81	82	-
<b>4107</b>	Elongated Bowl SmartHeight™ (16-1/2" high)	\$261.15	\$326.46	51	12
<b>3108</b>	Tank and Lid	\$145.09	\$181.36	31	20
<b>Parts and Accessories</b>					
<b>66 Trip Lever</b>	CH - Chrome	\$30.34	See pages 108-121		
	SN - Satin Nickel	\$52.79			
	SB - Sicilian Bronze	\$52.79			
<b>2206</b>	Pilot Operated Fill Valve	\$17.19			
<b>630-0207</b>	Replacement Flapper Kit	\$8.73			
<b>108-LID</b>	Tank Lid Fits model 3108	\$77.74	\$89.24		
<b>BC</b>	Plastic Bolt Caps Set of two (Specify Color)	\$1.13	\$1.13		
Colors: WHT - White Standard: BISC - Biscuit, BONE - Bone					



4197-3195 Waverly HET  
Elongated Front, SmartHeight™  
12" Rough-in

\*Less toilet seat and supply

**Waverly HET**

- Elongated toilet combination
- 1.28 Gpf / 4.86 Lpf
- Pilot operated anti siphon fill valve
- MagnaFlush high performance flushing technology with 3" flush valve
- Chrome trip lever with ceramic insert
- Does not include toilet seat



Model Number	Description	List Price		Approx Ship Wt (lbs)	Pallet Qty
		White	Standard		
12" Rough-In					
<b>4197-3195</b>	Waverly Elongated front SmartHeight™ combination* <b>ADA</b>	\$307.00	N/A	82	-
<b>4197</b>	Elongated Bowl SmartHeight™ (16-3/4" high)	\$184.46	N/A	50	18
<b>3195</b>	Tank and Lid	\$122.53	N/A	32	30
<b>Parts and Accessories</b>					
<b>72 Trip Lever</b>	CH - Chrome w/ White, Biscuit, Bone	\$30.34	See pages 108-121		
<b>2206</b>	Pilot Operated Fill Valve	\$17.19			
<b>630-0207</b>	Replacement Flapper Kit	\$8.73			
<b>195-LID</b>	Tank Lid Fits model 3195	\$70.34			
<b>BC</b>	Plastic Bolt Caps Set of two (Specify Color)	\$1.13			
Colors: WHT - White					

## ONE-PIECE HIGH EFFICIENCY (HET) TOILETS – 1.28 GPF / 4.86 LPF



708 Aegean™ ADA  
Elongated Front,  
12" Rough-in

\*\* Less supply

### Aegean™ ADA

- Elongated one – piece toilet
- 1.28 Gpf / 4.86 Lpf
- Pilot operated anti siphon fill valve
- MagnaFlush high performance flushing technology with 3" flush valve
- Chrome trip lever
- Includes SmartClose toilet seat



SmartClose™ Toilet Seat  
closes gently and quietly  
with a simple touch

Model Number	Description	List Price		Approx Ship Wt (lbs)	Pallet Qty
		White	Standard		
12" Rough-In					
708	Aegean™ Elongated front SmartHeight™ high-profile one-piece toilet** (16 5-/8" high) <b>ADA</b>	\$467.17	\$560.60	95	3
<b>Parts and Accessories</b>					
73 Trip Lever	CH - Chrome	\$29.46	See pages 108-121		
2206	Pilot Operated Fill Valve	\$17.19			
630-0207	Replacement Flapper Kit	\$8.73			
705-LID	Tank Lid Fits model 705NS & 708	\$76.52	\$92.90		
BC	Plastic Bolt Caps Set of two (Specify Color)	\$1.13	\$1.13		
Colors: WHT - White Standard: BISC - Biscuit, BONE - Bone					

## ONE-PIECE TOILETS – 1.6 GPF / 6.0 LPF



705NS Aegean™  
Elongated Front,  
12" Rough-in

\*\* Less supply

### Aegean™

- Elongated one – piece toilet
- 1.6 Gpf / 6.0 Lpf
- Pilot operated anti siphon fill valve
- MagnaFlush high performance flushing technology with 3" flush valve
- Chrome trip lever
- Includes SmartClose toilet seat

SmartClose™ Toilet Seat  
closes gently and quietly  
with a simple touch

Model Number	Description	List Price		Approx Ship Wt (lbs)	Pallet Qty
		White	Standard		
12" Rough-In					
705NS	Aegean™ Elongated front, high-profile one-piece toilet**	\$443.21	\$531.86	95	4
<b>Parts and Accessories</b>					
73 Trip Lever	CH - Chrome	\$29.46	See pages 108-121		
2206	Pilot Operated Fill Valve	\$17.19			
630-0207	Replacement Flapper Kit	\$8.73			
705-LID	Tank Lid Fits model 705NS & 708	\$76.52	\$92.90		
BC	Plastic Bolt Caps Set of two (Specify Color)	\$1.13	\$1.13		
Colors: WHT - White Standard: BISC - Biscuit, BONE - Bone					



BIDET

Bidet



ELONGATED FRONT



361 Alto™  
Elongated Front

\*Less drain assembly, fittings and supply

**Alto™**

- Elongated front bidet with flushing rim and vertical spray
- Concealed front overflow
- Above-floor or below-floor rough in

Model Number	Description	List Price		Approx Ship Wt (lbs)	Pallet Qty
		White	Standard		
361-3	Alto™ Bidet (three hole)*	\$242.92	\$303.71	42	18

Colors: WHT - White Standard: BISC - Biscuit, BONE - Bone

## PRESSURE-ASSIST, HIGH EFFICIENCY (HET) TOILETS – 1.0 GPF / 3.8 LPF

Pressure-Assist HET Toilets  
1.0 Gpf / 3.8 Lpf



**ELONGATED FRONT**



**SmartHeight™**

151-153 QuantumOne™  
Elongated Front, SmartHeight™  
Rear Outlet, Floor-Mount



**ROUND FRONT**

146-153 QuantumOne™  
Round Front,  
12" Rough-in



**ELONGATED FRONT**

**REAR OUTLET**

149-153 QuantumOne™  
Elongated Front, Rear Outlet  
Floor-Mount

### QuantumOne™

- Toilet combination
- 1.0 Gpf / 3.8 Lpf
- Pressure-Assist / High Efficiency
- Chrome trip lever
- Does not include toilet seat



**ONE GALLON FLUSH  
SAVES UP TO 40% MORE WATER**

**High Efficiency Vessel**  
Provides pressure-assist flushing action that is second to none, with superior performance over conventional gravity flush toilets

**Performance and Style**  
Contemporary lines fits any bathroom decor

**Large Water Surface Area**  
Provides complete bowl wash for maximum hygiene

**Large 2-1/8" Glazed Trapway**  
Quickly removes waste with less clogging



Model Number	Description	List Price		Approx Ship Wt (lbs)	Pallet Qty
		White	Standard		
<b>12" Rough-In</b>					
148-153	QuantumOne™ Elongated front SmartHeight™ combination* <b>ADA</b>	\$503.91	\$617.58	105	-
148	Elongated Bowl SmartHeight™ (16-1/2" high)	\$202.16	\$285.56	58	18
153	Tank and Lid ★	\$301.76	\$332.02	47	30
147-153	QuantumOne™ Elongated front combination*	\$432.32	\$540.42	100	-
147	Elongated Bowl	\$130.56	\$208.40	53	18
153	Tank and Lid ★	\$301.76	\$332.02	47	30
146-153	QuantumOne™ Round front combination*	\$427.96	\$517.19	97	-
146	Round Bowl ★	\$126.20	\$185.17	50	18
153	Tank and Lid ★	\$301.76	\$332.02	47	30
<b>Rear Outlet – Floor Mount</b>					
151-153	QuantumOne™ Elongated front SmartHeight™ rear outlet floor-mount combination* <b>ADA</b>	\$691.92	\$833.98	113	-
151	Elongated SmartHeight™ Bowl (16-1/2" high) ★	\$390.17	\$501.96	66	9
153	Tank and Lid ★	\$301.76	\$332.02	47	30
149-153	QuantumOne™ Elongated front, rear outlet floor-mount combination*	\$625.76	\$783.69	108	-
149	Elongated Bowl ★	\$324.00	\$451.67	61	9
153	Tank and Lid ★	\$301.76	\$332.02	47	30
<b>Tank Options</b>					
153RH	Same as 153, with right hand trip lever ★ (See page 24)	\$301.76	\$332.02	47	30
154	Same as 153, with push button actuator ★ (See page 24)	\$342.90	\$358.36	47	24
<b>Parts and Accessories</b>					
45 Trip Lever	CH - Chrome (Left Hand Trip Lever - Fits 153 & 123)	\$12.19	See pages 108-121		
49 Trip Lever	CH - Chrome (Right Hand Trip Lever - Fits 153RH & 123RH)	\$13.84			
47 Actuator	CH - Chrome (Push Button Actuator - Fits 154 & 122)	\$33.16			
125-LID	Tank Lid Fits models 153 & 153RH	\$70.00	\$81.50		
122-LID	Tank Lid Fits models 154 & 122	\$70.68	\$81.89		
BC	Plastic Bolt Caps Set of two (Specify Color)	\$1.13	\$1.13		
Colors: WHT - White Standard: BISC - Biscuit, BONE - Bone					

\* Less toilet seat and supply

**PRESSURE-ASSIST (HET) TOILETS – 1.28 GPF / 4.86 LPF**



\* Less toilet seat and supply

**Quantum® 1.28**

- Toilet combination
- 1.28 Gpf / 4.86 Lpf
- Pressure-Assist / High Efficiency
- Chrome trip lever
- Does not include toilet seat



**1.28 GALLON FLUSH SAVES UP TO 20% MORE WATER**

**High Efficiency Vessel**  
Provides pressure-assist flushing action that is second to none, with superior performance over conventional gravity flush toilets

**Performance and Style**  
Contemporary lines fits any bathroom decor

**Large Water Surface Area**  
Provides complete bowl wash for maximum hygiene

**Large 2-1/8" Glazed Trapway**  
Quickly removes waste with less clogging



Model Number	Description	List Price		Approx Ship Wt (lbs)	Pallet Qty
		White	Standard		
<b>12" Rough-In</b>					
<b>148-155</b>	Quantum 1.28 Elongated front SmartHeight™ combination* <b>ADA</b>	\$503.91	\$617.58	105	-
<b>148</b>	Elongated Bowl SmartHeight™ (16-1/2" high)	\$202.16	\$285.56	58	18
<b>155</b>	Tank and Lid ★	\$301.76	\$332.02	47	30
<b>147-155</b>	Quantum 1.28 Elongated front combination*	\$432.32	\$540.42	100	-
<b>147</b>	Elongated Bowl	\$130.56	\$208.40	53	18
<b>155</b>	Tank and Lid ★	\$301.76	\$332.02	47	30
<b>146-155</b>	Quantum 1.28 Round front combination*	\$427.96	\$517.19	97	-
<b>146</b>	Round Bowl ★	\$126.20	\$185.17	50	18
<b>155</b>	Tank and Lid ★	\$301.76	\$332.02	47	30
<b>Rear Outlet – Floor Mount</b>					
<b>151-155</b>	Quantum 1.28 Elongated front SmartHeight™ <b>ADA</b> rear outlet floor-mount combination*	\$691.92	\$833.98	113	-
<b>151</b>	Elongated SmartHeight™ Bowl (16-1/2" high) ★	\$390.17	\$501.96	66	9
<b>155</b>	Tank and Lid ★	\$301.76	\$332.02	47	30
<b>149-155</b>	Quantum 1.28 Elongated front, rear outlet floor-mount combination*	\$625.76	\$783.69	108	-
<b>149</b>	Elongated Bowl ★	\$324.00	\$451.67	61	9
<b>155</b>	Tank and Lid ★	\$301.76	\$332.02	47	30
<b>Tank Options</b>					
<b>155RH</b>	Same as 155, with right hand trip lever ★ (See page 24)	\$301.76	\$332.02	47	30
<b>Parts and Accessories</b>					
<b>45 Trip Lever</b>	CH - Chrome (Left Hand Trip Lever - Fits 153, 123 & 155)	\$12.19	See pages 108-121		
<b>49 Trip Lever</b>	CH - Chrome (Right Hand Trip Lever - Fits 153RH, 123RH & 155)	\$13.84			
<b>125-LID</b>	Tank Lid Fits models 153, 153RH & 155	\$70.00	\$81.50		
<b>BC</b>	Plastic Bolt Caps Set of two (Specify Color)	\$1.13	\$1.13		
Colors: WHT - White Standard: BISC - Biscuit, BONE - Bone					

Pressure-Assist HET Toilets  
1.28 Gpf / 4.86 Lpf

## PRESSURE-ASSIST, HIGH PERFORMANCE TOILETS – 1.6 GPF / 6.0 LPF

Pressure-Assist HET Toilets  
1.6 Gpf / 6.0 Lpf



SmartHeight™



151-123 Quantum®  
Elongated Front, SmartHeight™  
Rear Outlet, Floor-Mount



146-123 Quantum®  
Round Front,  
12" Rough-in



149-123 Quantum®  
Elongated Front, Rear Outlet  
Floor-Mount

\* Less toilet seat and supply

### Quantum®

- Toilet combination
- 1.6 Gpf / 6.0 Lpf
- Pressure-Assist / High Performance
- Chrome trip lever
- Does not include toilet seat



### POWERFUL PERFORMANCE

**High Performance Vessel**  
Quicker, more effective bowl evacuation than conventional gravity flush toilets

**Outstanding One Flush Performance**  
Quantum™ flushes first time — every time

**Large Water Surface Area**  
Provides complete bowl wash for maximum hygiene

**Large 2-1/8" Glazed Trapway**  
Quickly removes waste with less clogging



147-123 Quantum®  
Elongated Front,  
12" Rough-in

Model Number	Description	List Price		Approx Ship Wt (lbs)	Pallet Qty
		White	Standard		
<b>12" Rough-In</b>					
148-123	Quantum® Elongated front SmartHeight™ combination* <b>ADA</b>	\$503.91	\$617.58	105	-
148	Elongated Bowl SmartHeight™ (16-1/2" high)	\$202.16	\$285.56	58	18
123	Tank and Lid ★	\$301.76	\$332.02	47	30
147-123	Quantum® Elongated front combination*	\$432.32	\$540.42	100	-
147	Elongated Bowl	\$130.56	\$208.40	53	18
123	Tank and Lid ★	\$301.76	\$332.02	47	30
146-123	Quantum® Round front combination*	\$427.96	\$517.19	97	-
146	Round Bowl ★	\$126.20	\$185.17	50	18
123	Tank and Lid ★	\$301.76	\$332.02	47	30
<b>10" Rough-In</b>					
148-10-123	Quantum® Elongated front SmartHeight™ combination* <b>ADA</b>	\$598.03	\$702.40	101	-
148-10	Elongated Bowl SmartHeight™ (16-1/2" high) ★	\$296.28	\$370.38	54	18
123	Tank and Lid ★	\$301.76	\$332.02	47	30
147-10-123	Quantum® Elongated front combination*	\$511.63	\$594.36	94	-
147-10	Elongated Bowl ★	\$209.87	\$262.34	47	18
123	Tank and Lid ★	\$301.76	\$332.02	30	30
<b>Rear Outlet – Floor Mount</b>					
151-123	Quantum® Elongated front SmartHeight™ rear outlet floor-mount combination* <b>ADA</b>	\$691.92	\$833.98	113	-
151	Elongated Bowl SmartHeight™ (16-1/2" high) ★	\$390.17	\$501.96	66	9
123	Tank and Lid ★	\$301.76	\$332.02	47	30
149-123	Quantum® Elongated front, rear outlet floor-mount combination*	\$625.76	\$783.69	108	-
149	Elongated Bowl ★	\$324.00	\$451.67	61	9
123	Tank and Lid ★	\$301.76	\$332.02	47	30
<b>Tank Options</b>					
122	Same as 123, with push button actuator ★ (See page 24)	\$342.90	\$358.36	47	24
123RH	Same as 123, with right hand trip lever ★ (See page 24)	\$301.76	\$332.02	47	30
<b>Parts and Accessories</b>					
45 Trip Lever	CH - Chrome (Left Hand Trip Lever - Fits 123)	\$12.19	See pages 108-121		
49RH Trip Lever	CH - Chrome (Right Hand Trip Lever - Fits 123RH)	\$13.84			
47 Actuator	CH - Chrome (Push Button Actuator - Fits 122)	\$33.16			
122-LID	Tank Lid Fits model 122	\$70.68	\$81.89		
125-LID	Tank Lid Fits models 123 and 123RH	\$70.00	\$81.50		
BC	Plastic Bolt Caps Set of two (Specify Color)	\$1.13	\$1.13		
Colors: WHT - White Standards: BISC - Biscuit, BONE - Bone					



**HIGH EFFICIENCY (HET), TWO-PIECE TOILETS – 1.0 GPF / 3.8 LPF**



1013-1012 Maverick 1.0 Round Front, 12" Rough-in

\*Less toilet seat and supply

**Maverick 1.0**

- Toilet combination
- 1.0 Gpf / 3.8 Lpf
- Pilot operated anti siphon fill valve
- MagnaFlush high performance flushing technology with 3" flush valve
- Chrome push button actuator
- Does not include toilet seat



Model Number	Description	List Price	Approx Ship Wt (lbs)	Pallet Qty
		White		
<b>12" Rough-In</b>				
<b>1013-1012</b>	Maverick 1.0 Round Front Combination*	\$279.40	92	-
<b>1013</b>	Round Front Bowl	\$152.62	58	18
<b>1012</b>	Tank and Lid	\$126.78	34	30
<b>1014-3012</b>	Maverick 1.0 Elongated Front SmartHeight™ Combination*	\$340.18	92	-
<b>1014</b>	Elongated Front Bowl	\$213.41	58	18
<b>3012</b>	Tank and Lid	\$126.78	34	30
<b>Parts and Accessories</b>				
<b>209</b>	Flush Tower	\$17.13	See pages 108-121	
<b>1012/3012-LID</b>	Tank Lid Fits models 1012 and 3012	\$78.87	N/A	
Colors: WHT - White				

HET Two-Piece Toilets  
1.0 Gpf / 3.8 Lpf

# Toilets

List Price Effective January 1, 2016

## HIGH EFFICIENCY (HET) & HIGH PERFORMANCE, TWO PIECE TOILETS – 1.28 GPF / 4.86 LPF

HET & High Performance Toilets  
1.28 Gpf / 4.86 Lpf



ELONGATED FRONT

ADA SmartHeight

384-387 Summit 1.28 Elongated Front, SmartHeight™ 12" Rough-in



ELONGATED FRONT

382-387 Summit 1.28 Elongated Front, 12" Rough-in



ROUND FRONT

380-387 Summit 1.28 Round Front, 12" Rough-in

\* Less toilet seat and supply

### Summit 1.28

- Toilet combination
- 1.28 Gpf / 4.86 Lpf
- Pilot operated anti siphon fill valve
- MagnaFlush high performance flushing technology with 3" flush valve
- Chrome trip lever
- Does not include toilet seat



Standard 2" Flush Valve



Summit Oversize 3" Flush Valve

382-387 Summit 1.28 Elongated front 12" Rough-In



NON-CLOG

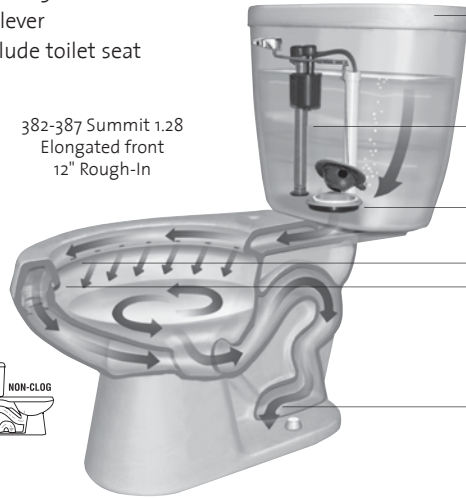

### POWER & HIGH EFFICIENCY. ONE FLUSH PERFORMANCE.

#### Tank Height

Taller tank design provides maximum head pressure for a more powerful flush

#### Pilot Operated Fill Valve

Quick, quiet and efficient with guaranteed shut-off

#### Extra-Large 3" Flush Valve

Offers more than twice the potential flushing volume as a standard 2" flush valve

#### Evenly Spaced Rim Holes

Precision drilled for complete bowl wash every time

#### Powerful Direct Jet Front Feed

Powerful front feed direct jet delivers peak performance, and faster water delivery with increased head pressure creates stronger jet pressure and quick siphon action

#### 2" Trapway

Glazed trapway design creates a strong vacuum and siphon action that virtually eliminates clogging and delivers "one flush" performance

Model Number	Description	List Price		Approx Ship Wt (lbs)	Pallet Qty
		White	Standard		
<b>12" Rough-In</b>					
<b>384-387</b>	Summit 1.28 Elongated front SmartHeight™ combination* ADA	\$272.81	\$327.82	95	-
<b>384</b>	Elongated Bowl SmartHeight™ (16-1/2" high)	\$186.44	\$219.82	59	18
<b>387</b>	Tank and Lid	\$86.37	\$107.99	36	36
<b>382-387</b>	Summit 1.28 Elongated front combination*	\$224.49	\$280.63	90	-
<b>382</b>	Elongated Bowl	\$138.12	\$172.64	54	18
<b>387</b>	Tank and Lid	\$86.37	\$107.99	36	36
<b>388-387</b>	Summit 1.28 Round front SmartHeight™ combination*	\$243.91	\$280.51	87	-
<b>388</b>	Round front SmartHeight™ Bowl	\$157.54	\$172.52	51	18
<b>387</b>	Tank and Lid	\$86.37	\$107.99	36	36
<b>380-387</b>	Summit 1.28 Round front combination*	\$190.04	\$240.93	87	-
<b>380</b>	Round Bowl	\$103.67	\$132.93	51	18
<b>387</b>	Tank and Lid	\$86.37	\$107.99	36	36
<b>Tank Options</b>					
<b>387RH</b>	Same as 387, with right hand trip lever (See page 24)	\$93.05	\$109.58	36	36
<b>387LT</b>	Same as 387, with tank liner (See page 24)	\$100.24	\$123.64	36	36
<b>Parts and Accessories</b>					
<b>55 Trip Lever</b>	CH - Chrome	\$14.08		See pages 108-121	
	SN - Satin Nickel	\$45.87			
	SB - Sicilian Bronze	\$45.75			
<b>55RH Trip Lever</b>	CH - Chrome (Right Hand Trip Lever - Fits 387RH)	\$11.71			
<b>2206</b>	Pilot Operated Fill Valve	\$17.19			
<b>630-0207</b>	Replacement Flapper Kit	\$8.73			
<b>386-LID</b>	Tank Lid Fits model 387	\$78.87	\$90.53		
<b>BC</b>	Plastic Bolt Caps Set of two (Specify Color)	\$1.13	\$1.13		
Colors: WHT - White Standard: BISC - Biscuit, BONE - Bone					



www.mansfieldplumbing.com | Customer Service: phone 877-850-3060, fax 419-938-6234

HIGH PERFORMANCE TWO-PIECE TOILETS – 1.6 GPF / 6.0 LPF

High Performance Toilets  
1.6 Gpf / 6.0 Lpf



ELONGATED FRONT

ADA SmartHeight™

384-386 Summit Elongated Front, SmartHeight™ 12" Rough-in



ELONGATED FRONT

382-386 Summit Elongated Front, 12" Rough-in



ROUND FRONT

380-386 Summit Round Front, 12" Rough-in

\* Less toilet seat and supply

Summit

- Toilet combination
- 1.6 Gpf / 6.0 Lpf
- Pilot operated anti siphon fill valve
- MagnaFlush high performance flushing technology with 3" flush valve
- Chrome trip lever
- Does not include toilet seat



Standard 2" Flush Valve



Summit Oversize 3" Flush Valve



NON-CLOG



QUIET. ONE FLUSH PERFORMANCE.

388-386 Summit Round front 12" Rough-In

Model Number	Description	List Price		Approx Ship Wt (lbs)	Pallet Qty
		White	Standard		
<b>12" Rough-In</b>					
<b>384-386</b>	Summit Elongated front SmartHeight™ combination* ADA	\$272.81	\$327.82	95	-
<b>384</b>	Elongated Bowl SmartHeight™ (16-1/2" high)	\$186.44	\$219.82	59	18
<b>386</b>	Tank and Lid	\$86.37	\$107.99	36	36
<b>382-386</b>	Summit Elongated front combination*	\$224.49	\$280.63	90	-
<b>382</b>	Elongated Bowl	\$138.12	\$172.64	54	18
<b>386</b>	Tank and Lid	\$86.37	\$107.99	36	36
<b>388-386</b>	Summit Round front SmartHeight™ combination*	\$243.91	\$280.51	87	-
<b>388</b>	Round SmartHeight™ Bowl	\$157.54	\$172.52	51	18
<b>386</b>	Tank and Lid	\$86.37	\$107.99	36	36
<b>380-386</b>	Summit Round front combination*	\$190.04	\$240.93	87	-
<b>380</b>	Round Bowl	\$103.67	\$132.93	51	18
<b>386</b>	Tank and Lid	\$86.37	\$107.99	36	36
<b>10" Rough-In</b>					
<b>385-386</b>	Summit Elongated front SmartHeight™ combination* ADA	\$320.37	\$368.11		
<b>385</b>	Elongated Bowl SmartHeight (16-1/2" high)	\$234.00	\$260.12		
<b>386</b>	Tank and Lid	\$86.37	\$107.99		
<b>Tank Options</b>					
<b>386RH</b>	Same as 386, with right hand trip lever	\$93.05	N/A	36	36
<b>386LT</b>	Same as 386, with tank liner	\$100.24	\$123.64	36	36
<b>386FM</b>	Same as 386, with Fluidmaster pilot valve	\$97.12	\$118.74	36	36
<b>386FMRH</b>	Same as 386, with Fluidmaster pilot valve and right hand trip lever	\$103.79	N/A	36	36
<b>Parts and Accessories</b>					
<b>55 Trip Lever</b>	CH - Chrome	\$14.08	See pages 108-121		
	SB - Sicilian Bronze	\$45.75			
	SN - Satin Nickel	\$45.87			
<b>55RH Trip Lever</b>	CH - Chrome (fits 386 RH tank)	\$11.71			
<b>2206</b>	Pilot Operated Fill Valve	\$17.19			
<b>630-0207</b>	Replacement Flapper Kit	\$8.73			
<b>386-LID</b>	Tank Lid Fits model 386	\$78.87	\$90.53		
<b>BC</b>	Plastic Bolt Caps Set of two (Specify Color)	\$1.13	\$1.13		
Colors: WHT - White Standard: BISC - Biscuit, BONE - Bone					

## HIGH PERFORMANCE, TWO-PIECE TOILETS – DUAL FLUSH, 1.1 / 1.6 GPF

High Performance Toilets  
Dual Flush



ELONGATED FRONT



**SmartHeight™**



384-3386 Summit Dual Flush Elongated Front, SmartHeight™ 12" Rough-in



ELONGATED FRONT



382-3386 Summit Dual Flush Elongated Front, 12" Rough-in



ROUND FRONT



388-3386 Summit Dual Flush Round Front, 12" Rough-in

\* Less toilet seat and supply

### Summit Dual Flush

- Toilet combination
- 1.1 Gpf / 1.6 Gpf (4.0 Gpf / 6.0 Lpf)
- Pilot operated anti siphon fill valve
- Dual Flush flushing technology with 3" flush tower
- Chrome push button actuator
- Does not include toilet seat



Model Number	Description	List Price		Approx Ship Wt (lbs)	Pallet Qty
		White	Standard		
<b>12" Rough-In</b>					
<b>384-3386</b>	Summit Dual Flush Elongated front SmartHeight™ combination*	\$294.30	\$349.40	95	-
<b>384</b>	Elongated Bowl SmartHeight™ (16-1/2" high)	\$186.44	\$219.82	59	18
<b>3386</b>	Tank and Lid	\$107.86	\$129.57	36	30
<b>382-3386</b>	Summit Dual Flush Elongated front combination*	\$245.98	\$302.21	90	-
<b>382</b>	Elongated Bowl	\$138.12	\$172.64	54	18
<b>3386</b>	Tank and Lid	\$107.86	\$129.57	36	30
<b>388-3386</b>	Summit Dual Flush Round front SmartHeight™ combination*	\$265.40	\$302.09	87	-
<b>388</b>	Round SmartHeight™ Bowl	\$157.54	\$172.52	51	18
<b>3386</b>	Tank and Lid	\$107.86	\$129.57	36	30
<b>380-3386</b>	Summit Dual Flush Round front combination*	\$211.53	\$262.51	87	-
<b>380</b>	Round Bowl	\$103.67	\$132.93	51	18
<b>3386</b>	Tank and Lid	\$107.86	\$129.57	36	30
<b>Parts and Accessories</b>					
<b>33 Actuator</b>	CH - Chrome	\$33.16	See pages 108-121		
<b>2206</b>	Pilot Operated Fill Valve	\$17.19			
<b>308</b>	Dual Flush Valve Tower	\$19.60			
<b>3386-LID</b>	Tank Lid Fits model 3386	\$82.20	\$90.44		
<b>BC</b>	Plastic Bolt Caps Set of two (Specify Color)	\$1.13	\$1.13		
Colors: WHT - White Standard: BISC - Biscuit, BONE - Bone					

HIGH EFFICIENCY TWO-PIECE TOILETS – 1.28 GPF / 4.86 LPF



SmartHeight™

4817-3816 Cascade  
Elongated Front, SmartHeight™  
12" Rough-in



4810-3816 Cascade  
Round Front,  
12" Rough-in

\*Less toilet seat and supply

Cascade®

- Toilet combination
- Rimless bowl design
- 1.28 Gpf / 4.86 Lpf
- Pilot operated anti siphon fill valve
- MagnaFlush high performance flushing technology with 3" flush valve
- Chrome trip lever
- Does not include toilet seat



HET Toilets  
1.28 Gpf / 4.86 Lpf

Model Number	Description	List Price	Approx Ship Wt (lbs)	Pallet Qty
		White		
<b>12" Rough-In</b>				
<b>4817-3816</b>	Cascade Elongated SmartHeight™ Combination* <b>ADA</b>	\$216.83	74	-
<b>4817</b>	Elongated Bowl SmartHeight™ (16-9/16" high)	\$134.83	44	18
<b>3816</b>	Tank and Lid	\$82.00	30	36
<b>4810-3816</b>	Cascade Round Front Combination*	\$166.49	70	-
<b>4810</b>	Round Bowl	\$84.49	40	18
<b>3816</b>	Tank and Lid	\$82.00	30	36
<b>Tank Options</b>				
<b>3816RH</b>	Same as 3816, with right hand trip lever	\$85.98	70	-
<b>Parts and Accessories</b>				
<b>58 Trip Lever</b>	CH - Chrome	\$19.14	See pages 108-121	
<b>58RH Trip Lever</b>	CH - Chrome	\$20.44		
<b>2206</b>	Pilot Operated Fill Valve	\$17.19		
<b>216</b>	Flapper Flush Valve	\$14.63		
<b>3816-LID</b>	Tank Lid Fits model 3816	\$42.81	N/A	
Colors: WHT - White				



# Toilets

List Price Effective January 1, 2016

## HIGH EFFICIENCY TWO-PIECE TOILETS – 1.28 GPF / 4.86 LPF

High Efficiency Two-Piece Toilets  
1.28 Gpf / 4.86 Lpf



137-3173 Alto®  
Elongated Front, SmartHeight™  
12" Rough-in



135-3173 Alto®  
Elongated Front,  
12" Rough-in



130-3173 Alto®  
Round Front,  
12" Rough-in

\* Less toilet seat and supply

### Alto® 1.28

- Toilet combination
- 1.28 Gpf / 4.86 Lpf
- Pilot operated anti siphon fill valve
- 3" flush valve
- Color match trip lever
- Does not include toilet seat



137-3120 Alto®  
Elongated Front,  
SmartHeight™  
12" Rough-in



SmartHeight™

**PROVEN PERFORMER.  
PREFERRED BY PLUMBING PROFESSIONALS.**

Model Number	Description	List Price		Approx Ship Wt (lbs)	Pallet Qty
		White	Standard		
<b>12" Rough-In</b>					
137-3173	Alto® 1.28 Elongated front SmartHeight™ combination* <b>ADA</b>	\$229.07	\$286.81	86	-
137	Elongated Bowl (16-1/2" high) SmartHeight™	\$161.30	\$202.11	52	18
3173	Tank and Lid with color match trip lever	\$67.76	\$84.69	34	36
135-3173	Alto® 1.28 Elongated front combination*	\$157.87	\$197.23	86	-
135	Elongated Bowl	\$90.11	\$112.54	52	18
3173	Tank and Lid with color match trip lever	\$67.76	\$84.69	34	36
130-3173	Alto® 1.28 Round front combination*	\$131.13	\$163.92	81	-
130	Round Bowl	\$63.37	\$79.22	47	18
3173	Tank and Lid with color match trip lever	\$67.76	\$84.69	34	36
<b>10" Rough-In</b>					
139NS-3173	Alto® 1.28 Elongated front SmartHeight™ combination* <b>ADA</b>	\$313.68	\$392.10	86	-
139NS	Elongated Bowl (16-1/2" high) SmartHeight™	\$245.92	\$307.41	52	18
3173	Tank and Lid with color match trip lever	\$67.76	\$84.69	34	36
138-3173	Alto® 1.28 Elongated front combination*	\$225.87	\$282.33	86	-
138	Elongated Bowl	\$158.11	\$197.64	52	18
3173	Tank and Lid with color match trip lever	\$67.76	\$84.69	34	36
131-3173	Alto® 1.28 Round front combination*	\$192.65	\$240.86	86	-
131	Round Bowl	\$124.89	\$156.17	52	18
3173	Tank and Lid with color match trip lever	\$67.76	\$84.69	34	36
<b>Tank Options</b>					
3173RH	Tank & Lid with right hand trip lever	\$67.76	N/A	34	36
3172	Tank & Lid with chrome trip lever	\$67.76	N/A	34	36
3174	Tank & Lid with tank liner	\$98.18	N/A	34	36
3120	Tank & Lid with Fluidmaster pilot valve and chrome trip lever	\$75.52	\$94.40	34	36
3120RH	Tank & Lid with Fluidmaster pilot valve and chrome right hand trip lever	\$79.80	\$98.69	34	36
3121	Tank & Lid with Fluidmaster pilot valve and color match trip lever	\$75.52	\$94.40	34	36
3121RH	Tank & Lid with Fluidmaster pilot valve and color match right hand trip lever	\$79.80	N/A	34	36
3122	Tank & Lid with Fluidmaster pilot valve, color match trip lever and liner	\$110.05	\$134.60	34	36
<b>14" Rough-In – Tank Option</b>					
3125	Tank and Lid with color match trip lever, with 14" rough-in	\$142.30	\$177.89	34	36
<b>Parts and Accessories</b>					
31 Trip Lever	WHT - White	\$6.12	See pages 108-121		
	BONE - Bone	\$6.12			
	BISC - Biscuit	\$6.12			
	CH - Chrome	\$6.12			
31RH Trip Lever	WHT - White	\$6.12			
	CH - Chrome	\$6.12			
2206	Pilot Operated Fill Valve	\$17.19			
228	3" Flapper Flush Valve	\$12.68			
160-LID	Tank Lid Fits model 3120, 3121, 3173, 3172, 3174, 3125	\$42.58	53.28		
BC	Plastic Bolt Caps Set of two (Specify Color)	\$1.13	\$1.13		

Colors: WHT - White Standard: BISC - Biscuit, BONE - Bone



www.mansfieldplumbing.com | Customer Service: phone 877-850-3060, fax 419-938-6234

TWO-PIECE TOILETS – 1.6 GPF / 6.0 LPF



Two-Piece Toilets  
1.6 gpf / 6.0 lpf



ELONGATED FRONT

ADA SmartHeight

137-160 Alto®  
Elongated Front, SmartHeight™  
12" Rough-in

Also Available:  
139NS-160 Alto®  
Elongated Front, SmartHeight™  
10" Rough-in



ROUND FRONT

SmartHeight

117-160 Alto®  
Round Front, SmartHeight™  
12" Rough-in



ELONGATED FRONT

135-160 Alto®  
Elongated Front,  
12" Rough-in

Also Available:  
138-160 Alto®  
Elongated Front,  
10" Rough-in

Alto®

- Toilet combination
- 1.6 Gpf / 6.0 Lpf
- Anti siphon Ballcock
- SmartFlush flushing technology with 2" flush tower
- Chrome trip lever
- Does not include toilet seat

**PROVEN PERFORMER.  
PREFERRED BY PLUMBING PROFESSIONALS.**



**Anti-Siphon Ballcock**  
Efficient toilet tank operation at high or low pressures. Adjustment screw allows water level adjustment without bending the float rod.

**Siphon Jet SmartFlush™ Flushing Technology**  
Exclusive Mansfield® flush tower provides outstanding flushing performance

**Three-Point Cushioned Tank-to-Bowl Connection**  
Perfect tank alignment with fast, accurate and leak-proof tank connections. Protects against tank breakage... can't be rocked loose

**Evenly Spaced Rim Jets**  
Provides complete bowl wash for maximum hygiene

**2" Glazed Trapway**  
Large trapway quickly removes waste with less clogging

Model 135-160 Shown

Model Number	Description	List Price		Approx Ship Wt (lbs)	Pallet Qty
		White	Standard		
<b>12" Rough-In</b>					
<b>137-160</b>	Alto® Elongated front SmartHeight™ combination* ADA	\$229.07	\$286.81	86	-
<b>137</b>	Elongated Bowl (16-1/2" high) SmartHeight™	\$161.30	\$202.11	52	18
<b>160</b>	Tank and Lid	\$67.76	\$84.69	34	36
<b>117-160</b>	Alto® Round front SmartHeight™ combination*	\$215.05	\$268.82	86	-
<b>117</b>	Round Bowl (16-1/2" high) SmartHeight™	\$147.29	\$184.13	52	18
<b>160</b>	Tank and Lid	\$67.76	\$84.69	34	36
<b>135-160</b>	Alto® Elongated front combination*	\$157.87	\$197.23	81	-
<b>135</b>	Elongated Bowl	\$90.11	\$112.54	47	18
<b>160</b>	Tank and Lid	\$67.76	\$84.69	34	36
<b>130-160</b>	Alto® Round front combination*	\$131.13	\$163.92	78	-
<b>130</b>	Round Bowl	\$63.37	\$79.22	44	18
<b>160</b>	Tank and Lid	\$67.76	\$84.69	34	36
<b>10" Rough-In</b>					
<b>139NS-160</b>	Alto® Elongated front SmartHeight™ combination* ADA	\$313.68	\$392.10	86	-
<b>139NS</b>	Elongated Bowl (16-1/2" high)	\$245.92	\$307.41	52	18
<b>160</b>	Tank and Lid	\$67.76	\$84.69	34	36
<b>138-160</b>	Alto® Elongated front combination*	\$225.87	\$282.33	83	-
<b>138</b>	Elongated Bowl	\$158.11	\$197.64	49	18
<b>160</b>	Tank and Lid	\$67.76	\$84.69	34	36
<b>131-160</b>	Alto® Round front combination*	\$192.65	\$240.86	79	-
<b>131</b>	Round Bowl	\$124.89	\$156.17	45	18
<b>160</b>	Tank and Lid	\$67.76	\$84.69	34	36
<b>14" Rough-In</b>					
<b>125</b>	Same as 160, with 14" rough-in (See page 24)	\$142.30	\$177.89	34	36

– Tank Options continued on next page –

Colors: WHT - White Standard: BISC - Biscuit, BONE - Bone

\* Less toilet seat and supply

# Toilets

List Price Effective January 1, 2016

## TWO-PIECE TOILETS – 1.6 GPF / 6.0 LPF

Two-Piece Toilets  
1.6 gpf / 6.0 lpf



130-160 Alto®  
Round Front,  
12" Rough-in

Also Available  
131-160 Alto®  
Round Front,  
10" Rough-in

Model Number	Description	List Price		Approx Ship Wt (lbs)	Pallet Qty	
		White	Standard			
<b>Alto® Tank Options</b>						
– See page 24 for tank option details –						
<b>160RH</b>	Same as 160, with right hand trip lever	\$67.76	\$84.69	34	36	
<b>161</b>	Same as 160, with Fluidmaster pilot valve	\$75.52	\$94.40	34	36	
<b>165</b>	Same as 160, with cover lock	\$83.87	N/A	34	36	
<b>170</b>	Same as 160, with tank liner	\$98.18	\$122.75	34	36	
<b>171</b>	Same as 160, with Fluidmaster™ and tank liner	\$110.05	\$134.60	34	36	
<b>172</b>	Same as 160, with Pilot Valve & 2" flapper & chrome lever	\$67.76	\$84.69	34	36	
<b>172RH</b>	Same as 160, with Pilot Valve & 2" flapper & right hand chrome lever	\$67.76	\$84.69	34	36	
<b>173</b>	Same as 160, with color match lever, Pilot Valve & 2" flapper	\$67.76	\$84.69	34	36	
<b>173RH</b>	Same as 160, with color-match, right hand lever, Pilot Valve & 2" flapper	\$67.76	N/A	34	36	
<b>173FM</b>	Same as 173, with Fluidmaster™	\$75.52	\$94.40	34	36	
<b>173FM RH</b>	Same as 173, with Fluidmaster™ & right hand trip lever	\$79.80	N/A	34	36	
<b>174</b>	Same as 160, with color-match lever, Pilot Valve, 2" flapper and tank liner	\$98.18	\$122.75	34	36	
<b>175</b>	Same as 160, with cover lock and tank liner	\$133.71	N/A	34	36	
<b>180</b>	Same as 160, with color-match trip lever	\$67.76	\$84.69	34	36	
<b>181</b>	Same as 160, with Fluidmaster™ & color-match trip lever	\$75.52	\$94.40	34	36	
<b>190</b>	Same as 160, with color-match trip lever and tank liner	\$98.18	\$122.75	34	36	
<b>Parts and Accessories</b>						
<b>40 Trip Lever</b>	WHT - White	\$6.12	See pages 108-121			
	BONE - Bone	\$6.12				
	BISC - Biscuit	\$6.12				
	CH - Chrome	\$6.12				
<b>55 Trip Lever</b>	CH - Chrome (Upgrade - 55 "Universal" Trip Lever)	\$14.08				
	SB - Sicilian Bronze	\$45.75				
	SN - Satin Nickel	\$45.87				
– Trip Lever Cross Reference Chart on page 113 –						
<b>08ULF-1112</b>	Anti-Siphon Ballcock	\$13.58		See pages 108-121		
<b>211-1112</b>	Flush Valve	\$9.48				
<b>160-LID</b>	Tank Lid Fits 160, 160RH, 161, 170, 171, 172, 173, 180, 181 & 190	\$42.58	53.28			
<b>165-LID</b>	Tank Lid with cover lock Fits 165 and 175	\$54.08	N/A			
<b>BC</b>	Plastic Bolt Caps Set of two (Specify Color)	\$1.13	\$1.13			
Colors: WHT - White Standard: BISC - Biscuit, BONE - Bone						

SMARTPAK™ COMPLETE TOILET KITS

SmartPak Complete Toilet Kits



**ELONGATED FRONT**  
 382CTK Summit Elongated Front Kit  
 12" Rough-in



**ELONGATED FRONT**  
 **SmartHeight™**   
 4184CTK Essence Elongated Front Kit, SmartHeight™  
 12" Rough-in

**SmartPak™ Complete Toilet Kits**

- Carton Includes:**
- Toilet bowl and tank
  - Toilet seat
  - Flange bolts
  - Wax ring with polyethylene flange
  - Instructions



PRO-FIT™ 3 Elongated Front SmartHeight™ Shown

**COMPLETE TOILET IN A BOX.  
 EASY TO INSTALL.**



Model Number	Description	List Price		Approx Ship Wt (lbs)	Pallet Qty
		White	Standard		
131CTK	CTK Alto RD 10" Rough-in ★	\$224.60	N/A	85	10
117CTK	CTK PRO-FIT® 4 RD SmartHeight* ★	\$245.40	\$309.13	89	10
130CTK	CTK PRO-FIT® 1 RD* ★	\$162.60	\$202.75	85	10
135CTK	CTK PRO-FIT® 2 EL* ★	\$186.59	\$231.85	88	10
137CTK	CTK PRO-FIT® 3 EL ADA* ★ <b>ADA</b>	\$249.37	\$306.72	92	10
130LTCTK	CTK PRO-FIT® 1 RD LT CLR Match* ★	\$186.95	N/A	85	10
135LTCTK	CTK PRO-FIT® 2 EL LT CLR Match* ★	\$216.53	N/A	88	10
137LTCTK	CTK PRO-FIT® 3 ADA LT CLR Match* ★ <b>ADA</b>	\$280.94	N/A	92	10
380CTK	CTK Summit RF* ★	\$220.89	\$274.39	89	10
382CTK	CTK Summit EL* ★	\$254.96	\$318.38	89	10
384CTK	CTK Summit EL ADA* ★ <b>ADA</b>	\$287.84	\$355.72	89	10
388CTK	CTK Summit RD SmartHeight* ★	\$277.78	\$322.00	89	10
4130CTK	CTK PRO-FIT® 1 RD 1.28* ★	\$162.60	\$202.75	85	10
4135CTK	CTK PRO-FIT® 2 EL 1.28* ★	\$186.59	\$231.85	88	10
4137CTK	CTK PRO-FIT® 3 EL ADA 1.28* ★ <b>ADA</b>	\$249.37	\$306.72	92	10
4130LTCTK	CTK PRO-FIT® 1 LT RD 1.28* ★	\$186.95	N/A	85	10
4135LTCTK	CTK PRO-FIT® 2 LT EL 1.28* ★	\$216.53	N/A	88	10
4137LTCTK	CTK PRO-FIT® 3 LT ADA 1.28* ★ <b>ADA</b>	\$280.94	N/A	92	10
4147CTK	CTK Brentwood EL ADA 1.6 <b>ADA</b>	\$485.68	N/A	94	8
4184CTK	CTK Essence EL ADA 1.28* <b>ADA</b>	\$462.58	N/A	89	8
4197CTK	CTK Waverly EL ADA 1.28* <b>ADA</b>	\$354.02	N/A	89	8
4380CTK	CTK Summit Dual Flush RD* ★	\$238.13	\$297.67	89	10
4381CTK	CTK Summit 1.28 RD* ★	\$220.89	\$274.39	89	10
<b>NEW</b> 4381LTCTK	CTK Summit 1.28 LT RD* ★	\$245.89	N/A	89	10
4382CTK	CTK Summit Dual Flush EL* ★	\$261.44	\$326.14	89	10
4383CTK	CTK Summit 1.28 EL* ★	\$254.96	\$318.38	89	10
4384CTK	CTK Summit Dual Flush SmartHeight* ★	\$327.81	\$396.94	89	10
4385CTK	CTK Summit 1.28 EL ADA* ★ <b>ADA</b>	\$287.84	\$355.72	89	10
4388CTK	CTK Summit 1.28 RD SmartHeight* ★	\$277.78	\$322.00	89	10

\* Less supply

Colors: WHT - White Standard: BISC - Biscuit, BONE - Bone

## TANK OPTIONS / TANK OPTIONS REFERENCE CHART

### Tank Options

Available on Selected Models



**Right Hand Trip Lever**  
Trip lever mounts on right hand side of toilet to meet special installation specification or design preference



**Color-Match Trip Lever**  
Offers versatility to match trip lever color with toilet color to fit any decor — Available on selected models in White, Biscuit, and Bone



**Push Button Actuator**  
Solid, durable, top mount push button actuator is the perfect solution in high volume usage areas



**Cover Lock**  
Tamper resistant locking device located on tank lid discourages vandalism — Ideal for commercial use



**Tank Liner**  
Insulating styrofoam inner tank liner reduces condensation on outside of tank from cold water in hot, humid climates



**Pilot Operated Fill Valve**  
provides consistent shut-off over a wide range of water pressures





**14" Rough-in 125 & 3125 Tank**  
Traditional 14" rough-in includes toilet tank, cover and trim — For use on 117, 130, 135, 137 toilet bowls



### Tank Option Reference Chart



Tank Model #	Right Hand Trip Lever	Color Match Trip Lever	Push Button Actuator	Cover Lock	Tank Liner	Fluidmaster™	Fluidmaster™ & Tank Liner	Cover Lock & Tank Liner	Chrome Trip Lever & Flapper	Color Match Trip Lever & Fluidmaster™	Color Match Trip Lever & Tank Liner	14" Rough-In	Flapper	Color Match Trip Lever, Tank Liner & Flapper	Fluidmaster™ Right Hand
123	123RH		122												
153	153RH		154												
155	155RH														
160	160RH	180 / 173		165	170	161	171	175	172	181	190	125	173	174	173FMRH
3173	3173RH	3173			3174	3121	3122		3172	3120		3125	3173	3174	3120FMRH & 3121FMRH
386	386RH				386LT										386FMRH
387	387RH				387LT										
3816	3816RH														





SELF-RIMMING LAVATORIES

 <p>254 Brentwood</p>	<h3>Brentwood®</h3> <ul style="list-style-type: none"> <li>• 22-7/16" x 18-15/16" self-rimming lavatory</li> <li>• Basin: 18-11/16" x 12-7/16"</li> <li>• Concealed front overflow</li> <li>• Available in single hole, 4" or 8" faucet centers</li> </ul> 						
	Model Number	Description	List Price		Approx Ship Wt (lbs)	Pallet Qty	
			White	Standard			
	<b>254 Brentwood self-rimming lavatory</b>						
	254-1	Lavatory (single hole)	<b>Not available in bone</b>		\$178.53	\$221.38	30
254-4	Lavatory (4" faucet center)	\$178.53	\$221.38	30	20		
254-8	Lavatory (8" faucet center)	\$178.53	\$221.38	30	20		
Colors: WHT - White Standard: BISC - Biscuit, BONE - Bone							

 <p>268 Barrett</p>	<h3>Barrett</h3> <ul style="list-style-type: none"> <li>• 23-1/16" x 18-5/8" self-rimming lavatory</li> <li>• Basin: 16-1/4" x 10-1/2"</li> <li>• Concealed front overflow</li> <li>• Available in single hole, 4" or 8" faucet centers</li> </ul> 						
	Model Number	Description	List Price		Approx Ship Wt (lbs)	Pallet Qty	
			White	Standard			
	<b>268 Barrett self-rimming lavatory</b>						
	268-1	Lavatory (single hole)	<b>Not available in bone</b>		\$170.78	\$207.33	29
268-4	Lavatory (4" faucet center)	\$170.78	\$207.33	29	20		
268-8	Lavatory (8" faucet center)	\$170.78	\$207.33	29	20		
Colors: WHT - White Standard: BISC - Biscuit, BONE - Bone							

 <p>242 Enso</p>	<h3>Enso®</h3> <ul style="list-style-type: none"> <li>• 19" x 15" oval, self-rimming lavatory</li> <li>• Basin: 16" x 12"</li> <li>• Splash-free bowl</li> </ul> 						
	Model Number	Description	List Price		Approx Ship Wt (lbs)	Pallet Qty	
			White	Standard			
242	Enso self-rimming lavatory	\$149.73	\$179.68	15	28		
Colors: WHT - White Standard: BISC - Biscuit							

 <p>269 Montclair</p>	<h3>Montclair</h3> <ul style="list-style-type: none"> <li>• 22-1/4" x 17-3/8" oval, self-rimming lavatory</li> <li>• Basin: 19" x 11-3/4"</li> <li>• Concealed front overflow</li> <li>• Available in single hole, 4" and 8" faucet centers</li> </ul> 						
	Model Number	Description	List Price		Approx Ship Wt (lbs)	Pallet Qty	
			White	Standard			
	<b>269 Montclair self-rimming lavatory</b>						
	269-1	Lavatory (single hole)	\$143.91	N/A	25	30	
269-4	Lavatory (4" faucet center)	\$143.91	N/A	25	30		
269-8	Lavatory (8" faucet center)	\$143.91	\$172.71	25	30		
Colors: WHT - White Standard: BISC - Biscuit, BONE - Bone							

Self-Rimming Lavatories

## SELF-RIMMING LAVATORIES



259 Essence

### Essence

- 19-7/8" x 17-1/4" self-rimming lavatory
- Basin: 14" x 10-1/2"
- Concealed front overflow
- Extra wide tapered rim
- Available in single hole, 4" and 8" faucet centers



Model Number	Description	List Price		Approx Ship Wt (lbs)	Pallet Qty
		White	Standard		
<b>259 Essence self-rimming lavatory</b>					
259-1	Lavatory (single hole)	\$138.21	\$165.86	22	24
259-4	Lavatory (4" faucet center)	\$138.21	\$165.86	22	24
259-8	Lavatory (8" faucet center)	\$138.21	\$165.86	22	24
Colors: WHT - White Standard: BISC - Biscuit, BONE - Bone					

Lavatories  
Self-Rimming



257 Waverly

### Waverly

- 21" x 17" oval, self-rimming lavatory
- Basin: 15-3/4" x 11-1/8"
- Concealed front overflow
- Available in 4" faucet center



Model Number	Description	List Price		Approx Ship Wt (lbs)	Pallet Qty
		White	Standard		
257-4	Lavatory (4" faucet center)	\$130.92	N/A	22	24
Colors: WHT - White					



249 Maverick I

### Maverick I

- 19" round, self-rimming lavatory
- Basin: 12-1/8" x 14-3/4"
- Concealed front overflow
- Available in single hole, 4" and 8" faucet centers



Model Number	Description	List Price		Approx Ship Wt (lbs)	Pallet Qty
		White	Standard		
<b>249 Maverick I self-rimming lavatory</b>					
249-1	Lavatory (single hole)	\$76.42	N/A	22	20
249-4	Lavatory (4" faucet center)	\$76.42	\$92.11	22	20
249-8	Lavatory (8" faucet center)	\$76.42	N/A	22	20
Colors: WHT - White Standard: BISC - Biscuit, BONE - Bone					



267 Maverick II

### Maverick II

- 20" x 17" oval, self-rimming lavatory
- Basin: 15-1/2" x 10-1/2"
- Concealed front overflow
- Available in single hole, 4" and 8" faucet centers



Model Number	Description	List Price		Approx Ship Wt (lbs)	Pallet Qty
		White	Standard		
<b>267 Maverick II self-rimming lavatory</b>					
267-1	Lavatory (single hole)	\$76.42	\$92.11	24	30
267-4	Lavatory (4" faucet center)	\$76.42	\$92.11	24	30
267-8	Lavatory (8" faucet center) <b>Not available in bone</b>	\$76.42	\$92.11	24	30
Colors: WHT - White Standard: BISC - Biscuit, BONE - Bone					

SELF-RIMMING LAVATORIES

 <p>251 Alto II</p>	<h3>Alto II</h3> <ul style="list-style-type: none"> <li>• 19" x 16" oval self-rimming lavatory</li> <li>• Basin: 12-1/4" x 14-1/4"</li> <li>• Concealed front overflow</li> <li>• Available in 4" and 8" faucet centers</li> </ul> <p style="text-align: right;">MADE IN THE USA ADA</p>					
	Model Number	Description	List Price		Approx Ship Wt (lbs)	Pallet Qty
			White	Standard		
	<b>251 Alto II™ self-rimming lavatory</b>					
	251-4	Lavatory (4" faucet center)	\$75.42	\$90.97	18	30
251-8	Lavatory (8" faucet center)	\$75.42	\$90.97	18	30	
251-LO	Lavatory less overflow (4")	\$75.42	N/A	18	30	
Colors: WHT - White Standard: BISC - Biscuit, BONE - Bone						

 <p>237 MS Oval</p>	<h3>MS Oval</h3> <ul style="list-style-type: none"> <li>• 20-1/2" x 17" self-rimming lavatory</li> <li>• Basin: 17" x 11-1/8"</li> <li>• Concealed front overflow</li> <li>• Available in single hole, 4" and 8"</li> </ul> <p style="text-align: right;">MADE IN THE USA ADA</p>					
	Model Number	Description	List Price		Approx Ship Wt (lbs)	Pallet Qty
			White	Standard		
	<b>237 MS Oval self-rimming lavatory</b>					
	237-1	Lavatory (single hole)	<b>Not available in biscuit</b>	\$40.43	\$46.09	18
237-4	Lavatory (4" faucet center)		\$40.43	\$46.09	18	30
237-8	Lavatory (8" faucet center)		\$40.43	N/A	18	30
Colors: WHT - White Standard: BISC - Biscuit, BONE - Bone						

 <p>239 MS Round</p>	<h3>MS Round</h3> <ul style="list-style-type: none"> <li>• 19-1/4 x 19-5/8" self-rimming lavatory</li> <li>• Basin: 15-1/4" x 12-3/8"</li> <li>• Concealed front overflow</li> <li>• Available in single hole, 4" and 8"</li> </ul> <p style="text-align: right;">MADE IN THE USA ADA</p>					
	Model Number	Description	List Price		Approx Ship Wt (lbs)	Pallet Qty
			White	Standard		
	<b>239 MS Round self-rimming lavatory</b>					
	239-1	Lavatory (single hole)	\$40.43	\$46.09	18	20
239-4	Lavatory (4" faucet center)	\$40.43	\$46.09	18	20	
239-8	Lavatory (8" faucet center)	\$40.43	N/A	18	20	
Colors: WHT - White Standard: BISC - Biscuit, BONE - Bone						

Lavatories  
Self-Rimming

## UNDERCOUNTER LAVATORIES



234 Brentwood

### Brentwood®

- 20-5/16" x 14-3/16" O.D. rectangular, undercounter lavatory
- Basin: 18-15/16" x 13"
- Concealed front overflow



Model Number	Description	List Price		Approx Ship Wt (lbs)	Pallet Qty
		White	Standard		
234	Brentwood Undercounter lavatory	\$149.73	\$185.66	20	30
Parts and Accessories					
CLIPS	Mounting Clips (Set of four mounting clips)	\$16.56			
Colors: WHT - White Standard: BISC - Biscuit, BONE - Bone					



218NS Petite Covington

### Petite Covington

- 21-3/8" x 13-5/8" O.D. rectangular, undercounter lavatory
- Basin: 19" x 11-3/8"
- Concealed front overflow



Model Number	Description	List Price		Approx Ship Wt (lbs)	Pallet Qty
		White	Standard		
218NS	Petite Covington Undercounter lavatory	\$142.64	\$171.15	27	30
Parts and Accessories					
CLIPS	Mounting Clips (Set of four mounting clips)	\$16.56			
Colors: WHT - White Standard: BISC - Biscuit, BONE - Bone					



217 Maple

### Maple

- 19-3/4" x 16" oval undercounter lavatory
- Basin: 17-5/16" x 14-1/8"
- Concealed front overflow



Model Number	Description	List Price		Approx Ship Wt (lbs)	Pallet Qty
		White	Standard		
217	Maple Undercounter lavatory	\$67.08	\$80.48	18	30
Parts and Accessories					
CLIPS	Mounting Clips (Set of four mounting clips)	\$16.56			
Colors: WHT - White Standard: BISC - Biscuit, BONE - Bone					



216NS Petite Maple









### Petite Maple

- 17-1/8" x 14-1/4" petite oval undercounter lavatory
- Basin: 15-1/8" x 12-1/4"
- Concealed front overflow



Model Number	Description	List Price		Approx Ship Wt (lbs)	Pallet Qty
		White	Standard		
216NS	Petite Maple Undercounter lavatory	\$57.40	\$68.89	17	36
Parts and Accessories					
CLIPS	Mounting Clips (Set of four mounting clips)	\$16.56			
Colors: WHT - White Standard: BISC - Biscuit, BONE - Bone					

## ABOVE COUNTER VESSELS

 <p>807 Rationale</p>	<h3>Razionale</h3> <ul style="list-style-type: none"> <li>• 18-3/8" x 18-1/2" Square, above counter vessel</li> <li>• Basin: 17" x 17"</li> <li>• Integral rear overflow with chrome-finished overflow cover</li> </ul>						
	<b>Model Number</b>	<b>Description</b>	<b>List Price</b>		<b>Approx Ship Wt (lbs)</b>	<b>Pallet Qty</b>	
			<b>White</b>	<b>Standard</b>			
	<b>807</b>	Rationale above counter vessel	\$215.25	N/A	-	-	
Colors: WHT - White							
 <p>825 Monet</p>	<h3>Monet</h3> <ul style="list-style-type: none"> <li>• 17" x 14" oval, above counter vessel</li> <li>• Basin: 14-1/2" x 11-1/2"</li> </ul> 						
	<b>Model Number</b>	<b>Description</b>	<b>List Price</b>		<b>Approx Ship Wt (lbs)</b>	<b>Pallet Qty</b>	
			<b>White</b>	<b>Standard</b>			
	<b>825</b>	Monet above counter vessel	\$172.70	N/A	12	40	
Colors: WHT - White							
 <p>805NS Tempo</p>	<h3>Tempo</h3> <ul style="list-style-type: none"> <li>• 16-3/5" Round, above counter vessel</li> <li>• Basin: 15-3/4"</li> </ul>						
	<b>Model Number</b>	<b>Description</b>	<b>List Price</b>		<b>Approx Ship Wt (lbs)</b>	<b>Pallet Qty</b>	
			<b>White</b>	<b>Standard</b>			
	<b>805NS</b>	Tempo above counter vessel	\$163.85	\$198.15	15	30	
Colors: WHT - White Standard: BISC - Biscuit							
 <p>826 Reo</p>	<h3>Reo</h3> <ul style="list-style-type: none"> <li>• 25-5/8" x 15-1/2" above counter demi-vessel</li> <li>• Basin: 16-3/4" x 12-3/8"</li> <li>• Demi-vessel height allows the use of standard 5" neck height faucets</li> <li>• No overflow</li> </ul> 						
	<b>Model Number</b>	<b>Description</b>	<b>List Price</b>		<b>Approx Ship Wt (lbs)</b>	<b>Pallet Qty</b>	
			<b>White</b>	<b>Standard</b>			
	<b>826</b>	Reo above counter demi-vessel	\$139.78	\$167.50	24	16	
Colors: WHT - White Standard: BISC - Biscuit, BONE - Bone							
 <p>437 Potenza</p>	<h3>Potenza</h3> <ul style="list-style-type: none"> <li>• 24-5/16" x 17-1/4" above counter vessel</li> <li>• Integral rear overflow</li> <li>• Available in single, 4" and 8" faucet centers</li> </ul> 						
	<b>Model Number</b>	<b>Description</b>	<b>List Price</b>		<b>Approx Ship Wt (lbs)</b>	<b>Pallet Qty</b>	
			<b>White</b>	<b>Standard</b>			
	<b>437 Potenza above counter vessel</b>						
	<b>437-1</b>	Lavatory (single hole)	\$141.61	N/A	24	20	
	<b>437-4</b>	Lavatory (4" faucet center)	\$141.61	N/A	24	20	
<b>437-8</b>	Lavatory (8" faucet center)	\$141.61	N/A	24	20		
Colors: WHT - White							

Lavatories  
Above Counter Vessels



## ABOVE COUNTER VESSELS



802 Luna

### Luna

- 17-1/2" round, above counter vessel
- Basin: 9-7/8" x 13-3/16" x 3-1/2"

Model Number	Description	List Price		Approx Ship Wt (lbs)	Pallet Qty
		White	Standard		
802	Luna above counter vessel	\$134.58	N/A	20	30

Colors: WHT - White



311 Enso

### Enso®

- 21-1/2" x 19-1/2" above counter vessel
- Basin: 18" x 12"
- Integral rear overflow with chrome-finished overflow cover
- Available in a single hole faucet center
- Spacious, splash-free bowl



Model Number	Description	List Price		Approx Ship Wt (lbs)	Pallet Qty
		White	Standard		
311	Enso above counter vessel	\$189.93	\$227.92	40.5	24

Colors: WHT - White Standard: BISC - Biscuit



884 Enso Vanity

### Enso® Vanity

- 22-2/5" x 21-1/5" x 29-9/10"
- Bottom drawer opens 9-1/2" to accommodate toiletries
- Contemporary design
- Completely assembled with pre-cut top for easy installation
- Solid wood legs provide strength and stability
- Top, base and drawer are made of plywood and MDF board
- All components are finished with polyurethane to protect them from moisture
- Adjustable metal feet provide stability on unlevel floors

Model Number	Description	List Price	Approx Ship Wt (lbs)	Pallet Qty
884	Enso vanity (lavatory not included)	\$420.00	40	-

Color: Java

PEDESTAL LAVATORIES



### Enso®

- 21-1/2" x 19-1/2" pedestal lavatory, luxury 34-1/4" height
- Basin: 18" x 12"
- Integral rear overflow with chrome-finished overflow cover
- Available in single faucet center
- Can be installed with pedestal or on a solid surface for a vessel look.



Model Number	Description	List Price		Approx Ship Wt (lbs)	Pallet Qty
		White	Standard		
310	Enso combination lavatory and pedestal	\$322.89	N/A	78	-
311	Lavatory (single hole)	\$189.93	N/A	47	24
312	Pedestal	\$132.96	N/A	31	12

Colors: WHT - White



### Barrett

- 24-3/8" x 19-1/8" pedestal lavatory with hanger, 34" luxury height
- Basin: 17-5/16" x 11-1/4"
- Integral rear overflow
- Available in single hole, 4" and 8" faucet centers

Model Number	Description	List Price		Approx Ship Wt (lbs)	Pallet Qty
		White	Standard		
330	Barrett combination lavatory and pedestal	\$312.81	\$379.77	67	-
328-1	Lavatory (single hole)	\$177.54	\$215.55	37	18
328-4	Lavatory (4" faucet center)	\$177.54	\$215.55	37	18
328-8	Lavatory (8" faucet center)	\$177.54	\$215.55	37	18
329	Pedestal	\$135.27	\$164.22	30	18

Colors: WHT - White Standard: BISC - Biscuit, BONE - Bone



### Montclair

- 23-13/16" x 18-5/8" pedestal lavatory with hanger, 34-1/4" luxury height
- Basin: 20" x 12-1/2"
- Integral rear overflow
- Available in single hole, 4" and 8" faucet centers

Model Number	Description	List Price		Approx Ship Wt (lbs)	Pallet Qty
		White	Standard		
335	Montclair combination lavatory and pedestal	\$242.02	\$290.44	60	-
333-1	Lavatory (single hole)	\$151.26	\$181.52	33	18
333-4	Lavatory (4" faucet center)	\$151.26	\$181.52	33	18
333-8	Lavatory (8" faucet center)	\$151.26	\$181.52	33	18
334	Pedestal	\$90.76	\$108.92	27	24

Colors: WHT - White Standard: BISC - Biscuit, BONE - Bone



### Essence

- 25-3/16" x 21-1/2" pedestal lavatory, luxury 33-5/8" height
- Basin: 16" x 13"
- Available in single hole, 4" and 8" faucet centers
- Optional chrome-plated, removable towel bar for added functionality



Model Number	Description	List Price		Approx Ship Wt (lbs)	Pallet Qty
		White	Standard		
320	Essence combination lavatory and pedestal	\$229.84	\$275.78	78	-
318-1	Lavatory (single hole)	N/A	\$166.35	47	12
318-4	Lavatory (4" faucet center)	\$138.64	\$166.35	47	12
318-8	Lavatory (8" faucet center)	\$138.64	\$166.35	47	12
319	Pedestal	\$91.20	\$109.43	31	24
882	Towel Bar Kit - "Optional" (chrome-plated finish)	\$95.84	N/A	27	24

Colors: WHT - White Standard: BISC - Biscuit, BONE - Bone

## PEDESTAL LAVATORIES



340 Waverly

### Waverly

- 24-1/2" x 18-3/4" pedestal lavatory with hanger, 34-1/2" luxury height
- Basin: 19" x 12-5/8"
- Concealed front overflow
- Available in single hole, 4" and 8" faucet centers

Model Number	Description	List Price		Approx Ship Wt (lbs)	Pallet Qty
		White	Standard		
340	Waverly combination lavatory and pedestal	\$220.67	\$271.65	64	-
338-1	Lavatory (single hole)	N/A	\$171.57	35	18
338-4	Lavatory (4" faucet center) <b>Not available in bone</b>	\$137.26	\$171.57	35	18
338-8	Lavatory (8" faucet center) <b>Not available in bone</b>	\$137.26	\$171.57	35	18
339	Pedestal	\$83.41	\$100.08	29	24

Colors: WHT - White Standard: BISC - Biscuit, BONE - Bone



438 Potenza

### Potenza

- 24-5/16" x 17-1/4" pedestal lavatory, 34-1/4" luxury height
- Integral rear overflow
- Available in single, 4" and 8" faucet centers
- Can be installed with pedestal or on a solid surface for a vessel look



Model Number	Description	List Price		Approx Ship Wt (lbs)	Pallet Qty
		White	Standard		
438	Potenza combination lavatory and pedestal	\$209.85	N/A	79	-
437-1	Lavatory (single hole)	\$141.61	N/A	46	20
437-4	Lavatory (4" faucet center)	\$141.61	N/A	46	20
437-8	Lavatory (8" faucet center)	\$141.61	N/A	46	20
436	Pedestal	\$68.23	N/A	33	24

Colors: WHT - White



290 Alto IV

### Alto IV

- 25" x 19" pedestal lavatory with hanger, 34-1/4" luxury height
- Basin: 20-1/2" x 12-3/8"
- Concealed front overflow
- Available in single hole, 4" and 8" faucet centers



Model Number	Description	List Price		Approx Ship Wt (lbs)	Pallet Qty
		White	Standard		
290	Alto IV™ combination lavatory and pedestal	\$193.25	\$222.24	55	-
292-1	Lavatory (single hole)	\$123.00	\$141.45	40	18
292-4	Lavatory (4" faucet center)	\$123.00	\$141.45	40	18
292-8	Lavatory (8" faucet center)	\$123.00	\$141.45	40	18
293	Pedestal	\$70.25	\$80.79	15	35

Colors: WHT - White Standard: BISC - Biscuit, BONE - Bone



349 Maverick

### Maverick

- 24 x 21-1/2" pedestal lavatory with hanger, 33" luxury height
- Basin: 19-1/2" x 14-9/16"
- Integral rear overflow
- Available in single hole, 4" and 8" faucet centers

Model Number	Description	List Price		Approx Ship Wt (lbs)	Pallet Qty
		White	Standard		
349	Maverick combination lavatory and pedestal	\$163.03	\$187.47	60	-
348-1	Lavatory (single hole)	\$99.43	N/A	36	18
348-4	Lavatory (4" faucet center)	\$99.43	\$114.34	36	18
348-8	Lavatory (8" faucet center)	\$99.43	\$114.34	36	18
344	Pedestal	\$63.60	\$73.13	24	18

Colors: WHT - White Standard: BISC - Biscuit

**PEDESTAL LAVATORIES**



270 West Hampton

**West Hampton**

- 20-1/8" x 16-1/4" pedestal lavatory with hanger, 33-1/2" luxury height
- Basin: 16-1/4" x 10-1/8"
- Concealed front overflow
- Available in 4" and 8" faucet centers



Model Number	Description	List Price		Approx Ship Wt (lbs)	Pallet Qty
		White	Standard		
270	West Hampton combination lavatory and pedestal	\$151.21	\$173.88	43	-
272-4	Lavatory (4" faucet center)	\$88.15	\$101.37	29	33
272-8	Lavatory (8" faucet center)	\$88.15	N/A	29	33
273	Pedestal	\$63.06	\$72.51	14	50

Colors: WHT - White Standard: BISC - Biscuit, BONE - Bone



230 Verona

**Verona**

- 18-1/2" x 17-1/4" pedestal lavatory
- Integral rear overflow
- Available in 4" faucet centers

Model Number	Description	List Price		Approx Ship Wt (lbs)	Pallet Qty
		White	Standard		
230	Verona combination lavatory and pedestal	\$121.98	N/A	40	-
232-4	Lavatory (4" faucet center)	\$69.70	N/A	22	-
233	Pedestal	\$52.28	N/A	18	-

Colors: WHT - White

Lavatories  
Pedestal & Vanity Top

**VANITY TOP**



2017 City I

**City I**

- 20" x 17" vanity top
- Concealed front overflow
- Available in 4" faucet center
- Integral back splash

Model Number	Description	List Price	Approx Ship Wt (lbs)	Pallet Qty
2017	Vanity Top	\$106.94	-	-

Colors: WHT - White

ELEMENTARY TOILET COMBINATION



5326-4320 Elementary Toilet Combination Round Front, 12" Rough-in

Elementary Toilet Combination

- 1.28 Gpf / 4.8 Lpf
- Round Front Bowl
- Includes SmartClose™ Toilet Seat

SmartClose™ Toilet Seat closes gently and quietly with a simple touch

Model Number	Description	List Price		Approx Ship Wt (lbs)	Pallet Qty
		White	Standard		
12" Rough-In					
5326-4320	Elementary Toilet combination	\$380.00	N/A	-	-
5326	Round Front Bowl	\$230.00	N/A	34	-
4320	Tank and Lid	\$150.00	N/A	22	-
Parts and Accessories					
4320-LID	Tank Lid Fits model 5326	\$62.40	N/A	-	-
ELEM	Toilet Seat Elementary	\$87.98	N/A	-	-

Colors: WHT - White

FLUSHOMETER TOILETS – FLOOR-MOUNT



1319BPL Adriatic Elongated Front 10" Rough-in

Adriatic BPL

- 1.28 or 1.6 Gpf / 4.8 Lpf or 6.0 Lpf
- SmartHeight (17" high bowl)
- 1-1/2" top spud
- Bedpan lugs
- Perfect for clinical applications.



Model Number	Description	List Price		Approx Ship Wt (lbs)	Pallet Qty
		White	Standard		
10" Rough-In					
1319BPL	Adriatic Elongated front* (1.28 or 1.6 Gpf / 4.8 or 6.0 Lpf)** ADA	\$231.59	N/A	58	12
Parts and Accessories					
BC	Plastic Bolt Caps Set of two (specify color)	\$1.13	\$1.13		

Colors: WHT - White

\*\*When using a 1.28 flush valve.



1319 Adriatic Elongated Front 10" Rough-in

Adriatic

- 1.28 or 1.6 Gpf / 4.8 Lpf or 6.0 Lpf
- SmartHeight (17" high bowl)
- 1-1/2" top spud or 1-1/2" rear spud
- Perfect for clinical applications



Model Number	Description	List Price		Approx Ship Wt (lbs)	Pallet Qty
		White	Standard		
10" Rough-In					
1319	Adriatic Elongated front* (1.28 or 1.6 Gpf / 4.8 or 6.0 Lpf)** ADA	\$220.68	N/A	58	12
1319RS	Adriatic Elongated front* with Rear Spud** ADA	\$232.04	N/A	58	12
Parts and Accessories					
Flushometer Valves (top spud toilets) (see page 40)					
FM-T2	Flushometer Valve for 1.28 Gpf	\$192.16	N/A		
BC	Plastic Bolt Caps Set of two (specify color)	\$1.13	\$1.13		

Colors: WHT - White

\*\*When using a 1.28 flush valve.

Commercial Elementary & Flushometer Toilets



FLUSHOMETER TOILETS – FLOOR-MOUNT



### Baltic

- 1.28 or 1.6 Gpf / 4.8 Lpf or 6.0 Lpf
- 1-1/2" top spud
- Specifically designed for industrial and commercial applications



Model Number	Description	List Price		Approx Ship Wt (lbs)	Pallet Qty
		White	Standard		
10" Rough-In					
<b>1311NS</b>	Baltic Elongated front* (1.28 or 1.6 Gpf / 4.8 or 6.0 Lpf)**	\$163.81	\$215.01	47	12
<b>Parts and Accessories</b>					
<b>Flushometer Valves (top spud toilets) (see page 40)</b>					
<b>FM-T2</b>	Flushometer Valve for 1.28 Gpf	\$192.16	N/A		
<b>BC</b>	Plastic Bolt Caps Set of two (specify color)	\$1.13	\$1.13		
Colors: WHT - White Standard: BISC - Biscuit, BONE - Bone <span style="float: right;">**When using a 1.28 flush valve.</span>					

ELONGATED FRONT



1311NS Baltic Elongated Front 10" Rough-in

FLUSHOMETER TOILETS – FLOOR-MOUNT BACK OUTLET



### 1312

- 1.28 or 1.6 Gpf / 4.8 or 6.0 Lpf
- Rear outlet, floor-mount
- Specifically designed for industrial and commercial applications



Model Number	Description	List Price		Approx Ship Wt (lbs)	Pallet Qty
		White	Standard		
Rear Outlet, Floor Mount					
<b>1312</b>	Elongated front* (1.28 or 1.6 Gpf / 4.8 or 6.0 Lpf)**	\$361.43	N/A	61	9
<b>Parts and Accessories</b>					
<b>Flushometer Valves (top spud toilets) (see page 40)</b>					
<b>FM-T2</b>	Flushometer Valve for 1.28 Gpf	\$192.16	N/A		
Colors: WHT - White <span style="float: right;">**When using a 1.28 flush valve.</span>					

ELONGATED FRONT



1312 Elongated Front



### 1313 ADA

- 1.28 or 1.6 Gpf / 4.8 or 6.0 Lpf
- Rear outlet, floor-mount
- Specifically designed for industrial and commercial applications



Model Number	Description	List Price		Approx Ship Wt (lbs)	Pallet Qty
		White	Standard		
Rear Outlet, Floor Mount					
<b>1313</b>	Elongated front* 16-1/2" high (1.28 or 1.6 Gpf / 4.8 or 6.0 Lpf)** <b>ADA</b>	\$431.44	N/A	66	9
<b>Parts and Accessories</b>					
<b>Flushometer Valves (top spud toilets) (see page 40)</b>					
<b>FM-T2</b>	Flushometer Valve for 1.28 Gpf	\$192.16	N/A		
Colors: WHT - White <span style="float: right;">**When using a 1.28 flush valve.</span>					

ELONGATED FRONT



1313 ADA Elongated Front

\* Less flushometer valve, toilet seat and supply

Commercial Flushometer Toilets

**FLUSHOMETER TOILETS – WALL-MOUNT BACK OUTLET**



ELONGATED FRONT  
1301BPL Erie Elongated Front

**Erie 1301 BPL**



- 1.28 or 1.6 Gpf / 4.8 Lpf or 6.0 Lpf
- 1-1/2" top spud
- Bedpan lugs
- Perfect for clinical applications

Model Number	Description	List Price		Approx Ship Wt (lbs)	Pallet Qty
		White	Standard		
1301BPL	Erie Elongated front *(1.28 or 1.6 Gpf / 4.8 or 6.0 Lpf)** ADA with built-in bedpan lugs	\$166.45	N/A	54	12

Colors: WHT - White

\*\*When using a 1.28 flush valve.



ELONGATED FRONT  
1301 Erie Elongated Front

**Erie 1301**



- 1.28 or 1.6 Gpf / 4.8 Lpf or 6.0 Lpf
- 1-1/2" top spud
- Perfect for clinical applications.

Model Number	Description	List Price		Approx Ship Wt (lbs)	Pallet Qty
		White	Standard		
1301	Erie Elongated front* (1.28 or 1.6 Gpf / 4.8 or 6.0 Lpf)** ADA	\$146.50	N/A	54	12

**Parts and Accessories**

**Flushometer Valves (top spud toilets) (see page 40)**

Model Number	Description	White	Standard	Approx Ship Wt (lbs)	Pallet Qty
FM-T2	Flushometer Valve for 1.28 Gpf	\$192.16	N/A		

Colors: WHT - White

\*\*When using a 1.28 flush valve.

\* Less flushometer valve, toilet seat and supply

URINALS



### Cascade™

- Half-stall, wall-mount, washdown (.5 Gpf) urinal with extended shields
- 18-3/8" x 26-7/8" x 14-3/4"
- Integral trap
- Includes 3/4" top spud, 2" outlet spud and gaskets, two concealed hangers and bolts



Model Number	Description	List Price		Approx Ship Wt (lbs)	Pallet Qty
		White	Standard		
410HE	Cascade™ Half-stall, wall-mount, wash down urinal with shields* ADA	\$306.07	N/A	61	12
410HERS	Cascade™ Half-stall, rear spud*	\$316.16	N/A	61	12
Parts and Accessories					
FM-U5	Flushometer Valve for 0.5 Gpf (see page 40)	\$192.16			
471-3265	Urinal Hanger (requires two)	Each \$0.99			
531-0017	Rear Outlet Urinal Spud Kit – 1-1/2" cast brass top urinal spud	\$26.93			
24	Urinal Top Spud – 1" x 3/4" cast brass top urinal spud	\$6.85			

Colors: WHT - White



### Brevity®

- Wall-mount, washdown (.125 Gpf / .4732 Lpf) urinal with extended sides
- 14-1/2" x 24-3/8"
- Flushing rim and integral trap
- Includes 2" outlet spud and hanger



Model Number	Description	List Price		Approx Ship Wt (lbs)	Pallet Qty
		White	Standard		
422	Brevity® ADA* (14-1/2" x 24-3/8") ADA	\$280.47	N/A	39	18
422RS	Brevity® rear spud ADA* (14-1/2" x 24-3/8") ADA	\$290.94	N/A	39	18
Parts and Accessories					
FM-U8	Flushometer Valve for 1 pint (see page 40)	\$192.16			

Colors: WHT - White



### Suburban™

- Siphon-jet, wall-mount (1.0 Gpf / 3.8 Lpf) urinal
- 14" x 21-1/4" x 14"
- Integral trap
- Includes 3/4" top spud and hanger



Model Number	Description	List Price		Approx Ship Wt (lbs)	Pallet Qty
		White	Standard		
475	Suburban™ Siphon-jet, wall-mount urinal* ADA	\$197.83	\$247.45	35	18
Parts and Accessories					
471-3261	Urinal Hanger	\$4.12			
531-0016	Rear Outlet Urinal Spud Kit – 1-1/2" cast brass top urinal spud	\$24.30			
24	Urinal Top Spud – 1" x 3/4" cast brass top urinal spud	\$6.85			

Colors: WHT - White Standard: BISC - Biscuit, BONE - Bone



### Adam HE

- Wash down (0.5 Gpf / 1.9 Lpf) urinal
- 13-5/8" x 19-1/2" x 13-1/4"
- 1-1/2" spud outlet
- Includes 3/4" top spud and hanger



Model Number	Description	List Price		Approx Ship Wt (lbs)	Pallet Qty
		White	Standard		
401HE	Adam Wash down urinal*	\$125.01	\$161.68	60	28
Parts and Accessories					
FM-U5	Flushometer Valve for 0.5 Gpf (see page 40)	\$192.16			
471-3261	Urinal Hanger	\$4.12			
23	Flushometer Bowl & Urinal Spuds – 1/2" x 1-1/2" cast brass bottom urinal spud or top bowl spud	\$5.61			
24	Urinal Top Spud – 1" x 3/4" cast brass top urinal spud	\$6.85			

Colors: WHT - White Standard: BISC - Biscuit, BONE - Bone

\* Less flushometer valve and supply

Commercial Urinals

WALL-MOUNT LAVATORIES



315 Wheelchair

Wheelchair

- 20" x 27" Wall-mount lavatory with concealed front overflow
- Basin: 13-1/4" x 12-3/4"
- Available in 4" and 8" faucet centers — Drilled for concealed arm carrier\*\*



Model Number	Description	List Price		Approx Ship Wt (lbs)	Pallet Qty
		White	Standard		
<b>315 Wheelchair</b>					
315-4	Wall-mount lavatory (4" faucet center)	\$267.66	N/A	50	20
315-8	Wall-mount lavatory (8" faucet center)	\$267.66	N/A	50	20
315-LO	Wall-mount lavatory less overflow (4" & 8")	\$267.66	N/A	50	20

\*\* Concealed arm carrier required

Colors: WHT - White



2040 Pamlico Shroud

Pamlico Shroud®

- 21-1/4" x 22" wall-mount lavatory with optional shroud pedestal
- Available in single, 4" and 8" faucet centers
- Perfect for clinical applications



Model Number	Description	List Price		Approx Ship Wt (lbs)	Pallet Qty
		White	Standard		
2040	Pamlico Combination lavatory and shroud	\$298.20	N/A	47	-
2038-1	Lavatory (single hole)	\$178.92	N/A	37	20
2038-4	Lavatory (4" faucet center)	\$178.92	N/A	37	20
2038-8	Lavatory (8" faucet center)	\$178.92	N/A	37	20
2038-LO	Lavatory less overflow (4" & 8")	\$178.92	N/A	37	20
2039	Shroud pedestal	\$119.27	N/A	10	96

Colors: WHT - White



2018HBNS Grande Isle

Grande Isle

- 22" x 18-1/8" Wall-mount lavatory with backsplash and concealed front overflow
- Basin: 16" x 10-5/8"
- Includes hanger
- Available in single, 4" and 8" faucet centers — Drilled for concealed arm carrier\*\*



Model Number	Description	List Price		Approx Ship Wt (lbs)	Pallet Qty
		White	Standard		
<b>2018HBNS Grande Isle</b>					
2018HBNS -1	Wall-mount lavatory (single hole)	\$105.29	N/A	37	24
2018HBNS-4	Wall-mount lavatory (4" faucet center)	\$105.29	N/A	37	24
2018HBNS-8	Wall-mount lavatory (8" faucet center)	\$105.29	\$126.37	37	24
2018HBNS-LO	Wall-mount lavatory less overflow (4" & 8")	\$105.29	N/A	37	24

\*\* Concealed arm carrier required

Colors: WHT - White Standard: BISC - Biscuit, BONE - Bone



2018C Cape Charles

Cape Charles

- 21" x 18-1/4" Wall-mount lavatory with concealed front overflow
- Basin: 17" x 12-5/8"
- Includes hanger



Model Number	Description	List Price		Approx Ship Wt (lbs)	Pallet Qty
		White	Standard		
<b>2018C Cape Charles</b>					
2018C-4	Wall-mount lavatory (4" faucet center) <b>Not available in biscuit</b>	N/A	\$111.17	37	20
2018C-8	Wall-mount lavatory (8" faucet center)	\$92.64	N/A	37	20

Colors: WHT - White Standard: BISC - Biscuit, BONE - Bone

Commercial Wall-Mount Lavatories

WALL-MOUNT LAVATORIES



2008 Walnut Knoll

**Walnut Knoll**

- 21" x 18-3/4" Wall-mount lavatory with backsplash and concealed front overflow
- Basin: 16" x 10-3/4"
- Includes hanger
- Available in 4" faucet center — Drilled for concealed arm carrier\*\*



Model Number	Description	List Price		Approx Ship Wt (lbs)	Pallet Qty
		White	Standard		
<b>2008 Walnut Knoll</b>					
2008-4	Wall-mount lavatory (4" faucet center)	\$86.01	N/A	37	20
Colors: WHT - White					

\*\* Concealed arm carrier required



1613NS Spruce Cove

**Spruce Cove**

- 16-1/8" x 13-1/4" Wall-mount, compact lavatory with concealed front overflow
- Basin: 13-1/4" x 8"
- Includes hanger
- Available in 4" faucet center



Model Number	Description	List Price		Approx Ship Wt (lbs)	Pallet Qty
		White	Standard		
<b>1613NS Spruce Cove</b>					
1613NS-4	Wall-mount, compact lavatory (4" faucet center)	\$84.78	N/A	22	24
Colors: WHT - White					



1917C Willow Run

**Willow Run**

- 19-1/2" x 16-3/4" Wall-mount lavatory with concealed front overflow
- Basin: 13-1/2" x 10"
- Includes hanger
- Available in 4" faucet center



Model Number	Description	List Price		Approx Ship Wt (lbs)	Pallet Qty
		White	Standard		
<b>1917C Willow Run</b>					
1917C-4	Wall-mount lavatory (4" faucet center)	\$83.79	\$101.73	38	20
1917C-L0	Wall-mount lavatory less overflow (4")	\$83.79	N/A	38	20
<b>Parts and Accessories</b>					
471-3261	Urinal/Lavatory Hanger One-piece, durable metal, adjustable For use on model 1613NS, 1917C, 2008 and 2018C lavatories	\$4.12		See pages 108-121	
Colors: WHT - White Standard: BISC - Biscuit, BONE - Bone					

CLINICAL SINK



3072 Medajeon

**Medajeon®**

- 20" x 24-1/2" clinical sink
- Blowout flushing action
- 6.5 Gpf / 24.5 Lpf (using proper flush valve)
- Optional stainless steel rim guard



Model Number	Description	List Price		Approx Ship Wt (lbs)	Pallet Qty
		White	Standard		
3072	Clinical Sink	\$1,328.00	N/A	68	12
872	Rim Guard (Set of 3)	\$93.37	N/A	-	1
Colors: WHT - White					



## FLUSHOMETER VALVES AND PACKAGES



Flushometer Valve – Toilets



Flushometer Valve – Urinals

### DuraFlo®

- Diaphragm style flushometer valve
- Filter protected timing orifice
- High luster chrome-plated finish
- Long lasting elastomeric materials

Model Number	Description	Part Number	List Price
<b>Flushometer Toilets</b>			
<b>FM-T2</b>	Flushometer Valve for 1.28 Gpf	<b>025220000</b>	\$192.16
<b>Flushometer Urinals</b>			
<b>FM-U8</b>	Flushometer Valve for 1 pint	<b>025180000</b>	\$192.16
<b>FM-U5</b>	Flushometer Valve for 0.5 Gpf	<b>025150000</b>	\$192.16

### Commercial Packages "M-1 Series"

Complete Kits Include:

- DuraFlo flushometer valve
- Commercial toilet seat (bowls)
- Hangers (urinals)
- Mansfield commercial bowl or urinal
- Flange bolts (bowls)
- Wax ring (floor-mount toilets)

Model Number	Description	Part Number	List Price
<b>M-1 Commercial Toilet Packages</b>			
<b>CP-1319-128</b>	Adriatic Commercial Package - ADA 1.28 GPF bowl	<b>131900089</b>	\$465.49
<b>CP-1311-128</b>	Baltic Commercial Package - ADA 1.28 GPF bowl	<b>131100089</b>	\$408.63
<b>CP-1312-128</b>	1312 Commercial Package - 1.28 GPF bowl	<b>131200089</b>	\$606.25
<b>CP-1313-128</b>	1313 Commercial Package - 1.28 GPF bowl	<b>131300089</b>	\$676.26
<b>CP-1301-128</b>	Erie Commercial Package - ADA 1.28 GPF bowl	<b>130100089</b>	\$391.33
<b>M-1 Commercial Urinal Packages</b>			
<b>CP-410-05</b>	Cascade Commercial Package - 0.5 GPF urinal & valve kit	<b>410010059</b>	\$498.97
<b>CP-422-125</b>	Brevity ADA Commercial Package - .125 GPF urinal & valve kit	<b>422010029</b>	\$473.37

### DuraFlo Parts

Relief valve and diaphragm ring are color-coded based on flush volume.

Model Number	Description	Color	List Price
<b>630-2511</b>	Pak Diaphragm FM-U1 (1 Gpf)	Yellow	\$44.17
<b>630-2515</b>	Pak Diaphragm FM-U5 (.5 Gpf)	Blue	\$44.17
<b>630-2518</b>	Pak Diaphragm FM-U8 (1 Pint)	Black	\$44.17
<b>630-2522</b>	Pak Diaphragm FM-T2 (1.28 Gpf)	Green	\$44.17
<b>630-2526</b>	Pak Diaphragm FM-T2 (1.6 Gpf)	Grey	\$44.17
<b>630-1681</b>	Pak Handle FM Series	-	\$36.13
<b>630-6601</b>	Pak Control Stop FM Series	-	\$36.34
<b>630-9291</b>	Pak Vacuum Breaker FM Series	-	\$7.07
<b>225-2511</b>	Stop Cap Control - 5 Pack	-	\$6.58



Diaphragm



Handle



Stop Cap Control



Control Stop



Vacuum Breaker

# BATHWARE – Showroom Series

SHOWROOM SERIES

# *mansfield* Cast Acrylic Whirlpool and Bath Systems

## Swirl-way® Whirlpools and Baths

*Relax in a luxurious whirlpool or bathtub rich with features and options perfectly designed to match your décor and budget.*

*Swirl-way®*

### Bathtub Standard Features include:

- Easy-to-clean, high-gloss Cast Acrylic surface
- Decorative handles on available models
- Pillow(s)
- Pre-leveled legs
- Limited 10-year warranty

### Option to ensure a prolonged, warm bathing experience:

Constant Heat water heater

**Options to make installation easier:** removable apron, cable drain, factory-installed nailing flange or nail flange kit for field installation

### Whirlpool Basic Package Features:

- All of the bathtub standard features listed above
- Easy-to-use, one button electronic keypad
- Single speed pump
- Individually adjustable back and body jets to increase and decrease volume
- Color-match trim

**Options:** Inline water heater, cable drain, metal finish trim, factory-installed nailing flange or nail flange kit for field installation

### Whirlpool Luxury Package Features:

- All of the bathtub standard features listed above
- Multi-function electronic keypad with digital display indicates water temperature, pump speed and time remaining in 20-minute cycle
- Variable speed pump
- Individually adjustable back and body jets to increase and decrease volume
- Chromatherapy color light system
- Inline water heater
- Metal finish trim (specify upon ordering)

**Options:** Cable drain, factory-installed nailing flange or nail flange kit for field installation

### A Custom Tailored, Perfect-for-you Massage

The **Hydro-V™ Backjet System** features six or eight jets strategically placed to provide the ultimate therapy for your back. Four to six jets target the shoulder blades, upper and middle back muscles while the bottom two jets give your lower back an invigorating wave of direct hydrotherapy. The volume of each jet is individually adjustable, allowing you to customize the massage to your preference by turning the jet ring clockwise or counter-clockwise to increase or decrease the amount of flow.

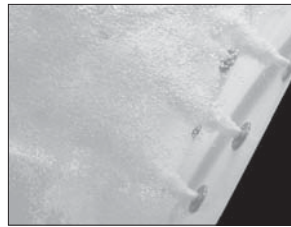

The **Swirl-way® body jet** allows you to adjust both direction and flow of powerful, soothing water. Simply turn the jet ring clockwise or counter-clockwise to increase or decrease the amount of flow ... and you can move the jet nozzle to pinpoint an exact area of your body designated for a custom massage.



## *MicroDerm™* THERAPEUTIC BATH

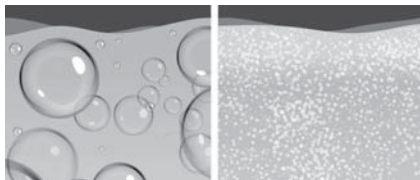

**MicroDerm™ Therapeutic Baths** combine the relaxing elements of bathing with therapeutic benefits that rejuvenate the skin. How does it work? The MicroDerm™ system silently immerses you in millions of oxygen-rich, magnetically-charged microbubbles that clean, exfoliate, soften and rejuvenate your skin, leaving it feeling relaxed and refreshed.

### Standard Features:

- Easy-to-clean, high-gloss Cast Acrylic surface
- Two microbubble jet ports
- Decorative handles on available models
- Pillow(s)
- Pre-leveled legs
- Limited 10-year warranty

**Options:** Removable apron, cable drain, factory-installed nailing flange or nail flange kit for field installation

# *mansfield* Cast Acrylic Whirlpool and Bath Systems

## Ariance® Air Massage Baths

*Enjoy your own oasis of comfort as our air massage baths immerse you and soothe away the stresses of everyday life. Choose from one of three massage systems to customize your hydrotherapy massage: HealthTouch™, GentleTouch™ or Dual Therapy.*



### Standard Features:

- **Electronic keypad** with multi-functions controls on/off, speed up or down, wave/pulse mode, light and heated backrest
- **Heated air blower** with sound suppressing features
- **PerfectBack™ System** – air is released from air holes or injectors in the back area for a therapeutic back massage
- **Chromatherapy System** - Seven healing light settings with full color spectrum sequencing mode
- **Automatic Purge System** - Two-minute automatic purge and dry cycle removes remaining water droplets and begins the drying process
- **Pillow(s)**
- **Decorative handles** on available models
- **Metal finish trim** for handles and injectors (available for GentleTouch™ and DualTherapy™ systems)

**Options:** Removable apron, cable drain, factory-installed nailing flange or nail flange kit for field installation

**HealthTouch™** - Benefit from a powerful and rigorous hydrotherapy massage designed to relax your muscles and body. Air bursts through side wall holes from the air channel create 46 to 63 side, back and foot jets for a full body experience. When it's time to leave the tub, the side-mounted QuickDrain™ channel system has smooth inner channels with radius corners and dual drain down ports to deliver superior cleanliness and reduce water retention.

**GentleTouch™** - Less forceful than the HealthTouch™ system, the GentleTouch™ system features multiple air injectors that create effervescent air streams and immerse you in a delightful, tranquil massage. Ergonomic injector placement throughout the bath ensures the delivery of full body, back, leg and foot hydrotherapy.

**DualTherapy™** – The best of both worlds, DualTherapy™ air massage baths feature both the HealthTouch™ air channel system and the GentleTouch™ air injector system. A multi-function keypad gives you flexibility to control each system individually or synchronized and operating together.

## PRO-FIT® Builder Series Bathware

### PRO-FIT® Whirlpools and Bathtubs

Enjoy luxurious style matched perfectly with installation flexibility and solid value in this line of reliable bathing products.

#### Whirlpool and Bathtub Standard Features:

- Easy-to-clean, high-gloss Cast Acrylic surface
- Six powerful, fully adjustable jets
- Single speed pump
- Simple air switch operation
- Pre-leveled legs
- Limited 2-year warranty

**Options:** Inline water heater, lift-and-turn drain, metal finish trim, removable apron, factory installed nailing flange or nail flange kit for field installation

**PRO-FIT® Whirlpools have fully-adjustable jets** to allow you complete control of your water massage. Increase or decrease the forcefulness of the water by turning the jet face clockwise and counter clockwise. Also, the jet nozzle can be moved to change the direction of air flow and water from each jet to pinpoint a direct area of massage.

### PRO-FIT® Air massage bathtubs

Relax with air bursts through holes in the side wall from the air channel that creates a powerful, invigorating hydro-massage. PRO-FIT® air massage baths offer quality and solid value, simple style, installation flexibility and reliable performance.

#### Standard Features:

- Easy-to-clean, high-gloss Cast Acrylic surface
- Three speed, heated blower
- Simple air switch operation
- Pre-leveled legs
- Limited 2-year warranty

**Options:** Metal finish air switch, lift-and-turn drain, removable apron, factory-installed nailing flange or nail flange kit for field installation

## SHOWROOM SERIES – BATHTUBS / WHIRLPOOL SYSTEMS / AIR SYSTEMS / MICROBUBBLE SYSTEMS



### Avalon

71-3/4" x 40-1/2" x 29"

Oval model with its uniquely engineered design and contoured back and arm supports, gives the bather an unrivaled, relaxing bathing experience. Includes one pillow.

Water Capacity: Minimum Capacity: 75 gal. Maximum Capacity: 90 gal.



Number	Model	Dimensions	Approx. Ship Wt (lbs)	PKG Dimensions	List Price	
					Standard	Premium
<b>Bathtub</b>						
5581	SWIRL-WAY® BATHTUB	71-3/4" x 40-1/2" x 29"	110	75-1/2" x 46-3/8" x 30-1/4"	\$1,468.00	\$1,708.00
<b>Whirlpool Systems</b>						
5081BAS	SWIRL-WAY® BASIC	71-3/4" x 40-1/2" x 29"	152	75-1/2" x 46-3/8" x 30-1/4"	\$2,903.00	\$3,143.00
5081LUX	SWIRL-WAY® LUXURY	71-3/4" x 40-1/2" x 29"	152	75-1/2" x 46-3/8" x 30-1/4"	\$4,663.00	\$4,903.00
<b>Air Systems</b>						
9081	ARIANCE® HealthTouch™	71-3/4" x 40-1/2" x 29"	180	75-1/2" x 46-3/8" x 30-1/4"	\$3,349.00	\$3,589.00
9181	ARIANCE® GentleTouch™	71-3/4" x 40-1/2" x 29"	180	75-1/2" x 46-3/8" x 30-1/4"	\$3,641.00	\$3,881.00
9281	ARIANCE® DualTherapy™	71-3/4" x 40-1/2" x 29"	195	75-1/2" x 46-3/8" x 30-1/4"	\$5,153.00	\$5,393.00
<b>Microbubble System</b>						
5281	MICRODERM™ Therapeutic Bath	71-3/4" x 40-1/2" x 29"	152	75-1/2" x 46-3/8" x 30-1/4"	\$3,318.00	\$3,558.00
<b>Options and Accessories</b>						
Number	Model	Dimensions	Approx. Ship Wt (lbs)	PKG Dimensions	List Price	
<b>Common Options</b>						
SW1319	Cable Drain - Standard Colors	-	4	16" x 7" x 4"	\$132.00	
SW1320	Cable Drain - Polished Chrome	-	4	16" x 7" x 4"	\$174.00	
SW1321	Cable Drain - Everbrass (PVD)	-	4	16" x 7" x 4"	\$313.00	
SW1322	Cable Drain - Brushed Nickel	-	4	16" x 7" x 4"	\$313.00	
SW1323	Cable Drain - Oil Rubbed Bronze	-	4	16" x 7" x 4"	\$334.00	
SWA100	"Rainbow" Pillow	-	4	14" x 8" x 2"	\$57.00	
<b>Whirlpool Options</b>						
SWP151	In-line water heater (factory installed)	-	-	-	\$533.00	
<b>Metal trim upgrade:</b>						
SW1335	Chrome	-	-	-	\$366.00	
SW1336	Everbrass (PVD)	-	-	-	\$366.00	
SW1337	Brushed Nickel	-	-	-	\$366.00	
SW1338	Oil Rubbed Bronze	-	-	-	\$392.00	
<b>Air Bath Options</b>						
AR1200	Blower relocation kit	-	4	14" x 14" x 4"	\$169.00	
<b>Metal trim kit:</b>						
AR1335	Chrome	-	-	-	\$366.00	
AR1336	Everbrass (PVD)	-	-	-	\$366.00	
AR1337	Brushed Nickel	-	-	-	\$366.00	
AR1338	Oil Rubbed Bronze	-	-	-	\$392.00	
<b>Bathtub Options</b>						
RS151	Constant heat system	-	-	-	\$533.00	
<b>Colors: See chart on inside back cover</b>						

**SHOWROOM SERIES – BATHTUBS / WHIRLPOOL SYSTEMS / AIR SYSTEMS / MICROBUBBLE SYSTEMS**



**Elba OV**

**59-1/2" x 42" x 23"**

This oval model adds versatility to any bathroom with a flat deck, allowing for undermounting or a simple drop-in installation. Also, plenty of room for mounting faucets. Includes one pillow.

Water Capacity: Minimum Capacity: 50 gal. Maximum Capacity: 70 gal.



Number	Model	Dimensions	Approx. Ship Wt (lbs)	PKG Dimensions	List Price	
					Standard	Premium
<b>Bathtub</b>						
5585	SWIRL-WAY® BATHTUB	59-1/2" x 42" x 23"	110	65-1/2" x 47-1/4" x 24"	\$1,386.00	\$1,626.00
<b>Whirlpool Systems</b>						
5085BAS	SWIRL-WAY® BASIC	59-1/2" x 42" x 23"	155	65-1/2" x 47-1/4" x 24"	\$2,703.00	\$2,943.00
5085LUX	SWIRL-WAY® LUXURY	59-1/2" x 42" x 23"	155	65-1/2" x 47-1/4" x 24"	\$4,463.00	\$4,703.00
<b>Air Systems</b>						
9085	ARIANCE® HealthTouch™	59-1/2" x 42" x 23"	155	65-1/2" x 47-1/4" x 24"	\$3,283.00	\$3,523.00
9185	ARIANCE® GentleTouch™	59-1/2" x 42" x 23"	155	65-1/2" x 47-1/4" x 24"	\$3,576.00	\$3,816.00
9285	ARIANCE® DualTherapy™	59-1/2" x 42" x 23"	170	65-1/2" x 47-1/4" x 24"	\$4,926.00	\$5,166.00
<b>Options and Accessories</b>						
Number	Model	Dimensions	Approx. Ship Wt (lbs)	PKG Dimensions	List Price	
<b>Common Options</b>						
SW1319	Cable Drain - Standard Colors	-	4	16" x 7" x 4"	\$132.00	
SW1320	Cable Drain - Polished Chrome	-	4	16" x 7" x 4"	\$174.00	
SW1321	Cable Drain - Everbrass (PVD)	-	4	16" x 7" x 4"	\$313.00	
SW1322	Cable Drain - Brushed Nickel	-	4	16" x 7" x 4"	\$313.00	
SW1323	Cable Drain - Oil Rubbed Bronze	-	4	16" x 7" x 4"	\$334.00	
SWA100	"Rainbow" Pillow	-	4	14" x 8" x 2"	\$57.00	
<b>Whirlpool Options</b>						
SWP151	In-line water heater (factory installed)	-	-	-	\$533.00	
<b>Metal trim upgrade:</b>						
SW1335	Chrome	-	-	-	\$366.00	
SW1336	Everbrass (PVD)	-	-	-	\$366.00	
SW1337	Brushed Nickel	-	-	-	\$366.00	
SW1338	Oil Rubbed Bronze	-	-	-	\$392.00	
<b>Air Bath Options</b>						
AR1200	Blower relocation kit	-	4	14" x 14" x 4"	\$169.00	
<b>Metal trim kit:</b>						
AR1335	Chrome	-	-	-	\$366.00	
AR1336	Everbrass (PVD)	-	-	-	\$366.00	
AR1337	Brushed Nickel	-	-	-	\$366.00	
AR1338	Oil Rubbed Bronze	-	-	-	\$392.00	
<b>Bathtub Options</b>						
RS151	Constant heat system	-	-	-	\$533.00	
<b>Colors: See chart on inside back cover</b>						



## SHOWROOM SERIES – BATHTUBS / WHIRLPOOL SYSTEMS / AIR SYSTEMS / MICROBUBBLE SYSTEMS



### Enso® 4272

72" x 42" x 22-1/4"

Drop-in or undermount this oval model with clean, organic lines and dual backjets. Includes two pillows.

Water Capacity: Minimum Capacity: 40 gal. Maximum Capacity: 62 gal.



Number	Model	Dimensions	Approx. Ship Wt (lbs)	PKG Dimensions	List Price	
					Standard	Premium
<b>Bathtub</b>						
5595	SWIRL-WAY® BATHTUB	72" x 42" x 22-1/4"	140	77-1/2" x 47-1/4" x 24"	\$1,468.00	\$1,708.00
<b>Whirlpool Systems</b>						
5095BAS	SWIRL-WAY® BASIC	72" x 42" x 22-1/4"	180	77-1/2" x 47-1/4" x 24"	\$2,903.00	\$3,143.00
5095LUX	SWIRL-WAY® LUXURY	72" x 42" x 22-1/4"	180	77-1/2" x 47-1/4" x 24"	\$4,663.00	\$4,903.00
<b>Air Systems</b>						
9095	ARIANCE® HealthTouch™	72" x 42" x 22-1/4"	180	77-1/2" x 47-1/4" x 24"	\$3,557.00	\$3,797.00
9195	ARIANCE® GentleTouch™	72" x 42" x 22-1/4"	180	77-1/2" x 47-1/4" x 24"	\$3,738.00	\$3,978.00
9295	ARIANCE® DualTherapy™	72" x 42" x 22-1/4"	195	77-1/2" x 47-1/4" x 24"	\$5,153.00	\$5,393.00
<b>Options and Accessories</b>						
Number	Model	Dimensions	Approx. Ship Wt (lbs)	PKG Dimensions	List Price	
<b>Common Options</b>						
SW1319	Cable Drain - Standard Colors	-	4	16" x 7" x 4"	\$132.00	
SW1320	Cable Drain - Polished Chrome	-	4	16" x 7" x 4"	\$174.00	
SW1321	Cable Drain - Everbrass (PVD)	-	4	16" x 7" x 4"	\$313.00	
SW1322	Cable Drain - Brushed Nickel	-	4	16" x 7" x 4"	\$313.00	
SW1323	Cable Drain - Oil Rubbed Bronze	-	4	16" x 7" x 4"	\$334.00	
SWA100	"Rainbow" Pillow	-	4	14" x 8" x 2"	\$57.00	
<b>Whirlpool Options</b>						
SWP151	In-line water heater (factory installed)	-	-	-	\$533.00	
<b>Metal trim upgrade:</b>						
SW1335	Chrome	-	-	-	\$366.00	
SW1336	Everbrass (PVD)	-	-	-	\$366.00	
SW1337	Brushed Nickel	-	-	-	\$366.00	
SW1338	Oil Rubbed Bronze	-	-	-	\$392.00	
<b>Air Bath Options</b>						
AR1200	Blower relocation kit	-	4	14" x 14" x 4"	\$169.00	
<b>Metal trim kit:</b>						
AR1335	Chrome	-	-	-	\$366.00	
AR1336	Everbrass (PVD)	-	-	-	\$366.00	
AR1337	Brushed Nickel	-	-	-	\$366.00	
AR1338	Oil Rubbed Bronze	-	-	-	\$392.00	
<b>Bathtub Options</b>						
RS151	Constant heat system	-	-	-	\$533.00	
<b>Colors: See chart on inside back cover</b>						

**SHOWROOM SERIES – BATHTUBS / WHIRLPOOL SYSTEMS / AIR SYSTEMS / MICROBUBBLE SYSTEMS**



**Enso<sup>®</sup> 3672**  
72" x 36" x 22-1/4"

Drop-in or undermount this oval model with clean, organic lines and dual backjets. Includes two pillows.

Water Capacity: Minimum Capacity: 35 gal. Maximum Capacity: 54 gal.



Number	Model	Dimensions	Approx. Ship Wt (lbs)	PKG Dimensions	List Price	
					Standard	Premium
<b>Bathtub</b>						
5593	SWIRL-WAY <sup>®</sup> BATHTUB	72" x 36" x 22-1/4"	150	77-1/2" x 41-1/4" x 24"	\$1,386.00	\$1,626.00
<b>Whirlpool Systems</b>						
5093BAS	SWIRL-WAY <sup>®</sup> BASIC	72" x 36" x 22-1/4"	175	77-1/2" x 41-1/4" x 24"	\$2,703.00	\$2,943.00
5093LUX	SWIRL-WAY <sup>®</sup> LUXURY	72" x 36" x 22-1/4"	175	77-1/2" x 41-1/4" x 24"	\$4,462.00	\$4,702.00
<b>Air Systems</b>						
9093	ARIANCE <sup>®</sup> HealthTouch™	72" x 36" x 22-1/4"	175	77-1/2" x 41-1/4" x 24"	\$3,448.00	\$3,688.00
9193	ARIANCE <sup>®</sup> GentleTouch™	72" x 36" x 22-1/4"	175	77-1/2" x 41-1/4" x 24"	\$3,630.00	\$3,870.00
9293	ARIANCE <sup>®</sup> DualTherapy™	72" x 36" x 22-1/4"	190	77-1/2" x 41-1/4" x 24"	\$4,922.00	\$5,162.00
<b>Options and Accessories</b>						
Number	Model	Dimensions	Approx. Ship Wt (lbs)	PKG Dimensions	List Price	
<b>Common Options</b>						
SW1319	Cable Drain - Standard Colors	-	4	16" x 7" x 4"	\$132.00	
SW1320	Cable Drain - Polished Chrome	-	4	16" x 7" x 4"	\$174.00	
SW1321	Cable Drain - Everbrass (PVD)	-	4	16" x 7" x 4"	\$313.00	
SW1322	Cable Drain - Brushed Nickel	-	4	16" x 7" x 4"	\$313.00	
SW1323	Cable Drain - Oil Rubbed Bronze	-	4	16" x 7" x 4"	\$334.00	
SWA100	"Rainbow" Pillow	-	4	14" x 8" x 2"	\$57.00	
<b>Whirlpool Options</b>						
SWP151	In-line water heater (factory installed)	-	-	-	\$533.00	
<b>Metal trim upgrade:</b>						
SW1335	Chrome	-	-	-	\$366.00	
SW1336	Everbrass (PVD)	-	-	-	\$366.00	
SW1337	Brushed Nickel	-	-	-	\$366.00	
SW1338	Oil Rubbed Bronze	-	-	-	\$392.00	
<b>Air Bath Options</b>						
AR1200	Blower relocation kit	-	4	14" x 14" x 4"	\$169.00	
<b>Metal trim kit:</b>						
AR1335	Chrome	-	-	-	\$366.00	
AR1336	Everbrass (PVD)	-	-	-	\$366.00	
AR1337	Brushed Nickel	-	-	-	\$366.00	
AR1338	Oil Rubbed Bronze	-	-	-	\$392.00	
<b>Bathtub Options</b>						
RS151	Constant heat system	-	-	-	\$533.00	
<b>Colors: See chart on inside back cover</b>						

## SHOWROOM SERIES – BATHTUBS / WHIRLPOOL SYSTEMS / AIR SYSTEMS / MICROBUBBLE SYSTEMS



### Enso® 4266

66" x 42" x 22-1/4"

Drop-in or undermount this oval model with clean, organic lines and dual backjets. Includes two pillows.

Water Capacity: Minimum Capacity: 37 gal. Maximum Capacity: 57 gal.



Number	Model	Dimensions	Approx. Ship Wt (lbs)	PKG Dimensions	List Price	
					Standard	Premium
<b>Bathtub</b>						
5594	SWIRL-WAY® BATHTUB	66" x 42" x 22-1/4"	150	71-1/2" x 47-1/4" x 24"	\$1,413.00	\$1,653.00
<b>Whirlpool Systems</b>						
5094BAS	SWIRL-WAY® BASIC	66" x 42" x 22-1/4"	175	71-1/2" x 47-1/4" x 24"	\$2,752.00	\$2,992.00
5094LUX	SWIRL-WAY® LUXURY	66" x 42" x 22-1/4"	175	71-1/2" x 47-1/4" x 24"	\$4,512.00	\$4,752.00
<b>Air Systems</b>						
9094	ARIANCE® HealthTouch™	66" x 42" x 22-1/4"	175	71-1/2" x 47-1/4" x 24"	\$3,502.00	\$3,742.00
9194	ARIANCE® GentleTouch™	66" x 42" x 22-1/4"	175	71-1/2" x 47-1/4" x 24"	\$3,685.00	\$3,925.00
9294	ARIANCE® DualTherapy™	66" x 42" x 22-1/4"	190	71-1/2" x 47-1/4" x 24"	\$5,039.00	\$5,279.00
<b>Options and Accessories</b>						
Number	Model	Dimensions	Approx. Ship Wt (lbs)	PKG Dimensions	List Price	
<b>Common Options</b>						
SW1319	Cable Drain - Standard Colors	-	4	16" x 7" x 4"	\$132.00	
SW1320	Cable Drain - Polished Chrome	-	4	16" x 7" x 4"	\$174.00	
SW1321	Cable Drain - Everbrass (PVD)	-	4	16" x 7" x 4"	\$313.00	
SW1322	Cable Drain - Brushed Nickel	-	4	16" x 7" x 4"	\$313.00	
SW1323	Cable Drain - Oil Rubbed Bronze	-	4	16" x 7" x 4"	\$334.00	
SWA100	"Rainbow" Pillow	-	4	14" x 8" x 2"	\$57.00	
<b>Whirlpool Options</b>						
SWP151	In-line water heater (factory installed)	-	-	-	\$533.00	
<b>Metal trim upgrade:</b>						
SW1335	Chrome	-	-	-	\$366.00	
SW1336	Everbrass (PVD)	-	-	-	\$366.00	
SW1337	Brushed Nickel	-	-	-	\$366.00	
SW1338	Oil Rubbed Bronze	-	-	-	\$392.00	
<b>Air Bath Options</b>						
AR1200	Blower relocation kit	-	4	14" x 14" x 4"	\$169.00	
<b>Metal trim kit:</b>						
AR1335	Chrome	-	-	-	\$366.00	
AR1336	Everbrass (PVD)	-	-	-	\$366.00	
AR1337	Brushed Nickel	-	-	-	\$366.00	
AR1338	Oil Rubbed Bronze	-	-	-	\$392.00	
<b>Bathtub Options</b>						
RS151	Constant heat system	-	-	-	\$533.00	
<b>Colors: See chart on inside back cover</b>						

**SHOWROOM SERIES – BATHTUBS / WHIRLPOOL SYSTEMS / AIR SYSTEMS / MICROBUBBLE SYSTEMS**



**Enso® 3666**  
66" x 36" x 22-1/4"

Drop-in or undermount this oval model with clean, organic lines and dual backjets. Includes two pillows.

Water Capacity: Minimum Capacity: 32 gal. Maximum Capacity: 51 gal.



Number	Model	Dimensions	Approx. Ship Wt (lbs)	PKG Dimensions	List Price	
					Standard	Premium
<b>Bathtub</b>						
5592	SWIRL-WAY® BATHTUB	66" x 36" x 22-1/4"	145	71-1/2" x 41-1/4" x 26"	\$1,359.00	\$1,599.00
<b>Whirlpool Systems</b>						
5092BAS	SWIRL-WAY® BASIC	66" x 36" x 22-1/4"	170	71-1/2" x 41-1/4" x 26"	\$2,653.00	\$2,893.00
5092LUX	SWIRL-WAY® LUXURY	66" x 36" x 22-1/4"	170	71-1/2" x 41-1/4" x 26"	\$4,412.00	\$4,652.00
<b>Air Systems</b>						
9092	ARIANCE® HealthTouch™	66" x 36" x 22-1/4"	170	71-1/2" x 41-1/4" x 26"	\$3,394.00	\$3,634.00
9192	ARIANCE® GentleTouch™	66" x 36" x 22-1/4"	170	71-1/2" x 41-1/4" x 26"	\$3,576.00	\$3,816.00
9292	ARIANCE® DualTherapy™	66" x 36" x 22-1/4"	185	71-1/2" x 41-1/4" x 26"	\$4,809.00	\$5,049.00
<b>Options and Accessories</b>						
Number	Model	Dimensions	Approx. Ship Wt (lbs)	PKG Dimensions	List Price	
<b>Common Options</b>						
SW1319	Cable Drain - Standard Colors	-	4	16" x 7" x 4"	\$132.00	
SW1320	Cable Drain - Polished Chrome	-	4	16" x 7" x 4"	\$174.00	
SW1321	Cable Drain - Everbrass (PVD)	-	4	16" x 7" x 4"	\$313.00	
SW1322	Cable Drain - Brushed Nickel	-	4	16" x 7" x 4"	\$313.00	
SW1323	Cable Drain - Oil Rubbed Bronze	-	4	16" x 7" x 4"	\$334.00	
SWA100	"Rainbow" Pillow	-	4	14" x 8" x 2"	\$57.00	
<b>Whirlpool Options</b>						
SWP151	In-line water heater (factory installed)	-	-	-	\$533.00	
<b>Metal trim upgrade:</b>						
SW1335	Chrome	-	-	-	\$366.00	
SW1336	Everbrass (PVD)	-	-	-	\$366.00	
SW1337	Brushed Nickel	-	-	-	\$366.00	
SW1338	Oil Rubbed Bronze	-	-	-	\$392.00	
<b>Air Bath Options</b>						
AR1200	Blower relocation kit	-	4	14" x 14" x 4"	\$169.00	
<b>Metal trim kit:</b>						
AR1335	Chrome	-	-	-	\$366.00	
AR1336	Everbrass (PVD)	-	-	-	\$366.00	
AR1337	Brushed Nickel	-	-	-	\$366.00	
AR1338	Oil Rubbed Bronze	-	-	-	\$392.00	
<b>Bathtub Options</b>						
RS151	Constant heat system	-	-	-	\$533.00	

Colors: See chart on inside back cover

Bathware - Acrylic Showroom Series

## SHOWROOM SERIES – BATHTUBS / WHIRLPOOL SYSTEMS / AIR SYSTEMS / MICROBUBBLE SYSTEMS



### Essence 4272

71-1/2" x 41-1/2" x 24"

Drop-in, oval model with dual backjets, deck space and integral armrests. Includes two pillows.

Water Capacity: Minimum Capacity: 70 gal. Maximum Capacity: 95 gal.



Number	Model	Dimensions	Approx. Ship Wt (lbs)	PKG Dimensions	List Price	
					Standard	Premium
<b>Bathtub</b>						
5535	SWIRL-WAY® BATHTUB	71-1/2" x 41-1/2" x 24"	160	77-1/2" x 44-1/4" x 26"	\$1,468.00	\$1,708.00
<b>Whirlpool Systems</b>						
5035BAS	SWIRL-WAY® BASIC	71-1/2" x 41-1/2" x 24"	180	77-1/2" x 44-1/4" x 26"	\$2,903.00	\$3,143.00
5035LUX	SWIRL-WAY® LUXURY	71-1/2" x 41-1/2" x 24"	180	77-1/2" x 44-1/4" x 26"	\$4,663.00	\$4,903.00
<b>Air Systems</b>						
9035	ARIANCE® HealthTouch™	71-1/2" x 41-1/2" x 24"	180	77-1/2" x 44-1/4" x 26"	\$3,557.00	\$3,797.00
9135	ARIANCE® GentleTouch™	71-1/2" x 41-1/2" x 24"	180	77-1/2" x 44-1/4" x 26"	\$3,738.00	\$3,978.00
9235	ARIANCE® DualTherapy™	71-1/2" x 41-1/2" x 24"	195	77-1/2" x 44-1/4" x 26"	\$5,153.00	\$5,393.00
<b>Microbubble System</b>						
5235	MICRODERM™ Therapeutic Bath	71-1/2" x 41-1/2" x 24"	180	77-1/2" x 44-1/4" x 26"	\$3,318.00	\$3,558.00
<b>Options and Accessories</b>						
Number	Model	Dimensions	Approx. Ship Wt (lbs)	PKG Dimensions	List Price	
<b>Common Options</b>						
SW1319	Cable Drain - Standard Colors	-	4	16" x 7" x 4"	\$132.00	
SW1320	Cable Drain - Polished Chrome	-	4	16" x 7" x 4"	\$174.00	
SW1321	Cable Drain - Everbrass (PVD)	-	4	16" x 7" x 4"	\$313.00	
SW1322	Cable Drain - Brushed Nickel	-	4	16" x 7" x 4"	\$313.00	
SW1323	Cable Drain - Oil Rubbed Bronze	-	4	16" x 7" x 4"	\$334.00	
SWA100	"Rainbow" Pillow	-	4	14" x 8" x 2"	\$57.00	
<b>Whirlpool Options</b>						
SWP151	In-line water heater (factory installed)	-	-	-	\$533.00	
<b>Metal trim upgrade:</b>						
SW1335	Chrome	-	-	-	\$366.00	
SW1336	Everbrass (PVD)	-	-	-	\$366.00	
SW1337	Brushed Nickel	-	-	-	\$366.00	
SW1338	Oil Rubbed Bronze	-	-	-	\$392.00	
<b>Air Bath Options</b>						
AR1200	Blower relocation kit	-	4	14" x 14" x 4"	\$169.00	
<b>Metal trim kit:</b>						
AR1335	Chrome	-	-	-	\$366.00	
AR1336	Everbrass (PVD)	-	-	-	\$366.00	
AR1337	Brushed Nickel	-	-	-	\$366.00	
AR1338	Oil Rubbed Bronze	-	-	-	\$392.00	
<b>Bathtub Options</b>						
RS151	Constant heat system	-	-	-	\$533.00	
<b>Colors: See chart on inside back cover</b>						

**SHOWROOM SERIES – BATHTUBS / WHIRLPOOL SYSTEMS / AIR SYSTEMS / MICROBUBBLE SYSTEMS**



**Essence 3672**

71-1/2" x 36" x 24"

Drop-in, oval model with dual back jets, deck space and integral armrests. Includes two pillows.

Water Capacity: Minimum Capacity: 65 gal. Maximum Capacity: 80 gal.



Number	Model	Dimensions	Approx. Ship Wt (lbs)	PKG Dimensions	List Price	
					Standard	Premium
<b>Bathtub</b>						
5530	SWIRL-WAY® BATHTUB	71-1/2" x 36" x 24"	150	77-1/2" x 41-1/4" x 26"	\$1,386.00	\$1,626.00
<b>Whirlpool Systems</b>						
5030BAS	SWIRL-WAY® BASIC	71-1/2" x 36" x 24"	175	77-1/2" x 41-1/4" x 26"	\$2,703.00	\$2,943.00
5030LUX	SWIRL-WAY® LUXURY	71-1/2" x 36" x 24"	175	77-1/2" x 41-1/4" x 26"	\$4,463.00	\$4,703.00
<b>Air Systems</b>						
9030	ARIANCE® HealthTouch™	71-1/2" x 36" x 24"	175	77-1/2" x 41-1/4" x 26"	\$3,448.00	\$3,688.00
9130	ARIANCE® GentleTouch™	71-1/2" x 36" x 24"	175	77-1/2" x 41-1/4" x 26"	\$3,630.00	\$3,870.00
9230	ARIANCE® DualTherapy™	71-1/2" x 36" x 24"	190	77-1/2" x 41-1/4" x 26"	\$4,922.00	\$5,162.00
<b>Microbubble System</b>						
5230	MICRODERM™ Therapeutic Bath	71-1/2" x 36" x 24"	175	77-1/2" x 41-1/4" x 26"	\$3,239.00	\$3,479.00
<b>Options and Accessories</b>						
Number	Model	Dimensions	Approx. Ship Wt (lbs)	PKG Dimensions	List Price	
<b>Common Options</b>						
SW1319	Cable Drain - Standard Colors	-	4	16" x 7" x 4"	\$132.00	
SW1320	Cable Drain - Polished Chrome	-	4	16" x 7" x 4"	\$174.00	
SW1321	Cable Drain - Everbrass (PVD)	-	4	16" x 7" x 4"	\$313.00	
SW1322	Cable Drain - Brushed Nickel	-	4	16" x 7" x 4"	\$313.00	
SW1323	Cable Drain - Oil Rubbed Bronze	-	4	16" x 7" x 4"	\$334.00	
SWA100	"Rainbow" Pillow	-	4	14" x 8" x 2"	\$57.00	
<b>Whirlpool Options</b>						
SWP151	In-line water heater (factory installed)	-	-	-	\$533.00	
<b>Metal trim upgrade:</b>						
SW1335	Chrome	-	-	-	\$366.00	
SW1336	Everbrass (PVD)	-	-	-	\$366.00	
SW1337	Brushed Nickel	-	-	-	\$366.00	
SW1338	Oil Rubbed Bronze	-	-	-	\$392.00	
<b>Air Bath Options</b>						
AR1200	Blower relocation kit	-	4	14" x 14" x 4"	\$169.00	
<b>Metal trim kit:</b>						
AR1335	Chrome	-	-	-	\$366.00	
AR1336	Everbrass (PVD)	-	-	-	\$366.00	
AR1337	Brushed Nickel	-	-	-	\$366.00	
AR1338	Oil Rubbed Bronze	-	-	-	\$392.00	
<b>Bathtub Options</b>						
RS151	Constant heat system	-	-	-	\$533.00	

Colors: See chart on inside back cover



## SHOWROOM SERIES – BATHTUBS / WHIRLPOOL SYSTEMS / AIR SYSTEMS / MICROBUBBLE SYSTEMS



### Essence 4266

66" x 41-1/2" x 24"

Drop-in, oval model with dual back jets, deck space and integral armrests. Includes two pillows.

Water Capacity: Minimum Capacity: 75 gal. Maximum Capacity: 90 gal.



Number	Model	Dimensions	Approx. Ship Wt (lbs)	PKG Dimensions	List Price	
					Standard	Premium
<b>Bathtub</b>						
5533	SWIRL-WAY® BATHTUB	66" x 41-1/2" x 24"	155	71-1/2" x 41-1/4" x 26"	\$1,413.00	\$1,653.00
<b>Whirlpool Systems</b>						
5033BAS	SWIRL-WAY® BASIC	66" x 41-1/2" x 24"	175	71-1/2" x 41-1/4" x 26"	\$2,752.00	\$2,992.00
5033LUX	SWIRL-WAY® LUXURY	66" x 41-1/2" x 24"	175	71-1/2" x 41-1/4" x 26"	\$4,512.00	\$4,752.00
<b>Air Systems</b>						
9033	ARIANCE® HealthTouch™	66" x 41-1/2" x 24"	175	71-1/2" x 41-1/4" x 26"	\$3,502.00	\$3,742.00
9133	ARIANCE® GentleTouch™	66" x 41-1/2" x 24"	175	71-1/2" x 41-1/4" x 26"	\$3,685.00	\$3,925.00
9233	ARIANCE® DualTherapy™	66" x 41-1/2" x 24"	190	71-1/2" x 41-1/4" x 26"	\$5,039.00	\$5,279.00
<b>Microbubble System</b>						
5233	MICRODERM™ Therapeutic Bath	66" x 41-1/2" x 24"	175	71-1/2" x 41-1/4" x 26"	\$3,265.00	\$3,505.00
<b>Options and Accessories</b>						
Number	Model	Dimensions	Approx. Ship Wt (lbs)	PKG Dimensions	List Price	
<b>Common Options</b>						
SW1319	Cable Drain - Standard Colors	-	4	16" x 7" x 4"	\$132.00	
SW1320	Cable Drain - Polished Chrome	-	4	16" x 7" x 4"	\$174.00	
SW1321	Cable Drain - Everbrass (PVD)	-	4	16" x 7" x 4"	\$313.00	
SW1322	Cable Drain - Brushed Nickel	-	4	16" x 7" x 4"	\$313.00	
SW1323	Cable Drain - Oil Rubbed Bronze	-	4	16" x 7" x 4"	\$334.00	
SWA100	"Rainbow" Pillow	-	4	14" x 8" x 2"	\$57.00	
<b>Whirlpool Options</b>						
SWP151	In-line water heater (factory installed)	-	-	-	\$533.00	
<b>Metal trim upgrade:</b>						
SW1335	Chrome	-	-	-	\$366.00	
SW1336	Everbrass (PVD)	-	-	-	\$366.00	
SW1337	Brushed Nickel	-	-	-	\$366.00	
SW1338	Oil Rubbed Bronze	-	-	-	\$392.00	
<b>Air Bath Options</b>						
AR1200	Blower relocation kit	-	4	14" x 14" x 4"	\$169.00	
<b>Metal trim kit:</b>						
AR1335	Chrome	-	-	-	\$366.00	
AR1336	Everbrass (PVD)	-	-	-	\$366.00	
AR1337	Brushed Nickel	-	-	-	\$366.00	
AR1338	Oil Rubbed Bronze	-	-	-	\$392.00	
<b>Bathtub Options</b>						
RS151	Constant heat system	-	-	-	\$533.00	
<b>Colors: See chart on inside back cover</b>						

**SHOWROOM SERIES – BATHTUBS / WHIRLPOOL SYSTEMS / AIR SYSTEMS / MICROBUBBLE SYSTEMS**



**Essence 3666**

66" x 36" x 24"

Drop-in, oval model with dual back jets, deck space and integral armrests. Includes two pillows.

Water Capacity: Minimum Capacity: 70 gal. Maximum Capacity: 85 gal.



Number	Model	Dimensions	Approx. Ship Wt (lbs)	PKG Dimensions	List Price	
					Standard	Premium
<b>Bathtub</b>						
5527	SWIRL-WAY® BATHTUB	66" x 36" x 24"	145	71-1/2" x 41-1/4" x 26"	\$1,359.00	\$1,599.00
<b>Whirlpool Systems</b>						
5027BAS	SWIRL-WAY® BASIC	66" x 36" x 24"	170	71-1/2" x 41-1/4" x 26"	\$2,653.00	\$2,893.00
5027LUX	SWIRL-WAY® LUXURY	66" x 36" x 24"	170	71-1/2" x 41-1/4" x 26"	\$4,412.00	\$4,652.00
<b>Air Systems</b>						
9027	ARIANCE® HealthTouch™	66" x 36" x 24"	170	71-1/2" x 41-1/4" x 26"	\$3,645.00	\$3,885.00
9127	ARIANCE® GentleTouch™	66" x 36" x 24"	170	71-1/2" x 41-1/4" x 26"	\$3,937.00	\$4,177.00
9227	ARIANCE® DualTherapy™	66" x 36" x 24"	185	71-1/2" x 41-1/4" x 26"	\$4,809.00	\$5,049.00
<b>Microbubble System</b>						
5227	MICRODERM™ Therapeutic Bath	66" x 36" x 24"	170	71-1/2" x 41-1/4" x 26"	\$3,213.00	\$3,453.00
<b>Options and Accessories</b>						
Number	Model	Dimensions	Approx. Ship Wt (lbs)	PKG Dimensions	List Price	
<b>Common Options</b>						
SW1319	Cable Drain - Standard Colors	-	4	16" x 7" x 4"	\$132.00	
SW1320	Cable Drain - Polished Chrome	-	4	16" x 7" x 4"	\$174.00	
SW1321	Cable Drain - Everbrass (PVD)	-	4	16" x 7" x 4"	\$313.00	
SW1322	Cable Drain - Brushed Nickel	-	4	16" x 7" x 4"	\$313.00	
SW1323	Cable Drain - Oil Rubbed Bronze	-	4	16" x 7" x 4"	\$334.00	
SWA100	"Rainbow" Pillow	-	4	14" x 8" x 2"	\$57.00	
<b>Whirlpool Options</b>						
SWP151	In-line water heater (factory installed)	-	-	-	\$533.00	
<b>Metal trim upgrade:</b>						
SW1335	Chrome	-	-	-	\$366.00	
SW1336	Everbrass (PVD)	-	-	-	\$366.00	
SW1337	Brushed Nickel	-	-	-	\$366.00	
SW1338	Oil Rubbed Bronze	-	-	-	\$392.00	
<b>Air Bath Options</b>						
AR1200	Blower relocation kit	-	4	14" x 14" x 4"	\$169.00	
<b>Metal trim kit:</b>						
AR1335	Chrome	-	-	-	\$366.00	
AR1336	Everbrass (PVD)	-	-	-	\$366.00	
AR1337	Brushed Nickel	-	-	-	\$366.00	
AR1338	Oil Rubbed Bronze	-	-	-	\$392.00	
<b>Bathtub Options</b>						
RS151	Constant heat system	-	-	-	\$533.00	
<b>Colors: See chart on inside back cover</b>						

## SHOWROOM SERIES – BATHTUBS / WHIRLPOOL SYSTEMS / AIR SYSTEMS / MICROBUBBLE SYSTEMS



### Essence 4260

60" x 41-1/2" x 24"

Drop-in, oval model with dual back jets, deck space and integral armrests. Includes two pillows.

Water Capacity: Minimum Capacity: 60 gal. Maximum Capacity: 75 gal.



Number	Model	Dimensions	Approx. Ship Wt (lbs)	PKG Dimensions	List Price	
					Standard	Premium
<b>Bathtub</b>						
5531	SWIRL-WAY® BATHTUB	60" x 41-1/2" x 24"	140	65-1/2" x 47-1/4" x 26"	\$1,386.00	\$1,626.00
<b>Whirlpool Systems</b>						
5031BAS	SWIRL-WAY® BASIC	60" x 41-1/2" x 24"	170	65-1/2" x 47-1/4" x 26"	\$2,703.00	\$2,943.00
5031LUX	SWIRL-WAY® LUXURY	60" x 41-1/2" x 24"	170	65-1/2" x 47-1/4" x 26"	\$4,463.00	\$4,703.00
<b>Air Systems</b>						
9031	ARIANCE® HealthTouch™	60" x 41-1/2" x 24"	170	65-1/2" x 47-1/4" x 26"	\$3,448.00	\$3,688.00
9131	ARIANCE® GentleTouch™	60" x 41-1/2" x 24"	170	65-1/2" x 47-1/4" x 26"	\$3,630.00	\$3,870.00
9231	ARIANCE® DualTherapy™	60" x 41-1/2" x 24"	185	65-1/2" x 47-1/4" x 26"	\$4,926.00	\$5,166.00
<b>Microbubble System</b>						
5231	MICRODERM™ Therapeutic Bath	60" x 41-1/2" x 24"	170	65-1/2" x 47-1/4" x 26"	\$3,239.00	\$3,479.00
<b>Options and Accessories</b>						
Number	Model	Dimensions	Approx. Ship Wt (lbs)	PKG Dimensions	List Price	
<b>Common Options</b>						
SW1319	Cable Drain - Standard Colors	-	4	16" x 7" x 4"	\$132.00	
SW1320	Cable Drain - Polished Chrome	-	4	16" x 7" x 4"	\$174.00	
SW1321	Cable Drain - Everbrass (PVD)	-	4	16" x 7" x 4"	\$313.00	
SW1322	Cable Drain - Brushed Nickel	-	4	16" x 7" x 4"	\$313.00	
SW1323	Cable Drain - Oil Rubbed Bronze	-	4	16" x 7" x 4"	\$334.00	
SWA100	"Rainbow" Pillow	-	4	14" x 8" x 2"	\$57.00	
<b>Whirlpool Options</b>						
SWP151	In-line water heater (factory installed)	-	-	-	\$533.00	
<b>Metal trim upgrade:</b>						
SW1335	Chrome	-	-	-	\$366.00	
SW1336	Everbrass (PVD)	-	-	-	\$366.00	
SW1337	Brushed Nickel	-	-	-	\$366.00	
SW1338	Oil Rubbed Bronze	-	-	-	\$392.00	
<b>Air Bath Options</b>						
AR1200	Blower relocation kit	-	4	14" x 14" x 4"	\$169.00	
<b>Metal trim kit:</b>						
AR1335	Chrome	-	-	-	\$366.00	
AR1336	Everbrass (PVD)	-	-	-	\$366.00	
AR1337	Brushed Nickel	-	-	-	\$366.00	
AR1338	Oil Rubbed Bronze	-	-	-	\$392.00	
<b>Bathtub Options</b>						
RS151	Constant heat system	-	-	-	\$533.00	
<b>Colors: See chart on inside back cover</b>						

**SHOWROOM SERIES – BATHTUBS / WHIRLPOOL SYSTEMS / AIR SYSTEMS / MICROBUBBLE SYSTEMS**



**Hampton OV**

**68" x 42" x 23-1/2"**

Unique oval model with a deep bathing well provides further choices in bathroom design. Exclusive ergonomic handles and pillow complement your personal oasis.

Water Capacity: Minimum Capacity: 60 gal. Maximum Capacity: 80 gal.



Number	Model	Dimensions	Approx. Ship Wt (lbs)	PKG Dimensions	List Price	
					Standard	Premium
<b>Bathtub</b>						
5578	SWIRL-WAY® BATHTUB	68" x 42" x 23-1/2"	160	74-1/2" 47-1/4" x 25"	\$1,413.00	\$1,653.00
<b>Whirlpool Systems</b>						
5078BAS	SWIRL-WAY® BASIC	68" x 42" x 23-1/2"	180	74-1/2" 47-1/4" x 25"	\$2,903.00	\$3,143.00
5078LUX	SWIRL-WAY® LUXURY	68" x 42" x 23-1/2"	180	74-1/2" 47-1/4" x 25"	\$4,663.00	\$4,903.00
<b>Air Systems</b>						
9078	ARIANCE® HealthTouch™	68" x 42" x 23-1/2"	180	74-1/2" 47-1/4" x 25"	\$3,394.00	\$3,634.00
9178	ARIANCE® GentleTouch™	68" x 42" x 23-1/2"	180	74-1/2" 47-1/4" x 25"	\$3,685.00	\$3,925.00
9278	ARIANCE® DualTherapy™	68" x 42" x 23-1/2"	195	74-1/2" 47-1/4" x 25"	\$5,153.00	\$5,393.00
<b>Microbubble System</b>						
5278	MICRODERM™ Therapeutic Bath	68" x 42" x 23-1/2"	175	74-1/2" 47-1/4" x 25"	\$3,265.00	\$3,505.00
<b>Options and Accessories</b>						
Number	Model	Dimensions	Approx. Ship Wt (lbs)	PKG Dimensions	List Price	
<b>Common Options</b>						
SW1319	Cable Drain - Standard Colors	-	4	16" x 7" x 4"	\$132.00	
SW1320	Cable Drain - Polished Chrome	-	4	16" x 7" x 4"	\$174.00	
SW1321	Cable Drain - Everbrass (PVD)	-	4	16" x 7" x 4"	\$313.00	
SW1322	Cable Drain - Brushed Nickel	-	4	16" x 7" x 4"	\$313.00	
SW1323	Cable Drain - Oil Rubbed Bronze	-	4	16" x 7" x 4"	\$334.00	
SWA200	Exclusive Custom Pillow	-	4	14" x 8" x 6"	\$57.00	
<b>Whirlpool Options</b>						
SWP151	In-line water heater (factory installed)	-	-	-	\$533.00	
<b>Metal trim upgrade:</b>						
SW1335	Chrome	-	-	-	\$366.00	
SW1336	Everbrass (PVD)	-	-	-	\$366.00	
SW1337	Brushed Nickel	-	-	-	\$366.00	
SW1338	Oil Rubbed Bronze	-	-	-	\$392.00	
<b>Air Bath Options</b>						
AR1200	Blower relocation kit	-	4	14" x 14" x 4"	\$169.00	
<b>Metal trim kit:</b>						
AR1335	Chrome	-	-	-	\$366.00	
AR1336	Everbrass (PVD)	-	-	-	\$366.00	
AR1337	Brushed Nickel	-	-	-	\$366.00	
AR1338	Oil Rubbed Bronze	-	-	-	\$392.00	
<b>Bathtub Options</b>						
RS151	Constant heat system	-	-	-	\$533.00	
<b>Colors: See chart on inside back cover</b>						

## SHOWROOM SERIES – BATHTUBS / WHIRLPOOL SYSTEMS / AIR SYSTEMS / MICROBUBBLE SYSTEMS



### Heathrow OV

72" x 42" x 23"

Subtle lines and distinct accents highlight this two-person model with dual back jets, a showcase in any bathroom setting. Includes two custom pillows.

Water Capacity: Minimum Capacity: 60 gal. Maximum Capacity: 72 gal.



Number	Model	Dimensions	Approx. Ship Wt (lbs)	PKG Dimensions	List Price	
					Standard	Premium
<b>Bathtub</b>						
5577	SWIRL-WAY® BATHTUB	72" x 42" x 23"	155	77-1/2" x 47-1/4" x 26"	\$1,468.00	\$1,708.00
<b>Whirlpool Systems</b>						
5077BAS	SWIRL-WAY® BASIC	72" x 42" x 23"	175	77-1/2" x 47-1/2" x 26"	\$2,903.00	\$3,143.00
5077LUX	SWIRL-WAY® LUXURY	72" x 42" x 23"	175	77-1/2" x 47-1/2" x 26"	\$4,663.00	\$4,903.00
<b>Air Systems</b>						
9077	ARIANCE® HealthTouch™	72" x 42" x 23"	175	77-1/2" x 47-1/2" x 26"	\$3,645.00	\$3,885.00
9177	ARIANCE® GentleTouch™	72" x 42" x 23"	175	77-1/2" x 47-1/2" x 26"	\$3,937.00	\$4,177.00
9277	ARIANCE® DualTherapy™	72" x 42" x 23"	190	77-1/2" x 47-1/2" x 26"	\$5,153.00	\$5,393.00
<b>Microbubble System</b>						
5277	MICRODERM™ Therapeutic Bath	72" x 42" x 23"	175	77-1/2" x 47-1/2" x 26"	\$3,318.00	\$3,558.00

### Options and Accessories

Number	Model	Dimensions	Approx. Ship Wt (lbs)	PKG Dimensions	List Price
<b>Common Options</b>					
SW1319	Cable Drain - Standard Colors	-	4	16" x 7" x 4"	\$132.00
SW1320	Cable Drain - Polished Chrome	-	4	16" x 7" x 4"	\$174.00
SW1321	Cable Drain - Everbrass (PVD)	-	4	16" x 7" x 4"	\$313.00
SW1322	Cable Drain - Brushed Nickel	-	4	16" x 7" x 4"	\$313.00
SW1323	Cable Drain - Oil Rubbed Bronze	-	4	16" x 7" x 4"	\$334.00
SWA200	Exclusive Custom Pillow	-	4	14" x 8" x 6"	\$57.00
<b>Whirlpool Options</b>					
SWP151	In-line water heater (factory installed)	-	-	-	\$533.00
<b>Metal trim upgrade:</b>					
SW1335	Chrome	-	-	-	\$366.00
SW1336	Everbrass (PVD)	-	-	-	\$366.00
SW1337	Brushed Nickel	-	-	-	\$366.00
SW1338	Oil Rubbed Bronze	-	-	-	\$392.00
<b>Air Bath Options</b>					
AR1200	Blower relocation kit	-	4	14" x 14" x 4"	\$169.00
<b>Metal trim kit:</b>					
AR1335	Chrome	-	-	-	\$366.00
AR1336	Everbrass (PVD)	-	-	-	\$366.00
AR1337	Brushed Nickel	-	-	-	\$366.00
AR1338	Oil Rubbed Bronze	-	-	-	\$392.00
<b>Bathtub Options</b>					
RS151	Constant heat system	-	-	-	\$533.00

Colors: See chart on inside back cover

**SHOWROOM SERIES – BATHTUBS / WHIRLPOOL SYSTEMS / AIR SYSTEMS / MICROBUBBLE SYSTEMS**



**Montclair**

71-1/2" x 41-1/2" x 23-1/2"

Drop-in, two-person model with dual back jets, contoured backrest and integral armrest. Includes two custom pillows and one ergonomic handle.

Water Capacity: Minimum Capacity: 75 gal. Maximum Capacity: 90 gal



Number	Model	Dimensions	Approx. Ship Wt (lbs)	PKG Dimensions	List Price	
					Standard	Premium
<b>Bathtub</b>						
5525	SWIRL-WAY® BATHTUB	71-1/2" x 41-1/2" x 23-1/2"	165	77-1/2" x 47-1/4" x 25"	\$1,468.00	\$1,708.00
<b>Whirlpool Systems</b>						
5025BAS	SWIRL-WAY® BASIC	71-1/2" x 41-1/2" x 23-1/2"	180	77-1/2" x 47-1/4" x 25"	\$2,903.00	\$3,143.00
5025LUX	SWIRL-WAY® LUXURY	71-1/2" x 41-1/2" x 23-1/2"	180	77-1/2" x 47-1/4" x 25"	\$4,663.00	\$4,903.00
<b>Air Systems</b>						
9025	ARIANCE® HealthTouch™	71-1/2" x 41-1/2" x 23-1/2"	180	77-1/2" x 47-1/4" x 25"	\$3,394.00	\$3,634.00
9125	ARIANCE® GentleTouch™	71-1/2" x 41-1/2" x 23-1/2"	180	77-1/2" x 47-1/4" x 25"	\$3,685.00	\$3,925.00
9225	ARIANCE® DualTherapy™	71-1/2" x 41-1/2" x 23-1/2"	195	77-1/2" x 47-1/4" x 25"	\$5,153.00	\$5,393.00
<b>Options and Accessories</b>						
Number	Model	Dimensions	Approx. Ship Wt (lbs)	PKG Dimensions	List Price	
<b>Common Options</b>						
SW1319	Cable Drain - Standard Colors	-	4	16" x 7" x 4"	\$132.00	
SW1320	Cable Drain - Polished Chrome	-	4	16" x 7" x 4"	\$174.00	
SW1321	Cable Drain - Everbrass (PVD)	-	4	16" x 7" x 4"	\$313.00	
SW1322	Cable Drain - Brushed Nickel	-	4	16" x 7" x 4"	\$313.00	
SW1323	Cable Drain - Oil Rubbed Bronze	-	4	16" x 7" x 4"	\$334.00	
SWA100	"Rainbow" Pillow	-	4	14" x 8" x 2"	\$57.00	
<b>Whirlpool Options</b>						
SWP151	In-line water heater (factory installed)	-	-	-	\$533.00	
<b>Metal trim upgrade:</b>						
SW1335	Chrome	-	-	-	\$366.00	
SW1336	Everbrass (PVD)	-	-	-	\$366.00	
SW1337	Brushed Nickel	-	-	-	\$366.00	
SW1338	Oil Rubbed Bronze	-	-	-	\$392.00	
<b>Air Bath Options</b>						
AR1200	Blower relocation kit	-	4	14" x 14" x 4"	\$169.00	
<b>Metal trim kit:</b>						
AR1335	Chrome	-	-	-	\$366.00	
AR1336	Everbrass (PVD)	-	-	-	\$366.00	
AR1337	Brushed Nickel	-	-	-	\$366.00	
AR1338	Oil Rubbed Bronze	-	-	-	\$392.00	
<b>Bathtub Options</b>						
RS151	Constant heat system	-	-	-	\$533.00	

Colors: See chart on inside back cover

Bathware - Acrylic Showroom Series



## SHOWROOM SERIES – BATHTUBS / WHIRLPOOL SYSTEMS / AIR SYSTEMS / MICROBUBBLE SYSTEMS



### Reo 4272

72" x 42" x 24"

Drop-in or undermount, oval model with chic organic lines and integral armrests. Includes one pillow and two ergonomic handles.

Water Capacity: Minimum Capacity: 75 gal. Maximum Capacity: 90 gal.



Number	Model	Dimensions	Approx. Ship Wt (lbs)	PKG Dimensions	List Price	
					Standard	Premium
<b>Bathtub</b>						
5599	SWIRL-WAY® BATHTUB	72" x 42" x 24"	160	77-1/2" x 47-1/4" x 26"	\$1,468.00	\$1,708.00
<b>Whirlpool Systems</b>						
5099BAS	SWIRL-WAY® BASIC	72" x 42" x 24"	180	77-1/2" x 47-1/4" x 26"	\$2,903.00	\$3,143.00
5099LUX	SWIRL-WAY® LUXURY	72" x 42" x 24"	180	77-1/2" x 47-1/4" x 26"	\$4,463.00	\$4,703.00
<b>Air Systems</b>						
9099	ARIANCE® HealthTouch™	72" x 42" x 24"	180	77-1/2" x 47-1/4" x 26"	\$3,448.00	\$3,688.00
9199	ARIANCE® GentleTouch™	72" x 42" x 24"	180	77-1/2" x 47-1/4" x 26"	\$3,630.00	\$3,870.00
9299	ARIANCE® DualTherapy™	72" x 42" x 24"	195	77-1/2" x 47-1/4" x 26"	\$5,153.00	\$5,393.00
<b>Options and Accessories</b>						
Number	Model	Dimensions	Approx. Ship Wt (lbs)	PKG Dimensions	List Price	
<b>Common Options</b>						
SW1319	Cable Drain - Standard Colors	-	4	16" x 7" x 4"	\$132.00	
SW1320	Cable Drain - Polished Chrome	-	4	16" x 7" x 4"	\$174.00	
SW1321	Cable Drain - Everbrass (PVD)	-	4	16" x 7" x 4"	\$313.00	
SW1322	Cable Drain - Brushed Nickel	-	4	16" x 7" x 4"	\$313.00	
SW1323	Cable Drain - Oil Rubbed Bronze	-	4	16" x 7" x 4"	\$334.00	
SWA100	"Rainbow" Pillow	-	4	14" x 8" x 2"	\$57.00	
<b>Whirlpool Options</b>						
SWP151	In-line water heater (factory installed)	-	-	-	\$533.00	
<b>Metal trim upgrade:</b>						
SW1335	Chrome	-	-	-	\$366.00	
SW1336	Everbrass (PVD)	-	-	-	\$366.00	
SW1337	Brushed Nickel	-	-	-	\$366.00	
SW1338	Oil Rubbed Bronze	-	-	-	\$392.00	
<b>Air Bath Options</b>						
AR1200	Blower relocation kit	-	4	14" x 14" x 4"	\$169.00	
<b>Metal trim kit:</b>						
AR1335	Chrome	-	-	-	\$366.00	
AR1336	Everbrass (PVD)	-	-	-	\$366.00	
AR1337	Brushed Nickel	-	-	-	\$366.00	
AR1338	Oil Rubbed Bronze	-	-	-	\$392.00	
<b>Bathtub Options</b>						
RS151	Constant heat system	-	-	-	\$533.00	
<b>Colors: See chart on inside back cover</b>						

**SHOWROOM SERIES – BATHTUBS / WHIRLPOOL SYSTEMS / AIR SYSTEMS / MICROBUBBLE SYSTEMS**



**Reo 3672**  
72" x 36" x 24"

Drop-in or undermount, oval model with chic organic lines and integral armrests. Includes one pillow and two ergonomic handles.

Water Capacity: Minimum Capacity: 65 gal. Maximum Capacity: 80 gal.



Number	Model	Dimensions	Approx. Ship Wt (lbs)	PKG Dimensions	List Price	
					Standard	Premium
<b>Bathtub</b>						
5598	SWIRL-WAY® BATHTUB	72" x 36" x 24"	155	77-1/2" x 41-1/4" x 26"	\$1,386.00	\$1,626.00
<b>Whirlpool Systems</b>						
5098BAS	SWIRL-WAY® BASIC	72" x 36" x 24"	175	77-1/2" x 41-1/4" x 26"	\$2,703.00	\$2,943.00
5098LUX	SWIRL-WAY® LUXURY	72" x 36" x 24"	175	77-1/2" x 41-1/4" x 26"	\$4,462.00	\$4,702.00
<b>Air Systems</b>						
9098	ARIANCE® HealthTouch™	72" x 36" x 24"	175	77-1/2" x 41-1/4" x 26"	\$3,339.00	\$3,579.00
9198	ARIANCE® GentleTouch™	72" x 36" x 24"	175	77-1/2" x 41-1/4" x 26"	\$3,520.00	\$3,760.00
9298	ARIANCE® DualTherapy™	72" x 36" x 24"	190	77-1/2" x 41-1/4" x 26"	\$4,922.00	\$5,162.00
<b>Options and Accessories</b>						
Number	Model	Dimensions	Approx. Ship Wt (lbs)	PKG Dimensions	List Price	
<b>Common Options</b>						
SW1319	Cable Drain - Standard Colors	-	4	16" x 7" x 4"	\$132.00	
SW1320	Cable Drain - Polished Chrome	-	4	16" x 7" x 4"	\$174.00	
SW1321	Cable Drain - Everbrass (PVD)	-	4	16" x 7" x 4"	\$313.00	
SW1322	Cable Drain - Brushed Nickel	-	4	16" x 7" x 4"	\$313.00	
SW1323	Cable Drain - Oil Rubbed Bronze	-	4	16" x 7" x 4"	\$334.00	
SWA100	"Rainbow" Pillow	-	4	14" x 8" x 2"	\$57.00	
<b>Whirlpool Options</b>						
SWP151	In-line water heater (factory installed)	-	-	-	\$533.00	
<b>Metal trim upgrade:</b>						
SW1335	Chrome	-	-	-	\$366.00	
SW1336	Everbrass (PVD)	-	-	-	\$366.00	
SW1337	Brushed Nickel	-	-	-	\$366.00	
SW1338	Oil Rubbed Bronze	-	-	-	\$392.00	
<b>Air Bath Options</b>						
AR1200	Blower relocation kit	-	4	14" x 14" x 4"	\$169.00	
<b>Metal trim kit:</b>						
AR1335	Chrome	-	-	-	\$366.00	
AR1336	Everbrass (PVD)	-	-	-	\$366.00	
AR1337	Brushed Nickel	-	-	-	\$366.00	
AR1338	Oil Rubbed Bronze	-	-	-	\$392.00	
<b>Bathtub Options</b>						
RS151	Constant heat system	-	-	-	\$533.00	
Colors: See chart on inside back cover						

## SHOWROOM SERIES – BATHTUBS / WHIRLPOOL SYSTEMS / AIR SYSTEMS / MICROBUBBLE SYSTEMS



### Reo 3666

66" x 36" x 24"

Drop-in or undermount, oval model with chic organic lines and integral armrests. Includes one pillow and two ergonomic handles.

Water Capacity: Minimum Capacity: 65 gal. Maximum Capacity: 70 gal.



Number	Model	Dimensions	Approx. Ship Wt (lbs)	PKG Dimensions	List Price	
					Standard	Premium
<b>Bathtub</b>						
5597	SWIRL-WAY® BATHTUB	66" x 36" x 24"	150	71-1/2" x 41-1/4" x 26"	\$1,359.00	\$1,599.00
<b>Whirlpool Systems</b>						
5097BAS	SWIRL-WAY® BASIC	66" x 36" x 24"	175	71-1/2" x 41-1/4" x 26"	\$2,653.00	\$2,893.00
5097LUX	SWIRL-WAY® LUXURY	66" x 36" x 24"	175	71-1/2" x 41-1/4" x 26"	\$4,412.00	\$4,652.00
<b>Air Systems</b>						
9097	ARIANCE® HealthTouch™	66" x 36" x 24"	175	71-1/2" x 41-1/4" x 26"	\$3,119.00	\$3,359.00
9197	ARIANCE® GentleTouch™	66" x 36" x 24"	175	71-1/2" x 41-1/4" x 26"	\$3,300.00	\$3,540.00
9297	ARIANCE® DualTherapy™	66" x 36" x 24"	190	71-1/2" x 41-1/4" x 26"	\$4,809.00	\$5,049.00
<b>Options and Accessories</b>						
Number	Model	Dimensions	Approx. Ship Wt (lbs)	PKG Dimensions	List Price	
<b>Common Options</b>						
SW1319	Cable Drain - Standard Colors	-	4	16" x 7" x 4"	\$132.00	
SW1320	Cable Drain - Polished Chrome	-	4	16" x 7" x 4"	\$174.00	
SW1321	Cable Drain - Everbrass (PVD)	-	4	16" x 7" x 4"	\$313.00	
SW1322	Cable Drain - Brushed Nickel	-	4	16" x 7" x 4"	\$313.00	
SW1323	Cable Drain - Oil Rubbed Bronze	-	4	16" x 7" x 4"	\$334.00	
SWA100	"Rainbow" Pillow	-	4	14" x 8" x 2"	\$57.00	
<b>Whirlpool Options</b>						
SWP151	In-line water heater (factory installed)	-	-	-	\$533.00	
<b>Metal trim upgrade:</b>						
SW1335	Chrome	-	-	-	\$366.00	
SW1336	Everbrass (PVD)	-	-	-	\$366.00	
SW1337	Brushed Nickel	-	-	-	\$366.00	
SW1338	Oil Rubbed Bronze	-	-	-	\$392.00	
<b>Air Bath Options</b>						
AR1200	Blower relocation kit	-	4	14" x 14" x 4"	\$169.00	
<b>Metal trim kit:</b>						
AR1335	Chrome	-	-	-	\$366.00	
AR1336	Everbrass (PVD)	-	-	-	\$366.00	
AR1337	Brushed Nickel	-	-	-	\$366.00	
AR1338	Oil Rubbed Bronze	-	-	-	\$392.00	
<b>Bathtub Options</b>						
RS151	Constant heat system	-	-	-	\$533.00	
<b>Colors: See chart on inside back cover</b>						

**SHOWROOM SERIES – BATHTUBS / WHIRLPOOL SYSTEMS / AIR SYSTEMS / MICROBUBBLE SYSTEMS**



**Reo 3660**

**60" x 36" x 24"**

Drop-in or undermount oval model with chic organic lines and integral armrests. Includes one pillow and two ergonomic handles.

Water Capacity: Minimum Capacity: 55 gal. Maximum Capacity: 65 gal.



Number	Model	Dimensions	Approx. Ship Wt (lbs)	PKG Dimensions	List Price	
					Standard	Premium
<b>Bathtub</b>						
5596	SWIRL-WAY® BATHTUB	60" x 36" x 24"	145	65-1/2" x 41-1/4" x 26"	\$1,331.00	\$1,571.00
<b>Whirlpool Systems</b>						
5096BAS	SWIRL-WAY® BASIC	60" x 36" x 24"	170	65-1/2" x 41-1/4" x 26"	\$2,502.00	\$2,742.00
5096LUX	SWIRL-WAY® LUXURY	60" x 36" x 24"	170	65-1/2" x 41-1/4" x 26"	\$4,323.00	\$4,563.00
<b>Air Systems</b>						
9096	ARIANCE® HealthTouch™	60" x 36" x 24"	170	65-1/2" x 41-1/4" x 26"	\$2,902.00	\$3,142.00
9196	ARIANCE® GentleTouch™	60" x 36" x 24"	170	65-1/2" x 41-1/4" x 26"	\$3,080.00	\$3,320.00
9296	ARIANCE® DualTherapy™	60" x 36" x 24"	185	65-1/2" x 41-1/4" x 26"	\$4,695.00	\$4,935.00
<b>Options and Accessories</b>						
Number	Model	Dimensions	Approx. Ship Wt (lbs)	PKG Dimensions	List Price	
<b>Common Options</b>						
SW1319	Cable Drain - Standard Colors	-	4	16" x 7" x 4"	\$132.00	
SW1320	Cable Drain - Polished Chrome	-	4	16" x 7" x 4"	\$174.00	
SW1321	Cable Drain - Everbrass (PVD)	-	4	16" x 7" x 4"	\$313.00	
SW1322	Cable Drain - Brushed Nickel	-	4	16" x 7" x 4"	\$313.00	
SW1323	Cable Drain - Oil Rubbed Bronze	-	4	16" x 7" x 4"	\$334.00	
SWA100	"Rainbow" Pillow	-	4	14" x 8" x 2"	\$57.00	
<b>Whirlpool Options</b>						
SWP151	In-line water heater (factory installed)	-	-	-	\$533.00	
<b>Metal trim upgrade:</b>						
SW1335	Chrome	-	-	-	\$366.00	
SW1336	Everbrass (PVD)	-	-	-	\$366.00	
SW1337	Brushed Nickel	-	-	-	\$366.00	
SW1338	Oil Rubbed Bronze	-	-	-	\$392.00	
<b>Air Bath Options</b>						
AR1200	Blower relocation kit	-	4	14" x 14" x 4"	\$169.00	
<b>Metal trim kit:</b>						
AR1335	Chrome	-	-	-	\$366.00	
AR1336	Everbrass (PVD)	-	-	-	\$366.00	
AR1337	Brushed Nickel	-	-	-	\$366.00	
AR1338	Oil Rubbed Bronze	-	-	-	\$392.00	
<b>Bathtub Options</b>						
RS151	Constant heat system	-	-	-	\$533.00	
<b>Colors: See chart on inside back cover</b>						

## SHOWROOM SERIES – BATHTUBS / WHIRLPOOL SYSTEMS / AIR SYSTEMS / MICROBUBBLE SYSTEMS



### Waverly

70" x 47" x 20-1/4"

Drop-in, oval form, simple in its style and its clean lines featuring integral armrests for both bathing wells. Can be undermounted. Includes two pillows.

Water Capacity: Minimum Capacity: 50 gal. Maximum Capacity: 75 gal.



Number	Model	Dimensions	Approx. Ship Wt (lbs)	PKG Dimensions	List Price	
					Standard	Premium
<b>Whirlpool Systems</b>						
5017BAS	SWIRL-WAY® BASIC	70" x 47" x 20-1/4"	155	77-1/2" x 53-1/4" x 27-1/2"	\$2,903.00	\$3,143.00
5017LUX	SWIRL-WAY® LUXURY	70" x 47" x 20-1/4"	155	77-1/2" x 53-1/4" x 27-1/2"	\$4,725.00	\$4,965.00
<b>Options and Accessories</b>						
Number	Model	Dimensions	Approx. Ship Wt (lbs)	PKG Dimensions	List Price	
<b>Whirlpool Options</b>						
SW1319	Cable Drain - Standard Colors	-	4	16" x 7" x 4"	\$132.00	
SW1320	Cable Drain - Polished Chrome	-	4	16" x 7" x 4"	\$174.00	
SW1321	Cable Drain - Everbrass (PVD)	-	4	16" x 7" x 4"	\$313.00	
SW1322	Cable Drain - Brushed Nickel	-	4	16" x 7" x 4"	\$313.00	
SW1323	Cable Drain - Oil Rubbed Bronze	-	4	16" x 7" x 4"	\$334.00	
SWA100	"Rainbow" Pillow	-	4	14" x 8" x 2"	\$57.00	
SWP151	In-line water heater (factory installed)	-	-	-	\$533.00	
<b>Metal trim upgrade:</b>						
SW1335	Chrome	-	-	-	\$366.00	
SW1336	Everbrass (PVD)	-	-	-	\$366.00	
SW1337	Brushed Nickel	-	-	-	\$366.00	
SW1338	Oil Rubbed Bronze	-	-	-	\$392.00	
<b>Colors: See chart on inside back cover</b>						

**SHOWROOM SERIES – BATHTUBS / WHIRLPOOL SYSTEMS / AIR SYSTEMS / MICROBUBBLE SYSTEMS**



**Barrett 4272**

72" x 42" x 24"

Drop-in, rectangular model with dual backjets, clean geometric lines and integral armrests. Can be undermounted. Includes two pillows.

Water Capacity: Minimum Capacity: 80 gal. Maximum Capacity: 95 gal.



Number	Model	Dimensions	Approx. Ship Wt (lbs)	PKG Dimensions	List Price	
					Standard	Premium
<b>Bathtub</b>						
5518	SWIRL-WAY® BATHTUB	72" x 42" x 24"	160	73-1/2" x 47-1/2" x 30"	\$1,468.00	\$1,708.00
<b>Whirlpool Systems</b>						
5018BAS	SWIRL-WAY® BASIC	72" x 42" x 24"	180	73-1/2" x 47-1/2" x 30"	\$2,903.00	\$3,143.00
5018LUX	SWIRL-WAY® LUXURY	72" x 42" x 24"	180	73-1/2" x 47-1/2" x 30"	\$4,663.00	\$4,903.00
<b>Air Systems</b>						
9018	ARIANCE® HealthTouch™	72" x 42" x 24"	180	73-1/2" x 47-1/2" x 30"	\$3,729.00	\$3,969.00
9118	ARIANCE® GentleTouch™	72" x 42" x 24"	180	73-1/2" x 47-1/2" x 30"	\$3,794.00	\$4,034.00
9218	ARIANCE® DualTherapy™	72" x 42" x 24"	195	73-1/2" x 47-1/2" x 30"	\$5,153.00	\$5,393.00
<b>Microbubble System</b>						
5218	MICRODERM™ Therapeutic Bath	72" x 42" x 24"	180	73-1/2" x 47-1/2" x 30"	\$3,318.00	\$3,558.00

**Options and Accessories**

Number	Model	Dimensions	Approx. Ship Wt (lbs)	PKG Dimensions	List Price
<b>Common Options</b>					
SW1319	Cable Drain - Standard Colors	-	4	16" x 7" x 4"	\$132.00
SW1320	Cable Drain - Polished Chrome	-	4	16" x 7" x 4"	\$174.00
SW1321	Cable Drain - Everbrass (PVD)	-	4	16" x 7" x 4"	\$313.00
SW1322	Cable Drain - Brushed Nickel	-	4	16" x 7" x 4"	\$313.00
SW1323	Cable Drain - Oil Rubbed Bronze	-	4	16" x 7" x 4"	\$334.00
SWA100	"Rainbow" Pillow	-	4	14" x 8" x 2"	\$57.00
SWP150 S	Factory Installed Nailing Flange - Special, Diagram Required				\$164.00
<b>Whirlpool Options</b>					
SWP151	In-line water heater (factory installed)	-	-	-	\$533.00
<b>Metal trim upgrade:</b>					
SW1335	Chrome	-	-	-	\$366.00
SW1336	Everbrass (PVD)	-	-	-	\$366.00
SW1337	Brushed Nickel	-	-	-	\$366.00
SW1338	Oil Rubbed Bronze	-	-	-	\$392.00
<b>Air Bath Options</b>					
AR1200	Blower relocation kit	-	4	14" x 14" x 4"	\$169.00
<b>Metal trim kit:</b>					
AR1335	Chrome	-	-	-	\$366.00
AR1336	Everbrass (PVD)	-	-	-	\$366.00
AR1337	Brushed Nickel	-	-	-	\$366.00
AR1338	Oil Rubbed Bronze	-	-	-	\$392.00
<b>Bathtub Options</b>					
RS151	Constant heat system	-	-	-	\$533.00

Colors: See chart on inside back cover



## SHOWROOM SERIES – BATHTUBS / WHIRLPOOL SYSTEMS / AIR SYSTEMS / MICROBUBBLE SYSTEMS



### Barrett 3672

72" x 36" x 24"

Drop-in, rectangular model with dual back jets, clean geometric lines and integral armrests. Can be undermounted. Includes two pillows.

Water Capacity: Minimum Capacity: 65 gal. Maximum Capacity: 80 gal.



Number	Model	Dimensions	Approx. Ship Wt (lbs)	PKG Dimensions	List Price	
					Standard	Premium
<b>Bathtub</b>						
5510	SWIRL-WAY® BATHTUB	72" x 36" x 24"	150	77-1/2" x 41-1/4" x 26"	\$1,386.00	\$1,626.00
<b>Whirlpool Systems</b>						
5010BAS	SWIRL-WAY® BASIC	72" x 36" x 24"	175	77-1/2" x 41-1/4" x 26"	\$2,703.00	\$2,943.00
5010LUX	SWIRL-WAY® LUXURY	72" x 36" x 24"	175	77-1/2" x 41-1/4" x 26"	\$4,462.00	\$4,702.00
<b>Air Systems</b>						
9010	ARIANCE® HealthTouch™	72" x 36" x 24"	175	77-1/2" x 41-1/4" x 26"	\$3,448.00	\$3,688.00
9110	ARIANCE® GentleTouch™	72" x 36" x 24"	175	77-1/2" x 41-1/4" x 26"	\$3,630.00	\$3,870.00
9210	ARIANCE® DualTherapy™	72" x 36" x 24"	190	77-1/2" x 41-1/4" x 26"	\$4,922.00	\$5,162.00
<b>Microbubble System</b>						
5210	MICRODERM™ Therapeutic Bath	72" x 36" x 24"	175	77-1/2" x 41-1/4" x 26"	\$3,239.00	\$3,479.00

### Options and Accessories

Number	Model	Dimensions	Approx. Ship Wt (lbs)	PKG Dimensions	List Price
<b>Common Options</b>					
SW1319	Cable Drain - Standard Colors	-	4	16" x 7" x 4"	\$132.00
SW1320	Cable Drain - Polished Chrome	-	4	16" x 7" x 4"	\$174.00
SW1321	Cable Drain - Everbrass (PVD)	-	4	16" x 7" x 4"	\$313.00
SW1322	Cable Drain - Brushed Nickel	-	4	16" x 7" x 4"	\$313.00
SW1323	Cable Drain - Oil Rubbed Bronze	-	4	16" x 7" x 4"	\$334.00
SWA100	"Rainbow" Pillow	-	4	14" x 8" x 2"	\$57.00
SWP150 S	Factory Installed Nailing Flange - Special, Diagram Required				\$164.00
<b>Whirlpool Options</b>					
SWP151	In-line water heater (factory installed)	-	-	-	\$533.00
<b>Metal trim upgrade:</b>					
SW1335	Chrome	-	-	-	\$366.00
SW1336	Everbrass (PVD)	-	-	-	\$366.00
SW1337	Brushed Nickel	-	-	-	\$366.00
SW1338	Oil Rubbed Bronze	-	-	-	\$392.00
<b>Air Bath Options</b>					
AR1200	Blower relocation kit	-	4	14" x 14" x 4"	\$169.00
<b>Metal trim kit:</b>					
AR1335	Chrome	-	-	-	\$366.00
AR1336	Everbrass (PVD)	-	-	-	\$366.00
AR1337	Brushed Nickel	-	-	-	\$366.00
AR1338	Oil Rubbed Bronze	-	-	-	\$392.00
<b>Bathtub Options</b>					
RS151	Constant heat system	-	-	-	\$533.00

Colors: See chart on inside back cover

**SHOWROOM SERIES – BATHTUBS / WHIRLPOOL SYSTEMS / AIR SYSTEMS / MICROBUBBLE SYSTEMS**



**Barrett 4266**

66" x 42" x 24"

Drop-in, rectangular model with dual back jets, clean geometric lines and integral armrests. Can be undermounted. Includes two pillows.

Water Capacity: Minimum Capacity: 65 gal. Maximum Capacity: 80 gal.



Number	Model	Dimensions	Approx. Ship Wt (lbs)	PKG Dimensions	List Price	
					Standard	Premium
<b>Bathtub</b>						
5522	SWIRL-WAY® BATHTUB	66" x 42" x 24"	145	71-1/2" x 47-1/4" x 26"	\$1,413.00	\$1,653.00
<b>Whirlpool Systems</b>						
5022BAS	SWIRL-WAY® BASIC	66" x 42" x 24"	165	71-1/2" x 47-1/4" x 26"	\$2,752.00	\$2,992.00
5022LUX	SWIRL-WAY® LUXURY	66" x 42" x 24"	165	71-1/2" x 47-1/4" x 26"	\$4,512.00	\$4,752.00
<b>Air Systems</b>						
9022	ARIANCE® HealthTouch™	66" x 42" x 24"	165	71-1/2" x 47-1/4" x 26"	\$3,502.00	\$3,742.00
9122	ARIANCE® GentleTouch™	66" x 42" x 24"	165	71-1/2" x 47-1/4" x 26"	\$3,685.00	\$3,925.00
9222	ARIANCE® DualTherapy™	66" x 42" x 24"	180	71-1/2" x 47-1/4" x 26"	\$5,039.00	\$5,279.00
<b>Microbubble System</b>						
5222	MICRODERM™ Therapeutic Bath	66" x 42" x 24"	165	71-1/2" x 47-1/4" x 26"	\$3,265.00	\$3,505.00

**Options and Accessories**

Number	Model	Dimensions	Approx. Ship Wt (lbs)	PKG Dimensions	List Price
<b>Common Options</b>					
SW1319	Cable Drain - Standard Colors	-	4	16" x 7" x 4"	\$132.00
SW1320	Cable Drain - Polished Chrome	-	4	16" x 7" x 4"	\$174.00
SW1321	Cable Drain - Everbrass (PVD)	-	4	16" x 7" x 4"	\$313.00
SW1322	Cable Drain - Brushed Nickel	-	4	16" x 7" x 4"	\$313.00
SW1323	Cable Drain - Oil Rubbed Bronze	-	4	16" x 7" x 4"	\$334.00
SWA100	"Rainbow" Pillow	-	4	14" x 8" x 2"	\$57.00
SWP150 S	Factory Installed Nailing Flange - Special, Diagram Required	-	-	-	\$164.00
<b>Whirlpool Options</b>					
SWP151	In-line water heater (factory installed)	-	-	-	\$533.00
<b>Metal trim upgrade:</b>					
SW1335	Chrome	-	-	-	\$366.00
SW1336	Everbrass (PVD)	-	-	-	\$366.00
SW1337	Brushed Nickel	-	-	-	\$366.00
SW1338	Oil Rubbed Bronze	-	-	-	\$392.00
<b>Air Bath Options</b>					
AR1200	Blower relocation kit	-	4	14" x 14" x 4"	\$169.00
<b>Metal trim kit:</b>					
AR1335	Chrome	-	-	-	\$366.00
AR1336	Everbrass (PVD)	-	-	-	\$366.00
AR1337	Brushed Nickel	-	-	-	\$366.00
AR1338	Oil Rubbed Bronze	-	-	-	\$392.00
<b>Bathtub Options</b>					
RS151	Constant heat system	-	-	-	\$533.00

Colors: See chart on inside back cover

## SHOWROOM SERIES – BATHTUBS / WHIRLPOOL SYSTEMS / AIR SYSTEMS / MICROBUBBLE SYSTEMS



### Barrett 3666

66" x 36" x 24"

Drop-in, rectangular model with dual back jets, clean geometric lines and integral armrests. Can be undermounted. Includes two pillows.

Water Capacity: Minimum Capacity: 60 gal. Maximum Capacity: 70 gal.



Number	Model	Dimensions	Approx. Ship Wt (lbs)	PKG Dimensions	List Price	
					Standard	Premium
<b>Bathtub</b>						
5508	SWIRL-WAY® BATHTUB	66" x 36" x 24"	145	71-1/2" x 41-1/4" x 26"	\$1,359.00	\$1,599.00
<b>Whirlpool Systems</b>						
5008BAS	SWIRL-WAY® BASIC	66" x 36" x 24"	170	71-1/2" x 41-1/4" x 26"	\$2,653.00	\$2,893.00
5008LUX	SWIRL-WAY® LUXURY	66" x 36" x 24"	170	71-1/2" x 41-1/4" x 26"	\$4,412.00	\$4,652.00
<b>Air Systems</b>						
9008	ARIANCE® HealthTouch™	66" x 36" x 24"	170	71-1/2" x 41-1/4" x 26"	\$3,394.00	\$3,634.00
9108	ARIANCE® GentleTouch™	66" x 36" x 24"	170	71-1/2" x 41-1/4" x 26"	\$3,576.00	\$3,816.00
9208	ARIANCE® DualTherapy™	66" x 36" x 24"	185	71-1/2" x 41-1/4" x 26"	\$4,809.00	\$5,049.00
<b>Microbubble System</b>						
5208	MICRODERM™ Therapeutic Bath	66" x 36" x 24"	170	71-1/2" x 41-1/4" x 26"	\$3,213.00	\$3,453.00

### Options and Accessories

Number	Model	Dimensions	Approx. Ship Wt (lbs)	PKG Dimensions	List Price
<b>Common Options</b>					
SW1319	Cable Drain - Standard Colors	-	4	16" x 7" x 4"	\$132.00
SW1320	Cable Drain - Polished Chrome	-	4	16" x 7" x 4"	\$174.00
SW1321	Cable Drain - Everbrass (PVD)	-	4	16" x 7" x 4"	\$313.00
SW1322	Cable Drain - Brushed Nickel	-	4	16" x 7" x 4"	\$313.00
SW1323	Cable Drain - Oil Rubbed Bronze	-	4	16" x 7" x 4"	\$334.00
SWA100	"Rainbow" Pillow	-	4	14" x 8" x 2"	\$57.00
SWP150 S	Factory Installed Nailing Flange - Special, Diagram Required	-	-	-	\$164.00
<b>Whirlpool Options</b>					
SWP151	In-line water heater (factory installed)	-	-	-	\$533.00
<b>Metal trim upgrade:</b>					
SW1335	Chrome	-	-	-	\$366.00
SW1336	Everbrass (PVD)	-	-	-	\$366.00
SW1337	Brushed Nickel	-	-	-	\$366.00
SW1338	Oil Rubbed Bronze	-	-	-	\$392.00
<b>Air Bath Options</b>					
AR1200	Blower relocation kit	-	4	14" x 14" x 4"	\$169.00
<b>Metal trim kit:</b>					
AR1335	Chrome	-	-	-	\$366.00
AR1336	Everbrass (PVD)	-	-	-	\$366.00
AR1337	Brushed Nickel	-	-	-	\$366.00
AR1338	Oil Rubbed Bronze	-	-	-	\$392.00
<b>Bathtub Options</b>					
RS151	Constant heat system	-	-	-	\$533.00

Colors: See chart on inside back cover

**SHOWROOM SERIES – BATHTUBS / WHIRLPOOL SYSTEMS / AIR SYSTEMS / MICROBUBBLE SYSTEMS**



**Barrett Alcove**

**60" x 32" x 21-1/2"**

Deep bathing well with clean geometric lines, integral armrests, flange and apron. Available in left hand or right hand installment options. Includes one pillow. For alcove installation.

Water Capacity: Minimum Capacity: 27 gal. Maximum Capacity: 57 gal.



Number	Model	Dimensions	Approx. Ship Wt (lbs)	PKG Dimensions	List Price	
					Standard	Premium
<b>Bathtub</b>						
5524L	SWIRL-WAY® BATHTUB - LEFT	60" x 32" x 21-1/2"	125	66" x 38" x 27"	\$1,359.00	\$1,599.00
5524R	SWIRL-WAY® BATHTUB - RIGHT	60" x 32" x 21-1/2"	125	66" x 38" x 27"	\$1,359.00	\$1,599.00
<b>Whirlpool Systems</b>						
5024LBAS	SWIRL-WAY® BASIC - LEFT	60" x 32" x 21-1/2"	160	66" x 38" x 27"	\$1,816.00	\$2,056.00
5024RBAS	SWIRL-WAY® BASIC - RIGHT	60" x 32" x 21-1/2"	160	66" x 38" x 27"	\$1,816.00	\$2,056.00
5024LLUX	SWIRL-WAY® LUXURY - LEFT	60" x 32" x 21-1/2"	160	66" x 38" x 27"	\$3,493.00	\$3,733.00
5024RLUX	SWIRL-WAY® LUXURY - RIGHT	60" x 32" x 21-1/2"	160	66" x 38" x 27"	\$3,493.00	\$3,733.00
<b>Air Systems</b>						
9024L	ARIANCE® HealthTouch™ - LEFT	60" x 32" x 21-1/2"	175	66" x 38" x 27"	\$3,416.00	\$3,656.00
9024R	ARIANCE® HealthTouch™ - RIGHT	60" x 32" x 21-1/2"	175	66" x 38" x 27"	\$3,416.00	\$3,656.00
<b>Options and Accessories</b>						
Number	Model	Dimensions	Approx. Ship Wt (lbs)	PKG Dimensions	List Price	
<b>Common Options</b>						
SW1319	Cable Drain - Standard Colors	-	4	16" x 7" x 4"	\$132.00	
SW1320	Cable Drain - Polished Chrome	-	4	16" x 7" x 4"	\$174.00	
SW1321	Cable Drain - Everbrass (PVD)	-	4	16" x 7" x 4"	\$313.00	
SW1322	Cable Drain - Brushed Nickel	-	4	16" x 7" x 4"	\$313.00	
SW1323	Cable Drain - Oil Rubbed Bronze	-	4	16" x 7" x 4"	\$334.00	
SWA100	"Rainbow" Pillow	-	4	14" x 8" x 2"	\$57.00	
<b>Whirlpool Options</b>						
SWP151	In-line water heater (factory installed)	-	-	-	\$533.00	
<b>Metal trim upgrade:</b>						
SW1335	Chrome	-	-	-	\$366.00	
SW1336	Everbrass (PVD)	-	-	-	\$366.00	
SW1337	Brushed Nickel	-	-	-	\$366.00	
SW1338	Oil Rubbed Bronze	-	-	-	\$392.00	
<b>Air Bath Options</b>						
AR1200	Blower relocation kit	-	4	14" x 14" x 4"	\$169.00	
<b>Metal trim kit:</b>						
AR1335	Chrome	-	-	-	\$366.00	
AR1336	Everbrass (PVD)	-	-	-	\$366.00	
AR1337	Brushed Nickel	-	-	-	\$366.00	
AR1338	Oil Rubbed Bronze	-	-	-	\$392.00	
<b>Bathtub Options</b>						
RS151	Constant heat system	-	-	-	\$533.00	
<b>Colors: See chart on inside back cover</b>						

## SHOWROOM SERIES – BATHTUBS / WHIRLPOOL SYSTEMS / AIR SYSTEMS / MICROBUBBLE SYSTEMS



### Baywood 6.0

72" x 36" x 19-3/4"

A dramatic, six-foot, drop-in, rectangular model with spacious bathing well and integral armrests. Featuring one custom pillow and two decorative handles.

Water Capacity: Minimum Capacity: 48 gal. Maximum Capacity: 60 gal.

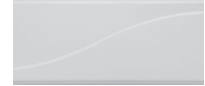

Optional removable apron

Number	Model	Dimensions	Approx. Ship Wt (lbs)	PKG Dimensions	List Price	
					Standard	Premium
<b>Bathtub</b>						
5504	SWIRL-WAY® BATHTUB	72" x 36" x 19-3/4"	160	77-1/2" x 41-1/4" x 24"	\$1,386.00	\$1,626.00
<b>Whirlpool Systems</b>						
5004BAS	SWIRL-WAY® BASIC	72" x 36" x 19-3/4"	180	77-1/2" x 41-1/4" x 24"	\$2,703.00	\$2,943.00
5004LUX	SWIRL-WAY® LUXURY	72" x 36" x 19-3/4"	180	77-1/2" x 41-1/4" x 24"	\$4,462.00	\$4,702.00
<b>Air Systems</b>						
9005	ARIANCE® HealthTouch™	72" x 36" x 19-3/4"	180	77-1/2" x 41-1/4" x 24"	\$3,283.00	\$3,523.00
9105	ARIANCE® GentleTouch™	72" x 36" x 19-3/4"	180	77-1/2" x 41-1/4" x 24"	\$3,576.00	\$3,816.00
9205	ARIANCE® DualTherapy™	72" x 36" x 19-3/4"	195	77-1/2" x 41-1/4" x 24"	\$4,922.00	\$5,162.00
<b>Microbubble System</b>						
5204	MICRODERM™ Therapeutic Bath	72" x 36" x 19-3/4"	180	77-1/2" x 41-1/4" x 24"	\$3,239.00	\$3,479.00

### Options and Accessories

Number	Model	Dimensions	Approx. Ship Wt (lbs)	PKG Dimensions	List Price	
					Standard	Premium
<b>Common Options</b>						
SW1319	Cable Drain - Standard Colors	-	4	16" x 7" x 4"	\$132.00	
SW1320	Cable Drain - Polished Chrome	-	4	16" x 7" x 4"	\$174.00	
SW1321	Cable Drain - Everbrass (PVD)	-	4	16" x 7" x 4"	\$313.00	
SW1322	Cable Drain - Brushed Nickel	-	4	16" x 7" x 4"	\$313.00	
SW1323	Cable Drain - Oil Rubbed Bronze	-	4	16" x 7" x 4"	\$334.00	
7004	Removable Apron - Baywood 6.0	72" x 16-1/4" x 2"	20	74-1/2" x 22-1/4" x 4"	\$483.00	\$723.00
SWA200	Exclusive Custom Pillow	-	4	14" x 8" x 6"	\$57.00	
SWAP00	Nailing flange kit (field installed)	-	4	13" x 9" x 3-1/2"	\$65.00	
<b>Nailing flange (factory installed)</b>						
SWP150L	Left Hand	-	-	-	\$164.00	
SWP150R	Right Hand	-	-	-	\$164.00	
SWP150S	Special/Center Drain, Diagram Required	-	-	-	\$164.00	
<b>Whirlpool Options</b>						
SWP151	In-line water heater (factory installed)	-	-	-	\$533.00	
<b>Metal trim upgrade:</b>						
SW1335	Chrome	-	-	-	\$366.00	
SW1336	Everbrass (PVD)	-	-	-	\$366.00	
SW1337	Brushed Nickel	-	-	-	\$366.00	
SW1338	Oil Rubbed Bronze	-	-	-	\$392.00	
<b>Air Bath Options</b>						
AR1200	Blower relocation kit	-	4	14" x 14" x 4"	\$169.00	
<b>Metal trim kit:</b>						
AR1335	Chrome	-	-	-	\$366.00	
AR1336	Everbrass (PVD)	-	-	-	\$366.00	
AR1337	Brushed Nickel	-	-	-	\$366.00	
AR1338	Oil Rubbed Bronze	-	-	-	\$392.00	
<b>Bathtub Options</b>						
RS151	Constant heat system	-	-	-	\$533.00	

Colors: See chart on inside back cover

**SHOWROOM SERIES – BATHTUBS / WHIRLPOOL SYSTEMS / AIR SYSTEMS / MICROBUBBLE SYSTEMS**



**Baywood 5.5**

**66" x 36" x 19-3/4"**

Medium size, drop-in rectangular model with spacious bathing well and integral armrests. Featuring one custom pillow and two decorative handles.

Water Capacity: Minimum Capacity: 48 gal. Maximum Capacity: 58 gal.



Optional removable apron

Number	Model	Dimensions	Approx. Ship Wt (lbs)	PKG Dimensions	List Price	
					Standard	Premium
<b>Bathtub</b>						
5528	SWIRL-WAY® BATHTUB	66" x 36" x 19-3/4"	120	71-1/2" x 41-1/4" x 23-1/2"	\$1,359.00	\$1,599.00
<b>Whirlpool Systems</b>						
5028BAS	SWIRL-WAY® BASIC	66" x 36" x 19-3/4"	165	71-1/2" x 41-1/4" x 23-1/2"	\$2,653.00	\$2,893.00
5028LUX	SWIRL-WAY® LUXURY	66" x 36" x 19-3/4"	165	71-1/2" x 41-1/4" x 23-1/2"	\$4,412.00	\$4,652.00
<b>Air Systems</b>						
9028	ARIANCE® HealthTouch™	66" x 36" x 19-3/4"	165	71-1/2" x 41-1/4" x 23-1/2"	\$3,169.00	\$3,409.00
9128	ARIANCE® GentleTouch™	66" x 36" x 19-3/4"	165	71-1/2" x 41-1/4" x 23-1/2"	\$3,459.00	\$3,699.00
9228	ARIANCE® DualTherapy™	66" x 36" x 19-3/4"	180	71-1/2" x 41-1/4" x 23-1/2"	\$4,809.00	\$5,049.00
<b>Microbubble System</b>						
5228	MICRODERM™ Therapeutic Bath	66" x 36" x 19-3/4"	165	71-1/2" x 41-1/4" x 23-1/2"	\$3,213.00	\$3,453.00

**Options and Accessories**

Number	Model	Dimensions	Approx. Ship Wt (lbs)	PKG Dimensions	List Price	
					Standard	Premium
<b>Common Options</b>						
SW1319	Cable Drain - Standard Colors	-	4	16" x 7" x 4"	\$132.00	
SW1320	Cable Drain - Polished Chrome	-	4	16" x 7" x 4"	\$174.00	
SW1321	Cable Drain - Everbrass (PVD)	-	4	16" x 7" x 4"	\$313.00	
SW1322	Cable Drain - Brushed Nickel	-	4	16" x 7" x 4"	\$313.00	
SW1323	Cable Drain - Oil Rubbed Bronze	-	4	16" x 7" x 4"	\$334.00	
7028	Removable Apron - Baywood 5.5	66" x 16-1/4" x 2"	15	70-1/2" x 22-3/4" x 4"	\$472.00	\$712.00
SWA200	Exclusive Custom Pillow	-	4	14" x 8" x 6"	\$57.00	
SWAP00	Nailing flange kit (field installed)	-	4	13" x 9" x 3-1/2"	\$65.00	
<b>Nailing flange (factory installed)</b>						
SWP150L	Left Hand	-	-	-	\$164.00	
SWP150R	Right Hand	-	-	-	\$164.00	
SWP150S	Special/Center Drain, Diagram Required	-	-	-	\$164.00	
<b>Whirlpool Options</b>						
SWP151	In-line water heater (factory installed)	-	-	-	\$533.00	
<b>Metal trim upgrade:</b>						
SW1335	Chrome	-	-	-	\$366.00	
SW1336	Everbrass (PVD)	-	-	-	\$366.00	
SW1337	Brushed Nickel	-	-	-	\$366.00	
SW1338	Oil Rubbed Bronze	-	-	-	\$392.00	
<b>Air Bath Options</b>						
AR1200	Blower relocation kit	-	4	14" x 14" x 4"	\$169.00	
<b>Metal trim kit:</b>						
AR1335	Chrome	-	-	-	\$366.00	
AR1336	Everbrass (PVD)	-	-	-	\$366.00	
AR1337	Brushed Nickel	-	-	-	\$366.00	
AR1338	Oil Rubbed Bronze	-	-	-	\$392.00	
<b>Bathtub Options</b>						
RS151	Constant heat system	-	-	-	\$533.00	

Colors: See chart on inside back cover



## SHOWROOM SERIES – BATHTUBS / WHIRLPOOL SYSTEMS / AIR SYSTEMS / MICROBUBBLE SYSTEMS



### Baywood 5.0

60" x 36" x 19-3/4"

Small, drop-in rectangular model with spacious bathing well, back jets and integral armrests. Featuring one custom pillow and two decorative handles.

Water Capacity: Minimum Capacity: 40 gals Maximum Capacity: 60 gals



Optional removable apron

Number	Model	Dimensions	Approx. Ship Wt (lbs)	PKG Dimensions	List Price	
					Standard	Premium
<b>Bathtub</b>						
5502	SWIRL-WAY® BATHTUB	60" x 36" x 19-3/4"	120	65-1/2" x 41-1/4" x 25-1/4"	\$1,331.00	\$1,571.00
<b>Whirlpool Systems</b>						
5002BAS	SWIRL-WAY® BASIC	60" x 36" x 19-3/4"	140	65-1/2" x 41-1/4" x 25-1/4"	\$2,502.00	\$2,742.00
5002LUX	SWIRL-WAY® LUXURY	60" x 36" x 19-3/4"	140	65-1/2" x 41-1/4" x 25-1/4"	\$4,323.00	\$4,563.00
<b>Air Systems</b>						
9004	ARIANCE® HealthTouch™	60" x 36" x 19-3/4"	140	65-1/2" x 41-1/4" x 25-1/4"	\$3,054.00	\$3,294.00
9104	ARIANCE® GentleTouch™	60" x 36" x 19-3/4"	140	65-1/2" x 41-1/4" x 25-1/4"	\$3,343.00	\$3,583.00
9204	ARIANCE® DualTherapy™	60" x 36" x 19-3/4"	155	65-1/2" x 41-1/4" x 25-1/4"	\$4,695.00	\$4,935.00
<b>Microbubble System</b>						
5202	MICRODERM™ Therapeutic Bath	60" x 36" x 19-3/4"	140	65-1/2" x 41-1/4" x 25-1/4"	\$3,186.00	\$3,426.00
<b>Options and Accessories</b>						
Number	Model	Dimensions	Approx. Ship Wt (lbs)	PKG Dimensions	List Price	
					Standard	Premium
<b>Common Options</b>						
SW1319	Cable Drain - Standard Colors	-	4	16" x 7" x 4"	\$132.00	
SW1320	Cable Drain - Polished Chrome	-	4	16" x 7" x 4"	\$174.00	
SW1321	Cable Drain - Everbrass (PVD)	-	4	16" x 7" x 4"	\$313.00	
SW1322	Cable Drain - Brushed Nickel	-	4	16" x 7" x 4"	\$313.00	
SW1323	Cable Drain - Oil Rubbed Bronze	-	4	16" x 7" x 4"	\$334.00	
7002	Removable Apron - Baywood 5.0	60" x 16-1/4" x 2"	15	62-1/2" x 22-3/4" x 4"	\$463.00	\$703.00
SWA200	Exclusive Custom Pillow	-	4	14" x 8" x 6"	\$57.00	
SWAP00	Nailing flange kit (field installed)	-	4	13" x 9" x 3-1/2"	\$65.00	
<b>Nailing flange (factory installed)</b>						
SWP150L	Left Hand	-	-	-	\$164.00	
SWP150R	Right Hand	-	-	-	\$164.00	
SWP150S	Special/Center Drain, Diagram Required	-	-	-	\$164.00	
<b>Whirlpool Options</b>						
SWP151	In-line water heater (factory installed)	-	-	-	\$533.00	
<b>Metal trim upgrade:</b>						
SW1335	Chrome	-	-	-	\$366.00	
SW1336	Everbrass (PVD)	-	-	-	\$366.00	
SW1337	Brushed Nickel	-	-	-	\$366.00	
SW1338	Oil Rubbed Bronze	-	-	-	\$392.00	
<b>Air Bath Options</b>						
AR1200	Blower relocation kit	-	4	14" x 14" x 4"	\$169.00	
<b>Metal trim kit:</b>						
AR1335	Chrome	-	-	-	\$366.00	
AR1336	Everbrass (PVD)	-	-	-	\$366.00	
AR1337	Brushed Nickel	-	-	-	\$366.00	
AR1338	Oil Rubbed Bronze	-	-	-	\$392.00	
<b>Bathtub Options</b>						
RS151	Constant heat system	-	-	-	\$533.00	

Colors: See chart on inside back cover

**SHOWROOM SERIES – BATHTUBS / WHIRLPOOL SYSTEMS / AIR SYSTEMS / MICROBUBBLE SYSTEMS**



**Brentwood® 4272**

72" x 42" x 22-1/2"

Drop-in, rectangular model with back jets, clean geometric lines, integral armrests, one pillow and two decorative handles. Can be undermounted.

Water Capacity: Minimum Capacity: 88 gal. Maximum Capacity: 99 gal.



Number	Model	Dimensions	Approx. Ship Wt (lbs)	PKG Dimensions	List Price	
					Standard	Premium
<b>Bathtub</b>						
5575	SWIRL-WAY® BATHTUB	72" x 42" x 22-1/2"	165	77-1/2" x 44" x 24"	\$1,468.00	\$1,708.00
<b>Whirlpool Systems</b>						
5075BAS	SWIRL-WAY® BASIC	72" x 42" x 22-1/2"	175	77-1/2" x 44" x 24"	\$2,903.00	\$3,143.00
5075LUX	SWIRL-WAY® LUXURY	72" x 42" x 22-1/2"	175	77-1/2" x 44" x 24"	\$4,663.00	\$4,903.00
<b>Air Systems</b>						
9075	ARIANCE® HealthTouch™	72" x 42" x 22-1/2"	175	77-1/2" x 44" x 24"	\$3,400.00	\$3,640.00
9175	ARIANCE® GentleTouch™	72" x 42" x 22-1/2"	175	77-1/2" x 44" x 24"	\$3,693.00	\$3,933.00
9275	ARIANCE® DualTherapy™	72" x 42" x 22-1/2"	185	77-1/2" x 44" x 24"	\$5,153.00	\$5,393.00
<b>Microbubble System</b>						
5275	MICRODERM™ Therapeutic Bath	72" x 42" x 22-1/2"	175	77-1/2" x 44" x 24"	\$3,318.00	\$3,558.00
<b>Options and Accessories</b>						
Number	Model	Dimensions	Approx. Ship Wt (lbs)	PKG Dimensions	List Price	
<b>Common Options</b>						
SW1319	Cable Drain - Standard Colors	-	4	16" x 7" x 4"	\$132.00	
SW1320	Cable Drain - Polished Chrome	-	4	16" x 7" x 4"	\$174.00	
SW1321	Cable Drain - Everbrass (PVD)	-	4	16" x 7" x 4"	\$313.00	
SW1322	Cable Drain - Brushed Nickel	-	4	16" x 7" x 4"	\$313.00	
SW1323	Cable Drain - Oil Rubbed Bronze	-	4	16" x 7" x 4"	\$334.00	
SWA100	"Rainbow" Pillow	-	4	14" x 8" x 2"	\$57.00	
SWAP00	Nailing flange kit (field installed)	-	4	13" x 9" x 3-1/2"	\$65.00	
<b>Nailing flange (factory installed)</b>						
SWP150L	Left Hand	-	-	-	\$164.00	
SWP150R	Right Hand	-	-	-	\$164.00	
SWP150S	Special/Center Drain, Diagram Required	-	-	-	\$164.00	
<b>Whirlpool Options</b>						
SWP151	In-line water heater (factory installed)	-	-	-	\$533.00	
<b>Metal trim upgrade:</b>						
SW1335	Chrome	-	-	-	\$366.00	
SW1336	Everbrass (PVD)	-	-	-	\$366.00	
SW1337	Brushed Nickel	-	-	-	\$366.00	
SW1338	Oil Rubbed Bronze	-	-	-	\$392.00	
<b>Air Bath Options</b>						
AR1200	Blower relocation kit	-	4	14" x 14" x 4"	\$169.00	
<b>Metal trim kit:</b>						
AR1335	Chrome	-	-	-	\$366.00	
AR1336	Everbrass (PVD)	-	-	-	\$366.00	
AR1337	Brushed Nickel	-	-	-	\$366.00	
AR1338	Oil Rubbed Bronze	-	-	-	\$392.00	
<b>Bathtub Options</b>						
RS151	Constant heat system	-	-	-	\$533.00	
<b>Colors: See chart on inside back cover</b>						

## SHOWROOM SERIES – BATHTUBS / WHIRLPOOL SYSTEMS / AIR SYSTEMS / MICROBUBBLE SYSTEMS



### Brentwood® 3672

72" x 36" x 22-1/2"

Drop-in, rectangular model with back jets, clean geometric lines, integral armrests, one pillow and two decorative handles. Can be undermounted.

Water Capacity: Minimum Capacity: 65 gal. Maximum Capacity: 80 gal.



Number	Model	Dimensions	Approx. Ship Wt (lbs)	PKG Dimensions	List Price	
					Standard	Premium
<b>Bathtub</b>						
5574	SWIRL-WAY® BATHTUB	72" x 36" x 22-1/2"	160	77-1/2" x 38-1/2" x 24"	\$1,386.00	\$1,626.00
<b>Whirlpool Systems</b>						
5074BAS	SWIRL-WAY® BASIC	72" x 36" x 22-1/2"	170	77-1/2" x 38-1/2" x 24"	\$2,703.00	\$2,943.00
5074LUX	SWIRL-WAY® LUXURY	72" x 36" x 22-1/2"	170	77-1/2" x 38-1/2" x 24"	\$4,462.00	\$4,702.00
<b>Air Systems</b>						
9074	ARIANCE® HealthTouch™	72" x 36" x 22-1/2"	170	77-1/2" x 38-1/2" x 24"	\$3,283.00	\$3,523.00
9174	ARIANCE® GentleTouch™	72" x 36" x 22-1/2"	170	77-1/2" x 38-1/2" x 24"	\$3,576.00	\$3,816.00
9274	ARIANCE® DualTherapy™	72" x 36" x 22-1/2"	180	77-1/2" x 38-1/2" x 24"	\$4,922.00	\$5,162.00
<b>Microbubble System</b>						
5274	MICRODERM™ Therapeutic Bath	72" x 36" x 22-1/2"	170	77-1/2" x 38-1/2" x 24"	\$3,239.00	\$3,479.00

### Options and Accessories

Number	Model	Dimensions	Approx. Ship Wt (lbs)	PKG Dimensions	List Price
<b>Common Options</b>					
SW1319	Cable Drain - Standard Colors	-	4	16" x 7" x 4"	\$132.00
SW1320	Cable Drain - Polished Chrome	-	4	16" x 7" x 4"	\$174.00
SW1321	Cable Drain - Everbrass (PVD)	-	4	16" x 7" x 4"	\$313.00
SW1322	Cable Drain - Brushed Nickel	-	4	16" x 7" x 4"	\$313.00
SW1323	Cable Drain - Oil Rubbed Bronze	-	4	16" x 7" x 4"	\$334.00
SWA100	"Rainbow" Pillow	-	4	14" x 8" x 2"	\$57.00
SWAP00	Nailing flange kit (field installed)	-	4	13" x 9" x 3-1/2"	\$65.00
<b>Nailing flange (factory installed)</b>					
SWP150L	Left Hand	-	-	-	\$164.00
SWP150R	Right Hand	-	-	-	\$164.00
SWP150S	Special/Center Drain, Diagram Required	-	-	-	\$164.00
<b>Whirlpool Options</b>					
SWP151	In-line water heater (factory installed)	-	-	-	\$533.00
<b>Metal trim upgrade:</b>					
SW1335	Chrome	-	-	-	\$366.00
SW1336	Everbrass (PVD)	-	-	-	\$366.00
SW1337	Brushed Nickel	-	-	-	\$366.00
SW1338	Oil Rubbed Bronze	-	-	-	\$392.00
<b>Air Bath Options</b>					
AR1200	Blower relocation kit	-	4	14" x 14" x 4"	\$169.00
<b>Metal trim kit:</b>					
AR1335	Chrome	-	-	-	\$366.00
AR1336	Everbrass (PVD)	-	-	-	\$366.00
AR1337	Brushed Nickel	-	-	-	\$366.00
AR1338	Oil Rubbed Bronze	-	-	-	\$392.00
<b>Bathtub Options</b>					
RS151	Constant heat system	-	-	-	\$533.00

Colors: See chart on inside back cover

**SHOWROOM SERIES – BATHTUBS / WHIRLPOOL SYSTEMS / AIR SYSTEMS / MICROBUBBLE SYSTEMS**



**Brentwood® 3666**

66" x 36" x 22-1/2"

Drop-in, rectangular model with back jets, clean geometric lines, integral armrests, one pillow and two decorative handles. Can be undermounted.

Water Capacity: Minimum Capacity: 60 gal. Maximum Capacity: 75 gal.



Number	Model	Dimensions	Approx. Ship Wt (lbs)	PKG Dimensions	List Price	
					Standard	Premium
<b>Bathtub</b>						
5573	SWIRL-WAY® BATHTUB	66" x 36" x 22-1/2"	155	71-1/2" x 38-1/2" x 24"	\$1,359.00	\$1,599.00
<b>Whirlpool Systems</b>						
5073BAS	SWIRL-WAY® BASIC	66" x 36" x 22-1/2"	165	71-1/2" x 38-1/2" x 24"	\$2,653.00	\$2,893.00
5073LUX	SWIRL-WAY® LUXURY	66" x 36" x 22-1/2"	165	71-1/2" x 38-1/2" x 24"	\$4,412.00	\$4,652.00
<b>Air Systems</b>						
9073	ARIANCE® HealthTouch™	66" x 36" x 22-1/2"	165	71-1/2" x 38-1/2" x 24"	\$3,169.00	\$3,409.00
9173	ARIANCE® GentleTouch™	66" x 36" x 22-1/2"	165	71-1/2" x 38-1/2" x 24"	\$3,459.00	\$3,699.00
9273	ARIANCE® DualTherapy™	66" x 36" x 22-1/2"	175	71-1/2" x 38-1/2" x 24"	\$4,809.00	\$5,049.00
<b>Microbubble System</b>						
5273	MICRODERM™ Therapeutic Bath	66" x 36" x 22-1/2"	165	71-1/2" x 38-1/2" x 24"	\$3,213.00	\$3,453.00
<b>Options and Accessories</b>						
Number	Model	Dimensions	Approx. Ship Wt (lbs)	PKG Dimensions	List Price	
<b>Common Options</b>						
SW1319	Cable Drain - Standard Colors	-	4	16" x 7" x 4"	\$132.00	
SW1320	Cable Drain - Polished Chrome	-	4	16" x 7" x 4"	\$174.00	
SW1321	Cable Drain - Everbrass (PVD)	-	4	16" x 7" x 4"	\$313.00	
SW1322	Cable Drain - Brushed Nickel	-	4	16" x 7" x 4"	\$313.00	
SW1323	Cable Drain - Oil Rubbed Bronze	-	4	16" x 7" x 4"	\$334.00	
SWA100	"Rainbow" Pillow	-	4	14" x 8" x 2"	\$57.00	
SWAP00	Nailing flange kit (field installed)	-	4	13" x 9" x 3-1/2"	\$65.00	
<b>Nailing flange (factory installed)</b>						
SWP150L	Left Hand	-	-	-	\$164.00	
SWP150R	Right Hand	-	-	-	\$164.00	
SWP150S	Special/Center Drain, Diagram Required	-	-	-	\$164.00	
<b>Whirlpool Options</b>						
SWP151	In-line water heater (factory installed)	-	-	-	\$533.00	
<b>Metal trim upgrade:</b>						
SW1335	Chrome	-	-	-	\$366.00	
SW1336	Everbrass (PVD)	-	-	-	\$366.00	
SW1337	Brushed Nickel	-	-	-	\$366.00	
SW1338	Oil Rubbed Bronze	-	-	-	\$392.00	
<b>Air Bath Options</b>						
AR1200	Blower relocation kit	-	4	14" x 14" x 4"	\$169.00	
<b>Metal trim kit:</b>						
AR1335	Chrome	-	-	-	\$366.00	
AR1336	Everbrass (PVD)	-	-	-	\$366.00	
AR1337	Brushed Nickel	-	-	-	\$366.00	
AR1338	Oil Rubbed Bronze	-	-	-	\$392.00	
<b>Bathtub Options</b>						
RS151	Constant heat system	-	-	-	\$533.00	

Colors: See chart on inside back cover

Bathware - Acrylic Showroom Series

## SHOWROOM SERIES – BATHTUBS / WHIRLPOOL SYSTEMS / AIR SYSTEMS / MICROBUBBLE SYSTEMS



### Brentwood® 3660

60" x 36" x 22-1/2"

Drop-in, rectangular model with back jets, clean geometric lines, integral armrests, one pillow and two decorative handles. Can be undermounted.

Water Capacity: Minimum Capacity: 56 gal. Maximum Capacity: 66 gal.



Number	Model	Dimensions	Approx. Ship Wt (lbs)	PKG Dimensions	List Price	
					Standard	Premium
<b>Bathtub</b>						
5569	SWIRL-WAY® BATHTUB	60" x 36" x 22-1/2"	150	65-1/2" x 38-1/2" x 24"	\$1,331.00	\$1,571.00
<b>Whirlpool Systems</b>						
5069BAS	SWIRL-WAY® BASIC	60" x 36" x 22-1/2"	160	65-1/2" x 38-1/2" x 24"	\$2,502.00	\$2,742.00
5069LUX	SWIRL-WAY® LUXURY	60" x 36" x 22-1/2"	160	65-1/2" x 38-1/2" x 24"	\$4,323.00	\$4,563.00
<b>Air Systems</b>						
9069	ARIANCE® HealthTouch™	60" x 36" x 22-1/2"	160	65-1/2" x 38-1/2" x 24"	\$3,036.00	\$3,276.00
9169	ARIANCE® GentleTouch™	60" x 36" x 22-1/2"	160	65-1/2" x 38-1/2" x 24"	\$3,311.00	\$3,551.00
9269	ARIANCE® DualTherapy™	60" x 36" x 22-1/2"	170	65-1/2" x 38-1/2" x 24"	\$4,695.00	\$4,935.00
<b>Microbubble System</b>						
5269	MICRODERM™ Therapeutic Bath	60" x 36" x 22-1/2"	160	65-1/2" x 38-1/2" x 24"	\$3,186.00	\$3,426.00
<b>Options and Accessories</b>						
Number	Model	Dimensions	Approx. Ship Wt (lbs)	PKG Dimensions	List Price	
<b>Common Options</b>						
SW1319	Cable Drain - Standard Colors	-	4	16" x 7" x 4"	\$132.00	
SW1320	Cable Drain - Polished Chrome	-	4	16" x 7" x 4"	\$174.00	
SW1321	Cable Drain - Everbrass (PVD)	-	4	16" x 7" x 4"	\$313.00	
SW1322	Cable Drain - Brushed Nickel	-	4	16" x 7" x 4"	\$313.00	
SW1323	Cable Drain - Oil Rubbed Bronze	-	4	16" x 7" x 4"	\$334.00	
SWA100	"Rainbow" Pillow	-	4	14" x 8" x 2"	\$57.00	
SWAP00	Nailing flange kit (field installed)	-	4	13" x 9" x 3-1/2"	\$65.00	
<b>Nailing flange (factory installed)</b>						
SWP150L	Left Hand	-	-	-	\$164.00	
SWP150R	Right Hand	-	-	-	\$164.00	
SWP150S	Special/Center Drain, Diagram Required	-	-	-	\$164.00	
<b>Whirlpool Options</b>						
SWP151	In-line water heater (factory installed)	-	-	-	\$533.00	
<b>Metal trim upgrade:</b>						
SW1335	Chrome	-	-	-	\$366.00	
SW1336	Everbrass (PVD)	-	-	-	\$366.00	
SW1337	Brushed Nickel	-	-	-	\$366.00	
SW1338	Oil Rubbed Bronze	-	-	-	\$392.00	
<b>Air Bath Options</b>						
AR1200	Blower relocation kit	-	4	14" x 14" x 4"	\$169.00	
<b>Metal trim kit:</b>						
AR1335	Chrome	-	-	-	\$366.00	
AR1336	Everbrass (PVD)	-	-	-	\$366.00	
AR1337	Brushed Nickel	-	-	-	\$366.00	
AR1338	Oil Rubbed Bronze	-	-	-	\$392.00	
<b>Bathtub Options</b>						
RS151	Constant heat system	-	-	-	\$533.00	
<b>Colors: See chart on inside back cover</b>						

**SHOWROOM SERIES – BATHTUBS / WHIRLPOOL SYSTEMS / AIR SYSTEMS / MICROBUBBLE SYSTEMS**



**Brentwood® 3260**

60" x 32" x 20-3/4"

Drop-in, rectangular model with back jets, clean geometric lines, integral armrests, one pillow and two decorative handles. Can be undermounted.

Water Capacity: Minimum Capacity: 40 gal. Maximum Capacity: 52 gal.



Number	Model	Dimensions	Approx. Ship Wt (lbs)	PKG Dimensions	List Price	
					Standard	Premium
<b>Bathtub</b>						
5567	SWIRL-WAY® BATHTUB	60" x 32" x 20 3/4"	110	65 1/2" x 37 1/2" x 23 1/2"	\$1,294.00	\$1,534.00
<b>Whirlpool Systems</b>						
5067BAS	SWIRL-WAY® BASIC	60" x 32" x 20 3/4"	130	65 1/2" x 37 1/2" x 23 1/2"	\$2,405.00	\$2,645.00
5067LUX	SWIRL-WAY® LUXURY	60" x 32" x 20 3/4"	130	65 1/2" x 37 1/2" x 23 1/2"	\$4,157.00	\$4,397.00
<b>Air Systems</b>						
9067	ARIANCE® HealthTouch™	60" x 32" x 20 3/4"	130	65 1/2" x 37 1/2" x 23 1/2"	\$2,948.00	\$3,188.00
9167	ARIANCE® GentleTouch™	60" x 32" x 20 3/4"	130	65 1/2" x 37 1/2" x 23 1/2"	\$3,225.00	\$3,465.00
9267	ARIANCE® DualTherapy™	60" x 32" x 20 3/4"	130	65 1/2" x 37 1/2" x 23 1/2"	\$4,525.00	\$4,765.00
<b>Microbubble System</b>						
5267	MICRODERM™ Therapeutic Bath	60" x 32" x 20 3/4"	130	65 1/2" x 37 1/2" x 23 1/2"	\$3,150.00	\$3,390.00
<b>Options and Accessories</b>						
Number	Model	Dimensions	Approx. Ship Wt (lbs)	PKG Dimensions	List Price	
<b>Common Options</b>						
SW1319	Cable Drain - Standard Colors	-	4	16" x 7" x 4"	\$132.00	
SW1320	Cable Drain - Polished Chrome	-	4	16" x 7" x 4"	\$174.00	
SW1321	Cable Drain - Everbrass (PVD)	-	4	16" x 7" x 4"	\$313.00	
SW1322	Cable Drain - Brushed Nickel	-	4	16" x 7" x 4"	\$313.00	
SW1323	Cable Drain - Oil Rubbed Bronze	-	4	16" x 7" x 4"	\$334.00	
SWA100	"Rainbow" Pillow	-	4	14" x 8" x 2"	\$57.00	
SWAP00	Nailing flange kit (field installed)	-	4	13" x 9" x 3-1/2"	\$65.00	
<b>Nailing flange (factory installed)</b>						
SWP150L	Left Hand	-	-	-	\$164.00	
SWP150R	Right Hand	-	-	-	\$164.00	
SWP150S	Special/Center Drain, Diagram Required	-	-	-	\$164.00	
<b>Whirlpool Options</b>						
SWP151	In-line water heater (factory installed)	-	-	-	\$533.00	
<b>Metal trim upgrade:</b>						
SW1335	Chrome	-	-	-	\$366.00	
SW1336	Everbrass (PVD)	-	-	-	\$366.00	
SW1337	Brushed Nickel	-	-	-	\$366.00	
SW1338	Oil Rubbed Bronze	-	-	-	\$392.00	
<b>Air Bath Options</b>						
AR1200	Blower relocation kit	-	4	14" x 14" x 4"	\$169.00	
<b>Metal trim kit:</b>						
AR1335	Chrome	-	-	-	\$366.00	
AR1336	Everbrass (PVD)	-	-	-	\$366.00	
AR1337	Brushed Nickel	-	-	-	\$366.00	
AR1338	Oil Rubbed Bronze	-	-	-	\$392.00	
<b>Bathtub Options</b>						
RS151	Constant heat system	-	-	-	\$533.00	
Colors: See chart on inside back cover						



## SHOWROOM SERIES – BATHTUBS / WHIRLPOOL SYSTEMS / AIR SYSTEMS / MICROBUBBLE SYSTEMS



### Brighton

72" x 48" x 24"

Drop-in, two person model with distinct accents featuring a deck wide enough for faucets. Includes two pillows.

Water Capacity: Minimum Capacity: 80 gal. Maximum Capacity: 95 gal.



Number	Model	Dimensions	Approx. Ship Wt (lbs)	PKG Dimensions	List Price	
					Standard	Premium
<b>Bathtub</b>						
5540	SWIRL-WAY® BATHTUB	72" x 48" x 24"	155	77-1/2" x 53-1/4" x 26-1/2"	\$1,521.00	\$1,761.00
<b>Whirlpool Systems</b>						
5040BAS	SWIRL-WAY® BASIC	72" x 48" x 24"	185	77-1/2" x 53-1/4" x 26-1/2"	\$3,202.00	\$3,442.00
5040LUX	SWIRL-WAY® LUXURY	72" x 48" x 24"	185	77-1/2" x 53-1/4" x 26-1/2"	\$5,028.00	\$5,268.00
<b>Air Systems</b>						
9040	ARIANCE® HealthTouch™	72" x 48" x 24"	185	77-1/2" x 53-1/4" x 26-1/2"	\$3,832.00	\$4,072.00
9140	ARIANCE® GentleTouch™	72" x 48" x 24"	185	77-1/2" x 53-1/4" x 26-1/2"	\$4,124.00	\$4,364.00
9240	ARIANCE® DualTherapy™	72" x 48" x 24"	200	77-1/2" x 53-1/4" x 26-1/2"	\$5,486.00	\$5,726.00
<b>Options and Accessories</b>						
Number	Model	Dimensions	Approx. Ship Wt (lbs)	PKG Dimensions	List Price	
<b>Common Options</b>						
SW1319	Cable Drain - Standard Colors	-	4	16" x 7" x 4"	\$132.00	
SW1320	Cable Drain - Polished Chrome	-	4	16" x 7" x 4"	\$174.00	
SW1321	Cable Drain - Everbrass (PVD)	-	4	16" x 7" x 4"	\$313.00	
SW1322	Cable Drain - Brushed Nickel	-	4	16" x 7" x 4"	\$313.00	
SW1323	Cable Drain - Oil Rubbed Bronze	-	4	16" x 7" x 4"	\$334.00	
SWA200	Exclusive Custom Pillow	-	4	14" x 8" x 6"	\$57.00	
SWAP00	Nailing flange kit (field installed)	-	4	13" x 9" x 3-1/2"	\$65.00	
<b>Nailing flange (factory installed)</b>						
SWP150S	Special/Center Drain, Diagram Required				\$164.00	
<b>Whirlpool Options</b>						
SWP151	In-line water heater (factory installed)	-	-	-	\$533.00	
<b>Metal trim upgrade:</b>						
SW1335	Chrome	-	-	-	\$366.00	
SW1336	Everbrass (PVD)	-	-	-	\$366.00	
SW1337	Brushed Nickel	-	-	-	\$366.00	
SW1338	Oil Rubbed Bronze	-	-	-	\$392.00	
<b>Air Bath Options</b>						
AR1200	Blower relocation kit	-	4	14" x 14" x 4"	\$169.00	
<b>Metal trim kit:</b>						
AR1335	Chrome	-	-	-	\$366.00	
AR1336	Everbrass (PVD)	-	-	-	\$366.00	
AR1337	Brushed Nickel	-	-	-	\$366.00	
AR1338	Oil Rubbed Bronze	-	-	-	\$392.00	
<b>Bathtub Options</b>						
RS151	Constant heat system	-	-	-	\$533.00	
<b>Colors: See chart on inside back cover</b>						

**SHOWROOM SERIES – BATHTUBS / WHIRLPOOL SYSTEMS / AIR SYSTEMS / MICROBUBBLE SYSTEMS**



**Camden**

59-1/2" x 32" x 21-1/2"

Drop-in, rectangular model featuring custom pillow, back jets and two decorative handles.

Water Capacity: Minimum Capacity: 42 gal. Maximum Capacity: 52 gal.



Optional removable apron

Number	Model	Dimensions	Approx. Ship Wt (lbs)	PKG Dimensions	List Price	
					Standard	Premium
<b>Bathtub</b>						
5553	SWIRL-WAY® BATHTUB	59-1/2" x 32" x 21-1/2"	110	65-1/2" x 37-1/2" x 23-1/2"	\$1,294.00	\$1,534.00
<b>Whirlpool Systems</b>						
5053BAS	SWIRL-WAY® BASIC	59-1/2" x 32" x 21-1/2"	130	65-1/2" x 37-1/2" x 23-1/2"	\$2,405.00	\$2,645.00
5053LUX	SWIRL-WAY® LUXURY	59-1/2" x 32" x 21-1/2"	130	65-1/2" x 37-1/2" x 23-1/2"	\$4,157.00	\$4,397.00
<b>Air Systems</b>						
9053	ARIANCE® HealthTouch™	59-1/2" x 32" x 21-1/2"	130	65-1/2" x 37-1/2" x 23-1/2"	\$2,948.00	\$3,188.00
9153	ARIANCE® GentleTouch™	59-1/2" x 32" x 21-1/2"	130	65-1/2" x 37-1/2" x 23-1/2"	\$3,225.00	\$3,465.00
9253	ARIANCE® DualTherapy™	59-1/2" x 32" x 21-1/2"	145	65-1/2" x 37-1/2" x 23-1/2"	\$4,525.00	\$4,765.00
<b>Microbubble System</b>						
5253	MICRODERM™ Therapeutic Bath	59-1/2" x 32" x 21-1/2"	130	65-1/2" x 37-1/2" x 23-1/2"	\$3,150.00	\$3,390.00
<b>Options and Accessories</b>						
Number	Model	Dimensions	Approx. Ship Wt (lbs)	PKG Dimensions	List Price	
					Standard	Premium
<b>Common Options</b>						
SW1319	Cable Drain - Standard Colors	-	4	16" x 7" x 4"	\$132.00	
SW1320	Cable Drain - Polished Chrome	-	4	16" x 7" x 4"	\$174.00	
SW1321	Cable Drain - Everbrass (PVD)	-	4	16" x 7" x 4"	\$313.00	
SW1322	Cable Drain - Brushed Nickel	-	4	16" x 7" x 4"	\$313.00	
SW1323	Cable Drain - Oil Rubbed Bronze	-	4	16" x 7" x 4"	\$334.00	
7053	Removable Apron - Camden	60" x 16-1/4" x 2"	15	62-1/2" x 22-3/4" x 4"	\$463.00	\$703.00
SWA200	Exclusive Custom Pillow	-	4	14" x 8" x 6"	\$57.00	
SWAP00	Nailing flange kit (field installed)	-	4	13" x 9" x 3-1/2"	\$65.00	
<b>Nailing flange (factory installed)</b>						
SWP150L	Left Hand	-	-	-	\$164.00	
SWP150R	Right Hand	-	-	-	\$164.00	
SWP150S	Special/Center Drain, Diagram Required	-	-	-	\$164.00	
<b>Whirlpool Options</b>						
SWP151	In-line water heater (factory installed)	-	-	-	\$533.00	
<b>Metal trim upgrade:</b>						
SW1335	Chrome	-	-	-	\$366.00	
SW1336	Everbrass (PVD)	-	-	-	\$366.00	
SW1337	Brushed Nickel	-	-	-	\$366.00	
SW1338	Oil Rubbed Bronze	-	-	-	\$392.00	
<b>Air Bath Options</b>						
AR1200	Blower relocation kit	-	4	14" x 14" x 4"	\$169.00	
<b>Metal trim kit:</b>						
AR1335	Chrome	-	-	-	\$366.00	
AR1336	Everbrass (PVD)	-	-	-	\$366.00	
AR1337	Brushed Nickel	-	-	-	\$366.00	
AR1338	Oil Rubbed Bronze	-	-	-	\$392.00	
<b>Bathtub Options</b>						
RS151	Constant heat system	-	-	-	\$533.00	

Colors: See chart on inside back cover

## SHOWROOM SERIES – BATHTUBS / WHIRLPOOL SYSTEMS / AIR SYSTEMS / MICROBUBBLE SYSTEMS



### Elba R

59-1/2" x 42" x 23"

This rectangular model adds versatility to any bathroom with a flat deck for placing toiletries. Also, provides plenty of room for mounting faucets. Can be under-mounted. Includes one pillow.



Water Capacity: Minimum Capacity: 50 gal. Maximum Capacity: 70 gal.

Number	Model	Dimensions	Approx. Ship Wt (lbs)	PKG Dimensions	List Price	
					Standard	Premium
<b>Bathtub</b>						
5584	SWIRL-WAY® BATHTUB	59-1/2" x 42" x 23"	135	65-1/2" x 47-1/4" x 24"	\$1,386.00	\$1,626.00
<b>Whirlpool Systems</b>						
5084BAS	SWIRL-WAY® BASIC	59-1/2" x 42" x 23"	155	65-1/2" x 47-1/4" x 24"	\$2,703.00	\$2,943.00
5084LUX	SWIRL-WAY® LUXURY	59-1/2" x 42" x 23"	155	65-1/2" x 47-1/4" x 24"	\$4,463.00	\$4,703.00
<b>Air Systems</b>						
9084	ARIANCE® HealthTouch™	59-1/2" x 42" x 23"	155	65-1/2" x 47-1/4" x 24"	\$3,283.00	\$3,523.00
9184	ARIANCE® GentleTouch™	59-1/2" x 42" x 23"	155	65-1/2" x 47-1/4" x 24"	\$3,576.00	\$3,816.00
9284	ARIANCE® DualTherapy™	59-1/2" x 42" x 23"	170	65-1/2" x 47-1/4" x 24"	\$4,926.00	\$5,166.00
<b>Options and Accessories</b>						
Number	Model	Dimensions	Approx. Ship Wt (lbs)	PKG Dimensions	List Price	
<b>Common Options</b>						
SW1319	Cable Drain - Standard Colors	-	4	16" x 7" x 4"	\$132.00	
SW1320	Cable Drain - Polished Chrome	-	4	16" x 7" x 4"	\$174.00	
SW1321	Cable Drain - Everbrass (PVD)	-	4	16" x 7" x 4"	\$313.00	
SW1322	Cable Drain - Brushed Nickel	-	4	16" x 7" x 4"	\$313.00	
SW1323	Cable Drain - Oil Rubbed Bronze	-	4	16" x 7" x 4"	\$334.00	
SWA100	"Rainbow" Pillow	-	4	14" x 8" x 2"	\$57.00	
SWAP00	Nailing flange kit (field installed)	-	4	13" x 9" x 3-1/2"	\$65.00	
<b>Nailing flange (factory installed)</b>						
SWP150L	Left Hand	-	-	-	\$164.00	
SWP150R	Right Hand	-	-	-	\$164.00	
SWP150S	Special/Center Drain, Diagram Required	-	-	-	\$164.00	
<b>Whirlpool Options</b>						
SWP151	In-line water heater (factory installed)	-	-	-	\$533.00	
<b>Metal trim upgrade:</b>						
SW1335	Chrome	-	-	-	\$366.00	
SW1336	Everbrass (PVD)	-	-	-	\$366.00	
SW1337	Brushed Nickel	-	-	-	\$366.00	
SW1338	Oil Rubbed Bronze	-	-	-	\$392.00	
<b>Air Bath Options</b>						
AR1200	Blower relocation kit	-	4	14" x 14" x 4"	\$169.00	
<b>Metal trim kit:</b>						
AR1335	Chrome	-	-	-	\$366.00	
AR1336	Everbrass (PVD)	-	-	-	\$366.00	
AR1337	Brushed Nickel	-	-	-	\$366.00	
AR1338	Oil Rubbed Bronze	-	-	-	\$392.00	
<b>Bathtub Options</b>						
RS151	Constant heat system	-	-	-	\$533.00	

Colors: See chart on inside back cover

**SHOWROOM SERIES – BATHTUBS / WHIRLPOOL SYSTEMS / AIR SYSTEMS / MICROBUBBLE SYSTEMS**



**Hampton R**  
72" x 42" x 23-1/2"



Unique rectangular model with a deep bathing well gives further choices in bathroom design. Exclusive ergonomic handles and custom pillow complement your personal oasis.

Water Capacity: Minimum Capacity: 60 gal. Maximum Capacity: 80 gal.

Number	Model	Dimensions	Approx. Ship Wt (lbs)	PKG Dimensions	List Price	
					Standard	Premium
<b>Bathtub</b>						
5572	SWIRL-WAY® BATHTUB	72" x 42" x 23-1/2"	155	77-1/2" x 47-1/4" x 24"	\$1,468.00	\$1,708.00
<b>Whirlpool Systems</b>						
5072BAS	SWIRL-WAY® BASIC	72" x 42" x 23-1/2"	175	77-1/2" x 47-1/4" x 24"	\$2,903.00	\$3,143.00
5072LUX	SWIRL-WAY® LUXURY	72" x 42" x 23-1/2"	175	77-1/2" x 47-1/4" x 24"	\$4,663.00	\$4,903.00
<b>Air Systems</b>						
9072	ARIANCE® HealthTouch™	72" x 42" x 23-1/2"	175	77-1/2" x 47-1/4" x 24"	\$3,394.00	\$3,634.00
9172	ARIANCE® GentleTouch™	72" x 42" x 23-1/2"	175	77-1/2" x 47-1/4" x 24"	\$3,685.00	\$3,925.00
9272	ARIANCE® DualTherapy™	72" x 42" x 23-1/2"	190	77-1/2" x 47-1/4" x 24"	\$5,153.00	\$5,393.00
<b>Microbubble System</b>						
5272	MICRODERM™ Therapeutic Bath	72" x 42" x 23-1/2"	175	77-1/2" x 47-1/4" x 24"	\$3,318.00	\$3,558.00
<b>Options and Accessories</b>						
Number	Model	Dimensions	Approx. Ship Wt (lbs)	PKG Dimensions	List Price	
<b>Common Options</b>						
SW1319	Cable Drain - Standard Colors	-	4	16" x 7" x 4"	\$132.00	
SW1320	Cable Drain - Polished Chrome	-	4	16" x 7" x 4"	\$174.00	
SW1321	Cable Drain - Everbrass (PVD)	-	4	16" x 7" x 4"	\$313.00	
SW1322	Cable Drain - Brushed Nickel	-	4	16" x 7" x 4"	\$313.00	
SW1323	Cable Drain - Oil Rubbed Bronze	-	4	16" x 7" x 4"	\$334.00	
SWA100	"Rainbow" Pillow	-	4	14" x 8" x 2"	\$57.00	
SWAP00	Nailing flange kit (field installed)	-	4	13" x 9" x 3-1/2"	\$65.00	
<b>Nailing flange (factory installed)</b>						
SWP150L	Left Hand	-	-	-	\$164.00	
SWP150R	Right Hand	-	-	-	\$164.00	
SWP150S	Special/Center Drain, Diagram Required	-	-	-	\$164.00	
<b>Whirlpool Options</b>						
SWP151	In-line water heater (factory installed)	-	-	-	\$533.00	
<b>Metal trim upgrade:</b>						
SW1335	Chrome	-	-	-	\$366.00	
SW1336	Everbrass (PVD)	-	-	-	\$366.00	
SW1337	Brushed Nickel	-	-	-	\$366.00	
SW1338	Oil Rubbed Bronze	-	-	-	\$392.00	
<b>Air Bath Options</b>						
AR1200	Blower relocation kit	-	4	14" x 14" x 4"	\$169.00	
<b>Metal trim kit:</b>						
AR1335	Chrome	-	-	-	\$366.00	
AR1336	Everbrass (PVD)	-	-	-	\$366.00	
AR1337	Brushed Nickel	-	-	-	\$366.00	
AR1338	Oil Rubbed Bronze	-	-	-	\$392.00	
<b>Bathtub Options</b>						
RS151	Constant heat system	-	-	-	\$533.00	

Colors: See chart on inside back cover

## SHOWROOM SERIES – BATHTUBS / WHIRLPOOL SYSTEMS / AIR SYSTEMS / MICROBUBBLE SYSTEMS



### Heathrow R

72" x 42" x 23"

Drop-in, two-person model with distinct accents featuring a deck wide enough for faucets. Includes two custom pillows.

Water Capacity: Minimum Capacity: 60 gal. Maximum Capacity: 72 gal.



Number	Model	Dimensions	Approx. Ship Wt (lbs)	PKG Dimensions	List Price	
					Standard	Premium
<b>Bathtub</b>						
5558	SWIRL-WAY® BATHTUB	72" x 42" x 23"	155	77-1/2" x 47-1/4" x 24"	\$1,468.00	\$1,708.00
<b>Whirlpool Systems</b>						
5058BAS	SWIRL-WAY® BASIC	72" x 42" x 23"	175	77-1/2" x 47-1/4" x 24"	\$2,903.00	\$3,143.00
5058LUX	SWIRL-WAY® LUXURY	72" x 42" x 23"	175	77-1/2" x 47-1/4" x 24"	\$4,663.00	\$4,903.00
<b>Air Systems</b>						
9058	ARIANCE® HealthTouch™	72" x 42" x 23"	175	77-1/2" x 47-1/4" x 24"	\$3,645.00	\$3,885.00
9158	ARIANCE® GentleTouch™	72" x 42" x 23"	175	77-1/2" x 47-1/4" x 24"	\$3,937.00	\$4,177.00
9258	ARIANCE® DualTherapy™	72" x 42" x 23"	190	77-1/2" x 47-1/4" x 24"	\$5,153.00	\$5,393.00
<b>Microbubble System</b>						
5258	MICRODERM™ Therapeutic Bath	72" x 42" x 23"	175	77-1/2" x 47-1/4" x 24"	\$3,318.00	\$3,558.00

### Options and Accessories

Number	Model	Dimensions	Approx. Ship Wt (lbs)	PKG Dimensions	List Price
<b>Common Options</b>					
SW1319	Cable Drain - Standard Colors	-	4	16" x 7" x 4"	\$132.00
SW1320	Cable Drain - Polished Chrome	-	4	16" x 7" x 4"	\$174.00
SW1321	Cable Drain - Everbrass (PVD)	-	4	16" x 7" x 4"	\$313.00
SW1322	Cable Drain - Brushed Nickel	-	4	16" x 7" x 4"	\$313.00
SW1323	Cable Drain - Oil Rubbed Bronze	-	4	16" x 7" x 4"	\$334.00
SWA100	"Rainbow" Pillow	-	4	14" x 8" x 2"	\$57.00
SWAP00	Nailing flange kit (field installed)	-	4	13" x 9" x 3-1/2"	\$65.00
<b>Nailing flange (factory installed)</b>					
SWP150S	Special/Center Drain, Diagram Required				\$164.00
<b>Whirlpool Options</b>					
SWP151	In-line water heater (factory installed)	-	-	-	\$533.00
<b>Metal trim upgrade:</b>					
SW1335	Chrome	-	-	-	\$366.00
SW1336	Everbrass (PVD)	-	-	-	\$366.00
SW1337	Brushed Nickel	-	-	-	\$366.00
SW1338	Oil Rubbed Bronze	-	-	-	\$392.00
<b>Air Bath Options</b>					
AR1200	Blower relocation kit	-	4	14" x 14" x 4"	\$169.00
<b>Metal trim kit:</b>					
AR1335	Chrome	-	-	-	\$366.00
AR1336	Everbrass (PVD)	-	-	-	\$366.00
AR1337	Brushed Nickel	-	-	-	\$366.00
AR1338	Oil Rubbed Bronze	-	-	-	\$392.00
<b>Bathtub Options</b>					
RS151	Constant heat system	-	-	-	\$533.00

Colors: See chart on inside back cover

**SHOWROOM SERIES – BATHTUBS / WHIRLPOOL SYSTEMS / AIR SYSTEMS / MICROBUBBLE SYSTEMS**



**Romanesque**

**68" x 42" x 22"**

Drop-in, rectangular model with classic Victorian styling and dual back jets, providing the romance to accompany any bathroom design. Includes two custom pillows.

Water Capacity: Minimum Capacity: 40 gal. Maximum Capacity: 70 gal.



Number	Model	Dimensions	Approx. Ship Wt (lbs)	PKG Dimensions	List Price	
					Standard	Premium
<b>Whirlpool Systems</b>						
<b>5011BAS</b>	SWIRL-WAY® BASIC	68" x 42" x 22"	155	73-1/2" x 47-1/4" x 24"	\$2,903.00	\$3,143.00
<b>5011LUX</b>	SWIRL-WAY® LUXURY	68" x 42" x 22"	155	73-1/2" x 47-1/4" x 24"	\$4,725.00	\$4,965.00
<b>Options and Accessories</b>						
Number	Model	Dimensions	Approx. Ship Wt (lbs)	PKG Dimensions	List Price	
<b>Whirlpool Options</b>						
<b>SW1319</b>	Cable Drain - Standard Colors	-	4	16" x 7" x 4"	\$132.00	
<b>SW1320</b>	Cable Drain - Polished Chrome	-	4	16" x 7" x 4"	\$174.00	
<b>SW1321</b>	Cable Drain - Everbrass (PVD)	-	4	16" x 7" x 4"	\$313.00	
<b>SW1322</b>	Cable Drain - Brushed Nickel	-	4	16" x 7" x 4"	\$313.00	
<b>SW1323</b>	Cable Drain - Oil Rubbed Bronze	-	4	16" x 7" x 4"	\$334.00	
<b>SWA100</b>	"Rainbow" Pillow	-	4	14" x 8" x 2"	\$57.00	
<b>SWP151</b>	In-line water heater (factory installed)	-	-	-	\$533.00	
<b>Metal trim upgrade:</b>						
<b>SW1335</b>	Chrome	-	-	-	\$366.00	
<b>SW1336</b>	Everbrass (PVD)	-	-	-	\$366.00	
<b>SW1337</b>	Brushed Nickel	-	-	-	\$366.00	
<b>SW1338</b>	Oil Rubbed Bronze	-	-	-	\$392.00	
<b>Colors: See chart on inside back cover</b>						



## SHOWROOM SERIES – BATHTUBS / WHIRLPOOL SYSTEMS / AIR SYSTEMS / MICROBUBBLE SYSTEMS



### Savannah

72" x 48" x 24"

A large two-person rectangular model featuring a deep bathing well with four seating areas. Clean lines and European style provide flair for any bathroom décor. Includes two pillows.

Water Capacity: Minimum Capacity: 80 gal. Maximum Capacity: 95 gal.



Number	Model	Dimensions	Approx. Ship Wt (lbs)	PKG Dimensions	List Price	
					Standard	Premium
<b>Bathtub</b>						
5551	SWIRL-WAY® BATHTUB	72" x 48" x 24"	160	77-1/2" x 53-1/4" x 26-1/2"	\$1,521.00	\$1,761.00
<b>Whirlpool Systems</b>						
5051BAS	SWIRL-WAY® BASIC	72" x 48" x 24"	180	77-1/2" x 53-1/4" x 26-1/2"	\$3,202.00	\$3,442.00
5051LUX	SWIRL-WAY® LUXURY	72" x 48" x 24"	180	77-1/2" x 53-1/4" x 26-1/2"	\$5,028.00	\$5,268.00
<b>Air Systems</b>						
9051	ARIANCE® HealthTouch™	72" x 48" x 24"	180	77-1/2" x 53-1/4" x 26-1/2"	\$3,832.00	\$4,072.00
9151	ARIANCE® GentleTouch™	72" x 48" x 24"	180	77-1/2" x 53-1/4" x 26-1/2"	\$4,124.00	\$4,364.00
9251	ARIANCE® DualTherapy™	72" x 48" x 24"	195	77-1/2" x 53-1/4" x 26-1/2"	\$5,486.00	\$5,726.00
<b>Options and Accessories</b>						
Number	Model	Dimensions	Approx. Ship Wt (lbs)	PKG Dimensions	List Price	
<b>Common Options</b>						
SW1319	Cable Drain - Standard Colors	-	4	16" x 7" x 4"	\$132.00	
SW1320	Cable Drain - Polished Chrome	-	4	16" x 7" x 4"	\$174.00	
SW1321	Cable Drain - Everbrass (PVD)	-	4	16" x 7" x 4"	\$313.00	
SW1322	Cable Drain - Brushed Nickel	-	4	16" x 7" x 4"	\$313.00	
SW1323	Cable Drain - Oil Rubbed Bronze	-	4	16" x 7" x 4"	\$334.00	
SWA100	"Rainbow" Pillow	-	4	14" x 8" x 2"	\$57.00	
SWAP00	Nailing flange kit (field installed)	-	4	13" x 9" x 3-1/2"	\$65.00	
<b>Nailing flange (factory installed)</b>						
SWP150S	Special/Center Drain, Diagram Required				\$164.00	
<b>Whirlpool Options</b>						
SWP151	In-line water heater (factory installed)	-	-	-	\$533.00	
<b>Metal trim upgrade:</b>						
SW1335	Chrome	-	-	-	\$366.00	
SW1336	Everbrass (PVD)	-	-	-	\$366.00	
SW1337	Brushed Nickel	-	-	-	\$366.00	
SW1338	Oil Rubbed Bronze	-	-	-	\$392.00	
<b>Air Bath Options</b>						
AR1200	Blower relocation kit	-	4	14" x 14" x 4"	\$169.00	
<b>Metal trim kit:</b>						
AR1335	Chrome	-	-	-	\$366.00	
AR1336	Everbrass (PVD)	-	-	-	\$366.00	
AR1337	Brushed Nickel	-	-	-	\$366.00	
AR1338	Oil Rubbed Bronze	-	-	-	\$392.00	
<b>Bathtub Options</b>						
RS151	Constant heat system	-	-	-	\$533.00	
<b>Colors: See chart on inside back cover</b>						

**SHOWROOM SERIES – BATHTUBS / WHIRLPOOL SYSTEMS / AIR SYSTEMS / MICROBUBBLE SYSTEMS**



**Ambria**

**59-1/2" x 59-1/2" x 21-1/4"**

A delightfully contemporary model provides a popular blend of beauty and comfort. This roomy corner model offers dual armrests that cradle the bather in delight. Includes two pillows.



Optional removable corner apron

Water Capacity: Minimum Capacity: 60 gal. Maximum Capacity: 85 gal.

Number	Model	Dimensions	Approx. Ship Wt (lbs)	PKG Dimensions	List Price	
					Standard	Premium
<b>Bathtub</b>						
5539	SWIRL-WAY® BATHTUB	59-1/2" x 59-1/2" x 21-1/4"	135	65-1/2" x 65-1/2" x 25-1/2"	\$1,521.00	\$1,761.00
<b>Whirlpool Systems</b>						
5039BAS	SWIRL-WAY® BASIC	59-1/2" x 59-1/2" x 21-1/4"	155	65-1/2" x 65-1/2" x 25-1/2"	\$3,052.00	\$3,292.00
5039LUX	SWIRL-WAY® LUXURY	59-1/2" x 59-1/2" x 21-1/4"	155	65-1/2" x 65-1/2" x 25-1/2"	\$4,878.00	\$5,118.00
<b>Options and Accessories</b>						
Number	Model	Dimensions	Approx. Ship Wt (lbs)	PKG Dimensions	List Price	
					Standard	Premium
<b>Common Options</b>						
SW1319	Cable Drain - Standard Colors	-	4	16" x 7" x 4"	\$132.00	
SW1320	Cable Drain - Polished Chrome	-	4	16" x 7" x 4"	\$174.00	
SW1321	Cable Drain - Everbrass (PVD)	-	4	16" x 7" x 4"	\$313.00	
SW1322	Cable Drain - Brushed Nickel	-	4	16" x 7" x 4"	\$313.00	
SW1323	Cable Drain - Oil Rubbed Bronze	-	4	16" x 7" x 4"	\$334.00	
7039	Removable Apron- Ambria	85" x 19-1/2" x 21-1/4"	30	87-1/2" x 24" x 22-1/2"	\$989.00	\$1,229.00
SWA100	"Rainbow" Pillow	-	4	14" x 8" x 2"	\$57.00	
SWAP00	Nailing flange kit (field installed)	-	4	13" x 9" x 3-1/2"	\$65.00	
<b>Nailing flange (factory installed)</b>						
SWP150S	Special/Center Drain (diagram required)	-	-	-	\$164.00	
SWP150C	Corner Unit	-	-	-	\$164.00	
<b>Whirlpool Options</b>						
SWP151	In-line water heater (factory installed)	-	-	-	\$533.00	
<b>Metal trim upgrade:</b>						
SW1335	Chrome	-	-	-	\$366.00	
SW1336	Everbrass (PVD)	-	-	-	\$366.00	
SW1337	Brushed Nickel	-	-	-	\$366.00	
SW1338	Oil Rubbed Bronze	-	-	-	\$392.00	
<b>Bathtub Options</b>						
RS151	Constant heat system	-	-	-	\$533.00	

Colors: See chart on inside back cover

## SHOWROOM SERIES – BATHTUBS / WHIRLPOOL SYSTEMS / AIR SYSTEMS / MICROBUBBLE SYSTEMS



### Bristol Bay

60" x 60" x 22"

Gentle curves flow across two contoured bathing wells, a two-person corner model that fits any bathroom décor. Includes two pillows.

Water Capacity: Minimum Capacity: 60 gals Maximum Capacity: 90 gals



Number	Model	Dimensions	Approx. Ship Wt (lbs)	PKG Dimensions	List Price	
					Standard	Premium
<b>Bathtub</b>						
5545	SWIRL-WAY® BATHTUB	60" x 60" x 22"	165	65-1/2" x 65-1/2" x 25-1/2"	\$1,521.00	\$1,761.00
<b>Whirlpool Systems</b>						
5045BAS	SWIRL-WAY® BASIC	60" x 60" x 22"	185	65-1/2" x 65-1/2" x 25-1/2"	\$3,052.00	\$3,292.00
5045LUX	SWIRL-WAY® LUXURY	60" x 60" x 22"	185	65-1/2" x 65-1/2" x 25-1/2"	\$4,878.00	\$5,118.00
<b>Air Systems</b>						
9003	ARIANCE® HealthTouch™	60" x 60" x 22"	185	65-1/2" x 65-1/2" x 25-1/2"	\$3,973.00	\$4,213.00
9103	ARIANCE® GentleTouch™	60" x 60" x 22"	185	65-1/2" x 65-1/2" x 25-1/2"	\$4,266.00	\$4,506.00
9203	ARIANCE® DualTherapy™	60" x 60" x 22"	200	65-1/2" x 65-1/2" x 25-1/2"	\$5,638.00	\$5,878.00
<b>Microbubble System</b>						
5245	MICRODERM™ Therapeutic Bath	60" x 60" x 22"	185	65-1/2" x 65-1/2" x 25-1/2"	\$3,370.00	\$3,610.00

### Options and Accessories

Number	Model	Dimensions	Approx. Ship Wt (lbs)	PKG Dimensions	List Price
<b>Common Options</b>					
SW1319	Cable Drain - Standard Colors	-	4	16" x 7" x 4"	\$132.00
SW1320	Cable Drain - Polished Chrome	-	4	16" x 7" x 4"	\$174.00
SW1321	Cable Drain - Everbrass (PVD)	-	4	16" x 7" x 4"	\$313.00
SW1322	Cable Drain - Brushed Nickel	-	4	16" x 7" x 4"	\$313.00
SW1323	Cable Drain - Oil Rubbed Bronze	-	4	16" x 7" x 4"	\$334.00
SWA100	"Rainbow" Pillow	-	4	14" x 8" x 2"	\$57.00
SWAP00	Nailing flange kit (field installed)	-	4	13" x 9" x 3-1/2"	\$65.00
<b>Nailing flange (factory installed)</b>					
SWP150S	Special/Center Drain (diagram required)	-	-	-	\$164.00
SWP150C	Corner Unit	-	-	-	\$164.00
<b>Whirlpool Options</b>					
SWP151	In-line water heater (factory installed)	-	-	-	\$533.00
<b>Metal trim upgrade:</b>					
SW1335	Chrome	-	-	-	\$366.00
SW1336	Everbrass (PVD)	-	-	-	\$366.00
SW1337	Brushed Nickel	-	-	-	\$366.00
SW1338	Oil Rubbed Bronze	-	-	-	\$392.00
<b>Air Bath Options</b>					
AR1200	Blower relocation kit	-	4	14" x 14" x 4"	\$169.00
<b>Metal trim kit:</b>					
AR1335	Chrome	-	-	-	\$366.00
AR1336	Everbrass (PVD)	-	-	-	\$366.00
AR1337	Brushed Nickel	-	-	-	\$366.00
AR1338	Oil Rubbed Bronze	-	-	-	\$392.00
<b>Bathtub Options</b>					
RS151	Constant heat system	-	-	-	\$533.00

Colors: See chart on inside back cover

**SHOWROOM SERIES – BATHTUBS / WHIRLPOOL SYSTEMS / AIR SYSTEMS / MICROBUBBLE SYSTEMS**



**Castille**

**66" x 66" x 23-1/2"**

A total new dimension in a two-person corner model with its spa-like features and size. A unique, contoured design provides three separate seating areas. Includes two pillows.



Water Capacity: Minimum Capacity: 75 gal. Maximum Capacity: 100 gal.

Number	Model	Dimensions	Approx. Ship Wt (lbs)	PKG Dimensions	List Price	
					Standard	Premium
<b>Bathtub</b>						
5589	SWIRL-WAY® BATHTUB	66" x 66" x 23-1/2"	205	71-1/4" x 71-1/4" x 28-1/2"	\$1,576.00	\$1,816.00
<b>Whirlpool Systems</b>						
5089BAS	SWIRL-WAY® BASIC	66" x 66" x 23-1/2"	205	71-1/4" x 71-1/4" x 28-1/2"	\$3,253.00	\$3,493.00
5089LUX	SWIRL-WAY® LUXURY	66" x 66" x 23-1/2"	205	71-1/4" x 71-1/4" x 28-1/2"	\$5,080.00	\$5,320.00
<b>Air Systems</b>						
9089	ARIANCE® HealthTouch™	66" x 66" x 23-1/2"	230	71-1/4" x 71-1/4" x 28-1/2"	\$3,886.00	\$4,126.00
9189	ARIANCE® GentleTouch™	66" x 66" x 23-1/2"	230	71-1/4" x 71-1/4" x 28-1/2"	\$4,279.00	\$4,519.00
9289	ARIANCE® DualTherapy™	66" x 66" x 23-1/2"	230	71-1/4" x 71-1/4" x 28-1/2"	\$5,900.00	\$6,140.00
<b>Options and Accessories</b>						
Number	Model	Dimensions	Approx. Ship Wt (lbs)	PKG Dimensions	List Price	
<b>Common Options</b>						
SW1319	Cable Drain - Standard Colors	-	4	16" x 7" x 4"	\$132.00	
SW1320	Cable Drain - Polished Chrome	-	4	16" x 7" x 4"	\$174.00	
SW1321	Cable Drain - Everbrass (PVD)	-	4	16" x 7" x 4"	\$313.00	
SW1322	Cable Drain - Brushed Nickel	-	4	16" x 7" x 4"	\$313.00	
SW1323	Cable Drain - Oil Rubbed Bronze	-	4	16" x 7" x 4"	\$334.00	
SWA100	"Rainbow" Pillow	-	4	14" x 8" x 2"	\$57.00	
SWAP00	Nailing flange kit (field installed)	-	4	13" x 9" x 3-1/2"	\$65.00	
<b>Nailing flange (factory installed)</b>						
SWP150S	Special/Center Drain (diagram required)	-	-	-	\$164.00	
SWP150C	Corner Unit	-	-	-	\$164.00	
<b>Whirlpool Options</b>						
SWP151	In-line water heater (factory installed)	-	-	-	\$533.00	
<b>Metal trim upgrade:</b>						
SW1335	Chrome	-	-	-	\$366.00	
SW1336	Everbrass (PVD)	-	-	-	\$366.00	
SW1337	Brushed Nickel	-	-	-	\$366.00	
SW1338	Oil Rubbed Bronze	-	-	-	\$392.00	
<b>Air Bath Options</b>						
AR1200	Blower relocation kit	-	4	14" x 14" x 4"	\$169.00	
<b>Metal trim kit:</b>						
AR1335	Chrome	-	-	-	\$366.00	
AR1336	Everbrass (PVD)	-	-	-	\$366.00	
AR1337	Brushed Nickel	-	-	-	\$366.00	
AR1338	Oil Rubbed Bronze	-	-	-	\$392.00	
<b>Bathtub Options</b>						
RS151	Constant heat system	-	-	-	\$533.00	

Colors: See chart on inside back cover

## SHOWROOM SERIES – BATHTUBS / WHIRLPOOL SYSTEMS / AIR SYSTEMS / MICROBUBBLE SYSTEMS

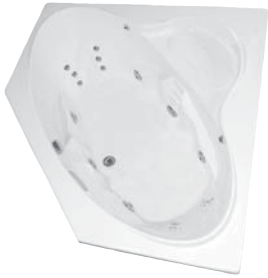

### Covington C

60" x 60" x 23"

This corner model features a large bathing well and a raised contoured seating area. Includes two pillows.

Water Capacity: Minimum Capacity: 55 gal. Maximum Capacity: 70 gal.



Number	Model	Dimensions	Approx. Ship Wt (lbs)	PKG Dimensions	List Price	
					Standard	Premium
<b>Bathtub</b>						
5562	SWIRL-WAY® BATHTUB	60" x 60" x 23"	140	65-1/2" x 65-1/2" x 25-1/2"	\$1,521.00	\$1,761.00
<b>Whirlpool Systems</b>						
5062BAS	SWIRL-WAY® BASIC	60" x 60" x 23"	175	65-1/2" x 65-1/2" x 25-1/2"	\$3,052.00	\$3,292.00
5062LUX	SWIRL-WAY® LUXURY	60" x 60" x 23"	175	65-1/2" x 65-1/2" x 25-1/2"	\$4,878.00	\$5,118.00
<b>Air Systems</b>						
9062	ARIANCE® HealthiTouch™	60" x 60" x 23"	175	65-1/2" x 65-1/2" x 25-1/2"	\$3,995.00	\$4,235.00
9162	ARIANCE® GentleTouch™	60" x 60" x 23"	175	65-1/2" x 65-1/2" x 25-1/2"	\$4,289.00	\$4,529.00
9262	ARIANCE® DualTherapy™	60" x 60" x 23"	190	65-1/2" x 65-1/2" x 25-1/2"	\$5,638.00	\$5,878.00
<b>Microbubble System</b>						
5262	MICRODERM™ Therapeutic Bath	60" x 60" x 23"	175	65-1/2" x 65-1/2" x 25-1/2"	\$3,370.00	\$3,610.00
<b>Options and Accessories</b>						
Number	Model	Dimensions	Approx. Ship Wt (lbs)	PKG Dimensions	List Price	
<b>Common Options</b>						
SW1319	Cable Drain - Standard Colors	-	4	16" x 7" x 4"	\$132.00	
SW1320	Cable Drain - Polished Chrome	-	4	16" x 7" x 4"	\$174.00	
SW1321	Cable Drain - Everbrass (PVD)	-	4	16" x 7" x 4"	\$313.00	
SW1322	Cable Drain - Brushed Nickel	-	4	16" x 7" x 4"	\$313.00	
SW1323	Cable Drain - Oil Rubbed Bronze	-	4	16" x 7" x 4"	\$334.00	
SWA100	"Rainbow" Pillow	-	4	14" x 8" x 2"	\$57.00	
SWAP00	Nailing flange kit (field installed)	-	4	13" x 9" x 3-1/2"	\$65.00	
<b>Nailing flange (factory installed)</b>						
SWP150S	Special/Center Drain (diagram required)	-	-	-	\$164.00	
SWP150C	Corner Unit	-	-	-	\$164.00	
<b>Whirlpool Options</b>						
SWP151	In-line water heater (factory installed)	-	-	-	\$533.00	
<b>Metal trim upgrade:</b>						
SW1335	Chrome	-	-	-	\$366.00	
SW1336	Everbrass (PVD)	-	-	-	\$366.00	
SW1337	Brushed Nickel	-	-	-	\$366.00	
SW1338	Oil Rubbed Bronze	-	-	-	\$392.00	
<b>Air Bath Options</b>						
AR1200	Blower relocation kit	-	4	14" x 14" x 4"	\$169.00	
<b>Metal trim kit:</b>						
AR1335	Chrome	-	-	-	\$366.00	
AR1336	Everbrass (PVD)	-	-	-	\$366.00	
AR1337	Brushed Nickel	-	-	-	\$366.00	
AR1338	Oil Rubbed Bronze	-	-	-	\$392.00	
<b>Bathtub Options</b>						
RS151	Constant heat system	-	-	-	\$533.00	

Colors: See chart on inside back cover

**SHOWROOM SERIES – BATHTUBS / WHIRLPOOL SYSTEMS / AIR SYSTEMS / MICROBUBBLE SYSTEMS**



**Covington C Round**

**60" x 60" x 23"**

This corner model features a large bathing well and a raised contoured seating area. Includes two pillows.

Water Capacity: Minimum Capacity: 55 gal. Maximum Capacity: 70 gal.



Number	Model	Dimensions	Approx. Ship Wt (lbs)	PKG Dimensions	List Price	
					Standard	Premium
<b>Bathtub</b>						
5548	SWIRL-WAY® BATHTUB	60" x 60" x 23"	140	65-1/2" x 65-1/2" x 25-1/2"	\$1,521.00	\$1,761.00
<b>Whirlpool Systems</b>						
5048BAS	SWIRL-WAY® BASIC	60" x 60" x 23"	175	65-1/2" x 65-1/2" x 25-1/2"	\$3,052.00	\$3,292.00
5048LUX	SWIRL-WAY® LUXURY	60" x 60" x 23"	175	65-1/2" x 65-1/2" x 25-1/2"	\$4,878.00	\$5,118.00
<b>Air Systems</b>						
9048	ARIANCE® HealthTouch™	60" x 60" x 23"	175	65-1/2" x 65-1/2" x 25-1/2"	\$3,995.00	\$4,235.00
9148	ARIANCE® GentleTouch™	60" x 60" x 23"	175	65-1/2" x 65-1/2" x 25-1/2"	\$4,289.00	\$4,529.00
9248	ARIANCE® DualTherapy™	60" x 60" x 23"	190	65-1/2" x 65-1/2" x 25-1/2"	\$5,638.00	\$5,878.00
<b>Options and Accessories</b>						
Number	Model	Dimensions	Approx. Ship Wt (lbs)	PKG Dimensions	List Price	
<b>Common Options</b>						
SW1319	Cable Drain - Standard Colors	-	4	16" x 7" x 4"	\$132.00	
SW1320	Cable Drain - Polished Chrome	-	4	16" x 7" x 4"	\$174.00	
SW1321	Cable Drain - Everbrass (PVD)	-	4	16" x 7" x 4"	\$313.00	
SW1322	Cable Drain - Brushed Nickel	-	4	16" x 7" x 4"	\$313.00	
SW1323	Cable Drain - Oil Rubbed Bronze	-	4	16" x 7" x 4"	\$334.00	
SWA100	"Rainbow" Pillow	-	4	14" x 8" x 2"	\$57.00	
SWAP00	Nailing flange kit (field installed)	-	4	13" x 9" x 3-1/2"	\$65.00	
<b>Nailing flange (factory installed)</b>						
SWP150S	Special/Center Drain (diagram required)	-	-	-	\$164.00	
SWP150C	Corner Unit	-	-	-	\$164.00	
<b>Whirlpool Options</b>						
SWP151	In-line water heater (factory installed)	-	-	-	\$533.00	
<b>Metal trim upgrade:</b>						
SW1335	Chrome	-	-	-	\$366.00	
SW1336	Everbrass (PVD)	-	-	-	\$366.00	
SW1337	Brushed Nickel	-	-	-	\$366.00	
SW1338	Oil Rubbed Bronze	-	-	-	\$392.00	
<b>Air Bath Options</b>						
AR1200	Blower relocation kit	-	4	14" x 14" x 4"	\$169.00	
<b>Metal trim kit:</b>						
AR1335	Chrome	-	-	-	\$366.00	
AR1336	Everbrass (PVD)	-	-	-	\$366.00	
AR1337	Brushed Nickel	-	-	-	\$366.00	
AR1338	Oil Rubbed Bronze	-	-	-	\$392.00	
<b>Bathtub Options</b>						
RS151	Constant heat system	-	-	-	\$533.00	

Colors: See chart on inside back cover

## SHOWROOM SERIES – BATHTUBS / WHIRLPOOL SYSTEMS / AIR SYSTEMS / MICROBUBBLE SYSTEMS



### Restore™

51-1/2" x 30" x 40"

Features sculpted, ADA height seat, stainless steel door locking system and inward swinging, watertight door. Includes wall bracket kit, front panel, end panel and cable drain.

Water Capacity: 40-50 gallons (with bather)



Number	Model	Dimensions	Approx. Ship Wt (lbs)	PKG Dimensions	List Price
					White Only
<b>Bathtub</b>					
8310	BATHTUB LH	51-1/2" x 30" x 40"	195	55-1/2" x 39" x 49"	\$5,433.00
8210	BATHTUB RH	51-1/2" x 30" x 40"	195	55-1/2" x 39" x 49"	\$5,433.00
<b>Whirlpool Systems</b>					
8110	WHIRLPOOL LH	51-1/2" x 30" x 40"	220	55-1/2" x 39" x 49"	\$6,652.00
8010	WHIRLPOOL RH	51-1/2" x 30" x 40"	220	55-1/2" x 39" x 49"	\$6,652.00
<b>Air Bath</b>					
8510	AIR BATH LH	51-1/2" x 30" x 40"	215	55-1/2" x 39" x 49"	\$6,873.00
8410	AIR BATH RH	51-1/2" x 30" x 40"	215	55-1/2" x 39" x 49"	\$6,873.00
<b>Combination Whirlpool/Air Bath</b>					
8710	COMBINATION LH	51-1/2" x 30" x 40"	240	55-1/2" x 39" x 49"	\$8,094.00
8610	COMBINATION RH	51-1/2" x 30" x 40"	240	55-1/2" x 39" x 49"	\$8,094.00
<b>Options and Accessories</b>					
Number	Model	Dimensions	Approx. Ship Wt (lbs)	PKG Dimensions	List Price
WIT-001	Extension Bracket	18" x 33" x 41"			\$367.00
WIT-002	End Panel	32" x 33" x 4", 34" x 35" x 6"		15	\$347.00
<b>Common Options</b>					
SWAP00	Nailing flange kit (field installed)	-	4	13" x 8-1/2" x 3-1/2"	\$65.00
<b>Colors: See chart on inside back cover</b>					



## BATHWARE – PRO-FIT® Builder Series



For outstanding quality and solid value, more architects, builders and contractors choose Mansfield®. Our builder series of bathtubs, whirlpools, air baths and shower bases offer luxurious style, installation flexibility, and reliable performance.

Mansfield Builder Series PRO-FIT® Whirlpools feature powerful pumps, six powerful UltraSwirl™ jets and simple air switch operation for easy use. PRO-FIT Air baths feature 46 to 58 perimeter air channels, a durable air heating element and automatic purge system for maximum hygiene. Models with the optional tile flange and apron increase versatility. All builder series baths, whirlpools and air baths offer the protection of a limited 2-year warranty and are IAPMO listed.

Mansfield shower bases are a stylish and practical choice for new construction or remodeling. Innovative engineering, great design, and affordable prices make our shower bases truly exceptional values.

PRO-FIT BUILDER SERIES

## BUILDER SERIES – BATHTUBS / WHIRLPOOL SYSTEMS / AIR SYSTEMS

Bathware - Acrylic  
PRO-FIT® Builder Series



### 3660 OV 60" x 36" x 22"

Oval whirlpool with clean lines and two backjets.

Water Capacity: Minimum Capacity: 36 gal. Maximum Capacity: 55 gal.



Number	Model	Dimensions	Approx. Ship Wt (lbs)	PKG Dimensions	List Price
					Standard
<b>Bathtub</b>					
6519	PRO-FIT® BATHTUB	60" x 36" x 22"	120	65-1/2" x 42-1/4" x 25-1/4"	\$780.00
<b>Whirlpool Systems</b>					
6019	PRO-FIT® WHIRLPOOL	60" x 36" x 22"	140	65-1/2" x 42-1/4" x 25-1/4"	\$1,263.00
<b>Air Bath</b>					
6719	PRO-FIT® AIR BATH	60" x 36" x 22"	140	65-1/2" x 42-1/4" x 25-1/4"	\$1,727.00
<b>Options and Accessories</b>					
Number	Model	Dimensions	Approx. Ship Wt (lbs)	PKG Dimensions	List Price
<b>Common Options</b>					
PF1320	Lift & Turn Drain - Polished Chrome	-	4	16" x 7" x 4"	\$50.00
PF1321	Lift & Turn Drain - Everbrass (PVD)	-	4	16" x 7" x 4"	\$80.00
PF1322	Lift & Turn Drain - Brushed Nickel	-	4	16" x 7" x 4"	\$80.00
PF1323	Lift & Turn Drain - Oil Rubbed Bronze	-	4	16" x 7" x 4"	\$85.00
<b>Whirlpool Options</b>					
SWP151	In-line water heater (factory installed)	-	-	-	\$533.00
<b>Metal trim upgrade</b>					
PF1335	Chrome	-	-	-	\$150.00
PF1336	Everbrass (PVD)	-	-	-	\$247.00
PF1337	Brushed Nickel	-	-	-	\$247.00
PF1338	Oil Rubbed Bronze	-	-	-	\$263.00
<b>Air Bath Options</b>					
PF2335	On/off Air Button- Polished Chrome	-	-	-	\$45.00
PF2336	On/off Air Button - Everbrass (PVD)	-	-	-	\$57.00
PF2337	On/off Air Button - Brushed Nickel	-	-	-	\$57.00
PF2338	On/off Air Button - Oil Rubbed Bronze	-	-	-	\$67.00
<b>Colors: See chart on inside back cover</b>					

**BUILDER SERIES – BATHTUBS / WHIRLPOOL SYSTEMS / AIR SYSTEMS**



**4260 OV**  
**60" x 42" x 20-1/4"**

Drop-in oval model with integral armrests

Water Capacity: Minimum Capacity: 42 gal. Maximum Capacity: 55 gal.



Bathware - Acrylic  
 PRO-FIT® Builder Series

Number	Model	Dimensions	Approx. Ship Wt (lbs)	PKG Dimensions	List Price Standard
<b>Bathtub</b>					
6515	PRO-FIT® BATHTUB	60" x 42" x 20-1/4"	128	65-1/2" x 47-1/4" x 24"	\$901.00
<b>Whirlpool Systems</b>					
6015	PRO-FIT® WHIRLPOOL	60" x 42" x 20-1/4"	148	65-1/2" x 47-1/4" x 24"	\$1,385.00
<b>Air Bath</b>					
6715	PRO-FIT® AIR BATH	60" x 42" x 20-1/4"	148	65-1/2" x 47-1/4" x 24"	\$1,788.00
<b>Options and Accessories</b>					
Number	Model	Dimensions	Approx. Ship Wt (lbs)	PKG Dimensions	List Price
<b>Common Options</b>					
PF1320	Lift & Turn Drain - Polished Chrome	-	4	16" x 7" x 4"	\$50.00
PF1321	Lift & Turn Drain - Everbrass (PVD)	-	4	16" x 7" x 4"	\$80.00
PF1322	Lift & Turn Drain - Brushed Nickel	-	4	16" x 7" x 4"	\$80.00
PF1323	Lift & Turn Drain - Oil Rubbed Bronze	-	4	16" x 7" x 4"	\$85.00
<b>Whirlpool Options</b>					
SWP151	In-line water heater (factory installed)	-	-	-	\$533.00
<b>Metal trim upgrade</b>					
PF1335	Chrome	-	-	-	\$150.00
PF1336	Everbrass (PVD)	-	-	-	\$247.00
PF1337	Brushed Nickel	-	-	-	\$247.00
PF1338	Oil Rubbed Bronze	-	-	-	\$263.00
<b>Air Bath Options</b>					
PF2335	On/off Air Button- Polished Chrome	-	-	-	\$45.00
PF2336	On/off Air Button - Everbrass (PVD)	-	-	-	\$57.00
PF2337	On/off Air Button - Brushed Nickel	-	-	-	\$57.00
PF2338	On/off Air Button - Oil Rubbed Bronze	-	-	-	\$67.00
<b>Colors: See chart on inside back cover</b>					

## BUILDER SERIES – BATHTUBS / WHIRLPOOL SYSTEMS / AIR SYSTEMS

Bathware - Acrylic  
PRO-FIT® Builder Series



### 4268 OV ED

68" x 42" x 20"

Drop-in oval model with integral armrests.

Water Capacity: Minimum Capacity: 59 gal. Maximum Capacity: 74 gal.



Number	Model	Dimensions	Approx. Ship Wt (lbs)	PKG Dimensions	List Price Standard
<b>Bathtub</b>					
6528E	PRO-FIT® BATHTUB	68" x 42" x 20"	138	73-1/2" x 47-1/4" x 24"	\$947.00
<b>Whirlpool Systems</b>					
6028E	PRO-FIT® WHIRLPOOL	68" x 42" x 20"	158	73-1/2" x 47-1/4" x 24"	\$1,405.00
<b>Air Bath</b>					
6728E	PRO-FIT® AIR BATH	68" x 42" x 20"	158	73-1/2" x 47-1/4" x 24"	\$1,807.00
<b>Options and Accessories</b>					
Number	Model	Dimensions	Approx. Ship Wt (lbs)	PKG Dimensions	List Price
<b>Common Options</b>					
PF1320	Lift & Turn Drain - Polished Chrome	-	4	16" x 7" x 4"	\$50.00
PF1321	Lift & Turn Drain - Everbrass (PVD)	-	4	16" x 7" x 4"	\$80.00
PF1322	Lift & Turn Drain - Brushed Nickel	-	4	16" x 7" x 4"	\$80.00
PF1323	Lift & Turn Drain - Oil Rubbed Bronze	-	4	16" x 7" x 4"	\$85.00
<b>Whirlpool Options</b>					
SWP151	In-line water heater (factory installed)	-	-	-	\$533.00
<b>Metal trim upgrade</b>					
PF1335	Chrome	-	-	-	\$150.00
PF1336	Everbrass (PVD)	-	-	-	\$247.00
PF1337	Brushed Nickel	-	-	-	\$247.00
PF1338	Oil Rubbed Bronze	-	-	-	\$263.00
<b>Air Bath Options</b>					
PF2335	On/off Air Button- Polished Chrome	-	-	-	\$45.00
PF2336	On/off Air Button - Everbrass (PVD)	-	-	-	\$57.00
PF2337	On/off Air Button - Brushed Nickel	-	-	-	\$57.00
PF2338	On/off Air Button - Oil Rubbed Bronze	-	-	-	\$67.00
<b>Colors: See chart on inside back cover</b>					

**BUILDER SERIES – BATHTUBS / WHIRLPOOL SYSTEMS / AIR SYSTEMS**



**4268 OV CD**  
**68" x 42" x 19-3/4"**

Drop-in oval with integral armrests. Can be undermounted.

Water Capacity: Minimum Capacity: 32 gal. Maximum Capacity: 65 gal.



Bathware - Acrylic  
 PRO-FIT® Builder Series

Number	Model	Dimensions	Approx. Ship Wt (lbs)	PKG Dimensions	List Price Standard
<b>Whirlpool Systems</b>					
<b>6028C</b>	PRO-FIT® WHIRLPOOL	68" x 42" x 19-3/4"	158	74-1/2" 47-1/4" x 24"	\$1,405.00
<b>Options and Accessories</b>					
Number	Model	Dimensions	Approx. Ship Wt (lbs)	PKG Dimensions	List Price
<b>Whirlpool Options</b>					
<b>PF1320</b>	Lift & Turn Drain - Polished Chrome	-	4	16" x 7" x 4"	\$50.00
<b>PF1321</b>	Lift & Turn Drain - Everbrass (PVD)	-	4	16" x 7" x 4"	\$80.00
<b>PF1322</b>	Lift & Turn Drain - Brushed Nickel	-	4	16" x 7" x 4"	\$80.00
<b>PF1323</b>	Lift & Turn Drain - Oil Rubbed Bronze	-	4	16" x 7" x 4"	\$85.00
<b>SWP151</b>	In-line water heater (factory installed)	-	-	-	\$533.00
<b>Metal trim upgrade</b>					
<b>PF1335</b>	Chrome	-	-	-	\$150.00
<b>PF1336</b>	Everbrass (PVD)	-	-	-	\$247.00
<b>PF1337</b>	Brushed Nickel	-	-	-	\$247.00
<b>PF1338</b>	Oil Rubbed Bronze	-	-	-	\$263.00
Note: Bathtub not available					
Colors: See chart on inside back cover					

## BUILDER SERIES – BATHTUBS / WHIRLPOOL SYSTEMS / AIR SYSTEMS

Bathware - Acrylic  
PRO-FIT® Builder Series



**3260**

59-3/4" x 32" x 19-1/4"

Rectangular whirlpool with integral armrests.

Water Capacity: Minimum Capacity: 27 gal. Maximum Capacity: 42 gal.

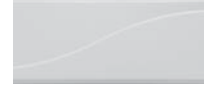

Optional removable apron

Number	Model	Dimensions	Approx. Ship Wt (lbs)	PKG Dimensions	List Price Standard
<b>Bathtub</b>					
6553	PRO-FIT® BATHTUB	59-3/4" x 32" x 19-1/4"	114	65-1/2" x 37-1/2" x 23-1/2"	\$715.00
<b>Whirlpool Systems</b>					
6053	PRO-FIT® WHIRLPOOL	59-3/4" x 32" x 19-1/4"	134	65-1/2" x 37-1/2" x 23-1/2"	\$1,208.00
<b>Air Bath</b>					
6755	PRO-FIT® AIR BATH	59-3/4" x 32" x 19-1/4"	134	65-1/2" x 37-1/2" x 23-1/2"	\$1,611.00
<b>Options and Accessories</b>					
Number	Model	Dimensions	Approx. Ship Wt (lbs)	PKG Dimensions	List Price
<b>Common Options</b>					
PF1320	Lift & Turn Drain - Polished Chrome	-	4	16" x 7" x 4"	\$50.00
PF1321	Lift & Turn Drain - Everbrass (PVD)	-	4	16" x 7" x 4"	\$80.00
PF1322	Lift & Turn Drain - Brushed Nickel	-	4	16" x 7" x 4"	\$80.00
PF1323	Lift & Turn Drain - Oil Rubbed Bronze	-	4	16" x 7" x 4"	\$85.00
SWAP00	Nailing flange kit (field installed)	-	4	13" x 9" x 3-1/2"	\$65.00
7253	Removable Apron - 3260	59-1/2" x 21-1/2" x 2"	15	62-1/2" x 22-3/4" x 4"	\$463.00
<b>Nailing flange (factory installed)</b>					
SWP150L	Left Hand	-	-	-	\$164.00
SWP150R	Right Hand	-	-	-	\$164.00
SWP150S	Special/Center Drain, Diagram Required	-	-	-	\$164.00
<b>Whirlpool Options</b>					
SWP151	In-line water heater (factory installed)	-	-	-	\$533.00
<b>Metal trim upgrade</b>					
PF1335	Chrome	-	-	-	\$150.00
PF1336	Everbrass (PVD)	-	-	-	\$247.00
PF1337	Brushed Nickel	-	-	-	\$247.00
PF1338	Oil Rubbed Bronze	-	-	-	\$263.00
<b>Air Bath Options</b>					
PF2335	On/off Air Button- Polished Chrome	-	-	-	\$45.00
PF2336	On/off Air Button - Everbrass (PVD)	-	-	-	\$57.00
PF2337	On/off Air Button - Brushed Nickel	-	-	-	\$57.00
PF2338	On/off Air Button - Oil Rubbed Bronze	-	-	-	\$67.00
<b>Colors: See chart on inside back cover</b>					

**BUILDER SERIES – BATHTUBS / WHIRLPOOL SYSTEMS / AIR SYSTEMS**



**3260 TFS LH – 59-3/4" x 31-3/4" x 20-3/4"**

**3260 TFS RH – 9-3/4" x 31-3/4" x 20-3/4"**

Rectangular whirlpool with integral apron and flange.  
Replaces standard bathtubs. For alcove installation.

Water Capacity: Minimum Capacity: 27 gal. Maximum Capacity: 42 gal.



Optional Access Panel  
on Apron

Bathware - Acrylic  
PRO-FIT® Builder Series

Number	Model	Dimensions	Approx. Ship Wt (lbs)	PKG Dimensions	List Price
					Standard
<b>Bathtub</b>					
6653	PRO-FIT® TFS LH without Panel	59-3/4" x 31-3/4" x 20-3/4"	115	65-1/2" x 37-1/2" x 23-1/2"	\$915.00
6654	PRO-FIT® TFS RH without Panel	59-3/4" x 31-3/4" x 20-3/4"	115	65-1/2" x 37-1/2" x 23-1/2"	\$915.00
6653A	PRO-FIT® TFS LH w/Access Panel	59-3/4" x 31-3/4" x 20-3/4"	115	65-1/2" x 37-1/2" x 23-1/2"	\$1,149.00
6654A	PRO-FIT® TFS RH w/Access Panel	59-3/4" x 31-3/4" x 20-3/4"	115	65-1/2" x 37-1/2" x 23-1/2"	\$1,149.00
<b>Whirlpool Systems</b>					
6153	PRO-FIT® TFS LH without Panel	59-3/4" x 31-3/4" x 20-3/4"	129	65-1/2" x 37-1/2" x 23-1/2"	\$1,398.00
6154	PRO-FIT® TFS RH without Panel	59-3/4" x 31-3/4" x 20-3/4"	129	65-1/2" x 37-1/2" x 23-1/2"	\$1,398.00
6153A	PRO-FIT® TFS LH w/Access Panel	59-3/4" x 31-3/4" x 20-3/4"	129	65-1/2" x 37-1/2" x 23-1/2"	\$1,632.00
6154A	PRO-FIT® TFS RH w/Access Panel	59-3/4" x 31-3/4" x 20-3/4"	129	65-1/2" x 37-1/2" x 23-1/2"	\$1,632.00
<b>Options and Accessories</b>					
Number	Model	Dimensions	Approx. Ship Wt (lbs)	PKG Dimensions	List Price
<b>Common Options</b>					
PF1320	Lift & Turn Drain - Polished Chrome	-	4	16" x 7" x 4"	\$50.00
PF1321	Lift & Turn Drain - Everbrass (PVD)	-	4	16" x 7" x 4"	\$80.00
PF1322	Lift & Turn Drain - Brushed Nickel	-	4	16" x 7" x 4"	\$80.00
PF1323	Lift & Turn Drain - Oil Rubbed Bronze	-	4	16" x 7" x 4"	\$85.00
<b>Whirlpool Options</b>					
SWP151	In-line water heater (factory installed)	-	-	-	\$533.00
<b>Metal trim upgrade</b>					
PF1335	Chrome	-	-	-	\$150.00
PF1336	Everbrass (PVD)	-	-	-	\$247.00
PF1337	Brushed Nickel	-	-	-	\$247.00
PF1338	Oil Rubbed Bronze	-	-	-	\$263.00
<b>Colors: See chart on inside back cover</b>					



## BUILDER SERIES – BATHTUBS / WHIRLPOOL SYSTEMS / AIR SYSTEMS

Bathware - Acrylic  
PRO-FIT® Builder Series



### 3660

59-3/4" x 35-3/4" x 21-1/4"

Rectangular whirlpool with integral armrests.

Water Capacity: Minimum Capacity: 32 gal. Maximum Capacity: 45 gal.

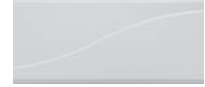

Optional removable apron

Number	Model	Dimensions	Approx. Ship Wt (lbs)	PKG Dimensions	List Price Standard
<b>Bathtub</b>					
6518	PRO-FIT® BATHTUB	59-3/4" x 35-3/4" x 21-1/4"	120	65-1/2" x 41-1/4" x 25-1/4"	\$780.00
<b>Whirlpool Systems</b>					
6018	PRO-FIT® WHIRLPOOL	59-3/4" x 35-3/4" x 21-1/4"	140	65-1/2" x 41-1/4" x 25-1/4"	\$1,263.00
<b>Air Bath</b>					
6718	PRO-FIT® AIR BATH	59-3/4" x 35-3/4" x 21-1/4"	140	65-1/2" x 41-1/4" x 25-1/4"	\$1,666.00
<b>Options and Accessories</b>					
Number	Model	Dimensions	Approx. Ship Wt (lbs)	PKG Dimensions	List Price
<b>Common Options</b>					
PF1320	Lift & Turn Drain - Polished Chrome	-	4	16" x 7" x 4"	\$50.00
PF1321	Lift & Turn Drain - Everbrass (PVD)	-	4	16" x 7" x 4"	\$80.00
PF1322	Lift & Turn Drain - Brushed Nickel	-	4	16" x 7" x 4"	\$80.00
PF1323	Lift & Turn Drain - Oil Rubbed Bronze	-	4	16" x 7" x 4"	\$85.00
SWAP00	Nailing flange kit (field installed)	-	4	13" x 9" x 3-1/2"	\$65.00
7218	Removable Apron - 3660	59-1/2" x 21-1/2" x 2"	15	62-1/2" x 22-3/4" x 4"	\$463.00
<b>Nailing flange (factory installed)</b>					
SWP150L	Left Hand	-	-	-	\$164.00
SWP150R	Right Hand	-	-	-	\$164.00
SWP150S	Special/Center Drain, Diagram Required	-	-	-	\$164.00
<b>Whirlpool Options</b>					
SWP151	In-line water heater (factory installed)	-	-	-	\$533.00
<b>Metal trim upgrade</b>					
PF1335	Chrome	-	-	-	\$150.00
PF1336	Everbrass (PVD)	-	-	-	\$247.00
PF1337	Brushed Nickel	-	-	-	\$247.00
PF1338	Oil Rubbed Bronze	-	-	-	\$263.00
<b>Air Bath Options</b>					
PF2335	On/off Air Button- Polished Chrome	-	-	-	\$45.00
PF2336	On/off Air Button - Everbrass (PVD)	-	-	-	\$57.00
PF2337	On/off Air Button - Brushed Nickel	-	-	-	\$57.00
PF2338	On/off Air Button - Oil Rubbed Bronze	-	-	-	\$67.00
<b>Colors: See chart on inside back cover</b>					

**BUILDER SERIES – BATHTUBS / WHIRLPOOL SYSTEMS / AIR SYSTEMS**



**3660 TFS LH – 60" x 35-3/4" x 23"**

**3660 TFS RH – 60" x 35-3/4" x 23"**

Rectangular alcove with integral flange and apron.  
Features "above the floor" drain. For alcove installation.

Water Capacity: Minimum Capacity: 32 gal. Maximum Capacity: 45 gal.



Optional Access Panel on Apron

Bathware - Acrylic  
PRO-FIT® Builder Series

Number	Model	Dimensions	Approx. Ship Wt (lbs)	PKG Dimensions	List Price
					Standard
<b>Bathtub</b>					
<b>6619</b>	PRO-FIT® TFS LH without Panel	60" x 35-3/4" x 23"	136	65-1/2" x 41-1/4" x 25-1/4"	\$971.00
<b>6618</b>	PRO-FIT® TFS RH without Panel	60" x 35-3/4" x 23"	136	65-1/2" x 41-1/4" x 25-1/4"	\$971.00
<b>6619A</b>	PRO-FIT® TFS LH w/Access Panel	60" x 35-3/4" x 23"	136	65-1/2" x 41-1/4" x 25-1/4"	\$1,204.00
<b>6618A</b>	PRO-FIT® TFS RH w/Access Panel	60" x 35-3/4" x 23"	136	65-1/2" x 41-1/4" x 25-1/4"	\$1,204.00
<b>Whirlpool Systems</b>					
<b>6119</b>	PRO-FIT® TFS LH without Panel	60" x 35-3/4" x 23"	156	65-1/2" x 41-1/4" x 25-1/4"	\$1,444.00
<b>6118</b>	PRO-FIT® TFS RH without Panel	60" x 35-3/4" x 23"	156	65-1/2" x 41-1/4" x 25-1/4"	\$1,444.00
<b>6119A</b>	PRO-FIT® TFS LH w/Access Panel	60" x 35-3/4" x 23"	156	65-1/2" x 41-1/4" x 25-1/4"	\$1,677.00
<b>6118A</b>	PRO-FIT® TFS RH w/Access Panel	60" x 35-3/4" x 23"	156	65-1/2" x 41-1/4" x 25-1/4"	\$1,677.00
<b>Options and Accessories</b>					
Number	Model	Dimensions	Approx. Ship Wt (lbs)	PKG Dimensions	List Price
<b>Common Options</b>					
<b>PF1320</b>	Lift & Turn Drain - Polished Chrome	-	4	16" x 7" x 4"	\$50.00
<b>PF1321</b>	Lift & Turn Drain - Everbrass (PVD)	-	4	16" x 7" x 4"	\$80.00
<b>PF1322</b>	Lift & Turn Drain - Brushed Nickel	-	4	16" x 7" x 4"	\$80.00
<b>PF1323</b>	Lift & Turn Drain - Oil Rubbed Bronze	-	4	16" x 7" x 4"	\$85.00
<b>Whirlpool Options</b>					
<b>SWP151</b>	In-line water heater (factory installed)	-	-	-	\$533.00
<b>Metal trim upgrade</b>					
<b>PF1335</b>	Chrome	-	-	-	\$150.00
<b>PF1336</b>	Everbrass (PVD)	-	-	-	\$247.00
<b>PF1337</b>	Brushed Nickel	-	-	-	\$247.00
<b>PF1338</b>	Oil Rubbed Bronze	-	-	-	\$263.00
<b>Colors: See chart on inside back cover</b>					

## BUILDER SERIES – BATHTUBS / WHIRLPOOL SYSTEMS / AIR SYSTEMS

Bathware - Acrylic  
PRO-FIT® Builder Series



**3672**

71-1/2" x 35-1/2" x 20"

Rectangle drop-in model with integral armrests.

Water Capacity: Minimum Capacity: 27 gal. Maximum Capacity: 52 gal.



Optional removable apron

Number	Model	Dimensions	Approx. Ship Wt (lbs)	PKG Dimensions	List Price Standard
<b>Bathtub</b>					
6521	PRO-FIT® BATHTUB	71-1/2" x 35-1/2" x 20"	134	77-1/2" x 42-1/4" x 24"	\$846.00
<b>Whirlpool Systems</b>					
6021	PRO-FIT® WHIRLPOOL	71-1/2" x 35-1/2" x 20"	154	77-1/2" x 42-1/4" x 24"	\$1,325.00
<b>Air Bath</b>					
6721	PRO-FIT® AIR BATH	71-1/2" x 35-1/2" x 20"	154	77-1/2" x 42-1/4" x 24"	\$1,727.00
<b>Options and Accessories</b>					
Number	Model	Dimensions	Approx. Ship Wt (lbs)	PKG Dimensions	List Price
<b>Common Options</b>					
PF1320	Lift & Turn Drain - Polished Chrome	-	4	16" x 7" x 4"	\$50.00
PF1321	Lift & Turn Drain - Everbrass (PVD)	-	4	16" x 7" x 4"	\$80.00
PF1322	Lift & Turn Drain - Brushed Nickel	-	4	16" x 7" x 4"	\$80.00
PF1323	Lift & Turn Drain - Oil Rubbed Bronze	-	4	16" x 7" x 4"	\$85.00
SWAP00	Nailing flange kit (field installed)	-	4	13" x 9" x 3-1/2"	\$65.00
7221	Removable Apron - 3672	72-1/2" x 16-1/4" x 2"	20	74-1/2" x 22-1/4" x 4"	\$483.00
<b>Nailing flange (factory installed)</b>					
SWP150L	Left Hand	-	-	-	\$164.00
SWP150R	Right Hand	-	-	-	\$164.00
SWP150S	Special/Center Drain, Diagram Required	-	-	-	\$164.00
<b>Whirlpool Options</b>					
SWP151	In-line water heater (factory installed)	-	-	-	\$533.00
<b>Metal trim upgrade</b>					
PF1335	Chrome	-	-	-	\$150.00
PF1336	Everbrass (PVD)	-	-	-	\$247.00
PF1337	Brushed Nickel	-	-	-	\$247.00
PF1338	Oil Rubbed Bronze	-	-	-	\$263.00
<b>Air Bath Options</b>					
PF2335	On/off Air Button- Polished Chrome	-	-	-	\$45.00
PF2336	On/off Air Button - Everbrass (PVD)	-	-	-	\$57.00
PF2337	On/off Air Button - Brushed Nickel	-	-	-	\$57.00
PF2338	On/off Air Button - Oil Rubbed Bronze	-	-	-	\$67.00
<b>Colors: See chart on inside back cover</b>					

**BUILDER SERIES – BATHTUBS / WHIRLPOOL SYSTEMS / AIR SYSTEMS**



**3672 TFS LH – 71-1/2" x 35-1/2" x 23"**

**3672 TFS RH – 71-1/2" x 35-1/2" x 23"**

Rectangular alcove with integral flange, apron and armrests for alcove installation.

Water Capacity: Minimum Capacity: 38 gal. Maximum Capacity: 52 gal.

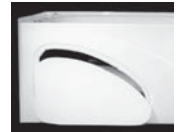

Optional Access Panel on Apron

Bathware - Acrylic  
PRO-FIT® Builder Series

Number	Model	Dimensions	Approx. Ship Wt (lbs)	PKG Dimensions	List Price
					Standard
<b>Bathtub</b>					
6623	PRO-FIT® TFS LH without Panel	71-1/2" x 35-1/2" x 23"	120	77-1/2" x 41-1/4" x 24"	\$1,112.00
6622	PRO-FIT® TFS RH without Panel	71-1/2" x 35-1/2" x 23"	120	77-1/2" x 41-1/4" x 24"	\$1,112.00
6623A	PRO-FIT® TFS LH w/Access Panel	71-1/2" x 35-1/2" x 23"	120	77-1/2" x 41-1/4" x 24"	\$1,345.00
6622A	PRO-FIT® TFS RH w/Access Panel	71-1/2" x 35-1/2" x 23"	120	77-1/2" x 41-1/4" x 24"	\$1,345.00
<b>Whirlpool Systems</b>					
6123	PRO-FIT® TFS LH without Panel	71-1/2" x 35-1/2" x 23"	145	77-1/2" x 41-1/4" x 24"	\$1,530.00
6122	PRO-FIT® TFS RH without Panel	71-1/2" x 35-1/2" x 23"	145	77-1/2" x 41-1/4" x 24"	\$1,530.00
6123A	PRO-FIT® TFS LH w/Access Panel	71-1/2" x 35-1/2" x 23"	145	77-1/2" x 41-1/4" x 24"	\$1,763.00
6122A	PRO-FIT® TFS RH w/Access Panel	71-1/2" x 35-1/2" x 23"	145	77-1/2" x 41-1/4" x 24"	\$1,763.00
<b>Options and Accessories</b>					
Number	Model	Dimensions	Approx. Ship Wt (lbs)	PKG Dimensions	List Price
<b>Common Options</b>					
PF1320	Lift & Turn Drain - Polished Chrome	-	4	16" x 7" x 4"	\$50.00
PF1321	Lift & Turn Drain - Everbrass (PVD)	-	4	16" x 7" x 4"	\$80.00
PF1322	Lift & Turn Drain - Brushed Nickel	-	4	16" x 7" x 4"	\$80.00
PF1323	Lift & Turn Drain - Oil Rubbed Bronze	-	4	16" x 7" x 4"	\$85.00
<b>Whirlpool Options</b>					
SWP151	In-line water heater (factory installed)	-	-	-	\$533.00
<b>Metal trim upgrade</b>					
PF1335	Chrome	-	-	-	\$150.00
PF1336	Everbrass (PVD)	-	-	-	\$247.00
PF1337	Brushed Nickel	-	-	-	\$247.00
PF1338	Oil Rubbed Bronze	-	-	-	\$263.00
<b>Colors: See chart on inside back cover</b>					

## BUILDER SERIES – BATHTUBS / WHIRLPOOL SYSTEMS / AIR SYSTEMS

Bathware - Acrylic  
PRO-FIT® Builder Series



### 4260

60" x 42" x 20-1/4"

Rectangular shaped drop-in, spacious oval bathing well with integral armrests

Water Capacity: Minimum Capacity: 42 gal. Maximum Capacity: 55 gal.



Optional removable apron

Number	Model	Dimensions	Approx. Ship Wt (lbs)	PKG Dimensions	List Price Standard
<b>Bathtub</b>					
6524	PRO-FIT® BATHTUB	60" x 42" x 20-1/4"	128	65-1/2" x 47-1/4" x 24"	\$901.00
<b>Whirlpool Systems</b>					
6024	PRO-FIT® WHIRLPOOL	60" x 42" x 20-1/4"	148	65-1/2" x 47-1/4" x 24"	\$1,385.00
<b>Air Bath</b>					
6724	PRO-FIT® AIR BATH	60" x 42" x 20-1/4"	148	65-1/2" x 47-1/4" x 24"	\$1,788.00
<b>Options and Accessories</b>					
Number	Model	Dimensions	Approx. Ship Wt (lbs)	PKG Dimensions	List Price
<b>Common Options</b>					
PF1320	Lift & Turn Drain - Polished Chrome	-	4	16" x 7" x 4"	\$50.00
PF1321	Lift & Turn Drain - Everbrass (PVD)	-	4	16" x 7" x 4"	\$80.00
PF1322	Lift & Turn Drain - Brushed Nickel	-	4	16" x 7" x 4"	\$80.00
PF1323	Lift & Turn Drain - Oil Rubbed Bronze	-	4	16" x 7" x 4"	\$85.00
SWAP00	Nailing flange kit (field installed)	-	4	13" x 9" x 3-1/2"	\$65.00
7224	Removable Apron - 4260	59-1/2" x 21-1/2" x 2"	15	62-1/2" x 22-3/4" x 4"	\$463.00
<b>Nailing flange (factory installed)</b>					
SWP150L	Left Hand	-	-	-	\$164.00
SWP150R	Right Hand	-	-	-	\$164.00
SWP150S	Special/Center Drain, Diagram Required	-	-	-	\$164.00
<b>Whirlpool Options</b>					
SWP151	In-line water heater (factory installed)	-	-	-	\$533.00
<b>Metal trim upgrade</b>					
PF1335	Chrome	-	-	-	\$150.00
PF1336	Everbrass (PVD)	-	-	-	\$247.00
PF1337	Brushed Nickel	-	-	-	\$247.00
PF1338	Oil Rubbed Bronze	-	-	-	\$263.00
<b>Air Bath Options</b>					
PF2335	On/off Air Button- Polished Chrome	-	-	-	\$45.00
PF2336	On/off Air Button - Everbrass (PVD)	-	-	-	\$57.00
PF2337	On/off Air Button - Brushed Nickel	-	-	-	\$57.00
PF2338	On/off Air Button - Oil Rubbed Bronze	-	-	-	\$67.00
<b>Colors: See chart on inside back cover</b>					

**BUILDER SERIES – BATHTUBS / WHIRLPOOL SYSTEMS / AIR SYSTEMS**



**4260 TFS LH – 59-3/4" x 42" x 21-1/4"**

**4260 TFS RH – 59-3/4" x 42" x 21-1/4"**

Rectangular alcove with oval bathing well, armrests integral apron and flange. For alcove installation.

Water Capacity: Minimum Capacity: 42 gal. Maximum Capacity: 55 gal.



Optional Access Panel on Apron

Bathware - Acrylic  
PRO-FIT® Builder Series

Number	Model	Dimensions	Approx. Ship Wt (lbs)	PKG Dimensions	List Price
					Standard
<b>Bathtub</b>					
6624	PRO-FIT® TFS LH without Panel	59-3/4" x 42" x 21-1/4"	121	65-1/2" x 47-1/4" x 24"	\$1,156.00
6625	PRO-FIT® TFS RH without Panel	59-3/4" x 42" x 21-1/4"	121	65-1/2" x 47-1/4" x 24"	\$1,156.00
6624A	PRO-FIT® TFS LH w/Access Panel	59-3/4" x 42" x 21-1/4"	121	65-1/2" x 47-1/4" x 24"	\$1,390.00
6625A	PRO-FIT® TFS RH w/Access Panel	59-3/4" x 42" x 21-1/4"	121	65-1/2" x 47-1/4" x 24"	\$1,390.00
<b>Whirlpool Systems</b>					
6124	PRO-FIT® TFS LH without Panel	59-3/4" x 42" x 21-1/4"	146	65-1/2" x 47-1/4" x 24"	\$1,609.00
6125	PRO-FIT® TFS RH without Panel	59-3/4" x 42" x 21-1/4"	146	65-1/2" x 47-1/4" x 24"	\$1,609.00
6124A	PRO-FIT® TFS LH w/Access Panel	59-3/4" x 42" x 21-1/4"	146	65-1/2" x 47-1/4" x 24"	\$1,843.00
6125A	PRO-FIT® TFS RH w/Access Panel	59-3/4" x 42" x 21-1/4"	146	65-1/2" x 47-1/4" x 24"	\$1,843.00
<b>Options and Accessories</b>					
Number	Model	Dimensions	Approx. Ship Wt (lbs)	PKG Dimensions	List Price
<b>Common Options</b>					
PF1320	Lift & Turn Drain - Polished Chrome	-	4	16" x 7" x 4"	\$50.00
PF1321	Lift & Turn Drain - Everbrass (PVD)	-	4	16" x 7" x 4"	\$80.00
PF1322	Lift & Turn Drain - Brushed Nickel	-	4	16" x 7" x 4"	\$80.00
PF1323	Lift & Turn Drain - Oil Rubbed Bronze	-	4	16" x 7" x 4"	\$85.00
<b>Whirlpool Options</b>					
SWP151	In-line water heater (factory installed)	-	-	-	\$533.00
<b>Metal trim upgrade</b>					
PF1335	Chrome	-	-	-	\$150.00
PF1336	Everbrass (PVD)	-	-	-	\$247.00
PF1337	Brushed Nickel	-	-	-	\$247.00
PF1338	Oil Rubbed Bronze	-	-	-	\$263.00
<b>Colors: See chart on inside back cover</b>					

## BUILDER SERIES – BATHTUBS / WHIRLPOOL SYSTEMS / AIR SYSTEMS

Bathware - Acrylic  
PRO-FIT® Builder Series



### 4260 TFS CD 60" x 42" x 21-1/4"

Rectangular alcove has deep oval bathing well with center drain and integral flange and apron. Access panel is standard on whirlpool and bathtub for easy drain installation.



Standard Access Panel on Apron

Water Capacity: Minimum Capacity: 42 gal. Maximum Capacity: 55 gal.

Number	Model	Dimensions	Approx. Ship Wt (lbs)	PKG Dimensions	List Price Standard
<b>Bathtub</b>					
6627A	PRO-FIT® TFS CD BATHTUB w/Access Panel	60" x 42" x 21-1/4"	148	65-1/2" x 47-1/4" x 24"	\$1,390.00
<b>Whirlpool Systems</b>					
6126A	PRO-FIT® TFS CD w/Access Panel	60" x 42" x 21-1/4"	168	65-1/2" x 47-1/4" x 24"	\$1,843.00
<b>Options and Accessories</b>					
Number	Model	Dimensions	Approx. Ship Wt (lbs)	PKG Dimensions	List Price
<b>Common Options</b>					
PF1320	Lift & Turn Drain - Polished Chrome	-	4	16" x 7" x 4"	\$50.00
PF1321	Lift & Turn Drain - Everbrass (PVD)	-	4	16" x 7" x 4"	\$80.00
PF1322	Lift & Turn Drain - Brushed Nickel	-	4	16" x 7" x 4"	\$80.00
PF1323	Lift & Turn Drain - Oil Rubbed Bronze	-	4	16" x 7" x 4"	\$85.00
<b>Whirlpool Options</b>					
SWP151	In-line water heater (factory installed)	-	-	-	\$533.00
<b>Metal trim upgrade</b>					
PF1335	Chrome	-	-	-	\$150.00
PF1336	Everbrass (PVD)	-	-	-	\$247.00
PF1337	Brushed Nickel	-	-	-	\$247.00
PF1338	Oil Rubbed Bronze	-	-	-	\$263.00
<b>Colors: See chart on inside back cover</b>					



**BUILDER SERIES – BATHTUBS / WHIRLPOOL SYSTEMS / AIR SYSTEMS**



**4272**  
71-1/2" x 42" x 19-3/4"

Rectangular drop-in model with oval bathing well and integral armrests.

Water Capacity: Minimum Capacity: 55 gal. Maximum Capacity: 80 gal.



Optional removable apron

Bathware - Acrylic  
PRO-FIT® Builder Series

Number	Model	Dimensions	Approx. Ship Wt (lbs)	PKG Dimensions	List Price Standard
<b>Bathtub</b>					
6527	PRO-FIT® BATHTUB	71-1/2" x 42" x 19-3/4"	110	77-1/2" x 47-1/4" x 24"	\$957.00
<b>Whirlpool Systems</b>					
6027	PRO-FIT® WHIRLPOOL	71-1/2" x 42" x 19-3/4"	130	77-1/2" x 47-1/4" x 24"	\$1,445.00
<b>Air Bath</b>					
6727	PRO-FIT® AIR BATH	71-1/2" x 42" x 19-3/4"	130	77-1/2" x 47-1/4" x 24"	\$1,808.00
<b>Options and Accessories</b>					
Number	Model	Dimensions	Approx. Ship Wt (lbs)	PKG Dimensions	List Price
<b>Common Options</b>					
PF1320	Lift & Turn Drain - Polished Chrome	-	4	16" x 7" x 4"	\$50.00
PF1321	Lift & Turn Drain - Everbrass (PVD)	-	4	16" x 7" x 4"	\$80.00
PF1322	Lift & Turn Drain - Brushed Nickel	-	4	16" x 7" x 4"	\$80.00
PF1323	Lift & Turn Drain - Oil Rubbed Bronze	-	4	16" x 7" x 4"	\$85.00
SWAP00	Nailing flange kit (field installed)	-	4	13" x 9" x 3-1/2"	\$65.00
7227	Removable Apron - 4272	72-1/2" x 16-1/4" x 2"	20	74-1/2" x 22-1/4" x 4"	\$483.00
<b>Nailing flange (factory installed)</b>					
SWP150L	Left Hand	-	-	-	\$164.00
SWP150R	Right Hand	-	-	-	\$164.00
SWP150S	Special/Center Drain, Diagram Required	-	-	-	\$164.00
<b>Whirlpool Options</b>					
SWP151	In-line water heater (factory installed)	-	-	-	\$533.00
<b>Metal trim upgrade</b>					
PF1335	Chrome	-	-	-	\$150.00
PF1336	Everbrass (PVD)	-	-	-	\$247.00
PF1337	Brushed Nickel	-	-	-	\$247.00
PF1338	Oil Rubbed Bronze	-	-	-	\$263.00
<b>Air Bath Options</b>					
PF2335	On/off Air Button - Polished Chrome	-	-	-	\$45.00
PF2336	On/off Air Button - Everbrass (PVD)	-	-	-	\$57.00
PF2337	On/off Air Button - Brushed Nickel	-	-	-	\$57.00
PF2338	On/off Air Button - Oil Rubbed Bronze	-	-	-	\$67.00
<b>Colors: See chart on inside back cover</b>					

## BUILDER SERIES – BATHTUBS / WHIRLPOOL SYSTEMS / AIR SYSTEMS

Bathware - Acrylic  
PRO-FIT® Builder Series



### 4872

71-1/2" x 47-5/8" x 22-1/2"

Spacious two person rectangular model with integral armrests.

Water Capacity: Minimum Capacity: 60 gal. Maximum Capacity: 90 gal.

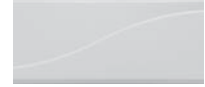

Optional removable apron

Number	Model	Dimensions	Approx. Ship Wt (lbs)	PKG Dimensions	List Price Standard
<b>Bathtub</b>					
6533	PRO-FIT® BATHTUB	71-1/2" x 47-5/8" x 22-1/2"	150	77-1/2" x 53-1/4" x 26-1/2"	\$977.00
<b>Whirlpool Systems</b>					
6033	PRO-FIT® WHIRLPOOL	71-1/2" x 47-5/8" x 22-1/2"	170	77-1/2" x 53-1/4" x 26-1/2"	\$1,505.00
<b>Options and Accessories</b>					
Number	Model	Dimensions	Approx. Ship Wt (lbs)	PKG Dimensions	List Price
<b>Common Options</b>					
PF1320	Lift & Turn Drain - Polished Chrome	-	4	16" x 7" x 4"	\$50.00
PF1321	Lift & Turn Drain - Everbrass (PVD)	-	4	16" x 7" x 4"	\$80.00
PF1322	Lift & Turn Drain - Brushed Nickel	-	4	16" x 7" x 4"	\$80.00
PF1323	Lift & Turn Drain - Oil Rubbed Bronze	-	4	16" x 7" x 4"	\$85.00
SWAP00	Nailing flange kit (field installed)	-	4	13" x 9" x 3-1/2"	\$65.00
7233	Removable Apron - 4872	72-1/2" x 16-1/4" x 2"	20	74-1/2" x 22-1/4" x 4"	\$483.00
<b>Nailing flange (factory installed)</b>					
SWP150L	Left Hand	-	-	-	\$164.00
SWP150R	Right Hand	-	-	-	\$164.00
SWP150S	Special/Center Drain, Diagram Required	-	-	-	\$164.00
<b>Whirlpool Options</b>					
SWP151	In-line water heater (factory installed)	-	-	-	\$533.00
<b>Metal trim upgrade</b>					
PF1335	Chrome	-	-	-	\$150.00
PF1336	Everbrass (PVD)	-	-	-	\$247.00
PF1337	Brushed Nickel	-	-	-	\$247.00
PF1338	Oil Rubbed Bronze	-	-	-	\$263.00
<b>Colors: See chart on inside back cover</b>					

**BUILDER SERIES – BATHTUBS / WHIRLPOOL SYSTEMS / AIR SYSTEMS**



**6060**

**59-3/4" x 59-3/4" x 21-1/4"**

Spacious two-person corner model with integral armrests.  
Can be undermounted.



Optional removable one-piece, three-sided apron



Water Capacity: Minimum Capacity: 60 gal. Maximum Capacity: 85 gal.

Bathware - Acrylic  
PRO-FIT® Builder Series

Number	Model	Dimensions	Approx. Ship Wt (lbs)	PKG Dimensions	List Price Standard
<b>Bathtub</b>					
6539	PRO-FIT® BATHTUB	59-3/4" x 59-3/4" x 21-1/4"	137	65-1/2" x 65-1/2" x 25-1/2"	\$1,230.00
<b>Whirlpool Systems</b>					
6039	PRO-FIT® WHIRLPOOL	59-3/4" x 59-3/4" x 21-1/4"	167	65-1/2" x 65-1/2" x 25-1/2"	\$1,520.00
<b>Air Bath</b>					
6739	PRO-FIT® AIR BATH	59-3/4" x 59-3/4" x 21-1/4"	167	65-1/2" x 65-1/2" x 25-1/2"	\$1,847.00
<b>Options and Accessories</b>					
Number	Model	Dimensions	Approx. Ship Wt (lbs)	PKG Dimensions	List Price
<b>Common Options</b>					
PF1320	Lift & Turn Drain - Polished Chrome	-	4	16" x 7" x 4"	\$50.00
PF1321	Lift & Turn Drain - Everbrass (PVD)	-	4	16" x 7" x 4"	\$80.00
PF1322	Lift & Turn Drain - Brushed Nickel	-	4	16" x 7" x 4"	\$80.00
PF1323	Lift & Turn Drain - Oil Rubbed Bronze	-	4	16" x 7" x 4"	\$85.00
SWAP00	Nailing flange kit (field installed)	-	4	13" x 9" x 3-1/2"	\$65.00
7239	Removable Apron - 6060	59-3/4" x 59-3/4" x 21-1/4"	50	65-1/2" x 65-1/2" x 25-1/2"	\$989.00
<b>Nailing flange (factory installed)</b>					
SWP150S	Special/Center Drain (diagram required)	-	-	-	\$164.00
SWP150C	Corner Unit	-	-	-	\$164.00
<b>Whirlpool Options</b>					
SWP151	In-line water heater (factory installed)	-	-	-	\$533.00
<b>Metal trim upgrade</b>					
PF1335	Chrome	-	-	-	\$150.00
PF1336	Everbrass (PVD)	-	-	-	\$247.00
PF1337	Brushed Nickel	-	-	-	\$247.00
PF1338	Oil Rubbed Bronze	-	-	-	\$263.00
<b>Air Bath Options</b>					
PF2335	On/off Air Button - Polished Chrome	-	-	-	\$45.00
PF2336	On/off Air Button - Everbrass (PVD)	-	-	-	\$57.00
PF2337	On/off Air Button - Brushed Nickel	-	-	-	\$57.00
PF2338	On/off Air Button - Oil Rubbed Bronze	-	-	-	\$67.00
<b>Colors: See chart on inside back cover</b>					

## BUILDER SERIES – BATHTUBS / WHIRLPOOL SYSTEMS / AIR SYSTEMS

Bathware - Acrylic  
PRO-FIT® Builder Series



### 6060 DL

60" x 60" x 20"

Spacious corner model with side-by-side soaking for two.

Water Capacity: Minimum Capacity: 42 gal. Maximum Capacity: 70 gal.



Number	Model	Dimensions	Approx. Ship Wt (lbs)	PKG Dimensions	List Price Standard
<b>Bathtub</b>					
6541	PRO-FIT® BATHTUB	60" x 60" x 20"	126	65-1/2" x 65-1/2" x 25-1/2"	\$1,231.00
<b>Whirlpool Systems</b>					
6041	PRO-FIT® WHIRLPOOL	60" x 60" x 20"	146	65-1/2" x 65-1/2" x 25-1/2"	\$1,520.00
<b>Options and Accessories</b>					
Number	Model	Dimensions	Approx. Ship Wt (lbs)	PKG Dimensions	List Price
<b>Common Options</b>					
PF1320	Lift & Turn Drain - Polished Chrome	-	4	16" x 7" x 4"	\$50.00
PF1321	Lift & Turn Drain - Everbrass (PVD)	-	4	16" x 7" x 4"	\$80.00
PF1322	Lift & Turn Drain - Brushed Nickel	-	4	16" x 7" x 4"	\$80.00
PF1323	Lift & Turn Drain - Oil Rubbed Bronze	-	4	16" x 7" x 4"	\$85.00
SWAP00	Nailing flange kit (field installed)	-	4	13" x 9" x 3-1/2"	\$65.00
<b>Nailing flange (factory installed)</b>					
SWP150S	Special/Center Drain (diagram required)	-	-	-	\$164.00
SWP150C	Corner Unit	-	-	-	\$164.00
<b>Whirlpool Options</b>					
SWP151	In-line water heater (factory installed)	-	-	-	\$533.00
<b>Metal trim upgrade</b>					
PF1335	Chrome	-	-	-	\$150.00
PF1336	Everbrass (PVD)	-	-	-	\$247.00
PF1337	Brushed Nickel	-	-	-	\$247.00
PF1338	Oil Rubbed Bronze	-	-	-	\$263.00
<b>Colors: See chart on inside back cover</b>					

**SHOWER BASES**

Bathware - Acrylic Shower Bases



**Single Threshold**



Number	Model	Dimensions	Approx. Ship Wt (lbs)	PKG Dimensions	List Price	
					Standard	Premium
7501	3232 ST, Center Drain	32" x 32"	46	36" x 35" x 8"	\$694.00	\$934.00
7502	3636 ST, Center Drain	36" x 36"	58	39" x 40" x 9"	\$727.00	\$967.00
7531	4242 ST, Center Drain	42" x 42"	65	46" x 45" x 9"	\$763.00	\$1,003.00



**Single Threshold – Short Side**



Number	Model	Dimensions	Approx. Ship Wt (lbs)	PKG Dimensions	List Price	
					Standard	Premium
7503	3642 STSS, Center Drain	36" x 42"	62	39" x 45" x 8"	\$763.00	\$1,003.00



**Single Threshold – Long Side**



Number	Model	Dimensions	Approx. Ship Wt (lbs)	PKG Dimensions	List Price	
					Standard	Premium
7504	4236 STLS, Center Drain	42" x 36"	62	39" x 45" x 8"	\$763.00	\$1,003.00
7505	4832 STLS, Center Drain	48" x 32"	75	52" x 35" x 9"	\$763.00	\$1,003.00
7506	4834 STLS, Center Drain	48" x 34"	77	52" x 37" x 9"	\$763.00	\$1,003.00
7507	6034 STLS, Center Drain	60" x 34"	83	64" x 37" x 9"	\$831.00	\$1,071.00



**Single Threshold – Long Side**



Number	Model	Dimensions	Approx. Ship Wt (lbs)	PKG Dimensions	List Price	
					Standard	Premium
7514	6032 STLS RH, End Drain	60" x 32"	79	64" x 35" x 9"	\$831.00	\$1,071.00
7515	6032 STLS LH, End Drain	60" x 32"	79	64" x 35" x 9"	\$831.00	\$1,071.00

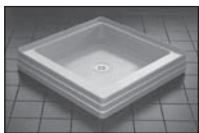

**Double Threshold**



Number	Model	Dimensions	Approx. Ship Wt (lbs)	PKG Dimensions	List Price	
					Standard	Premium
7508	3636 DT, Center Drain	36" x 36"	58	39" x 40" x 9"	\$727.00	\$967.00



**Triple Threshold**



Number	Model	Dimensions	Approx. Ship Wt (lbs)	PKG Dimensions	List Price	
					Standard	Premium
7509	3636 TTNA, Center Drain	36" x 36"	60	39" x 40" x 9"	\$778.00	\$1,018.00
7510	3838 TTNA, Center Drain	38" x 38"	62	48" x 42" x 11-1/2"	\$778.00	\$1,018.00
7530	4242 TTNA, Center Drain	42" x 42"	65	46" x 45" x 9"	\$831.00	\$1,071.00

**Shower Base Options**

SB1420	Drain Kit - Chrome	-	4	16" x 7" x 4"	\$22.00
SB1421	Drain Kit - Polished Brass	-	4	16" x 7" x 4"	\$40.00

Colors: See chart on inside back cover

## TOILET SEATS



### SmartClose™

- Plastic, closed front
- SmartClose™ technology gently and quietly closes toilet seat lid
- Includes mounting hardware and instructions



SmartClose™ Toilet Seat  
With a simple touch, Mansfield's SmartClose™ toilet seat closes gently and quietly

Model Number	Description	Part Number		List Price	
		Color	Number	White	Standard
SB700	Elongated front, closed front, plastic toilet seat and cover with SmartClose™ technology	White	007470700	\$53.01	\$53.01
		Bone	007470705		
		Bisc	007470743		

Colors: WHT - White



### Standard

- Plastic, closed front
- Includes mounting hardware and instructions

Model Number	Description	Part Number		List Price	
		Color	Number	White	Standard
SB200	Alto® Elongated front, closed front, plastic toilet seat and cover	White	007470038	\$26.05	\$26.05
		Bone	007470039		
		Bisc	007470041		
SB100	Alto® Round front, closed front, plastic toilet seat and cover	White	007470055	\$21.46	\$21.46
		Bone	007470056		
		Bisc	007470058		

Colors: WHT - White Standard: BISC - Biscuit, BONE - Bone



### Commercial

- Heavy duty plastic, open front
- Includes mounting hardware and instructions

Model Number	Description	Part Number		List Price	
		Color	Number	White	Standard
SB900	Elongated open front, heavy duty plastic toilet seat	White	007470900	\$46.22	N/A

Colors: WHT - White



### SmartClose™ Designer

- Heavy-duty plastic, closed front
- Includes mounting hardware and instructions

Model Number	Description	Part Number		List Price	
		Color	Number	White	Standard
SB1500	Enso SmartClose™ (Fits 177 Enso Bowl) Elongated front, closed front, heavy-duty plastic toilet seat and cover with SmartClose™ technology	White	007471500	\$110.61	\$110.61
		Bisc	007471543		

Colors: WHT - White Standard: BISC - Biscuit



## TRIP LEVERS



**31 Trip Lever**

- Left hand, plastic trip lever
- Front mount for flapper flush valve
- Includes locknut

Model Number	Description	Part Number	List Price (each)	Pack	Master Carton Quantity
31WHT	White - Each	001238865	\$6.12	N/A	N/A
31BONE	Bone - Each	001238889	\$6.12	N/A	N/A
31BISC	Biscuit - Each	001238890	\$6.12	N/A	N/A
31CH	Chrome - Each	001238864	\$6.12	N/A	N/A



**40RH Trip Lever**

- Right hand, plastic trip lever
- Front mount for tower flush valve
- Includes locknut

Model Number	Description	Part Number	List Price (each)	Pack	Master Carton Quantity
40RHCH	Chrome - Each	160000014	\$3.87	N/A	N/A



**31RH Trip Lever**

- Right hand, plastic trip lever
- Front mount for flapper flush valve
- Includes locknut

Model Number	Description	Part Number	List Price (each)	Pack	Master Carton Quantity
31RHCH	Chrome - Each	001238856	\$6.12	N/A	N/A
31RHWHT	White - Each	001238866	\$6.12	N/A	N/A



**41 Trip Lever**

- “Universal” left hand, plastic trip lever
- Front mount
- Special ABS arm can be shaped to fit a variety of toilet tank trim configurations — Works with all types of flush valve connections: lift wire, direct or chain
- Includes locknut

Model Number	Description	Part Number	List Price (each)	Pack	Master Carton Quantity
41CH-P	Chrome - Each	006300025	\$6.12	blister view	N/A
41CH-P-10	Chrome - 10 Pk	006300025	\$5.36	blister view	10*
41CH-P-20	Chrome - 20 Pk	006300025	\$5.10	blister view	20*
41CH-20	Chrome - 20 Pk	410000010	\$3.30	bulk packed	20*
41CH-50	Chrome - 50 Pk	410000010	\$3.19	bulk packed	50*



**33 Actuator**

- Plastic, push button actuator
- Top mount
- Includes locknut

Model Number	Description	Part Number	List Price (each)	Pack	Master Carton Quantity
33CH	Chrome - Each	005614500	\$33.16	bulk bagged	N/A



**42 Trip Lever**

- Left hand, plastic trip lever
- Front mount
- Includes locknut

Model Number	Description	Part Number	List Price (each)	Pack	Master Carton Quantity
42CH-P	Chrome - Each	006306033	\$6.12	blister view	N/A
42CH-P-10	Chrome - 10 Pk	006306033	\$5.36	blister view	10*
42CH-P-20	Chrome - 20 Pk	006306033	\$5.10	blister view	20*
42CH-20	Chrome - 20 Pk	001238867	\$3.49	bulk packed	20*
42CH-50	Chrome - 50 Pk	001238867	\$3.35	bulk packed	50*



**40 Trip Lever**

- Left hand, plastic trip lever
- Front mount for tower flush valve
- Includes locknut

Model Number	Description	Part Number	List Price (each)	Pack	Master Carton Quantity
40WHT-P	White - Each	006304002	\$6.12	blister view	N/A
40WHT-P-5	White - 5 Pack	006304002	\$5.36	blister view	5*
40WHT-20	White - 20 Pack	160000013	\$3.35	bulk packed	20*
40BONE-P	Bone - Each	006306031	\$6.12	blister view	N/A
40BONE-P-5	Bone - 5 Pack	006306031	\$5.36	blister view	5*
40BONE-20	Bone - 20 Pack	160000016	\$3.35	bulk packed	20*
40BISC-P	Biscuit - Each	006306032	\$6.12	blister view	N/A
40BISC-P-5	Biscuit - 5 Pack	006306032	\$5.36	blister view	5*
40BISC-20	Biscuit - 20 Pk	160000018	\$3.35	bulk packed	20*
40CH-P	Chrome - Each	006306030	\$6.12	blister view	N/A
40CH-P-10	Chrome - 10 Pk	006306030	\$5.36	blister view	10*
40CH-P-20	Chrome - 20 Pk	006306030	\$5.10	blister view	20*
40CH-20	Chrome - 20 Pk	160000015	\$3.30	bulk packed	20*
40CH-50	Chrome - 50 Pk	160000015	\$3.19	bulk packed	50*



**43 Trip Lever**

- Left hand, plastic trip lever
- Front mount
- Includes locknut

Model Number	Description	Part Number	List Price (each)	Pack	Master Carton Quantity
43CH-P	Chrome - Each	006306034	\$6.12	blister view	N/A
43CH-P-10	Chrome - 10 Pk	006306034	\$5.36	blister view	10*
43CH-P-20	Chrome - 20 Pk	006306034	\$5.10	blister view	20*
43CH-20	Chrome - 20 Pk	430000010	\$3.49	bulk packed	20*
43CH-50	Chrome - 50 Pk	430000010	\$3.35	bulk packed	50*





## TRIP LEVERS

					
<b>44 Trip Lever</b>					
<ul style="list-style-type: none"> <li>• Left hand, plastic trip lever</li> <li>• Front mount</li> <li>• Includes locknut</li> </ul>					
Model Number	Description	Part Number	List Price (each)	Pack	Master Carton Quantity
44CH	Chrome - Each	001238874	\$6.91	N/A	N/A

					
<b>45 Trip Lever</b>					
<ul style="list-style-type: none"> <li>• Left hand, metal trip lever</li> <li>• Front mount</li> <li>• Zinc die-cast handle &amp; brass arm</li> <li>• Includes locknut</li> </ul>					
Model Number	Description	Part Number	List Price (each)	Pack	Master Carton Quantity
45CH	Chrome - Each	001230126	\$12.19	N/A	N/A

					
<b>46 Trip Lever</b>					
<ul style="list-style-type: none"> <li>• Left hand, metal trip lever</li> <li>• Side mount</li> <li>• Zinc die-cast handle with brass arm</li> <li>• Includes locknut</li> </ul>					
Model Number	Description	Part Number	List Price (each)	Pack	Master Carton Quantity
46WHT	White - Each	005313562	\$27.68	N/A	N/A
46BONE	Bone - Each	005313563	\$27.68	N/A	N/A
46BISC	Biscuit - Each	005313566	\$27.68	N/A	N/A
46CH	Chrome - Each	005313560	\$27.68	N/A	N/A
46BC	Brushed Chrome - Ea	005313565	\$35.77	N/A	N/A
46SB	Sicilian Bronze - Ea	005313567	\$35.77	N/A	N/A
46SN	Satin Nickel - Each	005313564	\$35.77	N/A	N/A

					
<b>47 Actuator</b>					
<ul style="list-style-type: none"> <li>• Plastic, push button actuator</li> <li>• Top mount</li> <li>• Includes locknut</li> </ul>					
Model Number	Description	Part Number	List Price (each)	Pack	Master Carton Quantity
47CH	Chrome - Each	001230246	\$33.16	N/A	N/A

					
<b>48 Actuator</b>					
<ul style="list-style-type: none"> <li>• Metal push button actuator</li> <li>• Side mount</li> <li>• Durable, zinc die-cast construction</li> <li>• Includes locknut</li> </ul>					
Model Number	Description	Part Number	List Price (each)	Pack	Master Carton Quantity
48CH	Chrome - Each	001230118	\$34.02	N/A	N/A

					
<b>49 RH Trip Lever</b>					
<ul style="list-style-type: none"> <li>• Metal, right hand trip lever</li> <li>• Front mount</li> <li>• Durable zinc die-cast handle with brass arm</li> <li>• Includes locknut</li> </ul>					
Model Number	Description	Part Number	List Price (each)	Pack	Master Carton Quantity
49CH	Chrome - Each	001230127	\$13.84	N/A	N/A

					
<b>50 Trip Lever</b>					
<ul style="list-style-type: none"> <li>• Left hand or right hand trip lever</li> <li>• Front mount</li> <li>• Durable, zinc die-cast handle</li> <li>• Includes locknut</li> </ul>					
Model Number	Description	Part Number	List Price (each)	Pack	Master Carton Quantity
50CH	Chrome - Each	005313602	\$21.95	N/A	N/A

					
<b>51 Trip Lever</b>					
<ul style="list-style-type: none"> <li>• Metal, left hand trip lever</li> <li>• Side mount</li> <li>• Zinc die-cast handle with brass arm</li> <li>• Includes locknut</li> </ul>					
Model Number	Description	Part Number	List Price (each)	Pack	Master Carton Quantity
51CH	Chrome - Each	005613572	\$20.95	N/A	N/A
51SN	Satin Nickel - Ea	005613577	\$43.45	N/A	N/A

					
<b>51RH Trip Lever</b>					
<ul style="list-style-type: none"> <li>• Metal, right hand trip lever</li> <li>• Side mount</li> <li>• Zinc die-cast handle with brass arm</li> <li>• Includes locknut</li> </ul>					
Model Number	Description	Part Number	List Price (each)	Pack	Master Carton Quantity
51RHCH	Chrome - Each	005613571	\$20.95	N/A	N/A

\*No Broken Cartons

## TRIP LEVERS



### 55 Trip Lever

- "Universal" left hand, metal trip lever
- Front mount
- Zinc die-cast handle
- Shaped to fit a variety of toilet tank manufacturers and trim configurations
- Includes locknut

Model Number	Description	Part Number	List Price (each)	Pack	Master Carton Quantity
55CH-P	Chrome - Each	006306035	\$14.08	blister view	N/A
55CH-P-5	Chrome - 5 Pack	006306035	\$12.19	blister view	5*
55CH-P-10	Chrome - 10 Pack	006306035	\$10.61	blister view	10*
55SN-P	Satin Nickel - Ea	006306037	\$45.87	blister view	N/A
55SN-P-5	Satin Nickel - 5 Pk	006306037	\$39.89	blister view	5*
55SN-P-10	Satin Nickel - 10 Pk	006306037	\$38.27	blister view	10*
55SB-P	Sicilian Bronze - Ea	006306038	\$45.75	blister view	N/A



### 58RH Trip Lever

- Right hand, plastic trip lever
- Side mount
- Includes locknut

Model Number	Description	Part Number	List Price (each)	Pack	Master Carton Quantity
58RHCH	Chrome - Each	005313671	\$20.44	N/A	N/A



### 66 Trip Lever

- Left hand, metal trip lever
- Side mount
- Includes locknut

Model Number	Description	Part Number	List Price (each)	Pack	Master Carton Quantity
66CH	Chrome - Each	005313704	\$30.34	N/A	N/A
66SN	Satin Nickel - Each	005313705	\$52.79	N/A	N/A
66SB	Sicilian Bronze - Ea	005313706	\$52.79	N/A	N/A



### 55RH Trip Lever

- "Universal" right hand, metal trip lever
- Front mount
- Zinc die-cast handle with brass arm
- Includes locknut

Model Number	Description	Part Number	List Price (each)	Pack	Master Carton Quantity
55RHCH	Chrome - Each	001230130	\$11.71	N/A	N/A



### 69 Trip Lever

- Left hand, metal trip lever
- Side mount
- Includes locknut

Model Number	Description	Part Number	List Price (each)	Pack	Master Carton Quantity
69CH	Chrome - Each	005313701	\$19.77	N/A	N/A
69SN	Satin Nickel - Each	005313702	\$42.26	N/A	N/A
69SB	Sicilian Bronze - Ea	005313703	\$42.26	N/A	N/A



### 56 Trip Lever

- Left hand, plastic trip lever
- Front mount
- Includes locknut

Model Number	Description	Part Number	List Price (each)	Pack	Master Carton Quantity
56WHT	White - Each	005313658	\$5.80	N/A	N/A
56BISC	Biscuit - Each	005313657	\$5.80	N/A	N/A
56BONE	Bone - Each	005313656	\$5.80	N/A	N/A



### 70 Trip Lever

- Left hand, metal trip lever
- Side mount
- Durable metal handle with brass arm
- Includes locknut

Model Number	Description	Part Number	List Price (each)	Pack	Master Carton Quantity
70CH	Chrome - Each	005613583	\$23.43	N/A	N/A
70SN	Satin Nickel - Each	005613587	\$49.86	N/A	N/A



### 58 Trip Lever

- Left hand, plastic trip lever
- Side mount
- Includes locknut

Model Number	Description	Part Number	List Price (each)	Pack	Master Carton Quantity
58CH	Chrome - Each	005313670	\$19.14	N/A	N/A



### 72 Trip Lever

- Left hand, metal trip lever with color-match ceramic insert
- Front mount
- Includes locknut

Model Number	Description	Part Number	List Price (each)	Pack	Master Carton Quantity
72CHWHT	Chrome w/White-Ea	005313640	\$30.34	N/A	N/A
72CHBONE	Chrome w/Bone-Ea	005313641	\$30.34	N/A	N/A
72CHBISC	Chrome w/Biscuit-Ea	005313642	\$30.34	N/A	N/A

Sanitaryware Parts & Accessories

\*No Broken Cartons

# Sanitaryware Parts & Accessories

List Price Effective January 1, 2016

## TRIP LEVERS

		<b>73 Trip Lever</b> <ul style="list-style-type: none"> <li>• Left hand, metal trip lever</li> <li>• Side mount</li> <li>• Includes locknut</li> </ul>			
Model Number	Description	Part Number	List Price (each)	Pack	Master Carton Quantity
73CH	Chrome - Each	005313654	\$29.46	N/A	N/A

		<b>79 Actuator</b> <ul style="list-style-type: none"> <li>• Chrome-plated ABS push button actuator</li> <li>• Top mount</li> <li>• Includes locknut</li> </ul>			
Model Number	Description	Part Number	List Price (each)	Pack	Master Carton Quantity
79CH	Chrome - Each	005313690	\$27.45	N/A	N/A

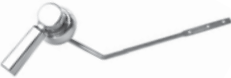
		<b>76 Trip Lever</b> <ul style="list-style-type: none"> <li>• Left hand, metal trip lever</li> <li>• Front mount</li> <li>• Includes locknut</li> </ul>			
Model Number	Description	Part Number	List Price (each)	Pack	Master Carton Quantity
76CH	Chrome - Each	005313801	\$30.36	N/A	N/A
76SB	Sicilian Bronze - Each	005313803	\$52.83	N/A	N/A
76SN	Satin Nickel - Each	005313802	\$52.83	N/A	N/A

		<b>85 Trip Lever</b> <ul style="list-style-type: none"> <li>• Left hand, metal trip lever</li> <li>• Front mount</li> <li>• Includes locknut</li> </ul>			
Model Number	Description	Part Number	List Price (each)	Pack	Master Carton Quantity
85CH	Chrome - Each	005313652	\$19.77	N/A	N/A

		<b>78 Actuator</b> <ul style="list-style-type: none"> <li>• Chrome-plated ABS push button actuator</li> <li>• Top mount</li> <li>• Includes locknut</li> </ul>			
Model Number	Description	Part Number	List Price (each)	Pack	Master Carton Quantity
78CH	Chrome - Each	005313678	\$33.16	N/A	N/A
78SN	Satin Nickel - Each	005313679	\$55.70	N/A	N/A

		<b>87 Trip Lever</b> <ul style="list-style-type: none"> <li>• Left hand, metal trip lever</li> <li>• Front mount</li> <li>• Includes locknut</li> </ul>			
Model Number	Description	Part Number	List Price (each)	Pack	Master Carton Quantity
87CH	Chrome - Each	005313653	\$19.77	N/A	N/A

\*No Broken Cartons

Sanitaryware Parts & Accessories

TRIP LEVER / FLUSH VALVE / FILL VALVE CROSS REFERENCE CHART												
Tank Model Number *	Trip Lever Model Number	Trip Lever Finishes							Alternate Trip Lever Model Number	Flush Valve Model Number	Fill Valve Model Number	Gpf
		Chrome	Brushed Chrome	Satin Nickel	Sicilian Bronze	White	Biscuit	Bone				
035	42	•							41	210-1112	08-1112	3.5
106	69	•		•						206-1112	2206	1.6
119	50LH	•		•						EcoFlush™		1.1/1.6
119CL	50LH	•		•						EcoFlush™		1.1/1.6
119RH	50	•								EcoFlush™		1.1/1.6
122	47	•								Sloan Flushmate III™		1.6
123	45	•								Sloan Flushmate III™		1.6
123RH	49	•								Sloan Flushmate III™		1.6
125	40	•							55	211-1112	08ULF-1112	1.6
153	45	•								Sloan Flushmate IV™		1.0
153RH	49	•								Sloan Flushmate IV™		1.0
154	47	•								Sloan Flushmate IV™		1.0
160	40	•				•	•	•	55	211-1112	08ULF-1112	1.6
160RH	40RH	•							55RH	211-1112	08ULF-1112	1.6
161	40	•				•	•	•	55	211-1112	Fluidmaster™ 400A	1.6
165	40	•				•	•	•	55	211-1112	08ULF-1112	1.6
170	40	•				•	•	•	55	211-1112	08ULF-1112	1.6
171	40	•				•	•	•	55	211-1112	Fluidmaster™ 400A	1.6
172	31	•				•	•	•		203A	2206	1.6
172RH	31RH	•				•	•	•		203A	2206	1.6
173	31	•				•	•	•		203A	2206	1.6
173RH	31RH	•				•	•	•		203A	2206	1.6
174	31	•			•	•	•			203A	2206	1.6
175	40	•				•			55	211-1112	08ULF-1112	1.6
178	78	•		•						208E	90	1.1/1.6
180	40	•				•	•	•	55	211-1112	08ULF-1112	1.6
181	40	•				•	•	•	55	211-1112	Fluidmaster™ 400A	1.6
188	87	•								206-1112	2206	1.6
190	40	•				•	•	•	55	211-1112	08ULF-1112	1.6
386	55	•		•	•					206-1212	2206	1.6
386LT	55	•		•	•					206-1212	2206	1.6
386RH	55RH	•								206-1212	2206	1.6
387	55	•		•	•					206-1212	2206	1.28
387LT	55	•		•	•					206-1212	2206	1.28
387RH	55RH	•								206-1212	2206	1.28
704	47	•								Sloan Flushmate IV™		1.0
705NS	73	•								204	2206	1.6
708	73	•								204	2206	1.28
722	70 or 73	•								204	2206	1.6
1012	79	•								209	90-9"	1.0
3012	79	•								209	90-9"	1.0
3106	69	•		•	•					206-1112	2206	1.28
3108	66	•		•	•					206-1112	2206	1.28
3120	31	•								228	Fluid-400A/2206	1.28
3120RH	31RH	•								228	Fluid-400A/2206	1.28
3121	31	•				•	•	•		228	Fluid-400A/2206	1.28
3121RH	31RH	•				•	•	•		228	Fluid-400A/2206	1.28
3122	31	•				•	•	•		228	Fluid-400A/2206	1.28
3125	31	•				•	•	•		228	2206	1.28
3147	76	•		•	•					206-1112	2206	1.6
3173	31	•								228	2206	1.28
3185	85	•								206-1112	2206	1.28
3195	72	•								-	2206	1.28
3386	33	•								308	2206	1.1-1.6
3816	58	•								216	2206	1.28
3816RH	58RH	•								216	2206	1.28

Sanitaryware Parts & Accessories

\*Model number can be found on inner tank wall

## FILL VALVE / FLUSH VALVE / BALLCOCK PARTS & ACCESSORIES



### 2206 Pilot Operated, Anti-Siphon Fill Valve

- Efficient operation at low or high water pressures — Positive shut-off
- Sufficient refill to cover all consumptions
- Includes 6" refill tube and plastic coupling nut

Model Number	Description	Part Number	List Price (each)	Pack	Master Carton Quantity	Lbs. Per Master Carton
2206 Pilot Operated Anti-Siphon Fill Valve — For use in 1.6 Gpf / 6.0 Lpf toilets						
8-12" Adjustable Length						
2206	Anti-Siphon Fill Valve – Each	11-1/2" – 001304029	\$17.19	ind. boxed	N/A	3
		12-1/2" – 001304032	\$17.19	ind. boxed	N/A	3
<b>Component Parts</b>						
630-2206	Fill Valve Service Kit for 2206 – Each	106302206	\$4.12	blister view	1	N/A
630-2206-20	20 Pack	106302206	\$3.49	blister view	20	N/A

### o8 Anti-Siphon Plastic Ballcocks

- Adjustable water level — Snap action shut-off
- Unified construction — Non-electrolytic and non-corrosive
- Efficient operation at low or high water pressures
- Includes 7-1/2" float rod, 7" refill tube, acetal locknut and coupling nut



1002 Approved



o8 Anti-Siphon Ballcock

Model Number	Description	Part Number	List Price (each)	Pack	Master Carton Quantity	Lbs. Per Master Carton
o8 Anti-Siphon Plastic Ballcocks — For use in 3.5 Gpf / 13.3 Lpf toilets						
10" Length						
08-10	Each	800010000	\$13.58	ind. boxed	N/A	N/A
08-10-20	20 Pack	800010000	\$12.35	ind. boxed	20*	17
10-3/4" Length — Fits tank models o20 and o25						
08-1034	Anti-Siphon Ballcock — Each	800010750	\$13.58	ind. boxed	N/A	N/A
08-1034-20	20 Pack	800010750	\$12.35	ind. boxed	20*	17
11-1/2" Length — Fits tank models o35						
08-1112	Anti-Siphon Ballcock — Each	800011500	\$13.58	ind. boxed	N/A	N/A
08-1112-20	20 Pack	800011500	\$12.35	ind. boxed	20*	18
o8 Anti-Siphon Plastic Ballcocks — For use in 1.6 Gpf / 6.0 Lpf toilets						
10" Length						
08ULF-10	Anti-Siphon Ballcock — Each	800010001	\$13.58	ind. boxed	N/A	N/A
08ULF-10-20	20 Pack	800010001	\$12.35	ind. boxed	20*	18
10-3/4" Length — Fits tank models 164 and 174						
08ULF-1034	Anti-Siphon Ballcock — Each	800010751	\$13.58	ind. boxed	N/A	N/A
08ULF-1034-20	20 Pack	800010751	\$12.35	ind. boxed	20*	18
11-1/2" Length — Fits tank models 125, 160, 165, 170, 175, 180 and 190						
08ULF-1112	Anti-Siphon Ballcock — Each	800011501	\$13.58	ind. boxed	N/A	N/A
08ULF-1112-20	20 Pack	800011501	\$12.35	ind. boxed	20*	17
<b>Component Parts</b>						
342-2067-50	Upper Diaphragm — 50 Pack	003422067	\$0.76	ind. packed	50*	N/A
342-2067-100	Upper Diaphragm — 100 Pack	003422067	\$0.63	ind. boxed	100*	N/A
936-2069-50	Lower Diaphragm — 50 Pack	009362069	\$0.87	ind. packed	50*	N/A
936-2069-100	Lower Diaphragm — 100 Pack	009362069	\$0.76	ind. boxed	100*	N/A
660-3718-50	Plunger — 50 Pack	006603718	\$0.49	ind. packed	50*	N/A
660-3718-100	Plunger — 100 Pack	006603718	\$0.43	ind. boxed	100*	N/A
609-5414-20	Cap Nut — 20 Pack	006095414	\$1.13	ind. packed	N/A	N/A
123-7838	Cap and Lever Assembly — Each	001237838	\$3.48	ind. packed	N/A	N/A
123-7838-20	Cap and Lever Assembly — 20 Pack	001237838	\$3.14	ind. packed	N/A	N/A



o8 Component Parts

\*No Broken Cartons

## FILL VALVE / FLUSH VALVE / BALLCOCK PARTS & ACCESSORIES



210 Flush Valve



211 Flush Valve

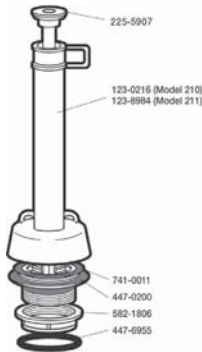

210 & 211 Component Parts

### 210/211 Plastic Flush Valves

- Accommodates all trip levers — Direct or chain connection
- Includes shank gasket and locknut

Model Number	Description	Part Number	List Price (each)	Pack	Master Carton Quantity	Lbs. Per Master Carton
210 Plastic Flush Valve — For use in 3.5 Gpf / 13.3 Lpf toilets						
10-3/4" Length — Fits tank models 010, 020 and 025						
210-1034	210 Plastic Flush Valve — Each	300210007	\$9.48	ind. boxed	N/A	N/A
210-1034-10	10 Pack	300210007	\$8.61	ind. boxed	10*	12
11-1/2" Length — Fits tank models 011, 021, 026 & 035						
210-1112-P	210 Plastic Flush Valve — Each	106306007	\$10.35	blister view	N/A	N/A
210-1112-P-4	4 Pack	106306007	\$9.73	blister view	4*	12
210-1112	210 Plastic Flush Valve — Each	300210000	\$9.48	ind. boxed	N/A	N/A
210-1112-10	10 Pack	300210000	\$8.61	ind. boxed	10*	12
211 Plastic Flush Valve — For use in 1.6 Gpf / 6.0 Lpf toilets						
10" Length — Fits tank model 163						
211-1000	211 Plastic Flush Valve — Each	300211009	\$9.48	ind. boxed	N/A	N/A
211-1000-10	10 Pack	300211009	\$8.61	ind. boxed	10*	12
10-3/4" Length — Fits tank models 162, 164 and 174						
211-1034	211 Plastic Flush Valve — Each	300211007	\$9.48	ind. boxed	N/A	N/A
211-1034-10	10 Pack	300211007	\$8.61	ind. boxed	10*	12
11-1/2" Length — Fits tank models 125, 159, 160, 161, 165, 170, 171, 175, 180, 181 and 190						
211-1112-P	211 Plastic Flush Valve — Each	106306008	\$10.35	blister view	N/A	N/A
211-1112-P-4	4 Pack	106306008	\$9.73	blister view	4*	12
211-1112	211 Plastic Flush Valve — Each	300211000	\$9.48	ind. boxed	N/A	N/A
211-1112-10	10 Pack	300211000	\$8.61	ind. boxed	10*	12
<b>Component Parts</b>						
225-5907-20	Stop Cap For 210 / 211 — 20 Pack	002255907	\$0.63	bulk packed	20*	N/A
225-5907-100	Stop Cap For 210 / 211 — 100 Pack	002255907	\$0.38	ind. boxed	100*	N/A
123-0216-20	Float Assembly For 210 — 20 Pack	001230216	\$2.49	bulk packed	20*	N/A
123-0216-50	Float Assembly For 210 — 50 Pack	001230216	\$2.12	bulk packed	50*	N/A
123-8984-20	Float Assembly For 211 — 20 Pack	001238984	\$2.42	bulk packed	20*	N/A
123-8984-50	Float Assembly For 211 — 50 Pack	001238984	\$2.07	bulk packed	50*	N/A
741-0011-50	Flush Valve Seal For 210 / 211 — 50 Pack	007410011	\$0.99	bulk packed	50*	N/A
741-0011-100	Flush Valve Seal For 210 / 211 — 100 Pack	007410011	\$0.87	bulk packed	100*	N/A
447-0200-50	Flush Valve Spud Gasket For 210 / 211 — 50 Pack	004470200	\$0.99	bulk packed	50*	N/A
447-6955-50	Tank-to-Bowl Gasket For 210/211 — 50 Pack	004476955	\$1.87	bulk packed	50*	N/A



212 Flush Valve

### 212 Plastic Flush Valve

- Provides 1.6 Gpf/6.0 Lpf water consumption
- Styrofoam float
- Includes gasket, locknut and chain

Model Number	Description	Part Number	List Price (each)	Pack	Master Carton Quantity	Lbs. Per Master Carton
212 Plastic Flush Valve						
10-3/4" Length — Fits tank models 700 and 705						
212-1034	212 Plastic Flush Valve Without Threads – Ea	001238951	\$11.10	bulk packed	N/A	N/A
212-1034-10	212 Plastic Flush Valve Without Threads – Ea	001238951	\$9.97	bulk packed	N/A	N/A

\*No Broken Cartons

## FILL VALVE / FLUSH VALVE / BALLCOCK PARTS & ACCESSORIES



89 Anti-Siphon Ballcock

### 89 Anti-Siphon Plastic Ballcock

- Adjustable water level
- Unified construction — Non-electrolytic and non-corrosive
- Efficient operation at low or high water pressures
- Includes 8" float rod, 8" refill tube, acetal locknut and coupling nut

Model Number	Description	Part Number	List Price (each)	Pack	Master Carton Quantity	Lbs. Per Master Carton
89 Anti-Siphon Plastic Ballcocks — For use in 1.6 Gpf / 6.0 Lpf toilets						
10-1/2" Length — Fits tank models 392 & 395						
89-1012	89 Anti-Siphon Ballcock – Each	001304089	\$14.84	ind. packed	N/A	N/A



90 Fill Valve

### 90 Fill Valve

- Adjustable water level

Model Number	Description	Part Number	List Price (each)	Pack	Master Carton Quantity	Lbs. Per Master Carton
Fits tank model 178- For use in 1.6 Gpf / 6.0 Lpf toilets						
90	Fill Valve – Each	001304035	\$17.21	ind. packed	N/A	N/A
Fits tank model 1012- For use in 1.0 Gpf						
90-9000	Fill Valve – Each	001304036	\$17.21	ind. packed	N/A	N/A



202 Flush Valve

### 202 Plastic Flush Valve

- Two-inch plunger
- Flapper design
- Provides 1.6 Gpf / 6.0 Lpf water consumption
- Includes flapper, plastic chain, stainless steel clip, spud gasket and nut

Model Number	Description	Part Number	List Price (each)	Pack	Master Carton Quantity	Lbs. Per Master Carton
202 Plastic Flush Valve						
10-1/2" Length — Fits tank models 392 & 395						
202-1012	Plastic Flush Valve	001304202	\$21.07	ind. packed	N/A	N/A



2" Replacement Flapper Kit

### 2" Replacement Flapper Kit

- Universal kit fits all Mansfield 2" flapper flush valves

Model Number	Description	Part Number	List Price (each)	Pack	Master Carton Quantity	Lbs. Per Master Carton
630-0173	2" Replacement Flapper Kit — Each	006300173	\$2.94	blister pack	N/A	N/A



3" Replacement Flapper Kit

### 3" Replacement Flapper Kit

- Universal kit fits all Mansfield 3" flapper flush valves

Model Number	Description	Part Number	List Price (each)	Pack	Master Carton Quantity	Lbs. Per Master Carton
630-0207	3" Replacement Flapper Kit — Each	106300207	\$8.73	Each	N/A	N/A
630-0207-3	3" Replacement Flapper Kit — 3 Pack	106300207	\$8.37	Each - 3	N/A	N/A
630-0207-12	3" Replacement Flapper Kit — 12 Pack	106300207	\$7.85	Each - 12	N/A	N/A





## FILL VALVE / FLUSH VALVE / BALLCOCK PARTS & ACCESSORIES

 <p>203A 2" Flapper Flush Valve</p>	<h3>203A 2" Flapper Flush Valve</h3> <ul style="list-style-type: none"> <li>• 2" flapper</li> <li>• Provides 1.6 Gpf / 6.0 Lpf water consumption</li> </ul>						
	Model Number	Description	Part Number	List Price (each)	Pack	Master Carton Quantity	Lbs. Per Master Carton
	203A	Plastic 2" Flapper Flush Valve	001304173	\$8.69	-	N/A	N/A

 <p>204 3" Flapper Flush Valve</p>	<h3>204 3" Flapper Flush Valve</h3> <ul style="list-style-type: none"> <li>• 3" flapper</li> <li>• Provides 1.6 Gpf / 6.0 Lpf water consumption</li> </ul>						
	Model Number	Description	Part Number	List Price (each)	Pack	Master Carton Quantity	Lbs. Per Master Carton
	Fits Tank Models 705NS, 708 & 722						
204	Plastic 3" Flapper Flush Valve	001304033	\$12.68	-	N/A	N/A	

 <p>206 3" Flapper Flush Valve</p>	<h3>206 3" Flapper Flush Valve</h3> <ul style="list-style-type: none"> <li>• 3" flapper</li> <li>• Provides 1.28 Gpf and 1.6 Gpf water consumption</li> </ul>						
	Model Number	Description	Part Number	List Price (each)	Pack	Master Carton Quantity	Lbs. Per Master Carton
	206-1112	11-1/2" - see page 113 for Tank Models	001304028	\$12.68	-	N/A	N/A
206-1212	12-1/2" - see page 113 for Tank Models	001304030	\$13.25	-	N/A	N/A	

 <p>208E Dual Flush Tower</p>	<h3>208E Dual Flush Tower</h3> <ul style="list-style-type: none"> <li>• Dual Flush Tower</li> <li>• Provides 1.1 Gpf and 1.6 Gpf water consumption</li> </ul>						
	Model Number	Description	Part Number	List Price (each)	Pack	Master Carton Quantity	Lbs. Per Master Carton
	Fits Tank Model 178						
208E	Dual Flush Tower	001304135	\$19.61	-	N/A	N/A	

 <p>209 Flush Tower</p>	<h3>209 Flush Tower</h3> <ul style="list-style-type: none"> <li>• Flush Tower</li> <li>• Provides 1.0 Gpf water consumption</li> </ul>						
	Model Number	Description	Part Number	List Price (each)	Pack	Master Carton Quantity	Lbs. Per Master Carton
	209	Flush Tower – Fits tank model 1012	001304136	\$17.13	-	N/A	N/A

## FILL VALVE / FLUSH VALVE / BALLCOCK PARTS & ACCESSORIES

 <p>216 Flapper Flush Valve</p>	<h3>216 3" Flapper Flush Valve</h3> <ul style="list-style-type: none"> <li>Provides 1.28 Gpf water consumption</li> </ul>						
	Model Number	Description	Part Number	List Price (each)	Pack	Master Carton Quantity	Lbs. Per Master Carton
	Fits tank model 3816						
<b>216</b>	Plastic 3" Flapper Flush Valve	<b>001304216</b>	\$14.63	-	N/A	N/A	

 <p>228 3" Flapper Flush Valve</p>	<h3>228 3" Flapper Flush Valve</h3> <ul style="list-style-type: none"> <li>Hybrid 3" to 2"</li> </ul>						
	Model Number	Description	Part Number	List Price (each)	Pack	Master Carton Quantity	Lbs. Per Master Carton
	Fits Tank Models 3121, 3122 – Provides 1.28 Gpf						
<b>228</b>	11-1/2" (Fits 2" Outlet Hole)	<b>001304400</b>	\$12.68	-	N/A	N/A	

 <p>308 3" Dual Flush Tower</p>	<h3>308 3" Dual Flush Tower</h3> <ul style="list-style-type: none"> <li>Dual Flush Tower</li> <li>Provides 1.1 Gpf and 1.6 Gpf water consumption</li> </ul>						
	Model Number	Description	Part Number	List Price (each)	Pack	Master Carton Quantity	Lbs. Per Master Carton
	Fits Tank Models 3386						
<b>308</b>	Dual Flush Valve	<b>001304500</b>	\$19.60	-	N/A	N/A	
<b>741-0308</b>	Dual Flush Valve Seal	<b>007410308</b>	\$1.60	-	N/A	N/A	

## TOILETS / URINAL PARTS & ACCESSORIES

 <p>Tank-to-Bowl Gasket Kit</p>	<h3>Tank-to-Bowl Gasket Kit</h3> <ul style="list-style-type: none"> <li>Includes tank-to-bowl gasket, three (3) hex nuts, three (3) washers, three (3) rubber washers and ballcock coupling nut. Bolts pre-installed in tank.</li> </ul>						
	Model Number	Description	Part Number	List Price (each)	Pack	Master Carton Quantity	Lbs. Per Master Carton
	<b>630-0034</b>	Quantum™ Tank-to-Bowl Gasket Kit	<b>006300034</b>	\$7.22	bagged ind.	N/A	N/A
<b>Tank-to-bowl gasket hardware sold separately in carded parts — See page 125</b>							







 <p>SmartFasten Tank-To-Bowl Kit</p>	<h3>SmartFasten Tank-To-Bowl Kit</h3> <ul style="list-style-type: none"> <li>Set includes tank-to-bowl gasket, three (3) patented bolts, three (3) nuts and ballcock coupling nut</li> </ul>						
	Model Number	Description	Part Number	List Price (each)	Pack	Master Carton Quantity	Lbs. Per Master Carton
	<b>630-0204</b>	Tank-to-Bowl Kit - 2"	<b>006300204</b>	\$6.18	bagged ind.	N/A	N/A
<b>630-0107</b>	Tank-to-Bowl Kit - 3"	<b>006300107</b>	\$8.73	bagged ind.	N/A	N/A	

 <p>Enso Floor Anchor Kit</p>	<h3>Enso Floor Anchor Kit</h3> <ul style="list-style-type: none"> <li>Includes two (2) floor brackets, four (4) anchoring screws, two (2) plastic anchors, two (2) plastic anchoring screws, two (2) plastic sleeve washers and two (2) plastic sleeve caps.</li> </ul>						
	Model Number	Description	Part Number	List Price (each)	Pack	Master Carton Quantity	Lbs. Per Master Carton
	Fits Bowl Model 177						
<b>123-8577</b>	Floor Anchor Kit	<b>001238577</b>	\$6.75	bagged ind.	N/A	N/A	

\*No Broken Cartons

Sanitaryware Parts & Accessories

## TOILETS / URINAL PARTS & ACCESSORIES

 Trip Lever Spud Locknut	<b>Trip Lever Spud Locknut</b>						
	Model Number	Description	Part Number	List Price (each)	Pack	Master Carton Quantity	Lbs. Per Master Carton
	609-7740	Trip Lever Spud Locknut — Plastic	006097740	\$0.99	poly bagged	N/A	N/A
 Dichromate Aluminum	<b>Float Rods</b>						
	Model Number	Description	Part Number	List Price (each)	Pack	Master Carton Quantity	Lbs. Per Master Carton
	Float Rods – Dichromate Aluminum, Excellent corrosion resistance						
	714-0424	7-1/2"	007140424	\$0.87	bagged ind.	N/A	N/A
 Tank Float	<b>Tank Float</b>						
	• Black polyethylene — High Buoyancy						
	Model Number	Description	Part Number	List Price (each)	Pack	Master Carton Quantity	Lbs. Per Master Carton
	630-6005-20	20 Pack	006306005	\$1.38	case	20	N/A
 Refill Tube	<b>Refill Tube</b>						
	• Flexible PVC						
	Model Number	Description	Part Number	List Price (each)	Pack	Master Carton Quantity	Lbs. Per Master Carton
	Refill Tube — Vinyl						
	918-4007	7"	009184007	\$1.93	bagged ind.	N/A	N/A
 208/209 Flush Valve Seal	<b>208/209 Flush Valve Seal</b>						
	• Rubber						
	Model Number	Description	Part Number	List Price (each)	Pack	Master Carton Quantity	Lbs. Per Master Carton
	Used with 5 Gallon Flush Valves						
	342-1685-20	208/209 Flush Valve Seal — 20 Pack	003421685	\$2.49	bulk	20*	N/A
	342-1685-50	208/209 Flush Valve Seal — 50 Pack	003421685	\$1.98	bulk	50*	N/A
 208E/209 Flush Tower Seal	<b>208E/209 Flush Tower Seal</b>						
	• Rubber						
	Model Number	Description	Part Number	List Price (each)	Pack	Master Carton Quantity	Lbs. Per Master Carton
	Used with Tank Model 1012 & 178						
	741-0016	208E/209 Flush Valve Seal — 20 Pack	007410016	\$2.82	bulk	20*	N/A
 Bolt Caps	<b>Bolt Caps</b>						
	• Set includes two caps and clips per poly bag						
	Model Number	Description	Part Number	List Price (each)	Pack	Master Carton Quantity	Lbs. Per Master Carton
	BCWHT	White	001238540	\$1.13	poly bagged	N/A	N/A
	BCWHT-20	White	001238540	\$0.87	poly bagged	20 sets*	N/A
	BCBISC	Biscuit	001238543	\$1.13	poly bagged	N/A	N/A
	BCBISC-10	Biscuit	001238543	\$0.99	poly bagged	10 sets*	N/A
BCBONE	Bone	001238541	\$1.13	poly bagged	N/A	N/A	
BCBONE-10	Bone	001238541	\$0.99	poly bagged	10 sets*	N/A	

\*No Broken Cartons

## TOILETS / URINAL PARTS & ACCESSORIES



Flushometer Bowl & Urinal Spuds

### Flushometer Bowl & Urinal Spuds

- Includes brass locknut, rubber seal and friction ring

Model Number	Description	Part Number	List Price (each)	Pack	Master Carton Quantity	Lbs. Per Master Carton
23	Flushometer Bowl and Urinal Spuds 1-1/2" x 1-1/2" Cast brass bottom urinal spud or top bowl spud For use on model 401 urinal outlet and models 1300NS, 1311NS and 1319 flush valve bowls (top)	008420150	\$5.61	-	N/A	N/A
24	Flushometer Bowl and Urinal Spuds 1" x 1-3/4" Cast brass top urinal spud For use on models 401, 410 and 475 top inlet	008420075	\$6.85	-	N/A	N/A



Rear Outlet Urinal Spud Kit

### Rear Outlet Urinal Spud Kit

- Includes sponge seal, 5/16" studs, chrome acorn nuts and oval washers

Model Number	Description	Part Number	List Price (each)	Pack	Master Carton Quantity	Lbs. Per Master Carton
531-0016	Rear Outlet Urinal Spud Kit 1-1/2" Rear outlet spud For use on model 475 urinal	005310016	\$24.30	poly bagged	N/A	N/A



Urinal Installation Kit

### Urinal Installation Kit

- Includes sponge seal, 5/16" studs, chrome acorn nuts, oval washers and two (2) 471-3265 urinal hangers

Model Number	Description	Part Number	List Price (each)	Pack	Master Carton Quantity	Lbs. Per Master Carton
531-0017	Urinal Installation Kit 1-1/2" Rear outlet spud For use on model 410HE urinal	005310017	\$26.93	poly bagged	N/A	N/A



Urinal/Lavatory Hanger

### Urinal/Lavatory Hanger

- One-piece durable metal adjustable urinal or lavatory hanger

Model Number	Description	Part Number	List Price (each)	Pack	Master Carton Quantity	Lbs. Per Master Carton
471-3261	Urinal/Lavatory Hanger For use on urinal models 401 and 475 and lavatory models 1613NS, 1917C and 2008	004713261	\$4.12	-	N/A	N/A



Urinal Hangers

### Urinal Hangers

- Durable metal adjustable urinal hangers

Model Number	Description	Part Number	List Price (each)	Pack	Master Carton Quantity	Lbs. Per Master Carton
471-3265	Urinal Hanger, For use on model 410 urinal (requires 2 per urinal)	004713265	\$0.99	-	N/A	N/A

## BALLCOCK / FLUSH VALVE / MISC CARDED PARTS



### Ballcock / Flush Valve Rebuild Kit







#### o8 Ballcock & 210-211 Flush Valve

- For use on o8 ballcocks: one (1) upper and one (1) lower diaphragm, one (1) cap and lever assembly, one (1) cap nut and one (1) plunger
- For use on 210/211 flush valves: one (1) stop assembly and two (2) flush valve seals

Model Number	Description	Part Number	List Price (each)	Pack	Master Carton Quantity
630-6003	Each	006306003	\$9.59	blister view	N/A
630-6003-10	10 Pack	006306003	\$7.98	blister view	10*

\*No Broken Cartons

## BALLCOCK / FLUSH VALVE / MISC CARDED PARTS







	<b>Flush Valve Stop Cap</b> • Fits 208/209 210 & 211 Flush Valves					
	Model Number	Description	Part Number	List Price (each)	Pack	Master Carton Quantity
	630-5907	Kit-210/211 FV Stop Top	006305907	\$2.13	blister view	N/A
	630-5907-3	Kit-210/211 FV Stop Top – 3 Pack	006305907	\$1.97	blister view	3*
630-5907-12	Kit-210/211 FV Stop Top – 12 Pack	006305907	\$1.81	blister view	12*	
	<b>Ballcock Diaphragm Kit</b> o8 Ballcock • For use on o8 ballcocks: one (1) upper and one (1) lower diaphragm					
	Model Number	Description	Part Number	List Price (each)	Pack	Master Carton Quantity
	630-7984	Each	006307984	\$4.12	blister view	N/A
630-7984-10	10 Pack	006307984	\$3.49	blister view	10*	
	<b>Flush Valve Seal Kit</b> 210/211 Flush Valves • For use on 210/211 flush valves: one (1) flush valve seal					
	Model Number	Description	Part Number	List Price (each)	Pack	Master Carton Quantity
	630-0030	Each	106300030	\$2.98	blister view	N/A
	630-0030-10	10 Pack	106300030	\$2.75	blister view	10*
630-0030-50	50 Pack	106300030	\$2.49	blister view	50*	
	<b>Flush Valve Seal Kit</b> 208/209 Flush Valves • For use on 208/209 flush valves: one (1) flush valve seal					
	Model Number	Description	Part Number	List Price (each)	Pack	Master Carton Quantity
	630-4837	Each	106304837	\$6.13	blister view	N/A
	630-4837-3	3 Pack	106304837	\$5.76	blister view	3*
630-4837-12	12 Pack	106304837	\$5.53	blister view	12*	
	<b>Tank Bolts</b> • For use on two (2) or three (3) tank-to-bowl connections: three (3) bolts, three (3) washers, three (3) rubber washers, and three (3) brass nuts					
	Model Number	Description	Part Number	List Price (each)	Pack	Master Carton Quantity
	630-6001	Each	006306001	\$5.85	blister view	N/A
630-6001-10	10 Pack	006306001	\$4.86	blister view	10*	
	<b>Tank-to-Bowl Gaskets</b> • For use on Mansfield® two-piece, 2" flush valve gravity flush toilets; one (1) tank-to-bowl gasket					
	Model Number	Description	Part Number	List Price (each)	Pack	Master Carton Quantity
	630-6002	Each	006306002	\$4.49	blister view	N/A
630-6002-10	10 Pack	006306002	\$3.74	blister view	10*	
	<b>2" SmartFasten Tank-to-Bowl Kit</b> • For use on two (2) or three (3) bolt connections: tank-to-bowl gasket, three (3) patented bolts, three (3) nuts, and ballcock coupling nut					
	Model Number	Description	Part Number	List Price (each)	Pack	Master Carton Quantity
	630-6204-P	Each	106306204	\$7.70	blister view	N/A
630-6204-P-4	4 Pack	106306204	\$7.23	blister view	4*	



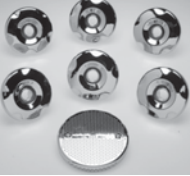



\*No Broken Cartons

# Bathware Parts & Accessories – Showroom Series List Price Effective January 1, 2016

Bathware Parts & Accessories

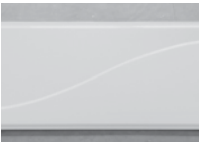





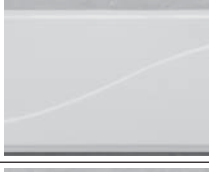

## FEATURES & OPTIONS

Product	Description	Suggested List Price
	<b>Exclusive Custom Pillow or Deluxe "Rainbow" Pillow</b> Soft, flexible, waterproof pillows to add comfort to your bathing experience. Pillows are detachable and quickly removable for cleaning. Available in White, Biscuit and Bone. Standard on most Swirl-way® whirlpools.	<b>SWA200</b> <b>SWA100</b>  \$ 57.00
	<b>Swirl-Way® Metal Trim Upgrade for Basic Package</b> This option allows an upgrade to Chrome, Everbrass (PVD), Brushed Nickel and Oil Rubbed Bronze trim including jets, intake and air control(s).	<b>SW1335 CH</b> <b>SW1336 EB</b> <b>SW1337 BN</b> <b>SW1338 OB</b> \$ 366.00 CH \$ 366.00 EB \$ 366.00 BN \$ 392.00 OB
	<b>Cable Drain</b> An optional feature on all Swirl-way® whirlpools. Provides fast and easy draining with a simple twist that opens the drain. As part of the trim package, you pick the finish. Choose from Color-Match (CM), Chrome (CH), Everbrass (EB), Brushed Nickel (BN) or Oil Rubbed Bronze Trim (OB).	<b>SW1319 CM</b> <b>SW1320 CH</b> <b>SW1321 EB</b> <b>SW1322 BN</b> <b>SW1323 OB</b>  \$132.00 CM \$174.00 CH \$313.00 EB \$313.00 BN \$334.00 OB
	<b>Factory Installed Exclusive Custom Handles (Pair)</b> Oval, rectangle or corner decorative grab bars add the finishing touches to your bath design.	
	<b>Factory Installed In-Line Heater</b> A reliable, heating control upgrade maintains water temperature at desired level and operates when flow of water is detected in the system. Features a standard plug for easy electrical connection (GFCI: 120V 20 amp dedicated circuit required to power this heater).	<b>SWP151</b> \$ 533.00
	<b>Blower Relocation Kit for Ariance Air baths</b> Optional kit to move blower(s) to remote location for ease of installation and noise reduction.	<b>AR1200</b> \$ 169.00
No photo available	<b>Factory Installed Constant Heat System</b> Optional inline water heater system for the bathtub.	<b>RS151</b> \$ 533.00
	<b>Air Control</b>	Contact Customer Service

Product	Description	Suggested List Price
	<b>Nailing Flange Kit</b> Code approved kit features flange material, sticky tape and instructions. Makes watertight installation easy and secure.	<b>SWAP00</b> \$ 65.00
	<b>Factory Installed Nailing Flange</b> Code approved, nailing flange option makes watertight installation easy and secure. Note: Nailing flange not available on all models, check specific model option listing.	<b>SWP150</b> L= Left Hand Drain R=Right Hand Drain S=Special/Center Drain (diagram required) \$164.00
	<b>Removable Apron Option - 5' Models</b> Option provides quick and easy access through removable apron to whirlpool pump and interior parts. Available on selected 5 foot models, check specific model option listings for availability.	<b>7002</b> <b>7053</b> \$ 463.00 Std \$ 703.00 Prem
	<b>Removable Apron Option - 5-1/2' &amp; 6' Models</b> Option provides quick and easy access through removable apron to whirlpool pump and interior parts. Available on selected 5-1/2 & 6 foot models, check specific model option listings for availability.	<b>7028: 5-1/2'</b> \$ 472.00 Std \$ 712.00 Pre <b>7004: 6'</b> \$ 483.00 Std \$ 723.00 Prem
	<b>Removable Apron Option - Corner Models - Three Sided Corner Models</b> Option provides quick and easy access through removable apron to whirlpool pump and interior parts. Check specific model option listings for availability.	<b>7039</b> \$ 989.00 Std \$ 1,229.00 Prem
	<b>Ariance® Metal Trim Upgrade</b> This option allows an upgrade to Chrome, Everbrass (PVD), Brushed Nickel and Oil Rubbed Bronze trim.	<b>AR1335</b> <b>AR1336</b> <b>AR1337</b> <b>AR1338</b> \$ 366.00 CH \$ 366.00 EB \$ 366.00 BN \$ 392.00 OB
<b>Walk-In Tub</b>		
	<b>Extension Box</b> The extension bracket is 18" x 33" x 41". This option makes it easier to fill the space left when replacing a larger tub with Restore walk-in tub. It is a decorative, L-shaped bracket that can be cut to size. A support frame must be built underneath. It is not meant to bear load. Must be ordered and shipped with the tub.	<b>WIT-001</b> \$ 367.00
	<b>End Panel</b> This removable panel is used to cover either end of the Restore walk-in tub. Note, the tub comes with one panel standard. The second end panel allows ready access to both ends. Must be ordered and shipped with the tub.	<b>WIT-002</b> \$ 347.00



# Bathware Parts & Accessories – Builder Series

			FEATURES & OPTIONS		
Product	Description	Suggested List Price	Product	Description	Suggested List Price
	<b>Factory Installed In-Line Heater</b> This upgrade provides reliable heating control to maintain desired water temperature and unit operates only when a flow of water is detected in system.	<b>SWP151</b> \$ 533.00		<b>Removable Apron – 5 ft. Model</b> This upgrade provides quick and easy access through removable apron to whirlpool pump and interior parts.	<b>7253</b> (for model 3260) <b>7218</b> (for model 3660) <b>7224</b> (for model 4260) \$ 463.00
	<b>Nailing Flange Kit</b> Code approved kit featuring flange material, sticky tape and instructions. Makes watertight installation easy and secure.	<b>SWAP00</b> \$ 65.00		<b>Removable Apron – 6 ft. Model</b> This upgrade provides quick and easy access through removable apron to whirlpool pump and interior parts.	<b>7221</b> (for model 3672) <b>7227</b> (for model 4272) <b>7233</b> (for model 4872) \$ 483.00
	<b>Factory Installed Nailing Flange</b> Code approved, nailing flange option makes watertight installation easy and secure. Note: Nailing flange not available on all models, check specific model optional upgrade listing. L= Left hand drain R= Right hand drain S=Special/ Center Drain (diagram required)	<b>SWP150L</b> <b>SWP150R</b> <b>SWP150S</b> \$ 164.00		<b>Removable Apron – Corner Model</b> This upgrade provides quick and easy access through removable apron to whirlpool pump and interior parts. Available on corner models, check specific model upgrade listing	<b>7239</b> \$ 989.00
				<b>Lift &amp; Drain – Chrome</b> This option provides a trim finish to match jets whenever a complete, interior trim finish is desired. Lift & Drain – Everbrass (PVD) Lift & Drain – Brushed Nickel Lift & Drain – Oil Rubbed Bronze	<b>PF1320</b> \$ 50.00 <b>PF1321</b> \$ 80.00 <b>PF1322</b> \$ 80.00 <b>PF1323</b> \$ 85.00
				<b>Metal Finish Trim</b> This option allows an upgrade to Chrome, Everbrass (PVD), Brushed Nickel or Oil Rubbed Bronze trim including jets, intake, control and air control(s) for whirlpools.	<b>PF1335</b> \$ 150.00 Chrome <b>PF1336</b> \$ 247.00 Everbrass (PVD) <b>PF1337</b> \$ 247.00 Brushed Nickel <b>PF1338</b> \$ 263.00 Oil Rubbed Bronze
				<b>On/off Button for Pro-Fit Air Bath</b> This option allows an upgrade to Chrome, Everbrass (PVD), Brushed Nickel or Oil Rubbed Bronze for air baths.	<b>PF2335</b> \$ 45.00 Chrome <b>PF2336</b> \$ 57.00 Everbrass (PVD) <b>PF2337</b> \$ 57.00 Brushed Nickel <b>PF2338</b> \$ 67.00 Oil Rubbed Bronze



---

# Terms & Conditions

## Order Acceptance:

Acceptance of any order is subject to the terms and conditions appearing herein. No other terms and conditions contained in the Buyer's purchase order, shipping release or elsewhere inconsistent or different to the terms and conditions herein shall be binding upon Mansfield Plumbing Products, unless specifically agreed to in writing by Mansfield Plumbing Products. For any order, each item ordered must include quantity, model, part number or description, and price.

**Minimum Order:** \$100 net

## Prices:

Prices in the current price book are subject to change without notice and supersede all previous price books and lists. All orders accepted are subject to prices in effect at date order is received. Possession of this book should not be construed as an offer to sell the products herein at the prices stated. Prices do not include installation, freight or taxes. All prices are shown in US dollars.

## Order Changes:

Only when Mansfield Plumbing Products Customer Service Department receives a written request via fax or email within 24 hours can any changes, cancellations, deletions or additions to orders be initiated. Due to the loss of time and material, there may be a cancellation fee. If an order has reached the Shipping Department, no changes can be made.

## Return Goods:

Approved written authorization is required from Mansfield Plumbing Products Customer Service Department to return any product. All products returned without approved written authorization will be refused. When product in salable condition is returned, a 30% restocking fee will be applied, plus any additional costs to bring the product to salable condition. All credits will be issued in the form of a merchandise credit, no cash credits are available. Product that is damaged, or not in otherwise salable condition, special order, customized (i.e. Ariance® and Swirl-Way® options), part of an inventory adjustment, phased out or discontinued, is not eligible for return or credit. Buyer is responsible for inbound and outbound freight, and any freight damage. Minimum return goods allowance is \$100 net.

## Credit Policy:

The acceptance of any order is subject to credit investigation and approval by Mansfield Plumbing Products credit department. Delivery may be withheld on accepted orders, without any liability on the part of Mansfield Plumbing Products, if, in its opinion, the Buyer's ability to pay for the products on these terms and conditions is in doubt. Any remittance received from or for the account of Buyer may be accepted or applied by Mansfield Plumbing Products against any indebtedness, regardless of any condition, provision or notation appearing on such remittance. After delivery, if Mansfield Plumbing Products brings legal action to collect amounts due and owed by Buyer, Buyer agrees to pay for all attorneys' fees and costs incurred by Mansfield Plumbing Products in such action.

## Payment Terms:

Standard terms are 2% 10th prox net 30. Freight charges or applicable taxes do not qualify for 2% net prox 30 cash discount. Visa or MasterCard payments do not qualify for 2% 10th prox net 30 cash discount. Credit card payments are capped at \$2,500 per year.

## Late Payment/Service Fees:

Interest rate of 1-1/2% per month will be charged from the date an account becomes past due. In addition to late payment charges, Buyer agrees to pay any and all collection costs, including reasonable attorney fees incurred by Mansfield Plumbing Products in collecting balance not paid within terms.

## Taxes:

Prices are exclusive of any taxes. Buyer agrees to pay any applicable taxes, duty surcharges, fees or similar charges however imposed. Current taxes and exempt

certificates must be filed with Mansfield Plumbing Products, or applicable taxes shall be added to the price and terms contained herein.

## Shipments:

All shipments are F.O.B. shipping point, freight prepaid and policies apply to all shipments within the continental United States, excluding Alaska, Puerto Rico, Hawaii and export. Mansfield Plumbing Products reserves the right to choose transportation carriers and shipping locations. Buyer may request specific carrier on orders shipping freight collect.

## Partial Shipments:

Unless otherwise specified, Mansfield may make partial shipments. Each shipment is considered a separate sale. Buyers must accept and pay for shipments regardless of any prior or subsequent failure to deliver any other shipments.

## Backorders:

Backorders available for shipment will be added to Buyer's next order. If Mansfield Plumbing Products misses the customer's order, it will be shipped prepaid.

## Shortages or Variances:

Any shortages or variances must be noted on the delivery receipt and reported to Mansfield Plumbing Products customer service in writing within 5 days of receipt. No claims reported after 5 days of delivery will be considered.

## Damage in Transit:

Mansfield Plumbing Products is responsible for delivering product free of damage to freight carriers. Buyer should carefully inspect product when delivered to insure products are damage free. All damages must be noted on the delivery receipt and reported to Mansfield Plumbing Products Customer Service no later than the day after delivery. Failure to note and report damages no later than the day after delivery shall be evidence the customer is satisfied with seller's performance. Buyer should hold damaged packaging until carrier's representative responds to the claim.

## Transit Claims:

All claims for recovery by Shipper for loss or damage to goods must be filed in writing with Carrier within 7 days after the delivery date. Each claim must contain information necessary to identify the goods affected, the basis for liability and the amount of the alleged loss or damage, as well as all appropriate supporting documentation. Mansfield Plumbing Products will manage the resolution of these claims with the Carriers. Shipper will cooperate with Mansfield Plumbing Products, the Carrier and their respective insurers in the investigation of any claim or potential claim by Shipper. Mansfield Plumbing Products will, upon Shipper's written request, assign its right against a Carrier for any particular claim to Shipper. Any civil action brought by Shipper for cargo lost or damaged must be filed by Shipper within the applicable statute of limitations. Mansfield Plumbing Products is not responsible or liable for any delays or any failure to perform due to unforeseen circumstances or causes beyond Mansfield Plumbing Products control, when such delays or failure is due directly or indirectly to acts of God, war (including civil war), riots, embargoes, acts (whether sovereign or contractual) of civil or military authorities, acts of any government, major changes in economic conditions, fires, floods, explosions, the elements, epidemics, quarantine restrictions, strikes, lockouts, plant shutdowns, slowdowns, accidents, shortages of raw energy, materials, component parts, labor, or delays of suppliers or subcontractors. In the event of delay, Mansfield Plumbing Products shall notify Buyer of such delay and an equitable adjustment shall be made in the delivery schedule and any other affected terms and conditions.

## Shipping Weights and Dimensions:

Shipping weights and dimensions are approximate, are shown for Buyers convenience, and are not guaranteed.

---

## Terms & Conditions (continued)

**Warranty:**

All Mansfield Plumbing product including fixtures and fittings are covered by Mansfield Plumbing's Limited One-year Warranty unless otherwise noted.

**Limitation of Liability:**

Mansfield Plumbing Products' liability for any and all claims of any kind, including negligence, for any loss or damage arising out of, connected with or resulting from Mansfield Plumbing Products performance or breach of the terms hereof shall, in the aggregate, not exceed the purchase price of the particular product. **IN NO EVENT SHALL MANSFIELD PLUMBING PRODUCTS BE LIABLE FOR INDIRECT, SPECIAL, INCIDENTAL OR CONSEQUENTIAL DAMAGES RESULTING FROM OR ARISING OUT OF PERFORMANCE OF OR FAILURE TO PERFORM ITS OBLIGATIONS HEREUNDER, WHETHER OR NOT MANSFIELD PLUMBING PRODUCTS HAD BEEN ADVISED OR KNEW, OR SHOULD HAVE KNOWN OF THE POSSIBILITY OF SUCH DAMAGES.**

**Severability:**

If any portion or provision of these terms applicable to any situation or circumstance is held invalid, the remainder of these terms or the remainder of such provision (as the case may be), and the application thereof to other situations or circumstances shall not be affected thereby.

**Waiver:**

Waiver by Mansfield Plumbing Products of any breach of these provisions shall not be construed as a waiver of any other breach.

**Assignment:**

None of the Buyer's rights under these terms shall be assigned or otherwise transferred by the Buyer to any other person, whether by operation of law or otherwise, without Mansfield Plumbing Products prior written approval.

**Entirety of Agreement:**

These terms are intended as a complete and exclusive statement of the terms and conditions of their agreement. No other terms and conditions, whether contained in Buyer's purchase order, shipping release or elsewhere that are inconsistent with, in addition to, or different from the terms and conditions herein shall be binding upon Mansfield Plumbing Products unless specifically agreed to by Mansfield Plumbing Products in writing.

**Law and Arbitration:**

These terms are governed by the laws of the State of Ohio. Any controversy or claim arising out of or relating to these terms or the breach hereof shall be finally settled by arbitration in Ashland County, Ohio in accordance with the prevailing commercial rules of the American Arbitration Association, and the parties shall have the right to take depositions and obtain discovery regarding the subject matter of the arbitration as if the subject matter of the arbitration were ending in a civil action before a Superior Court of the State of Ohio. Pending decision by the arbitrator(s), the parties shall diligently proceed pursuant to the terms and conditions hereof. The award of the arbitrator(s) shall be final, binding and conclusive on the parties hereto and their successors and assigns. Judgment upon an arbitration award hereunder may be entered in any court having jurisdiction thereof or application may be made to any court for individual acceptance of the award or any order of enforcement, as the case may be.

**Assent:**

Receipt by Buyer of acceptance of the order or receipt of the products without prompt objection to the terms and conditions herein set forth constitutes acceptance by the Buyer of these terms and conditions.

---

## Manufacturer's Limited Lifetime Warranty – Vitreous China Products

**PLEASE READ CAREFULLY AND RETAIN FOR YOUR RECORDS.**

Mansfield Plumbing Products LLC ("Mansfield") warrants its china products to be free from defects in materials and workmanship, under normal use and maintenance, for the lifetime of the product from the date of the initial retail purchase. Mansfield promises to provide a replacement china part for any china part of this product that proves upon our inspection to be defective in material or workmanship subject to the following conditions, exclusions, and limitations:

**EXCLUSIONS AND LIMITATIONS:**

1. The Manufacturer's Limited Lifetime Warranty does NOT apply to plumbing fittings and toilet tank trim products including: ballcock, flush valve and trip lever products. Please refer to the separate one-year limited warranty for toilet tank trim and fittings products provided at the time of purchase for the terms and conditions of that warranty.
2. Mansfield shall NOT be liable for any damages, including but not limited to incidental or consequential damages, except as specifically provided herein and regardless of the legal theory asserted. **SOME STATES DO NOT ALLOW THE EXCLUSION OR LIMITATION OF ANY INCIDENTAL OR CONSEQUENTIAL DAMAGES, SO THE ABOVE EXCLUSION OR LIMITATION MAY NOT APPLY TO YOU.**

3. Mansfield shall NOT be liable for damages resulting from improper installation, maintenance, repair, cleaning, handling, neglect, abuse, alteration, or Acts of God.
4. Mansfield shall NOT be liable for any implied warranty of fitness for a particular purpose or implied warranty of merchantability or any implied warranty that might arise from a course of dealing with the purchaser or usages of trade. **SOME STATES DO NOT ALLOW IMPLIED WARRANTIES TO BE EXCLUDED OR LIMITED, SO THE ABOVE EXCLUSION MAY NOT APPLY TO YOU.**

**NOTES:**

1. All labor costs for de-installation and re-installation and transportation costs or charges incidental to warranty service are the responsibility of the owner.
2. The foregoing written warranty statements are exclusive and in lieu of all other oral or written, express or implied warranties and remedies. No person is authorized to change, add to, or create any warranty or obligation other than as set forth herein. These written warranty statements give you specific legal rights, and you may have other rights, which vary from state to state.

**To obtain warranty service or a copy of the product warranty, contact your local dealer and/or the contractor from whom you purchased this product.**

© 1994 (Revised 4/2001) Mansfield Plumbing Products LLC • PHONE: 877-850-3060 • FAX: 419-938-6234 • EMAIL: [custserv@mansfieldplumbing.com](mailto:custserv@mansfieldplumbing.com)

---

## Manufacturer's Limited One-Year Warranty – Toilet Tank Trim and Fittings Products

**PLEASE READ CAREFULLY AND RETAIN FOR YOUR RECORDS.** Mansfield Plumbing Products LLC ("Mansfield") warrants its plumbing fittings and toilet tank trim products including: ballcock, flush valve, and trip lever products to be free from defects in materials and workmanship for a period of one (1) year from the initial date of retail purchase. Mansfield promises to replace any of these products that prove, upon inspection and within one (1) year from the date of initial retail purchase, to be defective in material or workmanship subject to the following conditions, exclusions, and limitations:

### EXCLUSIONS AND LIMITATIONS:

1. Mansfield shall NOT be liable for any damages, including but not limited to incidental or consequential damages, except as specifically provided herein and regardless of the legal theory asserted. **SOME STATES DO NOT ALLOW THE EXCLUSION OR LIMITATION OF ANY INCIDENTAL OR CONSEQUENTIAL DAMAGES, SO THE ABOVE EXCLUSION OR LIMITATION MAY NOT APPLY TO YOU.**
2. Mansfield shall NOT be liable for damages resulting from improper installation, maintenance, repair, cleaning, handling, neglect, abuse, alteration, or Acts of God.
3. Mansfield shall NOT be liable for any failure or damage to its plumbing fittings or toilet tank trim products: including ballcock, flush valve, or trip lever products

**To obtain warranty service or a copy of the product warranty, contact your local dealer and/or the contractor from whom you purchased this product.**

© 1994 (Revised 4/2001) Mansfield Plumbing Products LLC • PHONE: 877-850-3060 • FAX: 419-938-6234 • EMAIL: [custserv@mansfieldplumbing.com](mailto:custserv@mansfieldplumbing.com)

caused by the use of either chloramines or high concentration of chlorine, lime/iron sediments and/or other minerals not removed from public water during the treatment of public water supplies or caused by toilet tank type cleaners containing chlorine, calcium hypochlorite, or other chemicals.

4. Mansfield shall NOT be liable for any implied warranty of fitness for a particular purpose or implied warranty of merchantability or any implied warranty that might arise from a course of dealing with the purchaser or usages of trade. **SOME STATES DO NOT ALLOW IMPLIED WARRANTIES TO BE EXCLUDED OR LIMITED, SO THE ABOVE EXCLUSION MAY NOT APPLY TO YOU.**

### NOTES:

1. All labor costs for de-installation and re-installation and transportation costs or charges incidental to warranty service are the responsibility of the owner.
2. The foregoing written warranty statements are exclusive and in lieu of all other oral or written, express or implied warranties and remedies. No person is authorized to change, add to, or create any warranty or obligation other than as set forth herein. These written warranty statements give you specific legal rights, and you may have other rights, which vary from state to state.

---

## Manufacturer's Warranty Information for Ariance®, Swirl-way® and PRO-FIT® Bathware

### RESPONSIBILITIES OF OTHERS:

Inspecting the unit prior to installation is the responsibility of the installer or building contractor who acts on behalf of the user. They are responsible for ensuring the unit is free of defect or damage. Notices are placed on and in the unit and on the shipping carton advising the installer of this responsibility. In the event of a problem, the unit must not be installed. Mansfield Plumbing Products is not responsible for failures or damage that could have been discovered, repaired, or avoided by proper inspection and testing (including proper water testing) prior to installation.

Damage occurring in transit is the responsibility of the carrier. The user or installer MUST open the crate and inspect the unit for damage when it is delivered. If damage is discovered, it must be reported immediately to the seller and the carrier in writing, and an inspection requested. Failure of the carrier to respond should be reported to the seller and the carrier. Your freight claims should be filed promptly thereafter.

It is the responsibility of the installer, building contractor, or user to provide access for service. Mansfield Plumbing Products, LLC is not responsible for any costs relating to obtaining access for repair.

### WARRANTY SERVICE:

Mansfield Plumbing Products, LLC maintains a list of independent service personnel to perform required warranty service repairs. Such firms are not agents or representatives of Mansfield Plumbing Products, LLC and cannot bind us by words or conduct. We will provide warranty service when Mansfield Plumbing Products, LLC has been notified of the problem during the active warranty period and deemed the problem to be of the nature or type covered by the warranty. The product serial number, users address and contact information must be provided to obtain warranty service.

### WARRANTY LIMITATIONS:

In no event shall Mansfield Plumbing Products LLC be liable for incidental or consequential damages, for damages resulting from improper installation or for damages

caused by handling, neglect, abuse or alteration. Our warranty does not cover defects or damages caused by the common carrier, installer, user or other persons resulting from, without limitation: careless handling, improper voltage supply/electrical modifications, misuse; incorrect operation; lack of or improper routine maintenance; incorrect or inadequate water use or use of improper cleaners. Chips, cracks and scratches are damages and are not covered under warranty; however, they may be repaired by a qualified technician at the user's expense. Damages or defects that should have been detected before installation are not covered. All implied warranties, including any warranty or fitness for any particular purpose of merchantability, or those that might arise from a course of dealing with the purchaser or usages of trade, are hereby disclaimed or excluded.

Mansfield Plumbing Products is not responsible or liable for any delays or any failure to perform due to unforeseen circumstances or causes beyond Mansfield Plumbing Products' control, when such delays or failure is due, directly or indirectly, to acts of God, war (including civil war), riots, embargoes, acts (whether sovereign or contractual) of civil or military authorities, acts of any government, major change in economic conditions, fires, floods, explosions, the elements, epidemics, quarantine restrictions, strikes, lockouts, plant shutdowns, slowdowns, accidents, shortages of raw energy, materials, component parts, labor, or delays of suppliers or subcontractors.

### NOTE:

Some states do not allow limitations on an implied warranty, and some states do not allow exclusions or limitations regarding incidental or consequential damages, so the above limitations may not apply to you. This warranty gives you specific legal rights and you may have other rights which vary from state to state. No person is authorized to change, add to, or create any warranty or obligation other than set forth herein. This is our exclusive warranty.

---

## Manufacturer's Limited Ten-Year Warranty – Swirl-way® Whirlpools and Bathtubs, and Ariance® Air Baths

**PLEASE READ CAREFULLY AND RETAIN FOR YOUR RECORDS.** Mansfield Plumbing Products, LLC offers the following expressed warranty to the original purchaser of any Swirl-way Whirlpool or Bathtub or Ariance air bath who purchases the product for personal or single family residential use ("user"). We will repair or replace, at our sole option, the product or its equipment in accordance with the following terms and conditions.

### TEN (10) YEAR WARRANTY FOR ACRYLIC SHELL

Mansfield Plumbing Products, LLC extends to the user of the product a non-transferable ten (10) year warranty from the date the product was originally purchased by the user that the shell will maintain its structural integrity and be free of water loss due to a defect in the tub shell. The warranty covers only the product shell against defects in material or workmanship.

### FIVE (5) YEAR LABOR WARRANTY FOR ALL FACTORY INSTALLED COMPONENTS

Our limited labor warranty is for a period of five (5) years from the date the product was originally purchased by the user, but not more than six (6) years from the date of manufacture. All factory installed components (e.g., pump, motor, blower, jets and plumbing) are covered under our labor warranty against failure due to defects in materials and workmanship.

---

## Manufacturer's Limited One-Year Warranty – PRO-FIT® Air Baths, Whirlpools and Bathtubs

### PLEASE READ CAREFULLY AND RETAIN FOR YOUR RECORDS.

Mansfield Plumbing Products, LLC offers the following expressed warranty to the original purchaser of any PRO-FIT Air Bath, Whirlpool or Bathtub who purchases the product for personal or single family residential use ("user"). We will repair or replace, at our sole option, the product or its equipment in accordance with the following terms and conditions.

### ONE (1) YEAR WARRANTY FOR ACRYLIC SHELL

Mansfield Plumbing Products, LLC extends to the user of the product a non-transferable one (1) year warranty from the date the product was originally purchased by the user that the shell will maintain its structural integrity and be free of water loss due to a defect in the tub shell. The warranty covers only the product shell against defects in material or workmanship.

### ONE (1) YEAR LABOR WARRANTY FOR ALL FACTORY INSTALLED COMPONENTS

Our limited labor warranty is for a period of one (1) year from the date the product was originally purchased by the user, but not more than two (2) years from the date of manufacture. All factory installed components (e.g., pump, motor, blower, jets and plumbing) are covered under our labor warranty against failure due to defects in materials and workmanship.

---

## Bathware Order Change and Cancellation Policy

### POLICY SUMMARY:

Changes and cancellations are allowable within the first 24 hours after Mansfield receives the purchase order. After 24 hours, production of the order is well underway and changes are no longer possible.

Cancellations are permissible after 24 hours on standard color bathware. However due to the loss of time and material there will be a cancellation fee.

After 24 hours, orders for premium colors cannot be cancelled.

Level of Production	Percent of Completion	Cancellation Fee
Vacuum Formed	20%	10%
Fiber Reinforced Polymer Applied	40%	20%
Trimmed and Drilled	70%	30%

Note: PRO-FIT® bathware products are excluded from this policy.

# Shipping: U.S. Freight Policy

## SANITARYWARE

- Will call allowance = 3%
- Special handling charges apply for unique labeling (tags), stretch wrapping and foam packing.
- Truckload and drop charge criteria is calculated per ship to location.
- Additional fees will be assessed for:
  - Detention fee of \$50/hour for freight not unloaded within two hours of scheduled appointment.
  - California orders with cross dock requirements at \$25 per order.
  - Driver-assisted, job site and residential deliveries at \$50 per order.
  - Deliveries requiring the use of pallet jacks at \$40 per order.
  - LTL deliveries requiring the use of lift gates at \$100 per order. Lift gates are not available for truckload orders.
- Mansfield reserves the right to invoice customers for special handling charges and freight services incurred based on market conditions.
- \*Drop charge is subject to change based on market conditions.

Product Category	# of Pieces	Freight/Drop Charges	Will Call Allowance	Special Handling	Lead Time
Sanitaryware: U.S.*	900	N/A	3%	\$25	10 business days
	350	*\$100			
	250	*\$150			
	Less than 250	Customer pays freight			

## BATHWARE

- Six (6) total points in any combination of the products below qualifies for FFA and no drop charges.
- Shipments with Walk-in Tubs combined with other product categories for FFA will adjust to a lead time of 10 business days.
- Will call allowance = 5%
- NEW YORK SHIPMENTS: Freight table is available upon request. Contact Customer Service.
- Mansfield reserves the right to invoice customers for special handling charges and freight services incurred.

Product Category	# of Points Per Piece	# of Pieces	LTL Freight Charge	Will Call Allowance	Lead Time	
Bathware: U.S.*	1	6	FFA	5%	10 business days	
		1 to 5	\$100 per unit			
	3	2	FFA	5%	10 business days	
		1	\$100 per unit			
	3	2	FFA	5%	10 business days	
		1	\$100 per unit			
	Swirl-Way® Whirlpools and Ariance® Air Baths	6	1	FFA	5%	10 business days
	Walk-in Tub	6	1	FFA	5%	5 business days
	Shower Bases	1	6	FFA	5%	10 business days
			1 to 5	\$100 per unit	5%	10 business days

\* Contact Customer Service to obtain a copy of the **Canadian Freight Policy**.



**Sanitaryware – Toilets, Bidet**

Page #	Model #	Description	White	Standard
10	705LID	AEGEAN LID 705NS/708 WHT	\$76.52	\$92.90
10	705NS	AEGEAN ONE-PIECE 705NS EL 1.6	\$443.21	\$531.86
10	708	AEGEAN ONE-PIECE 708 EL ADA 1.28	\$467.17	\$560.60
20	3120	ALTO 1.28 TANK 3120	\$75.52	\$94.40
20	3120RH	ALTO 1.28 TANK 3120RH	\$79.80	\$98.69
20	3121	ALTO 1.28 TANK 3121 CTL	\$75.52	\$94.40
20	3121RH	ALTO 1.28 TANK 3121RH CTL	\$79.80	N/A
20	3122	ALTO 1.28 TANK 3122 LT CTL	\$110.05	\$134.60
11	361-3	ALTO BIDET 361 3-HOLE	\$242.92	\$303.71
21	117	ALTO BOWL 117 RF 16-1/2" SMARTHT	\$147.29	\$184.13
20	130	ALTO BOWL 130 RD	\$63.37	\$79.22
20	131	ALTO BOWL 131 RD 10"	\$124.89	\$156.17
20	135	ALTO BOWL 135 EL	\$90.11	\$112.54
20	137	ALTO BOWL 137 EL ADA	\$161.30	\$202.11
20	138	ALTO BOWL 138 EL 10"	\$158.11	\$197.64
20	139NS	ALTO BOWL 139NS EL ADA 10"	\$245.92	\$307.41
21	138-160	ALTO EL 10"RI COMBO	\$225.87	\$282.33
20	138-3173	ALTO EL 10"RI COMBO 1.28	\$225.87	\$282.33
21	139NS-160	ALTO EL ADA 10"RI COMBO	\$313.68	\$392.10
20	139NS-3173	ALTO EL ADA 10"RI COMBO 1.28	\$313.68	\$392.10
21	137-160	ALTO EL ADA COMBO	\$229.07	\$286.81
20	137-3173	ALTO EL ADA COMBO 1.28	\$229.07	\$286.81
21	135-160	ALTO EL COMBO	\$157.87	\$197.23
20	135-3173	ALTO EL COMBO 1.28	\$157.87	\$197.23
22	160LID	ALTO LID 160 WHT	\$42.58	\$53.28
22	165LID	ALTO LID 165/175 W/LOCK WHT	\$54.08	N/A
21	131-160	ALTO RF 10"RI COMBO	\$192.65	\$240.86
20	131-3173	ALTO RF 10"RI COMBO 1.28	\$192.65	\$240.86
21	130-160	ALTO RF COMBO	\$131.13	\$163.92
20	130-3173	ALTO RF COMBO 1.28	\$131.13	\$163.92
21	117-160	ALTO RF SMTHTG COMBO	\$215.05	\$268.82
21	125	ALTO TANK 125	\$142.30	\$177.89
21	160	ALTO TANK 160	\$67.76	\$84.69
21	160RH	ALTO TANK 160 RH	\$67.76	\$84.69
21	161	ALTO TANK 161	\$75.52	\$94.40
21	165	ALTO TANK 165 W/CVR LK	\$83.87	N/A
21	170	ALTO TANK 170 LINED	\$98.18	\$122.75
21	171	ALTO TANK 171 LINED	\$110.05	\$134.60
21	172	ALTO TANK 172	\$67.76	\$84.69
21	172RH	ALTO TANK 172 RH	\$67.76	\$84.69
21	173	ALTO TANK 173	\$67.76	\$84.69
21	173FM	ALTO TANK 173 F/M	\$75.52	\$94.40
21	173FM RH	ALTO TANK 173 F/M RH	\$79.80	N/A
21	173RH	ALTO TANK 173 RH	\$67.76	N/A
21	174	ALTO TANK 174 LINED	\$98.18	\$122.75
21	175	ALTO TANK 175 LINED CVR LK	\$133.71	N/A
21	180	ALTO TANK 180	\$67.76	\$84.69
21	181	ALTO TANK 181	\$75.52	\$94.40
21	190	ALTO TANK 190 LINED	\$98.18	\$122.75
20	3125	ALTO TANK 3125 14" 1.28	\$142.30	\$177.89
20	3172	ALTO TANK 3172 1.28	\$67.76	N/A
20	3173	ALTO TANK 3173 CTL 1.28	\$67.76	\$84.69
20	3173	ALTO TANK 3173 CTL 1.28	\$67.76	\$84.69
20	3173	ALTO TANK 3173 CTL 1.28	\$67.76	\$84.69
20	3173	ALTO TANK 3173 CTL 1.28	\$67.76	\$84.69
20	3173RH	ALTO TANK 3173 RH CTL 1.28	\$67.76	N/A
20	3174	ALTO TANK 3174 LINED 1.28	\$98.18	N/A
8	3106	BARRETT 1.28 TANK 3106	\$158.33	\$197.93
7	115	BARRETT BOWL 115CT EL ADA	\$269.44	\$335.85
8	4115	BARRETT BOWL 4115 ADA 1.28	\$269.44	\$335.85
8	4115-3106	BARRETT EL ADA 1.28 COMBO	\$427.77	\$533.78
7	115-106	BARRETT EL ADA COMBO	\$427.77	\$533.78
7	106LID	BARRETT LID 106/3106 WHT	\$69.98	\$80.27
7	106	BARRETT TANK 106	\$158.33	\$197.93
7	3148	BRENTWOOD 1.28 TANK 3148	\$162.16	\$203.42

Page #	Model #	Description	White	Standard
6	3147	BRENTWOOD 1.6 TANK 3147	\$162.16	\$203.42
6	4147	BRENTWOOD BOWL 4147 EL ADA 1.6	\$275.92	\$346.15
7	4148	BRENTWOOD BOWL 4148 ADA 1.28	\$275.92	\$346.15
7	4148-3148	BRENTWOOD EL ADA COMBO 1.28	\$438.08	\$549.58
6	4147-3147	BRENTWOOD EL ADA COMBO 1.6	\$438.08	\$549.58
6	3147LID	BRENTWOOD LID 3147 WHT	\$71.69	\$82.23
19	3816	CASCADE 1.28 TANK 3816	\$82.00	N/A
19	3816RH	CASCADE 1.28 TANK 3816RH	\$85.98	N/A
19	4810	CASCADE BOWL 4810 RD	\$84.49	N/A
19	4817	CASCADE BOWL 4817 EL ADA	\$134.83	N/A
19	4817-3816	CASCADE EL ADA 1.28 COMBO	\$216.83	N/A
19	3816LID	CASCADE LID 3816 WHT	\$42.81	N/A
19	4810-3816	CASCADE RD 1.28 COMBO	\$166.49	N/A
23	131CTK	CTK ALTO RF 10" ROUGH-IN	\$224.60	N/A
23	4147CTK	CTK BRENTWOOD EL ADA 1.6	\$485.68	N/A
23	4184CTK	CTK ESSENCE EL ADA 1.28	\$462.58	N/A
23	130CTK	CTK PRO-FIT 1 RD	\$162.60	\$202.75
23	4130CTK	CTK PRO-FIT 1 RD 1.28	\$162.60	\$202.75
23	130LTCTK	CTK PRO-FIT 1 RD LT CLR MTCH	\$186.95	N/A
23	4130LTCTK	CTK PRO-FIT 1 RD LT 1.28	\$186.95	N/A
23	135CTK	CTK PRO-FIT 2 EL	\$186.59	\$231.85
23	135LTCTK	CTK PRO-FIT 2 EL LT CLR MTCH	\$216.53	N/A
23	4135CTK	CTK PRO-FIT 2 EL 1.28	\$186.59	\$231.85
23	4135LTCTK	CTK PRO-FIT 2 EL LT 1.28	\$216.53	N/A
23	137LTCTK	CTK PRO-FIT 3 ADA LT CLR MTCH	\$280.94	N/A
23	137CTK	CTK PRO-FIT 3 EL ADA	\$249.37	\$306.72
23	4137CTK	CTK PRO-FIT 3 EL ADA 1.28	\$249.37	\$306.72
23	4137LTCTK	CTK PRO-FIT 3 EL LT ADA 1.28	\$280.94	N/A
23	117CTK	CTK PRO-FIT 4 RF ADA 1.6	\$245.40	\$309.13
23	4380CTK	CTK SUMMIT 380 DUAL FLUSH RD	\$238.13	\$297.67
23	4381LTCTK	CTK SUMMIT 380 LT RF 1.28	\$245.89	N/A
23	4381CTK	CTK SUMMIT 380 RF 1.28	\$220.89	\$274.39
23	380CTK	CTK SUMMIT 380 RF 1.6	\$220.89	\$274.39
23	4382CTK	CTK SUMMIT 382 DUAL FLUSH EL	\$261.44	\$326.14
23	4383CTK	CTK SUMMIT 382 EL 1.28	\$254.96	\$318.38
23	382CTK	CTK SUMMIT 382 EL 1.6	\$254.96	\$318.38
23	4385CTK	CTK SUMMIT 384 ADA 1.28	\$287.84	\$355.72
23	384CTK	CTK SUMMIT 384 ADA 1.6	\$287.84	\$355.72
23	4384CTK	CTK SUMMIT 384 DUAL FLUSH SMHT	\$327.81	\$396.94
23	4388CTK	CTK SUMMIT 388 RF ADA 1.28	\$277.78	\$322.00
23	388CTK	CTK SUMMIT 388 RF ADA 1.6	\$277.78	\$322.00
23	4197CTK	CTK WAVERLY EL ADA 1.28	\$354.02	N/A
6	177	ENSO BOWL 177 EL SMART HEIGHT CT	\$295.17	\$356.60
6	177-178	ENSO EL SMT HGT COMBO	\$461.90	\$558.02
6	178LID	ENSO LID 178 WHT	\$67.81	\$78.40
6	178	ENSO TANK 178 DUAL FLUSH	\$166.72	\$201.43
8	3185	ESSENCE 1.28 TANK 3185	\$145.80	\$184.26
8	4184-3185	ESSENCE 1.28 EL ADA COMBO	\$417.37	\$523.46
8	4184	ESSENCE BOWL 4184 ADA 1.28	\$271.58	\$339.21
8	3185LID	ESSENCE LID 3185 WHT	\$77.74	\$89.24
15	1012LID	LID 1012/3012 MAV 1.0 WHT	\$78.87	N/A
15	1013	MAVERICK 1.0 BOWL 1013 RD	\$152.62	N/A
15	1014	MAVERICK 1.0 BOWL 1014 EL ADA	\$213.41	N/A
15	1014-3012	MAVERICK 1.0 EL SMARTHEIGHT COMBO	\$340.18	N/A
15	3012	MAVERICK 1.0 TANK 3012 FOR 1014 BOWL	\$126.78	N/A
15	1013-1012	MAVERICK RD 1.0 COMBO	\$279.40	N/A
15	1012	MAVERICK TANK 1012 1.0	\$126.78	N/A
9	4107-3108	MONTCLAIR 1.28 EL ADA COMBO	\$406.24	\$507.81
9	3108	MONTCLAIR 1.28 TANK 3108	\$145.09	\$181.36
9	4107	MONTCLAIR BOWL 4107 ADA 1.28	\$261.15	\$326.46
9	108LID	MONTCLAIR LID 108/3108 WHT	\$77.74	\$89.24
14	147-10-123	QUANTUM EL 10" RI COMBO	\$511.63	\$594.36
14	148-123	QUANTUM EL ADA COMBO	\$503.91	\$617.58
14	151-123	QUANTUM EL ADA ROFM COMBO	\$691.92	\$833.98
14	147-123	QUANTUM EL COMBO	\$432.32	\$540.42
14	149-123	QUANTUM EL ROFM COMBO	\$625.76	\$783.69
14	146-123	QUANTUM RF COMBO	\$427.96	\$517.19

Page #	Model #	Description	White	Standard
13	148-155	QUANTUM 1.28 EL ADA COMBO	\$503.91	\$617.58
13	151-155	QUANTUM 1.28 EL ADA ROFM COMBO	\$691.92	\$833.98
13	147-155	QUANTUM 1.28 EL COMBO	\$432.32	\$540.42
13	149-155	QUANTUM 1.28 EL ROFM COMBO	\$625.76	\$783.69
13	146-155	QUANTUM 1.28 RF COMBO	\$427.96	\$517.19
13	155	QUANTUM 1.28 TANK 155 LH	\$301.76	\$332.02
13	155RH	QUANTUM 1.28 TANK 155 RH	\$301.76	\$332.02
12	146	QUANTUM BOWL 146 RD	\$126.20	\$185.17
12	147	QUANTUM BOWL 147 EL	\$130.56	\$208.40
14	147-10	QUANTUM BOWL 147-10 EL	\$209.87	\$262.34
12	148	QUANTUM BOWL 148 EL ADA	\$202.16	\$285.56
14	148-10	QUANTUM BOWL 148-10 EL ADA	\$296.28	\$370.38
12	149	QUANTUM BOWL 149 EL	\$324.00	\$451.67
12	151	QUANTUM BOWL 151 EL ADA	\$390.17	\$501.96
14	148-10-123	QUANTUM EL 10" RI ADA COMBO	\$598.03	\$702.40
12	125LID	QUANTUM LID 119/123/125/153 WHT	\$70.00	\$81.50
12	122LID	QUANTUM LID 122 WHT	\$70.68	\$81.89
14	122	QUANTUM TANK 122 CTR	\$342.90	\$358.36
14	123	QUANTUM TANK 123 LH	\$301.76	\$332.02
14	123RH	QUANTUM TANK 123 RH	\$301.76	\$332.02
12	148-153	QUANTUMONE EL ADA COMBO	\$503.91	\$617.58
12	151-153	QUANTUMONE EL ADA ROFM COMBO	\$691.92	\$833.98
12	147-153	QUANTUMONE EL COMBO	\$432.32	\$540.42
12	149-153	QUANTUMONE EL ROFM COMBO	\$625.76	\$783.69
12	146-153	QUANTUMONE RF COMBO	\$427.96	\$517.19
12	153	QUANTUMONE TANK 153 LH	\$301.76	\$332.02
12	153RH	QUANTUMONE TANK 153 RH	\$301.76	\$332.02
12	154	QUANTUMONE TANK 154 CTR	\$342.90	\$358.36
16	387	SUMMIT 1.28 TANK 387	\$86.37	\$107.99
16	380	SUMMIT BOWL 380 RD	\$103.67	\$132.93
16	382	SUMMIT BOWL 382 EL	\$138.12	\$172.64
16	384	SUMMIT BOWL 384 ADA	\$186.44	\$219.82
17	385	SUMMIT BOWL 385 EL SMARTHT 10" ROUGH-IN	\$234.00	\$260.12
16	388	SUMMIT BOWL 388 RF 16 1/2" SMARTHEIGHT	\$157.54	\$172.52
16	388LID	SUMMIT DF LID 388 WHT	\$82.20	\$90.44
18	384-3886	SUMMIT DUAL EL ADA COMBO	\$294.30	\$349.40
18	382-3886	SUMMIT DUAL EL COMBO	\$245.98	\$302.21
18	3886	SUMMIT DUAL FLUSH TANK 3886	\$107.86	\$129.57
18	3886	SUMMIT DUAL FLUSH TANK 3886	\$107.86	\$129.57
18	3886	SUMMIT DUAL FLUSH TANK 3886	\$107.86	\$129.57
18	380-3886	SUMMIT DUAL RD COMBO	\$211.53	\$262.51
18	388-3886	SUMMIT DUAL RF 16 1/2 COMBO	\$265.40	\$302.09
16	382-387	SUMMIT EL 1.28 COMBO	\$224.49	\$280.63
16	384-387	SUMMIT EL ADA 1.28 COMBO	\$272.81	\$327.82
17	384-386	SUMMIT EL ADA COMBO	\$272.81	\$327.82
17	382-386	SUMMIT EL COMBO	\$224.49	\$280.63
17	385-386	SUMMIT EL SMARTHEIGHT 16 1/2" 10" COMBO	\$320.37	\$368.11
17	386LID	SUMMIT LID 386 WHT	\$78.87	\$90.53
17	380-386	SUMMIT RD COMBO	\$190.04	\$240.93
16	380-387	SUMMIT RF 1.28 COMBO	\$190.04	\$240.93
16	388-387	SUMMIT RF 16 1/2 1.28 COMBO	\$243.91	\$280.51
17	388-386	SUMMIT RF 16 1/2" SMARTHEIGHT COMBO	\$243.91	\$280.51
17	386	SUMMIT TANK 386	\$86.37	\$107.99
17	386FM	SUMMIT TANK 386 F/M	\$97.12	\$118.74
17	386FMRH	SUMMIT TANK 386 F/M RH	\$103.79	N/A
17	386LT	SUMMIT TANK 386 LT	\$100.24	\$123.64
17	386RH	SUMMIT TANK 386 RH	\$93.05	N/A
16	387LT	SUMMIT TANK 387 LT 1.28	\$100.24	\$123.64
16	387RH	SUMMIT TANK 387 RH 1.28	\$93.05	\$109.58
9	3195	WAVERLY 1.28 TANK 3195	\$122.53	N/A
9	4197	WAVERLY BOWL 4197 ADA 1.28	\$184.46	N/A
9	4197-3195	WAVERLY EL ADA COMBO	\$307.00	N/A
9	195LID	WAVERLY LID 195/3195 WHT	\$70.34	\$81.50

## Sanitaryware – Lavatories

Page #	Model #	Description	White	Standard
27	251-4	ALTO II LAV 251 4"	\$75.42	\$90.97
27	251-8	ALTO II LAV 251 8"	\$75.42	\$90.97
27	251-L0	ALTO II LAV 251 L/O 4"	\$75.42	N/A
32	293	ALTO IV PEDESTAL 293	\$70.25	\$80.79
32	290	ALTO IV PED-LAV COMBO	\$193.25	\$222.24
25	268-1	BARRETT LAV 268 1H	\$170.78	\$207.33
25	268-4	BARRETT LAV 268 4"	\$170.78	\$207.33
25	268-8	BARRETT LAV 268 8"	\$170.78	\$207.33
31	328-1	BARRETT LAV 328 1H	\$177.54	\$215.55
31	328-4	BARRETT LAV 328 4"	\$177.54	\$215.55
31	328-8	BARRETT LAV 328 8"	\$177.54	\$215.55
31	329	BARRETT PEDESTAL 329	\$135.27	\$164.22
31	330	BARRETT PED-LAV COMBO	\$312.81	\$379.77
28	234	BRENTWOOD LAV 234	\$149.73	\$185.66
25	254-1	BRENTWOOD LAV 254 1H	\$178.53	\$221.38
25	254-4	BRENTWOOD LAV 254 4"	\$178.53	\$221.38
25	254-8	BRENTWOOD LAV 254 8"	\$178.53	\$221.38
33	2017	CITY I VANITY TOP 20" x 17"	\$106.94	N/A
25	242	ENSO LAV 242	\$149.73	\$179.68
30	311	ENSO LAV 311 1H	\$189.93	\$227.92
31	312	ENSO PEDESTAL 312	\$132.96	N/A
31	310	ENSO PED-LAV COMBO	\$322.89	N/A
30	884	ENSO VANITY - WOOD	\$420.00	N/A
26	259-1	ESSENCE LAV 259 1H	\$138.21	\$165.86
26	259-4	ESSENCE LAV 259 4"	\$138.21	\$165.86
26	259-8	ESSENCE LAV 259 8"	\$138.21	\$165.86
31	318-1	ESSENCE LAV 318 1H	N/A	\$166.35
31	318-4	ESSENCE LAV 318 4"	\$138.64	\$166.35
31	318-8	ESSENCE LAV 318 8"	\$138.64	\$166.35
31	319	ESSENCE PEDESTAL 319	\$91.20	\$109.43
31	320	ESSENCE PED-LAV COMBO	\$229.84	\$275.78
31	882	ESSENCE TOWEL BAR 882	\$95.84	N/A
33	272-8	LAVATORY 272 8"	\$88.15	N/A
33	272-4	LAVATORY 272 4"	\$88.15	\$101.37
32	292-4	LAVATORY 292 4"	\$123.00	\$141.45
32	292-1	LAVATORY 292 1H	\$123.00	\$141.45
32	292-8	LAVATORY 292 8"	\$123.00	\$141.45
30	802	LUNA VESSEL LAV 802	\$134.58	N/A
26	217	MAPLE LAV 217	\$67.08	\$80.48
26	249-1	MAVERICK I LAV 249 1H	\$76.42	N/A
26	249-4	MAVERICK I LAV 249 4"	\$76.42	\$92.11
26	249-8	MAVERICK I LAV 249 8"	\$76.42	N/A
26	267-1	MAVERICK II LAV 267 1H	\$76.42	\$92.11
26	267-4	MAVERICK II LAV 267 4"	\$76.42	\$92.11
26	267-8	MAVERICK II LAV 267 8"	\$76.42	\$92.11
32	348-1	MAVERICK LAV 348 1H	\$99.43	N/A
32	348-4	MAVERICK LAV 348 4"	\$99.43	\$114.34
32	348-8	MAVERICK LAV 348 8"	\$99.43	\$114.34
32	344	MAVERICK PEDESTAL 344	\$63.60	\$73.13
32	349	MAVERICK PED-LAV COMBO	\$163.03	\$187.47
29	825	MONET LAV 825	\$172.70	N/A
25	269-1	MONTCLAIR LAV 269 1H	\$143.91	N/A
25	269-4	MONTCLAIR LAV 269 4"	\$143.91	N/A
25	269-8	MONTCLAIR LAV 269 8"	\$143.91	\$172.71
31	333-1	MONTCLAIR LAV 333 1H	\$151.26	\$181.52
31	333-4	MONTCLAIR LAV 333 4"	\$151.26	\$181.52
31	333-8	MONTCLAIR LAV 333 8"	\$151.26	\$181.52
31	334	MONTCLAIR PEDESTAL 334	\$90.76	\$108.92
31	335	MONTCLAIR PED-LAV COMBO	\$242.02	\$290.44
27	237-1	MS OVAL 20X17 LAV 237 1H	\$40.43	\$46.09
27	237-4	MS OVAL 20X17 LAV 237 4"	\$40.43	\$46.09
27	237-8	MS OVAL 20X17 LAV 237 8"	\$40.43	N/A
27	239-1	MS ROUND 19" LAV 239 1H	\$40.43	\$46.09
27	239-4	MS ROUND 19" LAV 239 4"	\$40.43	\$46.09
27	239-8	MS ROUND 19" LAV 239 8"	\$40.43	N/A
33	273	PEDESTAL 273	\$63.06	\$72.51



Page #	Model #	Description	White	Standard
28	218NS	PETITE COVINGTON LAV 218NS	\$142.64	\$171.15
28	216NS	PETITE MAPLE LAV 216NS	\$57.40	\$68.89
29	437-1	POTENZA LAV 437 1H	\$141.61	N/A
29	437-4	POTENZA LAV 437 4"	\$141.61	N/A
29	437-8	POTENZA LAV 437 8"	\$141.61	N/A
32	436	POTENZA PEDESTAL 436	\$68.23	N/A
32	438	POTENZA PED-LAV COMBO	\$209.85	N/A
29	807	RAZIONALE LAV 807	\$215.25	N/A
29	826	REO LAV 826	\$139.78	\$167.50
29	805NS	TEMPO LAV 805NS	\$163.85	\$198.15
33	232-4	VERONA LAV 232 4"	\$69.70	N/A
33	233	VERONA PEDESTAL 233	\$52.28	N/A
33	230	VERONA PED-LAV COMBO	\$121.98	N/A
26	257-4	WAVERLY LAV 257 4"	\$130.92	N/A
32	338-1	WAVERLY LAV 338 1H	N/A	\$171.57
32	338-4	WAVERLY LAV 338 4"	\$137.26	\$171.57
32	338-8	WAVERLY LAV 338 8"	\$137.26	\$171.57
32	339	WAVERLY PEDESTAL 339	\$83.41	\$100.08
32	340	WAVERLY PED-LAV COMBO	\$220.67	\$271.65
33	270	WEST HAMPTON PED-LAV COMBO	\$151.21	\$173.88

**Sanitaryware – Commercial**

Page #	Model #	Description	White	Standard
37	1312	1312 BOWL	\$361.43	N/A
37	1313	1313 ADA BOWL	\$431.44	N/A
39	401HE	ADAM URINAL 401HE 0.5 GPF	\$125.01	\$161.68
36	1319	ADRIATIC BOWL 1319 EL 10" 1.28	\$220.68	N/A
36	1319RS	ADRIATIC BOWL 1319 R/S EL 10" 1.28	\$232.04	N/A
36	1319BPL	ADRIATIC BOWL 1319BPL EL 10" 1.28	\$231.59	N/A
42	CP-1319-128	ADRIATIC COMMERCIAL PACK 1319 1.28	\$465.49	N/A
37	1311NS	BALTIC BOWL 1311NS EL 10"	\$163.81	\$215.01
42	CP-1311-128	BALTIC COMMERCIAL PACK 1311 1.28	\$408.63	N/A
42	CP-422-125	BREVITY COMMERCIAL PACK 422 0.125	\$473.37	N/A
40	2018C-4	CAPE CHARLES LAV 2018C 4"	N/A	\$111.17
40	2018C-8	CAPE CHARLES LAV 2018C 8"	\$92.64	N/A
42	CP-410-05	CASCADE COMMERCIAL PACK 410 0.5 GPF	\$498.97	N/A
39	410HE	CASCADE URINAL 410HE 0.5 GPF	\$306.07	N/A
39	410HE RS	CASCADE URINAL 410HE R/S 0.5GPF	\$316.16	N/A
42	CP-1312-128	COMMERCIAL PACK 1312 1.28	\$606.25	N/A
42	CP-1313-128	COMMERCIAL PACK 1313 1.28	\$676.26	N/A
36	5326	ELEMENTARY BOWL 5326 RD	\$230.00	N/A
36	4320	ELEMENTARY TANK 4320	\$150.00	N/A
36	5326-4320	ELEMENTARY TOILET COMBO	\$380.00	N/A
36	ELEM	ELEMENTARY TOILET SEAT	\$87.98	N/A
38	1301BPL	ERIE BOWL 1301 BPL WALL 1.28	\$166.45	N/A
38	1301	ERIE BOWL 1301 WALL 1.28	\$146.50	N/A
42	CP-1301-128	ERIE COMMERCIAL PACK 1301 1.28	\$391.33	N/A
40	2018HBS-1	GRANDE ISLE LAV 2018HBS-1-HOLE	\$105.29	N/A
40	2018HBS-4	GRANDE ISLE LAV 2018HBS-4"	\$105.29	N/A
40	2018HBS-8	GRANDE ISLE LAV 2018HBS-8"	\$105.29	\$126.37
40	2018HBS-LO	GRANDE ISLE LAV 2018HBS-NS L/O 4" OR 8"	\$105.29	N/A
36	4320LID	LID 4320 ELEMENTARY	\$62.40	N/A
41	3072	MEDAJEAN CLINICAL SINK 3072	\$1,328.00	N/A
41	872	MEDAJEAN RIM GUARD 872 SET	\$93.37	N/A
40	2038-4	PAMLICO LAV 2038 4"	\$178.92	N/A
40	2038-1	PAMLICO LAV 2038 1-HOLE	\$178.92	N/A
40	2038-8	PAMLICO LAV 2038 8"	\$178.92	N/A
40	2038-LO	PAMLICO LAV 2038LO 4" W/O OVRFLW	\$178.92	N/A
40	2039	PAMLICO SHROUD 2039	\$119.27	N/A
40	2040	PAMLICO SHROUD LAV COMBO	\$298.20	N/A
41	1613NS-4	SPRUCE COVE LAV 1613NS 4"	\$84.78	N/A
39	475	SUBURBAN URINAL 475	\$197.83	\$247.45
39	422	URINAL 422 BREVITY ADA	\$280.47	N/A
39	422RS	URINAL 422R/S BREVITY ADA	\$290.94	N/A
41	2008-4	WALNUT KNOLL LAV 2008 4"	\$86.01	N/A
40	315-4	WHEELCHAIR LAV 315 4"	\$267.66	N/A

Page #	Model #	Description	White	Standard
40	315-8	WHEELCHAIR LAV 315 8"	\$267.66	N/A
40	315-LO	WHEELCHAIR LAV 315L/O 4" OR 8"	\$267.66	N/A
41	1917C-4	WILLOW RUN LAV 1917C 4"	\$83.79	\$101.73
41	1917C-LO	WILLOW RUN LAV 1917C L/O 4"	\$83.79	N/A

**Sanitaryware – Parts & Accessories**

Page #	Model #	Description	White	Standard
10	705LID	AEGEAN LID 705NS/708 WHT	\$76.52	\$92.90
22	160LID	ALTO LID 160 WHT	\$42.58	\$53.28
22	165LID	ALTO LID 165/175 W/LOCK WHT	\$54.08	N/A
118	123-8577	ANCHOR FLOOR KIT ENSO WHITE	\$6.75	N/A
115	212-1034	ASSY 212 FV 10-3/4" 700/705	\$11.10	N/A
115	212-1034-10	ASSY 212 FV 10-3/4" 700/705	\$9.97	N/A
109	31BISC	ASSY 31 TNK LVR BISC	\$6.12	N/A
109	31BONE	ASSY 31 TNK LVR BONE	\$6.12	N/A
109	31CH	ASSY 31 TNK LVR CH	\$6.12	N/A
109	31WHT	ASSY 31 TNK LVR WHT	\$6.12	N/A
109	31RHCH	ASSY 31 TNK RH LVR CH	\$6.12	N/A
109	31RHWHT	ASSY 31 TNK RH LVR WHT	\$6.12	N/A
114	123-7838	ASSY BLUE CAP/BLUE LEVER 08 BC	\$3.48	N/A
114	123-7838-20	ASSY BLUE CAP/BLUE LEVER 08 BC	\$3.14	N/A
115	123-0216-20	ASSY FLOAT 210 FV 11-1/2 IN	\$2.49	N/A
115	123-0216-50	ASSY FLOAT 210 FV 11-1/2 IN	\$2.12	N/A
115	123-8984-20	ASSY FLOAT 211 ULF FL V 11-1/2	\$2.42	N/A
115	123-8984-50	ASSY FLOAT 211 ULF FL V 11-1/2	\$2.07	N/A
114	08-10	BALLCOCK 08 10 BOX	\$13.58	N/A
114	08-10-20	BALLCOCK 08 10 BOX	\$12.35	N/A
114	08-10-P	BALLCOCK 08 10 POP	\$14.84	N/A
114	08-10-P-10	BALLCOCK 08 10 POP	\$13.58	N/A
114	08ULF-10	BALLCOCK 08 10 ULF BOX	\$13.58	N/A
114	08ULF-20	BALLCOCK 08 10 ULF BOX	\$12.35	N/A
114	08-1034	BALLCOCK 08 10-3/4 BOX	\$13.58	N/A
114	08-1034-20	BALLCOCK 08 10-3/4 BOX	\$12.35	N/A
114	08ULF-1034	BALLCOCK 08 10-3/4 ULF BOX	\$13.58	N/A
114	08ULF-1034-20	BALLCOCK 08 10-3/4 ULF BOX	\$12.35	N/A
114	08-1112	BALLCOCK 08 11-1/2 BOX	\$13.58	N/A
114	08-1112-20	BALLCOCK 08 11-1/2 BOX	\$12.35	N/A
114	08ULF-1112	BALLCOCK 08 11-1/2 ULF BOX	\$13.58	N/A
114	08ULF-1112-20	BALLCOCK 08 11-1/2 ULF BOX	\$12.35	N/A
114	2206-1112	BALLCOCK 2206 11.5 ADJUSTABLE	\$17.19	N/A
114	2206-1212	BALLCOCK 2206 12.5 ADJUSTABLE	\$17.19	N/A
116	89-1012	BALLCOCK 89 GRIVAL	\$14.84	N/A
116	90	BALLCOCK MODEL 90 ENSO	\$17.21	N/A
116	90-9000	BALLCOCK MODEL 90-9" MAV 1.0	\$17.21	N/A
7	106LID	BARRETT LID 106/3106 WHT	\$69.98	\$80.27
119	BCBISC	BOLT CAP SET-BISCUIT	\$1.13	N/A
119	BCBISC-10	BOLT CAP SET-BISCUIT	\$0.99	N/A
119	BCBONE	BOLT CAP SET-BONE	\$1.13	N/A
119	BCBONE-10	BOLT CAP SET-BONE	\$0.99	N/A
119	BCWHT	BOLT CAP SET-WHITE	\$1.13	N/A
119	BCWHT-20	BOLT CAP SET-WHITE	\$0.87	N/A
6	3147LID	BRENTWOOD LID 3147 WHT	\$71.69	\$82.23
115	225-2511	CAP CONTROL STOP FM SERIES	\$6.58	N/A
115	225-5907-100	CAP FV STOP CAP LRG HOLE	\$0.38	N/A
115	225-5907-20	CAP FV STOP CAP LRG HOLE	\$0.63	N/A
19	3816LID	CASCADE LID 3816 WHT	\$42.81	N/A
28	CLIPS	CLIPS UNDER MOUNT LAV	\$16.56	N/A
114	342-2067-100	DIAPHRAM 08 BALLCOCK	\$0.63	N/A
114	342-2067-50	DIAPHRAM 08 BALLCOCK	\$0.76	N/A
119	342-1685-20	DIAPHRAM 208/209 FL VLV PLSTC	\$2.49	N/A
119	342-1685-50	DIAPHRAM 208/209 FL VLV PLSTC	\$1.98	N/A
6	178LID	ENSO LID 178 WHT	\$67.81	\$78.40
8	3185LID	ESSENCE LID 3185 WHT	\$77.74	\$89.24
118	308	FLSH-VLV #308 DF 3" 10.75	\$19.60	N/A
117	206-1112	FLSH-VLV 11.5 #206 FLAPPER 3"	\$12.68	N/A
117	206-1212	FLSH-VLV 12.5 #206 FLAPPER 3"	\$13.25	N/A

Page #	Model #	Description	White	Standard
116	202-1012	FLSH-VLV 202 10.5 2" FLAPPER	\$21.07	N/A
117	203A	FLSH-VLV 203A 2" FLAPPER W/CHN	\$8.69	N/A
118	216	FLSH-VLV 216 FLAPPER 3"	\$14.63	N/A
117	208E	FLSH-VLV MODEL 208E 3" ENSO	\$19.61	N/A
117	209	FLSH-VLV MODEL 209M MAV 1.0	\$17.13	N/A
115	210-1034	FLUSH VALVE 210 10-3/4 BOX	\$9.48	N/A
115	210-1034-10	FLUSH VALVE 210 10-3/4 BOX	\$8.61	N/A
115	210-1112	FLUSH VALVE 210 11-1/2 BOX	\$9.48	N/A
115	210-1112-10	FLUSH VALVE 210 11-1/2 BOX	\$8.61	N/A
115	211-1000	FLUSH VALVE 211 10 BOX	\$9.48	N/A
115	211-1000-10	FLUSH VALVE 211 10 BOX	\$8.61	N/A
115	211-1034	FLUSH VALVE 211 10-3/4 BOX	\$9.48	N/A
115	211-1034-10	FLUSH VALVE 211 10-3/4 BOX	\$8.61	N/A
115	211-1112	FLUSH VALVE 211 11-1/2 BOX	\$9.48	N/A
115	211-1112-10	FLUSH VALVE 211 11-1/2 BOX	\$8.61	N/A
117	204	FL-VLV #204 3" FLAPR 70SNS/722	\$12.68	N/A
40	FM-T2	FM-T2 DURAFLO TV 1.28 GPF	\$192.16	N/A
40	FM-U5	FM-U5 DURAFLO UV .5 GPF	\$192.16	N/A
40	FM-U8	FM-U8 DURAFLO UV 1 PINT	\$192.16	N/A
117	206-1112	FV #206 11.5 FLAPPER 3" BOX	\$12.68	N/A
117	206-1212	FV #206 12.5 FLAPPER 3" BOX	\$13.25	N/A
118	228	FV 10.2 #228 HB FLAPPER 3"to2"	\$12.68	N/A
115	447-0200-50	GASKET 205/210/211 FL VALVE	\$0.99	N/A
115	447-6955-50	GASKET TANK/BOWL 3-BOLT	\$1.87	N/A
120	471-3265	HANGER 410 URINAL	\$0.99	N/A
120	471-3261	HANGER LAV/475/401 URINAL STL	\$4.12	N/A
121	630-5907	KIT-210/211 FV STOP TOP	\$2.13	N/A
121	630-5907-12	KIT-210/211 FV STOP TOP	\$1.81	N/A
121	630-5907-3	KIT-210/211 FV STOP TOP	\$1.97	N/A
121	630-6204-P	KIT-2lnch SmartFasten POP	\$7.70	N/A
121	630-6204-P-4	KIT-2lnch SmartFasten POP	\$7.23	N/A
120	531-0017	KIT-410 URINAL OUTLET	\$26.93	N/A
120	531-0016	KIT-475 URINAL OUTLET	\$24.30	N/A
121	630-7984	KIT-BALLCOCK 08 SERVICE POP	\$4.12	N/A
121	630-7984-10	KIT-BALLCOCK 08 SERVICE POP	\$3.49	N/A
121	630-4837	KIT-FV 208/9 SEAL POP UPDATE	\$6.13	N/A
121	630-4837-12	KIT-FV 208/9 SEAL POP UPDATE	\$5.53	N/A
121	630-4837-3	KIT-FV 208/9 SEAL POP UPDATE	\$5.76	N/A
121	630-0030	KIT-FV 211 SEAL POP UPDATE	\$2.98	N/A
121	630-0030-10	KIT-FV 211 SEAL POP UPDATE	\$2.75	N/A
121	630-0030-50	KIT-FV 211 SEAL POP UPDATE	\$2.49	N/A
110	45CH	LEVER 45 LH CHROME	\$12.19	N/A
110	49CH	LEVER 49 RH CHROME	\$13.84	N/A
111	56BISC	LEVER 56 BISC IND	\$5.80	N/A
111	56BONE	LEVER 56 BONE IND	\$5.80	N/A
111	56WHT	LEVER 56 WHT IND	\$5.80	N/A
111	58CH	LEVER 58 CHROME IND CASCADE	\$19.14	N/A
111	58CHRH	LEVER 58 RH CHROME IND CASCADE	\$20.44	N/A
111	66CH	LEVER 66 CH W/METAL ARM	\$30.34	N/A
111	66SB	LEVER 66 SB W/METAL ARM	\$52.79	N/A
111	66SN	LEVER 66 SN W/METAL ARM	\$52.79	N/A
111	69CH	LEVER 69 CH W/METAL ARM	\$19.77	N/A
111	69SB	LEVER 69 SB W/METAL ARM	\$42.26	N/A
111	69SN	LEVER 69 SN W/METAL ARM	\$42.26	N/A
111	72CHBISC	LEVER 72 CH W/BISCUIT INSERT	\$30.34	N/A
111	72CHBONE	LEVER 72 CH W/BONE INSERT	\$30.34	N/A
111	72CHWHT	LEVER 72 CH W/WHITE INSERT	\$30.34	N/A
111	72SNBISC	LEVER 72 SN W/BISC INSERT	\$52.79	N/A
111	72SNWHT	LEVER 72 SN W/WHITE INSERT	\$52.79	N/A
112	73CH	LEVER 73 CH INDV	\$29.46	N/A
112	76CH	LEVER 76 CH W/METAL ARM	\$30.36	N/A
112	76SN	LEVER 76 SB W/METAL ARM	\$52.83	N/A
112	76SB	LEVER 76 SN W/METAL ARM	\$52.83	N/A
112	85CH	LEVER 85 CH ESSENCE	\$19.77	N/A
112	87CH	LEVER 87 CH REO	\$19.77	N/A
110	50CH	LEVER ECO 50 CH INDV LH/RH	\$21.95	N/A
110	50SN	LEVER ECO 50 SN ETCHED INDV LH	\$46.88	N/A
111	55RHCH	LEVER FL 55 RH CH UNIVERSAL	\$11.71	N/A

Page #	Model #	Description	White	Standard
109	33CH	LEVER PUSH BUTTON 33 CH DUALFL	\$33.16	N/A
110	47CH	LEVER PUSH BUTTON 47 CH-BULK	\$33.16	N/A
110	48CH	LEVER PUSH BUTTON 48 CH-BULK	\$34.02	N/A
112	78CH	LEVER PUSH BUTTON 78 CH ENSO	\$33.16	N/A
112	78SN	LEVER PUSH BUTTON 78 SN ENSO	\$55.70	N/A
109	40BISC-20	LEVER TANK 40 BISC BULK W/NUT	\$3.35	N/A
109	40BONE-20	LEVER TANK 40 BONE BULK W/NUT	\$3.35	N/A
109	40CH-20	LEVER TANK 40 CH BULK W/NUT	\$3.30	N/A
109	40CH-50	LEVER TANK 40 CH BULK W/NUT	\$3.19	N/A
109	40RHCH	LEVER TANK 40 RH CH BULK W/NUT	\$3.87	N/A
109	40WHT-P	LEVER TANK 40 WH POP	\$6.12	N/A
109	40WHT-P-5	LEVER TANK 40 WH POP	\$5.36	N/A
109	40WHT-20	LEVER TANK 40 WHITE BULK W/NUT	\$3.35	N/A
109	41CH-20	LEVER TANK 41 CH BULK W/NUT	\$3.30	N/A
109	41CH-50	LEVER TANK 41 CH BULK W/NUT	\$3.19	N/A
109	41CH-P	LEVER TANK 41 CP POP	\$6.12	N/A
109	41CH-P-10	LEVER TANK 41 CP POP	\$5.36	N/A
109	41CH-P-20	LEVER TANK 41 CP POP	\$5.10	N/A
109	42CH-20	LEVER TANK 42 CH BULK W/NUT	\$3.49	N/A
109	42CH-50	LEVER TANK 42 CH BULK W/NUT	\$3.35	N/A
109	43CH-20	LEVER TANK 43 CH BULK W/NUT	\$3.49	N/A
109	43CH-50	LEVER TANK 43 CH BULK W/NUT	\$3.35	N/A
110	44CH	LEVER TANK 44 CP BULK	\$6.91	N/A
110	46BC	LEVER TANK 46 BC INDV	\$35.77	N/A
110	46BISC	LEVER TANK 46 BISC INDV	\$27.68	N/A
110	46BONE	LEVER TANK 46 BONE INDV	\$27.68	N/A
110	46CH	LEVER TANK 46 CH INDV	\$27.68	N/A
110	46SB	LEVER TANK 46 SB INDV	\$35.77	N/A
110	46SN	LEVER TANK 46 SN INDV	\$35.77	N/A
110	46WHT	LEVER TANK 46 WHITE INDV	\$27.68	N/A
110	51CH	LEVER TANK 51 CH BULK	\$20.95	N/A
110	51SN	LEVER TANK 51 SN INDV	\$43.45	N/A
110	51RHCH	LEVER TANK 51RH CH BULK	\$20.95	N/A
111	70CH	LEVER TANK 70 CH INDV	\$23.43	N/A
111	70SN	LEVER TANK 70 SN INDV	\$49.86	N/A
15	1012LID	LID 1012/3012 MAV 1.0 WHT	\$78.87	N/A
36	4320LID	LID 4320 ELEMENTARY	\$62.40	N/A
112	79CH	LVR PUSH BUTTON 79 CH MAV 1.0	\$27.45	N/A
9	108LID	MONTCLAIR LID 108/3108 WHT	\$77.74	\$89.24
114	609-5414-20	NUT CAP TO BODY GRAY - 08 BC	\$1.13	N/A
119	609-7740	NUT FLUSH LEVER	\$0.99	N/A
40	630-6004	PAK 08 BALLCOCK CAP/LEVER POP	\$6.85	N/A
40	630-6004-10	PAK 08 BALLCOCK CAP/LEVER POP	\$5.74	N/A
114	08ULF-1112-P	PAK 08ULF BALLCOCK 11-1/2" POP	\$14.84	N/A
114	08ULF-1112-P-10	PAK 08ULF BALLCOCK 11-1/2" POP	\$13.58	N/A
115	210-1112-P	PAK 210 FV 11-1/2" POP UPDATE	\$10.35	N/A
115	210-1112-P-4	PAK 210 FV 11-1/2" POP UPDATE	\$9.73	N/A
115	211-1112-P	PAK 211 FV 11-1/2" POP UPDATE	\$10.35	N/A
115	211-1112-P-4	PAK 211 FV 11-1/2" POP UPDATE	\$9.73	N/A
109	40BISC-P	PAK 40 LEVER BISCUIT POP	\$6.12	N/A
109	40BISC-P-5	PAK 40 LEVER BISCUIT POP	\$5.36	N/A
109	40BONE-P	PAK 40 LEVER BONE POP	\$6.12	N/A
109	40BONE-P-5	PAK 40 LEVER BONE POP	\$5.36	N/A
109	40CH-P	PAK 40 LEVER CP POP	\$6.12	N/A
109	40CH-P-10	PAK 40 LEVER CP POP	\$5.36	N/A
109	40CH-P-20	PAK 40 LEVER CP POP	\$5.10	N/A
109	42CH-P	PAK 42 LEVER CP POP	\$6.12	N/A
109	42CH-P-10	PAK 42 LEVER CP POP	\$5.36	N/A
109	42CH-P-20	PAK 42 LEVER CP POP	\$5.10	N/A
109	43CH-P	PAK 43 LEVER CP POP	\$6.12	N/A
109	43CH-P-10	PAK 43 LEVER CP POP	\$5.36	N/A
109	43CH-P-20	PAK 43 LEVER CP POP	\$5.10	N/A
111	55CH-P	PAK 55 LEVER CP POP	\$14.08	N/A
111	55CH-P-10	PAK 55 LEVER CP POP	\$10.61	N/A
111	55CH-P-5	PAK 55 LEVER CP POP	\$12.19	N/A
111	55SB-P	PAK 55 LEVER SB POP	\$45.75	N/A
111	55SN-P	PAK 55 LEVER SN POP	\$45.87	N/A
111	55SN-P-10	PAK 55 LEVER SN POP	\$38.27	N/A

Page #	Model #	Description	White	Standard
111	55SN-P-5	PAK 55 LEVER SN POP	\$39.89	N/A
40	630-6601	PAK CONTROL STOP FM SERIES	\$36.34	N/A
40	630-2522	PAK DIAPHRAGM FM-T2 1.28 GPF	\$44.17	N/A
40	630-2526	PAK DIAPHRAGM FM-T6 1.6 GPF	\$44.17	N/A
40	630-2511	PAK DIAPHRAGM FM-U1 1 GPF	\$44.17	N/A
40	630-2515	PAK DIAPHRAGM FM-U5 .5 GPF	\$44.17	N/A
40	630-2518	PAK DIAPHRAGM FM-U8 1 PT	\$44.17	N/A
119	630-6005-20	PAK FLOAT BALL POP	\$1.38	N/A
40	630-1681	PAK HANDLE FM SERIES	\$36.13	N/A
114	630-2206	PAK SERVICE-2206 FILL VLV POP	\$4.12	N/A
114	630-2206-20	PAK SERVICE-2206 FILL VLV POP	\$3.49	N/A
121	630-6001	PAK TANK BOLTS POP	\$5.85	N/A
121	630-6001-10	PAK TANK BOLTS POP	\$4.86	N/A
121	630-6002	PAK TANK TO BOWL GASKET POP	\$4.49	N/A
121	630-6002-10	PAK TANK TO BOWL GASKET POP	\$3.74	N/A
120	630-6003	PAK TANK TRIM REBUILD POP	\$9.59	N/A
120	630-6003-10	PAK TANK TRIM REBUILD POP	\$7.98	N/A
118	630-0204	PAK TNK/BWL 2" SMTFASTEN KIT	\$6.18	N/A
118	630-0107	PAK TNK/BWL 3" SMTFASTEN KIT	\$8.73	N/A
118	630-0034	PAK TNK/BWL QUANTUM	\$7.22	N/A
116	630-0173	PAK UNIVERSAL 2" FLAPPER	\$2.94	N/A
40	630-9291	PAK VBKR FM SERIES	\$7.07	N/A
116	630-0207	PAK WATERSENSE FLPR 3" UPDATE	\$8.73	N/A
116	630-0207-12	PAK WATERSENSE FLPR 3" UPDATE	\$7.85	N/A
116	630-0207-3	PAK WATERSENSE FLPR 3" UPDATE	\$8.37	N/A
114	660-3718-100	PLUNGER 08 NO PARTING LINE	\$0.43	N/A
114	660-3718-50	PLUNGER 08 NO PARTING LINE	\$0.49	N/A
12	125LID	QUANTUM LID 119/123/125/153 WHT	\$70.00	\$81.50
12	122LID	QUANTUM LID 122 WHT	\$70.68	\$81.89
119	714-0424	ROD AL FLOAT 7-1/2" LENGTH	\$0.87	N/A
115	741-0011-100	SEAL 210/211 FL V EPDM 55A	\$0.87	N/A
115	741-0011-50	SEAL 210/211 FL V EPDM 55A	\$0.99	N/A
118	741-0308	SEAL 308 DUAL FLUSH VALVE	\$1.60	N/A
119	741-0016	SEAL FV MODEL 208E ENSO	\$2.82	N/A
114	936-2069-100	SEAL LOWER DIAPHRAGM-08/12 BC	\$0.76	N/A
114	936-2069-50	SEAL LOWER DIAPHRAGM-08/12 BC	\$0.87	N/A
108	SB100	SEAT SB100 ROUND BISCUIT	\$21.46	N/A
108	SB100	SEAT SB100 ROUND BONE	\$21.46	N/A
108	SB100	SEAT SB100 ROUND WHITE	\$21.46	N/A
108	SB1500	SEAT SB1500 NEW ENSO BISC	\$110.61	N/A
108	SB1500	SEAT SB1500 NEW ENSO WHT	\$110.61	N/A
108	SB1600	SEAT SB1600 ENSO BISC	\$105.28	N/A
108	SB1600	SEAT SB1600 ENSO WHT	\$105.28	N/A
108	SB1700	SEAT SB1700 ESSENCE BISC	\$87.26	N/A
108	SB1700	SEAT SB1700 ESSENCE BONE	\$87.26	N/A
108	SB1700	SEAT SB1700 ESSENCE WHT	\$87.26	N/A
108	SB1800	SEAT SB1800 REO BISC	\$93.48	N/A
108	SB1800	SEAT SB1800 REO BONE	\$93.48	N/A
108	SB1800	SEAT SB1800 REO WHITE	\$93.48	N/A
108	SB200	SEAT SB200 EL BISCUIT	\$26.05	N/A
108	SB200	SEAT SB200 EL BONE	\$26.05	N/A
108	SB200	SEAT SB200 EL WHITE	\$26.05	N/A
108	SB400	SEAT SB400 EL SMART CL BISC	\$37.39	N/A
108	SB400	SEAT SB400 EL SMART CL BONE	\$37.39	N/A
108	SB700	SEAT SB700 EL SMART CL BISC	\$53.01	N/A
108	SB700	SEAT SB700 EL SMART CL BONE	\$53.01	N/A
108	SB700	SEAT SB700 EL SMART CL WHT	\$53.01	N/A
108	SB800	SEAT SB800 EL SMART CL BISC	\$61.09	N/A
108	SB800	SEAT SB800 EL SMART CL BONE	\$61.09	N/A
108	SB800	SEAT SB800 EL SMART CL WHT	\$61.09	N/A
108	SB900	SEAT SB900 EL COMMERCIAL WHT	\$46.22	N/A
120	23	SPUD "23" 1 X 1/2 BULK	\$5.61	N/A
120	24	SPUD "24" 1 X 3/4 BULK	\$6.85	N/A
16	3386LID	SUMMIT DF LID 3386 WHT	\$82.20	\$90.44
17	386LID	SUMMIT LID 386 WHT	\$78.87	\$90.53
34	ELEM	TOILET SEAT ELEMENTARY	\$87.98	N/A
119	918-4007	TUBE REFILL LARGE 7" LENGTH	\$1.93	N/A
9	195LID	WAVERLY LID 195/3195 WHT	\$70.34	\$81.50

**Bathware – Showroom Series Bathtubs**

Page #	Model #	Name	Measurements	Standard	Premium
83	5539	Ambria	59 1/2" x 59 1/2" x 21 1/4"	\$1,521.00	\$1,761.00
44	5581	Avalon	71 3/4" x 40 1/2" x 29"	\$1,468.00	\$1,708.00
66	5508	Barrett 3666	66" x 36" x 24"	\$1,359.00	\$1,599.00
64	5510	Barrett 3672	72" x 36" x 24"	\$1,386.00	\$1,626.00
65	5522	Barrett 4266	66" x 42" x 24"	\$1,413.00	\$1,653.00
63	5518	Barrett 4272	72" x 42" x 24"	\$1,468.00	\$1,708.00
67	5524L	Barrett Alcove LH	60" x 32" x 21 1/2"	\$1,359.00	\$1,599.00
67	5524R	Barrett Alcove RH	60" x 32" x 21 1/2"	\$1,359.00	\$1,599.00
70	5502	Baywood 5.0	60" x 36" x 19 3/4"	\$1,331.00	\$1,571.00
69	5528	Baywood 5.5	66" x 36" x 19 3/4"	\$1,359.00	\$1,599.00
68	5504	Baywood 6.0	72" x 36" x 19 3/4"	\$1,386.00	\$1,626.00
75	5567	Brentwood 3260	60" x 32" x 20 3/4"	\$1,294.00	\$1,534.00
74	5569	Brentwood 3660	60" x 36" x 22 1/2"	\$1,331.00	\$1,571.00
73	5573	Brentwood 3666	66" x 36" x 22 1/2"	\$1,359.00	\$1,599.00
72	5574	Brentwood 3672	72" x 36" x 22 1/2"	\$1,386.00	\$1,626.00
71	5575	Brentwood 4272	72" x 42" x 22 1/2"	\$1,468.00	\$1,708.00
76	5540	Brighton	72" x 46" x 24"	\$1,521.00	\$1,761.00
84	5545	Bristol Bay	60" x 60" x 22"	\$1,521.00	\$1,761.00
77	5553	Camden	59 1/2" x 32" x 21 1/2"	\$1,294.00	\$1,534.00
85	5589	Castille	66" x 66" x 23 1/2"	\$1,576.00	\$1,816.00
86	5562	Covington C	60" x 60" x 23"	\$1,521.00	\$1,761.00
87	5548	Covington C Round front	60" x 60" x 23"	\$1,521.00	\$1,761.00
45	5585	Elba OV	59 1/2" x 42" x 23"	\$1,386.00	\$1,626.00
78	5584	Elba R	59 1/2" x 42" x 23"	\$1,386.00	\$1,626.00
49	5592	Enso 3666	66" x 36" x 22 1/4"	\$1,359.00	\$1,599.00
47	5593	Enso 3672	72" x 36" x 22 1/4"	\$1,386.00	\$1,626.00
48	5594	Enso 4266	66" x 42" x 22 1/4"	\$1,413.00	\$1,653.00
46	5595	Enso 4272	72" x 42" x 22 1/4"	\$1,468.00	\$1,708.00
53	5527	Essence 3666	66" x 36" x 24"	\$1,359.00	\$1,599.00
51	5530	Essence 3672	71 1/2" x 36" x 24"	\$1,386.00	\$1,626.00
54	5531	Essence 4260	60" x 41 1/2" x 24"	\$1,386.00	\$1,626.00
52	5533	Essence 4266	66" x 41 1/2" x 24"	\$1,413.00	\$1,653.00
50	5535	Essence 4272	71 1/2" x 41 1/2" x 24"	\$1,468.00	\$1,708.00
55	5578	Hampton OV	68" x 42" x 23 1/2"	\$1,413.00	\$1,653.00
79	5572	Hampton R	72" x 42" x 23 1/2"	\$1,468.00	\$1,708.00
56	5577	Heathrow OV	72" x 42" x 23"	\$1,468.00	\$1,708.00
80	5558	Heathrow R	72" x 42" x 23"	\$1,468.00	\$1,708.00
88	5525	Montclair	71 1/2" x 41 1/2" x 23 1/2"	\$1,468.00	\$1,708.00
88	5596	Reo 3660	60" x 36" x 24"	\$1,331.00	\$1,571.00
88	5597	Reo 3666	66" x 36" x 24"	\$1,359.00	\$1,599.00
88	5598	Reo 3672	72" x 36" x 24"	\$1,386.00	\$1,626.00
88	5599	Reo 4272	72" x 42" x 24"	\$1,468.00	\$1,708.00
88	8310	Restore LH Soaking tub	51 1/2" x 30" x 40"	\$5,433.00	N/A
88	8210	Restore RH Soaking tub	51 1/2" x 30" x 40"	\$5,433.00	N/A
82	5551	Savannah	72" x 48" x 24"	\$1,521.00	\$1,761.00

**Bathware – Showroom Series Whirlpool Systems**

Page #	Model #	Name	Measurements	Standard	Premium
83	5039 BAS	Ambria	59 1/2" x 59 1/2" x 21 1/4"	\$3,052.00	\$3,292.00
83	5039 LUX	Ambria	59 1/2" x 59 1/2" x 21 1/4"	\$4,878.00	\$5,118.00
44	5081 BAS	Avalon	71 3/4" x 40 1/2" x 29"	\$2,903.00	\$3,143.00
44	5081 LUX	Avalon	71 3/4" x 40 1/2" x 29"	\$4,663.00	\$4,903.00
66	5008 BAS	Barrett 3666	66" x 36" x 24"	\$2,653.00	\$2,893.00
66	5008 LUX	Barrett 3666	66" x 36" x 24"	\$4,412.00	\$4,652.00
64	5010 BAS	Barrett 3672	72" x 36" x 24"	\$2,703.00	\$2,943.00
64	5010 LUX	Barrett 3672	72" x 36" x 24"	\$4,462.00	\$4,702.00
65	5022 BAS	Barrett 4266	66" x 42" x 24"	\$2,752.00	\$2,992.00
65	5022 LUX	Barrett 4266	66" x 42" x 24"	\$4,512.00	\$4,752.00
63	5018 BAS	Barrett 4272	72" x 42" x 24"	\$2,903.00	\$3,143.00
63	5018 LUX	Barrett 4272	72" x 42" x 24"	\$4,663.00	\$4,903.00
67	5024L BAS	Barrett Alcove LH	60" x 32" x 21 1/2"	\$1,816.00	\$2,056.00
67	5024L LUX	Barrett Alcove LH	60" x 32" x 21 1/2"	\$3,493.00	\$3,733.00
67	5024R BAS	Barrett Alcove RH	60" x 32" x 21 1/2"	\$1,816.00	\$2,056.00
67	5024R LUX	Barrett Alcove RH	60" x 32" x 21 1/2"	\$3,493.00	\$3,733.00

Page #	Model #	Name	Measurements	Standard	Premium
70	5002 BAS	Baywood 5.0	60" x 36" x 19 3/4"	\$2,502.00	\$2,742.00
70	5002 LUX	Baywood 5.0	60" x 36" x 19 3/4"	\$4,323.00	\$4,563.00
69	5028 BAS	Baywood 5.5	66" x 36" x 19 3/4"	\$2,653.00	\$2,893.00
69	5028 LUX	Baywood 5.5	66" x 36" x 19 3/4"	\$4,412.00	\$4,652.00
68	5004 BAS	Baywood 6.0	72" x 36" x 19 3/4"	\$2,703.00	\$2,943.00
68	5004 LUX	Baywood 6.0	72" x 36" x 19 3/4"	\$4,462.00	\$4,702.00
75	5067 BAS	Brentwood 3260	60" x 32" x 20 3/4"	\$2,405.00	\$2,645.00
75	5067 LUX	Brentwood 3260	60" x 32" x 20 3/4"	\$4,157.00	\$4,397.00
74	5069 BAS	Brentwood 3660	60" x 36" x 22 1/2"	\$2,502.00	\$2,742.00
74	5069 LUX	Brentwood 3660	60" x 36" x 22 1/2"	\$4,323.00	\$4,563.00
73	5073 BAS	Brentwood 3666	66" x 36" x 22 1/2"	\$2,653.00	\$2,893.00
73	5073 LUX	Brentwood 3666	66" x 36" x 22 1/2"	\$4,412.00	\$4,652.00
72	5074 BAS	Brentwood 3672	72" x 36" x 22 1/2"	\$2,703.00	\$2,943.00
72	5074 LUX	Brentwood 3672	72" x 36" x 22 1/2"	\$4,462.00	\$4,702.00
71	5075 BAS	Brentwood 4272	72" x 42" x 22 1/2"	\$2,903.00	\$3,143.00
71	5075 LUX	Brentwood 4272	72" x 42" x 22 1/2"	\$4,663.00	\$4,903.00
76	5040 BAS	Brighton	72" x 48" x 24"	\$3,202.00	\$3,442.00
76	5040 LUX	Brighton	72" x 48" x 24"	\$5,028.00	\$5,268.00
84	5045 BAS	Bristol Bay	60" x 60" x 22"	\$3,052.00	\$3,292.00
84	5045 LUX	Bristol Bay	60" x 60" x 22"	\$4,878.00	\$5,118.00
77	5053 BAS	Camden	59 1/2" x 32" x 21 1/2"	\$2,405.00	\$2,645.00
77	5053 LUX	Camden	59 1/2" x 32" x 21 1/2"	\$4,157.00	\$4,397.00
85	5089 BAS	Castille	66" x 66" x 23 1/2"	\$3,253.00	\$3,493.00
85	5089 LUX	Castille	66" x 66" x 23 1/2"	\$5,080.00	\$5,320.00
86	5062 BAS	Covington C	60" x 60" x 23"	\$3,052.00	\$3,292.00
86	5062 LUX	Covington C	60" x 60" x 23"	\$4,878.00	\$5,118.00
87	5048 BAS	Covington C Round front	60" x 60" x 23"	\$3,052.00	\$3,292.00
87	5048 LUX	Covington C Round front	60" x 60" x 23"	\$4,878.00	\$5,118.00
45	5085 BAS	Elba OV	59 1/2" x 42" x 23"	\$2,703.00	\$2,943.00
45	5085 LUX	Elba OV	59 1/2" x 42" x 23"	\$4,463.00	\$4,703.00
78	5084 BAS	Elba R	59 1/2" x 42" x 23"	\$2,703.00	\$2,943.00
78	5084 LUX	Elba R	59 1/2" x 42" x 23"	\$4,463.00	\$4,703.00
49	5092 BAS	Enso 3666	66" x 36" x 22 1/4"	\$2,653.00	\$2,893.00
49	5092 LUX	Enso 3666	66" x 36" x 22 1/4"	\$4,412.00	\$4,652.00
47	5093 BAS	Enso 3672	72" x 36" x 22 1/4"	\$2,703.00	\$2,943.00
47	5093 LUX	Enso 3672	72" x 36" x 22 1/4"	\$4,462.00	\$4,702.00
48	5094 BAS	Enso 4266	66" x 42" x 22 1/4"	\$2,752.00	\$2,992.00
48	5094 LUX	Enso 4266	66" x 42" x 22 1/4"	\$4,512.00	\$4,752.00
46	5095 BAS	Enso 4272	72" x 42" x 22 1/4"	\$2,903.00	\$3,143.00
46	5095 LUX	Enso 4272	72" x 42" x 22 1/4"	\$4,663.00	\$4,903.00
53	5027 BAS	Essence 3666	66" x 36" x 24"	\$2,653.00	\$2,893.00
53	5027 LUX	Essence 3666	66" x 36" x 24"	\$4,412.00	\$4,652.00
51	5030 BAS	Essence 3672	71 1/2" x 36" x 24"	\$2,703.00	\$2,943.00
51	5030 LUX	Essence 3672	71 1/2" x 36" x 24"	\$4,463.00	\$4,703.00
54	5031 BAS	Essence 4260	60" x 41 1/2" x 24"	\$2,703.00	\$2,943.00
54	5031 LUX	Essence 4260	60" x 41 1/2" x 24"	\$4,463.00	\$4,703.00
52	5033 BAS	Essence 4266	66" x 41 1/2" x 24"	\$2,752.00	\$2,992.00
52	5033 LUX	Essence 4266	66" x 41 1/2" x 24"	\$4,512.00	\$4,752.00
50	5035 BAS	Essence 4272	71 1/2" x 41 1/2" x 24"	\$2,903.00	\$3,143.00
50	5035 LUX	Essence 4272	71 1/2" x 41 1/2" x 24"	\$4,663.00	\$4,903.00
55	5078 BAS	Hampton OV	68" x 42" x 23 1/2"	\$2,903.00	\$3,143.00
55	5078 LUX	Hampton OV	68" x 42" x 23 1/2"	\$4,663.00	\$4,903.00
79	5072 BAS	Hampton R	72" x 42" x 23 1/2"	\$2,903.00	\$3,143.00
79	5072 LUX	Hampton R	72" x 42" x 23 1/2"	\$4,663.00	\$4,903.00
56	5077 BAS	Heathrow OV	72" x 42" x 23"	\$2,903.00	\$3,143.00
56	5077 LUX	Heathrow OV	72" x 42" x 23"	\$4,663.00	\$4,903.00
80	5058 BAS	Heathrow R	72" x 42" x 23"	\$2,903.00	\$3,143.00
80	5058 LUX	Heathrow R	72" x 42" x 23"	\$4,663.00	\$4,903.00
88	5025 BAS	Montclair	71 1/2" x 41 1/2" x 23 1/2"	\$2,903.00	\$3,143.00
88	5025 LUX	Montclair	71 1/2" x 41 1/2" x 23 1/2"	\$4,663.00	\$4,903.00
88	5096 BAS	Reo 3660	60" x 36" x 24"	\$2,502.00	\$2,742.00
88	5096 LUX	Reo 3660	60" x 36" x 24"	\$4,323.00	\$4,563.00
88	5097 BAS	Reo 3666	66" x 36" x 24"	\$2,653.00	\$2,893.00
88	5097 LUX	Reo 3666	66" x 36" x 24"	\$4,412.00	\$4,652.00
88	5098 BAS	Reo 3672	72" x 36" x 24"	\$2,703.00	\$2,943.00
88	5098 LUX	Reo 3672	72" x 36" x 24"	\$4,462.00	\$4,702.00
88	5099 BAS	Reo 4272	72" x 42" x 24"	\$2,903.00	\$3,143.00
88	5099 LUX	Reo 4272	72" x 42" x 24"	\$4,663.00	\$4,903.00

Page #	Model #	Name	Measurements	Standard	Premium
88	8110	Restore LH Whirlpool	51 1/2" x 30" x 40"	\$6,652.00	N/A
88	8010	Restore RH Whirlpool	51 1/2" x 30" x 40"	\$6,652.00	N/A
81	5011 BAS	Romanesque	68" x 42" x 22"	\$2,903.00	\$3,143.00
81	5011 LUX	Romanesque	68" x 42" x 22"	\$4,725.00	\$4,965.00
82	5051 BAS	Savannah	72" x 48" x 24"	\$3,202.00	\$3,442.00
82	5051 LUX	Savannah	72" x 48" x 24"	\$5,028.00	\$5,268.00
62	5017 BAS	Waverly	70" x 47" x 20 1/4"	\$2,903.00	\$3,143.00
62	5017 LUX	Waverly	70" x 47" x 20 1/4"	\$4,725.00	\$4,965.00

## Bathware – Showroom Series Air Baths

Page #	Model #	Name	Measurements	Standard	Premium
44	9281	Avalon DT	71 3/4" x 40 1/2" x 29"	\$5,153.00	\$5,393.00
44	9181	Avalon GT	71 3/4" x 40 1/2" x 29"	\$3,641.00	\$3,881.00
44	9081	Avalon HT	71 3/4" x 40 1/2" x 29"	\$3,349.00	\$3,589.00
66	9208	Barrett 3666 DT	66" x 36" x 24"	\$4,809.00	\$5,049.00
66	9108	Barrett 3666 GT	66" x 36" x 24"	\$3,576.00	\$3,816.00
66	9008	Barrett 3666 HT	66" x 36" x 24"	\$3,394.00	\$3,634.00
64	9210	Barrett 3672 DT	72" x 36" x 24"	\$4,922.00	\$5,162.00
64	9110	Barrett 3672 GT	72" x 36" x 24"	\$3,630.00	\$3,870.00
64	9010	Barrett 3672 HT	72" x 36" x 24"	\$3,448.00	\$3,688.00
65	9222	Barrett 4266 DT	66" x 42" x 24"	\$5,039.00	\$5,279.00
65	9122	Barrett 4266 GT	66" x 42" x 24"	\$3,685.00	\$3,925.00
65	9022	Barrett 4266 HT	66" x 42" x 24"	\$3,502.00	\$3,742.00
63	9218	Barrett 4272 DT	72" x 42" x 24"	\$5,153.00	\$5,393.00
63	9118	Barrett 4272 GT	72" x 42" x 24"	\$3,794.00	\$4,034.00
63	9018	Barrett 4272 HT	72" x 42" x 24"	\$3,729.00	\$3,969.00
67	9024L	Barrett Alcove LH HT	60" x 32" x 21 1/2"	\$3,416.00	\$3,656.00
67	9024R	Barrett Alcove RH HT	60" x 32" x 21 1/2"	\$3,416.00	\$3,656.00
70	9204	Baywood 5.0 DT	60" x 36" x 19 3/4"	\$4,695.00	\$4,935.00
70	9104	Baywood 5.0 GT	60" x 36" x 19 3/4"	\$3,343.00	\$3,583.00
70	9004	Baywood 5.0 HT	60" x 36" x 19 3/4"	\$3,054.00	\$3,294.00
69	9228	Baywood 5.5 DT	66" x 36" x 19 3/4"	\$4,809.00	\$5,049.00
69	9128	Baywood 5.5 GT	66" x 36" x 19 3/4"	\$3,459.00	\$3,699.00
69	9028	Baywood 5.5 HT	66" x 36" x 19 3/4"	\$3,169.00	\$3,409.00
68	9205	Baywood 6.0 DT	72" x 36" x 19 3/4"	\$4,922.00	\$5,162.00
68	9105	Baywood 6.0 GT	72" x 36" x 19 3/4"	\$3,576.00	\$3,816.00
68	9005	Baywood 6.0 HT	72" x 36" x 19 3/4"	\$3,283.00	\$3,523.00
75	9267	Brentwood 3260 DT	60" x 32" x 20 3/4"	\$4,525.00	\$4,765.00
75	9167	Brentwood 3260 GT	60" x 32" x 20 3/4"	\$3,225.00	\$3,465.00
75	9067	Brentwood 3260 HT	60" x 32" x 20 3/4"	\$2,948.00	\$3,188.00
74	9269	Brentwood 3660 DT	60" x 36" x 22 1/2"	\$4,695.00	\$4,935.00
74	9169	Brentwood 3660 GT	60" x 36" x 22 1/2"	\$3,311.00	\$3,551.00
74	9069	Brentwood 3660 HT	60" x 36" x 22 1/2"	\$3,036.00	\$3,276.00
73	9273	Brentwood 3666 DT	66" x 36" x 22 1/2"	\$4,809.00	\$5,049.00
73	9173	Brentwood 3666 GT	66" x 36" x 22 1/2"	\$3,459.00	\$3,699.00
73	9073	Brentwood 3666 HT	66" x 36" x 22 1/2"	\$3,169.00	\$3,409.00
72	9274	Brentwood 3672 DT	72" x 36" x 22 1/2"	\$4,922.00	\$5,162.00
72	9174	Brentwood 3672 GT	72" x 36" x 22 1/2"	\$3,576.00	\$3,816.00
72	9074	Brentwood 3672 HT	72" x 36" x 22 1/2"	\$3,283.00	\$3,523.00
71	9275	Brentwood 4272 DT	72" x 42" x 22 1/2"	\$5,153.00	\$5,393.00
71	9175	Brentwood 4272 GT	72" x 42" x 22 1/2"	\$3,693.00	\$3,933.00
71	9075	Brentwood 4272 HT	72" x 42" x 22 1/2"	\$3,400.00	\$3,640.00
76	9240	Brighton DT	72" x 48" x 24"	\$5,486.00	\$5,726.00
76	9140	Brighton GT	72" x 48" x 24"	\$4,124.00	\$4,364.00
76	9040	Brighton HT	72" x 48" x 24"	\$3,832.00	\$4,072.00
84	9203	Bristol Bay DT	60" x 60" x 22"	\$5,638.00	\$5,878.00
84	9103	Bristol Bay GT	60" x 60" x 22"	\$4,266.00	\$4,506.00
84	9003	Bristol Bay HT	60" x 60" x 22"	\$3,973.00	\$4,213.00
77	9253	Camden DT	59 1/2" x 32" x 21 1/2"	\$4,525.00	\$4,765.00
77	9153	Camden GT	59 1/2" x 32" x 21 1/2"	\$3,225.00	\$3,465.00
77	9053	Camden HT	59 1/2" x 32" x 21 1/2"	\$2,948.00	\$3,188.00
85	9289	Castille DT	66" x 66" x 23 1/2"	\$5,900.00	\$6,140.00
85	9189	Castille GT	66" x 66" x 23 1/2"	\$4,279.00	\$4,519.00
85	9089	Castille HT	66" x 66" x 23 1/2"	\$3,886.00	\$4,126.00
86	9262	Covington C DT	60" x 60" x 23"	\$5,638.00	\$5,878.00
86	9162	Covington C GT	60" x 60" x 23"	\$4,289.00	\$4,529.00



Page #	Model #	Name	Measurements	Standard	Premium
86	9062	Covington C HT	60" x 60" x 23"	\$3,995.00	\$4,235.00
87	9248	Covington C Round DT	60" x 60" x 23"	\$5,638.00	\$5,878.00
87	9148	Covington C Round GT	60" x 60" x 23"	\$4,289.00	\$4,529.00
87	9048	Covington C Round HT	60" x 60" x 23"	\$3,995.00	\$4,235.00
45	9285	Elba OV DT	59 1/2" x 42" x 23"	\$4,926.00	\$5,166.00
45	9185	Elba OV GT	59 1/2" x 42" x 23"	\$3,576.00	\$3,816.00
45	9085	Elba OV HT	59 1/2" x 42" x 23"	\$3,283.00	\$3,523.00
78	9284	Elba R DT	59 1/2" x 42" x 23"	\$4,926.00	\$5,166.00
78	9184	Elba R GT	59 1/2" x 42" x 23"	\$3,576.00	\$3,816.00
78	9084	Elba R HT	59 1/2" x 42" x 23"	\$3,283.00	\$3,523.00
49	9292	Enso 3666 DT	66" x 36" x 22 1/4"	\$4,809.00	\$5,049.00
49	9192	Enso 3666 GT	66" x 36" x 22 1/4"	\$3,576.00	\$3,816.00
49	9092	Enso 3666 HT	66" x 36" x 22 1/4"	\$3,394.00	\$3,634.00
47	9293	Enso 3672 DT	72" x 36" x 22 1/4"	\$4,922.00	\$5,162.00
47	9193	Enso 3672 GT	72" x 36" x 22 1/4"	\$3,630.00	\$3,870.00
47	9093	Enso 3672 HT	72" x 36" x 22 1/4"	\$3,448.00	\$3,688.00
48	9294	Enso 4266 DT	66" x 42" x 22 1/4"	\$5,039.00	\$5,279.00
48	9194	Enso 4266 GT	66" x 42" x 22 1/4"	\$3,685.00	\$3,925.00
48	9094	Enso 4266 HT	66" x 42" x 22 1/4"	\$3,502.00	\$3,742.00
46	9295	Enso 4272 DT	72" x 42" x 22 1/4"	\$5,153.00	\$5,393.00
46	9195	Enso 4272 GT	72" x 42" x 22 1/4"	\$3,738.00	\$3,978.00
46	9095	Enso 4272 HT	72" x 42" x 22 1/4"	\$3,557.00	\$3,797.00
53	9227	Essence 3666 DT	66" x 36" x 24"	\$4,809.00	\$5,049.00
53	9127	Essence 3666 GT	66" x 36" x 24"	\$3,937.00	\$4,177.00
53	9027	Essence 3666 HT	66" x 36" x 24"	\$3,645.00	\$3,885.00
51	9230	Essence 3672 DT	71 1/2" x 36" x 24"	\$4,922.00	\$5,162.00
51	9130	Essence 3672 GT	71 1/2" x 36" x 24"	\$3,630.00	\$3,870.00
51	9030	Essence 3672 HT	71 1/2" x 36" x 24"	\$3,448.00	\$3,688.00
54	9231	Essence 4260 DT	60" x 41 1/2" x 24"	\$4,926.00	\$5,166.00
54	9131	Essence 4260 GT	60" x 41 1/2" x 24"	\$3,630.00	\$3,870.00
54	9031	Essence 4260 HT	60" x 41 1/2" x 24"	\$3,448.00	\$3,688.00
52	9233	Essence 4266 DT	66" x 41 1/2" x 24"	\$5,039.00	\$5,279.00
52	9133	Essence 4266 GT	66" x 41 1/2" x 24"	\$3,685.00	\$3,925.00
52	9033	Essence 4266 HT	66" x 41 1/2" x 24"	\$3,502.00	\$3,742.00
50	9235	Essence 4272 DT	71 1/2" x 41 1/2" x 24"	\$5,153.00	\$5,393.00
50	9135	Essence 4272 GT	71 1/2" x 41 1/2" x 24"	\$3,738.00	\$3,978.00
50	9035	Essence 4272 HT	71 1/2" x 41 1/2" x 24"	\$3,557.00	\$3,797.00
55	9278	Hampton OV DT	68" x 42" x 23 1/2"	\$5,153.00	\$5,393.00
55	9178	Hampton OV GT	68" x 42" x 23 1/2"	\$3,685.00	\$3,925.00
55	9078	Hampton OV HT	68" x 42" x 23 1/2"	\$3,394.00	\$3,634.00
79	9272	Hampton R DT	72" x 42" x 23 1/2"	\$5,153.00	\$5,393.00
79	9172	Hampton R GT	72" x 42" x 23 1/2"	\$3,685.00	\$3,925.00
79	9072	Hampton R HT	72" x 42" x 23 1/2"	\$3,394.00	\$3,634.00
56	9277	Heathrow OV DT	72" x 42" x 23"	\$5,153.00	\$5,393.00
56	9177	Heathrow OV GT	72" x 42" x 23"	\$3,937.00	\$4,177.00
56	9077	Heathrow OV HT	72" x 42" x 23"	\$3,645.00	\$3,885.00
80	9258	Heathrow R DT	72" x 42" x 23"	\$5,153.00	\$5,393.00
80	9158	Heathrow R GT	72" x 42" x 23"	\$3,937.00	\$4,177.00
80	9058	Heathrow R HT	72" x 42" x 23"	\$3,645.00	\$3,885.00
88	9225	Montclair DT	71 1/2" x 41 1/2" x 23 1/2"	\$5,153.00	\$5,393.00
88	9125	Montclair GT	71 1/2" x 41 1/2" x 23 1/2"	\$3,685.00	\$3,925.00
88	9025	Montclair HT	71 1/2" x 41 1/2" x 23 1/2"	\$3,394.00	\$3,634.00
88	9296	Reo 3660 DT	60" x 36" x 24"	\$4,809.00	\$5,049.00
88	9196	Reo 3660 GT	60" x 36" x 24"	\$3,080.00	\$3,320.00
88	9096	Reo 3660 HT	60" x 36" x 24"	\$2,902.00	\$3,142.00
88	9297	Reo 3666 DT	66" x 36" x 24"	\$4,809.00	\$5,049.00
88	9197	Reo 3666 GT	66" x 36" x 24"	\$3,300.00	\$3,540.00
88	9097	Reo 3666 HT	66" x 36" x 24"	\$3,119.00	\$3,359.00
88	9298	Reo 3672 DT	72" x 36" x 24"	\$4,922.00	\$5,162.00
88	9198	Reo 3672 GT	72" x 36" x 24"	\$3,520.00	\$3,760.00
88	9098	Reo 3672 HT	72" x 36" x 24"	\$3,339.00	\$3,579.00
88	9299	Reo 4272 DT	72" x 42" x 24"	\$5,153.00	\$5,393.00
88	9199	Reo 4272 GT	72" x 42" x 24"	\$3,630.00	\$3,870.00
88	9099	Reo 4272 HT	72" x 42" x 24"	\$3,448.00	\$3,688.00
88	8510	Restore LH Air bath	51 1/2" x 30" x 40"	\$6,873.00	N/A
88	8710	Restore LH Combination	51 1/2" x 30" x 40"	\$8,094.00	N/A
88	8410	Restore RH Air bath	51 1/2" x 30" x 40"	\$6,873.00	N/A
88	8610	Restore RH Combination	51 1/2" x 30" x 40"	\$8,094.00	N/A

Page #	Model #	Name	Measurements	Standard	Premium
82	9251	Savannah DT	72" x 48" x 24"	\$5,486.00	\$5,726.00
82	9151	Savannah GT	72" x 48" x 24"	\$4,124.00	\$4,364.00
82	9051	Savannah HT	72" x 48" x 24"	\$3,832.00	\$4,072.00

**Bathware – Showroom Series MicroDerm Systems**

Page #	Model #	Name	Measurements	Standard	Premium
44	5281	Avalon	71 3/4" x 40 1/2" x 29"	\$3,318.00	\$3,558.00
66	5208	Barrett 3666	66" x 36" x 24"	\$3,213.00	\$3,453.00
64	5210	Barrett 3672	72" x 36" x 24"	\$3,239.00	\$3,479.00
65	5222	Barrett 4266	66" x 42" x 24"	\$3,265.00	\$3,505.00
63	5218	Barrett 4272	72" x 42" x 24"	\$3,318.00	\$3,558.00
70	5202	Baywood 5.0	60" x 36" x 19 3/4"	\$3,186.00	\$3,426.00
69	5228	Baywood 5.5	66" x 36" x 19 3/4"	\$3,213.00	\$3,453.00
68	5204	Baywood 6.0	72" x 36" x 19 3/4"	\$3,239.00	\$3,479.00
75	5267	Brentwood 3260	60" x 32" x 20 3/4"	\$3,150.00	\$3,390.00
74	5269	Brentwood 3660	60" x 36" x 22 1/2"	\$3,186.00	\$3,426.00
73	5273	Brentwood 3666	66" x 36" x 22 1/2"	\$3,213.00	\$3,453.00
72	5274	Brentwood 3672	72" x 36" x 22 1/2"	\$3,239.00	\$3,479.00
71	5275	Brentwood 4272	72" x 42" x 22 1/2"	\$3,318.00	\$3,558.00
84	5245	Bristol Bay	60" x 60" x 22"	\$3,370.00	\$3,610.00
77	5253	Camden	59 1/2" x 32" x 21 1/2"	\$3,150.00	\$3,390.00
86	5262	Covington C	60" x 60" x 23"	\$3,370.00	\$3,610.00
53	5227	Essence 3666	66" x 36" x 24"	\$3,213.00	\$3,453.00
51	5230	Essence 3672	71 1/2" x 36" x 24"	\$3,239.00	\$3,479.00
54	5231	Essence 4260	60" x 41 1/2" x 24"	\$3,239.00	\$3,479.00
52	5233	Essence 4266	66" x 41 1/2" x 24"	\$3,265.00	\$3,505.00
50	5235	Essence 4272	71 1/2" x 41 1/2" x 24"	\$3,318.00	\$3,558.00
55	5278	Hampton OV	68" x 42" x 23 1/2"	\$3,265.00	\$3,505.00
79	5272	Hampton R	72" x 42" x 23 1/2"	\$3,318.00	\$3,558.00
56	5277	Heathrow OV	72" x 42" x 23"	\$3,318.00	\$3,558.00
80	5258	Heathrow R	72" x 42" x 23"	\$3,318.00	\$3,558.00

**Bathware – Pro-Fit Builder Series**

**Bathtubs, Whirlpools and Air Bath Systems**

Page #	Model #	Name	Measurements	Price
94	6755	3260 - Pro-fit Air Bath	59 3/4" x 32" x 19 1/4"	\$1,611.00
94	6553	3260 - Pro-fit Bath	59 3/4" x 32" x 19 1/4"	\$715.00
94	6053	3260 - Pro-fit Whirlpl	59 3/4" x 32" x 19 1/4"	\$1,208.00
95	6153A	3260 TFS LH - Pro-fit Whirlpl w/Acc	59 3/4" x 31 3/4" x 20 3/4"	\$1,632.00
95	6653	3260 TFS LH - Pro-fit Bath	59 3/4" x 31 3/4" x 20 3/4"	\$915.00
95	6653A	3260 TFS LH - Pro-fit Bath w/Acc	59 3/4" x 31 3/4" x 20 3/4"	\$1,149.00
95	6153	3260 TFS LH - Pro-fit Whirlpl	59 3/4" x 31 3/4" x 20 3/4"	\$1,398.00
95	6154A	3260 TFS RH - Pro-fit Whirlpl w/Acc	59 3/4" x 31 3/4" x 20 3/4"	\$1,632.00
95	6654	3260 TFS RH - Pro-fit Bath	59 3/4" x 31 3/4" x 20 3/4"	\$915.00
95	6654A	3260 TFS RH - Pro-fit Bath w/Acc	59 3/4" x 31 3/4" x 20 3/4"	\$1,149.00
95	6154	3260 TFS RH - Pro-fit Whirlpl	59 3/4" x 31 3/4" x 20 3/4"	\$1,398.00
96	6718	3660 - Pro-fit Air Bath	59 3/4" x 35 3/4" x 21 1/4"	\$1,666.00
96	6518	3660 - Pro-fit Bath	59 3/4" x 35 3/4" x 21 1/4"	\$780.00
96	6018	3660 - Pro-fit Whirlpl	59 3/4" x 35 3/4" x 21 1/4"	\$1,263.00
90	6719	3660 OV - Pro-fit Air Bath	60" x 36" x 22"	\$1,727.00
90	6519	3660 OV - Pro-fit Bath	60" x 36" x 22"	\$780.00
90	6019	3660 OV - Pro-fit Whirlpl	60" x 36" x 22"	\$1,263.00
97	6119A	3660 TFS LH - Pro-fit Whirlpl w/Acc	60" x 35 3/4" x 23"	\$1,677.00
97	6619	3660 TFS LH - Pro-fit Bath	60" x 35 3/4" x 23"	\$971.00
97	6619A	3660 TFS LH - Pro-fit Bath w/Acc	60" x 35 3/4" x 23"	\$1,204.00
97	6119	3660 TFS LH - Pro-fit Whirlpl	60" x 35 3/4" x 23"	\$1,444.00
97	6618	3660 TFS RH - Pro-fit Bath	60" x 35 3/4" x 23"	\$971.00
97	6618A	3660 TFS RH - Pro-fit Bath w/Acc	60" x 35 3/4" x 23"	\$1,204.00
97	6118	3660 TFS RH - Pro-fit Whirlpl	60" x 35 3/4" x 23"	\$1,444.00
97	6118A	3660 TFS RH - Pro-fit Whirlpl w/Acc	60" x 35 3/4" x 23"	\$1,677.00
98	6721	3672 - Pro-fit Air Bath	71 1/2" x 35 1/2" x 20"	\$1,727.00
98	6521	3672 - Pro-fit Bath	71 1/2" x 35 1/2" x 20"	\$846.00
98	6021	3672 - Pro-fit Whirlpl	71 1/2" x 35 1/2" x 20"	\$1,325.00
99	6123A	3672 TFS LH - Pro-fit Whirlpl w/Acc	71 1/2" x 35 1/2" x 23"	\$1,763.00

Page #	Model #	Name	Measurements	Price
99	6623	3672 TFS LH - Pro-fit Bath	71 1/2" x 35 1/2" x 23"	\$1,112.00
99	6623A	3672 TFS LH - Pro-fit Bath w/Acc	71 1/2" x 35 1/2" x 23"	\$1,345.00
99	6123	3672 TFS LH - Pro-fit Whripl	71 1/2" x 35 1/2" x 23"	\$1,530.00
99	6122A	3672 TFS RH - Pro-fit Whripl w/Acc	71 1/2" x 35 1/2" x 23"	\$1,763.00
99	6622	3672 TFS RH - Pro-fit Bath	71 1/2" x 35 1/2" x 23"	\$1,112.00
99	6622A	3672 TFS RH - Pro-fit Bath w/Acc	71 1/2" x 35 1/2" x 23"	\$1,345.00
99	6122	3672 TFS RH - Pro-fit Whripl	71 1/2" x 35 1/2" x 23"	\$1,530.00
100	6724	4260 - Pro-fit Air Bath	60" x 42" x 20 1/4"	\$1,788.00
100	6524	4260 - Pro-fit Bath	60" x 42" x 20 1/4"	\$901.00
100	6024	4260 - Pro-fit Whripl	60" x 42" x 20 1/4"	\$1,385.00
91	6715	4260 OV - Pro-fit Air Bath	60" x 42" x 20 1/4"	\$1,788.00
91	6515	4260 OV - Pro-fit Bath	60" x 42" x 20 1/4"	\$901.00
91	6015	4260 OV - Pro-fit Whripl	60" x 42" x 20 1/4"	\$1,385.00
102	6126A	4260 TFS CD - Pro-fit Whripl w/Acc	60" x 42" x 21 1/4"	\$1,843.00
102	6627A	4260 TFS CD - Pro-fit Bath w/Acc	60" x 42" x 21 1/4"	\$1,390.00
101	6124A	4260 TFS LH - Pro-fit Whripl w/Acc	59 3/4" x 42" x 21 1/4"	\$1,843.00
101	6624	4260 TFS LH - Pro-fit Bath	59 3/4" x 42" x 21 1/4"	\$1,156.00
101	6624A	4260 TFS LH - Pro-fit Bath w/Acc	59 3/4" x 42" x 21 1/4"	\$1,390.00
101	6124	4260 TFS LH - Pro-fit Whripl	59 3/4" x 42" x 21 1/4"	\$1,609.00
101	6125A	4260 TFS RH - Pro-fit Whripl w/Acc	59 3/4" x 42" x 21 1/4"	\$1,843.00
101	6625	4260 TFS RH - Pro-fit Bath	59 3/4" x 42" x 21 1/4"	\$1,156.00
101	6625A	4260 TFS RH - Pro-fit Bath w/Acc	59 3/4" x 42" x 21 1/4"	\$1,390.00
101	6125	4260 TFS RH - Pro-fit Whripl	59 3/4" x 42" x 21 1/4"	\$1,609.00
93	6028C	4268 OV CD - Pro-fit Whripl	68" x 42" x 19 3/4"	\$1,405.00
92	6728E	4268 OV ED - Pro-fit Air Bath	68" x 42" x 20"	\$1,807.00
92	6528E	4268 OV ED - Pro-fit Bath	68" x 42" x 20"	\$947.00
92	6028E	4268 OV ED - Pro-fit Whripl	68" x 42" x 20"	\$1,405.00
103	6727	4272 - Pro-fit Air Bath	71 1/2" x 42" x 19 3/4"	\$1,808.00
103	6527	4272 - Pro-fit Bath	71 1/2" x 42" x 19 3/4"	\$957.00
103	6027	4272 - Pro-fit Whripl	71 1/2" x 42" x 19 3/4"	\$1,445.00
104	6533	4872 - Pro-fit Bath	71 1/2" x 47 5/8" x 22 1/2"	\$977.00
104	6033	4872 - Pro-fit Whripl	71 1/2" x 47 5/8" x 22 1/2"	\$1,505.00
105	6739	6060 - Pro-fit Air Bath	59 3/4" x 59 3/4" x 21 1/4"	\$1,847.00
105	6539	6060 - Pro-fit Bath	59 3/4" x 59 3/4" x 21 1/4"	\$1,230.00
105	6039	6060 - Pro-fit Whripl	59 3/4" x 59 3/4" x 21 1/4"	\$1,520.00
106	6541	6060 DL - Pro-fit Bath	60" x 60" x 20"	\$1,231.00
106	6041	6060 DL - Pro-fit Whripl	60" x 60" x 20"	\$1,520.00

Page #	Model #	Name	Standard	Premium
123	PF2338	Air button - Oil Rubbed Bronze	\$67.00	N/A
123	PF2335	Air button - Polished Chrome	\$45.00	N/A
123	AR1200	Blower Relocation Kit	\$169.00	N/A
122	SW1322	Cable Drain - Brushed Nickel	\$313.00	N/A
123	SW1321	Cable Drain - Everbrass (PVD)	\$313.00	N/A
123	SW1323	Cable Drain - Oil Rubbed Bronze	\$334.00	N/A
123	SW1320	Cable Drain - Polished Chrome	\$174.00	N/A
123	SW1319	Cable Drain - Standard Colors	\$132.00	N/A
123	SB1421	Drain Kit - Polished Brass	\$40.00	N/A
123	SB1420	Drain Kit - Polished Chrome	\$22.00	N/A
123	SWP151	Factory Installed Inline Heater	\$533.00	N/A
123	SWP150 L	Factory Installed Nailing Flange - Left Hand Drain	\$164.00	N/A
123	SWP150 R	Factory Installed Nailing Flange - Right Hand Drain	\$164.00	N/A
123	SWP150 S	Factory Installed Nailing Flange - Special, Diagram Required	\$164.00	N/A
123	PF1322	Lift & Turn Drain - Brushed Nickel	\$80.00	N/A
123	PF1321	Lift & Turn Drain - Everbrass (PVD)	\$80.00	N/A
122	PF1323	Lift & Turn Drain - Oil Rubbed Bronze	\$85.00	N/A
107	PF1320	Lift & Turn Drain - Polished Chrome	\$50.00	N/A
107	PF1337	Metal Trim Upgrade - Brushed Nickel	\$247.00	N/A
122	SW1337	Metal Trim Upgrade - Brushed Nickel	\$366.00	N/A
122	PF1336	Metal Trim Upgrade - Everbrass (PVD)	\$247.00	N/A
122	SW1336	Metal Trim Upgrade - Everbrass (PVD)	\$366.00	N/A
122	PF1338	Metal Trim Upgrade - Oil Rubbed Bronze	\$263.00	N/A
122	SW1338	Metal Trim Upgrade - Oil Rubbed Bronze	\$392.00	N/A
122	PF1335	Metal Trim Upgrade - Polished Chrome	\$150.00	N/A
122	SW1335	Metal Trim Upgrade - Polished Chrome	\$366.00	N/A
122	SWAP00	Nailing Flange Kit	\$65.00	N/A
122	SWA100	Pillow - Common	\$57.00	N/A
122	SWA200	Pillow - Exclusive	\$57.00	N/A
122	7039	Removable Apron - Ambria	\$989.00	\$1,229.00
122	7002	Removable Apron - Baywood 5.0	\$463.00	\$703.00
123	7028	Removable Apron - Baywood 5.5	\$472.00	\$712.00
123	7004	Removable Apron - Baywood 6.0	\$483.00	\$723.00
123	7053	Removable Apron - Camden	\$463.00	\$703.00
122	WIT-002	Restore End Panel	\$347.00	N/A
122	WIT-001	Restore Extension Box	\$367.00	N/A
122	RS151	Tranquility - Heater for bathtubs	\$533.00	N/A

## Bathware – Shower Bases

Page #	Model #	Description	Measurements	Standard	Premium
107	7501	3232 ST - Shwr Base, Cntr Drain	32" x 32"	\$694.00	\$934.00
107	7502	3636 ST - Shwr Base, Cntr Drain	36" x 36"	\$727.00	\$967.00
107	7503	3642 STSS - Shwr Base, Cntr Drain	36" x 42"	\$763.00	\$1,003.00
107	7504	4236 STLS - Shwr Base, Cntr Drain	42" x 36"	\$763.00	\$1,003.00
107	7505	4832 STLS - Shwr Base, Cntr Drain	48" x 32"	\$763.00	\$1,003.00
107	7506	4834 STLS - Shwr Base, Cntr Drain	48" x 34"	\$763.00	\$1,003.00
107	7507	6034 STLS - Shwr Base, Cntr Drain	60" x 34"	\$831.00	\$1,071.00
107	7508	3636 DT - Shwr Base, Cntr Drain	36" x 36"	\$727.00	\$967.00
107	7509	3636 TTNA - Shwr Base, Cntr Drain	36" x 36"	\$778.00	\$1,018.00
107	7510	3838 TTNA - Shwr Base, Cntr Drain	38" x 38"	\$778.00	\$1,018.00
107	7514	6032 STLS RH - Shwr Base, End Drain	60" x 32"	\$831.00	\$1,071.00
107	7515	6032 STLS LH - Shwr Base, End Drain	60" x 32"	\$831.00	\$1,071.00
107	7530	4242 TTNA - Shwr Base, Cntr Drain	42" x 42"	\$831.00	\$1,071.00
107	7531	4242 ST - Shwr Base, Cntr Drain	42" x 42"	\$763.00	\$1,003.00

## Bathware – Parts & Accessories

Page #	Model #	Name	Standard	Premium
122	7253	3260 Removable Apron	\$463.00	N/A
122	7218	3660 Removable Apron	\$463.00	N/A
122	7221	3672 Removable Apron	\$483.00	N/A
122	7224	4260 Removable Apron	\$463.00	N/A
122	7227	4272 Removable Apron	\$483.00	N/A
123	7233	4872 Removable Apron	\$483.00	N/A
123	7239	6060 Removable Apron	\$989.00	N/A
123	PF2337	Air button - Brushed Nickel	\$57.00	N/A
123	PF2336	Air button - Everbrass (PVD)	\$57.00	N/A

## PRODUCTS DISCONTINUED since 2015 Price Book

Model #	Name
119	EcoQuantum® - Tank and Lid
119RH	EcoQuantum® - Tank and Lid (right hand trip lever)
144	QuantumOne™ - Elongated front, rear outlet wall-mount Bowl
144	Quantum 1.28 - Elongated front, rear outlet wall-mount Bowl
144	Quantum® - Elongated front, rear outlet wall-mount Bowl
226-1	Reo - Undercounter lavatory (single hole)
226-4	Reo - Undercounter lavatory (4" faucet center)
226-8	Reo - Undercounter lavatory (8" faucet center)
257-1	Waverly - Lavatory (single hole)
257-8	Waverly - Lavatory (8" faucet center)
303	Foxhill & Grandview - Pedestal
350	Grandview - Combination
351	Foxhill - Combination
704	Prestigio 4 - One-piece toilet
2519	City II - Vanity Top
<b>COMMERCIAL</b>	
1311RS	Baltic - Elongated front 10" Rough-in with Rear Spud
2008-8	Walnut Knoll - Wall-mount lavatory (8" faucet center)
FM-T6	DuraFlo - Flushometer Valve for 1.6 Gpf
CP-1319-16	DuraFlo - Adriatic Commercial Package - ADA 1.6 GPF bowl
CP-1311-16	DuraFlo - Baltic Commercial Package - 1.6 GPF bowl
CP-1312-16	DuraFlo - 1312 Commercial Package - 1.6 GPF bowl
CP-1313-16	DuraFlo - 1313 Commercial Package - 1.6 GPF bowl
CP-1301-16	DuraFlo - Erie Commercial Package - ADA 1.6 GPF bowl

# Mansfield® Color Charts

## Bathware - Acrylic

### Standard Colors

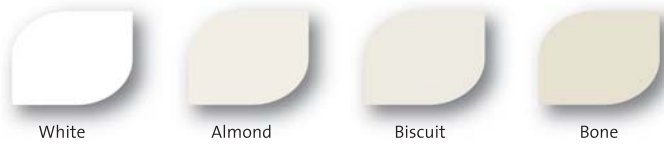

### Premium Colors

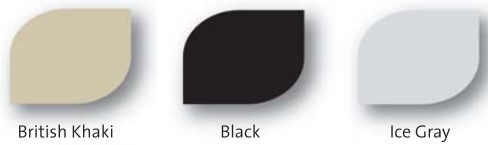

## Sanitaryware - Vitreous China

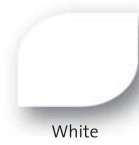

### Standard Colors

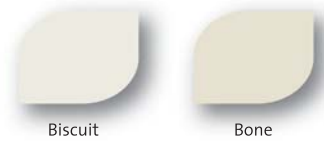

Colors shown are printed representations of vitreous china and acrylic product colors and may vary from actual product colors. Refer to the product listing in your Mansfield Plumbing list price book for complete color offering.

# Color Cross Reference Charts

## Sanitaryware

Mansfield® Plumbing Sanitaryware	Mansfield® Plumbing Sanitaryware - Coordinating Colors	American Standard	Briggs	Eljer	Gerber	Kohler	Peerless	St. Thomas	Sterling	Toto
White	White	White	White	White	White	White	White	White	White	White
Biscuit	Biscuit	Linen	Biscuit	Biscuit	Biscuit	Biscuit	Biscuit	Balsa	Biscuit	Sedona Beige
Bone	Bone	Bone	Bone	Natural/Bone	Bone	Almond	Bone	Bone	Bone	Bone

## Bathware - Showroom

Mansfield® Plumbing Acrylics - Showroom	Mansfield® Plumbing Bathware - Coordinating Colors	American Standard	Kohler	Jacuzzi	Eljer
White	White	White	White	White	White
Almond	—	—	Almond	Almond	Almond
Biscuit	Biscuit	Linen	Biscuit	Oyster	Biscuit
Bone	Bone	Bone	—	—	Natural
Black	—	Black	Black	Black	Onyx
British Khaki	—	—	Sandbar	Sand	—
Ice Gray	—	—	Ice Grey	—	—

## Bathware - Builder

Mansfield® Plumbing Acrylics - Builder	Mansfield® Plumbing Bathware - Coordinating Colors	American Standard	Kohler	Jacuzzi	Eljer
White	White	White	White	White	White
Almond	—	—	Almond	Almond	Almond
Biscuit	Biscuit	Linen	Biscuit	Oyster	Biscuit
Bone	Bone	Bone	—	—	Natural/Bone

Mansfield Plumbing Products, LLC is unaffiliated with goods of, or the services of: American Standard, Briggs, Crane Plumbing, Eljer, Gerber, Jacuzzi, Kohler, Peerless, St. Thomas, Sterling and Toto.





# 2016 LIST PRICE BOOK

Effective January 1, 2016

## LAVATORIES

## RESIDENTIAL & COMMERCIAL TOILETS

## SHOWROOM SERIES BATHWARE

## PRO-FIT<sup>®</sup> BUILDER SERIES BATHWARE

## PARTS & ACCESSORIES

CUSTOMER SERVICE Phone: 877.850.3060 | Fax: 419.938.6234 | [www.mansfieldplumbing.com](http://www.mansfieldplumbing.com)

